

JANUARY
1951
35¢
in Circulation

RADIO & TELEVISION NEWS

ANC

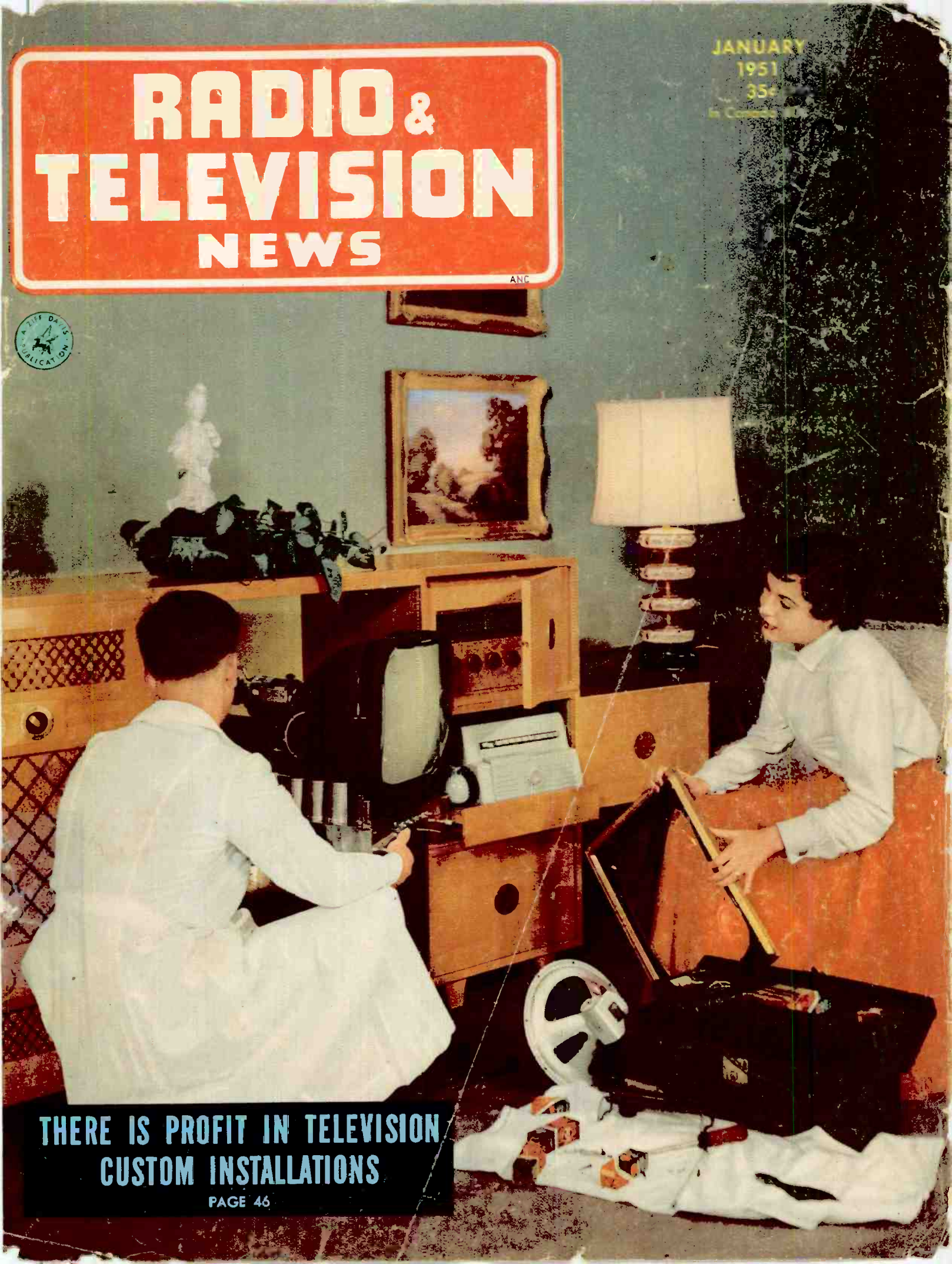

**THERE IS PROFIT IN TELEVISION
CUSTOM INSTALLATIONS**

PAGE 46

THE QUALITY OF RCA TUBES IS UNQUESTIONED

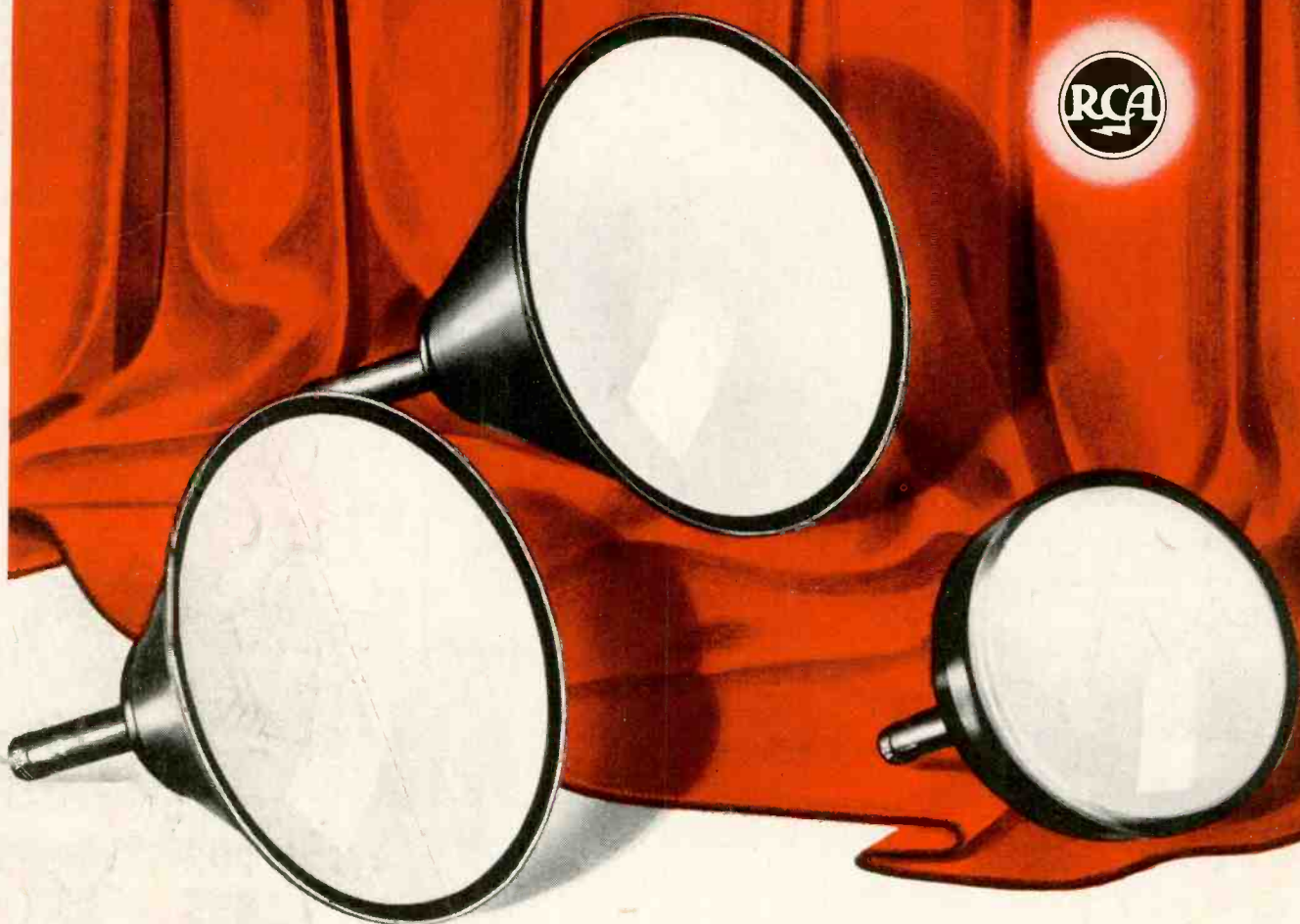

Best Sellers

IN PICTURE TUBES...

Most used . . . by brand
and by type . . . RCA kinescopes
are the fast-moving
profit makers

The largest and most profitable replacement business in television picture tubes comes from the types used in most television receivers . . . the Best Sellers.

RCA's types are Best Sellers. There are more of them in actual use in TV receivers than any other brand. Industry choice of these high-volume types reflects to your advantage. Inventory and stocking problems are simplified . . . and you have the assurance of rapid, profitable turnover.

In addition, when you sell RCA kinescopes, you gain from customer confidence in the RCA brand . . . solidly established by the proved performance of RCA kinescopes in millions of television receivers.

Remember, too, that the quality and dependability of RCA kinescopes mean fewer service failures and fewer costly call-backs. There is, therefore, more profit in every RCA kinescope you sell.

Always keep in touch with your RCA Tube Distributor



RADIO CORPORATION of AMERICA
ELECTRON TUBES

HARRISON, N. J.



I Will Show You How to LEARN RADIO-TELEVISION SERVICING OR COMMUNICATIONS by Practicing in Spare Time



YOU PRACTICE RADIO SERVICING

You build the modern Radio shown below as part of my Servicing Course. I send you speaker, tubes, chassis, transformer, loop antenna, everything you see pictured and EVERYTHING you need to build this modern Radio Receiver. Use it to make many tests, get practical experience.

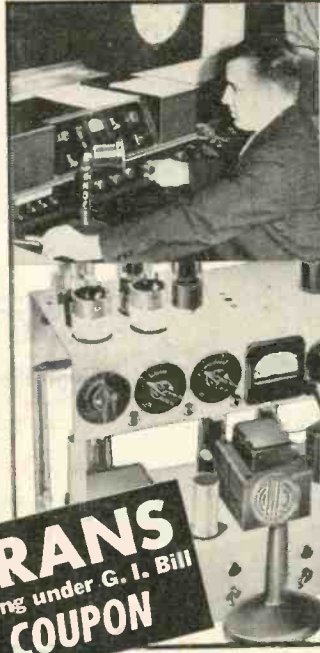

YOU PRACTICE RADIO COMMUNICATIONS

I send you all the parts to build Transmitter shown below as part of my new Communications Course. Conduct actual procedure of Broadcast Operators, practice interesting experiments, learn how to actually put a transmitter on the air.

VETERANS
Get this Training under G. I. Bill
MAIL COUPON

NEW

I TRAINED THESE MEN

"After graduating, worked for servicing shop. Now Chief Engineer of three Police Radio Stations."—S. W. DINWIDDIE, Jacksonville, Illinois.



"While learning, made \$5 to \$10 a week in spare time. Now have a profitable spare time shop."—L. ARNOLD, Pontiac, Mich.



"I accepted a position as Radio and Television Technician . . . was promoted to manager of Television Service and Installation."—L. HAUGER, San Bruno, California.



"Have my own shop. Am authorized serviceman for five manufacturers and do servicing for 7 dealers."—P. MILLER, Maumee, O.



"When I enrolled, had no idea it would be so easy to learn. Have equipped my shop out of spare time earnings. I am clearing about \$40 to \$60 a month."—J. D. KNIGHT, Denison, Tex.



"Four years ago, a bookkeeper on a hand-to-mouth salary, am now a Radio Engineer ABC network."—N. H. WARD, Ridgeland, Park, New Jersey.



I Will Train You at Home with MANY KITS OF PARTS I SEND

Do you want good pay, a job with a bright future and security? Would you like a profitable shop of your own? The fast growing, prosperous RADIO-TELEVISION industry is making these opportunities for you. Radio alone is bigger than ever. 90 million home and auto Radios, 3100 Broadcasting Stations, expanding use of Aviation and Police Radio, Micro-Wave Relay, Two-Way Radio for buses, taxis, etc., are making opportunities for Servicing and Communications Technicians and FCC-Licensed Operators.

Many Soon Make \$10 A Week Extra in Spare Time
Keep your job while training at home. Hundreds I've trained are successful RADIO-TELEVISION TECHNICIANS. Learn Radio-Television principles from illustrated lessons. Get PRACTICAL EXPERIENCE experimenting with circuits common to Radio and Television. Many students make \$5, \$10 a week extra fixing neighbors' Radios in spare time. Special Booklets start teaching you the day you enroll.

Television is TODAY'S Good Job Maker

In 1946 only 6,000 TV sets sold. In 1950 over 5,000,000. By 1954, 25,000,000 TV sets will be in use, according to estimates. Over 100 TV Stations are operating in 35 states. Authorities predict there will be 1,000 TV Stations. This means new jobs, more jobs, good pay for qualified men.

Send Now for 2 Books FREE—Mail Coupon

Send for my FREE DOUBLE OFFER. Get actual Servicing lesson. Also get my 64-page book, "How to Be a Success in Radio-Television." Read what my graduates are doing, earning. Send coupon in envelope or paste on postal. J. E. SMITH, President, Dept. 1AE, National Radio Institute, Washington 9, D. C. OUR 38TH YEAR.

NOW! Advanced Television Practice

New, special TV kits furnished to build high-definition SCOPE . . . RF OSCILLATOR with flyback power supply . . . complete TV SET . . . many other units. You see pulse, trapezoidal, saw-tooth wave forms. Get valuable PRACTICAL EXPERIENCE locating and correcting TV troubles. Mail coupon for facts and pictures.

A TESTED WAY TO BETTER PAY...MAIL COUPON NOW

Good for Both—FREE

MR. J. E. SMITH, President, Dept. 1AE
National Radio Institute, Washington 9, D. C.
Mail me FREE Lesson and 64-page book.
(No salesman will call. Please write plainly.)

NAME.....AGE.....
ADDRESS.....
CITY.....ZONE.....STATE.....
 Check if Veteran Approved for Training Under G. I. Bill

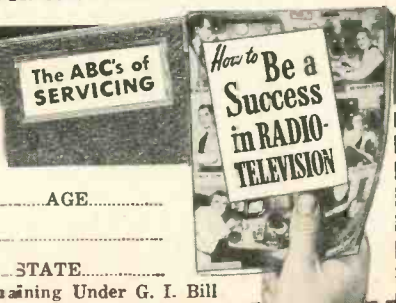

Editor
OLIVER READ, D. Sc., D. Litt., W9ETI

Managing Editor
WM. A. STOCKLIN, B.S.

Technical Editor
H. S. RENNE, M.S.

Associate Editor
RAY FRANK, W9JU

Eastern Editor
H. BECKER

Contributing Editor
R. HERTZBERG, W2DJJ

Television Consultant
MILTON S. KIVER

Short-Wave Editor
KENNETH R. BOORD

Editorial Assistants
I. M. CARROLL
E. V. HITZEL
P. B. HOEFER

Staff Artist
R. S. KUPJACK

Advertising Manager
L. L. OSTEN

Midwest Adv. Manager
JOHN A. RONAN, JR.

Art Director
HERMAN R. BOLLIN

RADIO & TELEVISION NEWS

First in
radio-television-electronics

Average Paid Circulation over 200,000

Radio News Trademark Reg. U.S. Pat. Office No. 521506 • Television News Trademark Reg. U.S. Pat. Office No. 517468
 Radio & Television News Trademark Reg. U.S. Pat. Office No. 517025

CONTENTS

JANUARY, 1951

Improving Performance of Older TV Sets.....	Walter H. Buchsbaum	33
Servicing the 16mm. Sound Projector.....	Don D. Emerson	36
Dielectric Heating.....	Ed Bukstein	39
Speech Compressor and Modulation Monitor.....	L. C. Watkins, Jr., W5JXO	40
A Low Cost, Square-Wave Generator.....	Smith Harris	44
Custom-Built for Profit.....	Dale Ellis	46
A Flexible Record-Reproduce System (Part 2).....	Oliver Read	47
Applications for Thyrite Resistors.....	Rufus P. Turner, K6AI	50
Crystal Controlled Two-Meter Converter.....	Harry G. Pratt, W2SEA	52
A Nondirectional Corner Speaker.....	Dean Post	55
An Easy-to-Build 10 Meter Rig.....	Stan Johnson, W0LBY	56
A Preamp with Tone Control.....	Glen Southworth	58
Mac's Radio Service Shop.....	John T. Frye	61
A Wide-Range Linear Sweep.....	Louis E. Garner, Jr.	62
A Deluxe Signal Tracer.....	R. H. Krueger	64
A Practical Approach to Negative Feedback.....	B. E. Parker	68
Television Synchronizing Circuits (Part 1).....	J. Racker and P. Selvaggi	70
2-Band Operation with Folded Dipole and Ribbon.....	Walter S. Rogers, W1DPS	98
The Ad-Viser (Part 5).....	Irving Settel	112
Radio-TV Service Industry News.....		160



COVER PHOTO: Making final adjustments on a custom installation. Housed in Jensen "Customode" cabinets are Jensen speaker, Radio Craftsman 16" TV set and AM-FM radio, and Talk-A-Phone "Chief" intercom with handset. A Milwaukee Stamping record changer is housed in bottom drawer. (Kodachrome by Art Haug)

Chairman of the Board and Publisher
WILLIAM B. ZIFF

President
B. G. DAVIS

Secretary-Treasurer
ARTHUR T. PULLEN

Vice-Presidents
MICHAEL H. FROELICH
 Dir. Eastern Div.

H. J. MORGANROTH
 Production Director

LYNN PHILLIPS, Jr.
 Advertising Director

H. G. STRONG
 Circulation Director

BRANCH OFFICES
 NEW YORK (17)
 366 Madison Ave., MUrray Hill 7-8080

LOS ANGELES (14)
 815 S. Hill St., TUcker 9213
 Manager, WILLIAM L. PINNEY

DEPARTMENTS

For the Record.....	The Editor	8	Manufacturers' Literature.....	106
Spot Radio News.....		16	Technical Books.....	115
Within the Industry.....		24	AFCA News.....	128
Short-Wave.....	K. R. Boord	67	New TV Products.....	142
What's New in Radio.....		87	MARS.....	150



COPYRIGHT 1950
 ZIFF-DAVIS PUBLISHING COMPANY
 185 North Wabash Ave., Chicago 1, Ill.
 VOLUME 45 • NUMBER 1



Member
 Audit Bureau of
 Circulations

RADIO & TELEVISION NEWS is published monthly by the Ziff-Davis Publishing Company at 185 N. Wabash Ave., Chicago 1, Ill. Entered as second-class matter July 21, 1948, at the Post Office, Chicago, Ill., under the act of March 3, 1879. Entered as second-class matter at the Post Office Department, Ottawa, Canada. SUBSCRIPTION RATES: in U. S., Canada, Mexico, South and Central America and U. S. Possessions, \$4.00 for twelve issues; in British Empire \$5.00; all other foreign countries, \$5.00 for twelve issues. RADIO-ELECTRONIC ENGINEERING EDITION: SUBSCRIPTION RATES: in U. S., Canada, Mexico, South and Central America and U. S. Possessions, \$6.00 for twelve issues; in British Empire \$7.00; all other foreign countries, \$7.00 for twelve issues. Subscribers should allow at least two weeks for change of address. All communications about subscriptions should be addressed to the Director of Circulation, 185 N. Wabash Ave., Chicago 1, Ill. CONTRIBUTIONS: Contributors are advised to retain a copy of their manuscripts and illustrations. Contributions must be accompanied by return postage and they will be handled with reasonable care, but this magazine assumes no responsibility for their safety. Any copy accepted is subject to whatever adaptations and revisions are necessary to meet the requirements of this publication. Payment covers all author's, contributor's and contestant's rights, title, and interest in and to the material accepted and will be made at our current rates upon acceptance. All photos and drawings will be considered as part of the material purchased.

**NOW... GET EVERYTHING YOU
NEED TO LEARN AND MASTER**

TELEVISION

RADIO-ELECTRONICS

...AT HOME!

Use REAL commercial-type equipment to get practical experience

Your future deserves and needs every advantage you can give it! That's why you owe it to yourself to find out about one of the most COMPLETE, practical and effective ways now available to prepare AT HOME for America's billion dollar opportunity field of TELEVISION-RADIO-ELECTRONICS. See how you may get and keep the same type of basic training equipment used in one of the nation's finest training laboratories... how you may get real STARTING HELP toward a good job or your own business in Television-Radio-Electronics. Mail the coupon today for complete facts — including 89 ways to earn money in this thrilling, newer field.



**Here's the
REAL THING!**

**SET UP YOUR OWN
HOME LABORATORY**



Oscilloscope



R-F Signal
Generator

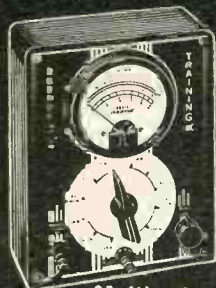

Multimeter

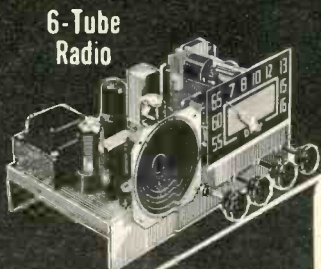

6-Tube
Radio

ABOVE: Build and keep a real 16 INCH commercial TV receiver. Optional after completing regular training at slight additional cost.

D.T.I., ALONE, INCLUDES BOTH MOVIES and HOME LABORATORY

In addition to easy-to-read lessons, you get the use of HOME MOVIES — an outstanding training advantage — plus 16 big shipments of Electronic parts. Perform over 300 fascinating experiments for practical experience. Build and keep real commercial-type test equipment shown at left.

**Get BOTH of these
information packed
publications FREE!**

MODERN LABORATORIES

If you prefer, get all your preparation in our new Chicago Training Laboratories—one of the finest of its kind. Ample instructors, modern equipment. Write for details!

MILITARY SERVICE!

If you're subject to military service, the information we have for you should prove doubly interesting. Mail coupon today.



**HOME
MOVIES**



De FOREST'S TRAINING, INC.
CHICAGO 14, ILLINOIS
A De VRY INSTITUTION

ACT NOW! MAIL COUPON TODAY!

DeFOREST'S TRAINING, INC., Dept. RN-I-H
2533 N. Ashland Ave., Chicago 14, Ill.

Without obligation, I would like your late News-Bulletin showing 89 ways to earn money in Television-Radio-Electronics... and how I may prepare to get started in this thrilling field.

Name..... Age.....
Street..... Apt.....
City..... Zone..... State.....

Smart TV Dealers are

HITTING THE TENNA-ROTOR JACK-POT!

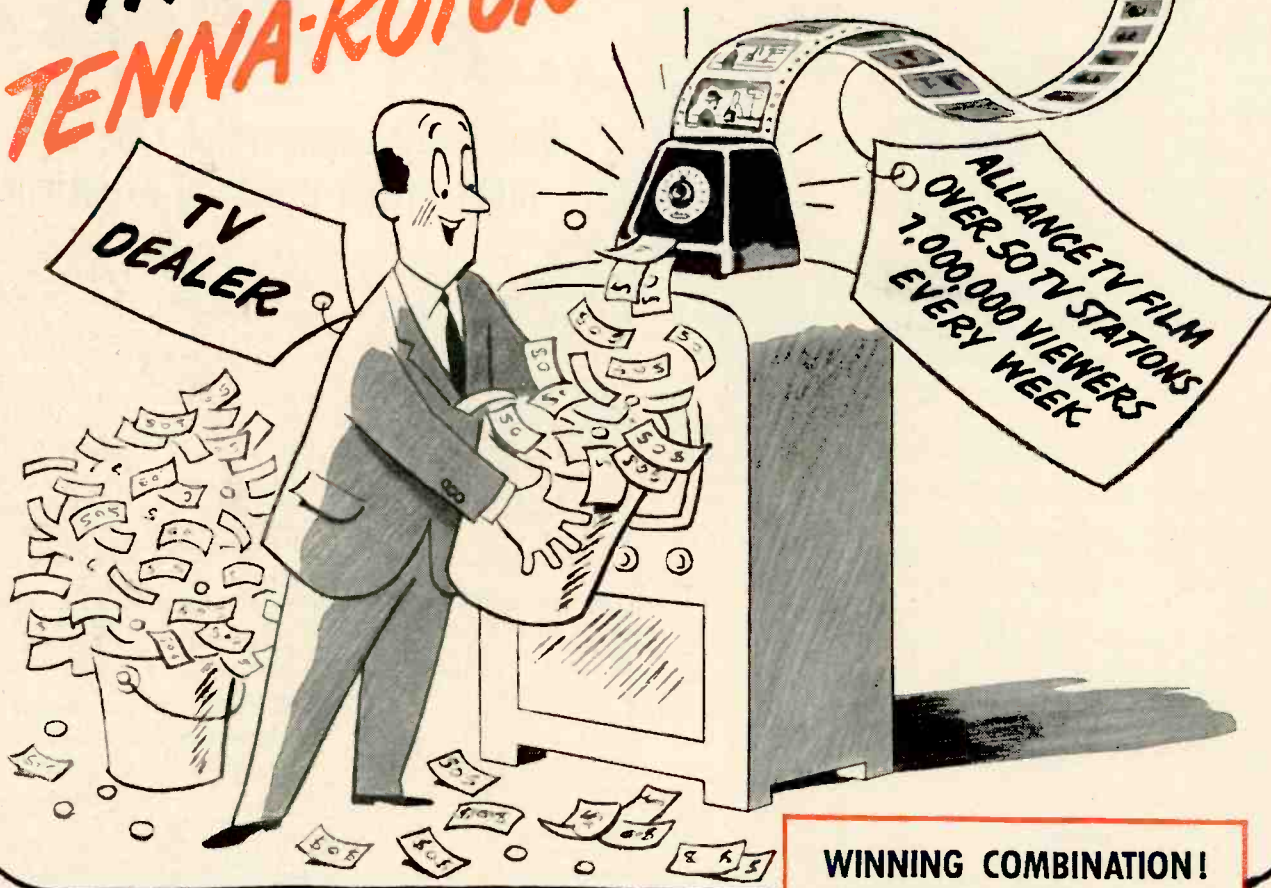

PROOF IS IN RESULTS! *Nation-wide TV Advertising Delivers Thousands of Sales—Every Week!*

Over 50 key TV stations demonstrate Alliance Tenna-Rotor to 7 million viewers! Tenna-Rotor is the only TV accessory backed by a powerful, sustained television campaign—national in scope! Hundreds of thousands of Alliance Tenna-Rotors are in use!

Alliance Tenna-Rotor offers faster installation with Alliance 4-conductor "Zip" cable—Works in all weather—Guaranteed for one year—Approved by Underwriters' Laboratories.

NEW DELUXE MODEL HIR IS FULLY AUTOMATIC!

WINNING COMBINATION!
Just Set It and Forget It!

The only fully automatic rotator. Set the pointer—antenna turns to that point and stops! North—East—South—West—direction indicator dial shows exact antenna position at all times. Extremely accurate!



MODEL HIR TENNA-ROTOR

ALLIANCE TENNA-SCOPE



—the New TV Booster! Features one simple control. Automatic on-off switch. Gives maximum uniform high gain on all channels—quick to install! An excellent companion item to Tenna-Rotor.

TENNA-SCOPE

ALLIANCE MANUFACTURING COMPANY • Alliance, Ohio

RADIO & TELEVISION NEWS

Every month

FORCEFUL CONSUMER ADVERTISING BOOSTS YOUR SALES OF G-E TUBES!



Full-page, eye-catching ads like this appear regularly in

LIFE

THE SATURDAY EVENING
POST

HERE'S a tube "first" that will put you first in volume, profits, and neighborhood prestige. Feature G-E tubes on your shelves; display them prominently on your counter. Your G-E tube distributor (better phone him, it's quicker) gladly will help you tie in with this national advertising. Or wire or write *Electronics Department, General Electric Company, Schenectady 5, New York.*

Inside story of television's
NEW LOOK

long-lasting
GE TUBES
for Radio Television

"Finest and set can have!"

You can put your confidence in
GENERAL ELECTRIC

You can put your confidence in —

GENERAL  ELECTRIC

101-KA1

NO SHADOWS

with new
**DUAL SPOTLIGHT
Soldering Gun**

Pull the trigger of your new light-duty Weller Soldering Gun, and instantly twin spotlights focus on the job—banish every shadow. Five seconds later the tip is at soldering heat! No waiting. No wasted current. This streamlined 135-watter—newest of the famous Weller line—is fast! Built compactly for working in crowded chassis, too. And the time and power you save pays for your Weller Gun in a few months.

New 135-Watt Weller Soldering Gun

*Specially Designed
for TV and Radio Work*

- **DUAL SOLDERLITE**—Two prefocused spotlights completely eliminate shadows.
- **OVER/UNDER DESIGN**—Tube construction braces tip and improves visibility.
- **5-SECOND HEATING**—Pull the trigger and you solder!
- **LONGER REACH**—Slides easily into deep chassis; reaches the tightest corners.
- **GREATER CAPACITY**—Smaller, lighter, with greater soldering capacity.
- **TRIGGER-SWITCH CONTROL**—Adjusts heat to the job. No need to unplug gun between jobs.
- **DUAL HEAT**—Single heat 100 watts; dual heat 100/135 watts; 120 volts; 60 cycles. Handles all light-duty soldering.

See new Models WS-100 and WD-135 at your distributor, or write for bulletin direct.

• **SOLDERING GUIDE**—Get your new copy of "Soldering Tips"—revised, up-to-date, fully illustrated 20-page booklet of practical soldering suggestions. Price 10¢ at your distributor, or order direct.

WELLER

ELECTRIC CORP.

810 Packer Street, Easton, Pa.



For the RECORD.

BY THE EDITOR

NEW AUDIO MAGAZINE SCHEDULED FOR MARCH

THE initial response to our recent announcement of plans to publish a new Audio Edition of RADIO & TELEVISION NEWS has been most gratifying. Ever since the publication of our annual audio issues, we have found an ever increasing interest in the many aspects of sound and related audio subjects. In attempting to satisfy all of our readers, we found that not nearly enough space was available, even in an annual audio issue, to adequately cover all of the new developments and techniques that have jelled in recent months.

In a few instances, however, the announcement was received with mixed emotions and a fear was expressed that we were going to discontinue audio subjects in RADIO & TELEVISION NEWS, placing such articles in the Audio Edition. Such is not our intention at all. Here's the reason:

We know that a large percentage of our 208,000 monthly readers have a common interest in audio, but there are many others whose preference is for service material on radio and television, amateur radio gear and gimmicks, various television subjects, communications, and for a general all-around coverage of radio and television. Accordingly, it is our responsibility to serve all interests to the best of our ability in the regular edition of RADIO & TELEVISION NEWS. We intend to continue with that policy and no changes are contemplated.

We are not disturbing the format of RADIO & TELEVISION NEWS. We are simply going to publish a new magazine, designed specifically for the audio reader who wants additional articles on audio and all its facets.

This "magazine within a magazine" means economy of production and permits the publisher to produce the material at but slight additional cost to the reader. It will be designed in similar fashion to our Radio-Electronic Engineering Edition, which is available by subscription only to engineers and persons interested solely in engineering subjects. The new magazine, *Audio*, will not be sold on the newsstands, but will be limited solely to those readers of RADIO & TELEVISION NEWS who wish the additional magazine, which will be bound within the regular edition.

The foremost audio writers in the country are already preparing material for the new edition. There will be at least five feature articles each month in the Audio Edition. Present plans call for the first edition in March 1951, providing total mobilization or curtailment of paper does not interfere.

We have made arrangements with Dr. Howard Tremaine, of the University of Hollywood, to write a complete course on audio. Here, for the first time, will be a common sense approach to a thorough understanding of all phases of audio. We believe that this series will be most profitable, not only to the student of audio, but to the engineer because of its review value.

Production Threatened by Shortages

The year, 1951, finds the entire television industry facing severe curtailments in production as the result of our defense program and the scarcity of cobalt, aluminum, and other materials and components. This curtailment of production is another real reason for sitting tight until Industry can come up with a compatible television system. As a matter of fact, this period of shortages may actually force the FCC and the Industry to shelve immediate plans for color television.

Copper is high on the scarcity list, and if the CBS System of color television is to hold the green light, many thousands of motors requiring copper in their construction will be required for the color disc scanner. Even now, there is a scarcity of motors of all types. Even though at this writing CBS has been stopped from commercial color telecasting, the FCC may eventually win out in its determined effort to give the American public the CBS color television system without further delay. It is also quite possible that as you read this, Industry will have perfected a compatible electronic system that may ultimately win out by sheer competition over the CBS system.

Color or no color, the television industry is in for a tough year and must face many hardships, if it is to continue at an adequate rate of production.

Service technicians, in the year ahead, have their greatest opportunity. Millions of television sets are not giving proper performance in the home, and authorities have estimated that approximately 70% of all television sets now in use are in need of proper realignment and other adjustments in their circuitry. Speaking of shortages, no one will challenge the statement that we still are in need of many thousands of trained television technicians, not only to take care of the 10,000,000 sets now in use, but as replacements for industry technicians called into service. Never before, and perhaps never again, will there be such an opportunity. Yes, 1951 should be a boom year for the technician. . . . O.R.

RADIO & TELEVISION NEWS

There's Only ONE COMPLETE CATALOG for EVERYTHING IN RADIO, TELEVISION & INDUSTRIAL ELECTRONICS

IT'S YOUR **FREE**
ALLIED 212-PAGE
 VALUE-PACKED CATALOG!

Send For It Today!

HERE'S the only *complete* Buying Guide to TV, Radio and Industrial Electronics—packed with the world's largest selections of quality equipment at lowest, money-saving prices. See the latest in TV, AM and FM receivers; radio-phonos; new Sound Systems and P.A. equipment; high-fidelity custom sound components; recorders and accessories; full selections of newest Amateur receivers and station gear; test instruments; builders' kits; huge listings of parts, tubes, tools, books—the world's *most complete stocks* of quality equipment.

ALLIED gives you *every* buying advantage: speedy delivery, expert personal help, lowest prices, assured satisfaction, liberal time payment terms. Get the 1951 ALLIED Catalog. Keep it handy—it will save you time and money. Send today for your **FREE** copy!

ALLIED IS YOUR TELEVISION HEADQUARTERS



To keep up with TV, depend on ALLIED! Count on us for the latest releases and largest stocks of picture tubes, component parts, antennas and accessories—plus the latest in TV tuners and kits. If it's *anything* in TV—we have it in stock! So remember—for TV—it's ALLIED First!



ALLIED RADIO

THE WORLD'S LARGEST RADIO SUPPLY HOUSE

Everything in Electronics

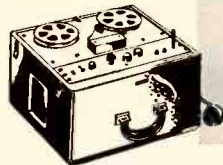
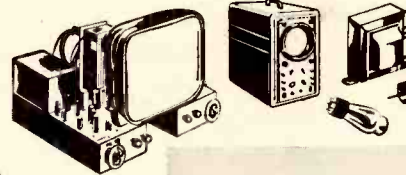

WORLD'S LARGEST STOCKS

- Radio Parts Unlimited
- Test Instruments—All Makes
- Television & Home Radios
- P.A. and Hi-Fi Equipment
- Amateur Station Gear
- Supplies for Industry

QUICK, EXPERT SERVICE



WRITE TODAY FOR RADIO'S LEADING BUYING GUIDE

FREE



ALLIED RADIO CORP.
 833 W. Jackson Blvd., Dept. 1-A-1
 Chicago 7, Illinois

Send **FREE** 212-page 1951 ALLIED Catalog.

Name.....

Address.....

City..... Zone..... State.....

Raytheon Backs its Products with a COMPLETE FIELD SERVICE PROGRAM!

WE AIN'T TELLIN' YOU NOTHIN' when we say that the major headache of the television business today is installation and service of TV sets.

But we *are* telling you something when we say that Raytheon backs its television dealers and servicemen with a *complete field service program!*

Seven factory-paid service representatives are in the field 12 months of the year, making scheduled calls in every TV community. These service experts call regularly on distributor service departments and, in conjunction with them, schedule regular servicemen's educational meetings.

At these meetings, they explain new techniques and simplified methods of servicing... they franchise Raytheon service agents and supply them with the

latest bulletin releases from the factory on new servicing techniques.

In addition to all this, the factory maintains a regular direct-by-mail program going to distributors for their franchised Raytheon service agents only, keeping them completely informed at all times.

THE NET RESULT is a complete, detailed, organized service program designed to simplify the problems of distributors, dealers and servicemen... to provide workable information on installation, service and maintenance of Raytheon TV receivers... and to save them time and money through a thorough understanding of Raytheon products.

For full details, contact your Raytheon field representative or write Service Manager, Belmont Radio Corp., 5921 West Dickens Ave., Chicago 39, Ill.

BELMONT RADIO CORPORATION • 5921 W. Dickens Avenue, Chicago 39, Ill.
Subsidiary of RAYTHEON MFG. CO.



Dependably Built

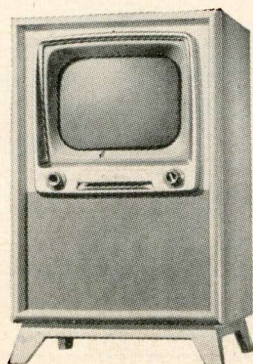

THE MAYFAIR—Model 1715

for Dependable Performance

List prices range from \$259.95 to \$625.00





Learn RADIO TELEVISION, ELECTRONICS

by
SHOP METHOD HOME TRAINING

Let NATIONAL SCHOOLS, of Los Angeles, a practical Technical Resident Trade School for almost 50 years, train you for today's unlimited opportunities.

You receive all parts, including tubes, for building this fine, modern Superheterodyne Receiver. This and other valuable standard equipment becomes your property.

these two FREE books will tell you how

**WE BRING
NATIONAL
SCHOOLS TO YOU!**

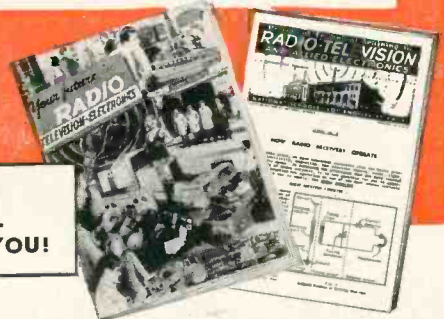

GOOD JOBS AWAIT THE TRAINED RADIO TECHNICIAN

You are needed in the great modern Radio, Television and Electronics industry! Trained technicians are in constant and growing demand at excellent pay—in Broadcasting, Communications, Television, Radar, Research Laboratories, Home Radio Service, etc. National Schools Master Shop Method Home Study Course, with newly added lessons and equipment, can train you in your spare time, *right in your own home*, for these exciting opportunities. Our method has been proved by the remarkable success of National Schools-trained men all over the world.

You Learn by Building Equipment with Standard Radio Parts We Send You

Your National Schools Course includes not only basic theory, but *practical* training as well—you *learn by doing*. We send you complete standard equipment of professional quality for building various experimental and test units. You advance step by step until you are able to build the modern superheterodyne receiver shown above, which is yours to keep and enjoy. You perform more than 100 experiments—build many types of circuits, signal generator, low power radio transmitter, audio oscillator, and other units. The Free Books shown above tell you more about it—send for them today!



NOW! NEW PROFESSIONAL MULTITESTER INCLUDED



This versatile testing instrument is portable and complete with test leads. Simple to operate, accurate and dependable. You will be able to quickly locate trouble and adjust the most delicate circuits. You can use the Multitester at home or on service calls. It is designed to measure AC and DC volts, current resistance and decibels. You will be proud to own and use this valuable professional instrument.

GET THE DETAILS - SEND THE COUPON →

Lessons and Instruction Material Are Up-to-date, Practical, Interesting

National Schools Master Shop Method Home Training gives you basic and advanced instruction in all phases of Radio, Television and Electronics. Each lesson is made easy to understand by numerous illustrations and diagrams. All instruction material has been developed and tested in our own shops and laboratories, under the supervision of our own engineers and instructors. A free sample lesson is yours upon request—use the coupon below.

TELEVISION TRAINING A complete series of up-to-the-minute Television lessons is an integral part of your course, covering all phases of Television repairing, servicing and construction.

Here are just a few of the interesting facts you learn with the **FREE SAMPLE LESSON**

1. How radio receivers operate.
2. How the antenna circuit is constructed.
3. Converting signal currents into sound.
4. How the R-F transformer handles the signal.
5. How the tuning circuit functions.
6. The Radio "bands."

**APPROVED
FOR
VETERANS**
Check
coupon below.

NATIONAL SCHOOLS

LOS ANGELES 37, CALIFORNIA EST. 1905



MAIL OPPORTUNITY COUPON FOR QUICK ACTION

National Schools, Dept. I-RN
4000 South Figueroa Street
Los Angeles 37, California

(Mail in envelope or
paste on penny postcard.)

Mail me **FREE** the book "Your Future in Radio-Television" and the sample lesson of your course. I understand no salesman will call on me.

NAME _____ AGE _____

ADDRESS _____

CITY _____ ZONE _____ STATE _____

Check here if veteran of World War II

Announcing **CENTRALAB'S**

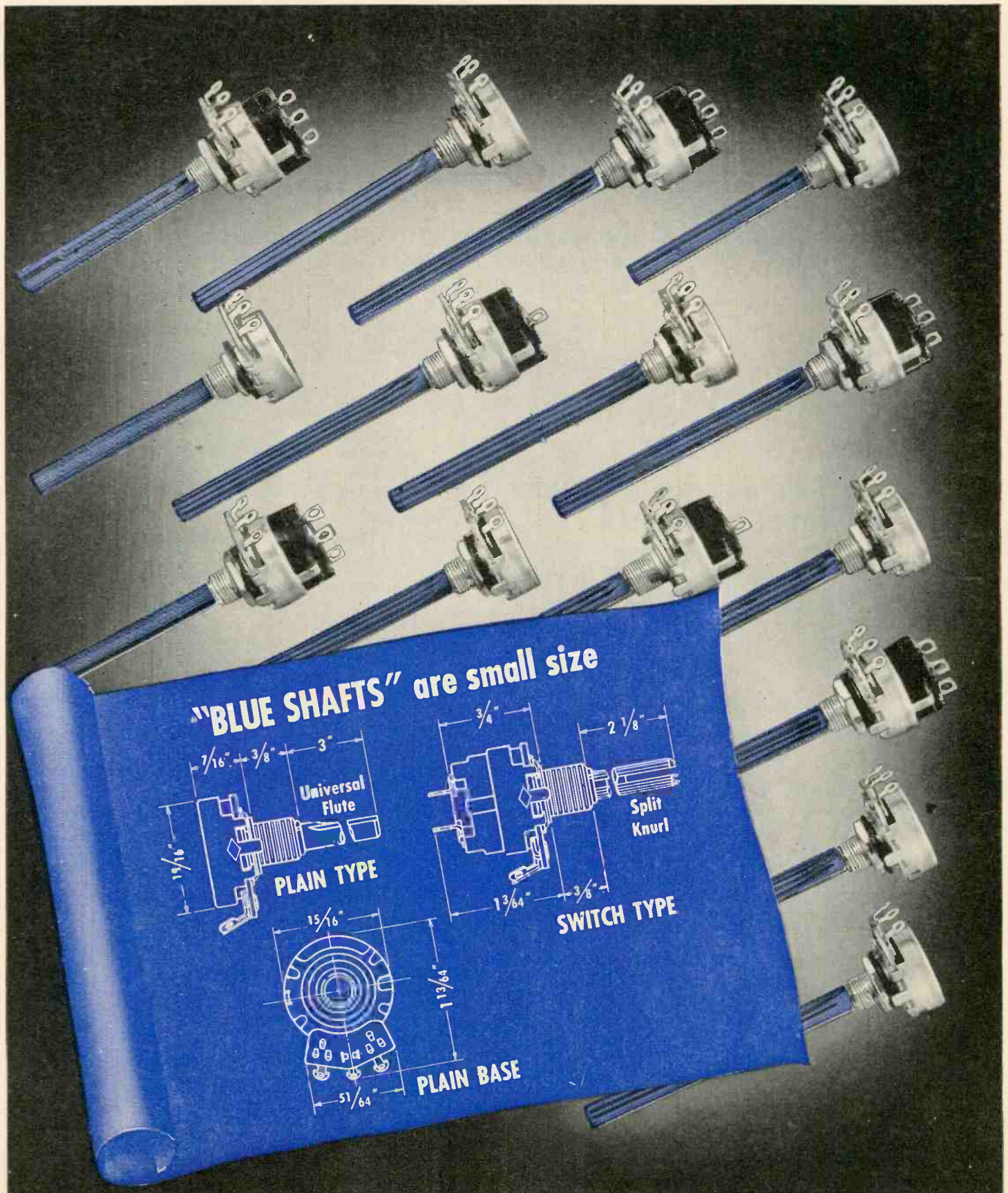

NEW Blue Shaft **CONTROLS**

Centralab now offers service engineers...today's finest replacement controls . . . quickest for servicing . . . at today's most favorable prices

8 Reasons why "Blue Shafts" are better

1. Blue Shaft controls are complete, ready-to-use units — factory assembled and tested including switches. No time lost fussing with assembly — smooth action guaranteed.
2. Blue Shaft Controls are *small size* — only 15/16" diameter — meet any modern service requirement.
3. Shafts — Standard Model B — 3" long — universal fluted — full length mill. Model BSK — 2 1/8" long with split knurl.
4. Switches — positive throw in both "on" and "off" positions. Terminals — surfaces elevated to eliminate danger of shorting to cover legs . . . 1/8" hole diameter for quick wiring . . . hot tin dipped for easy soldering.
5. Contact Spring gives you double wiping contacts on both resistor and center terminal ring . . . to insure noiseless operation.
6. Blue Shaft resistors are made of special resistance material bonded to high quality phenolic for smooth operation, low noise level, outstanding humidity characteristics.
7. Insulator's high dielectric strength permits breakdown test at 1000 volts R. M. S. *Dust and dirt can't get in.*
8. Blue Shaft Controls are produced and *guaranteed* by Centralab — the company that *introduced* carbon-type controls to the radio industry 25 years ago!

"Blue Shafts" offer complete range of all values

Service engineers! Centralab's new Blue Shaft controls are an exclusive *service item* and are available in a complete line of plain and switch types. Resistance ranges from 500 ohms to 10 megohms in a wide variety of tapers and tapped units suitable for any circuit.

Blue Shaft Controls are available packaged singly, in handy plastic boxes containing 12 — and in a special metal cabinet containing 22 controls—*No extra charge for the cabinet.* Ask your nearest Centralab distributor for complete details on all Blue Shaft controls.

Check These LOW PRICES on Popular Size Controls!

Cat. No.	Ohms Max. Resistance	Taper	Circuit Location	List Price
B-60	500,000	C-2 (audio)	Volume or Tone	\$1.00
B-60-S*	500,000	C-2 (audio)	Volume or Tone	\$1.50
B-70	1 megohm	C-2 (audio)	Volume or Tone	\$1.00
B-70-S*	1 megohm	C-2 (audio)	Volume or Tone	\$1.50

*Switch Type

Get More Information . . . You can get complete information on the entire Blue Shaft line of replacement controls from Centralab's new Bulletin No. 42-106. Ask your jobber or write direct.

Centralab[®]

CENTRALAB DIVISION OF GLOBE-UNION INC., 910 East Keefe Avenue, Milwaukee 1, Wisconsin

Please send me Blue Shaft Control Bulletin No. 42-106 Include new Centralab Catalog No. 27

Name.....

Company Name.....

Address.....

City.....Zone.....State.....

Please!

Your Distributor's Name.....

Address.....

City.....Zone.....State.....

THE **NEW HOME** OF

PYRAMID CAPACITORS

will be in full operation by FEBRUARY 1, 1951

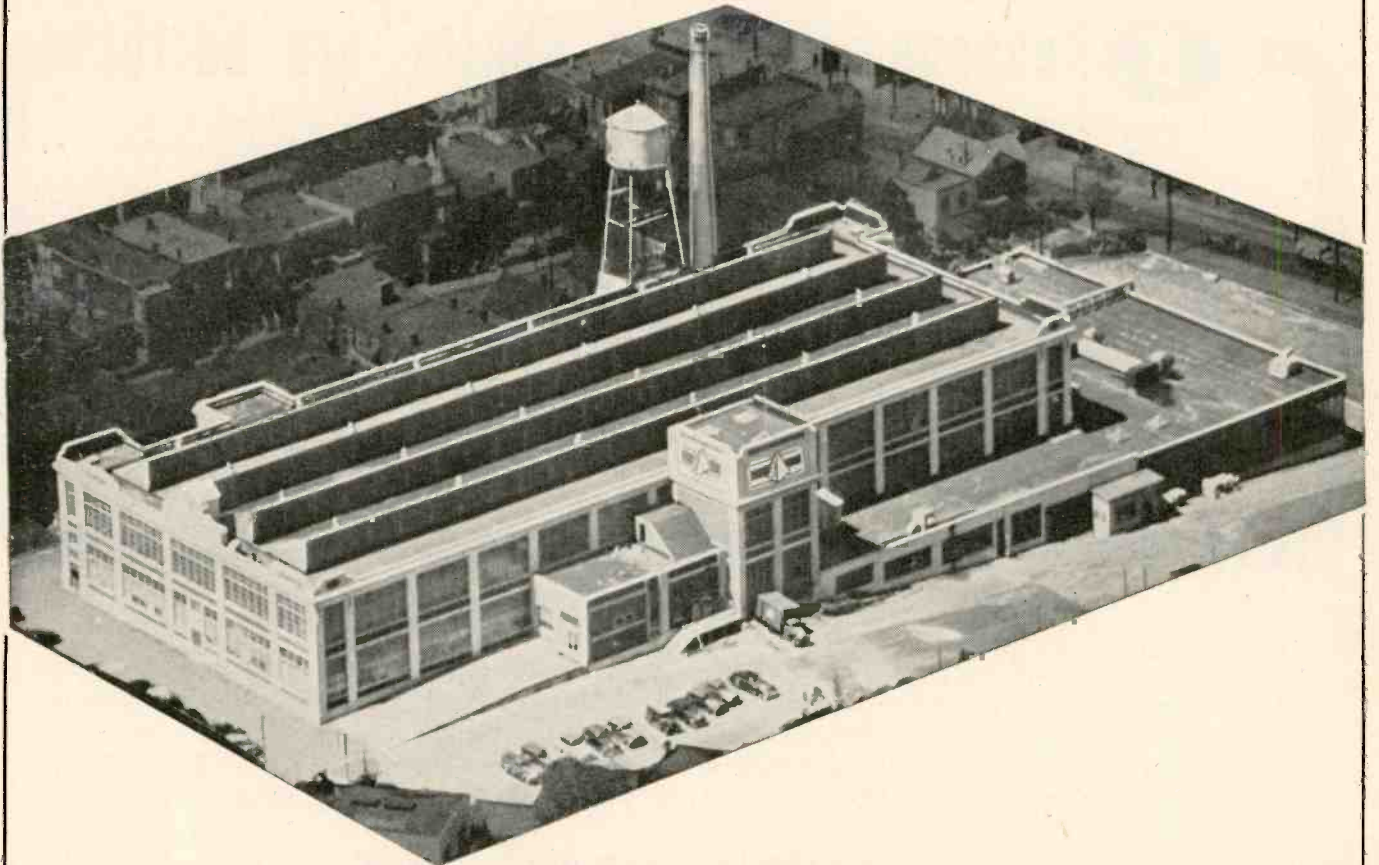

LOCATION 1445 HUDSON BOULEVARD, NORTH BERGEN, N. J.

SIZE 137,000 SQUARE FEET

PRODUCTS ELECTROLYTIC CAPACITORS
PAPER CAPACITORS
RF INTERFERENCE FILTERS

Your inquiries are invited

PYRAMID ELECTRIC COMPANY

NEW INDICATOR ION TRAP

*A
Rauland
"Exclusive"*



Speeds Service — Builds Profits

Rauland's new Indicator Ion Trap is winning the cheers of more service men and dealers every day — because of the time and trouble it saves in Ion Trap Magnet adjustment, and because it eliminates mirrors and guesswork.

Now it's a matter of seconds to adjust the ion trap magnet with absolute precision. The service man simply moves the magnet until the signal glow is reduced to minimum.

This important new Rauland development is incorporated in all Rauland tubes produced today — as a feature of Rauland's new Tilted Offset Gun. This gun offers the additional advantages of giving only a single Ion Trap Magnet and of maximum sharpness of focus.

Only Rauland offers this advanced feature — one of half a dozen post-war developments from Rauland.

For further information, write to . . .

RAULAND

The first to introduce commercially these popular features:

Tilted Offset Gun

Indicator Ion Trap

Luxide (Black) Screen

Reflection-Proof Screen

Aluminized Tube

THE RAULAND CORPORATION



Perfection Through Research

4245 N. KNOX AVENUE • CHICAGO 41, ILLINOIS



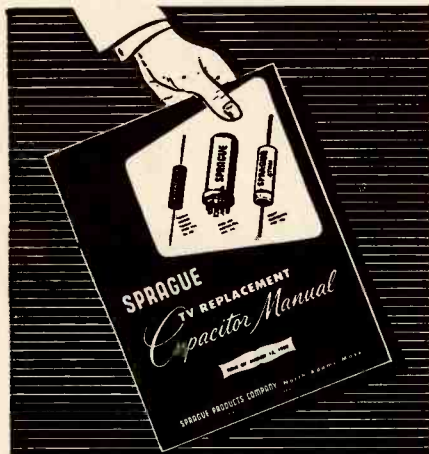

FREE!

This New TV REPLACEMENT Capacitor MANUAL

by

SPRAGUE

From A to Z, from Admiral to Zenith, this 16-page book is jam-packed with complete replacement recommendations for critical TV capacitors in 497 television sets from The Technical Service Division of Sprague, world's largest capacitor maker.

Get your copy FREE from your SPRAGUE DISTRIBUTOR or send 10c directly to Sprague to cover handling and mailing costs.

Remember! Avoid costly call-backs in your service work by sticking to Sprague — the capacitors you can depend upon.

SPRAGUE

PRODUCTS COMPANY

DISTRIBUTORS' DIVISION OF THE SPRAGUE ELECTRIC COMPANY

51 MARSHALL ST., NORTH ADAMS, MASS.

Spot Radio News

★ Presenting latest information on the Radio Industry.

By RADIO & TELEVISION NEWS'
WASHINGTON EDITOR

THE CHANNEL ISSUE, the original reason for the call of the allocation hearings, which was pigeon-holed for nearly a year by the vexing color debate, finally reached the discussion stage shortly before election day and appeared to be headed for a typical Washington festival of invectives. In the wrangling mill have been dropped such sizzling questions as . . . shall the present bands be continued and on what basis, or shall we rearrange and mix the channels with stations on the higher frequencies, or shall we extend the present bands to the, let us say, 300-megacycle region, now held in part by the military and simply forget the ultra-highs, or shall we add more stations to the present setup, allow less spacing between some stations in some territories and delay the ultra-high program indefinitely, or shall we use the program proposed by the Commission and add 42 channels to the higher bands, allow a specified intermixing of high and low bands in some areas, and insist on more separation between stations on the present bands. After several rounds of heated testimony, with ayes and nays bouncing from all sides, confusion in the hearing halls was quite rampant. Oddly enough, the replies offered appeared to have considerable merit. For instance, when Paul Raibourn, prexy of *Paramount Television Productions*, concluded his commentary, even the government's experts stared and appeared to wonder if an answer could be found. Seems as if Raibourn remembered his legal history very well and recalled that in the early days of AM development, an effort had been made through law by the so-called Davis amendment to freeze the frequencies and classification of stations, including power and hours of operation, into a rigid geographical formula by a system of zoning. Economic support could not be obtained in many of the less populous areas, while the demand for frequencies in the larger markets developed with increasing intensity. Accordingly, on the Commission's recommendations, Congress abandoned this statutory straitjacket, according to Raibourn, and placed upon the Commission the responsibility of insuring an equitable distribution of facilities, based primarily on demand. In the opinion of Raibourn, while it may have been that the pattern of nationwide broadcast

coverage would ultimately have been enhanced in some areas if the AM frequencies had been withheld for a decade or more, it is doubtful whether there would have been the fullest development of competitive opportunities had not the more populous areas been permitted to make the fullest utilization of the AM frequencies. It was then pointed out that perhaps the important significance of the experience under the Davis amendment was the fact that the Commission found, in the early development stage of sound broadcasting, that geographical formulas were unduly restrictive. In the present stage of television development, disclosed Raibourn, *Paramount* felt that the assignment of the ultra-high frequencies would be even more restrictive.

Citing several interesting personal experiences in present band reception, the film executive said that he has been able to pick up signals from Washington, a distance of 245 miles away from his home, the pictures being equal to those from the Bridgeport ultra-high transmitter nine miles away. Pictures from Channel 3 in Philadelphia were also often found to be equal in enjoyment to the upper v.h.f. channels in New York. Adjacent channel interference didn't seem to bother the receivers in his home, Raibourn reported. He felt that existing standards of separation, developed in '45, were still proper and could continue to be used if receivers were made with higher tuning discrimination. The receiver design criteria needed to permit the existing channel allocation to continue were not extreme or difficult, the *Paramount* official declared.

Describing his views on the higher-band problem, Raibourn said: "As regards the proposed ultra-high allocation plan, and particularly the fact that major economic and population centers were not assigned channels, it is my fear that the u.h.f. as a broadcasting medium will not develop rapidly to the degree of which it is capable. Even when it does, the u.h.f. stations will stand in relation to the entire scheme as the clear-channel stations do now in the AM broadcasting structure."

Somewhat of a contrary view appeared in the testimony of Albert F. Murray, appearing on behalf of *Philco*, who reported that the residents of

RADIO & TELEVISION NEWS

For PERFORMANCE,
PRICE, ADAPTABILITY,

you just can't beat
the *Tarzian
Tuner!*

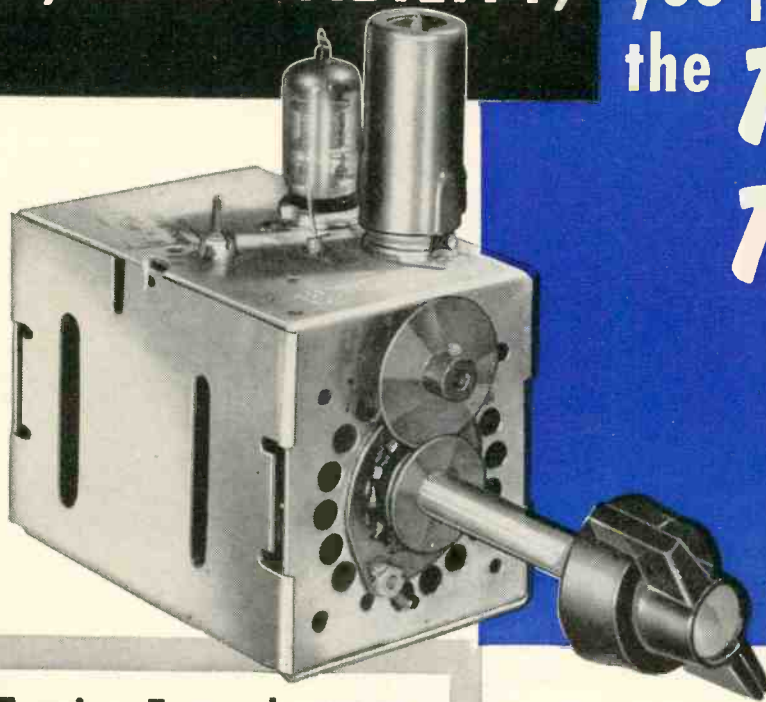

A compact, precision-built "package," offering maximum performance per dollar cost. And, backed by TARZIAN engineering "know-how."

Only Tarzian Tuner has ALL
of these desirable Features

- Low oscillator radiation
- High gain and low noise
- Designed for 21 or 41 megacycle I.F. systems
- Insulated shaft design available at low cost
- Anti back lash, air dielectric fine tuning, giving uniform coverage on low and high channels
- Three tube performance with two tubes
- Each channel individually aligned for maximum performance
- Good input balance—no tracking difficulties
- Completely shielded
- Oscillator tube shield provides rigid horizontal and vertical positioning of the tube
- Extra terminals provided for tie-points

Write for complete information,
specifications and technical data.

- Since the time it was first introduced, the TARZIAN front-end tuner has won the acclaim of the industry. It is small, skillfully designed, well-built and low-priced. That's why 17 of the nation's set manufacturers today are specifying the TARZIAN tuner as a component for their products.

Engineering service available
upon request

Sarkes Tarzian, inc.

TUNER DIVISION, DEPT. TV-1

537 South Walnut Street • Bloomington, Indiana

The SARKES TARZIAN
stations in Bloomington
WTTS-WTTV
5000 Watts Channel 10

For Matchless Performance—Use

CHICAGO

MATCHED

Power Transformers
& Filter Reactors

Optimum performance is no accident. CHICAGO transformers insure optimum performance, first by advanced design geared to today's electronic tubes and circuits, second by famous Sealed-in-Steel construction, and third by matching associated units to perfection.

Electronic designers, engineers, experimenters and builders are fast learning about CHICAGO advantages. There's proof in the increasing preference for Sealed-in-Steel power units. They're exactly suited to requirements—one range of ratings specifically designed for capacitor input, another for reactor input. Filter reactors are perfectly matched to power transformer units both in rating and construction characteristics. For a complete range of matching units, designed for matchless performance, you'll want to refer to the CHICAGO New Equipment Line Catalog. Send for your copy today.

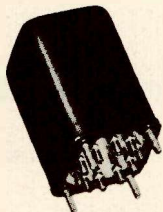
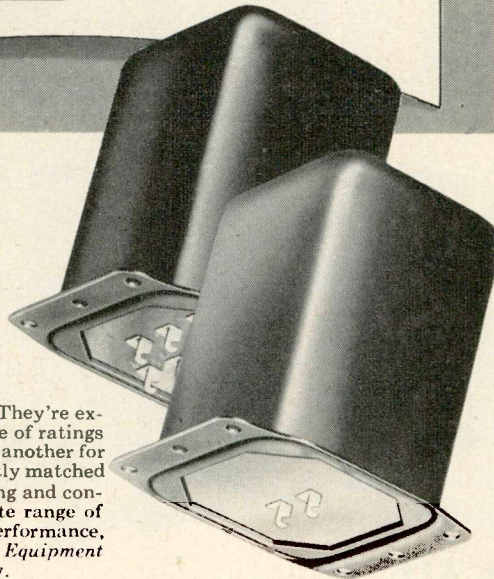

**Full Frequency
Range Audio
Transformers**

within $\pm \frac{1}{2}$ db
30-15,000 cycles

For uniformly low distortion, for response curves that are truly flat over the full frequency range, use these famous CHICAGO Sealed-in-Steel input and output units. Get the facts on the BO-6 (P-P 6L6's to 6/8 or 16/20 ohm speaker), the BO-7 (600/150 ohm line to 6/8 or 16/20 ohm speaker), and the full line of CHICAGO full frequency units—years ahead in audio transformer design—tops for performance.

**Public Address
Range Audio
Transformers**

within $\pm \frac{1}{2}$ db
50-10,000 cycles



CHICAGO P.A. range units are geared to today's public address circuit requirements and to latest tube types. Line and voice impedances used in the advanced Sealed-in-Steel output designs meet RMA standards. The 4, 8, and 16-ohm voice coil impedances can also be used with 3.2, 6 and 20-ohm speakers without appreciable mismatch. Available in a complete range of perfectly matched driver and output units.

SEND FOR FREE NEW EQUIPMENT LINE CATALOG

You'll want the full details on CHICAGO'S New Equipment Line—the famous Sealed-in-Steel line that offers advanced engineering design to fit today's circuits. Lists units for all purposes: Power, Bias, Filament, Filter Reactor, Audio (in 3 frequency ranges), JAN-T-27, Modulation, Stepdown and Isolation, High Q, Splotter, Low Pass. Write for your FREE catalog today—or get a copy from your distributor.



CHICAGO TRANSFORMER

DIVISION OF ESSEX WIRE CORPORATION

3501 ADDISON STREET • CHICAGO 18, ILLINOIS



Bridgeport and vicinity could receive excellent television service a greater percentage of the time from the present ultra-high station than they could from any New York City station and that, in addition, they could enjoy the advantages of much less ignition interference, practically no diathermy interference, lower and less-costly antenna structures, and smaller high-gain antennas. However, there were some u.h.f. disadvantages which must be considered, too, he said. For instance, the receiving antenna position is much more critical; swaying due to wind can cause signal variation. The shadow effect is also more noticeable, and the absorption of buildings and trees is greater, too.

Murray disclosed that he used a Philco 48-1001 table model set, equipped with a fixed, cavity-tuned converter and three types of receiving antennas; the usual dipole, a Yagi, and an eight-element stacked array with a reflector. To connect the antenna with the receiver either of two lengths of 50-ohm RG-9/U coax cable were applicable, one having a 2 db. loss and another a 3 db. loss. A motor-driven rotator served to select the proper pickup point. The directional higher-gain antennas were found to provide the best results.

Still another opinion on the ultra-high situation was offered by the industry's official association, the TBA, which asked that the Commission assign 70 channels for the higher bands in the entire 470 to 890 megacycle band, so that manufacturers could plan now in their design and production of receivers for the coming year.

Reviewing how they arrived at their proposal, the association declared that they felt that there should be at least four stations in each of the first 140 metropolitan districts, and at least as many stations in each metropolitan district and community as specified by the Commission. Spacing could be determined by considering where oscillator interference would be expected, using 58 and 75 mile separation as a basis of planning. The proposed RTMA intermediate frequencies of 41.25 mc. for the sound carrier and 45.75 mc. for the picture carrier served as a medium of reasoning for this approach. Explaining this point, the association said that with the considered intermediate frequencies, oscillator interference may be caused seven channels above the desired channels when the receiver is tuned to the desired channel; and two channels, the fourteenth and the fifteenth above the desired channel, are capable of creating image interference in the desired channel. The fifteenth channel image is the more damaging and with the receiver attenuations considered at this time to be feasible, geographical separation of stations assigned fifteen channels apart should be 75 miles or more. Signals, fourteen channels above the desired signal, will also cause image interference, but in this

(Continued on page 139)



Train at Home in Spare Time for and **RADIO TELEVISION**

**I Send You
18 BIG
KITS
OF RADIO-
TELEVISION
EQUIPMENT**



**My Famous Training System Prepares
You in Double-Quick Time for a Good
Job or Your Own Profitable Radio-
Television Business**

Radio-Television is now America's greatest opportunity field! Trained men are needed to fill good jobs and handle profitable Radio-Television Service work. I have trained hundreds of men for success in Radio-Television—and I stand ready to Train you too, even if you have no previous experience. My training is 100% practical—designed to give you the knowledge and experience you need to make money in Radio-Television in the shortest possible time. I Train you with up-to-the-second revised lessons—PLUS many big kits of Radio-Television equipment. You actually do over 300 demonstrations, experiments and construction projects. In addition, you build a powerful 6-tube 2-band radio, a multi-range test meter and a complete Television receiver! All equipment is **YOURS TO KEEP!**

EASY TO MAKE EXTRA MONEY WHILE YOU LEARN

You do all your training with me **AT HOME** in spare hours. Keep right on with your present job and income while learning—and earn extra cash besides! The day you enroll I begin sending you plans and ideas for doing profitable spare-time Radio-TV work. Many of my Sprayberry students pay for their entire training this way! You get priceless experience and many plans for making extra money. You build all your own Radio-TV Test Equipment from parts I send you—nothing else to buy. Just one more reason why I believe I offer the ambitious man the biggest value in top notch Radio-TV Training available anywhere in America today.

Be Ready for Top-Paying Radio-Television Jobs

Radio-Television is growing with amazing speed. More than 2000 Radio broadcasting stations PLUS an additional 102 Television stations are now on the air. Radio sets and TV receivers are being made and sold in record-breaking numbers. If you enjoy working with your hands . . . if you like to do interesting and varied work . . . if you really want to make good money and work in an industry that has a future . . . **YOU BELONG IN RADIO-TELEVISION.** But you **MUST** have good Training to "cash in" . . . the kind of Training that starts you out with basic fundamentals and carries you right through every circuit and problem of Radio-Television Servicing and Repair. In a word . . . that's Sprayberry Training . . . the course backed by more than 20 years of association with the Radio-Television industry!

FREE 3 BIG RADIO-TELEVISION BOOKS

I want you to have ALL the facts about my complete system of Radio-Television Training! Act now! Rush the coupon for my three big Radio-Television books: "How to Make Money in Radio-Television," PLUS my new illustrated Television Bulletin PLUS an actual sample Sprayberry Lesson—all FREE with my compliments. No obligation and no salesman will call on you. Send the coupon in an envelope or paste on back of post card. I will rush all three books at once!

**Sprayberry Academy of Radio, Dept. 25-S
111 North Canal St. Chicago 6, Ill.**

**Mail
Coupon
Today!**
**NO OBLIGATION
No Salesman
Will Call**

VETERANS: My Radio Training is Approved for Veterans.

IF YOU ARE EXPERIENCED in Radio I'll qualify you for Television in 4 to 8 weeks. Rush coupon.

**SPRAYBERRY ACADEMY OF RADIO, Dept. 25-S
111 North Canal St., Chicago 6, Ill.**

Please rush to me all information on your Radio-Television Training Plan. I understand this does not obligate me and that no salesman will call upon me.

Name..... Age.....
Address.....
City..... Zone..... State.....
Please Check Below About Your Experience
 Are You Experienced? No Experience

Learn more!
Earn
more!

8 GREAT BOOKS



A. A. GHIRARDI
radio
electronics
most famous
teacher

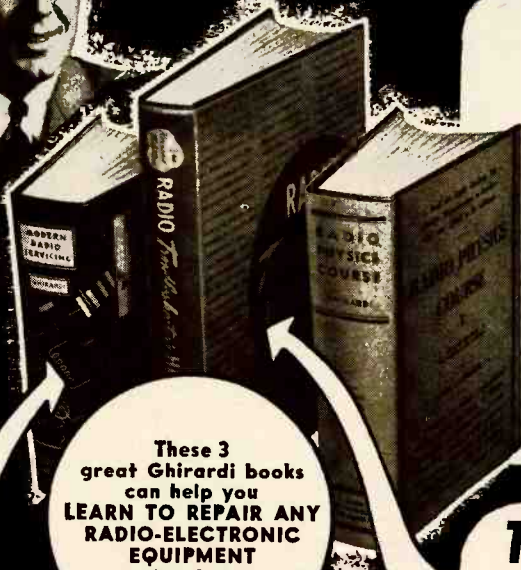

These 3
great Ghirardi books
can help you
LEARN TO REPAIR ANY
RADIO-ELECTRONIC
EQUIPMENT
easier, better,
faster!

This Giant Book Brings You complete PROFESSIONAL SERVICE TRAINING

...at home...for only \$5
(\$5.50 outside U. S. A.)

A. A. Ghirardi's giant, 1300-page MODERN RADIO SERVICING gives a complete education in truly professional radio-electronic service work—the kind that pays the real money! Radio itself is only the beginning of this big book's usefulness to you. What it teaches you about electronic circuits, test instruments and professional service procedure is exactly the training you need for a good job in modern electronic-radio-television work!

A COMPLETE GUIDE TO INSTRUMENTS— TROUBLESHOOTING—REPAIR

Read from the beginning, MODERN RADIO SERVICING is a complete service course. Used for reference, it is a quick guide to jobs that puzzle you. Explains service test instruments and how, when and why and where to use each type; how to make preliminary trouble checks; how to analyze circuits; how to replace components; how to speed up your work—and literally dozens of other subjects including How to Start and Operate a Successful Service Business of Your Own. 706 illustrations make study easy. Order Book No. 3 in coupon. Return book in 10 days if not more than satisfied! (SEE OUR MONEY-SAVING OFFER!)

HERE IS YOUR COMPLETE TRAINING IN BASIC RADIO-ELECTRONICS

- 36 courses
in one!
- No lessons to
wait for!
- Learn fast—
Learn right!

No matter what part of ELECTRONICS-RADIO-TELEVISION work you plan to enter, a knowledge of basic fundamentals is essential. Ghirardi's world-famous 972-page RADIO PHYSICS COURSE book gives exactly the training you need—for only \$5 complete (\$5.50 outside U.S.A.). If sent as monthly lessons, you'd regard it as a bargain at \$50 or more! Written for beginners, RADIO PHYSICS COURSE starts with Basic Electricity—then takes you step by step through Radio-Electronics principles. You can easily understand it without previous training. Actually it has given more beginners their start than any other book or course. During the war it was more widely used for Signal Corps and Navy basic training than any other book of its kind. Read it for 10 days at our risk. Order Book No. 1 in coupon!

This "AUTOMATIC TEACHER" shows HOW TO REPAIR OVER 4800 RADIO MODELS

... without expensive test equipment

Ghirardi's big manual-size, 744-page RADIO TROUBLE-SHOOTER'S HANDBOOK is a dependable guide to locating and repairing the common troubles in the most widely used radios, auto radios and radio-phonograph combinations. Whether you repair radios for a living or work with them occasionally, this book will save you time and money on thousands of jobs—especially on older sets where data is often lacking. Eliminates useless testing!

SAVES TIME—HELPS YOU MAKE MORE MONEY!

Just look up the case history notes on the old radio you want to fix. RADIO TROUBLESHOOTER'S HANDBOOK tells what the trouble is—what causes it—and exactly how to repair it, often in half the usual time. Hundreds of additional pages contain valuable data on tubes, parts and equipment, plus graphs, diagrams and money-making service hints. Ideal for training new service helpers. Worth another man in the average shop! Price only \$5 (\$5.50 outside U.S.A.). Order Book No. 2 in coupon. 10-day money-back guarantee.

**MONEY
SAVING
OFFER!**

Make your servicing library really complete! Get BOTH Ghirardi's RADIO TROUBLESHOOTER'S HANDBOOK (Book No. 2) and MODERN RADIO SERVICING (Book No. 3) at the special price of only \$9.50 for the two. (\$10.50 outside U.S.A.) Use coupon today!

IT PAYS TO KNOW HOW TO USE THE OSCILLOSCOPE *fully!*

Learn to use the oscilloscope fully on service and laboratory jobs—and watch your efficiency and earnings soar! MODERN OSCILLOSCOPES AND THEIR USES makes it easy! First, this great book gets right down to earth in explaining oscilloscopes and showing exactly how and where to apply them on AM-FM and TV jobs. Then, in easily understood terms, you learn all of the tricks of using this handy instrument—from locating receiver troubles to aligning and adjusting the most complicated circuits. Complete chapter sections deal with television and AM and FM servicing and show how the oscilloscope can solve many of your toughest problems.

CHOCK FULL OF HOW-TO-USE-IT DATA

Each oscilloscope operation is carefully explained including the making of connections, adjustment of circuit components, setting controls and analyzing patterns. About 400 illustrations including dozens of pattern photos make things doubly clear. Price \$6 (\$6.50 outside U.S.A.). Order Book No. 4 in coupon. Read it for 10 days at our risk!



What it is! How it works! Exactly how to use it on the job!

READ ANY OF THEM FOR 10 FULL DAYS.

TO HELP YOU INCREASE YOUR MONEY-EARNING POWER!!



... This big book MAKES AUTO RADIO REPAIR TWICE AS EASY!

Includes over 500 car radio circuit diagrams



There are more auto radios in use than ever before. Be the well paid expert who can repair them!

Here—written by a leading auto radio expert—is everything needed to help the beginner or experienced serviceman gain profitable skill in this fascinating field. **SERVICING THE MODERN CAR RADIO** describes installation, testing and repair methods fully. Also, it gives needed special data on car radio circuits, differences between car and home radio servicing problems, shop set-up and business getting methods. Covers antenna installations; loudspeaker servicing; input circuits; power supplies; car radio alignment; circuit features; auto electrical systems; set installations; interference cures; vibrator maintenance and dozens of other subjects. In addition, there are 500 actual car radio circuit diagrams that are worth the entire price of the book to the busy service shop! 702 manual-size pages. Price \$7.50 (\$8.00 outside U.S.A.). 10-Day money-back guarantee. Order Book No. 5 in coupon.

Train for better pay in TELEVISION SERVICING!



The book that helps you GET WHERE THE BIG MONEY IS!

Here, in one handy, 334-page volume is a complete guide to installing and servicing television receivers. **PRACTICAL TELEVISION SERVICING** tells you what to do—how to do it—how to set up shop—what mistakes to avoid. Clearly explained are the differences between radio and TV work. Included are dozens of actual TV service case histories and full explanations of wiring, repair and component replacement techniques, antenna erection, TV installations, etc. Also, you get dozens of helpful tips on testing, improving picture linearity, getting good fringe area reception, and other vital TV service data. In a way you can easily understand, it shows step by step exactly how to do the work. Price only \$4.00 (\$4.50 outside U.S.A.). Our 10-day money-back guarantee protects you absolutely. Order Book No. 8 in coupon.

LEARN ELECTRIC MOTOR REPAIR

A good-paying modern profession!



There's big money in installing, maintaining and rewinding electric motors! Actually, there are more motors than any other type of electric appliance—and the field is growing fast.

OPPORTUNITIES EVERYWHERE

Based on what can be learned from this 500-page **ELECTRIC MOTOR REPAIR** book alone, you can train quickly for this profitable field. Explains every detail of motor trouble shooting, repair and rewinding. Covers all types of a-c and d-c motors in common use plus motor control systems. Quick reference guides show how to handle specific jobs. Every type of work is explained in the text AND ALSO visually by more than 900 helpful drawings, photos and diagrams. Practice from the book for 10 days on our money-back guarantee offer. Price \$5.00 (\$5.50 outside U.S.A.). Order Book No. 6.

It pays to specialize in something different!

The book that helps you BE A WELL-PAID SPECIALIST IN F-M!



FM theory and service procedure clearly explained.

FM is a mighty important part of radio—and, with its wide use in Television, mobile units and high-fidelity reception—is becoming more so every day! Written by a well-known expert, this book **FREQUENCY MODULATION** makes it easy for you to understand FM fundamentals and equipment clearly. Equally important, it explains how to handle FM service. Basic FM theory, circuits, transmitters, receivers and mobile FM are discussed in an easily understood manner—with special emphasis on modern methods of installing, adjusting and repairing FM receivers. Other subjects include FM circuit peculiarities; tuning indicators; antennas; FM test units; receiver alignment; general servicing procedure and many others. A complete guide to one of electronic's fastest-growing yet least understood developments! 448 pages, over 300 illustrations. Price \$5 (\$5.50 outside U.S.A.). Order Book No. 7 in coupon.

FREE!

WITH YOUR PURCHASE OF TWO BOOKS OR MORE

Here's an offer you can't afford to miss! With your purchase of ANY TWO of the eight books shown on these pages, we will GIVE you one of the following famous MHB Manuals in Applied Electricity. Your purchase of four regular books entitles you to two of the Manuals—AT NOT ONE CENT OF EXTRA CHARGE. Indicate your choice of gift books on coupon.

Manual A—INDUSTRIAL ELECTRIC WIRING

Construction, operation and maintenance data on a-c and d-c systems. 336 pages, over 100 illus. (Regular price \$2.75).

Manual B—PRIMARY AND STORAGE BATTERIES

Data on selection, maintenance and use—plus rectifiers, charging generators and battery controls. 168 pages profusely illustrated. (Regular price \$2.25).

Manual C—ELECTRICAL MEASURING INSTRUMENTS

Operating principles and details of all industrial types including guides to instrument selection and use. 284 pages, over 200 illus. (Regular price \$2.50).



10-DAY MONEY-BACK GUARANTEE COUPON

Dept. RN-11, MURRAY HILL BOOKS, Inc.
232 Madison Ave., New York 16, N. Y.

Enclosed find \$_____ for books checked below: or send C.O.D. and I will pay postman this amount plus postage. In either case, it is understood I may return books after 10 days and you guarantee to refund my purchase price promptly. (No C.O.D.'s if you live outside U.S.A. Cash only, but same 10-day return privilege.)

Send the following books
 Book No. 1 Book No. 2 Book No. 3 Book No. 4
 Book No. 5 Book No. 6 Book No. 7 Book No. 8
 As per above offer send following gift Manuals at no extra charge:
 Manual A Manual B Manual C

Name

Address

City, Zone, State.....

PRINT OR WRITE CLEARLY

Read any of them for 10 FULL DAYS . . . at OUR risk!

... AT OUR RISK!

FREE

TELLS HOW—

**WE GUARANTEE
TO TRAIN AND COACH YOU AT HOME
IN SPARE TIME UNTIL YOU GET
YOUR FCC LICENSE**

If you have had any practical experience — Amateur, Army, Navy, radio repair, or experimenting.

TELLS HOW—

OUR AMAZINGLY EFFECTIVE JOB-FINDING SERVICE HELPS CIRE STUDENTS GET BETTER JOBS. HERE ARE JUST A FEW RECENT EXAMPLES OF JOB-FINDING RESULTS:

GETS FIVE JOB-OFFERS FROM BROADCAST STATIONS

"Your 'Chief Engineer's Bulletin' is a grand way of obtaining employment for your graduates who have obtained their 1st class license. Since my name has been on the list I have received calls or letters from five stations in the southern states, and am now employed as Transmitter Engineer at WMMT."

Elmer Powell, Box 274, Sparta, Tenn.

GETS CIVIL SERVICE JOB

"I have obtained a position at Wright-Patterson Air Force Base, Dayton, Ohio, as Junior Electronic Equipment Repairman. The Employment Application you prepared for me had a lot to do with me landing this desirable position."

Charles E. Loomis, 4516 Genesee Ave., Dayton 6, Ohio

GETS JOB WITH CAA

"I have had half a dozen or so offers since I mailed some fifty of the two hundred employment applications your school forwarded me. I accepted a position with the Civil Aeronautics Administration as Maintenance Technician. Thank you very much for the fine cooperation and help your organization has given me in finding a job in the radio field."

Dale E. Young, 122 Robbins St., Owosso, Mich.

HERE'S PROOF FCC LICENSES ARE OFTEN SECURED IN A FEW HOURS OF STUDY WITH OUR COACHING AT HOME IN SPARE TIME:

Name and Address	License	Lessons
Leo Warthy, 2210 1/2 Wilshire St., Bakersfield, Cal.	2nd Phone	16
Clifford E. Vogt, Box 1016, Dania, Fla.	1st Phone	20
Francis X. Foerch, 38 Beauler Pl., Bergenfield, N. J.	1st Phone	38
S/Sgt. Ben H. Davis, 317 North Roosevelt, Lebanon, Ill.	1st Phone	28
Albert Schoell, 110 West 11th St., Escondido, Cal.	2nd Phone	23

CLEVELAND INSTITUTE OF RADIO ELECTRONICS
Desk RN-25, 4900 Euclid Bldg., Cleveland 3, Ohio
(Approved for Veteran Training Under "GI Bill of Rights")

TELLS HOW—

EMPLOYERS MAKE JOB OFFERS LIKE THESE TO OUR GRADUATES EVERY MONTH!

Telegram, August 9, 1950, from Chief Engineer, Broadcast Station, Pennsylvania. "Have job opening for one transmitter operator to start immediately. contact me at once."
Letter, August 12, 1950, from Dir. Radio Div. State Highway Patrol. "We have two vacancies in our radio Communication division. Starting pay \$200; \$250 after six months' satisfactory service. Will you recommend graduates of your school?"

Letter, August 24, 1950, from radio-television sales and service company, Ohio. "We are in need of a good television man. The pay will be good, also good surroundings to work in. Please let us hear from you."
These are just a few of the examples of the job offers that come to our office periodically. Some licensed radioman filled each of these jobs; it might have been you!

Ours is the only home study course which supplies FCC-type examinations with all lessons and final tests.



MONEY MAKING

FCC

Commercial Radio Operator

LICENSE

INFORMATION

ACT NOW!

Get All 3 FREE

Your FCC ticket is Always Recognized in All Radio Fields as Proof of Your Technical Ability.

MAIL COUPON NOW

Cleveland Institute of Radio Electronics
Desk RN-25—4900 Euclid Bldg.,
Cleveland 3, Ohio
(Address to Desk No. to avoid delay.)

I want to know how I can get my FCC Ticket in a minimum of time. Send me your FREE booklet, "How to Pass FCC License Examinations" (does not cover exams for Amateur License), as well as a sample FCC-type exam and the amazing new booklet, "Money-Making FCC License Information."

Name.....

Address.....

City.....Zone.....State.....

Veterans check for enrollment information under G.I. Bill.

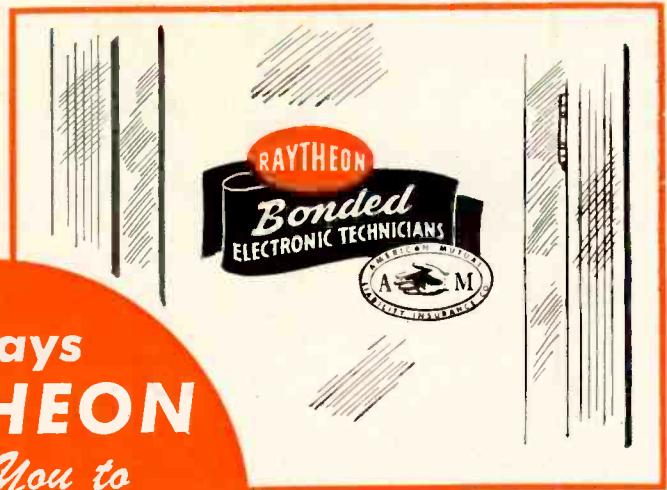
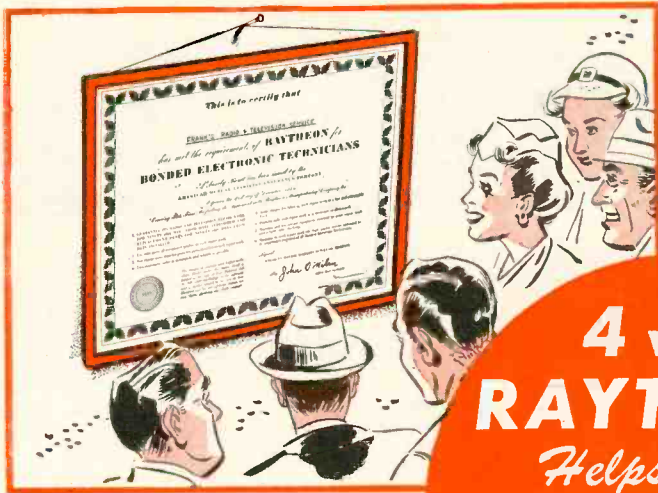

4 ways
RAYTHEON
Helps You to
WIN FRIENDS and
INFLUENCE
CUSTOMERS



The RAYTHEON *Bonded* ELECTRONIC TECHNICIAN PROGRAM provides four compelling ways to create customer confidence—Certificates, Identification Cards, Creed Displays and Decals. Bonded Dealers who use these service-business builders to identify themselves as capable, dependable technicians are finding them positive protection against the recent attacks on the integrity of Television and Radio Service companies.

If you're a Raytheon *Bonded* Dealer, prominently display your *new* 1951 Certificate—be sure your men use their *Identification Cards*. Ask your

Raytheon Distributor for more *Creed Displays* for window and counter use, and get enough *Bonded Decals* to adorn every window and door. These *Bonded* pieces are as important to your business as the tools in your kit.

If you're not a Bonded Dealer, better get in touch with the Raytheon Distributor in your locality. Find out if you can qualify for the Bond! If you can, this great program that cash-protects your 90-day guarantee on TV and Radio repairs is yours *absolutely free*, because *the Bonded Program is Raytheon's investment in your future!*

HERE ARE MORE WAYS TO INFLUENCE CUSTOMERS!
 RAYTHEON'S TERRIFIC COLLECTION OF
 SALES AND SERVICE AIDS!

ILLUMINATED TEST PATTERN CLOCKS • METAL OUTDOOR SIGNS • EDGELIGHTED SIGNS • DUMMY TUBE CARTONS • DISPLAYS • JUMBO TUBE CARTONS • SHOP JACKETS • STATIONERY • REPAIR STICKERS • SHIPPING LABELS • TUBE DATA CHARTS • AND MANY OTHERS

SEE YOUR RAYTHEON DISTRIBUTOR ABOUT THEM TODAY!



Excellence in Electronics

**RAYTHEON MANUFACTURING
 COMPANY**

Receiving Tube Division

Newton, Mass., Chicago, Ill.

Atlanta, Ga., Los Angeles, Calif.

RADIO AND TELEVISION RECEIVING TUBES • CATHODE RAY TUBES
 SPECIAL PURPOSE TUBES • SUBMINIATURE TUBES
 MICROWAVE TUBES

©1950 RAY

new!

ACTUAL
SIZE



PYRAMID TINY TYPE 85LPT TUBULAR PAPER CAPACITORS

Fit anywhere!

Suitable for
85°C. operation!

CAPACITANCE RANGE:
.0001 TO .5 MFD.

VOLTAGE RANGE:
200 TO 600 V., INCLUSIVE

Sturdily built in phenolic-impregnated tubes. Ends are plastic-sealed.

WRITE FOR COMPLETE LITERATURE
Representatives and Distributors
Throughout the U.S.A. and Canada



PYRAMID

PYRAMID ELECTRIC COMPANY

155 Oxford Street
Paterson, N. J., U.S.A.

TELEGRAMS: WUX Paterson, N. J.
CABLE ADDRESS: Pyramidusa

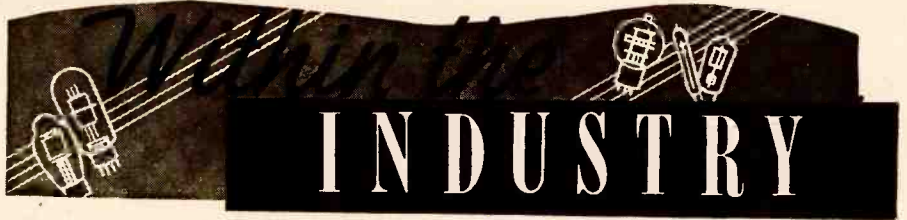

INDUSTRY

JOHN WILLIAM WALT, assistant advertising manager of *Admiral Corporation* since February 1949, has been promoted to the post of sales promotion manager for the company.



In his new position, Mr. Walt will have charge of the general promotional activities for the company including the handling of display advertising, national conventions, and printed matter.

Prior to joining *Admiral*, he was affiliated with *Webster-Chicago* as promotion manager for two years and served in a similar capacity with *Westinghouse* for one year.

During World War II, Mr. Walt served in the U. S. Navy for four years, entering service from the Chicago branch of *RCA Victor* where he was advertising manager from 1937 to 1941.

I. J. KAYLE AND ASSOCIATES, INC., has been recently formed in Chicago by I. J. Kaluzna and Sol Miller for the purpose of engineering and installing master television antenna systems for apartment buildings and commercial establishments. The company has offices at 1313 West Randolph Street in Chicago . . . **SIGHTMASTER CORP.** has announced its withdrawal from the television receiver manufacturing field to devote all of its facilities to the production of television glass . . . **THOMPSON PRODUCTS, INC.**, of Cleveland, Ohio, has entered the electronic field and will manufacture, sell, and service coaxial switches. The company has long been prominent in the automotive and aircraft parts field . . . **TRAD TELEVISION CORPORATION** has acquired control of the **WIL-RAY PRODUCTS COMPANY**, manufacturers of television cabinets. The new affiliate has been renamed the **TRAD CABINET CORPORATION** and will continue to produce cabinets at its Marlboro, New Jersey plant . . . **WHOLESALE ELECTRONIC SUPPLY** has recently opened its doors at 2800 Ross Avenue in Dallas, Texas to serve radio and television dealers, technicians, and industrial accounts in the northeast Texas area. John N. Leedom and M. B. "Pat" Patterson, both widely-known industry figures, are the principals in this new firm.

NEDA, through its president Arthur C. Stallman, has announced the establishment of an annual award to be bestowed on the person or persons in the

electronic parts and equipment industry "whose work and/or activities in our industry directly improve and enhance manufacturer-representative-distributor relations."

Complete details on the award program will be announced following the next meeting of the organization's executive committee.

C. W. HIGBEE, manager of the electrical wire and cable department of *United States Rubber Company*, was recently elected president of the National Electrical Manufacturers Association.

Five vice-presidents were chosen in the same election and the following men will serve during 1951: Arthur A. Berard, president of *Ward Leonard Electric Co.*; J. H. Jewell, vice-president of *Westinghouse Electric Corporation*; J. F. Lincoln, president of *The Lincoln Electric Co.*; R. E. Murphy, vice-president in charge of sales for the *I-T-E Circuit Breaker Company*; and Alan F. Sheldon, vice-president and general manager of the *Kennecott Wire & Cable Company*.

L. G. Hall, president of *Stackpole Carbon Company*, was chosen treasurer.

JAMES M. TONEY, advertising manager of the *RCA Victor Home Instruments Department*, has been appointed director of public relations for the *RCA Victor Division*.



Mr. Toney succeeds John K. West who resigned to join the *National Broadcasting Company*, an *RCA* subsidiary, as vice-president in charge of its western division.

The new director of public relations brings to his new position a varied experience in the advertising, publicity, and public relations fields. He joined the company in 1943 as an expeditor in the Purchasing Department, working in the Chicago office. Since that time he has held diversified posts in the sales and advertising departments of the company.

IVAN S. COGGESHALL, general traffic manager of *Western Union Telegraph Company's* overseas communications, was named president of the Institute of Radio Engineers for 1951. He succeeds Raymond F. Guy, manager of radio and allocation engineering for the *National Broadcasting Company*.

Jorgen C. F. Rybner of Copenhagen was named vice-president succeeding Sir Robert Watson-Watt of London in

RADIO & TELEVISION NEWS

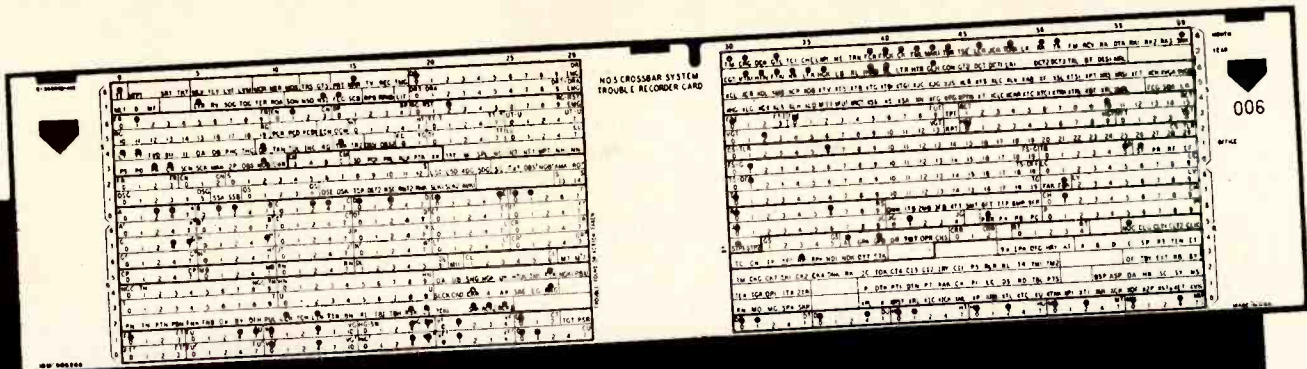

Another reason why your telephone gives so much for so little

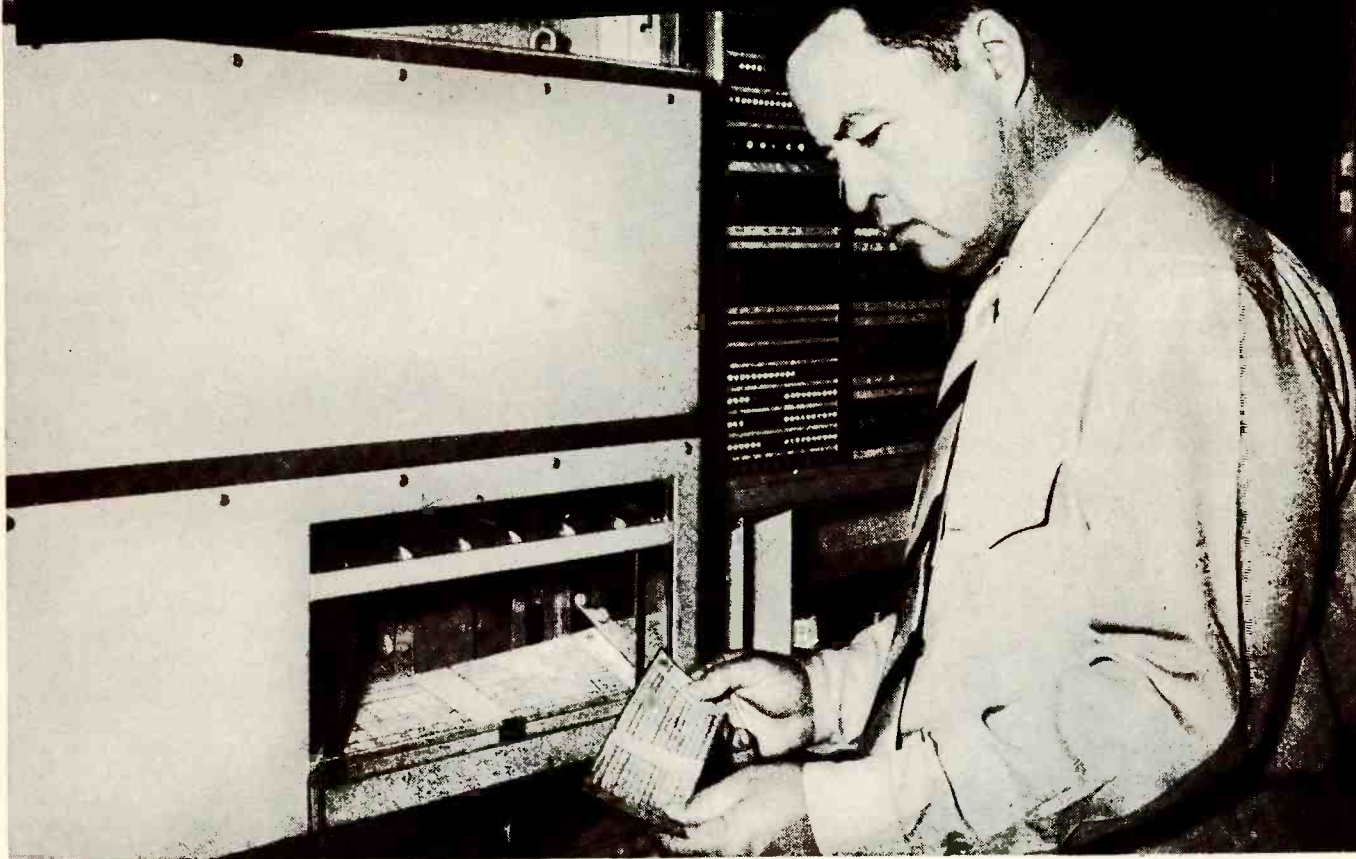

Studying punched card record of dial system operation. Each card (top) can report 1080 items

In a large, modern dial telephone office, 2,000,000 switch contacts await the orders of your dial—and 10,000 of them may be needed to clear a path for your voice when you make a single telephone call. Within this maze of signal paths, faults—though infrequent—must be detected and fixed before they can impair telephone service.

The latest system developed by Bell Telephone Laboratories automatically detects its own faults, detours calls around them without delay—then makes out a “written” report on what happened.

The fault may be a broken wire, or a high resistance caused by specks of dirt on switch contacts. In one second, the trouble recorder punches out a card, noting in detail the circuits involved and the stage in the switching operation where the fault appeared.

Maintenance men examine the reports at intervals and learn what needs attention. Between times they go about their own duties in keeping service moving.

This is another example of how research at Bell Laboratories helps your telephone system operate at top efficiency, so the cost to you stays low.

BELL TELEPHONE LABORATORIES



WORKING CONTINUALLY TO KEEP YOUR TELEPHONE SERVICE BIG IN VALUE AND LOW IN COST.

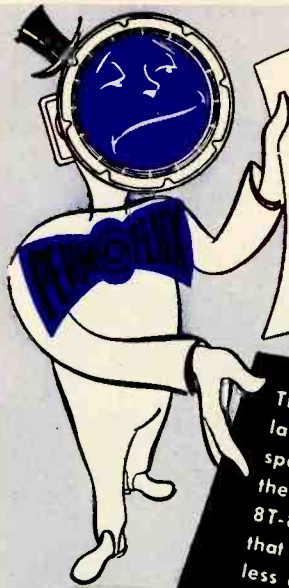

We CHALLENGE the performance of any 12" speaker with a

Permoflux
ROYAL EIGHT"

SAYS PERMOFLUX'S MR. HY-FY

This averaged laboratory response curve of the Permoflux 8T-8-1 proves that it compares with the finest speakers regard-
less of size or price.



Hi-Fi Fans the country over have accepted this challenge—have asked their "soundman" for a demonstration—then, have installed a Permoflux Royal Eight" in their own audio equipment. Now they possess a magnificent speaker at a reasonable price which reproduces sound with superior sensitivity and fidelity as well as tonal qualities which YOU too will want to add to perfect the excellence of your own equipment.

Send for beautifully illustrated catalog No. J201 to address listed below for further information including a full page devoted to correct baffling of Royal Eight" and other size speakers.



Servicemen!



PERMOFLUX ROYAL EIGHT" WITH THE FAMOUS BLUE CONE

DEALER'S PRICE

\$10⁵⁰

Check These Exclusive Features

Permoflux's exclusive slotted, treated cone gives the following results which makes their speaker comparable to any 12" speaker:

- Soft-suspended cone and extra-large spider provide extended low frequency response.
- Deeper, curvilinear cone greatly extends high-frequency response.
- High permeance yoke increases output.
- 8 ohm—10 watt voice coil.
- Big speaker performance in a small frame allows smaller more economical baffle.

Here's BIG SPEAKER performance—clean, brilliant, musical reproduction but at a sensible price level. Your customers will approve and buy. Order one for test today—your money refunded if you do not agree that it is truly outstanding in performance.

Inquire about Permoflux's Complete Royal Blue Line 6" to 15" Speakers

10-DAY TRIAL—MONEY BACK GUARANTEE



PERMOFLUX CORPORATION
4910 W. Grand Ave., Chicago 39, Ill.
 Please send _____ Permoflux Royal Eight" (8T-8-1)
 Check Money order enclosed



Name of Favorite Distributor.....
Your Name.....
Address.....
City..... Zone..... State.....

this post. Directors elected by the Institute for 1951 include: William H. Doherty, director of electronic and television research for *Bell Laboratories*; George R. Town, associate director of the engineering experiment station at Iowa State College; Harry F. Dart, office manager of the electronics department of *Westinghouse Electric Corporation*; Paul L. Hoover, head of the department of electrical engineering, Case Institute of Technology; William M. Rust, Jr., head of geophysics research for *Humble Oil and Refining Company*; and Allan B. Oxley, chief engineer of *RCA Victor Company*. The following directors will continue to serve on the board during 1951: S. L. Bailey, R. F. Guy, W. L. Everitt, D. G. Fink, W. R. Hewlett, J. W. McRae, H. J. Reich, F. Hamburger, Jr., J. D. Reid, and A. V. Eastman.

* * *

AUSTIN ELLMORE, formerly director of sales and engineering for *Crescent Industries, Inc.* of Chicago, has been upped to the post of vice-president in charge of sales and engineering for the speaker, record player, and wire recorder firm.



Mr. Ellmore, who joined *Crescent* three years ago, is well-known as an audio and acoustics engineer and for his work as chairman of the Committee on Acoustic Devices and the Committee on Speakers of the RTMA's Engineering Department.

Prior to his present association, Mr. Ellmore spent 18 years at *Utah Radio* where he was vice-president in charge of the *Utah Radio Products Division* of *International Detrola Corp.*

* * *

RADIO RECEPTOR CO., INC., has just purchased a 90,000 square foot factory structure at Wythe Avenue and North 3rd Street in Brooklyn. The company's sales offices will continue at 251 West 19th Street, New York . . . **PHOENIX ELECTRONICS, INC.**, recently took over enlarged quarters in Lawrence, Mass., to provide new production facilities to take care of the demand for its line of TV antennas and hardware . . . **RICHARDSON-ALLEN CORPORATION**, manufacturers of selenium rectifiers, battery chargers, etc., has moved to new quarters at 116-15 Fifteenth Avenue, College Point, Long Island, New York . . . **ARTHUR ANSLEY MANUFACTURING COMPANY** of Doylestown, Pa., has completed work on a new building adjoining its former plant. The company will manufacture cabinets for its line of phonographs in the new structure . . . **HUDSON WIRE COMPANY** has established a magnet wire plant in Cassopolis, Michigan, to handle the requirements of its midwestern and far western customers . . . **WESTINGHOUSE ELECTRIC CORPORATION** has opened negotiations for a tract of land near Baltimore's "Friendship Airport" on

(Continued on page 137)

**TV
MANUFACTURERS**

TV DEALERS

**TV
SERVICEMEN**

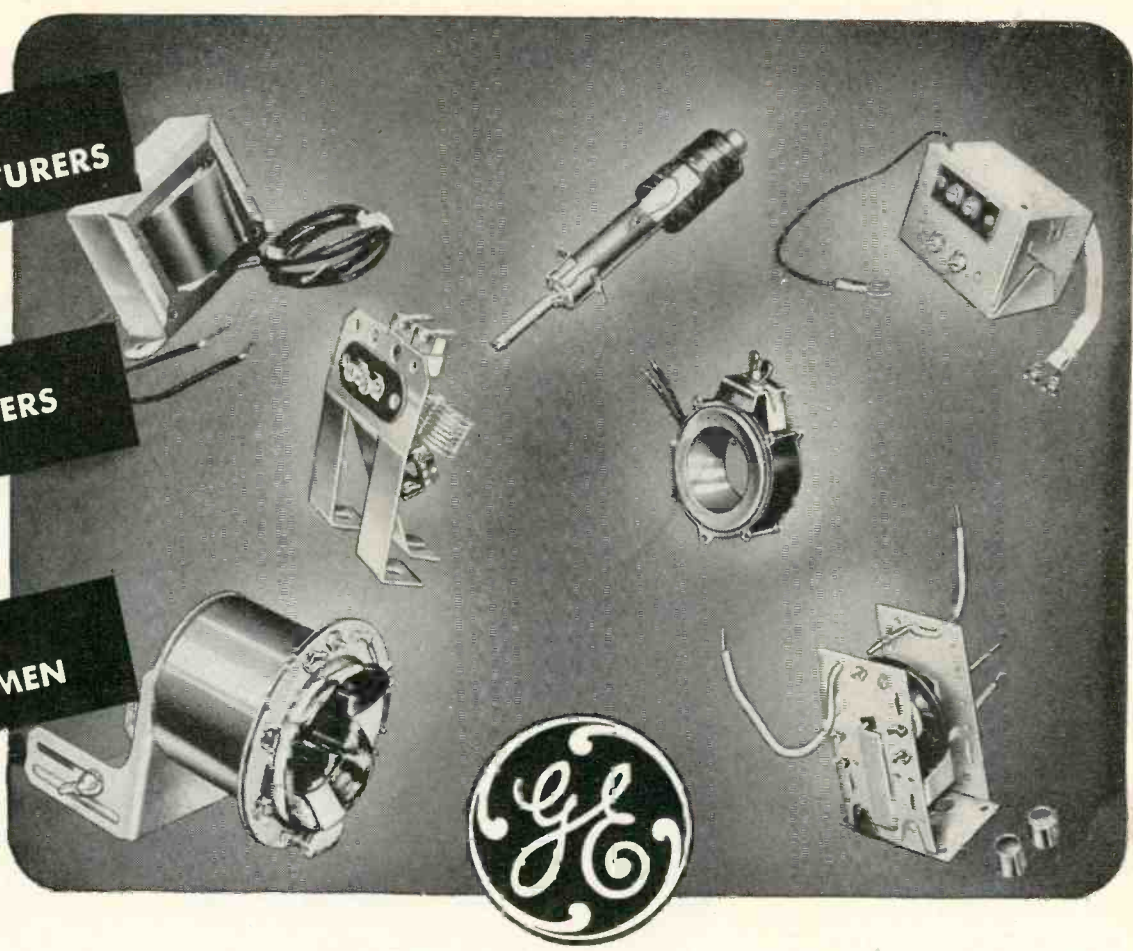

Available Now! CRITICAL TV COMPONENTS

DEALERS AND SERVICEMEN—Your share of today's multi-million dollar TV replacement market is limited only by your ability to handle it. Now you can get *ferrite transformers, ferrite core yokes, linearity controls, focus coils*—the vital TV components you need—from one dependable source—General Electric! Don't wait to cash in on the biggest *new* business in television history—call your distributor today and stock the General Electric line!

RECEIVER MANUFACTURERS—Here's a way to cut production headaches and manufacturing costs! You simplify ordering and delivery when you design G-E components into your sets. Remember, too, that your sets will be serviced *in the field* because G-E distributors and dealers everywhere stock these parts. Let us review your requirements for next year's production right now. General Electric application engineers are at your service.

GENERAL ELECTRIC

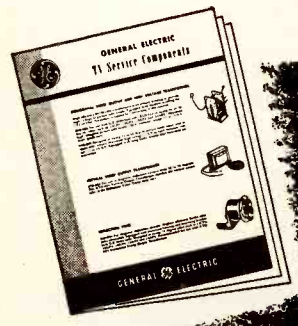

**MAIL COUPON
FOR NEW
FREE
CATALOG**

General Electric Company, Section 911
Electronics Park, Syracuse, New York
Rush me the new G-E Catalog of TV Components.

NAME _____
ADDRESS _____
CITY _____ STATE _____

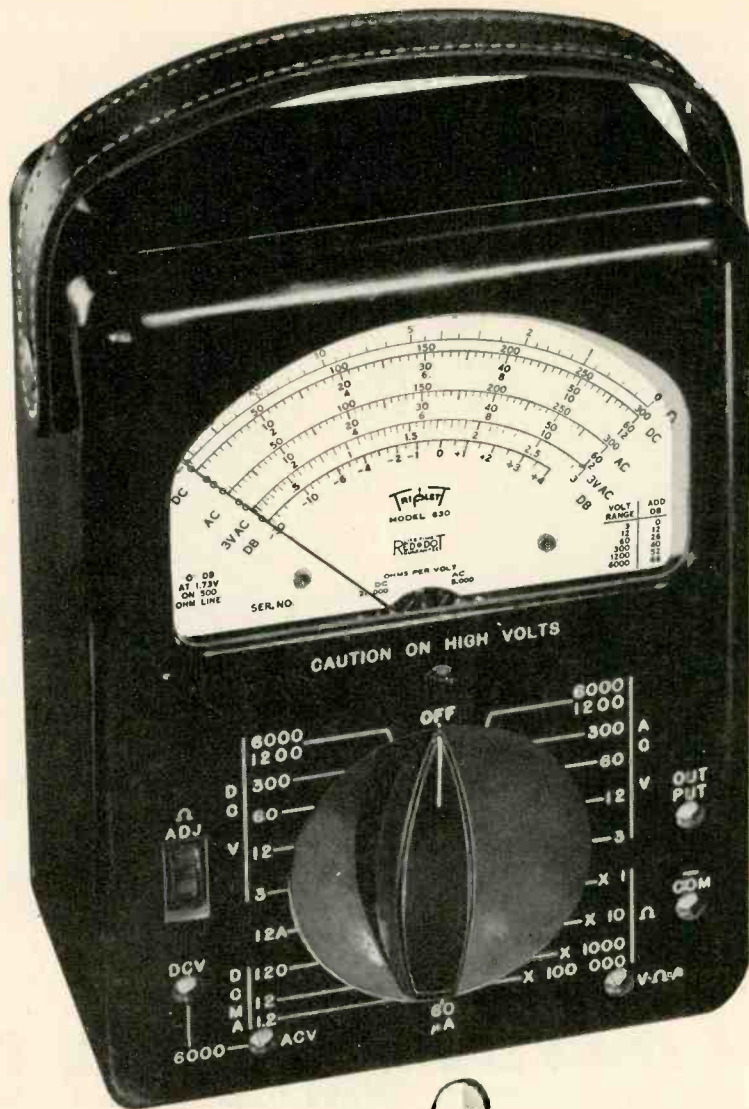

ALL RANGES WITH THIS ONE CONTROL

**Model
630**

Just *one* knob—extra large—easy to turn—flush with the panel, controls all ranges. This one knob saves your time—minimizes the chances of “burn-outs” because you don’t have to remember to set another control. You can work fast with Model 630 with your eyes as well as your hands. Look at that scale—wide open—easy to read, accurately. Yes, this is a *smooth TV* tester. Fast, safe, no projecting knobs, or jacks, or meter case. Get your hand on that single control and you’ll see why thousands of “Model 630’s” are already in use in almost every kind of electrical testing



ONLY \$39.50 AT YOUR DISTRIBUTOR

In Canada: Triplet Instruments of Canada, Georgetown, Ontario

FOR THE MAN WHO TAKES PRIDE IN HIS WORK

Triplet

TRIPLET ELECTRICAL INSTRUMENT COMPANY • BLUFFTON, OHIO, U.S.A.

YOUR OPPORTUNITY IS HERE NOW! LEARN

TELEVISION

RIGHT AT HOME!



By the new method of **TRANSPONDENCE**

training on film and tape recordings

Now the De Forest-Sanabria Corporation—a division of the world's largest television training school—brings class-room instruction to you right in your own home! You actually hear your instructor's recorded voice. At the same time you watch "blackboard" size projected pictures, diagrams and illustrations. It's the quick, easy way to equip yourself for the big earnings in television—today!

LOOK . . . You get the tape recorder and projector right at the start of your course!



HEAR your instructor

It's even better than the classroom, because you can repeat the instructor's lectures until they're thoroughly understood.

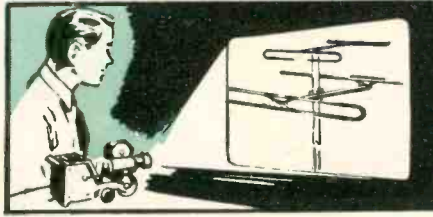

SEE 2000 illustrations

You learn quicker when you see diagrams and illustrations in black-board size.

You get the famous "TRANSPONDER" precision built, high fidelity tape recording machine with your very first lesson—and a powerful projector with which you can view diagrams and illustrations enlarged to a size that makes them easy to see and understand.



READ from reference library

You receive complete books, pamphlets and manuals to supplement your instructor's lessons.



ASK your questions on tape

Tell your instructor about anything that puzzles you and get his answers back pronto.



BE A SUCCESS . . . ACT NOW!

Millions of television set owners are demanding qualified television technicians to service their sets. There is a tremendous shortage of such qualified men today and will be for many years to come. Get in on the ground floor of this booming industry and be prepared to accept a steady, big pay job for life. We can qualify you quickly, easily, surely—and help get you a job when you complete your course. Send for illustrated booklet that gives the complete details.

MAIL COUPON TODAY!

De Forest-Sanabria Corporation **FREE BOOK**
Dept. RN-1
5050 Broadway, Chicago 40, Ill. **TELLS HOW**

Dear Sirs:
Please send me copy of your free illustrated booklet which describes the new TRANSPONDENCE method of learning television at home under the direction of Dr. Lee de Forest and U. A. Sanabria.

NAME _____ AGE _____
ADDRESS _____
CITY _____ STATE _____
(Mail in envelope or paste on a postcard.)

The De Forest-Sanabria Corp.
An affiliate of American Television, Inc.
5050 North Broadway, Chicago 40, Illinois

The Most Powerful RADIO - Advertising

**BIG
NATIONAL
ADS**



See these big-space ads! They're appearing in the *Saturday Evening Post*, *Life*, *Look*, and *Collier's Magazine*. Each is loaded with stop-appeal and sales-appeal. Each one features an endorsement of *your service* by a famous star such as Paulette Goddard, Marie Wilson, Diana Lynn, or Patrice Munsel.

Marie Wilson says:

"I think it is wonderful when the Sylvania Service men come. It is wonderful how they get my radio and television sets in such perfectly wonderful condition."

Now you can get the same quality of service from the men who bring you the Sylvania Service men. They will get your radio and television sets in such perfectly wonderful condition. Call them for a free estimate and Sylvania Service men will take care of you. They are the Sylvania men.

RADIO TELEVISION SERVICE

SYLVANIA TUBES
RADIO AND TELEVISION PICTURE TUBES

Diana Lynn says:

"I'm not the superstitious type, but there is one thing I believe in... Sylvania Service men. They are the best!"

Now you can get the same quality of service from the men who bring you the Sylvania Service men. They will get your radio and television sets in such perfectly wonderful condition. Call them for a free estimate and Sylvania Service men will take care of you. They are the Sylvania men.

RADIO TELEVISION SERVICE

SYLVANIA TUBES
RADIO AND TELEVISION PICTURE TUBES

Paulette Goddard says:

"The radio and television sets are wonderful. That's why I call the Sylvania Service men. They are the best!"

Now you can get the same quality of service from the men who bring you the Sylvania Service men. They will get your radio and television sets in such perfectly wonderful condition. Call them for a free estimate and Sylvania Service men will take care of you. They are the Sylvania men.

RADIO TELEVISION SERVICE

SYLVANIA TUBES
RADIO AND TELEVISION PICTURE TUBES

Patrice Munsel says:

"I'm happy about the same quality of service from the men who bring you the Sylvania Service men. They will get your radio and television sets in such perfectly wonderful condition. Call them for a free estimate and Sylvania Service men will take care of you. They are the Sylvania men."

Now you can get the same quality of service from the men who bring you the Sylvania Service men. They will get your radio and television sets in such perfectly wonderful condition. Call them for a free estimate and Sylvania Service men will take care of you. They are the Sylvania men.

RADIO TELEVISION SERVICE

SYLVANIA TUBES
RADIO AND TELEVISION PICTURE TUBES



SYLVANIA

RADIO TUBES; TELEVISION PICTURE TUBES; ELECTRONIC PRODUCTS; ELECTRONIC TEST EQUIPMENT;
RADIO & TELEVISION NEWS

TV SERVICE Campaign ever launched!

HERE'S the hardest hitting . . . and the most complete advertising campaign ever planned, to bring service business to every dealer who displays the Sylvania emblem.

All during 1951, your prospects are certain to SEE, HEAR, and READ about your expert service in magazines, on television, and through window displays.

**POPULAR
WEEKLY
TV SHOW**



The great Nation-wide TV show, "Beat the Clock," featuring Bud Collyer over CBS-TV, will go to bat for your service and the Sylvania products which you sell. Clever animated cartoon commercials on the CBS-TV station in your area will inform prospects of your expert workmanship and prompt service.

Tying everything together is the greatest and most colorful dealer tie-in program you have ever seen!

You get FREE giant, full-color displays of the featured stars. You get counter cards . . . bright window streamers . . . spot radio announcements . . . mailing pieces . . . all designed to identify you as the Sylvania Service Dealer advertised on television and in the national magazines.

Ask your jobber for full information about the bigger-than-ever 1951 Service Dealer Advertising Program. If he can't give you all the facts, mail the coupon now!

**DEALER
TIE-IN
PROGRAM**

"Service business is booming . . . tie-in with Sylvania's national advertising and get a bigger share!"



Be sure to display this emblem. Put up these Sylvania decals right now! This seal is the target of the whole Sylvania Service Dealer campaign. Put them on your windows and on your trucks. Made in 8-inch and 12-inch sizes. Order a supply from your jobber TODAY! They're free!

Sylvania Electric Products Inc.
Dept. R-2101, Emporium, Pa.
Please send me full details about the greatest in the history of the industry.

Name _____
Street _____
City _____ Zone _____ State _____

ELECTRIC

FLUORESCENT TUBES, FIXTURES, SIGN TUBING, WIRING DEVICES; LIGHT BULBS; PHOTOLAMPS; TELEVISION SETS

**EICO KITS
and INSTRUMENTS**



320K SIG. GEN. KIT \$19.95
Wired \$29.95



New 950K COND.-RES. COMP. BRIDGE KIT \$19.95
Wired \$29.95



New 1040K BATTERY ELIM. KIT \$22.95
Wired \$29.95



511K VOM KIT \$14.95
Wired \$17.95



145K SIG. TRACER KIT \$18.95
Wired \$28.95



HV PROBE
(Wired only) \$6.95

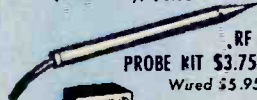

RF PROBE KIT \$3.75
Wired \$5.95

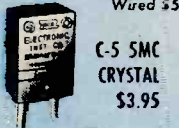

C-5 SMC CRYSTAL
\$3.95



New 315K DELUXE SIG. GEN. KIT \$39.95
Wired \$59.95



Harry R. Ashley, President of EICO, inspecting the use of the EICO Model 425 Oscilloscope and Model 221 Vacuum Tube Voltmeter at one of the important alignment positions on the Emerson television production line, New York plant.

For Laboratory Precision at Lowest Cost—the Leaders Look to EICO!

FOR electronics test equipment, there's no tougher proving ground than the factories where TV sets are made. There's where the pace is fastest, precision requirements the highest, costs the tightest—and day-after-day dependability an absolute *must*.

In both the giant New York and New Jersey television plants of the Emerson Radio & Phonograph Corporation — at many critical constant-duty testing positions along the production line—EICO instruments stand guard. For Emerson has found that for speed, accuracy and trustworthiness, at lowest cost, EICO instruments always deliver the fullest measure of value.

From coast to coast, in one leading TV factory after another, this is the experience—*this is the proof of EICO superiority*—that is repeated again and again. The top-flight TV set makers have discovered—and over 50,000 servicemen have learned—that for the industry's greatest instrument values, at the industry's lowest costs—it's EICO!

Be sure you look at the EICO line *before you buy any higher-priced equipment!* Each EICO product is jam-packed with unbelievable value. **YOU** be the judge—compare EICO at your local jobber today—and **SAVE!** Write **NOW** for free newest Catalog R.



New 221K VTVM KIT \$23.95
Wired \$49.95



New 425K 5" SCOPE KIT \$39.95
Wired \$69.95



New 625K TUBE TESTER KIT \$29.95
Wired \$44.95

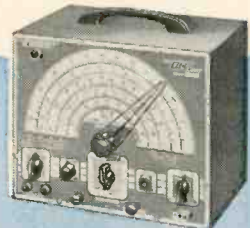

360K SWEEP GEN. KIT \$29.95
Wired \$49.95



ELECTRONIC INSTRUMENT CO., Inc.
276 NEWPORT STREET, BROOKLYN 12, NEW YORK

© 1950, Electronic Instrument Co., Inc.

Prices 5% higher on West Coast. Due to unsettled conditions, prices and specifications are subject to change without notice.

Improving Performance of

Older TV Sets

By
WALTER H. BUCHSBAUM*

Unlike AM radios, video receivers should be checked at least once a year in order to restore their new-set picture quality.

IN 1948 over a million television receivers were sold, and an additional two million sets found their way into American homes in 1949. While the majority of these sets are performing satisfactorily, most of them will require some repairs after the first year of operation. Even if an actual failure does not occur, most viewers realize that their pictures are not as bright and clear as they were when the set was new. Many earlier models feature 10 or 12 inch screens which appear small in comparison with the new full-sweep, large screen models.

In overhauling and improving the performance of these television receivers the service technician will find a source of profit which will grow as more and more "old" sets come up for service. In many instances it will be profitable to include this overhaul and picture improvement in a second year service contract, a procedure already advertised by some enterprising service organizations.

The actual work required depends on the condition of the set and whether a new, large screen tube is to be used, or the sweep on the present tube merely expanded. In the following paragraphs the basic steps of such an overhaul are outlined and finally the problem of inserting a larger picture tube is taken up.

Dim Pictures

The most frequent complaint in the case of dim pictures is loss of brightness. This can be due to any or all of these causes:

1. Dust on face of picture tube.
2. Weak picture tube or weak ion trap.
3. Low high voltage.

The photograph in Fig. 1 is a good

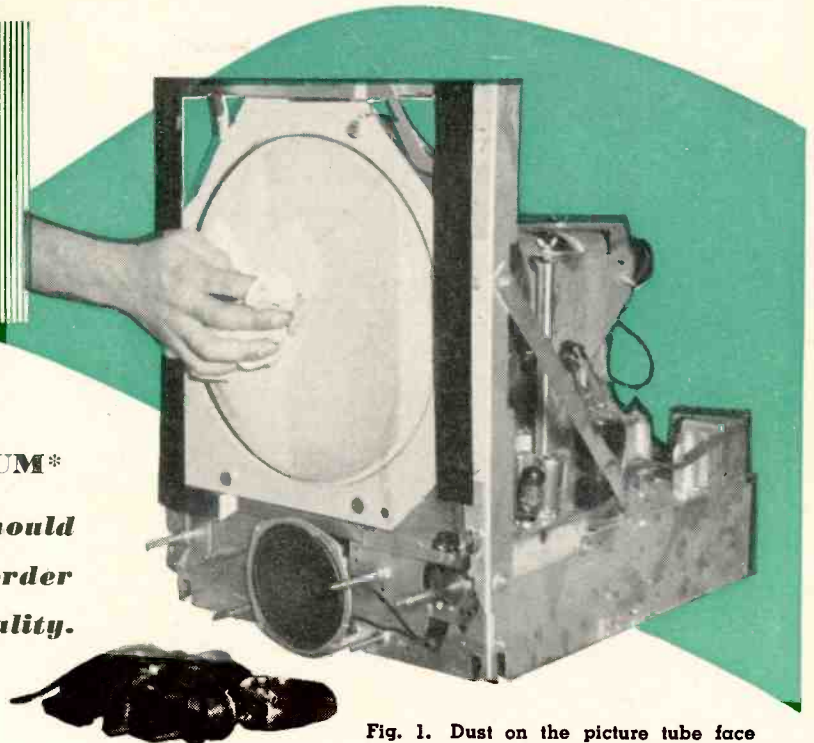

Fig. 1. Dust on the picture tube face is one of the frequent causes of the complaint that the pictures are dim.

example of the dust problem. Because of the electrostatic charge on the face of the picture tube, dust not only collects easily but tends to stick to the glass. Some receivers have a dust-proof space between the picture tube screen and the safety glass but in the majority of the sets, a good coating of dust accumulates on the screen.

Cleaning the face of the picture tube is accomplished easiest by using window cleaning fluid or water and a very soft cloth.

Where a weak picture tube is suspected make sure that the picture tube is at fault by re-adjusting the ion trap magnet first. Permanent magnet types often lose some of their strength and it is therefore advisable to have an extra single and double magnet ion trap on hand. If the ion trap cannot produce a bright enough picture, the d.c. voltages on the picture tube cathode, grid, and first anode should be measured next. Most magnetically deflected tubes should give full brightness with about zero to 8 volts between cathode and grid. First anode voltages usually range from 500 to 250 volts.

If the second anode voltage of the picture tube is low, this will also result in a dim picture. The most dependable way of ascertaining this is to measure the high voltage directly at the picture tube with a high voltage probe and v.t.v.m. unless a special high voltage meter is available. Some serv-

ice technicians can approximate the voltage by the length of the arc they can draw from a grounded screwdriver to the second anode terminal, but this is not an exact procedure.

Weak Tubes

If the high voltage is lower than about 7 kv. for a 10 or 12 inch tube, one of several components may be at fault. The tubes should be exchanged first. In 1948 and 1949 models the most frequently used horizontal output tube was the 6BG6, and this is a likely culprit. The 6W4 or 5V4 damping diodes are the next likely offenders and the 1B3 high voltage rectifier the least likely. Occasionally the horizontal oscillator tube may be weak and sometimes the trouble is due to low "B plus" voltages caused by an aging rectifier tube.

Weak Components

If tubes and operating voltages appear to be correct, the flyback transformer might have changed, due to a change in the powdered iron core. Since the circuits seem to function but are merely weak, a resistor or condenser failure is not likely, with one exception. In most receivers a 1 megohm resistor is used in series with the high voltage lead, and a high voltage condenser connects to one side of this resistor.

The high voltage condenser is rarely at fault, but the resistor may change in value or develop a very high resistance. This results in low second anode voltage and very poor regulation.

* Author of the recently published book "Television Servicing, Principles and Practice" (Prentice-Hall).

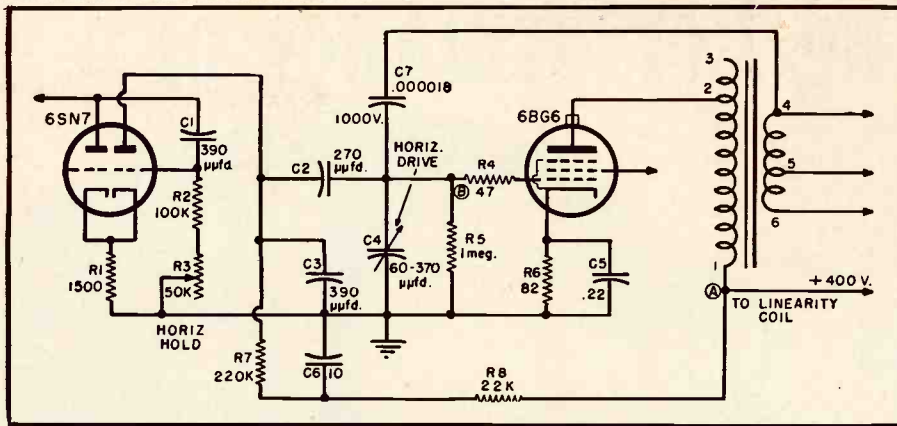

Fig. 2. Wiring diagram of a conventional phase detector drive circuit.

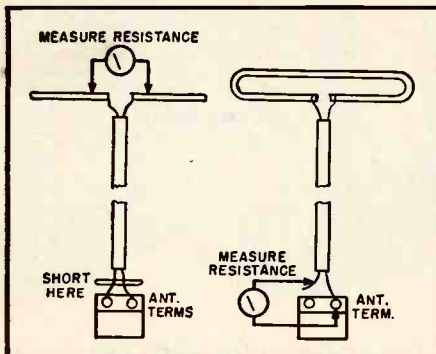

Fig. 3. Checking for bad antenna connections.

When the screen is dark, the high voltage may be sufficient but as soon as the brightness control is advanced the high voltage drops considerably. A defective 1 megohm resistor or a gassy 1B3 are almost invariably the cause of this defect.

Occasionally the customer is unwilling to purchase a new picture tube if his is only slightly dimmer and demands that something be done to increase the brightness of his old tube. By increasing the high voltage, a brighter picture can usually be obtained even on an old tube, but at the expense of tube life. A 10BP4, for example, will never last as long if operated at 13 kv. than if the prescribed 9.5 kv. is applied. Before attempting to increase the high voltage, check to make sure that sufficient width and

height are obtained, because at higher second anode potential the picture will shrink somewhat.

Circuit Changes

To increase the high voltage several or all of the following steps may be required:

- Return low side of high voltage condenser to plate of damper tube.
- Reduce screen resistor of 6BG6 to 8000 ohms, 5 watts.
- Remove all connections to the vertical sweep section from point A in Figs. 2, 4, and 5, and return them to the highest "B plus" point instead.
- If a damping resistor is used, substitute a 10,000 ohm, 30 watt unit in its place.
- Add a second 500 μ fd. high voltage condenser. This condenser is connected between the second anode terminal side of the 1 megohm resistor and the plate of the damper tube.

Poor Contrast and Sensitivity

Many complaints state that the pick-up from distant stations is poor after the first year of service or that the picture does not have the contrast and crispness it used to show. Most of these defects are due to aging of tubes, although some other factors can also be responsible.

The i.f. amplifier tubes are usually good for only one year. After that time their transconductance drops considerably and while not completely bad

they may register as slightly weak on the tube tester. Since the tube tester does not show their performance at the i.f. frequency, the best method is to check them by substituting new ones. If the same tube type is used for substitution it is rarely necessary to realign the i.f. coils. In some instances, however, a complete realignment will greatly improve the performance of the set. A complete alignment should be done only with the manufacturer's alignment instructions and the proper instruments, including a sweep generator, marker, and oscilloscope. The improvement in performance of a properly aligned set is well worth the extra time and work.

When pick-up from distant stations appears good, but the crispness of the black and white portions is lacking, the video amplifier tube may be weak. Occasionally a video peaking coil opens up, which results in smearing of the image from left to right.

The tubes in the front end tuner are also likely to deteriorate after a year or so of service. While replacement of the r.f. amplifier and mixer tube rarely causes any trouble, the oscillator tube is often very critical. In the RCA Model KRK-2 tuner, for example, the 6J6 oscillator tubes were hand-picked for each unit and not every 6J6 will work as an oscillator on all channels. In any event, when the oscillator tube is replaced it usually means that the oscillator coils must be realigned for all channels. Tuning the local oscillator can be done on a station signal from the air, provided the sound and picture i.f. sections are aligned correctly. Adjust the oscillator coil's slug for each channel, starting with Channel 13. To make sure that the fine tuning control will compensate for any slight frequency drift, set this control to a halfway point when adjusting the oscillator. Check and recheck all available stations for good sound and picture, in each case making certain that the fine tuning knob is in a center position.

Poor reception from distant stations and intermittent reception on any channel are often due to corroded antenna connections. These connections of the lead-in to the antenna elements are subject to all kinds of weather conditions and naturally tend to corrode and oxidize even if all parts are aluminum or brass. It is very difficult to judge the connections by their appearance. Measuring d.c. resistance as shown in Fig. 3 is often the quickest way. If the terminals appear badly corroded they should be replaced.

Changes For Increased Sensitivity

If it is desired to increase the sensitivity of a particular receiver, several different steps are possible:

- Substituting higher gain tubes. If the receiver uses 6AU6 tubes as i.f. amplifiers, 6BC5's or 6CB6's may be used. It should be noted, however, that these tubes have different tube capacities and their use will mean realigning of the i.f. section. The 6BC5

Fig. 4. Diagram of the most commonly used synchroguide circuit.

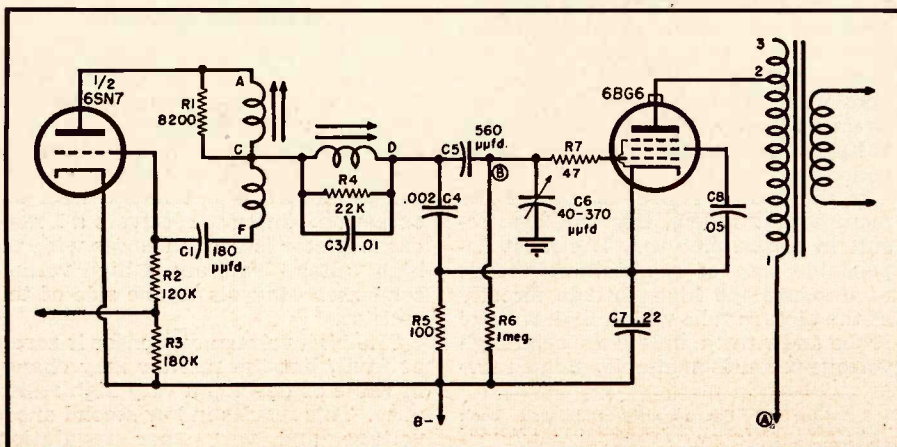

is different from the 6AU6 in that the suppressor grid is connected to the cathode internally. This means that pin #2 on the 6AU6 must be disconnected from ground and remain unconnected if a 6BC5 is to be used. The 6CB6 is a higher gain tube than the 6AG5 or 6BC5 and its suppressor grid is not internally connected to the cathode. By using higher gain tubes as outlined above, the increase in sensitivity may be as much as two times.

b. For the reception of Channels 7 to 13 it may be advisable to use a 6AK5 r.f. amplifier in place of the 6AG5 used in the *Standard Coil* and similar tuners. If a 6J6 or other triode is used in the r.f. stage it cannot be replaced by a higher gain tube.

c. In some receivers it is possible to increase the i.f. and r.f. gain by connecting these tubes to a higher "B plus" point. Usually the "B plus" voltage is about 135 to 150 volts. If the plate and screen resistors are returned to a 200 or 250 volt point instead, additional amplification will result.

d. As a last resort the i.f. response curve may be changed so as to bring the picture i.f. carrier to the top of the slope and narrow the over-all curve down to obtain more gain. This should only be attempted if a sweep generator, marker, and oscilloscope are available and the technician is thoroughly familiar with i.f. alignment procedure.

Increased Width

Occasionally the customer complains of insufficient width or else the width problem comes up when the second anode voltage is raised. In some instances the technician wants to improve the picture size by substituting a new, full sweep screen cut-out in place of the old rectangular mask, or a new picture tube is used which might require more sweep. Barring weak tubes or a deteriorated flyback transformer or deflection yoke, it will be necessary to change the circuit to obtain more width. Two different approaches are possible, either the drive on the horizontal output tube can be increased or else the high voltage can be lowered.

Lowering High Voltage

- Shunt the width coil with a .05 to .1 μ fd condenser.
- Connect a 100 to 500 μ fd. mica, 1000 volt condenser from the plate of the damper tube to ground.

Increasing Drive

This depends on the type of horizontal oscillator used. Steps a. and b. will help with all types of oscillators.

a. Increase screen voltage of the 6BG6 up to 300 volts above cathode by changing the screen resistor. Do not exceed the screen current of 15 ma. at 300 volts.

b. If the vertical oscillator and output tube obtain their "B plus" voltage from the horizontal boost voltage (point A in Figs. 2, 4, and 5) connect them to the next highest "B plus" point instead. This will cause the boost volt-

age to increase and produce more sweep as well as more high voltage.

c. The circuit in Fig. 5, is typical of receivers like the RCA 630 and many similar models. To increase the drive on the 6BG6 change R_1 to 1 megohm, R_2 to 470,000 ohms, and C_2 to 2000 μ fd. Changing C_1 to 330 μ fd. and R_2 to 10,000 ohms may also improve the width.

d. The circuit shown in Fig. 4, is used in later models and is today probably the most widely used horizontal oscillator. To obtain more width change C_3 to 2000 μ fd., C_4 to 1500 μ fd., and R_1 to 10,000 ohms.

e. The phase detector type of horizontal oscillator shown in Fig. 2, is used in such receivers as the *Admiral 20A1* series and many other recent, low cost models. To increase the width, C_1 can be either increased to 30 μ fd. or reduced to 10 μ fd., depending on the individual receiver. C_2 can be changed to 390 μ fd., C_3 reduced to 220 μ fd. and R_3 can be made 10,000 ohms, 2 watts, with the electrolytic C_3 replaced by a paper, .25 μ fd., 600 volt condenser. This provides a higher voltage for the oscillator and reduces the loading at point A at the same time.

Increasing Height

As in the preceding discussion on insufficient width, tubes and the transformer are the most likely reasons for insufficient vertical sweep. In some receivers additional sweep can be obtained by returning the red, or "B plus," lead of the vertical output transformer directly to the highest available "B plus" point. When sufficient high voltage and width are present the red lead from the output transformer may be connected to the boost voltage (point A in Figs. 2, 4, and 5) through a 3300 ohm decoupling resistor. An 8 to 30 μ fd. electrolytic condenser should be connected from the transformer "B plus" to "B minus" or ground. To increase the height further, the resistor in series with the vertical linearity

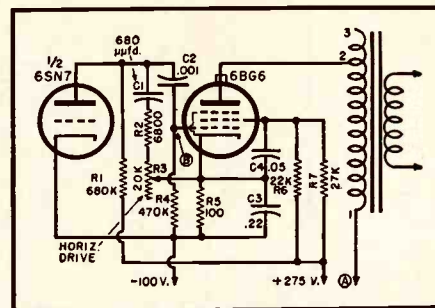

Fig. 5. Diagram of synchrolock drive circuit.

Tube Size (in inches)	Deflection Angle (in degrees)	2nd Anode (in kv.)	Focus Coil (type)
10	50	9.5	RMA #106
12	54	9.5	RMA #106
15	54	9.5	RMA #106
			or 109
16 (16AP4)	54	12	RMA #109
16 (16GP4, round)	70	12	RMA #109
All other 16 round	63	12	RMA #109
All 16 rectangular	68	12	RMA #109
19	68	12	RMA #109

Table 1. Important variations in some of the most commonly used cathode-ray tubes.

control, usually about 560 ohms, can be reduced to 100 ohms. The 1 megohm series resistor in the height control circuit can be reduced to about 220,000 ohms, permitting a wider range of height adjustment.

Improving Sound

If the set has been completely realigned, the sound i.f. and discriminator will have been checked and tuned for best sound quality. The sound amplifier stages rarely require attention other than replacement of weak tubes. In the event that the set has not been realigned it is often advisable to retouch the sound i.f. and discriminator transformers.

In the photograph in Fig. 6, the retouching of the ratio detector transformer in a *Westinghouse 12 inch table* model is illustrated. The receiver is (Continued on page 96)

Fig. 6. Checking alignment of ratio detector transformer in a Westinghouse receiver.

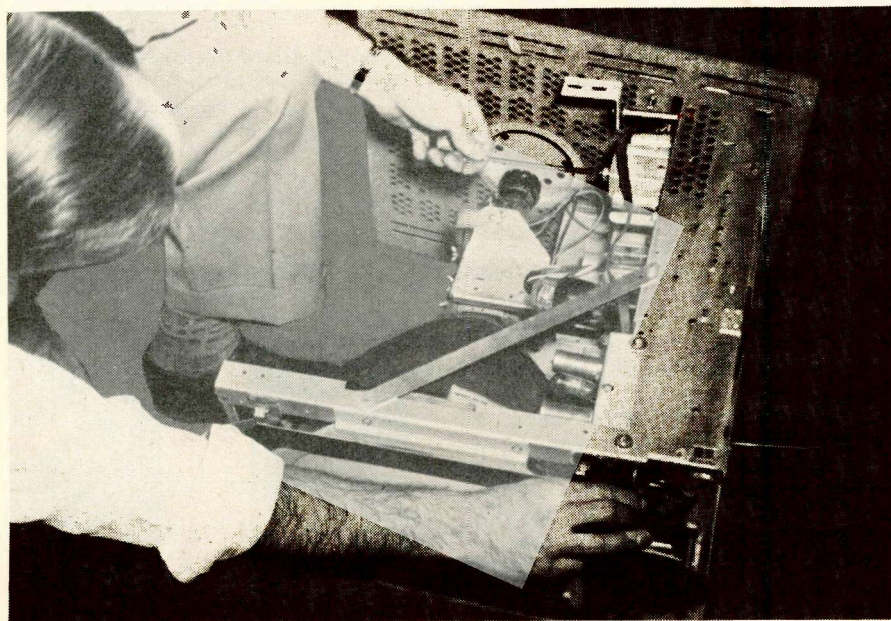

Servicing The 16mm. SOUND PROJECTOR

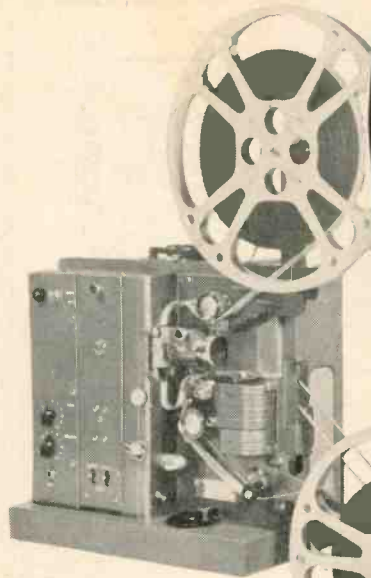

An RCA projector.

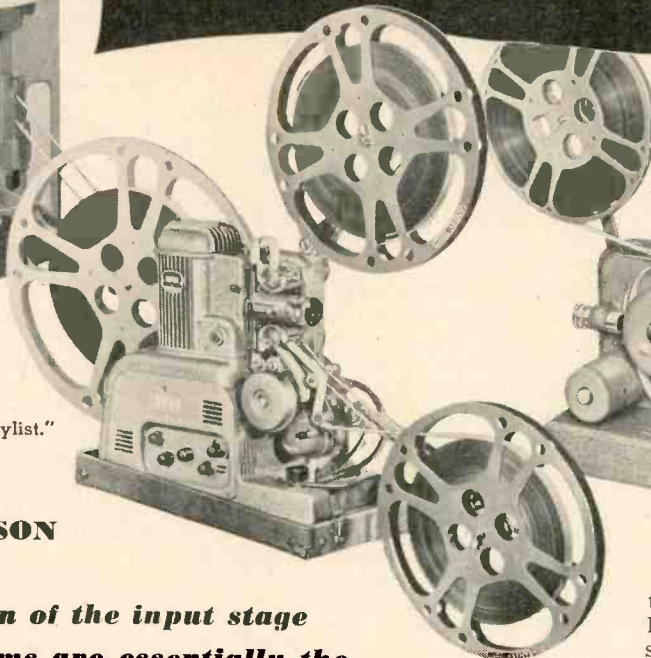

The Ampro "Stylist."

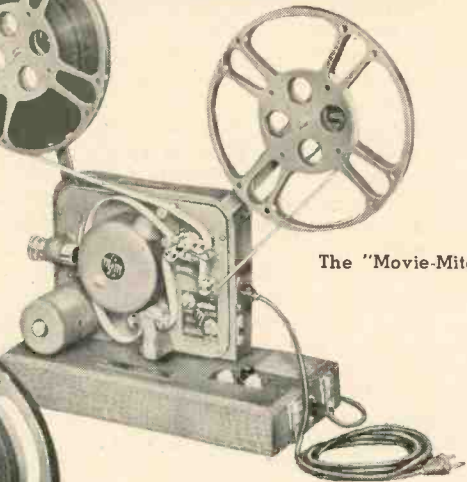

The "Movie-Mite."

By
DON D. EMERSON

With the exception of the input stage these sound systems are essentially the same as any conventional audio amplifier.

WITH the tremendous strides taken in the audio-visual education field in the past few years a new service that can be rendered by the radio technician has developed. Servicing the 16mm. sound projector is a field of its own; but the servicing of the sound and minor mechanical adjustments can be handled by the average technician. Fortunately, most of the 16mm. machines are equipped with instruction manuals, complete with schematics of the amplifier, etc. You will also find that many manufacturers are very cooperative when it comes to supplying service information as well as up-to-date service bulletins at a very moderate cost. You will also find that a few companies prefer to service their own equipment and these few will be reluctant, if they do not flatly refuse, to cooperate when you indicate your intention of servicing their machines.

With the exception of the input stage, there is essentially no difference between the sound system of a projector and that of any conventional audio amplifier. This input stage has a tendency to throw the old "seat of the pants" technician off his balance though for this first stage is capable of giving a remarkable imitation of many common amplifier troubles; such as open or shorted coupling and bypass

condensers or even motorboating filters. Learning to spot these ailments can save the technician many hours of tedious labor.

This input stage is more mechanical than electronic in its operation and it is very important that everything in this stage be working properly. Before we go into the operation of this stage in detail, first let us examine its function.

Although there are several methods of achieving sound-on-film, the 16mm. field has narrowed itself down to either a variable density or variable area system of recording that is very satisfactory. On the edge of the film, opposite the sprocket holes (see Fig. 1) there is a continuous strip on the film

Fig. 1. (Left) Variable area sound track, and (Right) the variable density sound track.



that is not divided by the framing lines; this is the sound track. This sound track varies in density in direct ratio with the audio intelligence it represents. A bright light is focused on this film in the form of a very narrow rectangle at right angles to the edge of this film. As the film passes in front of this light, a photoelectric cell on the opposite side of the film from the light source picks up the resultant variations in light intensity. These variations are translated into minute electrical currents by the photoelectric cell. This cell is coupled to the amplifier and from there on, the problems usually encountered are no different from those developing in any normal audio amplifier.

Simple as all this sounds, there is plenty that can go wrong at this point without looking any further and right here is the stumbling block for most uninitiated technicians.

In Fig. 3, we see a typical input stage. This stage is made up of film guides, a flywheel and drum, exciter lamp, optical system, and photoelectric cell. These components function as follows: The film guides control the lateral positioning of the film over the stabilizer drum. These guides, in most machines, can be adjusted and do occasionally go out of adjustment. This can be recognized as a motorboat effect in which the framing lines of the picture interrupt the exciter light as it passes to the photoelectric cell. This is easily spotted by the fact that this thumping will be in step with the flow of film over the drum and only exists while the film is in motion. Another effect will be a "hissy" type of distur-

tion and very low volume as the bulk of the light bypasses the sound track on its way to the photoelectric cell with only a small portion picking up the sound track.

The flywheel and drum form a stabilizer which insures that the film is kept taut and moving at a constant rate as it passes in front of the exciter light. Trash on this drum will produce a thumping noise that is easily recognizable because this noise is produced only while the drum is in motion and is not dependent on the film being threaded up. This trash can be so minute that it is difficult to see, even so small an object as a bit of hair will upset the entire operation. It is very essential that this drum be perfectly balanced and moving very freely. The slightest touch should set it in motion. If this drum is not rotating freely, the film will not ride smoothly, instead, it will have a tendency to ride in and out causing a distortion, not unlike that of an open screen bypass condenser in extreme cases, or more usually a flutter or wow.

The exciter lamp is the heart of the entire system since it supplies the light that actuates the photoelectric cell. This lamp is usually a low voltage, high current device and in most cases this supply is furnished by a high frequency oscillator. If the customer's complaint is "no sound" and an ohmmeter check proves the lamp to be OK, investigate the oscillator circuit. A word of caution; the fact that the lamp is not burning while the amplifier is working does not necessarily mean this circuit or the lamp is defective. Many machines have the circuit so arranged that the exciter supply is not fully operational until the projection lamp, motor, and amplifier are on! Be sure the machine is in full operation before you decide this is the trouble. If the bulb is burned out, make certain that you replace it with exactly the same type of lamp. The placement of the filament of the exciter lamp is very critical and the base of the bulb is so arranged that no mistake can be made here. It is necessary that the filament of the exciter lamp line up perfectly with the tiny slot in the optical system to get proper operation. Be sure the lamp is secure in its base. A loose base that can shake with motor vibration will cause plenty of grief. The varying intensity of the light on the photoelectric cell will create some peculiar noises! Question your customer closely to insure that he hasn't replaced the burned out lamp with the wrong kind. Remember this, only the proper lamp will work in a given machine. It might light up all right, but the filament may be lateral instead of vertical or *vice versa*. Another thing to remember; if the complaint is "low volume" and the exciter lamp does not produce a good, full brilliance, you have probably discovered the trouble.

In many cases the volume of the projector sound is controlled by varying the intensity of the exciter lamp. Don't fly into the exciter circuit with-

out making certain the volume control is well advanced and you still have no light. In one model, the *Movie-Mite*, there is no exciter lamp! A small amount of the light produced by the projection lamp is utilized for this purpose. Some exciter lamps are lighted by a special winding on the power transformer or a separate transformer; although the latter two are seldom seen in the more modern 16mm. machines. I hate to be repetitious, but be sure you have the machine in full operation before you decide that the exciter lamp or its circuit is inoperative!

The optical system is the critical baby and the most unlikely to become out of adjustment. Again question your customer carefully as to the machine's history and whether or not he or anyone else has tampered with this assembly. As shown in Fig. 2, the light from the exciter lamp is condensed and focused across the film track in a thin line at right angles to the edge of the film. Unless you are certain the trouble is here, do not tamper with the lens assembly or the tiny slot through which the light is beamed.

If the audio amplifier has passed a good proof-of-performance test and the sound still isn't right, here are a few clues: Severe garbled sound exists if the slot of light is not at right angles to the edge of the film as shown in Fig. 2. A very "bass-y" effect will appear if this light strip is too wide, generally caused by the optical system being out of focus and not the slot being out of adjustment. A crisp absence of lows and low volume exists if this band of light is too narrow. Whether the band is at one extreme or the other, the machine will demonstrate distortion of some sort if it isn't properly adjusted. If it should be necessary to readjust the slot, the type of machine you are working on will be the clue as to the next step. Some optical systems have

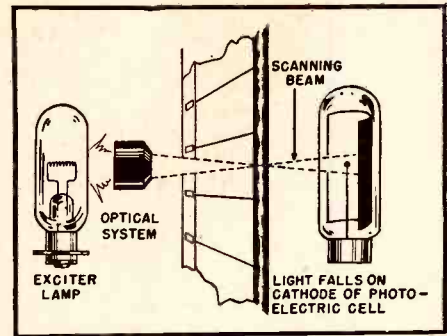
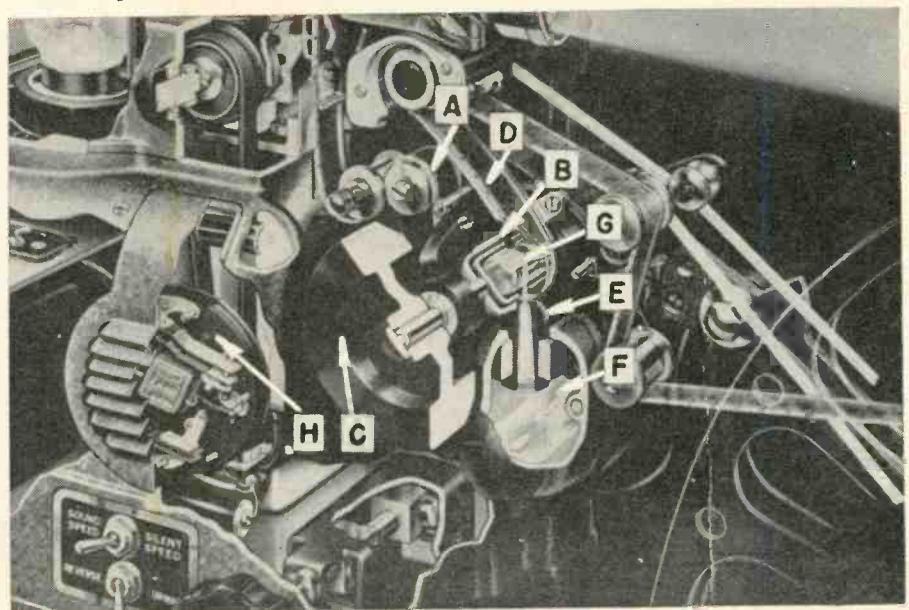

Fig. 2. Mechanical details of input stage.

to be dismantled before you can get to the slot. In others, this adjustment is made by a setscrew on the side of the lens holder. You will also find that many slots cannot be adjusted at all; since it is unusual to ever have to tamper with this after it is once properly set at the factory. Do not tamper with the slot unless you know it is out of adjustment. The next step is to focus this light on the film. This focusing is done by sliding the entire optical assembly back and forth in its holder until the light beam is at right angles to the edge of the film and in a thin line about the size of this dash—. The best way to adjust this is to have a film in the machine when the adjustment is made. You can easily tell when the system is focused properly by the quality of the sound when the optical system passes in and out of focus. Another thing; if there is a minute piece of trash on one of the lenses or the reflecting mirror, if one is used, you will have poor sound, if any at all!

The photoelectric cell is mounted so that the only light reaching it is a light from the exciter lamp; this light having passed through the sound track before reaching the photoelectric cell. It is very seldom that you will have to replace this cell unless it becomes shorted or broken. Caution!! If you

Fig. 3. Cutaway view of a section of the Ampro "Premier-20" 16mm. sound-on-film projector. (A) Curved film guide, (B) sound drum, (C) flywheel, (D) curved film guide, (E) optical system, (F) exciter lamp, (G) photoelectric cell, and (H) motor speed governor.



are servicing the amplifier, always remove the photoelectric cell and wrap it carefully in cloth or tissue to protect it from bright light. This is, of course, assuming you are servicing a set which has the photoelectric cell mounted right on the amplifier chassis. The photoelectric cell operates with a plate supply that varies from about 45 to 90 volts. This is a very stable d.c. If the customer's complaint is low volume, insufficient photoelectric cell voltage may be the reason. In some machines, this cell supply is lowered in conjunction with other volume controlling devices; so make sure you have the volume control well advanced when measuring this voltage. If the volume control has two decks, it is usually a good clue that one of them is controlling the photoelectric cell voltage and the other is controlling the current to the exciter lamp. Sometimes this cell pot is located elsewhere on the chassis and can be adjusted with a screwdriver. Be careful when advancing this control that you do not have too much voltage applied to the cell. This will be apparent if the photoelectric cell takes off in a high pitched squeal or a motorboating sound. Many models of machines don't have this pot and the photoelectric cell supply is a fixed voltage.

For perfect reproduction, the film should pass the optical system at a uniform rate of 24 frames-per-second. For perfect synchronization with the picture, the sound track should lead the picture by 26 frames. Many projectors are equipped with a "Sound-Silent" switch and many times this switch is accidentally left in the "Silent" position while the operator attempts to run a sound movie. In this case, one of two things will occur; either very low indistinguishable sound (caused by the film moving past the exciter light at too slow a speed) or no sound at all. The latter is caused by a special circuit arrangement to prevent the former. Always make certain that this

switch, if the machine has it, is in the "Sound" position before attempting to service the sound.

As I have attempted to point out, the servicing of the sound in these machines is not at all difficult if you fully understand what is supposed to happen when the machine is operating correctly. Fortunately, most of the components are readily available and unless something serious, such as a broken lens, worn film guides or a burned out oscillator coil is the trouble, you should find all the parts you need at your local wholesale house.

If you have a projector that is mechanically defective, it is best to return it to the factory. The majority of cam and shuttle arrangements used in the operation of the claw are matched movements and expensive; so there is no advantage in tackling the replacement of this type of unit when the factory or an authorized service depot can do a much better job. However, there is still plenty that you can do to these machines to keep them in operation; providing the trouble isn't too serious.

Briefly, let's discuss how motion pictures work. The fact that the human eye is lazy and has a persistence of vision, is the only reason that movies work at all. Movies as they appear on the screen are nothing but a series of still pictures flashed on the screen in rapid succession. Each of these still pictures is called a frame. The secret of the entire operation lies in the action of the claw and shutter. These two work together in such a way as to insure that no light will get from the lamphouse to the film while the film is in motion. As soon as the claw starts to pull the film past the aperture, the shutter closes off the light until the film is at rest again and the next frame is ready to be flashed on the screen. Shutters vary in different machines but their effect is the same. Some models have the shutter interrupt the film more than once during the time the film is at rest in the aper-

ture. These unnecessary interruptions actually help to smooth out the operation and greatly reduce flicker.

If the shutter should get out of adjustment, the figures on the screen will streak either upward or downward depending on whether or not the shutter is leading or lagging the actual movement of the film. There are usually one or more screws that may be loosened to allow you to slide the shutter either forward or backward a few degrees, giving you enough leeway to stop the streaking.

Another adjustment along the mechanical lines that can be done in the shop is the setting of the motor speed. In many machines, this is held to a definite rate by a governor that has either a single or double set of contacts. These contacts are controlled by a setscrew which opens or closes the gap *versus* spring tension. If the governor has a pair of contacts, one set will furnish the speed control for the sound speed and the other set for the silent speed. If the sound speed is not proper it will be apparent in the sound reproduction. The silent speed should be as close to 16 frames-per-second as you can get it. Caution! Before adjusting the motor governor, make certain there isn't something wrong elsewhere to cause the change in speed. You may save your customer the cost of a new motor.

As a protection against fire, there is a device installed in most machines which is called a fire shutter. This shutter is usually a wafer shaped disc of metal which has been perforated one or many times with tiny holes. Should the motor speed slow to a rate that might permit the intense light from the lamphouse to harm the film, the fire shutter will drop down cutting off a large percentage of the light. If you have a machine which puts out a very small amount of light, leaving the picture on the screen difficult to see, you will probably find that the fire shutter is stuck in the down position. Most fire shutters work on a centrifugal basis; that is, they will fall down across the aperture should the speed of the mechanism slow to a dangerous rate. Some machines depend on the rush of air that cools the lamp for this function and if there is a leak anywhere, it will cause the fire shutter to fall. One other safety device that has been installed on some machines is an automatic trip to disengage the mechanism from the motor should the film get stuck somewhere. The mechanism is again placed in motion by raising a lever which reengages it with the motor drive.

There are other adjustments that can be made on the machines to prevent unnecessary noise as the film passes through the gate or to prevent loss of the upper or lower film loop. Unfortunately, these adjustments vary with different models of machines and it would take a text of many pages to give the details for adjusting the lateral and vertical cut of the claw and

(Continued on page 102)

Fig. 4. Threading diagram for the 16mm. Ampro "Premier 20" sound-on-film projector.

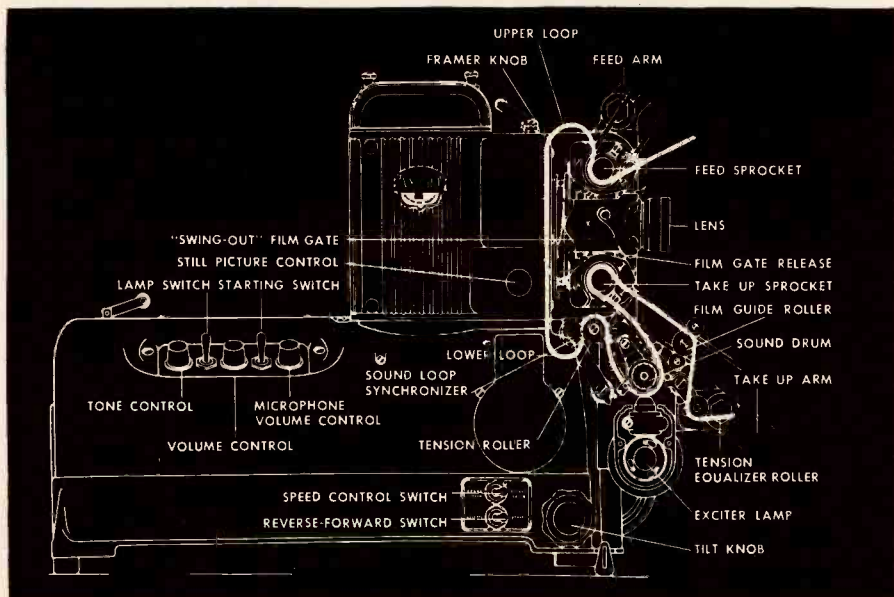

DIELECTRIC HEATING

By
ED BUKSTEIN

IN THE induction heating system, the metal to be heated acts as a secondary of a transformer, and the currents induced in the metal produce the heat. When the material to be heated is a nonconductor of electricity, dielectric heating is employed. In this system, the material to be heated is used as the dielectric of a condenser.

The principle of dielectric heating is illustrated in Fig. 2. An r.f. voltage is applied to the condenser so that its plates are driven alternately positive and negative. The positive plate of the condenser exerts an attracting influence on the electrons in the dielectric, and the negative plate repels these electrons. As a result, the electron orbits in the dielectric are distorted first in one direction and then in the other, millions of times per second. The power consumed in the process of altering the electron orbits manifests itself as heat in the dielectric.

One advantage of dielectric heating is that the work heats uniformly throughout its mass. When other heating methods are employed, the outside of the work heats first, and the heat slowly penetrates to the interior. Not only does this produce nonuniform heating and distortion of the material, but also causes the surface to become overheated or even charred before the temperature of the interior is raised sufficiently. Actually, when dielectric heating is employed, the interior of the work heats slightly faster than the outside due to heat radiation from the surface. This, of course, can be easily controlled, but when desired, the material can actually be heated from the inside out.

Dielectric heating time is measured in minutes instead of the hours required by older heating methods. Consequently, production time and cost are considerably reduced.

Dielectric Equipment

The equipment used for dielectric heating is similar in design to that used for induction heating. The dielectric heating unit consists essentially of a self-excited oscillator, its associated power supply circuits, and an automatic process-timing device. Colpitts, Hartley and other conven-



Fig. 1. By means of dielectric heating, a plywood panel is formed and the glue set in 120 seconds. Each panel, when sawed, will yield four curved fronts for radio cabinets.

**Some interesting facts you should know about
this popular and widely used industrial process.**

tional oscillator circuits are common in this application.

In many cases, the same unit is usable for either induction or dielectric heating. The r.f. output is fed to a heating coil for the former application, or to a pair of plates for the latter.

In dielectric heating, the amount of heat developed in the work is in proportion to the number of times per second the electron orbits are distorted. Dielectric heaters therefore normally operate at higher frequencies than induction heaters. Frequencies ranging from 1 mc. to 100 mc. have been used, but the 5 mc. to 30 mc. range is most common. In some cases, frequencies extending up

into the microwave region have been employed. Dielectric heaters normally generate powers ranging from 2 kw. to 100 kw.

Applications

The medical profession has for many years employed dielectric heating (diathermy) to warm the tissues of the body and to produce artificial fever.

The woodworking industry has long been harassed by the time delay produced while waiting for glue to set. Dielectric heating has attacked this problem with the result that glue setting can now be accomplished in seconds instead of hours. This high speed glue setting also obviates the necessity of providing the additional storage space formerly occupied during glue setting.

Fig. 4 illustrates the bonding of plywood by dielectric heating. Laminations of plywood are glued, stacked and placed between the plates. Former methods of glue setting involved the use of steam heating or hot platens and often damaged the surface of the wood. In addition, the heat dehydrated the wood and caused it to become excessively dry. Dielectric heating overcomes both of these disadvantages. In the first place, the heating is uniform and charring of

(Continued on page 92)

Fig. 2. The electron orbits of the dielectric are distorted first in one direction and then in the other, millions of times per second. The power consumed in altering the orbits causes the dielectric to heat.

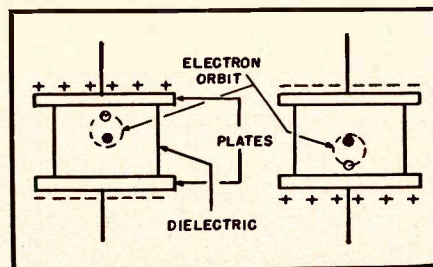

SPEECH COMPRESSOR and MODULATION MONITOR



Fig. 1. Front view of unit. Modulation peak percentages up to 100% can be measured.

By
L. C. WATKINS, JR.,
W5JXO

The compressor is of the logarithmic type and features a meter calibrated directly in decibels of compression. The monitor indicates negative peaks by means of flasher lamp and a dial calibrated in terms of modulation percentage.

THE average phone operator is usually in a receptive frame of mind when he hears about a gadget that will help him increase the communication effectiveness of his rig, or add to the operating convenience of his station.

Described here are two such gadgets combined in one small package. One of them is a low-distortion (relatively speaking) logarithmic type speech compressor and its companion-in-arms is a peak-indicating modulation monitor of considerable accuracy.

If conditions at the receiving end of the conversation are unfavorable to your transmitted signal the compressor, when used intelligently, may give you a very decided boost in readability. Be sure your audio system is clean in its present state and then limit the decibels of compression to the amount your present modulator can handle. Better still, if your rig is shy on audio, consider rebuilding the modulator so that you can at least modulate your carrier 100% with a sine wave and with negligible distortion. Then with voice modulation you may approach the happy compromise of about 10 db. of compression (10 to 1 in power) with an all-around acceptable distortion content.

In the unit described here, a compression-level meter, calibrated directly in decibels, has been provided for its invaluable assistance in obtaining optimum performance from the system.

A filter network effectively reduces the amplitude of frequencies above about 3000 cycles, eliminating the compressor high-order distortion products and keeping the radiated signal narrow. Low frequency attenuation, below about 300 cycles, has been provided to maintain a good frequency balance with regard to maximum intelligibility, and to remove the power consuming bass frequencies.

The modulation monitor will give a positive indication of negative peaks that are too short in duration to be easily seen on an oscilloscope under usual viewing conditions. These short peaks may still cause overmodulation if they are allowed to exceed their proper amplitude for 100% modulation.

The Compressor

The basic circuit of the compressor has been ably presented in an earlier

¹ Floyd, George H.; "Logarithmic Compressor," G-E Ham News, May-June, 1950.

article¹, to which the reader should refer for important background information. The major difference between the original circuit and the circuit presented here is the addition of the calibrated compression level meter. A parallel-T, 60-cycle hum filter has also been included for an additional 20 db. of attenuation at the a.c. supply frequency. Many operators prefer dynamic microphones and with the extra gain of the compressor in use stray magnetic fields around the operating position frequently induce annoying hum voltages into the microphone. A small unavoidable amount of hum is also introduced in the first stage of amplification since the tube heater is supplied with alternating current.

T_1 (secondary winding unused) may be nearly any small replacement type, push-pull plates-to-voice coil output transformer. It should not be mounted near the power transformer or filter choke. The actual limiting circuit consists of R_s and $Rect.$, connected as a voltage divider from the center tap of T_1 to ground. The back-to-back copper oxide instrument rectifier acts as the non-linear element of the voltage divider, producing an approximate logarithmic shaped transfer characteristic.

With sine wave input, the compressed waveform from the output jack of the unit very closely resembles the original waveshape. Under the same conditions a conventional clipper would have produced almost a square wave output with its much higher percentage of distortion and high frequency cross modulation products. The sharp cut-off LC filter necessary to satisfactorily eliminate these high frequency components introduces serious distortion of its own from the shock excitation and resulting "ringing" effect from the square wave input signal. The copper oxide rectifier,

being a non-linear device, also introduces distortion but of a much lower magnitude. In fact it is so much lower that a simple *RC* filter does an excellent job of removing the higher frequency distortion products. No "ringing" effect in the filter is possible and the phase shift characteristics within its passband are excellent.

Tube V_1 is an isolation amplifier and provided in its plate circuit is the output level control and a voltage divider proportioned so that a normal level voltage may be fed to the input jack of the regular speech amplifier. Although one section of V_2 is not in use, the circuit application is conveniently served by the characteristics of the type 12AT7 tube.

The lead connected between J_1 and J_2 is the microphone push-to-talk relay circuit, wired through the compressor.

The compression level meter is simply an audio frequency vacuum tube voltmeter connected from the center tap of T_1 to ground. It is a simplified version of a circuit previously described² by the writer and is well suited for use in this application.

The Modulation Monitor

The basic circuit of the modulation monitor has also been previously described in detail³ and again the reader's attention is directed to that article for the basic theory of operation. Several changes have been made in the circuit for use in the present instrument.

Modulated r.f. to operate the unit is taken from a two or three turn link placed near the final tank coil in the transmitter. The coupling should be no closer than necessary for about half-scale indication of M_1 when the "Set Carrier" control, C_{20} , is tuned through resonance. A length of coaxial cable connects the link to the input binding posts at the rear of the monitor. Another short piece of coax is run from the binding posts to the 3-turn link, L_1 , on the Millen Type 74002 shielded plug-in coil. L_2 consists of 57 turns of No. 18 enameled wire

closewound on the coil form immediately above L_1 . Taps are brought out at 6 and 13 turns from the ground end of the coil to permit bandswitching the monitor for the 75, 20, and 10 meter phone bands.

Demodulation is provided by a 1N34 rectifier. It is important that r.f. not be allowed to get into the grid circuits of V_1 or V_2 as serious inaccuracies would result. The a.f. monitor jack permits listening to the detected signal. The carrier-shift meter, M_2 , has been "red-lined" at half scale to serve as a convenient reference point for adjusting the input r.f. voltage level, although proper operation of the monitor does not depend on a critical reference setting. Around 2½ ma. of current through the meter gives about the right volume level in the monitoring headsets. Plugging in the headset does not affect the calibration of the monitor.

As stated in the original article, the monitor operates on a bias cancellation scheme by comparison of the a.c. and d.c. voltage components that result from diode detection of a modulated carrier. The a.c. component is proportional to the modulation percentage and is equal to the d.c. component when the carrier is modulated 100%, the relationship being independent of carrier strength.

By use of a resistance bridge, or accurate ohmmeter, R_{30} and its dial may be calibrated directly in percentage of modulation. Reference to Fig. 1 will show the dial calibrated in 5% steps, with the 10% steps lettered in. The dial is marked according to the percentage of resistance between ground and the moving contact. The actual resistance of the stock "50,000 ohm" linear potentiometer used in our unit was 51,500 ohms. The 90% calibration point was then 46,350 ohms, etc. The potentiometer should be of

the wirewound type if it is to hold calibration satisfactorily.

Potentiometer R_{31} adjusts the resting bias of V_1 to the proper operating point. Potentiometer R_{32} performs an identical function for V_2 .

The energy stored in condenser C_{20} , which has been charged through a high resistance, R_{28} , furnishes operating plate voltage for V_1 . When the tube is triggered C_{20} discharges rapidly through R_{29} , the flasher light RL_1 , and of course the tube itself. The time constant of the discharge circuit has been made such that the filament of the 115-volt flasher lamp has time to reach full brilliance and produce a bright red flash through the one-inch diameter smooth jewel. The flasher is able to operate two or three times per second, and if V_1 is triggered before C_{20} has reached full charge the flash will still occur but will be of shorter duration.

The power supply makes use of gaseous voltage regulator tubes to provide the degree of voltage stability necessary for maintaining calibration of the modulation monitor. The dual filter condenser, C_{30} - C_{31} , should be mounted on an insulating plate so that its negative terminal (the can) may be connected to the power transformer high voltage center-tap and filament center-tap leads with insulated wire and grounded at one common point on the chassis. This prevents the circulating condenser current from flowing through the chassis and introducing hum voltages into the low level audio circuits.

Construction and Adjustment

The entire unit is constructed on a 7 x 9 x 2 inch chassis and housed in an 8 x 10 x 10 inch utility box. As a further aid in reducing hum and r.f. pickup a bottom plate is used on the chassis. The r.f. section of the modulation monitor is built on a sub-chassis placed at the left end of the main chassis (viewed facing the panel). The remainder of the monitor components are on another sub-chassis mounted

Fig. 2. Top view of the completed unit showing parts layout.

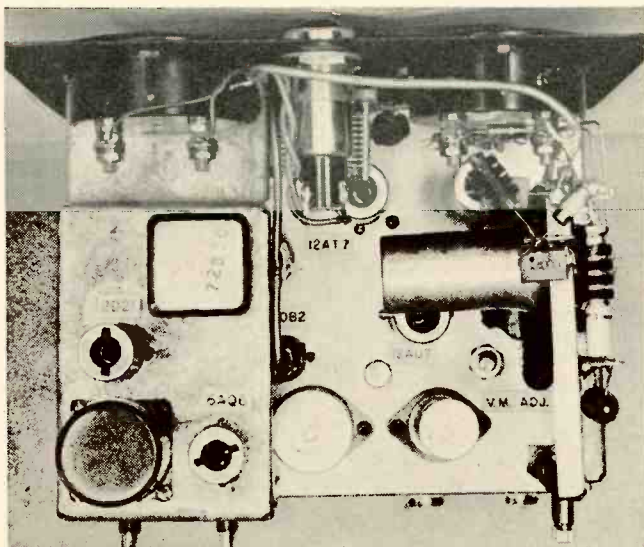
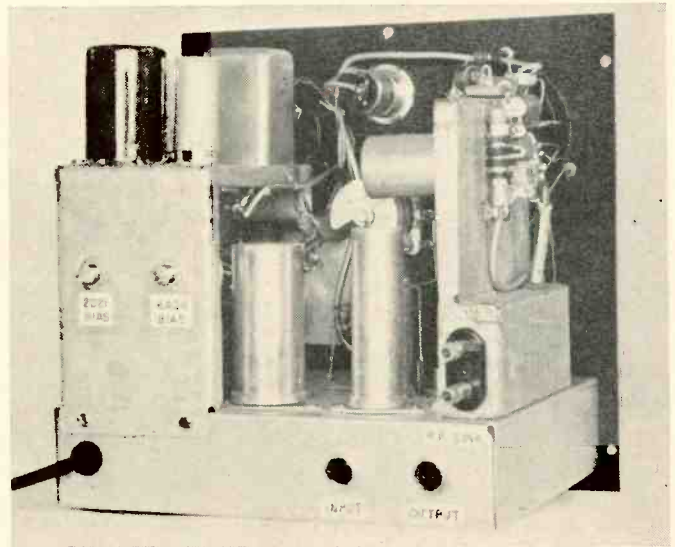

Fig. 3. Rear view showing location of the various sub-chassis.



5 shows the actual results from our compressor. Since $N_{db} = 20 \log_{10} (E_1/E_2)$, we have at hand the information necessary to calculate the decibels of compression. We simply obtain the decibels of increase in voltage along each axis of the graph and take the difference between the two to learn the number of decibels of compression. If we solve the formula, always setting E_2 equal to the minimum voltage on one axis and letting E_1 equal any other voltage on the same axis, we will have the number of decibels of voltage increase for those particular voltage values. The same thing holds true for the other axis. Now if we select a point on the x -axis, say 4.5 volts, we may read the corresponding y -axis voltage by use of the curve. We then figure separately the db. increase in voltage for each axis and take the difference between the two values. This figure is the number of decibels of compression for an input voltage of 4.5; in our case it was 10 db.

Since it is convenient to have the meter calibrated in even steps from 1 through 10 db., we select by the trial and error method other voltages on the x -axis less than 4.5 volts so that the final calculated result is a desired calibration point, 1, 2, 3, 4, etc.

Potentiometer R_{13} is now set so that the value of x -axis voltage, as monitored by the external v.t.v.m. from T_1 center-tap to ground (which represents 10 db. of compression), produces full scale deflection on M_1 . Continue to monitor voltage with the external v.t.v.m. and adjust the compression control, R_8 , so that the proper voltage is applied to produce 9 db. of compression. Mark this point on the scale of M_1 , and proceed in this manner until all desired points from 1 to 10 db. have been marked on the M_1 scale. These may now be inked in and the calibration is complete.

After connection of the unit into the transmitter, and with the compressor switched out of the circuit, adjust the regular speech amplifier gain control for 100% modulation. Then,

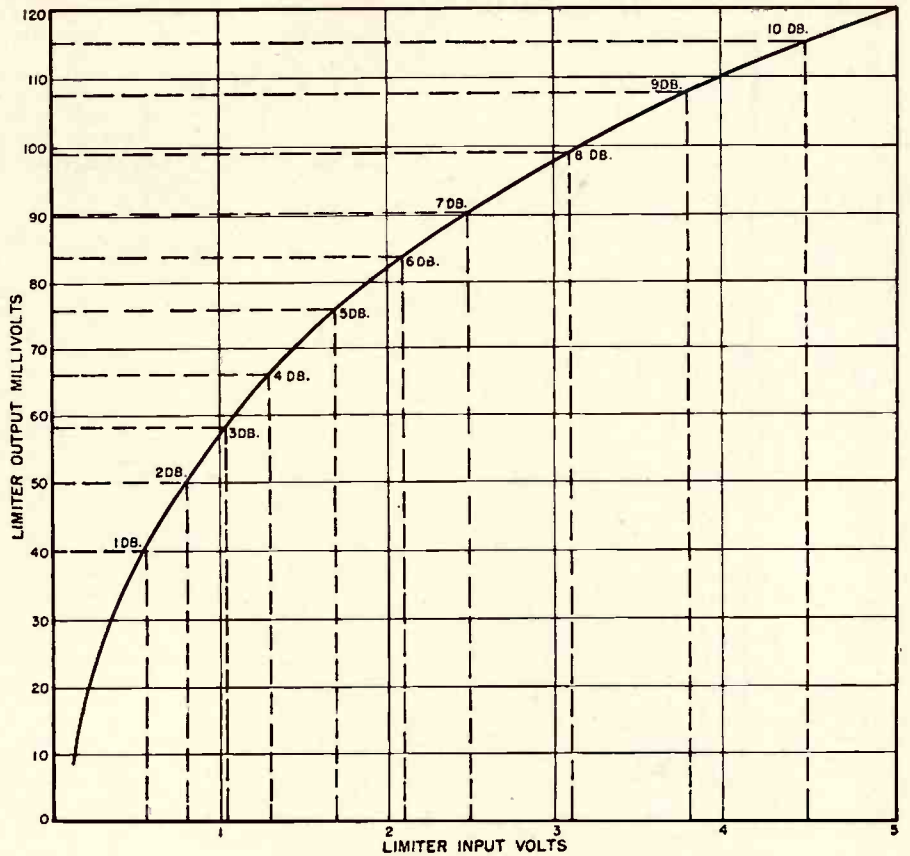

Fig. 5. Compression curve showing the decibel meter calibration points.

with the compression control set for the desired decibels of compression as indicated on the meter, the compressor may be switched in and the output level control advanced until 100% modulation is again obtained. The compressor may now be cut in or out at will with no further juggling of controls necessary.

The modulation monitor is best calibrated with the aid of a sine wave signal source and an oscilloscope. With no r.f. signal present at the input of the monitor, adjust the 2D21 bias control, R_{30} , so that the flasher will operate when the grid of the 2D21 is

touched with a screwdriver. If the bias is left at too low a setting the gas tube will not de-ionize, preventing C_{20} from receiving a new charge after a discharge cycle.

Now with 100% sine wave modulation of the transmitter, as indicated by the scope, adjust the 6AQ6 bias control, R_{31} , so that the flasher light just does operate. If the flasher refuses to operate, T_2 is probably connected so that a negative pulse is being sent to the V_2 grid, driving the tube further beyond cut-off. To correct this, reverse the primary or secondary winding of T_2 (not both). -30-

Fig. 6. Under chassis view. The a.c. wiring should be twisted and kept away from low level audio circuits used in the unit.

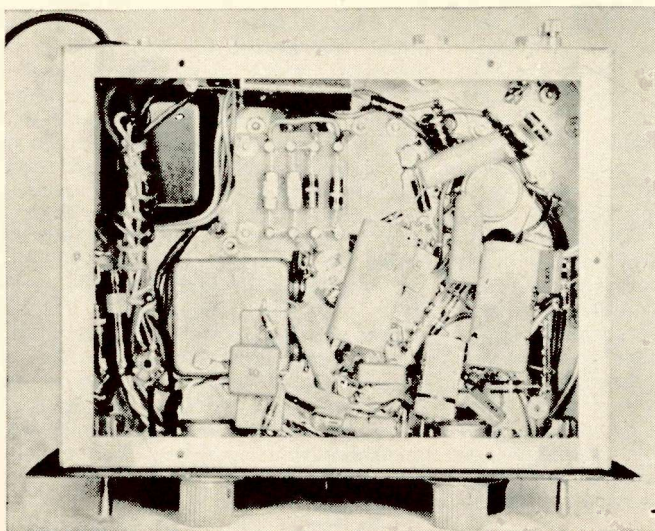
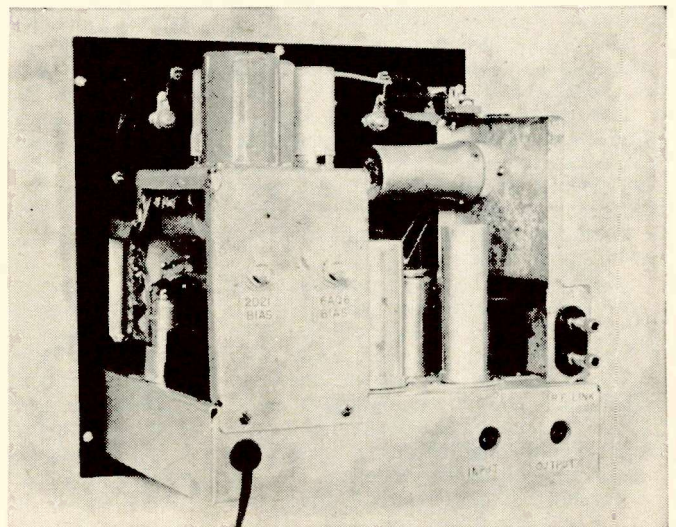
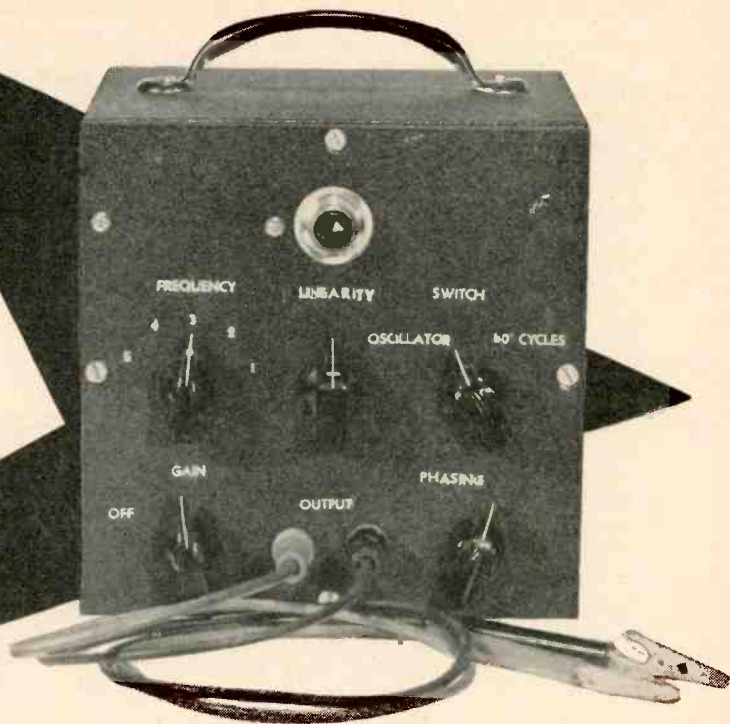
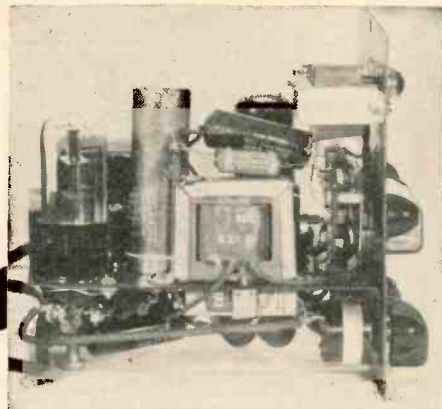

Fig. 7. View of the modulation monitor sub-chassis. Note T_1 behind the r.f. link terminals in "well" of the r.f. sub-chassis.



A Low Cost Square-Wave GENERATOR



Two views of the home-built square-wave generator. The front panel view shows correct location of controls. The shunting choke, mentioned in the text, is mounted on the front panel just above oscillator transformer and is visible in the side view. If enclosed cabinet is used vent holes must be provided.

By
SMITH HARRIS

This test instrument can be used to check frequency response of audio amplifiers from 60 to 20,000 c.p.s.

THE utility of a square-wave generator for checking audio amplifiers is too well known to require comment. Unfortunately, commercial generators cost more than many audio enthusiasts, technicians, and experimenters care to invest. The generator described in this article, however, can be built at a very nominal cost largely from junk box components and is entirely adequate for checking the frequency response and characteristics of an amplifier from 60 to 20,000 cycles. It consists essentially of a simple audio oscillator and amplifier followed by the clipper developed by Louis E. Garner, Jr. (March and July, 1950, issues of *RADIO & TELEVISION NEWS*.)

The entire unit can be housed in a standard 6"x6"x6" utility cabinet, such as the *Bud C-1798*.

The power supply is conventional. Current and voltage requirements are: 3 ma. at approximately 350 volts, 1.05 amperes at 6.3 volts, and 2 amperes at 5 volts. Any power transformer with a secondary producing from 250 to 350 volts a.c. can be used.

The audio oscillator employs a 3:1 interstage transformer and half of a 6SN7. While the transformer used by the author was a *Stancor A-63C*, any similar transformer may be used. In wiring up the *Stancor* transformer, either of the grid leads may go to pin 1 of the 6SN7 while the other lead is not used. The lead marked "CT" goes to ground. Temporarily connect one of the primary leads to pin 2 and the

other to R_3 and after the generator is completed, reverse them should oscillation fail to occur. R_1 is a linearity control and is used to correct any slight differences in width that may exist between positive and negative halves of the final square wave and to disable the oscillator as explained later. The oscillator frequency is varied by shunting the primary of the transformer with various values of condensers by means of a rotary switch, S_1 .

Only three frequencies are normally needed to cover the entire audible range, namely 20, 200, and 2000 cycles-per-second, as a square wave contains strong harmonics through at least the tenth. Thus these three basic frequencies could be used to check the response of an amplifier from 20 through 20,000 cycles-per-second. It is convenient, however, to employ five or six frequencies within this range in order to more easily determine the exact point at which some change may take place in the response. The lowest frequency at which the transformer used by the author could be made to oscillate was approximately 150 cycles-per-second. Sixty cycles is obtained from the power line, therefore, and fed directly to the clipper through S_2 and C_1 to obtain a low frequency test wave. Although the response of an amplifier may extend below this frequency, a good, clean response at 60 cycles will give adequate low-frequency reproduction for normal listening.

The other half of the 6SN7 is used as a voltage amplifier. In order to obtain a good square wave, the amplitude of a *sine* wave applied to the clipper should be at least 75 volts. As it is impractical to obtain this value in a single-stage amplifier, the values of R_3 and R_4 , as well as the excitation voltage, were determined experimentally so that the amplifier is overdriven to produce a wave that is already partially squared off. While the amplitude of this wave is considerably below 75 volts, the sides are so steep that the clipper has no difficulty in producing a good square wave from it.

A 6H6 is used as a clipper in the circuit developed by Mr. Garner as previously mentioned. The theory of its operation is fully covered by Mr. Garner in his two articles and will not be repeated here. The values of R_8 , R_9 , and R_{10} are different from those recommended by him, but were chosen to give the best results in this particular application. S_2 allows either 60 cycles obtained from the power line or any frequency generated by the oscillator to be fed to the clipper.

The phasing control following the clipper was added to correct a severe phase shift of the lower frequencies (low frequencies leading) occurring in the author's oscilloscope. It should not be necessary if the oscilloscope used with the generator has a good low frequency response.

Selection of the proper values of the

RADIO & TELEVISION NEWS

condensers shunting the primary of T_1 is easily made. Turn on the generator and feed its output into an oscilloscope. Throw switch S_2 to obtain a 60 cycle figure and adjust the controls of the oscilloscope to obtain one complete square wave on the screen. Turn off the generator, as the primary of T_1 is "hot," and temporarily connect a condenser across the primary with one position of switch S_1 . Then turn the generator back on, set switch S_2 to the oscillator position, and without changing the setting of the oscilloscope controls, observe the number of complete cycles appearing on the screen. If, for example, three complete cycles are seen, the frequency of the generator is three times 60 or 180 cycles; if six are seen, the generator frequency is 360 cycles and so on. The size of the test condenser is varied until the approximate frequency desired is produced. The other condensers are selected in the same manner. It will probably not be possible to arrive at the exact frequency desired except by using odd values of capacitance obtained by tedious paralleling, but this is not necessary. If one of the frequencies desired is 500 cycles, a frequency of 480 or 540 will do just as well. The frequencies used by the author were 60, 180, 480, 720, 900, and 2000 cycles-per-second obtained as follows:

- 60 cycles: obtained from power line
- 180 cycles: $C_3 = .05 \mu\text{fd.}$
- 480 cycles: $C_2 = .005 \mu\text{fd.}$
- 720 cycles: $C_1 = .001 \mu\text{fd.}$
- 900 cycles: no condenser used, see below
- 2000 cycles: no condenser used, see below.

The values of C_1 , C_2 , C_3 will be different if a transformer other than the one specified is used or if other frequencies are selected.

The distributed capacity of the audio transformer together with its inductance will result in its having a natural resonant frequency above which it will not oscillate. Should this frequency lie below the highest frequency desired, it will be necessary to shunt the primary on one position

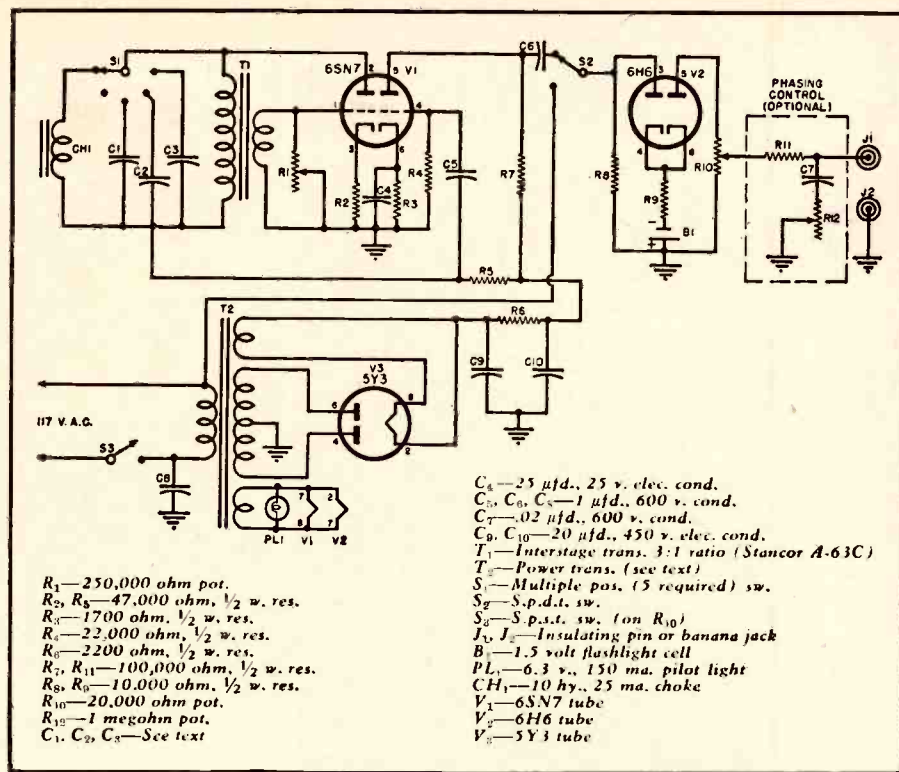

Complete schematic diagram and parts list covering the square-wave generator.

of switch S_1 with an added inductance to reduce its inductance and hence raise its resonant frequency. The resonant frequency of the Stancor transformer specified is approximately 900 cycles. To obtain a top frequency of 2000 cycles, it was shunted with a 10 henry, 25 ma. choke. This choke is visible in the photographs mounted against the rear of the front panel just above the rotary switch. If the frequency obtained in this manner is too high, it may be lowered by paralleling the choke with a condenser of suitable value.

Unless S_1 possesses a very low capacity, the oscillator frequency may jump it when the switch is set to the 60 cycle position and be superimposed on the latter frequency. Should this condition occur, disable the oscillator by turning the linearity control (R_1) until there is zero resistance between

the grid of the oscillator tube (V_1) and ground.

To use the generator to check the response of an audio amplifier, feed its output into the amplifier while observing the resulting pattern on an oscilloscope connected to the amplifier's output. Interpretation of various patterns is beyond the scope of this article. This matter has been covered in previous articles in this magazine, most recently by Mr. Garner in the two articles cited. It is advisable to become familiar with the response of your oscilloscope before condemning the generator or the amplifier if results are below expectations. That loss of highs, as indicated by the rounding of the leading edge of the square wave, can very well be due to poor high frequency response of the vertical amplifier of the oscilloscope.

—30—

Under chassis (left) and top chassis views of generator. The 5Y3 is at lower left while the 6SN7 appears at the upper right.

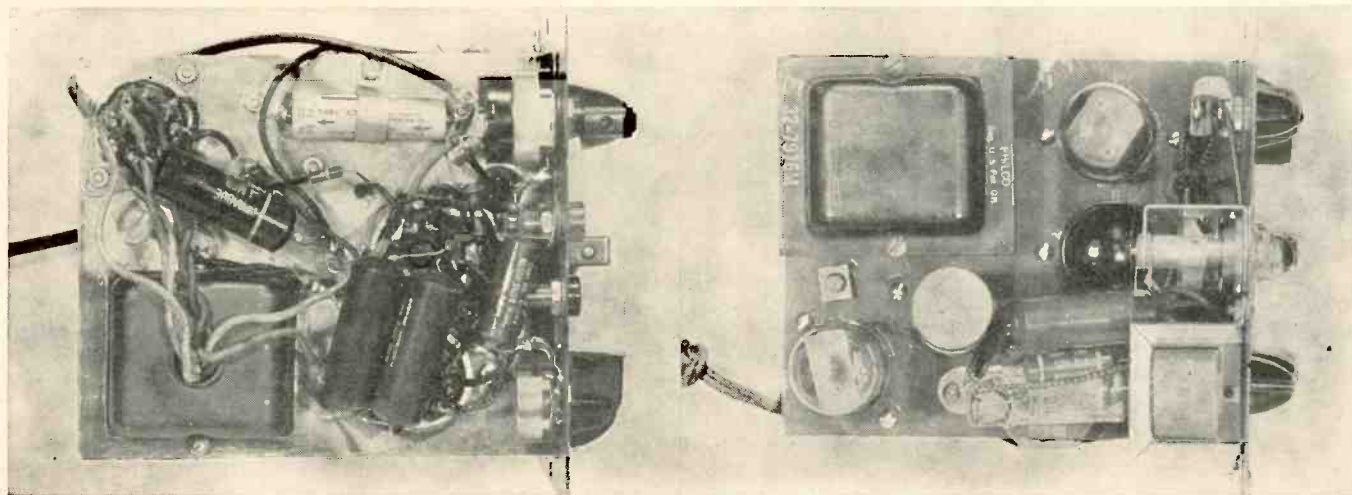

CUSTOM-BUILT for PROFIT

By DALE ELLIS
Electronics Information Bureau

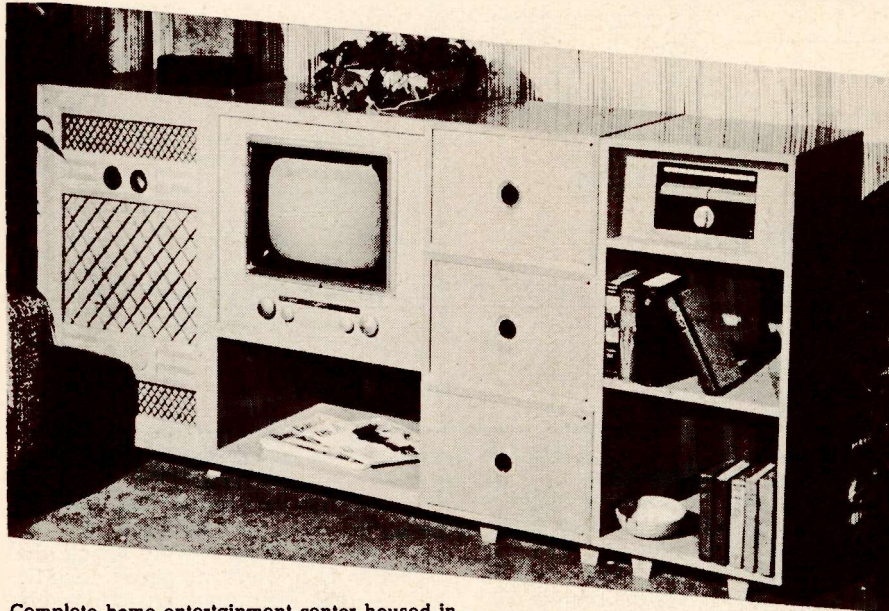

Complete home entertainment center housed in Jensen "Customode" cabinets. From the left are the Jensen speaker cabinet, Radio Craftsmen Model RC 101 16" TV set, and, in the enclosed cabinet, a Radio Craftsmen Model R-10 AM-FM radio, and a Milwaukee Stamping Co. record player. The bottom drawer may be used for storage or a tape recorder. A Talk-A-Phone "Chief" intercom tops the extra cabinet unit.

An abundance of custom radio and TV equipment now makes custom work easy and very profitable.

CUSTOM installation, once considered a novelty confined to a select few persons in the upper income brackets, is rapidly becoming an important factor in the radio, television, sound, and home intercommunications market.

And this is deservedly so, for service technicians and home owners alike find in this relatively new field an outlet for their originality in installation, in design, and in home decoration which gives electronics a new place in modern living.

Some enthusiasts in this new medium compare custom installation's progress with that of home heating—which began with open fireplaces, then changed to bulky living room stoves, to fancy baseburners, and eventually to the furnace and the heating unit hidden away in the basement or utility room. They claim that radio-television and other home units will undergo the same development, and ultimately will be recessed and built in.

Whatever may be its ultimate development, however, custom installations have caught the public's fancy, and the manufacture of chassis designed to be built into cabinets, book-

cases, and paneled walls has grown five-fold in the past three years, it is estimated.

One advantage of the custom installation is the fact that the sound units can be placed anywhere in the room to achieve maximum acoustical benefit. With remote control devices, the units themselves may be built into any advantageous spot, regardless of accessibility for dialing or operating.

This new field has found instant favor with an increasing number of radio technicians, partly because it offers almost unlimited scope for originality and technical skill, and in addition presents a lush market, not only for single installations, but for multiple unit sales, ranging all the way from a single TV set to combination radio-TV-intercom, wire or tape recorders, record changers and in many instances built-in boosters, antenna rotators, and all the other "plus" equipment which attracts the built-in electronics enthusiast.

Paradoxically, the more competitive the conventional television set business becomes, the larger the custom-built market grows. The case of a large Eastern department store which

has discontinued all stock TV lines is a typical example. This store, faced with the necessity of stocking a dozen different brands, with several models of each line, announced that it would offer only a custom-built chassis, with choice of specially built cabinets. While this is not likely to start a trend, it indicates that at least one merchant saw an opportunity for merchandising custom chassis and fine cabinets together.

The number of ways that custom radio-television can be combined with deluxe cabinets, bookshelves, and panels is limited only by the imagination of the buyer or installer. One collector of period furniture had a TV set built into an oversize grandfather's clock. Many have utilized desks, breakfronts, and other favorite pieces of furniture.

Many installers claim that once the home installation bug bites a customer he will stay up nights figuring out new and more novel ways to build in electronic devices. One of the biggest attractions at the recent Chicago Furniture Mart was a multiple section cabinet which housed a 16 inch TV set, an AM-FM-short wave radio, a record player, a tape recorder, special speaker, and a twelve station intercommunications unit which connected all the bedrooms, living room, dining room, kitchen, basement, garage, and front and back doors to a single master control—the ease-loving housewife's dream, since it did away with the necessity for half the trips that make up a woman's day in the home.

And of course interior decorators and home designers are having a field day with the new custom-built electronics idea. By the simple addition of wall cable and lead-in wiring, the new homes are being equipped to carry an ambitious allotment of electronic devices. One new home on Chicago's North Shore is being designed to do away with all cords for toasters, mixers and other kitchen aids, by the simple device of a plug panel, table-high along one entire wall of the kitchen. A toaster, mixer, or waffle iron can be literally plugged into the wall at any place on the kitchen work table, a plug having been substituted for the cord on each kitchen device.

An ingenious architect has come up with the idea of an open wall between living and dining room, so that a built-in television set can be swiveled into viewing range for the youngsters whose meal time coincides with their most popular TV program. Another parent has placed a television set in his children's room, with remote control to the living room, so that he enforces a TV curfew each night by simply shutting off the set.

But aside from the novelty aspect of custom-installation, the idea of integrating TV and radio into the decor and design of a home is growing rapidly, with its accompanying opportunity for service technicians and installers to find new markets, and for householders to utilize these new media of entertainment in the home. —30—

A Flexible RECORD- REPRODUCE SYSTEM

By
OLIVER READ
Editor, RADIO & TELEVISION NEWS

IN PART 1 of this present series (November, 1950 RADIO & TELEVISION NEWS, page 42) we listed and described briefly the basic equipment used in this system. The discussion pointed out why certain components were selected in order to meet our own requirements.

Our first requirement was a combined preamplifier and equalizer, in order that a choice of program circuits could be made by means of a selector switch and this program material amplified and equalized before being passed to the line amplifier. Fig. 2 shows the block diagram of the combined preamp-equalizer. Note that the volume control is a tandem-connected unit which affords smooth control of gain over two stages rather than the conventional single stage control.

The circuit arrangement (Fig. 3) provides complete freedom from impulse types of distortion and a stable feedback circuit permits full adjustment of either the treble or bass controls without amplifier instability.

Bass boost of approximately 20 db. and bass attenuation of approximately 13 db. is available and is independent of the treble control. Likewise the treble boost of approximately 15 db. and a treble cut of approximately 20 db. is independent of the bass control.

A switch is provided which makes possible the selection of either 300 or 600 cycle turnovers at a 6 db. per octave rate for channels 3 and 4. In addition, separate adjustable gain controls are provided for the tuner and crystal pickup inputs so that the program level may be preset for these two channels.

Typical curves for the preamplifier are shown on the graph of Fig. 6. These provide more than adequate

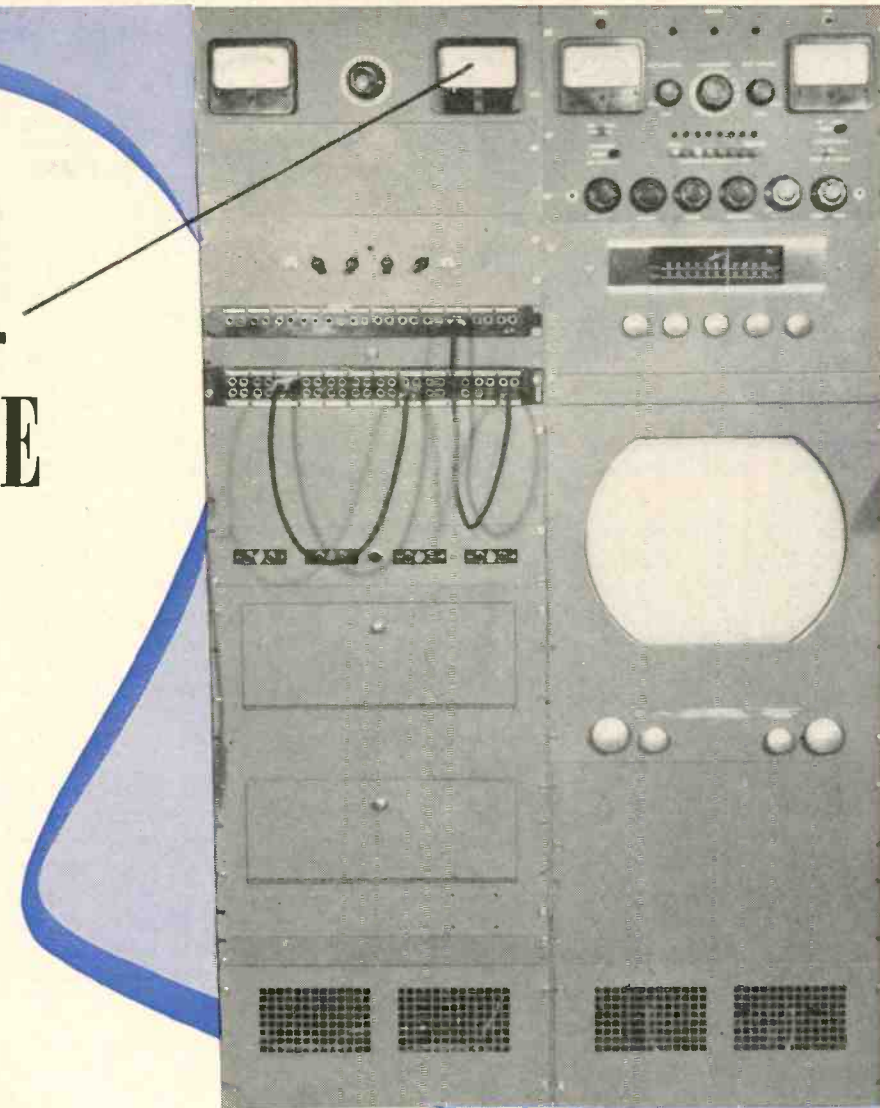

The symmetrical layout of this two-bay assembly is also practical electrically.

Part 2. Continuing the discussion on a record and playback system as used by the author for studying performance of audio equipment and accessory items.

equalization for nearly every listening condition, and are also highly useful in the recording of sound on disc where treble frequencies must be accentuated during the recording process at slow speeds and at inner diameters.

The output of the preamplifier connects to a plate-to-line transformer as mentioned in Part 1 of this series. The output, therefore, becomes 600 ohms, unbalanced. The 600 ohm line from the preamplifier output matching transformer connects to the jack field. This line feeds through two pairs of double jacks and is "normalled" to the input of the line amplifier, as shown in Fig. 5.

The Line Amplifier

The circuit for this amplifier is entirely conventional and is used in sev-

eral manufactured units. It was home-built with components on hand and meets the requirement for approximately 40 db. gain at extremely low distortion. The 600 ohm input terminates in a triode ($\frac{1}{2}$ of a 12AY7) voltage amplifier with a gain control in the grid circuit. The 100,000 ohms shunted across the secondary of the transformer provides sufficient loading to reflect an impedance of 600 ohms back into the primary. The triode output employs the other section of the 12AY7 and is coupled with a plate-to-line output transformer. The primary is 15,000 ohms when so connected. The secondary is 600 ohms which is standard for all lines used in this system.

In order to reduce heat and to make the line amplifier more compact the

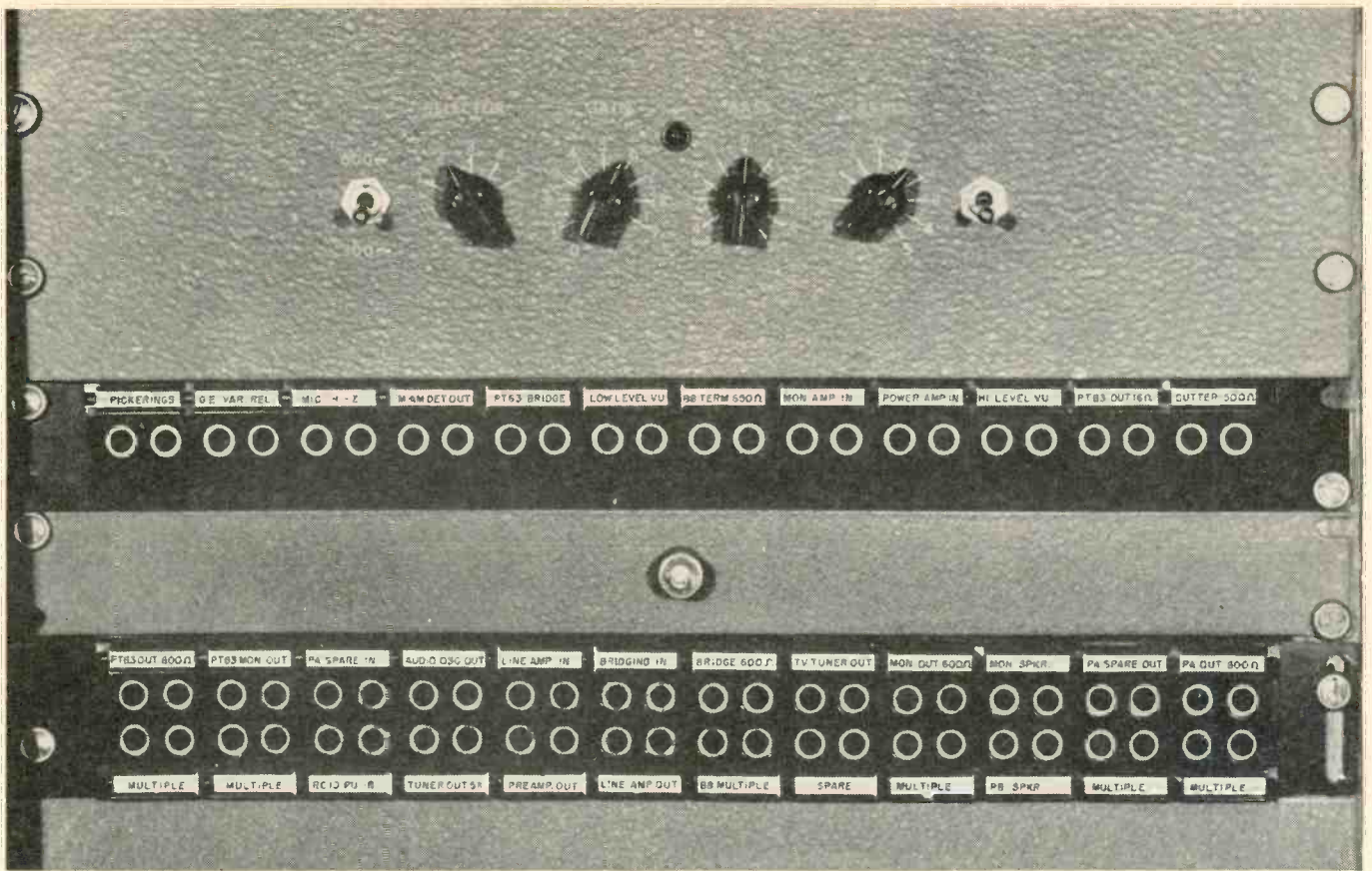

Fig. 4. The jack field comprises one single and one double jack strip. Note separation of low and high level circuits. Connector on center panel is for the high-impedance microphone.

sides of the circuits are connected to the swingers of the jacks and the normal springs connect to other circuits where connection of that sort is indicated. The construction of a typical

double plug is illustrated in Fig. 11. It is good engineering practice in audio work to ground only one end of the shield of the connecting cable. This is necessary to prevent ground loops.

Inasmuch as all of the jack frames are at ground potential there will be proper grounding of the plug when it is inserted into any of the jacks, but
(Continued on page 134)

Fig. 5. Simplified block diagram of complete system described in this series. Many combinations can be made with patch cords. Separate leads to a grounding bus prevent "ground loops."

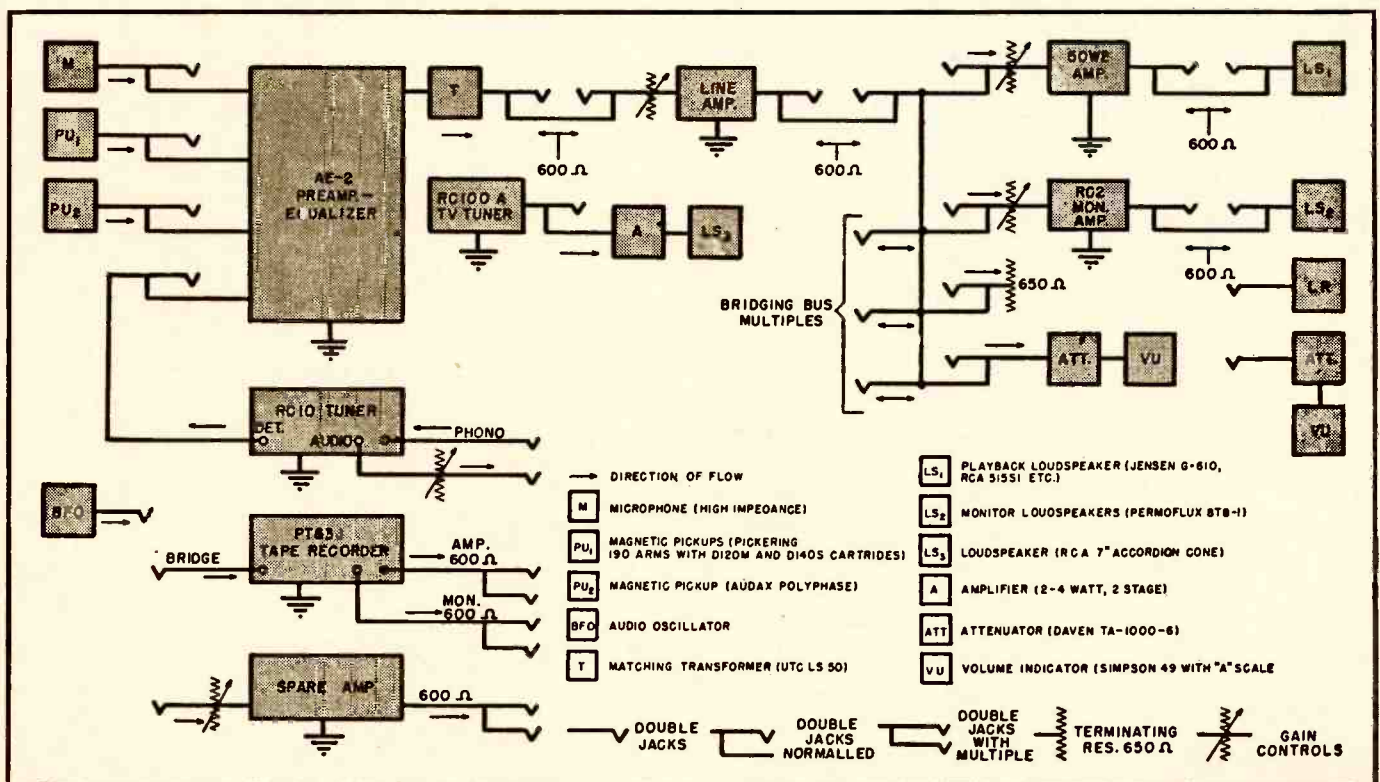

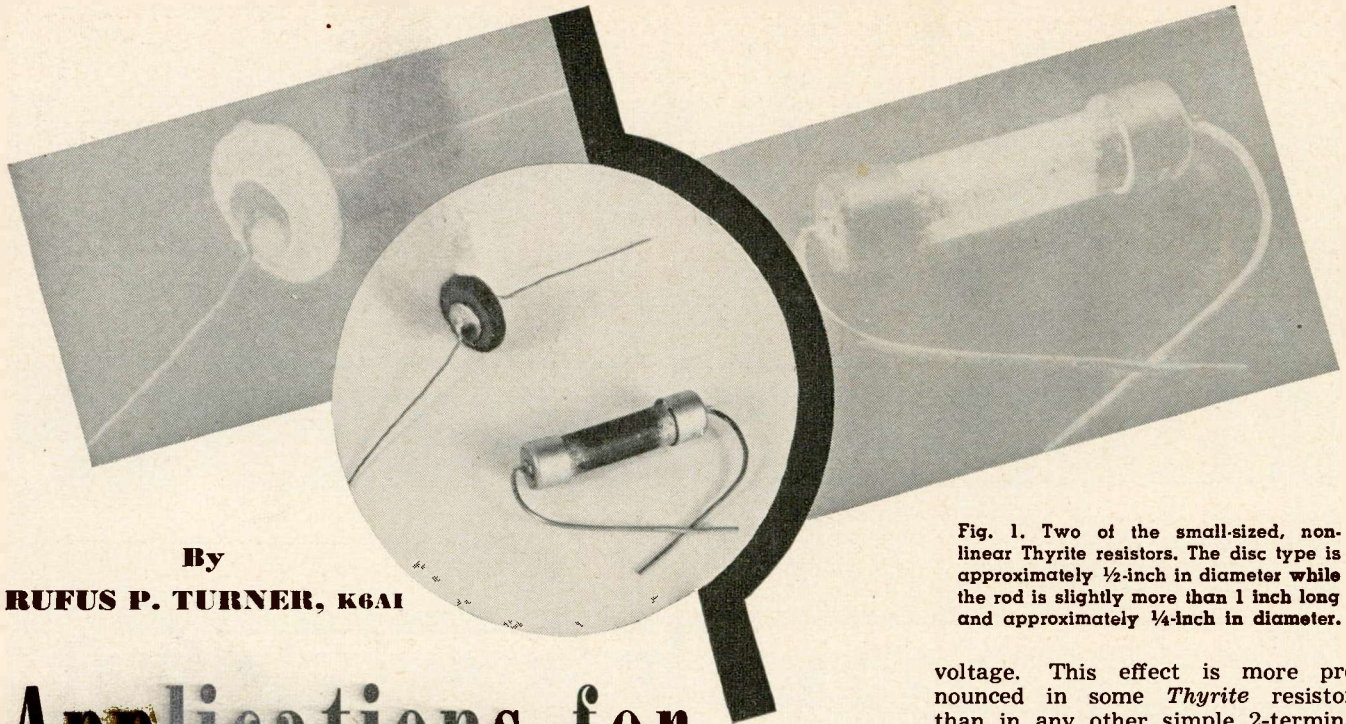

Fig. 1. Two of the small-sized, non-linear Thyrite resistors. The disc type is approximately 1/2-inch in diameter while the rod is slightly more than 1 inch long and approximately 1/4-inch in diameter.

By
RUFUS P. TURNER, K6AI

Applications for THYRITE RESISTORS

A non-linear component that can be used to perform special functions, alone or in conjunction with tubes.

IN THE growing list of non-linear resistance materials, *Thyrite* is both interesting and important. However, the practical applications of this material undoubtedly are better known to power engineers than to the electronic engineer. The distinguishing features of *Thyrite* resistors indicate the suitability of the latter for performing special functions, alone and in conjunction with tubes, in electronic circuits. For this reason, it appears appropriate to direct the attention of electronic personnel to *Thyrite* characteristics and applications.

Thyrite is a *General Electric Company* product. It is made from silicon carbide pressed with a ceramic binder and fired at approximately 1200 degrees Centigrade. Commercial *Thyrite* resistors are made in several sizes and shapes including flat discs whose two faces form the contact surfaces, flat discs with pigtail wire leads, washers whose two faces form the contacts and whose central holes may be used for mounting or stacking, and rods with pigtail leads. For contact purposes, a metallic coating is sprayed on each surface of the *Thyrite* disc and washer, and on each end of the rod. An impregnating compound provides protection against humidity.

Disc-type *Thyrite* resistors are supplied in diameters ranging from 1/4 inch to 6 inches and thicknesses of 0.03 to 0.25 inch, depending upon power rating. Further discussion of *Thyrite* resistor specifications appears near the end of this article. Fig. 2 shows four shapes in which *Thyrite* resistors are supplied.

Electrical Characteristics

In common with other non-linear resistance materials, *Thyrite* is not "ohmic." When a voltage is applied to a *Thyrite* resistor, the current flow does not obey Ohm's Law but is proportional to some power of the applied

Fig. 2. Some of the Thyrite resistor shapes.

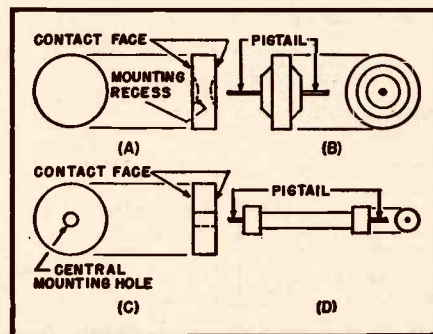

voltage. This effect is more pronounced in some *Thyrite* resistors than in any other simple 2-terminal non-linear resistance. Thus, for the *Thyrite* resistor:

$$I = kE^n \dots \dots \dots (1)$$

where: I = the instantaneous alternating or direct current through the *Thyrite*

E = the instantaneous a.c. or d.c. applied voltage

k = amperes at 1 volt (a constant)

n = an exponent between 3.5 and 7 governed by the manufacturing process

From this relationship, it is seen that an exceedingly large current change is obtained by doubling the applied voltage, when the exponent n is high. Conversely, this means also that the change in voltage drop across a *Thyrite* resistor of high n value is low when current flowing through the resistor undergoes a large change in value. This latter feature is the basis of a simple *Thyrite*-type voltage regulator.

Unlike several other familiar 2-terminal non-linear resistance devices, the *Thyrite* resistor is not a rectifier. Any rectification effects are said by *General Electric* to be less than 1 percent. *Thyrite* accordingly may be used in a.c. as well as d.c. circuits. The positive and negative portions of the volt-ampere characteristic curve for *Thyrite* are symmetrical (See Fig. 3). The non-linear characteristic of the *Thyrite* resistor extends over a wide current range. The curves in Fig. 4 show the extent of current and voltage ranges for seven *Thyrite* resistor types.

When a sine-wave voltage is applied to a *Thyrite* resistor, the current flowing through the resistor is in phase with the voltage and is symmetrical but is distorted by the shape of the conduction curve. From Fig. 5, it is apparent that the current wave contains considerable odd-harmonic components. This ability of the *Thyrite*

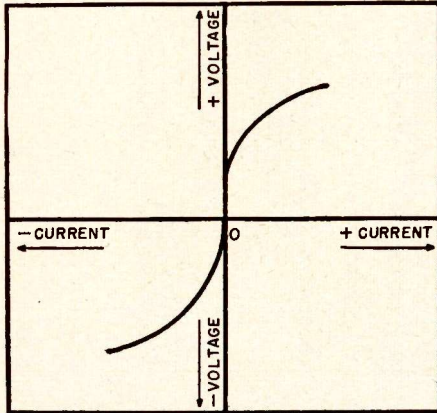

Fig. 3. Conventional volt-ampere characteristic curve of the Thyrite resistor.

resistor to generate harmonics is the basis of a simple frequency multiplier circuit used principally for tripling or quintupling the frequency of the applied voltage. This distorting characteristic should be considered when planning use of *Thyrite* resistors in a.c. circuits. The power factor of this resistor is less than 1 because of the difference in current and voltage waveforms. For this reason, the average a.c. power loss in the resistor is expressed as $E \times I \times p.f.$; where the loss is in watts, E is the applied voltage in r.m.s. volts, I the current in r.m.s. amperes, and $p.f.$ the power factor expressed as a decimal.

The electrical characteristics of *Thyrite* are stated to be the same for impulses of a few microseconds as for d.c. It appears, however, that the maximum practical operating frequency will be governed appreciably by the self-capacitance of the resistor. The dielectric constant of *Thyrite* is given as 30 to 100 or more and is dependent to some extent upon applied voltage. This results in a rather high capacitance in the larger discs having parallel metallized faces.

Thyrite resistors are employed in power circuits as simple 2-terminal voltage regulators, protectors against voltage surges, lightning arrestors, as the sensitive elements in voltage-selective circuits, and in potentiometers giving constant voltage output under varying load conditions. The electrical characteristics of these resistors make them suitable for use in portions of electronic circuits where a non-linear current flow or voltage drop is desired.

Thyrite Circuits

Fig. 6 shows nine simple circuits incorporating *Thyrite* resistors. These circuits have been selected as typical of those in which the non-linear resistance characteristic of *Thyrite* might be utilized. Elaborations and modifications of these circuits, as well as entirely new applications, will suggest themselves to the circuit designer.

In Fig. 6A, the conventional linear cathode resistor in an electronic tube circuit has been replaced with a single *Thyrite* resistor (or several such re-

sistors connected in series to obtain the desired resistance). As the applied signal voltage, E_0 , increases, the tube plate current also increases. This fluctuating plate current flows through the *Thyrite* cathode resistor. The voltage drop across the latter is applied to the grid, in the conventional manner, as negative bias. The cathode voltage drop cannot alter to the same extent as the plate current, because of the non-linearity of the *Thyrite*. The result is a more nearly constant grid bias voltage under varying input-signal conditions. Use of the *Thyrite* cathode resistor may introduce complications in a.c. amplifier stages because of the harmonic content of the *Thyrite* current.

In Fig. 6B, signal output is taken across the *Thyrite* cathode resistor in a cathode follower type amplifier circuit. This circuit can be used when a fairly constant output is desired from a varying grid signal voltage. As in 6A, the voltage drop across the cathode resistor will contain relatively high odd-harmonic distortion. Means must be provided for suppression of the harmonics when they are not desired in the output voltage.

The harmonic-generating property of *Thyrite* is utilized in the simple frequency multiplier circuit shown in Fig. 6C. Because of the predominance of odd-numbered harmonics in the *Thyrite* current, this circuit is most effective for multiplying the input frequency by 3 or 5. Condenser C and the transformer primary inductance must resonate at the desired multiple frequency. It should be noted that a frequency multiplier of this type is not an amplifier, but on the other hand consumes power. The output power always is less than the input. In spite of this disadvantage, there are many

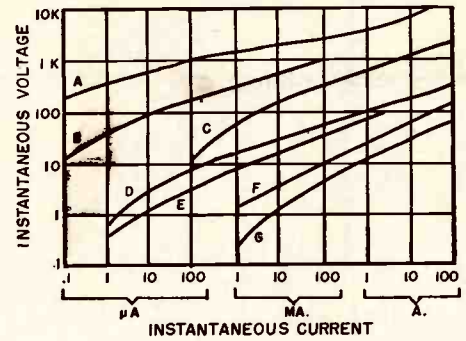

Fig. 4. Typical characteristic curves for several *Thyrite* resistors. (A) 3" diam., .78" thick. (B) 1" diam., .75" thick. (C) 6" diam., .75" thick. (D) 3" diam., .13" thick. (E) 2" diam., .13" thick. (F) 3" diam., .062" thick. The scale is logarithmic.

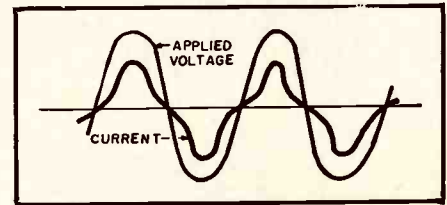

Fig. 5. *Thyrite* a.c. voltage-current waves. The presence of odd harmonics in the current wave is clearly visible in diagram.

applications in which such a simple frequency multiplier will be desirable.

The 4-arm bridge circuit in Fig. 6D contains both linear resistors and *Thyrite* resistors. Since the resistance of the *Thyrite* units varies with voltage, the bridge will be balanced only at one value of applied voltage. At this point, the output voltage accordingly will be zero. As the applied voltage is increased beyond the value required for null, the output voltage will increase,

(Continued on page 157)

Fig. 6. *Thyrite* circuits. (A) constant self-bias, (B) constant output, (C) frequency multiplier, (D) voltage regulator and polarity reversing control circuit for fluctuating input voltage, (E) potentiometer, (F) output voltage regulator, (G) cascade output voltage regulator, (H) multiplier of voltage variations, and (I) cascaded multiplier of voltage variations.

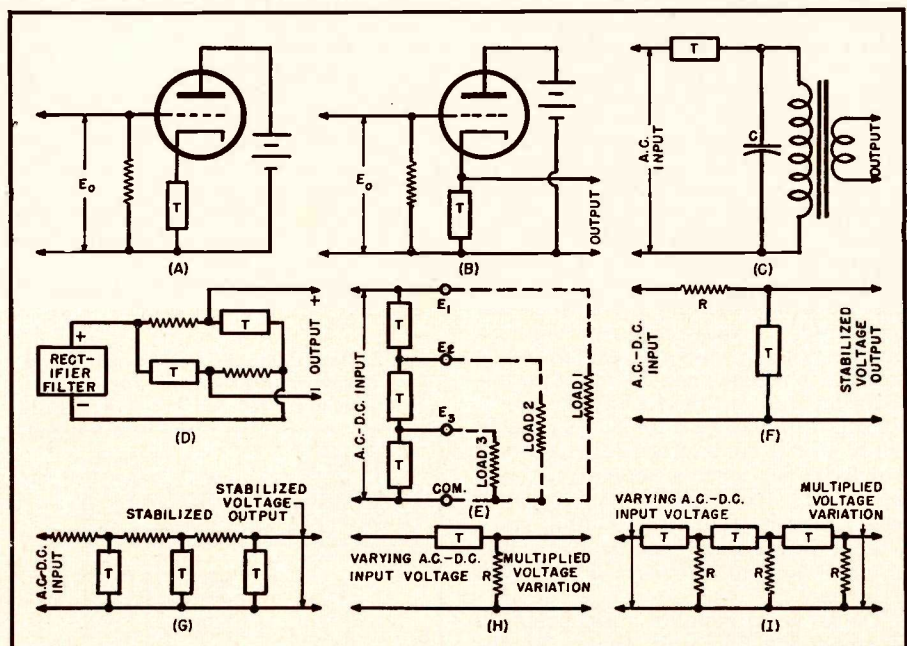

CRYSTAL CONTROLLED TWO-METER CONVERTER

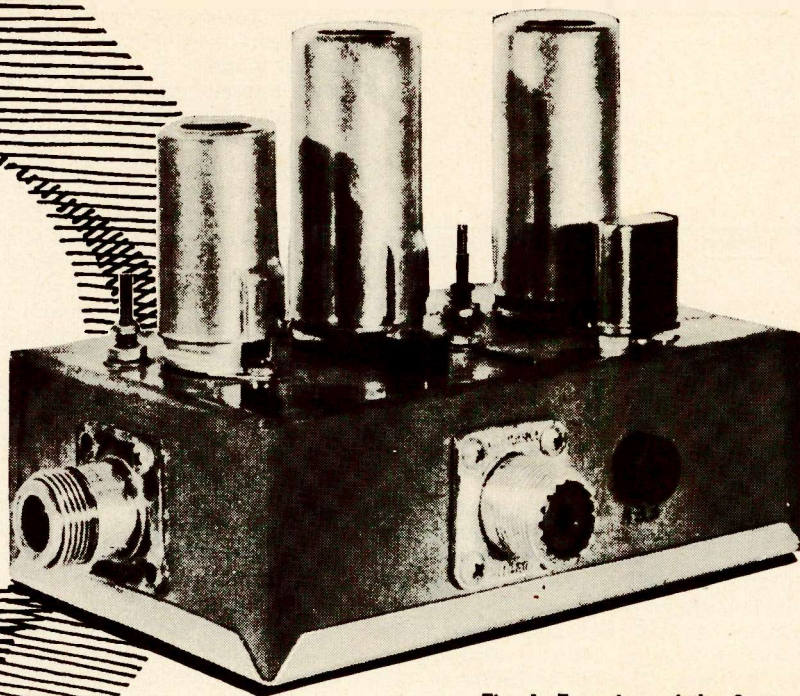

Fig. 1. Top view of the 2-meter converter which is built on a standard 3" x 5" x 1 1/2" chassis.

By
HARRY G. PRATT,
W2SEA

Bandpass circuits for r.f. and detector stages simplifies design. It is easy to build.

MUCH interest has been shown in recent years in improved equipment for the higher frequency amateur bands. Crystal controlled transmitters have been accepted as standard equipment on 2 meters; however, little consideration has been given to increasing receiver stability. The converter described in this article has been designed to provide good sensitivity, stability, and at the same time, ease of operation.

As the design is a bit unconventional, the following explanation is given. Most 2 meter converters are built as shown in Fig. 3A, following the pattern of a conventional low frequency receiver front end. The r.f. and detector tuned circuits must track with the oscillator and produce a fixed output frequency, which is fed into the communications receiver.

Considerable simplification can be achieved by using bandpass circuits for r.f. and detector, as shown in Fig. 3B. Here no tracking problem is encountered as only the oscillator is tuned. With careful design the bandpass r.f. amplifier can be made to operate as well as the tuned r.f.

Both of the systems in Fig. 3 require the use of a communications receiver which is fed with a fixed frequency input. The front end of the receiver, which may be capable of tuning from 1 to 30 mc., is then used as a glorified i.f. amplifier, set at one predetermined frequency.

There is a popular misconception among many amateurs that a broad-

band amplifier is more noisy than the conventional tuned type. This is not true in the case of an application such as this since the i.f. in the receiver used actually determines the bandwidth and, consequently, the noise level is no greater than that of a tuned converter.

One disadvantage of a converter of this type lies in the possibility of signals from services in the tunable i.f. range getting directly into the front end of the receiver.

With modern, well-designed receivers this is not a serious problem if reasonable precautions are taken to shield the lead from the converter to the receiver and if a cabinet is used on the converter. The lead from the converter to the receiver should be kept as short as possible.

With the arrangement shown in Fig. 2, better use is made of the communications receiver, and at the same time the converter is greatly simplified. Bandpass circuits are used in the r.f.

and detector, while the oscillator is operated at a fixed frequency. Using the 130 mc. oscillator as shown, incoming signals between 144 and 148 mc. are mixed in the detector to produce output signals in the range of 14 to 18 mc. The receiver may then be tuned over this range to select the desired 2 meter signal. Thus no tuning controls are needed within the converter and, in effect, it is connected into the antenna line and all operation carried on from the communications receiver.

An oscillator frequency of 130 mc. was chosen so the converter could be used with a BC-348 receiver, which does not cover above 18 mc. Placing the oscillator below the signal frequency and using an even multiple of 10 for the oscillator frequency allows for easy interpolation of the receiver calibration. With the 130 mc. oscillator, 14 mc. at the receiver corresponds to 144 mc., 15 mc. tunes to 145 mc., etc. Other frequencies could be used to match a particular receiver. For example, with the oscillator at 120 mc., the receiver would be required to tune from 24 to 28 mc.

Use of a fixed frequency oscillator facilitates stabilization. A self-excited oscillator may be used; however, series mode crystals are available which allow operation in this frequency range without additional multiplier stages.

As shown in Fig. 4, an 8.66 mc. crystal is operated on the 5th mode in a cathode-coupled circuit using a

Fig. 2. Block diagram of crystal controlled 2-meter converter. Advantages of this type of design are discussed in detail in text.

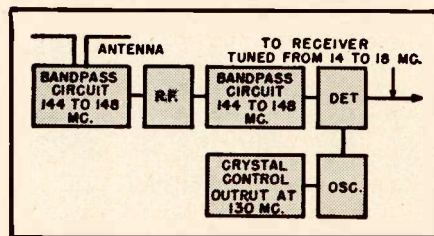

12AT7 twin triode. This gives output of 43.3 mc. at L_2 , which is fed back to the cathode follower section to sustain oscillation. Now if an additional tank is connected in the plate circuit of the cathode follower, it may be used as a multiplier. In the circuit shown the tank, L_6 , is tuned to 130 mc. or the third harmonic of the crystal output.

Crystals intended for harmonic operation are made with small electrodes plated at the center of the crystal. They are available on special order at a corresponding price. However several conventional AT cut crystals from surplus sources have been tried and found to operate well in this circuit. The cathode-coupled oscillator works well at the third or fifth mode, and the multiplier can be used to double, triple, or quadruple. Thus the crystal may be some frequency other than 8.66 mc. For example, a 6.5 mc. crystal-operated fifth mode, and multiplied four times in the cathode follower plate circuit will produce 130 mc. output.

Use of the harmonic mode crystal is not only desirable from the standpoint of attaining a high frequency output with a minimum of tubes, but almost a necessity to reduce spurious responses. If the 6 or 8 mc. crystal was operated at its fundamental and followed by several multiplier stages, spurious responses or "birdies" would be found every 6 or 8 mc. By operating the same crystal at 30 or 40 mc. the chances of birdies within the tuning range of the receiver and converter are greatly reduced.

R. F. Amplifier

The r.f. amplifier consists of a neutralized triode-connected 6AK5, and one-half of a 12AT7 connected in the now popular "cascode" circuit.¹ Bandpass of 144 to 148 mc. is required in all coupling circuits from antenna to detector grid.

Input coil, L_8 , is loaded by close antenna coupling to provide optimum operation of the input stage. With the tap located as indicated in the coil data the bandpass is in excess of 4 mc. when fed from a 50 or 72 ohm cable. L_2 is broadbanded by virtue of the low input impedance of the grounded-grid stage and by shunting this coil with R_1 .

Coupling between the grounded-grid amplifier and detector is through bandpass transformer L_3 and L_4 . It is essential that this arrangement be used instead of a loaded single-tuned circuit, to actually limit the response to approximately 4 mc. Without inductive coupling, signals at the receiver frequency (14 to 18 mc.) may pass through the converter and cause interference.

Detector

One half of V_2 is used as a triode first detector. Oscillator output is coupled directly to the grid through the $2 \mu\text{fd.}$ condenser C_{20} producing some grid-leak bias. This bias may be read at Test Point #2 (J_2), which

is included as an aid in tuning the oscillator as described under "Initial Adjustments."

The detector plate circuit must also have a bandpass of 4 mc., in this case from 14 to 18 mc. Capacity coupling as shown was used to provide flexibility, so the converter could be used with different communications receivers. It is capable of matching a wide range of receiver input impedances and has been used successfully with the BC-348, SX-28, and HQ-129 receivers. The capacity of the connection cable from converter to receiver becomes part of the circuit, and should represent approximately $25 \mu\text{fd.}$ To obtain this capacity, a two-foot length of RG-62-U low capacity cable was used. If another type of cable is used, the length should be cut down to maintain essentially the same capacity.

Power Supply

Power requirements are 6.3 volts at

¹ Wallman, Macnee, & Gladsden: "A Low-Noise Amplifier," Proc. IRE, June 1948.

Fig. 4. Complete circuit diagram covering the crystal controlled, 2-meter converter.

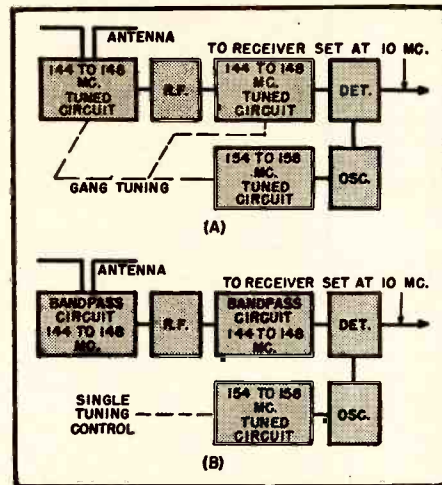
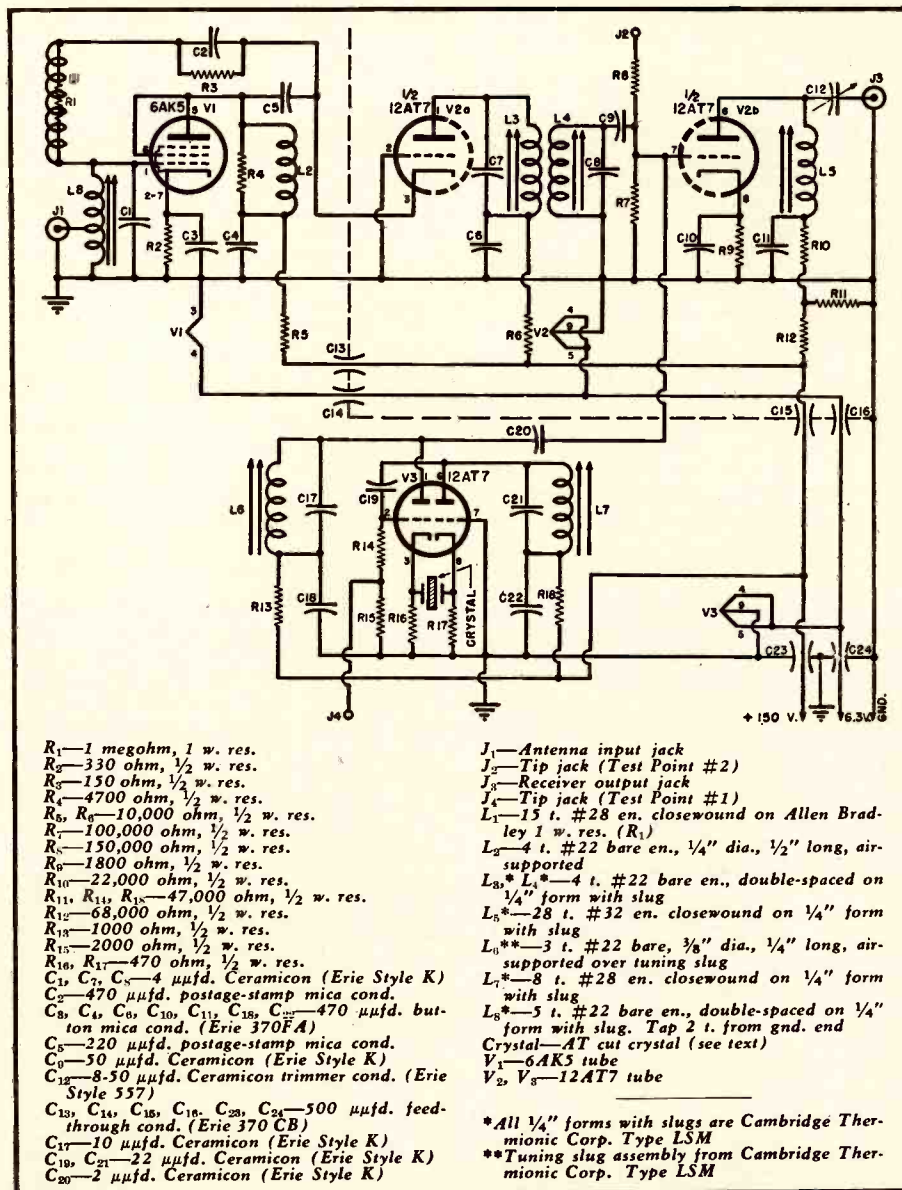

Fig. 3. Two of the most-commonly used two-meter converters. See text for explanation.

.775 amp. and 150 volts at 18 ma. which can be taken from the supply of most receivers, or a separate supply may be used if desired. In either

case, the plate supply should preferably be regulated with a VR150.

The converter shown in Figs. 1 and 5 was built on a 3x5x1½ inch chassis. Brass was used in preference to aluminum so that the shields could be soldered in place. Good shielding and careful placement of parts is required, as in any 2 meter equipment.

Fig. 5 shows the under chassis layout. Shields were placed between each tube socket as shown, and feedthrough condensers used where power leads pass through shields. Incidentally, all necessary holes should be cut in these shields before they are soldered in place. The shield between V_1 and V_2 has an opening on the center line for C_2 , C_5 , and R_3 , as well as holes at one end for feedthrough condensers C_{13} and C_{14} . The shield between V_2 and V_3 requires openings for C_{15} , C_{16} , and C_{20} .

It was also found necessary to install a shield between pins 1 and 3 of V_2 , to shield the input from the output of the grounded-grid amplifier. This shield consists of a small plate approximately 1 inch square, which is soldered in place vertically, starting at the center post of the tube socket and passing through pin 2, which is grounded.

For purpose of alignment, it is desirable to provide means of decreasing coupling between L_3 and L_4 . For this reason, L_4 was mounted in a slot, such that at maximum coupling the coils are spaced ⅜" between centers, while with L_4 at the far end of the slot, the coils are spaced approximately 1 inch.

Initial Alignment

With power applied, the oscillator should be tuned first. A high impedance voltmeter is connected from Test Point #1 (J_1) to ground and a small negative voltage will be observed. As L_1 is tuned through resonance, this voltage will increase. Proper adjustment is slightly higher in fre-

quency than the crest of this peak, as in tuning a conventional crystal oscillator. The purpose of this slight detuning is to insure starting of the crystal which may be checked by turning plate voltage off and back on again and observing that the test meter returns to the same reading. Using a Simpson Model 260 meter on the 2.5 volt scale, off-resonance deflection was approximately .25 volt, which increased to .45 volt at resonance. Wide variation may be expected with different crystals; however, there should be a definite rise as L_1 is tuned through resonance.

The multiplier plate coil (L_5) may now be tuned. Connect the test meter from Test Point #2 (J_2) to ground, and a similar negative voltage will be observed. When L_5 is tuned through resonance, this voltage will rise. As this is a multiplier tuning adjustment, proper operation is at the crest of this rise.

The r.f. alignment can be made using a sweep generator and scope, in which case the over-all response is adjusted for a bandpass of 144 to 148 mc. Fortunately for most of us, alignment can also be made with only a signal generator, using the following procedure.

Set the receiver to the center of tuning range, in this case 16 mc., with receiver antenna trimmer at center of its range. C_{12} is also set at about one-half of maximum capacity. Now a good hefty 16 mc. signal is applied to Test Point #2 (J_2), and the generator frequency trimmed up to obtain maximum signal at receiver, as indicated on "S" meter, or by using a modulated signal and listening to the audio output of receiver. L_5 , the detector plate coil may now be peaked.

After L_5 is peaked at 16 mc. the band ends should be checked by tuning both the receiver and signal generator to first 14 and then 18 mc. At each end frequency, rock the antenna trimmer on the receiver to determine if it may

be peaked up. If not, increase C_{12} , return to 16 mc. and repeat the whole procedure.

When finished with the detector plate circuit, connect signal generator to converter input and apply 146 mc. Tune the receiver around 16 mc. to locate the signal and proceed to align L_3 and L_4 . This is done by decoupling L_3 and L_4 until the space between coils is approximately 1 inch. Both coils may now be tuned and will peak quite sharply. Once they have been peaked, the slugs are locked, and the coupling increased by moving the coils closer together. With a spacing of ⅜" between centers the bandpass should be satisfactory.

This leaves only L_6 , the input coil to be tuned, which is best done by disconnecting the generator from the converter, thus removing the loading from L_6 . With the generator output lead near L_6 , the signal is increased until heard in the receiver through the loose coupling. With 146 mc. signal, L_6 is tuned for maximum signal and the slug locked.

Over-all operation may be checked by connecting the signal generator to the input jack and comparing the relative sensitivity at 144 and 148 mc. (The generator should represent a 50 or 72 ohm source to load L_6 properly.) If any great difference is apparent, it can be flattened out by trimming L_2 . As this is not a critical adjustment no slug has been provided, and trimming is done by spreading or squeezing turns.

Operation and Results

Once the converter has been aligned actual operation is pretty much determined by the receiver in use. Best sensitivity is normally obtained with a.v.c. turned off, audio gain near maximum, and r.f. gain advanced until noise is just noticeable. When tuning from one end of the band to the other it will be necessary to repeak the receiver "antenna trimmer" in the same manner as would be required when using the receiver without the converter.

Sensitivity tests of the converter show that the cascode front end performs as well as many enthusiastic users have claimed. With a 30% modulated signal of .1 μ v. applied, the resulting output signal was some 12 db. above noise level. This would tend to indicate a sensitivity of about .05 μ v. for a 3 db. signal-to-noise ratio, although no direct measurements could be made at this level due to test equipment limitations.

On-the-air checks also showed the crystal controlled cascode converter to be superior to the conventional pentode front end. This was in part due to the cascode performance and partially due to the fact that with stable first oscillator the receiver i.f. could be operated in a sharper position than would otherwise be possible. In general the results were very gratifying and felt to be well worth the time and effort involved in designing and building the converter.

Fig. 5. Under chassis view of the crystal controlled, 2-meter converter.

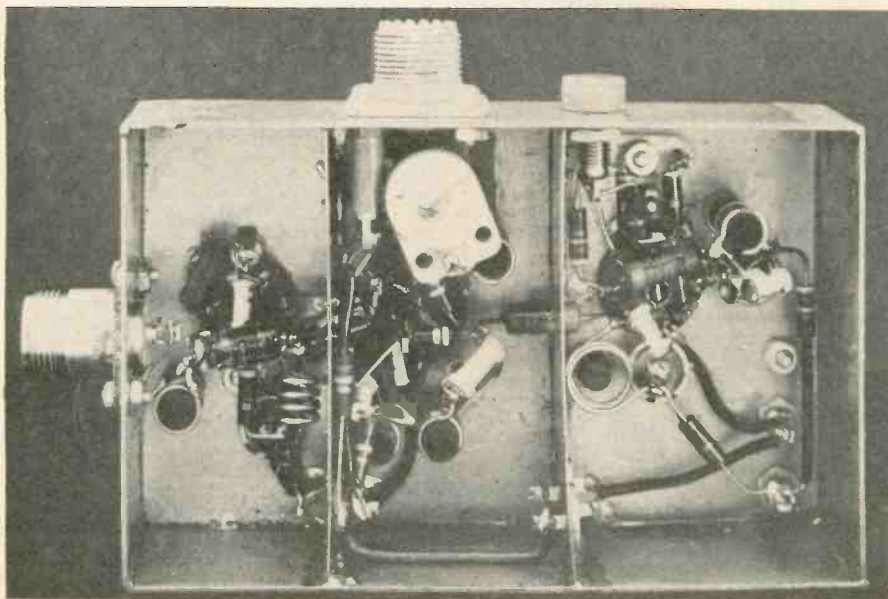

A Nondirectional CORNER SPEAKER

By DEAN POST

**Complete details on a sound chamber
that can be home-built at relatively
low cost. Any speaker can be used.**

Fig. 1. Over-all view of sound chamber. Speaker is mounted at top of column and reflector is used to direct sound into room.

THIS article deals with a satisfactory and, at the same time, economical answer to the problem of directional high-frequency sound radiation of loudspeakers. The solution also offers a saving in space requirements, plus a realistic physical placement of the sound aperture. Total cost of materials was less than \$10.00.

The usual speaker baffle construction places the sound vent relatively close to the floor. This is an exceedingly unrealistic arrangement. Violinists, for example, do not usually play in a prone position. The realism afforded by sound radiating at ear level is well worth the effort required to obtain it.

The enclosure described here largely overcomes the above shortcomings. See Fig. 1. The speaker is mounted horizontally and at the top of the column, where it radiates into a 45 degree reflecting conic section. This device reflects sound over a 90 degree arc. Placement of the box in a corner thus insures that practically all listening positions in the room receive equal amounts of high-frequency radiation.

The totally enclosed portion is one foot square (outside dimensions) and 3 feet high; total height of the unit is about 4 feet. A 7 inch British speaker is used by the writer, but larger units can readily be employed. The size speaker used will determine the total height of the box. Volume is the critical dimension. A 7 inch diameter speaker requires about 3 cubic feet of enclosed space, while a twelve inch unit requires about twice that amount. A box suitable for a 12 inch speaker would thus be about 15 inches square and 4 feet high, with a correspondingly larger reflector.

The lower portion of the baffle is constructed of $\frac{3}{4}$ inch plywood with edges butted. Interior corner 1" x 1" strips are utilized for screw mounting, since wood screws do not enter plywood edges in a satisfactory manner. Glue would do as well.

Sound absorbent material—rug padding, Celotex, or the like—lines the entire box interior. Even though the box is of columnar construction, no resonance effects have been detected.

The exterior is finished by enclosing it with $1\frac{1}{4}$ yards of tapestry. This greatly simplifies construction and finishing problems, and the cost of the cloth is most reasonable.

The top portion is easily constructed. After the speaker cone is located in the center of a 1-foot square mounting board and a suitable hole is cut out, vertical $\frac{3}{4}$ inch pine boards are cut for mounting in the form of a corner as shown in Fig. 2. The boards are square when measured from the speaker side, and are placed tangent to the hole.

A diagonal cut on each board is made with a hack saw or other thin blade, to a depth of $\frac{3}{8}$ inch, as indicated by the lines marked *D* in Fig. 2. This is to hold the edges of the conic section.

A piece of 0.025 inch aluminum should now be laid out and marked as shown in Fig. 3.



A compass centered at point *O* with *D* as a radius should then describe the arc *S*. *D* is the length of the slots, from Fig. 2, and *S* is equal to $1.57H$. The distance *S* should be measured along the arc. This section should then be cut out and gently formed into a slight curve of a cone. The $\frac{3}{8}$ inch strip on each side will serve as a retaining and mounting portion.

Now mount the side boards securely on the speaker mounting board, and slide the cone into the slots. A nice

(Continued on page 149)

Fig. 2. Mechanical details of reflector mounting. Cut slots to $\frac{3}{8}$ " deep along both diagonals "*D*."

Fig. 3. Reflector dimensions. Aluminum .025" thick was employed.

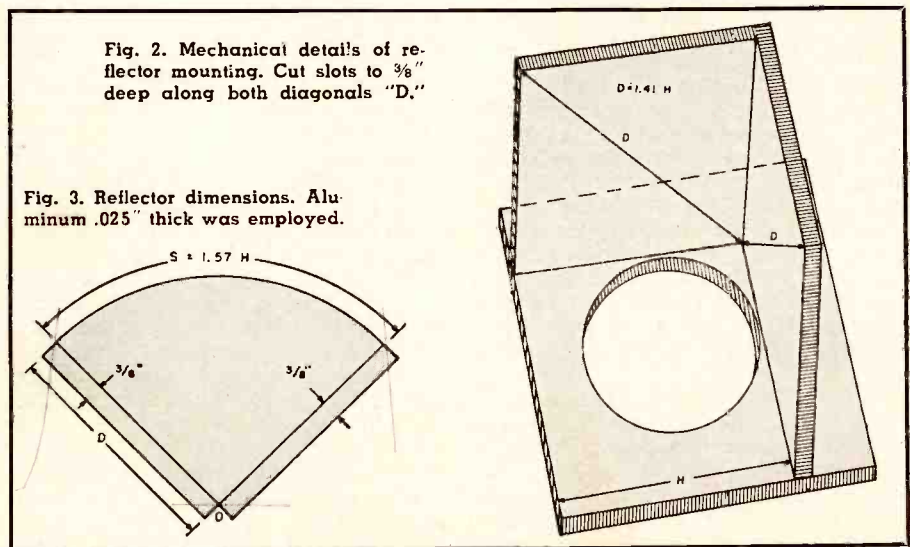

An Easy-To-Build 10 METER RIG

By
STAN JOHNSON,
W0LBY

This unit uses three tubes, operates from single power supply, and has "clammer tube" modulation.

THIS 10 meter phone transmitter was designed with one thought in mind: to build a compact transmitter which would require an absolute minimum of parts and yet be capable of a reasonable amount of output and be easy to adjust and put on the air. The result is a transmitter which has but two tubes in the r.f. section and a single modulator.

Because the rig uses so few parts—and these parts are all standard values which can be used later in a more complicated rig—the transmitter is ideal for the beginner. And for the old timer the transmitter is an excellent standby unit for use when the big rig is being revamped—or for mobile, portable, or emergency use.

The r.f. section uses a 6L6 tritot oscillator with a fixed-tuned cathode circuit, thus eliminating one variable condenser. The 6L6 plate output circuit (which provides output at twice the crystal frequency) likewise is untuned, being tightly coupled to the grid circuit of the following stage. This stage, using an 829-B (or 3E29) is very efficient as a push-push doubler, and provides the 10 meter output. The tuning condensers in the grid and plate circuit of this stage are the only variable condensers in the set.

Modulation for the transmitter is provided by a 6V6 which is used as a "clammer tube" modulator. This is a now-familiar form of screen grid modulation. The arrangement illustrated is the last word in simplicity—not even needing a modulation trans-

former or choke. Actually, it is a form of series modulation, which the writer and many others used nearly 15 years ago.

The entire transmitter is built up on a standard 3" by 7" by 13" chassis. The modulator is placed at one end of the chassis to get it as far as possible from the r.f. output end. Down the center of the chassis in a row, starting from the left end, are: the sockets for the crystal; the 6L6 oscillator; the combination plate coil for the 6L6 and the grid coil for the 829-B; the 829-B socket; and the socket for the plate coil in the output circuit.

On the rear of the chassis is a 4-prong socket which is used to provide connection with the 6.3 volt heater voltage source and for the 45 volt "C" battery. A feedthrough insulator is used as a high voltage terminal for the 600 volt power supply. The latter can be any standard supply which will furnish 600 volts at 200 ma. plus 6.3 volts for the tube heaters.

The values chosen for the parts in the rig are all standard. However, some are rather critical so unless you are an old hand at modifying circuits it is urged that you use the parts specified. For example, the writer tried using a single-gang condenser for C₁. This resulted in a very unstable transmitter which would oscillate without rhyme or reason. Replacing the single gang condenser with the dual condenser whipped the trouble completely.

Another critical spot is the output

plate coil. A standard manufactured coil was tried—but it would not work, apparently because paralleled tube plates add enough capacity so that the coil used must be smaller than normal. If you do use a manufactured coil you will have to peel off turns—and further, it is doubtful if the antenna pick-up coil will have enough inductance. For that reason, the writer urges that for this set the builder "roll his own" coils, following the coil specifications given in the parts list.

Getting the set into operation is no trick at all if everything has been wired properly. The first thing to do, of course, is to get the oscillator working, as indicated by r.f. on the grid coil when a standard pick-up loop and flashlight bulb is coupled to it. Then, with an 0-200 ma. or larger milliammeter plugged into the cathode jack, the plate circuit is tuned to resonance.

If the set is working properly so far—the next step is to put it on the air. *It is imperative that the antenna loading be heavy*—if both good efficiency and good modulation are to be obtained. This means first of all that the antenna should be one which "takes" r.f. readily—one which will overload a standard transmitter if the antenna coupling on it is turned all the way in.

Assuming that a good antenna is available, adjust the slider on R, until the screen voltage on the 829-B reads 150 volts. (If you do not have a voltmeter the setting is approximately the half-way point on the 1000 ohm cathode resistor.) Next, couple up for maximum antenna loading—which should be so "tight" that the resonance dip, as noted on the milliammeter, is very broad. Now, plug in



This neat rig is ideal for beginner or as stand-by for the old timer.

the microphone, and speak into the mike. When you really "hit" the mike there should be a very slight upward "kick" of the milliammeter, and total current indicated on the milliammeter should be about 135 ma.

If the transmitter modulates "down" it is an indication that (1.) the antenna coupling is too loose, or (2.) the screen voltage is too high. The latter can be lowered by adjusting the slider on R_1 . However, lowering screen voltage reduces efficiency, so if possible increase the antenna load. This may involve changing the number of turns on L_6 , or modifying the antenna so that it loads better.

When adjusted, using the procedure outlined, the rig is capable of excellent quality—in fact, to the writer's consternation, a local ham reported that the little rig sounded as good as the regular transmitter, which has Class B modulation, a crystal mike, and all the trimmings. Subsequent checks proved that the local was a trifle optimistic, but quality reports have been uniformly good on both local and long haul contacts.

A gain control for the mike was regarded as an unnecessary luxury—simply "backing off" from the mike originally used kept the gain at the proper level. However, it would be a simple matter to put a 500,000 ohm variable resistor across the output side of T_1 .

A word about microphones. The plentiful T-17 type mikes have relatively low output, so low that they will barely provide enough audio, with very close talking. Their output can be improved a good deal by prying them apart with care, and drilling some extra holes in the front for the sound to enter. Even so, the writer prefers the standard "F" type microphone from a telephone, because it has superior quality and output. Contrary to popular conception, it is not necessary to "scrounge" these—many local phone companies will sell them, providing they recover from the shock of somebody trying to acquire one honestly.

Like any low power transmitter this one will not consistently slug it out down in kilowatt alley at the low end of the band, and the user will probably have better luck with it if he operates 29,000 kilocycles and higher. Also, it is asking too much of any modest transmitter to expect it to perform miracles with a folded dipole or other simple antenna. In fact, the writer has always been a little amazed at the number of folded dipoles in use considering the fact that a simple beam (such as the two element, end-fire array described in the writer's article "No Space for an Antenna?" in April 1950 issue of RADIO & TELEVISION NEWS) costs practically nothing to build, takes up very little more space than a dipole, and will give infinitely better results. The beam mentioned, incidentally, has been found to work even better if spaced 6 feet instead of 4 feet as specified in the original article.

January, 1951

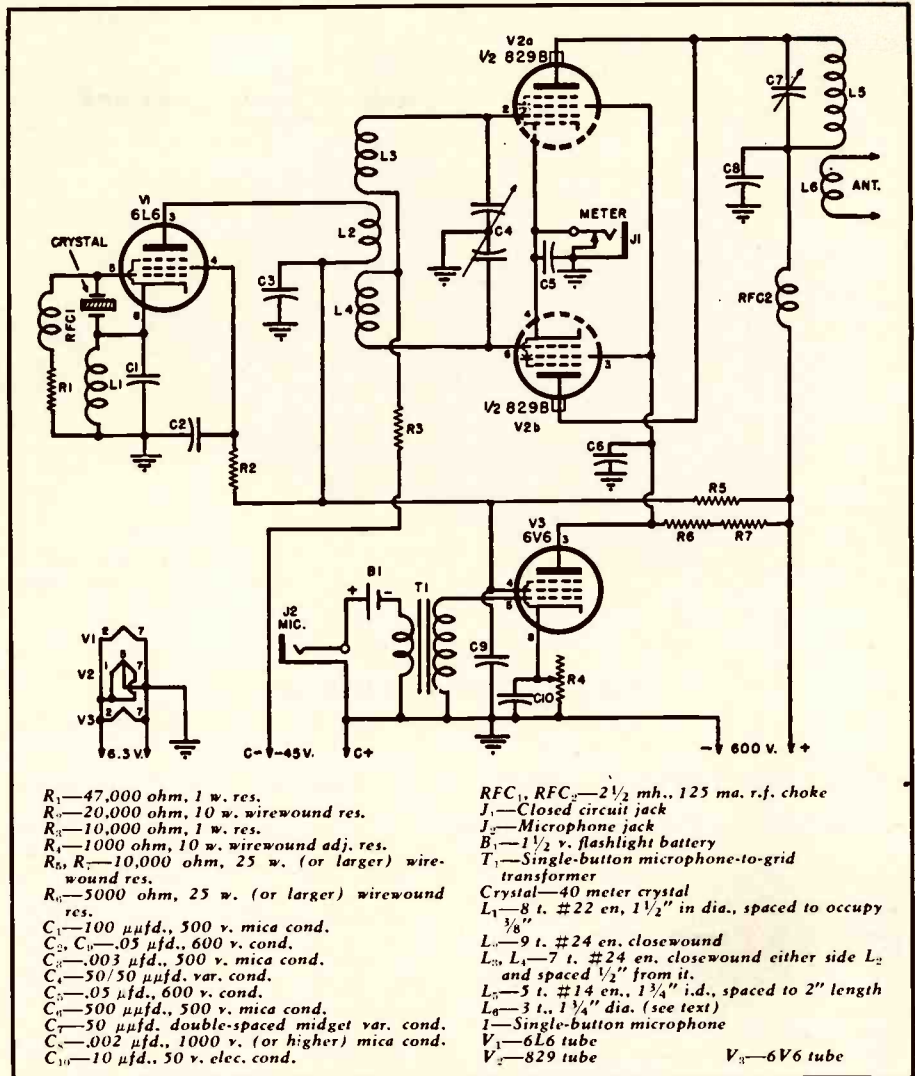

Complete circuit diagram of a 10 meter transmitter which uses only three tubes.

One caution—in order to provide tight antenna coupling, the antenna coil is wound of flexible wire so that it can be "poked" into the plate coil. This means that it must have very good insulation—otherwise there is

the grim possibility that high voltage will appear on the antenna feeders. The moral is obvious—use wire with a high voltage breakdown rating, such as auto ignition wire.

—30—

Under chassis view of transmitter shows how few components are required in unit.

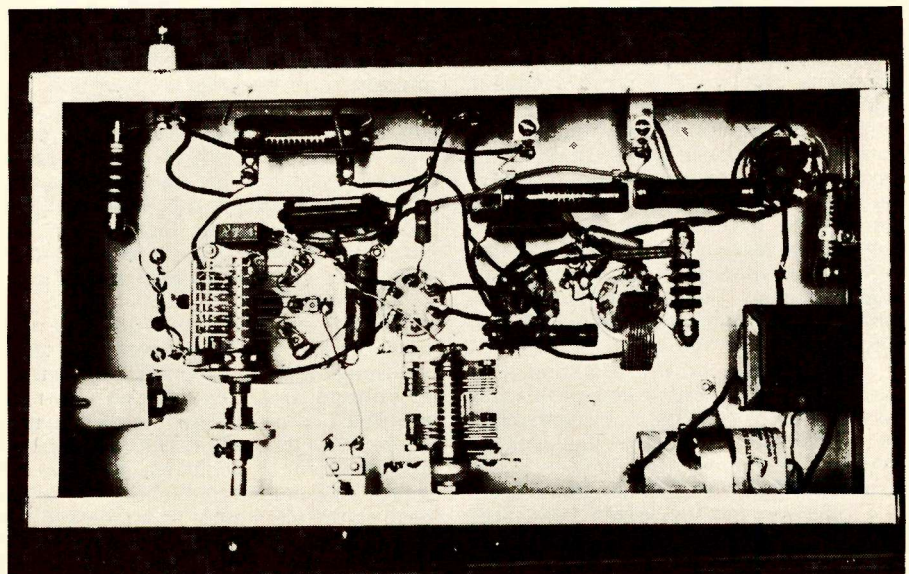

A Preamp With TONE CONTROL

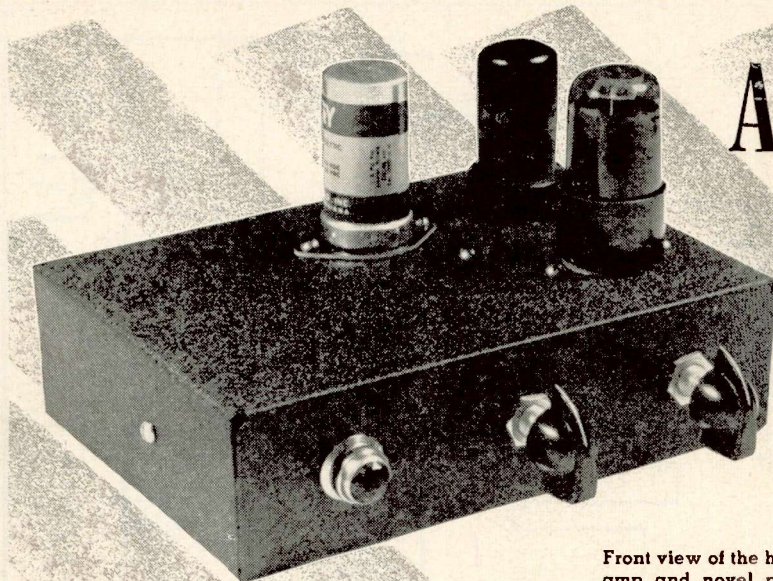

Front view of the home-built pre-amp and novel power supply.

By
GLEN SOUTHWORTH

This novel preamp features simplified power supply and combination "low-high" frequency boost control.

IN RECENT years an increasing amount of audio equipment has been offered to that part of the listening public which desires to assemble its own reproducing system. This trend has been reinforced by the recommendations of various consumer organizations and an increasing number of not too technically minded persons are joining the experienced constructor in the assembly of their own equipment.

In many instances the interactions between various sections of the audio setup may be largely ignored, even though careful attention is paid to the selection of highest quality components. Probably the most obvious example of this is the conventional radio phonograph wherein the close proximity of the loudspeaker to the pickup produces electromechanical feedback which, in turn, causes hangover, distorted reproduction, and limited low frequency response capabilities. This problem is often accentuated where microgroove recordings are concerned due to the lighter tracking pressures involved and the fact that some of the lightweight plastic arms have serious mid-frequency resonances, as may be tested by turning up the gain and tapping lightly on the arm.

Probably one of the best and simplest solutions to the above problem is to move the record playing mechanism to a distance from the loudspeaker system. As most listeners usually prefer to sit somewhat back from the speaker, it is often desirable to locate the player nearby, together with some means of tone and volume

control. To do this almost always requires some form of preamplifier with a relatively low impedance output in order to prevent the capacitance of the connecting shielded cable from seriously attenuating the high frequencies.

A compact preamplifier incorporating cathode follower output as well as a novel power supply and tone arrangements is shown in the accompanying diagram and photographs. The power supply is unique in that only the six volt heater voltage is drawn from the power supply of the main amplifier. This is used for the tube filaments and is stepped up by a small filament transformer which is connected backwards to supply the plate voltage for the preamp tubes. This arrangement has several advantages, prominent of which is the fact that the only power connection required is a single pair of wires carrying low voltage, which is additionally desirable under certain wiring codes. Secondly, an arrangement of this kind provides excellent decoupling from the main amplifier power supply in the event that high gains or a large power output is desired.

With the exception of the tone circuit, the rest of the preamp is of conventional design, using a 6J5 as a stage of voltage amplification and one half of a 6SL7 as a cathode follower output stage. In the event that additional amplification is required, such as for a low level magnetic pickup, the other half of the 6SL7 may be connected for extra gain.

Upon examination it will be noted

that the tone circuit used is somewhat similar to the increasingly popular compensation circuits for the *Fletcher-Munson* effect, in that it boosts both high and low frequencies simultaneously. In principle, its operation is considerably different in that it is intended to be used at high volume levels as well as low to create a form of "Distance Control."

The average living room does not have the acoustic characteristics of a concert hall and, as a result of a combination of factors, home reproduction may sound distinctly unnatural to the listener accustomed to live performances. This difference does not necessarily result from a longer reverberation time in the concert hall, as both acoustic design and the absorption of a large audience can reduce this to a fairly low value, but rather due to the characteristics of binaural hearing.

An interesting analogy is to assume two microphones, connected in parallel, spaced about six inches apart, and placed toward the rear of an auditorium. Under these conditions, sound generated on the stage will reach the microphones mostly in the form of reflections from various angles, except at the higher frequencies where directional effects start to occur. At low frequencies the wavelengths of the reflected sounds will be small in comparison to the distance between the mikes, and little effect will occur no matter from what angle the sound is received. In the region around one thousand cycles the distance between the two microphones will approximately equal one-half wavelength and a large degree of cancellation will result over a considerable angle of reflected sound. Above this point an increasing amount of direct radiation is received in relation to reflected energy due to directional effects and greater efficiency of sound absorbing materials. The resulting frequency response characteristic under these conditions may have an attenuation of six decibels or more in the mid-frequency region.

Although the foregoing analogy does not necessarily hold true for live lis-

tening, various experiments in listening and recording tend to indicate that it has considerable validity. Inasmuch as many commercial recordings are made with the microphone placed relatively close to the performer, due to limitations imposed by the equipment or acoustics, the resultant reproduction when played back over a flat system in a small room may sound harsh with excessive middle register. As a result, a device such as the distance control, which allows controlled attenuation of the mid-frequencies, may be definitely desirable in obtaining the illusion of concert hall presence.

In some cases the experimenter may succeed in putting together just the right combination of audio components which, together with the room acoustics, seem to give nearly perfect reproduction, yet after a period of days or months the quality may not seem to sound nearly as good as it did at first. This, again, is often the result of the interaction of a number of different factors. Usually electromechanical devices are the worst source of trouble. Speaker suspensions dry up and lose their elasticity, phono pickups become defective due to heat from adjacent tubes, and other sources cause crystals to go flat or rubber damping blocks to harden. Similarly, microphonic tubes, particularly in high gain preamps, can cause serious distortions if within range of loudspeaker radiations, often causing a serious transient peak somewhere in the high frequency range.

A number of other factors might be noted, both for the benefit of the novice constructor or the technician who may be called upon to fix a special system. One of these relates specifically to unwanted electrical feedback, especially in the case of audio amplifiers capable of supersonic bandpass. When a high gain system is used, such as is increasingly the case, sufficient energy may be fed back from the output of the system to a poorly shielded input to cause damped or continuous supersonic oscillations. This can cause splatter on high level musical passages and can cause a serious limitation on the undistorted power output available from the system.

Another source of annoying distortion results from the earlier mentioned arm resonance problem in phono pickups. This appears to be especially serious where certain crystal cartridges are concerned due to the fact that these elements may be sensitive to vibration applied at any part of the cartridge case. As a result, ringing resonances in the arm, or motor board noise, is readily transmitted through the audio system. By isolating the cartridge case from the tone arm with foam rubber or similar material a notable improvement may be obtained, particularly in cases where the needle apparently distorts on certain passages. Although magnetic cartridges appear to be relatively insensitive compared to the crystal it may be beneficial in some instances to use a

similar treatment. In either case, care should be taken that the compliance of the isolating material is not such as to cause or accentuate a serious low frequency resonance as an arm resonance of even a few cycles-per-second can cause fuzziness and modulation of high frequency components.

Loudspeaker Arrangements

Although the choice of a loudspeaker is of considerable importance in obtaining superior reproduction, in general, less specific information is available on this component than about the other links in the audio "chain." For the most part, the trend in recent years has been toward woofer-tweeter combinations for wide range reproduction. Although representing one of the simplest means of obtaining wide range sine wave reproduction, the high and low frequency speaker combination can result in some serious transient distortions. The transient reproducing ability of a direct radiator appears to be closely related to the primary resonant frequency of the diaphragm. Thus a woofer with a resonant frequency of forty cycles may exhibit poor transient reproduction throughout nearly all of its useful range. The tweeter, on the other hand, usually has a very light moving element with a relatively high resonant point. The result may be that the transient response is very uneven and distorted compared to the steady state measurements. The listening effects may be of harshness in the upper register, due to partial reproduction of transients in this area, and poorly reproduced low frequency tones which contain strong modulations.

A situation that more nearly seems to fit the requirements of good reproduction is to use a number of identical small radiators with relatively high resonance frequencies. An arrange-

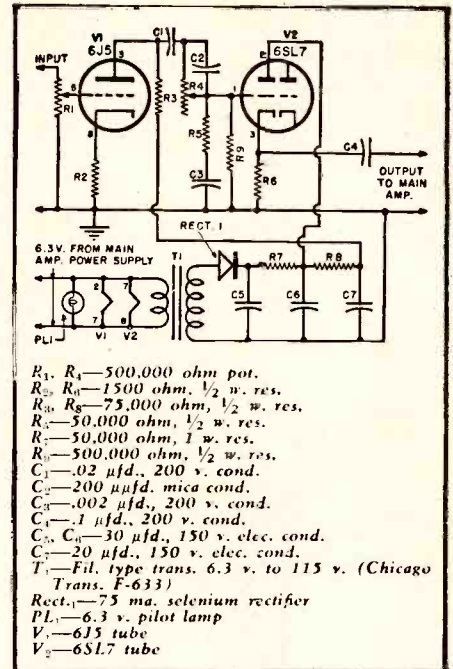
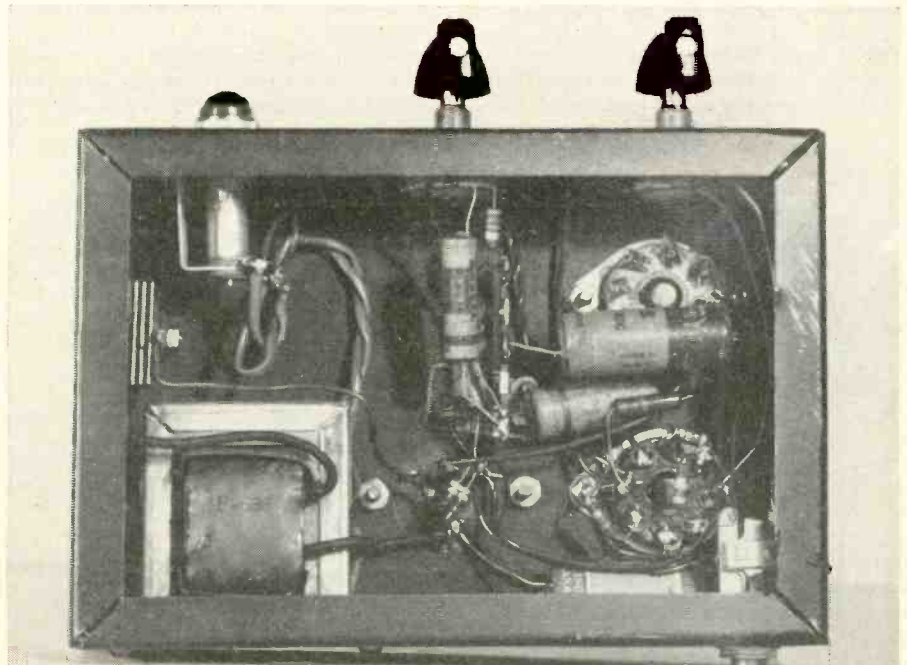

Diagram of preamp which incorporates distance control and novel power supply unit.

ment of this nature provides sufficient cone area to be effective at low frequencies but still maintains sufficiently low individual mass to provide good high frequency efficiency. Transient response of such a setup will tend to be equal to sine wave response below resonance and fall off smoothly above this point, a characteristic which tends to approximate the audible effects produced by a room in which the sound absorbency of the walls and furnishings increases with ascending frequency, a condition usually found in studios and concert halls.

Several problems are to be considered in setting up a system using a number of small loudspeakers. Chief

Bottom view of the preamp. The entire unit is built on a single, compact chassis.



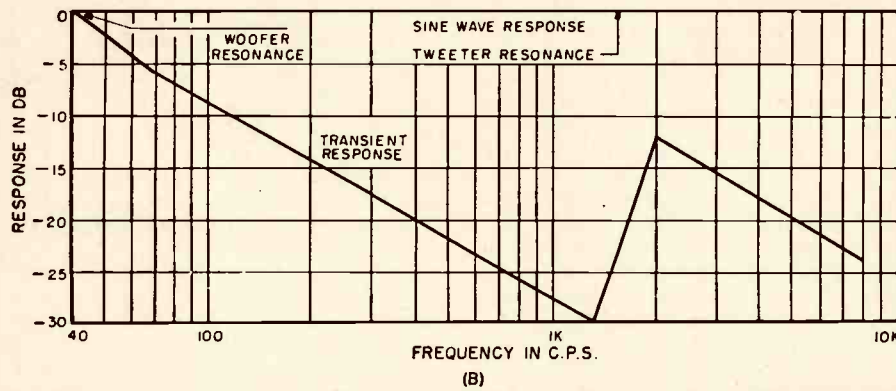
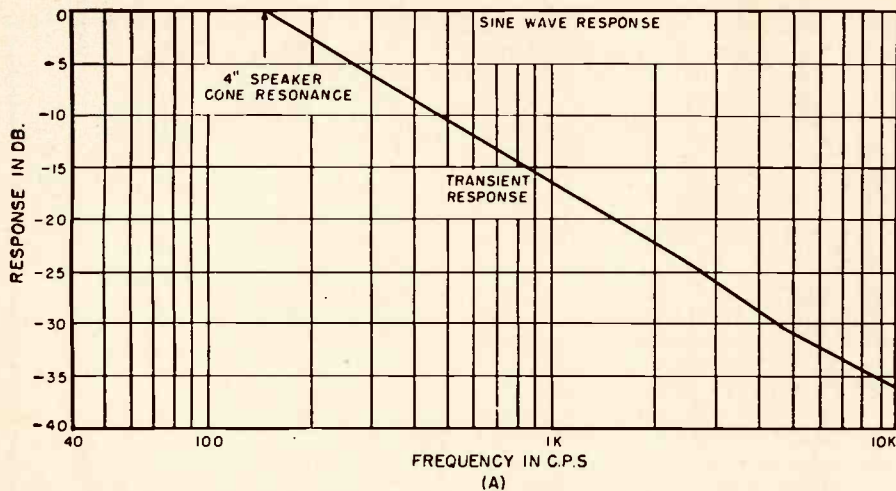

Graph of relationships between sine wave and transient characteristics in (A) a hypothetical woofer-tweeter combination, and (B) system using group of identical small speakers.

among these is the fact that the primary resonant frequency of a small five- or six-inch loudspeaker usually lies between one hundred and two hundred cycles, well within the audible range. To keep this from producing a peak in the frequency response it is preferable to use some means of speaker damping, either acoustical or electrical. In the latter case an amplifier with an appreciable amount of inverse feedback from the voice coil is desirable, with designs such as those described in the author's article, "Audio Transient Distortion" in the June 1949 issue of *RADIO & TELEVISION NEWS* performing very satisfactorily.

An arrangement using nine four-inch speakers is shown in the accompanying photographs. The cone area involved is about the equivalent of a single twelve-inch speaker but in comparison tests with a single extended-range twelve-inch cone the multiple speaker assembly showed superior power handling capabilities at both low and high frequencies as well as better transient characteristics although the over-all efficiency was somewhat lower. Conventional four-inch speakers, such as are obtainable for about one dollar from radio wholesalers, were used. However, in selecting loudspeakers, it is best to endeavor

Front and rear views of a multiple loudspeaker system using nine 4-inch speakers.

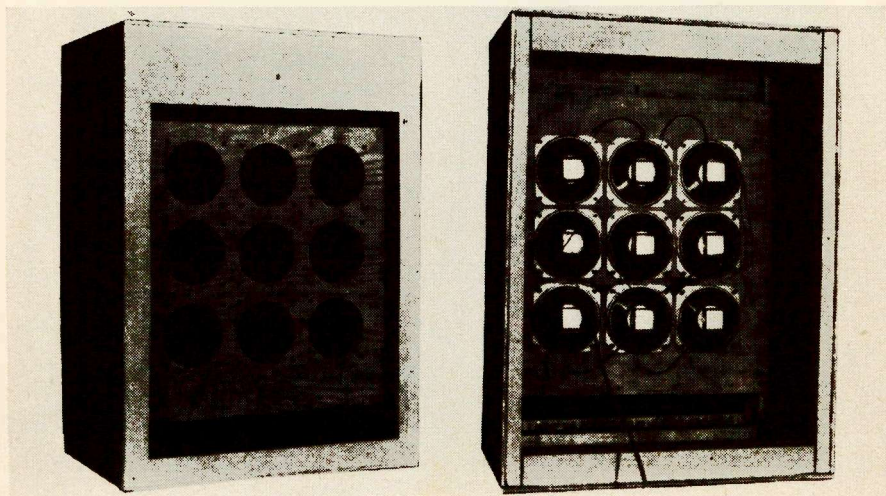

to obtain units with a relatively smooth over-all response, even though this may mean a falling off of response at high frequencies. The foregoing is the general characteristic of a simple piston type direct radiator, but in some cases the manufacturer may use special cone treatment to increase the apparent loudness or brilliancy of the speaker, with the result that some of the previously mentioned transient troubles of the woofer-tweeter combination may occur.

In the arrangement shown, all of the speakers are identically phased, with the exception of the one in the center. The voice coil leads are reversed with this unit, providing a small amount of acoustic inverse feedback. A series connection was used for all nine speakers as this tends to reduce the effects of impedance variations in individual units. However, as this provides a total speaker impedance of approximately thirty ohms, the constructor may prefer to use a series-parallel arrangement to lower the output impedance.

Due to the superior transient response in the low frequency region, it is wise to pay particular attention to the loudspeaker baffle used. A relatively heavy cabinet with rigid walls is preferable in order to prevent spurious vibrations of the speaker housing itself. Similarly, the cabinet should be lined with sound absorbent material, particularly in the case of a bass reflex type of enclosure, and all parts of the system should be tightened down carefully to prevent rattles.

In actual performance, from such high quality program sources as master tape recordings of band and orchestral music, the multiple speaker system described performed very well with excellent dynamic balance between high and low frequencies. Reproduction of low frequency transient tones, such as piano and string bass, was very good, being comparable to other systems using horn loading in the low frequency region. Even at high output levels no distortion was observed that was directly attributable to the speaker system. Even when used without any inverse feedback or loudspeaker damping the reproduction was quite acceptable although bass response was much heavier and speaker hangover tended to alter the tone color of certain sounds.

In conclusion it may be stated that the use of a group of small loudspeakers appears to have several advantages that may be of definite importance to the critical listener. An arrangement of this nature can be assembled at relatively low cost, compared to other high quality speaker systems. It should further be realized that a descending high frequency response in a loudspeaker does not necessarily mean poor power handling capabilities in this region and under certain circumstances it seems definitely desirable to introduce frequency correction in the audio amplifier rather than in the loudspeaker system.

EVEN the weather seemed to have a sort of hangover from the gay holiday season just passed. There was nothing about the bleak January morning to distinguish it from any other winter day, for it was neither exceptionally cold nor exceptionally warm, exceptionally bright or exceptionally dark. It was just another monotonous stretch of the calendar that had to be passed over on the way toward Spring.

Things were a little in the doldrums at Mac's Radio Service Shop, too. The work, for once, was all caught up, and Barney was taking advantage of this hiatus to clean up an old electric typewriter motor he had acquired. Mac watched him turning down the worn commutator, undercutting the mica between the segments, and cleaning the points that were part of the speed regulating mechanism before he finally spoke:

"May I be so bold as to ask what you intend to do with that thing when and *if* you get it running?"

"Ignoring the snide insinuation of that 'if,'" Barney replied, "I intend to use it in the color television converter I am building. This motor is a variable-speed, governor-controlled job, and I figure it will be just the ticket to turn the color disc. Do you concur?"

"I never like to discourage optimistic youth," Mac drawled lazily; "so I'll 'concur'; but you kind of remind me of the guy who finally pleads until he gets a car salesman to accept his order for a new car and then buys a can of auto-polish on the way home. A man in this ultra-fringe area is bettering par if he pulls a fair black-and-white picture four nights out of seven, and here you are getting all set for color."

"Well, doggone it," Barney said defensively, "I feel that I have to do something to keep abreast of this television game. The technicians in the good TV areas are getting so much ahead of us in experience that we'll never be able to catch up unless we use experimenting or something to make up for our lack of experience. We seldom have more than a couple of TV calls a week, while many of those birds in the large cities do nothing but TV work. By the time good television reception does get here, we'll be about as up to date as a three-circuit tuner."

Mac suppressed a grin at the glib way the boy mentioned a piece of radio apparatus that he had doubtless never seen, but he said gravely, "You've got a point there, Red, and I am glad to see you've been thinking about it; but I can't quite go along with you in believing that we are being left hopelessly behind in television servicing simply because we do not have the large volume of sets to work on. That *could* happen, but it doesn't have to."

"What's to stop it?"

"Concentrating on the 'Know-why' of television instead of the 'Know-how'."

Mac's RADIO SERVICE SHOP

By JOHN T. FRYE

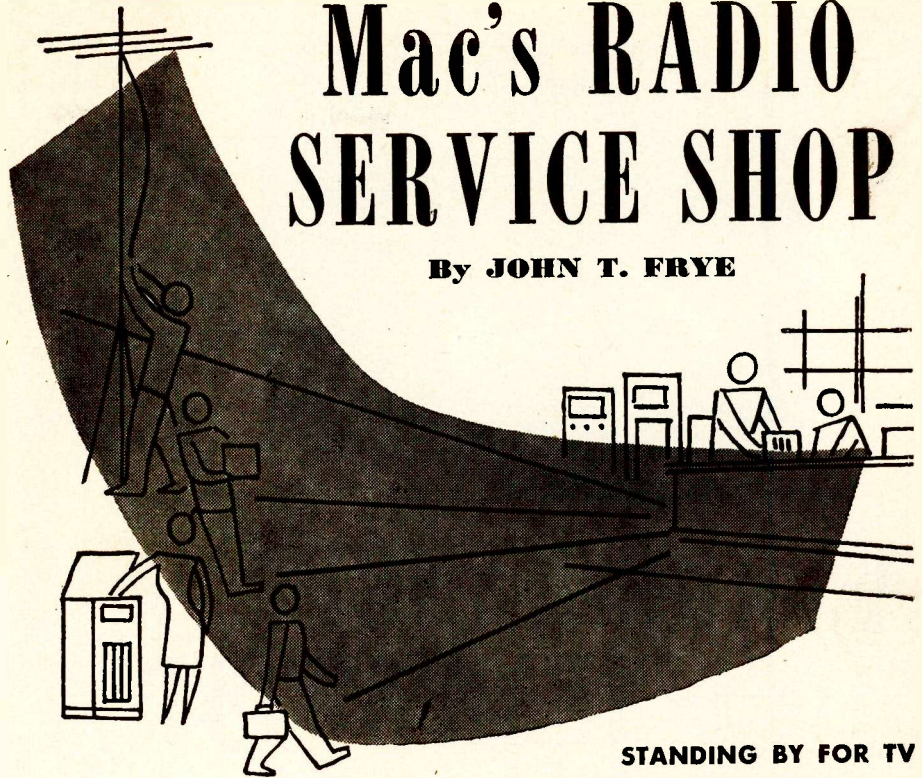

STANDING BY FOR TV

Barney's freckled face screwed up in puzzlement. "This is not one of my bright days, Boss; suppose you drag that past again a little more slowly."

"I mean that while our actual experience with television is likely to be pretty limited for some time to come, there is nothing to prevent our boning up on television theory; and I, for one, believe that in the long run a good sound knowledge of theory is worth more to a technician than any amount of unqualified experience."

"Whoa there! Back up!" Barney exclaimed. "Do you mean to sit there and say that it is better for a fellow to have a lot of theory sticking out of his ears than it is to be so familiar with a set that he can diagnose its trouble just as soon as he lays eyes on it? Why the experienced guy would have the set fixed and the ticket on it before your theory-man could unlimber his slide rule."

"Granted, but what is your learn-by-doing man going to do with the next set that comes in, a set that is a total stranger to him? Suppose it has a radically new type of tuning mechanism, a sweep circuit that is hot off the drawing board, and a fancy audio detector that he never even heard of before. None of the work he has done previously will help him find his way about these unfamiliar circuits. All he can do is probe around in the dark hoping that sooner or later he may stumble on the trouble. His experience, if he tries to depend upon it, may actually lead him astray, for the fact that one of the new circuits *looks* a little like one he is familiar with may cause him to waste hours working on the false assumption they are the same. Since he does not know why the various parts

are connected exactly as they are; he is in no position to judge whether or not those parts are doing the job they should."

"And what will your theory-man be doing with it?" Barney challenged.

"He, too, will be seeing the set itself for the first time, but he has studied the circuits long before this in books and magazines and has made himself thoroughly familiar with the way they operate. Knowing, as he does, why each part occupies the place it has in the circuit, he can quickly determine if it is properly performing its function. His testing will not be a hit-and-miss affair but will be an orderly comparison between actual operation and intended functioning."

"Sounds as though you are trying to fast-talk me," Barney stubbornly contended. "I think you can get your knowledge from books or you can get it from experience; but what you learn by doing is a lot more dependable and sticks with you a lot better. If that guy had worked on enough sets, he would not be meeting up with new ones. His trouble was simply that he did not have *enough* experience."

"There just isn't enough experience to keep you from meeting up with new problems," Mac patiently explained, "but let's approach it from another angle: experience is like a set of handmade wrenches that a mechanic has fashioned to take care of the nuts he ordinarily encounters in his daily work. Being handmade each wrench really fits the nut for which it was made and is quick to use. Theory, on the other hand, is an adjustable wrench that must be reset for every different size, but it will fit *any* nut, large or small. The advantage

(Continued on page 104)

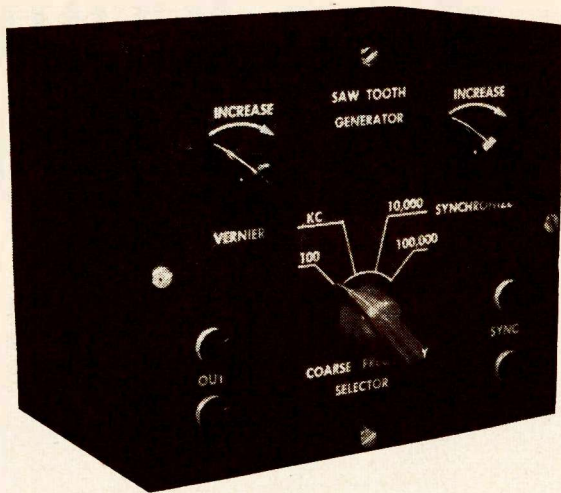

Fig. 1. Over-all view of unit built into a small utility cabinet.

A WIDE-RANGE LINEAR SWEEP

By
LOUIS E. GARNER, JR.

FOR a long time gas triode sweep circuits were used almost exclusively to provide a linear time base in both commercial and home-built cathode-ray oscilloscopes. The result has been that the majority of scopes in use at the present time employ this type of sweep circuit.

Basically, the gas triode sweep circuit, shown schematically in Fig. 2, is very good, providing a linear sweep with short "flyback" time over a reasonably good range of frequencies. In operation, a condenser (C_1 to C_6) is charged through a series resistor (R_1 and R_2) from the "B" supply. The gas triode is connected across the condenser and when the d.c. voltage across the condenser reaches the proper value for "firing" the gas triode, this tube conducts heavily and discharges the condenser. As the voltage across the condenser drops to a low value, the tube stops conducting, and the condenser starts charging again. The entire operation is repeated. Thus, the saw-tooth or linear sweep produced follows a portion of the "charge" curve for the RC circuit.

The frequency of operation is controlled by varying the time constant of the resistor-condenser charge-discharge circuit. Selecting different capacity values by means of the "Coarse Frequency" switch selects the range, while the exact operating frequency is adjusted by means of a "Fine Frequency" rheostat. Synchronization of the circuit with an external signal can be accomplished by feeding a small signal to the grid, which serves to "trigger" the gas triode at the proper

A multivibrator type unit which has four ranges and covers 10 to 100,000 c.p.s.

point, causing it to discharge the condenser earlier on the charge curve, and thus bringing the sweep into sync with the observed signal.

Unfortunately, this type of sweep circuit, while satisfactory for sweeps up to about 30 kc., cannot be easily used at much higher frequencies. This is due to a number of factors, the most important of which are the tube characteristics themselves—the fact that the tube takes a certain time to discharge the condenser (limiting the "flyback" time), the fact that the tube takes a certain time to "recover" (limiting the frequency of operation), etc.

For the study of wide-band amplifiers, for checking and testing video amplifiers, and for similar applica-

tions, it is often desirable to observe signals as high as *several hundred kilocycles*, or more. A 30 kc. sweep would present too many cycles of a high frequency signal on the cathode-ray screen, and thus make close observation and analysis difficult. For this reason, many of the modern scopes as well as the more expensive units, employ a multivibrator type of sweep, permitting sweeps as high as 100 kc. or more.

A suitable wide-range, multivibrator sweep circuit is shown in Fig. 3. This circuit will provide an essentially linear sweep (saw-tooth signal) from approximately 10 cycles per second to 100,000 cycles per second in four ranges. The sweep, as shown, can be added to an existing oscilloscope by building it in a small metal utility box as shown in Fig. 1, or, if preferred, the old sweep can be removed from the scope, and the new circuit wired in place.

In operation, this sweep is somewhat similar to the thyatron sweep previously described, in that the saw-tooth signal is obtained by utilizing a portion of the charge curve of a resistor-condenser combination. The essential difference is in the fact that a multivibrator is used for discharging the condenser rather than a gas tube. By doing this, a faster discharge can be obtained, together with a wider range of operation as far as frequency is concerned. The only disadvantage of the circuit is that it is slightly more complex than the gas triode sweep.

Two RC combinations are used in the multivibrator sweep, one for controlling the frequency of operation and one for the charge-discharge circuit across which the saw-tooth signal is produced. In Fig. 3, with the "Coarse Frequency" switch set as shown, the combination $R_1-R_2-C_1$ acts as the charge-discharge circuit, while the combination $R_3-R_4-C_2$ serves to determine the frequency of operation. Note that the time constant (RC product) of the charge-discharge circuit is much greater than that of the frequency determining circuit. This is necessary to insure a linear sweep.

A dual pot is used for the fine frequency or "Vernier" control so that both RC circuits can be varied simultaneously. This serves to keep the output amplitude at a reasonably constant value over any range.

To minimize the number of parts required, and thus to keep both the cost and the size of the circuit down, the condenser used in the frequency determining circuit on one range is used in the charge-discharge circuit on the next higher range.

Synchronization of this circuit can be obtained by applying a negative-going pulse to the grid of the multivibrator. As shown, a pot is provided for controlling the level of the "sync" signal.

This particular circuit, known as a "Potter" multivibrator, is quite popular and has been used, in modified

Fig. 2. The gas triode sweep circuit.

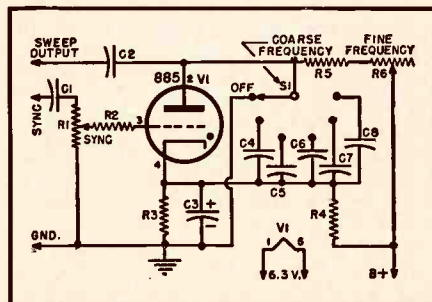

form, in a number of the better commercial scopes.

The entire unit can be easily built in the 4x5x6 metal utility box as shown in Fig. 1. When decal labels are applied, a neat professional appearance can be obtained.

Since only one tube is used, power requirements are small, and a terminal strip or plug can be provided on the back of the unit. Power can then be supplied either from a small power supply, or from the oscilloscope itself.

Leads should be kept as short as possible, and small parts should be used to minimize distributed capacities and to prevent "rounding" of the higher frequency sawtooth signals. Otherwise, wiring is not especially critical.

It may be difficult to find the special dual pot required as a stock item at your local wholesalers, but an inquiry indicated that special dual pots could be obtained on order, at regular prices, although there might be a delay of one or two weeks. In addition, it is understood that at least one resistor manufacturer is producing "kits" from which almost any desired dual pot combination can be assembled by the builder.

If it is not desired to build the sweep as a separate unit to be used as an accessory with an already existing scope, but to wire the circuit in as an integral part of the unit, then it is convenient to add the "Sweep-Sync Selector" switch shown in Fig. 5. Again, part numbers and connections refer to Fig. 3.

A 3-pole, 5-position switch is employed to provide a variety of sweep and sync conditions. With the switch in the position shown, the multivibrator sweep is used and it is synchronized with the signal applied to the vertical plates of the scope (internal signal). The shielded lead shown connects to the plate of one of the vertical amplifier tubes in the scope.

When the switch is turned to the "Ext." position, the linear sweep is still used, but can now be synced with an external signal applied to the "Sync" terminals.

With the switch in the "Line" position, the linear sweep is still connected, but is now synced with the 60 cycle line voltage.

In both the "H Amp." and "60 Cycle" positions, the linear sweep is turned off. An external sweep signal can be applied to the scope horizontal amplifier at the "H Input" terminals when the switch is in the "H Amp." position, while a 60 cycle sine wave provides the sweep in the "60 Cycle" position.

Return trace blanking may be obtained by applying the pulse on pin 6 of the 12AT7 (Fig. 3) to the cathode of the CRT through a 250 $\mu\text{fd.}$, 1500 volt condenser. If the cathode of the CRT is bypassed to ground, connect a 100,000 ohm, $\frac{1}{2}$ w. resistor in series.

When building the sweep, if you cannot find the capacity values speci-

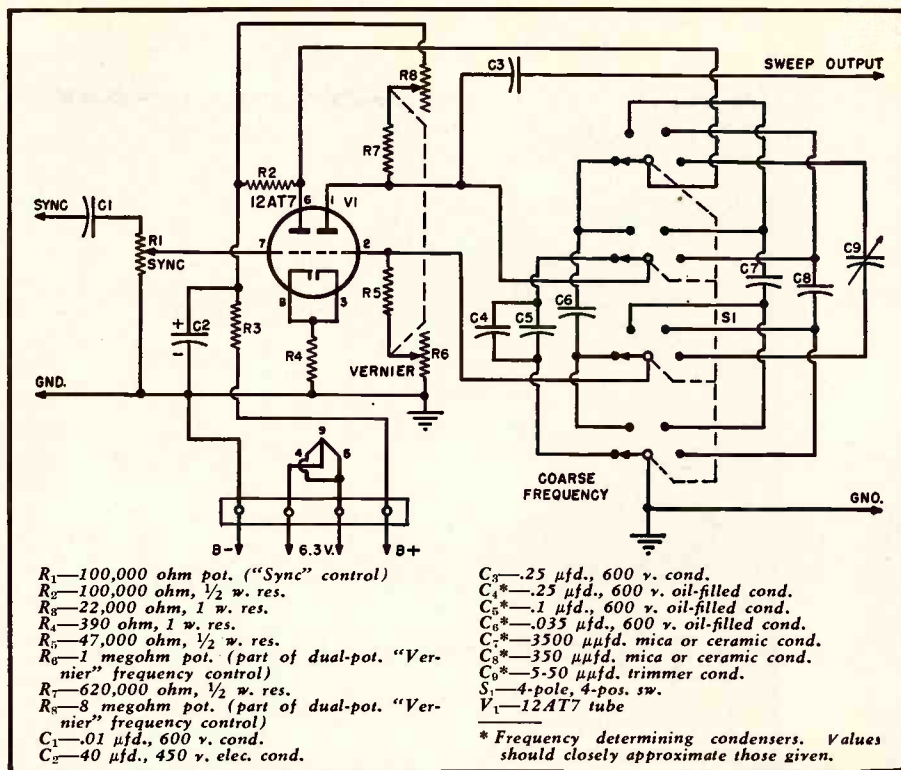

Fig. 3. Complete schematic diagram of the wide-range, multivibrator sweep circuit.

fied at your local supplier, parallel combinations may be used to get the values shown.

If the sweep is built as an integral part of the scope, it is used in the conventional manner. With the "Coarse Frequency" switch in the position shown, the frequency range is approximately 10 to 100 cycles; in the next position from 100 to 1000 cycles; in the next position from 1000 to 10,000 cycles; and in the last position from 10,000 to 100,000 c.p.s. This last range is determined by the adjustment of C_9 . All values are approximate only, for there is actually an overlap on each range. In addition, the actual frequency will change somewhat with different "B" voltages.

To set C_9 , turn the fine frequency control or "Vernier" to its highest frequency position, with the "Coarse Frequency" control in its last range. Apply a 100 kc. signal to the scope, and adjust C_9 and the "Sync" controls until only one cycle appears on the screen. An insulated alignment tool should be used for this adjustment.

If the sweep circuit is built as an accessory, as shown in the photo (Fig. 1), then the connections to the scope are as shown in Fig. 4. Power can be supplied either from the scope itself or from a separate supply. The scope sweep selector is set so that the internal sweep is disconnected and a signal can be applied directly to the horizontal amplifier. Once this is done, the sweep controls (except for "H. Gain") are disregarded on the scope, and the controls on the sweep unit used instead. They are operated in a conventional manner, sync being supplied by the input signal.

If the scope with which this unit is

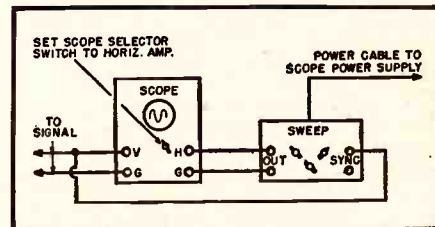
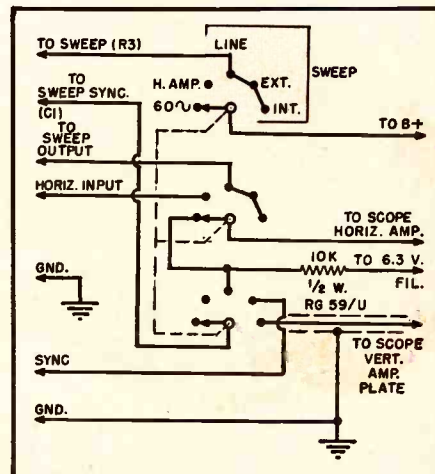

Fig. 4. Method for hooking up sweep unit.

used does not have a wide-band horizontal amplifier, there may be some rounding of the higher frequency sawtooth signals, resulting in a sweep which is non-linear at the ends. The effect of this can be minimized by expanding the sweep to "oversweep" the screen and using only a portion of the sweep for observing signals.

—30—

Fig. 5. "Sweep-Sync Selector" switch for use when unit is built into scope cabinet.



By
R. H. KRUEGER

A Deluxe SIGNAL TRACER

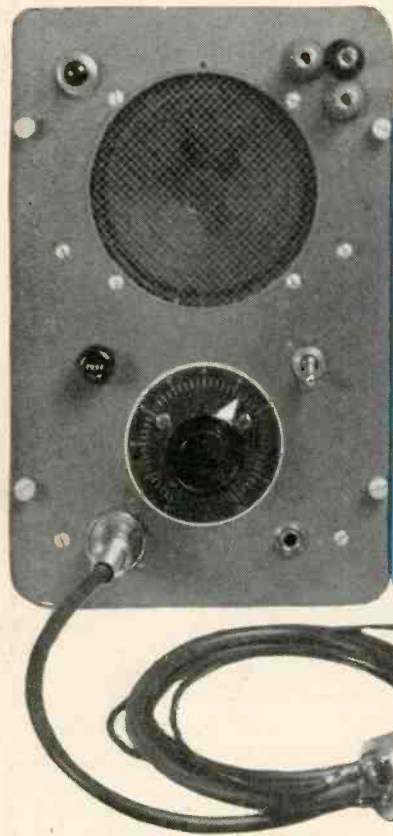

Fig. 1. View of signal tracer. The panel measures 10 5/8" x 7". Unit is 6" deep.



Fig. 2. Detailed view of the untuned detector probe assembly.

In combining a good, all-purpose, 3-stage audio amplifier and an untuned detector, the author has devised a handy, laboratory-type instrument.

THE need for a good, all-around audio amplifier with high voltage gain and a moderate amount of power output for checks in laboratory and radio service shops is not to be disputed. The one herein described meets these requirements admirably, however it was designed primarily as a signal tracer.

The instrument consists of a power supply, a three-stage audio amplifier with wide frequency response, and an untuned detector—the detector being contained in a probe. Of particular interest in the power supply is the filter circuit which is composed of a conventional filter choke and condensers followed by the resistance-capacitance filter circuit described by H. H. Scott in "Electronics" (Vol. 12, No. 8, pages 42 to 48, August, 1939).

As will be seen from the diagram, the high voltage d.c. for the power audio stage is taken from the filter choke. The high voltage d.c., which is supplied to the first and second audio stages, is additionally filtered by the resistance-capacitance filter. Additional filtering is also used on the detector stage.

In the design of any piece of test equipment certain techniques must be followed so that the over-all appear-

ance and the ease with which the instrument may be assembled and wired will not be impaired. A few of these features will be described. First, the over-all appearance of the finished article must be neat and the panel, if one is used, (and most equipment pertaining to radio and electronics will have a main panel) must have a well-designed and finished appearance. This was accomplished in the design of this instrument as shown in Fig. 1. Secondly, the controls, such as gain control, "On-Off" switch, and the input and output connections together with any other items such as the power line cord and fuse must be easily accessible and arranged for the utmost ease in operation. Next, and one of the most important features, is the actual design and layout of parts on the chassis so that when all of these features are combined we have an instrument which will not only have a good appearance but will work to the utmost satisfaction with the greatest of ease. Not to mention, however, are the features in the design and construction which enable the instrument to be easily assembled and wired. Too often little consideration is given to the problem of servicing the instrument and since any

piece of electrical or electronic equipment will need a bit of service from time to time as years go by this is a factor which requires attention.

Since this instrument is comprised of a high gain audio amplifier of excellent tone qualities, a detector circuit which is contained in the probe, plus a power supply, it is not likely that it will ever become dated. With this in mind it was decided to design and construct this instrument and then present all the necessary information so that the future duplication of this instrument would be possible.

Although some items could have been omitted and some savings could have been made, such as the panel which could have been constructed of much thinner material, these savings were not considered practical.

The probe was made removable so that the audio amplifier could be used alone, and several output connections were made in order to give the user a choice. The whole instrument was housed in a welded sheet aluminum cabinet which was finished in dark gray crackle finish. A handle has been provided on top of the cabinet so it can be carried easily.

With all the design features mentioned and with great thought as to the final product, a check was made on the necessary parts to be used. Wherever possible standard parts were used so that replacements could be easily obtained in the event that they are needed for repairs. The items of particular interest are the *General Radio* dial plate which is used as a gain or

volume indicator and the binding posts, made by the same company, which are located in the upper right hand corner of the main panel. These items add greatly to the appearance of the finished signal tracer and give the instrument a very professional look. In addition, resistor and condenser mounting terminal boards were used wherever the wiring called for such. This type of construction is neat appearing and lends itself to cable wiring wherever possible. In addition, such individual groups of resistors and condensers can be placed as to make them easily accessible for checking the circuits. The wires were laced together as shown in Fig. 5. Care should be taken so that none of the parts are arranged in such a manner as to produce unwanted feedback circuits which will cause oscillations. Fig. 3, from left to right, shows the 6SN7, the 6V6, and the 5Y3 tubes. The guide pin on the 6SN7 points to the lower right hand corner, that of the 6V6 points to the upper left hand corner, with that of the 5Y3 in the same direction. This arrangement is conducive to good wiring practice as all coupling condensers and resistors can then be mounted directly on the tube sockets.

A voltage output curve vs. frequency (Fig. 4) was plotted on a piece of graph paper and shows the gain without the probe. It can be seen from this chart that the gain is nearly constant over the frequency range of from 50 cycles to 30 kilocycles. Since the chart was plotted in volts rather than db, it falls off on either end. The voltage to the input of the amplifier was kept constant and measurements were made across the voice coil winding with a 3.2 ohm non-inductive resistor load.

The Main Panel

The main panel was constructed out of a piece of three-sixteenths inch thick aluminum. A piece of one-eighth inch wire mesh is used to cover the speaker opening in the panel. The panel light is placed to the left and at the top of the panel (Fig. 1). To the right of the speaker and at the top are placed the three *General Radio* binding posts. Two red and one black binding posts are used, as indicated in the schematic diagram (Fig. 6). The black binding post is used as "common," the other two for either high or low impedance, for speakers with or without output transformers. At the bottom (Fig. 1) and to the right is the phono-jack which, when plugged in with phones or speaker, automatically disconnects the speaker within the signal tracer. A vacuum tube voltmeter may also be connected to either the high or low impedance for visual signal tracing.

On either side and just below the speaker are located the fuse (left) and the power switch (right). At the bottom of the panel, at the left, is the *Amphenol* connector for the probe cable. Below the speaker and in the center of the panel is located the vol-

ume control which uses a *General Radio* dial plate.

In laying out the panel every effort was made to provide well-balanced appearance and yet have all connections and controls within reach of the operator. Quality parts were used throughout with the result that this unit is a very rugged instrument. The panel was finished in dark gray crackle lacquer. Oval head machine screws were used to mount chassis and speaker while knurled head thumbscrews were used to hold the unit in its cabinet.

The Amplifier

The amplifier consists of three stages wired in a resistance-capacity coupled circuit as shown in Fig. 6. The first two stages are triode voltage-amplifier, followed by a beam power output stage. Cathode degeneration is employed on the input stage, followed by additional degeneration between the second and output stage. The design of this circuit results in low hum, wide frequency range, excellent stability, low distortion, and good phase-shift characteristics, because of the inverse feedback used. The number of tubes was kept to a minimum by the employment of a dual triode in the first two stages of the amplifier. Fig. 5 shows the signal tracer in the position for wiring. All wiring is done before the panel is attached to the chassis, with the exception of the four wires and shield which are visible at the lower left hand corner. These wires go to the speaker and panel lamp and are easy to reach for soldering after the panel is attached.

Again referring to Fig. 5 the two wires which run from the phono-jack to binding posts and speaker transformer were shielded. The wire which leads from the volume control to the tube grid and the plate lead from the output tube were also shielded. All wires from the power transformer to the tubes, resistor strips, and probe receptacle wire were laced together to form a neat wiring job.

The two cutouts in the mounting flanges, as shown in Fig. 5, were made in order to clear the "On-Off" switch and fuse holder, when the chassis is

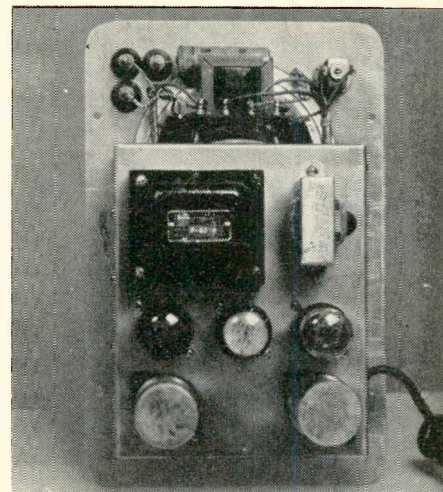

Fig. 3. Rear view of signal tracer. Note how all of components are, in final assembly, secured to the front panel of unit.

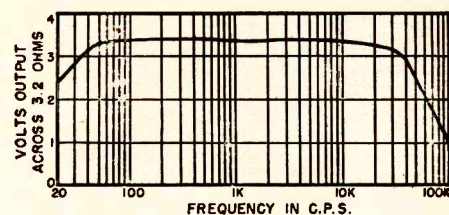

Fig. 4. Frequency response of audio amplifier. Over-all gain (without probe) is reasonably constant from 50 to 30,000 c.p.s.

mounted to the main panel. The power output and gain is adequate for all test purposes including reluctance pickups and microphones. The over-all gain and frequency response are indicated on the frequency chart shown in Fig. 4.

The Probe

The probe was made up as follows and is diagrammed in Fig. 7. Nos. 1, 2, and 4 were made from a standard test prod. No. 1 is the phono-needle and No. 2 the chuck. The chuck was cut off, drilled and tapped to take the screw (No. 9) which is a 4-40 machine screw, and just long enough to make a tight fit so that the whole assembly is held together firmly. No. 4 is the insulated sleeve which was cut to a length of one and three-sixteenths inches, drilled out with a one-quarter inch drill and then countersunk to fit the chuck as shown.

Fig. 5. Wiring details. Chassis on left folds over and is secured to the front panel.

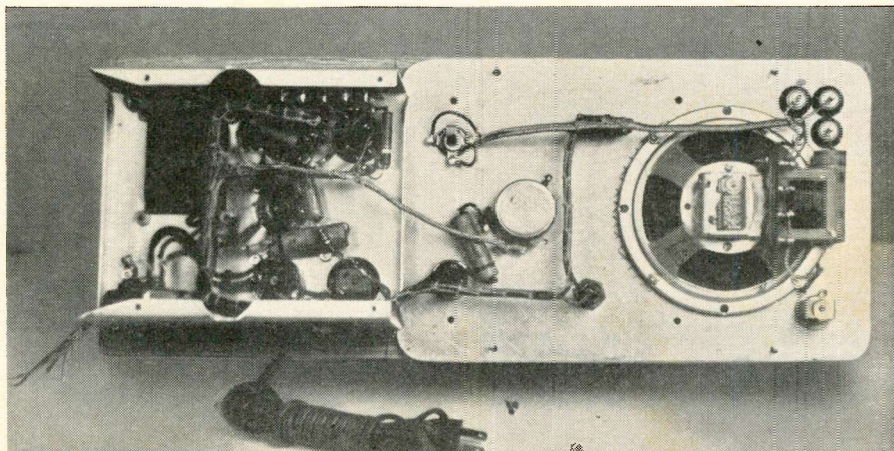

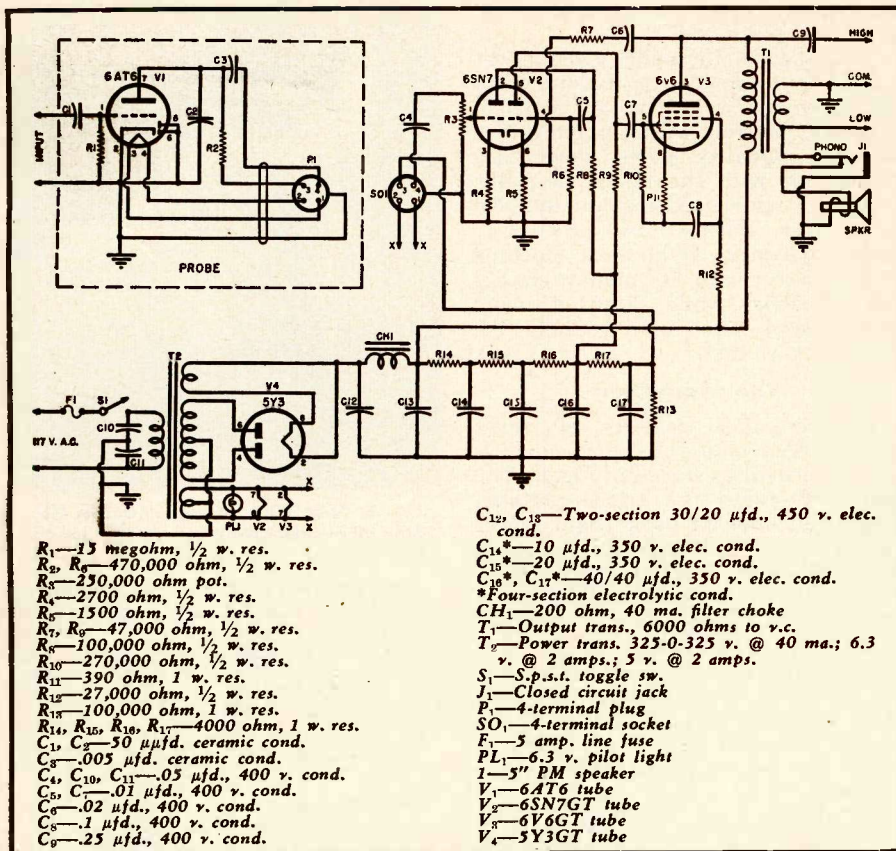
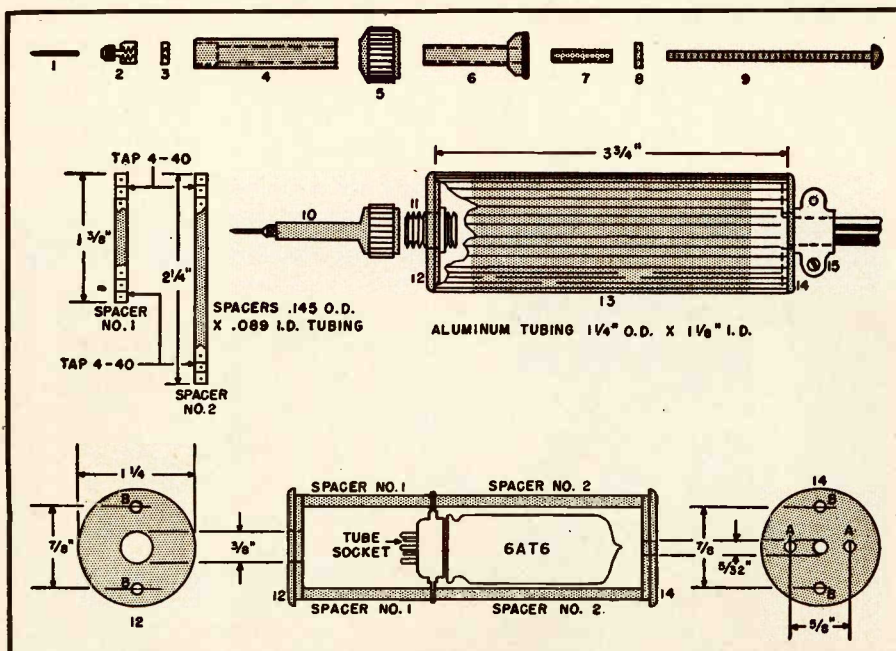

Fig. 6. Schematic diagram of signal tracer. The probe assembly is shown in upper left.

Nos. 3, 6, 7, and 8 were parts from a Yaxley phono-plug. The plug was taken apart and part No. 6 was cut down, as shown, to fit into part No. 5. Part No. 5 was taken from an Amphenol connector, since it has the same thread inside as the threads on the phono-plug. No. 7 is the insulated sleeving that insulates screw No. 9 from the phono-plug. In Fig 7 looking at Nos. 1, 2, 3, 4, 5, 6, 7, 8, and 9, we have, in order, the assembly of the

probe tip. This tip is removable from the rest of the main probe. This assembly results in a tip which is shielded right out to within three-fourths of the end, and which is insulated to prevent shorts in case the probe should accidentally slip when making tests on a receiver. In Fig 7, No. 10 shows the tip assembled and ready to be screwed into the Amphenol microphone connector which is mounted on the end plate of the probe proper. Nos. 12 and 14

Fig. 7. Complete mechanical details for constructing the untuned probe assembly.



are the two end plates of the probe. They are made out of a piece of aluminum. The tube housing of the probe was made out of aluminum tubing and a medium knurl was put on, thus adding considerably to the appearance of the probe. A cable clamp was used, No. 15, to take the strain from the connections inside the probe. Ceramic condensers and one-quarter watt resistors were used inside the probe since space was at a premium. The two sets of spacers also hold the miniature tube socket in place, a length of 4-40 threaded rod couples both sets of spacers together. A small insulated terminal strip with two insulated lugs was soldered to the metal part on the tube socket and serves as a tie point for the "B" positive and plate leads. The two filament wires from the probe cable were connected directly to the filament terminals on the miniature socket, the shield of the cable being soldered directly to the metal part of the socket.

In order to remove the tube from the probe all that is necessary is to loosen the two 6-32 screws on the cable clamp, remove the 4-40 screws that hold the cable clamp to the end plate, remove the end plate and slide it back together with the outer shell of the probe and the tube is easily lifted out of its socket. The material for the outer shell and spacers was procured from a hardware supply dealer. A thirty inch length of four-wire shielded rubber-covered cable and an Amphenol four-contact male connector completes the probe. This unit measures about six and one-half inches long overall and one-quarter inch in diameter, a size which is easily handled and is not too bulky. The slender tip of the probe is easily applied to any part within a radio set. A ground wire and alligator clip were attached to the cable clamp for clipping onto the ground of a radio set when the probe is used.

The power is turned on and the unit is allowed to warm up. With the probe attached several stations will be heard when the probe is touched to the antenna terminal of a radio. The signal can be traced right down to the speaker by touching the probe to various connections within the radio. A general discussion of signal tracing has been published in past issues, so it will not be given here. The three binding posts at the top of the panel are for connecting to a vacuum tube voltmeter or other suitable meter for visual indication and measurements of approximate gain in signal strength. Other uses of this instrument include checking of speakers for tone quality, etc. Microphones and phono-pickups may be checked for quality and output characteristics by plugging them directly into the probe receptacle or the probe tip may be removed and used as an input receptacle. This will increase the over-all amplification as the tube in the probe is also used as a stage of amplification.



International

SHORT-WAVE

Compiled by **KENNETH R. BOORD**

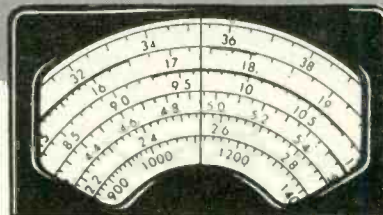

THIS month—through the courtesy of Flavio Serrano, *ISW DEPARTMENT* monitor in Rio de Janeiro, Brazil, we present this data on Mexican radio activities:

Mexico has 95 commercial stations and 4 cultural stations operating on m.w.; there are 14 commercial and 4 cultural stations operating on s.w. Highest-powered station on s.w. (XE-WW) uses 10 kw., while the highest-powered m.w. outlet (XEX) has 250 kw., reported to be "the world's tops." Two 500 kw. m.w. stations now are under construction and more than 130 licenses have been issued for the Tropical Band; two TV transmitters—a *RCA* and a *G-E*—are under construction in Mexico City, and another TV license has been issued for a location near the Mexico-USA border.

Short-wave outlets are listed—*Commercial Stations*—XEOI, 6.01, 2.5 kw., Mexico City, D.F.; XEUW, 6.02, 250 w., Veracruz, Ver.; XEKW, 6.03, 500 w., Morelia, Mich.; XETW, 6.045, 100 w., Tampico, Tams.; XEUZ, 6.13, 100 w., Mexico City, D.F.; XECC, 6.185, 50 w., Puebla, Pue.; XEWW, 9.50, 10 kw., Mexico City, D.F.; XEFT, 9.545, 250 w., Veracruz, Ver.; XETT, 9:555, 500 w., Mexico City, D.F.; XERQ, 9.61, 500 w., Mexico City, D.F.; XEBT, 9.625, 500 w., Mexico City, D.F.; XEQQ, 9.68, 1 kw., Mexico City, D.F.; XEBR, 11.82, 150 w., Hermosillo, Son., and XEHH, 11.88, 1 kw., Mexico City, D.F. *Cultural Stations*—XEJG, 4.82, 200 w. Guadalajara, Jal.; XEEP, 6.155, 1 kw., Mexico City, D.F.; XEXA, 6.175, 100 w., Mexico City, D.F., and XEYU, 9.60, 250 w., Mexico City, D.F. (Not listed is the Mexican s.w. outlet on 11.90 which appears to relay XEX.—KRB).

Here are the s.w. calls, local QRA's, and m.w. calls—XEOI, Fomento de Radio, Plaza Santos Degollado 10 (XEOY); XEUW, Independencia 230 (XEU); XEKW, Aldama 154 (XESF); XETW, Madero 204 Ote. (XEFW); XEUZ, Radio Central de Mexico, Reforma 51 (XEFO); XECC, 2 Norte 803 (XECD); XEWW, Cadena Radio-difusora Mexicana, Ayuntamiento 54 (XEW); XEFT, Independencia 74 (XETF); XETT, Dolores 17 (XEQK);

(Note: Unless otherwise indicated, all time is expressed in American EST: add 5 hours for GCT. "News" refers to newscasts in the English language. In order to avoid confusion, the 24 hour clock has been used in designating the times of broadcasts. The hours from midnight until noon are shown as 0000 to 1200 while from 1 p.m. to midnight are shown as 1300 to 2400.) The symbol "V" following a listed frequency indicates "varying." The station may operate either above or below the frequency given.

XERQ, Corporacion Mexicana de Radio, Reforma 51 (XEQR); XEBT, El Buen Tono, Calle del Buen Tono 6 (XEB); XEQQ, Radio Panamericana, Jose Maria Marroqui 11 (XEQ); XEBR, Serdan 144, (XEBH); XEHH, A.R.S.E., Zempoala 77 Col. Narvarte (XERH); XEJG, Gobierno del Estado de Jalisco, Palacio de Gobierno (XEJB); XEEP, Secretaria de Educacion Publica, Av. Argentina y Gonzales Obregon (XEOF); XEXA, Radio Gobernacion, Calle de Bucareli (XEDP), and XEYU, Universidad Nacional de Mexico, Calle de Justo Sierra 16 (XEUN).

* * *

Club Notes

New Zealand—The *New Zealand Radio DX League* at its recent annual meeting chose these officers for the coming year—Dominion president, Arthur T. Cushen; vice-presidents, A. M. Branks, J. I. Martin; secretary-treasurer, D. L. Lynn; members of the Board of Directors, L. E. Warburton, W. Marsh, A. Allen (Invercargill), L. M. Gerrie, J. F. Fox, F. T. Wilson (Dunedin); magazine committee (*N.Z. DX Times*), Messrs. Branks, Cushen, Warburton, Marsh, Allen; administrative committee (Dunedin), Messrs. Fox, Lynn, Martin, Wilson, Gerrie. (*N.Z. DX Times*.)

* * *

This Month's Schedules

Albania—Radio *Korce*, in southeastern Albania, is a new station on 7.680, heard 0100-0200, 0700-0900, 1200-1430; times vary from day to day; poor modulation; seems to be on test. Scutari, 8.215, is on the air 0100-0200, 0700-0830, 1100-1530. (Radio Sweden.)

Algiers—The 9.57 outlet noted with news in French 1745; signs off 1800.

Frank G. Harile, Oil City, Pa. uses a Hammarlund HQ129X and an RME DB20 preselector.



Anglo-Egyptian Sudan—Radio *Omdurman* is again heard nightly on its old frequency of 9.747 with good-to-excellent level at 2315-2345; all-Arabic. (Fargo, Ga.)

Angola—Radio Club de Benguela broadcasts in Portuguese on 4.815 and 9.165 at 0615-0745 (Sun. to 0700) and 1230-1400 (Sun. from 1200); Radio Club de Malange, Malange, can be heard on 7.165 weekdays 0700-0745, 1430-1530, Sundays 0200-0300, 0730-0830; Radio Club da Huila, sa da Bandira, has programs in Portuguese daily 0630-0730, 1300-1500 on 5.024 and 9.755. (*World Radio Handbook Bulletin*) Radio Club de Nova Lisboa, 11.925, noted 1345 with varied recordings; heard until after 1500. (Pearce, England).

Argentina—At the time this was compiled, LRA, 9.69, the new 100 kw. s.w. outlet, appeared scheduled to North America daily 1800-1900 in Spanish and 1900-0000 sign-off in *English*. Operates separately from other Buenos Aires international outlets, including LRY, 9.455 which has *English* evenings also around 2115-0100.

LRA, 9.69, comes on the air 1800 with 5-note chime and announces in Spanish "SIRA, Servicio Internacional Radiofonica Argentina." (Stark, Texas) Serrano, Brazil, says LRA is the call now used also by former LRY, LRS, and LRU.

LRT, 11.84, Tucuman, noted 1959 with recorded music. (Bromley, Ontario.)

Australia—Radio *Australia* currently is using VLCT, 11.81, to North America daily 0700-1115; news 0715, 0815, 0930.

VLX, 4.897, Perth, Western Australia, heard with news 0645 daily. (Cox, Delaware.)

Austria—Salzburg, 9.615, signs on now 2355 with schedule, then carries "Rise and Shine" at 0000. (Cushen, N.Z.)

Azores—CSA92, 11.090, Ponta Delgada, heard opening 1500 and closing 1559; good level in North Carolina.

Belgian Congo—OTC2, 9.767, now broadcasts 1100-0100 in French, Dutch, *English*, and Flemish; *English* periods include 1400-1500 and 2030-0015. (Neeley, Calif.)

Bolivia—Stark, Texas, is again hearing La Paz on 9.497 at 1850-2116 sign-off; has "Noticias Internacionales" (world news) in Spanish 2100 to sign-off. Oskay, N.J., reports CP21, 9.428, Sucre, with music 1850.

(Continued on page 120)

A Practical Approach To NEGATIVE FEEDBACK

A review of the advantages of inverse feedback. Several proven circuits on how degeneration can be applied are also included.

By
B. E. PARKER
V.H.F. Eng., Gates Radio Co.

MANY of us have often considered adding a negative feedback circuit to existing audio amplifiers or incorporating it in new ones we may be building. A large amount of material has been published on this subject; however, it has all been on a highly technical level, usually accompanied by long mathematical formulas. Often the net result is that we forget about the whole thing or wind up with an arrangement not at all suited to our needs.

Strangely enough, the application of feedback does not necessarily require struggling with these long complicated formulas and equations. Like most other radio problems it can be attacked quite effectively from the old practical shirt-sleeve approach. A general understanding of what constitutes negative feedback and the factors involved, together with a few proven circuits, can achieve the same results just as effectively.

It would be foolish to say that the approach via mathematical equations is no better than our practical shirt-sleeve approach. To do so would be comparable to saying a wrench is no better for removing a nut than a pair of gas pliers. Naturally the wrench will do a better job quicker. But the pair of gas pliers will accomplish the same end result if applied with a will. Our approach to the feedback problem is the "gas pliers" approach. We analyze the fundamental requirements for feedback and present a few practical circuits with parts values used in commercial equipment. From there on it is a case of the plain application of horse sense.

Why Use Negative Feedback?

The justifications for using feedback are many and varied. The following, however, represent a good cross-section of the most important reasons.

1. It permits economical reduction of harmonic distortion for a given output. Or putting it another way, it permits increasing the power output of

a given output stage for a specified maximum distortion figure. It is not uncommon to be able to increase the power output of a pentode stage for a specified distortion figure of, say, 5% at its rated output of 3 watts without feedback to a full five watts by the addition of feedback.

2. It provides an excellent and economical means of flattening the audio frequency response curve. An amplifier using relatively low cost components and having a frequency response of, say, 100 to 5000 cycles \pm 3 db. can often, by the addition of sufficient feedback, extend the frequency response range to 50 and 10,000 cycles. It is interesting to note at this point that it is by means of large amounts of feedback that broadcast and other high quality amplifiers are held to such close frequency response tolerance as \pm 1/2 db. from 30 to 20,000 cycles in production runs of large quantities.

3. Damping is considerably increased when feedback is properly applied. This is a factor most readily appreciated in listening checks. Few laboratories make tests to determine the amount of damping in their amplifiers. This is often the reason two amplifiers having the same frequency response, distortion, and power output may sound radically different when heard side by side. The amplifier having the greatest amount of damping will have "cleaner" sound. Many readers will recall how clean some of the old amplifiers using 45's and 2A3's sounded. This was largely because of the damping resulting from the low plate impedance of the high current triodes used. The popular pentode and tetrode

tubes used today have relatively high plate impedance. The use of sufficient feedback can effectively lower the plate impedance, as seen from the loudspeaker end, and increase the damping to a marked degree.

4. The internal impedance of an amplifier may be reduced to a fraction of its former value by the use of feedback. Internal impedance is a formidable sounding engineering term which has been gaining attention in recent months. Actually it is little more than the damping discussed in the preceding paragraph. Reducing it to a simple example this formidable term becomes far less awesome. The voltage is measured across the output terminals of an amplifier operating into a resistive load. Remove the load completely and re-measure the output voltage. If the voltage has increased by a large amount, the amplifier may be said to have high internal resistance. If it has not increased materially, the amplifier has very low internal resistance. This is analogous to measuring the voltage of a dry cell battery with the normal load and then noting the voltage with the load removed. A new battery will change very little as its internal resistance is quite low. The voltage of an old battery almost discharged will change radically between no-load and full-load conditions. Since loudspeakers and most telephone lines do not present a constant impedance to the output of the amplifier throughout the frequency range, it becomes obvious that an amplifier having low internal impedance will outperform one with high internal impedance when operated under conditions of this nature.

5. Feedback assists materially in maintaining a constant over-all gain characteristic with tube aging as well as the tube-to-tube variation found even in new tubes. While this is of little importance in the average radio, ham transmitter, or p.a. system, it is of paramount importance in installations where the gain must remain at a fixed value from day to day. Long-distance telephone and broadcast termination equipment do require constant gain for stabilization.

6. Noise of a recurrent nature, such

Fig. 1. Simplest form of negative feedback.

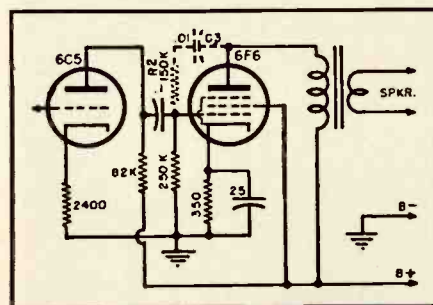

as hum, may be reduced by the application of feedback around the point of hum origination. No amount of feedback, of course, can reduce hum originating at some point outside the feedback loop. Noise of a periodic nature, such as thermal and shot type noises, cannot be reduced by feedback. In fact the application of feedback may appear to increase this type of noise.

In order to produce negative feedback, the voltage fed back must be of opposite phase. Since phase is an instantaneous measurement, this might be stated as; the voltage fed back must be of opposite polarity in order to cancel out part of the incoming signal. In other words, the energy fed back tends to cancel a portion of the signal and reduce it in amplitude. From this, it may be rightly assumed that the over-all gain will be reduced proportionally to the amount of feedback.

In applying feedback, it must be remembered that it must be 180 degrees out-of-phase with the signal at the point feedback is applied. When the energy is fed back in-phase, oscillations will result. All amplifiers have some degree of phase shift. This is usually most predominant at the high and low frequency extremes. The amount of phase shift is dependent on the value of the coupling condensers and resistors between stages, cathode and screen bypassing, and transformers used. The last is by far the most difficult to correct, as it is usually directly related to the price of the transformer. Large coupling screen and cathode bypass condensers and low value plate coupling resistors result in less phase shift. Should the phase shift of the amplifier approach 180 degrees at some frequency, the feedback will then be in-phase at that frequency and will be what is known as positive feedback. This invariably results in oscillations in high gain amplifiers. It is the phase shift that largely limits the amount of permissible negative feedback.

In designing feedback circuits, consideration must be given to the fact that the phase is shifted 180 degrees between the grid and plate circuit of a stage. In other words, if the instantaneous voltage at the grid of a tube is positive, the instantaneous voltage at the plate will be negative. Conversely, if the instantaneous voltage at the grid is at the negative crest of the cycle, the instantaneous voltage at the plate will be at the positive crest of the cycle. A rule of thumb is: Plate and grid are out-of-phase, while plate and cathode are in-phase.

Feedback loops over three stages of amplification are rarely used because of the susceptibility to oscillation and, in general, it is easier to work with from the design viewpoint when it is used over only two stages. Where a large number of stages are cascaded or connected in series for high gain, it is common practice to use several separate feedback loops, and apply a

separate loop for every two or three stages. This is referred to as pairing or tripling. (Tripling in this instance is not to be confused with frequency multiplication.) In commercial designs of high quality amplifiers, such as those used for broadcasting, it will be noted that coupling condensers are on the order of .25 and .5 μ fd., and plate coupling resistors of less than 100,000 ohms are favored. The reason for this is twofold. It extends the frequency response at both ends and results in less phase shift which might otherwise be troublesome if the phase shift is considerable at either the high frequency or low frequency end.

Methods of Feedback

Figs. 1 through 6 illustrate several methods of applying negative feedback. These are methods which have been found sound and dependable enough for their incorporation in commercial broadcasting equipment.

Fig. 1 illustrates what is perhaps the simplest form of negative feedback. Voltage is fed back from the plate to the grid by means of R_2 and C_3 . As mentioned previously, the voltage at the plate is approximately 180 degrees out-of-phase with that at the grid. The amount or amplitude of the feedback voltage is determined by R_2 in the middle audio range with C_3 serving as a d.c. blocking condenser. At the low frequency end, however, the reactance of the condenser becomes appreciable, further reducing the amount of feedback voltage. Since feedback results in decreased gain, we have less feedback at the low frequency end and a consequent increase in low frequency gain. This increase in low frequency gain is usually purposely introduced to compensate for the low frequency drop off in response of the output transformer.

The parts values shown are for use with an output transformer of fair quality. By decreasing the value of R_2 , the amount of feedback will be increased, "pulling" the middle range of the amplifier response curve further down to compensate even more for poor low frequency response in the output transformer. As is to be expected, the larger the value of C_3 the lower in frequency the compensation occurs. For example, assume an amplifier using a value of .01 μ fd. for C_3 with a response curve flat down to 100 cycles and dropping off 3 db. at 50 cycles. By decreasing the value of R_2 the response could be flattened out until the amplifier was flat down to 50 cycles; or for that matter by further decreasing the value of R_2 we could cause a rise in response at fifty cycles making a definite hump at that frequency. In this event, we can use a larger value of C_3 , say .1 μ fd., and move the hump further down in frequency, resulting in an extension of the low frequency response. From this it appears that this could be carried on further until the low frequency response is extended down to, maybe, 10 cycles. Unfortunately, this is not

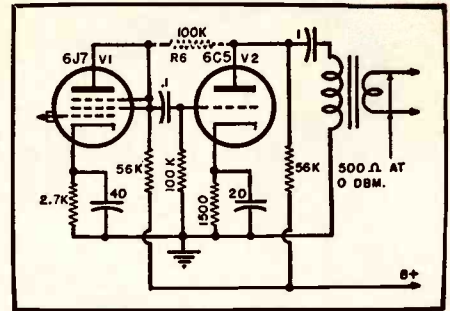

Fig. 2. A modification of Fig. 1. The coupling condenser can be omitted in this case.

true in practice. As mentioned previously, the phase shift of the output transformer limits the permissible amount of feedback.

Fig. 2 is actually a modification of Fig. 1. The difference is that C_3 , the d.c. blocking condenser, is not used. Since the plate of V_1 and grid of V_2 are virtually in-phase, the feedback voltage may be fed directly from the plate of V_2 to the plate of V_1 . In this event, R_6 serves as the feedback resistor limiting the amount of feedback. Obviously, to increase the amount of feedback, it is merely necessary to decrease the value of R_6 . To keep the RC phase shift to a minimum, the value of the grid-to-plate coupling condenser between the plate of V_1 and the grid of V_2 should be as large as economically feasible. It is interesting to note that R_6 also furnishes another d.c. path for the plate current of V_1 . This is, as a whole, desirable since it serves to further increase the plate voltage on V_1 .

Fig. 3 is essentially a further variation of Fig. 2. As pointed out earlier, the cathode and plate of a tube are normally in-phase. Then by modifying Fig. 2, by moving the feedback lead from the plate of V_1 to the cathode of V_1 , the same effect is obtained. It is necessary, however, to put C_2 in to block the d.c. current which would otherwise flow. This can be an advantage, since this blocking condenser can be used to extend the low frequency response by judicious selection of its value.

Often it is just as desirable to increase or extend the high frequency response as it is the low frequency response. By the addition of C_1 we can gain considerable control over the high frequency response by decreasing the amount of feedback at the high frequency end. If completely unby-

(Continued on page 80)

Fig. 3. Plate-to-cathode feedback loop. C_1 and C_2 provide a means of controlling low and high frequency response.

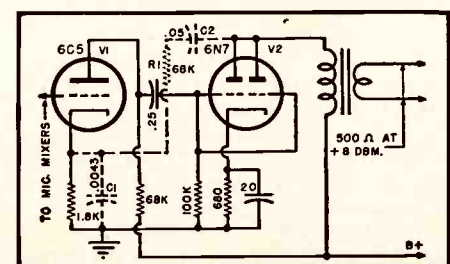

TELEVISION SYNCHRONIZING CIRCUITS

By J. RACKER and P. SELVAGGI

Part 1. Operational characteristics of several of the popular sync circuits being used in modern TV receivers. Concluding article appears next month.

ONE of the most common and bothersome troubles encountered in television receivers today is the poor operation of the synchronizing circuits. Many people will tolerate relatively poor definition, some distortion, weak images, but when the picture "rolls," "tears," or shifts periodically—the service technician is sure to get a call. The reason for this is easy to understand. It is possible to enjoy television—if you are not overly critical—even though the quality is not especially good, but it is impossible to watch a picture that is rolling, tearing, or shifting.

This problem is further complicated by the fact that in many cases it is difficult, if not impossible, to correct the trouble due to the inherent characteristics of the particular synchronizing circuit used in the set. One of the major objectives of this article is to show the reader how to modify such a circuit so that good performance can be obtained. Of course before the technician can modify a given circuit he must clearly understand its basic principles of operation and consequently such a description is also included in this article.

The author would like to emphasize one point before delving into actual circuit descriptions. The television set manufacturer's engineer is confronted with two problems when designing any circuit. One is to make the circuit as economical as possible—for a given performance specification—and the second is to make one circuit suit as wide a variety of reception conditions as possible.

In order to economize it is frequently necessary to reduce the num-

ber of tubes employed. This means that if one tube will meet the requirements of the majority of installations, a second tube will not be used although it is known that it will be difficult to obtain good reception in some localities without its inclusion in the circuit. The second factor usually means that some engineering compromise must be made between two conflicting conditions. For example, the "Q" of a flywheel circuit (to be described later) should be increased to minimize effects of noise and decreased to minimize possibility of picture shift. The manufacturer generally selects a "Q" that represents a compromise between the two.

The technician, on the other hand, is concerned with each installation as an individual problem. If adding a stage to a customer's set saves two or three calls, if a set located in a noise-

Fig. 1. Simplified schematic of blocking oscillator used in early television sets.

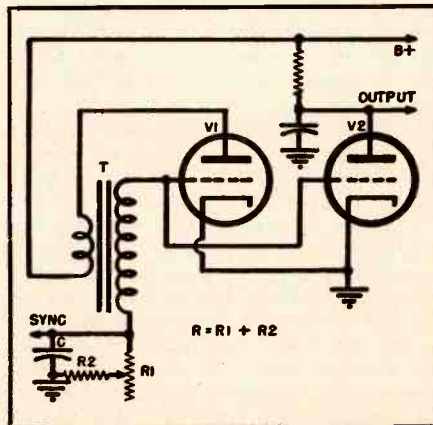

free area shifts its image frequently, he is justified in modifying the circuit used in the set to meet these individual conditions.

One of the most important functions of a television set is to synchronize and phase the horizontal deflection sweep voltages to the framing and scanning rate of the pickup camera at the transmitter. To achieve this end, vertical and horizontal synchronizing pulses are transmitted along with the video intelligence. These pulses are then used to establish the frequency of the vertical and horizontal sweep circuits. The reader can refer to Parts 17, 18, and 19 of the series of articles "Modern Television Receivers" by M. S. Kiver (RADIO & TELEVISION NEWS, August, September, and October, 1949) for a general idea of the functioning of the various circuits with respect to the synchronizing pulses. The author will assume that the reader is reasonably familiar with these principles in the ensuing discussion.

Blocking Oscillator

One of the simplest and most economical synchronizing circuits is the blocking oscillator. This circuit was used extensively in early sets and, because it has several serious disadvantages, the technician may have many occasions to repair or adjust blocking oscillators. A simplified schematic of the blocking oscillator is shown in Fig. 1. First let us consider the action of this circuit without synchronizing pulses.

The transformer, *T*, in this circuit has the following characteristics. When the plate current increases it induces a positive voltage in the grid leg; when the plate current stays constant, no voltage is induced in the grid leg; and when the plate current decreases, a negative voltage is induced in the grid leg. When the set is first turned on, tube *V*₁ begins to draw current which induces a positive voltage in the grid circuit, causing a further increase in plate current. The high positive grid voltage draws grid current which charges condenser *C* negatively. This sequence continues until the saturation current of the tube is reached, at which time the plate current stays constant. The grid voltage therefore drops from some positive value to zero, which reduces plate current. Reduction of plate current causes the grid to go negative, causing a further decrease in plate current. This sequence continues until tube cut-off is reached, at which time a negative voltage is induced across the grid which drives it well beyond the cut-off value.

The tube is maintained at this highly negative value by the charge across condenser, *C*, which slowly discharges through resistor *R*. (It should be noted that during the positive cycle, the tube is conducting and hence represents a low resistance so that the time constant is small; however, with the tube cut off the *RC* constant is large.) As the condenser discharges,

the grid voltage increases until the cut-off value is reached. At this point the tube begins to conduct and the entire cycle is repeated. The waveform of the grid voltage versus time is shown in Fig. 2A. The frequency of this cycle is determined by the RC constant chosen and the cut-off of the tube. In practice, this frequency is made slightly less than the frequency of the incoming sync pulses.

The sync pulses are applied at some time just prior to the return of the grid voltage to the cut-off value and are of sufficient amplitude to raise the grid voltage above cut-off as shown in Fig. 2B. The oscillator begins its cycle exactly at the time that the sync pulse is applied. This process is repeated as long as sync pulses exist and the receiver is now in synchronism with the transmitter scanning rate. The grid voltage at the time that the sync pulse is applied can be varied by adjusting R_1 .

The synchronized positive pulses at the output of the blocking oscillator are then used to generate the saw-tooth waveform. The circuit of V_2 is such that a saw-tooth voltage will appear at its output with the flyback time corresponding to the blocking oscillator sync pulse as shown in Fig. 3A. Thus the effect of the blocking oscillator pulse is to discharge the condenser in the plate of V_2 and cause the electron beam to go from the extreme right hand side of the CRT to the extreme left whence it starts scanning across the tube again.

The disadvantage of the blocking oscillator circuit is that it is extremely susceptible to noise. Two effects may occur. One is that a pulse of noise voltage will appear at the grid just prior to the sync pulse and cause the tube to conduct. In this case the saw-tooth starts prematurely and a point B_1 which should appear at the extreme left of the picture is shifted toward the center. If the noise pulse occurs soon enough, a few cycles may be required for the sync pulse to be in position to fire the tube. This effect is shown graphically in Fig. 3B.

The other effect that may occur is that the noise pulse will partially cancel the sync pulse and the tube will fire later than it should. In this case the picture is displaced to the left, as indicated in Fig. 3C, and again several cycles may be required to return to normal operation. Both these effects, if they occur for a few cycles only, appear as a "tear" on the picture.

It should be noted that up to a certain point the magnitude of the sync pulse is proportional to the signal input, so that for a strong signal a large pulse is available and a small one for a weak signal. If a large amplitude is available the RC constant of the oscillator can be adjusted so that the pulse appears considerably before the time that the cut-off value is reached. This increases the magnitude of noise voltage required to trip the circuit prematurely. However, if

a weak pulse is available, then the time between the sync pulse and natural oscillation must be made closer so that a weak signal will raise the grid above cut-off.

The manufacturer permits adjustment of the synchronizing circuit to meet these divergent conditions by placing a potentiometer in the grid of the blocking oscillator, corresponding to R_1 in Fig. 1. R_2 in this circuit affects both the upper and lower limit of the RC constant and when the picture rolls at the maximum setting of R_1 then the value of R_2 should be checked. In some cases when this resistor overheats its value decreases and a sufficiently high RC constant cannot be obtained. In other instances, where low signal and much less noise exists, it may be desirable to lower the value of this resistance for better synchronization.

Another disadvantage of the blocking oscillator is that the flyback time starts exactly at the same time as the leading edge of the sync pulse. Since this pulse is located in the middle of the blanking pulse, part of the sweep near the peak is blanked and the flyback time is limited to the period between the leading edge of the sync pulse and the end of the blanking pulse. Other synchronizing systems will cause the flyback time to start at the beginning of the blanking pulse thus giving more time for flyback and therefore allowing the deflection circuits to be designed more efficiently as far as deflection sensitivity is concerned.

Comparison System

An improvement over the blocking oscillator can be achieved through the use of a comparison circuit which is quite insensitive to noise pulses. In this system a blocking oscillator is also used but in this case its natural frequency is set as close to the sync frequency as possible. The frequency of the blocking oscillator is then compared with that of the sync pulses. If the two frequencies coincide, no action takes place, if they do not, the frequency of the oscillator is varied until they do.

This system is immune to random

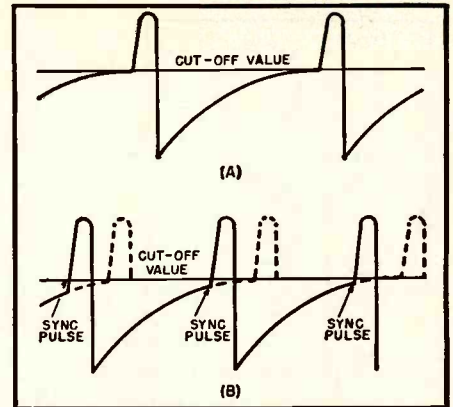

Fig. 2. Blocking oscillator grid voltage, without sync pulses (A) and with pulses (B).

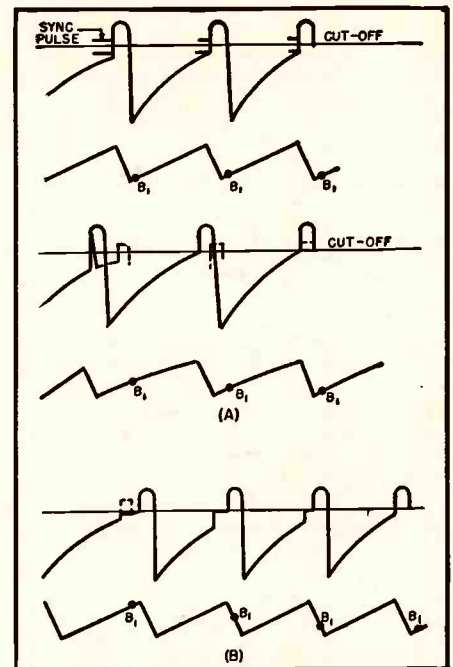
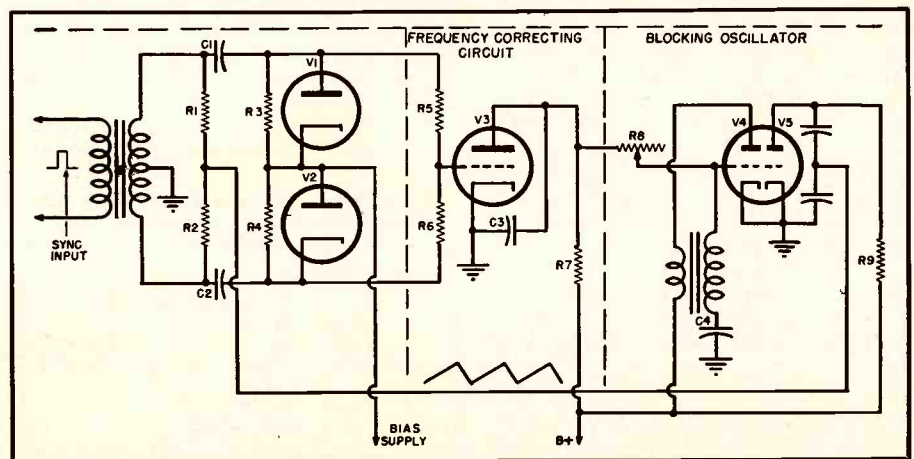

Fig. 3. Effect of noise on blocking oscillator, large pulse tripping oscillator too soon (A), cancelling pulse causing "miss" (B).

noise pulses because it is highly unlikely that noise pulses of sufficient amplitude will recur at a frequency near that of the sync pulses. However, as may be expected, correction of the blocking oscillator frequency is not

Fig. 4. Simplified schematic diagram of blocking oscillator comparison circuit.



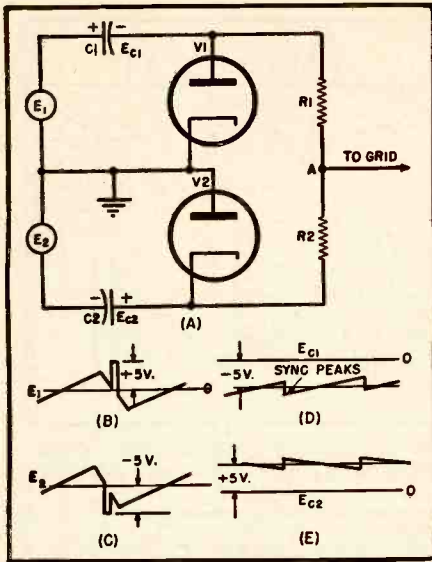

Fig. 5. A simplified schematic diagram of comparison circuit (A) showing voltage E_1 (B), and E_2 (C), and the voltage across the condenser C_1 (D), and across C_2 (E).

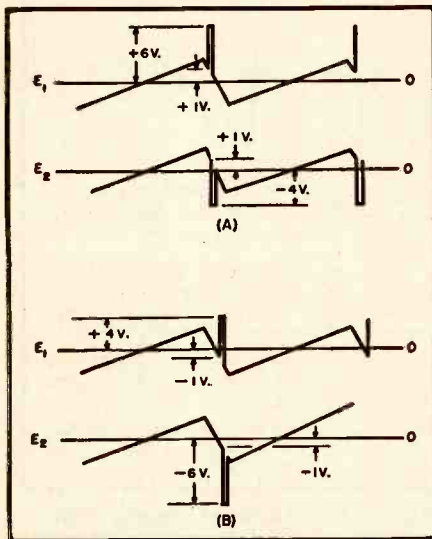

Fig. 6. Waveforms obtained when the sync frequency is higher than the oscillator frequency (A) and when the sync frequency is less than the oscillator frequency (B).

immediate since several cycles of sync pulses are required before the circuit will react to the frequency difference.

Fig. 4 is the simplified schematic of a typical blocking oscillator comparison circuit. At the right hand side of this schematic V_3 , there is a blocking oscillator which operates in much the same manner as the one described previously. The grid of this tube is tied to that of V_5 , the saw-tooth generator. V_4 and V_5 are conductive and cut-off over the same periods. Thus it is seen that the fly-back time of the saw-tooth again occurs when there is a positive pulse in the blocking oscillator output. This is merely another way of effecting this action and the circuit shown in Fig. 1 could have been used to obtain this result.

The frequency of oscillation of this circuit is a function of the RC constant in the grid of V_4 , as before, and

of the bias provided by the plate of V_3 . Varying the voltage at the plate of V_3 will also vary the frequency of operation.

The voltage at the plate of V_3 is a function of its grid bias which, in turn, is a function of the comparison circuit output. To understand the action of the comparison circuit consider the schematic shown in Fig. 5A. E_1 and E_2 in this circuit are the voltage waveforms shown in Figs. 5B and 5C respectively.

Diode V_1 will conduct when E_1 is positive and charge condenser C_1 to the peak positive value of E_1 . When E_1 starts to decline, the voltage across the diode will be negative, due to the charge in C_1 , and it will cut-off. Since R_1 has a high resistance, the voltage across C_1 will decline very gradually over the cycle until the next sync pulse recharges it to the maximum value. The voltage across C_2 will have the same waveform in the negative direction. These waveforms are shown in Figs. 5D and 5E. Note the voltage across the condenser is of opposite polarity to that of the applied voltage.

The positive voltage across C_1 cancels out the negative voltage across C_2 , so that the voltage at point A will be equal to zero. Now consider the effect of the sync pulses when they do not occur exactly at the center but are shifted to the left as shown in Fig. 6A. In this case C_1 charges up to a peak value of -6 volts, while C_2 charges up to a value of only +4 volts. The voltage at point A will no longer be equal to zero, but will be approximately equal to -1 volt (one half the difference). Similarly, a shift to the right will cause a positive voltage to be reflected at point A.

The comparison circuit shown in Fig 4 acts in this manner with the sync pulses introduced by the transformer and the saw-tooth pulses derived from the output of V_5 . When the frequency of the blocking oscillator is exactly equal to that of the sync pulses, the pulses will occur exactly at the center of the flyback time. However, when the frequencies do not coincide, the bias on V_3 will be changed which, in turn, varies the frequency of the blocking oscillator in the direction that will cancel the frequency difference. Condenser C_3 in this circuit has a high value so that the circuit will not respond to sudden momentary changes in plate voltage, but will react only if the plate change is maintained over a relatively long period of

Fig. 7. Phase shift due to frequency difference between oscillator and sync pulses.

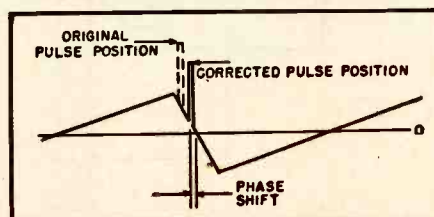

time. Thus a single noise pulse, which may have caused C_1 , C_2 , or C_3 to charge excessively for one cycle, will not affect the frequency of the blocking oscillator. In fact this condenser is frequently large enough to affect insensitivity to low frequency disturbances such as hum or the 30 cycle vertical sweep.

The degree to which the system is sensitive to noise also depends upon the gain of V_3 . If the gain is high just a few sync pulses will be necessary, for a given condenser value of C_3 , to cause the oscillator to sync. However this condition makes the circuit more sensitive to random noise pulses. If the gain is low more pulses are needed to synchronize, but, by the same token, the circuit is less sensitive to random noise. In this latter case it will take much longer for the circuit to get back into synchronization after it is thrown out of sync by a severe disturbance. The manufacturer usually designs his circuit as a compromise between the two extremes of design to cover the majority of reception conditions. The service technician can, however, modify a particular set that is subject to individual conditions to effect better performance. This is most easily done by varying the value of C_3 .

Returning to the over-all description of this circuit, it may be seen that when the sync pulses do not fall at the center of the flyback portion of the saw-tooth voltage, an error voltage is applied to the grid of V_3 which corrects the blocking oscillator frequency. Two factors may cause the sync pulse to be off-center. The sync and blocking oscillator frequencies may be the same, but will be out-of-phase as is usually the case when first turning the set on. In this case an error voltage will be developed across the grid of V_3 , which increases or decreases, as required, the blocking oscillator frequency until the sync pulse is at the center of the flyback time. This makes the error voltage zero, and returns the oscillator to the starting frequency.

The sync pulse may be off-center due to a difference in frequency between the blocking oscillator and sync. In this case the initial error voltage will change the oscillator frequency so that the sync pulse moves toward the center. The sync pulse will not remain at the center position, however, because at this position the error voltage would be equal to zero, and the oscillator would return to its initial frequency. The sync pulse does not move to the exact center but to some intermediate position. In this condition, shown in Fig. 7, the sync pulse is out-of-phase with the blocking oscillator pulses. This out-of-phase condition is seen on the screen as a shifting of the whole picture to the right, left, up, or down, depending upon the polarity of the phase shift and the sweep affected. This can be adjusted manually by varying R_3 which changes the blocking oscillator frequency.

(To be continued)

You GET
THE BEST IN
Heathkits

Heathkits are the Quality Line of TEST INSTRUMENT KITS



Modern STYLING KITS THAT MATCH

Heathkits are styled in the most modern manner by leading industrial stylists. They add beauty and utility to any laboratory or service bench. There is a complete line of Heathkit instruments allowing a uniformity of appearance.

An attractive service shop builds a feeling of confidence. Many organizations have standardized on Heathkits providing uniform service departments.

There is no waste space or false effort to appear large in Heathkits — space on service benches is limited and the size of Heathkit instruments is kept as small as is consistent with good engineering practice.



Accuracy ASSURED BY PRECISION PARTS

Wherever required, the finest quality 1% ceramic resistors are supplied. These require no aging and do not shift. No matching of common resistors is required. You find in Heathkit the same quality voltage divider resistors as in the most expensive equipment.

The transformers are designed especially for the Heathkit unit. The scope transformer has two electrostatic shields to prevent interaction of AC fields.

These transformers are built by several of the finest transformer companies in the United States.

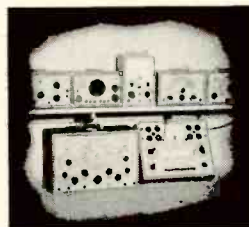

Used BY LEADING MANUFACTURERS

Leading TV and radio manufacturers use hundreds of Heathkits on the assembly lines. Heathkit scopes are used in the alignment of TV tuners. Impedance bridges are serving every day in the manufacture of transformers. Heathkit VTVM's are built into the production lines and test benches. Many manufacturers assemble Heathkits in quantity for their own use thus keeping purchase cost down.

rurers assemble Heathkits in quantity for their own use thus keeping purchase cost down.

Famous HEATHKIT PARTS

- MALLORY FILTER CONDENSERS
- WILKOR PRECISION RESISTORS
- GRIGSBY ALLISON SWITCHES
- ALLEN-BRADLEY RESISTORS
- GENERAL ELECTRIC TUBES
- CHICAGO TRANSFORMER
- CENTRALAB CONTROLS
- SIMPSON METERS
- CINCH SOCKETS

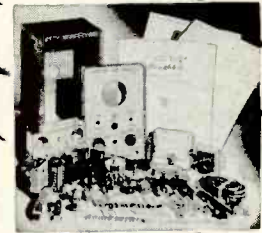

Complete KITS WITH PARTS THAT FIT...

When you receive your Heathkit, you are assured of every necessary part for the proper operation of the instrument.

Beautiful cabinets, handles, two-color panels, all tubes, test leads where they are a necessary part of the instrument, quality rubber line cords and plugs, rubber feet for each instrument, all scales and dials ready printed and calibrated. Every Heathkit is 110 V 60 Cy. power transformer operated by a husky transformer especially designed for the job. Heathkit chassis are precision punched for ease of assembly. Special engineering for simplicity of assembly is carefully considered.



Complete INSTRUCTION MANUALS

Heathkit instruction manuals contain complete assembly data arranged in a step-by-step manner. There are pictorials of each phase of the assembly drawn by competent artists with detail allowing the actual identification of parts. Where necessary, a separate section is devoted to the use of the instrument. Actual photos are included to aid in the proper location of wiring.



Used BY LEADING UNIVERSITIES

Heathkits are found in every leading university from Massachusetts to California. Students learn much more when they actually assemble the instrument they use. Technical schools often include Heathkits in their course and these become the property of the students. High schools, too, find that the purchase of inexpensive Heathkits allows their budget to go much further and provides much more complete laboratories.

YOU SAVE BY ORDERING DIRECT FROM MANUFACTURER — USE ORDER BLANK ON LAST PAGE

EXPORT AGENT
ROCKE INTERNATIONAL CORP.
12 E. 40th ST.
NEW YORK CITY (16)
CABLE ARLAB N.Y.

The HEATH COMPANY

... BENTON HARBOR 15, MICHIGAN

12 Improvements IN NEW 1951

MODEL O-6

PUSH-PULL

Heathkit OSCILLOSCOPE KIT

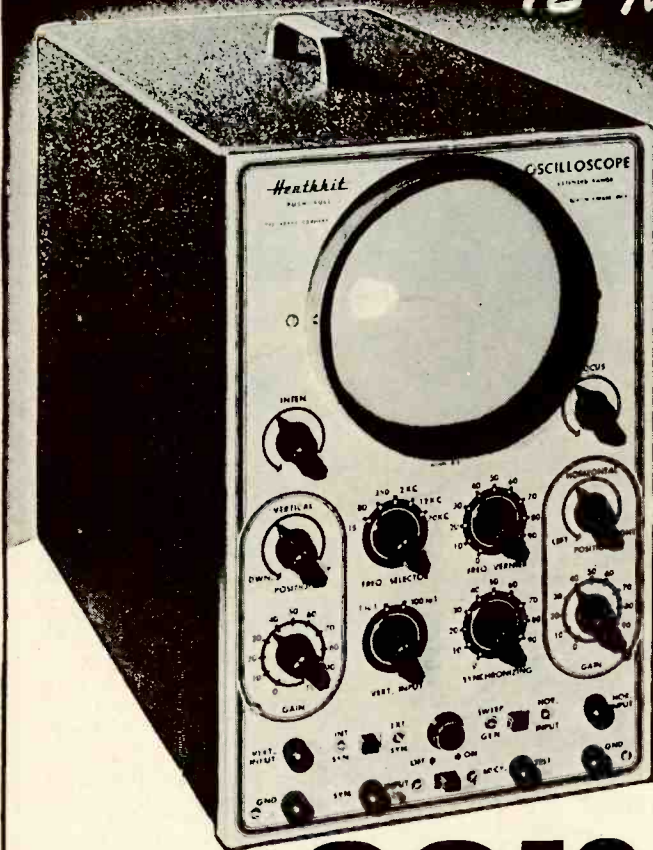

Only **\$39⁵⁰**

New INEXPENSIVE MODEL S-2 ELECTRONIC SWITCH KIT

Twice as much fun with your oscilloscope — observe two traces at once — see both the input and output traces of an amplifier, and amazingly you can control the size and position of each trace separately — superimpose them for comparison or separate for observation — no connections inside scope. All operation electronic, nothing mechanical — ideal for classroom demonstrations — checking for intermittents, etc. Distortion, phase shift and other defects show up instantly. Can be used with any type or make of oscilloscope. So inexpensive you can't afford to be without one.

Has individual gain controls, positioning control and coarse and fine switching rate controls — can also be used as square wave generator over limited range. 110 Volt transformer operated comes complete with tubes, cabinet and all parts. Occupies very little space beside the scope. Better get one. You'll enjoy it immensely. Model S-2. Shipping Wt., 11 lbs.

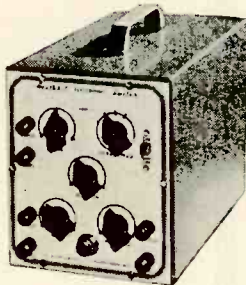

Only **\$19⁵⁰**

- ★ New AC and DC push-pull amplifier.
- ★ New step attenuator frequency compensated input.
- ★ New non frequency discriminating input control.
- ★ New heavy duty power transformer has 68% less magnetic field.
- ★ New filter condenser has separate vertical and horizontal sections.
- ★ New intensity circuit gives greater brilliance.
- ★ Improved amplifiers for better response useful to 2 megacycles.
- ★ High gain amplifiers .04 Volts RMS per inch deflection.
- ★ Improved Allegheny Ludlum magnetic metal CR tube shield.
- ★ New synchronization circuit works with either positive or negative peaks of signal.
- ★ New extended range sweep circuit 15 cycles to over 100,000 cycles.
- ★ Both vertical and horizontal amplifier use push-pull pentodes for maximum gain.

The new 1951 Heathkit Push-Pull Oscilloscope Kit is again the best buy. No other kit offers half the features — check them.

Measure either AC or DC on this new scope — the first oscilloscope under \$100.00 with a DC amplifier.

The vertical amplifier has frequency compensated step attenuator input into a cathode follower stage. The gain control is of the non frequency discriminating type — accurate response at any setting. A push-pull pentode stage feeds the C.R. tube. New type positioning control has wide range for observing any portion of the trace.

The horizontal amplifiers are direct coupled to the C.R. tube and may be used as either AC or DC amplifiers. Separate binding posts are provided for AC or DC.

The multivibrator type sweep generator has new frequency compensation for the high range it covers; 15 cycles to over 100,000 cycles. The new model O-6 Scope uses 10 tubes in all — several more than any other. Only Heathkit Scopes have all the features.

New husky heavy duty power transformer has 50% more laminations. It runs cool and has the lowest possible magnetic field. A complete electrostatic shield covers primary and other necessary windings and has lead brought out for proper grounding.

The new filter condenser has separate filters for the vertical and horizontal screen grids and prevents interaction between them.

An improved intensity circuit provides almost double previous brilliance and better intensity modulation.

A new synchronization circuit allows the trace to be synchronized with either the positive or negative pulse, an important feature in observing the complex pulses encountered in television servicing.

The magnetic alloy shield supplied for the C.R. tube is of new design and uses a special metal developed by Allegheny Ludlum for such applications.

The Heathkit scope cabinet is of aluminum alloy for lightness of portability.

The kit is complete, all tubes, cabinet, transformer, controls, grid screen, tube shield, etc. The instruction manual has complete step-by-step assembly and pictorials of every section. Compare it with all others and you will buy a Heathkit. Model O-6. Shipping Wt., 30 lbs.

YOU SAVE BY ORDERING DIRECT FROM MANUFACTURER — USE ORDER BLANK ON LAST PAGE

EXPORT AGENT
ROCKE INTERNATIONAL CORP.
12 E 40th ST
NEW YORK CITY (16)
CABLE APLAB NY

The **HEATH COMPANY**

... BENTON HARBOR 15, MICHIGAN

New 1951 • • MODEL V-4A

Heathkit VTVM KIT

HAS EVERY EXPENSIVE Feature

- ★ Higher AC input impedance, (greater than 1 megohm at 1000 cycles).
- ★ New AC voltmeter flat within 1 db 20 cycles to 2 megacycles (600 ohm source).
- ★ New accessory probe (extra) extends DC range to 30,000 Volts.
- ★ New high quality Simpson 200 microampere meter.
- ★ New 1/2% voltage divider resistors (finest available).
- ★ 24 Complete ranges.
- ★ Low voltage range 3 Volts full scale (1/3 of scale per volt).
- ★ Crystal probe (extra) extends RF range to 250 megacycles.
- ★ Modern push-pull electronic voltmeter on both AC and DC.
- ★ Completely transformer operated isolated from line for safety.
- ★ Largest scale available on streamline 4 1/2 inch meter.
- ★ Burn-out proof meter circuit.
- ★ Isolated probe for dynamic testing no circuit loading.
- ★ New simplified switches for easy assembly.



New
LOW PRICE **\$23.50**

The new Heathkit Model V-4A VTVM Kit measures to 30,000 Volts DC and 250 megacycles with accessory probes — think of it, all in one electronic instrument more useful than ever before. The AC voltmeter is so flat and extended in its response it eliminates the need for separate expensive AC VTVM's. + or - db from 20 cycles to 2 megacycles. Meter has decibel ranges for direct reading. New zero center on meter scale for quick FM alignment.

There are six complete ranges for each function. Four functions give total of 24 ranges. The 3 Volt range allows 33 1/3% of the scale for reading one volt as against only 20% of the scale on 5 Volt types.

The ranges decade for quick reading.

New 1/2% ceramic precision are the most accurate commercial resistors available — you find the same make and quality in the finest laboratory equipment selling for thousands of dollars. The entire voltage divider decade uses these 1/2% resistors.

New 200 microampere 4 1/2" streamline meter with Simpson quality movement. Five times as sensitive as commonly used 1 MA meters.

Shatterproof plastic meter face for maximum protection.

Both AC and DC voltmeter use push-pull electronic voltmeter circuit with burn-out proof meter circuit.

Electronic ohmmeter circuit measures resistance over the amazing range of 1/10 ohm to one billion ohms all with internal 3 Volt battery. Ohmmeter batteries mount on the chassis in snap-in mounting for easy replacement.

Voltage ranges are full scale 3 Volts, 10 Volts, 30 Volts, 100 Volts, 300 Volts, 1000 Volts. Complete decading coverage without gaps.

The DC probe is isolated for dynamic measurements. Negligible circuit loading. Gets the accurate reading without disturbing the operation of the instrument under test. Kit comes complete. cabinet, transformer, Simpson meter, test leads, complete assembly and instruction manual. Compare it with all others and you will buy a Heathkit. Model V-4A. Shipping Wt., 8 lbs. Note new low price, \$23.50

New 30,000 VOLT DC PROBE KIT

Beautiful new red and black plastic high voltage probe. Increases input resistance to 1100 megohms, reads 30,000 Volts on 300 Volt range. High input impedance for minimum loading of weak television voltages. Has large plastic insulator rings between handle and point for maximum safety. Comes complete with PL55 type plug.

No. 3366 High Voltage Probe Kit.
Shipping Wt., 2 pounds. **\$550**

Heathkit RF PROBE KIT

Crystal diode probe kit extends range to 250 megacycles = 10% comes complete with all parts, crystal, cable and PL55 type plug.

No. 309 RF Probe Kit. **\$550**
Shipping Wt. 1 lb.

YOU SAVE BY ORDERING DIRECT FROM MANUFACTURER—USE ORDER BLANK ON LAST PAGE

EXPORT AGENT
ROCKE INTERNATIONAL CORP.
13 E. 40th ST.
NEW YORK CITY (16)
CABLE ARIAS NY

The HEATH COMPANY
... BENTON HARBOR 15, MICHIGAN

NEW
Heathkit

T.V. ALIGNMENT GENERATOR KIT



Shipping Wt., 16 lbs.

\$395.00

- ★ New simplified circuit for easy calibration and assembly.
- ★ New 2 band built-in marker covers 19 to 75 Mc.
- ★ New dual spider sweep motor for long life.
- ★ New blanking circuit gives base line for better alignment.
- ★ New variable oscillator gives high output fundamentals on high TV band.
- ★ New standby switch keeps instrument ready for instant use.
- ★ New 6 to 1 slow speed drive on both master oscillator and marker tuners.

The new Heathkit TV Alignment Generator incorporates the new developments required for modern TV servicing. An absorption marker circuit covering all possible IF bands and even several of the RF bands. The new blanking circuit provides a base reference line which is invaluable in establishing proper traces. The new sweep motor incorporates dual spiders in the speaker frame assuring better alignment and long life. The mounting of the speaker sweep motor has been simplified for easy alignment.

The variable master oscillator covers 140 to 230 Mc. thus giving high output fundamentals where they are most needed. Low band coverage 2 Mc. to 90 Mc.

A new step attenuator provides excellent control of output.

Planetary 6 to 1 drives on both oscillator and marker provides smooth easy control settings.

A standby position is provided making the instrument always instantly available.

Horizontal sweep voltage with phasing control is provided. No other sweep generator under \$100.00 provides all these features — comes complete with instruction manual. Model TS-2.

Heathkit CONDENSER CHECKER KIT

Only
\$195.00

Features

- Power factor scale.
- Measures resistance.
- Measures leakage.
- Checks paper-mica-electrolytics.
- Bridge type circuit.
- Magic eye indicator.
- 110 V. transformer operated.
- All scales on panel.

Checks all types of condensers over a range of .00001 MFD to 1 000 MFD. All on readable scales that are read direct from the panel. NO CHARTS OR MULTIPLIERS NECESSARY. A condenser checker anyone can read. A leakage test and polarizing voltage for 20 to 500 Volts provided. Measures power factor of electrolytics between 0% and 50%. 110 V. 60 cycle transformer operated complete with rectifier and magic eye tube, cabinet, calibrated panel, test leads and all other parts. Clear detailed instructions for assembly and use. Model C-2. Shipping Wt., 7 lbs.

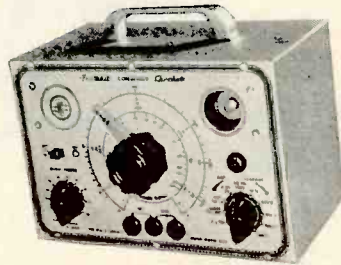

NEW *Heathkit* SIGNAL TRACER AND UNIVERSAL TEST SPEAKER KIT

\$195.00

Features

- High sensitivity
- Complete set of speaker impedances
- Tests microphones and PA systems
- Tests both single and push-pull speaker circuits

The popular Heathkit Signal Tracer has now been combined with a universal test speaker at no increase in price. The same high quality tracer follows signal from antenna to speaker — locates intermittents — defective parts quicker — saves valuable service time — gives greater income per service hour. Works equally well on broadcast — FM or TV receivers. The test speaker has assortment of switching ranges to match push-pull or single output impedance. Also test microphones, power transformer — comes complete — cabinet, 110 V. 60 cycle, for assembly and use. Model T-2. Shipping Wt., 8 lbs.

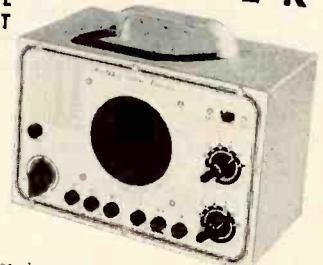

Heathkit TUBE CHECKER KIT

Features

Sockets for every modern tube — blank for new types.

Fastest method of testing tubes — saves time — makes more profit.

Rugged counter type birch cabinet.

Test your tubes the modern way — dynamically — the simplest, yet fastest and surest method — your Heathkit has a switch for each tube element and measures that element — no chance for open or shorted elements slipping by, all the advantages of the mutual conductance type without the slow cumbersome time consuming setups.

Your Heathkit Tube Checker has all the features — beautiful 3 color BAD-GOOD meter — complete selection of voltages — roller chart listing hundreds of tubes including the new 9 pin miniatures — finest quality Centralab lever switches for each element — high grade birch counter type cabinet — continuously variable line adjust control — every feature you need to sell tubes properly. The most modern type tube checker with complete protection against obsolescence. The best of parts — rugged oversize 110 V. 60 cycle power transformer — finest of Mallory and Centralab switches and controls, complete set of sockets for all type tubes with blank spare for future types. Fast action brass gear driven roller chart quickly locates the settings for any type tube. Simplified switching cuts necessary testing time to minimum and saves valuable service time. Short and open element check. Simple method allows instant setup of new tube types without waiting for factory data. No matter what the arrangements of tube elements, the Heathkit flexible switching arrangement easily handles it. Order your Heathkit Tube Checker Kit today. See for yourself that Heath again saves you two-thirds and yet retains all the quality — this tube checker will pay for itself in a few weeks — better assemble it now. Complete with instructions — pictorial diagrams — all parts — cabinet — ready to wire up and operate. Model TC-1 Shipping Wt., 12 lbs.

Gear driven roller chart gives instant setup for all types.

Tests each element separately for open or short and quality.

Beautiful 3 color meter — reads good-bad and line set point.

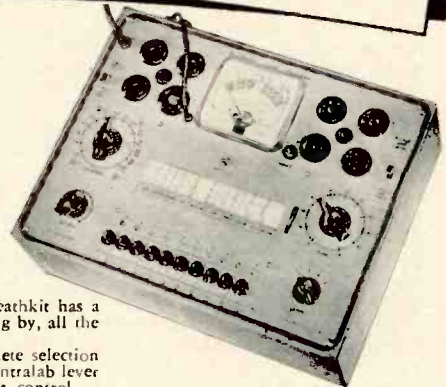

\$295.00

YOU SAVE BY ORDERING DIRECT FROM MANUFACTURER — USE ORDER BLANK ON LAST PAGE

EXPORT AGENT
ROCKE INTERNATIONAL CORP.
12 E. 40th ST.
NEW YORK CITY (16)
CABLE: ARSAD N.Y.

The **HEATH COMPANY**

... BENTON HARBOR 15, MICHIGAN

NEW 1951
Heathkit

SIGNAL GENERATOR KIT

Features

- Sine wave audio modulation.
- Extended range 160 Kc. to 50 megacycles fundamentals.
- New step attenuator output.
- New miniature HF tubes.
- Transformer operated for safety.
- Calibrated harmonics to 150 megacycles.
- New external modulation switch.
- 5 to 1 vernier tuning for accurate settings.

A completely new Heathkit Signal Generator Kit. Dozens of improvements. The range on fundamentals has been extended to over 50 megacycles; makes this Heathkit ideal as a marker oscillator for T.V. New step attenuator gives controlled outputs from very low values to high output. A continuously variable control is used with each step. New miniature HF tubes are required for the high frequencies covered.

Uses 6C4 master oscillator and 6C4 sine wave audio oscillator. The set is transformer operated and a husky selenium rectifier is used in the power supply. The coils are precision wound and checked for calibration making only one adjustment necessary for all bands.

New sine wave audio oscillator provides internal modulation and is also available for external audio testing. Switch provided allows the oscillator to be modulated by an external audio oscillator for fidelity testing of receivers.

A best buy — think of all the features for less than \$20.00. The entire coil and tuning assembly are assembled on a separate turret for quick assembly — comes complete — all tubes — cabinet — test leads — every part. The instruction manual has step-by-step instructions and pictorials. It's easy and fun to build a Heathkit Model SG-6 Signal Generator. Shipping Wt., 7 lbs.



\$19.50

Heathkit SINE AND SQUARE WAVE AUDIO GENERATOR KIT

Either sine or square wave.
Stable RC bridge circuit.
Covers 20 to 20,000 cycles.
Less than 1% distortion.

Hundreds of Heathkit Audio Generators are used by speaker manufacturers — definite proof of their quality and dependability. The added feature of square wave opens up an entirely new field of amplifier testing. Uses the best of parts, 4 gang condenser, 1% calibrating resistors, metal cased filter condensers, 5 tubes, completely calibrated panel and detailed instruction manual. One of our best and most useful kits. Model G-2. Shipping Wt., 12 lbs.

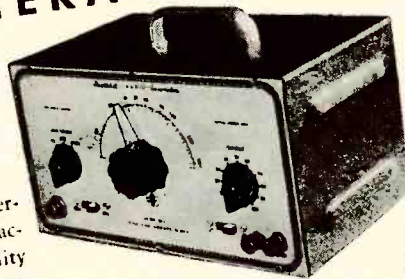

\$34.50

THE NEW *Heathkit* HANDITESTER KIT

- Beautiful streamline Bakelite case.
- AC and DC ranges to 5,000 Volts.
- 1% Precision ceramic resistors.
- Convenient thumb type adjust control.
- 400 Microampere meter movement.
- Quality Bradley AC rectifier.
- Multiplying type ohms ranges.
- All the convenient ranges 10-30-300-1,000-5,000 Volts.
- Large quality 3" built-in meter.



\$13.50

A precision portable volt-ohm-milliammeter. An ideal instrument for students, radio service, experimenters, hobbyists, electricians, mechanics, etc. Rugged 400 ua meter movement. Twelve complete ranges, precision dividers for accuracy. Easily assembled from complete instructions and pictorial diagrams. An hour of assembly saves one-half the cost. Order today. Model M-1. Shipping Wt., 2 lbs.

NEW *Heathkit* BATTERY ELIMINATOR KIT

Features

- Provides variable DC voltage for all checks.
- Voltmeter for accurate check.
- Locates sticky vibrators-intermittents.
- Has 4000 MFD Mallory filter for ripple-free voltage.

Even the smallest shop can afford the Heathkit Battery Eliminator Kit. A few auto radio repair jobs will pay for it. It's fast for service, the voltage can be lowered to find sticky vibrators or raised to ferret out intermittents. Provides variable DC voltage 5 to 7½ Volts at 10 Amperes continuous or 15 Amperes intermittent. Also serves as storage battery charger. Ideal for all auto radio testing and demonstrating.



\$22.50

A well filtered rugged power supply uses heavy duty selenium rectifier, choke input filter with 4,000 MFD of electrolytic filter for clean DC. 0-15 V. voltmeter indicates output which is variable in eight steps. Easily constructed in a few hours from our instructions and diagrams — better be equipped for all types of service — it means more income. Model BE-2. Shipping Wt., 19 lbs.

YOU SAVE BY ORDERING DIRECT FROM MANUFACTURER — USE ORDER BLANK ON LAST PAGE

EXPORT AGENT
ROCKE INTERNATIONAL CORP.
13 E. 40th ST.
NEW YORK CITY (16)
CABLE ABLAS N.Y.

The **HEATH COMPANY**

... BENTON HARBOR 15, MICHIGAN

New
**LABORATORY
INSTRUMENT KITS**

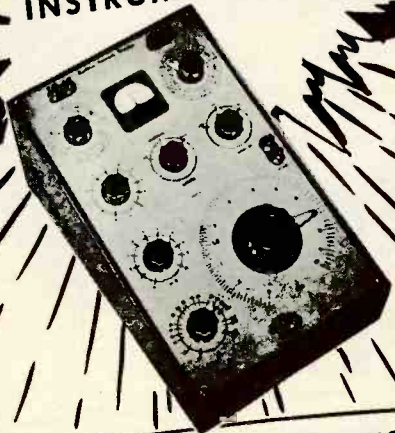

HUNDREDS OF LABORATORIES USE

Heathkit **IMPEDANCE BRIDGE as Standard**

Features

- Measures inductance 10 microhenries to 100 henries • Measures resistance .01 ohms to 10 megohms • Measures capacitance .00001 MFD to 100 MFD • Measures "Q" and power factor.

Measures inductance from 10 microhenries to 100 henries, capacitance from .00001 MFD to 100 MFD. Resistance from .01 ohms to 10 megohms. Dissipation factor from .001 to 1. "Q" from 1 to 1,000. Ideal for schools, laboratories, service shops, serious experimenters. An impedance bridge for everyone — the most useful instrument of all, which heretofore has been out of the price range of serious experimenters and service shops. Now at the lowest price possible. All highest quality parts. General Radio main calibrated control. General Radio 1,000 cycle hummer. Mallory ceramic switches with 60 degree indexing — 200 microamp type binding posts with standard 3/4" centers. Beautiful birch cabinet. Directly calibrated "Q" and dissipation factor scales. Ready calibrated capacity and inductance standards of Silver Mica, accurate to 1/2 of 1% and with dissipation factors of less than 30 parts in one million. Provisions on panel for external generator and detector. Measure all your unknowns the way laboratories do — with a bridge for accuracy and speed.

\$69.50

Internal 6 Volt battery for resistance and hummer operations. Circuit utilizes Wheatstone, Hay and Maxwell circuits for different measurements. Supplied complete with every quality part — all calibrations completed and instruction manual for assembly and use. Deliveries are limited. Model IB-1. Shipping Wt., 15 lbs.

**NEW Heathkit LABORATORY
RESISTANCE DECADE KIT**

Features

- 1/2% Accuracy
- Birch Cabinet
- Ceramic Switches
- Covers 1 ohm to 99,999 ohms



\$19.50

The new Heathkit Resistance Decade is a handy tool for laboratory, school and service shop. Ideal for test setups, calibrating instruments, bridge measurements, selecting multipliers, etc.

Uses the finest Centralab ceramic switches. 1/2% ceramic decade resistors and heavy birch cabinet matching other laboratory equipment. The range is 1 ohm to 99,999 ohms in one ohm steps.

Finest quality throughout to withstand school usage — heavy aluminum panel — laboratory type binding posts — the fine decades are extremely simple to assemble — complete kit. Model RD-1. Shipping Wt., 4 lbs.

**NEW Heathkit LABORATORY
POWER SUPPLY KIT**

Features

- Supplies 6.3 V. AC at 4.5 Amps.
- Heavy duty construction.
- Handy for schools, labs., and service shops.
- Supplies variable DC 50-300 Volts.
- Shows voltage or current on 3 1/2" meter.

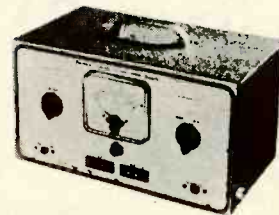

\$29.50

This new Heathkit Variable Power Supply Kit fills hundreds of needs — use it for experimental circuits — no need to build a separate power supply — use it for a test voltage to determine proper coefficients in unknown circuits — calibrate instruments with its variable voltage, etc. This new Heathkit supplies 50 to 300 Volts continuously variable DC together with an AC filament voltage of 6.3 Volts at 4.5 Amperes. A built-in 1 MA 3 1/2" meter has proper shunts to read 0-500 Volts and 0-200 Milliamperes. The circuit uses a 5Y3 rectifier, two 1619 tubes as electronic control tubes to vary the output voltage with a single potentiometer. Case measures 7 1/8" x 13" x 7 1/4". Has instruction manual for assembly and use. Model PS-1. Shipping Wt., 18 lbs.

Heathkit **RECEIVER & TUNER KITS for AM and FM**

**TWO HIGH QUALITY Heathkit SUPERHETERODYNE
RECEIVER KITS**

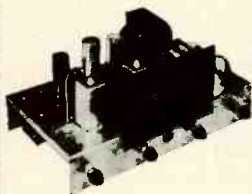

Model BR-1 Broadcast Model Kit covers 550 to 1600 Kc. Shipping Wt., 10 pounds.

\$19.50

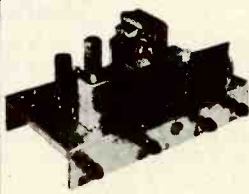

Model AR-1 3 Band Receiver Kit covers 550 Kc. to over 20 Mc. continuous. Extremely high sensitivity. Shipping Wt., 10 lbs.

\$23.50

Two new Heathkits. Ideal for schools, replacement of worn out receivers, amateurs and custom installations.

Both are transformer operated quality units. The best of materials are used throughout — six inch calibrated slide rule dial — quality power and output transformers — dual iron core shielded I.F. coils — metal filter condensers and all other parts. The chassis has phono input jack — 110 Volt outlet for phono motor and there is a phono-radio switch on panel. A large metal panel simplifying installation to used console cabinets is included. Comes complete with tubes and instruction manual incorporating pictorials and step-by-step instructions (less speaker and cabinet). The three band model has simple coil turret which is assembled separately for ease of construction.

**TRUE FM FROM Heathkit
FM TUNER KIT**

\$22.50



The Heathkit FM Tuner Model FM-2 was designed for best possible tonal reproduction. The circuit incorporates the most desirable FM features — true FM — ready wound and adjusted coils — 3 stages of 10.7 Mc. I.F. (including limiter).

Tube lineup: 7E5 oscillator, 6SH7 mixer, two 6SH7 I.F. stages, 6SH7 limiter, two 7C4 diodes as discriminator, 6X5 rectifier.

The instrument is transformer operated making it safe for connection to any type receiver or amplifier. The R.F. coils are ready wound — mounted on the tuning condenser and the condenser is adjusted — no R.F. coils to wind or adjust.

A calibrated six inch slide rule dial has vernier drive for easy tuning. The finest parts are provided with all tubes, punched and formed chassis, transformers, condensers and complete instruction manual. Model FM-2. Shipping Wt., 10 lbs.

REPORT AGENT
ROCKE INTERNATIONAL CORP.
13 E 40th ST
NEW YORK CITY (16)
CALL ARIAR 4-7

The **HEATH COMPANY**

... BENTON HARBOR 15, MICHIGAN

ENJOY MUSIC AT ITS *Finest* WITH **Heathkit AMPLIFIERS**

NEW *Heathkit* HIGH FIDELITY 20 WATT **AMPLIFIER KIT**



\$21.50

Features

- Push-pull 6L6's.
- Full 20 Watts output.
- Fully enclosed chassis.
- Provisions for reluctance pickup compensation stage.
- Cased high fidelity output transformer.
- Treble and bass boost tone controls.
- Full range of output impedances 3.2 ohms to 500 ohms.

The finest amplifier kit we have ever offered — check the features. This inexpensive amplifier compares favorably with instruments costing five times as much. Nothing has been spared to provide the best reproduction — an ideal amplifier for the new Heathkit FM Tuner listed below.

Dual tone controls for control of both treble and bass. Bass control is of the boost type for maximum listening pleasure. Optional preamplifier stage for use with G. E. reluctance pickup or microphone. Uses inverse feedback to give excellent response over entire range. Tube lineup: 6SJ7 preamplifier stage, 6J5 phase splitter stage, two 6L6's in push-pull and 5Y3 rectifier. (6SC7 as optional compensation stage).

Uses highest quality Chicago Transformer Corporation cased output transformer with taps of 3.2, 8, 15, 60 and 500 ohms to match any speaker combination. Power transformer is conservatively rated for continuous operation in sound systems. Tone control gives maximum bass boost of 6 db at 70 cycles. Amplifier has maximum gain of 75 db. Response within 3 db 20 to 20,000 cycles. Shipping Wt., 17 lbs. Complete with all parts, tubes and instruction manual. Model A-5A Amplifier with preamplifier for G. E. cartridges or microphone **\$23.50**
12" 20 Watt Speaker, No. 326..... **7.50**

Heathkit ECONOMY 6 WATT PUSH-PULL **AMPLIFIER KIT**



\$12.50

No. 304,
12-inch Speaker... **\$6.95**

This new Heathkit Amplifier was designed to give quality reproduction at a very low price. Has two preamp stages, phase inverter stage and push-pull beam power output, comes complete with six tubes, quality output transformer (to 5-4 ohm voice coil), husky cased power transformer and all other parts. Has tone and volume controls. Instruction manual flat $\pm 1\frac{1}{2}$ db from 50 to 15,000 cycles. A quality amplifier kit at new low price. Better build one. Model A-4. Shipping Wt., 7 lbs.

Heathkit RECEIVERS and TUNER CABINETS



\$4.95

Order No. 350 for FM tuner

Blonde birch veneer cabinet for either the receivers or tuner. Modern styling is an asset to any room. 5" speaker fits in end of cabinet when used with receivers. Size 7 x 13 $\frac{1}{2}$ x 8 $\frac{3}{4}$ inches. Shipping Wt., 5 lbs. Order No. 345 for either receiver

Metal professional type communications receiver cabinet. Finished in deep grey to fit the panel supplied with Heathkit BR-1 and AR-1 Receivers (panel shown not included with cabinet). 5" speaker mounts in end of cabinet. Gives professional appearance to Heathkit receivers. Size 7 x 14 x 7 $\frac{3}{4}$ inches. Shipping Wt., 6 lbs.

5" Permoflux Speaker for either cabinet for use with either Heathkit Receiver No. 320 5" Speaker..... **\$2.75**



\$4.50

No. 335 Cabinet for receivers only.

ORDER BLANK

To **HEATH COMPANY**
BENTON HARBOR 15,
MICHIGAN

From _____

SHIP VIA

- Parcel Post
 Express
 Freight
 Best Way

(PLEASE PRINT)

Quantity	Item	Price	Quantity	Item	Price
	Heathkit Oscilloscope Kit — Model O-6			Heathkit VTVM Kit — Model V-4A	
	Heathkit T.V. Alignment Gen. Kit — TS-2			Heathkit R.F. Probe Kit — No. 309	
	Heathkit FM Tuner Kit — FM-2			Heathkit H.V. Probe Kit — No. 336	
	Heathkit Broadcast Receiver Kit — Model BR-1			Heathkit R.F. Signal Gen. Kit — Model SG-6	
	Heathkit Three Band Receiver Kit — Model AR-1			Heathkit Condenser Checker Kit — Model C-2	
	Heathkit Amplifier Kit — Model A-4			Heathkit Handitester Kit — Model M-1	
	Heathkit Amplifier Kit — Model A-5 (or A-5A)			Heathkit Variable Power Supply Kit — Model PS-1	
	Heathkit Tube Checker Kit — Model TC-1			Heathkit Resistance Decode Kit — Model RD-1	
	Heathkit Audio Generator Kit — Model G-2			Heathkit Impedance Bridge Kit — Model IB-1	
	Heathkit Battery Eliminator Kit — Model BE-2			Heathkit Signal Tracer Kit — Model T-2	
	Heathkit Electronic Switch Kit — Model S-2				

On Parcel Post Orders, include postage for weight shown and insurance. (We insure all shipments.)

On Express Orders, do not include transportation charges — they will be collected by the Express Agency at time of delivery.

Enclosed find Check Money Order for _____

Please ship C.O.D. Postage enclosed for _____ lbs.

EXPORT AGENT
ROCKE INTERNATIONAL CORP.
13 E 40th ST.
NEW YORK CITY (16)
CABLE ARLAB-N.Y.

The **HEATH COMPANY**

... BENTON HARBOR 15, MICHIGAN

630 TV CHASSIS SPECIAL

1951 Improved De Luxe RCA licensed 630 Chassis complete with 30 tubes. Not a kit, but a factory wired, engineered, tested and aligned TV Chassis. Just plug it in and it works.

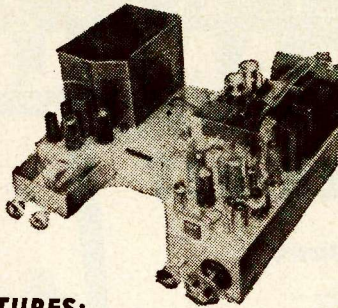

IMPORTANT FEATURES:

- Newly developed keyed automatic gain control
- Improved Automatic frequency control (syncrolock)
- Voltage doubler produces 14KV for maximum brilliance
- Wide angle deflection yoke will spread any 14", 16", 19" or 20" picture tube
- Large cartwheel focus coil for razor sharp focusing
- Armstrong FM high quality sound using Standard coil selector
- Moulded condensers
- 12" R.C.A. Speaker

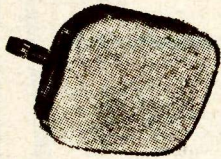

Perfect Chassis for any size and shape picture tube—complete with knobs, escutcheon plate and hardware

\$179.50 (less CRT plus Federal Tax)

14" Glare Proof Tube.....	\$29.50	
16" Glare Proof Tube.....	41.50	(Plus Fed. Tax)
17" Glare Proof Tube.....	46.50	
20" Glare Proof Tube.....	74.50	

Standard RMA Warranty

RCA LICENSED T-20 CHASSIS

- 20 Tube Chassis
- FM high quality sound (not intercarrier)
- Standard Coil Front-end
- Phono jack and switch

For all size picture tubes to 20" — **\$139.50** (less CRT plus Fed. Tax)

WIRE, PHONE, WRITE or Come in TODAY!

J & H TELEVISION CO.

1845 Pitkin Ave. (near Sackman St.), Brooklyn 12, N. Y.

PHONE: HYacinth 8-5932

Prices and Models Subject to Change Without Notice

TERMS:

25% Deposit with order — Balance C. O. D., F. O. B. Brooklyn, N. Y.

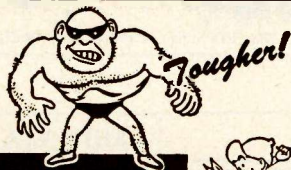

PHOENIX

Speed-Mounts
and
Speed-Tennas

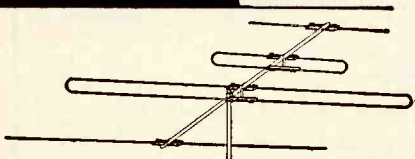

Phoenix IN-LINE SPEED-TENNA PAR-3

High gain consisting of director, high and low folded dipoles and reflector. Speed-rig. Lo Loss insulation. Complete with all hardware, less mast.

PHOENIX ELECTRONICS, INC.
Lawrence, Mass.

AT LEADING JOBBERS
Write for folder V of complete line of television accessories.

RCA VICTOR Camden, N. J.

Requires Experienced Electronics Engineers

RCA's steady growth in the field of electronics results in attractive opportunities for electrical and mechanical engineers and physicists. Experienced engineers are finding the "right position" in the wide scope of RCA's activities. Equipment is being developed for the following applications: communications and navigational equipment for the aviation industry, mobile transmitters, microwave relay links, radar systems and components, and ultra high frequency test equipment.

These requirements represent permanent expansion in RCA Victor's Engineering Division at Camden, which will provide excellent opportunities for men of high caliber with appropriate training and experience.

If you meet these specifications, and if you are looking for a career which will open wide the door to the complete expression of your talents in the fields of electronics, write, giving full details to:

National Recruiting Division
Box 110, RCA Victor Division
Radio Corporation of America
Camden, New Jersey

Negative Feedback

(Continued from page 69)

passed, the audio input signal would produce a voltage drop across the cathode resistor of V_1 , varying at an audio rate. Simultaneously the feedback voltage fed through C_2 and R_1 would "buck" or cancel some of this audio voltage, reducing the effective gain. C_1 serves to increase the high frequency response in two ways:

1. All of us are familiar with the way bypassing the cathode of a stage increases the gain. C_1 accomplishes a certain amount of high frequency gain by this method since it furnishes a fairly low high frequency path to ground. A .0043 μ fd. condenser would not, however, cause any appreciable gain in the middle register around 1000 cycles.

2. Since C_1 tends to serve as a low impedance circuit to ground for the higher audio frequencies, it also bypasses some of the feedback voltage. Since the feedback results in reduced gain in the middle audio frequency range and is effectively bypassed to ground at the high frequency end, then it is to be expected that the middle register will be "pulled" down and the high end left unchanged. With the value of parts shown in Fig. 3, used with a good quality output transformer, the high frequency compensation starts at around 7000 cycles, and the low frequency compensation around 80 cycles. The amount of feedback or "pull down" in the middle register is determined by R_1 . Increasing the value of C_1 tends to pull the high frequency "hump" toward the middle register. Increasing the value of C_2 tends to push the low frequency "hump" further toward 30 cycles.

Fig. 4 is a modification of Fig. 3. The cathode of V_1 is returned to ground through the output transformer secondary winding. The voice coil being in series with this return impresses its full voltage between the grid and cathode of V_1 . By proper phasing of the two output voice coil wires the feedback is made negative. R_2 merely serves as the usual cathode bias resistor with the proper capacity bypassing.

Fig. 5 is a further modification of Fig. 3 in which the output transformer has been so wound as to have a special

Fig. 4. The entire voice coil voltage is impressed between the cathode and grid of V_1 . By proper phasing of the voice coil wires the feedback can be made negative.

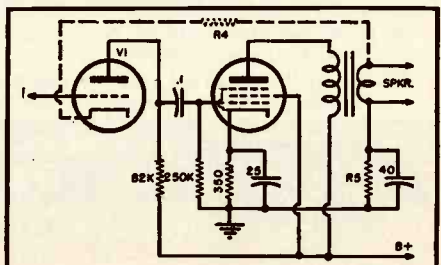

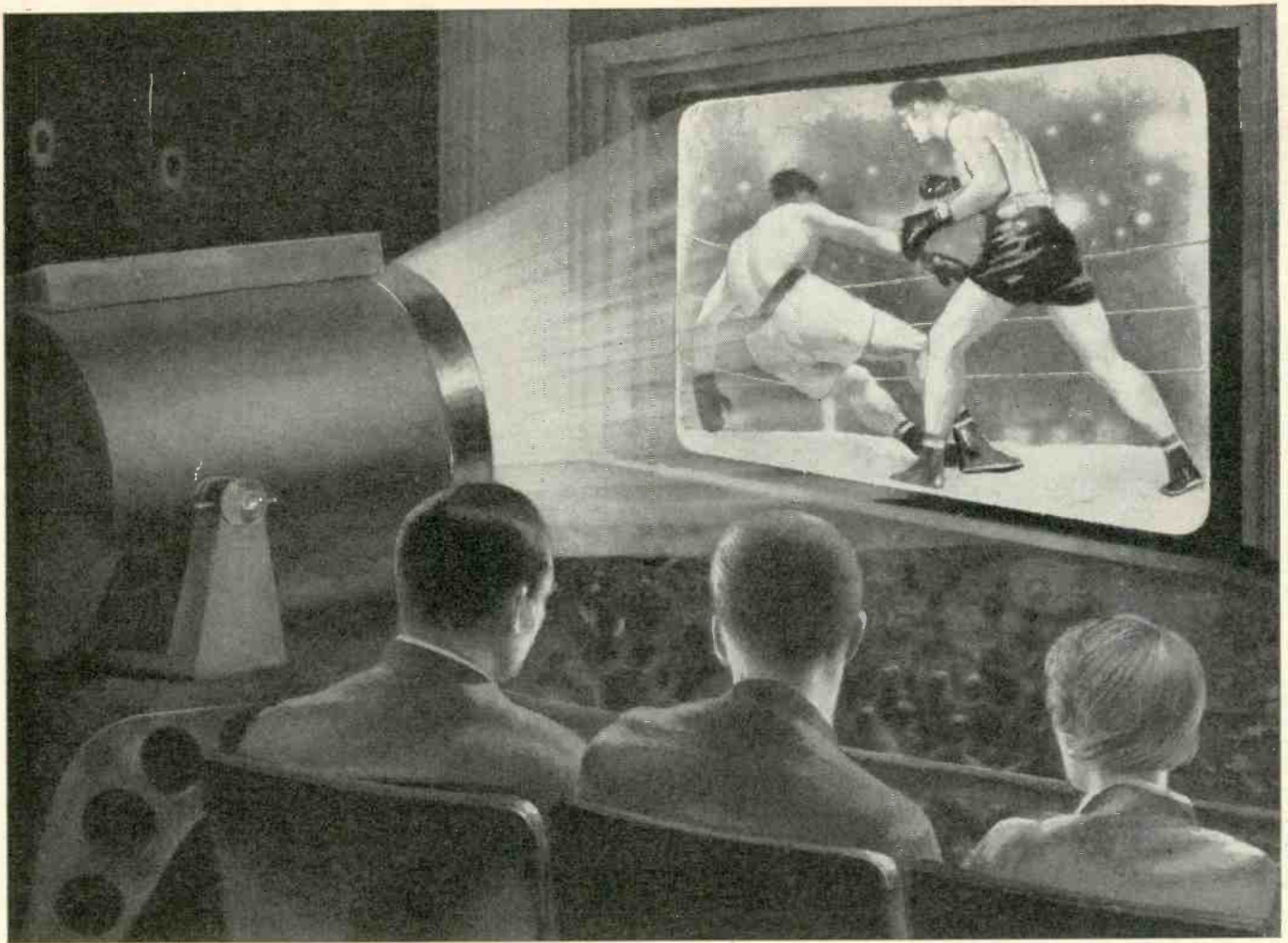

New RCA Theatre Television System projects 15x20 foot pictures of television programs.

Giant size Television— “shot from a barrel!”

● You've seen television. Now you'll see it in its very finest form—giant projections of special events, transmitted *only* to motion picture theatres on private wires or radio beams to make movie-going *better than ever!*

Success of the new system comes from a remarkable RCA kinescope, and something new in projection lenses. The kinescope tube, developed at RCA Laboratories, is in principle the same as the one on which you see regular telecasts. But it is *small*—only a few inches in diameter—and produces images of extremely high brilliance. These are magnified to 15x20 feet by a “Schmidt-type” lens system like those

used in the very finest of astronomical telescopes.

Because of its size and shape, the new projector is referred to by engineers as the “barrel.” It's already going into theatres, where you'll be seeing giant television—shot from a barrel.

* * *

See the latest wonders of radio, television, and electronics at RCA Exhibition Hall, 36 West 49th St., New York. Admission is free. Radio Corporation of America, RCA Building, Radio City, New York 20, New York.



Radio Corporation of America
WORLD LEADER IN RADIO—FIRST IN TELEVISION

The HIT of the AUDIO FAIR!

Plays 10½" Reels!



Complete, for console installation with single or dual track heads:

\$345⁰⁰

CONCERTONE

■ The professional quality tape recorder you have been waiting for! NAB standards; triodes throughout; 40-15000 cycles at 15", 40-8000 cycles at 7½". Three motors; flutter less than 0.1%; signal-to-noise better than 50 db. Three heads for simultaneous erase, record, playback. Quick change from single to dual track. Write for booklet.

FISHER RADIO CORPORATION • Distributors • 39 E. 47th St., N. Y.
IN LOS ANGELES: MAGNETIC RECORDERS CO., 7120 MELROSE AVE., L. A. 46, CALIF.

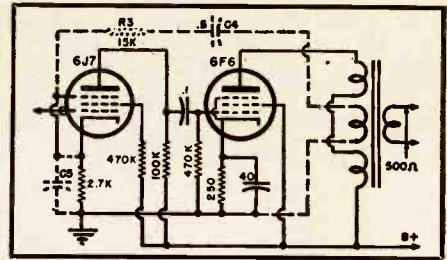

Fig. 5. Instead of obtaining feedback voltage from the voice coil winding as in Fig. 4, a special winding known as a tertiary feedback winding is used. Transformers incorporating these windings are gradually disappearing from the market as less costly methods are used to get degeneration.

winding for supplying feedback voltage. Standard output transformers of this type have appeared on the market since the war. War surplus transformers which have incorporated this tertiary feedback winding are also available.

Fig. 6 is an outgrowth of Fig. 2. In Fig. 6 the feedback resistance has been broken up into two resistors with a high frequency bypassing condenser added at the junction point. This condenser, C_6 , serves as a method of controlling the high frequency response since it controls the amount of high frequency feedback allowed through the feedback resistors, R_7 and R_8 . C_7 has been added to permit some control over the amount of low frequency response. R_7 , R_8 , C_6 and C_7 actually constitute a frequency sensitive network. As the value of C_6 is decreased the amount of high frequency compensation is likewise decreased. As C_7 is decreased the amount of low frequency compensation is increased.

In all the preceding circuits the values of the resistors and condensers have been given to assist the builder and designer by giving him a starting point. The actual values will depend on the transformers used and the physical layout. These values for the most part were used in conjunction with transformers having excellent frequency and phase characteristics. Where transformers are used which have either poor frequency response or excessive phase shift, oscillations may be experienced with the given values of feedback resistors. Decreasing the amount of feedback will be necessary and may be taken care of by increasing the value of the feedback resistor.

Fig. 6. A modification of Fig. 2. The feedback resistance has been broken up into two resistors with high frequency bypass condenser added at junction of resistors.

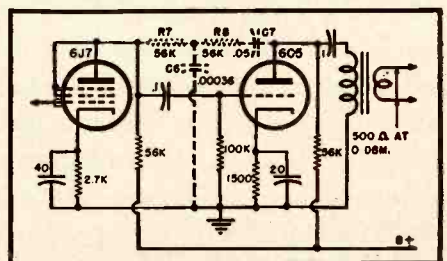

BETTER SOUND with 37% LESS POWER



New RACON "Cobra" Wide Angle Horn

COB-11 List Price \$7000

The RACON COB-11 delivers greatest useful power by concentrating maximum uniform sound in a horizontal sweep of a full 120°. Vertical angle is only 40°. Especially suited for indoors or outdoors where reverberation, echoes and "hangover" exist. In wide-range systems using 2 or 3 loudspeakers, it's excellent too as a mid- or high-frequency horn.

2 db Higher Efficiency: True exponential flare gives higher sound velocity; no sound-absorbing material on horn mouth; "straight" horn design eliminates attenuation caused by re-entrant members.

Better Response: True exponential flare plus "straight" design produces smoother, more uniform response throughout transmission range.

Crisper Non-"Boomy" Sound: The 250-cycle cut-off eliminates the power-wasting lower frequencies which mar articulate quality.

Sturdier Construction: Consists of heavy 2-piece non-vibratory aluminum casting. Finish is weather-resistant grey hammertone over zinc chromate primer. 17½" h, 22¼" w, 13¾" d. Thread is 1¾"-18 for any RACON 25-35 watt driver unit.

WRITE NOW FOR CATALOG R.

In Canada: Dominion Sound Equipments Ltd. Branches in all principal cities.

ACOUSTICAL EXCELLENCE



Racon Electric Co., Inc.
52 East 19th Street, New York 3, N. Y.

TESCO

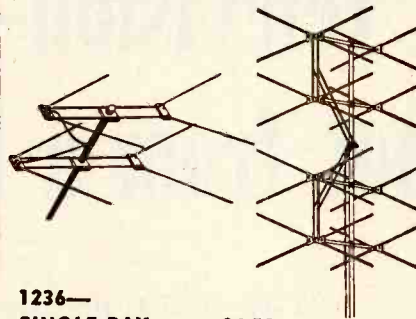

1236—SINGLE BAY \$4.58

1237—DOUBLE BAY \$9.15

No. 1231 \$20.85

- 1230—Double Bay Conical.....\$9.56
- 1215—Swift Rig Folded Hi Folded Low... 5.37
- 1814—Economy Chimney Mount... Dozen Lots 1.32
- 1302 to 1306—Five El. Yagi any Lo Channel. 13.62
- 1307 to 1313—Five El. Yagi any Hi Channel 5.45
- 1219—Swift Rig Folded Hi Straight Low... 4.92
- 2113—DeLuxe Indoor Antenna..... 2.48
- 1860—Chimney Mount..... Dozen Lots 1.54
- 1905—3½" Mast Snap-On Standoff, per 100 4.00
- 1873—3½" Mast Standoff Insulator, per 100 6.50
- 1872—4" Nail-In Insulator, Lots of 250... .025
- 1870—3½" Wood Screw-Eye Insulator
- Lots of 250025
- 1229—Single Bay Conical..... 4.58
- 1231—Four Bay Conical..... 20.85

Send for quantity prices and complete list

TELEVISION SUPPLY CO.
Box 213 Grace Square Station
New York, N. Y.



THE EYE IS QUICKER THAN THE EAR

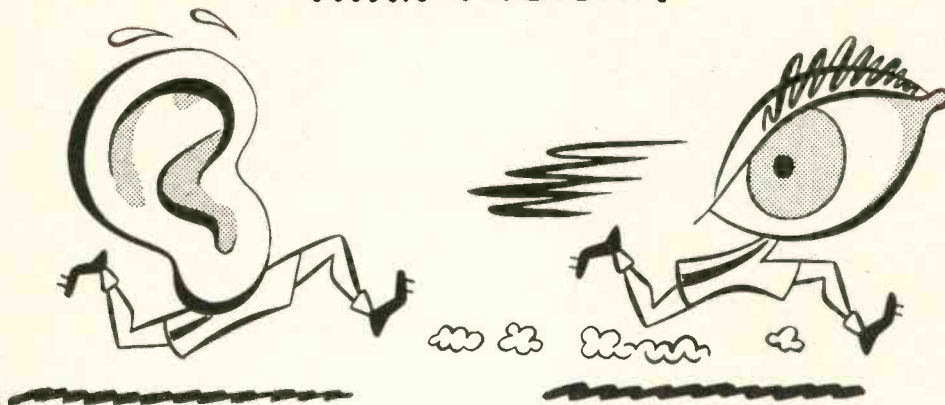

IF YOU SERVICE TV, YOU KNOW THIS!

Customers are quick to *see* imperfections. Much slower to *hear* them. Therefore *premium-quality* Hytron receiving tubes for the tougher TV jobs. *At no extra cost!* You gain also: Through fewer expensive service call-backs. Better customer satisfaction and confidence. More profits.

How does Hytron do it? By working closely with leading TV set manufacturers. By endless striving

to better already superior performance. By improved design...processing...inspection...testing.

Try Hytron TV receiving tubes: 1X2A, 5U4G, 6AG5, 6AL5, 6AU6, 6BC5, 6BG6G, 6BQ6GT, 6CB6, 6SN7GT, 6V6GT, 6W4GT, 12BH7, 25BQ6GT, etc. Also Hytron rectangular picture tubes: 14BP4, 16RP4, 17BP4A, 20CP4. You pay no more for Hytron. But *see* the difference yourself...on the TV screen...on your cash register.

THEY COST PENNIES, BUT SAVE DOLLARS!

Order from your Hytron jobber today



HYTRON SOLDERING AID — 49¢ net. Fork tip effortlessly, quickly unwraps "mechanically solid" joints. Straddles wire, grips, unwraps, pulls it free. Guides new wire; holds it firm while soldering. Spade tip reams solder from lug hole; pushes other wires aside. Tips are hardened, twist-proof, insulated, hard-chromed to shed solder. Tool handles like pencil. Reaches tight spots. Has dozens of other uses.



HYTRON TUBE LIFTER — 15¢ net. Lift 'em all the e-a-s-y prybar way: Tubes (GT, G, standard, lock-in, metal). Vibrators and plugs (Jones, Amphenol) — and knobs. A natural for compact auto radios, etc. Slotted and lifts lock-ins, snap-in trimounts... easily, safely. Of stainless steel with comfortable rolled edges.

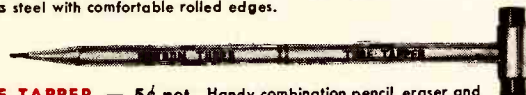

HYTRON TUBE TAPPER — 5¢ net. Handy combination pencil, eraser and tube tapper. Discovers microphonism, shorts, and opens in tubes, etc. Compact, non-metallic, rugged. Doubles in brass for writing orders, etc.



HYTRON TUBE PULLER

— 75¢ net. Pull or insert 7-pin miniatures the e-a-s-y way. Neoprene rubber puller works by suction and friction on top of tube. Positive grip. Reaches tight spots. Another Hytron time-temper-and-money saver.



HYTRON AUTO RADIO TOOL — 24¢ net. Substitutes for control cables of universal auto radio. Quickly, precisely turns set on/off, tunes, adjusts volume and tone, re-aligns dial. Square also fits splines. Vee fits spade and other key fittings. Minimum backlash. Compact. Bright-zinc plated. Non-rolling large handle for fine adjustments.



HYTRON PIN STRAIGHTENERS,

7-Pin and 9-Pin — 55¢ net ea. You merely press tube gently into Hytron Straightener until button base seats squarely. Presto, pins are straight! Fast... safe. Avoiding one broken tube pays for Straightener twice over. Precise, stainless-steel insertion die. Comfortable knurled aluminum holder. Far hand, bench or tube tester use.



OLDEST MANUFACTURER OF RECEIVING TUBES
HYTRON
RADIO AND ELECTRONICS CORP.

MAIN OFFICE:
SALEM, MASSACHUSETTS



McGEE'S "SUPER STORE" OPERATION SAVES YOU MONEY!



024 4 PRONG VIB. 5 OZ4 TUBE & 5 VIB. DEAL No. RN-V5 \$8.49

Here's a red hot deal for you fellows that do a lot of auto radio service. 5 standard brand metal 024 tubes and 5 of our famous 4-prong serrated can vibrators. This vibrator is of the latest design, for long life. Standard diameter can, short enough to fit all Chrysler auto sets, also fits Motorola, etc. Our 20th Anniversary, big deal No. RN-V5. You can get 5 OZ4 tubes and 5 4-prong vibrators, all for \$8.49. Shipping weight 3 lbs.

MN-8.	8 mfd 450 volt.	29c
MN-16.	16 mfd 450 volt.	39c
MN-30.	30 mfd 450 volt.	49c
MN-40.	40 mfd 150 volt.	29c
MN-40.	40 mfd 150 volt.	39c
MN-220.	20-20 mfd 150v.	39c
MN-220.	20-20 mfd 150v.	49c
MN-442.	40-40-15 mfd 150v.	39c

All cond. guaranteed one year.

RED HOT SPEAKER VALUES
McGee has a tremendous stock of 100,000 speakers to fill your needs. Every speaker is fully guaranteed. Order your speakers now.

4 inch, square.	1.1 oz. magnet	\$1.29
5 inch, pincushion	1.1 oz. magnet	1.29
5 inch, pincushion	1.47 oz. magnet	1.79
4 x 6 inch.	1.1 oz. magnet	1.69
5 x 7 inch, oval.	1.47 oz. magnet	2.19
7 inch, pincushion	2.15 oz. magnet	2.99
8 inch, pincushion	2.15 oz. magnet	3.29
6 x 9 inch, oval.	2.15 oz. magnet	2.95

100 Molded Plastic Bypasses \$9.49
100 molded plastic tubular bypass condensers. All 600 volt. And all by the same nationally known migr. Regular dealers' net is over two and one-half times our 20th Anniversary sale price. You'll chuckle when you look these over. Here's what you get: 10-.001, 10-.002, 20-.005, 20-.01, 10-.02, 10-.05, 10-.1. Our big deal No. RN-202, 100 molded plastic tubulars. Shipping weight 2 lbs. Net price, \$9.49.

100 600 VOLT TUBULARS \$6.49
100 top quality 600 volt tubular by-pass condensers. Made this year by a famous condenser factory. Don't confuse these with grab-bag surplus. McGee's deals are guaranteed to please you. Here's what you get: 10-.001, 10-.002, 20-.005, 20-.01, 10-.02, 10-.05 and 10-.1 600 volt condensers. Our big deal No. RN-203. Shipping weight 2 lbs. Net price, \$6.49.

20 50 x 30 150 V. \$9.75 ELECTROLYTICS
Here's a red hot value. 20 of our XX quality replacement electrolytics. The most popular condensers in use today. Takes care of 90% of your AC-DC radio filter needs. Compact construction 1950 production. 1-year guarantee. 50-30 mfd. 150 volt, housed in a cardboard tube with common negative, has long flexible leads. 20th Anniversary, big deal No. RN-204. Sale price, \$9.75.

SELENIUM RECTIFIERS
65 mil Selenium Rectifier, net 59c each
100 mil Selenium Rectifier, net 69c each
150 mil Selenium Rectifier, net 79c each
200 mil Selenium Rectifier, net \$1.09 each
250 mil Selenium Rectifier, net 1.19 each
350 mil Selenium Rectifier, net 1.49 each
450 mil Selenium Rectifier, net 1.89 each
McGee offers you the finest in Selenium Rectifiers. All standard 130 volt.

1 or 4 VOLT CRYSTAL CARTRIDGES \$1.99
McGee offers you a famous make crystal cartridge. Standard size and shape, but very light weight. Will track on 3/8 oz. or more pressure. Stock A-6, one volt output, replaces Astatic L-70 etc., Net \$1.99. Stock No. A-10, 4 volt output, replaces Astatic L-72 and L-82, Net \$1.99. Buy 10 assorted for \$19.00.

REG. \$54.00 LIST 25 WATT DRIVER AND TRUMPET \$23.95
This trumpet and driver is especially designed for all outdoor speaker uses; churches, sound trucks, etc. It is the most popular size sold today. McGee offers you more for your money. Each speaker is fully guaranteed. Model XX-100, all weather proof 3 1/2 foot trumpet, made of aluminum castings and spinings. 19" bell trumpet can be used with any standard driver. Regular \$29.00 list. Ship. weight 15 lbs. Net price \$13.50. Model RM-30, standard 15 ohm, 25 watt driver for use with above trumpet. Quality second to none. Shipping weight 6 lbs. Net \$12.50. Combination offer. Buy 1 trumpet and RM-30 25 watt driver, both for \$23.95.

10 WATT PAGING SPEAKER \$11.95
Model 10-XX-P. 10 watt paging speaker with built-in weather proof driver. Spun aluminum construction, 8 ohm voice coil. Regular net on this speaker is over \$15.00. A special purchase by McGee makes this \$11.95 price possible. Shipping weight 4 lbs.

19 TUBULAR ELECTROLYTICS DEAL RN-PL19 \$5.95
19 tubular electrolytics, guaranteed for one year. All fresh stock in aluminum tubes with cardboard insulating sleeves. You must be satisfied or money back. You get, 10 8 mfd 450 volt and 2 mfd 450 volt, 20 mfd 150 volt and 2 mfd 150 volt condensers. Shipping weight 2 lbs. Deal #RN-PL-19, Net \$5.95.

6 UNIVERSAL OUTPUT TRANS. DEAL RN-UP6 \$5.29
Any push-pull or single plate to any voice coil. Popular strap mounting, the same as you see every day. You get 4-5 watt, 1-8 watt, 1-1 watt transformers. Shipping weight 4 lbs. Deal #RN-UP6, Net \$5.29.

BIG SALE ALUMINUM CAN ELECTROLYTICS
McGee offers you Nationally known brands of FP type electrolytic condensers at a tremendous saving. After these are gone, we don't know where we can buy any more to sell at these prices. Order a good supply now. Unconditionally guaranteed.

10 FP ELECTROLYTICS DEAL RN-10DS \$3.49
10 assorted F.P. aluminum can electrolytics. Popular twist tap mounting. Most popular section banks. 150, 350 and 450 volts. A red hot deal, shipping weight 2 lbs. Deal #RN-10DS, Net \$3.49.

10 BOXES OF PILOT LIGHTS \$5.49
Pilot lamps, boxed 10 to a handy carton. American made. 7 boxes #47, 1 box #40, 1 box #44 and 1 box #46. A total of 100 lamps. Deal #RN-10, Net \$5.49.

10 SMALL OUTPUTS DEAL RN-10PT \$4.49
5 outputs for any single universal plate to voice coil, 5 watt. And 5 single 5016 outputs to voice coil. These outputs are small size design. Shipping weight 4 lbs., Deal #RN-10PT, Net \$4.49.

40-40 mfd.	25v.	FP cond. 1 x2"	\$0.19	40-40 mfd.	150v, 40-4025v.	FP cond. 1 1/2x3"	\$0.39
250 mfd.	25v.	FP cond. 1 x2"	29	60-40 mfd.	150v, 10 25v.	FP cond. 1 x3"	49
20-20 mfd.	150v.	FP cond. 1 x2"	29	40 mfd. 300v.	50 250v, 20 200v.	FP cond. 1 1/2x3"	59
20-20 mfd.	150v, 25 25v.	FP cond. 1 x2"	34	15 mfd.	400v, 10-5350v.	FP cond. 1 x3"	49
20-20 mfd.	150v, 100 25v.	FP cond. 1 x2"	44	8 mfd.	450v.	FP cond. 1 x3"	29
40 mfd.	150v, 200 10v.	FP cond. 1 x2"	29	10 mfd.	450v.	FP cond. 1 x3"	34
30-30 mfd.	150v.	FP cond. 1 x2"	39	15 mfd.	450v.	FP cond. 1 x3"	39
40-20 mfd.	150v.	FP cond. 1 x2 1/2"	39	20 mfd.	450v.	FP cond. 1 x3"	39
80 mfd.	150v.	FP cond. 1 x2 1/2"	29	24 mfd.	450v.	FP cond. 1 x3"	39
50-50 mfd.	150v, 25 25v.	FP cond. 1 x2 1/2"	49	30 mfd. 450v.	30 350v, 40 25v.	FP cond. 1 x3"	49
30-40 mfd.	150v.	FP cond. 1 x3"	49	20-10 mfd.	450v.	FP cond. 1 x3"	69
80-40 mfd.	150v, 25 25v.	FP cond. 1 x3"	59	20-20 mfd.	450v.	FP cond. 1 1/2x3"	89
40-40-20 mfd.	150v.	FP cond. 1 x3"	59	32 mfd.	450v.	FP cond. 1 x3"	39
15-15 mfd.	150v, 1200 1 1/2v.	FP cond. 1 x2"	49	30-15-10 mfd.	450v, 20 25v.	FP cond. 1 x3"	69
30 mfd.	250v.	FP cond. 1 x2"	19	10-10-10 mfd.	450v, 20 25v.	FP cond. 1 x3"	59
40 mfd.	250v.	FP cond. 1 x2"	19	80 mfd.	450v.	FP cond. 1 1/2x3"	119
15-15 mfd.	250v.	FP cond. 1 x2"	29	40-30-10 mfd.	450v, 20-25v.	FP cond. 1 1/2x3"	149
40-20 mfd.	150v, 100 15v.	FP cond. 1 x2"	39	40-40-40 mfd.	450v.	FP cond. 1 1/2"	149
30-50 mfd.	150v, 20 50v, 100 10v.	FP cond. 1 1/2x2"	49				

100 KNOBS Set-Screw Type \$3.95
100 bakelite set screw knobs, for radio or television. All standard. 1/4" shaft. Assorted walnut, black and ivory. Enough of each style to give you matched sets. This value worth \$7.50. Shipping weight 2 lbs. Deal #RN-10K, Net \$3.95. 1/2 a Deal or 50 knobs, \$2.00.

115 PHONO NEEDLES \$4.95
2 \$3.50 list Duotone Ruby needles, with handy record brush, \$2.50 list Duotone Sapphire needles in plastic case and 4 packages of 25 cheap needles and 1 package of 10 cheap needles. 115 phono needles, Deal #RN-P12, Net \$4.95.

\$19.95 BUYS A NEW St. George Wire Recording Mechanism

Antenna, R.F., Osc. and I.F. Coils
Small Universal, adjustable slug tuned RF Coil, 39c; Antenna Coil, 39c; Oscillator Coil, 39c.
Made to match any condenser gang. Midget 456 I.F. transformers 3x1 1/2" can with leads 1st or 2nd I.F. 59c each. Small 5x8" standard loop antenna, 29c ea.

V.M. 3 SPEED Record Changers
VM Model 406 deluxe 3 speed automatic record-changer—plays 78, 45 and 33 rpm. Dual 45 and 78 rpm records of the same speed intermixed. 12 7-in. 33 1/3 or 12 7-in. 45 rpm. Automatically shuts off after the last record. Size 13 1/2 x 11 1/2 x 7 1/2 in. high. Offers with crystal cartridge, G.E. VR cartridge, or either with a base. VM-406, 3 speed changer with standard output crystal cartridge and needles for 78 and 33. (78 rpm, 33 1/3, 45 rpm.) Net \$28.35.
VM-406, 3 speed changer with the new reluctance cartridge with stylus. Net \$31.27.
VM-955, 3 speed changer with crystal cartridge on a base. Net \$31.93.
VM-855GE, 3 speed changer with RFX-050 VR cartridge and stylus. With base. Net \$33.59.

22 AC LINE CORDS \$4.95
20 ft. AC cords, with G.E. unbreakable molded caps. 10 brown and 10 ivory, plus 2 ICA universal resistance AC-DC cord sets. Shipping weight 3 lbs. Deal #GE-22, Net \$4.95.

ONLY 200 TO SELL

10" HEAVY DUTY P.M. WITH RED HOT \$7.49 SPECIAL

20 CONTROLS \$5.95
All have SPST switch, which may be used by pulling a small tab. A red hot value. All National Union, individually boxed. 1 each 5,000, 10,000, 25,000, 50,000, 100,000 and 5 each 250,000, 500,000 and 1 megohm. Shipping weight 1 lb. Deal #RN-NU20, Net \$5.95.

McGee offers you at a terrific saving the St. George Series 1100, wire recording mechanism. Brand new and factory cartoned. This unit will record and playback from a standard recording wire, up to 1 hour. The wire take-up reel turns at 78 RPM and will play and record from a 78 RPM phonograph record. The base is punched for a phono pickup. Space required, 9x13x3 1/2". Shipped with a diagram of how to connect and also how to wire a 3 tube converter to enable the wire recorder to be used in conjunction with any radio or amplifier. St. George wire recording mechanism, Series 1100. Shipping weight 15 lbs. Net price \$19.95 each. \$14.95 extra. Recording wire, 15 minute spool. Net price \$1.19. 30 minute spool. Net price \$1.79. 1 hour spool. Net price \$2.79. Crystal mike and desk stand \$4.95 extra.

Super heavy duty 10" 32 oz. Alnico 3 PM speaker, with 8 ohm voice coil. Ideal for music box operators and all sound installations. A lucky purchase makes this possible. The baffle is of the slanting wall type mounting, made of plywood and covered with leatherette. Stock No. MP-10. Net price \$7.49 each. In lots of 3 or more, \$7.00 each.

\$2.95 FOR A REG. \$7.77 PROBE
Boes signal tracer probe, with instructions. Made to sell to you for \$7.77. A heavy bakelite probe containing a 6F5GT tube. (The end of the probe is secured by three screws and is taken apart easily.) A 5 foot lead with 3 circuit amphenol plugs and receptacle and Mueller new clip. Connect this probe to any AC amplifier and have a signal tracer. Shpg. wt. 1 lb. Net. \$2.95; 2 for \$4.95.

10-Station Intercom Master \$24.95

WIRE RECORDER CONVERTER
3 tube AC wire recorder oscillator and erase circuits for use with the St. George mechanism, or any wire recorder head. Adapts any radio or amplifier to operate a wire recorder, mike and phono inputs, self powered. Wired with tubes and instructions. Model RR-V, shipping weight 6 lbs. Net price, \$13.95.

HALLICRAFTERS S-78 AM-FM CHASSIS WITH 12" COAXIAL PM \$99.95

5-Station Intercom Master \$14.95
Model 2700 5-station intercom master, in an attractive walnut cabinet 10x5 1/2 x 8". Push-button for each sub and talk-listen switch and volume control. AC-DC amplifier with lots of power and full size Alnico V PM speaker. 1950 production of a famous factory. Only 300 left, weight 7 lbs. Model 2700, net, \$14.95.

Heavy duty Model 2520 10-station intercom master in a sleek beautiful walnut cabinet. Inet. 14x6 1/2 x 7 1/2" high. Powerful AC amplifier with 8V8 output, 6S7 and 80 rectifier. Heavy 1.15 oz. Alnico V 2" PM speaker. Push-button for each of 10 stations, talk-listen switch and all call buttons; volume control. Installs in a 3-wire system. A fortunate purchase by McGee makes a saving for you. Model E 2520, weight 12 lbs. Net, \$24.95 each.

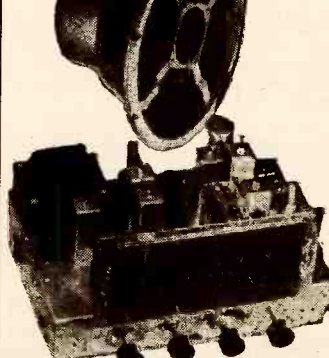

Sensational new Hallicrafters, 10 tube, plus rectifier, Model S-78 AM-FM chassis, for custom installation. A complete radio chassis with its own power supply and push-pull high fidelity system. Chassis with 12 1/2 x 7 3/4 x high and 11" deep. Output transformer matches 32 ohm speaker and 500 ohm. Receives FM, AM, mc and standard broadcast. Automatic frequency control (AFC) on FM holds receiver in perfect tune. A set used in radios of the 1000 class. Frequency response, 50 to 14,000 CPS. Bass boost tone control and phono input. Why buy an ordinary chassis when you can buy a Hallicrafters from McGee's Complete with dial escutcheon, knobs and tubes. Buy your S-78 Hallicrafters chassis with a 12" wide range speaker. S-78 Hallicrafters chassis, complete. Net price, \$89.95. S-78 chassis with \$32.50 list 12" coaxial PM speaker, both for \$99.95. S-78 chassis with \$60.00 list 15" coaxial PM speaker, both for \$104.95. See automatic record changer listed elsewhere in this ad. One tube pre-amplifier for S-78; adapts chassis for use with the G.E. variable reluctance pickup or crystal mike \$8.99. No. 83.95. Crystal mike and desk stand, \$4.95 extra.

SUB-STATION FOR ABOVE INTERCOMS \$3.95
Model MG-300 molded walnut plastic sub-station with call-back switch and heavy PM speaker. 5 1/2 x 4 1/2 x 3 1/2", for wall or desk. Weight 2 lbs. Net, \$3.95 each; 5 for \$18.95.
3 wire intercom cable, plastic, \$1.95 per 100 ft.; 500 ft., \$9.50.

IT'S MCGEE'S FOR RADIO-AMP KITS, T.V. PARTS



16JP4 \$24.95
12LP4 \$17.95

We have a few neutral face television picture tubes available at terrific prices. All 1st quality tubes; unconditionally guaranteed for 90 days.

16JP4, 16" round, shipping weight 25 lbs. Net price, \$24.95.

12LP4, 12" round, shipping weight 19 lbs. Net price, \$17.95.

20 MATCHED VIDEO COIL KIT \$7.95

20 matched TV video and sound I.F. coils. Intended for use with the RCA circuit. You get 8 peaking coils, 4-25.75 mc picture I.F.'s, 2-21.25 mc sound I.F.'s, discriminator and converter coil and 5 filament chokes. Stock No. 205-XX, weight 3 lbs. Net price, \$7.95. \$6.95 if purchased with a Sarkes-Tarzian TV tuner; all coils identified.

SARKES-TARZIAN TV TUNER \$7.95

Sarkes-Tarzian 13-channel television front end tuner. Factory wired. Rotary switch type, popular today on many TV sets. Also good for building picture tubes. 6C4 oscillator, 6BH6 RF and 6AG5 mixer. Output of tuner feeds your converter coil, I.F.'s, etc. Stock No. ST-1E, weight 3 lbs., less tubes, \$7.95. Our 205-XX video coil kit, \$6.95 extra, when ordered with tuner.

15" COAXIAL PM \$17.95

Only \$17.95 buys a full 15" 20 watt coaxial PM speaker, with built-in high pass filter. Hook to radio or amplifier. Response below 20 to above 17,500 CPS. Good bass response. A lucky purchase makes this price possible. Full 32 ohm magnet in the woofer. 15" tweeter. Model No. 15-5, weight 14 lbs. Sale price, \$17.95, or two for \$34.00.

MAHOGANY BAFFLE \$32.95

Mahogany armchair height speaker baffle for 12 and 15" speakers. 24" high, 27" wide and 16" deep. Specify whether baffle is needed for 12 or 15" speaker. Beautiful matched mahogany, furniture quality finish. High quality, non-rattle construction baffle. No. 1S-4, weight 40 lbs. Net price \$32.95.

BRAND NEW GENERAL INST. TELEVISION FRONT END-TUNERS Sale Price \$7.95

All completely wired, brass new and pre-aligned 13 channel selector incorporating fixed inductance and variable capacitance. Converter output transformer is attached to be coupled direct to separate sound and video I.F.'s. 3 6J6 tubes are required. Shaft length 2 1/4". Built in fine frequency control. Original factory cost over \$20.00. Weight 4 lbs. Stock No. GI-13P, less tubes. Net price \$7.95.

201R1 width control. Net \$0.44
201R3 Linearity control .44
20878 Syncroklok .99
Deflection yoke for 10 and 12" tube. Net .249
Deflection yoke for 16" tube. .249
Focus coil, 247 ohms, for 10, 12 or 16" .195
Vertical deflection output trans. 10, 12, 16" .149
Vertical oscillator transformers. .99
Horizontal scanning output transformer. Full 100 ohm input and feeds horizontal scanning coil of deflection yoke. Either 9.5 or 13 K.V. .295
Alnico V ion trap. .49
Picture tube sockets with leads. .49

12" COAXIAL PM \$12.95

A \$32.50 retail value, 20 watt 12" coaxial PM speaker of quality used on radios of the \$300 to \$500 bracket. Hook up like any PM speaker. High pass filter is built on shield. Shipping weight 10 lbs. Wide range response. 20 to 17,500 CPS. Model No. 12-5, weight 10 lbs. Special sale price, \$12.95, or two for \$25.00.

SUPER HEAVY DUTY 10" PM \$4.95

We made a special purchase on several hundred 20 watt, 10", 32 oz. Alnico 3 magnet PM speakers. All high fidelity sound systems and radio replacement. The magnet on this speaker is usually used on a 16" size. Very efficient, good high and bass response. You'll appreciate it when you get your hands on this speaker. Attractive copper finish. 8 ohm voice coil. Stock No. 1025PS. Weight 7 lbs. Net price \$4.95 each.

Order three of these and use them in a cluster of three. They will take 60 watts of audio and have more cone area than any 15" speaker. For high power, top quality P.A. work. Think this over. 3 No. 1025PS speakers for only \$13.95.

4-Prong V.B. \$1.29

No. V-53, standard 4 prong vibrator in aluminum serrated can. Replacement for Motorola, Chrysler, etc. \$1.29, 10 for \$11.90. Deleo Bulck vibrator. In aluminum serrated can. New 1951 production. \$1.39 each, 10 for \$12.90. Deleo Bulck vibrator replacement. Individually cartoned. No. 500500. Net \$1.95 each, 10 for \$17.95.

Mallory 534C, 7 prong reversible sync vibrator. Late auto sets and two-way mobile units. Net \$1.95 each, 10 for \$17.95. All vibrators are unconditionally guaranteed.

TV BOOSTERS AND ROTORS

Regency DB-400 television booster. A real engineered unit, small and compact. Supplies H.V. and tuned, using 2-6J6 tubes as neutralized focus pull amplifiers. Dollar for dollar, your best booster buy. 534C 430V, for 110 volt operation. Weight 6 lbs. Net price \$19.10.

Astatic AT-1, "Channel-Chief" booster. Two tuned circuits and two broad circuits on all channels. Dual controls tune sound and focus independently. 1 1/2" x 8 1/2" x 7 1/4". Weight 6 lbs. Net price \$29.10.

Astatic BT-1 television booster. Continuous variable tuning on all channels; simplified single knob tuning; 100 noise design, uses single 6AK5 tube and selenium rectifier. For either 72 or 300 ohm input and output. Woodgrain metal cabinet. Weight 4 lbs. Net \$19.10.

Koenig, "Tele-Beamer" antenna rotor will carry any weight antenna with 3/4 to 2" mast. Takes winds up to 60 mph. Positive action push-button control. Uses 2 heavy duty motors. A precision light weight instrument with machine cut gears and electrical stops. Net \$24.95.

McGee's Super High Fidelity Best Value in U.S.A. OUTPUT TRANS. \$7.95

Model A-403 High fidelity output transformer. Why pay \$20 or \$30 for an output, when our A-403 sells at \$8.95? Impedance, 6600 ohms plate to plate, (for PP 6L6 or 6V6), 10% feedback winding, 4-8-15-250 and 500 ohm secondary. Housed in a potted case. Net weight 6 lbs. Recommended for all amplifiers up to 34 watts. Size 3 3/4" x 4 1/2" x 3". Suggested diagram included. Shipping weight 6 lbs. Net price A-403 \$7.95.

HIGH FREQUENCY TWEETER 750 TO 17,500 CPS. \$10.95

1951 model high frequency speaker, designed for reproduction from 750 to above 17,500 CPS. Use with any high output cone speaker as a woofer for putting a 2 mf condenser in series with high frequency tweeter. Has removable 8 ohm Bell diameter 4 1/2", length 10 3/4". Model HF-5 speaker, \$10.95 each.

G.E. variable reluctance pickup up

Deep throat and easy moving cone. Ideal for all high fidelity sound systems and radio replacement. The magnet on this speaker is usually used on a 16" size. Very efficient, good high and bass response. You'll appreciate it when you get your hands on this speaker. Attractive copper finish. 8 ohm voice coil. Stock No. 1025PS. Weight 7 lbs. Net price \$4.95 each.

Order three of these and use them in a cluster of three. They will take 60 watts of audio and have more cone area than any 15" speaker. For high power, top quality P.A. work. Think this over. 3 No. 1025PS speakers for only \$13.95.

2-STATION INTERCOM \$14.95

Complete, top quality two station intercom system. \$14.95. With 50 feet of connecting cable. New 1951 production, housed in matching walnut plastic case. Master has push-to-talk switch. May be used on wall or desk. Conventional amplifier using 125W7, 50L6 and 32N6 tubes. Stock No. 125W7-3S, weight 8 lbs. Net price \$14.95. Extra sub for use in parallel with other sub as a non-selective 3 station system, \$3.95.

PUSH PULL TRIODE OUTPUT TRANS. \$4.95

High fidelity push-pull 2A3 to 6A3 voice coil transformer. Wide range response, upright mounting. Use with push-pull 2A3 or 6A3 tubes, 3,000 ohms plate to plate. No. K-94157, weight 2 1/2 lbs. Net \$4.95.

High fidelity push-pull 78 output transformer. Upright, shielded. Matches push-pull 6V6 or any 10,000 ohm plate to 8 ohm voice coil. Weight 2 1/2 lbs. No. K-94241. Net price \$4.95.

MOTOROLA REMOTE CONTROLS

Genuine Motorola Controls Heads, 99c each. Pick any of these automatic control heads in factory cartons at 99c each. Automatic heads with push buttons and manual tuning for the following: 42-46 Cadillac, 42, 46, 47 Hudson, 40 Lincoln Zephyr, 42-46 Lincoln Zephyr, Cadillac, 42 Oldsmobile, 41, 46, 47 Packard. Shipping weight 3 lbs. each. Net 99c. 10 for \$7.95.

T.V. AERIALS WITH 300 OHM LINE

201/XL, all hand conical, as picture, less mast. Individually cartoned, with 50 feet of good standard quality 300 ohm twin lead. Net price \$7.95 each; 10 for \$69.95.

402-XL, all hand, stacked conical, 1 e s s mast. Individually cartoned with 50 feet of good standard quality 300 ohm twin lead. Net price, \$12.45 each; 10 for \$114.95.

12" 32 OZ. PM SPEAKER \$6.95

12", 32 oz. magnet, 20 watt PM speaker, with 8 ohm voice coil. A regular \$17.00 list consolidated speaker. Weight 8 lbs. No. CN-1232, \$6.95 each, 4 for \$26.00.

78 RPM AMPLIFIER RECORD PLAYER \$11.95

78 RPM record player with self-contained amplifier and speaker. Complete ready to play, housed in plastic case. Excellent tone quality for this size player. Model E-100F, weight 8 lbs. \$11.95.

G.E. 78 RPM record player attachment, housed in beautiful plastic case, with heavy duty motor and crystal pickup. Has volume control and on-off switch. Model GE-78, weight 8 lbs. Net \$6.95. 3 for \$19.50.

Built Your Own Phono-Mike Oscillator Kit \$6.95

Kit Model DE-6X. With this simple kit, you can build a 4 tube phono oscillator that also has a mike input. Will broadcast over any radio, within your home, (about 75 feet) from 800 to 1500 kc. Inputs for crystal mike or crystal phono pickup. Favor control fades from mike to record. Ideal for a home P.A. system, baby listener and home entertainment. A complete kit of parts including tubes. Kit Model DE-6X. Net price, \$6.95. DE-6XWT, wired and tested. Net price, \$8.95. Crystal mike and stand, \$4.95 extra. Concealed microphone unit, only 1" in diameter and 1/2" thick. Specify hidden mike when ordering. Stock No. T-001. Net, \$3.95 extra.

Mahogany Armchair radio-phonograph cabinet

With blank panels. 24" high, 27" long and 16 1/2" wide. Will hold 27" changer up to 14" square; radio compartment 14" long, 9" high and 10" deep. Baffle cut for speaker. Top quality furniture construction. Weight 40 lbs. Net price \$32.95.

3-SPEED RECORD PLAYER KIT \$13.95

Complete record player kit to build a 3 speed amplifier. Heavy 3 speed phono motor, universal crystal pickup, all parts and tubes to build a 70L7 type amplifier in an attractive walnut case with grill for speaker cut on top. Kit model D-3378, net price \$13.95.

COMPLETE RADIO AND AMPLIFIER KITS FOR SCHOOLS AND CUSTOM BUILDERS

5-TUBE BROADCAST SUPERHERO RADIO KIT \$11.95

Model NS-5X 5 tube AC-DC superhero type radio kit. Has loop antenna and 2 gang condenser, with lighted slide rule dial and attractive plastic cabinet. Receives broadcast, 550 to 1650 kc. Full size dynamic speaker, matched 450 I.F.'s, automatic volume control. This is a complete radio kit. Everything furnished, including diagram, photos and tubes: 148B, 147, 147, 50B5 and rectifier. Shipping weight 7 lbs. Stock No. NS-5X. Net price \$11.95.

8-TUBE 22 WATT Wide Range Amp. Kit Only \$29.95

A complete kit, including tubes (3-7E5, 2-7F7, 2-6A3 or W.E. VT-52, plus rectifier, diagram and photos. All triode circuit makes for minimum harmonic distortion. Inputs for radio tuner any kind of phono pickup (crystal or G.E. variable reluctance) and either crystal or dynamic mike. Output transformer matches 8 ohm voice coil. Twin electronic tone controls with range selector switch for either juke box quality with heavy bass response or brilliant symphonic range. The best quality amplifier kit we know how to make. Has very heavy power transformer. Response 8 to 20,000 CPS. 8 tube kit includes amplifier kit, complete with tubes. Weight 25 lbs. Net \$29.95.

New 16 Watt Utility Amp Kit \$14.95

Kit Model TM-16, push-pull wide-range 16 watt amplifier kit. Ideal for a high quality record player, as a P. A. system or recording amplifier. Matched component parts, ready punched chassis. One control fades from phono to mike. Input compensation for G.E. variable reluctance, or crystal pickup, fully shielded. Output matches 8 ohm voice coil, 100 mill power transformer. Complete with tubes, photos and diagram. 2-7C5, 7F7 and rectifier. Variable tone control. Model TM-16. Weight 10 lbs. Net \$14.95.

\$19.95 BUYS THIS ALL PURPOSE 18 WATT AMP KIT

High fidelity amplifier kit. Model S-2020. Has inputs for radio tuner, any phono pickup, crystal or G.E. variable reluctance as well as crystal or dynamic mike. Controls can be mounted on the chassis or on extension leads, as pictured. Has broad quality shielded \$10.00 value output transformer. Matches 8 ohm speaker. A complete amplifier kit with tubes, 3-7F7, 2-7C5, plus rectifier, fine amplifier for the home music system. Model No. S-2020, weight 16 lbs. Net \$19.95.

SELF POWERED AC Broadcast Tuner Kit. 3-Gang Tuning. Complete Kit, \$11.95

A self powered, 3 gang superhero tuner kit, with R.F. stage. When wired according to our diagram will make the best possible broadcast tuner, (550 to 1650 kc) for use with any amplifier. Has a 6" lighted slide rule dial. Don't class this with ordinary tuners, this has its own transformer. The complete kit is furnished with a diagram and photos, with tubes: 6SK7, E.F. 6SA7 converter, 6SK7 I.F., 6H6 detector, 6X4 rectifier. Connect to any audio amplifier. Ideal for use with our 7X5, TM-16 or S-2020 amp kits. Chassis size: 9 1/2" x 8 1/2" x 4 1/2". Shipping weight 8 lbs. Broadcast tuner kit. Model BT-38. Net price \$11.95.

8-TUBE 22 WATT Wide Range Amp. Kit Only \$29.95

A complete kit, including tubes (3-7E5, 2-7F7, 2-6A3 or W.E. VT-52, plus rectifier, diagram and photos. All triode circuit makes for minimum harmonic distortion. Inputs for radio tuner any kind of phono pickup (crystal or G.E. variable reluctance) and either crystal or dynamic mike. Output transformer matches 8 ohm voice coil. Twin electronic tone controls with range selector switch for either juke box quality with heavy bass response or brilliant symphonic range. The best quality amplifier kit we know how to make. Has very heavy power transformer. Response 8 to 20,000 CPS. 8 tube kit includes amplifier kit, complete with tubes. Weight 25 lbs. Net \$29.95.

8-TUBE 22 WATT Wide Range Amp. Kit Only \$29.95

A complete kit, including tubes (3-7E5, 2-7F7, 2-6A3 or W.E. VT-52, plus rectifier, diagram and photos. All triode circuit makes for minimum harmonic distortion. Inputs for radio tuner any kind of phono pickup (crystal or G.E. variable reluctance) and either crystal or dynamic mike. Output transformer matches 8 ohm voice coil. Twin electronic tone controls with range selector switch for either juke box quality with heavy bass response or brilliant symphonic range. The best quality amplifier kit we know how to make. Has very heavy power transformer. Response 8 to 20,000 CPS. 8 tube kit includes amplifier kit, complete with tubes. Weight 25 lbs. Net \$29.95.

\$19.95 BUYS THIS ALL PURPOSE 18 WATT AMP KIT

High fidelity amplifier kit. Model S-2020. Has inputs for radio tuner, any phono pickup, crystal or G.E. variable reluctance as well as crystal or dynamic mike. Controls can be mounted on the chassis or on extension leads, as pictured. Has broad quality shielded \$10.00 value output transformer. Matches 8 ohm speaker. A complete amplifier kit with tubes, 3-7F7, 2-7C5, plus rectifier, fine amplifier for the home music system. Model No. S-2020, weight 16 lbs. Net \$19.95.

McGEE RADIO COMPANY Prices F.O.B. K.C. Send 25% Deposit with Order. Balance Sent C.O.D. With Parcel Post Orders. Include Postage. **TELEPHONE VICTOR 9045. WRITE FOR FLYER 1422 GRAND AVE., KANSAS CITY, MISSOURI**

PRICES Slashed

OUR \$50,000 STOCK OF RECONDITIONED, "GOOD-AS-NEW" EQUIPMENT MUST GO AT A RECORD-BREAKING SACRIFICE TO MAKE ROOM FOR NEW MERCHANDISE!

SAVE UP TO 50% during GIGANTIC CLEARANCE SALE of USED TEST and COMMUNICATION EQUIPMENT

Each and every instrument thoroughly checked and guaranteed to be in normal operating condition when shipped to you. While the following is only a partial list of our huge inventory (available at the time this publication goes to press) bargains like these simply can't last! So act now and avoid disappointment. Wire, write, phone or use the handy coupon, today! When ordering, indicate first, second and third choice. All merchandise subject to prior sale.

COMMUNICATION EQUIPMENT

RECEIVERS

COLLINS 75A	with spkr. only	\$299.50
HAMMARLUND SUPER PRO	with spkr. only	139.50
HAMMARLUND HQ129X	less spkr. only	27.50
NATIONAL 1-10	with spkr. only	175.00
NATIONAL HROSTA1	with spkr. only	239.50
NATIONAL HRO7	with spkr. only	147.50
NATIONAL NC173	with spkr. only	210.00
NATIONAL NC183	with spkr. only	155.00
NATIONAL NC240D	only	14.95
PILOTUNER FM TUNER	with spkr. only	95.00
RME 45	with spkr. only	99.50
RME 45A CALOMATIC	with spkr. only	57.50
RME 84	with spkr. only	79.50
RME 99	less spkr. only	49.50
SURPLUS BC348 110V		

TRANSMITTERS

(With tubes and coils for one band)

HALLICRAFTERS HT9	only	\$225.00
HALLICRAFTERS HT18	"	89.50
HARVEY WELLS TBSS0	"	79.50
HARVEY WELLS TBSS0A	"	94.50
HARVEY WELLS TBSS0C	"	89.50
HARVEY WELLS TBSS0D	"	110.00

HARVEY WELLS APS50 Pwr. Supply for TBS-50 Series	"	\$ 25.00
McMURDO SILVER 700	"	29.50
MECK T60-1	"	89.50
TELVAR T60-2	"	129.50
WRL GLOBE TROTTER	"	57.50

NBFM EQUIPMENT

SONAR XE10	only	\$14.95
SONAR AMP50	only	29.50
SONAR MB611	only	29.50
SONAR VFX680	only	39.50

MILLEN EQUIPMENT

90700 VARIARM	only	\$19.00
90501 FREQ. STANDARD	only	69.50
92105 SIDEBAND SEL.	only	34.50

MISCELLANEOUS EQUIPMENT

GON-SET 6-15 CONV.	only	\$49.50
GON-SET 10M CONV.	only	27.50
MEISSNER EX SHIFTER WITH FM	only	59.50
LESS FM	only	49.50
SYLVANIA MOD. METER	only	19.50

TEST EQUIPMENT

TUBE TESTERS

HICKOK 51X COMBINATION	only	\$22.50
R.C.P. 802N COMBINATION	only	24.50
DACO 303 OR DACO 606	only	19.50

SIGNAL GENERATORS

McMURDO SILVER 906 FM-AM	only	\$69.50
McMURDO SILVER 909 SWEEP	only	17.50
PRECISION E200 FM-AM	only	42.50

VACUUM TUBE VOLTMETERS

McMURDO SILVER 900 VOMAX	only	\$29.95
McMURDO SILVER 900A VOMAX	only	44.50
ST. CLAIR 451	only	37.50
SUPREME 565	only	29.50
TRIPLETT 2450	only	59.50

OSCILLOSCOPES

DUMONT 164E 3"	only	\$ 64.50
DUMONT 208 5"	only	145.00
DUMONT 274 5"	only	99.50
HICKOK 195 5"	only	99.50
HICKOK 905 3"	only	89.50
RCA TMV122B 3"	only	35.00
SUPREME 546 3"	only	35.00
WATERMAN S10A POCKET-SCOPE	only	29.50

Brand New Equipment Specially Priced

	Reg. Price	Sale Price
FERRET 730 SIGNAL TRACER & VTVM COMB.	\$ 99.95	\$67.50
SIMPSON 415 SIGNAL GENERATOR FM-AM	115.00	77.50

Miscellaneous Equipment

MEISSNER ANALYST 9-1040	only	\$57.50
McMURDO SILVER 905 SPARX	only	24.95
PHILCO 7030 SIG. TRACER	only	32.50
RCA CHANALYST	only	89.50
RCA 154 AUDIO OSC.	only	32.50
TRIPLETT 2470 APP. TESTER	only	52.50
WESTON 785 VOM	only	67.50

All prices F. O. B. St. Louis Phone Chestnut 1125

FREE!

Complete List of Used Test and Communication Equipment... also new 164-page catalog. Send for your list and catalog today!

Walter Ashe Radio Co. R-51-1
1125 Pine St., St. Louis 1, Missouri

Rush my order for Used Equipment as follows:
(1st choice)
(2nd choice)
(3rd choice)

Remittance for \$..... is enclosed.

Send FREE List of Additional Used Equipment Bargains.

Name

Address

City..... Zone..... State.....

Walter Ashe RADIO CO.
1125 PINE ST. • ST. LOUIS 1, MO.

What's New in Radio

For additional information on any of the items described herein, readers are asked to write direct to the manufacturer. By mentioning RADIO & TELEVISION NEWS, the page, and the issue number, delay will be avoided.

AMPEX RECORDER

Ampex Electric Corporation of San Carlos, California, has recently introduced a new recorder unit, the Model 400.

The new instrument provides simultaneous erase, record, and playback and permits the recording of 132 minutes of program material on a single 10" standard reel. The recorder has a



range of 15,000 cycles on half-track tape recorded at 7 1/2" per second tape speed.

The Model 400 comes in a single portable case weighing approximately 62 pounds. The same machine is also available in console cabinets and for standard rack mounting.

AUDIO OSCILLATOR

The Electronic Workshop of 351 Bleeker Street, New York 14, New York has announced the availability of a new model audio oscillator, the 510-A.

This test instrument has a frequency range of 18 cycles to 210,000 cycles in four decades. It will deliver 10 volts into 10,000 ohms with input constant within .5 db. over the entire frequency range. Distortion at this amplitude is less than .3% from 100 cycles to 15,000 cycles and rises to no more than

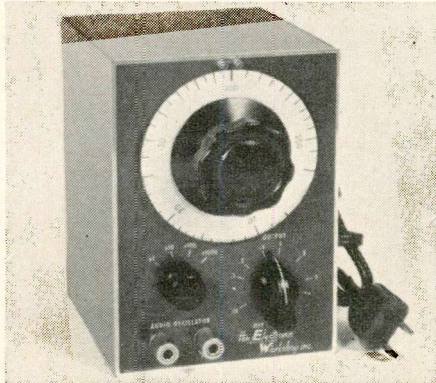

.5% at 30 cycles, according to the company.

The source impedance of the cathode-follower output is 560 ohms. A

matching transformer for feeding low-impedance balanced lines is available as an accessory. The total frequency error due to drift and dial calibration is less than $\pm 2\%$. The 320 degree dial gives a scale length of over 8". The output control is logarithmic and is calibrated approximately in output voltage. The new unit measures 4"x5 1/2"x4".

Full details are available from the company.

CLARKSTAN PICKUP

A new variable reluctance pickup has been developed by the Clarkstan Corporation of 11921 West Pico Blvd., Los Angeles 64, California.

The unit is a "junior" model of the company's well-known Type RV cartridge. Known as the Model 204, the new pickup has several unusual features. The stylus is easily removable and interchangeable so that micro-groove, standard, and transcription recordings can be played. Styli are available with ball points for all these various types of records.

The instrument is housed in a crystal clear polystyrene plastic which permits the operator to see the inner

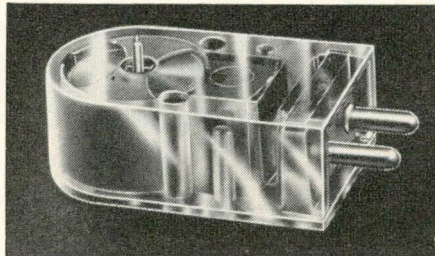

workings of the pickup. The cartridge weighs 14 grams. The compliance is adequate for all types of recordings. The instrument is velocity responsive and is essentially flat, by recording playback standards, to above 10,000 c.p.s. The cartridge is 1 1/2 inches long.

V.T.V.M. KIT

Allied Radio Corporation of 833 West Jackson Blvd., Chicago, Illinois has just introduced a new vacuum tube voltmeter kit which has been designated the "Knight V.T.V.M."

The new instrument, which is low in cost and easy to build, includes 4 milliamper ranges and 6 capacity v.t.v.m. ranges in addition to the 20 standard v.t.v.m. ranges. Because of these added features the company recommends this kit as an all-around test instrument for the service technician, experimenter, kit-builder, student, ham, or for industrial or school laboratory use.

The available ranges of the instrument include 7 d.c. volts, 6 a.c. volts, 4 d.c. milliamperes, 6 ohms, 5 decibels,

You Can't Beat Wholesale Radio for Quality and Price

TV ANTENNAS

DOUBLE CONICAL LAZY XX
For fringe areas. Extremely hi-gain. All TV and FM channels. Completely pre-assembled. Three 3 1/2 ft. masts and adj. mounting base included. Model TX-2 \$15.95
HI-LO FOLDED DIPOLE ARRAY
Two folded dipoles, hi & lo, with reflectors. Less mast. AR-21 \$4.39
HI-LO FOLDED DIPOLE ANTENNA
Complete with 2-1/2 ft. mast sections and guy ring. Two folded dipoles, hi & lo, with reflectors \$5.95
TV HI-BAND ARRAY
Folded dipole and reflector. Channels 7 to 13. Model HF-3. Less mast. \$1.49
TV LO-BAND ARRAY
Folded dipole and reflector. Channels 2 to 6. Model AR-26. Less mast. \$3.95
HI-LO DIPOLE IN-LINE ARRAY
All channels. 2 folded dipoles with reflector. Universal U clamp for masts up to 1 1/4". Model AR-29. Less mast. \$4.75

Lowest Price Conical Array
CAN BE STACKED FOR FRINGE AREAS
HAS 8 INTERCHANGEABLE ELEMENTS
Model XA-44 \$3.95
Less Mast

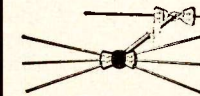

Complete TV-FM band. Hi-tensile 3/8" aluminum alloy elements. Includes mast clamp for poles up to 1 1/4". Can be used with any type lead-in 72 to 300 ohms.

TV ANTENNA ACCESSORIES

STEEL EXTENSION POLES
10 ft. long. 1 1/4" di. \$1.69
5 ft. long. 1 1/4" di.98
3 1/2 ft. long. 1 1/4" di.89
SWIVEL BASE. Aluminum.
Fits 1 1/4" O.D. mast section.39
GUYWIRE. 6 stranded No. 20. Per 50 ft.39
24 reels. 50 ft. ea. interconnected. 6.00
72 OHM COAXIAL CABLE RG59
6c per ft. Per 100 ft. 5.25
CHIMNEY MOUNT BRACKETS. Complete with strap
3" 300 OHM STAND-OFF INSULATORS
Wood screw-in type (4c ea.). Per 100 2.95
SAMS TV ANTENNA MANU.
SNAP ON TWIN LEAD INSULATORS
Fit 1 1/4" masts. Each.06
FLAT 4 CONDUCTOR LEAD-IN
3c per ft. Per 100 ft. 2.50
AT105 JFD LIGHTNING ARRESTOR. For twin lead. Mounts to baseboard75
4B STACKING ASSEMBLY. 4 rods and a center tie point. For stacking 2 double XX arrays 1.95
PEAK ROOF MOUNTS for all types of antennas. Flat roof, side wall, any angle. Fits masts 3/4" to 1 1/2". Model PRA-148 2.89
HEAVY DUTY MAST BRACKETS. Model WB-2. Adj. up to 18" from wall. Fits masts 1" to 1 1/2" di. 3.75
MAST COUPLINGS. 10" long. for 1 1/4" masts.90
HEAVY DUTY TIE RODS. 10" long. for 1 1/4" masts.75
TIE RODS for conical type antenna. Pair.75

Convert To Big Screen TV
Wholesale Radio Has Everything You Need for Easy Conversion!

FOR 14" SCREENS

Shelden rectangular tube 14BP4.
G.E. rectangular tube 14CP4. \$26.50
70° Deflection Yoke MD70
For 14" or 16" tubes. 4.95
Focus Coil 202D-2 6.80
Mounting Brackets for 202D-2 2.65
Type BR-67. Rectangular. 3.45
14" Plastic Mask. Rectangular. 9.45
Deluxe Hi-Sweep Kit B
Universal metal chassis. Type UB. For
adapting 630 type chassis to 14", 16", 19"
round or rect. tubes. Set. 4.65

FOR 16" SCREENS

G.E. Rectangular Tube 16KP4. \$40.60
70° Deflection Yoke M-D-70-F.
Greater deflection sensitivity for
16" rectangular tubes. 6.00
Focus Coil 202D-2 6.80
16" Plastic Rectangular Mask. 4.75
Mounting Brackets for 202D-2 Type BR-67 2.65
Universal metal chassis. Type UB. For
adapting 630 type chassis to 14", 16", 19"
round or rect. tubes. Set. 4.65
Deluxe Hi-Sweep Kit B. (See details below) 9.45

Hi-Sweep Voltage Multiplier Kit!

FOR CONVERTING TO 14", 16" or 19" TUBES

For converting 630 or similar type sets. Supplies 14 kv with full sweep using a single 1B3 rectifier. Kit complete with T771 flyback transformer, special width coil and all other components necessary to complete your voltage multiplier kit. Plus wiring instructions. Type A for 16" round tubes. Type B for 14-16 rectangular and 19" tubes \$9.45

Address Orders to Dept. RN-1 or Phone Mulberry 2134

WHOLESALE RADIO PARTS CO., Inc.
311 W. Baltimore St.
BALTIMORE 1, MD.

Write for Free Monthly "FYI" Bulletin

and 6 capacity. The unit reads up to 5000 volts d.c., 1000 volts a.c., and to 1000 megohms. Special probes are available for extending the d.c. range to 30,000 volts and for extending the a.c. range to read r.f. to 100 mc.

Matched pair resistors are used for high accuracy. The unit has a zero-center d.c. scale for use in FM discriminator alignment, and a pilot light for "off-on" indication. The instrument uses a 4 1/2" meter. The all steel case is finished in Hammertone gray and is 10"x6"x5".

The kit comes complete with all parts and step-by-step instructions for assembling the instrument.

"MAGNEROTOR"

The *Viking Tool & Machine Corp.* of 2 Main Street, Belleville 9, New Jersey has developed a new type of motor which produces high starting torque, can be reversed, and has variable speed.

Tradenamed the "Magnerotor," the new unit supplies speeds of from 1/2 r.p.m. to 100 r.p.m., without reduction gears, in either unidirectional or reversible models operating on 6, 24, 115, or 220 volts, 60-cycle a.c.

At 35 watts input, the starting torque at 1 r.p.m. is 80 inch-pounds. The standard model is supplied in a weatherproof diecast housing which requires no oiling and will operate at extremely high and low temperatures under extreme weather conditions.

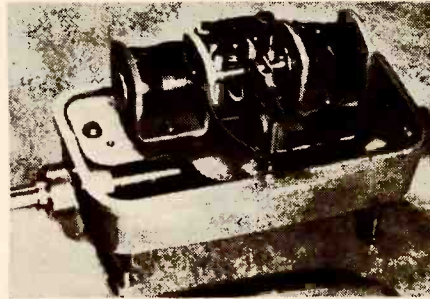

The motor can be remotely controlled in much the same way as a servo-mechanism. The unit can be used as an antenna rotator, for operating radio tuning and direction finding controls, for operating remote controlled rheostats, etc.

Additional details on the new unit are available from the company.

LUG TWISTER

A new and handy tool, designed for twisting mounting lugs on fabricated plate condensers, has been introduced to the trade by *Kenneth D. Clayton*, Box 1032, Bethlehem, Pa.

The new unit makes use of a slotted end which fits over the lug. A simple twist in either direction anchors or loosens the lug as desired. A skirt around the slot prevents the tool from slipping off and damaging other parts. Lugs which are soldered to the chassis can be twisted until they break off. The skirt on the tool is removable so

that twisted lugs may be disengaged from the slot in case of jamming.

The tool has a sturdy plastic handle, with the over-all design emphasis being placed on slenderness so that the unit may be used to reach into tight spots on radio and television chassis.

CRYSTAL CARTRIDGE

The *Astatic Corporation* of Conneaut, Ohio has recently introduced a new crystal cartridge, the CAC-J, which has been especially designed for playing all types of slow-speed records.

The new cartridge is internally equalized to follow *Columbia* records

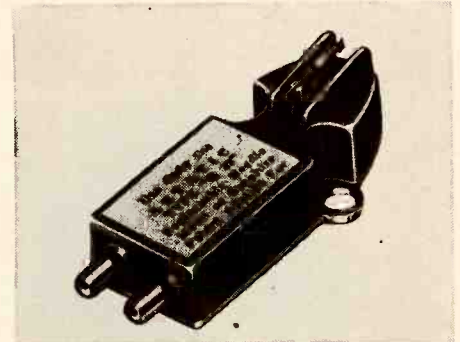

and provides ideal frequency response for the recording characteristics of the LP records (30 to 11,000 cycles).

The unit has a small, lightweight aluminum housing with standard 1/2" (Continued on page 118)

BARGAIN
740 Volts CT @ 185 MA
6.3V @ 4A, 5 Volts @ 3A
110 V. 60 cy. pri. Half-shell mount.
\$3.49

PEAK ELECTRONICS CO.
COMPONENTS
SELECTED AND GUARANTEED SURPLUS AT A FRACTION OF ORIGINAL COST.
188 WASHINGTON ST., NEW YORK 7, N.Y.

SIGMA SENSITIVE RELAY
S.P.D.T. adjustable from 7 MA to 1.5 MA, 8000 ohm coil.
\$2.29 ea.
10 for \$19.50

PANEL METERS
GE-General Electric
WH-Westinghouse
W-Weston S-Simpson
SU-Sun Special Sale
SQ-Square Case

2" Meters

0-500 UA, S*	\$2.95
0-500 UA, WH*	2.95
0-5 MA, S, SQ*	2.45
0-5 MA, S*	1.95
0-5 MA, GE*	1.75
0-20 MA, S*	1.75
0-25 MA, SU*	1.95
0-50 MA, SU*, SQ	1.95
0-2 AMP RF, S, SQ	1.95
0-4 AMP RF, GE	1.95
0-9 AMP RF, WH	1.95
0-250 MA AC, GE	2.35
0-20 VOLT DC, W	2.45
0-30 AMP DC, GE	1.95

3" Meters

40-0-40 UA, W*	\$7.95
0-100 UA, GE, SQ	8.95
0-1 MA, S*	4.50
0-2 MA, WH, S	3.95
0-5 MA, GE, SQ	3.95
0-10 MA, WH*	2.95
0-20 MA, S, WH	3.95
0-20 MA, GE, SQ	3.95
0-30 MA, GE, SQ	3.95
0-200 MA, GE, SQ	3.95
0-300 MA, GE, SQ	3.95
0-2 AMP, WH	3.95
0-10 VAC, GE, SQ	3.95
0-15 VOLT AC, GE	3.95
0-30 VOLT DC, DA	2.75
0-2 KV DC, GE, SQ	6.95
0-3KV DC, GE, SQ	7.95

RC100B Consisting of
BC768, 769, 770, RA52
and Cabinet\$119.00

CERAMICS
MMF: 1.5, 3, 10, 20, 22, 120, 50005 ea.

SILVER MICA CAPACITORS
MMF: 10, 50, 60, 340, 750, 780, 100009 ea.

METER MULTIPLIERS

2 Meg 1/2 of 1% Cage Enclosed 2 KV	\$3.95
2 Meg 1/2 of 1% Tubular 2 KV	1.95
4 Meg 1/2 of 1% Tubular 4 KV	3.75

PANEL METER KIT
Here's what you get:
• 2" Sq. bakelite cased meter, Gov't. Surplus
• Scales for all the following ranges: 0-50 ma, 0-100 ma, 0-200 ma, 0-500 ma.
• Pre-calculated shunt sizes for all ranges.
• Complete instructions, Only \$2.50 ea. 3 for \$6.75

RAYTHEON SWINGING CHOKE
2 to 12 Henrys, 1 Amp to 100 MA, 15 Ohms DC fully cased. High voltage insulation, ceramic insulators. Very conservatively rated. Weight 60 Lbs. \$14.95 ea.

HIGH WATTAGE ANTENNA RELAY
110/220 volt 60 cycle Solenoid. D.P.D.T. Heavy duty paralleled contacts rated 5000 Volts @ 15 Amps. Sturdy Construction. Isolantite Insulation \$18.50
As above but DPST 12.50
As above but SPDT 12.50

GUARDIAN LATCHING RELAY
SPDT, 110 V 60 cy Coil, 15 Amp Contacts \$1.95

SENSITIVE RELAY
2000 ohm coil, SPDT, breaks at 3 MA, plugs into 5 prong socket \$9.99 ea.

POWER TRANSFORMERS
Fully Cased. Pri. 110 Volts 60 cy.

1110 volts CT 60 MA, 920 volts CT 100 MA, 6.3V, 18A, 6.3V, 1.25V, 5V2A, 5V2A	4.95 ea.
300 volts CT 300 MA, 2.5V7A, 2.5V7A	0.3V, 1.5A
940 volts CT 425 MA, 65V BIAS	7.95
4400 V @ 4.5 MA, 5V 3A, 15 KV INS.	4.95
550 volts CT 125 MA, 5V @ 2A, 6.3V 4A	1.95

Vibrator Trans. 6V 1A, 300V @ 100MA Out. 2.95

FILAMENT TRANSFORMERS
110 V 60 Cy Primaries

6.3V 12 AMPS	\$1.95	2.5V 20A, 2.5V 20A	\$6.95
2.5V 10A, HV INS.	3.95	2.5 VCT 3A	7.95

WIRE WOUND RESISTORS

5 watt ohms: 25-50-200-2500	\$.09 ea.
10 watt ohms: 25-40-84-400-1325-2K-4K	.15 ea.
20 watt ohms: 50-70-100-300-750-1K-1.5K	.20 ea.
2.5K-2.7K-5K-16K-20K	.20 ea.

30 WATT WIRE WOUND RESISTORS
Ohms: 100-2500-4500-5300-18K 8 for .99

ADJUSTABLE SLIDER RESISTORS

20 Watt: 1, 5, 50 Ohms	.25
50 Watt: 100, 500 Ohms	.35
75 Watt: 100, 150, 200 Ohms	.39
100 Watt: 20, 50, 75, 100, 500 Ohms	.49

MISCELLANEOUS BARGAINS

25 ohm 675 watt Rheostat	\$2.95
50 meg 35 watt Resistor	.99
250 mmf Midget Var. Ceramic Ins.	.69
15 mmf Midget Var. Ceramic Ins.	.39
4PST Lever Switch	.89
Ceramic RF Switch SP 1 P	.89
4PDT Relay, 4500 Ohm DC Coil	1.95

SOLA CONSTANT VOLTAGE TRANSFORMER
2 KVA, 17.4 Amps, Input 95-135 Volts, 60 cy., 1 Phase. Constant Output 115 Volts, Type 4, 3 1/2" L, 9 1/2" H., 7 7/8" W. \$137.00 ea.

WESTON PORTABLE AC VOLTMETER
Model 433, 0-150 Volts AC, 25 to 2400 cycles, 3/4%, mirrored hand calibrated scale. Bakelite case with leather handle \$27.50

HIGH CURRENT MICAS
Ceramic Case, Tolerance 5% or Better.

TYPE G4		TYPE G5	
CAP MFD	Amps KV	CAP MFD	Amps KV
.005	30 20	.0001	6 35
.0005	9 30	.00015	10 35
		.0005	20 35
		.003	40 25

BAKELITE CASED MICAS

VDC	Price	Price	Price
.001	600 \$.18	.002	2500 .45
.002	600 \$.24	.004	2500 .50
.01	600 .26	.005	3 KV 1.00
.02	600 .26	.0001	5 KV .70
.027	600 .26	.00045	5 KV 1.10
.01	1 KV .45	.001	5 KV 1.60
.002	1200 .35	.0015	5 KV 1.60
.024	1500 .65	.003	5 KV 1.90
.033	1500 .75	.0003	8 KV 2.50
.02	2 KV .90	.0005	8 KV 2.90

OIL CONDENSERS

56 mfd 220 vac	\$.35	10 mfd 2000 vdc	\$.45
4 mfd 600 vdc	.59	2 mfd 4000 vdc	4.90
6 mfd 600 vdc	.79	1 mfd 5000 vdc	4.50
8/8 mfd 600 vdc	1.39	1/1 mfd 7000 vdc	2.25
10 mfd 600 vdc	1.29	.05 7000 vdc	.85
6 mfd 1500 vdc	2.95	1 7500 vdc	1.25
10 mfd 1500 vdc	3.75	2 mfd 6000 vdc	9.95
2 mfd 2000 vdc	2.25	2 mfd 7500 vdc	12.75
8 mfd 2000 vdc	3.95	.65 mfd 12,500 vdc	12.95

CHOKE BARGAINS

D-Open Frame	C-Cased
6 Hy, 50 MA, D	6 Hy, 400 MA, C
6 Hy, 80 MA, D	8 Hy, 100 MA, C
8 Hy, 175 MA, D	5 Hy, 170 MA, C

Prices: \$0.39, \$1.49, \$1.49, \$1.25

PIGTAIL MICAS

MMF: 5, 20, 50, 60, 100, 250, 300, 400, 500, 750, 800, 1000, 2000, 3000, 4000, 5000, 6000, 10000. \$0.09 ea.

PRECISION 1% W. W. RESISTORS
Ohms: 2K, 5K, 8500, 50K 25 ea.

100 WATT NON-INDUCTIVE RESISTORS
Ohms: 250, 500, 12,500 \$0.75

YOU'RE FIRST IN LINE!

FOR TOP VALUES IN TV, RADIO & ELECTRONICS

TYPICAL CONCORD BUYS

When your name is on Concord's Mailing List you're first to receive news of the Latest and Best Buys in TV, Radio and Electronics Parts and Equipment. This will be especially true in 1951 for Concord is going to issue periodically special

THE MODERN CONTROL MECHANISM



Sessions SWITCH TIMERS

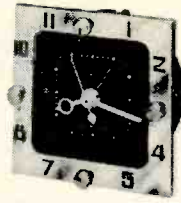

Especially designed for turning radios, TV sets, Air Conditioners, and other common household appliances on and off automatically. Offers the best in clock-radio movements. Easily installed as replacement unit in old clock-radios. All controls, including on-off, switch set, time set, and "Sleep Selector" are conveniently located on front of attractive clock face. "Wake-up" feature turns your radio on in the morning or turns on any desired program at any pre-set time within a 12 hr. period. Special safety feature turns off controlled appliance within 1-1/2 to 2 hrs. should you forget to turn it off manually. "Sleep Selector" lets you go to sleep with your radio playing and turns it off at a pre-set elapsed time up to 90 min. Has low speed, long life motor... built compactly, neat in appearance extremely quiet in operation... no buzz or whine of high speed gears. Size: 3-1/2" dia., 2" deep from clock face. Bezel finished in bronze. Shipped complete with mounting bracket, and mounting and operating instructions. Switch rating 10 amps at 115 V. For 110V, 60 cycle AC. UL approved.

- 33-25472 - Model W-31, Shpg. wt. 3 lbs. **6.50**
- 33-25492R - As above except with 3-1/2" square face and bezel. \$6.50
- Model W-26, same as W-31 except without "Sleep Selector" and has switch rating of 15 amps at 115 volts. \$5.50
- 33-25473R. \$5.50
- 33-25493R - As above except with 3-1/2" square face and bezel \$5.50

MOBILE HIGH VOLTAGE PWR. UNIT

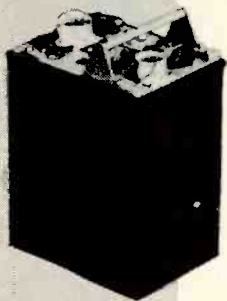

For mobile radios, amateur equipment, PA amplifiers, and many other types of equipment. Well built made of the finest materials available to meet strict specifications. Especially adapted to furnish plate supply for above mentioned units. Input 12 volts at 10 amps. Output consists of two volt ranges: (1) 275 volts at 10 ma., 12 volts @ 3 amps. (2) 500 volts at 50 ma. Contains two nationally known permanent magnet dynamotors, complete with all hash filters. Each high voltage range individually fused and the input has an "on and off" switch and an indicating pilot light assembly. Olive drab wrinkle finish. Size: 8-3/8" x 6-1/4" x 11-5/8".

5-9513R - Shpg wt. 27 lbs. **9.50**

PERMANENT MAGNET DYNAMOTOR

Input 12/24 volts @ 8/4 amps., Output 12/275 volts @ 3/110 amps.
99-9589R - Shpg wt. 10 lbs. \$3.95

RECORDING TAPE

Best Recording Tape Buy on the market! Made by a famous national manufacturer to Concord's strict specifications. 1200' long, 1/4" wide with uniform coating of red oxide particles on kraft paper base. Magnetic coating wound facing in. Plastic reel included. Order while our supply lasts.

35-16297R - 1200' Kraft Paper Base Tape. **1.49**

As above but on stronger more efficient plastic base for more uniform output and lower noise level.
35-16296R - 1200' Plastic Base Tape. \$1.95

BUYER'S GUIDES

jam-packed from cover to cover with TV, FM and AM receivers phonos, high-fidelity sound components, amateur equipment, servicemen's supplies, tubes and other critical parts. All listed as they are available and ready for immediate shipment to you.

CONCORD BUYER'S GUIDE IT'S YOUR KEY TO

- Complete Listings of Available Merchandise
- Current Low Prices
- Prompt Expert Shipment
- Satisfaction Plus

PUT YOUR NAME ON CONCORD'S MAILING LIST **NOW!**

CONCORD RADIO

Mail Order Center and Showroom
901 W. Jackson Blvd., Chicago 7, Ill.
Branch Showroom: 265 Peachtree St., Atlanta 3, Ga.

EXPORT

For PROMPT Service on Export Orders & Inquiries Address to CONCORD RADIO CORP., EXPORT DIVISION, 901 West Jackson Blvd., Chicago 7, Illinois.

CONCORD RADIO CORP., Dept. RA-51
901 West Jackson Blvd., Chicago 7, Illinois

Please forward your latest Buyer's Guide

Name.....

Address.....

City..... Zone... State.....



SUPERIOR'S AN ACCURATE POCKET-SIZE
new model 770 **VOLT-OHM MILLIAMMETER**

(SENSITIVITY: 1000 OHMS PER VOLT)

FEATURES

- ★ Compact-measure 3 1/8" x 5 7/8" x 2 1/4".
- ★ Uses latest design 2% accurate 1 Mil. D'Arsonval type meter.
- ★ Same zero adjustment holds for both resistance ranges. It is not necessary to readjust when switching from one resistance range to another. This is an important time-saving feature never before included in a V.O.M. in this price range.

★ Housed in round-cornered, molded case.

★ Beautiful black etched panel. Depressed letters filled with permanent white, insures long-life even with constant use.

The Model 770 comes complete with self-contained batteries, test leads and all operating instructions.

SPECIFICATIONS

- | | |
|--|---|
| 6 A.C. VOLTAGE RANGES:
0—15/30/150/300/1500/3000 VOLTS | 4 D.C. CURRENT RANGES:
0—1.5/15/150 MA. 0—1.5 AMPS. |
| 6 D.C. VOLTAGE RANGES:
0—7.5/15/75/150/750/1500 VOLTS | 2 RESISTANCE RANGES:
0—500 OHMS 0—1 MEGOHM |

\$14.90
NET

Superior's new model 670

SUPER-METER

A COMBINATION VOLT-OHM MILLIAMMETER PLUS CAPACITY REACTANCE INDUCTANCE AND DECIBEL MEASUREMENTS

SPECIFICATIONS:

- D.C. VOLTS: 0 to 7.5/15/75/150/750/1,500/7,500 Volts
- A.C. VOLTS: 0 to 15/30/150/300/1,500/3,000 Volts
- OUTPUT VOLTS: 0 to 15/30/150/300/1,500/3,000 Volts
- D.C. CURRENT: 0 to 1.5/15/150 Ma. 0 to 1.5 Amperes
- RESISTANCE: 0 to 500/100,000 Ohms 0 to 10 Megohms
- CAPACITY: .001 to .2 Mfd. .1 to 4 Mfd. (Quality test for electrolytics)
- REACTANCE: 700 to 27,000 Ohms 13,000 Ohms to 3 Megohms
- INDUCTANCE: 1.75 to 70 Henries 35 to 8,000 Henries
- DECIBELS: -10 to +18 +10 to +38 +30 to +58

ADDED FEATURE:

The Model 670 includes a special GOOD-BAD scale for checking the quality of electrolytic condensers at a test potential of 150 Volts.

The Model 670 comes housed in a rugged, crackle-finished steel cabinet complete with test leads and operating instructions. Size 5 1/2" x 7 1/2" x 3".

\$28.40
NET



Superior's
new model TV-20

20,000 OHMS PER VOLT MULTI-METER and TELEVISION KILOVOLTMETER

The Model TV-20 was designed to provide all the multi-meter measurement requirements of A. M., F. M. and Television. Unlike other recent models, which are actually standard V.O.M.'s converted to test the new Television Voltages, the Model TV-20 is a completely new unit. It provides the sensitivity, ranges and accessories which are needed to service F. M. and Television in addition to A. M. Radio. The High Voltage Probe for example, with a range of 50,000 volts and designed to withstand 100,000 volts, is an integral part of the instrument with a special compartment for housing it when not in use.

SPECIFICATIONS

- 9 D. C. VOLTAGE RANGES: (At 20,000 ohms per Volt)
0-2.5/10/50/100/250/500/1,000/5,000/50,000 Volts
- 8 A. C. VOLTAGE RANGES: (At 1,000 ohms per Volt)
0-2.5/10/50/100/250/500/1,000/5,000 Volts
- 5 D. C. CURRENT RANGES
0-50 Microamperes
0-5/50/500 Milliampers
0-5 Amperes
- 4 RESISTANCE RANGES:
0-2,000/20,000 ohms 0-2/20 Megohms
- 7 D. B. RANGES: (All D. B. ranges based on
Odb = 1 Mv. into a 600 ohm line)
— 4 to +10 db + 36 to + 50 db
+ 8 to + 22 db + 42 to + 54 db
+ 22 to + 34 db + 48 to + 62 db
+ 28 to + 42 db
- 7 OUTPUT VOLTAGE RANGES:
0 to 2.5/10/50/100/250/500/1,000 Volts

ADDED FEATURE:

The Model TV-20 includes an Ultra High Frequency Voltmeter Probe. A Silicon V. H. F. Diode together with a resistance capacity network provides a frequency range up to 1,000 MEGACYCLES. When plugged into the Model TV-20, the V. H. F. Probe converts the unit into a Negative Peak-Reading H. F. Voltmeter which will measure gain and loss in all circuits including F. M. and T. V.; check capacity and impedance; test efficiency of all oscillator circuits; measure band-width of F. M. and T. V.; etc.

\$39.95
NET



The Model TV-20 operates on self-contained batteries. Comes housed in beautiful hand-rubbed oak cabinet complete with portable cover. Built-in High Voltage Probe, H. F. Probe, Test Leads and all operating instructions. Measures 4 1/2" x 10 1/4" x 11 1/2". Shipping Weight 10 lbs.

USE CONVENIENT RUSH ORDER FORM ON OPPOSITE PAGE

GENERAL ELECTRONIC DISTRIBUTING CO. DEPT. RN-1, 98 PARK PLACE
NEW YORK 7, N. Y.

Here it is again!

SUN RADIO'S ANNUAL WAREHOUSE INVENTORY CLEARANCE SALE!

CRYSTALS FOR S.S.B. EXCITER As in Nov. '50 QST—Lo. Freq.

Also many other uses—in FT 241-A Holder—1/2" Pin SPC. Marked in 54th OR 72nd Harmonic MC Freq. Listed Below by Fundamental Frequency. Fractions Omitted.

412 429 446 485 497	390 401	372 381	450 530
413 431 447 487 503	391 402	374 383	452 531
414 433 448 488 504	392 403	375 384	461 533
415 434 462 490 506	393 404	376 386	465 536
416 435 468 491 507	394 405	377 387	526 537
418 436 472 492 509	395 408	379 388	529 538
419 437 473 493 511	396 409	380	
420 438 474 494 516	397 411		
422 440 475 495 518	400		
423 441 477 496 519			
424 442 479			
425 443 481	EACH		
426 444 483	79¢		
427 445 484	49¢		

EACH 39¢
EACH 99¢
Special—200 KC XTALS without Holders. 2 1/2" x 2 3/4" 69¢ EA 3 for \$2

HAM CRYSTALS

FT-243 Holders—1/2" SPC. Fractions Omitted

4190 6106 6873 7840	3735 5775 5906 6406 6573 7340 7573
5030 6140 6906 7873	5305 5806 5925 6425 6606 7373 7640
5485 6173 6973 7906	5677 5825 5940 6440 6640 7406 7673
6006 6206 7740 7973	5706 5840 5973 6450 6673 7440 7706
6040 6773 7773 8273	5740 5850 5975 6473 6705 7473 7806
6073 6840 7806 8306	5750 5873 6273 6475 6740 7506 8340
	5760 5875 6340 6506 6806 7540
	5773 5900 6373 6540 7306

49¢ EACH 10 for \$4.50
99¢ EACH 10 for \$9.00

SCR-522 XTALS	BC-610 XTALS 2 Banana Plugs 1/2" SPC.
5910 6620 7580	2045 2220 2360 2537 3520
6370 6750 7810	2105 2258 2390 3202 3550
6450 7480 7930	2125 2260 2415 3215 3570
6470	2145 2282 2435 3237 3580
6407.9	2155 2300 2442 3250 3945
6522.9	2305 2532 3322 3955
6547.9	2320 2545 3510 3995

Payments must accompany order. Enclose 20c for Postage & Handling. Crystal shipped packed in cloth bags. All Shipments Guaranteed.

REPLACEMENT FILTER CONDENSERS Famous Make, New, Boxed, Upright Can. Twist Prong Mounting

Cap. W.V.	List Price	Your Cost	Cap. W.V.	List Price	Your Cost
20x20 150	\$1.55	.47	30x20 150	\$2.20	.80
20x20 150	2.20	.80	20 25	2.30	.83
20 25	2.65	.96	40x30 150	2.35	.85
20x20 150	2.85	1.03	20 25	2.40	.87
20 25			20 25		

REDUCED FOR CLEARANCE

Bendix 100 Watt Transmitter

4 separate ECO's with tubes, 3-807, 4-12SK7. Complete instructions for converting to 10, 20, 40, and 80 meters supplied. Only a few left at this low price!

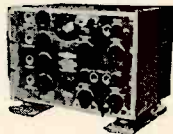

\$29.95 LIKE NEW | \$19.95 USED

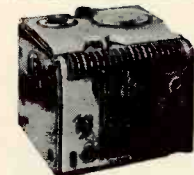

FAMOUS WEBSTER WIRE RECORDERS
Orig. \$137.50
Sensationally Reduced to **\$85.00**

These are brand new (77) models but discontinued. That's why Sun can offer them at this low, low price! They operate by simple foot control that leaves hands free... takes dictation, transcription and play back. Use wire over and over again. Terrific buy!

TERMS: All items F. O. B., Washington, D. C. All orders \$30.00 or less, cash with order. Above \$30.00, 25 per cent with order, balance C.O.D. Foreign orders cash with orders, plus exchange rate.

SUN RADIO
OF WASHINGTON, D. C.
938 F STREET, N. W. WASH 4, D. C.

Dielectric Heating

(Continued from page 39)

the surface is prevented. Secondly, because the loss factor of the glue is greater than that of the wood, the glue heats more rapidly and is set before the moisture content of the wood can be affected.

The plywood may be formed or curved in the same operation. Fig. 1 illustrates this process. In 120 seconds, the glue is set and the panel is formed for curved-front radio cabinets. Each panel will eventually be sawed to produce four cabinet fronts. The completed cabinet contains twenty-eight electronically glued joints, and no nails, screws or other fastening devices are necessary.

Fig. 3 shows a staggered arrangement of electrodes used for edge gluing. In this manner, wide panels are readily and rapidly built up from narrow stock. Raw lumber fed into a continuous edge gluer will emerge as a glued and set panel at a rate up to thirty lineal feet per minute.

Dielectric heating is employed in a variety of food preparation and processing operations. It is used, for instance, for destroying larvae in stored grains and for roasting coffee.

Fig. 5 shows the use of dielectric heating to cure and dry foam sponge rubber. A rubber latex mixture is poured into the mold and r.f. power applied. In six minutes the rubber is cured. This same process, by steam-oven methods, required thirty minutes. After having been cured, the rubber is washed and is then dried again by the same heating equipment.

The plastics industry has made wide use of dielectric heating. Before being subjected to the compression molding operation, the plastic must be pre-

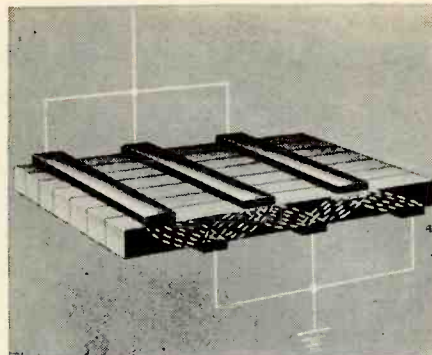

Fig. 3. Staggered arrangement of electrodes used for edge gluing. In this way, wide panels can be built up from narrow stock.

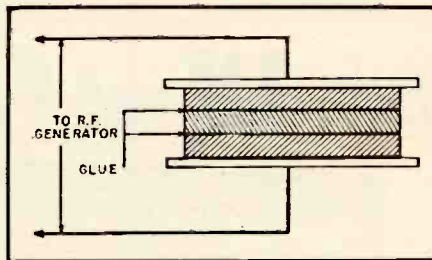
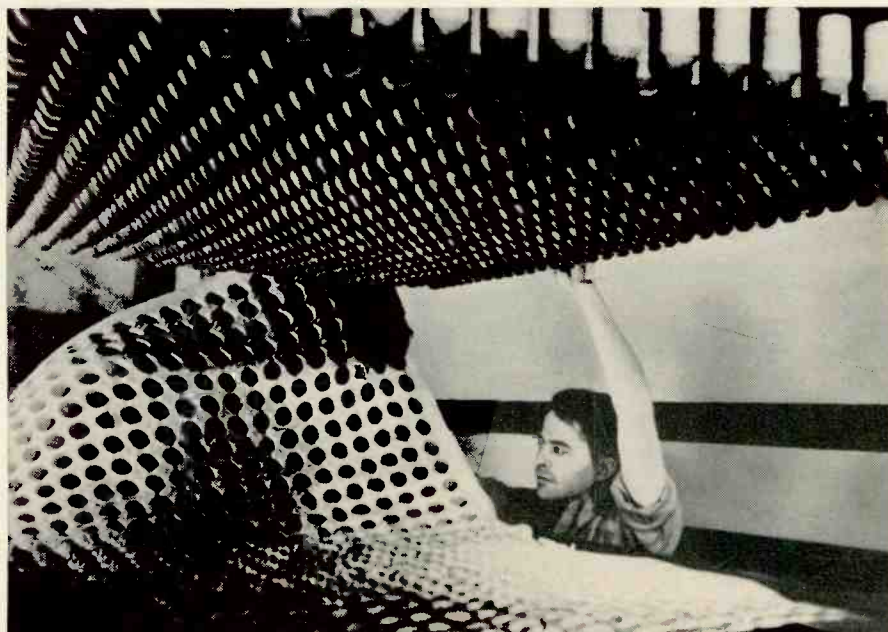

Fig. 4. Bonding of plywood by dielectric heating. This system is superior to older methods which involved the use of steam heat or hot platens which often damaged or charred the surface of the plywood.

heated. By older heating methods, the outside became "soft" before the interior was affected. Continued heat eventually made the interior workable, but by that time the outside had passed the "soft" stage and begun to harden. Dielectric heating completely eliminates this problem by heating the plastic uniformly. By decreasing production time and increasing mold life, r.f. preheating has established itself as a standard procedure in the plastics industry.

-30-

Fig. 5. Dielectric heating is used to cure and dry foam sponge rubber. Curing time by this method is six minutes as compared to thirty minutes by older methods.



**Jobs are looking for men again!
Qualified Technicians Needed for**

TELEVISION and FM SERVICING



**TELEVISION
SERVICEMEN
\$100 PER WEEK**
Inside or outside men, with or without car. We pay car expenses! Modern, air-conditioned shop! Vacation with pay! Group hospitalization! 20% employe discount privileges! Time and one-half for all overtime work! Wonderful opportunity for advancement!
Box 474-E, Star-

TELEVISION INSTALLERS
One of Washington's largest television installation companies has an opening for a thoroughly experienced crew. This is a permanent job, averaging better than
\$150 PER WEEK.
Must have car, ladders, tools. ED-WARD M. MEYER CO., 8350 3rd St. N.W., No. 7.
TELEVISION SERVICEMAN, TV experience for home service calls; car allowance; excellent pay; perma-

CREI HOME STUDY
**Can help you to better jobs
in servicing or Armed Services!**

ADS like these testify to the demand that exists for qualified TV technicians. As one well-informed industry spokesman puts it, "Technicians may soon be as scarce as certain tubes." With the electronics industry expanding, and with growing military demands cutting sharply into the available supply of skilled personnel, now is certainly the time to improve your electronics know-how. And if you're headed for the Armed Services, your improved technical ability can be recognized and rewarded with interesting supervisory work at higher ratings in vital radar, navigation, or communications units.

Anyone already in the field—if he is to get ahead—can't depend on hit-and-miss methods for TV servicing. Practical knowledge is required. CREI home study offers just the practical course

you need to qualify for the well-paid technical jobs. Designed by teaching specialists—the same group which has made the CREI Residence School outstanding—this practical course is kept up-to-date through daily contact with CREI's affiliated retail sales-and-servicing stores (one of Washington's largest TV retailers).

Now is unquestionably the time to prepare. If you want promotion, more money, and the kind of training that is respected by industry and the Armed Services, investigate CREI. Send for—and study—the free booklet offered below. The sooner you begin your training, the better off you'll be—in TV servicing work, or in military service. The cost is nominal for this training, the terms easy. Send for complete data—right now!

THE THREE BASIC CREI COURSES:

- ★ **PRACTICAL RADIO ENGINEERING**
Fundamental course in all phases of radio-electronics
- ★ **PRACTICAL TELEVISION ENGINEERING**
Specialized training for professional radiomen
- ★ **TELEVISION AND FM SERVICING**
Streamlined course for men in "top-third" of field

ALSO AVAILABLE AS RESIDENCE SCHOOL COURSES

CAPITOL RADIO ENGINEERING INSTITUTE

An Accredited Technical Institute Founded in 1927
Dept. 111C, 16th & Park Rd., N. W. Washington 10, D. C.
Branch Office: San Francisco, 760 Market St.

MAIL COUPON FOR FREE BOOKLET

CAPITOL RADIO ENGINEERING INSTITUTE

Dept. 111C, 16th & Park Road, N. W., Washington 10, D. C.

Gentlemen: Send booklet, "Your Future in the New World of Electronics," together with details of your home study training. CREI self-improvement program and outline of course. I am attaching a brief resume of my experience, education and present position.

- Check Field of Greatest Interest:
- | | |
|---|---|
| <input type="checkbox"/> TV, FM & Advanced AM Servicing | <input type="checkbox"/> Aeronautical Radio Engineering |
| <input type="checkbox"/> Practical Television Engineering | <input type="checkbox"/> Broadcast Radio Engineering (AM, FM, TV) |
| <input type="checkbox"/> Practical Radio Engineering | <input type="checkbox"/> Radio-Electronics in Industry |
- If Residence School Preferred, Check Here

NAME.....AGE.....
ADDRESS.....
CITY.....ZONE.....STATE.....

OPPONENT:

TIME

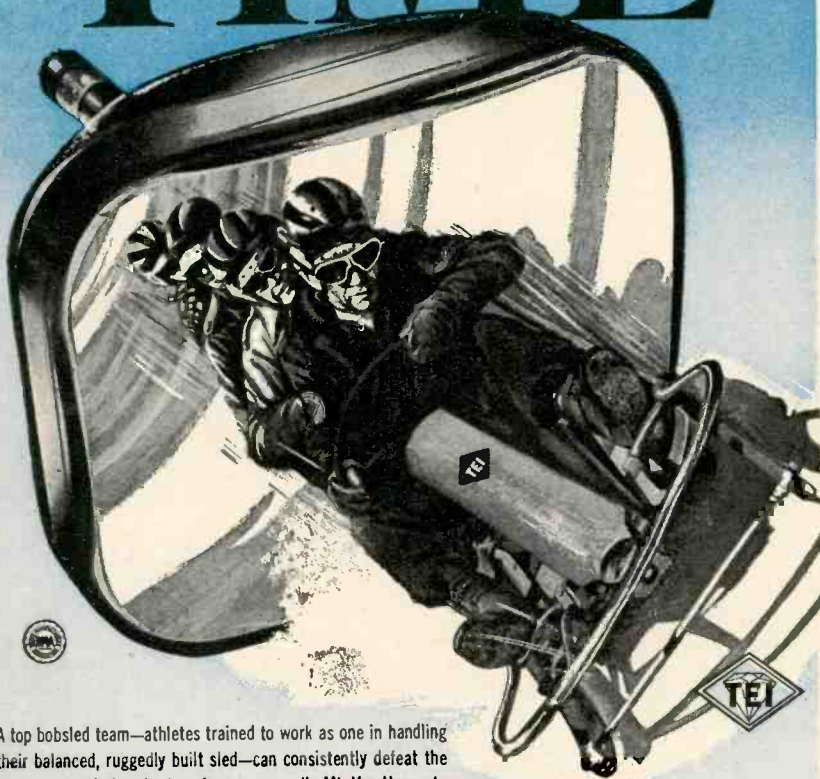

A top bobsled team—athletes trained to work as one in handling their balanced, ruggedly built sled—can consistently defeat the clock in negotiating the treacherous, one-mile Mt. Van Hoevenberg run.

Likewise, T. E. I. engineers and production personnel work as a unit with a similar goal—the conquering of TIME's deteriorating effects through the building of an ever-stronger picture tube. For Thomas' highly trained personnel, specially designed equipment, and efficient production techniques are consistently increasing the life of Thomas tubes in the contest with TIME.

For the greatest value in today's television picture tubes—for top operating efficiency and truly LONGER life—specify T. E. I. In all popular rectangular sizes, black-face.

ABSOLUTELY FREE

A penny postcard with your return address will bring you the very latest 1951 colored T.V. chart showing the growth and scope of television in the U. S. Simply address "Dept. A"

THOMAS ELECTRONICS, Inc.

118 Ninth Street

Pasadena, N. J.



RADIO ENGINEERING TELEVISION ELECTRONICS

Thorough training in all phases of radio and electronics, open to high school and junior college graduates. Old established school specializing in Radio training exclusively. Modern laboratories and courses. Enrollments limited. Approved veteran training.

VALPARAISO TECHNICAL INSTITUTE
Dept. RD Valparaiso, Ind.

SCHEMATICS—CONVERSIONS FOR SURPLUS GEAR

NEW LIST! MANY ADDITIONS!

Send stamped, self addressed envelope for List B. Add 25c for chart explaining AN nomenclature.

R. E. GOODHEART 345 1/2 N. PALM DRIVE
BEVERLY HILLS, CALIF.

ANOTHER OUTSTANDING JOBBER

VARIETY Electric Co., Inc.

601 BROAD STREET
Newark 2, New Jersey



\$23.95

HAS THE
SENSATIONAL NEW
EICO 221-K
VTVM KIT
IN STOCK!

Improving TV Sets

(Continued from page 35)

tuned to a station, preferably one with a test pattern and tone, and the fine tuning adjusted for maximum detail. Then the top and bottom of the ratio detector or discriminator transformer are adjusted very slowly. The bottom adjustment usually tunes the secondary. If the sound is clear but weak, the top and the sound i.f. transformers are touched up last.

Bigger Picture Tube

Installing a new larger picture tube depends on the physical construction of the chassis and cabinet as well as certain electrical limitations. To substitute a magnetically deflected tube for an electrostatic type requires a complete redesign of the sweep and high voltage sections and is, therefore, not recommended.

Whenever a larger picture tube is installed it is necessary to change the cut-out or mask. Sometimes it is advisable to purchase a standard size plastic mask or else a suitable picture frame with a safety glass insert can be mounted in front of the screen. The picture tube, deflection, and focus coils, can be fastened either to the cabinet or chassis, whichever is more convenient. Before proceeding to drill or screw things on, however, the actual physical dimensions of the new tube should be checked again.

The electrical characteristics of all magnetically deflected tubes are not the same and deserve some consideration. Table 1 lists the most important electrical differences between present day cathode ray tubes.

Picture tubes having a 63 to 70 degree deflection angle require a special deflection yoke and to obtain the high voltage necessary, either a voltage doubler or a high-efficiency flyback transformer must be used. Most of the tubes listed use either a single or double pole ion trap. Either can be tried and the one giving the brightest picture used.

Undoubtedly there are many other circuit changes possible which will improve the performance of older television receivers. Whatever steps are taken, the technician should make sure that the customer is well satisfied with his overhauled set. One of the shortcomings of many technicians is their lack of neatness and cleanliness in finishing the job. A few extra minutes spent in finishing the job right will leave a good impression and will add to the customer's satisfaction in your work.

Borrowing the vacuum cleaner to clean the inside of the chassis and cabinet as well as the rug surrounding the working area shows your tidiness and thoroughness. Polishing the cabinet lightly with furniture polish or lemon oil after the chassis is in the set and cleaning the glass one last time leaves that good impression as well as no fingerprints.

-30-

A Good New Year's Resolution BUY FROM PLATT

AND SAVE PLENTY!

Stop in at Our Store at
489 Broome St., N. Y. C.

FREE! WRITE FOR OUR BIG 1951 CATALOG



SPECIAL!! A BUNDLE OF KITS

Unfortunately space does not allow us to list all the individual parts of these sensational kits, but take Platt's word—

they're value-packed!

- 1 Kit of 25 assorted metal and plastic ES-CUTCHION PLATES.....\$2.49
- 1 Kit of 25 assorted DIAL FACES, finished in various stages and used on present high priced broadcast receivers. (Can be used with above kit)..... 2.79
- 1 Kit of 100 assorted RADIO KNOBS—push-on, screw-on, pointer-type, long neck..... 3.89
- 1 Kit of 12 assorted SWITCHES—many uses: TV, electrical, circuit breakers, wafers, etc. 3.49
- 1 Kit of 25 assorted COILS AND CHOKES—IF's, antenna, broadcast and short wave... 1.79

20 POUNDS OF ASSORTED RADIO PARTS

Transformers, Chokes, Wire, Condensers, Knobs, Sockets, Switches, Dynamotor. ONLY \$3.39

TURBO AMPLIFIER

4 tube Amplifier used by U.S. Air Force, 115 V. input at 400 cyc.

With tubes—BRAND NEW \$3.95

Without tubes—BRAND NEW \$1.49

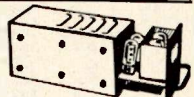

HEADSETS

H8-33 low impedance with cord and plug, used, fine condition \$0.79

H8-23 high impedance, BRAND NEW with ear pads..... 2.75

H8-33 low impedance, BRAND NEW with ear pads, cord and plug..... 2.75

PL-54 plug..... 2.95

TH-37A—1200 ohms with dual plugs..... 2.95

H8-16 high impedance with cord and pin plugs, BRAND NEW..... 1.95

H8-30 with ear plugs, low impedance, used, good condition..... .89

SCR-27N

COMMAND and ARC-5

EQUIPMENT

RECEIVERS

BC-452—190 to 550 KC..... \$12.95

BC-454—3 to 6 MC..... 5.95 \$10.95

BC-455—6 to 9 MC..... 6.95 10.95

R-25—ARC 5—100-550 KC..... 21.95

TRANSMITTERS

BC-457—4 to 5.3 MC..... 5.95

BC-458—5.3 to 4 MC..... 5.95 8.95

BC-696—3 to 4 MC..... 14.95 24.95

T-19—ARC 5—3 to 4 MC..... 24.95

BC-450—7 to 9.1 MC..... 12.95 24.95

T-22—ARC 5—7 to 9.1 MC..... 12.95 24.95

ADDITIONAL EQUIPMENT

BC-456 Modulator..... 2.25 3.25

BC-450 Control Box (3 Receiver)..... .98 1.95

BC-431 Control Box (Transmitter)..... 1.49

BC-442 Relay Unit (ANT)..... 1.95 2.95

Plugs: PL-147, 148, 151, 152, 153, 154, 156—EACH..... .75

Flexible Shafting with gear to fit Receivers..... 1.69

3 Receiver Rack..... 2.25

2 Transmitter Rack..... 1.89

APN-2 COMPLETE AIRBORNE NAVIGATIONAL RADIO UNIT

Consists of transmitter, receiver and power supply. Frequency range of receiver: 214 and 234 MC. Maximum operating range: 100 miles. Power requirement: 115 VAC—400 cyc. Contains a considerable amount of excellent parts.

ONLY \$6.95 less tubes

BEACON RECEIVER BC-1206-C

Manufactured by Satchell-Carlson

Frequency Range—195 KC to 420 KC, IF Frequency—135 KC Receiver Sensitivity—3 Microvolts for 10 Milliwatts output. Output Impedance—300 Ohms and 4000 Ohms to be selected internally. Power Output—230 Milliwatts. Volume Control—RF Gain Control. Power Supply—24-28 Volts Aeroplane Battery. Current—75 Amperes.

BRAND NEW—ONLY \$795

MINIMUM ORDER \$2.00

Immediate Delivery—Send 25% deposit on C.O.D. orders. All shipments F.O.B., N.Y.C. (N.Y.C. residents add sales tax to your remittance.)

PLATT ELECTRONICS CORP.

Dept. A, 489 Broome St., N. Y. 13, N. Y.

PHONES: WO 4-0827 and WO 4-0828

2-Band Operation With Folded Dipole and Ribbon

Ordinary 300 ohm twin-lead wire is used as an antenna for operation with 2-band transmitter.

By

WALTER S. ROGERS,
W1DFS

SO MANY hams have benefited from the convenience and efficiency of the two-wire, 300 ohm ribbon (twin-lead) antenna that it seems too bad that more amateurs do not use it. Because it is usually just a one-band antenna, many hams shy away from ribbon antennas. This is unfortunate since it is light, easy to string, and gets out with the greatest of ease.

Back in the fall of 1946, the author started doing something about two-band operation. His first thought was to write W9SZ, an OM capable of shedding some light on the subject. Dick used to be in Boston and his interest in the "unusual" always manifested itself in the form of some new twist in his ham station. With his encouragement, several types of two-band antennas were tried with sufficiently good results to warrant telling other hams about them.

In the early spring of 1947 the first two-band rig, as shown in Fig. 2B, was hauled up at North Falmouth on Cape Cod. This antenna was rather low by "ideal" standards but an average of 20 feet was the best that could be managed with this temporary lash-up around an old Cape Cod house. After being limited to an indoor apartment house antenna in Boston, this layout seemed fairly lavish!

The center folded dipole was cut for the high frequency band, 40 meters in this case, and lengthened, in accordance with the suggestion from W1DBM, not for the high frequency

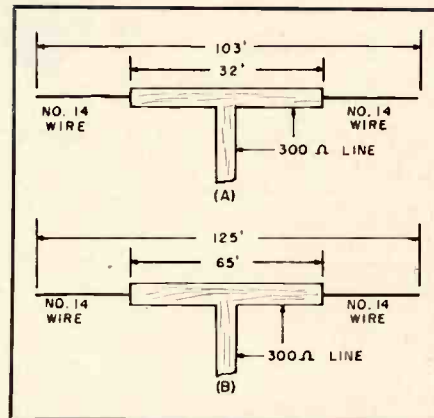
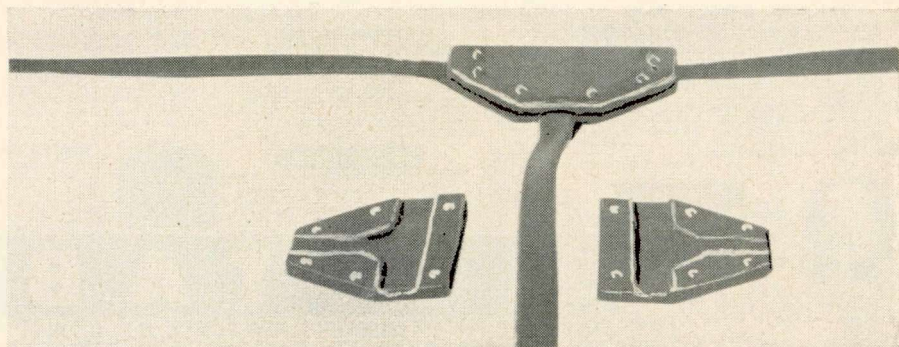

Fig. 2. (A) Mechanical details of 20-75 meter antenna and (B) the 40-75/80 meter antenna.

band but for the low frequency with the over-all length for the 75 meter phone band. This was not difficult to do, using the W1DFS center block and end pieces of brass, as shown in Fig. 1. Without these center pieces and the end blocks, the folded dipole is liable to come down just when most needed.

The transmitter was a surplus Navy TCS unit which was modified and then powered by a variable voltage power supply which had been built for lab testing rather than this particular application. One side of the transmitter output is grounded. There is a variable inductance in series with the hot antenna lead, a means of controlling the coupling, and a 50 μfd. condenser that may be used in series with the antenna or across the antenna to ground. See Fig. 3. At times it was found convenient to use an auxiliary 200 μfd. condenser in order to secure the best possible match for the antenna. For a balanced antenna, two

Fig. 1. Over-all view of 300 ohm twin-lead antenna assembly for 2-band operation.





THE SAME
LOW PRICE
\$38.95

the Volt-Ohm-Milliammeter
that needs no introduction!

DO YOU HAVE B-A's
148 PAGE 1951
FREE CATALOG ?



INCLUDES
33 PAGES OF
DOLLAR-SAVING
BARGAINS!

Complete Guide
to the Latest
Products of Top
Makers in Radio,
TV, Sound and
Recording Fields

BURSTEIN-APPLEBEE CO.
1012-14 McGee St.
Kansas City 6, Mo.

FREE

Send me your 1951 Catalog.

Name.....
Address.....
City..... State.....

BURSTEIN-APPLEBEE CO.

The BROOK High Quality AUDIO AMPLIFIER

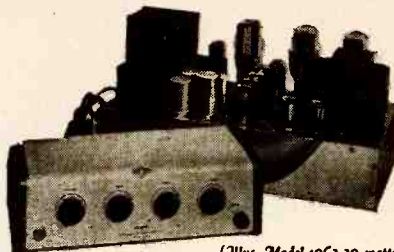

(Illus. Model 10C3-30 watts)
Also available; Model 12A3-10 watts.

All Low Mu Triodes Plus Brook made Transformers Plus Brook's own Circuits	} = {	Finest Audio Quality you ever listened to Minus Listening Fatigue Plus High Quality at extremely low volume Plus High quality at the full loudness of a band or symphony
---	-------	--

"You can believe your ears when you
listen with a Brook Audio Amplifier"

Write TODAY for FREE Technical Bulletin
and Detailed Distortion Analysis

BROOK ELECTRONICS, Inc.
Dept. RA-1, 34 DeHart Place • Elizabeth, N. J.

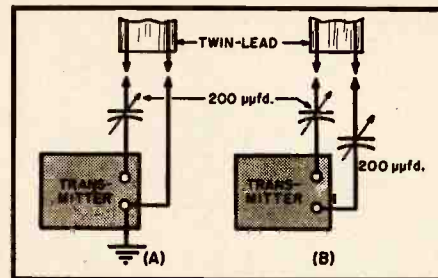

Fig. 3. Methods for feeding the antenna.
(A) Unbalanced and (B) balanced methods.

series condensers are recommended. There were losses with this arrangement but on these frequencies repeated tests, using the whole antenna system against ground, indicated that the dipole was superior. With the limited power available (the Navy rated these sets at 25 watts output c.w. and 10 watts phone) it was possible to maintain many skeds and have a good time keeping in touch with friends. It was impossible to feel any heat along the line. Despite the disadvantages of the dipole, it was still preferable to using the whole antenna system.

It was another story when W1DFS was to go on the air in Melrose, Massachusetts. I was anxious to get on 20 as well as 75/80. The antenna for operation on these bands was cut as shown in Fig. 2A. This setup worked very well on these two bands with inputs up to 500 watts, but usually at low power. Here again repeated tests using the system against ground showed that the folded dipole was superior in every respect.

On this particular antenna there are three half-waves on 20 and one on 75 and it loads up less efficiently than it would if it had been cut for that 75. These dipoles are really rather broad-band antennas.

Both of these two-band folded antennas have been given a good workout in the open and tests indicate that they may be good antennas for emergency or portable use where more than one-band operation is a desirable feature.

An antenna which will give satisfactory results in restricted space is shown in Fig. 4. The coil at the center of the antenna should resonate with the condenser used at a somewhat higher frequency than the operating frequency. Either direct coupling by means of variable taps or link coupling may be used.

Fig. 4. Center-fed capacity and inductively loaded low frequency antenna for use in operating on the 75 meter phone band.

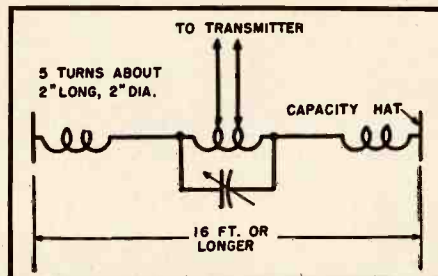

To Ambitious Young Men Who Want Profitable Careers

in

• **RADIO**
• **ELECTRONICS**
• **TELEVISION**



CREI Residence School Trains You for Vital Industry —qualifies you for better jobs in the Armed Services too!

Whether you're seeking a career in the electronics industry, where critical shortages of trained men exist, or planning on entering military service, one thing is sure: If you are *qualified* in electronics, you're qualified for the better jobs. Radar, communications, guided missiles, and television work not only offer present employment at high pay—they are keys to lifetime careers.

Residence School training in Washington, D. C., at CREI arms you with a priceless asset—electronics know-how!

Recognized as outstanding by engineers, educators, the Armed Services, and important firms like RCA-Victor, Bendix, and United Air Lines (whose technicians have received CREI training at company expense) your electronics course can be completed in approximately 20 months. New classes start twice a month. You work with the latest facilities in modern classrooms, studios, and labs. To insure your training act now. Send for FREE catalog today.

APPROVED FOR VETERANS

CAPITOL RADIO ENGINEERING INSTITUTE

An accredited technical institute
founded in 1927.

16th Street and Park Road, N. W.,
Dept. 131C Washington 10, D. C.

Please send FREE Residence School Catalog 131C

Name.....
Street.....
City..... Zone..... State.....
Veteran Non-Veteran Age.....
 Send details about Home Study Courses

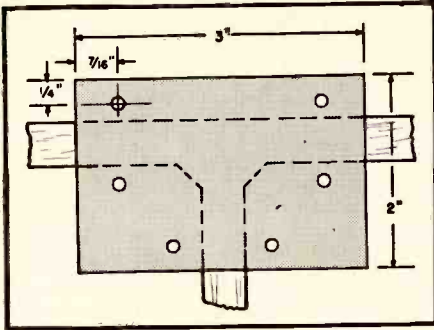

Fig. 5. Details of the center block assembly.

The coils at the end of the antenna, together with the "capacity-hats," serve to add to the electrical length of the antenna. In one experimental set-up the "capacity hats" consisted of the window screens at opposite ends of the room.

No exact dimensions can be given for an antenna of this type due to the many variables. With the dimensions shown it is possible to obtain satisfactory performance on the 75 meter band. In one exceptional case, an 18-foot length of wire was loaded to 105 kc. with good results.

Of course, one of the ever-present threats to operation with a folded dipole is the possibility that it may come down during really rugged weather. The 300 ohm line is light in copper and insulation and unless one secures a factory-molded job it is not easy to make a good electrical and mechanical connection capable of taking the strain and bending to which these antennas are subjected.

The first try at licking this particular problem involved the construction of a light $\frac{1}{4}$ " bakelite "sandwich" which was made by bolting the center splice as shown in Fig. 5. This unit, as suggested by WIDBM, proved to be larger than the hand-milled version shown in Fig. 6. Hams who have access to a machine shop have a decided advantage in making this unit although the job can be done reasonably well with a hand grinder. Use $\frac{1}{4}$ " phenolic stock for each piece. The squeeze, which can be further regulated by the use of friction tape if required, should be sufficient to hold the ribbon securely without having to depend on the light copper wire as a supporting member.

For terminal pieces with the ribbon

Fig. 6. Two pieces of $\frac{1}{4}$ " phenolic are required. One piece should be milled or hand ground to $\frac{1}{16}$ " to hold the 300 ohm ribbon.

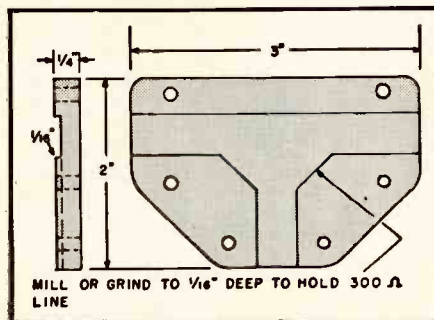

Low Price on Towers?

"TO GET TO THE BOTTOM YOU HAVE TO GO TO THE TOP"

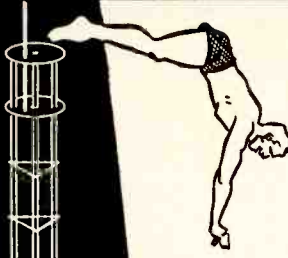

Have "deals and whispers" on tower prices got him so confused he's decided to solve it all by jumping off one of the d----d things? No--this is just our screwy way of illustrating the fact of the matter: To get to the bottom of the tower price situation, you have to go to the maker of the top tower . . . the Penn Teletower.

Penn prices low on the straight, open basis of superior mass production . . . without benefit of "deals." Only Penn could dare to offer a tower improved in design at a reduced price in the teeth of today's market . . . for only Penn has dared to go "all out" in applying mass production technique to tower making.

Penn towers weigh less than two pounds a foot . . . feature exclusive, automatic pilot hole alignment that permits safe, easy 2-man erection without use of rigging hoists . . . provide sectional construction that cures inventory and storage headaches.

New, Free Price List!

PENN BOILER & BURNER MFG. CORP.
Dept. N2, Lancaster, Pa.

Please send me a copy of your Teletower Bulletin, complete with new retailer price list.

Name

Company

Address

CANADIAN REPRESENTATIVE:

J. R. McVity & Company

53 Dalewood Road, Toronto, Ontario, Canada

PENN Teletowers
Whiftowers

PENN BOILER & BURNER MFG. CORP.
LANCASTER, PA.

SOLVE your hi-fidelity problems with University TWEETERS

WIDEST SELECTION • BEST VALUE • HIGHEST QUALITY

SINGLE UNIT TWEETERS

MODELS 4408, 4409—600 CYCLE TWEETERS: Recommended for highest quality reproduction systems requiring a low crossover frequency. Cobra shaped horn results in perfect wide angle distribution. Frequency response 600 to 15,000 cycles. Model 4408 handles 6 watts and 4409 25 watts.



MODEL 4407 ADAPTER MOUNTS 4401 TWEETER IN ANY 12" CONE UNIT: Converts any 12" cone speaker into a wide-range coaxial reproducer in a few minutes. Installation is extremely simple and results in a dual speaker occupying little more space than the original cone speaker. Complete with 4401 tweeter.



MODEL 4401—2000 CYCLE TWEETER: An economical 6 watt unit for converting any good 10-15" cone speaker for extended response to 15,000 cycles. Wide Angle horn, compact design and low price bring excellent high fidelity well within the popular price range.



DUAL TWEETERS



MODEL 4402, MODEL 4404: Model 4402 reproduces to 15,000 cycles. Crossover at 2000 cps. Horizontal dispersion 100°, Vertical 50°. Handles 12 watts. Compact design mounts in any radio, phono, or speaker cabinet. Model 4404 incorporates 4402 tweeter in handsome walnut cabinet complete with high-pass filter and high frequency volume control. Any one can install.

CROSSOVER NETWORKS



MODEL 4405 HIGH PASS FILTER: An effective and economical unit for preventing lows reaching the tweeter unit. Contains high frequency control to balance highs and lows. Cutoff frequency 2000 cycles.



MODEL 4410, 4420 LC CROSSOVER NETWORK: Genuine LC frequency dividers for segregating highs and lows. Not to be confused with ordinary high-pass filters. Crossover frequencies: Model 4410 600 cycles, Model 4420 2000 cycles. Attenuator controls included and wired.

Write today for illustrated literature—address inquiries to Department A

University LOUDSPEAKERS • INC

80 SO. KENSICO AV., WHITE PLAINS, N.Y.

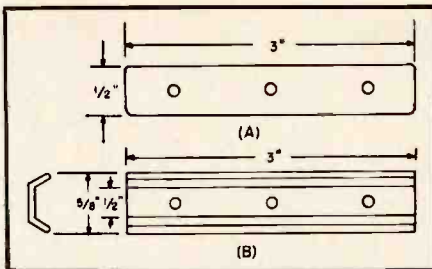

Fig. 7. One of each of these pieces is required in order to clamp ends of 300 ohm twin-lead. To be made from 1/16" brass. 6/32 brass bolts and washers are employed.

folded dipole, a pair of brass pieces about 3" long were cut and drilled as shown in Fig. 7A. One of the 6/32 brass bolts goes through the webbing and pinches the whole ribbon while the second bolt is around a soldered loop in the line and is equipped with the necessary washers to hold it firmly. The outboard bolt holds the 14 gauge antenna trim section of the folded dipole. A further improvement was made at a later date by bending one of the larger side pieces in order to center the ribbon positively in position, as shown in Fig. 7B.

In about two years of weathering the antenna the author built didn't break once.

-30-

Servicing Projectors

(Continued from page 38)

positioning of the aperture plate. The best advice I can give you here is to secure an instruction manual for the particular machine you are working on, or better yet, send the machine to the factory or to one of the company's authorized service depots.

It is not advisable to try to stock oscillator coils, photoelectric cells, film guides, etc., etc., because the net gain doesn't warrant such an investment. I would suggest that you inquire around and find out what machines might be needing your services and stock a few exciter lamps for these. It would also be a good idea to purchase a good 16mm. sound film. You can secure a short subject such as one of the "News Parade" series, that will have both speech and music in excellent quality. Be sure to check the film with a good machine before you make the purchase as sometimes a defective print does slip on the market. There are test films available for servicing purposes but good ones are quite expensive and unless you plan to do plenty of this work, it is not advisable to invest that much money.

-30-

NEW SOUND TAPE TESTING SERVICE

THE Minnesota Mining and Manufacturing Co. of St. Paul, Minnesota, maker of the "Scotch" brand recording tape, has recently set up laboratory equipment that can test the performance characteristics of sound recording tape, recorders, and playback units in a matter of minutes.

This new equipment and the staff to operate it is being supplied by the company as a service to the industry.

The three racks of laboratory equipment, plus recorders and speakers, permit measuring such performance characteristics as output at any frequency, uniformity of output at any frequency, signal-to-noise ratios, dynamic range, wow, flutter, harmonic distortion, intermodulation, and modulation noise.

Included in the equipment are an AM-FM tuner, oscilloscope, wow meter, Ballantine voltmeters, dual-channel oscillograph with associated d.c. amplifiers, two high-fidelity audio amplifiers, two professional-type recorders that operate at any speed from 3 3/4 to 15 inches-per-second, and a sonic analyzer for measuring distortion and frequency response and for showing noise spectra.

A special bias circuit was built into the recorders to permit introducing wide variations in bias.

-30-

Over-all view of the new sound tape testing laboratory set up by Minnesota Mining.

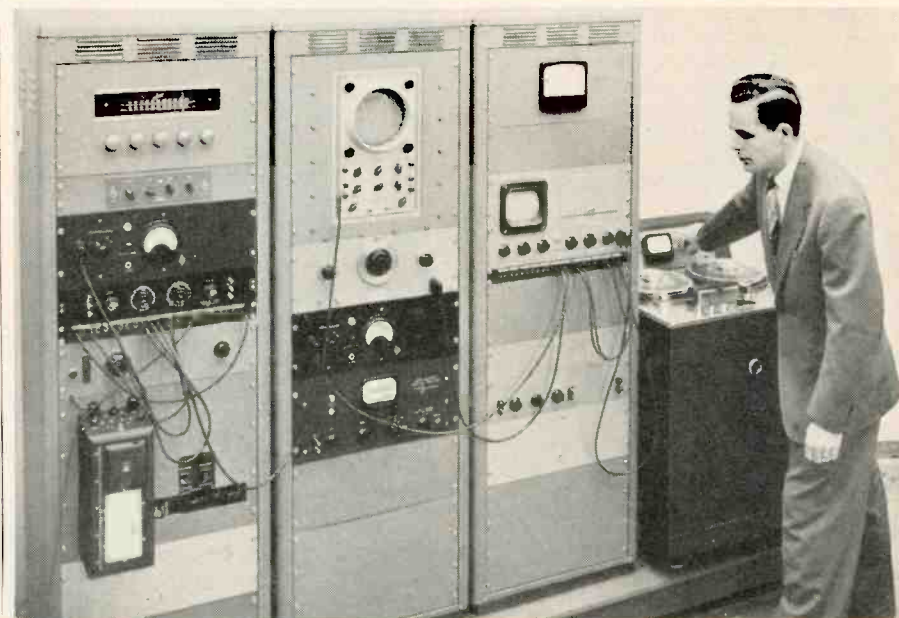

NIAGARA'S GIGANTIC WAREHOUSE CLEARANCE "VALUES GALORE"



BC-459A—28 MEG. V.F.O. CONVERSION KIT



Complete Kit of Parts required to convert any BC-457A, or ARC-5 equivalent, to a fixed or mobile, 6 volt, 10-meter V.F.O. Transmitter.

Kits contain: 1 copy—Vol. II "Surplus Radio Conversion Manual" (Containing full conversion instructions and worth \$2.50 by itself!), all 6V tubes (807, 6V6, 6J5) sockets, slug-tuned coils, resistors, condensers, wire, etc. Absolutely COMPLETE. ONLY **\$995**

Extra Special! SELENIUM RECTIFIER AC-DC POWER UNIT

A versatile foundation power supply kit, providing 6 to 24 V. D.C. at 5 Amps., 110 V. A.C. or D.C. input. Kit contains: 1—6 point heavy duty tap switch, 1—DPDT toggle switch, 10—6 Amp. cartridge fuses, 10—3 Amp. cartridge fuses, circuit diagram, parts list. All waterproof packed for overseas shipping in wood cases. All this for less than the price of the Selenium Rectifiers! Shpg. Weight 50 lbs. SPECIAL. **\$1295**



Just Arrived!

EICO'S FAMOUS NEW BATTERY ELIMINATOR & CHARGER KIT

0-15 V. Output. Continuous: 5-8 V., 10 Amps.; intermittent: 20 Amps. Metered current and voltage output. Automatic reset for secondary. Variac type Xfmr. MODEL 1040-K Kit. **\$22.50**
Model 1040 Wired and Tested. **\$29.95**

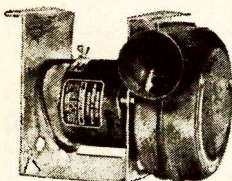

BLOWERS

THREE TYPES ALL 110V. A.C. 60 CYCLE MOTORS ALL BRAND NEW

TYPE A—Single section (illustrated above) approximately 100

Cubic Ft. Per Minute. 2 1/2" intake, 2" outlet. 3200 R.P.M. 25 cycle motor measures 6" x 6 1/2". SPECIAL. **\$9.95**

TYPE B—DUAL BLOWER—100 C.F.M. Per Section. Mounted side by side with 60 cycle motor in center. Otherwise same as TYPE "A." SPECIAL **\$14.95**

TYPE C—Single section (not illustrated). Somewhat smaller than TYPE "A." Approximately 50 C.F.M. 25 cycle. VERY SPECIAL **\$6.95**

RECEIVING TUBE VALUES!

Guaranteed New—Branded

1B5 / \$0.88	11M4 \$0.64	6K7 \$0.48
1B7GT 1.06	11L5 .66	6K8 .78
1C5GT .66	174 .98	6L7G 1.16
1C6 .88	175GT .78	6N7 .78
1C7G .88	2V3G .98	6R7 .78
1D5GP .96	3A4 .36	6SD7GT .88
1D7G .88	3B7 .35	6SF6GT .89
1D8GT .94	3D6 .34	6SG7 .98
1E5GT 1.38	3Q5GT 1.10	6SH7 .48
1E7G 1.56	354 .98	6S17 .80
1F4 .74	874 .88	6SL7GT 1.20
1F5G .74	8A3 1.28	6SR7 .58
1F8 1.56	8A6 .88	6SS7 .89
1H4G .68	8B5 1.56	7C5 .56
1G4GT .68	8AB7 .78	7B5 .72
1G6GT .68	8AD6 .88	7B8 .58
1H4G .68	8B5 1.56	7C5 .56
1H5GT .53	6B7 .88	7C6 .72
1H6G .86	8B8 .88	12A6 .18
1J6GT .86	8C9G 1.28	12B8 .58
1L4 .54	6C5 .46	12SH7 .34
1LA4 .78	6C6 .56	12SL7GT .58
1LA6 .88	6C8G .68	12SR7GT .48
1LB4 .88	6D6 .46	19 .97
1LC5 .78	6F7 .84	76 .38
1LC6 .96	6G6 .98	90A1 .56
1LD5 .78	6J5 .88	9005 1.90
1LE3 .88	6J8G 1.28	
1LG5 .88	6K5GT .98	

Transformer Bargains!

Plate	
1025-0-1025-500 MA.	\$17.95
2500 V.-4 MA.	3.95
Filament	
2.5V-5A, 7.5V-4A.	\$2.60
2.5V-10A phased.	4.95
5 V.C.T.-3A.	1.35
5V-10A.	1.85
5 V.C.T.-10.5A.	2.15
5 V.C.T.-15A.	5.95
6.3V-3A.	1.29
6.3 V.C.T.-3.5A.	1.49
Three 6.3 V.C.T.-4A each.	1.80
6.4V-8A.	2.05
7.5V-5A.	2.49
Power	
40-0-40—250 MA.—5V-3A.	\$1.25
175-0-175—150 MA.—6.3V-6A.	2.15
275-0-275—70 MA.—5V-5A, 2.5V-10.5A.	3.00
325-0-325—40 MA.—5 V.C.T.-2A, 2.5 V.C.T.-4A.	2.25
325-0-325—70 MA.—6.3V-1.2A, 5V-3A.	2.95
350-0-350—70 MA.—5V-3A, 6.3V-3A.	3.05
350-0-350—100 MA.—6.3V-6A, 6.3V-2A.	3.25
Modulation	
807 to P.P. 6L6.	\$2.49
P.P. 807 to single 6L6, 4D32 (2400 ohms).	3.49
From 200,500 ohms to 5, 6, 7, 8, 9, 10K ohms at 150 MA.	4.49
Driver Xfmsr.	
200, 10,000 ohm P. to single G.	\$.79
10,000 ohm P. to single G.89
P.P. 45, 2A3, etc. to P.P. 210, 801, etc.	1.95
P.P. 6L6, 2A3, etc. to P.P. grids.	1.65
Output	
P.P. par. 2A3, 45, etc. "AB" to 4, 8, 15, 500 ohms.	\$1.89
6V6 to 2, 4, 8 ohms.69
P.P. par. 6N7 Class "B" to 8000 ohms.	1.49
Input	
600 ohm C.T. to 300 ohm mike.	\$1.49
Mike to Line	
From and to 50, 125, 200, 330, 500 Ohms.	\$2.49
30 ohm mike to 600 ohm C.T. Bal. line.	1.65
Chokes	
.875 HY. 2.5 Amps.	\$8.95
2.5 HY. 4 Amps.	8.95
2.5 HY. 130 MA.	1.10
4 HY. 40 MA.25
8 HY. 200 MA.	2.35
10 HY. 180 MA.	3.49
40 HY. 90 MA.	
10 HY. 200 MA.	2.49
12 HY. 150 MA.	1.75
15 HY. 125 MA.	1.60
15 HY. 200 MA.	2.65
20 HY. 125 MA.	1.75

ARC-5/R-28

(Plus \$2.50 BONUS)*

HOTTEST 2-METER RECEIVER EVER BUILT!

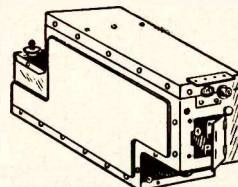

Here is the 2-meter superhet you have been looking for! Absolutely the BEST available today! Tunes from 100 to 156 Mcs. in four crystal channels. (Easily converted to continuous tuning.) Tube lineup is as follows: 717A—R.F., 717A—Mixer, 2-12SH7—1st and 2nd I.F. (6.9 Mc.)

12SL7—Det.-A.V.C.-Squelch, 12SL7—1st audio-squelch amplifier, 12A6—2nd audio, 12SH7—R.F. Osc.—4th Harmonic Gen., 717A—Trip. 12th Harmonic Gen., 717A—Oblr.—12th harmonic gen. A highly desirable superhet, made of rigidly inspected parts and contained in a louvered aluminum cabinet measuring 7 1/2" x 7 1/2" x 14". Complete with all tubes in original sealed cartons. **\$1995**

*FOR A LIMITED TIME ONLY!

With each order for ARC-5/R-28 Receivers, one copy of Vol. 2 "Surplus Radio Conversion Manual" (Regular price \$2.50) will be shipped with you at no additional cost! This volume contains circuit diagram and full description of above receiver, plus a wealth of additional conversion data on many other popular items of surplus equipment. ACT NOW, for YOUR \$2.50 BONUS!

New Low Price Niagara Famous High Pass Filter



Banish Interference with Niagara's Hi-pass filter! Positive protection against interference from amateur transmitters, diathermy, and all other devices

generating radio frequency interference below 40 MCS. Designed for 300 ohm leadin. No loss in brightness or clarity. Wired and tested. **\$2.50**
Postpaid if entire amount is included with order.

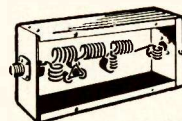

LOW PASS FILTER

Don't be blamed for TVI! Tests have proven that Niagara's low pass filter attenuates all frequencies above 40 MC.

May be used on all bands from 10 to 160 meters. Will easily handle a full kw. Matches 52-72 ohm line. Plus 25c shipping charges in U. S. A. **\$4.99**

FREE SAMPLE!

TRANSMISSION TWINLEAD

Heavy duty twinlead for transmission line. Will easily handle 3 full KW. Ideal for Ham and industrial users. FREE SAMPLE ON REQUEST! In standard 250 Ft. Packaged Lengths **8c per Ft.** Cut-to-order lengths less than 250 Ft. **10c per Ft.**

AC-DC AUDIO AMPLIFIER

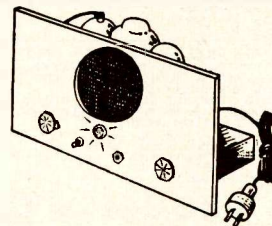

Complete with speaker and 3 tubes. Hi-impedance output for XTAL mike or Photo-pickup. Volume and tone controls. 5 W. amplif. with 5" speaker **\$8.95**
Same as above with 8" speaker. **9.95**

IMPORTANT NOTICE: Minimum Order \$5. Quantity prices on request. All items in stock now—subject to prior sale—prices subject to change without notice. 20% Deposit with orders unless rated. All prices F.O.B. our N.Y.C. Warehouse.

Niagara Radio Supply Corp. Phone Digby 9. 1132-3-4
Dept. N-11 160 Greenwich Street, New York 6, N. Y.

BUILD 15 RADIOS At Home

WITH THE NEW IMPROVED 1951
PROGRESSIVE RADIO "EDU-KIT"

\$19.95
ONLY ...

FREE TOOLS
WITH KIT

ABSOLUTELY NO
KNOWLEDGE OF
RADIO
NECESSARY

NO
ADDITIONAL
PARTS
NEEDED

EXCELLENT
BACKGROUND
FOR TELEVISION



10-DAY MONEY-BACK GUARANTEE

WHAT THE PROGRESSIVE
RADIO "EDU-KIT" OFFERS YOU

The Progressive Radio "Edu-Kit" offers you a home study course at a rock bottom price. Our Kit is designed to train Radio Technicians, with the basic facts of Radio Theory and Construction Practice expressed simply and clearly. You will gain a knowledge of basic Radio Principles involved in Radio Reception, Radio Transmission and Audio Amplification.

You will learn how to identify Radio Symbols and Diagrams; how to build radios, using regular radio circuit schematics; how to mount various radio parts; how to wire and solder in a professional manner. You will learn how to operate Receivers, Transmitters, and Audio Amplifiers. You will learn how to service and trouble-shoot radios. In brief, you will receive a basic education in Radio exactly like the kind you would expect to receive in a Radio Course costing several hundreds of dollars.

THE KIT FOR EVERYONE

The Progressive Radio "Edu-Kit" is specifically prepared for any person who has a basic knowledge of the English language, and has the desire to learn Radio. The Kit has been used successfully by young and old in all parts of the world. It is not necessary that you have even the slightest background in science or radio.

The Progressive Radio "Edu-Kit" is used by many Radio Schools and Clubs in this country and abroad. It is used by the Veterans Administration for Vocational Guidance and Training.

The Progressive Radio "Edu-Kit" requires no instructor. All instructions are included. All parts are individually boxed, and identified by name, photograph and diagram. Every step involved in building these sets is carefully explained. You cannot make a mistake.

PROGRESSIVE TEACHING METHOD

The Progressive Radio "Edu-Kit" comes complete with instructions. These instructions are arranged in a clear, simple and progressive manner. The theory of Radio Transmission, Radio Reception and Audio Amplification is clearly explained. Every part is identified by photograph and diagram; you will learn the function and theory of every part used.

The Progressive Radio "Edu-Kit" uses the principle of "Learn By Doing." Therefore you will build radios to illustrate the principles which you learn. These radios are designed in a modern manner, according to the best principles of present-day educational practice. You begin by building a simple radio, the next set that you build is slightly more advanced. Gradually, in a progressive manner, you will find yourself constructing still more advanced radio sets, doing work like a professional Radio Technician. Altogether you will build fifteen radios, including Receivers, Amplifiers and Transmitters.

THE PROGRESSIVE RADIO

"EDU-KIT" IS COMPLETE

You will receive every part necessary to build 15 different radio sets. This includes tubes, tube sockets, variable condensers, electrolytic condensers, mica condensers, paper condensers, resistors, tie strips, coils, tubing, hardware, etc. Every part that you need is included. In addition, these parts are individually packaged, so that you can easily identify every item.

TROUBLE-SHOOTING LESSONS

Trouble-shooting and servicing lessons are included. You will be taught to recognize and repair troubles. While you are learning in this practical way, you will be able to do many a repair job for your neighbors and charge fees which will far exceed the cost of the Kit. Here is an opportunity for you to learn radio and have others pay for it.

FREE EXTRAS IN 1951

- ELECTRICAL AND RADIO TESTER
- ELECTRIC SOLDERING IRON
- BOOK ON TELEVISION
- RADIO TROUBLE-SHOOTING GUIDE
- MEMBERSHIP IN RADIO TELEVISION CLUB
- CONSULTATION SERVICE
- QUIZZES

The Progressive Radio "Edu-Kit" is sold with a 10-day money-back guarantee. Order your Progressive Radio "EDU-KIT" Today, or send for further information.

**PROGRESSIVE
ELECTRONICS CO.**

497 UNION AVE.
DEPT. RN-1 BROOKLYN 11, N. Y.

Mac's Service Shop

(Continued from page 61)

that 'Experience' gains in working on familiar material is lost when an odd-sized nut for which he has no wrench is encountered and he has to stop and make a whole new wrench just for that one job."

"You mean that theory is more flexible than experience," Barney said slowly. "Could be, at that. I suppose a lot of the stuff a guy had to learn at the very beginning of television is of no use at all to him now. But where is a man going to get this theory without going back to school?"

Mac waved a hand at the shelves carrying books and magazines at one end of the service shop. "You are practically standing up to your chin in it all of the time," he declared. "Anyone who can read has every opportunity to be right up to the minute on every aspect of radio and television these days. The first thing to do, of course, is to study a good book on television fundamentals.

"After you have all of that stored under your curly red thatch, all you have to do is supplement it by doing a lot of current reading. The radio magazines are doing a wonderful—and sometimes unappreciated—job of keeping their readers right up to the second on every new development in TV theory, design, application, and service. Those magazine editors must almost steal some of the new ideas right off the drawing boards of the engineers, for you invariably read about a new development many months before you have a chance to encounter it in actual service work."

"But I read the magazines. Why is it I feel so dumb about television?"

"Mostly because you skip entirely or at least barely skim over any article that is not concerned with something you think you may need tomorrow or the next day at the latest. For example, if you see an article entitled 'Improvements in A.G.C. Systems', that looks rather weighty and has some complicated-looking diagrams, you turn past it hastily to read an article on 'How I Use Old Discarded Razor Blades to Solve Intermittents.' You shy away from any information unless you think you can put it to practical use right away."

"I plead guilty, Your Honor," Barney said with a grin, "but I promise to do better—not because of any of your preaching, mind you, but because of some thinking I was doing on my own while you were talking.

"As I see it, a knowledge of theory is something that will keep, while practical experience is good just for a little while. If I really study everything I can get my hands on about television, I'll sort of be putting away in a deep-freeze a lot of information that can be thawed out and used in a hurry whenever I really need it—no matter if that time is tomorrow or five years from now. From here on

in, just call me Bookworm Barney!"

"Now you're talking," Mac applauded, "and don't forget that your knowledge of theory will allow you to absorb experience in the large king-size bites when the opportunity affords. When you already have the 'Know-why,' you can learn the 'Know-how' in jig time."

"What really convinces me," Barney muttered almost to himself, "is something I was reading just yesterday. It seems that one of the world's outstanding authorities on the American Indian is a plumber in England who never set foot in the United States or Canada. If he can do it, Old Barney can do it too!"

-30-

MORE FREAK TV

SINCE the item concerning freak television reception appeared in the November issue (page 184) we have received several letters concerning the experiences of our readers.

From LeRoy H. Smeltzer, 243 South Washington Avenue, Greensburg, Pa., comes a report on an unusual evening of video fare. On October 30, 1950, Mr. Smeltzer reports that from 5 to 7 p.m. sound was available on all channels but that there was no picture. Then from 7 to 10:35 p.m. thousands of set owners in his area were able to get pictures on every channel although about 95 percent of the viewers had never been able to get any station but WPTV (Channel 3) in Pittsburgh before.

Every channel, except 6, came in with moving picture quality, according to Mr. Smeltzer. Erie, Cleveland's three stations, and Detroit were all received well.

At 10:35 p.m. the stations began to fade and by 10:45 p.m. they were all too weak for good reception except in some high locations where reception remained good until 11:15 p.m. when all reception ceased.

As a result of this "big night of video," Mr. Smeltzer reports that the whole of Western Pennsylvania is TV "crazy."

-30-

CLEANER USES

By JIM KIRK, W6DEG

MY customers see a deluxe, tank-type vacuum cleaner sitting along-side my service bench and often ask me if I also repair vacuum cleaners, which I definitely do not. However, not a day goes by but what I use this useful device. First I blow out the dust in all sets brought in. Then I keep the bench and floor near the bench neat at all times by immediately picking up filings and bits of insulation with the suction end. It will pick up small tools so these are laid aside. The cleaner is left plugged in and handy so all I have to do is reach for it. Before I bought this outfit, I used to step in iron and aluminum filings and get them on my shoes and then track muss all over the place. I also used to take an old-fashioned broom to sweep the sidewalk in front of the store. It took only the large pieces of litter off. The dirt was swept into the cracks and it was hard work. Now I take the blower on a long rod and in a few minutes, standing up, I blow the sidewalk "clean as a hound's tooth."

-30-

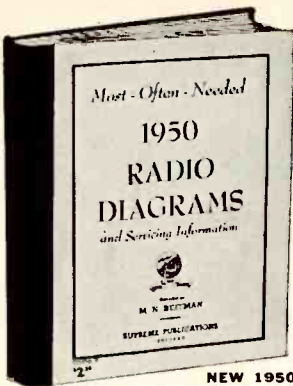

NEW 1950
In this one, newly printed manual, you have all the service data you need to repair all types of 1950 radio sets of all manufacturers. Schematics, needed alignment data, parts lists, voltage values, and dial stringing illustrations. Extra large size: 8½x11", manual-style binding; at your jobber or by mail only \$2.50, postpaid.

How Supreme Manuals Simplify Repairs

NEW 1950 RADIO VOLUME AMAZING BARGAIN at only \$2⁵⁰

Now you can benefit and save money with Supreme amazing scoop. This one giant, low-priced volume has all the service data you need on all recent radio sets. Here you have clearly-printed large schematics, needed alignment data, parts lists, voltage values, and information on stage gain, location of trimmers, and dial stringing illustrations. This is the help you need to find tough faults in a jiffy. The new 1950 radio manual is a worthy companion to the 9 previous volumes described directly below.

The new 1950 SUPREME Radio Diagram Manual, like the volumes for previous years, has all the information you need to service expertly all sets covered. With these manuals every repair is simplified, better adjustments are made, time is cut, and the manuals pay for themselves with time saved. Repairs that required hours can be completed in minutes with SUPREME service manuals. And at the amazing bargain price of only \$2.50 for the 1950 volume, and only \$2 for most of the older volumes, you just can't pass up this special offer. Be wise, get the complete set of ten Supreme radio manuals for less than other publishers charge you for a single manual.

Models Made by:
R.C.A., Zenith, Philco, Sears, Fada, Emerson, DeWald, Sentinel, Crosley, C.E., Westinghouse, United Motors, Stewart-Warner, Admiral, Delco, Stromberg-Carlson, Wards, Motorola, Travler, Arvin, Western Auto, and many others.



Supreme Publications Most-Often-Needed Radio Diagram Manuals. Each Manual only \$2 (1950, 1949, 1926-38 at \$2.50); 192 pages of diagrams, alignment facts, voltage values, parts lists, and service hints; large size: 8½x11". To order, see coupon below, at right.

SUPREME TELEVISION MANUALS MOST AMAZING MONEY-SAVING BARGAINS

The television series manuals are the most remarkable values offered by Supreme Publications in their 17 years of business. These TV manuals at only \$3 and \$2 each are amazing bargains and defy competition. There is nothing else like them. Each manual is a virtual treatise on practical television repairs. By normal standards, each such large manual packed as it is with practical facts, hundreds of illustrations, diagrams, charts, photographs, and expensive extra-large blueprints, should sell for \$10—but as SUPREME special values they are priced at \$3 and \$2 each. Only a publisher who sold over one million TV and radio manuals can offer such bargains based on tremendous volume-sales.

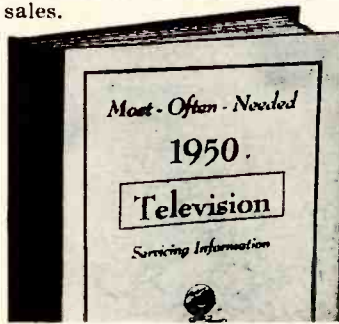

New 1950 Television Manual. This newest giant volume of the series covers 1950 factory data on all popular television sets of all makes. There are circuit explanations, 144 pages of alignment procedure, test patterns, response curves, pages of waveforms, voltage charts, service hints, and ten nammoth 11x17" blueprints. Manual-style binding. Price postpaid, only..... \$3
1949 T.V. Manual. Similar to the volume listed above. Has 160 extra-large pages, plus 9 double-spread giant blueprints. To order see coupon below, only..... \$3
1948 T.V. Manual. Earlier volume has material on all popular T.V. sets of this period. Large size: 8½x11". Remarkable value. Including 8 fold-out blueprints, only... \$3
1947 FM and T.V. Manual. Covers all needed FM and television sets including popular R.C.A. 630TS. Manual-style binding. Data on 192 pages. Only..... \$2

SUPREME RADIO MANUALS 1926-38 TO 1949 BIGGEST BARGAIN IN SERVICE DATA

Here is your economical, money-saving source of all radio diagrams and service data for all popular sets. Above is a photograph of these giant-size manuals—still available at only \$2 for most volumes. Just turn to the manual dealing with the set on your bench, and in a flash this material almost tells you what is wrong and how to complete the repair. Eliminate guesswork, cut hour-wasting jobs to pleasant moments. Each manual has its own index, but as an extra—just check the circle in coupon and a Master Index will be included FREE.

USED BY 128,000 RADIO SERVICEMEN

Words can tell a story, advantages and benefits of Supreme Diagram Manuals can be told, but the real proof of the value and super-usefulness is shown by the 128,000 servicemen who use these manuals day-in and day-out. They know. Because every customer gets a 10-day no-risk trial, we had to satisfy every one of these thousands of servicemen. Some of these were rank beginners and used our manuals to help them on their very first job. Other radiomen using Supreme manuals operate the country's biggest shops. Join these servicemen to save and earn more with Supreme Publications—you must be satisfied or you get your money back.

10-DAY NO-RISK TRIAL GIVEN

Any of the Radio Diagram Manuals described above or the Television Manuals at left, can be yours on trial. Use coupon below to order. You must be completely satisfied or your money will be refunded. Act today, before a possible price increase. Rush no-risk coupon, below.



Compiled by M. N. Beitman, radio engineer, teacher, author, and serviceman.

RADIO SERVICING COURSE-BOOK



Here is your practical radio course of 22 easy-to-follow lessons. Review fundamentals, learn new servicing tricks, all about signal tracing, oscilloscopes, P.A., test equipment. Just like a \$100.00 correspondence course. With questions and index. Large size: 8½x11". At your radio parts jobber or by mail. **\$2⁵⁰** Price now, only.....

Supreme Publications

Sold by all Leading Radio Jobbers

January, 1951

NO-RISK TRIAL ORDER COUPON

SUPREME PUBLICATIONS, 3727 W. 13 St., Chicago 23, ILL.

Send on trial manuals checked below and at right. You guarantee complete satisfaction.

- 1950 Television Manual, \$3. 1949 TV, \$3.
- 1948 TV, \$3. 1947 TV & FM, only \$2.
- Radio Servicing Course, complete..... \$2.50

- I am enclosing \$..... Send postpaid.
- Send C.O.D. I am enclosing \$..... deposit.

Name:

Address:

MOST-OFTEN-NEEDED Radio Diagram Manuals

- New 1950 Manual, \$2.50
- 1949 Radio Manual, \$2.50
- 1948
- 1947
- 1946
- 1942
- 1941
- 1940
- 1939
- 1926-1938 Manual, \$2.50

PRICED AT ONLY \$2 EACH

PUZZLED?



TUBE TESTER?
BATTERY TESTER?
CONDENSER TESTER?
AM SIGNAL GENERATOR?
AUDIO OSCILLATOR?
FM SIGNAL GENERATOR?

MULTITESTER?
Here's Your Answer Now

ALL IN ONE!

SERVISHOP

NEW MODEL 8773

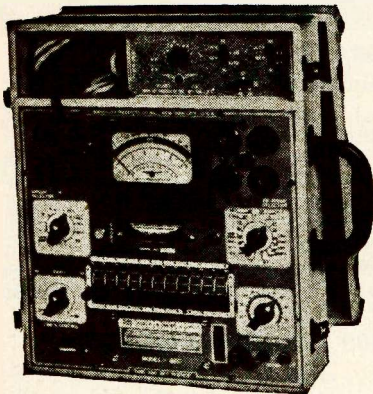

EQUIVALENT TO A COMPLETE SERVICE SHOP!

- TUBE TESTER
- SET TESTER
- A.M. GENERATOR
- F.M. GENERATOR
- A.F. GENERATOR
- CONDENSER TESTER
- FUSE PROTECTED METER

\$99⁹⁵

Every square inch solid-packed with value! Look what you get in this phenomenally low priced tester: a complete latest model obsolescent proof tube tester with approximately 1000 listings on improved roll chart together with an elaborate multimeter for measuring all AC & DC voltage DC currents—resistance in ohms and megohms—output in decibels—condenser leakage—signal generators for audio—radio AM and radio FM signals.

DC Voltmeter: 0-10-50-500-1000-2500

AC Voltmeter: 0-10-50-500-1000-2500

DC Milliammeter: 0-10-100-1000

DC Ammeter: 0-10

Decibel Meter: —8 to +15, 15 to 29, 29 to 49, 32 to 55

Ohmmeter: 0-500-5000 ohms, 0-0.1-1-10 meg-ohms

Complete with tubes, batteries, test leads, output leads, etc., in beautiful natural finish oak case.

Available at your distributor
Insist on R.C.P. Instruments
Write for Catalog 1RN

RADIO CITY PRODUCTS CO., INC.

152 West 25th St.  New York 1, N. Y.

Manufacturers' Literature

Readers are asked to write directly to the manufacturer for the literature. By mentioning RADIO & TELEVISION NEWS, the issue and page, and enclosing the proper amount, when indicated, delay will be prevented.

TELEVISION EQUIPMENT

Polarad Electronics Corporation of 100 Metropolitan Avenue, Brooklyn 11, New York, has recently issued a comprehensive catalogue covering its line of television equipment for broadcast, manufacturing, and laboratory use.

The new 14-page publication fully describes the company's television cameras, synchronizing generators, monitors, TV amplifiers, and TV power supplies designed for broadcast operation. The equipment described is adaptable to either 525 or 625 line standards.

Of particular interest to management personnel of television stations is the complete line of portable monitoring equipment included.

Copies of the new catalogue may be secured without charge by writing direct to the company.

CONDENSER CATALOGUE

Astron Corporation of 255 Grant Avenue, East Newark, New Jersey, has recently issued a new 12-page catalogue covering its line of condensers for radio, television, and electronic applications.

Designated the Catalogue AC-2, the new publication covers dry electrolytics, molded paper tubulars, oil paper condensers, and the company's new "Metalite" units which are self-healing, subminiature, and fabricated of metallized paper.

In addition to the condenser listings, the new catalogue includes complete descriptive material on standard r.f. filters, as well as units for aircraft and heavy duty applications.

Copies of the new catalogue may be secured from the company.

ALLIED'S 1951 CATALOGUE

Allied Radio Corporation of 833 W. Jackson Blvd., Chicago 7, Illinois, has just released copies of its 1951 catalogue, a 212-page buying guide covering radio, television, and industrial electronic equipment.

Designated Catalogue No. 124, the new publication contains a comprehensive listing of radio, television, and electronic parts; test equipment, public address systems, television and radio sets and accessories, TV components, recording equipment and accessories, new 3-speed record players and changers, high-fidelity amplifiers, speakers, tuners and other components for custom installations, as well as complete high-fidelity phono-radio systems, amateur gear, radio builders' kits and supplies, tools and hardware, books, manuals, and diagrams.

The new catalogue will be sent free to those requesting it from the company.

HIGH SPEED RELAYS

A data sheet covering the company's ultra-high speed relays is now available from *Stevens-Arnold Inc.*, 22 Elkins Street, South Boston, Massachusetts.

Catalogue 105B describes the new units in some detail as to contacts, life expectancy, load, contact rating, mounting, operating speed, and coil specifications.

Copies of this catalogue sheet are available without charge from the company.

HERMETIC TERMINALS

To assist those persons concerned with the design and specification of hermetic terminals for electrical and electronic products, the *T. C. Wheaton Co.* has recently published a 12-page catalogue containing much essential engineering data on the subject.

Designed for practical use, this two-color catalogue contains complete details on glass-to-metal, "Alumina," "Alumina" lead-thru, multiple refrigerator types, as well as other units in the company's line. In addition there is a special section devoted to metallized glass seals and electronic insulators and another section containing helpful engineering information relating to terminal selection and use.

Copies of the catalogue may be secured without charge. Address all requests to the company at Millville, New Jersey.

PORTABLE AUDIO EQUIPMENT

A complete new catalogue covering portable sound equipment for schools, churches, clubs, recreational activities, etc., has just been issued by *Newcomb Audio Products Co.* of 6824 Lexington Ave., Hollywood 38, California.

The publication lists a wide selection of combination transcription players and public address systems with both two- and three-speed turntables. Two recently-developed portable phonograph units are also described.

All of the models are illustrated and full specifications are given on all of the units. All of the products listed carry the *Underwriters' Laboratories* approval.

Copies of the new catalogue are available from the company.

ANTENNA GAIN CHART

Technical Appliance Corporation of Sherburne, New York, is making its new Engineering Bulletin No. 64

"Premier" Prices on TUBES and PARTS

World's Best Indoor TV Antenna

A beautiful antenna which is the ultimate in reception, highest signal gain, nothing to adjust.

List price \$9.95 Each **\$4.78**

TV Antennas:

Hi-Low Conical with 8-ft. mast **\$5.94**

WORLD'S BEST DELUXE CONICAL \$10.74
with 9-ft. mast and heavy cast fittings.

RED HOT VIBRATOR SPECIAL!

Standard small size, 2 1/2" in height (the popular small size), bright and shiny, **\$1.29**
Stock up while they last, all 4-prong Universal Vibrators. each

Standard replacement crystal cartridge L76-L72 **\$1.96**
NYLON 1J CARTRIDGE **\$2.59**

Output Transformers

STANDARD REPLACEMENT

For 50L6, 35L6, 50A5, 35A5, 117L7 **47c ea.**
For 6V6, 6F6, 3Q5, 3Q4, 35A, 3V4, 41, 42, 6K6, 2A3, 45, 6L6 **54c ea.**



UNIVERSAL OUTPUT TRANSFORMERS SPECIAL

Up to 12 watts to any speaker (while they last) **\$1.18** ea.

FILTER CONDENSERS

Very best brands. Fresh stock



450 Working Volts	
8-450 V.....	ea. 29c
10-450 V.....	ea. 35c
20-450 V.....	ea. 47c
30-450 V.....	ea. 59c
30-450 V w/.....	
20-20-25 V.....	ea. 35c
10-10-450 V.....	ea. 52c
20-20-450 V.....	ea. 59c
10-10-10-20.....	
450V-150-25 V.....	ea. 59c
30-30-400 V-.....	
350 V.....	ea. 47c
30-30-25-400 V-25 V.....	ea. 47c

150 Working Volts	
8-150 V.....	ea. 23c
8-8-150 V.....	ea. 23c
10-150 V.....	ea. 23c
10-10-150 V.....	ea. 29c
10-10-10-150 V.....	ea. 35c
15-150 V.....	ea. 25c
20-150 V.....	ea. 30c
30-150 V.....	ea. 35c
40-150 V.....	ea. 35c
15-15-150 V.....	ea. 35c
20-10-150 V.....	ea. 35c
30-20-150 V.....	ea. 47c
30-30-150 V.....	ea. 47c
35-35-150 V.....	ea. 47c
40-20-150 V.....	ea. 47c
40-40-150 V.....	ea. 47c

40-40-150 V		10 or more Each		Price Each	
20-25 V.....	ea. 47c	1/2 meg. or 1 meg. or 1/10 meg. with switch—long shaft.....	35c	2 meg. for battery sets—switch, long shaft.....	42c
50-30-150 V.....	ea. 47c	1/2 meg., 1 meg., 1/10 meg. or 2 meg., long shaft, less switch.....	19c	1000 ohm.....	23c
20-16-350 V.....	ea. 47c	5000 ohm.....	19c	1/2 meg. with 6" shaft.....	23c
Sprague type.....			59c		71c
25-25-150 V-200-10 V.....	ea. 47c				
15-15-40-20.....					
150 V-25 V.....	ea. 35c				
20-20-150 V-25 V.....	ea. 47c				
30-30-200-150 V-10 V.....	ea. 47c				
20-16-16-150 V.....	ea. 47c				
Cathode Condensers					
10-25 V.....					
20-20-25 V.....					
20-20-20-25 V.....					
30-50 V.....					
100-25 V.....					

Ballast Tubes for AC-DC TV Sets.....	ea. .60
TV Discriminator Transformers.....	ea. .83
TV Screen Filters with suction cups—best quality INDI-VIDUALLY BOXED for highest re-sale value.....	10" 1.40 12" 2.34 16" 3.06

OSCILLATOR COILS for any 5-tube AC-DC 23c	
300 ohm twin lead.....	
1000 ft. rolls.....	\$29.00
100 ft. rolls.....	\$3.25
100 ft. of twin lead with any TV antenna.....	\$1.98

7-PIN MINIATURE SOCKETS MOLDED.....	10 for 59c
9-Pin Miniature Sockets.....	10 for 59c
Local Sockets.....	10 for 59c

6-FT. LINE CORDS	
Good Rubber with plug.....	10 for \$1.50
Underwriters' Approved.....	10 for \$2.03

SPECIAL—CONDENSER KITS	
Kit of 50 BY-PASS CONDENSERS very best, assorted size.....	\$1.98
SELENIUM RECTIFIERS Standard 100 mil. Ea.....	95c

Special on #47, #44 and #51 100 PILOT LIGHTS... ..	\$4.74
Box of 10.....	59c

PILOT LIGHTS #40 #41 #46 100 Bulbs.....	\$5.88
Box of 10 Bulbs.....	65c

10% deposit with order balance COD. \$1.00 handling charge for orders less than \$5.00. All shipments FOB Chicago. Our parts and tubes are warranted to be 100% replacements for the prototypes in the listings above. Satisfaction Guaranteed. Illinois residents add 2% sales tax. **ORDER TODAY!**

TV PICTURE TUBES

10BP4.....	\$ 8.95
12LP4.....	\$19.95
14BP4.....	\$22.95
16RP4.....	\$29.95
16TP4.....	\$29.95
17BP4A.....	\$31.95

VOLUME CONTROLS

VERY BEST BRANDS	10 or more Each	Price Each
1/2 meg. or 1 meg. or 1/10 meg. with switch—long shaft.....	35c	42c
2 meg. for battery sets—switch, long shaft.....	35c	42c
1/2 meg., 1 meg., 1/10 meg. or 2 meg., long shaft, less switch.....	19c	23c
1000 ohm.....	19c	23c
5000 ohm.....	19c	23c
1/2 meg. with 6" shaft.....	59c	71c

TUBES

024.....	\$0.83	618G.....	\$1.60	12SH7.....	\$1.10
024G.....	.83	6K5GT.....	1.20	12SH7GT.....	1.10
1A5GT.....	.90	6K6GT.....	.83	12SJ7.....	.90
1A6.....	1.60	6K7G.....	.83	12SJ7GT.....	.90
1A7GT.....	1.00	6K7GT.....	.83	12SK7.....	.90
1B3GT.....	1.00	6K8.....	1.20	12SK7GT.....	1.00
8016.....	1.33	6K8GT.....	1.20	12SL7GT.....	1.20
1C5GT.....	1.10	6L5G.....	1.33	12SN7GT.....	1.10
1C8.....	1.60	6L6.....	1.78	12SQ7.....	.75
1C7G.....	1.60	6L6G.....	1.78	12SQ7GT.....	.83
1D5GP.....	1.95	6L6GA.....	1.78	12SR7.....	1.10
1D7G.....	1.60	6N6G.....	1.95	12SR7GT.....	1.10
1D8GT.....	1.95	6P5GT.....	1.20	12Z3.....	1.33
1F4.....	1.33	607.....	1.00	12Z3GT.....	1.33
1F7.....	1.33	6R7GT.....	.90	14A7.....	1.20
1G4GT.....	1.33	6R7GT.....	1.33	14B6.....	1.10
1G6GT.....	1.33	6S4.....	.90	14B8.....	1.10
1H6G.....	1.60	6S7GT.....	1.60	14E6.....	1.10
1J5G.....	1.33	6S8GT.....	1.33	14E7.....	1.33
1J6G.....	1.60	6S7.....	1.00	14F7.....	1.10
1J6GT.....	1.60	6SA7GT.....	1.00	14F8.....	1.33
1LA4.....	1.33	6S7GT.....	1.00	14G7.....	1.45
1M7.....	1.33	6S7GT.....	1.00	14H7.....	1.33
1N5GT.....	1.00	6S5F.....	.83	14N7.....	1.33
1P5GT.....	1.33	6S5GT.....	.90	14Q7.....	1.10
1Q5GT.....	1.33	6S7.....	1.00	14X7.....	1.33
1R5.....	1.00	6S7.....	1.00	14Y4.....	1.20
1S5.....	.90	6S7.....	1.10	19B6G.....	3.00
1T4.....	1.00	6S7GT.....	1.10	20A8.....	1.45
1T5GT.....	1.33	6S7GT.....	.90	20A.....	1.95
1U4.....	1.00	6S7GT.....	.90	22.....	1.60
1U5.....	.90	6S7GT.....	1.00	24A.....	1.10
1V.....	1.10	6S7GT.....	1.45	25A7GT.....	3.00
1X2.....	1.33	6S7GT.....	1.10	25AC5GT.....	1.45
2A3.....	1.60	6S7.....	.75	25B6GT.....	1.60
2A5.....	1.10	6S7GT.....	.83	25B6GT.....	1.45
2A7.....	1.33	6S7GT.....	.90	25D8.....	1.95
2E5.....	1.33	6S7.....	.90	25L6GT.....	.90
3A8GT.....	2.40	6T7G.....	1.60	25W4GT.....	1.00
3B7 1291.....	1.33	6T8.....	1.45	25Y5.....	1.45
3C6.....	1.60	6U5.....	1.00	25Z5.....	.83
3E6.....	1.33	6U6GT.....	1.00	25Z6GT.....	.75
3F4.....	1.33	6U7G.....	.90	27.....	.90
3W4.....	1.33	6V7GT.....	1.00	27.....	1.33
30S5GT.....	1.20	6V7G.....	.90	30.....	1.00
354.....	1.00	6W4GT.....	.90	31.....	1.33
3V4.....	1.00	6W6GT.....	.90	32L7GT.....	1.60
5T4.....	1.95	6X4.....	.75	33.....	1.60
5U4G.....	.83	6X5GT.....	.75	35/81.....	1.00
5V4G.....	1.20	6Y6G.....	1.20	35B5.....	1.00
5W4.....	1.33	6Y7GT.....	1.00	35B6.....	1.45
5W4GT.....	.83	7A4.....	1.00	35L6GT.....	.90
5X4G.....	.90	7A5.....	1.10	35W4.....	.63
5Y3GT.....	.68	7A6.....	.90	35Y4.....	.90
5Y4G.....	.75	7A7.....	.90	35Z3.....	.90
5Z3.....	.90	7A8.....	.90	35Z4GT.....	.75
5Z4.....	1.33	7A7.....	.90	35Z6GT.....	.75
6A3.....	1.60	7B4.....	.90	35Z6GT.....	1.33
6A4.....	1.00	7B5.....	.90	36.....	1.33
6A7.....	1.00	7B6.....	.90	39 44.....	1.33
6A8GT.....	1.00	7B7.....	.90	41.....	.83
6B4.....	1.00	7B8.....	.90	42.....	.83
6A87.....	1.60	7C4.....	1.60	43.....	.83
6AC3GT.....	1.45	7C5.....	.90	45.....	.83
6AC7.....	1.45	7C6.....	.90	45Z5GT.....	.90
6AG5.....	1.33	7C7.....	.90	46.....	1.33
6AG7.....	1.60	7E5.....	1.33	47.....	1.20
6AH6.....	1.95	7E6.....	1.10	50.....	1.95
6AK5.....	1.95	7E7.....	1.33	50A5.....	1.10
6AK6.....	1.20	7F7.....	1.10	50B5.....	1.00
6AL5.....	1.00	7F8.....	1.33	50C5.....	1.00
6AL7GT.....	1.33	7G7.....	1.33	50D5.....	1.45
6AQ5.....	1.00	7H7.....	1.00	50L6GT.....	.83
6A06.....	.90	7J7.....	1.33	50X6.....	1.10
6A07GT.....	1.20	7K7.....	1.33	50Y6GT.....	.90
6AR5.....	1.33	7L7.....	1.33	55.....	1.10
6AS5.....	1.00	7N7.....	1.10	56.....	.90
6AT5.....	.75	7Q7.....	.90	57.....	1.00
6AUG.....	1.33	7R7.....	1.10	58.....	1.00
6AV6.....	.75	7V7.....	1.33	707GT.....	1.95
6AX5GT.....	.68	7W7.....	1.33	71A.....	1.00
6B4G.....	1.60	7X7.....	1.33	75.....	.83
6B8GT.....	1.60	7Y4.....	.90	76.....	.83
6BA6.....	.90	7Z4.....	.90	77.....	.83
6BA7.....	1.20	10.....	1.80	78.....	1.33
6BC5.....	1.00	12A.....	.68	79.....	.83
6BC7.....	1.10	12A6.....	1.45	80.....	.68
6BE6.....	.90	12A7.....	1.60	81.....	1.95
6BF5.....	1.10	12ABGT.....	1.00	82.....	1.33
6BF6.....	.83	12AT6.....	.75	83.....	1.33
6BG6G.....	.80	12AT7.....	1.45	84.....	.90
6BH6.....	1.00	12AUS.....	1.00	85.....	1.10
6BJ6.....	1.00	12AU7.....	1.20	89.....	1.10
6BN6.....	1.60	12AV6.....	.75	117L.....	1.95
6BG6GT.....	.83	12AV7.....	1.60	117N7GT.....	1.95
6C4.....	1.10	12AX7.....	1.00	117P7GT.....	1.95
6C5GT.....	.83	12BA6.....	.90	117Z6GT.....	1.20
6C6.....	1.00	12BA7.....	1.20	117Z6GT.....	.50
6C8.....	.83	12B6.....	.90	117Z6GT.....	.50
6CD6G.....	3.00	12BF6.....	.90	117Z6GT.....	.50
6D6.....	1.00	12F5GT.....	.90	12H6.....	.30
6D8G.....	1.60	12H6.....	.90	12J5GT.....	.30
6F5GT.....	.83	12J5GT.....	.75	12K7GT.....	.30
6F6GT.....	.83	12K7GT.....	1.00	12Q7GT.....	1.50
6F8G.....	1.60	12Q7GT.....	.90	12S8GT.....	1.33
6G6G.....	1.33	12S8GT.....	1.33	12S7.....	1.10
6H4GT.....	1.33	12SA7.....	1.00	12S7.....	1.10
6H6.....	.83	12SA7GT.....	1.00	12S7.....	1.10
6HG6GT.....	.83	12SC7.....	1.10	12S7.....	1.10
6J5GT.....	.75	12S7.....	1.00	12S7.....	1.10
6J6.....	1.45	12SF7.....	1.00	12S7.....	1.10
6J7G.....	1.00	12SG7.....	1.00	12S7.....	1.10

Individually boxed—Standard factory guarantee.

PREMIER RADIO TUBE CO.

Phone: ANdover 3-1590
551 West Randolph St.
Chicago 6, Ill.

"Your Tube Source Since 1926"

Lowest prices!



SYNCHRON MOTOR
Model 600, 1 RPM, 115 Volts, 60 cycles. Brand New.
Special Price \$2.75 each



BEAM INDICATOR
1-82F Compass Indicator. 0-360°-5 in. dial. 26 v 400 cy. 8-12 v. 60 cy. Ideal position indicator. Brand new.
Price \$3.95 each

C-1 AUTOPILOT VERTICAL GYROS



May be used to conduct many interesting and amusing experiments. Operates from 24 V. DC or may be operated for short periods on 110 V. AC. Gyro will run for approx. 15 minutes after actuating. Size—approx. 8"x8½"x8½". Less Amphenol Connector. Removed from new aircraft. Special. . . . **\$4.95**



C-1 AUTOPILOT AMPLIFIERS
Three channel servo amplifier consisting of many valuable electronic parts including 6 relays, 7 tubes.
With Tubes. **\$5.95**
Less Tubes. **\$3.95**



DYNAMOTOR
WinCo Type 41S6. Input 13 volts DC at 13 amps. Total output 250 volts at 0.060 amps. and 300 v. at .225 amps.

Price Only \$5.95 Each

SWITCHES



Mallory Water type. Double Water. 3 Position. Special 29c each.
Mallory Single water. Three Position. Special 29c each.
Hi-Detent—Heavy duty—4P.3T. Pos. #1, 3 on, 1 off. Pos. #2 all off. Pos. #3, 2 on, 2 off. Special low price 39c each.
Push button Switch—Enclosed—s.p.s.t. Metal housing for panel or chassis mtg. Special 19c each.



CONTACTOR RELAY
Cutter Hammer 6041H30B. 12 v. dc. (50 amps. contacts).
Special at \$2.95 Each



PUSH-BUTTON SWITCH SPECIAL
D.P.D.T. Momentary type.
Special at 59c Each

TERMS: 20% cash with order—balance C.O.D. Orders accompanied by payment in full must include sufficient postage. Otherwise shipment will be made via Railway Express collect. Minimum order \$2.00.

Electro Devices

INCORPORATED
BOX NO. 1941 PATERSON, N.J.

available to television technicians and others interested in antenna measurements.

This new publication contains actual measurements in db. gain over half-wave dipoles for all popular antenna types. The information contained in the bulletin is based on actual laboratory and field tests conducted by the company. The booklet is designed to assist service technicians in selecting the proper antenna for a given television installation.

Any television technician can secure a copy of this bulletin by writing the company direct or by contacting his "Taco" jobber.

REPLACEMENT DATA

Additional data sheets covering TV control and resistor replacements have just been released by *Clarostat Mfg. Co., Inc.* of Dover, New Hampshire.

Following up on the first release covering *RCA* chassis types, the latest sheets deal with additional *RCA* models and with *Du Mont*, *Stromberg-Carlson*, *Crosley*, and *Emerson* models. Handy reference charts indicate model and chassis, stock and part numbers, *Clarostat* catalogue number, list price, function, and description. Any standard TV control or resistor replacement can be readily identified in these data sheets, and ordered by corresponding catalogue numbers.

These 8½ x 11 sheets with standard binder punchings may be obtained directly from the company or through *Clarostat* distributors without obligation.

TV FIELD EQUIPMENT

A 6-page illustrated folder which covers the company's latest field television equipment has just been released by the Engineering Products Department of *Radio Corporation of America*.

Listed are an improved friction head, a new tripod, a new field desk, and a rotatable mount, and remote control for microwave parabola.

Distribution of the brochure (Form 2J-6881) entitled "New TV Field Equipment" is limited to broadcasters. Copies may be obtained from any of the *RCA* district sales offices or by writing to Department No. 522, *RCA Engineering Products*, Camden 2, N. J.

TV-AM-FM COILS

Stanwyck Winding Co. of Newburgh, New York has just issued a comprehensive catalogue covering its line of TV-AM-FM coils.

Included in the new 24-page catalogue are adapter plates, antenna coils, broadcast antenna coils, cartwheel i.f. coils, chokes, traps, FM coils, horizontal output transformers, horizontal linearity controls, i.f. transformers, long-wave antenna coils, long-wave oscillator coils, long-wave r.f. coils, loop antennas, marine antenna coils, mid-get i.f. transformers, oscillator coils, peaking coils, permeability-tuned units, r.f. chokes, r.f. coils, ratio detector coils, regenerative i.f. transformers, sound discriminators, synchro-

music lovers

Unless you hear recorded music recreated by a fine record playing system, you cannot enjoy the realism, the beauty, the concert hall quality inherent in modern recordings.



PICKERING Audio Components are the choice of leading audio engineers, lovers of fine music, record critics and specialists who design and build the better music systems.

PICKERING Pickups, Preamplifiers, Compensators, Arms and Speakers are available through leading jobbers and distributors everywhere; detailed literature will be sent upon request.



PICKERING & CO., Inc.
Oceanside, L. I., N. Y.
Address Department C.

a sweet note...

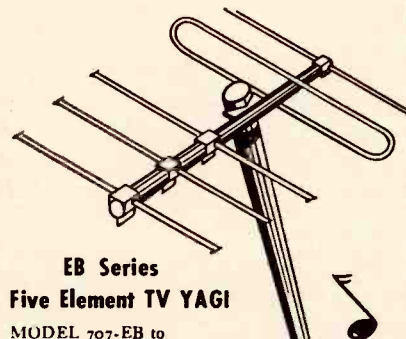

EB Series

Five Element TV YAGI

MODEL 707-EB to 713-EB L.P. \$8.75
Cut for any high channel 7 to 13

MODEL 302-EB to 306-EB L.P. \$20.60
Cut for any low channel 2 to 6

All Elincor Yagi now furnished with transformer for matching perfectly to 300-ohm line. No stacking bars required for stacking.



send for literature

ELECTRONIC INDICATOR CORP.

259 GREEN STREET • BROOKLYN 22, N. Y.

lok coils, syncro-guide coils, TV coils, wavetraps, and width controls.

Complete specifications are given on all of these units in addition to five pages of pertinent circuit diagrams.

SPEAKER BAFFLES

Acousti-Craft, 48 East San Jose Avenue, Burbank, California is currently offering copies of a six-page folder covering its line of speaker baffles.

The company's line includes 506 styles, colors, and sizes of baffles and range from wall speaker baffle units, bass reflex cabinets, corner speaker units, flush mount grilles, to reducing speaker baffles.

Available colors include walnut, blonde, ivory enamel, mahogany, and maple in wood cabinets; ivory, brown, red, and grey leatherboard, and a variety of colors in wood and leatherboard combinations.

Full details on all of these units are included in the new folder. Write the company direct for your copy.

RCA TUBE MANUAL

A new edition of the "RCA Receiving Tube Manual" has been announced by the Tube Department of *Radio Corporation of America*, Camden, New Jersey.

This well-known publication, long used by radio and television technicians, electronics engineers, schools, laboratories, hams, and experimenters, incorporates many new features reflecting new developments in electronics.

Designated RC-16, the new manual has been completely revised, expanded, and brought up-to-date. Containing over 300 pages, it is 25 per-cent larger than the previous (RC-15) edition.

The same complete coverage of technical data which characterized previous editions, ranging from elementary theory to descriptions of latest receiving tube applications, has been continued and enlarged in the new RC-16. In addition, the new manual, which now has a new "lie-flat" binding for ease of use, contains many new features. Detailed technical information is provided on more than 460 RCA receiving tubes and kinescopes including many discontinued types. The section on tube and circuit theory has been expanded and includes formulas and examples for calculation of power output, load resistance, and distortion for several classes of amplifier service as well as cathode follower design information. Television coverage includes kinescope installation data and handling information.

The manual is 50 cents and is available from RCA tube and parts distributors.

SERVICE WALL CHART

Of interest to radio and television technicians is the new and completely revised edition of the "Tell-U-How" wall chart which has just been issued by *Sprague Products Company* of North Adams, Massachusetts.

ENTER RADIO-TV thru *This Plan*-

As a young man with a career to build, you may *today* be interested primarily in training for Radio — and perhaps for TV. But — *who knows* . . . you may some day have both the desire and opportunity to climb further and become an Electrical Engineer! Here, then, is a world-renowned educational *plan* that permits you to use your Radio training as a *major stepping-stone* to an even greater career.

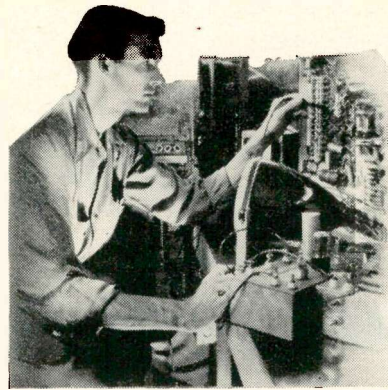

IN 12 MONTHS... become a RADIO TECHNICIAN

You are trained here for functions such as Radio shop operator or Serviceman, Supervisor of service personnel, and Serviceman for Mobile Receivers and all types of Transmitters. The Radio Technician's certificate is awarded. You may then advance immediately or at any future date into courses described below.

IN 6 ADDITIONAL MONTHS you become a RADIO-TELEVISION TECHNICIAN

On completion of the Radio-TELEVISION Technician's course, you are equipped for opportunities in Television — America's fastest growing industry. You are trained for such work as Radio-TV Service—Audio, Transmitter or Communication Technician—and Broadcast Operator (upon passing FCC examination).

ALSO... your radio course is full credit toward a B.S. degree in ELECTRICAL ENGINEERING

Your Radio Technician's course, while complete in itself, is also *one-third* of the program necessary to achieve the Electronics major (with a minor in Electrical Power). In the final stage of this college program you receive an added, important service . . . your aptitudes and desires are analyzed scientifically — thus guiding you to choose specialized preparation for design or research — manufacturing production — or engineering sales and management.

● Over 1500 students, from all states and 23 foreign countries, annually enrolled in this 47-year-old nonprofit school. Over 35,000 alumni. Faculty of 85 specialists. Terms open April, July, October, January.

● Military, practical or prior academic training will be evaluated for advanced credit. Preparatory and refresher courses available. Laboratory training, on modern equipment, is given immediately and in each term.

MILWAUKEE SCHOOL OF ENGINEERING

Technical Institute • College of Electrical Engineering



FREE—
Write today for helpful "Occupational Guidance Bulletin" and 1951 catalog. If possible, state course having your interest.

MILWAUKEE SCHOOL OF ENGINEERING
Dept. RN-151, 1020 N. Broadway, Milwaukee, Wis.
Without obligation, rush following: 1951 Catalog; Occupational Guidance Bulletin on Radio Television Electrical Engineering (Electronics) Electrical Service Electro Technician Heating Electrical Engineering (Power) Refrigeration Air Conditioning Welding.

Name.....Age.....

Address.....

City.....Zone.....State.....

Check if World War II Veteran

TECH-MASTER

TELEVISION

2 latest TECH-MASTER Developments!

NEW "Universal" AC/DC Kit for Tubes Up to 14" Rect.

The first low cost TV Receiver Kit designed for Universal AC-DC operation. Can be assembled in approximately 8 hours with easy-to-follow wiring instructions. Pre-wired aligned 1-F "Synchro-Strip" makes further alignment unnecessary. New unique circuit design features 2-knob control, providing Automatically Synchronized Picture and Sound Tuning. "Beam Power" Audio Output assures excellent tone quality. Small chassis (17"x14"x4½") is light in weight (approx. 30 lbs.) and shock-proof, completely "above ground."

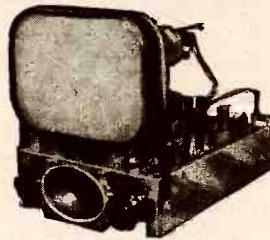

Supplied complete with tubes, parts, and picture tube mounting bracket, less kine.

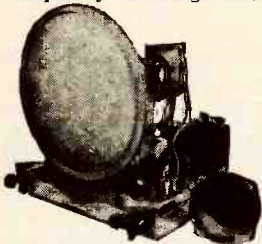

Model 630D19—Deluxe Kit—All principal components mounted.
Model 630S19—Standard Kit—Parts not mounted.
Both kits supplied with all tubes, parts, picture tube mounting bracket, less kine.

NEW! ADVANCED! Tech-Master 630 Type KIT

for All Tubes from 12" Rd. to 20" Rect.

Features Keyed AGC and "Hi-Sweep" Voltage Multiplier system. Indisputably the finest commercial TV circuit in the world! Pictorial diagrams guide each wiring step, making it easy to achieve excellent results. The latest and most advanced TV engineering developments have been added to the time-proven RCA 630 circuit. Two-stage video amplifier, 4 stage picture IF, full 4 mc bandwidth and newest 12-channel turret tuner give a sensitivity of less than 20 microvolts. Chassis size 21¾" wide by 15¾" deep. Approx. Shpg. Wt. 65 lbs.

Contact your jobber or write Dept. RN-1 for literature.

TECH-MASTER PRODUCTS CO.

443-445 Broadway, New York 13, N. Y.

More leading engineers and technicians have built Tech-Master for their own use than any other Television Kit.



Lithographed in color, the 22 x 28 inch chart includes valuable service application data on condensers as well as descriptions of common circuit troubles and their remedies, complete color codes for all types of condensers, transformer color codes, resistor color codes, electrical formulas, and other useful and related service information.

The new chart is free of charge if secured from *Sprague* distributors. Orders by mail addressed to the company in North Adams, Massachusetts carry a ten cent postage and handling charge.

REPLACEMENT MANUAL

A 16-page "Television Replacement Capacitor Manual" which lists critical replacement condensers for 497 television models, produced by 55 different manufacturers, is currently available from distributors of the *Sprague Products Company*, North Adams, Massachusetts.

Designed specifically for the television technician, the new manual (Form M-461) lists all original equipment parts by their manufacturers' part numbers and shows the recommended replacements which are regularly available from television parts distributors.

STRIP THERMOSTATS

Stevens Manufacturing Company, Inc. of Mansfield, Ohio is currently offering copies of a new bulletin which describes in detail the company's Type S bi-metal strip thermostats.

These units have been designed for use in appliances and industrial apparatus and schematic diagrams showing operating principles and dimensions have been included in the bulletin. Also given are photographs of the 13 standard Type S models and typical thermostat response curves.

A copy of this data sheet is available on request.

GEIGER COUNTERS

The New York University College of Engineering is currently offering a four-page booklet to those interested in various phases of Geiger counter circuitry and operation.

Entitled "Counters," the booklet has been prepared by Dr. Serge A. Korff, a well-known authority on Geiger counters. The folder is illustrated with a dozen drawings and the text explains the elements of a Geiger counter as well as the behavior of electrons, positive ions, ion clouds, and impulses.

Another section of the folder deals with penetrating, non-penetrating, and decaying cosmic ray particles.

The author concludes with a discussion of the use of Geiger counters for oil prospecting, thickness gauges, monitoring of x-ray machines, radioactive wastes, and in locating lost tubes of radium.

The booklets are ten cents each and may be secured from V. W. Palen, Bureau of Public Information, New York University College of Engineering, New York 53, N. Y.

* VOLOMETERS

MODEL 102

(1000 ohms per volt meter)

- 3" SQUARE METER
- 3 AC CURRENT RANGES (0-30/150/600 ma.)
- Same zero adjustment for both resistance ranges (0-1000 ohms, 0-1 megohms)
- 5 DC & 5 AC Voltage Ranges to 3,000 Volts. Also 4 DC Current Ranges.

\$14.90



MODEL 104

(20,000 ohms per volt meter)

- 4½" SQUARE METER (50 microamperes—Alnico magnet)
- Includes carrying strap
- 5 DC Voltage Ranges at 20,000 ohms/volt to 3,000 V.; 5 AC Voltage Ranges to 3,000 V., 3 Resistance Ranges to 20 meg. Also 3 AC & DC Current Ranges & 5 DB Ranges.

\$26.95



All of the above have round cornered, bakelite, molded cases. (*Reg. Trade Mark for Volt-Ohm-Milliammeter)

Export Dept., 303 W. 42nd St., N.Y.C.
Write Dept. A-1 for Free Catalog

Gives More Measurement Value Per Dollar



ELECTRONIC MEASUREMENTS CORPORATION

423 Broome Street, New York 13, N.Y.

NOW... quickly, easily
cut SQUARE and
OBLONG openings
in radio chassis

WITH THE GREENLEE No. 731
SQUARE RADIO CHASSIS PUNCH

Now, in 1½ minutes or less you can do hole-cutting jobs that might take an hour with old "drilling and filing" methods. Simply insert GREENLEE Punch and turn with an ordinary wrench... a square or oblong opening is cut immediately. An indispensable, timesaving tool that pays for itself in a hurry.



In sizes ½", ¾" and 1"



Write today for facts and prices on this handy Punch.
Greenlee Tool Co., 1881 Columbia Ave., Rockford, Ill.

ARROW → "The Home of Values!"

BC 906—Frequency Meter

Range 150-225 MC with modification possible for lower frequencies of TV, etc. Contains 0-500 DC microammeter and uses Battery pack of 1.5 V and 45 VDC. Like New—Less Batteries. **\$10.95**

HERMETICALLY SEALED CHOKES

10 H. 100 M.A. 59c
3.7 H. 145 M.A. 59c
10 H. 20 M.A. 39c

CONDENSERS

Each
1 mfd. 6000 VDC. OIL FILLED \$1.98
.00025 mfd. 25000 VDC. OIL FILLED 2.95
1 mfd. 600 VDC. OIL FILLED24
5 for 1.00
50 mmfd—5KV—5 Amp. Vacuum Cond. 1.19

TUBE SPECIALS!

211 \$0.39
307A 5.50
703A 1.89
723A B 12.95
724B 1.89
803 2.89
805 3.29
807 1.89
813 6.95
832 2.95
832A 7.95
837 1.19
84149
860 4.95
86424

Dynamotors

DM 32A PE 73
DY2/ARR2 PE 94
DA 1A PE 86
DM 34 DM 28
DM 35 DM 33
DM 36 PE 206
DM 37 PE 101
DM 40 DM 53A
DY 12 PE 218
DY 17 MG 149
BD77

Many other types are also in stock. Your inquiry is invited. Prices upon Request.

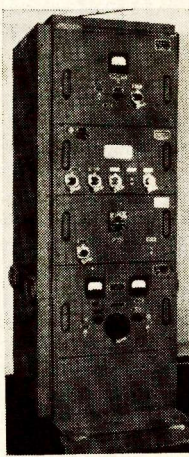

RADIO EQUIPMENT RC 100 B

This equipment made by General Electric, was designed for ground use as an identification of friendly aircraft.

CABINET CH-118 is of the Standard 19 inch rack type structural steel frame with runner angles for each of the units. A full length access door with safety interlocks forms the rear of the cabinet. **\$34.95**

TRANSMITTER BC-769 is designed to transmit RF pulsed signals at 470 megacycles with the use of the two type 15E Tubes operating in push-pull with resonant grid, plate and filament lines. **\$19.95**

KEYING UNIT BC-770 furnishes the pulse of the transmitter. **\$14.95**

RECEIVER BC-768 was used to detect the 493.5 megacycle reply pulses from the interrogated station and to sufficiently amplify these signals for oscilloscope observation. **\$19.95**

RECTIFIER RA-52 produces the high voltage. An O-15 kilowatt DC Meter is connected across the output of the filter to measure the voltage fed to transmitter BC-769, while an O-20 milliammeter is connected to the ground return to measure the average current drawn with tube. **\$74.50**

AIR COMPRESSOR M-349 together with 12 feet of 1/4 inch soft copper tubing and necessary hardware is used to fill and maintain transmission lines with dry air under pressure. Operation is direct from 110 VAC 60 cycles. **\$42.50**

OVEN M-348 is furnished for removal of moisture from the dehydrating cylinders of the compressor. It too operates from 110 VAC 60 cycles. **\$29.50**

FREQUENCY METER BC-771 is used for frequency checking and for tuning operations on Radio Transmitter BC-769 and Radio Receiver BC-768. It is a separate unit mechanically and has its own power supply, which requires a 110 to 120 Volt, 50 to 60 cycle source. **\$49.50**

TECHNICAL MANUAL TM11-1113B covering entire equipment **\$ 5.00**

COMPLETE UNITS are available at amazing low price... WRITE TODAY!

BC-604 Transmitter FM 20-28 MC

11 and 15 meters. Can be operated on 10 meters—10 channel push button crystal. With all tubes and meter but less dynamotor. Excellent Condition. **\$19.95**

Crystals—Set of 80. **\$19.95**

BC 603

Receiver—Good. Used **\$24.95**

Complete SCR-508 Installation available—price and information upon request.

Flap Pitch Motor

24 VDC. will operate on AC—3300 or 11,000 R.P.M. Complete with gear box and limit switches. each **\$2.95**

MISCELLANEOUS SPECIALS!

	Used	New
ASB 7 Indicator Scope	\$12.95	
MN 26 C	17.50	\$24.95
RA 10 DA Receiver	17.50	24.95
RT7/APN1 Transceiver	6.95	9.95
APN 1 Complete		24.50
BC 347 Interphone Amplifier		2.95
I-70 Tuning Meter		.59
BC 461 Veeder Root Counter		.89
BC 442 Less Condenser	1.49	1.95
APS 13 UHF Antenna, Pair		2.95
FL 8 Filter		2.95
I-97 Bias Meter	3.95	.98
RM 29 Remote Telephone Control	7.95	9.95
RL 42 Antenna Gearbox Motor and Reel	4.95	7.50
TS 10—Sound powered phones		6.50

BC 1066 B—150 to 225 MC Portable Receiver adaptable to many amateur uses. In Canvas Carrying Bag. Used. **\$5.95**

Tuning Units for **BC 375**—Presently most numbers are available in excellent condition with case at. **\$2.95 ea.**

One Tube Interphone Amplifier—Small compact aluminum case fully enclosed. 2 1/4"x3 3/4"x5 3/4". Less Tube **79c**

96Q1 Complete Autotune assembly with motor and frame as used in **ARC-1** Transmitter. New **\$35.00**

BC 709 Battery operated lightweight interphone amplifier. Complete with tube and shock mount, but less battery. New **\$3.95**

SCR 183 Complete. New **\$49.50**

220 MA Circuit Breaker. New **.59**

Collins VFO Dial—5 calibrated ham bands from 3.2 Mc to 32 Mc; complete with pointer, gears, logging dial and flywheel. Scale 6" on 8" plate. New. each **.95**

C-18—Antenna coil assembly slug tuned used in BC 603 receiver. Frequency range 20-27.9 Mc. fully shielded. New. 10 for **\$1.95**

I 82 F—Five Inch 360 degree compass indicator and Selsyn receiver. New **\$4.95**

A-81-2 Transmitter selsyn for I82 indicator. \$2.45 (Both I82 F & Trans. Selsyn for \$7.00)

MC 385A—Headset Adapter. New **49c**

Information and Prices on Request

RTA 1B Transceiver
TA 2J24 Transmitter and **MP 10G** Power Pack
SCR 269 Compass Installation
R 5/ARN 7 Compass Installation
MN 26 Compass Installation
AN AP1 Receiver and Tuning Units
ASB7 Complete Radar Installation

IS-185 Weston Voltmeter Model 433—0 to 150 VAC 25 to 2400 cycles. **\$24.95**

AS-138/ARN—10 inch streamline loop as used with direction finding receivers. Fixed position, it is ideal for planes, boats, auto-mobiles. New **\$1.95**

HEADSETS—MIKES

HS-30 Hi Imp. Headsets. New **\$1.50** Used **\$0.79**
T-24 Hi Imp. Carbon Mike. New **1.19**
T-30 Throat Mike. New **.98**
T-45 (or Navy) Lip Mike. New **.98**

Microphone and Headgear

This RCA unit consists of Dynamic hand microphone with switch and Dynamic headset with cushioned ear pieces. Complete with cord assembly. Brand New. **\$1.59**

BC 788 Seventeen Stage Receiver Transmitter designed for Radio Altimeter at 440 MC. Contains 30 MC IF Strip. (6 stage). Excellent internal condition with tubes and crystal removed. **\$9.95**

R-18/APS3 Receiver-Amplifier containing circuits as follows: Blocking oscillator, CRT gate circuit, Azimuth and Vertical sweep circuit, five stage 30 MC IF strip with AFC circuit. Used Less Tubes **\$4.95**

COMMAND (SCR 274 N) EQUIPMENT

	Used	New
BC-453	\$12.95	
BC-454	5.95	
BC-455	7.95	\$9.95
BC-456		2.95
BC-457	5.95	
BC-458	5.95	8.95
BC-696	14.95	24.95
BC-450—3 Receiver Remote Control	.89	1.95
BC-442		2.95
3 Receiver Rack	1.95	
2 Transmitter Rack	1.50	

Complete Command set as removed from aircraft—3 receivers—2 transmitters—Relay unit—control boxes—mounting racks—plugs—modulator and dynamotors—crated Set. **\$34.50**

SURPRISE PACKAGE

20 lbs. Ass't radio parts. A \$25.00 value for only **\$1.95**

1D6/APN4 Scope unit complete with 5CP1 cathode ray tube and shield and all parts except smaller tubes and crystal. Used. **\$9.95 ea.**

MONTHLY SPECIAL

MN 26 Y Compass Receiver, twelve stage superhet covering frequencies of 150 to 325 KC; 325 to 695 KC; and 3400 to 7000 KC in three bands.

These units are brand new but with Dynamotor, Band switch motor and tubes removed. Schematic Furnished. While they last. **\$4.95** each

PP2/APQ5 Power Supply Chassis less tubes a good buy for salvage purposes. each **\$1.49**

BC 620

Receiver-Transmitter—2 crystal channels—20 to 27.8 MC FM—13 tubes. Metered, Plate and Filament. Used **\$9.95**

PE 97 or **PE 117** or **PE 120** Power Supply for above 6-12 volt vibrator type. Used less tubes, vib. & con. **\$2.95**

Used, complete. **\$6.95**

FT 150 Mount for both BC 620 and PE 97 New **\$1.50**

PP12A/APS—3 Power Pack

used to supply many voltages for APS 3 equipment from an 800 cycle source. A good parts buy less tubes. **\$1.49**

R 4 ARR2 Receiver

used for reception of double AM carrier in the range of 234 to 258 MC. New units less tubes and dynamotor. **\$2.95**

RT7/APN1 TRANSCEIVER UNIT—

Used as an altimeter, it may be converted for signaling control circuits, etc. Complete with 14 tubes and dynamotor they are in good used condition at the amazingly low price of **\$6.95**

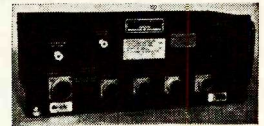

TS-293/CPA 5 Range Calibrator

designed for testing Radar set AN/CPAS, it contains a good 110 volt, 60 cycle power supply, plus other circuits. Tubes have been removed, but the power supply alone is a terrific buy at **\$3.95** each

O-27 CPAS5 Range notch generator is similar to the above described TS/293/CPAS and will be substituted when necessary.

Note: At this low price we are unable to answer technical inquiries or furnish other information on these two above items.

SN1/APQ 5 Synchronizer Unit chassis consists of resistors, condensers, sockets, relays and other salvageable parts. less tubes. each **\$2.95**

All shipments FOB warehouse. 20% Deposit required on all orders. Minimum order accepted—\$5.00. Illinois residents, please add regular sales tax to your remittance.

ARROW SALES, Inc.

Dept. N

1712-14 S. Michigan Ave., Chicago 16, Ill.

PHONE: HArrison 7-9374

HARVEY

has in stock



TECHMASTER

America's Finest
TV Chassis

Made by Technmaster
Products Co. 630 circuit
RCA licensed. For
all size Kinescopes,

round or rectangular. Full-rated high voltage
...improved AGC...advanced turret 12-channel
tuner...molded tubular condensers...perfect
linearity...four tube split sound circuit...full
4 Mc bandwidth...hi-fidelity FM TV sound.
1630 Chassis—Turret Tuner\$189.50
1930 Chassis—Turret Tuner\$189.50
1930T Chassis—With Push-Pull Audio...\$199.50
1930D Chassis—With Push-Pull Audio...\$199.50

NEW AC-DC KIT

Now available for the first time! Simple—Complete with step-by-step instructions. Can be assembled within 8 hours. Complete with all tubes, but less Kine.....\$ 89.50
Chassis Prices Are Less Kine

16AP4A\$ 44.00
19AP4A or B\$ 68.25
17AP4 (Rectangular Tube)\$ 44.00
(All Tubes Are Black Face)

WILLIAMSON HR-15 AMPLIFIER KIT

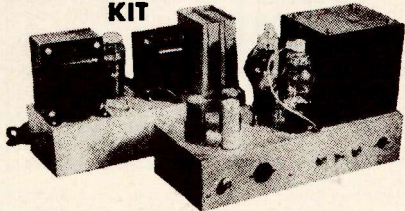

The famous Williamson HR-15 amplifier circuit... now available with the original Partridge transformers built to Williamson's specifications. Build this kit in 3 hours or less, and enjoy sound of a quality you never heard before. The HR-15 is a 2-Chassis power amplifier for use with tuners or other front ends having own volume and tone controls. All American triodes, 2-6SN76GT, 2-807, or 6BG6G in PP output, 5V4G rectifier. Response $\pm .5$ db, 10-100,000 cycles. Output impedances 1.7 to 109 ohms in 8 steps. Absolute gain 70.8 db. 20 db. of feedback around 4 stages and the output transformers. Kit is Complete with Tubes, Punched Chassis, Pre-wired Resistor Board, Sockets, Genuine Partridge Output Transformer, and All Necessary Parts.....\$75.00

KOLLSMAN Remote



Reading THERMOMETER

There are thousands of applications for this BRAND NEW (Aircraft Surplus) unit. Complete with 12 ft. of tubing in woven copper sleeve. Black Face, Illuminated Dial. Temperature Range from -40° to $+120^{\circ}$ F. At a fraction of initial cost\$ 4.95

General Electric Pyranol Capacitors. Brand New. Filled with 1 gallon of non-flammable dielectric. Impd. at 15,000 working volts D.C. or $1/2$ mfd. at 25,000 working volts D.C. Harvey Special Price, Each\$ 34.50

CONVERT TO LARGER TV TUBE SIZES with these two essentials which can accommodate the larger sizes from 14" through 20".

G.E. #77J1—High Voltage Transformer, 14,000 volts output. TODD #70W85-70" Yoke. Specially Priced. Both for only.....\$ 10.95

Telephone: Luxemburg 2-1500

HARVEY

RADIO COMPANY INC.

103 West 43rd St., New York 18, N. Y.

THE AD-VISER

5

DISPLAYING YOUR MERCHANDISE

By
IRVING SETTEL

SOME years ago, a radio and television store used a full page advertisement in a local newspaper in an attempt to sell overstocked radios. The advertisement was composed exclusively of copy. No illustration was used. However, the story was readable and offered some very interesting price inducements. The promotion "pulled" but far from anticipated volume. Sorely distressed by the results, the retailer confronted the local newspaper advertising manager. Together, they decided to rerun the advertisement but this time to include a picture of the radios on sale. The results were amazing! The same advertisement with the same headline and copy in the same newspaper "pulled" so well that much of the stock was sold out in a short time.

What was the reason for this great difference in results? Did the picture of the radios make so great a difference? Although there is no way to arrive at a positive answer, it can be assumed that the simple illustrations actually made the difference between success and failure. The radios displayed in the ad attracted the readers' attention to the story of the sale. Once the story had been understood, a potential customer was born.

The importance of illustrations in advertisements has long been recognized by outstanding merchants. Yet there are still a few who make the serious mistake of completely eliminating pictures. The major offenses are committed by retailers who make a poor choice of subject matter and method of presentation.

Your advertisement should be considered your "impersonal window or display case." It is advisable to show the same items which are currently being displayed in your windows or store. If possible, avoid using stock photographs and drawings unless they actually represent items within your store. Lay out the merchandise in your advertisement as interestingly as possible. Use short descriptive copy close by. Wherever you can, use prices. They are always appreciated by present day economy-minded readers.

One problem which often presents itself to the advertiser is the selection of the kind of illustration to use.

Among the many types available to you both original and from mat services, are the following:

1. Wash Drawings
2. Pen and Ink Drawings
3. Dry Brush Drawings
4. Photographs

The advertiser is often confronted with the choice of one of the above four. The selection should depend upon the effect desired. Each medium serves its own purpose well.

WASH DRAWINGS are used to portray a subtle gradation of tone. It is a drawing made with black or grey water color, applied with a brush. By varying the amount of lampblack and water, gradations from light to dark grey and solid black may be obtained.

Wash drawings are used in illustrations to portray leather, metal, and other reflecting surfaces for items of all sorts. In many cases, wash is more satisfactory than photographs because the artist can glorify the subject by adding or subtracting certain factors. Wash is excellent for all types of radios. However, there is an added expense since it is necessary to make a halftone engraving to capture the tones.

PEN AND INK DRAWINGS are well adapted to illustrations requiring strong contrasts and sharp outlines. No variation in tone is possible with this technique. Pen and ink is used in drawing many types of radios and television sets. It is excellent for fine details and delicate lines. Because there is no gradation of tone in line drawings, halftone engravings are not necessary and savings will result.

DRY BRUSH DRAWINGS are similar in production to pen and ink. No halftones are necessary. Ink, on a partly dried brush, is used to produce a "tonal" effect. Most subjects look good in dry brush and while production is inexpensive, the art work may cost a little more.

PHOTOGRAPHS are best when an impression of realism is required. Faithful portrayal of all merchandise is possible here. Many people believe that photographs are necessarily factual. We know that this may not be true. Modern photographers can perform miracles with their cameras. In addition to realism, a photograph is an excellent medium to use when it is necessary to illustrate a multitude of items. There may be so many that it becomes too expensive and impractical to draw by hand. If, for example, you wanted to show a vast stock of radios

1000 KC crystal BT cut.....\$3.95
 3" scope shield..... 1.29
 2 speed dial drive for 1/4" shaft ratios 5:1 1 to 1 .39
 ATC 100 mmdf oil trimmer screwdriver shaft..... .29
 Sigma Sens. Relay 8000 ohms..... 1.98
 Centralab 850 S 50MMF 5KV BUTTON COND..... .39
 500 watt 12.5 ohm power rheostat..... 3.49



50 mmdf 5 KV vacuum condenser.....\$1.49
 6v, 12v vibrators any type..... .98
 Rotary switch Mycalex, 2 deck SP3T..... .39
 1 mfd 5000v oil condenser..... 2.98
 2 mfd 3000v oil condenser..... 3.25
 3 mfd 4000v oil condenser..... 3.95
 24 mfd 1500v DC 3KV flash. Excellent for speed lamp..... 3.95

TUBES!! BRAND NEW! STANDARD BRANDS! NO SECONDS! COMPARE! TUBES!!

0A3/VRT5	\$1.29	3C23	\$2.95	204A	\$69.50
0B3/VR90	1.29	3C24/24G	2.25	211	49.50
0C3/VR105	1.49	3C30	2.12	212E	49.50
0D3/VR150	1.49	3C31/C1B	3.49	215A	1.19
1B22	3.45	3C45	1.27	217C	8.95
1B23	12.50	3CP1	8.25	227A	5.95
1B24	6.95	3CP1 S1	2.95	249C	3.95
1B26	3.95	3DP1	4.95	250R	12.95
1B27	24.50	3DP1A	6.95	250TH	21.50
1B28	2.75	3EP1 32A	3.95	250UL	9.45
1B32	8.95	3D21A	1.98	274A	5.50
1B36	24.95	3E29	14.95	274B	2.65
1B37	32.25	3EP7	3.95	300B	9.95
1N21 Xtal	1.25	3FF7	3.95	293A	2.98
1N21B Xtal	2.25	3GP1	4.75	294A	5.75
1N22 Xtal	3.25	3H7	3.95	300C	9.95
1N23 Xtal	2.25	4-65A	14.21	304TH	27.50
1N23A Xtal	3.25	4-125A	26.95	304TL	29.95
1N23B Xtal	3.25	4-250A	29.95	307A/RK75	5.95
1N23C Xtal	3.25	4B22/EL5B	9.95	310A	8.95
1N27	1.65	4B24/EL3C	7.95	316A	6.45
1N34	1.05	4B28/2000	8.95	323A/B	24.50
1N34A	1.05	4B28	4.95	327A/5C37	12.95
1P23	3.95	4C27	9.45	350A	8.95
1P24	1.79	4CV92	49.50	350B	8.95
1P25	2.85	4D22	12.95	350C	8.95
1S21	6.95	4D32	14.95	358A	1.49
2A2P1	8.95	4E2R	4.95	383A	1.49
2A2P2	8.95	4F2R	4.95	393A	6.95
2C21/RK33	6.95	5A1P1	3.69	394A	4.95
2C22/7193	4.95	5B1P1	5.95	434A	4.95
2C23/RK34	8.95	5B2P1	5.95	448A	4.95
2C39	24.50	5C1P1	4.95	450TH	47.50
2C40	4.95	5C2P1	4.95	450TL	47.50
2C41	1.49	5C3P1	24.95	559	1.39
2C44	1.49	5D1P1	1.95	582	97.50
2C46	7.50	5D2P1	1.95	575A	13.95
2C51	3.75	5E1P1	1.95	701A	3.95
2D21	1.79	5F1P1	1.95	702A	3.95
2E22	1.95	5G1P1	1.95	703A	7.95
2E23	1.95	5H1P1	1.95	704A	7.95
2E26	3.69	5I1P1	1.95	705A	8.95
2E30	2.29	5J1P1	1.95	708BY	39.50
2E31	2.95	5K1P1	1.95	708C	39.50
2E32A	8.45	5L1P1	1.95	708E	42.50
2E32B	29.50	5M1P1	1.95	708G	42.50
2E33	39.50	5N1P1	1.95	708H	4.95
2E34	39.50	5O1P1	1.95	709A	3.95
2E35	39.50	5P1P1	1.95	710A/8011	1.49
2E36	39.50	5Q1P1	1.95	711A	1.49
2E37	39.50	5R1P1	1.95	714AY	6.95
2E38	39.50	5S1P1	1.95	715A	12.95
2E39	39.50	5T1P1	1.95	716A	12.95
2E40	39.50	5U1P1	1.95	717A	24.50
2E41	39.50	5V1P1	1.95	722A	1.69
2E42	39.50	5W1P1	1.95	723A	1.69
2E43	39.50	5X1P1	1.95	724B	2.95
2E44	39.50	5Y1P1	1.95	725A	2.95
2E45	39.50	5Z1P1	1.95	726B	29.50
2E46	39.50	5A2P1	1.95	726C	49.50
2E47	39.50	5B2P1	1.95	730A	12.95
2E48	39.50	5C2P1	1.95	750TL	79.50
2E49	39.50	5D2P1	1.95	800	1.95
2E50	39.50	5E2P1	1.95	801A	4.49
2E51	39.50	5F2P1	1.95	802	4.49
2E52	39.50	5G2P1	1.95	803	4.49
2E53	39.50	5H2P1	1.95	804	4.95
2E54	39.50	5I2P1	1.95	805	4.49
2E55	39.50	5J2P1	1.95	806	29.95
2E56	39.50	5K2P1	1.95	807	1.98
2E57	39.50	5L2P1	1.95	808	4.49
2E58	39.50	5M2P1	1.95	809	2.45
2E59	39.50	5N2P1	1.95	810	9.95
2E60	39.50	5O2P1	1.95	811	2.95
2E61	39.50	5P2P1	1.95	812	2.95
2E62	39.50	5Q2P1	1.95	813	6.90
2E63	39.50	5R2P1	1.95	814	8.95
2E64	39.50	5S2P1	1.95	815	2.95
2E65	39.50	5T2P1	1.95	816	1.19
2E66	39.50	5U2P1	1.95	817	12.75
2E67	39.50	5V2P1	1.95	818	12.95
2E68	39.50	5W2P1	1.95	819	14.95
2E69	39.50	5X2P1	1.95	820	3.95
2E70	39.50	5Y2P1	1.95	821	3.95
2E71	39.50	5Z2P1	1.95	822	3.95
2E72	39.50	5A3P1	1.95	823	3.95
2E73	39.50	5B3P1	1.95	824	3.95
2E74	39.50	5C3P1	1.95	825	3.95
2E75	39.50	5D3P1	1.95	826	3.95
2E76	39.50	5E3P1	1.95	827	3.95
2E77	39.50	5F3P1	1.95	828	3.95
2E78	39.50	5G3P1	1.95	829	3.95
2E79	39.50	5H3P1	1.95	830	3.95
2E80	39.50	5I3P1	1.95	831	3.95
2E81	39.50	5J3P1	1.95	832	3.95
2E82	39.50	5K3P1	1.95	833A	37.50
2E83	39.50	5L3P1	1.95	834	3.95
2E84	39.50	5M3P1	1.95	835	3.95
2E85	39.50	5N3P1	1.95	836A	3.95
2E86	39.50	5O3P1	1.95	837	3.95
2E87	39.50	5P3P1	1.95	838	3.95
2E88	39.50	5Q3P1	1.95	839	3.95
2E89	39.50	5R3P1	1.95	840	3.95
2E90	39.50	5S3P1	1.95	841	4.45
2E91	39.50	5T3P1	1.95	842	4.45
2E92	39.50	5U3P1	1.95	843	4.45
2E93	39.50	5V3P1	1.95	844	4.45
2E94	39.50	5W3P1	1.95	845	4.45
2E95	39.50	5X3P1	1.95	846	4.45
2E96	39.50	5Y3P1	1.95	847	4.45
2E97	39.50	5Z3P1	1.95	848	4.45
2E98	39.50	5A4P1	1.95	849	29.50
2E99	39.50	5B4P1	1.95	850	29.50
2E100	39.50	5C4P1	1.95	851	29.50
2E101	39.50	5D4P1	1.95	852	29.50
2E102	39.50	5E4P1	1.95	853	29.50
2E103	39.50	5F4P1	1.95	854	29.50
2E104	39.50	5G4P1	1.95	855	29.50
2E105	39.50	5H4P1	1.95	856	29.50
2E106	39.50	5I4P1	1.95	857	29.50
2E107	39.50	5J4P1	1.95	858	29.50
2E108	39.50	5K4P1	1.95	859	29.50
2E109	39.50	5L4P1	1.95	860	29.50
2E110	39.50	5M4P1	1.95	861	29.50
2E111	39.50	5N4P1	1.95	862	29.50
2E112	39.50	5O4P1	1.95	863	29.50
2E113	39.50	5P4P1	1.95	864	29.50
2E114	39.50	5Q4P1	1.95	865	29.50
2E115	39.50	5R4P1	1.95	866	29.50
2E116	39.50	5S4P1	1.95	867	29.50
2E117	39.50	5T4P1	1.95	868	29.50
2E118	39.50	5U4P1	1.95	869	29.50
2E119	39.50	5V4P1	1.95	870	29.50
2E120	39.50	5W4P1	1.95	871	29.50
2E121	39.50	5X4P1	1.95	872	29.50
2E122	39.50	5Y4P1	1.95	873	29.50
2E123	39.50	5Z4P1	1.95	874	29.50
2E124	39.50	5A5P1	1.95	875	29.50
2E125	39.50	5B5P1	1.95	876	29.50
2E126	39.50	5C5P1	1.95	877	29.50
2E127	39.50	5D5P1	1.95	878	29.50
2E128	39.50	5E5P1	1.95	879	29.50
2E129	39.50	5F5P1	1.95	880	29.50
2E130	39.50	5G5P1	1.95	881	29.50
2E131	39.50	5H5P1	1.95	882	29.50
2E132	39.50	5I5P1	1.95	883	29.50
2E133	39.50	5J5P1	1.95	884	29.50
2E134	39.50	5K5P1	1.95	885	29.50
2E135	39.50	5L5P1	1.95	886	29.50
2E136	39.50	5M5P1	1.95	887	29.50
2E137	39.50	5N5P1	1.95	888	29.50
2E138	39.50	5O5P1	1.95	889	29.50
2E139	39.50	5P5P1	1.95	890	29.50
2E140	39.50	5Q5P1	1.95	891	29.50
2E141	39.50	5R5P1	1.95	892	29.50
2E142	39.50	5S5P1	1.95	893	29.50
2E143	39.50	5T5P1	1.95	894	29.50
2E144	39.50	5U5P1	1.95	895	29.50
2E145	39.50	5V5P1	1.95	896	29.50
2E146	39.50	5W5P1	1.95	897	29.50
2E147	39.50	5X5P1	1.95	898	29.50
2E148	39.50	5Y5P1	1.95	899	29.50
2E149	39.50	5Z5P1	1.95	900	29.50
2E150	39.50	5A6P1	1.95	901	29.50
2E151	39.50	5B6P1	1.95	902	29.50
2E152	39.50	5C6P1	1.95	903	29.50
2E153	39.50	5D6P1	1.95	904	29.50
2E154	39.50	5E6P1	1.95	905	29.50
2E155	39.50	5F6P1	1.95	906	29.50
2E156	39.50	5G6P1	1.95	907	29.50
2E157	39.50	5H6P1	1.95	908	29.50
2E158	39.50	5I6P1	1.95	909	29.50
2E159	39.50	5J6P1	1.95	910	29.50
2E160	39.50	5K6P1	1.95	911	29.50
2E161	39.50	5L6P1	1.95	912	29.50
2E162	39.50	5M6P1	1.95	913	29.50
2E163	39.50	5N6P1	1.95	914	29.50
2E164	39.50	5O6P1	1.95	915	29.50
2E165	39.50	5P6P1	1.95	916	29.50
2E166	39.50	5Q6P1	1.95	917	29.50
2E167	39.50	5R6P1	1.95	918	29.50
2E168	39.50	5S6P1	1.95	919	29.50
2E169	39.50	5T6P1	1.95	920	29.50
2E170	39.50	5U6P1	1.95	921	29.50
2E171	39.50	5V6P1	1.95	922	29.50
2E172	39.50	5W6P1	1.95	923	29.50
2E173	39.50	5X6P1	1.95	924	29.50
2E174	39.50	5Y6P1	1.95	925	29.50
2E175	39.50	5Z6P1	1.95	926	29.50
2E176	39.50	5A7P1	1.95	927	29.50
2E177	39.50	5B7P1	1.95	928	29.50
2E178	39.50	5C7P1	1.95	929	29.50
2E179	39.50	5D7P1	1.95	930	29.50



HENRY HAS THE NEW hallicrafters

MODEL SX-71 NOW!



This new type of receiver—the first of its kind on the market—has extra sensitivity, selectivity, and definitely superior image rejection. Continuous AM reception from 538 kc to 35 Mc, and 46 to 56 Mc. One RF, 2 conversion, and 3 IF stages. 105-125 volts AC. 11 tubes plus voltage regulator and rectifier. Only \$199.50. (R-46 matching speaker only \$19.95)



LOW-COST HALLICRAFTERS MODEL S-77

Temperature compensated oscillator; tuned r-f stage, two i-f stages for better selectivity. Covers 540 kc to 43 Mc in four bands. Sensitivity, volume, three-position Tone, BFO Pitch, controls; AVC, BFO, Rec./Standby, and Noise Limiter switches. Built-in PM speaker. Gray steel cabinet, 18 1/2" wide, 9" high, 9 1/2" deep. Piano hinge top. External power, remote control connections. 7 tubes plus rec. This is AC/DC version of popular S-40B. For 115 V. AC/DC. \$99.95

I have a complete stock of Hallicrafters receivers and transmitters. I'll make you the best deal on a trade-in for your communications receiver. I give you prompt delivery, and 90-day FREE service. Nobody can beat Bob Henry on a trade-in, and I offer you the world's lowest credit terms. Write, wire, phone, or visit either store today for the best deal. Export orders solicited.

Bob Henry
WPARA

Butler 2, Missouri

HENRY RADIO STORES

1120 Olympic Blvd
LOS ANGELES 25
CALIF.

WORLD'S LARGEST DISTRIBUTORS OF SHORT WAVE RECEIVERS

TWIN LEAD, TELEVISION LIGHTNING ARRESTER

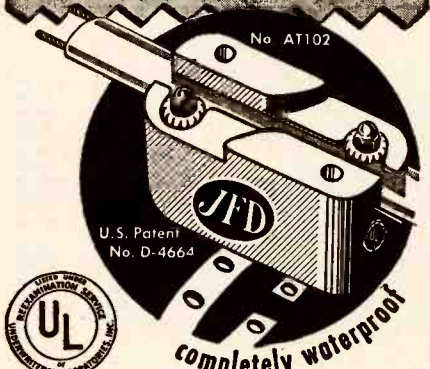

U.S. Patent No. D-4664

completely waterproof

APPROVED for OUTDOOR-INDOOR Use \$2.25
Protects Television Sets Against Lightning and Static Charges

JFD SAFE TV GUARD

Simple to install everywhere and anywhere...no stripping, cutting or spreading of wires. More than 300,000 in use today!

SEE YOUR JOBBER OR WRITE TO

JFD MANUFACTURING CO., Inc.
6127 16th Avenue, Brooklyn 4, N. Y.
First in Television Antennas & Accessories

Leotone

MIKE-SPK. (1 1/8" x 1 1/2" Exc. 1.10)
MIKE, PHONE or FIL-LOW SPKR. Replacement unit for AN-BK-1 phone. ea. 59c; 4/\$2.00

18 FT. WHIP ANTENNA... 6 steel screw sects. 2.49
MERCURY SWITCH... 1A/115V... 39c; 3/ 1.00
ARMY GAS MASKS... NEW; less side can. 39c; 3/ 1.00
PL-259 CO-AX PLUGS... 22 on 4 1/4" RG-38 cable. 1.49
4 RPM MOTOR... 115VAC. 2 1/2" x 2 1/4". 2.75
2 1/2" H.P. REVERSIBLE MOTOR... 3000 RPM. 3 1/2" shaft. 4 1/2" x 4 1/2". 3.95
115VAC INDUCTION MOTOR... 1750 RPM, fract. HP. 2 1/2" x 3 1/4" x 1 1/2". 1.39

T-30V THROAT... 1.54
MIKE... BRAND! NEW... ea. 49c; 5/ 2.00
CD-508 EXT. CORD & SWITCH for T-30mike ea. 49c; 5/ 2.00

CRYSTAL MIKE... HI-imped. rubber shock-mtd. 1 1/2" x 1 1/2" housing. .98
A U M... 1.10
H O U S I N G for crystal mike .15

#30 P.E. MAGNET WIRE... 400 ft. roll. 23c; 5/ 1.00
MFD-600V OIL COND. .50... ea. 1.49
.05 MFD-600V OIL CONDENSER. 1" x 1 1/2". 12/ 1.00
TUBE CARTONS... Plain white (prices per 100). Mini 1" sq. x 2 1/4" - \$1.20; GTV 1 1/2" sq. x 3 1/4" . 1.45
Medi 1 1/4" sq. x 1 1/4" - \$1.65; Large (2" sq. x 3") . 1.98
S. SCOPE VISOR... Hvy. leather & rubber. .59
S.V. BUZZER... 115V. 5/8" dia. base. 1.49
HEARING AID BONE CONDUCTION RECEIVER. Makes excel. MUSICAL or CONTACT MIKE. MIN. SPKR. 1 1/2" x 3 1/2". Low impedance. HEARING AID AMPLIFIER (2 tube) . MAKE A REAL VEST POCKET RADIO adding simple tuner. 1 1/2" x 2 1/2" WITH SCHEMATICS FOR 2 or 3 TUBE SET. Less tubes & . 2.49
HEARING AID TUBES... set of 2 for above. . 2.49
SUB-MINIATURE TUBES (RAYTHEON)... CK503 or 505 . 1.49
W-110 FIELD WIRE rolls 150-400 ft. ONLY 1/4c ft.
RUBBER SHOCK MOUNTS... 8 lbs. 1 1/2" sq. 10/ 1.00
P-23 HEADSET... HI-imped. 5 ft. cord & PL-55 1.98
HS-33 HEADSET... 10-imped. 5 ft. cord & PL-55 1.98
RUBBER PHONE CUSHIONS... per pair .29
JK-26 (PL-54) CONNECTOR... per set 39c; 6 sets/ 1.98
1/2" RED JEWEL ASSBLY... min. bay. ea. 29c; 4/ 1.00
BROWN BAKELITE PANELS (1 1/2" x 7" x 10" - 39c; 7" x 14" - 49c; 7" x 18" - 49c; 6" x 15" . .65
3:1 AUDIO TRANSFORMER (Cardwell)... 2" x 1 3/8" x 1 1/2" . .69
NEO-TECTOR... 110-220V. AC/DC. . 1.00
ROTARY SELECTOR SWITCHES-5 pos. D.P. . 1.00
3 pos. D.P. 2 deck... 29c; 4/ 1.00
6 pos. S.P. 2 deck... 39c; 3/ 1.00
BALL BEARINGS... O.D. 5/8", I.D. 3/8" . 23c; 5/ 1.00
O.D. 3/8", I.D. 1/8" . 23c; 4/ 1.00
EXPERIMENTAL TUBES... for testing, research, etc. Filament tested. 20 asstd. receiving types 1.00
"ALNICO MAGNET ASSORTMENT" Powerful BAR, BLIND, RING of 10 asstd. 1.98
(WRITE FOR "ALNICO MAGNET" SUPPLEMENT)
MOULDED BAKELITE CONDENSERS (Mecamold)... 00001 to 2mfd; 300-600 W.V. Kit of 50 asstd. 1.98
KNOBS... Screw, spring. Kit of 25 asstd. . .98
WAFER SOCKETS... 4 to 8 pin. Kit of 12 asstd. .25
WIGA PADDERS-TRIMMERS... Kit of 15 asstd. .98
POTENTIOMETERS... WW, carbon. Less switch 1.49
WIRE-WOUND RESISTORS... 5-20 watt. 15 asstd. .98
ROTARY SELECTOR SWITCHES... Kit of 6 asstd. 1.49
DIAL SCALES... FM, AM. 25 asstd. . .2.49
SPEAKER CONES... 4" to 12" incl. free-edge. Less voice coil. Assortment of 15 asstd. 1.98
FACTORY SPEAKER REPAIRS SINCE 1927
Min. Orders \$3.00. 20% deposit on all COD's
Full Remittance with foreign orders
Please add sufficient postage-excess refunded

LEOTONE RADIO CO.
65 Dey Street
New York 7, N.Y.

and television sets, it would be more practical to use photographs.

Photos usually end up a little more expensive than art work. They almost always require retouching and half-tone screens are necessary for reproduction.

The use of stock photographs or mats are all right when you can match them up with your own merchandise. Do not illustrate items in your advertisements which you cannot supply to the public upon request. Stock illustration books or mat services may or may not carry your items. If they do, you will save the cost of an artist or photographer.

If it is necessary for you to hire an artist, you can keep your costs down to a minimum by employing some of the following suggestions:

1. Remember that artists differ in techniques and abilities as well as in their prices. Always choose a specialist in a particular field. It may cost a little more at the time but will save you money in the long run.

2. Always give an artist complete instructions to avoid mistakes and "redo's." Always demand first to see a rough so that you can see what you are getting.

3. Try to anticipate your art work requirements in advance. In this way, it will be possible to order art work in quantity and thereby afford a saving. Artists will always charge less for quantity work.

4. Always ask the engraver for the original art work. You may have some use for this in the future and you can use the same work over and over again. This holds true for engravings. Do not hesitate to re-use an old photo or drawing if you have the item in stock. If you change layout and copy, it will appear completely new to the average reader.

Remember that the main function of illustrations is to attract attention through interest, novelty, and contrast. Hundreds of years ago, the Chinese discovered that "one picture is worth a thousand words." This proverb is truer than ever today.

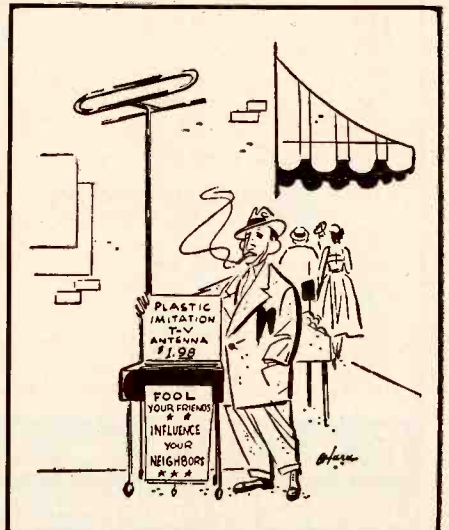

31,475



There are 31,475 models covered completely in RIDER TV-AM-FM-PA MANUALS.

And you may be called upon to service any one of these models . . . today . . . tomorrow . . . next week. Make sure you have the BEST servicing information—when you need it. Complete your RIDER MANUAL Library now. RIDER MANUALS—PROVEN BEST BY 21 YEARS OF TEST.

**In TELEVISION
5 RIDER TV MANUALS**
★ 10,544 Pages*
★ 1,849 Models
Equivalent of 8 1/2 x 11 ins. size

RIDER P.A. MANUAL
★ 2,024 Pages
★ 1,285 Models

**In AM-FM-Auto Radio-Phono
21 RIDER MANUALS**
★ 31,382 Pages
★ 28,341 Models

These comprise the world's greatest compilation of ACCURATE — AUTHENTIC — RELIABLE Servicing Information . . . as furnished by the Service Departments of the Manufacturers themselves. And all of it is yours . . . at the astonishingly low cost of LESS THAN 1c PER PAGE!

Plus an **EXTRA** feature that is exclusive with **RIDER TV MANUALS**

CIRCUIT ANALYSIS . . . descriptions of important functions within the receiver . . . pertinent data originating from the manufacturers and presented by RIDER in a manner which makes this added information a valuable aid to the servicing technician—as well as a practical education in the actual design of television receivers.

John F. Rider Publisher, Inc.
480 Canal Street New York 13, N. Y.

See Your Jobber For RIDER MANUALS
PROVEN BEST BY 21 YEARS OF TEST

Technical BOOKS

"TRAINING THE LOCAL ANNOUNCER" by Samuel B. Gould & Sidney A. Dimond. Published by Longmans, Green and Co., New York. 200 pages. Price \$2.50.

This little handbook, written by two of the faculty members of the Boston University Division of Radio and Speech, is a practical approach to a problem in professional training that has received very little formal attention from educators and station management.

Since most of the big-name announcers started in a small way with local stations the authors have assumed that those who follow in their footsteps will make their radio debuts in a similar manner. Because of this, the text material covers more than just purely announcing techniques. Most small stations utilize their personnel to the fullest extent by having announcers "double in brass" as disc jockeys, time salesmen, public relations men, etc., so some information on these varied duties is also included.

The book contains a large number of drills and exercises for the tyro announcer, including lists of difficult proper names and unusual words for pronunciation practice.

All-in-all, the prospective announcer as well as those just "trying their wings" should find a lot of down-to-earth advice in this handbook which will be of immediate and practical use.

* * *

"PRIMARY BATTERIES" by George W. Vinal. Published by John Wiley & Sons, Inc., New York. 329 pages. Price \$5.00.

While this is a specialized text on a highly specialized subject such a book has long been needed to help round out the technical literature available on batteries.

Written by the Chief of the National Bureau of Standards' Division of Electrochemistry, this authoritative work traces the development of primary batteries from Volta's early experiments in 1800 to the present state of the art.

After an outline of the history of primary batteries, the author devotes a chapter to the discussion of the elementary theory of electric cells. He next discusses dry cells, materials and production; the operating characteristics of dry cells; the effect of low temperatures on dry cells and low-temperature types; standard cells and standards of e.m.f.; air-depolarized and other batteries; copper and copper oxide cells; silver oxide and chloride batteries; lead cells having soluble reaction products; mercuric oxide and vanadium dry cells; and, finally, fused-electrolyte cells.

This book contains a wealth of valuable information written in an easily-understood style. If the tremendous popularity of the author's previous

BECOME EXPERT

with **OSCILLOSCOPES**

This practical book tells you everything you should know about an oscilloscope! WHAT it is . . . what it can DO . . . and HOW to use it properly!

ENCYCLOPEDIA ON CATHODE-RAY OSCILLOSCOPES AND THEIR USES

by John F. Rider and Seymour D. Uslan

The **FIRST** and **ONLY** book that so fully and clearly describes the "scope" . . . its construction . . . its capabilities . . . its applications in servicing, engineering, research . . . with thousands of time-saving and labor-saving references, charts, waveforms, etc.



All oscilloscopes produced during the past ten years, a total of more than 70 different models, are accurately described—with specifications and wiring diagrams.

Planning to buy a "scope"? This book will help you select the type best suited to your needs! If you already own one, the book will

show you how to increase your instrument's usefulness and, naturally, its value to you!

We GUARANTEE that it will SAVE and EARN many, many times its cost for you!

998 Pages • 500,000 Words • 3,000 Illustrations
8 1/2 x 11" Size • 22 Chapters • Completely Indexed
Easy to Read • Cloth Bound And only \$9.00

with **ANTENNAS**

TV and OTHER RECEIVING ANTENNAS

(Theory and Practice)

by Arnold B. Bailey



Tells you . . . WHAT each type can do . . . HOW to use it . . . and WHICH is best!

This is a text book on all types of receiving antennas. If you have any questions—you'll find the answers in this book! Teacher, engineer, student, service technician—all can use this text. **WE GUARANTEE IT!** Antenna data never before published anywhere will be found in it. And it's readable—because mathematics has been translated into charts and graphs.

Everything you hoped for . . . and asked for!
603 Pages . . . 310 Illustrations And only \$6.00

at **TV INSTALLATIONS**

Stop wasting time, patience, and money in trying to "dope out" those difficult TV installations!

TV INSTALLATION TECHNIQUES

by Samuel L. Marshall



Order this RIDER book, the **ONLY** text that gives you complete information on all the mechanical and electrical considerations.

KNOW the absolute facts about such things as ice loading, wind surface, and mounting requirements—whether for short chimney-attached mast or an 80 ft tower, including foundation.

HAVE at your fingertips, accurate data on receiver adjustments in the home . . . municipal regulations governing the installation of TV antennas and masts in all of the major television areas in the U. S.

SURE to help you wherever and whenever an installation becomes a problem! A **TIMELY** and **IMPORTANT** book!

336 Pages • 270 Illustrations • 8 1/2 x 11" Size
Cloth Bound And only \$3.60

10-DAY FREE TRIAL—Make these books **PROVE** their value! Unless you agree they are the best investments you've ever made—return the books in 10 days and pay nothing!

RUSH THIS COUPON TODAY

JOHN F. RIDER PUBLISHER, INC. 2
480 Canal Street, New York 13, N. Y.
Please send me the following books on your 10-day FREE trial offer. Within 10 days, I will either pay \$_____ for them, or return the books to you in good condition.
"ENCYCLOPEDIA ON CATHODE-RAY OSCILLOSCOPES AND THEIR USES" \$9.00
"TV AND OTHER RECEIVING ANTENNAS" 6.00
"TV INSTALLATION TECHNIQUES" 3.60
Name _____
Address _____
City _____ Zone _____ State _____
SAVE POSTAGE. If you enclose check or money-order WITH coupon, we will prepay postage charges.
Money back if you return books within 10 days.
 Check Enclosed. Money-Order Enclosed.

HIGH FIDELITY is here!

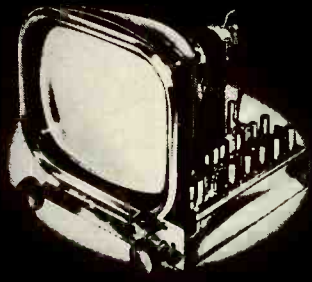

TWO BRILLIANT NEW CUSTOM CHASSIS —

Now, for the first time, you can enjoy the finest television and FM—plus high fidelity audio—all in one superbly-designed instrument! Now, at last, custom builders and electronics enthusiasts can choose the Craftsman Television which best suits their needs. SEE them! HEAR them! Above all—COMPARE them!

The RC-101

An outstanding new high fidelity custom video tuner with the same fine, big-picture quality and sensitivity as its famous predecessor, the RC-100. Features include keyed AGC and booster switch, plus new, double-shadow tuning eye for precision tuning. 20-20,000-cycle audio output permits remote hook-up with high fidelity audio and FM-AM tuners. Turret-type channel selector.

The RC-200

Here, at last, is a TV-FM-high fidelity audio receiver which, in one chassis, combines true high fidelity television and FM reception! Has all features of RC-101, plus 5-watt, push-pull high fidelity audio system and coverage of FM band. Continuous-type tuner and tuning eye permit 1-knob control of TV, FM or phono. Both chassis finished in polished chrome.

Write for information—or send \$30 for instructions and schematics.

THE RADIO **craftsmen** INCORPORATED

Dept. R-11, 1617 S. Michigan Ave., Chicago 16, Ill.

book, "Storage Batteries," is any criterion, there is no doubt that this newest work will be eagerly sought by engineers, research men, as well as students of the subject.

* * *

"DATA AND CIRCUITS OF MODERN RECEIVER AND AMPLIFIER VALVES" First Supplement. Published by *Philips' Industries*, Eindhoven, Holland. Distributed by *Elsevier Publishing Co.*, New York. 213 pages. Price \$1.90.

This publication is Book III in the *Philips' Technical Library* series covering tubes developed during the years 1940 and 1941 by *Philips Industries*.

In addition to furnishing full descriptions and complete data on each of the tubes, the manual contains valuable application and circuit information for users of these tubes. Included in this handbook are complete details on the *Philips' "Miniwatt"* key series of tubes, the 1.4 volt battery series, 100 ma. tubes for a.c.-d.c. applications, and data on two special tubes for a.c. operation (the ECH 4 and EL 50). Circuits of a.c. and a.c.-d.c. receivers based on the use of the "Miniwatt" key series, and battery receivers using the new 1.4 v. battery tubes are also given.

A special section of the book describes some of the latest *Philips* test equipment including a signal generator, service oscillator, thermionic voltmeter, stabilized voltage d.c. supply unit, a 500 v. supply unit and projection adapter, and a vibratory converter.

Manufacturers, laboratories, military and government agencies will undoubtedly want to have a copy of this manual handy for reference and study.

* * *

"TELEVISION SERVICE ENCYCLOPEDIA" by The Mallory Staff. Published by *P. R. Mallory & Co., Inc.*, Indianapolis. 204 pages. Price \$1.50. Second Edition.

Service technicians who have been

using this company's First Edition will find in this Second Edition a consolidation of servicing facts needed for the repair of both television and conventional radio equipment.

The new edition has been designed so that when used in conjunction with the company's 6th Edition of the "Radio Service Encyclopedia" it provides a complete reference library of replacement parts information on virtually all standard AM-FM radio sets, TV sets, TV boosters and preamplifiers, communications receivers, and professional audio amplifiers produced since the start of commercial radio.

This work is divided into two main sections, the first covering television receivers and the second devoted to radio and electronic equipment other than television.

A special appendix lists special servicing notes which could not be included in the tables, 616 control circuit diagrams, and 332 condenser circuits.

Service technicians should find ample use for this handy volume which will more than justify its purchase price.

* * *

"CAPACITORS FOR INDUSTRY" edited by W. C. Bloomquist. Published by *John Wiley & Sons, Inc.*, New York. 242 pages. Price \$4.50.

This handbook dealing with the selection, application, and economics of capacitors for power factor improvement in industrial plants is the work of a group of *General Electric Company* engineers.

The treatment of the subject matter is entirely practical and the authors have presented much of the material in easy-to-use tabular and curve form. The information included is designed for the industrial plant engineer and electrician, the utility power salesman, the consulting engineer, and the industrial power application engineer and provides them with an accurate solution to their capacitor application problems. This book should find wide acceptance in the power field.

-30-

TWENTY-SEVENTH BOARD of DIRECTORS R. T. M. A. 1950-51

Switches

FINEST QUALITY

Immediate Delivery from Our Huge Stock...
All New and Unconditionally Guaranteed!

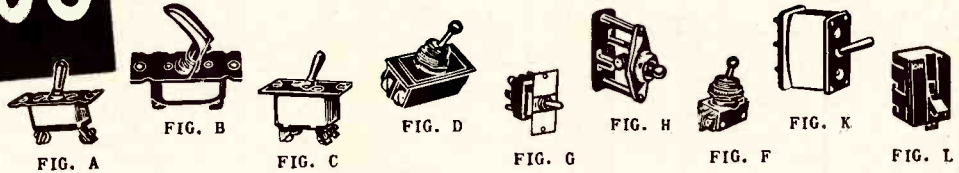

WIDE SELECTION OF ELECTRONIC COMPONENTS AT **WELLS**

Tubes • Resistors
Condensers
Wire and Cable
Volume Controls
Co-ax Connectors
Relays • Rectifiers
Transformers • Chokes
Micro Switches, Toggles
Antennas, Accessories
Electronic Assemblies
Dial Light Assemblies

TOGGLE SWITCHES

STOCK NUMBER	FIG.	CONTACT ARRANGEMENT	MANUFACTURER & NUMBER	PRICE EACH
PH-500	A	SPDT.	B1B.	\$0.35
PH-503	A	SPDT Center Off Mom Each Side.	B11.	.32
PH-505A	A	SPDT Momentary.	B21.	.30
PH-505	A	SPST.	AN-3022-2B.	.30
PH-506	A	SPDT Center Off.	AN-3022-1.	.35
PH-507	A	SPDT Center Off Mom Each Side.	AN-3022-7B.	.32
PH-513	A	SPDT Center Off.	Cutler Hammer AN-3022-1B.	.38
PH-514	A	SPST.	Cutler Hammer B-5A.	.35
PH-516	A	SPST.	B5.	.35
LT-104	A	SPDT One Side Momentary.	Cutler Hammer 8905K568.	.35
309-168	A	SPST.	168553.	.30
309-178	A	SPDT Momentary.	AN-3022-11B.	.35
309-181	A	SPST Momentary.	Cutler Hammer 8211K6.	.35
305-172	A Spcl.	SPST Momentary.	Cutler Hammer 8905K531.	.35
305-182	A Spcl.	SPST Momentary.	Cutler Hammer 8905K630.	.45
370-14	A	SPDT Center Off 1 Side Mom.	Cutler Hammer B-7A.	.30
370-4	A	SPDT Center Off.	Cutler Hammer B-9A.	.35
370-25	A	SPST Momentary.	Cutler Hammer B-6B.	.25
309-169	B	SPST Momentary.	Cutler Hammer B-19	.35
PH-509	C	DPST.	AN-3023-2B.	.45
PH-510	C	DPDT Momentary.	Cutler Hammer 8715K2.	.50
PH-511	C	DPDT Momentary.	Cutler Hammer 8715K3.	.50
PH-512	C	DPST Center Off.	Cutler Hammer 8720K1.	.55
303-65	C	DPST.	Cutler Hammer AN-3023-2.	.45
309-163	C	DPDT Center Off Momentary.	Cutler Hammer C-11.	.55
309-162	C	DPST.	Cutler Hammer C-1.	.45
309-164	C	DPST Momentary.	Cutler Hammer 8711K3.	.40
305-87	D	1 Side DPST Mom, 1 Side SPST.	AH & H.	.95
LT-100	F	SPST.	Cutler Hammer.	.22
LT-101	F	SPST Momentary.	AH & H. W/Leads.	.20
301-51	G	4PDT Momentary.	Cutler Hammer 8905K12.	.75
305-140	H	DT No Make Each Side.	Open Frame.	.25
309-161	K	SPST.	Cutler Hammer 8781K3.	1.95
309-170	K	SPST.	Cutler Hammer 8905K656.	2.25
301-41	L	DPST.	AH & H	.75
305-76	L	DPST.	AH & H—Open Frame.	.75
319-50	L	SPST.	Allied Elec. Mfg. Corp.	.28
305-170	Spcl.	SPST.	Cutler Hammer Type B13.	.40

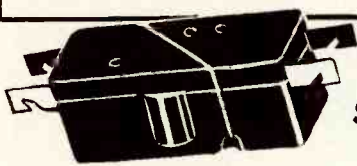

SWITCHETTES

STOCK NUMBER	MANUFACTURER'S TYPE NUMBER	CONTACTS	TERMINAL LOCATION	UNIT PRICE
303-20	CR1070C103-A3	N.C.	Side	\$0.47
301-29	CR1070C103-B3	N.O.	End	.47
303-34	CR1070C103-C3	1-N.O. 1-N.C.	End	.47
303-18	CR1070C103-F3	1-N.O. 1-N.C.	Side	.47
303-19	CR1070C103-E3	N.O.	Side	.47
303-43	CR1070C123-B3	N.O.	End	.47
303-23	CR1070C123-C3	1-N.O. 1-N.C.	End	.47
305-83	CR1070C123-J2	SPDT	End	.47
303-22	CR1070C123-J4	SPDT	End	.47
303-17	CR1070C124-M4	SPDT	Side	.47
303-16	CR1070C128-C3	1-N.O. 1-N.C.	End	.47

LEAF SPRING SWITCHES

STOCK NUMBER	CONTACT ARRANGEMENT	SPEC. INFORMATION	BACK OF PANEL DIM.	PRICE EACH
303-96	HPDT One Side.	W/Escutcheon Plate	3/4x1 3/4x3/4	\$1.65
311-58	1A Momentary & 1A.		3/4x3/4x3/4	1.35
309-167	2C One Side.		3x3/16x1 1/16	1.25
305-183	3A Momentary & 3A Momentary.		3/8x1 1/8x3/4	1.50
319-43	DPDT Center Off.	Mossman.	3/8x2x1 3/8	.85
319-42	4PDT Center Off Mom One Side.	Mossman.	3/8x2x1 3/8	.95
309-159	3B.	Mossman.	3/8x2 1/4x1 1/4	.85
309-158	2D.	Mossman.	3/8x2 1/4x1 3/8	.85
309-165	1A.	Mossman.	3/8x1 3/16x1 1/4	.75
311-96	4PDT.	Bakelite Actuator.	3 1/16x1 3/8x7/8	.85
305-164	3A.		3/8x1 1/16x1 1/16	1.25
319-43A	DPDT Center Off Mom Each Side.	Mossman.	3/8x1 3/8x2	.95
305-165	3A & 3A.	Switchboard Type.	4 3/4x1 1/2x3/4	.95

Many Other Types in Stock. Send Us Your Requirements.
Order From Your Parts Jobber or Directly From Wells.

WRITE FOR NEW WELLS CATALOG

World's Largest Display of Radio and Electronic Components. 9000 Square Feet of Display All on One Floor.



320 N. LA SALLE ST. DEPT. R, CHICAGO 10, ILL.

Columbia

GEM OF THE SURPLUS

ARD-3 UHF RECEIVER: 400-500 mc. Ideal unit for 420 meter ham band or citizen's band. 26 VDC input or 115 V 400 cycles. Easily converted to 60 cycles. Less tubes \$6.95

SCR-522 TRANSCEIVER: Freq. range 100-150 mc. Hot 2-meter rig, also C.A.P. mobile rig. Complete, all tubes, push-button control box. THIS IS A BUY! \$34.50

GO-9 RECTIFIER-TRANSMITTER: 100 W. output. 3 units hi & low frequency transmitter and rectifier. Covers 20-40-80 meter bands using an E.C.O. 115 V. 400 cycles. Easily converted to 60 cycles. Can be put on 10 meters. Used, in excellent cond. Complete. ONLY \$57.50

MARK 11 TRANSCEIVER: Can't be beat for mobile or stationary rig. Low band 2-8 mc. Phone, CW and NCW 25 W. Hi freq. 240 mc. on phone. Complete receiver and transmitter, antenna, control boxes, all the works. Ready to operate. Brand new in original crate. The whole deal. ONLY \$89.50

BC-221 FREQUENCY METER: Xtal. calibrated from 125-20,000 kc. Swell for signal generator and VFO. Used, but excellent cond. THIS IS THE BEST DARN METER BUY IN THE COUNTRY! With tubes, xtal calibration book \$55.00

BC-500-A LINK CRYSTAL CONTROLLED RECEIVER-TRANSMITTER: 1825 in final. 25 W. output. Input to receiver & transmitter 12 V. Ideal unit for mobile rig. Covers 20 meters and can be easily converted to 10 meters. FM receiver has 1 RF and 2 IF stages. Fully enclosed speaker and face control panel. Used but excellent cond. \$42.95

MN-26C RECEIVER: Freq. 150-1500 kc. 28 V. with control box, flex. cables, azimuth indicator and loop. Extra hot for aircraft or marine use. Most parts brand new. THIS IS HOT! Only \$32.50

FIXED WIRE WOUND RESISTORS: 10 watts 25 M ohm, 50 M ohm, 75 M ohm, 100 M ohm. .29c ea. NEW! \$29.00

POSTAGE STAMP MICA CONDENSERS: 20 asstd. .95c

ARB RADIO RECEIVER: 195 to 9050 kc in 4 bands. Sharp or broad tuning for extra sensitivity. In excellent condition \$29.50

ABOVE UNIT WITH DU-1 LOOP for automatic direction finding; loop contains 2 tubes and built-in amplifier. COMPLETE \$52.00

ARC-5 OR 274-N TRANSMITTERS COMPLETE

2.1-3 mcs. Excel. for ship use.....	\$12.95
3-4 mcs. Used, excel. cond.....	10.95
4-5.3 mcs. Used, excel. cond.....	3.50
5.3-7 mcs. Used, excel. cond.....	4.50
7-9.1 mcs. Used, excel. cond.....	10.95

ARC-5 OR 274-N RECEIVERS

1.5-3 mcs. For ship use. Excel. cond.....	\$14.50
3-6 mcs., excel. cond.....	6.95
6-9.1 mcs., good cond.....	6.95
100-550 kc., excel. cond.....	12.50
Command Receiver flex. cable 8'.....	.95
Command Receiver 28V dynamotor.....	.79
Command Knobs for Receiver. Ea.....	.69
MDT/ARC-5 Plate Modulator.....	7.95
Triplet Receiver Control Box.....	1.75

274N ANTENNA RELAY BOX

Contains RF meter plus 50 mmfd H. V. vacuum cond. and relay. New in carton..... 2.25

SIGNAL LAMP

Pistol grip. 12 V. 6.6 amp. Use it on your car. Or even on yer boat, launch or yacht—you plutocrat! New in original box. Only..... \$2.50

METERS! THE BEST BUYS IN THE BOOK!

0-3 VDC 2 in. round. Simpson.....	\$2.49
0-15 VAC 3 in. round. Weston or Roller-Smith.....	3.29
0-50 amp. AC 2 in. square. Triplet.....	2.99
0-25 MADC 2 in. round. Weston.....	2.99
0-50 MADC 2 in. square. Simpson.....	2.99
0-800 MADC 3 in. square. De Jur.....	3.49
0-1 amp RF 2 in. round. G.E.....	2.99
0-2 amp RF 2 in. round. Thermocouple type.....	2.99
0-9 amp RF 2 in. round. Westinghouse.....	2.99
1 MIL MOVEMENT with 0-10 scale. 2 in. round. Hickok.....	3.29
CONTROL UNIT C-5R/ATP-1 complete with 0-1 mil movement with 0-200 scale. Box contains 2 toggle switches, control knobs, panel light, etc., all for only.....	4.50

TUBES! THE BESTEST BUYS! TUBES!

7BP7.....	\$3.50	4E27.....	\$8.95
5BP4.....	2.50	7E6.....	1.00
3CP1.....	1.95	1S5.....	1.25
3BP1.....	1.75	0Z4.....	1.15
902P1.....	3.50	1J6.....	1.25
803.....	3.50	61.6M.....	2.50
6AC7.....	2.00	6SR7.....	1.25
705A.....	.79	12AT6.....	1.15
717A.....	.89	1819.....	.39
211.....	.85	0Z5.....	.50

CLAIRE S.P.D.T. RELAYS: Platinum contacts. NEW..... Ea. \$1.25

VOLTAGE REGULATOR: Tube 956. Mod. 1, style A. 24 V. Voltage set at 13..... \$1.50

TWIN LEAD HEAVY DUTY XMISSION LINE: 205 ohm. FB for KW xmission. Per foot..... .7c

MIDGETS VARIABLE CONDENSERS: 55 mmfd..... Ea. 29c
125 mmfd..... Ea. 39c

OIL FILLED CONDENSER: Cornel Publier. 1 mfd at 5,000 VDC..... \$3.50
02 mfd 2,000 W VDC..... 1.50

BATHTUB CONDENSERS: 3 x .1 at 500 VDC..... Ea. 59c
2 x .5 at 600 W VDC..... Ea. 59c

CHEST SETS

TD-1-A: Has F1 carbon capsule in mike. on-off switch, approx. 8 ft. of cord. New, boxed. Excel. for mobile work or home xmtr. New, boxed..... \$1.95

NEW..... Ea. \$1.25

NEW..... Ea. \$1.25

NEW..... Ea. \$1.25

NEW..... Ea. \$1.25

NEW..... Ea. \$1.25

NEW..... Ea. \$1.25

NEW..... Ea. \$1.25

NEW..... Ea. \$1.25

NEW..... Ea. \$1.25

NEW..... Ea. \$1.25

What's New in Radio

(Continued from page 88)

mounting holes to fit most tone arms. It is furnished with an adapter plate to permit mounting in RCA and similar 45 r.p.m. record changers.

Output is listed at approximately 6/10 volt at 1000 cycles on a Columbia No. 103 test record and 1 volt on the RCA 12-5-31-V test record.

OUTLET BOX

Equipment and Service Company of 6815 Oriole Drive, Dallas 9, Texas is currently marketing a new lightweight outlet box which provides five all-weather outlets from a single inlet.

Known as the "Greenbilt" Type 6005, the new box is especially designed for AM and FM remote applications, TV remotes, and for use in service shops and ham shacks. When used with the company's accessory connector Types 106 and 115 the unit



becomes a waterproof, weatherproof, and disconnect-proof power connector. The Type 106 inlet connector is rated for 6000 watts and the outlet connector Type 115 is rated for 1500 watts.

An illustrated bulletin covering the new outlet box is available from the company.

SERVICE TOOL

Rosenberg Brothers of 625 West 55th Street, New York, N. Y., has recently introduced a handy service tool which technicians will undoubtedly find of help in their servicing work.

The unit is a Rosco "Flash-Driver," a combination screwdriver and flashlight which features an unbreakable plastic handle, complete flashlight assembly including a light directing tube and clear plastic lens, and a magnetized blade to hold screws. A large knurled switch knob on the handle operates the flashlight.

The "Flash-Driver" is available in two models, one with a 1/8" x 4" blade and the other with a 3/16" x 4" blade. Information on either unit may be obtained from the manufacturer.

PANEL INSTRUMENTS

The Simpson Electric Company of 5200 W. Kinzie Street, Chicago, Illinois is currently in production on a line of modernistic panel instruments which are available in three different sizes.

The new models come in 4 1/2", 3 1/2", and 2 1/2" sizes. The design is identical

"HAVE YOU HEARD THE SOUND OF QUALITY?"



NEWCOMB SOUND IS BETTER

- Manufacturers of public address, mobile, phonograph, musical instrument and wired music amplifiers • Portable systems • Portable phonographs and radios • Transcription players • Rack and panel equipment.
- Write today! Circle items of interest and indicate whether you are a Dealer, Parts Jobber or Sound Specialist.

NEWCOMB AUDIO PRODUCTS CO.
DEPT. F, 6824 LEXINGTON AVE.
HOLLYWOOD 38, CALIFORNIA

STAY ON THE AIR WHEN POWER FAILS...with an ONAN Electric Plant



Model 10EL, 10KW A.C.

When storms, floods, or fires interrupt electricity and force you off the air, you lose listeners and income. Guard against loss, assure vital public service during emergencies by installing an Onan Electric Plant. Onan Standby Electric plants serve many network and private stations. Automatic models to 35,000 watts.

PORTABLE ELECTRIC PLANTS FOR MOBILE RADIO USES
Supply A.C. power for broadcasting at scene of events. Can be carried by hand or in trunk of car. Weigh as little as 80 pounds. A.C. models 350 to 35,000 watts.

Write for FREE Folder

D. W. ONAN & SONS INC.
4810 Royalston Avenue
Minneapolis 5, Minnesota

RADIO & TELEVISION NEWS

on all three sizes. Model numbers are 1029, 1027, and 1127 respectively.

The large, easy-to-read scale provides good readability under all light conditions. Etched faces extend across the entire fronts of the meters and

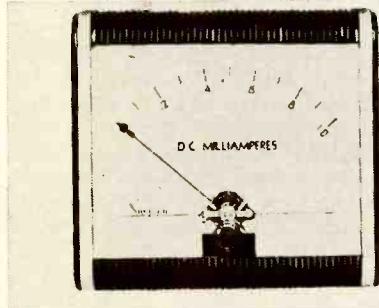

are protected with unbreakable plastic. Vertical chrome-plated strips are recessed into the plastic fluted cover. The open scale layouts provide space for the use of the customer's name, trademark, or distinctive color combinations.

Full details are available from the company on request.

NEWCOMB PORTABLE

Newcomb Audio Products Company of 6824 Lexington Avenue, Los Angeles 38, California has added an AM receiver to its line of audio equipment.

The Model B-100 is a rugged unit which can be used for schools and other locations where the receiver is subject to abuse. It features a jack for connection of additional amplification to cover larger areas. The jack may also be used for headphones.

A built-in loop makes an external antenna unnecessary in most areas and the 3-gang design eliminates annoying



heterodyne squeals and assures adequate selectivity, according to the company.

The set is of all-a.c. construction, has a 6" Alnico V PM speaker, and an amplifier design which utilizes an inverse feedback circuit and beam powered output. The tuning knob avoids the use of strings and may be turned beyond the range of the dial without damage.

The set is housed in a plywood cabinet covered with washable two-tone fabricoid material. A heavy metal grille protects the speaker. The entire unit measures 7 1/2" x 15 1/4" x 8" and weighs 13 1/4 pounds.

BASE AND SOCKETS

Alden Products Company of 117 North Main St., Brockton 64, Mass. has recently added the Alden "20" non-

January, 1951

REVOLUTIONARY GIVES YOU

maximum replacement

WITH A **minimum of cartridges!**

THIS MEANS MONEY TO YOU!



ORTHOGONAL SERIES 32, 33 and 34

This TORQUE DRIVE* vertical-type crystal cartridge is being used more and more in original equipment and for replacement. The 32 series greatly improves 78 rpm reproduction—saves record wear. The 34 series for 33 1/2 and 45 rpm beautifully plays the new wide-range, high fidelity recordings—tracks perfectly at 5 grams pressure. The 33 series handles all three speeds, with remarkable efficiency. All specially moisture protected for extra long life. Has 1/2" and 5/8" hole spacing. Color coded. Simple to install. Replaceable osmium-tip or sapphire-tip needles.

*E-V Pat. Pend. Licensed under Brush patents.

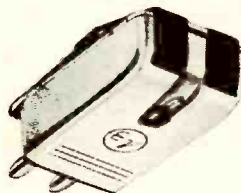

SERIES 12 and 14

The Series 12 TORQUE DRIVE crystal cartridge replaces over 150 types in general use for 78 rpm. Saves time and work—speeds servicing. Gives better reproduction and longer record life. Series 14 for 33 1/2 and 45 rpm is performing brilliantly in thousands of record changers. Tracks perfectly at 5 grams pressure. Color coded. Replaceable osmium-tip or sapphire-tip needle.

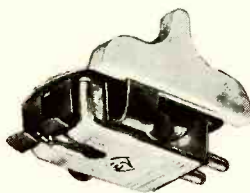

SERIES 16 TWILT FOR ALL 3 SPEEDS

Superbly plays 33 1/2, 45 and 78 rpm records with a single twin-tip replaceable needle without weight change, with tracking pressure of only 6 grams, and does it with TORQUE DRIVE efficiency. You merely tilt the Twilt and select the 1-mil or 3-mil needle tip for fast or slow speed records. Setdown is accurate. Mounts easily in most any standard pickup arm, with nothing more required than reducing needle pressure. Also available without tilting mechanism.

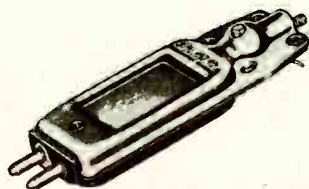

SERIES 60 REPLACES OVER 20

New Econo-Cartridge for economical replacement of over 20 conventional Bimorph crystal types. Frequency response to 6000 cps. Output is 3.5 volts with compliant needle, and 4.5-5 volts with straight shank needle. Has exclusive E-V needle stop which prevents chuck from rotating excessively and damaging crystal.

INCORPORATED

410 CARROLL STREET • BUCHANAN, MICHIGAN

Export: 13 East 40th Street, New York 16, N.Y., U.S.A. Cable: Arlab

Research-Engineered Phono Pickups, Microphones, High-Fidelity Speakers

ASK YOUR E-V
DISTRIBUTOR OR
WRITE FOR
FREE BULLETINS

USE PHOTOFAC

the world's best Radio-TV service data—it pays for itself every working day



Try PHOTOFAC!

FREE We'll send you any Photofact Folder listed in the Photofact Cumulative Index

WE'LL PROVE YOU'LL SAVE TIME and EARN MORE WITH PHOTOFAC

NOW—learn for yourself—at our expense—how PHOTOFAC makes your Radio and TV work quicker, easier, more profitable! Examine an actual PHOTOFAC Folder. Use it. You'll learn first-hand why over 35,000 successful service technicians use PHOTOFAC daily. You'll learn that no other service gives you PHOTOFAC'S completeness, accuracy, uniformity, and lowest cost. PHOTOFAC is the only radio and TV service data prepared from laboratory analysis of the actual equipment. Know the facts—get your FREE Folder now. Examine, use, compare—learn why no modern service shop can afford to be without PHOTOFAC!

WRITE FOR FREE INDEX

PAY AS YOU EARN! Ask your distributor about this amazing plan. Only \$18.39 puts the entire profit-boosting Photofact library in your shop now!

NOTE: Our FREE Folder offer is limited to Service Technicians only. Attach coupon below to your letterhead and mention your jobber's name. If you have no letterhead, send coupon to your jobber. Experimenters and others may obtain the Photofact Folder by remitting amount shown below.

HOWARD W. SAMS & CO., INC.
2201 E. 46th St., Indianapolis 5, Ind.

- Send FREE Photofact Cumulative Index
- Send Full Easy-Pay Details

I am a Service Technician:

- Send FREE Folder for set model.....

I am an Experimenter: Enclosed \$.....

- Send Folder for set model.....

TV-\$1.00. Record Changer or Comm. Receiver-75c. AM/7M-50c

Name.....

Address.....

City.....Zone...State.....

interchangeable base and sockets to its line of plug-in components.

The new "20" pin base with matching sockets was designed specifically for plug-in unit construction. There is no molded center boss to break and the pins are strong and stubby. By selecting variations of pin layout of less than 20 pins, critical voltages and frequencies can be isolated and the base can be made non-interchangeable so that it will mate only with the correct socket.

These new units have been suggested for applications in open units, shielded units, relays, filters, or for terminal cards for wiring complete assemblies.

Two types of sockets are currently available, the 400-20 for chassis mounting, and the 400LG-20 designed for rack mounting. The first unit takes a minimum of space and can be eyeleted or riveted to the chassis. The rack units mount on "U" channels side-by-side or in series with overlapping ears.

Data sheets giving all pertinent data on these new base and sockets are available. Address your requests to Norman Curtis in care of the company.

-50-

International Short-Wave

(Continued from page 67)

Brazil—ZYK3, 9.565, Recife, noted 1630 on Sunday with "Brazil Calling" (English); ZYB8, 11.765, Sao Paulo, heard 1945, easily separated from CKRA. (Bromley, Ontario) *Radio Record*, Sao Paulo, is still using 9.505; noted evenings (EST). (Lane, South Dakota.)

Radio Club de Para, Belem, is on the air daily in Portuguese 1800-2030 on 4.865. (*World Radio Handbook Bulletin*.)

Radio Nacional, Rio de Janeiro, uses a 250 w. transmitter on 6.147 in parallel with PRL7, 9.72, and m.w. and FM outlets; this transmitter was used once on 17.85 relaying m.w. PRE8, PRL7, 9.72, and PRE8-FM, in Portuguese, and feeding the U.S.-beamed antenna. Fine reports were received from the USA. As this is an experimental transmitter, frequency and call are not included in announcements for the 49-m. or 16-m. channels. All reports are welcomed and answered. A new Tropical Band outlet is now active in Brazil; it is *Radio Cultura de Bahia*, Salvador, capital of the State of Bahia; call is ZYN22 (first time the Brazilian Government has issued a call with two digits after the letters) on 3.345 with 1 kw., along with two m.w. outlets. Salvador is the principal port of Bahia and is known for its 365 Catholic churches; Bahia's principal products are cocoa and tobacco; the State is situated in northeastern Brazil, is the sixth largest State in the country, and has a population of more than four million. (Serrano, Brazil.)

Bulgaria—Sofia, 7.671, has news 1545 and 1645. (Pearce, England.) The 1645 newscast is heard in Delaware; improved signal lately. (Cox.)

Canada—CBC's International Service is now scheduled—*European Service*. 0915-1130, CKNC, CKCX; 1130-1330, CKNC, CKCS; 1330-1345, CKCS; 1345-1400, CKCS, CHOL; 1400-1420, CHOL; 1420-1730, CHOL, CKLO; 1730-1745, CKLO; 1745-1830, CKLO, CKRZ. *Australasian Service*—2330-0005 (except Sat., Sun.), commentaries from the UN, CHOL, CKLO; 0340-0530 (Sun. only), English for Southwest Pacific Area, CHOL, CKLO. *Caribbean and Latin American Service*—1850-2235, CKRA, CKLO, with English 2100-2145. *North West Territories* (Northern Messenger) Service—2320-2400 (Sun. only), in English and French, CKLO, CKOB. Channels are CKNC, 17.82; CKCS, 15.32; CKCX, 15.19; CKRA, 11.76; CHOL, 11.72; CKLO 9.63; CKOB, 6.09, and CKRZ, 6.06.

CHNX, 6.130, Halifax, Nova Scotia, still closes 2310. (Grove, Ill.) Noted from 0500 weekdays, from 0800 Sundays. (Dary, Kansas) VE9A1, 9.54, Edmonton, Alberta, noted with news 1500. (Richards, Sask., Canada) VED, 8.265, also Edmonton, heard with music 2240, fair level in Delaware. (Cox.)

Canary Islands—EA8AB, 7.517, heard when tuned 1735; fair level in Delaware. (Cox.)

Cape Verde Islands—Praia's CR4-AA, approximately 5.900, is good level to 1700 sign-off. (Cox, Delaware, and others.)

Ceylon—*Radio Ceylon's* new "commercial service" noted signing on 2045 on 15.12. (Leary, Indiana.) Carries BBC news relay 2100. (Fargo, Ga.) At the time this was compiled, the schedule for the "commercial service" was 1830-2030 and 2330-0130 on 21.620; 2045-0230 on 15.120 and 9.520, and 0630-1130 on 11.775. BBC programs are relayed by *Radio Ceylon* at 0325-0900 on 17.730; 0325-1205 on 21.620, and 0910-1205 on 15.120.

Chile—CE1174, 11.74, Santiago, noted 2040 with drama in Spanish; continued after 2110 with music. (Russell, Calif.) CE776, 7.660, Santiago, heard 1817 through QRM. (Bromley, Ontario.)

China—A Chinese-speaking station on 9.73 noted 0541-0600 sign-off; believed Nanking. (Winch, Calif.)

Radio Peking appears to use 11.6851 and 15.054V for English news 0835; some days the 10.26 outlet carries that program and other days has separate session in Chinese. Cox, Delaware, hears the 10.260 outlet evenings from 1800 or earlier; sign-off varies 1920-1930; all-Chinese.

Colombia—HJCH, 4.895, signs off 2305; HJAG, 4.897, signs off 2303; the 4.797 outlet is HJFY (or I), "La Voz de Comercio," RCN, one of the Radio Cadena Nacional stations, location is Armenia, noted signing off 2220. (Stark, Texas.) HJDP, 4.885, Medellin, heard 1905. (Cox, Delaware.)

"Emisoras Unidas" Barranquilla, is broadcasting in Spanish on 4.785 at 0600-2300. (*World Radio Handbook Bulletin*) HJKD, 6.00, heard with native music 2335; HJFA, 4.86, Pereira, heard signing off 2301 after march-anthem. HJCQ, 11.68, Bogota, heard

OUTSTANDING VALUES NOW AVAILABLE

CABINET SPECIALS

- A.** Mahogany table model cabinet. For changer radio combination or straight changer. Beautifully finished, highest quality, heavy gauge wood. Size—17" long by 16½" wide by 10½" deep overall. Inside dimensions—15¼" long by 15" wide by 10" deep. Includes motor board.
NOW ONLY.....\$4.49
- B.** Portable phono case. Well built, attractively covered in two-tone brown leatherette. Heavy hardware used throughout. Dimensions: 13" by 15½" by 8".
NOW ONLY.....\$3.95
- C.** Heavily built—Utility case. For phono or transcription player. Built of 5-ply wood. Attractively covered in brown leatherette. Corners reinforced with leather. Heavy hardware used throughout. Can also be used as tool case. Dimensions: 19" by 16¾" by 7½".
A REAL BUY.....\$4.95



LIMITED QUANTITIES—WHILE THEY LAST

CERAMICON CONDENSERS

Standard Manufacture
Kit of 100 most often used ceramicons—now only.....\$4.95

GT TUBE CARTONS

Sturdy—Many Uses.
Box bulk tubes, spare parts, nuts and bolts.
\$.79 per 100
4.95 per 1000

Standard Type Replacement Phono Cartridge

All New—All Guaranteed
Type No. 1 will replace Shure W58A
Webster N10
Astastic L70
Price—only \$1.85 ea. Lots of 10 \$17.90

Type No. 2 will replace Shure W56A
Webster N10
Astastic L-72
Price—only \$1.99 ea. Lots of 10 \$18.90

INDOOR TELEVISION ANTENNA



Now TV reception without the outdoor antenna. Effective range 20 to 25 miles from station. Excellent reception. Easily installed—takes 5 seconds. Easily orientated. Heavy base—will not tilt. Attractive. Friction clutch-type action on the rods. Complete with lead in.....\$2.49
Case lots of 25..... 2.25

NOW! LARGE 14" or 16" PICTURE FROM YOUR 10" or 12" TELEVISION SET

Servicemen: Convert customers' sets for extra profits! 90% of all conversions can be made by use of the RAPARCO conversion kit.



Includes 14BP4 CR tube, 70° deflection yokes, and attractive lucite mask.

Complete, only.....\$34.95

TV AUTOMATIC VOLTAGE REGULATORS

Keep your voltage stable. Remove that flicker from your television set. Voltage change from 90 to 140 volts kept at 115 volts. Protects your TV set and other electrical units from line changes. Especially fine for rural areas.

Model RPA—

For use with units of 200 to 300 watts.
\$2.00 List. YOUR COST.....80c

Model RPB—

For use with units of 300 to 375 watts.
\$2.50 List. YOUR COST.....\$1.00

3-SPEED RECORD CHANGER

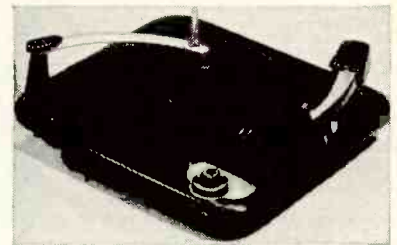

Completely automatic—33½—45—78 R.P.M. 7"—10"—12" Records. Plays twelve 10"—ten 12" or twelve 7" records, at all speeds. Jam proof. Simple centralized control. Underwriters Approved. Minimum Mounting Space: 12" x 10" x 7½" overall depth. A real value for a fine standard manufactured changer. Only.....\$21.95

SIGNAL CORPS EARPHONES (DUAL)

Highest quality. Impedance 20,000 ohms. Strong, lightweight adjustable band. 6 ft. waterproof card with plugs. Heavy duty bakelite shell. Inside terminals.
SALE PRICE.....\$2.25

GUARANTEED PICTURE TUBES RECTANGULAR

16"—Replaces 16TP4—16XP4..\$28.50
17"—17BP4.....\$29.95
TUBES MUST BE SHIPPED RAILWAY EXPRESS

150W SOLDERING IRON

Underwriters Laboratories approved. Standard ¾" Plug-In-Tip. A very good utility iron. Comes with stand.....\$2.29 each

Radio Parts Company, 614 RANDOLPH ST., CHICAGO 6, ILL.

CAVITY RESONATOR

Every ham and experimenter will want one of these great UHF buys. This Navy test oscillator with its gold-plated cavity resonator contains a 955 oscillator and a 955 modulator. Range from 234 to 258 Mc—covers entire 235-240 Mc ham band. Heavy aluminum shield divides case allowing space for batteries. 1/16" aluminum case with handle makes excellent transmitter or test instrument case. 99-9627—Wired, with tubes, 6 1/2"x7"x10".

1.95

HAMS



GREAT
VALUES
FOR
30
YEARS

ALL CHANNEL TV ANTENNA

A great buy in an excellently designed 2-band TV array. Dual unit with matched, separate folded dipole and reflector for high and low bands. Receives all channels plus FM band with good response. Average gain above tuned dipole, 2.5 db on low band and 1.5 db on high band. Each unit can be rotated independently for maximum signal strength. Quickly and easily erected. With 5-ft. mast. 28F21983—Hi-Lo All Channel TV Antenna.

5.75

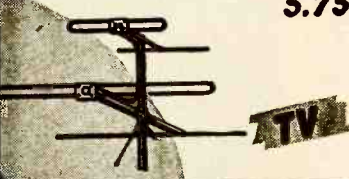

Radio Wire Television Inc. Lafayette Radio

EVERYTHING IN RADIO & ELECTRONICS

For Dealers, Industry, Amateurs, Institutions, Government Agencies

HOME



5.50

SESSIONS SWITCH ALARM

Turns your radio, TV set or other electrical appliance on or off automatically. Go to bed with radio playing, "Sleep-Switch" automatically turns it off at any pre-set elapsed time up to 90 minutes. Next morning, timer automatically turns on radio to awaken you at time you wish. 3 1/2" diameter, 2" deep from timer face. With mounting ring and bracket, less case. For 115 volts, 60 cycles A.C. P15720—Wt. 3 lbs. 6.50 P15721—As above, less "Sleep-Switch".

NEW YORK

100
SIXTH
AVE.

BOSTON

110
FEDERAL
STREET

NEWARK

24
CENTRAL
AVE.



HI-FI

29.50

LAFAYETTE HI-FI AMPLIFIER

This Lafayette 10-watt High Fidelity Amplifier has a range of 40 to 15,000 cps and is ideal for use with AM-FM tuners, record players and recorders. Built-in preamp, separate bass and treble controls; mike, phono and recorder high gain input. 4, 8, 15 & 500 ohm output impedances. Furnished with 2-6J7, 6SC7, 2-6V6 and 5Y3. Crackle finish chassis with sloping control panel, 7" H, 10 1/2" D, 14" W. For 105-125 V, 50/60 cycles. 2N190—Amplifier with tubes, less cover.

AMPERITE

Studio Microphones
at P.A. Prices

Ideal for
BROADCASTING
RECORDING
PUBLIC ADDRESS

"The ultimate in microphone quality," says Evan Rushing, sound engineer of the Hotel New Yorker.

• Shout right into the new Amperite Microphone—or stand 2 feet away—reproduction is always perfect.

• Not affected by any climatic conditions.

• Guaranteed to withstand severe "knocking around."



Models
RBLG—200 ohms
RBHG—Hi-imp.
List \$42.00



"Kontak" Mikes
Model SKH, list \$12.00
Model KKH, list \$18.00

Special Offer: Write for Special Introductory Offer, and 4-page illustrated folder.

AMPERITE Company, Inc.

561 BROADWAY • NEW YORK 12, N. Y.

Canada: Atlas Radio Corp., Ltd., 560 King St. W., Toronto

PHOTOCON SALES

Mail Order Address
1060-2 N. Allen Ave.
Pasadena 7, Calif.
SYcamore 4-7156
RYan 1-8271

Retail Sales Store
1240 East Colorado St.
Pasadena 1, Calif.
SYcamore 6-7217

January Specials

Write for Our Latest Sales Bulletins

We will buy new or clean used ARC-1, ARC-3, ART-13, BC-348 original condition or converted to 115V. A.C., BC-312, BC-342, Test Equipment, etc. All letters will be answered promptly. Please list equipment, condition, and lowest price.

HS-23 Hi Imp. Headset with plug and ear cushions NEW \$ 2.45
HS-38 Headset, Low Imp. leas head-band NEW 1.75
FL-8 Range Filter NEW 1.95
Welding Transformer—5 V., 190 amp. output—115V. 60 cycle input. 18.50
APN-1 Altimeter. Indicator basic movement 0-1 ma., 5 ma. shunt 270" dial. An excellent basic movement for constructing your own meters. BRAND NEW 1.95

PLUGS

PLQ-171, PL-172, PLQ-60, PLQ-63, PL-147, PL-148, PL-151, PL-152, PL-153, PL-154, PL-156, PLQ-103. Plugs for ARC-1, ARC-3, ARC-5, BC-375, SCR-522, BC-348, GP-6, GP-7, LM Frequency Meters, and many others.

IE-19A Test Set for SCR-522 complete with manual NEW \$325.00
LM Frequency Meter with cal. book, crystal tubes. EXCELLENT 79.50
BC-221 Frequency Meter with cal. book, crystal tubes. EXCELLENT 79.50
TS-323/UR Frequency Meter Calibrated, complete NEW 490.00

BC-348, ATC, T47/ART13, T47/ART13, MN26C, BC-342, BC-312, BC-224, RT18/ARC-1, R5/ARN7, SCR-522, SCR-625, BC-375, BC-222, BC-684, BC-375, BC-464, RA10, and many others. Prices on Request.

Weston Tachometer Generator Model 724, Type C. GOOD USED \$12.95
Weston Electrical Tachometer Model 545 for use with 724 Generator. Speed 0-2000 R.P.M. Ratio 2:1. NEW 14.50

We have thousands of Tubes, High Voltage Oil Capacitors, Mica Capacitors, Transformers, and Miscellaneous Items. Please send us your requirements.

TERMS: Prices f.o.b. Pasadena, Cal. 25% on all C.O.D. orders. Californians add 3% sales tax.

with music 1904-1930, poor level. (Russell, Calif.)

Costa Rica—TIGPH, San Jose, is now on 5.8744; noted 2045; previous measurement was 5.871. (Oskey, N. J.)

Cuba—COCW, measured on new channel of 6.318 at 2010; previous measurement was 6.3223. COBZ, 9.0256, heard 1810 with English grammar lesson in progress. (Oskey, N. J.)

Cyprus—Limassol, 11.72, noted 0815 with Eastern music; identified at 0900 and continued with music. (Ferguson, N. C.) A good program of dance music is radiated on Sundays 1045-1115 on 6.135, 6.170, 6.790, 9.650, 11.720. (Radio Sweden.)

Czechoslovakia—Prague, 9.55, noted with English 1415-1440; announced next English period for 1530 on 9.55 (Pearce, England.)

Denmark—Copenhagen is still noted to North America over OZF, 9.52, at 2100-2230; at least last half-hour is English. (Arthur, W. Va.)

Dominican Republic—HI1A, 4.980, Santiago, noted with popular music 1915. (Cox, Delaware.)

Ecuador—"Radio Bolivar" or "La Voz de la Libertad," Quito, is radiating in Spanish daily 0700-0930, 1200-1400, 1800-2200 on 4.770. (World Radio Handbook Bulletin) HCJB, Quito, recently has tested to the British Isles 1430-1530 daily (except Mon.) on 17.890. (Patrick, England.)

El Salvador—YSCF, 6.30, San Salvador, identifies at 2335; continues with native music at least 0000. (Russell, Calif.) YSBR has moved from 4.795 to 4.785. (Stark, Texas.)

England—BBC recently tested on 9.555 at 0100-0245 for relay of Pacific Service; may be in regular use by now (?). (Cushen, N. Z.)

France—Paris, 17.85, noted 0700-0730 in French. (Stark, Texas.)

French Cameroons—Radio Douala, 9.150, noted with recordings 1400; closes with French march 1517 after a news bulletin in French; signs on 1230.

French Equatorial Africa—Brazzaville, 17.841, noted with news for Far East ending 1115, followed by music. (Ferguson, N. C.) Heard on 15.600 at 1820. (Cox, Delaware.)

French Morocco—Radio Maroc, Rabat, is radiating on 6.005 with 2.5 kw., in French 0145-0300, 0800-0930, 1515-1800; in Spanish 0700-0730, 1300-1430. (World Radio Handbook Bulletin.)

French West Africa—A World Radio Handbook Bulletin says Radio Dakar is now scheduled on 11.895 weekdays 0200-0300, 0700-0830 (Fri. to 0845), 1300-1800, and Sundays 0200-0900 and 1330-1800; also daily on 15.347 at 1400-1530; says has news in English 1745, news in French at 1630, 2015; however, the English news was still reported to me as heard 1400 on both 15.341 (measured) and 11.896 (measured).

Germany—Berliner Rundfunk Deutcherland Sender, approximately 6.115, heard at good strength 0100; "evening" transmission is 1005-1945. According to a German radio program publication, schedules include Baden Baden, 6.315, 2300-1800; Frankfurt,

NEW!
ALPRODCO
ECONOMY
ALUMINUM
"TOWER-PAC"

**36' TOWER IN
 ONE COMPACT**

PACKAGE

Consisting of

- 4 ea. 6' ASSEMBLED TOWER SECTIONS
- 2 ea. 6' SECTIONS INTERLOCKING MAST
- 1 ea. HINGED BASE PLATE
- 1 ea. MAST KIT
- 3 ea. GUY BRACKETS

Complete (Tower-Pac)

Part No. TP-36

**TO DEALERS
 ONLY**

\$34.85

ALSO AVAILABLE AS
 ROTATING TOWER-PAC

Part No. TP36-R

FOR ONLY

\$39.64

ALPRODCO, INC.

**KEMPTON, IND.
 MINERAL WELLS, TEX.**

6.190, 2330-1800; Munich, 6.160, 2330-1900; Stuttgart, 6.030, 2300-1900. (Cushen, N. Z.) Hamburg, 7.290, heard 0056 with music, fair to good level. (Cox, Delaware.)

Greece—Radio Athens, 7.300, noted with news 1045-1100, then French. Greek Armed Forces Radio Station, 6.340, Athens, noted with daily broadcast in *English* 1615-1630; recordings; asks for reports to 3 Zalucostra Street, Athens, Greece. Unknown Greek reported to 1500 near 5.975 or 5.980 may be *Radio Epiros*, Jannina; another Greek station, believed *Radio Macedonia*, is heard afternoons to 1600 sign-off on low-frequency side of Alicante (around 7.950). (Pearce, England.) Larissa, 6.754, heard 0025; weak signal in Delaware. (Cox.)

Guatemala—TGNA, Guatemala City, is now using 9.660 in addition to 6.040; *English* period has been extended to 2200-2230 daily. (Grove, Ill.) Reports are requested to Box 601, Guatemala City, Guatemala; noted signing off with "O, Come All Ye Faithful." (Lane, South Dakota.) Sent two miniature Guatemalan dolls in native costume in reply to report. (Russell, Calif.) Mailbag Program heard 2225. (Richards, Sask., Canada.) TGOA, 6.49, noted signing off 0005. (Russell, Calif.) TGDA, 7.46, Quezaltenango, heard around 0050 with marimba music. (Russell.)

Haiti—The Magloire Broadcasting Circuit, Port-au-Prince, has programs in French, with *English* and Spanish announcements, over 4VCM, 6.165, 0600-1000, 1200-1500, 1700-2300. (*World Radio Handbook* Bulletin.) Has been heard 0430 in *English* by Balbi, Calif. Measured at 0600 by Oskay, N. J., on 6.167; fine musical program then.

The "wanderer," 4VRW, more recently on 9.84 again, closes 2200 on Mon.-Sat.; at 1700 Sun. (Grove, Ill.) 4V2S, 5.95, tuned 2130; signed off 2137. (Russell, Calif.)

Honduras—HRN, 5.87, Tegucigalpa, noted with talk in Spanish 2215. (Russell, Calif.)

Hong Kong—ZBW3, 9.525V, noted signing off 0930 with "God Save the King"; relays "Radio Newsreel" from BBC, London, 0900; then has local weather report. (Neeley, Calif.) Noted with news 0515, poor signal, QRM'd. (Balbi, Calif.)

Hungary—Budapest appears to be using 6.248, 9.833, 11.910 to Europe-British Isles as early as 1145 (tune-in) to 1830 closedown; news 1600 and 1810 (a late, *unconfirmed*, report from abroad says news has been changed from 1600 to 1700—KRB); and 7.2221, 9.833, 11.910 to North America at 1930-2030, 2300-2400, news 1900 and 2300. The 7.2221 outlet is "sandwiched" between Malta, 7.220, and BBC, 7.230. (Grove, Ill., Oskay, N. J., others.)

India—Radio Sweden says Delhi is now radiating to the West Indies 1830-1930 on 9.620, 11.760, 15.160.

VUM2, 4.920, Madras, noted 1030-1045 with news relay from Delhi. (Pearce, England.) Noted in Delaware 0730 with news relay. (Cox.) VUB2, 4.84, Bombay, heard 1030. (Pearce.)

ALPRODCO
ALUMINUM
TOWERS

The
HEIGHT
 of
Perfection!

LIGHT!
 STRONG!
 EASILY
 ERECTED!
 ATTRACTIVE!

NEW!

Economy 6' assembled
 Tower Sections for

ONLY
\$6⁴⁹

Part No. E-AT-6—Same
 as supplied in 'Tower-
 Pac.' Standard Alpro-
 dco accessories fit this
 new light weight tower.

ALPRODCO, INC.

MINERAL WELLS, TEXAS
 KEMPTON, INDIANA

COMMERCIAL HEAVY DUTY
 TOWER NOW AVAILABLE.
 WRITE FOR INFORMATION

LET US PUT THIS
MAGNIFICENT NEW 1951
MIDWEST
TELEVISION
RADIO-PHONO CONSOLE
In Your Home For
30 DAYS MONEY TRIAL
BACK



MAMMOTH 19 1/2 Inch PICTURE TUBE
AM-FM RADIO and 3-Speed PHONOGRAPH

"VIDEO GRAND" 19 1/2" Television-Radio-Phonograph Console
Be your own judge! See and hear Midwest Television in your own home before you buy any television receiver. Then decide whether to keep it or have your down payment refunded. Low Factory Prices. Factory authorized service available.

Another Sensational
NEW 1951
MIDWEST
19 1/2-Inch Picture
TELEVISION
CONSOLE



"CONSTELLATION" 19 1/2"
Television Console
Another beautiful Midwest
Television Console featuring
the mammoth 19 1/2-
inch black face picture tube with 225 square-inch
bright, clear image . . . Synchronized sound and picture . . .
Simplified One-Knob Tuning . . . Video-Sonic Tuner . . . Big
12" Panasonic Speaker, and scores of other features. Available
also with Giant 16 1/2-inch picture tube.

MAMMOTH
19 1/2-Inch
PICTURE
TELEVISION
CHASSIS

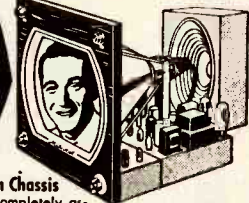

MIDWEST 19 1/2" Television Chassis
THIS IS NOT A KIT! It is a completely assembled ready-to-use Television receiver and 12" Speaker for custom installation in your own cabinet. Available also with Giant 16 1/2" picture tube.

Also Available On 30 DAYS TRIAL
THE NEW 1951
MIDWEST
5 WAVE BAND RADIOS
Beautiful Consoles • Complete Chassis

Send This COUPON on 1c Post Card for NEW 1951 FREE 4 Color MIDWEST CATALOG

MIDWEST RADIO & TELEVISION CORP.
Dept. 37-G, 909 Broadway, Cincinnati 2, Ohio

NAME _____
ADDRESS _____
CITY _____ ZONE _____ STATE _____

Indo China—Radio France Asie ("The Voice of France in the Far East"), Saigon, noted on 11.78 in French signing off 1030, fair level. (Neeley, Calif.) Has news 0900. Noted by Balbi at 0500 with news on 11.83. Heard in New Zealand on 9.495 in Siamese 0530; verified; stated frequency is 9.524 and new schedule for English periods as 1730-1800, 1930-2000 on 9.524; 0415-0515 on 11.830, and 0800-1010 on 11.780, according to the *N.Z. DX Times*. "The Voice of Vietnam," 9.62 and 7.263, now has English (news) only at 0915-0930 when leaves the air. (Neeley, Calif.) The 9.62 channel noted 0625 in clear; in native. (Cox, Delaware.)

Iran—"Radio Watani el Kurds," The Kurdish National Radio, is now on 7.040 at 1030-1130; no location is given but local news items in Persian seem to indicate is Hermanshah. (Bluman, Israel, via *NATTUGGLAN*, Sweden.)

Israel—Tel Aviv, 9.0108, continues with fair-to-good signal during the English news period 1515 (also carried on 6.83) and 1700-1745 sign-off when has the World Zionist Movement program in English (on 9.0108 only). (Pearce, England, others.)

Italy—Rome continues to "bounce" around the spectrum. Has been reported on many channels in all popular s.w. bands lately.

Noted on 6.010 with news 2145-2200; the announced 15.120 (measured 15.1194) outlet heard with news 0600; noted on 21.560 at 0720, off 0730. (Os-kay, N. J.) Broadcasts to N.Z. with news daily 0315 on 15.310, 15.120, 17.772, 21.570; has English again 0600. (Cushen, N. Z.) Heard in Italian around 1230 on 5.980 and near 6.260. (Pearce, England.)

Jamaica—Radio Jamaica, 4.950, when signing 2300 with "God Save the King," said would return 0715. (Kroll, N. Y.) Although the 3.480 channel has been reported widely as discontinued, Navarre, Texas, recently reported it at 2130 in parallel with 4.950. Verified by QSL card and letter from Jamaica Broadcasting Co., Ltd., Broadcasting House, 32 Lyndhurst Road, Cross Roads, Jamaica, B. W. I., says Belling-ton, N. Y.

Japan—JKL, 4.8604, heard 0625, music; JKI, 4.910, heard 0628, talk in native; JKM, 4.940, heard 0630 with music, QRM'd by YVMQ; JKH, 7.2575, heard 0615 with music; JKJ, 7.285, noted 0620 with music; JBD, 9.505, noted 0635 with talk in native, some CWQRM. (Os-kay, N. J.) JKL2, 9.605, heard 0115-0130. (Bellington, N. Y.) JBD4, 15.225, noted at weak level 0105, some QSB. (Cox, Delaware.)

The BCOF station, 6.105, Kure, verified with new card—red call on white background; schedule was listed 1630-0830, power 1 kw. (Cushen, N. Z.)

Kenya Colony—Nairobi still noted from 1330 to 1500 closedown (closes 1400 on Wed., Sat.) on 4.855 although has been reported on 4.950. (Pearce, England.)

Korea—Seoul's radiophone outlet, HL2, 7.700, is operating by permission of the *International Telephone and*

Telegraph Bureau in Seoul; has been heard around 0715-0945 (sign-off varies) with reports to American networks. (Neeley, Calif.) Has been heard on 10.05 around 0815 calling Oakland, Calif., according to Deskins, Calif.

HLKA, 7.933, is audible in Calif. after 0530, bad CWQRM and usually has poor signal. (Balbi.) Noted in Texas at poor level around 0745-0800. (Stark.) Organ music heard 0830-0900, weak signal. (McPhadden, Calif.)

Lebanon—Beirut, 8.036, is scheduled 0000-0130, 0600-0730, 1000-1535. (ISWC, London.)

Luxembourg—The 15.35 channel noted 0809; knocked out by VOA carrier at 0810; should be in clear 0700. (Stark, Texas.) Noted testing at 1052. (Navarre, Texas.) The 6.090 outlet noted Sundays 1700 with "Bringing Christ to the Nations" (English.) (Pearce, England.)

Madagascar—Radio Tananarive has programs in French on 3.900, 6.172, and 9.515 weekdays 2230-0030, 0400-0600, 1000-1430; Sundays 2300 (Sat. EST)-Sun. 0245, 0330-0600, 0915-1430; news in French is given weekdays 2310, weekdays 0000, Sundays 0015, daily 0400, 1100, 1315; programs in Malgache are radiated on 7.375 and 9.693 (no time given but opens 2230). (*World Radio Handbook Bulletin*.)

The 9.515 channel is good strength in Israel around 1200. (Bluman via *NATTUGGLAN*, Sweden.) Noted in N. Z. signing off 1430. (*N. Z. DX Times*.) And in England 1118 with news in French. (Pearce.)

Malaya—Kuala Lumpur, 6.025, has request program for Forces 0530. (Cushen, N. Z.)

Neeley, Calif., has received word from *Radio Malaya* that the signal he heard last May in the 20-m. amateur band was undoubtedly a harmonic of either the 7.200 or 7.250 outlet of *Radio Malaya*. Other data in the letter included—"Our short-wave senders in Singapore are directed north to the Federation of Malaya and to our stations at Malacca, Kuala Lumpur, and Penang for re-radiation on m.w. for local consumption. We do not intentionally cater to listeners outside Malaya but we are always extremely interested in reports from other territories. The short-wave station at Kuala Lumpur is a general radiator to cover outlying areas in Central Malaya. Next year (1951) will see considerable increase in transmitters, power, coverage, and program time from all stations in Singapore and the Federation of Malaya, and then a general list of transmitter information will be circulated." Listed for Singapore in current use were JT1, 740 kc., 8 kw.; JT2, 620 kc., 10 kw.; JS2A, 7.250, 8 kw.; JS3A, 6.135, 5 kw., and JS3B, 4.780, 5 kw.; Kuala Lumpur s.w. was listed 6.025, 1 kw.

The 7.200 and 7.250 outlets noted by Cox, Delaware, recently in parallel with news 0630.

Malta—Radio Sweden says FBS, Middle East, is now on the air 2300-0115, 0430-0830 on 7.220, 11.895, 15.125;

NO PICTURES ON THIS PAGE NOTHING BUT NEW YEARS BARGAINS!

R-9A/APN-4. 160-meter Loran receiver plus high (for scope) and low voltage power supply. Three channels, 1.6-3.3 mc, 2-3.3, 3.3-11.75 mc. With schematic and instructions for 60 cy. **\$4.50**
Excellent used, less tubes.

VHF TRANSCEIVER. Ideal substitute for SCR-522. Xmitr is crystal controlled, 10 watts. Recvr has two individual RF sections feeding a common 3 stage 10 mc IF. Both RF sections may be operated simultaneously or individually. Recvr uses 13 tubes. Xmitr is straightforward, uses 7 tubes, including 832 final modulated by push-pull 6L8's. In one neat case. Excellent used, less tubes, xtals, dynamotor. We furnish complete conversion and power supply instructions. A steal at only. **\$6.95**

EXPERIMENTER'S SPECIAL

A receiver you can do wonders with! Make intermod. analyzer for testing audio amplifiers, convert to FM, etc. Has plate bridge, banana plugs. All in handy aluminum box, 3"x4 1/2"x2 1/2". Use this for remote control in audio systems, etc., or rewire for your individual needs, or dismantle for parts. This is a real buy! **\$9.95**
New, original schematic and conversion do to FM broadcast. Excellent used.

A-27 PHANTOM ANTENNA. Use on 160 or 80 meters or marine freq., 2 to 4.5 mc. Contains: 1 Var Capacitor system, RF is 108.3 to 110.3. Has 3-717A tubes which as direct replacement for 6SK7, with much more gain, 2-125F7, 1-12AR5, 1-12AT6, 2-12SR5. With original schematic and conversion do to FM broadcast. Excellent used. **\$9.95**

BC-366.5 POSITION SWITCH. 150,000 ohm pot with knob, mike jack, phone jack, 11 pt. terminal block and receptacle for standard banana plugs. All in handy aluminum box, 3"x4 1/2"x2 1/2". Use this for remote control in audio systems, etc., or rewire for your individual needs, or dismantle for parts. This is a real buy! **\$2.9c**
New, only

VARIABLE CONDENSER. 33 to 495 mmfd. Steatite or molded mycalex end panels. Spacing .040". Has 3/4" shaft, 7/8" long. Frame 6 21/32" long by 1 29/32" square. Four of these were used in 102-103 BC-353 to tune four channels, with plug-in antenna, circle 4 to 4.5 mc. Many of the boys have been splitting the stator in this beauty to use on higher frequencies. **\$1.49**
New. Each, 39c; 5 for

BC-906 FREQ. METER. Here is a laboratory-type precision instrument. Freq. range is 150-225 mc upper TV channels, or modify for any other use. Use one as is and modify a second to cover lower TV channels. Needs only 2 batts (1.5 and 45 v). Precision vernier dial. Hand calibrated tuning charts. Diode-triode tube, 0-500 DC microammeter. Pick-up from tuned resonant cavity is detected by diode. Negative DC is applied to triode grid, and dips the plate current. Diode-triode tube, 0-500 DC microammeter, carrying case (1 1/2"x3 3/4"x1 1/2") with leather handle. Schematic inside. In orig. wood storage case. Like New **\$17.95**

DYNAMOTORS

DM-42-A. 12 v, two outputs: 1030 v, 260 ma; plus 515 v, 215 ma. With schematic of transmitter BC-653 showing schematic and terminals of DM-42 and how **\$9.95**
each was used. New. **\$17.50**
DY-12. 24 v, two outputs: 1050 v 350 ma, plus 400 v 400 ma, with schematic of AN/ART-13 showing schematic and terminals connected and used. Less filter and relay base. **\$7.95**
PE-73. 24 v 450 ma, with relay, filters, etc. With schematic. **\$4.95**
INVERTER DC-218. 24 v in, output 115 v regulated, 400 v, 1500 ma. **\$17.50**
DYNAMOTORS for AN/ART-13. Specify single voltage (27 or 30 v) or step-down transformer (or 27 v). Excellent used. **\$14.95**

LOOK WHAT \$2.65 WILL BUY!
The most versatile dynamotor in surplus! The best dynamotor for conversion to 6v. Multiple windings. In one conversion you get choice of 160 v 350 v at 50 MA or 250 v at 100 MA. No brushes to shift around, no mechanical work. Or use it as a 2:1 or 1:2 step-up or step-down transformer for DC voltage! Changes 6 to 12, or 12 to 24, or vice versa, up to 3 A. Or use it as a GENERATOR. Turn your dynamotor to get 12 v DC at 12.6 A or 24 v DC at 6.3 A, plus high voltage. Includes easily removable self-contained. Turn your dynamotor with reduction unit. Complete dope sheet furnished. Brand New. **\$2.65**
RCA CEILING SPEAKER, 23" **\$8.95**
dia., 6 ohm

AC VOLT-METER. New boxed, Weston 476, 0-130 v AC, full 3 1/2" round **\$3.95**
OIL FILLED 4x8 mfd. 600 v condenser, in one case, common ground, with mtg. hooks, as used in Army Super-Pro power supply. **\$2.89**
supply. New.

10-METER FM TRANSMITTER-RECEIVER complete. Very compact. Semi-portable. 27 to 38.9 mc. With vibrator for 6, 12, or 24 v. Use either of two preset xtal-controlled channels. Effective transmission coverage of 10 to 15 miles with a minimum of power consumption. Built-in speaker. Built-in meter for checking voltages of various circuits. Schematic and complete instructions furnished. Here is communications equipment for Industrial, Commercial, or Amateur use. In excellent condition. Complete installation consisting of BC-659, PE-120 vibrapack, telescoping antenna **\$24.95**

BABY WINCH. Geared motor. Dozens of uses around home, boat, or shack. Just the thing for operating garage doors, gates, etc. Makes excellent beam retractor or barbecue drive. Has two low-speed, high-torque outputs, both reversible by electrical switching. One is a sprocket toothed wheel, the other is a ratchet-coupled cable drum. Both or either are stopped and/or reversed by adjustable limit switch or remote electrical control. 24 v DC Universal motor.

WANTED!

Your Spare Surplus Equipment and Tubes, Dynamotors, Recvrs, Xmitrs, Test Equipment. Send list, stating condition and rock bottom price.

MARINE SPECIALS

G.L. "MARINER" TRANSMITTER. 180 w input, 120 w to antenna, 90% modulated, 4 channel xtal cont, 12 to 24 v input, 24 v output, connecting cord, xtals, tubes, mike, all aligned and ready to operate. (Specify volt. and freq. when ordering). Contains break-in relay for recvr in addition to switching relay. Dimensions: 8 1/4" deep, 17 1/4" wide, 19 1/4" high. Tubes included: 10Y speech amp., two 211 mod., 12J5 osc., 1625 1PA, two 814 parallel PA. We add over \$150 worth of skilled engineering and parts to equipment which cost U.S. over \$1200 to start with. How can you lose? With instructions. FCC license approval guaranteed. **\$275.00**

G.L. "MARINER" RECEIVER. Long wave, broadcast, marine and short wave reception. A beautiful conversion of finest Navy surplus! All controls, vernier tuning, BFO on-OFF and AVC-MVC on entirely new front panel. Coaxial type antenna fittings furnished. Tagged wires out of rear to battery to power a DU-1 loop, and to kill B+ with xmitr break-in relay, 12 or 24 v DC. Only 1 1/2" long, 3" wide, 6 3/4" high, and self-contained; no plugs needed. With 6 tubes, 2 neon voltage limiters, and dynamotor. Requires an external speaker. Alignment instructions and schematic furnished. Specify voltage. **\$69.50**

BC-223 TRANSMITTER. 15 to 25 w output, 4 chan xtal control. To modify for FCC approval, just remove channel selector switch from being turned to MO position. WE CHECK THEM OUT! With tubes, 12 v dynamotor PE-55, connecting cable, 4 marine freq. xtals, mike, and schematic. Don't forget to specify voltage. **\$89.50**

Additional plug-in unit for above, with custom-ground 4 mc ship-store band xtal. Get through when lower band is busy. Brand new, specify freq. **\$6.19**

NAVY TYPE ARA (SCR-274N) 6-tube receiver, 1.5-3 mc. We rewire it for 12 v, with dynamotor mtd on back, and with phone plug and all controls built into front panel. Furnished with schematic, alignment data, with harness and plug for battery input and for output to power a DU-1 loop. Requires an external speaker or head set. New, converted, **\$32.50**
Same as above, but for 24 v. **\$27.50**

DU-1 Manual Loop Direction Finder. 12 or 24 v. Goes ahead of the G.L. "Mariner" ARA, or any other receiver. We convert it to the Marine band. Still retains lower half of broadcast band, and all the lighthouse and beacon band. 2-tube phasing circuit, no 180° ambiguity. Gives true bearing in 3 seconds! Schematic and complete instructions furnished. **\$32.50**
Brand New, specify voltage.

NAVY WATERPROOF BULKHEAD SPEAKER with universal matching transformer, cord and phone plug. Very hi-fi. **\$9.95**

We're stuck with a lot of Salt Water Soap! Navy detergent powder in 50 lb. kegs. Clean-out **\$2.95**
price per keg.

T-30-S THROAT MICROPHONE, 69c
3-DIGIT resettable Vee-Root counter with 10° bevel-gear drive, pilot lamp assembly, wafer switch, case. **79c**

COMMAND RECEIVERS
With schematic, alignment, and AC power instructions. **\$12.95**
BC-454. 3-6 mc. New **\$6.95**. **\$4.95**
GOOD USED **NEW \$12.95**. **\$7.95**
GOOD USED **NEW \$12.95**. **\$7.95**

Make a local control adaptor for your command recvr. We furnish exact pt. switch, knobs, an etched plate, and instructions. **\$1.29**
Spline Tuning Knob for Command **50c**
27AN PLUG. 7 prong male plug to fit back of command recvr and xmitrs. This is the same plug as used in the racks. **\$1.00**
New, each, 21c; five for **\$1.00**

COMMAND TRANSMITTERS
With Dope Sheet and Schematic

T-19/ARC-5, 3-4 mc, repacks, like new **\$10.95**
Excellent used **9.95**
BC-457. 4-5.3 mc, excellent used. **4.95**
BC-458. 5.3-7 mc, excellent used. **5.95**
BC-459. 7-9.1 mc, excellent used. **9.95**
T-22/ARC-5, 7-9.1 mc, repacks, like new **9.95**
MD-7/ARC-5. Push-pull mod., excel. cond. **9.95**
MOD BC-456. Brand New **\$5.95**. Excellent used **2.49**
T-18/ARC-5 2.1-3 mc (Marine). Like new **14.95**

FREQ. METER BC-438. Easily converted to precision lab. xtal calibrated heterodyne type, with meter and sig. gen. 20 to 440 mc., with audio modulation. We furnish simple instructions for conversion and calibration. Has power supply, tubes, and lab. standard xtal. Start where your BC-221 or

starts perfectly on 8 to 24 v, 60 cy AC, geared down to nice, easily controlled low speed. With simple instructions. Only **\$4.95**

BC-347-C Booster Amplifier, especially useful as mike-input amplifier to boost modulation or as phone pre-amplifier. Compact, only 5 1/4"x2 1/2"; contains dual power tube 6F8G and two hi- μ ounce transformers, one for mike to push-pull grids, one for push-pull output. The transformers net for over \$7.00 each. With schematic. Requires external power source. Orig. use was **\$1.29**
Brand New **\$3.45**

ZA-TEST OSCILLATOR CDE-60050. Used to feed 90 and 150 cy modulation to recvr. Input. Contains 12 v vibrator which also works on 6 v. Two vibrating reeds give two tone outputs. In black plastic case with mtg. plate, instructions and schematic. Has switch, capacitors, choke, pot., octal socket, etc. Brand new, **49c**
orig. pack

LM ends, Excellent cond., complete as described. **\$27.50**
While they last. **\$1.29**
HS-33 HEADSETS. 600 ohm. Used or checked out. **\$1.29**
ANGULAR POSITION Autosyn Transmitter. Use as beam position transmitter with I-82 indicator, or build a rotating display table or a high speed RADAR Axiator. Schematic and connections for I-82 for 60 cy, also shows how to connect and use the motor. **\$3.79**
CY **I-82-F** Autosyn indicator. New. **5.95**

TUBE SPECIALS
3FP7 C.R. Tube **98c**
58P4 C.R. Tube **98c** Same as 58P1 but white screen, ideal for TV. **\$2.95**
616G checked out. **\$1.95**
211 New. **\$1.95**
318A New. **29c**
832 checked out. **\$4.95**
824 New. **\$1.95**
625 New. **49c**
RX-21 New Mercury rectifier, peak inverse 11 kv, 2.5 v, 1 1/2 A. Fil. **\$1.49**
tubes. Each

WILLARD Wet Cell Batt. 2 v 20AH, **98c**
TUNING UNIT FOR BC-375 (except TU-5, sold out). Specify freq coverage desired. Exc. condition. With schematic and parts descriptions. **\$1.95**
CITIZENS RADAR AXIATOR with director, radiator, reflector, hardware and cords. Two complete sets. New. **98c**
Angular Position Transmitter of the Eastman-Kodak Mark 18 gunlighting type. Orig. pack. **49c**
VHF TAP SETS and WALKIE-TALKIE. Complete with antenna, handset, etc. Less xtals. New, postwar. Write for description and schematic. **\$79.50**

CMX AUDIO AMPLIFIER. Contains three 12AG tubes and transformers, with following impedance ratings: Input-1676 or 1169; output-25; or 100:1. Both are Magnavox hi-fi, hermetically sealed. Also sealed filter choke 4.1 h 60 ma and assorted cond., resistors, sockets, etc. Nice case and cover. Use as is or for parts. With schematic. Less dynamotor. New, with tubes. **\$2.95**

TRANSFORMERS

SCOTT HI-FIDELITY. Essentially flat from 20 to 20,000 cy., 25 w, hermetically sealed. Impedances: 5000 ohm primary for single end output, 2000 ohm CT secondaries, 600 ohm and 60 ohm, thus providing 150 and 15 ohm secondaries also. The 60 ohm secondary was used for in-verse feedback, you can also use it for 12-300 ohms to match 60 ohm and 15 ohm. Brand New. **\$1.89**

FILE XFORMER. HV Amertran type W.S., 115 v 60 cy pri; sec 5 v CT at 10 a, insulated for 35 KV test. 12 KV DCWV. Built on socket for 872A, 250T 371, **\$10.95**
etc. With new 872A

500 OHM LINE TRANSFORMER. Secondary 8 to 10 ohms, tested at 10 watts. Only 3 db down at 15,000 cycles. Essentially flat from 40 to 12,500 cycles. **89c**
New

SUPER-MODULATION XFORMER. Get 400% modulation with no distortion. Make amazing voice-power rig described on page 50 of June '49 and Feb. '50 RADIO & TV NEWS. Class A. Good up to 1 KW, 2500 v insu- **\$4.95**
lation. Rebuild your present rig

TRANSFORMER INTERSTAGE TRANSFORMER used in BC-191 and BC-375 Couples #10 to push-pull 211's **\$1.49**

25 VAC TRANSFORMER, 40 VA, Primary 115 v, 50/60 cycles. **\$1.79**

CHOKO. 3.7 H, 145 MA, 125 ohms DC resistance. Potted **79c**

SYNCHRONOUS VIBRATOR XFORMER. Peerless, upright, shielded. Primary yellow, green. Black CT and 6 recv. switches, 1250 v, 2500 v, 5000 v. **\$1.29**
6 v. 500-0-500 or 12 v. 50 ma. New. A steal at only

VIBRATOR. 6 or 12 v, synch, 7-prong, OAK, **69c**
New

TAPPED POWER! Here is the depot-spares replacement main transformer which is used in replacement for TV or 400 ma in steps of 20 V. Variable hi-voltage is obtained by using the coarse and fine taps to feed the primary switches. Same as standard, but with heavy duty tap switches all wired up. In addition, it has outputs to AC feed dry rectifier which put out 12 v at 2.4 A and an AC output of 12-14 v at 1 1/2 A. Input is 115 or 250 v, 60 cy. With schematic of RA-34-F showing all connections. New. **\$17.50**

TU-25 80-meter plug-in tuning unit for xmitr BC-223, 3500-5250 KC. Use as foundation for xmitr or a feast for parts, including unit coupling ant. inductance, with 12 switches, coils, condensers, etc. With schematic. **\$1.29**
New

OIL FILLED, OIL IMPREGNATED CONDENSER. .05 at 1000 v. Aerovox tubular, metal case, wax cardboard covered, can insulated from foil. A quality replacement for TV or 400 ma in steps of 20 V. Variable hi-voltage is obtained by using the coarse and fine taps to feed the primary switches. Same as standard, but with heavy duty tap switches all wired up. In addition, it has outputs to AC feed dry rectifier which put out 12 v at 2.4 A and an AC output of 12-14 v at 1 1/2 A. Input is 115 or 250 v, 60 cy. With schematic of RA-34-F showing all connections. New. **\$17.50**

SENSITIVE! Relay for plate or cathode circuits, 7500 ohm coil, closes on 2 to 6 ma, opens on 1 to 3 ma, depending on contact-spring adjustments. SPDT contacts rated 5 A. Ideal for photo-cell, capacity-operated circuits, electronic counters, etc. Comes in lots of 500 is **\$3.20**
each. Our price is only **\$1.29**

ULTRASONICS!

DZ RECEIVER. 8 tube superhet, 15 through 1500 kc. Requires external B+ of 200 to 250 v. Uses 6 v tubes, require in parallel for 6 v AC supply. Excellent used, with tubes, schematic, and almost complete reprint of tech. **\$49.50**
manual.

3-DIGIT resettable Vee-Root counter w/pilot lamp assy, wafer switch, **79c**
case. New

MM-26-C Manual Direction Finder and Communications recvr. 150 to 1500 KC. With schematic and dope sheet which also covers accessory units listed below. **\$19.95**
New. **\$24.95**. Exc. used.

MM-28-C Master Control Box for MM-26-C. **\$9.95**
MM-20-E Loop, New. **7.50**
IN-4A Left-Right homing indicator. **9.95**

MM-52 Manual Loop Drive with azimuth scale. New **\$4.50**
MM-26-S. 50-1500 KC. **9.95**
MM-31 ADF. 24 v. sold only with matching control box MM-28-P, which has loop L-R switch. Both units in excellent used condition. Combination price **\$47.50**
MM-36-C ADF loop with original name plate. New **\$95.00**

TS-10 Sound Powered Handsets. Speak up to 25 miles with no external power. No batteries needed. Portable. Use as many as you wish. Checked out, guaranteed. **\$17.50**
Each, **\$8.95**. Per Pair.

R-89/ARN-54 with orig. schematic and FM broadcast conversion instructions. **\$9.95**
case and cover. Use as is or for parts.

AERONAUTICALS: Write for price on new R-89/ARN-54 and new BC-733-D.

AP-13 Tall-warning Radar xmitr-recvr. 410-420 mc, 5 stage 30 mc IF. Brand new, with schematic. **\$9.95**
tubes.

BC-788 Airborne pulse radar altimeter xmitr-recvr. 420-460 mc. 8-stage 30 mc IF. Less tubes and xtal. Excellent used, with schematic. **\$9.95**

RF AND AF SIGNAL TRACER BZ-5. Tiny dual vibrator gives beautiful 1400 cps tone with harmonics to 40 mc. New, with 79c schematic and instr. **\$9.95**

BC-375-E TRANSMITTER, 200 KC to 12.5 mc with tuning units. With schematic showing complete parts description for use with dynamotor PE-73 and also with conversion instructions to 12 v for operation with AC power supply with 12 v heaters, mike, and relay. Brand new, export packed, complete. **\$75.00**

ID-6A/APN-4 LORAN INDICATOR. Convert to test scope, panadapter, etc. Double deck chassis, lots of octal sockets, lots of room for any scope circuit you can dream up. Contains 22 pots, pads of switches, condensers, transformers and small parts. Used, less small tubes and crystal but with schematic. **\$7.95**

BC-375-E TRANSMITTER, 200 KC to 12.5 mc with tuning units. With schematic showing complete parts description for use with dynamotor PE-73 and also with conversion instructions to 12 v for operation with AC power supply with 12 v heaters, mike, and relay. Brand new, export packed, complete. **\$75.00**

G. L. ELECTRONICS 905 S. VERMONT AVE. LOS ANGELES 6, CALIF.

ALL PRICES FOR LOS ANGELES. CALIFORNIA BUYERS ADD SALES TAX

MINIMUM ORDERS \$200

Timely Specials—
Prices Still Way Down!

While they last!
400 Cycle Motor Generators!

Holtzer Cabot type MG 218
 Motor: 115 Volts D.C. @ 2.3 Amperes, 1/4 HP, 3430 RPM
 Generator: 110 Volts A.C., 400 Cycles @ 1 Ampere
 Complete with hash-filters, etc.

Price **\$49.50**

PRECISION RESISTORS

These are standard NATIONALLY ADVERTISED BRANDS priced ridiculously low. All are brand new, non-inductive, non-aging wire-wound types, insensitive to wide temperature variations. Sizes not listed below can readily be made up by series, and/or parallel arrangements at a fraction of the cost of precision resistors available elsewhere.

Following sizes are \$.25 each; \$19.50/100

220,000 2% WW5	7,500 1% WW3
95,000 1% WW1	5,000 1% WW3
92,000 1% WW3	4,300 2% WW3
84,000 2% WW4	4,000 1% WW3
	2,200 1% WW3
80,000 1% WW4	1,500 1% WW5
50,000 1% WW4	1,000 1% WW3
46,000 1% WW3	750 1% WW3
33,000 2% WW3	500 1% WW3
25,000 1% WW4	130 1% WW3
20,000 1% WW3	125 1/2% WW3
17,000 1% WW3	30 1% WW3
15,000 1% WW3	22 1/10% WW4
12,000 2% WW3	20 1% WW4
11,000 1% WW4	14 1% WW4
10,000 1% WW4	12 1/10% WW4
8,000 1% WW1	

Following sizes are \$.35 each; \$27.00/100

800,000 1% WW5	600,000 1% WW4
750,000 1% WW5	125,000 1% WW5
700,000 1% WW5	120,000 1% WW3

Following sizes are \$.15 each; \$12.50/100

700,000 3% WW5	4,285 1/10% WW3
399,000 3% WW5	2,500 5% WW3
268,000 1% WW5	2,230 1% WW3
109,000 1% WW5	280 1/10% WW3
54,500 1% WW3	235 2% WW3
50,000 3% WW5	110 5% WW3
	70 5% WW3
26,500 1% WW3	50 5% WW3
22,000 5% WW3	35 5% WW4
20,000 1/2% WW3	30 5% WW3
17,000 1/10% WW5	6.0 3% WW4
14,460 1/2% WW4 1/2	40 5% WW3
500,000 1% WW4	
100,000 1% WW4	\$0.55
	.55

Following sizes are \$.10 each; \$8.50/100

53.96 1/2% WW4	4.35 1% WW3
53.32 3/8% WW4	4.3 1% WW4
33.22 1/2% WW4	3.94 3% WW4
23.29 1% WW4	3.5 5% WW4
13.52 1/4% WW3	2.56 1/2% WW4
13.333 1% WW4	1.563 1% WW4
10.2 2% WW4	.29 3% WW4
5.1 1% WW4	.25 5% WW4

PRECISION METER SHUNTS-MULTIPLIERS
 4 Ohm.....\$0.15 15,000 Ohm.....\$0.15
 Both above are wire-wound units

New! Flexible TV Flashlight!
 Consists of a thin 7" flexible gooseneck attached to small battery case with a pre-focused bulb at end of gooseneck. Light can be directed in the tiniest corners, around obstructions, inside grill, etc. The gooseneck can be clamped around pipes to direct light without holding lamp—leaving hands free—or stuck out of your pocket, etc.
 One of the handiest flashlights we have ever seen and sold at a price of only **\$.95** with batteries.

WRITE FOR COMPLETE CATALOG N-1
EDLIE ELECTRONICS INC.
 154 Greenwich St. New York 6, New York

1100-1700 on 6.020 with 11.895 parallel at 1100-1200, and 7.220 parallel at 1200-1700. However, 6.015 has been widely reported in parallel with 7.220 in the 2300 period, heard in USA.

The 15.125 channel noted 0830-0900 with QRM from Rome's 15.120 outlet; relays "Radio Newsreel" from BBC, London, 0900. (Cox, Delaware.)

Mauritius—Noted on 15.060V on Sunday with all-French program around 1050. (Pearce, England.)

Monaco—Monte Carlo, 9.785 and 6.035, noted 0300 with news in French. (Cox, Delaware.)

Mozambique—According to ISWC, London, Lourenco Marques has *English* broadcasts daily 2300-0100 on 11.764, 9.766, 4.925, and 1100-1530 on 9.766, 4.925.

The Portuguese program was noted recently 0000 on 9.817. (Stark, Texas.) Lourenco Marques has returned to 15.196V from approximately 15.370, noted 1200 to 1500 sign-off; all-Portuguese; good level. (Grove, Ill.) Noted in Brazil; asks for complete reports on all stations. (Serrano.) Call is CR7BG. (Peddle, Newfoundland.) Heard in Britain as early as 1215. (Pearce.)

New Caledonia—FK8AA, Noumea, measured 6.0346 recently; previous measurement was 6.0384. (Oskay, N. J.)

New Zealand—Radio New Zealand now has a DX program on the first Tuesday of each month; it is called "This Radio Age" and is carried on ZL3, 11.78, and ZL4, 15.28; time of broadcast has not been learned but is

presumed to be during the 0200-0530 period.

ZL4, 15.28, is now used parallel ZL3, 11.78, from 0200, replacing ZL8, 9.62; also noted from 2100 onwards. (Balbi, Calif.) Cushen, N. Z., lists schedule to February 17 as 1300-1545, 0200-0530 on 11.780; 1600-0145 on 15.220, and 1300-0530 on 15.280; however, by this time the sign-off may be 0630 if restrictions on electricity use have been removed as expected.

Nicaragua—YNOW, 6.8396, heard 1921; gave call in Spanish followed by American recordings; previous measurement was 6.8497. YNLAT, 7.6185, Granada, heard with music 1935; previous measurement was 7.6156. YNDG, 7.6445, Leon, heard with music 1845; previous measurement was 7.6486. (Oskay, N. J.)

Outer Mongolia—A station heard mornings on approximately 4.96 is believed Ulan-Bator. (Balbi, Calif.) Also heard in Texas. (Stark.) The 8.400 channel noted in Delaware 0645 in native, weak-to-fair. (Cox.)

Pakistan—The 9.645 outlet is fair in Chicago at 2100 with news. (Grove.) Noted on this channel as late as 2200. (Lane, South Dakota.) And as early as 2015 (in native). (Navarre, Texas.) Heard with news on 15.335 at 2100. (Fargo, Ga.) The 41-m. outlet measures 7.1402; noted 0700 with news, parallel measured 11.5782 and 11.845. (Oskay, N. J.) The 9.645 outlet noted 0800-1000, news 0825; QRM'd by VOA. (Dary, Kansas.) Heard on 11.5782 with news

A NOVEL LAMP

By JAY J. LUCAS

WHILE shopping at a surplus radio supply store, my XYL spotted a 304TL and exclaimed: "Now isn't that cute!" She wasn't referring to its characteristic curves, either. Aside from its filament requirements, I agreed that, for the price, it was plenty cute. So, with utter disregard for our financial conditions, I laid out the best part of a buck and carried out a 304TL.

Considering the filament current requirements, it was quickly decided that the best way to "light it up" was to use a 60 watt bulb. A little more inspiration of this kind led to the design of this unique lamp. But after reading Guy Dexter's article, "Putting the 304TL to Work," the 304TL was carefully stored for future use and a 304TH which had previously died from "kilowattitis," was withdrawn from the scrap pile.

A 2 x 2 x 4 metal utility box serves as the "chassis." The top cover plate was drilled to take the base pins. The tube is held in place by soldering the pins to the cover plate. To mount the socket, a heat-dissipating plate connector was modified by sawing most of it away, leaving only the small shoulder with the set-screw. This forms a bushing to mount the socket onto the plate connection. The connecting wire was run into the socket by drilling a hole through the side of the cap. The wire was passed through this hole, and along side the tube through a hole in the base cover plate, close to the tube. The line cord enters the base through a hole in the rear. A s. p. s. t. rotary switch, fitted with a National HRS-1 knob, eliminat-

ed the need for a switch-type socket. (Using a switch-type socket might put undue strain on the glass during "on-off" operation). A 60 watt bulb and a shade with a bulb-clamp completed the construction.

Although it is advisable to handle the lamp carefully during construction, it is fairly rugged and will withstand the usual handling without danger of "letting the vacuum out."

—50—

Over-all view of the novel "ham shack" lamp built from surplus xmitter tube.



1015; on 15.27 at 0110 with news for E. Bengal. (Pearce, England.)

Peru—OAX4Z, 5.898, Lima, noted 2050 with classical music; previous measurement was 5.894. (Oskey, N. J.)

Philippines—DZH6, 6.030, and DZH8, 15.300, Manila, "The Call of the Orient," closedown 1015; frequently asks for reports. (Neeley, Calif.) DZH8 is heard in Calif. signing on 1800 to 2000; announces DZH6, 6.03, in parallel; signal fair; mostly religious programs. (Balbi.)

Radio Philippines, 9.500, Manila, noted in England 1040-1100 when has news and signs off 1107 after program preview for next day. (Pearce.)

Poland—Warsaw is reported on a new channel of 7.205 to 1600 closedown. (Radio Australia.) The 9.525 outlet recently was audible around 1920 in Texas. (Stark.)

Portugal—Lisbon, 6.374, is excellent nightly to 2100 closedown. (Leary, Indiana.)

Portuguese Guinea—A *World Radio Handbook* Bulletin says CQM7, Bissau, is operating over 6.993 daily 1630-1800; power 1 kw. However, Bellington, N. Y., and Oskey, N. J., have heard Bissau recently on approximately 5.839 to 1800 when closes with "A Portuguesa." Was measured by Oskey as 5.8392.

Portuguese India—Radio Goa operates on 9.610 daily except Sunday 2030-1230; Sunday schedule is 2130-1230; English on weekdays is 2030-0430, 0730-0930, and Sundays 2300 (Sat. EST)-0330, 0530-0730. Reported heard in England on 9.608 to 1215. (Radio Australia.)

A new 10 kw. transmitter soon will be put into service. (Radio Sweden.)

Roumania—Bucharest, 9.252, noted afternoons; news 1500; leaves the air 1600. (Maurice, N. Y.) Has improved signal lately. (Cox, Delaware.)

Saudi-Arabia—Djeddah, 11.950, is heard at good strength at 1300, closing time varies 1340-1400. (Radio Sweden.) Still noted in Arabic nightly around 2300-2330 on 11.95, 11.75 (best). (Bellington, N. Y., Stark, Texas.) Heard in Britain on 5.975 in Arabic 1230. (Pearce.)

South Africa—Radio Australia lists these current SABC schedules—Johannesburg "A" (English), 2345-0130, 0900-1130 on 7.220, 0315-0710 on 9.870, 1140-1605 on 4.800. Johannesburg "B" (Afrikaans), 2345-0130, 0900-1150 on 7.270, 0315-0710 on 9.520, 1200-1605 on 4.890. Cape Town "B" (Afrikaans), 2345-0130, 1200-1605 on 5.890, 0315-0710, 0900-1145 on 9.610. Pietermaritzburg carries "B" (Afrikaans) programs on same schedule as Cape Town. Johannesburg "C" (commercial—"Springbok Radio"), 2345-0145 on 7.290, and same channel 0900-1100; 0145-0900, on 9.600, and 1100-1600 on 4.940.

This list may not be complete as on Sundays most transmissions start 0155 rather than 2345; Saturday closings usually are 1645 rather than 1605.

Southern Rhodesia—Salisbury is now scheduled 0400-0615, 7.280; 1000-1500, 3.320, 6.018, 9.490. (Radio Australia.)

(Continued on page 151)

this makes TV alignment simple
from **End to End**

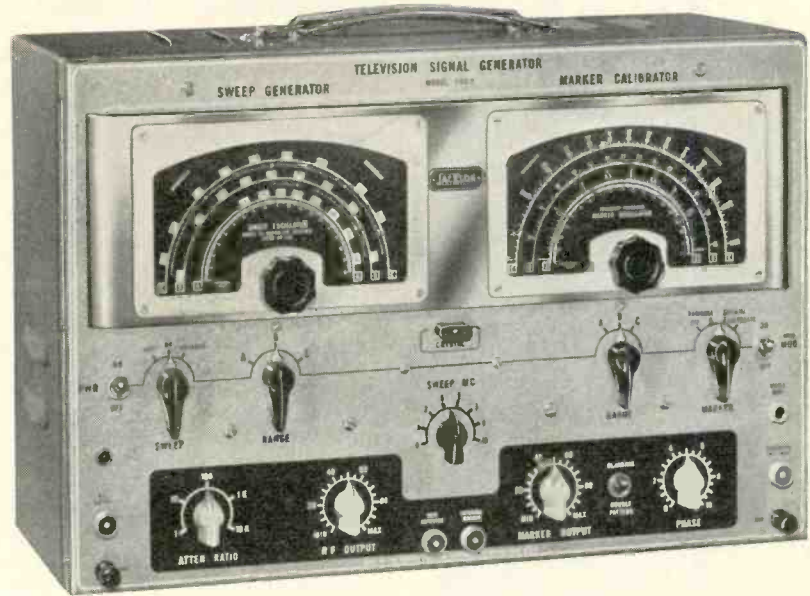

the **NEW** Jackson Model TVG-2

Service men the world over buy Jackson instruments for accuracy and simplicity of operation And why not? Just look at the features incorporated in this new '51 model Television Generator:

- Continuously variable sweep frequencies over all TV and FM bands
- Reversible single response pattern with base line or double pattern
- Adjustable sweep width from 100 KC thru 18 MC
- Marker Calibrator continuously variable from 100 KC thru 216 MC
- Separate Crystal Oscillator for use either as a marker or calibrator
- Video Modulation Jack provides for picture or pattern modulation
- Marker Calibrator IF frequencies all on highly stable fundamentals
- Multiple shielding of attenuators and circuits insures low leakage
- Complete Sweep and Marker Generators in one beautiful instrument
- Styled to match the famous Jackson Model CRO-2 Oscilloscope

Truly another "Service Engineered"
electronic instrument.

Ask your Jackson Distributor
or write for free bulletin.

JACKSON

Electrical Instrument Co. Dayton 2, Ohio

In Canada: The Canadian Marconi Co.

SERVICE MEN!

We've "Scooped" these "Buys" for You!

We're always on the lookout for savings to pass on to our Customers. They're especially welcome when prices everywhere are going up.

PHILCO

Model 7170 FM & AM Signal Generator
A \$97.50 Instrument for **\$64.50**

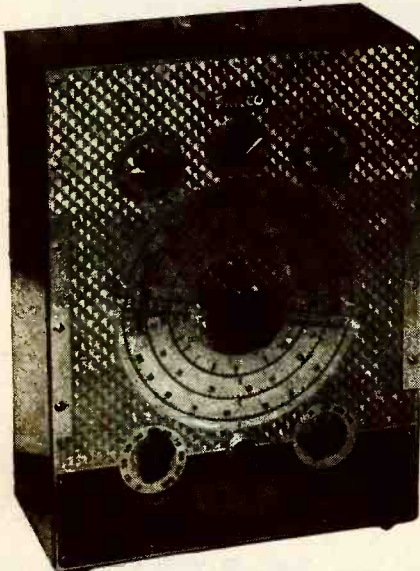

A great help to every Serviceman. Ideal for both AM and FM use. No switching trouble between bands, calibration accurate within $\pm 1\%$. Exceptional stability. Drift not over $\frac{1}{2}$ of 1% .

SPECIFICATIONS

Frequency Range	
R-F. (AM)	100 kc. to 110 mc. (six bands)
R-F. (FM)	100 kc. to 170 mc.
Audio Frequency	400 cycles
R-F Output Amplitude	.6—1 volt (r.m.s.), depending upon range
A-F Output Amplitude	1 volt (r.m.s.) approximately
Sweep Width	Variable from 4 kc. to 500 kc.
Sweep Rate	60-c.p.s. (fixed)
Calibration	Direct reading (for AM)
FM-Oscillator Frequency	60 mc.
Operating Voltage	110—120 volts, 60 cycles a.c.
Power Consumption	25 watts
Tube Complement	6C4 (1), 7F8 (2), 6X5GT (1)

ORDER QUICKLY!
QUANTITY LIMITED \$64⁵⁰



ALL GLASS **16"** ALL GLASS

16FP4 BENT-GUN C R TUBE

Fully Guaranteed, in Factory-Sealed Carton

SPECIAL \$29⁹⁵ SPECIAL

READY for SHIPMENT—ORDER NOW!

FREE WITH **RADIO'S**
ORDER **MASTER**
1200 PAGE REFERENCE MANUAL

Federated Purchaser
INCORPORATED

66 DEY ST., NEW YORK 7, N. Y.

Digby 9-3050

NEWARK, N. J. 114 Hudson St.
ALLEN TOWN, PA. 1115 Hamilton St.
EASTON, PA. 701 Northampton St.

AFCA



NEWS

CHAPTER NEWS

Augusta-Camp Gordon

Ralph S. Grist, General Coordinator of Military Services for the Southern Bell Telephone and Telegraph Company, was guest speaker at the chapter's October 19th meeting. He described the many problems incurred in meeting the large scale communication demands made on his company by the armed forces during World War II. The quest to solve these problems led to the establishment of a "Coordinator's" office. Mr. Grist also cited several interesting incidents whereby the services of his office were employed in furnishing communication demands.

A nominating committee was appointed by Chapter President Henry J. Hort as follows: Col. Kenneth F. March, Sgt. John W. Owen, Henry A. Wright, Lt. Col. William W. Rakow, Maj. Norman J. Kinley, and F. A. Saxon.

The chapter's November meeting was devoted to the subject of photography and its industrial and military applications. Capt. Roger L. Leonard and Lt. William F. Rockar, photographic experts from Camp Gordon, discussed combat photography.

Baltimore

A tour of the Aberdeen Proving Ground featured the Baltimore Chapter's October 25th meeting. Following luncheon in the post cafeteria, Colonel T. K. Vincent, Deputy Commander of the Post, welcomed the group and outlined the routine for the afternoon.

Highlights of the tour were visits to the Ordnance Museum, the Ballistic Research Laboratories, and the Supersonic Wind Tunnel.

Boston

Maj. General Francis L. Ankenbrandt, USAF, Director of Communications, United States Air Force, was the principal speaker at the chapter's October 19th meeting at the Boston Naval Shipyard, Charlestown. Special guests of the chapter were members of the Volunteer Air Reserve Training Squadron, USAFR, and the Volunteer Electronics Company, 1-3, USNR.

After dinner, the meeting was opened by Chapter President T. F. Halloran who introduced the two guest units. A round robin of self-introductions was held to introduce members of AFCA. Announcement was made of the appointment of Edward A. Johnson, vice-president of the Barry Corporation, as the new Chairman of the Membership Committee.

Capt. A. R. Taylor, USN, Chairman of the Communications Committee, re-

This Association is a patriotic non-profit organization, with chapters in most of the larger cities, dedicated to developing and maintaining efficient personnel, commissioned, enlisted, civilian, for the supply (including design and development), installation, maintenance, and operation of communications and electronic equipment for Army, Navy, and Air Force and their supporting civilian activities. It publishes a magazine "SIGNALS" at its national headquarters in Washington. Every American interested in any way in communications is eligible and invited to join. Dues are \$5.00 per year. Application should be submitted to the secretary at 1624 Eye St., N. W., Washington 6, D. C., who will furnish details upon request.

ported the formation of a subcommittee on Civil Defense Communications with Myron D. Chase, of the New England Tel. & Tel. Co., as chairman. A prospectus outlining preliminary plans for Civil Defense communications with a preamble listing data on trained personnel and facilities available, and offering the talents of AFCA members in the New England area, has been submitted to the Director of Civil Defense, Massachusetts.

Program Chairman Raymond B. Meader, New England Tel. & Tel. Co., introduced General Ankenbrandt who addressed the meeting on "Air Force Communications—Electronics Problems in Korea."

Decatur

The Decatur Chapter met on October 12th at the Decatur Signal Depot. The Board of Directors presented the revised constitution of the chapter to the membership, which was adopted unanimously.

The speaker of the evening was Lt. Colonel Jack N. Nahas, Deputy Commanding Officer of the Decatur Signal Depot. His talk, illustrated with motion pictures, covered the geographical, political, and economical aspects of the Kingdom of Yemen. Colonel Nahas had represented the Army as a member of an eleven man diplomatic mission to this small country of the Arabian League.

New York

A very interesting and colorful demonstration-lecture by C. N. Hoyler of RCA Laboratories Division, Princeton, N. J., was the feature attraction of the chapter's October meeting.

In his talk on "A Glimpse into a

NEW!

RADIO & TELEVISION LIBRARY SET

containing

The BASIC KNOWLEDGE, TECHNIQUES & DATA

of RADIO TELEVISION ELECTRONICS

LEARN . . . PLAN . . . DO . . .



ON
APPROVAL
IF YOU WISH

. . . everything in radio, television and electronics with this famous Library Set containing two practical, thorough handbooks: "The RADIO & ELECTRONICS HANDBOOK," second edition, with complete data sections included; and Television's manual, "The VIDEO HANDBOOK." Both books mounted in a handsome slip case.

Covers the fundamentals, theory, complete technique and on the job know-how, with all data, of radio, television and electronics. Learn complete ground work; latest developments; how to plan, construct, install, test, troubleshoot, trace, align, engineer the most modern equipment in all three fields.

Entire set was written with instruction and reference for all levels by the same BOYCE-ROCHE staff of experts who write and illustrate electronic manuals for the Signal Corps. Over 25,000 sets are approved and used by leading trade schools, companies, government agencies, shops, technicians and amateurs.

You may SAVE ONE DOLLAR by sending your order in now for the set, including "RADIO & ELECTRONICS HANDBOOK" and "VIDEO HANDBOOK" in handsome slip case for only \$10.90. (The two books alone regularly cost \$11.90.)

Send your order with or without money, but send it today, while the offer lasts!

Improved, enlarged second edition

THE RADIO & ELECTRONICS HANDBOOK

18 Sections, over 1000 illustrations

A great storehouse of knowledge and reference, covering: Fundamentals of radio and electronics, vacuum tube theory, resistors, capacitors, transformers, chokes, switches, dry rectifiers, basic circuits, vacuum tube rectifiers, R.F. Amplifiers, audio amplifiers, oscillators, detectors, converters, filters, AM receivers, AM transmitters, frequency

modulation, television, sound systems, recording, power supplies, antennas, transmission lines, meters, test equipment, testing, measuring, aligning, codes, charts, graphs, nomographs, formulas, standards, receiving tubes, transmitting tubes, rectifier tubes, cathode ray tubes, regulator tubes, AND MORE.

Send for **RADIO & ELECTRONICS HANDBOOK TODAY!** \$5.95

Television . . . Complete!

The VIDEO HANDBOOK

Everything in television in one handy volume

14 sections—over 800 patterns, pictures, drawings, schematics and charts.



ON APPROVAL
IF YOU WISH

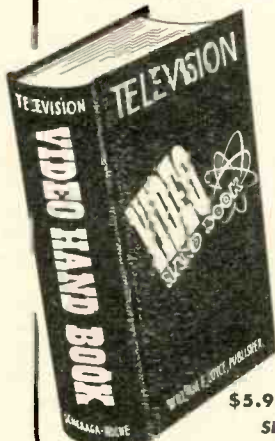

\$5.95

SEND for VIDEO HANDBOOK TODAY

ON APPROVAL IF YOU WISH

\$5.95

BOYCE-ROCHE BOOK CO.,
PRINCETON 11, N. J.

FREE EXAMINATION COUPON

BOYCE-ROCHE BOOK CO., Dept. 11
Princeton, New Jersey

Please send me () *The Radio & Electronics Handbook*, price \$5.95; or () *The Video Handbook*, price \$5.95; or () *Both Books In Handsome Slip-Case As Illustrated*, price only \$10.90 on this special offer. (Save \$1.00.) Send me book(s) I have checked, for 10-day total approval reading. In 10 days I will remit full price(s) plus postage or return book(s) postpaid.

GOOD ONLY WHILE SPECIAL OFFER LASTS

NAME

ADDRESS

CITY ZONE STATE

SAVE POSTAGE! We pay postage if you enclose full price(s) now. Money back on same return privilege. Amount of money order or check enclosed \$.....

Not a kit, but a complete chassis assembled and checked by professional experts

14 reasons why our RCA 630 chassis is your best TV buy!

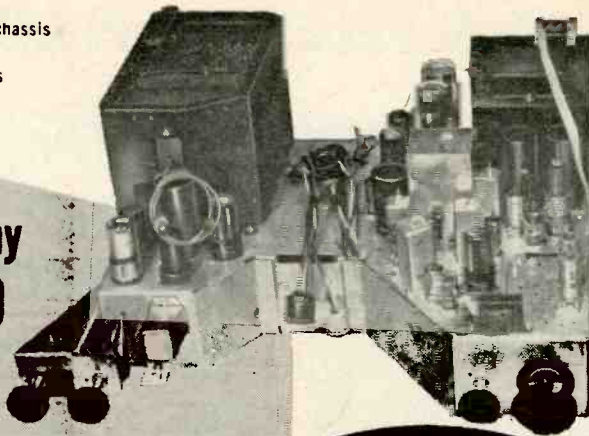

Contact us immediately for low price of this unbelievable buy!

manufactured by

TRAD TELEVISION CORP.

Tradtel sold by **DISTRIBUTORS, INC.**

a division of TRAD TELEVISION CORP.

Dept. 12N, 1001 First Avenue Asbury Park, New Jersey
Asbury Park 2-7447. In New York, WOrth 4-1197

1. 30 tubes—27 tubes, 3 rectifiers
2. AFC horizontal hold, featuring Syncrolok
3. High voltage doubler circuit
4. Maximum brilliance with any picture size up to 19"
5. Co-channel sound featuring good limiting for maximum noise immunity
6. Keyed AGC (using extra 6AU6 tubes), minimizes airplane flutter, keeps picture level constant and uniform when switching from channel to channel
7. Overall band width four m. c. for maximum definition and picture crispness
8. Original 630 sync chain for maximum picture stability
9. Molded condensers throughout
10. Full complement of electrolytics as specified in original design
11. Focus coil and yoke assembly with removable plugs for easy servicing
12. Top quality video amplification assuring good contrast range for full blacks and white
13. Same chassis used in highest-priced sets and custom installations
14. Complete with mounting hardware ready for installation

Research Laboratory," Mr. Hoyler first reviewed the various steps in the development of modern electronic computers. He demonstrated some of their applications by means of laboratory models. Next was shown an improved electronic computer utilizing a crystal controlled oscillator. With this device, it is possible to ascertain electronically speeds of very fast moving objects such as shells fired from a gun or guided missiles. As a demonstration of this effectiveness, Mr. Hoyler let a small metallic ball roll down an inclined plane between two coils of wire separated about a foot apart. The electronic computer showed on lamps the exact intervals in thousandths of a second required for the ball to travel the distance between the two coils.

The basic elements of color television were shown in another laboratory model by Mr. Hoyler. The field sequential method of producing television was first demonstrated by means of a mechanical laboratory model followed by the RCA method. It is believed that all those present learned a great deal about the advantages and disadvantages of color television.

Pittsburgh

Plans for the year, designed to attract additional individual and group members, were made at the Pittsburgh Chapter's October 10th meeting in the Bell Telephone Company auditorium. The program schedule, submitted by Sylvester C. Stoehr, chairman of the arrangement committee, includes the following: tour of the Copperweld Steel Company plant at Glassport; address by Colonel Arthur Pulsifer, Chief Signal Officer, Second Army; demonstration-lecture by Dr. J. O. Perrine, assistant vice-president, AT&T Co.; discussion of military procurement by a representative of the Department of Defense, Washington; tour of the new RCA plant at Canonsburg.

Donald Phillips of Western Union Telegraph Co. gave a most interesting resume of plans being made by the communications division of the Civilian Defense Organization.

Washington

The first of a series of meetings scheduled by the Washington Chapter took place on October 18th with Major General Spencer B. Akin, Chief Signal Officer of the Army, as the guest speaker. Rear Admiral Stanford C. Hooper, "father" of Navy radio, addressed the chapter at a luncheon meeting on November 16th. The January meeting will feature a discussion of controls, allocations and priorities by H. B. McCoy, Assistant Administrator of the National Production Authority for Industry Operations.

In his address on "Communications in Korea," based on his recent survey at the front and in the area of Signal Corps operations, General Akin emphasized that the imperative need of the Army Signal Corps in combat military communications is to have enough trained specialists who are familiar

FOR BETTER TOWERS AT LOWER COST! Ask about AERO

• COST LESS

Because Aero Towers are aircraft-designed, lower manufacturing costs offer you a lower price. Lower weight and lower shipping costs are passed on as savings to you.

• LAST LONGER

Coated INSIDE and OUT. DIP-COATED process keeps Aero Towers bright and new. Rust resistant. Will not brown.

• EASY TO CLIMB AND SERVICE

Strong electric aircraft welds at EACH joint (not just one or two) prevents sway. Provides sturdy safe ladder-like cross members.

• QUICKER TO INSTALL

Aircraft precision tolerances assure accurate fit of components. Light and easy to erect. Strong durability assures customer satisfaction.

Jobber Territories Open
Dealers—Write for FREE Booklet

AERO TOWER DIVISION
Knepper Aircraft Service
1016 Linden Street
Allentown, Pa.



SHOOTS TROUBLE FASTER!

MAKES MORE MONEY FOR YOU ON JOB OR AT SERVICE BENCH!



PRICE \$9.95

at distributor or postpaid, direct. No C.O.D.'s, Please. Ohlsons add 3% State Sales Tax

Signalette

MULTI-FREQUENCY GENERATOR

In radio service work, time means money. Locate trouble faster, handle a much greater volume of work with the SIGNALETTE. As a trouble shooting tool, SIGNALETTE has no equal. Merely plug in any 110 V. AC-DC line, start at speaker end of circuit and trace back, stage by stage, listening in set's speaker. Generates RF, IF and AUDIO Frequencies, 2500 cycles to 20 Megacycles. Also used for Checks on Sensitivity, Gain, Peaking, Soldering, Tube testing. Wt. 13 oz. Fits pocket or tool kit. Satisfaction, or money back! See at your distributor or order direct.

Clippard Instrument Laboratory, Inc.
DEPT. A, 1125 BANK STREET
CINCINNATI 14, OHIO
QUALIFIED JOBBERS WRITE, WIRE FOR DETAILS.

FIVE VITAL QUESTIONS

- What does color television mean to me?
- Am I missing out on any of the newest developments in AM-FM-TV?
- Can I honestly say I am ready to cope with that new amplifier — oscillator — receiver — calibrator — converter — ?
- Where can I get designs for lowest cost building of my own rig?
- What one source may I turn to for authoritative answers to *all* my electronics questions?

ONLY ONE ANSWER



**RADIO &
TELEVISION
NEWS**

SUBSCRIBE TODAY!

SAVE MONEY

by subscribing. Be sure impending paper shortages won't cause you to miss a single vital issue! Use the handy order card facing this page.

Month after month

RADIO & TELEVISION NEWS' broad coverage will keep you sharply up-to-date on all phases of electronics!

COMING IN THE BIG FEBRUARY ISSUE — "TELEVISION STATUS 1951"
— A complete summary of 1950 events. Plus revealing advance information concerning television in 1951!



ZIFF-DAVIS PUBLISHING COMPANY • 185 N. WABASH AVENUE • CHICAGO 1, ILLINOIS

Publishers also of: RADIO-ELECTRONIC ENGINEERING Edition of RADIO & TELEVISION NEWS * POPULAR PHOTOGRAPHY * PHOTOGRAPHY ANNUAL 1951 Edition * MASTERPIECES * FLYING * MODERN BRIDE * FICTION GROUP *

ZIFF-DAVIS COMICS.

These Men are Getting PRACTICAL TRAINING

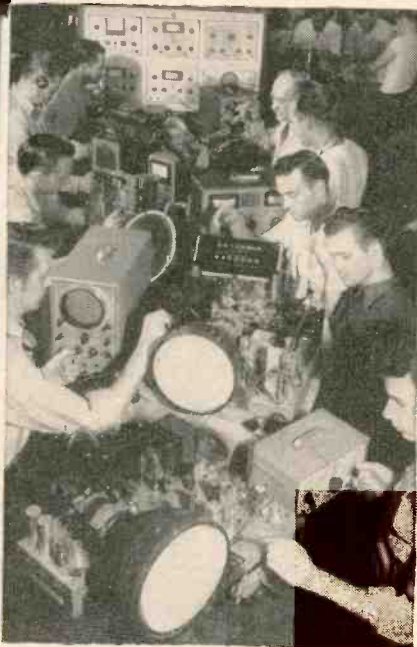

IN TELEVISION-RADIO ON REAL TELEVISION SETS RADIO RECEIVERS F.M. RECEIVERS IN THE GREAT SHOPS OF COYNE

Big opportunities are waiting for men who know the practical and technical end of Television and Radio. That's what you get at COYNE—besides practical Shop Training in F.M., Electronics and other branches of this giant field. Remember, Television is the fastest growing opportunity field today, and Radio is one of the biggest.

NOT "HOME STUDY" COURSES

All Coyne Training is given in our mammoth Chicago training shops. We do not teach by mail. You train on actual equipment, under friendly instructors. Previous experience unnecessary. Hundreds of firms employ Coyne trained men.

START NOW—PAY LATER

Come to the Great Shops of Coyne in Chicago. Established 1899—now in our 52nd Year. Oldest, largest, best equipped school of its kind in America. Fully approved for G.I. training. Finance plan for non-veterans.

MAIL COUPON FOR FREE BOOK

Send today for big new book packed with large pictures taken in Coyne Shops. No obligation. No salesman will call. Get the facts now!



COYNE B. W. Cooke, Pres.
ELECTRICAL & TELEVISION-RADIO SCHOOL
 An Institution not for Profit
 500 S. Paulina St., Chicago 12
 Dept. 11-1K

B. W. COOKE, Pres.
 COYNE Electrical, & Television-Radio School,
 500 S. Paulina Street, Dept. 11-1K, Chicago 12, Ill.

Send FREE BOOK and full details on Television-Radio Course.

NAME.....

ADDRESS.....

CITY.....STATE.....

with the capabilities and limitations of the electronic, radio, and wire communications equipment supplied to the war theater.

With enough trained communication specialists available, the Chief Signal Officer told the group of approximately 250, his observations in Korea showed communications for the Army operations both in the front lines and in the divisional and rear echelons had operated successfully, both in the use of short-range handie-talkies and walkie-talkies and the higher-powered SCR-300, 193, and 399 stations, and in the installation of radio relay systems which overcame the transmission obstacles of the mountainous terrain.

"No major changes are indicated in our present long-range Signal Corps research and development program," General Akin stated, bringing out that the Signal Corps equipment had met all tests of combat in Korea. "The new equipments that are now coming out of this program or already rolling off the production lines (to join the new military field wire WD-1 which proved so successful in the Korean fighting) will insure that our troops will continue to have the most modern and effective type of military signal communications that can possibly be devised," he said. Providing enough highly skilled personnel, which had been greatly limited during the previous peacetime "economy" period, "is our big problem," the Chief Signal Officer reiterated, and the training of technical specialists for the Army in the Signal Corps schools is imperative.

The Signal Corps plunged into action immediately upon the outbreak of hostilities in Korea, General Akin related, and shipments over the tremendous

10,000-mile supply route began at once, after he had asked the Far East Command for its supply needs. There was "complete coordination of all communication facilities available to the Army, Navy, and Air Force, the Chief Signal Officer emphasized.

At the luncheon the national directors of the AFCA, who held a special meeting during the day to make plans for the next national convention in Chicago at the Drake Hotel April 19-20, were the guests of honor. Theodore S. Gary, vice-president of *Automatic Electric* and national AFCA president, was at the head table at the luncheon. Other head table guests were: Maj. Gen. K. B. Lawton, Deputy Chief Signal Officer; Rear Admiral S. C. Hooper, USN, Ret.; Brig. Gen. Wallace B. Smith, who commands the AACS; Capt. W. D. Ammon, Deputy Chief of Naval Communications; Vice-President and General Manager J. R. B. Crigler of the *Chesapeake & Potomac Telephone Co.*; Col. W. W. Watts, *RCA Engineering Division* executive vice-president and AFCA national vice-president; and Col. George Dixon, AFCA executive secretary. Francis Engel, *RCA Victor* Washington manager and president of the AFCA Washington Chapter, presided at the luncheon.

Other national AFCA directors at the affair included Russell Cunningham, *United Air Lines* communications superintendent; Rear Admiral Earl E. Stone, of the Joint Chiefs of Staff; William H. Mansfield, secretary of the *Southern Bell Telephone & Telegraph Co.*; former FCC Commissioner E. K. Jett; David Hull of *Raytheon Manufacturing Co.*; and General Counsel Frank Wozencraft.

-50-

Pretty Shirley Stolper poses with a DuMont television receiver which was the largest set displayed at the 3rd annual Television and Electrical Living Show held recently in Chicago. The screen is 30 inches and the set stands 7 feet high and is 5 feet wide.



**SUPER SENSATIONAL
TERRIFIC SAVING ON
ANTENNA TOWERS**

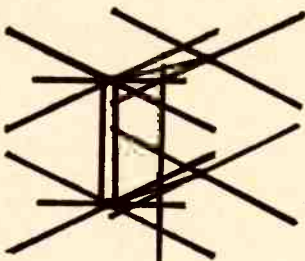

A TOAST TO YOU AND A NEW YEAR

Let the music request and my thought to mine

BUFFALO RADIO SUPPLY

LINE FILTERS

Type "A"—Each unit contains two 4 Mfd. oil filled condensers and a high inductance 50 Amp. choke in fully shielded case. Suitable heavy current connectors are provided to attach to the input and output connectors at each end of the filter from your input and output wires. A filter with innumerable uses on oil burners, refrigerators, boats, automobiles and wherever noise is to be suppressed or interference abolished. A \$17.00 value for \$2.98.

TYPE "B"—Heavy duty line filter consisting of 2 condensers and R.F. choke in plated steel case. Conservatively rated at 4 amps and 600 volts. Perfect for refrigerators, oil burners, power supply input of signal generators or to block out almost any interference you can think of. Super special \$7.5 each or **\$5.00** 10 for.....

NEW G-E TRANSMITTER
Brand new General Electric BC-375 or BC-191 transmitters, export packed, complete set of spare tubes as well as 10 and 20 meter conversion instructions. \$100.00 BC-312, BC-348 or BC-224 receivers sold with the above transmitters (unit for unit, 1000-mile range). **\$125.00**

Universal 4 lead broadcast band oscillator coil (can be converted to 3 lead type by addition of jumper). Ten for.....\$1.00

**SCR 274N Command Set
(Made by Western Electric)
THE GREATEST RADIO EQUIP-
MENT VALUE IN HISTORY**

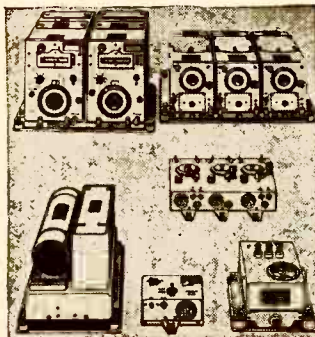

A mountain of valuable equipment that includes 3 separate Communications Receivers, covering up to 9.1 MC. 2 separate 40 watt Transmitters including crystals. 4—28v Dynamotors (easily converted to 110v AC operation). Pre-Amplifier and Modulator. 2 Tuning Control Boxes and 1 Antenna Coupling Box complete with R.F. Ammeter. 29 tubes supplied in all. Receivers and Transmitters instantly detached from mounting racks for use in separate locations. Removed from unused aircraft and in guaranteed electrical condition. A super value at \$59.95 complete.

"P.M. SPEAKERS"

Latest type PM Speaker in a fully-enclosed crackle finished metal cabinet. This speaker and case match communication receivers, and in addition make perfect intercom remote stations. Our price \$4.50. With output transformer.....\$4.95

SPEAKERS—These PM speakers are the finest that are available. All have heavy oversize Alnico V magnets.

3 1/2"\$1.15	6 for \$6.60
4"\$1.15	6 for \$6.60
5"\$1.10	6 for \$6.50
6"\$1.50	6 for \$8.70
6"x4" Oval\$2.10	6 for \$10.80
7" (Car Radio Size)\$4.50	6 for \$21.50
8"\$3.95	6 for \$22.50
8"\$4.95	6 for \$26.50
10"\$5.50	6 for \$33.00
12"\$7.95	6 for \$42.00



Extremely light but strong!! Chrome Molybdenum alloy steel. Made for use in cargo plane airframes. Enormous load carrying capacity—no comparison with ordinary steels. We will not ship more than 12 masts to any dealer, as the quantity available is limited.



and no more steel of this quality is available, even at many times this price. All tower hardware, except guy wire, is furnished including large mast base, adjustable to any angle. Base suitable for mounting on sloping roofs or on a concrete block set on ground. Total price for 30 ft. tower—\$15.00. Total price for 40 ft. tower—\$20.00. Double Stack Antenna as shown—\$15.00 extra.

WE ARE LOOKING FOR TUBES and other surplus. Large or small quantities. Send your list for our bid. We especially want BC654 and SCR284 components.

CYBERNETICS!

RT1463 12 Stage Electronic Brain containing 3—7F7, 1—7Y4, 3—7N7, 4 potentiometers, numerous resistors, filter and bypass condensers, filter chokes, power and audio transformers, and six sensitive plate relays. A military development that provided amazing stepless control proportional to correction required, in the original application. This phenomenal unit, with its 3 multistage push-pull amplifiers and six 5,000 ohm relays in bridge circuits, will accurately control any 3 operations, related or unrelated, in minutely adjustable uniquely quantitative variations in either forward or reverse directions. 9"x7"x8" black crackle aluminum case. Brand new in original carton.....\$9.95

All-Purpose Neon Tester

60 to 550 volt. Indicate all kinds of current. AC, DC, or RF, and comes complete with instruction booklet outlining various tests on radio sets, including the location of fading, dead stages, shorts, and making screen-grid and plate circuit tests. 35c ea. Per doz. on attractive display card—\$3.50.

SPAGHETTI

Terrific Bargain in Spaghetti at lower than carload lot prices. Plastic Spaghetti made to U. S. Air Force Specs. Safe for 10,000 volts.

1/8" to 1/4" diam.1c per ft.
5/16" to 3/8" diam.1 1/2c per ft.
7/16" to 1/2" diam.5c per ft.
1"10c per ft.

We can supply continuous lengths up to 100' clear or black in most sizes.

FCC AUTHORIZES RADIO FOR PRIVATE SERVICE!

In the "Citizen's" band neither code test nor technical knowledge is necessary. Brand new General Electric 15 Tube Transmitter set. A clinch for any experimenter to connect this unit for 110V AC operation from the instructions and diagrams supplied, which cover numerous applications, including television. For those intending to use on car or boat a new dynamotor, exactly as originally supplied costs only \$15.00. Don't fail to write for FREE descriptive bulletin. Order our RT-1248 for only \$29.95 or two for \$59.90.

SENSATIONAL BUY

RT-1711 Brand New 12 Tube, 110 Volt Receiver-Indicator-Oscilloscope complete with all tubes and power supply (Govt. APA1 Radar Set). Scope tube is equipped with a detachable calibrated screen....\$39.95

SENSATIONAL, FASCINATING, MYSTERIOUS SELSYNS.

Brand new Selsyns made by J. E. Company. Two or more connected together work perfectly on 110V AC. Any rotation of the shaft of one Selsyn and all others connected to it will rotate exactly as many degrees in the same direction, following unerringly as if the units were connected together by shafting instead of wire. This is true whether you twist the shaft of the master unit a fraction or a revolution or many revolutions. Useful for indicating direction of weather vanes, rotating directional antennas, or controlling innumerable operations from a distance. Complete with diagram and instructions. Per Matched pair \$4.95.



SIGNAL GENERATOR

Genuine Laboratory-type precision signal generator. Manufactured and sold for \$68.00 each in large quantities during the war by Northeastern Engineering Corp., one of the top manufacturers of electronic equipment for the U. S. Govt. Five fundamental bands starting at 150 KC. Strong harmonics up to 120 MC. Five step ladder type attenuator as well as potentiometer output control. Regular 1000 cycle audio oscillator using vacuum tube, not a cheap neon sawtooth audio oscillator. Audio output separately available externally. Weight without packing material 16 lbs. which should show what a world of difference exists between this signal generator and the ordinary cheap oscillator used by the average serviceman. Complete with fused plug and coaxial output lead. Super Special \$28.75



**Supreme Instrument Corp.
Model 592 SPEEDTESTER. Not just 20,000 ohms per volt, but**

25,000 ohms per volt

The world's most sensitive volt ohmmeter. The finest multimeter money can buy. "Tops" in quality, accuracy, complete coverage, and speed of operation. 44 ranges at your fingertips. 1 Microampere to 14 amperes. Either 100 ohms per volt or 25,000 ohms per volt meter sensitivity, instantly available. 0.1 to 1400 D.C. Volts. 1/4 ohm to 50 megohms. No removal of test prods necessary—1 pair pin jacks for all ranges. In beautiful oak case. Regularly \$58.95. We are offering these brand new testers for a limited time of **\$48.95.**



\$6.95 TAKES ALL THREE BIG BARGAINS "E"

- AUDIO AMPLIFIER**—Brand new push-pull output triode amplifiers having 2 of the valuable and scarce ounce type audio transformers that sell for over \$10.00 apiece. Neat aluminum case, fully enclosed (largest dimension 6 inches). Perfect for intercom systems, phone amplifiers, mike amplifier, or signal tracer amplifier for testing radio sets. A sensational bargain at only.....\$3.40 each
 - BANDSWITCHING TUNING TURRET** made by Western Electric. Covers 4 bands above 100 MC. All coils wound with #14 silver-plated wire. Complete with tuning condensers and powerful electric driving motor. ONE OF OUR MOST TERRIFIC VALUES—ONLY.....\$2.95
 - CARBON MIKE** with Push-To-Talk Switch and Gold Plated Carbon Label Mike. Combination offer on both mikes.....\$1.75
- SCR610 portable 6, 12, and 24 Volt crystal controlled transmitter receiver with built-in loudspeaker on receiver. Complete \$59.95
- SCR-522 Transmitter-receiver in guaranteed condition complete with remote control antenna and mike. No conversion necessary to license for taxicab use. A natural for any 2 meter use. \$100.
- REMOTE CONTROL UNIT**—Aluminum case 4 x 3 x 2 containing revolution counter, 2 potentiometers, triple pole switch, 4 knobs, phone jack, and gear mechanism. Including 8 prong JAN connector to fit box—\$1.39.

The BUFRAD Model BR8 portable indoor antenna adjusts easily to any channel and any station direction. Triple-chrome-plated brass pole. Antique finished base with felt pad to prevent scratching furniture. Can also be readily installed attached to ceiling with base up. 300 ohm line furnished. Your cost \$3.50. Lots of 12 at \$30.00 each.

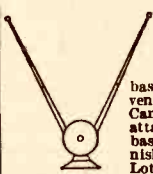

SIGNAL CORPS INTERCONNECTOR RELAY BOX 730A

This valuable unit, made by Bell, and more familiarly known by the U. S. Army designation BC618, is encased in a highly polished aluminum case 6 1/2 x 5 1/2 x 2 1/2", and contains 150 mfd of condenser capacity sensitive relays, resistors, and terminal strips. Order several at the giveaway price of only.....\$1.95

INVENTORY SALE ALL PRICES CUT TO BONE

Westinghouse Cuprox Rectifier 0.64 Amp. 28
Volts. Reg. \$11.00 ea. Special... \$2.95
25c TUBE SALE—2 50-2A7-55-27-85-31... 6 for \$1.00
50-57... 6 for \$1.00

TUBES—024, 79c; 117P7, 95c; 68L7... 35c

12 BRAND NEW 10" PHONO RECORDS—Ass't.
Jazz—Pop—Hillbilly—Polkas... \$1.79

3 Ft. 5 Wire Shielded Cable with Amphenol Connection
750 to 800 Volts, DC, 200 mils. when connected to a
rectifier tube and filter condenser. Cost Uncle Sam
\$23.00—our price per pair, \$2.98. Shipping weight
33 lbs. 6 for \$1.00

U. S. ARMY GAS MASKS

Has O.D. covered case suitable for lunch or tool bag
and charcoal container for use in refrigerators to
eliminate fish or other odors.
Brand new—39c each; 3 for \$1.00

TRANSMITTING PLATE TRANSFORMERS

A pair of Signal Corps transformers connected in series
to 110-125 Volts, AC, will deliver approximately
750 to 800 Volts, DC, 200 mils. when connected to a
rectifier tube and filter condenser. Cost Uncle Sam
\$23.00—our price per pair, \$2.98. Shipping weight
33 lbs.

Signal Corps Phones—2 M. Ohms (8 M. Ohms
Imp.)... \$1.00
2 Ft. Ext. Cord (and Plug)... 40c

OIL FILLED FILTER CONDENSERS

1.—MFD—1000 working volts... 6/99c; 12/\$1.75
CD. 4 MFD. 600 V. Upright Bottom Lug... 49c

TOBE TUBULAR ELECTROLYTICS

20-20 MFD. 150 V... 35c 30-30 MFD. 150 V... 37c
40-40 MFD. 150 V... 39c

Low-Loss Short Wave Lock Type Air Trimmer Variable Condensers

3 Pl.—12-15 Mmfd. 12c
7 Pl.—25-30 Mmfd. 15c
8 Pl.—30-35 Mmfd. 16c
10 Pl.—40 Mmfd. 17c
14 Pl.—56 Mmfd. 24c
27 Pl.—100-110 Mmfd 35c

3 GANG T.R.F.
VARIABLE CON-
DENSERS
.000365 Con. 65c

D.P.D.T. SLIDE
TOGGLE
SWITCH... 15c

4 PR. WAFER SOCKETS—\$1.49 per C. each... 3c
5-6 PRONG WAFER SOCKETS... \$2.50 per C
100 ASST. SOCKETS—5-6-7... \$3.50 per C
1,000 OHM WIRE WOUND POTENTIOMETER... 15c
30 HY-FILTER CHOKE SHIELDED... 3 for 1.00
UNSHIELDED... \$1 per doz.
2,000 ohm Wire Wound Rheostats... \$1 per doz.
CARTER WIRE WOUND C.T. VARIABLE 20 OHM
RESISTORS... 85c per doz.
RCA 6 OHM POWER RHEOSTATS... 15c; 7 for \$1.00
GEN. ELEC. WESTINGHOUSE, etc. 60 CYCLE WATT
HOUR METERS, slightly used, perfect condition,
same as used in home, 110-125 volts.
5 Amps. \$2.95; 10 Amps... \$3.95

PIEZO CRYSTAL HOLDERS with cover... 12 for \$1.00
Grind your own crystals—Pure Brazilian Quartz, all
sizes and thicknesses—1/2 lb. package... \$1.00

RCA Band Switches—
3 gang, 3 pos. 3 band. 30c 6 gang, 4 pos. 4-5 band. 40c

Trimmer-Padder Ass't.—all isolantite—singles, dual;
triples—100 asst. pieces... \$2.25

Philco push button Rotary Switch Double Pole... 35c

ATTENTION: Prospectors, Explorers for Hidden Treasures!
Construct a U.S. Army Type of Metallic Mine Detector
Amplifier. Amplifier unit only (less tubes and bat-
teries) with cables, headphone cord, and jack. Army
wiring diagram, Type AN/PRS-1... \$1.95

RCA Ass't Mica By-Pass Cond. .001, .002, .0025,
100 for... 95c
8 or 9 Gang Push Button Switch... 59c

DRILLED CHASSIS FOR 5-6 tubes 5"x10"x1/4" .25c
PHONE JACKS—OPEN & CLOSED AUTO... 18c
NATIONAL 20 MFD—450 VOLT CAN FILTER
CONDENSER... 25c

EBY SPEAKER VOL. CONTROL—60 OHMS... 15c
SALE—PHONO RECORD ALBUMS—12"—3 comp. 15c;
10"—3 comp. 15c; 4 comp. 20c; 12 comp. 49c

4 Post Terminal Strip with Lugs & Screws... 10c
Lots of 100... \$9.00

IRC—300 Watt—300,000 OHM Wire Wound Res. 95c

6 Prong Amphenol Sockets... \$4.00 per C

AMERTRON FILAMENT TRANSFORMER—6.3 V. 1
Amp. Encased Isolantite Terminal Posts... \$1.50

AMERTRON XMITTING AUDIO XFORMER—For Class
B or Modulator. Pri. 6400/1800—Sec. 5500 @
160 MA. Cost \$75.00... SPECIAL \$2.49

AMERTRON AUDIO OUTPUT XFORMER—Pri. 10,000
@ 15 MA; Sec. 300, 6-1 Ratio... \$1.49

AMERTRON MIXER AUDIO XFORMER—Pri. 600-10-
000 Ohms... \$1.00

156-1 RATIO VERNIER DIALS—4 in., 3/4 in. Hub. 35c

LINE VOLTAGE NOISE ELIMINATOR—Plugs in Be-
tween Radio and Elec. Socket... 35c

NATIONAL VELVET VERNIER DIAL—1/4 in. Hub, 4
in. Diam, Silver Plated... \$2.19

12 in. MAGNAVOX SPEAKER, 2500 Ohms... \$2.95

HEARING AID CORDS—Assortment of 12 for... \$1.00

BY-PASS COND. ASST.—25 Cans, Bake., Paper,
etc... \$1.00

MINIMUM ORDER \$2.00—NO C.O.D.
SHIPMENTS—PLEASE INCLUDE POSTAGE

NEWARK

SURPLUS MATERIALS CO.

Dept. JA

324 Plane Street

NEWARK 1, N. J.

Record-Reproduce

(Continued from page 49)

at one end only. Patch cords should be checked as many come from certain manufacturers with "both ends grounded."

Another system, used by CBS and by certain recording studios, is a "single jack" system. Its only difference lies in the mechanical construction of the jacks and plugs, and will not be discussed in this article.

To further illustrate the action of the jacks, we refer you to Fig. 9A. Here the secondary of the transformer is shown in its "normalled" position to the line amplifier. When connected in this fashion, the signal will flow as indicated by the arrows. Fig. 9B is the simplified version of the same circuit, with only one side of the line indicated. This same technique is used throughout the diagram of Fig. 5 to show the jacks and their use in the entire system.

When the double plug is inserted

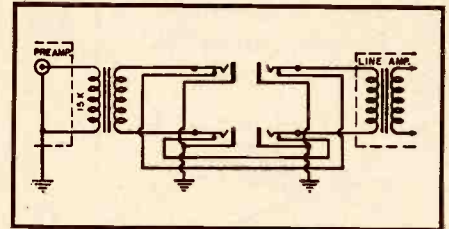

Fig. 8. Detailed wiring of two pairs of double jacks (in "normalled" position).

from the patch cord the action illustrated in Fig. 9C will take place. Here the swingers are lifted from contact with the normal springs and the circuit is broken, as far as the normal springs are concerned. By inserting a double plug the program would continue if one end of the patch cord were inserted into the output jack of the preamp and the other end into the line amplifier input jacks. There are many cases where it is desirable to break the circuit at this point, either for measurements or to introduce the signals from an audio oscillator, etc. Another use is found in the inclusion

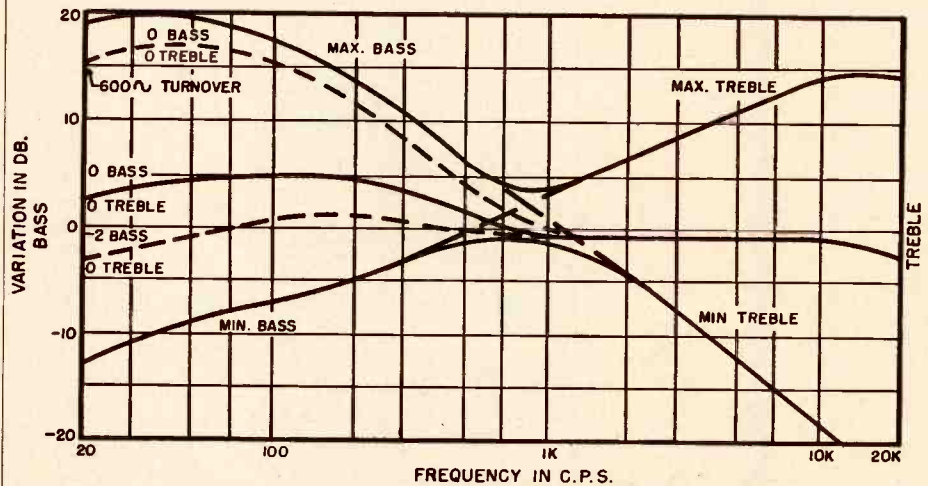
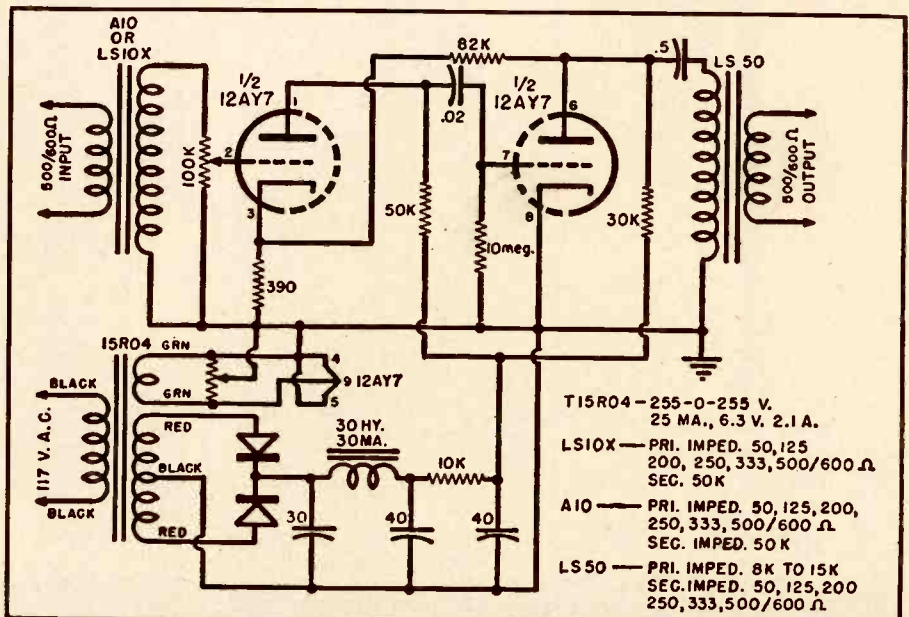

Fig. 6. Frequency response curves for the AE-2 equalizer. Dotted curves are obtained when using channels 3 and 4, and the solid curves when using channels 1, 2, and 5.

Fig. 7. The line amplifier. Quality transformers are required for optimum results.



T15R04—255-0-255 V.
25 MA., 6.3 V. 2.1 A.
LS10X—PRI. IMPED. 50, 125
200, 250, 333, 500/600 Ω
SEC. 50K
A10—PRI. IMPED. 50, 125, 200,
250, 333, 500/600 Ω
SEC. IMPED. 50K
LS50—PRI. IMPED. 8K TO 15K
SEC. IMPED. 50, 125, 200,
250, 333, 500/600 Ω

SAVE

THAT GOOD LOOKING OLD CONSOLE—
REPLACE THE OBSOLETE RADIO

with a modern, easily installed

ESPEY AM/FM CHASSIS

and your favorite console is "right-up-to-date"



Rated an excellent instrument by America's foremost electronic engineers. Fully licensed under RCA and Hazeltine patents. The photo shows the Espey Model 511-B, supplied ready to play. Equipped with tubes, antenna, speaker, and all necessary hardware for mounting.

NEW FEATURES—Improved Frequency modulation circuit, drift compensated • 12 tubes plus rectifier, electronic tuning eye and pre-amplifier pick-up tubes • 4 dual purpose tubes • High quality AM-FM reception • Push-pull beam power audio output 10 watts • Switch for easy changing to crystal or variable reluctance pick-ups • Multi-tap audio output transformer supplying 4—8—500 ohms.

Makers of fine radios since 1928.

Write for literature RN for complete specifications on Model 511-B and others.

ESPEY TEL. TRafalgar 9-7000
MANUFACTURING COMPANY, INC.
528 EAST 72nd STREET, NEW YORK 21, N. Y.

New "MIGHTY MITES"



SELENIUM RECTIFIERS

8J1

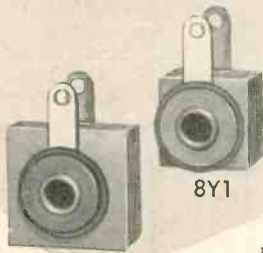

8Y1

Rectifiers are shown actual size

CHALK UP another First for SELETRON! Here is "mite-size" 8J1, keyed to the requirements of modern electronic circuits . . . A new and smaller 65 mil rectifier with particularly low reverse leakage, built to the following specifications: Input 130 V rms; Max. Peak Inverse Voltage 380 V; Max. D.C. Output Current 65 MA; Plate Size 11/16" square; Stack Thickness 9/16".

. . . And don't forget the 20 Mil "Mite"—No. 8Y1, designed especially for power and bias supply in Radio and Television!

A complete tabulation of all SELETRON miniatures is available. For your copy, write Dept. TN-3

RR RADIO RECEPTOR COMPANY, INC. RR
SELETRON DIVISION
Since 1922 in Radio and Electronics
Factory: 84 North 9th St., Brooklyn 11, N. Y. • Sales Department: 251 West 15th St., New York 11, N. Y.



WALSCO

—in any
climate,
anywhere...

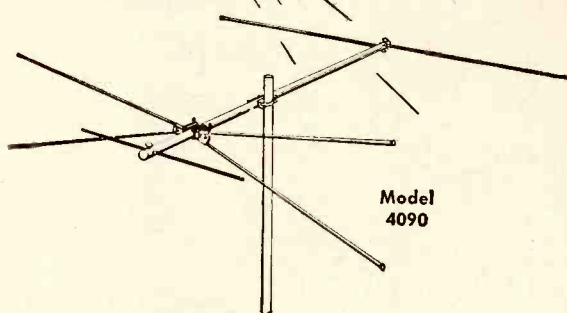

Model 4090

INSTALL IT and FORGET IT

new WALSCO SIGNAL-KING

No fear of costly "call backs" that eat up a dealer or installer's profit. In any climate, anywhere . . . the new WALSCO Signal King antenna provides sharper, clearer response over entire TV spectrum. Rugged aluminum alloy construction for elements, cross-arm and mast. Corrosion resistant. All steel parts are cadmium plated to AN specifications.

NOTHING LIKE IT ANYWHERE . . .

- High gain on all channels—no weak spots. Excellent for fringe areas.
- Entirely new insulator guaranteed unbreakable under all operating conditions. Outstanding and lasting dielectric properties.
- Marine type aluminum alloy elements, reinforced and closed ends.
- Assemble in a jiffy (less than 2 minutes).

Write for Information Bulletin No. 51-N

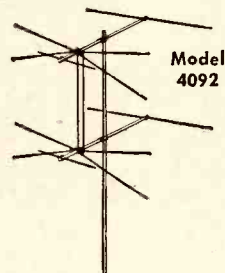

Model 4092

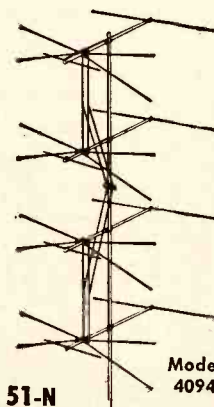

Model 4094

WALTER L. SCHOTT CO. Beverly Hills, Calif. • Chicago 6

For AC CURRENT ANYWHERE . . .
NO MAGIC just use
ATR
INVERTERS

STANDARD AND HEAVY DUTY INVERTERS



For Inverting D. C. to A. C.
 Specially Designed for operating A. C. Radios, Television Sets, Amplifiers, Address Systems, and Radio Test Equipment from D. C. Voltages in Vehicles, Ships, Trains, Planes and in D. C. Districts.

NEW MODELS ✓ **NEW DESIGNS**
 ✓ **NEW LITERATURE**
 "A" Battery Eliminator, DC-AC Inverters, Auto Radio Vibrators
See your jobber or write factory

AN TELEVISION & RADIO CO.
 Products Since 1931
 1111 MINNESOTA - U. S. A.

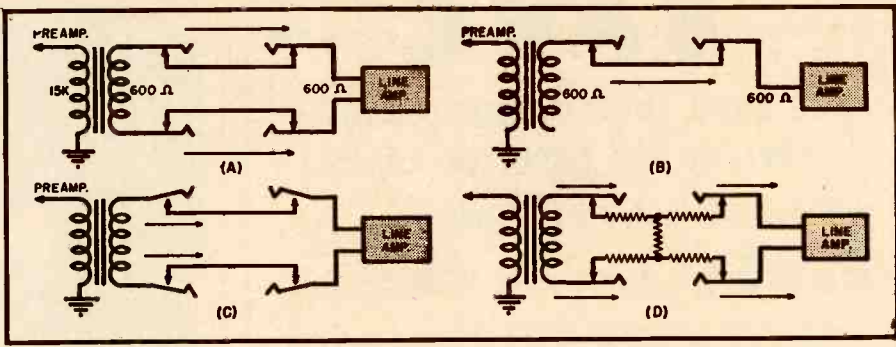

Fig. 9. Functional diagrams of the double jack system referred to in the text.

of a loss pad which affords isolation between the preamp and the line amp. Such a loss pad may be purchased or home-constructed to provide any fixed loss. It may be connected permanently in circuit with the normal springs as shown in Fig. 9D or it may be made up into a separate unit and patched into the line at the point shown.

Note that grounds are not shown except on the individual pieces of equipment on the diagrams. Each unit is grounded to the ground bus at only one point in order to prevent ground loops. Actually, the grounding system comprises a pair of #8 copper wires, securely connected to a cold-water system and terminating in a special terminal block within the racks of the audio bay. Circuits are usually grounded in order of their level. For example, the most direct connection through the grounding bus to the cold-water system is from the phono input, microphone inputs, preamp, line amp, etc., in that order.

It is of extreme importance in audio work that a good return-to-ground be made on all equipment to reduce the normal residual hum and noise of the system. Waterpipes which are buried underground are probably the most effective for average use.

The physical layout of the jack field must receive due consideration. Program circuits of low level should be widely separated from those of power circuits, especially when they carry signal levels that differ by approximately 20 db. In the layout shown, nearly all of the low-level inputs are located at the left hand side of the jack panels, as shown in Fig. 4. All power level circuits are situated at the extreme right of the jack panels. Shielded 2-wire cable of low loss is used to connect the various units in the entire system. Those of low level circuits are grouped together and brought in at the left side of the rack while those of high level are brought in from the right side of the rack. They are all 2-wire, cotton-covered shielded cable and after having been dressed in place, they are covered with spaghetti tubing. This eliminates shorts in the cabling and permits grounding of each cable at one point only, usually at the jack of the circuit.

Identification strips are removable. Several were made since the photo of Fig. 4 was taken and therefore do not agree entirely with the diagrams.

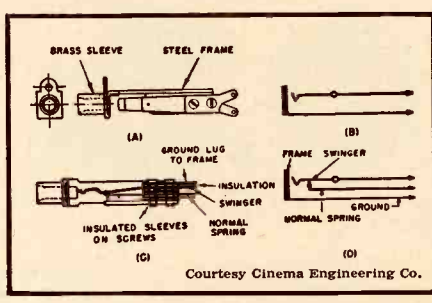

Fig. 10. Construction of standard jacks of the types widely used in sound studios.

It is advisable, when laying out the jack fields, to locate them so that they will be conveniently located for insertion of the patch cords and so that the identification of each jack may be easily seen. It will be obvious to the reader that great flexibility is afforded by use of the jack field. With it we can make insertions or connections either into or from various circuits and components for purposes of tests or for monitoring. Furthermore, by providing multiple jacks on commonly used circuits, such as the bridging bus, to be described in later chapters, we are able to substitute or to bypass certain units when desirable. The multiple jacks are nothing more than parallel connections which do not employ a normal spring. They are simply a convenient means for reaching a circuit by means of a patch cord.

When the jacks are properly normalized and when the impedance of the bridging bus is held to 600 ohms ($\pm 10\%$) the entire system is operative without any patch cords inserted. Changes in circuitry may then be made without materially changing the loads.

(To be continued)

Fig. 11. Construction of double plug. Notches show polarity. When plug is inserted notches are held toward the left.

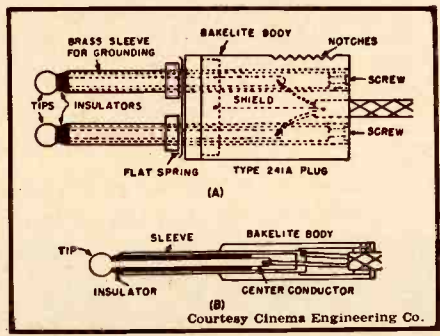

Within the Industry
(Continued from page 26)

which to build a plant to handle the expanding military demand for the products of the company's electronics and x-ray divisions . . . **GENERAL ELECTRIC COMPANY** has announced the reopening of its radio tube plant in Utica, New York. The factory will be converted for the manufacture of emergency radio communications equipment . . . **SIMPSON ELECTRIC COMPANY** of Chicago has opened its fifth factory at 932 Benton Street, Aurora, Illinois . . . **C.G.S. LABORATORIES, INC.**, has moved to 391 Ludlow Street, Stamford, Conn. . . **AMERICAN ELECTROENGINEERING CORPORATION** has recently taken over new and larger quarters at 5025-29 West Jefferson Boulevard in Los Angeles . . . **CORNISH WIRE COMPANY, INC.**, has moved its general executive offices to a new address at 50 Church Street, New York City . . . **RADIO CRAFTSMEN, INC.**, Chicago manufacturer of custom-built television and radio chassis and electronic equipment, has acquired 12,000 feet of space at 4401 N. Ravenswood, Chicago, which will be used in the production of television chassis . . . **RAYTHEON MANUFACTURING COMPANY** has recently set up a new plant at Quincy, Massachusetts, for the manufacture of electronic tubes of the sub-miniature and miniature construction for military requirements . . . **STEINER PLASTICS MFG. CO., INC.**, has taken over a new plant at Pratt Oval, Glen Cove, New York. The company forms and fabricates thermoplastic sheets, rods, and tubes used in the electronics industry.

* * *

INSTITUTE OF RADIO ENGINEERS has just announced the winners of four of its annual awards for 1951.

Robert B. Dome, electrical consultant for the *General Electric Company* has been named recipient of the Institute's Morris Liebmann Memorial Prize which is awarded annually.

Mr. Dome's award was made for his contributions to the intercarrier sound system of television reception, wide-band phase shift networks, and various simplifying innovations in FM receiver circuits.

The Browder J. Thompson Prize was awarded to Alan B. MacNee, assistant professor of electrical engineering at the University of Michigan, for his paper "An Electronic Differential Analyzer." The award is given annually to the author under thirty years of age for the paper recently published by the Institute which constitutes the best combination of technical contribution to the field of radio and electronics and presentation of the subject.

The Harry Diamond Memorial award, given annually to a person in government service, was awarded to Marcel J. E. Golay of the Signal Corps Engineering Laboratories, Fort Mon-

Real values on hard-to-obtain items

"S" METER . . . An outstanding buy!



Here is a beautiful instrument exactly suited for use as an "S" meter. Illuminated face, (supplied with miniature lamp) with a full-scale reading of 5 ma, a standard value for most "S" meter circuits. Diameter across face is 2 3/4", black bakelite case, reverse-set pointer. New, surplus . . . limited quantity. Only . . . \$1.95 ea.

836 hi-vacuum rectifiers. 2 for . . . \$1.50

TRANSFORMER-CHOKES:

2.5V, 10A. 10KV insulation. Suitable for 866, 836, etc. Reduced to \$2.79 ea.

5H, 400ma chokes. Fully shielded, drawn steel case. Made by Chicago Transf. Reg. \$4.95, reduced to \$2.95 ea.

10H, 200 ma choke. Hermetically-sealed steel case. Also has hum-bucking tap. A beautiful item only \$1.98.

10H, 50 ma choke. Strap mounting. Handy for dozens of applications. Reg. 98c, reduced to 65c. Charger or fil. trans. Pri. 110V, 60 cycle. Secondary, 9-10-11-12-13 volts @ 1.2 A. Fully cased. A buy at \$1.49.

Vibrator transformer. 6V inp. Secondary 345-0-345 @ 150 ma. Also has bias winding. Fully cased. Bargain at \$1.49 ea.

Power transformer. 780V, CT @ 200 ma. 2.5V at 8A, 5V at 8A, 6.3V at 6A. Pri. 115V, 60cy. AC. Has electrostatic shield. Upright mount. Shipping weight 11 lbs. Only \$4.95.

Fil. transf. 24V at .6 amp. Open frame type, \$1.95 ea.

5V, 25A transf. Cased, upright mtg. A buy at \$3.95 ea.

MICROPHONES:

Aircraft-type, push-to-talk mike. Button on top. NEW. A real buy! Were \$1.15 ea. now reduced to 59c.

RCA Hand Mike. Hi-grade, single button. Bronze colored w/cord and plug. NEW. Were \$1.98 now reduced to 98c ea.

TELEPHONE EQUIPMENT:

EE89 Repeaters (see previous ada). Only a few left. NEW! Regularly \$9.95 ea. now \$6.95 ea. TS-10 Sound powered handsets. A limited quantity only. BRAND NEW! . . . \$25.95 pair. Handset hanger. Beautiful cast aluminum shell finished in black wrinkle. Takes all makes and models. An extremely useful, well-made item only \$1.95 ea.

EE-8 FIELD TELEPHONES

Used, workable . . . \$10.95 pair
Used, good . . . \$12.95 pair
All units tested before shipment.

STORAGE BATTERIES:

2 volt, Willard. Dry packed. Very special at \$1.19 ea.
36 volt storage bat. Consists of 18, 2V units in sturdy case. Here is really a bargain! Only \$17.95.

RECEIVERS:

SCR-522 Receiver. Used, good condition. With tubes \$14.85 ea.

R89/ARN 5A RECEIVERS. See March Radio-Electronics for converting to FM set. Brand new, orig. boxes. Now only \$10.95 ea.

LOW FREQUENCY CRYSTALS

Precise units in holders. Ideal for oscillators as markers, BFO, etc. Can also be used as resonators for crystal filters. 453.70, 457.4, 464.81, 466.66, 468.51, Freq. in KC. These are an excellent buy at only . . . 89c ea.

SPECIAL PLUGS & CONNECTORS

For PE-103, male and female (male fits PE-103), new . . . 85c set
R8-ARN8. Two special plugs. . . \$1.00 set
PL-Q103 for BC-348—new . . . 75c ea.
SCR-522 meter plug, U-13/U. . . 25c ea.
PL-58 fits into EE-8 telephones and many switchboards—new . . . 30c ea.
PL-106 fits RM-14 telephones and others—new . . . 45c ea.
8 pr. Female. Fits SCR-284 equip. . . 35c ea.

HS-30 Phones. NEW in boxes. Only . . . \$1.29
HS-16 phones. Used, with headband and 6' cord. A hot buy at . . . 98c

BC-454 RECEIVERS

Frequency range, 3 to 6 mcs. Good condition. An astonishing low close-out price.
Less tubes . . . \$3.95 ea.

PARTS KITS FOR 1/2 WAVE TVI FILTERS

Assure yourself of success with the highly effective 1/2 wave TVI filters described in G-E HAM NEWS. Kit consists of drawn aluminum case, 11" long, 2 7/8" deep and 2 3/4" wide, finished black wrinkle. (Surplus.) Also three 150 mmf variable capacitors with transmitting type shunting mica where required in the circuit. Two air-wound inductors set to approximate inductance are supplied. Combination makes it possible to set internal circuits for exact resonance for optimum harmonic reduction and minimum interaction on transmitter. Instructions for assembly and tuning are supplied. Kits available for either 10 or 20 meters (specify). For 52 ohm line. Complete kit as above . . . only \$5.95

TU-10 B TUNING UNITS

One of the most desirable tuning units for the BC-375E. Has three excellent variable condensers. Limited quantity. Only . . . \$1.75 ea.

AN-GSC-TI CODE TRAINING SET

Complete with 10 keys. Consists of a variable pitch audio oscillator powered by universal power supply. DC, 6-12-24-115V. AC, 115-230V. Voltage selectable by switch. Has loudspeaker and volume control. Contained in carrying case 17 x 10 1/4 x 13". Ideal for code training groups, clubs, schools, etc. NEW original boxes. Were \$49.50, now \$16.95 ea.

TM-11-437 Manual. Completely describes above equipment. Circuit diagrams, parts list, etc. \$1.00 ea.

SCOPE COMBO OFFER

The makings for an excellent scope. Includes: 1-5NP1 C-R tube, transformer for hi-voltage and fil. for 2X2 rectifier, circuit diagram, only \$7.95

FL-8 Filters, New . . . only 98c ea.

ULTRA-VIOLET LIGHT SOURCE FOR TELEVISION AND C/R TUBE EXAMINATION

O-R now presents . . . new . . . an 8-watt, ultra-violet, "black-light" source! Here is a highly effective and time saving device for checking burn spots and other defects in phosphors of C/R tubes. C/R tube face fluoresces when exposed to this special black-light to give visual indication of condition of phosphor. Reflected light from C/R tube face is negligible and tube does not have to be in operation. An invaluable device for TV service shops, schools, laboratories. Also used in medical, chemical, foods, stamps, criminology . . . a thousand uses.

In kit form including Sylvania 8 watt, black-light tube, ballast, starter, mounting panel, tube clips, reflector, line cord/plug, hardware, instructions. Simple shadow box for outer housing is easily made. Complete kit (less outer housing) . . . only \$4.95 Also . . . complete "black-light" equipment for any industrial or experimental application. Inquiries invited.

TWELVE FOOT, HEAVY-DUTY WHIP

Actually 12'8" in length. Composed of four, sturdy sections which plug-in and screw together. Consists of sections MS-50, 51, 52, 55. BRAND NEW! A handsome buy on a highly desirable mobile antenna. Only \$150 complete.

SMALL PRECISION LATHE—110-V. AC

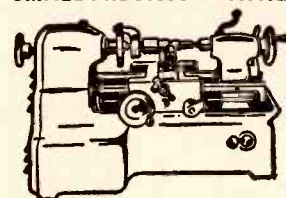

Now with Larger Motor
\$44.50

A small lathe for radio shops, jewelers, laboratories, dentists, hobby-crafters, model makers, machine shops, schools, etc. Automatic Feed. Work capacity 3" between centers. Swing over bed 2". Constructed of steel and cast iron. Accurately machined and finished. Fan-Cooled Motor mounted inside the base. Complete with 1 1/4" face plate, 2 lathe centers, tool post and rocker, one lathe dog, one tool-bit and test rod.

COMPLETE ACCESSORY KIT

Including 4-jaw chuck, drill chuck, center counter-sink drill, 2 tool-bits, 2 lathe dogs, 1 face plate with 8 drilled and tapped holes, 4 collets, 1 collet chuck, 1 Allen wrench. . . . \$24.50

MINIMUM ORDER \$2.00. ALL ITEMS SUBJECT TO PRIOR SALE.

ALL PRICES SUBJECT TO CHANGE WITHOUT NOTICE.

20% DEPOSIT MUST ACCOMPANY ALL ORDERS, BALANCE C.O.D.

OFFENBACH & REIMUS CO.

372 ELLIS ST.

SAN FRANCISCO, CALIF.

PHONE ORdway 3-8551

MOSLEY Low Loss TV Accessories . . .



provide **BETTER TV PICTURES**
through more efficient installation!

NEW! MOSLEY SOCKET-SWITCH, F-10

Combination 3 position switch and socket provides neat, efficient connection of TV set to any one of three antennas with easy, instant change-over. Flush-mounted in standard outlet box. Fits double receptacle plate. Acrylic plastic with non-ferrous metal parts. List, \$3.75



MOSLEY Transmission Line Plug, 301 (not illustrated). Mates with F-10 and F-11 Sockets. Many other uses. See these and other MOSLEY antenna accessories at your dealer. No. 301 Plug, List, \$0.48



DUAL FLUSH SOCKET, F-11

For terminating two 300 ohm TV lead-ins. Fits standard outlet box and double receptacle plate for neat, in-the-wall connections. Low-loss. Also available in single style. List, \$2.09

MOSLEY
W O F Q Y

Electronics

2126 LACKLAND OVERLAND, MISSOURI

A SINGLE SOURCE OF SUPPLY

MOSLEY ELECTRONICS manufactures the only complete line of antenna transmission line connectors, plugs, sockets and other accessories. MOSLEY products are solderless and designed for maximum electrical efficiency. Install MOSLEY accessories with complete confidence. Write for new Catalog No. 50-51.

mouth, N. J., for his contributions in the over-all Signal Corps research and development program and particularly for his accomplishments leading toward a reduction in the infrared-radio gap.

Willis W. Harman, associate professor at the University of Florida, received the Editor's Award, established to stimulate the use of good English in technical writing, for his paper "Special Relativity and the Electron" which appeared in the November 1949 issue of the "Proceedings of the I.R.E."

* * *

DR. HARRY STOCKMAN has been named director of research of the *Tobe Deutschmann Corporation* of Norwood, Massachusetts.



Prior to accepting his new post, Dr. Stockman served as consulting engineer and scientist to several industrial firms in the greater Boston area. During 1945-48 he was associated with the USAF research program in Cambridge and taught the 1941-45 pre-radar and other courses at Harvard University.

Active in electronics research and development for more than twenty years, Dr. Stockman served on the Communications Panel of the RDB during 1947-48. He is the author of numerous scientific and experimental papers, reports, patent communications, and textbooks. He is a senior member of the IRE.

* * *

GEORGE F. WUNDERLICH and **HAROLD E. SORG** have recently been named vice-president and general manager, and vice-president in charge of research, respectively, for *Eitel-McCullough, Inc.*, manufacturer of transmitting tubes and TV picture tubes . . .

BILL ROLLINS has been promoted to the post of vice-president in charge of production and purchasing for *Crescent Industries, Inc.* He has been with the firm since 1939 . . . **THOMAS G. BANKS** has assumed the post of director of research and development at *Gates Radio Company* of Quincy, Illinois. The position is a newly-created one . . . The Radio and Television Division of *Sylvania Electric Products Inc.*, has named **HOWARD RIORDON** as general manufacturing manager for that division . . . **WALTER A. BUCK**, vice-president and general manager of the *RCA Victor Division*, has been elected to the Board of Directors of *Radio Corporation of America*. He succeeds **EDWARD J. NALLY**, who retired because of age . . . **BEN MILLER** has resigned his post as general sales manager of *United Transformer Company* to "go fishing." **HANK RUSSELL** has taken over the duties of the retiring official . . . **SIDNEY A. JOFFEE** has been elected president of *Pathe Radio and Television Corporation*, succeeding **A. H. STOBBE** in the position . . . **WILLIAM D. LOUGHLIN**, prominent radio engineer and chairman of the board of directors

RADIO & TELEVISION NEWS

1951 TELEVISION CYCLOPEDIA

A "MUST" FOR EVERY RADIO-TV MAN!

Have hundreds of time-saving, money-making TV facts at your finger-tips . . . 750 fact-packed pages cover every phase of Television! Over 450 illustrations, charts and diagrams! All complete, easy-to-understand . . . all in alphabetical order and cross-indexed for quick reference. It's yours for 7 days' Free Trial!

HELPS YOU GET AHEAD FASTER IN TV

The NEW 1951 COYNE TELEVISION CYCLOPEDIA tells you why things happen . . . how to handle any TV problem . . . and does it quickly! Covers alignment, amplifiers, antennas, frequencies . . . UHF and COLOR TV . . . converters and adapters . . . television r-f ion traps and every other TV fact. Includes a complete explanation of what Test Patterns are . . . how to use them to adjust TV sets . . . with dozens of actual Test patterns. Mathematics is limited to easy, grade-school arithmetic. Formulas are simplified. Everything explained in detail. **SEND NO MONEY!** Just mail coupon for this book. Have TV Cyclopedias for 7 days. Then send either \$5.95 plus postage or return book and owe nothing. Act now!

BRAND NEW
750
PAGES
450
ILLUSTRATIONS

Yours
on
7-Day
FREE
TRIAL

MAIL THIS COUPON TODAY!

Educational Book Publishing Division
COYNE ELECTRICAL & TELEVISION-RADIO SCHOOL
500 S. Paulina St., Dept. 11-T3, Chicago 12, Ill.

Send me the 1951 Coyne Television Cyclopedias for 7 days' FREE Trial per your offer.

Name Age

Address

City Zone State

Where Employed

() Check here if you are enclosing \$5.95. We pay postage. 7-day Money-Back Guarantee.

FOR THE "GOLDEN EAR" CROWD

THE STRAIN SENSITIVE PHONOGRAPH PICKUP

Here's why this truly faithful reproducer appeals to people gifted with the "Golden Ear" . . . why the STRAIN-SENSITIVE PICKUP developed by the PFANSTIEHL CHEMICAL COMPANY brings out the brilliance of great voices and orchestras . . . the latent music on your records that other pickups leave untouched.

- The STRAIN-SENSITIVE PICKUP is an amplitude transducer with a CONSTANT RESISTANCE of about 250,000 ohms.
- Signal output is at a practically CONSTANT IMPEDANCE LEVEL.
- Excellent Transient Response.
- NO DISTORTION, phase shift or evidence of intermodulation is audible.
- LINEAR RESPONSE, free from peaks or resonances.

Cartridges are available for both standard and micro-groove, and can be had with Famous PFANSTIEHL M47B Precious Metal Alloy or diamond tipped styli.

A special preamplifier is necessary to provide the correct D.C. voltage for the pickup element and to provide the first stages of signal gain. Four styles are ready, or, if you prefer, you can build your own from the circuit in the literature.

Ask your radio supply man, or write today for complete FREE INFORMATION.

PFANSTIEHL
CHEMICAL COMPANY

101 Lake View Avenue, Waukegan, Illinois

of *Boonton Radio Corporation*, passed away recently at the age of 57 after an illness of several months . . . **GEORGE R. SIEGRIST**, executive vice-president, treasurer, and director of the *Acheson Colloids Corporation*, retired recently because of ill health. He was associated with the company for thirty years . . . At a recent stockholders meeting of *Herman Hosmer Scott, Inc.*, **VICTOR H. POMPER**, sales manager of the firm, was elected a director of the corporation . . . **JOHN F. BYRNE** has been named associate director of research for the Division of Communications & Electronics of *Motorola, Inc.* . . . **SHANNON C. POWERS** is the new general sales manager of the *Russell Electric Company*, a *Raytheon* subsidiary located in Chicago . . . **DR. IRVING LANGMUIR**, the recently-retired associate director of the *General Electric Research Laboratory*, was awarded the John J. Carty Gold Medal of the National Academy of Sciences. The medal, together with an accompanying certificate and honorarium, was presented at a recent meeting of the Academy. -30-

Spot Radio News

(Continued from page 18)

instance sufficient protection may be obtained if the service areas do not overlap. As an added factor, it was pointed out, it was believed that channels to be received in any given area should be grouped insofar as possible so that the frequency range, for which receiver antennas will have to be provided, could be minimized and receiver tuning simplified.

The plan, offered by John Preston, chief allocations engineer of the *American Broadcasting Company*, on behalf of the association, was soundly criticized by FCC Counsel Harry Plotkin who said that the proposal was purely a theoretical one without substantial support. His fire was directed particularly on the association's assumption that the intermediate frequencies would be adopted, whereas no official word had been received that such a move had been approved, industry-wide. The thought that radiation would have to be tolerated also irked the Commission's attorney who declared that such interference might have a serious effect on other services, some of which might involve public safety. This blast recalled to many the seething letter Major Armstrong had sent to the Commission on radiation. In the Major's opinion, the radiating receiver problem in FM and TV was . . . "a disgrace to the engineering profession." He believed that the present conditions were the result . . . "of the disregard of rules of engineering that were known twenty years ago . . . In both TV and FM these rules have been and are now being flagrantly violated by a large part of industry, perhaps to their immediate profit, but certainly to the ultimate detriment of the public."

January, 1951

CLEARER PICTURES

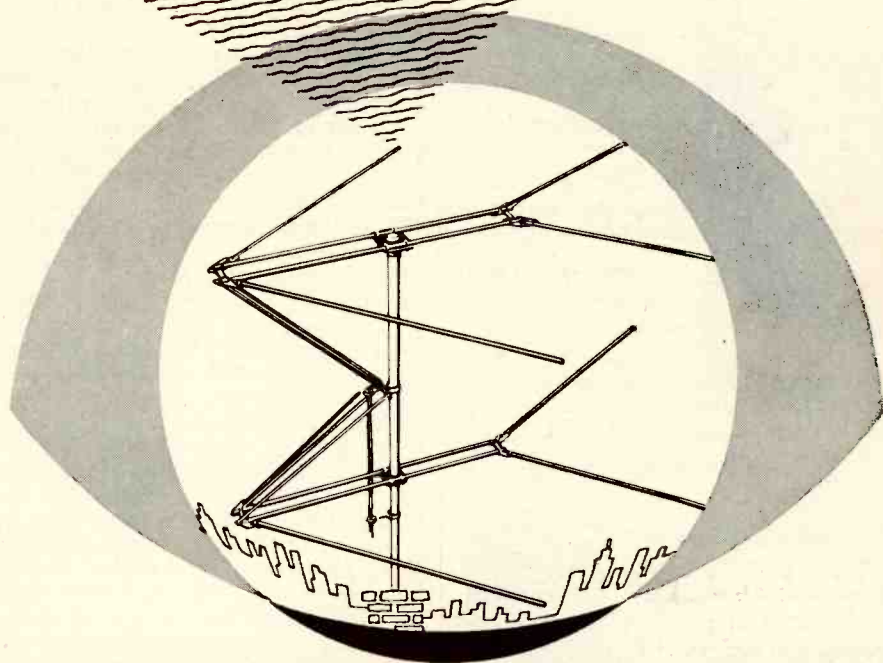

WORKSHOP

DUBL-VEE TV ANTENNA

PATENT PENDING

By applying the proven "end-fire" principle to TV antennas the WORKSHOP DUBL-VEE set the pace for 1950. Its quick acceptance — over 80,000 installed in three short months — is a testimonial to WORKSHOP'S acknowledged leadership in antenna design and engineering.

The DUBL-VEE is typical of WORKSHOP antennas in other fields — commercial, amateur and aircraft. In every instance, advanced engineering and outstanding performance have established ready acceptance. You know when you specify the DUBL-VEE, or any other WORKSHOP antenna, that you are getting the best.

Write for Bulletin A



THE WORKSHOP ASSOCIATES, Inc.

135 CRESCENT ROAD, NEEDHAM 94, MASSACHUSETTS

RADIO HANDBOOK

Greater Than Ever
In TWO EDITIONS

ELEVENTH EDITION



- Theoretical
- Reference
- Constructional

The STANDARD work on all aspects of radio communication.

ALL NEW MATERIAL; none repeated from prior editions.

\$3.00

By mail: \$3.25. Foreign, \$3.50.
(Add sales tax in California)

TWELFTH EDITION

- All-constructional

A wealth of information on construction of radio communication equipment. Practical how-to-build-it data. ALL BRAND NEW—all different from prior editions. More than ever before shown in a single book.



BOTH these top-notch books are a necessity for everyone interested in radio communication. There is no overlap in coverage; each is a perfect companion to the other.

\$3.00

By mail: \$3.25. Foreign, \$3.50.
(Add sales tax in California)



BETTER TV RECEPTION

THE "Fringe Area TV" Reference Book.

By W. W. Smith and R. L. Dawley

TV signal propagation, evaluation of TV antenna, making a TV signal survey, types of masts and towers and recommended installation practices. Full data on rhombics, how to use open-wire feed line, how to eliminate ghosts, minimizing fading, TVI, etc.

AT YOUR DEALER — On mail orders from us, \$2.60 postpaid. Add sales tax in California.

\$2.50

ANTENNA MANUAL

The most practical, comprehensive book on antennas. 300 pages of down-to-earth help on antenna, feed line, radiation and propagation for all frequencies up to 1000 Mc. including FM and TV. Plain language; no need to brush up on math. A necessity for everyone interested in transmission or reception.

\$3.50

AT YOUR DEALER — On mail orders from us, \$3.60 postpaid. Add tax in Cal. Foreign, \$3.75

AT YOUR FAVORITE DEALER

OR DIRECT BY MAIL FROM

Editors and Engineers

1302 KENWOOD ROAD, SANTA BARBARA, CALIFORNIA

The hearings were also sparked by a blistering exchange between consulting engineer Paul A. DeMars and Plotkin, as well as Commissioner Webster, when DeMars questioned the qualifications of K. A. Norton, the Bureau of Standards' propagation specialist, whose advice had been sought by the Commission on several occasions. DeMars said that Norton had not only erred in many instances, but reversed his opinions. Norton's statement of 1944 was cited as one illustration. At that time, according to DeMars, Norton said that the very-high stations at high power operating on 80 megacycles, in such places as South America and Australia, during times of high sun-spot activity would interfere with the TV and FM stations in this country. When queried in '47 during another proceeding by Major Armstrong, whether the frequency of 80 megacycles was correct, Norton was said to have admitted that he was wrong and that 40 megacycles should have been specified. Several other instances during which Norton changed his mind were cited by DeMars who declared that . . . "here is a man who has contradicted himself." In his opinion this was a serious affair which tends to "cast serious doubts" about his abilities. Quizzed on this serious charge by Commissioner Webster and asked specifically whether Norton should be disbarred from appearing before the Commission, DeMars replied that the answer could be yes, insofar as the subject of propagations is concerned. Plotkin then asked DeMars if honest admission of an error could disqualify one as an expert, and the consulting engineer replied it all depended on the number of times such mistakes might be made. When the word battle ended, Plotkin said that . . . "Nothing has been shown in any way which impairs the qualifications of . . . K. A. Norton."

As the barrage of testimony continued to accumulate, it looked as if the record set during the color marathon of speeches might be seriously challenged. In any event, it was felt that the hearings would last and last, and '51 would see many phases of the subject still to be covered.

WHILE WASHINGTON BRISTLED with problems of TV and Federal jurists deliberated on the finality of the Commission's decision on color, the FCC became a target of hostile criticism, with the members being hounded for answers to an endless parade of questions from everyone on the buying or selling fronts.

An eloquent answer to the mountainous task which faces the ether guardians was provided by Commissioner E. M. Webster, in an address before the Kansas City section of the IRE. Explaining the important phases of the policy-making processes involved during a hearing, and particularly during the recent color session, Webster said: "As an engineer, I was expected to have an opinion as to the

technical competence of the various color television systems that were presented to the Commission. My role in the final decision, however, went beyond evaluating the system from solely the technical viewpoint. For instance, consideration of the economic impact of a new system on the several million persons in this country who now own black and white television sets had to be balanced against the 40-million potential new set owners and the ability of the television manufacturing industry to meet the needs of both groups. It was also essential for me to consider legal limitations under the Communications Act, our responsibilities to the Congress and interests of military, industrial, and other specialized groups, before our decision could be crystallized. All of this and the weight to be given to each element enters into the determination as to what constitutes—"public interest, convenience and necessity."

Discussing the problems of personal issues involving integrity of engineers which were so prevalent during the hearings and continue to be in the present channel sessions, Webster said that . . . "when personal biases or prejudices of one sort or another are thrown into a situation only havoc, resulting in the gravest consequences can result. This fact was forcefully brought to my mind while I was listening to engineering testimony during the recent color television hearing. An attorney for one of the major broadcasting interests attacked the integrity of the engineer who was then testifying. This radio engineer is a fellow of the IRE and a highly respected member of our profession. While the attack did not appear to me to have succeeded, I was somewhat shaken by the fact that the attorney had made the effort. I realized then, as at no other time, that engineers who are called upon to represent private interests must be doubly careful to maintain their integrity, so that they do not subject themselves to a valid claim that they are selling out on their profession. The Commission, which is so dependent upon the advice of private radio engineers, must have complete confidence that the information it is receiving from them is thoroughly reliable; otherwise we will fail in our duty to render decisions in the public interest."

THE SINCERE INTEREST which the Commissioners have in rendering decisions was also aptly described by Madame Commissioner Frieda Hen-nock before the New York Women's Advertising Club. Pointing out that of the possible 2000 new stations that might be assigned in the new upstairs band, she was urging that twenty-five per-cent should be reserved for the use of educators for non-commercial and non-profit broadcasting. In Miss Hen-nock's opinion educators . . . "cannot overlook or ignore television . . . for TV is here to stay just as surely as the electric light, automobile, or airplane."

She felt that the potentialities of visual education by way of TV offer new and almost unlimited horizons to teachers. Television channels assigned to educators will be an investment in the future of America, culturally as well as commercially, she emphasized.

In a prior talk before the National Association of Women Lawyers in Washington, Miss Hennock also hammered away at the obligations which she felt she had to meet as a member of the Commission. Disclosing that, in fulfilling the statutory mandate under the Communications Act to study . . . "new uses for radio, provide for experimental uses of frequencies, and generally encourage the larger and more effective use of radio in the public interest . . ." the Commission has a duty to look into the future. "Accordingly," she said, "we . . . cannot be content with what is here today, but we must look to see what may be tomorrow, what new developments radio may bring which may make us more secure, more happy, and more comfortable."

Explaining that the Commission's role is not merely a technical one, Miss Hennock said that Congress has been quite explicit in defining the function of the body, to see to it . . . "that the use of the valuable domain of the airwaves, the property of the people of the United States, shall be in the public interest, which means nothing more or less than that it shall be for the benefit of the people of the United States."

Citing that the burden for the . . . "improvement of the quality of America's broadcasting lies squarely on the shoulders of the public and the broadcasters," Miss Hennock declared that every citizen must take broadcasting seriously. She felt that none of us can ignore broadcasting . . . for it will . . . "in any event have a great effect on our lives and futures of us all."

Her comments at these two meetings were particularly interesting in view of her opinions on the color decision which called for a delay in final action until June 30 of '51, when she felt that all proponents would have had an opportunity to display what they might have to offer to meet the criteria established by the Commission. Hastening the ruling and demanding that a decision must be made now, did not, in her opinion, provide for a fulfillment of the obligation to encourage the larger and more effective use of radio in the public interest, as cited in the Act.

TEXAS has received the first grant for a reactivated State Guard Radio Service providing for the use of twenty base stations and seventy-two mobile units, operating on 2726 kilocycles. The State Guard, distinctive from the National Guard, has established communications headquarters at San Antonio and will begin an active training public-safety program. Congratulations to the alert radiomen of the Lone Star State. . . . L.W.

AMAZING RECORD SMASHING VALUES!

1949 and 1950 FORD AUTO RADIOS



List Price \$54.95

1949 and 1950 PLYMOUTH-DODGE RADIOS

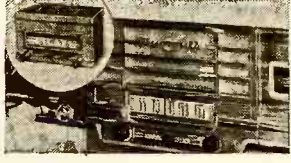

List Price \$54.95

1949 and 1950 CHEVROLET RADIOS



List Price \$54.95

ATTRACTIVE DISCOUNTS TO DEALERS

Each auto radio is specifically designed to fit all 1949 and 1950 cars shown above and all incorporate the same outstanding features. . . . Six-tube superheterodyne. Six-volt storage battery operation. Two dual-purpose tubes. Eight-tube performance. Installation in a few minutes. Three-gang tuning condenser and tuned R.F. stage for extreme sensitivity. Permanent magnet dynamic speaker with Powerful Alnico #5 magnet. Low battery drain. Weight 10 lbs.

SPECIALS

- R5/ARN-7 Radio Compass Receiver w/tubes. Used, excel. cond. \$34.95
- BC-433G Radio Compass Receiver w/tubes. Used, excel. cond. \$34.95
- Gibson Girl Distress Transmitter, complete with bag and parachute. New. . . \$8.95
- Gibson Girl Kit includes 2 balloons w/hydro. generators, kite, lamp, wire. New. \$8.95

CAPACITORS

UPRIGHT MOUNT

	EA.	TEN
2X.25MFD	400 VDC	.30 \$.25
.5MFD	400 VDC	.30 .25
1MFD	500 VDC	.35 .30
2X.05MFD	600 VDC	.30 .25
.25MFD	600 VDC	.30 .25
2X.1MFD	600 VDC	.35 .30
.1MFD	600 VDC	.35 .30
.5MFD	600 VDC	.35 .30
1MFD	600 VDC	.35 .30

BATTIUB

40MFD	25 VDC	.35 \$.30
4MFD	25 VDC	.35 .30
50MFD	50 VDC	.45 .40
4MFD	100 VDC	.45 .40
2X.1MFD	200 VDC	.20 .25
3X.1MFD	400 VDC	.30 .25
2MFD	400 VDC	.45 .40
.05MFD	600 VDC	.30 .25
.5MFD	600 VDC	.30 .25
.1MFD	600 VDC	.30 .25
1MFD	600 VDC	.30 .25
2MFD	600 VDC	.50 .45
2X.1MFD	600 VDC	.50 .45
10MFD	1000 VDC	.65 .60
2X.1MFD	1000 VDC	.65 .60

OIL FILLED AND GE PYRANOL

.5 MFD	400 VDC	.35 \$.30
1MFD	500 VDC	.35 .30
1MFD	500 VDC	.35 .30
2MFD	600 VDC	.40 .35
4MFD	600 VDC	.80 .75
5MFD	600 VDC	.85 .80
8MFD	600 VDC	1.10 1.00
1-8MFD	600 VDC	1.45 1.35
10MFD	600 VDC	1.25 1.20
.5MFD	1000 VDC	.50 .45
2MFD	1000 VDC	.60 .55
5MFD	1000 VDC	1.45 1.40
.25MFD	3000 VDC	1.95 1.75
.5MFD	3000 VDC	2.25 2.00
1MFD	3000 VDC	2.60 2.50
1MFD	7500 VDC	9.50 9.00
.1MFD	12,000 VDC	12.95 12.00
.006MFD	15,000 VDC	1.50 1.25
.045MFD	18,000 VDC	5.95 5.65

PAPER

8-8MFD	600 VDC	\$1.45 \$1.25
.06MFD	Tube Hermetic	
3X8MFD	600 VDC	\$1.75 \$1.45
8-8-4MFD	650 VDC	1.75 1.45
160-160MFD	150 VDC	1.50 1.25

ELECTROLYTICS

2500MFD	3 VDC	\$.20 \$.15
500MFD	12 VDC	.25 .20
25MFD	25 VDC	.25 .20
50MFD	25 VDC	.30 .25
100MFD	25 VDC	.55 .50
150MFD	50 VDC	.30 .25

TRANSMITTING MICA

.002MFD	600 VDC	\$.20
.005MFD	2500 VDC	.25
.0035MFD	2500 VDC	.25
.006MFD	2000 VDC	.30
.00075MFD	5000 VDC	.40
.000375MFD	5000 VDC	.90
.003MFD	5000 VDC	1.80
.0015MFD	5000 VDC	3.60
.001MFD	5000 VDC	5.40
.0037MFD	5000 VDC	4.10
.006MFD	5000 VDC	8.20
.0012MFD	20,000 VDC	19.95

CERAMIC ROTARY SWITCHES

Pole Position	Section	Shaft	Eq.	Price
1	3	6	1/8"	\$0.40
2	4	4	1/8"	.40
2	8	2	30A9KVA flashover	.45
2	8	2	30A9KVA flashover	2.50

The ONLY . . . "SELF-CHARGING" Portable



RECHARGES the "B" Battery
Features: Battery AC-DC-Battery
Charger Operation
5 Tubes Plus Rectifier • 3 Gang
Condenser • Tuned RF Stage

List Price . . . \$39.95 Batteries

TUBES

2C34 \$.35	1629 \$.30
2X2A70	205175
2X2/87960	719330
802A75	8011 2.40
7C4/1203A40	900650
10Y35	CSB 9.75
21140	CEA72 1.40
15R75	CK-70 3.50
39/74425	CRP-72 1.40
45 SPEC.75	E114830
203A 5.95	HY-61540
218 10.00	RKR-7275
316A75	RK-7375
WL-531 4.95	VT-127A 2.00
702B 2.50	VT-98 21.00
713A75	3BF1 3.45
801A40	5B14 4.25
803 4.25	5FP7 1.95
82675	116G75
83A 3.60	3A450
86445	6SG785
882B 23.45	6S765
CK100535	6Y6G95
CK100790	12SN7GT75
162840	3365

Linear POTENTIOMETERS WW

Ohms	Watts	Mfg'r	Eq.	Price
200	2	Chicago Tel.	\$0.30	\$0.25
1000	2	Trefz	30	25
3000	2	Chicago Tel.	30	25
10,000	2	Chicago Tel.	35	30
5000	3	Trefz	30	25
7500	3	Trefz	35	30
10,000	3	Trefz	35	30
25,000	3	Wirt	35	30
50,000	4	Trefz	50	45
15	25	Dejur	65	60
20	25	Ohmite	65	60
25	25	Dejur	65	60
50	25	Dejur	65	60
25	15	IRC	65	60
200	25	Dejur	65	60
500	25	Dejur	65	60
1000	25	Dejur	65	60
3000	25	Dejur	65	60
5000	25	Dejur	65	60
10,000	25	Dejur	65	60
15,000	25	Dejur	65	60
20,000	25	Dejur	65	60
150/5witch	50	AN3155-50	1.10	.90
200/W Switch	50	IRC	1.10	.90
800	50	Ohmite	1.10	.95
10,000	50	Dejur	1.75	1.50
15	60	Ohmite	1.50	1.25
15	75	IRC	1.50	1.25
750	150	Ohmite	2.45	2.10

ROUND PANEL METERS

0-5 RF Amps—Weston	3 1/4"	\$4.50
0-300 MA DC—Simpson	2 1/4"	3.75
0-300 MA DC—Weston	2 1/4"	3.75
5-0-5 MA DC—Weston with 50 MA Shunt	3 1/4"	4.25
0-50 Amps DC—Weston	3 1/4"	4.75
0-100 Amps DC—Hoyt	3"	3.50
0-3 Volts DC—Sun	2 1/4"	1.95
0-15 Volts AC—GE	3 1/4"	4.95
0-2500 Volts DC—Simpson with Multiplier	3 1/4"	5.95
0-5KVDC 0-10 MA DC	3 1/4"	5.50
0-150 Volts DC—Hoyt	3 1/4"	3.50
10-0-4 6DB—Weston	2 1/4"	4.50

PORTABLE METERS

0-10 Amps DC—Weston	489	7.50
0-3-6-30 Volts DC—Weston	280	17.50
0-100 Amp DC—Weston with 100 Amp Shunt	269	19.95
0-25 Amps AC—Weston	433	29.95
0-1.5-5 Volts AC Output-meter—Weston	571	12.00

TIME DELAY SWITCHES

1 Minute 115VAC 60CY Enc. in Waterproof Metal Case. New. \$5.25
3 Micro Switches Make Contact at 40-41-42 Sec. Time Delay 110 VAC Motor New \$4.00
Thermo Switch 50° to 300° F. 115 VAC @ 6A. 230 VAC @ 5A Breaks Contact with Increase of Temperature. New. \$1.35
30-40 Second Mercury Time Delay Relay 110 VAC Adlake. New \$6.50

POWER EQUIPMENT

Voltage Regulator Raytheon 95/130 V 60CY 25 Amp Output 15V 60 Watt. New \$12.50
Generator Voltage Regulator 115V 400CY GE—GEA—200C. New \$14.95
Vibrapak VPG 369 12VDC Output 250V @ 70MA Synchronous Motor. New \$4.00
AT-1 Inverter and Regulator 110VDC to 110VAC 50/60 Cy 100 Watt Model RSB. New \$19.95

RELAYS

6 VDC DPST Contacts 6A Coil	33 Ohms	\$1.15
12 VDC DPST Allied Control	# Box 32	1.25
12 VDC DPST 64 Ohms	24 VDC DPST 64 Ohms	.60
24 VDC SPDT 8 Amp	24 VDC Solenoid Operates 2	.95
40 VDC DPST—SPDT 1000 Ohm	110 VAC DPST 1 Amp Contacts Str'th's Dunn CXA 1970	3.65
110 VAC DPDT 25 Amp Contacts Ward Leonard	115 VAC DPST Str'th's Dunn CXA-2997	3.65
220 VDC DPDT Str'th's Dunn CX2122		4.50

RECORDER — REPRODUCER

Sound-on-Film Hartron Recorder Reproduces #A-30 with Crystal Mike, Accs.—Inst. Book—Plays Back Immediately. No Processing of Film Required. Brand New. \$170.00
MN-28V Radio Compass Recorder. New. \$39.95

SPECIALS

80-86 KC Crystal with Holder	\$1.50
CD-501A Cord Connects BC Transceiver to GN-45 Gen with Hydrogen Gen	1.59
Balloon with Kitegen Gen	2.50
Gibson Girl Box Kite 7 1/2" x 17" x 36"	2.25
33-440 MMF Variable Condenser	.75
Micro Second Delay Line 15 KV 400 Cy 0hm. New.	\$14.95

TERMS: Minimum order \$5.00—Mail orders promptly filled—All prices F.O.B. Boston, Mass. Send M.O. or check. Shipping charges sent C.O.D. 25% deposit required with all C.O.D. orders.

COMET ELECTRONIC SALES CO.

22 Washington St. Brighton 35, Mass.
Beacon 2-7863

1951 BARGAINS

6 HV 70 MA CHOKES 2 for.....	\$0.99
12 HV 180 MA CHOKES \$1.25 ea., 2 for.....	1.98
110 V 60 CY-700 VCT 150 MA, 5 V 3A, 2.5 V 10A.....	2.95
110 V 60 CY-6.3 V 4A, 6.3 V 4A.....	2.95
110 V 60 CY-6.3 V 1.2A 2 for.....	1.59
110 V 60 CY-6.3 V 1.2A 2 for.....	1.59
50LA Con. V. Trans 115 V 50 CY, Out. 115 V 120 VA.....	19.95
ART 713 Mod. Trans FP 811 to 813.....	9.95
UTC Converter Type 04 Sing. Plate to Grid.....	4.95
Beachmaster Output Transformer, 250W.....	9.95
Wagge Tube Heaters, 110 V 100 W, 2 5/16" ID, 2 for.....	3.90
IBC 50K 100W fixed, 2.5K 100W ADJ., Pr. Counter Type Instrument Dial, 3"x3", 1/4" to 1/2" Shaft, 3 Digit Counter.....	1.40
.1MF 600 V Metal Cased Oil Tub. Cap. . . . 10/.....	1.99
Aerovox Type 484 .5MF 400 V Tube Cap. 10/.....	2.50
Four Quadrant Phasing Capacitor.....	3.50
CH Luminous Tip Bat Handle Aircraft Togr. SW., SPDT, 5A 125 V 10 for.....	1.98
5 Way Binding Post, Red or Black.....ea.	.40
100KC Precision Crystal.....	5.95
1000KC xtal \$3.95; 5 Mc xtal.....	3.50
Pot.-Brom. Type SP Relay, 6 VAC DPST.....	1.95
Cramer Time Delay Relay 120 Sec. 12 VAC.....	6.95
APN-1 Altimeter Transceiver, New.....	17.50
RB9/ARN5 Receiver, New.....	29.50
BC221 Freq. Meters, excellent cond.....	79.50

METER SPECIALS

RD 3 1/2" O-20 ua (O-100 Scale) WH.....	\$14.50
SQ 3 1/2" O-20 ua DC.....	6.50
RD 3 1/2" O-5 MA (SP Scale).....	2.75
SQ 2 1/2" O-9 VDC.....	.99
SQ 2 1/2" O-100 AMP DC with shunt.....	.99

3" METERS

0-50 ua.....	\$14.50	0-50 AMP AC WH.....	\$5.95
100-0-100 ua.....	8.95	0-75 AMP AC Trip.....	5.95
0-500 ua OE.....	6.95	JBT 31-F PR.MTR.....	7.95
0-1 MA S Scale.....	3.95		
0-1 MA DC.....	2.95		
0-5 MA SP Scale.....	2.95		
0-15 MA DC GE.....	4.50		
0-20 MA DC WH.....	4.50		
0-30 MA DC GE.....	4.50		
0-50 MA DC WH.....	4.50		
0-80 MA DC WE.....	6.00		
0-100 MA DC.....	4.50		
0-150 MA DC WH.....	4.50		
0-200 MA DC GE.....	4.50		
0-300 MA DC.....	4.50		
0-500 MA DC.....	4.50		
0-1 AMP DC WH.....	4.95		
0-2 AMP DC Trip.....	6.95		
0-300 VDC Sun.....	7.95		
0-750 VDC.....	7.95		
0-8 VAC WES 476.....	8.50		
0-15 VAC GE.....	4.50		
-10-+5 DB WES.....	10.95		
501.....	10.95		
0-150 VAC WH.....	5.95		
30-0-30 AMP DC.....	5.95		

2" METERS

0-500 ua SP Scale.....	\$3.95
0-1 MA DC SUN.....	3.85
0-50 MA DC WH.....	3.50
0-5 MA SP Scale.....	2.49
0-800 MA DC.....	3.25
0-30 "D" and shunt.....	4.95
0-20 MA SP Scale.....	2.49
0-50 MA DC.....	2.49
0-25 MA SP Scale.....	3.50
0-500 MA DC.....	2.95
0-3 VDC, 1 MA.....	3.50
0-5 VDC.....	3.50
0-30 VDC.....	3.50
0-30 AMP DC.....	3.50
0-8 VAC GE.....	4.95
0-300 VAC.....	4.95
0-1 AMP RF GE.....	3.50
0-1 AMP RF GE.....	3.50
0-4 AMP RF GE.....	3.50
0-9 AMP RF WH.....	3.50

CO-AXIAL RELAY

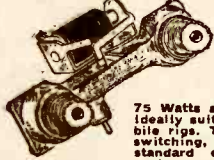

Allied Control type RA, SPDT, 6VDC operated. Designed to handle a maximum of 75 Watts at 150 mc. Ideally suited for mobile apps., TV antenna switching, etc. Uses standard co-ax connectors.

\$3.95 Each

Set of 83-1SP Co-ax connectors for above \$0.99

CHOKES

200 HY 6MA 620 OHM, Cased.....	\$ 0.99
8 HY 50 MA 240 OHM.....	.59
10 HY 80 MA 240 OHM.....	.89
7 HY 125 MA 200 OHM, Cased, \$1.10 ea.....	2.00
10 HY 150 MA 140 OHM.....	1.59
7 HY 200MA 100 OHM, Cased.....	3.49
4-16 HY 200 MA 140 OHM Swinging CH.....	4.25
3 HY 250 MA 15 OHM Herm. Seal.....	1.25
15 HY 250 MA 80 OHM, Cased.....	3.49
3-14 HY 300 MA 80 OHM Swinging CH.....	6.20
6 HY 300 MA 85 OHM, Cased.....	6.10
6 HY 300 MA 80 OHM, Cased.....	6.10
6 HY 350 MA 72 OHM, Cased.....	5.50
4 HY 400 MA 100 OHM, Cased.....	5.95
4 HY 450 MA 80 OHM, Cased.....	6.50
7 HY 750 MA 40 OHM, Cased.....	11.50

115V FILAMENT TRANSFORMERS 60 CY

2.5 VCT 10 A, 10KV Insulation.....	\$3.95
2.5 V @ 6 Amp, 2.5 V @ 6 Amp.....	3.45
5 VCT 3A, 2.5 KV Insulation.....	2.35
5 V 20 A, 2.5 KV Insulation.....	6.25
6.3 V 1.2 A.....	.85
6.3 V 3 Amps.....	2.14
6.3 V 12 Amps.....	3.95
6.3 V 3 Amps, 6.3V 3 Amps.....	3.75
6.3 V 3.5 A, 2 x 2.5 V 3 Amps ea.....	3.95
6.3 V 3A, 2.5 V 6 Amp Herm. Seal.....	3.49
10 VCT 10 A, 2.5 KV Insulation.....	5.55
10 V 5A.....	3.45
6.3 V 12A, 6.3 V 2 A Herm Seal.....	4.50

115 V POWER TRANSFORMERS 60 CY

700 VCT 90 MA, 6.3V 4A, 5V 3A.....	\$ 3.50
700 VCT 125 MA, 6.3V 3A, 5V 3A.....	2.49
700 VCT 150 MA, 5V 3A.....	2.95
610 VCT 180 MA, 6.3V 3A, 5V 3A.....	4.50
800 VCT 200 MA, 6.3V 4A, 5V 3A.....	6.50
800 VCT 300 MA, 6.3V 10.8A, 5V 6A, 5V 2A.....	9.50
750-600-0-600-750 225 MA.....	8.95
3200 VCT 450 MA.....	24.50
115 V, 230 V TAP, PRI.-850 VCT 280 MA -36V 7A-6.3V 3A-3V 3A, Cased.....	12.50

OIL CAPACITORS

7 MF 330 VAC.....	\$0.95	25 MF 2000 VDC.....	\$1.95
5 MF 600 VDC.....	.45	1 MF 2000 VDC.....	2.10
2 MF 600 VDC.....	.79	2 MF 2000 VDC.....	2.75
4 MF 600 VDC.....	.99	4 MF 2000 VDC.....	2.95
6 MF 600 VDC.....	1.05	8 MF 2000 VDC.....	5.95
10 MF 600 VDC.....	1.75	5 MF 2500 VDC.....	1.39
2 MF 1000 VDC.....	.90	25 MF 3000 VDC.....	2.25
5 MF 1000 VDC.....	1.79	5 MF 3000 VDC.....	1.49
10 MF 1KV DC.....	2.75	4 MF 3000 VDC.....	8.95
15 MF 1KV DC.....	3.95	3 MF 4000 VDC.....	5.95
2 MF 1.5 KV DC.....	1.45	1 MF 5000 VDC.....	8.50
4 MF 1.5 KV DC.....	2.49	2 MF 5000 VDC.....	8.95
6 MF 1.5 KV DC.....	2.95	4 MF 5000 VDC.....	13.50
1 MF 2000 VDC.....	1.79	1 MF 7500 VDC.....	1.25

TERMS: 25% Deposit with order, balance C.O.D. Rated firms open account

POLY-TECH

919 Dawson St., New York 59, N. Y.
Tel. Murray Hill 6-2650

NEW TV PRODUCTS on the Market

THE "MARKA-SWEEP"

Kay Electric Company of Pine Brook, New Jersey has recently introduced a new all-electronic i.f. sweep and



marker generator designed especially for the production alignment of TV receiver i.f. systems.

Designated the "Marka-Sweep," Model IF, a three-position switch in the unit selects the 20-30, 30-40, or 40-50 mc. range with overlap. The sweep width is approximately 15 mc. All carriers are oscillator fundamentals. The instrument produces a true zero amplitude reference baseline on the oscilloscope display. The output level may be varied between approximately 50 microvolts and 250 millivolts across the 70 ohm unbalanced output. A panel switch narrows the sweep and recenters it to make it suitable for sound channel measurements.

Provisions are made for simultaneous injection of picture carrier, resulting in a 4.5 mc. swept signal at the second detector which is suitable for aligning intercarrier receiver sound channels. Up to nine extremely narrow crystal-positioned, pi-type markers are available at i.f. frequencies specified by the customer. There is an individual "on-off" control for each of the nine marks.

TV MICROPHONE

The RCA Engineering Products Department has developed and is currently marketing a new ribbon-



pressure microphone which has been designed especially for the television industry.

The "Starmaker" is a slender and unobtrusive microphone which will not hide the faces of singers, speakers,

or others using it. The 15 ounce mike is inconspicuous not only because of its size and shape but because of its special "TV gray" finish which makes it appear to fade into studio backgrounds or blend with the clothing of entertainers.

The Type BK-4A is suited for sound reinforcement and radio broadcast pickup, and has an output comparable to larger conventional studio microphones. It has an output of 110 μ v. per dyne/sq. cm. for an output impedance, in accordance with RTMA standards, of 30, 150, and 250 ohms. The microphone is non-directional and provides uniform frequency response between 50 and 15,000 cycles. Its effective output level at 1000 cycles is -50 dbm. Special transformer design results in a low hum pickup level of -125 dbm.

G-E SERVICE PARTS

General Electric Company of Syracuse, New York has announced a com-



plete line of television receiver parts, applicable to G-E and many other receiver makes.

The new line includes 70 degree deflection yokes for magnetic deflection circuits, horizontal sweep output and high voltage transformers, and other components such as EM-PM focus coils, width and linearity controls, ion trap magnets, etc.

A new catalogue which gives a complete description of the various components may be obtained from the Parts Section of the company's Receiver Division.

BRACH ANTENNA

The Brach Manufacturing Corporation of 200 Central Avenue, Newark, New Jersey has developed a new television antenna known as the "Bow-Tie V Antenna."

The new Model No. 452 antenna does not require directors or reflec-

tors. It is a closed circuit "V" antenna in which three antenna rods of the same electrical length emanate from each side of a non-hygroscopic insulator and joined at the ends by means of shorting bars. The shorting bars provide more surface area and raise the gain of the antenna, proportionately higher than would the adaption of directors or reflectors, especially on the upper channels, according to the company.

As there are no free vibrating elements and the antenna uses seamless tubing and a high impact insulator the new antenna is said to be able to withstand virtually all wind velocities and ice loading conditions.

LIGHTNING ARRESTER

LaPointe-Pluscomold Corporation of Unionville, Conn. is now constructing

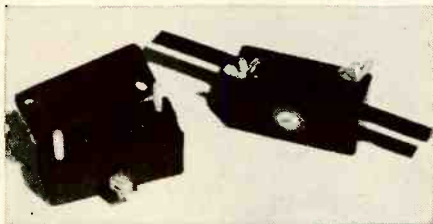

its "Vee-D-X" four-wire lightning arrester of a high dielectric, double phenolic material.

The new RW-204 arrester is designed for installation in accordance with the National Electric Code and is also approved by Underwriters' Laboratories. The unit will accommodate four-wire rotator line as well as the regular 300 ohm transmission line.

ANTENNA HOIST

The Haugen Mfg. Co., 412 S. Front Street, Mankato, Minnesota, has developed a unique television mast and tower hoist which will erect and lower towers up to fifty feet in height.

The new "Jiffy-up" unit permits one man to make the antenna installation on any type of rooftop. The base, which is permanently installed on the roof, is especially designed so that the mast hoist can be easily attached for raising or lowering the mast or tower. The base is extra heavy in construction, will work on any type of roof, and will accommodate large masts. The installer needs one hoist for all of his installation work and a base unit for each installation.

Descriptive literature on the new hoist is available from the company.

7-INCH SCOPE

A new 7" cathode-ray oscilloscope, especially designed for general use in radio and television receiver testing and in laboratory and production applications, has been announced by the Radio Tube Division of Sylvania Electric Products Inc. of 1740 Broadway, New York 19, New York.

The new instrument incorporates a multivibrator sweep circuit for linear internal sweep from 10 to 30,000 cycles which may be synchronized to 60 cycles, an external signal, or signal ap-



The PROFIT-WISE
Serviceman Specifies . . .

New

STANCOR PRODUCTS

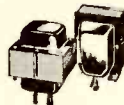

8400
POWER
SERIES

A comprehensive line of 35 part numbers designed for replacement and new construction. Wide range of applications based on a thorough study of today's power transformer needs. Most ratings available in a choice of vertical or horizontal mountings.



OUTDOOR LINE
TO VOICE
COIL

Two new units designed to fit most needed outdoor applications. Primary impedances of 3,000/2,000/1,500/-1,000/500 ohms; secondary impedances of 16/8/4 ohms. Part Number A-3333 rated at 14 watts. A-3334 rated at 25 watts.

STANCOR TRANSFORMERS

Using Stancor replacement transformers for your radio, TV and sound service jobs is the sure way to fatten your bank account. Here's why —

- Quality comes first with Stancor. Ability to "take it" cuts down call-backs—keeps your customers happy with a good job.
- Stancor has the largest line in the industry. A choice of 450 part numbers, in some 30 mounting and terminal styles, enables you to get exactly the right unit for almost any application.
- Easy-to-read instruction sheets and clearly marked terminals make your job quicker and easier. Saves valuable shop time.

New Stancor units are coming out all the time. Keep posted. Ask your Stancor distributor for our latest catalogs.



Most Complete Line in the Industry

STANDARD TRANSFORMER CORPORATION 3584 ELSTON AVE., CHICAGO 18, ILL.

Acclaimed by All — BRADLEY Coin-Operated Radios!

An attractive, serviceable night-table—perfect reception—fool proof coin mechanism—accessible coin box—trouble-free timer and chassis—rapidly retire investment. "BRADLEY" has incorporated ALL these desirable features in One Radio! Exclusive Territories Available—DISTRIBUTORS WANTED! List Price (F.O.B. Chicago) Model 150-1 **\$74.50**

- Guaranteed 90 days
- Finish—Lined Oak
- H—24", W—15", D—13"
- Super-Heterodyne
- Separate locks & keys for Cabinet & Cash Box
- R.C.A. Licensed
- Timer—Int'l Register Co.
- Built-in Antenna
- 2 hrs. "Quarter" play—Other timings

Order Today!

BRADLEY Associates

1650 N. Damen Ave.

Write for
Quantity Prices!

Chicago 47, Ill.



COMMERCIAL SURPLUS SPECIALS

DRY ELECTROLYTIC CAPACITORS POPULAR SERVICE TYPES

Type A. Hermetically sealed in aluminum tubes, cardboard cased—tinned copper leads—dual capacitors have common negative.

Type B. Constructed in strong cardboard tubes, impregnated under pressure—long insulated leads of U.L. approved wire out both ends. With mounting strap.

Cap. In MFD	WVDC	Type	Per ea.	Lots of 5 per ea.
10	25	A	\$0.29	\$0.26
25	25	A	.33	.30
100	25	A	.47	.42
10	50	A	.31	.28
50	50	A	.41	.37
100	50	A	.59	.53
8	150	A	.31	.28
20	150	A	.37	.33
30	150	A	.39	.35
40	150	A	.43	.39
50	150	A	.47	.42
150	150	A	.82	.74
20-20	150	A or B	.51	.46
30-20	150	A or B	.59	.53
40-20	150	A or B	.59	.53
40-40	150	A or B	.67	.60
50-30	150	A or B	.67	.60
50-50	150	A or B	.73	.66
40-30-20	150	B	.84	.76
30-20/20	150/25	B	.76	.69
40-30/20	150/25	B	.80	.72
50-50/20	150/25	B	.88	.79
20-20	150			
	(sep. neg.)	B	.78	.70
8	450	A	.37	.33
10	450	A	.41	.37
12	450	A	.45	.40
16	450	A	.53	.48
20	450	A	.59	.53
30	450	A	.65	.59
40	450	A	.78	.70
8-8	450	A	.67	.60
8	525	A	.51	.46
16	525	A	.78	.70

OUR ECONOMY LINE OF P.M. SPEAKERS

Save money on these brand new bulk packaged speakers. These are from set manufacturer's overstock. Every speaker fully guaranteed.

Size	Stk. No.	Magnet	Per ea.
3 1/2"	X17-3	.68	\$1.49
4"	X17-4	.68	1.49
5"	X17-5	.68	1.59
6"	X17-6A	1.47	1.99
8"	X17-8A	1.47	2.50
4" x 6"	X17-11	1.47	1.90

SPEAKER BAFFLES

A handsome, solidly constructed quality-built non-resonant speaker baffle covered with dark brown leatherette. Gold beading and plastic grill cloth add to the attractiveness.

Size	Stk. No.	Your cost
6"	WB-6	\$2.64
8"	WB-8	2.94
10"	WB-10	3.46
12"	WB-12	4.65

PHONO CARTRIDGE

Standard replacement cartridge for most standard mount Astatic, Shure, Webster, etc., cartridges. A regular \$3.75 seller.

Your cost \$1.75 ea. 10 for \$16.00
Stock No. RN-C10

G. E. VARIABLE RELUCTANCE CARTRIDGE

Standard cartridge for 78 R.P.M. records. Stylus pressure 12-14 grams. Output 15 MV at 1000 C.P.S. with replaceable .003" sapphire tip needle. \$9.95 list.

Stock No. RPX-040 Net \$2.50 ea.

TERMS: Cash with order or 25% on C.O.D. All shipments F.O.B. Chicago, Ill. All items subject prior sale. \$1.00 service charge on orders less than \$5.00. We reserve the right to limit quantities.

IRVING JOSEPH RADIO PARTS, INC.

215 South Halsted St., Chicago, Ill.

plied to its vertical input terminal. Balanced, non-astigmatic sweep is assured by push-pull deflection. Terminals are provided for direct connection to horizontal and vertical deflection plates and to the control grid of the cathode-ray tube for intensity modulation.

The vertical deflection amplifier provides a sensitivity of .1 volt r.m.s. for one inch peak-to-peak deflection, sine wave frequency response at full gain flat within 3 db. of 1000 cycles value from 7 to 70,000 cycles free of peaking and usable to much higher frequencies, and an input impedance of 1/2 megohm and 34 μfd.

Designated the Type 132Z oscilloscope, the new unit measures 17 1/16" high, 11 3/8" wide, and 17 3/4" deep and weighs 39 pounds. The sale of this new scope is being handled by the company's authorized distributors.

REPLACEMENT BALLASTS

JFD Manufacturing Co., Inc. of 6101 Sixteenth Avenue, Brooklyn 4, New York is currently offering its line of air-cooled TV ballast tubes as replacement items.

Employed as original components by several TV set manufacturers, the ballast tubes are available in seventeen different models. Heavy resistance elements and large insulating surfaces are designed to provide efficient operation. The black enameled shell is perforated for greater heat dissipation.

Further information and literature is available direct from the manufacturer, its representatives, and distributors.

"TENNA-SCOPE"

The Alliance Manufacturing Company of Alliance, Ohio has added a new TV booster to its line as a companion item to its "Tenna-Rotor."

Known as the "Tenna-Scope," the new unit is a booster which features a single tuning control for all channels, an automatic "on-off" switch which operates when the television set is turned on or off, high and low band



amplifiers on separate circuits, and each circuit designed to give maximum performance on its own channels.

The new booster uses a dual 6J6 with selenium rectifier. The unit is housed in a walnut plastic cabinet with a gold and maroon dial and comes

equipped with an 8 foot cord. The unit will match both 72 ohm and 300 ohm impedances.

Additional details on the new "Tenna-Scope" are available from the company.

TV SCREEN POLISH

The Jim Robbins Company of 1555 E. Eight Mile Road, Hazel Park, Michigan has begun the national distribution of a new polish designed specifically for cleaning the outer screens of television receivers.

Known as "TV Care," the new polish leaves the plastic tube protector clean,



scratch-free, and conditioned against many of the future scratching hazards. Investigation has shown that almost 90% of the scratching of such screens is due to the tiny dust particles, which are attracted to the plastics, being ground into the surface under the pressure of normal cleaning or wiping. These particles are negatively charged and cling to a positive static-charged screen.

The new polish uses a grounding agent to completely eliminate the static charge while another ingredient cleans the plastic surface. Thus, the plastic is left clean, scratch-free, and virtually dust-resistant by being conditioned against future recharging.

WALSCO "SIGNAL KING"

The Walter L. Schott Company of 9306 Santa Monica Blvd., Beverly Hills, Calif., has just announced the availability of a new television antenna, the Walasco "Signal King."

According to the company, the new unit is a universal antenna capable of receiving all channels. A special signal "director" has been added to improve gain on high band channels and eliminate ghosts. Ease of stacking makes the new antenna suitable for fringe area applications, in the opinion of the manufacturer.

Catalogue information on the new antenna is available from the company.

INPUTUNER

Mechanically and electrically designed for replacement of switch-type TV tuners, the new Series T3A Inputuner just introduced by the Electronic Parts Division of the Allen B.

Du Mont Laboratories, Inc. of East Paterson, New Jersey provides reception of FM as well as TV channels.

This new and improved continuous tuner is available to both jobbers and set manufacturers. It employs a Mal-lory-Ware three-section spiral Inductuner plus antenna tuning. The company claims that this combination provides good sensitivity and selectivity. The space required is identical with that of most leading switch-type tuners. Standard mounting holes further facilitate interchangeability. Electrically, the new Inputuner is designed to work into the i.f. system of TV receivers using a separate sound i.f. It is available with variations in the mixer plate network, making it adaptable, without alteration, to various types of separate sound i.f. receivers.

TWIN-DRIVEN ANTENNA

A new all-driven-element antenna has been announced by Technical Appliance Corporation of Sherburne, New York.

This new "Taco" antenna has been designated as the 1700 series and is known as the "Twin-Driven Corner Antenna." With all of the elements driven, the directivity of reception has been narrowed, thus minimizing ghosts caused by reflected signals. The front-to-back ratio is high. Both high and low band lobes coincide due to the phase relationship controlled through feeding.

Mechanically, the new unit offers low wind resistance and is rigid when assembled. Assembly is accomplished by means of the company's "Jiffy-Rig" type of construction. The antenna elements are merely swung into place and wing nuts tightened to prepare the antenna for installation.

These new units are available in single or stacked models depending on the requirements of the installation.

SWEEP GENERATOR

The Triplett Electrical Instrument Co. of Bluffton, Ohio has recently introduced a low-cost TV-FM sweep signal generator in response to the demand for accurate test equipment priced within the range of the average technician.

According to the company, any good AM signal generator can be used with the new unit as a marker thus making it possible for the service technician to reduce his investment in sweep signal generator equipment.

The Model 3435 provides continuous range coverage to 240 mc. for all TV carrier and i.f. frequencies. There is no gap in frequency and continuous tuning is provided over all of the TV and FM bands. The main frequency dial is marked with channels as well as frequencies.

The instrument features continuously variable sweep width, effective from 500 kc. to 12 mc., with "Off" position; phase controlled sweep voltage for scope horizontal input; and a standby switch for the temporary silencing of the generator during other work on equipment under test.

January, 1951

SEE LEO FIRST . . .

for hallicrafters!

HALLICRAFTERS SX-71 RECEIVER



Double Conversion sharp selectivity, plus built-in NBFM at moderate cost. 11 tubes plus voltage regulator and rectifier.

\$199.50

Low Down Payment

HALLICRAFTERS S-78 FM/AM CHASSIS

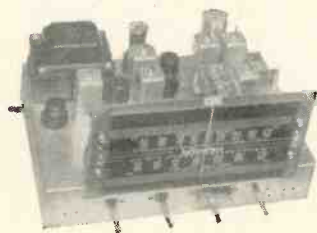

Superb broadcast performance for custom installations. 10 tubes, rectifier. 8 watt output. One RF, 21F.

Only **\$89.50**

Low Down Payment



WRITE FOR DETAILED SPECIFICATION EQUIPMENT SHEETS

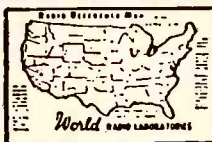

RADIO REFERENCE MAP
CU ON 10-20 & 75 METERS
Just right for your control room walls. Approximately 28" x 36". Contains time zones, amateur zones, monitoring stations. Mail coupon today and . . . **25c**

FREE

Send for the 1951 complete WRL Catalog containing everything new in radio and television. Deal with the "World's Most Personalized Radio Supply House."



PHONE 7795

WRITE—WIRE



WORLD RADIO LABORATORIES
744 West Broadway
Council Bluffs, Iowa

R-1

Please send me: SX-71 Info
 Radio Map S-78 Chassis Info
 New Catalog
 List of Guaranteed Used Equipment

Name

Address

City..... State.....

The February issue of **RADIO & TELEVISION NEWS** will be on sale January 30. Be sure to reserve your copy with your Newsdealer.

Greylock's NEW TELEVISION & ELECTRONIC CATALOG

Crammed full of

- Great Money-saving Values for YOU
- Bargains you can't afford to miss
- More than TWENTY Standard Brand lines of Merchandise

Write TODAY for your copy, to Dept. N-1

**GREYLOCK ELECTRONICS
SUPPLY CO.**

115 Liberty Street, New York 6, N. Y.

EASY TO LEARN CODE

It is easy to learn or increase speed with an Instructograph Code Teacher. Affords the quickest and most practical method yet developed. For beginners or advanced students. Available tapes from beginner's alphabet to typical messages on all subjects. Speed range 5 to 40 WPM. Always ready—no QRM.

ENDORSED BY THOUSANDS!

The Instructograph Code Teacher literally takes the place of an operator-instructor and enables anyone to learn and master code without further assistance. Thousands of successful operators have "acquired the code" with the Instructograph System. Write today for convenient rental and purchase plans.



INSTRUCTOGRAPH COMPANY

4711 SHERIDAN ROAD, CHICAGO 40, ILLINOIS

ATTENTION ALL ELECTRONIC- TELEVISION ENGINEERS

For more than 6 years RADIO-ELECTRONIC ENGINEERING, a special edition of RADIO & TELEVISION NEWS, has kept alert engineers dependably and thoroughly informed on all that's really important in electronic engineering.

Selected and exclusive articles and other specialized features of practical and lasting value to electronic engineers are added to the content of the regular edition of RADIO & TELEVISION NEWS.

Subscribers to the regular edition may change to the RADIO-ELECTRONIC ENGINEERING edition by remitting an extra dollar for each 6 months of the unfulfilled portion of their subscriptions.

New subscribers please use the lower half of order card in this issue.

The RADIO-ELECTRONIC ENGINEERING edition is available only by subscription.

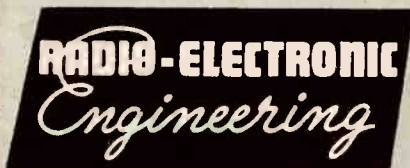

edition of
RADIO & TELEVISION NEWS
185 N. Wabash Ave.
Chicago 1, Ill.

The unit is copper-plated steel construction throughout. All critical circuits are inclosed and the power transformer is static shielded.

V.T.V.M. KIT

Approved Electronic Instrument Corp. of 142 Liberty Street, New York,



New York is currently offering a new v.t.v.m. kit, the Model A-220K.

Suitable for television servicing applications, the new instrument has 5 a.c. ranges and 5 d.c. ranges. 5 resist-

ance ranges cover from 0-100, and 0-10,000 ohms and 0-1, 0-10, and 0-1000 megohms.

The unit incorporates a balanced bridge circuit, a zero-center reading for FM-TV discriminator alignment, and has a d.c. input impedance of 26 megohms. The instrument uses three tubes, a 6IH6, a 6SN7 and a 6X6. The meter used is a 4½" 0-200 microampere unit with an open-face, non-glare calibrated meter scale. The meter circuit is "burn-out proof."

The power supply is 110-120 volts, 60 cycles and the power consumption is 15 watts. The power transformer is electrostatically shielded.

The kit comes complete with a heavy gauge steel cabinet in a battle-ship gray crackle finish, three standard brand tubes, all parts including the power supply, operating instructions, pictorial and circuit diagrams, and a guarantee.

Complete details are available from the company.

TV BOOSTER

Television Equipment Corporation of 238 William St., New York 7, has developed a new television booster which is said to be particularly effective in fringe areas.

AN INEXPENSIVE DIODE PROBE

By SAMUEL T. WALTON

SEARCHING for non-standard hardware to construct test equipment is, in general, a time-consuming process.

The main part needed in the construction of this diode probe was a suitable metal tube with a dielectric end in order to house the condensers, resistor, and diode crystal as well as hold the metal probe.

A pencil flashlight with a plastic end, such as those sold in the five-and-ten cent stores for thirty to forty cents, met my requirements satisfactorily. The condensers, resistor, diode crystal, test prod pin, coaxial lead, and the jack may be obtained from an electronic accessories store.

In building this unit, first remove Parts A, B, and D as shown in Fig. 1B. Parts A and B may be removed by means of a long screwdriver after Part C has been unscrewed. This is best accomplished by standing the penlight on end and pressing down Part A, then giving the screwdriver a sharp rap with the palm of your hand. Part D is the penlight bulb. This may be retained and used in your absorption wavemeter as it is a low-current lamp.

Next, assemble the condensers, resistor, and diode crystal as shown in Fig. 1C, using varnished cambric tubing (spaghetti) where insulation is needed. This assembly is completed while the components are out of the penlight tube. This assembly is then wrapped with low-loss insulating tape. This wrapping should be done carefully in order to provide sufficient insulation and hold the assembly in place.

The next step is to dress the coaxial or auto radio lead in the cable to the correct length and attach to the components. Attach and solder a bare wire, 8 to 10 inches in length, to the shield at Point 1 in Fig. 1C. This wire is laid back along the cable and fed through

the opening in the end of the penlight tube. It is used for making the ground after the components are installed in the penlight tube. Pull and slide the components into the tube and solder the ground wire to the case. Be sure the lead of the .01 microfarad condenser is long enough to attach easily to the test pin prod.

Finally, install the test pin prod in the plastic cap and feed the wire of the .01 microfarad condenser through the hole of the test pin prod and screw the plastic cap in place. Pull the wire of the condenser tight and secure it with the nut of the test pin prod, taking care not to over-tighten lest the plastic cap be damaged.

There are several circuits for diode probes, published recently in radio magazines, which may be used in place of the one shown in Fig. 1A. The one shown worked well with a v.t.v.m., however. A clip and lead can be attached to the probe case for a shorter ground connection, a condition which is often desirable when testing some circuits.

-50-

Fig. 1.

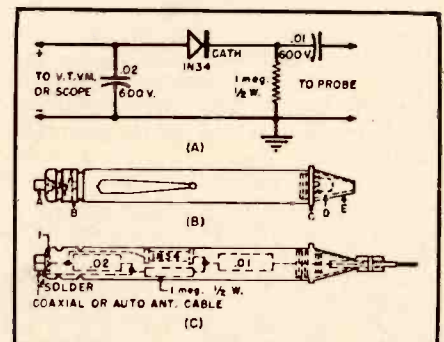

Known as the S-505, the new unit includes a gain control for reducing the gain of the booster on strong signals, and two untuned broadband amplifiers for both low and high bands. This latter feature is said to be especially applicable to intercarrier type television receivers inasmuch as it gives equal amplification to video and audio signals.

AUDIO AMPLIFIER

A new audio amplifier, designed by *N.J.R. Electronics Company* for TV applications, is now being distributed nationally by *Milo Sound* of 200 Greenwich Street, New York 7, New York.

The new Model 10MT can be used either with the receiver's existing speaker or with a higher quality reproducer. With the set's own speaker,

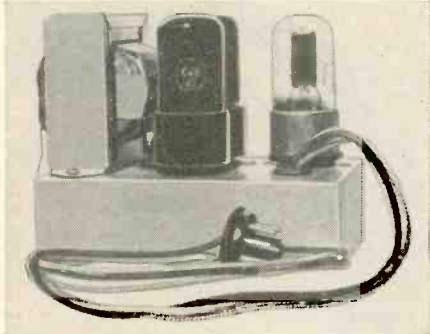

a 75% aural improvement is obtained, according to the distributor. With a quality speaker, the amplifier delivers its full range of 100 to 13,000 c.p.s.

The amplifier plugs into most of the existing single-ended amplifiers. It uses two 6K6's or 6V6's in push-pull and a 6J5 driver. The harmonic distortion is less than 3% and power output is 6 to 8 watts.

Because the unit measures only 3"x 5" it can be fitted directly onto most television chassis. It comes complete with tubes and a 2-foot extension.

Details are available from *Milo Sound*.

UNIDIRECTIONAL ANTENNA

Tricraft Products Company, 1535 North Ashland Avenue, Chicago 22, Illinois is currently in production on a unidirectional antenna for FM and television applications.

The new P-38 is a single bay incorporating seven elements. The design of the antenna is such that in the high television band three colinear elements are fed with in-phase equal currents, which single element group gives a gain over a half-wave dipole of approximately 6 db.

Behind the three elements are placed two colinear reflectors cut for the high television band and a third longer reflector that is active in increasing the forward gain in both the high and low television bands. The resultant high band antenna gain is nearly 10 db. over the entire high TV band, according to the company.

When operated in the low TV band, the three fed element group of the high band becomes a single half-wave dipole with the approximate sinus-

SNAP-ON TV FUSE HOLDER!

DEAL NUMBER 1
Catalog No. D94024

Snap-on fuse holder for quick, easy replacement of TV pigtail fuses. Snap regular replacement fuses in other side - the job is done. No more cutting out the pigtail. No more messy soldering. No more fuses blown by hot irons. Save time, save work, save the customer's money, and still make big TV profits.

2 TV PROFIT DEALS!

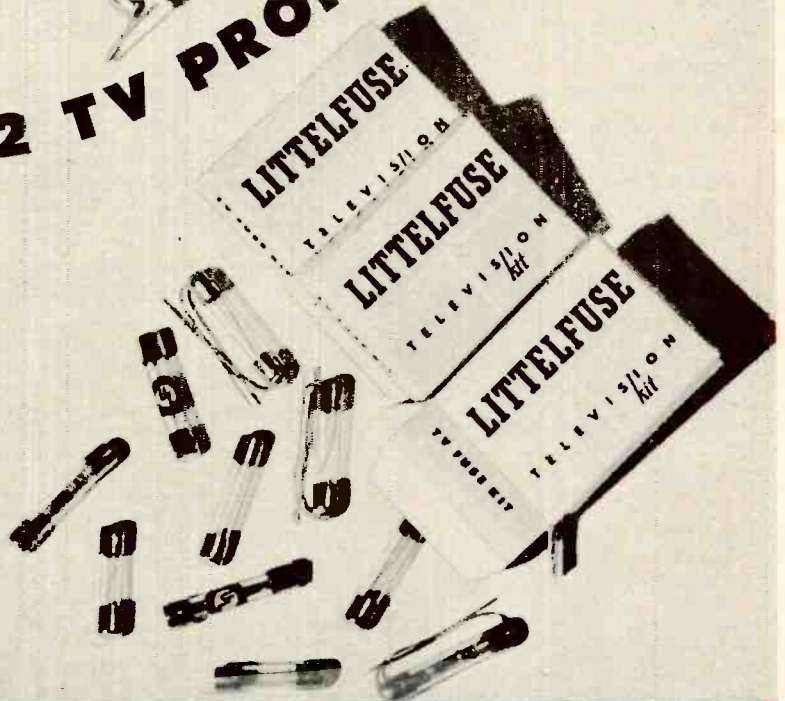

TV FUSE KIT

DEAL NUMBER 2
Catalog No. D94023

TV fuse kit - 10 assorted fuses that service all TV receivers - Acornair, Philco, RCA, Zenith, Emerson, Hallicrafters, etc., etc., etc. The serviceman needs the right fuse in his box - it is in this kit when he needs it. Saves time, saves profit.

LITTEFUSE, CHICAGO 40, ILLINOIS • Longbeach 1-4970



Get
EMERGENCY BAND
CALLS At Home!

Many fans spend hundreds of happy hours listening to city and state police calls on their Police Alarm radios. Police Alarm Model PR-31 is a quality radio which will give years of trouble-free service on the 30-50 mc. band. Can be used on either AC or DC current of 115 volts.

Besides police calls, the 30-50 mc. band also is used by fire departments, ambulances, border patrol, forestry, maritime, railroads, bus lines, and other services. Enjoy the thrill of listening to these vital messages at home. Model PR-31 (illustrated) \$44.95

Police Alarm Model PR-8 is available for 152-162 mc. band reception. Price, complete \$44.95

POLICE FM ALARM
RADIO APPARATUS CORPORATION

DEPT. RN-1, 310 FOUNTAIN SQUARE THEATRE
BLDG., INDIANAPOLIS 3, INDIANA

NEW!

**RECTANGULAR
BLACK TUBE**

16in. TELEKIT

PRICES
BEGIN AT **49.95**
LESS TUBES

**JOBBER: WRITE FOR CONFIDENTIAL
PRICE INFORMATION**

16 BR Telekit

\$79.95 Less
Tubes

Console Cabinet shown

\$39.95

You can build this fine 16 in. rectangular black tube TV set. All you need is pliers, screw driver, and soldering iron. It's easy to assemble; no previous knowledge of TV is required. The tuning unit and hi-voltage supply are factory wired and tested for you. A big 54 page illustrated instruction book guides you through easy assembly. Satisfactory results are **GUARANTEED** by Factory Service Plan and Warranty. Write today for complete information.



12-B Telekit

\$69.95

8-B Telekit
\$49.95

Both Less Tubes

Exciting new low prices on Telekits let you have a fine 8 1/2 or 12 1/2 inch set for a price far lower than comparable commercial sets. Over 35,000 Telekits have been successfully assembled by following the big illustrated Telekit instruction book. No previous knowledge of TV is required. Satisfactory results are **GUARANTEED** under the Telekit Factory Service Plan. Write for full information.



12 Channel Tuner

\$12.95

Pre-built, factory aligned. Stage of R.F. amplification. Telekit 12 channel tuner equips any TV set with video I.F. of 23.75 to 26.1 Mc and sound I.F. of 21.25 to 22 Mc. Not a kit. Complete with tubes. Only 4 wires to connect.



Telekit Booster

\$12.95

Brings in TV signals bright and clear. Especially helpful in fringe areas. For use with any TV set. **NOT A KIT**. Completely assembled with tubes.



TELEKIT

ELECTRO-TECHNICAL INDUSTRIES
1432 N BROAD ST. DEPT. R PHILADELPHIA 21 PA

oidal current distribution of any thin half-wave dipole. Behind this dipole is placed the reflector, cut to give maximum forward gain on Channel 2 and in front of this dipole is placed a director cut to give maximum forward gain on Channel 6. As a result, the antenna gain is nearly constant over the entire low TV band at approximately 6 db. over a half-wave dipole.

The company will forward a data sheet giving complete details and reception patterns to those requesting one. **-30-**

NEW SERVICE GROUP

A MEETING of independent service technicians has been called for January 28th in Washington, D. C. for the purpose of organizing a new national service group to be known as the National Association of Electronic Technicians.

At a recent meeting held in New York City, delegates from 29 different technicians' organizations passed a resolution calling for a national association. Any service group interested in being represented at the Washington meeting are asked to contact Norman Chalfin, 545 Fifth Avenue, c/o ARSNY, New York 17, N. Y. **-30-**

"GREAT EAGLE"

WHEN the Simpson Electric Company held its annual sales conference late in September at Lac du Flambeau, Wisconsin, Ray Simpson, the past president and present chairman of the board, acted as host to the group.

The Indian headdress Mr. Simpson is wearing in the picture is no gag. It signifies his new status as honorary chieftain of the Chippewa Tribe. His official name is "Me-gese" or "Great Eagle." The Indians at Lac du Flambeau accepted him into the tribe at a ceremony, complete with war dances, which was held during the sales conference. The honor was conferred on Mr. Simpson in recognition of his rehabilitation work among the Indians, made possible by his employment of members of the tribe at the Simpson factory opened there four years ago. **-30-**

Ray Simpson, chairman of the board of the Simpson Electric Company, shown wearing his ceremonial headdress to which he is entitled by virtue of his recent acceptance as an honorary chieftain of the Chippewa Tribe.



NOW!
SPEED UP ALL SOLDERING WITH
UNGAR
FEATHER-LIGHT SOLDERING PENCILS WITH
HI-HEAT
INCREASED WATTAGE
TIPS



For use with No 776
Handle & Cord Set

Stop wrestling with big irons. New HI-HEAT TIPS in your Ungar Electric Soldering Pencil produce a really versatile tool that'll perform on a par with the big, bulky 100-150 watt irons. If you can't get immediate delivery, please be patient, for production hasn't yet caught up with demand. Ask your supplier for No. 1236 Pyramid or No. 1239 Chisel. List price, \$1.25 each.

Ungar

ELECTRIC TOOL CO., Inc.

LOS ANGELES 54, CALIFORNIA

PREMAX

THE FASTEST SELLING

Ground Rods

For TV

WIRE IN
SCREW CLAMP

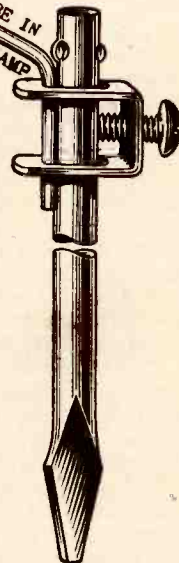

AND OTHER
INSTALLATIONS

With a new quick-acting, time-saving clamp that insures positive contact on #4 to #14 gauge conductor. 3/8-inch solid steel rods, copper plated and pointed for easy driving. Available in 4 and 6-foot lengths. Also 1/2-inch rods in 5, 6 and 8-foot lengths.

At Your Jobber

PREMAX PRODUCTS

DIVISION CHISHOLM-RYDER CO., INC.

5105 Highland Ave., Niagara Falls, New York

RADIO & TELEVISION NEWS

Corner Speaker

(Continued from page 55)

45 degree conic section will result. Small finishing nails can be driven into the edges for securing the aluminum.

To avoid possible flexing of the aluminum when reflecting sound, the cone can be filled with paster of paris or fine sand. A top section should now be fitted to conform to the outlines of the cone and screwed into position.

The writer was content to paint the reflecting arrangement black and leave it open. It is suggested, however, that if this offends other eyes, the top piece can readily be extended in dimensions so that grille cloth can be fixed to the entire top portion, enclosing reflector and all. A vertical piece in front of the speaker would allow a square corner for mounting the grille cloth.

Bass response is as good as the speaker itself can provide. The fact has previously been established by competent authorities that the reflex type box gives pronounced bass boost. If such boost is desired, a suitable port can be cut near the top of the enclosure. -30-

GOOD NEWS FOR HAMS

IN HER article, "21 Years a Ham," in the September 1950 issue, Helen Cloutier, W8GJX happened to mention that she was awarded a box of oranges for working fifteen Orlando stations.

According to a letter received from Jess R. Leach, W4CMI, this offer was discontinued as of May 1, 1950, leaving a considerable number of disappointed hams throughout the country who had twelve, thirteen, or fourteen of the Orlando stations logged.

According to Mr. Leach, the offer has again been renewed as of November 10, 1950 on the same basis as previously. In other words, all postwar Orlando contacts are valid so that the hams who have worked a number of the Orlando group do not have to start from scratch but may add to the list until they have fifteen.

The offer, as it stands now, is this: The Orlando Amateur Radio Club will ship prepaid a box of select tree-ripened Central Florida citrus fruit upon receipt of proof that the ham has worked fifteen different ham stations in Orange County. Mr. Leach stresses that there are no strings or catches to this offer. "Proof" consists of a list of the stations worked since the band opened after the wartime ban, with the date of the QSO, time, and the operator's name, if possible.

Mr. Leach explains that the reinstatement of the offer was made after the club members decided that the cost of the project was incidental compared with the pleasure the group derived from its contact with hams throughout the United States.

Hams who already have several QSO's recorded will be happy to hear of the reinstatement of the offer and the hams who haven't entered the "orange sweepstakes" will want to try their hands at winning their morning orange juice. -30-

4 Easy Steps to

✓ GOOD MONEY ✓ BIG JOB OPPORTUNITIES ✓ A BUSINESS OF YOUR OWN
✓ SPECIALIST RATINGS

IN Television-Radio

Complete Self-Training Course in TELEVISION and RADIO by Famous Experts—Starts from Scratch, Takes You BY SIMPLE STEPS from Basic Theory to Repair, Installation, Televising, Color TV, etc.



PARTIAL CONTENTS

BASIC TELEVISION
592 pages, 415 illus.
Scanning • Synchronizing • Video Signal • Brightness Control • D-C Reinsertion • Picture • FM Alignment • Picture Tubes • Reception Generators and Circuits • Antennas • Frequency Modulation • Color Television • etc.

TELEVISION SERVICING
429 pages, 388 illus.
Antennas • Transmission Lines • Test Pattern and Picture Analysis • Localizing Reception Troubles • Interference Remedies • Deflection Circuits • Video Detection • The Cathode-Ray Tube • High- and Low-Voltage Power Supplies • etc.

ESSENTIALS OF RADIO
800 pages, 433 illus.
Circuit Analysis • Vacuum Tubes • Circuits: Detector, Amplifier, Tube Oscillator, Power Supply, Transmitting and Receiving Equipment, Audio Units • Frequency Stability • Microphones • Transmission Lines • etc.

ELEMENTS OF RADIO SERVICING
475 pages, 375 illus.
Multimeters • AC Power Supply • Speakers • Antennas • Auto Radios • Push-Pull Output Stage • Detector Stage • AVC • Converter Variations • etc.

2296 Pages—
1611 Illustrations

Complete 4-volume course, by outstanding radio and TV instructors. Every detail clearly explained. Over TWO THOUSAND PAGES of step-by-step instruction. Over SIXTY-TWO HUNDRED "how-to-do-it" illustrations, cross-section diagrams, etc. "Trouble-shooting" charts show how to diagnose any radio or TV breakdown, how to repair it expertly.

Pays for itself many times over. Can qualify a beginner for FCC's 1st-Class License test; shows experienced technician new tricks.

SEND NO MONEY

Over 8 million TV sets . . . 60 million radios in use. Shortage of skilled workers is critical. Men who know electronics can write their own ticket in Government OR private enterprise! They are ESSENTIAL! Course can put you in line for success in America's fastest growing industry!

Mail coupon to examine complete four-volume course FREE for 10 days. No obligation. You get ABSOLUTELY FREE a valuable illustrated book, "Successful Soldering" (Reg. price: \$2.00), or examine individual books FREE for 10 days by checking proper boxes in coupon. Mail coupon at once!

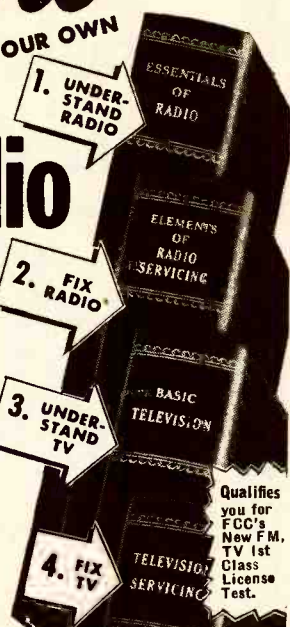

Qualifies you for FCC's New F.M. TV 1st Class License Test.

ABSOLUTELY FREE

Yours to keep whether or not you keep the course. "Successful Soldering" (reg. price: \$2).

All about: Soldering coppers; fluxes; Tinning; sweating; stainless-steel; other special solders; heating methods. Many illustrations.

FREE 10-DAY TRIAL COUPON

McGRAW-HILL BOOK CO., Inc., Dept. RTN-1,
327 West 41st St., New York 18, N. Y.

Please send me for 10 days' FREE EXAMINATION McGRAW-HILL'S Basic Course in TV and Radio . . . including Essentials of Radio, Elements of Radio Servicing, Basic Television, Television Servicing. (Total retail price of the four books is \$22.50—Special Course Price: Only \$19.95 in easy installments). Also send ABSOLUTELY FREE, "Successful Soldering." If not satisfied with course, I will return the four course books; pay nothing; and keep "Successful Soldering" free. Otherwise, I will send you only \$1.95 plus postage then; and the balance in 6 monthly installments of only \$3.00 each.

If you wish to examine any of these books individually, check below the ones you wish us to send you for 10 Days' FREE EXAMINATION:

- | | |
|--|--|
| <input type="checkbox"/> Essentials of Radio, \$6.00 | <input type="checkbox"/> Elements of Radio Servicing, \$4.50 |
| <input type="checkbox"/> Basic Television, \$6.50 | <input type="checkbox"/> Television Servicing, \$5.50 |

For whichever of these books I decide to keep, I will send you \$2.00, plus postage, at the end of 10 days; balance in easy monthly installments.

Name RTN-1

Address

City State

WE'LL PAY POSTAGE if you enclose first payment of \$1.95 when ordering the course, or the full price of book when ordering individual books (see prices above). Same 10-Day Return Privilege for full refund.

KLIPZON* CLIPS-ON

IT'S A TREAT to TEST with KLIPZON PRODS

Here is NEW convenience in testing BOTH HANDS FREE for adjustments and soldering.

Built-in self-holding jaws slip onto wires, lugs and terminals easily. Grip test points until pulled off. Stencor and streamlined for easy contact with inaccessible wires and terminals.

Klipzon V. H. F. Crystal Probes bring added versatility to your vacuum tube voltmeter and volt-ohm-milliammeter.



Use KLIPZON MINI-PROD CONNECTORS for quick, easy to make TEST HOOKUPS Order a box of 20 Today! . . . for AMAZING NEW TEST CONVENIENCE.

At Your Local Parts Distributors, if not in stock write us direct for free KLIPZON folder. C

*T.M.

UNITED TECHNICAL LABORATORIES MORRISTOWN, New Jersey

Wide Range Reproduction For the Home



* Triad Hi-Fidelity Amplifier Kit...

The Triad HF-10 Amplifier, from a circuit designed in cooperation with J. N. A. Hawkins, prominent sound engineer, has been produced especially for those who like to build their own sound reproducing systems. When used with the high quality speakers, tuners, turntables, and pick-ups now available, a system can be built that will meet the requirements of even the most critical music lover. The Triad HF-10 kit supplies the basic engineering and solves the most difficult mechanical layout problems. With 18 db. of feedback, affording a reflected impedance of less than 2 ohms to the 16 ohm speaker tap, within 1 db. linear frequency response from 20 to 20,000 cycles, and with a minimum of distortion over this same range, the HF-10 is worthy of use in the very finest home music installations.

* Features...

- Wide Frequency Response:** Within one db. from 20-20,000 cycles.
- Low Distortion:** Less than 2% from 50-18,000 cycles at full 10 watts output. Less than 1% from 20-20,000 cycles at 5 watts.
- Heavy Speaker Damping:** Reflects less than 2 ohms to speaker from 16 ohm tap.
- Equalization:** Continuously variable to +12 db. or -30 db. at 50 or 8000 cycles.
- High Gain:** 74 db. from crystal microphone or radio receiver; 96 db. (equalized for magnetic pickup) through preamplifier.
- Low Noise:** Hum and other noise 60 db. below maximum output. A-74J equalizing coil has 70 db. shielding.
- Beautiful Appearance:** Gray hammertone chassis with ivory silk-screened lettering, matching gray Triad transformers.

* Prices

- HF-10 Kit**—Includes S-31A, R-14A, A-74J, and C-10X Triad transformers, chassis, prints and assembly instructions. List Price \$39.85
- HF-10A Kit**—Same as above except for substitution of HS-81 output transformer for S-31A. List Price \$57.75

See your dealer or write for Bulletin HF-10, and Catalog TR-49A which describes the complete Triad line.

TRIAD
TRANSFORMER MFG. CO.
2254 Sepulveda Blvd.
Los Angeles 64, Calif.



MARS Station of the Month

MARS OPENS RANKS TO CIVILIAN HAMS

The Department of the Army has announced that it will accept civilian members in its MARS program. Civilians interested in joining the system are invited to contact the Signal Officer of their nearest Army installation. Authorization for civilian membership in MARS-Army insures the continued use of the net as a back-up communication system if activities and reserves of the Army are mobilized. MARS membership does not affect draft status, the Army emphasized. Civilian members must be 21 years of age or older and must hold a valid FCC amateur radio station license. They must also agree to operate their stations in accordance with rules and regulations prescribed for the MARS by the Army. Only amateurs who own stations, in operation at time of application for MARS membership, can be considered. No radio equipment can be furnished civilian amateurs under existing law.

AJ3AA-CS3AA at Lages Field, Terceira Island, in the Azores Archipelago, has been named "MARS Station of the Month" by Major Rawleigh H. Ralls, Chief, MARS, U. S. Air Force. The station has proven a big morale factor to Air Force personnel stationed on the "rock" by permitting them to talk to the folks back home via 10 and 20 meter phone. Daily contacts with AIR at the Pentagon and with AK2AA at McAndrews Field, permits informal handling of a lot of squadron affairs.

Lt. Col. Sidney Nutt, "Sid," is the licensee, MARS Director, station custodian, and Commanding Officer of the 1936th AACS Squadron. Sid does just about everything as can be seen from his titles and he does spend some time at the mike. Master Sergeant Nick Pozarich, W6ZGB-AF6ZGB/CS2 (boy, what a c.w. call) is chief radar mechanic for the squadron. Nick keeps all the radar gear in tip-top shape so that maintenance does not interfere too heavily with his skeds. Myron Kisselburg, W6ZNA, a civilian employee

of the *Gilfillan Corporation*, also does his bit of brass pounding.

The prefix Charley Sugar coming from the Azores rather than the accustomed Charley Tare has thrown many DX men and SWL's for a loss but it has helped the gang at CS3AA to work all continents in record time and get well along the road toward WAZ and DX Century Club certificates. The station was granted an experimental license by the Portuguese government and is permitted to operate in the amateur bands and on MARS frequencies. It is the experimental aspect of the license that accounts for the "Sugar." For those looking for an exclusive QSL, CS3AA roosts right around 14,350 kc. most of the time.

The station layout consists of a TDO transmitter. This is a 10-channel remote control job manufactured by *Collins Radio*. It produces 350 watts of r.f. from a pair of 813's and is modulated by 805's. The receiver is a "Super-Pro," BC 779. The antenna is a long, long wire aimed at St. Louis,

The gang at CS3AA-AJ3AA. From left to right are Myron Kisselburg, W6ZNA, Lt. Col. Sidney Nutt, Jr., and M/Sgt. Nick Pozarich, W6ZGB who operate this MARS station in the Azores.



Missouri and loads up nicely on all frequencies.

Chief MARS played Santa Claus to the Gang and sent them a new MARS package station consisting of a Collins 32V2 transmitter, Collins 75A2 receiver, a Gordon dual 10-20 beam and a v.h.f. 152 converter. The West Lages Antenna Erection Society spent the Christmas holidays building a tower and erecting the beam which accounts for a boost in the signals.

Nick and Myron are currently building a six-meter gear and if the results are encouraging they threaten to go in for two meters. It does offer potentialities for some v.h.f. DX records. European v.h.f. men please copy.

-30-

International Short-Wave (Continued from page 127)

Spain—EDV10, Madrid, noted on approximately 7.167 signing off 1903 with "Arriba Espana" and two pieces of music after program summary in Spanish. (Stark, Texas.) Oskay, N. J., recently measured this one as 7.190 at 1550; previous measurements included 7.1695 and 7.1802.

Surinam—Paramaribo, 15.405, noted signing off 2035. (Stark, Texas.) Noted in California with musical program 2000 with announcements in both Dutch and English. (Russell.) PZH5, 5.758, parallel with 15.405, now announces as "Radio Surinam, Avros" (in Dutch); closes 2100; the 15.045 outlet usually joins 5.758 at 1645 (generally without announcement); 5.758 fades in around 1730; "Bringing Christ to the Nations" (transcribed in English) is a Sunday feature 1730-1800, followed by "The Lutheran Hour" (also transcribed in English). (Grove, Ill.)

Sweden—"Sweden Today" (English) has been heard well lately 0815-0830 over both 11.705 and 15.155. A Danish DX broadcasts says Radio Sweden now is using 6.065 and 10.780 for the 1900-2030 and 0015-0235 broadcasts.

Tahiti—Radio Tahiti, Papeete, sent mimeographed verification via airmail two months after report was sent; asked for further reports and suggestions. (Richards, Sask., Canada.)

Taiwan—Winter schedule of "The Voice of Free China" is 2300-0100 on 15.235 and 11.735, first hour is English; 0500-1130 on 6.040, 7.135, and 11.735, news 0630-0640; best time to listen on 6.040 is after KCBR leaves this channel 1000. (Neeley, Calif.) Balbi, Calif., says the second transmission signs on 0430 and not 0500. Oskay, N. J., measures the 41-m. outlet as 7.1338.

Taipei on approximately 7.334 has fair signal mornings (EST); call appears BCSF or BCFS. (Neeley, Calif.) Heard in N. Z. at 0530 onwards at fair strength. (Cushen.) Dilg, Calif., says this one is directed to Occupied China; believes call may be BCSS; frequency varied considerably last spring around 7.450 but seems now set on approximately 7.334. He believes call of the Chinese Air Force Station on approxi-

SELENIUM RECTIFIERS AND SPECIALIZED ELECTRONIC COMPONENTS

SINGLE PHASE

Full Wave Bridge

Input: 0-18 VAC		Output: 0-12 VDC	
Type No.	Current		Price
B1-250	250 Ma.		\$.98
B1-1	1.0 Amp.		2.49
B1-1X5	1.5 Amp.		2.95
B1-3X5	3.5 Amp.		4.50
B1-5	5.0 Amp.		5.95
B1-10	10.0 Amp.		9.95
B1-20	20.0 Amp.		15.95
B1-30	30.0 Amp.		24.95
B1-40	40.0 Amp.		27.95
B1-50	50.0 Amp.		32.95

Input: 0-36 VAC		Output: 0-26 VDC	
Type No.	Current		Price
B2-150	150 Ma.		\$.98
B2-250	250 Ma.		1.25
B2-300	300 Ma.		1.50
B2-2	2.0 Amp.		4.95
B2-3X5	3.5 Amp.		6.95
B2-5	5.0 Amp.		9.95
B2-10	10.0 Amp.		15.95
B2-20	20.0 Amp.		27.95
B2-30	30.0 Amp.		36.95
B2-40	40.0 Amp.		44.95

Input: 0-115 VAC		Output: 0-90 VDC	
Type No.	Current		Price
B6-250	250 Ma.		\$ 2.95
B6-600	600 Ma.		5.95
B6-750	750 Ma.		6.95
B6-1X5	1.5 Amp.		10.95
B6-3X5	3.5 Amp.		18.95
B6-5	5.0 Amp.		24.95
B6-10	10.0 Amp.		36.95
B6-15	15.0 Amp.		44.95

Full Wave Center Tap

Input: 10-0-10 VAC		Output: 0-8 VDC	
Type No.	Current		Price
C1-10	10.0 Amp.		\$ 6.95
C1-20	20.0 Amp.		10.95
C1-30	30.0 Amp.		14.95
C1-40	40.0 Amp.		17.95
C1-50	50.0 Amp.		20.95

THREE PHASE

Full Wave Bridge

Input: 0-234 VAC		Output: 0-250 VDC	
Type No.	Current		Price
3B13-1	1.0 Amp.		\$22.00
3B13-2	2.0 Amp.		32.00
3B13-4	4.0 Amp.		56.00
3B13-6	6.0 Amp.		81.50
3B13-10	10.0 Amp.		105.00
3B13-15	15.0 Amp.		120.00

RECTIFIER MOUNTING BRACKETS

For Types B1 through B6, and Type C1. \$.35 per set
For Types 3B..... 1.05 per set

ATTENTION MANUFACTURERS

We are in a position to furnish Selenium Rectifiers, in quantity, to specifications. Excellent delivery, prompt quotations.

POWER SUPPLIES

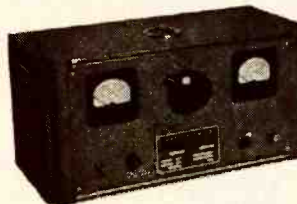

GENERAL PURPOSE low voltage DC power supplies, with variable outputs. Rugged—Dependable—Precision Control.

- ✓ Features
- ✓ Long Life FULL WAVE SELENIUM RECTIFIERS
- ✓ Output voltage continuously adjustable from zero to maximum
- ✓ 3" Voltmeter and Ammeter—2% accuracy
- ✓ Stepless control
- ✓ Instant Power—no warm-up period
- ✓ Dimensions: 8 1/2 x 16 1/2 x 8"
- ✓ Assembled and Ready to Operate
- ✓ For 115 VAC 60 cycles

Write for descriptive bulletin GPA

Model	Voltage	Current	Price
GPA510	0-8 VDC	10 Amps.	\$69.50
GPA1210	0-12 VDC	10 Amps.	75.00
GPA2810	0-28 VDC	10 Amps.	85.00

RECTIFIER CAPACITORS

Model	Volts	Current	Price
CF-1	1000 MFD	15 VDC	\$.98
CF-20	2500 MFD	15 VDC	1.95
CF-6	4000 MFD	30 VDC	3.25
CF-19	500 MFD	50 VDC	1.95
CF-16	2000 MFD	50 VDC	3.25
CF-21	1200 MFD	90 VDC	3.25
CF-9	200 MFD	150 VDC	1.69
CF-10	500 MFD	200 VDC	3.25

Mounting clamps for above capacitors..... 15c ea

RECTIFIER TRANSFORMERS

All Primaries 115 VAC 50/60 Cycles

Type No.	Volts	Amps.	Shpp. wt.	Price
XF15-12	15	12	7 lbs.	\$ 3.95
TXF36-2	36	2	10 lbs.	4.25
TXF36-5	36	5	8 lbs.	6.50
TXF36-10	36	10	12 lbs.	9.95
TXF36-15	36	15	20 lbs.	11.95
TXF36-20	36	20	25 lbs.	17.95
XFC18-14	18 VCT	14	10 lbs.	6.95

All TXF Types are Tapped to Deliver 32, 34, 36 Volts. XFC Type is Tapped to Deliver 16, 17, 18 Volts Center-tapped.

RECTIFIER CHOKES

Type No.	Hv.	Amps.	DC Res.	Price
HYX6	.055	600MA.	2.0	\$ 1.50
HY5A	.028	5	.20	5.25
HY10A	.014	10	.04	9.95
HY20A	.007	20	.02	13.95

D-C PANEL METERS

Attractive, rugged, and reasonably priced. Moving vane-solenoid type with accuracy within 5%. Square case
0-6 Amperes DC } Any range \$2.49 each
0-12 Amperes DC }
0-15 Volts DC }

All prices FOB our N. Y. C. warehouse. Send M.O. or check. ONLY shipping charges sent COD. Rated concerns send P.O., Terms Net 10 days.

OPAD-GREEN COMPANY

71-3 WARREN ST., NEW YORK 7, N. Y. PHONE: BEekman 3-7385-6

WE HAVE LARGE
QUANTITIES OF

RADIO TUBES

TYPE	TYPE	TYPE	TYPE	TYPE	TYPE	TYPE
5U4G	6AG5	6D6	6K6GT	6SH7	42	813
5Y4G	6AL5	6H6	6K7GT	6SN7GT	803	866A
6AB7	6C4	6J7	6N7GT	12SG7	805	1622
6AC7	6C5GT	6J5GT	6SG7	12SK7	807	9005

Packed in Original Cartons
PRICES ON REQUEST

SUBSTANTIAL DISCOUNTS ON LARGE ORDERS

All tubes are brand new standard brands. This offer subject to change without notice and prior sale. Terms: 25% deposit with order, balance C.O.D. \$25.00 minimum order.

MANUFACTURERS: WANT MORE EXPORT SALES? CONTACT: MICHEL LEVIT
Domestic Division: TUBE DEPARTMENT

METROPOLITAN OVERSEAS SUPPLY CORPORATION
1133 Broadway, New York 10, N. Y. Telephone: CHelsea 3-1105

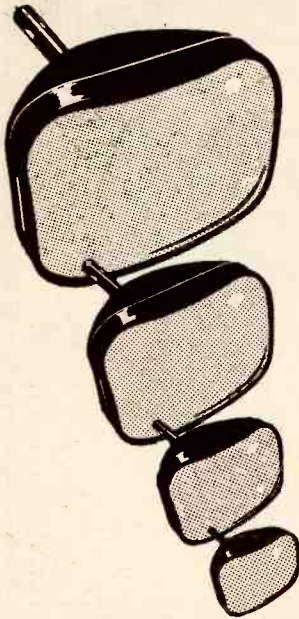

ELECTRONIC BUSINESS MACHINES

That's what we call the 16", 17" and 20" rectangular neutral-density-filter tubes that Reeves Soundcraft Corp. is manufacturing as successors to Remington Rand's TV Picture Tube Division.

IT IS GOOD BUSINESS to INCORPORATE Reeves Soundcraft "TRULUMES" as the BUSINESS end of TV sets you manufacture, service, convert, or for which you stock tubes.

In the coming months more and more of these fine rectangulars will become available. An inquiry NOW will enable us to tell you how YOU may sooner become one of our happy kinescopic beneficiaries.

Dictate an inquiry today.

Reeves — 20 YEARS WITH ELECTRONICS IN PEACE AND WAR: Optical and magnetic film sound recording facilities, equipment, and supplies; "acetate" discs and magnetic tape; transformers; projection TV; crystals; electronic computers.

REEVES Soundcraft CORP.

COLORCRAFT PICTURE TUBE DIV.
35-54 36th STREET, LONG ISLAND CITY 6, N. Y.

SUCCESSORS TO REMINGTON-RAND TELEVISION PICTURE TUBE DIV.

NEW PRECISION ELECTRONICS SIGNAL TRACERS



MODEL 201 A
\$34.50

MODEL 251 A
\$49.75

Write for literature and name of your nearest Jobber

PRECISION ELECTRONICS, Inc.
641-643 MILWAUKEE AVENUE
CHICAGO 22, ILLINOIS

SIGNAL TRACER SPECIALISTS

REK-O-KUT presents a New

Continuously Variable-Speed Turntable of Broadcast Quality



Plays at any speed from 25 to 100 R. P. M., without "wow!" Operates on 50 or 60 Cycles!

Now for the first time . . . a continuously variable turntable at a popular price. Ideal for record collectors, musicians, singers, disc jockeys, broadcast stations, music schools, dance studios, skating rinks, gymnasiums, etc. Plays through amplifier, radio, TV set or phonograph. Model CVS-12 (illustrated) Chassis, motor and turntable . . . \$84.95 net. Model CVS-12P, mounted in portable case with 16" dual stylus pickup . . . \$124.95.

REK-O-KUT Model LP-743 3-Speed 12" Transcription Turntable

Recommended by outstanding music critics. Induction-type motor designed for smooth, quiet, vibration-free operation. 3 speeds, 78, 45 and 33 1/3. \$49.95 net.

Write for Illustrated Catalog of REK-O-KUT Line of Hi-Fidelity Recording Instruments, Phonographs, Transcription Tables, Accessories.

REK-O-KUT CO., INC.
38-05 QUEENS BLVD., LONG ISLAND 1, N. Y.

mately 8.995 may have been changed from BCAF to BED32. This Air Force outlet noted by Cox, Delaware, at 0645 recently with Chinese singing, very weak level.

Tangiers—Radio International is radiating on 6.110 with *English* 0600-0630; *French* 0630-0715; *Spanish* 0715-0800; *French and Spanish* 0800-1000; "Bringing Christ to the Nations" (in different languages) 1000-1200; *Arabic* 1200-1400; *French* 1400-1515; *Spanish* 1515-1635; *French and Spanish* 1635-1800 closedown. (*World Radio Handbook Bulletin*.)

Patrick, England, says *Radio Africa* is now on 7.130 with improved signal.

Pan American Radio heard on 15.048 around 0700-0740; opening and closing announcements are in both *Spanish and English*. (Pearce, England.)

Thailand—Bangkok appears to be using 6.24, 11.91, 15.91 for its overseas transmission daily 0500-0630 and for the native period 0700-1000 or later; news 0515, 0615.

Trans-Jordan—The Hachemite Broadcasting Service has an *English* transmission daily 1000-1100 on 7.058; says "This Is Jerusalem Calling" but studios and transmitters now are located at Ramallah, north of Jerusalem. (Radio Sweden.)

Turkey—TAS has been measured 7.2863 at 1605; according to schedules just received, *English* programs from *Radio Ankara* are on TAP, 9.465, and TAS, 7.285, 1600-1645; news from *Turkey* 1602-1612; on Sundays at 1630-1645 has Mail Bag; on Sundays and Thursdays, programs in *English* continue to 1700, the final minutes being devoted to selections of recorded music. (Oskay, N. J., others.)

USI—Ambon, 3.380, Maluccas, heard to sign-off 1030 when clock strikes 2300 local time; appears to relay *Djakarta* transmissions. (Cushen, N. Z.) Menado, 9.845, Celebes, is good signal 0800 with variety of songs, announcements in Dutch. (Cox, Delaware.)

USSR—Moscow's evening schedule to North America remains 1820-2300 on (announced) 15.23, 15.18, 15.11, 11.96, 11.82, 9.69, 7.29, and 7.24. (Kroll, N. Y.) Mailbag Program is Saturday 2100. (Sams, Oregon.)

Soviet, 9.340, heard in native 2015; parallel 9.380. (Oskay, N. J.) Moscow noted 7.245 good level 1745 with *English*; parallel 7.295; heard on 6.110 at 1535 with talk in *English*; also noted on 6.000 at 1630 with *English*. (Cox, Delaware.)

Moscow II, the cultural program which includes interesting popular music by Russian composers, is also relayed on s.w., according to announcements, on 7.329 and 11.830 at 1000-1700. (Radio Sweden.)

Venezuela—"La Voz del Tachira," San Christobal, is broadcasting in Spanish on 4.830 at 0700-0900, 1000-1300, 1600-2200; output 5 kw. (*World Radio Handbook Bulletin*) YVQF, 6.20, Ciudad Bolivar, noted 2130 with news, very heavy QRM; noted in Spanish 2145. YVKB, 4.89, Caracas, noted with music 2310, (Russell, Calif.) Caracas,

RADIO & TELEVISION NEWS

6.168, has been heard on Monday at 2130 with news; on Tuesday at 2200 with news; strong signal in Calif. (Balbi.) Station heard on 9.700 at 1710-1800 and later seems to be harmonic of Venezuela's 4.850 outlet. (Stark, Texas.) YVRK, 3.500, Caracas, good level 1840 with music. (Cox, Delaware.) Station "battling" with Bogota, Colombia, on 4.960, is YVQA, *Radio Sucre*, Cumana. (Stark, Texas.) YVKF, 4.880, Caracas, still has news daily 1845-1900. (Cox, Delaware.)

Yugoslavia—Belgrade, 6.100, noted in foreign language 1525; identified with four chimes 1530; completely jammed 1531. (Cox, Delaware.)

Last Minute Tips

Here are some late tips on Mexican radio stations. "Radio Universidad Nacional," operated by the autonomous Mexican National University, has programs in Spanish daily 1100-1800 over XEYU, 9.600; works on a cultural, non-commercial basis. (*World Radio Handbook Bulletin*.) Grove, Ill., others, report strong signal from XEX, 11.90, from before 0900 to after 0000; Bellington, N. Y., has heard this one signing off 0100. Cushen, N. Z., says XECC, 15.205, a new short-wave relay, 500 watts, was to have started operations in August to relay XEMC continuously; QRA is Apartado 22717, Mexico City, D. F., Mexico; had not been reported as heard, however, when this was compiled. Grove, Ill., reports XEBT, 9.625, Mexico City, noted with relay of commercial programs of XEB in *English* at least from tune-in 0820 to tune-out 0840.

A news dispatch recently stated the Navy will build one of the world's most powerful transmitters at Tangiers. (Leary, Indiana.) Will operate on short-wave?

Deskins, Calif., reports an Oriental station signing on 0100 on approximately 11.440. Who?

Radio Australia reports the Forces Broadcasting Service, East Africa, is currently using 6.117 to 1500 close-down; may sign on as early as 2300. Location is not definite but it may be Mombassa. The *N. Z. DX Times* reports this one closing 1500 and says has some sideband QRM from Berlin (6.115) and Finland (6.120).

Stark, Texas, is hearing a station on 7.125 fading in 0845 and running to after 0915 that may be *Radio Somali*, British Somaliland. He recently noted *Radio Splendid*, Buenos Aires, on 5.987 to after 1900; may be last year's listed LRS, 6.065, a 5 kw. job, back near its old 5.896 channel. Adds that a station fading in around 2200 (using French) on approximately 15.060 may be Mauritius.

DZB2, 3.320, Manila, Philippines, Far East Broadcasting Company, "The Call of the Orient," heard 0530-1130 sign-off; announces "This is F.E.B.C., Stations DZAS, 680 kc., medium-wave; DZB2, 3.32, Tropical Band; DZH6, 6.03, 49-meter band, and DZH8, 15.30, 19-meter band." DZH8 suffers background interference from BFEB5,

CHECK THESE MONEY-SAVING SURPLUS "BUYS"!

COMPLETELY CONVERTED AND READY FOR USE! 80 METER EXCITER OR 75 METER PHONE RIG

These are BC457's converted and retrofitted to 3-4 Megs — at a fraction of cost — and we've done all the work for you. Only the crystal frequency is different. Dial reads 3.5 to 4 mcs. It's all complete — ready to add the power supply and easily a \$25 value! The buy of a lifetime. **READY FOR USE WITH MODULATOR. \$10.95**
F.B. FOR MOBILE AND HOME STATION USE. \$14.95
POWER SUPPLY KITS for the above transmitter. Complete, nothing else to buy or assemble. Chassis, transformer, sockets, tubes, etc. add \$3.50
Power Supply already wired and tested. add \$3.50

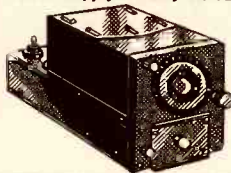
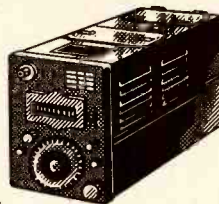

HERE IS AN IDEAL LOW PRICED 10 METER RECEIVER—A BC 454 3-6mc converted to cover the entire 10 meter band. All brand new, converted for you by expert lab technicians at a fraction of the cost. Complete with tuning knob. Just add the power supply and it's the hottest 10 meter receiver you've ever used. Volume control and head phone jack on front panel. **\$16.95**
ORIGINAL DYNAMOTOR. Complete kit with all parts and diagrams. No wiring changes necessary. \$7.95
Completely wired and tested. add \$3.00

ARR-1 RECEIVERS

With 4 RCA 954 Acorn Tubes
(Res \$5.65 ea.)
Schematic Diagrams and Conversion Information for
\$4.95



Postpaid in U.S.A.
Includes the Receiver, 4 tubes, schematic diagrams and a reprint of "A 220 mc Converter from the Surplus R-1/Arr-1" by Leroy W. May, Jr. (WSAIG) an article which appeared in *RADIO & TV NEWS*, Jan. 1940. Ideal for 50, 144, 220 mc Converters or Pre-Selectors. Also for TV boosters. PB for hopping up the SCR-522 Receiver on 2 meters.
ARR-5 RECEIVER. The airborne version of VHF S-38. 27-144 MC. Easily padded into the SCR-522 meter band. Used, good condition. **\$94.50**

NOISE FILTERS
Made especially for industrial use.
Miller 7841, . . . \$4.95
5-amps
Miller 7842, . . . \$5.95
10-amps
Miller 7843, . . . \$6.95
20-amps
Max. 220 v.

OHMITE SWITCHES
Non-shorting type ceramic tap switches for high current use. Available in 5, 6, 7, 8, 9, 10, and 11 contacts. **98c** Ea.

Brand New AMPHENOL AN CONNECTORS @ 75% OFF LIST! Write for complete listing!

MIDGET VARIABLE CONDENSORS
Hammarlund MC-20-MX, 20 MMF Double Spaced . . . 7.95
Hammarlund MC-50-SC, 50 MMF Double Spaced . . . 7.95
Hammarlund MCD-50-M 50 MMF Split Stator . . . \$1.49
National SSD-50, 50-50 Split Stator. **\$1.49**

BD 77 DYNAMOTORS \$9.95
Brand New—Packed for export. 1000 volts, 350 MA output. 12-14 V.D.C. input.

• STANCOR ISOLATION & STEP-DOWN TRANSFORMER
No. P-3065, Primary 220-250 volts, 50-60 cycle.
Secondary 10-125 volts, 250-300 watts.
• THORDARSON T16V22 LINE VOLTAGE REGULATOR
95, 105, 125 V to 115 V 60 cycle. Complete with cord and plug, 250 VA.
• THERMADOR CS 10535 ISOLATION TRANSFORMER
105, 115, 125 v to 115 v 60-cycles Complete with cord and plug, 250 VA
YOUR CHOICE \$6.69 Ea. BRAND NEW
THORDARSON SWINGING CHOKE
T-19-C-38 5-20H, 500 ma. **\$8.95**

TRANSFORMER BUYS

All Brand New—Mostly Boxed
All 115 V, 60 cy. unless otherwise listed.
UTC LS-183 POWER TRANSFORMER, 3500-300 CT at 400 MA 110 or 220 **\$24.50**
Primary
UTC LS-184 POWER TRANSFORMER, 7000-6000-5000, CT at 500 MA 110 or 220 Primary **\$69.50**
UTC LS-191 POWER TRANSFORMER, 650-300 CT at 125 MA, 3 filament windings, tapped primary **\$5.95**
UTC LS-73 POWER TRANSFORMER, 1000-800 CT at 500 MA, 140 CT at 50 MA, 5 filament windings, tapped primary **\$12.95**
FILAMENT TRANSFORMER for hi-voltage rectifiers. Pa. 115 V, 5/50/60 cy. Sec. 5 V. C/T @ 10 amps, 35 K.V. R.M.S. Test 12 KV D.C. New. **\$9.95**
THORDARSON T21220 FILAMENT TRANSFORMER, Primary 115 V, 60-cycles, Secondary 5 V center tapped, 15 amps, 10,000 V insulation. **\$3.95**

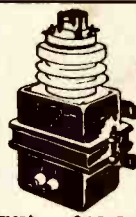

SCOPE TRANSFORMERS
THORDARSON T17R32 Primary 115 v, 60-cycles. Secondary 2300 v, 2 1/2 v. Shielded. **\$3.95**
HERCULES 115 v., 60 cycles primary, 1800 v., secondary 6.3, 2.5, 2.5. Shielded. **\$3.95**

THERMADOR SPECIAL TRANSFORMERS
Built for Gov't lab. use. All hermetically sealed with glass terminals. Priced at approx. 1/10th of Gov't cost.
CS5727, 900, 700 CS5728, 800 v, 650 CS5729, 1000 v, v CT at 150 MA, 3 CT at 100 MA, 3 filament windings, 6.3-5A, 6.3-5A, 5-6.3-4A, 6.3-1.5A, 3A. Shp. **\$3.50** 5-2A. Shp. **\$3.95** wt. 14 lbs.
CS5079, 1000 v, 850 v. ct. at 250 MA, 3 filament windings, 6.3-6A, 6.3-4A, 5-3A. Shp. wt. 25 lbs. **\$4.50**

TS323/U FREQUENCY METER CASES. Brand new. See QNT, Oct. 1950 issue for construction article. Shipping wt. 12 lbs. **\$3.95 ea.**

Over 10,000 Sold—and More just arrived!
TELEVISION, HAM BEAM MOTOR KITS
Complete with Instruction Sheet and Data
\$5.95 Postpaid
Complete less connecting cable. Consists of motor, phasing condenser and switch.

Scopel Weston AIRCRAFT METERS
1-Milliamperes \$1.95 Post-zero center. \$1.95 paid FB for field strength meters, grid-dip meters, tuning meters, beam antenna indicators, vacuum tube voltmeters. Brand new, limited quantity. Hurry!

ORDER DIRECT FROM THIS AD!
Prompt, speedy shipment. Cash with order. Minimum order \$2.00. 25% deposit on C.O.D. orders. Shipments by truck. Collect. Shipments by collect. Calif. buyers please add postage tax. All prices subject to change. All merchandise subject to prior sale.

ALVARADIO SUPPLY CO.

DEPT. A-8, 341 S. VERMONT, LOS ANGELES 5, CALIF., Dunkirk 8-2211

SPECIAL LOW PRICES ON PICTURE TUBE and 630 CHASSIS
Lic. by RCA
Chassis Features:—
Molded Condensers
Voltage Tripler
Keyed AGC, etc.
Send Card For Details
"ELECTRONIC" APPLIANCES, INC.
9220 Church Ave., Brooklyn, N. Y.

RADIO ENGINEERING IN 27 MONTHS
DEGREE IN
Radio engineering is a big field. There's room for you in it—if you're good. Get first-class training at Indiana Tech. Intensive specialized course, including strong basis in mathematics and electrical engineering, advanced radio theory and design, television, Modern laboratory. Low tuition. Also 27-month courses in Aeronautical, Chemical, Civil, Electrical and Mechanical Engineering. Approved for G.I.'s. Enter March, June, September, December. You can earn part of your expenses right here in Fort Wayne while you are studying.
INDIANA TECHNICAL COLLEGE
911 E. Washington Blvd., Fort Wayne 2, Indiana
Please send me free information on B.S. Engineering Degree in 27 months as checked.
 Radio-Television Aeronautical
 Civil Mechanical Electrical
Name
Address

SUN RADIO'S "REALIST"



A New Corner Speaker System

A new conception of speaker design by Sun's audio experts. Performs equally well in large or small rooms. Consists of 12" woofer and 8" tweeter in modern or classic cabinet design. Speakers are installed back to back with tweeter facing wall. Treble notes are distributed throughout room with crisp, clear definition. Bass notes have no hangover. Realist has choice of speakers:

Altec 400B & 600B	\$158.92
Jim Lansing 208 & D131	\$167.75
Western Electric 755A & 728B	\$143.55
Western Electric 755A & Altec 600B	\$158.92
Electro-Voice 101A System	\$171.70
Wharfedale WCB/AL & W12CS with		
A-1000 Crossover	\$165.20

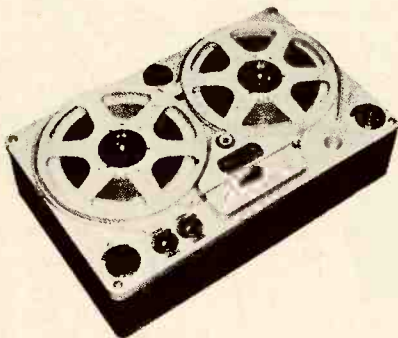

Concertone Broadcast Quality Tape Recorder -- only \$345

A magnetic taperecorder chassis that rivals the most expensive professional equipment, yet sells at only a fraction of the price! For the unskilled user. Connects to any home music system equipped with a separate amplifier chassis. Compare these features: (1) Dual Speed: 7.5" and 15" per second; (2) Uses RMA 7" and NAB 10 1/2" reels; (3) Single or Dual Track Heads quickly interchangeable; (4) Automatic equalization for speed; (5) Frequency response ± 2 db from 50-12,500 cycles at 15"/sec. and 50-7000 cycles at 7.5"/sec.; (6) Simultaneous monitoring from tape; (7) Separate heads for high frequency erase, record, playback. Write for free folder.



TWO BLOCKS NORTH OF CHAMBERS STREET
Established 1922 • Open Daily 9-6, Sat. 9-4:30

Singapore; has news 0500. (Cushen, N. Z.)

Surinam recently noted on approximately 2.460 (perhaps the listed 2.313 moved?), parallel 5.010, at 1915-2132 sign-off; may run later some days. (Stark, Texas.)

The new 100 kw. SIRA transmitter is located at General Pacheco, near Buenos Aires, and is reported to be the most powerful transmitter in South America; is to operate in the 49-, 31-, 25-, 19-, and 16-m. bands; several antennas are beamed to various parts of the world covered by SIRA programs in at least 7 languages. (Serrano, Brazil.)

At the time this was compiled, Lisbon's 19-m. channel apparently had been changed from 15.018 to approximately 15.380; noted 0800 and at greater strength than when was using 15.018; bad QRM, however. (Stark, Texas; Oskay, N. J.)

Pearce, England, confirms that Damascus, Syria, is now using 6.000, 7.145, 12.000, having dropped its 31-m. outlet for the present; *English* 0600, 1630.

Serrano, Brazil, flashes that *Radio Quitandinha* in Petropolis, State of Rio de Janeiro, had started tests around the time this was compiled; operates with a 10 kw. Philips transmitter on 5.045; will appreciate all reports in any language and assures that they will be answered; mail should be sent only to the Rio offices—Radio Quitandinha, Avenida Rio Branco 311 s. 924, Rio de Janeiro, D. F., Brazil. Serrano has asked this one to use *English* at opening and closing and the matter is being taken up by the Board of Directors of the station. When on regular schedule—perhaps by now—will operate 0600-2200 and sometimes to 2400; will have a FM outlet and later a TV outlet.

* * *

Press Time Flashes

Bangkok, 6.24, 11.91, 15.91, noted 0515 with news; YDQ3, 11.080, Makassar, Celebes, USI, noted 0600 with program for Dutch Forces; *Radio Makronissos*, 7.965, Greece, heard 1445 with Western music, then news in Greek; CR7BU, 4.932, Mozambique, noted 1115 with good signal in request program; ZPA5, 11.945, Encarnacion, Paraguay, noted 0615 with news in Spanish. (Sanderson, Australia)

World Radio Handbook and *How to Listen to the World*, published by O. Lund Johansen, Copenhagen, Denmark, in *English*, are now available direct from the American representative, Ben E. Wilbur, 32 Whittlesey Ave., East Orange, New Jersey. (Sutton, Ohio)

TIFC, 9.645, San Jose, Costa Rica, "Lighthouse of the Caribbean," verified with letter and beautiful QSL card; schedule was given as 1600-2400, *English* on Sundays 1600-1700, and 2300-2400, and Mon.-Sat. at 2330-2400. (Cohn, Ill.)

OAX4B, 6.530, Peru, noted 2200 in Spanish. (Denneny, Ill.)

Brazil went on *Summer Time* on

USE

KESTER

FLUX - CORE

SOLDER



FOR TV AND RADIO WORK—Kester Plastic Rosin Core Solder and Kester "Resin-Five" Core Solder. Kester Solders are made only from newly-mined grade A tin and virgin lead.

KESTER SOLDER COMPANY

4235 Wrightwood Ave.
Chicago 39

Newark, N.J. Brantford, Canada

KESTER SOLDER



INTERLOCKING SMALL PARTS CABINETS TO FIT ANY SPACE

MULTI DRAWERS are the handy small parts steel storage cabinets you and your friends have always wanted! Each 5 x 2 7/8 x 2 1/4 drawer (painted green) interlocks on top, bottom or sides making it possible to fit them around existing fixtures for economy of space. Card holder on front of each MULTI DRAWER. Immediate delivery in sets of 12 at \$3.50 per set. Mail coupon now!

THE CINCINNATI VENTILATING CO., INC.

Third and Madison Sts., Covington, Ky.

- Please send ___ sets of MULTI DRAWERS @ \$3.50 per set
 C.O.D. Check Money order enclosed. I agree to pay postage.
 I am interested in being a MULTI DRAWER dealer. Send full information.

Name _____
 Address _____
 City and State _____

December 1; will return to *Standard Time* around March; Rio de Janeiro Time now is *three hours ahead of EST*; Manaus Time is *two hours ahead of EST*. (Serrano, Brazil)

The Florence-Repallo High Frequency Broadcasting Conference ended without reaching agreement on an assignment plan. The Hague Conference, which was to have set the implementation date for the Atlantic City Allocations, has been postponed indefinitely, so it may be a long time before these allocations—which include expanded high-frequency broadcast bands and the new 21-megacycle amateur band—come into effect. (Legge, N. Y., via URDXC)

Radio Athens, 9.607, noted testing daily 1430-1445 in *English*. (Boice, Conn., Ferguson, N. C.) Also noted testing 2000-2058, in *English* 2000-2015; asks for reports. (Stark, Texas)

Vancouver's CBRX, 6.160, heard signing off 0300 after news and weather report. (Alcock, Ky.)

Grovè, Ill., says LRA, 9.69, Buenos Aires, has news daily 1905, 2050, 2105, 2250, 2300, 2345; Mailbag is Sundays 2245; gives detailed schedule 1900, 2100, 2300.

Radio Jamaica, 4.950, Kingston, announces 4.950 and m.w. 800 kc. daily at 2300 closedown; says will re-open 0630 Mon.-Sat. and 0715 on Sun. (Grove, Ill.)

CE1180, 11.99, Santiago, Chile, noted 1930 with news in Spanish. (Russell, Calif.)

HRXW, Comayaguela, Honduras, verified but did not send schedule; gave frequency as 8.990. (Ferguson, N. C.)

BFEB, Singapore, noted on 11.88 at 0745 when announced 15.300, 11.880, 9.690, and a 49-m. outlet.

The new Mexican outlet on 11.90 which relays m.w. XEX, Mexico City, announces only as "La Voz de Mexico." (Ferguson, N. C.)

In verifying, Prague, Czechoslovakia, listed schedule to North America as 1900 on 15.230; 2100 and 2230 on 11.84, 15.23. (Maurice, N. Y.) Prague, 6.010, noted with *English* 1715-1730. (Bellington, N. Y.) *English* programs for Europe now are listed for 0645-0730 on 11.840; 1415-1445 and 1530-1545 on 9.504 (may mean 9.55?); 1715-1730 on 6.010, 9.504, and 1800-1845 on 6.010. (Radio Sweden)

YNAS, 6.300, Managua, Nicaragua, noted to 2100 or later. (Stark, Texas)

The station heard around 1730-1800 on approximately 9.430 is *Radio France Asie*, Saigon, Indo-China; has *English* 1730, then French and usually signs 1800 with "La Marseillaise." (Stark, Texas) Claims is on 9.524.

ZAA, 7.845, Tirana, Albania, noted 1515 with news; signs off around 1615. (Bellington, N. Y.)

Ponta Delgada, Azores, is on the air 1500-1600 on 11.094, and at that time on Thur. and Sun. on 7.015; at 1700-1900 daily on 4.845. (Arnold, Bermuda)

Budapest, Hungary, definitely now has news 1700 instead of former 1600



NOW! Learn PRACTICAL TV SERVICING From These PRACTICAL TV SERVICEMEN!

PROFIT FROM THE DAILY SERVICING EXPERIENCES OF THESE TELEVISION EXPERTS!

Use your present radio skill to learn television servicing the right way... the practical way... the way successful TV servicemen do television servicing. Take T.C.I. television training! T.C.I. training is based on the experience gained in the shops of Central Television Service... the many homes where TV receivers are located... and from the TV set manufacturers themselves. PRACTICAL TELEVISION is not a theory course in servicing, but a non-mathematical training program where you actually practice television servicing procedures used by expert TV servicemen!

LOOK AT THE EXPERIENCE YOU GET!

You learn the experience-tested, field-tested servicing techniques of more than 225 successful servicemen. You learn testing, servicing, trouble-shooting, repairing, set conversion, master antenna installation, field servicing short-cuts and every other phase of TV servicing by actually doing this work. Even COLOR TV, including conversion from black and white as developed by CTS engineers, is part of this practical, up-to-date training. To help you succeed in your own TV servicing business, you learn CTS' successful business methods, too.

TRAIN AT HOME—SET YOUR OWN PACE!

You don't have to leave your present job to get TV servicing training with T.C.I. You learn at home with easy-to-understand practical lessons prepared by Milton S. Kiver. You build and train on a large screen 29-tube RCA 630 TS type television receiver, given to you as part of your course. You learn television servicing the right way... the practical way... by doing actual television servicing. You don't have to repeat your radio training. Every lesson is on television. You learn easier and remember longer when you set your own pace and let your mind and hands work together.

ACT NOW! Send today for FREE catalog and sample lessons. See how T.C.I. practical training can help you. Write NOW!

GET FREE FACTS... MAIL COUPON NOW!

MILTON S. KIVER, *President*
TELEVISION COMMUNICATIONS Inst., Dept. I-D
205 W. Wacker Drive, Chicago 6, Illinois.

O.K., Mr. Kiver. Rush FREE Catalog and sample lesson on your practical TV servicing course. I am not obligated. Salesman will not call.

Name

Address

City..... Zone..... State.....

BEGINNERS! Check here for facts on PRE-TV radio course.

Join These Successful Servicemen of CENTRAL TELEVISION SERVICE — Chicago's Largest

T.C.I. is the only television servicing school connected with such a large organization as Central Television Service. As an optional feature, you get two weeks experience at C.T.S., making service calls and shop repairs. You learn TV servicing from a leading TV servicing company!

Facts Worth Knowing About CENTRAL TELEVISION SERVICE

- Over 225 practical servicemen.
- Over 100,000 television sets serviced annually.
- Over \$3 million in servicing work every year.
- Largest Master Antenna installer in the Midwest.
- Authorized service agency for all TV manufacturers.

Extra! COMPLETE SECTION INCLUDED ON COLOR TV!

Color TV is here! So up-to-date is TCI practical training, this course includes a complete section on converting present sets to color... on servicing color television sets. You get experience-tested, field-tested facts on Color TV from CTS. You'll need to know Color TV servicing to go places in this fast-growing field. You learn Color TV with TCI's PRACTICAL TELEVISION training!

MILTON S. KIVER, *active president* of T.C.I., is a registered professional engineer, Television Consultant, and internationally known author of TV books and magazine articles.

When Answering Advertisements Please Mention RADIO & TELEVISION NEWS

REMOTE SPEAKER CASES

Will take either a 4" or 5" Speaker, ideal for rear deck in car. Gray Plastic case, control and knob \$.98

10 to 33 points \$.98

Jones Connectors
2 MFD 1000 VDC Solar or G.E. \$.79
5 X5 MFD 400 VDC Tobe \$.98
3 .2 MFD 4000 VDC Tobe \$.98
.5 x .1 MFD 2000 VDC Aerovox \$.40

115 V. 60 Cy. Pri. Transformers
Dual 6.3 V 7 amps. Ea. \$2.49
220V-50 mil 6.3-2 amps 6.3-1 amp 5V-6.5 amp 2 for \$1.95

Carbon Microphone
Automatic Electric, New \$.99
SPST momentary toggle switches 7 for \$1.00

Tube Line Filters
30 Amp 250 vac/dc, 0.15 to 1000 mc's cont. duty \$2.50 ea.
..... 2/\$4.00

INSULATED Carbon Resistor Kit
100 Resistors, color coded 1/2, 3/4, 1 and 2 Wts. \$3.45

Mica Condenser Kit
100 Mica Condensers \$2.98
100 Ceramicon Condensers \$2.98



WESTERN SALES CO.

1218 PROSPECT AVE.

PH. MAIN 1-1052
Ohio buyers add 3% Sales Tax

CLEVELAND 15, OHIO

Service-Dealers: DO A

\$50,000

TV BUSINESS
ON A \$500 INVESTMENT

WITH THE

TRANSVISION

Factory Agent Plan

Why this Plan is BEST FOR YOU:

- You have NO INVENTORY PROBLEM because you work from our MILLION-DOLLAR stock.
- You get SPECIAL PRICES to enable you to undersell competition at a profit.
- You get EXCLUSIVE TERRITORY benefits.

REQUIREMENTS: You must be a Radio-TV Technician (experienced only); and you must have a presentable business place.

The TRANSVISION TV LINE is of the finest quality. Has the famous "A" chassis, housed in beautiful cabinets. 28 models. 17" or 19" Tubes.

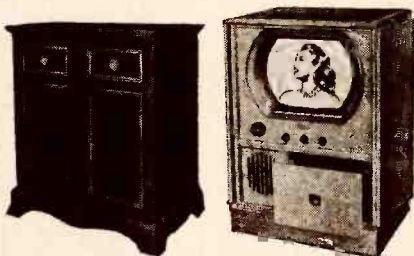

Write for Details on
FACTORY AGENT PLAN today!

TRANSVISION, INC.

Dept. RN NEW ROCHELLE, N. Y.

on 6.248, 9.833, 11.910. (Bellington, N. Y.)

FBS, Middle East, Malta, now signs on 2330 on 7.22, 6.14, and 6.015; off 0200. (Bellington, N. Y., Stark, Texas, others)

Lisbon noted on 15.38 and 11.04 opening 1230; off 1530 and back at 1600; final daily sign-off is 1800. (Bellington, N. Y.)

At press time, Moscow was announcing its evening transmission for North America, 1820-2300, on 15.23, 11.89, 11.82, 9.67, 7.29, 7.25. (Fargo, Ga.) Same data received direct from *Radio Moscow*. (Schilling, Calif.)

Radio Douala, French Camerouns, in verifying listed frequency of 7.287, 1 kw. (Peddle, Newfoundland) *ISWC*, London, says is now using 7.287 and 9.150 in parallel daily 1230-1515.

Lusaka, Northern Rhodesia, 3.914 and 7.220, noted 0900-1230; has *English* on Sundays and Tuesdays 0400-0600. ZRB, 9.110, Pretoria, South Africa, is scheduled 2345-1015. V3USE,

15.055V, Mauritius, is again audible in the United Kingdom around 1100; closes down 1230 with "God Save the King." (*ISWC*, London)

Schedules just in from *Radio Pakistan* list news for 2100 on 9.645, 15.335; 0110, 15.270; 0210, 11.885, 15.270; 0700, 11.885, 11.570; and 1015, 9.645, 11.570. (Dary, Kans.)

Radio Sweden's winter schedule is 1900-2030 on 6.065, 10.780; 0015-0235, 6.065, 10.780; 0235-1015, 11.705, 15.155; 1015-1300, 10.780, 15.155; 1300-1330, 6.065, 10.780; 1330-1400, 10.780, 6.065; 1400-1700, 10.780, 6.065; DX session is Saturdays 0215, 1015, 2015; stations are SBO, 6.065; SDB2, 10.780; SBP, 11.705, and SBT, 15.155.

Acknowledgment

The winter DX season is off to a good start! Please keep your reports coming—from anyone, anywhere in the world—to 948 Stewartstown Road, Morgantown, West Virginia, USA. Thanks! KRB.

AMATEUR TV STATION IN CANADA

ON September 1st, a complete TV transmitter, using equipment designed by J. R. Popkin-Clurman, W2LNP and described in the May, June, and July 1950 issues of *RADIO & TELEVISION NEWS*, was set up at the home of John D. Woodlock, VE2HE in Iberville, Quebec, approximately 28 miles north of the United States border and 32 miles from the city of Montreal.

The equipment was on the air continuously from September 1st to 5th putting out a test pattern and pictures. Propagation tests were made using this equipment. The carrier frequency was 53.51 mc. (6 meter amateur band) and standard television receivers, slightly modified by shifting the local oscillators down from Channel 2, were used for field tests. The transmitter radiated 25 watts peak and was fed into a "Vec-D-X" Type RD-13-A array which was rotatable. Effective radiated power was estimated at 250 watts.

Strong signals were received at La-

colle, Quebec by VE2AMO, 21 airline miles away and at several places in the city of Montreal, about 32 miles away. The blanking bars were received at La-valtrie, Quebec at the station of VE2SV, approximately 51 miles distant, with a faint picture being seen.

A receiver was set up at the home of VE2JN in St. Johns, Quebec, and a program transmitted for his benefit. Others participating in this series of television tests were VE2WF, VE2AEZ, VE2SG, VE2RC, VE2AG, VE2LQ, and C. M. Berry of Montreal and O. Fontaine. The effective resolution of the pictures up to 8 miles was better than 325 lines. VE2HE expects to start TV transmissions again within a month, probably with higher power.

Since September 8th, the transmitter has been on the air with test patterns and has been received in many of the suburbs of Montreal with good picture detail.

-30-

John D. Woodlock (right foreground) checking operation of his ham TV setup. Since this original item was written, word has been received that Mr. Woodlock died suddenly in his sleep on October 31, 1950 at his home in Iberville, Quebec, Canada.



Thyrite Resistors

(Continued from page 51)

with the top output terminal positive as shown in 6D. As the applied voltage is lowered from the value required for null, the output voltage will reverse polarity and increase to a maximum in the opposite direction.

This circuit has two useful applications; one as a polarity-reversing control circuit, the other as a voltage regulator. Operation as a control circuit results from the action just described. The output voltage of reversing polarity, produced by changes in value of the input voltage, may be applied to polarized relays or to thyatron grids. Voltage regulator action is obtained when the applied voltage is somewhat more positive or more negative than the value required for bridge null. Under these conditions, output voltage changes will be a small percentage of supply voltage changes. The closeness of voltage regulation will depend upon the *Thyrite* exponent (See Equation 1).

Fig. 6E shows a potentiometer (voltage divider) in which the load taps are taken between series-connected *Thyrite* resistors. When the load currents are small with respect to the current flowing through the *Thyrite* string, the load voltages will be fairly constant. Variations in load voltage resulting from variations in load current, while not entirely eliminated, are much lower with the *Thyrite* potentiometer than with a conventional unit using linear resistance sections.

A simple voltage regulator is shown in Fig. 6F. The ratio of linear resistance (*R*) to *Thyrite* resistance (*T*) is chosen such that the *Thyrite* resistor operates within the steepest portion of its volt-ampere characteristic. Large changes in *Thyrite* current, resulting from corresponding changes in applied voltage, accordingly will produce small changes in voltage drop across the *Thyrite* resistor. Since output voltage is taken across the latter, output variations will be a fraction of supply voltage changes. The effectiveness of this regulator is enhanced when the output load current is small compared to current flowing through the *Thyrite* resistor. A particular advantage of the circuit is its ability to regulate alternating, as well as direct voltages.

The effectiveness of the voltage regulator may be increased by cascading several sections, as shown in Fig. 6G. Variations in the output of each section are a small percentage of variations in the voltage applied to that section. As the number of sections is increased, the output voltage variation accordingly approaches zero. However, each regulator section attenuates the initial applied voltage, as well as the voltage variation. The practical limit to the number of cascaded sections which can be used in a particular case is determined by the

SAVE 95% SENSATIONAL SURPLUS VALUES!

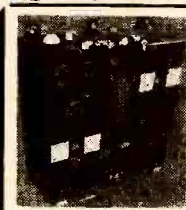

GO-9 XMITTER. Frequency range 3-18 MC and 300-600 KC. Band switching 100 w output. Brand new, in original mfg. crates. Comes complete with tubes and spare parts kit. Comes in three units; high and low frequency xmitter and rectifier. Dimensions: 14" deep x 27" long x 29 1/4" high. Net wt. 137 lbs. Shpg. wt. approx. 250 lbs. Finished in black crackle, shock mounted. Has 7 meters for indicating plate and grid current, also antenna current. Operates 110V 800 cycles. Single phase and 24V DC. Contains 2—803 tubes, 1—807, 1—801, 2—837, 1—523, 2—1616. Comes with maintenance manual and test data. **\$72.50**
EXPORT QUANTITIES AVAILABLE. Write for complete information.

SURPLUS RADIO CONVERSION MANUAL NO. 2 containing conversion information for GO-9 to 10 meters and 110V 60 cycles. Contains 18 other popular conversions and complete information. **\$2.50**

COMMAND RECEIVERS

Tested Before Shipping

190-550 KC Used. Orig. \$40. Now	\$12.50	
3-6 MC Used. Orig. \$30. Now	4.95	
3-6 MC New. Orig. \$35. Now	7.95	
6-9-1 MC Used like new	7.95	
1.5-3 Meg Brand New	24.50	
ARR-1, brand new	9.95	

COMMAND XMITTERS

T-22 ARC, 5 MC. Used. SAME as BC-459	\$ 9.95
T-22 ARC-5-7-9.1. New. Orig. \$50. Now	12.75
3-4 MC. Used. Orig. \$50. Now	12.50
T-23/ARC-5 100-156 Megs. 4channel Xtal. Used.	25.00
MD7/ARC5 Modulator Plate & Screen for T23ARCS, with Dynamotor	15.00
T-21 ARC-5-3-7. New. Orig. \$40. Now	8.95
4-5.3 MC. Used. Orig. \$30. Now	5.95
2.1-3 MC. LN. Orig. \$40. Now	16.95

BC-906 ABSORPTION-TYPE FREQ. METER

Freq. range 150-225 Mc. Uses 0-500 DC Microammeter for indicator. In black crackle carrying case with handle. 12 1/2 x 8 1/4 x 6 1/2". Net 18 lbs. With tubes and calibration chart. **\$14.95**

BC-221 FREQ. METER **\$72.50**

BC-221 AK Modulated Freq. Meter... **\$92.50**

BC-434 RADIO COMPASS CONTROL BOX, contains tuning meter. Brand new in original carton. **\$2.95** each or **10 for \$19.95**

AN-29C ANTENNA for BC 659 FM Unit **\$2.95** new

WESTERN ELECTRIC AUDIO AMPLIFIER TYPE D-150300

An excellent mod. driver or PA system with hi-quality components. Input stage consists of 2-6J7's into 2-6L7's feeding 2-6C5's. Impedance couple to 6L6's in PP parallel. Class A 40 W output, 225 ohms output impedance. Power supply 110V 60 cyc. using 2-5Y4's. Has Built-in limiter and compression circuits. Maximum gain 110 DB. Fits standard 17" rack. Tube sub-chassis is hinged and folds back. Comes in hvy. dty. wood carrying case with 110V. Cy. blower for air circulation. With TUBES, DIAGRAM. LIKE NEW INSIDE. Case scratched slightly. **\$69.50**

EXPORT INQUIRIES INVITED!
LARGE STOCK OF AIRLINE EQUIPMENT, TEST EQUIPMENT, RADAR SETS, ETC.
WRITE FOR COMPLETE INFORMATION.
INQUIRIES ANSWERED IMMEDIATELY.

NO ORDER LESS THAN \$5.00. Send 30% deposit on cost of item or full amount to save C.O.D. charges. Do not send shipping costs. It will be C.O.D. only. Shipments sent via Railway Express unless other instructions given. Merchandise subject to prior sale. Prices subject to change at any time.

BC-347 INTERPHONE AMPLIFIER. Contains 6F8 Dual Triode and matching transformer. New. **1.49**
HS-33 HEAD SETS. Used **1.50**
TBY VIBROPACK for TBY Transceiver. Supplies all voltages. Operates on 4-volt source. Brand new. Only **\$12.50**
T-85/APT-5 VHF TRANSMITTER. New, 350 to 1200 meg. 5 to 30 watts output. Brand new complete with tubes **\$59.50**

BC-620 FM TRANSCIVER AND PE 120 VIBROPACK

20 to 20.9 Megacycles. Xtal Controlled. Part of SCR-509. Includes PE-120 Vibrator Power Supply Battery Case, Shock Mounting. Used, but in excellent condition. **\$22.50**

NEW STANDARD BRAND CHOKES

SWINGING CHOKES		SMOOTHING CHOKES	
HY	BRAND MILS OHMS PRICE VOLTAGE CASE WT.	BRAND MILS OHMS PRICE VOLTAGE CASE WT.	
8-40	Stancor 175 100 2.75 3KV Closed 3.5	5	GTC 500 600 4.95 2KV Closed 4
8-30	Stancor 200 80 3.25 3KV Closed 4.5	7	Stancor 150 200 1.25 2KV Open 2
5-25	UTC 200 100 4.95 2KV Closed 5	10	UTC 500 60 12.95 7KV Closed 28
5-25	UTC 300 90 9.95 5KV Closed 18	12	Stancor 300 80 5.95 5KV Closed 9
8-25	Stancor 300 80 5.95 5KV Open 8 1/2	12	Thordarson 375 105 3.95 5KV Closed 8
5-25	Stancor 300 80 4.95 3KV Open 4	15	Stancor 200 120 2.95 3KV Open 4.5 lbs.
5-25	UTC 500 60 12.95 7KV Closed 28	20	Stancor 300 80 4.95 3KV Closed 9 lbs.
8-40	UTC 1 amp 50 39.95 10KV Closed 58	20	UTC 300 90 4.50 4KV Closed 10 lbs.
		20	UTC 400 85 5.95 5KV Closed 14 lbs.
SMOOTHING CHOKES WITH HUM BUCKING TAP			
HY	BRAND MILS OHMS PRICE VOLTAGE CASE WT.		
20 Series	UTC 1A 50 39.50 10K Closed 80		
5 Parallel	UTC 2A 12.5		
16 Series	UTC 175 96 5.95 2.5K Closed 15		
4 Parallel	UTC 350 24		
26 Series	UTC 200 112 6.95 3.5K Closed 15		
6.25 Parallel	UTC 400 28		



TBYS TRANSCIVER

VHF Transmitter-Receiver 28-80 MC in 4 Bands. Voice of MCW XTAL Calibrated on 130 Channels. Uses 2-30 tubes, 1-1E7 and 1-959. Comes with carrying trunk, Vibropack, headset and mic. ant. spare tubes, instruction book, canvas carrying case. Like new. Originally \$150—now only **\$59.00**

VACUUM CONDENSERS

50 MMFD 5 Amps. 5 KV.....	\$1.15	100 MMFD 20 KV.....	\$7.95
12 MMFD 20 KV.....	5.95	150 MMFD 20 KV.....	7.95
50 MMFD 20 KV.....	6.95	200 MMFD 20 KV.....	7.95

While They Last!

PORTABLE FM XMITTERS AND RCVR'S!

Operate on 6v DC. 34 MC varied either direction depending stals, xmitter and Rcvr has aluminum case with antenna relay. Xmitr uses 1073.125 KC extral in osc. stage followed by 4 doublers and 1 fm. amp. all using HY 65 tubes. Mike amp. and Fre. Mod. use 1C76 tubes. Xmitr stages have metering jacks. Rcvr is superhet. Xtal cont. local osc. at 8060 KC. Power Supply on chassis using Carter 6v gen. output 450 v. 250 ma 6v vibrator power supply for receiver. All tubes inst. heating. Included is control box, hand set, 8" speaker and extra microphone. Used, complete set only **\$45.00**

V&H RADIO & ELECTRONICS SUPPLY DEPT-R-17, 2033-37 W. VENICE BLVD. LOS ANGELES 6, CALIFORNIA

Advance with ELECTRONICS CITY

You need firm grasp of fundamentals to keep pace with these complex, fast-growing fields. In thorough 2-year course learn electricity, electronics, physics, mathematics, drafting, etc. Employers want Franklin graduates. (Coed, G.I. approved. Day, evening. 43rd year. Write for Catalog.)

FRANKLIN TECHNICAL INSTITUTE
46 Berkeley Street Boston 16, Mass.

BARGAIN HUNTING? **RADIO SERVICEMEN!**
Write for SENSATIONAL CATALOG
HENSHAW RADIO SUPPLY
3619 TROOST KANSAS CITY, MO.

No Experience Needed To

PRINT YOUR OWN POST CARDS

The GEM STENCIL DUPLICATOR saves money... gets results quickly! Hundreds of uses for every type of business and organization. We ship the GEM complete with all supplies, Guide Board for accurate printing and 60-page Book of Ideas at the special low price of only **\$8.50** (a \$15.00 value)

FREE TRIAL OFFER

Use the GEM FREE at our expense! SEND NO MONEY. Write and complete GEM outfit will be sent you postpaid. After ten days, send us only **\$8.50** or return the GEM. You must be satisfied! WRITE TODAY.

BOND EQUIPMENT CO. Dept. 52
6633 Enright • St. Louis 5, Mo.

IT'S **NEW!**

IT'S A **NATIONAL!**



\$49⁹⁵ SW-54

*the most compact
general coverage
receiver
ever built!*

- 540kc — 30mc
- VOICE
- MUSIC
- CODE

Designed especially for the shortwave fan, the new SW-54 covers ship, police, amateur, foreign and standard broadcast bands. Yet it's housed in a smart, modern, unbreakable metal cabinet that measures only 11" x 7" x 7". Uses new miniature tubes in superheterodyne circuit, for astonishing sensitivity. Unique adjustable plastic bandsread dial assures logging accuracy over entire range. AC/DC operation. Write for details and name of nearest supplier.



amount of voltage reduction which can be tolerated.

The circuits of both 6F and 6G may be employed as signal limiters ahead of, or between the stages of a tube amplifier. Such limiters differ from clipper circuits in that they keep the signal amplitude reasonably constant without squaring the wave. However, the odd-harmonic distortion introduced by the *Thyrite* must not be neglected.

The circuit of 6H may be considered the inverse of the voltage regulator (Fig. 6F). Here, the non-linearity of the *Thyrite* resistor is used to multiply variations in the applied voltage. It should be noted that it is only the *variation ratio* which is multiplied by this circuit, and not the voltage itself. Actually, the input voltage is attenuated, although the ratio of change is increased in the output. The ratio may be increased still further by additional sections in cascade, as shown in Fig. 6I. The practical limit to the number of sections which may be added is set by the permissible amount of voltage reduction. For best results, circuits 6H and 6I both should operate into high-impedance loads. Also, the linear resistances (*R*) must be small in comparison with the *Thyrite* resistances.

Operating Data

The following properties of *Thyrite*, which are of interest to circuit designers, are quoted directly from *General Electric Bulletin GEA-4138B*.

(1) *Electrical Stability*. (a) No change with time. (b) With proper application, *Thyrite* can be operated indefinitely without change in characteristic. (c) Unaffected by pressure or vibration. (d) Has same characteristics for impulses of microseconds duration as it has for d.c. or a.c. instantaneous values of current and voltage. (e) Free from polarization effects.

(2) *Power Ratings*. (a) *Continuous*. Depends upon permissible temperature rise of *Thyrite* and provision made for dissipation of heat. A continuous rating of 0.25 watt per square inch of *Thyrite* surface is usually allowable for separated discs, with the plane surfaces vertical, in still air. This conservative rating can be increased, where necessary, by the use of special provisions for cooling, such as radiating fins, forced-air draft, or immersion under oil, or *Pyranol*. (b) *Short-time*. Short-time rating depends on volume of disc. Assuming no time for radiation, a temperature rise of 80 C. results from energy input of 2000 watt-seconds per cubic inch of *Thyrite*.

(3) *Effect of Temperature*. An increase in *Thyrite* temperature tends to increase the current, the increase in current also being dependent upon the voltage applied. The change in resistance at constant voltage is from -0.4 per-cent to -0.73 per-cent per degree C. over the temperature range 0 to 100 C. To avoid undue oxidation of

TV TUBES

For Manufacturers

The tough-to-get TV tubes you want are at **HY-GRADE-NOW!** TV Receiving Tubes—all types! TV Picture Tubes—all types! Fully guaranteed under the Standard RMA Guarantee! Prompt Delivery!

Write us your tube needs on your company letterhead—for our quotation. Get these scarce tubes now—from **HY-GRADE**—while the getting is still good!

Be **First** in **TV COLOR PROFITS!**

Watch for **HY-GRADE'S** spectacular exclusive scoop on the *newest invention* in **COLOR TELEVISION Accessories**—in next month's issue! It's your biggest money-making opportunity in TV!

WRITE FOR DETAILS NOW

Send us your name and address on a post card *right now!* We'll mail you the complete details about this sensational new invention on January 15th—a full 2 weeks before the ad itself appears. Then you'll be first to know all about it—and first to cash in on it!

Only **HY-GRADE** has this terrific new profit-maker! Don't miss this chance-of-a-lifetime to be in on the ground floor—*first* in **COLOR TELEVISION** in your community! **SEND YOUR POST CARD NOW!**

Hy-Grade Electronics, inc.

Dept. R, 1509 EAST NEW YORK AVE., BROOKLYN 12, N. Y.

National Distributors of Electronic Parts and Equipment

OUTSTANDING - TV - VALUES

MODEL #300
Folded dipole complete with reflector and high frequency adapter. Covers 13 channels. All alum. construction. Less mast. Shpg. wt. 7 lbs. PRICE..... \$4.95

MODEL #200-D
Stacked array. Consists of 2 complete conicals and connecting bars. Very rigid construction. Covers all 13 channels. Matches 300 Ohm or 72 Ohm. Center impedance 150 Ohm. Ideal for low signal areas. An outstanding buy. Shpg. wt. 12 lbs. **SENSATIONAL \$9.75**
OFFER at, less mast.

MODEL #200-S
Single array. Same construction as above. Shpg. wt. 7 lbs. Price, less mast. **\$4.50**

MODEL #500
All-band folded dipole antenna. Ideal for rotator use. Maximum gain on any channel. All alum. construction. Less mast. Shpg. wt. 8 lbs. Price..... **\$4.95**

MODEL #Y-100
5 element Yagi Hi-Gain beam designed specifically for fringe area use. All alum. construction. Cut to specific channels. Shpg. wt. 4 lbs. Channel #7, \$4.50; Channel #9, \$4.25; Channel #11, \$4.00; and Channel #13, \$3.75. The prices are less mast. "V" type antenna. Price \$4.25

ANTENNA ACCESSORIES

CM-100 Chimney Mount.....	\$ 1.50
WM-100 Wall Mount.....	.98
U-100 "Universal" Ant. Mtg. Bkt. Offset to 8" Price as U-100 but Offset to 12".....	3.95
U-200 Same as U-100 but Offset to 12".....	6.95
5-ft. 1 1/2" OD Steel Mast, Plated.....	1.25
3-ft. 1" OD Alum. Mast.....	1.90
3/2" 300-ohm stand-off insulators (fit coax cable). Per 100, \$3.00; per 500, \$12.00; Best Quality 300-ohm twin lead.....	per 1000 20.00

High Quality 72-ohm Coax Cable. Send for prices.
Folded Dipole Hi-Frequency Adapters..... 1.50
Conical Hi-Frequency Adapters..... 1.50
Straight Dipole Hi-Frequency Adapters..... 1.50

TERMS: All shipments F.O.B. Newark, New Jersey. 25% deposit with orders, balance C.O.D. Minimum order \$2.00. Include ample postage.

Prices Subject to Change Without Notice

EAST COAST ELECTRONICS

40 St. Francis Street Newark 5, New Jersey

the metallized surface and to preclude depreciation of impregnating compound, the operating temperature of *Thyrite* should not exceed 110 C. continuously, nor exceed 150 C. for short times. However, proximity of *Thyrite* to other materials may dictate lower operating temperatures.

(4) *Effect of Humidity.* Effect on *Thyrite* volt-ampere characteristics is minimized by use of impregnating compound. At currents below one milliampere, and for high-humidity conditions, further precautions may be necessary.

BIBLIOGRAPHY

The author has consulted the following references and recommends them to readers desiring a more extensive treatment of *Thyrite* characteristics and applications.

1. Dubar; "Conductors Which Do Not Obey Ohm's Law," General Electric Review, Vol. 24, p. 153.
2. "Thyrite," General Electric Company, Bulletin GEA-4138B.
3. "Thyrite (Resistance Material)," General Electric Company, Catalogue GEA-4244B, p. 56.
4. McEachron & Brinton; "Performance of Thyrite Arrestors," General Electric Review, Vol. 33, p. 350.
5. McEachron; "Thyrite, a New Material for Lightning Arrestors," Transactions of the A.I.E.E., Vol. 49, p. 350. Also General Electric Review, Vol. 33, p. 92.
6. Brownlee; "The Calculations of Circuits Containing Thyrite," General Electric Review, Vol. 37, pp. 175 and 218.
7. Ashworth, Needham & Sillars; "Silicon Carbide Non-Ohmic Resistors," Journal of the Institution of Electrical Engineers, Vol. 93, No. 69, p. 385.
8. Patchett; "Theory of the Non-Linear Bridge Circuit as Applied to Voltage Stabilizers," Journal of the Institution of Electrical Engineers, Vol. 93, No. 21, p. 16.

-50-

BYPASS REPLACEMENT

By L. FLEMING

A COMMON failure in transformer-operated TV receivers, such as the Philco Model 48-1000, is the shorting out of the 0.1 μ d. paper bypass condenser connected between ground and the screen of the horizontal deflection output tube. When this condenser shorts, it places the full "B" supply voltage across the screen dropping resistor, which is usually a carbon unit of around 2000 ohms. The result may be smoke, smells, and burned-out 5U4C rectifiers.

An overheated carbon resistor tends to go down in resistance, rather than up, so that the overloaded dropping resistor becomes practically a dead short across the plate supply. The failure is just the opposite of a "safe" failure. The usual fuse protection against excessive plate current in the 6BG6 tube is of no help, because the short is external to the tube.

This type of failure can be made "safe" by using one of the new metallized paper condensers for the screen bypass replacement. The self-healing characteristic of metallized paper is just the thing for this application. According to the manufacturers, if one of these condensers breaks down, the resulting arc discharged through the paper dielectric removes the weak spot in the paper and at the same time vaporizes the metal film around the spot, clearing the fault.

-50-

January, 1951

PRICES ARE BORN HERE RAISED ELSEWHERE

RADIO ELECTRONICS

BC-605 INTER-PHONE AMPS.

(See conversion of this Unit on Page 140 in April issue—Radio-Telv. News). Ideal for Inter-Com; Office to office; airplane inter-com, etc.; Complete with Tubes, Diagram and Case. Easily converted.

ALL BRAND NEW.
OUR LOW PRICE... **\$3.95 ea.**



MINE DETECTOR, AN/PRS-1

Easy to operate, easy to carry. Can be used for detecting ore deposits, both metallic and non-metallic. Now being used extensively by Miners, Prospectors, Beachcombers, and Explorers. These sets are brand new and come complete with Detector head with antenna; Reflector meter and housing and exploring rod; a bag for carrying equipment while operating and a wooden case for storing or transporting unit when not in use. These units contain Tubes, and instruction books. Shipping weight is 125 lbs. Weight when operating unit is 22 lbs. All New—Complete with Batteries and ready to operate

Set **\$29.95**

METERS

Westinghouse—G.E. Weston

MILLIAMPERE D.C.

3"-0 to 50	\$3.95 Ea.
3"-0 to 100	3.95 Ea.
3"-0 to 200	3.95 Ea.
3"-0 to 250	3.95 Ea.
3"-0 to 300	3.95 Ea.
3"-0 to 400	3.95 Ea.
3"-0 to 500	3.95 Ea.

KILOVOLT D.C.

3"-0 to 400 DC	\$3.95 Ea.
3"-0 to 500 DC	3.95 Ea.
3"-0 to 2500	3.95 Ea.
DC	3.95 Ea.
3"-0 to 1.5	3.95 Ea.
3"-0 to 4	3.95 Ea.
3"-0 to 20	3.95 Ea.

(All are 1 M.A. full scale, require external multiplier.)

2" WESTON SPECIAL

0 to 30 V. DC and 0 to 120 Amps. DC	\$3.95 Ea.
0 to 30 V. DC and 0 to 240 Amps. DC	3.95 Ea.

VOLT METERS

3"-0 to 8 A.C.	\$2.95 Ea.
3"-0 to 15 A.C.	2.95 Ea.
3"-0 to 30 DC	3.95 Ea.
3"-0 to 150 DC	3.95 Ea.

TIME HOUR METERS

99999.9 Hrs.	
10-12 Volts, 60 Cycle or 110 Volts, 60 Cycle	
3 inch	\$6.95 Ea.

MODEL 60-9 TRANSMITTER

All brand New. 100 Watts CW or MCW emission. Operates from 110 V., 800 Cycle, easily converted to 60 Cycle operation. Low frequency range, 300 KC. to 600 KC. High frequency 3,000 KC. to 18,000 KC. using an E.C.C. We furnish complete conversion data with each transmitter. Complete with tubes and schematics. **\$59.95**



MIDGET SELSYNS

AY type operates from 6-12 Volts 60 Cycle. Use as both transmitter and receiver. These compact little units draw almost no current and work fine for all remote position indicating applications. OD 2 1/4 x 2 1/4 x 2". All New (Appr. wt. 1 lb.)... Each **98c**

3" TRIUMPH OSCILLOGRAPH

Complete Test Scope, with built-in Wobbulator, so as to be used on TV or FM servicing. Operates from 110 Volt, 60 Cy. A.C. Limited Supply. All these units have been carefully checked and are in excellent condition. **\$34.95 Ea.**

A Real Buy. SPECIAL



All Mail Orders Promptly Filled, F.O.B. San Francisco send postage stamps. Write for our free booklet listing our Motors, Wire, Meters, Batteries, Aluminum Sheets, etc. 20%

STANDARD SURPLUS

1230 Market St., San Francisco 3, Cal.
Telephone Hemlock 1-3106

RADIO COURSES

- RADIO OPERATING • CODE
- RADIO SERVICING • ELECTRONICS • F.M. TELEVISION
- PREPARATION FOR CIVILIAN, MARITIME, ARMY AND NAVY LICENSE REQUIREMENTS.

Write for Catalog T.S.

YMCA TRADE & TECH. SCHOOL 229 W. 66 St., N. Y. 23
Endicott 2-8117

ANOTHER OUTSTANDING JOBBER

Westchester Electronic Supply Co., Inc.

420 MAMARONECK AVENUE
White Plains, N. Y.

HAS THE SENSATIONAL NEW
TECO 425-K 5" SCOPE KIT
IN STOCK!

\$39.95



PROP PITCH MOTORS

For your Beam Antenna:
20 Volt to 32 Volt, A.C. or D.C. 1/4 H.P. Motor;
1 1/4 RPM Gear Reduction,
7000 to 1.
ALL BRAND NEW..... **\$13.95 ea.**



ARMY FIELD TELEPHONES

Type EE-8—Talk as far as 17 miles, wonderful 2-way communication at a very low cost, ideal for homes, farms, factories, etc., up to 6 phones can be used on one line. Each phone complete with Ringer, Mag-neto, Batteries, etc. Used, but good as new **\$16.95 pair**

360 Foot Roll Wire for above..... **\$1.95 roll**

DYNAMOTORS

DM-512 Input 12 V. D.C. @ 3.8 Amps.
Output—380 V. D.C. @ 100 MA. **\$3.95 ea.**

DY-82—Input 28 V. D.C. @ 1.1 Amp.
Output 250 V. D.C. @ 60 MA **\$1.50 ea.**

WILLARD 2 VOLT RADIO BATTERY

NEW, Uncharged (Appr. wt. 4 lbs.)
TYPE 20-2 **\$1.45**

Complete set of three with Box and Connections to make a 6 volt, 20 Amp. Hr. Battery Uncharged (Appr. wt. 15 lbs.)..... Set **\$4.95**



COMMAND RECEIVERS

190 KC to 550 KC (Appr. wt. 12 lbs.) **\$8.95 ea.**

3 MC to 6 MC (Appr. wt. 12 lbs.) **6.95 ea.**

All used but complete and in good condition.

COMMAND TRANSMITTERS

3 to 4 MCS **\$8.95 ea.** 5.3 to 7 Meg. **\$4.95 ea.**

Complete with Tubes and Crystals, excellent condition.

GYRO MOTOR UNITS

Dual Gyro Unit which was used in conjunction with Auto-Pilot equip. Both Gyro Motors mounted on a single base, wired in parallel for 12 or 24 Volt operation. One used as the Azimuth control and the other as an elevation control. When ordering these Units, specify 12 or 24 Volt.

Our price—Special..... **\$4.95 ea.**

C-1 SERVO UNIT

Part of C-1 Gyro. Contains 24 V. DC. Servo Motor Clutch & Relays which control rotation of motor and a set of differential gears which control speed of output shaft in either direction. Can be used by itself to rotate beam antenna or as a boat rudder control. Excellent condition. **\$4.95 ea.**

RU-16 RECEIVERS

190 KC.—12 Meg. in separate coils. All Brand New..... **\$5.95 ea.**

Plug-in Coils **\$1.50 Ea.**

RU-19 Control Box for Receiver **\$1.00 Ea.**

BC-430 Transmitter companion to RU-16 2 Meg. to 9 Meg. in separate coils. Similar to G.F.-11 transmitter. All New..... **\$5.95 Ea.**

Plug-in Coils **\$1.50 Ea.**

EDISON NICKEL ALKALINE 6 V. CELLS

Five 1.25 Volt Cells banked together. 75 Amp. Hour complete with Electrolyte. **\$22.50 per set**

All Brand New.....

HI VOLTAGE MICA CAPACITOR

TYPE G.I.

2 3/4" Diam. x 2 1/2" Height, 02, 04, 08, 09 MFD @ 1500 Volts **\$2.50 Ea.**

DC.



All California Orders—Add 3% Sales Tax... Do not stock and prices on Radio, Electronics, Tools, Hardware, Dep. on all C.O.D. orders. All items subject to prior sale.

WAR EQUIPMENT MAIL SALE!

SAVE up to 70% on Electronic, Radio, Mechanical Equipment!

For home experimenters, laboratories, schools, etc. New fully guaranteed. Fraction of original cost. 1000s of items including:

- 2500-w, 60-c, 110-v Plants..... **\$289.20**
- 1500-w, 400-c, 110-v (A-C Plant)..... **129.60**
- 1000-w, 800-c, 115-v generator..... **18.96**
- G. E. Wall Heater, 3000-w, 110-220-v **26.80**
- General Electric Selsyns (pair)..... **3.39**
- Raytheon 110-v Electric Timer..... **8.94**
- Meg-A-Lite Continuity Tester..... **1.99**
- Resistor Capacitor Asst. 4 lb. **1.89**
- City Desk Telephones..... **5.98**
- Photo Cell Light Control Kit..... **4.87**
- Other bargains—Compressors, Paint Spray Guns, Engines, Pumps, Tools, etc.

18 yrs. in business in Lincoln. Satisfaction Guaranteed. We prepay all shipments.

Card brings catalog, 1000s bargains.

BURDEN SALES COMPANY

853 "O" St. Lincoln, Nebr.

FREE CAT. ALONG

**RADAR, COMMUNICATIONS
AND
SONAR TECHNICIANS
W-A-N-T-E-D
For Overseas Assignments**

Technical Qualifications:

1. At least 3 years practical experience in installation and maintenance.
2. Navy veterans ETM 1/c or higher.
3. Army veterans TECH/SGT or higher.

Personal Qualifications:

1. Age, over 22—must pass physical examination.
2. Ability to assume responsibility.
3. Must stand thorough character investigation.
4. Willing to go overseas for 1 year.

Base pay, Bonus, Living Allowance, Vacation add-up to \$7,000.00 per year. Permanent connection with company possible.

Apply by Writing to
**D-4, P.O. Box 3575,
Philadelphia 22, Pa.**

Men qualified in RADAR, COMMUNICATIONS or SONAR give complete history. Interview will be arranged for successful applicants.

PEN-OSCIL-LITE

Extremely convenient test oscillator for all radio servicing; alignment • Small as a pen • Self powered • Range from 700 cycles audio to over 600 megacycles u.h.f. • Output from zero to 125 v. • Low in cost • Used by Signal Corps • Write for information.

GENERAL TEST EQUIPMENT
38 Argyle Buffalo 22, N. Y.

STAR SPECIAL!

GENERAL ELECTRIC

L PADS AND T PADS

Properly designed to provide correct taper for attenuation or impedance in audio amplifiers and loud speaker systems. 5 to 30 db range in 90° rotation, last 10% affording infinite attenuation. Limited quantities available. Another great STAR special!

L PADS

For constant impedance at either source or load. Ideal for individual volume controls in multiple speaker set-ups without affecting source impedance.
URA-007 8 ohms \$.95 URA-009 200 ohms \$.95
URA-008 15 ohms .95 URA-010 500 ohms 1.15

T PADS

Variable attenuators for use in circuits where line impedance to and from load must not be disturbed.
URA-012 8 ohms \$.95 URA-014 200 ohms \$.95
URA-013 15 ohms .95 URA-015 500 ohms 1.15

COMPLETE STOCKS
All Standard Brands

Just off the press

BIG BARGAIN BULLETIN

STAR

**ELECTRONIC
DISTRIBUTORS, INC.**

Dept. RN 2-7736 S. Halsted, Chicago 20, Ill.

**RADIO-TV
Service Industry News**

**AS REPORTED BY THE
TELEVISION TECHNICIANS LECTURE BUREAU**

THE crystallization of a plan that was launched in Chicago in September by a group of Chicago television service contractors occurred at a conference held in Washington in late October. At this meeting, which was attended by service representatives from many sections of the country, the *National Alliance of Television and Electronic Service Associations (NATESA)* was formed. The general plan for the operation of the national federation was agreed upon and a slate of officers selected.

Frank J. Moch, the dynamic president of the *Television Installation Service Association of Chicago*, was chosen president of the new organization. Albert M. Haas, president of the *Television Contractors Association of Philadelphia* was named vice-president, while Jim Hustad of the *Omaha Television Installation Service Association*, Omaha, Nebraska, was named secretary. The duties of treasurer will be handled by Bertram L. Lewis of the

American Radio Technicians Guild of Rochester (N. Y.)

The philosophy and purpose of the *National Alliance of Television and Electronic Service Associations* is outlined in a letter from Mr. Moch to the editor of your "NEWS" department:

"NATESA was formulated to give the service profession an equal footing with the rest of the industry. We are certain that this new national group, when it is given its rightful place at the council tables of the industry, can do a great service for the entire industry.

"As President of both *TISA* and *NATESA* I am pledged, as I have always been in the past, to achieve full stature for the service profession. I am certain that such a goal can be reached very soon. Many conferences have already been held with other elements of the industry; many others are scheduled for the near future. One of the cardinal principles of *NATESA* is that it will not be a 'racket.' It will be

What's the best fringe area antenna—Yagi, conical, circle, or fan? Norman L. Chalfin answers questions for a group of Akron technicians at a recent service lecture session.



operated by service people. It will work unselfishly to the end that service will be recognized not as a necessary evil but as a very essential, integral element of the industry.

"NATESA will adopt a code of ethics and an emblem which will be the symbol of competence to the public. It will vigorously prosecute any service racket from without or within the profession. Among its goals will be:

1. Recognition of service as an honorable element of the industry.
2. The establishment of standards.
3. The establishment of "post graduate" training.
4. The establishment of adequate compensation for personnel and management.

5. A place on industry's councils." Organizations that want to contact NATESA should address their letters to: Frank J. Moch, President NATESA, 5908 South Troy Street, Chicago 29, Ill.

Manpower Situation

Government agencies, the Armed Services, and the television and electronics manufacturers are taking experienced field service technicians at a quickening rate. While the most serious inroads on the ranks of experienced service personnel have occurred in the metropolitan areas its effects are being felt by the service industry throughout the country.

The seriousness of the situation is clearly reflected in a frank "open" letter recently released to the leaders of the television industry by Albert M. Haas, president of TCA in Philadelphia.

"In Philadelphia the picture is clear: The loss of service technicians in television to the Armed Services and to the manufacturers of television and electronic equipment has become appreciable. Service calls are now being handled in five days instead of 24 hours because there just aren't enough technicians to handle them!

"Reports from members of this association indicate that the spread in service time will become wider unless something is done to forestall it. Published reports in trade publications confirm that Philadelphia is not alone in this predicament; other television centers report that their situation is even more alarming."

That this situation will become extremely critical was further evidenced in a talk given by E. C. Cahill, president of the RCA Service Company, before a group of 200 technicians at the Electric Institute of Boston. Mr. Cahill pointed out that an additional 10,000 television service technicians are required to handle the installation and service of the current television production output of the industry.

Citing the incredible speed of television's growth as one factor in the expanding need for trained service personnel, Mr. Cahill pointed out the complications posed by the fact that it takes years to train a technician to full competence while the present field forces are being skimmed off by gov-

YOU GET MORE FOR YOUR MONEY IN CHELSEA'S FAMOUS C-4 CHASSIS NOW BETTER-THAN-EVER!

**A Great Buy Before!
A Greater Value Today!**

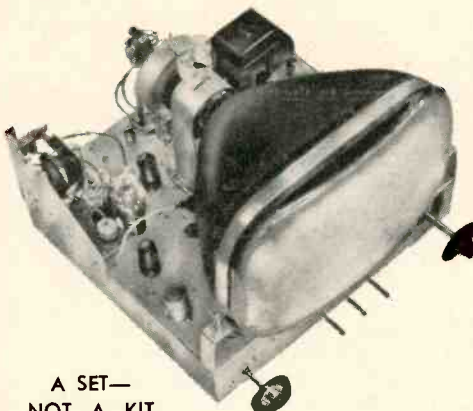

A SET—
NOT A KIT

**Full R M A Guarantee
Free Chelsea Warranty**

JUST PLUG IT IN—AND IT WORKS!

- Completely wired
- Improved AFC
- 13K anode voltage
- Super-power circuit
- Keyed AGC
- Phono jack & switch
- Factory-engineered
- Front End down
- One-Knob Control
- aligned and tested
- to 45 microvolts
- Greater Sensitivity
- Long Range Reception

In the NEW, Improved, 1-Knob Control Chelsea Chassis you get all the quality-controlled features for which it has become nationally famous— PLUS many operational improvements —at the low prices for which Chelsea is equally famous!

**NEW, BETTER-THAN-EVER
1-KNOB CONTROL C-4-11**

FOR LESS CRT
17" — \$119⁹⁵
round or plus \$1.40
rect. tube Fed. Tax

**NEW, BETTER-THAN-EVER
1-KNOB CONTROL C-4-13**

FOR LESS CRT
20" — \$129⁹⁵
rect. tube plus \$1.40 Fed. Tax

GUARANTEED FACTORY-FRESH PICTURE TUBES IN SEALED CARTONS

16" — round, \$40	16" — rectangular, \$41	17" — rectangular, \$42 ⁵⁰	19" round, \$69 ⁹⁵ 20" rect.,
----------------------	----------------------------	--	---

ALSO AVAILABLE—630 TYPE CHASSIS

Write Dept. Z for latest literature and prices—AND COMPARE!

Phone and mail orders filled on receipt of certified check or Money Order for \$25.00 as deposit. Balance C.O.D., F.O.B., N. Y.

The House of Bargains

CHELSEA TELEVISION CENTER, INC.

Office and Showroom: 130 West 42nd Street, near Broadway
New York 18, N. Y. LOnacre 5-2254-5-6

Prices and Models subject to change without notice.

IF . . . You are buying or building a TAPE RECORDER

OR . . . you are a RECORDER ENTHUSIAST

don't fail to read A. C. Shaney's dynamic new booklet

3rd printing, increased to 144 pages!
Price still \$1.00 postpaid
Order today. Enclose dollar bill, check or money order

ELEMENTS of SINGLE AND DUAL TRACK TAPE RECORDING and 1001 APPLICATIONS

Booklet mailed same day

AMPLIFIER CORP. of AMERICA
398-2 Broadway, New York 13, N. Y.

RADIO Engineering

Complete Radio Engineering course incl. Telev., U.H.F., and F.M. B.S. Degree Courses also in Civil, Elect., Mech., Chem., and Aero Eng.; Bus. Adm., Acct. Visit campus, see well equipped labs. Low cost. Prep courses. Personalized instruction. Grads successful. Founded in 1884. Enter Jan., March, June, Sept. Write for catalog.

DEGREE IN 27 MONTHS

TRI-STATE COLLEGE
1611 COLLEGE AVENUE ANGOLA, INDIANA

QUAM Adjust-A-Cone SPEAKERS

15-inch Coaxial

FIRST IN REPLACEMENT FIELD

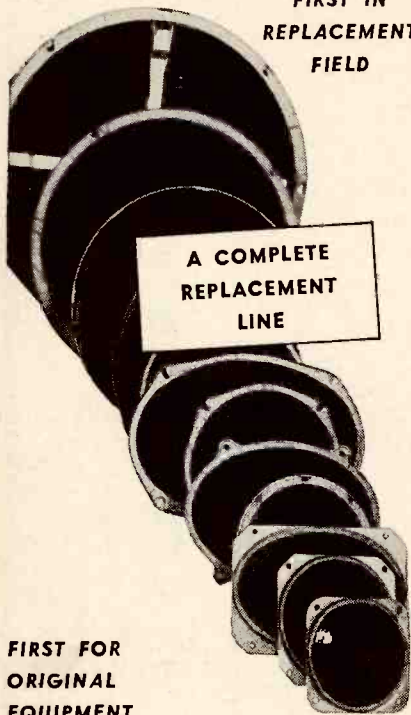

A COMPLETE REPLACEMENT LINE

FIRST FOR ORIGINAL EQUIPMENT

3-INCH

With P.M. and Dynamic Speakers from a 3" model to a 15" coaxial speaker, there isn't a radio set built today that cannot be fitted with a Quam Adjust-A-Cone Speaker. And every one is designed for the superior, trouble-free performance that means customer satisfaction and more profitable business for you.

And remember, every Quam Speaker has the exclusive U-Shaped Coil Pot that increases speaker efficiency, plus the patented Adjust-A-Cone construction that makes a rubbing voice coil as rare as a Sahara snowball.

For customer satisfaction, it pays to "Replace with Quam."

Write for Complete Quam Catalog
Also makers of Quam Focalizer Unit
and ION TRAPS

QUAM-NICHOLS COMPANY

522 E. 33rd Place CHICAGO 16, ILLINOIS

MAKERS OF QUALITY SPEAKERS FOR 27 YEARS, UNDER THE SAME MANAGEMENT



RADIO and TELEVISION

Thorough Training in All Technical Phases

APPROVED FOR VETERANS WEEKLY RATES DAYS—EVENINGS
FREE PLACEMENT SERVICE FOR GRADUATES

For Free Catalog write Dept. RN-51
RCA INSTITUTES, INC.

A Service of Radio Corporation of America
350 West 4th St., New York 14, N. Y.

ON-THE SPOT BATTERY RECORDER

WALKIE-RECORDALL 8 lb. miniature BATTERY RECORDER-PLAYBACK
Continuous, permanent, accurate, indexed recording at only 1¢ per hr. Instantaneous, permanent playback. Picks up sound up to 60 ft. Records conferences, lectures, dictation, 2-way phone & sales talks; while walking, riding or flying. Records in closed briefcase with "hidden mike." Write for details.

MILES REPRODUCER CO., INC.

812 BROADWAY Dep't RN-2 NEW YORK 3, N. Y.



A group of Akron technicians take a breather between lectures presented by the Lecture Bureau in a recent Radio-Television Service Industry Day program in that city. From left to right are: W. O. Parsons, East Akron Radio Service; Bill McPherson, Medina Radio & TV; John Ablett, Mac's Radio Service; and Mike M. Strboya, Medina Radio & TV.

ernment agencies that are drawing heavily on the service industry for technicians for top priority work.

The statistics given in Mr. Haas' "open letter" are helpful in getting a clear picture of the problem:

"We understand that there are about 60,000 qualified electronics experts engaged in television service. This means that we have one man to handle 167 sets of the ten million now said to be in operation.

"Without losing any of these men the service job involved in keeping ten million sets functioning, aggravated by the parts and tube shortages, is staggering. For each man to handle the service on an average of 167 sets, under today's conditions, is impossible. The line has to break somewhere under the pressure."

But despite the known and widely recognized seriousness of the situation no industry plans of any kind have been advanced toward solving the problem. In a few cities like Philadelphia and Chicago, where strong, active service organizations are operating, steps are being taken to put into operation planned programs to utilize the available personnel most efficiently. But these local programs cannot solve the pressing problem of manpower depletion. The problem cannot be solved by the service industry alone.

The real solution lies in some aggressive, soundly-conceived industry-wide program that will take into account the technical manpower needs of all segments of the industry and operating under a plan that will capture the interest of more men and women in this great new opportunity that is Television.

Parts Problem Serious

The service industry seems to have acquired "Trouble" as its stepmother in these arduous days. Another facet of the problem of providing satisfactory service is the difficulty in getting replacement tubes and parts.

Many manufacturers continue to sell the "tied-in" 12-month parts warranty contracts which, in the face of their in-

COLUMBIA Distributors, Inc.

ROUTE 8 (opp. school), COLUMBIA, N. J.

CARRIES THE ENTIRE LINE OF

EICO KITS

and factory-wired Instruments



425-K
5" SCOPE
KIT
\$39.95



221-K
VTVM
KIT
\$23.95



625-K
TUBE
TESTER
KIT
\$29.95



HVP-1
HIGH VOLTAGE
PROBE (wired)
\$6.95

Write us about your TV needs!

TWIN-TRAX* TAPE RECORDERS



...give you more

MORE MODELS

the most complete variety of recorders for professional, semi-professional and experimenter use.

MORE FEATURES

for better quality, smoother performance and easier operation.

MORE VALUE

because our direct sales policy saves you dealer markups.

Send today for our catalog 5109 which lists complete technical specifications and performance ratings for all recorder models and accessories. *Trademark Reg.

AMPLIFIER CORP. OF AMERICA

398 Broadway New York 13, N. Y.

When answering advertisements

please mention

RADIO & TELEVISION NEWS

SOLAR CAPACITOR ANALYZERS

Model CBB—Measures the capacity of any electrolytic, paper, mica or air capacitor between 10 mfd. and 800 mfd. Uses a 6E5 tube in bridge circuit with a 6E5 tube to indicate balance. Measures the power factor of electrolytic cond. Checks resistance from 100 ohms to 7 meg. and insulation resistance at voltages up to 450 V. DC. Operates on 115 V. 50-60 cps. Complete with tubes, test leads & instruction manual; shipping wgt. 9 lbs. **\$42.49**



20% deposit with order. Balance C.O.D.
JOBBERS—WRITE FOR DISCOUNTS

ARCEE ELECTRONICS CO.

ROOM 204 96 WARREN ST., N. Y. CITY, N. Y.

Specialized Service Men

CRYSTALS FOR LESS! If you are servicing aircraft, marine, police, mobile or industrial radio you may be entitled to our SPECIAL DISCOUNT on highest quality quartz control units. Write for full details... it will mean money to you!

RADIO SPECIALTY MFG CO. Dept. RT
2023 S.E. Sixth Ave. Portland 14, Oregon

RADIO & TELEVISION NEWS

ability to meet replacement commitments on previous contracts for the past several months, will have some very unfavorable repercussions unless distributor "pipelines" are soon filled with the necessary replacement supplies.

At the beginning of this period of shortages practically all service operators accepted distributor "due bills" for tubes and parts replaced under warranties and used parts and tubes from their own stocks. However when it became evident that their own stocks soon would be depleted leaving them holding the bag on the parts' investment and without supplies to take care of their growing COD business needs, service contractors found it necessary to take drastic protective action.

TISA of Chicago advised its members: "In the case of inability to get a replacement part on 'in warranty' sets, advise the customer that the parts replacement is the sole responsibility of the manufacturer and his distributor since the factory collected the parts fee. If you have the part available in your stock, use it in the set if the customer so requests, however, charge the customer full list price for the part and return the defective part to him with the instructions that he return it to the distributor otherwise a long delay will result."

And TCA of Philadelphia stated its position in a letter to the manufacturers of television receivers and their distributors in the Philadelphia area: "... this association has gone on record (10-19-50) as advocating that all contractors charge the customer for the replacement of parts in warranty and to advise the customer that he should take up with the manufacturer the replaceability of the affected parts and reimbursement for any parts provided by the contractor.

"We are impelled by the urgency of the present parts situation to take this step, much as we regret it. It is our hope that the manufacturers will take whatever steps are necessary to reduce the urgency and permit us to function in our accustomed role. When that happens we will be most happy to cooperate with the manufacturer in maintaining the customer's enjoyment and appreciation in his television receiver."

Before the present serious international situation developed the manufacturers of tubes and components were months behind in meeting the growing needs of the industry. They were allocating definite percentages of their production for distribution through regular replacement parts channels. Although the independent parts distributing pipelines were adequately stocked on most replacement items they were not overstocked.

The war-scare buying that boomed television and radio sales during the normally light summer months sent many set manufacturers scurrying into the replacement parts field to buy additional supplies of the components they needed to increase their set pro-

SURPLUS!

CIRCUIT BREAKERS
 Heineemann, 2-pole, 120 VAC; 15 A \$2.25
 Heineemann, 2-pole, 125 VAC; 25 A 2.25
 Cutler-Hammer, 2-pole, 115 VAC; 25 A, with type MO rainproof container. 3.65

AIRCRAFT GENERATORS
 Eclipse NEA-3; output, 115 VAC; 10.4 A; 800 to 1,400 Cye., 1 1/2 and 30 VDC; 60 A. Brand new! Original Packing. \$38.50
 Eclipse 1235-1A; output, 30 VDC; 15 A; Brand new—Original Packing. \$9.50

SELENIUM RECTIFIER STACKS FULL WAVE BRIDGE
 Max. input—18 VAC Max. output—14.5 VDC
 1.2 A \$ 2.64
 2.4 A 3.07
 6.4 A 4.09
 13.0 A 7.67
 17.5 A 8.69
 26.0 A 15.33
 39.0 A 25.00
 52.0 A 30.67
 65.0 A 38.33

Max. input—40 VAC Max. output—34 VDC
 6 A \$ 3.00
 1.2 A 3.44
 3.2 A 5.15
 6.0 A 9.32
 9.0 A 10.65
 12.0 A 18.64
 18.0 A 20.12
 24.0 A 35.96
 36.0 A 41.24

Current ratings can be increased up to 2 1/2 times max. values by forced cooling.
COAXIAL CONNECTORS
 83-1AC. \$0.42 83-1T. \$1.12 UG-30/U. \$1.20
 83-1AP. .15 83-22AP. 1.10 UG-58/U. .63
 83-1F. 1.12 83-22R. .48 UG-85/U. .88
 83-1H. .10 83-22SP. .85 UG-87/U. .79
 83-1J. .10 83-22U. .67 UG-175/U. .15
 83-1R. .40 UG-27/U. .68 UG-176/U. .15
 83-1SPN. .40 UG-29/U. .83

Full Line of JAN approved UHF, UG & British Coax Connectors in Stock. Prices Sent on Request.
CRYSTAL DIODES
 1N21. \$.79 1N23. \$1.19 1N45. \$.94
 1N21A. 1.19 1N23A. 1.55 1N52. 1.05
 1N21B. 2.75 1N27. 1.09 1N63. 1.39
 1N22. .89 1N34. .79

COAXIAL CABLE
 RG-7/U. \$0.06 ft. RG-54A/U. \$0.07 ft.
 RG-22/U. .12 ft. RG-58/U. .06 ft.
 RG-25/U. .10 ft. RG-62/U. .07 ft.
 RG-34/U. .16 ft. RG-77/U. .06 ft.
SPECIAL—Federal X-1128 72 ohm, 1KW twin lead (use instead of RG-8/U) 07 ft. Minimum order 500 ft. Add 50% for shorter lengths.
SOUND POWERED PHONES
 TS-10 handsets. each \$8.92
 RCA head and chest sets. each \$8.92
 RCA S.P. Units (use as mike or recvr.) pair 3.33

SELSEYS
 General Electric 2J1G1. pair \$2.95
 Caps for connecting to above. pair 1.00
 General Electric 2J1F1 generators. each 2.85
 C-78248 transmitters—110V., 60 Cye. 3 1/2" D x 5 1/2" L. pair 8.95
 C-78249 differentials—110V., 60 Cye. each 2.95
 Extra Heavy Duty bronze—4 1/2" D x 6" L; 115V., 60 Cye. pair 13.95
 Many other types in stock including 5F, 5G, 5CT, etc.

ANTENNAS
 AT-38A/APT (70 to 400 MC). \$13.70
 AT-49/APR-4 (300 to 3300 MC). 13.70
 AT-48/UP 3CM horn antenna. 4.95
 DZ-2 loop antenna with pedestal. 14.50
 AN-74B (125 to 150 MC). 1.65
 AN-65A (P/O SCR-521). .95
 AN-66A (P/O SCR-521). 1.25
 A1A 3CM conical scan. 125.00
 ASB Yagi 5 element—450 to 560 MC. 7.00
 ASB Yagi double stacked 6 element. 12.70
 ASA Yagi double stacked 370 to 430 MC. 29.40
 Include Postage with Orders

Minimum Order \$5.00, 25% with order, balance C.O.D.

ELECTRONIC RESEARCH LABORATORIES

1021-R Callowhill St.

Philadelphia 23, Pa.

AN CONNECTORS
 Large Stock—Send Us Your Inquiries
TROUBLE SHOOTING MANUALS
 (Includes schematics)
 BC-348-J, N, Q SCR-522 \$1.00 ea.
 BC-779 BC-610

POSTAGE STAMP MICA CAPACITORS
 MMF STANDARD SILVER
 5 to 1000 \$0.05 each \$0.10 each
 1100 to 2500 .07 each .20 each
 2600 to 9000 .12 each .50 each
 .01 MFD .18 each .20 each

PLUGS AND JACKS
 PL-55. \$0.35 JK-33. \$0.18
 PL-68. .22 JK-34. .18
 Mallory XP-2B. .28 Mallory 704B Jr. .18

TUBES
 3C24. \$.44 815. \$ 1.92 958A. \$.49
 10Y. .39 816. 1.45 959. .49
 RK-34. .28 826. .89 1613. .81
 100TH. 10.25 828. 13.38 1614. 2.29
 VT-127A. 2.40 829. 6.95 1622. 1.80
 211. .62 830B. 3.35 1624. .97
 304TH. 3.86 832. 4.91 1625. .29
 316A. .66 832A. 7.95 1626. .29
 446A. .49 836. 1.09 1629. .29
 803. 4.85 837. 1.38 8012. 1.45
 805. 4.75 838. 2.93 8025. 3.95
 807. 1.60 866A. 1.45 VR-75. 1.51
 808. 2.19 872A. 1.88 VR-90. .95
 809. 2.40 954. .39 VR-105. .95
 810. 10.95 955. .39 VR-150. .89
 813. 7.25 956. .49 OA2. 1.55
 814. 3.75 957. .49 OB2. 1.85

We carry a full line of surplus receiving, transmitting, cathode ray, photocell, klystron, magnetron and other special purpose tubes.

EQUIPMENT
 AN/APS-13 less tubes—excel. cond. \$12.95
 AN/APS-1 less tubes—excel. cond. 6.95
 T-9 APV-2 less tubes—excel. cond. 16.50
 BC-645A complete—new. 18.95
 RCA AV-15 Beacon receiver—new. 15.50
 TBY Transmitter receiver—complete. 29.95
 SCR-522 With tubes—good condition. 36.95
 BC-1206 CM2 Complete—new. 7.95
 FL-5 Filter. Used. .92
 FL-8A Filter. Used. 1.37
 T-17 Mikes. Used. 7.75
 BC-433 less tubes—good condition. 10.95
 RM-29 Remote control unit. 8.95
 RM-14 Remote control unit. 8.95
 ASB Radar equipment—complete. 69.75
 AN/APA-23 Recorder—new. 147.50

METERS
 500 Microamps, DC—2 1/2" round—Sun. \$4.30
 1 ma, DC—3 1/2" R. (4 KV scale)—Roller Smith. 4.17
 1 ma, DC Fan type—4" scale (rem. from equip) 3.95
 500 ma, DC 2 1/2" R.—General Electric. 2.95
 3 amp, RF 3 1/2" R.—Weston. 4.95
 2 amp, RF 2 1/2" Sq.—Simpson. 3.15
 5 amp, AC 4 1/2" R.—JBT. 4.11
 1 ma, DC 4 1/2" Sq.—Marion. 6.95
 50 VAC 3 1/2" R.—General Electric. 2.95
 50 amp, AC 3 1/2" R.—General Electric. 4.11
 56-62 Cycles (115 V.) 3 1/2" R.—JBT. 6.85
 10 amp, RF 3 1/2" R.—Simpson. 4.95

FILTER CHOKES
 10 Henry, 40 ma. \$.44
 10 Henry, 65 ma. 1.75
 10 Henry, 100 ma, cased. 1.75
 15/29 Henry, 150 ma, swinging full shield. 2.45
 4 Henry, 175 ma. 1.95
 10 Henry, 400 ma, HV insul. herm. sealed. 4.88
 12 Henry, 500 ma, cased. 9.20
 14/7 Henry, 370 ma, swinging cased. 9.85
 .2/9 Henry, 3.45A., 20KV, Ins. 16.95
 .02 Henry, 5 Amp, 2Ω. 3.95

RADIO and TELEVISION
 Over 30 years N.E. Radio Training Center. Train for all types FCC operators' licenses. Also Radio and Television servicing. FM-AM broadcasting transmitters at school. Send for Catalog M.
MASS. RADIO SCHOOL
 271 Huntington Avenue Boston 15, Massachusetts
 Lic. by Comm. Mass. Dept. Educ.

SOUND POWERED PHONES RCA-MI-2454
 Complete with 24' of Rubber Covered Wire.
NEW EXPORT PACKED
 Shipping weight 6 lbs.
\$6.45 PER SET
2 FOR \$12.50
 EACH SET GUARANTEED
 Brand New, Gov't. Cost, \$42.00
 INCLUDE POSTAGE WITH ORDER
McCONNELL'S
 3834 Germantown Ave. Phila., Pa. RA 5-6033

COLOR TONE ON YOUR TELEVISION
 Simply attach Telecolor Filter to front of your set and enjoy your favorite programs in many shades of a glorious color tone instead of dull black and white.
 Telecolor Filter is guaranteed to work on every make or size set.
 Find new happiness in color depth and contrast, less eyestrain and glare. Free Information, Dept. RN-1.
HARVARD LABORATORY 659 FULTON STREET BROOKLYN 1, N. Y.
ORDER BY MAIL:
 10 inch. \$ 3.00
 12 inch. 4.00
 16 inch. 6.00
 19 inch. 10.00

World Headquarters for TV ★ RADIO ★ ★ INDUSTRIAL ★ Test Equipment and Supplies

- ★ Dumont
- ★ Simpson
- ★ Sprague
- ★ Supreme
- ★ Eico
- ★ Superior
- ★ Jackson
- ★ Precision
- ★ Hickok
- ★ R.C.A.
- ★ R.C.P.
- ★ E.M.C.
- ★ Silver
- ★ Weston

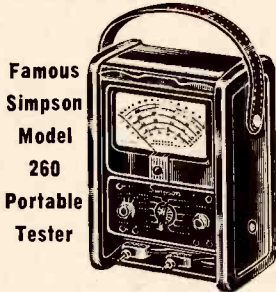

Famous Simpson Model 260 Portable Tester
Black bakelite roll top safety case prevents injury or damage to meter or tester. Ranges: Volts AC and DC 0-2.5/10/50/250/1000/5000 ± 20,000 ohms/volt DC and 1000 ohms/volt AC. Output AC volts 0-2.5/10/50/250/1000/5000. DC micro-amperes 0-100, milliamperes 0-10/100/500. DC amps 0-10. Decibels -10 to plus 52 db. Resistance 0-2000/200,000 ohms and 0-20 megohms. With test leads. \$45.96
Shipping weight 3 lbs. Same as above but less \$38.17
roll-top case features...



RCP Model 447B Multitester
1000 ohms/volt. DC volts: 0-5/50/250/500/2500. DC ma: 0-1/10/100/1000. DC amps: 0-1/10/ AC volts: 0-10/100/500/1000. Ohms: 0-10M/1 meg/10 Meg ext. DB -8 to plus 55 db. Output ranges same as AC volts. Open-face hardwood case, test leads, battery. 3x8 1/2 x 5 1/2. \$15.63
Shpg. wt. 4 lbs. Model 447 BP in portable hardwood case. Shpg. wt. 5 lbs. \$19.55



Sensational F.M. Signal Generator
• Stable • High Output • Accurate • Good Attenuation
Complete with tubes, shielded output cable line cord and plug ready to operate—attractive hammetone grey case and panel. Size 3x6x4 inches. 2 3/4 inches. Weight 2 lbs. \$14.95

20% Deposit with Order Required, Balance C.O.D.

VARIETY ELECTRIC CO., INC.
601 BROAD ST. NEWARK 2, N. J.

LEARN DAY and EVENING CLASSES
TELEVISION
ELECTRONICS-RADIO
Modern Laboratory Instruction in
• SERVICING
• BROADCAST OPERATING
• ELECTRONIC and TV ENGINEERING
G.I. APPROVED
WRITE FOR ILLUSTRATED CATALOG
ELECTRONICS INSTITUTE, Inc.
21 HENRY, DETROIT 1, MICH.

duction. Several receiver manufacturers shipped tubeless television receivers to their distributors with instructions to pick up the necessary tubes from an independent parts distributor.

In the light of these developments it appears that receiver manufacturers have concentrated on the production of complete receivers without regard to their obligations to supply adequate stocks or replacement parts to maintain these receivers in service. Perhaps their thinking is based on a gamble that the normal post-Christmas buying letdown will slow sales and permit the replenishment of distributors stocks of tubes and parts. It is a gamble all right. It is a gamble against a rising crescendo of customer complaints that will bring the great "White Fathers" in Washington with more ropes to hamstring our greatest potential industry.

This problem harbors lots of trouble for service operators. They are powerless to do anything about it except to keep pounding away at other industry organizations urging them to take fast, concrete action toward a correction of the situation before it results in complete service chaos.

What Size TV Service Companies?

Amidst all of the confusion created by the impending defense demands of the industry, scare buying, and critical shortages of replacement parts and tubes, economic patterns for the efficient and profitable operation of independent service companies are becoming apparent. The editors of your "NEWS" department have been conducting an exhaustive survey of successful service business operations in all sections of the country. Our report to you will be carried in a feature article in the February issue of RADIO & TELEVISION NEWS. Watch for it. You will find it interesting.

TV Set Conversions

The best barometer of the great differences in the activities of independent service business operators in various sections of the country is reflected in what they are doing in the business of converting television receivers. This business was a lifesaver to many of the smaller service contractors in metropolitan areas last Spring when the battle for installation and service business got rough. And it was a boon to the larger contractors in keeping their organizations busy during slack periods.

Yet in many cities independent service operators have been indifferent to the stable business possibilities of the television conversion business. Some said they had converted one set and found they could not handle the business at competitive prices. Others had paid no attention to it.

The conversion of television receivers is a long-range business activity. Where we are now converting from 7", 10", and 12" picture tubes to the currently desirable larger sizes, we are also establishing a user acceptance

Dear Om: Wondering what to do with your excess tubes?

Send list of quantities and types.

I'll buy all types of new tubes in small or large quantity and pay you highest cash offer.

B. N. GENSLER
W2LNI
136 Liberty St. New York 6, N. Y.

TECHNICAL DECALS

GIVE PRODUCTION LINE APPEARANCE TO YOUR ELECTRONIC EQUIPMENT!

EASY-TO-APPLY! • PERMANENT!
SAVES TIME! • SAVES ERRORS!

Complete decal sets for labeling Transmitter, Receiver, Audio, Instruments, Television and Dial markings. Each set labels several items. State type of decal set and color preference (black or white letters) with order. See your local jobber. If he cannot supply you—order direct and include his name and address. Price per set... \$1.35 net.

TEKNI-LABELS COMPANY DEPT. R - 732 SO. VICTORY BURLINGAME, CALIFORNIA

BUILD YOUR OWN 5 TUBE SUPERHET RADIO...

\$2.95 ONLY

We furnish all the components.

- A Beautiful Plastic (Buterine) Cabinet
- A Copper Plated Chassis—Stamped for Mounting Parts
- A Name Plate
- A Calibrated Tuning Dial
- A Volume Control Knob
- A Stamped Jute Back
- 3 Rubber Grommets
- 4 Sheet Metal Screws—For Chassis & Back Mounting
- 5 Miniature Tube Sockets.

All yours to get you started on your own radio. \$1.00 Deposit with C.O.D. orders. You pay postage. Send only \$2.95 and we will pay postage.

THE LORMEL PRODUCTS CO.
10408 Superior Ave. Cleveland 6, Ohio

CODE SENDING SPEED

Free Book

HIGH SPEED

WITHOUT NERVOUS TENSION

REVEALING BOOK shows how "crack" operators develop high speed and proficiency. Learn code for Amateur or Commercial Radiotelegraph License, or improve your sending and receiving with the Candler System which develops radiotelegraph experts and code champions.

CANDLER SYSTEM Box 928, Dept. 2-A, Denver, Colorado

300 OHM WIRE AVAILABLE

.045 POLYETHYLENE

Minimum Quantities 5,000 Ft.
Prices on Request
Box 509

c/o Radio & Television News
185 N. Wabash, Chicago 1, Ill.

pattern for changing receivers to adapt them to the latest developments in the art. Color? Sure. Quite a number of technicians have converted 7" sets to receive the CBS color transmissions.

The secret of profitable television receiver conversion business for the small operator is in specializing in one make of receiver and size of picture tube at a time. Once you have solved the "mechanics" of converting a particular type of receiver in your shop and have determined the cabinet changes that must be made, you can set up a simple "conversion line" and handle this type of receiver profitably.

If you are not a good "customer contact man" yourself you will have to get someone to solicit the business for you. Conversions are not hard to sell.

What Do You Do?

The question we are asked most often about customer relations is this: "How do you handle a customer and get him to pay for trouble he caused by tinkering with his TV receiver without making him mad?"

For many years one of the basic faults of radio service operators in dealing with customers was the tendency to assume an almost apologetic attitude in quoting prices for service work or in telling a customer frankly all of the parts that should be replaced to put his receiver in first-class playing condition. Maybe it was because we were selling our service time in competition with \$9.95 a.c.-d.c. sets; or perhaps it was caused by our own feeling of inadequacy to turn the stuff out faster. Regardless of its cause it was an almost universal trait among service operators. They thought so little of their own abilities as business men that they applauded speakers who told them how lousy they were!

The men who have become successful television service operators have built their businesses on the sound thesis that customers are justly entitled to receive the service they pay for but only the service they pay for.

Good customer relations are an essential element in any successful television service business. One of the most useful booklets for establishing sound customer relations with TV set owners that we have examined is the booklet published by the Better Business Bureau of New York called "Things you should know about the purchase and servicing of Television Sets." It is written for the TV receiver purchaser and owner and it sets out clearly what the user has a right to expect and what he is not entitled to receive.

If you do not have a satisfactory television user booklet available for distribution in your town you should get a couple of copies of this booklet and carry one of them with you whenever you call on your service customers. You can get these booklets at a cost of ten cents each from the Better Business Bureau. Here is the address: The Better Business Bureau of New York, Inc., 280 Broadway, New York 7, N.Y.

BC-223 TRANSMITTER

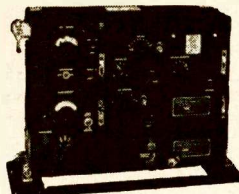

30 Watt transmitter with Crystal or MO control on four pre-selected channels. CW, MCW cover frequency range 2000-5200 KC. by use of plug-in coils. Complete with tubes and choice of one Tuning Unit (listed below), Less Mfg.—11c.

NEW: \$29.95
USED: \$23.50

CABLE—Trans. to Power Supply.....\$2.00
TUNING UNITS: TU-17—2000-3000 KC.; TU-18—3000-4500 KC.; TU-25—3500-5250 KC. \$3.50 EACH
SPARE TUBE KIT in metal box, f/BC-223...\$4.95
OPERATING MANUAL for BC-223.....\$2.00
PE-125 POWER SUPPLY f/BC-223—12/24 Volt input; output 500 Volt 150 MA.....NEW: \$9.95
SPARE VIBRATOR & TUBE KIT f/PE-125...\$4.95
SHOCK MOUNTING for PE-125.....\$1.50

BC-375 TRANSMITTER

BC-375 Transmitter—100 Watt Voice, CW, MCW covers frequency range 200 KC. to 12 MC. by the use of Plug-in Tuning Units, as listed below. Complete. \$18.95 with tubes, less Tuning Units.....USED:

TUNING UNITS FOR BC-375 OR BC-191 TRANSMITTERS (Listed Below).....\$3.95 EA.
TU-5—1500 to 3000 KC. TU-9 — 7700 to 10000 KC.
TU-6—3000 to 4500 KC. TU-10—10000 to 12500 KC.
TU-7—4500 to 6200 KC. TU-26 — 200 to 500 KC.
TU-8—6200 to 7700 KC. BC-306—Antenna Loading
FT-151 Shock Mounting for BC-375-191.....\$2.00
CABLES F/BC-375-191 w/PL-64, 59, or 61 ea. end.....\$2.00 EA.

PROP PITCH MOTOR for rotating 10 and 20 meter beams. Small size. NEW.....\$14.95
TRANSFORMER for operating above motor from 110 V. 60 cycle. 24 V. Secondary.....\$3.95

COMMAND TRANSMITTERS AND RECEIVERS with SCHEMATICS

	USED:	NEW:
BC-453 Receiver—190-550 KC.	\$11.95	
BC-454 Receiver—3 to 6 MC.	5.95	
BC-455 Receiver—6 to 9.1 MC.	6.95	
BC-457 Transmitter—4 to 5.3 MC.	5.95	\$8.95
BC-458 Transmitter—5.3 to 7 MC.	5.95	8.95
BC-459 Transmitter—7 to 9 MC.	14.95	24.95
BC-696 Transmitter—3 to 4 MC.	14.95	24.95
T-20/ARC-5 Trans.—4 to 5.3 MC		8.95
T-23/ARC-5 Trans.—100 to 156 MC		29.50

RECEIVER (MOBILE-BOAT-AIRCRAFT)

BENDIX RA-10 RECEIVER—8 Tube Set covering frequency range 150 to 1100 KC. and 2000 to 10000 KC. in four bands by use of remote control unit. Set size: 18" L x 10" W x 8" H. Wt. 3 1/2 lbs. Comes complete with remote control unit, dynamotor, and plugs. BRAND NEW.

Order RA-10 CA f/ 14 Volt DC operation. \$49.95
Order RA-10 DA f/ 28 Volt DC operation.

Address DEPT. RN • Minimum Order \$2.00 • Prices F.O.B., Lima • 25% Deposit on C.O.D. Orders

3/4 RPM ANTENNA ROTATOR MOTOR

High torque, reversible motor—operates directly from 110 Volt 60 cycle by use of condenser. Light weight, quiet running, ruggedly built, positive stop, easily mounted. Normally operates from 110 Volt 400 cycle. Complete—with instructions. NEW.....\$4.95
10 MFD 400 Volt Cond. \$1.00, SPST Momentary Switch, 35c, DPDT Momentary Switch, 75c, Resistor, 100 ohm 25 Watt, 50c, 4 Wire Cable, 5c per ft.

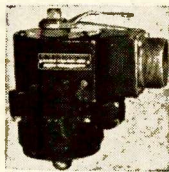

ATD TRANSMITTER

50 Watt, 540 to 9050 KC. MO control. CW and Phone complete with tubes 44/61A6G, 1/814, 12SL7, V11051, 24 V. Dynamotor, Control Boxes, Spare Tubes, Parts, etc. BRAND NEW.....\$150.00

TDQ TRANSMITTER

45 Watt, 115 to 156 MC. Crystal control, MCW and Phone complete with Tubes, 110/220 Volt 60 cycle Power Supply, and Instruction Book. LIKE NEW.....\$450.00

DYNAMOTORS:

INPUT	OUTPUT:	STOCK No.	PRICE
9 V. DC	450 V. 60 MA.	DM-9450	
@ 6 V. DC	275 V. 50 MA.	w/Blower	\$3.95
12 or 24 V. DC	440 V. 200 MA. & 220 V. 100 MA.	D-104	9.95
12 V. DC	600 V. 300 MA.	BD-86	7.95
12 V. DC	330 V. 150 MA.	BD-87	6.95
12 V. DC	375 V. 150 MA.	BD-83	6.95
12 V. DC	1000 V. 300 MA.	BD-77	7.95

PERMANENT MAGNET FIELD DYNAMOTORS:
12 or 24 V. DC 275 V. 110 MA. USA/0516 \$3.95
12 or 24 V. DC 500 V. 50 MA. USA/0515 \$2.95
@ V. DC 240 V. 50 MA.

Tell Us Your Dynamotor, Inverter, & Small Motor Needs!

TRANSFORMERS	RG-8/U COAXIAL CABLE
(110 V. 60 CYCLE PRIMARIES:	(W/PL-259 Plugs, ea. end):
SEC.: 24 V. 1/4 amp. \$1.50	65 Foot length...\$4.95
24 V. 4 1/2 amps. 3.95	50 Foot length... 3.95
36 V. 2 1/2 amps. 2.95	35 Foot length... 2.95
	Junction Connectors for PL-259's..... 75c

WHIP ANTENNA EQUIPMENT

MAST BASES—INSULATED:
MP-132—(Illustrated) 1" heavy coil spring, 2" insulator. Overall length: 11 1/4". Weight 2 1/2 lbs. Price.....\$3.95
MP-22—Spring action direction of bracket, 4"x6" mounting. Price.....\$2.95
MAST SECTIONS FOR ABOVE BASES:
Tubular steel, copper coated, painted, 3 foot sections, screw-in type. MS-53 can be used to make any length, with MS-52-51-50-49 for taper. Price—any section.....Ea. 50c
MS-54 or 55. Larger sections than MS-53.....Ea. 75c
BAG BG-56 for carrying 5 Mast Sections..... 50c



FAIR RADIO SALES 132 SOUTH MAIN ST. LIMA, OHIO

NOW FOR THE FIRST TIME!

SIGNAL TRACING by SIGNAL SUBSTITUTION OF ALL TV RECEIVER CIRCUITS!



MODEL 101 SUBSTITUTION TESTER

Has test speaker with voice coil, transformer connections, range of resistors, paper, ceramic, electrolytic condensers, variable pot.—and a simple signal tracer—can be used as audio signal tracer for radio & TV. Dealers' Net.....\$17.95

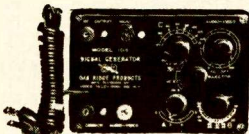

MODEL 103 SIGNAL GENERATOR

Combines small size, sturdiness, ACCURACY and dependability. Locates trouble fast, from antenna to CRT or speaker. Packed with features to make TV servicing easier, faster, and more profitable! Dealers' Net.....\$33.50



MODEL 104 "SYNCHRO-SWEEP"

New invention for TV testing, widely endorsed by experts. Supplies own sync. and sweep pulses for signal tracing sync. and sweep circuits with or without test pattern, scope, or bench equipment! Dealers' \$44.50
Net.....\$44.50
*Pat. App. For

Designed for the TV Serviceman EXCLUSIVELY by OAK RIDGE

A group of revolutionary new MINIATURE instruments (each 5 1/4"x4 1/4", in black bakelite case) built to exacting standards of HIGH PRECISION and amazing ruggedness—permit TV servicemen to do ON-THE-SPOT TV servicing by the only fool-proof method: Signal Tracing by Signal Substitution! Included in above group (not illustrated), is Model 102 High Voltage Meter for TV Testing. Dealers' Net.....\$17.95
SEE THESE INSTRUMENTS AT YOUR JOBBERS or write for information to

PORTABLE PRECISION INSTRUMENTS

OAK RIDGE PRODUCTS Mfg. Div. of VIDEO TELEVISION, INC. 37-01-N Vernon Blvd., Long Island City I, N.Y.

ORDER FROM RED ARROW FOR IMMEDIATE DELIVERY

We specialize in Ceramics, Resistors and Condensers. If you don't see what you want listed, be sure to write. (Manufacturers: ask for our quantity prices.)

SPECIAL!

300 ohm Twin Lead TV Line, 100 ft. . . \$3.89
3 Conductor Flat Wire—Used for Rotor Antenna4c per ft.
5 Conductor Flat Wire—Used for Rotor Antenna6c per ft.

FILTER UNIT

This unit is an excellent buy for the parts alone. Some parts are worth more than we're asking for the whole unit.
1—40 MFD @ 450V
1—1000 MFD @ 12V
1—5 MFD @ 400V
2—5 MFD @ 50V
1—.01 MFD @ 400V
2—20 watt Resistors
2—Filter Chokes
3—RF Chokes
1—DFT Toggle Switch
Miscellaneous hardware, wire, etc.
BRAND NEW, ORIGINAL PACKING, 89c ea. (10 for \$7.50)



TEST SET PICK-UP ASSEMBLY

Brand NewTS-121/AP . . . \$14.95 complete

DYNAMOTOR SALE!

BD77—Brand New \$6.95
PE34—Used, excellent 4.95
PE73—Used, excellent 4.95
DM33A—Used, excellent 1.45

HS33 HEADPHONES

Used, excellent \$1.19 pair

HANDSET TS-13-C

Brand New, 6 ft. cord with PL68 and PL55**SPECIAL! \$4.95**

TERRIFIC TUBE SALE

Brand New—Standard Brands—Immediate Delivery
3C24/24G59c
162639c
10Y39c

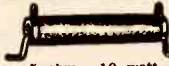

WARD LEONARD RESISTORS

5 ohm—10 watt14c
85 ohm—10 watt14c
2500 ohm—25 watt17c
2500 ohm—33 watt20c
250 ohm—50 watt, lamp base24c
105 ohm—100 watt, 4 taps45c
50 ohm Muter Resistor8c ea.
(\$6.00 per hundred)



BATHTUB CONDENSERS

20 VDC @ 350 MFD14c each (\$12.50 per hundred)
2 x .25 MFD @ 100 VDC14c each (\$12.50 per hundred)
5—5 MFD @ 100 VDC14c each (\$12.50 per hundred)
3 x 1 MFD @ 400 VDC14c each (\$12.50 per hundred)
G.E. Oil Condensers—2-1-1-12 MU .F 600 VDC59c ea.

CORDS

CD478—5 ft. long with Alligator Clips19c pair
CD307A with PL55 and JK2689c each
PL6820c each
PL5529c each
PL5317c each
MINIMUM ORDER—\$2.00. Send 25% deposit with order, balance C.O.D. Shipped F.O.B., N.Y.C. (N.Y.C. residents add 2% sales tax.)

RED ARROW SALES

Dept. A 63 East Broadway, N.Y.
Phone COrtlandt 7-5425

Classified

Rate 50c per word. Minimum 10 words

RADIO ENGINEERING

RADIO Engineering Broadcasting, Aviation and Police Radio, Servicing, Marine Operating and Electronics taught thoroughly. Expenses low. Write for catalog. Valparaiso Technical Institute, Dept. N, Valparaiso, Ind.

PANELS for electronic, nucleonic construction projects. Complete service for designers, custom builders. Circular upon request. Gilpin Instrument Works, P. O. Box No. 8, Mt. Clemens, Mich.

SALE

HEWLETT Packard 200 A Audio Oscillator, \$85.00. Warren Plastics, Warren, Pa.

APPROVED A200 Generator 100KC. 75MC. Precision 200 Tracer, Daco 606 Tube Tester, near new, with data. Sobey, 11814 McGowan, Cleveland 11, Ohio.

RT-18/ARC-1 VHF transceiver complete with antenna, cables, 9 crystals, etc. Tested and operating, \$525.00. Flight Radio Sales, Municipal Airport, Cleveland 11, Ohio.

BARGAINS. New and reconditioned Hallicrafters, National, Collins, Hammarlund, RME, Meissner, other receivers, tuners, television receivers, transmitters, amplifiers, speakers, etc. Lowest wholesale prices. Terms. Shipped on trial. Liberal trade-in allowances. Write Henry Radio, Butler, Mo., and 11240 W. Olympic, Los Angeles, Calif.

HOTTEST surplus list in the country. Electronics-Hydraulics, Aircraft-Gadgets. Dick Rose, Everett, Wash.

RADIO Diagrams 50c; Record Changers, Recorders 60c; Television Diagrams with service data \$1.00 up. State Manufacturer and model number. Kramer's Radio Service, Dept. RX, 36 Columbus Ave., New York 23, N. Y.

COLOSSAL bargain in radio parts, over 150 assorted radio parts including resistors, condensers, controls, coils, etc. All new, \$75.00 value, guaranteed satisfaction or money refunded, postpaid in U. S. A. \$2.50. Write for catalog. Buyers Syndicate, 30 N. Taylor St., Springfield 3, Mass.

RECORD Changer Parts for leading makes. We ship everywhere. Friend's Wholesale Distributors, 106 N. 6th St., Philadelphia 6, Pa.

STARTLING values! Example, hook-up wire 1/2c ft. Free lists. Airline Salvage, 1275 N.W. 33rd St., Miami 42, Fla.

SURPLUS BC453, \$12.95; BC457, BC458, \$5.95 each; BC1206, \$4.95; Jan transmitting, receiving tubes, other items, list free. Albert Arnold, Box 706, Amarillo, Tex.

EDISON storage batteries, Nickel, Iron, Alkaline type. 32 volt complete sets 25 cells 19 ampere-hours, all assembled, perfect, only \$40.00. Fine for laboratory testing, standby emergency lighting; will last many years. Also ampere-hour meters, Sangamo make 200 ampere-hour scale, each \$5.00; factory price was \$60.00. John L. Pulster, Battery Specialist, 510A Audubon Bldg., New Orleans 16, La.

TCS 12 Transm. Rec. 110 volt A.C.; TCS 8 Transm. Rec. 12 volt A.C.; BC-191 Transmitter 12 volt A.C.; BC-348Q Receiver 24 volt D.C.; BC-221AK Modulated Freq. Meter; LM-15 Freq. Meter 110 volt; 50UFS Link Transm. Rec.; 1498 Link Transm. Rec. All complete, new, unconverted equipment. French-Van Breems, Inc., Chrysler Bldg., N. Y.

HIGHEST Bidder. Brand new TM54-APR4 2150 to 4000 mc., with schematics. W. C. Motz, 219 Elm St., Pittsburgh 18, Pa.

2 EA. .25mf 80,000V and .02mf 250,000 Condensers. Box 510, % Radio & Television News, 185 N. Wabash Ave., Chicago 1, Ill.

BARGAIN. 10BP4 Picture Tubes. Used, perfect, guaranteed 90 days, \$9.95. Shipped anywhere. Express collect. Pacific Television, Box 703, Culver City, Calif.

GE 12DP7, new, \$6.98. Philco TF400, new, \$8.98. 100 Silver Mica Condensers, \$5.98. Add postage. Free list. No Dealers. Betz, 73 Caroline Ave., Yonkers 5, N. Y.

53 OHM coax, prices reasonable. Inquire: Harry H. Van Dick, Little Falls, N. J.

CODE Practice Tapes for phototube keyers. Designed for rapidly increasing your code speed. Manufactured by Ultradyn Electronics, Oswego, Ore. Write for complete information.

WANTED

WANTED: APR-4 receiver and tuning units. State condition and price. W2DB, 274 Boulevard, Scarsdale, N. Y.

EVERY RADIOMAN

Can Use These

SERVICE HINTS!

Valuable Manual Yours—FREE!

Every page of "How to Simplify Radio Repairs" is packed with on-the-bench, practical ideas. Contains photos, charts, diagrams—no fluff—no vague theory. In plain every-day language it gives you priceless suggestions—new servicing ideas. You'll use and benefit from the experience of experts. Partial list of contents: How to Localize Trouble; How to Service Amplifiers; How to Test for Distortion; How to Test Audio Circuits; How to Test Speakers; How to Find Faults in Oscillators; How to Test Radio Parts—and it's all yours—FREE! No obligation.

SEND COUPON OR PENNY POSTCARD FOR YOUR FREE COPY TODAY!

FEILER ENGINEERING CO., Dept. 1H1
1601 S. Federal St., Chicago 16, Illinois

Please RUSH my FREE copy of "How to Simplify Radio Repairs."

Name

Address

City Zone State

MORE THAN

50,000 TV SETS

MONTHLY

rightly rely on

J S C

TWIN LEAD

300 ohm

Television

Transmission

Wire

TV manufacturer, installation engineer, TV sponsor and televiewer all form an inseparable chain, securely linked by the world's finest television transmission wire. J S C is justly proud of its important role in the development and progress of television. Rigid adherence to the principle of "quality before quantity" will pave the way to greater accomplishments for J S C! Write for Descriptive Pamphlet.

Jersey Specialty Co.

LITTLE FALLS • NEW JERSEY

All Phones: Little Falls 4-0784, 1404, 1405

RECEIVERS SUP HET 2 RF 4 IF'S 15 TUBES 19 1/2 MC IF COILS

CONVERTS TO 2-5-10 MTR'S & 420 band now tunes 195-210 MC

115 VAC 60 cycle 15 tube 2 RF & 4 IF stages on one chassis 25"x11"x8" in a metal case with the following tubes and main parts PWR, trans. Thor. 70R62 chokes 4 Thor. 13C30 filter cond. 4 Aerovox 8-8 oil filled. RF & IF coils and tubes shielded, 2 plate tuning cond. has following tubes 1-6S5, 2-6S4 4-6SK7 one for each stage IF 2-6SJ7 2-6N7 1-5T4 Rect. this is a super Het circuit each unit cost the Govt. \$292.95 orig. tunes 195 to 210 megas we have converted one to 2 meters & plenty hot, orig. print with ea. unit we furnish you with a print of our changes for 2 meters, and minor changes. Condensers are mica or silver mica Tubes except the acorns are metal. Check Feb. issue CQ 1946 for hot 10 meter write-up. This Hot 10 Meter Write-up with Print is Available free with ea. unit. The 115 VAC pwr. unit has four section filter capacitors and chokes in place of the usual one this can not be beat. These are a new lot just received, a large quantity in both the 406 and 406A, the only difference in the 406 and the 406A is there is a 115 VAC motor .65 RPM forward and reversible used for variable freq. control, this motor can be used for a geared beam plenty of torque 75 ounce inch units are later model with the same circuit and all like new. Send your order early send check or money order for the receiver but do not send the shipping charges: we will ship the units F.O.B. by freight, this is the greatest \$ value on the surplus market; sold on a money back guarantee. Each unit with orig. print; we furnish conversion instructions and print for 2 meters and 10 meters free.

MFG. W.E. COST GOVT. \$292

McCONNELL'S 3834 Germantown Ave. Phila., Penna. RA 5-6033

BC406 \$12.95

XTALS 500KC

BC406A \$15.95

standards 2 pin holder

CR-2B/U brand new \$1.50

SNIPERSCOPE & Snooperscopes wanted. Any type, any condition. Needed immediately. Box 495, % Radio & Television News, 185 N. Wabash Ave., Chicago 1, Ill.

AUDIO Equipment, highest quality, used. Want amplifiers, changers, speakers, recorders. M. Wax, 85-08 168 Place, Jamaica, N. Y.

AN/APR-1, other "APR," "ARR," "TS," "IE," ARC-1, ARC-3, everything surplus. Special tubes, Tech. Manuals, Lab. quality Test Equipment, etc. Describe, price in first letter. Littell, Fairhills, Box 26, Dayton 3, Ohio.

HELP WANTED

EXPERIENCED T.V. Technician desiring moving Southern California. Capable taking full responsibility Service Dept. of large well financed established retail T.V. store. Write details of education, experience, age, marital and draft status and rate desired. Telecenter, 4096 30th St., San Diego, Calif.

EXPANDING Southwest organization has need for Electronic Engineers and Technicians, Mechanical Engineers, Machinists, Draftsmen, Mechanical and Electronic; to work with Cinetheodolites, Cameras, Radars, Computers and Telemeters, as used for guided missile test instrumentation. Work consists of operation, maintenance, development and construction. Write for application form. Salary offer based on application and personal interview are commensurate with education, training, experience, job responsibility and other factors. Particularly needed: Engineers and Technicians experienced in small quantity production to JAN specifications. Address reply to: C. E. Riggs, Jr., Land-Air, Inc., Box 16, Holloman, Air Force Base, N. M.

TECHNICIANS! Engineers! Interested in a top-paying electronic position? Send post card for information on How, Why, Where. Mid-Continent Research Bureau, P. O. Box 121, Wichita, Kan.

CORRESPONDENCE COURSE

USED Correspondence Courses and Books sold and rented. Money back guarantee. Catalog free. (Courses bought.) Lee Mountain, Pisgah, Ala.

USED Correspondence Courses and Educational Books bought, sold, rented, catalog free. Educational Exchange, Summerville, Ga.

PATENT ATTORNEYS

LANCASTER Allwine & Rommel Registered Patent Attorneys. Patent practice before U.S. Patent office. Validity and infringement investigations and opinions. Booklet and form "Evidence of Conception" forwarded upon request. Suite 414, 815 15th St., N.W. Washington 5, D.C.

HERMAN Lewis Gordon, Registered Patent Attorney. Patent Investigations and Opinions. Warner Building, Washington, D. C.

MISCELLANEOUS

ELECTRONIC Research. Equipment designed or built to specifications. Inventors, experimenters, inquiries invited. E. A. K. Research Laboratory, Box 62, Tarrytown, N. Y.

RADIOMEN. Servicemen, Beginners. Make more money, easily, quickly. \$2.50 weekly possible. We show you how. Information free. Merit Products, 216-32R 132 Ave., Springfield Gardens 13, N. Y.

QSL's, SWL's! Neat, reasonable. W1HJ Press, Box 32C, Manchester, N. H.

PHOTO CREDITS

Page	Credit
36 (top left)	Radio Corporation of America
36 (center), 37, 38	Ampro Corporation
36 (right)	MovieMite Corp.
39, 92	Westinghouse Electric Corp.
46	Art Haug
50	General Electric Company
102	Minnesota Mining and Manufacturing Co.
116	Radio-Television Manufacturers Assn.
132	Acme
148	Simpson Electric Company
150	MAHS
160, 162	Paul Wendel

ERRATUM

Several errors occurred in the article, "Noise Reduction for High Quality Reproducing Systems" (Matthews), appearing on page 70 of the September 1950 issue of this magazine.

In Fig. 3 (page 72) the arm of the potentiometer R_{12} should be connected to the lower end of R_{12} at its juncture to C_{11} . R_{12} , which is listed as 5000 ohms, should be a 51,000 ohm unit.

Some readers have reported erratic behavior of the suppressor. This has been traced to the fact that an input of less than .1 volt appears at pin #1 of V_4 . At least this voltage, but not over 1 volt average signal level, should appear at this point.

the **chicago** V.T.V.M. ELECTRONIC MULTITESTER

A versatile new Chicago Vacuum Tube Volt Meter with more ranges and greater utility—at the lowest price in the industry!

\$39⁰⁰
net



RANGES

DC VOLTS

0-5, 10, 50, 100, 500, 1000, 5000. Input impedance: 20 megohms (including 10 megohms in the DC probe)

AC VOLTS

0-5, 10, 50, 100, 500, 1000, 5000
Input impedance: 10 megohms

OHMS

0 to 1000 megohms in 6 ranges with center scale readings of 10, 100, 1000, 10K, 1Meg., 10Meg.

CAPACITANCE

50 MMF to 5000 MF in 6 ranges. Low voltage-power source enables testing of electrolytic condensers.

MILLIAMPERES

DC 0-1, 10, 100, 500
(Not electronic) 50 millivolt drop.
Operates on 115 V.A.C. Dimensions: 6 3/4" Wide x 9 1/2" High x 6" Overall Depth

The big 5 1/2" meter is mounted in a handsome brown Hammerloid case slanted for easy reading.

See Your Parts Distributor or Write for Complete Information

CHICAGO INDUSTRIAL INSTRUMENT CO.

536 W. ELM ST. • CHICAGO 10, ILL.

The Biggest Tool Kit Value in the Whole World of Television!



JFD TV ALIGNING TOOL KIT

MADE OF UNBREAKABLE NYLON

NO. TK 60 LIST PRICE \$395
12 Essential Tools in One Handy Kit

Another JFD first... moulded of tough, unbreakable Nylon to provide the best combination of strength and durability. Each of the six tools furnishes two different tuning tips, for a total of 12 separate aligning ends to suit every TV or FM servicing adjustment. Each tool has a different color for easy identification. Packed in a handy plastic case.

Each Tool Is Available Separately As Follows:

- JFD TV All-Purpose Aligning Tool, for tuners, trimmers and I.F. transformer adjustments. No. 5-73. List, Each 45¢
- JFD TV I.F. Oscillator Aligner, for I.F. midget transformer and oscillator adjustments. No. 5-74. List, Each 75¢
- JFD TV Extra Long Aligner, for tuning nested iron cores that are difficult to reach. No. 5-78. List, Each 95¢
- JFD TV Midget Duplex Aligner, for tight, difficult adjustments where space is limited. No. 5-79. List, Each 65¢
- JFD TV Aligning Wrench, for K-Tran and Midget I.F. transformers. No. 5-80. List, Each 75¢
- JFD TV Tuning Rod, a vital necessity, extra thin and flexible. No. 5-81. List, Each 75¢

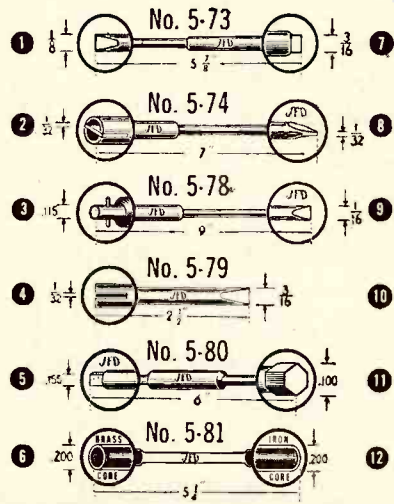

JFD MANUFACTURING CO., Inc. 6117 16th Ave., B'klyn 4, N. Y.
"The 'Exclusiveness' Of JFD Is The Quality Of Its Products"

GET THE LATEST IN
RADIO & TELEVISION
From These **BRAND NEW**
PAY RAISING BOOKS!

**Yours for 7 Days
FREE TRIAL**

**COMPLETE SECTION
IN FULL COLOR ON
COLOR TELEVISION**

Handle the tough, big-pay television and radio jobs with Coyne's brand new, 5-volume APPLIED PRACTICAL RADIO-TELEVISION. Gives you practical working knowledge of Radio-Television servicing. Includes latest time-saving, trouble-shooting and servicing methods. Written in simple, down-to-earth language. Covers everything from basic principles to newest in Television and FM. Explains UHF and color TV, adapters and converters, picture tubes, testing instruments, alignments, as well as public address systems, short wave, auto radio, aviation radio, other important phases. More than 1500 pages, 1000 illustrations, charts and diagrams you can work from.

UP-TO-DATE!

FREE TRIAL OFFER!

NO MONEY! Examine this new pay-raising set for 7 days at our expense. Just fill in and mail below. It is not an order. Merely a re-book.

TV Picture Patterns & Wave Forms Book... Free with APPLIED PRACTICAL RADIO-TELEVISION, new book on TV SERVICING WITH PICTURE TUBE PATTERNS. If you keep the set, pay \$3.00 after 7 days and \$3.00 a month until \$16.50 plus postage is paid (Cash price \$15.00). If not satisfied with the set send it back and owe nothing. Either way, book of TV PICTURE PATTERNS is yours FREE. Offer limited. Act now!

MAIL THIS FREE BOOK COUPON NOW!

Educational Book Publishing Division
COYNE ELECTRICAL & TELEVISION-RADIO SCHOOL
848 S. Paulina St., Dept. H-72, Chicago 12, Ill.
O.K. I Rush "Applied Practical Radio-Television" post-paid for FREE 7-day trial per your offer. Include FREE book on TV PICTURE PATTERNS.

Name..... Age.....
Address.....
Town..... Zone..... State.....
Where Employed.....

ELECTRONIC SPECIALS

1N34 CRYSTALS..... 69c

THROAT MIKE (MT 81-A), 2 mikes in leather zipper case with 56" cord & PL 58—Brand New 59c
CARBON MIKE T-17, Slightly used. Guaranteed. Has 5-ft. cord and PL 68..... 89c

VERNIER DIAL (From BC-221)
2 3/4" Dia. 0-100 in 360°. Black with silver marks. Has thumblock..... 85c

VERNIER DRUM (From BC-221)
0-50 in 180° black with silver marks..... 85c

OIL FILLED CONDENSER SPECIALS
4mfd, 2,000 V.D.C. \$3.75 | 8 mfd, 2,000 V.D.C. \$4.75
2mfd, 4,000 V.D.C. 2.50 | 4 mfd, 600 V.D.C. .79
HAYDON Timing Motor, 4 R.P.M., 115 Volt, 60 cycle..... \$1.79

FILAMENT TRANSFORMER
Pri., 115V., 60 Cyc.—Sec., 5 V., 115 Amp. 6000 volt insulation..... \$9.95 each

SELSYNS 2J1G1—Brand New—400 Cyc...... \$1.85

SOUND POWERED Handset—
Includes 6-ft. cord..... \$17.60 pr.
Minimum order \$3.00—All orders FOB, Phila.

RELIANCE Merchandizing Co.

2221 Arch Street • Philadelphia 3, Pa.
Telephone: Rittenhouse 6-4927

TELEVISION

PREPARE FOR A GOOD JOB!
BROADCAST ENGINEER
COMMERCIAL OPERATOR (CODE)
RADIO SERVICEMAN

Television Servicing

(Approved for Veterans)
SEND FOR FREE LITERATURE
BALTIMORE TECHNICAL INSTITUTE
1425 EUTAW PLACE, BALT. 17, MD.

**INDEX
OF**

Advertisers

JAN.
1951

[While every precaution is taken to insure accuracy, we cannot guarantee against the possibility of an occasional change or omission in the preparation of this index.]

ADVERTISER	PAGE
Alliance Manufacturing Company	6
Allied Radio Corporation	9
Alprodeco Inc.	123
Alvarado Supply Company	153
American Television & Radio Company	136
Amperite Company, Inc.	122
Amplifier Corporation of America	161, 162
Arcee Electronics Company	143
Arrow Sales, Incorporated	111
Ashe Radio Company, Walter	86
Baltimore Technical Institute	168
Bell Telephone Laboratories	25
Bond Equipment Company	157
Boyer-Roche Book Company	129
Bradley Associates	143
Brook Electronics, Incorporated	100
Buffalo Radio Supply	133
Burden Sales Company	159
Burstein-Appiebee Company	100
Candler System	164
Capitol Radio Engineering Institute	93, 100
Centralab, Division of Globe-Union, Inc.	12, 13
Chelsea Television Center	161
Chicago Industrial Instrument Company	167
Chicago Transformer Company	18
Cincinnati Ventilating Company, Inc.	154
Cleveland Institute of Radio Electronics	22
Clippard Instrument Laboratory	130
Columbia Electronic Sales	118
Comet Electronic Sales Company	141
Communications Equipment Company	169
Concord Radio Corporation	89
Coyne Electrical & Television-Radio School	132, 138, 168
De Forest-Sanabria Corporation	29
DeForest's Training, Inc.	5
Du Mont Laboratories, Allen B., Third Cover	
East Coast Electronics	158
Editors & Engineers, Ltd.	140
Eddie Electronics, Inc.	126
Electro Devices, Incorporated	108
Electro-Technical Industries	148
Electro-Voice, Inc.	119
Electronic Appliances, Inc.	153
Electronic Indicator Corporation	108
Electronic Instrument Co.	32, 96, 159, 162
Electronic Measurements Corp.	110
Electronics Institute, Inc.	164
Espey Manufacturing Company, Inc.	135
Fair Radio Sales	165
Federated Purchaser Incorporated	128
Feller Engineering Company	166
Fisher Radio Corp.	82
Franklin Technical Institute	157
G. L. Electronics	125
General Electric Company	7, 27
General Electronic Distributing Co.	90, 91
General Test Equipment	160
Gensler, B. N.	164
Goodheart, R. E.	96
Greenlee Tool Company	110
Greylock Electronics Supply Co.	145
Harvard Laboratory	163
Harvey Radio Company	112
Heath Company, The	73 thru 79
Henry Radio Stores	114
Henshaw Radio Supply	157
Hy-Grade Electronics, Inc.	158
Hytron Radio & Electronics Corp.	83
Indiana Technical College	153
Instructograph Company	145
J & H Television Co.	80
J. F. D. Manufacturing Co., Inc.	114, 167
Jackson Electrical Instrument Co.	127
Jersey Specialty Company	166
Joseph Radio Parts, Inc., Irving	144
Kester Solder	154
Knepper Aircraft Service	130
Lectronic Research Laboratories	163
Leotone Radio Company	114
Littelfuse Incorporated	147
Lormel Products Company, The	164
Mallory & Company, P. R., Fourth Cover	
Mass. Radio School	163
Metropolitan Overseas Supply Corporation	151
Midwest Radio & Television Corp.	124
Miles Reproducer Company, Inc.	162

ADVERTISER	PAGE
Milwaukee School of Engineering	109
Mosley Electronic Specialties	138
Murray Hill Books, Inc.	20, 21
McConnell's	163, 166
McGee Radio Company	84, 85
McGraw-Hill Book Co., Inc.	149
National Company, Inc.	158
National Radio Institute	3
National Schools	11
Newark Surplus Materials Co.	134
Newcomb Audio Products	118
Niagara Radio Supply Corporation	103
Oak Ridge Products	165
Offenbach & Reimus Co.	137
Olson Radio Warehouse, Inc.	94, 95
Onan & Sons, Inc., D. W.	118
Opad-Green Company	161
Peak Electronics Co.	88
Penn Boller & Burner Mfg. Corp.	101
Permotlux Corporation	26
Pfanstiehl Chemical Company	138
Phoenix Electronics, Inc.	80
Photocon Sales	122
Pickering & Company, Inc.	108
Platt Electronics Corporation	98
Poly-Tech	142
Precision Electronics, Inc.	152
Premax Products	148
Premier Radio Tube Co.	107
Progressive Electronics Company	104
Pyramid Electric Company	14, 24
Quam-Nichols Company	162
R. C. A. Institutes	162
Racon Electric Company, Inc.	82
Radio Apparatus Corp.	147
Radio City Products Co.	106
Radio Corporation of America	Second Cover, 80, 81
Radio Craftsmen, Inc., The	116
Radio Ham Shack, Inc.	113
Radio Parts Company	121
Radio Receptor Company, Inc.	135
Radio Specialty Mfg. Co.	162
Radio Wire Television, Inc.	122
Rauland Corporation	15
Raytheon Manufacturing Company	23
Raytheon Television	10
Red Arrow Sales	166
Reeves Soundcraft Corporation	152
Rek-O-Kut Company, Inc.	152
Reliance Merchandizing Company	168
Rider, Publisher, Inc., John F.	115
Sams & Company, Howard W.	120
Sarkes Tarzian, Inc.	17
Schott Company, Walter L.	135
Simpson Electric Company	99
Sprague Products Company	16
Sprayberry Academy of Radio	19
Standard Surplus	159
Standard Transformer Corporation	143
Star Electronic Distributors, Inc.	160
Sun Radio & Electronics Company, Inc.	154
Sun Radio of Washington, D. C.	92
Supreme Publications	105
Sylvania Electric Products, Inc.	30, 31
Tab	97, 170
Tech-Master Products Co.	110
Tekni-Labels Company	164
Television Communications Institute	155
Television Supply Company	82
Thomas Electronics, Inc.	96
Trad Television Corporation	130
Transvision, Inc.	156
Tri-State College	161
Triad Transformer Manufacturing Co.	150
Triplet Electrical Instrument	28
Ungar Electric Tool Company, Inc.	148
United Technical Laboratories	149
University Loudspeakers, Inc.	102
V & H Radio & Electronics Supply	157
Valparaiso Technical Institute	96
Variety Electric Company, Inc.	164
Weller Electric Corporation	8
Wells Sales, Inc.	117
Western Sales Company	155
Wholesale Radio Parts, Inc.	87
Workshop Associates, Inc., The	139
World Radio Laboratories	145
YMCA Trade & Tech. School	159
Ziff-Davis Publishing Company	131



1619-1619-1619
Oetal Base Pentode
A versatile High Per-
formance Tube. **35c**
New
5 for\$1.50



ELECTROLYTICS
Prong Mount
D. Y. Type

MFD	Volt	Price
8	450	.25
30	450	.29
30	300	.25
48	450	.40
8-8	450	.40
10-10	450	.40
24-24	400	.45
40-40	400	.70
80-50	450-50	.69
50-40	300-50	.69
80-10	450	.98
250	10	.98
1000	6	.98
20-10	350-300	.40
10-10	450	.29
20	10	.70
10-30	450-400	.59
30	300	.70
10-15	350	.49
100	10	.70
20-20	400	.69
20	25	.69
20-10	450	.59
50	50	.75
20	150	.79
250-100	15	1.00
40-40	450-50	.79
130	50	.69
40-40	450	.69
20	125	.49
50-50	150	.49
50-50	200	.69
20	25	.69
20-40	400	.79
150	50	.75
90-90	200	1.10
20-60	20	1.10
20	25	1.10

Many Others
Write for List

AUDIO TRANSFORMERS

ITEM	DESCRIPTION	PRICE
AT766	Input to Grid, 250Ω	\$0.79
AT Sub.	Multi-match Sub- ouner 200Ω/15KΩ C.T. 100KΩ/20KΩ	.69
AT707	Input to Grid, 250Ω; 60KΩ HI FI	1.19
AT566	Input to Grid, 50Ω; 200Ω 50KΩ	.95
AT227	Output to Line 7500K/500Ω C.T. 200-50KΩ	1.45
AT353	Output PP 6L6 to 300/20/12/15Ω 25 watt	2.95
AT871	Day Output, HI FI, Pri. 20KΩ C.T. 16KΩ/25K/4KΩ See 15/7.5/3.75/ 1.25/500Ω	2.79
AT554	Interstage 10KΩ; 250KΩ 150Ω Level	1.95
AT765	Input 600Ω to 50KΩ	.79
AT707	Interstage Output 10KΩ/125K/125KΩ	.79
AT750	Input Pri. 15/15Ω; Sec. 150KΩ	.59
AT449	Driver 5KΩ to 4KΩ PP6L6 to PP805 Class B	3.89
AT21	Dual XFMR 300Ω; 300Ω and 600Ω; 250KΩ	1.35
AT083	Output 850Ω/10Ω 25W	1.79
AT415	Output 18KΩ C.T. to Line 125Ω 175W	2.95

Heineman Ckt Bkrs
for AC-DC opera-
tion.
AMI 5101M 7 AMP
1614 80 AMP
1614 80 AMP
100 100 AMP
Price ea. \$1.10
P-0322 Dual 10
Amp.
Price ea. \$2.25



400 MA
Choke 12 HY
902 H.V. IN-
SUL. HERM.
Sealed.
\$3.75 ea.

FILTER CHOKES RATINGS

ITEM	DESCRIPTION	PRICE
CH488	10HY .030A	\$0.45
CH791	Dual 1.75-125HY 100MA	.59
CH100	10HY 450A	12.95
CH86C	20HY 080A	1.10
CH881	Dual .01-3.5HY 950-75MA	1.10
CH19-1	15HY 110A	1.59
CH921	20HY 80MA	1.49
CH22-1	7HY 900A	29.00
CH22-1	1HY 100A	.49
CH22-1	1HY 490A	.49
CH25A	SW .09/.018HY 3/3A	8.79
CH528	20HY .100MA	1.69
CH922	10000HY OMA	2.75
CH043	2.2HY 80MA	.59
CH047	2HY 200MA	.79
CH229	SW/29HY 150A	3.25
CH867	1.8HY 190A	.95
CH323	2.1HY 200A	1.95
CH360	15HY 15MA	.98
CH7A-1	.577HY 7.7MA	1.79
CH791	1.75HY 100A	.59
CH161	Dual 30HY 020A	.98
CH173	11.5HY 90MA	1.39
CH21-A	0.045HY 900A	1.69
CH045	5HY .040A	.35

ITEM	DESCRIPTION	PRICE
CH884	.01HY 2.5A	1.45
CH136	25HY 80MA	2.25
CH131	14HY .250A	9.95
CH102	6HY .070A	1.29
CH163	25HY .070A	1.95
CH116	.030HY 2A	1.39
CHC52	10HY 800A	12.95
CH917	10HY 500A	12.45
CH756	30HY 25MA	.79
CH127	3.5HY 35A	2.49
CH38A	Dual 20HY 100A	2.49
CH064	SW 3/6HY .570/130A	8.95
CH366	20HY .300A	7.95
CH110	25HY 30A	3.50
CH480	.335HY 1.12A	2.29
CH189	120HY 17MA	2.49
CH89A	Dual 1.52HY 167A	9.95
CH14A	.100HY 1.4A	1.95
CH012	5HY 300A	1.95
CH382	5HY 150A	1.45
CH246	15HY 100A	1.39
CH141	Dual 7-11HY 75-60MA	1.29
CH161	Dual 1.25HY 6-4A	1.75
CH351	.033HY 7A	15.95
CH583	.116HY 150A	19.95
CH1A1	5HY 100A	.79
CH007	3.5HY 500A	4.95

Tuning Units for BC375 &
VHF Diag. for Converter to
WHF Freq. Meter in Oct.
X950.
TU5 1500-3000KC.
TU6 3000-4500KC.
TU7 4500-8200KC.
TU8 6000-7000KC.
TU9 7700-10000KC.
TU26 200-500KC.
Price \$2.49 ea.

TUNING UNITS FOR BC 223
KMITT
TU17A 200-3000Kc.
TU18 3000-4500Kc.
TU25 3500-5200Kc.
Price \$2.80 ea.

SCR274 T. U. for
BCAR230 or
Screen Mod. 430
XFMR for 3.2-4MC
PP-PP or
Parll Side-
tone Wndg. 95c
ARC-5 XTAL \$1.69
Mud. XFMR P-807 to
P-P or PAR
807's \$9446
\$1.65

6V Input
Dynamotor
Output 150V/
75MA or 12V
Input, 500V/
50MA Ckt.
\$3.49

ARC 5 MODULATOR
MD7 / ARC5
Plate Modulator
with dynamotor
complete w/Tubes 1-12J5,
1-6X4, 1-6X5, 1-6X6, 1-6X7,
cond. Price \$1.79 ea.
BC456 Screen Mod. \$2.25

Voltage Stabilizer VR3 95-
130V 2.4A 60cy 1d out
115V 120W 100% Raytheon
w/Ext. BK Box Sockets, Cab-
le. Used but good.
Price\$19.95

Voltage Regulator VH023
95-130V 1.75A 60cy 1d CU
115V 150W 100%. Slightly
used. Excellent.
Price\$19.95

GIBSON GIRL
The Emergency
Radio Trans-
mitter Send S
O S signals au-
tomatically on
500KC. 150
mte range. No
batteries re-
quired. Has handdriven gen-
erator, tube, wire. New
It's only\$3.95

Special Oil Condensers
2 MFD 330VAC 1000VDC
2 MFD 600VDC.....49c
14 MFD 330VAC 1000VDC
\$3.95

COMMUNICATIONS EQUIPMENT

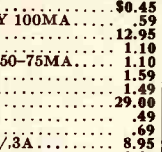

These XFMRs are Army
Spec. All Underrated.

Comb. Transformers-115V/50-60 cps input

Item	H.V.	Amp.	Filaments	Price
CT-861	2100VCT	.175	7.5VCT/4A, 2.5V/10A.	\$7.29
CT-142	645VCT	.060	5V/2A, 6.3V/1.2A.	4.25
CT-825	360VCT	.340	6.3VCT/3.6, 6.3VCT/3A.	3.95
CT-076	600V	.100	2 x 12.6V/1	1.95
CT-626	1500V	.160	2.5/12.30/100	9.95
CT-56A	350VCT	.070	6.3/6, 6.3/1.8 3 lbs.	2.95
CT-071	110V	.200	33/200, 5V/10, 25/10	4.95
CT-378	2300V	4 MA	2.5/2	6.95
CT-367	580VCT	.050	5VCT/3A	2.25
CT-721	550VCT	.100	6.3/1, 2.5VCT/2	2.95
CT-99A	2x10VCT	.010	6.3/1A, 2.5VCT/7A.	3.25
CT-399	725V	.100	5V/3A, 6.3/3.5	3.25
CT-080	700VCT	.205	5V, 5V/2A	3.95
CT-441	50V	.020	5V/2A, 5V/1.2	2.29
CT-408	350VCT	.026 MA	5V/3A	2.75
CT-26B	1100VCT	400 MA	6.3V/1.6	6.95
CT-931	585VCT	.086	5V/3A, 6.3V/6A	4.25
CT-610	1250	.002 MA	2.5V/2.1A, 2.5V/1.75A	4.95
CT-399	350VCT	.070 MA	5V/3A	2.75
CT-102	1080VCT	.055	25V/3A, 6.3V/1.8A, 6.3V/1.2A.	9.95
CT-866	330V	.065	6.3V/1.2, 6.3V/600 MA	1.75
CT-319	330VCT	.085	5V/2, 6.3/7.5, 6.3/3	3.25
CT-526	510VCT	.025	12.5/900 MA, 6.3/5A.	1.95

Filament Transformers-115V/50-60 cps input

Item	Rating	Each
FT-852	23V .35	\$1.79
FT-30B	58V/2.2A	2.25
FT-599	78V/300, 6.3V/2A	1.95
FT-719	1.3V/6A	.79
FT-029	13.5V/1.1A	1.79
FT-07	2.5V/10A, 6.3V/9A	1.79
FT-23-1	6.3V/3A	1.10
FT-346	5VCT/13.5, 5VCT/6.75, 5VCT/6.75	5.95
FT-781	866 Trans. 2 x 2.5/5A	2.25
FT-36-4	6.3/2, 6.3/4.5	1.49
FT-511	3.4V/300A, 7 1/2 H x 10" x 5" 2W	14.95
FT-512	2.5V/2.5, 7V/7A (Tape @ 2.5V/2.5A), 16 lbs.	9.95
FT-674	8.1V/1.5A	1.10
FT-157	4V/16A, 2.5V/1.75A	2.95
FT-391	6.4V/3A	1.49
FT-736	2 x 6.3VCT/3.2-1.2A	1.10
FT-481	2 x 6.3VCT/1A	1.49
FT-899	245 V/5.5A 2000 Rms.	12.95
FT-418	6.3VCT/1A, 6.3VCT/7A	1.95
FT-735	6.3VCT/5A, 6.3VCT/1A	1.79
FT-101	6V 2.5A	1.95
FT-738	6.3VCT/1A, 5V/2A	1.69
FT-774	6.3V/16A	.79
FT-589	9V/1.6A	.49

Plate Transformers-115V/50-60 cps input

Item	Rating	Each
PT-976	Auto: 120VCT/10 MA	\$.69
PT-31A	2 x 300V/5 MA	.79
PT-46A	4080VCT N.L. 3 1/2 to 1 1/8" H x 6" W x 7" L 20 lbs.	29.95
PT-31A	415V/400 MA 1 1/4 x 9 1/4 x 9" D 70 lbs.	49.95
PT-75-2	3780/3446/3112VCT/77 MA	49.95
PT-28-1	4600VCT/077	12.95
PT-403	Auto: 70V/1A	2.29
PT-160	1120VCT/770 MA, 590VCT/82 MA, 25 lbs.	24.95
PT-170	Auto: 156/146/137/128-71A	3.29
PT-948	210VCT/750 MA for BC545, BC1069A	69.95
PT-135	42V/46V/50V/55V/15.2A 7 1/2" H x 6 1/2" H	10.95
PT-637	400V/20 MA	9.95
PT-67-1	62V/3.5A	2.95
PT-12A	280VCT/2A	2.95
PT-104	690V/450 MA	4.95
PT-104	980V/450 MA	1.95
PT-997	78V/8075A KVA. AUTO	5.25

SPECIAL TYPES

Item	Pri.	Output	Price
STF-946	210/220/230	2.5V/4A 3 1/2" H x 2 1/2" D	\$1.29
STF-443	220/440	11VCT 125A 6 1/2" H x 6 1/2" x 8" 15 lbs.	15.95
STF-638	230/460	5V/9A 5 1/2" H x 4 1/2" x 3 1/2" D	1.25
STF-05A	115/230	2 x 5V/7.5 7" H x 7" x 5" D	4.25
STF-682	220	30-25/200/1 MA	.69
STF-968	230	2.5V/6.5A	1.10
STF-405	230/115	5V 12/9A	1.95
STF-370	220/440	3 x 2.5V/5A, 2.5V/15A, 5 1/2 x 5 x 4 1/2	5.25
STF-610	220	15/10V/100 MA	29.95
STF-11A	220	2 x 40V/05/2 x 5V/6A, 12.6/1A.	1.95
STF-631	230	2 x 5V/27A 2 x 5V/9A, 103/4H x 5 x 7 30 lbs.	24.95
STF-608	220	24V/600, 5V/3A, 2 x 6.3V/1A.	2.25
STF-45A	43/78/30	2 x 2.5/6.5, 6.3V/4 7 Few.	3.25
STF-306	100/120	5VCT 10 amp 2000 V Test.	13.95

SPECIAL PLATE TRANSFORMER

STP-945	210/20/30	110VCT/300 5/4 x 4 x 3 1/2	\$5.95
STP-444	230/460	230/105/115/125 15 lbs. 5 1/2 x 6 1/2 x 4 1/2	14.95
STP-613	230V	2 x 230/05	1.29
STP-823	137V	222VCT/300 MA	2.95
STP-780	82V	4000V/002	1.29
STP-085	50V	2 x 750V/1 MA	.98
STP-311	30/35 40	95 NL-50VFL 1 Amp.	.59

T.V. Transformer, 110V 60 cy 7" or 9" scope, 3000V/5 MA, 720 vct/200 MA, 6-8, 8.7, 8.4, 1.6A, 5/3A, 1.25/3A.
New\$3.95



BATHTUB CAPACITORS

MFD	VOLT	TYPE	EACH	FOR
.5	600	ZST	\$25	\$2.40
.5	400	2BT	.23	2.20
.5	600	2TT	.25	2.40
3X1	600	3TT	.45	4.35
3X1	600	3ST	.45	4.35
2X1	400	3ST	.26	2.50
2X1	600	3ST	.28	2.65
2X1	600	3BT	.28	2.65
2X1	400	2TT	.26	2.50
2X1	600	2TT	.23	2.20
2X1	600	2BT	.26	2.50
2X1	600	3TT	.26	2.50
.1-1	400	3ST	.28	2.65
.025	400	3ST	.28	2.65
1	600	2BT	.22	2.10
1	600	1ST	.22	2.10
1	600	2TT	.22	2.10
1	600	2ST	.22	2.10
.13	600	2ST	.25	2.40
2X25	600	3ST	.30	2.85
.05	600	2TT	.21	2.00
1	100	2TT	.	



The one millionth Teletron recently rolled off the production line. It was all in the day's work for Du Mont's vast Allwood plant geared to over a million TV picture tubes a year. Yet that tube established a unique record, because it represented the one millionth BIG TUBE. No other manufacturer has made that many BIG TUBES.

Ever since 1939 when Du Mont introduced the first commercial television set with its 14" Teletron, Du Mont has pioneered BIG TV TUBES. While others were offering 7" and 10" tubes, Du Mont was satisfied with nothing less than 12". Even as early as 1939, Du Mont made 20" Teletrons. Since then the public and industry have followed the Du Mont lead, but Du Mont remains in the lead with still larger tubes climaxed by the 30" Teletron available shortly.

Obviously, in BIG TUBES the BIG NAME is DU MONT.

DU MONT

*Teletrons**

First with the Finest in Television

Literature on request

*Trade-Mark

ALLEN B. DU MONT LABORATORIES, INC.
TUBE DIVISION • CLIFTON, N. J.

Because

**Break is Fast
and Clean...**

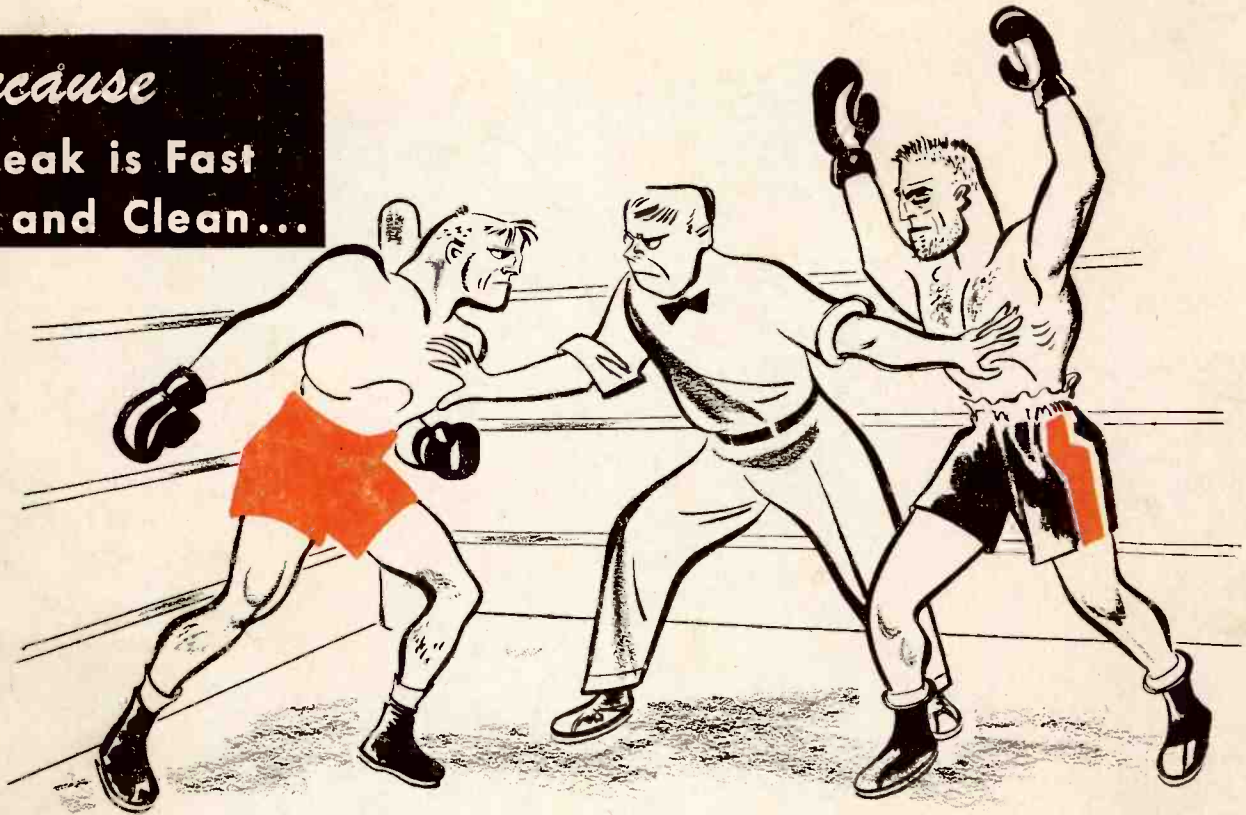

Mallory Vibrators Give Peak Performance!

Fast, clean break of contacts minimizes arcing and pitting. It teams up with gentle contact impact for less wear, and high contact pressure for low resistance—to produce a combination of features attainable only with the patented, tuned mechanism in Mallory Vibrators. That's the secret of their peak performance.

Mallory Vibrators are a result of Mallory's unique facilities in electronics, electrochemistry and metallurgy. The perfect tuning is accomplished by an exclusive design and individual adjustment by skilled technicians. The contacts are made by Mallory's Contact Division, among the largest in the world. They possess an unusual "self-cleaning" action which prevents oxidation in service.

That's why more Mallory Vibrators are used in original equipment than all other makes combined. When you use Mallory Vibrators for replacement you can be sure of long life, dependable starting and high output efficiency. See your Mallory distributor now!

More Mallory Vibrators Are Used in Original Equipment Than All Other Makes Combined.

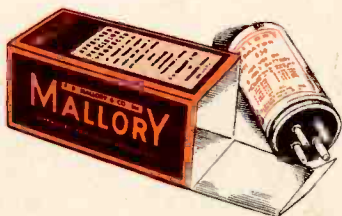

P. R. MALLORY & CO. Inc.
MALLORY

CAPACITORS • CONTROLS • VIBRATORS • SWITCHES • RESISTORS
• RECTIFIERS • VIBRAPACK* POWER SUPPLIES • FILTERS

*Reg. U.S. Pat. Off.

APPROVED PRECISION PRODUCTS

P. R. MALLORY & CO., Inc., INDIANAPOLIS 6, INDIANA