

# RADIO & TELEVISION NEWS

JANUARY  
1950

RADIO-ELECTRONIC  
ENGINEERING  
EDITION



COMMERCIAL AVIATION OPPORTUNITIES FOR RADIOMEN . . . PAGE 31

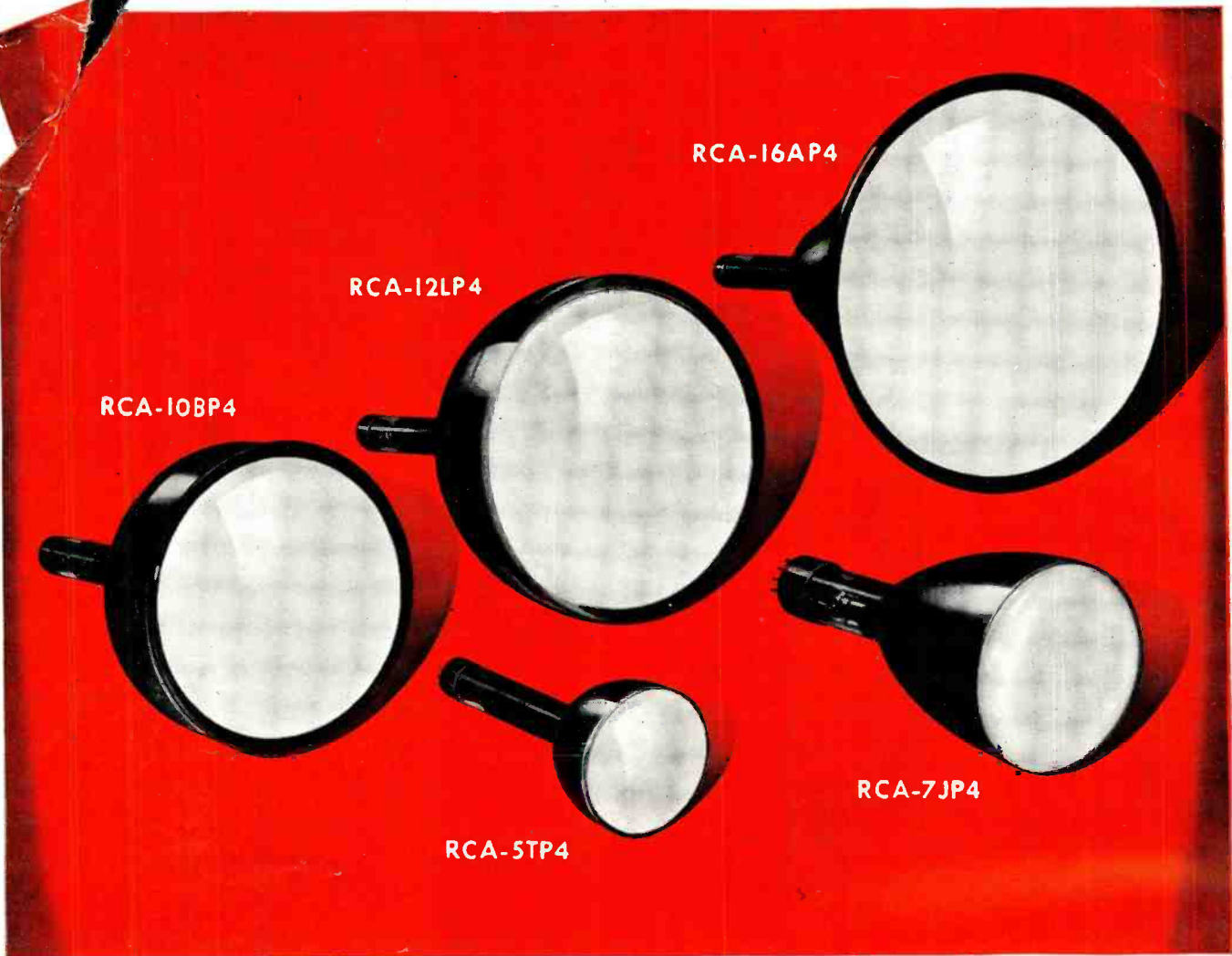

THE FOUNTAINHEAD OF MODERN TUBE DEVELOPMENT IS RCA

## **RCA knows how to make television picture tubes . . . the best your money can buy**

RCA has all the popular type television picture tubes to meet your present and future renewal requirements. And you can get them from *one* dependable source . . . your RCA Tube Distributor.

Mass-produced under superior quality controls, RCA television kinescopes of all types are the best that money can buy. You can count on them to meet the critical requirements of television reception.

When you renew with an RCA kinescope, you're selling the brand that has top public preference. RCA kinescopes will help *your* business grow by leading customers to you as a dependable source for television and radio needs.

Get the full details on the leading line of television picture tubes and sales promotion material from your local RCA Tube Distributor today.

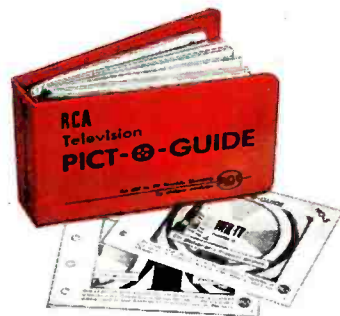

**NOW . . . TV TROUBLE SHOOTING BY PICTURE ANALYSIS!** Another RCA First in servicing aids . . . the Pict-O-Guide tells at a glance where to look for trouble in a TV receiver—and indicates how to cure it. To learn how you can get your copy, see your RCA Tube distributor without delay! The supply is limited.

**ALWAYS KEEP IN TOUCH WITH YOUR RCA TUBE DISTRIBUTOR**



**RADIO CORPORATION of AMERICA**  
ELECTRON TUBES  
HARRISON, N. J.

# You Practice COMMUNICATIONS

I Send You Parts To Build This Equipment

As part of my new Communications Course I send you parts to build your own Transmitter. Conduct actual procedure demanded of Broadcast Station Operators, practice many interesting experiments and tests, learn how to put a transmitter on the air.



# You Practice Radio SERVICING

On This Modern Radio You Build With Parts I Send

As part of my Servicing Course, I send you the speaker, tubes, chassis, transformer, loop antenna, EVERYTHING you need to build this modern Radio Receiver that brings in local and distant stations. You use it to conduct many tests and experiments.

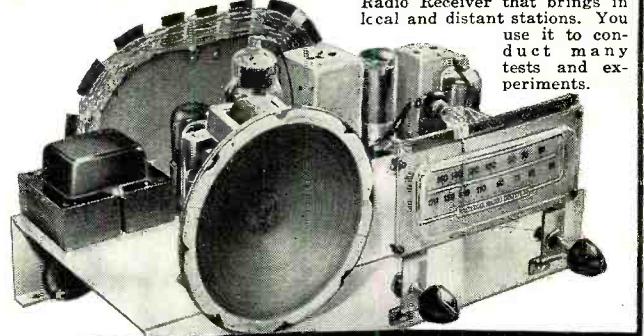

# BE A RADIO-TELEVISION TECHNICIAN

Learn Servicing or Communications

by Practicing in Spare Time

with MANY KITS OF PARTS I Send

**YOU BUILD** this Tester as part of my Servicing Course. It soon helps you earn \$5, \$10 and more a week EXTRA MONEY fixing neighbors' Radios in spare time while learning.



**YOU BUILD** this Power Pack as part of my new Communications Course. Use it to conduct fascinating experiments with frequency amplifiers and multipliers, buffer stages, etc.



**YOU BUILD** this Superheterodyne Receiver Circuit and conduct Frequency Modulation experiments and many other tests as part of my Servicing Course.

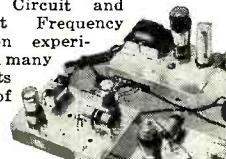

**YOU BUILD** this Signal Generator as part of my Servicing Course for more valuable experience. It provides amplitude-modulated signals for many interesting tests and experiments.

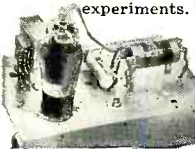

**VETERANS GET THIS TRAINING WITHOUT COST UNDER G. I. BILL MAIL COUPON**

**YOU BUILD** this Wavemeter as part of my new Communications Course. Use it with Oscillator you also build that furnishes basic power to transmitter and determines transmitter frequency.



J. E. SMITH, President National Radio Institute

Want a good-pay job in the fast-growing Radio and Television industries or to be boss of your own money-making Radio and Television shop? I've trained hundreds of men with no previous experience to be Radio technicians. I can do the same for you! Or now, for the first time, enroll in my new practical course in Radio—Television Communications—learn to be a Broadcasting and Communications technician. You learn Radio and Television principles from clear, illustrated lessons. You get practical Radio experience with MANY KITS OF PARTS I SEND in my train-at-home method. All equipment yours to keep.

### MAKE EXTRA MONEY IN SPARE TIME

As part of my Radio Servicing Course, I send EXTRA MONEY booklets, starting the day you enroll. Use your know-how to make \$5, \$10 and more a week EXTRA MONEY fixing Radios in spare time while training. The next step is your own Radio shop or a good-pay Radio servicing job. Or, if you prefer, get into Government, Police, Aviation or Marine Radio, Broadcasting, Radio Manufacturing or Public Address Work.

### BRIGHT FUTURE IN TELEVISION

Think of the present and future opportunities in the fast-growing Television field. New stations are going on the air every month. . . . Television manufacturers are producing over 100,000 sets a month. It's a fast-growing field and the man who knows Television will be in demand.

### GET ACTUAL LESSON AND BOOK FREE

Send now for my special DOUBLE FREE OFFER. Get actual lesson on Radio Repairing short-cuts absolutely free. Also get 64-page book, "HOW TO BE A SUCCESS IN RADIO—TELEVISION—ELECTRONICS." See how quickly, easily you can start. J. E. SMITH, President, Dept. OAR, National Radio Institute, Pioneer Home Study Radio School, Washington 9, D. C.

## I TRAINED THESE MEN AT HOME

**Good Job In Radio Station**  
"Am Chief Engineer of Station WORD, in charge of four men. Owe all I know about Radio to NRI."—CLYDE J. BURDETTE, Spartanburg, South Carolina.



**Makes Extra Cash In Spare Time**  
"Earned enough spare time cash to pay for my course by time I graduated. NRI training is tops!"—ALEXANDER KISH, Carteret, New Jersey.



**Operates Own Radio Business**  
"Now have two Radio shops servicing about 200 sets a month. Have largest service establishment in Southeast Missouri."—ARLEY STUDYVIN, DeSoto, Mo.



**MAIL COUPON! FIND OUT ABOUT THIS TESTED WAY TO BETTER PAY**

## Good for Both—FREE

MR. J. E. SMITH, President, Dept. OAR National Radio Institute, Washington 9, D. C.

Mail me FREE Sample Lesson and 64-page book about how to win success in Radio and Television—Electronics. (No salesman will call. Please write plainly.)

Name..... Age.....  
Address.....  
City..... Zone..... State.....  
 Check If Veteran APPROVED FOR TRAINING UNDER G. I. BILL

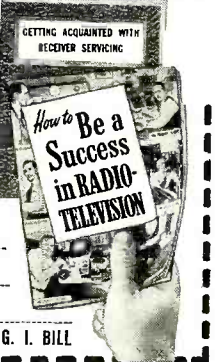

Editor

**OLIVER READ, L.H.D., W9ETI**

Managing Editor

**WM. A. STOCKLIN, B.S.**

Technical Editor

**H. S. RENNE, M.S.**

Associate Editor

**RAY FRANK, W9JU**

Contributing Editor

**R. HERTZBERG, W2DJJ**

Television Consultant

**MILTON S. KIVER**

Short-Wave Editor

**KENNETH R. BOORD**

Editorial Assistants

**I. M. CARROLL**  
**E. V. HITZEL**  
**P. B. HOEFER**

Staff Artist

**R. S. KUPJACK**

Advertising Manager

**L. L. OSTEN**

Midwest Adv. Manager

**JOHN A. RONAN, JR.**

Art Director

**HERMAN R. BOLLIN**

# RADIO & TELEVISION NEWS

*First in*  
*radio-television-electronics*  
 Average Paid Circulation over 200,000

Television News Trademark Reg. U.S. Pat. Office No. 517468

Radio News Trademark Reg. U.S. Pat. Office No. 373427

## CONTENTS

## JANUARY, 1950

Aircraft Radio.....	James Holahan	31
Frequency Measurements for Citizens Radio.....	Harold McKay	35
Is Stratovision the Answer?.....	Kenneth R. Boord	36
A Crystal Receiver with Transistor Amplifier.....	Rufus P. Turner, K6AI	38
The Beginning Amateur (Part 12).....	Robert Hertzberg, W2DJJ	40
A Two-Meter Quad.....	G. P. Oberto	43
Mac's Radio Service Shop.....	John T. Frye	44
Modern Television Receivers (Part 21).....	Milton S. Kiver	45
Converting the TR-4 for 420 mc.....	D. H. Rogers, W2MLF	48
Make Your Own Self-Generating Photocell.....	Guy Dexter	50
Eliminating Broadcast Interference Caused By TV Receivers.....	Jack Najork, W2HNN	52
Printed Circuits (Part 2).....	John T. Frye	53
Dynaurl Preamplifier Provides Wide Compensation.....	Hermon H. Scott	56
A Single Tube A.F.C. Circuit for TV Deflection Systems.....	John A. Cornell	58
A Versatile, Low-Power Transmitter.....	G. L. Countryman, W3HH; W1RKB	62
Improving Performance of Small P.A. Amplifiers.....	John B. Ledbetter	64
Oscillator and Gain Set for Audio Measurements.....	Hal Bumbaugh, W6HI	66
A Volume-Compensated Tone Control.....	Alan Schwan	70
A Handy TV Service Kit.....	Ralph E. Hahn	86
Oscilloscope Quiz.....	Ed Bukstein	132



COVER PHOTO. F. J. Weisenberger, one of American Airline's radio technicians, checks a piece of radio gear before it is re-installed in one of the airplanes. (Kodachrome by Merle Oelke)

Chairman of the Board and Publisher  
**WILLIAM B. ZIFF**

President  
**B. G. DAVIS**

Secretary-Treasurer  
**ARTHUR T. PULLEN**

Vice-Presidents  
**MICHAEL H. FROELICH**  
 Dir. Eastern Div.

**H. J. MORGANROTH**  
 Production Director

**H. G. STRONG**  
 Circulation Director

### BRANCH OFFICES

NEW YORK (11)  
 Empire State Bldg., W1 7-0400

LOS ANGELES (14)  
 815 S. Hill St., TUcker 9213  
 Manager, **WILLIAM L. PINNEY**

## DEPARTMENTS

For the Record.....	The Editor	8	AFCA News .....	92
Spot Radio News.....		16	Letters from Our Readers.....	98
Within the Industry.....		22	New Television Receivers.....	124
Short-Wave.....	K. R. Boord	61	MARS .....	146
What's New in Radio.....		79	Manufacturers' Literature .....	150
Technical Books .....			156	



COPYRIGHT 1949  
 ZIFF-DAVIS PUBLISHING COMPANY  
 185 North Wabash Ave., Chicago 1, Ill.  
 VOLUME 43 • NUMBER 1



Member  
 Audit Bureau of  
 Circulations

RADIO & TELEVISION NEWS is published monthly by the Ziff-Davis Publishing Company, 185 N. Wabash Ave., Chicago 1, Ill. Subscription Rates: in the United States \$4.00 (12 issues), single copies 35c; in Canada \$4.00 (12 issues), single copies 40c; in Mexico, South and Central America, and U. S. Possessions, \$4.00 (12 issues); in British Empire, \$5.00 (12 issues)—all other foreign countries \$5.00 (12 issues). Subscribers should allow at least 2 weeks for change of address. All communications about subscriptions should be addressed to: Director of Circulation, 185 N. Wabash Ave., Chicago 1, Ill. Entered as second class matter July 21, 1948, at the Post Office, Chicago, Illinois, under the Act of March 3, 1879. Entered as second class matter at the Post Office Dept., Ottawa, Canada. Contributors should retain a copy of contributions and include return postage. Contributions will be handled with reasonable care but this magazine assumes no responsibility for their safety. Accepted material is subject to whatever revisions and by-line changes that are necessary. Payment made at our current rates, covers all authors', contributors' or contestants' rights, title, and interest in and to accepted material, including photographs and drawings.

**RADIO & TELEVISION NEWS**

# Want To Double Your Pay?



## How To Pass FCC COMMERCIAL RADIO OPERATOR LICENSE EXAMINATIONS

**GET THIS AMAZING NEW BOOKLET FREE!**

Add Technical Training to Your Practical Experience and

## GET YOUR FCC COMMERCIAL RADIO OPERATOR LICENSE

**IN A FEW SHORT WEEKS!**

It's EASY if you use CIRE Simplified Training & Coaching AT HOME in SPARE TIME

Get your license easily and quickly and be ready for the jobs open to ticket holders which lead to \$3000 to \$7500 (average pay reported by FCC nationwide survey).

CIRE training is the only planned course of coaching and training that leads directly to an FCC license.

### CIRE GRADUATES FIND FCC LICENSE PAYS OFF

"I now hold ticket Number P-10-3787, and holding the license has helped me to obtain the type of job I've always dreamed of having. Yes, thanks to CIRE, I am now working for CAA as Radio Maintenance Technician, at a far better salary than I've ever had before. I am deeply grateful."  
Student No. 3319N12

"I took the FCC examination on March 4th and received my second class radiotelephone license March 9th. I go to work for the Trans-Texas Airways in the maintenance department. Thanks for all the assistance."  
Student No. 2394A1

**CLEVELAND INSTITUTE OF RADIO ELECTRONICS**  
Desk RN-13 • 4900 Euclid Bldg. • Cleveland 3, Ohio  
Approved for Veteran Training Under the "G.I. Bill of Rights"

January, 1950

1. Tells of Thousands of Brand-New, Better Paying Radio Jobs Now Open to FCC License Holders.
2. Tells How We Guarantee to Train and Coach You Until You Get Your FCC License.
3. Tells How Our Amazing Job-FINDING Service Helps You Get the Better Paying Radio Job Our Training Prepares You to Hold.

YOUR FCC TICKET IS ALWAYS RECOGNIZED IN ALL RADIO FIELDS AS PROOF OF YOUR TECHNICAL ABILITY



**Get All 3 FREE Send Coupon Now!**

**CLEVELAND INSTITUTE OF RADIO ELECTRONICS**  
Desk RN-13—4900 Euclid Bldg., Cleveland 3, Ohio  
(Address to Desk No. to avoid delay)

I want to know how I can get my FCC ticket in a few short weeks by training at home in spare time. Send me your amazing new FREE booklet "Money Making FCC License Information," as well as a FREE sample FCC-type exam and FREE booklet, "How to Pass FCC License Examinations," (does not cover exams for amateur License).

Name .....

Address .....

City..... Zone..... State.....

Veterans check for enrollment information under G.I. Bill

# Profits climb when you use G-E SPEAKERS

## ...WITH MOUNTING BRACKETS AT NO EXTRA COST!

**H**ERE'S the answer to a serviceman's prayer! Time-saving mounting brackets that solve dozens of awkward replacement problems are now available at no extra cost with

every General Electric small-size speaker you get from your distributor or jobber! Adjustable up, down, or sideways, these brackets save your time and simplify tough jobs.

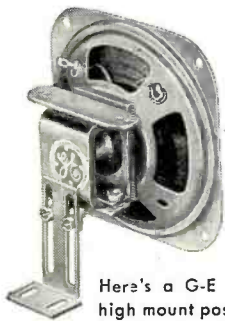

Here's a G-E 4" unit in high mount position. Note how bracket eliminates an awkward blocking job, helps turn out neater, cleaner work.

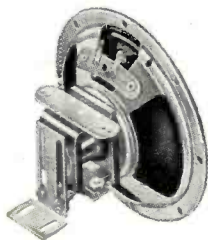

Bracket can be adjusted up or down to fit the cabinet problem. This G-E 5" Round speaker is especially designed for service replacement.



Lateral mounting feature of bracket saves fingers, time and temper. Screws hold bracket arms and speaker securely and permanently in place.

### How To Build Customer Goodwill

Your customer gains confidence in you when you replace with components of the best quality. When you install a G-E speaker in his set, tell him about its advantages—

- ★ Aluminum Base Voice Coil—a famous G-E feature! High humidity won't warp it! Extremes of temperature won't affect it!
- ★ Much higher power handling capacity... Tough, all-weld construction...G-E Alnico 5 Magnet, securely and efficiently mounted, steady as a rock.
- ★ Power, sensitivity, fidelity! More of everything for his money!

Call your G-E distributor or jobber today!

Mail coupon for  
Free Sample Bracket!

This offer open only to radio and TV servicemen!

General Electric Company, Bldg. 1, Section 5091  
Electronics Park, Syracuse, New York

Send me free sample bracket and all the facts on G-E Small-Size Speakers.

NAME.....

FIRM.....

ADDRESS.....

CITY.....STATE.....

You can put your confidence in—  
**GENERAL**  **ELECTRIC**

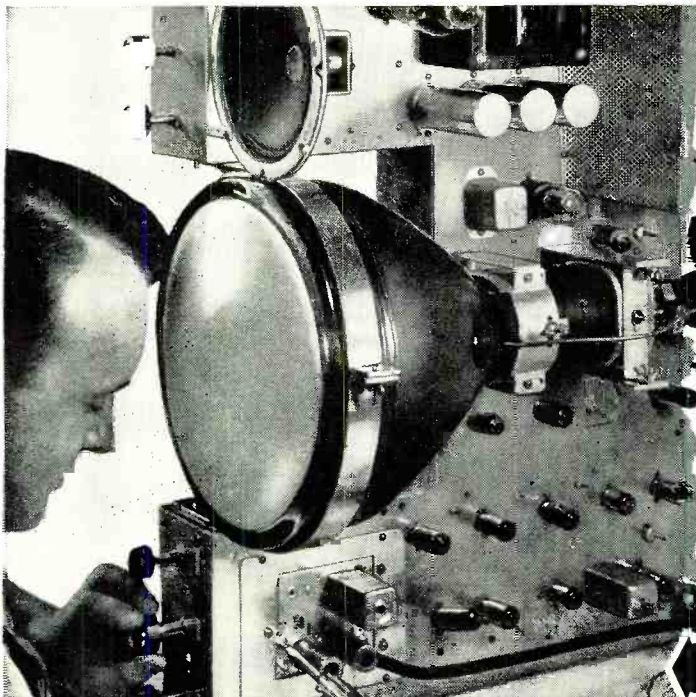

Only D.T.I.  
offers you the  
**"BIG 5"**  
**TELEVISION**  
RADIO-ELECTRONICS  
Laboratory Type  
**HOME TRAINING**

**Build and Keep 10, 12½ or 16 inch Picture Tube Quality TELEVISION RECEIVER as you prepare for a Profitable Future**

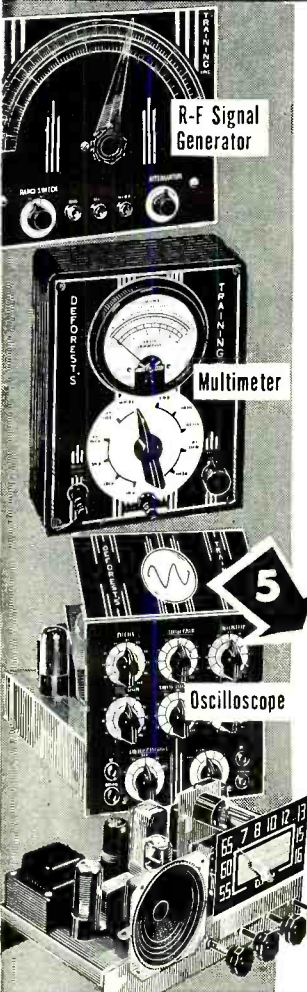

Here is everything you need to prepare you at home for FASCINATING WORK, GOOD MONEY and a THRILLING FUTURE in one of America's most promising fields.

This includes the opportunity to build and keep the top quality Television Receiver shown above—with choice of a 10, 12½ or 16 inch picture tube that gives big, bright, sharp, steady pictures. Get the complete facts. This is an optional feature — available when you complete your training described below. See how D.T.I.'s wonderfully practical "BIG 5" method meets industry's needs. No previous experience needed. Mail coupon today!

**16 Big Shipments of Parts — Plus Lessons**  
Work over 300 electronic experiments and projects from 16 big shipments of parts. This includes building and keeping all test equipment and radio set shown at left side of page. Modern easy-to-read lessons with handy fold-out diagrams simplifies your entire training.

**You Also Use Home Movies**  
D.T.I., alone, includes the modern, visual training aid . . . MOVIES to help you learn faster, easier at home. See electrons on the march and other fascinating "hidden action"—a remarkable home training advantage that speeds your progress.

**EMPLOYMENT SERVICE**  
When you complete your training, our effective Employment Service helps you get started toward a real future in Television-Radio-Electronics.

**Modern Laboratories**  
If you prefer, you can get ALL your preparation in our new, Chicago training laboratories . . . one of the finest of its kind. Ample instructors . . . modern equipment. Write for details!

6 Tube  
Radio  
Receiver

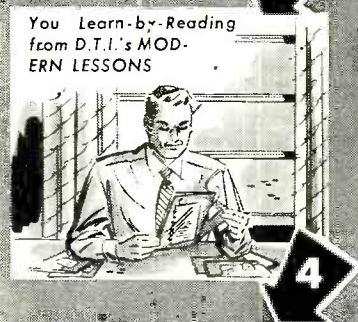
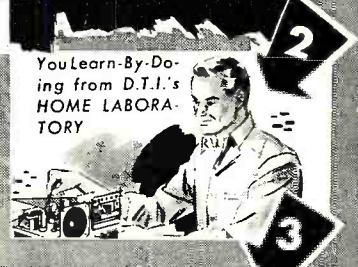

**MAIL THIS COUPON TODAY!**

DeFOREST'S TRAINING, INC.  
2533 North Ashland Avenue, Dept. RN-G-1  
Chicago 14, Illinois.

Without obligation, give me complete facts showing how I may make my start in Television-Radio-Electronics.

Name \_\_\_\_\_ Age \_\_\_\_\_  
Street \_\_\_\_\_ Apt. \_\_\_\_\_  
City \_\_\_\_\_ Zone \_\_\_\_\_ State \_\_\_\_\_

**DeFOREST'S TRAINING, INC.**  
Chicago 14, Illinois  
A DeVry Institution

# For the RECORD.

BY THE EDITOR

## IS TELEVISION GOING "MODEL T"?

THE past year lived up to all expectations, as far as television was concerned, with but one exception. Price cutting and competition found sets produced late in 1949 having all the earmarks of the "Model T Era." Circuits developed during 1948 were able to operate in fringe areas with good results. They were also capable of good audio performance. There was little skimping of parts to save a few pennies in production costs.

Engineers were left pretty much in charge of development and improvements, and their recommendations were accepted by the set maker. The result was quality merchandise, capable of trouble-free performance in the customer's home. Then came the price war. Dealers would make almost any deal that meant an easy sale and the disposal of a TV set. Sales slowed down and price cutting techniques swept the country.

Profits dwindled and to make a bad situation even worse, manufacturers looked for a solution in cheaper sets. Circuits were streamlined by eliminating tubes and components. Cheap audio circuits were employed and 69-cent speakers appeared in many consoles as well as table models. Acoustical requirements were shoved aside and six-inch speakers appeared in random locations—anywhere where space could be found.

Sound was projected in any old direction, much like a 1930 auto radio, and many TV sets of recent manufacture don't compare to prewar standards, either in performance or pleasant listening.

The public has been led to believe that FM audio, with its superb tonal range possibilities will provide the purchaser with response from 30-15,000 c.p.s., but when facts rear their ugly heads we discover that many of the TV programs sent over the networks pipe the sound through regular AM lines with highest frequencies around 8000 cycles.

So why all the ballyhoo about "high-fidelity sound" in TV sets? The trend in modern television design has been to decrease manufacturing costs in order to increase the volume of receivers purchased by the public. Although this abbreviation in cost has served the purpose of bringing entertainment into the home of Mr. Average American, one salient fact sticks out like the proverbial "sore thumb." Little is, apparently, being done to produce *better* television receiver design. Engineering along video lines is being regimented to produce the same thing or some-

thing that will pass for less money, instead of serious thought being directed toward better operation.

This has resulted in numerous short cuts in receiver design, all of which have degenerated television engineering, and have put the technician service depots and honest dealers in quite a dilemma. Practically no manufacturer is immune to this charge. There seem to be but few producers of television receivers willing to hold fast and buck the commercial debauchery which has placed television, a lush promising new industry in both the technical and entertainment fields, into the chiseling price-cutting bracket in which it is to be found today.

Effort is being expended on fooling the public with indoor antenna gimmicks, guaranteed to work better than the old reliable antenna, quick adaptability to the ultra-high frequencies, color and a host of other hoaxes, but apparently no effort is being directed toward improving what we have attained up to 1948. There is no denying the fact that we must have "cheapies" since not everyone can afford an investment of several hundred dollars, but let's have some real good television receivers too. Automobile manufacturers know that a really fine car will always be in demand by those wanting "something better."

THE year 1950 promises to be a very lucrative period for the television service technician. As a matter of interest it is estimated, for example, that during 1949 TV servicing accounted for approximately \$90,000,000 in installation and service charges, another \$22,500,000 in antenna sales, and a further \$20,750,000 in accessory sales. This totals over \$133,000,000. It is predicted that this figure will be greatly exceeded during 1950 as new markets open up throughout the country.

We have been hearing rumors that radio will soon be obsolete. We don't share in that belief. As a matter of fact, radio production of receiving sets for 1949 was a bit over 10,000,000 as against 2,500,000 television sets. In many remote areas dealers haven't been supplied with enough AM to meet demand.

According to *Television Digest*, Max Balcom of *Sylvania* forecasts a 3,750,000 TV set production in 1950, and that's a lot of television. Yes, 1950 will also be a television year, and the dealer and service technician have much to look forward to as many new markets open around the country. We hope you get your share.....O.R.

## SOLDERING IS A CINCH



when you know these SIMPLE TRICKS!

SEND NOW ONLY 10¢

No matter how much you know about soldering, there's always a trick that will make it easier. This little 20-page pocket guide is crammed full of such time-and-trouble savers.

Without wasting words, it covers the whole soldering operation—points out DO's and DON'T's—refreshes your memory on difficult points—suggests methods that help you work faster. Yet there's no hard studying, no tough technical talk. Every word is plain everyday English and every point is made clear by easy-to-understand illustrations.

Get this handy Soldering Guide today, and keep it on your bench for ready reference. It's a real handbook of professional soldering—not a catalog. Just mail the coupon with 10c in coin and we'll send your copy at once.



When you send for your Guide to Easy Soldering, be sure to ask about the New Weller Soldering Guns. They're a handful of convenience, better from tip to grip.

# WELLER

MANUFACTURING COMPANY

Weller Mfg. Co., 810 Packer St., Easton, Pa.

Enclosed find ten cents (10c) for which please send my copy of the Weller "Soldering Tips".

I am also interested in the new Weller Soldering Guns. Please send Catalog Bulletin.

Name \_\_\_\_\_

Address \_\_\_\_\_

City \_\_\_\_\_ State \_\_\_\_\_

RADIO & TELEVISION NEWS



# There's Only ONE COMPLETE CATALOG that Brings You EVERYTHING IN RADIO, TELEVISION & ELECTRONICS

IT'S YOUR

**FREE**

**ALLIED** 196-PAGE  
VALUE-PACKED CATALOG!

SEND FOR IT TODAY



## Get Radio's Leading Buying Guide

Here's the Buying Guide to *everything* in radio for *everyone* in radio! It's the *one complete* catalog, preferred in the field because it fills *every* TV, Radio, and Electronic supply need. It's packed with the world's largest selections of quality equipment at lowest money-saving prices. See the latest in TV, AM and FM receivers; radio-phonos; new Sound Systems, P.A. equipment and high-fidelity sound components; recorders and accessories; full selections of newest Amateur receivers and station gear; test instruments; builders' kits; huge listings of parts, tubes, tools, books, diagrams.

ALLIED gives you every buying advantage: speedy delivery, expert personal help, lowest prices, assured satisfaction—plus the most liberal Time Payment plan in radio. Get the 1950 ALLIED Catalog—it will save you time and money. Send today for your FREE copy!



## WORLD'S LARGEST STOCKS

*Radio Parts Unlimited*  
*Test Instruments—All Makes*  
*Television & Home Radios*  
*P. A. and Hi-Fi Equipment*  
*Amateur Station Gear*  
*Experimenters' Supplies*

**QUICK, EXPERT SERVICE**

## ALLIED IS YOUR TELEVISION HEADQUARTERS



You keep up with TV when you depend on ALLIED! Count on us for the latest releases and largest stocks of picture tubes, component parts, antennas and accessories—plus the latest in TV receivers, tuners and kits. If it's anything in TV—we have it in stock! So remember—for TV—it's ALLIED First!

**ALLIED RADIO**

THE WORLD'S LARGEST RADIO SUPPLY HOUSE

*Everything in Radio, TV and Electronics*

Send for Radio's Leading Buying Guide

**FREE**

ALLIED RADIO CORP.  
833 W. Jackson Blvd., Dept. 1-A-0  
Chicago 7, Illinois

Send FREE 196-page 1950 ALLIED Catalog.

Name .....

Address .....

City ..... Zone ..... State .....

# Brush adds this new all-purpose mike



## FOR PA, HOME AND AMATEUR... EQUALLY FINE FOR VOICE OR MUSIC

(BA-109)

It's a "natural". Here's a popular-priced microphone that delivers "naturally" and faithfully orchestra, vocal or the speaking voice—essentially flat frequency response from 40 to 10,000 cps. It can be used anywhere. It employs a further perfection of the famous and exclusive Brush "Acoustical" principle with its "metaseal" crystal, providing protection from high humidity. Its pickup is non-directional in the horizontal plane . . . has unusually high output of 54 db. below 1 volt/dyne/cm<sup>2</sup> . . . and is built for a long, rugged life. Fits on any standard 5/8" 27-thread stand. List ----- \$22.50.

### HAND OR DESK MICROPHONE

(BA-116)



Rugged dependability and uniform frequency response. Unbeaten in its price range for PA, home, institutional and industrial use. Use in hand or on desk without need of stand. But also equipped for use with standard 5/8" 27-thread stand. Brown metallic finish, 8' cable. List ..... \$14.75.

### GENERAL PURPOSE MICROPHONE

(BA-106)

Using the exclusive "Acoustical" cartridge. Vibration, shock, low frequency wind noise or humidity do not affect the high fidelity . . . essentially flat frequency response from 40 to 6,000 cps. Excellent for general use. Output level Minus 50 db. below 1 volt/bar. List, \$19.75.



*You can get them!*

Brush products are distributed all over U.S.A. If your own radio parts jobber does not have them, write to us and we will send you name of nearest jobber.

**THE BRUSH DEVELOPMENT COMPANY**  
3405 Perkins Avenue • Cleveland 14, Ohio



**YOU  
Build This  
Superheterodyne**

You receive complete standard equipment, including latest type High-Mu Tubes, for building various experimental and test units. You progress step by step until you build a complete Superheterodyne Receiver. It is yours to use and keep.

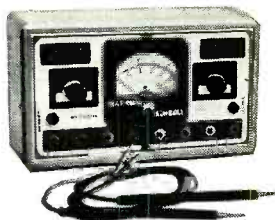

**YOU RECEIVE THIS  
PROFESSIONAL MULTITESTER!**

You will use this professional instrument to locate trouble or make delicate adjustments—at home—on service calls. You will be proud to own this valuable equipment. Complete with test leads.

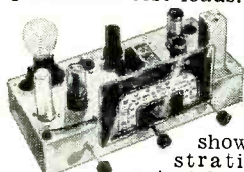

**SIGNAL  
GENERATOR**

You construct the Transistron Signal Generator shown here, demonstrating Transistron principles in both R.F. and A.F. stages. You study negative type oscillators at firsthand.

**AUDIO OSCILLATOR:**

An electronic device, which produces audio-frequency signals for modulating R.F. (radio frequency) carrier waves, testing A.F. (audio frequency) amplifiers, speakers, etc.



**T.R.F.  
RECEIVER**

You build several T.R.F. Receivers, one of which, a 4-tube set, is shown here. You learn construction, alignment, make receiver tests, and do trouble shooting.

# Get Into **RADIO, TELEVISION** and **ELECTRONICS** Master ALL Phases

**Get Complete Training. You Receive and Keep All Equipment, Parts and Lessons. No Extra Charges.**

**GOOD PAY  
and Unlimited Opportunities  
in JOBS LIKE THESE:**

Business of Your Own. Radio Manufacturing, Sales, Service. Broadcasting. Telecasting. Television Manufacturing, Sales, Service. Laboratories: Installation, Maintenance of Electronic Equipment, Electrolysis, Call Systems. Garages: Auto Radio Sales, Service. Sound Systems and Telephone Companies; Oil Well and Drilling Companies; Engineering Firms. Theatre Sound Systems. Police Radio.

**And scores of other good jobs  
in many related fields**

**YOU CONDUCT MANY  
EXPERIMENTS LIKE THESE!**

Checking action of condensers  
Experiments with AF and RF amplifiers  
Experiments with resonance  
Producing beat frequencies  
Calibrating oscillators  
Experiments with diode, grid-bias, grid-leak and infinite impedance detectors  
Practical experience in receiver trouble shooting  
Application of visual tester in checking parts and circuits  
Experiments with audio oscillators  
Advanced trouble-shooting  
... and many, many others.

**Complete Training by Practical  
Resident Trade School, Est. 1905**

The same highly trained faculty, instruction materials and methods used here in our large, modern resident school, are adapted to your training in your own home. Shop Method Home Training has been proved by hundreds of successful graduates.

**Both Resident and Home Study  
Courses Offered**

**YOU  
LEARN BY  
DOING**

You receive special laboratory experimental lessons to show you how to build with your own hands various experimental units such as those shown at left, and how to conduct many tests.

You will find all lessons easy to understand because they are illustrated throughout with clear diagrams and step-by-step examples that you work out yourself. Every piece of the equipment and complete lesson material we send you is yours to keep and enjoy, including the multitester, experimental equipment, all parts of the Superheterodyne, tube manual, radio dictionary, and complete, modern Television texts. All parts are standard equipment.

**Shop Method Home Training ...  
Earn While You Learn**

With our practical resident Shop Method Home Training, you study in your spare time. You receive Spare Time Work Lessons, which show you how to earn while you learn. Service neighbors' radios and TV receivers, appliances, etc., for extra money and experience. Many National students pay all or part of their training with spare time earnings!

**DON'T DELAY! The Radio-Television  
Industry needs trained men NOW!**

**APPROVED  
FOR  
VETERANS!**  
Check coupon below!

For quick action,  
mail coupon  
today and we'll  
rush you full in-  
formation.

**Free!**

**NEW, ILLUSTRATED  
OPPORTUNITY  
BOOK AND SAMPLE  
LESSON SHOW YOU  
HOW WE TRAIN  
YOU ... SEND FOR  
THEM TODAY! NO  
COST. NO  
OBLIGATION.**



**NATIONAL SCHOOLS**

LOS ANGELES 37, CALIF. • EST. 1905



**FIND OUT NOW ... MAIL COUPON TODAY**

National Schools, Dept. RN-1  
4000 South Figueroa Street  
Los Angeles 37, California

Mail in envelope  
or paste on  
penny postal.

Send me your FREE book "Your Future in Radio" and the sample lesson of your course. I understand no salesman will call on me.

NAME..... AGE.....

ADDRESS.....

CITY..... ZONE..... STATE.....

Check here if Veteran of World War II

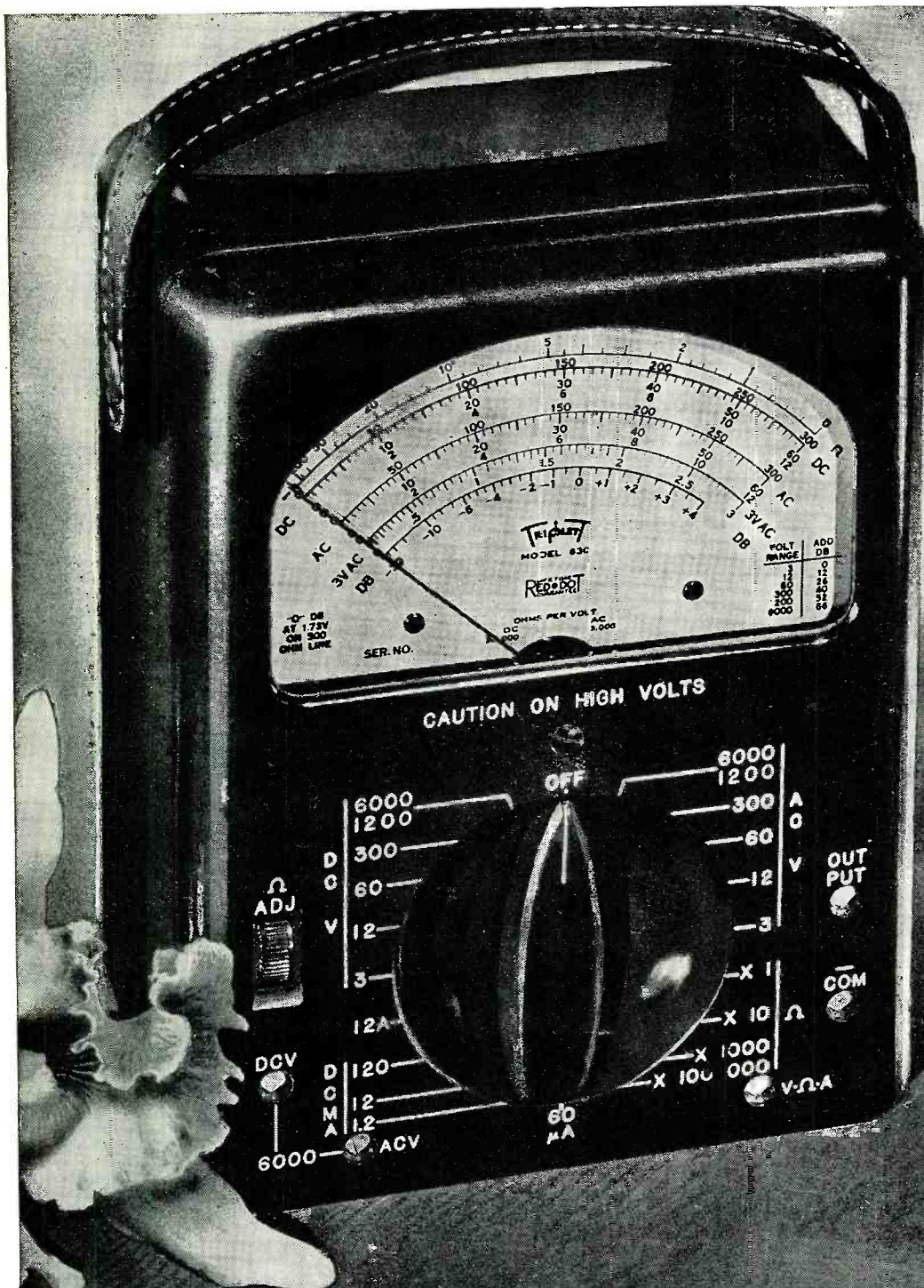

Model  
630

*There is no more useful  
and dependable instrument made*

FOR THE MAN WHO TAKES PRIDE IN HIS WORK

**Triplet**

TRIPLET ELECTRICAL INSTRUMENT COMPANY - BLUFFTON, OHIO, U.S.A.

ONLY \$37.50 AT YOUR DISTRIBUTOR

RADIO & TELEVISION NEWS

# Good Listening! for EVERYONE!

## with the NEW Genuine JENSEN WIDE-RANGE LOUDSPEAKERS

### 16 COMPLETELY NEW MODELS

Three 15-inch Coaxials, one 12-inch Coaxial  
Eleven 5-inch to 15-inch Single-Radiator Models

- No longer is truly *good* listening ruled out by cost or size restrictions. Now music can come to life for everyone, for Genuine JENSEN Wide-Range Loudspeakers include *small sizes* as well as large . . . *low cost units* as well as more expensive models.
- Not alone in frequency range but also in smooth response, wide-angle distribution, low distortion, good efficiency and power handling capacity . . . in all 7 Performance Points Genuine JENSEN Wide-Range loudspeakers establish new standards of reproduction quality.
- So whether you choose a 5" single-unit direct-radiator type loudspeaker at \$8.00 list, a 12" Coaxial at \$33.40 list, or a 15" Coaxial with the new JENSEN Wide-Angle Acoustic Lens, you get superior performance all the way . . . in every attribute that makes for enhanced listening pleasure.

## New WIDE-ANGLE ACOUSTIC LENS

Typical of JENSEN leadership in loudspeakers engineering is the Acoustic diverging Lens used on Model H-510 illustrated at the left. Adapting optical principles to acoustics, this lens acts in conjunction with the h-f horn to distribute h-f radiation uniformly over a wide angle . . . insures constant balance and high quality reproduction throughout the whole room.

*Write now for Data Sheet No. 152 describing all the new loudspeakers in the new Genuine JENSEN Wide-Range series, and booklet, "Let Music Come to Life."*

**Jensen**  
WIDE RANGE

This trademark identifies an advanced-design loudspeaker . . . with performance to meet today's exacting requirements for faithful music reproduction . . . achieved through the most modern applications of acoustics.

JENSEN MANUFACTURING COMPANY

Division of the Muter Company

6617 SOUTH LARAMIE AVENUE • CHICAGO 38, ILLINOIS  
In Canada: Copper Wire Products, Ltd., 351 Carlaw Avenue, Toronto

# TRANSVISION TELEVISION INSTRUMENTS

## Now... 16" WIRED CHASSIS

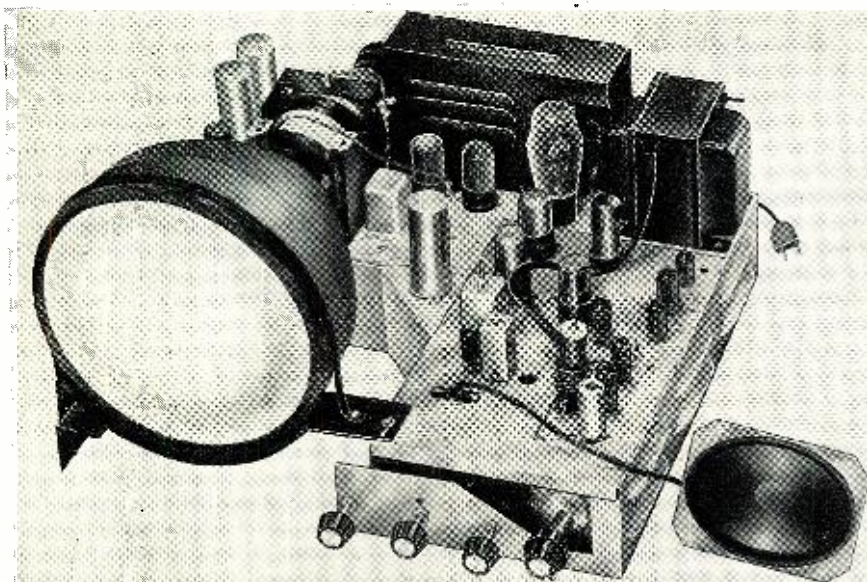

**\$ 39**

LIST, LESS C.R. TUBE

Yes... **COMPLETELY WIRED** and **ALIGNED TV CHASSIS** by **TRANSVISION**. The finest television money can buy! Designed for 16" TV. Just insert your picture tube. **SPECIFY: Transvision Model W16RS TV CHASSIS.** List, less C.R. Tube, \$139.

Also **AVAILABLE AS A KIT** which **\$119**  
 can be **COMPLETED** in **ONE DAY!** **SPECIFY: Model W16RS TV KIT** ..... List price, less C.R. Tube

### Eliminate the Variables in Television Installation with the Transvision **FIELD STRENGTH METER**

*Improves Installations! ! Saves 1/2 the work! !*



Has numerous features and advantages, including—(1) Measures actual picture signal strength . . . (2) Permits actual picture signal measurements without the use of a complete television set . . . (3) Antenna orientation can be done exactly . . . (4) Measures losses or gains of various antenna and lead-in combinations . . . (5) Useful for checking receiver re-radiation (local oscillator) . . . (6) **12 CHANNEL SELECTOR** . . . (7) Amplitudes of interfering signals can be checked . . . (8) Weighs only 5 lbs. . . (9) **Individually calibrated** . . . (10) Housed in attractive metal carrying case . . . (11) Initial cost of this unit is covered after only 3 or 4 installations . . . (12) Operates on 110V, 60 Cycles, AC.

**NEW LOW PRICE**

Model FSM-1, complete with tubes.....Net \$79.50

**TRANSVISION, INC., Dept. RN, New Rochelle, N. Y.**

All Transvision Prices are fair traded; subject to change without notice. Prices 5% higher west of the Mississippi.

For **FREE 20-page TV BOOKLET and CATALOG SHEETS, SEE YOUR TRANSVISION OUTLET!**

- CALIF:** 8572 Santa Monica Blvd., Hollywood  
3471 California St., San Francisco  
4 East 15th St., Wilmington
- DEL:** 42 Southeast Eighth St., Miami
- FLA:** 1002 So. Michigan Ave., Chicago
- ILL:** 1912 No. Charles St., Baltimore
- MD:** 1306 Boylston St., Boston
- MASS:** 23216 Wilson Ave., Dearborn
- MICH:** 401 Broad St., Newark
- N. J.:** 1425 Boscobel Ave., The Bronx
- N. Y.:** 485 Coney Island Ave., Brooklyn

- OHIO:** 167-01 Hillside Ave., Jamaica  
75 Church St., New York City  
606 Central Park Ave., Yonkers  
622 No. Salina St., Syracuse  
901 Race St., Cincinnati
- PENNA:** 2001 Euclid Ave., Cleveland  
54 E. Long St., Columbus
- PENNA:** 235 N. Broad St., Philadelphia  
620 Grant St., Pittsburgh
- TEXAS:** 700 Commerce St., Dallas
- CANADA:** Hamilton, Ont.

**Service-Dealers:  
WORRIED ABOUT  
COMPETITION?**

**Become the  
TV SALES  
and SERVICE  
CENTER  
IN YOUR COMMUNITY**

- **Beat competition at a profit.**
- **Stop being undersold — by anybody!**

Here's a real opportunity to **MAKE MONEY** in Television. If you can qualify, you can become the Transvision Television Center in your community—and **BUY TV and RADIO PARTS AT JOBBER PRICES.** Practically no investment required. This offer is open only to service-dealers in territories where we do not have an authorized distributor.

Contact Transvision Outlets listed, or write to New Rochelle, for details on Transvision's "TV Center Plan." **DO IT TODAY!**

- **NO FORCED PURCHASES**
- **NO "TIE-IN" DEALS**
- **NO CAPITAL PROBLEM**
- **NO INVENTORY PROBLEM**

Get the **FACTS** about the amazing Transvision Dealer Plan. It will give you a big stake and big future in television.

**FILL OUT AND MAIL THIS  
COUPON NOW!**

**TRANSVISION, INC.**  
NEW ROCHELLE, N. Y.

Please ship **THROUGH YOUR NEAREST LOCAL OUTLET:** RN 1-50

( ) .....  
 I am enclosing 10% **DEPOSIT** in the amount of \$....., balance **C.O.D.**  
 ( ) Send details of **TV CENTER PLAN.**

Name .....  
 (please print)

Address .....

City & State .....

**RADIO & TELEVISION NEWS**

ANOTHER **HYTRON FIRST** YOU'LL BE BUYING SOON

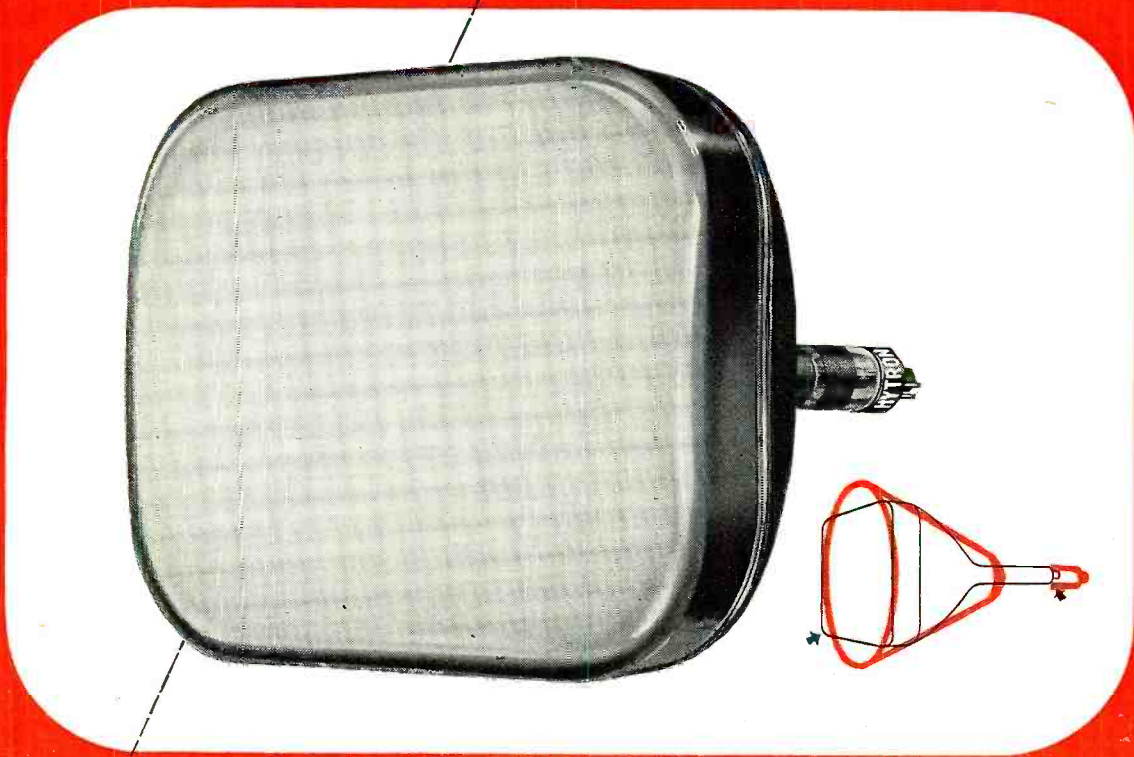

# NEW HYTRON RECTANGULAR all-glass 16RP4

Meet Hytron's space and money saver. The new Hytron 16RP4. Revolutionary 16-inch rectangular picture tube. Takes approximately same cabinet space as 12LP4. Automatically sets the pace for more compact and economical TV set design. You'll be seeing it . . . buying it . . . soon.

The new 16RP4 is latest in a long series of Hytron firsts. Including: The GT tube. Over 50 GT types. The subminiature. Many new miniatures. Special low-cost TV deflection-circuit tubes: 1X2, 6BQ6GT, 6U4GT, 25BQ6GT. Check the 16RP4's many features. Watch for it. Buy the best by the leader. Buy Hytron!



With old-style round tube, you lose the corners.



With Hytron 16RP4, you see the picture just as transmitted.

## Features of HYTRON 16RP4

- 1 Rectangular shape permits smaller, less costly cabinets.
- 2 Also just as short as 12LP4.
- 3 Weight is approximately two-thirds that of 16-inch, all-glass round tube.
- 4 Easy to mount. Can't roll or twist.
- 5 No high-voltage isolation of tube required.
- 6 Neutral gray face . . . increases contrast ratio.
- 7 Large viewing screen. You get the entire transmitted picture; no lost corners. Gives picture (with standard 3 by 4 aspect ratio) 10 1/8 inches by 13 1/2 inches.

Write for Bulletin E-147 giving complete data.



MAIN OFFICE: SALEM, MASSACHUSETTS.



January, 1950

# SUPER-INSTANT QUICK-HEATING SOLDERING IRON

A RUGGED, PRECISION-MADE INSTRUMENT  
A PRODUCT OF  
SCIENTIFIC RESEARCH & MODERN ENGINEERING

## A NEW LONG-LIFE TIP

- FOR CONTINUOUS USE OR FOR INTERMITTENT QUICK-HEATING.

TWO TYPE SWITCHES ARE AVAILABLE—SPRING SWITCH WITH LOCK RING OR AN ON-OFF SWITCH FOR EASE IN CONTINUOUS USAGE.



• **FACTORY AND LABORATORY TESTS OF OVER 500 HRS. OF CONTINUOUS HEAT IN THE TIP.**

• **NEVER OVER-HEATS BEYOND SOLDERING HEAT. NO WEAR ON TIP FROM LONG PERIODS OF HEAT. NO EROSION.**

• **THE GREATEST ADVANCE IN SOLDERING IRON DESIGN**

• **QUICK-INSTANT HEATING**

• **LONG-LIFE**

• **WORKS ON AC-DC**

• **No Transformer  
No Thermostat  
No Tinning  
No Filing  
No Oxidation  
No Lost Heat**

• **TYPE G-60  
TYPE G-60-A**

**\$7.95**  
LIST

• **ON SALE NOW AT ALL LEADING DEALERS**

• **Literature Available Write Dept. 150-N**

**INSTANT TOOL CORPORATION**

GENERAL OFFICES: 231 WEST 29th STREET, NEW YORK 1  
FACTORY: BINGHAMTON, NEW YORK



★ Presenting latest information on the Radio Industry.

By RADIO & TELEVISION NEWS'  
WASHINGTON EDITOR

**TV**, still enmeshed in the most sizzling battle of words in technical history, has now entered the roaring phase of the fury with operation CD and CCD at hand. "Operation CD" or color demonstration covering all available systems began in the early fall and "Operation CCD" or comparative color demonstration, was scheduled to begin as this column was being prepared.

The CD days were riotous ones with invectives bouncing all over the crowded hearing and look-in ballrooms in uptown and downtown Washington, where the tests were held. There was substantial evidence that the look-and-see-what-we-have days would be exciting when the FCC prepared its notice covering the procedure CBS would follow during its trial moves.

Said the notice: "On this day camera equipment, color television receivers, monochrome receivers, and converted monochrome receivers will be demonstrated. The receivers to be demonstrated will include four receivers receiving color only in 6 megacycle channel width, one receiver for demonstration of 6 megacycle color versus wider channel color off-the-line, one conventional black and white receiver converted for color reception and probably one combination black and white receiver. . . . The demonstration will be divided into seven sections: Introduction, image brightness and flicker, compatibility, color breakup and fringing, image registration and definition, including tests over a coax cable of 2.7 megacycle bandwidth and over radio relay circuits of 4 megacycle width, ghosts and noise, and color fidelity and camera light sensitivity. . . . In these demonstrations, program material will include slides and test patterns, dancing, singing, juggling, fashions, near and far shots, different types of lighting and backgrounds. . . . In one demonstration the camera equipment will be located at a local high school football field."

The tests were quite impressive, with the Commissioners and over one hundred and fifty industry representatives looking on at the Hotel Carlton ballroom. Particularly interesting was the first attempt to try a remote pickup of the football game from the Woodrow Wilson High School field. Although the skies were overcast and there was even

a heavy rain during the final moments of play, the results were comparatively satisfactory.

Much of the equipment was basically similar to that displayed in '47. There were, however, available this time, special converters for black and white receivers. These were quite large and consisted of an enclosed spinning disc, speed control, and glass-type enlarger, which could be slid into position.

Several days after the CBS show, RCA presented their version of color TV with an all-electronic system, the operation of which was described by your correspondent in a previous report. This demonstration originated in the NBC studios at WNBW in the Wardman Park Hotel. Employed were two cameras for live subjects in the studio, one camera for color motion picture film and one camera for color slides. In the control room were two color monitors and a control-room console, plus a specially-built sixteen-inch color receiver. The color camera was equipped with three separate tubes, each equipped with a color filter to receive the three primary colors—red, blue, and yellow. The receivers were large, requiring three picture tubes arranged to transmit images to dichroic type mirrors and then to a viewing screen.

The program was very elaborate and ranged from solo performances by network favorites to a musical display by a nineteen-piece orchestra, all attired in brightly colored costumes.

Some of the results were satisfactory and others disappointing, RCA engineers indicating that there were quite a few bugs still to be ironed out before consistently perfect performances could be provided. The degree of compatibility displayed by this system in monochrome reception of color signals on standard TV models impressed observers.

Tests were held by RCA during the entire week and as the days passed on, some of the pickup problems were solved and the pictures improved considerably. In fact, when one of the later demonstrations was viewed by Senator Edwin C. Johnson, chairman of the Senate Interstate and Foreign Commerce Committee who sparked the color TV investigation, the Senator appeared quite pleased. He commented

**RADIO & TELEVISION NEWS**



# Simpson

INSTRUMENTS THAT STAY ACCURATE

# Presents

the  
**New!**  
MODEL 303

## VACUUM TUBE VOLT-OHMMETER

... A Worthy Companion  
of the 260



### SPECIFICATIONS

**DC Voltage**  
Ranges—1.2, 12, 60, 300, 1200 (30,000 with Accessory High Voltage Probe)  
Input Resistance—10 megohms for all ranges  
DC Probe—with one megohm isolating resistor  
Polarity reversing switch

**Ohms**  
Ranges—1000 (10 ohms center)  
100,000 (1000 ohms center)  
1 megohm (10,000 ohms center)  
10 megohms (100,000 ohms center)  
1000 megohms (10 megohms center)

**AC Voltage**  
Ranges—1.2, 12, 60, 300, 1200  
Impedance (with cable) approx. 200 mmf shunted by 275,000 ohms

**AF Voltage**  
Ranges—1.2, 12, 60  
Frequency Response—Flat to 100,000 cycles

**Decibels**  
Ranges—-20 to +3, -10 to +23, +4 to +37,  
+18 to +51, +30 to +63  
Zero Power Level—1 M. W., 600 ohms

**Galvanometer**  
Zero center for FM discriminator alignment and other galvanometer applications

**R. F. Voltage**  
(Signal tracing with Accessory High Frequency Crystal Probe)  
Range—20 volts maximum  
Frequency—Flat 20 KC to 100 M.C.  
105-125 V., 60 cycles

**Size** 5 1/4" x 7" x 3 1/8" (bakelite case). Weight: 4 lbs.  
Shipping Wt.: 6 1/2 lbs.

**Dealer's Net Price** Model 303, including DCV Probe, ACV—Ohms probe and Ground Lead—\$58.75; Accessory High Frequency Probe, \$7.50  
Accessory High Voltage Probe, \$14.85  
Also available with roll top case, Model 303RT—\$64.75

### Smaller and Handier for Greater Portability

A worthy companion of the world-famous Model 260 is this brand new addition to the Simpson line—the Model 303!

Skilled Simpson engineers spent months of painstaking research in the laboratory to produce the Model 303, which is one of the most versatile instruments ever made for TV servicing. This ruggedly constructed instrument offers the maximum in portability because it is approximately 60% smaller than other vacuum tube volt-ohmmeters. However, no sacrifice has been made in readability. The 303 has a large 4 1/2" meter, despite its handy compactness.

One of the many features of the 303 is its low current consumption. The AC voltage range is wider than on any other similar instrument—from 1.2 volts minimum to 1,200 maximum. Like all other instruments bearing the Simpson name, the Model 303 is an instrument of highest quality at an amazingly low price.

### SIMPSON ELECTRIC COMPANY

5200-5218 West Kinzie Street, Chicago 44, Illinois  
In Canada: Bach-Simpson, Ltd., London, Ontario

**ATOM®**

SPRAGUE TYPE TVL  
TWIST-LOK®

Every  
**SPRAGUE**  
**TV**  
dry electrolytic  
is processed  
FOR **185°F** (85°C.)  
**OPERATION!**

Sprague leads again with the largest, most complete line of replacement electrolytic capacitors for television receivers. Each type is engineered especially for tough video applications and will stand up under the high temperatures, high ripple currents and high voltage surges encountered in TV equipment. *Every Sprague TV capacitor rated at 450 d-c working voltage or less has been processed for 185°F. (85°C.) operation.* Send postcard for special TV Bulletin.

**SPRAGUE PRODUCTS CO.**  
51 Marshall Street  
NORTH ADAMS • MASS.

that he was indeed surprised at the reproduction, predicting that the *RCA* method appears to have some very vital acceptance features.

During a subsequent review of the color situation, the Senator revealed that side-by-side tests would permit the Commission to determine just what type of standards we should have and as a result, within a year, we could have color TV on the air. When queried about the survey results collected by the impartial TV color committee the Bureau of Standards set up at his request, he replied that their report would not be submitted until the conclusion of the color hearings. The Senator told FCC Commissioner Robert Jones that the findings of this committee would "... sustain the position of those Commissioners who do not have a closed mind on color TV and will make impossible again the FCC action in the last hearing, when it shut the door on television progress."

In another statement on standards, the fiery Senator emphasized that the Commission should not decide in an arbitrary manner as to the virtues of any particular system. Instead, he said, they should set up a flexible type of standard which would permit the art to develop in the customary manner of all American industry.

**THE DEMONSTRATIONS** apparently piqued representatives of *DuMont*, who have contended that color TV is still in its breadboard stage, and a few days after the two color shows, they put on a demonstration that will be remembered for years and years. With a specially constructed 700-pound mechanical-type adapter, six and a half feet long, four and a half feet thick and four and a half feet high, and a separate generator and motor, the boys from *DuMont* presented their version of the equipment required to convert a twenty-inch tube set for color reception at present. When the huge four-foot color wheel, speeding at a rate of 210 miles an hour began to spin, and a fuse blew because of the load, FCC Headman Coy became riled and roared at Dr. Goldsmith, conducting the test, to stop the test which he called a "sideshow." Commissioner Frieda Hennock also blasted Goldsmith, citing the *demonstration* as one of ridicule and completely unfair to *CBS*. She pointed out that *Columbia* at no time stated that its system could be used for receivers having tubes larger than 12½ inches. An adjournment followed the abrupt halt and when the recess was over, only Commissioners Jones and Sterling were in their seats. With permission to continue the show, Goldsmith set the cumbersome affair into motion. Explaining the purpose of this admittedly noisy and complex setup, Goldsmith said: "We just got sick and tired of all the claims about easy conversion of present receivers to *CBS* type color and decided to show folks how ridiculous such conversions really are."

*CBS* attorney Richard S. Salant eyed Goldsmith and accused *DuMont* of setting up "... a publicity gag at considerable expense."

At the conclusion of this circus, Commissioner Hennock resumed her tirade against *DuMont* and asked Dr. *DuMont* how many of the deluxe 20-inch receivers, like the type he had used in the test, were in use. Dr. *DuMont* explained that while the model used was a \$2500 type, the same unwieldy assortment of apparatus would be required for any 20-inch type set, many of which are selling for \$500 or less. And incidentally, he added, *DuMont* is currently producing about 10,000 such models a month.

During one of the sessions, when Dr. Goldmark of *CBS* appeared on the stand, the question of projection was raised by Ed Wheeler, counsel for *RMA*. He asked Goldmark why the FCC had not been shown any projection type sets by *CBS*, and Goldmark smiled, and said quite frankly: "I was ashamed of our projection tests, but after seeing its performance with other systems (*apparently referring to RCA*) I feel it was not too bad."

The tests did little to clarify the basic issues and FCC decided to probe a bit deeper by requesting that the three color developers submit receivers to the Commission's laboratories at Laurel, Maryland for test. This edict brought forth a storm of protest, even from *CBS* who claimed that its equipment was on tour with the medical conferences and it would be difficult to alter that program. *RCA* indicated that it would probably send its receivers, although they felt that the equipment hadn't been sufficiently developed to warrant a full-scale intensive viewing test.

Shortly after the Laurel request was fired at industry, FCC hit the color boys with another test shell. This time they said that they wanted to hold a series of comparative tests within a few weeks in Washington. *RCA* revolted at this demand and raced a healthy reply to FCC, stating in part that "... The only purpose of demonstrations, comparative or otherwise, is to demonstrate to the Commission the principles and operating characteristics of the color systems which have been proposed. If a comparative demonstration is to be held and is to accomplish its purpose, the demonstration must be made with apparatus which will fairly reflect the principles and operating characteristics of the various systems, must provide an opportunity for the parties to demonstrate their systems with comparable types of receivers and must provide an opportunity for all proponents of color television systems to demonstrate their systems simultaneously. . . . Unless these basic requirements are met, no useful purpose will have been served. To conduct comparative demonstrations on any other basis would not provide a fair hearing to the parties con-

(Continued on page 135)

JANUARY, 1950

**RADIO  
& TELEVISION  
NEWS**

**RADIO-ELECTRONIC**

*Engineering*

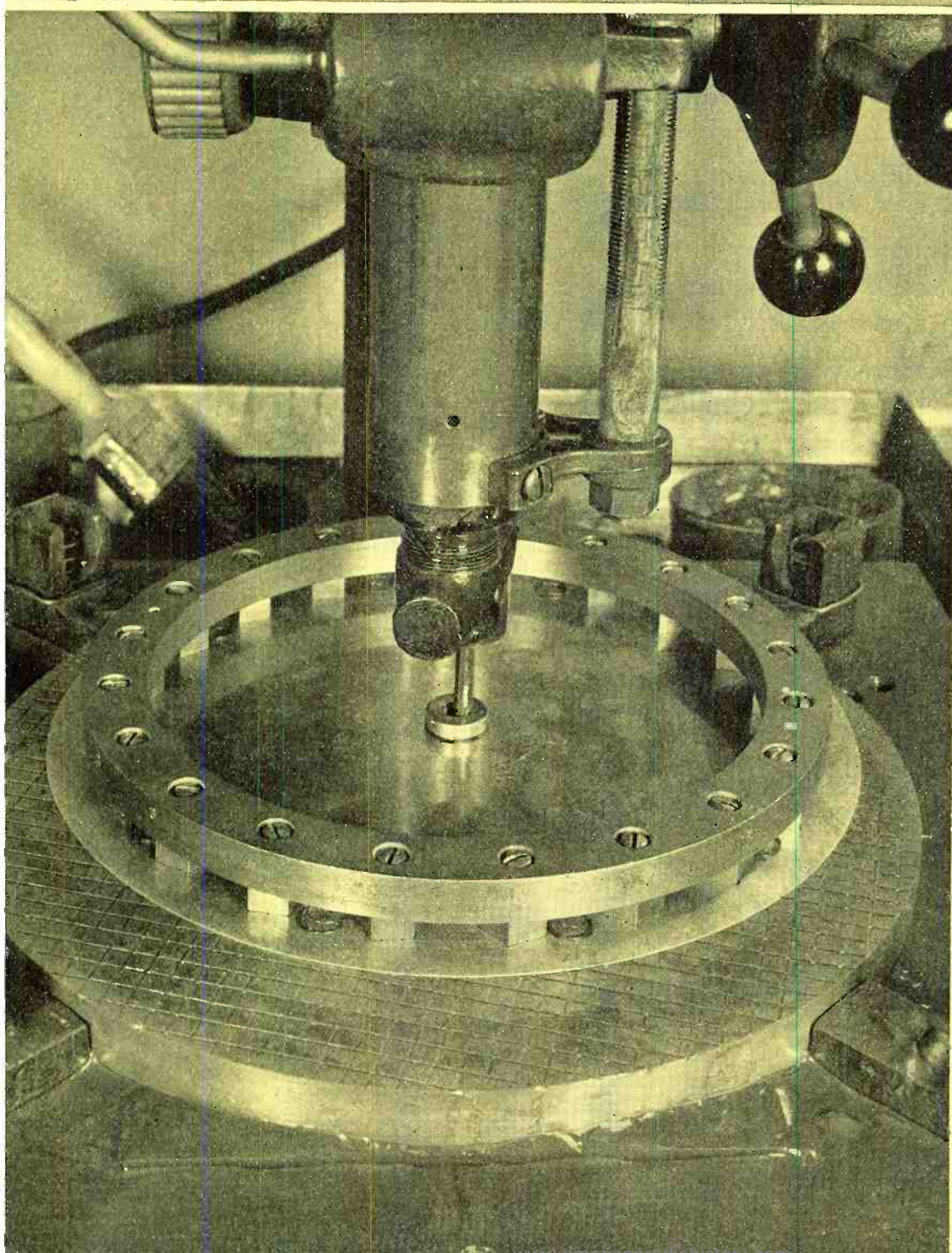

TELEVISION

RADAR

ELECTRONICS

RESEARCH

COMMUNICATIONS

MAINTENANCE

# RADIO-ELECTRONIC

*Engineering*

Trade Mark Registered U.S. Patent Office No. 428507

ELECTRONICS • COMMUNICATIONS • TELEVISION • RESEARCH • MAINTENANCE

## JANUARY, 1950

KLYSTRON POWER SUPPLY AND SQUARE WAVE MODULATOR.....	Samuel Freedman	3
HIGH IMPEDANCE D.C. VOLTMETERS.....	Edwin N. Kaufman	7
V.H.F. TANK DESIGN.....	B. E. Parker	8
RUGGED ELECTRON TUBE DEVELOPMENT.....		10
BRIDGE-BALANCED D.C. AMPLIFIER.....	G. A. and T. M. Korn	12
AUTOMATIC ANTENNA PATTERN RECORDER.....	Harry L. Gerwin	14
MEASUREMENT OF STUDIO AND ROOM ACOUSTICS.....	David Fidelman	16
SENDING END IMPEDANCE OF UNIFORM LINE.....		32

### DEPARTMENTS

NEW PRODUCTS.....	22		
NEWS BRIEFS.....	24	TECHNICAL BOOKS.....	28
NEW TUBES.....	26	PERSONALS.....	29



RADIO-ELECTRONIC ENGINEERING is published each month as a special edition in a limited number of copies of RADIO & TELEVISION NEWS, by the Ziff-Davis Publishing Company, 185 N. Wabash Avenue, Chicago 1, Illinois.

VOLUME 14, NUMBER 1, Copyright, 1949, Ziff-Davis Publishing Company

COVER PHOTO—Courtesy of National Bureau of Standards

Pentagonal block apparatus developed at NBS for producing quartz oscillator plates thin enough for high frequency use. Twenty pentagonal blocks, rigidly attached to a steel ring, are shown resting on crystals (not visible) in corresponding nest openings.



**This equipment provides a square wave  
d.c. output for feeding a reflex  
klystron microwave generator.**

Fig. 1. Bench test setup including the power supply and square wave modulator along with various microwave equipments.

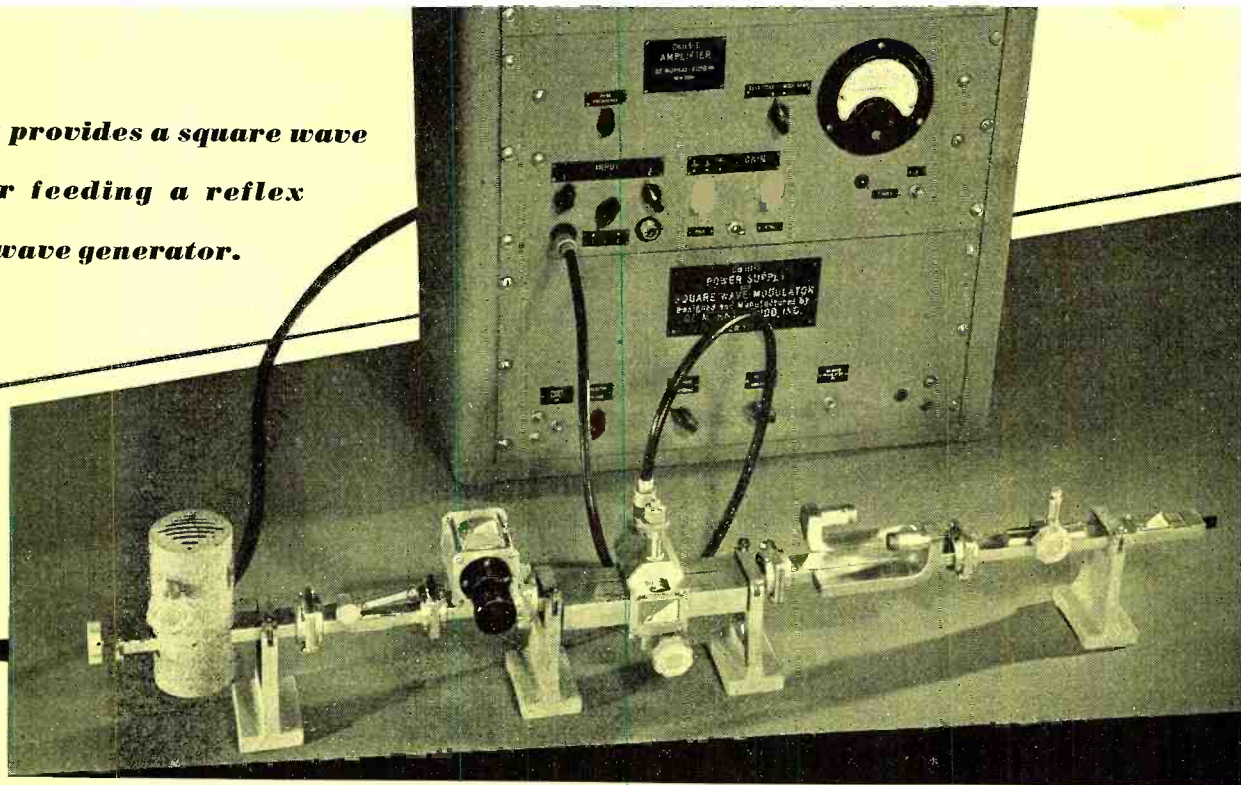

# Klystron Power Supply And Square Wave Modulator

By **SAMUEL FREEDMAN**

New Developments Engr., DeMornay Budd, Inc.

MICROWAVE test and evaluating setups including the field of microwave spectroscopy commonly depend on tubes employing velocity modulated electron beams with repeller electrodes known as reflex klystrons for microwave power source. Such tubes are employed instead of conventional types because of the effect of the inductance in connections and the fact that the transit time is comparable with or in excess of the period of oscillation for the latter.

Any velocity-modulated tube or so-called "klystron" derives a radio frequency intensity-modulated current for operating an output circuit. Instead of dependence upon the number of electrons, the power is dependent on the changes in the velocity of the electrons with respect to each other. In what would be the cathode-grid region of a conventional triode, the following is provided:

a. The cathode emits electrons when subjected to sufficiently high temperature just as in the case of a conventional tube.

b. Two closely separated grids connect to a resonant cavity which is kept

highly positive. Their separation forms an r.f. gap. The region between the cathode and this r.f. gap may be called a cathode-anode region in which the electrons emitted by the cathode receive their d.c. acceleration.

c. The r.f. gap subjects these electrons to an oscillating or r.f. field. This field alternately slows down or speeds up the electrons to produce velocity modulation.

d. A drift space beyond the r.f. gap permits the electrons to continue travel until they come under the influence of a "repeller" or "reflector" which is biased negative with respect to the cathode and much more so with respect to the r.f. gap and its associated cavity.

The acceleration or deceleration of the electrons in traversing the r.f. gap causes each electron to have a different speed beyond that point. This results in the bunching or grouping of the electrons. The more an electron is accelerated in traversing the r.f. gap, the further it can travel in the direction of the negatively charged repeller electrode before being reflected back in the direction of the r.f. gap. On the initial trip through the r.f. gap, as

many electrons speed up and gain energy from the r.f. field as are slowed down and give up energy to the same r.f. field. They balance to zero. However, when the electrons are repelled back by the repeller, they are bunched. In returning to the r.f. gap, with the proper phase relations based on correct values of beam and repeller voltages, they can be made to give up energy. The amount of useful power between zero and maximum for a stated tube depends entirely on the correct phase relations of the oscillation which in turn depend on the availability of the proper potentials derived from a power supply.

If the tube transit time conditions are met and there is sufficient d.c. beam current to compensate for load losses and circuit power dissipation, the tube will oscillate and deliver power. The transit time depends upon the reflector voltage and the beam voltage. This results in oscillation and useful power for certain values of voltage and none for others. Each set of voltages resulting in power conditions is known as a *mode*. A dominant or more efficient mode will always exist for a particular tube at a particular frequency. The availability and utilization of this mode is dependent on the power supply voltages necessary to energize the tube being readily available.

In microwave test setups the amount

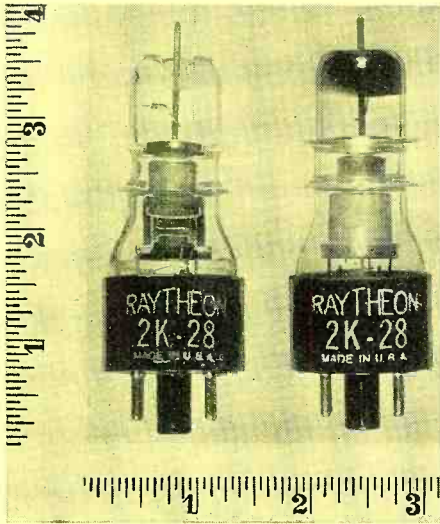

Fig. 2. Two views of the type 2K28 reflex klystron.

of power required is sufficiently low to permit operations even with low tube efficiency, such as operation at one of the less efficient modes of the reflex klystron. A few milliwatts are normally sufficient in most cases. In many setups, an attenuator capable of providing attenuation of 10 to 30 db. is placed between the signal source and point of measurement to assure stability of measurement. As little as 10 to 25 milliwatts may be used. In some cases, systems have been tested with a few hundred microwatts, or even less.

The reflex klystron type of tube

normally used in this work differs from other types of klystrons in that it is a single-resonator instead of a multi-resonator type. The electron beam passes once through the resonating cavity and then encounters a negative electrode which causes the electron to return through the cavity on a second transit at which time useful power is developed. The reflex type of tube may have its resonant cavity within the enclosed vacuum envelope or it may employ an externally attached cavity for the type of tube illustrated in Fig. 2. In the latter case, as for the Type 2K28, a cavity encompasses and electrically connects to the copper fins extending through the glass seals.

Most of the conventional reflex klystron tubes operate at a beam voltage of 300 volts and a beam current averaging about 22 milliamperes. The repeller voltage is applied to an electrode which normally draws only a few microamperes of current. Modes of oscillation where any reflex tube does and does not function occur in the range of reflector voltage from zero to over 300 volts negative with respect to the cathode. In the case of the 2K25 tube, at least four or five modes can be developed depending on the range of voltage available from the power supply and the construction of a particular tube. In other cases such as the 726 or 2K29, less modes can be developed. In the case of the 2K50 tube which has

been produced in limited number but for which a demand exists for resumption of production, despite the much higher frequency (1 centimeter region), fine tungsten grids for the cavity gap permit larger beam and shorter transit distance through the gap. This tube requires more critical adjustment of potentials and a power supply must have special or additional provisions to meet this requirement. Optimum reflector voltage varies from tube to tube of the same type as much as plus or minus 30 volts.

Two tubes of considerable interest because of their availability in quantity at low cost in the postwar surplus market are the types 2K28 and 2K25 for the 10 and 3 centimeter bands respectively. The following data is based on the Raytheon Velocity Variation Oscillator (their name for the reflex klystron). Fig. 4 describes various electrical characteristics for the type 2K25 tube versus changes of negative repeller voltage. Fig. 7 describes additional data versus frequency and changes in resonator potential. The power output changes about 1½% per volt change in resonator potential.

Heater requirements are 6.3 volts a.c. or d.c. at .44 amperes. The maximum ratings are 330 volts d.c. for resonator or shell voltage, 0 to -400 volts d.c. for repeller voltage range, 32 milliamperes d.c. for cathode current, 45 volts d.c. for heater-cathode potential difference and a frequency range of 8702 to 9548 mc. Power output varies from 20 to 33 milliwatts.

Fig. 6 shows graphs for the 2K28 comparing repeller voltage range versus change in wavelength. The frequency of this tube is determined by its resonator geometry. The complete resonator consists of two gold-plated copper discs and an external cavity which makes contact to them. The cavity used with the tube should have a dimension of .4 inch and should grasp an outer annular ring of 1/16". Maintaining proper cavity dimensions is important in that the cavity is usually made of brass and has a relatively large expansion coefficient compared to the glass between the two discs. By contacting the outer edges of the discs most of the movement caused by expansion will be taken up by the flexing of the copper discs without placing undue strain on the copper-to-glass seals.

Heater requirements for the 2K28 call for 6.3 volts a.c. or d.c. at .65 amperes. The maximum ratings are 300 volts d.c. for the grids, 45 milliamperes d.c. for cathode current, 0 to -300 volts d.c. for repeller voltage, 45 volts d.c. for heater-cathode potential difference and 1200-3750 megacycles for the frequency range with suitable

Fig. 3. Circuit diagram of the power supply and square wave modulator.

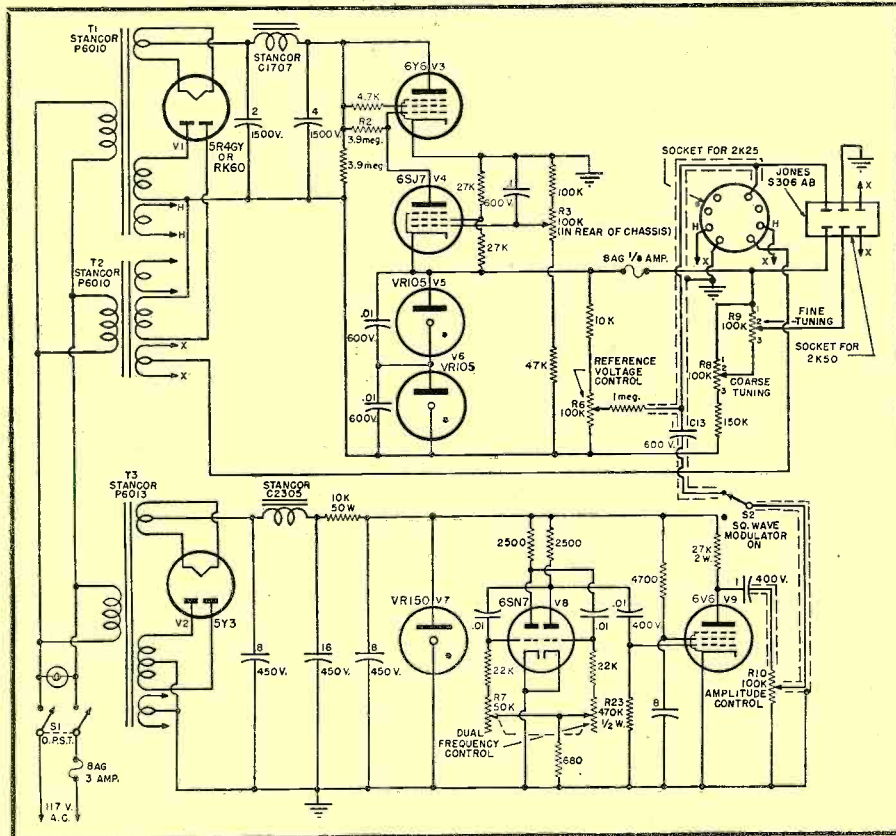

cavity. The tube is rated at 115 milliwatts output in the frequency range 3400-3600 megacycles with 250 volts d.c. on the grids, 20 milliamperes d.c. cathode current and -170 to -300 volts d.c. repeller voltage when operated on the 4th mode. When operated with 300 volts on the grid, this changes to 30 milliamperes d.c. cathode current, -155 to -290 volts d.c. repeller voltage on the 4th mode, 140 milliwatts power and frequency range still 3400-3600 megacycles.

In addition to special power supply requirements for these tubes, there must be modulating provisions of the microwave signal source in order to permit demodulation later by means of a crystal detector. Amplitude rather than frequency modulation is necessary. There are two methods normally used for AM. These are the sawtooth and the square wave. The square wave form of modulation is normally used because the sawtooth type has a marked FM component in the output of a klystron. Square waves will have a much lower FM component and it will not distort the readings. FM particularly cannot be tolerated if the energy is to be detected on a standing wave detector since the maximas and minimas will not fit the frequency and will create confusion. Reflex tubes are modulated by applying the square-wave signal to the oscillator repeller. FM is minimized by using a square wave with sufficient amplitude so that the oscillator drops out of oscillation for alternate half cycles, provided this be done below a limit where the tube is not driven into the next lower mode of oscillation.

Fig. 5 is the front panel view of a power supply and square wave modulator developed to meet the requirements of properly energizing and modulating the reflex klystron type of tubes. It is widely used in the microwave art by schools and laboratories for the so-called low voltage type of reflex oscillators described here. It is similar to the TVN-7BL unit used by the MIT Radiation Laboratory during World War II but is now known as the Type DB-407 from commercial sources. Fig. 3 is the complete circuit diagram including part values. Fig. 1 shows the unit mounted in a rack with a companion amplifier to furnish energy indications. In a typical application, working with a microwave bench test setup of fabricated wave guide components, a power cable leading from the back of the power supply and modulator unit energizes and modulates a tube such as the 2K25 located within a shielded and ventilated tube housing. In the Fig. 1 setup, the output is fed through the following components when viewed from left to right:

a. Tube mount for the Type 2K25

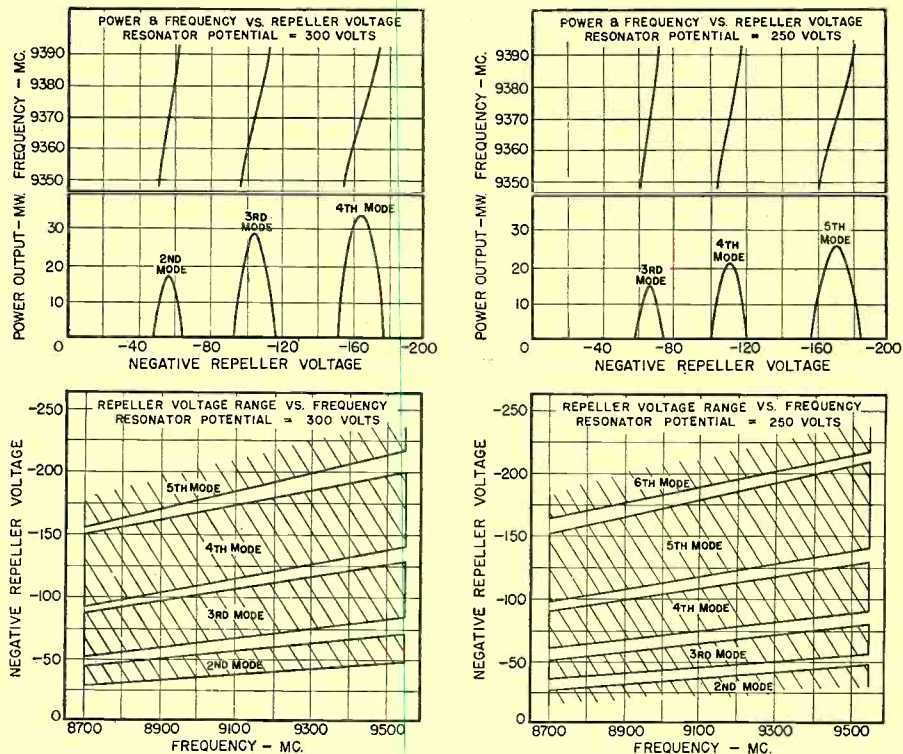

Fig. 4. Electrical characteristics of the type 2K25/723A/723B klystron oscillator.

tube. The tube supply and modulator voltages are fed into the tube mount via an octal socket. The tube's antenna extremity protrudes into a wave guide forming part of the over-all assembly. A tunable back plunger is provided for terminating the wave guide with an adjustable short. A knob on the ventilated tube shield is used to vary the physical dimension of the klystron for tuning purposes. It controls the tuning screw on the tube to change position of tuning bows which are part of the tube's physical construction.

b. Flap attenuator for padding purposes. A hinged attenuator strip is made of carbon coated bakelite. The position of this flap can be varied, thereby permitting the strip to be inserted any desired depth into the wave guide. The attenuation will increase with increasing depth of pene-

tration. The unit illustrated is designed for a maximum of 10 db. attenuation.

c. Frequency meter of the absorption cavity type. The cavity size is varied by a movable plate to resonate at any frequency throughout its operating range. It is moved by a micrometer with engraved calibrations on the micrometer barrel. These calibrations can be converted to frequency or wavelength by referring to the calibration charts furnished by the manufacturer.

d. Standing wave detector for measuring amplitude and phase conditions within the wave guide system. A silicon crystal detector or a bolometer (which may be a 1/200 ampere Littelfuse) connects from the moving probe traveling in the wave guide slot. A coaxial cable connects from the detector to a tuned amplifier to furnish an indication on the meter.

Fig. 5. Front panel view of the square wave modulator.

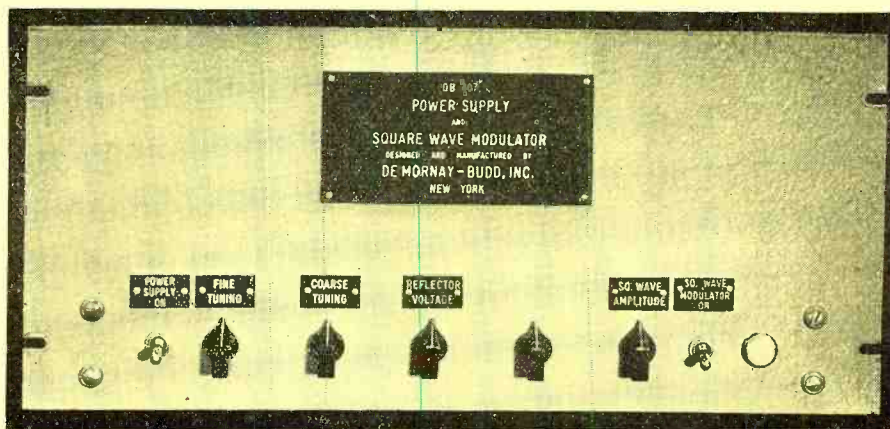

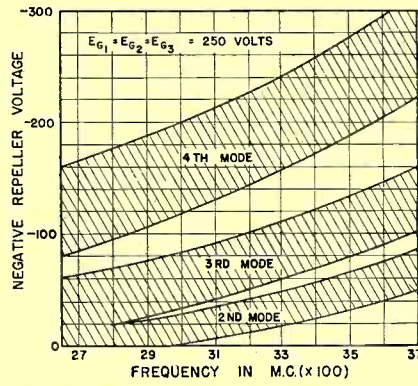
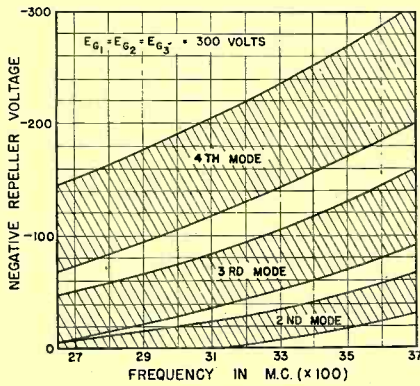

Fig. 6. Repeller voltage range vs. wavelength for type 2K28 tube. The exact value of repeller voltage producing maximum output at a certain frequency will vary somewhat from tube to tube, but the voltage for all tubes will fall within the shaded area indicated for each mode.

e. An optional bi-directional coupler in which samples of energy traveling in both directions in the wave guide are taken from the primary or main wave guide line by two auxiliary wave guides. It provides a means for measuring actual wave-guide power propagating in either or both directions at low power levels without disturbing the main transmission line. These may be taken off at the coaxial connections leading from the auxiliary guides.

f. Power termination and variable stub tuner. The power termination terminates a wave guide in its characteristic impedance and dissipates all of the microwave energy incident to it. It is a dummy load to provide practically reflectionless impedance match.

The variable stub tuner further serves to vary the impedance in phase and magnitude to the optimum value.

The DB-407 power supply and modulator described in this article draws 80 watts from 115 volts, 60 cycle, single phase source. It delivers 6.3 volts at 2 amperes for heater and -300 volts for cathode as well as -300 to -450 volts d.c. for repeller requirements. When used with the 6-prong socket in the case of the 2K50 tube, there is also provided control triode voltage of -300 to -350 volts. The square wave modulator has a frequency range of 500 to 2000 c.p.s. The amplitude of the square wave is 0 to 100 volts peak to peak.

Referring to Fig. 3, the main power supply functions from the two trans-

formers  $T_1$  and  $T_2$  and a full-wave rectifier  $V_1$ . It is separate from the square-wave modulator power supply, which functions from the transformer  $T_3$  and the full-wave rectifier  $V_2$ .

Control of the output voltage of the main supply is accomplished by tubes  $V_3$  and  $V_4$ .  $V_3$  acts as a current-regulator tube, its grid voltage being determined by the plate current of the 6SJ7 ( $V_4$ ) flowing through the bias resistor of that tube. The resultant increase of the drop in  $R_2$  changes the grid voltage of the 6Y6 ( $V_3$ ) negatively. For a given current delivered to the klystron cathode, this change in grid voltage must be balanced by an increase in the drop across the 6Y6. With proper circuit adjustment, this restores the output voltage to its original value.

The voltage which appears at the grid of the 6SJ7 is the difference between a positive voltage, taken from a voltage divider across the output voltage, and the fixed negative bias provided by tubes  $V_5$  and  $V_6$  voltage regulators. The constant bias provided by these regulator tubes, including especially the independence of this bias on the 6SJ7 plate current, is essential to the operation of this system. Adjustment of the bias, by means of the variable resistor  $R_3$ , provides the means of adjustment of cathode voltage for the klystron. This resistor is set and locked at -300 volts. The regulated reflector voltage is obtained by tapping off from a voltage divider  $R_6$  placed across the two voltage regulator tubes.

The voltage supply for the square wave modulator is regulated by tube  $V_7$  (VR150). Tube  $V_8$  (6SN7) and its associated circuit form a conventional multivibrator consisting of a two-stage resistance-capacitance coupled amplifier with the output leads of the second stage connected to the input leads of the first. The dual adjusting control of the grid returns  $R_7$  adjusts the frequency of operation. In order to prevent the load from affecting the multivibrator frequency, the output voltage is taken from a buffer amplifier tube  $V_9$  which is excited by the multivibrator.

Sequence of operation is as follows:

1. With chassis grounded, connect the unit to klystron tube with the appropriate cable.
2. Turn square wave modulator switch to "ON" position.
3. Adjust all panel controls to central position.
4. Turn power supply switch "ON."
5. After 5 minute warm up, tune reflector voltage for maximum output of the tube as indicated on the meter.
6. Adjust square wave amplitude for maximum output.
7. Tune square wave frequency for maximum response. The setup is then ready for operation.

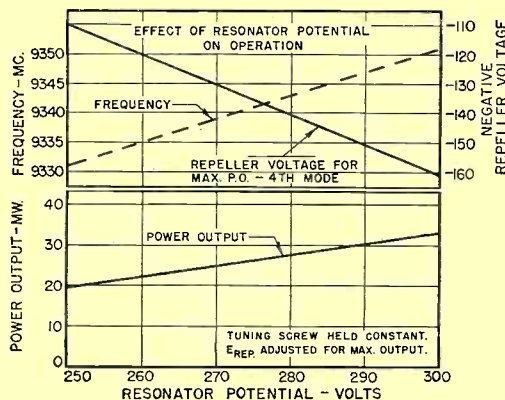
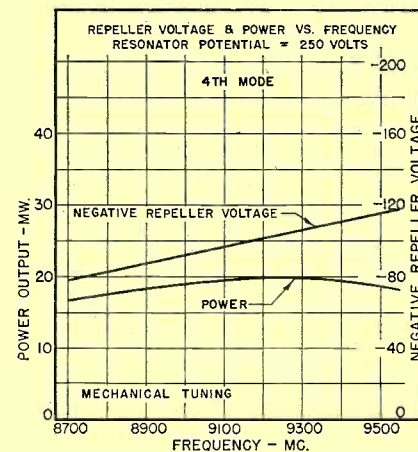
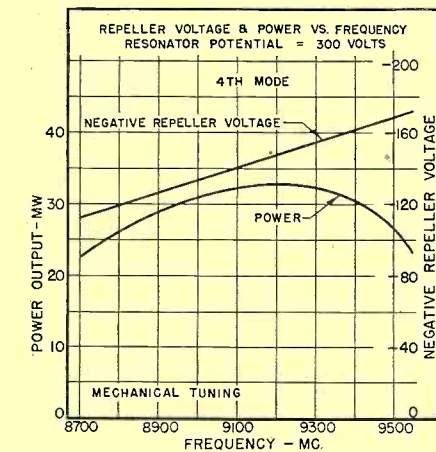

Fig. 7. Electrical characteristics of the type 2K25/723A/723B reflex tube for changes in resonator potential.



# HIGH IMPEDANCE D. C. VOLTMETERS

By

EDWIN N. KAUFMAN

FOR many applications a direct current voltmeter with very high input impedance would be desirable. The average 'high' impedance voltmeter boasts of 10, 20, or possibly 100 megohms input resistance. These same meters are incapable of being used to indicate potentials on the order of ten millivolts. It has been possible for some time to construct d.c. voltmeters with almost inconceivably high input resistances. With comparatively little trouble voltmeters with an input value of 1,000,000 megohms (1,000,000,000,000 ohms) can be constructed. Resistance values of this magnitude are generally referred to as log functions, the above being  $1.0 \times 10^{12}$ . This advance has been assisted greatly by the advent of the electrometer tube pioneered and perfected by the *Victoreen Instrument Company*

Fig. 1. Typical electrovoter using the 5803 electrometer triode. Note that the leakage resistance of the tube is used as the grid resistor.

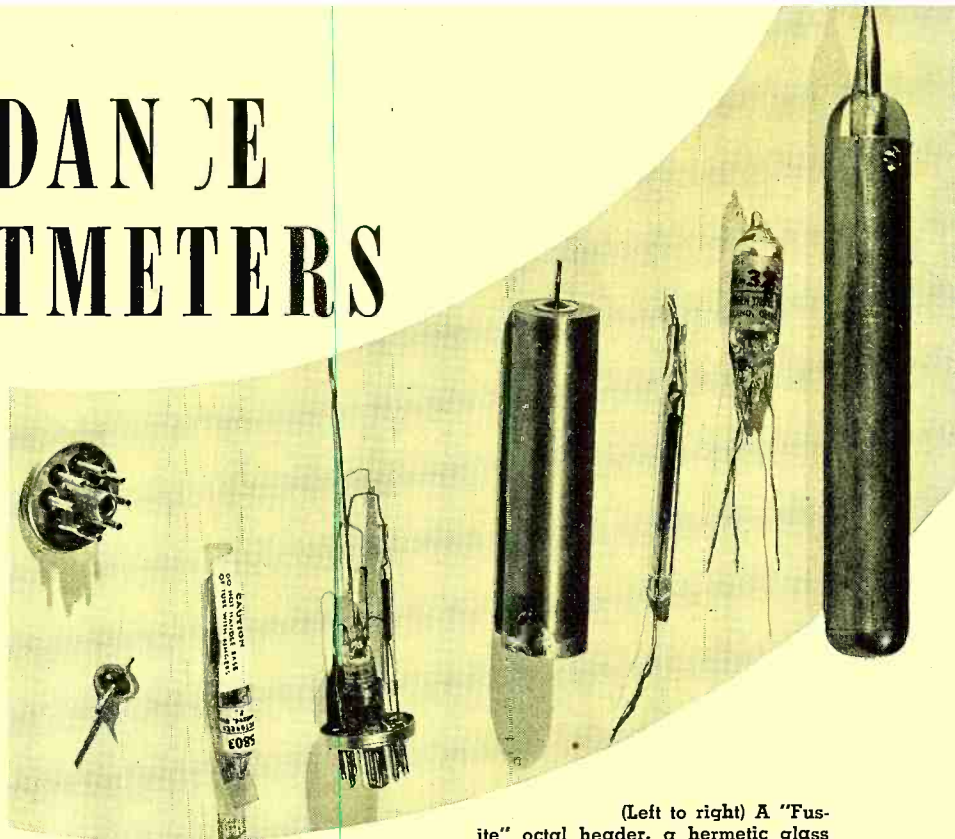
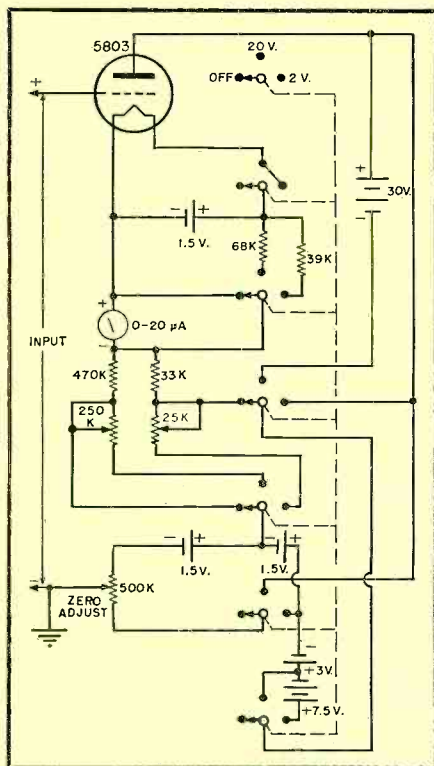

(Left to right) A "Fusite" octal header, a hermetic glass bead, a type 5803 tube, and interior and exterior views of a probe such as that shown in Fig. 2. Next is a 50,000 megohm resistor, a type 5803 electrometer tube and a very small probe.

**Input impedances of the order of  $10^{12}$  ohms are possible with electrometer tubes now available.**

of Cleveland, Ohio. Electrometer tubes are so designed and constructed that minute grid current is drawn. This is necessary, because it can easily be seen that a very small amount of grid current thru a grid resistor of the above magnitude would place a varying and objectionable grid bias on the tube. The electrometer tubes VX32/5803 and VX41/5800 have grid currents on the order of  $10^{-14}$  ampere when properly operated. Converting  $10^{-14}$  into decimal figure we arrive at .000,000,000,000,01 amperes. Due to the liberation of photoelectrons when in light these tubes must be enclosed so that no light falls upon them. Careful shielding is also required to prevent 60 cycle hum pickup which in any strength will cause the tube to become paralyzed. Without shielding it is possible to detect a 60 watt electric light bulb twenty feet away due to its alternating magnetic field, if this sort of application is desired. Due to the very high leakage resistance of the electrometer tube base and grid resistor they should not be touched with the fingers or contamination will occur. Should contamination occur by some accident it is possible to restore the original surface resistance by washing the tube base with alcohol and distilled water and baking in an oven for about an hour at  $100^{\circ}\text{C}$ .

Resistors can be obtained from  $10^8$  to

$10^{14}$  ohms to be used with the above tubes. The temperature and voltage coefficient of these resistors are very small, in the order of 0.1 per-cent combined per degree Centigrade. Normal operating range is from  $-40^{\circ}\text{C}$ . to  $120^{\circ}\text{C}$ .; relative humidity up to 98, and a voltage range of 100 microvolts to 1,000 volts. Resistors cost \$5.50 up to 100,000 megohms, while electrometer tubes list at \$12.50 each. For the average use the VX32/5803 electrometer tube is recommended.

It must be realized that substances normally thought of as insulators are in reality resistances which if allowed in contact with the grid of the electrometer tube will shunt the effective grid resistance to a lower value. It is strongly recommended that the grid probe support be a hermetic glass bead feed thru insulator; such as manufactured by *Electrical Industries, Inc.*, 42 Sum-

(Continued on page 30)

Fig. 2. Probe for use with Fig. 3.

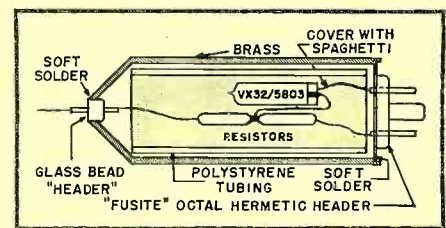

# V.H.F. TANK DESIGN

*This flat type quarter-wave tank combines the desirable characteristics of coaxial and balanced two wire circuits.*

By  
**B. E. PARKER**

At V.H.F. the design of the grid and plate tank circuits becomes of increasing primary importance. Many factors often completely disregarded at lower frequencies must be carefully evaluated in the design. Some of these practical considerations are shown for the three most commonly used forms of quarter-wave sections of transmission line. Each of these three types, coaxial, balanced two wire, and flat element, may be represented by the equivalent low frequency lumped form shown in Fig. 3. In transmission lines the inductance and capacity are in actuality distributed throughout the entire length.

The effective values of  $L$  and  $C$  are determined by the surge impedance of the line. It is apparent from this that the design of the tank circuit is largely dependent on this characteristic surge impedance.

Each of the three types of transmission lines when used for tank circuits has its distinctive advantages.

The coaxial type tank lends itself readily to single-ended construction where only one tube is used. The radiation losses are extremely low since the conducting surfaces are effectively shielded by the outer conductor. Short tube connections are realizable as the tube can be placed often right into the end of the coaxial tank. Numerous coaxial tube types are available on the market and are designed specifically for this application. The characteristic surge impedance of the tank can be made quite low to permit tank lengths sufficiently long for good efficiency. The relationship of the surge impedance to the effective electrical and physical length of the tank will be shown later.

The balanced two wire line lends itself quite readily to push-pull operation. With push-pull operation the tube input and output interelectrode capacities are in effect connected in series which decreases considerably the shortening effect of the tube capacities on the physical length of the tank. In other words, the use of a tube type having 10  $\mu\mu\text{fd.}$  input capacity in a push-pull circuit would result in only 5  $\mu\mu\text{fd.}$  appearing across the end of the tank. Even order harmonics are largely eliminated by the push-pull operation. This is often advantageous where second harmonic radiation must be suppressed to a high degree.

The flat type quarter-wave tank is essentially an outgrowth of the balanced two wire line, in which the wires or round elements have been replaced with flat elements. Fig. 2 is a representative tank circuit of this type. It has most of the desirable characteristics of both the coaxial and balanced two wire line circuits, as it can be made to have low characteristic surge impedance and fairly low radiation loss. It is easy to fabricate in even the most modestly equipped workshop which makes it ideal for experimental work. The flat type tank is adaptable to either push-pull or single ended operation. Fig. 5 shows a commercial application of such construction for push-pull operation. Fig. 1 shows an experimental laboratory unit using single-ended construction with a type 2E26 tube operating at approximately 170 mc. The commercial evolution of flat tank circuits is quite new, in fact, the writer knows of only one prominent

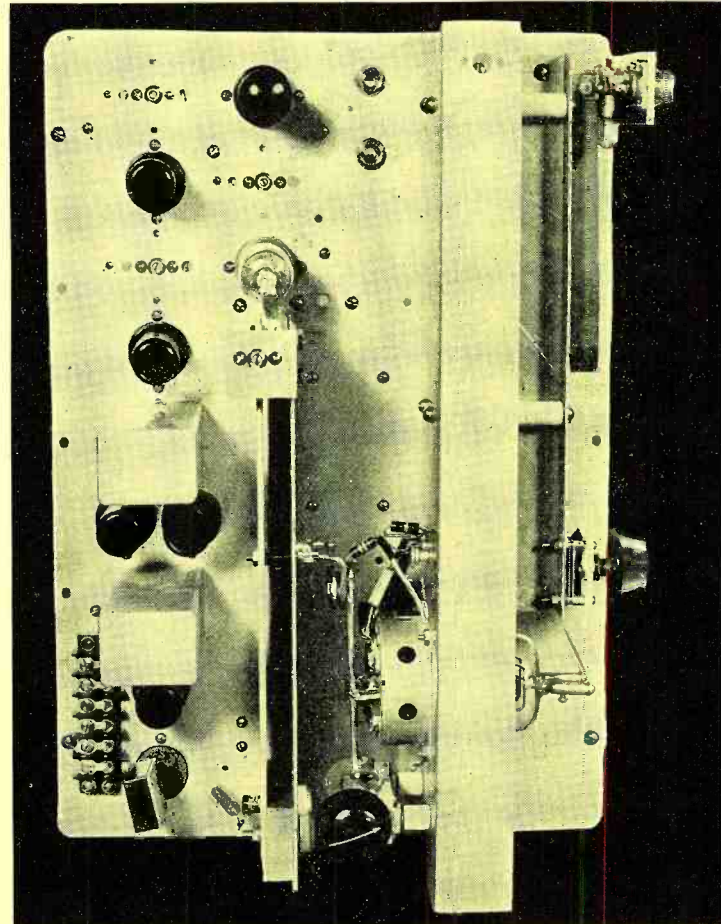

Fig. 1. Experimental laboratory unit using single-ended construction operating at approximately 170 megacycles.

FM manufacturer and two television manufacturers who have utilized this type of construction in new models.

## Physical Lengths of Tanks

The physical lengths of all three types are dependent on characteristic surge impedance, tube interelectrode capacity, effective tube lead length, and shielding or proximity effects.

The characteristic surge impedance may be calculated for a coaxial tank by:

$$Z_0 = 138 \log_{10} b/a \quad (1)$$

where  $Z_0$  = characteristic surge impedance  
 $b$  = radius of outer conductor  
 $a$  = radius of inner conductor

For balanced two wire line:

$$Z_0 = 276 \log_{10} D/a \quad (2)$$

where  $D$  = center to center spacing  
 $a$  = radii of conductors

For flat element type:

$$Z_0 \approx 377 s/w \quad (3)$$

where  $w$  = width of line  
 $s$  = spacing between surfaces ( $w \gg s$ )

With the characteristic surge impedance and effective tube interelectrode capacity known, the physical length of the tank for any of the above types may be figured for a given frequency. Since for resonance the inductive reactance must equal the capacitive reactance ( $X_L = X_C$ ) it will be necessary to find the reactance of the effective tube interelectrode capacity. The value of this capacity in  $\mu\mu\text{fd}$ . may be found in the tube handbook or manufacturer's literature. The line in order to be resonant must present an inductive reactance equal to this capacitive reactance. By the following, the length of the line may be calculated:

$$\tan \theta = jZ_o/Z_{in} \quad (4)$$

where  $\theta$  = length of line in degrees  
 $Z_{in}$  = input impedance in ohms  
 $Z_o$  = characteristic surge impedance

Taking a typical example for a flat element tank with the following parameters:

Tank spacing between elements	1"
Width of tank elements	2.5"
Effective shunt capacity due to tubes	16.5 $\mu\mu\text{fd}$ .
Frequency	88 mc.

The capacitive reactance of this shunt capacity is 110 ohms.

To find the characteristic surge impedance, substitute in Eq. (3). This gives  $Z_o = 151$  ohms. Now to arrive at the electrical length in degrees and the actual physical length in inches, merely substitute in Eq. (4). This gives a value of  $\theta$  of  $36.1^\circ$ .

Since the wavelength is expressed in degrees ( $360^\circ$ ), this must be converted to inches.  $36.1^\circ$  corresponds to approximately one tenth (.1) of a wavelength. A wavelength at 88 mc. is 134 inches, making the tank length 13.4 inches.

Consideration must be given to two other factors which affect the final over-all length in practice, namely, tube electrode lead lengths and proximity effects of shielding. The

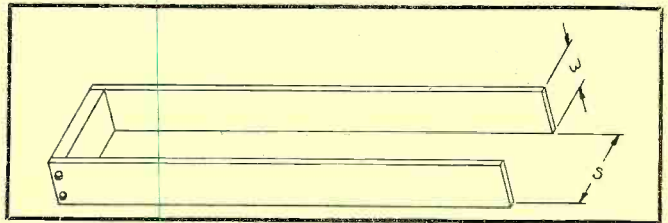

Fig. 2. Representative flat type of quarter-wave tank.

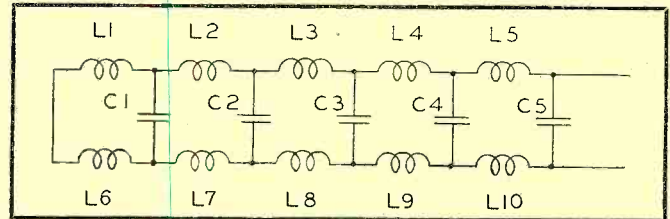

Fig. 3. Equivalent low frequency circuit of quarter-wave tank.

length of tube leads will serve to make the tank effectively longer electrically. The presence of shielding due to the enclosure and the chassis will serve to lower the actual characteristic surge impedance of the tank. This has the effect of shortening the electrical length of the tank. These effects may be considerably lessened by careful layout and mechanical design.

#### Tuning Methods

Tuning is usually accomplished by one or more of the following methods:

1. A variable capacitor placed across the high impedance end has been the most popular method. This works quite

(Continued on page 27)

Fig. 4. Power amplifier of a Gates 3 kw. FM transmitter, tuned by varying surge impedance of tank.

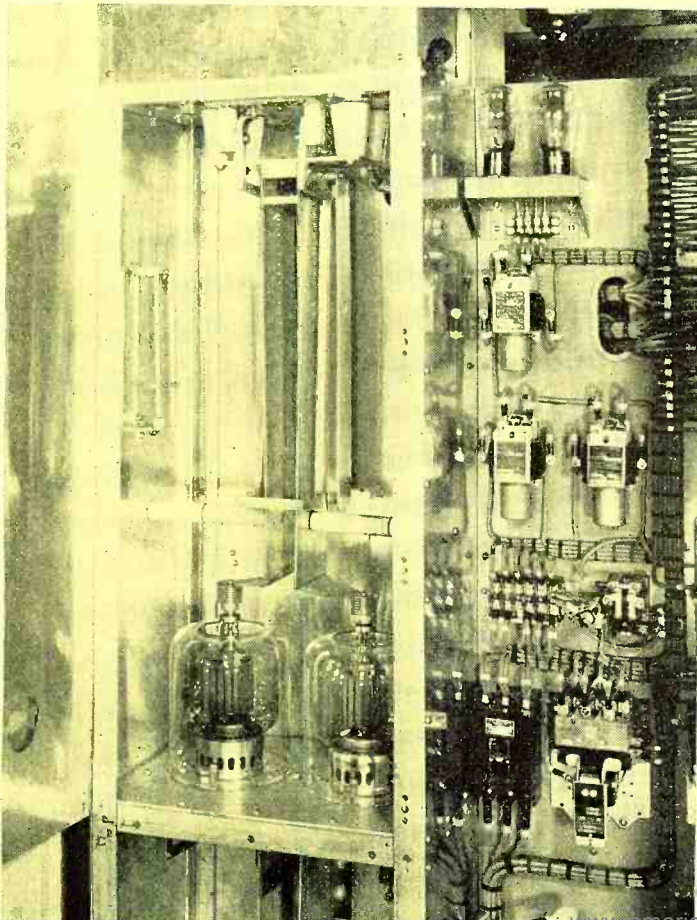
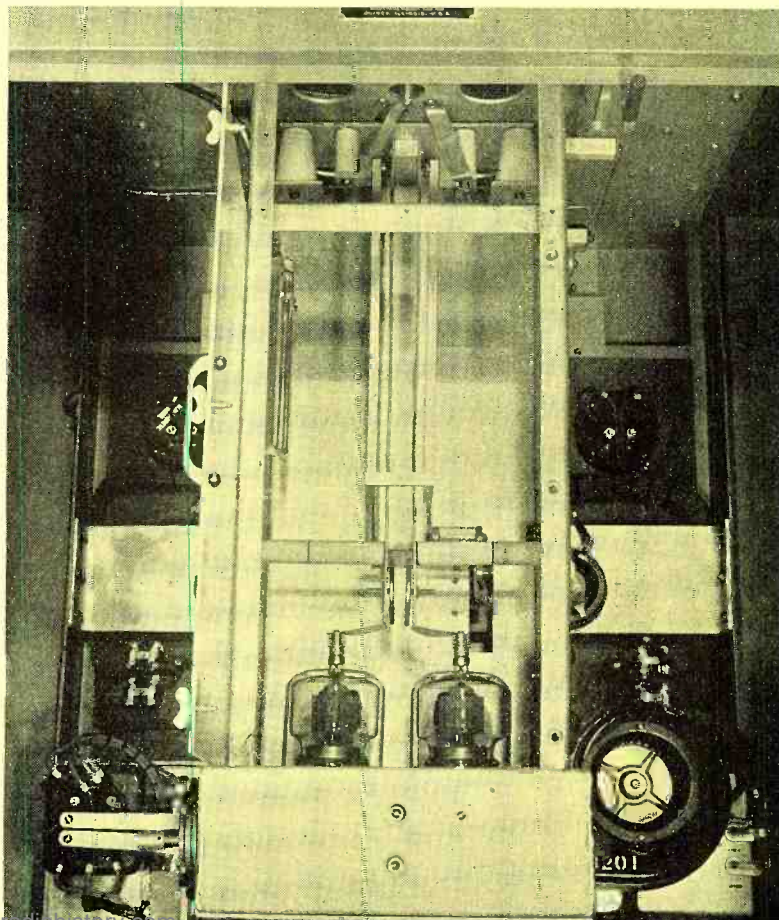
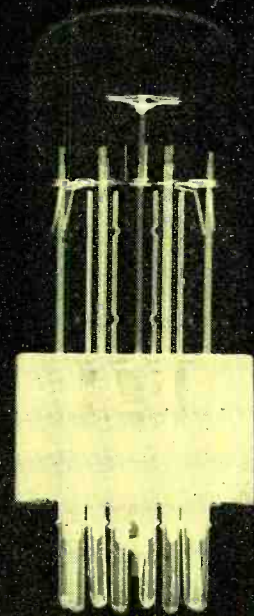

Fig. 5. Commercial application of the flat type of quarter-wave construction for push-pull operation.



# RUGGED ELECTRON TUBE DEVELOPMENT



***Mechanical vibration and resonance, high impact shock and centrifugal acceleration tests at NBS show up tube weaknesses and assist in evaluating more rugged designs.***

Radiograph of two 6SN7GT tubes. Left, normal construction. Right, ruggedized version. Below, interior view of motor-driven centrifuge.

**R**UGGED electron tubes are indispensable wherever electronic equipment is used under severe conditions of vibration, shock, or acceleration. Important in the development of such tubes are methods of testing for sturdiness and durability. These methods are now being studied and developed at the National Bureau of Standards as part of a comprehensive tube ruggedization program under the direction of I. L. Cherrick of the Bureau's Electron Tube Laboratory. One phase of the project consists of a survey of the actual operating conditions for electron tubes in various kinds of commercial, industrial, and military applications. This study provides a practical basis for the design of test equipment to simulate hazards of actual use.

In addition to working out adequate test methods, the Bureau is developing new kinds of rugged tubes. The design of these tubes is based on an analysis of the ways in which ordinary tubes fail under test or in service. A detailed knowledge of operating conditions and tube failures is thus a useful guide to the design of tubes that will be strong enough to operate properly under severe mechanical abuse. Some tubes may have to withstand great extremes of temperature as well, but in any case the mechanical design of a rugged tube is

strictly governed by the required electrical properties.

The Bureau's facilities for testing the ruggedness of electron tubes now include vibration apparatus, mechanical resonance testers, high-impact shock machines, and high-speed centrifuges. Some tests are conducted with typical electrical potentials applied to the tube elements so that noise modulation, short circuits, and other effects can easily be studied. Destructive field conditions can be reproduced through the proper choice of vibration, resonance, impact, and acceleration tests.

After receiving various ruggedness tests, tubes are examined for structural failures. X-rays are sometimes used to reveal the extent of structural changes without opening the tube envelope. Materials for certain tube elements are examined spectroscopically to determine their exact composition and to find impurities that might weaken the tube structure. This determination of the real causes of tube failure is an important part of the rugged tube program. Out of these studies will come recommended specifications for materials best suited to particular ruggedization problems. In some cases new materials and new methods of fabrication must be developed to meet the unusual requirements of ruggedization.

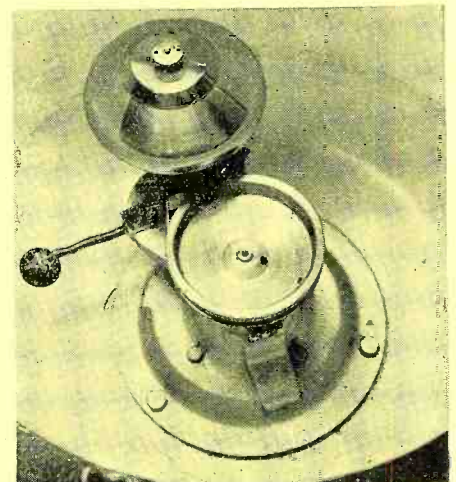

Vibrations produce the most common mechanical stress encountered by electron tubes under service conditions. Continuous and intermittent vibrations are present in vehicles, in aircraft, on shipboard, and in industrial applications. A survey of the actual vibrations in each type of service shows that there are definite, characteristic vibration frequencies—a noise spectrum—associated with each application. In motor vehicles the vibrations are usually of rather low frequency, but in aircraft they may range up to 10,000 c.p.s.

The Electron Tube Laboratory's mechanical vibration machines employ electric-motor drive arranged so that motor speed can be adjusted to vibrate the driven element at any selected frequency between 7 and 60 c.p.s. Vibration equipment of this type can, of course, be designed to produce higher

frequencies, but this is not usually done because of the lack of precision in frequency control, excessive wear on moving parts, and the appearance of unwanted harmonics. In some cases it may be useful to construct a vibration machine to work at a particular fixed frequency up to several thousand cycles per second, although it would be necessary to limit the amplitude of vibration to prevent self-destruction of the machine.

Several different types of low-frequency vibration apparatus are in use at the Bureau. One vibrator employs an unbalanced fly-wheel suspended on leaf springs; the frequency of vibration depends on the speed of rotation, and the amplitude depends on the stiffness of the springs. Also in use is a vibrator in which the circular motion of a fly-wheel is converted to linear vibration of a test table through a simple mechanical linkage. The amplitude of vibration is approximately 0.2 inch peak to peak.

Electron tubes are often tested by continuous vibration for periods of several days to produce fatigue failures at the points of weakness. These tests are usually conducted at a fixed frequency that is representative of field conditions. In shorter runs the vibration frequency is usually varied cyclically in order to study the effect of a range of frequencies on the performance of the tube under test.

Mechanical vibrations have many different effects on the operation and life of electron tubes. Fatigue failures due

to vibration are very common in ordinary tubes. They are especially likely to occur in tube elements made of crystalline materials, such as filaments and cathode coatings. Improperly welded joints are another frequent source of trouble. When the tube is operated under vibratory conditions, flashovers between electrodes may occur, and mica contacts will often chip or split if they are placed against a glass envelope. The grid wires and the plate of an electron tube, however, seldom exhibit fatigue failures. High-amplitude resonance vibrations in the tube structure may occur at particular frequencies, and the vibration of tube elements may affect the operation of the tube by introducing microphonics. Noise modulation results from the vibration of tube elements and the consequent variation in interelectrode spacing.

### Mechanical Resonance Tests

The most severe effects are encountered in cases where the vibration applied to the tube contains components of a particular frequency which corresponds to the natural frequency of vibration of some tube element or structure. The electrical noise in the output of the tube will then have a sharp peak at this resonant frequency which may be large enough to completely override the desired signal. Microphonic effects are a major problem in applications where the normal mechanical vibration occurs over such a broad frequency spectrum that the natural resonant fre-

quency of a particular tube element is excited by some component of the incident vibrational energy.

Mechanical resonance apparatus differs from vibration equipment principally with regard to size—resonance testers are smaller and involve lower energies. The mechanical resonance testers in use at the Bureau are in the form of loudspeaker-type vibrators. The vibrator is excited by means of an audio oscillator and amplifier which produce an audio-frequency signal that can be varied from low frequencies up to more than 20,000 cycles per second. This vibration is monitored by means of a magnetic-type moving-coil vibration pickup attached to the tube mounting. The proper electrode potentials are furnished by a battery power supply to minimize extraneous noise effects. In testing for microphonism a special mounting is used to transmit the vibrational energy directly to the tube, and a cathode-ray oscilloscope is connected to the plate circuit of the tube so that noise modulation corresponding to a given mechanical vibration frequency will appear as a deflection on the oscilloscope screen.

At certain critical frequencies noticeable resonances may occur in any tube. The vibration of the plate itself may be sufficient to produce an objectionable noise effect. In some cases the mechanical resonance vibration may be sufficient to cause fatigue failure of tube elements. For example, oxide coatings of cathodes will often flake off as a result of resonance vibrations. The best preventive for resonance conditions is to design the tube so that the natural resonant frequencies of the various tube elements are higher than the vibration frequencies met in practice. It is important to use stiff materials for structural parts, to shorten the tube structure, and to design the cross sections of elements for greatest rigidity.

In general, mechanical resonance can be reduced by isolating the tubes from sources of low and high frequency vibration by means of rubber mountings of suitable design and by making

*(Continued on page 31)*

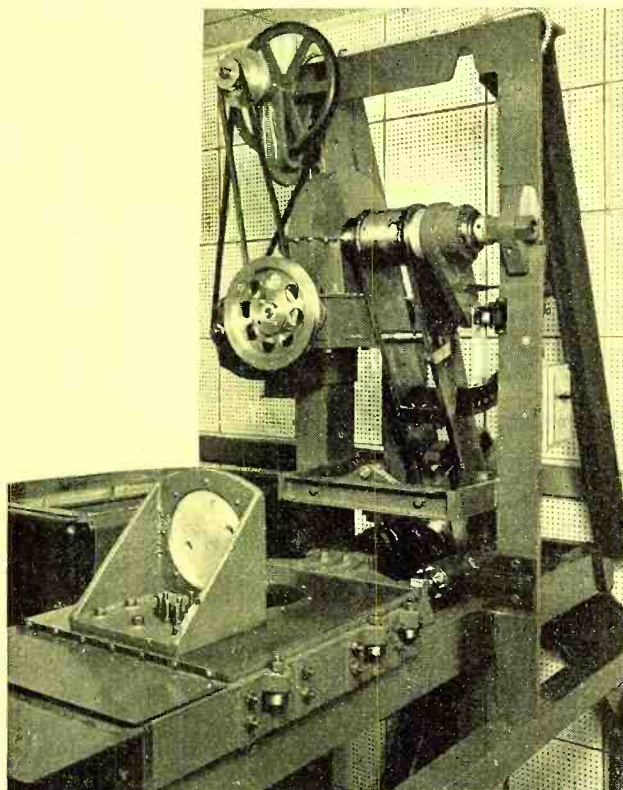

High-impact machine used at NBS to administer severe mechanical shocks to electron tubes. These tests determine the ability of tubes to withstand rough handling and dropping.

Mechanical vibration machines are used to test the ability of tubes to withstand low-frequency vibrations. This machine employs a cardioid cam to vary vibration frequency through a continuous cycle.

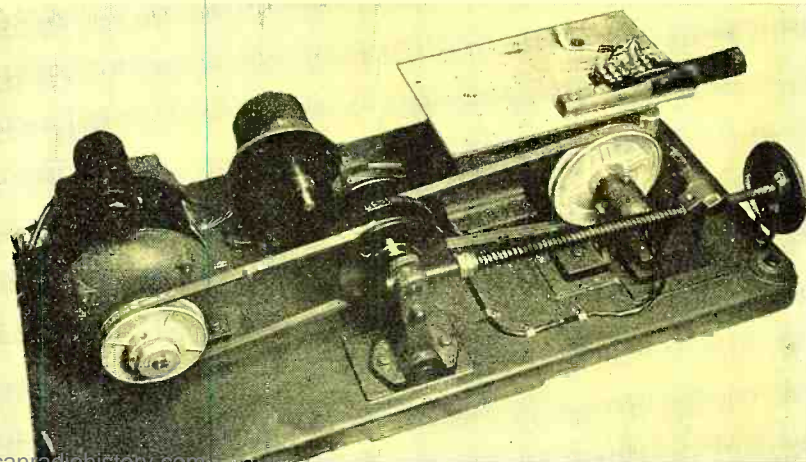

# BRIDGE-BALANCED D.C. AMPLIFIER

By  
**G. A. and T. M. KORN**  
Curtiss-Wright Corp.

***This amplifier overcomes drawbacks of earlier d.c. amplifiers and also offers some important advantages.***

ALL TOO many present day engineers, physicists and experimenters shy away from d.c. amplifiers because they believe that difficulties in their design and operation render them impractical. In many cases, this attitude has arisen from misconceptions that have been fostered by teachers, associates and many frequently used electronics textbooks.

Modern circuits and techniques have overcome many of these difficulties. The new type of bridge-balanced d.c. amplifier described in this article not only overcomes earlier drawbacks of d.c. amplifiers but also offers several important advantages in ease of operation and low-cost construction. Furthermore, this new amplifier is particularly well suited to portable battery operation, making it valuable not only to engineers, physicists and experimenters but also for certain applications in physiology and photography.

A d.c. amplifier might be defined as one which has a finite gain at zero frequency, but perhaps a more meaningful definition may be obtained by comparing a d.c. amplifier with an ordinary a.c. amplifier. In the a.c. amplifier, the output voltage is not affected by d.c. voltage changes at the input since the output and input are isolated by capacitors. A change in the input level of a d.c. amplifier, however, results in an amplified change of the output d.c. level.

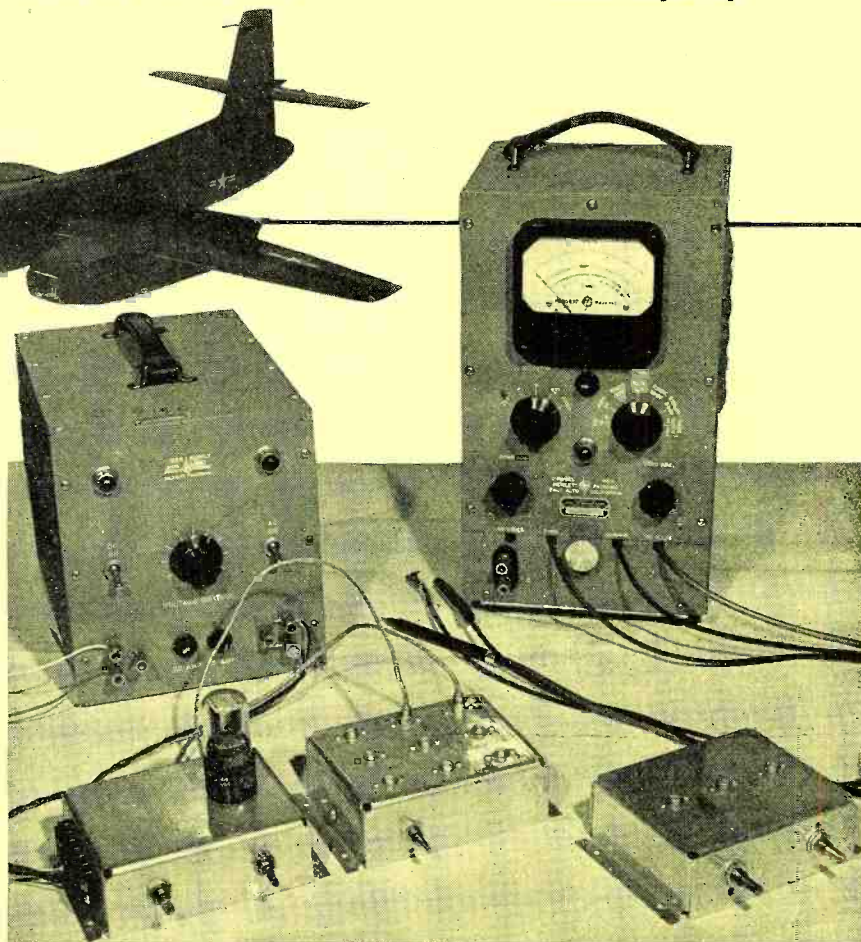
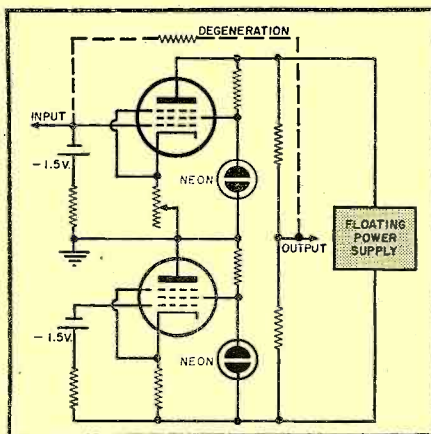

Fig. 1. D.c. amplifiers, a simple power supply, and some capacitive networks form a small electronic computer. Raggazini<sup>1</sup> has shown that such devices can simulate flight conditions of a new type airplane long before the first model is built. The aircraft shown is a Curtiss XF-8T.

This property of d.c. amplifiers permits them to amplify voltages which vary quite slowly, such as those

Fig. 2. Loss in gain due to unbypassed cathode resistors may be avoided through the use of bias cells.



obtained from pressure gauges, thermocouples and certain other measuring devices. High quality d.c. amplifiers have long been applied in physiological research work to measure nerve currents. More recently, they have acquired a new and striking usefulness in their application to servomechanisms and analog computers. They serve as electronic voltmeters and also provide low-frequency amplifiers for photocells, oscilloscope deflection plates, etc.

The ideal d.c. amplifier for all these applications would be one having high stable gain, good frequency response and freedom from drift. Drift in d.c. amplifiers may be caused by changes in plate and filament voltages as well as changes in contact potential, tube characteristics, and circuit component values. It would also be highly desirable to obtain the output at the same d.c. level as the input using a minimum

number of power supplies. This latter characteristic would permit convenient cascading of similar stages and application of feedback circuits. The ideal d.c. amplifier should also provide ease of operation, ruggedness, and easy balancing while requiring only readily available, low-cost circuit components.

Several means for achieving these desirable characteristics are already available. In addition to the familiar parallel or Miller compensator,<sup>1</sup> series compensation,<sup>2</sup> as shown in Fig. 4, has been used to eliminate the effects of changes in filament emission and contact potential in d.c. amplifiers. Emission and contact potential changes similar to those in the amplifier tube  $V_1$  occur in the compensator tube  $V_2$  and tend to balance out the resulting drift at the output terminal  $B$ . If the output is taken between  $B$  and  $C$ , changes in the plate supply voltage also tend to be balanced out and little or no regulation is necessary in the plate supply. In this series compensating circuit, the signal is applied to the grid of tube  $V_1$ , with the output being taken from the plate. For zero signal input, the quiescent output voltage varies from slightly above to slightly below 100 volts. This tends to make cascading and application of feedback from the output to the input difficult since the following grid would have to operate at a high positive potential. If, however, output is desired at zero d.c. level, a negative power supply is needed as indicated in dotted lines, and both supplies must be regulated.<sup>3</sup>

The new type of bridge-balanced d.c. amplifier to be described has all the advantages of series compensation and at the same time directly provides output at zero d.c. level and permits both the output and input voltages to be conveniently referred to a common ground reference.

In the simplest form of the new amplifier, shown in Fig. 6A, the amplifier tube  $V_1$  and the compensator tube  $V_2$  constitute two arms of a bridge in such a way that both input and output voltages appear at zero d.c. level. The power supply may or may not be left floating with respect to d.c. ground, thereby presenting several possibilities. It should be noted that only a single power supply is needed, although one positive and one negative supply may be used in series if desired.

The output voltage is balanced to the zero d.c. reference level at zero input by means of the variable cathode resistors indicated in Figs. 2, 3, 4, 6A, and 7.

The power supply may be center-tapped, as shown by the dotted lines in Fig. 6A. This scheme is used if several stages are to be cascaded, as in Fig. 3, and must be operated from the

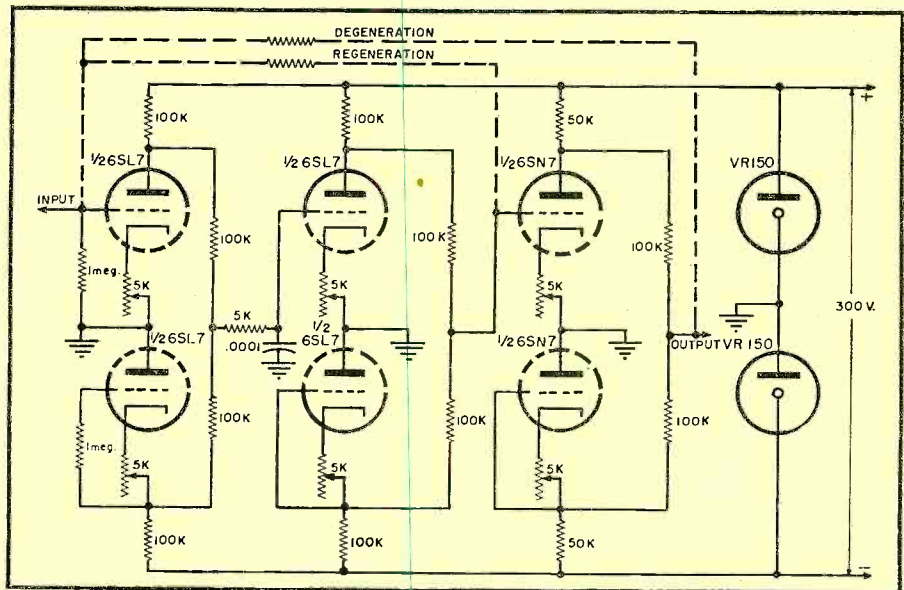

Fig. 3. Center-tapped power supply used when several stages are cascaded.

same power supply. An inspection of the circuit in Fig. 6A shows that the stage gain of the new amplifier is exactly one-half of the gain of the conventional stage shown in Fig. 6B. Comparison of the corresponding circuit elements in Figs. 6A and 6B enables one to design the new amplifiers by means of *standard resistance-coupled amplifier tables*, if allowance is made for the degeneration due to the unbypassed cathode resistors. The loss in gain may be avoided through the use of bias cells as shown in Fig. 2.

If only a single stage of amplification is involved, the power supply may also be floating with respect to ground (except for high audio frequencies at which the distributed capacitances  $C$  effectively bypass both sides of the supply  
(Continued on page 28)

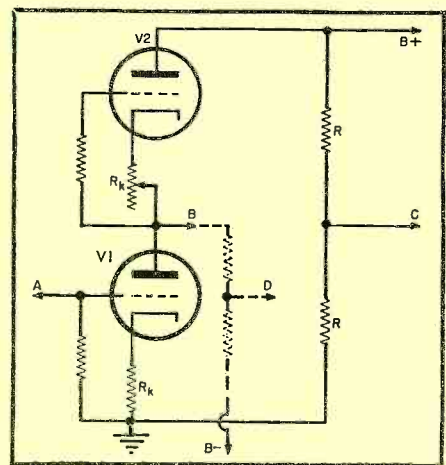
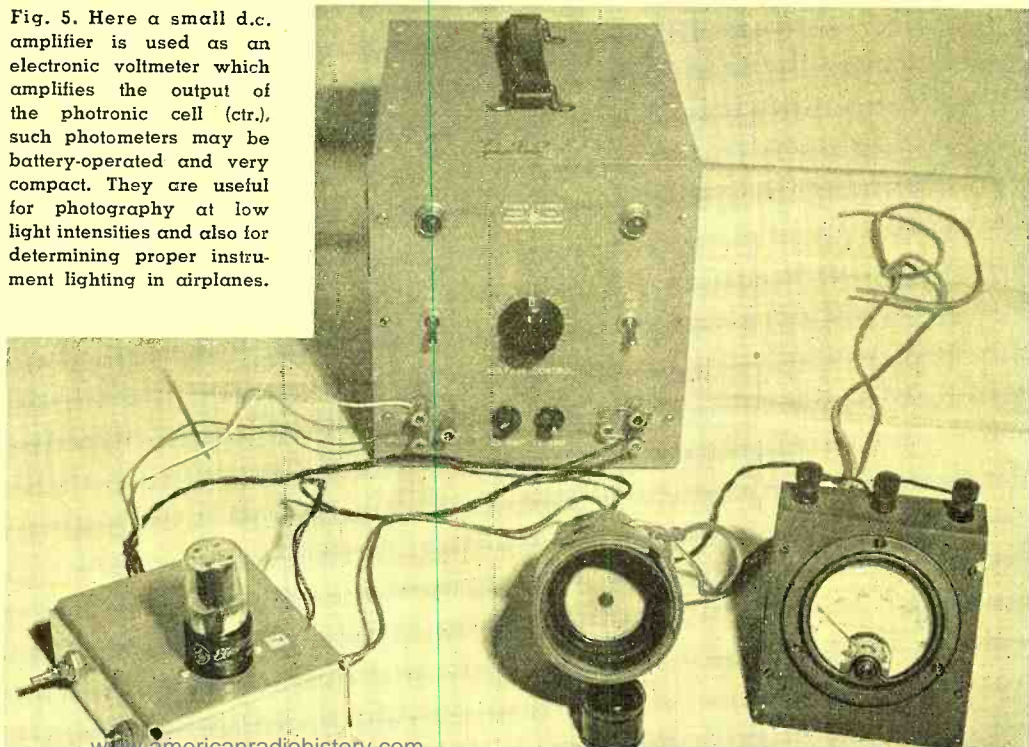

Fig. 4. Series compensation has been used to eliminate the effects of changes in filament emission and contact potential in d.c. amplifiers.

Fig. 5. Here a small d.c. amplifier is used as an electronic voltmeter which amplifies the output of the photonic cell (ctr.), such photometers may be battery-operated and very compact. They are useful for photography at low light intensities and also for determining proper instrument lighting in airplanes.



By  
**HARRY L. GERWIN**

*High sensitivity and rapid response make this recorder suitable for checking a wide variety of antennas.*

Fig. 1. The complete automatic recorder ready for operation.

# AUTOMATIC ANTENNA Pattern Recorder

THE LARGE number of field strength pattern measurements required to adjust properly and/or evaluate an antenna inevitably lead to the use of automatic recording equipment. An automatic recorder has been devised which is capable of recording accurately and quickly a complete field strength pattern. The principal objective in the design of this device was high-speed response of the writing pen drive system without loss of accuracy. This feature is necessary, since the system is required to record patterns of rotatable antenna systems in which the mount is sometimes limited in how slowly it can rotate and still rotate smoothly. This minimum rotational rate determines the pen-writing response required, because the faster the antenna is rotated the faster the pen must travel to trace out the pattern.

## Characteristics of Recorder

It is generally desirable to measure the relative radiation power of an antenna pattern in decibels. The recorder must then produce a linear writing pen displacement proportional to the logarithm of the r.f. power derived at the antenna. The linear decibel output is particularly advantageous because it produces a recording of the power variations encountered in measuring a field strength pattern of an antenna that has the same degree of accuracy at any point on the scale. The measur-

ing range of this recorder is 40 db. plotted on a 10-inch scale.

An indication of the response characteristics of the pen servo is shown in Fig. 4, which is the output curve plotted by the pen servo system for a 19.6 db. amplitude square wave input. It is seen that the pen servo will correct for an approximate 20 db. step function in 0.185 seconds. Over-all accuracy of the system is dependent primarily on an input potentiometer made up of inherently stable resistive elements.

Since the chart displacement must be linear it is made proportional to the angle of rotation of the antenna. As the recorder was designed for measuring narrow beam antennas, the patterns are plotted in cartesian coordinates. The paper can be driven at any one of three speeds:  $20\frac{1}{4}$ " per  $10^\circ$ ,  $20\frac{1}{4}$ " per  $60^\circ$ , or  $20\frac{1}{4}$ " per  $360^\circ$ .

## Pen Drive System

A block diagram of the pen drive servo system is shown in Fig. 2. To facilitate the measurement of r.f. power, the power source is amplitude-mod-

Fig. 2. Block diagram of pen drive system.

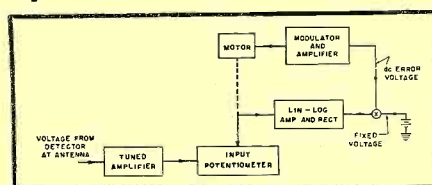

ulated at a convenient frequency, generally between 500 and 2000 c.p.s. The voltage derived from the detector (usually a bolometer) affixed to the antenna under test is fed to a tuned amplifier which has a bandpass of approximately 10 per-cent of the modulating frequency. The tuned amplifier is used to reject unwanted signal frequencies, thereby obtaining higher sensitivity. This characteristic is necessary because the recorder must be extremely sensitive to measure the side lobes and minima of an antenna pattern when the power output of the r.f. source is limited and the gain of the antenna under test is low.

The output of the tuned amplifier, which is linear over an amplitude range of 100 db., feeds an input potentiometer in which the output voltage of the sliding contact varies in a negative exponential fashion with a linear movement of the contact. This output voltage provides the control signal for the servo motor which repositions the sliding contact and the writing pen attached to it. Servo systems are designed on a linear basis; therefore it is necessary to modify the voltage from the sliding contact so that it varies linearly with a linear movement of the contact. This function is performed by the lin-log amplifier, whose output varies as the logarithm of the input function.

Up to this point in the system the original modulating voltage has been used. The output of the lin-log amplifier is rectified to produce a d.c. voltage which is compared with an arbitrary fixed voltage, and the difference or error voltage is fed to a modulator. The modulator converts the d.c. error voltage to



a 60-cycle a.c. error voltage which drives one phase of a 2-phase motor. The motor then positions the sliding contact on the potentiometer, thus reducing the error voltage to a minimum. The sliding contact and writing pen seek a position which is proportional to the logarithm of the voltage fed to the input potentiometer. In this way the linear decibel type of pen writing is obtained.

The fast response time with a critically damped system was made possible by the unique pen drive system. The pen carriage (which also holds the movable tap of the input potentiometer) is driven by a cable from a drum fastened to the motor shaft. This type of drive system (shown in Fig. 5) provides low inertia, no backlash, low friction, and a mechanical resonant frequency above the passband characteristics required. Local feedback is applied in the usual manner to extend the frequency characteristics of the two-phase induction motor, to reduce its nonlinearity and to improve the servo output stiffness, thus improving static accuracy.

The input or negative-exponential potentiometer mentioned above is approximated by cascading a number of symmetrical  $\pi$  sections made up of resistive elements. It is constructed by starting with a slide-wire potentiometer to which shunt resistors have been added at equally spaced intervals to form the  $\pi$  sections (see Fig. 3). The potentiometer is an approximation to the desired function since the function is correct only at the tap points; at all other points the voltage at the sliding contact is a linear interpolation of the voltage between taps. By the use of a suitable number of elements the maximum error can be reduced below the operating accuracy expected of the entire system.

The antenna pattern recorder has a voltage range of 80 db. Using a bolometer as a detecting element (square-law detection) a total range of 40 db. variation of r.f. energy can be recorded on the chart.

### Chart Drive

The chart drive performs the function of maintaining a chart displacement that is directly proportional to the angle of rotation of the antenna. A block diagram of the basic system is shown in Fig. 5. It consists of a synchro generator, a synchro control transformer, a servo motor amplifier and a two-phase induction motor.

The synchro generator, driven mechanically from the antenna mount, initiates 60-cycle voltages which are transmitted to the synchro control transformer at the recorder. A difference in the relative angular position of the synchro generator at the antenna

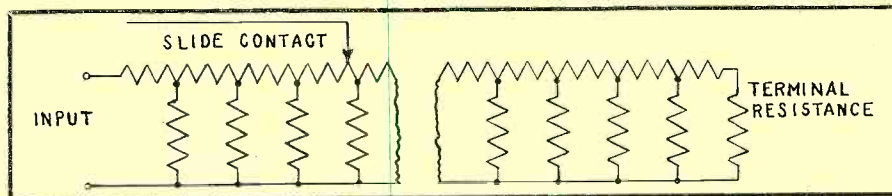

Fig. 3. Schematic diagram of negative-exponential potentiometer.

mount and the synchro control transformer at the recorder generates an electrical error signal which is applied to the input of a servo motor amplifier. The amplifier output operates the two-phase chart motor which drives, through appropriate gearing, the synchro control transformer in such a direction that the error signal is reduced to a minimum. The angular position of the control transformer is thereby kept aligned with the synchro generator at the antenna mount. The recording chart drum is geared directly to the control transformer, and thus, the paper displacement will always indicate the antenna position. Actually, two synchro control transformers are appropriately geared to the chart paper drum and the chart drive motor. When the antenna system is provided with two synchro output speeds geared 36 to 1, and 1 to 1, the three chart speeds are available by switching electrical connections without the necessity for shifting gears at any time.

Local feedback is also applied in the chart drive system to obtain improved operation. This insures precision tracking between the chart paper and the antenna mount.

### Systems Operation

Fig. 1 is a photograph of the complete recorder system, which is built as five individual units in order to make it portable. Most antenna work is done at fixed installations and the equipment lends itself to rack mounting, but in many cases it is desirable to measure antenna patterns of radar or radio equipment on location. Such patterns are easily obtainable. The radar transmitter can usually be used as the power source and the only additional equipment needed is a bolometer holder matched to the frequency being measured, an r.f. pickup element such as

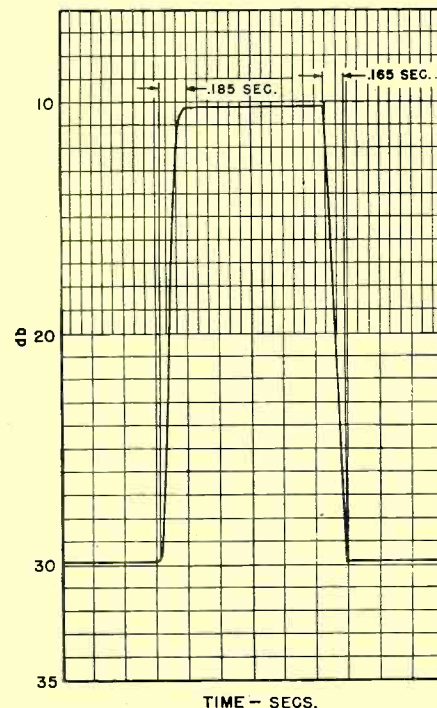

Fig. 4. Output curve plotted by pen servo system for a 19.6 db. square-wave input.

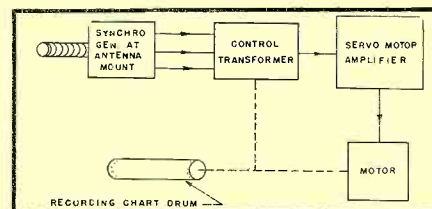
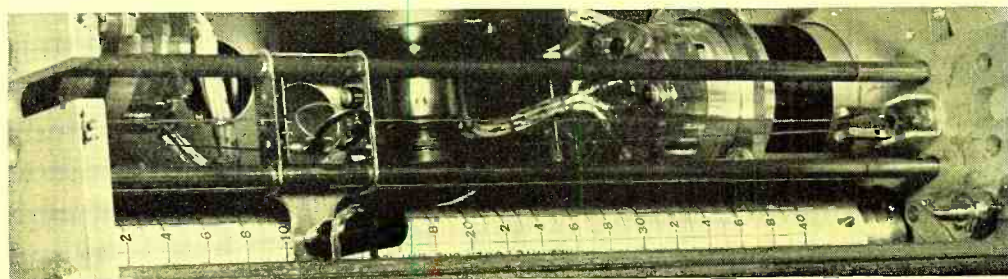

Fig. 5. Block diagram of the basic chart drive system.

a dipole, horn, or parabola, synchro inter-connecting wiring and a suitable location for the pickup element. The precautions taken in setting up a permanent installation must also be  
(Continued on page 31)

Fig. 6. A view of the pen drive system.



# MEASUREMENT of STUDIO and ROOM ACOUSTICS

by

**DAVID FIDELMAN**

THE FIELD of sound reproduction has at the present time reached the stage of development where it is possible to reproduce sounds from a loudspeaker, after numerous stages of recording and transmission, which will sound almost indistinguishable from the original sounds which entered the microphone. In addition, present electronic and electromechanical techniques are constantly being used to improve sound reproduction equipment toward the ultimate purpose of making the reproduced sound identical with the original.

However, no matter how well the output sound reproduces the input, the entire character of the reproduction can be drastically altered by faulty acoustic design either in the room where the sound originates, or in the room where it is reproduced. Bad acoustic design can result in loss of intelligibility and "presence," increased noise level and reduction of dynamic range, resonances and spatial distribution defects, and generally make good program material unpleasant to the ear. This factor has long been recognized, and considerable work has been done in the design of studios, rooms and auditoriums to determine how to attain the best acoustic qualities. The problem is a complex and difficult one, and has still not been solved to complete satisfaction, although considerable progress has been made toward its solution.

Even under ideal conditions, the design of any room, studio or auditorium is difficult because of the limitations imposed by architectural factors. Therefore compromises usually must be made in designing for optimum acoustic performance. Then, once the room has been completed it is tested to see how well it meets the performance requirements. Methods of testing form an extremely important part of any type of design procedure, and in acoustics this is especially true. The ideal test gives a measure of the performance,



The General Radio type 759-B Sound Level meter.

## **Part I of a 2-part article discussing such factors as reverberation, sound diffusion, and noise level.**

indicates what may be wrong and by how much, and gives some indications of what steps may be taken to correct any defects which may exist.

Such tests have only recently been developed for acoustic measurement, and have considerably increased our knowledge about what factors are important in determining the acoustic quality of a room, and what their effects are. The purpose of this article is to describe these measurement techniques, and to show how they aid in the improvement of acoustic designs.

In order to understand the methods and equipment used for the measurement of studio and room acoustic properties, it is first necessary to understand what factors are involved and their effects upon any sounds which are present in the room.

### **Specific Factors Which Determine Acoustic Properties of Rooms**

When sound is listened to in a room

or an auditorium, the room has two important effects: (a) it reverberates and reflects the sound from the walls, ceiling and floor; otherwise, if there were no reverberation, the sound would appear as if it were being heard in a completely open space; (b) it excludes external noises. Therefore measurements of the acoustic properties of rooms must concern themselves primarily with various types of reverberation and noise measurements.

Reflections from the boundary surfaces of the room, which basically determine its acoustic character, can have several different effects depending upon the nature of the sound which is heard. These different effects require different measurement techniques.

In general, a number of measurements must be performed before it can be determined whether the acoustic properties of a room will be acceptable. Usually the factors which should be known include the following:

- (1) Reverberation and reverberation time, including
  - (a) fluctuation during decay
  - (b) echo and flutter echo
- (2) Sound diffusion (and sound concentrations)
- (3) Transient characteristics
- (4) Noise level

and when the room is the one in which the sound is being reproduced, it is also desirable to know the relationship between the reproducing system and

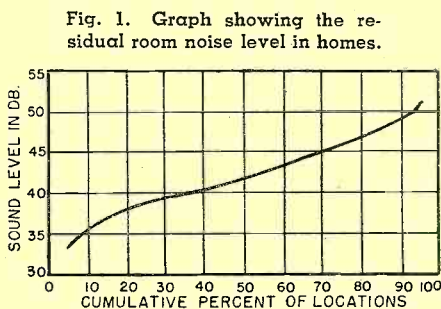

the room acoustics, as given by:

- (5) Power output of the reproducing system
- (6) Frequency response of reproduced sound

Some of these factors have been studied extensively, and standards determined which correlate the measured value with the acoustic performance. In the case of a few of the above factors, standards have not yet been determined, but practical experience has

sound intensity than at other points in the room, and creating the impression that the sound originates at the concave surface. If standing-wave patterns are possible at certain frequencies, these frequencies will tend to be over-accentuated at positions where the standing-wave patterns are set up. For best acoustic properties, the sound pattern in the room should be as *diffuse* as possible at all frequencies, with no standing-wave patterns and no points

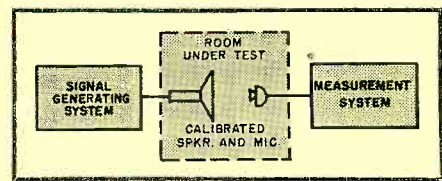

Fig. 2. Basic test setup for performing acoustic measurements in rooms.

level of most residences is given in Fig. 1, which shows that there is a wide variation in noise from one location to another.

In any audio reproduction, it is important also to know the relationship between the reproducing system and the acoustics of the listening room. The power output from the loudspeaker should be capable of producing a minimum sound intensity of 80 db., and for best performance should be capable of producing a level up to 100 db. without distortion. Fig. 3 shows the acoustical power required, as a function of the room volume, to produce a sound level of 80 db.

The sound output from the loudspeaker should have a flat frequency response characteristic. The function of the reproducing system is to reproduce at the ear of the listener a duplication of the sound which is present at the microphone, and to affect the tonal qualities as little as possible. In certain cases it is necessary to restrict the reproduced frequency range because of acoustic or reproduction difficulties, but in such cases the restriction is a compromise rather than a desirable situation.

### General Technique of Acoustic Measurements

Acoustic measurements consist essentially of generating a known sound signal in the room which is under test, and determining the resulting sound distribution. The basic setup for performing measurements of this type is shown in Fig. 2. A signal generator of the proper type supplies the desired

shown what should be the requirements for acceptability.

When a sound is started in a room the intensity does not immediately reach its maximum, because it takes an appreciable time for some of the sound to reach the walls and undergo one or more reflections before it reaches the listening point. The intensity reaches its maximum when the steady-state condition is attained. After the sound source stops, it also takes an appreciable time before the various reflections are no longer heard, having been completely absorbed. This persistence of sound is called *reverberation*, and is different from an echo in that it consists of a large number of reflections which blend evenly with one another and with the original sound. The *reverberation time* has been defined as the time required for the sound intensity to decrease 60 db. after the source has been stopped.

When there are large flat surfaces, these may give rise to distinct reflections which are heard as *echoes* if the path difference is too great. When parallel walls are located opposite one another, there may be heard a succession of distinct reflections between them—this effect is known as *flutter echo*.

The presence of concave surfaces tends to focus sounds towards their center of curvature, giving a greater

of excessive sound concentration. Under these conditions, the decay of sound (reverberation) when the source stops will be smooth, marked only by small fluctuations.

The reverberation time and the sound diffusion characteristics of a room are essentially steady-state characteristics, since the sound is allowed to reach equilibrium conditions before these factors are measured. However, all natural sounds are essentially transient in nature, therefore the behavior of the room for transient sounds is of great importance. It is therefore necessary also to know whether the steady-state reverberation time and sound diffusion are accurate for transient sounds, and what differences may exist. In many cases the transient characteristics are much more important than the steady-state, and sometimes give much more information about the characteristics of the room.

The ease with which the reproduced sound may be heard and understood, and the dynamic range which is possible, depend upon the residual noise level in the room. The tolerable noise level in the studio and in the reproducing system depends upon the noise level in the listening room. The average noise level in empty theaters is 25 db. (reference level is  $10^{-16}$  watts per square centimeter); with an audience the average will generally be about 42 db. The noise

Fig. 3. Acoustic power required to produce an intensity level of 80 db. as a function of the room volume.

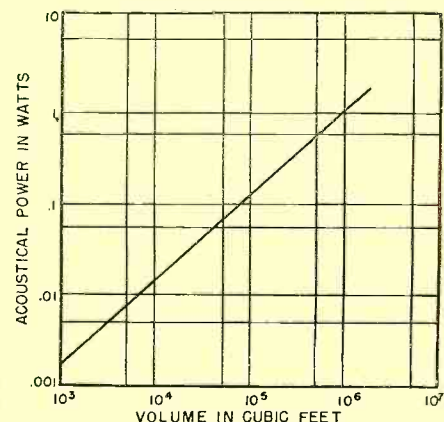



The General Radio type 759-B sound level meter being used to perform acoustic measurements in a motion picture theater.

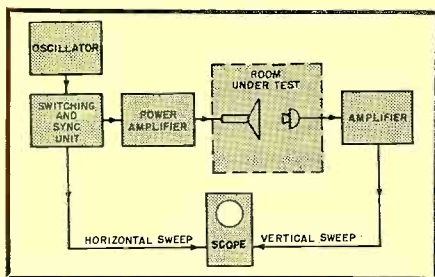

Fig. 4. Setup for performing transient acoustic measurements.

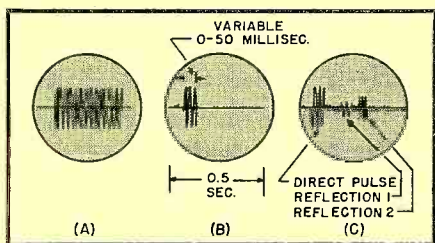

Fig. 5. Typical oscillograph pictures of wave shapes in various parts of a test setup. (A) audio oscillator output, (B) sound output of loudspeakers, (C) sound received at microphone.

signal which is applied to the calibrated loudspeaker. (The signal generator here is taken to include not only the generator of the low-level signal, but also any auxiliary amplifiers which may

be necessary to increase the electrical signal level before applying it to the loudspeaker so that the necessary amount of sound energy may be supplied for testing.) When testing a room in which sound is to be reproduced, it is often preferable to use the amplifier and loudspeaker system which is already installed; then the electrical test signal is applied directly to the amplifier input. The sound in the room is picked up by a microphone of known characteristics, whose output is amplified and applied to the measuring device. The specific type of signal which is generated, and the type of measurement system, will be determined by the particular acoustic characteristic under test.

Generally, a calibrated loudspeaker will not be available, whereas standard calibrated microphones are readily available. It is not necessary that both the loudspeaker and the microphone have known characteristics, since if the characteristics of one are known it can be used to calibrate the other. Therefore only a standard microphone is necessary to obtain completely accurate and reliable acoustic measurements. A calibrated microphone which has been widely used for this type of service is the condenser microphone. These microphones are calibrated against a primary standard sound source, and may therefore be used as secondary measurement standards. Because of its small physical dimensions this type of microphone is effectively a "point pickup" which does not appreciably disturb the sound field, and it has good frequency response characteristics up to approximately fifteen thousand cycles per second.

The characteristics of the loudspeaker may be calibrated in terms of the microphone characteristics. However, such a calibration must be done in such a manner that the acoustics of the measuring room do not affect the results. The measurement must be performed in what is known as a "field-free" room. The requirement of such a room is that all reflected sound and the noise level be so low that they can be neglected in the measurement. The simplest and most direct method

of obtaining these conditions would be to perform the calibration out of doors at a great distance from reflecting objects, if favorable weather and noise conditions can be obtained. Field-free conditions are also achieved in special rooms which are carefully designed to have extremely small reflections from the boundary surfaces. In practice the best measuring room available will be a small deadened or partially deadened room. In such cases, the most satisfactory results are obtained by placing the microphone close to the loudspeaker so that the level of the direct sound striking the microphone is at least 20 db. or more above the reflected sound.

In most acoustic room measurements the effects of standing waves are undesirable and should therefore be minimized. This can most readily be done by frequency-modulating the test signal (usually called "warbling") by about  $\pm 10\%$  of the mean frequency, at a rate of several times per second. When this method is used there will be continuous small changes in the standing-wave pattern, but resonances will not have a chance to build up.

### Measurement of Specific Acoustic Characteristics

The basic setup of Fig. 2 is used for measurement of all the various factors that represent the acoustic properties of studios and rooms. Different types of signal generators and measuring devices are used, according to the specific factor being measured.

The method of measuring reverberation time is indicated schematically in Fig. 6. The signal is generated by an audio oscillator set to the desired frequency and warbled. The output of the oscillator is applied to the switching and synchronizing unit, which controls the sequence of measurement operations. The signal is then amplified by a power amplifier which drives the loudspeaker that generates the sound signal. The sound in the room is picked up by the microphone and amplified, then detected by a logarithmic detector to give a d.c. reading on a (decibel) scale, and fed to a low-pass filter. The output of the filter is then amplified by a d.c. amplifier. The amplified output, which gives the reverberation decay characteristics of the room, may be observed either by means of a graphic pen-and-ink level recorder or upon the screen of a long-persistence oscilloscope.

The switching and synchronizing unit turns on the sound source for a time long enough for steady-state conditions to be reached, then switches off the signal and permits the sound in the room to decay. The microphone picks up the sound intensity in the room at all

Fig. 6. Measurement setup for determining reverberation time.

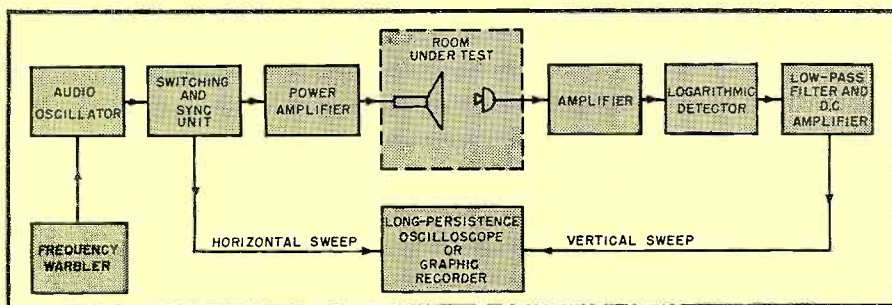



## TRIPLE "A" BATTERY LIFE OF YOUR 1950 PORTABLES

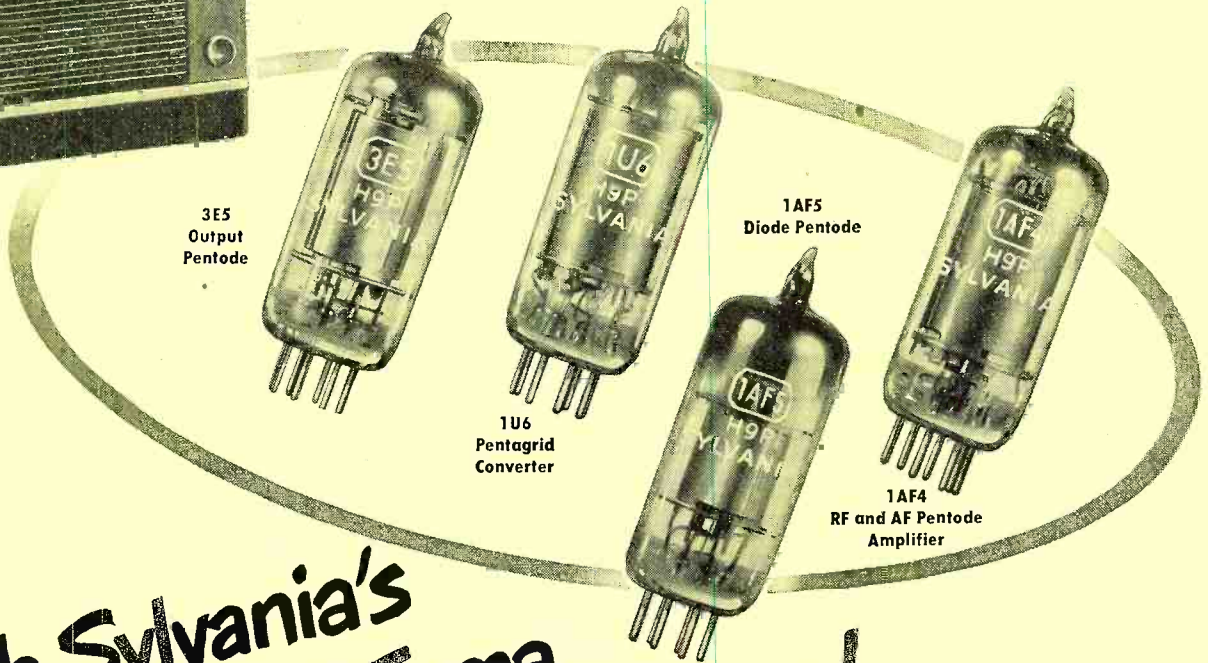

3E5  
Output  
Pentode

1U6  
Pentagrid  
Converter

1AF5  
Diode Pentode

1AF4  
RF and AF Pentode  
Amplifier

with Sylvania's  
new line of 25 ma  
battery miniatures!

### A complete tube complement for longer-service portables

Sylvania—and *only* Sylvania—brings set manufacturers this group of low-drain battery-type tubes that consume only half as much heater current as previously available types. Requiring only 25 ma filament current, they will triple life of present "A" batteries!

These new tubes also offer opportunities for the design of *smaller* "A" batteries, which will permit manufacture of more compact portables without sacrifice of performance.

The four types include a pentode amplifier, a converter, a diode pentode and an output pentode—forming a complete tube complement for portables. They offer comparable power output and sensitivity to previous types... and give excellent performance with a plate supply of only 45 volts.

Remember... these new tubes come to you from the *same* company that first made the 1.4 volt battery tube available!

# SYLVANIA ELECTRIC

RADIO TUBES; CATHODE RAY TUBES; ELECTRONIC DEVICES; PHOTOLAMPS;  
FLUORESCENT LAMPS, FIXTURES, WIRING DEVICES, SIGN TUBING; LIGHT BULBS

#### Typical Operating Conditions

Characteristic	1AF4	1AF5	1U6	3E5
Filament Voltage (volts)	1.4	1.4	1.4	2.8
Filament Current (ma)	25	25	25	25
Plate Voltage (volts)	90	90	90	90
Transconductance ( $\mu$ mhos)	950	600	275*	1100
Plate Resistance (megohms)	1.8	2.0	0.6	0.12
Power Output (mw)	—	—	—	175

\*Conversion Transconductance

#### MAIL COUPON FOR SPECIFICATION SHEETS

Sylvania Electric Products Inc.  
Radio Tube Division, Advertising Dept. R-2301  
Emporium, Pa.

Gentlemen: Please send me complete specifications  
on Sylvania low-drain tubes 1AF4, 1AF5, 1U6 and 3E5.

Name \_\_\_\_\_  
Company \_\_\_\_\_  
Address \_\_\_\_\_  
City \_\_\_\_\_ State \_\_\_\_\_

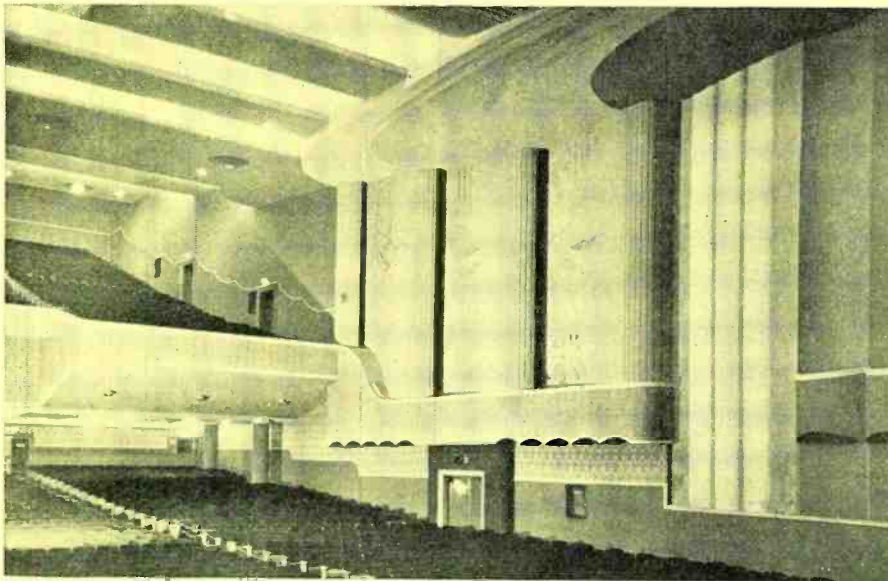

Photograph of the interior of the Cine Orfeon, Mexico City. Note sound-diffusive construction of walls and ceilings; undesirable resonances and reflections are further minimized by use of sound-absorbing material on back and side walls above wainscoting, and on front of balcony.



The H. H. Scott Type 410-A Sound Level Meter.

times, and the sound intensity at the microphone is plotted upon the oscilloscope screen or by the graphic recorder. The decay of sound from the moment the source is switched off is observed, and the slope of the decay curve is measured to give the reverberation

time for 60 db. decay. There may be fluctuations during decay of the order of 10 or 20 db., but the average slope is the one which is used. In estimating the decay time it is preferable to use the initial slope, since this is the most important to the ear and the remaining portion of the decay is normally masked by subsequent sounds. The presence of large-scale fluctuations and changes in the average slope of the decay curve indicates that the room does not have a completely diffuse sound pattern, and that best acoustic performance has not been achieved.

When the sound decay curve is being measured by a graphic recorder, the measurement setup shown in Fig. 5 may be used without the synchronizing and switching unit. In this case, the sound source is turned on and kept on long enough for steady-state conditions to be reached, then the paper is allowed to run in the recorder and the sound source switched off. The sound decay pattern will then be recorded.

Because of the cyclically changing standing-wave pattern due to the frequency-modulated signal, when the

graphic recorder type of measurement is used the recorded decay curve will be different depending upon the exact time at which the signal is cut off. With the oscilloscope method of measurement these fluctuations tend to average out, due to the superposition of a number of different decay curves which in general start at different times in the warble cycle. The effects of standing-wave patterns and interference effects can be further smoothed out by the use of multiple loudspeakers and microphones. In practice, it is desirable to reduce these errors by taking several measurements for each of several locations of loudspeaker and microphone, differing in position by about one yard. If three readings for each of four different positions are taken, accuracy in reverberation time to about 0.1 sec. can be obtained.

The degree of sound diffusion is measured mainly by observing the standing-wave pattern in the room when sound is present. Some indications can be obtained from the reverberation characteristic, but such observations are not too good because in measuring reverberation steps are taken to eliminate the effects of standing waves. The simplest and most direct method of determining the standing-wave characteristics of a room is to produce a steady sound in the room and survey the room with the microphone to determine the intensity pattern. (In this type of measurement an omnidirectional microphone should be used, and the directional pattern of the loudspeaker radiation taken into account.) With complete diffusion the sound intensity will be uniform throughout the room for all frequencies, or will vary gradually with position according to the directional characteristic of the loudspeaker and the absorption by air of the higher frequencies. The relative intensity of maximum and minimum points will be a measure of the diffusive character of the room, and any sound concentrations will also be detected. Another method of performing this measurement is to keep the microphone fixed and slowly sweep the signal frequency over the entire audio range. Assuming the frequency characteristics of the loudspeaker and the microphone to be reasonably flat, variations in response will indicate standing waves in the room. However, this latter method does not indicate whether there may be any concentrations of sound at various points in the room.

The transient characteristics are measured by applying a test signal which has transient properties similar to those of natural sounds, and observing the resulting sound at the loudspeaker. This method has the advantage that the results can be expected to

Fig. 7. Typical decay curve obtained in measuring reverberation with a graphic recorder.

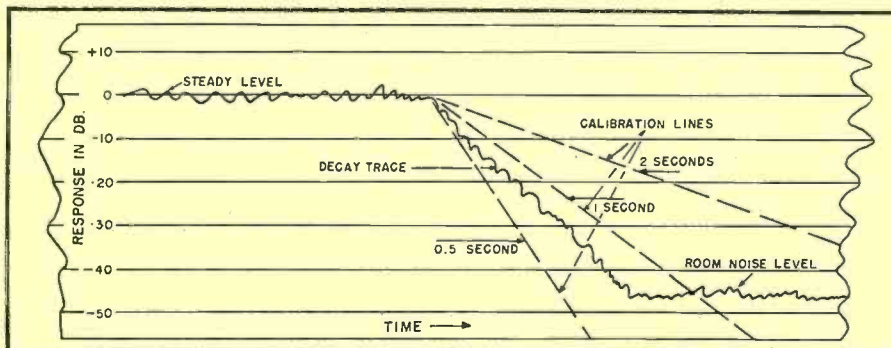

correspond closely to the actual conditions under which the room will most often be used. The complete test setup for this type of measurement is shown in Fig. 4. For a permanent record, the oscilloscope screen may be photographed. Otherwise, a graphic recorder may be used with a low-pass filter and d.c. amplifier as used in the reverberation-time measurement system shown in Fig. 6. In addition to the transient acoustic characteristics of the room, this system also gives considerable information concerning echoes and the location of the various reflecting surfaces which give rise to echoes and large-scale reflections.

The signal wave shapes are shown in more detail in Fig. 5, to give a better indication of the type of data obtained with this method of measurement. The output of the audio oscillator is a continuous sine wave which may be set to any frequency at which the acoustic characteristics are desired. The switching and synchronizing circuit contains a gating mechanism (either a motor-driven cam-operated switch or an electronic gating circuit) which permits the signal through in pulses as shown in Fig. 5B. The signal pulse length is adjustable from 0 to 50 milliseconds duration and is repeated at intervals of about 1 second, so that the reflected sound decays to a negligible value before the next impulse. The horizontal time scale on the oscilloscope screen can be set for a sweep time of 0.5 sec. across the face of the screen. (If a graphic recorder is used, the switching and synchronizing circuit will be set for just one signal pulse, and the recorded response will be the response to this one pulse.) The type of signal received by the microphone consists of the direct sound pulse plus whatever reflections there may be from any parts of the room, as shown in Fig. 5C. By measuring the time taken for any reflections to arrive at the microphone after the direct pulse, and by actually laying out and plotting the various possible sound paths between the loudspeaker and the microphone in the room under test, the location of the various reflecting surfaces can readily be determined.

In practice, each measurement should be taken at three different positions at each location in the room, and at several different frequencies over the entire audio-frequency spectrum. A total of at least 10 to 15 different pulse reflection measurements should be averaged for each location. This type of averaging will tend to cancel out any spurious spatial or frequency effects.

Part 2 of this article will include a discussion of such items as noise level, sound power output, frequency response, and room acoustics.

(To be continued)

# Special TRANSFORMERS

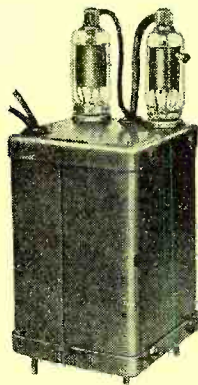

*Above: Special DC power supply unit, input 115 volts 60 cycles—output 2500 volts filtered DC at 5 MA.*

*Right: A high quality speaker line auto transformer, used in multiple speaker installations to adjust volume and impedance for each individual speaker.*

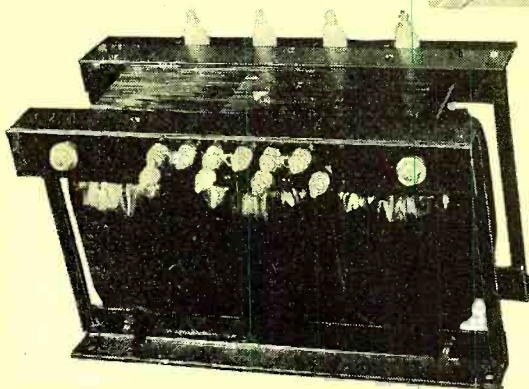
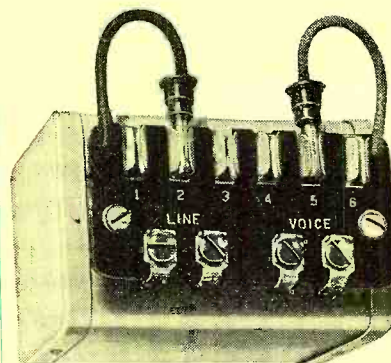

*Left: A three phase high voltage plate transformer, weighing over 300 pounds. Rectifier output is 11 KVA DC (7000 volts at 1.5 amps).*

The transformers illustrated show only three of the many which have been developed or manufactured by New York Transformer Company for special applications in radio, television and electronics. No matter how unusual your specifications, NYT will build transformers to

meet them! Special facilities also include the manufacture of hermetically sealed units to meet current JAN T-27 and other government specifications; and specially treated, lightweight, uncased units for airborne equipment.

*Let us know about your specifications and development problems. NYT experts and engineers are at your service.*

**NEW YORK  
TRANSFORMER CO., INC.**  
ALPHA, NEW JERSEY

# NEW PRODUCTS

## MERCURY ARC LAMP

Huggins Laboratories, 738 Hamilton Ave., Menlo Park, Calif., has announced the Ames Type-A mercury arc lamp



for light source in interferometers, Schlieren optical systems, shadowgraphs, monochrometers, and in high-speed photography. Light intensities of 90,000 candles per square centimeter can be reached at maximum brilliance with these units.

Arc dimensions are 2.85 cm. (1.125 in.) by 1 mm. (0.039 in.). Cooling is accomplished with ordinary tap water requiring 2½ gallons per minute, and average life at rated maximum brilliance is five hours.

Shown are the lampholder with lamp extracted, and in the background, the fully-controllable a.c. power supply. Light output is 65 lumens per watt; power input is 2 kw.; 1.2 amp. at 1750 volts.

## TEMPERATURE TEST CHAMBER

A compact, economical, and convenient temperature-controlled chamber for the rapid performance of ambient temperature tests is now being produced by *Statham Laboratories, Inc.*, 9328 Santa Monica Blvd., Beverly Hills, California.

The Model TC-1 Temperature Test Chamber is completely portable and self-contained and is especially de-

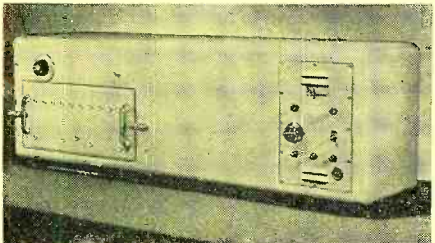

signed for the convenience of individual research workers and the small

laboratory unit as well as for the production line tests of all types of small products.

The unit is fully insulated and consists of a completely sealed inner chamber and outer cabinet of welded dural construction.

## COMPONENTS FOR DEFLECTION SYSTEMS

Four new components for use in 10-inch and 12-inch television receivers having deflection systems designed to use the horizontal-deflection amplifier tube 6AU5-GT and the high-voltage rectifier tube 1V2, are now being offered to equipment manufacturers by RCA's Tube Department, Harrison, N. J.

These new components, designed to operate efficiently with each other and

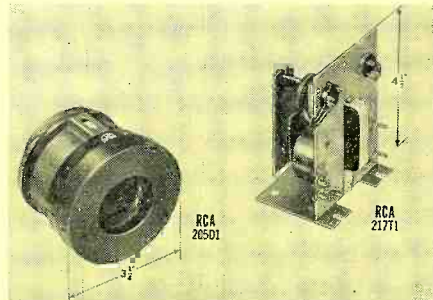

with the 6AU5-GT and 1V2, are Deflecting Yoke, Type 205D1; Width Control, Type 206R1, Horizontal Linearity Control, Type 207R1; and Horizontal-

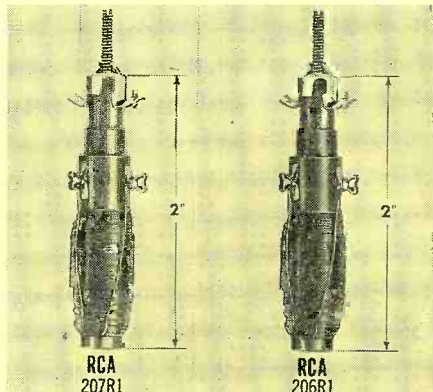

Deflection-Output and High-Voltage Transformer, Type 217T1.

The 205D1 magnetic deflecting yoke is intended for use with picture tubes having a deflection angle up to about 60° and operating at an anode potential up to 12 kilovolts. The 217T1 is designed for use with a single 6AU5-GT driver tube and with two 1V2 rectifier tubes in a voltage-doubler arrangement

to supply a d.c. output voltage up to 12 kilovolts.

## R.F. PHASE MONITOR

Model 109 high-precision phase monitor for measuring phase relations at radio frequencies was recently an-

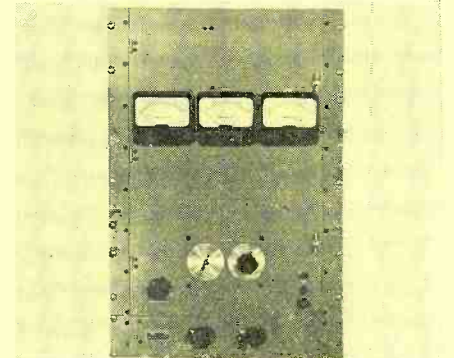

nounced by *Clarke Instrument Corporation*, 910 King St., Silver Spring, Md.

According to reports, the instrument has an absolute accuracy of  $\pm 1$  degree and resolution and repeatability of  $\pm 0.1$  degree. Phase is read directly from two dials calibrated in 0.1-degree increments. The instrument continuously and automatically indicates the phase difference and requires no manipulation on the part of the operator.

Model 109 Phase Monitor requires 28 inches of panel space and is supplied with finishes to match those used by the various manufacturers of transmitting and associated equipment.

## PULSE TRANSFORMERS

*Raytheon Manufacturing Company*, Waltham, 54, Massachusetts, is offering a complete line of pulse transformers suitable for use in driver circuits as blocking oscillator or interstage units.

A chart giving complete data on many of *Raytheon's* pulse transformer designs is available upon request. Write for DL-K-315, and address request to Department 6460-NR2.

## MINIATURE RESISTORS

*International Resistance Co.*, 401 N. Broad St., Philadelphia 8, Penna., has added to its line of BT Insulated Resistors two new miniature units. Type BTR at ½ watt meets JAN-RC10 specification and type BTB at 2 watts is equivalent to JAN type RC40.

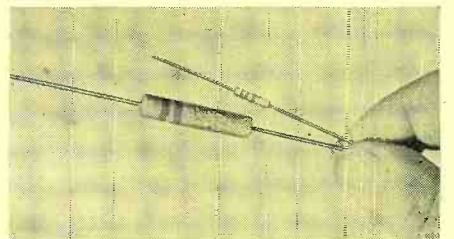

Like all Advanced Type BT's, these resistors are protected against moisture



by a phenolic resin housing molded at high pressure and copper leads are securely anchored inside insulation and heavily tinned for easy soldering.

Full data in catalog form is available by writing the company.

#### UHF OSCILLATOR

The Model 112 u.h.f. oscillator announced by *Measurements Corporation*, 116 Monroe St., Boonton, N. J., covers the frequency range of 300 mc. to 1000 mc. The frequency calibration is accurate to  $\pm 0.5\%$ .

Model 112 has a maximum output voltage, varying with frequency, between 0.3 volt and 2 volts, and provides

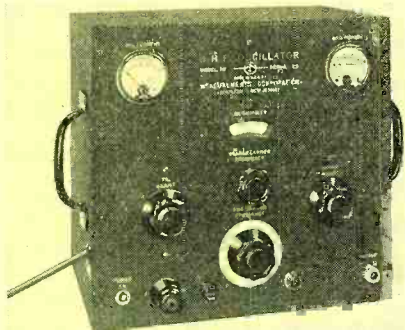

a tunable signal source between 300 mc. and 1000 mc. for measurements and testing such as tracking and alignment of u.h.f. receivers; standing wave measurements, transmission line measurements, antenna pattern measurements, impedance measurements and other applications.

#### ONE HALF OCTAVE FILTER

The Applied Acoustics Model SA-2 one-half octave filter is now available from *Gertsch Products, Inc.*, 11846 Mississippi Ave., Los Angeles 25, California.

Each filter is comprised of separate high and low pass filters each having seventeen different cutoff frequencies ranging from 37.5 cycles per second to 13,600 cycles per second in one-half octave steps. Selection of each cutoff frequency is made by push-button switches providing 203 useful positions.

The unit is available either in rack panel or carrying case and weighs 87 pounds.

#### COLOR SENSITIVE INSTRUMENT

A color-sensitive device which breaks up a light beam from any source into its spectrum, measures the relative spectral energy at each wavelength, and makes a permanent record of the measurements in the form of a graph has been announced by *General Electric's Special Products Division*.

Designated a "recording spectroradiometer," the instrument consists of a

grating monochromator, photometer recorder, and power supply. The spectroradiometer measures 25 x 27 in. x 23 in., weighs 150 lbs., and can scan the complete spectrum from 230 to 650 micrometers at speeds varying from 1 to 10 minutes, depending upon the nature of the spectrum.

Additional information on this device is contained in publication GEC-604 which is available to readers from *General Electric Co.*, Schenectady 5, N. Y.

#### TRANSFORMER CORE MATERIAL

Ferrocube is the new transformer core material introduced by *North American Philips Company, Inc.*, 100 E. 42nd St., New York 17, N. Y. It is a ferromagnetic ferrite which reduces electrical losses in components such as horizontal output transformers of the type used in television receivers; in intermediate frequency transformers such as are used in superheterodyne circuits and in amplifier transformers for long distance wire communication circuits. It is applicable also in other circuits requiring low-loss inductors, coupling transformers and intermediate frequency transformers.

Ferrocube is said to be extremely adaptable in molding and lends itself readily to the production of unusual or

difficult shapes and is now available from *Philips* in a number of standard shapes or in custom shapes to meet manufacturers' requirements.

#### D. C. CHOPPER

In response to a demand for a Chopper which will operate from d.c., *Stevens-Arnold, Inc.*, 22 Elkins St.,



South Boston, Mass., has announced the availability of their line of Self-Excited Choppers.

These Choppers offer modulation/de-  
(Continued on page 30)

**"DIE-FORMED TO GIVE YOU BETTER, MORE DEPENDABLE COILS!"**

**PRECISION PAPER TUBES . . .**

Precision gives you the plus . . . coil bases formed under heat and pressure. The result, a coil base of less weight—greater strength—more thorough insulation—more effective resistance to moisture, oil and heat. All at the very minimum of cost. It's a better coil that has a Precision base.

Precision Di-formed Paper Tubes are available in the best quality, dielectric Kraft, Fish Paper, Cellulose Acetate, Asbestos or combinations. Round, square or rectangular.

**TODAY — WRITE FOR FREE SAMPLE AND COMPLETE MANDREL LIST OF OVER 1,000 SIZES.**

#### LOOK AT THESE FEATURES:

- No need for coil, forming after winding.
- Automatic stacking.
- Wire saved by closer engineering of coil.
- No side bow.

**PRECISION PAPER TUBE CO.**

2063 West Charleston St.  
Chicago 47, Ill.  
Plant No. 2, 79 Chapel St.  
Hartford, Conn.

# NEWS BRIEFS

## PHYSICAL SCIENCE INTERNSHIPS

An integrated work-study program, beginning at the college-sophomore level, has been established by the National Bureau of Standards which offers vacation-time employment and graduate

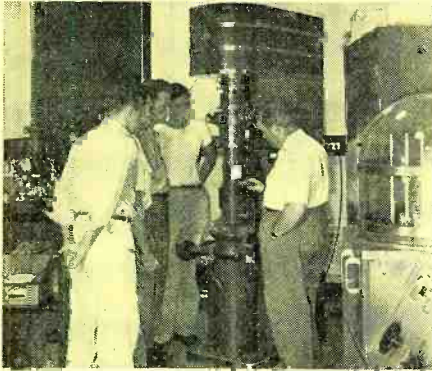

fellowships to outstanding students in science and engineering to broaden their undergraduate or graduate training.

Dr. L. L. Marton is shown demonstrating the operation of the electron microscope to a group of Science Aids in the Bureau's electron physics laboratory.

This program permits the student to alternate periods of full-time study with actual experience in his chosen field, supplemented by on-the-job training and orientation courses at the Bureau.

Information regarding qualifications for appointment may be obtained from the Personnel Division, National Bureau of Standards, Washington 25, D. C.

## ELECTRO HAS NEW PLANT

Electro Products Laboratories, pioneer manufacturers of Electro battery eliminators for radios, has a new location at 4501 North Ravenswood Ave.,

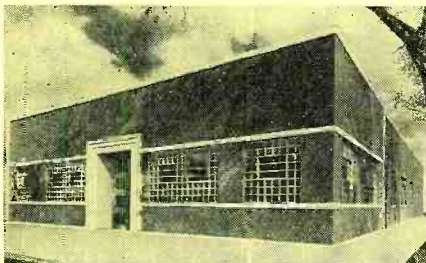

Chicago, Illinois, where both manufacturing and servicing facilities will be

improved. Expanded production facilities are also expected to improve delivery on the Pressuregraph and Synchronizer.

Spacious display rooms are designed for displaying and demonstrating electronic instruments, and a staff of factory trained technicians is ready to offer a systematized, highly efficient service for quickly repairing electronic instruments.

## PACKAGED TV STUDIO LIGHTING

The newest improvement to the modern television studio is RCA's packaged studio lighting system designed for use with television studio cameras. Among the items featured are high-intensity fluorescent banks, high-intensity spots, and incandescent banks to meet all studio lighting requirements.

All lights can be rotated 360° horizontally and 170 degrees vertically.

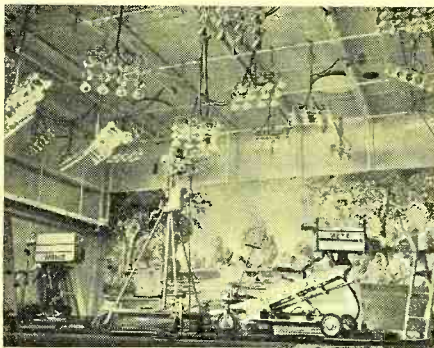

They are designed for pyramid-mounting on studio ceilings, and all are mechanically controlled through silent-operating fairleads that terminate in a central control board.

Shown is a typical studio layout using the packaged studio lighting system which is available through the Broadcast and Television Studio Equipment Section of the RCA Engineering Products Department, Camden, N. J.

## TV MONITOR REGISTERED

Television Utilities Corporation's TV monitor has been registered under the trade-mark "Private Eye." The first 30 units have been undergoing tests for many weeks at broadcasting stations, the company reports, with good results.

According to the manufacturer, these

monitors will match the performance of units costing three times as much and will stand any test required by engineers. Some of the equipment incorporated into this low priced unit is a foolproof synchronizing system, a video frequency response out to 4.5 mc. plus or minus 1 db. or better, and is equipped to operate on a wide range of input voltages.

## CONTROL TOWER INSTALLATION

A compact, modern control tower which aeronautical engineers expect will set the pattern for future installa-

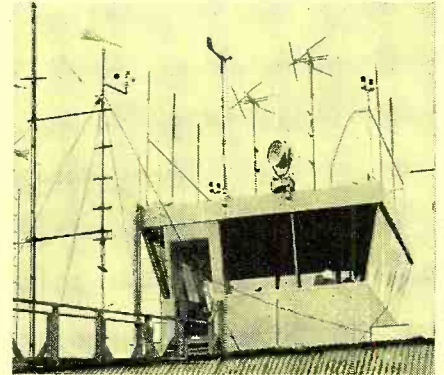

tions has been installed at the Reno, Nevada airport. Constructed by *United Air Lines* and operated by the CAA, the tower features polarized angled windows to eliminate glare, v.h.f. receivers and transmitters on all frequencies for contact with private, military and commercial aircraft, and a counter device to keep daily totals of all planes using the field.

Seen in the photograph are the two "spider web" type antennas for v.h.f. transmission, obstruction lights, anemometer, beacon light, and a flashing light gun to direct aircraft with no radio receivers.

## MARITIME STUDENTS STUDY RADAR

A *Westinghouse* three-centimeter radar set has been installed at the Alameda, California, Training Station of the U. S. Maritime Service to give



students a thorough training in the theory and operation of radar, as well

as scope interpretation and radar navigational techniques. Students receive first hand experience under simulated marine conditions and are given approximately eight hours of practical instructions using the radar set.

Left, Lt. Commander Jack Halpern, instructor in charge of radar and loran classes, is showing a student how to adjust the brightness of the range markers.

The *Westinghouse* radar set, consisting of two parts, has a 50 kw. nominal peak power output. The antenna, on the top of the "deck house," is of the enclosed radome type.

#### MAST FOR PROBING OF TRANSONIC SPEEDS

*G. M. Giannini & Co.*, Pasadena manufacturer of flight test instruments for supersonic aircraft, has designed a new instrument mast for *Northrop Aircraft, Inc.* which delivers its information by radio telemetering to ground recorders.

Housing self-contained temperature, speed, pitch and yaw instruments, it is expected to reduce lag errors seen in



conventional cockpit dial instruments operated by air pressure lines carried in a probing mast. Telemetered reactions of instruments in the *Giannini* mast are flashed to recorders at the speed of light.

#### ELECTRONIC DISPATCHER FOR ELEVATORS

Engineers of the *Westinghouse Elevator Division*, Jersey City, N. J. have developed sensitive vacuum tube devices to accelerate the automatic dispatching of high speed elevators.

These electronic circuits, which transmit thousands of split-second impulses every hour, have been incorporated into the *Westinghouse* Selectomatic elevator control system to integrate cars, floors and push-button calls into a smooth flow of service to all floors.

First installations of the system will be made in the Merchants Exchange,

Memphis, Tenn., and the projected 39-story Mellon-U. S. Steel skyscraper at Pittsburgh, Pa.

Two of the new developments include an electronic timer which serves as the core of the dispatching system, and an electronic counter which insures adequate service on the lower floors when regular low-zone cars have been speeded up to aid service on upper floors.

#### CENSUS MACHINE DEMONSTRATED

A machine which combines in one operation the simultaneous functions of classifying, counting, accumulating,

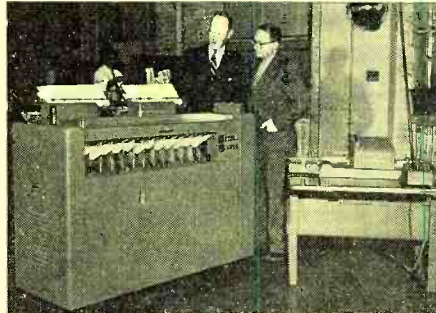

and editing and then prints the statistical data resulting from groupings of information was recently demonstrated at the Washington head-

quarters of the Bureau of the Census.

The Electronic Statistical Machine, which was developed by *International Business Machines Corporation*, has a capacity up to 10,000 units in each of 60 different classifications while simultaneously sorting the cards into predetermined groups at the rate of 450 cards a minute.

Mr. Louis H. LaMotte, *IBM* Vice-President, is shown making the presentation to Dr. Philip M. Hauser, right, Acting Director of the Bureau of the Census.

#### U. OF MASS. ENGINEERING LAB

The School of Engineering at the University of Massachusetts recently dedicated its newest addition, The Gunness Engineering Laboratory, named for Christian I. Gunness, late head of engineering at the university.

The building contains classrooms and laboratories for the departments of civil, mechanical and electrical engineering, servicing the needs of about 500 students majoring in these fields.

At a cost of \$475,000, the building contains a double classroom seating 100 students, five staff offices, a main office and quarters for the maintenance staff.

# Large or Small

## SQUARE, ROUND OR RECTANGULAR PAPER TUBES

FOR COIL WINDING



SEND FOR ARBOR LIST  
OF OVER 1000 SIZES

**Inside Perimeters from .592" to 19"**  
With specialized experience and automatic equipment, **PARAMOUNT** produces a wide range of spiral wound paper tubes to meet every need . . . from 1/2' to 30' long, from .592" to 19" inside perimeter, including many odd sizes of square and rectangular tubes. Used by leading manufacturers. *Hi-Dielectric, Hi-Strength.* Kraft, Fish Paper, Red Rope, or any combination, wound on automatic machines. Tolerances plus or minus .002". Made to your specifications or engineered for YOU.

---

Paramount PAPER TUBE CORP.

613 LAFAYETTE ST., FORT WAYNE 2, IND.

Manufacturers of Paper Tubing for the Electrical Industry

# NEW TUBES

## RCA TV TUBES

Two new tubes which will, according to reports, provide high efficiency operation of horizontal deflection systems

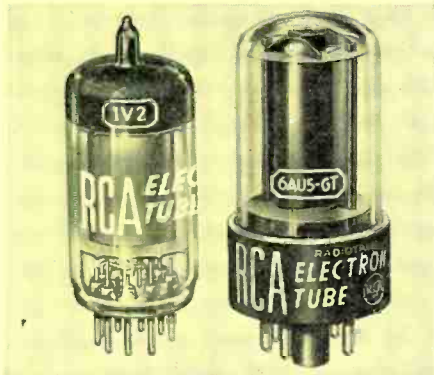

for ten-inch and 12-inch picture tubes are now available from the Tube Department, *Radio Corporation of America*, Harrison, N. J.

The 6AU5-GT is a high-perveance, beam power amplifier of the single-ended type. Its features include low mu-factor, high plate current at low plate voltage, and a high operating ratio of plate current to grid-No. 2 current. A power supply of 250 volts, or less, is all that is required for a receiver utilizing such a deflection circuit and the 6AU5-GT.

The 1V2 is a high-voltage, half-wave rectifier tube of the single-ended, 9-pin miniature type. When used in a doubler circuit which is transformer coupled to a horizontal-deflection circuit employing the 6AU5-GT, the 1V2 is especially suited for rectifying the high-voltage pulses provided by the transformer.

## SYLVANIA TUBES

### Transmitting Tubes

*Sylvania Electric Products Inc.*, 500 Fifth Ave., New York 18 now has available five transmitting tubes for ama-

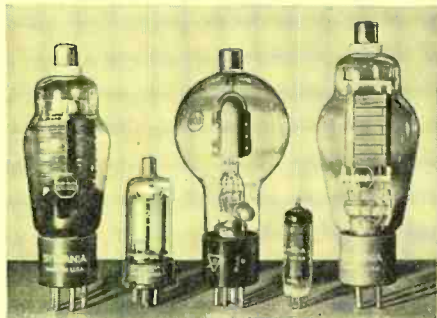

teur, mobile and portable applications. Tubes in this group include two power

triodes, a v.h.f. beam power amplifier, a pentode power amplifier oscillator and a miniature beam pentode.

Types 811A and 808 power triodes are suitable as a class B a.f. power amplifier and modulator; for plate modulated r.f. power amplification in class C telephony; as a self rectifying amplifier; and as a class C amplifier.

The v.h.f. beam power amplifier, type 2E24, is designed for use as a plate modulated r.f. power amplifier in class C telephony and as an r.f. power amplifier and oscillator in class C telegraphy.

The pentode power amplifier oscillator is type 2E22 for class C r.f. amplifier or oscillator service and as a suppressor modulated class C amplifier. The miniature beam pentode, type 2E30 is suitable for use as a class A1, AB1 or AB2 a.f. power amplifier and modulator; r.f. power amplifier and oscillator in class C telegraphy; and as an r.f. power amplifier in class C telephony.

### Receiving Tubes

Three new receiving type tubes have also been announced by *Sylvania*. They



are an audio frequency amplifier, type 12AY7, an r.f. amplifier for television, type 6BC5, and a horizontal deflection amplifier for television, type 6BQ6GT.

Type 12AY7 is a T6½ miniature, medium-mu duotriode particularly suitable for use in the first stage of an a.f. amplifier where absence of noise and microphonism is desirable. The r.f. amplifier is a T5½ miniature sharp cut-off pentode having high mutual conductance, designed for r.f. and i.f. amplifier applications in television receivers. Type 6BQ6GT has been designed and processed for transformer operated sets where high peak inter-electrode voltages are encountered.

### REDESIGNED PENTODE

The Application Engineering Department of *Eitel-McCullough, Inc.*, San Bruno, California, has announced a radically redesigned 4E27 type pentode including such features as a moulded-glass header, shell type base, low-loss

leads, non-emitting grids and a Pyrovac plate.

Designated 4E27A/5-125B, its physical size and basic electrical characteristics make it directly interchangeable

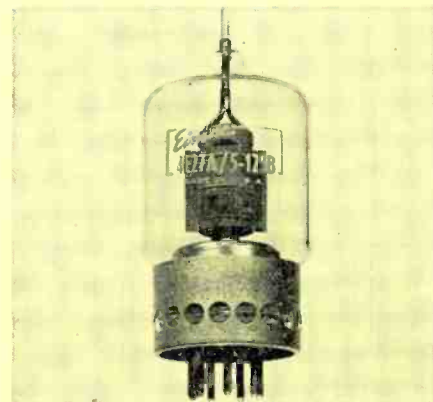

with type 4E27. It is rated at 125 watts plate dissipation and although designed for v.h.f. service, is well suited for television service and air-navigational aids, as well as for general r.f. and audio applications.

## GE TUBES

### Wide-Angle TV Tube

Production in limited quantities on a new wide-angle 16-inch metal television picture tube has been announced by *General Electric's* plant in Syracuse, New York.

Type 16GP4 is five inches shorter than conventional tubes of this size to allow for development of more compact home receivers for the larger picture. Also featured is a "filter-glass" face plate which is said to improve picture contrast and clarity by reducing halation and cutting down reflections from surrounding light sources.

### Miniature Tube

Also announced is the 6BC5 miniature tube designed primarily for use as a radio-frequency and intermediate



frequency amplifier in television and FM receivers now in production.

The 6BC5 is an improved version of the 6AG5 and is interchangeable with that tube. The chief difference is an increased transconductance which was obtained with a plate voltage of 250 volts and a screen voltage of 150 volts, thus raising the transconductance from 5000 to 5700 micromhos.

## V. H. F. Tank Design

(Continued from page 9)

well at low frequencies and where the tube interelectrode capacities are small. At higher frequencies, or with tubes having high interelectrode capacities, the added tuning capacity often results in sharply reducing the effective physical length of the tank and a consequent reduction of efficiency.

2. A variable shorting bar provides a tuning method which is essentially a means for electrically lengthening or shortening the tank to the desired frequency. While its approach is simple and straightforward, the mechanics for smooth positive operation may become somewhat involved. The mechanics of the shorting bar action must also assure that there will be no arcing or appreciable wear at the shorting points. Since these parts are usually silver-plated this requires a heavier plating of silver because of the wear encountered.

3. Varying the surge impedance of the tank is being used advantageously in several pieces of commercial equipment which are now on the market. Fig. 4 shows the power amplifier of a Gates 3 kw. FM transmitter. This was the first commercial transmitter to utilize this method of tuning.

As was shown in Eq. (4), the resonant frequency of the tank circuit is also dependent on the characteristic surge impedance. The characteristic surge impedance is lowered by the presence of a metal plate or plane parallel to the tank. As this plane is brought closer, the surge impedance is rapidly lowered which results in a consequent increase in resonant frequency. Referring to Fig. 5, it will be seen that in practice this metal plate or vane is bent in a "U" shape and pivoted at the shorted end of the tank. The top end is swung in to increase the frequency and swung out to decrease the resonant frequency. This has the obvious advantages of eliminating all r.f. wiping contacts, while simultaneously providing a simple positive mechanical arrangement which maintains complete circuit symmetry. In common with the shorting bar method, the physical length of the tank is kept long enough to maintain highest efficiency.

4. The introduction of a variable dielectric material between the tank legs or elements provides another method of tuning a tank circuit. The dielectric serves to decrease the propagation constant and change the surge impedance. Probably a pivot arrangement similar to Fig. 4 would serve as a convenient mechanical method for varying the dielectric between the legs of the tank. To the writer's knowledge there is yet no commercial adaptation of this on the present market.

Since the tank circuit and its shielding are so closely related, the design of the tank should encompass this as well. An effective shield enclosure of the tank and/or tubes provides an often mandatory degree of isolation required for stability and freedom from oscillations which might otherwise occur. Often this enclosure can conveniently serve as part of the cooling system. The radiation losses from a balanced type push-pull tank may be reduced to a negligible amount by using highly conductive shielding material. Fig. 5 illustrates such an enclosure. It is interesting to note that a high degree of isolation for increased stability is provided by this construction, as is an efficient tube cooling system. Further examination will disclose that flat type tank elements are employed and the variable surge impedance method of tuning is used in conjunction with semi-fixed capacitor plates at the bottom of the tank. The tuning vane affords a fine or vernier tuning range of several hundred kilocycles, while the capacitor plates serve to extend the lower frequency limit enabling coverage of the complete 88-108 mc. FM band.

Since the flow of r.f. currents is confined to the surface at v.h.f., due to skin effect, it is paramount that this surface present low r.f. resistance. Silver offers

the lowest resistance and is to be preferred. It is, however, quite expensive and for this reason silver plating is usually employed for the conducting surface. As brass takes a fine even plating and is very machineable, it is often used.

It is necessary that the plating be smooth with a highly polished surface as a spongy plated surface is little better than the brass itself.

In laboratory and experimental work the polished brass or copper surface will often suffice. A coating of very thin clear lacquer will assist materially in keeping the surface bright and free from tarnishing.

Aluminum also has high conductivity. While its conductivity is not quite as good as that of silver, the writer has used it successfully in several experimental models. Fig. 1 illustrates one such experimental unit in which sheet aluminum was used as the tank elements.

Aluminum is favored by several manufacturers for fabricating the shield enclosures of the plate and grid tanks of their equipment. The plate tank enclosure of Fig. 3 is of all aluminum welded construction. Aluminum is easily and beautifully finished by a simple etching process. A thin coating of clear lacquer will retain the finish almost indefinitely. —(C)—

# HOOK-UP WIRE

**in all color tracers  
all gauges—single  
& multiple cond.  
Also shielded**

as per **JAN-C-76**

	STRANDED	SOLID
gauge #20	9.89	8.90
#22	9.07	8.16

per thousand feet of EACH  
color and size f.o.b. New York.

**25% discount if color tracer per our choice**

**LEGRI S COMPANY, INC.**

New York 25, N. Y.

Phone: Academy 2-0018

130 West 102nd Street

"HEADQUARTERS" for resistors  
and potentiometers made by  
*Allen-Bradley Co.*

**ASK FOR  
OUR PRICES**

# TECHNICAL BOOKS

## "ACOUSTIC MEASUREMENTS"

by Leo L. Beranek, S.D., D.Sc. (Hon.). Published by *John Wiley & Sons, Inc.*, 440 Fourth Avenue, New York 16, N. Y. 914 pages. \$7.00.

Dr. Beranek, vice-president of the Acoustical Society of America, has written this clear and concise exposition of acoustic measuring techniques as an aid to five main groups of research workers; the acoustic physicist, the communications engineer, the psychologist, the otologist, and the industrialist.

It is an encyclopedia of acoustic measuring techniques which presents the source of the theory of many electroacoustic phenomena, and a detailed description of the basic types of acoustic measuring devices. Topics range from the calibration of microphones and loudspeakers to evaluation of over-all audio systems, and to chapters on the audiometer, speech articulation tests and the sound level meter.

The material in this book, which is one of the few of this nature published, is of prime importance to all concerned with acoustics in any phase of their work or study and will be equally valuable to the graduate student or research worker.

## "ELECTRICAL ENGINEERS HANDBOOK, Volume 1, Electric Power, by Harold Pender and William A. Del Mar. Published by *John Wiley & Sons, Inc.*, 440 Fourth Avenue, New York 16, N. Y. 1698 pages. \$8.50.

This is the fourth edition of Pender's "Handbook for Electrical Engineers," which first appeared in 1914. This fourth edition, as was the third, is divided into two volumes: one on electric power and the other on electrical communication and electronics. Tables and fundamental theory are duplicated in the two volumes in order that each might be complete and independent of the other.

Seventy-one specialists in their respective fields have contributed to this edition which is entirely rewritten. Subjects including circuit stability and symmetrical components, electronic rectifiers, aircraft equipment, heat pumps, servomechanisms, permanent magnets, plastic insulating materials, and induction and dielectric heating apparatus, all of which have become of increased importance, are thoroughly covered.

Although a greater degree of specialization in the various phases of

electrical engineering have necessitated enlarging both volumes, these books have been kept compact and readable.

## "INDUSTRIAL ELECTRONICS"

by Andrew W. Kramer. Published by *Pitman Publishing Corporation*, 2 West 45th St., New York, N. Y. 311 pages. \$6.00.

Here is a valuable book for the practical man in industry who is interested in all the various new uses of electronics. A complete description of electron tubes, how they were evolved, and how they work is given as an invaluable aid in determining how the new methods and equipment can be used for improving maintenance and operations in the industrial plant.

The book begins with a brief historical background and a consideration of electron theory presented in a simple, clear, language. The fundamental principles of electronics are explained without the use of mathematics and the application of these principles in industry is clearly shown. The book also supplies necessary information on the operation and maintenance of electronic equipment.

The basic material of this volume appeared first as a series of articles on electron tubes in *Power Plant Engineering*. All the original material has been revised and a great deal of new material added to bring the entire work up to date.

## D. C. Amplifier

(Continued from page 13)

to ground). In this case, it can be shown that the gain of one stage working into infinite load impedance is one-half the amplification factor of the tube used, whether the cathode resistors are bypassed or not. A formula giving the gain for finite load impedances will be given later. This formula shows that bias cells may be useful to avoid degeneration in the cathode resistors.

The use of pentodes with a floating power supply permits the realization of extremely high d.c. stage gains (up to 4000) into loads of high impedance, such as tube grids or cathode-ray deflection plates. Fig. 2 shows how constant screen voltages of about 70 volts may be obtained by means of small neon bulbs.

Many variations on the original scheme are possible. As an example, Fig. 7 shows a stable low-impedance driver circuit with output at zero d.c. level. This is the equivalent of a compensated cathode follower, and is useful to drive recorders, indicating devices, and similar instruments.

## Application of Feedback

Since both input and output voltages of the new amplifier constitute positive and negative excursions with respect to a zero d.c. reference level, the application of feedback over one or more stages is especially easy. In Fig. 3 regeneration over two stages and degeneration over three stages is shown; this is a typical balanced feedback circuit and reduces distortion in the output stage to a minimum. Fig. 2 shows how a high-gain pentode stage is stabilized through the use of inverse feedback.

## Experimental Results

An electronic voltmeter connected to the output of the three-stage amplifier in Fig. 3 did not show any noticeable deflection when the *B* supply was switched on or off after careful balancing. Changes of 20% in the filament voltage had similarly little effect on the balance. Long-term drift seems to depend largely on the stability of the resistors used in the circuit.

## Circuit Analysis of the Bridge-Balanced Amplifier

It can be shown from the equivalent circuit of the amplifier that the circuit design equation for the case of the floating power supply is:

$$E_o = \frac{-\mu R_L}{(\mu + 1) R_k + R_p + 2 R_L + R} E_i$$

which is independent of plate and filament voltages. For very large load re-

Fig. 6 (A) Simplest form of the new amplifier. Power supply is shown with center tap grounded. (B) Conventional amplifier stage for computing gain. The gain of (A) is exactly half that of (B).

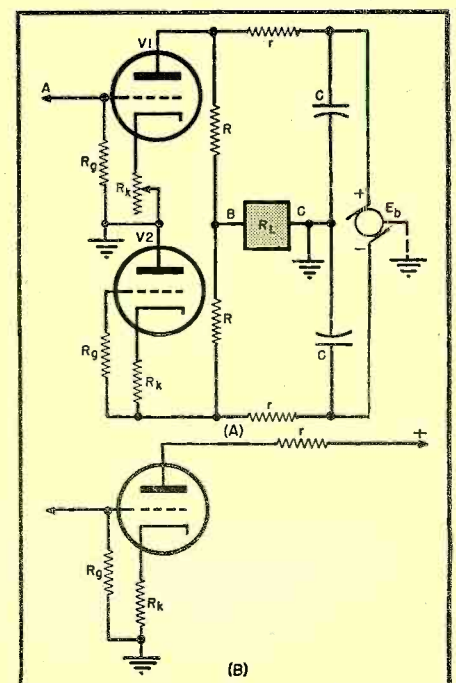

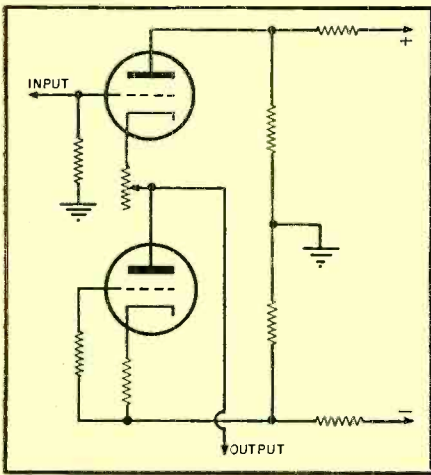

Fig. 7. A stable low impedance driver circuit with output at zero d.c. level.

sistances  $R_L$  may be expressed as:

$$\frac{E_o}{E_i} \approx -\frac{\mu}{2}$$

From the equivalent circuit of the amplifier with a center-tapped power supply, it can be shown that the gain is:

$$E_o = \frac{-R_L \mu}{[R_p + R_k(\mu + 1)]r + Rr + 2R_L[R_p + (\mu + 1)R_k + r]} E_i$$

for  $R_L = \infty$ , this reduces to

$$E_o = \frac{-E_i}{2} \frac{\mu r}{R_p + (\mu + 1)R_k + r}$$

which is just one-half of the gain of the amplifier shown in Fig. 6B.

For a perfectly balanced condition of the bridge, the effect of slow plate and filament variations on the output will be very small.

The engineer, physicist and experimenter will discover many new uses for this simple circuit which is easily built with a minimum of circuit components and is particularly well-suited to portable battery-operated applications.

A few modern applications of the new d.c. amplifiers are suggested by the illustrations presented.

#### Acknowledgement

The project described in this article was carried out in May, 1947, under a grant from the Applied Mathematics Division, Brown University, Providence, R. I. The writers wish to thank Professors Krumhansl and Prager for their encouragement and cooperation, and to thank Mr. G. Heckler for his able assistance with the laboratory work.

#### REFERENCES

1. Miller, *Electronics*, November, 1941.
2. Artzt, *Electronics*, August, 1945.
3. Ginzton, *Electronics*, March, 1944.
4. Ginzton, *IRE Proceedings*, November, 1948.
5. Raggazini et al., *IRE Proceedings*, May, 1947.

# Personals

**WILLIAM B. BERGEN**, director of the Special Weapons Department of *The Glenn L. Martin Company*, has been named chief engineer in charge of the company's engineering activities. A graduate of the Massachusetts Institute of Technology, Mr. Bergen received the Lawrence Sperry Award of the Institute of the Aeronautical Sciences in 1943 for his theoretical and experimental investigations of dynamic loads on aircraft.



**R. T. CAPODANNO** has been appointed Director of Engineering at *Emerson Radio and Phonograph Corporation*, New York. Mr. Capodanno was previously connected with the University of Illinois as engineering adviser on technical devices for the hard-of-hearing, brain wave studies and spinal work. He is a member of RMA's Sound Systems Committee and has served as an engineer on communications with *Illinois Bell Telephone Co.*



**DR. ALEXANDER ELLETT** was recently elected vice president in charge of research by directors of *Zenith Radio Corporation*, Chicago, Illinois. Dr. Ellett, who has headed *Zenith's* research laboratories since 1946, was formerly head of Division 4 of the NDRC where he directed the development of the V-T proximity fuse for bombs and rockets for which he received the President's Medal for Merit. He was also formerly professor of physics at the University of Iowa.



**CARL J. HOLLATZ**, formerly vice-president of the *Belmont Radio Corporation*, has been retained as a consultant to the Sales division of the Tube Department of RCA. Mr. Hollatz will make his headquarters in Chicago. Prior to his connection with *Belmont*, Mr. Hollatz was Manager of the *Westinghouse Company's* tube operations in Indianapolis, and later President and General Manager of *Ken Rad Tube and Lamp Corporation*.



**DR. THOMAS J. PARMLEY** has been appointed to the staff of the National Bureau of Standards where he will do research in the x-ray laboratory of the Atomic and Molecular Physics Division. Before joining the Bureau in 1927, Dr. Parmley was a professor of physics at the University of Utah. He has done considerable research in nuclear physics, including investigations of the radioactivities of the heavier cobalt isotopes.



**DR. FRANK B. JEWETT**, for many years vice president of the *American Telephone and Telegraph Company* and former president of the National Academy of Sciences, passed away November 18. Dr. Jewett had been named to receive the 1950 medal of the Industrial Research Institute, Inc., in April.



## D. C. Voltmeter

(Continued from page 7)

mer Avenue, Newark 4, New Jersey—and used to seal electronic components into metal cans. The leakage resistance of these beads is quoted at 10,000 megohms after a salt spray test. Before this test and as normally received these

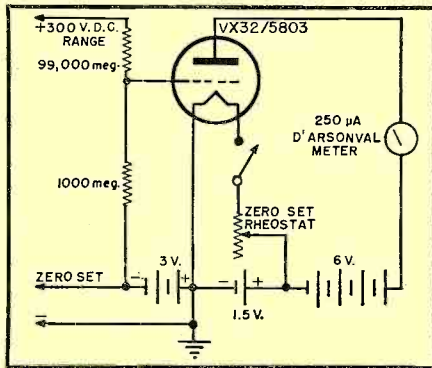
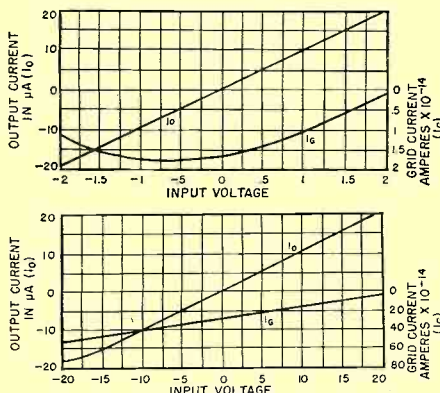

Fig. 3. Basic schematic of voltmeter. Basic voltmeter range is seen to be 3.0 volts full scale.

beads are of infinitely higher leakage resistance, probably on the order of  $10^{12}$  ohms. To maintain this leakage resistance it is advisable to cover the bead surface with *Dow-Corning DC4* if the instrument is to be used in a high humidity area or if other contamination is possible. Under no condition use any cleaning agent other than clean pure alcohol or carbon tetrachloride and a piece of clean cotton cloth, if contamination is suspected. If it is desired to use a plastic insulator then polystyrene should be used, but for the use indicated in this article a glass bead is to be preferred. Polystyrene is very difficult to clean and maintain in a clean state. It would require several pages to go fully into a cleaning technique for use with polystyrene but the following will generally prove adequate. Polish the polystyrene surface with ordinary paper towel to a brilliant surface. After installation wash the exposed leakage

Fig. 5. Calibration and grid current for the electrovoter circuit of Fig. 1. Top, 0-2 volt range; bottom, 0-20 volt range.



paths with carbon tetrachloride. If desired then coat with *Dow-Corning DC4*.

Electrometer tubes do not as a rule use over 6 volts on the plate, while the filament requires 1.1 to 1.5 volts with a filament current of 10 milliamperes. The plate current (VX32/5803) will be about 250 microamperes with zero bias and 6 volts plate supply. Two and one half volts bias will provide cutoff. For maximum sensitivity a plate current of 150 microamperes should be used and a balancing circuit utilized so that a plate current meter will indicate only the change in plate current. This will minimize any tube nonlinearity as well as provide very high gain. In cases where high gain and low drift are desired the filament should be lit a few seconds before the plate voltage is supplied. The input impedance on these circuits can be made so high that static electric charges, such as generated on a hair comb, can be measured.

One major factor which limits the usable input resistance is  $RC$ . In the design of these circuits,  $TIME\ IN\ SECONDS$  to obtain a meter deflection is a product of resistance (in megohms)

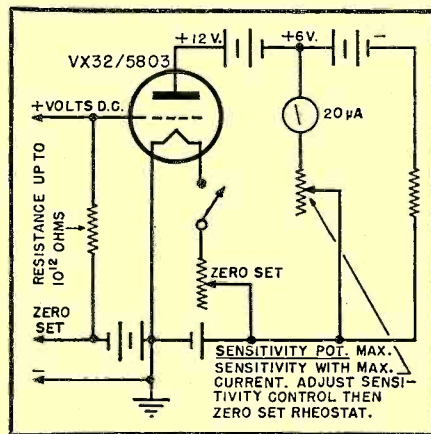

Fig. 4. An ultra-sensitive voltmeter.

times capacity in  $\mu fd.$  and is an important consideration. VX32/5803 electrometer tubes have an internal capacity of approximately  $2.0\ \mu\mu fd.$  An additional capacitance of  $2.0\ \mu\mu fd.$  can nominally be expected due to external wiring—even though great care is used. The product of  $10^{12}$  ohms resistance times  $4.0\ \mu\mu fd.$  is some four seconds,  $10^{11}$  (100,000 megohms) some 0.4 seconds. It is not considered good practice to have an instrument which requires over 1.0 second ( $RC$ ) time, and it is preferable to have an  $RC$  time of 0.1 second. In actual practice time up to several seconds is not too objectionable providing the d.c. voltage to be measured is stable. To minimize capacity the electrometer tube should be in a probe (with its grid resistor) and an extension cable used to connect it to the D'Arsonval meter and batteries. Several circuits will be found in the text, any one of

which will be suitable for measurements where very high input impedances are required.

## New Products

(Continued from page 23)

modulation in one unit, and are particularly well-suited for use in aircraft where there is a d.c. as well as an a.c. power source available.

A complete description of the Self-Excited Choppers appears in the company's Catalog No. 267 which may be obtained upon request.

## RADIATION COUNTER TUBE

A new, thin metal wall Radiation Counter Tube for beta and gamma detection is now being manufactured by

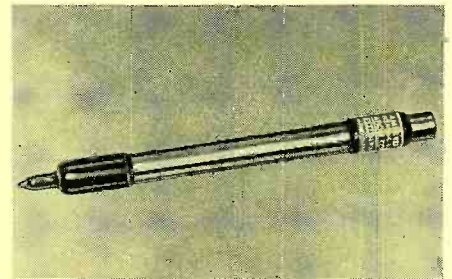

*Amperex Electronic Corporation*, 25 Washington St., Brooklyn 1, N. Y.

Type 52N may be operated over a wide temperature range without affecting tube life or electrical characteristics, and accidental overvoltage will not harm this tube.

Complete data on the Radiation Counter Tube, Type 52N may be obtained by addressing an inquiry to Mr. Myron Smoller, Sales Engineer.

## WELDING CONTROL EQUIPMENT

*Westinghouse Electric Corporation*, Pittsburgh, Pa., now has available two all-electronic, high-speed resistance welding control equipments for synchronous and non-synchronous operation. These equipments have no moving parts in power and control circuits except initiation and solenoid relays.

Basic control panels consist of the plug-in Rectox rectifier tube firing panel for non-synchronous units, or a heat-control firing panel for synchronous units. Space is also provided for the addition of auxiliary control panels such as a.c. forge timer, d.c. precision-type forge timer, wave-shape control, voltage compensator, initial-squeeze attachment, current regulator, temper sequence weld timer, dual weld attachment, interlocking relay attachment, dual weld interval attachment, and a Timatic control attachment.

Further information may be obtained by writing to *Westinghouse* at P.O. Box 868, Pittsburgh 30, Pa.



## Antenna Pattern

(Continued from page 15)

taken when the equipment is used in measuring the pattern of an antenna on location. The principal advantage of measuring antenna patterns on location is the opportunity afforded to determine the effect of surrounding objects such as guy wires, smoke stacks, and other mounts.

### Acknowledgment

The work described in this paper was carried out as a development program of the Naval Research Laboratory and a production engineering program of *Airborne Instruments Laboratory, Inc.*

## Rugged Electron Tube

(Continued from page 11)

the tube structure as rigid as possible to avoid resonance with high-frequency vibrations. It is extremely important to employ low-strain designs at all points of glass-to-metal contact and to eliminate brittle materials wherever possible. It is often useful to carry out a theoretical analysis for an idealized structure approximating the structure of the tube under consideration. In this way, the designer can achieve a rough guide to the resonant frequencies of each tube element and an indication of whether or not a proposed design will be satisfactory.

### High-Impact Shock Tests

Impact tests determine the ability of electron tubes to withstand rough handling and dropping. Shocks of this sort occur in shipment of tubes, in motor vehicles, in military operations, and in use with industrial equipment. Impact shocks result in tube failures of the same general type as those produced by vibration and resonance, but shattering of the glass envelope and breaking of brittle metal parts are more frequent.

The high-impact machine used at the Bureau consists of a test table, on which the tube is mounted, and a hammer suspended like a pendulum so that the energy imparted to the table will be a function of the angle from which the hammer is released. The table and hammer weigh about 75 pounds apiece, and the impact machine can test tubes weighing up to 25 pounds. Tubes may

be mounted in any desired plane, and normal operating potentials or shorting indicators can be connected to the tube elements. Instantaneous accelerations up to a maximum of several hundred times the acceleration of gravity and down to a minimum of 50g may be readily selected. The duration of impact is less than a millisecond. Impact accelerations are measured with a quartz-crystal accelerometer and verified by means of streak photography.

### Centrifugal Acceleration Tests

High-acceleration conditions are met principally in the application of electron tubes to electronic equipment in high-speed devices, where tubes receive large continuous forces for relatively long periods of time compared to the brief, transient-force conditions under impact. A tube which will withstand high accelerations must have great structural rigidity to prevent shifting and bowing of the various electrodes.

The motor-driven centrifuge now in use in the Electron Tube Laboratory of the Bureau can produce accelerations up to several thousand times the acceleration of gravity. Its rotational speed, as measured with a tachometer or with a stroboscopic pick-up, ranges up to 18,000 r.p.m. The centrifuge can be modified to increase the acceleration by evacuating the chamber so that the driven element will not be opposed by the resistance of the air. The speed of a centrifuge can be closely and easily controlled, making it possible to reproduce particular test conditions on different centrifuges. This cannot usually be done with other types of dynamic test equipment.

Objects weighing up to several ounces—and this includes almost all miniature and subminiature tubes—may be tested in the present centrifuge. As many as a dozen tubes can be placed in the chamber at one time. Tubes can be oriented at various angles to the direction of acceleration in order to study the differences in rigidity of components in different directions. Newer centrifuges permit connection of typical operating potentials to the tube elements so that the electrical performance can be studied during high acceleration. Centrifuges have been designed to give very high accelerations—the Beams type is notable in this respect. In the near future the Electron Tube Laboratory will place such a high-acceleration centrifuge into operation.

Centrifuge acceleration tests provide a good over-all quality check for electron tubes. The most common tube defects revealed by acceleration tests are high bending moments, inability of the glass envelope to support the internal structure, breaking of welds, bowing of elements, and interelectrode

shorts. Taken together, the vibration, resonance, impact, and acceleration tests provide a useful picture of tube behavior when subjected to mechanical forces.

### Testing and Design

The development of rugged electron tubes is a good example of the interdependence of testing and design. In a sense, the creation of rugged tubes is brought about through a series of successive approximations. The development of a rugged tube might begin by applying appropriate mechanical tests to an existing commercial type whose electrical characteristics suit the intended application. The results of these tests would show in what way this tube type fails to meet the ruggedness requirements. A preliminary revision of the tube design could then be made with the test results as a guide, and a hand-made model constructed in the model shop. The same tests could then be repeated for this experimental tube. Usually the tube would turn out to be a vast improvement over the commercial type, but in some respects it might not yet fulfill the necessary ruggedness requirements. At this point the designer would probably have a clear idea of the direction to take in order to achieve a satisfactory rugged tube. It might involve a search for better materials for use in some tube elements, new methods of fabrication adapted to eventual mass production, or better geometrical configurations and alignment of tube elements for maximum rigidity. The influence of each structural element on the over-all strength of the tube would be carefully considered. Thus, through a succession of several trial designs a suitable rugged tube would be evolved.

At present the cost of rugged tubes is about three or four times more than conventional tubes. But it is not unreasonable to expect that as more is learned about production methods and materials applicable to rugged tube types the cost will be much less and all preferred tube types will eventually be available in ruggedized form.

### PHOTO CREDITS

- 3, 4.....DeMornay Budd, Inc.
- 10, 11...Nat. Bureau of Standards
- 12, 13.....Curtiss-Wright Corp.
- 16, 17, 18.....General Radio Co.
- 20 (top)...John and Drew Eberson, Architects
- 20 (ctr.).....H. H. Scott

## C.T.I. TRAINED MEN ARE AVAILABLE!

Each month C.T.I. graduates ambitious young men who have completed an intensive course in Radio and Television maintenance and repairing. Their training has been practical. They've learned by working on modern equipment under personal, expert supervision.

If you need a trained technician, we invite you to write for an outline of our course, and for a prospectus of the graduate. (No fees, of course). Address:

Placement Manager, Dept. P106-1

COMMERCIAL TRADES INSTITUTE

1400 Greenleaf • Chicago 26

# SENDING END IMPEDANCE OF UNIFORM LINE

*This chart may be used to obtain input resistance of lossless shorted and open transmission lines.*

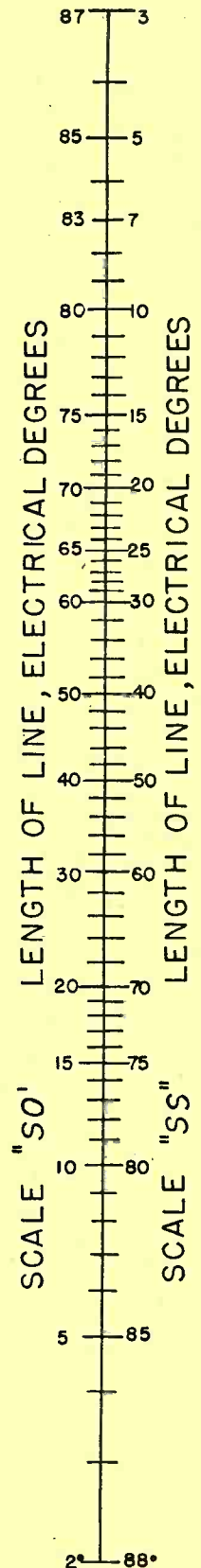
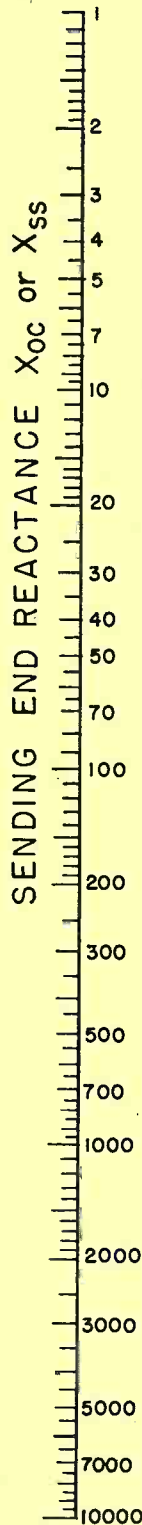
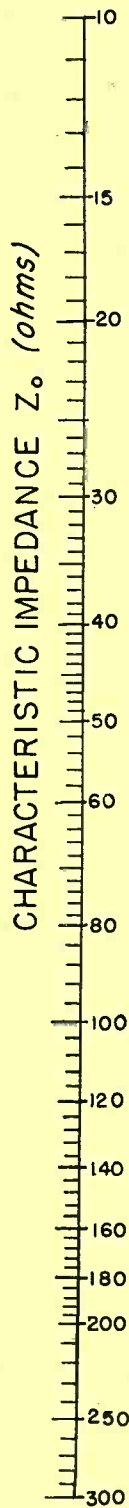

*For open lines:*

$$Z_{so} = -j X_{0c}$$

where

$$X_{0c} = \frac{Z_0}{\tan \theta^\circ}$$

Find  $\theta^\circ$  on scale "SO".

*For shorted lines:*

$$Z_{ss} = +j X_{ss}$$

where

$$X_{ss} = Z_0 \tan \theta^\circ$$

Find  $\theta^\circ$  on scale "SS".

*Courtesy of Federal Telephone and Radio Corporation.*

**YOU** Need My PRACTICAL Training to Make Money in

# TELEVISION- RADIO and ELECTRONICS!



*I'll Send You*  
**8 BIG KITS of**  
Radio Parts and Equipment . . .

Learn at  
**HOME**  
IN YOUR  
**SPARE TIME**

**NOW IS THE TIME To Get Into This Fast Growing Industry—Prepare For A Fine Paying Job Or Your Own Business!**

If you want to get into Radio-Television and Electronics . . . you owe it to yourself to get the facts about my training. I have trained hundreds of men to become outstanding service technicians—and I'm ready to do the same for you. Whether your goal is a fine paying job in one of Radio's many branches—or a successful Radio and Television business of your own—you need the kind of training I offer! My training is practical and down to earth. YOU NEED NO PREVIOUS EXPERIENCE. You'll be astonished at your rapid progress. I start you with basic fundamentals and give you plenty of practical shop-bench training with many kits of parts I send you. This is the training that sticks with you and makes money for you on the job!

## Get Paid For Spare Time While Learning

Soon after you start training I send you my famous BUSINESS BUILDERS that show you how to make money in spare time doing interesting Radio jobs. Look at the useful and valuable equipment you get while training with me (illustrated at left)—I send you these 8 big kits of Radio parts and equipment and help you build step-by-step a powerful 6-tube superhet radio, a 16-range test meter, plus other mighty useful equipment for Radio and Television servicing. You will perform over 175 fascinating experiments while training. You will learn about Television—so that you will be qualified to step into this fast growing, profitable field. I also send you many valuable service manuals, diagrams and my book telling exactly how to set up your own Television and Radio shop. I want you to learn all about my training—and that is why I urge you to clip and mail the coupon below for my two big FREE Radio books. I employ no salesmen—and nobody will call on you. The important thing is to act now and get the facts.

## HAVE A BUSINESS OF YOUR OWN

A profitable Radio and Television Service Shop may be started with little capital. I will show you how to get started and how to build your small business. At left is pictured one of my graduates, Mr. Merrit C. Sperry of Fairmont, Minnesota in his own shop. The way is also open for you to build a good SERVICE BUSINESS FOR YOURSELF.

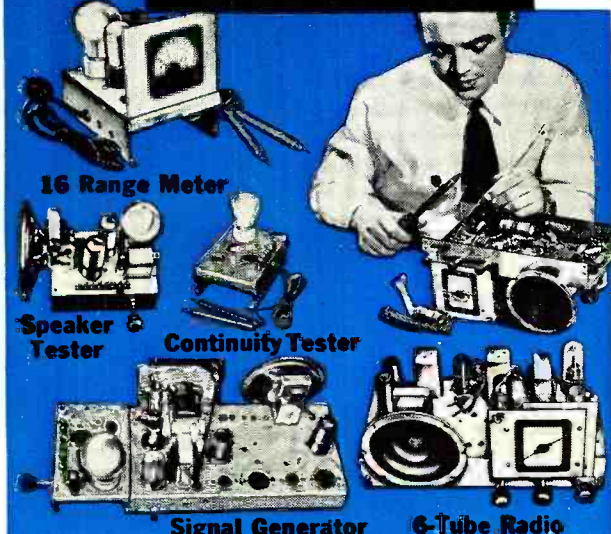

**16 Range Meter**

**Speaker Tester**

**Continuity Tester**

**Signal Generator 6-Tube Radio**

## ALL KITS ARE YOURS TO KEEP

Each of the hundreds of Radio parts and other items I send my students is theirs "for keeps." You may use this equipment in your Radio and Television service work and save many dollars by not having to buy expensive "ready-made" test equipment. Each of my 8 kits will help you advance and learn important steps in Radio and Television servicing.



**CALVIN SKINNER** of New Orleans, La. tells us he makes \$5 to \$10 in spare time repairing radios. He is now also working with his own Television set.



**LOREN D. SAUCIER** of Coloma, Mich. reports that my training has made it possible for him to repair large numbers of Radio and Television receivers.

## RADIO AND TELEVISION INDUSTRY BOOMING

You couldn't pick a better time to get into Radio-Television and Electronics. New Television stations are going on the air to serve every major city—hundreds of new AM and FM Radio broadcasting stations are also on the air to serve practically every community in America. All this creates new and bigger opportunities for the trained man who knows Radio-Television and Electronics. Good Radio and Television service men are needed NOW!

## VETERANS

**THIS TRAINING AVAILABLE TO YOU UNDER THE G. I. BILL**

My Training Includes:  
**Radio Servicing**  
**Television**  
**FM Frequency Modulation**  
**Public Address and High Frequency Applications**

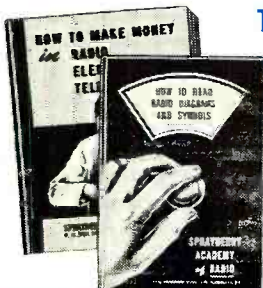

These Two Big Radio Books **FREE!**

Just mail coupon for a FREE sample Sprayberry Lesson and my big FREE book "How To Make Money in Radio-Television and Electronics." Learn why my really practical training is best of all for you. Discover what's ahead for you in the fast moving Radio-Television and Electronics industry. No obligation. Don't delay—the future is too important to you. Mail the coupon now—and count on me for fast action.

## RUSH COUPON Today!

**SPRAYBERRY ACADEMY of RADIO, Dept. 25-E 111 North Canal St., Chicago 6, Ill.**

Please rush my FREE copies of "How To Make Money In Radio-Television and Electronics" and "How To Read Radio Diagrams and Symbols."

Name.....Age.....

Address.....

City.....State.....

( ) Check here if you are a Veteran.

**SPRAYBERRY ACADEMY OF RADIO**  
111 N. CANAL, DEPT. 25-E, CHICAGO 6, ILL.

# This Proved Money-Making Service Data Library to Work ... in your shop *NOW!*

NOW YOU CAN OWN

## PHOTOFACT

**this Amazing  
EASY-PAY WAY!**

**Pay as you Profit  
Earn with it Now**

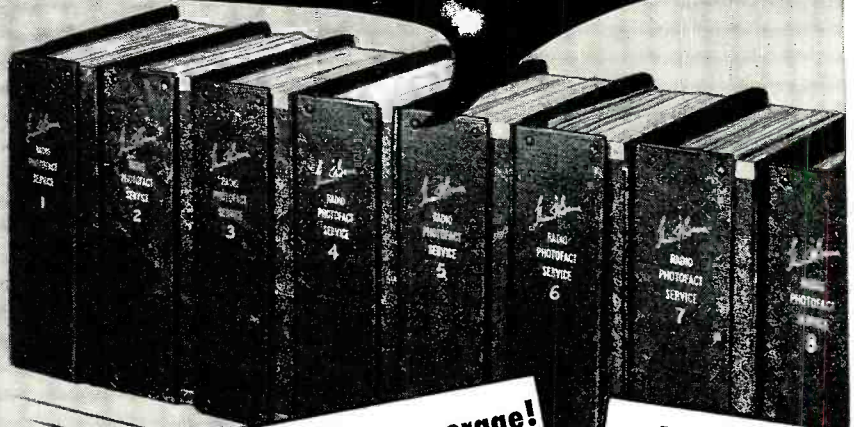

**100% Service Coverage!**  
AM, FM, TV Receivers,  
Record Changers, Tuners,  
Amplifiers, Ham Radios

**Everything  
You Need to Know  
for Profitable  
Servicing**

**NO CARRYING  
CHARGES  
NO INTEREST**

**ONLY  
\$18.<sup>39</sup>  
DOWN**

*Gets You  
Started!*

Includes your membership in the Howard W. Sams Institute.  
Entitles you to valuable service help at no cost to you.

NOW—you can afford to own the Service Data Library that is earning extra profits every day for more than 25,000 successful Service Technicians! NOW—for the first time—the famous PHOTOFACT Library can be yours with this new “Pay-as-You-Profit” Plan! Here’s all you have to do: See your parts jobber. Order 4 or more PHOTOFACT Volumes. Pay only \$18.39 down. You get your Library immediately. You use it now. It earns for you—and you pay as you profit! If you’re not already a money-making PHOTOFACT user, here’s your easy-pay chance to own the most productive radio service data in the world. If you’re already using PHOTOFACT, here’s your chance to complete your library by filling in those missing volumes. Now that you can afford PHOTOFACT, don’t be without its time-saving, money-making advantages a single day longer. See your parts jobber today!

### HAVE COMPLETE, ACCURATE DATA ON ALL POST-WAR SETS YOU SERVICE!

With the Easy-Pay Plan, you can boost your earnings now, using proved superior PHOTOFACT. Have complete, accurate, uniform data on all post-war receivers—own the only Radio and TV service data based on actual laboratory analysis of the equipment. Here’s why PHOTOFACT is better in every way. You get: 1. Exclusive TV coverage in easy-to-use individual envelopes. 2. Exclusive Standard Notation Schematics. 3. Exclusive oscilloscope wave forms. 4. Photos of all chassis views with each part identified. 5. Full alignment instructions, plus circuit voltage and resistance analysis. 6. Complete parts lists and proper replacements. 7. Dial cord stringing diagrams. 8. Disassembly instructions. 9. Record Changer service data. 10. Exclusive keyed data system—all values right on the schematic. There’s nothing like PHOTOFACT! It pays for itself in saved time, bigger work output and greater profits. To protect your future in Radio-TV servicing, act now—own the PHOTOFACT Library the Easy-Pay Way!

**SEE YOUR PARTS JOBBER  
OR WRITE DIRECT TODAY**

**Get the  
EASY-PAY  
Details**

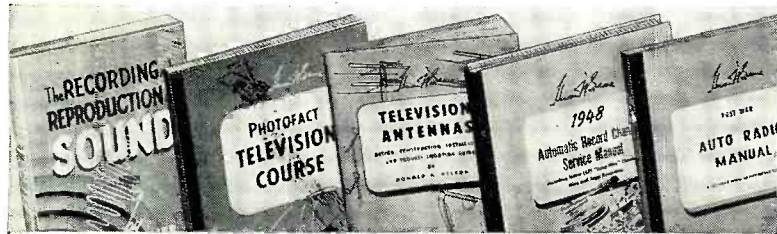

### CURRENT PHOTOFACT BEST-SELLERS

- The Recording and Reproduction of SOUND, by Oliver Read. The complete, authoritative treatment of the entire subject of Sound, written by the editor of *Radio & Television News* . . . . . **\$5.00**
- Photofact Television Course. The book used by thousands; gives you a clear understanding of TV principles, operation and practice. **\$3.00**
- Television Antennas. Shows you how to select and install the proper antenna, and how to overcome antenna problems. . . . . **\$1.25**
- 1948 Record Changer Manual. Covers 45 models made in 1948, including new LP and dual-speed changers, plus leading wire recorders. Based on actual analysis of the equipment. . . . . **\$6.75**
- Auto Radio Manual. Complete Photofact service data on more than 100 post-war auto radio models—a time-and-money-saver. **\$4.95**

**HOWARD W. SAMS & CO., INC.**  
955 N. Rural St., Indianapolis 1, Ind.

- Send full Easy-Pay Details
- Send FREE PHOTOFACT Cumulative Index
- Send PHOTOFACT Folder for Set Manual. . . . .  
(FREE to Service Technicians writing in on letter-head; 50c charge to Experimenters)

Name . . . . .

Address . . . . .

City . . . . . Zone . . . . . State . . . . .

**HOWARD W. SAMS & CO., INC. INDIANAPOLIS 1, IND.**

*If your  
Pictures  
look like this* →

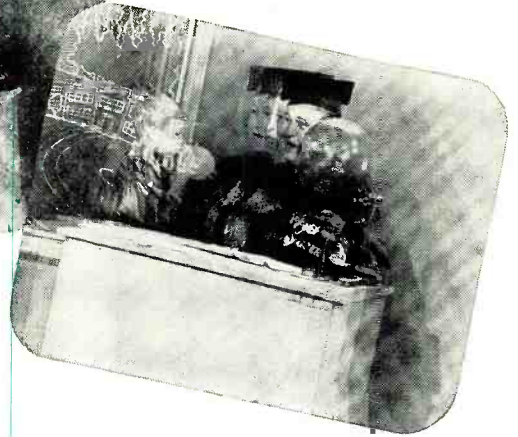
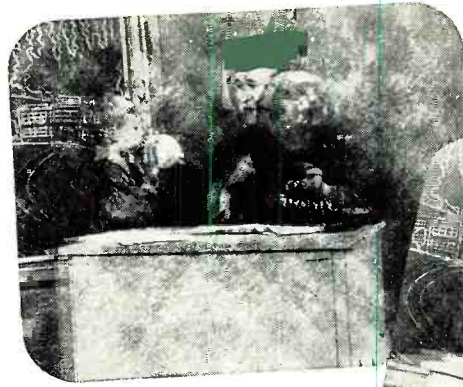

# YOUR TELEVISION WILL BE IMPROVED WITH A WARD OUTDOOR AERIAL

*to give you  
Pictures like this* →



*The modern miracle of pictures by air can be a most satisfying means of entertainment. But be satisfied only with a picture comparable to a class "A" motion picture—on every station in your area. It is unnecessary to compromise!*

**HERE'S WHY:** Television waves are like light beams — solid objects reflect and refract them, making it impractical to pick up all stations from an indoor aerial. That is why you get double images on some stations.

In addition, indoor aerials have poor signal pickup making it difficult to get good pictures on all stations.

**FURTHERMORE:** Your indoor antenna may have a high noise level which increases the amount of interference as you advance the contrast control to bring up a weak picture. All of these technical difficulties are eliminated by a WARD outdoor aerial installed by a competent radio serviceman. In every case, a Ward outdoor antenna will improve reception over an indoor aerial. Also, Ward aerials are so well designed, they are attractive on a house. *It is unnecessary to compromise!*



*WARD is the largest and oldest exclusive maker of television and auto radio aerials.*



Does the antenna on your automobile need repair? Replace it with  
WARDS'S 8-BALL—world's largest selling auto aerial.

**WARD PRODUCTS CORPORATION**  
1523 E. 45TH STREET, CLEVELAND, OHIO  
*Division of the Gabriel Company*

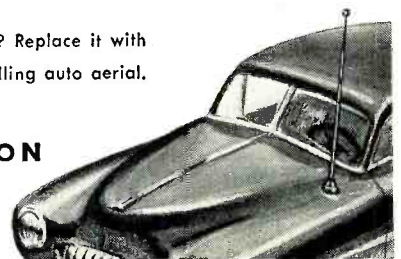

You'll Get the **MOST FOR** Your **MONEY** by specifying **PYRAMID** Capacitors

WRITE FOR COMPLETE LITERATURE  
Representatives and Distributors  
Throughout the U.S.A. and Canada

**PYRAMID CAPACITORS**

**PYRAMID ELECTRIC COMPANY**  
155 Oxford Street  
Paterson, N. J., U.S.A.  
TELEGRAMS: WUX Paterson, N. J.  
CABLE ADDRESS: Pyramidusa

# Within the INDUSTRY

**ROBERT A. SEIDEL** has joined the *RCA Victor Division* as vice-president in charge of distribution. He resigned his post as vice-president and controller of the *W. T. Grant Co.* to assume his new duties.



He joined the *Grant* organization in 1940 as controller and was appointed vice-president in 1944. He is well-known for his activities in the National Retail Dry Goods Association, where he served as a member of the board of directors, chairman of the executive committee, and chairman of the Association's committee on government affairs. He was awarded the association's gold medal of honor in 1946 and a special citation of merit in 1949.

Mr. Seidel is a member of the board of directors of the American Standards Association and chairman of the Consumers Goods Committee. He will make the home office at Camden, New Jersey his headquarters.

**NATIONAL ASSOCIATION OF ELECTRICAL DISTRIBUTORS** will conduct a series of meetings covering the problems facing distributors of electrical appliances, television, and radios the early part of January in Chicago.

The meetings, which will be held at The Drake, find the association's Major Appliances Committee convening on January 11th, the Radio, Television, and Tubes Committee gathering on the 12th, and the Electrical Housewares Committee meeting on the 16th.

The schedule coincides with the Furniture Mart and Housewares Show being held concurrently in Chicago.

**FRED D. WILSON** was named president of *Capehart-Farnsworth Corporation* at a meeting of the company's board of directors held in New York.



Mr. Wilson brings to the *Capehart-Farnsworth* organization more than 25 years of experience in manufacturing and sales in the home appliance field of which 12 years were served with the *RCA Victor Division of Radio Corporation of America*.

In 1948 Mr. Wilson accepted a position as assistant to the president of the *Bendix Home Appliance, Inc.*, and shortly thereafter became executive vice-president. He succeeds Ellery W.

Stone in the presidency. Mr. Stone will continue as a member of the board of directors and as president of the *International Standard Electric Corporation*, another *International Telephone and Telegraph Corporation* subsidiary.

**AEROVOX CORPORATION** has purchased for cash the entire outstanding stock of the *Electrical Reactance Company* which has plants at Franklinville, New York; Jessup, Pennsylvania; and Myrtle Beach, South Carolina.

*Electrical Reactance Company*, which will be operated as a wholly-owned subsidiary, will continue under the management of Charles E. Krampf, president. Mr. Krampf will also serve as a director of the parent company.

**RALPH BRENGLE**, general sales manager of *Potter & Brumfield*, has moved his office to Princeton, Indiana and will hereafter conduct sales from the company's plant there.



Since 1945 Mr. Brengle has maintained offices at 549 W. Washington Blvd., Chicago. The Chicago office will continue at the same address under John Newman for regional sales.

*Potter & Brumfield* has recently doubled its engineering and manufacturing facilities with the opening of the new Main Street Plant in Princeton.

**ELECTRIC SUPPLY CORPORATION** of Chicago has been appointed selective franchise distributor for the Chicago area by *John Meck Industries, Inc.* . . . *Pyramid Instrument Company* has named **KOEHLER-PASMORE COMPANY, ENGINEERING PRODUCT, NORTHWESTERN AGENCIES, and INDUSTRIAL SPECIALTIES SALES** as representatives of the firm. . . .

**DAVID RANDOLPH** has been appointed music consultant for *Lafayette Radio* of New York. . . .

**KARL HASSEL** has been elected to the post of secretary of *Zenith Radio Corporation* while **JOHN KUHAJEK** and **ALBERT J. FRANZAK** have been named assistant treasurer and assistant controller, respectively. . . . **IRVING B. SHURACK** is the new regional manager in the New York Metropolitan area for *Trans-Vue Corporation* of Chicago. . . .

**MAYFLOWER INDUSTRIES'** New Jersey division has been named Newark distributor for *Stewart-Warner* television and radio products. . . . **SUN RADIO AND ELECTRONICS COMPANY, INC.**, is the new jobber for *Peerless* transformers in the New York Metropolitan area. . . . The formation of **MARATHON**

# SYLVANIA'S EXTENSIVE NATIONAL ADVERTISING IS Building business for *you* every minute

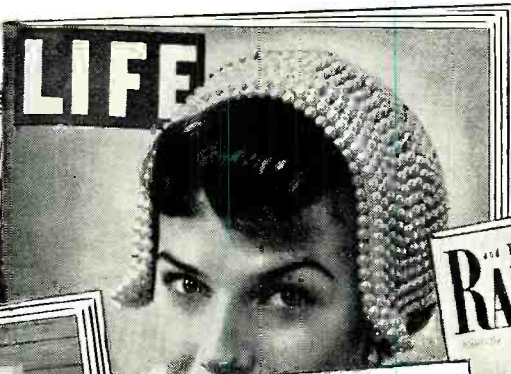

LOOK FOR THIS SIGN OF DEPENDABLE RADIO SERVICE

If your television becomes a terrible vision, call the expert who displays the Sylvania service sign. He knows these complex sets inside out . . . has the "savvy" to make the delicate adjustments and repairs they sometimes need. He relies on super-keen Sylvania testing devices to detect and diagnose troubles accurately . . . Sylvania radio tubes, the proper television picture tubes and other custom parts to restore perfect sight and sound. Stop at the shop showing the Sylvania sign for top television and radio repairs.

**SYLVANIA RADIO TUBES**  
PRODUCT OF SYLVANIA ELECTRIC PRODUCTS INC.



LOOK FOR THIS SIGN OF DEPENDABLE RADIO SERVICE

Whistling sounds in your set really give reception a black eye. Get rid of unwanted noises now by calling the radio serviceman who displays the Sylvania sign. He'll make you



LOOK FOR THIS SIGN OF DEPENDABLE RADIO SERVICE

Does your radio give out with squeals and grunts? Then call the serviceman who displays the Sylvania sign. Because your radio needs expert care, the kind this fellow is trained

Sylvania ads especially prepared to boost your service are telling 15,500,000 people from coast to coast all about the valuable service and parts you're offering them. Readers of these magazines are attracted to the lively cartoon-type ads, three of which are reproduced above. They tell them to stop at the Sylvania sign

of dependable service . . . for the best radio and television repairs at the fairest prices!

Hundreds of these readers are your potential customers. These humorous ads, running in the cream of the nation's publications, help assure you a steady stream of new customers and greater profit.

There's Still Time To Cash In On The First 1950 Sylvania Service Dealer Campaign—Write Sylvania Electric Products Inc., Advertising Dept. R-1201, Emporium, Pa.

**SYLVANIA ELECTRIC**

RADIO TUBES; CATHODE RAY TUBES; ELECTRONIC DEVICES; FLUORESCENT LAMPS, FIXTURES, WIRING DEVICES, SIGN TUBING; ELECTRIC LIGHT BULBS; PHOTOLAMPS

**JUST OFF PRESS!**

**Now you'll really  
know HOW TO USE  
AN OSCILLOSCOPE**

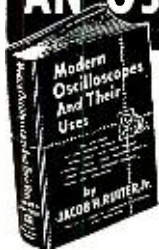

Don't let the oscilloscope "stump" you!

Learn to use it fully — and watch your efficiency soar. This easy-to-understand book by an expert gives you the facts and how-to-use-it data you've been wanting.

**MODERN OSCILLOSCOPES  
AND THEIR USES**

by **JACOB H. RUTER, Jr.**

of **Allen B. Du Mont Laboratories, Inc.**  
326 pages, 370 illustrations, \$6.00

This big book gets right down to earth in explaining oscilloscopes (cathode ray oscillographs) and showing exactly how to apply them to specific AM-EM-TV service jobs. No involved mathematics! First the author explains oscilloscopes fully. Then, in easily understood terms, he tells exactly how to employ them on specific jobs—from locating receiver troubles to aligning and adjusting the most complicated circuits.

**WHAT IT IS—HOW IT WORKS**

1. Introduction to Oscilloscopes
2. History of the Oscillograph
3. Development of the Cathode Ray Tube
4. Principles of Cathode Ray Tube Operation
5. Details of the Modern Cathode Ray Tube
6. The General Purpose Oscilloscope
7. Power-Supply Circuits
8. Amplifiers, Attenuators, and Positioning Circuits
9. Time-Base Circuits



**HOW TO USE IT ON THE JOB**

- |   |   |
|---|---|
| <ol style="list-style-type: none"> <li>10. Operation of the Oscilloscope</li> <li>11. Interpretation of Basic Patterns</li> <li>12. Auxiliary Equipment</li> <li>13. Typical Applications in the Electronic Industry</li> <li>14. Servicing A-M Radio Receivers</li> <li>15. Servicing F-M Radio Receivers</li> </ol> | <ol style="list-style-type: none"> <li>16. Servicing Television Receivers</li> <li>17. Use of the Radio Transmitter</li> <li>18. Using the Oscilloscope in Teaching</li> <li>19. Additional Industrial Uses of the Oscilloscope</li> <li>20. Photographing Cathode Ray Patterns<br/>(a) Glossary</li> </ol> |
|---|---|

**EASY TO UNDERSTAND**

Each operation is carefully explained including the making of connections, adjustment of circuit components, setting the oscilloscope controls, and analyzing oscilloscope patterns. About 400 illustrations, including literally dozens of pattern photos, make things doubly clear.

Besides its radio and TV uses, you learn about many oscilloscope applications in industry and teaching. Send coupon today for your copy of MODERN OSCILLOSCOPES AND THEIR USES. If not more than satisfied, return it after 10 days and we'll gladly refund the purchase price.

**10 DAY MONEY-BACK GUARANTEE**

Dept. RN-10, Murray Hill Books, Inc.  
232 Madison Ave., New York 16, N. Y.

- Send me a copy of MODERN OSCILLOSCOPES AND THEIR USES for which I enclose \$6 (\$6.50 outside U.S.A.) or
- Send book C.O.D. (U.S.A. only) for \$6 plus postage. I will pay postman.

In either case, if book is not satisfactory, I will return it in 10 days and you guarantee to refund my \$6.

Name .....

Address .....

City, Zone, State .....

**SALES COMPANY** has been announced by Ben Willig and Eddie Deutsch. The company has offices at 466 West 42nd Street, New York. . . . **MARVIN W. SMITH**, president of the *Baldwin Locomotive Works*, has been elected a director of the *Westinghouse Electric Corporation*. . . . **L. J. N. DU TREIL**, a radio engineer for the FCC and its predecessors for the past 30 years, has retired from government service and will engage in the practice of consulting radio engineering in New Orleans. . . . **CHARLES W. COLEMAN** has been elected controller of *The Workshop Associates, Inc.* of Newton Highlands, Mass. . . . *American Television and Radio Company* has named **BENRAY DISTRIBUTORS** of Brooklyn as exclusive distributors in the Flatbush area. . . . **THE FRANK W. TAYLOR COMPANY** of DeWitt, New York, will represent *Cannon Electric Development Company* in all New York counties north of Ulster, Sullivan, and Dutchess. . . . **EDWARD J. BACHER** is the new tube sales manager for initial equipment accounts in the Chicago area according to an announcement from *National Union Radio Corporation*. . . . **ALBERT E. KELEHER, JR.**, has been named manager of Raytheon's mobile radiophone sales. . . . **EDWARD E. SCHULTZ** and **EMERY L. HALL** have been appointed electronics engineer and mechanical engineer, respectively, for *Magnecord, Inc.* . . . **R. C. COSGROVE** has resigned as executive vice-president of *Avco Manufacturing Corporation*. He will continue as a member of the board and in a consulting capacity to the management. He will also continue to represent the *Crosley Division* in the RMA of which he is president.

**ROLAND R. HAND** has been appointed to the post of district radio sales supervisor for the Central New York State District of the *Westinghouse Electric Supply Company* with headquarters in Rochester, New York.



Mr. Hand, a native of Englewood, New Jersey, was formerly New York district manager for the *Motor Products Corporation* and was employed by *General Electric Supply Company* for some time as a district appliance sales manager.

**ELECTRONIC INDICATOR CORP.** has moved to new and larger quarters at 259 Green Street, Brooklyn 22, New York. . . . **INDUSTRIAL ELECTRONICS, INC.** has added a new laboratory to their facilities at 205 Donovan Building, Detroit 1, Michigan. . . . **FIDELITY CHEMICAL PRODUCTS CORPORATION**, manufacturers of industrial metal treating and cleaning compounds, has taken over its new quarters at 470 Frelinghuysen Avenue, Newark, New Jersey. . . . **RADIO ELECTRIC SERVICE CO.**,

wholesale distributors of radio and television parts with headquarters in Philadelphia, has opened a new branch at 406 N. Albany Avenue, Atlantic City, New Jersey. It is their ninth unit. . . . **ALLIED ELECTRIC PRODUCTS, INC.** has moved its Chicago offices and warehouse to enlarged quarters at 426 South Clinton Street in Chicago. . . . **RUBANE RADIO SERVICE** has moved to 4903 Belair Road, Baltimore 6, Maryland.

**ERLING G. FOSSUM** has been appointed general manager of *Stewart-Warner Electric*, the company's radio and television division in Chicago.



An employe of the *Stewart-Warner Corporation* since 1926, Mr. Fossum fills the vacancy created by the resignation of Samuel Insull, Jr. In his new position he will be responsible for all phases of engineering, production, and marketing of radio, television, and other electronic products made by the company. He has been serving as assistant to the president and formerly was associated with the *Alemite Instrument and Heater* divisions as service manager.

**C. T. LAWSON**, vice-president in charge of sales for the *Kelvinator Division* of *Nash-Kelvinator Corporation*, was named president of the National Electrical Manufacturers Association (NEMA) at the association's annual meeting. He succeeds B. W. Clark of *Westinghouse*.

Serving with Mr. Lawson as vice-presidents are: C. W. Higbee of *U.S. Rubber Co.*, J. H. Jewell, *Westinghouse Electric Corporation*, James F. Lincoln, *The Lincoln Electric Company*, E. E. Potter, *General Electric Company*, and A. F. Sheldon, *Kennecott Wire & Cable Co.* Everett Morss of *Simplex Wire & Cable Co.* was named treasurer.

**L. W. ALEXANDER** has been appointed manager of the Marketing Services Division in the *General Electric Company's* Electronics Department.



In his new position, Mr. Alexander who was formerly assistant manager of the Receiver Division, will have responsibility for market research activities of the department, will advise its product divisions on distribution, production, and inventory control, and will represent the manager of marketing in coordinating programs for product planning and service.

Mr. Alexander joined *General Electric* in 1933 and has worked at Schenectady, Bridgeport, Owensboro, and Syracuse.



"We prefer Rauland Tubes  
for decidedly Selfish Reasons..."

**says Phil Kudler,** *President, The Universal Radio Supply  
Company, Los Angeles, California*

"We, at Universal Radio Supply, prefer the Rauland TV Picture Tube line over all others and for decidedly selfish reasons. Not only are Rauland Picture Tubes tops in quality performance but by reason of this advantage, they are tops in sales as well and so we make more profit. Those kit builders who have used Rauland Picture Tubes have adopted them as their standard and these facts, coupled with being able to replace the tube in any set with a Rauland tube, means there is no sales resistance when we offer our customer a Rauland Picture Tube. Rauland's new Luxide Screen Tubes with the black face are 'out of this world'—no glare whatever and soothing to the eyes—no filter necessary."

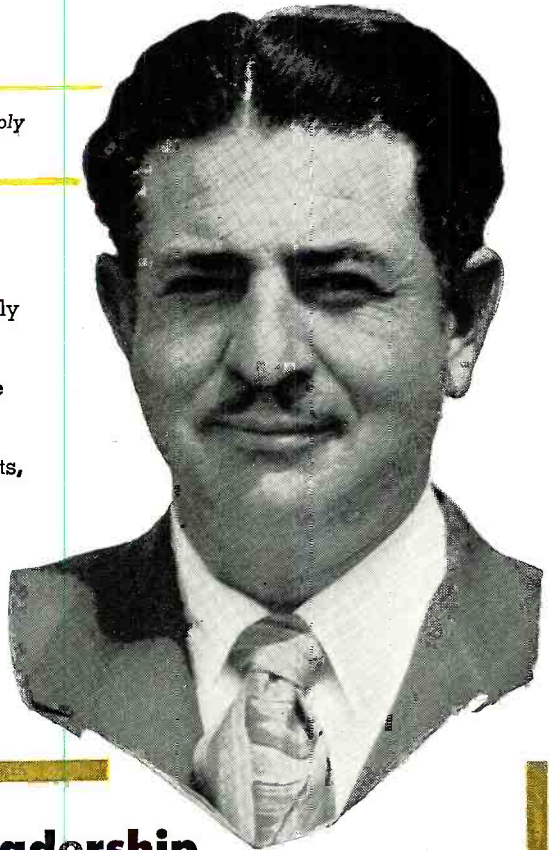

## Two Reasons for Rauland's Leadership

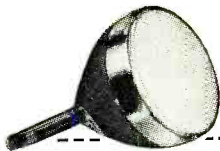

**Rauland  
Aluminized Tubes**

The preferred replacement tube that gives users a better picture than when their sets were new. Gives up to 80% brighter picture than standard tubes, with better contrast and definition. Replaces any magnetic tube—needs no ion trap magnet—eliminates risk of damage resulting from faulty magnet adjustment. Boosts filter sales too—because the extra brightness carries a clear, sharp picture through even a heavy filter.



**Rauland  
Luxide Screen Tubes**

The sensational new "Black" Tube that gives notable improvement in contrast, clarity and picture detail. The special light-absorbing glass of the Luxide screen sharply reduces reflection of ambient light from the phosphors of the screen—greatly reduces halation—two reasons why pictures "wash out." All-glass 12LP4A and metal cone 16AP4A are available for replacement of corresponding standard tubes.

## THE RAULAND CORPORATION



*Perfection Through Research*

4245 N. KNOX AVENUE • CHICAGO 41, ILLINOIS



# W O S ANDOU S

from the

## OUTSTANDING LINE

### CHANNEL MASTER'S FAN-FLECTOR

This sensational new preassembled antenna, the Fan-Flector, a development of Channel Master's research laboratories, is the most sensitive all-channel antenna developed to date.

No high band attachments.  
No multiple lead in wires.  
No wasted assembly time.  
Dealer after dealer has made his most difficult fringe installations stick with the Fan-Flector, America's fastest selling antenna.

**OVER 100,000  
SOLD IN 3 MONTHS**

		List
BM312	Fan-Flector	13.75
BM312X2	Stacked Fan-Flector	29.30
BM312X4	Double Stacked Fan-Flector	63.25

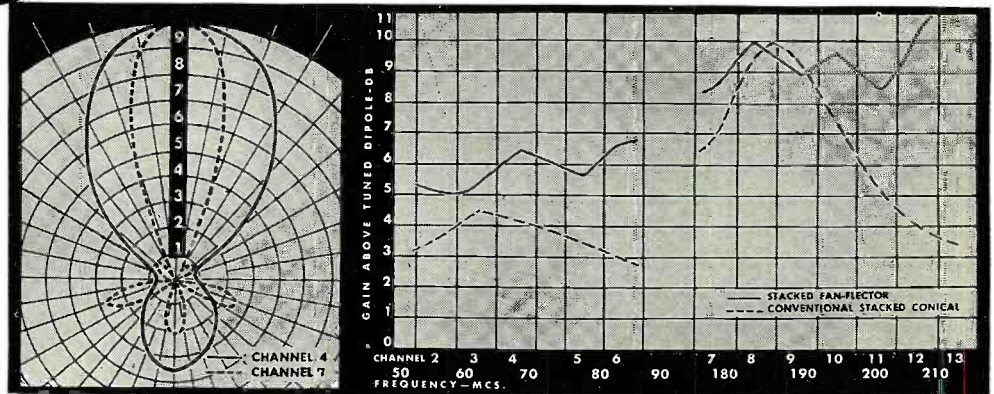

**HORIZONTAL POLAR DIAGRAMS**

Low band front-to-back ratios between 3 and 4 to 1. Lobe width decreases on high band for ghost-free reception. Vee-Beam engineering minimizes side lobes.

**GAIN CURVES**

"Most popular" conventional stacked conical antenna (broken lines) compared to the stacked Fan-Flector (solid lines).

TO: CHANNEL MASTER CORP., ELLENVILLE, N. Y.

Dept. N-1

Please send me:

- Name of nearest Channel Master Distributor
- Technical data and literature

YOUR NAME.....  
 COMPANY NAME.....  
 ADDRESS.....  
 CITY..... STATE.....

# CHANNEL MASTER'S HIDEAWAY

*Combines*  
**THE DISAPPEARANCE  
OF A BUILT-IN ANTENNA**  
*with*  
**THE PERFORMANCE OF  
AN OUT-DOOR ANTENNA**

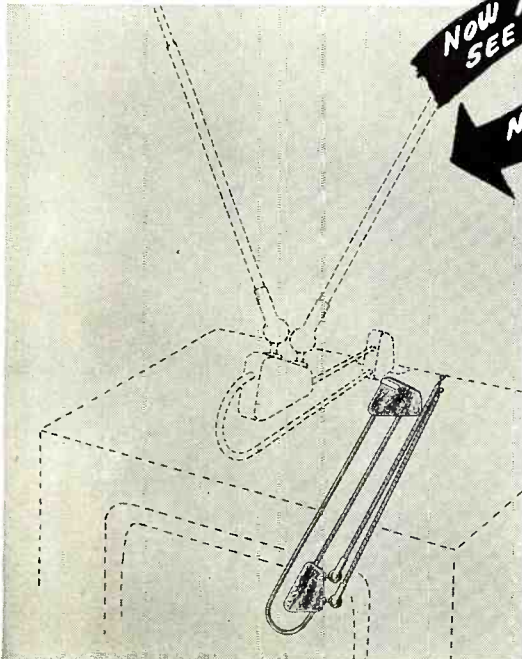
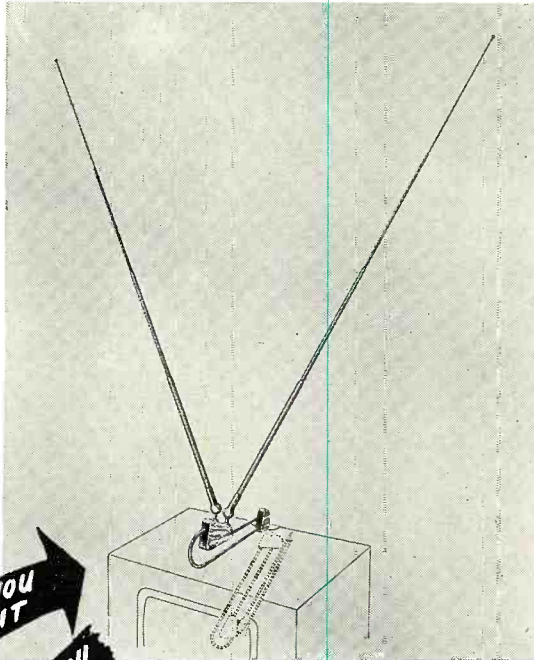

**NOW YOU  
SEE IT**

**NOW YOU  
DON'T**

Channel Master's exclusive Multiflex Action\* enables this antenna to be hidden away behind the set when not in use. The elements can be arranged to form a horizontal Vee for any channel in any direction thus increasing the gain.

The hand rubbed hardwood surfaces, nickel plated metal components and smart design makes the Hideaway the most attractive indoor antenna on the market today.

## LIST 975

available in blond, mahogany and walnut

\*Pat. Pend.



**FIRST IN PREASSEMBLED ANTENNAS**

# SANGAMO *Electrolytic* CAPACITORS

give the maximum in  
dependability and  
long-life...

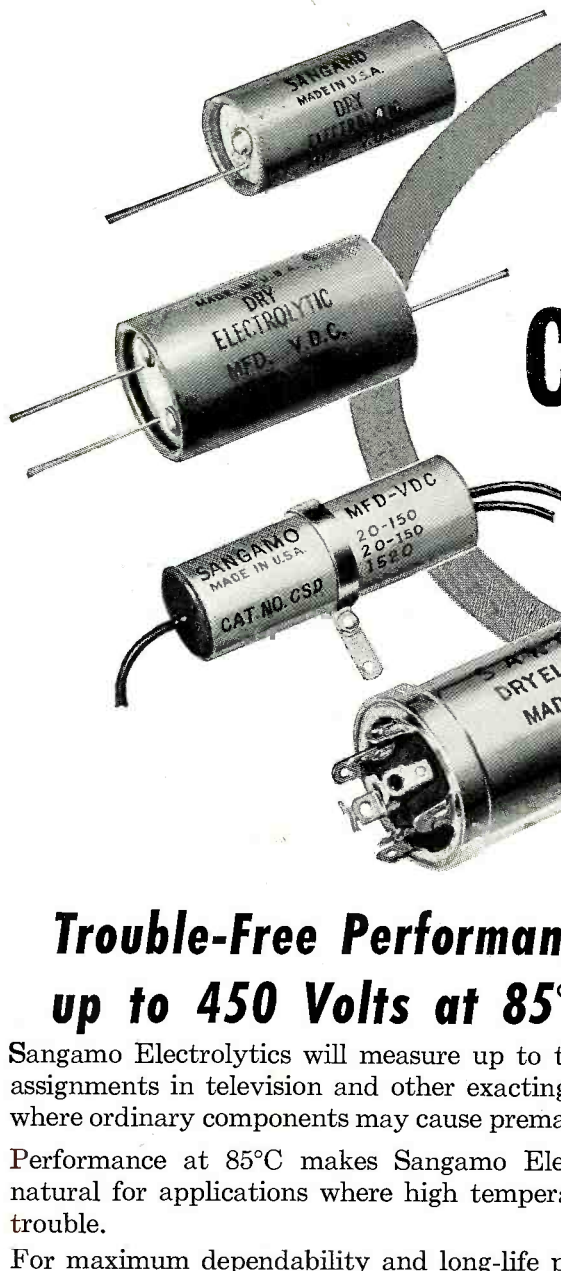
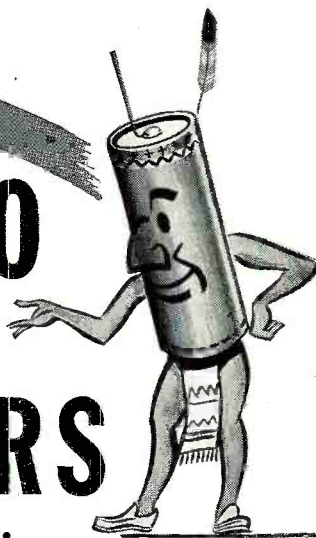

## Trouble-Free Performance up to 450 Volts at 85°C

Sangamo Electrolytics will measure up to the toughest assignments in television and other exacting equipment where ordinary components may cause premature failure.

Performance at 85°C makes Sangamo Electrolytics a natural for applications where high temperatures cause trouble.

For maximum dependability and long-life performance, choose Sangamo Electrolytics for original equipment or replacement needs—they are better for every radio and electronic application.

See for yourself how new standards of dependability and longevity have been built into Sangamo Electrolytics. Order from Sangamo Electrolytic Capacitor Catalog No. 825, which is yours for the asking.

Your Assurance of

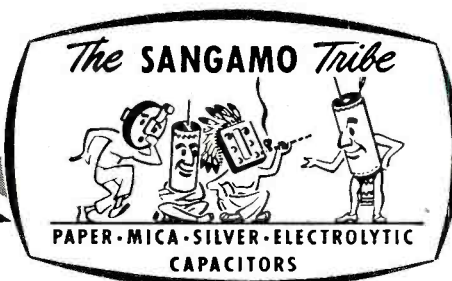

Dependable Performance

# SANGAMO ELECTRIC COMPANY

SPRINGFIELD, ILLINOIS

IN CANADA: SANGAMO COMPANY LIMITED, LEASIDE, ONTARIO



**NEW for 1950**

# MIDWEST

Celebrates its 30th YEAR of FACTORY-TO-YOU Selling with a Sensationally NEW 1950 LINE of

# TELEVISION

CONSOLES and Complete CHASSIS

**New GIANT 16" PICTURE**

Here is Television at its finest! . . . brought to you by Midwest, for 30 years a leader in the field of radio and electronics. Immense 151-square-inch screen on new 16" metal-glass tube . . . clear, steady, bright pictures . . . Synchronized sound and picture that a child can tune in perfectly . . . Highest quality FM sound . . . Big 12" Electro-Dynamic Panasonic Speaker. Available in beautiful Television-Radio-Phonograph Consoles, as illustrated, or in complete chassis (not a kit) ready for custom installation in your own cabinet. And you can buy Midwest Television at Low Factory Prices, with Low Down Payment and Long Easy Terms — and on 30 Days Trial! Send for Catalog TODAY!



LOW FACTORY TO-YOU PRICE

**30 DAYS TRIAL**

... also a Magnificent Line of NEW 1950 **MIDWEST RADIOS** featuring the latest Improved FM Circuit and the New 3-SPEED RECORD PLAYER



Powerful new 1950 Series 16 and Series 12 AM-FM Radio in complete chassis. Also beautiful new Console models including the magnificent Symphony Grand Radio-Phonograph with latest FM circuit and new 3-Speed Automatic Record Player.

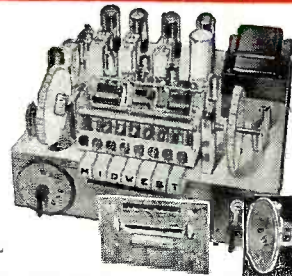

BUY DIRECT FROM THE MIDWEST FACTORY and **SAVE!**

**MIDWEST RADIO & TELEVISION CORP.**

Dept. X376, 909 Broadway, Cincinnati 2, Ohio

SEND FOR FREE 32-Page Full Color CATALOG



Write in Name and Address (Please Print) on Coupon or 1c Postcard.

MIDWEST RADIO & TELEVISION CORP.  
Dept. X376, 909 Broadway, Cincinnati 2, Ohio  
Please send me your new FREE 1950 Catalog.

NAME \_\_\_\_\_  
ADDRESS \_\_\_\_\_  
CITY \_\_\_\_\_ ZONE \_\_\_\_\_ STATE \_\_\_\_\_

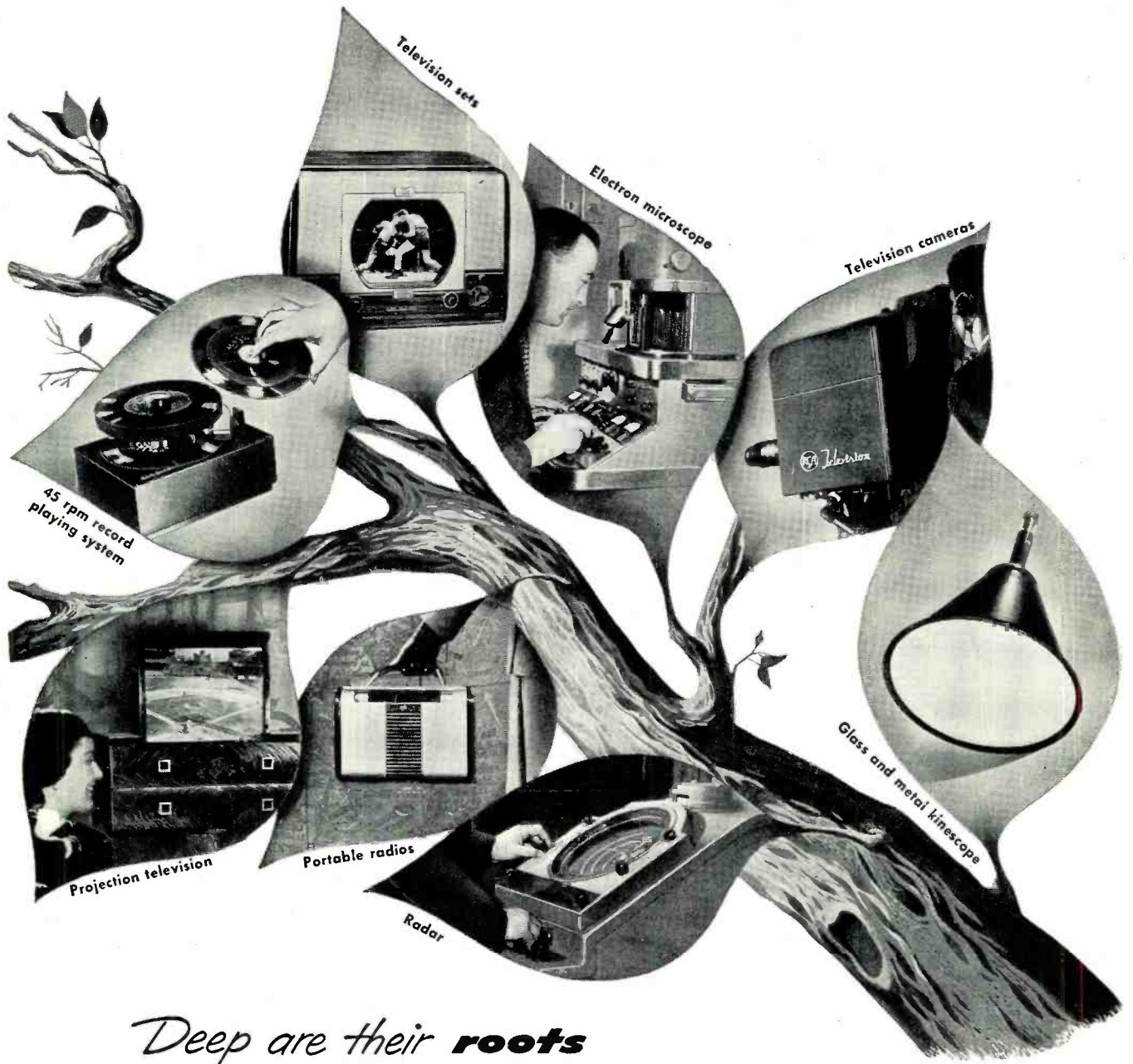

## Deep are their **roots**

With television, you see far beyond the horizon. Radio brings you sounds from around the world. Electron microscopes peer deep into the world of the infinitesimal.

These, and other "leaves" on our new tree of knowledge are rooted in creative research—as carried out at RCA Laboratories in Princeton, N. J. Here, research scientists seek new scientific principles, improve on old ones, or put them to new uses.

Already on their achievement list are hundreds of important and basic developments in electronics, television, radio, electron tubes, radar, and recorded music. RCA research works continually to give you better products.

Examples now working for you include: Today's sharp-eyed Image Orthicon television cameras, television picture tubes, compact portable radios made possible by tiny new RCA electron tubes, the 45-rpm record-playing system with the fastest record changer

ever devised and distortion-free records.

Research in your behalf: Creative research into new principles is another way in which RCA Laboratories work to improve your way of living. Leadership in science and engineering adds value beyond price to any product or service of RCA and RCA Victor.

Examples of the newest advances in radio, television, and electronics—in action—may be seen at RCA Exhibition Hall, 36 West 49th St., N. Y. Admission is free. Radio Corporation of America, Radio City, N. Y. 20.



**RADIO CORPORATION of AMERICA**

*World Leader in Radio — First in Television*



One of American Airlines' postwar fleet of DC-6's.

# Aircraft RADIO

By  
**JAMES HOLAHAN\***

***A brief review of the field of aircraft radio, covering the nature of the work, the necessary qualifications for entering this field, and the available opportunities. The various types of radio equipment found in modern commercial planes are also discussed.***

IN THE few brief years that comprise the history of aviation the expansion of air travel has been tremendous. The blockade of Berlin has proven to the world that life in a modern metropolis can, in an emergency, be sustained through the medium of air transport, in spite of the hazards of weather.

Throughout the United States hundreds of airfields, built by the military for training, are now serving in a commercial capacity as municipal airports. Few populated areas in the country are farther than a short drive from a local landing field. Foreign travel, too, has expanded. Giant wings and powerful engines are shrinking distances, formerly measured in weeks, into hours.

With this expansion of air travel new opportunities are opening up for the radio technician and electronic specialist.

Practically every aircraft in use today, both privately and commercially, carries some form of radio equipment ranging from a single receiver to complete racks of electronic gear.

Modern day flying has placed radio in the "essential" class. Improperly functioning radios are not only useless but hazardous because such great dependence is placed upon them.

This was pointed out as far back as 1929 in an article by an unnamed manager of the National Air Transport Company, when he wrote:

"There is no question as to the assistance that radio can give the air transport pilot. The problem is to insure against failure of the system. A catastrophe may easily be caused if the pilot relies on radio and it fails him for one cause or another. It would be far better if he had no radio at all."

These were the days when flying was in its infancy

\* The author is a radioman who became a pilot in the USAAF during the war. At the end of the war he was placed in charge of radio and radar maintenance at Rapid City Army Air Base. Since separation from service he has been in the aircraft radio field and is employed by Air Associates Inc.

and many airmen used radio with caution and distrust. Today our entire system of instrument flying is built around radio. Complete radio failure in an airplane could result in disaster not only to the occupants of the affected aircraft but to other aircraft in the vicinity.

The use of radio in aircraft has transformed the airplane from a contraption reserved for daredevils to an instrument of commercial utility. It permits the pilot to fly through the worst weather without reference to the ground. It gives him a course to follow and enables him to keep in contact with ground stations and other aircraft.

Aircraft radio may be divided into two categories, communications and navigation. The radio gear carried on any aircraft is used for one or both of these purposes.

The communications category includes voice transmission and reception of pertinent messages, such as takeoff and landing instructions, flight plans, weather information, emergency calls, etc. On long trips away from ground stations, such as on transoceanic flights, c.w. is used.

The aircraft receives these voice and c.w. messages on the aircraft band (200-400 kc.) or on v.h.f. (100-150 mc. voice only) and transmits on a variety of medium high frequencies between 3 and 9 mc. with 3105 kc. and 6210 kc. being most frequently used in the United States. Communications from air to ground are also transmitted on any of the allotted channels between 100 and 150 mc.

Air navigation by radio requires more of a discussion. An extensive system of radio aids to navigation, which form the civil airways of the United States, is maintained by the Civil Aeronautics Authority, an agency of the Department of Commerce. The principal component of this system is the radio range station.

A radio range station consists of a transmitter emitting a carrier on an assigned frequency in the aircraft band. It has two independent r.f. channels differing in frequency by 1020 cycles, controlled by matched crystal oscil-

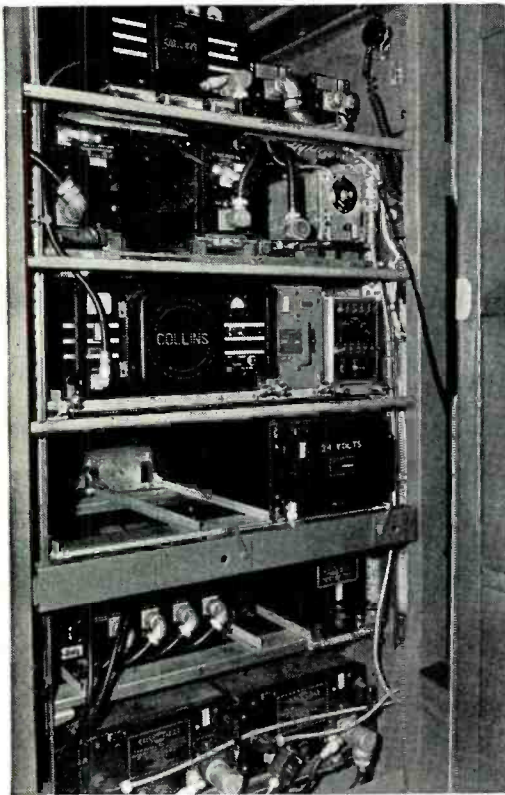

A few of the radio operators employed by Trans World Air Lines. On these men fall the responsibility of transmitting important weather and flying data which keeps the planes aloft and safe during bad weather and good, clear skies and overcasts.

The radio installation in the "Convair." This 300 m.p.h. 40-passenger plane has a built-in loading ramp, a cruising range of 800 miles, and an air-conditioned cabin.



The v.h.f. transmitting and receiving equipment installed in a Beach Bonanza baggage compartment.

lators. The antenna system is comprised of two crossed Adcock antennas that are 90 degrees in space with respect to each other, together with a center vertical antenna. The central tower is constantly fed by the output of one r.f. channel while the output of the other is switched from one Adcock antenna to the other. First the code letter "A" is fed to one Adcock then an "N" is fed to the other. A receiver monitoring these signals will pick up the 1020 cycle beat note which corresponds to the difference between the r.f. channels. A steady tone is heard whenever the energy from the two antenna systems is received with equal intensity. This is called the "on course" or beam. Each range station produces four beams, the direction of which is controlled by the directional antenna systems. These beams give the pilot a definite course to follow toward or away from the station. In the sectors between the courses either an "A" or "N" is received depending upon what quadrant the plane receiving the signal may be in.

Actually the civil airways are aerial routes whose courses are determined by these beams. While flying on

the airways the pilot is aware of his position with respect to the range station, which he can locate on his map, from the type and intensity of the received signal. The point directly over the range station is identified by the lack of signal because the vertical antenna system used will radiate negligible energy directly upward. This "no signal" area widens with height and for that reason is called the "cone of silence." On most ranges the cone is further identified by a "Z" marker, operating on a frequency of 75 mc., which constantly keys the letter "Z". A special receiver is necessary to pick up this signal.

An important piece of equipment for radio navigation is the loop antenna.

We all know the directional qualities of a loop. For instance, a portable radio with a loop antenna will receive the maximum signal when the plane of the loop is in line with the station and minimum signal when the plane of the loop is at right angles to the station.

This same principle is used in navigation. In its simplest form, the loop is used with a receiver as an extra antenna which may be switched into the circuit for direction finding.

More elaborate receivers employ amplifiers and balancing networks which greatly increase the loop's sensitivity.

The loop is the heart of the radio compass or, as it is also called, the automatic direction finder. The operation of an ADF is simple—just tune in the desired station, identify it, flip a switch and a needle, mounted on a 360 degree azimuth scale, points to the angular direction of the station relative to the aircraft.

Formerly the radio compass, because of its weight, was confined to large aircraft only. Now a manufacturer has come out with an ADF weighing 24 lbs. including the power supply.

About the latest thing in radio navigation is the omnidirectional range which will soon be in operation all over the country. These ranges operate in the v.h.f. spectrum between 90 and 110 mc. In contrast to the low frequency ranges which present four beams or pathways to the station, the omnirange allows the aircraft to come in "on the beam" in any direction. The aircraft having this equipment installed will have a "To-From" indicator which tells the pilot whether he is going toward or away from the station he is working. On the low frequency ranges the



pilot determines this from the build or fading of signal strength which can often be difficult in times of poor reception due to precipitation static and the like.

For navigating great distances by radio, such as in transoceanic flying, a system called "loran" is used. The name is a coined word derived from the words LONG RANGE Navigation. Developed during the war, this system is composed of a receiver operating on a band just above the broadcast frequencies. There is no audio. Pips appearing on the face of the cathode-ray tube furnish visual information, which when applied to special loran charts gives very accurate fixes. The only installation required in the aircraft is the loran receiver.

Ground installations consist of several pairs of transmitting stations operating on the same frequency. In each pair one is termed the "master" the other the "slave" station. The system is based upon the microsecond interval between the reception of the signals emitted by the master and the slave.

A navigator, specially trained in the loran method of navigation, is required to operate this system. It is possible to obtain accurate fixes from stations up to 1500 miles distant by means of loran.

The instrument landing system may also be included in the navigation category. Two receivers and an instrument panel indicator comprise the main components of the ILS equipment as it is installed in the aircraft.

One receiver, the localizer, operates on any of six crystal-controlled frequencies located between 108 mc. and 110 mc. This receiver tells the pilot, through movements of a vertical needle of a specially designed microammeter, whether he is to the right or left of the runway. Actually the needle is differentiating between an area of 150 cycle modulation and 90 cycle modulation.

The path of descent can be seen in the movement of a

horizontal needle of another microammeter utilizing the same meter face as the vertical needle. A glide path receiver controls the movement of the horizontal needle. It operates on three crystal-controlled channels between 332 mc. and 335 mc. The glide path signal when modulated by 150 cycles will indicate position above the correct path while 90 cycle modulation is used to show position below the correct path.

Also used for blind landings is the much publicized GCA-ground controlled approach. All the equipment that is needed in the aircraft in order to use this system is voice communication between the pilot and ground. The path of the aircraft is accurately plotted and the pilot is literally talked into a landing by ground operators.

Non-directional radio beacons and marker beacons are two more of the facilities offered by the Federal airways system. The former is simply a station transmitting a continuous carrier in the aircraft band interrupted by regular station identifications. It is used only with direction finders as a homing aid.

Marker beacons are vertically directed signals on 75 mc. These are located along the "on course" of low frequency radio ranges. They enable the pilot to definitely establish his position while flying the ranges.

Thus it may be seen that the present day aircraft is well equipped with radio gear. In flying, radio is essential. Just as essential is the personnel which maintains this equipment.

Commercial operators (airlines, flight schools, charter companies, etc.) and most private owners who engage in regular and frequent flights away from their home airport have their radios checked periodically.

Scheduled airlines probably have as complete a radio maintenance system as can be found in the aviation industry. Here all radio equipment is given periodic checks

A 4-place Stinson, a private aircraft, showing rotatable loop antenna.



The instrument panel of the DC-6. Much of the responsibility for the safe operation of such sky giants rests with radio equipment.

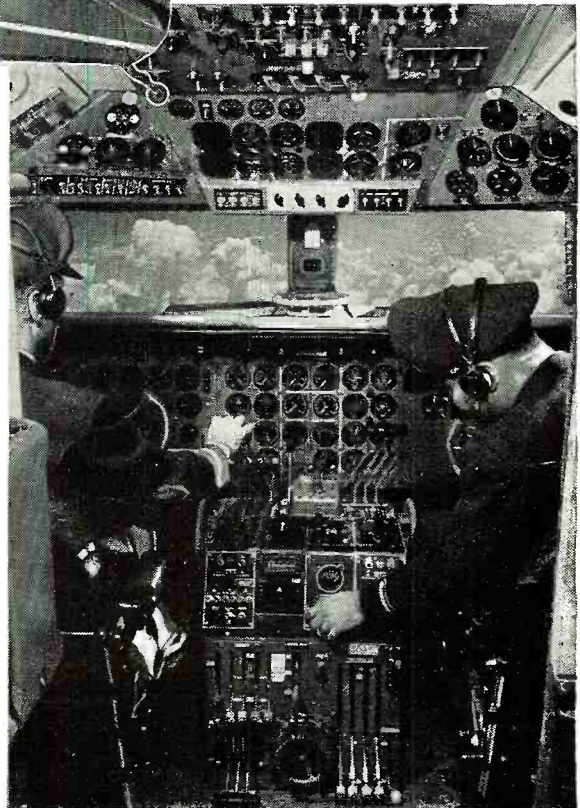

An over-all view of American Airlines' radio overhaul shop. As mentioned in the article, the large commercial outfits stress preventive maintenance and subject all radio equipment to periodic and thorough checks.



according to the number of hours which the ship has flown. There are checks approximately every 25 hours. Each succeeding check involves more operations until, at the end of a set period of time, say 2000 hours, all the radio gear is removed for overhaul and bench checks.

Aviation companies have found that it doesn't pay to wait until a unit breaks down before servicing it—preventive maintenance is the watchword. Those used to servicing home sets would find aircraft radio quite different in this respect—less than half the time is spent repairing defective units; more time is consumed looking for troubles before they cause the delay of a flight.

The more technical aspects of an aircraft radioman's job involve making new installations and modifying certain types (especially surplus) radio equipment, either to improve performance or to conform with government regulations. In large companies very little of the installation or conversion work is left to the initiative of the technician. In small outfits the success of the installations and conversions is largely dependent upon the skill of the technician.

The qualifications necessary for an aircraft radio technician can be summed up in five basic requirements:

1. *Technical knowledge.* He must possess a high degree of widely diversified theoretical and practical knowledge of radio.

2. *Mechanical ability.* He must be able to work well with tools and be fairly skillful in designing and building things of a mechanical nature.

3. *Familiarity with aircraft.* Since most of the equipment is installed in aircraft, familiarity with the location of the power sources, switches, controls, etc., are of vital importance.

4. *Physical fitness.* This work involves a good deal of climbing in and out of tight places, much walking, and lugging of heavy equipment.

5. *FCC license.* A 2nd class phone is the minimum license requirement. If a man has the proper technical knowledge all the preparation needed to pass this exam is a study of the FCC regulations governing the holders of commercial licenses. However, a review of a "question and answer" book (sold at most technical book stores) for this exam, might prove helpful to those who might be rusty on theory.

Now, providing a man has the proper qualifications, the next step would be applying for a position. Let us consider the main sources of employment. There are five.

1. Scheduled airlines
2. Non-scheduled airlines
3. Maintenance and overhaul shops
4. Civil service
5. Own business

The scheduled airlines hire the bulk of the personnel, each major airline having in the neighborhood of 50 to 175 men over-all, doing radio work. The starting pay is fair—about \$1.52 per hour with periodic increases governed by the length of service. The work is shift work. Working conditions and equipment are excellent. There is a strict union shop with its attendant seniority regulations.

Non-scheduled airlines pay on a par with the scheduled lines but do not offer the same security since the "non-scheduleds" have not as yet attained any form of inherent stability.

The working conditions are just fair while oftentimes the equipment is worse. Here more skill and versatility is required. Hours are frequently long and irregular. However, experience is plentiful and the opportunities of high gains that go along with new enterprise are ever present.

Maintenance and overhaul shops usually pay scheduled airline rates to the regular technicians but the rates of the leadmen and foremen are somewhat higher. Here the hours and working conditions depend upon many factors, such as the size and policy of the particular shop.

Civil service positions are sometimes available in the aircraft radio field as civilian technicians with the armed services and with the Civil Aeronautics Authority.

With the latter the work is for the most part installing and maintaining the ground stations of the radio aids to aerial navigation that span the entire country. Such positions for technicians pay between three and four thousand per year, depending upon the classification of the work. Announcements of examinations for these positions appear in the Civil Service periodicals.

Operating one's own business will offer opportunity only to those experienced in aircraft radio as well as business techniques.

Not unlike similar ventures in the home sales-service field it offers advantages, such as being your own boss, on the one side and disadvantages, like a seven day-ninety hour week, on the other.

For the benefit of those considering an entry into this phase of electronics let me outline briefly the future of aviation radio.

(Continued on page 106)

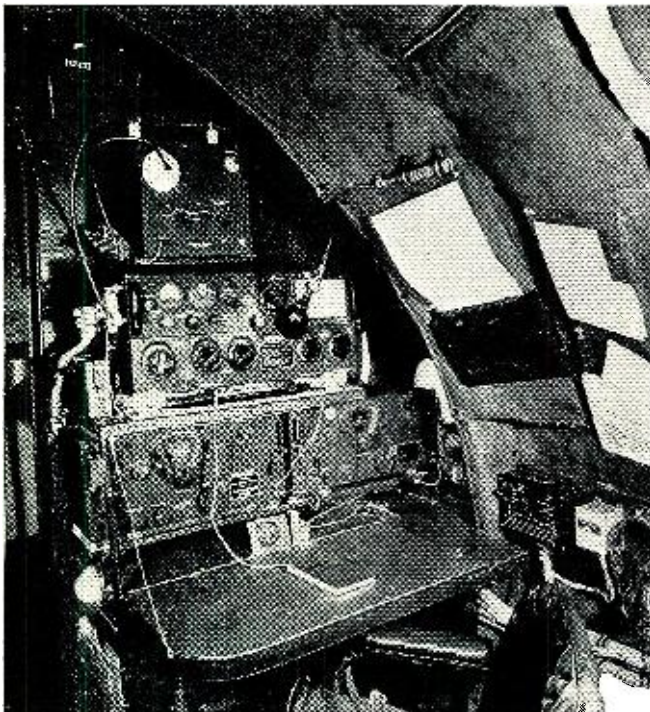

(Below) The radio operator's station in a Douglas DC-4. Note the many different types of radio equipment used in the operation of this craft. (Left) The radio panel of the four-engined "Constellation." Because the "Connie" is used for long, over-ocean flights the radio equipment includes c.w. as well as phone equipment. Note the sending key in the right center of the photograph.

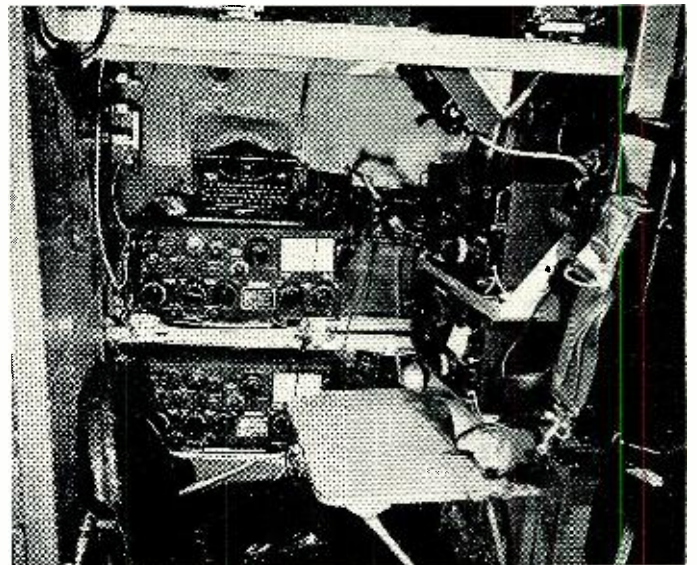

# FREQUENCY MEASUREMENTS for Citizens Radio

By **HAROLD McKAY**  
Electronic Consultant

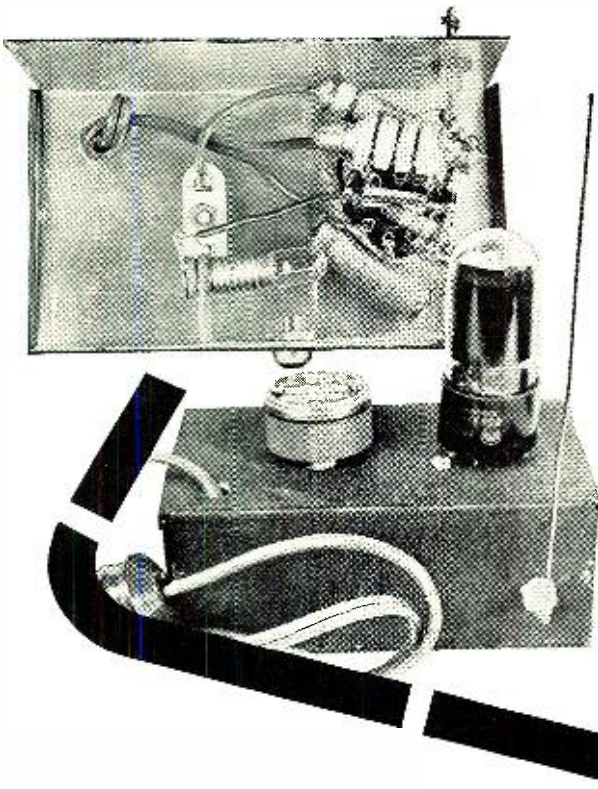

Top and bottom views of the home-built test unit designed for adjusting the transmitter frequency of citizens band transceivers.

**Complete construction details for a single-tube frequency test instrument covering 460-470 mc. FM broadcast stations are used as frequency standards.**

HOSE who would experiment with radio equipment for use in the citizens radio band (460-470 mc.) will require certain test equipment in order to properly service and adjust their sets.

Most important of the test instruments which will be needed is a device for adjusting the transmitter frequency within the limits prescribed by the Federal Communications Commission.

Commercial frequency meters which cover this band range in price from \$42 to several hundred dollars. These instruments provide a degree of accuracy which is not needed for citizens radio. Therefore, simple devices may be constructed which will serve the purposes and at a cost of \$10 or less.

## Crystal Oscillator

One such device is a simple oscillator, such as shown in Fig. 1. This unit employs a 5 mc. crystal which is available as a surplus item at nominal cost. While the basic circuit is of standard design, this application features a power supply without filtering equipment.

The pulsating direct current, which is applied to the plate of the oscillator portion of the tube, results in the creation of a large number of harmonics, and, in addition, provides an audible tone composed of power line harmonics which can readily be identified in a receiver.

Radio frequency harmonics in the 460-470 mc. region are accentuated by the use of an antenna connected to the plate of the oscillator. This antenna is one-quarter wavelength (161 mm.) long.

In use, the oscillator should be compared at its fundamental with station WWV, by listening to both on any receiver which will bring in the station on 5 megacycles. If the crystal deviates too much from WWV, a small trimmer condenser may be placed in parallel with the crystal to bring it to proper frequency.

Bear in mind that the 93rd harmonic of the crystal is being used at 465 mc., and any error in crystal calibration is multiplied accordingly.

FCC requirements for Class B citizens radio call for all operation (tolerance and communication band) to be within plus or minus 0.4% of 465 mc. This provides a bandwidth of 3.72 megacycles, which allows a great deal of leeway. Practically, if the crystal beats within the audio range with WWV it will be satisfactory without further adjustment.

To adjust a transmitter with the crystal oscillator, it is first necessary to make an approximate adjustment with a Lecher wire system, or a calibrated receiver.

This is necessary because the crystal oscillator will put out harmonics at 5 mc. points, out to 1500 mc. The signal from the oscillator will appear at 460,

465, and 470 mc. and it is necessary to identify the correct frequency.

A calibrated receiver will locate these points readily but if this is not available the transmitter must be tuned by the Lecher wire system, to a point near 465 mc.

The transmitter is then tuned in on a receiver, on which the 465 mc. harmonic of the oscillator can be heard. The transmitter is then carefully adjusted to zero-beat with the oscillator.

Harmonics from the crystal can be heard at 465 mc. even on such insensitive receivers as the BC-645, if the receiving antenna is brought within an inch or so of the oscillator antenna.

It may be necessary to move the transmitter some distance away from the receiver while comparing its signal with that from the crystal in order to diminish the strength of the signal.

(Continued on page 102)

Fig. 1. Schematic diagram of crystal oscillator for 465 mc. frequency measurements.

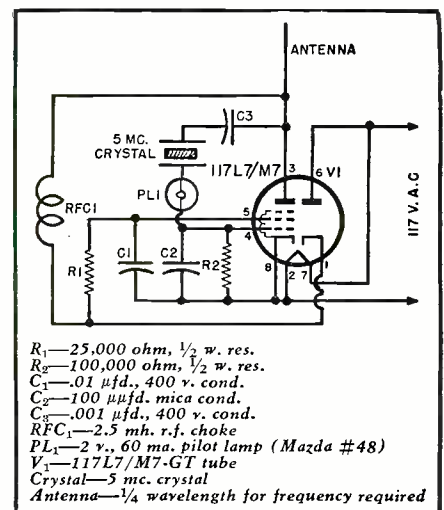

# IS Stratovision THE ANSWER?

By **KENNETH R. BOORD**

**Fourteen planes would provide adequate coverage for approximately 78% of the people in the U.S.A.**

ALTHOUGH *Stratovision* experiments in the United States have been suspended temporarily, there are many TV authorities who believe it is the *only* answer to truly adequate "nationwide" video coverage—including the small towns and rural areas as well as the large metropolitan centers of the country. Five years ago (1945), the *Westinghouse Electric Corporation*, in cooperation with *The Glenn L. Martin Co.*, announced the intention of developing this system in the United States.

What is Stratovision?

It is airborne television—transmission relay from planes in motion at high altitudes. By raising the broadcasting antenna to greater heights, relatively large improvements in v.h.f. (very-high frequency) and u.h.f. (ultra-high frequency) transmission range may be obtained. "Radio" horizon distances, of course, are largely dependent upon atmospheric conditions. A transmitting antenna 30,000 feet above the earth's surface has a "line of sight" distance to the horizon of 211 miles, and this distance roughly represents the service area of such a v.h.f. or u.h.f. transmitting antenna. Assuming true spherical earth conditions, calculations indicate that television coverage over this large distance is attainable with powers equivalent to those used in present-day commercial television stations.

A transmitter operating at 600 megacycles, airborne 30,000 feet above the surface of the earth, with an effective radiated power of 25 kw. assumed, will achieve a field intensity of 2 millivolts per meter for a 30-foot high receiving antenna, out to 238 miles. This distance represents the coverage from an airborne station over the earth.

Minimum values of field intensity occur at several points closer to the transmitter and fall below the value of two mv/m. required for service. These minimums will not occur at the same distances for a different receiving antenna height. This makes it possible to increase the field intensity at any location by changing (either raising or lowering) the receiving antenna

by a few feet. Energy at the receiving antenna arrives from the transmitting antenna over two paths—a *direct* path and a *reflected* path. Thus, the net energy at the receiving antenna is a vectorial addition of these two components. As the distance between transmitter and receiver is changed (or the antenna heights are changed), the changing vectorial relationship produces nulls and maximums. There are as many nulls between the transmitter and its horizon as the number of half-wavelengths that the receiving antenna is above ground. It is desirable to reduce the receiving antenna height as the receiver is moved closer to the transmitter, even to the point of laying it close to the ground when the location is near the transmitter.

Naturally, terrain factors influence the coverage obtained, and these factors have a greater attenuative effect in the u.h.f. television band than in the v.h.f. band.

## Testing

The *Westinghouse* and *Glenn Martin* companies undertook two series of flight tests to study the propagation and plane motion effects. The first of these studies was made with a twin-engine PV-2 aircraft, capable of operation at 25,000 feet. (This ship was by no means of the type suitable for day-to-day broadcasting but was quite suitable for propagation measurements.)

Two transmitters were installed in the unpressurized cabin of this ship. A 250-watt transmitter, operating on 107.5 mc., and a 5 kw. (peak of pulse) transmitter operating at 514 mc., were flown at various altitudes away from Baltimore (Maryland), and continuous recordings of field intensity were made at locations ranging from Norfolk (Virginia), to Pittsburgh (Pennsylvania), and Boston (Massachusetts).

During the one-year flight-test period using PV-2, measured field intensities were compared with calculated values and effects of motion of the plane upon the pulsed waveform of the 500 mc. transmitter were studied. No effects of the motion of the plane were found except for the expected

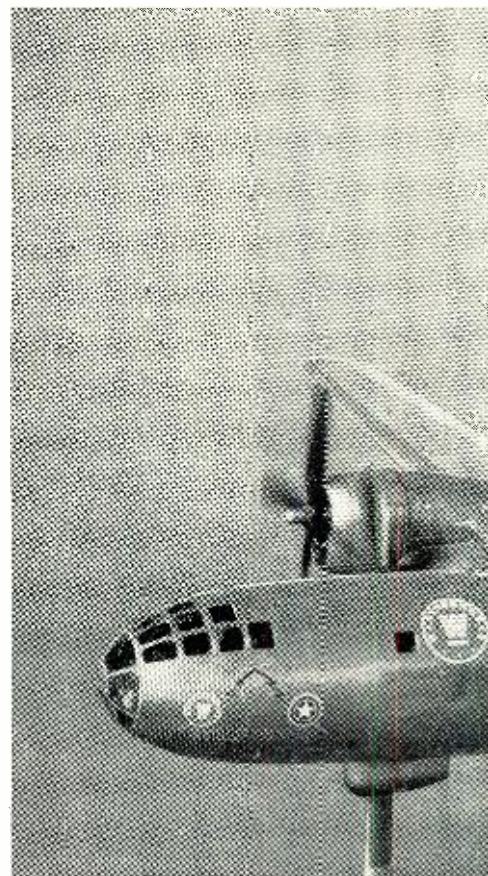

The experimental Stratovision station (a modified B-29), flying at 25,000 feet over the Pittsburgh area, rebroadcast telecast picked up from the east coast television network over an estimated area 525 miles in diameter. Programs from the ground stations are picked up on the antenna projecting above the tail, and rebroadcast from the long, mast-like antenna extending down from the nose of the plane.

variation of field intensity as the distance changed. Measured field intensities agreed with calculated values reasonably well when the receiving antenna site approached a true spherical earth condition. Departure below predicted values was noted when the receiving antenna was down behind a hill. In a comparison study of measured and calculated values when the receiving antenna was set up on a beach at Norfolk (Virginia)—the total path between transmitter and receiver being over the waters of Chesapeake Bay—it was noted that even with this ideal "spherical earth" location, the minimums were never as deep as calculated.

As a result of these tests, the two companies were encouraged to equip a more suitable plane for actual picture transmission in accordance with commercial television standards.

A complete set of modern TV transmission equipment was built and in-

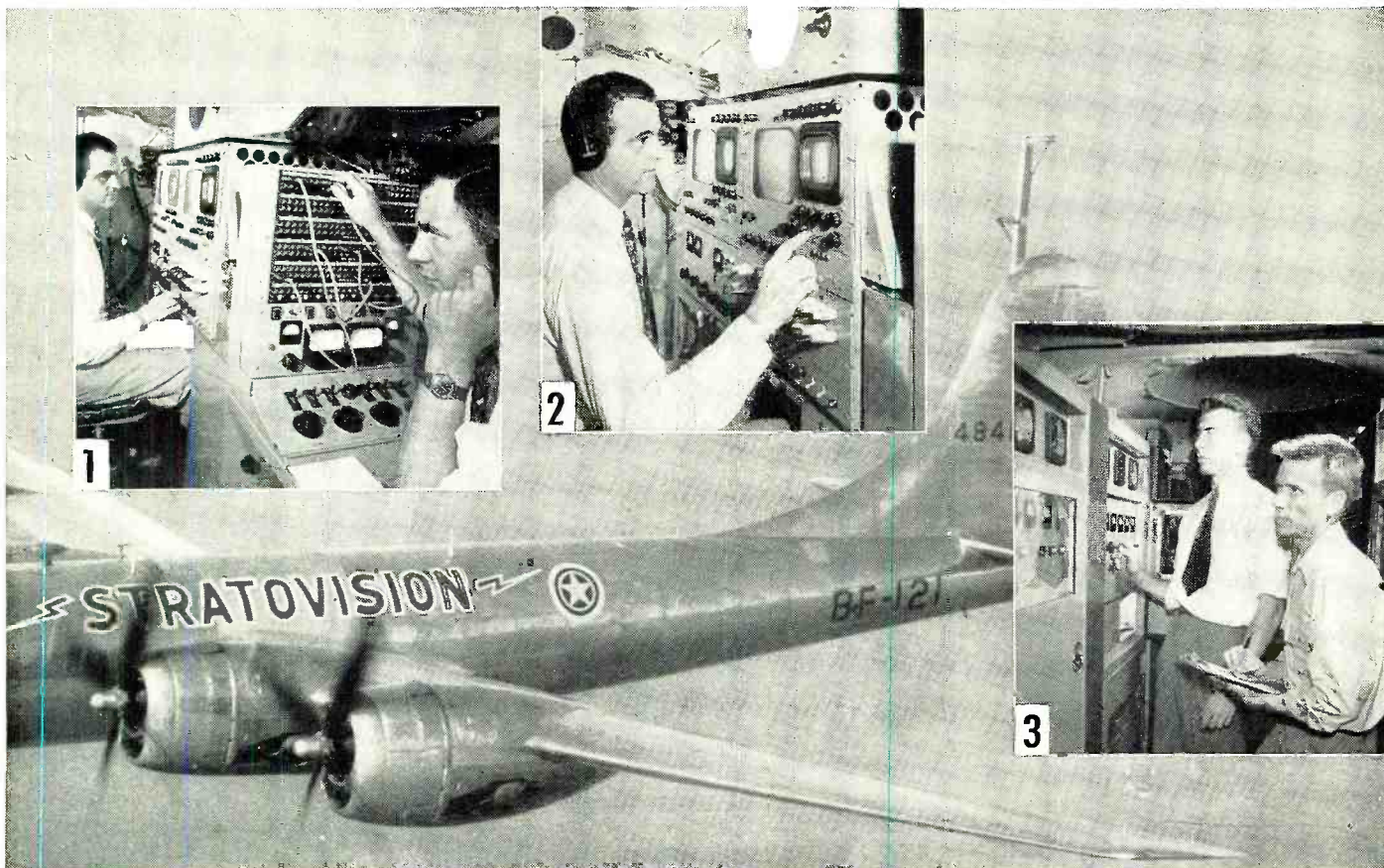

**1** C. E. Nobles (shown at left), originator of the Stratovision system for airborne television and frequency modulation transmission, monitors the television signal received and transmitted from the Stratovision airplane. Ben Carroll (shown at right), Martin Stratovision project engineer, listens at the sound monitoring position.

**2** C. E. Nobles at the twin video monitoring boards in the experimental Stratovision airplane. The boards are so arranged that each can be used separately to monitor the video signal coming to the plane or the signal being transmitted by the plane, or they may be used together so that the signal picked up by the plane appears on one screen while the plane's broadcasted video signal is monitored on the other. The TV picture is viewed on the large screen.

**3** Angus A. Macdonald (left) and Larry Smith, Westinghouse engineers, record current and voltage readings of the 1000 watt transmitter used to rebroadcast frequency modulation sound signals from the airplane. This transmitter plus the TV transmitter and the other equipment aboard the plane generated so much heat in early flight tests that a refrigeration system, capable of air conditioning a seven room house, was installed promptly.

stalled in a B-29 "Super Fortress" with all military armament removed to make room for the TV equipment. This aircraft is a pressurized, four-engine, high-altitude airplane capable of operation at 30,000 feet.

Television equipment installed in this ship consisted of receivers capable of receiving standard commercial television stations or a special 547.5 mc. relay link from the Westinghouse studios in Baltimore (Maryland). Transmitting equipment capable of emitting 5 kw. of video and 1 kw. of sound on TV Channel 6 (82-88 mc.) and monitoring and control equipment were also installed. In addition, other transmitters operating on 250 mc. (with 200 watts c.w.), 750 mc. (with 200 watts c.w.), and 3300 mc. (with 50 kw. peak of pulse) were installed to carry out further propagation measurements.

Receiving circular dipoles were located on an eight-foot streamlined mast atop the vertical tail fin. These antennas were used to receive standard ground stations for rebroadcast. The vertical tail fin was chosen as a

location for the receiving array because it was the spot most isolated from the transmitting array, thereby reducing the problems of receiving weak signals in close proximity with the 5 kw. video and the sound transmitters. This location plus the use of filters made it possible to receive any commercial channel except Channel 5, where the lower sideband components of the Channel 6 transmitter were relatively high.

In broadcasting position, the main transmitting antenna mast hung vertically downwards. This mast carried a two-element turnstile array for the Channel 6 video carrier, a single-element circular dipole sound antenna, and a 547.5 mc. relay link receiving array. The mast is 28 feet long and induced some 600 h.p. of additional drag to the plane in spite of its being streamlined. This array, of course, was retractable for take-offs and landings.

Power for all equipment was obtained from three 15 kva., 500-cycle alternators coupled directly to the plane's engines. The plane used a 70,-

000-BTU-per-hour air conditioning system in order to dissipate the heat from the operating compartment. Without air conditioning, the compartment temperatures reached 134 degrees Fahrenheit in spite of the fact that outside air temperatures were 25 degrees Fahrenheit.

This equipment was flown more or less regularly from June of 1948 to February of 1949. Usual flight procedure after take-off from Baltimore (Maryland) was to climb to operating altitude at Baltimore. During the hour required to climb, equipment was brought on the air and checked out. Upon reaching altitude, the plane was flown away from Baltimore while continuous propagation measurements and range measurements were being made. The programs of WMAR-TV of Baltimore usually were broadcast on Channel 6.

After each flight, many TV fans wrote in to describe results of the test at their particular location. These reports from the public were numerous; several hundred letters were received

(Continued on page 145)

# A Crystal Receiver with Transistor Amplifier

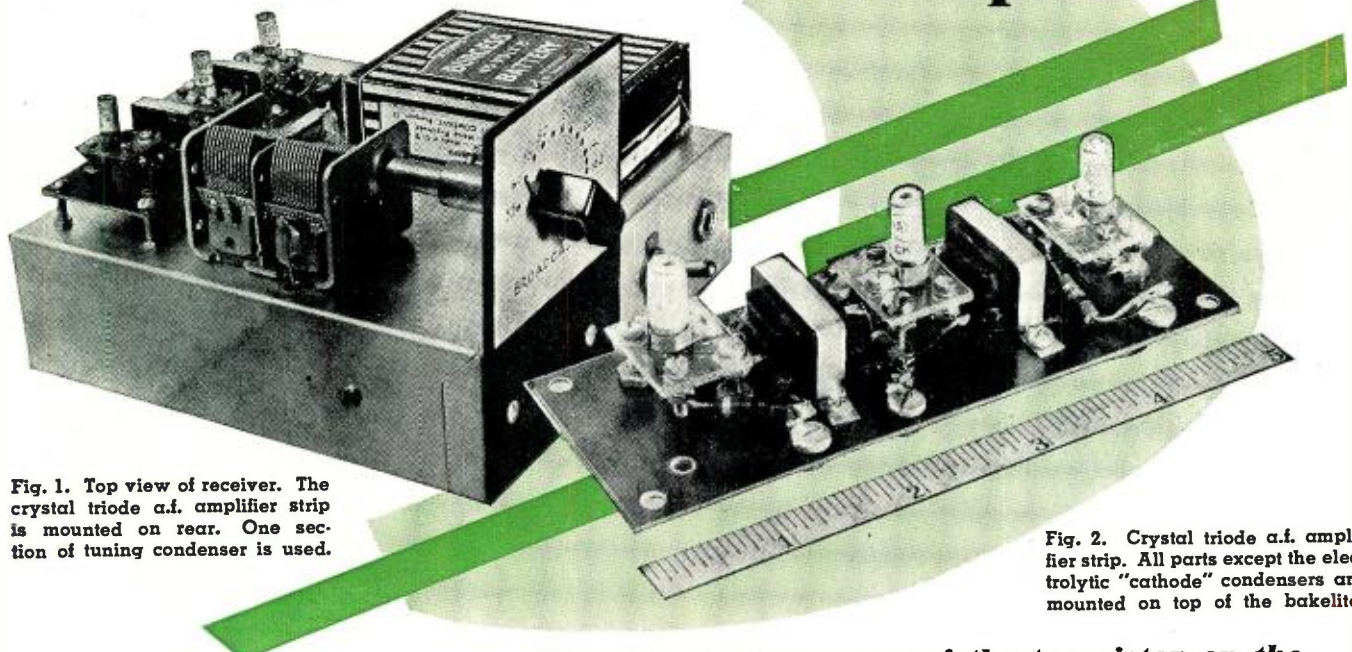

Fig. 1. Top view of receiver. The crystal triode a.f. amplifier strip is mounted on rear. One section of tuning condenser is used.

Fig. 2. Crystal triode a.f. amplifier strip. All parts except the electrolytic "cathode" condensers are mounted on top of the bakelite.

By  
**RUFUS P. TURNER, K6AI**

**The recent appearance of the transistor on the commercial market opens new fields to the radio experimenter. One of its uses is discussed here.**

**T**HE introduction of Raytheon's new CK-703 crystal triode opens up a new field of interest for the radio experimenter. Recommended for use at frequencies up to the video range, this commercial transistor can be used as a medium mu a.f. or r.f. amplifier, oscillator, or control "tube." Simple, small-sized, and lightweight electronic equipment may be built around crystal triodes. Enterprising radio men undoubtedly will find a host of applications for this device.

This article describes a simple crystal diode broadcast receiver with a crystal triode audio amplifier. Although this set will not operate a loudspeaker, it will give a walloping good signal in high-impedance headphones, provided it is connected to a good outside antenna and ground. A

Fig. 3. Under chassis view of the receiver showing components and simple wiring.

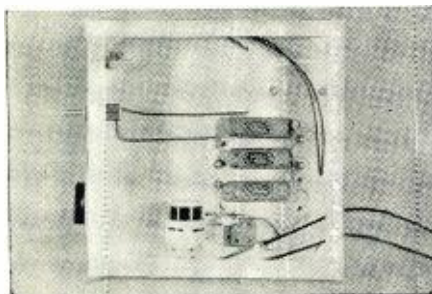

great deal of satisfaction may be derived from its operation, and some experience with crystal triodes gained as well.

Before describing the receiver, however, we will explain briefly the characteristics and construction of the crystal triode.

## Features of Transistor

The transistor is a germanium crystal device. It differs from the familiar crystal diode, of which the 1N34 is a well known example, chiefly in that the transistor has two catwhiskers instead of one. One whisker, called the *emitter*, acts in a manner comparable to the grid of a triode vacuum tube. The point of the second whisker, called the *collector*, touches the surface of the germanium crystal extremely close to the place of contact of the first whisker and acts like the plate of a triode tube. The crystal itself (called the *base* in crystal triode terminology) is comparable to the cathode of a tube. Unlike a tube, however, the emitter (grid) of the crystal triode is biased with a low *positive* voltage, while the collector (plate) receives a high *negative* voltage. Another important difference is that the crystal triode has a low-impedance input and a high-impedance output. The recommended circuit symbol for the transistor is shown in Fig. 5A.

The CK-703 (See Figs. 5B and 7)

is a small-sized unit, being only 0.78 inch (maximum) long and 0.255 inch in diameter. The housing of the CK-703 is a cylindrical brass shell to which the crystal is connected internally. This shell serves as the base (cathode) terminal. The emitter and collector whiskers are connected to two nickel contact pins which extend through an insulating disc-plug in one end of the brass shell. Fig. 5B identifies these pins in bottom view. The CK-703 has an input (emitter) impedance of 500 ohms and output (collector) impedance of 10,000 ohms. It is rated at 2 milliwatts average power output with an average power gain of 16 db. The power rating is on the basis of a 50-microwatt signal applied to the emitter. Table 1 gives the important electrical characteristics of the CK-703.

From the impedance ratings, it is evident that a conventional amplifier circuit employing crystal triodes must provide for an impedance step-down between stages. This means that interstage transformers must have a step-down turns ratio.

## Receiver Circuit

Fig. 4 is the complete schematic for the receiver. This circuit is entirely conventional except for the employment of a 3-stage crystal triode audio amplifier.

The input coupler,  $L_1-L_2$ , is a standard broadcast antenna coil of the type

used in midget receivers (*J. W. Miller 20-A*). This coil has been center tapped in order to match the impedance of the crystal detector more effectively and to improve selectivity. The center tap must be provided by the builder, since this coil normally is not supplied with one. Tuning is accomplished by means of a midget 365  $\mu\text{fd}$ . variable condenser,  $C_1$ .

The detector diode is the new *Sylvania 1N54* high-efficiency unit. The cathode of this diode is connected directly to the high end of a 500 ohm load resistor,  $R_1$ , and to the emitter terminal of the first CK-703 socket.

In order to dispense with emitter batteries in the amplifier, the author has employed base or "cathode" resistors,  $R_2$ ,  $R_3$ , and  $R_4$ , in each stage. Collector current flowing through each of these resistors develops a voltage drop which is applied as a small positive potential to the emitter terminals. The 500 ohm value is correct for  $R_2$ ,  $R_3$ , and  $R_4$ . Reducing this resistance decreases power output and increases distortion. While there has been some criticism regarding this method of operation, it has given satisfactory operation in practice.

The interstage transformers,  $T_1$  and  $T_2$ , employed by the author are *U.T.C.* sub-ouncers Type SO-2. These transformers are connected backward. That is, the normal secondary (high impedance) is connected to the collector output of one crystal triode, while the primary (low impedance) is connected to the emitter input of the following crystal triode. While these transformers were not designed specifically for this application, they have approximately the proper turns ratio for the required impedance transformation and are very small in size. To improve fidelity, an individual builder may prefer to shunt-connect the transformers to keep d.c. out of their windings.

The headphones are connected in series, through the output jack, with the collector of the last crystal triode and the negative battery terminal. Operation of a pair of 2000 ohm headphones has been satisfactory in this circuit.

In the event that crystal headphones are used it will be necessary to use a choke and condenser coupling arrangement to keep the d.c. out of the headphones.

A single 45 volt battery is employed for power and is bypassed by a 10  $\mu\text{fd}$ ., 150 volt electrolytic condenser,  $C_6$ . There is sufficient voltage drop across the high-impedance windings of the two transformers to reduce the collector-to-base d.c. voltage in each amplifier stage to about 37 volts.

It is absolutely imperative that proper polarities of the crystal diode and of the three crystal triodes be observed. For this reason, the cathode terminal of the diode has been labeled in Fig. 4, and so have the emitter (E), collector (C), and base (B) terminals of each crystal triode. The builder must be careful to ground the positive

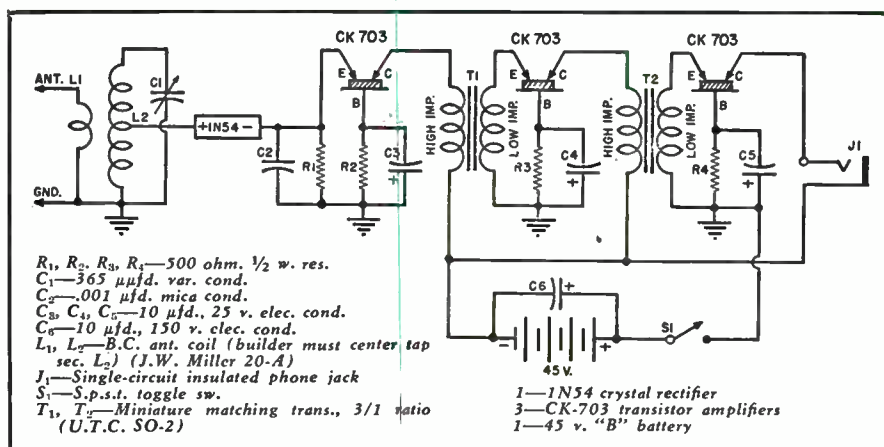

Fig. 4. Complete circuit diagram and parts list for the crystal-transistor receiver.

TYPICAL OPERATION	
Emitter Voltage	..... 0.2 v.
Emitter Current	..... 0.75 ma.
Collector Voltage	..... 30 v.
Collector Current	..... 2.0 ma.
Transconductance	..... 5000 micromhos
Emitter Impedance	..... 500 ohms
Collector Impedance	..... 10,000 ohms
Average Power Output	..... 2 milliwatts
Average Power Gain	..... 16 db.
MAXIMUM RATINGS	
Collector Voltage	..... 70 v.
Collector Current	..... 4.0 ma.
Collector Dissipation	..... 200 milliwatts
Emitter Current	..... 10 ma.

Table 1. Electrical characteristics of CK-703.

terminals of electrolytic condensers  $C_3$ ,  $C_4$ , and  $C_5$  and also to connect the positive battery terminal to ground. It will be easy to make a mistake in these connections, since radio technicians are well-schooled in the opposite procedure of connecting "B-minus" and the negative terminals of cathode bypass condensers to ground. The crystal triodes definitely will be burned out if the battery polarity is reversed.

### Construction

At this writing, no sockets have been manufactured for the CK-703. For this reason, the author made his own. Fig. 8 gives constructional details of the home-made socket, and Fig. 6 shows two completed sockets. Undoubtedly, the sockets could have been made smaller in size. The reader who is mechanically proficient may prefer to follow an entirely different design.

The basic requirement in the tran-

Fig. 6. Home-made water-type CK-703 sockets. Bottom view shows transistor plugged into socket with the two base pins in contact with the wire springs. Brass shell for gripping the CK-703 case is shown at right.

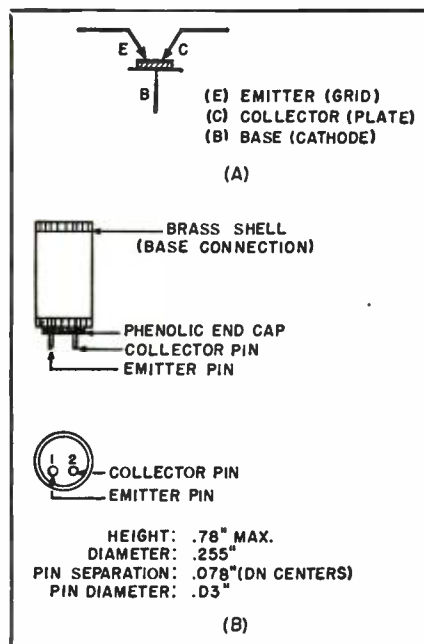
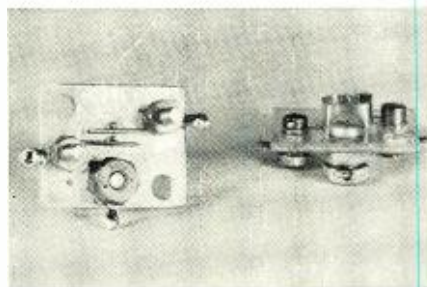

Fig. 5. (A) Circuit symbols for the transistor. (B) Details of CK-703 crystal triode.

sistor socket is that good contact be made separately to the outer metal shell of the CK-703 and to each of the base pins. Whatever type of contact is used, it must grip the shell and pins firmly but without bending, twisting, or denting. Soldering to the CK-703 is not advised.

(Continued on page 153)

Fig. 7. Three new CK-703 crystal triodes. The contact pins are the collector (plate) and emitter (grid) terminals. Brass shell is connected to the crystal and is the base (cathode) terminal. Triode is .78" by .255".



# The BEGINNING AMATEUR

**Part 12. Covering the radio ham and how he can prepare for a career in radio and electronics industry. This article concludes the series.**



Radio engineers at work in the electronics laboratory of the General Electric Co., Syracuse. Elaborate equipment setups of this kind are common.

**By ROBERT HERTZBERG,  
W2DJJ**

**N** MANY young men take up ham radio as a hobby and become so engrossed in it that they decide to make electronics their life work. This is a perfectly natural development and should be encouraged by parents, because radio in its multiple ramifications offers almost unlimited opportunities to serious, diligent workers.

Former and present hams are scattered throughout every level of the radio game: engineering, manufacturing, selling, advertising, broadcasting, and servicing. The history of the art is full of the names of hams who made good in a big way. Edwin H. Armstrong, whose invention of the regenerative, superregenerative, and superheterodyne circuits, and of FM broadcasting easily rates him the title "Radio's No. 1 Wizard," still talks proudly of his pioneer amateur station of 1906 in which he started his famous researches. Allen B. DuMont, whose name is synonymous with television, was an active ham two decades ago while he was an engineer with various radio firms. The huge organization which he now heads is the direct outgrowth of a modest laboratory-shop he had in the basement of his home in Upper Montclair, N. J., in 1931. Sound broadcasting as we know it today had its real beginning in 1920 with W8XK, a ham station in the backyard garage of Frank Conrad in Wilkensburg, Pa. This modest rig became KDKA, and Dr. Conrad became assistant chief engineer of *Westinghouse*, the recipient of numerous awards for his accomplishments. The great Marconi himself, the man who literally electrified the world at the turn of the century with his demonstrations of communication through space, was scarcely 20 years old when he undertook his initial "wireless" experiments with odds and ends of equipment, just as many an aspiring ham does today!

Amateur experience is valuable to the embryo engineer

because it gives him a feeling for the *practical* side of a science that too often wanders into the realm of abstract mathematics. Since a ham is by nature an experimenter, a ham-turned-engineer is likely to use his soldering iron *as well as* his slide-rule, with very beneficial results.

Because electronics plays such a large part in our national military establishment, the Army, the Navy, and Air Forces practically compete with each other to get hams to join up. All the services offer extensive courses of training to further the technical competence of the men and women who are responsible for the operation of billions of dollars worth of radio-radar equipment. The attractions and advantages of service careers appeal to many young men. As with industry, the services are loaded with hams in all ranks, from privates and seamen to generals and admirals. Lieut. General Curtis LeMay, former commander of the U.S. Air Force in Germany and present commander of the Strategic Air Command, is an ardent ham of long standing and while in Germany was on the air almost nightly with a D4 call. At the big schools for electronic technicians run by the military departments there are so many amateurs, among both the instructors and the students, that the general atmosphere of these places almost resembles that of a hamfest. At Fort Monmouth, N. J., the home of the Army's Signal School, there are four separate ham clubs, and barracks and other quarters are festooned with antennas. There is some feeling among the officers there that a CQ whistled over the p.a. system would get quicker results than the bugle call "Assembly."

How does a ham become something more than a ham? For a lad whose objective is engineering, the course is very clear: A sojourn of four years at a recognized college offering the degree of electrical engineering, or, more commonly, bachelor of science in electrical engineering (B.S., E.E.). Some schools give all applicants an entrance examination, regardless of their previous training; some admit high school graduates on the strength of their diplomas alone. A man studies basic electrical engineer-



ing and majors, or specializes, in electronics or communications toward the end of the course. After graduation, he can take further specialized courses at universities that have advanced facilities, and he can obtain additional degrees, such as master of science or doctor of science. If his money, his eyesight, and his girl friend don't disappear in the meantime, he can work up to the degree of doctor of philosophy and earn the right to be called "Doctor Whoozis" in academic and technical circles.

No matter how much practical and theoretical instruction and experience a radio man has had, he is not considered an "engineer" by the great majority of radio-electronics companies unless he can show a B.S.E.E., as a minimum. An engineer, by commonly accepted standards, is a man who can undertake original design work on projected equipment, or do a major revamping job on existing equipment; he can also do research work on circuits, tubes, materials, etc. Although degrees mean only that the holder has boned his way through college and are no indication of native intelligence, ability to get along with others, or willingness to work, the fact remains that they

are the basis for selection of prospective employees by many employment managers.

A man who cannot show a degree from a recognized institution of learning, but who obviously knows a great deal about radio, is almost automatically classified as a "technician." This is a catch-all word meaning little because it is such broad term, but it does serve to separate the college-trained men from all others. Many "technicians" are employed in responsible jobs in large factories, laboratories, and telecommunications installations, but on the pay and recognition levels they rate below engineers. A highly competent "technician" can be a self-taught man, virtually without formal schooling. Starting as a ham at the age of 15 or 16, assiduously studying the excellent "amateur handbooks" available for a few dollars, and gathering practical experience with tools, meters, receivers, transmitters, etc., an intelligent lad can really learn a lot before he reaches voting age. He probably knows much more about some phases of radio than does another youngster who studied electronics through this time, but his deficiencies will show up very quickly in a

## WHAT LEADERS IN THE RADIO FIELD THINK ABOUT HAM RADIO

**RADIO & TELEVISION NEWS** asked a few prominent figures in the radio field for their opinion of ham radio as a background for a career in electronics. Here are their exact replies:

"**A**MATEUR radio has been a valuable adjunct in helping me to keep abreast of the advances that have characterized radio from the time Marconi first spanned the Atlantic with wireless telegraph signals.

"In my particular case, amateur radio has paid double dividends. Its development in my early days as a ham encouraged me to study in order to apply new ideas to my amateur station. And, by continuing to study, I was able to be informed on the fast pace of the art. The knowledge gained has been of great assistance to me in my Government service.

"I am glad that through the years I have made it a point to find time to continue my amateur activity. This has kept me posted on the practical use of equipment and techniques which, I feel, has made me better qualified for administrative responsibilities."

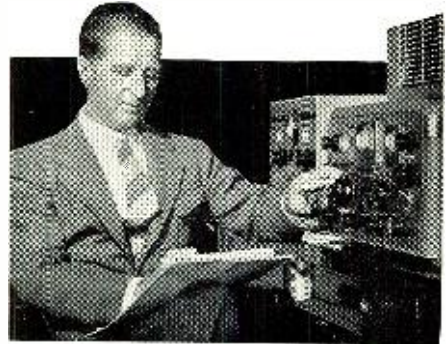

George E. Sterling, W3DF, Federal Communications Commissioner



Dr. L. R. Fink, mgr., Electronics Lab., General Electric Co., Syracuse, N. Y.

"**H**AM radio is probably the most useful hobby for a young man who plans to make a career in the electronics industry. Many of our leading engineers got their introduction to electronics through their experience as hams.

"The construction, maintenance, and operation of a ham rig gives a man valuable experience in troubleshooting, gives him a feel for electronic circuitry, and it gives him confidence, which means a definite edge over fellows without this experience.

"Many men who are classed as engineering assistants or lab technicians in our development labs find that day-to-day work gives them the same challenge, the same kind of effort, and the same pride of accomplishment that they used to get from tinkering with their ham rigs.

"Some of our engineers whose administrative responsibilities keep them at a desk find particular satisfaction in poking a hot soldering iron into their rigs at home.

"A vital part in the production of thousands of television sets is the troubleshooting of those which fail to pass regulation tests at the end of the assembly lines. Ham training is excellent background for these troubleshooters."

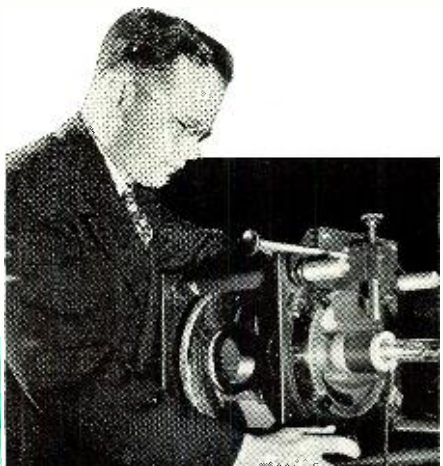

Dr. E. W. Engstrom, vice-president, in charge of research, RCA Labs., Princeton, N. J.

"**A**MATEUR radio is, in my opinion, an excellent foundation for the young man who intends to follow one of the numerous branches of electronics as a career. Certainly the knowledge of electron tubes, circuits, and measuring instruments, which he acquires while pursuing his hobby, should provide a good background for his later studies in college or vocational school. Rosters of radio firms almost invariably reveal one or more engineers, designers, or sales representatives whose first interest in electronics was acquired through the assembly and operation of a ham station."

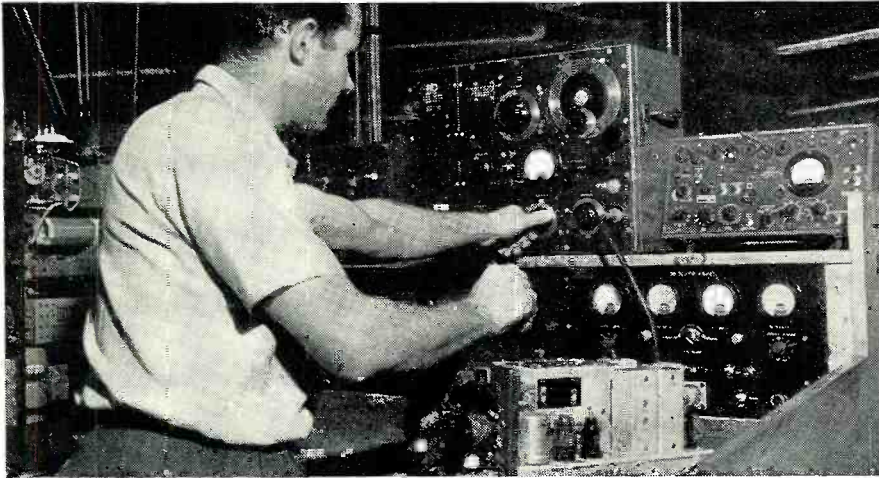

↑ Service technician at work in the radio maintenance shop of American Airlines, located at LaGuardia Field, N. Y. He is shown aligning a high-frequency aircraft receiver with the aid of a signal generator.

→ Another shot of the radio maintenance shop of the American Airlines at LaGuardia Field. This technician, using highly accurate test equipment, is checking the calibration of a direction finder before installation.

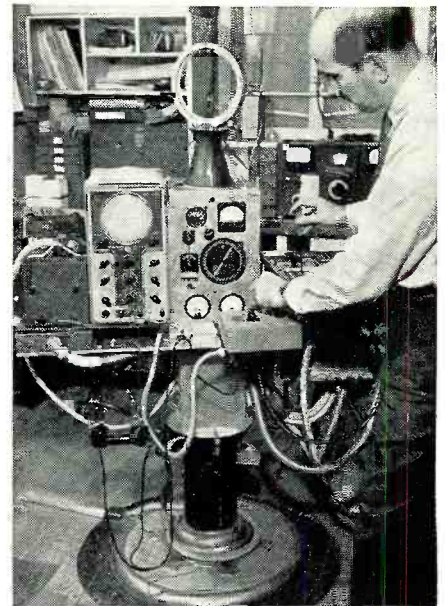

real test. For example, the "technician," with his bench-acquired "know how," is able to assemble and repair complicated equipment, such as a radar set, with ease and confidence. However, he's lost if the device starts to give false readings, because he doesn't know ordinary geometry, much less solid trigonometry, and radar is all a matter of angles in space. Here is where the "engineer" steps in and earns his salary. He solves the problem in a few minutes because he had solid trig and a dozen other forms of difficult math drummed into his head all during his college course. It might be said that mathematics is the dividing line between the true engineer and the technician.

Some radio executives think that *too* much emphasis is placed on math in some schools, at the expense of practical training in the lab or field. This tendency is probably the result of our wartime (and even current) need for "brainy" guys who can use higher forms of math to solve the fantastically complex questions that arise in connection with guided missiles, nuclear physics, radar and telemetering, supersonics as applied to aircraft, etc. Many capable radio engineers who finished their schooling between ten and twenty years ago are quietly taking refresher courses at night; they find that the young squirts they hire fresh from college as their assistants know more theory and math than they do!

Suppose you can't afford to go to college, or feel that you

are too old to start. Is there still a career for you in radio? Most definitely, *Yes*. There are excellent resident radio schools in several parts of the country where you can get concentrated, relatively short-term instruction in one or several phases of radio. Upon completion of the course, you are fully qualified to work as a service technician, factory production man, or radio station attendant. Don't for a moment think that you are an "engineer," because you're not. But don't let that bother you. For many of the jobs in radio, technicians are actually preferred to engineers.

If you can't get away from home to attend an out-of-town school, you can do very well or even better with correspondence courses. Thousands of successful, independent service technicians throughout the country can testify to the value of mail-order training. The lessons are carefully organized into small units, and you can do them as slowly or as quickly as your ability to assimilate them permits. And it's not merely "book learning"; with most of the courses you now get actual equipment that you assemble and operate yourself. With one television course there is provided a complete kit for an RCA 630TS receiver.

One very important feature of the correspondence training is financial: You can pay for most of the avail-

*(Continued on page 131)*

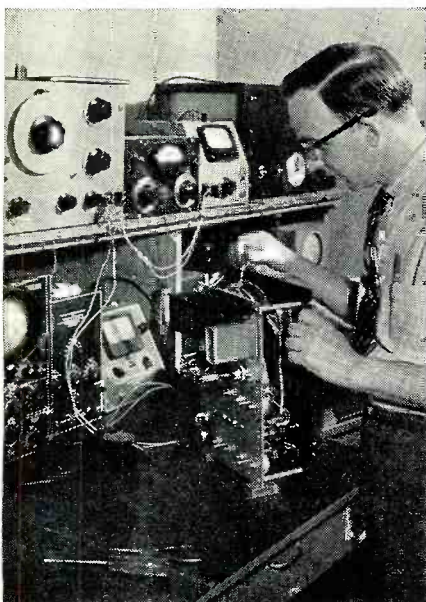

← Troubleshooting in an experimental circuit setup with a bench full of laboratory equipment is an everyday job for a trained engineer. This is the electronics lab of the General Electric Company in Syracuse.

↓ A typical assignment for a graduate engineer, checking the performance of an experimental piece of high-frequency "plumbing." Another view of the electronics lab of the General Electric Co., Syracuse, N. Y.

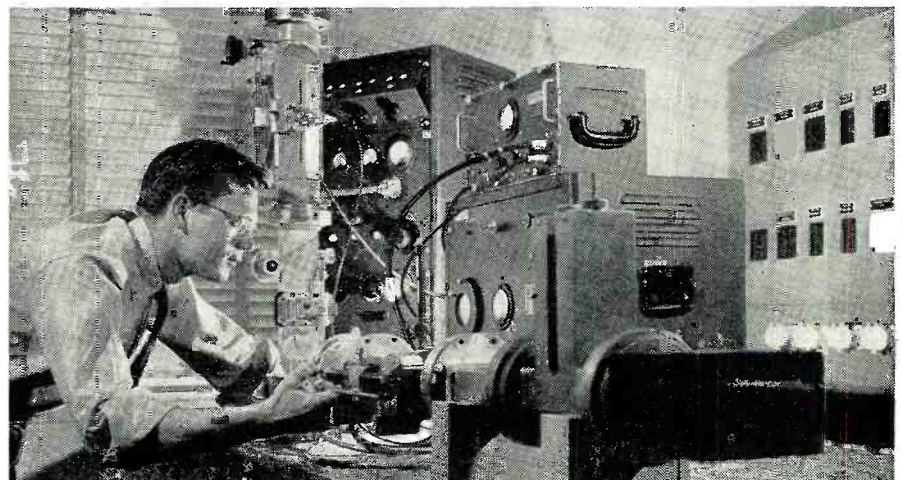

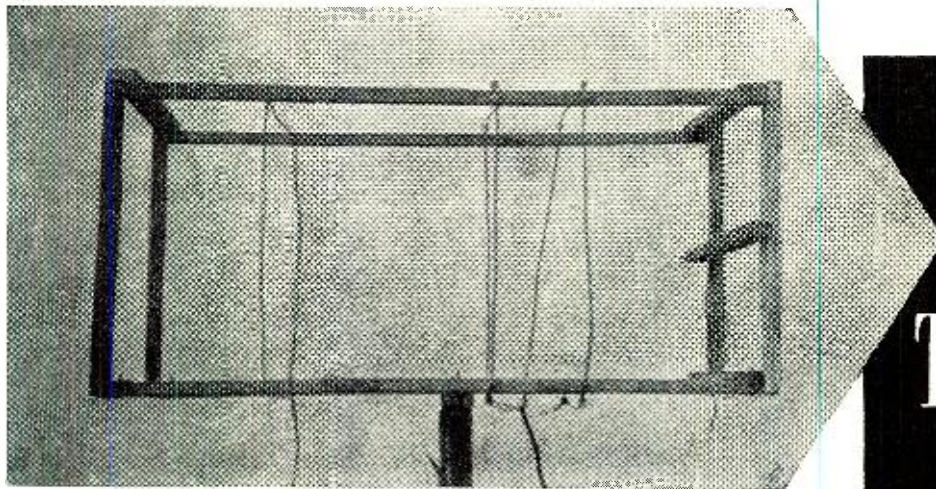

# A Two-Meter QUAD

**M**ANY hams and experimenters have been searching for an antenna that will give outstanding results on two meters and still fit into the family budget.

The type of quad to be described has a lower angle of radiation than that of the original cubical quad, because it is mounted horizontally instead of in accordance with the diamond mounting system used with the original quad. Height is not too important in using this type of antenna. Getting the array above trees and surrounding objects is all that is necessary for DX work on two meters.

Front-to-back ratio is very good. With a field-strength meter you will obtain readings only within 30°, standing 50 feet away from the front of the quad. Impedance is approximately 150 ohms, with one director loop and one reflector. The results obtained with this quad seem better on horizontal polarization than on vertical polarization.

Making a frame, 18 by 36 inches in size, is the first step, using 1" by 1" wooden strips. Take care to make this as light as possible, yet sturdy enough to withstand bad weather. For good, secure construction, slot the ends of each strip and use small bolts.

The radiator is made by winding two turns of No. 12 wire around the center of the frame with one-inch standoffs at each corner to give the wire a 19-inch length for each side. Space the turns five inches apart; no matching stub is required at this point. The 150 ohm feedline is connected to the ends of the loop.

Construct the director by making one turn of No. 12 wire, spaced 15 inches from the center of the two-turn loop, wound on the inside of the frame with insulators mounted one inch above each corner, leaving a 17-inch length of wire for each side. A 9- to 10-inch matching stub is fastened to the end of the one-turn loop. Proper matching can be determined by varying the length of the stub. A shorting bar will save a lot of time. However, a piece of 150 ohm twin-lead can be used by experimenting with different lengths.

The reflector is formed from two

The antenna is built on a simple wooden frame. A pipe mast is used for support and permits rotation.

By **G. P. OBERTO**

***A three-element, high-frequency version of the quad antenna, giving a unidirectional pattern.***

sections of No. 12 wire, 10¼ inches long for each section, mounted on a 22-inch board; the first two insulators are mounted one inch apart from the center of the board, and the last two are mounted 10¼ inches apart from the inside insulators. The board is fastened on the inside, 10 inches from the center of the two-turn loop. A 9- to 10-inch matching stub is also required at this point.

Although it was not tried, it is probable that the reflector could be a du-

plicate of the director if the reflector were wound on the outside of the framework to give the necessary added length.

The radiation pattern of an antenna of this type is horizontal, and parallel to the long dimension. The maximum radiation is off the director end.

Judging from experiments made with this antenna, it should perform as well or better than two five-element beams stacked.

-30-

Construction details and dimensions for the antenna. Rigid construction is necessary.

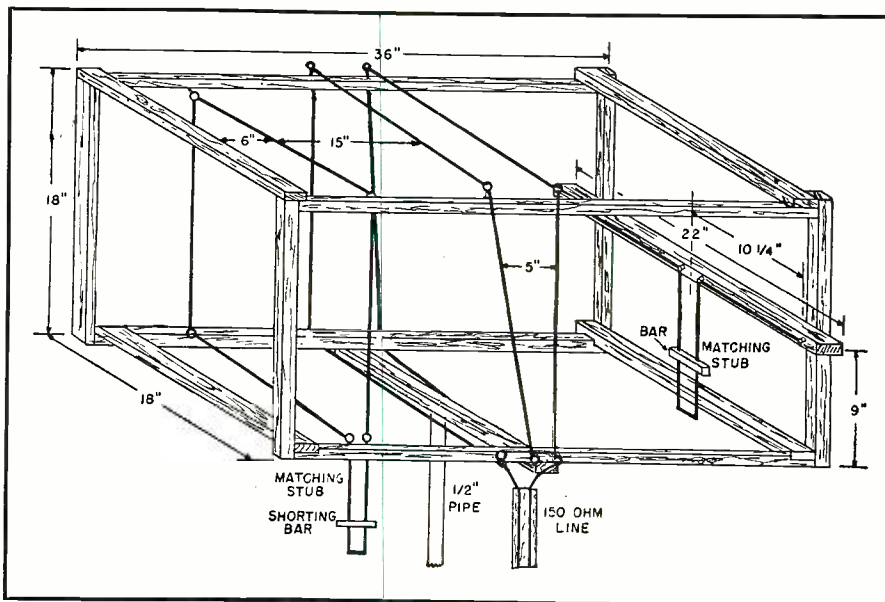

# Mac's RADIO SERVICE SHOP

By JOHN T. FRYE



## Mac and Free Estimates

three job will be very fine business. Now why didn't I think of that?"

"Probably because you were too busy scheming how you could get me to do the work for you," Mac said dryly. "I suggest you write the turns ratio on each of the transformers. Then if you ever want to know if one of them will work in a particular spot, you can figure it out."

"Check!" Barney said as he carried out the suggestion. "And while you are in such an informative mood, I'd like to ask you something else: what do you think about giving free estimates on radios? I see where a guy across town is advertising this feature."

"I feel about the free estimate as the New England preacher felt about sin: I'm 'agin' it," Mac said promptly. "In the first place, if you will think the thing clear through, you will see that it is neither 'free' nor an 'estimate.'"

"What you have to keep in mind," he went on, "is that a service technician has just so many hours of work to sell each week. His income depends directly upon the time he spends with a hot soldering iron in his hand. If he gives some of this time away for free, he simply must get more money for the working time left. That means that the cost of the 'free' estimate is simply passed on to the other customers in the form of higher charges."

"Does making an estimate take much time?"

"If it is of any value, it does. Finding what is wrong with a radio is always the thing that takes both brains and time. Fixing it is usually accomplished by a few passes with the diagonal cutters and the soldering iron. Before you can say how much it will cost to repair a set, you have to restore it to good playing condition. That means tubes must be checked, defective parts located and removed and new ones 'tacked' in place, circuits must be aligned, etc. If these things are not done, your estimate is nothing more than a guess."

"Well, what's wrong with that? It is an estimate, you know."

"Yes, I know, and you know, but the customer doesn't. To him an 'estimate' is actually the determined cost of putting the set into first class shape. Of course, if you find out that you have made a mistake and the bill is less than you anticipated, he is delightfully surprised; but if the cost is more than you calculated, he definitely feels that is a horse on you."

"The thing to do, then, is to make the estimate plenty high."

"That is exactly what happens in free estimating, because the estimate must be made quickly. Not much time can be squandered on a free service. Even a veteran service technician, though, never knows when what looks like a simple blown bypass condenser job will develop a noisy i.f. or output transformer when the set is thoroughly warm; or even a warped speaker cone may show up at this time. The only thing to do is to make the estimate

(Continued on page 147)

NLY a coal dealer could have seen anything good about the bleak January day. Before day-break a mixture of rain and sleet had begun to fall, and now at nine o'clock in the morning it was still hissing against the window of Mac's Radio Service Shop and slowly but surely coating everything outside with a sheath of ice.

Inside, though, things were proceeding quite normally. As usual, Barney was trying to beguile some information out of Mac, his boss.

"—and so," he was saying, "when I started to build this little phono-amplifier for Margie, I needed an output transformer. I found those three on the bench there in my parts collection, but they have no name on them. There's no way of knowing whether any of them will match a 6K6 to my four-ohm voice-coil. Unless you know what impedances an output transformer was designed to match, you might just as well not have the transformer."

"Well, now, I wouldn't say that!" Mac exclaimed in a startlingly-good imitation of Gildersleeve's Peavy.

Without further comment he clipped a couple of test leads to the secondary of one of the transformers and then inserted the other ends of the leads in the filament-pin holes of the four-prong socket of the tube tester. With the v.t.v.m. across these leads, he manipulated the filament voltage switch and the "line voltage adjust" control until he had exactly one volt across the voice-coil winding. Then he measured the voltage across the primary winding.

The procedure was repeated with the other two transformers, care being

taken each time to see that exactly one volt was applied to the normal secondary. The primary voltage readings were respectively 30, 35, and 43.

"If you put an a.c. voltage into one winding of an unloaded transformer and measure the voltages appearing across both windings, the ratio between these two voltages is very nearly equal to the ratio of the number of turns of wire on each of the two windings. Since our v.t.v.m. does not load the windings," Mac went on, "we can safely figure that the secondary-to-primary turn ratios of these three transformers are 1/30, 1/35 and 1/43."

"Very interesting, professor," Barney applauded, "but so what?"

"So-o-o-o, there is a connection between the turns ratio of a transformer and the impedance ratio of the windings. It is given by this formula," Mac said as he scribbled on the blackboard at the end of the bench:  $N = \sqrt{Z_s/Z_p}$ .

"N stands for the secondary-to-primary turns ratio;  $Z_s$  is the impedance to be used across the secondary; and  $Z_p$  is the impedance or plate load resistance presented by the primary. If we substitute the turns ratio of the first transformer and the four-ohm impedance of the speaker you intend to use across the secondary, we get:  $1/30 = \sqrt{4/Z_p}$ .

"Squaring both sides gives us:  $1/900 = 4/Z_p$ .

"When we 'cross-multiply,' we end up with  $Z_p = 3600$  ohms. Using the same method, we find that when the other two transformers are used on a four-ohm voice-coil, they will have primary impedances of 4900 and 7396 ohms. What was the load resistance of your 6K6?"

"It was 7600 ohms; so that number

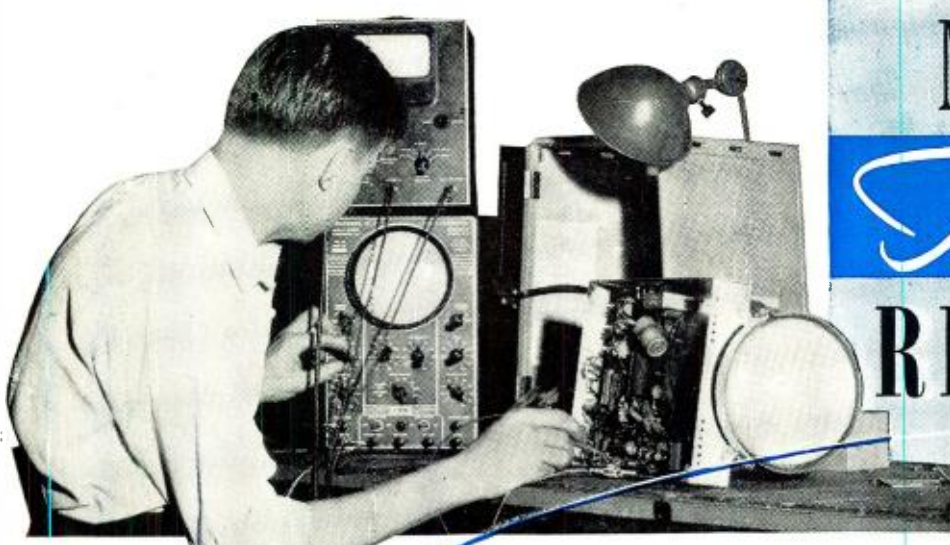

A. W. Behrend of Television Engineers, Inc., Chicago, checks a Sentinel Model 400 TV receiver during service test.

# MODERN Television RECEIVERS

By

**MILTON S. KIVER**

## **Part 21. Covering horizontal automatic frequency control systems used in present-day TV receivers.**

**U**SE OF the incoming sync pulses to trigger and control the vertical and horizontal sweep oscillators represents the simplest, most economical, and most direct method of controlling the motion of the electron beam in the image tube. Unfortunately, however, this method possesses limitations and disadvantages which outweigh its economy and simplicity. Perhaps the greatest disadvantage is its susceptibility to noise disturbances arising from electrical apparatus and equipment operating in the vicinity of the receiver. The noise pulses, combining with the video signal and extending usually in the same direction as the desired sync pulses, pass through the same stages as the pulses, and arrive at the sweep oscillators. They do their greatest damage when they arrive during the interval between sync pulses. If the amplitude of the noise pulses are sufficiently great, they will trigger the sweep oscillator, initiating a new cycle prior to its proper time. When the vertical oscillator is so triggered, the picture will move vertically either up or down, until the proper sync pulses in the signal can again assume control. If the horizontal oscillator is incorrectly triggered, a series

of lines in a narrow band will be jumbled, giving the appearance of streaking or tearing across the image. When the interference is particularly heavy and persistent, the entire picture becomes jumbled and may even be thrown out of horizontal sync permanently, requiring manual adjustment of the horizontal hold control.

Of the two sweep systems in a television receiver, interference is particularly destructive to the horizontal

the amount of charge contained in the condenser decreases, the discharging rate decreases, too, and for more than half the discharge cycle may be said to be exponential. In Fig. 1, the exponential region extends from points "A" to "B."

Now, when the negative charge present on the grid condenser is large, the oscillator is relatively immune to incoming positive pulses. With continued discharge, however, the immunity decreases. Experience has indicated that off-cycle triggering of the oscillator is generally concentrated in the last 15 per-cent of its discharge cycle. This is true regardless of the frequency at which the oscillator is operating. Hence, one would expect to experience equal difficulty with both deflecting systems in the receiver. That this is not so is due to the nature of the noise pulses and the type of filters inserted before each sweep oscillator.

Noise pulses which are most troublesome to television receivers possess high amplitude, but are narrow in width or, what is the same thing, are of short duration. (The energy in noise pulses is distributed over a wide range of frequencies. In order for a peak to occur, the phase relationship among the various frequencies must be such as to permit them to add, forming the high amplitude pulse or peak. This condition, however, usually exists only for a brief interval, which explains the narrow width of these pulses.) When the pulses reach the path leading to the horizontal sweep oscillator they are readily passed because of the short time-constant of the filter leading to the horizontal system. A short time-constant filter is necessary because the horizontal sync pulses themselves have a time duration of only 5 microseconds. On the other hand, the filters leading to the vertical system have a long time-constant and automatically act to suppress the effects of all horizontal sync pulses and

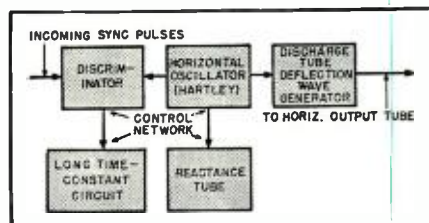
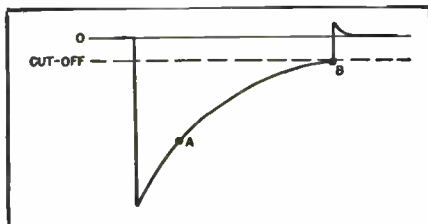

Fig. 2. Block diagram of an a.f.c. system.

system. To understand why this is so, we must examine the nature of most interference voltages and their effect upon the vertical and horizontal sweep oscillators.

Whenever a blocking oscillator is triggered by a sync pulse, for example, its grid, after a short period of conduction, becomes highly negative due to an accumulation of electrons on the grid condenser. This negative voltage is sufficient to keep the tube beyond cut-off until the charge on the grid condenser has decreased to a value at which current is permitted once again to flow through the tube. In most circuits now in use, the condenser discharge occurs in the manner shown in Fig. 1. At the start, the discharge is fairly linear. However, as

Fig. 1. Condenser discharge in grid circuit of blocking and multivibrator oscillators.



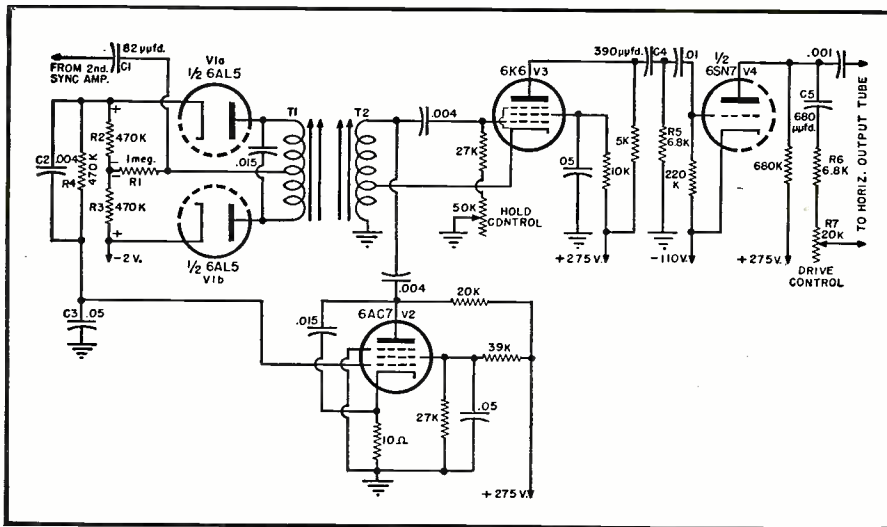

Fig. 3. Schematic diagram of the a.f.c. system shown in block form in Fig. 2.

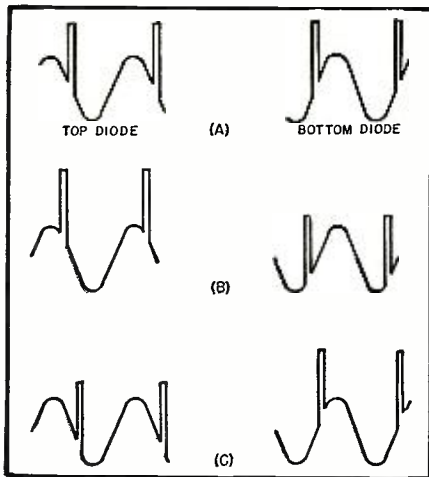

Fig. 4. Combination of the sync pulses and the sine wave from the horizontal oscillator in the discriminator circuit.

noise pulses of short duration. The presence of this low-pass filter (called an integrating network) is largely responsible for the greater immunity to noise pulses enjoyed by the vertical system. Of course, when a wide noise pulse is received, it contains enough energy to cause off-time firing of the vertical oscillator, but the annoyance caused the viewer from this source is seldom great. To reduce the susceptibility of the horizontal sweep system to noise pulses of any type, several automatic frequency (and phase) control systems have recently been developed.

In each of these special control systems an oscillator is set to operate at 15,750 cycles, and the output of the oscillator controls the horizontal motion of the electron beam across the screen of the image tube. The next step is to synchronize the frequency of this sweep oscillator with the incoming horizontal sync pulses of the signal, and this is accomplished through an intermediate stage known by one of the following names: control tube, a.f.c. phase detector, or horizontal sync discriminator. Whatever the name, the purpose of this intermediate network is to compare the frequency of the incoming horizontal sync pulses with the frequency of the horizontal sweep oscillator in the receiver. If a difference in frequency exists, a d.c. voltage is developed which, when fed back to the horizontal sweep oscillator, changes its frequency until it is exactly equal to that of the incoming sync pulses.

Note that the incoming sync pulses are not applied directly to the sweep oscillator. They are merely compared (in frequency) with the output of the sweep oscillator and if a frequency difference exists, then a d.c. voltage is developed which, when fed back to the sweep oscillator, forces its frequency back into line with that of the sync pulses.

Now (and here is the crux of the whole matter), by having the d.c. control voltage pass through a long time-constant filter before it reaches the sweep oscillator, we can eliminate the

effects of most noise impulses and permit only relatively slow changes in frequency of the sync pulses to affect the sweep oscillator. We have thus incorporated into the horizontal sweep system the same type of long time-constant filter that is present in the vertical sweep system.

Remember, it was through the use of a similar long time-constant filter in the vertical sweep system that this network obtained its immunity from most noise pulses (which have a short time duration). A long time-constant filter could not be used directly in the horizontal system because it would have prevented the desired horizontal sync pulses (together with the noise pulses) from reaching the horizontal sweep oscillator. Hence the need for the indirect method outlined above.

Now let us analyze the various automatic frequency control systems currently in use.

### Horizontal A.F.C. Systems

One of the first and still one of the best a.f.c. systems used is shown in block form in Fig. 2. In this circuit, a stable oscillator is set at 15,750 cycles. Connected to the oscillator is a synchronizing discriminator circuit which receives the pulses of the incoming television signal and compares the frequency and phase of these synchronizing pulses with the generated sine wave of the Hartley oscillator. Any variations between the two will produce a d.c. voltage which is applied to the grid of a reactance tube after passing through a long time-constant filter. The plate circuit of this reactance tube is connected across the tuning circuit of the horizontal oscillator, and, as the d.c. voltage at the grid of the reactance tube varies, it will alter the plate current of this tube and with it the oscillator frequency. (It is suggested that the reader refer back to Part 2 of this series, in the May, 1948 issue of RADIO & TELEVISION NEWS, where the operation of reactance tubes was discussed. It was shown there how they can be made to control the frequency of an oscillator.)

The schematic diagram of the circuit is shown in Fig. 3, with parts allocated as follows:

1.  $V_{1a}$  and  $V_{1b}$  comprise the horizontal sync discriminator circuit.
2.  $V_2$  is the reactance or horizontal oscillator control tube.
3.  $V_3$  is the horizontal sweep oscillator.
4. The long time-constant network consists of  $C_2$ ,  $C_3$ , and  $R_4$ . Now let us see how all these operate as a unit.

The sweep oscillator ( $V_3$ ) is the well-known Hartley. The oscillator coil,  $T_2$ , is inductively coupled to the horizontal sync discriminator by means of a center-tapped primary winding,  $T_1$ . Each diode in the discriminator circuit is connected across one-half of  $T_1$ , receiving sine wave voltages which are equal in amplitude but opposite in phase. Disregarding  $R_4$  for the moment, let us see how the voltages appearing across  $T_1$  will affect this circuit.

Fig. 5. (Left) Waveform produced at the plate of  $V_3$ . (Right) The same wave after passage through the differentiating network of  $C_2$ ,  $R_4$  of Fig. 3.

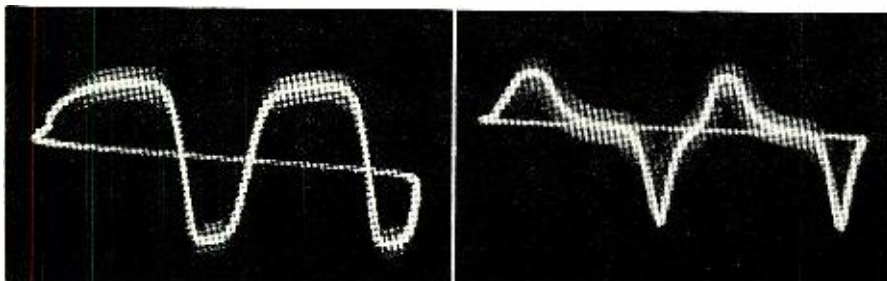

During one half-cycle, the top end of the secondary of  $T_1$  is positive, forcing  $V_{1a}$  to conduct. The current flows from cathode to plate, through the top half of the coil, through  $R_1$  and  $R_2$  back to the cathode again. The voltage developed across  $R_2$  is such that the bottom end is negative and the cathode end is positive. Throughout this interval,  $V_{1b}$  is non-conductive because the sine wave voltage applied to its plate is negative.

During the next half cycle,  $V_{1b}$  conducts and  $V_{1a}$  is cut-off. Current now flows through this tube, up through the bottom half of the secondary winding of  $T_1$ , through  $R_1$  and  $R_3$  back to  $V_{1b}$  again. The voltage developed across  $R_3$  is such that its top end is negative. If the circuit is operating properly, the voltages across  $R_2$  and  $R_3$  will be equal. However, if these two voltages are added, the resultant will be zero because of the back-to-back placement of the two resistors. In this circuit their voltages are added, which means that no output voltage will be obtained, using this network alone. However, inspection of the circuit reveals that the horizontal sync pulses are also inserted into the circuit by means of  $C_1$  and  $R_1$ .

$C_1$  connects to the output of the sync separator and transfers the horizontal pulses appearing here to  $R_1$ , where both  $V_{1a}$  and  $V_{1b}$  receive this pulse voltage in equal amplitude and phase. Now, let us see how this affects circuit operation.

A horizontal sync pulse can arrive at one of three times. It can appear across  $R_1$  when the sine wave voltage at  $T_1$  is zero; it can arrive when  $V_{1a}$  is conducting; or it can arrive when  $V_{1b}$  is conducting. If the pulse arrives when the sine wave applied to each tube is passing through zero, there will be no change in circuit conditions. The incoming synchronizing pulse appears across  $R_1$  and combines with the sine wave voltage from each half of the secondary coil  $T_1$  to form the driving voltage for each diode. If the pulses arrive when the sine wave voltage across  $T_1$  is zero, Fig. 4A, then each diode will receive the same pulse voltage and the same amount of rectified voltage will appear across the diode load resistors  $R_2$  and  $R_3$ . The total net output from both tubes will be canceled because their load resistors are connected in opposition (back-to-back).

Note again that the reason each diode produces equal voltages across  $R_2$  and  $R_3$  at this moment is because there is no sine wave voltage and each tube receives the same synchronizing pulse voltage from  $R_1$ .

Suppose, however, that the pulse arrives at some other instant. Two such situations are shown in Fig. 4B and C. In Fig. 4B, the pulse arrives when the top diode ( $V_{1a}$ ) is positive and the bottom diode is cut-off. Obviously, then, there will be on the average, more voltage developed across  $R_2$  than across  $R_3$ . The average voltage, over one cycle, will be positive and this, fed



Fig. 6. When the frequency of the horizontal sweep oscillator is not in step with the incoming sync pulses the image will appear in one of these forms.

to  $V_2$ , will make its grid more positive. On the other hand, if we consider the situation of Fig. 4C, we see that  $R_3$  will develop the greater voltage and that, on the average, the voltage from the combination will be negative. The effect on  $V_2$  will be different in each instance. It is seen, therefore, that the double-diode arrangement of  $V_1$  is a very sensitive phase discriminator and will develop an output voltage which may be negative, zero, or positive depending upon the phase of the pulses with respect to the voltage generated by the Hartley oscillator.

The d.c. voltage developed in the phase discriminator, together with a fixed negative biasing voltage ( $-2$  volts) is applied through the long time-constant filter of  $C_2$ ,  $R_4$  and  $C_3$  to the grid of a reactance tube,  $V_2$ . This tube is so connected that its plate current is 90 degrees out of phase with the voltage across it and it functions as an inductance. Since  $V_2$  is connected directly across the tuning coil of the Hartley oscillator, changes in its plate current will produce changes in the frequency of the oscillator and force the oscillator to operate at the frequency of the synchronizing pulses. The d.c. voltage developed at the phase discriminator is fed directly into the grid of the reactance tube and thereby controls the plate current flow. In this manner, all differences in frequency between the synchronizing pulses and the Hartley oscillator are instantly corrected.

$C_2$ ,  $R_4$  and  $C_3$  smooth out any rapid changes in d.c. developed in the phase discriminator by noise pulses. Only the relatively slow changes in frequency caused by differences between the horizontal oscillator and the incoming horizontal sync pulses are permitted

to reach  $V_2$ . A hold control is available in case the oscillator frequency should be too far from the frequency of the incoming pulses to permit lock-in.

**Horizontal Discharge.** A horizontal discharge tube,  $V_4$ , follows the horizontal oscillator and produces, in its plate circuit, the peaked deflecting voltage which is needed for the horizontal deflecting coils. In  $V_3$ , the Hartley oscillator is connected between the cathode, control grid, and screen-grid. The plate circuit contains only a resistance, and consequently the waveform found here is not the symmetrical sine wave that would be produced by a resonant circuit; rather it has the form shown in Fig. 5 (left). The peak-to-peak voltage on the grid of  $V_3$  is about 130 volts. This grid swing produces a square wave in the plate circuit, with a peak-to-peak voltage of 225 volts. The square wave is differentiated by  $C_4$  and  $R_5$ , resulting in the waveform shown in Fig. 5 (right). The positive portion of the differentiated wave is sufficiently sharp to trigger the discharge tube. Normally, the discharge tube is cut-off due to bias produced by grid rectification of the pulses from the oscillator. The positive tip of each pulse overcomes this bias and drives the tube into heavy momentary conduction. During this period, the plate voltage of  $V_4$  falls to cathode potential and  $C_5$  discharges. The discharge, however, is not complete due to  $R_6$  and  $R_7$ , both of which are in series with  $C_5$ .

When the conduction period of  $V_4$  ends, some voltage remains on  $C_5$  and condenser charging starts from this point and rises slowly until the arrival of the next positive pulse. The deflection waveform produced by this action is received by the following horizontal

(Continued on page 128)

Fig. 7. The waveforms obtained at pin 2 (shown at left) and pin 7 (right) of the 6AL5 phase discriminator tube ( $V_1$ ) in Fig. 3. These represent the normal waveforms which will be recorded when a signal is being received.

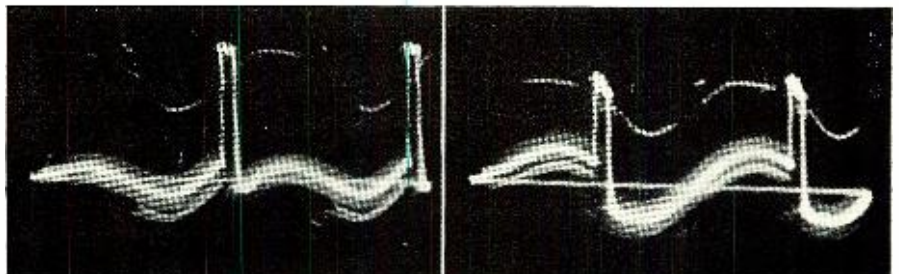

# CONVERTING The TR-4 for 420 mc.

By D. H. ROGERS,\* W2MLF

**It is easy to convert this Abbott transmitter-receiver to 420 mc. The only changes required are in detector and oscillator circuits.**

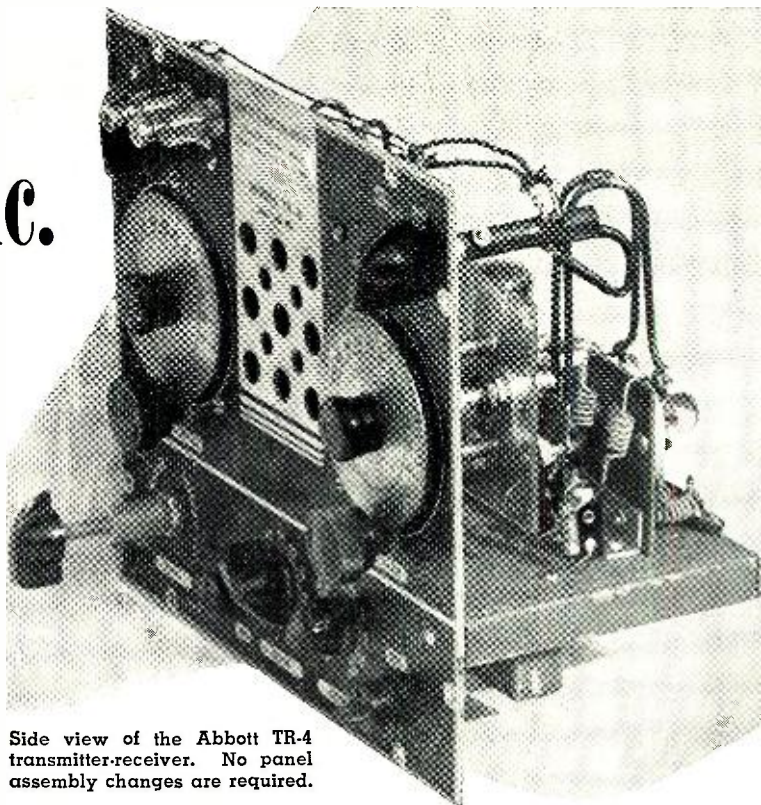

Side view of the Abbott TR-4 transmitter-receiver. No panel assembly changes are required.

THE Abbott transmitter-receiver TR-4 has earned a good name on two meters, but its day is past. Two meters has gone crystal control, and neither the modulated oscillator nor the superregenerative detector of the TR-4 is equal to present conditions.

Fig. 1. Transmitting oscillator circuit.

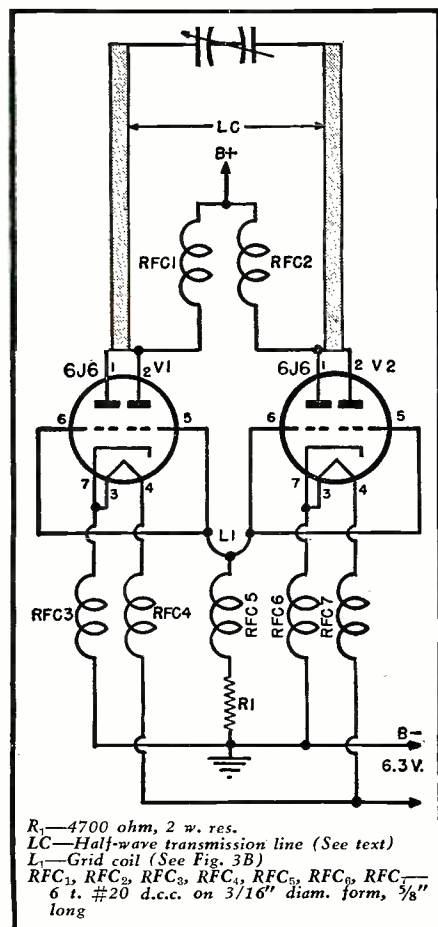

So a once sweet portable rig gathers dust on the shelf, while the band is given over to the SCR-522, the ARC-5, and the superheterodyne converter.

## Dust It Off For 420

But anything goes on the 420 megacycle band. Crystal multipliers and superheterodynes are not required under present conditions of band population. The TR-4 will do the job, and is a natural for the ham who wants to pioneer. A few hours' work, and you can get on and operate, share the thrills of exploring a new band, analyze new conditions, and set new records.

The conversion described here requires replacing the detector and oscillator circuits, but uses a minimum of new parts. Its simplicity and effectiveness result from using half-wave lines. They are large enough to work with conveniently, and permit retaining the original tuning condensers, which are modified by splitting the stator plates and using the outer ends of the line elements as stator posts.

At these high frequencies an ordinary tuned circuit is hard to handle. The coil shrinks to a single turn in the form of a hairpin loop, and is equivalent to a quarter-wave line, a large part of which is inside of the tube.

Condenser leads must be prohibitively short, and the condenser has to be tapped on part way down the line, because it cannot connect any nearer the tube elements than the socket. Under these conditions it is hard to get good performance or to cover the whole range from 420 to 450 mc.

With a half-wave line, however, we can place the tube at one end and the condenser at the other, with the point of maximum current falling at the center. The condenser leads then become part of the line as effectively as do the tube leads.

## Oscillator Conversion

The transmitting oscillator uses push-pull 6J6 tubes with a plate line and a grid coil. The tuned-plate, tuned-grid circuit is shown in Fig. 1 and the mechanical details in Fig. 3. The terminals of the HY-75 socket are used as tie points for the grid leak and heater leads. The tube shelf is mounted exactly 1 1/2" above the chassis and the line elements are anchored to the socket terminals with #22 wire before soldering. They are twisted in slightly from the condenser to get proper spacing (caution—do not bend them in place, to avoid cracking the ceramic insulator) and the condenser plates are soldered directly to them. The new stator plates are made by cutting the old one in two, removing a 1/16" strip to provide clearance.

Fine frequency adjustment is accomplished by bending the grid loop to increase or decrease the area it encloses. Major changes in calibration require shortening or lengthening the line. The range of the dial is controlled by the plate spacing in the condenser. In the model, the band covers the space from 5 to 85, frequency increasing with reading. Here a 1/16" shim was used to space the stator plates from the rotor plate during soldering.

The current maximum in the line can be located by touching one of the

\* 41 Fourth St., Fanwood, N. J.



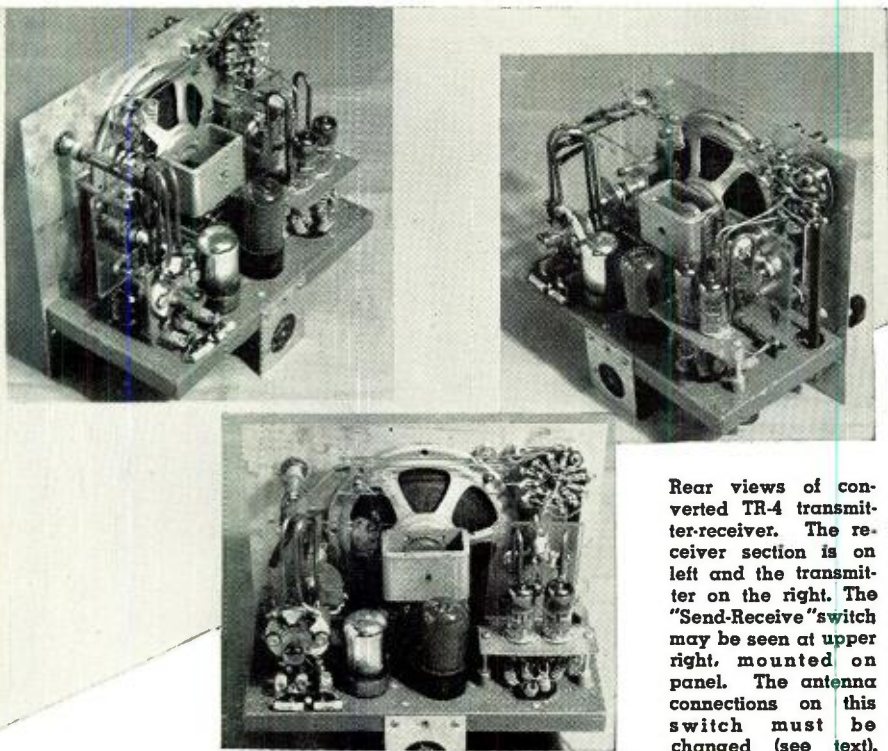

Rear views of converted TR-4 transmitter-receiver. The receiver section is on left and the transmitter on the right. The "Send-Receive" switch may be seen at upper right, mounted on panel. The antenna connections on this switch must be changed (see text).

elements while watching the plate milliammeter. This point of no-reaction will be found a short distance above the sockets. The antenna should be coupled here. The coupling loop is supported by an insulator mounted on a long bolt to permit adjustment. It must be fairly loose to secure good speech quality at high modulation levels. Under these conditions the transmitter draws about 50 ma. at 300 volts. This rises to 75 ma. if oscillation is stopped by placing a finger on a hot point of the line.

### Detector Conversion

The superregenerative detector uses a 955 acorn tube with a half-wave tuned line. The circuit is shown in Fig. 2 and the mechanical details in Figs. 4A and 4B. The separate cathode choke is used to avoid introducing hum voltage into the detector when operating from a.c. power. The values of grid leak and condenser  $C_1$  (Fig. 2) were chosen for the best combination of sensitivity and smooth operation. To further this end it was found necessary to remove the original .004  $\mu$ fd. mica phase-shifting condenser between the tube and the audio transformer, and to add a 5000 ohm resistor across the primary. The plate supply bleeder was also adjusted to provide a higher voltage range than that originally afforded.

The detector line is slightly skewed to secure clearance between the tube and the 7F7 first audio. This shaping is easily accomplished by twisting the ends of the elements slightly after forming. The close spacing provides better performance than wide spacing, probably by impedance matching the tube lead inductance and element capacity. It also affords a means of

fine frequency adjustment. The band-setting can be trimmed by adjusting the spacing at the top of the bend, and held by cementing in a small block of polystyrene, as shown in the photograph.

The condenser plates are cut and mounted like those in the transmitter section, except for the use of a  $\frac{1}{32}$ " spacing shim in order to secure wider frequency coverages. The additional range is desirable to allow for detuning by the antenna and to help in

Fig. 2. Detector circuit diagram. Mechanical details of the assembly are shown in Fig. 3.

- $R_1$ —22 megohm,  $\frac{1}{2}$  w. res.
- $R_2$ —5000 ohm,  $\frac{1}{2}$  w. res.
- $R_3$ —39,000 ohm, 2 w. res.
- $R_4$ —Original 100,000 ohm regenerative control
- $R_5$ —150,000 ohm, 2 w. res.
- $C_1$ —5  $\mu$ fd. pigtail ceramic cond.
- $C_2, C_3$ —100  $\mu$ fd. pigtail ceramic cond.
- $C_4$ —Original 250  $\mu$ fd. cond.
- LC—Half-wave transmission line (See text)
- $T_1$ —Original audio trans.
- $RFC_1, RFC_2, RFC_3, RFC_4, RFC_5, RFC_6$ —6 t. #20 d.c.c. on 3/16" diam. form,  $\frac{1}{8}$ " long
- $V_1$ —955 tube

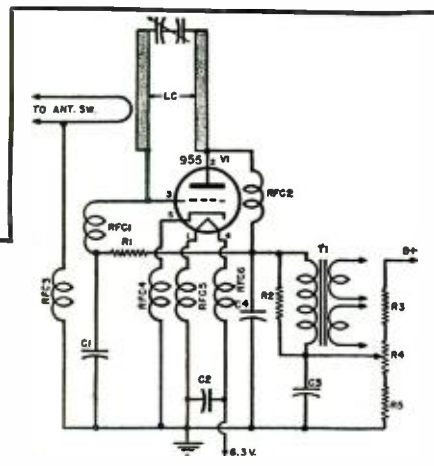
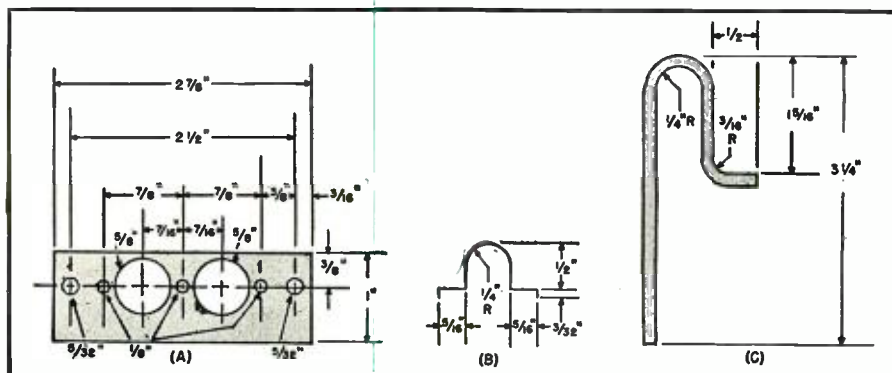

Fig. 3. (A) Shelf for transmitting tubes, drilled for Cinch sockets. Made from 1/16" phenol fabric. (B) Push-pull grid coil for transmitter. Made from #20 A.W.G. tinned copper wire (C) Transmitter line element (see text for twisting). Made from  $\frac{1}{8}$ " copper rod or wire.



# Make Your Own SELF-GENERATING PHOTOCELL

By  
**GUY DEXTER**

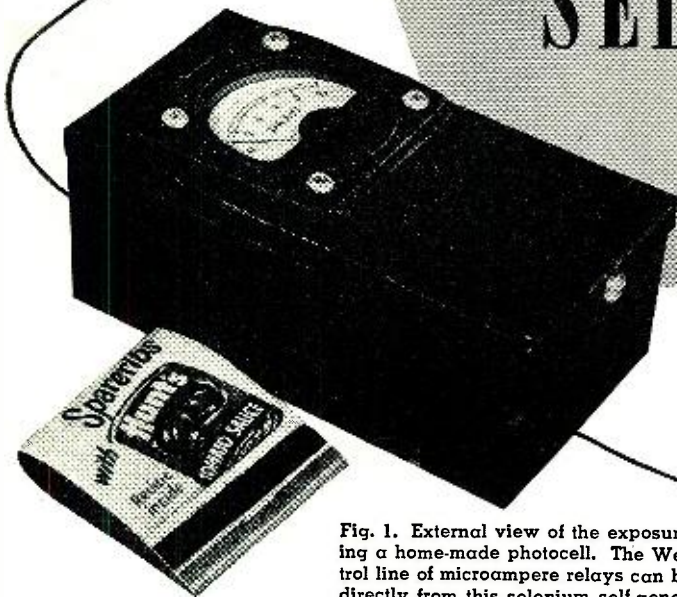

Fig. 1. External view of the exposure meter using a home-made photocell. The Weston Sensitrol line of microampere relays can be operated directly from this selenium self-generating cell.

**Parts of a small selenium rectifier are used to build this compact "Photronic" type cell.**

THE electronic gadgeteer knows of many interesting experiments to perform and of serviceable devices to build using the electric eye. Just a few of these are intrusion (burglar) alarms, "customer announcers" for stores, passing object counters, safety devices for machinery, headlight-controlled garage door openers, room door openers, light meters, photographic exposure meters, color matchers, light-beam telephones, photoswitches for turning on artificial lights when sunlight dims, and speed (revolutions-per-minute) counters. The owner of an electric eye need never be lost for something new to try.

There are three principal types of electric eyes. They are: (1) phototubes, (2) photoconductive cells, and (3) photovoltaic cells. Of the three, the latter type is especially attractive to the experimenter because it is self-generating. That is, the photovoltaic

cell will produce a voltage, without the aid of any external battery or power supply, whenever light strikes it. The self-generating photocell is the type found in the familiar photographic exposure meter.

Self-generating photocells are rather expensive for the amateur electronic experimenter. For this reason, they seldom are bought for the prime purpose of amateur experimentation. However, few amateurs know that a good photocell of this type can be home made very easily. A simple light-sensitive element for a home-made cell, requiring no chemical processing by the builder, is a plate taken from one of the small selenium rectifiers widely used at present in transformerless radio power supplies. The 150 milliamperere size rectifier has five plates, each a little larger than 1 inch square. When electrical contact is made to each of the two faces of one of these

plates, and the selenium-coated face is illuminated, a small but useful voltage will be set up. The plain metal face will be positive, and the selenium-coated face negative. This voltage will actuate a sensitive meter-type d.c. relay directly, or it may be applied to the grid input circuit of a vacuum tube to operate a heavier relay. It will also deflect a d.c. microammeter directly.

A complete, rugged photocell is obtained by mounting the rectifier plate securely in a protective housing and providing output terminals. The finished cell may be used in a variety of experiments or may be installed permanently in electronic equipment. A single 150 milliamperere selenium rectifier costing less than one dollar will furnish enough plates to build five photocells. This article describes the simple construction of a simple self-generating photocell and of an exposure meter using one of the cells.

## Description of the Home-Made Cell

Appearance and construction details of the photocell are shown in the photographs (Figs. 2 [left] and 5) and the working drawing (Fig. 4A).

The unit is 2 inches in diameter and ½ inch thick. "Watchcase" type housing is employed. Fig. 5 (inset) shows the completed cell before its transparent window-disc was cemented in place. A banana plug is provided for the double purpose of plugging the unit into a circuit and holding it in position. A screw terminal with solder lug, on the back of the case (see Fig. 5), is the second photocell connection. The case is a screw-on jar cap made of black plastic. Jar tops of this type can be obtained at hardware and kitchen furnishings stores. After assembling the cell, the open front of

Fig. 2. Photocell parts ready for assembly. (Left) Jar top has been drilled and the banana plug and contact strip installed. Other parts (l. to r.) are: rectifier disc, transparent window-disc, and contact lug-screw assembly. (Right) Small selenium rectifier provides the light-sensitive plates for five photocells.

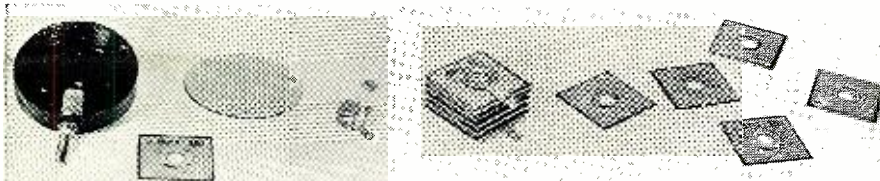

the case is covered with a protective disc of transparent, colorless celluloid or other plastic which admits light rays but protects the cell from dust and vapors.

Construction of the cell is shown in Fig. 4A. The light-sensitive rectifier plate is fastened to the inside back of the jar top with its selenium-coated face exposed to receive incoming light rays. Contact to the selenium surface is made by means of a solder lug bent downward to rest firmly upon the coated surface of the plate. The lug is held in place by a 6-32 screw which passes through the large clearance hole in the center of the rectifier plate and through an aligned hole in the back of the jar top. An outside nut secures this screw, preventing contact between it and the sides of the clearance hole in the rectifier plate. Under this nut is a second solder lug (see Figs. 4A and 5) for connection of the selenium-coated surface to the external circuit. The bakelite washer separating the screw end of the inside lug from the selenium surface is necessary since the selenium coating on most rectifier plates does not extend unbroken to the edges of the central hole. Without the washer the lug would touch the uncoated portion of the metal plate and short-circuit. Connection is made to the uncoated rear face of the rectifier plate by means of a narrow, flat strip of brass or phosphor bronze attached to the banana plug. Fig. 2 (left) shows the spring strip mounted in place prior to bolting the rectifier plate over it.

#### Building Instructions

(1.) Secure a 100- or 150-ma. selenium rectifier. This unit must be an unpainted model. (Several commercial rectifiers are completely dipped in paint which conceals the light-sensitive selenium surface from light rays, and these models are unsatisfactory for photocell use. The paint probably can be removed with paint remover or lacquer thinner, but the author hesitates to recommend a paint-stripped unit, since he has not tested one). The author used a Seltron 5P1 rectifier, made by Radio Receptor Co. This unit has a silvery conductive spray on the selenium surface but is not paint covered, and responds very satisfactorily to light rays. Remove the plates from the rectifier by carefully drilling or cutting out the central eyelet which holds the unit together. Fig. 2 (right) shows a complete rectifier alongside five plates obtained by tearing apart a similar unit.

(2.) Be careful not to scratch or cut the selenium-coated surface of the rectifier plate. Using fine emery cloth or sandpaper, clean the uncoated rear face of the plate so as to insure good electrical contact.

(3.) Secure a 2-inch-diameter black plastic jar top. Drill a 6-32 clearance hole through its center and an identical hole through its rim. The first hole is for the plate-holding back screw; the second one for the banana

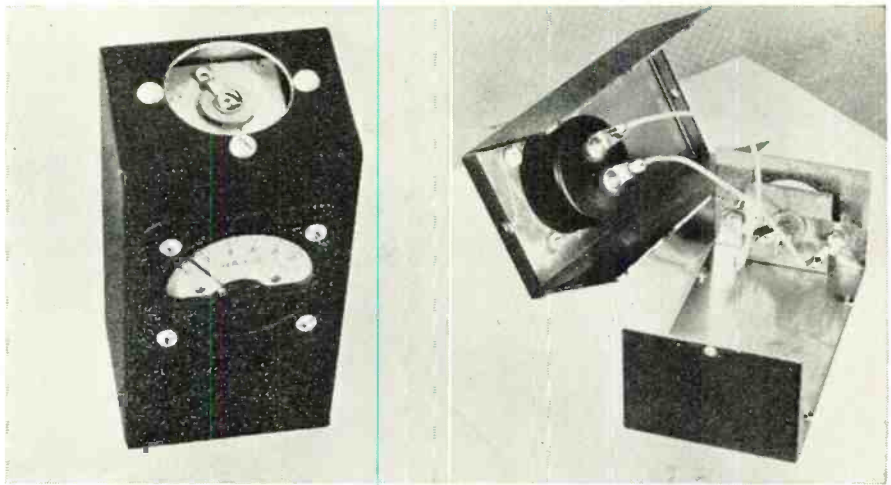

Fig. 3. (Left) The photocell plate peeps through a relatively large hole cut in the end of the box. The meter deflection was caused by the photographic lamps. (Right) Simplicity of construction and wiring are apparent in this illustration.

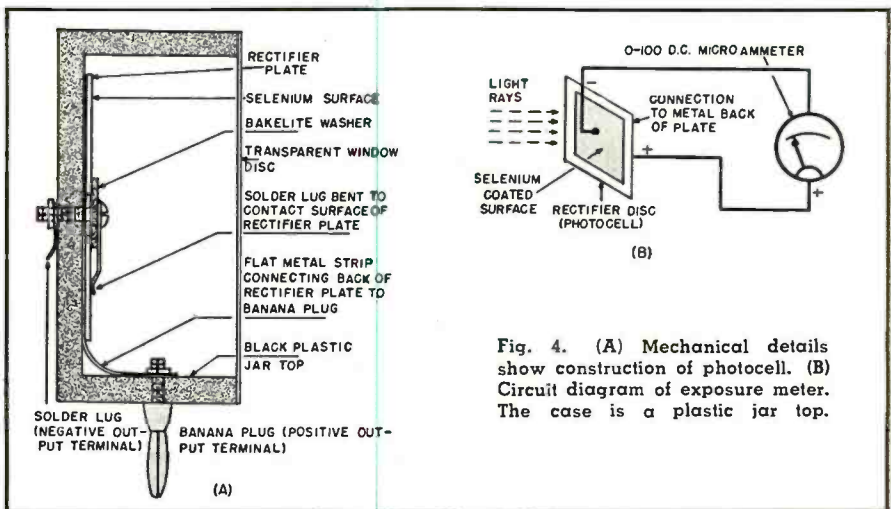

Fig. 4. (A) Mechanical details show construction of photocell. (B) Circuit diagram of exposure meter. The case is a plastic jar top.

plug. Fig. 5 clearly illustrates this assembly.

(4.) Cut a flat strip of thin brass or phosphor bronze about 3/4 inch long

and 1/4 inch wide. Drill a 6-32 clearance hole near one end of this strip and make a right-angle bend in the  
(Continued on page 122)

Fig. 5. Both output terminals are visible in this photograph. Cigarette package shows comparative size of completed cell. Inset shows the selenium rectifier plate bolted in place. The banana plug, contacting the back of the plate, is the positive output terminal. The lug-holding screw, contacting the selenium surface, provides the negative output terminal at the rear of the case.

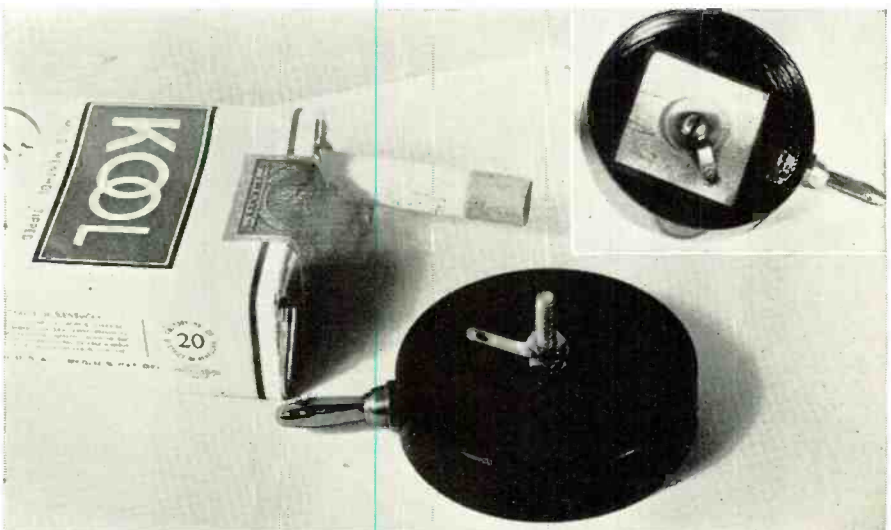

# Eliminating BROADCAST INTERFERENCE Caused By TV Receivers

By JACK NAJORK, W2HNH

**Technicians have a new servicing problem in TV interference. Here's how to whip this problem.**

AS WITH any other rapidly advancing art, television is having its normal run of growing pains and the service technician often finds himself suddenly confronted with an entirely new problem, the likes of which have never been encountered in the more stable realm of broadcast receiver service work.

One of the more serious problems being encountered by the service technician is broadcast interference caused by television receivers. This situation usually crops up in apartment houses and congested residential sections where broadcast receivers are operated in close proximity to television receivers using the popular "flyback" type of high-voltage power supply.

The interference manifests itself as a series of "birdies" or rough carriers, spread across the entire broadcast

band at intervals of approximately 15 kilocycles. It is caused by harmonics of the horizontal oscillator frequency (15,750 c.p.s.) in the TV receiver being radiated with sufficient strength to be picked up at the broadcast receiver. These harmonics are usually tuned in at broadcast band frequencies, although there is also a possibility that they can find their way into the i.f. channel of the broadcast set and thereby cause a continuous whistle or heterodyne, irrespective of the broadcast receiver dial setting.

The horizontal output tube in the TV receiver employing the "flyback" type power supply generally operates as a class B amplifier and its output is, therefore, rich in harmonics. This condition is made even worse by the transient oscillation which takes place during flyback time. It is this transient oscillation which is used to generate the high voltage in the flyback type power supply, hence the problem cannot be solved by attempting to change the operating conditions of the horizontal output tube.

There are several effective measures which can be taken, however, which will usually eliminate the interference entirely or reduce it to a negligible level.

It is first necessary to determine whether the interference is being radiated by the TV antenna and transmission line or by the TV receiver itself. This can be checked quickly by disconnecting the transmission line at the antenna terminals and moving it several feet away from the TV receiver. If the interference persists, direct radiation is taking place from the TV receiver itself. If disconnecting the transmission line reduces or eliminates the interference, then the first step is the introduction of a simple high-pass filter between the TV receiver antenna terminals and the transmission line.

Although most TV receivers use

some form of high-pass filter at the input to the front end to prevent low frequency signals from getting into the tuned circuits, these filters are sometimes not too effective in preventing the radiation of harmonics of the horizontal frequency. This is particularly true if the filter circuit is located some distance from the antenna terminals and an open wire line such as 300 ohm cable is used between these two points. For this reason, the filters shown in Figs. 1A and 1B should always be installed directly at the antenna terminals of the TV receiver rather than at the input to the front end.

Fig. 1A shows a simple high-pass filter suitable for use with sets having a balanced 300 ohm input. This filter, incidentally, will also be helpful in preventing low frequency interference from finding its way into the TV circuits but it will have no noticeable effect on the reception of regular TV channels, high or low.

The 100  $\mu$ fd. condensers present a high impedance path to low frequency signals but their reactance at television frequencies is negligible. The center-tapped choke provides an easy path to ground at frequencies below the television channels but has sufficiently high reactance at the higher frequencies to offer very little attenuation. In weak signal areas it is best not to use lacquer or cement to hold the choke windings in place because this will raise the distributed capacity of the choke and introduce slight losses on the higher TV channels. The filter should be mounted as close as possible to the antenna terminals of the TV set and the center-tap connection of the choke should be as short as possible.

Fig. 1B shows a filter suitable for receivers having unbalanced 72 ohm input circuits. Transmission line radiation is most severe with the open type 300 ohm cable and it will be found that receivers using shielded transmission lines usually cause interference by direct radiation from the chassis rather than through the antenna system. If the TV antenna proper is close to the broadcast an-

(Continued on page 104)

Fig. 1. (A) Simple high-pass filter used between antenna terminals of TV receiver and 300 ohm transmission line to prevent radiation of horizontal frequency harmonics by transmission line and antenna. (B) A simple high-pass filter suitable for use with TV receivers having 72 ohm unbalanced input.

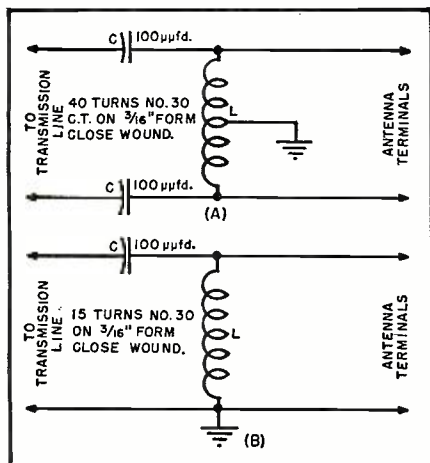

# PRINTED CIRCUITS



Fig. 1. Kit of printed circuit paints made by Microcircuits Co. of New Buffalo, Mich. The code oscillator (see circuit, Fig. 6) is built from kit.

By JOHN T. FRYE

## Part 2. A discussion of the techniques and equipment used in making printed circuits for home-built units.

**P**ART 1 of this article, appearing in the December issue, presented the various methods by which these miniature circuits are produced commercially. Now we are ready to roll up our sleeves and get down to the pleasurable business of making our own printed circuits.

A quick review of all the methods of producing these circuits reveals that the simple brushing of conductor and resistor paints onto a base plate is the most practical way to start experimenting. Such a system requires an absolute minimum of equipment; yet it produces results that compare quite favorably with the much more complicated methods used in mass production.

The first things we need are conductor and resistor paints. There are two kinds of conductor paint in general use—copper and silver. The copper paint is cheaper, but its resistance increases with age to a terminal two to five ohms per inch. Silver paint, on the other hand, will maintain its resistance of only a few tenths of an ohm per inch for years. In all circuits except temporary experimental ones, the silver paint is well worth its additional cost.

Next, we need two or three different mixtures of resistor paint. More than one degree of conductivity is needed if we are to be able to draw a wide range of resistance values and still

keep our resistors of reasonably uniform size.

We shall also need a solvent material that can be used to thin the paints when they become too thick through evaporation, and to clean the brushes. In addition, we should have a good insulating lacquer, the uses of which will be described later. Finally, we must provide ourselves with base materials upon which we can draw the printed circuits.

We could prepare our own paints, but most of us do not have the materials, facilities, nor inclination to do this. Fortunately, it is not necessary as the paints can be purchased already prepared. The *E. I. duPont de Nemours Co., Inc.*, the *Metaplast Co., Inc.*, and the *Acheson Colloids Corporation* are among the companies that supply these paints commercially, but it is doubtful if they would be interested in supplying small quantities. The *Microcircuits Company* of New Buffalo, Michigan, however will supply any quantity of needed materials. In fact, they sell a "kit" of supplies for the beginning experimenter that is illustrated in Fig. 1. This kit includes a bottle of copper paint, another of silver paint, three resistor paints of different degrees of conductivity, a bottle of lacquer, and a bottle of thinner and brush-cleaner.

Just about any material, if it is properly prepared, can be used as a

base upon which to paint the circuits. The only requirements are that the material be rigid so that it will not flex and cause the lines painted upon it to crack; that its surface be not too rough or porous; that it be chemically inert; and that it have an insulated surface or one capable of being insulated.

The paints do not stick too well to glass unless the surface has been roughened by sand-blasting or etching; but the experimenter can overcome this by applying a thin coat of lacquer to the glass and then painting his circuits on this coating. Fig. 2 shows a complete two-stage amplifier circuit painted on the envelope of a 6J6 tube.

Asbestos board, fiber-board, etc., can be used; but if the surface of this porous material is not treated, absorption will cause the characteristic

Fig. 2. Two-stage amplifier painted on the glass envelope of a twin-triode 6J6 tube.

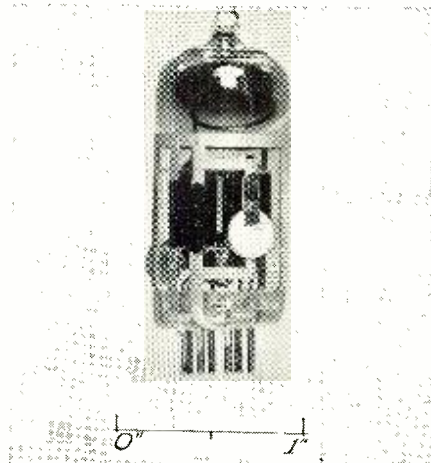

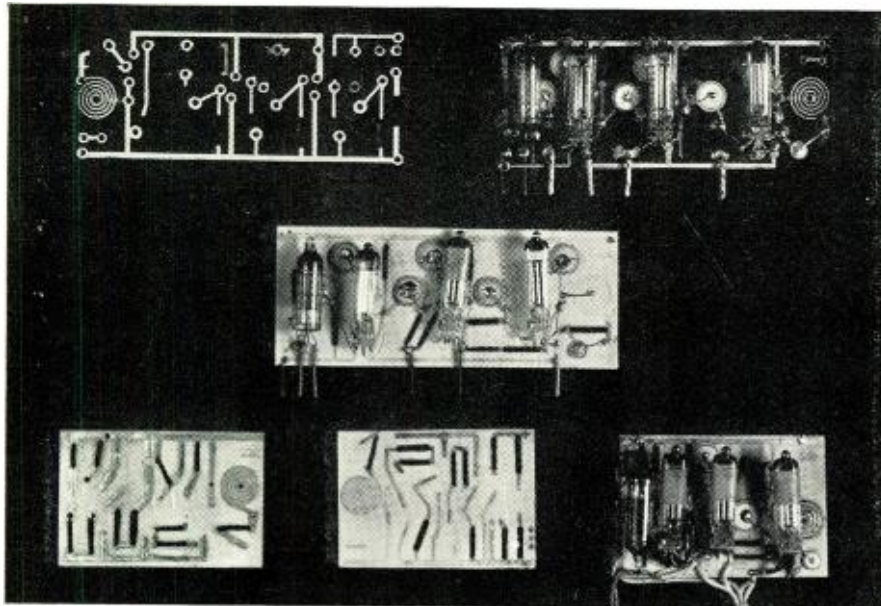

Fig. 3. (Top row) Four-tube receiver printed on 3/32" Lucite plate, 2" wide and 5" long. At left is stenciled silver wiring with complete receiver at right. (Center) Four-tube receiver printed on thin steatite plate 2" wide and 3" long. (Bottom row) Development of a four-tube receiver on thin steatite plate 2" wide and 3" long. The plate at left had paints applied with a brush except for spiral inductances. The center one was stenciled. Leads from the complete receiver at right connect to batteries and speaker. All receivers use square law detector, two stages of pentode amplification, and triode output.

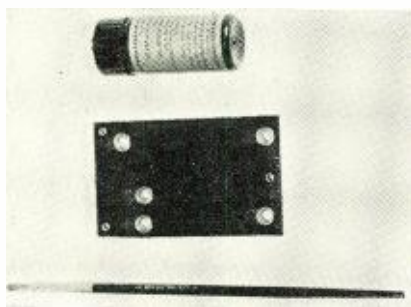

Fig. 4. A base plate all ready for the painting of conductors. Note that brass rivets are used as terminals and to form crossovers.

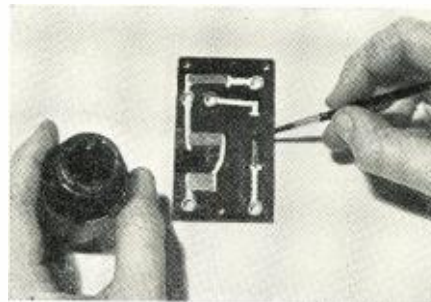

Fig. 5. Actual painting of resistors. Note how resistance lines are lapped over the conductor lines and preparation of abutments.



Table 1. Resistance and wattage values for various sizes of resistors painted with one kind of resistor paint. The intersection of the width and length values gives the resistance value above and the wattage rating below. For example, a resistor 1/4" wide and 3/4" long has a resistance of 1500 ohms and a wattage rating of 1.8.

Width (Inches)	Length in Inches Resistance values in ohms							
	1/8"	1/4"	3/8"	1/2"	5/8"	3/4"	7/8"	1"
1/8"	500 .15	1000 .3	1500 .5	2000 .6	2500 .75	3000 .9	3500 1.1	4000 1.2
1/4"	250 .3	500 .6	750 1.0	1000 1.2	1250 1.5	1500 1.8	1750 2.2	2000 2.4
3/8"	167 .5	335 .9	500 1.5	665 1.8	830 2.2	1000 2.8	1165 3.3	1330 3.7
1/2"	125 .6	250 1.2	375 2.0	500 2.5	625 3.0	750 3.7	875 4.4	1000 5
5/8"	100 .8	200 1.6	300 2.4	400 3.1	500 3.8	600 4.6	700 5.5	800 6.2
3/4"	84 .9	168 1.9	252 2.9	333 3.7	417 4.5	500 5.5	584 6.6	665 7.5
7/8"	72 1.1	144 2.2	216 3.4	285 4.2	357 5.2	429 6.4	500 7.7	570 8.7
1"	63 1.2	125 2.5	187 3.7	250 5.0	315 6.2	375 7.5	438 8.7	500 10.0

values of resistors painted upon it to be greatly changed. A sealing coat of lacquer will avoid this trouble.

The paint adheres very well to plastics because the solvent used causes the surface of many of them to become slightly dissolved. A heat-resisting coating on a metal base works quite well, for the metal aids in carrying the heat away from the resistors. Two coats of lacquer will provide such a coating.

No matter what base is used, the cardinal principle is that the surface receiving the paints must be absolutely clean. The slightest trace of grease, even that left by the touch of a finger, will prevent the paint from making a good bond with the base. Lacquered surfaces must not be touched. Glass, porcelain, and plastics can first be cleaned with alcohol, gasoline, or carbon tetrachloride, then washed with soapy water, and finally thoroughly rinsed with clear water and dried.

Laying out the circuit should be done with great care. Conducting lines should be as short and direct as possible. "Cross-overs" of conducting lines should be held to a minimum. Correct spaces should be left for resistors. Terminals should be provided in the form of rivets. The possibility of inductive and capacitive effects between adjacent conducting lines must be considered.

All of these details should be worked out with paper and pencil, and then the complete diagram can be transferred to the base plate by means of carbon paper. When actually drawing on the base with a pencil or drawing ink, it must be remembered that these lines are conductors in themselves and must not be left where they will connect parts of the finished circuit.

Fig. 4 shows a base plate of laminated paper and phenolic material all ready for painting. Brass eyelets have been inserted at the proper places to furnish terminals; the small brush and the silver conducting paint are all ready to paint the conducting lines.

Before starting to brush on the paint, though, it is important to see that the paint is very thoroughly mixed. Remember our "paint" is composed of metal particles and a carrying solution. When undisturbed, the heavy particles settle to the bottom and stay there. A line drawn with a brush dipped into a bottle of this undisturbed paint would consist chiefly of non-conducting thinner and be a very poor conductor.

Lengthy stirring will mix the paint, but that makes it necessary to have the bottle uncorked while doing the stirring. The thinner used is extremely volatile so that the drying time will be short, and if the bottle is left unstoppered for any appreciable length of time, the paint becomes too thick to brush. A temporary cover should always be set on top of the bottle of paint except when the brush is inserted. A quick stirring followed by

lengthy shaking of the stoppered bottle is the best way to mix the paint, and it should be kept mixed by repeated shakings during the painting process.

The conducting lines should be carefully drawn along the direction of current flow, care being taken to make the lines of as nearly uniform thickness and width as possible. The paint should be run up over the edges of the eyelets to make sure that a good electrical connection is obtained at these points. "Abutments," across which the resistors will be bridged should be drawn in as shown in Fig. 5.

The manufacturer of the paint used will provide information on the drying time required. In the case of the *Microcircuits* silver paint, the air-drying time is one half hour to an hour. Copper and resistance paints take considerably longer. The process can be speeded up by mild heating, not over 150° F., in an oven or with an infrared lamp. Greater heat than this may result in "bubbling" of the paint.

When the silver paint is dry, you are ready to paint in the resistances. Painted resistors are figured from a standard resistor one inch square, painted with a single thickness of the given paint, and having a heat dissipation of ten watts. As you know, the resistance of such a resistor will be directly proportional to the length measured along the direction of current flow and inversely proportional to the width and the thickness. The wattage rating varies directly with the surface area.

Reductions in the dimensions of this standard square will result in other resistors whose resistance and wattage values are in accord with these laws. The resistance may be higher or lower than that of the standard resistor, depending upon whether the "width" or the "length" of the square was reduced. Table 1 shows the different values of resistance and watt-

Electrical Characteristics	CK-505AX Pentode Voltage Amplifier	CK-503AX Pentode Output	2E31, 2E32 Pentode Shielded R.F.	2E41, 2E42 Diode Pentode	2G21, 2G22 Triode Heptode	CK-509AX Triode Voltage Amplifier
Fil. Volt. (d.c.)	.625	1.25	1.25	1.25	1.25	.625
Fil. current (in ma.)	30	45	50	30	50	30
Plate volt.	30	45	22.5	22.5	22.5	45
Screen volt.	30	45	22.5	22.5	22.5	0
Control grid volts*	0	-4.5	0	0	0	0
Peak a.f. grid volt.		4.5				
Transconductance	175	500	500	400	60(Gc)	160
Plate res. (in meg.)	1	.12	.35	.25	.5**	.15
Plate current (in ma.)	.15	1.25	.35	.4	.2	.15
Screen current (in ma.)	.05	.4	.3	.15	.3	1
Load res. (in meg.)	1	.03				
Screen res. (in meg.)	3	0				
Power output (in mw.)		25				
Voltage gain	35					16
% distortion		10				
Max. grid-plate cap. (in $\mu$ fd.)			0.18	.10	.065***	
Osc. plate volt.					22.5	
Osc. plate current (in ma.)					1	

\*With 5 meg. grid res. connected to F.

\*\*Approx. conversion plate res.

\*\*\*Signal grid-to-mixer plate capacitance.

Table 2. Characteristics of some typical subminiature tubes used in printed circuits.

age obtained when a standard resistor of 500 ohms is reduced in  $\frac{1}{8}$ " steps along its width or length or both. In the same way, when you know the resistance of a standard one-inch-square resistor painted with a particular resistance paint, you can always estimate the dimensions of a needed resistor whose value lies within the range of that particular paint.

The resistors should be drawn with a thick, even layer of paint that overlaps the silver paint by at least  $\frac{1}{16}$ ". If the resistor is of uneven thickness, the heat generated by the  $I^2R$  losses will be unequally distributed and may cause the resistor to be damaged when operated near its maximum wattage rating.

After the resistors have dried for fifteen minutes, they may be baked at up to 250° F. without danger of bubbling. The cold resistance of a resistor that has been baked at 200° F. is about one half that of the same resistor with normal air-drying; so the method of drying should be taken into account when calculating the size of resistors.

It is impossible to avoid having some

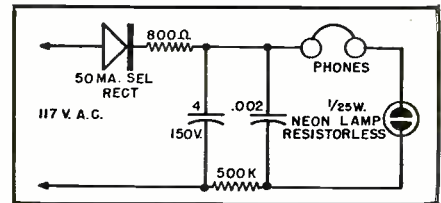
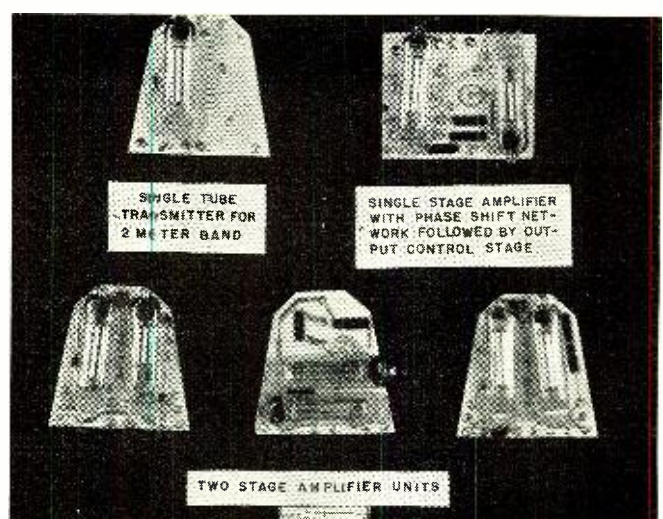
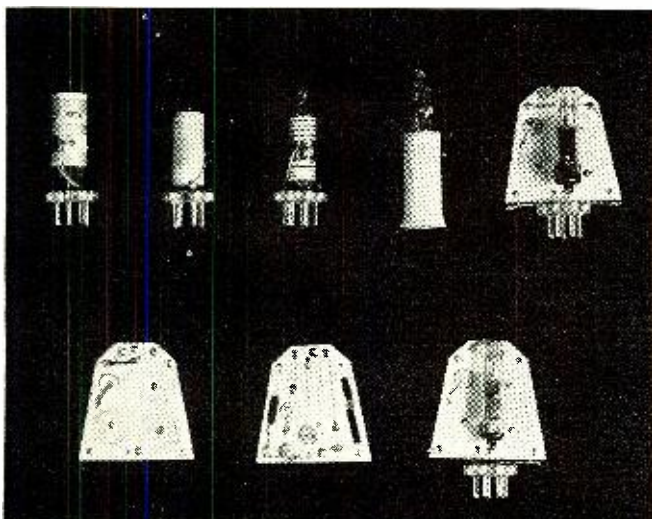

Fig. 6. Circuit diagram of the code oscillator shown in the photograph of Fig. 1.

crossovers of conducting lines, and there are two ways of making them: first, you can bridge one of the lines with a piece of paper that has been soaked in an insulating varnish, shellac, or lacquer; and, after it has thoroughly dried, you can paint the other line right over the top of this bridge. The other method is to place a brass or copper rivet on each side of the line to be crossed and then carry the crossing line down through one of these rivets to the opposite side of the base plate, along a conducting line to the other rivet, and then back up. This latter scheme is more permanent and is less likely to cause trouble because

(Continued on page 149)

Fig. 7. (Left) Five types of grid-modulated 132-144 mc. transmitters. The two at the top left are painted on thin steatite cylinders housing subminiature tubes. The one top center is printed on the envelope of the 6K4 triode. The second from top right is painted on the envelope of a T-2 subminiature type tube while the circuit at top right is a flat-plate transmitter. The bottom row (left) shows front and back views of a plate transmitter with the completely assembled transmitter at the right. (Right) A self-explanatory photograph of various printed circuit units.



# DYNAURAL PREAMPLIFIER

## Provides Wide Compensation

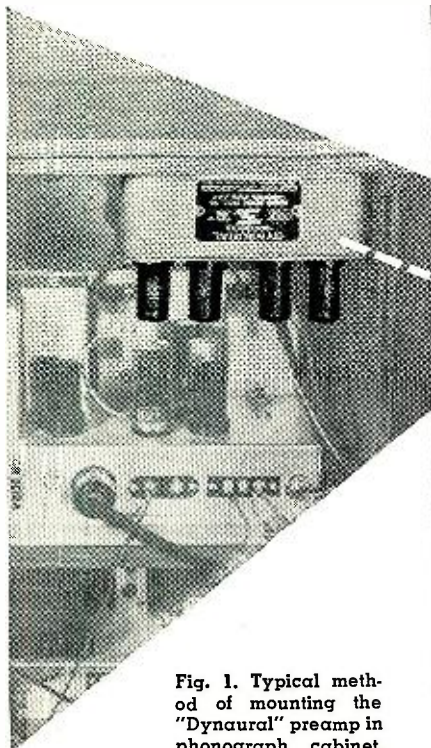

Fig. 1. Typical method of mounting the "Dynaural" preamp in phonograph cabinet.



Fig. 2. Showing installation of remote control unit in record space. It is connected to the unit shown in Fig. 1 by short cable.

By  
**HERMON H. SCOTT\***

***A combination preamplifier and dynamic noise suppressor which will improve your phono's performance. It provides the necessary boost for new wide-range magnetic pickups and reduces usual surface noise present on all recordings.***

RECENT improvements in recording have produced phonograph discs which rival the range of the human ear. All records, however, have a definite and generally annoying background noise which increases with wear and dust and detracts from the realism of the reproduced performance. With the new, fine-groove techniques the effects of both surface noise and turntable rumble have been aggravated. Also, the new wide-range magnetic pickups are characterized by a very low output level, thus requiring extra amplification or "preamplification."

Many music lovers want to take advantage of all the remarkable post-war phonograph improvements. Irrespective of how good the amplifier and speakers, two fundamental features are necessary to make a phonograph

installation really modern. The first is a true "Dynaural" type Dynamic Noise Suppressor to reduce both scratch and rumble without fixed loss of high overtones or deep bass. The second is use of the new wide-range magnetic pickups which are able to reproduce the full range of recorded music. Such a combination is unbeatable on all types of records, shellac or plastic, high or low speed, fine or standard groove.

In "Dynaural" reproduction, the range of the system is constantly and automatically controlled by the music in accordance with the characteristics of the music and the ear so that excess noise, scratch, and rumble are suppressed with little noticeable change

in tone quality. This control action is obtained by reactance tube "gate" circuits.<sup>1</sup>

### **Preamp and Bass Compensation**

By combining the functions of noise suppression and preamplification in a single integrated circuit, certain economies can be effected, and what is even more important, the over-all performance can be improved. Fig. 3 shows a typical circuit. The preamplifier stages are fairly conventional except for the low-frequency compensation. The 6SC7 tube was chosen because of its low hum level even when operated on a.c. Since both halves of this tube have a common cathode, the only practical bias arrangement is the grid leak type.

In most "Dynaural" circuits, to obtain best operating impedances for the high frequency gate, an L-pad matches the input of the gate circuit to the preceding tube. This naturally introduces some loss. Similarly, bass boost circuits introduce loss depending upon how much the bass must be increased. In this circuit, by inserting the bass boost condensers directly in the impedance matching L-pad, both functions of impedance matching and bass compensation are accomplished with a single circuit with only a single loss.

At high frequencies, where low gate circuit impedance is important, the bass boost condensers have little effect. Consequently, this arrangement does not adversely affect suppressor performance. Similarly, the gate circuits present a comparatively high impedance at low frequencies and do not affect the bass boost. This design effectively eliminates one amplifying stage, and, at the same time, allows the bass compensation to operate at a relatively low impedance and high level—thus precluding difficulties with capacitance and hum pickup, if the leads are extended several feet for remote control of bass turnover.

### **Turnover Control**

The low frequencies in records are attenuated generally at an average rate of 6 db. per octave below some frequency known as the "turnover" point as shown in Fig. 4. In the early electrical recordings the turnover frequency was generally at approximately 250 or 300 cycles per second. Many commercial recordings still have the turnover at this frequency. However, as the recording art progressed there was a tendency to record at louder levels to override noise. Consequently, to avoid overcutting on the bass, the turnover point was raised progressively to as high as 800 or 1000 cycles by some companies while the National Association of Broadcasters standardized on 500 cycles for transcriptions.

To reproduce all recordings prop-

\* Hermon Hosmer Scott, Inc., 385 Putnam Ave., Cambridge 39, Mass.



erly with natural bass some adjustment must be possible in the reproducing equipment to shift the effective turnover point below which the bass must be boosted as shown in Fig. 5. If Figs. 4 and 5 are added together for any particular turnover point, the over-all response is obviously flat.

Since most recording characteristics have had average turnovers around 300, 500, and 800 cycles, these values were chosen for the "Dynaaural" preamplifier. This further allows all recording bass turnovers, from below 250 to over 1000 cycles, to be matched within about 2 db. which is a generally unnoticeable difference in sound reproduction. Fig. 6 shows the maximum error in frequency response for various recording turnovers between 250 and 1000 cycles.

### The Gate Circuits

The "Dynaaural" gate circuits are the latest wide-range type originally developed particularly for the British Dynamic Noise Suppressor licensee, *Electric and Musical Industries, Ltd.*, manufacturers of *His Master's Voice* and *Columbia* records and a pioneer in extended range recordings.

To provide extended range and also remote control, the circuits operate at a lower impedance than earlier models. This allows the range, as well as the suppression, to be controlled remotely without difficulty due to cable capacitance or hum pickup.

The first 6SG7 tube acts as a variable capacitive reactance, thus controlling the upper limit of the range. The second one simulates a variable inductive reactance, controlling the lower limit. Separate control circuits bias the grids of these tubes in accordance with the signal, thus providing automatic and substantially instantaneous dynamic bandpass action.

The coils are *H. H. Scott* types RL-1 and RL-2, rated at 1.3 and 0.4 henrys. These coils are designed for the correct "Q" over the entire frequency range and use of other types may result in inefficient gate operation.

The "Dynaaural" suppression control, as in all of the original Dynamic Noise Suppressors, operates in a d.c. circuit, the leads of which may be extended to any desired length. This control simultaneously adjusts the degree to which the gate circuits may close to decrease the noise bandwidth and the sensitivity of the control action. On reasonably good records this control need be turned only partly on, that is, it should not be operated too close to 0 ohms.

Fig. 4. Typical low frequency attenuation for various turnover frequencies as used in recording different phonograph discs.

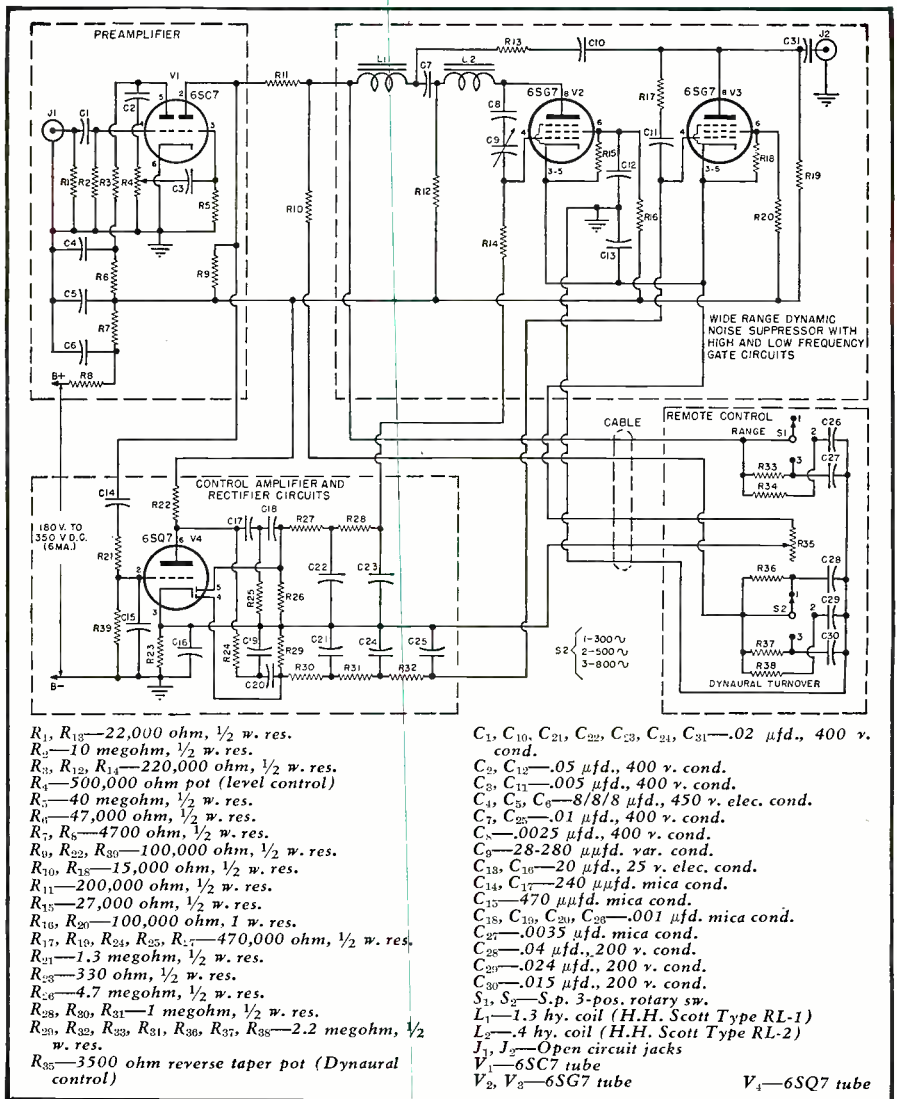
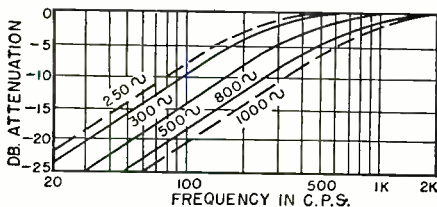

Fig. 3. Schematic shows how the "Dynaaural" preamplifier and noise suppressor are combined in a single assembly. Connections for remote control are also indicated.

The factory adjustment of a Dynamic Noise Suppressor is rather complex and involves considerable laboratory equipment. Where factory adjustment is impossible, however, the following procedure will suffice.

The trimmer (C<sub>9</sub>) in the grid circuit of the first 6SQ7 determines the maximum suppression. With the control (R<sub>35</sub>) set to 0 ohms and the grid of the 6SQ7 grounded, this trimmer should be set for maximum noise reduction without regard to quality.

The ground should be removed from the grid of the 6SQ7 and the "Dynaaural" control (R<sub>35</sub>) set at some intermediate position, such as 400 ohms.

Fig. 5. Theoretical bass compensation required to equalize for 300-, 500-, and 800-cycle turnover frequencies on recordings.

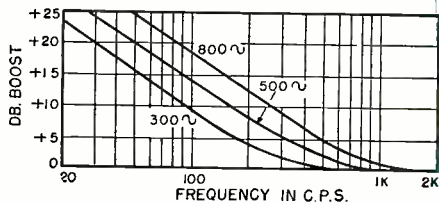

The *level* control (R<sub>4</sub>) is normally left fixed and compensates for the sensitivity of different pickups. If the control is set too high the gate circuits may be heard opening on loud passages. If it is set too low the gate circuits will not open enough and a "dead" quality will result. The best setting is that at which all types of records can be played satisfactorily by merely readjusting the "Dynaaural" control setting and, if necessary, reducing the setting of the *range* control (S<sub>1</sub>) when the signal is distorted.

It is obviously useless to attempt to reproduce frequencies above the range (Continued on page 108)

Fig. 6. Max. error in l.f. response resulting from use of 300-, 500-, and 800-cycle equalization for 250-1000 turnover points.

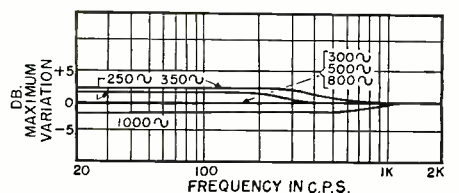

# A Single Tube A.F.C. Circuit for TV Deflection Systems

*Covering a horizontal deflection oscillator which has been used in television receivers made by RCA. The oscillator incorporates in a single tube a special saw-tooth wave generator of inherently high stability and all the elements of an a.f.c. system.*

By  
**JOHN A. CORNELL**  
RCA Service Co., Inc.

GOOD noise immunity in the horizontal-deflection circuit of a television receiver practically dictates the use of an automatic frequency control system for the deflection-waveform generator. Such systems generally employ a phase detector which compares the phase of the stripped sync signal with that of the deflection waveform. The output of the phase detector is essentially a direct potential with a level that is a function of the magnitude of the phase difference between the sync signal and the deflection waveform. When this phase difference is altered for any reason, the phase detector translates the change into a proportional change in the level of its output potential. This

potential is applied as a frequency-controlling bias to the horizontal oscillator. Any change in the phase relationship between the sync signal and the deflection waveform changes the oscillator frequency in the proper direction to correct the phase shift. Once phase coincidence of the deflection waveform and the sync signal is established, the phase-detector output potential stabilizes at a value required to maintain that coincidence until such time when further correction is required.

Good noise immunity is obtained with this type of synchronization by inserting a low-pass filter between the output of the phase detector and the controlled line-frequency generator. The filter averages the effects of random noise pulses while, at the same time, it passes the low-frequency error voltage necessary to maintain a fixed phase relationship between the deflection waveform and the sync signal.

A simple circuit for accomplishing the foregoing action with but a single tube is shown in Fig. 1. This circuit illustrates the principles of the more complex circuit employed in actual receivers. The right-hand triode,  $V_{1b}$ , operates as a conventional blocking oscillator and discharge tube. Across  $C_5$  is developed a saw-tooth waveform which is fed to the horizontal deflection amplifier. A sample of this waveform is also fed to the grid of the oscillator control tube,  $V_{1a}$ , along with the stripped sync signal of positive polarity. The saw-tooth, the sync, and their resultant combination are illustrated in Figs. 2A, 2B, and 2C, respectively. These waveforms are shown in the time positions they would normally occupy in a synchronized condition. The bias on the control tube is adjusted so that plate conduction, shown shaded in Fig. 2, occurs mainly during the pulse interval.

Notice, in Fig. 2C, that the leading half of the sync pulse rests on the positive slope of the waveform, and

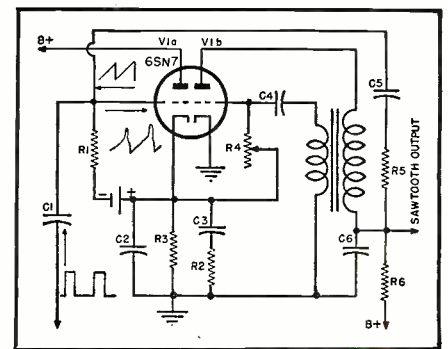
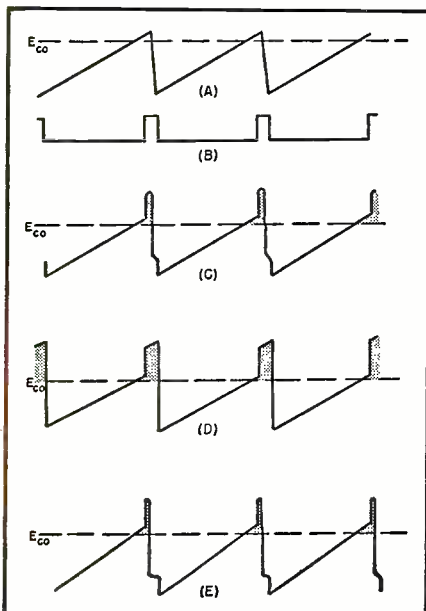

Fig. 1. Simplified a.f.c. oscillator circuit.

the trailing half is down on the sharp negative slope. Only the leading half of the sync pulse is effective in producing plate-current flow in the control tube, since the trailing half occurs beyond cut-off. Plate-current flow charges condenser  $C_2$  to a potential which is a function of the shaded area shown in Fig. 2C. This potential decreases somewhat between sync pulses as a function of the complex time constant in the cathode circuit of the control tube. The net result is that an average positive voltage, which is a function of the charge placed on  $C_2$  during the control-tube conduction time, appears across  $C_2$  and is applied as a bias to the blocking-oscillator grid. This bias, together with the constant parameters of the oscillator circuit, establishes the oscillator frequency at the sync-pulse frequency.

If, for any reason, the oscillator should tend to drift toward a lower frequency, the trailing half of the sync pulse would slide up the negative slope of the saw-tooth as shown in Fig. 2D. The shaded area increases under this condition, so that the average potential across  $C_2$  rises. The greater positive bias on the grid of the blocking oscillator increases the oscillator frequency until the proper degree of phase coincidence, as illustrated in Fig. 2C, is again attained. Fig. 2E shows the reduction in average

Fig. 2. Waveforms of circuit of Fig. 1, showing width modulation of sync pulse.



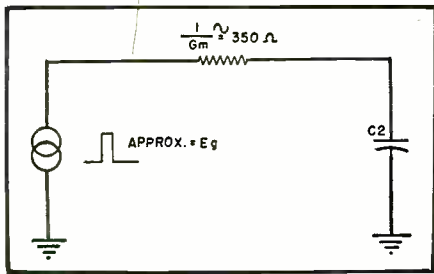

Fig. 3. Showing the equivalent circuit of the control tube during conduction period.

control-tube current when the oscillator frequency is slightly higher than the sync-pulse frequency.

Several interesting features of the circuit shown in Fig. 1 can now be pointed out. A study of Fig. 2C will show that no extreme differentiation of the stripped sync signal should be required to remove the low-frequency vertical sync components, as is required with some other methods of synchronization, in order to avoid loss of horizontal sync during the vertical sync interval. Since only the leading half of each sync pulse is effective in producing current flow in the control tube under normal conditions, the shaded area shown in Fig. 2C remains essentially constant, regardless of whether the pulse at a particular instant is a horizontal pulse, a vertical pulse, or an equalizing pulse. The trailing edges of the serrated vertical sync pulses may cause a small amount of conduction just before the shaded areas, but in practice this is not objectionable and can be partially compensated for by slightly differentiating the sync signal.

An important consideration of the circuit is that the amplitude of the sync pulse fed to the control tube should remain essentially constant. Since the control voltage developed by the phase detector is a function of the sync-pulse area, this voltage will depend not only on the width of the pulse, but also on the amplitude. If a receiver using a poor sync-separation system and employing this circuit were to be switched from a strong-signal station to a weak-signal station, the lower nominal control voltage developed by the phase detector due to the decrease in sync-pulse amplitude might necessitate resetting the horizontal-hold control. Receivers employing conventional sync separators and limiters of good design will normally keep the amplitude of the stripped sync pulses constant over a wide range of signal strengths.

A fairly critical item of the circuit is the cut-off potential of the control tube, which should remain constant at the value indicated in Figs. 2C, 2D, and 2E. A decrease in cut-off potential would result in lower phase-detector sensitivity and decreased pull-in range, while an increase would cause the control tube to conduct too heavily previous to the sync-pulse interval. This might force the blocking oscillator

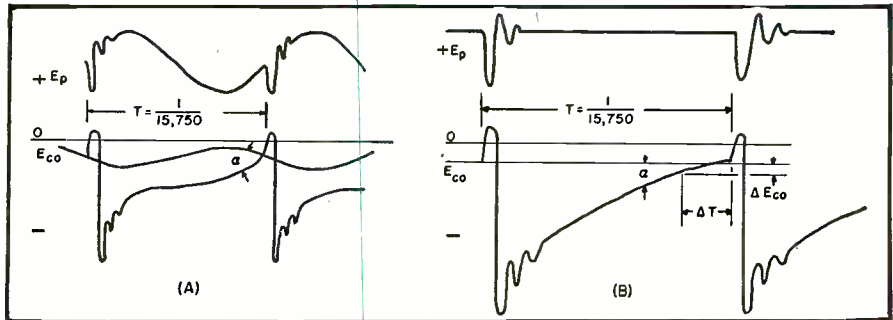

Fig. 4. (A) Grid and plate waveforms of blocking oscillator with sine wave stabilization. (B) Grid and plate waveforms of conventional blocking oscillator.

frequency to increase beyond the hold-in range of the phase detector. Sufficient stabilization of the control-tube bias at the proper value, despite the wide variations in line voltage that might occur in normal use, can be obtained by deriving the control-tube bias from the grid-leak voltage of the blocking oscillator. A potentiometer can be used to vary the control-tube plate voltage and, consequently, the cut-off voltage over a small range. This potentiometer, which replaces the usual horizontal-hold control found on other receivers, is, in effect, a vernier frequency control which takes care of extreme line-voltage variations and aging of tube and components.

The components in the cathode circuit of the control tube are chosen to obtain maximum phase sensitivity consistent with over-all stability and optimum noise immunity. An equivalent circuit of the control tube during the time it is conducting is shown in Fig. 3. Resistance  $R_3$  and the series

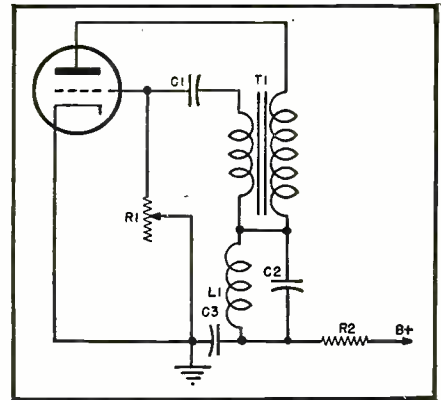
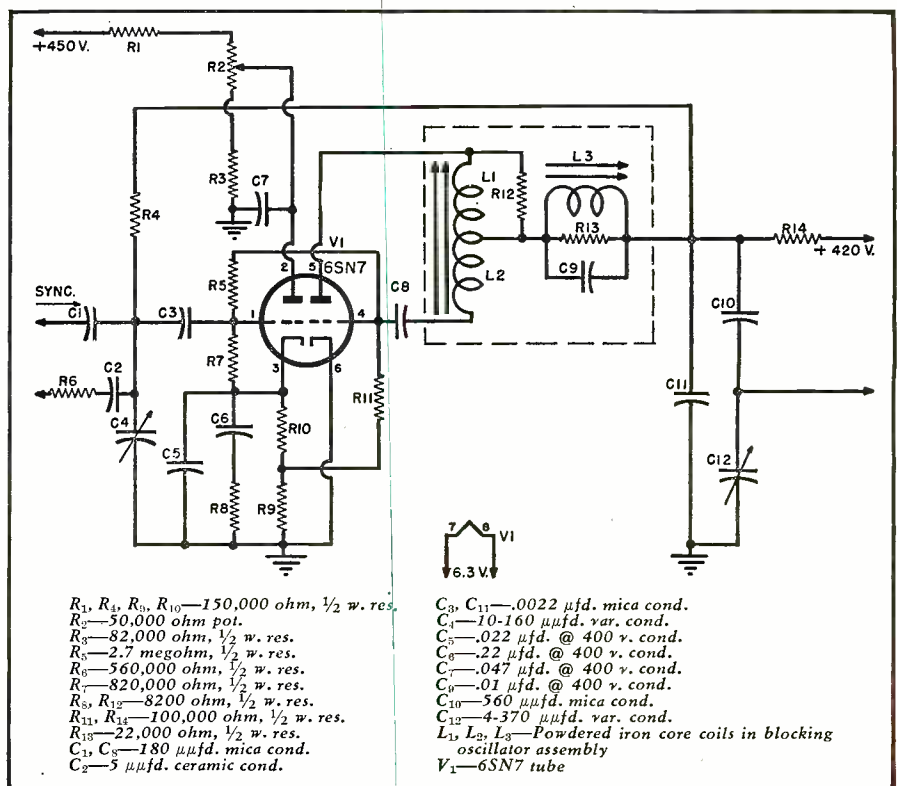

Fig. 5. Showing circuit diagram of blocking oscillator with sine wave stabilization.

combination of  $R_2$  and  $C_3$  have been neglected, since their impedances are large compared to the internal impedance of the control tube. The internal impedance of a triode operated in the circuit of Fig. 1 during the conduction

Fig. 6. Combined a.f.c. circuit and blocking oscillator with sine wave stabilization.



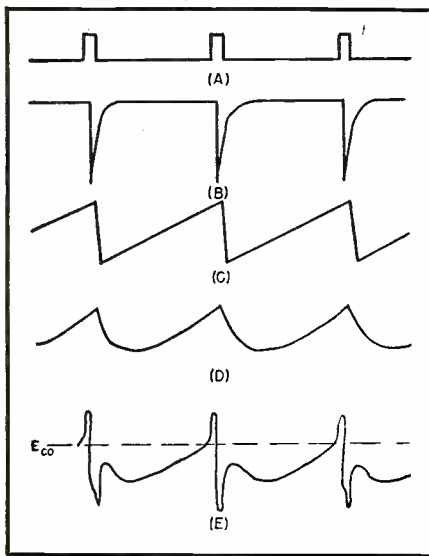

Fig. 7. Waveforms of the circuit given in Fig. 6, showing the synthesis of the waveform applied to the control-tube grid.

interval is approximately  $1/G_m$ . For a 6SN7, this is about 350 ohms. The equivalent generator of Fig. 3 delivers a pulse almost equal in amplitude to the peak value of the sync pulse applied to the control-tube grid. This pulse can have a duration of anywhere from the standard sync-pulse width of five microseconds to practically zero, depending upon the phase shift between the sync signal and the deflection waveform.

In order to make the average voltage across  $C_2$  a linear function of phase shift, the  $RC$  charging curve should be linear for the full sync-pulse duration of five microseconds. If the time constant of the equivalent circuit of Fig. 3 is made equal to about 150% of five microseconds, the curve will be sufficiently linear for the first five microseconds. This gives a time constant of 7.5 microseconds; consequently, the value of  $C_2$  should be about .021  $\mu$ fd. A smaller value will result in lower phase-detector sensitivity; a

larger value will slow down the control action and tend to cause hunting.

The value of  $R_2$  is chosen to prevent hunting of the oscillator frequency after a high acceleration of the error voltage across  $C_2$ . This might occur, for instance, when the receiver is switched from one channel to another or after any disturbance in the signal. A properly chosen value of  $R_2$  will add a derivative of the error voltage to the initial error voltage applied to the oscillator grid, thus decreasing the delay in the system to a value below that necessary to produce transient or sustained oscillations. Condenser  $C_3$  is made about ten times the value of  $C_2$  so as not to interfere with the error-rate function of  $C_2$  and  $R_2$ . The other element of the network,  $R_3$ , should be made high in value so that the original error voltage, which eventually appears across  $C_3$ , will also be applied to the oscillator grid along with the error-rate voltage.

### Blocking Oscillator with Sine-Wave Stabilization

An extremely stable blocking oscillator can be produced if a sine wave is used to stabilize the blocking period. To illustrate the principle of sine-wave stabilization, a curve representing the grid-voltage waveform of a conventional blocking oscillator is shown in Fig. 4B. The nearly asymptotic approach of the positive slope of the grid waveform to the tube cut-off potential is the primary reason for the inherent poor stability of such oscillators. A small change in cut-off potential due to a line-voltage variation, or to a small change in the positive slope of the grid waveform resulting from thermal drift of the components, would result in a considerable change in the period.

A rough measure of the oscillator stability is the ratio of  $\Delta E_{eo}$  to  $\Delta T$ , or  $\tan \alpha$ , as shown in Fig. 4B. The stability of a blocking oscillator can be measurably improved if the angle  $\alpha$  is made larger. A circuit which accomplishes the increase in  $\alpha$ , with an attendant improvement in stability, is shown in Fig. 5. This circuit can be recognized as a blocking oscillator with the addition of a parallel  $LC$  circuit inserted in the plate supply line. When the tube conducts,  $C_3$  discharges through the tuned circuit, the plate winding of the transformer, and the tube. The discharge current shocks the tuned circuit into oscillation, and the ensuing sine-wave voltage across  $L_1C_2$  is applied to the grid and the plate of the tube in phase. (Continued on page 144)

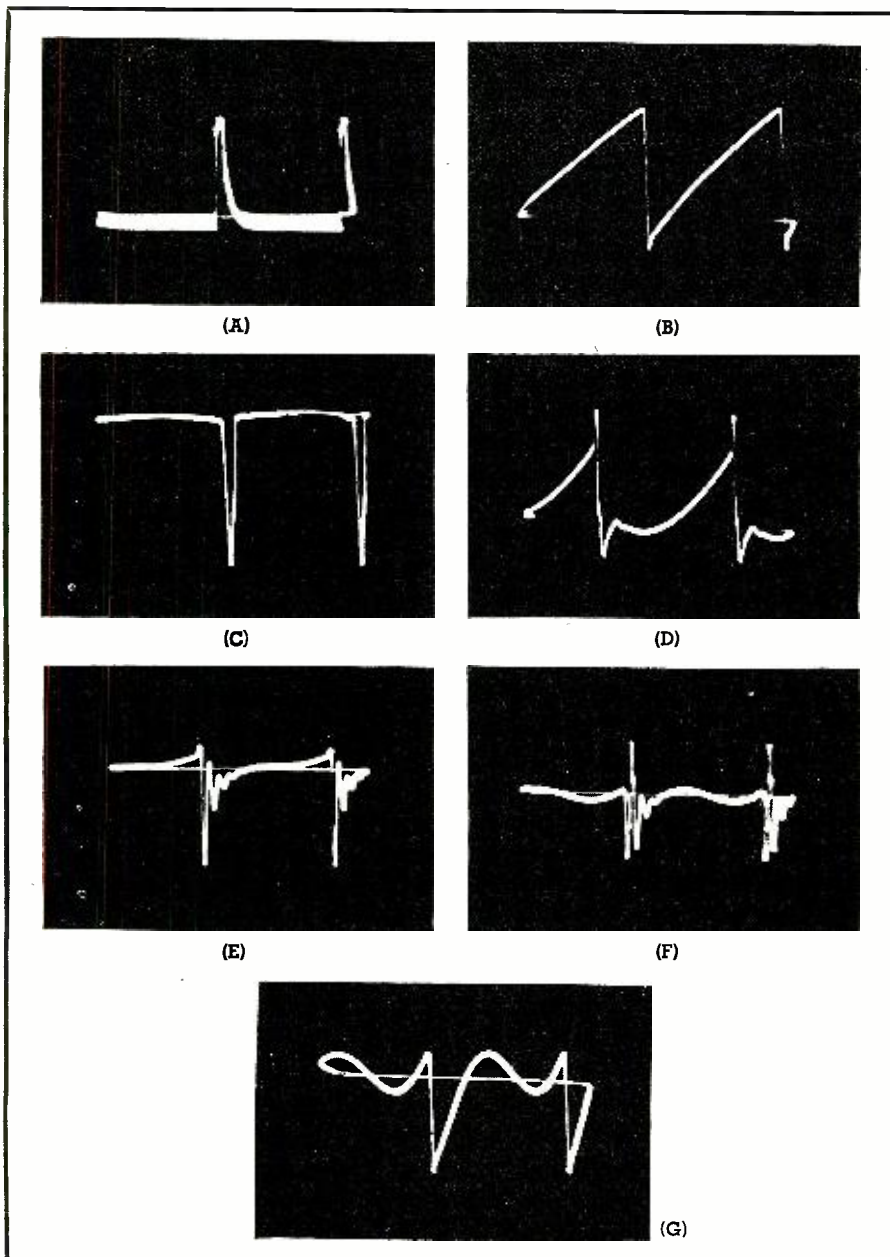

Fig. 8. Waveform photographs of the circuit shown in Fig. 6. (A) Horizontal sync signal applied to left terminal of  $C_1$ . (B) Saw-tooth output across  $C_1$ . (C) Voltage across horizontal deflection coils applied to left terminal of  $R_3$ . (D) Composite signal on control tube grid. (E) Oscillator grid voltage. (F) Oscillator plate voltage. (G) Saw-tooth wave plus sine wave at the junction of coils  $L_1$ ,  $L_2$ , and  $L_3$ .



# International

# SHORT-WAVE

Compiled by **KENNETH R. BOORD**



THIS month's club news includes items of interest regarding two clubs in the United States.

**United States**—The *Newark News Radio Club* has announced that Henry (Hank) and Amelia Bennett, 302 Laurel Avenue, Woodlynne, New Jersey, have been appointed short-wave editors of that organization.

A new club is the *United 49-ers Radio Society*; officers include Ed Broome, president; Jim Zaloudek, vice-president; Anna Carson, secretary; Dan Ainsworth, treasurer; Charles McCormick, chaplain; Bill Peters, editor, and Walt Carson, assistant editor. Both SWL's and hams are welcomed. QRA is Dan Ainsworth, 62 Dickinson Street, Binghamton, New York. (Boice, Conn.)

### This Month's Schedules

**Alaska**—Fox, New Zealand, has received verification from a Coast Guard station in Alaska which asks for reports from distant listeners; it is NMJ, 2.698, with voice broadcasts daily of marine information, including weather report, at 0100, 1300; power 3 kw. into antenna. (Radio Australia)

**Albania**—Radio Shkodra, 8.220, Skutari, has extended its schedule to weekdays 1200-1600, Sundays 1100-1600.

**Angola**—Experimental transmissions have taken place from Radio Clube de Louanda at Nova Lisboa; transmitter operates in the 25-m. band and was heard at 1545; announcements in Portuguese and French; reports requested to P.O. Box 125, Nova Lisboa, Angola; transmitter directed to Belgian Congo and Fr. Equatorial Africa. A later report lists frequency as 11.925. (Radio Sweden) Gillett, South Australia, is hearing Angola on 7.140 in parallel with CR7RN, 9.470, until closing 1600 with "A Portuguesa"; callsign on 7.140 is unknown, he says. (CR6RN, Luanda, "Radio Clube de Angola," is listed 7.130V with 1 kw.—KRB.) Gillett hears CR6RG, 8.242, from opening a few minutes after 1330, good signal.

**Arabia**—Bluman, Israel, reports Mecca some time ago was broadcasting on 11.950, 5.98, 3.975 at 1200-1300; programs included readings from the

Koran, prayers, and news for pilgrims (presumably all-Arabic); says transmitters actually are commercial phone stations at Djedda. This was for a special religious festival season—but may be heard later on occasion.

**Argentina**—LRY, 9.455, Buenos Aires, now has a "pen-pal" session Sundays 2130, called "International Mail." QRA given as Box 1841. (Leary, Ind.) LRM, 6.18, Mendoza, opens 0500 with music, then has news in Spanish. (Sanderson, Australia) LRT, Tecuman, seems to have settled down on 11.84, opens 0500. (Cushen, N.Z.) Operates daily in Spanish 0700-1200, 1600-2100. (Radio Sweden) LRT is good level in New Zealand around 2000 (Collett)

**Australia**—VLX, 4.897, Perth, noted 0515 with music, then news. (Sanderson, Australia) I have been hearing this ABC outlet in West Virginia best around 0630-0730. Sanderson reports VLM, 4.917, new Brisbane outlet, 0430 with news, music.

**Austria**—Simpson, Australia, reports Blue Danube Network, Salzburg, is now heard on 9.480 from around 0145. (Radio Australia) Is listed 9.535. Pearce, England, reports this one on 9.494 at 0100 with "Rise and Shine," recordings; sports 0110; 15 minutes of world news 0115; also heard later around 0900. Heard in Alabama by Hagen around 0000-0100. Brownless, England, says has program details around 1155 and appears to close 1900.

**Azores**—Patrick, England, says Ponta Delgada, 4.845, is fine level around 1700. Alcock, Ky., reports the 11.090

channel is good 1500-1600 but has severe CWQRM. Pearce, England, lists winter schedule of 1500-1600 on 11.090, 1700-1900 on 4.845.

**Balearic Islands**—Radio Menorca, Mahon, moved back to 7.54 from 7.495; heard 1330-1530. (Pearce, England)

**Belgian Congo**—Bluman, Israel, lists OQ2RC, 6.010, Leopoldville, 250 watts, at 1200-1330.

OTC, 9.757, 50 kw., sent schedule of 1300-1400 and 1400-1415 in Dutch; 1415-1430 French; 1430-1530 English (news 1432, headlines 1527); 1530-1645, 1645-1845 French and Dutch; 1900-2030, 2030-2045 French; 2045-2100 Dutch; 2100-2300 English for US-Canada (news 2102, headlines 2255). (Hedrick, W. Va.)

**Belgium**—M. Swaenepoel, head of the Foreign Relations Service of INR, writes Worris, N. Y., that "there are plans for an extensive international broadcasting service from Belgium, which will probably start in 1952. It is as yet impossible to say which frequencies will be used, this will be decided by international agreement. Broadcasts will be directed principally to the Belgian Congo. In addition, there will be programs—as there are now—for France and Empire, Great Britain and Empire, Holland, South Africa, USA, and Canada. There will be new programs for South America and for Europe in general. OTC, Leopoldville, will relay so that you will always be able to hear this station. Broadcasts will be in French, Dutch,

(Continued on page 115)

This group recently attended the convention of the International Short-Wave Club held at "Chez Auguste" in London, England. The ISWC, which was founded in the United States, has just celebrated its 20th anniversary. Pictured left to right at the speaker's table are T. E. Port, winner of the ISWC's DX Contest No. 2; J. E. Alfrey, F. C. Speller, and W. J. Wilson (chairman), judges in the Contest; Arthur E. Bear, Hon. Secretary of ISWC; William Olsson, of the British Broadcasting Corporation; and Patricia Board, ladies' representative of the International Short-Wave Club.



(Note: Unless otherwise indicated, all time is expressed in American EST; add 5 hours for GCT. "News" refers to newscasts in the English language. In order to avoid confusion, the 24 hour clock has been used in designating the times of broadcasts. The hours from midnight until noon are shown as 0000 to 1200 while from 1 p.m. to midnight are shown as 1300 to 2400.)

The symbol "V" following a listed frequency indicates "varying." The station may operate either above or below the frequency given.

# A Versatile, Low-Power TRANSMITTER

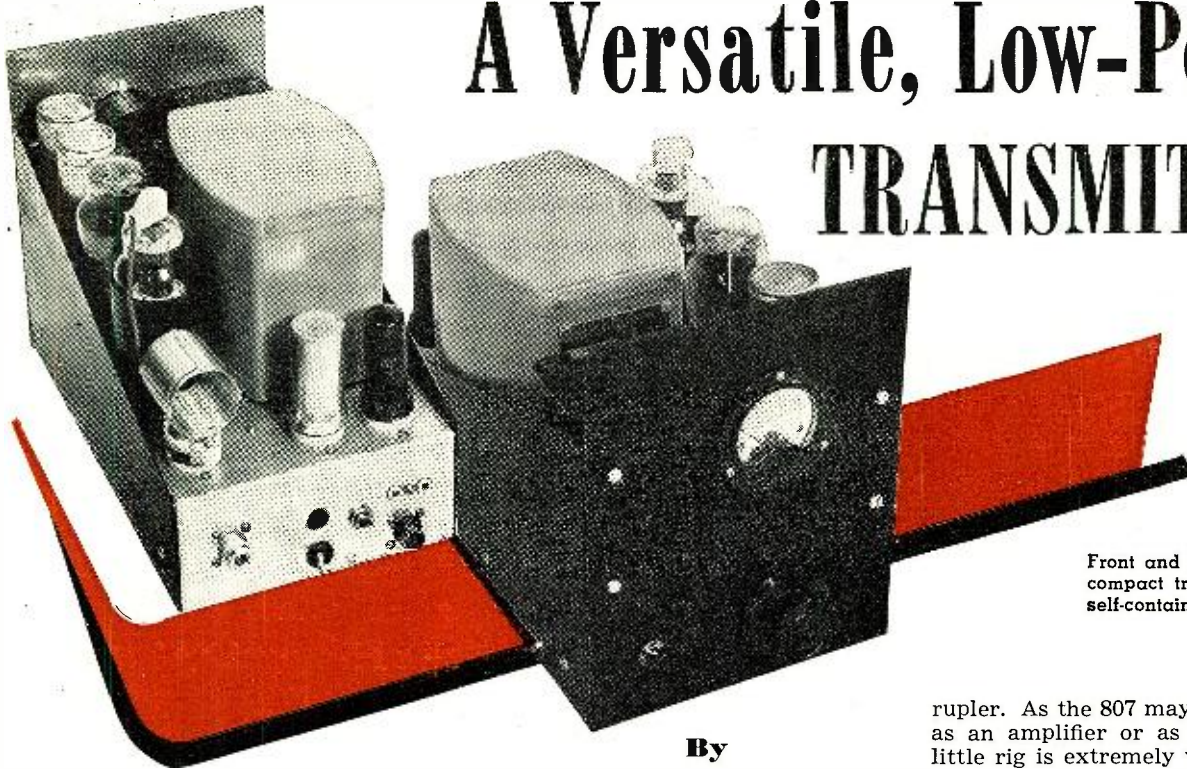

Front and rear views of the compact transmitter with its self-contained power supply.

By  
**G. L. COUNTRYMAN,\***  
W3HH, WIRBK

**An efficient oscillator plus fixed bias on the final permits chirp-free keying.**

**C**AREFUL consideration should be given to the little unit to be described herein. A newcomer to amateur radio can build it, knowing that it will never be discarded when he goes to high power; the more advanced ham may construct it for his multiplier and driver stage, and the experimenter will find it invaluable for testing out different v.f.o.'s, various driver and amplifier circuits, etc. Its small, compact size makes it especially desirable. It can be used, as is, on the operating table, or it can be mounted on less than half of a standard 8 $\frac{3}{4}$ " x 19" rack panel. The latter procedure requires cutting a minimum number of holes in the rack panel. Obviously, if the unit is to be mounted on a rack panel, the 8 $\frac{3}{4}$ " x 7 $\frac{1}{2}$ " panel shown in the photographs should be removed.

By itself, this unit is a full-fledged, 50 watt transmitter, crystal controlled and completely self-contained including the power supply. The amplifier is biased to cut-off which keeps the 807 tube on an even keel. The output is a link coil connected to a coaxial jack so that the rig can feed directly into a center-fed dipole or folded dipole, or to the grids of one or two high-power final amplifier tubes. Controls have been kept to a minimum. The first stage is broadband and requires no tuning over any one amateur band. In fact, the only adjustable control on the rig is the 807 plate tank tuning control. Omission of a

dial scale for this control was deliberate to preclude adjustment to a predetermined setting which may or may not be correct, rather than to the setting which results in a dip in the plate current.

The key jack is located on the rear chassis apron along with a *Millen*  $\frac{3}{4}$ " crystal socket, the output coaxial jack and an input coaxial jack paralleling the crystal socket. A *Mosley* adaptor is used when it is desired to plug  $\frac{1}{2}$ " spacing crystal holders into the crystal socket. The  $\frac{3}{4}$ " socket was selected as the single bolt provided a good mounting for the 6AG7 grid r.f. choke (*RFC.*, Fig. 1). The cone insulator furnished with this choke is reversed as the small end will fit between the crystal prongs. This r.f. choke is a "must" for dependable operation if both crystal and v.f.o. drive are contemplated. The spacing between the crystal socket and the input coaxial jack is sufficient to permit the use of crystals in the large round holders if desired.

By removing the crystal from its socket and connecting a coaxial cable to the input jack, a v.f.o. may be used to drive the transmitter in lieu of the crystal. With a simple one-tube *Clapp* circuit v.f.o., using a 6C4 tube connected to the input, the 6AG7 not only serves as an excellent broadband isolation tube and amplifier, but will also function as a doubler, tripler, or quad-

rupler. As the 807 may be used either as an amplifier or as a doubler, the little rig is extremely versatile as far as its frequency range is concerned.

The key jack is a closed-circuit type. Thus, when the phone plug connecting the key is removed, the cathode circuits of the tubes are closed, permitting v.f.o. keying to be used as the 807 is biased to cut-off. On the other hand the v.f.o. may be allowed to run continuously, and the two stages in the transmitter may be keyed simultaneously by merely inserting the key plug in this unit. Be sure that a plug is in the key jack when testing.

The chassis is a standard 7" x 12" x 3" and should be fairly husky with the sides folded in. *Bud* brackets are used rather than *Parmetal* as the *Bud* type are cut out, permitting the chassis to fit flush against a panel. The high voltage winding of the power transformer furnishes 500 volts at 100 mils to the 807 tube when loaded. A 65 volt bias tap is provided, and the bias voltage is rectified by a 100 mil selenium rectifier. The 4  $\mu$ fd., 600 volt oil condensers are a surplus item at about fifty cents each. The 150 mil choke has plenty of iron in its core and also came from the surplus store as did the milliammeter. Either an 83 or 5Z3 rectifier tube may be used.

All component values shown were determined experimentally and, as is frequently the case, are not always those recommended by the manufacturer, nor are they necessarily the values derived when you sit down with a pencil and paper to figure out exactly what value some component should have. No resistor was found necessary across the iron core coil form used in the plate circuit of the 6AG7 for broadbanding this stage. Even without a resistor good response is obtained across any one amateur band, and the trimmer condenser and core adjustments are not critical. In

\* Comdr. U.S.N., Electronics Officer, Boston Naval Shipyard.

winding the *Millen* coil forms, the directions on the data sheet accompanying each form may be followed. Using the coil data set forth in Fig. 1, the ceramic trimmer should be set at about mid-value and the core adjusted for maximum output on each ham band for which coils are wound. The core adjustment will be about half way within the winding. This method eliminates the necessity for changing the setting of the trimmer condenser when changing coils. No bleeder is used across the selenium rectifier to ground. With a bleeder in the circuit the effect was to ground the approximate center of the high-voltage winding of the transformer as well as the exact electrical center, and some weird results were forthcoming! Several different kinds of electrolytic condensers were tried for the filter following the selenium rectifier. None was satisfactory. A good old surplus "bathtub" condenser was placed in the circuit and functioned perfectly. The selenium rectifier is mounted vertically on the side of the chassis, underneath, for good heat dissipation.

With bias on the 807 and the small resistors in the control grid and screen grid leads of the 6AG7 it is impossible to make the rig behave in other than a normal manner. It is virtually "bug-proof" and works along day after day as steady as a rock. Incidentally, when mounting these grid resistors, the pig-tail leads should be clipped off as short as possible and the resistor mounted directly at the socket terminals. The cathode resistor should be 56 ohms. A substantially higher value will be unsatisfactory.

For crystal operation, two bands may be used with one crystal provided the harmonic relationship is correct, as the 807 delivers as much output when doubling as it does when amplifying straight-through. This means that output on both 20 meters and 10 meters can be obtained with a 20-meter crystal of the fundamental type. Crystal current is low and barely lights a 60 mil pilot bulb. The 807 can be amplitude modulated with equal effectiveness when being used as a straight amplifier or as a doubler, although the latter is not in accordance with good engineering practice.

No particular constructional difficulties should be experienced. It is recommended that the panel meter hole not be cut until the unit is completely assembled. There is not too much clearance between the filter condensers and the choke, and the meter must be accurately located. Fasten the meter to the panel before attaching the panel, as the holes for the bolts holding the meter are nearly inaccessible after the panel is in place. The use of lock washers with every nut and bolt will pay dividends in reliability and stability. Don't forget to ground the shell of the 6AG7 (terminal 3).

The *Bud* coils are inexpensive and are very satisfactory. The combination of a *Millen* socket and *Bud* coil

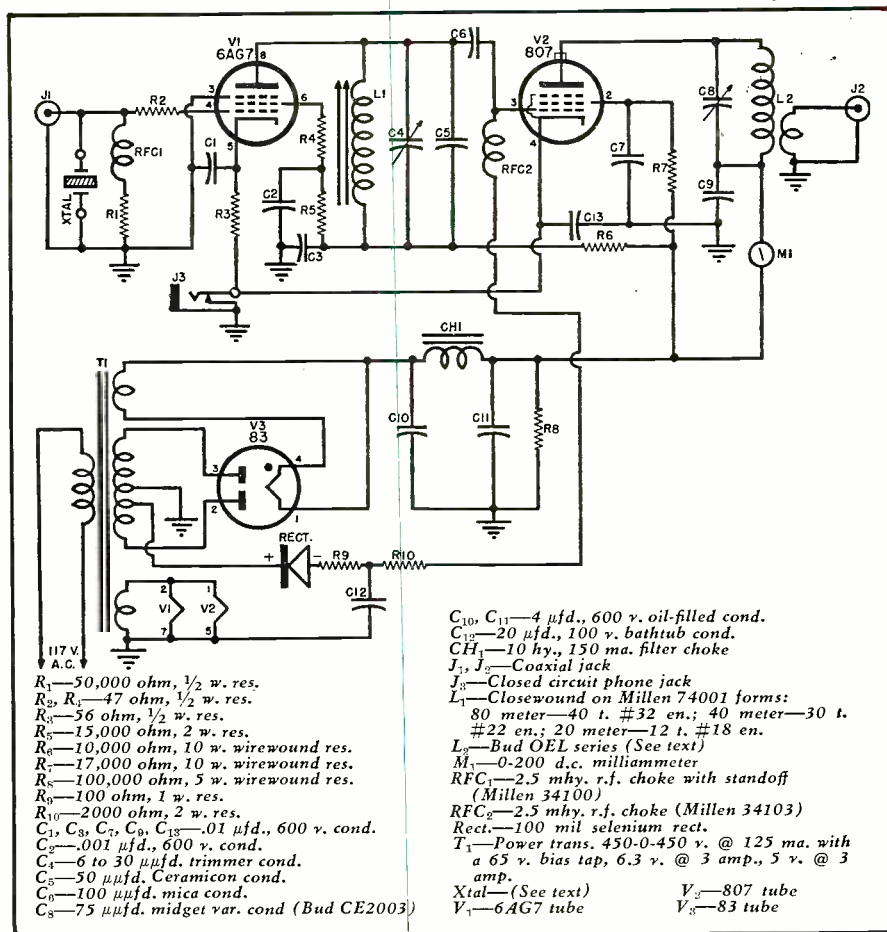

Fig. 1. The transmitter schematic. A selenium rectifier furnishes bias for the final.

keeps the coil winding well above the metal chassis. The fixed link on the 40-meter coil did not give sufficient energy transfer so it was removed, and a link made of three turns of pushback wire was wound directly over the windings at the cold end of the coil.

If it is planned to operate this unit as a transmitter using the convenient twin lead folded dipole antenna, it is easy to attach the 300 ohm twin-lead feeder to a coaxial connector. The

fact that one side of the coaxial socket or jack is grounded to the chassis made no operational difference when compared to a connection with the twin-lead going directly to the pickup coil.

The unit including its power supply occupies about the same space as the popular "command" series of transmitters and can be constructed as readily as a "command" transmitter can be modified.

—30—

Fig. 2. Under-chassis view. An extension shaft is used on the final tank condenser.

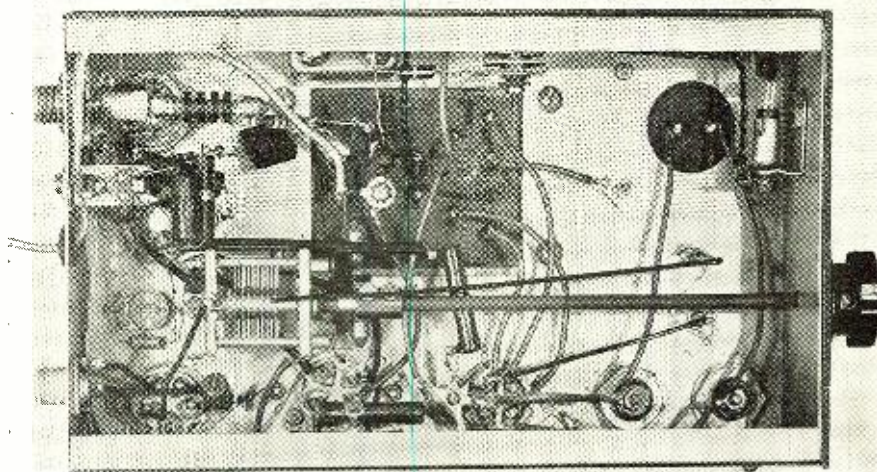

# Improving Performance

# Of Small P.A. Amplifiers

By  
**JOHN B. LEDBETTER**  
Eng., Station WKRC-TV

**These simple circuit changes and additions will go a long way toward improving p.a. performance.**

THE service technician engaged in maintenance of p.a. equipment is often confronted with small, low-power amplifier systems whose performance and output could be increased to a worthwhile degree. In some of these amplifiers, this would mean simply replacing a tube, increasing voltages, adding a tone or gain control, etc., while in others a major circuit change, such as adding an extra stage of amplification, in-

stalling a limiter circuit, replacing the speaker system, etc. would be advantageous.

### Basic Considerations

In most small or medium-power amplifiers, there are a number of changes which can be made to improve performance and flexibility.

Some of these are (1) an increase in amplifier output, (2) improvement in frequency response, (3) reduction of

noise and distortion, (4) addition of extra microphone or phonograph stages, (5) variable-frequency filters or equalizers, and (6) the installation of remote controls or extra speaker units. Before modifications or circuit changes are made, however, the limitations of the individual amplifier must be determined. Some models, for example, allow very little margin or safety factor in the design of power and output transformers. Obviously, it is unwise to replace the output tubes with types delivering greater power if the power transformer will not stand the extra filament or plate current drain, or if the output transformer is not capable of handling the added power output without distortion or overloading. The economical factor, or cost of making individual changes or circuit modifications must also be considered.

### Bell 510 Modifications

A good example of a small amplifier which lends itself well to circuit modifications is the Bell Model 510. This model, first released in 1939, is still very popular and can be found in relatively large numbers. The tube lineup in this particular model consisted of a 6J7 preamplifier, a 6N7 phase inverter, and two 6V6 output tubes connected in push-pull Class AB1. The output was approximately 14 watts maximum. (Later models used a 6SJ7 and 6SN7.)

The following circuit changes are mentioned in detail, since a comparatively large number of these amplifiers are still in service, and since the majority of changes are equally applicable to other similar amplifiers.

In the Model 510, the output can be increased by replacing the 6V6 tubes with two 6L6's. Since two 6L6 tubes in Class AB1 will give about 18.5 watts output (as compared with 14 watts for two 6V6 tubes under identical conditions) this change may be considered worthwhile. The filament winding of the power transformer is capable of providing the extra ampere of current drain. No circuit changes are necessary either in the bias circuit or in obtaining a proper impedance match. The cathode bias for the 6V6's and 6L6's is very similar; the plate load resistance of the latter is 9000 ohms as compared with 8000 ohms for the 6V6 tubes. The power-handling capabilities of the output transformer are such that the additional power output is carried without appreciable increase in distortion or transformer saturation.

Added drive for the output stage and additional amplification for both the microphone and phono inputs can be obtained by adding an extra stage of amplification. The power transformer can also supply the extra filament and plate current for this stage. In the Model 510, a dry can-type 8  $\mu$ fd., 450 volt electrolytic filter condenser is used. Since the mounting hole for this unit already has been cut to accommodate a standard octal tube socket,

Fig. 1. Schematic diagram of the Bell Model 510 before circuit changes were made.

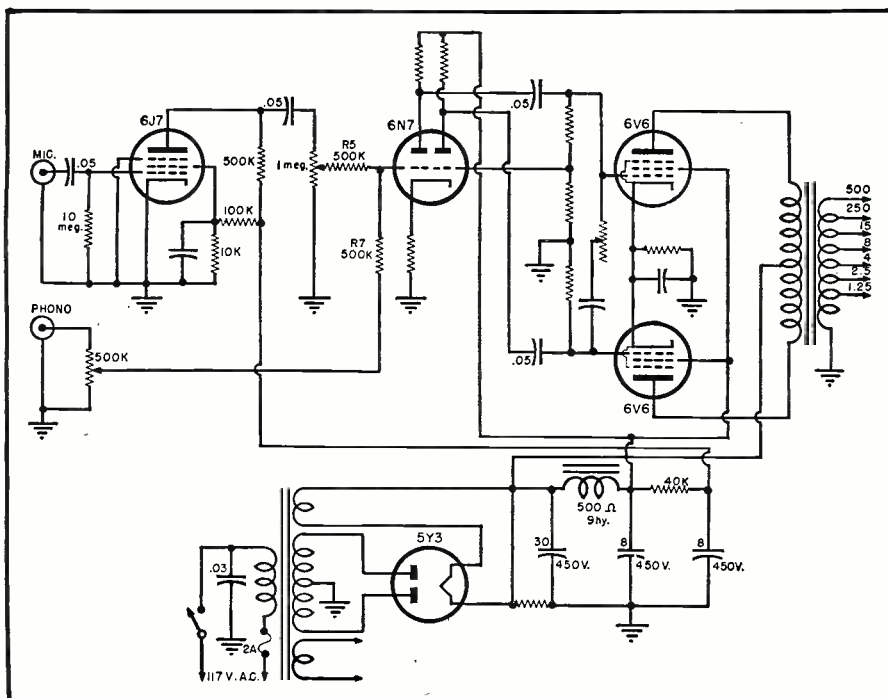



the installation of an extra stage is greatly facilitated. The condenser can be removed and replaced with a tubular 8  $\mu$ fd., 450 volt filter condenser, which can be mounted near the rectifier socket. Although *any* desired type of tube may be used, it is recommended that a twin-triode type such as the 6SC7, 6SN7, or 6SL7 be employed so that isolated, individual inputs can be provided for the microphone and phonograph. The tube used by the author in a similar modification some time ago was a 6Z7. At that time, a number of these tubes were available, and tests proved their superiority in several ways over other types then available both in gain and circuit stability.

Parts required for the addition of this stage are an octal tube socket, .05  $\mu$ fd., 600 volt coupling condenser ( $C_2$ ), a 1000 ohm, 1 watt cathode resistor, a 15  $\mu$ fd., 25 volt electrolytic condenser, and a 100,000 ohm, 1 watt plate load resistor. Circuit changes and modifications can be seen by comparing the original schematic (Fig. 1) with the modified circuit shown in Fig. 3. In Fig. 1, both the microphone preamplifier and the phono input circuit were connected to a common grid in the 6N7 stage through series limiting resistors  $R_5$  and  $R_7$ . These resistors were removed and the individual microphone and phono gain controls fed into separate grids. This affords complete isolation between the two input circuits and allows much smoother operation.

To carry modifications a bit further, the 6J7 preamplifier can be replaced with a 6SJ7. This requires very little change in wiring and allows a much shorter grid lead, with a subsequent reduction in hum pickup. Improved results can be obtained by replacing the 10 megohm grid resistor with a 2 megohm, 1 watt resistor in series with a single 1 volt bias cell. Excellent quality and performance, considering the straightforward circuit design, can be obtained with this amplifier, and the 4.5 watts or so increase in output power will make the unit more valuable as a rental for small and medium-size p.a. jobs.

The flexibility and frequency response of the 510 and similar amplifiers may be increased still more by the addition of a continuously-variable bass and treble boost circuit. In this instance, the original microphone and phono input circuits can be left connected as shown (Fig. 1), and the 6Z7 stage wired as indicated in Fig. 2A. The treble control ( $R_1$ ) and bass control ( $R_2$ ) may be mounted on the front panel, preferably above and at either side of the phono gain control. With this circuit, a boost of from 12 to 15 db. can be obtained on both low- and high-frequency response. The regular tone control in the amplifier can still be used to attenuate the higher frequencies to any desired degree. Other tubes, such as the 6SC7, 6SL7, 6SN7, etc. can be used with equally good results.

In certain installations, a volume

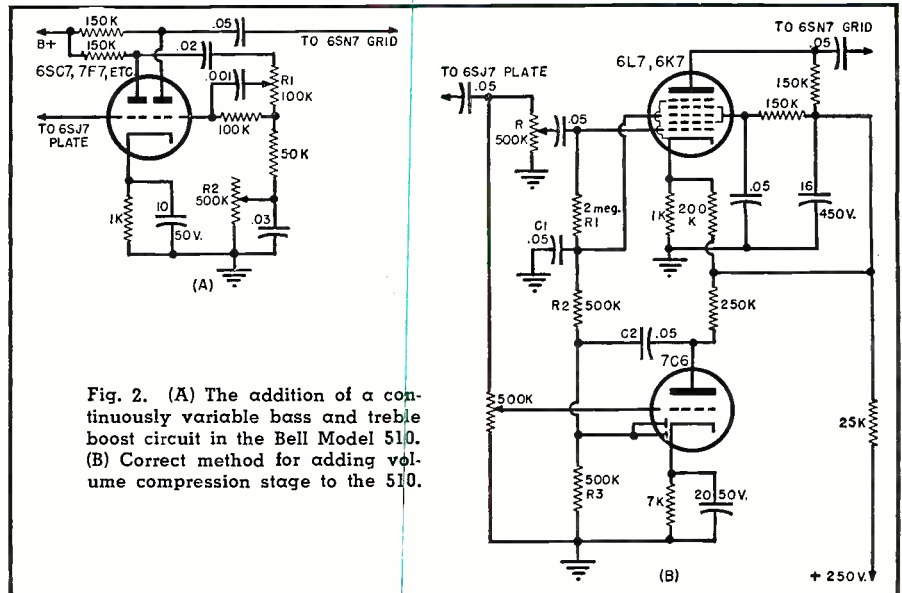

Fig. 2. (A) The addition of a continuously variable bass and treble boost circuit in the Bell Model 510. (B) Correct method for adding volume compression stage to the 510.

compression stage may be more desirable or useful than either of the two modifications previously mentioned. Again taking the *Bell Model 510* as a specific example, the 6L7 limiter tube (see Fig. 2B) can be installed in the space originally taken by the filter condenser. In this particular limiting circuit, an extra tube (7C6) is used as a combination bias amplifier and rectifier. Space for this tube and the compression volume control can be found at the rear of the chassis, with the 7C6 mounted horizontally. For individual applications, a slower or faster attack time may be desired. This may be arranged by changing the values of  $C_1$  and  $C_2$  and  $R_1$ ,  $R_2$ , and  $R_3$ . The 7C6 cathode bias resistor may also be changed. Try different combinations, changing the values of each component about 20 per-cent each time. For proper adjustment of the limiter circuit as shown, the microphone gain

control should be set to give the desired output and the compressor control ( $R$ ) advanced until the amplifier output begins to cut-off sharply on peaks. The proper limiting or compression level is just below this point. With  $R$  adjusted correctly, it should be possible to obtain an average increase of approximately 6 db. in amplifier output. This should prove especially beneficial in noisy or outdoor installations. Precautions should always be taken to avoid over-compression, since this produces drastic reduction in amplifier output, along with excessive distortion. Smoother compression in some cases will be obtained by using a sharper cut-off pentode such as the 6K7 instead of a 6L7.

#### Silvertone Model 12860

The tube complement in *Silvertone Models 12860, 12861, and 12862* public (Continued on page 119)

Fig. 3. Modified circuit of the Bell Model 510 public address amplifier unit.

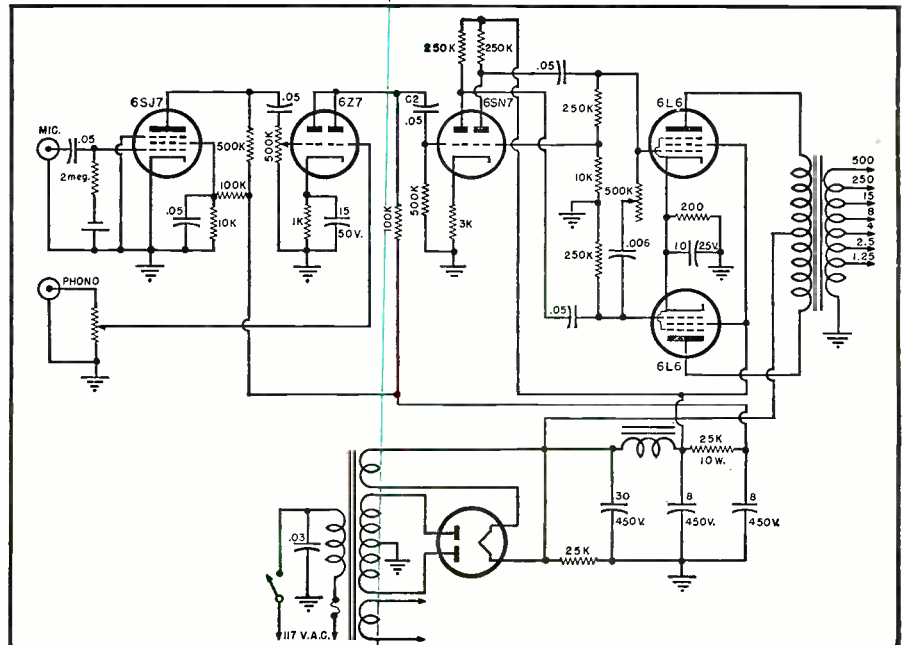

# OSCILLATOR and GAIN SET for AUDIO MEASUREMENTS

By  
**HAL BUMBAUGH, W6HH**

IN GENERAL the service technician, amateur, or experimenter is not concerned with such things as phase shift and intermodulation as they pertain to audio equipment nor is he generally in a position to make such measurements but he is, or should be, vitally interested in the over-all response of any audio amplifier or other allied equipment since such a response curve gives a fundamental concept of what can be expected of that equipment. Such a curve also will show where and to what degree correction must be applied to get certain wanted effects. In addition, the response curves of such auxiliary equipment for the audio circuit as filters, equalizers, attenuators, and tone control circuits should be known. All this information can be easily obtained with the equipment to be described.

The first requirement is a good audio oscillator. Of the many audio oscillators available the beat frequency type is one of the better ones and is the type to be described. This type oscillator has excellent waveform and the one to be described has a frequency range which covers the range of normal human hearing.

The oscillator is shown in the photograph of Fig. 1. In this view the components appearing on the front panel are, from left to right, pin jack for ground connection, power plug receptacle, 500 ohm line input, tuning dial vernier knob, "Send-Receive" key for switching the volume indicator, and 500 ohm line output. On the top row, left to right, are the output control knob, main tuning dial, and volume indicator meter, or *VI*. The case measures 15" x 8" x 8" deep.

Fig. 2 is the wiring diagram of the oscillator. As will be seen there are two oscillatory circuits, one relatively fixed in frequency, and one variable. The beat frequency (in the audio range) developed between the output of the two oscillators is dependent on the setting of the tuning condenser of the variable oscillator (and to a degree on the setting of the vernier tuning condenser on the "fixed" oscillator as will be explained under calibration.) It is this frequency that is used in audio measurements.

This audio frequency beat developed between the two oscillating circuits is fed to an intermediate or combining amplifier then to a push-pull output stage whose output, in turn, is fed

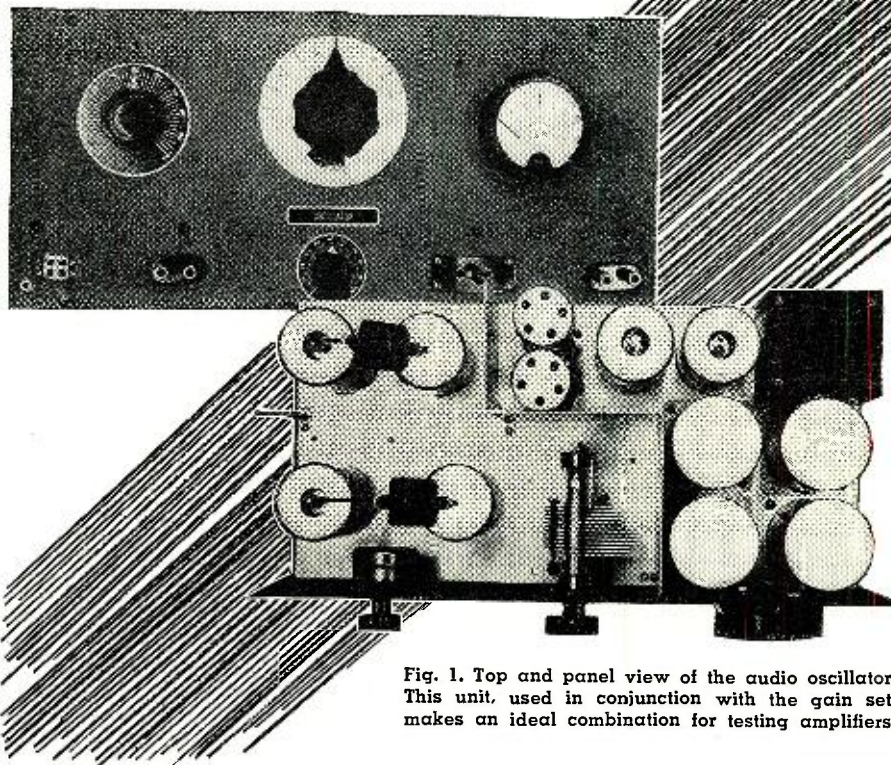

Fig. 1. Top and panel view of the audio oscillator. This unit, used in conjunction with the gain set, makes an ideal combination for testing amplifiers.

## **Two useful pieces of test equipment for the service technician, experimenter, or amateur radio operator.**

through a high-quality transformer to the 500 ohm output terminals of the oscillator.

Several of the components should be of the highest obtainable quality. They are, first, the main tuning condenser which should be of the straight-line frequency type having a maximum capacity of 350  $\mu\text{fd}$ . and the lowest possible minimum capacity. For this purpose we used a *National* girder frame type whose curve of capacity followed very closely that of the condenser used in the *Western Electric* 4-A gain set.

Secondly the padding condensers (fixed) across the tuned circuits of the oscillators should be of the highest quality. We used *General Radio* Type 505-G in the 2000  $\mu\text{fd}$ . size.

Two coils of 200 microhenrys inductance each will be required. One is to have but one winding with a center tap (for the "fixed" oscillator) and the other a similar winding with the addition of a secondary wound over the first at the center of the coil. This secondary winding should also be center tapped. The coils should have shield cans of a diameter at least twice the diameter of the coil form and should

have provision for bringing out the necessary terminals, three in the case of the first coil and six for the second coil. We had a local coil concern wind these up for us and equip them with shield cans. The price was nominal considering the excellent workmanship.

For those who desire to wind their own coils a form 1 inch in diameter and at least 2 inches long is recommended. The desired 200 microhenrys for  $L_1$  and  $L_2$  can be obtained by winding 122 turns of #29 enamel wire close-wound and tapped at the 61st turn over the middle  $1\frac{1}{2}$  inches of the coil form length. This will give  $\frac{1}{4}$  inch on the form at each end for terminals and mounting brackets. The coils should be mounted in shield cans having a diameter of about 3 inches and sufficient length to allow at least 1 inch clearance between the top of the coil form and the can and the same distance between the bottom of the coil form and the bottom of the can, or face of the chassis.

The coil  $L_2$  consists of 20 turns of #29 enamel wire, center tapped, and wound over the center of  $L_1$ .

The circuit is not complicated and there are no bugs to remove after completion if reasonable care is taken in the layout and wiring.

Placement of the various parts, as well as the shielding employed, is shown in Fig. 1. The components are, top row, left to right, tube and coil for the first or "fixed" frequency oscillator, next the two tubes of the intermediate or combining amplifier; the two tubes of the push-pull output stage, and the output transformer.

In the lower row at the left are the tube and coil for the variable oscillator. The four shield cans at the right end house the 250 millihenry chokes and their associated condensers which make up the high frequency filters for the plate circuits of the intermediate amplifier. These chokes and their associated capacities should be of the best quality and the choke winding should be positioned well away from the chassis.

Fig. 3 is the bottom view of the chassis showing the relatively simple wiring. No difficulty should be experienced in making the finished oscillator function satisfactorily.

When the wiring is completed it will be necessary to calibrate the oscillator. This can be done easily using any commercial audio oscillator as the signal source. The signal from the commercial oscillator should be fed to the outputs of the completed job and the known oscillator set to one of the calibration frequencies desired. Then, by tuning our own oscillator very slowly through its range we will find a point where the VI meter will make rapid swings up and down as the energies from the two oscillators beat against each other. A position will be found where the VI meter settles down to a steady reading and at this point the two oscillators are at the same frequency and phase. This should be marked on the scale as one calibration point and the frequency (from the reading of the commercial oscillator) recorded. As many of these points may be taken as is desirable. If the calibrated range does not turn out to be exactly as wanted—with respect to upper and lower limits—the 100  $\mu\mu\text{fd.}$  vernier tuning condenser on the "fixed" oscillator should be varied until the range is moved up or down to the position desired. Since the actual range or band of frequencies covered is governed solely by the tuning condenser on the variable oscillator, use of the 100  $\mu\mu\text{fd.}$  vernier merely serves to slide this fixed band of frequencies up or down. In our case we chose settings giving us a band of oscillator output frequencies from 30 to 20,000 cycles.

While any type tuning dial may be used on the oscillator the one shown in the photographs was chosen for quick changes in setting and ease of reading. A chart of dial readings versus frequency is on top of the oscillator case. A long slide rule type dial might be preferred by some constructors as frequencies could be noted directly on such a dial.

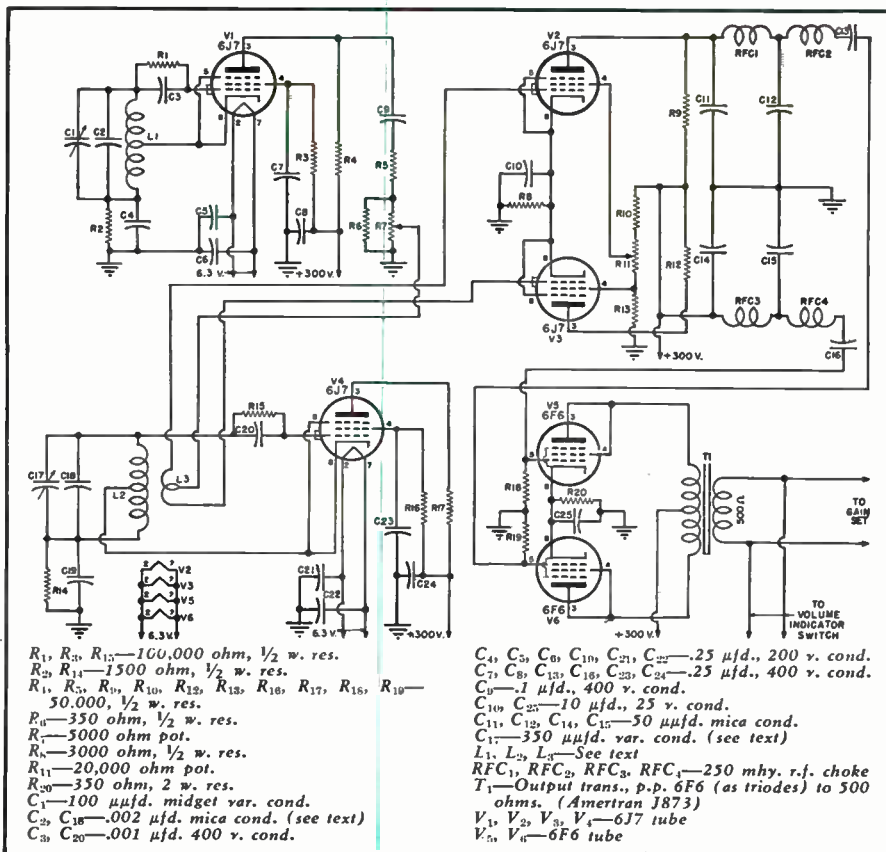
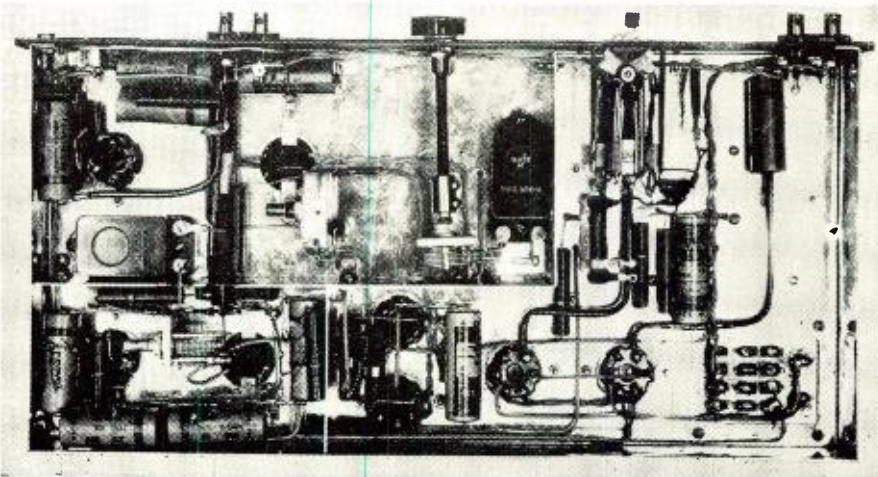

Fig. 2. Complete wiring diagram of the beat frequency oscillator circuit.

In order that we may use the oscillator in making gain runs or performance curves on transmitters, audio amplifiers, filters, equalizers, tone control circuits, etc., it is necessary to have a variable attenuator, "losser" or, as we shall call it, a calibrated gain set. It is the function of this gain set to insert in the circuit an attenuation or loss very nearly, if not exactly, equal to the gain through the amplifier being measured. Thus, if we have 0 level out of our test oscillator and are to feed an amplifier having 40 db. gain we can set our attenuator or gain set for 40 db. attenuation or loss which causes the signal to enter the amplifier at minus 40 db., then experience a

gain of 40 db. and emerge at 0 level. Thus the original and final levels are compared by means of the VI and since we attenuated the oscillator output 40 db. to obtain this equality of VI reading between the input and output (the VI always reading across a 500 ohm line as will be explained later) we can say that the amplifier has a gain of 40 db. In general we can say that any amplifier being measured has a gain in db. equal to the db. loss inserted by the gain set when the VI readings are the same on the oscillator output and the amplifier output—the VI being given a 500 ohm termination out of the amplifier as it already has out of the oscillator (see Fig. 6). This

Fig. 3. Bottom view of the oscillator chassis. Note careful shielding and parts placement.



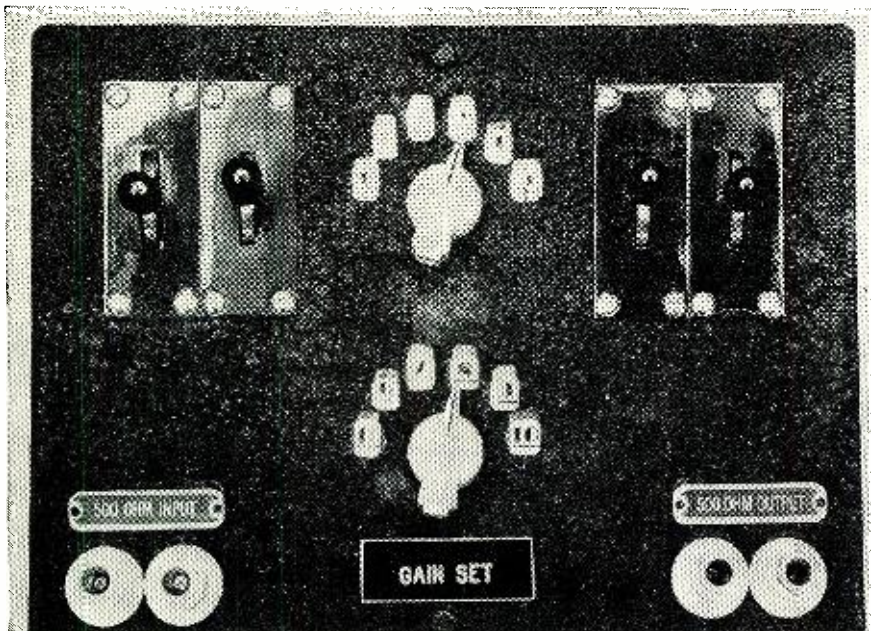

Fig. 4. Panel view of gain set. Controls are placed symmetrically to give "professional" look.

will be dealt with at greater length under the measuring procedure to be described later.

Fig. 4 shows the small gain set unit employed with the oscillator in audio measurements. The gain set has a total possible attenuation of 110 db.

Fig. 5 shows the circuit arrangement of the gain set. The resistors were 1 watt carbons and each was originally chosen for having a value of resistance somewhat lower than that ultimately required for that resistor. Each resistor was then connected across a Wheatstone Bridge which was set for the wanted value of resistance and a three-cornered file used to file a "V" slot in the body of the resistor thus decreasing its cross section and consequently raising its effective resistance. Filing was continued until the correct value was reached, as indicated by balance on the bridge.

As may be seen from the wiring diagram there are four fixed pads of 10,

20, 30, and 40 db. loss respectively which can be placed in the circuit by means of key switches of the anti-capacity type which are mounted on the front panel.

In addition, ten steps of a fixed value of 1 db. loss can be placed in the circuit by the two knobs on the front panel, each knob providing a range of from 0 to 5 db. loss.

By proper positioning of the knobs, or point switches, and the anti-capacity keys any attenuation from 0 to 110 db. may be placed in the circuit. The only precautions to be taken in building up the gain set is to keep all the elements well separated and wires well spaced from each other. If these precautions are observed excellent accuracy can be obtained. On checking our set against a standard commercial set our set had a maximum error of 0.4 db. at the maximum setting of 110 db.

Although the case of our gain set measures only 6" x 8" x 6" deep a

slightly larger case would perhaps be desirable from the standpoint of construction and wiring.

The resistors comprising the fixed value pads of 10, 20, 30, and 40 db. loss are mounted directly on the elements of the anti-capacity switches and wired so that when the handle is in the "up" position the top contact (shown neutral for all series elements in Fig. 5) is opened and the lower contact—that for the shunt element—is closed. These switches are shown in the diagram of Fig. 5.

This puts the resistances for that particular pad in the circuit and causes the proper loss for the pad in use.

With the handle in the "down" position the series resistors are shunted out of circuit and the circuit of the shunt resistors is opened, thus taking that particular pad out of circuit.

The two switches showing the semi-circular shorting-plate segments at the bottom of Fig. 5 each represent one deck of the unit (1 db.) switches shown on the front panel, the top group 0-5 db. and the bottom group 6-10 db., each with its off position. These are *Centralab* Type G 10-position, single-pole shorting type and serve to connect the successive shunt resistors of the 1 db. pads in the circuit as the switch knob is rotated to the right.

The second deck of this switch assembly (on a *Centralab* switch index assembly K 121) is a *Centralab* single-pole, 10-position, single-circuit Type J 121. Thus, the two decks on each unit switch are operated simultaneously and serve to connect the series and shunt resistors of the successive 1 db. pads in the circuit as the switch knob is rotated to the right.

For frequency stability, no heat-developing power supply was mounted on the chassis with the oscillator components. Any well-filtered supply capable of furnishing 6.3 volts at 3 amp. a.c. for the filaments and 300 volts at 80 milliamperes for the plates will be adequate.

Although the technique of making  
(Continued on page 108)

Fig. 5. Wiring diagram showing variable attenuator of the gain set.

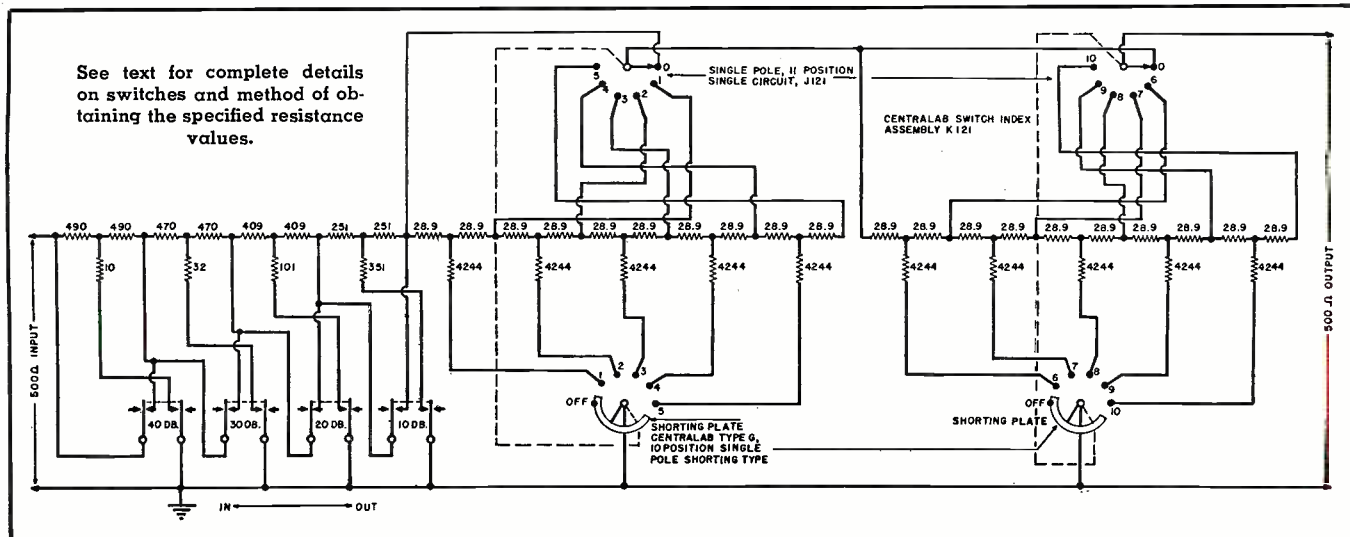

# PARTNER?

**"I'm looking at  
a good one!"**



"Like having someone to run interference for me on every sale!" Radio-TV servicemen feel that way about the General Electric trademark because experience has shown how highly their customers respect the symbol "G-E".

This is only the start of the G-E dealer-profit story. For General Electric helps you with an unexcelled group of tube promotion aids—income-builders every one! G.E.'s complete line of tubes includes newest types made possible only by superior resources in research, development, and manufacture ... meaning that you can go after *all the tube business, all the time!*

Unwrap this G-E dealer success-package! Give *your* skill and efforts as serviceman a rich reward! Your G-E tube distributor gladly will cooperate in every way. Phone or write him today! *Electronics Department, General Electric Co., Schenectady 5, N. Y.*

*You can put your confidence in—*

**GENERAL  ELECTRIC**

181-JA2

TV PICTURE TUBES

METAL TUBES

GLASS TYPES

MINIATURES

**ONE SOURCE FOR  
ALL YOUR TUBE  
REQUIREMENTS!**



—also GERMANIUM DIODES and SELENIUM RECTIFIERS. Stock G-E 100-percent, to save time and routine in ordering— to have the benefit of bulk deliveries from your distributor—to profit from General Electric tube quality and product popularity.

you can  
do it better

with the  
revolutionary

# ALTEC 21B MINIATURE MICROPHONE

ACTUAL  
SIZE

It achieves uniformity of response... provides greater tonal fidelity... it is omnidirectional... it is blastproof, shockproof... there is no false bass build-up... mere net acoustic gain before encountering feedback... tiny size contributes to remarkable versatility of positioning... extends the fidelity of sound transmission.

*talent deserves  
to be Seen  
as well as Heard*



111 Sixth Avenue  
New York 13, N.Y.  
116 North Vine St.  
Hollywood 38, Cal.

# A Volume-Compensated TONE CONTROL

By ALAN SCHWAN

**When it comes to audio controls, most of the emphasis has been placed on tone compensated volume controls. What about volume compensation in the tone control circuit? Here's one answer.**

**I**F YOU are an audio enthusiast whose resources are limited, you want to get as much as possible out of your investments. You have probably played around with various and assorted tone control circuits with some extremely tepid results only because feeding the family must be put before buying parts for that "really good" tone control. If our respective problems are similar, your trouble has been a three-way battle: effect on frequency vs. effect on volume vs. effect on wallet.

Fig. 1 is the schematic of a tone control flexible enough for almost any job; it can be adjusted for constant power output, constant voltage output, or constant apparent volume level. What's more, the triodes more than make up for the reduction of signal level due to filter attenuation. In fact, a .5 volt crystal pickup is being run through this circuit directly to the phase inverter with plenty of gain to spare.

Here's how it works. Condenser  $C_2$  filters out the lows so that  $V_{1a}$  acts as a treble amplifier, and  $C_1$  makes  $V_{1b}$  a bass amplifier. Now, if the arm of  $R_6$  is set at the  $V_{1a}$  side, it will tap off the output of  $V_{1a}$  with no attenuation from  $R_6$ . But the signal from  $V_{1b}$  has 1 megohm of resistance to the final output and only 50,000 ohms to ground, so little of it gets through. Operation is similar with a setting near the  $V_{1b}$  side. Any intermediate position just changes the ratio between the output voltages received at

the arm. The loading ( $R_6$ ) of  $R_6$  should be kept to a minimum (over 500,000 ohms), or volume will drop considerably when  $R_6$  is at center position. Running it straight into a grid is the best system, but a 1 meg. volume control doesn't reduce volume to any great extent.

Adjustment is simple. Resistor  $R_3$  varies the gain of  $V_{1a}$ , the treble amplifier and the amount of high frequency signal to  $R_6$ . If constant volume level is desired, turn  $R_6$  to the  $V_{1b}$  (bass) side and set volume at a comfortable position. Then move the arm of  $R_6$  to the extreme  $V_{1a}$  side, and adjust  $R_3$  to a point where the volume is the same as when  $R_3$  was at  $V_{1b}$  side. For constant power or voltage characteristics, follow the same procedure, but make output measurements instead of listening tests.

If you haven't enough room, or for some other reason you don't wish to use a potentiometer at  $R_3$ , fixed resistors can be used if their ratio is kept within certain bounds. Make the hot side about four times the grid-to-ground resistance. This will vary depending on the other component values used. In this construction, the values range from 35,000 ohms to ground in one amplifier to 70,000 ohms to ground in another; both use 250,000 ohm pots.

When built and adjusted correctly, this circuit will have no effect on volume but will have a tremendous frequency response range.

-50-

Fig. 1. Schematic diagram of tone control circuit.

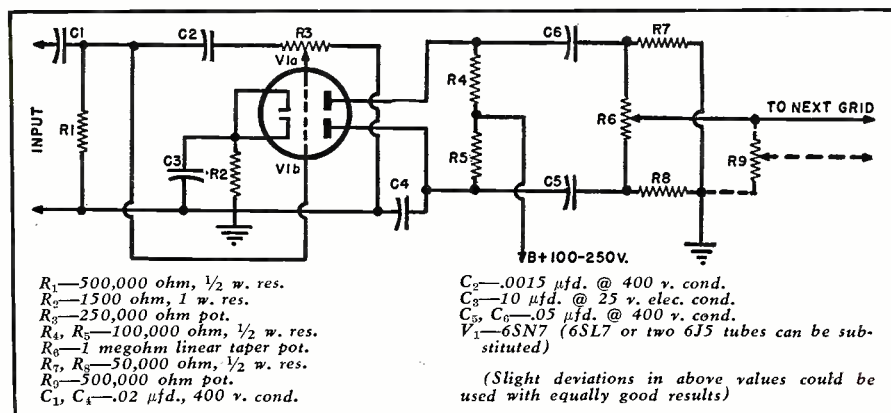

# Study THE Features

# Heathkits ARE THE QUALITY LINE OF TEST EQUIPMENT KITS

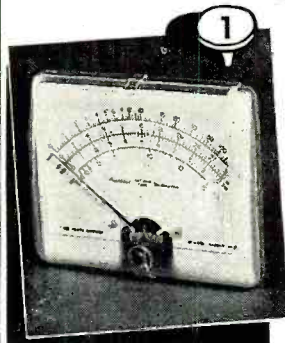

## MODERN STYLING

Heathkits have brought a new conception of beauty to laboratories and service benches.

Many organizations have standardized on Heathkits to make their shops appear attractive and uniform.

The panels are produced in grey and maroon and the modern streamline aluminum handles give the instruments a pleasant, professional appearance.

There is no waste space or false effort to appear large in Heathkits — space on service benches is at a premium and the size of Heathkit instruments is kept as small as is consistent with good engineering design.

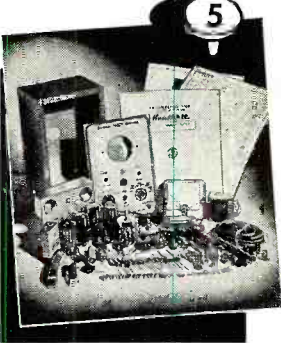

## COMPLETE KITS

When you receive your Heathkit, you are assured of every necessary part for the proper operation of the instrument.

Beautiful cabinets, handles, two-color panels, all tubes, test leads where they are a necessary part of the instrument, quality rubber line cords and plugs, rubber feet for each instrument, all scales and dials ready printed and calibrated. Every Heathkit is 110V 60 cy. power transformer operated by a husky transformer especially designed for the job.

## BEST OF PARTS

You will find many famous names on the parts in your Heathkit. Mallory switches and filter condensers, Chicago Transformer Corporation and Electrical Assembly Transformers, Centralab Potentiometers, Belden Cable, IRC and Allen Bradley resistors, G.E. tubes, Cinch and Amphenol sockets with silver plated contacts, Defiance variable condensers, Eby binding post and many other quality parts. The finest of parts are used to assure long trouble-free service from Heathkits.



## PRECISION PARTS

Wherever required, the finest quality 1% ceramic resistors are supplied. These require no aging and do not shift. No matching of common resistors is required. You find in Heathkit the same quality voltage divider resistors as in the most expensive equipment.

The transformers are designed especially for the Heathkit unit. The scope transformer has two electrostatic shields to prevent interaction of AC fields.

These transformers are built by several of the finest transformer companies in the United States.

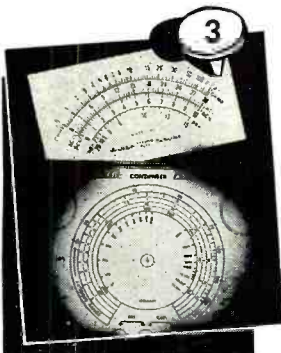
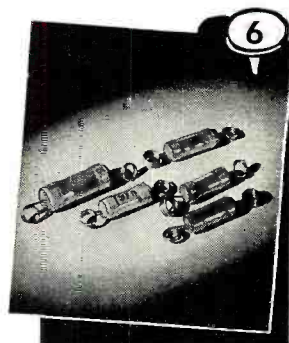

## LARGE EASILY READ CALIBRATIONS

No charts or calculations are necessary to use any Heathkit properly. All scales are simply and plainly marked.

The operator instantly knows the proper use of the instrument and can proceed confidently. No multiplication is required as each scale is calibrated independently of the others.

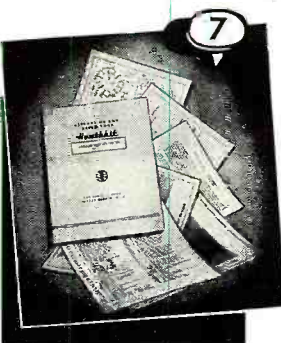

## COMPLETE INSTRUCTION MANUALS

Everyone is pleased at the thorough instructions covering the assembly of each Heathkit instrument. Every detail of the assembly is covered, together with sections on the use of the instrument and trouble shooting instructions in case of difficulty. Actual photos of the assembled instrument enable fast and accurate assembly, clear schematics and pictorial diagrams of the confusing parts such as rotary switches, enable the wiring to be completed quickly.

## KITS THAT FIT

Heathkit chassis are precision punched to fit the quality parts supplied. The grey crackle aluminum cabinet and the two-color panels are die punched to assure proper fitting.

Many builders have written marveling at the ease with which assembly can be accomplished.

The chassis are specially engineered for easy assembly and wiring — there are no small, tight corners which cannot be reached — the ends of the chassis are left open in order that installation of parts and soldering can be done with both hands.

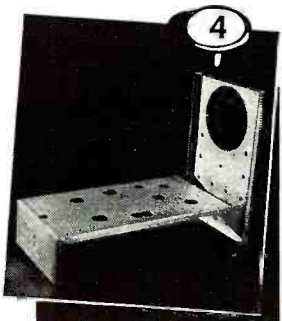

## IDEAL FOR SCHOOLS

Heathkits have been adopted as standard equipment of many of the largest universities and colleges. The low cost plus the fact that the students learn by actual assembly make them ideal training mediums. Many high schools and small colleges are finding that they too can have a modern physics and electronics laboratory by using Heathkits.

Some of the largest technical schools recommend Heathkits to their students as the best means of securing the necessary equipment to start their own shops.



EXPORT DEPT.  
13 East 40th St.  
NEW YORK CITY (16)  
CABLE: ARLAB-N.Y.

# The HEATH COMPANY

... BENTON HARBOR 15, MICHIGAN

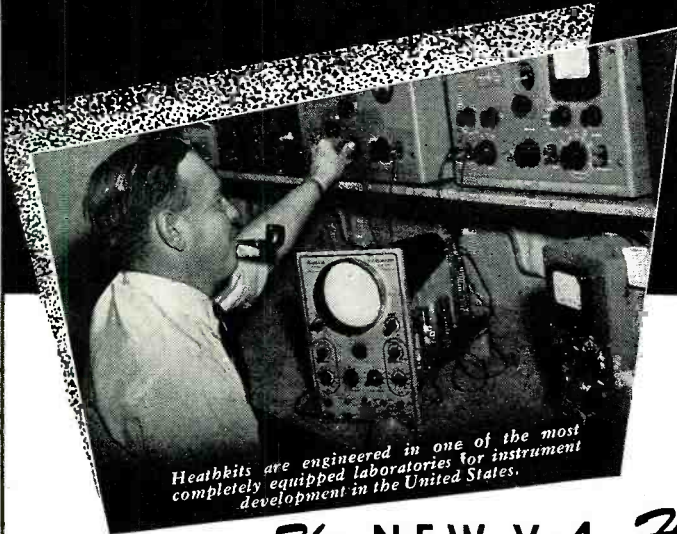

Heathkits are engineered in one of the most completely equipped laboratories for instrument development in the United States.

# Heathkits ARE LABORATORY ENGINEERED...

## The NEW V-4 Heathkit VACUUM TUBE VOLTMETER KIT

### Features

- Meter scale 17% longer than average 4½" meter.
- Modern streamline 200 ua meter.
- New modern streamline styling.
- Burn-out proof meter circuit.
- 24 Complete ranges.
- Isolated probe for dynamic testing.
- Most beautiful VTVM in America.
- Accessory probes (extra) extend ranges to 10,000 Volts and 100 Megacycles.
- Uses 1% precision ceramic divider resistors.
- Modern push-pull electronic voltmeter circuit.
- Electronic AC circuit. No current drawing rectifiers.
- Shatterproof plastic meter face.

The new Heathkit Model V-4 Vacuum Tube Voltmeter has dozens of improvements. A new modern streamlined 200 microampere meter has Alnico V magnet for fast, accurate readings. The new electronic AC voltmeter circuit incorporates an entire new balance control which eliminates contact potential and provides greater accuracy. New simplified switches for quicker assembly. New snap-in battery mounting is on the chassis for easy replacement.

The Heathkit VTVM is the only kit giving all the ranges. Check them — DC and AC full scale linear ranges of 0-3V, 0-10V, 0-30V, 0-100V, 0-300V, 0-1000V and can be extended to 0-3000V and 0-10,000V DC with accessory probe at slight extra cost. Electronic ohmmeter has six ranges measuring resistance accurately from .1 ohm to one billion ohms. Meter pointer can be offset to zero center for FM alignment.

The DC probe is isolated for dynamic measurements. Has db scale for making gain and other audio measurements.

The new instruction manual features pictorial diagrams and step-by-step instructions for easy assembly. The Heathkit VTVM is complete with every part — 110V transformer operated with test leads, tubes, light aluminum cabinet for portability, giant 4½" 200 microamp meter and complete instruction manual.

Order now and enjoy it this entire season. Shipping weight 8 lbs., Model V-4

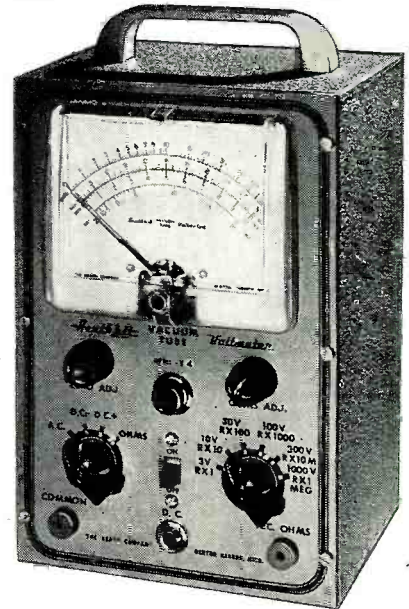

# \$24.50

THE FINEST VTVM KIT AVAILABLE  
FOR THIS PRICE.

Accessory: 10,000V high voltage probe, No. 310, \$4.50.  
Accessory: RF crystal diode probe kit extends RF range  
to 100 Mc., No. 309, \$6.50.

## New Heathkit HANDITESTER KIT

### Features

- Beautiful streamline Bakelite case.
- AC and DC ranges to 5,000 Volts.
- 1% Precision ceramic resistors.
- Convenient thumb type adjust control.
- 400 Microampere meter movement.
- Quality Bradley AC rectifier.
- Multiplying type ohms ranges.
- All the convenient ranges 10-30-300-1,000-5,000 Volts.
- Large quality 3" built-in meter.

A precision portable volt-ohm-milliammeter. An ideal instrument for students, radio service, experimenters, hobbyists, electricians, mechanics, etc. Rugged 400 ua meter movement. Twelve complete ranges, precision dividers for accuracy. Easily assembled from complete instructions and pictorial diagrams. An hour of assembly saves one-half the cost. Order today. Model M-1. Shipping wgt., 2 lbs.



# \$13.50

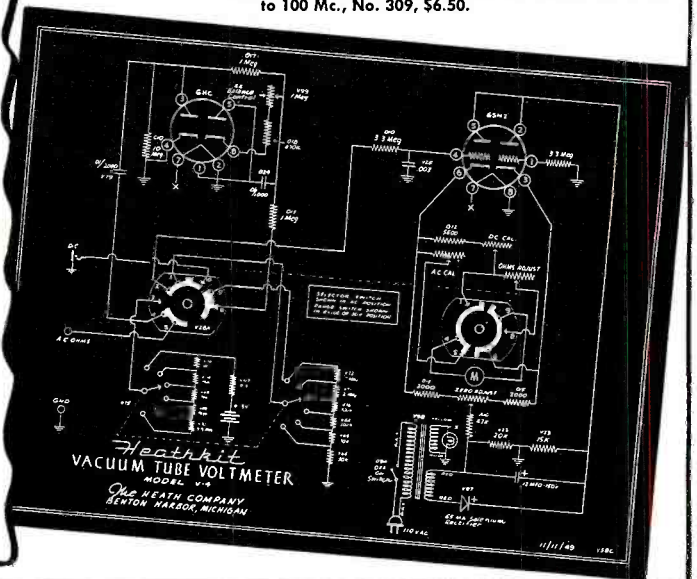

EXPORT DEPT.  
13 East 40th St.  
NEW YORK CITY (16)  
CABLE: ARLAB-N.Y.

# The HEATH COMPANY

... BENTON HARBOR 15, MICHIGAN



# TEST INSTRUMENT KITS

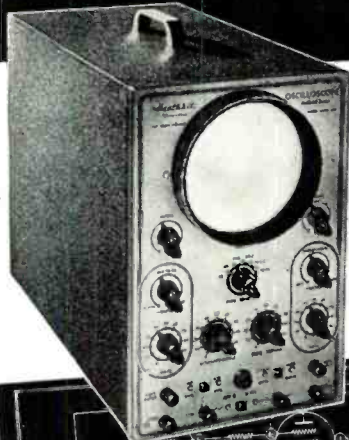

Only  
**\$39<sup>50</sup>**

## Heathkit PUSH-PULL EXTENDED RANGE 5" OSCILLOSCOPE KIT Features

- The first truly television oscilloscope.
- Tremendous sensitivity .06 Volt RMS per inch deflection.
- Push-pull vertical and horizontal amplifiers.
- Useful frequency range to 2½ Megacycles.
- Extended sweep range 15 cycles to 70,000 cycles.
- New television type multivibrator sweep generator.
- New magnetic alloy shield included.
- Still the amazing price of \$39.50.

The new 1950 Push-Pull 5" Oscilloscope has features that seem impossible in a \$39.50 oscilloscope. Think of it—push-pull vertical and horizontal amplifiers with tremendous sensitivity only six one-hundredths of a volt required for full inch of deflection. The weak impulses of television can be boosted to full size on the five-inch screen. Traces you couldn't see before. Amazing frequency range, clear, useful response at 2½ Megacycles made possible by improved push-pull amplifiers. Only Heathkit Oscilloscopes have the frequency range required for television. New type multivibrator sweep generator with more than twice the frequency range. 15 cycles to 70,000 cycles will actually synchronize with 250,000 cycle signal. Dual positioning controls will move trace over any section of the screen for observation of any part. New magnetic alloy CR tube shield protects the instrument from outside fields. All the same high quality parts, cased electrostatically shielded power transformer, aluminum cabinet, all tubes and parts. New instruction manual now has complete step-by-step pictorials for easiest assembly. Shipping weight, 25 lbs. Model O-5

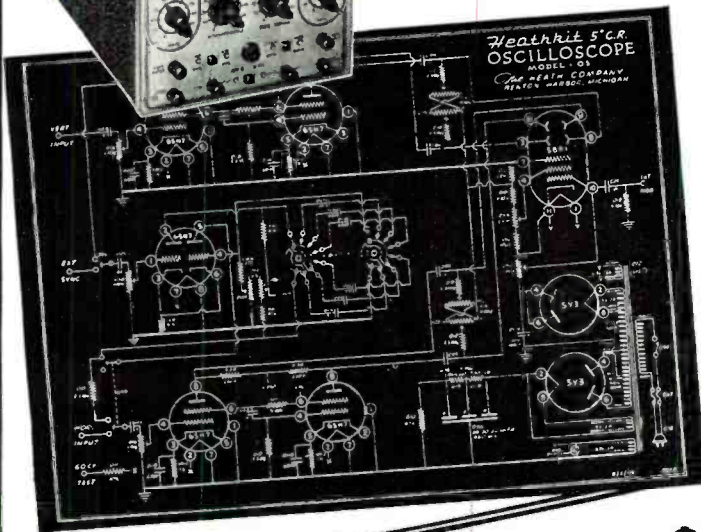

**\$34<sup>50</sup>**

## Heathkit

### ELECTRONIC SWITCH KIT

DOUBLE THE UTILITY OF ANY SCOPE

An electronic switch used with any oscilloscope provides two separately controllable traces on the screen. Each trace is controlled independently and the position of the traces may be varied. The input and output traces of an amplifier may be observed one above the other or one directly over the other illustrating perfectly any change occurring in the amplifier. Distortion-phase shift and other defects show up instantly, 110V. 60 cycle transformer operated. Uses 5 tubes (1 6X5, 2 6SN7's, 2 6SJ7's). Has individual gain controls, positioning control and coarse and fine switching rate controls. The cabinet and panel match all other Heathkits. Every part supplied including detailed instructions for assembly and use. Shipping weight 11 lbs. Model S-1



EXPORT DEPT.  
13 East 40th St.  
NEW YORK CITY (16)  
CABLE: ARLAB-N.Y.

The **HEATH COMPANY**

... BENTON HARBOR 15, MICHIGAN

# Heathkits ENABLE THE BUILDER



*By assembling your own laboratory equipment, you control the quality of workmanship and learn the entire story of the instrument.*

## New 1950 VERNIER TUNING RF Heathkit SIGNAL GENERATOR KIT

### Features

- New 5-to-1 ratio vernier tuning for ease and accuracy.
- New external modulation switch — use it for fidelity testing.
- Covers 150 Kc. to 34 Mc. on fundamentals and calibrated strong harmonics to 102 Mc.
- 400 cycle audio available for audio testing.
- Most modern type R.F. oscillator.
- New precision coils for greater output.
- Cathode follower output for greatest stability.

The most popular signal generator kit has been vastly improved — the experience of thousands combined to give you the best. Check the features in this fine generator and consider the low price \$19.50. A best buy for any shop, yet inexpensive enough for hobbyists. Everyone can have an accurate controlled source of R.F. signal voltage.

The new features double the value — think of being able to make fidelity checks on receivers by inserting a variable audio signal. Internal 400 cycle saw-tooth audio oscillator modulates R.F. signal and is available externally for audio testing. The new 5-to-1 ratio vernier drive gives hairline tuning for maximum accuracy in scale settings. The coils are already precision wound and calibrated. Uses turret type coil and switch assembly for ease of construction. The generator is 110V. 60 cycle transformer operated and comes complete in every detail — cabinet, tubes, beautiful two color calibrated panel and all small parts — new step-by-step pictorial diagrams and complete instruction manual make assembly a cinch even for novices. Why try to get along without a signal generator when you can have the best for less than a twenty-dollar bill. Better order it now. Shipping weight, 7 lbs. Model G-5.

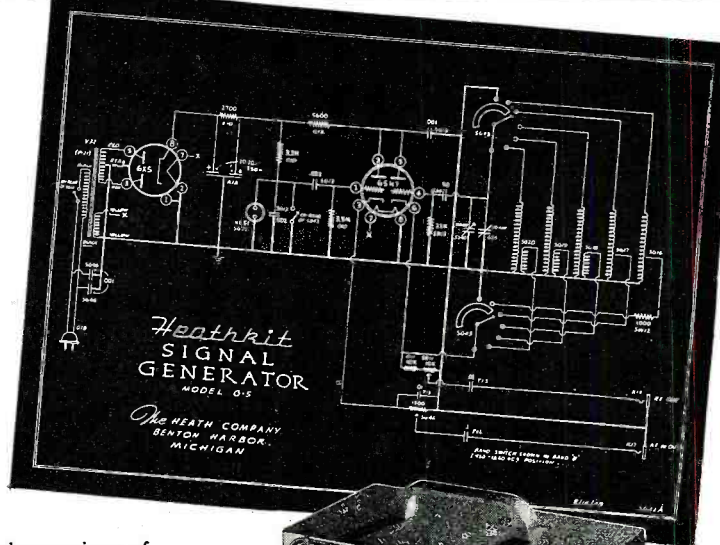

**\$19.50**

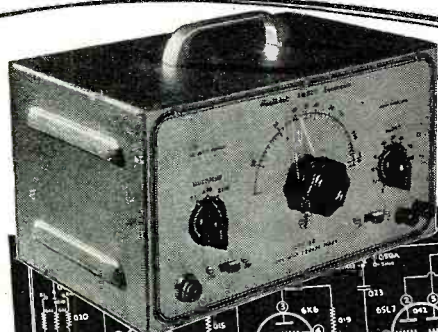

**\$34.50**

### Heathkit

## SINE AND SQUARE WAVE AUDIO GENERATOR KIT

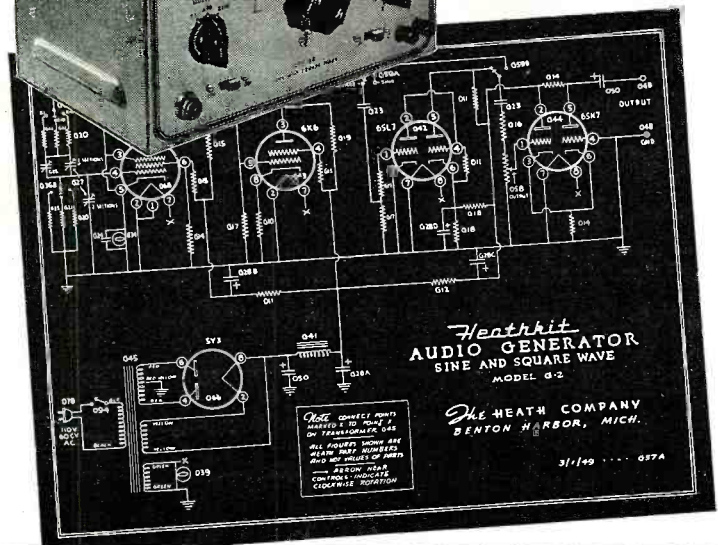

Experimenters and servicemen working with a square wave for the first time invariably wonder why it was not introduced before. The characteristics of an amplifier can be determined in seconds compared to several hours of tedious plotting using older methods. Stage by stage, amplifier testing is as easy as signal tracing. The low distortion (less than 1%) and linear output ( $\pm$  one db) make this Heathkit equal or superior to factory built equipment selling for three or four times its price. The circuit is the popular RC tuning circuit using a four gang variable condenser. Three ranges 20-200, 200-2,000, 2,000-20,000 cycles are provided by selector switch. Either sine or square waves instantly available at slide switch. All components are of highest quality, cased 110V. 60 cycle power transformer. Mallory F.P. filter condensers, 5 tubes, calibrated two-color panel, grey crackle aluminum cabinet. The detailed instructions make assembly an interesting and instructive few hours. Shipping weight, 12 lbs. Model G-2.

*Nothing ELSE TO BUY*

EXPORT DEPT.  
13 East 40th St.  
NEW YORK CITY (16)  
CABLE: ARLAB-N.Y.

**The HEATH COMPANY**

**... BENTON HARBOR 15, MICHIGAN**

# TO USE THE *Best* OF WORKMANSHIP

## Heathkit TUBE CHECKER KIT *Features*

1. Measures each element individually.
2. Has gear driven roller chart.
3. Has lever switching for speed.
4. Complete range of filament voltages.
5. Uses latest type lever switches.
6. Uses beautiful shatterproof full view meter.
7. Large size 11" x 14" x 4" complete.
8. Checks new 9 pin miniatures.

Check the features and you will realize that this Heathkit has all the features you want. Speed, simplicity, beauty, protection against obsolescence. The most modern type of tester — measures each element — beautiful Bad-Good scale, high quality meter — the best of parts — rugged oversize 110V. 60 cycle power transformer — finest of Mallory switches — Centralab controls — quality wood cabinet — complete set of sockets for all type tubes including blank spare for future types — fast action gear driven roller chart uses brass gears to quickly locate and set up any type tube. Simplified switching cuts necessary time to minimum and saves valuable service time. Short and open element check. No matter what arrangement of tube elements, the Heathkit flexible switching arrangement easily handles it. Order your Heathkit Tube Checker today. See for yourself that Heath again saves you two-thirds and yet retains all the quality — this tube checker will pay for itself in a few weeks — better build it now.

Complete with detailed instructions, all parts, cabinet, roller chart, ready to wire up and operate. Shipping weight, 12 lbs. Model TC-1.

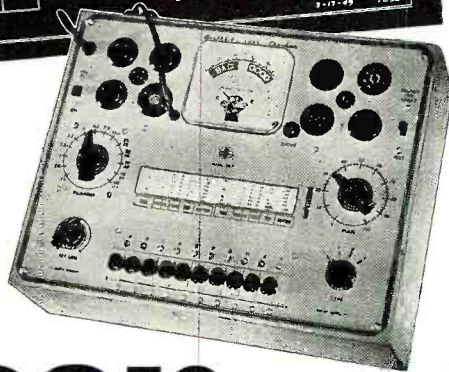
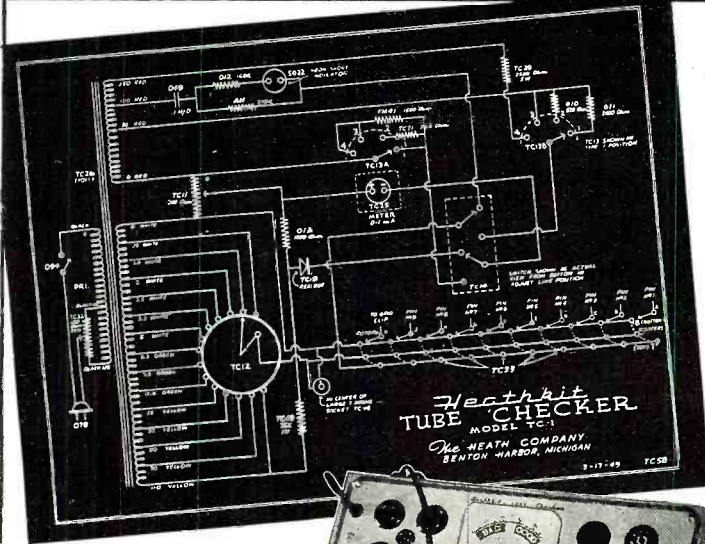

*Nothing*  
ELSE  
TO BUY

Only \$29<sup>50</sup>

## Heathkit BATTERY ELIMINATOR KIT

Now a bench 6 Volt power supply kit for all auto radio testing. Supplies 5 - 7½ Volts at 10 Amperes continuous or 15 Amperes intermittent. A well filtered rugged power supply, uses heavy duty selenium rectifier, choke input filter with 4,000 MFD of electrolytic filter. 0 - 15 Volt meter indicates output. Output variable in eight steps. Excellent for demonstrating auto radios. Ideal for servicing — can be lowered to find sticky vibrators or stepped up to equivalent of generator overload — easily constructed in less than two hours. Complete in every respect. Shipping wgt., 19 lbs.

Model BE-1

*Nothing* ELSE TO BUY

\$22<sup>50</sup>

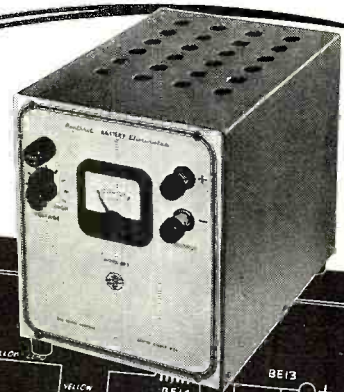

EXPORT DEPT.  
13 East 40th St.  
NEW YORK CITY (16)  
CABLE: ARLAB-N.Y.

The **HEATH COMPANY**

... BENTON HARBOR 15, MICHIGAN

# Heathkits ELIMINATE

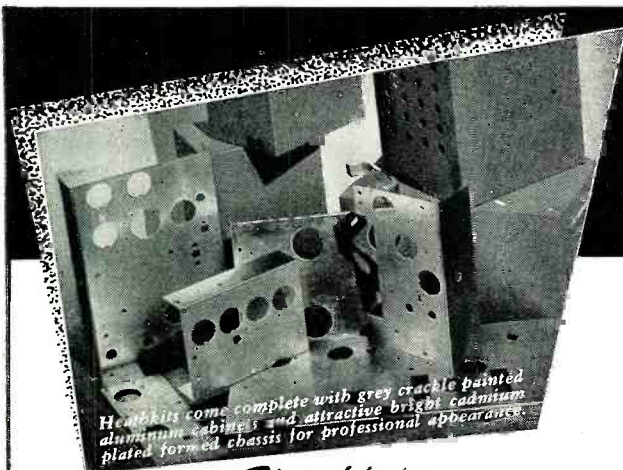

Heathkits come complete with grey crackle painted aluminum cabinets and attractive bright cadmium plated formed chassis for professional appearance.

## Heathkit TELEVISION ALIGNMENT GENERATOR KIT

Everything you want in a television alignment generator. A wide band sweep generator covering all TV frequencies 0 to 46 — 54 to 100 — 174 to 220 Megacycles — a marker indicator covering 19 to 42 Megacycles, AM modulation for RF alignment — variable calibrated sweep width 0-30 Mc. — mechanical driven inductive sweep. Husky 110V. 60 cycle power transformer operated — step type output attenuator with 10,000 to 1 range — high output on all ranges — band switching for each range — vernier driven main calibrated dial with over 45 inches of calibration — vernier driven calibrated indicator marker tuning. Large grey crackle cabinet 16 1/8" x 10 3/8" x 7-3/16". Phase control for single trace adjustment. Uses three high frequency triodes plus 5Y3 rectifier — split stator tuning condensers for greater efficiency and accuracy at high frequencies — this Heathkit is complete and adequate for every alignment need and is supplied with every part — cabinet, calibrated panel, all coils and condensers wound, calibrated and adjusted, tubes, transformer, test leads — every part with instruction manual for assembly and use. Actually three instruments in one — TV sweep generator — TV AM generator and TV marker indicator.

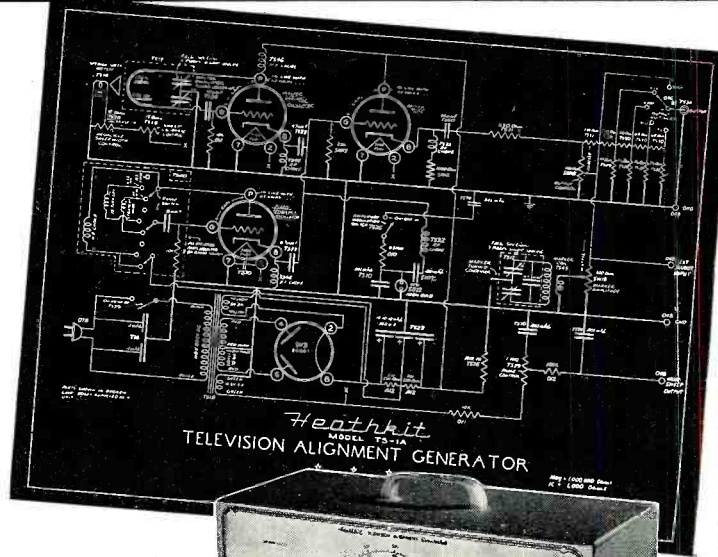

**\$39.50**

Shipping weight 20 lbs.  
Model TS-1A

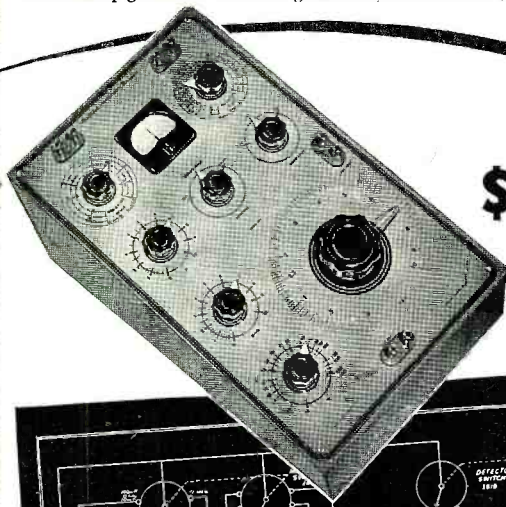

**\$69.50**

Shipping weight 15 lbs.  
Model IB-1

*New Heathkit*

## IMPEDANCE BRIDGE KIT

A LABORATORY INSTRUMENT NOW WITHIN  
THE PRICE RANGE OF ALL

Measures inductance from 10 microhenries to 100 henries capacitance from .00001 MFD. to 100 MFD. Resistance from .01 ohms to 10 megohms. Dissipation factor from .001 to 1. "Q" from 1 to 1000.

Ideal for schools, laboratories, service shops, serious experimenters.

An impedance bridge for everyone — the most useful instrument of all, which heretofore has been out of the price range of serious experimenters and service shops. Now at the lowest price possible. All highest quality parts. General Radio main calibrated control. General Radio 1000 cycle hummer. Mallory ceramic switches with 60 degree indexing — 200 microamp zero center galvanometer — 1/2 of 1% ceramic non-inductive decade resistors. Professional type binding posts with standard 3/4" centers. Beautiful birch cabinet. Directly calibrated "Q" and dissipation factor scales. Ready calibrated capacity and inductance standards of Silver Mica, accurate to 1/2 of 1% and with dissipation factors of less than 30 parts in one million. Provisions on panel for external generator and detector. Measure all your unknowns the way laboratories do — with a bridge for accuracy and speed.

Internal 6 Volt battery for resistance and hummer operation. Circuit utilizes Wheatstone, Hay and Maxwell circuits for different measurements. Supplied complete with every quality part — all calibrations completed and instruction manual for assembly and use. Deliveries are limited.

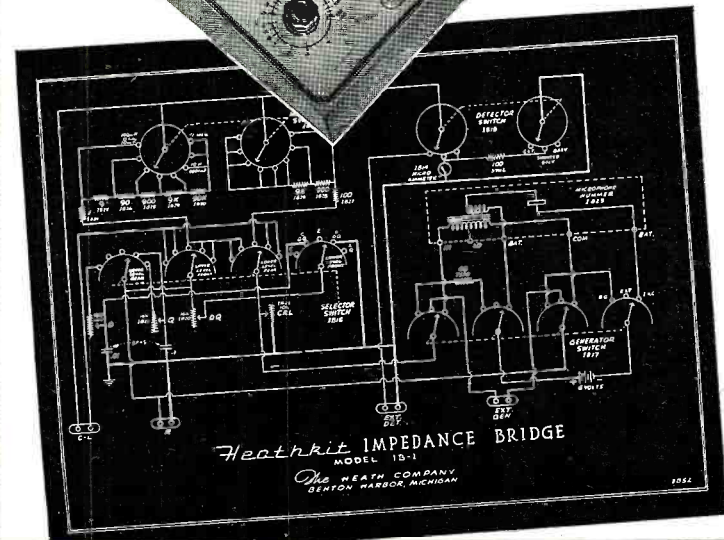

EXPORT DEPT.  
13 East 40th St.  
NEW YORK CITY (16)  
CABLE: ARLAB-N.Y.

*The* **HEATH COMPANY**

... BE TON HARBOR 15, MICHIGAN

# DIFFICULT METAL FABRICATION....

## NEW *Heathkit* SIGNAL TRACER AND UNIVERSAL TEST SPEAKER KIT

The popular Heathkit Signal Tracer has now been combined with a universal test speaker at no increase in price. The same high quality tracer follows signal from antenna to speaker, locates intermittents, defective parts quicker, saves valuable service time, gives greater income per service hour. Works equally well on broadcast, FM or TV receivers. The test speaker has assortment of switching ranges to match push-pull or single output impedance. Also tests microphones, pickups, PA systems; comes complete—cabinet, 110V. 60 cycle power transformer, tubes, test probe—all parts and detailed instructions for assembly and use. Shipping Wt., 8 lbs. Model T-2.

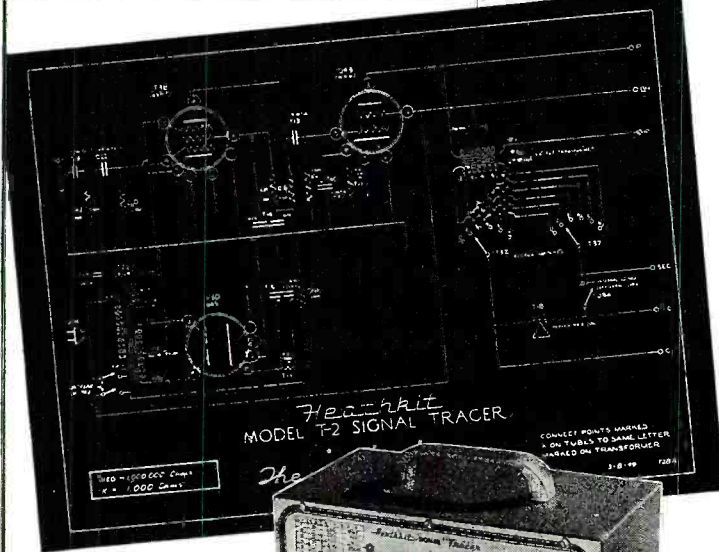

**\$19.50**

*Nothing*  
ELSE TO BUY

**\$19.50**

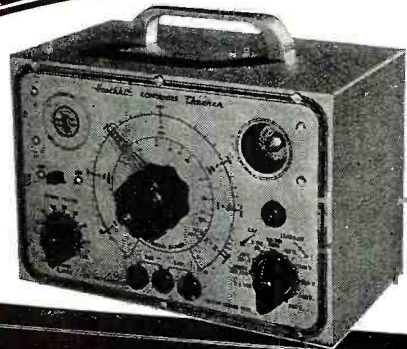

## *Heathkit* CONDENSER CHECKER KIT

### *Features*

- Power factor scale
- Measures resistance
- Measures leakage
- Checks paper-mica-electrolytics
- Bridge type circuit
- Magic eye indicator
- 110V. transformer operated
- All scales on panel

Checks all types of condensers, paper-mica-electrolytic-ceramic over a range of .00001 MFD. to 1000 MFD. All on readable scales that are read direct from the panel. NO CHARTS OR MULTIPLIERS NECESSARY. A condenser checker anyone can read without a college education. A leakage test and polarizing voltage for 20 to 500 volts provided. Measures power factor of electrolytics between 0% and 50%. 110V. 60 cycle transformer operated complete with rectifier and magic eye tubes, cabinet, calibrated panel, test leads and all other parts. Clear detailed instruction for assembly and use. Why guess at the quality and capacity of a condenser when you can know for less than a twenty dollar bill. Shipping weight, 7 lbs. Model C-2.

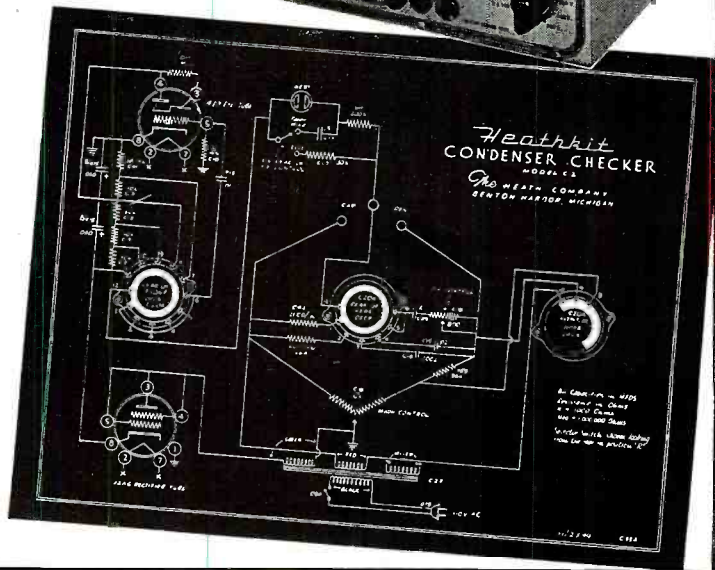

EXPORT DEPT.  
13 East 40th St.  
NEW YORK CITY (16)  
CABLE: ARLAB-N.Y.

*The* **HEATH COMPANY**

... BENTON HARBOR 15, MICHIGA

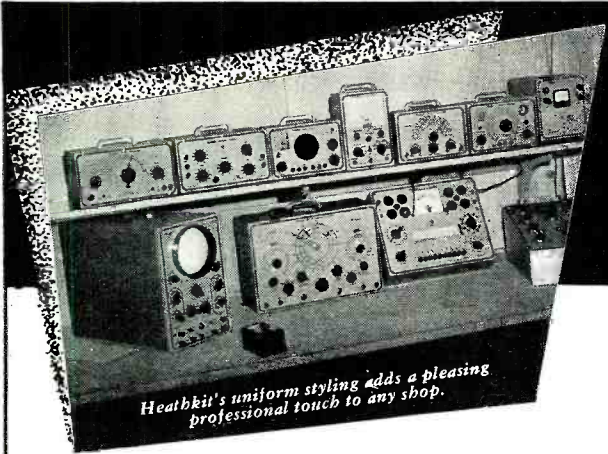

Heathkit's uniform styling adds a pleasing professional touch to any shop.

# Heathkits PROVIDE PROFESSIONAL LABORATORY APPEARANCE

## New Heathkit BROADCAST AND 3 BAND SUPERHETERODYNE RECEIVER KIT

**BROADCAST MODEL BR-1**  
550 to 1600 Kc.

**\$19.50**

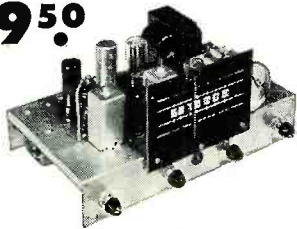

Two new Heathkit Superheterodynes featuring the best of design and material. Beautiful six inch slide rule dials — 110 V. 60 cy. AC power transformer operated—metal cased filters—quality output transformers, dual iron core metal can IF transformers — two gang tuning condenser. The chassis is provided with phono-radio switch—110 V. outlet for changer motor and phono pickup jack. Each kit is complete with all parts and detailed instruction booklet. Pictorial diagrams and step-by-step instructions make assembly quick and easy.

Ideal AC operated superheterodyne receiver for home use or replacement in console cabinet. Comes complete with attractive metal panel for cabinet mounting. Modern circuit uses 12K8 converter, 12SH7 input IF stage, 12C8 output IF stage and first audio 12A6 beam power output stage, 5Y3 rectifier. Excellent sensitivity for distant reception with selectivity which effectively separates adjacent stations.

The husky 110 V. cased power transformer is conservatively rated for long life. The illuminated six inch slide rule dial is accurately calibrated for DX reception. Enjoy the pleasure of assembling your own fine home receiver. Has tone, volume, tuning and phono-radio controls. Chassis size 2¼" x 7" x 12½" Comes complete with all parts including quality output transformer to 3.4 ohm voice coil, tubes, instruction manual, etc. (less speaker). Shipping Wt., 10 lbs. No. BR-1 Receiver \$19.50.

No. 335 Communications Type Table Model Metal Cabinet.....\$4.50  
No. 320 High Quality 5" PM Speaker for above..... 2.75

**3 BAND MODEL AR-1**  
550 Kc. to 20 Mc.

**\$23.50**

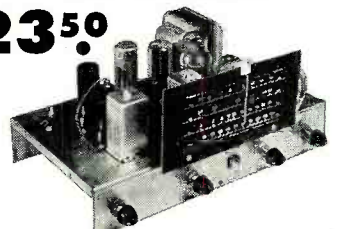

Enjoy the thrill of world wide short wave reception with this fine new AC operated Heathkit 3 band superheterodyne — amazing sensitivity 15 microvolt or better on all bands. Continuous coverage 550 Kc. to over 20 Mc. Easy to build with complete step-by-step instructions and pictorial diagram. Attractive accurately calibrated six inch slide rule dial for easy tuning. Six tubes with one dual purpose tube gives seven tube performance. Beam power output tube gives over 3 watts output.

Separately assembled coil turret with band switch eliminates difficult construction. Conservatively rated 110 V. power transformer supplies full operating voltages to all tubes for maximum reception. Has band switch, tuning, volume, tone and phono-radio controls. Chassis size 2¼" x 7" x 12½" — supplied complete — punched chassis — tubes — controls — transformers (quality output to 3.4 ohm voice coil) — all small parts — hardware and instructions (less speaker). Shipping Wt., 10 lbs. No. AR-1 Receiver \$23.50.

No. 335 Communications Type Table Model Metal Cabinet..... \$4.50  
No. 320 High Quality 5" PM Speaker for above..... 2.75

### Heathkit PUSH-PULL HIGH FIDELITY AMPLIFIER KIT



**\$12.50**

Build this high fidelity push-pull amplifier and save two-thirds the cost—has two pre-amplifier stages, phase inverter stage and push-pull beam power output stage. Comes complete with six tubes—quality output transformer (to 3-4 ohm voice coil) tone and volume controls—varnish impregnated cased 110V. power transformer and detailed instruction manual and all small parts. Six watt output with output flat within 1½ db between 50 and 15000 cycles.

Build this amplifier now and enjoy it for years. Shipping Wt. 7½ lbs. Model A-4  
12" PM Speaker for above..... \$6.95

## ORDER BLANK

<b>HEATH CO.</b> BENTON HARBOR MICHIGAN		FROM _____ _____ _____	SHIP VIA — Parcel Post — Express — Freight — Best Way	
Quan.	DESCRIPTION	Price	Total	

ENCLOSED FIND  CHECK . . .  MONEY ORDER FOR \_\_\_\_\_  
PLEASE SHIP C.O.D. . . . POSTAGE ENCLOSED FOR \_\_\_\_\_ POUNDS

EXPORT DEPT.  
13 East 40th St.  
NEW YORK CITY (16)  
CABLE: ARLAB—N.Y.

# What's New in Radio

For additional information on any of the items described herein, readers are asked to write direct to the manufacturer. By mentioning RADIO & TELEVISION NEWS, the page, and the issue number, delay will be avoided.

## TV TRANSFORMERS

The addition of three horizontal deflection output and high-voltage transformers to the *Stancor* line of television replacement transformers has

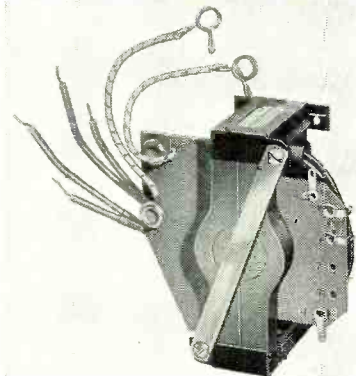

been announced by *Standard Transformer Corporation*, 3580 Elston Ave., Chicago 18.

Included are the A-8119, an exact duplicate of *RCA* Type 211T5, for use with the 16AP4 and similar kinescopes; the A-8127, an exact duplicate of *RCA* Type 211T3, for use with the 10BP4; and the A-8128, designed to fill the need for a transformer between the 10 and 16 inch sizes and also for use in converting a small receiver to a 16 inch unit.

A complete description of these replacement transformers is given in Bulletin DA5-354 which is available on request from the company.

## HYPASS CONDENSERS

*Sprague Products Co.* of North Adams, Massachusetts is offering a line of "Hypass" 3-terminal network feedthrough condensers which are especially suited for minimizing television interference from amateur transmitters, or for attenuating power-line conducted interference from diathermy machines, industrial

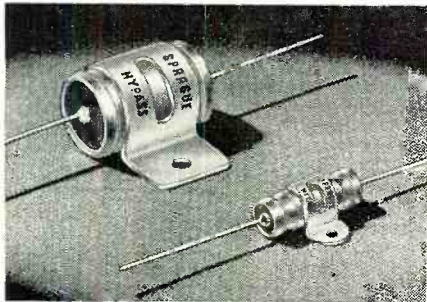

electronic heating apparatus, or other high-frequency signal sources.

These "Hypass" condensers effec-

tively bypass currents at frequencies in the v.h.f. range which ordinary units and some *LC* filters fail to do. High-voltage units were developed at the request of the ARRL. The line is available in all capacities and voltages (up to 5000 volts) for practically any high-frequency filtering requirement.

A bulletin, M-432, is available covering the line. A postcard to the company will bring your copy.

## LITTELFUSE PLASTIC DISPLAY

A transparent plastic case for displaying the company's fuses and holders which can also be used as a storage compartment for screws, nuts, bolts, tackle, and other such items, has been introduced by *Littelfuse, Inc.*, 4757 N. Ravenswood Ave., Chicago 44, Illinois.

All of the fuses and holders packed in the case have been carefully selected to cover the most frequent needs of the service technician and



dealer and of the engineer in the radio, communications, instruments, and television fields.

Refilling after inventory is simple because of the transparency of the case, and the entire unit may be replaced when necessary.

## SIMPSON V.T.V.M.

Designed especially for television servicing, *Simpson Electric Company's* new Model 303 vacuum-tube voltohmmeter features low current consumption and wide voltage and resistance ranges.

Although the instrument is only 120 cubic inches in size it has a large, sensitive  $4\frac{1}{2}$  inch 0-200 d.c. microammeter for easy and accurate readability. The d.c. input resistance is 10 megohms for

all ranges providing negligible circuit loading. There are five d.c. voltage and five a.c. voltage ranges, five resistance ranges, three a.f. voltage ranges, decibels from -20 to +63 in five ranges, a zero center galvanometer for FM discriminator alignment and other galvanometer applications, and an r.f. voltage range with 20 volts maximum and flat frequency measure-



ments between 20 kc. and 100 mc. The 1% "Carbofilm" resistors used in this instrument have negligible voltage coefficient. The instrument's accuracy is maintained for line voltages varying from 105 to 125 volts. In addition, tube replacements are infrequent due to the fact that the tubes are operated at low filament and plate voltages.

The Model 303 comes equipped with a d.c. voltage probe, an a.c. voltage-ohms probe, and a ground lead. An accessory probe and a high voltage probe (30,000 volts) for measuring high cathode-ray tube voltages are available at additional cost.

As with other *Simpson* test instruments, this v.t.v.m. is accompanied by an "Operator's Manual" which is complete yet concise, and easy to understand. In addition to a complete schematic of the unit, there are diagrams of simplified d.c. voltmeter, a.c. voltmeter, and ohmmeter circuits. A complete replacement parts list is also included.

The company's main office is at 5200 W. Kinzie Street, Chicago 44, Illinois.

## HI-FI AMPLIFIER

A new, low-distortion 25 watt amplifier for school auditoriums, churches, theaters, and other large-audience applications has been introduced by *Newcomb Audio Products Company* of 6824 Lexington Avenue, Hollywood 38, California.

The amplifier has a frequency response from 20 to 20,000 cycles and offers six input channels, five for microphone and one for phonograph with a built-in preamp to permit the use of magnetic pickups.

# Telrex brings you JACKPOT ANSWERS to your TV ANTENNA QUESTIONS



**QUESTION**—What's the one antenna that cuts installation troubles and service call-backs to the bone in all locations?

**ANSWER**—Telrex Conical Antennas, the conical "V" beams that cover all TV channels and FM, and afford best reception in every signal area. There's an engineer-designed, service-tested model for every TV location.

**2. QUESTION**—Why have Telrex Conical "V" beams replaced every possible combination of antennas for TV reception?

**ANSWER**—Because Telrex "V" beams are the only antennas offering true conical performance—top TV reception without bulky metal cones. For experience-designed models to meet every problem, workmanship that gives longer service . . . continue to look to Telrex!

**3. QUESTION**—Who has built 95% of all conical antennas installed today?

**ANSWER**—Telrex! Leadership in engineering and quality keeps Telrex out in front. The Telrex staff is ever seeking better methods, improved materials and design advancements. Supply a Telrex antenna on your next TV installation—you'll see the difference!

## TELREX MODEL 2X-BD



- Bi-Directional Stacked Conical "V" Beam
- Low Vertical Angle
- Extremely High Signal to Noise Ratio
- Constant Center Impedance
- Uses 72, 150 or 300 Ohm Transmission Lines
- Universal Mounting Clamp

PATENTS PENDING  
COPYRIGHT 1949

®  
**telrex** INC.  
CONICAL ANTENNAS

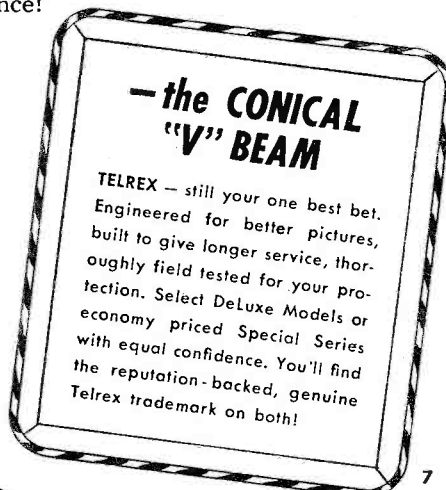

Telephone—ASBURY PARK 2-7252

AMERICA'S  
OUTSTANDING  
TELEVISION  
BEAM

ASBURY PARK 7, N. J.

All six channels may be remote controlled from the audience by means of a control unit that weighs less than two pounds. A locked cover over the controls prevents tampering with adjustments.

An exclusive bandwidth control adjusts the frequency bandwidth of the amplifier in keeping with the program quality.

### RECTANGULAR TV TUBE

Of interest to the television industry is Hytron Radio & Electronics Corp.'s recent announcement of the de-



velopment of a directly-viewed 16-inch picture tube with a rectangular screen.

This new all-glass tube takes approximately the same cabinet space as a standard round 12-inch tube. Another feature of this picture tube is the large viewing screen. The picture, with standard 3 by 4 aspect ratio, has a usable screen area of 138.7 square inches. A neutral gray face increases the contrast ratio.

(Continued on page 110)

One of the features opening the Philadelphia Community Chest drive was a carillon concert and recordings of the "Voice of Billy Penn." A Stromberg-Carlson 25 note carillon was connected to 300 watts of audio power and a University B-12 speaker. It was projected from City Hall tower in Philadelphia. Coverage of the city was exceptionally good with reports of distinct understanding coming from as far as Convention Hall, a distance of 2 miles from City Hall. In the photo Burton B. Fagan is shown testing the carillon on low power before the demonstration. The carillon was installed by Edmar Communication Co. and the audio equipment was furnished by Air Tone Company of Philadelphia.

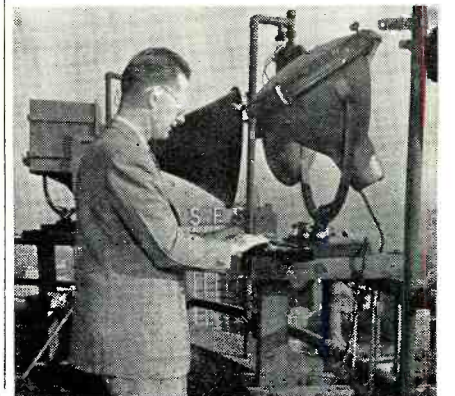

RADIO & TELEVISION NEWS



# FREE! NEW RADIO CATALOG

Packed with bargains! Big, new 164-page catalog teeming with everything new in radio, television and electronic equipment — at prices you want to pay. Thousands of outstanding bargains of popular brand name merchandise, fully described and illustrated. It's a gold-mine of helpful information...a practical encyclopedia used by economy-minded servicemen, dealers and technicians throughout the world. Lafayette makes it easy for you to order from this complete "one-source" guide, guaranteed to save you money on every purchase. And best of all, it doesn't cost you anything to have a copy. Clip the coupon below, paste it on a penny postcard and mail it today. Lafayette's 29 years of "know-how" in the radio and electronic field is yours to command with this valuable buying guide.



## LAFAYETTE SLASHES PRICES ON SUPREME TEST EQUIPMENT



**AF & RF OSCILLATOR**  
~~Was \$141.60~~ **NOW \$63.95**

Both AF and RF signals available at the same time — push button operated. Also has FM oscillator providing visual alignment of IF amplifiers of amplitude modulated receivers. 5 RF Ranges: 65/205 KC, 205/650 KC, 650/2050 KC, 2050/6500 KC, 6.5/20.5 MC. Harmonics above 60 MC. Frequency modulated 15 KC; rate 120 cps; 60-cycle time base. Range of AF oscillator: 15-15,000 cps. Output impedances: center tap transformer 50/500/5000 ohms. High impedance resistor 50,000 ohms, 110-125V., 50/60 cycles. Metal case 1 1/2 x 1 1/2 x 3/4". Shpg. Wt. 33 lbs. With Test Leads.  
 99A9633—Supreme Model 666..... **63.95**

All five ranges read on two basic scales, accurately calibrated at both ends. 65-205 KC; 205-650 KC; 650-2050 KC; 2050-6500 KC; 6.5-20.5 MC. Harmonics to 82 MC. 400-cycle audio; continuously variable voltage output. RF carrier modulated at 50% at 400 cycles; can be cut off to provide unmodulated signal. Jack for external audio modulation. Electron coupled circuit assures maximum stability. 110-125 volts, 50/60 cycles. Heavy steel case measures 9 1/2 x 8 3/4 x 7-3/8". Shpg. Wt. 15 lbs.

99A9632—Supreme Model 661..... **32.95**

**RF SIGNAL GENERATOR**  
~~Was \$72.50~~ **NOW \$32.95**



All ranges selected by push-button operation with exception of 14 ampere ranges. DC Ranges: 0/70/700 microamps; 7/35/140/350 ma; 0/1.4/14 amps. DC Volts: 7 ranges at 1000 ohms/V, and 7 ranges at 25,000 ohms/V. 0/3.5/7/35/140/350/700/1400. Ohms: 0/500/5000/50,000/500,000; 0/5/50 megs. All operated by self-contained battery, AC Volts & Output Ranges: 0/7/35/140/350/700/1400. 4 DB Ranges: 0 to +46 Size: 9-1/16 x 6 1/4 x 5 1/4".  
 99A9631—Supreme Model 592...Shpg. Wt. 9 lbs.... **29.95**  
 Battery Kit for above. (4) Burgess No. 1 & (1) M30 20A20621—#1 Cell, Each...6 1/4¢ 20A20617-M30, Each...1.54



**PUSH BUTTON SET TESTER**  
~~Was \$58.95~~ **NOW \$29.95**

*Lafayette Radio*

Lafayette's huge purchasing power makes bargains like these possible. Many other outstanding values are listed in our FREE CATALOG and also featured in our showrooms located in the following cities:

- NEW YORK.....100 Sixth Avenue
- BRONX.....542 E. Fordham Road
- CHICAGO.....901 W. Jackson Blvd.
- BOSTON.....110 Federal Street
- NEWARK.....24 Central Avenue
- ATLANTA.....265 Peachtree Street

### MAIL THIS COUPON TODAY

LAFAYETTE RADIO, Dept. RA-50  
 100 6th Avenue, New York 13

- Check here for FREE CATALOG
- Ship 99A9633-Model 666 AF & RF Oscillator.....\$63.95
- Ship 99A9632-Model 661 RF Signal Generator.....\$32.95
- Ship 99A9631-Model 592 Push Button Set Tester...\$29.95
- Ship 20A20621 Burgess #1 Cells (4 needed @ 6 1/4¢).....26¢
- Ship 20A20617-Burgess M30 Battery.....\$1.54

My postal note, money order or check includes shipping charges based on weight and postal zone.

NAME.....  
 ADDRESS.....  
 CITY.....ZONE.....STATE.....

# CANNON PLUGS

FOR THE  
RADIO  
TECHNICIAN



## TYPE AN

has greatest number of inserts, variety of amperages and voltages. More than 200 layouts.

## TYPE K

and RK similar to "AN" but an exclusive Cannon product, more rugged than type "AN". 210 inserts-layouts.



## TYPE XL

Fast growing in popularity as the leading quality low cost microphone connector. 10 & 15 amps. contacts.

## TYPE X

3 insert arrangements; friction type engagement. 10 and 15 amps.



## TYPE P

Standard sound and microphone series in 7 insert arrangements. 15 & 30 amps. contacts.

## TYPE DP

Rack & Panel type connectors with standard contacts and coaxials.



## AND 7 OTHER MAJOR TYPE SERIES.

Write for the new C-48  
Condensed Catalog.  
Address Department A-228

SINCE 1915

# CANNON ELECTRIC

Development Company

Division of Cannon Manufacturing Corp.  
3209 HUMBOLDT ST., LOS ANGELES 31, CALIF.

IN CANADA & BRITISH EMPIRE:  
CANNON ELECTRIC CO., LTD., TORONTO 13, ONT.

WORLD EXPORT (Excepting British Empire):  
FRAZER & HANSEN, 301 CLAY ST., SAN FRANCISCO

## SQUARE WAVE GENERATOR

By L. H. TRENT

**CIRCUITS** of square wave generators have appeared in various publications from time to time, but the majority of these employ five or more tubes, using some precision components besides. This may prohibit the average service technician from constructing them. The generator to be described has none of these disadvantages, and the components are readily available.

Frequently in audio or radio frequency work it would be an advantage to be able to inject different types of waveforms for response checking. Four types of waveforms are available from this unit. Three are used for external checking purposes, while the fourth is a sharp pulse that can be injected into the oscilloscope for locking purposes.

In reference to the schematic, Fig 2, a 6-volt auto radio vibrator unit is used as the frequency controlling element. The fundamental frequency of this particular unit is 133 cycles. However, the usable harmonics of this square wave generator extend higher than 30 megacycles. The double-pole, three-position switch,  $S_1$ , selects the first three waveforms as shown in Fig. 1 (A, B, and C). Control  $R_1$  varies the shape of waveform (A), while control  $R_4$  varies the shape of waveform (C). Waveform (B) is the square wave out-

put. Waveform (D) is the scope sync.

The power supply for this unit should be able to supply a total drain of about 50 ma., and a voltage regulated tap at 105 volts for the 6L6 screen supply. Parts layout can be any way the constructor desires, as nothing is critical.

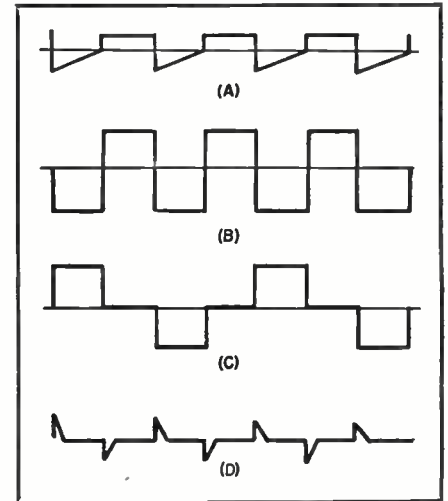
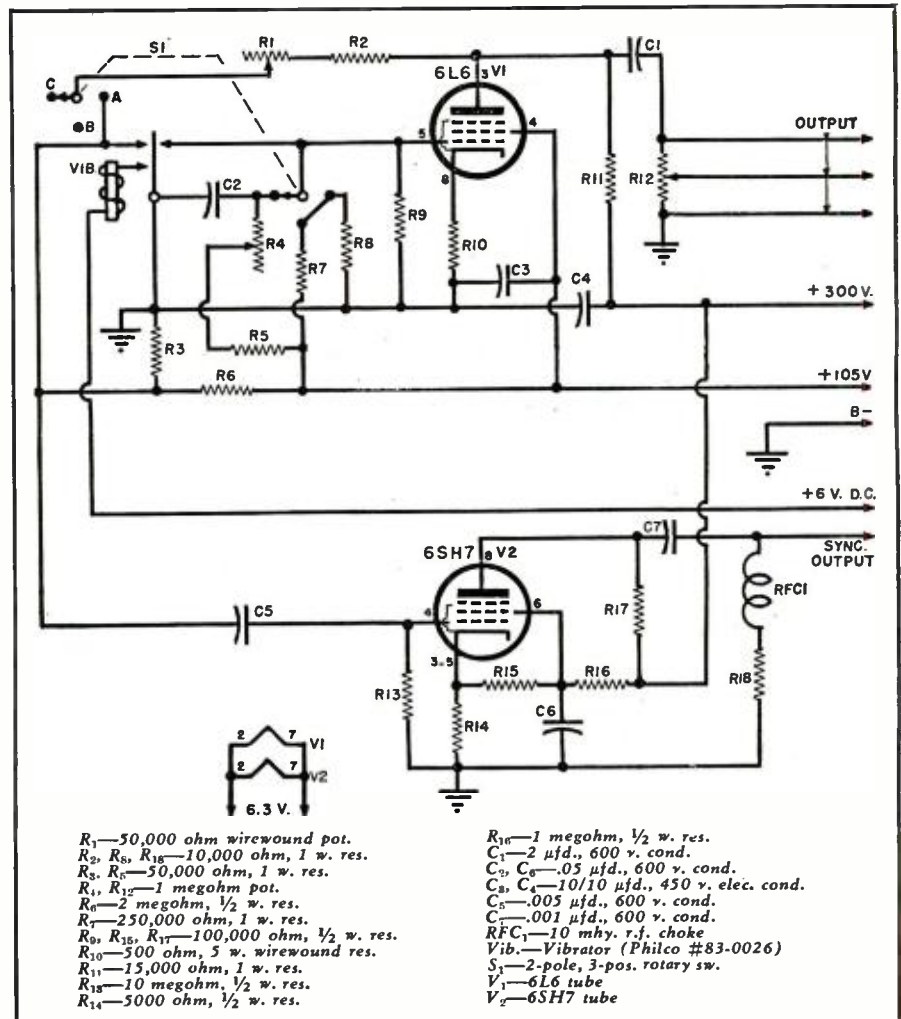

Fig. 1. Output waveforms.

Fig. 2. Wiring diagram of a square wave generator.









# HARVEY has

## BELL HI-FI AMPLIFIER



Medium priced, high fidelity, many important features. Inputs: Radio tuner, crystal pickup, 2 magnetic pickups (built-in pre-amp). Bass and treble controls, equalized inputs. Gain 74-110 db; output 10 watts; response  $\pm 3/4$  db, 30 to 15,000 cycles.

**Complete with tubes . . \$41.70**  
Shpg. Wt. 15 lbs.

## JIM LANSING SPEAKER



New 8" general purpose speaker for commercial and industrial systems. Aluminum ribbon voice coil, Alnico V magnet, 8 ohms impedance, power input 10 watts.

Shpg. Wt. 6 lbs. **\$20.70**

## FM TRANSLATOR

### General Electric Model XFM-1

Covers 88-108 mc range, dial 12 inches long, power inputs for 110 to 250 volts, 50/60 cy. Quantity limited.



**Special Price . . . . . \$49.50**

## BELL TAPE RECORD-O-fone

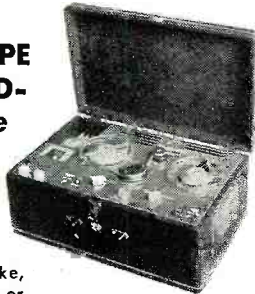

Record from mike, external radio or phonograph on dual track tape. Speaker or headphone monitoring while recording. Output can be connected to amplifier or PA system. Records on 5" reels with lid closed, also takes 7" reels for up to 1 hour recording.

**Model shown, with built-in radio . . . . . \$126.34 net**  
**Same, less radio . . . . . 106.34 net**  
Shpg. Wt. 37 lbs.

**NOTE:** All prices are Net, F.O.B. N.Y.C. and are subject to change without notice.

Telephone: **7rc** Luxembourg 2-1500

**HARVEY**  
**RADIO COMPANY INC.**  
103 West 43rd St., New York 18, N. Y.

# A Handy TV Service Kit

*This efficient tool kit lends a "professional" air to your calls and speeds up TV servicing.*

By  
**RALPH E. HAHN**

**B**ECAUSE the television technician who makes house calls is somewhat handicapped by the amount of service equipment he can conveniently carry around with him, and also by the lack of bench facilities, a neat and well designed service kit is essential to quick and efficient servicing in the home. A kit which contains enough tools and parts to repair most of the sets in the home will save many costly trips to the shop. It does not, however, need to contain "everything but the kitchen sink." A few well-chosen tools and parts will suffice for most jobs. The following is a description of a kit used by the author for a long time. Customers have made many favorable comments on the "nice looking tool box."

As may be seen by the photographs, the case is a portable record player cabinet. These cabinets can be obtained at any of the large radio supply houses. The one shown measures 19 x 14 x 8 inches. The exact size or shape is not important, however, as these dimensions may be varied to

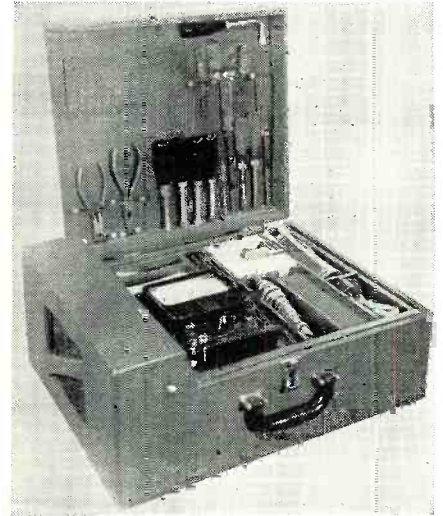

Cover and tray layout of home-built kit.

suit individual requirements. Perhaps no two service technicians will agree as to exactly what should be carried to the customer's home. However, the equipment listed under the suggested list of contents should meet the basic requirements of most TV men. This article may be used as a

Fig. 1. Details for mounting service tools in the cover of the home-built kit.

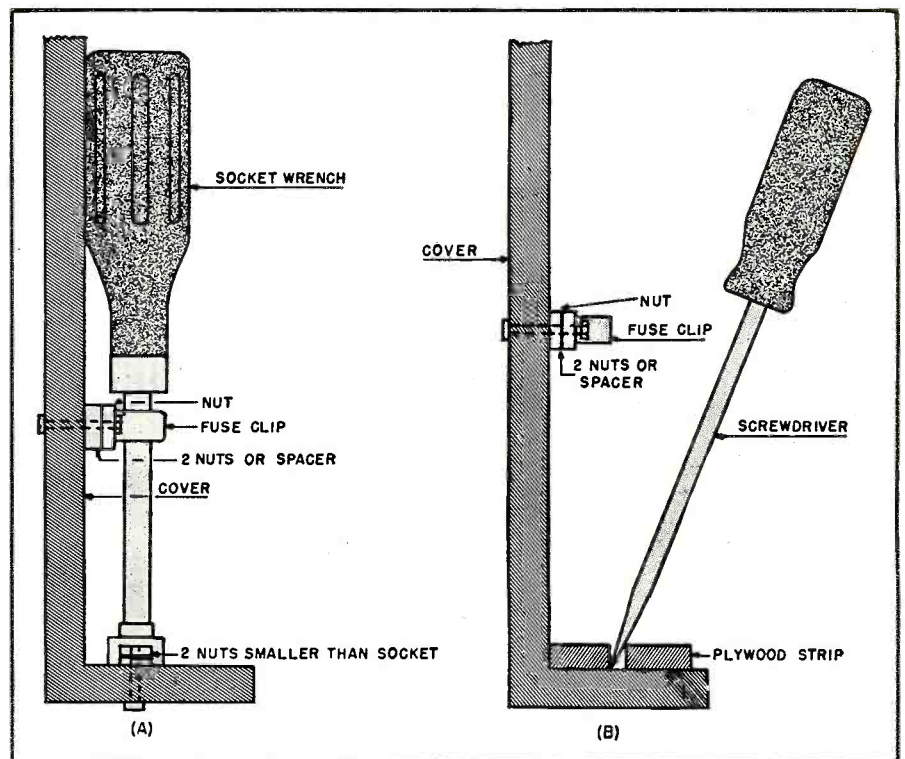

## WE KNOW THE PRICE IS UNBELIEVABLY LOW,

but that's not all! In addition, this finely engineered instrument provides a degree of accuracy never before attained in a unit selling for even double this price. Furthermore in designing this unit, we took advantage of every recent improvement in components. For example, by using slug-tuned coils, we are able to efficiently adjust each instrument

for perfect accuracy. This feature will also enable you to recalibrate the model 200 periodically without having to return it to the factory. The use of a Noval tube (the 12AU7) with its extremely low inter-electrode capacity enabled us to reach a higher frequency range than was heretofore possible in a unit of this type.

# THE NEW MODEL 200 **AM and FM** **SIGNAL GENERATOR**

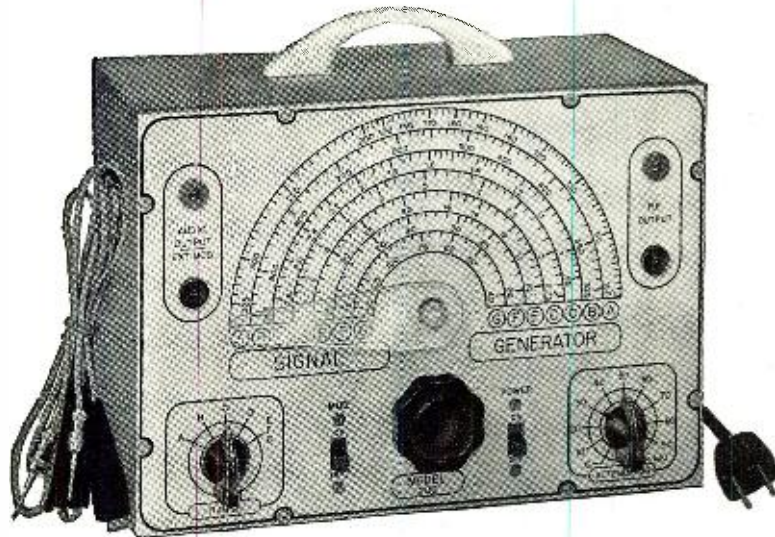

### SPECIFICATIONS

- ★ **R.F. FREQUENCY RANGES:** 100 Kilocycles to 150 Megacycles.
- ★ **MODULATING FREQUENCY:** 400 Cycles. May be used for modulating the R. F. signal. Also available separately.
- ★ **ATTENUATION:** The constant impedance attenuator is isolated from the oscillating circuit by the buffer tube. Output impedance of this model is only 100 ohms. This low impedance reduces losses in the output cable.
- ★ **OSCILLATORY CIRCUIT:** Hartley oscillator with cathode follower buffer tube. Frequency stability is assured by modulating the buffer tube.
- ★ **ACCURACY:** Use of high-Q permeability tuned coils adjusted against 1/10th of 1% standards assures an accuracy of 1% on all ranges from 100 Kilocycles to 10 Megacycles and an accuracy of 2% on the higher frequencies.
- ★ **TUBES USED:** 12AU7—One section is used as oscillator and the second is modulated cathode follower. T-2 is used as modulator. 6C4 is used as rectifier.

The Model 200 operates on 110 volts A.C. Comes complete with output cable and operating instructions

**\$18<sup>85</sup>**  
**NET**

20% DEPOSIT REQUIRED ON ALL C.O.D. ORDERS

**GENERAL ELECTRONIC DISTRIBUTING CO.**

Dept. RN-1, 98 PARK PLACE  
NEW YORK 7, N. Y.

# TOPS IN PERFORMANCE



Here is the most sensational single channel performer. The YAGI array has achieved astounding results because in it Vee-D-X engineers have successfully combined every desirable feature for optimum performance. Compare what this YAGI offers you!

- Four element beam cut especially for each particular channel
- High forward gain and sharply directional
- Stepped-up driven element affords excellent match to 300 ohm transmission line. (Can also be supplied for 72 ohm match.)
- Exceptionally high front to back ratio helps reject unwanted signals
- Fabricated from highest quality 61 ST duraluminum (3/4" O.D. elements)
- Extremely light weight, easy to assemble, and neat appearing

## STACKED ARRAY

To provide additional gain and improve signal to noise ratio on any one channel, two YAGIS can be stacked together. Also several arrays may be mounted on the same mast and directed to different transmitters.

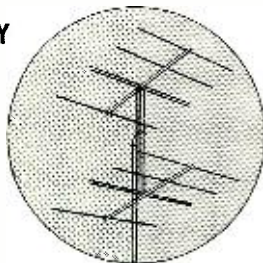

# VEE-D-X

VEE-D-X means video distance

LaPointe Plascomold Corp., Unionville, Conn.  
Send new catalog and prices on the YAGI array and other Vee-D-X television accessories.

Name.....  
Company.....  
Street.....  
City..... Zone..... State.....

guide for making a new kit or improving your present tool box.

Because tubes cause the greatest number of television breakdowns, it is advisable to carry at least one of each of the types used in the makes of sets he services. The author carries about 45 TV tubes plus about 20 radio tubes. This may seem like a lot of tubes to lug around but as they are light they are not a burden and it pays off in fewer trips to the shop.

All tubes are placed "below deck" and are arranged into compartments according to size. If desired, these compartments may be subdivided into smaller ones and the tubes then segregated according to use, i.e., sweep, oscillator, rectifier, etc. This minimizes hunting for a particular tube. Partitions may be made of plywood, Masonite, or any similar material. They are held in place by cleats of the same material.

A removable tray is built to fit on top of the tube compartments. This tray is used to hold the meter, flashlight, etc. Partition it to fit your particular equipment. A coat of paint will improve its appearance. No handle is provided as it was found that the tray was easily removed by merely grasping one of the partitions. Glue a piece of sponge rubber on the bottom of the meter compartment also in the cover directly above the meter. This will hold it in place and cushion it at the same time.

Tools are mounted in the cover to facilitate easy removal and replacement. Also when they are spread out and mounted in an orderly fashion, a glance will tell whether anything is missing, thereby minimizing the possibility of leaving tools in the customer's home.

In mounting the socket wrenches and long screwdrivers, a very handy method is to use fuse clips to hold the shank while the bottom ends are held to the bottom of the cover. This is illustrated in Fig. 1. For the screwdrivers, a strip of plywood with holes

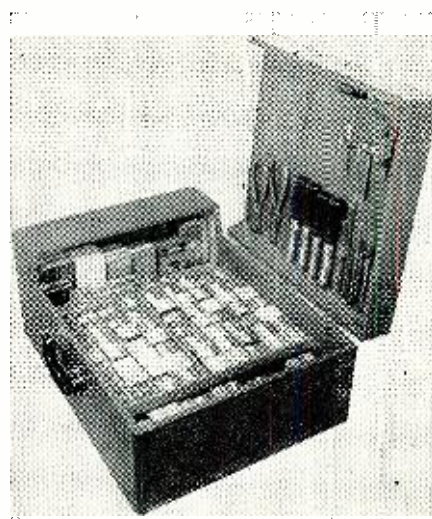

Arrangement of the kit's tube compartment.

that will just pass the end of each tool is used. A screw and two nuts which are slightly smaller than the socket are used to hold the tool in two places, yet it is easy to remove and replace with one hand. Place a nut or two between each fuse clip and the cover otherwise the handles will not permit the fuse clip to grasp the shank. For appearance sake, use screws with ornamental heads in mounting the fuse clips.

Small screwdrivers and the pliers are held in place with ordinary flat transmission line. Fasten the transmission line in place with thumbtacks or preferably, short woodscrews with washers.

Tacking in a kit of Allen wrenches completes the job. Avoid mounting any tools directly over the meter in order to provide enough clearance and prevent possible damage.

You now have a service kit which is both good looking and efficient, make the most of it by being neat and orderly when working in the customer's home.

Suggested list of tools and tubes to be carried in this handy TV service kit.

One set of the following tubes:			1—Special a.c. cord (used on Stromberg-Carlson, some Philcos, Zenith, etc.)
1B3-GT/8016*	6BG6-G	6X5-GT	1—Box 1/2 amp. fuses (Type 3AG)
5U4-G	6C4	7B4	1—Box 3 amp. fuses
5V4-G	6F6-GT	7B5	1—Complete set of socket wrenches, 3/16" to 3/8"
5Y3-GT	6H6	7B6	1—Screwdriver, 4" blade, 1/4" tip
6AC7/1852	6J6*	7F8	1—Screwdriver, 6" blade, 1/8" tip
6AG5*	6K6-GT	7H7	1—Screwdriver, 6" blade, 3/16" tip
6AH6	6SB7Y	7W7	1—Screwdriver, 1 1/4" stubby, 1/4" tip
6AK5	6SG7	7N7	1—Short set-screwdriver
6AL5	6SH7	12BA6	1—No. 1 Phillips screwdriver
6AS7-G	6SL7-GT	12AT7*	1—Long-nose pliers
6AT6	6SN7-GT*	12AU7	1—Diagonal cutters
6AU6	6T8	12SN7-GT*	1—No. 6 Allen wrench, or
6BA6	6V6-GT	25L8-GT	1—Complete set of small hex wrenches
6BE6	6Y6-G	25Z6-GT	Several small cardboard boxes to hold small parts such as test condensers, resistors, snap-in type coils, fuses, etc.
Tools and Instruments			Various extension cords for audio, speaker, etc. These will vary depending on the types of sets serviced.
1—Multimeter, preferably 20,000 ohms/volt			
1—Pencil-type soldering iron			
1—Flashlight			
1—Standard TV a.c. cord			
* Because the frequency of replacement of these tubes is quite high, it is advisable to carry at least two of each of these tubes.			





# Centralab Reports to

CENTRALAB  
CAPACITORS

... More Than Meet Your  
Replacement Needs



HI-VO-KAPS  
for TV Power Supplies.

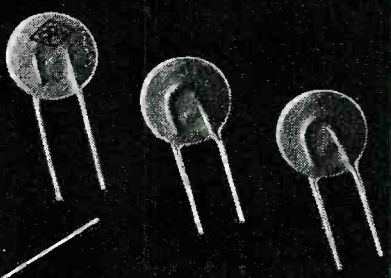

KOLORDISKS  
for by-pass and coupling in AF,  
RF, VHF, UHF, TV, FM and AM  
circuits.

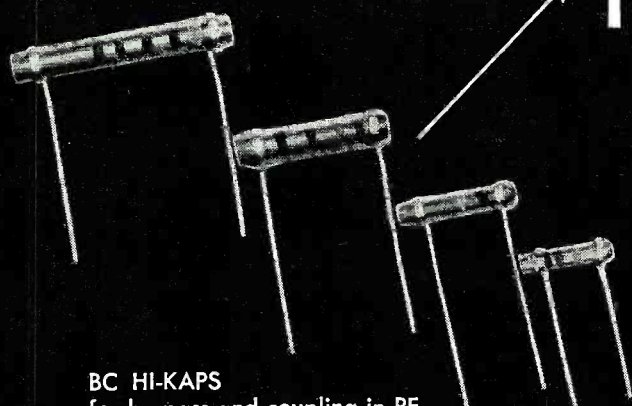

BC HI-KAPS  
for by-pass and coupling in RF,  
HF, VHF, UHF, TV, FM and AM  
circuits.

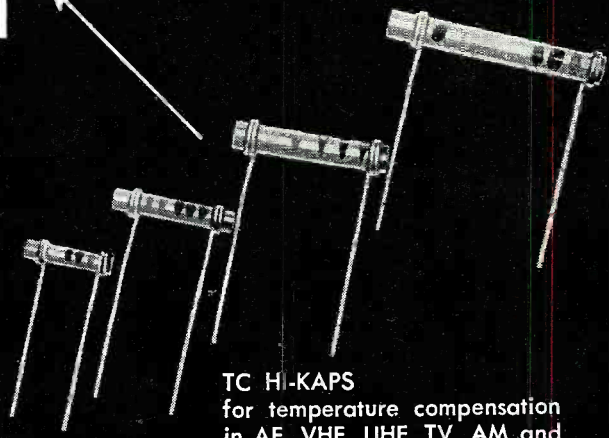

TC HI-KAPS  
for temperature compensation  
in AF, VHF, UHF, TV, AM and  
FM circuits.

## CRL CAPACITORS MEAN PROFITS FOR YOU!

WHEN YOU use high quality Centralab replacement capacitors in repairing radio sets, television receivers and other electronic equipment, you can be sure of customer satisfaction. You can be sure of new business. What's more, Centralab capacitors — *Hi-Vo-Kaps*,

*Kolordisks*, *TC* and *BC Hi-Kaps* — make your job easier, save you time. Here's why. They're simple to install . . . easy to stock. Get all the facts on profit-making CRL replacement capacitors from your nearby Centralab distributor.

# Service Engineers

*A successful serviceman spoke recently of a plan he uses to get each new year off to a fresh, profitable start. Here are some of the questions he asks himself. "1) Do the replacement parts I use give my customers trouble-free service? 2) Are these parts designed to help me do a good job quickly? 3) Are they packaged to save shelf space . . . to make accurate selection easy? 4) Am I getting the kind of service I want from my distributor?" If you can answer "Yes" to all these questions, it's very likely you use quality Centralab parts, too. If you can't, we're confident you'll find it profitable to ask your nearest Centralab distributor for all the facts. Call him today!*

**Centralab**  
Division of GLOBE-UNION INC. • Milwaukee

## Ask Your Distributor for These CRL Parts

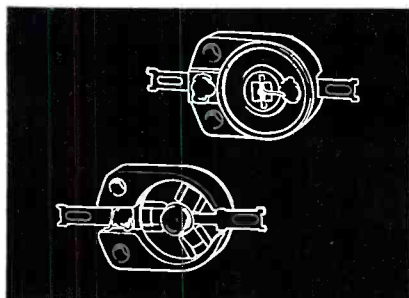

### TRIMMERS

**CERAMIC TRIMMERS** for padder application in RF and HF circuits. These trimmers are noted for their great mechanical strength and electrical stability; low power factor. Hold circuit drift to a minimum. Truly an indispensable "must." Ideal for amateur, experimental and industrial use.

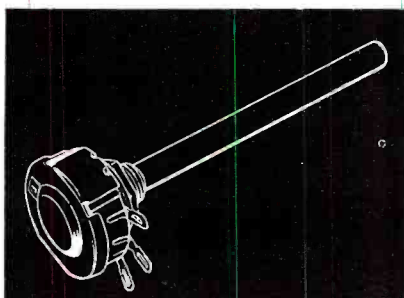

### CONTROLS

**MODEL "M"** for voltage-divider, antenna shunt and "C" bias control, tone control, AF grid control. **MODEL "1"** for all miniature applications; rated at 1/10 watt, actually smaller than a dime. **MODEL "R"**, wire wound, for voltage divider, antenna shunt, "C" bias, AF grid or tone control circuits.

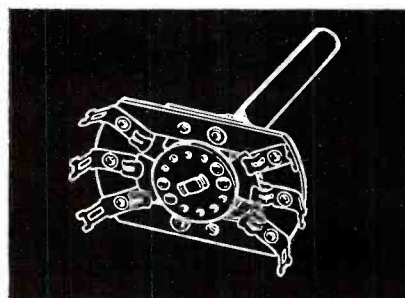

### SWITCHES

**ROTARY** for band change, meter, intercom circuits; made in ceramic and phenolic models. **ROTARY SPRING RETURN** for meter selection, intercom, phono-radio applications. **MEDIUM DUTY** for band changing in low power exciter-transmitters and receivers. **LEVER ACTION** for intercom, speaker, microphone and other applications.

**These Men are Getting PRACTICAL TRAINING**



# IN RADIO-TELEVISION

**ON REAL TELEVISION SETS RADIO RECEIVERS F.M. RECEIVERS**

## IN THE GREAT SHOPS OF COYNE

Big opportunities are waiting for men who know the practical and technical end of Radio and Television. That's what you get at COYNE—besides practical Shop Training in F.M., Electronics and other branches of this giant field. Remember, Television is the fastest growing opportunity field today, and Radio is one of the biggest.

### NOT "HOME STUDY" COURSES

All Coyne Training is given in our mammoth Chicago training shops. We do not teach by mail. You train on actual equipment, under friendly instructors. Previous experience unnecessary. Hundreds of firms employ Coyne trained men.

### OLDEST, LARGEST, BEST EQUIPPED SCHOOL OF ITS KIND IN AMERICA

Come to the Great Shops of Coyne in Chicago. Established 1899—now in our 51st Year. Fully approved for G.I. training. Finance plan for non-veterans.

### MAIL COUPON FOR FREE BOOK

Send today for big new book packed with large pictures taken in Coyne Shops. No obligation. No salesman will call. Get the facts now!



**COYNE** B. W. Cooke, Pres.  
**ELECTRICAL, RADIO & TELEVISION SCHOOL**  
500 S. Paulina St., Dept. 10-1K  
Chicago 12, Illinois

B. W. COOKE, Pres.  
COYNE Electrical, Radio & Television School,  
500 S. Paulina Street, Dept. 10-1K Chicago 12, Ill.

Send FREE BOOK and full details on Radio-Television Course.

NAME.....  
ADDRESS.....  
CITY.....STATE.....



*This Association is a patriotic non-profit organization, with chapters in most of the larger cities, dedicated to developing and maintaining efficient personnel, commissioned, enlisted, civilian, for the supply (including design and development), installation, maintenance, and operation of communications and electronic equipment for Army, Navy, and Air Force and their supporting civilian activities. It publishes a magazine "SIGNALS" at its national headquarters in Washington. Every American interested in any way in communications is eligible and invited to join. Dues are \$5.00 per year. Application should be submitted to the secretary at 1624 Eye St., N. W., Washington 6, D. C., who will furnish details upon request.*

### 1950 Annual Meeting

Previously the dates and places of the annual meeting had been announced as New York and Fort Monmouth, April 26, 27 and 28. For a number of reasons, one being conflicts with Army maneuvers which might prevent certain tactical units from participating at Fort Monmouth, it was decided by the Executive Committee to change the dates to: Friday, May 12th—New York City: business meetings, panel discussions, conferences, luncheon, and banquet, plus a visit to the Photographic Center at Astoria, L. I. Saturday, May 13th—Fort Monmouth: exhibits and demonstrations of communications and photographic equipment and operations. The signal Corps, which is sponsoring the Fort Monmouth show, promises some events never before scheduled for any AFCA shows.

### ROTC Prizes

Medals and other prizes are being awarded in 1949-50 to ROTC cadets who excel in leadership and electronics in Army, Navy, or Air Force Units. Awards will be made next spring at the following colleges which have qualified for participation: A & M College of Texas, Carnegie Institute of Technology, Cornell University, Georgia Institute of Technology, Iowa State College, Massachusetts Institute of Technology, Michigan State College, New York University, North Carolina State College of A & E, Ohio State University, Oklahoma A & M College, Oregon State College, Rensselaer Polytechnic Institute, Rutgers University, Southern Methodist University, State College of Washington, Texas Technological College, University of Alabama,

University of California, University of Florida, University of Maine, University of Miami, Fla., University of Tennessee, University of Texas, University of Wisconsin, University of Wyoming, Virginia Polytechnic Institute.

### AFCA CHAPTER NOTES Augusta-Camp Gordon

The October meeting was held at the Signal Corps Training Center Demonstrator, Camp Gordon on the 26th. Visitors introduced by President H. A. Fleming included Col. H. A. Vest, Communications Officer, Third Army; Col. Leroy, Executive Officer, Augusta Arsenal; and Capt. A. B. Gibson, the chapter's only life member, who was attending his first meeting with the chapter.

At the close of the business session, Capt. Claude E. Leslie, officer in charge of the Demonstrator Building, gave an account of the various uses to which the building is put, following which the equipment was demonstrated by the enlisted staff attached to the building. A short Signal Corps movie was also shown.

### Baltimore

The Chesapeake and Potomac Telephone Company was host to the chapter for its November meeting. The members met for dinner at the company's Headquarters Building in Baltimore and then participated in the excellent program arranged by telephone company officials. Preparatory to a tour of the Headquarters Building, William E. Purdue, Plant Extensions Engineer, gave a talk on "Nationwide Toll Dialing." The group then inspected the equipment being installed which will tie Baltimore into the nationwide toll dialing layout. Other interesting exhibits included a cable splicer performing the intricate operation of splicing a telephone cable containing several hundred pairs of wires.

### Chicago

The Chicago Chapter of the Armed Forces Communications Association held its October meeting at the Hallicrafters Company's Chicago plant on the evening of October 26th.

Chapter President Oliver Read presided at the meeting, while William J. Halligan welcomed the group in his dual capacity as host and as a national director of the AFCA.

After dinner Charles Honeywell, Television Engineer of Hallicrafters, gave a short talk summarizing the current important details of Color Television. He pointed out that two

**RADIO & TELEVISION NEWS**



# SAVE \$ ON \$UN SURPLUS AND STANDARD SPECIALS!

## HI-FIDELITY MUSIC LOVERS

Now in stock for immediate delivery all the components necessary to assemble the hi-quality-lo-cost radio phono combination as recommended by a well known consumer research organization.

MEISSNER 8C FM Tuner with cabinet	\$38.33
MEISSNER 8C FM Tuner less cabinet	34.33
GENERAL ELECTRIC 1201 D Speaker	17.70
UNIVERSITY 4401 Single Tweeter	12.00
UNIVERSITY 4402 Dual Tweeter	24.00
UNIVERSITY 4405 Filter Network	6.00
BELL 2122 Amplifier	41.50
BOGEN PH 10 Amplifier	29.25
G. E. Preamp, self powered	9.57
WEBSTER 356 27 Record Changer with GE Cartridges	39.75

We will do all the necessary adaptation so that all you have to do is plug in and play after installation in your own cabinet. There is no charge for adaptation, except for extra wire, plugs, etc., which amounts to very little. When ordering please include sketch of layout and length of wire needed on each item. Allow one week for adaptation.

### PICKERING MAGNETIC PHONO CARTRIDGES FOR THE ULTIMATE IN HI-FIDELITY RECORD REPRODUCTION

S-120 M. Sapphire, Standard Play	\$9.90
S-140 S. Sapphire, Long Play	15.00
D-120 M. Diamond, Standard Play	24.90
D-140 S. Diamond, Long Play	36.00
R-150. Replaceable Stylus Cartridge, jess stylus	9.90
Standard Play Stylus for R-150	2.40

PRESTO 15G 3-Speed 12" balanced turntable and motor, Professional quality for home use	\$38.00
REK-O-KUT LP-743, 3-Speed 12" Balanced Turntable and Motor	\$49.50

### PARTS ASSORTMENTS

100 Ass't. Elec. and Tubular Cond	\$3.49
100 Ass't. Resistors	1.00
100 Ass't. Mica Cond., unmarked	1.00
25 Ass't. Pots	4.95
100 Octal Water Sockets	2.95
100 Octal Bakelite Sockets	3.95

### PHONO ARMS

American model No 1-1 with CR 12 3.5 volt output cartridge. Unboxed. New	\$1.65
Astatic SL 8 and D 9 with L-26a cartridge Standard replacement unit Boxed New	\$1.89
Phono arms less cartridge, but with all necessary hardware, straight or curved.	
Five (5) for	\$1.95

45 AND 78 RPM ADAPTER for 78 RPM record changers and manual players. Converts any 78 RPM record player to a 3-speed player. Quickly attached and removed, just slip on spindle. Only

\$13.50

RECORDING MOTOR AND TURNTABLE, Professional 33 1/3 and 78 RPM with 16" aluminum alloy casting table, famous make. Reg. price \$165.45. Brand new: reduced to

\$116.00

GONSET, 6 meter converter, easily converted to 10 meters or use as is on 6. Reg. 39.95; reduced to

\$27.95

POTENTIOMETERS, 20 assorted, singles, duals, pads, etc. Some with switch

\$3.95

DUAL SPEED RECORD PLAYER, 78 and 33 1/3 RPM, AC or DC in Portable leatherette carrying case with 8" speaker and 3-tube amplifier. Heavy 12" table, adjustable speed motor, slightly used but reconditioned and guaranteed

\$12.50

TERMS All items F.O.B., Washington, D. C. All orders \$30.00 or less, cash with order. Above \$30.00, 25 per cent with order, balance C.O.D. Foreign orders cash with orders, plus exchange rate.

**SUN RADIO**  
OF WASHINGTON, D. C.  
938 F STREET, N. W. WASH. 4. D. C.

possible color systems are being considered, a CBS improved mechanical filter disc combination, and an RCA all electronic system. At public insistence, FCC hearings are being held to weigh the merits of each system.

An Army Signal Corps sound film entitled "Attack Signal (Electronics)" was viewed by the group. Arranged through the courtesy of Colonel Glen H. Palmer, Chief Signal Officer, Fifth Army, the film depicted the importance of "Walkie-Talkie" sets in assault operations.

Following the film, Harold Rensch, *Hallicrafters'* Project Engineer, gave a talk on Citizens Radio, the civilian equivalent of "Walkie-Talkie."

After the talks the meeting was adjourned to form convenient groups to tour the company's plant.

### Cleveland

The first meeting of the 1949-50 season was held at the Coast Guard's Cleveland Lifeboat Station, Lake Erie, on October 13th. Bosn. W. H. Wilmot, commander of the station, greeted the chapter members in the station lounge. Lt. H. E. DeLong, Electronics Officer at Coast Guard headquarters in Cleveland, gave an interesting talk on "Electronics as Applied to Navigation." After a trip to the top of the tower to examine equipment used in these electronics aids, all hands were taken by small boat out into the lake to visit additional installations there.

Brig. Gen. S. H. Sherrill, AFCA Executive Director, who came on from Washington for the meeting, spoke informally to the group. He outlined progress made by the association and offered suggestions for increasing the membership of the chapter so that it might better carry out its mission of bringing together to their mutual benefit all the Army, Navy, Air Force, Marine, Coast Guard, and civilian personnel engaged in communications and photographic activities in the area.

The November meeting was conducted jointly with the local units of the AIEE and the IRE. The featured speaker was Dr. T. T. Goldsmith, Director of Research of the *DuMont Laboratories*.

### Fort Monmouth

An intensive membership drive, organized by Col. T. J. Tully, former chapter president, has resulted in a 100% increase in chapter membership. Arrangements are also well under way for the AFCA 1950 annual convention which will be sponsored by both the Fort Monmouth and New York Chapters next spring.

Chapter officers were recently elected as follows: President—Col. James D. O'Connell; Vice-President—Lt. Col. W. R. Herrlein; Secretary—Maj. T. H. Giles; Treasurer—Miss Florence Adair.

### Kentucky

The regular November meeting took place at the Phoenix Hotel in Lexing-

ton on November 10th. A stimulating talk on "Political Preparedness" by Dr. H. W. Hargreaves, Professor of Economics at the University of Kentucky, was the feature of the evening.

### Philadelphia

Rear Admiral Earl E. Stone, former Chief of Naval Communications, was the guest speaker at a meeting sponsored jointly by AFCA's Philadelphia Chapter, the Franklin Institute, and the Institute of Aeronautical Sciences. The meeting was held at the Franklin Institute on November 2nd. Members and guests gathered at 6:30 p.m. in the Institute's dining hall. Among those at the head table were: Dr. H. B. Allen, Executive Vice-President of the Franklin Institute; Col. W. W. Watts, President of AFCA's Philadelphia Chapter; Rear Admiral Roscoe E. Schuirmann, Commander of the Fourth Naval District; Rear Admiral Earl E. Stone; Col. Albert Wolfe of the Institute of Aeronautical Sciences; Frederick R. Lack, National President of AFCA; Walter Evans, National Director of AFCA from Baltimore; and Brig. Gen. S. H. Sherrill, AFCA Executive Director.

Immediately after dinner, those present examined some of the splendid exhibits of the Franklin Institute and then gathered in the auditorium. Dr. Allen greeted the guests and introduced Col. Watts who presided at the meeting. After a brief outline of the objectives of AFCA and an expression of appreciation to the Franklin Institute, he introduced Admiral Stone, who was until recently Chief of Naval Communications and now has a special assignment with the Joint Chiefs of Staff in Washington. Admiral Stone explained in a most interesting and detailed manner, "Communications and Electronics—the Most Essential Tools of Joint Command."

A showing of the film, "Pro Patria Vigilans," the story of the Signal Corps' activities and accomplishments during World War II, concluded the program.

### Pittsburgh

Dutch Henry's Restaurant in downtown Pittsburgh was the meeting-place of the chapter on October 11th. After dinner, Chapter President E. J. Stautbitz of the *Blaw-Knox Co.* introduced Brig. Gen. S. H. Sherrill, AFCA Executive Director, who had come from Washington for the meeting. Gen. Sherrill outlined the progress made by AFCA since his talk to the founders of the chapter on an earlier visit in 1946 and stressed the fact that the main mission of the association is to bring communications, electronics, and photography personnel closer together in the three Armed Services and in industry.

Maj. A. L. Hall, Asst. PMS&T at Carnegie Institute of Technology, was present and indicated he expects considerable interest in the association and its award to the outstanding stu-



# Get On The TV Band-Wagon Now!

**GOOD PAYING JOBS ARE WAITING FOR GOOD MEN — CREI TRAINING IS YOUR BEST REFERENCE**

*Add CREI Technical Training to Your Present Radio Experience, Get That Better Television Job —Make More Money—Enjoy Increased Security.*

You can make your own opportunity in Television, if you start preparing *now*. No need to tell you how fast this great new field is expanding—or, of the great number of jobs that are being created. If you are in Television now, expect to be, or wish to get in, CREI offers the very training you need to help accomplish your aims.

CREI can show you the way with convenient spare-time study at home that gives you the up-to-date technical background you *must have* for Television. CREI courses are designed to give you a thorough grounding in basic principles and take you step-by-step through the more advanced

subjects of Television and its related fields. It must be remembered that all new electronic developments have their roots in past techniques. CREI training is basic and helpful in your daily work right from the start. You will learn about and understand such subjects as: Optics; Pulse Techniques; Deflection Circuits; RF, IF, AF and Video Amplifiers; FM; Receiving Antennas; Power Supplies; Cathode Ray, Iconoscope, Orthicon and Projection Tubes; UHF Techniques, Television Test Equipment, etc. *Veterans: CREI training is available under the G.I. Bill. For most veterans July 25, 1951 is the deadline. Act now!*

**FREE SAMPLE LESSON** "THE ORTHICON AND IMAGE ORTHICON"—this lesson describes the development of the small, 3-inch image orthicon tube; theory and operation of the orthicon; image orthicon; specific features. Read this lesson. See for yourself how interesting it is to improve your ability the CREI way.

## THE THREE BASIC CREI COURSES:

- ★ **PRACTICAL RADIO ENGINEERING**  
*Fundamental course in all phases of radio-electronics*
- ★ **PRACTICAL TELEVISION ENGINEERING**  
*Specialized training for professional radiomen*
- ★ **TELEVISION AND FM SERVICING**  
*Streamlined course for men in "top-third" of field*

ALSO AVAILABLE IN RESIDENCE SCHOOL COURSES

## CAPITOL RADIO ENGINEERING INSTITUTE

*An Accredited Technical Institute Founded in 1927*

Dept. 291B, 16th Street & Park Road, N. W.  
Washington 10, D. C.

*Branch Offices:*

New York (7) 170 Broadway • San Francisco (2) 760 Market St.

January, 1950



**FREE BOOKLET plus SAMPLE LESSON**

### CAPITOL RADIO ENGINEERING INSTITUTE

Dept. 291B, 16th & Park Rd., N. W. Washington 10, D. C.

*Gentlemen:* Send me FREE SAMPLE LESSON and complete details of the TV and FM Servicing home study course. Also send brochure that explains the CREI self-improvement program and gives complete details and outline of course. I am attaching a brief resume of my experience, education and present position.

- Check the Field of Greatest Interest
- PRACTICAL TELEVISION ENGINEERING
  - TV, FM & ADVANCED AM SERVICING
  - PRACTICAL RADIO ENGINEERING
  - AERONAUTICAL RADIO ENGINEERING
  - BROADCAST RADIO ENGINEERING (AM, FM, TV)
  - RADIO-ELECTRONICS IN INDUSTRY

I AM ENTITLED TO TRAINING UNDER G.I. BILL.

NAME..... AGE.....

ADDRESS .....

CITY..... ZONE..... STATE.....



- PLUS**...Exclusive Ceramic Materials and Cores—of high density, low porosity and high dielectric, with correct thermal co-efficient of expansion—developed and produced by Ward Leonard!
- PLUS**...Exclusive WL Vitreous Enamel—tough, crazeless, moisture-proof, and acid-proof!
- PLUS**...Specially Drawn Resistance Wire—and High Precision Winding!
- PLUS**...Consistent Accuracy and Stability—even under extremes of temperature, humidity, corrosive atmospheres, shock, vibration, altitude!
- PLUS**...All Connections *Silver-Soldered*—with special silver solder developed in the WL laboratories!
- PLUS**...Wide Range of Stock Types—as well as Vast Variety of Special Units!
- PLUS**...Proved Over Half a Century of Resistor Experience in all types of applications!



Electronic Distributor Division  
**WARD LEONARD ELECTRIC CO.**  
 53-N West Jackson Blvd., Chicago 4, U.S.A.

**SEND FOR STOCK-UNIT CATALOG D-130**  
 Gives helpful data on Resistors and Rheostats available from stock... lists Radio Amateur Relays.

## WARD LEONARD

RESISTORS • RHEOSTATS • RELAYS

WHERE BASIC DESIGNS ARE RESULT ENGINEERED FOR YOU

**ANOTHER OUTSTANDING JOBBER**  
**ISLAND RADIO DISTRIBUTORS**  
 412 FULTON AVE.,  
 Hempstead, L. I.

HAS THE SENSATIONAL NEW  
**TEIGO 400-K**  
 5" Scope Kit  
**IN STOCK!**  
 \$39.95

### Resistance and Capacitance Standards

Mounted precision resistors 1, 10, 100, and 1000 ohms up to 1/20th of 1% accuracy. Mica capacitance standards .01 and .1 mfd up to 1/5th of 1% accuracy. Moderately priced so that every serious amateur, set builder and experimenter can now have his own basic precision laboratory standards. Write for circular RC-1.

The Greylin Co.—P.O. Box 258—Chicago 90, Ill.

# BLISS

## Electrical Training

**ELECTRICAL SCHOOL**

Intensive 32 weeks' residence course in fundamentals of industrial electrical engineering, including radio and electronics. Extensive laboratory, shop work, drafting. Prepares for electrical technician and engineering

aides in communications, power, manufacturing, business machines, sales, service. G. I. approved. 57th year. Enter Mar. 6, Sept. 5. Catalog. **7601 TAKOMA AVE. WASHINGTON 12, D. C.**

dent at the college next spring. Past president Robert Disney spoke of his experiences in organizing the chapter; and Fred Moran, last year's president of the Baltimore Chapter, who has been transferred to Pittsburgh as superintendent of *Western Union* there, outlined the procedures used at Baltimore in making it one of the outstanding chapters.

### Sacramento

An inspection and demonstration of California State Highway Patrol operations and communications featured the October 25th meeting of the Sacramento Chapter.

### Seattle

Television was the topic of the October chapter meeting at the American Legion Hall. A brief summary of the subjects to be covered was given by Chapter President M. F. Kerr.

After a short film on television, showing relay stations, use of movie film in television, special event broadcasts and television studios in operation, Marshall James, entertainment chairman, introduced the guest speaker, Phil Hamlin of the *General Electric Supply Company*. Mr. Hamlin discussed types of television screens and advantages peculiar to each, grain of picture and size in relation to room size, use of color in television and the relative engineering problem.

The program concluded with a movie entitled, "Where Will You Hide?"—the answer being very aptly photographed that there is no hiding place in future wars.

### Washington

The officers, directors, and committee chairmen of the chapter met on September 27th at the Raleigh Hotel to adopt a program for the current year. It was agreed to hold four meetings during the year—each of the first three to be sponsored by one of the services and the fourth to be sponsored by a local communications organization.

In line with this program, the first meeting was held at the U. S. Naval Academy in Annapolis on November 9th. After lunch at the Officers' Club, the members were conducted on an extensive tour of the U. S. Navy Communication Station. Capt. Richard E. Elliott, USN, in command of the station, welcomed the guests, and Comdr. Guy M. Neeley, Chief Engineer, Shore Communication System, described the various operations of the station.

-30-

### BRUSH EXCESS SOLDER

**Q**UITE often when soldering a tap on a close-spaced coil, the solder will stick on turns adjacent to the tapped turn. This excess solder may be easily removed by carefully heating the turns, and then quickly brushing with a small paint brush. It is advisable to cut about two-thirds of the bristle length from the brush in order to form a stiffer brush.....C.J.H.

**RADIO & TELEVISION NEWS**



# Come and Get It! THIS IS OUR ANNUAL BARGAIN ROUND-UP

EVERY PRICE IS SLASHED • EVERY ITEM MUST BE SOLD



**STROMBERG CARLSON**  
Power Switching Relay Box. Neat, 3 1/2 x 4 x 5 1/2. Steel case with tight fitting cover, finished in Stromberg's beautiful crackle finish. \$1.00

## SIGNAL GENERATOR

Genuine Laboratory-type precision signal generator. Manufactured and sold for \$68.00 each in large quantities during the war by Northeastern Engineering Corp., one of the top manufacturers of electronic equipment for the U. S. Gov't. Five fundamental bands starting at 150 K.C. Strong signals up to 120 M.C. Five step ladder type attenuator as well as potentiometer output control. Regulated 1000 cycle audio oscillator using vacuum tube, not a cheap neon sawtooth audio oscillator. Audio output available separately. Weight without packing material 16 lbs. Complete with fused plug and coaxial output lead. Super Special. **\$38.75**



## NEW G. E. TRANSMITTER

Brand new General Electric BC-375 or BC-191 transmitters, export packed, absolutely complete and including complete set of spare tubes as well as 10 and 20 meter conversion instructions \$100.00. BC-312, BC-344 or BC-224 receivers sold with the above transmitters **\$125.00** (unit for unit)

SCR610 portable 6, 12 and 24V crystal controlled transmitter-receiver with built-in loudspeaker on receiver, complete **\$59.95**

SCR522 Transmitter-receiver in guaranteed condition complete with remote controls, antenna and mike.

No conversion necessary to license for taxicab use. A national **\$100.00** for any 2 meter use.

## AC-DC POCKET TESTER

This analyzer, featuring a sensitive repulsion type meter housed in a bakelite case, is the result of 15 years achievement in the instrument field by a large company specializing in electronic test equipment. Specifications of the AC-DC Model Volt-Ohm-milliammeter: AC and DC Volts—0-25, 50, 125, 250. Milliamperes AC—0-50. Milliamperes DC—0-50. Ohms Full Scale—100,000. Ohms Center Scale—2400. Capacity—.05 to 15 Mfd. Total price, prepaid anywhere in the USA—**\$7.00**. Similar DC Meter, lacking AC operated ranges of above, \$5.50 prepaid.



## NEW G. E. SELSYNS

Sensational Selsyns by G. E. Two or more connected together work perfectly on 110V AC. Any rotation of one Selsyn and all others connected to it will rotate exactly as many degrees in the same direction. Useful for indicating direction of weather vanes, rotating directional antennas, or controlling many operations from a distance. Complete with diagram and instructions. Per Matched Pair **\$4.95**

## PHONO SCRATCH ELIMINATOR

Consists of 2 condensers and powdered iron core choke connected in filter network. Same as used in most jukeboxes. Connects instantly between pick-up and amplifier **\$2.00**

## PORTABLE ELECTRIC DRILL

Cannot mention brand name as we are selling under established factory price, ONLY **\$19.95**



Equipped with 1/4" Jacobs Geared Chuck and Key. Not an intermittent duty drill, but a fine sized rugged tool. Most convenient type switch, natural grip handle. Precision-cut gears—turbine type cooling blower—extra long brushes. No stalling under heaviest pressure because of powerful 110V AC or DC motor and multiple ball thrust bearing. Other bearings self-aligning. Lifetime-lubricated Oilite type. Amazing perpetual factory guarantee assures you of a lifetime of trouble-free use (no return pay transportation) if not pleased with drill after trial.

## D. C. POWER PLANT PE-109

A gasoline engine coupled to a 2000 watt 32V DC generator. Adjustable to give 12 to 40V output. Ideal for rural areas, or to run any items requiring 24-32V DC. Tested and in good condition, only **\$79.95**. Converter that will supply 110V AC from this unit, for only **\$12.95**. We also have a limited supply of brand new PE-109s in original factory packaging for **\$125.00** each, F.O.B. Buffalo.

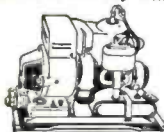

## DELUXE AC-DC RADIO KIT

High quality standard production line radio in kit form with complete instructions. Features 2-gang condenser, 2 iron core I.F. transformers, and polyethylene insulated edge wound antenna loop. Tubes include 12AT6, 12BA6, 12BE6, 50B5 & 35W4. Receives broadcast band from 550 to 1700 KC. Kit form **\$8.75** or 2 for **\$17.00**. Assembled, wired and tested **\$12.95** or 2 for **\$25.00**.



## ISOLATION TRANSFORMERS \$2.95

Many adjustments on radio and TV sets require that the chassis be grounded for successful results. Using an isolation transformer this can be done as routine procedure on every set on the test bench, ending the hazard of shock. Connected as auto transformers these isolation transformers can also be used to change 110V to 220V or the reverse. We do not believe that 100 watt 110V isolation transformers have ever before been offered at less than double our price of **\$2.95**.

## 274N COMMAND SET MADE BY WESTERN ELECTRIC

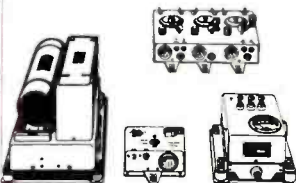
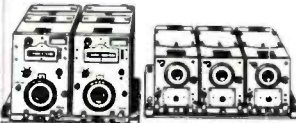

A mountain of valuable equipment that includes 3 separate Communications Receivers, covering up to 1MC. 2 separate 40 watt Transmitters including crystals, 4-25V Dynamotors (easily converted to 110V AC operation). Pre-amplifier and Modulator, 2 Tuning Control Boxes, and 1 Antenna Coupling Box complete with R.F. Ammeter, 25 tubes supplied in all. Receivers and Transmitters instantly detached from mounting racks for use in separate locations. Removed from unused aircraft and in guaranteed electrical condition. A super value at **\$59.95** complete.

## CO-AXIAL CONNECTORS

Army No. PL 239 or Amphenol 83-15P  
Army No. SO-239 or 83-1R  
Army No. PL 238 or 83-1J  
Army No. M-335 or 83-1AP  
49c ea.—in lots of 10 assorted 39c ea.

## TOGGLE SWITCHES

Order Number:  
SW-11—Single Pole, Single Throw. 35c  
SW-12—Single Pole, Double Throw. 45c  
SW-13—Double Pole, Single Throw. 57c  
SW-14—Double Pole, Double Throw. 69c  
SW-15—Spar, Double Throw.  
Center Off ..... 69c

## POWER RHEOSTATS

Very rugged. Will withstand severe overloading to many times nominal 25 watt rating, without burning or smoking. 3 sizes: 50, 60 and 200 ohms. Reg. price \$5.20. Special—**\$1.00**.

## 3-FOR-1 BARGAIN

\$7.00 TAKES 'EM ALL

### Aluminum Gear

Box 18 x 8 x 7 contains 2 powerful electric motors and 2 matched gear trains, 62 gears in all, varying in size from 1/2 to 1/4" in diameter. x 2 1/2. Contains 150mfd. of condenser capacity, sensitive relays, resistors and terminal strips. Order several at this giveaway price of only **\$1.95**.

### Relay Box 730A

Signal Corps Inter-connector Relay Box. This unit made by Bell (BC616) in aluminum case 6 1/2 x 5 1/2 x 2 1/2, contains 150mfd. of condenser capacity, sensitive relays, resistors and terminal strips. Order several at this giveaway price of only **\$1.95**.

### Remote Control

Aluminum case 4x3x2 contains revolution counter, 2 potentiometers, triple pole switch, 4 knobs, phone jack, and gear mechanism. Includes 8 prong JAN connector to fit box — **\$1.39**.

## BUFRAD SECTIONAL TOWER

This addition to the famous line of BUFRAD antenna products makes up to a hundred foot tower from any number of strongly welded ten foot sections, which are shipped assembled and painted. Erection is a matter of minutes. Assembly is a one man job, and is accomplished by climbing up the completed portion of the tower with the next



25 lb. section to be installed. Hand and footholds are provided for safety and ease. Cap at top of tower provides bearing surface for rotating, and prevents water from entering tubes. Useful for police or amateur transmitters. In addition, tower provides satisfactory TV reception where otherwise impossible. Ideal for supporting temporary or permanent power lines, wind generators, stadium public address speakers or spotlights for gas stations or parking lots. "B" and "C" sections to gether cost a total of **\$15.75** and total 20 feet. "A" sections, which make up the entire tower top, are each ten feet long and cost but **\$12.75** apiece. Mast base (not shown) is obtainable for only **\$6.00**. Base is especially useful when erecting tower on a sloping roof.

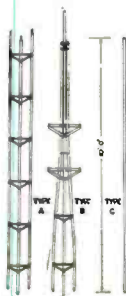

## PORTABLE AIR COMPRESSOR \$14.50

Portable air compressor and storage tank. Ruggedly built of best materials using lifetime-lubricated ball bearing on connecting rod and oil-immersed main bearing on shaft. Unusual design forever eliminates valve trouble. PATENTED unique air intake system increases efficiency tremendously over other compressors. Will deliver approximately 3500 cu. in. of air per minute at maintained pressure of 30 lbs. Comes complete with 100 lb. gauge. Finger-tip adjustment allows setting of output pressure at any value, which is automatically maintained. Works from any 1/4 H.P. motor. Useful for spraying paints or lacquers, disinfectants, insecticides, anacoring or brazing with natural gas, inflating tires, etc. Price **\$14.50** prepaid anywhere in the U.S. Efficient, completely adjustable syphon type spray gun complete with 12 ft. of 100-lb. tested hose available for only **\$7.75** with pint container, also prepaid. 25% required on all C.O.D. orders.

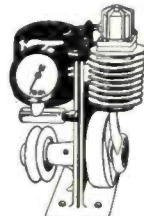

**BUFFALO RADIO SUPPLY, 219-221 Genesee St., Dept. RN 1, BUFFALO 3, N. Y.**

# SPECIAL JANUARY CLEARANCE!

## Tubes—New Standard Brands

Type	Price	Type	Price	Type	Price
2A3	\$.95	12A6	\$.22	2051	\$.85
2X2A	\$.85	14E6	\$.25	RK72	\$.85
6AC7	\$.65	249B	1.95	RK73	\$.85
6SL7	\$.65	249T	1.95	VR78	\$.35
6SN7	\$.65	446B	\$.85	VR105	\$.75
6Y6	\$.65	721A	2.95	CIA	2.95
7F8	\$.65	878	2.45	TaylorLVR	.45

## New Surplus Relays

Following types are \$23 each  
Any combination of 50 for \$10.00

Allied No. 808050 Miniature type. Contacts—3 pole; 2-single-pole single-throw normally open, plus single-pole, double-throw. Wide spacing—high-voltage insulation, isolantite spacers. Coil 300 ohms, 28 volts, D.C.  
Clare No. A-20545 Miniature type. Contacts—single-pole single-throw normally closed. Coil 45 ohms—6 volts, D.C.  
GE B101W3. 170 ohm, 20 volts, D.C. Contacts—3 single make.  
LEACH No. 1054. Coil 260 ohms, 24 volts, D.C. Heavy contacts, two pole single throw.  
CLARE No. S18062. 2 pole single throw. Miniature type. Resistance 140 ohms. Will operate from 10 volts D.C. or 20 volts A.C.  
TELEPHONE TYPE RELAY No. DB28091. Dual contacts, 4 P.S.T. Normally open Dual Winding Coil, 175 ohms and 180 ohms, 12 volts, D.C.  
MINIATURE RELAY No. D4913 S.P.D.T. Coil 300 ohms, 24 volts, D.C.  
STRUTHERS DUNN S.P.D.T. Relay 1800 ohm coil—20 ma. Contacts 2 amps. at 115 volts, A.C.

## VACUUM RELAY

RCA VACUUM RELAY. Relay contacts will break 3000 volts and carry 10 amperes. Solenoid resistance. 200 ohms, 24 volts, D.C. Excellent at R.F. antenna relay. Price..... **\$1.95**

## TIME DELAY RELAYS

THERMAL VACUUM TYPE. S.P.S.T. 100 ohm coil. 24 volts A.C./D.C. 90 second delay. Price..... **\$4.95**

WESTERN ELECTRIC No. KS10149. 60 second time delay relay. Cramer motor, 115 volts, 60 cycles. Switch S.P.S.T., 15 amps. May be internally adjusted for faster timing. Price..... **\$4.95**

## AC RELAYS

Allied type BJX. Operates on 6.3 volts A.C. Contacts SPDT. Small size. Price..... **\$1.95**

STRUTHERS DUNN No. CS2366. Coil 110 volts, 60 cycles, 3PST Contacts. 110 volts, A.C. 30 amps. Price Only..... **\$2.95**

CASED A.C. RELAY ALLIED No. BJH 6A115. Coil 115 volts, 50/60 cycles, D.P.D.T. Contacts. Housed in hermetically sealed can with feed-thru glass-wire terminals. Price..... **\$1.95**

## Nationally Famous Brands

### Precision Resistors

Types WW3, WW4, WW5

500,000 1% ..... \$1.65  
100,000 1% ..... .55

Following sizes are \$0.35 each; \$27.50/100:  
800,000 1% 220,000 2% 50,000 1%  
700,000 1% 125,000 1% 25,000 1%  
600,000 1% 109,000 1%

Following sizes are \$0.25 each; \$19.50/100 most sizes are 1% or better—others 2%:  
95,000 20,000 7,500 1,400 70  
92,000 17,000 5,000 1,200 50  
84,000 15,000 4,500 1,000 30  
82,000 12,000 4,300 750 22  
80,000 11,000 4,000 140 20  
66,000 10,000 2,200 130 14  
46,000 8,000 1,500 125 12  
33,000

Following sizes are \$0.15 each; \$12.50/100 odd types are 1% or better, round numbers are 3% or better:

.399 meg.	26,500	2,230	235	40
.268 meg.	22,000	1,123	110	35
109,000	20,820	988	70	30
54,500	17,300	280	50	6

Following sizes are \$0.10 each; \$8.50/100 most sizes are 1% or better:  
414.3 53.96 13.333 3.94 1.563  
366.6 53.32 10.2 3.5 .29  
220.4 33.22 5.1 2.56 .256  
147.5 23.29 4.3 2.14 .25  
105.8 13.52

FOR COMPLETE LISTINGS OF SPECIAL BUYS ON RELAYS, TUBES, METERS, CONDENSERS, ETC., WRITE FOR FREE CATALOG R1

## EDLIE ELECTRONICS, INC.

Telephone Digby 9-3143

154 Greenwich Street New York 6, N. Y.

# LETTERS

from our readers

## "FAIR TRADE" AIN'T FAIR!

**R**ARELY do I read anything that makes me blind with rage. I am of a phlegmatic nature, but that article on fair (so-called) trading the prices of television sets made me feel like a Republican when low tariffs are mentioned.

"Do you remember 1946? OPA and price control? Industry propagandists hollered 'Loosen the chains from our great enterprising system! Sure prices will go up for a while, but the resulting volume of goods will soon bring on competition and competition will lower prices!' As far as I can remember, nothing was said about these nefarious un-fair trade laws.

"I went along with them about removing price controls. As a consumer I was apprehensive, but I put myself in the businessmen's shoes and agreed that I wouldn't want anyone telling me what I was going to charge for the articles that I made or sold. Let Freedom ring!

"Then comes Christensen with his Machiavellian article. Just about the time the industry has started to catch up, he says, 'Well, well, perhaps we were a little hasty about price controls. I believe we were wrong about that theory of free enterprise—freedom can go to excess too. Of course, we couldn't let government bureaucrats determine what prices should be, but our bureaucrats are of a higher order and their prices will protect us against the stern realities that we will have to face if open-field competition takes over. It was very naughty of the government to put a ceiling on prices but helping us to keep a floor under them is as virtuous as padlocking a bawdy house. Let Law and Order prevail!"

"Take that slick wording 'which is in open competition with commodities of the same general class produced by others.' Just look at the prices of refrigerators and toasters, if there is 1/2 per-cent difference in them I'll chew the chromium plating off a sample of each.

"About that poor department store that was complaining it would have to discontinue the sale of television sets. Well, isn't that a case of an inefficient business that must fall by the wayside to make room for a hustling organization? Competition must be with respect to prices and not with respect to screaming advertisements and slick-tongued salesmen.

"One of the main reasons that I am writing this letter is that I am one of those people that are not 'sold' any product. Why should I contribute to the support of some overpaid adver-

tising copywriter and his ulcers or a flashily dressed salesman and his gardenia? Why can't I objectively and scientifically pick up the article I want to buy and pay the minimum price as set by unrestricted competition? Why?

"I hope that your magazine will take up the challenge and start a campaign against this latest threat to our free enterprise system."

Frederick R. Redwine  
Chattanooga, Tenn.

## NEW RECRUIT

**J**UST a note to tell you how much I enjoyed the July issue of RADIO & TELEVISION NEWS.

"I quit buying it for awhile because the articles were way over my head. The article on the 'Beginning Amateur' is really tops for I appreciate any tips that are offered there, as I imagine other beginners do.

"At the present time I am trying to learn the code and learning it by myself is one heck of a job. If you print this letter I would appreciate it if any amateur in this city would contact me and tell me if there is a "ham" club around here."

Albert Baumgartner  
423 Walnut Court  
Jacksonville, Florida

Here's a chance to help Albert get his ticket and also garner some valuable points toward the prize in RADIO & TELEVISION NEWS' big ham contest.

## OPEN LETTER

**T**HROUGH years of reading your magazine, I have found it to be an unbiased one. I was wondering if you couldn't give a helping hand to the radio technician by printing an open letter to the radio manufacturers that I have written. This message, you will find, is not unreasonable, but on the contrary makes a lot of sense to anyone in the rural districts unfortunate enough to be in the radio business today.

"We, the service technicians of the radio industry, have a good cause to gripe. We would like to know what is the matter with the radio manufacturers and why they let us down when the season for selling radios comes around.

"They announce, with great fanfare, the coming of the next line with the result that we try our best to sell them. Then what happens? They won't let us have any! They always have some poor excuse that does not make sense.

"When we have occasion to service these sets we have to wait for weeks for a replacement part.

"In other words, they are all so busy with television that they forget all

# ***Y*our telephone uses ceramics, too!**

Five thousand years ago, potters were making household vessels of clay. As skill grew, grace of shape and ornament were added. The beauty of fine china has been recognized by every civilization, while the availability, ease of manufacture and durability of other ceramics have given them wide use.

Your telephone, too, uses ceramics. Behind its dial is a metal plate, glazed as carefully and in much the same manner as this fine piece of pottery. It carries the letters and numbers you dial, so it must resist both fading and abrasion. You will find other ceramics as insulators, supporting wires on pole lines; in eighty thousand miles of underground conduit, where fired clays defy decay and corrosion.

Today at Bell Telephone Laboratories scientists utilize ceramics in ways undreamed of in ancient times. Thermistors, made of a ceramic, provide automatic controls for electric current, to offset fluctuations in temperature and voltage. One kind of ceramic makes low-loss insulation at high frequencies, while another supplies controlled attenuation for microwaves traveling in waveguides.

Each use demands a special composition, scientifically controlled and processed. Basic studies in the chemistry and physics of ceramics have shown how to utilize their versatile properties in electrical communication. And research continues on ceramic materials as well as on every other material which promises better and cheaper telephone service.

**BELL TELEPHONE LABORATORIES**



*EXPLORING AND INVENTING, DEVISING AND PERFECTING, FOR CONTINUED IMPROVEMENTS AND ECONOMIES IN TELEPHONE SERVICE.*

# 3 GREAT NEW TITONES

## meet changing pickup needs!

NOW a full line of Titone's amazing ceramic pick ups—made by famous Sonotone! All with these great basic features: Full frequency (response from 50 to 10,000 cycles.) Bell-like supertone makes new or old players thrilling. Climate-proof, moisture-proof, fungus-proof! Lightest pressure saves needle wear, revives worn records. NO needle talk! NO crystals, magnets, filaments to fail. NO pre-amplifiers. Performs perfectly for years!

### 3 NEWEST! TITONE

#### MICROGROOVE PICKUP

For all 45 and 33 1/2 rpm players. Highest compliance and 5 to 6 grams needle pressure give minimum wear on record and needle! Aluminum case—1 mil permanent sapphire needle.

Order # W 7530 ..... \$7.95 list

### 2 NEWER! TITONE

#### 3-MIL PICKUP

New superlight aluminum pickup complements famous original Titone pickup below. 15 grams needle pressure gives unparalleled reproduction, lowest wear!

Order # W 7540 ..... \$7.95 list

### 1 NEW! ORIGINAL

#### CERAMIC TITONE

Within a few scant months in widest use from coast to coast! Plays at 20 grams needle pressure. Used instead of the newer aluminum Titone above for changers requiring over 15 grams pressure to "flip" records.

Order # 7500 ..... \$7.50 list

NO TONE LIKE TITONE



Call your Jobber or write to SONOTONE, Box 5, Elmsford, N. Y.

about radio, and all the rural areas that cannot possibly get television reception. We have come to the conclusion that they don't care about us at all.

"If we can't get radios to sell when the selling is good, how are we to make a living? If they would stop and think, we are the ones who keep them in business for the simple reason that if they had to service their own sets, they wouldn't have time to make any.

"Consequently when television does come, the people will look to the manufacturer who has given them good service, has supplied them with fine radios, and has been prompt in the delivery of replacement parts and radios to the proper outlet when they want them."

Paul B. Begin,  
Rumford, Maine

\* \* \*

#### SUGGESTION

JUST a line or so to let you know how much I enjoy, and have enjoyed, your magazine for the past 12 years or longer. I have been in radio about that length of time and at present am employed as an electronic engineer at the United States Naval Academy at Annapolis.

"The purpose of this letter is to ask you about an idea that has occurred to me every time I use your magazine, which is quite often. I find it extremely helpful as a reference but am one of those unfortunate fellows with a short memory and can't remember in what issue I saw such-and-such an article.

"Last January 1st I made a resolution not to have this trouble again so as each issue came out I read it and then tore out the Table of Contents, punched three holes in it and put it in a loose-leaf notebook. This gives me an instant index to any article. In this way I have increased the value of the magazine 100 per-cent because I have made it a reference book rather than an occasional magazine.

"Why don't you folks publish an index (loose-leaf) with a binder which could be included with each mag for a few cents extra. Believe me, it would be a boon to us all, and the time saved would be worth many times the yearly price of the magazine.

"Yours for the continued success of a great magazine."

Joseph H. Griscom, Jr.  
Eastport, Md.

We hope the yearly index, published in the December issue, is of help to Mr. Griscom. All articles are indexed as to subject matter.

\* \* \*

#### IT WORKS FINE!

I HAVE just renewed by subscription to RADIO & TELEVISION NEWS and thought I would write you a letter to let you know how much I like the wonderful magazine. I have been a reader of the "News" a long time and have gotten a lot of enjoyment out of every issue. Radio is only a hobby with me and I spend a lot of time with it.

"I have the October issue before me right now and have it opened to page

54 to the article on the construction of "A Low-Cost Ham Receiver." I have already constructed the set and find that it is all that it is said to be. I have made only one change in the set and that is that instead of using plug-in coils as in the article, I have used the coil changing assembly from a surplus BC 321 which I happened to have on hand. I still have a little work to do on the coil circuit and as soon as I get it finished I'll write up an article on this change and send it in to you.

"I find that many of the radio magazines nowadays are going too much towards television. I know that television is the coming thing but I don't see any reason why a magazine should devote all of its space to just television. There are a lot of radio bugs that are still interested in the construction of radio sets of all types. I notice that you have articles to suit all radiomen. I buy all the radio magazines at the newsstands but find yours the only one that I can get anything out of without getting too deep in technicalities. I am studying for a ticket so will soon be a ham and of course I will construct a transmitter from your magazine.

"I thought maybe you would like to hear from me and know how much I like the magazine. Please keep up the good work and let's have more construction articles on s.w. receivers. Will be looking for your swell articles from month to month."

Howard D. Thompson  
Salem, Oregon

\* \* \*

#### NECK STRETCHER

THE November issue of RADIO & TELEVISION NEWS was purchased today and I enjoyed the articles very much.

"As I perused the pages my eyes fell on the cartoon by Russ Priestly at the lower right hand corner of page 116. The gentleman depicted seems to be enjoying the television program very much but I wonder if he objects very much to the projected video picture being upside down."

Donald F. Suppes, W2KDQ  
Winchester, Mass.

If he doesn't now he will later!

-30-

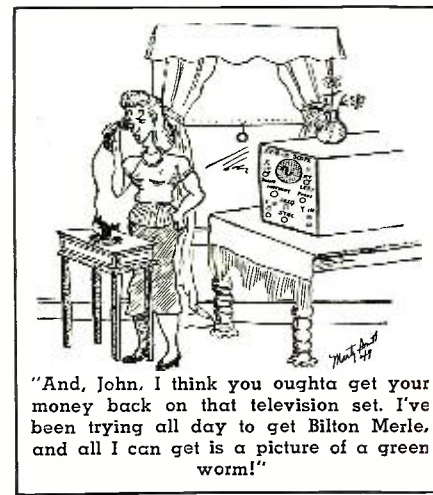

"And, John, I think you oughta get your money back on that television set. I've been trying all day to get Bilton Merle, and all I can get is a picture of a green worm!"

# it's ALLIED for hallicrafters!



ONLY **\$1795** down

## hallicrafters SX-71 Communications Receiver

The new top-performing communications receiver at amazingly moderate cost! Designed especially for the discriminating Amateur and SWL fan. Covers five full bands: 538-1650 kc; 1600-4800 kc; 4.6-13.5 mc; 12.5-35 mc; 46-56 mc. Features double conversion superhet circuit, high image rejection, razor-sharp selectivity, extremely high sensitivity. Includes: full electrical bandspread; tuned RF stage, 3-step crystal filter; built-in NBFM adapter; automatic noise limiter; calibrated "S" meter; BFO pitch; tone control; extra-wide-vision dials; 3-watt communications-peaked audio; temperature compensation; universal antenna input. In satin-black steel cabinet; 18½ x 7¾ x 12". Complete with 11 tubes, rectifier and regulator. For 105-125 volts, 50-60 cycles. Shpg. wt., 33 lbs.

97-506. SX-71, less speaker. Only **\$1795.00**  
 \$17.95 down, \$14.27 monthly for 12 months

97-786. R-44B matching speaker. Shpg. wt., 19 lbs. Only \$24.50

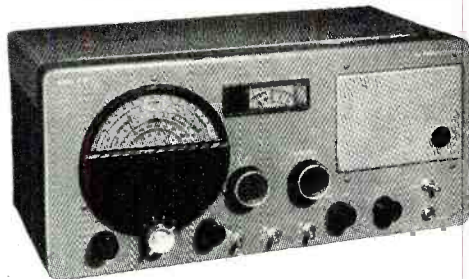

## hallicrafters S-40A All-Wave Receiver

ONLY **\$8.00** down

Popularly-priced Hallicrafters communications receiver, packed with advanced features. Covers 550 kc to 43 mc in 4 bands. Highlights include: full electrical bandspread; inertia flywheel tuning; calibrated main dial; automatic noise limiter; adjustable pitch BFO; standby switch; code-phone switch; headphone jack; shock-mounted speaker; separate sensitivity and volume controls; 3-position tone control. All tubes included. In handsome all-steel cabinet, 18½" x 9" x 11". For 105-125 volts, 50-60 cycles AC. Shpg. wt., 32 lbs.

97-546. Hallicrafters S-40A Receiver. Only **\$7995**  
 \$8.00 down, \$6.36 monthly for 12 months

(ALL PRICES NET F. O. B. CHICAGO)

# ALLIED RADIO

## Everything in Radio, TV & Electronics

January, 1950

# FREE

Send for Your Copy of the 196-Page 1950



## ALLIED CATALOG!

Get the only complete Radio Buying Guide! It's used daily by thousands of expert servicemen, engineers, amateurs, soundmen, builders and experimenters. Get every buying advantage at ALLIED: widest selection of equipment at money-saving low prices — speedy, expert shipment — personal attention — complete satisfaction on every order. Get your latest ALLIED Catalog today — use handy coupon below!

**GET IT NOW!**



## hallicrafters S-38A the Super-Value All-Wave Receiver

The all-star, all-wave value that amazes even the experts. Covers 4 full wave bands, continuous range from 540 kc to 32 mc. Features: full electrical bandspread; Band Selector; Voice-Code switch; Speaker-headphones switch; Standby-receive switch, latest PM speaker. In handsome furniture-steel cabinet, 12¾ x 7¾ x 7¼". Complete with all tubes. For 105-125 volts DC, or 40-60 cycles AC. Shpg. wt., 15 lbs.

97-508. Model S-38A Receiver. Only **\$3995**



## S-72 All-Wave Portable

The DeLuxe portable! Covers 4 bands: 540-1600 kc, 1500-4400 kc, 4.3-13 mc, and 12-31 mc. Has built-in loop for standard broadcast and 27" whip for short wave. Automatic Noise Limiter; sensitivity control; AVC; BFO; main and fine tuning controls; tone control; phone jack. Brown leatherette-covered cabinet, 14 x 12¼ x 7¼". For 105-125 volts DC, or 60 cycles AC, or self-contained batteries. Complete with tubes, less batteries. Shpg. wt., 16 lbs.

97-505. S-72 Portable. Only **\$7995**  
 ONLY **\$8.00** down, \$8.00 down, \$6.36 monthly for 12 months  
 80-585. Battery Pack. Only **\$3.85**

# FREE

ALLIED RADIO CORP., Dept I-AA-0  
 833 W. Jackson Blvd., Chicago 7, Illinois

- Send FREE ALLIED Catalog
- Enter order for Hallicrafters Model ..... Enclosed \$.....  Full Payment  Part Payment (Bal. C.O.D.)
- Send ALLIED Easy Payment details and order blank

Name.....

Address.....

City..... Zone..... State.....





## Offers Full Frequency Type Recording at a SAVING!

The widely acclaimed Magnecorder PT6-JA portable magnetic tape recorder is the *only* moderately priced instrument on the market today that gives you a flat frequency response all the way from 40 to 15,000 cps  $\pm$  2 db. — *twice* the range of many others! Low in distortion and wow, the Magnecorder PT6-JA meets high NAB broadcast standards.

### RECORDER

This is the same type recorder used by commercial stations and recording studios throughout the world. Includes quick-change capstans for recording

at 7½ or 15 in./sec., high-speed rewind, and high speed forward.

### AMPLIFIER

This amazingly low priced, high quality amplifier includes low impedance microphone and bridging inputs, gain control with VU type meter, 10 watt audio amplifier with monitor speaker and terminal for external speaker, zero level line output terminal. Three-position switch selects erase/record, playback, or public address.

### PORTABLE UNIT CONSTRUCTION

The PT6-JA is built in two conveniently proportioned cases averaging about 25 lbs. each. Carry it anywhere. Either unit can be combined with other Magnecord field or studio equipment.

See, hear, operate this outstanding tape recorder today. Call on your Magnecord dealer, or write for his name and PT6-JA specifications.

**Magnecord, INC., CHICAGO 1, ILL.**  
360 NORTH MICHIGAN AVENUE  
World's Largest and Oldest Manufacturer of Professional Magnetic Recorders



## MAKE HENRY YOUR hallicrafters HEADQUARTERS!

### POPULAR HALLICRAFTERS MODEL SX-43

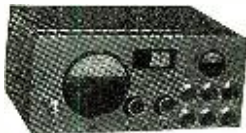

All essential ham frequencies from 540 kc to 108 Mc. In the band of 44 to 55 Mc, wide band FM or narrow band AM, just right for narrow band FM reception is provided. 115 V. AC. 10 tubes plus rectifier. Only \$159.50, less speaker.

### MEDIUM PRICED HALLICRAFTERS MODEL S-40A



540 kc. to 43 Mc. Temperature compensated. One RF, 2 IF. 3-watt output, 4 bands. 115 V. AC. 8 tubes plus rectifier. Internal speaker. Only \$79.95.

I have a complete stock of Hallicrafters receivers and transmitters and Television equipment. I'll make you the best deal on a trade-in of your communications receiver for a television receiver. I give you immediate delivery, 10-day FREE trial, and 90-day FREE service. Nobody can beat Bob Henry on a trade-in, and I offer you the world's lowest credit terms. Write, wire, phone, or visit either store today for the best deal.

*Bob Henry*  
WΦARA

Buffet 2, Missouri

**HENRY RADIO STORES**

11240 Olympic Blvd.  
LOS ANGELES 29  
CALIF.

WORLD'S LARGEST DISTRIBUTORS OF SHORT WAVE RECEIVERS

## Frequency Measurements

(Continued from page 35)

A difficulty will arise in making these tests if the receiver used has an i.f. frequency which is a multiple of 5 mc. The oscillator signal may be received directly by the i.f. stages. If this occurs the signal will persist, regardless of how the receiver dial is tuned. This difficulty may be overcome by realigning the i.f. stages to a slightly different frequency.

### Signal Generator Method

Most signal generators used by radio service technicians will issue harmonics which fall in the FM broadcast band. Such generators, with the use of an auxiliary oscillator, can be used to mark frequency points in the citizens radio band.

To use this method, the signal generator should first be calibrated at a lower frequency either with WWV, or with its own crystal. The harmonics of this signal should then be tuned in on an FM broadcast receiver.

A simple oscillator, such as that shown in Fig. 2, can be constructed from an acorn tube and a National AR-5 slug-tuned coil or its equivalent. This oscillator will tune over a range which includes the FM broadcast band.

This oscillator can be aligned with the harmonic from the signal generator by the beat-frequency method, using the FM receiver to match the two signals.

The fifth harmonic of the signal from this oscillator will then fall in or about the 460-470 mc. band. A wavemeter or receiver which will receive the citizens frequency may then be calibrated by marking the harmonics as they appear.

A less accurate method calls for calibrating the test oscillator by zero-beating with an FM broadcast station rather than a signal generator and WWV. The result will be most accurate if the oscillator is checked during those brief moments when the FM car-

Fig. 2. Diagram of 89-120 mc. test oscillator.

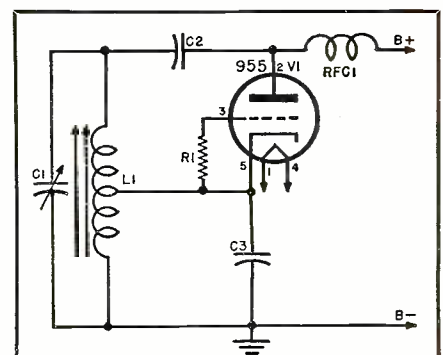

R<sub>1</sub>—27,000 ohm, ½ w. res.  
C<sub>1</sub>—25 μfd. var. cond.  
C<sub>2</sub>—1000 μfd. mica cond.  
C<sub>3</sub>—100 μfd. mica cond.  
RFC<sub>1</sub>—1.8 μh. r.f. choke (Ohmite Z-144)  
Additional chokes of same value may be placed in heater supply leads  
L<sub>1</sub>—National AR-5 slug-tuned coil  
V<sub>1</sub>—955 tube

rier is unmodulated at station breaks.

Ordinarily, the wide deviation of FM stations under modulation conditions will make it difficult to identify the center frequency of the station.

The FM band oscillator, regardless of the means used to check its fundamental frequency, should be equipped with a paper dial which can be marked for its harmonics. Three or more check points against the signal generator or FM station should be made. The fundamental frequencies of each of these points are then multiplied by five, and the result marked on the dial.

If FM stations are used as frequency standards, those transmitting on 91 to 94 megacycles will have harmonics in or near the citizens band.

While none will probably provide a check point at exactly 465 mc., the dial can be calibrated by interpolation between the known points. If a straight-line frequency condenser is not used in the oscillator, the scale will not be linear, and due allowance should be made for this fact when calibrating the oscillator. -30-

### TRANSMISSION LINE CONNECTOR LOSSES

By MATTHEW MANDL

**M**OST television receivers use a 300-ohm twin-lead section from the tuner at the front of the chassis to the transmission line terminal posts at the back of the set. If any portion of this twin lead section touches the chassis or other metal parts of the receiver the result will be a pronounced decrease in signal strength. Even though this section of line does not actually touch the chassis, but runs parallel to it by one or two inches, it will affect reception, particularly on the higher channels where the shunt capacity effect would be greater.

After any servicing procedures involving chassis removal or other disturbance of this twin lead connecting link, it should be bent up and away from chassis and other metal parts. The soldered terminal connections at each end should also be checked, because the stranded wire of the twin-lead section often breaks at these points due to the constant movement this section undergoes during normal servicing procedures when the chassis is on the work bench. -30-

The antenna leadin (bottom right) should be held away from chassis to prevent losses.

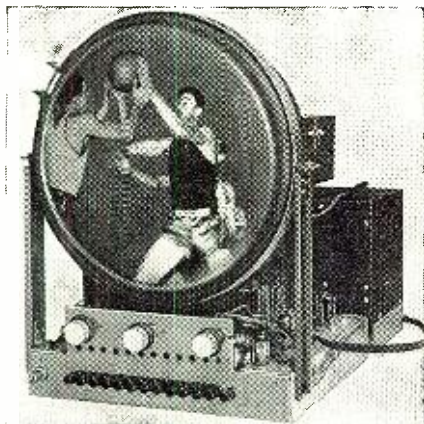

# ...after 9 months of daily use ON 30,000 MILE TREK THROUGH AFRICAN JUNGLE

with Arch Oboler

Famous Radio Playwright.

**E-V CARDYNE takes everything...from  
the heat and humidity of the Congo to  
the rain-swept slopes of the Mountains  
of the Moon, to the snow and ice of  
16,000 foot Mt. Kenya's glacier fields!**



Shows Arch Oboler recording Masai savages in Kenya, British East Africa

"...trip was made by boat, pack horse, jeep and foot under most difficult conditions...apparatus had to endure penetrating dust and great variations in humidity...used the Cardyne almost entirely...never failed, during months of use and abuse...

made recordings of experiences on African safari...for a series of transcribed radio broadcasts...after return to U.S., found the Cardyne to be in thoroughly operative condition from every standpoint...built-in ruggedness of E-V microphones means a longer, more useful life at any time, anywhere."

Arch Oboler...Author-Director. Winner of Radio's Top Awards, including the Peabody Award (Radio's Pulitzer).

Shown using E-V Cardyne Cardioid Microphone in recording the Ituri pygmies in the Belgian Congo.

Write for Cardyne Bulletin No. 139

**ELECTRO-VOICE INC., BUCHANAN, MICH.**

Export: 13 East 40th St., New York 16, U.S.A.

Cables: Arlab

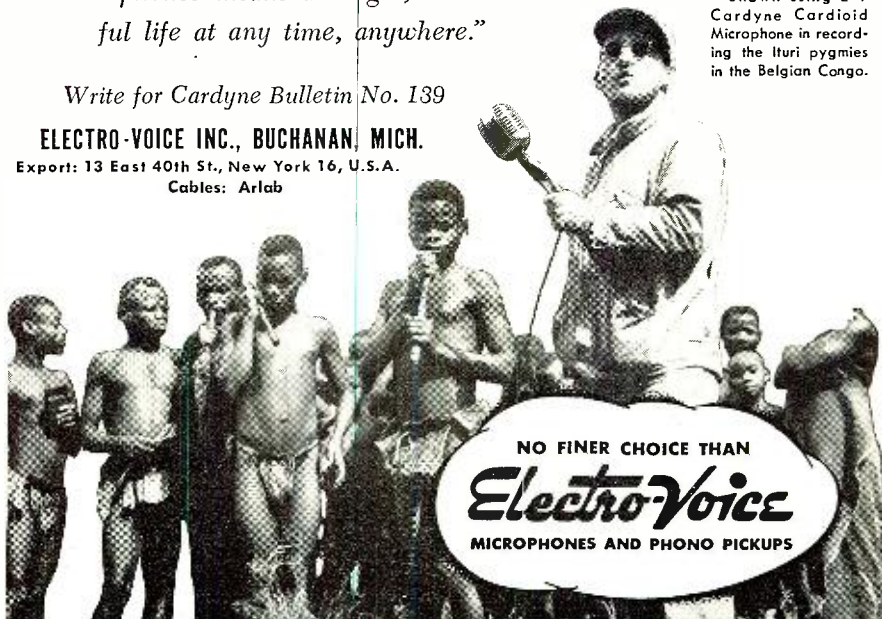

NO FINER CHOICE THAN  
**Electro-Voice**  
MICROPHONES AND PHONO PICKUPS

# WHAT IS YOUR PROBLEM?

You will find the answer in

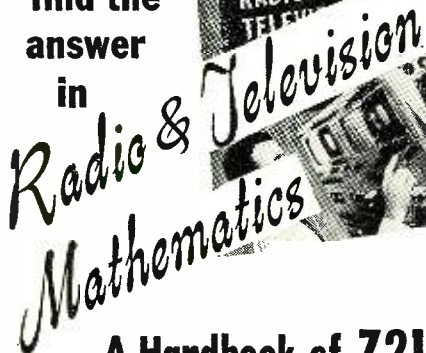

## A Handbook of 721 problems AND SOLUTIONS

Save time and trouble. Arranged under radio and electronic headings and completely indexed for quick reference, these problems give you step-by-step solutions to every problem commonly arising in work on receivers, power supplies, antennas, amplifiers, tubes, transmitters, etc. If you are ever "stuck" on a calculation; if you need a check on your figuring; or if you want to refresh your memory on the formulas to use for a certain problem—you will find your answer quickly and easily in this book.

Good practice for your FCC exams. This book shows you how to solve every problem requiring mathematics in the FCC STUDY GUIDE for licenses of all classes. You will find no better handbook for practice in solving problems with ease, speed and accuracy. \$6.00

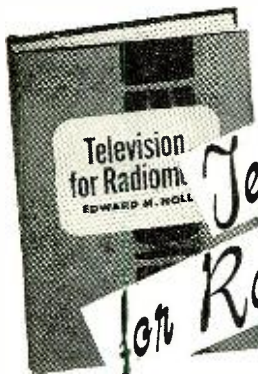

Just Published

## Television for Radiomen

The how's AND WHY'S in the practical terms of operation & servicing

This book explains the theory as well as the techniques of television construction, operation, and servicing in the clearest, most practical terms. It gives the radioman all the basic information he needs to meet the increasing demand for skilled television technicians. It shows how and why all modern equipment operates; includes all the essential mathematics and especially good material on antennas. \$7.00

### SEE THEM FREE

The Macmillan Co., 60 Fifth Ave., New York 11

Please send me a copy of the books checked below. I agree to remit in full or return the books within ten days without further obligation.

- Radio & Television Mathematics, \$6.00  
 Television for Radiomen, \$7.00

Signed.....

Address.....

## Eliminating Broadcast Interference

(Continued from page 52)

tenna, however, a filter may still be necessary to prevent the horizontal frequency harmonics from finding their way up into the antenna and being radiated from this point.

The majority of better quality receivers with well-designed front ends have efficient high-pass filters and on such sets it will be found that disconnecting the antenna transmission line does not reduce the interference. Under these conditions, radiation is taking place either from the power line of the TV receiver or from the chassis itself or both. Bypassing both sides of the power line directly at the point where it enters the chassis with .001  $\mu$ fd. condensers to ground will minimize power line radiation. Support the condensers on terminal strips and make the ground connections as short and direct as possible. If the interference still persists after this modification (and frankly, it usually does!), it is time to go to work on the TV chassis itself.

Remove the chassis from the cabinet and inspect the spring-like strap which makes contact between the chassis and the black aquadag coating on the bell of the picture tube. This coating, in conjunction with a similar coating on the inside of the bell, forms a capacity of approximately 500  $\mu$ fd. which helps filter the high-voltage applied to the picture tube. If the outer coating is not well grounded, it will act as an effective radiator for the horizontal frequency harmonics. Most receivers use one or more spring straps riveted to the chassis which make pressure contact to the bell of the picture tube when it is properly seated. These spring clips are sometimes unintentionally bent out of place when the picture tube is inserted in the chassis and the result is that the conductive coating on the bell of the tube is left floating. The remedy, of course, is to bend the springs so that firm contact is made to the bell of the tube.

If the bell of the tube is grounded, more drastic measures must be taken to eliminate radiation which can be taking place from anywhere in the horizontal output circuit. The horizontal output transformer, the horizontal output tube, and the damping tube are the "hottest" parts of the offending circuit and most TV set manufacturers provide partial or complete shielding of these components to suppress radiation. Heavy radiation also takes place from the face of the picture tube but obviously nothing can be done about this.

If the shielding is fairly complete, considerable radiation can still occur from the wiring in the horizontal output circuits, particularly between the deflection yoke around the neck of the tube and the horizontal and vertical output transformers. Such radiation can be suppressed by using shielded

wire between the vertical and horizontal output transformers and the deflection yoke. It is necessary to shield both the vertical and horizontal leads since coupling can take place between the two windings in the yoke and result in radiation from the leads running to the vertical output transformer.

It will sometimes be found that resonant conditions are formed in the deflection yoke to output transformer wiring which peak the harmonics over a small portion of the broadcast band. This can best be cured by shielded wire or more simply by wrapping flexible metal braid around the existing wiring and grounding it securely to the chassis.

If shielding around the horizontal output circuit is skimpy, dress all external leads such as loudspeaker voice-coil connections, pilot lamp leads, etc., as far away as possible from this section of the chassis to prevent these leads from picking up and radiating harmonic energy.

Although incomplete shielding around the horizontal output circuit can be improved upon by fabrication and installation of makeshift shields made from copper screening, a more satisfactory solution consists of lining the inside of the TV cabinet with copper screening. If the chassis does not have a bottom plate, then copper screening on the inside bottom of the cabinet will nearly always be beneficial. It is usually easier to line the inside of the cabinet than it is to try to form and secure odd size shields around the various offending components.

Improving the signal-to-interference ratio at the broadcast receiver by a more efficient antenna is helpful in severe cases and often merely changing the location of the broadcast set by ten feet or so and orienting it slightly to take advantage of the directional properties of the loop will cut down the interference greatly. If the broadcast set uses an outside antenna make sure that the lead-in is dressed as far away as possible from the general vicinity of the TV receiver. Although the interference can often be reduced or eliminated by these and similar measures at the broadcast receiver, it is best to take all possible steps to reduce radiation at the TV receiver itself since it is the actual offender and the owner of an a.c.-d.c. broadcast midget may be loathe to make concessions for the "capitalistic" owner of a television set.

Fortunately, TV receiver manufacturers are now cognizant of the potential seriousness of this interference condition and most of the later model TV sets being produced incorporate improved design and shielding to minimize this condition. It still remains for the individual service technician, however, to use his native skill and ingenuity in overcoming interference created by existing sets and it is hoped that the suggestions offered in this article will serve as a starting point in such cases.







## Do They Haunt Your Pictures?

You can eliminate ghosts by installing a WORKSHOP antenna. The heart of most TV problems is *signal-to-noise ratio*. If the ratio is high, you get sharp, brilliant pictures. If it's low, you get one or several kinds of disturbances — ghosts, snow, noise, or interference.

By using high-gain, 3-element arrays directly matched to coaxial cable for each channel, Workshop gets the maximum signal-to-noise ratio. This means your pictures are *always* strong, clear, and steady. Why not know in advance you are going to get the ultimate in TV reception? . . . Specify WORKSHOP.

TV Antenna Catalog 49 shows how WORKSHOP solves reception problems. Write for your free copy today.

### WORKSHOP ANTENNA FEATURES

- HIGH GAIN** — 5 to 11 db. over a conventional dipole.
- SHARP DIRECTIONAL PATTERN** — narrow "beam" in both horizontal and vertical planes.
- HIGH SIGNAL - TO - NOISE RATIO** — to eliminate interference.
- SINGLE CHANNEL SELECTIVITY** — single, tuned array for each channel.
- FRINGE AREA RECEPTION** — exceptional signal strength — even beyond 100 miles.
- RUGGED CONSTRUCTION** — 1/2-inch duraluminum elements — strong, weatherproof assembly.
- CLEANCUT APPEARANCE** — streamlined design.



## Aircraft Radio

(Continued from page 34)

Aircraft radio's future is tied up with aviation. If aviation rises or falls so will its electronic offspring.

Do not be deceived into thinking that aviation is the industry open to a chosen few booted and goggled supermen where everything is booming and everybody carries off a bucket of gold for his daily labors.

It is a new industry; in its short life it has had its share of depressing times when many employees were fur-

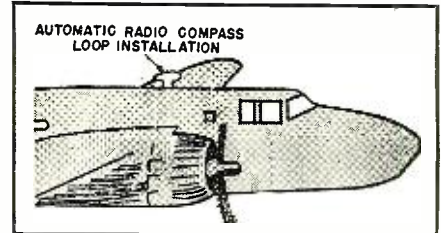

Showing the positioning of the radio compass loop in relation to the fuselage.

loughed. In the years since the war most of the companies have lost money. Those that survived are beginning to get into the black and show signs of an upward trend.

What can be definitely stated is that aviation is a young industry and that aviation is here to stay.

There is a tremendous amount of wealth, both government and private, invested in aviation.

In spite of all its fine achievements aircraft radio has its shortcomings; it still has vast room for improvement.

Much of aviation's future is dependent upon the advancement of electronics.

The administrator of Civil Aeronau-

How a radio signal is used to "home" a plane during adverse weather conditions.

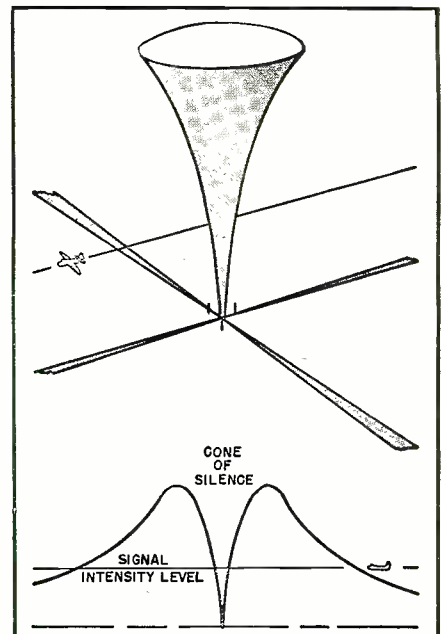

## THE WORKSHOP ASSOCIATES, Inc.

Specialists in High-Frequency Antennas

62 NEEDHAM STREET, NEWTON HIGHLANDS 61, MASSACHUSETTS



## WHILE THEY LAST!



Navy "WALKIE-TALKIE" Model "M" series, 2.3 mc to 4.5 mc crystal controlled rec-transmitter. Ideal for hams, forest service, foreign, etc. Uses 7 peanut tubes and ordinary dry batteries that fit into same case. Weight less batteries, 6 lbs. With all tubes, mike, headset, antenna, bag, diagram and 2 crystals. LIKE NEW, 2 for \$48.00. Each..... \$25.00

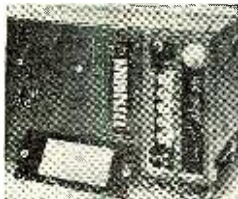

**20 to 28 MC FM TRANSMITTER BC-604** for 11 & 15 meters; can be operated on 10 meters by use of proper crystal; 10 channels; with all tubes, meter, diagram, case and covers; less xtals and drawer.

USED, Excellent, w/dyn..... \$19.95  
 USED, Good, w/dyn..... 15.95  
 USED, Good, w/o dyn..... 10.95  
**BC-684 TRANSMITTER** 27 to 38.9 MC; 30 watt 10 channel (as above); with covers, tubes, meter, diagram; less crystals and drawer.  
 U-1 with dynamotor \$34.95 Without dyn..... \$29.95  
 U-2 with dynamotor 29.95 Without dyn..... 24.95  
**PLUG**, Cannon female fits into any of above FM sets. Does away with Mounting P-T-237 ..... \$2.45  
**GUN CAMERA type N-6** for 16 mm film; 35 mm f/3.5 lens; footage indicator, variable shutter speed & aperture, 24VDC motor & magazine. Used, excellent..... \$24.95

Postage extra. 25c charge on orders under \$2.00.  
 TERMS: Net cash, 25% deposit on C.O.D.'s

**ELECTRONIC SUPPLIES**  
 219 R East 1st St. Tulsa 3, Oklahoma

### BURGESS VIBRO-SPRAYER



Just plug-in and spray! No compressor or other extra equipment needed. Sprayer applies enamel, lacquer, varnish, shellac. Sprays light oils, liquid wax, insecticides. An absolute "must" around any service shop, ham shack, home. At this low price you can't afford to be without one! Only \$12.95 ea.

### SPARE PARTS BOX

An extremely well-built steel box, hinged cover with two side carrying handles. Dimensions, 18" long, 12" wide, 6" deep. Finished in grey enamel. This light-weight but rugged box is ideal for fishing tackle, tools, portable sets and dozens of other applications. Hard to beat at this low price or at any price..... \$1.45 each

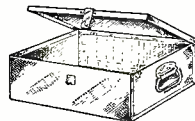

### BEAUTIFUL, 3 1/2" G-E METERS

Round phenolic cases, brand-new, backed in original boxes. Here is real value!  
 0-15V, AC. Check those  
 filaments ..... \$2.95 ea.  
 0-500 ma. Ideal for xmters..... \$2.95 ea.  
 100-0-100 ma. Galvanometer  
 for bridges ..... \$2.95 ea.



### MARKET SPECIALS!!

\$14 Tubes. New—not surplus—G-E..... \$2.95 ea.  
 Sigma, 8000 ohm relays—sealed..... \$1.95 ea.  
 Sigma, 2000 ohm relays—sealed..... \$1.95 ea.  
 11S-16 phones. Use on most comm. revrs... \$1.39  
 815 twin tetrodes . . . priced right at..... \$1.95 ea.

### P-T-T HIGH-QUALITY CARBON MIKE

Molded phenolic case—p-t-t button—cord spring—hi-quality W-E, P1 button. A mobile necessity at..... \$3.95  
 W-E, P1 unit only..... 1.50  
 American carbon button..... 49c  
 Kellogg carbon button..... 49c



### MARKET RADIO STORES

Two stores to serve you.  
**MARKET RADIO SUPPLY CO.**  
 1240 Market St., San Francisco, Calif.  
 Phone Market 1-2115  
**MARKET RADIO STORES, INC.**  
 1918 16th St., Sacramento, Calif.  
 Phone Gilbert 3-2913

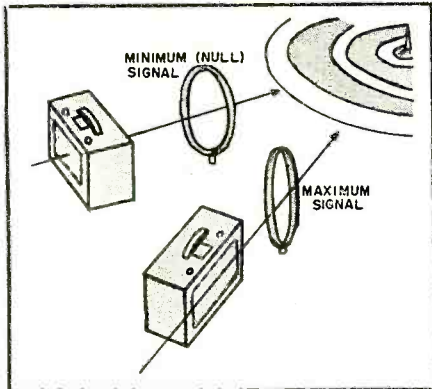

Loop position characteristics.

tics, D. W. Rentzel, recently made the following statement:

"The most urgent need of aviation today—civil and military—is a reliable, all-weather navigation and landing system. . . . The United States already has approximately six billion dollars invested in civil airports. Because of weather these airports are closed fifteen per-cent of the time. . . . The gravity of this situation, which is a bottleneck to commercial aviation and a weak link in our national defense, has been recognized in every group which has studied air transportation problems. Both the President's Air Policy Commission report and the report of the Congressional Aviation Policy Board emphasize the need for a safe, efficient, all-weather navigation system, estimated at one hundred million dollars to implement and requiring fifteen years—until 1963—to be placed in operation. This represents about five per-cent of our present investment in aviation in the United States. . . . The system must accomplish a task of almost fantastic complexity. Before the war, such a system could not have been established. But new developments, such as radar and other electronic devices using extremely high frequencies, have given us the tools which make such a system possible."

-30-



"I wish you wouldn't watch those bowling matches. Sam, they make you so nervous."

# LET THIS "AUTOMATIC TEACHER" show you exactly how to repair over 4800 RADIO MODELS without expensive test equipment!

## GHIRARDI SAVES YOU TIME —HELPS YOU MAKE MONEY

Ghirardi's RADIO TROUBLESHOOTER'S HANDBOOK is the ideal manual to show you exactly how to repair radios at home in spare time—quickly and without a lot of previous experience or costly test equipment. It contains MORE THAN 4 POUNDS OF FACTUAL, time-saving, money-making data for repairing all models and makes of radios better, faster and more profitably than you may have thought possible!

### NOT A "STUDY" BOOK

RADIO TROUBLESHOOTER'S HANDBOOK can easily pay for itself the first time you use it. You don't have to study it. Simply look up the make, model, and trouble symptom of the Radio you want to repair and go to work. No lost time! Clear instructions tell exactly what the trouble is likely to be—EXACTLY how to fix it. Actually, this big 744-page manual-size HANDBOOK brings you factual, specific repair data for the common troubles that occur in practically every radio in use today—for over 4800 popular models of Home and Auto radio receivers and Automatic record changers of 202 manufacturers! In addition, there are hundreds of pages of helpful repair charts, tube charts, data on tuning alignment, transformer troubles, tubes and parts substitution, etc., etc.—all for only \$5 (\$5.50 foreign). Read it for 10 days . . . at our risk! Use coupon.

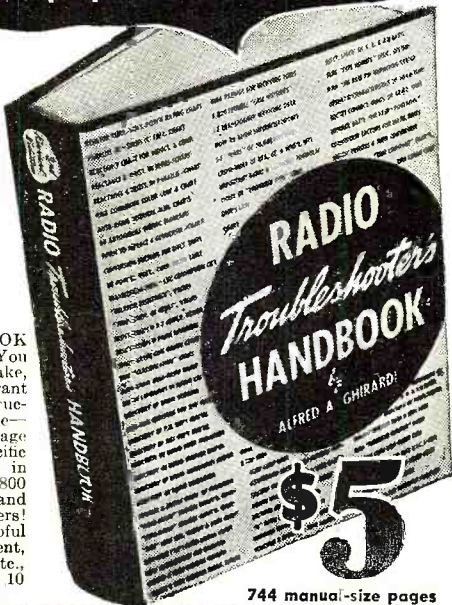

744 manual-size pages

## Get a Complete RADIO-ELECTRONIC SERVICE EDUCATION AT HOME—WITHOUT AN INSTRUCTOR

### COMPLETE DATA ON TEST INSTRUMENTS —TROUBLESHOOTING—REPAIR



1300 pages. 706 illus. 723 review questions

A. A. Ghirardi's big 1300-page MODERN RADIO SERVICING is the finest, most complete instruction book on Radio-Electronic service work for either the novice or the professional Radio-Electronic serviceman — bar none! Read from the beginning, it is a COMPLETE COURSE IN SERVICING by the most modern methods. Used for reference, it is an invaluable means of brushing up on any servicing problem. Gives complete information on all essential service instrument

types; how they work (with wiring diagrams), when and why to use them; how to build your own; preliminary trouble checks; circuit and parts analysis; parts repair, replacement, substitution; obscure radio troubles; aligning and neutralizing; interference reduction—and hundreds of other subjects including How to Start and Operate a Successful Radio Electronic Service Business. 723 self-testing review questions help you check your progress EVERY STEP OF THE WAY. Only \$5 complete (\$5.50 foreign).

## 10 DAY MONEY-BACK GUARANTEE

Dept. RN-10, MURRAY HILL BOOKS, INC., 232 Madison Ave., New York 16, N. Y.

- Enclosed find \$\_\_\_\_\_ for books checked below; or send C.O.D. (in U.S.A. only) for this amount plus postage. In either event, if books are not what I want, I may return them in 10 days and you guarantee to refund the purchase price.
- MODERN RADIO SERVICING \$5 (\$5.50 foreign)
- RADIO TROUBLESHOOTER'S HANDBOOK \$5 (\$5.50 outside U. S. A.)
- Special MONEY-SAVING COMBINATION Both Big Books for only \$9.50 (\$10.50 outside U. S. A.)

Name.....  
 Address.....  
 City, Zone, State..... (Please print or write plainly)

You Can't Go Wrong on a Ghirardi Radio Book



**MONEY-SAVING OFFER!** Get BOTH big books — Radio's most famous Service Library — over 2030 pages — at a bargain combination price. See coupon.



**AUTOMATIC RECORD CHANGER:** Plays 10" and 12" records. Both new and used, BUT NOT SURPLUS!

Garrard's—V.M. Corp.—Webster's. All late models in guaranteed cond. before shipment. Limited quantity. Get yours now!

NEW.....\$14.95  
USED.....9.95

**ARC-5 RECEIVERS:** complete with all tubes, used, excel. cond.

19-35 Mcs., 85 Kc. IF. Ea.....\$ 9.95  
3-6 Mcs., 705 Kc. IF. Ea.....3.95  
6-9.1 Mcs., 1415 Kc. IF. Ea.....5.95  
.52-1.6 Mcs., Broadcast 239 Kc. IF. Ea. 19.95  
1.5-3 Mcs. Ideal for small boat.....12.95

**ARC-5 TRANSMITTERS—COMPLETE:** complete, used, excel. cond.

3-4 Mcs. Ea.....\$9.95  
4-5.3 Mcs., less cover. Ea.....2.95  
5-3.7 Mcs., less cover. Ea.....2.95  
7-9 Mcs. Ea.....9.95

**APN-1 ALTIMETER-TRANSCIVER:** Operates approx. 420 Mcs. FM designed to give accurate height above ground. Unit can be reamped for the 420 Mcs. ham or foundation for citizen's band. Contains 2-955, 2-9001, 5-12SH7, 2-12SJ7. A dynamic vibrating capacitor for producing an FM signal, many other useful parts. (Makes excel. unit for FM or TV sweep generator.) Excel. cond.....\$3.95

**ANTENNA RELAY, BC-442 OR RE-2, ARC-5:** a 0-10 amp. RF thermo-couple meter. 50 uuf, 5,000 V vacuum condenser. Antenna switching relay. Used, excellent cond. Ea. \$1.75

**R5/ARN-7 ADF COMPASS RECEIVER:** covers from 100-1750 Kcs. Ideal for hi-fi broadcast tuner or receiver. Excellent cond. Ea.....\$15.95

**APQ-5 POWER SUPPLY:** Electronically controlled power. Embraces 2-5U4G, 4-6Y6, 2-VR150, 1-6S17, 1-6X5. Operates from 115 V, 400 cycle. Replacing xformer with 60 cycle. Makes ideal lab or test supply. Excellent cond. Ea.....\$4.95

**METERS—ALL TYPES:** from .5 Ma. to 300 Amps. from 0-10,000 V, 2-5 inch. Write for info.

**FL-8 FILTERS, the lazy Q5er. Ea.....\$1.39**

**OIL FILLED CONDENSERS: NEW**

2x8 mfd, 600 V.....Ea. \$0.89  
10 mfd, 600 V.....Ea. .75  
4 mfd, 600 V.....Ea. .49  
2 mfd, 600 V.....Ea. .29  
.25 mfd, 2000 V.....Ea. .79  
.02 mfd, 2000 V.....Ea. .79  
1 mfd, 3000 V.....Ea. 2.29  
.1 mfd, 3000 V.....Ea. 1.49  
.1 mfd, 7000 V.....Ea. 1.89  
.1 mfd, 7500 V.....Ea. 2.20  
SPECIAL: 2 mfd, 150 V, paper.....Ea. .10

**2 V-WILLARD WET CELL BATTERIES:** No. 20-2, Brand new, Individually boxed. Each.....\$0.87  
Order 2 for only.....1.69

**12 FOOT COLLAPSIBLE BRASS ANTENNA:** Collapses to 15". Good, used cond. Ea.....\$2.75

**W. E. HANDSET, TYPE TS-7, push button:** Brand New.....Ea. \$3.50

**CE-1, FACSIMILE OF THE LS-7 SPEAKER:** high and low impedance xformer. New, ea.....\$4.95

**SPECIAL TUBE REPLACEMENT KIT:** for AC-DC Receivers, 12SA7, 12SK7, 12SQ7, 3Z5, 50L6. Each Kit.....\$2.50

**6" PM SPEAKER, new and boxed. Ea. \$1.95**

**HEADPHONES:** 2,000 ohm, Used, Gd. Cond. Ea.....59c

**Come on in and see the tremendous stock in one of the largest SURPLUS ELECTRONICS companies in the country.**

**Rush Orders to:**

**COLUMBIA ELECTRONIC SALES**  
522 South San Pedro Street  
LOS ANGELES 13, CALIFORNIA

**Dynaural Preamplifier**

(Continued from page 57)

that is present on the records cleanly and without distortion.

The "Dynaural" preamplifier is equipped with a range control ( $S_1$ ) providing three positions, one wide open for the best recordings, another slightly restricted for average recordings and the third with a suitable restriction for early recordings. This allows elimination of "rattles" and other distortion without sacrificing any of the usable range. Because of the relatively low impedance of the circuit this range control is mounted on a cable for remote control.

The load resistance on the phonograph pickup should be in accordance with the manufacturers' specifications for correct high-frequency response.

Naturally an auxiliary unit like the "Dynaural" preamplifier requires maximum flexibility and compactness to facilitate mounting in practically any type of installation.

Figs. 1 and 2 show the general appearance of a factory-built unit with

the controls as regularly supplied mounted on a separate panel. The small chassis can be mounted in a radio cabinet or other convenient location, as shown in Fig. 1. The small control panel can be mounted practically anywhere, such as in the record changer compartment, in extra record storage space, or on the main panel of the associated equipment.

The many convenient features of the "Dynaural" preamplifier, in addition to its performance, make it a natural choice for all high-grade installations where purchase of a complete "Dynaural" noise suppressor amplifier<sup>2</sup> is not warranted.

**REFERENCES**

- <sup>1</sup> Scott, H. H.; "Dynamic Suppression of Phonograph Record Noise," *Electronics*, Dec., 1946, pages 92-95. (Also 1946 edition of *Proceedings of the National Electronics Conference*.)  
—; "Dynamic Noise Suppressor," *Electronics*, Dec., 1947, pages 96-101. (Also 1947 edition of *Proceedings of the National Electronics Conference*.)  
—; "Dynamic Noise Suppressors and Recordings" *FM and Television*, Oct., 1946, pages 27, 60, 65.
- <sup>2</sup> Scott, H. H. & Dyett, E. G., Jr.; "An Amplifier and Noise Suppressor Unit," *FM and Television*, Mar., 1948.

-30-

**Oscillator and Gain Set**

(Continued from page 68)

gain runs with such equipment is simple and well-known, a few suggestions are offered for those who have not had occasion to make such runs.

A block diagram of such a setup appears in Fig. 6. It will be noted that no provision for terminating the oscillator output is provided since the gain set itself provides the necessary termination.

If we are making a run on a transmitter or amplifier which has a 500 ohm input we merely connect the output terminals of the gain set across the input terminals of the equipment on which the run is to be made. However if, as is very frequently the case, the input impedance of the device to be measured is greater than 500 ohms we must make other arrangements. Let us say the input is to a grid. In this case we terminate our gain set with a 500 ohm non-inductive resistor and "build out" the impedance to look like the correct value to feed into the

equipment to be measured. This procedure is illustrated in Fig. 6A where the 100,000 ohm non-inductive resistor is the build out to satisfy the input requirements. This value of 100,000 ohms is conventional for grid inputs. The same technique will apply to the output of the equipment in order to obtain an output impedance of 500 ohms across which our VI can be switched as shown in the diagram.

Let us assume now that the input circuit of an amplifier has been designed for a 50 ohm microphone. In this case we proceed as shown in Fig. 6B where we terminate the gain set with two non-inductive resistors in series, one of 450 ohms and one of 50 ohms on the lower, or grounded, side of the output. The input connection for the amplifier is taken from across the 50 ohm resistor as shown.

After making the proper connections between the test equipment and the equipment to be measured the oscillator should be set at 1000 cycles (this should always be taken as the reference frequency) and the level adjusted to make the VI read 0 level when connected across the oscillator output.

Fig. 6. Block diagram of the setup used for making the test measurements.

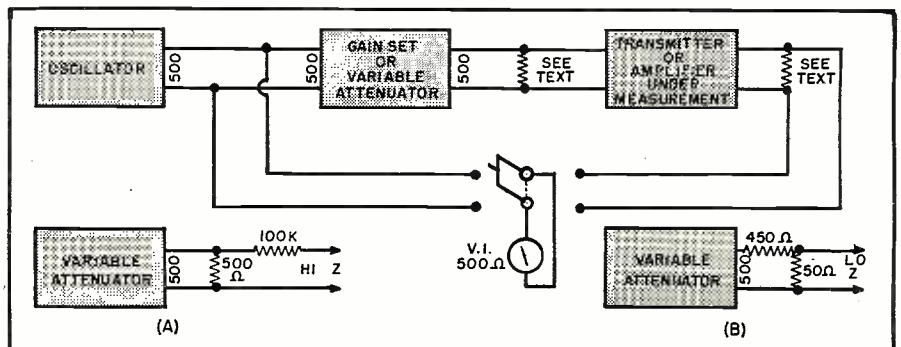

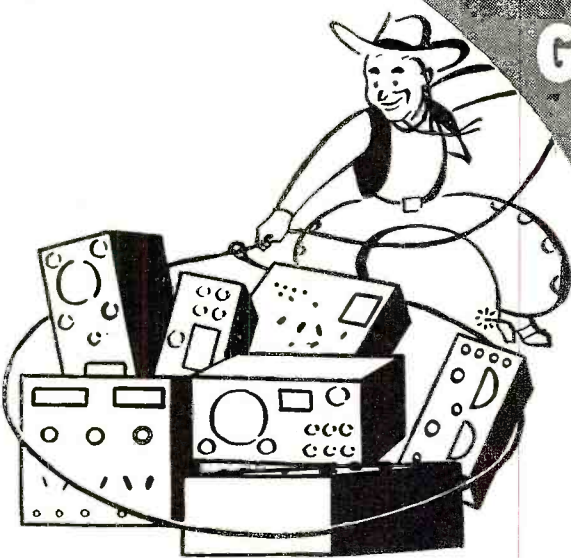

# Gigantic January USED EQUIPMENT ROUND-UP

**Terrific Bargains in  
COMMUNICATION EQUIPMENT  
TEST INSTRUMENTS  
TELEVISION and TV CUSTOM  
CHASSIS made possible by**  
*Surprise* **TRADE-IN  
ALLOWANCES on your  
USED TEST and  
COMMUNICATION  
EQUIPMENT**

**EASY TERMS ON YOUR  
NEW EQUIPMENT  
PURCHASES**

Yippee and yessirree! The wild and woolly west hasn't seen anything *half* as wild as the way we're trading our brand New Communication equipment, Test instruments, Television sets and TV custom chassis for your used Test or Communication equipment. In the gosh darndest trade-in offer ever attempted, Walter Ashe is fixin' to corral every old, unwanted (factory-built) unit in the land! So round up the "doggies!" Tell us what you have to trade. We'll come right back with a "Surprise" allowance that's bound to knock the Stetson off your head. Don't delay, pardner. Wire, write, phone or use the handy coupon!



Amazing new Hallicrafters SX-71. Only..... **\$179<sup>50</sup>**  
Less trade-in value of your used equipment.  
Shpg. wt., 33 lbs.



Sensational! National HRO-50. Only..... **\$349<sup>00</sup>**  
Less our special, "Surprise" allowance.  
Shpg. wt. 80 lbs.

Phone: CHEstnut 1125  
All prices F. O. B. St. Louis, Missouri

**Walter Ashe  
RADIO CO.**  
THE HOUSE OF "SURPRISE" TRADE-INS  
1125 PINE ST. • ST. LOUIS 1, MO.

January, 1950

**FREE!**  
NEW 1950  
CATALOG

**"Get the Drop" on These Typical Used Equipment Values!**  
Reconditioned, "good as new" **\$110.00** SX-42 (less spkr.) only..... **\$175.00**  
RME 45-A (less spkr.) only..... **\$110.00** spkr.) only..... **\$175.00**  
Subject to further astounding price reduction when you apply our extra-liberal trade-in allowance on your used equipment against the purchase price!

## MAIL THIS COUPON TODAY

Walter Ashe Radio Co.  
1125 Pine St., St. Louis 1, Mo. RN-50-1

O. K. Walter, Rush "Surprise" Trade-in offer on my \_\_\_\_\_  
(describe used equipment)

for \_\_\_\_\_  
(show make and model No. of new equipment desired)

Send \_\_\_\_\_ Hallicrafters Catalog \_\_\_\_\_ National Catalog

Rush Free Copy of your new 1950 Catalog ( ✓ )

NAME \_\_\_\_\_  
ADDRESS \_\_\_\_\_  
CITY \_\_\_\_\_ ZONE \_\_\_\_\_ STATE \_\_\_\_\_

Send  
for  
Free  
National  
and  
Halli-  
crafters  
Catalogs

# NEW... the TELEVISION TRACER

DESIGNED FOR EXTRA  
FAST, EXTRA SIMPLE  
TELEVISION SERVICING!

MODEL  
201A  
3450



★ NEW  
OSCILLOSCOPE  
APPLICATION!



★ NEW  
PROBE!



MODEL  
251A  
4975

See these Tracers at your  
Jobbers or write us for literature.

PRECISION ELECTRONICS, Inc.  
641-643 MILWAUKEE AVENUE  
CHICAGO 22, ILLINOIS

SIGNAL TRACER SPECIALISTS

Next introduce an amount of attenuation in the circuit, by means of the gain set, which is thought to be about equal to the expected gain through the amplifier and switch the VI to the output of the equipment under measurement. Correct the amount of attenuation in the circuit and the oscillator output gain control until the VI reads 0 level on both oscillator and amplifier outputs (the amplifier output having been to 500 ohms as explained, and shown in Fig. 6) as it is switched back and forth between the two points. The amount of attenuation remaining in the gain set when the VI reads 0 level in both positions is the gain in db. of the amplifier at 1000 cycles. As many other frequencies may be used as needed to get an adequate curve; the procedure is repeated for each change in frequency. Plotting the results on semi-log paper will facilitate matters since the scales will not be so crowded. Thus, the final result will be a curve showing the gain, or loss, in db. at all frequencies referred to the 1000 cycle reference point.

It might be mentioned here that any vacuum tube voltmeter such as the *Ballantine* or other similar type meter may be substituted for the VI meter shown. Where one has access to a laboratory or test station where a number of such meters are available one may be used on the oscillator output and another on the amplifier output thus avoiding the necessity of switching meters.

Many additional types of measurement may be made with the equipment described such as measuring transformer response, power handling capability, output determinations, etc. Terman's "Measurements In Radio Engineering" and "Radio Engineers Handbook" are among the many excellent references available. -30-

## What's New in Radio

(Continued from page 80)

The weight of the 16RP4 is approximately two-thirds that of the 16-inch all-glass round tube. No high-voltage isolation of the tube is required. Magnetic focus and deflection are employed.

Complete technical data on the 16RP4 is available from the company in Salem, Massachusetts.

### IMPEDANCE BRIDGE KIT

Heath Company of Benton Harbor, Michigan, has added an impedance



bridge kit to its line of build-it-yourself test instruments.

The kit includes a *General Radio* main calibrated control and 1000 cycle hummer, *Mallory* ceramic switches with 60 degree indexing, and a 200 microampere zero-center galvanometer. The ceramic non-inductive decade resistors have a tolerance of 1/2 of 1%.

When assembled, the instrument will measure inductance from 10 microhenrys to 100 henrys, capacitance

William J. Knott, president of The Knott Corporation, presses the button which puts into operation the RCA Master Television Antenna System installed at New York's Shelton Hotel. With Mr. Knott (left to right) are B. T. Davey, manager of the Shelton, Frank Folsom, president of RCA, and Frederick O. Cosgrove, vice-president and general manager of The Knott Corporation and president of the Hotel Association of New York City. The Shelton is the first hotel in the country to install free television for the use of all of its transient guests.

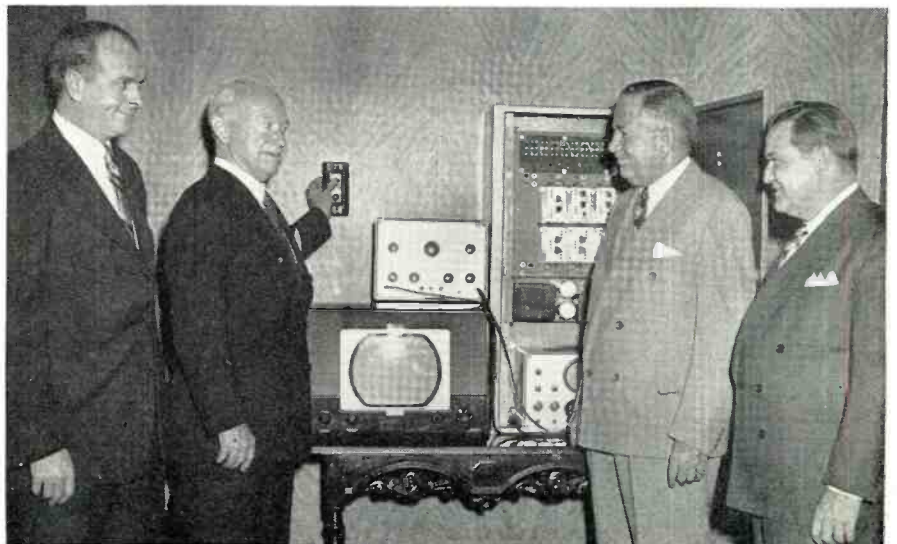



# NOW!

## All the Fundamentals of Television in One Up-to-the Minute Book

Here at last is everything you need to know to succeed in television. This great new book, now in a new third edition, brings you a clear, authoritative picture of the entire field, including complete descriptions of all leading projection systems, and the methods of color television being considered right now by the F.C.C.

New Third Edition

# TELEVISION SIMPLIFIED

by Milton S. Kiver

*Television Consultant, Radio and Television News. Also author of a series of articles appearing in this publication.*

You'll be delighted with the way this newly revised handbook covers each and every subject—video I. F. amplifiers of the various types; the latest d. c. re-insertion circuits; power supplies including selenium rectifiers and pulse-type high-voltage systems; the saw-tooth, sine-wave, and pulse methods of achieving automatic frequency control; and the new Intercarrier sound television system. You'll be especially delighted with the way this new edition simplifies television-receiver servicing. Hundreds of illustrations, scores of fresh facts make this volume indispensable.

### BRIEF OUTLINE of CONTENTS

The Television Field; Ultra-high Frequency Waves and The Television Antenna; Wide-band Tuning Circuits; Radio-frequency Amplifiers; The High-frequency Oscillator; Mixer and Immediate-frequency Amplifiers; Diode Detectors and Automatic Gain-control Circuits; Video Amplifiers; Direct Current Reinsertion; Cathode-ray Tubes; Synchronizing-circuit Fundamentals; Deflecting Systems; Typical Television Receiver—Analysis and Alignment; Frequency Modulation; Intercarrier Television Sound System; Servicing Television Receivers; Color Television; Glossary of Television Terms. Plus Other New Chapters and Expanded Sections.

### EXAMINE THIS BOOK FREE

Let this practical book prepare you for your future in the expanding television field. Send for it NOW!

### —MAIL THIS COUPON—

D. Van Nostrand Company, Inc. RTN-150  
250 Fourth Avenue, New York 3, N. Y.

Please send me "Television Simplified." Within 10 days I will either return the book and owe nothing, or I will send you \$2.00, plus a few cents postage, and \$2.00 for two months.

Name.....

Address.....

City.....State.....

(If you send the \$6.00 with this coupon, we will pay the postage. Same return privilege and refund guarantee.)

from .00001  $\mu$ fd. to 1000  $\mu$ fd., and resistance from .01 ohm to 10 megohms. Dissipation factor from .001 to 1 and "Q" from 1 to 1000 can be measured. The bridge uses an internal 6 volt battery for resistance and hummer operation. The circuit uses Wheatstone, Hay, and Maxwell circuits for various measurements.

### TV MULTIPLIER PROBE

A new multiplier probe that extends the usefulness of existing d.c. voltmeters into the television range has



been introduced by *Insuline Corporation of America*, Long Island City 1, New York.

Designated the "Kilovoltter," the device is built with a phenolic barrel and a clear lucite nose piece, providing positive protection against the highest television voltages. The probe is 8½ inches long and is fitted with a 5-foot heavy-duty test lead.

The new probe, in effect, adds 15,000 volts to the scale reading of conventional high-resistance voltmeters used in radio servicing and general experimental work. Three models are available, for 50, 100, and 200 microampere meter movements.

### NEW SIGNAL TRACER

The Model 777A Dynatracer, a new model signal tracer marketed by *Radio City Products Co.*, of 152 W. 25th Street, New York 1, N. Y., features exceptionally high amplification which permits actual gain measurements to be made on receivers or other apparatus. An accurate meter gives cal-

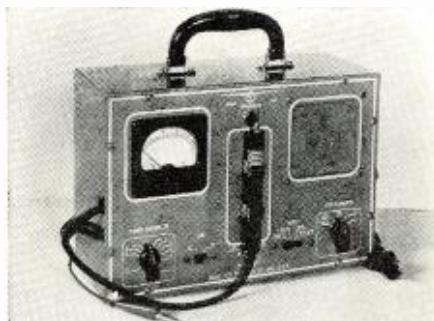

ibrated indications which are impossible with magic eye indicators.

The input capacity of the unit is 3  $\mu$ fd. Attenuation is 10,000 to 1 by means of a ladder attenuator with vernier control. Sensitivity is 10,000 microvolts for full scale deflection of meter or 200 microvolts per division. The frequency range covers approximately 160 mc.

A jack is provided for testing microphones and pickups. An automatic control switch permits either a speaker or the meter to be used alone, together or as standby.

### CONVERSION KITS

*Teleramic* Conversion Kits, which convert 10" size television sets to 15" glass or 16" metal direct view sets, are now being manufactured by *Eagle Electronics, Inc.*, 88 Walker St., New York 13.

Any set using the *RCA 630 TS* circuit, or other standard TV with fly-back circuit, the *Transvision* chassis, or other similar kit chassis may be converted in one hour by following the simple illustrated instructions. No magnifiers or lenses are used and there are no holes to drill.

The new kit contains all the necessary components including front and rear mounting brackets plus an insulation ring and sleeve, horizontal output transformer, and tube. The sub-assembly chassis is completely wired and ready for installation.

### PLAYBACK UNIT

*Proctor Soundex Corporation* of Mount Vernon, New York, is introducing its new "Floating Disc Drive" playback unit to the trade.

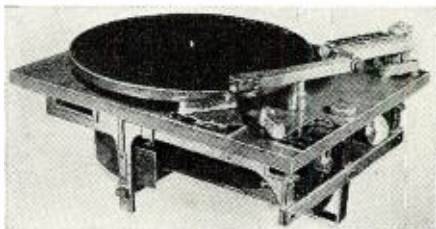

The multi-speed turntable employs a new drive system which consists of a flexible aluminum drive disc, shock mounted at the center to the turntable shaft. The drive disc and turntable shaft are isolated from direct contact and the drive disc is held free by the shock mounting so that it is self-aligning with two drive rollers that it passes between. The speed is continuously variable between 30 and 110 r.p.m. Pickup pressures can be varied between 0 and 25 grams. Various types of cartridges can be used.

### 4-ELEMENT YAGI

*Trio Manufacturing Company* of Griggsville, Illinois, is currently marketing a 4-element Yagi antenna with a double dipole for extreme fringe area reception.

This antenna provides high forward gain with unusual directional characteristics. It is available for each of the 12 channels although considerable gain may be expected on adjacent channels, according to the company. The gain on the optimum channel is 10 db. with a front-to-back ratio of 25 db.

This Yagi weighs only 5 pounds for channel 5. Satisfactory installations may be made using a 30 foot mast of 1¼ inch aluminum. An adjustable

**RADIO & TELEVISION NEWS**



**DONT DELAY!**



# ORDER from ARROW!

## BC-605 INTERPHONE AMPLIFIER

Easily converted to an ideal inter communications set for office—home—or factory. **\$4.95**  
Original—New. **3.95**  
Like  
New..... (With schematic)



Conversion Diagram and Instructions complete with necessary parts

This kit consists of 3 tubes—2 speakers—1 speaker baffle (for remote speaker)—100 ft. 2-cord cable—1 switch—1 line cord—2 etched plates—miscellaneous resistors—condensers—hardware—and all that is necessary to convert. **\$8.25**  
New.....

## BC-604 TRANSMITTER FM 20-28 MC

11 and 15 meters. Can be operated on 10 meters—10 channel push button crystal. With all tubes and meter but less dynamotor. **\$12.95**  
Excellent Condition..... **\$12.95**  
Crystals—Set of 80..... **14.95**

### MISCELLANEOUS SPECIALS

ARB Receiver 200 to 9000 Kc....Exc.. Used	\$19.95
SCR 522 Transceiver 100 to 156 MC.Used	34.95
BC 1206 Receiver 200 to 400 KC....New	5.95
Used	3.95
MN 26 C or Y Receiver.....New	24.95
Used	17.50
RA 10 DA Receiver.....New	24.95
Used	17.50
BD 71 Switchboard.....New	12.95
Used	7.95
PE-237 Power Supply.....New	9.95
BC-347 Interphone Amplifier with tubes.....New	.95
I-70 Meter.....New	.89
10 for	8.00
RT 7—APN-1 Transceiver.....New	9.95
APN-1 complete.....New	34.50
R-78—APS 15—Complete with Tubes.....Excellent	34.50
AM 61 Indicator Amplifier.....New	9.50
BC 929 Scope.....New	17.95
Used	12.95
SCR 625 Mine Detector.....New	39.50
C 1 Autopilot with Tubes, Etc.....Used	2.95
ASB-7 Scope.....Used	12.95
BC 461 Veeder Root Meter.....New	.59
BC 442 Less Condenser.....Used	1.49
BC 342-J—EC-312-J—Manual.....	1.00
SCR 269 G Manual.....	2.50
BC 306 Antenna T.U. for BC 375.....	1.50
A-27 Phantom Antenna—2000 to 4500 KC.....New	.95
APS-13 UHF Antenna—Suitable for 400 MC citizen band, ideal for UHF experimenters. With director and reflector elements....Brand New, 2 for 88c	

### COMMAND (SCR 274 N) EQUIPMENT

BC-453.....Used	\$12.95	
BC-454.....	4.95	\$6.95
BC-455.....	7.95	
BC-456.....	1.95	2.95
BC-457.....	5.95	
BC-458.....	5.95	7.95
BC-459 (or T22).....	9.95	
BC-696 (or T19).....	14.95	24.95
ARCS Transm 2.1-3MC.....	9.95	
BC-450—3 Receiver Remote Control	.89	1.95
BC-442.....		2.95
3 Receiver Rack.....	1.95	
2 Transmitter Rack.....	1.50	
Complete Command set as removed from aircraft— 3 receivers—2 transmitters—Relay unit—control boxes—mounting racks—plugs— modulator and dynamotors—crated. Set		<b>\$34.50</b>

### MIKES—HEADSETS

HS-23 Hi Imp.....New	\$2.95
HS-33 Lo Imp.....New	2.95
HS-30 Hi Imp.....New	1.50
Used	.79
T-17D Carbon Mike.....New	2.75
T-24 Hi Imp. Carbon Mike.....New	1.19
T-30 Throat Mike.....New	.98
T-45 (or Navy) Lip Mike.....New	.98
CD-307 Extension Cord for Headsets.....New	.59
RS-38—Navy hand Mike Carbon... ..	2.75

### BEAM INDICATORS

I 82—5".....New	\$4.95
Transmitter selsyn for above.....	2.45
both for	7.00
I 81—3".....New	3.45
Transmitter Selsyn for above.....	2.45
both for	5.25
I 81.....Used	2.45

### HERMETICALLY SEALED CHOKES

10 H. 100 M.A.....	59c
59 H. 100 M.A.....	95c
3.7 H. 145 M.A.....	59c
10 H. 20 M.A.....	39c

### PP 12A/APS-3 RECTIFIER POWER SUPPLY

110 VAC—800 to 2400 CPS input. Used to supply many voltages for APS 3 equipment. Contains four VR105; Three 5U4G; 2x2; 6AC7; 6Y6-G; VR 150; 6X5GT-G condensers, chokes, etc. Parts **\$6.95** alone worth more than.....

### BC-223

**Ideal Marine or Ham Transmitter  
2000 to 5250 KC**  
New with all tuning units and T. U. cases... \$19.95  
Tuning Units—For BC-223..... 2.50  
Cases—For Tuning Units—for BC-223..... .95

### NEW CATALOG

Listings many surplus values, write for your **FREE** copy TODAY.

All shipments FOB Chicago. 20% Deposit required on all orders. Minimum order accepted—\$5.00. Illinois residents, please add regular sales tax to your remittance.

## ARROW SALES, Inc.

Dept. N  
1712-14 S. Michigan Ave., Chicago 16, Ill.  
PHONE: HArrison 7-9374

### AN/APN-4

Indicator: Uses 5 CPl, Loran, converted to test scope, fanadapter, etc. Contains extremely accurate 100 kc stal to time sweeps and marker pips at 2, 20 and 100 kc. Two parallel horizontal sweeps, obtain time differences between signals, between half power points on passband curves, and numerous other scope uses. Experimenters' delight! Use the counter circuits to try the new system of FM demodulation (July Proc. IRE) or to time camera shutters, 25 tubes. Condition: used, excellent. With schematic **\$29.50**

### RECEIVER

**Easily Converted for Use in Citizens Band**

Crystal Controlled Local Oscillator. Erood Band Pass—20.7 MC I.F.'s. Complete with 7-6A/5, 1—12SR7, 2—12SN7, 1—28D7, relays, crystals. Schematic furnished..... Used **\$7.95**

**SURPRISE PACKAGE** 20 lbs. Ass't radio parts. A \$25.00 value for only **\$1.95**

**BC-620 F.M.—Receiver, Transmitter—2** channel crystal—Freq. 20-27.8 MC, 13 tubes—metered plate and fil. New **\$14.95**  
Used **\$9.95**

**FT-250 Mount for PE-97 and BC-620.....** \$1.50

### OUTPUT TRANSFORMER

Hi-Fil used in Scott Manufactured Navy receiver. Fully potted. Pri. 5000 ohms; output secondary 600 ohms C.T.—Inverse feedback secondary **\$1.45**  
CT-60 ohms. New.....

### FLAP PITCH MOTOR

24V DC will operate on AC—11,000 RPM. Complete with gear box and limit switches.....ea. **\$2.95**

### CONDENSERS

2 mfd. 4000 VDC G.E.....	Each \$2.95
4 for	10.00
2 mfd. 5000 VDC. G.E.....	3 for <b>10.00</b>
1 mfd. 6000 VDC.....	<b>1.98</b>
.25 mfd. 15000 VDC.....	<b>4.95</b>
.00025 mfd. 25000 VDC.....	<b>2.95</b>
.4 mfd 1500 VDC.....	<b>.19</b>
10 for	<b>1.49</b>

### DYNAMOTORS

DM-28—For BC-348 with Mount and Filter.....	New \$6.95
Used	3.95
DY-12—For ART-13 less filter and base.....	New <b>6.95</b>
Used	.95
DM-36.....	New <b>1.95</b>
BD-77.....	New <b>5.95</b>
PE-206.....	New <b>6.95</b>
Used	2.75
PE-101.....	New <b>2.75</b>
DM-53.....	New <b>3.95</b>
Used .95	(3 for \$2.00)
DM-32.....	New <b>1.95</b>
Used .95	3 for \$2.00

**PE-97 6-12 Volt Vibrator Power Supply for BC 620.** Excellent—used—complete..... **\$6.95**  
Less Vibrator—tubes—condenser..... **2.95**

A



B



# PREVIEW of WARRE 'S SENSATIONAL VALUE PARADE

Consult Us for Everything  
in Radio and Television

Write at once for new catalog  
and dealer discounts



C

**A . . . . S-C Personalized Radio**  
For 115 V—AC or DC . . . 4 tubes . . .  
Demountable Dynamic Pillow Speaker . . .  
Built-in loop . . . AVC Superhet . . . With  
bed mounting brackets and table base.  
Colors: Black, Yellow, Rust, Ivory or Blue.  
List . . . . . \$21.95

**B . . . . World Wide Portable—3 Band—  
3 Way**  
Broadcast Band and two short wave bands  
from 2.0 to 18.5 mc . . . 3 way superhet  
using batteries or AC-DC . . . Telescopic  
antenna . . . Smart cabinet covered with  
Alligator grain simulated leather . . . 16" x  
12" x 8" . . . Full vision illuminated dial . . .  
Big value. List . . . . . \$69.95

**C . . . . DeWald DT-161 Television Console**  
High definition—Giant Screen 16" Direct  
View. Built-in self-contained antenna . . .  
Height 40 1/4", Width 21 1/4", Depth 23 3/8".  
Beautifully styled fine cabinet work in ma-  
hogany or walnut. An outstanding value.  
List . . . . . \$369.95

**IMMEDIATE DELIVERIES**

**WARREN DISTRIBUTORS 3145 Washington Street  
Jamaica Plain 30, Mass.**

most clamp allows installation of more than one antenna on a single mast with independent orientation of each. The units are supplied complete with a 6 foot section of 1 1/4 inch mast, adjustable roof bracket, guy wire ring, etc.

### MAST BASE

McKinney Steel & Sales Co. of 8 Madison Street, Waukegan, Illinois, has introduced an ingenious mast base for use in antenna installations in fringe areas or in locations where proper support and ease of erection are additional factors in the cost of installation.

Known as the "Swiv-L-Lock" mast base, this unit will accommodate masts up to 1 1/4" in diameter without adaptors. It permits complete rotation and locking of the antenna mast. The base is constructed of rustproof steel and measures 8" by 8" by 5" high. The base can be installed on any pitch surface, flat, slant, or perpendicular. It will handle up to a 65 foot antenna. The unit is completely assembled at the factory.

### MOBILE ANTENNA

Master Mobile Mounts, Inc., 5200 Wilshire Blvd., Los Angeles, California, has introduced the Master M-75 mobile antenna for amateur applications.

An all-band, plug-in coil antenna, the M-75 especially designed center load is engineered for maximum efficiency and flexibility. It is possible to change coils to any band, 80 through 10. The unit is supplied with a coil for 75 meters and comes tuned to approximately 3600 kc. It may be adjusted to the desired operating frequency and

**Leotone JANUARY SPECIALS!**

**METER SPECIALS!! 0-9 VOLTS DC.** \$1.29  
2 1/2" sq. panel. BRAND NEW and ONLY

**PORTABLE DC AMMETER, 0-15 AMPS—WITH DATA FOR EASY CONVERSION TO "VOLT-OHM-MILLIAMMETER."** 3 1/2" fan type, mirror scale, int. shunt. PERFECT AS IS for testing: ELECTRIC APPLIANCES, BATTERIES, MOTOR, AUTOMOTIVE, INDUSTRIAL and MEDICAL EQUIP. With 36" leads and hinged lid metal case. BRAND NEW! Shpg. wt. 6 lbs. . . . \$3.95

**HEARING AID AMPLIFIER ASSEMBLY.** Sensitive Vacuum Tube type. WEIGHS ONLY 3 1/2 OZS. (2"x3/4"x5")! MAKE A REAL VEST POCKET RADIO, adding only speaker or phone & simple tuner. Ready-wired with: tone & vol. controls, output switch, choke, etc. COMPLETE WITH SCHEMATIC FOR BUILDING 2- or 3-TUBE RECEIVERS. Less tubes and case. ONLY \$2.49  
**HEARING AID TUBES** for amplifier. . . . \$2.49  
Set of 2 . . . . .

**HIGH FIDELITY CRYSTAL MICROPHONE.** Sensitive diaphragm type, hi-imped. 1 3/4" x 1/4" deep. 98c  
Rubber shock-mtd. Less housing. . . . .

**ALUMINUM HOUSING** for crystal mike. . . . \$0.15  
**PLAIN TUBE CARTONS**  
Miniature (1" sq. x 2 1/4"). Per 100. . . . \$0.98  
GT size (1 1/4" sq. x 3 1/4"). Per 100. . . . 1.25  
Medium (1 1/2" sq. x 4 1/4"). Per 100. . . . 1.49  
Large (2" sq. x 5"). Per 100. . . . 1.79

**RADIO HARDWARE TREASURE.** A FULL POUND OF NUTS, SCREWS, WASHERS, LUGS, ETC. All in HANDY SELF-SEALING HINGED LID CAN. 49c  
Shpg. wt. 2 lbs. . . . .

**EXPERIMENTAL TUBES** for Servicers, Experimenters, Students. Fil. tested. . . . \$1.00  
Kit of 20 asstd. revg. types. . . . .

**110 V. AC INDUCTION MOTOR.** Self-starting. 1750 RPM, fract. HP. 2 3/4" O.D. x 2". . . . \$1.25  
Shpg. wt. 2 lbs. . . . .

**MORE & MORE FOR YOUR MONEY!!** LEOTONE'S "JUMBO RADIO PARTS KIT" 17 FULL POUNDS of selected new & dismantled Radio & Electronic parts for every Radioman. COILS, TRANSFORMERS, WIRES, SOCKETS, HARDWARE, SPEAKER ACCESSORIES, RESISTORS, CONDENSERS, ETC., ETC. All these (shpg. wt. \$2.95  
21 lbs.) AND MUCH MORE FOR ONLY . . . .

**STEEL MAST SECTIONS.** MS-49, 50, 51, 53 or 54. ea. 39c. Shpg. wt. 1 lb. ea. 39c. 3 for . . . . \$1.00

**CABINET DRAW SLIDES.** Smooth ball-bearing action: steel-aluminum. For CONSOLE RECORDERS, CHANGERS, drawers of every type. Shpg. wt. 2 lbs. . . . .

9" extension (13" overall) . . . . \$1.89 pr.  
11" extension (15" overall) . . . . 1.98 pr.  
12 1/2" extension (16 1/2" overall) . . . . 2.19 pr.  
12 1/2" / 16 1/2" Hvy. duty, all-steel. . . . 2.89 pr.

**FACTORY SPEAKER REPAIRS SINCE 1927**  
Min. order \$2.00 20% deposit on all COD's  
Please add sufficient postage—excess refunded.

**LEOTONE RADIO CO.**  
67 Dey Street,  
New York 7, N. Y.

**150 WATT XMITTERS**  
Govt. Cost, \$1,800.00

**BC 375-E (COMPLETE)**  
INCLUDES:  
7 Tuning Units (Plug-in drawers, with handles, to cover freq. range 200 kc—12.5 mc., except 500—1,500 kc.)

Made by G.E. for aircraft, ground & mobile use. Has 24-volt (filtered) DC Dynamotor; antenna tuning unit; connectors, mounts. Net wgt. 225 lbs. Excellent condition. \$79.50 ea.  
YOUR PRICE . . . . .  
(Write for literature, quan. discts.)



**RADIOSONDES**  
**Uncle Sam's Aerial Weather Station**  
This AN/AMQ-1D battery powered midjet xmitter operates on 72 mc. Comes with 3A5 tube; ant. and counterpoise wires; hygrometer, barometer and thermometer elements; sensitive relay. Wired ready to use! Original packing! 4 1/4 x 8 1/4 x 8 inches high; Net wgt., 1 1/4 lbs. \$2.49 ea.  
SPECIAL . . . . .

20% with order, bal. C.O.D. Specify method of transportation. All prices F.O.B., N.Y.C. Items subject to prior sale. . . . .

**COMPONENTS SUPPLY CO.**  
161A Washington St.  
New York 6, N. Y. BEekman 3-8717, 8

may be used for 10 meter operation by simply shorting the coil. 20 and 40 meter coils are available. The unit weighs 28 ounces and has an over-all length of 8 feet, 10 inches. It is entirely chromium plated. The antenna is designed to fit into any of the company's "Master Mounts" or 3/8 SAE threading.

### FM-AM TUNER

Approved Electronic Instrument Corp., 142 Liberty Street, New York 6, New York, is marketing its new Model A-710 high fidelity FM-AM tuner for

the custom builder, service technician, manufacturer, and experimenter.

This 12-tube tuner measures only 8¼ inches wide, 5¾ inches high, and 8 inches in depth. It features a six-section variable condenser, temperature-compensated trimmers on FM, separate tuning and i.f. channels for FM and AM. The set has a horizontal

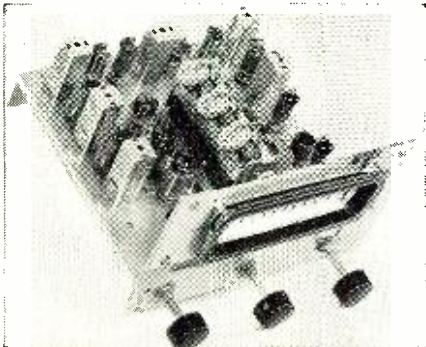

tuning scale and escutcheon plate and knobs. Complete operating instructions and a circuit diagram accompany the unit. Net weight is 5½ pounds. Standard miniature tubes are used throughout.

-50-

### International Short-Wave

(Continued from page 61)

English, Spanish, and Portuguese—and maybe in other languages, too.”

**Brazil**—Radio Nacional, PRL-8, 11.72, has discontinued its “Hello, America” broadcasts in English; confirmed in letter from station authorities but no reason given. (Worris, N. Y.) PSL, 7.935, Rio de Janeiro, noted 1730-1800. (Sutton, Ohio) *Radio Journal do Commercio*, ZYK-2, 15.145. 6.085, and ZYK-3, 9.565, 11.825, is sending out attractive literature in English; lists English programs as “About Brazil,” 2030 Monday through Saturday, and “Brazil Calling” 1530 Sunday. Slogan in English appears “Pernambuco Speaking to the World.”

**British Honduras**—ZIK-2, 10.599, Belize, recently has been audible to fairly good weekdays around 1300-1330 or slightly later; has “folksy” program of news, announcements, music. On Sundays this one extends to after 1415, according to Stark, Texas.

**British New Guinea**—Balbi, Calif., converts current Pt. Moresby schedules to VLT7, 9.52, Sunday to Friday 2100-2300, 0030-0300, Saturday 2100-0300, Sunday 0100-0300. VLT5, 7.28, Sunday, Tuesday, Thursday 1645-1900, Friday to 1730, Saturday to 2000, Monday 0315-0930, Saturday to 0800, Sunday to 0700.

**Canada**—According to CBC's current program listings, a DX program called “International Short-Wave Listening” is now radiated 1745 Tuesdays over CKLO, 9.63, CHOL, 11.72. (Hilton, Fla., Lyttle, Ontario) Latest schedules are given for CKRP, 21.60; CKNC, 17.82; CKCS, 15.32; CKCX, 15.19;

January, 1950

# Build Your Career! Become an ELECTRICAL ENGINEER

- Major in Electronics
- B. S. Degree in 36 Months

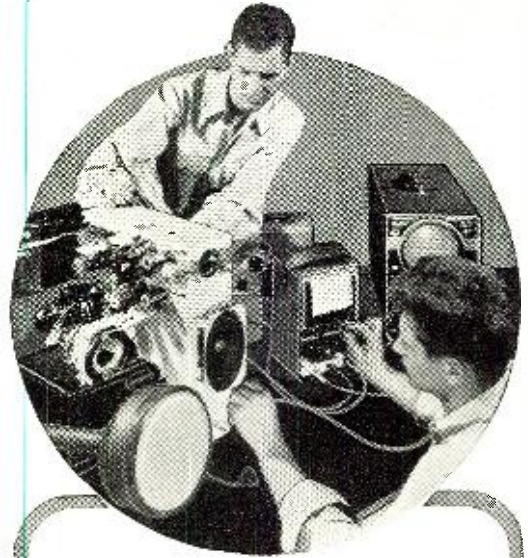

THE Electrical Engineering course offered by this non-profit, 46-year-old Technical Institute and College is world famous.

Save a valuable year by gaining your major in Electronics and a Bachelor of Science degree in 36 months of year-round study.

Follow an industry-guided program which is constantly attuned to current developments. It presents a solid program in the basic sciences . . . chemistry, physics, mathematics, economics and electrical engineering subjects . . . plus 19 technical specialty courses in Engineering Electronics, including four courses in electronic design.

You are invited to request helpful guidance literature which illustrates how your electronic interests can be the foundation of a worthwhile career.

Over 30,000 graduates and 1,555 students • Faculty of 85 specialists • Train in modern, well-equipped shops.



## MILWAUKEE SCHOOL of ENGINEERING

Founded 1903 by Oscar Werwath



**A Special Preparatory Program** is offered for students who wish to review basic subjects or who require additional background.

**Military or Practical Academic** training will be evaluated for advanced credit.

Next Terms Open

**APRIL 3 . . . JULY 3**

### AN EXPANDING INDUSTRY

Electronics is of tremendous, growing importance to industrial applications—high frequency heating, power system control, air conditioning, printing, welding and many others. And business leaders predict television will be among America's top ten industries by 1951. Prepare now to become an Electrical Engineer, with a specialized, practical background to capitalize on all these fast-growing opportunities.

### In one year of study, become an ELECTRONIC TECHNICIAN

This certificate is yours at the end of 12 months of study in the Electrical Engineering Course.

### Prepare Here for a Career in RADIO AND TELEVISION

In 18 months you can become a Radio-Television Technician, ready for positions in receiver and transmitter testing, servicing, sales, supervision and production. Because of this school's *concentric curriculum*, the Bachelor of Science degree in Electrical Engineering (Electronics Major) may be earned in 24 additional months.



WRITE today for the helpful 48-page pictorial bulletin, “Your Career”; and the 110-page 1950 catalog.

MILWAUKEE SCHOOL OF ENGINEERING  
Dept. RN-150, N. Broadway and E. State, Milwaukee, Wis.

Without obligation, send  48-page pictorial bulletin, “Your Career”;  110-page 1950 Catalog. I am

interested in . . . . . course.

NAME . . . . . AGE . . . . .

ADDRESS . . . . .

CITY . . . . . STATE . . . . .

Veteran of World War II.

# NEW *Telecote* Means NEW Life for *Teletower*

## Armor-Tough Coating Can't Flake Off!

WITHOUT A PENNY'S INCREASE IN THE *LOW PRICE*, Penn's Teletowers and Thriftowers are now being finished with *Telecote*—the new, armor-tough coating that can't flake off. Developed by one of America's leading steel makers, the use of *Telecote* in the television tower field is exclusive with Penn. *Telecote* is *impervious to weather* . . . protects equipment . . . reduces servicing . . . preserves the sparkling appearance of the tower when new.

*Telecote* is one of the most important new developments in the whole field of television accessories. Profit-minded dealers will write today for details.

## PRICES TO RETAILERS (Shipped prepaid)

**THRIFTOWER "30"** —  
Composed of 20' of tower welded as a single unit with 10' 1" O.D. adjustable pole, total approximately 30' overall . . . . . \$24.75  
**THRIFTOWER "40"** —  
Composed of 20' of tower, same as *Thriftower 30*, with 20' 1" O.D. doubly reinforced adjustable pole giving a total overall extended height of approximately 40' . . . . . \$29.75

**PENN *Teletower***  
Penn Boiler & Burner  
Mfg. Corp.  
**Makers of Penn**  
*Packaged Heat*  
ESTABLISHED SINCE 1932  
LANCASTER, PA.

CKLA, 15.09; CKRA, 11.76; CHOL, 11.72; CKLO, 9.63; CKRZ, 6.06. To Europe 0945-1130, CKCX, CKNC; 1130-1500, CKCS, CKNC; 1500-1530, CKCS, CHOL; 1530-1815, CKLO, CHOL; 1815-1850, CKLO, CKRZ. To South Africa (except Sunday, Monday) with commentaries from the UN, 0850-0920, CKRP, CKNC. To Australia, New Zealand (Except Saturday, Sunday) with commentaries from the UN, 2320-0000, CKLX, CHOL; on Sunday only with *English* for listeners in Southwest Pacific area, 0340-0530, CHOL, CKLO. To Latin America and the Caribbean, 1910-2235, CKCX, CKRA.

CFRX, 6.070, Toronto, Ontario, scheduled 0530-2330. (Drummond, N. J.) St. John's, Newfoundland, 5.970, heard signing off 2234, said would return 0730; fair signal in Kentucky. (Alcock)

*Canary Islands*—Tenerife, 7.517.2 (measured), noted with good signal 1715. (Oskay, N. J.) Pearce, England, lists winter schedule of 1700-1800; sent QSL card.

*Ceylon*—*Radio Ceylon* verified with nice letter; listed schedule as 15.120, 0915-1205 to India, Pakistan; 17.730, 0325-0900 for Hongkong, China, Japan, and 21.620, 0325-1205 for Fr. Indo-China, Burma, Malaya. (Oskay, N. J.) Colombo, 4.900, logged in England around 1145; closes 1200 with "God Save the King." (Patrick)

*China*—Peiping, 10.26, recently has been heard in the Eastern U.S. opening 1800 with a long march-anthem; sometimes is better level than mornings (EST). I also have heard this one lately around 0030. Bellington, N.Y., reports it around 0215 to sign-off with march, closedown varying 0312-0350.

Old XGOE, 9.86, heard 0530 with Chinese news; is listed 9.82 as at Kweilin. BEL2, 11.50, noted 0630 with Chinese news; identifies as BEL2 and BEL7; BEL-, Hankow, listed 11.492. ZBW-3, 9.525, Hongkong, noted 0430,

good signal in news, music. (Sanderson, Australia)

Dilg and Balbi, Calif., confirm that Chungking, 11.913, now runs to around 1245 final sign-off.

"The Voice of Free China" at Taiwan, Formosa, operates around 0500-1130 (irregularly) on 11.725; some *English*. Widely reported. A similar outlet is heard with programs for the U.S. daily 2300-0100 on 15.235; first hour is *English* but at times is difficult to copy due to QRM underneath from Tokyo; best in West Virginia during last hour (in Chinese). Definitely announces "This is the Voice of Free China, broadcasting from Taiwan," and gives call BED3.

Revised winter schedule for Chungking is daily BEF7, 11.913, 0800-1250 (news 0900, 1100); lists religious programs for BEF8, 15.17, Sunday 0525-0635; Monday 0640-0705; Saturday 0555-0635. (Fried, Mich., Lyttle, Ontario)

*Colombia*—Current frequencies and schedules of *Radiodifusora Nacional de Colombia* are HJCQ, 11.680, HJCT, 6.200, HJCQ, 4.955, and HJCR, 1200 kc., weekdays 1000-1400, 1700-2315; Sundays 1030-1515, 1815-2315; this is from latest monthly bulletin. (McPheeters, N.Y.)

*Costa Rica*—Widely reported is new "Lighthouse of the Caribbean," TIFC, 9.645, 1600-0005; QRA is P.O. Box 1307, San Jose; 350 watts.

*Czechoslovakia*—OLR2A, 6.010, Prague, signs on 1415; news 1445, 1645. The 11.76 outlet heard daily signing on 0100 with Spanish news bulletin, evidently for Spain. (Pearce, England) When this was compiled was still using 11.84 at 1900-2000 to North America, bad QRM.

*France*—Paris has inaugurated a French transmission for Canada 1830-1845 and in Spanish for Latin America 1800-1815 on (announced) 9.55, 11.70. These channels are still used for the

Transmitter buildings of the "Voice of America's" relay station at Manila.



English transmission to North America 1945-2000. (Worris, N.Y.) Paris by this time or shortly should expand its North America transmissions.

**French Indo-China**—By this time, Saigon was to have changed identification from "Voice of France in the Far East" to "France-sie, Saigon" (may mean "Francaise, Saigon"—KRB). This was to be announced at the beginning and end of all sessions. This station has been in the process of reorganization and has been installing some new equipment; expected to make changes in schedule. (Good, England)

The 11.78 outlet has been heard opening 1800 with "La Marseillaise;" uses a little sequence of notes as a "coming-on" interval. (Stark, Texas) I hear this one with bad QRM. Sanderson reports it 0500 with news. English sessions scheduled 1830-1845, 1930-2000, 0430-0530, 0830-0930.

**French Morocco**—Bluman, Israel, lists CNR-3, 6.006, Rabat, 2.5 kw., at 0145-0330, 1300-1830.

**French West Africa**—FHE2, Radio Dakar, heard 1500-1530 sign-off on approximately 15.340. (GDX-aren, Sweden) Listed 15.345.

On 11.898 now has English news by woman daily 1400. (Pearce, England) May be as low as 11.890 now.

**Gold Coast**—Cushen, N.Z., received verification from ZOY, Accra, listed 9.640 Monday through Saturday 0530-0700, 4.915 Monday through Saturday 1030-1300. (Radio Australia)

**Greece**—Radio Athens, 15.345, noted opening 1015 with Greek at dictation speed. (Fargo, Ga.) Bluman, Israel, says the Greek Communist Radio has not been heard lately; the number of low-powered s.w. stations—presumably run for the benefit of the Greek Army—is still increasing; at present, Greek stations can be heard on 6.350 at 1100-1645, unidentified; 6.530, Chios, 1200-1500; 6.745, Larissa, 2330-0130, 1200-1600; 7.020 from 0000, unidentified; 7.050, Nauplia, 2330-0200, 1100-1630; 7.105, Makronesio, 0000-0130, 1200-1500; says 6.350 appears to be a relay of m.w. outlet.

**Greenland**—A station heard on 5.942 around 1653-1745 is believed to be Godthaab. (Bellington, N.Y., Sutton, Ohio, Oskay, N.J.) Heard in Sweden 1700-1745. (NATTUGGLAN)

**Guatemala**—TGWA, 9.76, Guatemala City, off the air since the Revolution in that country, should be back on regular schedule by this time, according to word direct from the station. (Boice, Conn.) Formerly used 15.17 daytime, 9.76 nights.

**Haiti**—Full schedule of 4VRW, 10.135, Port-au-Prince, is daily 0600-0800, 1200-1500, 1800-2200; Sunday 1200-1700. (Sutton, Ohio) The Haiti station on 6.407 at 1830-2030 is 4VCN, Port-au-Prince; all-French; fair level with some CWQRM. (Black, Pa.)

**Holland**—PCJ, Hilversum, is sending out a free picture of a Constellation airship in celebration of the 30th anniversary of KLM Airlines; also a

# LOOK! IT'S STILL XMAS TO PLATT

## \$1 AUTOMATIC CREDIT AGAINST ALL \$10 ORDERS

Last month we tried something new—\$1 off on every \$10 order. And orders are still pouring in. NOW Platt says, "Let's try it again." So put \$1 back in your pocket—as Platt's gift—for every \$10 order you place. (Keep \$2 on a \$20 order, etc.) REMEMBER—This offer may never be repeated again. So ACT NOW! Place your order today!



**FIELD TELEPHONES**  
Army surplus, completely reconditioned with new handsets, electrically tested, in good used condition.  
Only..... **\$6.95**  
LIKE-NEW FIELD TELEPHONES.....\$8.95

**T-24-G MICROPHONE**  
with PL-106, JK 38, Brand New, Original Packing.  
LOOK! ONLY..... **\$1.95**



**TYPE MN-20E ROTATABLE LOOP UNIT**  
3' diameter, used with MN-20 Compass and RA 10DB. Manufactured by Bendix.  
A TERRIFIC BUY!  
ONLY..... **\$11.95**

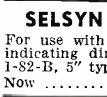

**SEL SYN INDICATOR**  
For use with beam antennas for indicating direction of antenna.  
I-82-B, 5" type.  
Now..... **\$4.95**



**ANTENNA TIE DOWN EQUIPMENT**  
One rope 15 ft., 1 steel fitting, 1 porcelain insulator.  
Each..... **29c**  
In lots of 6 only 25c each.

**SPECIAL! DYNAMOTOR**  
for DY-12 Power Supply for AMT-13.  
NOW ONLY..... **\$9.95** complete

**Control Box BC-434-A**  
Used with Radio Comp and Receiver R5-A R N. 7. B c n d l x ADF Equipment.  
Only \$4.95

**Control Box BC-648-A**  
Brand New. Includes 2 meters—0.5 milliamperes and 0-40 Volts. Made by Westinghouse. Excellent Value!  
ONLY..... **\$4.95**

**CONTROL BOX BC-690-A**  
Brand New..... **\$3.95**

**COIL SETS FOR RADIO SET SCR-183**  
All Brand New—Terrific Buys!

**TYPE**  
C-381—Transmitting 2500-3200 KC..... **\$1.95**  
C-382—Transmitting 3200-4000 KC..... **1.95**  
C-384—Transmitting 5000-6200 KC..... **1.95**  
C-266—Receiving 2500-4700 KC..... **3.95**  
C-376—Receiving 2500-4700 KC..... **3.95**  
C-377—Receiving 4150-7850 KC..... **3.95**  
MC-125 Tuning Unit, part of radio set SCR-183..... **.79**

**DYNAMOTORS**  
Type DM-33-A, in. 28 V. out. 540 VDC, 250 mills..... Brand New (Excellent—Used)..... **\$1.95**  
Type DM-53-A, 24 V. in. 220 V, 80 MA out..... Brand New..... **1.95**  
INVERTER—PE-206, 28 V. in., 80 V at 500 VA, 800 cy. out..... Brand New (Used, Excellent Condition)..... **4.95** (3.25)

**HEADSETS—Excellent Buys!**  
HS-33 with cord and plug, used, good condition..... **\$1.19**  
HS-23—Brand New with ear pads 2.75  
HS-33—Brand New with ear pads, cord and PL54 plug..... **2.75**

**EXTENSION CORD**  
DC-307A with PL55 and JK26—65 inches..... only **59c**

**AN/APN-1 RADIO ALTIMETER**  
New—original packing, complete ready for operation. Just few left! Only..... **\$29.95**

**Minimum Order \$2.00**  
Immediate Delivery Send 25% deposit on C.O.D. orders. All shipments F.O.B. N.Y.C. (N.Y.C. residents add sales tax to your remittance.)



**TRANSMITTER-RECEIVER**  
Conversion of BC-645 Bringing Excellent Results.  
Navy Model ABA-1 (CG-43AAG)  
Army Model SCR-515A known as the BC-645

**BRAND NEW ORIGINAL CARTON.** Can be easily converted for phone or CW 2-way communication. Covering for the following bands: 420-450 MC ham band, 450-460 MC for fixed or mobile, 460-470 MC for citizens, 470-500 MC television experimental. Size 10 1/2 x 1 3/4 x 4 3/4. Contains 15 tubes: 4-7P7, 4-7H7, 2-7E6, 2-6F6, 2-955, 1-WE-316A door knob. Complete as shown above..... only **\$17.95**

**BC-645 ANTENNA..... only 39c**  
**BC-645 TRANSMITTER-RECEIVER ONLY, Brand New, ORIGINAL PACKING..... \$12.95**  
Special.....

**OIL FILLED CONDENSERS**  
FAMOUS MAKE TH 50020, 2 MFD, 5000 VDC..... **\$4.25**  
NATIONALLY KNOWN 2 MFD, 600 VDC..... **.29c**  
PROMINENT MAKE 4 MFD, 600 VDC..... **.79c**  
FAMOUS MAKE 23F47, 2 MFD, 4000 VDC..... **\$3.25**  
FAMOUS MAKE 25 Mu-f, 6900 VDC..... **1.95**  
FAMOUS MAKE 30 Mu-f, 90 V, 3 phase, 60 cycles..... **1.19**

**PLATT'S TOPS IN TUBES, TOO!**  
5BP4..... **\$2.45** 4AP10..... **\$4.95**  
872A..... **1.47** 7CP1..... **2.95**  
10Y..... **.39**  
Standard Brands All New Tubes

**BEACON RECEIVER BC-1206-C**  
Manufactured by Satchell-Carlson  
Frequency Range—195 KC to 420 KC, IF Frequency—135 KC, Receiver Sensitivity—3 Microvolts for 10 Milliwatts output. Output Impedance—300 Ohms and 400 Ohms to be selected internally. Power Output—230 Milliwatts. Volume Control—RF Gain Control, Power Supply—24-28 Volts Aeroplane Battery, Current—75 Amperes.  
BRAND NEW—ONLY **\$6.95**

**Multitester Foundation BIAS METER 1-97A**  
Contains a zero center 3 1/2" round Marion voltmeter calibrated 0-100 volts each side. Movement is one mill each side of center. The unit is mounted in a steel box 7" x 5" x 4 1/2" and contains 3 contact push button, line cord dual 100 MFD at 200 V. DC condenser, a potentiometer 6 IRC 1% wire wound non-inductive resistors; one 400 ohm, two 2500 ohm, one 5000 ohm, one 10,000 ohm, one 15,000 ohm.  
Excellent for building a zero center multitester with ranges of 1, 10, 100, 1000 volt.  
COMPLETE BRAND NEW **\$3.95**

Allen-Bradley Relay—24 Volts, DC..... **\$ 0.79**  
Reel Control Box, 4 BC-61-A..... **.89**  
FL-5 Lazy Q Radio Filter Unit, High Impedance, Brand New..... **.75**  
FL-8 FILTER..... Special **1.49**  
BC-348 RECEIVER—Brand New—Original Packing..... **165.00**  
BC-348—Excellent Condition—Used..... **125.00**  
PE-94C Dynamotor for SCR-522—Brand New..... **5.95**  
BC-602 Control Box for 522—Brand New..... **Special .98**  
Plugs—Set for 522—Brand New..... **Only 4.95**  
PL55 Plug..... **Only .25**  
PL68 Plug..... **Only .12**

**274-N COMMAND EQUIPMENT Sensational Buys!**

	USED	BRAND NEW
BC-442	1.85	\$ 2.75
BC-443	12.95	
BC-454	4.95	6.95
BC-455	6.95	
BC-456	3.95	2.95
BC-457	5.95	9.95
BC-458	5.95	24.95
BC-459	14.95	24.95

**RUSH THIS COUPON TODAY FOR FREE CIRCULAR**  
PLATT ELECTRONICS CORP., Dept. A, 489 Broome St., New York 13, N. Y.  
NAME.....  
ADDRESS.....  
TOWN..... ZONE..... STATE.....

**PLATT ELECTRONICS CORP.**  
DEPT. A, 489 BROOME ST., NEW YORK 13, N. Y.  
PHONES: RE 2-8177 and WO 4-2915

# RACON TWEETER

Highest Music Quality  
At Low Cost!



**Clean  
Output to  
15,000 Cycles!  
Wide Distribution Pattern!**

**MODEL  
CHU-2  
\$37.50  
List Price**

Add this Racon tweeter to your present 12 or 15" cone speaker and enjoy concert hall music as you have always wanted to—rich, brilliant, life-like—right in your own living room.

Response is clean and smooth to 12,000 cycles, with usable output to 15,000 cycles. High frequency horn logarithmically expanded as two horns for wide, uniform distribution pattern. When used with crossover network, will handle amplifiers rated to 25-30 watts. Input impedance 4-15 ohms. Dimensions 10 $\frac{3}{4}$ " wide, 7" high, 8 $\frac{3}{4}$ " deep.

Cast aluminum throughout. Cutout template provided for easy flush mounting. Free wiring diagram and instructions to build an economical professional type 1,000-cycle crossover network.

Listen to the Racon tweeter at your nearest distributor or write for free Catalog N.

**ALL RACON PRODUCTS GUARANTEED  
18 MONTHS**

ACOUSTICAL  EXCELLENCE

*Racon Electric Co., Inc.*

52 East 19th Street, New York 3, N. Y.

**LEARN DAY and EVENING CLASSES**

## TELEVISION

**ELECTRONICS-RADIO**  
Modern Laboratory  
Instruction In

- SERVICING
- BROADCAST OPERATING
- ELECTRONIC and TV ENGINEERING

**WRITE FOR ILLUSTRATED CATALOG**

**ELECTRONICS INSTITUTE, Inc.**  
21 HENRY, DETROIT 1, MICH.

**G.I.  
APPROVED**

map showing principal s.w. stations of the world. (Bellington, N.Y.) The 21-480 outlet transmits to Surinam and West Indies 0945. (McPheeters, N.Y.) New schedule for the "Happy Station Programs" presented by Eddie Startz is Sunday and Wednesday 0930-1100 on 6.025, 15.220, 17.770, repeated 1600 and 2200 on 6.025, 9.590, 11.730; for Pacific on Tuesday 0600-0730 on 6.025, 15.220, 17.770, 21.480. (Radio Sweden)

**Hungary**—Budapest seems to have increased power; heard on about 9.830 with good level in New York 1630 with news by man. (Bellington) Is good level in West Virginia; asks for reports. Pearce, England, says appears to be testing with increased power on both 6.247, approximately 9.830.

**India**—AIR announces its 1400-1500 daily broadcast for Overseas Listeners as on 11.71, 11.76, 9.62, and 7.24 now; heard on all these in England. (Pearce) Madras, 4.920, is audible to fair now in West Virginia 0730 with news; heard in England by Brownless at 1215, good level.

**Indonesia**—At the time this was being compiled I received word from Balbi, Calif., that he had heard a *Radio Batavia* outlet on 6.05 which may be the new 100 kw. transmitter. Noted 0500-0630 with "local" signal; had *English* news 0600. Dilg, Calif., noted this one the same day as Balbi at 0900 in Dutch; signs off 1000 with Dutch National Anthem; listed frequencies of 15.15, 11.77, 7.27, but did not mention the new one. Dilg gave frequency as approximately 6.045; says has QRM from BFEBS, 6.045, Singapore. Fuller, Rhode Island, has again been hearing *Batavia's* 19.345 channel around 1200.

**Radio Sumatra**, Medan, signs off 1100 on 7.355 with "Marching Through Georgia" and Dutch National Anthem; *English* request program heard from 0939 (may not be daily). Pontianak,

8.090, closes 0930 with Dutch National Anthem. "This is Radio Republic Indonesia broadcasting from Djokjakarta" is the identification during *English* session 0900-0930 from the Indonesian outlet on 5.060. (Gillett, Australia)

**Iran**—Teheran, 15.100, lately has had two short periods of news—1400 and 1500. (Pearce, England)

**Iraq**—GDX-aren, Sweden, says Baghdad, 7.062, "The Voice of Iraq," transmits in *English* 1230. Also reported by other Swedish sources.

**Israel**—The new 7.5 kw. transmitter at Tel Aviv is now on regular schedule on 9.000 at 1200-1300 with special programs for new immigrants and displaced persons, using Yiddish, French, Spanish; at 1300-1315 relays "Kol-Israel." *The 50 kw. transmitter is expected to start tests in the spring.* (Bluman, Israel) Heard well on 9.000 at 1430 news period by Gillett, South Australia, who hears Tel Aviv, 6.830, and Haifa, 8.170, in parallel but much weaker; Haifa has been heard as late as 1645.

**Italy**—Rome, 9.63, 11.81 (best), has news 1430. (Fargo, Ga.) Some weeks ago *Radio Sweden* reported experimental transmissions had been heard from a station at Parma on approximately 7.590 at 1500-1530 sign-off.

**Jamaica**—ZQI, 3.48, Kingston, good lately evenings around 1930-2200. (Cox, Dela.) The 4.950 outlet has been fairly good around 1700-1730 recently. (Sink, N.Y.) Latter heard well here in West Virginia.

**Japan**—JBD-4, 15.235, noted with weak signal 1850; measured 15.235.4; some QRM from Moscow on (measured) 15.231, and from KNBX; however, QRM eases when KNBX signs off 1900. JBD-3, 15.225, quite good around 1830, measured 15.225.5. (Oskay, N.J.)

**Kashmir**—Nordh, Sweden, flashes  
(Continued on page 138)

## DOCKET 9295 REVISIONS

**F**OLLOWING the recent FCC hearing on the controversial Docket 9295 covering the proposed new amateur regulations, a revised Docket 9295 was issued. Oral arguments on this revised docket may be held depending on the comments received. Essentially, these revised rules are as reported in the December issue of **RADIO & TELEVISION NEWS** on page 54. A brief resume of the new proposals is as follows:

### BAND ALLOCATIONS

AM phone: 3800-4000 kc., 14,200-14,300 kc., 28.5-29.7 mc. NBFM phone: 3800-3850 kc., 14,200-14,250 kc., 28.5-29.7 mc. with these frequencies limited to Advanced Class (Class A) operators. A1, A2, A3, A4, and NBFM: 50-54 mc. NBFM is defined as having a bandwidth no greater than that occupied by an AM signal containing the same frequencies.

### LICENSE CLASSES

**Extra Class:** No special privileges at this time but additional privileges may be granted in the future. Exam consists of elements 1(E), 2, 3, and 4(E).

**Advanced Class (Class A):** No new Advanced Class or Class A licenses will

be issued after December 31, 1951. Exam consists of elements 1, 2, 3, and 4.

**General Class (Class B) and Conditional Class (Class C):** Exam covers elements 1, 2, and 3.

**Technician Class:** Exam covers elements 1(NT), 2, and 3.

**Novice Class:** Exam covers elements 1(NT), and 3(N).

### EXAMINATION ELEMENTS

1. 13 w.p.m.; 1(E). 20 w.p.m.; 1(NT). 5 w.p.m. code speed.

2. Amateur radio operation and apparatus, including telephone and telegraph.

3. Provisions of treaties, statutes, and regulations affecting amateurs. 3(N) Rules and regulations essential to beginner's operation, including elementary theory.

4. Advanced amateur radiotelephony. 4(E). Advanced radio theory and operation as utilized in modern amateur techniques, including, but not limited to radiotelephony, radiotelegraphy, transmissions of energy for measurements and observations applied to propagation, to the radio control of remote objects and for similar experimental purposes.

-30-

**P.A. Amplifiers**  
(Continued from page 65)

address amplifiers is very similar to that employed in the Bell 510, except that a 6Y7G is used instead of the 6N7 as a phase inverter and driver for the 6V6's. The same modifications for the Bell amplifier will also apply to this and similar amplifiers. In the 12860 series, low-frequency response may be improved a great deal by installing a 10  $\mu$ fd., 50 volt electrolytic condenser across the cathode of the 6V6 output stage in case of unbalance.

**Miscellaneous Improvements**

Old-type amplifiers not equipped with a tone control or equalizer can be improved by adding a simple series circuit comprising a 500,000 ohm potentiometer and a .006 to .01  $\mu$ fd., 600 volt condenser. This control circuit can be connected across the grids, or from plate-to-plate in push-pull stages, or from grid-to-ground (or plate-to-screen) in single-ended stages. Although this circuit admittedly is not the most desirable, it will aid considerably in reducing record scratch, background and surface noise, etc. with not too much sacrifice of the higher frequencies. Since most small amplifier systems are used in conjunction with a record-player or changer, this feature will be worth including. In high-fidelity amplifiers, of course, and in the higher-powered systems where a 10 to 20 db. drop in gain can be spared, a commercially-built equalizer can be added. Some high-fidelity amplifiers employ feedback and special filter circuits to attain precision performance.

In most cases, especially in older-model amplifiers, the percentage of a.c. and extraneous hum pickup can be reduced by shielding the grid leads in low-level stages and redressing, as far as possible, from a.c. leads and filament circuits. In some models improved quality and a much better signal-to-noise ratio can be obtained by installing a 50 to 100 ohm wire-wound potentiometer across the filament or heater winding in a humbucking arrangement. The arm of the potentiometer is connected to the chassis or common ground return of the amplifier and the original filament ground return (if any is used) disconnected. The control is then adjusted for minimum hum in the speaker. This adjustment can best be made with the amplifier gain controls at maximum but with the input circuit shorted. An output meter connected across the plates of the output stage can be used as an indicator.

Connecting an .01 to .1  $\mu$ fd. condenser across one or both of the primary terminals of the power transformer, or from these terminals to ground, often will result in improved quality, reduction in hum, and increased circuit stability or freedom from oscillation.

Quite often the major factor which

*Spotlighting* **CHE SEA VA UES**

**12" DUMONT PICTURE TUBE**

in sealed cartons . . . \$19<sup>95</sup>

SEE OTHER PICTURE TUBE BARGAINS BELOW!

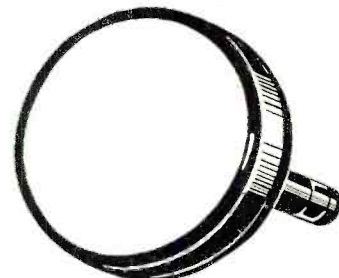

**FOR CUSTOM-BUILT INSTALLATIONS**

**29 TUBE, RCA LIC. 630 TYPE CHASSIS**

Completely wired, factory-engineered, aligned and tested  
**FOR 12½" OPERATION**

**PLUG IT IN —AND IT WORKS!**

**COMPLETE with DUMONT Picture Tube**

\$149<sup>95</sup>

Plus \$2.25 Fed. Tax

**A SET . . not a kit!**

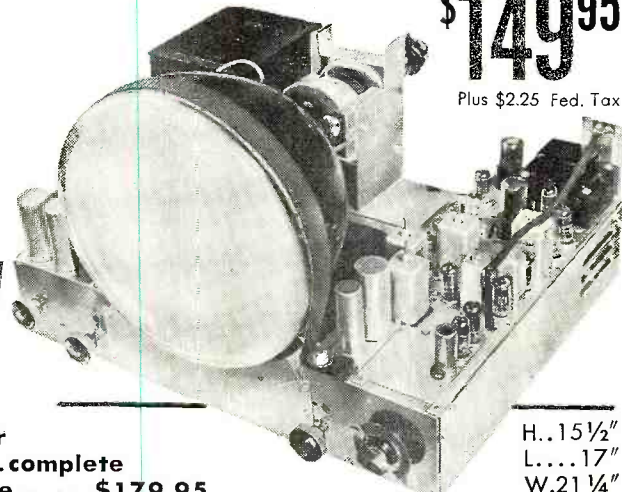

Same Chassis for 16" operation . . . complete with picture tube . . . \$179.95

Plus \$2.25 Fed. Tax

H. 15½"  
L. . . . 17"  
W. 21 ¼"

Standard RMA Guarantee

**THE IMPROVED CUSTOM-MADE 30-TUBE 630 CHASSIS WITH VOLTAGE DOUBLER, COMPLETE WITH 16" PICTURE TUBE . . . plus \$2.25 Fed. Tax \$199<sup>95</sup>**

Highly Sensitive No-Drift AM and FM Tuner . . . \$31.50 plus \$1.80 Fed. Tax

**BRAND NEW TV TUBES**

IN SEALED CARTONS

10" . . . \$19.50	15" . . . \$ 44.50
12" . . . 19.95	16" . . . 44.50
12½" . . 26.00	20" . . . 189.34

**RECORD CHANGERS**

PRICE INCLUDES TAX

Webster 256-1 Dual Speed 78 and 33½ RPM . . . . .	\$28.44
Webster 356-1 Three-Speed 78, 45 & 33½ RPM . . . . .	\$29.70

High and Low Frequency All-Channel Antenna from \$6.71 to \$471.00

**WHY PAY MORE ELSEWHERE?**

Write Dept. N for latest literature and prices . . . and COMPARE!

Phone and mail orders filled on receipt of certified check or money order for \$25 as deposit . . . balance COD FOB N. Y.

FOR FREE DEMONSTRATIONS, VISIT OUR STREET-LEVEL SHOWROOM

**THE HOUSE OF BARGAINS**

**CHELSEA TELEVISION CENTER, Inc.**

187 Seventh Avenue, New York 11, N. Y.      Phones: CHelsea 3-4425-6-7

PRICES SUBJECT TO CHANGE WITHOUT NOTICE

# Lowest prices!



**SYNCHRON TIMING MOTOR**  
Model 600, 1 RPM, 115 Volts, 60 cycles.  
Special Price \$2.45 each



**NOISE FILTERS**  
3 chokes and three oil-filled AC capacitors mounted in an assembly with 4 pin Amphenol connector.  
A Steal at 39c

**NEON BLOWN FUSE INDICATORS**  
Rated for 110-220 volts either AC or DC. Can also be used for general testing for "opens" "shorts", etc.



Price 39c

**PIONEER AMPLIFIERS**  
Shock-mounted case and chassis includes many transformers, condensers, potentiometers, etc. Supplied less output transformer and tubes.



Our Low Price 98c

**C-1 AUTOPILOT VERTICAL GYROS**

Gyro, driven by series motor, provides electrical signals for both the roll and pitch of the aircraft. Has many valuable parts such as precision variable resistors, bearings, contacts, etc. Amphenol connector not included. Original price \$1500.00.



Special \$4.95



**C-1 AUTOPILOT AMPLIFIERS**

Three channel servo amplifier consisting of many valuable electronic parts including 6 relays, 7 tubes, etc. Unit removed from new aircraft.

Super Special \$5.95

**EDISON TIME DELAY RELAY**  
Vacuum sealed in glass, s.p.s.t. contacts normally closed. 30 v. 7 second delay to open. Many experimental applications.  
Special Price Three for \$1.95

**TUBES**

6SN7; 7F7; 7N7; 7Y4.....\$ .59 ea.  
6H6 ..... .39 ea.  
83 ..... .65 ea.  
CIB—Grid control rectifier (thyatron).. 1.95

**TERMS:** 20% cash with order—balance C.O.D. Orders accompanied by payment in full must include sufficient postage, otherwise shipment will be made via Railway Express collect. Minimum order \$2.00.

**Electro Devices**  
INCORPORATED  
BOX NO. 1941 PATERSON, N.J.

governs the output quality of an amplifier is the limited frequency range of the speaker, especially in small, low-cost systems. Many of these systems employ 6- and 8-inch permanent magnet or dynamic speakers of medium quality and performance. As a rule, a worthwhile improvement in frequency response, along with an increase in output and operating efficiency, will be noted when these speakers are replaced with 10- or 12-inch units employing *Alnico 5* permanent magnets. An improvement in low-frequency response and over-all efficiency in delivery will also result if the speaker is enclosed in an acoustically-treated baffle, or equipped with an exponential horn-type enclosure.

Some of the older amplifiers equipped with dynamic speakers can also be given new life by replacing these units with new PM types. The field coil should be replaced with a filter choke (or in some cases a resistor) of approximately the same resistance as the coil. An exact value is not critical unless the field coil was used in the "B—" circuit to furnish grid bias.

In this case the replacement choke should be the proper ohmic value to produce the correct bias voltage. It is best not to depend entirely on the resistance value of the old field coil—

this may have changed or may not have been the optimum value in the first place. Measure the actual bias and supply voltages and change the resistance if necessary to produce the voltages recommended in the tube manual or in the manufacturer's notes, if available. Amplifier efficiency can often be stepped up by increasing plate and screen voltages, provided the maximum recommended ratings are not exceeded.

Extension speakers can often be used to solve the problem of coverage without necessitating the purchase or installation of a more powerful system. Speakers may be connected in parallel, series, or series-parallel as required to properly match the output impedance of the amplifier. Any speaker installed at a considerable distance should be fed through a 500 ohm line, with a suitable matching transformer at the amplifier and speaker end.

Many more modifications and improvements will be apparent to the p.a. service technician in individual cases. Most of these can be made without considerable cost to the customer, and in the majority of cases will give added life and utility not only to the small p.a. systems, but to large installations as well.

## PICTURE DISTORTION IN TV TUBES WITH METAL SIDES

By MATTHEW MANDL

**M**ETAL-SIDED picture tubes such as the 16AP4 will sometimes give a distorted raster and picture which cannot be corrected by linearity controls. When such a condition occurs the likely cause may be that the metal cone side of the picture tube has become magnetized. A magnetized cone means that the magnetic fields thus produced will influence the electron beam within the tube in fashion similar to a permanent magnet. A small pocket compass will give an indication of the presence of magnetization, and the portions of the cone so affected can be determined by moving the compass about the entire metal surface area. If the picture tube is one of those incorporating a permanent magnet type ion trap, this will have to be removed before this check is made, otherwise the compass will give a false indication. When the places of magnetization have been determined, they can be nullified by the use of an a.c. field.

Westinghouse, in their later service notes, recommend the use of a coil which can be connected directly to the 110 volt lines. This coil consists of 1250 turns of No. 24 insulated copper wire wound around a form seven inches in diameter. Such a coil will generate magnetic lines of force of sufficient intensity to cancel out the unwanted magnetism of the cone structure. The coil is connected to the a.c. lines, and the coil end is passed over the surface of the magnetized cone. Move the coil away from the cone before removing the a.c. plug. Since this coil will overheat in a relatively short time, it should only be used at intervals. If it is to be used on several tubes, wait a few minutes between usage.

When the tube has been demagnetized, the pocket compass no longer will give an indication of the presence of magnetism, though this test should be made with the set shut off to eliminate the stray magnetic fields of yoke, focus coil, and ion trap. A further check can be made with the tube in actual use, and the picture as well as the plain raster should no longer be distorted, pulled out of shape, or have a kink at the edge of the raster.

As a precaution when servicing sets with metal cone tubes, care should be exercised to keep this metal side away from the frames of PM speakers, permanent magnet beam benders, or other magnetic fields. If the small end of the metal cone becomes magnetized, it will have the greatest effect on the electron beam within the tube because the magnetic field will be closer to the beam. Portions near the middle of the cone are also influential in disturbing the raster, though not to as great an extent as the small end of the metal cone.

Construction details covering the coil used for demagnetizing metal tubes.

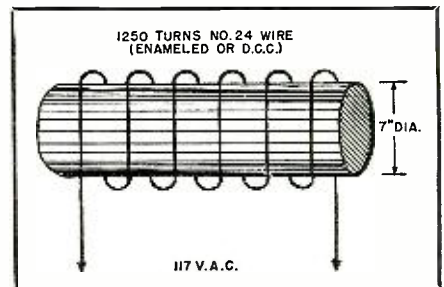



# RADIO TUBES at Lowest Prices!

AM, FM, TV—Tremendous Selection of All Types—ORDER TODAY!

<b>29<sup>c</sup></b> ea.	1T4 1U4 3A4 6S8GT 01A 4A6G 6A3	6C4 6F8GT 6SD7GT 10 12A 14X7 39/44	47 50 71A 112A 182B 183	25S 25Z6GT 482B 483 1A4 1A4P	1A6 1B5 1D5GT 1D7 1D8GT 1F4	1F5G 1G4GT 1G6GT 1H4G 1H6GT 1J6G	<b>FREE!</b> \$20.00 List Value Cornell-Dubilier, Mallory, Aerovox, Sprague, Solar. Filter Condensers —ten fast moving filters FREE with each 100 tubes.	<b>69<sup>c</sup></b> each	32 33 34 35 35B5 35C5 35W4 35Z4GT 35Z5GT 35Z6GT 24A 25L6GT 25X6 30 46	50B5 50C5 50Y6 51 5T-52 56 57 58 75 76 77 78 80 85 89	1B3GT 2A3 3Q5 6A7 6B6G 6E5	6G5 6U5 19BG- 6G 50A5 807
<b>39<sup>c</sup></b> ea.	3V4 5U4G 5W4GT 5X4G 5Y3GT 5Y4G 6AB4 6AC4 6AC5 6AC5GT 6AG5 6AK5 6AL5 6AL6 6AQ5 6AR5	6AS5 6AT6 6AU6 6A8G 6A8GT 6B6 6BA6 6BD6 6BE6 6BH6 6BJ6 6C5 6C8G 6D6 6F5GT 6F6GT	6G6 6H6 6H6GT 6J5 6J5GT 6J6 6J7G 6J7GT 6K6GT 6K7GT 6K8GT 6P5GT 6SA7GT 6SC7GT 6SG7 6SG7GT	6SH7 6SJ7 6SJ7GT 6SL7GT 6SK7GT 6SN7GT 6SQ7GT 6SR7 6U6G 6U6GT 6U7G 6U7GT 6V6GT 6W4 6X4 6X5GT	6Z4 12A8GT 12AT6 12AU6 12AU7 12AX7 12BA6 12BA7 12BE6 12F5GT 12H6 12J5GT 12J7GT 12K7GT 12K8GT 12S8GT	12SA7GT 12SF5 12SF7 12SH7GT 12SN7GT 12SR7GT 1619 1629 (eye) 2050 2051 24A 25L6GT 25X6 30 31	10Y 12A7 12AT7 12C8 12J5 12Q7GT 12SG7 12SJ7GT 12SK7GT 12SL7	12SQ7GT 12Z3 14N7 19T8 20 32L7GT 35/51 35L6GT 36 40	41 42 43 50 53 84 86/24 117Z3 VR150 XXL			
<b>49<sup>c</sup></b> ea.	1LA4 1LE3 1N5GT 1P5GT 1Q5GT 1T5GT OZ4 1A5GT 1A7GT 1C7G	5Z3 5Z4 6A8 6AC7 6AV6 6B4G 6BA7 6B8 6C6 6D8	6D8G 6F5 6F8G 6K7G 6R7 6SF5GT 6Q7GT 6T7G 6T8 6U7	6W7G 6Y6G 6Z7G 7A4 7A7 7B6 7E5 7E6 7E7 7F7	7G7 7H7 7J7 7L7 7M7 7Q7 7S7 7T7 7V7 7W7	10Y 12A7 12AT7 12C8 12J5 12Q7GT 12SG7 12SJ7GT 12SK7GT 12SL7	12SQ7GT 12Z3 14N7 19T8 20 32L7GT 35/51 35L6GT 36 40	41 42 43 50 53 84 86/24 117Z3 VR150 XXL				
<b>59<sup>c</sup></b> ea.	1AB5 1AD5 1H5GT 1LA6	1LB4 1LC5 1LC6 1LH4	1LN5 1S4 2C34 2V3G	2X2 25Z5 35Z3 3LF4	6B7 6BF6 6J8G 6LG6	6L6 6S7G 6SU7GT 7C4	12A6 12BF6 14H7 45	50C6 70L7GT 81 83	117Z6GT 9001 XXB			

Less than 50 tubes, 5c per tube extra.

Above prices are for 50 tubes or more—may be assorted.

Individually boxed—Standard factory guarantee.

50L6, 35Z5, 12SK7, 12SQ7, 12SA7... 5 tubes for **\$1.95**  
 10BP4 TV Picture Tube... \$17.95 each  
 12LP4... \$24.95 each

Miniature tubes 12AT6, 12BA6, 12BE6, 35W4, 50B5... 5 tubes for **\$1.69**

1R5, 1S5, 1T4, 3V4 Battery Tube Special... 4 tubes for **\$1.29**

**SPEAKERS**  
 Best Quality Alnico 5 PM Speakers  
 10 or more Each Price Each  
**5" -95c-\$1.05**  
 2 1/2", 8", 4"-95c - \$1.05  
 6" \$1.49 \$1.59  
 8" 2.95 3.25  
 10" 4.25 4.50  
 12" 4.95 5.95



**VOLUME CONTROLS**  
 10 or more Each Price Each  
**VERY BEST BRANDS**  
 1/2 meg. or 1 meg. or 1/10 meg. with switch—long shaft... **29c 35c**  
 2 meg. for battery sets—DPST switch, long shaft... **29c 35c**  
 1/2 meg., 1 meg., 1/10 meg. or 2 meg., long shaft, less switch... **16c 19c**

**NEW TEST EQUIPMENT**  
 All makes, all models. Tell us what you need and we will quote best prices.

**OUTPUT TRANSFORMERS**  
 For 50L6, etc. **39c** ea.  
 For 6V6, 6F6, 3Q5, etc. **45c** ea.

**UNIVERSAL OUTPUT TRANSFORMER SPECIAL**  
 Up to 8 watts to any speaker... **98c** ea. (while they last)



**IF TRANSFORMERS**  
 Standard Replacement Regular size... **29c**  
 Midget... **39c**

**4 PRONG VIBRATORS—VERY BEST BRANDS**  
 Standard replacement—Sensational Value... **\$1.29** ea.

**BY-PASS CONDENSERS**  
 100 Condensers assorted in package... **\$5.95**  
 .001 mfd. 600 V... ea. 6c  
 .002 mfd. 600 V... ea. 6c  
 .005 mfd. 600 V... ea. 6c  
 .01... ea. 7c  
 .02... ea. 7c  
 .05... ea. 8c  
 .1... ea. 9c

**400-VOLT BY-PASS CONDENSERS**  
 .05 mfd... ea. 6c  
 .2 mfd... ea. 6c  
 .25 mfd... ea. 10c  
 .5 mfd... ea. 15c

**BUFFER CONDENSERS**  
 .005 mfd. 1600 WV...  
 .008 mfd. 1600 WV... **15c** ea.  
 .01 mfd. 1600 WV...

**PILOT LIGHTS—100 BULBS \$4.90**  
 1 box of 10 bulbs... **54c**  
 No. 40 6-8 V. 15 Amps. No. 46 6-8 V. 25 Amps.  
 No. 41 2.5 V. 50 Amps. No. 47 6-8 V. 15 Amps.  
 No. 44 6-8 V. 25 Amps. No. 51 6-8 V. 20 Amps.

**6-FT. LINE CORDS**  
 Good Rubber with Underwriters' Approval...  
 10 for **\$1.25** 10 for **\$1.69**

**SELENIUM RECTIFIERS**  
 Standard 100 mil. Each... **79c**

**OCTAL SOCKETS**... 10 for **49c**  
**MINIATURE TUBE SOCKETS**... 10 for **49c**

**CRYSTAL CARTRIDGE**  
 Standard replacement crystal cartridge. Each... **\$1.39**

**RESISTORS**  
 100 resistors—packed in a box IRC etc. Best values only—1/2 watt, 1 watt, 2 watt... **1.98**

**VARIABLE CONDENSERS**  
 Two gang for superhet Standard 1/4" shaft... **69c**

**FILTER CONDENSERS**  
 Very best brands Fresh stock

**450 Working Volts**  
 8-450 V... ea. 21c  
 10-450 V... ea. 24c

**150 Working Volts**  
 15-150 V... ea. 29c  
 20-20-150 V... ea. 29c  
 20-450 V... ea. 39c  
 30-450 V... ea. 49c  
 30-450 V with 20-20-25 V... ea. 29c  
 8-8-450 V... ea. 39c  
 10-10-450 V... ea. 43c  
 20-20-450 V... ea. 49c

**25 Working Volts**  
 10-25 V... ea. 16c  
 20-25 V... ea. 16c  
 25-25 V... ea. 16c  
 100-25 V... ea. 16c  
 20-16-16-350 V Sprague type... ea. 39c  
 25-25-150 V-200-10 V... ea. 39c

**25 Working Volts**  
 10-25 V... ea. 16c  
 20-25 V... ea. 16c  
 25-25 V... ea. 16c  
 100-25 V... ea. 16c  
 20-16-16-350 V Sprague type... ea. 39c  
 25-25-150 V-200-10 V... ea. 39c

**TV PARTS**  
 Horizontal output.  
 RCA Type Flyback... **\$3.45** ea.  
 Discrimination Transformers... \$1.29 ea.

**OUR NEW ADDRESS**  
**PREMIER RADIO TUBE COMPANY**  
 551 West Randolph St., Chicago 6, Ill.  
 Phone: Andover 3-1590

**"Your Tube Source Since 1926"**



# Easy on the Ears...



## TELEX Monoset\*—Under Chin Headset

Stethoscope design of the Telex *Monoset* eliminates tiresome pressure—instrument swings lightly *under* the chin. Wear it for hours without fatigue!

## TELEX Earset\*—Slips onto the Ear

Weighing only 1/2 oz., *Earset's* flat plastic frame slips onto the ear, holds the sensitive receiver securely in place. User's other ear is always free for phone calls or conversation.



## TELEX Twinset\*—Nothing Need Touch Ears!

Lightest twin-receiver headset made—weighs only 1.6 oz. Adjust to any head. Flexible, slips into pocket.



Write for Colorful FREE Specifications Folder Today!

# TELEX

DEPT. H-20-1, TELEX PARK  
MINNEAPOLIS, MINNESOTA

In Canada, Atlas Radio Corp., Toronto



## Photocell (Continued from page 51)

last 1/4 inch at the drilled end. Place the strip inside the jar top, as shown in Fig. 2 (left), with the screw of the banana plug passing through its clearance hole. Fasten the strip and plug with a 6-32 nut. Bend the free portion of the strip slightly upward so as to make contact with the rectifier disc when the latter is placed into position.

(5.) Bend a solder lug into the shape of a wiper contact (See Figs. 2 [left] and 4A), pass a 6-32 screw through its hole, and pass the screw through a 1/2-inch-diameter bakelite washer. This complete assembly may be seen in Fig. 2 (left).

(6.) Place a rectifier disc into the jar top with its selenium-coated surface outward, and press it down against the metal contact strip previously installed. Then, pass the screw holding the lug and washer through the large clearance hole in the rectifier disc and through the hole in the back of the jar top, holding all of the parts stationary to keep the screw in the exact center of the hole and out of contact with the rectifier disc. Tighten the entire assembly by means of a nut on the outside of the jar top. Be careful that the inner lug does not bite through the selenium coating.

(7.) Place a solder lug on top of the outside back nut and add a second nut to secure this lug. (See Fig. 5).

(8.) Cut a 2-inch-diameter disc of transparent, colorless celluloid or other thin plastic and mount this disc over the open side of the photocell by means of Duco household cement.

### Performance of the Unit

After the photocell has been completed, connect it to a d.c. microammeter, 0-1 d.c. milliammeter, or d.c. vacuum tube voltmeter. The banana plug contacts the uncoated rear face of the rectifier plate and must be connected to the positive terminal of the meter. The rear contact lug communicates with the selenium-coated surface and must be connected to the negative terminal of the meter. When light is directed upon the surface of the rectifier plate within the cell, the meter will be deflected upward.

There will, of course, be some variation in results obtained by different experimenters. However, the following data obtained by the author is indicative of performance to be expected: A 60-watt lamp (without lens or reflector) placed about 3 feet from the cell gives a photocell output of 10 millivolts across a 1000-ohm load. In broad daylight (high noon in sunny California) with the cell pointed away from the sun, 0.2 ma. is obtained with the cell connected to a 0-1 d.c. milliammeter (meter internal resistance=100 ohms). Feeding the cell into a Sylvania Type 221 Polymeter (input resistance=17 megohms), the deflection is 0.2 volt away from the sun and 0.3

## TRANSMISSION LINE ACCESSORIES

### MOSLEY TRANSMISSION LINE PLUG

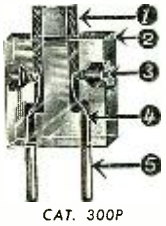

CAT. 300P

1. Any standard 300-ohm line.
2. Plastic body of high dielectric.
3. Non-magnetic plated brass screws. No-rust.
4. Phosphor spring bronze contact strips. Anchored separately for permanence.

5. Long plated pins press-fit so that they are extraordinarily tight.

### MOSLEY TRANSMISSION LINE SOCKET

1. Any standard 300-ohm line.
2. Only brass non-magnetic rust-proof screws used.
3. Plastic body of high dielectric.
4. Phosphor spring bronze contact strips.
5. Contacts anchored separately.

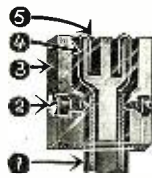

CAT. 300F

Insist that your supplier give you MOSLEY PRODUCTS because of their quality and permanence.

FOR SALE AT YOUR JOBBER

MOSLEY ELECTRONIC SPECIALTIES  
(WØFQY) 2125 LACKLAND ROAD  
OVERLAND (14) MISSOURI.

## ADSON FOR VALUE!

### SAVE \$\$\$ ON TV ACCESSORIES!



#### ANCHOR TV BOOSTER

Recommended By Famous Consumer Research Organization  
Boosts signal in fringe areas and trouble locations. Gives 2 1/2 times more gain in signal strength across all channels. Minimizes ghosts. Features exclusive impedance matching of its output to input of set.



#### DIETZ ENLARGING LENS

With 4-Way Adjustable Bracket.  
Optically perfect picture magnifier gives bigger and better pictures for your TV enjoyment. Compare these prices and order today!

10" ..... \$ 8.95  
12" ..... \$ 11.95  
15" ..... \$ 15.95

Snyder Indoor TV Antenna Adjustable 3-sectional construction for maximum signal gain. Precision engineered, attractively designed with brown crackle base and polished brass elements. Lowest priced! ... \$2.89

TV WAVE TRAP  
An amazing device for improving TV reception. Connects to lead-in line. Eliminates interference from FM and amateur stations. Now only... \$2.89

### The Amplifier You've Heard So Much About!

BOGEN PX-10 AMPLIFIER  
10 watt output, frequency response from 13 to 18,000 cycles, with volume expander and pre-amp stage. ... \$50.01  
SPECIAL JENSEN "10" SPEAKER, standard high fidelity, reg. \$7.00. Our Price... \$4.95

#### MINIATURE COMPONENTS

For Walkie Talkie, Hearing Aids, Etc.

- MINIATURE BATTERIES
  - 1.5V (1 1/32 x 5/8 x 1 15/32) ..... \$ .85
  - 22 1/2V (1 1/32 x 5/8 x 2) ..... 1.00
  - 30V (1 1/32 x 5/8 x 2 9/16) ..... 1.25
  - 150 VOLT MINIATURE CONDENSERS
  - .001, .002, .004 MFD. .... .19
  - .0056 MFD ..... .17
  - .01 MFD ..... .24
  - .02, .05 MFD ..... .27
  - .1, .25 MFD ..... .29
  - MINIATURE RCA TUBES
  - 1AD5, 1T6, 1ES, 1AC5 ..... 1.23
- Satisfaction guaranteed. Send check or money order. 25% deposit with C.O.D. All orders shipped within 24 hours. F.O.B. New York.

ADSON RADIO & ELECTRONICS CO.  
221 Fulton Street, New York 7, N.Y.

volt when the cell is pointed toward the sun. Higher outputs may be obtained when employing light bulbs by using a stronger lamp than the 60-watt unit mentioned in the foregoing, and also by concentrating the rays with a lens or reflector.

For higher outputs, several rectifier plates converted into photocell units may be fastened close together on a plate of metal or insulating material and connected in parallel. The parallel connection is preferred to series-connecting the cells, since a shaded series cell tends to offer high resistance to currents produced by illuminated cells in the string. A 4-cell unit of this type constructed by the author gave the following performance: (1.) In strong daylight, but pointing the cell away from the direction of the sun, 0.95 ma. deflection was obtained in a 0-1 d.c. milliammeter. (2.) Illuminated by a 60-watt lamp at a distance of 3 feet, 110 millivolts output was obtained across a load resistance of approximately 1000 ohms.

#### A Simple Light Meter

One of the simple applications of the home-made photocell is the light (or exposure) meter shown in photograph in Figs. 1 and 3. Fig. 4B is the light meter circuit. The small size of this instrument, made possible by use of a 1-inch 0-100 d.c. microammeter, is apparent from the comparison with a book of matches in Fig. 1.

The instrument is built into a 4½ inch x 2 inch x 1½ inch metal "chassis box." The single-plate photocell peeps out through a 1½ inch-diameter hole cut in one end of the box, as shown in Fig. 3 (left). Interior construction and wiring are visible in Fig. 3 (right).

After completion, the instrument may be calibrated against a factory-made exposure meter, such as the *Weston* or *General Electric* model.

-30-

### TELEVISION RECEIVERS AFFECT THERMOSTATS

By STUART COFFE

**WHAT** appears to be faulty operation of automatic heating systems can sometimes be directly attributed to incorrect placement of TV or radio receivers.

The location of the TV receiver is oftentimes against an inside wall centrally located in the living room where it can be comfortably viewed without moving the furniture. Unfortunately the heating system thermostat is often found on the same wall above the receiver and the heat radiated from the set can cause the thermostat temperature to rise so high that it will not close even though the room becomes uncomfortably cool.

The only satisfactory cure is to move the receiver to another part of the room although a partial cure can sometimes be effected by placing a deflector directly under the thermostat. Care should be taken to see that adequate air circulation is allowed the receiver or premature failure of component parts will result.

-30-

January, 1950

# FOR A NEW HIGH IN HIGH FIDELITY!

## University MODEL 6201 COAXIAL SPEAKER



#### CUTAWAY VIEW

showing coaxial arrangement of rugged 12" cone and full size tweeter with cobra horn, built-in LC frequency dividing network and new super efficient W shaped Alnico 5 magnet.

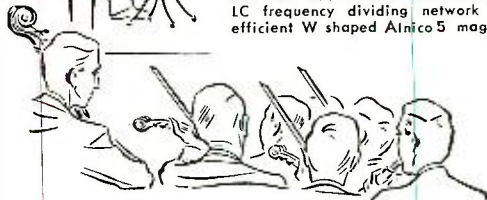

### Leading again in PRICE AND QUALITY!

**ECONOMY**—The Model 6201 is one of the greatest coaxial speaker values ever offered. Despite its economical price, it offers no compromise in efficiency, response, or power handling capacity. A listening test in comparison with higher priced competitive speakers is the most convincing demonstration we can suggest to substantiate these claims.

**MANY NEW FEATURES**—These include an oversize woofer 2" voice coil capable of extreme excursion for perfect low frequency response, a professional driver—driven tweeter

unit with "cobra" shaped horn for clean, wide angle projection of the highs, and a built-in LC type frequency dividing network with a variable attenuator.

**UNIVERSAL REPLACEMENT**—The self-contained features of the Model 6201 permit rapid, easy replacement of any standard speaker for conversion to high fidelity reproduction. Only two wires to connect and the job is complete. Ample cable is provided for mounting the attenuator control in any convenient location.

**CONTINUOUS POWER:**  
20 watts of integrated program material  
**NOMINAL IMPEDANCE:**  
6-12 ohms  
**FREQUENCY RESPONSE:**  
45 to 15,000 cycles

WRITE DEPT. A FOR ILLUSTRATED CATALOG



## University LOUDSPEAKERS INC

80 SO. KENSICO AVE., WHITE PLAINS, N. Y.

Famous World-Wide for LOUDSPEAKERS • DRIVER UNITS • TWEETERS • PORTABLE POWRMIKES

123

# NEW TV RECEIVERS on the Market

## "CUSTOM DELUXE 12"

Stewart-Warner's 12½" TV-AM-FM table model receiver is being marketed under the name "Custom Deluxe 12."

This 27 tube set has the company's exclusive "Channel Eye Tuning," a



new "Unipanel" control which reduces the number of operating controls, and an advanced design "Turret Tuner." A simple, quick adjustment of the turret tuner is said to provide reception of the proposed u.h.f. channels without the use of a converter. The receiver covers 535-1650 kc. standard broadcast and 88-108 mc. FM.

Stewart-Warner Corporation is located at 1826 Diversey Parkway, Chicago 14.

## 19-INCH CONSOLE

A 19-inch television console with a 203 square inch picture has been added to the line of receivers being produced by The Hallicrafters Company, 4401 West Fifth Ave., Chicago 24, Illinois.

The new set is available in cordovan mahogany (Model 605) and fruitwood-



finish oak veneer (Model 606) cabinets. Both cabinet designs are "Chinese-influenced."

## VIDEON

Reeves Soundcraft Corp. of 10 East 52nd Street, New York 22 has introduced a projection model television receiver for theater and other large-audience applications.

Designated the "Videon" system, the

unit provides a 7 by 9 foot image in theater darkness or a 3 by 4 foot picture with average indoor lighting. Projection may be either front or rear according to space requirements, size of the audience, viewing angles, and ambient lighting.

The "Videon" consists of a master-control console, audio and video amplifier units, a video reflector-projector, and a viewing assembly which combines a daylight-type screen with a wide-range sound reproducer.

## STARRETT'S "JOHN HANCOCK"

Starrett Television Mfg. Corp. of 601 W. 26th Street, New York has introduced a deluxe 16" combination television console which has been designated "The John Hancock."

Housed in a cabinet of either bleached or natural mahogany, walnut, or ebony with gold striping, the

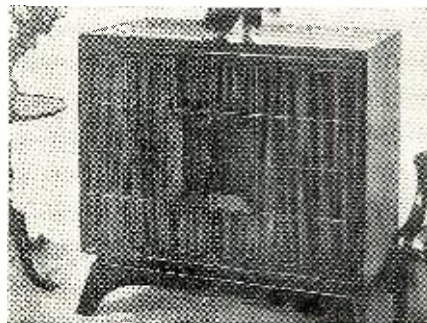

set has 22K gold-plated knobs on the various controls.

The set uses 36 tubes including 4 rectifiers and the 16" cathode-ray tube. An automatic all-channel station selector covers all TV channels. The picture lock circuit synchronizes and locks the picture in tune with the transmitting station.

In addition to providing television coverage, the receiver offers AM and FM reception, and a deluxe record changer which handles all three types of records.

## 1950 NATIONAL SET

The National Company of Malden, Massachusetts recently introduced part of its 1950 line of television receivers to the public.

One unit, the TV-1225, is a console model featuring a 12½" expanded screen picture tube and a 10" speaker. The cabinet is of hand-rubbed mahogany veneer.

Of special interest to service technicians is the manner in which the tube is mounted. Both the kinescope and the deflection yoke assembly are mounted inversely on a wooden slide

so that the chassis can be removed without removing the picture tube assembly. To remove the latter, the technician simply takes out two screws and the assembly slides out. The assembly is also mounted at a slight



angle so that the face of the tube is slanted toward the viewer when sitting normally in a chair.

## LOW-COST TABLE MODEL

John Meck Industries, Inc. of Plymouth, Indiana has leveled its sights at the low-priced and second-set market with its new 10" table model television receiver.

Designated the XN-752, the set employs 17 tubes and 2 rectifiers, which with the 10" tube gives a full-sized 65 square inch picture. The tubes are newly developed dual and triple section tubes which perform multiple functions in the circuit.

The cabinet is of hand-rubbed mahogany with rounded sides and measures 21x15x19 inches.

## TRANS-VUE CONSOLE

The first television receiver in Trans-Vue Corporation's 1950 line of video receivers is the "Aristocrat 400" console.

This 12½" model is housed in a cabinet which is available in mahogany, blonde mahogany, or limed oak finish. It features a built-in antenna, eye level, angle-compensated viewing and perma-magnet focalizer. Also featured is the synchro set tuner that enables all circuits for each channel to be adjusted by means of one adjust-

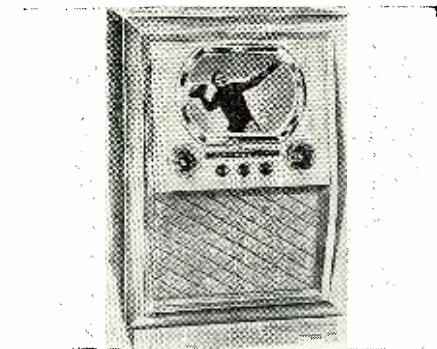

ment screw. Vernier adjustments and multiple knobs are eliminated.

The chassis incorporates the company's u.h.f. adaptor so that when and if new channels in the u.h.f. bracket

# SELENIUM RECTIFIERS

— and —

## ELECTRONIC COMPONENTS

### THREE PHASE FULL WAVE BRIDGE RECTIFIERS

Input 0-234VAC Type No.	Current	Output 0-250*VDC Price
3B13-4	4 AMP.	\$56.00
3B13-6	6 AMP.	81.50
3B13-15	15 AMP.	120.00

### CENTER TAPPED RECTIFIERS SINGLE PHASE FULL WAVE

Input 10-0-10VAC Type No.	Current	Output 0-8*VDC Price
C1-10	10 AMP.	\$6.95
C1-20	20 AMP.	10.95
C1-30	30 AMP.	14.95
C1-40	40 AMP.	17.95
C1-50	50 AMP.	20.95

### RECTIFIER MOUNTING BRACKETS

For Types B1 through B6, and  
Type C1 ..... \$0.35 per set  
For Types B13 ..... 70 per set  
For Types 3B ..... 1.05 per set

### SINGLE PHASE FULL WAVE BRIDGE RECTIFIERS

Input 0-18VAC Type No.	Current	Output 0-12*VDC Price
B1-250	250 MA.	\$0.98
B1-500	500 MA.	1.95
B1-1	1 AMP.	2.49
B1-1X5	1.5 AMP.	2.95
B1-3X5	3.5 AMP.	4.50
B1-5	5 AMP.	5.95
B1-10	10 AMP.	9.95
B1-20	20 AMP.	15.95
B1-30	30 AMP.	24.95
B1-40	40 AMP.	27.95
B1-50	50 AMP.	32.95

Input 0-36VAC Type No.	Current	Output 0-26*VDC Price
B2-150	150 MA.	1.25
B2-250	250 MA.	1.50
B2-300	300 MA.	1.50
B2-2	2 AMP.	4.95
B2-3X5	3.5 AMP.	6.95
B2-5	5 AMP.	9.95
B2-10	10 AMP.	15.95
B2-20	20 AMP.	27.95
B2-30	30 AMP.	36.95
B2-40	40 AMP.	44.95

Input 0-115VAC Type No.	Current	Output 0-90*VDC Price
B6-150	150 MA.	\$1.95
B6-250	250 MA.	2.95
B6-600	600 MA.	5.95
B6-750	750 MA.	6.95
B6-1X5	1.5 AMP.	10.95
B6-3X5	3.5 AMP.	18.95
B6-5	5 AMP.	24.95
B6-10	10 AMP.	36.95
B6-15	15 AMP.	54.95

### CUSTOM DC POWER SUPPLIES

Built to your specifications.  
We will be pleased to quote on your requirements.  
Kindly send for our specification form.

### RECTIFIER CAPACITORS

CF-14	3000 MFD	12VDC	\$1.69
CF-15	6000 MFD	12VDC	2.95
CF-1	1000 MFD	15VDC	.98
CF-2	2000 MFD	15VDC	1.69
CF-20	2500 MFD	15VDC	1.95
CF-3	1000 MFD	35VDC	1.25
CF-4	2X3500 MFD	35VDC	3.45
CF-5	1500 MFD	30VDC	2.49
CF-6	4000 MFD	30VDC	3.25
CF-7	3000 MFD	35VDC	3.25
CF-8	100 MFD	50VDC	.98
CF-19	500 MFD	50VDC	1.25
CF-16	2000 MFD	50VDC	3.25
CF-21	1200 MFD	90VDC	3.25
CF-9	200 MFD	150VDC	1.69
CF-10	500 MFD	200VDC	3.25
CF-12	125 MFD	350VDC	2.49

Mounting clamps for above capacitors .15c ea.

### RECTIFIER TRANSFORMERS

All Primaries 115VAC 50/60 Cycles

Type No.	Volts	Amps.	Price
XF15-12	15	12	\$3.95
TXF36-2	36	2	3.95
TXF36-5	36	5	4.95
TXF36-10	36	10	7.95
TXF36-15	36	15	11.95
TXF36-20	36	20	17.95
XFC18-14	18VCT	14	5.95

All TXF Types are Tapped to Deliver 32, 34, 36 Volts. XFC Type is Tapped to Deliver 16, 17, 18 Volts Center Tapped.

### RECTIFIER CHOKES

Type No.	Hv.	Amps.	Dc Res.	Price
HY5	.02	5	.25	\$3.25
HY5A	.028	5	.09	3.95
HY10	.02	10	.30	9.95
HY10A	.014	10	.04	7.95
HY15	.015	15	.30	13.95
HY20A	.007	20	.02	12.95

Type "A" low resistance chokes are specially suited to circuits requiring excellent voltage regulation.

## ADDITIONAL SELENIUM RECTIFIER TYPES AND GENERAL INFORMATION MAY BE FOUND IN OUR CATALOG No. 719

### VACUUM CAPACITORS

Standard Brands

12 Mmfd. 20 Kv \$4.95  
50 Mmfd. 32 Kv 5.95

Overall length 6 1/2" diameter 2 3/8" terminal diameter 3/4" shpg. wt. 2 lbs.

### EDISON THERMO TIME DELAY RELAY

Heater voltage 115 V. Norm. oper. SPST contacts. 15-30 sec. delay. Contact rating 115 V. 3A., 440 V. 2A. Size 3 3/4"x1 1/4" diam. Standard 4-prong tube base ..... Ea. **98c**

### OIL CONDENSERS

5 Mfd. 400VDC. Telephone Type ..... \$0.20  
2X1 Mfd. 600VDC Bath Tub ..... .39  
6 Mfd. 600VDC w/mtg. clamp ..... .79  
8 Mfd. 660VAC/2000VDC w/brkts. .... 3.50  
.15-15 Mfd. 8000VDC Voltage Doubler  
Type 26F381 w/brkts. .... 3.95

### SPECIAL—LIMITED QUANTITY

Sprague Vitamin Q Photo-Flash Capacitors. 8 MFD—3000 VDC—36 watt/sec. 4 1/2"x3 3/4"x1 1/4". Weight, 1 lb., 12 oz. each. Price. **\$5.95 ea.**

**3 for \$15.00**

ATTENTION!!!  
Bulletin No. 713, listing various government and commercial surplus items, is now available upon request.

### PILOT LIGHT ASSEMBLIES

Aircraft type, panel mounting, amber jewel. Knurled rim controls "DIM-BRIGHT." Bakelite and aluminum construction. Bulb replaceable from front panel. For single contact bayonet bulbs, up to T-3 1/2" size. Dimensions: 2 1/2" overall length, 3/4" diameter, 5/8" panel mtng. hole. IMMEDIATE DELIVERY. 500 to carton, nested.

Request prices on company letterhead.

### VARIABLE AIR TRIMMERS

Standard Brands—Screw Driver Adjust

Each	10 for	100 for
7.5 MMFD	\$0.29	\$2.20
25 MMFD	.31	2.40
50 MMFD	.33	2.60
100 MMFD	.41	3.40
140 MMFD	.49	4.20

### DC POWER SUPPLY

Limited quantity—  
Gov't Surplus

Ready to operate. Full-wave bridge, copper-oxide rectifier, heavy-duty multi-tapped transformer. Input: 85/95/105/115 VAC 50/60 cps. Output: 2.5/24/28/32/36 VDC at 5 amperes, unfiltered. For wall or bench mounting. Overall dimen. 9"x8 1/2"x8 1/2" high. Shpg. wt. 30 lbs. Tested and guaranteed. **\$36.00**

Filter Kit, 2% ripple ..... \$6.65

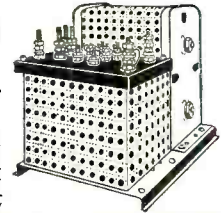

### DIEHL MOTOR

Fan duty, brushless induction type (no TV interference). For 115 VAC 60 cycles. 46 watts, 1800 RPM. Shaft 3/8" diam. 1 1/2" long. Noiseless ball bearings heavy cast construction. Brand new. **\$4.50**

### RECTIFIER KIT No. 612-10

6 and 12 VDC at 10 Amps.

This unit will deliver unfiltered direct current for operation of motors, dynamotors, solenoids, electroplating, battery charging and similar equipment. The two output voltages can be used simultaneously, and can be varied above and below their nominal ranges. Complete with schematic diagram and instructions. Shpg. wt., 12 lbs. **\$15.95**

### FILTER KITS For No. 612-10

1 section choke input, 10% ripple. **\$9.64**  
2 section choke input, 2% ripple. **9.28**

### D-C PANEL METERS

Attractive, rugged, and reasonably priced. Moving vane solenoid type with accuracy within 5%.

0-6 Amperes D-C	Any range \$2.49 each
0-12 Amperes D-C	
0-15 Volts D-C	

Minimum order **\$3.00**. No C.O.D.'s Add 10% for Prepaid Parcel Post and Handling. Terms: Net 10 days in the presence of approved credit.

All prices subject to change without notice. Prices and delivery F.O.B. our NYC Warehouse. All merchandise subject to prior sale.

### WESTERN ELECTRIC BLOWER

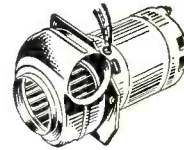

#KS5881—Brand New—Heavy-duty Sirocco type blower, capacitor start, 1/40 H.P., 3400 RPM, 115 VAC, 60 cycles. Displaces 84 CFM. Extremely quiet operation. Opening 2 3/4", overall size 7 1/2" long, 6" diam. Moisture and fungus resistant. With capacitor. Shpg. wt. 15 lbs. Quantity limited. **\$13.95**

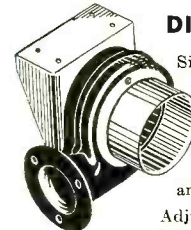

### DIEHL BLOWER

Sirocco type, displaces 100 CFM, 115 VAC, 60 cps. Moisture and fungus resistant. Flange diameter 4". Overall size 7 1/2"x6 1/2". Removed from equipment. Tested and guaranteed. **\$9.95**

Adjustable right angle aluminum extension tube to fit flange. **98c**

### WESTINGHOUSE AIRCRAFT MOTOR

Brand new—24 VDC or AC, reversible on both. 1/50 H.P., 4800 RPM continuous duty. Length of leads 18". Dimensions 3 1/2"x2 1/4", shaft 1/4" diam. by 3/8" long. Price. **\$2.95**

Reversing switch with "off" position. Each. **79c**



# OPAD-GREEN COMPANY

71 Warren St.  
New York 7, N. Y.  
Phone: BEekman 3-7385-6

# SENCO'S

low--low  
PRICES  
ring the  
bell

Brand New Immediate Delivery **TUBES** Individually Cartoned Guaranteed

**SPECIAL QUANTITY DISCOUNT OFFER**  
Order 25 or More Assorted Tubes and Deduct 5c from the Price of Each Tube.

<b>15c Each</b>	6F6G 6H6GT 6J7 6K6GT 6K7G 6K7GT 6N4 6SA7GT 6SD7GT 6SF7 6SJ7 6SK7GT 6SQ7GT 6UG6T 6V6GT 6X4 6X5GT 12A8 12A8B 12AV6 12AX7 12B5 12J7GT 12K7GT 12Q7GT 12S47GT 12SF5 12SH7 12SK7GT 12SL7GT 12SN7GT 12SQ7GT 19T8 2A4 25Z6GT 27 32 35/51 35B5 35B5GT 35W4 35Z5 35Z6 41 47 50B5 5Y 76 78 80 85 88 884	6F5GT 6G6G 6P5GT 6S7GT 6SL7GT 6SN7GT 6SS7GT 6V5 6V6G 7A4/XXL 7A5 7B6 7C6 7E5/1201 7K7 12AT8 12AU7 12BA6 12BE5 12S7GT 12Z3 14I7 25L6GT 32L7GT 35Y4 35Z4GT 43 48 53 61 117Z3	7C5 7F7 7Q7 12BD6 12C8 14B6 50C3 50L6 20S1 350B 75
<b>19c Each</b>	1644 V99 X99		
<b>29c Each</b>	2A7 2X2 6C4 6SH7GT 6U7G 7Y4 12A6 12A8GT 12FSGT 12H6 26 36 957 958 957 8011/VT80 HY615 RK72 RKR72 RKR73 VT25	50c Each 1A5GT 1A6 1C6G 1C7G 1D7G 1D8G 1E7G 1F5G 1G4G 1H4G 1H6G 1J6G 1R4 306 304 354 374 523 524 6A5G 6A6 6A6G 6A95 6B8G 6D6 6F8G 6L5G 6T7G 7A7	69c Each OA2 0T4 1LA4 1LC6 1LD5 1LE3 1LH4 1LN5 1NG4 1T4 SV4G 6AB5G 6AB7 6AG5 6B4 6BF6 6BG6 6BH6 6J6 6J6G 6W4 6W6 6Y3 6Y3 12AT7 14A7 14Q7 14R7 22 50A5 70L7GT
<b>39c Each</b>	1A3 1U4 1U5 1V 2A6 4A8 5U4G 5W4 5Y3GT 5Y4G 6AB4 6AH6 6AT6 6AUB 6BA6 6BE6 6C5GT 6C6	45c Each 1B5/255 1L4 1R5 1S4 1S5 1TSGT 2A5 2B6 327 6AL5 6BJ6 6D7	89c Each 6AC7/1852 6AG7 6AK5 11726GT 183GT/8016 6L6G 8308

MINIMUM ORDER \$2.50. Send 25% deposit for all C.O.D. shipments. Include sufficient postage, excess will be refunded. Orders without postage will be shipped express collect. All prices F.O.B. New York City.

## NEW RECEIVING TUBE INTERCHANGEABILITY CHART

Very latest . . . complete data on direct interchangeability. It's SENCO'S way of greeting New Customers and thanking old ones. . . Its yours for the asking.

Nothing to Buy . . . Just fill in  
Coupon . . . MAIL TODAY!

NAME . . . . .  
ADDRESS . . . . .  
CITY . . . . . ZONE . . . . . STATE . . . . .

Radio Men Who Know  
**SAVE AT SENCO**

SENCO RADIO, INC., DEPT. Q  
71 WEST BROADWAY NEW YORK 7, N. Y.

are opened no revision or changes in circuitry will be required.

The sets are being turned out at the company's plant at 1139 S. Wabash Ave., Chicago 5, Illinois.

### TV-AM-PHONO MODEL

Admiral Corporation of Chicago is offering its Models 24X15 and 24X16 television-radio-phonograph combina-



tions as the answer to the demand for a complete home entertainment unit at low cost.

The set provides a full-vision 10" screen, built-in directional antenna, standard AM radio, and an automatic record player which will handle all three types of recordings. The Model 24X15 is the walnut finish set while the Model 24X16 is the same set but in mahogany finish.

### DU MONT'S "CANTERBURY"

The new 12½ inch console television receiver introduced recently by Allen B. Du Mont Laboratories, Inc., Passaic, New Jersey will be marketed under the name "Canterbury."

Featuring reception on all channels, the new unit provides 85 square inches of picture material. In addition, the "Canterbury" incorporates full-range FM and a record player attachment. The cabinet is of Hepplewhite design and is finished in mahogany veneers.

The receiver has 25 tubes plus 5 rectifiers. The company's "Local-Distant" switching arrangement for increased sensitivity on distant or weak stations is also included in this model.

### SIX-WAY CONSOLE

The "top of the line" unit being introduced by Sylvania Television is a



six-way mahogany console combination, the Model 076.

Colonial Radio Corp., wholly owned subsidiary of Sylvania Electric Prod-

ucts Inc., is producing the new line of receivers.

The Model 076 features a 10 inch picture tube and 63 square inch screen, all 12 channel reception, AM-FM reception with a 10 inch speaker and balanced tone control, in addition to a three-speed automatic record changer for all types of records, and a built-in antenna.

The console is housed in a mahogany finished cabinet of Georgian design. The cabinet measures 34½x31x21½ inches.

### ANNIVERSARY MODEL

In order to commemorate 25 years in the radio receiver field, Stromberg-Carlson Company of Rochester, New York has placed on the market a "Silver Anniversary" television receiver, the Model TC 125 LM2.

A console model with an 89 square



inch viewing screen on a 12½ inch picture tube, the new set is housed in a hand-rubbed, striped Honduras mahogany veneer cabinet. Bronze tuning controls are conveniently located at one side of the picture tube. The receiver has a 12 inch PM speaker and a built-in antenna system. A phono jack in the rear of the chassis will accommodate any type record changer unit. The built-in antenna system for both low and high band television channels is standard equipment on this model.

### "THE BEAUMONT"

A custom-built television console with a cabinet of genuine mahogany is Mattison Radio and Television Corporation's latest offering to the public.

Known as "The Beaumont," this set measures 43x25x23 inches and is available in mahogany or bleached mahogany finishes. The receiver has a 31 tube, high-voltage chassis which incorporates the RCA 630 circuit. Also featured is the exclusive "Reflecto-Circle" which is actually a part of the cabinet and serves to eliminate dead areas and utilizes the entire picture tube surface.

The company has headquarters at 220 Fifth Avenue in New York, New York.

### 7-INCH RECEIVER

Motorola Inc. of Chicago is currently marketing a 7-inch television receiver which will retail in the low-price field.

A high voltage tube which was developed especially for *Motorola* is said to give great brilliance, clarity, and

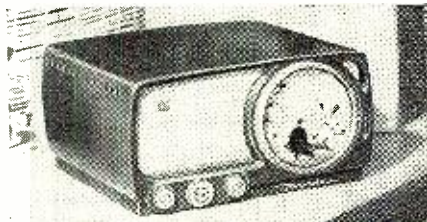

picture stability. The set is operated through three simple controls.

The unit weighs 25½ pounds and may be carried from room to room without difficulty.

### DEWALD TABLE MODEL

*Dewald Radio Manufacturing Corp.* of 35-15 37th Avenue, Long Island City 1, N. Y., is currently marketing a direct-view table model receiver which features a 16 inch tube.

Designated the Model DT-160, this set provides all-channel coverage, a 145 square inch screen, a built-in an-



tenna, illuminated channel marker, a 22-tube circuit including 2 rectifiers and a damper tube, oversized power transformer, full wide-angle vision, and a large electrodynamic speaker.

### NEW PILOT MODEL

*Pilot Radio Corporation*, 37-06 Thirty-Sixth Street, Long Island City 1, New York is introducing the Model TV-123 to mark its 21st year in television.

The new model has a 12½ inch picture tube and a built-in antenna. In addition, the receiver will provide FM reception and a phono-jack plug-in to which any phonograph can be connected.

Although technically a table model,



a coordinated supporting cabinet base can be used to transform the set into

## PERMANENT MAGNET FIELD DYNAMOTORS —POWER SUPPLY

### POWER SUPPLY:

12 or 24 Volt DC input; output 275 Volt 110 MA.; 500 Volt 50 MA.

Completely filtered and housed in metal case. These units were originally used with Mark II No. 19 radio sets and cost Govt. \$150.00. The dynamotors will operate on 6 VDC at approx. half the voltage, thereby giving you a good motor for car shaver or AC-DC radio operation, and a power supply for your mobile receiver from your 6 Volt auto battery. This power supply unit contains all of the items pictured and described in the column to the right. Size: 8" H x 6" W x 10" D. Shipping Weight: 62 lbs.

Complete Unit—Order No. RPS #3..... \$5.00

### EACH UNIT CONTAINS THE FOLLOWING PARTS

WHICH MAY BE PURCHASED SEPARATELY:

- 1—Dyn. 12/24 input; output 275 V 110 MA. \$3.95
- 1—Dyn. 12/24 input; output 500 V 50 MA. 2.95
- 8—.1 500 V Oil Tubular Cond. 1.00
- 2—.1 1000 V Oil Tubular Cond. .50
- 2—15 MFD. 400 V DC Elect. Cond. .80
- 1—DPST 15 A. Toggle Switch. .40
- 1—3PDT 20 A. Toggle Switch. 1.00
- 2—Fuses—Holders & ¼ A. Fuses. .30
- 1—Pilot Light 12 V & Holder. .20
- 5—Filament & RF Chokes. 1.00
- 1—Spare Brush Kit. 1.00
- Also—Resistors, Plugs, Panel Chassis, Cable, Case, and Grill. 3.00

### CONDENSER ASS'Y.

5 Gang with vernier tuning, 25 MMFD. to 450 MMFD. each section. Size: 7½"x3½"x3¼" \$2.95

CONDENSER—3 Gang, 25 MMFD. to 450 MMFD. each section. Size: 6"x3¼"x3" \$1.95



### SELSYN TRANSMITTER AND INDICATOR SYSTEM

Ideal for antenna direction indicator to remote position. Complete with Autosyn Trans., 3" I-81 Indicator, Transformer, and instructions.

Price..... \$6.75 Autosyn Trans. only: \$2.95 Plug I-81: \$1.00

### NEW TRANSFORMERS And CHOKES

#### ALL FOLLOWING TRANSFORMERS—CASED 115 V.A.C. 60 CYCLE INPUT:

OUTPUT: 750-0-750 V.A.C. (600 V.D.C. after choke input filter at 250 MA.) Includes 6.3 V.A.C. winding at 5 amps and 5.0 V.A.C. winding at 4 amps. NH-106..... \$7.95

OUTPUT: 625-0-625 V.A.C. (500 V.D.C. after choke input filter at 250 MA.) Includes 6.3 V.A.C. winding at 5 amps and 5.0 V.A.C. winding at 4 amps. NH-107..... \$7.35

OUTPUT: 600-0-600 V.A.C. at 250 MA. 12 V.A.C. at 3 amps; 12 V.A.C. at 3 amps and 5 V.A.C. at 3 amps. Designed for Army surplus transmitters. NH-108..... \$6.90

OUTPUT: 250-0-250 V.A.C. at 60 MA. 24 V.A.C. at 3 amps; 6.3 V.A.C. at 6 amps. Designed for Army surplus Receivers. NH-109..... \$3.00

OUTPUT: 6.3 V.A.C. at 6 amps. NH-110..... \$2.25

OUTPUT: 24 V.A.C. at 2 amps. NH-111..... \$2.25

OUTPUT: 2.5 V.A.C. at 10 amps, center tapped and shielded. Open frame mounting insulated for continuous operation at 5,000 volts. NH-113..... \$4.20

#### CHOKES—CASED:

NH-115-8 Henries at 500 MA. filter choke. 5,000 volt insulation..... \$9.95

NH-116-5-20 Henry 500 MA. swinging choke. 5,000 volt insulation..... \$9.95

NH-117-8 Henries at 700 MA. filter choke. 7,500 volt insulation..... \$14.95

NH-118-5-20 Henries at 700 MA. swinging choke. 7,500 volt insulation..... \$14.95

NH-121-15 Henries at 250 MA. filter choke. 1,500 volt insulation..... \$4.95

#### COMMAND RECEIVERS—TRANSMITTERS—ACCESSORIES:

BC-453 RECEIVER—190-550 KC. USED: \$12.95 NEW: \$19.95

BC-455 RECEIVER—4-9.1 MC. \$7.95 \$8.95

BC-454 RECEIVER—3-6 MC. \$5.95 \$6.95

Dual or Triple Receiver Rack. 1.50

BC-456 Triple Con. Box. 1.95

TRANSFORMER f/Comm. Rec. See NH-109 above (New) 3.00

BC-459 TRANSMITTER—7-9 MC. USED: \$12.95 NEW: \$19.95

BC-457 TRANSMITTER—4-5.3 MC. \$5.95 \$8.95

BC-458 TRANSMITTER—5.3-7 MC. \$5.95 \$8.95

T-18 TRANSMITTER—2.1-3 MC. \$8.95

BC-456 Trans. Modulator Re-issue. 1.95 2.95

Dual Transmitter Rack. 1.50

BC-451 Trans. Control Box. 1.50

BC-442 Antenna Relay Box with Cond. 2.95

TRANSFORMER f/Comm. Trans. See NH-108 above (New). 6.90

CHOKES 15 Hy. 250 MA. No. NH-121. 4.95

#### DYNAMOTORS AND INVERTERS:

Write us today, advising your requirements. We have big stock!

#### BC-223 TRANSMITTERS:

WITH: USED: NEW:

One Tuning Unit..... \$19.95 \$24.95

Three Tuning Units..... 24.95 29.95

CABLE—Power Supply f/Trans. .... \$1.75

PE-125 POWER SUPPLY f/BC-223 Trans. Prices: USED: \$7.95 NEW: \$ 9.95

#### TRANSFORMERS—110 V. 60 CYCLE PRIMARIES:

SEC.: SEC.:

12 V. 1 amp. .... \$1.50 24 V. 2 amps... \$2.25

24 V. 1 amp. .... 1.95 24 V. .5 amp ... 1.50

Sec. 36 V.A.C. 2.5 amps. .... 2.95

Sec. 14-14 or 28 V. 7½ or 15 amps. .... 4.95

Address DEPT. RN • Minimum Order \$2.00 • Prices F.O.B., Lima • 25% Deposit on C.O.D. Orders

### WHIP ANTENNA EQUIPMENT

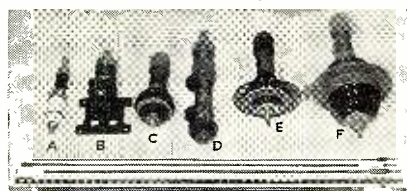

#### MAST BASES—INSULATED:

- A. MP-132-1" heavy coil spring, 2" insulator, over 21 length: 14½". Wt.: 2¾ lbs. Price: \$3.95
- B. MP-22—Spring action direction of bracket, 4" x 6" mounting. Price: 2.95
- C. MP-57-2" heavy coil spring, 5" insulator. 3.95
- D. MP-48-2" heavy coil spring, 3" insulator. 2.95
- E. MP-37-2" heavy coil spring, 8" insulator. 3.95
- F. MP-47-2" heavy coil spring, 9" insulator. 5.95

#### MAST SECTIONS FOR ABOVE BASES:

Tubular steel, copper coated, painted, 3 foot sections, screw-in type. MS-53 can be used to make any length with MS-52-51-50-49 for taper. Price—any section..... 50c ea. BAG BG-56 f/carrying 5 mast sections. .... 50c

### BC-645-A TRANSCEIVER—ALSO

#### 110 VOLT TRANSFORMER AND CHOKES

15 Tube Transceiver, ideal for conversion to 460 MC. Frequency coverage 435 to 500 MC. With conversion instructions.

Price: New and Boxed..... \$14.95

TRANSFORMER for BC-645-A—110 Volt 60 cycle input 400 Volt 150 MA. after filter. 12, 9, and 6 V.A.C. 4 amps and 5 V. 3 amps.

No. NH-645..... \$6.95

CHOKES—15 Hy. 150 MA. Order No. NH-646..... 2.95

### BC-1206 RECEIVER—SETCHELL-CARLSON:

5 Tubes, 24-28 VDC. 200-400 KC. IF Freq. 135 KC. Size: 4"x4"x6". Price, I.N. .... \$6.95

#### "BUYS" OF THE MONTH:

MARK II No. 19 Transmitter & Receiver 15 Tube Set, complete with operating equipment. Prices: \$59.50 USED... \$39.50 NEW..... \$59.50

FL-8A FILTER—1200 CPS..... \$1.95

SELSYNS 2J1G1 with Caps and instructions. Pair. \$3.00

SELSYNS #V.C.78248—110 V. 60 cycle & Instr. \$2.95

Cable 125 OHM cotton covered. 50 Ft. .95

FT-237 MOUNTING BASE f/BC-604 & 603's, & f/BC-604 & 603's. Prices: USED..... \$5.95 NEW..... \$7.00

Cable—4 Conductor, shielded, 50 Ft. length. .... 2.00

Co-213 Cable—Seven conductor No. 20 AWG, with 2 cond. separately shielded within the outer shield for all 7 conductors. Insulated, rubber covered, 35 ft. length. .... \$1.25

CABLE—2 #16 wire, rubber covered—20 ft. .... 1.00

Cable f/BC-375 w/PL-59 ea. end. .... 1.75

Cable f/BC-375 w/PL-61 ea. end. .... 1.75

Cable f/BC-375 w/PL-64 ea. end. .... 1.75

RG-8U Coaxial Cable..... Per Ft. .05

Coaxial Cable—125 OHM cotton covered. 50 Ft. .... 1.00

Tuning Unit f/BC-375 TU-6-8-10-20. .... Each 3.95

FT-151 Mounting f/BC-375-191 ..... 1.50

GN-45 Generator ..... 5.00

Leg & Seat Ass'y. f/hand generators. .... 2.75

Crank for hand generators. .... Each .75

BC-357 Marker Beacon (used)..... 2.95

BC-301 Marker Beacon, less tube. .... 1.95

BC-347 Amplifier, Used, less tube. .... .79

BC-709 Amplifier—with Tube, less battery..... 4.95

HS-17 Head Phone & Chest Set used w/EE-8 for extensions. .... Prices: NEW \$3.95; USED 2.95

If you don't receive our  
**FREE** BARGAIN CATALOGS  
you're losing money!

## TV Money Savers! TV ANTENNAS

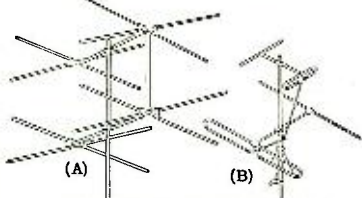

### A STACKED CONICAL TV ARRAY

High gain, all band, TV array at amazingly low cost. Direct coupling to 72, 150 or 300 ohm line with minimum loss. All dural construction, 10 foot mast included. Shpg wt: 16 lbs. Cat. No. Q852... **\$1195**

### B HI-LO DIPOLE AND REFLECTOR

An ALL-BAND TV antenna that's easy to install, trouble-free and highly efficient. Corrosion resistant, 8 foot steel mast. Adjustable mounting base and bracket. All elements securely locked. Dipole and reflectors of hard aluminum to prevent twisting and turning. Separate orientation for each bay. Shpg wt: 13 lbs. Cat. No. Q802... **\$597**

## TUBES Can't mention name; top brand, fully guaranteed!

1B3GT... \$1.40	6BG6G... \$2.10	6AK5... \$0.99
6AG5... 1.00	6J6... 1.10	12SN7GT... .79
6AU6... .79	6SN7GT... .79	6AG7... 1.40
6AU6... .79	6K6GT... .65	6V6GT... 1.10
6BA6... .75	5U4G... .65	6SH7... .55

⊥ Packed in manufacturer's or white boxes ⊥

## Federal's K-111 300 ohm shielded transmission line

All the advantages of 300 ohm twin-lead and coaxial cable combined. Minimize ghosts and noise. 100 ft. \$9.90. Ft. **11¢**

Fine quality, 20 gauge twin-lead, 1000 ft. \$11.25; 100 ft. \$1.25; per foot. **1 1/2¢**

### Famous Manufacturer



All 110/120V, 60 cycle pri. Dull black case.  
Fig. A. 720VCT @ 160 ma; 6.3VCT @ 4A; 5V @ 3A. 7 lbs. Cat. No. Q203... **\$2.95**  
Fig. A. 800VCT @ 200 ma; 6.3VCT @ 4A; 5V @ 4A. 9 lbs. Cat. No. Q204... **\$3.95**  
Fig. B. 700VCT @ 100 ma; 6.3V @ 4A; 5V @ 3A. 6 lbs. Cat. No. Q233... **\$2.39**  
Fig. C. 200 ma. choke. 4.5 hy. 100 ohms DC resistance. 3 lbs. Cat. No. Q206... **\$1.39**

TERMS: 20% deposit with order, balance C.O.D.

## RADIONIC EQUIPMENT CORPORATION

Tribune Theater Entrance  
170-AA Nassau Street :: New York 7, N. Y.  
WOrrh 2-0421 :: Open daily 9 to 6—Sat. 9 to 5

### MAIL TODAY!

RADIONIC EQUIPMENT CORPORATION  
Dept. 51  
170-AA Nassau Street, New York 7, N. Y.  
Please rush FREE copy of your latest Bargain Catalog of Radio and Television Sets, Parts, Tubes and Accessories.  
NAME.....  
ADDRESS..... STATE.....  
CITY.....

a console-type unit. Both sets and cabinets are available in modern limed oak or period mahogany.

### "ACADEMY" BY MARS

One of the interesting features of the new "Academy" model video receiver recently introduced by Mars Television Inc. of Long Island City, is



the removable front panel which permits the insertion of the picture tube without dismantling the back of the set.

The set uses 31 tubes and features a clear vision control panel. The receiver is housed in a hand-rubbed mahogany finished cabinet measuring 41x25x24 inches. **50-**

## Modern TV Receivers (Continued from page 47)

amplifier, amplified, and transferred to the deflection coils.

*Servicing And Alignment of A.F.C. System.* Failure of the a.f.c. system to function properly will immediately reveal itself by one of the symptoms shown in Fig. 6. When the frequency of the horizontal oscillator is not controlled, it will, in general, differ from the frequency of the incoming sync pulses. When this happens, the image will appear either as shown in Fig. 6 (left) or (right). When correcting this condition, rotate the hold control (which is either on the front or rear panel of the receiver). If the picture snaps back into proper position, then the hold control was improperly set. As a test to determine whether any other defect exists, momentarily remove the signal by turning the contrast control fully counter-clockwise and returning it to the operating position. The picture should immediately

pull back into sync. Turn the horizontal hold control to the extreme clockwise position and to the extreme counter-clockwise position. The picture should remain in horizontal sync. If the receiver passes these tests, the horizontal oscillator is correctly aligned.

In dealing with a.f.c. systems, the service technician should be aware of the fact that there is a difference between the pull-in range and the hold-in range. Once in sync, the circuit will hold about 50% to 100% more variation in frequency than it can pull in. Thus, suppose that the hold control is in the extreme clockwise or counter-clockwise position and the set is turned on. It is entirely possible that the horizontal oscillator will not be locked in by the incoming pulses. However, once lock-in is effected, then rotating the hold control completely will generally not cause it to fall out of sync.

If the picture is not in sync and variation of the hold control does not correct this condition, try adjusting the slug of the winding on transformer  $T_1$  which is connected to the grid of  $V_3$ . If neither control is effective in re-establishing lock-in, then the following tests should be made, preferably in the order indicated:

1. Change tubes  $V_1$  and  $V_3$  (Fig. 3).
2. Check the waveforms at the plates of  $V_{1a}$  and  $V_{1b}$  (pins 2 and 7 of a 6AL5). See Fig. 7.
3. Check the waveforms at the plate and cathode of  $V_2$ . See Fig. 8.
4. Check the waveforms at the plate of  $V_3$ . See Fig. 5 (left).
5. Make resistance and voltage checks at any point where the waveform is not as specified.

Another defect that sometimes occurs in this system is the appearance of a stationary picture, but with the horizontal blanking bar visible on the

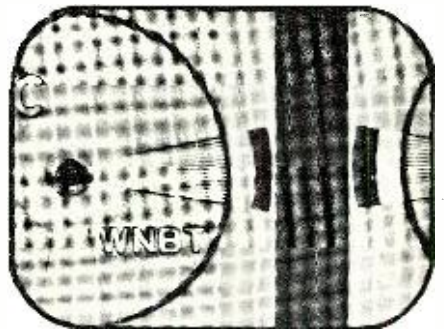
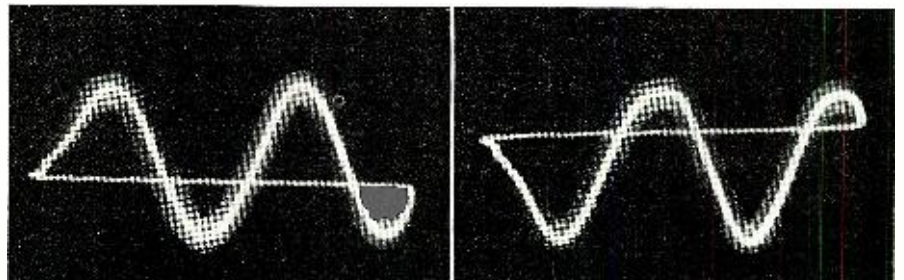

Fig. 9. The appearance of the image when the slug in the  $T_1$  winding (shown in Fig. 3) is misadjusted.

Fig. 8. Waveforms at the plate (left) and the cathode (right) of  $V_2$  in Fig. 3.





# PHOTOCON SALES

SYCAMORE 4-7156  
PASADENA 7, CALIF.

1060-2 N. ALLEN AVE.

## JANUARY SPECIALS

ARC-1 AIRCRAFT TRANSMITTER-RECEIVER—10 channel RT18/ARC-1. Excellent Condition with tubes. . . . . \$695.00

HS-23 HEADSET—BRAND NEW 8,000 ohm with ear pads. . . . . \$2.45  
 HS-33 HEADSET—With ear pads. . . . . NEW 1.29  
 HS-30 HEADSET—Complete with matching transformer, 6' cord & PL 55 Plug. NEW 1.95  
 HS-30 HEADSET. . . . . NEW .95  
 DYNAMIC HEADSET AND MIKE—P. O. Mark 11. . . . . NEW 1.95  
 HEADSET EXTENSION CORD—CD-3074A with PL-55 and JK-26. . . . . .49  
 HEADSET ADAPTER MC-385D—High to low impedance. . . . . NEW .35  
 T-17 HAND MIKE. . . . . NEW 1.95  
 T-32 DESK MIKE. . . . . USED \$1.95; NEW 3.00

### BASSETT AIRCRAFT RADIOS & ACCESS

Two Way Radio Freq. 3105 K.C.  
ALL NEW EQUIPMENT

MC6—1 1/2 Watt Trans.-Recr., tubes, crystal, battery case, antenna. . . . . \$31.50  
 MC6B—8 Watt Trans.-Recr., tubes, crystal, vibrapack, antenna, 12 volts. . . . . 49.50  
 MR3A Receiver Range, weather and tower freq. . . . . 13.50  
 MCUI Aircraft Microphone. . . . . 4.95  
 HEADSET and PLUG. . . . . 2.95  
 MODEL TR 15—Trailing Antenna Wire Set. . . . . 6.95

T-47/ART-13 TRANSMITTER with operating manual. . . . .  
 . . . . .GOOD USED \$200.00; NEW \$295.00

**TEST EQUIPMENT**  
 BC-221 Freq. Meter—125 K.C. to 20,000 K.C. . . . . Excellent condition \$69.50  
 I-122 Signal Generator by Espy Mfg. Co. 15-27, 95-127 M.C. . . . . 79.50  
 I-200 Calibrator, 115 V., 60 cycles, 345 and 621 cps., Western Electric. . . . . NEW 39.50  
 TEST SET, Type 89. . . . . 19.50  
 LM Frequency Meter, Excellent condition, less Cal. book. . . . . 29.50

MN-26C—BENDIX RADIO COMPASS, 150-1,500 K.C. tube. . . . .  
 . . . . .Like new condition \$17.50

BC-464—TARGET RECEIVER—5 channel remote, battery case, antenna 68-73 MC. NEW \$14.95  
 INTERPHONE AMPLIFIER—CMX60128A, 12 V. 6 watts P.O. T.C.S. equipment—tubes and dynamotor. . . . . \$5.50  
 HANDY-TALKIE Crystal and Coil Sets—3885 K.C. to 5,600 K.C. Specify frequency—2 crystals and 2 coils per set. NEW 2.25

TRANSFORMERS—6200 v. @ 325 Ma. secondary—easy C.T. for 3100-0-3100 @ 650 ma.—Primary 105/110/115 V. 60 cycles —American Transformer Co. NEW \$49.50  
 2.5 V. @ 10 amps. C.T.—15,000 volt insulation—115 V. A.C. primary—Kenyon S-9883 . . . . . 5.95  
 200-0-200 @ 50 ma.—6.3 V. @ 3 amps, 115 V. A.C. Primary. NEW 1.95  
 115 V. A.C. Primary—700 volts C.T. @ .075 amps; 6.3 V. @ 1.2 amps; 5 V. @ 3 amps. . . . . NEW EA. 2.25  
 WELDING TYPE W TRANSFORMER—190 amp.—5 volt secondary—115 V. A.C. primary, mfg. by American Transformer Co. . . . . BRAND NEW 16.95

APN-1 ALTIMETER INDICATOR, basic movement 0-1 ma; 5 ma. shunt, 270° dial. An excellent basic movement for constructing your own meters. . . . . NEW \$ 1.95  
 METER RECTIFIER, full wave midjet Selenium 10 volts, 30 ma. . . . . .29  
 APN-1 ALTIMETER, Complete. . . . . NEW 34.50  
 I. F. Transformer—1st, 2nd or 3rd, from SCR-522, 12,000 K.C. Iron Core tuning, can be tuned to television I.F. Frequency by removing padder cond. . . . . each .35  
 . . . . . 3 for 1.00

PE-103 DYNAMOTOR POWER SUPPLY, COMPLETE with dynamotor, filter, relay unit, battery cables, and shock mount. Part of SCR-284. BRAND NEW \$19.50

BC-620 Mobile FM TRANSCEIVER—P.O. SCR-610. Includes 10 meter band. Excellent condition with tubes. . . . . \$11.95  
 PE-120 Power Supply with tubes—Excellent condition . . . . . 5.50  
 Combination BC-620 and PE-120. . . . . Both for 14.95

WESTON ELECTRICAL TACHOMETER METER, Model 545 for use with Model 724 Magneto. Speed 0-2,000 R.P.M. Ratio 2:1 . . . . . BRAND NEW \$17.50  
 WESTON TACHOMETER GENERATOR, Model 724, Type C. . . . . GOOD USED 16.75

INTERPHONE AMPLIFIER — BC-709 — Ideal for Aircraft, booster for telephone system. etc. . . . . NEW \$4.50

**SCR-522 EQUIPMENT**  
 SCR-522 TRANSMITTER-RECEIVER, with tubes. Excellent condition. . . . . \$60.00  
 PLUGS—Set for SCR-522. . . . . NEW 3.75  
 PE-94C-24 Volt DYNAMOTOR. . . . . USED 2.50  
 . . . . . NEW 4.50  
 PE-98-12 Volt DYNAMOTOR. . . . . NEW 19.50  
 BC-602 Control Box. . . . . NEW .95  
 BC-631 Jack Box. . . . . NEW .79  
 AN-104A Antenna. . . . . NEW STEEL 1.95  
 . . . . . COPPER 2.95

SOUND POWERED HEAD & CHEST SET, made by Automatic Elec. Co. . . . . PAIR \$11.00  
 . . . . . NEW—EA. 5.95

ELECTRONIC MEGAPHONE — Light weight portable for use by coaches, cheer leaders, police, fire dept., etc. Ready to operate, includes LS-6C Speaker, BC-641C Amplifier, carrying case, and batteries. . . . . \$42.50  
 BC-641C AMPLIFIER only. . . . . 9.95

400 Cycle INVERTER—G.E. 5DZ1NJ3A Input 27 V., 35 amps. Output 115 V.—485 V.A. single phase. . . . . \$12.50  
 400 Cycle INVERTER—G.E. PE-218 Input 27 V., 100 amps. Output 115 V., 1,500 V.A. Single phase. . . . . USED 17.50  
 . . . . . NEW 29.50  
 800 Cycle INVERTER—PE-206. . . . . NEW 5.95  
 800 Cycle Blower and Motor—1 ph 6,700 R.P.M. 120 V. CAY-21773. . . . . 1.50  
 24 V. D.C. Blower and Motor—1700 R.P.M.—1.35 amps. A. G. Redmond Co. . . . . 1.95

BC-348 Mounting Base. . . . . \$2.25  
 BC-348 Outlet Plug. . . . . .69  
 BC-348 Mounting Base and Outlet Plug. . . . . 2.50

MINE DETECTOR-SCR-625A Used for locating metal, underground pipes, gold, etc. NEW WITH MANUALS. . . . . \$69.50  
 USED EXCELLENT COND. . . . . 45.00

**IDEAL MOBILE POWER SUPPLY**  
 PE-237 Heavy duty vibrator, power supply, 6, 12, or 24 V. Input: 225 V., 95 ma.; 105 V., 42 ma.; 6.5 V., 2 amps; 6 V., 500 ma.; 1.3 V., 450 ma.; small supply 100 V., 17 ma.; 1.35-450 ma. with tubes, shock mounted. . . . . BRAND NEW \$27.50

SURPLUS RADIO CONVERSION MANUAL, Vol. 1, 115 pages of circuits & data. . . . . Postpaid \$2.50  
 CD-501 CABLE for PE-103 BC-654. . . . . NEW 1.95  
 SPEAKER—6" P.M. Component, 25 watts, 50-6,000 ohms, waterproof. Excellent Used. . . . . 8.95  
 TERMS: Prices f.o.b. Pasadena, 25% on all C.O.D. orders. Californians add 3% sales tax.

## For Greater Earnings . . . LEARN RADIO-ELECTRONICS

This fast-growing science of RADIO, TELEVISION, RADAR and ELECTRONICS, offers tremendous opportunities, and in no industry is RADIO-ELECTRONICS more important than in aviation. A skilled technician who *knows* the modern application of electronic devices, as used in the aircraft industry, is always in demand . . . not only in aviation, but in many other industries. Many large organizations call on Spartan regularly for graduates. Often, students are hired months before graduation.

Don't confuse the RADIO-ELECTRONICS course offered by SPARTAN with other courses, offered anywhere! As a graduate from this famous school you will know the application to industrial control devices; to the search for petroleum; and the important uses of radar, television and other electronic equipment.

SPARTAN offers two complete and thorough courses. You will work on the most modern and complete equipment. You will build equipment. You may join the SPARTAN "Ham" Club. Either course prepares you for Federal Communication Commission license tests — first class radio telephone, second class radio telegraph, or class "B" radio amateur.



SPARTAN'S 21 years of teaching civilian and army personnel is your assurance of receiving the best possible training in the least possible time. You'll not need MORE than Spartan training — you cannot afford to take LESS.

**BIG CATALOG—Free**

NAME \_\_\_\_\_ AGE \_\_\_\_\_

ADDRESS \_\_\_\_\_

CITY \_\_\_\_\_ STATE \_\_\_\_\_

G. I. APPROVED—Write TODAY for Complete Information

**SPARTAN**  
 SCHOOL OF RADIO AND ELECTRONICS

SCHOOL OF AERONAUTICS COLLEGE OF ENGINEERING  
 MAXWELL W. BALFOUR, DIRECTOR ADDRESS DEPT. NEN-1 U  
 TULSA, OKLAHOMA

# NEW TELEKITS

NOW **49<sup>95</sup>**

Jobbers: Write for Confidential Price Information

NEW TELEKITS  
10-B \$69.95  
7-B \$49.95  
Less Tubes

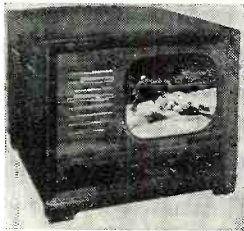

Sparkling new Telekit 10-B has 52-inch screen. Brand new compact lay-out has video tube mounted on chassis. Big illustrated easy-to-follow instruction book guides you step by step through easy assembly. No special knowledge of television is required. All you need is a soldering iron, pliers, and screw driver. 10-B kit can be used with 12½, 15, 16 inch tubes. Telekit 10-B, \$69.95. 10-B Telekit cabinet \$15.95 and \$24.50. Satisfactory Telekit performance guaranteed by Factory Service Plan.

Write for catalog listing 10-B and 7-B Telekits. New 7-B Telekit for 7-inch tube, \$49.95. 7-B cabinet, \$15.95 and \$24.50.

TELEKIT BOOSTER  
12.95

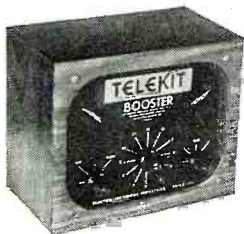

This Telekit booster will bring in TV signals bright and clear in the fringe areas. Has a 20 times boost on all TV channels. NOT A KIT. Completely assembled. With tubes. Works with Telekit or any TV receiver.

13 CHANNEL TUNER  
12.95

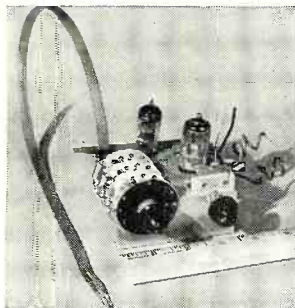

This compact front end has a stage of RF for extra distance. Made to conform with Telekit or any TV set having a video I.F. of 25.75 Mc. Complete with tubes, pre-wired, pre-assembled. Only four connections to make.

Write for catalog of Telekit antennas, boosters, television kits tuners, television parts and tubes.

# TELEKIT

ELECTRO-TECHNICAL INDUSTRIES  
1432 NORTH BROAD STREET PHILADELPHIA 21, PA.

screen. See Fig. 9. This indicates that the slug in the winding of  $T_1$  which connects to  $V_{1a}$  and  $V_{1b}$  is not properly positioned. Adjust this slug until the blanking bar moves to the right and off the raster.

The foregoing adjustments pertain only to this particular sync system. Thus, in some systems to be described presently, it is normal for the picture to drop out of sync at the extreme clockwise and counter-clockwise positions of the hold control. In this system this is generally not true. When doing repair work on any of the a.f.c. systems, it is necessary for the service technician to know what represents normal operation and what does not. It is the purpose of these articles to make these facts known.

(To be continued)

## Converting TR-4

(Continued from page 49)

tion from the circuits is appreciable, and under some conditions there apparently can be standing waves on the panel itself.

### Calibration

Frequency calibration was derived from a pair of Lecher wires and the harmonics of a two-meter transmitter on 145 mc., with the aid of a *Little Gem* crystal wavemeter. The Lecher wires were made simply by folding seven feet of #14 wire in the middle and anchoring it to a lath with four small insulators. The wires are spaced

one inch and the lath is ruled off in inches from a yardstick. A machine screw makes a convenient shorting bar. No turnbuckles or springs were included because the availability of crystal harmonics made high accuracy unnecessary.

The *Little Gem* wavemeter consists of a small split-stator condenser mounted as close as possible to a four-prong coil socket. The pick-up side of the dual hairpin coil feeds a germanium crystal diode and a 100 microampere meter. The whole circuit, shown in Fig. 4D, is mounted in a 4x4x2 metal box, with only the condenser shaft grounded.

After the detector was operating, the two-meter transmitter was turned on at 145 mc. and the receiver tuned through its range. A series of signals were found which proved to be the harmonics of the 8.056 mc. crystal oscillator. On one of these at the third harmonic of the final, or 435 mc., microphone feedback appeared readily. This one identified the center of the band, and approximate limits were indicated by the second harmonic signal each way. These three points at center and edges were checked with the Lecher wires and found to agree, with readings at 13, 13½, and 14 inches. The *Little Gem* was then calibrated from the receiver and used to determine safe transmitter dial settings for in-band radiation. These dial settings must, of course, be found for the particular antenna and adjustment of antenna coupling to be used in actual transmission.

-30-

Fig. 4. (A) Detector line elements, right and left required, right shown (see text for details on twisting). Made from ⅜" copper rod or wire. (B) Detector socket mounting, drilled for Millen socket. Made from ¼" phenol fabric. (C) Antenna switch connections. (D) Little Gem crystal wavemeter.

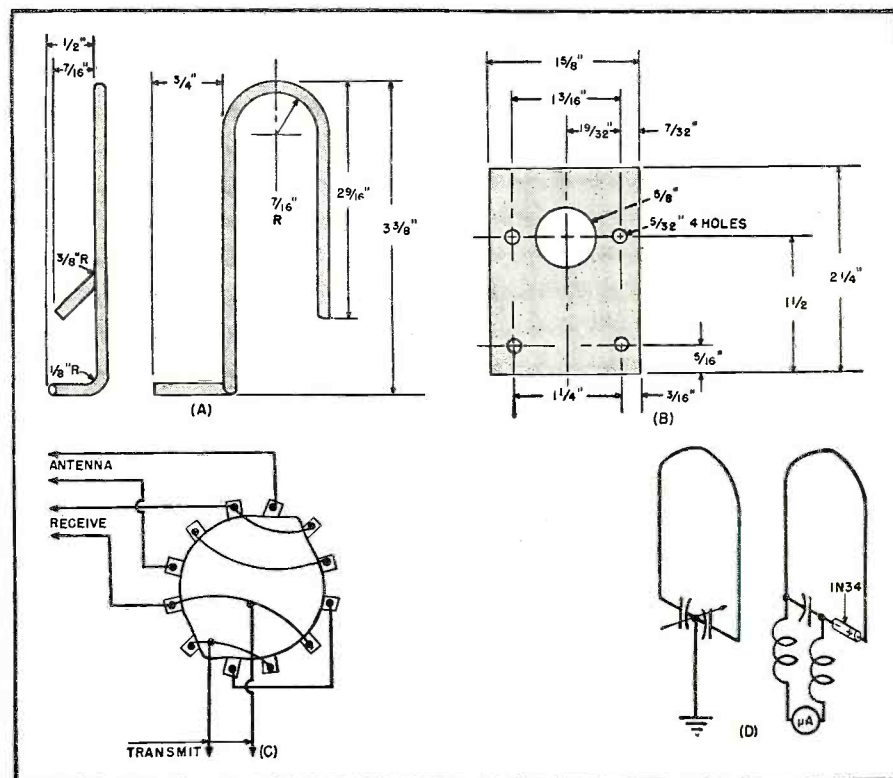

## Beginning Amateur

(Continued from page 42)

able courses piecemeal, instead of having to dig into the family finances for a big chunk of money all at once.

Some courses start really at the bottom. They are written on the assumption that the student knows absolutely nothing about radio but wants to learn. Even a ham with a few months of experience can usually learn something from the early lessons, and of course they build up gradually. Other courses are more or less "refreshers," intended for service technicians, station operators, etc., who want to branch out a bit. The advanced lessons are on the engineering level, with enough math included to keep the student awake for many nights.

Would-be service technicians, station operators, etc., are not the only people who benefit from correspondence courses. They are taken with great profit by salesmen, advertising men, manual training teachers, and many others who are connected directly or indirectly with radio and find it desirable to know something about its technical aspects.

Wherever a ham goes in the radio business, he'll find other hams ready and willing to help him. And they turn up in the most unexpected places, sometimes even in the office of the president of the company. —30—

## DDT DAMAGES PLASTICS

SEVERAL common types of aerosol and liquid DDT sprays and solutions will adversely affect certain types of plastics. Upon contact, the liquid or spray will turn milky or fog meter glass dials and other clear plastics. It further tends to roughen or pit the plastic, ruining cabinets and cases.

DDT, while of value in insect control, should be kept away from plastics or plastic trimmed items.

To date, no good method of repair has been found except to buff and polish the surface below the level to which the plastic has been affected . . . J.W.S.



"No, no, Ed. . . . try it a little to the left of the chimney!"

# No BULL in the R&M BULLETIN!



JUST DOLLAR SAVING VALUES FOR YOU  
YOU CAN'T AFFORD TO MISS  
THESE BARGAINS!

GET ON THE MAILING LIST • DROP US A CARD TODAY

The R & M BI-MONTHLY BULLETIN gives you the latest releases of rock-bottom prices on choice TV and Standard or Surplus Radio Equipment.

### TV CONICAL STACKED DE LUXE

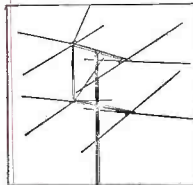

## ANTENNA \$13.29

Unexcelled—Good up to 125 miles for use with 72 or 300 ohms receivers. LESS MAST.

### All Band TV ANTENNA \$5.29

Pre-assembled for quick installation; highly efficient, easy to install; for 300 ohm sets. Less mast.

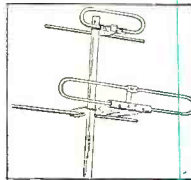

\$26.50 value



## TV PICTURE TUBES

One full year guarantee (misuse or mishandling excepted)

7JP-4 \$16.88 | 10BP-4 \$24.75 | 10FP-4 \$26.80  
12-KP-4 \$36.45 | 12LP-4 \$34.40 | 16AP-4 \$55.88

### Horiz. Deflection Output & High Voltage



## TRANSFORMER

Reg. \$6.90 R&M'S \$3.29  
wholesale PRICE



### SPRAGUE MOLDED

## CONDENSERS

Rugged, small size, heat resistant, non-inflammable and completely insulated.	Mfd.	DC V	Price
	.01	600	18c
	.05	600	24c
	.0005	6000	81c
	.001	6000	81c
	.005	6000	81c
	.0005	10000	90c

TERMS: F. O. B. Arlington, Va. Under \$10—cash with order. Over \$10—25% deposit, bal. C.O.D.



Stand Off 3 1/2"

## INSULATORS 3 1/2c each

300 ohm; screw-type. 100 .....\$2.75  
1000 .....\$24.75

300 ohm Chocolate Twin Lead  
100 ft. ....\$1.29 1000 ft. ....\$9.95

5-ft. Steel Extension Masts .....75c

4-ft. Aluminum Extension Masts .....75c

12-ft. Heavy Duty Aluminum Mast \$3.49



## CHIMNEY QUICK MOUNT \$1.45

Steel, heavily plated. Two complete easily mounted brackets supporting masts up to 1 1/2" diam. All strap and hardware included.

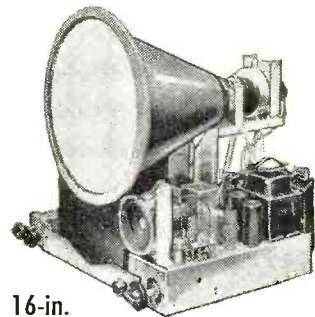

16-in.

## TV deluxe KIT \$163.50

Complete with 31 matched RCA tubes. less picture tube

Kit as above, completely wired \$197.50

less picture tube

Build your own 1949 model television set—and save! The kit is complete—major components, all controls, all sockets and terminal strips mounted in place; ultra-simplified wiring diagrams furnished. RCA 13-channel front end tuner completely wired, aligned and tested; final adjustments can be made without additional test equipment.

# R & M RADIO COMPANY

2701 WILSON BLVD. DEPT. RN1 ARLINGTON, VA.

UP IN THE CLOUDS PERFORMANCE  
... DOWN TO EARTH PRICE!

**Americas Finest!**

**At a price EVERYONE CAN PAY ...**

**GE TELEVISION TOWER**

*Featuring:*

- NEW DESIGN
- BETTER — STRONGER
- MORE ATTRACTIVE
- 30' ALL TOWER — NOT A MAST

Here's a new triangular TV tower that really meets the requirements of the most exacting Radio Serviceman. It sets a new high — has tremendous strength because of its new type construction — and is easy to erect.

**Lighter Weight Greater Strength**

Completely new in design, it has uprights of hard drawn tubular steel—offering greatest possible strength to weight ratio. Weight of the basic 30' tower is a mere 62 lbs. Base is 19" center to center triangle, tapering to 4" at the top. Top has hole for 2" mast. It's easy to erect, coming in 10 foot sections. Additional extensions available to provide any height up to 100 feet. Extensions are quickly added by bolting above the first 10-foot section. Tower has hinged feet for bolting to peaked or level roof.

**Withstands Ice-Winds**

The tower will easily carry any TV or FM antenna, directional array and rotator.

**Durably Finished**

It's durably finished with two coats of aluminum enamel.

**LOW-LOW PRICE**

30' GC Tower  
No. 8352RN.....List **\$79.50**

10' GC Extensions  
No. 8353RN.....List **\$29.50**

(Subject to the usual Dealer and Jobber Discounts)

**ALL GC Products Are Fully Protected By Product Liability Insurance**

Write For Complete, New GC Television Catalog of TV Accessories.

**GENERAL CEMENT Mfg. Co., Rockford, Ill., U. S. A.**  
Manufacturers of over 3,000 products  
Sales offices in principal cities

# OSCILLOSCOPE QUIZ

By **ED BUKSTEIN**  
Northwestern Vocational Institute  
(For answers see page 152)

**Because television is taking up a greater portion of the service technician's time than ever before, it is well to check up and see just how well acquainted you are with your oscilloscope and its operation. All questions refer to the diagram shown.**

- Switch 1 serves as the (a) sweep frequency control (b) horizontal gain control (c) attenuator (d) vertical centering control.
- Tube  $V_1$  is a (a) cathode follower (b) grounded grid amplifier (c) saw-tooth generator (d) horizontal amplifier.
- Potentiometer  $R_2$  is the (a) fine sweep control (b) coarse sweep control (c) horizontal gain control (d) vertical gain control.
- Inductance  $L_1$  is used to compensate for (a) low frequency gain (b) high frequency gain (c) saw-tooth linearity (d) pattern drift.
- The combination of  $R_1$ - $C_1$  serves to increase the (a) low frequency response (b) saw-tooth amplitude (c) high frequency response (d) external synchronization.
- When switch 2 is in the position shown, the scope is being used with (a) external synchronization (b) internal synchronization (c) 60 cycle synchronization (d) no synchronization.
- Potentiometer  $R_3$  controls the (a) vertical gain (b) horizontal gain (c) vertical centering (d) sync amplitude.
- Tube  $V_2$  is used as the (a) cathode follower (b) sweep generator (c) deflection amplifier (d) wide-band amplifier.
- Switch 3 is the (a) coarse sweep control (b) fine sweep control (c) vertical attenuator (d) horizontal centering.
- $R_4$  controls the (a) focus (b) contrast (c) brightness (d) sweep frequency.
- $R_5$  is the (a) vertical gain control (b) horizontal gain control (c) focus control (d) intensity control.
- $V_3$  is the (a) cathode follower (b) high-voltage rectifier (c) low-voltage rectifier (d) full-wave rectifier.
- The voltage at the plate of the

Fig. 1.

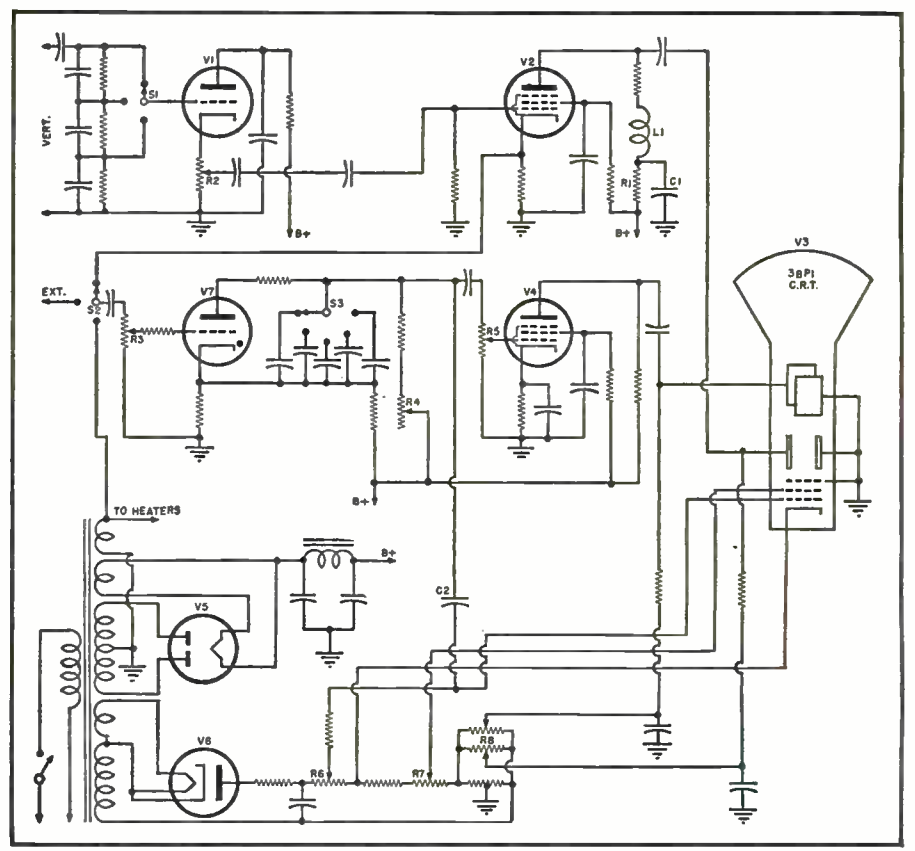

# NOW!

**EXCELLENT AUDIO PERFORMANCE**  
at Reasonable Cost



4-AJ  
AUDIO AMPLIFIER

Ideal for use with  
MEISSNER 8C  
FM RECEPTOR  
and others...

Meissner, with the new 4-AJ Power Amplifier, has demonstrated that excellent audio performance can be obtained at very reasonable cost. By a better output transformer and latest amplifier design, the new 4-AJ amplifier provides top audio quality — especially for FM reception. Fidelity and power output is more than adequate to provide flawless reception. Output impedance is designed to match **your** speaker. Complete instruction manual provided. Here's a listing of only a few of the outstanding features.

## Features

- Fidelity** Flat within 2 db. from 45 to 20,000 cycles
- Power Output** 20 watts, less than 5% harmonic distortion
- Hum and Noise** 60 db. below full output
- Output Impedance** 4, 8, 15, 250 and 500 ohms, unbalanced

Write Meissner for Complete Information.

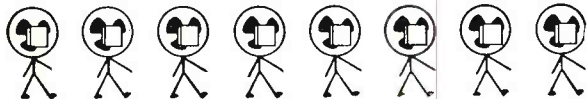

only

# QUAM

offers you this PLUS value

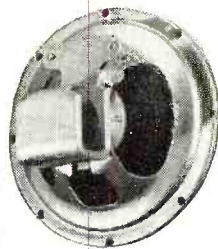

Among all the radio speakers made today there's only one that's different.

Only Quam has the adjustable voice coil, permitting accurate centering after assembly, and virtually eliminating rubbing voice coil trouble!

Only Quam has the U-Shaped Coil Pot, providing an unbroken path for the magnetic flux, thus producing a stronger magnetic field, greater efficiency and better performance.

Only Quam has these plus values, only Quam is different. Specify Quam for all replacements!



QUAM-NICHOLS CO.  
522 E. 33rd Place  
Chicago 16, Ill.

Please send me Quam catalog.  
Name .....  
Address .....  
City ..... State .....

Mail This  
Coupon for  
Free Catalog

January, 1950

# NEW YORK'S RADIO TUBE EXCHANGE

A VERY LARGE STOCK OF  
NEW STANDARD MAKE  
Minimum order \$5.00

# TUBES

Quantity Prices on Request



TYPE	PRICE	TYPE	PRICE
1A3	2.29	WL530	7.95
1B23	2.25	WL531	2.35
1B24	8.95	WL532	2.95
1B25	4.95	WL533	35.95
1B38	12.50	575A	12.50
1N21	.85	579B	12.50
1N21A	1.50	701A	3.95
1N21B	.85	705A	.75
1N23	.85	707A	6.95
1N23A	3.75	709A	2.40
2C40	5.75	714AY	6.95
6L2C43	17.50	715A	6.95
2C51	2.25	715C	24.95
2D31	1.08	717A	4.95
2J26	12.75	720BY	45.00
2J27	12.75	720DY	45.00
2J32	19.95	722	3.95
2J36	105.00	723A	2.95
2J49	24.50	723A/B	16.95
2J50	24.50	724A	2.95
2J61	45.00	725A	12.95
2J63	45.00	726B	19.95
2K25	19.95	730C	26.00
2K28	19.95	730AY	45.00
2C45	24.95	801A	.69
2N2A	.69	802	4.30
2W3G	.99	804	10.95
2A49	4.25	805	4.95
3BP1	3.95	807	2.75
3B24	1.25	808	2.50
3D31	3.95	810	2.11
3C24	.95	811	2.40
3C31	3.95	812	6.95
3D32	3.95	813	2.95
3DP1	1.95	814	2.95
3DP1A	2.75	817	2.50
3P24	6.75	826	.59
3I31	59.95	827R	10.95
4A1	29.95	829B	16.75
4A2	19.95	834	5.50
4C35	95.00	837	1.95
4J30	95.00	838	3.75
4J32	95.00	840	4.50
4J41	195.00	841	19.95
4J65	195.00	842	19.95
5BP1	2.75	843	3.75
5BP4	3.95	844	1.15
5CP	1.95	845	1.95
5D21	24.95	846	2.75
5E7	9.95	847A	1.95
5F7	7.95	848	7.75
6A	1.25	849	2.25
6AC7W	19.95	850	1.45
6C21	6.8	851	95.00
6E4	4.95	852	3.95
6AU6GT	1.25	853	.45
6-8	.95	854	.45
6P7	4.95	855	.45
7D7	12.50	856	1.35
10Y	1.25	857	1.10
15E	1.00	858	.99
15F	2.50	859	.99
RV21	.95	860R	1.25
CR72	6.95	931A	.95
7K7	249.00	951	.45
VR90	.79	956	.45
100TH	10.95	957	.25
VR105	.79	958A	.55
FL23	8.95	959	.75
VR150	3.95	99	.25
203A	3.95	CK1006	.95
217C	6.95	1613	.75
249C	1.95	1616	1.10
250TH	1.25	1618	.50
250R	15.00	1624	.99
254B	5.95	1625	.45
257A	1.75	1626	.45
304TH	3.95	1629	.45
304TL	2.95	1635	1.00
307A	1.25	1641	1.35
310A	4.25	1851	1.10
316A	4.95	1853	.99
350A	3.95	1855	.99
350R	1.80	2050	.95
363AS	2.40	8011	1.25
371B	.89	8012A	3.95
383A	1.80	8013A	22.95
394A	4.25	8014A	1.25
417A	4.95	8016	1.25
446B	12.95	8020	3.95
450TH	1.80	8025	.55
446A	.90	9001	.55
450TH	17.50	9002	.55
446A	.90	9003	.55
450TH	17.50	9004	.45
446A	.90	9005	1.10
WL468	3.95	9006	1.10
527	9.95		

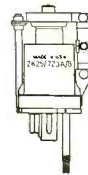
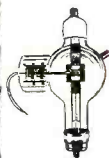

## ATTENTION AMATEURS

The 35DA Tube is a long life 807.  
The 350B Tube is a long life 6L6G.  
The 701A could be used instead of a long life 813.

Attention Radio Executives, Amateurs and Dealers  
We buy your inventories or exchange for other types  
COMPLETE STOCK NOW ON HAND • SUBJECT TO PRIOR  
SALE • PRICES SUBJECT TO CHANGE WITHOUT NOTICE



**LIBERTY ELECTRONICS, INC.**  
135 LIBERTY STREET NEW YORK 6, N Y  
PHONE WORTH 4-8262

# Sensational NEW LOW PRICE on Guaranteed Quality Tubes



1A5GT	3Q4	6AU6	6J5	6SL7	12AU7	12SL7	35W4	53
1A7	3Q5	6BA6	6J6	6SN7	12AX7	12SN7	35Z5	5B
1H5	3S4	6BA7	6J7GT	6SQ7	12BA6	12SQ7	38	70L7
1L4	3V4	6BE6	6K5GT	6SU7	12BA7	19T8	41	75
1N5	5U4	6BF6	6K6GT	6T8	12BE6	25L6	42	76
1P5	5Y3	6BG6	6K7GT	6V6	12F5	25Z6	43	77
1Q5	6A7	6BH6	6P5	6W4	12I7	26	45	78
1R5	6A8GT	6BJ6	6Q7	6X4	12K7	27	45Z5	80
1S5	6AC5	6C4	658	6X5	12L7	32L7	46	82
1T4	6AG5	6C6	6SA7	12A8	1258	32L7	47	84
1T5	6AK5	6D6	6SD7	12AL5	12SA7GT	35	47	84
1U4	6AL5	6F5GT	6SF5	12AT6	12SF5	35B5	50B5	85
1U5	6AQ5	6F6GT	6SJ7	12A77	12SJ7	35C5	50C5	117Z3
2A5	6AT6	6H6GT	6SK7	12AU6	12SK7	35L6	50L6	117Z6

**\$27.50 PER 100 ASSORTED**

Any Tube Above 32c Each.  
35c Handling Charge On Orders Under 100 Tubes.

ALL ORDERS SHIPPED C.O.D.

## OWL RADIO TUBE COMPANY

32 BEECHER STREET • NEWARK 2, N. J.

All Orders Filled Promptly. All Tubes Individually Boxed.

Order NOW... this offer limited to stocks on hand HURRY!

high-voltage rectifier is (a) positive with respect to ground (b) negative with respect to ground (c) has no polarity with respect to ground.

14. R<sub>1</sub> is the (a) focus control (b) centering control (c) intensity control (d) gain control.

15. R<sub>2</sub> is the (a) vertical centering (b) horizontal gain (c) focus (d) intensity.

16. Condenser C<sub>2</sub> is used for (a) synchronizing (b) centering (c) blanking.

17. R<sub>3</sub> is the (a) vertical centering control (b) focus control (c) brightness control (d) attenuator.

18. The 3BP1 cathode-ray tube has a (a) white trace (b) blue trace (c) green trace.

19. Tube V<sub>1</sub> is a (a) vacuum rectifier (b) plotron (c) thyatron.

20. The screen diameter of the cathode-ray tube is (a) three inches (b) five inches (c) four inches (d) seven inches.

### INFRARED LAMP

By DOMENIC R. RIPANI

AN INFRARED lamp is a handy tool to have around the shop for baking moisture out of coils, or "bringing out" those puzzling intermittents due to heat.

A lamp of the 250-watt variety equipped with a standard base may be obtained at any electrical supply house for a little more than a dollar. Used with a small extension over the bench, the lamp may be adjusted in height above the set "being cooked."

A few minutes of baking will invariably put new life into those i.f.'s that have been absorbing moisture for a long time. Intermittents caused by expansion due to rising temperature will become very apparent under this treatment.

### NOVEL TV ANTENNA

By DONALD PALLATZ

AN ORDINARY wire type coat hanger (Fig. 1) makes a dandy TV aerial. Simply cut the bottom section in half and connect paired lead to each end. The hook is used to hang on moulding, desk or table. It may be bent so that hanger is at its best position of rotation.

It was thought at first that this antenna would favor the higher frequency channels, however reception will be found to be good over the entire range. This aerial will not operate where other types of indoor antennas fail.

Fig. 1.

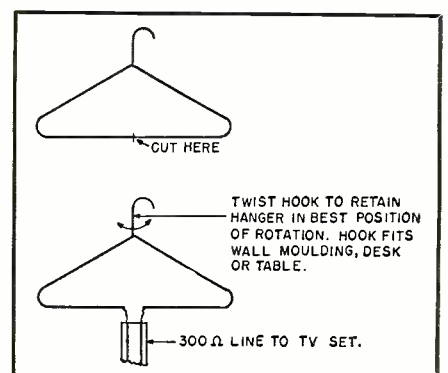

## JOBS in TELEVISION



**TELEVISION TECHNICIANS NEEDED AT ONCE**

QUALIFIED MEN ONLY • GOOD PAY  
STEADY WORK • GOOD FUTURE

**AMERICAN RADIO INSTITUTE**

CAN TRAIN YOU FOR THIS JOB

Syracuse, N. Y.  
2010 Broadway (68 St.)  
Buffalo, N. Y.  
640 Main St.

Mount Vernon, N. Y.  
174 Gramatan Ave

FREE EMPLOYMENT SERVICE—GI APPROVED

## Approved TELEVISION FIELD STRENGTH METER



**\$79.50 ONLY**

Field Strength Meter; television 12 channel tuner; video IF channel; large 6" directly calibrated meter; hammer tone finished panel; ideal for locating antenna systems; testing transmission lines; testing efficiency of indoor antennas; checking booster efficiency, etc.

Model A-460 is housed in a heavy gauge steel cabinet, battleship grey finish with 6 tubes (standard brands) IN34 Crystal, operating instructions, circuit diagram and guarantee. Weight 25 lbs. D-8" x H-10" x W-12".

Write for 12-page catalogue.

**APPROVED ELECTRONIC INST., CORP.**  
142 Liberty St. N.Y.C.

## INVEST IN PART TIME BUSINESS COIN OPERATED RADIOS

R.C.A. Licensed and Approved Heavy Duty, 5 Tube, A.G. Super-Het Radio

• EXTRA HEAVY PLASTIC CABINET

Sets on floor—no stand needed. Richly grained brown or ivory marble. No stains—no burns—no refinishing. Exceptional acoustics only equaled by this type of cabinet. METAL BACK WITH NO CHEAT COIN BOX.

DELUXE CONSOLE MODEL COMPLETE  
**\$19.50**

**RADIO COIN MATIC** 1110 S. NORMANDIE AVE.  
LOS ANGELES 6, CALIFORNIA



**Spot Radio News**  
(Continued from page 18)

cerned." RCA felt that the demonstrations should be postponed for at least sixty days to provide a reasonable opportunity for field testing its system "... to a point when the comparative demonstration would be meaningful."

**AS USUAL** CBS did not agree with RCA and in a blunt rebuttal said: "The RCA petition on its face, and the actual facts and circumstances surrounding the petition, require the conclusions that the reasons assigned for postponement of the comparative demonstration are specious, and that the actual reasons for its desire for delay lie elsewhere. . . . Columbia suggests that any one of the following may well be true, though unstated, basis for RCA's petition: Either RCA now realizes the inadequacy of its proposed system and hopes that somehow and in some way before January, 1950, its experts and technicians will come upon something which will rescue RCA from its present embarrassed position, or RCA now realizes that a comparative demonstration of its color television with the CBS system will show, even more clearly than . . . the separate demonstrations, the markedly inferior performance of the RCA system, and hence RCA wishes to put off as long as possible the day of direct comparison."

RCA wasn't too meek in its reply to CBS, stating that "... The arguments set forth in the CBS opposition consist of no more than efforts on the part of CBS to obtain a premature decision, based on inadequate facts, in favor of its system. It completely ignores the fact that the public interest can be served only by a sound decision and not necessarily by a quick decision."

When the smoke cleared, the Commissioners began to ponder, aware perhaps that they were all riding on an infuriated lion and a tactful move was necessary. Thus came about another decision, that two comparative tests would be held, one which we mentioned was being held as this column was being typed and the second during the new year.

A comprehensive two-day program was authorized for the first test, with program material on the air from nine in the morning until nearly three in the afternoon and viewing in three rooms with nine types of receivers: DuMont 12-inch black and white, CBS converter (10 inch) and 10-inch table model, and RCA black and white of the 12-inch or smaller variety; RCA color model with a 10-inch screen, CBS color with a 12-inch viewer and a DuMont 12-inch black and white; RCA and CBS 16-inch or less color receivers and DuMont 16-inch or less black and white. Direct and coax and radio relay circuits were scheduled, with direct programs consisting of wrestling or boxing, choirs or chorus, slides, paint-

**NOW . . . IN KIT FORM!**  
**NARROW-BAND, PHASE OR FREQUENCY MODULATION UNITS**

Here's an opportunity to obtain an NFM unit that will insure excellent performance at a price very substantially less than ready-built units. Has three tubes including voltage regulator permitting operation from existing power supply. Ample gain for use with crystal mike. Adjustable swing control. FM unit provides more than sufficient swing for 80, 20, 10 meters and connects to grid or cathode of master oscillator. Phase unit does not affect oscillator calibration since it connects to plate of first buffer. Excellent for 20, 10 meters or higher. These are carefully engineered units, proven by months of on-the-air performance. Tubes, fabricated chassis, all necessary parts and complete assembly, testing and wiring instructions. A sure-fire setup!  
FM-3R Frequency modulated kit.....only **\$8.45**  
PM-3R Phase modulated kit.....only **\$8.45**

**THREE NEW NOISE-LIMITER AND "CLIPPER" KITS**

At long-last, a completely adjustable noise limiter suitable for use on the earphone connection on BC-274N and other surplus receivers. (BC-453, BC-454, BC-455, BC-342, BC-348, BC-312.) Positive and negative peak limiting, continuously adjustable from strong signal levels to near cutoff. Highly effective, double-diode circuit—B plus and filament taken from receiver—particularly effective on CW—can maintain all signals to a common level. Kit is complete—tube, all parts, complete assembly, testing and wiring instructions. Simple! Highly effective!  
NL-6R for 6V fil.....complete **\$4.20**  
NL-24R for 24V fil.....complete **\$4.58**

**"CLIPPER" KIT**

Same as above except high impedance for inter-stage use in speech amplifiers. (Clipping level fully adjustable to permit higher average percentage without overmodulation.)  
SP-6R (6V fil.).....complete **\$4.20**

**Power Supply for Any 274-N Receiver**



Here it is—at last! Just plug it into the rear of your 274-N RECEIVER . . . any model! Complete kit, and black metal case, with ALL parts and diagrams. Simple and easy to build in a jiffy. Delivers 24 volts plus B voltage. No wiring changes to be made. Designed especially for the 274-N receiver. All necessary parts for conversion of rest of receiver also included. ONLY \$7.95. TUNING KNOB for 274-N Receiver, 59c ea.

**CONDENSER TESTER**

• One of our best sellers! Useful, versatile laboratory item, in kit form. Simple, and easy to build in less than an hour. Checks condenser leakage and continuity up to 8 megohms. Will test any paper, electrolytic, mica or oil capacitor from 50 mmf. to 50 mf. Self-contained power supply and neon bulb indicator with socket and bezel. Drilled metal cabinet. Complete instructions and diagrams included with each kit. Only \$4.85.

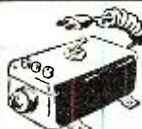

**HEAVY-DUTY FILTER CHOKE**

A hermetically sealed unit, conservatively rated at 10 henries @ 200 ma. Has hum-bucking tap. Steel cases—ONLY \$1.98 each.

**HOT SPECIAL ON OIL CAPACITORS**

8 mfd., 1000V, oil-filled. Made by Aerovox. Rect. case grey finish, complete with mounting brackets.  
\$1.95 ea.; 5 for \$8.95  
4 mfd., 600V, oil-filled—Round case, upright single-hole mounting. With mfg. hardware.....95c ea.; 5 for \$3.75



**LOOK! NO HANDS!**



This mike leaves both hands free for mobile QSO's. Fastens to operator by simple s n a p strap. Western Electric button assures best quality obtainable from any carbon mike. Adjustable. Double action sw. operates push-to-talk or holds on. BRAND NEW only \$1.75 ea. POST-PAID in U.S.A. and CANADA.

**CHECK THESE C-R TUBE VALUES!**

3CP1 3" C-R tube. Green, med. persist. screen.....\$2.95  
3DPLA 3" C-R tube. Green, med. persist. screen, 14 pin base for oscilloscope use.  
A real buy at only.....2.50 ea.  
3FP1 3" C-R tube. Green, med. persist. ....2.95 ea.  
5MP1 5" C-R tube. Green, med. persist. ....2.50 ea.  
5NP1 5" C-R tube. Green, med. persist. screen.....2.50 ea.

**YOUR FONE-PATCH PROBLEM IS SOLVED!**

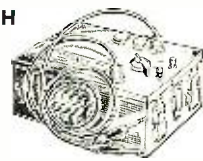

A special purchase of the highly desirable RM-53, Signal Corps phone-patch units. Expressly designed for this purpose, this unit provides the necessary means for connecting the transmitter and receiver into the telephone lines. These are brand new and the offering price is exceptionally low for such a fine unit. Act fast . . . they're hard to obtain!  
Only .....\$3.95 ea.

**HI-LEVEL NEGATIVE PEAK CLIPPER! 836 RECTIFIER TUBES**

Use an 836 high-vacuum, high-voltage rectifier tube. Ideal for "clippers"—no "hash" troubles. Same tubes also used to replace 866's in normal, high-voltage rectifier applications.  
Rock-bottom price on a really "hot" tube 2 for \$1.10  
High-voltage Filament Transformer for "Clipper" or Rectifier applications.  
Pri. 110V, 60cy. Sec. 2.5V @ 10A. 10,000V insulation .....\$2.76 ea.

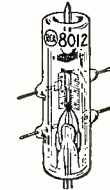

**RCA 8012 VHF TRIODE**

TANTALUM plate and grid! 35 watts output, 40 watts plate diss. Use as osc. or amp. at full ratings up to 500 mc! C.T., 6.3V filament reduces fl. lead inductance. ALL BRAND NEW! Normally sells for \$14.50, large quantity purchase permits our extremely low prices of \$1.50 each. 4 for \$5.00.

**PROTECT COSTLY TUBES AND EQUIPMENT AGAINST OVERLOAD!**

Here's a buy on a fast-acting, reset-type circuit breaker. Designed to trip at 220 ma; cinch to shunt for higher currents. Excellent construction—panel or desk mount—use also as combo on-off sw. and bkr. Priced low because of quantity purchase .....89c ea.

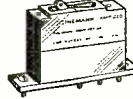

**SCOOP!**

**6L6 METAL . . .90c ea. Four for \$3.40**  
**6L6 GLASS . . .79c ea. Four for \$3.00**  
BRAND NEW . . . STANDARD BRANDS

**HANDSET HANGER**

Accommodate all makes and models, (Kellogg, W-E, American etc.). Beautiful, cast aluminum shell finished in rich black wrinkle. Felt facing protects handset. Provision to fasten directly to desk or to telephone equipment. An extremely useful, well-made item .....\$1.95 ea.

**TS-10 Sound Powered Handsets**  
Brand New! \$16.95 per pair  
RM-29A TELEPHONE: Brand New...\$12.95 ea.  
EE-89A TELEPHONE REPEATER:  
New .....\$9.95 ea.

**FL-8 FILTERS AND "FL-8 FILTER FACTS" BOOKLET**

A sure bet for better reception, an FL-8. The low-down on the filter is given in "Filter Facts" booklet. See past issues RADIO NEWS for more complete dope on this fine duo.  
FL-8 Filter and booklet—combo offer....\$2.98  
Booklet only. (Postpaid in U. S.).....50

**INCREASED RECEIVER OUTPUT TO HEADPHONES!**

Use these matching transformers to obtain big increase in output when using hi-imp. phones with the average receiver. (300-600 ohms.) Use also with FL-8 filters for greatly improved results. Hermetically sealed, plated brass case, good LF response. Imp. ratio approx. 10:1.  
An excellent value at.....95c ea.  
Special hi-ratio for 75A receivers.....95c ea.

**BC-221 FREQUENCY METERS**

Two models available. Metal case, used in good condition. With original crystal and calibration charts .....\$90.00 ea.  
BC-221 A.J. Brand new—with modulation. Original crystal and calibration charts .....\$125.00 ea.

**POWER SUPPLY KIT FOR BC-221**

Contains all parts needed for BC-221 power supply including chassis and diagram.....only \$5.85

**SPECIAL PURCHASE—BC-624 RECEIVER**

A few of these well-known UHF receivers from the SCR-522. Complete with tubes. Good, electrical and mechanical condition .....\$14.95 ea.

★ 4-HOUR MAIL-ORDER SERVICE. WE SHIP ANYWHERE.

20% DEPOSIT MUST ACCOMPANY ALL ORDERS. BALANCE C.O.D.

**OFFENBACH & REIMUS CO.**

372 ELLIS ST. SAN FRANCISCO, CALIF.

'PHONE—ORdway 3-8551

**LOOK! LOOK! LOOK! LOOK!**

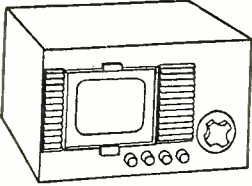

**COMPLETE TV FOR \$59.50**

(plus shipping from Chicago)

**ASSEMBLE IT YOURSELF!** Discontinued model, best 7" TV ever made. Name brand, hush hush, we can't say who. In get very best part in the Bill of Material; all tubes incl. 7JP4. **BEAUTIFUL CABINET**, schem., align. instr., etc. Tuner and HV preassembled. Best TV Deal Ever Offered!!

**FOR THE FIRST TIME!**

**AN/TRR-2 RECR.** Late production, modern, sub-units plug into standard octal tube sockets, each contain miniature tube and complete circuit. Input 28-40 mc. Coded signals close final relay to detonate mine. Includes AF filter, sensitive relay, 10-step, 3-bank stepping relay, cold-cathode thyristors, etc. Remodel for remote control purposes with input either RF in coded sequence with correct AF, or ultrasonic tone from dog whistle, or visible or invisible light beam. **BRAND NEW** ..... \$14.95

**NEW G.E. 3 1/2" PANEL METERS**

DO53	0-50 MA DC Square	\$3.95
DO41	0-150 MA DC Round	3.95
DO41	0-1.5 Amp. DC Round	4.95
DO41	0-5 V DC Round	3.95
A022	0-5 V AC Round	4.95
A022	0-10 V AC Round	4.95
A025	0-1.5 V AC Square	4.95
DO54	0-2 Amps RF Square	4.95
DO54	0-5 Amps RF Square	5.95

**AN RF & AF SIGNAL TRACER FOR 79c!**

**BZ-5**, a carbon mike that sings! Tiny dual vibrator, only 2 1/2" x 2 1/2" x 2", reads work in damped pools of carbon granules, 4 to 8 V DC in, 2 V AC out, at beautiful 1700 CPS tone. Harmonics to 40 mc for RF signal-tracing, fundamental for AF, or use as tubeless tone oscillator for code practice set or for MCW. **NEW.**

**ATTENTION MOBILE MEN!**

**BC-604** 10-channel push-button 35 W FM Xmtr. 20-27.9 mc. Good used, less xtal and dynamotor. **\$9.95**  
**BC-924** 4 chan. 35 W FM Xmtr. 27.0-38.9 MC. good used, with 12V dynamotor. Latest model! **\$24.95**  
 Less dynamotor ..... **19.95**

**BC-223 OWNERS, ATTENTION!**

**PE-55** 12V w/bases, ex. used. **\$9.95**  
 Cord with plugs. **PE-55** to **BC-223**, 10 ft. **1.50**

**ATTENTION MARINE RADIOMEN!!!**

Don't screw around with surplus! Your time is worth too much! Let us do it for you!  
 (1) **G.L. "MARINER" RECRV.** specify 12 or 24 V DC, EPO ON-OFF AVC-AVC. Long wave, Broadcast, Marine. Short wave. A beautiful conversion of a doggone good Navy surplus recvr., entirely new front panel, vernier on-the-nose resetting tuner, all controls on front panel, no plugs needed, ready to go. **\$49.50**  
 (2) **DU-1 Manual Direction Finder**, specify 12 or 24 V. Converted for marine band, still retains half of Broadcast Band and all the lighthouse and beacon band. 2-tube pre-amplifier. No 180° ambiguity, true bearing immediately. Goes ahead of G.L. "Mariner" or any other receiver. **Brand New \$31.50**  
 (3) **BC-223 TRANSMITTER**, 15 watts, brand new. With used 12 V dynamotor, 15, connecting cable, 4 marine freq. xtals mike. Specify freq. beam. **\$29.50**

**Scott Hi-Fi Output Transformer**, Essentially flat 20-20,000 cy., 25 w., hermetically sealed. Impedance 5000 ohms pri., two CT secondaries 600 & 60 ohms, thus providing 150 and 15 ohm secondaries also. **NEW** ..... **\$1.89**

**HERE'S YOUR 500 OHM LINE TRANSFORMER!** Secondary 8-10 ohms, tested at 10 watts -3 DB at 15 kc, essentially flat 40-12,500 cycles. **NEW! ONLY** ..... **\$1.49**

**3-DIGIT** resettable Veeder-Root counter with pilot lamp assembly, water switch, nice case. **NEW** ..... **79c**

**Willard 2-V wet cell battery**, new, 20 amp. hours. **98c**  
**RG-8/U-NEW**, Cut to order at **\$4.95 per 100 ft.**

**COIL KIT:** 125 all new coils! Contains IP cans, tuners, chokes, less than 1c per unit.  
 A real treasure chest for..... **\$2.19**

**WANTED!** Your Spare Surplus Equipment and Tubest Dynamotors, recrs., xmtrs, test equipment. Send list, stating condition and your rock-bottom price. Remit with order. Calif. buyers add sales tax.

**G.L. ELECTRONICS**

1260 S. Alvarado St., Los Angeles 6, Calif.

**SCHEMATICS-CONVERSIONS FOR SURPLUS GEAR**

**PARTIAL LIST:**

<b>NEW BC-433-G Conversion</b> .....	\$2.00
<b>R-5/ARN-7 Conversion</b> .....	\$2.00
<b>ARC-4 schematic, parts, cabling</b> .....	\$1.00
Another \$2.00 for 2-meter AC conversion with all specs, tune-up, color-coded wiring diagrams.	
<b>BC-375-E original schematic, tuning units, complete parts list, values, characteristics, circuit functions, plate and ant. currents.</b> .....	\$2.00
<b>BC-645 original and conversion</b> .....	\$1.00
<b>ARC-5 schematics, all units</b> .....	\$2.00
<b>SCR-522-A, AM, and C schematics, parts lists with circuit functions, explanation of differences, chart for xtal selection.</b> .....	\$2.00

Please remit with order. We pay postage. Send 25c and stamped addressed envelope for comprehensive list, cross-indexed for BC and SCR. Includes chart explaining code used in Army-Navy nomenclature.

**R. E. GOODHEART** 345 1/2 N. PALM DRIVE  
 BEVERLY HILLS, CALIF.

ings, films, short plays and a women's program including a session in a cooking class, fashion setups, etc. Interview type programs were scheduled for some of the coax tests and a variety show for the radio relay, which was to be routed from Baltimore on a 4 megacycle circuit. Even a commercial potentiality type of program was arranged with toweling, canned goods, breakfast foods, such as bananas and strawberries and cream, and cigarette packages set up for screening. Lighting was also to be studied, particularly during the women's colorcasts, with light to be reduced to approximately ten footcandles during one portion of the transmission.

The *DuMont* contingent was not too keen about the first set of demonstrations, but did feel that the new-year tests might be productive. *DuMont* indicated that *Color Television, Inc.*, of San Francisco would not be able to participate in the current tests and *RCA* and *CBS* were handicapped by equipment problems. These experts felt that the tests would not produce any conclusive information, and would in the main duplicate the unconvincing tests of '47 which proved that color was still a test-tube project. Dr. Goldsmith stressed that before any color could be practical a single tube would be required. He then referred to the experimental work being conducted on one such type of tube, a trichroscope, based on the designs of Professor Arthur B. Bronwell of the Northwestern University Technological Institute, who described the basic concepts during a National Electronics Conference at the

Edgewater Beach Hotel in Chicago, two years ago. At that time Professor Bronwell called his system a composite viewing tube with a single electron gun. Describing its design, he said: "By coating three screens with a different color phosphor which corresponds with the three primary colors, we have a composite image screen which enables the viewer to see the programs in natural color. The three screens are optically superimposed upon each other but are separated by a microscopic distance and electrically insulated from each other."

By controlling the voltage on the screens automatically, each screen may be made to fluoresce in red, blue, and green color sequence, the Professor reported.

*Philco* also objected to the tests and presented a five-point program which they believed would permit orderly development that "will protect the public." *Philco's* approach to the problem, presented by David B. Smith, vice-president in charge of research and development, stated that: "The standards must be such as to permit the public individually, and at their personal option, to be able to have either black and white or color reception with no loss of program service either way. . . . Both color and black and white must be transmitted on a single set of standards so that each type of signal can be received interchangeably on either black and white or color receiver. . . . The standards must provide a quality of service at least as good as that now provided by the present commercial standards. . . . The continuity

**LENSLESS LENS DEVELOPED FOR TELEVISION**

**A** REVOLUTIONARY new lens has recently made its television debut in this country. It is a lens without any lenses—a unique telephoto unit designed by Dr. Frank G. Back, creator of the Zoomar lens, to bring sharp, ultra-close-ups of sports and news events to the nation's home television screens. With this unit on a camera every televiewer has a "better than front row seat."

In the new "Video-Reflector," as Dr. Back calls his new 40-inch lensless lens, the optical trick is accomplished with mirrors. There is not a lens element in the entire system. Four special reflectors bounce the light beams back and forth to obtain magnification that is said to be so high that the figure of a man more than a block away from a TV camera completely fills the screen of a video receiver.

Up until now, extra long-focus telephoto lenses were out of the question as far as TV pickups were concerned. A lens with a focal length of 25 inches (which by old standards meant that it had to be at least 25 inches long) were about the longest that could be used. Longer focal-length lenses, because of their multiple lens elements, were too heavy and too long, which meant that they were not only shaky but projected into the fields of other lenses used on a camera's turret and their resolution, and thus their picture clarity and quality, was poor.

The new unit is said to overcome all

of these objections. It is only 16 inches long in spite of its 40-inch focal length. It weighs only 6 pounds, no more than many other TV lenses. It can be mounted directly on a TV camera turret with other lenses without interfering with their operation, and its light weight creates no problems of shakiness nor the need of additional lens or tripod supports.

The new long-focus lens consists of a correction plate (which in position corresponds to the front element on a conventional lens), an aspherical reflector (a mirror shaped like a segment of a large sphere), and three aluminized flat mirrors. The light enters the lens through the correction plate, is picked up by the aspherical reflector, and is then zig-zagged back and forth by the three flat reflectors to the target of the camera's image orthicon.

Lens control (f stop opening) is obtained, not through the use of a conventional iris, but by the adjustment of the position of a rotatable "damper" (similar to the simple damper used in a chimney flue) which is placed directly in front of the aspherical reflector. Depending on the damper's position, it cuts off or supplies more light to provide f stops ranging from f/8 to f/22.

Viewers watching CBS's telecast of the Columbia-Brown football game on November 19th were the first to see the new lensless lens in commercial operation.



of existing service to receivers in the hands of the public must be maintained. Any proposal of non-compatible standards must include a detailed program to accomplish this purpose. . . . In arriving at these standards there shall be no experimenting at the expense of the public and the Commission will require assurance for the public that the system has been thoroughly proven before authorization of commercial service."

**THE STRONGEST BLAST** against color TV came from *Zenith Radio's* vice-president, H. C. Bonfig, who before a meeting of Kansas City's Co-op Club declared that there was today no color system with which ". . . both the public and the industry could live."

Commenting on the mechanical systems of reproduction, Bonfig said: "Black and white television started more than twenty years ago with revolving discs, but got precisely nowhere until an all-electronic system was found. . . . I do not believe that we are going to take a step backward to the revolving mechanical discs of yesteryear. . . . This business of revolving color discs is much older than television. . . . it is a route that was followed by the motion picture industry many years ago. As early as 1920, and probably before that, there was a projection device developed for producing colored pictures on the screen by means of such color discs. This device was called, I believe, a kinemenascope, and had its origin in England. But it was abandoned, just as mechanical discs were abandoned by black and white TV."

The father of the triode, Dr. Lee deForest, now research director for *American Television, Inc.*, testifying on the stand in Washington, also criticized non-compatible mechanical systems, even including the one he had developed. And thus the debates continued, with apparently most agreeing that a compatible system is the basic need and that perhaps in the new year such a system may be generally approved and adopted, temporarily or otherwise, as a pattern for color TV of the future. In any event, the controversy rages on and on. . . . L.W.

## TWIN-TRAX\* TAPE RECORDERS

*feature*

- WIDER FREQUENCY RESPONSE
- GREATER DYNAMIC RANGE
- LONGER PLAYING TIME
- - - - - and lower price!

Professional-type specifications that mean professional quality, operating ease, and trouble-free construction that you would normally associate with recorders selling at \$1000 and more. Yet the Twin-Trax Recorder series is available to you direct from the factory at low factory prices, starting at \$285 for complete high-fidelity recorders, and \$59.50 for precision-built basic tape transport mechanisms.

If you are thinking of buying a tape recorder, or if you use recorded sound for any purpose—for personal enjoyment or in your business, there is a Twin-Trax instrument for you. There are more than 30 standard and special Twin-Trax models available, including continuous-playing instruments, two-speed models, 24-hour recorder, etc.

Learn why Twin-Trax is the only professional recorder in the popular-price field. Save many dollars by dealing direct with the factory. Write today for illustrated 16-page catalog, including complete technical data.

\*TRADE MARK REG. U.S. PAT. OFF.



For the Home  
\$285



Broadcast Studio  
\$375



Educational Institution  
\$335



Wired Music System  
\$495



Experimenter  
\$59.50

**AMPLIFIER CORP. OF AMERICA**  
398-2 Broadway New York 13, N. Y.

# PRACTICAL HOME-STUDY RADIO COURSE

## AMAZING BARGAIN OFFER — ONLY \$2.50 COMPLETE

Here is a practical home-study course that will teach you how to repair all radio sets faster and better. The 22 lessons cover all topics just like other correspondence courses selling for over \$100.00. Our amazing offer permits you to obtain the course complete for only \$2.50, nothing else to pay. Easy-to-follow, well illustrated parts on all types of test equipment, circuit tracing, T-V, use of oscilloscope, and every other topic needed to be an expert in radio repairing. Trouble-shooting hints, circuits, short cuts, suggestions, new developments. Send coupon today, and use the complete course at our risk. Satisfaction guaranteed. All 22 lessons, in large manual form, + self-test questions, \$2.50 supplementary data. complete.

The practical lessons making up this course-book are easy to follow and apply to actual radio jobs. Hundreds of radio facts that puzzled you will be quickly cleared up. You will find yourself doing radio repairs in minutes instead of hours—quickly finding the faults or making needed adjustments. Every new radio development of importance and thousands of time-saving radio facts are packed into this complete course-manual. Use the no-risk-coupon to order the Course for 10-day examination in your own home. Look over the material, read a few lessons, apply some of the ideas. Then decide to keep the lessons at the bargain price of \$2.50 (full price), or return the material and get a cash refund.



**MADE MONEY FIRST WEEK**  
"You should get more money for your Course. The first week I studied it, I made \$10.00 repairing sets. I built my own test outfit from details given in this course. I have repaired 100 radios to date."  
Signed: Robert C. Hammel, 120 W. 13th, Davenport, Iowa.



**COMPLETED IN 8 WEEKS**  
"I am very satisfied with the course. When I was at the twelfth lesson I started repairing radios. It took me two months to master your course." From a letter written by Roger Langlois, 1679 Poupart St., Montreal, Quebec, Canada.

**MODERN, UP-TO-DATE**  
"Your course is modern and up-to-date. There is not one page in the whole course which anyone can afford to miss. Your course started me on the road to a well paid job and has repaid me many times." Charles Aspach, 433 Elm St., Reading, Pa.



1949 1948 1947 1946 1942 1941 1940 1939 1926-1938  
**Supreme Most-Often-Needed Radio Diagrams**  
 Each manual has an average of 154 pages of diagrams, alignment data, voltage values, parts lists, and service hints; large size, 8 1/2 x 11". To order, see coupon →  
**RADIO DIAGRAMS**  
 240 Pages  
 Price \$2.50

*Supreme Publications*

PUBLISHERS OF RADIO BOOKS, MANUALS, AND DIAGRAMS

Available at All Better Radio Jobbers

January, 1950

### NO-RISK TRIAL ORDER COUPON

SUPREME PUBLICATIONS, 3727 W. 13th St., Chicago 23, ILL.

Ship the  Radio Servicing Course at the special price of only \$2.50 complete, and also the diagram manuals checked at right.

I am enclosing \$..... send postpaid.  
 Send C.O.D. I am enclosing \$..... deposit.

Name: .....

Address: .....

**Most-Often-Needed Radio Diagram Manuals**

New 1949 Manual \$2.50

1948

1947

1946

1942

1941

1940

1939

1926-1938 Manual \$2.50

**PRICED AT ONLY \$2 EACH**

**FREE KNIFE**



With the Purchase of \$3 or More

Mottled gray Pyremite handle, 2 blades; 1 clip, 1 pen, both full mirror fin. Length closed 3"

**\$6.95**

**If You Don't See What You Want SEND FOR OUR BIG 16 PAGE BARGAIN BULLETIN**

WITH ORDERS BY MAIL

HRU-24-28 Volt at 70 Amps. DC Power Supply Gasoline Engine Generator with Electric Starter. A thousand uses. This is in Excellent Condition

Cable—6-wire No. 16, glass insul. shielded, plastic covered, for beam control. 12c ft. - 100 ft. **\$10.00**  
 Wire, shielded No. 20 stranded 100 ft. for **\$1.50**  
 Twin Lead 300 ohm Amphenol.....per C **\$1.95**  
 Twin Lead 75-ohm Amphenol.....per hund. **\$6.95**  
 Toggle Switch, center off, - S.P.D.T. 4 for **\$1.00**  
 Toggle Switch, SPST & spring return..... 4 for **75c**  
 Toggle Switch, heavy duty 12 amp. 125V.....ea. **49c**  
 CO-AX Amphenol—Beaded No. 72-20.....per ft. **4c**  
 3-SPEED MOTOR - 1/20th H.P. 115V 60-cycle AC motor with integral gear box having three 1/4" drive shafts turning simultaneously at the following speeds:



4000 RPM Grinders, Buffers, Slow Speed tools, 25 & 5 RPM Sent **\$7.95**  
 Postpaid.....

A 1000 USES AROUND THE WORKSHOP

ANTENNA MASTS  
 35-foot high with guys. Complete. 7 Sections 5'-6" Long. 1 1/2 O.D. Steel-Alloy. Painted. Brand New. Bargain..... **\$19.95**  
 ANTENNA WIRE - 250 ft. 10 gauge 7 strands No. 18 Phosphor Bronze.. **\$1.95**  
 ANTENNA WIRE - 1000 ft. No. 14 solid Copperweld **\$6.96**. 2200 ft. coils **\$12.95**  
 CO-AX RG34—71 OHM Xmitting - New 50 foot coils — Bargain..... **\$1.95**  
 NEW B & W 500-Watt center tapped ceramic bars, banana plugs. 7 types:  
 3.5—4.5 8.0—11.0  
 4.5—5.7 11.0—14.0  
 5.7—8.0 14.0—18.0  
 Specify frequency range coil desired.  
**BARGAIN — Either Type .....\$1.50**



**DOW TRADING CO.**

70 W. Union Street, Pasadena, California  
 Phones Pasadena SY. 3-8281 - L.A. RY. 1-7944

**WILL BUY**

Any quantities of new or used Electronic Surplus Equipment: APN-9, RTA-1B, TS-67, TS-170, ARC-1, ARC-3, ART-13, BC-221, BC-348, SCR-522, etc.

State Condition and Best Price.

**NORMAN RADIO DISTRIBUTORS, INC.**  
 94-29 Merrick Road Jamaica, N. Y.  
 Telephone Republic 9-4651

**Mass. Radio School**

273 Huntington Ave., Boston 15, Mass. Offers Training Courses for Radio Technician (Pre-Television) and Licensed Radio Operator (All Types) including maintenance and operation of General Electronic Equipment. Over 20,000 Alumni and 30 years' radio-training EXPERIENCE. Courses approved for Training for Veterans.

Send for Catalog  
 Licensed by Commonwealth of Mass.  
 Department of Education

**SUP HET REC'S 2-5-10 METERS W/19 1/2 MC IF BC406 AND 406A**

C.Q. February, 1946, gives 6-page write up w/prints and parts for 2-5-10 meters

115 VAC 60 cycle 15 tube 2 RF & 4 IF stages on one chassis 25"x11"x8" in a metal case with the following tubes and main parts PWR. trans. Thor. 70R62 chokes 4 Thor. 13C30 filter cond. 4 Aerovox 8-8 oil filled, RF & IF coils and tubes shielded, 2 plate tuning cond. has following tubes 1-954 B osc. 1-954 B osc. amp. 1-954 mixer 2-954 1st RF 1-954 2nd RF 4-6SK7 one for each stage of IF 1-6S17 2nd Det. 1-6S17 V. Amp. 1-6N7 SW Osc. 1-6N7 SW amp. 1-5W4 rect. this is a super Het circuit each unit cost the Govt. \$292.95 orig. tubes 202 to 208 megs we have converted one to 2 meters & plenty hot, orig. print with ea. unit we furnish you with a print of our changes for 2 meters, all minor changes. Condensers are mica or silver mica Tubes except the accents are metal. The 115 VAC pwr. unit has four section filter capacitors and chokes in place of the usual one this can not be beat. These are a new lot just received, a large quantity in both the 406 and 406A, the only difference in the 406 and the 406A is there is a 115 VAC motor 85 RPM forward and reversible used for variable freq. control, this motor can be used for a geared beam plenty of torque 75 ounce inch units are later model with the same circuit and all like new. Send your order in early; send check or money order for the receiver but do not send the shipping charges; we will ship the units F.O.B. by freight, this is the greatest \$ value on the surplus market; sold on a money back guarantee. Each unit with orig. print; we furnish conversion instructions and print for 2 meters.

**MFG. W.E. COST GOVT. \$292. BC406 \$12.95, BC406A \$15.95.**  
**McCONNELL'S** 3834 Germantown Ave., Phila., Penna. RAS-6033 **XTALS 500KC** standards 2 pin holder CR-2B/U brand new **\$1.50**

**SAVE WITH SOVEREIGN!**

THE "ALL PURPOSE"

**TELEVISION KIT**  
 10" — 12 1/2" — 16"

**MONEY BACK GUARANTEE**

FEATURING

- Latest Type of Circuits
- AGC—Automatic Gain Control
- Picture and Sound Automatically Locked
- Sound Cannot Drift
- Non-Microphonic
- Stagger Tuned I.F. for Max. Gain and Ease of Alignment
- 12 Channel Tuner
- Electromagnetic Focus and Deflection
- Automatic Stabilized Synchro-Lock Circuit Holds Picture Steady
- Voltage Regulated Circuit for Stability

Large clarified stage-by-stage pictures and schematics to insure ease of construction. Guaranteed to work. Money-Back Guarantee—Buy it, inspect it, if you don't think it's the best buy on the market—return unused within 5 days and your money will be refunded.

All prices F.O.B. New York. 20% deposit with order. IMMEDIATE DELIVERY  
 Any model wired up, tested, ready to play \$20.00 additional.

**\$84.50**  
**84**

LESS TUBES

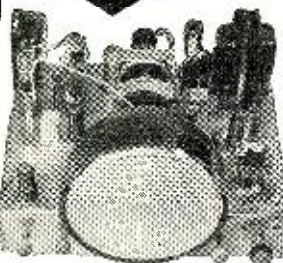

Complete with All Tubes, Incl. C.R. Tube  
 10" KIT - - - - - **\$129.50**  
 12 1/2" KIT - - - - - **\$137.50**  
 16" KIT - - - - - **\$157.50**

**SOVEREIGN TELEVISION CO. 5508 New Utrecht Ave. Bklyn 19, N. Y.**

**International Short-Wave**  
 (Continued from page 118)

that *Radio Kashmir*, Striniagar, operates on 4.860 at 2130-2330 and at 0700-1230, 0100-0230 on 7.270; radiated power 1 kw.

*Kenya Colony*—Nairobi, 4.855, has been putting in a nice signal lately in England around 1200; on Thursday 1130-1230 carries BBC's "Variety Bandbox"; BBC news relay daily 1300. (Patrick) Forces Broadcasting Service, Mombasa, is presumed to be the station heard around 1100 on 7.220; this one for some time was on 7.200 although it then announced as operating on 7.220. (Bluman, Israel, via Radio Australia)

*Korea*—HLKA, 7.933, Seoul, heard in Britain again from 1600. (Pearce) Heard from 0300 by Balbi, Calif.

*Luxembourg*—Radio Luxembourg, 6.090, noted in England 1330 with dance music. (Staples)

*Madagascar*—FIQA, 6.06, Tananarive, heard in Sweden to 1500 sign-off. (NATTUGGLAN)

*Malta*—Forces Broadcasting Service, Middle East, 4.782, is good to fair here in West Virginia from opening 2330; mostly music; announces rarely; takes some BBC relays. Patrick, England, says this station has been putting in a good signal on 6.139, also heard on 4.782 to closing 1700. Heard regularly by Pearce, England, on 4.782 from 1230 to 1700 sign-off when says will return 0430 GMT (2330 EST); BBC news relay daily 1300. Gillett, South Australia, hears the 7.270 outlet to after 1630.

*Malaya*—The British Far Eastern Broadcasting Service, Singapore, has replaced 6.77 with 6.045 at 0415-1130 to Sumatra, Java, Dutch East Indies Archipelago. Schedule of BFEBs includes also 11.88, 15.30, at 0415-1130, 9.690 at 0630-1130.

*Radio Malaya*, 9.712, Singapore, noted 0530, news. (Sanderson, Australia)

*Mauritius*—A Swedish DX-er in receiving verification from V3USE, Forest Side, learned that the station soon would move to the 19-m. band with a schedule of 0930-1130. (Radio Sweden) An airletter just in from Gillett, South Australia, says he hears Mauritius on 7.340 concluding program in French 1230 and then signing off with "God Save the King."

*Monaco*—Radio Monte Carlo, 9.785, 6.035, on Sundays 1600-1700 has musical program with both French and English announcements; widely reported on 9.785 channel. Cox, Dela., says gives QRA of Monte Carlo Calling, Radio Monte Carlo, Principality of Monaco; continues in French news to 1715 or 1720 sign-off. Bellington, N.Y., says on some days is good on both outlets at 1700.

*Mozambique*—CR7BU, 4.91, noted 1545 with request sessions of music, then news. (Sanderson, Australia)

*New Zealand*—Sanderson, Australia, reports a good, strong signal from the new outlet of *Radio New Zealand*, ZL7, 6.080, at 0530 with news, then music.

*Nicaragua*—YNDG, 7.660, Leon, "Radio Colonial," sent QSL card and letter; said from January 1, power would be increased to 1 kw. and would change frequency to 5.995. (Pearce, England) Listed on 7.660 with 400 watts.

*Pakistan*—Karachi, 11.885, is still fair to good with news 0700 and 2100; Dacca, 15.335, occasionally is readable 0700 when is parallel with Karachi.

*Paraguay*—ZPA-5, 11.945, Encarnacion, heard with music 1815; verified with interesting QSL card; QRA given ZPA5, Radio Encarnacion, Rea Paraguaya de Radiodifusion, Encarnacion, Paraguay. (Mesquita e Sousa, Portugal)

*Philippines*—DYH2, 6.14, Cebu, heard in Australia 0830 with request session of music, news. (Sanderson) Some days DZH2, 9.64, Manila, is a good signal in West Virginia around 0630-0730 with sponsored programs. Announces, "This is NBC, Manila Broadcasting Station, Voice of the Philippines."

*Poland*—*Radio Polskie*, 6.215, Warsaw, now has *English* 1415-1500. (Radio Sweden) Heard in England on 9.530 at 0205-0230 with announcements in Polish, French, *English*; broadcast repeated 0604-0630. (Pearce, England) May be testing? Has been heard in Alabama by Hagen at 0000-0315.

*Reunion*—*Radio Saint-Denis* is using 7.170 and 4.800 with 200 watts, 2200-2230, 0300-0400, 0830-0930. QRA is Service Radioelectrique, Saint-Denis de la Reunion, Ile de la Reunion. (NATTUGGLAN, Sweden) Verified reception for Gillett, South Australia, and gave schedule of only 0830-0930; 7.170 is fair in Australia, but 4.800 had not been heard as yet; program in French concludes with "La Marseillaise" 0930.

*Saint Thomas*—The 1949 Edition of "World Radio Handbook" says that this small island has started programs in Portuguese over CR5SA, 11.785, and CR5ST, 9.615, with output of 1 kw. each; no schedules given; QRA is Radio Clube de S. Tome e Principe, S. Tome (Saint Thomas) Island. (Radio Sweden) Saint Thomas is a volcanic island and Portuguese Colony of 259 sq. miles; capital is Sao Thome. The islands of San Tome and Principe (joint population 48,809 according to the 1938 census), about 125 miles off the west coast of Africa in the Gulf of Guinea, form a province under a Governor. The islands have an area of 597 sq. miles; chief products are cacao, coffee, rubber, cinchona. (Has anyone heard either of these outlets?—KRB.)

*South Africa*—Winter schedules of SABC received via airmail list Johannesburg, 3.450, not operating; 4.895, 2345-0130 (weekdays), 0055-0130 (Sunday), 1200-1605 (weekdays and Sunday), 1200-1645 (Sat.); 6.007, not operating; 9.523, 0315-0710 (weekdays),

## PROGRESSIVE TELEVISION DEALERS:

# CASH-IN

on this

## Exclusive FRANCHISE DEAL

REEVES  
VIDEON

# GIANT SCREEN ... television

## ... Motion Picture Quality by Motion Picture Engineers

Here is a rare opportunity to be the only dealer in your area with a PROTECTED MARK UP

CHECK THESE PLUS FEATURES

- REAR OR FRONT PROJECTION picture up to 8 ft. x 8 ft.
- PICTURE STABILITY permits channel switching without readjustment
- CABINET MODELS in addition to custom equipment
- AUDIO QUALITY unequalled high fidelity sound.
- BRILLIANT PICTURE pin point definition
- FLEXIBLE PLUG IN UNITS for easy servicing

Write or Wire

TODAY FOR COMPLETE DETAILS

on

REEVES  
VIDEON

REEVES Soundcraft CORP.  
10 EAST 52nd STREET • NEW YORK 22, N. Y.



### EIMAC 304TH

BRAND NEW, JAN INSPECTED

\$2

WANT TO BUY QUANTITIES  
ELECTRONIC SUPPLIES

GOULD GREEN, 252 Greenwich St., N. Y. C. 7

## HOW

Learn how to simplify radio repairs FREE! Send penny postcard for big 32-page illustrated FREE MANUAL. No Obligation.

FEILER ENGINEERING CO., Dept. 1RN5  
1601 S. Federal St. Chicago 16, Illinois



## RADIO ENGINEERING TELEVISION ELECTRONICS

Thorough training in all phases of radio and electronics, open to high school and junior college graduates. Old established school specializing in radio training exclusively. Modern laboratories and courses. Enrollments limited. Approved veteran training.

VALPARAISO TECHNICAL INSTITUTE  
Dept. BD Valparaiso, Ind.

# PROGRESSIVE ELECTRONICS CO. for the greatest selection of kits in the world . . .

## VACUUM TUBE VOLTMETER KIT

- 6SN7 bridge-type voltmeter circuit for utmost sensitivity with minimum current drain.
- 600 balance linear AC rectifier, can actually measure antenna voltage with this meter.
- 0-1000 scale, meter movement, the finest available.
- Output Meter, you can measure AC-DC millivolts directly, 5 separate scales covering 0-3, -30, -100, -300, -1000 volts.
- 5 separate ranges: 0-1000, -100,000, -10 meg, -100 meg, -1000 meg.
- Ohm range can now be spotted in a condenser work.
- DC Input impedance . . . 11 megohms . . . perfectly linear for tops in accuracy.
- AC Input impedance . . . 6.5 megohms . . . perfectly matched specifically for use in AM, FM, and Television work.

**VTVM KIT COMPLETE WITH SET OF PROBES . . . COMPLETE WITH KIT ON VOLTS, IN CHOH, AND 30 KV HIGH VOLTAGE PROBE . . . \$29.95**

**Free Gift: Book on Advanced Servicing Techniques**

## OSCILLOSCOPE KIT

- All controls on front panel.
- Horizontal sweep circuit range . . . 15 to 20,000 cycles.
- Frequency response flat from 50 cycles to 50 KC on both horizontal and vertical amplifiers.
- Input impedance, 1 megohm and 50 micro-microfarads; excellent for FM and TV work.
- Identifying Thyra-tube type tube # 884.
- Uses 2-6X57, 2-5Y3, 1-884, 1-6B7 tubes.
- Deflection sensitivity: 30 volts per inch full gain.
- Provision for external synchronization.
- Test voltage lock.
- Intensity modulation.
- Large screen: 5" tube.
- Detailed instructions for assembly and wiring.
- Pictorial diagrams included.
- The finest Oscilloscope Kit obtainable anywhere.

**OSCILLOSCOPE KIT . . . \$39.95**

**Free Book on Cathode-Ray Tube Oscilloscopes**

## Signal Tracer & Universal Test Speaker Kit

Engineered for audible tracing of I.F., R.F., E.M., video and audio circuits. Provisions included for VTVM visual signal tracing, enabling actual step-by-step tracing of any signal. Signal tracer may also be employed as a small public address or intercom system. Handsome etched panel, sturdy steel case. 110-125 volts, 60-60 cycles A.C. Complete with 6S7, 6X5, 6X6 and crystal probe. . . . .

**COMPLETE . . . \$18.95**

**Free Book on Radio Test Instruments**

**Write for information concerning other kits. Deduct 2% if full payment accompanies order. C.O.D. orders accepted in U.S.A.**

**PROGRESSIVE ELECTRONICS CO., Dept. RN-29**  
 497 Union Ave. Brooklyn 11, N. Y.  
 Phone: EVERgreen 8-0054

0900-1150 (weekdays), 0315-1150 (Sat. and Sun.); 11.710, not operating; 4.800, 2345-0130 (weekdays), 0055-0130 (Sunday), 1140-1605 (weekdays and Sunday), 1140-1645 (Sat.); 9.870, 0315-0710 (weekdays and Sunday), 1140-1645 (Sat.); 3.290, not operating; 6.095, not operating; 4.373, all sessions. Cape Town, 5.88, 1200-1605 (daily), 2345-0130 (weekdays), 0055-0130 (Sun.); 9.61, 0315-0710 (weekdays), 0900-1145 (weekdays), 0315-1145 (Sun.). Pietermaritzburg, 4.878, all sessions.

**Southern Rhodesia**—Bluman, Israel, lists ZEA, 6.000, Salisbury, 350 watts, at 0300-0330.

**Spain**—Madrid, 9.369V, now has *English news* 1515, 1800. (Fargo, Ga.)

**Spanish Morocco**—Radio Tetuan, 6.067, 1.5 kw., operates weekdays 0230-0330, 0830-1000, 1300-1800; Sundays 0830-1000, 1430-1800. (Radio Sweden)

**Syria**—Bluman, Israel, lists Damascus on 6.000, 500 watts, at 0000-0100, 0530-0800, 1000-1600; 11.750 (moved from 12.000) is in parallel; the 41-m. outlet has been off the air but was to return soon; previously operated in 41-m. band on 7.250.

**Tahiti**—Papeete, 12.080, scheduled daily 2315-2400, is now using some *English*, in addition to French; seems to be trying to attract tourists to Tahiti. (Bellington, N.Y.) When using *English* gave QRA of P.O. Box 478, Papeete, Tahiti. Music comes through better than voice. (Dallemer, N.Y., others)

**Tangier**—Radio International, 6.110, opens weekdays 1200 with commercial for *Coca-Cola* (in Arabic). (Bluman, Israel, via Radio Australia)

**Thailand**—Bangkok recently was heard back on approximately 9.796 at 0615 with news; normally this is carried on 11.65, 6.01. (Sanderson, Australia) Bangkok verified reception of the 11.65 channel, listed power of 500 watts, schedule 0500-0630. (Fellers, Japan)

**Trinidad**—Radio Trinidad, 9.625, Port-of-Spain, sends *new* schedule of weekdays 0500-0800, 0930-1300, 1500-

2200, Sunday 0500-1300, 1500-2200. (McPheeters, N.Y., others)

**Turkey**—The Mailbag Program on Sundays from *Radio Ankara* is now radiated over TAP, 9.465, 1630-1700. TAP still has news daily 1445. (Fargo, Ga.)

**Uruguay**—CXA-19, 11.835, Montevideo, noted recently 1700 identifying in *English*; then had news in Spanish. (Alcock, Ky.) Verified with a nice, light-yellow card with a cowboy riding a horse; gave schedule on 11.835 as 0600-2200, using 5 kw. (Oskey, N.J.)

**USA**—It is possible that the "Voice of America" may soon have a special program for SWL's on the air; if this materializes, I will have details as soon as available.

**USSR**—Winter schedules as copied from transmissions of *Radio Moscow* include these *English* broadcasts—For North America on 15.23, 11.88, 9.72, 9.67, 7.29 for the three daily transmissions—1820-1930, 2000-2100, and 2200-2255; for the first transmission also uses 7.36; for the second adds 7.36, 9.60, and for the last adds 15.41, 11.78. For Britain, 1230-1300, 11.63, 7.32, 6.09, 6.00; 1430-1530, 9.67, 7.34, 6.09, 6.00; 1630-1700, 9.67, 7.34, 6.09; on Monday, Thursday, Saturday only, 1700-1730, concert, 7.34, 6.09, 6.00; 1730-1900, 7.34, 6.09, 6.00; Sunday only, young people's program, 1100-1130, 11.63, 6.09, 6.00. (Feldman, N.Y.)

**Vatican**—HVJ, 11.74, 9.645, heard in Australia with *English* 1315, good signal. (Gillett)

**Venezuela**—Caracas, 4.88, now has *English* news daily 1845-1900. (Boice, Conn.)

\* \* \*

### Last Minute Tips

**Radio Makassar**, Indonesia, soon should be using *Brahms' Lullaby* sung by Bing Crosby as its closing tune; on request, Jerry Pierce, Okla., has forwarded that recording to the station.

Boice, Conn., has just received an attractive QSL card from Radio Clube de Mozambique, Lourenco Marques, Mozambique, verifying his report of

Transmitters of the "Voice of America" relay station at Manila, Philippines.



some months ago; stated the 15.24 channel is not carrying any regular schedule and that the broadcasts Boice heard on that channel were special programs beamed to Portugal; 10 kw. used.

At the time this was compiled, Kol-Israel, Tel Aviv, seemed to be radiating irregularly; some days at 1430 on 9.000 was at good level; other days was inaudible. *Over-seas Service should be in operation soon.*

*Radio Vorarlberg-Innsbruck*, 6.005, Austria, is heard in Britain 0030 with early morning music; news in German 0100; on Wednesdays 1700 carries "Bringing Christ to the Nations" (*English*). (Pearce) Bluman, Israel, lists schedule of 2300-0130, 0400-0800, 0900-1700 (*this may be for summer*).

An unidentified station heard 2135 on 6.226 with programs of Indian songs and music is believed to be Kashmir. (Radio Sweden) Trarkhel, Kashmir, "Azad Kashmir Radio," is listed 6.230V, inactive.

Simpson, Australia, believes a station heard on 7.200 to closing 1530 may be OQ2AC, Elizabethville, Belgian Congo; can be heard only from 1515 since GWZ, London, uses this channel earlier to relay "Voice of America" broadcasts. (*New Zealand DX Times*)

*Radio Belgrade*, Yugoslavia, is using 9.505 at 2345-1000, and 6.100 at 1100-1730. (Bluman, Israel) Sometimes is readable on 9.505 at 0115 when has *English* news.

Bluman, Israel, airmails me that the Forces Broadcasting Service, Middle East, Malta, is at present using a 7.5 kw. transmitter; schedule on 7.270 is weekdays 0430-1115, Sunday 0230-1115; 4.782 weekdays 2330-0130, Sunday 2330-0215, and daily 1130-1700. During summer it is likely that 4.782 will be replaced by 6.140 or 7.270, and that 7.270 will be replaced by 11.785 during "daylight."

A station heard mornings on approximately 11.914.5 from before 0700 to around 0759 sign-off, with oriental-type programs at times, has been identified as a Soviet outlet; do not confuse with Chungking, 11.913, which does not sign on now until 0800.

(Continued on page 142)

# WANTED

**GOOD LOOKING OLD CONSOLES THAT NEED A NEW "HEART"**

install an

**ESPEY AM/FM CHASSIS**

and your favorite console is "right-up-to-date"

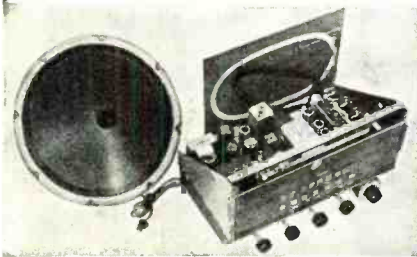

Rated an excellent instrument by America's foremost electronic engineers. Fully licensed under RCA patents. The photo shows the Espey Model 511, supplied ready to play. Equipped with tubes, antenna, speaker and all necessary hardware for mounting.

**ATTENTION SERVICEMEN**—Did you know there are over 19 million consoles waiting to have a modern AM/FM chassis installed? Here is a gigantic sales market just waiting for you to develop. Send for Espey Bulletin "19 million customers". It will tell you how to make real money!

Makers of fine radios since 1928.

Write for literature R.N. for complete specifications on Model 511 and others.

**ESPEY** TEL. TRafalgar 9-7000  
**MANUFACTURING COMPANY, INC.**  
528 EAST 72nd STREET, NEW YORK 21, N. Y.

January, 1950

only **WALSCO**

gives so much for so little...

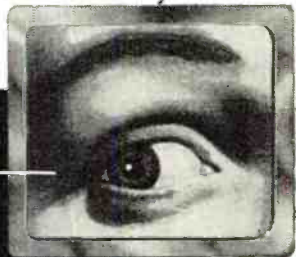

crystal-clear TV reception.

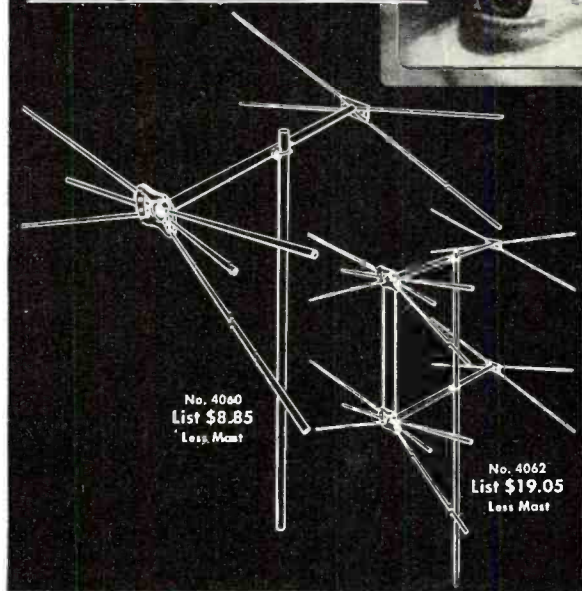

amazing antenna out-sells all others!

- only **WALSCO** features a silicone-treated styron molded insulator to assure crystal-clear TV reception.
- only **WALSCO** uses marine type high tensile dural for elements . . . with a "yield point" 94% higher than ordinary aluminum.
- only **WALSCO** uses a butt-seamed tubing for elements to assure the highest elasticity.

WRITE FOR FREE ILLUSTRATED CATALOG 49-T

WALSCO New TV Alignment Tools are used everywhere. Available at your local jobber.

**WALTER L. SCHOTT CO.**

Beverly Hills, California  
Chicago 5, Illinois

# TELEVISION SCOPE

## SUPERIORITY AT A GLANCE!

The vertical response of this economy TV scope is usable to 5000 kc, not 50 kc. Response is flat to 750 kc, down 3 db at 1000 kc. Amplifier supplies a voltage gain of 20 at 5000 kc.



AR-3

Check this necessary feature before you buy any scope for TV use.

The R.S.E., AR-3 Scope has been built by Ross Armstrong to our rigid specifications. It's a complete unit that embodies standard horizontal amplifier and sweep circuits with normal sensitivity.

The case is 8" high x 5" wide x 14" long, attractively finished in "hammered" opalescent blue enamel. Operates on standard 110 volts—60 cycles—40 watts. Tubes, 3BP1-6AC7-6SJ7-6X5-5Y3-884. Instructions included. Complete specifications upon request. Satisfaction or your money back.

PRICE  
**\$4995**

AVAILABLE TO JOBBERS  
IN QUANTITY

F. O. B.  
DETROIT

## INTERCOM & RADIO

AT A PRICE THAT CAN'T BE BEAT

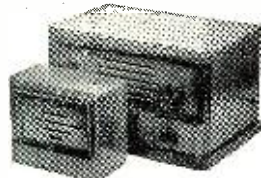

6 tube superhet—3 tube intercom permits communication between radio-master and up to 4 sub-stations.

Original cost \$64.50

WHILE THEY LAST

**\$2995**

With 1 sub-station and 50 feet of cable  
Extra Sub-stations  
**\$3.95 each**

## PUSHBACK WIRE



25% BELOW MILL COST!

1st class, Essex or Lenz, ALL SOLID tinned copper, double cotton serve, waxed finish.

SIZE	COLORS	100 feet	1000 feet	Production Reel
22	BLACK-BROWN	.39	3.79	3.65M
20	RED-WHITE-BLUE	.49	4.49	3.95M
18	BROWN	.69	5.98	

## ORDER INSTRUCTIONS

Minimum order—\$2.00. 25% deposit with order required for all C.O.D. shipments. Be sure to include sufficient postage—excess will be refunded. Orders received without postage will be shipped express collect. All prices F.O.B. Detroit.



**RADIO SUPPLY & ENGINEERING CO., Inc.**  
89 SELDEN AVE. DETROIT 1, MICH.

Quantity and Export Orders Solicited

Bangkok, Thailand, seems to have replaced 11.65 with 9.796 for its 0700-1035 native transmission; 7.105, 6.010 remain parallel. (Dilg, Calif.)

Late flashes from Nordh, Sweden, and Worris, N.Y., confirm definitely that Budapest, Hungary, has increased power to 2 kw. on 6.247 and 9.820 (claimed by station but at times seems high as 9.830); has 15-minute news bulletins at 1200 in Russian, 1300 in French, 1320 in German (for Austria), 1530 in German, and 1830 in *English*; wants reports to Radio Budapest, Budapest, Hungary. Bellington, N.Y., flashes that definitely signs off 1800 with closing announcement in Hungarian, French, German, and *English*.

YDF, Garoet, Java, D.E.I., is back on 2.810; wants reports as was soon to inaugurate a new 500-watt transmitter; wants to use a frequency around 19- to 25-meters, providing it can get permission from authorities. (Radio Sweden)

NATTUGGLAN, Sweden, lists YDK, 4.855, 0.25 kw., *Radio Palembang*, 0530-1000; QRA given as Radio Indonesia, Studio Palembang, Talang Djawa 7, Palembang, Sumatra, Indonesia.

Saigon is anxious to know if it is being heard in the United States at the present time; write to Miss Florence Paverelly, 86, Rue Mac-Mahon, Saigon, Fr. Indo-China. (Butcher, La.) Best chance of hearing this one is on 11.78 at 1800 and/or 0500.

An airmail report from Fellers, Tokyo, says the New China Radio Network (key station is Peiping, 10.260) operates now around 0400-1100 with *English* news 0830-0850 (runs longer irregularly—KRB); frequencies include 10.26, 9.73, 9.01 (moved from 9.04), 7.50, 7.10, and 640 kc. He says that Hankow on approximately 11.47 operates with call BEL-7, a good signal in Tokyo, easily recognized by loud carrier hum; heard irregularly around 0700-1000. *He still has no information as to whereabouts of any Shanghai s.w. outlet. Does anyone have this data?*

At press time a flash was received from Worris, N.Y., that Leopoldville, Belgian Congo, using 9.767, appears to be changing schedules; may use other frequencies now, also. May relay UN programs at times.

A last-minute flash from Dorothy Sanderson, Australia, says that BCAF, Chinese Air Force Station at Taiwan, Formosa, has moved from its noisy 11.68 spot to approximately 8.990; watch for it there mornings. Also that she is hearing a station on approximately 11.740 with news 0700 that she believes is Lahore, Pakistan; seems to be in parallel with Karachi, 11.885, and Dacca, 15.335.

HZM, 4.790, Dhahran, Arabia, usually heard 2330 calling Cairo. (Bluman, Israel, via Radio Australia)

I have just heard the Forces Broadcasting Service, Middle East, 4.782, Malta, at 1600-1700 in addition to from 2330.

According to *Radio Sweden*, Fort-de-

## EE-8 FIELD TELEPHONE Army Signal Corps

Complete with New Handset, Excellent Used Condition, Factory Tested and completely reconditioned in our own shop.

Price per pair \$12.95

In lots of 100—Price \$5.65 each

25% with order, Balance C.O.D.

## MASPETH TELEPHONE & RADIO CORPORATION

142 Ashland Place  
Brooklyn 1, N. Y.  
Tel.: MAin 4-2982

LOW PRICED **2WAY INTER-COM!**

Sound Powered Two-Way Interphone Here is a complete, ready-to-use, guaranteed electro-magnetically operated inter-communication system. Set includes two stations, wire and simple instructions. **NOTHING ELSE TO BUY!** SAVE TIME AND STEPS. Perfect for use in stores, shops, garages, anywhere between rooms and houses. Additional station for 3-way conversation, add \$1.35. Don't delay! Order now for fast delivery.

C.O.D.'s, send \$1.00, pay postman balance plus charges.  
The ROBIN HOOD CO.  
7 Alling St., Dept. RN-2, Newark 5, N. J.

**\$295** Post Paid

**BARGAIN HUNTING? RADIO SERVICEMEN!**

Write for SENSATIONAL CATALOG  
**HENSHAW RADIO SUPPLY**  
3619 TROOST KANSAS CITY, MO.

GET THE LATEST IN  
**RADIO & TELEVISION**  
New 7-Volume Set  
**FREE for 7 days trial**

**RADIO-TELEVISION**  
with Television Servicing

MAKE MORE MONEY Servicing the Tough Radio-Television Jobs

This new, 7 volume set gives you solid working knowledge of Radio and Television. Very latest on Television Servicing, UHF and Color TV. Everything from fundamentals to newest in FM, TV, Electronics, etc. Clear, practical. Tells you how to construct, install, service. Short-cut trouble shooting methods. Handy "on the job" Radioman's Handbook included. More than 2500 pages, 1200 illustrations, charts, diagrams.

**FREE TRIAL OFFER:** Examine these great, pay raising books for 7 days at our expense. Just mail coupon below.

**FREE RADIO-TELEVISION DIAGRAM BOOK**

Act at once and get with APPLIED RADIO-TELEVISION, new book of "150 Radio-Television Diagrams Explained" FREE. Keep it even if you send the set back at our expense within 7 days. If you keep the set, send either \$22 cash, or \$3 in 7 days and \$3 a month until \$23.50 is paid. Either way, Diagrams book is yours! Send coupon TODAY! It's not an order—just a request to see Set and get Diagrams book FREE. Act now!

**GOOD FOR FREE TRIAL and FREE BOOK!**

Educational Book Publishing Division  
COYNE ELECTRICAL & RADIO SCHOOL  
500 S. Paulina St., Dept. 10-T, Chicago 12, Ill.  
Rush 7-Volume "Applied Practical Radio-Television," postpaid, for 7 days FREE Trial per your offer. Include FREE Book of 150 Radio-Television Diagrams.

Name..... Age.....  
Address.....  
Town..... Zone..... State.....

France, Martinique, has been heard testing on 8.185 and 12.905 at 1730-1800; stated 10.230 would be used another day for test; signal was powerful in England. May be "rumored" new 50 kw. transmitter?

SRI, Buenos Aires, Argentina, is sending out an attractive, well-illustrated program-booklet of 60 pages covering the next two months' schedules; has short articles in several languages. Can be had from Servicio Radiofonico Internacional, Calle Belgrano 1841, Buenos Aires, Argentina.

The Alaskan Command Service noted with WVD on new channel of 17.500 at 2130-2200, testing. (Arthur, W. Va.)

The Worldwide Broadcasting Corp. transmits to Europe on WRUW, 11.71, 1515-1600; WRUL, 15.35, 1500-1600, and WRUX, 17.775, 1500-1600; says 11.71 expected to give good reception in Africa and wants reports from that area. (Worris, N. Y.)

On the day this was written, I picked up *Radio Pakistan* on the new channel of approximately 11.768 at 0700 with *English* news; was in parallel with Dacca, 15.335, which was quite readable; Karachi, 11.885, could not be found although BFEBS, 11.88, Singapore, was in the clear at the time; perhaps Karachi has moved from 11.885 to 11.768, or perhaps the latter is the long-heralded Lahore s.w. outlet? It has been heard 0800 in Texas by Stark, in native; and by Dilg, Calif., at 1015 with *English* news.

Patrick, England, flashes he has received word from Holland that the *Philips* factory at Hilversum is constructing a 100 kw. transmitter for the *Vatican Radio*, expected to be in operation some time this year.

*Radio Luxembourg*, 6.090, is now unreadable most of the time in Britain due to a powerful Moscow transmitter on this channel. (Patrick)

Patrick, England, says he has lately been hearing a station in England that belongs to the Royal Observatory; call is GMT; carrier frequency is 2.000; located at Leith Hill, N. Dorking; power 250 watts; aerial is inverted L, 70 ft. high, fed by 120 yds. of coaxial feeder; schedule weekdays *only* at 0455-0500 station announcement; 0500-0515 unmodulated on 2 mc.; 0515-0525 modulation at 1000 cycles, and 0525-0530 voice announcement and closedown.

Japanese outlets on 4.910 and 4.930 are good level in California, mornings. (Dilg)

Montevideo, 11.835, Uruguay, heard weekdays at 1900 with religious program. (Bellington, N. Y.)

Sutton, Ohio, reports Lourenco Marques, Mozambique, heard on 9.763 in parallel with approximately 9.720 in native 0130-0200.

Stark, Texas, reports YSW, 5.987, Santa Ana, El Salvador, signs off 2200. He has been hearing TGWB, Guatemala City, Guatemala, on approximately 6.068, evenings. He also had just heard TGWA back on the air but on new channel of 9.790 evenings instead of former 9.760. TGWA also re-

January, 1950

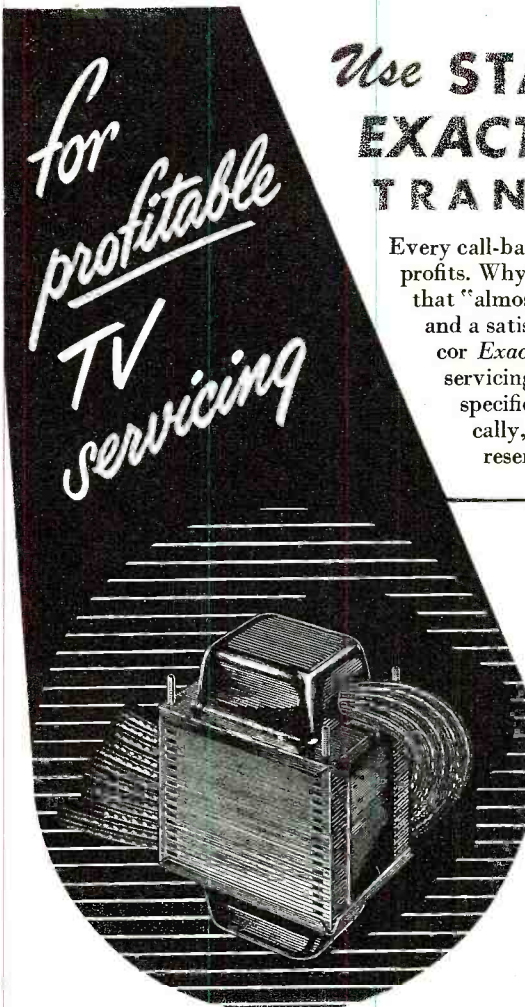

## Use STANCOR EXACT DUPLICATE TRANSFORMERS

Every call-back you make means lost time and profits. Why take a chance with transformers that "almost fit?" You're sure of a good job and a satisfied customer when you use Stancor *Exact Duplicate* transformers for TV servicing. These units meet the exact specifications, electrically and physically, of the original components. Representative types are listed below.

**Vertical Blocking - Oscillator Transformer.** Stancor Part Number A-8121. Exact duplicate of RCA type 208T2. For generation of 60 cps required to drive grids of vertical discharge tubes.

**Plate and Filament Transformer.** Stancor Part Number P-8156. Exact duplicate of RCA type 201T6 used in model 630TS receiver.

**Deflection Yoke.** Stancor Part Number DY-1. Exact duplicate of RCA type 201D1. For use with direct viewing kinescopes such as 7DP4 and 10BP4.

**Focus Coil.** Stancor Part Number FC-10. Exact duplicate of RCA type 202D1. For use with magnetically focused kinescopes such as RCA type 10BP4.

**Horizontal Deflection Output and HV Transformer.** Stancor Part Number A-8117. Exact duplicate of RCA type 211T1. For use with direct viewing kinescopes, such as types 7DP4 and 10BP4.

For complete specifications and prices of these and other Stancor TV replacement components, see your Stancor distributor or write for Television Catalog 337.

**JUST PUBLISHED**—Ask your Stancor distributor or write for your free copy of the New **STANCOR TV COMPONENTS REPLACEMENT GUIDE**, Bulletin 338C. Lists Stancor replacement components for two-hundred and fifteen models and chassis made by forty-three leading receiver manufacturers.



## STANDARD TRANSFORMER CORPORATION

3584 ELSTON AVENUE • CHICAGO 18, ILLINOIS

### AUDIO OSCILLATOR SPEECH & AUDIO AMPLIFIER BC423 WE.

115VAC 60 Cycle W.E. Mod. that with very few changes can be converted to an Audio Oscillator or Audio Amplifier, with the following component parts: Thor. Pwr. transformer 70R61 Thor. Choke 43C92 Amertran Audio trans. Silcor 3871 Pri. 20000 16000 5000 4000 Sec. 1.25 3.25 7.5 15 500 ohms, gain 30 DB flat 17000 Cycles, W.E. Retard coil 167D for the Audio Osc. Circuit, tubes 6B7 1st Audio 6B7 2nd Audio 6B6 output 5W4 rectifier, has a complete RF osc. circuit with 955 tube, this unit mounted separately on 1/4" insulated base this unit is removed in one piece by 4 screws consists of 15 MMP Var. Cond. Hi Freq. Coil 955 tube insulated coupl. long shaft and National Vernier Velvet dial, this unit you will find is worth the price for use with the 2 meter rig. Unit in orig. form puts out a Var. Audio Square wave 4000 and 4100 cycles by putting a condenser across the Audio tank circuit the Freq. drops to any freq's, depending on capacities added, for the Audio Amplifier conversion we supply you with print and procedure, you will note upon seeing the original print it is a minor change to use this unit for either of the above 2 purposes 1/2 hour's work and after one look if you are not satisfied I will refund the purchase price, we also supply a print of the taps on the Audio trans. for the above mentioned impedances, unit on chassis in steel case 15"x9"x8" orig. price with each unit weight for shipping approx. 35 lbs. This unit will drive a 12" outdoor spk. or any PM spk. with plenty of gain and the Freq. response of the output trans. will amaze you, if you are a Ham they are ideal for a speech Amplifier, if you are interested in an Audio Osc. this is Quality, and for audio work they are perfect. Send check or money order for unit but do not send the shipping charges we will ship P.O.B. Units sold on a money back Guarantee

**NEW \$10.95 PERFECT \$9.95**

**McCONNELL'S** 3834 Germantown Ave., Phila., Penna. RA5-6033

### AUDIO ENGINEERING SCHOOL

Practical engineering training in Audio fundamentals, Disc, Film, Magnetic Recording, and Audio frequency measurements. Studio training simulates Broadcast, Motion Picture, Television, and Commercial Recording work.

Approved for Veterans

### HOLLYWOOD SOUND INSTITUTE, Inc.

1040-N North Kenmore, Hollywood 27, Calif.

Correspondence Courses Available

Specify if Veteran or Non-Veteran

### BILL SUTTON'S WHOLESALE ELECTRONICS

COMMERCE at FIFTH ST.

Fort Worth 2, Texas

HAS THE SENSATIONAL NEW

425-K

EGCO 5" Scope Kit

IN STOCK!



\$39.95

**WHERE TO BUY IT . . .**  
**WHOLESALE RADIO**  
of Baltimore

**UNBEATABLE TV RECEPTION**  
**BEST FOR THE FRINGE AREAS**

**Snyder Lazy XX**  
**TV ANTENNA**

Complete with three  
3 1/2 ft. masts &  
adj. mounting base

Extremely hi-gain. Easily  
stacked double conical lazy  
XX type. Just unfold,  
tighten and erect. All TV  
channels and FM. Overall height 11  
ft. erected. Complete with 3 mating  
mast sections, guy wire anchors, stand-  
off pole insulators and adjustable  
mounting base. Complete & assem-  
bled. Can be used with any type of  
lead-in 72 to 300 ohms imp. Order  
model TX-2A.

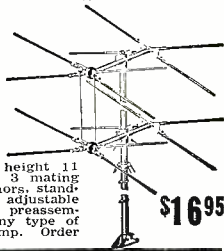

\$1695

**NEW SIMPSON MODEL 303**  
**VACUUM TUBE**  
**VOLT-OHMMETER**  
**For TV Servicing**

Ranges: DCV-1.2-12-60-300-  
1200 (30,000 with hi-voltage  
probe) ACV ranges wider than  
any other similar instrument:  
1.2-12-60-300-1200. OHMS:  
1000-100,000-1 megohm 10  
megohms-1000 megohms. Size  
5 1/2" x 7" x 3 1/8". Weight 4  
lbs.  
Model 303 inc. DCV probe, ACV  
Ohms probe and ground lead.  
Also available with roll top case-303RT . . . \$64.75  
Accessory Hi-Frequency probe . . . 7.50  
Accessory Hi-Voltage Probe . . . 14.85



\$58.75

**Assures Best Picture in Fringe Area**  
**Anchor All Channel T.V. Booster**  
**Increases Signal**  
**2 1/2 Times**

Covers a 1-1 T.V. Channels.  
Simultaneous iron core tun-  
ing of grid and plate cir-  
cuits. Uniform response on  
all channels. Impedance  
matching to input.



\$22.50

RMS BOOSTER-SP4 . . . \$22.50  
JERROLD BOOSTER TV-FM with match-a-  
tran . . . \$22.50

**BELL 2122 HI-FIDELITY**  
**RADIO PHONO**  
**AMPLIFIER**

Frequency response: 3/4  
db. 30 to 15,000 cycles  
with controls set for  
flat response. Four in-  
put-radio, crystal and  
two magnetic pick-ups.  
Built-in pre-amplifier for each  
magnetic input. Bass and treble boost  
with attenuation. Output 10 watts. Pow-  
er: 117 1/2, 60 cycles. 7 1/2" deep; 6"  
high; 11 1/2" long.

**HI-FIDELITY SOUND ACCESSORIES**  
GE 1201 Deluxe 12" PM. Speaker . . . \$17.70  
MEISSNER FW TUNER Model 8C . . . \$8.33  
**NEW GE TRIPLE PLAY CARTRIDGE**  
Plays all 3 speeds: 33 1/3-45-78 rpm Dual  
stylus. Model RPX-050 . . . \$ 8.37

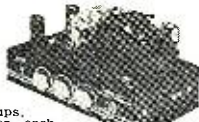

\$4170

**G.E. TV PICTURE TUBES**

7JP4 . . . . . \$16.88	12JP4 . . . . . 36.25
8AP4 . . . . . 16.50	12KP4 . . . . . 36.45
10BP4 . . . . . 26.00	12LP4 . . . . . 32.50
10FP4 . . . . . 29.56	16AP4 . . . . . 55.80

**Sensational High Quality Value!**  
**GE 33 1/3 RECORD PLAYER**  
**Complete with New**  
**GE Variable Reluc-**  
**tance Cartridge**

Reg. Price . . . \$19.95  
**While They Last \$6.95**

Think of it as a com-  
plete GE long-playing  
player for little more than the cost of the reluctance  
cartridge alone. We bought a close-out lot cheap  
but very cheap. And Mister, look at the  
saving we're passing along to you. Has molded  
one-piece streamlined plastic cabinet. Plays 33 1/3  
microgroove records with the most beautiful record  
reproduction you ever heard. Plays thru any radio  
or amplifier with addition of any preamplifier.  
14 5/16" wide, 4 3/4" high, 10 5/8" deep. Get yours  
now while they last.

**GE PHONO PRE-AMPLIFIER UPX-003 . . . \$9.57**



WRITE FOR FREE "FYI" BULLETIN  
Address Orders to Dept. QR-101 or Call  
Mulberry 2134

**WHOLESALE**  
**RADIO PARTS CO., Inc.**  
311 W. Baltimore St.  
**BALTIMORE 1, MD.**

ported heard on 9.790 by Bellington, N. Y., and Ferguson, N. C.; has been heard early as 1800, late as 2330. These Guatemala outlets now announce as "Estacion Commercial de la Voz de Guatemala." Ferguson says he heard *English* announcement around 2330 when said would operate TGWA in 31-m. band evenings, and in 19-m. band mornings; old 19-m. channel was 15.170. *Asks for reports.*

DZH4, 6.000, Manila, noted at 0500 relaying DZMB. Lisbon heard opening 1900 on 6.374. (Stark, Texas)

Bangkok, approximately 9.796, heard the day this was compiled at 0615 with *English* news; left air 0630; bad CWQRM and weak; man read news and definitely announced as "The Overseas Broadcasting Station of Thailand" (no longer says "Siam"). And Saigon, 11.78, was heard from tuning 1810 (signs on 1800 with "La Marseillaise"); French news 1815; at 1845 woman said (in *English*), "This is Radio Saigon," and continued with news in *English*. Good signal but cut to pieces by CWQRM. BFEBS, 11.88, Singapore, Malaya, was in clear 0700, good level, relaying BBC news from London. Chungking, 11.913, opened 0800.

Ulan Bator, 8.397, Outer Mongolia, best in Michigan around 0645-0715; quite good except for sporadic CWQRM. Could not find the parallel outlet on 5.265. (DeMyer, Mich.)

Bellington, N. Y., flashes he had just heard Kol-Yisrael, Tel Aviv, on a new channel of 8.80 to 1630 sign-off, strong signal. May have been test.

Budapest, Hungary, frequencies have been measured by Oskay, N. J., as 6.248 and 9.834.6. (Sutton, Ohio)

**Acknowledgement**

Thanks for all reports received. Keep them coming through the New Year to Ken Boord, 948 Stewartstown Road, Morgantown, West Virginia, USA. Good listening, fellows! . K.R.B.

**TRADE SCHOOL GETS**  
**LICENSE**

**WHAT** is said to be the first FM station license granted to a privately endowed trade school in the Philadelphia area was recently issued to the Philadelphia Wireless Technical Institute of 1533 Pine Street, Philadelphia.

The license, which is termed a non-commercial educational permit, will allow the school to construct a transmitter capable of covering a 5 mile radius. The institute will program live talent from other schools in the Philadelphia area as well as recorded educational programs.

The station will be operated and managed by students of the radio classes headed by W. W. Zerfing, radio instructor, who is licensed by the FCC to handle the operation of the station. The control room and air-conditioned studio, located in the school building, will have remote control connections to the radar lab, basic radio lab, television lab, refrigeration shops, combustion shops, and the president's office.

The station will broadcast on 90.1 mc. with the call letters WPWT.

**A.F.C. Circuit for TV**

(Continued from page 60)

The modifications in the waveforms of Fig. 4B as a result of the sine wave superposition are shown in Fig. 4A. It is evident that the angle  $\alpha$  is markedly increased over the value shown in Fig. 4B. The phase relationships displayed in Fig. 4A are obtained in a practical circuit by providing  $L_1$  with an adjustable iron core. The amplitude of the sine wave can be set at an optimum value by shunting  $L_1 C_2$  with a resistance to fix the circuit "Q" at the proper value.

**Circuit Combining A.F.C. and Sine Wave Stabilization**

The principles embodied in the circuits of Figs. 1 and 5 are combined in the circuit of Fig. 6, which is essentially what is employed in current-model RCA Victor television receivers. This circuit delivers a saw-tooth waveform to the horizontal deflection amplifier through the adjustable capacity divider,  $C_{10}$  and  $C_{12}$ .

Bias for the control tube is obtained from the negative voltage on the oscillator grid through the resistive divider,  $R_5$  and  $R_7$ . Rough control of the oscillator period is secured by adjusting the amount of feedback by means of an adjustable powdered iron core common to  $L_1$  and  $L_2$ , which are magnetically coupled. Vernier frequency adjustments are made by the front-panel hold control,  $R_2$ . This control varies the cut-off potential of the oscillator-control tube, thus altering the nominal average cathode voltage of the tube enough to effect changes in oscillator frequency over a range of approximately 3.5%.

The voltage impressed on the grid of the control tube is a composite of three waveforms obtained from three different sources in the receiver. The stripped sync signal, shown in Fig. 7A, is fed to the tube through  $C_1$ . A saw-tooth, shown in Fig. 7C and obtained from across  $C_{11}$ , is also fed to the control tube through an integrating network,  $R_4$  and  $C_4$ , plus  $C_1$ . This network integrates the saw-tooth to the parabolic form shown in Fig. 7D. To steepen the negative slope of the parabola, a negative pulse, shown in Fig. 7B, is obtained from the horizontal deflection yoke windings and is fed to the control tube through  $R_6$  and  $C_2$ . This pulse is attenuated and slightly integrated by  $R_6$ ,  $C_1$ ,  $C_2$ , and  $C_4$ . The resultant waveform impressed on the control-tube grid is a composite of A, B, and D of Fig. 7, and is shown in Fig. 7E. Since the leading edge of the pulse obtained from the deflection yoke forms the negative slope of the composite waveform, initiation of the horizontal retrace coincides with the center of the sync pulse. Sufficient time is thus assured for the completion of the retrace before the end of the blanking pulse.



A trimmer condenser,  $C_4$ , is employed to set the amplitude of the control-tube grid waveform at the desired value. Fig. 8 illustrates actual oscilloscope photographs of some of the waveforms in the circuit of Fig. 6.

### Acknowledgment

The author wishes to express his sincere appreciation to the inventor of the herein-described circuits, Simeon Tourshou, of the *RCA Victor Division*, for his kind assistance in the preparation of this paper.

-30-

### Stratovision

(Continued from page 37)

on some flights and proved to be a valuable source of information. Area covered by reports agreed very well with predicted coverage.

An angle of five degrees or greater is obtained for only the first mile from a 500-foot high antenna compared with 64 miles from the 30,000-foot antenna. An angle of one degree or greater is obtained for only five miles from a 500-foot high antenna as compared with 168 miles from the 30,000-foot antenna.

*Stratovision* proponents estimate that it would require only eight planes in "relay" to provide a transcontinental network and six additional planes to give adequate coverage to 78 percent of the 149,000,000 people in the United States.

As to the future of airborne TV, C. E. Nobles, head of *Stratovision* work for *Westinghouse*, says "The major technical problems of the system have been solved, and the commercial development awaits only the crystallization of public demand for the expanded services offered by airborne broadcasting, application of the system by the radio industry to meet this demand, and the clarification of channel facilities available to make possible this application."

-30-

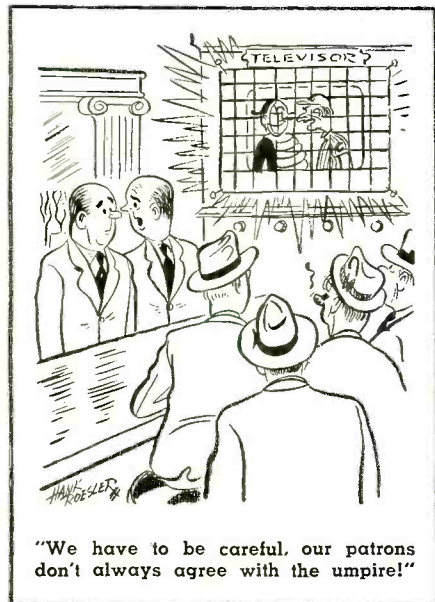

## COMET SPECIAL

Westinghouse  
Insertion Capacitor  
1 Mfd.—7500 VDC  
Brand New  
**\$525**

# RECORD SMASHING VALUES!

### CHECK THESE VALUES

VCB-709—Interphone Amplifier, Ideal for Aircraft Booster Telephone, New, \$4.00  
VMN-26Y—Radio Compass Receiver, 150-325 KC, 325-695 KC, 3-4.7.0 MCS, 28 Volts, Migr Bendix, New, \$34.50  
VCB-733 D—Receiver, New, Less Dynamotor, \$21.95  
Used w/Dynamotor, Excellent Cond., \$7.95  
VCB-224—Receiver, New, Less Mounting, \$100.00  
VRA-10DB—Receiver, Bendix, New, \$34.50  
VCB-312—Receiver, Used Good Condition, \$75.00

### TUBES

2C34 .....	50.25	9003 .....	50.35
2C44 .....	65	9006 .....	25
2N2A .....	55	C5B .....	7.75
2X2 870 .....	35	CE072 .....	1.30
3C24 .....	38	CK70 .....	3.95
7C4/1203A .....	35	CRP-72 .....	1.50
39/44 .....	45	HY-615 .....	70
15E .....	1.50	RKR-72 .....	.95
15R .....	.75	RT-127A .....	2.25
45 SPEC .....	.28	VT-1 .....	.65
5.4 GAM .....	.75	VT-1 .....	.65
211 .....	.45	3BP1 .....	2.50
713A .....	.90	CEP1 .....	1.85
717A .....	.55	5BP4 .....	3.50
801A .....	4.45	5FP7 .....	1.00
803 .....	8.70	16GT .....	.25
804 .....	3.50	3Q4 .....	.55
805 .....	3.75	6AJ5 .....	.75
806 .....	1.00	6C4 .....	.25
826 .....	40	6HG .....	.45
872A .....	1.45	6K6GT .....	.45
1005 .....	6.60	6L6 .....	1.40
1626 .....	.35	6S7 .....	.40
1829 .....	.25	6SH7 .....	.50
246 .....	1.40	12A6 .....	2.40
7193 .....	.20	12SN7GT .....	.50
8011 .....	.65	25L6GT .....	.50
9022 .....	.30	25Z5 .....	.45

### ROTARY SWITCHES

Pole	Position	Section	Shaft	Price
2	2	3	1/8"	\$0.35
2	4	2	1/8"	.35
2	4	2	1/4"	.30
2	4	2	3/8"	.35
2	4	2	1/2"	.45
2	8	2	3/32" KVA	1.45
2	0	1	FLASH OVER	1.45
2	2	3	3"	.50
3	2	3		.50
2	2	2	2	.33

### SPECIALS

80.86 KC Crystal with Holder, \$1.50  
200 KC Crystal with Holder, \$1.35

### WIREWOUNDS

Cat. No.	OHMS	WATT	TAPER	Bushing	Shaft	MFG'R	EA.	TEN	PRICE
.095	2000	Dual	2	LINEAR	1/8"	3/8"	TREFZ	\$0.45	\$0.40
.00385	5000		2	LINEAR	3/8"	17/32"	WIRT	.30	.25
.096	7500		3	LINEAR	1/2"	3/8"	TREFZ	.25	.20
.005810	25,000		3	LINEAR	3/8"	1/2"	WIRT	.30	.25
.09285	15		3	LINEAR	3/8"	1 1/8"	DEJUR	.45	.40
OHMITE	20	25	LINEAR	3/8"	1/2"	OHMITE	.45	.40	
.04881	50	25	LINEAR	3/8"	1 1/8"	DEJUR	.50	.40	
.19081	100	25	LINEAR	3/8"	1 1/8"	DEJUR	.55	.45	
.14781	200	25	LINEAR	3/8"	1 1/8"	DEJUR	.55	.45	
.03281	500	25	LINEAR	3/8"	1 1/8"	DEJUR	.55	.50	
.033	3000	25	LINEAR	3/8"	1 1/8"	DEJUR	.65	.55	
.09183	5000	25	LINEAR	3/8"	1 1/8"	DEJUR	.65	.60	
.15581	15,000	25	LINEAR	3/8"	1 1/8"	DEJUR	.70	.65	
.099	20,000	25	LINEAR	3/8"	1 1/8"	DEJUR	.85	.70	
.105	20,000	25	LINEAR	3/8"	1 1/8"	DEJUR	.85	.70	
.03081	6	50	LINEAR	3/8"	1/2"	DEJUR	1.00	.90	
.06581	50	50	LINEAR	3/8"	1/2"	OHMITE	1.10	.95	
OHMITE	800	50	LINEAR	3/8"	1 1/8"	DEJUR	1.50	1.25	
.024	10,000	50	LINEAR	3/8"	1 1/8"	DEJUR	1.50	1.25	
HC	15	60	LINEAR	1/2"	1/2"	OHMITE	1.50	1.25	
IR2	15	75	LINEAR	1/2"	1/2"	IR2	1.50	1.25	
OHMITE	750	150 w/KNOB	LINEAR	3/8"	1 1/8"	OHMITE	2.45	2.10	
HELIPOT	20,000	5	0.5%	LINEAR	1/4"	GIBBS	4.50	4.00	

### TERMS:

Minimum order \$5.00—Mail orders promptly filled—All prices F.O.B. Boston, Mass. Send M.O. or check. Shipping charges sent C.O.D. 25% deposit required with all C.O.D. orders.

SEND FOR OUR  
CATALOGUE NOW!

Inquiries from Dealers, Schools  
and Industrial Firms Invited

**COMET ELECTRONIC SALES CO.**  
22 Washington St. Brighton 35, Mass.  
BEacon 2-7863

### ROUND PANEL METERS

0-4 RF AMPS	GE	2 1/2"	\$3.95
0-5 RF AMPS	Weston	3 1/2"	4.50
0-15 RF AMPS	GE	2 1/2"	3.75
0-300 MA DC	Simpson	2 1/2"	3.75
0-300 MA DC	Weston	2 1/2"	3.75
5-5 MA DC	Weston	with 50 Ma Shunt	4.25
0-8 AMPS DC	McClint	2 1/2"	1.95
0-50 AMPS DC	Weston	3 1/2"	4.00
0-100 AMPS DC	Hoyt	3"	3.75
0-3 VOLTS DC	Gruen	2 1/2"	1.95
0-15 VOLTS AC	GE	3 1/2"	4.95
0-2500 VOLTS DC	Simpson	3 1/2"	4.95
0-5 KV DC-10MA DC	Hoyt	3 1/2"	5.75
0-150 VOLTS DC	Hoyt	3 1/2"	3.95
10-0+6 DB	Weston	2 1/2"	4.50

### PORTABLE METERS

0-10 AMPS DC	Weston	489	7.50
0-3-6-30VOLTS DC	Weston	259	17.50
0-100 AMPS DC	Weston	269	
with 100 AMP SHUNT	AWHUNT		24.95
0-25 AMPS AC	Weston	433	23.95
0-300 VOLTS AC	Weston	433	24.95
0-1.5-6 VOLTS AC	Output Meter		12.00
	Weston	571	

### POWER EQUIPMENT

Inverter PE-151 Input 1.7 VDC Output 110 VAC 150 W 60 Cy.  
NEW  
Vibrapak VPS 260 15 VDC Output 250 V @ 70 MA Synchronous Rectification, NEW \$34.45  
Voltage Regulator Raytheon 95/130 V 60 Cy 1.25 Amp Output 115 V 60 Watt, NEW \$9.50  
Vibrator ATR 2410 24 VDC Output 110V 100 W, NEW \$22.95  
ATR Inverter 12 VDC to 110 VAC 50/60 CY 100 W, NEW \$16.75  
Vibrator PE-135 ME X 12-24 VDC Output 900 V @ 160 MA, NEW \$16.95  
USED \$9.95  
PE-140 Power Supply \$29.95

### TIME DELAY SWITCHES

1 Minute 115 VAC 60 Cy Enc. in Waterproof Metal Case, NEW \$2.95  
3 Micro Switches Make Contact at 40-41-42 Sec. Time Delay 110 VAC Motor, NEW \$4.00  
Thermo Switch 50° F to 300° F 115 VAC @ 6 A 230 VAC @ 5 A Breaks Contact with Increase in Temperature, NEW \$6.95

### GIANT BARGAIN!

TRANSFORMERS  
PRIMARY 115 V 60 CY/CL  
9V @ 750 MA 6.3 @ 3.9 @ 3.5V @ 6 A 2400 W West. \$3.00  
6.6 V @ 0.6 A 2000 W Ins. 2.60 V @ 1.75 A, 2700 Ins. \$1.75  
6.4 V @ 10 A 6.3 @ 0.6 A \$5.00  
375.363 KVA 1000/7500— \$5.50  
660/350 V @ .08 A CT 5.0/2.5 @ 3A CT \$3.45



## RADIO and TELEVISION

Thorough Training in All Technical Phases  
APPROVED FOR VETERANS  
WEEKLY RATES DAILY—EVENINGS  
RCA GRADUATES ARE IN DEMAND  
For Free Catalog write Dept. RN-50  
A Service of Radio Corporation of America  
RCA INSTITUTES, Inc.  
350 West 4th St., New York 14, N. Y.

### TWIN LEAD TRANSMISSION LINE

for Television Lead-in. 300 ohm. 1,000 ft. to roll. 1 roll, \$10.50 ea.; 5 rolls or more, \$9.95 per roll. Order Today!

### SUFFOLK TELEVISION AGENCY

41 Suffolk Ave., Central Islip, L. I., N. Y.

## GOVERNMENT SURPLUS! WORLD'S LOWEST PRICE!

### PHOTO FLASH EQUIPMENT



COMES COMPLETE WITH  
**4 EDGERTON FLASH TUBES & REFLECTORS**

EASY TO CONVERT INTO A 2-WAY PHOTO FLASH UNIT  
OPERATES ON 110V. AC & 12V. BATTERY

Brand new at a fraction of original cost. Contains finest component parts available. All necessary parts and complete instructions included. After conversion, works on 110V AC or 12V battery by a flick of a switch.

IMMEDIATE DELIVERY ON ALL MAIL ORDERS

**\$68**  
COMPLETE

CINEX, INC., 165 W. 46th St., N. Y. 19, N. Y., Dept. RN-1

sold exclusively in the U. S. by Sun Radio & Electronics Co., Inc., of New York City. We have no branches or affiliates in any other city.

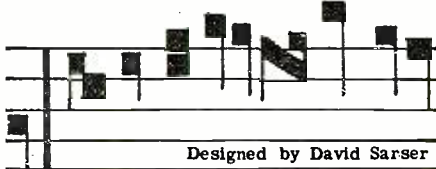

Designed by David Sarser

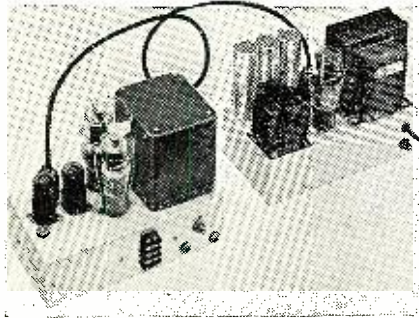

### The "Musician's Amplifier"

First demonstrated at the Audio Fair at the Hotel New Yorker, it took the show by storm, captivating musicians and engineers alike with its "room presence" sound. You'll find nothing better at any price. An all-triode, fixed-gain, 2-chassis power amplifier for use with tuners or other front ends containing their own volume and tone controls. Uses the Williamson circuit. Sun Radio's Kit can be wired in 3 hours. All capacitors and resistors in the amplifier chassis are already mounted and wired on resistor board for simple installation. Chassis punched to accommodate all components.

#### SPECIFICATIONS:

Peerless Transformers used exclusively throughout. Output transformer is the famed Peerless S-265Q.

Power output 12.2 Watts.

Intermodulation distortion at 5 Watts less than 0.2%! less than 8% at 12.2 W.

Frequency response better than  $\pm 0.5$  db from 20-80,000 cps.

Absolute gain 70.8 db.

Tubes: 6SN7 voltage amplifier and cathodyne phase inverter, 6SN7 push-pull driver, 2- 807's used as triodes in push-pull output stage, 5U4G rectifier.

20 db feedback around 4 stages & the output transformer.

Source impedance 0.75 ohms.

On 2 chassis, each 5" x 10" x 3", each properly punched and cadmium finished.

Kit comes complete with tubes, 2 punched chassis, prewired resistor and capacitor board, sockets and all necessary parts and instructions.

NET PRICE . . . . . \$89.50

Lab wired & tested, complete with curves of tests run on each individual amplifier. Tests include 3 curves showing frequency response, power output and harmonic content.

NET PRICE \$119.50

Order by mail today!

**Sun Radio**  
AND ELECTRONICS COMPANY, INC.  
122-124 DUANE STREET  
New York 7, N. Y. BR 4-7-1840  
2 BLOCKS NORTH OF CHAMBERS ST.

# MARS Station of the Month

## MARS BEAMS WEEKLY BROADCASTS

MARS—Army Headquarters station, WAR, located at the Pentagon Building, Washington, D. C., broadcasts a weekly message each Tuesday at 0100Z and at 0400Z. (This is Monday at 8 p.m. and 11 p.m., Eastern Standard Time; Monday at 7 p.m. and 10 p.m., Central Standard Time; Monday at 6 p.m. and 9 p.m., Mountain Standard Time; and Monday at 5 p.m. and 8 p.m., Pacific Standard Time.)

Simultaneous broadcasts are made on frequencies 6997.5 kc., 14405 kc., and 20994 kc. Each message is sent three times, once at 10 words per minute, once at 15 words per minute, and once at 20 words per minute.

Designed especially to transmit quasi-official traffic and training information to MARS members, the broadcast offers an excellent opportunity to all amateurs in building up their code proficiency.

**N**OW hear this! The Military Amateur Radio System afloat now consists of one ship station (A6WAD-K6WAD) and two MARS members, A6GRP-W6-GRP and A6WFZ-W6WFZ, aboard the U.S. Army Mine Planter *Ellery W. Niles*.

A Navy terminology which refers to doors as "hatches," floors as "decks," walls as "bulkheads" and latrines as "heads" is not new to these boys. A6GRP is Warrant Officer Louis M. Sieber, U. S. Army Mine Planter Service, and A6WFZ is Sgt. 1/C Leroy G. Hankins. "Hank" (ex-W9ABG) is the ship's radio operator.

The boys do most of their hamming on 40 meters at present. However, they're working on a 10-meter rig and expect to have it on the air right away.

Equipment aboard the *Niles* consists of two RCA transmitters and a Collins TCS-1. The 8010 is used exclusively for ship's work, the TCS-1 for MARS. Receivers are an RCA AR8510 and an SX28.

The *Ellery W. Niles*, assigned to the Coast Artillery for Harbor Defense, is currently assigned to mine work and cable operations in San Francisco Bay and other West Coast ports as needed. Details of her activities are not available because of security reasons. However, the ship will be remembered as



A6GRP copies at the mill while A6WFZ keeps careful eye on the ocean-going transmitter.

the first and only diesel electric Mine Planter in the Army.

Commissioned in 1938, the *Niles* toured all East Coast ports enroute to San Francisco Bay where she was stationed until 1939. She next went to the Pacific side of the Panama Canal where she directed the laying of the Pacific side mine fields to defend the Canal Zone.

The *Niles* was returned to San Francisco in 1940, played a major part in laying mine fields, assisted the Navy in maintaining Navy Loops, and laid cable in San Francisco Bay.

Seamen remember her for her peculiar characteristics when under way. One Coast Artilleryman referred to her as the "ship to end all ships."

The U.S. Army Signal Cables ship "Ellery W. Niles" as she looked in 1947.

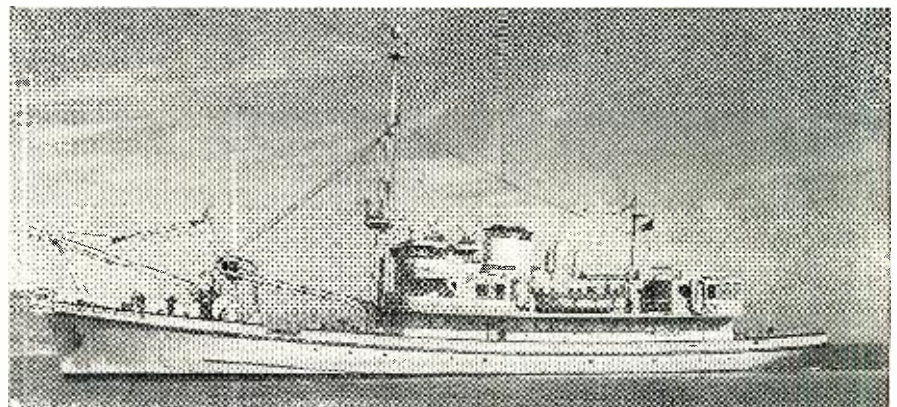

"Of course I remember her," he said, "she pitched like a blinkin' billygoat."  
 But the mine planting/cable-laying MARS members laugh away all suggestions that they might be too sick to operate.

"We take great pride," they aver, "in having strong stomachs and even stronger radio signals. You give a shout, we'll QSO and QSL."

-30-

### Mae's Service Shop

(Continued from page 44)

high enough to cover such possibilities.

"That way of doing business places a heavy strain on the service technician's ethics. After the customer has indicated that he will hold still for the higher charge, there is always the temptation to let that figure stand, even though the repairs needed do not warrant it. The service technician can always quiet his conscience by telling himself that on the next job matters will probably be reversed and he will take the licking. A technician I know argues, 'If you lose on the popcorn, you gotta make it up on the peanuts.' That's no good. There is no such thing as 'averaging up' your honesty. Either you shoot square in every little detail or quit trying to claim you are an honest man."

"Any more reasons why you are so fond of free estimates?"

"Plenty of 'em. The practice encourages slipshod work. If the service technician feels forced to stay inside a hastily-given estimate, he is quite likely to try to patch or cobble up some repairs that were not foreseen or provided for in the price quoted."

"But the practice does bring in business, doesn't it?"

"I have never been convinced that it does—at least not the kind of business you want. It does attract the 'shoppers,' the something-for-nothing individuals, and the characters who believe that all service technicians are automatically cheats and swindlers; but people in general have come to distrust 'free' offers. The word has come to be associated with cheap, come-on tricks in advertising. You yourself know the kind of offers you usually get in second-class envelopes that have the word FREE! plastered all over the outside in big red letters."

"Why is it that every now and then a radio parts manufacturer comes out in favor of free estimates?"

"It is easy to play Santa Claus with someone else's time or money. Can't you just hear the manufacturer scream if we suggested he give away some of his tubes or resistors or condensers? Very, very few of the veteran service technicians with whom I have talked are in favor of free estimates. They say that when doctors start giving free diagnoses, they will start giving free estimates, but not before. They argue that the radio service business has enough headaches in it now without adding those that are a part of free estimating."

January, 1950

# SEE LEO FIRST... for HALLICRAFTERS!

## SX-71 RECEIVER

The SX-71 offers superior Ham Band performance in the moderate price range—value packed with features specifically asked for by Hams. Features include Double Conversion sharp selectivity, plus built-in NBFM at moderate cost. 10 tubes plus voltage regulator and rectifier.



**\$179.50**

Low Down Payment

LEO I. MEYERSON  
WØGQ



## S-40A RECEIVER

Frequency Range 540 KC to 43 MC. Temperature compensated oscillator. One RF, 2 IF, 3 plus rectifier. Internal speaker. Has AF & es. The finest set on the market at this low price.

**\$79.95**

Low Down Payment



## GIANT RADIO REFERENCE MAPS

Just right for your control room walls. Approximately 28" X 36". Contains time zones, amateur zones, monitoring stations. Mail coupon today and

**25c**

# READY FOR YOU!

## LEO'S 1950 CATALOG

A brand new catalog containing the most complete listing of radio and television parts and accessories—everything for the radio man and the amateur radio operator. You'll save money buying from our new catalog,

and it's **FREE!**



WRITE—WIRE  
PHONE 7795

WORLD RADIO LABORATORIES R-1  
744 West Broadway  
Council Bluffs, Iowa  List Of Used Equipment  
Please send me:  SX-71 Info  
 Radio Map  New Catalog  S-40A Info

Name .....  
Address .....  
City ..... State .....

World Radio LABORATORIES INCORPORATED  
COUNCIL BLUFFS, IOWA

# 30-44 Megacycles FM

## PR-30 Receiver For MOBILE CALLS

Emergency thrills... hear "news in the making"... as it happens.

• Tube superheterodyne, 115 volts, AC or DC. Now you may enjoy... **\$44.95**  
 • POLICE • MARITIME  
 • FIRE • FORESTRY  
 • HIGHWAY TELEPHONE LIST PRICE

PR-7 POLICALARM tunes 152-162 mc. \$39.95  
See your dealer or write Dept. RN-3



★ POLIC FM ALARM

RADIO APPARATUS CORP.  
303 FOUNTAIN SQ. THEATER BLDG.  
INDIANAPOLIS 3, INDIANA

## RADIO Surplus Buys

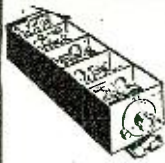

### R-1/ARR-1 HOMING RECEIVER

Jan. RADIO NEWS article tells how to convert this receiver to high freq. converter for use with your present receiver. Easily converted, compact, well built. Like new with four acorn tubes and plug.  
Priced at only..... **\$9.95**

### COMMAND RECEIVERS

BC 453	1.9-550 KC	\$12.95
BC 454	3-6 MC	\$5.85
BC 455	6.9-1 MC	\$6.95
6 1/2' CONTROL CABLE for above command sets		\$1.00

Like New

R-5/ARN-7 COMPASS RECEIVER	\$14.95
BC-433G COMPASS RECEIVER	\$14.95
BC-603 FM RECEIVER	\$12.95
BC-604 FM TRANSMITTER	\$15.95

### ARC-4 VHF TRANSMITTING RECEIVER

140 to 144 MC Crystal controlled. 10 watt output. 13-tube receiver, containing 2 individual RF sections and A10 MC. IF amplifier. Both RF sections may be operated simultaneously or individually. Less crystal, dynamotor and tubes.

USED, GOOD	\$5.95
ARC-4 SCHEMATIC	\$1.00
CONVERSION TO 144-148 MC	\$1.00
12 & 24V DYNAMOTOR FOR ARC-4	\$4.95

LINEMAN'S TOOL & SAFETY BELT (Web Type). NEW..... **\$3.95**

SEND 10c FOR COMPLETE SURPLUS CATALOG!

Enclose full amount with order. All Equipment F.O.B. Pasadena

## C & H SALES CO.

2176 RO-I East Colorado • Pasadena 8, Calif.

# "Alumilite" TV TOWER

LIGHT—6 pounds to 12-foot section—no heavy roof burden

EASY TO ERECT. Universal base fits any pitch or flat roof. Bolt sections together and install in one to two hours

STRONG. Cross braces every two feet, lattice braces between, resist high winds

DURABLE. All aluminum, needs no painting, no maintenance

LOW PRICED. Engineered design uses all material to best advantage. Sales method cuts out middlemen's profit

Order immediately one of two ways:

- (1) Remit 20% now, balance C.O.D.
- (2) Send full amount with order, save collection fee and transportation charges. We ship prepaid, guarantee satisfaction or money refunded.

PRICES: All prices include universal base. All sections completely fabricated, ready to bolt together. All bolts and hardware furnished.

12-ft. Tower.....	\$17.50
24-ft. Tower (Two 12-ft. Sections).....	32.50
36-ft. Tower (Three 12-ft. Sections).....	47.50
48-ft. Tower (Four 12-ft. Sections).....	62.50
10-ft. Mast, if desired, adds 8 feet to Tower height. Price.....	\$2.00

**\$ 750 UP**

Factory-to-user plan not only means lower price but avoids pick-up cost and bother. You'll appreciate it.



## ASSOCIATED TELEVISION COMPANY

513 Pennwood Ave. Pittsburgh 21, Pa.

"Then you think the birds who give these estimates are dopes?"

"Oh me!" Mac sighed. "I did not say that. That is the trouble with being young: you cannot be sure you are right unless you can prove someone else is wrong! In some cases and in some localities, free estimates may be a good thing. I do not know. All I know is that I do not like them or intend to give them. We charge a flat minimum for making an estimate; but we do a good, thorough, unhurried job of finding everything that is wrong with a set and the cost of putting it right. There is no padding of the estimate to take care of overlooked items, because we have taken the time to make a careful survey of the set. We could afford to take this time because we were being paid for it. The estimate is well worth our customer's money for it gives him an accurate figure upon which he can depend in deciding whether he should have the set repaired or buy a new one."

"In short," said Barney with his flair for slogans, "all we 'give' our customers is a square deal—but who wants anything more?"

## SERVICE HINTS

By R. J. KIEFER

HERE ARE several handy service hints that will save time and money.

To remove filings from PM speakers, remove the cone with coil, wrap a toothpick with a thin layer of absorbent cotton and work it gently around the speaker's center pole piece. Small filings will work into the cotton while the large pieces can be brought out to the front where they can be picked out with tweezers.

Very thin cardboard shims can be used for positioning and gluing the cone on the speaker frame. Make the cardboard several inches long and slip the speaker cone on the end. Then apply speaker cement to the required areas and rapidly push the cone down to the proper place on the frame.

On cabinet scratches where the finish is not broken down to the wood, a slight puncture should be made with a needle underneath the scratch. This allows stain to soak into the wood and will go a long way toward making the scratch inconspicuous.



"Nervous contestants!"

# WE HAVE 'EM

New Year's Best Surplus Buy  
Assorted D.C. Relays  
6v., 12v., 24v., 48v.  
All New, 10 for \$2.95

### G. E. TRANSFORMERS

110 V. 60 Cy. AC  
850V CT. 6.3V @ 5A, 6.3V  
@ 3A, 5V @ 3A. Con-  
servatively rated @ 148  
Mil. tested @ 250 mil and  
will handle more. **\$2.95**  
A steal at.....



G. E. 12  
HENRY  
CHOKE  
Made as com-  
panion to, only  
**\$1.95**



F.O.B. Oakland. 25% cash with order. Bal. C.O.D.

## EMMONS RADIO SUPPLY

405 - 10th ST. OAKLAND, CALIF.  
Phone TWinoaks 3-9103

### AUTOMATIC M-90 AUTO RADIO



- Six Tube Superheterodyne
- Powerful, Long-Distance Reception
- Fits All Cars
- Easy Installation
- Mounting Brackets Included
- Net \$29.97
- 6 Tube model M90..... \$29.97
- 5 Tube model X50..... \$24.36

MAIL US YOUR ORDERS  
All orders filled within 24 hours. Illustrated parts list on request. Sylvania and Cunningham tubes 50% off list

*Bill Sutton's*

Wholesale  
Electronics  
Fifth at Commerce Fort Worth, Texas

## LEARN RADIO!

PREPARE FOR A GOOD JOB!

BROADCAST ENGINEER  
COMMERCIAL OPERATOR (CODE)  
RADIO SERVICEMAN

### Television Servicing

(Approved for Veterans)

SEND FOR FREE LITERATURE  
BALTIMORE TECHNICAL INSTITUTE  
1425 EUTAW PLACE, BALT. 17, MD.

### TELEVISION RECEIVER—\$1.00

Complete instructions for building your own television receiver. 16 pages—11" x 17" of pictures, pictorial diagrams, clarified schematics, 17" x 22" complete schematic diagram and chassis layout. Also booklet of alignment instructions, voltage and resistance tables and trouble-shooting hints. —All for \$1.00.

CERTIFIED TELEVISION LABORATORIES  
5507-13th Ave., Brooklyn 19, N. Y.

## RADIO COURSES

- RADIO OPERATING • CODE
- RADIO SERVICING • ELECTRONICS
- F.M. TELEVISION
- REFRIGERATION SERVICING

Write for Catalog T.S. and Picture Brochure

LYMCA

TRADE & TECH. 229 W. 46 St., N. Y. 23  
SCHOOL ENdison 2-8117

## BLUFF CITY DISTRIBUTING COMPANY

905 Union  
Memphis 1, Tenn.



\$23.95

HAS THE  
SENSATIONAL NEW  
EICO VTVM Kit  
IN STOCK!

**Printed Circuits**  
(Continued from page 55)

of any high capacitance between the crossed conductors.

As mentioned in Part 1, small condensers can be painted by using silver-painted areas on opposite sides of the base plate, especially when the plate is of thin, high-dielectric material; but the experimenter will find it much easier and more accurate to use the tiny disc-type ceramic condensers by connecting them to the conducting lines at the points needed.

These condenser leads, as well as tube leads, transformer leads, etc., can be connected to the painted lines by either soldering or painting. When soldering, the painted surface is first sanded clean and a drop of solder placed on it and flattened out; then the tinned conductor is placed on this drop of solder, which is remelted just enough to bond it to the conducting lead.

In order to get the "feel" of drawing printed circuits, it is a good idea to reproduce in miniature some simple electronic device such as the code oscillator shown in connection with the *Microcircuits* kit; but the real field for these printed circuits lies in those pieces of equipment where the reduction in bulk and weight is of actual and not just "curiosity" value. Careful study of the accompanying pictures of transmitters, receivers, and amplifiers will show the reader what has been accomplished along these lines by expert technicians and will provide him with many valuable pointers in regard to layout, printing of inductors, tube-placement, etc.

While standard components can be used with printed circuits, there is not much sense in using a log-chain leash on a Pekingese or in employing a tube or transformer that is five or six times as big as all of the rest of the circuit. Subminiature tubes and the other tiny components used in hearing aids make ideal companion units for printed circuits, and practically all of them will be found advertised in the pages of *RADIO & TELEVISION NEWS*. Table 2 gives subminiature tube characteristics that will be found useful in designing printed circuits.

In conclusion, the writer would like to say that he never could understand what pleasure the head-hunters got out of shrinking the noggins of their enemies to the size of a human fist; but he knows there is a very decided thrill in building equipment in about one-tenth the space normally required.

**BIBLIOGRAPHY**

- Bradley, Robert F.; "Design and Repair of Printed Circuits."  
 Brunetti, Cleo & Curtis, Roger W.; "Printed Circuit Techniques," National Bureau of Standards, Circular 468.  
 Brunetti, Cleo & Khouri, A. S.; "Printed Electronic Circuits," *Electronics*, April, 1946.  
 Pritikin, Nathan; Glass Products Co., Inc.  
 Schwab, M.; "Printed Electronic Circuits," Centralab Div.

for superb **HIGH-FIDELITY** reproduction  
**MASCO high frequency tweeter unit HFT-100**

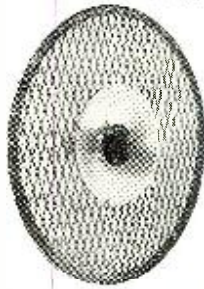

HFT-100 with mounting screen

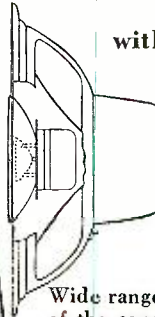

HFT-100 mounted within cone speaker

**HFT-100 Specifications**

Frequency range... 900 to beyond 15,000 cycles  
 Impedance 5 ohms  
 Power Handling 8 watts  
 Capacity  
 Dispersion, horizontal and vertical 70 degrees  
 Width, less screen 5 1/4 in.  
 Height, less screen 5 1/4 in.  
 Depth 2 3/8 in.

- with **NO** distortion
- NO** cumbersome horns
- NO** crossover network necessary
- NO** additional space required
- NO** narrow dispersion angles
- NO** need for separating sound sources

Wide range reproduction from the lowest response of the cone speaker to better than 15,000 cycles is obtained by using the HFT-100 Tweeter.

The tweeter is mounted within the cone speaker and connected in series with it.

No filter network is necessary. The HFT-100 has a built-in mechanical filter.

**HFT-100** with attached mounting screen for 12" cone speaker.....\$24.50 List Price  
**HFT-100** with attached mounting screen for 15" cone speaker.....\$26.50 List Price

Write to factory for Catalog RN-1



**MARK SIMPSON MANUFACTURING CO., Inc.**  
 32-28 49th Street, Long Island City 3, N. Y.

**SOUND SYSTEMS and ACCESSORIES**

RAvenswood 8-5810-1-2-3-4

There's a **BIG** Future for **YOU** in  
**TELEVISION**  
**RADIO-ELECTRONICS**

**Builds Your Career in a Minimum of Time**  
**Industry Needs More Trained Men Now**  
**Day and Evening Classes Now Forming**

**G**RADUATES of CREI Residence School are preferred by industry because of their *training and ability*. This recognition is the reason that CREI men quickly find good jobs. With 23 years of practical teaching experience in these highly technical fields, CREI offers an outstanding faculty, modern and complete laboratories, shops and equipment.

New students are accepted twice monthly and each may advance as rapidly as he is capable.

CREI is recognized as one of the country's leading technical institutes, offering college-calibre education for the young man who wants a practical career education that leads to a good-paying job in a minimum of time.

Approved for  
 Veterans' Training

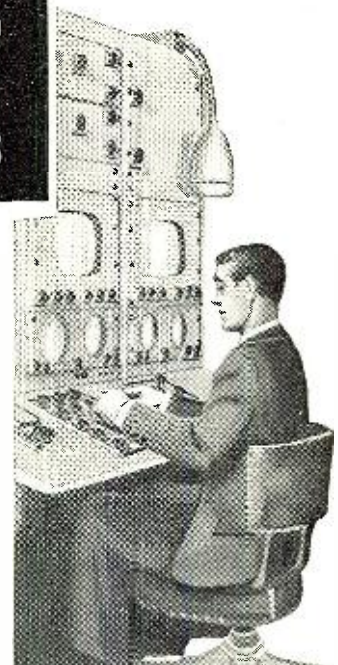

Mail Coupon for **FREE** Catalogue

**CAPITOL RADIO**  
**ENGINEERING INSTITUTE**

Dept. 131 B, 16th & Park Rd., N.W.  
 Washington 10, D. C.

Please send me your illustrated catalog and complete details about the CREI Residence School.

NAME .....

AGE.....IF IN SCHOOL, WHAT TERM?.....

STREET .....

CITY..... ZONE..... STATE.....

I am entitled to training under G.I. Bill

Send information on Home Study Courses

# INVENTORY SALE ALL PRICES CUT TO BONE

**WESTINGHOUSE KUPROX RECTIFIER**  
0.64 amps—28 volts. Reg. \$11.00 ea., SPECIAL \$1.95  
25c **TUBE SALE**—#53-2A7-55-27-01A-85-31 ..... 6 for \$1.00  
12 **BRAND NEW 10" PHONO RECORDS**—Ass't.  
Jazz—Pop—Hillbilly—Polkas ..... \$1.79  
**WOOD MIDGET CAB.** 8 1/8x5 1/2x4 1/4" ..... 69c

**POWER PACK KIT**  
COMPLETE COMPONENT PARTS for Heavy Duty Power Pack. Made from Signal Corps Brand Re-Parts—Delivers approx. 350 volts—150 ma. 1 Plate Trans., 1 Filament Trans., 2 Chokes and Schematic Diagram. U. S. Gov't cost over \$60. Shipping wt. 50 lbs. SPECIAL PRICE ..... \$3.00  
JONES 20 TERMINAL BARRIER TYPE STRIP ..... 25c

**TRANSMITTING FILTER CHOKES**  
63 Henries. .018 Amp. 930 Ohms ..... 75c  
Signal Corps Phones—2 M. Ohms (8 M. Ohms (Imp.) ..... \$1.00  
2 Ft. Ext. Cord (and Plug) ..... 40c

**OIL FILLED FILTER CONDENSERS**  
1.—MFD—2000 volts ..... 75c ea.  
1.—MFD—1000 working volts ..... 6/99c; 12/\$1.75

**FAMOUS BRAND RECORD CUTTING HEAD**  
Size 1 3/8x2 1/8 ready to fit your cutting arm or bracket. SPECIAL ..... \$2.95

**TOBE TUBULAR ELECTROLYTICS**  
20-20 MFD. 150 V. .... 25c 40-40-20 MFD. 49c  
40-40 MFD. 150 V. .... 32c 150 V. .... 33c  
30-30 MFD. 150 V. .... 30c  
2 1/2 M.H. R.F. CHOKE COIL—27c ea. 5 for \$1.00  
3 BAND OVAL DIAT—7 1/2" L x 5 1/2" H. .... 60c  
100 RESISTOR ASST. 1/4-1/2 WATT ..... 95c

**Low-Loss Short Wave Variable Condensers**  
1/2" Shaft  
5 Plate—20 MMFD ..... 20c  
14 Plate—55-60 MMFD ..... 27c  
Lock Type Air Trimmer Variable Condensers  
3 Plate—12-15 MMFD ..... 10c  
8 Plate—20 MMFD ..... 12c  
8 Plate—30-35 MMFD ..... 13c  
10 Plate—40 MMFD ..... 14c  
14 Plate—56 MMFD ..... 14c  
20 Plate—80-100 MMFD ..... 25c  
27 Plate—100-110 MMFD ..... 35c

4 PR. WAFER SOCKETS—\$1.49 per C. each ..... 3c  
PHILCO 4 MF 300 V—1 1/2 CAN CONDENSER—10c ea.  
6-6 PRONG WAFER SOCKETS ..... 10c  
100 ASST. SOCKETS 4-5-6-7 ..... \$3.50 per C  
1,000 OHM WIRE WOUND POTENTIOMETER ..... 15c  
20 MVA FILTER CHOKE SHIELDED ..... 39c  
UNSHIELDED ..... 39c  
10 WIRE WOUND RES. KIT—5.50 W. ASST. ..... 49c  
2,000 ohm Wire Wound Res. Kit ..... 49c  
CARTER WIRE WOUND C.T. VARIABLE 20 OHM RESISTORS ..... 85c per doz.  
RCA 6 OHM WAFER SOCKETS ..... 7c ea.  
PHILCO AUTO SUPPRESSORS—\$5.00 per C ..... 7c ea.  
GEN. ELEC. WESTINGHOUSE, etc., 60 CYCLE WATT HOUR METERS, slightly used, perfect condition, same as used in your home. 1-10-125 volts. 5 Ampere ..... \$2.95 10 Amps. .... \$3.95

Grind your own crystals—Pure Brazilian Quartz, all sizes and thicknesses—1/2 lb. package ..... \$1.00  
340-degree dial with 10 push button attachment 1/4" shaft—ideal for Xmitters—Sig. Gen. or Osc 39c

**RCA Band Switches**  
3 rang. 3 pos. 3 band. 30c 6 rang. 5 pos. 4-5 band. 40c  
1. C. A. 30 MH RF choke ..... 25c  
Trimmer-Padder Asst.—all isolantite—singles, dual; triples—100 asst. per doz. ..... \$2.25  
5"—450 ohm AC dynamic \$1.35 Philco relay 4sp  
5"—5M OHM RCA SPEAKER. 1.00 tone control. 25c

**ATTENTION: Prospectors, Explorers for Hidden Treasures!**  
Construct a U.S. Army Type of Metallic Mine Detector Amplifier. Amplifier unit only (less tubes and batteries) with cables, headphone cord, and jack. Army wiring diagram. Type AN/PRS-1 ..... \$1.95  
**TUBES—OZ4** ..... 79c  
6 ASST WET ELECTROLYTIC CONDENSERS ..... 59c

**RADIO EXPERIMENTER'S SURPRISE PACKAGE—CONTAINS BYPASS & FILTER CONDENSERS, SHORT WAVE TUNING UNITS, POWER AND AUDIO TRANSFORMERS, SOCKETS, RESISTORS, CHASSIS HARDWARE, OVER 20 LBS. OF VALUABLE PARTS.** \$4.95

DRILLED CHASSIS FOR 5-6 tubes 7"x10"x1 1/8" ..... 29c  
5"x10"x1 1/8" ..... 25c  
RCA ADJUSTABLE CODE INTERFERENCE WAVE TRAP 456-475 K.C. ..... 25c  
PHONE JACKS—GEN. 1.00 CLOSED AUTO ..... 18c  
NATIONAL 5-15-450 VOLT CAN FILTER CON. DENSER ..... 39c  
KEY SPEAKER VOL. CONTROL—60 OHMS ..... 15c  
SALE—PHONO RECORD ALBUMS—SALE  
10"—3 comp. 15c; 4 comp. 20c; 12 comp. 49c  
12"—3 comp. 15c; 4 comp. 20c; 12 comp. 49c  
WESTERN ELEC. TRANSMITTING STEP-DOWN TRANSFORMER—AC. 190, 210, 230, 250 V. W.E. 20 AMP RETARD CHOKE TO MATCH. Wt. 125 lbs ea. Freight Shipments Only. SPECIAL. \$5.00 ea.

75 MFD., 25 V. Tubular Cond. .... 15 for \$1.00  
Line Noise Elim. R.F. Choke, #14 Wire ..... 10c  
7 Wire Shielded Cable, 24" with Octal Plug ..... \$1.00 per doz.  
4 Wire Shielded Cable, 6 Ft. with Plug. 7 for \$1.00  
Upright Elec. Cond. Clamps, 1 3/8" Diam. 25 for \$1.00  
RCA 2-Way Intercommunication Set ..... \$16.50  
6 Pr. Amphenol Sockets ..... \$4.00 per C  
G.E. Power Trans., 1 1/2 V., 5V., High V. .... 50c  
Majestic 6 V. Auto Vibrator ..... 50c  
Tube Ring Holders ..... 7c ea.; 15 for \$1.00  
10 MFD., 300 V. Cond. .... \$1.00 per doz.  
Transmitting Filter Cond. Ass't., W.E., Parvoh, RCA, G.E., etc. 1 MFD—3 1/2 MFD. 6 for \$1.00  
2-Gang S.W. Variable, 50 MMFD per Sec., Double Spaced 10-20 Meters with Tank Coil—1/4" Shaft ..... 39c  
Same with National Isolantite Grid Caps ..... 49c

**MINIMUM ORDER \$2.00—NO C.O.D.  
SHIPMENTS—PLEASE INCLUDE POSTAGE**

**NEWARK  
SURPLUS MATERIALS CO.**

Dept. JA  
324 Plane Street NEWARK 1, N. J.

# Manufacturers' Literature

Readers are asked to write directly to the manufacturer for the literature. By mentioning RADIO & TELEVISION NEWS, the issue and page, and enclosing the proper amount, when indicated, delay will be prevented.

## SOLDERING EQUIPMENT

The complete line of soldering products made by *P. Wall Manufacturing Company* and its new division, *Harmic Manufacturing Company*, is described in the new *Wall* catalogue which is currently available.

Included in the line are gasoline and kerosene blow torches, self-generating alcohol blow torches, electric soldering irons, solder, splicer's furnaces, paraffin supplies, and compound kettles. Also described is the company's line of oilers, grease buckets, shop torches, and steel gongs and shells.

Copies of Catalogue No. 85 may be secured by writing to *P. Wall Manufacturing Company*, 425 Erie Street, Grove City, Pennsylvania.

## POWER TOOLS

The extensive *Thor* line of portable power tools is presented in the new catalogue issued recently by *Independent Pneumatic Tool Company* of Aurora, Illinois.

Known as Catalogue E-2, this publication gives complete data including prices on all *Thor* universal electric tools. A special circular (No. JE-1131) covering the new *Thor* Silver Line 4 1/2" universal electric belt sander is also available on request.

Copies of either the catalogue or the circular, or both, may be obtained by writing the company at 175 State Street, Aurora, Illinois.

## FREE TV HISTORY

A four-color, illustrated booklet entitled "History and Manufacture of Television Receivers" and written by Frank A. D. Andrea is being made available to the public by *Andrea Radio Corp.* of Long Island City, New York.

In addition to covering the background and development of television, Mr. Andrea gives suggestions on what the television buyer should look for when purchasing a video receiver.

Distribution is being made through *Andrea* dealers. Copies are free of charge for the asking.

## RCA'S VESTPOCKET GUIDE

The 1950 edition of the *RCA Tube Department's* "Tube Reference and Calendar Notebook" is now available from the company's tube distributors.

A miniature encyclopedia of practical, everyday radio and television service data, this book has been especially prepared for radio and television service dealers, engineers, technicians, radio amateurs, and purchas-

ing agents. It is a memo book, world atlas, and business diary as well.

Now in its 20th year of publication, the 1950 edition has been brought up-to-date and includes a valuable television service data section and the latest information on tubes and batteries. There are 47 pages of receiving tube characteristics and socket-connection diagrams and 12 pages of technical data on 300 of the company's power, cathode-ray, photo, and special tubes for radio and the industry.

Copies may be obtained from *RCA, RCA Victor, and Cunningham* tube distributors.

## "THE PERMO REPORTER"

Persons interested in the art of recording and reproduction will welcome the addition of a new publication, "The Permo Reporter" to the literature available on the subject.

Bulletin 1, the first of a series of such leaflets, covers the topic "There is no Permanent Phonograph Needle." Subsequent issues will discuss characteristics of shellac-type and plastic records and their effect on the phonograph needle, needle problems and solutions incident to the introduction of microgroove and 33 1/3 and 45 r.p.m. turntable speeds, etc.

Readers may receive this bulletin regularly by sending their name and address to *Permo, Incorporated*, 6415 Ravenswood Avenue, Chicago 26, Illinois. Ask that your name be added to "The Permo Reporter" mailing list.

## 1950 NEWARK CATALOGUE

The company's 1950 catalogue of radio, television, electronic, and sound equipment is now available, according to *Newark Electric Company, Inc.*

The new publication features kits, sets, parts, and accessories. There is a special section devoted to high fidelity FM and AM radio and phono instruments for custom installation. This equipment is specially grouped in the catalogue.

Newark is also offering a free brochure explaining FM, what it is, and what it does.

Either or both of these publications may be secured by writing to the company at 242 West 55th Street, New York 19, New York.

## MINIATURE RECTIFIERS

*Federal Telephone and Radio Corporation* has released a data sheet covering its line of standard miniature selenium rectifiers and selenium rectifier stacks.

The various units in the line are pictured and complete operating data is provided in tabular form.

This handy and compact reference sheet may be secured by writing the company at 900 Passaic Avenue, East Newark, New Jersey.

#### BI-METAL THERMOSTATS

A single-sheet bulletin describing the company's Type R bi-metal strip thermostats for use in appliances, industrial apparatus, and electronic equipment has just been released by *Stevens Manufacturing Company, Inc.* of Mansfield, Ohio.

Illustrations include a schematic diagram of the operating principle, typical thermostat response curves, cutaway view of the unit, and a photograph showing various standard designs.

#### PENN TV TOWERS

*Penn Boiler & Burner Mfg. Corp.* of Lancaster, Pennsylvania is currently offering a four-page bulletin which covers its line of television towers.

These video receiving antenna towers feature sectional construction and hinged base plates which provide safe and easy mounting of the tower on sloping surfaces. Other construction and installation features are described in the folder. A dealer price list is included.

Copies of this bulletin are available from the company on request.

#### TRANSFORMER CATALOGUE

A 16-page catalogue which illustrates and describes the company's line of transformers for original equipment, radio and television, replacement, and amateur applications, has just been issued by *Triad Transformer Manufacturing Company* of Los Angeles.

Formerly available only as components in original equipment, the *Triad* line is now being stocked by distributors. The new catalogue is the first to be issued under the new sales program.

Featured in the catalogue are the company's "HS" (hermetically sealed) series transformers.

Copies of this catalogue, known as the TR-49, may be obtained by writing *Triad Transformer Manufacturing Company* at their new address, 2254 Sepulveda Blvd., Los Angeles 64, California.

#### SELENIUM RECTIFIERS

A new booklet which describes standard and high-voltage rectifiers for use in power supplies and electronic circuits is currently available from *Westinghouse Electric Corporation*.

Efficiency curves for both the standard (type M) and high-voltage (type H) cells are included, together with discussions entitled "Efficiency—Aging—Life," "Back Leakage—Reverse Resistance," and "Forward Resistance." Life characteristics of types H and M cells, for various overload conditions

# WOW LOOK AT THIS SAVING!



quantities are limited so get in your order TODAY

**NATIONALLY FAMOUS!**  
15 In. (130 Sq. In. Picture)

**TV CHASSIS**  
\$259.50 Value **\$169.95**

Complete with Picture Tube

**THIS IS NOT A KIT!**  
But a Factory Custom Engineered, Factory Wired and Tested, Factory Aligned TV Chassis THAT'S READY TO USE—JUST PLUG IT IN AND IT WORKS!

We agreed not to mention the name but you've seen it Nationally Advertised a name you respect for "know how" and quality. You get the identical Chassis regularly priced at \$259.50 for only \$169.95! Big Picture Television at a cost as low as usually quoted for pictures half as large plus the convenience of a custom installation.

Mount it in a cabinet of your own choosing—in a wall—in any location that meets your own requirements.

130 sq. in. picture on a 15" direct view tube. All channel selector switch provides instant tuning. Fine tuning control on front



panel. 8" electro-dynamic speaker provides rich tone.

Supplied mounted on reinforced wood frame ready to be slipped in cabinet, wall installations etc. Dimensions: 19 1/2-in. high, 23-in. wide, 2 1/4-in. deep. Factory wired and tested, complete with 19 tubes, plus 3 rectifiers and 15DP4 Dumont picture tube. For 110-120 V 60 cycle AC. Shipping Wt. 80 lbs.

Quantities are limited—all orders subject to prior sale Order Now!

No. 39A18X **\$169.95**  
NET EACH

## hallicrafters S-59

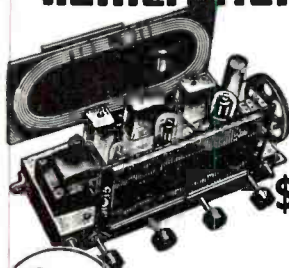

\$49.50 VALUE

Only

**\$32.95**

## 8-TUBE CUSTOM FM-AM CHASSIS

High fidelity. Receives broadcast 540 to 1700 kc and FM 88 to 108 mc. Excellently engineered—ideal for custom installations. Size 13 1/4 x 6 x 5 1/2" high. Complete with tubes and broadcast loop antenna. 8 ohm output transformer matches most speakers. Limited quantity still available. Order Now! With or without speaker. Complete description on page 137 in our catalog No. 501. Write us if you do not have this catalog. Wt. 18 1/2 lbs.

No. 34A19—Hallicrafters S-59 Chassis **\$32.95**  
No. 31B8—12" Coaxial Speaker. Wt. 6 lbs. **\$ 9.95**

Prices FOB Kansas City. Remit with order or send 25% deposit when COD.



## BURSTEIN-APPLEBEE CO.

1012-14 MCGEE ST. KANSAS CITY 6, MO.

### PEN-OSCIL-LITE

Extremely convenient test oscillator for all radio servicing; alignment • Small as a pen • Self powered • Range from 700 cycles audio to over 600 megacycles u.h.f. • Output from zero to 125 v. • Low in cost • Used by Signal Corps • Write for information.

**GENERAL TEST EQUIPMENT**  
38 Argyle Buffalo 9, N. Y.

### RADIO ENGINEERING DEGREE IN 27 MONTHS

Intensive, specialized course, including strong basis in mathematics and electrical engineering, advanced Radio Theory and Design, Modern Laboratory. Low tuition. Self-help opportunities. Also 27-month courses in Aeronautical, Chemical, Civil, Electrical and Mechanical Engineering. Gov't approved for G.I.'s. Enter March, June, Sept. Catalogue.

**INDIANA TECHNICAL COLLEGE**  
910 E. Washington Blvd., Fort Wayne 2, Indiana

**\$1.95 ea.** { 5 IRC 50K 100W BLEEDERS  
4HY 250MA 90 OHM CSD CH  
1000 or 5000KC MTD XTAL

AN/APA 10 PANADAPTER, 21 tubes can be used as scope. 110V 400CY input \$95.00. DC SUPPLY 12VDC at 5A, SELENIUM, 110V input. Completely wired (less filter) just plug in. \$14.95  
866 Fil Xform 2.5V at 10A Cased. 3.25

3" METERS	
0-200uA WH	\$10.50
0-1maDC S scale	3.95
0-1maDC WH	7.50
0-2maDC SIMP	4.95
0-15maDC GE	3.45
0-20maDC WH	3.45
0-100maDC DEJ	3.45
0-200ma GE	3.45
0-1000maDC	3.95
0-2AMP DC SIMP	\$4.95
0-8VAC WEST	3.95
0-150VAC TRIP	5.95
0-50AMP AC WH	5.50
0-75AMP AC TRIP	5.50

2" METERS	
0-30AMP DC GE	3.45
0-30VDC GE	3.45
0-300VAC TRIP	5.95

CHOKES	
6HY 50 MA 90 ohms	\$0.39
8HY 150MA 140 ohm	\$1.39
6HY 80MA 240 ohm	75
5HY 300MA 75 ohm	3.75

CAPACITORS	
4MF 600VDC oil	\$0.79
10MF 600VDC oil	1.10
2MF 2000V oil	2.49
8uF 1000VDC oil	1.35
4MF 2000VDC oil	3.95
.01uF 1200V mica	.39
1MF 15KVDC oil	17.50
.002uF 2500VDC mica	.49
.005MF 2500VDC mica	.49

**POLY-TECH**  
919 DAWSON ST., NEW YORK 59, N. Y.  
25% Deposit with orders, balance C.O.D.

# STAY ON THE AIR WHEN POWER FAILS...with an ONAN Electric Plant



**AUTOMATIC  
START & STOP**

Model 10EL, 10KW A.C.

When storms, floods, or fires interrupt electricity and force you off the air, you lose listeners and income. Guard against loss, assure vital public service during emergencies by installing an Onan Electric Plant. Onan Standby Electric plants serve many network and private stations. Automatic models to 35,000 watts.

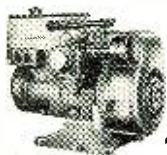

**PORTABLE ELECTRIC PLANTS  
FOR MOBILE RADIO USES**  
Supply A.C. power for broadcasting at scene of events. Can be carried by hand or in trunk of car. Weigh as little as 80 pounds. A.C. models 350 to 35,000 watts.

Write for **FREE Folder**



**D. W. ONAN & SONS INC.**  
4804 Royalston Avenue  
Minneapolis 5, Minnesota

## ACORN



**G.E. 8" SPEAKER  
S-810D**  
With Aluminum Foil Base  
Voice Coil

6.8 oz. Alnico V Magnet,  
3.2 ohms, 1" v.c., 12w  
output. Excellent frequency  
range. List price \$12.  
**OUR PRICE** .....

**\$329**

### MAGNET FOR MAGNETRONS

Made by Cinaudagraph. C.F.S.  
4866 Gauss.



**BRAND  
NEW \$495**

### FILAMENT TRANSFORMER Thordarson and Stancor

Pri. 115v 60 cy. Sec. 6.3v 10 amps.  
c.t.

**\$299**

### KENYON FILAMENT TRANSFORMER

No. T376. 2,000 V. test. Pri. 115v  
60 cy.

Sec. No. 1—5v @ 3 amps.  
No. 2—6.3v c.t. @ 4 amps  
No. 3—6.3v c.t. @ 4 amps

**\$339**

### RG-8U COAXIAL CABLE

Minimum order 35  
feet.  
Short lengths—none  
over 100 ft.

**3¢  
PER FOOT**

### CONNECTORS FOR RG-8U

PL-259, .35c ea.  
PL259a .35c ea.  
SO-239 .39c ea.

### TELEVISION IF TRANSFORMERS

21.9 IF Sound  
..... ea. **89¢**

21.9 Discriminator  
Sound ..... ea. **99¢**

### 300 OHM TWIN LINE

100 ft. .... \$1.49  
1 M ft. .... **12.95**

**WRITE FOR OUR  
FREE MONTHLY  
BULLETINS!**

**TERMS:** 20% cash with order. Balance C.O.D.  
All prices F.O.B. our warehouse in New York City.  
No orders under \$2.50.

Phone: WOrth 4-3270

**ACORN ELECTRONICS CORP.**  
76 Vesey Street, Dept. N-1, New York 7, N. Y.

or high ambient temperatures, are plotted graphically.

The booklet concludes with a tabular presentation of schematic diagrams, formulas for calculating rectifier performance, and cell ratings for a wide range of applications.

For a copy of this booklet, DB 19-025, write *Westinghouse Electric Corporation*, P. O. Box 868, Pittsburgh 30, Pa.

### "NEEDLE TIPS"

*Jensen Industries, Inc.* is currently distributing an interesting sales bulletin "Needle Tips" to jobbers and distributors of the *Jensen* line of phonograph needles.

Written in informal style, the first issue of the bulletin covers such topics as long-playing records, the trend in retail sales of records and accessories, the need for salesmanship, and information about several new needles being introduced by the company.

Copies of "Needle Tips" can be obtained by writing to the company at 329 S. Wood Street, Chicago, Illinois.

### TV "PICT-O-GUIDE"

A second volume of *RCA's* Television "Pict-O-Guide" for video technicians has just been announced by the *RCA Tube Department*.

This popular servicing aid contains troubleshooting photographs which enable the technician to locate TV receiver troubles by the "picture analysis" method. The new book is authored by John Meagher, TV service authority of the *RCA Tube Department*, who also prepared the first volume. Volume 2 contains more than twice as many new pictures and a greatly expanded text to supplement the information in the first book.

These two volumes are unique in the television servicing field and are designed to simplify television service by reducing abstract television servicing theory to practical, down-to-earth working information.

The books are in loose-leaf album form and contain unretouched photos taken from the face of a kinescope which show the effects of operating troubles on the television image. By careful study and comparison of the images appearing on the face of faulty receivers and the photographs in the "Pict-O-Guide" the service technician can narrow down the cause of a faulty image to a specific section of the receiver.

Distribution is through regular *RCA* distributor channels.

-30-

### ANSWERS TO "SCOPE QUIZ" PAGE 132

1. c	5. a	9. a	13. b	17. a
2. a	6. b	10. d	14. c	18. c
3. d	7. d	11. b	15. c	19. c
4. b	8. b	12. b	16. c	20. a

### SCORING TABLE

19-20 correct	.....	excellent
16-18 correct	.....	Very good
13-15 correct	.....	good
10-12 correct	.....	fair
9 or less	.....	poor

## EASY TO LEARN CODE

It is easy to learn or increase speed with an Instructograph Code Teacher. Affords the quickest and most practical method yet developed. For beginners or advanced students. Available tapes from beginner's alphabet to typical messages on all subjects. Speed range 5 to 40 WPM. Always ready—no QRM.



**ENDORSED BY THOUSANDS!**

The Instructograph Code Teacher literally takes the place of an operator-instructor and enables anyone to learn and master code without further assistance. Thousands of successful operators have "acquired the code" with the Instructograph System. Write today for convenient rental and purchase plans.

## INSTRUCTOGRAPH COMPANY

4711 SHERIDAN ROAD, CHICAGO 40, ILLINOIS

### GREYLOCK

#### RADIO TUBE BARGAINS!

GT, Glass and Miniature Types

1R5	6AG5	6BE6	6SQ7GT	12AU7	} <b>\$3295</b> Per 100 ASSTD.
1S5	6AQ5	6BH6	6U7C	12AR6GT	
1T4	6AT6	6J6	6V6GT	12J5GT	
1U4	6AU6	6SA7GT	6X4	25L6GT	
1U5	6BA6	6S17GT	6X5GT	25Z6GT	
3A4	6BA7	6SK7GT	12AU6	11Z3	

Also available in smaller quantities at 39c each.

#### SPEAKER SPECIALS!

3", 4", or 5" PM, less output, Alnico

5, each ..... 97c

In cartons of 30, each ..... 87c

6" x 9" Oval PM, Alnico 5, 3.16 oz. magnet, each ..... \$2.59

In cartons of 24, each ..... \$2.39

TERMS: Net C.O.D., F.O.B. NYC.



MINIMUM ORDER \$10.00.  
Write for Terrific CR Tube Prices and Bargain Catalog N-1

**Greylock Electronics Supply Co.**  
30 Church Street New York 7, N. Y.

## HAMMOND ORGANS WANTED

Any Model — Any Condition

**Box 492, % RADIO  
& TELEVISION NEWS**

185 N. Wabash Ave.  
Chicago 1, Ill.

### SUB-MINIATURE

## Printed Electronic Circuits

on ceramics, glass electron tubes, plastics and paper bases from your schematics. Special attention given to small orders. All service and correspondence held strictly confidential.

Write for full details and our latest bulletins on **printed circuit components and assemblies** available from stock.

**PLASTICS & ELECTRONICS COMPANY**  
P.O. Box 38, Station J Buffalo 8, New York

## R & T BARGAINS

KEY Code practice TAC J38 (prepaid) .. \$0.59  
CATHODE RAY TUBE 5CP7 ..... 1.49

TRANSFORMER Kenyon Trans. Co. primary  
110v 60cy; seedy. 5v 60amp CT. .... 4.49

METERS Westinghouse or Weston 0-150v  
2 inch panel mount. .... 2.79

SCR522 and SCR274N still available. Reasonable.

F.O.B. Berwyn, Md. Cash with order. Orders without postage will be shipped express collect. No exports.

**R. & T. ELECTRONICS COMPANY, INC.**  
9715 Baltimore Blvd.

Berwyn, Md. Phone: TOWer 5384



# Crystal Receiver

(Continued from page 39)

The author's socket (See Figs. 6 and 8) consists of a ring-shaped base shell for clamping the CK-703 shell, and two short lengths of spring wire for pressure contact against the side of each base pin. The wafer is a rectangular piece of thin lucite, but can be made of bakelite or other phenolic. The CK-703 is inserted into the tight-fitting base shell, and its pins pass through small-diameter clearance holes in the wafer to be contacted by the straight wire springs mounted underneath. Small soldering lugs are provided for circuit connections to the three contact members of the socket.

Since the contact pins protrude just below the center line of the CK-703 base (See Fig. 5B), the unit can be plugged into the socket only in the correct position. Thus, all danger is removed of inserting emitter or collector pin into the wrong hole.

The entire audio amplifier is built on a strip of  $\frac{1}{16}$ -inch-thick bakelite,  $4\frac{7}{8}$ " long and  $1\frac{3}{4}$ " wide. Fig. 2 is a view of this amplifier strip. All components are mounted on the strip, except condensers  $C_3$ ,  $C_4$ , and  $C_5$  which are mounted directly under the main chassis (See Fig. 3), and electrolytic condenser  $C_6$  which is "hung" between the battery terminals. The small coupling transformers are held to the strip by means of bands bent from  $\frac{3}{16}$ -wide brass. (These mounting bands must not be used if the transformers are mounted directly in contact with a metal chassis, since they might form eddy current loops). The amplifier strip is supported on the chassis (See Fig. 1) by means of four 1-inch 6-32 screws.

The entire set, as shown in Fig. 1, is built on a 7"x7"x2" metal chassis. The tuning dial plate is home-made. The headphone jack, which must be insulated from the chassis, is mounted along the front lip of the chassis, as is the battery "On-Off" switch.

The author employed a 2-section tuning condenser (with only one section in use), as shown in Fig. 1, simply because a single-section unit was not immediately available. The antenna coil,  $L_1$ , is mounted under the chassis directly below the tuning condenser. This coil is provided with a slip-over primary ( $L_2$ ) which may be slid off temporarily while a center tap is soldered to the secondary coil ( $L_2$ ).

Center tapping the coil is a delicate operation, since the coil is wound with rather fine wire. But it can be accomplished easily, provided a reasonable amount of care is used. Locate the center turn and, using a sharp razor blade, carefully scrape about  $\frac{1}{4}$  inch of the enamel off the wire. Avoid scraping the adjacent turns. Solder a length of No. 32 insulated wire to this scraped portion, replace the primary, and run the tap lead directly to the 1N54 crystal diode.

# TUBES! NATIONALLY ADVERTISED BRANDS TUBES!

RCA—Kenrad—Sylvania—Tung-Sol—National Union—G. E.—Philco—Hytron  
All new tubes. 100% guaranteed. Individually boxed.

TYPE	PRICE	TYPE	PRICE	TYPE	PRICE	TYPE	PRICE
DA4G	\$.09	3U4C	\$.09	7N7	\$.08	31	\$.09
D41	.10	5Y4G	.15	707	.72	32	1.15
DZ1	.50	6X4	.85	7V7	.96	32L7GT	1.15
LA3	.80	5Y4G	.85	7W7	.96	34	1.15
LA5P	1.40	5Y3GT	.45	7X7	.96	34	1.15
LA5P	.65	5Y4G	.54	(XXFM)	.96	35	.72
LA6	1.15	5Z3	.65	7Y4	.72	35A5	.72
LA7GT	1.40	5Z4	.65	7Z4	.72	35B5	.72
IB4P	1.40	6A3	.96	10	1.40	35L7GT	.66
IB5/25S	1.15	6A4/LA	.96	12A	.65	35W4	.45
CB5GT	.80	6A6	.96	12A5	1.15	35Y4	.65
CB6	1.15	6A7	.72	12A6	.96	35Z3	.65
1D5	1.40	6A8GT	.72	12A7	1.15	35Z4GT	.54
1D5GP	1.15	6A8T	1.15	12A8	.72	35Z5GT	.45
1D7G	1.40	6A9	.96	12AH7GT	1.40	36	.96
1D8GP	1.40	6AC7	.96	12AT6	.60	36	.96
EG5GP	1.40	6AD7G	1.15	12BA6	.65	38	.80
1F5	.96	6AE6	1.40	12BB6	.65	39/44	.96
1G4	.96	6AF6G	.96	12C8	1.15	41	.60
1G6GT	.96	6AG5	.96	12H6	.65	42	.60
H4G	.80	6AL5	1.25	12J5GT	.54	43	.60
H6GT	.60	6AL7	.96	12J7GT	.72	45	.60
1B6	.96	6AQ5	.72	12K7GT	.60	45Z3	.65
1L4	.72	6AT6	.54	12K8	.65	45Z5GT	.65
1LA4	.96	6AUB	.72	12Q7GT	.65	46	.96
1LA6	.96	6B4E	.65	12SA7GT	.65	47	.85
1LB4	.96	6B4E	.65	12S6T	.90	48	.80
1LC5	.96	6B4G	.96	12SF5	.65	49	.96
1LD5	.96	6B8G	1.15	12SF7	.72	50	1.40
1LD5	.96	6C4	.60	12SG7	.72	50A5	.80
1LE3	.96	6C5	.60	12SH7	.80	50B5	.72
1H4	.96	6C6	.72	12S17	.60	50X6	.80
1H5	.96	6C8G	1.15	12SK7GT	.60	50Y6GT	.65
1N5GT	.80	6D8	.60	12SL7GT	.85	51	.96
1N5GT	.80	6D8	1.15	12SN7GT	.80	53	.96
1N5GT	.96	6E5	.80	12SQ7GT	.60	56	.65
1N5GT	.96	6F5GT	.80	12SR7	.80	58	.72
1N5	.96	6F6	.72	1223	.96	70L7GT	1.40
1N5	.96	6F6	.72	14A4	.96	71A	.72
1N5	.96	6F7	.85	14A5	.80	75	.60
1N5	.96	6F8G	1.15	14A7	.80	76	.60
1T4	.72	6G6G	.96	14B6	.80	76	.60
1T5GT	.96	6H6GT	.60	14C5	.80	78	.60
IV	.80	6J5GT	.54	14C7	.80	79	.96
2A3	1.15	6J6	.96	14F7	.80	80	.45
2A4	1.15	6J7	.96	14H7	.80	81	1.40
2A6	.96	6K6GT	.54	14N7	.96	82	.96
2A7	.96	6K7	.60	14N7	.96	83V	1.15
2B7	.96	6K8	.85	14Q7	.80	84/6Z4	.65
2X2	1.15	6L6GA	1.15	14R7	.80	85	.80
3A4	.72	6L7	1.15	14W7	.96	89	.80
3A8	1.75	6N7	.85	24A	1.40	117L7GT	1.40
304	.80	6P5GT	.80	25A	.80	117M7GT	1.40
303GT	.85	6Q7	.72	25A	.80	117N7GT	1.40
354	.72	6R7	.96	2525	.54	117Z3	.65
5T4	1.40	6S7	.85	2526GT	.60	117Z6GT	.85

**SPECIAL "ALL AMERICAN" PACKAGE DEAL**

10 each of the following tubes

**12SA7GT—12SK7GT**

**12SQ7GT**

**35Z5GT—50L6GT**

50 Tubes for only **\$24.95**

All Nationally Advertised Brands Package Cannot Be Split

6S8GT	\$.85	6V7G	\$.96
6SA7GT	.60	6W7G	.96
6SC7	.72	6X5GT	.54
6SD7GT	1.15	6Y6G	.85
6SF5	.72	6Y7G	1.15
6SF7	.72	6Z7G	1.40
6SH7	.80	6Z7G	1.40
6S17	.60	7A4	.72
6SK7GT	.60	7A5	.72
6SL7GT	.85	7A6	.72
6SN7GT	.80	7A7	.72
6S7	.60	7B4	.72
6S7	.60	7B5	.72
6S7	.65	7B6	.72
6S7	.96	7B7	.72
6S7	1.15	7C5	.72
6S7	.96	7C6	.72
6S7	1.15	7C7	.72
6S7	.72	7E6	.72
6S7	.72	7E7	.80
6S7	.65	7F8	.96
6S7	.65	7F9	.96
6S7	1.15	7H7	.72
6S7	.72	7L7	.80

**TERMS: 25% with Order**  
Balance C. O. D.—F. O. B. Chicago. Prices Subject to Change Without Notice.  
Minimum Order \$2.00.

**FRANKLIN-ELLIS CO. 1313 West Randolph Street**  
Dept. RN-1A Chicago 7, Illinois

## SAVE UP TO 95% SENSATIONAL SURPLUS VALUES!

**TBY8 TRANS-CEIVER**  
VHF Transmitter-Receiver 28-80 MC  
In 4 Bands  
Voice or MCW  
XTAL Calibrated on 130 Channels,  
Uses 2-30 Tubes.  
1-1E7 & 1-959.  
Comes with Carrying Trunk, Vibropack, Reaset and Mic. Ant. Spare Tubes, Instruction Book, Canvas Carrying Case.  
Like New. **\$49.00**  
Orig. \$150.00

**ARC-5 VHF TRANSMITTER**  
T-23 XMITTER: MCW & phone on 4 channels, 100-156 MC, automatic turret tuning, tank circuits remote controlled. 4 tubes 2-1625, 2-832A. Originally **\$30.00**  
All Plugs, Racks, Control Boxes, etc. for ARC-5 274N Equipment available  
**BRAND NEW APS-13 WARNING RADAR**  
17 Tubes as follows: 9-6AB5, 5-6J6, 2-2D21, and VR-105, 410 to 420 MC. and 30 MC. IF. Good deal for conversion & citizen band. With instruction book.  
Orig. over \$100. **\$17.50**

**ARB RECEIVER**  
6-Tube, 4 Band Super Het. Frequency Range 156 Kc to 9 Mc.  
Covering Range Broadcast, Boat and Amateur Frequencies. The Unit also has facilities for Loop Input, with Tubes, Dynamotor. Used.  
Very clean condition **\$24.50**

**ASB-7 INDICATOR**  
Makes a beautiful scope foundation kit. Has 5BPL, 4-6AC7, 3-6H6. Can also be used for remote television indicator with **\$10.75** conversion. Good cond. Orig. \$30.00

**COMMAND RCVRs.**  
Tested Before Shpg. W/DYN.  
190-350 KC. Used. Orig. \$40 Now **\$9.95**  
3-6 MC. Used. Orig. \$30. Now. **4.95**  
3-6 MC. New. Orig. \$35. Now **6.50**  
6-9.1 MC. Used. **7.95**  
520-1500 KC. Used. Orig. \$85. Now **\$24.50**

**COMMAND XMITTERS**  
BC-459 7-9.1 Mc. Excell. Cond. **\$ 8.95**  
Y-22 ARC-5 7-9.1. New. Orig. \$50. Now **12.75**  
3-4 MC. Used. Orig. \$50. Now **12.95**  
5.3-7 MC. Used. Orig. \$30. Now **4.95**  
Y-21 ARC-5 5.3-7. New. Orig. \$40. Now. **6.75**  
4-5.3 MC. Used. Orig. \$30. Now **3.95**  
T-20 ARC-5. New. Orig. \$40. Now **6.95**  
2.1-3 MC. L.N. Orig. \$40. Now **12.75**

**ARC-4 VHF TRANSMITTER**  
140 to 144 Mc. Crystal Controlled. Xmitter has 832 final Modulated by 6L6's. 10 Watt Output. 13 Tube Receiver, containing 2 individual RF sections and a 10 Mc IF Amplifier. Both RF sections may be operated simultaneously or either one individually. Comes with Xtal, Dynamotor and Tubes. Used. Good.  
Originally \$150.00. **\$17.49**

**BC-611 "HANDIE-TALKIES"**  
No wires to attach. Easy to operate. Push button controlled. No skill necessary. Already tuned to set frequency. Crystal controlled. Transmitter and receiver in same case. Only 5 1/2 lbs. with batteries (batteries can be supplied). Small. 15 1/2" x 3 1/2" x 5 3/4". Aluminum case. Frequency coverage 3500 to 6000 KC. Complete with tubes, crystals and 1 set of batteries.  
BRAND NEW. Large Quantity Available. **PRICE ON REQUEST**

**BC-1072 XMITTER**  
157-187 MC. Input 117VAC 60 cy. Has parallel rod OSC using 2-826 PP. contains power supply, general radio variac 1.5A. 3 1/2" 0-5 kilovoltmeter, 10 tubes and loads of other parts too numerous to mention. With tubes. Less Blower. **\$19.75**  
Used.

**GO-9 XMITTER**—Brand New with tubes for HI-Freq. and Mod. Unit only. Consists of 3 Units. HI-FREQ. XMITTER 3000-18000 Kc Band Switching, 837 ECO, 837 BUFFER, and 803 FINAL AMP. LOW-FREQ. SECTION uses 801 OSC, 807 Buffer, 803 Final Amp. Freq. Range 300-600 Kc. RECTIFIER UNIT 523 Low-Voltage Rect. 2 Type 1616 HI-V. Rect. Refer to surplus list for conversion manual for complete writeup and conversion to 10 meters. **\$79.50**

**BC-1068 RCVR**  
150-210 MC. Input 115VAC 60 cy. Inductance tuning for RF ant., detector & OSC. Has tuning ind. with few conversions. Makes good 2 meter or FM receiver. With 14 Tubes. Used. **\$22.50**  
BOTH BC-1058 and BC-1072. **\$38.95**

**COLLINS AUTO-TUNE XMITTER**  
2-18 megs 100 watt output.  
Uses 813 final, 811's mod.  
With tubes and xtal., control box and cables. Excellent condition **\$169.50**

**BC-924 FM XMITTERS**  
Freq. range 27-39 MC. 35 watts output 4 channels, tunable throughout entire range, band width 20 Kc, ECO controlled, 2-6S17, 2-6J5, 1-8AG7, 1-8V6, 1-VR-150/3A, 1-6SL7, and 2-815.  
Complete with tubes, less dynamotor. **\$21.95**

**AMERICAN RADIO & ELECTRONICS SUPPLY**  
DEPT. R-5 2033-37 W. VENICE BLVD. LOS ANGELES 6 CALIFORNIA  
Send 30¢ with order or full price. Save C. O. D. charge. Shipments made via Railway Express unless other instructions given. Prices subject to change without notice. Merchandise subject to prior sale. Quantity Prices on Request. WRITE FOR CATALOG.

# SAVE MONEY BRAND NEW GUARANTEED GENERAL ELECTRIC SELSYN

Type 2J1G1

Will operate from 110 volts, 60 cycle by using a resistor or a condenser in series. Size is  $2\frac{3}{4}$ " in diameter x  $4\frac{1}{2}$ " long. Ideal for beam antenna position indicator.



Price **\$2.75**  
per pair — removed from new equipment

## HAYDEN TIMING MOTORS

Type 45629R

110 volts, 60 cycle, 2.2 watts, 1/240 R.P.M.

Price **\$3.00**  
ea. net, new

Type 36938-2

110 volts, 60 cycle, 2.2 watts,  $\frac{1}{2}$  R.P.M.

Price **\$3.00**  
ea. net, new

Type 33669-2

110 volts, 60 cycle, 2 watt,  $\frac{1}{60}$  R.P.M.

Price **\$3.00**  
ea. net, new

Type 1600

110 volts, 60 cycle, 2.3 watts, 1 R.P.M.

Price **\$2.70**  
ea. net, new

NEW ADDRESS

**INSTRUMENT ASSOCIATES**  
37 EAST BAY VIEW AVE.  
GREAT NECK, N. Y.  
IMperial 7-1147



He's doing fast, profitable business with the complete Phoenix line of television mounts and accessories. Are you one?

There's a **PHOENIX** Mount and Accessory for Every Television need!

**PHOENIX** ELECTRONICS, INC.  
Lawrence, Mass.

AT LEADING JOBBERS  
Write for folder V of complete line of television accessories.

For simple mounting, the 1N54 pig-tails are soldered to a 2-lug insulated terminal strip mounted near the coil. The r.f. bypass condenser,  $C_2$ , is mounted near the 1N54. Load resistor  $R_1$  is mounted on the audio amplifier strip near the first CK-703.

Hookup wire leads from the amplifier strip and battery pass through clearance holes in the chassis to reach under-chassis contact points. A stiff, bare lead extends from the tuning condenser stator lug through a large chassis clearance hole to the coil,  $L_2$ , below the chassis.

### Testing and Alignment

Do not connect the battery until all connections in the circuit have been checked and found to be correct. After verification, connect the battery, plug in the high-impedance headphones, and throw the "On-Off" switch to "On." A gentle rushing sound should be heard, due to the inherent noise level of the crystal triodes, but there should be no oscillation nor singing. If there is oscillation, it will be necessary to re-rin critical leads and possibly to orient the transformers to prevent the feedback.

A modulated r.f. signal generator may then be connected to the antenna and ground leads of the receiver and the dial calibrated at fixed broadcast band points in the usual manner. Use the signal in the headphones to indicate resonant points, or connect a high-resistance a.c. voltmeter in parallel with the headphones for visual in-

dication. If a manufactured broadcast dial is used, line-up first at the top of the band (1600 kc.) and bend the outside plates of the tuning condenser to make the other frequencies coincide with the dial graduations.

The noise level of the crystal triodes is somewhat higher than with comparable triodes in the same circuit, but is not objectionable in this arrangement. In the absence of a signal, a soft steady hiss will be heard.

Current drain of the amplifier is low and the battery consequently will give long service. However, the receiver should be switched off whenever it is not in use. This will prolong the life of the battery and of the crystal triodes as well. The set should not be left connected to the outside antenna during a thunderstorm unless an efficient lightning arrestor is attached.

No data is available at this writing regarding transistor life. The crystal triode is not yet old enough to have undergone prolonged life tests. However, it seems reasonable to expect life comparable to that of germanium diodes which presently are guaranteed up to 5000 hours.

The little receiver shown in this article is only an example of successful crystal triode application. The author does not intend to imply that this is the ultimate by any means. Certainly, a much smaller set could be built and a smaller battery of the hearing aid type could be employed. Higher power output can be obtained by using 4

Fig. 8. Construction details of transistor socket. The terminal markings (E, C, and B) indicated on both of the lower drawings refer to the symbols given in Fig. 5A.

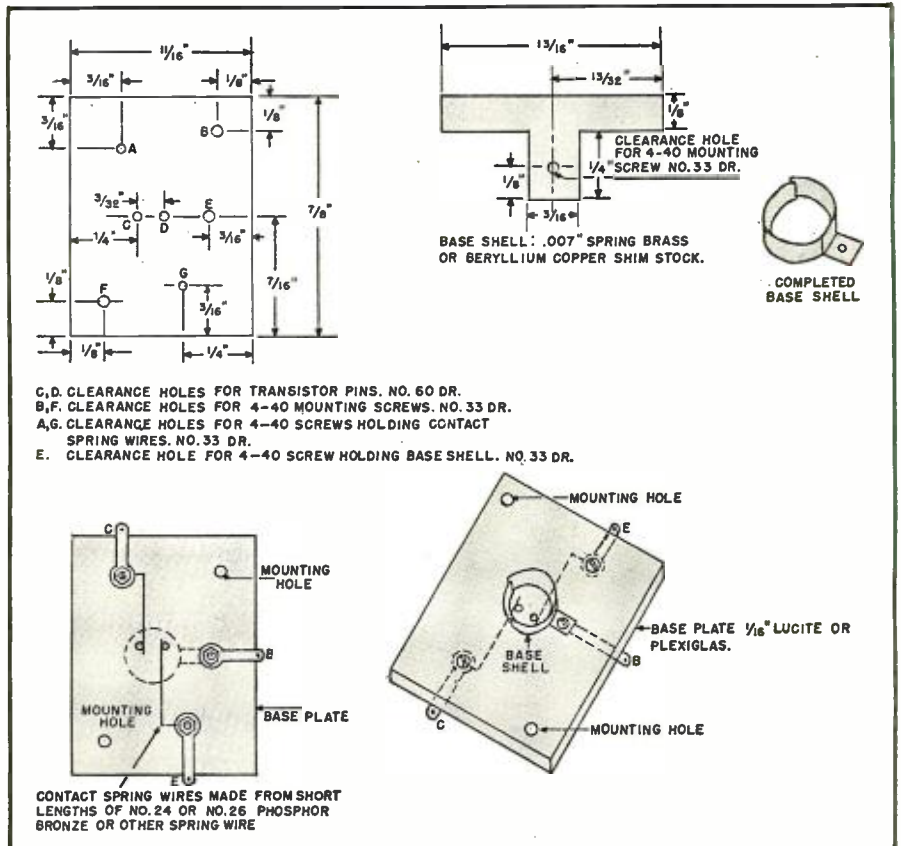

# RADAR, COMMUNICATIONS AND SONAR TECHNICIANS W-A-N-T-E-D

## For Overseas Assignments

### Technical Qualifications:

1. At least 3 years practical experience in installation and maintenance.
2. Navy veterans ETM 1/c or higher
3. Army veterans TECH/SGT or higher.

### Personal Qualifications:

1. Age, over 22—must pass physical examination.
2. Ability to assume responsibility.
3. Must stand thorough character investigation.
4. Willing to go overseas for 1 year.

Base pay, Bonus, Living Allowance, Vacation add-up to \$7 000 00 per year. Permanent connection with company possible.

Apply by Writing to  
D-4, P.O. Box 3575,  
Philadelphia 22, Pa.

Men qualified in RADAR, COMMUNICATIONS or SONAR give complete history. Interview will be arranged for successful applicants.

# HOW

**LEARN HOW TO SIMPLIFY RADIO REPAIRS!**

**Free Manual**

Nothing complex to learn, no calculating. Used by beginners and experts. Send for FREE manual, "THE INSIDE STORY," today. 32 pages—illustrated—easy to read! Shows how obsolete methods prevent full use of your real ability. Explains use of NEW techniques. You owe it to yourself and your future to "get out in front" in your work.

**FEILER**

SEND COUPON OR PENNY POSTCARD FOR FREE MANUAL TODAY!

---

FEILER ENGINEERING CO., Dept. 1-R5  
1601 S. Federal St., Chicago 16, Illinois

Please RUSH my FREE copy of "The Inside Story."

Name .....

Address .....

City..... Zone..... State.....

transistors in push-pull parallel in the output stage. A crystal triode r.f. amplifier might be added. An individual experimenter may prefer to employ fixed emitter bias, possibly derived from a "lower than ground" point on a voltage divider across the battery. Many applications, other than receivers and audio amplifiers, will undoubtedly occur to the reader. -30-

## ANTENNA FOR THE SWL

By CHARLES KUNDE

DESPITE the large number of short-wave listeners currently pursuing their hobby there is surprisingly little data on suitable antennas available for the SWL. The usual operating manual accompanying a short-wave receiver devotes a few lines to the antenna problem and lets it go at that. Books on antennas devote a major portion of their space on transmitting antennas with maybe a footnote indicating that these antennas may also be used for reception on that particular wavelength.

What SWL wants to go to a great expense or a lot of trouble to set up an elegant beam cut for ten meters when he can have more fun listening to all the bands? When the band for which his antenna is cut starts to fade the results obtainable on other bands are not going to be too good either.

Thus, it appears that to get the utmost satisfaction from his receiver he will have to plan on a number of antennas that will come close to giving good response in a wider group of bands, with a minimum amount of labor and expense.

Employing for the purpose a low-priced modern short-wave receiver (S-38), the writer has found that by having a switching arrangement that is simple to make and by installing three very ordinary antennas he could get excellent results and interesting activity most of the time. None of the antennas require much labor or cash.

Antenna number one is a vertical rod which may be anywhere from six to twenty feet high. Antenna number two is a fourteen foot, seven inch length of 300 ohm transmission line used as a folded dipole and covering the ten meter band. The third antenna is a straight wire from forty to sixty feet in length which may be anything from bell wire to outdoor rubber-covered wire.

The average clothes closet or back porch will easily house the vertical, with any kind of wire running to the switchboard. The 300 ohm transmission line dipole will be fully concealed under a rug or hidden behind a picture molding. The long straight wire can be run from the front window to the back window or stretched along the floor somewhere. If the SWL has access to an attic or a roof, the job will, of course, be much neater.

The lead-ins from these simple antennas are then run to a main switchboard which is equipped with three d.p.d.t. switches mounted on masonite and wired or fastened in any acceptable manner.

The use of this antenna will provide an interesting study on the effects secured by going from one antenna to another at various stages of band response. In addition the short-wave log should show a nice increase in listings.

-30-

## At last—a built-in booster!

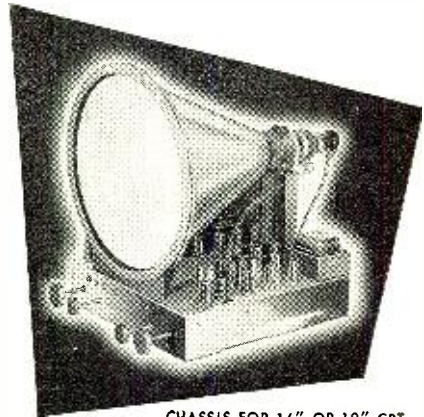

CHASSIS FOR 16" OR 19" CRT  
25 TUBES PLUS 4 RECTIFIERS

### ... brings 'em in out of the snow



**FRINGE AREAS** now can enjoy excellent reception without cumbersome,

costly external boosters! Craftsmen Television alone gives you a built-in booster that literally brings a picture right out of the "snow"—gives a 10 db. video boost simply by shifting a knob! Unparalleled performance, and it will not interfere with audio reception.

FM CHANNELS now are available on the Craftsmen RC-100. And this outstanding television—engineered from the mounting bolts up for big picture operation—is twice as sensitive as before! Automatic phase control of both vertical and horizontal synchronization guarantees perfect interlace. Keyed AGC, too. Will accommodate UHF channels.

COMPLETE THE PICTURE with Craftsmen high fidelity audio—RC-8 FM-AM tuner featuring automatic frequency control that entirely eliminates drift, and RC-2 high fidelity amplifier.

THE RADIO  
**craftsmen**  
INCORPORATED

Write for Information—or send 50¢ for instructions and schematics.

Dept. D, 1617 S. Michigan Ave., Chicago 16, Ill.



Stay On Top  
in TV Get

# TELEVISION SERVICING for RADIO MEN

Get This Much Needed Book Now and  
Keep Up-to-Date—Helps You Earn More

This is the TV book of the hour, and it's for the professional radio man only. Not for TV owners who want to tinker with their sets. It starts where the radio man's knowledge and experience with AM sound receivers stops and provides simplified instruction, easy to follow, on all service operations. If you are in radio work, get this timely book now. Protect your job and your future with TELEVISION SERVICING—the complete TV service manual that will keep you up-to-date. Covers alignment and other adjustments, replacements, test set-ups and connections, and trouble shooting with test patterns and oscilloscope traces. Includes instructions for using sweep and marker generators, oscilloscopes and electronic voltmeters in such work. Over 400 pages. 302 illustrations. The only book of its kind.

### Be an Expert on All These Subjects

The Television Picture—Section—Sweep Oscillators—Automatic Control of Sweep Frequency—Sweep Amplifiers and Controls—Magnetic Deflection Amplifiers—Television Power Supplies—Trouble Shooting with Test Patterns.

### Rush Order Today

Get this practical, helpful Television Servicing now. Protect your job and your future. Rush order to F. J. Drake & Co., 117 Green Bay Road, Dept. 191, Wilmette, Ill.



Mail Coupon  
MONEY BACK IF  
NOT SATISFIED

Frederick J. Drake & Co., Dept. 191  
117 Green Bay Road, Wilmette, Ill.

Send me Television Servicing for Radiomen. If not satisfied I will return book in 5 days and money will be refunded.

- Check or Money Order for \$4.00 enclosed. Send book postpaid.  
 Send C.O.D. plus postage.

Name .....

Address .....

City ..... State.....

## L. I. SPECIALS

20 asst xmtg restrs & cndrs.....	\$1.50
Dynamotor gear reduction assy.....	.35
Shockmount for small rig.....	.35
Tuning shaft for SCR 269, ARB.....	2.45
ARC5/274N Tuning shaft.....	1.95
Dual-trans rack 274N. 59c. Quad.....	.89
Shockmounts for 274N.....ea.	1.45
200KC Crystal for ART13.....ea.	4.25
Plug for BC348, BC733, APN1.....ea.	.43
BC348 dual-section pot.....ea.	2.25
MC211A r/angle drive.....ea.	.75
MT36C Load Unit, like new.....	85.00
TS10A/APN Test Set, new.....	40.00
IE36 Test Set, new.....	30.00
TS16 Test Set, new.....	145.00

Please include sufficient postage

LONG ISLAND RADIO CO.  
164-21 Northern Blvd., Flushing, N. Y.

## Technical BOOKS

"TELEVISION SERVICING FOR RADIO MEN" by H. P. Manly. Published by Frederick J. Drake & Co., Wilmette, Illinois. 406 pages. Price \$4.00.

This is a practical elementary text written for the radio technician who wishes to add television to the services rendered by his shop.

The author has assumed that his reader is familiar with the elementary principles of radio, the technique of servicing AM receivers, and the various types of test instruments used in such work. Other than these three assumptions the author takes nothing for granted. He starts his discussion with the picture tube and progresses painstakingly through television receiver circuits.

There are chapters on the television signal, the r.f. section, the video i.f. amplifier, the video detector, and the video amplifier as well as a discussion of the instruments used for alignment. Other chapters discuss the alignment of video i.f. and traps, the sound section and its alignment, front-end alignment, intercarrier sound, picture tube controls, signal input to the picture tube, the sync section, sweep oscillators, automatic control of sweep frequency, sweep amplifiers and controls, magnetic deflection amplifiers, television power supplies, and trouble-shooting with test patterns.

The book is well-written, the language clear and straightforward. Persons with a basic working knowledge of radio should experience no difficulty in grasping the subject matter as presented in this text. The book is prepared as a self-help manual but could be equally well adapted to classroom instruction. The text material is lavishly illustrated with diagrams and photographs.

"SATURATING CORE DEVICES" by Leonard R. Crow. Published by The Scientific Book Publishing Co., Vincennes, Indiana. 367 pages.

This book, which has been designed as a handbook for students at the elementary electrical engineering level, is intended as an introduction to this vast subject rather than an all-inclusive text.

According to the author his purpose was to offer a collection of simplified descriptions of saturable core devices and their applications. This purpose has been admirably achieved. The book is divided into twelve chapters and two appendices. The author discusses in some detail such subjects as the fundamentals of saturable-core reactor devices, applications and modifications of d.c. controlled saturable-core reactors in non-electronic applications, saturable-core reactor applications involving special and ad-

## Build Your Own Geiger Counter

(See Radio & Television News—July, 1949)  
Type 1B98 GAMMA COUNTERS  
ONLY \$9.87

BC-1206C—BEACON RANGE RECEIVER.  
"LAZY Q-FIVER"—BRAND NEW. Complete with tubes.....\$5.95

SPECIAL!!

FL-8A FILTERS . . . \$1.37

SURPLUS EQUIPMENT  
TROUBLE SHOOTING MANUALS  
(includes schematics)

BC-348 SCR-522 \$1.10 ea.

BC-779 BC-610 postpaid

BRAND NEW SOUND POWER PHONES

TS-10 HANDSET—\$8.92 ea., \$17.60/pr.

RCA Navy head and chest set—20 ft. cord—\$14.88 ea., \$28.00/pr.

RCA sound power unit. Use as mike or recvr.—\$1.11 ea., \$2.22/pr.

G.E. 2J1G1 selsyns—new \$1.16 ea.

Caps for conn. to 2J1G1 selsyns—39c.

T-17 mikes, clean, used—69c.

Std. 6V 4 prong vibrators—69c, 10/\$5.00.

Send for free monthly bulletin

ELECTRONIC RESEARCH LABS.

1021-R Gallowhill St. Phila. 23, Pa.

## TUBES • TUBES • TUBES

NATIONALLY ADVERTISED BRANDS ONLY

BRAND NEW—BRAND NEW

0Z4 . . . \$0.55	5U4 . . . \$0.59	6Y6 . . . \$0.69
1A7 . . . .69	5V4 . . . .89	6SA7 . . . .49
1B3 . . . 1.44	6A3 . . . .79	6SK7 . . . .49
1H5 . . . .69	6A7 . . . .69	6SQ7 . . . .49
1LN5 . . .69	6A8 . . . .89	12SA7 . . .55
1LA4 . . .89	6AC7 . . .79	12SK7 . . .55
1LA6 . . .89	6AQ5 . . .89	12SQ7 . . .49
1LC6 . . .89	6AU6 . . .69	35Z5 . . .42
1N5 . . . .69	6BG6G . 1.69	50L5 . . .55
1Q5 . . . .79	6CG . . . .59	35L6 . . .55
2B7 . . . .69		

We carry a complete line of Tubes

Write Dept. RNI for Descriptive Literature

All Prices F.O.B., New York. 25% Deposit required on All Orders. Minimum Order \$5.00.

THE ROSE COMPANY, 98 Park Place  
NEW YORK 7, N. Y. (Corner Greenwich Street)

## WANTED!

COMPLETE SETS SCR-195  
(Walkie-Talkie)

or any of following components

Transceiver BC-322 — Bag BG-71

Chest CH-33 (Containing spare parts)

Antenna AN-30-B — Handset TS-11-E

Cord CD-195 (Has built in resistor)

Mast Base MP-22 — Binding Post TM-176

ADVISE QUANTITY, CONDITION AND PRICE

COASTAL AVIATION CORPORATION

447 Calvert Avenue, Alexandria, Virginia

Attention:

SERVICEMEN, TECHNICIANS,  
EXPERIMENTERS, STUDENTS

16" TV METAL CABINET

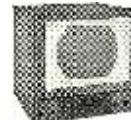

\$2950  
F.O.B.

MAHOGANY WALNUT BLOND  
Permanent Finish

Adaptable to any chassis for 12 1/2-15 or 16". Specify chassis and mask size with order.

20% deposit with order. Balance C.O.D.

GARSON INDUSTRIES

314—67th St., West New York, N. J.

RADIO & TELEVISION NEWS

# FACTORY TO YOU DIRECT!

THE NEW  
*Certified*  
TELEVISION KIT

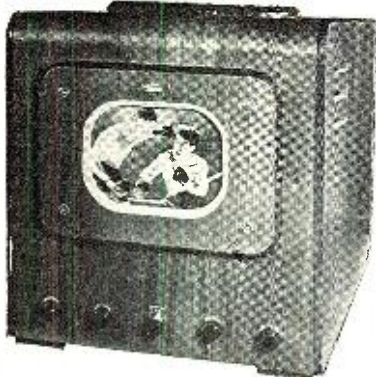

**8 1/2" KIT.. \$59.50**  
**\$89.50 WITH TUBES**

This kit can be used with 10" electrostatic tube without any changes  
This kit includes a 12 channel tuner

Money Back Guarantee—Buy it, inspect it, if you don't think it's the best buy on the market—return unused within five days and your money will be refunded.

All prices F. O. B. New York. 20% deposit with order  
IMMEDIATE DELIVERY

*Certified* TELEVISION LABORATORIES  
5507 — 13th AVE. BKLYN. 19, N. Y.

## RADIO MAGAZINE LIBRARY



Another  
Walter Ashe  
Exclusive!

Here  
it is...

Only **50¢**

A brand new way to preserve every treasured issue of Radio and Television News Magazine.

An ingenious, custom-built storage file made of high quality Kraft fibre board printed and constructed to look like a Buckram bound book. Measures 12" x 8 1/2" x 2 3/16".

per set of 2  
Set of 2 holds  
12 complete issues

(Plus 15¢ per set for pkg. & pstg. anywhere in U.S.)

**SPECIAL OFFER!**

New low prices on QST & CQ Magazine Libraries.

Formerly 35¢  
Now Only **25¢** each

Hold 12 issues  
(Plus 6¢ ed. to cover pkg. & pstg. anywhere in U.S.)

**ORDER YOURS TODAY!**

## RADIO ENGINEERING I

Complete Radio Engineering course incl. Telev., U.H.F., and F.M. B.S. Degree Courses also in Civil, Elect., Mech., Chem., and Aero. Eng.; Bus. Adm., Acct., Visit campus, see well equipped labs. Low cost. Prep courses. Personalized instruction. Grads successful. Founded 1884. Enter Jan., March, June, Sept. Write for Catalog.

**TRI-STATE COLLEGE** 1610 College Ave.  
Angola, Indiana

DEGREE IN  
27 MONTHS

January, 1950

vanced theories of operation, the permanent magnet controlled saturable-core reactor, the a.c. controlled saturable-core reactor, peaking transformers and voltage waveforms, a.c. voltage regulators applying magnetic regulation, saturable-core frequency multiplier apparatus, flux gates or valves, saturable-core type servomechanisms, magnetic amplifiers, and electronics and the saturable-core reactor. A bibliography and a listing of U.S. Patents related to saturable-core reactor devices completes the book.

The generous use of diagrams and charts adds appreciably to the value and easy understandability of this text. The book serves its avowed purpose as a springboard to further study adequately and should find wide acceptance among engineering students and experimenters.

\* \* \*

**"MODERN OSCILLOSCOPES AND THEIR USES"** by Jacob H. Ruiter, Jr. Published by *Murray Hill Books, Inc.*, New York. 318 pages. Price \$6.00.

There has long been a demand for a book which explains, in simple terms, the operation of an oscilloscope. From all indications Mr. Ruiter, due to his familiarity with the field, has come up with the answer to the problem in this book.

The text is written for the electronics student, the radio technician, and the repairman with a background of general physics, however it should prove useful to anyone who uses oscilloscopes in his work. Written in a clear and succinct style it can be easily understood by anyone with elementary electronics training.

Although written for a diversified audience the text is comprehensive to the point that one feels all of the fundamentals of the oscilloscope and its uses have been fully covered.

The oscilloscope, its application, its construction, and operation are thoroughly covered. Considerable space has been devoted to a history of the instrument, the development of the cathode-ray tube, fundamentals of cathode-ray tube operation, and a description of a modern CR tube. The uses of the oscilloscope in AM, FM, and television servicing are covered completely. A chapter on photographing cathode-ray patterns is particularly valuable to those interested in retaining a permanent record of their investigations.

—50—

## RESTORING TUBE MARKINGS

**TUBES** which have obliterated markings often are thrown into a catch-all box and are of no further value to the technician. However, there is a surprisingly simple method of restoring identifying marks on such tubes, making them useful once more.

Marks which at one time have been on the tube leave a roughened surface on the glass. A soft colored pencil rubbed over the surface will cause the original marking to become clearly perceptible in complete detail. . . . P.G.

# BARGAIN COLUMN

## TRANSMITTER-RECEIVER

Navy Model ABA-1—BC-645

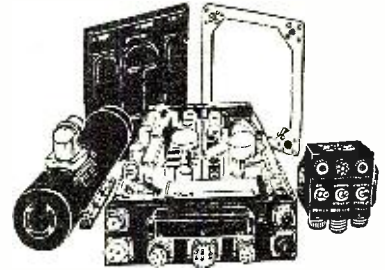

### 450 MC—15 TUBES, Brand New

Can be easily converted for phone or CW 2-way communication. Covering the following bands: 420-450MC ham band, 450-460MC for fixed or mobile, 460-470MC for citizens, 470-500MC television experimental. Size 10 1/2 x 13 1/2 x 4 3/4. Contains 15 tubes: 4—7F7, 4—7H7, 2—7EG, 2—6F6, 2—955, 1—WE-316A door knob.

Here is what you get:

BC-645 with 15 tubes  
Dynamotor/Keyer Unit.  
Remote Control Unit.  
Instruction Book  
**COMPLETE \$15.95**

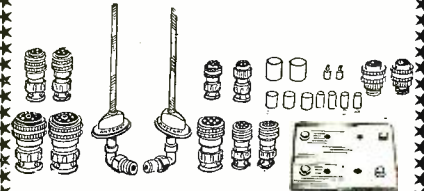

Complete set of plugs, antennas and rack mountings for control box. . . . **\$9.95**

### WESTINGHOUSE METERS

3" Round & Square 0-15 Mill DC	Each <b>\$3.45</b>
3" Round 0-1 Amp DC	
3" Round 0-150 Amp AC	
3" Round 0-15V AC	
3" Round 0-50 Amp AC	
3" Round 0-300 Amp AC	\$2.25
2" Round 0-1 Mill	

### GENERAL ELECTRIC METERS

2" Round 0-3 Amp RF	\$2.25
2" Round 0-15C AC & DC	2.50
3" Square 0-15 Mill DC	3.45
3" Round 0-30 Mill DC	3.95
3" Round 200 Mill DC	3.45

### MISCELLANEOUS METERS

2" Round 0-35 Mill DC Triplett	\$2.25
3" Round 100-0-100 Mill DC W.E.	3.45
3" Round 1 Mil McClintoc	3.45
2" Round 0-3 Amp RF Simpson	2.25
3" Round 75 Amp AC Burlington	3.45
3" Round 1000 Mill DC Beede	1.95
2" Round 5-0-5 Amp DC	.59
Roller/Smith portable lab 0-15V DC with handle; 5 1/2 x 6 x 3 1/2	19.50

### STANDARD RACK CABINETS

Heavy gauge steel, gray crackle finish; panel opening 19" wide, 27" high

**\$12.95**

### SELSYN MOTORS

50V, 50/60 cycles. Can be used to turn small beam antenna or as indicators. 3/4" diameter x 5 1/2" high. Two can be used in series on 110V, A.C.  
Brand New . . . Pair **\$4.95**

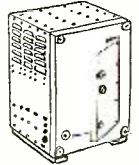

### AT LAST

We have available **CODE PRACTICE TAPE**, which was used for code practice work by the Signal Corps—from slow to fast practice. 15 rolls on 16MM metal reels in heavy wooden slotted case, to be used with McElroy #7410 Keyers, Tone Keyers or any code practice unit using type. **\$9.95**  
Special . . .

Prompt Delivery—25% deposit required on C.O.D. order. Shipped F.O.B. New York. Write Dept. RN-1

## MICHAEL STAHL, INC.

39 VESEY ST.

WO 4-2882

New York 7, N. Y.

when you use  
the **Audax**  
**POLYPHASE...**  
**ONE** single unit  
plays **ALL**  
your records  
**SUPERBLY...**  
and at less  
than the cost  
of ordinary  
magnetic pick-ups

"The Standard  
by which  
Others  
Are Judged  
and Valued"



Microgroove,  
78 r.p.m., etc.

Only **\$11.70**  
net cost to you—  
believe it or not!

See it at your  
local distributor  
or write us

**AUDAK COMPANY**  
500 5th Ave., Dept. 66, New York 18  
Fine Music Reproducers Since 1915

**CODE SENDING  
RECEIVING SPEED**



**Free Book**

**HIGH SPEED**

**WITHOUT NERVOUS TENSION**

REVEALING BOOK shows how "crack" operators develop high speed and proficiency. Learn code for Amateur or Commercial Radiotelegraph License, or improve your sending and receiving with the Candler System which develops radiotelegraph experts and code champions.

**CANDLER SYSTEM** Box 928, Dept. 7-A  
Denver, Colorado

**ALMO SPOTLIGHT  
SPECIAL**

**SPECO SIGNAL TRACER KIT**

**\$17.95**

- A.C. operated • Excellent tone • Mx. Power output: 5 watts • Probe, 8 1/2" • Highly Sensitive • Weight: 11 pounds
- Tubes: 1—6SQ7GT/G, 1—6VGG7/G, 1—5Y3, 1—6ES, 1—6J5GT. Supply limited. Order your kit now. 10% Cash with Orders.



**ALMO RADIO CO.**  
509 ARCH STREET • Philadelphia  
6205 MARKET STREET • West Phila.  
6th & ORANGE STS. • Wilmington  
4401 VENTNOR AVE. • Atlantic City

# Classified

Rate 20c per word. Minimum 10 words

## RADIO ENGINEERING

PANEL engraving, machining, painting. Complete service. Circular upon request. Gilpin Instrument Works, Box 517R4, Mt. Clemens, Mich.

RADIO Engineering Broadcasting, Aviation and Police Radio, Servicing, Marine Operating and Electronics taught thoroughly. Expenses low. Write for catalog. Valparaiso Technical Institute, Dept. N., Valparaiso, Ind.

CUSTOM Building of electronic equipment. See past issues of News for examples of superior workmanship. Robert Lewis, W8MQU, 3806 LeErda, Flint, Mich.

## SALE

SYLVANIA tubes. All types. Year's guarantee. Discount 50 and 10% off list. Also free replacement service. Economy Electronics, Lyndhurst, New Jersey.

PHOTOFLASH Ignition Transformer, 15,000V, \$1.95, regular \$4.50. Charger, 2V Wetcell, \$1.95, regular \$4.95. Universal Battery Tester, \$3.95, regular \$15.00. Modelectric Products, Asbury Park, N. J.

NOTICE: Surplus Radio Equipment, parts and supplies. Write John R. Aab, Radio Division, Spartan Aero Repair, Municipal Airport, Tulsa, Okla.

THE Ideal Guy Wire 3/32" Aircraft Cable. Brand new @ fraction of original cost. 7x7 construction (49 wires) Galvanized and Preformed. Extra flexible. Breaking Strength 920 lbs. 1000 ft. reel \$10.00, prepaid. Send \$1.00 for 100 ft. sample, postpaid. Cash with order please. No C.O.D.'s Distributor inquiries invited. F. R. Wilson, P. O. Box 264, Lexington, Kentucky.

PHOTOFLASH Tubes Sylvania R4330 brand new. \$10. Quantities of ten \$8. V. Iavarone, 1218 LeLaud Ave., Bronx 60, N. Y.

BARGAINS: New and reconditioned Hallierafters. National, Collins, Hammarlund, RME, Meissner, other receivers, tuners, television receivers, transmitters, amplifiers, speakers, etc. Lowest wholesale prices. Terms. Shipped on trial. Liberal trade-in allowances. Write: Henry Radio, Butler, Mo., and 11246 W. Olympic, Los Angeles, Calif.

BARGAIN Hunting? Radio Servicemen write. Sensational catalog. Henshaw Radio Supply, 3619 Troost, Kansas City 3, Mo.

RADIOS, record players, tubes, parts, send for free list. Mr. Morillo, Mike's Radio Service, 173 E. 101st St., New York 29, N. Y.

LOWEST Prices Radio Tubes, parts. Bargain lists, 3c. Potter, 1314 McGee, Kansas City 6, Mo.

HOTTEST surplus list in the country. Electronics-Hydraulics, Aircraft-Gadgets, Dick Rose, Everett, Wash.

RECORD Changer Parts for leading makes. We ship everywhere. Friend's Wholesale Distributors, 106 N. 6th St., Philadelphia 6, Pa.

PARTS for articles described in this magazine. Reasonable. Leo J. Vince, W8FYA, 2805 E. 117th St., Cleveland 20, Ohio.

EDISON Storage Batteries, Nickel-Iron-Alkaline type, Government surplus, 32 volt 25 cells 125 watts normal capacity 19 ampere-hours assembled in trays \$40.00 complete ready for use. Factory price over \$160.00. Will last many years, a bargain. The finest money can buy. John L. Pulster, Battery Specialist, 510A Audubon Bldg., New Orleans 16, La.

CABLES & Wire. Multi-conductor #18 to 30 AWG solid or stranded copper. Cotton, shielded, or weatherproof plastic covering. Single conductors or twisted pairs. Write for quotations. Tel-Rad Company, 61 Allyn St., Hartford, Conn.

SURPLUS, BC454, BC455 receivers, \$5.95 each. BC457, BC458 Transmitters, \$5.95 each. ARC5/T22 Transmitters, \$9.95 each. Used, good condition. Many other items. Write, complete list. Albert Arnold, Box 706, Amarillo, Tex.

BC-348 K. RECEIVER AC powered. Perfect condition. \$69. Fred A. Reibert, 330 E. 196th St., New York 58, N. Y.

BATTERIES. Eveready #487 45V. fully charged. 50c. Wt. 4 lbs. Free list. S. Colen, 1120 Wyatt St., Bronx, N. Y.

RECEIVER BC-348-Q. Converted, \$60.00. Frank Chiorello, 243 2nd St., Trenton, N. J.

COAXIAL Cable. Identical Characteristics as RG-58/U. Send dime for 3-foot sample. Harry H. Van Dick, Box 236, Little Falls, N. J.

NO drilling, instantaneous sheet metal punch. 3/8, 1/2, 3/4, \$1.65. 1, 1 1/8, \$2.10. Postpaid each. Irvine Punch, 243 88th St., Brooklyn 9, N. Y.

ALL Steel T.V. Towers which can be erected to 70' or more. Build to climb. Shipped direct from the factory at \$8.50 F.O.B. per 10' section. Weight 20 pounds per section. Write for more details. The Youngstown Steel Towers, 1316 Wilson Avenue, Youngstown 8, Ohio.

FIVE Element TV Yagi Beams. High Band \$6.75, Low Band \$8.50. Aluminum Tubing, etc. Willard Radcliff, Fostoria, Ohio.

RADIO Diagrams under seven tubes, 30c; over six tubes, 60c. Record Changers, 60c; Television Diagrams, \$1.00, with service data, \$2.00 up. State manufacturer and model number. Kramer's Radio Service, 36 Columbus Ave., New York 23, N. Y.

## WANTED

DIRT Cheap, but good condition. R5A/ARN7 (not R5/ARN7) Receiver. MN42A Dual Bearing Ind. C166/AIC3 Control Box, MN53A Marker Beacon Receiver, F3 Wilcox Receivers, RTA1B Trans/Receiver, 24 volt, MR16D Range Filter. Box 2808, Juneau, Alaska.

USED Meissner 8C Tuner and Arvin Model 664. F. E. Gray, P. O. Box 43, Portsmouth, N. H.

LABORATORY quality test equipment urgently needed for cash. Overbrook Co., Overbrook 81, Mass.

WANT to buy BC447, APS-6, ARC-5. Interested in substantial quantity for parts requirements new or used condition acceptable. Harry O. Eyrse, P. O. Box 218, Grand Prairie, Tex.

WANTED: T47/ART-13 Transmitters, good condition, complete with accessories. Box 490, c/o Radio & Television News, 185 N. Wabash Ave., Chicago 1, Ill.

## HELP WANTED

SERVICE Technician: Radio Service Dealer requires capable mechanic. Should be qualified to efficiently service all types radio and television equipment. Also assist mechanics installing TV aerials, servicing refrigerators, air conditioning ranges, etc. Must assume responsibility for managing repair department. Salary open. Compensation in proportion to skill and diversification. Applicant should submit complete resumé showing educational background, positions, and salary. Previous retail experience not essential. All replies confidential. Box 494, c/o Radio & Television News, 185 N. Wabash Ave., Chicago 1, Ill.

INSTRUCTORS in Electronics and Radio. Prefer former Navy Radio Technician instructors willing to locate in the Detroit, Mich., area. Write to Box 452, c/o Radio & Television News, 185 N. Wabash Ave., Chicago, Ill.

## SITUATIONS WANTED

BROADCAST position wanted: Man, single, 25, hold first class phone and telegraph licenses, Naval and Airline experience, travel anywhere U.S. Salary secondary. Charles Glock, 137-35 Springfield Blvd., Springfield Gardens, N. Y.

WORK in Broadcast Station. First class phone license; B.S., Television Engineering; other qualifications. Charles A. Green, S.O.D., Sidney, Nebr.

## PATENT ATTORNEYS

LANCASTER. Allwine & Rommel. Registered Patent Attorneys. Patent practice before U.S. Patent office. Validity and Infringement investigations and opinions. Booklet and form "Evidence of Conception" forwarded upon request Suite 414, 815 15th St., N.W. Washington 5, D.C.

HERMAN Lewis Gordon, Registered Patent Attorney. Patent Investigations and Opinions. Warner Building, Washington, D. C.

## CORRESPONDENCE COURSE

AMATEUR radio licenses. Complete code and theory preparation for passing amateur radio examinations. Home study courses. American Radio Institute, 101 West 63rd St., New York 23, N. Y.

USED Correspondence Courses and Books, bought, sold, rented, and exchanged. Catalog free. Lee Mountain, Pisgah, Ala.

USED Correspondence Courses and Educational Books bought, sold, rented, catalog free. Educational Exchange, Summerville, Ga.

## MISCELLANEOUS

"HEADPHONES." 24 pages. Complete repair handbook, including "Radiobuilder," catalog—25c. Laboratories, 578-H, San Carlos, Calif.

EMBOSSER Business Cards 1,000, \$3.45 postpaid. Spada Enterprises, 10D Lexington, Wethersfield 3, Conn.

MAGAZINES, radio, electronic, etc., sold and bought. Landa, 157a Leverett, Boston 14, Mass.

## RADIO & TELEVISION NEWS

HELLO America! Foremost British radio-television experts contribute regularly to Britain's famous monthly, "Practical Wireless and Practical Television." Latest British-European radio and television developments; newest transmitters and receivers fully analyzed, etc. Send only \$1.50, made payable to our authorized agent, Jeremy North, Bookseller (P.W. 47), "Friendship House," Jamestown, Rhode Island, for 12 consecutive issues sent direct to your address from London. Two years, \$2.75.

**RADIOMEN.** Servicemen, Beginners. Make more money, easily, quickly. \$250 weekly possible. We show you how. Information free. Merit Products, 216-32R 132 Ave., Springfield Gardens 13, N. Y.

**PHONOGRAPH Records,** 15c. Catalogue free. Paramount, VE-313 East Market, Wilkes-Barre, Pa. QSL's, SWL's. Snappy service! W1HJJ, Box 32C, Manchester, N. H.

### CONTACT BAN OFF

**THE** Federal Communications Commission has announced (Public Notice 42642) that the ban imposed on some foreign ham contacts (Public Notice 41636) as reported on page 107 of the December issue of **RADIO & TELEVISION NEWS** has been removed.

The notice lifting the restriction advises that "amateurs and all others concerned are hereby authorized by the Commission to disregard, until further notice, the Commission's Public Notice (41636) dated October 13, 1949."

The original notice banned contacts with amateurs in the following countries: Austria, Burma, French Settlements in Oceania, Greece, Indo-China, Indonesia, Iran, Israel, Lebanon, Madagascar and dependencies, Mauritius, Netherlands Antilles, Siam, S. Pierre and Miquelon, and Togoland.

-30-

### REDUCING HUM LEVEL

By MITCHEL KATZ

**C**onsiderable improvement in the hum level of electronic equipment can be obtained by proper placement of transformers, chokes, etc. A very simple way to check for proper placement is to mount the power transformer on the chassis and connect it to the a.c. line. Now connect a pair of earphones across the choke, or any winding of an audio transformer to be positioned. When this unit is held close to the energized power transformer a hum will be heard in the phones, due to induction. Merely move the choke or audio transformer away and rotate it on its axis until a minimum hum is heard. Although using this method may not lend itself to a uniform chassis layout, it will provide a definite reduction in the hum level.

-30-

### ERRATUM

In the circuit diagram shown in connection with the article "A Wide Range Equalizing Amplifier" by Harry R. Hyder, appearing on page 53 of the October issue, a condenser necessary to the proper operation of the unit has been inadvertently omitted. There should be a .1  $\mu$ d., 400 v. condenser inserted in the circuit just before the resistor  $R_8$  but after  $R_7$ .

### Photo Credits

Pages	Credit
31, 32 (bottom left & right), 33 (top left), 42 (top)	American Airlines
32 (top), 33 (center)	H. F. Beane
33 (top right), 34	TWA
36, 37	Westinghouse & Glenn L. Martin Co.
40, 41 (center), 42 (bottom)	General Electric Co.
41 (top)	Harris & Ewing
41 (bottom)	RCA
45	Robert Vondran
53 (top)	Microreprints Co.
53 (bottom), 54 (top), 55	National Bureau of Standards
56	Herman Hosmer Scott, Inc.
60	RCA Service Co., Inc.
61	International Short-Wave Club
80	Edman Communication Co.
110	The Knott Corporation
116, 140	"The Voice of America"
128	Station WNBZ, New York
146	U. S. Army

# WESTERN ELECTRIC

## BELOW MANUFACTURERS COST!



### BRAND NEW DRIVER UNIT with REFLEX PROJECTOR

• A Blast-Proof, Blare-Proof Reflex Speaker with a Projector especially designed for use with the famous WESTERN ELECTRIC DRIVER UNIT.

• Heavy Gauge metal construction throughout, including the main trumpet section, gives you peak performance without blaring or blasting.

**WILL HANDLE UP TO 50 WATTS WITH NO DISTORTION**

#### EXCELLENT FOR:

- INDUSTRIAL PURPOSES
- CALL SYSTEMS
- CONCESSIONS
- BALL PARKS
- SCHOOLS and
- P. A. WORK

25% Deposit  
With Order  
Unless Rated  
BALANCE  
C.O.D.

**19<sup>95</sup>**  
F.O.B.  
N.Y.C.  
**4 FOR \$75.00**

#### ANOTHER WESTERN ELECTRIC SPECIAL

A fortunate purchase of genuine Western Electric Voice Coil and Diaphragm Assembly for the above unit at a close-out price.

**BRAND NEW IN SEALED CARTONS \$2<sup>95</sup>**

**MANUEL KLEIN 76 CORTLANDT ST.**  
NEW YORK 7, N. Y.  
BECKMAN 3-9530 • RECTOR 2-6668

## PREMAX

6 to 8 db. Gain  
on MOBILE 75  
WITH THE PREMAX  
BASE LOADED  
ANTENNA

Vastly improves the radiation characteristics over those of the ordinary "whip" types! Its 6 db. gain is immediately apparent as it is more than equal to quadrupling transmitter power and greatly increases effectiveness and range.

Available as a "75" Base-Loaded or can be had with auxiliary to make a powerful center-loaded job with an additional 2 to 3 db. gain.

Write for special bulletin and prices.



### PREMAX PRODUCTS

DIVISION CHISHOLM-RYDER CO., INC.  
5006 HIGHLAND AVE., NIAGARA FALLS, N. Y.

## SHOOTS TROUBLE FASTER!

MAKES MORE MONEY FOR YOU ON JOB OR AT SERVICE BENCH!



PRICE \$9.95

at distributor or postpaid, direct. Sorry, no C.O.D.'s. Ohioans add 3% State Sales Tax

## Signalette

### MULTI-FREQUENCY GENERATOR

In radio service work, time means money. Locate trouble faster, handle a much greater volume of work with the SIGNALETTE. As a trouble shooting tool, SIGNALETTE has no equal. Merely plug in any 110 V. AC-DC line, start at speaker end of circuit and trace back, stage by stage, listening in set's speaker. Generates RF, IF and AUDIO Frequencies, 2500 cycles to 20 Megacycles. Also used for Checks on Sensitivity, Gain, Peaking, Shielding, Tube testing. Wt. 13 oz. Fits pocket or tool kit. See at your distributor or order direct.

**Clippard** Instrument Laboratory, Inc.

DEPT. N, 1125 BANK STREET  
CINCINNATI 14, OHIO  
QUALIFIED JOBBERS WRITE, WIRE FOR DETAILS.

# FEDERATED PRESENTS TWO GREAT TV ANTENNA BUYS!

## WARD MAGIC WAND INDOOR ANTENNA

- A sensational value!
- Positions for superior reception on all channels!

Comes with two 45" telescopic tunable elements of chrome plated brass tubing, 2 1/4 ft. metal mast, 12 ft. of collinear transmission line. Handsome brown finish blends with every interior. Portable, weighs only 9 lbs. Complete with instruction sheet. Model TVI-43.



NOW \$295  
Reduced from \$17.95

## VERTROD 4'n 1 ROOFTOP ANTENNA

- Assures super-sensitive reception!
- Sturdy—will resist the strongest winds!

This great rooftop antenna will match 72 ohm or 300 ohm line. High gain array. High and low sections can be separately orientated. All aluminum construction. Comes complete with 5 foot mast and instruction sheet.

only \$595



## COMPACT 1000 OHM PER VOLT AC-DC MULTITESTER

A real bargain! This quality instrument made by Electronics Measurement Corp. only \$1390



Features include large easy-to-read 3" meter, 1000 ohm low ohm scale with center scale reading at 50 ohms. High ohm scale to 1 meg.

DC VOLTAGE RANGES—6-60-300-600-3000 V. DC. AC VOLTAGE RANGES—12-120-600-1200 V. AC. DC MILS—30-120 M.A.D.C. 1.2 Amps DC.



## FEDERATED WAVE TRAP

Reduces interference from FM stations. Stabilizes picture. Connects to antenna terminals on TV set. Use with any set. Terrific value. Order now 98c

## 1000 ft. roll HIGH QUALITY BROWN POLYETHYLENE INSULATED 300 ohm TV TRANSMISSION LINE

Only \$1295 per thousand ft.

First quality. Low-loss.

Please include 25% deposit with order. Balance C. O. D. Minimum order \$5.00. Dept. 28-A.

**Federated Purchaser**  
INCORPORATED  
NEW YORK CITY ALLENTOWN, PA.  
80 PARK PLACE 1115 HAMILTON ST.  
Digby 9-3050 Allentown 3-7441

## TELEVISION • ELECTRONICS

Learn Radio the Northwestern Way

- BASIC RADIO
- RADIO SERVICE
- COMMUNICATIONS
- INDUSTRIAL ELECTRONICS
- TELEVISION

Highly Trained Instructors • Modern Equipment • Spacious Building and Grounds G.I. and Rehab. Approved

### NORTHWESTERN VOCATIONAL INST.



745 Grand Ave.  
ST. PAUL 5  
MINN.

# INDEX OF Advertisers

JANUARY 1950

While every precaution is taken to insure accuracy, we cannot guarantee against the possibility of an occasional change or omission in the preparation of this index.

ADVERTISERS	PAGE	ADVERTISERS	PAGE
Acorn Electronics Corp. ....	152	Lafayette Radio .....	81
Adson Radio & Electronics Co. ....	122	LaPointe Plascomold Corp. ....	88
Allied Radio Corp. ....	9, 101	Lectronic Research Labs. ....	156
Almo Radio Co. ....	158	Leotone Radio Co. ....	114
Altec Lansing Corporation. ....	70	Liberty Electronics, Inc. ....	133
American Radio Institute. ....	134	Long Island Radio Co. ....	156
Amplifier Corp. of America. ....	137		
Approved Electronic Inst., Corp. ....	134	MacMillan Co., The. ....	104
Arrow Sales, Inc. ....	113	Magnecord, Inc. ....	102
Ashe Radio Co., Walter. ....	109, 157	Mallory & Co., Inc., P. R. ....	4th Cover
Associated Television Company. ....	148	Market Radio Stores. ....	106
Audak Company. ....	158	Maspeth Telephone & Radio Corporation. ....	142
		Mass. Radio School. ....	138
Baltimore Technical Institute. ....	148	Meissner Mfg., Division Maguire Ind., Inc. ....	133
Bell Telephone Laboratories. ....	99	Merit Coil & Transformer Corp. ....	24
Bliss Electrical School. ....	96	Midwest Radio & Television Corp. ....	29
Brook Electronics, Inc. ....	161	Milwaukee School of Engineering. ....	115
Brush Development Company, The. ....	10	Mosley Electronic Specialties. ....	122
Buffalo Radio Supply. ....	97	Murray Hill Books, Inc. ....	24, 107
Burstein-Applebee Co. ....	151		
		McCormell's. ....	138, 143
C & H Sales Co. ....	148	McGee Radio Company. ....	83, 84, 85
Candler System. ....	158		
Cannon Electric Development Company. ....	82	National Radio Institute. ....	3
Capitol Radio Engineering Institute. ....	95, 149	National Schools. ....	11
Centralab, Division of Globe-Union, Inc. ....	90, 91	Newark Surplus Materials Co. ....	150
Certified Television Laboratories. ....	148, 157	Norman Radio Distributors, Inc. ....	138
Channel Master Corp. ....	26, 27	Northwestern Vocational Inst. ....	160
Chelsea Television Center, Inc. ....	119		
Cinex, Inc. ....	145	Offenbach & Reimus Co. ....	135
Cleveland Institute of Radio Electronics. ....	5	Onan & Sons, Inc., D. W. ....	152
Clippard Instrument Laboratory, Inc. ....	159	Opad-Green Company. ....	125
Coastal Aviation Corporation. ....	156	Owl Radio Tube Company. ....	131
Columbia Electronic Sales. ....	108		
Comet Electronic Sales Co. ....	145	Peak Electronics Co. ....	105
Communications Equipment Company. ....	111	Penn Boiler & Burner Mfg. Corp. ....	116
Components Supply Co. ....	114	Phoenix Electronics, Inc. ....	154
Coyne Electrical, Radio & Television School. ....	92, 142	Photocon Sales. ....	129
		Plastics & Electronics Company. ....	152
DeForest's Training, Inc. ....	7	Platt Electronics Corp. ....	117
Dow Trading Co. ....	138	Poly-Tech. ....	151
Drake & Co., Frederick J. ....	156	Potter Radio Co. ....	161
		Precision Electronics, Inc. ....	110
Edlie Electronics, Inc. ....	98	Premax Products. ....	159
Electro Devices Incorporated. ....	120	Premier Radio Tube Company. ....	121
Electro-Technical Industries. ....	130	Progressive Electronics Co. ....	140
Electro-Voice Inc. ....	103	Pyramid Electric Company. ....	22
Electronic Instrument Co., Inc. ....	96, 143, 148, 3rd Cover		
Electronic Supplies. ....	106	Quam-Nichols Co. ....	133
Electronics Institute, Inc. ....	118		
Emmons Radio Supply. ....	148	RCA Institutes, Inc. ....	145
Espey Manufacturing Company, Inc. ....	141	R & M Radio Company. ....	131
		R & T Electronics Company, Inc. ....	152
Fair Radio Sales. ....	127	Racon Electric Co., Inc. ....	118
Federated Purchaser, Incorporated. ....	160	Radio Apparatus Corp. ....	147
Feller Engineering Co. ....	139, 155	Radio Coin Matic. ....	134
Franklin-Ellis Co. ....	153	Radio Corporation of America. ....	30, 2nd Cover
		Radio Craftsmen Incorporated, The. ....	155
G. L. Electronics. ....	136	Radio Ham Shack Inc. ....	89
Garson Industries. ....	156	Radio Supply & Engineering Co., Inc. ....	142
General Cement Mfg. Co. ....	132	Radionic Equipment Corporation. ....	128
General Electric Company. ....	6, 69	Rauland Corporation, The. ....	25
General Electronic Distributing Co. ....	87	Reeves Soundcraft Corp. ....	139
General Test Equipment. ....	151	Robin Hood Co., The. ....	142
Goodheart, R. E. ....	136	Rose Company, The. ....	156
Gould Green. ....	139		
Greenlee Tool Co. ....	161	Sams & Co., Inc., Howard W. ....	20
Greylin Co., The. ....	96	Sangamo Electric Company. ....	28
Greylock Electronics Supply Co. ....	152	Schott Co., Walter L. ....	141
		Senco Radio, Inc. ....	126
Harvey Radio Company, Inc. ....	86	Simpson Electric Company. ....	17
Heath Company, The. ....	71, 72, 73, 74, 75, 76, 77, 78	Simpson Manufacturing Co., Inc., Mark. ....	149
Henry Radio Stores. ....	102	Sonotone. ....	100
Henshaw Radio Supply. ....	142	Sovereign Television Co. ....	138
Hollywood Sound Institute, Inc. ....	143	Spartan School of Radio and Electronics. ....	129
Hyron Radio and Electronics Corp. ....	15	Sprague Products Co. ....	18
		Sprayberry Academy of Radio. ....	19
Indiana Technical College. ....	151	Stahl, Inc., Michael. ....	157
Instant Tool Corporation. ....	13	Standard Transformer Corporation. ....	143
Instructograph Company. ....	152	Suffolk Television Agency. ....	145
Instrument Associates. ....	154	Sun Radio and Electronics Company, Inc. ....	146
		Sun Radio of Washington, D. C. ....	94
Jensen Manufacturing Company. ....	13	Supreme Publications. ....	137
		Sutton's Wholesale Electronics, Bill. ....	148
Klein, Manuel. ....	159	Sylvania Electric Products Inc. ....	23



ADVERTISERS

PAGE

TAB	162
Telex	122
Telex, Inc.	80
Thordarson Electric Manufacturing Division Maguire Industries, Inc.	100
Transvision, Inc.	14
Tri-State College	157
Triplett Electrical Instrument Company	12

University Loudspeakers Inc. . . . . 123

V & H Radio & Electronics Supply . . . . . 153  
 Valparaiso Technical Institute . . . . . 139  
 Van Nostrand Company, Inc., D. . . . . 112

Ward Leonard Electric Co. . . . . 96  
 Ward Products Corporation . . . . . 21  
 Warren Distributors . . . . . 114  
 Weller Manufacturing Company . . . . . 8  
 Wells Sales, Inc. . . . . 93  
 Wholesale Radio Parts Co., Inc. . . . . 144  
 Workshop Associates, Inc., The . . . . . 106  
 World Radio Laboratories Incorporated . . . . . 147  
 YMCA Trade & Tech. School . . . . . 148

**NEW TUBES FOR TV AND FM**

GENERAL Electric Company has announced production on two new electronic tubes which reduce the number of tubes and circuit elements required for FM and television receivers.

Each of the tubes (known as the 6BN6 and 12BN6) is designed to operate as a combined limiter and FM discriminator in an improved and simplified FM detection circuit. According to the company some of the potential applications of each tube include use in limiter circuits, sync clipper circuits, square-wave generators, frequency multipliers, and phase measuring devices.

The tubes also simplify alignment in television sets and eliminate the need for special transformers. Use of the tubes in television sets is said to provide good AM rejection, including exceptional rejection of pulse noise owing to absence of time constants.

These two gated-beam tubes are essentially the same, except for their heater ratings. Construction of the 6BN6 and 12BN6 differ from the conventional types in that the electrons pass from cathode to plate in the form of a narrow sheet or beam. Principles of low-voltage electron optics are employed and the internal construction involves focus, lens, and shield arrangements. Two control grids are employed which exhibit nearly step-function control over the plate current. As a result the grids act as voltage-controlled gates which determine whether or not plate current can flow.

The new tubes are being produced at the company's Owensboro, Kentucky plant.

-30-

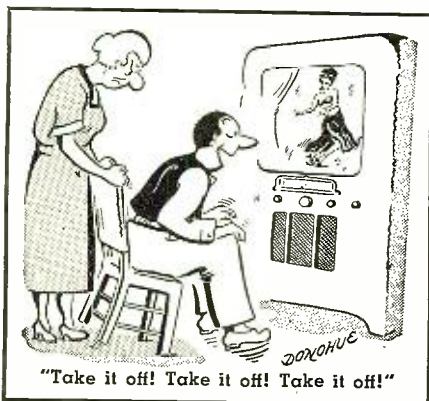

January, 1950

**Add TONE & VOLUME to your TELEVISION with a BROOK High Quality AUDIO AMPLIFIER**

ALL TRIODES Attractive small remote control console for maximum convenience in operation and installation

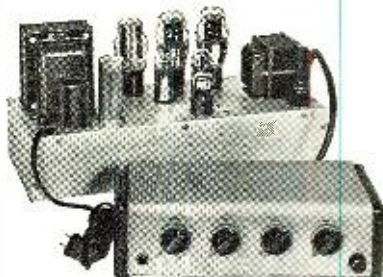

Model 12A3-10 watts

For you who revel in fine music and abhor distortion—over radio, television, phonograph—the BROOK all-triode high quality AUDIO AMPLIFIER has been developed, after years of intensive engineering research. Now you can have "live" music in your own home . . . clean . . . clear . . . bright music through any good speaker. The use of triodes in all stages—together with Brook designed transformers—means amplification at its level best. For REALISM in critical music reproduction, hear this finest of amplifiers at your Brook Dealer's NOW!

ALL TRIODES

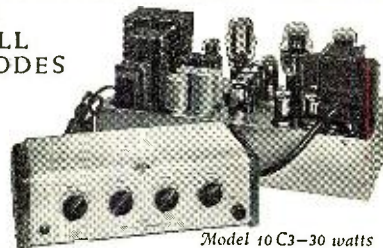

Model 10C3-30 watts

FOR BEST RESULTS — BROOK GIVES

- Extremely High Volume Without Any Loss of Quality
- Brilliant, Clear Tone
- Separate Controls — Stepped for Bass and Treble
- Minimum Distortion
- Reduces Listening Fatigue

Write TODAY for FREE Technical Bulletin and Detailed Distortion Analysis

Sales Agent

**BROOK ELECTRONICS, Inc.**  
 Dept. RA-O, 34 De Hart Place, Elizabeth, N.J.

**"America's Best Buy"**

**RADIO TUBES — 34c each**  
**100 for \$29.95**

GT type. Cartoned and guaranteed.					
1R5	12BE6	12AU6	6SU7	12E8	
1T4	12AT6	12BF6	6AQ5	6EH6	
1U5	35W4	6BA6	6AQ6	11Z3	
3A4	35B5	6BE6	6C4	19T8	
155	50B5	6AT6	6X4	6EJ6	
3V4	12AT7	6AL5	6W4	6EA7	
3Q4	12AU7	6AQ5	6AG5	6EJ6	
354	12AX7	6BF6	6AU6	35C5	
12BA6	12BA7	6AU7	6BG6	31	

- 4" or 5" P.M. Speakers—A BUY . . . . . 99c each
- 300-Ohm Twin-Lead . . . . . 100-foot roll \$1.29
- Phono-motor with turntable AC 78 rpm . . . \$1.75
- Phono-motor spring wound with crank . . . \$1.79
- Phono amplifier with tube . . . . . \$2.49
- 4-prong standard vibrator \$1.29 each; 10 for \$11.90
- Top cowl ear antenna less lead-in 3 section 89c ea.
- Blank replacement cabinets . . . . . No. 1—\$1.40; No. 2 \$1.75
- No. 3—\$2.25; No. 2 center speaker grill . . \$1.75
- Crystal calibrator 98c, this CFI gives a 50 KC beat note, see Jan 49 CQ, less tubes and crystal. Only . . . . . 98c

**CRYSTALS 98c each**

Your frequency plus or minus 10KC

160	Meter, 1975-2000KC
80	Meter, 3500-4000KC
40	Meter, 7000-7300KC
for multiplying into	
20	Meter, 7300-7425KC
10	Meter, 7300-7425KC
2½	Meter, 8000-8222KC

200 QSL CARDS . . . . . \$2.25  
 Neatly printed in black with your name, address and call letters. Two-color QSL's \$3.50 for 200. Postpaid.

Postage extra 20% deposit on C.O.D.

Write for latest bargain list featuring "America's Best Buys."

**POTTER RADIO CO.**

1314 McGee St., Kansas City 6, Mo.

**NOW . . . quickly, easily**  
**cut SQUARE and OBLONG openings**  
**in radio chassis**

**WITH THE GREENLEE No. 731 SQUARE RADIO CHASSIS PUNCH**

Now, in 1½ minutes or less you can do hole-cutting jobs that might take an hour with old "drilling and filing" methods. Simply insert GREENLEE Punch and turn with an ordinary wrench . . . a square or oblong opening is cut immediately. An indispensable, timesaving tool that pays for itself in a hurry.



In sizes ⅜", ¼" and 1"



Write today for facts and prices on this handy Punch. Greenlee Tool Co., 1881 Columbia Ave., Rockford, Ill.

# "TAB" THAT'S A BUY



PRECISION RESISTORS—

Over 2 1/2 Million in Stock

"TAB"—Specialists in Precision Resistors

Accuracy Up To 0.1 Percent—We Ship Types in Stock

0.1	182	684	1913	5500	20500
0.116	182.4	689	1914	5500	21500
0.42	200	697	1915	5730	21500
0.425	209.4	699	1916	5770	22000
0.607	216	700	1917	5910	22500
0.7	220	711	1918	6000	22990
1.03	220.4	723	1919	6140	23000
1.3	225	740	1920	6125	23150
1.75	230	750	1922	6140	23325
2.5	235	800	1924	6200	23400
2.5	240	806	1926	6300	23500
3.83	245	845	1926	6495	24000
3.95	245.4	854	1980	6500	24600
1	250	899	2000	6840	25000
4.35	260	900	2045	6980	25200
14.25	260	1000	2065	7000	25400
5.025	275	917	2095	7320	25833
6.25	280	946	2141	7500	26000
6.5	286	978	2142	7700	26500
10.5	289	1050	2165	7717	26700
7.8	299	1030	2150	7900	27000
7.9	300	1056	2160	7930	27500
8	310	1067	2180	7950	28000
10.38	311.5	1100	2187	8000	28430
11.25	320	1110	2196	8094	28500
12	325	1150	2200	8250	29000
13.52	330	1155	2250	8500	29500
14.2	340	1162	2300	8700	29990
14.25	350	1190	2300	8770	30000
14.5	360	1200	2450	9000	31000
15	366.6	1225	2463	9100	31500
16	370	1250	2485	9445	32000
17	375	1270	2480	9500	32500
19	380	1300	2500	9710	33000
20	389	1322	2525	9800	37000
22	390	1350	2600	9900	38140
23	400	1355	2625	9902	38500
41.5	410	1400	2635	10000	38500
26	414.3	1488	2700	10430	39500
28	418.8	1495	2750	10500	40000
30	425	1500	2850	10600	42000
31.5	425.9	1510	2860	10900	42500
37	427	1518	2870	10936	45000
48	440	1600	2900	11000	47000
49	450	1640	3000	11400	47500
50	452	1646	3100	11600	48000
55	470	1670	3250	12000	49000
56.7	475	1680	3290	12500	50000
60	478	1710	3333	12600	52000
60	483	1740	3384	12700	54000
68	487	1740	3500	13100	56000
74	500	1770	3509	13500	57065
75	518	1800	3700	13550	58333
75	520	1818	3700	13600	59000
81.4	525	1830	3760	14000	61430
88	540	1865	4000	14250	62000
89.8	550	1892	4030	14400	64000
90	575	1894	4200	14500	65000
95	580	1950	4250	14500	66000
100	588	1896	4280	14600	66500
101	600	1897	4300	15000	67500
105	612	1898	4314	16000	68000
105.7	625	1926	4340	16000	68400
107	633	1900	4444	16800	72000
120	640	1901	4500	17000	73500
121.2	641	1902	4720	17500	75000
125	645	1910	4750	18000	76000
130	649	1904	4850	18000	82000
135	650	1905	4885	18300	84000
140	657	1906	4900	18380	85000
147.5	663	1907	5000	18500	85750
160	670	1908	5100	18800	87000
160	673	1909	5210	19000	90000
165	675	1910	5235	19500	91000
170	680	1911	5270	20000	93300
175	681	1912	5300	20441	95000
179					

Any Size Above, Each .25c; Ten for . \$1.98

10000	17500	24000	35350	57000
11000	18000	24500	37500	57500
11500	18600	25000	38000	60000
11667	19000	26500	40000	62000
12000	18600	26000	40200	60000
12500	19000	27000	42000	65400
13000	19800	27500	42200	66000
13500	20000	29400	42500	69000
14000	20100	30000	45000	70000
14100	20500	30750	45800	71630
14500	21000	31000	47000	75000
14700	21500	31400	47800	76130
15000	22000	31600	50000	80000
15500	22500	32500	52000	81300
16000	22900	33000	52100	85000
16500	23000	33000	52500	90000
16750	23500	33350	54300	93000
16700	23800	35000	55000	95000
169200				

Any Size Above, Each .35c; Ten for . \$2.98

MEG OHMS

1	1.579	2.5	3.9	6.5	9.05
1.1	1.6	2.5	4.2	6.7	10.5
1.2	1.65	2.75	4.23	6.7	11.55
1.25	1.75	2.8	4.25	7	11.55
1.3	1.8	3.055	4.5	7.5	11.55
1.35	1.9	3.1	4.7	7.62	12.83
1.39	2	3.3	5	7.74	13
1.42	2.11	3.3	5	7.8	13.85
1.5	2.2	3.673	6	8.02	15
1.57	2.25	3.75	6.3	8.5	

Any Size Above, Each .70c; Ten for . \$5.98

**SENSATIONAL AC/DC PHONO-AMPLIFIER 2" SPEED COMBINATION** in professional carrying case. Powerful Heavy Duty Governor Controlled, Gear Drive Green Flyer Motor, Weighted Turntable for Records to 12-inches. Adj. Speed Control 78 and 33 1/3 RPM. Plus Exceptional Fidelity Built-in 3-Tube 2 to 4 Watt Amplifier. HwyDdy Spkr. Volume & Tone Controls, Mike or Radio Jacks Used, Tested, Gnd. Ready to Operate. 110V AC or DC. Easily a \$35 Buy! Grab Yours Now for ONLY \$12.49

# UNCONDITIONALLY GUARANTEED TUBES

Each Tube INDIVIDUALLY TESTED—BRAND NEW!

Standard RMA Guarantee  
Smaller Quantities, 39c Each



1R5	6AG5	6BA6	6SH7	12AU7	19T8
1S5	6AH6	6BE6	6SN7GT	12AX7	35B5
1T4	6AK5	6BF6	6T8	12BA7	35C5
1U4	6AL5	6BG6G	6X4	12BE6	35W4
1U5	6AQ5	6BJ6	6X5	12C8	50B5
3A4	6AT6	6C4	7C4/1203A	12H6	50C5
8Q4	6AF5	6J5	12A6	1258GT	
354	6AU6	6P5GT	12AL5	125H7	117Z3
3V4	6AS5	6S8GT	12AT7	125N7GT	9001
		6SD7GT	12A6U6	125R7GT	

### TUBES AT GIVE-A-WAY PRICES!

183GT	81	6B16	5.59	12BD6	5.59	1388A	4.49	1629	...	26
1X2	38	6R06G	...	25R06GT	...	1.08	HY615	...	30	
2C22/7153	18	6K6GT	42	25W4GT	...	79	826	...	35	
2C26	25	6SK7GT	45	455/VT52	...	27	CK1005	...	27	
2X2	37	6V6GT	59	NR74	...	29	1619	...	18	
6AV6	43	6W4GT	72	211/V74C	...	45	1625	...	37	
6BH6	52	16X4	54	916A	...	49	1626	...	35	

### SIG CORPS DRY BATTERIES—GTD

BRAND NEW Shelf Dated—Tested	35c
BA34 7 1/2 V 4 1/2" Neg. Volts...	35c
BA35 1 1/2 V 5mm BUC-4FH	39c
BA38 45.22V Burg 5308	39c
BA37 1 1/2 V Walky-Talky	29c
BA38 103V Walky-Talky	\$1.49
BA39 150 7 1/2 V Burg FSA100	\$1.29
BA40 90 1 1/2 V Burg 4GB60	89c
BA43 90 4 3/4 V	99c
BA51 87 1/2 V MiniMax	79c
BA70 90 80 4 1/2 V	\$2.50
BA205U 3V Burg P2BP	.8 for \$1.00

### ELECTROLYTIC CONDENSER SPECIALS!!!

6000 mfd/15vac	98c
15 mf/300 vdc	7 for 98c
30 mf/350 vdc	5 for 98c
30-15-10 mf/250vdc	5 for 98c
40mf/250v & 20mf/250v	6 for 98c
30Mf/450v & 2X20mf/25vdc FP	4 for 98c
10mf/450v & 2X20mf/25vdc FP	5 for 98c

### CRYSTAL DIODE SPECIALS!!!

Type	Each	2 for	10 for
1N21	.50	.96	5.00
1N34	.63	1.16	7.98
1N48	1.15	2.25	10.49
1N51	1.08	2.10	9.49

### SNOOPERSCOPE INFRARED

Image Converter Tube Hi-Sensitivity simplified design 2" dia., Willemite screen—Resolution up to 350 lines/in. Tube, "TAB" SPECIAL. \$7.90; 2 for \$14.50

### G.E. 2 I 61 G S.E.LYSINS with DATA 24 V or 110V 60 cyc AC, Used, Tested for . \$1.49

### BASIC PHOTOFLASH KIT

Complete Pwr Supply with cndrs, lamp, data, etc. 115VAC. Studio Kit Air Cont. \$29.95 115VAC or Batt w/2 1" amp. \$53.95 1169AIRC Flash Pwr Pack, NEW, incl. Data \$24.98 PFLASH Replacement Cndrs \$10.98

### PHOTOFLASH CONDENSERS

7mfd/2500 vdc/21.9 W-Sec.	\$2.75;
15mfd/330vac/1800vdc INT	3.49
25mfd/330vac/1800vdc INT	6.49
16mfd/600vac/280vdc INT	5.98
16mm PAN film GSAP camera	54
rolls	5.49

### "SUNFLASH" SPECIAL!

100to300W-Sec. Inpt Non-Darkening Shock Mtd 100000 Flashes 4-prg Int Chrgle 5804 X Data \$10.98 SWL var14330 12MILLION Lens .00W Sec. \$14.98 X-400 Auto Corp's Lamp. Hi-V PFLASH Pwr Kit Ideal 1800V Dbr Ckt. 115VAC Inpt. Output 900V/35mA & 2x2.5V/2Aea Wndg/4/1/2" Insig. Capse H sid. PLUS 2x35mfd/300vdc-sec Flash Cndrs & Data for Flash \$17.98 W/Flash Lamp \$26.98

### COLLINS ART-13 SPEECH AMPLIFIER

Dynamic or Carbon Mike or line Inpt. Audio Driver to PPG & Monitor Tube. Less Tubes & W/CLIPPER KIT, TUBES & SAME W/CLIPPER KIT, TUBES & Data. New \$6.98

### ARC-5 SPECIALS!!

BC456 Modulator, Less Tubes & Dyn. As Is	98c
BC457 (4to5.3Mc) or BC458 (5.3 to 7.8) Xmr, As Is, Less Tubes	\$3.49
BC455 Rcvr (6to9.1 Mc) As Is, Less Tubes & Dyn	\$4.95

### POWER PACK KITS

250VDC/60Ma&Filter	\$2.98
350VDC/125Ma&Filam	9.98
330VDC/200 Ma&Filam	9.98
1200VDC/300Ma&Filam	21.95
1500V Dbr/35Ma&Filter	39.95

### 6 VOLT CARTER "MAGMOTORS"

Perm Magnets. Extremely Hi-ER. Compact 5/4x3/4x2 1/2". 20 Temp Rise. XMTG "MAGMOTOR" Inpt 5.5 VDC; Output 400V/150Ma 57 1/2% ER; 6500 RPM; 4 1/2 lbs. ONLY \$4.98 "MAGMOTOR" Inpt 6VDC; Output 250V/100 Ma. 52% ER. 4800 RPM 4 1/2 lbs. ONLY \$4.98 Both Units above SPECIAL \$12.49

### XTAL HEATER OVEN

Terrific Buy! Takes Any FT2 Xtal, ONLY 98c

### CRYSTALS

Mtd FT243 S. C. Specs		
3525Kc	4190Kc	5235Kc
3735Kc	4730Kc	5485Kc
3980Kc	ca. 89c	
3	for \$2.00	

### FL-5 RANGE OR VOICE FILTER

Filters Out 1020 cycle Audio Exc. for 98c CW work. With Switch & Diagram.

### SUPER WIDE-RANGE HIGH FIDELITY AMPLIFIER KIT

20 to 20,000 cycles, 10 Watts. Man. Harmonic Distortion 13 1/2% at Full Output; only 0.5% at 5 Watt Output. Works with ANY Mike, Pickup or RCVR. All-Electronic stage for use with GE/Picker, etc., VarReluc Magnetic & Coil Pickups & Mike. Separate Electronic Bass & Hi-Freq Tone Boost Tube Ckts. Self-balancing CathFoil, Phase Invt, 2A3/6B4G FP & other stages. Plus All Pwr & partly Built-Up RCA Chassis. Less Output Xmr, RCA SPECIAL \$24.95

### 10 Watt Hi-Fi Kit—20to20000cps. Self-balancing. Cath. Foil. Perfect Response.

Phase Invt. 2A3/6B4G Poutpt. All parts, data, less Output Xmr, RCA SPECIAL \$14.95

**MERCURY THERMO-REG'LATOR**  
Dual Ckt. 105° & 32° F. Extremely Sensitive & Accurate for Most Exacting Projects—RESEARCH, FIRE PREV. FREEZE PT CONTROL, CO. MAX-N. TEM. CONTROL, Brand New Individ. Boxed w/data & ckt list OVER \$20. "TAB" SPECIAL 12 for \$10

**TELEVISION PWR SUPPLY XFORMER**  
HiVolts for 17" to 20" Wide Voits ALL Tubes & ALL Fil's. Supply Compl w/data for 1000 to 20000 Ckt. WDGs; Full Wave Divrg 300 VDC/275Ma. 4V. Hypersil Core Oil-impreg USN Spec by WECo \$7.98

**1800 VOLT SCOPE PWR SUPPLY KIT**  
Ideal Ckt Xmr 1800V Dbr Ckt. 15VAC Inpt; Output 900V/50Ma. 2x2.5V/2a ea&st 4KV ins SigC Spec. HermSlid. Two 2x2 tubes & ALL Filr Parts & Data \$5.98

**RCA UNIV OUTPT XFORMER**  
10W to 10Kc. Matches Any Line Or Spkr w/V/C's 3 to 4 or 15 ohms to ANY Load & Tube Imped Bet. 10 &

**YOU BUILD 'EM  
IN ONE EVENING  
BUT...**

**THEY LAST A LIFETIME!**

**SAVE 50% WITH**

**LABORATORY  
PRECISION**



**INSTRUMENTS  
& KITS**

**SENSATIONAL NEW  
EICO Model 360-K TV-FM SWEEP  
SIGNAL GENERATOR**

• Crystal marker oscillator with variable amplitude. • Covers all TV and FM alignment frequencies between 500 kc. and 228 mc. • Sweepwidth variable from 0-30 mc, with mechanical inductive sweep. • Extremely wide sweepwidth allows gain comparison of adjacent RF TV Channels. • Provides for injection of external signal generator marker. • Phasing control included. • Large, easy-to-read dial is directly calibrated in frequencies. Comes complete with all tubes (including new, high-frequency miniature types): 6X5GT, 12AU7, two 6C4's. Crystal not included. 10"x8"x6 3/4".

**\$29.95**

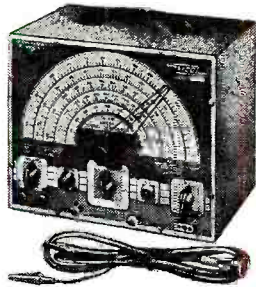

**FACTORY-WIRED AND TESTED \$39.95**  
Model 360. Ready to use Sweep Signal Generator. See it at your local jobber!

**ANYONE  
CAN BUILD  
THEM!**

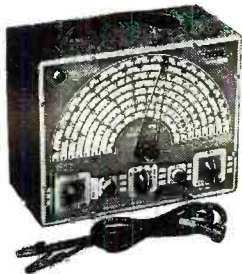

**NEW! MODEL 320-K  
SIGNAL GENERATOR**

**\$19.95**

For FM, AM alignment and to provide TV marker frequencies. Highly stable Hartley oscillator has range of 150 kc to 102 mc with fundamentals to 34 mc. Colpitts audio oscillator supplies pure 400 cycle sine wave voltage for modulation. Audio oscillator voltage can be used for testing distortion in audio equipment, bridge measurements, etc. Complete with tubes.

**FACTORY-WIRED AND TESTED \$29.95**

Model 320. Ready to use.

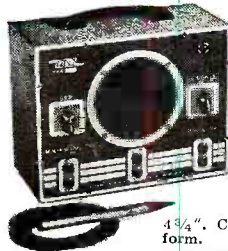

**VERSATILE MULTI-SIGNAL TRACER**

**\$18.95**

Model 145-K. Versatile, high gain — high frequency instrument. Self-contained test speaker permits audible signal tracing of RF, IF, FM, audio, and video circuits. Has provision for visual tracing with VTVM. Response is well over 200 mc 3-color hammertone panel. 110-125 V. AC. Size: 10"x8"x4 3/4". Comes complete with tubes and diode probe in kit form.

**FACTORY-WIRED AND TESTED \$28.95**  
Model 145. Ready to operate.

**NEW EICO PUSH-PULL  
WIDE RANGE HIGH-SENSITIVITY TV 5" OSCILLOSCOPE**

**MODEL 425-K**

Laboratory precision — sensational new features — at this low price! The only scope kit with all these features. This ALL-NEW scope has Push-Pull deflection. Amazing sensitivity:

**\$39.95**

.05 to .1 volts per inch. Wide range, flat from 5 cps to 500 kc with full gain setting, useful to 2 1/2 MC. Wide-range, multi-vibrator, sweep circuit from 15 cps to 75,000 cps. Direct connection to plates of CR tube available at rear of cabinet. Z axis intensity modulation feature included. Size: 8 1/2"x17"x13". High. Complete with 8-6SN7s, 2-6J5s, 2-5Y3s, and 5BP1 CR tube.

**FACTORY-BUILT OSCILLOSCOPE \$69.95**  
Model 425. Fully wired and tested.



**HIGH-PRECISION  
VACUUM TUBE  
VOLTMETER**

**Model 221-K**

**\$23.95**

Tops in work bench versatility. 15 different ranges! AC and DC ranges: 0.5/10/100/500/1000 volts. Electronic ohmmeter ranges from .2 ohms to 1000 megohms in 5 steps. New features include Zero Center for TV discriminator alignment. DC input impedance is 26 megohms. Exceptionally accurate, big 4 1/2" meter cannot burn out. Double triode balanced bridge circuit assures stable guaranteed performance. Sturdy portable steel case with etched, rubproof panel. 110-130 V. AC 50-60 cycle. Size: 9 1/4" x 6" x 5".

**FACTORY-WIRED AND TESTED \$49.95**  
Model 221. Same, but completely wired, calibrated, and tested.



**DELUXE SIGNAL  
GENERATOR**

**MODEL 315**

Completely wired, ready-to-use Signal Generator with 1% accuracy! A wonderful instrument with dozens of expensive features. Frequency range: 75 kc to 150 mc. Has microcycle band-spread vernier tuning for FM, AM, and TV. Voltage regulator. Write for full details. **\$59.95**



**SEE THEM—TRY THEM—  
AT YOUR LOCAL JOBBER!**

EICO Instruments and Kits are on display at your local jobber—the nationally advertised kits which you can see and use before you buy. You take no chances with EICO!

Prices Higher  
on West Coast

**EASY-TO-FOLLOW SCHEMATIC &  
PICTORIAL DIAGRAMS**

Come complete with every EICO instrument kit. Each kit fully guaranteed to operate perfectly when assembled according to our simple instructions!

**EXCLUSIVE LIFE-TIME REPAIR SERVICE:** For a nominal charge, we will repair and service your EICO instrument, regardless of its age!



**ELECTRONIC INSTRUMENT CO., INC.**  
276 Newport Street, Brooklyn 12, N. Y.

...speaking of  
fan mail



## THE MALLORY MIDGETROL IS GETTING FAN MAIL FROM COAST TO COAST

Run your eyes down the quotes below. They are convincing proof that the Mallory Midgetrol is a star performer with servicemen everywhere.

### FAN MAIL FROM SERVICEMEN WHO KNOW!\*

- "The Midgetrol is a life-saver in the radio repair business!"
- "The new Mallory Midgetrol is the handiest control I have seen."
- "I have been in the servicing game for 17 years now and this is really the first universal control I have ever seen."
- "Your many innovations make this the outstanding control."
- "I like it very much . . . the small size, the better shaft and the improved switch are all very good."
- "It is sure a time and space saver."
- "Thanks for Midgetrol. It's a sensation!"

\*Actual quotations from a few of hundreds of unsolicited letters from servicemen.

### MALLORY MIDGETROL

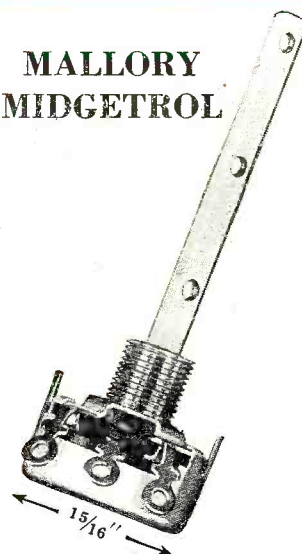

- *Fastest of all to install*
- *Saves time*
- *Saves trouble*
- *Saves money*
- *Easiest switch to attach*
- *Eliminates sawing and filing*
- *1 5/16" size fits all sets*

See your Mallory distributor  
today!

P. R. MALLORY & CO. Inc.  
**MALLORY**

CAPACITORS • CONTROLS • VIBRATORS • SWITCHES • RESISTORS  
RECTIFIERS • VIBRAPACK\* POWER SUPPLIES • FILTERS

\*Reg. U. S. Pat. Off.

**APPROVED PRECISION PRODUCTS**

P. R. MALLORY & CO., Inc., INDIANAPOLIS 6, INDIANA