

APRIL
1948

RADIO-ELECTRONIC
ENGINEERING
EDITION

RADIO NEWS

RADIO IMPULSES CONTROL
THIS MODEL SAILBOAT
page 39



Special
RADIO MIX...



RCA VS-099 Farm Pack and RCA VS-036 A Batteries

... for extra energy ... extra hours

● It's RCA's special "Radio Mix" in these super-powered radio batteries that gives them longer life *at less cost per hour!* The RCA VS-099 Farm Pack will power a 4-tube battery set for a period $\frac{1}{3}$ longer than the average farm pack—at least *a full season's service!* The RCA VS-036 A battery has *twice* the life of average cells . . . *50 per cent more life* than standard "long-life"

types in *heavy-drain* portable radio receiver service!

What's more, the RCA VS-099 and VS-036 are *leak-resistant, swell-proof and climate-proof*—because they're *sealed in steel*. They *stay powerful and fresh!*

The RCA VS-099 and VS-036 give the customer the most for his money. You can get your stock conveniently and quickly from your local RCA Distributor.

SELL RCA BATTERIES—THE COMPLETE LINE FOR THE RADIO AND ELECTRONIC TRADE



TUBE DEPARTMENT

RADIO CORPORATION of AMERICA

HARRISON, N. J.

*Here's how
hundreds of men
working in Radio*

**WIN PROMOTIONS,
EXTRA PAY**

I TRAINED THESE MEN AT HOME



Sixteen Years' Previous Experience

"Before I enrolled with NRI, I had 16 years of actual Radio experience, but I found many helps in your Course. I am now Administrative Assistant to the Officer in Charge of a U.S. Army Applied Electronics School." —Wallace G. Baptist, 1907 Willow Spring Road, Dundalk, Maryland.



Seven Years' Previous Experience. Now Department Head

"I did not start as a beginner, but had seven years' experience as a commercial Radio operator. Last April I came to work for the Gates Rubber Company to set up, train and install a complete industrial equipment department." —Norman R. Hood, Denver, Colo.

Ten Years' Previous Experience. Doubles Earnings

"I had been servicing Radios for ten years. I found it necessary to get the technical knowledge I lacked, so enrolled with NRI. I believe my earnings have more than doubled since taking the NRI Course." —J. L. Hankey, Jr., 278 W. 5th St., Frederick, Md.



NRI Training Helps Operator Win Advance

"Before taking the NRI Course I felt I was a phony holding a job as Assistant Communications Operator. Now I feel I am worthy of the job and future advancement. I have advanced to Assistant Aircraft Communicator." —John Keller, S. Market St., Martinsburg, Pa.



**NOW LET THIS WORLD-FAMOUS
NRI COURSE HELP YOU STEP AHEAD**

**MAKE MORE
MONEY IN RADIO!**

**My Course Teaches Timesaving
Service Methods, Techniques,
Television, FM, Electronics**

Here are just a few of the topics covered:
Photoelectric Control Circuits with Relays
Peak and Band-Pass R.F. Tuning Circuits
Broadcast, All-Wave and Television Superhet Receiver Principles
Light-Sensitive Cells for Control Circuits
The Vacuum Tube as an A.C. Generator in Radio-Television Circuits
Current, Voltage and Resistance Measurements
Vacuum Tube Voltmeters, Cathode Ray Oscilloscopes

Frequency Modulated Signals, the F-M Receiver
Automatic Tuning Control Systems
Professional Radio Servicing Techniques
How to Isolate Defective Section and Stage
How to Isolate Defective Circuit and Part
Tuning Circuit Troubles
Field and Bench Testing of Radio Parts
Uses for Optics in Electronics and Television
Practical Electronic Equipment Essentials of Outdoor and Indoor Public Address Systems

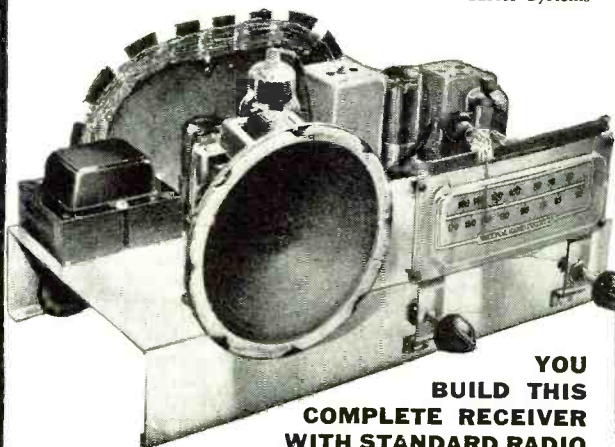

**YOU
BUILD THIS
COMPLETE RECEIVER
WITH STANDARD RADIO
PARTS I SUPPLY**

You get valuable experience testing and repairing this and many other circuits you build from N.R.I. Kits. These kits are not loaned to you, but become your property. Mail coupon for full details!

THE way to EARN more money in Radio is to handle MORE service jobs in LESS time! And the N.R.I. Course is designed to help you do just that! With N.R.I. training, you KNOW the shortcuts and timesavers that speed up routine repair jobs. You KNOW how to locate trouble fast on the tough jobs as well as the easier ones. And you KNOW up-to-date servicing methods needed on FM, Television and Electronics.

Find Out What N.R.I. Can Do for YOU

Read the letters at top of this page. They are from just a few of many men who were working in Radio before they took my training. I helped them get ahead and I can help you. Mail the coupon for my 64-page book, "How to be a Success in Radio, Television, Electronics," FREE. See how I train you at home, how I give you UP-TO-DATE, PRACTICAL knowledge . . . how you get professional experience building, testing, repairing real Radio circuits with kits I send.

SAMPLE LESSON

FREE I'll send you a Sample Lesson FREE to show you how quickly you learn from my illustrated, easy-to-understand lessons. No obligation. Get Sample Lesson and Book by mailing coupon. Just mail Coupon NOW in envelope or paste on penny postal! J. E. Smith, President, Dept. 8DR, The National Radio Institute, Pioneer Home Study Radio School, Washington 9, D. C.



**J. E. SMITH, President
National Radio Institute**

**VETERANS
APPROVED
UNDER
G. I. BILL**

Good for Both - FREE

Mr. J. E. SMITH, President, Dept. 8DR, National Radio Institute, Washington 9, D. C.

Mail me FREE Sample Lesson and 64-page book. (No Salesman will call. Please write plainly.)

Name..... Age.....
Address.....
City..... Zone..... State.....
 Check If Veteran



Editor
OLIVER READ, W8ETI
Managing Editor
WM. A. STOCKLIN
Technical Editor
H. B. RENNE, EX-W8PYS
Associate Editors
RAY FRANK, W9JU
NORMAN L. CHALFIN
FRED HAMLIN
GAITHER LITRELL
P. B. HOEFER
C. M. SULLIVAN
Staff Photographer
ARTHUR E. HAUG
Staff Artist
R. S. KUPJACK

Advertising Manager
L. L. OSTEN
Midwestern Advertising Manager
JOHN A. RONAN, JR.

Art Director
HERMAN R. BOLLIN



COVER PHOTO: Putting final touches on the radio controlled model sailboat in the model boat sailing basin on the Charles River, Boston. Under FCC regulations, an amateur radio operator's license is required.
 (Photo by Walter Steinhard)

Chairman of the Board and Publisher
WILLIAM B. ZIFF
President
B. G. DAVIS
Secretary-Treasurer
ARTHUR I. PULLEN
Vice-Presidents
GEORGE BERNER
Advertising and Sales Director
MICHAEL H. FROELICH
Editorial Director
H. J. MORGANROTH
Production Director
H. G. STRONG
Circulation Director

BRANCH OFFICES
NEW YORK (1)
 Empire State Bldg., W1 7-0400
Manager, Eastern Division
CHARLES R. TIGHE
LOS ANGELES (14)
 815 S. Hill St., TUcker 9213
Manager, Western Division
WILLIAM L. PINNEY
TORONTO
 21 King Street, East
ASSOCIATED COMPANIES
 Ziff Davis, Ltd., Grampians Bldg.
 Western Gate, London, England
 Ziff-Davis-Patel, Ltd.
 190 Hornby Road, Bombay, India

RADIO NEWS

First in radio-electronics

Average Paid Circulation over 148,000

Trade Mark Registered U.S. Patent Office No. 378427

CONTENTS

APRIL, 1948

Radio Controlled Model Sailboat.....	R. C. Schmidt, W1VDY and L. A. Williams	39
Money—What You Need and How to Get It.....	R. W. Pitman	42
High Fidelity—Too Much Confusion Too Little Clarification.....	Harry W. Becker	43
The APS-42 Radar.....	L. W. Mallach	44
A Doorbell that is Different.....	Richard H. Houston	46
Failures Don't Just Happen!.....	Dr. Louis Bader	48
Putting the 522 Transmitter on 6 and 10 Meters	H. S. Brier, W9EGQ	50
New Band FM Receiver.....	J. C. Michalowicz	51
A Versatile Service Test Instrument.....	C. T. Haist, Jr.	54
A Simple NBFM Transmitter.....	J. P. Simmons, W6EBT	56
Modern Television Receivers (Part I).....	Milton S. Kiver	59
Mac's Radio Service Shop.....	John T. Frye	63
A Television Oscilloscope (Part I).....	L. H. VanArsdale, Jr.	64
A Unique A.V.C. Amplifier.....	J. T. Goode	67
"S" Meter Calibration Techniques for Communications Receivers.....	Robert M. Berler, W2EPC	68
A Two-Meter Converter.....	A. David Middleton, W1CA	70
The Recording and Reproduction of Sound (Part 14).....	Oliver Read	72
Design Features of a Deluxe Receiver.....	Carl V. Hays, W6RTP	75
High Speed Receiver Squelch.....	H. W. Kline, W2DKE	94

DEPARTMENTS

For the Record.....	The Editor	8	RN Circuit Page	90
Spot Radio News.....	Fred Hamlin	18	Technical Books	106
Within the Industry.....		28	Letters from Our Readers.....	126
Short-Wave.....	K. R. Boord	74	New Receivers	182
What's New in Radio.....		84	Manufacturers' Literature	186



COPYRIGHT 1948
 ZIFF-DAVIS PUBLISHING COMPANY
 185 North Wabash Ave., Chicago 1, Ill.
 VOLUME 39 • NUMBER 4



Member
 Audit Bureau of
 Circulations

RADIO NEWS is published monthly by the Ziff-Davis Publishing Company, 185 N. Wabash Ave., Chicago 1, Ill. Subscription Rates: in U. S. and Canada \$4.00 (12 issues), single copies 35 cents; in Mexico, South and Central America, and U.S. Possessions, \$4.00 (12 issues); in British Empire, \$5.00 (12 issues)—all other foreign countries \$5.00 (12 issues). Subscribers should allow at least 2 weeks for change of address. All communications about subscriptions should be addressed to: Director of Circulation, 185 N. Wabash Ave., Chicago 1, Ill. Entered as second class matter March 9, 1938, at the Post Office, Chicago, Illinois, under the Act of March 3, 1879. Entered as second class matter at the Post Office Dept., Ottawa, Canada. Contributors should retain a copy of contributions and include return postage. Contributions will be handled with reasonable care but this magazine assumes no responsibility for their safety. Accepted material is subject to whatever revisions and by-line changes that are necessary. Payment made at our current rates, covers all authors', contributors' or contestants' rights, title, and interest in and to accepted material, including photographs and drawings.

RADIO NEWS

APRIL, 1948

**RADIO
NEWS**

RADIO-ELECTRONIC

Engineering

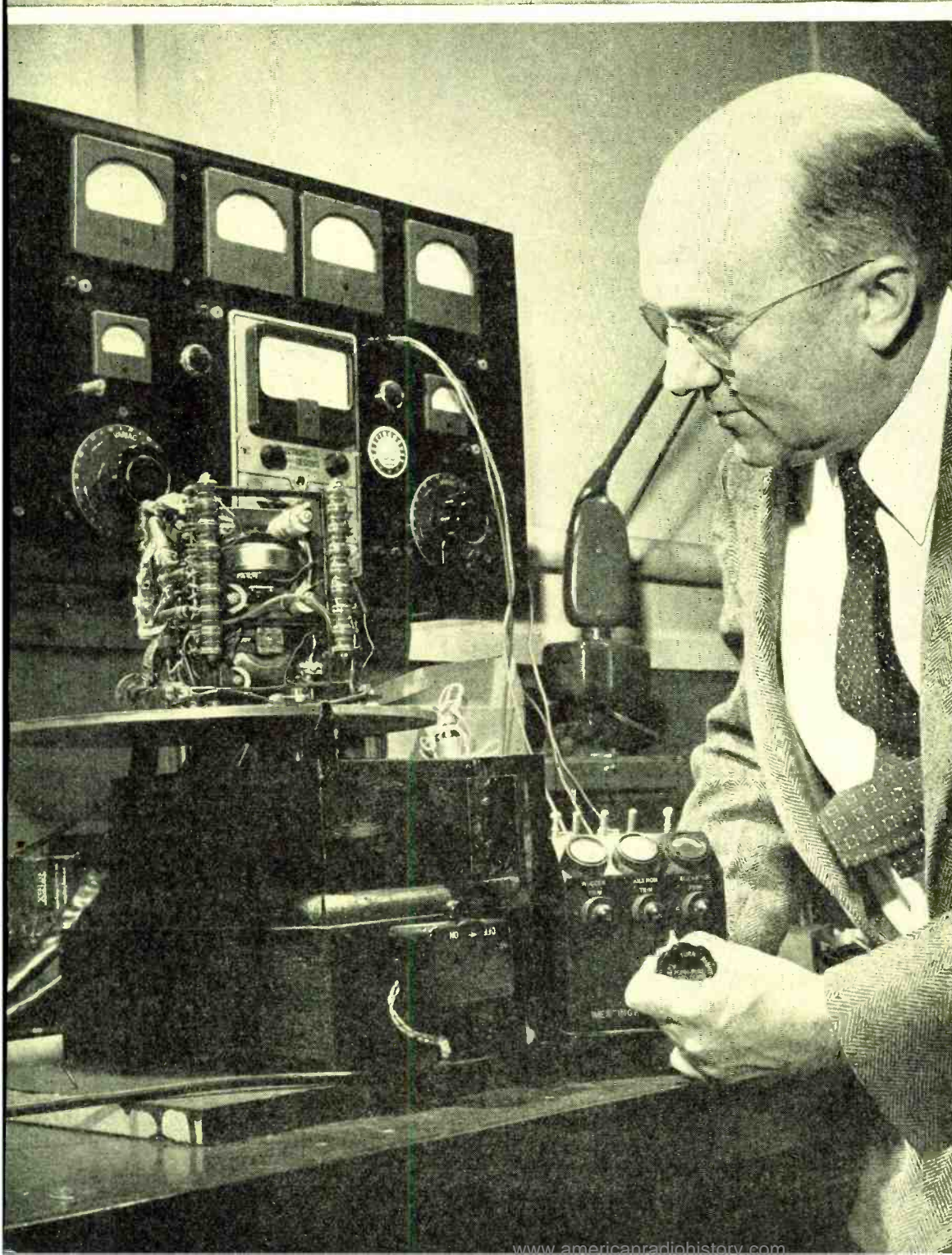

TELEVISION

RADAR

ELECTRONICS

RESEARCH

COMMUNICATIONS

MAINTENANCE

ELECTRONICS • COMMUNICATIONS • TELEVISION • RESEARCH • MAINTENANCE

APRIL, 1948

ATTENUATORS.....Llewellyn Bates Keim 3

LIQUID DIELECTRICS FOR VARIABLE CONDENSERS....Sidney Wald 7

PROTELGRAM—A NEW PROJECTION TELEVISION SYSTEM..... 10

BEAD-SUPPORTED COAXIAL ATTENUATORS.....
.....Herbert J. Carlin and John W. E. Griemsmann 12

DELAY LINES FOR PULSE APPLICATIONS.....
.....Sidney Moskowitz and Joseph Racker 15

DEPARTMENTS

NEWS BRIEFS.....20	PERSONALS.....26
NEW PRODUCTS.....22	NEW TUBES.....28
TELEVISION.....24	CALENDAR.....29



RADIO-ELECTRONIC ENGINEERING is published each month as a special edition in a limited number of copies of RADIO NEWS, by the Ziff-Davis Publishing Company, 185 N. Wabash Avenue, Chicago 1, Illinois.

VOLUME 10, NUMBER 4, Copyright, 1948, Ziff-Davis Publishing Company

COVER PHOTO—By Acme

Kurt A. Oplinger of Westinghouse Elec. Co., Pittsburgh, Pa. at the controls of the automatic pilot which he helped develop. The unit is mounted on a turntable for testing purposes, to simulate motion of a plane in flight. Three small gyros are contained in the unit to control the motion of the plane.



ATTENUATORS

By LLEWELLYN BATES KEIM

Consulting Radio Physicist*

THE modern attenuator has evolved through the last two decades from a simple, crude, slide wire unit, reminiscent of an old-fashioned filament rheostat, to the present day precision unit universally used in broadcasting and sound recording installations and in laboratory measurement procedures. However, little has been written during this period to assist the younger engineer and newcomer to these industries in the proper method of using these devices; and even less has been written on the selection of the correct type of attenuator for a specific use and the reasons for that selection. The catalogues offered by the makers of these units do not give any real assistance on technical data. So the author will attempt to cover all aspects of this field of the sound industry.

In order to present the matter clearly, varying uses and applications of attenuators will be discussed before attacking the problem of selecting the proper type for a particular application. A discussion of the electrical circuits associated with these interesting controls will be dealt with later.

Three forms of the attenuator can serve as a simple gain control for amplifiers, but the most frequently chosen is the potentiometer. The tee, ladder or tone-compensated ladder are used, depending upon the purpose of the amplifier, but the high impedance gain control is most popular. Both broadcasters and sound men have found the cheap paper with carbon deposit type of resistance far from satisfactory and have insisted upon a step-by-step construction of the gain control, whose resistance elements themselves are frequently of the carbon resistance type, selected for both accuracy of calibration and freedom from noise in the audio spectrum. Wire wound resistances can also be used, but their higher cost is not justified except in precise laboratory installations. Figs. 2 and 5A show the circuits of these units; Fig. 3 is a modern attenuator of the potentiometer type.

Studio installations of speech input equipment almost universally use ladders (Fig. 2C) or bridged tee (Fig. 5B) attenuators as the mixing and volume



Copyright Altec Service Corp.

Fig. 1. The Roxy Theatre Control Console. Provision is made for 52 slide attenuators; 38 are shown in operation. In left foreground, front rotary attenuator is stereophonic control

First of two papers covering the modern attenuator as used in the broadcasting and sound industries. Problems of use and proper selection are discussed.

level controls. Where the cost factor must be considered, a potentiometer is frequently used as master gain control, but only where the entire speech equipment is built as a unit incorporating amplifiers and mixing equipment in one housing. This is done to avoid long, high impedance leads, and the attendant danger of hum pickup. The design of a mixing system is covered in later paragraphs.

Changing the characteristic impedance of a sound channel is often necessary, particularly in test installations, and a special type of attenuator is available for this purpose, offering either the minimum loss for the ratio of impedances matched, or a constant loss for any ratio selected. This is a little known but useful piece of equipment for the research worker.

Installations of any form of public address equipment for sound reinforcement present the problem of control of level from individual or groups of loudspeakers where a single amplifier feeds more than one transducer. The power attenuator can be used to control the sound level delivered without altering the volume from the remaining speakers connected to the

same power amplifier source. Such installations are desirable when it is necessary to give the individual control of the speaker near him without affecting the group. As the control must dissipate power, its size and selection depends upon the level at which the loudspeaker is designed to work. Frequently these devices for group control assume large physical dimensions. In this connection it is well to observe that the power rating of such devices is based upon sine waveform, and use for speech and music will allow a slight overloading of the control with safety. However, not more than 25 per-cent overload can be economically tolerated unless it is for a very short period of time, or the attenuator's life is endangered.

There are more complicated uses of attenuators and a few of them are discussed here. The tone compensating attenuator, a newcomer, is illustrated in Fig. 4, and this unit can be converted from the intended function to a straight ladder by means of the special external connections shown. Electrically, it appears diagrammed in Fig. 7A. Here we find a unit especially engineered to overcome the loss

* Formerly Sales Manager, The Davenport Company, Newark, N. J.

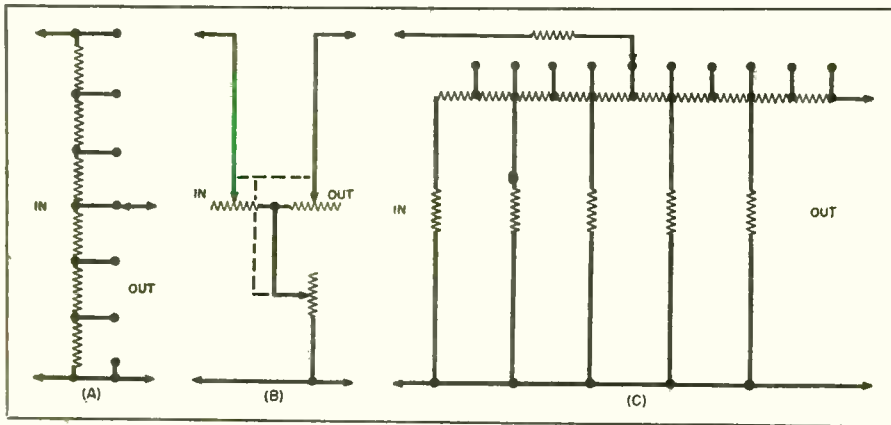

Fig. 2. (A) Potentiometer schematic. (B) The Tee pad. Note that all three resistors vary simultaneously. (C) The Ladder schematic.

of sensitivity of the human ear to certain tones at low volume levels, but attenuators can generally be used to achieve tone compensation where they are merely elements of a complex correcting circuit, as in the familiar equalizing units offered in the trade. In the recording process, at 33½ r.p.m. used in making transcriptions, there must be considerable equalization as the recording radius is reduced. Attenuators lend themselves nicely to this function, and can be actuated by the recording lead screw mechanism or manipulated separately at the discretion of the recording engineer. When attached to the recorder they take the form of sliding units, or those with an arc movement, operated through mechanical linkages to the traveling recording head.

Readers who attended the 1936-37 Dallas, Texas exposition perhaps witnessed the open air stereophonic sound installation, where the voice of the performing artist moved across stage, with the actor's motion. This is a special application of attenuators, which in its simplest form allows one control to govern two banks of power

amplifiers and their loudspeakers. At mid-position, half power is delivered to each bank of loudspeakers and as rotation takes place, left or right of center, one bank of speakers is driven at full power, while the other is greatly reduced, but not quite cut off. Thus there is an illusion of movement of the projected voice. The degree of loss introduced is in the neighborhood of 12-15 decibels. A variant of this was automatically accomplished in a separate sound track run coincidentally with the projection print of *Fantasia*, and was utilized in those theaters which had been equipped to handle this type of sound projection.

The last special use of attenuators to be discussed here is the application in circuits measuring volume level. The familiar decibel meter, a rectifier type of voltmeter, has long been used in all sound installations, and is still widely used in laboratory, test, and recording studios. Where it is necessary to terminate the measured circuit in its characteristic impedance, the meter can be connected to a tee pad across the line thus serving to adjust the range of the meter too. If it is electrically possible to bridge the

meter across the circuit to be measured, a potentiometer can be used. The accuracy of measurement is determined by the accuracy of calibration of the resistances built into these meter multipliers. Eight years ago the broadcasting organizations cooperated in developing a standard measuring instrument, the VU meter, which today is universally used in that industry. Possessing specific, desirable ballistic characteristics and reading a power level of plus 4 dbm.* at zero VU on its scale, it is clearly evident that some form of multiplier is necessary here too. This takes the form of a pure tee pad, so that the characteristics of the meter are not changed, nor any inordinate loss imposed upon the audio line being measured. A small attenuator, in the form of a rheostat, is incorporated in these circuits wherever it is necessary to standardize many instruments throughout a broadcasting network to read alike. Such standardization takes place daily with a constant tone signal transmitted before network operations commence.

So far we have been talking about variable attenuators, but there is a vast field of applications for fixed attenuators, or fixed pads. In mixing installations, the several incoming signals are frequently not of identical level and any great discrepancy can be compensated for by a fixed pad of suitable circuit configuration—to match the general schematic of the mixer—balanced or unbalanced to ground. When two amplifiers are coupled together at low impedance, good engineering practice dictates that at least six decibels of loss in the form of a fixed attenuator should be included in the circuit between the two connected transformer windings. This will eliminate any circulating audio currents.

Multiple end use of a single source of sound energy, such as feeding both an AM and FM transmitter or driving many power amplifiers in a sound system, calls for the use of a dividing network. This is a form of fixed attenuator, offering a small loss between the source and its respective loads, but simultaneously presenting considerable separation between the several loads. Inverted, the same pad becomes a combining network, for assembling several sources into one load. Usually these pads are designed to present a uniform impedance to all terminals, and assume several complicated circuit configurations, but they are all examples of attenuators.

When connecting a bridging amplifier across a properly terminated junction of source and load, a bridging pad can be used, if the second

Fig. 3. The Potentiometer. A 20 step unit with protective cover removed.

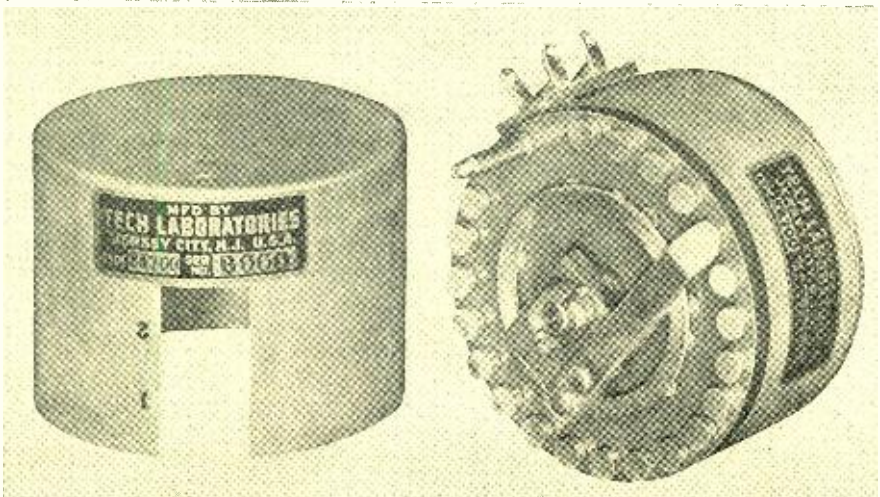

*Reference level 1 mw. at 600 ohms Z.

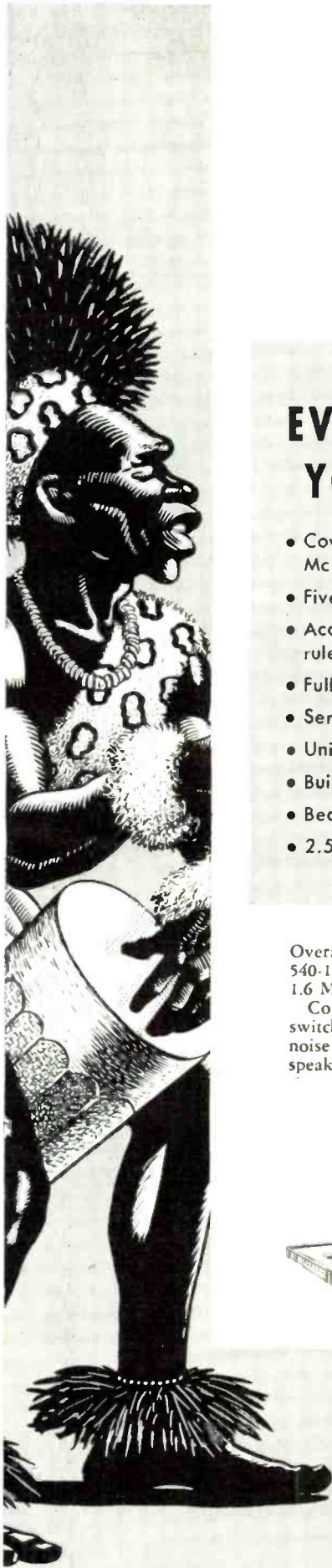

EVERYTHING YOU WANT..... in a high quality low cost receiver *Model*
hallicrafters NEW S-53

- Coverage: 540 kc to 54.5 Mc
- Five bands
- Accurately calibrated slide rule dials
- Full electrical bandspread
- Series noise limiter
- Universal antenna input
- Built-in PM speaker
- Beat oscillator
- 2.5 watt audio output

Hallicrafters Model S-53 takes an important position in the Hallicrafters line of high quality communications receivers. Completely modern. Superbly engineered for top flight performance at remarkably low price. All the Hallicrafters built-in quality features amateurs expect and demand in a good receiver. Extended frequency range from 540 kc to 54.5 Mc in five bands. Uses two Mc IF which positively eliminates all amateur station images or repeat points within the ham bands. The strikingly designed, edge lighted dial is precisely calibrated. A separate bandspread control provides full electrical bandspread on all frequency bands. Latest series type noise limiter circuit; voltage stabilized oscillator; iron core IF's; built-in PM dynamic speaker. Rich satin-black steel cabinet with satin chrome trim. Complete with seven tubes and rectifier. 105-125 volts, 50-60 cycles AC. **\$79.50**

Overall tuning range: 540 kc to 54.5 Mc. Band 1: 540-1630 Kc; Band 2: 2.5-6.3 Mc; Band 3: 6.3-1.6 Mc; Band 4: 14-31 Mc; Band 5: 48-54.5 Mc.
 Controls: main tuning, bandspread, band-switch, RF gain, audio volume, tone control, noise limiter, standby-receive, phone-code switch, speaker-headphone switch and phone jack on rear

panel. Input jack for record player pickup connection.

New superhet circuit uses: 1-6C4 oscillator; 1-6BA6 mixer; 2-6BA6 IF's; 6H6 detector-AVC-noise limiter; 6SC7 BFO-1st audio; 6K6GT audio output and SY3 rectifier.

Size: 12⁷/₈" x 6⁷/₈" x 7⁷/₈".

Copyright 1948, The Hallicrafters Co.

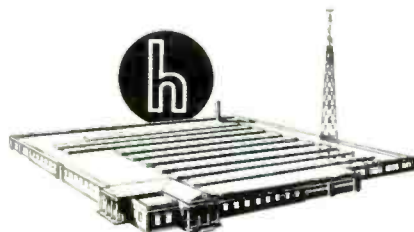

hallicrafters
RADIO
 THE HALLICRAFTERS CO.
 4401 W. Fifth Ave., Chicago 24, Illinois
 MANUFACTURERS OF RADIO AND ELECTRONIC EQUIPMENT

LISTEN FOR THE *Gatti*- hallicrafters *expedition*

Hallicrafters mobile, radio-equipped expedition now operating via short wave from the Mountains of the Moon, Africa. Listen for these call letters:

VQ5-GHE VQ3-HGE VQ4-ENG VQ5-HEG

Visit your distributor for maps, itinerary, schedules, other details.

NOW SMALLER THAN EVER!

Federal Offers You a New
75-Ma Selenium Rectifier
that is

OCCUPIES ONLY $\frac{3}{4}$ OF A CUBIC INCH

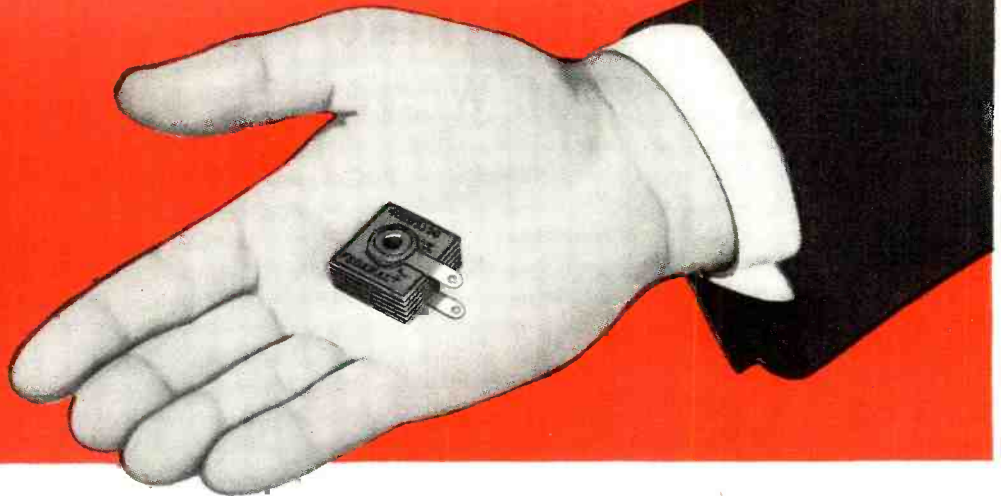

A new solution to the space problem in your smallest electronic equipment

WHEN FEDERAL first introduced the Miniature Selenium Rectifier to replace the rectifier tube in AC-DC radio receivers, it was the smallest, most compact unit of its type ever developed. Now the new 75-Ma rectifier is even *smaller* than before—providing additional space savings so valuable in modern miniature receivers and equipment. It's easier to install in restricted spaces—leaves more "hand room" to work in. And this reduction in size has been made without any sacrifice in performance or dependability. In fact, it incorporates *added* safety factors for longer trouble-free operation. Compared to a rectifier tube, this space-saving Selenium Rectifier offers the advantages of longer life, rugged all-metal construction, only two soldered connections, and instantaneous current output without warm-up. For complete data on the new 75-Ma rectifier, write to Federal today-Dept. F 559.

APPROXIMATE DIMENSIONS 75-Ma Rectifier — No. 402D3150

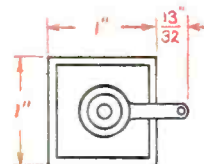

NOTE: This rectifier is electrically interchangeable with Rectifier No. 402D2788.

Federal Telephone and Radio Corporation

SELENIUM and INTELIN DIVISION, 1000 Passaic Ave., East Newark, New Jersey

In Canada:—Federal Electric Manufacturing Company, Ltd., Montreal, P. Q.
Export Distributors:—International Standard Electric Corp. 67 Broad St., N. Y.



KEEPING FEDERAL YEARS AHEAD... is IT&T's world-wide research and engineering organization, of which the Federal Telecommunication Laboratories, Nutley, N. J., is a unit.

The battle of the atoms

Telephone equipment is constantly at war against invisible forces of nature which seek to take it apart, atom by atom. On all fronts, Bell Laboratories chemists must fight corrosion — an enemy able to make a telephone circuit noisy or perhaps to sever it altogether.

An example: for years lead cable had lain protected in wooden ducts. Then in certain areas something began to eat the sheath, exposing wires to moisture. Corrosion chemists of the Laboratories were called in. The corrosion, they found, came from acetic acid generated in the wood during the preservative treatment then in use. They pumped in neutralizing ammonia. Corrosion stopped. Now telephone duct wood is controlled for acidity.

In a large city, smoke-polluted air was coating the silver surfaces of contacts with sulphide. Noisy circuits resulted. Chemists discovered minute traces of sulphur vapor in the air. They filtered incoming air with activated charcoal. Today, the latest telephone contacts are of palladium — not affected by sulphur.

Corrosion in metals is only one type of deterioration which engages Bell chemists against hostile forces. Plastics, paper, metals, rubber, textiles, coils, waxes and woods all have enemies. But knowledge, and persistence, are steadily winning out — to the benefit of the telephone user.

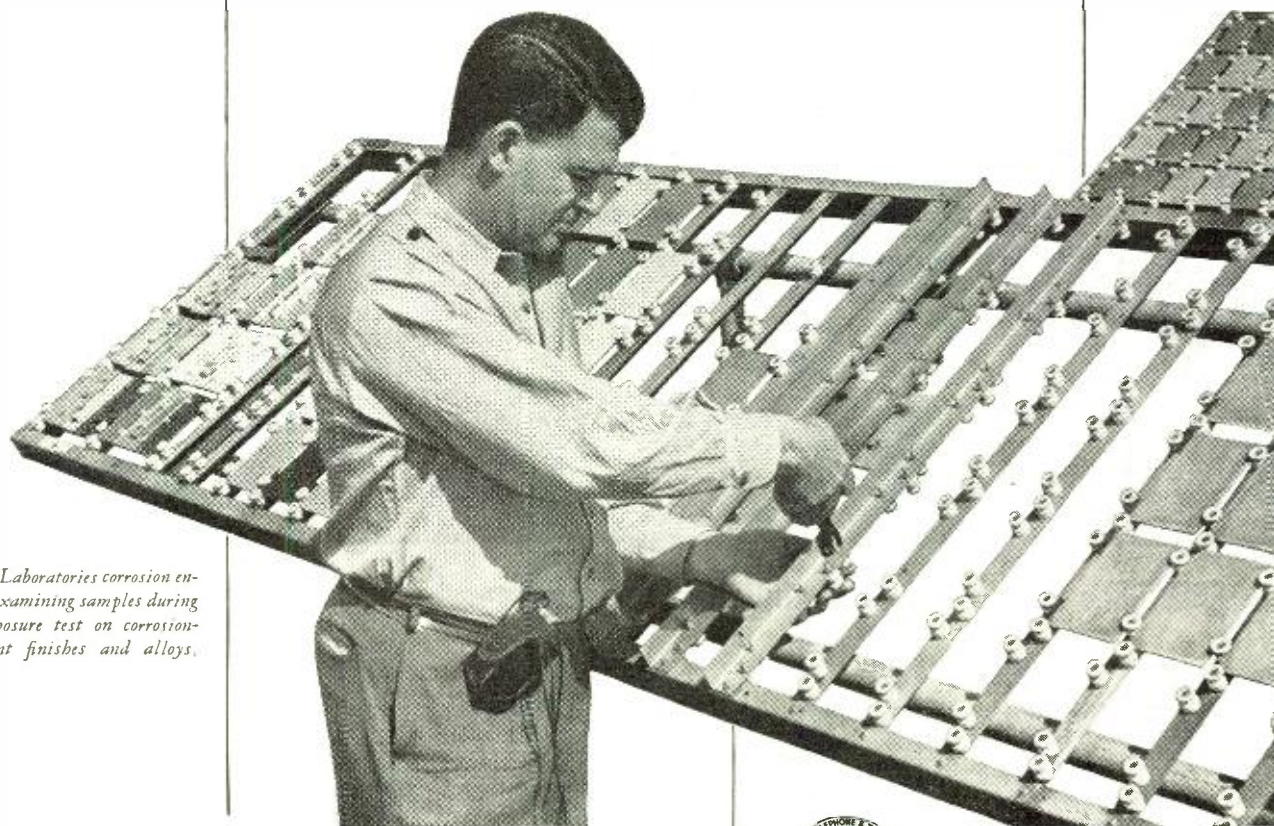

A Bell Laboratories corrosion engineer examining samples during an exposure test on corrosion-resistant finishes and alloys.

BELL TELEPHONE LABORATORIES



EXPLORING AND INVENTING, DEVISING AND
PERFECTING FOR CONTINUED IMPROVEMENTS
AND ECONOMIES IN TELEPHONE SERVICE

Improved "Adashaft" * Radiohm!

SIX TYPES OF SHAFTS GIVE YOU WIDE VARIETY!



K-185 3" Fluted "Adashaft" (supplied standard)



K-176 1 $\frac{1}{8}$ " Split "Adashaft"



K-177 3 $\frac{7}{8}$ " Split Knurl "Adashaft"



K-166 3" Auto Type "Adashaft"



Long Guide Funnel



Short Guide Funnel



K-167 6" Auto Type "Adashaft"



Long Guide Funnel



K-165 10" "Adashaft" $\frac{1}{32}$ " flat



K-184 Slotted Insulating Coupler



K-161 Coupler Shaft

 See how "Adashaft" Radiohms cut down overhead on service and repairs!

NOW, YOU CAN HAVE a small stock of controls on hand, yet be prepared to handle almost any kind of control replacement problem for your customers! Yes, that's what Centralab "Adashaft" Radiohms give you, and that's why more and more radio service dealers are using them to speed up service and cut down inventory.

ble in all sizes for all Model "M" volume control applications. See for yourself how they can streamline your service operations. Ask your jobber about them, or write direct for further information.

Centralab

Division of GLOBE-UNION INC., Milwaukee

Centralab Announces an

See how **EASILY** and **QUICKLY** "Adashaft"* Radiohms can be assembled!

No WIGGLE, no wobble, no slip when you use Centralab's "Adashaft" Radiohm. Just insert shaft pilot in hole provided in control stub shaft, and slip "C" washer into place. Quick as a wink, control and shaft become an integral unit, ready for smooth, trouble-free operation. Notice the wide selection of shaft types which Centralab offers you — for every kind of set from large radio-phonograph combinations to small automobile receivers. Shafts are rugged—built to withstand hard usage, yet easy to cut to lengths required.

**Trademark registered*

BEFORE ASSEMBLY

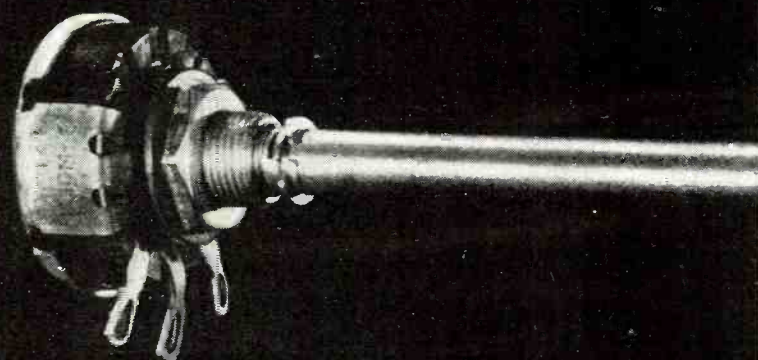
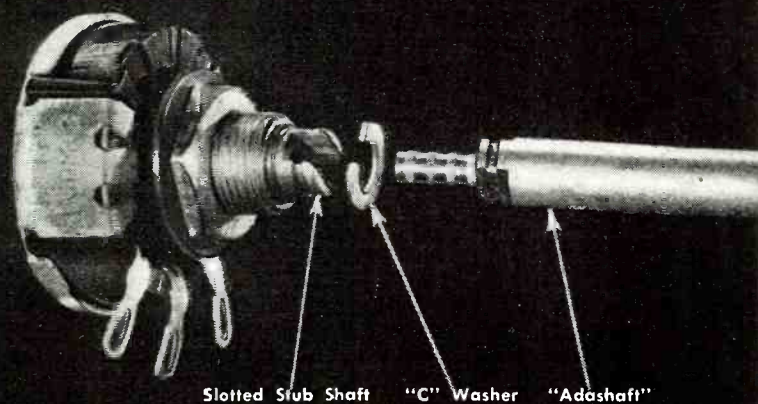

AFTER ASSEMBLY

Where line switches are required, use **CRL attachable Switch Covers!**

Available in five types for "R" Radiohms, 4 types for "M" Radiohms, 1 type for "E" Radiohms. Minimum life of 50,000 mechanical and electrical operations. Underwriters approved. Contact carrier is propelled by full-floating, compression type spring, provides easy, positive action. Rated at 3 amp., 125 volts; 1 amp., 250 volts.

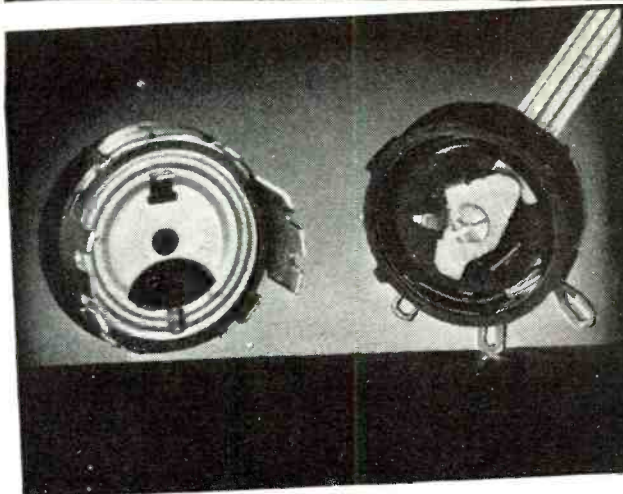

SAVE TIME — SAVE MONEY SAVE TUBES....

With the New HYTRON Miniature Pin STRAIGHTENER

Ever cursed the pins of miniatures when they broke as you fussed to straighten them with your fingers or with long-nose pliers? Unfortunately the pins have to be pliable to avoid cracked buttons. But you can make pin straightening easy and safe.

For only 49c — less than cost — a fraction of normal price, you can own a new Hytron Miniature Pin Straightener. You then merely press a 7-pin miniature gently into the Straightener until the button base seats squarely. Presto, the pins are straight again! Best of all, avoiding just one broken tube can pay for the Straightener twice over.

Features: precision die of wear and rust resistant steel for long life and close tolerances, production-tested, easy clean-out, adapted to hand or bench use. It's faster, cheaper, safer to use the Straightener *always* before plugging in miniatures. You need three Pin Straighteners — for bench — for field tool kit — for counter. Available only from Hytron jobbers. Order yours today.



ONLY 49c
AT YOUR HYTRON JOBBER'S

A PREVIEW

The Hytron Miniature Tube Pin Straightener and Handy Tube Tapper are just the beginning. Watch for more lower-than-cost Hytron tube tools designed especially for you. They will save you time — help you make more money. Follow the Hytron ads for announcements. Order the tools from your Hytron jobber.



Hytron Handy Tube Tapper — novel and useful tool locates elusive intermittent "shorts" and "opens". Pencil, eraser, and tube tapper. Fits breast pocket. Compact and nonmetallic. Rugged and effective. Only 5c at your Hytron jobber's.

BENDIX RADIO
REG. U.S. PAT. OFF.

TUBES ARE KNOWN BY THE COMPANY THEY KEEP

Bendix MRT-3A, 152-162 mc f-m taxicab transmitter uses Hytron tubes generously.

Companies with top names like Bendix pick top quality components. You, too, choose the best when you ask for Hytron. Join the leaders. Specify Hytron tubes.

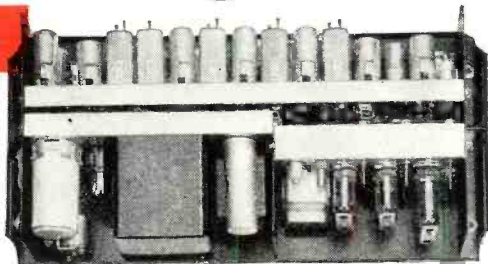

SPECIALISTS IN RADIO RECEIVING TUBES SINCE 1921

These service tools made available to you on a non-profit basis by both Hytron and its jobbers.

HYTRON
RADIO AND ELECTRONICS CORP.



MAIN OFFICE: SALEM, MASSACHUSETTS

LET THIS "AUTOMATIC TEACHER" show you exactly how to repair over 4800 RADIO MODELS without expensive test equipment!

GHIRARDI SAVES YOU TIME — HELPS YOU MAKE MONEY

Ghirardi's RADIO TROUBLESHOOTER'S HANDBOOK is the ideal manual to show you exactly how to repair radios at home in spare time—quickly and without a lot of previous experience or costly test equipment. It contains MORE THAN 4 POUNDS OF FACTUAL, time-saving money-making repair data for repairing all models and makes of radios better, faster and more profitably than you may have thought possible!

REPAIR 2 RADIOS IN THE TIME NORMALLY REQUIRED FOR ONE!

RADIO TROUBLESHOOTER'S HANDBOOK can easily pay for itself the first time you use it. You don't have to study it. Simply look up the make, model, and trouble symptom of the Radio you want to repair and go to work. No lost time! Clear instructions tell exactly what the trouble is likely to be—EXACTLY how to fix it. Actually, this big 744-page manual-size HANDBOOK brings you factual, specific repair data for the common troubles that occur in practically every radio in use today—for over 4800 most popular models of Home and Auto radio receivers and Automatic record changers of 202 manufacturers! In addition, there are hundreds of pages of helpful repair charts, tube charts, data on tuning alignment, transformer troubles, tube and parts substitution, etc., etc.—all for only \$5 (\$5.50 foreign) on an UNRESERVED 5 DAY MONEY-BACK GUARANTEE!

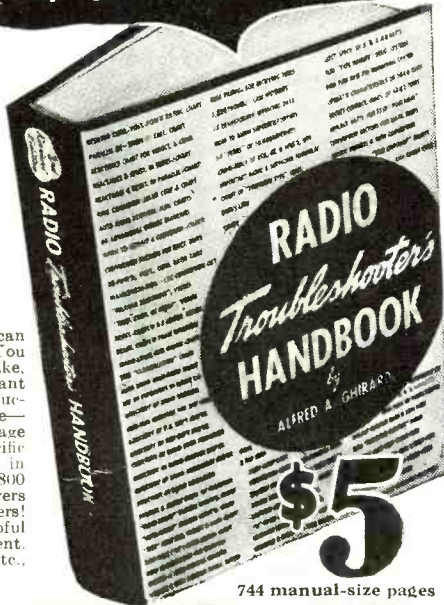

744 manual-size pages

Get a Complete RADIO-ELECTRONIC SERVICE EDUCATION AT HOME—WITHOUT AN INSTRUCTOR

COMPLETE DATA ON TEST INSTRUMENTS—TROUBLESHOOTING—REPAIR

A. A. Ghirardi's big 1300-page MODERN RADIO SERVICING is the finest, most complete instruction book on Radio-Electronic service work for either the novice or the professional Radio-Electronic serviceman—bar none. Read from the beginning, it is a COMPLETE COURSE IN SERVICING by the most modern methods. Used for reference it is an invaluable means of brushing up on any servicing problem. Gives complete information on all essential service instrument

types; how they work (with wiring diagrams), when and why to use them; how to build your own; preliminary trouble checks, circuit and parts analysis; parts repair, replacement, substitution; obscure radio troubles, aligning and neutralizing; interference reduction—and hundreds of other subjects including How to Start and Operate a Successful Radio-Electronic Service Business. 723 self-testing review questions help you check your progress EVERY STEP OF THE WAY. Only \$5 complete (\$5.50 foreign).

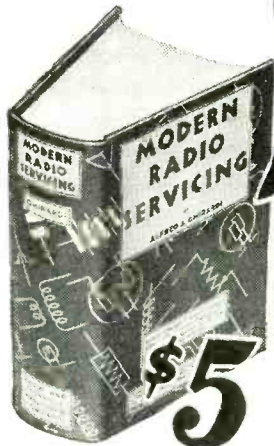

1300 pages, 706 illus. 723 review questions

5-DAY MONEY-BACK GUARANTEE

Dept. RN-48, MURRAY HILL BOOKS, INC., 232 Madison Ave., New York 16, N. Y.

Enclosed find \$..... for books checked or send C.O.D. (in U.S.A. only) for this amount plus postage. If not fully satisfactory, I may return the books at the end of 5 days and receive my money back.

- MODERN RADIO SERVICING \$5 (\$5.50 foreign) RADIO TROUBLESHOOTER'S HANDBOOK \$5 (\$5.50 foreign)

Special Money-saving combination Both big books for only \$9.50 (\$10.50 foreign)

Name
Address
City & Dist. No. State
(Please print or write plainly)

"You Can't Go Wrong on Ghirardi Radio Book"



MONEY-SAVING OFFER! Get BOTH big books — Radio's most famous Service Library — over 2030 pages — at a bargain combination price. See coupon.

eleven years. He was also associated with the *Pan American Airways System* for eighteen months during the war as a flight radio officer on trans-Pacific clippers.

Before joining the *Farnsworth* company two years ago, Mr. Patton was the acting chief engineer of the Common Carrier Engineering Section of the Federal Communications Commission. During the war, he served with the Board of War Communications and was the Engineering Department's representative in the coordination of activities with the FCC legal staff.

* * *

RAY HUTMACHER is *Utah Radio Products, Division of International Detrola Corporation's* new representative in Illinois, Wisconsin, and St. Louis County, Missouri. Also appointed at the same time as Mr. Hutmacher, of *Roy Hutmacher & Associates* of Chicago, was William S. Lee of Detroit, who will cover the entire state of Michigan for *Utah*.



Both Mr. Lee and Mr. Hutmacher have many years' experience in the marketing of radio replacement parts and are well-known through their respective territories.

* * *

DAVID T. SIEGEL, Chicago manufacturer, has announced the purchase of *American Relay & Controls, Inc.* This company manufactures electrical relays, switches, and specialized controls.

The newly purchased firm is now located at 4900 West Flournoy Street, Chicago 44, Illinois.

* * *

FRED T. STERRITT, was recently appointed Advertising and Sales Promotion Manager of *Sparks-Withington Company's* Radio and Appliance Division.



Mr. Sterritt, recently District Merchandiser for *Sparton* in Chicago and Northern Illinois, had been an advertising and sales promotion executive for *Sparton* for some years before the war, and later acted in a similar capacity for *Zenith Radio Corporation*.

* * *

GENERAL ELECTRIC COMPANY has appointed Richard H. Rudolph as Sales Manager of precision and laboratory test equipment and crystals for the *Specialty Division*.

Formerly a commercial engineer in the division, he will now have charge of the sale of this equipment to nucleonic, research, manufacturing, and educational organizations.

Mr. Rudolph holds a B.S. degree in electrical engineering from Ohio University. In 1943 he joined *General*

(Continued on page 201)

READ MORE RANGES • MORE ACCURATELY • MORE EASILY



12 D. C. Voltage Ranges on 4.4" scale. Mirrored for Accuracy. Special multipliers for permanent accuracy.

6 A. C. Voltage Ranges on 4" Scale. Mirrored for Accuracy. Special multipliers for permanent accuracy.

6 D. C. Current Ranges on 4.4" Scale. Mirrored for Accuracy. Wire wound shunts for permanent accuracy.

3 Resistance Ranges on 5" scale. Mirrored for Accuracy. Special multipliers for permanent accuracy.

6 Decibel Ranges on 3.33" scale. Mirrored for Accuracy. Special multipliers for permanent accuracy.

**MODEL
625-NA**
Dealer Net Price \$45⁰⁰

For the Man who takes Pride in his work

The new Model 625-NA, with 39 ranges and many added features, is the widest range tester of its type. Note the long mirror scale on the large 6" meter for easier, more accurate reading. Resistance ranges to 40 meg-ohms give you all the ranges needed for general servicing, plus Television and FM. And with 10,000 ohms per volt A. C. you can check many audio and high impedance circuits where a Vacuum Tube Volt meter is ordinarily required. A proven super-service instrument for laboratory, field maintenance and radio repair.

Write for complete technical information on Dept. N47.

RANGES

- D. C. VOLTS: 0-1.25-5-25-125-500-2500, at 20,000 Ohms/Volt
- 0-2.5-10-50-250-1000-5000, at 10,000 Ohms/Volt
- A. C. VOLTS: 0-2.5-10-50-250-1000-5000, at 10,000 Ohms/Volt
- D. C. MICROAMPERES: 0-50, at 250 Millivolts
- D. C. MILLIAMPERES: 0-1-10-100-1000, at 250 Millivolts
- D. C. AMPERES: 0-10, at 250 Millivolts
- OHMS: 0-2000-200,000 (12-1200 at center scale)
- MEGOHMS: 0-40 (240,000 ohms at center scale)
- DECIBELS: -30 +3 +15, +29, +43, +55, +69 (Reference level "0" DB at 1.73 V. on 500 ohm line)
- OUTPUT VOLTS: 0-2.5-10-50-250-1000-5000, at 10,000 Ohms/Volt

TRIPLETT ELECTRICAL INSTRUMENT CO. • BLUFFTON, OHIO
In Canada: Triplett Instruments of Canada, Georgetown, Ontario

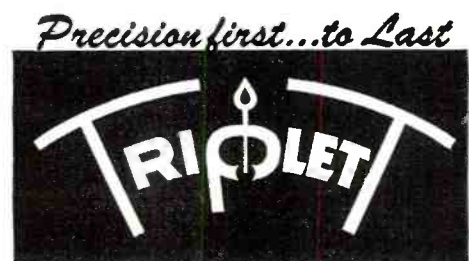

PROJECTION TELEVISION!

Convert your RCA 630 or Crosley 307 to this

OUTSTANDING
TELEVISION
CONVERSION
OF 1948!

The gigantic picture this set is capable of projecting must be seen to be believed! One set converted by a Los Angeles company, was demonstrated at the Shriner's Temple in Los Angeles, during the Rose Bowl game. It was viewed by 4800 people at one sitting! A 12x16-foot rear projection plastic screen of our type was used.

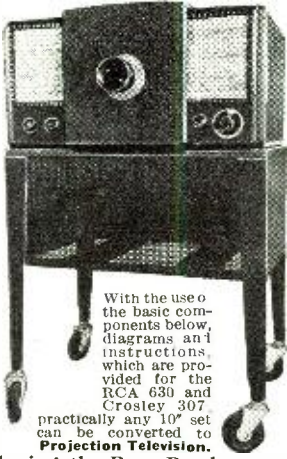

With the use of the basic components below, diagrams and instructions, which are provided for the RCA 630 and Crosley 307, practically any 10" set can be converted to Projection Television.

F 1.9 TELEVISION PROJECTION LENS

Dimension—
Length 7", Diam-
eter 4 1/4".

F 1.9 EF. 5 in. (127.0 mm). This lens incorporates in barrel a corrective lens for use with a 5TP4 projection tube. It is easily removable for use with flat type tubes. Lens can be utilized to project picture sizes from several inches to 7x9 feet. Made by Bausch & Lomb Optical Co. Price, complete..... \$125.00
Mounting ring available for above lens... Price \$2.50



30 KV RF POWER SUPPLY

Dimensions—
Length 14", Width
11", Height 11 1/4".

This unit has a low voltage supply separate from high voltage pack. Low voltage DC supply has control which enables you to vary voltage from approximately 12 KV to 40 KV. Unit has focus control built in for use with 5TP4 projection tube. Price, complete..... \$99.50



STAND FOR PROJECTION TELEVISION SETS

Dimensions—23" High, 25" Wide, 18 1/2" Depth. For use with RCA 630 chassis or Crosley table model sets. Unit mounted on ball bearing soft tired wheels. Depth is designed to accommodate RF Power Supply. Open grill allows free circulation of air. This stand a natural for mounting scopes and other lab. equipment for easy mobility. Specify whether for Television use or shop. Stand as shown in top photo. Price..... \$31.50

REAR PROJECTION TELEVISION SCREENS

The screen surface consists of a conglomerate arrangement of microscopic plastic crystals that "Pin Point" the projected image providing unexcelled angular viewing with a minimum loss of projected light. It is estimated that there is a loss of approximately 10% of light viewing the image at 45 degrees off center.

Light transmission percentages are controlled to obtain the maximum efficiency of the television optical projection system.

The percentage of 80% of transmission has been determined as that providing maximum efficiency. Stock sheets are available from 3x4 feet down. Specify inside dimensions of screen desired. If larger sizes are required, they can be made to order. Frames can be had on request, small sizes \$5.00—large sizes \$10.00. Price of screen, per sq. foot..... \$4.50

Include 25% Deposit With Order, Balance C.O.D.

Pioneers in Projection Television
SPELLMAN TELEVISION COMPANY
2898 JEROME AVENUE, NEW YORK 58, N. Y.

Within the INDUSTRY

RALPH T. BRENGLE of *Potter and Brumfield Sales Company*, Chicago, was reelected president of the National Association of Relay Manufacturers at their first annual meeting at the Graemere Hotel, in Chicago.



Daniel R. Dooley, vice-president in charge of sales of *C. P. Clare & Co.*, Chicago, was elected vice-president; J. J. Rowell of *Guardian Electric Mfg. Company*, Chicago, secretary and treasurer. Directors elected included: H. W. Pfeffer, *Struthers-Dunn, Inc.*, Philadelphia, Pa.; L. V. Roughan, *Price Electric Co.*, Frederick, Md.; E. Gillette, *Allied Control Co., Inc.*, New York, N. Y.; H. L. Huntsinger, *R. B. M. Division, Essex Wire Corp.*, Logansport, Ind.; and Fred W. Falk, *Advance Relay Company*, Los Angeles, Cal.

A constitution and by-laws were adopted and a committee on standards and nomenclature appointed to make a thorough study of the subject of relay contact ratings with a view to setting acceptable standards.

NEWELL B. PARSONS, associated for the past several years with *Webster-Chicago Corporation*, has been appointed sales representative for the company.

Mr. Parsons will cover the Chicago and Milwaukee trading areas for the *Webster-Chicago* line of recorders, record changers, and phonographs in order to maintain closer contact with manufacturers, distributors, and dealers.

HARLEY R. WALL has been named manager of *Air King's* contract division. In his new capacity, Mr. Wall will contact all private brand users in the country.



Previously Mr. Wall was associated with *International Detrola Corporation* as Sales Manager and prior to that was connected with the *Sparks-Withington Company*.

BELDEN MANUFACTURING COMPANY, Chicago manufacturers of electrical wire and cable products, recently inducted four new members into their 25-Year Club. All received watches in recognition of their quarter-century of service.

These four members are, H. W.

Clough, Vice-President, who joined the company in April of 1922; Shelton Wright, industrial sales division, who joined a little more than a week after Mr. Clough; Hoyne Howe, also of industrial sales, who came with the company in May of 1922, and Thomas P. Redmond, in charge of sales estimating for the merchandise division, an employee since December of 1922.

SIGHTMASTER CORP. of New York has appointed Henry L. Haines and John Cooper French as Philadelphia representatives. Mr. Haines and Mr. French will have offices at 1500 Walnut Street, Philadelphia, Pa., where they will be in charge of sales and distribution of the *Sightmaster* line of television receivers.

CARL K. NICKELL was recently appointed Vice-President in Charge of Sales for the *H. M. Tower Corporation*, *Crosley* distributors in Connecticut.

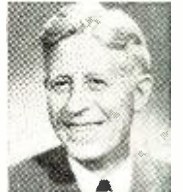

For the past two years Mr. Nickell was Sales Manager for the *J. N. Ceazan Company*, *Crosley* distributors in San Diego, California, and previously he was associated with the *Midland Company*, of Indianapolis. Mr. Nickell is a veteran of the radio and electric appliance industry.

OWEN P. NANGLE, district sales manager for *Zenith Radio Corporation*, died recently at Grant Hospital in Chicago at the age of 42.

Mr. Nangle started in radio sales in 1935, and served during the war with the Army-Navy Expediting Production Agency. He joined *Zenith Radio Distributing Corporation* in 1944 as key account salesman in Chicago, and in September, 1947 was appointed district sales manager of *Zenith Radio Corporation*, serving Lower Michigan and most of Indiana.

PHILIPS B. PATTON, for the past two years technical coordinator of the Mobile Communications Division of the *Farnsworth Television & Radio Corporation*, has been appointed West Coast engineering and sales representative of the Division.

Mr. Patton will make his headquarters at 42 Beverly Street, in San Francisco and will represent *Farnsworth's* mobile products in California, Oregon, Washington, and Nevada.

A native of California, Mr. Patton was with the *Western Union Telegraph Company* in San Francisco for

**NEW!
VERSATILE!
EFFICIENT!**



TUBE CHECKER YTW-1



Obsolescence is the big problem with tube checkers. The new YTW-1 has been especially designed to guard against early obsolescence. Blanks, mounted with locking rings, for easy removal, provide for future tube types that may be developed. This, together with exceptional circuit switching flexibility, makes the YTW-1 an outstanding piece of equipment—the tube checker you must have on your bench.

The YTW-1 is crammed full of features which servicemen will appreciate. Study them carefully—then place your order.

- Checks virtually all receiving type tubes, including the nine pin types. Tuning indicator tubes are checked by visual indication—just as if they were operating in a set.
- Tube checker "short" light remains "on" unless there is a short. This gives constant indication of the YTW-1's operation.
- Loads are so chosen that tubes "on their way out" will show up as weak or questionable, even though their mutual conductance may be within factory tolerances. This is a prime advantage of the emission check.
- Where tubes have internal "jumpers" it is possible to tell that "jumpers" are present and they are indicated on the roll chart by asterisks.
- Makes "short" tests with minimum stress on delicate tube elements. It is possible to directly identify the shorted elements.
- Like numbered pins on all sockets are connected—sockets for tubes developed in the future, easily connected.
- Roll chart is placed directly under the levers for easy reading and fast operation and can be readily removed for replacement.
- The YTW-1 includes an exceptionally accurate d-c voltmeter.

Save time—save money—speed service—order the YTW-1 today. For complete information write: *General Electric Company, Electronics Park, Syracuse, N. Y.*

GENERAL  ELECTRIC
164-G2

BENDIX 100 WATT TRANSMITTER 49.95



FOUR SEPARATE ELECTRONIC COUPLED OSCILLATORS CHECK THESE VALUES: Three 807 Tubes, four 12SK7, one 2 inch 5 amp. RF meter, four Separate Master oscillators. (These can be easily changed to cover 20-40-80 meters and by using crystal for the 10 meter band you will have a complete coverage transmitter.)

Four separate output tanks.

One 4 position selector channel switch having seven sections which changes the ECO, IPA and output tanks simultaneously. All the controls are mounted on the front panel. The housing is cast aluminum; shields and case are sheet aluminum. Dimensions 11 x 12 x 15 inches, weighing 35 1/4 lbs. Complete, simple instructions for conversion furnished. Complete with tubes.



110-VOLT AC SUPERHETERODYNE RECEIVER

This crystal fixed frequency receiver comes with full conversion instructions for variable tuning of all ham bands and broadcast. A highly selective superheterodyne receiver, 110 V. A.C. power supply built in. Using the following tubes: 6K7—RF Amplifier; 6K8 Output and Noise Suppressor; 80 Rectifier. Dimensions—3 1/2 x 19 x 11 1/2 inches. Comes complete, brand new, with one set of coils and two sets of tubes... **\$16.95**
Extra set of coils.....\$2.95

BC-221 FREQUENCY METER



We have just received another shipment of these meters, probably our last. Complete with tubes, crystal, calibration chart (from 125kc to 20,000kc) and guaranteed accuracy of .01% or 500 cycles whichever is greater. These are slightly used but guaranteed perfect and A-1..... **\$36.75**

V.H.F. TRANSMITTER



Here is one of the greatest offerings in war-surplus! Hundreds sold at \$20 and now closed out at an amazingly low price. Brand new. Battery operated (67 1/2 v B and 1 1/2 v A.) Frequency 80 to 105 mc. Complete with 2—1G4 tubes and full instruction manual. Ready to go on the air. Less Batteries..... **\$6.95**



PANEL METERS

ALL METERS BRAND NEW AND
GUARANTEED

West	2" Round	O-300 D.C.-M.A.	\$2.97
GE	2" Round	O-500 D.C.-M.A.	2.97
Simpson	2" Round	O-15 D.C.-V.	2.97
Triplett	2" Square	O-40 D.C.-V.	2.97
Sun	2" Round	O-300 D.C.-V.	2.97
GE	3" Square	O-150 A.C.-V.	3.49



NAVY SPEAKER

Stromberg Carlson and RCA waterproof speakers. Brand new in original cartons. 25 Watt PM driver unit with line matching transformer and projector mounted in heavy duty round metal baffle. Ideal for communication receivers and sound systems at lowest **\$14.95** price ever offered.



1-222 SIGNAL GENERATOR

Brand new; Frequency from 8MC to 230 MC in 2 bands. Calibration graph furnished. Crystal controlled check points. 110V AC power supply. Output attenuator. Dial calibration 10 points per division. A true laboratory instrument. A \$350 value for only **\$54.95**

TS-13 HANDSET



Combining a 200 ohm carbon mike and 2500 ohm earphone with butterfly switch for listen and talk. Has 6' flexible rubber cord with 1—P155 and P168 plugs attached.

Brand New..... **\$2.95**



MAGNETIC HEADPHONES

2000 ohms, 8' cords with Army plug. All unused; show slight handling..... **\$1.98**

Sun Radio

FOR THE HOTTEST VALUES
IN *Surplus Parts*

CRYSTALS!

In the greatest purchase of radio transmitting crystals ever made by one wholesaler in the history of the Radio Parts Industry Sun Radio acquired title to over a half million dollars (\$500,000) of Army Surplus, precision built, exactly tuned crystals in moisture proof holders which are shock mounted. Please note that crystal shipments of 6 or less are packed in cloth containers to expedite handling. . . . No worry because all crystals are shock mounted and guaranteed delivered perfect. All crystals have Army MC harmonic rating but Sun encloses directions for deriving the correct fundamental frequency in kilocycles.

CRYSTALS WITH A MILLION USES Fractions Omitted

kc	kc	kc	kc	kc	kc	kc	kc	kc	kc	kc	kc
412	420	429	437	445	457	469	479	490	497	506	516
413	422	430	438	446	458	470	481	491	498	507	518
414	423	431	440	447	459	472	483	492	501	508	519
415	424	433	441	448	462	473	484	493	502	509	522
416	425	434	442	451	463	474	485	494	503	511	523
418	426	435	443	453	466	475	487	495	504	512	
419	427	436	444		468	477	488	496	505	515	

49¢
each

I.F. Frequency Standards	Crystal Frequency Standards 98.356kc	For Crystal Controlled Signal Generators 525kc
kc	kc	kc
450	454.166	461.111
451.388	455.556	464.815
452.777	459.259	465.277

99¢ each **\$3.89 each** **99¢ each**

ASSORTED MISCELLANEOUS CRYSTALS

Fractions Omitted

370kc	376kc	381kc	384kc	387kc
372	377	383	386	388
374	379			
375	380			

39¢ each
priced at a fraction of the cost of their holders alone.

FOR HAM AND GENERAL USE

Fractions Omitted

390kc	395kc	402kc	405kc	408kc
391	396	403	406	409
392	397	404	407	411
393	398			
394	401			

79¢ each

* Payments must accompany order. Enclose 20c for postage and handling. Minimum order—\$2.00 plus postage.
* Crystals are shipped packed in cloth bags inasmuch as they are shock mounted. All shipments guaranteed.

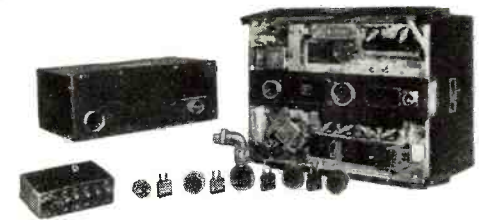

SCR-522 VHF XMTR-RCVR

The finest all purpose equipment on the surplus market. Tunes 100-156 MC. Don't confuse these with other incomplete and abused 522s. Sun Radio offers electronically perfect and guaranteed 522s... AND COMPLETE with tubes (one 10 tube superhet receiver with squelch circuit and one 7 tube transmitter), remote control box, 28 volt dynamotor (can be converted to 110V operation), 4 crystals and ALL CABLE CONNECTORS but less cables..... **\$24.95**



5-GANG TUNING CONDENSER

Brand new... 5 gang, 365 mmfd. per section... a truly precision built condenser with ceramic insulation. A \$13.50 value in the greatest offering ever made in tuning condensers for... **\$2.95**

• All Items F.O.B., Washington, D. C. All orders \$30.00 or less cash with order. Above \$30.00 25 per cent with order balance C.O.D. Foreign orders cash with all orders, plus exchange rate.

SUN RADIO

OF WASHINGTON, D. C.

938 F STREET, N. W. WASH. 4. D. C.

Mr. Radio Dealer

DON'T BREAK



Give FM a Break... with the

Pilotuner

Face the Facts! FM can be a Smash Hit . . . if YOU don't smash it — by selling the public "LAME DUCK" FM tuners.

FM "bloopers" . . . "fly-by-night" FM tuners . . . chiselling, cut-corner, half-way FM equipment can ONLY give a black eye to FM — and to the misguided dealer who sells them.

Why not play the proven winner . . . the FM PILOTUNER . . . which knows no compromise on quality! Into the Pilotuner go Pilot Radio's more than 30 years of experience . . . the "know-how" that assures complete satisfaction—first, last and always.

A sensation in '47, the amazing PILOTUNER is headed for an even greater '48. Display it—promote it . . . get your share of the new business, extra traffic, satisfied customers! Send coupon now for complete information.

PILOT RADIO CORPORATION

37-06 36th ST., LONG ISLAND CITY, N. Y.
Makers of PILOTONE VINYLITE RECORDS • PIONEERS IN FM

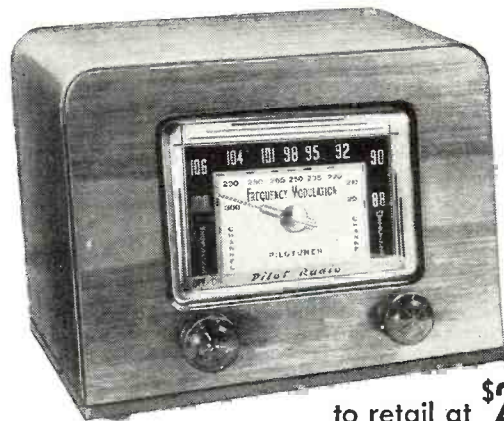

6 3/4" high,
8 3/4" wide,
5 3/4" deep

to retail at **\$29.95**
Slightly Higher West of Rockies

PILOT RADIO CORP., 37-06 36th St., Long Island City, N. Y..

Send me full information concerning the FM PILOTUNER.

NAME

ADDRESS

CITY.....ZONE NO..... STATE.....

McMurdo
SILVER

ADDS 3 NEW LCETI

1

NEW MODEL 905A "SPARX" SIGNAL TRACER AND UNIVERSAL TEST SPEAKER

The new "SPARX" is here — the *super-sensitive* r.f., i.f. a.f. signal tracer, phono pick-up, microphone and speaker tester. Like all SILVER LCETI, it goes far beyond the ordinary. Built-in is a 6" PM speaker and 8 watt *truly universal* output transformer with two panel switches give impedances of 325 thru 70,000 Ω single or push-pull. In the new 905A "SPARX" you get the world's finest signal tracer, the world's most universal test speaker, separately usable universal output transformer — *three instruments for the price of one.*



ONLY
\$44.50 NET

2

NEW FM & TV SWEEP SIGNAL GENERATOR

FM and TV are here — must be serviced by every technician today. Model 909 and any good 'scope does the TV and FM alignment job — visually — easily — simply — perfectly — and fast. Three bands 2 thru 266 mc., linear electronic sweep panel variable from 40 kc. to 10 mc. It's no wonder Model 909 — first announced in late January — is the "hottest" instrument in radio. Model 909 is another "must" for every service laboratory — new Silver inventions make it newest and by far the best. With complete instructions.



ONLY
\$48.50 NET

3

NEW MODEL 910 UNIVERSAL TEST SPEAKER

Six-inch high-quality PM speaker and 8 watt *truly universal* output transformer of the new "SPARX" give you any transformer impedance, single or push-pull, from 325 thru 70,000 Ω . Panel jacks and switches permit combined or independent use of transformer and/or high-quality 6" PM (3 Ω voice coil) speaker. Chart on panel instantly shows correct switch positions for 30 different impedances — can't get lost. Size and style matches "VOMAX", 906 FM/AM Signal Generator — all SILVER LCETI.

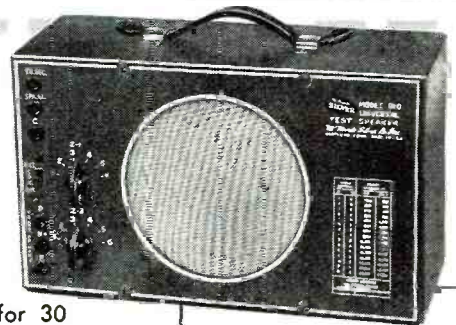

ONLY
\$22.70 NET

★ **LCETI** — Laboratory Caliber Electronic Test Instruments.
See them at your favorite jobber.

SEND FOR COMPLETE CATALOG.
See these and Silver communication transmitters, receivers, "Micromatch", TV preamplifier, pretuned freq. multiplier at your jobber.

OVER 37 YEARS OF RADIO ENGINEERING ACHIEVEMENT

McMurdo Silver Co., Inc.

EXECUTIVE OFFICES: 1240 MAIN ST., HARTFORD 3, CONN.
FACTORY OFFICE: 1249 MAIN ST., HARTFORD 3, CONN.

Make More Money in

Radio TELEVISION & ELECTRONICS

NOW!

Get these 2 BIG BOOKS
FREE!



You build this fine modern Superheterodyne Receiver and other units, with the complete standard parts we send you. This valuable equipment becomes yours to use and keep.

You learn by building equipment with standard radio parts we send you



If you are already employed in the great Radio Industry, you know how great the demand is for trained, experienced servicemen, operators and technicians. You know how fast the field is growing and how important it is to keep up with new developments in F.M., Television and Electronics. The Radio Industry is alive with opportunity for the qualified technician whose knowledge is up-to-the-minute. You can be an F.M. and Television specialist... get into the lucrative Radio Service Field... own a business of your own. If you prefer, National Schools of Los Angeles, for over 40 years a practical resident and home study trade school, has put into effect its New 1948 Training Program. This program, adapted to National's Master Shop Method Home Study Course, can qualify you in your spare time as a Radio and Television technician. For details of this Program fill out and mail the coupon below.



NOW! New Professional Multitester Included! This versatile testing instrument is portable and complete with test leads and batteries. Simple to operate, accurate and dependable. You will be able to quickly locate trouble and adjust the most delicate circuits. You can use the Multitester at home or on service calls. It is designed to measure AC and DC volts, current, resistance and decibels. You will be proud to own and use this valuable professional instrument.

SHOP METHOD HOME TRAINING FROM A TECHNICAL TRADE RESIDENT SCHOOL

National Schools brings its exclusive Shop Method of training right into your own home. You can learn the most up-to-date approved practical training projects, systems and modern circuits from the very beginning in your spare time. Here is sound and practical home training—the development of experienced instructors working with students right in the shops, NEW Television and Broadcast Studios and Experimental Laboratories of NATIONAL SCHOOLS—one of the most advanced technical trade education centers in the world.

LEARN BY DOING
Work with Real Experimental Equipment Furnished without Extra Cost as Part of your National Schools Training



Send Coupon and prove to yourself what YOU can do in RADIO and TELEVISION!

Take Advantage Now of these Outstanding Features of National Schools 1948 Training Program

1. National Schools' 1948 Course is planned to prepare you for real success in Radio, Television and Electronics.
2. Experimental equipment supplied with the Course has been completely revised to give you the most up-to-date practical experience with new circuits, new units, etc., right in your own home.
3. New Television Lessons have been expanded to give you training in the latest developments in this important field.
4. The 1948 Course includes a Professional Multitester (shown above) for your use in spare or full-time Radio work.
5. National Schools gives you advanced training—the key to the better positions in Radio, Television, Electronics.
6. You are sent standard Experimental Equipment, including tubes and accessories, for building a modern Short Wave and Standard Broadcast Superheterodyne Receiver. All equipment becomes your personal property.
7. National Schools' 43 years of experience in Technical Trade Training... our modern shops and laboratories... highly trained instructors are back of your time-tested Training Plans for a brighter future.



VETERANS
If you qualify for training under G. I. Bill, check the coupon for a Special Bulletin.

Experience is the best teacher. You learn by experience with the exclusive National Shop-Method of Home Training. With the apparatus sent you, you actually build various types of standard equipment—a powerful superheterodyne receiver, a signal generator, an audio oscillator, low power Radio transmitter and other units. You make tests and conduct experiments that show you the why and how of Radio. You understand what makes the various elements of Electronics operate because you actually see them work for you. Not only do you gain splendid experience by this method of learning, but you receive valuable equipment you will use on the job in the practice of your profession as a Radio Technician. Mail the coupon and learn what this means to you.

G. I. APPROVED

NATIONAL SCHOOLS

LOS ANGELES 37, CALIFORNIA EST. 1905



FREE LESSON INCLUDED

MAIL OPPORTUNITY COUPON FOR QUICK ACTION

MEMBER: NATIONAL COUNCIL OF TECHNICAL SCHOOLS
MEMBER: NATIONAL HOME STUDY COUNCIL

NATIONAL SCHOOLS; Dept. RN-4
4000 South Figueroa Street, Los Angeles 37, California (Mail in envelope or paste on penny post card)

Mail me FREE the two books mentioned in your ad, including a sample lesson of your course. I understand no salesman will call on me.

NAME AGE

ADDRESS

CITY ZONE STATE

.... Check here if Veteran of World War II

Examine the exclusive National Shop Method of Home Training. See for yourself how sound and practical it is. Be convinced that you can learn Radio, Electronics, Television quickly and easily in your spare time. This trial is ABSOLUTELY FREE.

Mail the coupon here for the books that tell you the complete story of National Schools Master Shop Method of Home Training in Radio, Electronics and Television.

This is the MODERN SYSTEM OF TRAINING. It matches the rapid progress constantly being made in Radio, Television and Electronics. It is TIME TESTED, too. National Schools has been training men for more than a third of a century. It is the very same training that has helped thousands to more pay and greater opportunity. You owe it to yourself—your future—to read the book "Your Future in Radio, Electronics and Television"—FREE to you when you send in the coupon.

April, 1948

HOWARD W. SAMS WINS "OSCAR" FOR AID TO RADIO SERVICE INDUSTRY!



The handsome plaque awarded to Howard W. Sams carries the inscription: "The Federation of Radio Servicemen's Associations of Pennsylvania Award to Howard W. Sams in Recognition of His Outstanding Efforts in Behalf of the Radio Service Industry, 1947." The award is a tribute to the practical usefulness of PHOTOFACT Publications—the world's finest radio service data—indispensable to the Radio Serviceman.

PHOTOFACT Publications Cited as Outstanding Effort in Behalf of Servicemen

"For Outstanding Efforts in Behalf of the Radio Service Industry"—reads the citation of the first annual award bestowed on Howard W. Sams by the Federation of Radio Servicemen's Associations of Pennsylvania. The "Oscar" was presented before a group of over 600 persons, including many radio industry leaders, at a banquet held on January 12, 1948, at Philadelphia's Bellevue-Stratford Hotel. The surprise ceremony was arranged as a demonstration of appreciation for the significant, practical aid made available to Radio Servicemen in PHOTOFACT Publications, and for the efforts of the SAMS' organization in behalf of the Radio Service Industry. This spontaneous demonstration marks a milestone in the Radio Service field. It is a healthy sign of growing recognition of the Serviceman's importance to the Radio Industry.



These Are the Award-Winning Service Aids that Earn More Money for You!



Own PHOTOFACT Volumes 1, 2 and 3—world's most complete, accurate, practical radio service data manuals. Here is everything you need for faster, easier, more profitable servicing—bound in easy-to-use volumes. Exclusive Standard Notation Schematics; photo views keyed to complete replacement parts lists; exhaustive electrical and mechanical analysis of every set covered. Brings you right up to January 1948! Have the exclusive advantages that are now earning bigger profits for thousands of servicemen!

Vol. 1. All post-war models up to Jan. 1, 1947.
Vol. 2. Models from Jan. 1, 1947 to July 1, 1947.
Vol. 3. Models from July 1, 1947 to Jan. 1, 1948.

YOUR PRICE, EACH VOLUME, IN \$18³⁹
EASY-TO-USE DELUXE BINDER . . .



Radio Receiver Tube Placement Guide

Shows you exactly where to replace each tube in 5500 radio models, covering 1938 to 1947 receivers. Each tube layout is illustrated by a clear, accurate diagram. Saves time—eliminates risky hit-and-miss methods. You'll use this handy pocket-sized book every single day. 192 pages, completely indexed. Order several copies now. **ONLY . . . \$1²⁵**



Dial Cord Stringing Guide

The book that shows you the *one right* way to string a dial cord. Here, for the first time, in one handy pocket-sized book, are all available dial cord diagrams covering over 2300 receivers, 1938 through 1946. Makes dial cord restringing jobs quick and simple. A "must" for every service bench and tool kit. Order your copies now. **ONLY .75c**

1947 Automatic Record Changer Manual



Nothing like it! Complete, accurate data on over 40 post-war models. Exclusive exploded views, photos from all angles. Gives full change cycle data, information on adjustments, service hints and kinks, complete parts lists. PLUS—for the first time—complete data on leading WIRE, RIBBON, TAPE and PAPER DISC RECORDERS! 400 pages; hard cover; opens flat. Order now! **ONLY . . . \$4⁹⁵**

BOOST YOUR EARNING POWER!

Mail This Order Form

to HOWARD W. SAMS & CO., INC.
2924 E. Washington St., Indianapolis 6, Indiana.

My (check) (money order) for \$ enclosed.

- Send SAMS' TUBE PLACEMENT GUIDE(S) at \$1.25 per copy.
- Send PHOTOFACT Volume 3 (including Sets Nos. 21 through 30) in DeLuxe Binder, \$18.39.
- Send Volume 2. Send Volume 1 (\$18.39 each).
- Send SAMS' 1947 AUTOMATIC RECORD CHANGER MANUAL(S) at \$4.95 each.
- Send SAMS' DIAL CORD STRINGING GUIDE(S) at \$0.75 per copy.

Name

Address

City State

HOWARD W. SAMS & CO., INC.
INDIANAPOLIS 6, INDIANA

Export—Ad. Auriema—89 Broad St., New York 4, N. Y.—U. S. of America
Canada—A. C. Simmonds & Sons, 301 King St., East—Toronto, Ontario

PHOTOFACT SERVICE

"The Service that pays for itself over and over again!"

Are you Building a Business ... or Burning your Bridges?

Would you patronize a dentist who filled your teeth with plaster of Paris?

Would you trust your children's lives to a doctor who prescribed cut-rate pills?

Your business, too, is built on *customer confidence!* And your reputation is too valuable to risk with inferior or unknown products. The cost of the parts you use in the average repair job is insignificant com-

pared with your investment in *your reputation.*

That's why we say—**YOUR CUSTOMERS AND YOUR REPUTATION CAN AFFORD ONLY THE BEST! . . . SPRAGUE.**



CAPACITORS

SPRAGUE

*KOOLOHM
RESISTORS

* T.M. Reg.
U. S. Pat. Off.

SPRAGUE PRODUCTS COMPANY, North Adams, Mass.

JOBGING DISTRIBUTING ORGANIZATION FOR PRODUCTS OF SPRAGUE ELECTRIC CO.

Reach for a **SPRAGUE** and Know You're Right!

The superiority of the new Sprague type TM High-Temperature Molded Paper Capacitors didn't happen by chance. You can use this better unit in your work today only because of more than four years of intensive research and one of the largest retooling programs in Sprague's history. That's why we can say "*The First Truly Practical Molded Paper Tubulars are Sprague TM's*"—and it is also the reason you can use them on any job with confidence and pride.

- Highly Heat Resistant
- Conservatively Rated
- Moisture Resistant
- Small in Size
- Non-inflammable
- Mechanically Rugged
- Completely Insulated

**UNCONDITIONALLY
GUARANTEED!**

You can stake your reputation on Sprague replacement parts. If used at rated capacitance and voltage, they are **UNCONDITIONALLY GUARANTEED** to give satisfactory performance. Insist on Sprague and get the best!

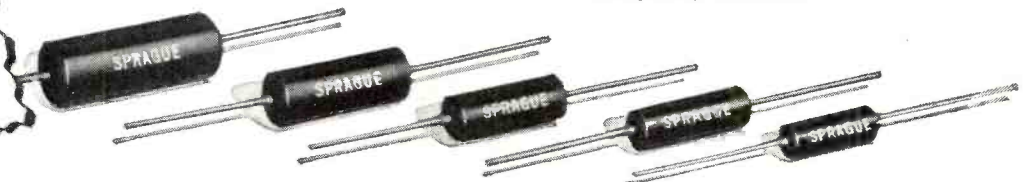

April, 1948

21

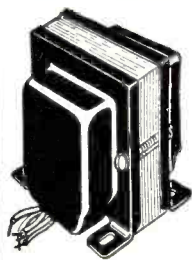
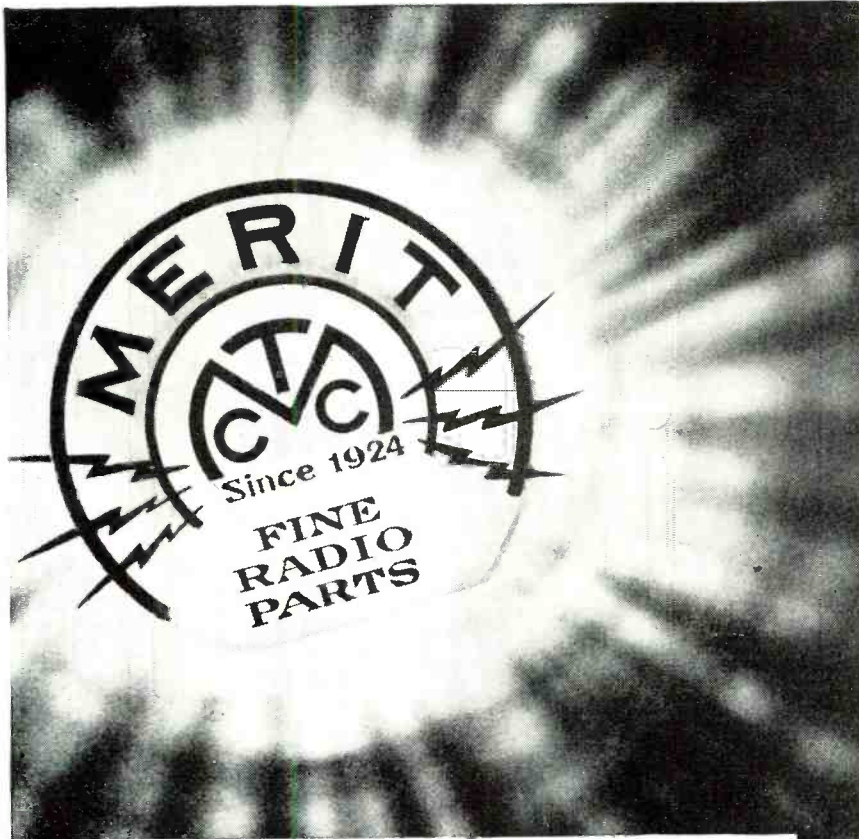

PRICE ECONOMY with MERIT QUALITY!

MERIT Model "D"

In transformers the greatest economy is found in the highest quality. It is quality thruout that insures dependable performance, freedom from service. But MERIT Quality can also be had at a first saving.

Check These Values with Your Local Jobber

MERIT PLATE TRANSFORMERS

Type No.	List Price	Sec. Rms. Volts	Sec. DC Volts	DC Sec. M.A.
P-3157	\$ 9.25	(660-660)† (550-550)	(500) (400)	250
P-3159	10.00	(900-900) (800-800)	(750) (600)	225

† Has 40 volt bias tap

Dimensions

Type No.	H.	W.	D.	Mtg.
P-3157	4 $\frac{3}{8}$	3-13/16	4 $\frac{3}{8}$	D
P-3159	4 $\frac{5}{8}$	3-13/16	5 $\frac{1}{8}$	D



MERIT COIL & TRANSFORMER CORP.

TELEPHONE

4427 North Clark St.

Long Beach 6311

CHICAGO 40 ILL.

facturers "may exceed 18,500,000, compared with 15,000,000 in 1946, the previous industry record." Forty-eight will have to go some to beat that.

ONE MORE television item that you may have missed and might be of interest. The *Crosley Division* of the *Avco Manufacturing Corporation*, Cincinnati, has come up with a gadget that makes it possible for you to see your home-set television screen without wearing out the rug moving your chair in front of the set. It's called a "Swing-a-View" picture tube. It can be turned from side to side over a sixty degree angle. The gadget is already in quantity production and is scheduled for early distribution in all areas having television service. It enables viewers to swivel the screen so that they may watch the picture directly from any point in a room within a 60 degree arc in front of the receiver.

ALL OF WHICH, for our money, isn't quite as interesting as some dope we picked up the other day on a ham station—J2ROC, at Nagoya, Japan. Maybe you've heard of it—it was very much on the air during the Texas City disaster last year. One of Japan's strongest amateur stations, it is operated by hams in the Fifth Air Force. For the job it did in informing U.S. troops with relatives in Texas City, it earned the American Radio Relay Certificate of Merit, but reporting Texas City to Americans in Japan is only one of the many things the little station does. Indeed, it is one of the busiest communications terminals in the Orient, from all we hear. It's pure ham—operated as a spare-time hobby by two Air Force captains—Stanley Rodby and Frank Bowden. They are Rod and Tex to their friends on both sides of the Pacific. In a typical morning, they will complete calls to Tampa, Florida (a worried private-first-class wanting to talk to his sick mother); Chicago (a sergeant who has won a jeep in a raffle and wants his wife to sell the family jalopy before joining him in Japan), and Minneapolis (strictly romance between a Tokyo captain and his bride-to-be).

MOST CALLS are made directly over telephone rather than through a mike at the ham shack. The boys hook the phone directly into their radio transmitter. Thus, when a man in Nayoga wants to talk to his wife in Wabash, Indiana, he phones the ham shack from his office desk and stands by for a hook-up. Sometimes, with a station already alerted on this end of the line, calls go through with a speed rivalling long distance. Helping civilians talk with distant relatives is the same the whole world over at times, if what Rod and Tex report is true. There was the case of the WAC who wanted to talk to her mother, just for the fun of it, and finally they got the call through. Both mother and daughter devoted
(Continued on page 140)



ABOVE: TELEVISION offers YOU one of today's thrilling, newer fields with possibilities for a bright and promising future. The above scene shows some of the modern equipment at D.T.I. used in preparing men for TELEVISION.

• Television

• RADIO

• Industrial ELECTRONICS

Get FREE Facts About YOUR Future in These Fields

SEE HOW YOU MAY MAKE REAL MONEY, HAVE A GOOD JOB, OR A BUSINESS OF YOUR OWN . . .

Mail the coupon below and you will receive, absolutely FREE, facts showing how you may get started toward a good job or a business of your own in RADIO or ELECTRONICS. See how readily you may begin to realize your life-long ambition for a REAL FUTURE. See how you may make your start toward a field that also includes such interesting branches as F-M Radio, Broadcast Radio, Aviation Radio, 2-Way Train Radio, Police-Cab-Truck Radio, Sound Recording.

NO ADVANCED EDUCATION, NO EXPERIENCE NECESSARY

Our Chicago Laboratory and Home Training have been designed to prepare you and to get you started in Radio and Electronics — whether or not you have a higher education or previous experience. Don't delay . . . mail the coupon below today!



With our HOME TRAINING you receive actual radio parts from which you make 133 experiments and build 7 radio receivers . . . plus loose-leaf lessons with fold-out diagrams . . . plus HOME MOVIES to help you learn easier, faster.

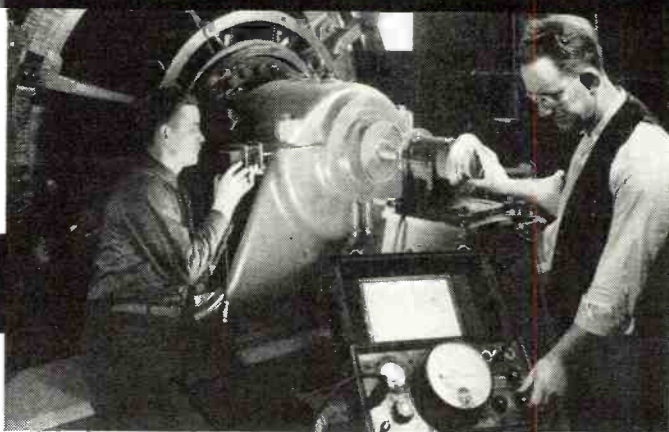

One of today's most promising fields is INDUSTRIAL ELECTRONICS. D.T.I. can prepare you for this field — either at home or in our modern Chicago laboratories. See HOW you may get started toward this fascinating work now. Fill in — mail the coupon below today!

2 TRAINING PLANS—TAKE YOUR CHOICE

1. You may come to our modern, Chicago laboratories, where you train with the aid of capable instructors and some of the finest Radio-Electronic equipment. We will find comfortable living quarters for you.
2. Or, if you prefer, you may STUDY AT HOME — using modern, commercial-type radio equipment, well illustrated lessons and HOME MOVIES. You can do this in your SPARE TIME, without interfering with your present job.

VALUABLE EMPLOYMENT SERVICE

When you complete either training, our effective Employment Service goes to work for you, to help you get started toward a real future in Radio-Electronics. Don't delay!

MAIL THIS OPPORTUNITY COUPON NOW!

Mr. E. B. DeVRY, President
DeForest's Training, Inc.
2533 N. Ashland Ave., Dept. RN-E4
Chicago 14, Illinois

ACCEPTED FOR G.I. TRAINING

Please show me how I may get started toward a good job or a business of my own in Radio-Electronics.

Name _____ Age _____

Address _____ Apt. _____

City _____ Zone _____ State _____

If under 16, check here for special information.

If a discharged Veteran of World War II, check here.

DeForest's Training, Inc.
CHICAGO, ILLINOIS

Associated with the DeVry Corporation
Builders of Electronic & Movie Equipment



HARVEY HAS
TELEVISION COMPONENTS...

for engineers, experimenters, servicemen and set builders. These genuine RCA components plus everything else you need.

201R1, Width Control.....	\$.78
201R2, Projection size control....	1.32
201R3, Horizontal linearity control.....	.84
204X1, I.F. and Video coil kit....	19.80
204L1, Filament choke.....	.18
208T8, Horizontal synch-discriminator.....	2.85
201D1, Deflection yoke direct view.....	8.25
201D2, Deflection yoke, projection.....	8.94
201X1, Yoke mounting hood.....	1.63
202D1, Focus coil.....	5.46
203D1, Ion trap magnet.....	3.90
204T1, Horiz. output transformer..	13.80
204T3, Horiz. output transformer..	8.73
211T1, Horiz. output transformer..	10.11
211T2, Horiz. output transformer..	13.65
204T2, Vertical output trans.....	5.40
208T1, Horiz. bl-osc. transformer..	3.60
208T2, Vertical bl-osc. trans.....	3.42
208T3, Horiz. bl-osc. trans.....	2.73
RCA 13-channel RF assembly (complete front end for tele receiver).....	58.65

IN STOCK AT ALL TIMES all makes and types of TV tubes. Also complete TV set construction kits.

Be sure and visit our exhibit at the IRE Show and see all the above on display at Booth 19.

Note: All prices are Net, F.O.B. N.Y.C. and are subject to change without notice.

Telephone: **7 nrc** LO. 3-1800

HARVEY
RADIO COMPANY INC.
103 West 43rd St., New York 18, N. Y.

Spot Radio News

*** Presenting latest information on the Radio Industry.**

By FRED HAMLIN
Washington Editor, RADIO NEWS

IF ANYBODY ASKS YOU to guess which is going to grow faster this year—FM or television—you'll probably be nearer right if you answer, "Both." FM is, of course, more nearly established with a wider sector of the public, and growing spectacularly. But some of the things that are happening in television these days make it seem a safe bet to expect anything to happen—and soon. Everybody—including large segments of the public which the industry anticipated it would take years to win—is showing signs of going for video in a bigger and bigger way.

TO PUT IT MORE conservatively, both these branches of the radio industry are unquestionably in for a big year. A broad hint of what's in store for FM was revealed not long ago when the Radio Manufacturers Association, in releasing its final round-up figures for 1947, showed that a total of 1,175,104 FM-AM receivers were produced during the year, as compared with only 181,485 in 1946. FM-AM production shows every sign of going beyond the '47 figure this year, assuring an even wider listener potential. FM stations, keeping pace, are in the four-figure brackets as of the most recent Federal Communications Commission totals—1010 broadcasting stations authorized.

TELEVISION SET production in 1947 was just under the total number of FM-AM receivers made the year before. The '47 television figure was 178,571 as contrasted with 6476 during '46. But by the end of the year—and the trend continues—television set production had jumped from 5437 during January to nearly 30,000 in December. These sets have been accepted so enthusiastically by the public that a parallel rush to FCC for television licenses is now going on. So great are the current demands for broadcast posts that there seems a very real danger there will not be enough spectrum, as now reserved for commercial video, to go around. Nearly one hundred stations are on the air, with as many more applications pending.

AS FOR THE BROADCASTING end of the field—and audience acceptance—a number of surprising things have been happening. First place, Joe Public has decided what he

likes and has found ways of seeing it, whether he can afford a set or not. Second place, he's been talking television up among his friends. Programs have also improved. Television is therefore reaching a surprisingly large audience in a surprisingly short time.

INDICATIONS ARE that broadcasters aren't too eager to have the audience grow too rapidly. Few days back, for instance, a big movie house in New York wired radio editors that they were going to telecast boxing bouts from a local arena on a "giant" movie screen. Few days later, editors were informed that the show had been called off. NBC, running the telecast, had said "no" on the grounds that the broadcast was their property and they didn't like the idea. The theater took the ruling without putting up a fight. Could be, another time, another theater would take it to court. But nobody has seemed to want to so far in television history, and if nobody does, you'll see your telecasts, not in a movie, but in a bar or your home.

STRAW-IN-THE-WIND as to television's drawing power is a recent announcement by the Veterans Administration that they are going to use the medium as one means of reaching veterans. This is the first large-scale use of television by a government agency. The Administration has produced five 16-mm. sound film cartoon shorts, ranging from one to three minutes, and prints will be distributed from branch offices.

IN THE EXCITEMENT and headlining being done over FM and television, sight should not be lost of the fact that standard broadcasting is doing nicely, thank you. Better than its precocious kid brothers, if you want to know. FCC reports that the number of authorized AM stations increased by 167 in the last six months of '47, as contrasted with an FM increase of only 92, and TV's jump from 66 to 73—only seven. Boxcar figures featured the year-end RMA AM round-up, for while FM-AM sets were breaking all records with 1,175,104, and television was running up its score of 178,571, the grand total RMA score on all sets was 17,695,677. AM's made up most of the difference. These totals are for RMA manufacturers only. The Association says that total production by all manu-

The **ONLY**
Complete Servicing Reference
on ALL Pre-War and Post-War Receivers

25% More Listings
Than the
5th Edition

Accurate
Authoritative
Complete
in One
Volume

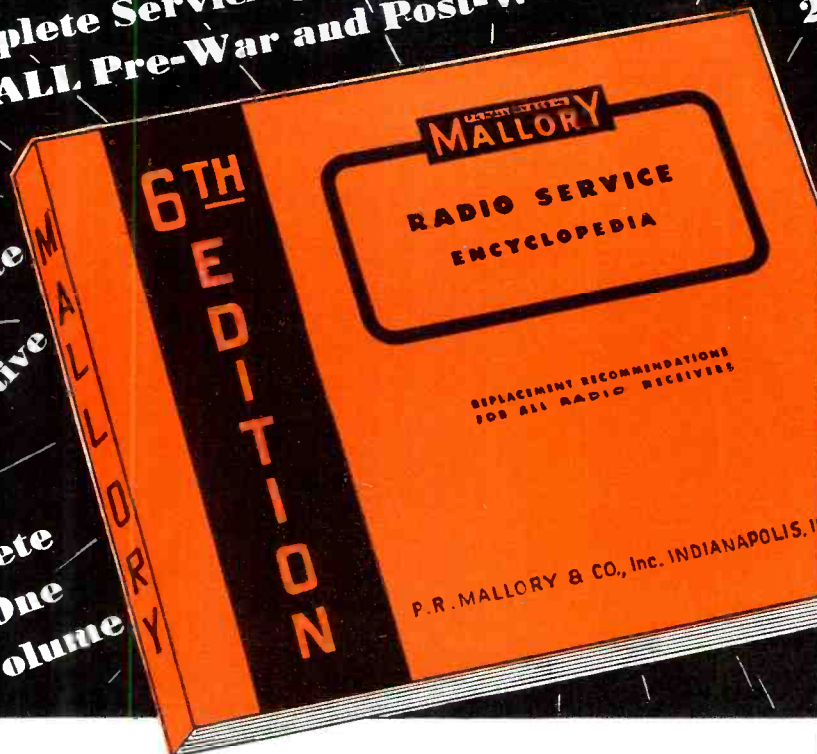

SALES of previous editions offer the best evidence of its worth.

Edition	Year	Copies sold
1st	1937	51,000
2nd	1938	25,000
3rd	1939	55,000
4th	1941	60,000
5th	1946	75,000

Here's what you get:

- Data on correct replacement parts
- Circuit information
- Servicing hints
- Installation notes
- IF peaks
- Tube complements and number of tubes
- References to Rider, giving volume and page number

RESERVE YOUR COPY NOW

**Ready April 1st—
 The 6th Edition**

Mallory Radio Service Encyclopedia

Here it is—up to date—the only accurate, authoritative radio service engineers guide, complete in one volume—the Mallory Radio Service Encyclopedia, 6th Edition.

Made up in the same easy-to-use form that proved so popular in the 5th Edition, it gives you the complete facts on servicing all pre-war and post-war sets . . . volume and tone controls, capacitors, and vibrators . . . circuit information, servicing hints, installation notes, IF peaks, tube complements and

number of tubes . . . and in addition, cross-index to Rider by volume and page number for easy reference. **NO OTHER BOOK GIVES YOU ALL THIS INFORMATION**—that's why it's a **MUST** for every radio service engineer.

25% more listings than the 5th Edition. Our ability to supply these books is taxed to the limit. The only way of being sure that you will get *your copy quickly* is to order a copy today. Your Mallory Distributor will reserve one for you. The cost to you is \$2.00 net. It's the buy of the year.

THE MALLORY RADIO SERVICE ENCYCLOPEDIA

Complete—Authoritative—All in One Volume

P. R. MALLORY & CO., Inc.
MALLORY

CAPACITORS . . . CONTROLS . . . VIBRATORS . . .
 SWITCHES . . . RESISTORS . . . RECTIFIERS . . .
 VIBRAPACK* POWER SUPPLIES . . . FILTERS

® Reg. U. S. Pat. Off.

APPROVED PRECISION PRODUCTS

P. R. MALLORY & CO., Inc., INDIANAPOLIS 6, INDIANA

New SUPREME 1948 and F.M. Manuals

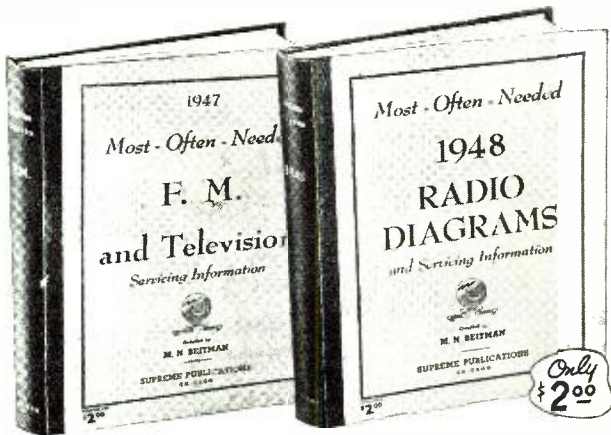

F.M. and Television

Use this new giant manual of factory instructions for troubleshooting, repairing, and alignment of any 1947-1948 F.M. and Television set. Covers every popular make, including F.M. tuners, AM-FM combinations, and all types of television receivers. Detailed circuit diagrams, theory of operation, test hints, alignment data, including both meter and oscilloscope methods. This is the material you need to fix any modern F.M. or Television set. Don't turn this profitable work away for lack of knowledge and information. Use this newest Supreme manual to save time and money on your very next F.M. job. Data presented on 192 large-size pages, 8½ x 11 in. Sturdy, manual-style binding. Special price, postpaid. **\$2.00**

New 1948 Manual

Be prepared to repair quickly all new 1948 receivers. In this big single volume you have clearly-printed, large schematics, needed alignment data, replacement parts lists, voltage values and information on stage gain, location of trimmers and dial stringing, for almost all recently released sets. A worthy companion to the 7 previous volumes used by over 120,000 shrewd radio servicemen. New manual covers models of 42 different manufacturers. Giant size: 8½x11 inches, 192 pages + index. Manual-style binding. **\$2.00** Bargain price, only

Only \$2.00

BIGGEST BARGAIN IN RADIO DIAGRAMS

Make these two new mammoth volumes your money-saving source for data on all recently released receivers. Learn about modern circuit developments, be ready to repair any new radio no matter how complex. You pay only \$2.00 for each of these large manuals. With these two volumes on your workbench there is nothing else to buy, nothing else to pay — a whole year of service data and radio diagrams yours for a couple of dollars total. Again Supreme Publications beats all competition and gives radio servicemen greatest bargains in service information. Read about other volumes for previous years described below at left. **No-risk** examination granted to servicemen.

FIND ALL RADIO FAULTS DOUBLE-QUICK

You can speed-up and simplify radio repairs with SUPREME PUBLICATIONS Manuals. Service radios faster, better, easier, save time and money, use these most-often-needed diagram manuals to get ahead, earn more per hour. For the remarkable bargain price (only \$2 for most volumes) you are assured of having in your shop and on the job, needed diagrams and other essential repair data on 4 out of 5 sets you will ever service. Every popular radio of all makes from old-timers to new 1948 sets, including F.M. and Television, is covered. Clearly printed circuits, parts lists, alignment data, and helpful service hints are the facts you need to improve your servicing ability. Save hours each day, every day, begin to earn more by making repairs in minutes instead of hours. Let these manuals furnish you with diagrams for 80% of all sets. There is no need to spend large sums for bulky, space-wasting manuals, or to buy additional drawings every few weeks; be wise, use SUPREME Manuals to get the most in diagrams and service data for the smallest cost.

YOU CAN SERVICE ALL OLDER RADIOS WITH



MOST-OFTEN-NEEDED RADIO DIAGRAMS Each manual has between 192 and 208 pages of diagrams and service hints: large size, 8½x11". Price, each **\$2.00**

DIAGRAMS 240 Pages Price \$2.50

Record Changer Manuals

Post-War Models

Service expertly all modern (1945-1948) record changers. Just follow simplified factory instructions to make needed adjustments and repairs. Hundreds of photographs and exploded views; thousands of test hints; service instructions for all popular makes. Large size: 8½x11", 144 fact-filled pages. Available at your jobber or sent postpaid, special price, only. **\$1.50**

Pre-War Models

Just what you need to repair quickly thousands of pre-war (before 1942) automatic record changers, manual units, pickups, wireless oscillators, recorders, and combinations. Hundreds of mechanical and electrical diagrams. Instructions for adjustments and repairs. Most popular units of all makes. 128 large pages; size: 8½x11 inches. Price postpaid, only **\$1.50**

SATISFACTION GUARANTEED

Select Supreme Diagram Manuals and Record Changer Books you want to examine.



Compiled by M. N. Beltman radio engineer, teacher, author, and serviceman.

These manuals pay for themselves with time saved on a few jobs—after that you use them FREE. See listing in left-hand column. Send trial coupon. Use these manuals in your own home or shop for 10 days at our risk. Decide for yourself that Supreme Publications are the greatest values in service data. You must be completely satisfied, or return manuals and receive your money back. Write today—24-hour shipping service.

Models Made by:

R.C.A., Zenith, Philco, Sears, Fada, Emerson, Belmont, Detrola, Crosley, United Motors, G.E., Westinghouse, Arvin, Majestic, Midwest, Meck, Olympic, Pilot, Stewart-Warner, Admiral, Delco, Stromberg-Carlson, Western Auto, Sparton, Motorola, Wards, Gamble, and many others.

See Your Radio Jobber or Send Coupon →



NO RISK TRIAL ORDER COUPON

SUPREME PUBLICATIONS, 9 S. Kedzie Ave., Chicago 12, ILL.

Ship the following manuals on trial under your guarantee of satisfaction or money-back.

- New F.M. and Television Manual **\$2.00**
- Post-War Record Changers. **1.50**
- Pre-War Record Players & Recorders **1.50**
- I am enclosing \$ send postpaid.
- Send C.O.D. I am enclosing \$ deposit.

- 1948
 - 1947
 - 1946
 - 1942
 - 1941
 - 1940
 - 1939
 - 1926-1938. **\$2.50**
- PRICED AT ONLY \$2 EACH**

Name:
Address:

"For Unfailing Dependability Give Me OHMITE"

You can be sure the resistors, rheostats, and tap switches you buy will provide accurate, dependable service if they're made by Ohmite. Every Ohmite product is designed and constructed to stand up under severe operating conditions . . . to give extra performance . . . to withstand the effects of shock, vibration, temperature extremes, altitude, and humidity. This extra performance is the reason thousands of particular parts buyers are regular Ohmite customers.



● Close Control RHEOSTATS

All ceramic and metal. Winding is permanently locked in vitreous enamel. Metal-graphite contact brush insures perfect contact with negligible wear on the wire. Available in 10 sizes from 25 to 1000 watts.

● Vitreous-Enameled RESISTORS

Vitreous enamel permanently locks and insulates each turn of wire on ceramic core. Prevents shorts, conducts generated heat away. All types and resistance values from 5 to 1500 watts.

● High Current TAP SWITCHES

Compact, dependable, and convenient to operate. Heavy, one-piece ceramic body is unaffected by arcing. Five models, A.C. ratings 10 to 100 amperes.

Write Today for Ohmite Catalog No. 19

Provides 16 pages of useful data on the selection and application of rheostats, resistors, tap switches, chokes, attenuators, and other equipment.



**OHMITE
MANUFACTURING COMPANY**
4883 Flournoy St., Chicago 44, Ill.

Be Right with
OHMITE

RHEOSTATS • RESISTORS • TAP SWITCHES • CHOKES • ATTENUATORS

DEDICATED TO
THE CONSTANT
BETTERMENT
OF SOUND



ONE STANDARD
OF QUALITY
ONLY...THE
HIGHEST

250 W. 57th ST., NEW YORK 19 • 1161 N. VINE ST., HOLLYWOOD 38

ALTEC LANSING SCIENTISTS DISCLOSE BASIC IMPROVEMENTS IN HIGH QUALITY SOUND REPRODUCTION IN NEW SPEAKERS



← NEW MODEL 604B DUPLEX SPEAKER SHOWS REMARKABLE EFFICIENCY AND PERFORMANCE

Authorities on sound quality—the experts in the broadcasting, recording, and motion picture industries—who considered the previous Altec Lansing Duplex speaker (the 604) as the finest two-way speaker unit that science has produced, were literally thunder-struck when they listened to "previews" of the new improved Model

604B. Among outstanding new features are: 1,000 cycle crossover frequency using the new N-1000B network with adjustable high frequency control; an exclusive Altec Lansing development used with the high frequency metal diaphragm to smooth the frequency response beyond belief from 1,000 cycles to 16,000 cycles.

SPECIFICATIONS

Angle of Horizontal Distribution60°
Angle of Vertical Distribution40°
Power Rating30 watts

Network Impedance ...16 ohms
Required Amplifier
Output Impedance ...8-16 ohms
Diameter15-3/16"
Depth11 1/2"
Weight40 lbs.

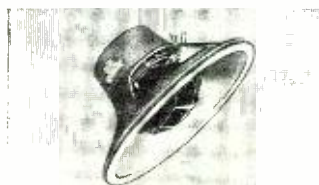

NEW 603B MULTICELL DIA-CONE SPEAKER

The new 603B Multicell Dia-cone speaker is as superior to the original 603 Model as the 603 was superior to its competitors. The new 603B has a 30% larger Alnico V permanent magnet; massive circular magnetic circuit; almost 100% increase in acoustic efficiency (2.5 db increase over the 603).

SPECIFICATIONS

Angle of Horizontal Distribution60°
Angle of Vertical Distribution40°
Power Rating25 watts
Voice Coil Impedance...8 ohms
Required Amplifier
Output Impedance...6-10 ohms
Voice Coil Diameter...3"
Weight18 lbs.
Speaker Diameter15-3/16"
Depth7"

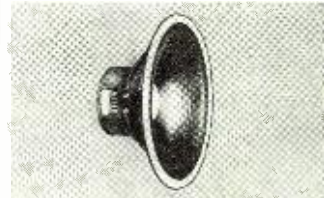

NEW MODEL 600 B DIA-CONE SPEAKER

"Greater quality per dollar" describes the new low-priced high quality 600B Dia-cone speaker unit. Because of the high efficiency, small space requirements, light weight and superior quality of reproduction, the 600B is ideal for home use, sound reinforcement systems and industrial applications.

SPECIFICATIONS

Power Rating20 watts
Voice Coil Impedance...8 ohms
Required Amplifier
Output Impedance...6-10 ohms
Voice Coil Diameter...3"
Speaker Diameter12 1/4"
Depth5 1/4"
Weight12 lbs.



NEW 8" MODEL 400 B DIA-CONE SPEAKER

A low-priced high quality unit with a much higher efficiency than is found in ordinary 8" speakers; important in use with amplifier capable of delivering only from 5 or 6 watts. Exceptionally high power rating results from Altec Lansing design and use of a large Alnico V permanent magnet.

SPECIFICATIONS

Power Rating12 watts
Voice Coil Impedance...8 ohms
Required Amplifier
Output Impedance...4-8 ohms
Voice Coil Diameter...1 3/4"
Speaker Diameter8 1/4"
Speaker Depth3 5/8"
Weight4 lbs.

Altec Lansing Corporation, one of the world's largest makers of professional and theatre-type speaker systems, has announced a new, basically improved line of general purpose, high quality speakers. Altec scientists call attention to the fact that these new speakers,—constituting a complete new line—have been fundamentally re-engineered, and are the result of the application of new scientific discoveries resulting from intensive original research in Altec Lansing laboratories; they are *not*, it is emphasized, mere modifications or "re-working" of present models. The new line of speakers is offered "with the fullest conviction that never before has such a superb group of speakers been presented to a discriminating and quality-conscious public."

FREQUENCY RESPONSE CURVES PUBLISHED IN ILLUSTRATED BROCHURE

With the announcement of the new line of speakers, Altec Lansing announces that frequency response curves will be published on all its speakers. These curves are guaranteed to be accurate, dependable and true reproductions, made on production run speakers with equipment used by Motion Picture Research Council for establishing speaker system standards in the motion picture industry.

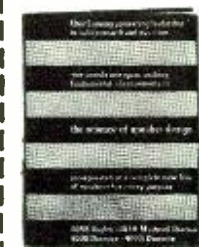

SEND FOR ILLUSTRATED BROCHURE
DESCRIBING THE NEW IMPROVED LINE
OF ALTEC LANSING HIGH QUALITY SPEAKERS

NAME.....
BUSINESS.....
ADDRESS.....
CITY..... STATE.....



USE ADDRESS NEAREST YOU:
250 W. 57th St., New York 19
1161 N. Vine St., Hollywood 38

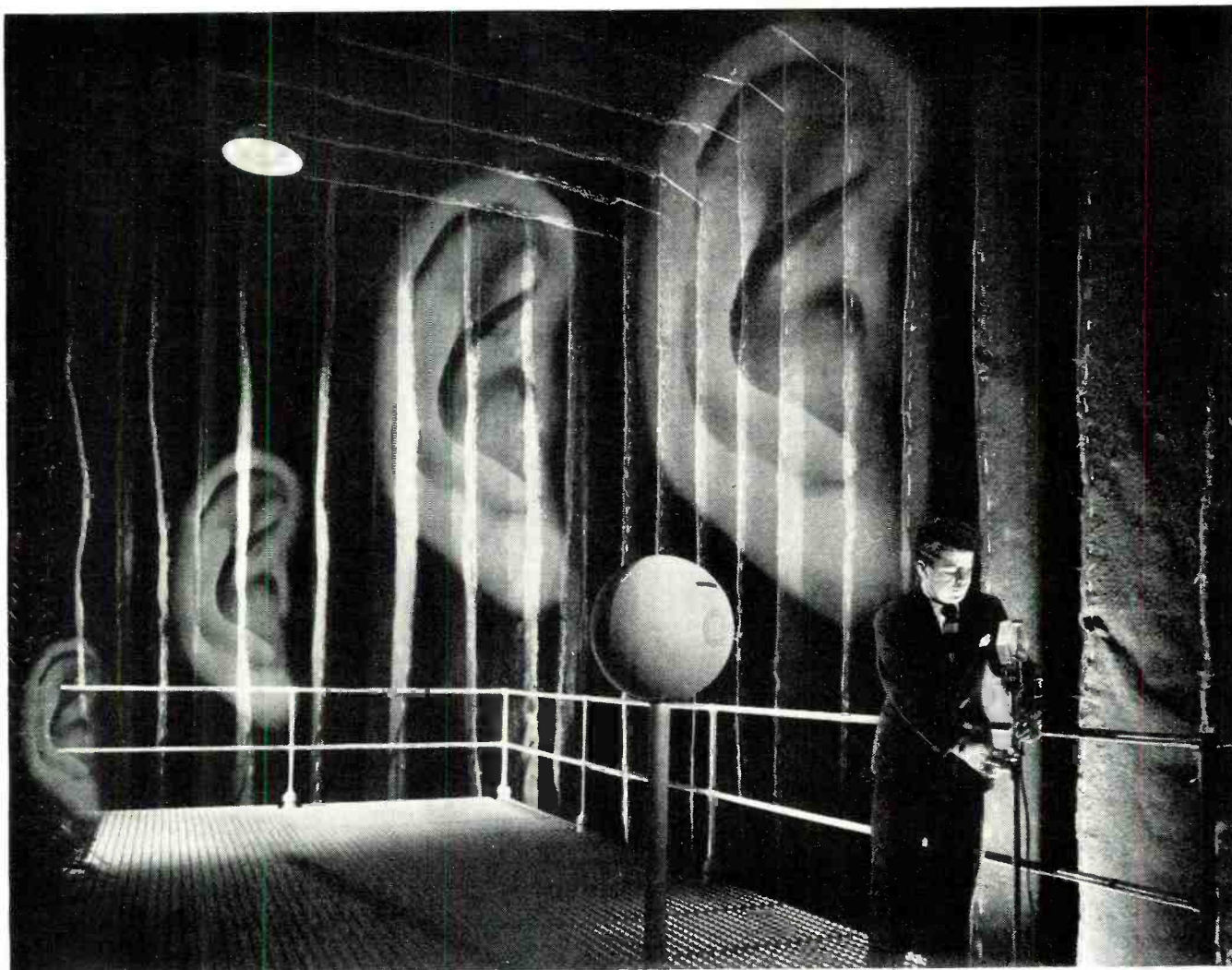

RCA Laboratories' "Chamber of Silence"—proving ground of tonal quality in radio and television instruments.

Ever hear SILENCE?

You walk into an eerie room. The door swings shut and you're wrapped in a silence so complete that it's an effort to listen. Sound in this vault-like cavern is reduced to the minimum of hearing.

But even *silence* has a sound of its own. Faintly you hear a subdued hiss; sometimes a soft hum. Scientists have suggested this may be the "noise" of molecules hitting the eardrums. Others wonder if it is caused by the coursing of the body's bloodstream.

On the walls, ceiling, beneath the open, grated floor of this RCA sound laboratory,

hangs enough heavy rug padding to cover 250 average living rooms. Sound is smothered in its folds—echoes and distortion are wiped out.

When acoustic scientists at RCA Laboratories want to study the actual voice of an instrument, they take it to this room. What they hear then is the instrument itself—and only the instrument. They get a true measure of performance.

Information gained here is part of such advances as: The "Golden Throat" tone system found only in RCA Victor radios and Victrola radio-phonographs . . . superb sound systems for television

. . . the true-to-life quality of RCA Victor records . . . high-fidelity microphones, clear voices for motion pictures, public address systems, and interoffice communications.

Research at RCA Laboratories moves along many paths. Advanced scientific thinking is part of any product bearing the names RCA, or RCA Victor.

When in Radio City, New York, be sure to see the radio, television and electronic wonders on display at RCA Exhibition Hall, 36 West 49th Street. Free admission. *Radio Corporation of America, RCA Building, Radio City, N. Y. 20.*



RADIO CORPORATION of AMERICA

RIDER MANUALS
Mean
**SUCCESSFUL
 SERVICING**

MANCHESTER-CHANDLER HAS ALL 16
 (AND VOL. XVII ON ORDER)



**"No Shop
 Can Give Efficient Service
 Without . . . These Volumes"**

"Rider Manuals give us the authentic data we need to locate quickly trouble in sets brought us for repair. This speed means time and money saved, means Rider Manuals have been a profitable investment for us. We feel no shop can give efficient service without the information contained in these volumes," says G. B. Manchester of the Manchester-Chandler Co., Portland, Ore.

So say successful servicemen everywhere, over whose benches you will find well-used copies of all 16 Rider Manuals. For, during the past seventeen years, money-making shops have depended upon "The World's Greatest Compilation of Radio Servicing Data" for authentic

presentations of manufacturers' original servicing data on American-made receivers issued since 1920. This is vital information.

Rider Manuals keep pace with the manufacturers' releases. Volume XVII, just out, contains both FM and AM sets, record changers and wire recorders. The separate "How It Works" book explains theory and complexities of new receivers. Hundreds of Rider-exclusive "Clarified-schematics," time-saving breakdowns of multi-band jobs, are also in Volume XVII.

Nowhere else but in Rider Manuals will you find such coverage!

You NEED ALL 17—ORDER TODAY

VOLUME XVII.....	\$15.00	Record Changers and Recorders	\$ 9.00
Volume XVI	8.40	Master Index, (covering Manuals,	
Volume XV	18.00	Vols. I to XV)	1.50
Volumes XIV to VII (ea. vol.) . . .	15.00		
Volume VI	11.00	NOTE: Individual Volumes VI, VII and VIII	
Abridged Manuals I to V (one vol.)	17.50	will be replaced after this year by a single	
		Abridged Manual Vol. VI to VIII.	

JOHN F. RIDER, PUBLISHER, Inc., 404 Fourth Avenue, N. Y. 16
 Export Agent: Rocke International Corp., 13 E. 40th St., N.Y.C. Cable ARLAB

VOL. XVII
 (Brings your Rider Manuals
 up-to-the-minute)
JUST OUT!
 1600 PAGES—Plus
 "How It Works" Book
 \$15.00 (Less than a penny a page)
 Your Jobber is taking orders for
DELIVERY NOW!

Watch for Publication
 Date in Late Spring
**RIDER
 TELEVISION MANUAL**

*Give Your Shop the Sign
 of Successful Servicing* **RIDER MANUALS**

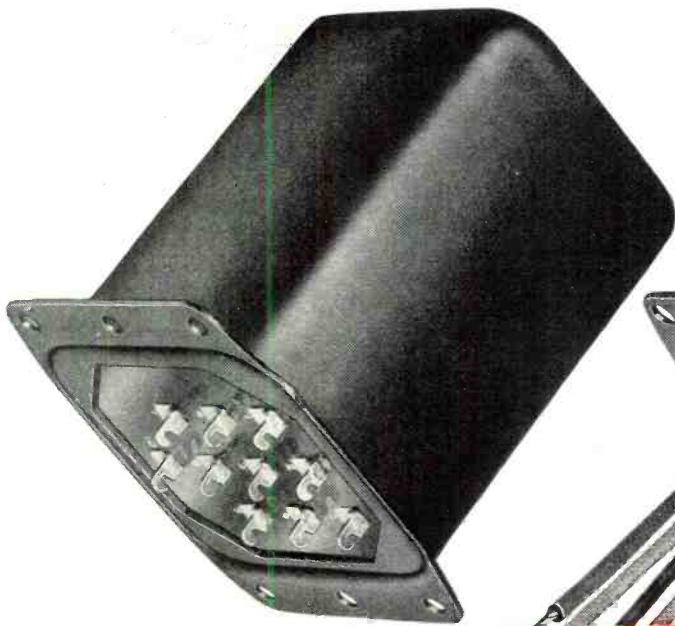

Note The New Look in Power Transformers



Typical Motorola FM two-way radiotelephone receiver utilizing Sealed in Steel Chicago Transformers.

With CT's Famous Sealed in Steel Construction

The clean, streamlined appearance and compactness of CT's new *Sealed in Steel* construction contribute immeasurably to the trim, precision-like effect of any electronic equipment.

In addition, CT Transformers provide "steel wall" protection against atmospheric moisture, efficient magnetic and electro-static shielding, unsurpassed strength and rigidity to withstand shock and vibration, and unusual convenience of mounting.

Two base styles are available for most of the units in this catalog line, one with clearly identified solder lugs in a phenolic terminal board, the other with RMA color coded leads, stripped and tinned for easy soldering.

The design of these new power transformers assures maximum performance with minimum physical size and minimum temperature rise in accordance with RMA standards.

The wide range of carefully selected ratings achieves maximum flexibility of application, close matching with today's preferred types of tubes, and conformance with all industry standards.

Write direct for catalog illustrating, describing and listing the complete line, or contact your nearest radio parts jobber at once.

PLATE AND FILAMENT SUPPLY TRANSFORMERS

Primary 117 Volts, 50-60 Cycles

Catalog Number	For CAPACITOR INPUT SYSTEMS					
	HIGH VOLTAGE SECONDARY			FILAMENTS		
	A.C. Volts	D.C. Ma.	D.C. Volts Output	Rectifier Volts Amps.	No. 1 Volts Amps.	No. 2 Volts Amps.
PC-55	270-0-270	55	260	5 2	6.3CT 2
PC-70	335-0-335	70	320	5 2	6.3CT 3
PC-85	330-0-330	85	320	5 2	6.3CT 3
PC-105	345-0-345	105	320	5 2	6.3CT 3.5
PC-120	375-0-375	120	380	5 3	6.3CT 4
PC-150	370-0-370	150	390	5 3	6.3CT 4	6.3CT 1
PC-200	385-0-385	200	390	5 3	6.3CT 4.5	6.3CT 1
	For REACTOR INPUT SYSTEMS					
PR-55	350-0-350	55	260	5 2	6.3CT 2
PR-70	425-0-425	70	320	5 2	6.3CT 3
PR-85	440-0-440	85	325	5 2	6.3CT 3
PR-105	445-0-445	105	325	5 2	6.3CT 3.5
PR-120	500-0-500	120	400	5 3	6.3CT 4
PR-150	505-0-505	150	400	5 3	6.3CT 4	6.3CT 1
PR-200	520-0-520	200	410	5 3	6.3CT 4.5	6.3CT 1
PR-300	550-370-75-0 -75-370-550	300	425	5 6	6.3CT 5	6.3CT 1

Also available in the *Sealed in Steel* constructions:
FILTER REACTORS with current ratings to match power transformers above.
FILAMENT TRANSFORMERS to meet a wide range of modern tube requirements.

AUDIO TRANSFORMERS — Input, Output, Driver, and Modulation — that provide uniformly high fidelity response in three frequency ranges: 30-15,000 cycles, 50-10,000 cycles, and 200-3,500 cycles.

CHICAGO TRANSFORMER

DIVISION OF ESSEX WIRE CORPORATION

3501 ADDISON STREET • CHICAGO 18, ILLINOIS



LOOKING FOR HIGH FIDELITY IN AUDIO COMPONENTS?

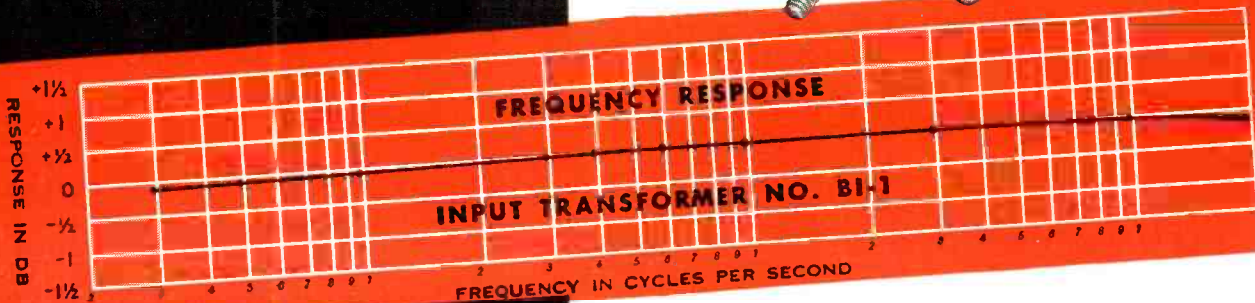

INPUT TRANSFORMERS

Catalog No.	Application	Impedance Primary—Secondary	Max. Power Level
BI-1	Line to Single or P.P. Grids	*Pri.—600/150 ohms CT *Sec.—50,000 ohms CT	+20 dbm.
	Line to Single or P.P. Grids	*Pri.—600/150 ohms CT *Sec.—50,000 ohms CT	+20 dbm.
BI-2	Line bridging to P.P. Grids	*Pri.—8,000/6,000 ohms CT *Sec.—50,000 ohms CT	+20 dbm.
	Line to line	*Pri.—600/150 ohms CT *Sec.—600/150 ohms CT	+20 dbm.
BI-4	Line to line	*Pri.—600/150 ohms CT *Sec.—600/150 ohms CT	+20 dbm.
	Line to line	*Pri.—600/150 ohms CT *Sec.—600/150 ohms CT	+30 dbm.
BI-5	Interstage—P.P. Plates to Single or P.P. Grids	*Pri.—20,000 ohms CT *Sec.—50,000 ohms CT	+20 dbm.
	Line to line	*Pri.—600/150 ohms CT *Sec.—600/150 ohms CT	+20 dbm.

OUTPUT TRANSFORMERS

Catalog No.	Application	Impedance Primary—Secondary	Max. Power Level
B0-1	Single Plate to Line	Pri.—15,000 ohms at 0 to 10 ma d-c.	+20 dbm.
		*Sec.—600/150 ohms CT *Pri.—20,000 ohms CT	
B0-2	P.P. Plates to Line	*Sec.—600/150 ohms CT *Pri.—5,000 ohms CT	+30 dbm.
		*Sec.—600/150 ohms CT *Pri.—7,500 ohms CT	
B0-3	P.P. Plates to Line	*Sec.—600/150 ohms CT *Pri.—10,000 ohms CT	+43 dbm.
		*Sec.—600/150 ohms CT *Pri.—10,000 ohms CT	
B0-4	P.P. Plates to Line	*Sec.—600/150 ohms CT *Pri.—10,000 ohms CT	+43 dbm.
		*Sec.—600/150 ohms CT *Pri.—10,000 ohms CT	
B0-5	P.P. Plates to Line	16/8/4 ohms	+37 dbm.

†Has tertiary winding to provide 15% inverse feedback.
*Split and balanced windings.

Characteristic of C.T.'s New Full

Frequency Range Input and Output Transformers

They provide response within $\pm 1/2$ db over the full range from 30 to 15,000 cycles . . . and response within ± 1 db up to 20,000 cycles. That's tested performance . . . not just a curve.

Their percentage of distortion is exceptionally low over the full range . . . at low as well as high frequencies.

They're *Sealed in Steel* to protect the delicate, fine wire coil windings against corrosion by atmospheric moisture. The drawn steel cases are compact and streamlined . . . help achieve a clean, uncluttered appearance for any gear.

Input units have hum-bucking core construction and additional inner cases of special alloy for hum shielding of -70 dbm or better.

For 250-watt, 1-KW, and 5-KW Transmitters

Matched sets of Driver and Modulation Transformers, and Modulation Reactors, Response within ± 1 db over the Full Frequency Range of 30 to 15,000 cycles. Distortion very low . . . well within FCC limits for transmitters.

Distributorships for this new stock line are now being established. For full information, see your radio parts jobber or write direct.



CHICAGO TRANSFORMER

DIVISION OF ESSEX WIRE CORPORATION

3501 ADDISON STREET • CHICAGO 18, ILLINOIS

ALLIED'S NEW **FREE** 1948 RADIO CATALOG

172 VALUE-PACKED PAGES

Send for it now!

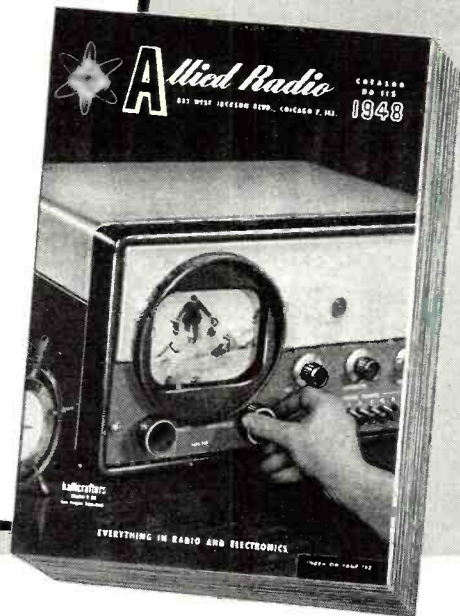

The Preferred Radio Buying Guide

It's off the press—the new 1948 ALLIED Radio Catalog! Get the Radio Buying Guide that's used by thousands of expert servicemen, engineers, soundmen, Amateurs, builders and experimenters. The new ALLIED Catalog—radio's biggest book—brings you 172 pages packed with the widest selections of the newest and finest equipment, at really low, money-saving prices! Here's everything in radio for everyone in radio: new Television and home receivers, packaged Sound Systems and P. A. equipment, latest Amateur receivers and station gear, test instruments, builders' kits, thousands of parts, tubes, tools, books—the world's largest stocks of nationally-known equipment. Take advantage of ALLIED'S speedy, expert shipment and the personal attention of seasoned old-time radio men. Get the details, too, of radio's newest and most liberal Time Payment Plan. Send today for your FREE copy of ALLIED'S newest, greatest Catalog—the preferred Radio Buying Guide!

LARGEST STOCKS • QUICK, EXPERT SERVICE

Get your **FREE** copy of
Radio's most complete Catalog
Use the coupon below—**NOW!**

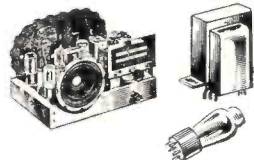

MORE THAN 10,000 ITEMS

Everything in radio for everyone in radio! Complete lines of all leading makes of parts and equipment—all from one great, centralized source. For newest developments and best values, see your ALLIED Catalog.

TELEVISION & HOME RADIOS

A special selection of outstanding models—table radios, consoles, combinations, FM-AM—plus new Television, offered first by ALLIED at real savings. Hand-picked models—the choice of experts!

AMATEUR STATION GEAR

Here's heaven for the Ham! You'll find everything you need for your shack in the new ALLIED Catalog. See all the latest releases in receivers, transmitters, parts, station equipment—biggest Ham listings in radio!

NEW P. A. EQUIPMENT

Packaged, ready-to-use Sound Systems; amplifiers guaranteed for one full year; everything in speakers, microphones, P. A. accessories, intercom and recording equipment—leading headquarters for Soundmen!

**RADIO'S LEADING
BUYING GUIDE!**



**THE WORLD'S
LARGEST
RADIO
SUPPLY
HOUSE . . .**

★ **ALLIED
RADIO**
*Everything in Radio
and Electronics*

ALLIED RADIO CORP.
833 W. Jackson Blvd., Dept. 1-D-48
Chicago 7, Illinois

Send FREE New ALLIED Catalog.

Name.....

Address.....

City.....Zone.....State.....

For the **RECORD.**

BY THE EDITOR

TEN YEARS OF PROGRESS

about five times the number of copies that came off the presses ten years ago in April, 1938. Of even more importance to our readers and advertisers is that because of their continued interest and support we have been able to give them much more editorial material each month than any other similar publication.

Many new advertisers have come into RADIO NEWS, but the additional number of pages required for these new accounts has resulted in an additional quota of editorial space for new features and departments, such as "Mac's Radio Service Shop." Don't let that title fool you. The series is jam-packed with some well founded advice, not from a fiction writer, but from an established radio serviceman who has learned radio the hard way. Don't miss it!

Our follow-up article on the Recording Amplifier, (page 54, January, 1948, RADIO NEWS) is scheduled for the next issue. We will have a separate Dynamic Noise Suppressor unit all complete and ready for you constructors of audio equipment. And we have improved the circuit of the record-reproduce amplifier as the result of exhaustive tests on all types of records, etc. Watch for the complete data in next month's issue.

Don't miss Milton Kiver's excellent article on TV set comparisons in this issue. You'll be needing such information almost before you realize it.

We have assigned a new series of articles on sound and p.a. to one of the country's outstanding audio engineers. This series will tell you how to select and install every known type of equipment designed for the distribution of sound and how to conduct a profitable business along these lines. This is scheduled to start in an early issue.

There is a definite trend toward custom built tuners and audio equipment in many cities. Many servicemen are already specializing on such installations. Handsome profits may be made from the sale of AM-FM tuners and quality amplifiers. In fact, many new homes are now being built with special provisions for the installation of such equipment. Complete data is now being compiled on a wide assortment of these units and is scheduled to appear soon.

We look forward to other new uses for radio, electronics, television, and facsimile in future years with optimistic enthusiasm. Yes—the vacuum tube will continue to be man's most useful servant.O.R.

AS WE go to press with this issue, we look back over the past ten years to April, 1938. That was the date that Ziff-Davis took over the publishing of RADIO NEWS. It appeared at that time that radio had about reached its ultimate objective as an entertainment medium. The art of television was still in an experimental stage and no one could venture a guess as to when video would become a reality. Early television programs were quite satisfactory, considering that few were engaged in any serious research and those who witnessed those early pictures felt that some day they too would like a television receiver in their homes.

The outbreak of war applied a quick brake to any further development of television except for military purposes. Now, ten years later, we find that the entire radio-electronic industry is beginning to feel the impact from the rapid acceptance of video by the public. It has been reliably predicted that by the end of this year nearly 40% of our population will be within range of at least one television station.

As new transmitters loom on the horizon, more and more service technicians will realize that they have, at their finger tips, a real opportunity to take an active part in the fastest growing industry of our time. We know of several groups of advanced radio technicians who have already formed small groups to handle the demands for installation and maintenance of TV sets in the larger cities such as Chicago, New York, Los Angeles, etc.

We, too, are bending our efforts to satisfy the ever-increasing demand for more and more technical information for our expanding readership.

We recognize the fact that we must, at all times, keep pace with our industry and broaden our service to our readers and advertisers. It is fact, not fancy, that editorial material is appearing each month in RADIO NEWS in ever increasing quantity. We have continuously assigned top quality authors to present specialized material in such a manner as to be of greatest help to the majority of radio-electronic minded readers.

Paper shortages have long prevented us from printing enough copies of RADIO NEWS every month to satisfy an ever increasing readership. This situation has been somewhat relieved. As a result we go to press with a run of over 252,000 copies. This represents

NOW is the time to MAKE YOUR DOLLARS COUNT!

Now, when your dollar is getting smaller, "Servicing with a STAR" is more than good radio sense . . . it's good dollar sense! This is no time to buy your test equipment blind. It's time to weigh your money against value — if you do, you'll choose STAR.

TUBE CHECKER

Model TE-1

This compact checker gives you precision testing at a low price.

Features: checks any

standard receiving tube; line check; short test and tube data chart. Operation: 105-130 V, 50-60 cycles. Size: 9" x 7" x 3 1/2".

Weight: 6 lbs.

Price, ONLY.....\$29.95



STAR TESTER

Model M-11

Here's a quality tester made for your budget. It features: 1000 Ohm per volt sensitivity - AC and DC; 400 Microamp meter; 27 separate ranges; precision resistors through-

out; rugged metal cabinet; lightweight (4 lbs.); handy size (9" x 7" x 3 1/2"). Design: 5 AC & 5 DC volt ranges to 1000, 5 output ranges to 1000, 4 DC current ranges to 1 amp., 3 resistance ranges to 5 megohms, 5 DB ranges to +54 db.

OUR NEW LOW PRICE.....\$24.25



SET TESTER

Model MT-12

Combination tube checker and multitester in a handsome wooden cabinet. Tester Section: 5 DC & 5 AC volt ranges to 1000V; 4 DC current ranges to 1 amp; 5 DB ranges to +54 db; 5 output ranges to 1000 V; 3 resistance

ranges to 5 megohms. Tube Section: tests all receiving tube types, multipurpose tubes, condensers, pilot lights, tube noises and tube shorts.

REDUCED PRICE.....\$53.50



Instruments come completely equipped with batteries, test leads, instructions, etc. They are available at all leading jobbers. Inspect them and convince yourself. If your jobber is out of stock — order direct from

STAR MEASUREMENTS CO.

Dept. R-4, 442 East 166 Street
New York 56, N.Y.

Catalogs mailed on request.

HOW TO MAKE MONEY
in
RADIO
ELECTRONICS
TELEVISION

HOW TO READ
RADIO DIAGRAMS
AND SYMBOLS

SPRAYBERRY
ACADEMY
OF RADIO

GET THESE 2 BIG BOOKS
FREE!

IF YOU
WANT TO LEARN
RADIO!

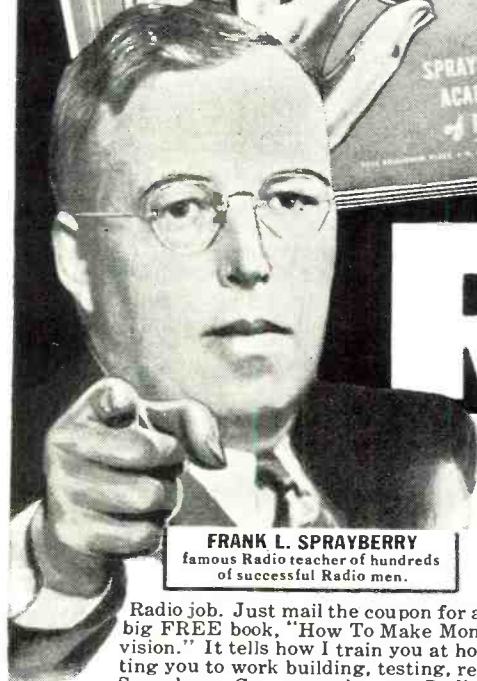

FRANK L. SPRAYBERRY
famous Radio teacher of hundreds
of successful Radio men.

I TRAIN YOU RIGHT BY SENDING YOU 8 BIG KITS OF RADIO EQUIPMENT INCLUDING A POWERFUL 6 TUBE SUPERHET RECEIVER AND 16 RANGE TEST METER!

Radio job. Just mail the coupon for a FREE Sample Lesson and my big FREE book, "How To Make Money In Radio, Electronics, Television." It tells how I train you at home during spare hours by putting you to work building, testing, repairing Radio equipment. The Sprayberry Course teaches you Radio by working with 8 big kits of Radio parts I supply. You build a powerful 6 tube superhet Radio, a 16-range test meter, perform over 175 interesting, PRACTICAL experiments. My lessons are easy and interesting — you need no previous experience in Radio. I start you at the beginning ... and give you valuable "bench" experience that sticks with you.

Soon after you start I send you my famous BUSINESS BUILDERS that help you earn EXTRA CASH getting and doing neighborhood Radio Service jobs while learning. You couldn't pick a better time to get into Radio. The Radio Repair Business is booming! Good Radio Service and Repair Shops are needed everywhere as millions of new sets are in use. Trained men are wanted for opportunities in Police, Aviation and Marine Radio, F.M. and Standard Broadcasting and Television. Manufacturers are looking for men who know Radio as production reaches new peaks. GET THE FACTS ABOUT YOUR FUTURE IN RADIO. MAIL the COUPON TODAY for my FREE BOOKS!

LEARN HOW TO BUILD-TEST-REPAIR RADIOS By Working with YOUR HANDS!

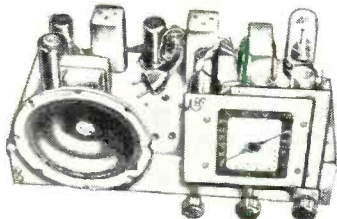

You really learn Radio the PRACTICAL way ... when you build this big, powerful 6-tube Superhet Radio from parts I send you.

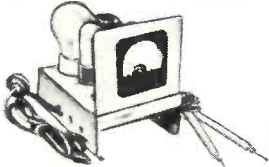

give you a fine, moving coil type Meter—with parts for a complete analyzer and Circuit Continuity Tester. "Trouble-shoot" with professional accuracy.

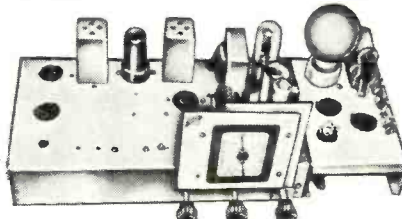

You don't have to buy expensive ready-made equipment. You get valuable experience building this Signal Generator and Multi-purpose Tester.

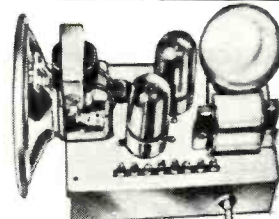

You construct this rectifier and filter, resistor and condenser tester, and really get on the Practical end of Radio.



Trained Radio men can step into their own profitable Radio Service Shop—or—



New developments are constantly opening new big pay job opportunities in Radio.

LOW COST RADIO TRAINING STUDY AT HOME IN SPARE HOURS

Sprayberry Training costs surprisingly little! Easy monthly payments, if desired. Everything you need is furnished — nothing else to buy. With Sprayberry Training to back you up, you will be able to step into your own profitable Radio Service Business or go on to a big opportunity in Radio, Electronics or Television. The equipment I send you is yours "for keeps" — to use in your business or job. I have trained thousands of successful Radio men — and I can help you, too. Get the facts about Sprayberry Training — it's your first step to success, security and a bigger income in a field where you'll really enjoy your work. Fill out and mail coupon TODAY. I'll rush my two FREE books to you by return mail.

VETERANS: Approved for G. I. Training under Public Laws 16 and 346.

Sprayberry Academy of Radio
F. L. SPRAYBERRY, President
Room 2548, Sprayberry Bldg., Pueblo, Colorado

RUSH COUPON Today!

SPRAYBERRY ACADEMY OF RADIO
F. L. SPRAYBERRY, President

Room 2548, Sprayberry Bldg., Pueblo, Colorado
Please rush my FREE copies of "How To Make Money In Radio, Electronics and Television" and "How To Read Radio Diagrams and Symbols." No salesman will call.

Name _____ Age _____

Address _____

City and Zone _____ State _____

CHECK HERE IF A VETERAN

(Mail in an Envelope or Paste on Penny Postcard)

amplifier does not possess a bridging transformer. This special pad offers high impedance to the source, generally 20,000 ohms, and presents a lower impedance, usually 600 ohms, to the amplifier input terminals. However, any manner of impedance ratio can be engineered into these pads, in accordance with the equipment requirements. The high degree of isolation thus afforded the main circuit prevents any noise being introduced from the auxiliary amplifier or other device bridged.

In order to properly guide anyone in the choice of an attenuator for a specific application problem, the physical forms in which attenuators are most generally fabricated should be considered. Possibly, because they are an outgrowth of the old rheostats used in the early days of radio, they are most frequently made in a circular form, with diameters varying from 1.75" to 3.5", governed by the mechanical requirements of parts and contact placement. The rotary motion approximates 345 degrees of arc. These are most generally used. However, the comparatively new sector attenuator, illustrated in Fig. 6, has been used in many complex theatre installations (Fig. 1). Straight line motion, ease of controlling more than one unit with each hand, fast adjustment and the ability to gang several for simultaneous operation has made this unit extremely popular. Formerly there was an attempt to translate the rotary motion to a linear one through the use of pulleys and cords, as shown some while ago in a Hollywood mixing and re-recording installation, but this makeshift is no longer necessary. Another very recent use of the sector attenuator was to mount it on the familiar transcription playback machine so the operator could release the cued record and open his gain with the motion of one hand with imperceptible time loss. ABC has made a number of these installations, with great operating success.

Electrically, modern attenuators can be grouped into four main classifications. (Of these, two classes are variations of each other.) These are the ladder, tee, bridged tee, and potentiometer. It may be well to refer to Figs. 2 and 5B, to review the electrical differences among these units. Although at one time or another additional forms of attenuators have been made, these have been discarded as outmoded, because of their performance, now considered inferior. Circuit position is the dominant factor in the selection of the correct attenuator. The salient points are:

The ladder, Fig. 2C, has but one row of contacts and moving arm. It is easy to operate, possesses smooth mo-

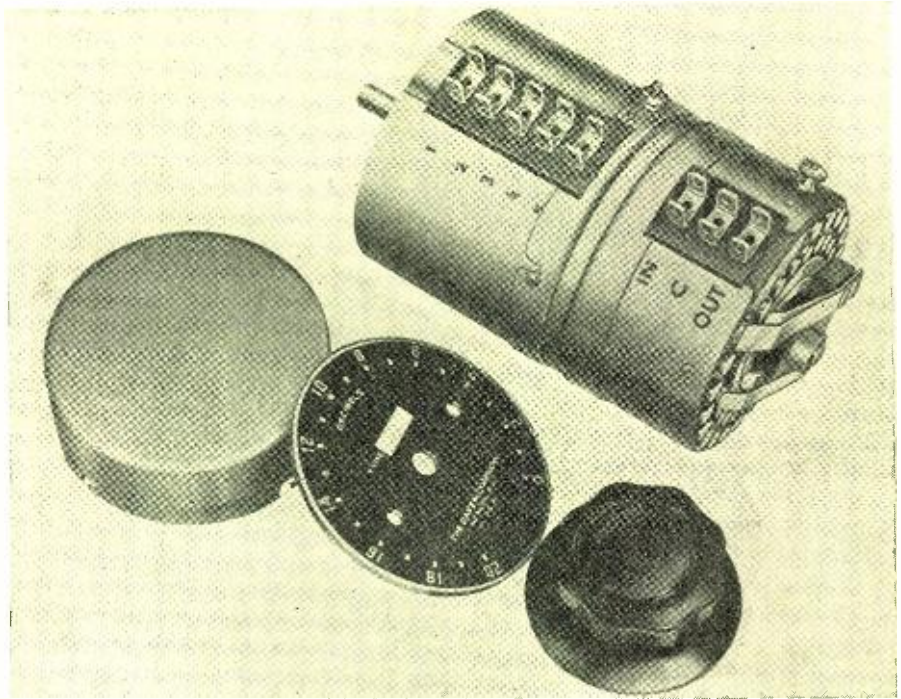

Fig. 4. Daven type LAC 720 tone compensating ladder attenuator. Notice the five extra contacts to convert this unit to a straight ladder if desired.

tion, is quiet electrically and mechanically and relatively low in cost. But since it offers an insertion loss of 6 db., and because this means cutting in half the gain of the source signal, additional amplification is necessary. If the impedance ratio of the ladder can be made 1:2, then the insertion loss becomes 2 db. This change in impedance ratio is also an undesirable factor. A special case of zero insertion loss ladder has been made, but it is costly and mechanically complex, and therefore has not met with wide commercial acceptance.

The tee pad of Fig. 2B requires two or three sets of contacts. The latter is for the pure tee, but no collector rings are used. While it is possibly a bit harder to rotate, the advantages of a zero insertion loss and smoother impedance characteristics favor the

selection of this form of control. The bridged tee offers smoother over-all impedance characteristics when the brush shunts a pair of contacts and requires fewer resistors in its construction. Consequently, it is cheaper to make than the tee pad, but the latter is the more accurate and better for the precision measurement of laboratory equipment.

The potentiometer, as its name implies, is a voltage measuring device, and is usually found in high impedance installations. Similar to the ladder in physical appearance (Fig. 2A), these units can be made comparatively economically, commensurate with their accuracy and the smoothness of control they afford. It is apparent that the load side of the potentiometer offers a varying impedance, and unless this can be accepted,

Fig. 5. (A) Tone compensated ladder, simple form. (B) Bridged Tee attenuator. Note that both resistors vary simultaneously.

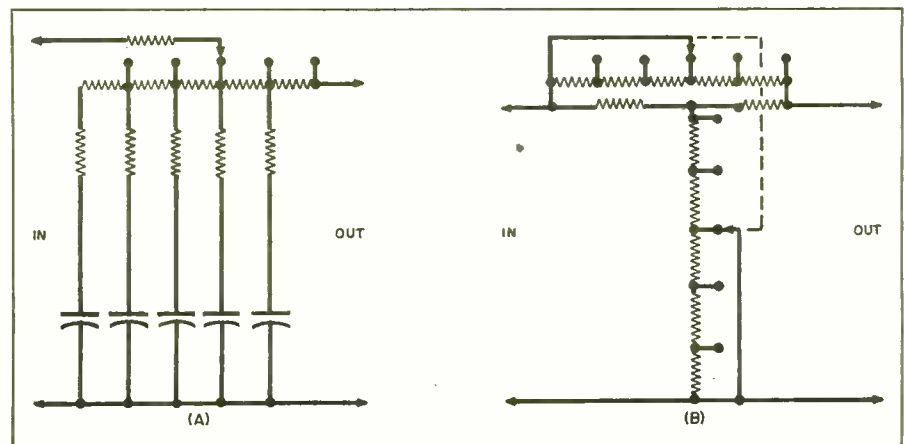

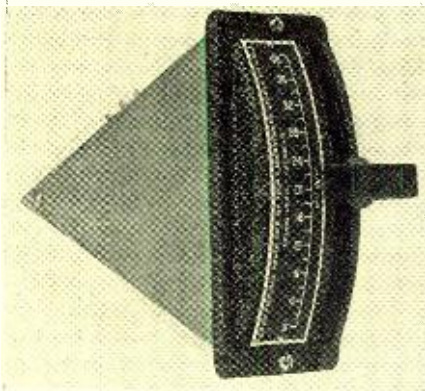

Fig. 6. The Sector or Slide Attenuator introduced by Tech Laboratories. Any electrical configuration can be built in this mechanical form.

its compensated form must be used. However any type of compensation presents serious frequency discrimination even at audio frequencies, due to the series resistors, and the attendant Miller effect in the grid circuit to which it is connected. (See Fig. 7B.)

Fifteen years ago, mixer circuits were almost universally of the low level variety, that is, mixing took place right after the microphone, and before any amplification had been inserted into the system. This was practical then, as most microphones were not of the highest fidelity, possessed higher output than now, and the noises introduced by the mixer were not so noticeable. With the acceptance and universal use of the wide range, high fidelity, low output microphone and transcription reproducer, some form of pre-amplification became essential. Mixer circuits then were moved to a higher level position in the speech input installation, and this is the generally accepted form today. Consequently, we shall consider such

mixers here with the exception of those mixers used in some forms of remote broadcasting pickup equipment, where low level mixing still persists, for economy of pre-amplifiers required and power drain upon the battery power supply frequently employed for this form of equipment. The ladder is almost universally used for low level mixing circuits because it tends to be quieter. An attenuator's noise, along with the signal, receives the effect of the full system amplification so consideration must be given to noise characteristics. Today it is possible to make attenuators so quiet that the only noise they introduce is that of thermal agitation of component resistors. Even this is less than that due to thermal agitation tube noises. However, the ladder is also used in high level mixing where cost of components is a consideration and where ease of rotation is desirable. If the mixing installation is a large one, and the inclusion of ladder attenuators will tend to increase the loss of the mixer, then bridged tee pads are to be recommended. They are the better of the two for this service, and frequently are used as master gain controls. But as already noted, in complete console construction master gain control is frequently a potentiometer. Noise voltages introduced by the controls are smaller in high level mixing, and, with a suitable form of internal wiring, the noise can be made to decrease with the signal as added loss is inserted in the circuit.

Perhaps because of the lack of description in the makers' catalogues, a great deal of misunderstanding exists as to what differentiates a linear from a tapered control, and where each should be used.

A linear control is just what its name implies—the loss it introduces

is a linear function, and increases an identical amount for each step of rotation. Thus the amount of loss inserted is uniform for each increment of motion of the knob, and the total loss is as stated on the nameplate of the unit. Smooth opening and closing of a program is impossible if the control used has a loss of 40 decibels, and the circuit has a sound level of about 60 decibels above the threshold of hearing. The first step will be up 20 decibels from silence, clearly an undesirable condition.

The tapered control, on the other hand, offers a uniform amount of attenuation per step for approximately 70-75 per-cent of its travel, and then increasing amounts for each extra step of attenuation, so that the over-all loss it is possible to introduce into the circuit is far and above that of a similar linear control of like number of steps and loss per step. Electrical smoothness of operation of the controlled circuit is thus afforded, without any sudden jump from no signal to one of appreciable level. It should be mentioned here that while tapered controls of only 20 steps are quite common, smoother operation, especially on tones of long sustained duration is afforded by controls of 30 or more steps. Thus, in selecting controls for a deluxe mixer, the control having the greater number of steps is more than proportionately desirable.

While the master gain control has usually been selected from among the linear controls offered, the writer from his years of operational and consulting experience recommends that this too be tapered, with one exception, and that is for the system master in network operation, where this control is used only to compensate for line level losses. All studio masters should be tapered so that the mixing operator can then open or close his show with a multiplicity of microphones in use at their preset levels without having to manipulate a number of controls simultaneously. Those stations and studios that have followed this recommendation are more than pleased with the operating facility it provided.

What is probably the next most confusing problem in selecting an attenuator is what loss per step to buy. This is not a problem simply solved. It involves many factors. Still some points can be mentioned for guidance. The over-all gain of the amplifiers installed, the level of the sources being mixed and the outgoing level, whether feeding a line or a recording head all bear on this problem. It can be stated that generally the low cost mixer can be designed with controls of the tapered variety offering loss of

(Continued on page 21)

Fig. 7. (A) Electrical connections of the LAC 720 shown in Fig. 4. (B) Schematic of the compensated potentiometer. Build-out resistors keep total impedance constant.

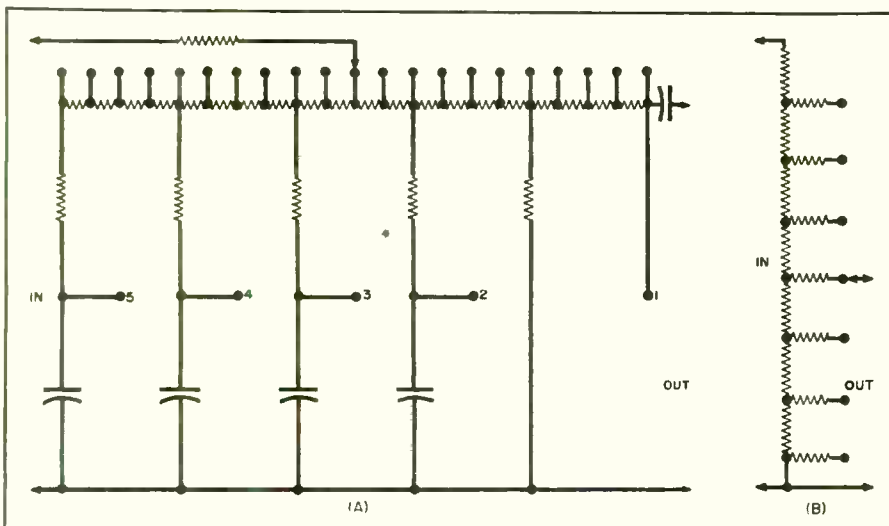
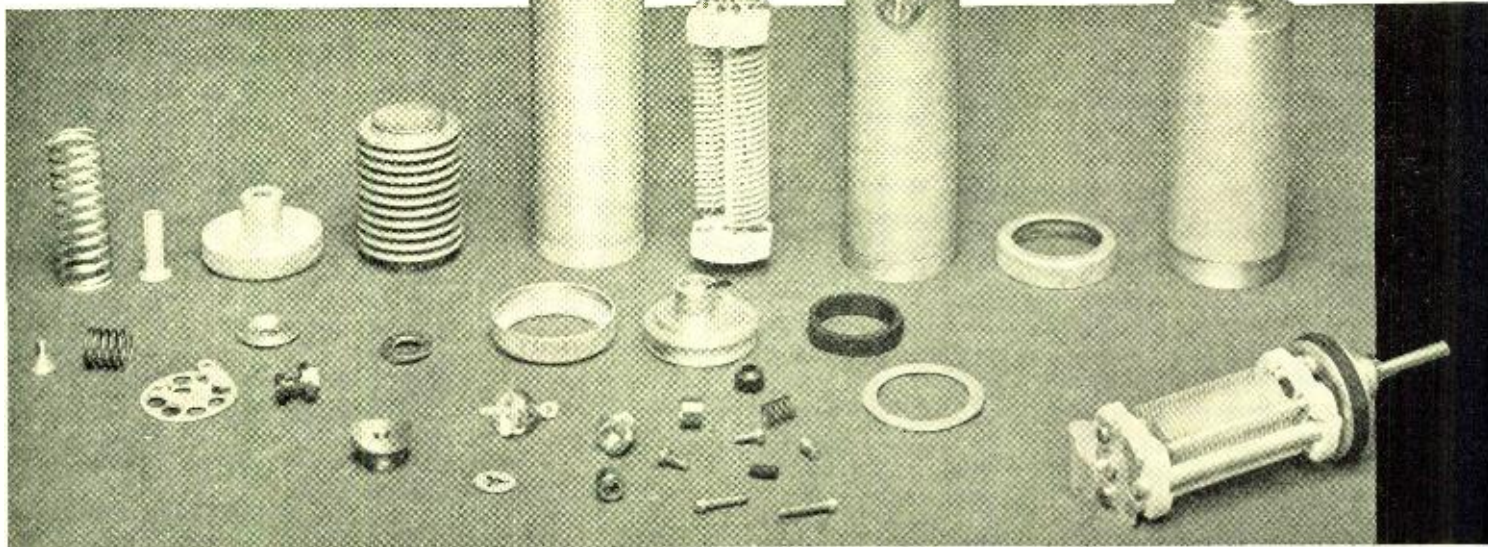

Fig. 1. Liquid-filled variable condenser components. Capacity range —36 to 220 mmfd. Working voltage, 5000 peak; puncture voltage, 8500 peak; frequency, 2 mc.; temperature, —55 to +85°C., spacing, .030 inch; power factor, .0001 to .0005.



IN 1924 a Bureau of Standards publication commented on the desirability of utilizing oil as a dielectric for high power variable capacitors. The reference stated that "... using ordinary petroleum oils about doubles the capacity. Condensers with oil as a dielectric are very well suited for power condensers. The breakdown voltage is very high, dielectric and brush losses low, and on account of the high dielectric constant of some oils, it is easy to get a large capacity in moderate volume."

While this statement is undoubtedly true under certain conditions, the rigors of most practical applications have seriously limited the use of variable capacitors with liquid dielectrics. Questions of operating frequency, temperature range, losses, and maintenance have in general remained indefinite, and a host of misconceptions as to the electrical properties of various liquid insulators have become the basis of much skepticism as to their practicability and utility in radio frequency condensers.

There are several fields of electrical engineering wherein the use of petroleum oils has been developed to a high level. The use of oil in circuit breakers, switches, insulating bushings, transformers and high voltage cables has been thoroughly discussed in the literature. However, all of the applications referred to are limited in operating frequency to several hundred cycles. Moreover, the oil in many cases has been used as a cooling medium (transformers) or an arc quenching medium (circuit breakers and

Liquid Dielectrics for Variable Condensers

By **Sidney Wald**
Aviation Equipment Engineer, RCA

Results of tests and recommendations concerning the use of liquid dielectrics in variable capacitors.

switches). In some applications of power-engineering, oils are used in high voltage underground cables to reinforce the insulating properties of paper as a dielectric and to increase the breakdown potential of the cable. Examples have been cited where oil-filled cables are being operated at voltages up to 130 kv. In all of these low frequency power applications, permittivity has been unimportant except as the lower values would be more desirable to reduce the displacement current.

In the electronics field various dielectric liquids are used as saturants and fillers for paper capacitors. Three types of liquids in general use include mineral oil, castor oil, and chlorinated diphenyl compounds. These capacitors have not been used or recommended for critical tuning applications or at radio frequencies. They are used as low frequency by-pass and buffer ca-

pacitators where the principal requirements are high capacity and high dielectric strength. For example, castor oil filled capacitors may lose as much as 20 per-cent of their capacity when the temperature drops to —50° C. Pyranol capacitors suffer a loss of capacity at low temperatures.

The principal advantage of the Pyranol type of liquid is its non-inflammability. Neither castor oil nor the chlorinated compounds are suitable for exacting or critical applications due to their rapid change of electrical and physical constants with temperature and frequency. It may be noted in passing that oil-filled paper capacitors are not self-healing, that is, the first flash-over destroys the unit.

Variable Air Capacitors

This form of capacitor for radio frequency resonant circuits has been the accepted standard of excellence up to

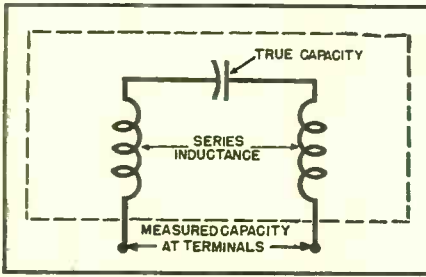

Fig. 2. Equivalent circuit of test capacitor.

and including the present state of the art. Some of the more familiar advantages of the air capacitors are:

1. Stability of capacity with changes in temperature, pressure, humidity, composition of air, frequency and applied voltage.
2. Extremely low power loss or very high Q (over 10,000). The power loss of an air capacitor is not due to the loss in the air dielectric but to the parts involved in mechanical construction such as plates, supports, solid insulation and terminals.
3. Low cost and ease of fabrication.
4. Self-healing after breakdown.

The disadvantages include low capacity for a given size, and relatively low breakdown voltage gradient. (For large spacings, this voltage is approximately 31 kv. (max.) per centimeter at sea level. This reduces to about 6 kv. per centimeter at 40,000 feet of altitude at room temperature.)

For airborne communication transmitters, variable tuning capacitors are required in the frequency range of 1 to 20 megacycles. These units must be small in size and weight, have relatively high capacity and withstand high r.f. voltages at altitudes up to 50,000 feet. Capacitors with air dielectric become extremely large and heavy for this application. It is, of course, commercially feasible to construct high pressure variable air capacitors to withstand high voltage, but these units are bulky and again

have a very poor capacity/size ratio. Generally, compressed gas capacitors require intermittent pumping to maintain the required pressure.

Since liquid dielectrics possess the desirable electrical characteristics of high capacity per unit size together with high dielectric strength for short gaps, they would appear to be a good solution to the aircraft condenser problem.

In order for variable tuning capacitors to function properly in modern high altitude aircraft, they must be capable of maintaining constant capacity, low loss, high dielectric strength, and long life under the following conditions:

1. Temperature range of -55°C . to $+85^{\circ}\text{C}$.
2. External barometric pressure from sea level to that existing at 50,000 feet altitude.
3. Humidity variations up to temporary immersion in salt water.
4. Frequency range from 1 to 10 mc. (for present requirements).
5. Capacity up to 600 micromicrofarads.
6. High current carrying ability (up to 20 amps. r.m.s.).

There are many liquid dielectrics capable of fulfilling some of these conditions, but usually they are deficient in one or more of the remaining requirements. In terms of physical properties of liquids, the specifications call for a freezing or pour point well below -50°C . and low vapor pressure at $+85^{\circ}\text{C}$.

The liquid should be non-inflammable or possibly no more dangerous to handle than ordinary kerosene. The flash point should not be under 100°F . Finally, the material should be non-toxic and capable of being maintained at elevated temperatures for long periods of time in a hermetically sealed enclosure.

The most desirable fluids would be

those with low permanent dipole moment and high permittivity (large induced dipole polarization). This combination would yield a liquid having little temperature sensitivity and good dielectric constant with low power factor over a wide frequency range. Additional requirements are, of course, low freezing point, low coefficient of volumetric expansion, high boiling point, and negligible reaction with the shaft seal in the hermetically sealed container.

The most common group of substances meeting the above requirements and which are liquid at ordinary temperatures are the petroleum hydrocarbons.⁸ These liquids are of two distinct origins. One group is derived from naphthenic crude petroleum, the other from paraffin crudes. In general, the pour point (low temperature solidification) of the naphthenic distillates is much lower than that of the paraffin base distillates. Consequently, other factors being equal, it is more desirable to utilize the former for low temperature work.

Petroleum distillates have the additional advantage of being composed principally of mixtures of saturated hydrocarbons, few double bond carbon atoms being available to take on oxygen or other elements. Prolonged heating at about 100°C . in contact with air will cause these liquids to oxidize slowly. In order to prevent all oxidation and deterioration the liquid must completely fill a hermetically sealed container with no exposure to atmospheric oxygen. Units which are not subject to vibration or overturn (i.e. for stationary use) may employ an inert gas such as nitrogen in contact with the fluid.

Liquids like Pyranol, styrene monomer, castor oil, halowax oil, and chlorinated naphthalene were considered unsuitable for various reasons such as high freezing point, thermal instability at prolonged high temperatures, or excessive variation of dielectric constant with changes in ambient temperature.

Since some of the most important requirements are mechanical in nature, a large group of liquids was immediately excluded. All liquids to be checked electrically must have a pour point below -50°C ., and not more than about 125 mm. vapor pressure at 85°C .

After selection of the liquids to be tested, they must each be processed or purified to make them useful as dielectric liquids. There are three distinct factors involved in processing the fluid.

1. Removal of solids, such as lint, fibers, and colloidal particles.⁹
2. Removal of moisture (colloidal and dissolved water).

Table I. Physical properties of various dielectric fluids.

Name	Supplier	Distill. Range $^{\circ}\text{C}$.	Flash Pt. $^{\circ}\text{C}$. Tag Closed Cup	Aniline Pt. $^{\circ}\text{C}$.	Specific Gravity	Pour Pt. or Freezing Pt.	Vol. Coeff. of E-x pansion/ $^{\circ}\text{C}$ (-55 to +30) (+30 to +85)
10-C Transil Oil.	General Electric	250-400	135			-40°C .	0.0008 0.00107
Mineral Ins. Oil—Light.	Sun Oil Co.		132			-45°C .	
Univolt No. 35....	Std. Oil of N.J.		149			-40°C .	
T-76 Oil....	Socony Vac. N.Y.		104			-55°C .	
Sun Spirits. Special Heavy Spirits No. 58....	Sun Oil Co. Atlantic Ref. Co.	149-207	38	49	0.811		
Fluid No. 500 5 centi-stokes....	Dow-Corning Chemical Co.	186-235 B.P. 120 at $\frac{1}{2}$ mm.	64	60	0.811		
Instrument Oil "A"....	Gulf Refining Co.		316 no effect on rubber or elastomers		0.918	-70°C .	0.001095 at 3°C . 0.000656 0.000704
			135			-50°C .	

3. Elimination of dissolved gases (including air and CO₂).

Tests Performed

1. Spark-over voltage at approximately 2000 kc. vs. temperature at constant pressure. Comparison of 60 cycle and r.f. values.
2. Q vs. frequency at room temp.
3. Q vs. temp. at 2 and 9 mc.
4. Dielectric constant vs. temp.
5. Dielectric constant vs. freq.

Test Methods

In order to arrive at the dielectric constant and losses of a liquid dielectric, it is necessary to utilize the liquid as a filler in a parallel plate air capacitor whose characteristics are known. In this case a type APC (brass plates, silver plated) *Hammarlund* double bearing capacitor with dry capacity of approximately 106 μfd. and 0.025 to 0.030 inch spacing was chosen. This capacitor was installed in a pint-size glass mason jar fitted with mycalex lid and neoprene lid gasket. Besides the capacitor terminal studs, the lid contained a neoprene bushed hole for a thermometer. See Fig. 3.

A *Boonton* Type 160A Q meter was the basic measuring instrument used to determine the losses and dielectric constant of the various insulating liquids.

In order to secure controlled temperature variation, the test capacitor with fluid and thermometer immersed is set in a "dry ice" bath until the indicated fluid temperature is below -55°C. Then the test capacitor is checked on the Q meter while the temperature rises slowly to the ambient value.

For temperatures between ambient (25-30°C.) and 85°C., a thermostatically controlled *Weber* oven is used to bring the test cell up to the high temperature. The jar is removed from the oven, transferred to the Q meter, and measurements made as the temperature falls to the ambient value.

Formulas

In using the Q meter to determine Q and dielectric constant K the Q meter is resonated at 2 mc. with a test coil whose Q is about 250. Readings C₁ and Q₁ are recorded. The test capacitor is connected across the capacity terminals, and the Q meter is again tuned to resonance.

New readings of Q₂ and C₂ are recorded.

$$Q_x = \frac{C_1 - C_2}{Q_1 - Q_2} \times Q_2 \times \frac{Q_1}{C_1} \dots (1)$$

where Q_x = Q of unknown liquid and capacitor assembly. The dielectric constant K of the liquid is:

$$K = \frac{C_1 - C_2}{C_0} \dots (2)$$

where C₀ = dry capacity of the test cell.

Due to the unavoidable series distributed inductance of the test capacitor, high frequency measurements are in error to a certain degree because of approach of series resonance. In order to correct for the inductance of the capacitor and leads, we make use of the equivalent circuit shown in Fig. 2.

The inductance of the capacitor is found by short circuiting the plates at the center and measuring the inductance in series with a larger standard coil. Then:

$$L_s = \frac{2.53 \times 10^{10} (C_1 - C_2)}{f^2 C_1 C_2} \dots (3)$$

where:

- L_s = series inductance microhenries
- C₁ = Q meter setting with L_s shorted out (μfd).
- C₂ = Q meter setting with L_s in series with larger coil (μfd).
- f = frequency (kc.).

Once the residual inductance L_s is known, the true capacity may be obtained from the apparent measured capacity by:

$$X_{c1} = X_{c2} + X_L \dots (4)$$

where:

- X_{c1} = true capacitive reactance
- X_{c2} = measured capacitive reactance
- X_L = inductive reactance of capacitor = L_s
- C₁ = 1/X_{c1} = true capacity

If it is desirable to arrive at the true Q of the liquid rather than the resultant of the liquid and container and capacitor, the following formula may be used:

$$Q_2 = \frac{Q_1 Q_3}{Q_1 - Q_3/K} \dots (5)$$

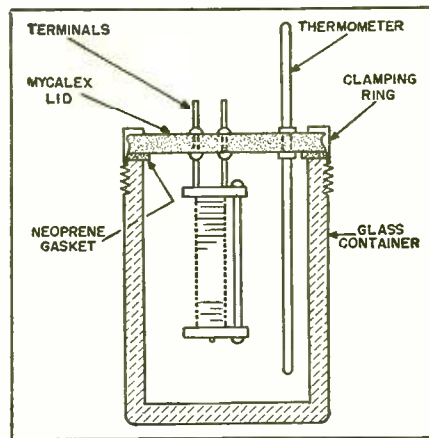

Fig. 3. Test Capacitor.

Q₁ = Q of empty test capacitor in container (corrected for inductance of leads)

Q₃ = Q of filled capacitor (corrected for inductance of leads)

K = true dielectric constant of liquid (checked at a frequency less than 1/10 of the resonant frequency of the filled unit)

Q₂ = true Q of liquid.

For a low loss test capacitor this correction will be small and is given here if extreme accuracy in the determination of Q is required.

The apparent high frequency Q of the filled capacitor is in error (too low) because of the effect of the inductance of the leads. This is an appreciable error and must be corrected to obtain the true value.

The true high frequency Q of the capacitor is:

$$Q_{hf} = \frac{Q_m}{1 - \omega^2 LC} \dots (6)$$

where:

Q_{hf} = true Q of capacitor at a frequency approaching natural resonance

(Continued on page 25)

Table III. Tabulated results of tests at 9 mc. except for 4 columns at right, which are at 2 mc. Q values given are for the complete assembly.

Liquid	Measured Dielectric Constant at 25°C.	Change of K from -55°C. to +85°C. Percent Based on 25°C.	Measured Q at				Q at 2 mc. (Measured)			Minimum Q (2 mc.) at Temp. Stated. °C.
			-55°C	+25°C	+85°C	Minimum Q at Temp. Stated. °C.	-55°C	+25°C	+85°C	
Atlantic Special.....	2.10	-11	660	650	720	620 at -40				
Heavy Spirits										
Sun Min. Ins.										
Oil Light.....	2.30	-6	230	450	670	150 at -10	230	1400	1800	100 at -25
GE 10-C										
Transil Oil...	2.26	-7	200	470	560	130 at -15				
Esso Univolt										
No. 35 Oil....	2.26	-7	300	450	580	120 at -25				
Gulf Instrument Oil "A".	2.25	-6.5	280	550	610	190 at -15	300	2600	4000	200 at -30
Dow-Corning Fluid No. 500										
5 cs. Viscosity.	2.77	-23	236	785	900	236 at -55	650	3500	6000	650 at -55

Fig. 1. Over-all view of complete unit. High-voltage supply is in the foreground.

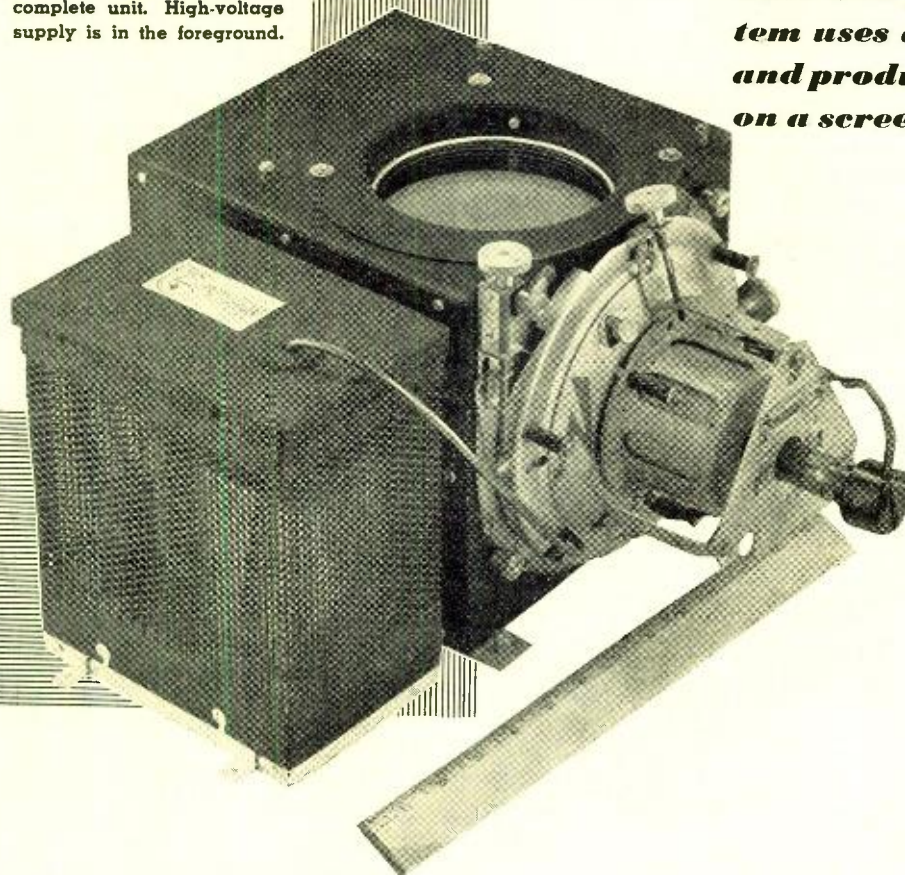

This new projection television system uses a 3 inch cathode-ray tube and produces a picture 12x16 inches on a screen 31 inches from the lens.

10BP4-type, 10 inch, direct-viewing, cathode-ray tube at 9 kilovolt second-anode potential, provided that an input power of 50 milliamperes at 350 volts d.c. and 1.2 amperes at 6.3 volts a.c. (which may usually be obtained from a 10BP4-type chassis) is available for the high-voltage unit.

The following components usually required for a 10BP4-type, 10 inch, direct-viewing set are not needed or already contained in the *Protelgram* system:

- Focus coil
- Deflection coil
- Ion trap circuit and its d.c. supply
- 10BP4 tube socket and wires
- 10BP4 high-voltage cable

9-kilovolt high-voltage supply with rectifier tube, filter capacitor and so-called "kick-back" winding, or such components as might be used for a separate r.f.—or pulse-type high voltage supply

Miscellaneous mounting provisions for 10 inch tube

Tube-mask and safety glass.

Depending upon specific circuit properties, other simplifications or economies can be obtained. *Protelgram* is designed to comply, to the greatest extent, with standard circuit practice.

The application of the *Protelgram* system is considerably less complex than with other projection systems. This is reflected in appreciable cost reduction in complete projection-type receivers. The physical size, light weight and ease of mounting allow a reduction in cabinet size and permit great flexibility of cabinet design.

Description

The "projection box" (Fig. 5) serves to enlarge the 1.4 x 1.86 inch picture, available on the face of the projection tube, to a size of 12 x 16 inches on the viewing screen. Means are provided for alignment of the projection tube with respect to the optical elements within the projection box. Dimensions are 14 inches long, 9 inches wide and 9 inches high; the projection tube (including its socket) extends approximately 3 inches beyond the 14 inch dimension of the projection box. Simple mounting brackets are provided. Special provisions for adjustment of the projection box with respect to the cabinet, which might be required in some special cases, are not supplied. A throw distance of 31 inches

PROTELGRAM-

A New Projection Television System

A COMPACT, light weight, efficient projection television system producing a clear 12 x 16 inch image from a 1.4 x 1.86 inch picture on the face of a new magnetic 2.5 inch cathode-ray tube was shown for the first time in this country at the New York Radio Engineering Show. Designated by the trademark *Protelgram*, the system consists of three small units: a short cathode-ray tube 3NP4, a metal optical box with focusing and deflection coils, and a high-voltage power supply. The system originated in the *Philips Research Laboratories* in Holland, and was further developed in the *Engineering Laboratories of North American Philips* in this country.

By using a high-perfection 2.5 inch cathode-ray tube with very small spot size and an efficient fine grain phosphor screen, *Protelgram* makes it possible to manufacture projection-type television

sets which are considerably less complex than other projection systems used so far and to incorporate a 12 x 16 inch television picture in relatively small cabinets. A resolution of 450 lines on the 12 x 16 inch viewing screen with a contrast ratio of 30:1 and a highlight brightness of 45 foot-lamberts produce an image of extremely pleasing quality. The color of the picture is an agreeable white which stands up very well under average ambient lighting conditions.

One of its major features is that the system can be driven by a normal 10BP4-type 10 inch direct-viewing chassis, with little or no alterations, but with considerable economy.

This development will make large size television pictures an actuality for the average manufacturer in the near future.

In general, *Protelgram* can be driven from a chassis designed to operate a

from the corrector lens, which is part of the projection box, to the viewing screen is required. This light throw forms an elongated projected beam with a circular base of 4.5 inch diameter at the corrector lens and a rectangular base of 12 x 16 inches at the viewing screen, for which unobstructed clearance is needed. The projected beam may be folded by the use of one or more auxiliary plane cabinet mirrors. The optical elements consist of a circular concave mirror of 6 inch diameter with a radius of curvature of 200 mm., a corrector plate with an effective aperture of 4.5 inches and a plane mirror.

Focusing and deflection coils are an integral part of the *Protelgram* projection box and are supplied with it. A nominal value of 1000 ampere-turns is required for the focusing coil. Two types of coils are available, the series and the shunt. For the series, $r = 300$ ohms and $i = 120$ ma, $\pm 10\%$; for the shunt type, $r = 11,200$ ohms and $i = 20$ ma, $\pm 10\%$. Focusing coil leads of standard length are 36 inches long.

Approximate deflection yoke specifications are, for horizontal deflection, $L = 8.5$ millihenry and $r = 15$ ohms; for vertical deflection, $L = 50$ millihenry and $r = 65$ ohms. The deflection angle is 40 degrees.

Description of the 3NP4

Sealed to the 2.5 inch face of the 3NP4 (Fig. 4) is a plate of optically correct special glass which is not discolored by the low intensity, soft x-radiation caused by the 25 kv. electron bombardment. The tube, a triode of five-prong base, requires a special socket. Tube length is 10.5 inches, diameter of the neck is 0.875 inches. The neck withstands 25 kv. strain and does not accumulate disturbing static charges. Near the face of tube is a glass cup, which surrounds the second-anode contact, and into which fits a molded

Fig. 4. The new 2½ inch magnetic cathode-ray tube, type 3NP4. Picture size is 1.4 inches by 1.86 inches.



thermo-plastic cable terminal carrying the 25 kv. potential.

An aluminum coating on the phosphor screen increases light output and prevents ion spots, eliminating the need for an ion trap. This fine grain screen gives off a pleasant white light with a color temperature of approximately 6200 degrees Kelvin, which is highly satisfactory under average ambient lighting conditions. The second-anode inside coating covers most of the cone. The outside Aquadag coating is grounded and serves as a static shield. Capacitance between the two coatings serves as the final filter capacitor for the 25 kv. unit.

The average beam current is approximately 90 microamperes. Highlight peaks reach 500 microamperes and higher. Spot size remains substantially constant at approximately 0.003 inch, even with a peak brightness on the tube face of 3000 foot-lamberts.

For focusing, a 1000 ampere-turn coil is used; deflection coils are of standard electrical specifications. Total deflection angle is 40 degrees and full deflection can be obtained with the excitation required to deflect a 10BP4-type, 10 inch, direct-viewing cathode-ray tube operated at 9 kv. Approximately 50 volts peak to peak is required to drive the picture grid. The filament operates at 6.3 volts, 0.75 ampere.

The 25 kv. High-Voltage Unit

The compact high-voltage power supply (Fig. 2) has great stability and no r.f. radiation. It occupies a space 8½ x 4½ x 7 inches.

Mounted on the 7 x 4.5 inch chassis of the unit are a 6SR7 (duplex-diode triode), a 6BG6G (beam power amplifier), circuit components and a sealed transformer assembly. The sealed transformer assembly contains the following components, which are impregnated and

(Continued on page 27)

Fig. 5. Inside view of the optical unit with alignment assembly inserted. Note optical triangle formed by the spherical mirror, the plane mirror with an elliptical hole providing clearance for the tube face, and the corrector lens.

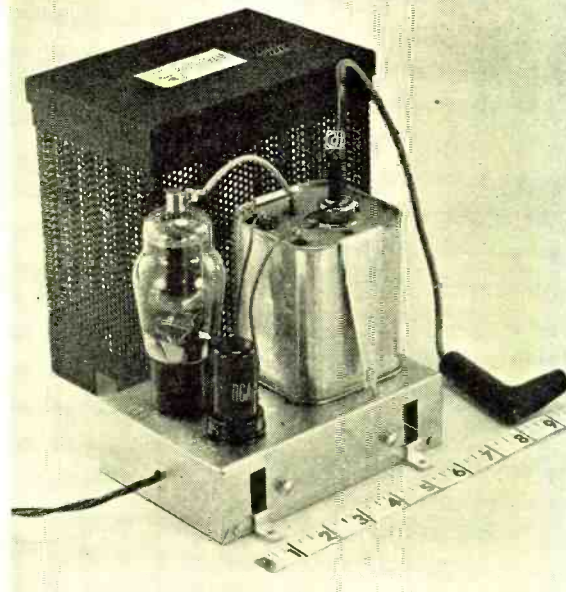
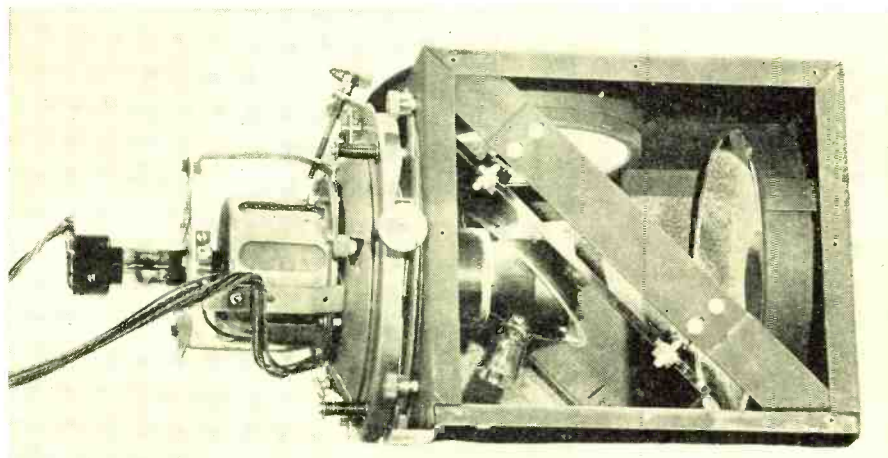
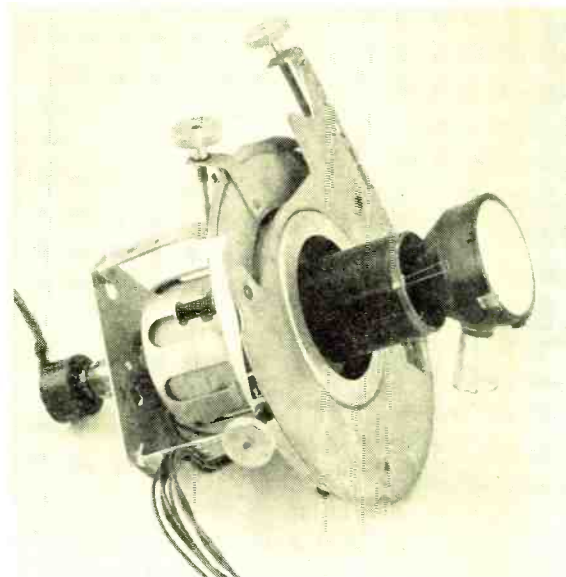

Fig. 2. Cover has been removed to give closer view of the new stable 25 kv. high-voltage second anode supply.

Fig. 3. Alignment assembly of the new Norelco Protelgram television system has adjustments which align tube in the optical system. A 3NP4 tube is used.



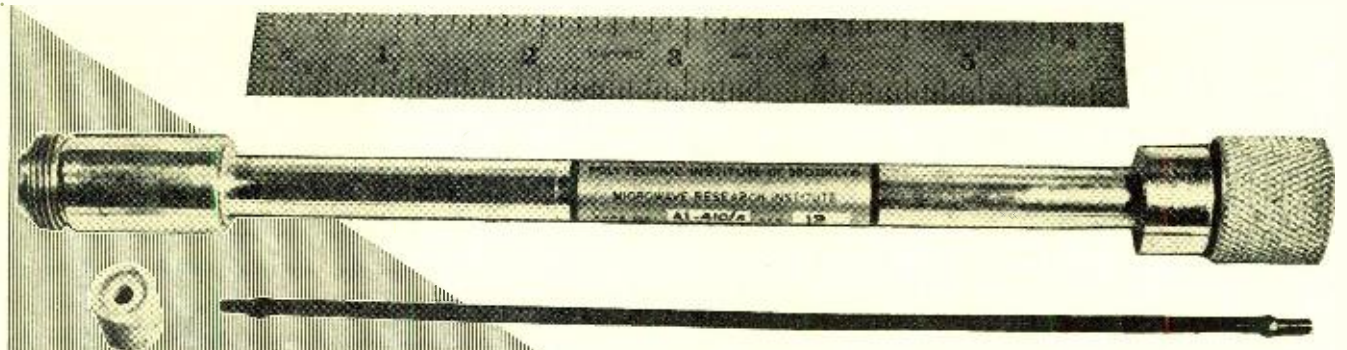

Fig. 1. Over-all view of a bead-supported coaxial attenuator for use in the 4000-10,000 mc. range of frequencies.

Bead-Supported Coaxial Attenuators

By
**HERBERT J. CARLIN and
 JOHN W. E. GRIEMSMANN**

Microwave Research Institute of the
 Polytechnic Institute of Brooklyn.

Theory, design, and construction of coaxial attenuators for the 4000 to 10,000 mc. band. VSWR is held to a very low value.*

ENERGY dissipating broad band coaxial attenuators may be made at microwave frequencies by utilizing a metallized resistance film for the inner conductor. The metallized films used are thin compared with the depth of penetration insuring essentially uniform current distribution through the thickness of the film at microwave frequencies, and permitting application of the distributed parameter solution for transmission lines in the design of the attenuator units¹. The metallic film is shown formed on a glass tube in Fig. 3.

As will be evident later, the section of coaxial line having the resistive metallic film is characterized by a complex characteristic impedance and propagation constant which are functions of the resistance per unit length of the metallic film. This resistance per unit length, however, is independent of frequency, thus permitting prediction of performance from calculations based on audio frequency resistance measurements. Special techniques have been developed for calculation of the microwave performance using approximate expressions for the complex propagation constant and characteristic impedance.

In order to insure broad band operation of the complete attenuator up

to frequencies of 10,000 mc., where even short lengths of line are an appreciable fraction of a wavelength, special couplings and bead supports were devised which allow the unit to terminate in type *N* jack pins and plugs, without the introduction of large components of reflection.

The continuous film attenuator consists of a single section of metallized glass. The ends of the film are connected to high conductivity platinized collars to which bullets are soldered so that the unit may be inserted as the center conductor of a coaxial casing. Fig. 3A illustrates the construction of the attenuator insert.

The constants which characterize such a lossy transmission line are:

- R* = total resistance of the lossy film
- r* = resistance per unit length = *R*/*l*
- L* = inductance per unit length
- C* = capacitance per unit length
- g* = leakage per unit length, assumed zero
- l* = total length of lossy film

The characteristic impedance of the continuous film section is given by:

$$Z_c = \sqrt{\frac{r + j\omega L}{g + j\omega C}} = \sqrt{\frac{L}{C}} \sqrt{1 - jX} = Z_0 \sqrt{1 - jX} \dots (1)$$

- where:
- Z_c* = lossless characteristic impedance of the section
- X* = a wavelength variable = $r\lambda / 2\pi Z_0 = R\lambda / 2\pi Z_0 l$

- ω = radian frequency = $2\pi v / \lambda$
- v* = velocity of propagation

The propagation constant is:

$$\gamma = \sqrt{(\tau + j\omega L)(g + j\omega C)} = j \frac{2\pi}{\lambda} \sqrt{1 - jX} = \alpha + j\beta \dots (2)$$

- where:
- α = attenuation constant in nepers per unit length
- β = phase constant in radians per unit length

If $\delta = Re \sqrt{1 - jX}$ (*Re* = real part)
 $\sigma = -Im \sqrt{1 - jX}$ (*Im* = imaginary)
 then:

$$\frac{Z_c}{Z_0} = \sqrt{1 - jX} = \delta - j\sigma \dots (3)$$

$$\gamma = \frac{2\pi}{\lambda} (\sigma + j\delta) \dots (4)$$

The total attenuation of the continuous film attenuator neglecting mismatch losses is therefore given by:

$$a_T = \alpha l = \frac{2\pi \sigma l}{\lambda} \dots (5)$$

For the ideal attenuator, a_T should be independent of frequency, or the ratio σ/λ is required to remain constant. This condition cannot be completely realized over very broad frequency bands but may be closely approached under proper design conditions. To indicate these, a useful approximation may be employed for $\sigma = -Im \sqrt{1 - jX}$.

$$\sigma \doteq aX(1 - bX^2) \dots (6)$$

*This work was done under contract NObS-28376 between the Microwave Research Institute of the Polytechnic Institute of Brooklyn and the U.S. Navy Bureau of Ships. This paper was presented at the 1947 National Electronics Conference in Chicago.

where, for $0 < X < 2$, $a = 0.452$, $b = 0.0362$.

Using the approximation of Eq. (6) in Eq. (5), the total attenuation is given by:

$$a_T = \frac{aR}{Z_0} (1 - bX^2) \quad (7)$$

If the parameters of design and frequency limits of operation are chosen so that X is small, Eq. (7) indicates that the attenuation will be nearly constant over the frequency band and equal to a nominal value:

$$a'_T = \frac{aR}{Z_0} \quad (8)$$

The second term of Eq. (7) is responsible for the variation in attenuation. Using Eq. (8), this may be written:

$$bX^2 = b \left(\frac{R\lambda}{2\pi Z_0 l} \right)^2 = b \left[\frac{a'_T}{2\pi a(l/\lambda)} \right]^2 = \text{constant} \times A_\lambda^2 \quad (9)$$

where A_λ is the nominal attenuation per unit length, the latter measured in wavelengths:

$$A_\lambda = a'_T / (l/\lambda) \quad (9a)$$

Therefore, to realize a small attenuation spread over the frequency limits of operation, the design parameter, A_λ , must be small, and hence the longer the maximum wavelength and the higher the nominal attenuation, the greater must be the length of the unit. Essentially, this sets an upper limit of attenuation, and a lower limit of frequency for this type of attenuator since it is mechanically undesirable to increase the length of the metallized-glass insert beyond a value of 6" to 8".

It is important that the reflections introduced by the junction of the lossy film section and the main transmission line be small, so that matched conditions be maintained as closely as possible. The reflection at the junction of two transmission lines is given by:

$$K_T = \frac{Z_0 - Z_{load}}{Z_0 + Z_{load}} \quad (10)$$

The assumption is now made that the attenuation of the length of lossy film is great enough so that the input impedance is the same as that of an infinite length of lossy line, or identical with the characteristic impedance Z_0 . Utilizing this in conjunction with Eq. (10) and the usual transmission line impedance relationships, the expression for the total reflection at the input terminals of a continuous film attenuator becomes:

$$K_T = \frac{a_T \lambda}{4\pi l} \left[\epsilon^j \left(\frac{a_T}{2\pi l} + \frac{\pi}{2} \right) - \epsilon^{-2a_T} \epsilon^{-j \frac{2\pi l}{\lambda}} \right] \quad (11)$$

The second term within the bracket of Eq. (11) represents the contribu-

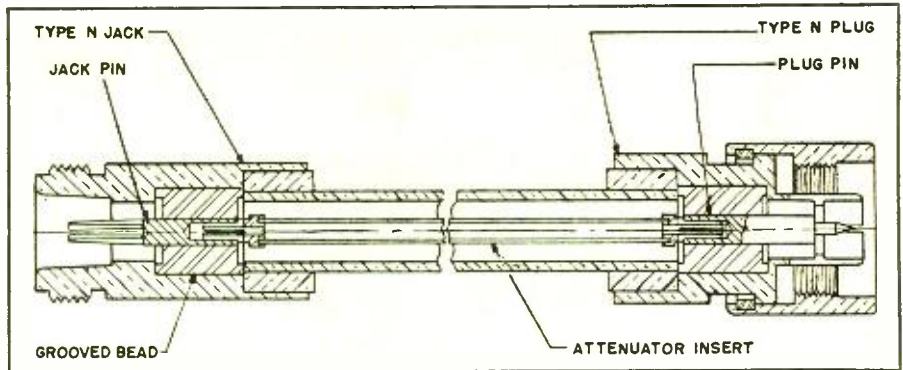

Fig. 2. Cross-section of coaxial attenuator for the frequency band at 4000-10,000 mc.

tion to the total reflection by the back end of the attenuator. The effect of this component is usually small, since its magnitude is reduced by an exponential factor of twice the total attenuation of the insert. If then this second term is neglected, the reflection may be simplified to:

$$|K_T| = \frac{a_T \lambda}{4\pi l} = \frac{1}{4\pi} \frac{a_T}{(l/\lambda)} = \frac{1}{4\pi} A_\lambda \quad (12)$$

Eq. (12) indicates that for the reflection factor to be small, the wavelength variable A_λ must be small. This is the same conclusion arrived at from the previous study of attenuation spread with frequency. Therefore, both from the standpoint of low attenuation variation with respect to frequency, and low reflection factor, with frequency band and maximum mechanical length specified, an upper limit is placed on maximum allowable total attenuation.

Reference to Eq. (12) indicates that the mismatch of a single film attenuator increases with A_λ . The latter is inversely proportional to frequency, so that maximum reflection for a given unit occurs at the low frequency end of the band. Therefore, in order to improve over-all broad band performance, it becomes desirable to apply some method of compensation

which will correct for the high standing wave ratio which occurs at the longer wavelengths. This compensation was introduced by adding, as a portion of the pad, lengths of low attenuation resistive sections. These were arranged symmetrically at either end of the main section of attenuating film as shown in Fig. 3C.

The short length of matching section causes an additional component of reflection, which arises at the junction of the matching and main films. This is adjusted to combine with the other components of reflection present so that minimum standing wave ratio occurs near the low frequency end of the band. The resultant VSWR spectrum curve is of the type shown in Fig. 3D.

This method of compensation can be analyzed quantitatively by considering the total reflection at the input end of the attenuator. If relatively high loss is assumed in the main attenuating film, that is between the points x_2 and x_3 of Fig. 3C, the total reflection factor at the input end may be written as:

$$K_T = \left[\frac{a_{T1} \lambda}{4\pi l_1} \epsilon^j \left(\frac{a_{T1}}{2\pi l_1} + \frac{\pi}{2} \right) + \left(\frac{a_{T2}}{l_2} - \frac{a_{T1}}{l_1} \right) x \frac{\lambda}{4\pi} \epsilon^{-a_{T1}} \epsilon^j \left(\frac{a_{T1} + a_{T2}}{2\pi(l_1 + l_2)} \lambda - \frac{4\pi l_1}{\lambda} + \frac{\pi}{2} \right) \right] \quad (13)$$

Fig. 3. (A) Continuous section metallized glass attenuator with (B) standing wave ratio. (C) Compensated section metallized glass attenuator with (D) standing wave ratio.

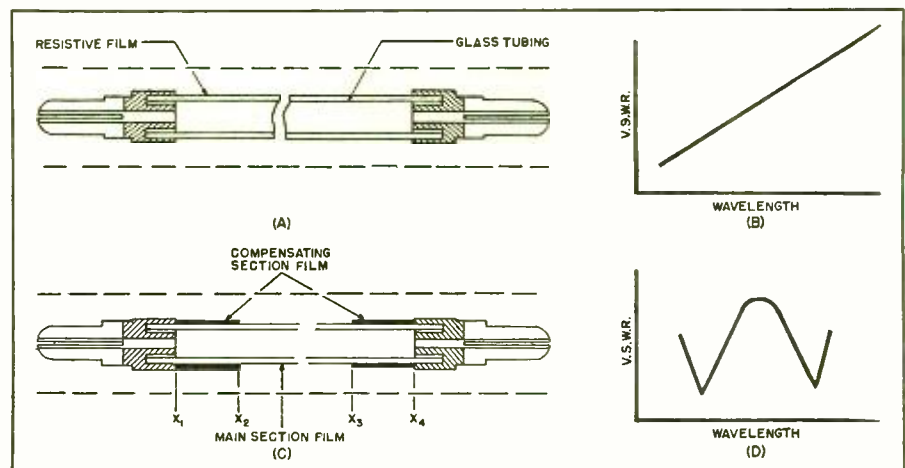

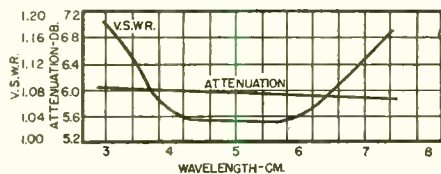

Fig. 4. Attenuation and voltage standing wave ratio for a 6 db. metallized glass attenuator plotted against wavelength.

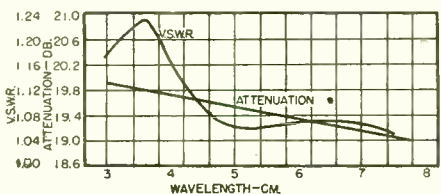

Fig. 5. Attenuation and VSWR of a 20 db. metallized glass attenuator.

l_1 = length of compensating film
 l_2 = length of main attenuating film
 α_{T1} = total attenuation introduced by a compensating section
 α_{T2} = total attenuation introduced by main section.

The second term of Eq. (13) is the reflection introduced by the junction of main and compensating sections of film at the point x_2 of Fig. 3C. Since the attenuation of the compensator, α_{T1} , is small, this second term is comparable in magnitude to the first and may be adjusted to cancel the initial term. The condition for such a zero in total reflection is that the two terms be equal in magnitude and 180° out of phase. That is:

$$\frac{\alpha_{T1}}{l_1} = \epsilon^{-\alpha_{T1}} \left[\frac{\alpha_{T2}}{l_2} - \frac{\alpha_{T1}}{l_1} \right] \dots \dots (14)$$

and

$$\frac{4\pi l_1}{\lambda_n} = \left[\frac{\alpha_{T1} + \alpha_{T2}}{l_2} - \frac{\alpha_{T1}}{l_1} \right] \frac{\lambda_n}{l_1} + (2n + 1)\pi \dots \dots (15)$$

$n = 0, 1, 2, \dots$

From Eq. (15) it is seen that when $K_T = 0$, l_1 is somewhat greater than an odd multiple of a quarter wavelength. For small values of attenuation, l_1 approaches this value closely, or:

$$l_1 = \frac{2n + 1}{4} \lambda_n \dots \dots (16)$$

Eq. (16) may be considered only a rough estimate at the higher values of attenuation, but a useful one for qualitative analysis.

From the above discussion it is clear that the advantage of matching sections for broad band operation is that instead of monotonically increasing the reflection versus frequency function of the single section attenuator shown in Fig. 3A, a characteristic may be obtained which has one or more minima, as shown in Fig. 3D. Since the continuous film attenuator has a maximum reflection at the low frequency end of the band, a minimum is introduced near this frequency and the length of compensating section designed accordingly, using Eq. (16) as a rough guide.

Fig. 3D shows a maximum in the VSWR characteristic near midband. It is important to determine the approximate frequency and magnitude of this point. Such a maximum will result when the two terms of Eq. (13) are in phase. This occurs at an approximate wavelength:

$$\lambda_m = 2ml_1, m = 0, 1, 2 \dots \dots (17)$$

Substituting this in Eq. (13) for $m = 1$, a simple expression for maximum reflection is obtained:

$$|K_m| = \frac{\alpha_{T1}}{\pi} \dots \dots (18)$$

Thus the attenuation of the compensator should be small for low values of $|K_m|$. To determine the length of the main section, Eq. (14) may be rewritten as:

$$l_2 = \frac{\alpha_{T2}}{\frac{\alpha_{T1}}{l_1} (1 + \epsilon^{-\alpha_{T1}})} \dots \dots (19)$$

l_1 is determined by the required zero in reflection, and since α_{T1} must be small for low maximum reflection factor, $|K_m|$, the denominator of Eq. (19) is small, or other things being equal a low maximum reflection demands a long length of main section, l_2 .

An approximate design procedure may be summarized as follows:

1. With the band limits specified, determine the length of compensating film, l_1 , by Eq. (16) with $n = 0$, and λ_n chosen near the low frequency end of the band. For frequencies of 4000-10,000 mc. $\lambda_n = 7.0$ cm. The exact determination of this design point is somewhat more involved than given here. Further details are given in a companion paper.¹
2. Determine the attenuation of the compensating section by inserting the maximum permissible value of reflection in Eq. (18).
3. The attenuation of the main section is found by subtracting the total compensator attenuation from the required total attenuation. Thus $\alpha_{T2} = \alpha_T - 2\alpha_{T1}$.
4. The length of main section l_2 is now given by Eq. (19).
5. The resistance of the main and compensating sections can be ascertained from the values of α_1 and α_2 by using Eq. (7).

Although both the continuous film attenuator and the compensating attenuator have similar attenuation-frequency curves, and a similar design criterion in that long length makes for improved performance, for a given mechanical length and frequency band the compensating section attenuator will be superior in operation, with respect to mismatch. Thus the metallized-glass insert of a 20 db. attenuator designed as a 6" continuous film gave a theoretical maximum VSWR of 1.20. This was not considered sufficiently low, since with the addition of couplings the mismatch would be too great. The same total length of insert designed as a compensated section unit had a maximum VSWR of only 1.10. However, since the continuous film inserts are easier to build, they are preferred where

(Continued on page 29)

Fig. 6. (A) Grooved bead with (B) reactive cancellation. (C) Bullet for attenuator insert and (D) bullet shoulder cancellation. (C) and (D) are admittance diagrams.

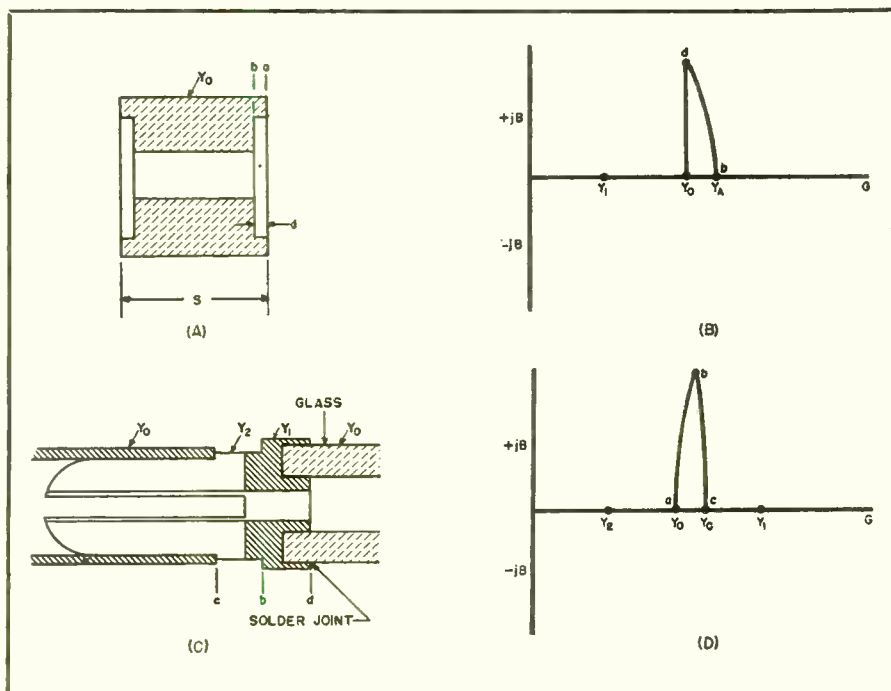

Delay Lines for Pulse Applications

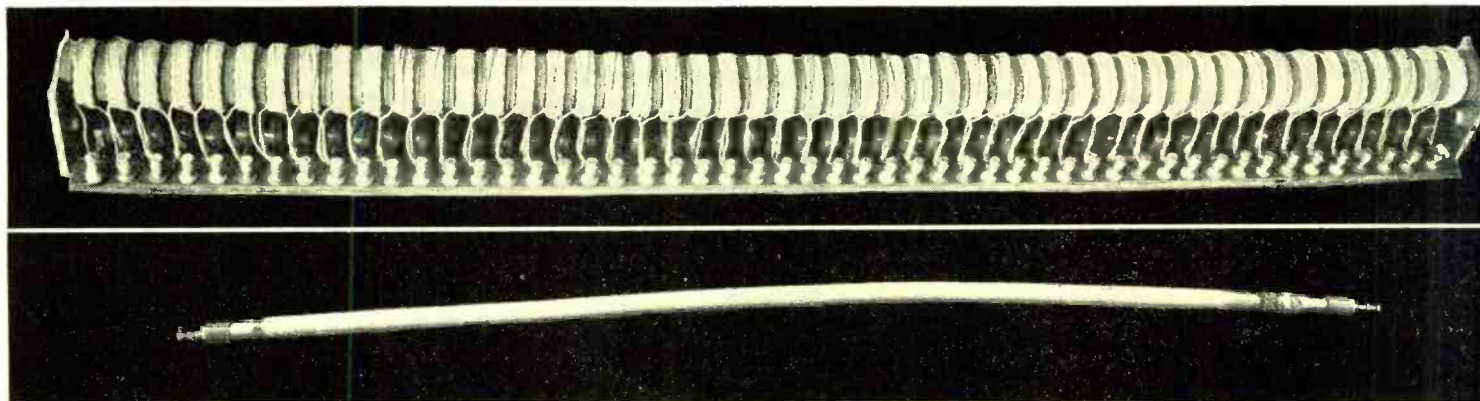

By **SIDNEY MOSKOWITZ** and **JOSEPH RACKER**

Federal Telecommunication Laboratories

Part IV of this series covers the design and construction of delay networks in common use.

Fig. 1. (Top) Typical artificial line using multilayer "universally" wound coils to achieve a higher delay per unit length than the single layer type. Fig. 2. (Bottom) Typical video delay cable.

THE articles presented heretofore in this series covering the design of amplifiers¹ and shapers² were, in general, characterized by the fact that basically familiar circuits were used, modified to permit pulse transmission. These circuits, on the whole, employ standard, commercially available components. This will not be true of the subject matter to be covered in this article. Delay lines are not standard items and must usually be designed to meet a specific requirement by the engineer. Hence the importance of this article.

Delay lines are used to perform many special operations on pulse voltages. In some applications, such as electronic computers, pulses must be stored for a given period of time in order to permit the operation of circuits which require a finite time for their actuation. This is done by utilizing a circuit which has a definite period of transmission between its input and output. The pulse is then said to be delayed and the circuit is called a delay or storage network.

Delay circuits are also employed to measure time intervals and form pulses in radar applications; provide channel separation in time sequence in multiplex communication systems; and for synchronization of sweep circuits in oscilloscopes.

Several types of delay lines have been evolved. Pulse delays of the order of a thousandth of a microsecond may be accomplished through the use of conventional transmission lines, usually coaxial cable. In the range of

0.01 to 100 microseconds, either a variation of the coaxial cable or an artificial line consisting of m -derived filter sections may be used. Above this range up to several thousand microseconds, the pulse may be delayed by transmitting it via supersonic waves through a liquid or solid medium.

From the above, it is obvious that a review of transmission line theory would be helpful in understanding pulse delaying storage circuits. The characteristics of a transmission line that are of interest are the characteristic impedance, cut-off frequency, attenuation and time delay.

The characteristic impedance of the

line, sometimes referred to as the natural, iterative, or surge impedance, is usually denoted by Z_0 and expressed in ohms. If a line is infinitely long, its input impedance will be equal to Z_0 . The input impedance will also be equal to the characteristic impedance for a finite line terminated in an impedance equal to Z_0 .

In terms of the electrical constants of the line, the characteristic impedance is equal to:

$$Z_0 = \sqrt{\frac{R + j\omega L}{G + j\omega C}} \text{ ohms} \dots \dots \dots (1)$$

where:

R is resistance in ohms per unit length

L is inductance in henrys per unit length

Close-up of a lumped line using the single-layer, continuously wound coil.

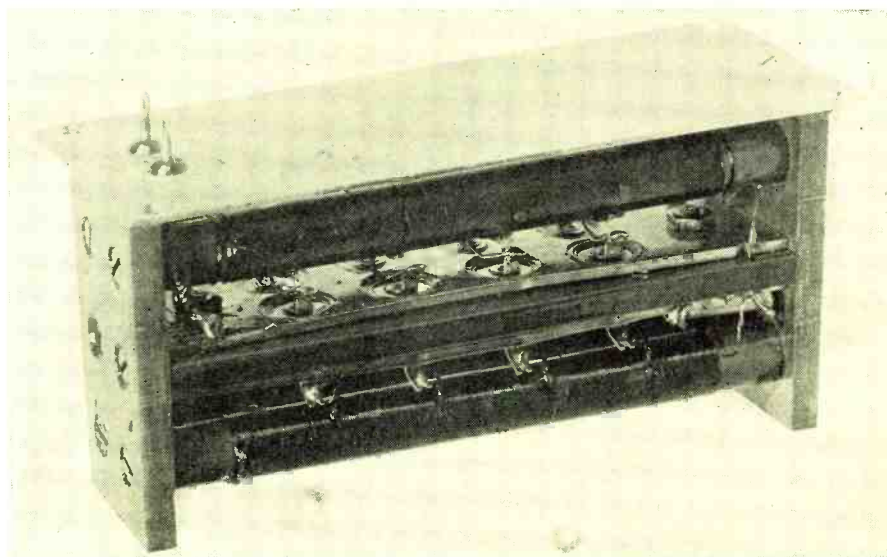

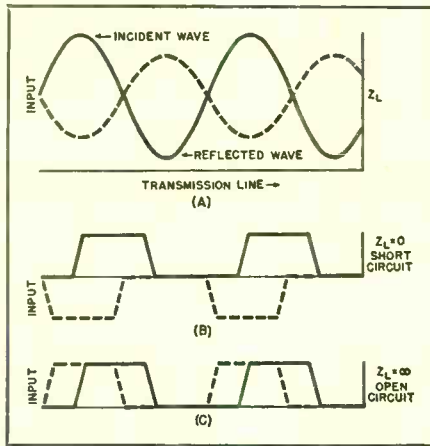

Fig. 3. Types of voltage distributions produced on a transmission line due to different load impedances.

C is capacitance in farads per unit length

G is conductance in ohms per unit length

From this relationship it can be seen that the characteristic impedance is essentially equal to $\sqrt{L/C}$ and is independent of frequency if $\omega L \gg R$ and $\omega C \gg G$. This will generally be the case for all radio frequencies and for all but the lowest audio frequencies. At the frequencies where R is comparable to ωL and G is comparable to ωC , the characteristic impedance varies with frequency and approaches $\sqrt{R/G}$ as the frequency approaches zero. It should be noted that if R/L is equal to G/C , the characteristic impedance is a pure resistance, equal to $\sqrt{L/C}$, at all frequencies and the line is said to be distortionless.

Knowledge of the characteristic im-

pedance is necessary for determining the magnitude and phase of volages reflected from the termination of the line. The vector ratio of the incident wave voltage to that of the reflected wave (see Fig. 3A), known as the coefficient of reflection, is given by:

$$K = \frac{Z_0/Z_L - 1}{Z_0/Z_L + 1} \dots \dots \dots (2)$$

where K is the coefficient of reflection.

Thus if a line is shortcircuited at the output, $Z_L = 0$, K is then equal to -1 . This means that the voltage is completely reflected but in negative polarity as shown in Fig. 3B. If the line is open, $Z_L = \infty$ (infinity), and $K = 1$ so that the voltage is completely reflected in the same polarity (Fig. 3C). For the case $Z_L = Z_0$, $K = 0$ which indicates that no reflection occurs.

The second important parameter of a transmission line is its attenuation. The attenuation has been determined to be the real part of the following expression:

$$\alpha = \text{Real part of } \gamma = \text{Real part of } \sqrt{(R+j\omega L)(G+j\omega C)} \dots (3)$$

where α is the attenuation in nepers per unit length and γ is the propagation constant.

At very low frequencies the attenuation is minimum and equal to $\sqrt{R/G}$. This attenuation increases with frequency for $\omega L \gg R$ and $\omega C \gg G$, it becomes:

$$\alpha = \frac{R}{2Z_0} + \frac{GZ_0}{2} \text{ nepers per unit length. } (4)$$

where Z_0 is equal to $\sqrt{L/C}$.

The first term in this expression represents the attenuation due to

losses in the conductors. The resistance, R , increases with frequency due to the skin effect in accordance with the following expression:

$$R_{ac} = \frac{83.2 \sqrt{f} 10^{-9} R'}{d} \text{ ohms per cm. } (5)$$

where:

f = the frequency in cycles per second

R' = $\frac{\text{resistivity of conductor}}{\text{resistivity of copper}}$

d = the diameter of conductor in cm.

The second part of Eq. (4) is the loss due to the dielectric. Here again the loss increases with frequency since G is equal to:

$$G = \omega CP \text{ mhos per cm. } \dots \dots \dots (6)$$

where P is the power factor of the dielectric.

Of course L and C may also vary with frequency. However these effects are usually small compared to the variation in R and G and can be neglected in the calculation of the attenuation. It should be noted that for the special case where R/L is equal to G/C , the attenuation is independent of frequency and is equal to $\sqrt{R/G}$.

The imaginary part of Eq. (3) represents the phase constant of the line. For $\omega L \gg R$ and $\omega C \gg G$, the phase constant becomes:

$$\theta = \omega \sqrt{LC} \dots \dots \dots (7)$$

where θ is the phase constant.

Thus for such a transmission line, the angle of transmission delay is proportional to frequency. The time delay, T , is related to the angle, θ , by:

$$T = \theta/\omega \text{ seconds per foot } \dots \dots \dots (8)$$

so that $T = \sqrt{LC}$.

This means that for lines in which $\omega L \gg R$ and $\omega C \gg G$, the time delay is independent of frequency and therefore no pulse distortion, due to non-uniform phase response, will occur.

It is known that the phase velocity, v , of the wave traveling through a uniform line must be:

$$v = \frac{1}{T} = \frac{1}{\sqrt{LC}} = \frac{c}{\sqrt{\mu\epsilon}} \text{ ft. per sec. } \dots (9)$$

where:

μ is the permeability of the material

ϵ is the dielectric constant

c is the velocity of light.

It is the property of the electromagnetic field that, for a dissipationless, uniform line in free space, L and C are so related that their product is constant and the phase velocity is equal to the velocity of light (or μ, ϵ are equal to 1). The time delay of these lines would therefore be equal to:

$$T = \frac{1}{c} = .0011 \text{ microsecond per ft. } \dots (10)$$

Typical artificial delay line using a continuously wound coil.

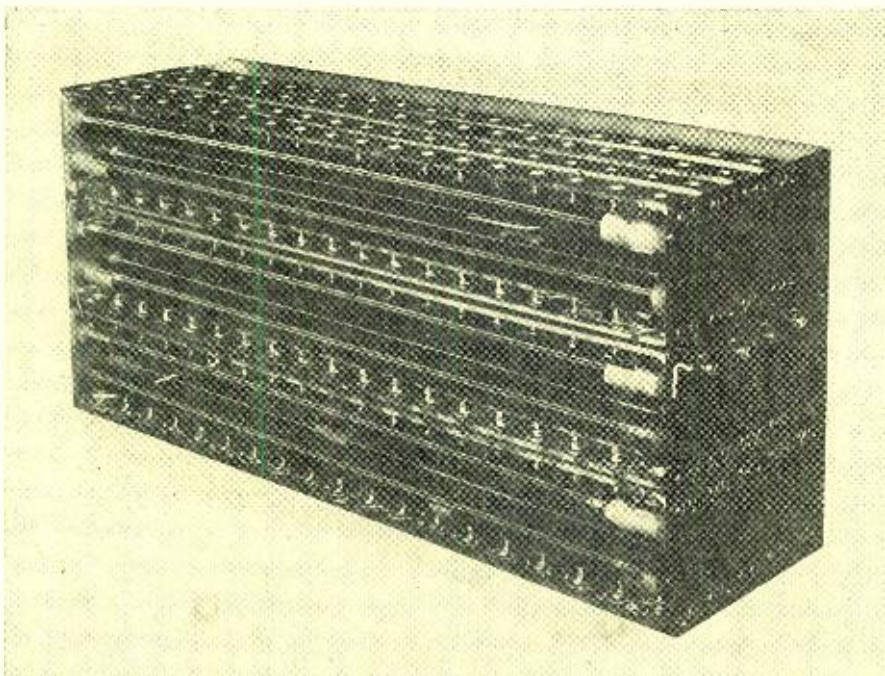

The use of a dielectric other than air to separate the conductors of the line decreases the velocity of propagation and therefore increases the time delay by a factor of $\sqrt{\epsilon}$. One of the most common insulators is polyethylene whose dielectric constant is approximately 2.25. The time delay of a polyethylene insulated line is therefore:

$$T = .0017 \text{ microseconds per ft.} \quad (11)$$

Special Delay Lines

It was noted above that a delay of only .0017 microseconds per foot is obtained with polyethylene lines. It would be impractical to use these lines for delays of the order of microseconds since prohibitively long lines would be necessary. Consequently lines with more delay per unit length are required. There are a number of ways in which this can be accomplished.

One method would be to increase the delay of a coaxial cable by winding the inner conductor around the core in a manner similar to a solenoid. There are two possible explanations for the increase in delay. The first is that the inductance per unit length has been increased and since delay is equal to \sqrt{LC} , the delay has been increased. LC in this case is not a constant since the line is no longer a uniform line.

Another approach is that the velocity of propagation remains the same; however, the wave now follows the inner conductor around the core rather than traveling in a straight line as before. Thus if there are n turns per foot and the diameter of the core is d , the distance the wave travels for each foot of cable is approximately (for $n \gg 1$):

$$l = n \pi d \text{ feet} \quad (12)$$

where l is the length of the inner conductor.

Thus the delay of the line is increased by $(n\pi d)$ or is equal to, for polyethylene coaxial cable:

$$T = .0017 n \pi d \text{ microsec. per ft.} \quad (13)$$

This latter "rule of thumb" formula provides a very good first approximation particularly when the spacing between the inner and outer conductor is not large. However, it should be noted that this delay is also proportional to $\sqrt{\mu\epsilon}$. In fact, insulators with higher dielectric constants (Saran) and cores with higher permeabilities (iron) are often employed to increase the delay.

There are two commercially available delay lines. One is the spiral delay line manufactured by *Federal Telephone and Radio Corporation*. The appearance and construction of

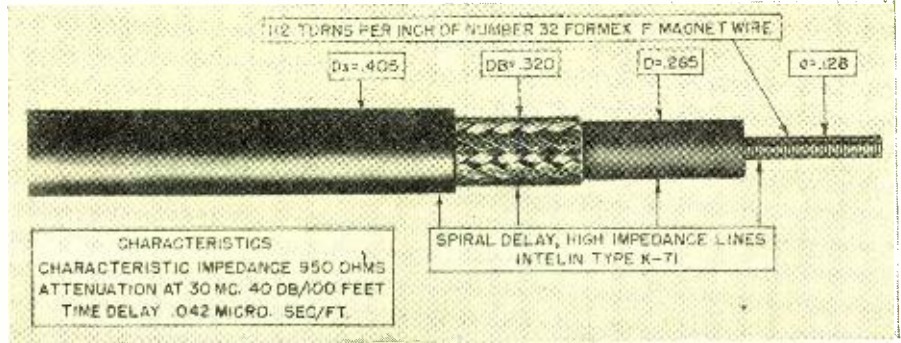

Fig. 4. Spiral delay cable.

this cable is exactly similar to that of a solid dielectric coaxial cable. The only difference is that the inner conductor is a helix of enameled wire closely wound over an insulating core as shown in Fig. 4. The time delay of this cable has been determined to be:

$$T = \frac{4.75 \times 10^{-4} \pi n a \sqrt{\epsilon}}{\sqrt{\log_{10} D/d}} \text{ } \mu\text{sec./ft.} \quad (14)$$

where:

- n = the turns per foot
- a = diameter of inner conductor from wire center to wire center in inches
- D = outer diameter over dielectric
- d = diameter over inner conductor.

The characteristics of *Federal's* K-71 spiral delay line are as follows:

- Turns per inch—112
- Overall diameter—.405 inch
- Characteristic impedance—950 ohms
- Capacitance—44 $\mu\text{fd./foot}$
- Time delay—.042 $\mu\text{sec./ft.}$

The other commercially available delay cable is the video delay line (shown in Fig. 2) developed by *General Electric*. This line consists of an inner conductor wound around a flexible insulating core of polyvinylidene chloride ("Saran") about 0.19" in diameter. A layer of insulating tape serves as a dielectric between the conductors of the line. The outer conductor is a braid of insulated wires connected together at one end of the line. A cotton covering and an outer

shell of polyvinyl tubing complete the line. The delay of this line has been determined to be:

$$T = 7 \times 10^{-5} n D \sqrt{D/s\epsilon} \text{ } \mu\text{sec./ft.} \quad (15)$$

where:

- n = the turns per foot
- D = the diameter of the line
- s = the separation between inner and outer conductor.

A typical video delay line has the following characteristics:

- Turns per inch—277
- Characteristic impedance—1100
- Capacitance—42 $\mu\text{fd./inch}$
- Time delay—.55 $\mu\text{sec./ft.}$

It should be noted that the inductance of these lines varies appreciably with frequency. A number of factors contribute to this variation among which is the fact that as the wavelength along the line becomes short, an out-of-phase coupling between successive turns exists which may result in a material decrease in effective inductance. This change in inductance, of course, causes the delay to become a function of frequency also. Fig. 6 shows the delay error vs. frequency of a cable with a solenoid type of inner conductor.

Lumped Lines

For delays of the order of 10 microseconds, or when low characteristic impedances are required (both the spiral and video delay lines have high

Fig. 5. Schematic and one cell "constant k" prototype of a lumped line.

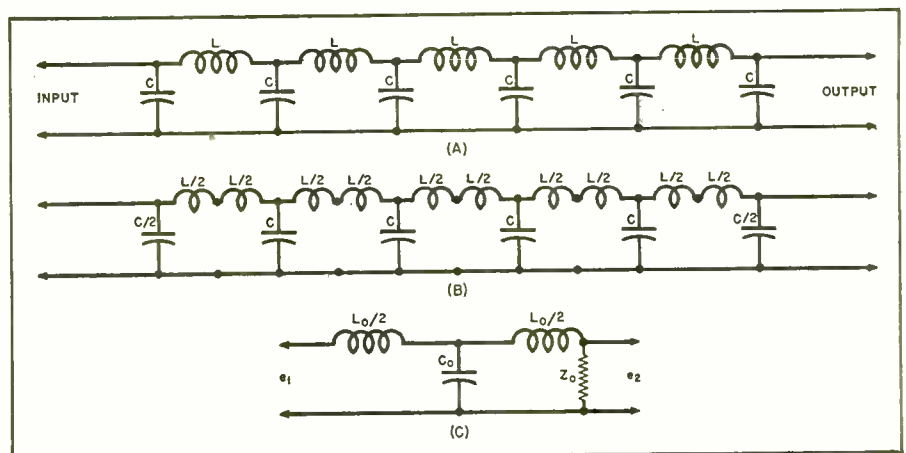

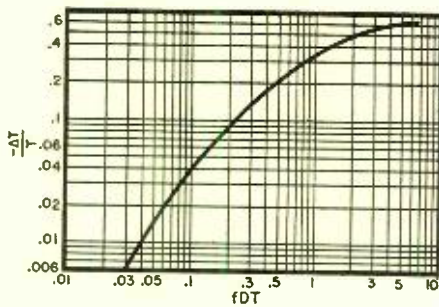

Fig. 6. Delay error as a function of frequency, low-frequency delay, and line diameter.

characteristic impedances), a lumped-constant, sometimes called artificial, line can be utilized. These lines employ coils and condensers in a manner which simulates a transmission line. Either a single section lumped line may be used or a large number of cascaded sections. In designing these lines we are interested in maintaining the phase delay proportional to frequency (time delay independent of frequency), develop a maximum delay per section (except for special cases), and keep the attenuation as low as possible. The characteristic impedance is also of prime importance but its optimum value varies for different applications.

Theory of Lumped Lines

The configuration of coils and condensers shown in Fig. 5A which make up an artificial line can be considered to be a ladder of four terminal networks (Fig. 5B), each four terminal network consisting of a "constant K " type, T network terminated in the characteristic impedance of the line as shown in Fig. 5C. If we place a voltage e_i across the input of this network, the output voltage, e_o , will be equal to:

$$e_o = e_i \left[1 - 2 \left(\frac{\omega}{\omega_0} \right)^2 + j 2 \left(\frac{\omega}{\omega_0} \right) \left(1 - \left(\frac{\omega}{\omega_0} \right)^2 \right) \right]^{-1} \dots \dots \dots (16)$$

where $\omega_0 = 2/\sqrt{L_0 C_0}$ is 2π times the cut-off frequency, f_0 , and ω is the angular frequency of e_i

When $\omega/\omega_0 \ll 1$, this equation reduces to:

$$e_o \approx \left(1 - j \frac{2\omega}{\omega_0} \right) e_i = e_i e^{-j2\omega/\omega_0} \dots (17)$$

This latter relationship between e_o and e_i indicates that the output voltage is the same as the input voltage except that it is delayed in phase by an angle equal to $2\omega/\omega_0$. The time delay of this network is, as previously indicated by Eq. (8), the phase delay divided by the angular frequency or:

$$T = \frac{2\omega}{\omega_0} \cdot \frac{1}{\omega} = \frac{2}{\omega_0} = \frac{2}{\sqrt{L_0 C_0}} \dots (18)$$

It is thus seen that if the network is designed to have a much higher cut-off frequency than the highest frequency applied to it, the input wave will be delayed by a period, equal to T , without any appreciable distortion.

This requirement of $\omega \ll \omega_0$, however, makes this circuit impractical since the delay of each four terminal network or cell is inversely proportional to the cut-off frequency and is therefore very low. Furthermore, the more cells that are used, the higher the cut-off frequency since any distortion that does occur within one cell, for a given f_0 , is multiplied with each additional section. In order to maintain the same over-all distortion, the cut-off frequency must consequently be increased by a factor approximately equal to $\sqrt[3]{n}$, where n is the number of sections used.

In designating the four terminal network shown in Fig. 5C as one cell

of the artificial line shown in Fig. 5A, it was assumed that there was no mutual coupling between successive coils. However, if these coils are mutually coupled, as shown in Fig. 8A, the resulting four terminal network takes the form of an m -derived filter as shown in Fig. 8B. With this type of a network, it is possible by proper selection of m , to pass without distortion frequencies that are a much higher percentage of the cut-off frequency than is possible with the use of the "constant K " type of network.

It can be shown that the ratio of output voltage to input voltage of an m -derived filter is approximately:

$$e_o/e_i = 1 - \epsilon^{j\theta} \dots \dots \dots (18a)$$

when θ , the phase constant is equal to:

$$\theta = 2 \arcsin \frac{m x}{\sqrt{1 + x^2 (m^2 - 1)}} \dots (19)$$

where x is equal to ω/ω_0 .

The time delay, T , can then easily be found by dividing θ by ω . Fig. 7 plots $T\omega_0$ versus $x = (\omega/\omega_0)$ for different values of m greater than one. From this figure it can be seen that when $m = 1.275$, the delay is most nearly constant over the longest per-cent of the cut-off frequency, i.e. about 75 per-cent. For this reason, $m = 1.275$ is the value chosen in the design of these lines. From this graph it can also be seen that the time delay over the range where it remains nearly constant with frequency is equal to:

$$T = 2m/\omega_0 = 0.404/f_0 \dots \dots \dots (20)$$

for $m = 1.275$.

It should also be noted that $m = 1$ corresponds to the "constant K " network.

Design of Lumped Lines

With the determination of the optimum value of m , the design of the lumped lines can be undertaken. The problem involved consists of selecting and spacing $L/2$ and C of Fig. 5B in such a manner that the circuit becomes equivalent to the network shown in Fig. 8B, with $m = 1.275$. The elements comprising the m -derived network are related to those of the "constant K " prototype by the following expressions:

$$L/2 = (1 + m^2) L_0/4m = .52 L_0 \dots (21)$$

$$C = m C_0 = 1.275 C_0 \dots \dots \dots (22)$$

$$M = - (1 - m^2) L_0/4m = 0.013 L_0 \dots (23)$$

where M is the mutual coupling. From these equations for $L/2$ and M , the coefficient of coupling, k , between two series coils can be given as:

$$k = \frac{M}{L/2} = \frac{-(1 - m^2) L_0/4m}{(1 + m^2) L_0/4m} = - \frac{(1 - m^2)}{(1 + m^2)} = 0.12 \dots \dots \dots (24)$$

(Continued on page 30)

Fig. 7. Delay vs. frequency curve for different values of m greater than 1.

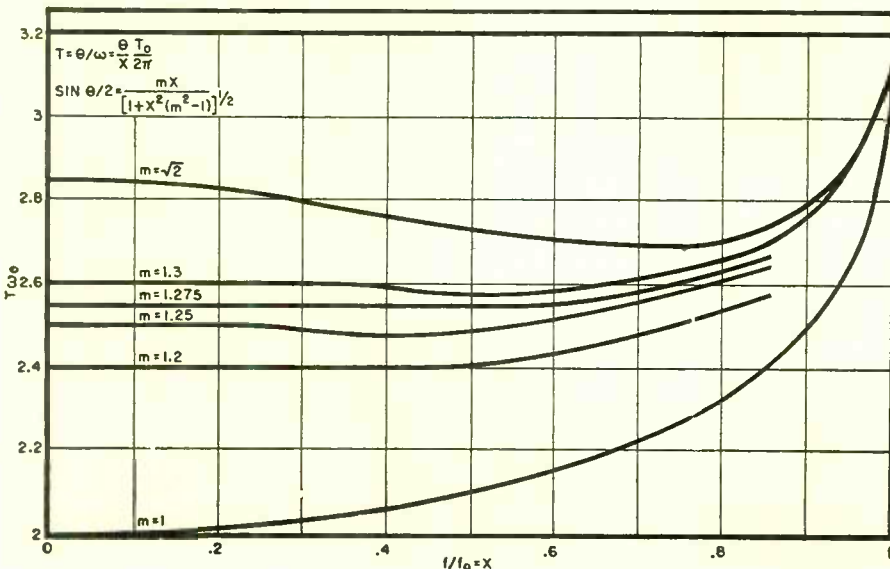

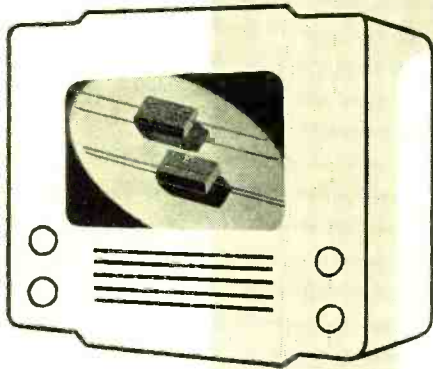

A GOOD TRADEMARK
is
BUT A REFLECTION OF
Many **OTHERS**

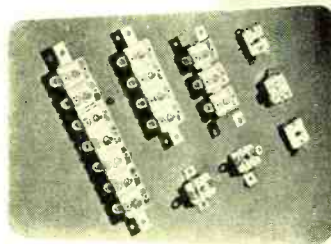
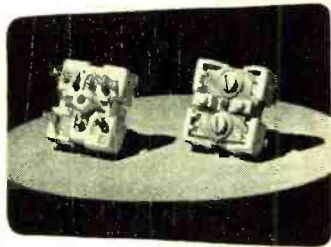
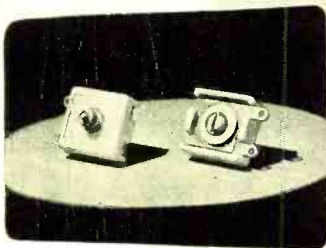

WHEN a manufacturer puts his trademark on a product, he not only expresses pride in his own workmanship, but also his confidence in the trademarks of those who have contributed vital parts to its manufacture. For instance — on capacitors he recognizes the El-Menco branding as his assurance of trustworthy performance under all operating conditions.

JOBBERS & DISTRIBUTORS
 Arco Electronics,
 135 Liberty St., New York, N. Y.
 is Sole Agent for El-Menco Products

Foreign Radio and Electronic Manufacturers communicate direct with our Export Department at Willimantic, Conn., for information.

THE ELECTRO MOTIVE MFG. CO., Inc., Willimantic, Conn.



Write on firm letterhead for samples and catalog.

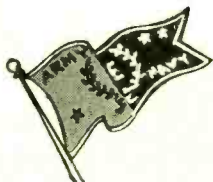

MOLDED MICA

EL-MENCO
CAPACITORS

MICA TRIMMER

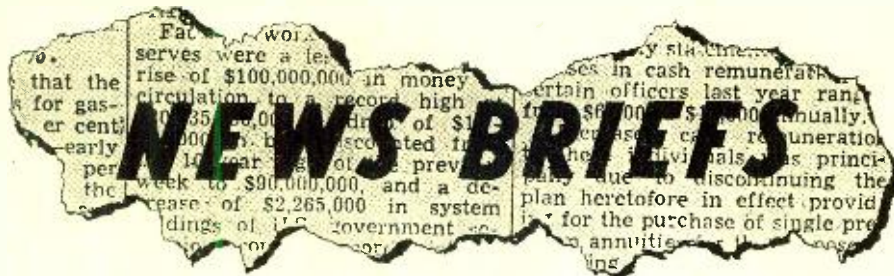

NEW PHYSICS LAB FOR SYLVANIA

The first of a series of modern research labs for *Sylvania Center*, Bay-side, N.Y., will be completed this fall. Fully equipped for scientific research in fluorescent lighting, radio, radar, television and the general electronics field, the lab will cost about \$900,000. In addition to the physics lab there will be others for metallurgical research,



chemical research, electrochemical research and advanced product development. The project, when finished, will be the first campus type scientific research center in the corporate limits of New York City.

"ELECTRONIC TRACKS" FOR AIRCRAFT

An air navigation and traffic control system, called *Tricon*, is being developed by *General Electric* engineers at *Electronics Park*, Syracuse, N.Y. Using triple coincidences of pulses as the base of the system, a master station and "slave" units, a 50-mile section can be scanned with triple coincidence about once a second. An airplane in the area continually establishes its position by means similar to the block system in railroading. The master station thus has complete data on a given sector and transmits the information to the instrument panel of each aircraft in the area. Lights corresponding to commands "turn left," "hold," etc., can also be flashed.

ROYALTY-FREE PATENTS

Sixty patents on the production and use of electrical apparatus have been released for unrestricted licensing by the *Office of Alien Property, Department of Justice*, Washington 25, D.C. Some of their most important applications were formerly limited by pre-war patent agreements. They are now available on a royalty-free, non-exclusive basis for an administrative fee of \$15.

The patents can be used in the fields of prime movers and their accessories, control of electricity for light, heat, power and traction purposes, and in steam turbines, reduction gears, condensing plants, heat exchangers and certain types of pumps. The list of patents is available without cost and copies of the patents may be purchased for \$.25 from Commissioner of Patents, Washington 25, D.C.

CHICAGO I.R.E. CONFERENCE

The annual Chicago I.R.E. Conference will be held on April 17 at the *Illinois Institute of Technology*. It will be an all-day affair featuring exhibits of new commercial products and a presentation of technical papers which should be of interest to all radio and electronic engineers within a 500-mile radius of Chicago. The registration fee is \$1.50 and further information may be obtained from *Lloyd Hershey* of the *Hallcrafters Co.*, 4401 W. 5th St., Chicago, Ill.

MEASURING OZONE

Variation in the total amount of ozone in the stratosphere has a direct correlation with latitude and season, and different types of air masses show varia-

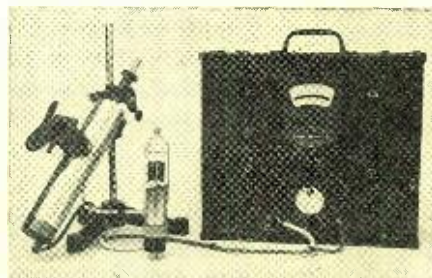

tions in ozone content, which are associated with their origin or movement. However, there is no proof of direct relationship between ozone variations and current weather conditions. But if such correlations do exist, ozone data may become useful in weather forecasting.

A technique of measuring the total ozone of the stratosphere has been developed by the *National Bureau of Standards*, Washington 25, D.C. Ground-based equipment employing a photocell and selected filters makes use of photo-

tubes sensitive to ultraviolet radiation. Ozone, strongly absorbent within a specific region, affects the spectral distribution of sunlight reaching the earth's surface. When transmittances of the filters are measured for sunlight, the observed value depends upon solar energy distribution, and therefore is a function of the amount of ozone within the beam of sunlight under study.

940-960 MC. FM EQUIPMENT

Final development of FM studio to transmitter link equipment for 940 to 960 mc. has been announced by *Radio Engineering Laboratories, Inc.*, 35-54 36th St., Long Island City 1, N.Y. This equipment consists of a transmitter, receiver, monitor, transmitting and receiving antennas with their supporting structures, and a supply of transmission line. It is the result of a program of studio to transmitter link design, accelerated by demand of broadcasters for equipment capable of operating in the band allocated by the F.C.C.

NEW LITERATURE

Voltage Regulators

A complete series of papers analyzing applications, circuits, and construction of electronic a.c. voltage regulators and Nobatrons has been released for free distribution by *Sorensen & Company, Inc.*, 375 Fairfield Avenue, Stamford, Conn. The pamphlets, compiled and written by the chief engineer and the project engineer of the company, have, for the most part, been published in electronic journals.

Phenolic Bobbins

Mayfair Molded Products Corp., which specializes in volume production of small phenolic pieces, has put out a pamphlet describing standard sizes of molded phenolic bobbins which are now available. They are manufactured by using stock molds. Inquiries should be addressed to 4440 North Elston Ave., Chicago 30, Ill.

Par-Metal Products

Par-Metal Products Corp., 32-62 49th Street, Long Island City 3, N.Y., has released a booklet which presents a complete description of cabinets, chassis, panels, racks and accessories as applied to electronic apparatus. Catalogues may be obtained by writing to the firm.

Erratum: In the March issue, p. 24, was an item describing the *Western Electric Inter-modulation Distortion* equipment. The last line of this item should read "Output levels range between 23 and minus 44 dbm. at 600 ohm output impedance." Since this item was published, the equipment has been improved and now is capable of being used down to minus 105 dbm.

Attenuators

(Continued from page 6)

2 db. per step, and a master gain control of 1.5 to 2 db. per step. When it is possible to engineer the more flexible system, and for all network and similar stations, the mixing controls are best selected to offer 1.5 db. per step with at least 30 steps of control, and a similar master,

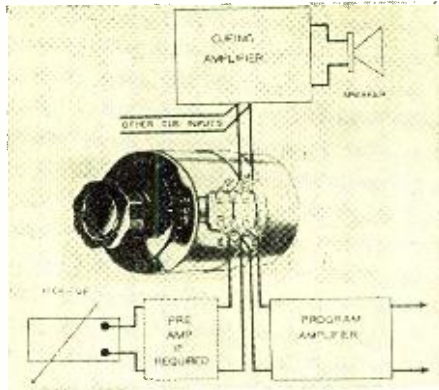

Fig. 8. The Daven Cueing Attenuator, and its proper schematic for wiring.

or one of even 45 steps is to be desired. The system master is never more than 1.0 db. per step, with 0.5 db. quite frequently found. In all recording installations, where a most careful control of the sound level must be maintained to prevent over-cutting into adjacent grooves, a master gain of 0.5 db. per step is a prerequisite.

For monitoring amplifiers and those used in p.a. work, a control as coarse as 3 db./step is allowable, and is good engineering practice. For audiometric and laboratory work, the decade attenuator is selected, with two bridged tee pads connected in tandem to afford control of 1 db. per step for a total of 110 db.

From many contacts in this field, the writer became aware that some means of cueing a record, or an incoming program source without throwing a switch would be a great boon to the broadcast mixing operator. Any saving of time and manual effort in this work is very desirable. Accordingly, during his tenure with the *Daven Co.*, this control was suggested to them. The operation of this unit (illustrated mechanically and electrically in Fig. 8) is quite normal, with the exception that a detent is applied at the off position. To cue the incoming source it is merely necessary to continue the counterclockwise rotation, whereupon the source is automatically transferred, without loss, to a separate contact. Any reasonable number of cue contacts can be multiplied to the input of a single cueing amplifier. This control allows performance of another very important function, transferring a microphone from the main system to a reverberation chamber, then restoring it to straight use, all without switching operations. Other uses will become apparent to the designer of speech input equipment. Its wide commercial acceptance by the trade will soon require its incorporation on any studio facilities offered to the broadcast station field by equipment manufacturers.

In closing this first part, some mention of the cost of the attenuators involved in a speech system seems in order. Generally speaking, they represent between 25 per-cent and 35 per-cent of the total cost of components of such an installation, so the engineer building his own gear can be guided accordingly. Whether the ladder or tee pad will be selected is a matter of both cost and amount of mixing loss that can be tolerated. With the present day use of silver alloy contacts, selected resistance wire or carbon resistances, proper soldering and quality control, the noises introduced by the controls themselves are in the order of 140 db. below a zero reference level of 6 milliwatts. Consequently the engineer must base his selection and choice of controls upon the needs of his system, as to amount of attenuation and fineness or gradation of control, and upon the amount of impedance change that can be tolerated.



CAMCAR

Can Give You Prompt Deliveries On SHEET METAL SCREWS

STEEL or STAINLESS STEEL —types "A", "B" (or "Z") and "C" . . . all standard sizes, heads, threads, points and platings. Minimum order, 100,000 of a kind. Special sizes where required.

Tell us what units (and quantities) you need and we'll gladly send you samples, quotations and approximate delivery schedules.

We shall be glad to quote you, also, on
STANDARD MACHINE SCREWS
BRASS . . . 100,000 Minimum
STEEL . . . 200,000 Minimum

SPECIALS

EXCEPTIONAL facilities for making SPECIALS (Steel or Stainless Steel) to your specifications . . . or for converting your screw-machine parts to the cold forged process at substantial savings. Precision made to close tolerances; stronger, tougher, cheaper and more durable. All automatic secondary operations.

Give us samples, sketches or blue prints, plus supplementary data about use, functions, tolerances, etc., so we may quote you promptly.

CAMCAR PRODUCTS CO.
610 18th Avenue
ROCKFORD, ILLINOIS



NEW PRODUCTS

LABORATORY AMPLIFIER

A laboratory amplifier incorporating the Scott dynamic noise suppressor is now being manufactured by *H. H. Scott, Inc.*, 385 Putnam Ave., Cambridge, Mass. Supplied with a matched variable reluctance pickup cartridge, the unit provides a complete phonograph system except for turntable and loudspeaker.



There is a 20 watt output with less than two per-cent distortion. Maximum frequency range exceeds 20,000 cycles—with the dynamic noise suppressor, response is flat to 10,000 cycles and extends to 16,000 cycles. Independent tone controls allow boost or attenuation at either end of the frequency range, and a whistle filter is provided for AM reception.

PRECISION CHANNEL LIMITING

Precision channel limiting without cutting the channel width and sacrific-

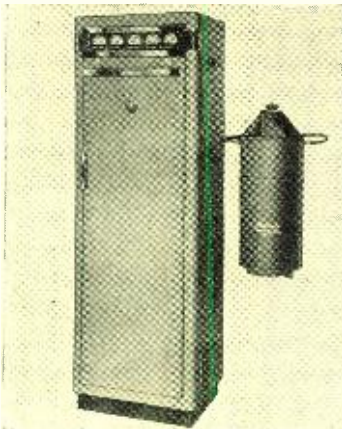

ing high signal to noise ratio is accomplished by a high band pass filter of the cavity resonator type to suppress interference. The development of the cavity brings the principles of *Motorola Inc.*'s "Precision Selectivity" receiver

system into the r.f. carrier system frequency of the 152-162 mc. band. The cavity resonator is designed to permit two transmitters to operate from a single antenna when channels are separated by 1 mc. or more. When used with receivers it will eliminate interference of high signal intensity from nearby stations. Inquiries should be addressed to 4545 Augusta Blvd., Chicago 51, Ill.

MULTICHANNEL DATA RECORDER

An electronic-magnetic multichannel data recorder has been developed by the *Cook Research Laboratories*, 1457 Diversey Parkway, Chicago 14, Ill. It is applicable to the recording of test or performance data of any kind that can be picked up electrically or audibly by a magnetic recorder. Specifications include an over-all drift of less than 2

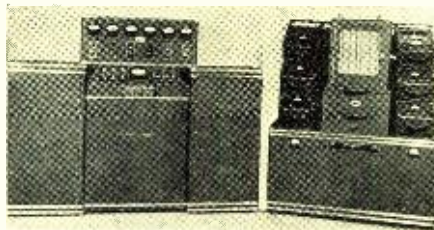

per-cent and an over-all interpretation accuracy of ± 2 per-cent. Tape capacity is thirty minutes and the shock acceleration handling capabilities go up to 75 G's.

DISTORTION AND NOISE METER

The *Specialty Division of the General Electric Co.*, Electronics Park, Syracuse, N.Y., has produced a distortion and noise analyzer, type YDA-1, for broadcast, television, research, and developmental applications. The unit will measure percentage distortion down to 0.1 per-cent, measure the hum or noise in an audio signal, act as a high sensitivity vacuum tube voltmeter, and perform as a frequency meter over the range of 50-15,000 cycles. Weighing approximately 45 pounds, it is 21 x 10½ x 15 inches.

NEW POTENTIOMETER

Newest in the line of precision variable resistors produced by the *Tech-*

nology Instrument Corp. is the type RV3-5 potentiometer. It has standard features of precious metal contacts, two rotor take-off brushes, continuous 360 degree rotation, precision resistance



winding, and dust proof construction. The important improvement is the reduction in overall depth, measuring 15/16 inches. The power rating is 5 watts and it is available in nine standard resistance values ranging from 100 ohms to 50,000 ohms. Detailed information is available by writing to the manufacturer at 1058 Main St., Waltham 54, Mass.

LABORATORY MONITOR

Model Su-3 has recently been developed by *Tracerlab, Inc.* for specific use as a routine contamination monitor in radio activity laboratories. It is a small, compact portable a.c. operated counting rate meter of moderate accuracy, with three full scale meter ranges of 200, 2000 and 20,000 counts per minute. It comes complete, equipped with a thin mica window, sensitive Geiger tube, enclosed in a probe connected by a four foot length of shielded



cable. Further data is available from the laboratory at 55 Oliver St., Boston 10, Mass.

SOUND PRESSURE MEASUREMENTS

Absolute sound pressure measurements can now be made over the complete audible and ultrasonic frequency range to 250 kc. Model GA-1005, manufactured by *Massa Laboratories, Inc.*, 3868 Carnegie Ave., Cleveland 15, O.,

combines a standard microphone, a shock mounted preamplifier with a 25 foot output cable and a power supply unit and batteries for such measurement. Diffraction errors are completely eliminated beyond 20 kc. because the



microphone diameter is only 1/8 inch. Other data is available on request.

AUTOMATIC WELDER

An electronic welding and timing device is the newest machine designed to cope with the small, light parts difficult to process manually. In addition to decreasing the necessary amount of labor, the welder reduces shrinkage. Assemblies or small parts are fed to a

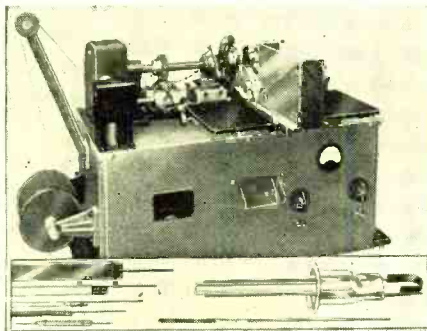

turret either by hand or automatically from a hopper. Components can be shaped so that welded parts leaving the machine are ready for assembly into the final product. The manufacturer is Tweezer-Weld Corp., 1060 Broad St., Newark, N.J.

EL-3 EQUALIZER

A new EL-3 Equalizer has been developed by Radio-Music Corporation, Port Chester, N. Y. Designed for simplified operation plus fine reproduction, it affords high quality tone reproduction with both Vertical and Lateral recordings.

The EL-3 Equalizer uses one arm for Vertical and one arm for Lateral only on one turntable, or separate tables, by connecting both arms to the Equalizer.

Switching the EL-3 Equalizer from Vertical equalization to Lateral allows changing from one arm to the other. At the same time, correct equalization is thrown in.

Both the RMC Vertical and Lateral reproducers can be replaced by the RMC universal head on either or both units.

For further information write to Radio-Music Corporation, Port Chester, New York, for Bulletin EL3-44.

SMOOTH POWER MOTOR

Redesigned to meet increased power requirements of wire and tape recording units, a RM-4 smooth power motor for general small motor applications was announced by the General Industries Co., Elyria, Ohio.

The new model includes the addition of a bottom motor cover and special locating and locking means for both top and bottom covers, which assures high accuracy in alignment of rotor within the stator bore. Combined with dynamic balancing of each rotor, these features result in greater freedom from vibration, minimum noise and magnetic field radiation.

The motor is compact 3 3/8 x 3 3/8 x 2 7/8-inches over the main body of the motor, and weighs 4 1/2 pounds. It is

a four pole, shaded pole induction motor, designed for 60 cycle a.c. operation at 115 volts.

GAMMA RADIATION METER

A gamma ray meter of the ionization chamber type, combining stable operation with rugged construction, has been designed primarily for field surveys. The portable meter has four ranges of

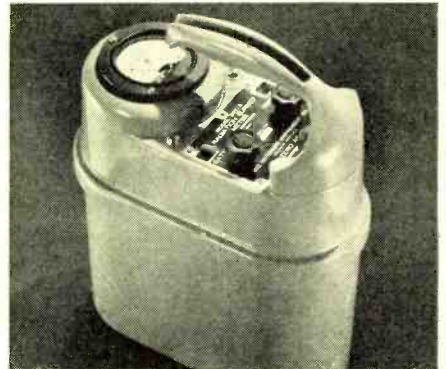

sensitivity and is calibrated to read in roentgens over full scale readings of 2.5, 25, 250 and 2500 milliroentgens per hour. The case is watertight and the entire unit hermetically sealed. A color code is provided with the range switch for visual indication of the range at
(Continued on page 26)



Paramount
PAPER TUBES

are used in winding coils for

ARVIN
RADIOS

● This is typical of the wide use of PARAMOUNT paper tubes by leading manufacturers of electrical, radio and electronic products. With over 15 years of specialized experience, PARAMOUNT can produce exactly the shape and size tubes you need for coil forms or other uses. Square, rectangular, or round. *Hi-Dielectric, Hi-Strength, Kraft, Fish Paper, Red Rope*, or any combination, wound on automatic machines. Tolerances plus or minus .002". Made to your specifications or engineered for you.

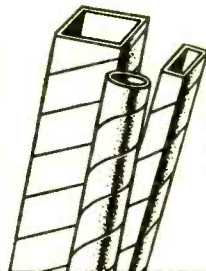

SEND FOR ARBOR LIST OF OVER 1000 SIZES

Lists great variety of stock arbors. Includes many odd sizes. Write for Arbor List today.

Inside Perimeters from .592" to 19.0"

PARAMOUNT PAPER TUBE CORP.

613 LAFAYETTE ST., FORT WAYNE 2, INDIANA

Manufacturers of Paper Tubing for the Electrical Industry

Television

LARGE SCREEN TELEVISION

Projection television featuring a variable size picture that can be increased to theatre screen dimensions has been developed by *Tradio, Inc.*, As-



bury Park, N.J. It includes an aluminum screen, a projection unit mounting of tube and lens and a control unit housed in a compact rack case; the whole known as *Tradiovision*. The control unit may be completely divorced from the projector, making it possible to hook up several projector units to one master control.

TELEVISION CAMERA

A streamlined fifty-six pound television camera, believed to be the lightest television camera ever built for studio applications, has been developed by the Transmitter Division of the *General Electric Company's* Electronics Department at Syracuse, N. Y.

Equipped with a turret of three lenses, the new camera is mounted on a mobile dolly and may, because of its weight and specially designed head, be operated with fingertip control. Though the camera is designed primarily for studio work, it may be adapted to operate over greater distances with a telephoto lens.

The camera will produce acceptable pictures at 50-foot-candles and $f/3.5$. Smaller stop openings may be used for greater depth of focus if 100-200 foot-candles are supplied. The unit employs an optical view-finder.

REFLECTIVE TYPE OPTICAL SYSTEM

Television screen images having six to seven times the illumination that can be transmitted by the highly efficient $f/2$ lens system are being reproduced

by a reflective type optical system. Concave spherical glass reflectors, machine pressed in cast iron molds like oven glassware, have an important part in solving the problem of transmitting enough light from the cathode ray projector tube to the screen for good visibility and satisfactory magnification. Such reflectors, made by *McKee Glass Co.*, Jeannette, Pa., have recently been incorporated in television sets for commercial and home use.

DUAL ICONOSCOPE FILM PICKUP

The *Television Equipment Division* of *Allen B. du Mont Labs, Inc.*, 42 Harding Ave., Clifton, N.J., announces the dual iconoscope film pickup system. Housed in metal cabinets, the units are floor-



mounted or mounted on a track attached to the wall, allowing rapid positioning. The control console is built in sections, all units being mounted on sliders which facilitate access to components, tubes and wiring. The controls on the panels are laid out in four arcs and the over-all frequency response is flat up to 6 megacycles, permitting excellent picture resolution.

TV RECORDING CAMERA

Eastman Kodak Co., Rochester 4, N.Y., announces a 16 mm. motion picture camera for recording television programs on film. The first of its kind, it produces movies directly from the face of the monitoring "picture tube" in a television broadcasting station. Developed in collaboration with the *NBC* studio at station *WNBT* and the *Allen B. du Mont* studio at station *WABD*, it is expected to facilitate reuse of programs, keeping records for legal use,

and rebroadcasting for a potential film network of television.

BEYOND HORIZON TELEVISION

Expansion of television service to communities beyond the horizon, and even to homes in valleys cut off by mountains from the primary transmitting antenna, has been proven practicable by tests conducted recently by Station *WBRE* of Wilkes-Barre, Pa., with the cooperation of *NBC* and *RCA Victor*.

Television signals picked up by a mountain-top antenna from the *WNBT* transmitter in New York, 105 miles away, were successfully amplified and carried by an *RCA* microwave television relay system to six *RCA* Victor television receivers in the *WBRE* booth at the Wyoming Valley Parade of Progress in the Field Artillery Armory at Kingston.

The Wilkes-Barre experiment constituted a pioneer test of repeater-type television station operation, and was one of the first in which microwave relay equipment was used to carry television "over the hump" by beaming it from an elevated receiving antenna down to receivers or a rebroadcast transmitter in an area ringed by mountains.

ORTHICON CAMERA

Developed and manufactured by *Allen B. du Mont Laboratories, Inc.*, 2 Main Ave., Passaic, N.J., a new image-orthicon camera features a super-sensitive image-orthicon pickup tube, a lens turret of four lenses of various focal lengths and controls concentrated at the rear of the camera. It also in-



corporates the electronic viewfinder, wide voltage control, and an intercommunication system for the studio or outside crew. Further information on the television camera may be secured by writing the laboratory.

G-E TELEVISION TRANSMITTER

General Electric, Electronics Park, Syracuse, N. Y., has developed new television transmitters, types *TT-6-A*

(Continued on page 28)

Liquid Dielectrics

(Continued from page 9)

$\omega = 2\pi f$ (where f is the frequency of measurement, cycles)

L = series inductance of leads

C = true capacity (corrected for series resonance effect)

Q_m = apparent high frequency Q (as measured on Q meter).

Results of Tests

When properly processed, all fluids tested are able to withstand 8500 volts (peak) at 2500 kc. This measurement is made with an APC type capacitor having a gap between plates of 0.025 to 0.030 inches at an ambient temperature of 25°C. Repeated flashovers when voltages in excess of 8500 are applied cause no damage if severe arcing is not permitted to take place. Thus if the circuit is protected by a limiting device, the capacitor may withstand an indefinite number of individual breakdowns without permanent injury.

When the capacitor is initially placed in service one or two preliminary sparks may be observed to take place at lower potentials than noted above. However, these breakdowns are harmless and are part of a process known as cataphoresis. This has been noted by many observers.¹¹ It seems that residual impurities are cleaned up by the action of the electric field.

It is found that liquids which have not had all moisture removed suffer a reduction in dielectric strength below a temperature of 0°C. A small amount of moisture in the liquid will cause spark-over at 8500 volts in the above gap. Moisture has very little effect from 0°C. to +85°C.

Although liquids are commonly assumed to be incompressible, it has been found that the dielectric strength varies to a large degree with the external pressure. Removable of atmospheric pressure by means of a vacuum pump applied to the test capacitor caused the breakdown voltage to decrease from 8500 to 3000 volts. According to Schwaiger, the breakdown voltage of oil increases about 90kv/per cm. per atmosphere. It is thus very desirable to maintain a pressure in the capacitor no lower than atmospheric and if possible to increase the value to the maximum practicable.

The addition of water (2 drops to 1 pint of fluid) has the effect of reducing the breakdown strength from 8500 volts across 0.025 gap to 6000 even after the mixture is thoroughly agitated to simulate distributed moisture. This test is performed above 0°C.

After the addition of two drops of water as above, a pinch of dust was sprinkled into the liquid, and the mixture agitated to distribute to impuri-

ties. The dielectric strength fell from 6000 to 2800, showing that the dust problem is normally much more important than the moisture problem. With the addition of 15 pounds per sq. inch of pressure, the breakdown was decreased to 4300 volts.

Due to the number of variable factors involved in the processing and handling of dielectric fluids it is desirable to have the actual working voltage of the capacitor far below the ultimate strength of the dielectric. It is intended to operate a capacitor with 0.025 to 0.030 spacing at 2500 peak volts. This gives a factor of safety of about 5 to insure reliability under any condition of operation. Schwaiger⁹ recommends a maximum working gradient of 50 kv. per centimeter.

The selection of any one liquid for a given application will in general be a compromise depending upon the particular application. For example, the most desirable liquid considering losses and capacity would undoubtedly be the Dow-Corning Fluid No. 500. However, inspection of the percent capacity change over the operating range will prevent the use of this material unless the temperature can be kept constant.

The ordinary transformer oils, of which 10-C Transil Oil is a good example, has one outstanding disadvantage, namely, in the temperature

range 0 to -30° C., the Q falls to an extremely low value. This would be detrimental to the operation of transmitting equipment since the power output will decrease. While it is possible that the internal heat generated due to the increased loss would tend to correct this condition, the time taken for the Q to recover may be excessive. Of the mineral oils, Gulf Instrument Oil "A" represents the best material of those tested. Its usefulness is impaired by the low value to which Q falls at low temperatures.

REFERENCES

1. Bureau of Standards circular No. 74.
2. GE Review, April 1928, "Liquids as Insulators."
3. F. W. Peek, "Dielectric Phenomena in High Voltage Engineering," Chapter on Oil.
4. M.I.T. Report V, February 1944 "Tables of Dielectric Materials," Contract OEMsr-191.
5. M.I.T. Progress Report, Dec. 1942 on Dielectric Materials for Ultra-High Frequency.
6. A. Gemant, "Liquid Dielectrics," John Wiley, 1935.
7. Attwood, "Electric and Magnetic
8. "Industrial Petroleum Naphthas," Gulf Refining Co.
9. Schwaiger, "Theory of Dielectrics," page 41, John Wiley, 1932.
10. Seals Corporation of America, Phila., Pa., booklet on "Physical Separations of Immiscible Fluids Through Porous Materials by Means of Surface and Interfacial Tension."
11. Pender-McIlwain, "Handbook for Electrical Engineers," Liquid Dielectrics.
12. Dielectric Phenomena II, "Electrical Discharges in Liquids," S. Whitehead, 1928. Ernest Benn, Ltd., London.

FREQUENCY MODULATED SIGNAL GENERATOR

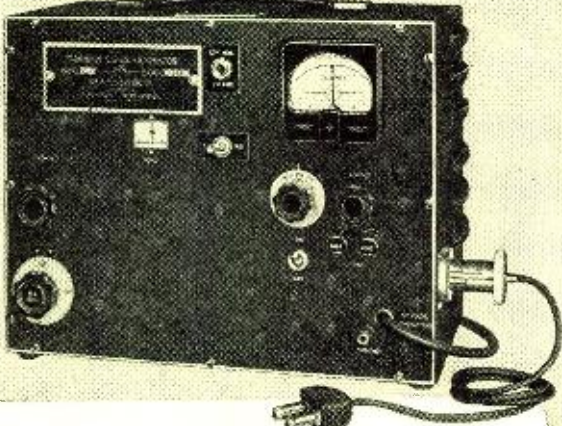



MODEL 78FM
86-108 MC

Also Available For
Other Frequency Ranges

**1 to 100,000
MICROVOLTS**

Variable Output
With Negligible Carrier Leakage

MODULATION: 400 cycle internal audio oscillator. Deviation directly calibrated: 0 to 30 kc. and 0 to 300 kc. Can be modulated from external audio source.

Audio fidelity is flat within 2 db from dc to 15,000 cycles. Distortion less than 1% at 75 kc. deviation.

The Model 78FM when used with Measurements Model M-275 Converter provides output in the IF ranges of 4.5, 10.7 and 21.7 mc.

Circular on Request

MANUFACTURERS OF
Standard Signal Generators
Pulse Generators
FM Signal Generators
Square Wave Generators
Vacuum Tube Voltmeters
UHF Radio Noise & Field Strength Meters
Capacity Bridges
Megohm Meters
Phase Sequence Indicators
Television and FM Test Equipment

MEASUREMENTS CORPORATION

BOONTON  NEW JERSEY

Personals

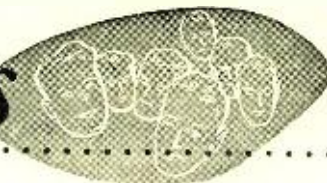

CHARLES FRANCIS ADAMS, JR. has been elected president of *Raytheon Manufacturing Company*, Waltham, Massachusetts. He replaces Laurence K. Marshall, who has been elected chairman of the board. Mr. Adams was a director of *Raytheon* for several years prior to entering the Naval Service during the war. He has been a director since May, 1946 and executive vice-president since May, 1947.



E. G. F. ARNOTT has been appointed assistant director of research for the *Westinghouse Lamp Division*. He joined the company in 1932 after being an instructor of physics at Princeton for two years, and has been a factory engineer in electronic tube manufacturing, an electronic engineer, and later a member of the research staff. Mr. Arnett is a specialist in the study of gas discharges for fluorescent lamps and electronic tubes.



DONALD H. COOPER, staff member of *NBC* station WRC in Washington, D.C. since 1928, has been appointed chief engineer. He is responsible for all *NBC* Washington broadcasting plant facilities and the engineering staff of WRC, WRC-FM and television station WNBW. Mr. Cooper is a graduate of the George Mason School and Loomis Radio School and was formerly employed by the *Independent Wireless Co.* and the *RCA Marine Division*.



R. P. LAMONS has joined the *Federal Telephone and Radio Corp.* as the District Representative for broadcast equipment. His territory will cover Illinois, Indiana, Michigan, Ohio, Kentucky, Minnesota, Wisconsin, Missouri and Kansas. Mr. Lamons was formerly associated with the *Western Electric Co.*, in radar equipment and with the *Andrew Corp.* as Eastern Representative. He is a graduate of the Illinois Institute of Technology.



DONALD W. PUGSLEY, designing engineer for *General Electric* television receivers, was awarded honorable mention as "an outstanding young electrical engineer" by Eta Kappa Nu, electrical engineering fraternity. The award is based on accomplishment in engineering, social, and community activities as well as cultural and educational endeavors. Mr. Pugsley has been associated with the *General Electric Company* for thirteen years.



IRVIN R. WEIR has been named the new designing engineer of the transmitter division of *General Electric* at Electronics Park. Formerly section engineer, with complete responsibility for engineering and drafting activities at the Syracuse plant during the war, he will now be in charge of the design of all Transmitter Division products. Mr. Weir entered the employ of the company in 1921 and is a senior member of the Institute of Radio Engineers.

New Products

(Continued from page 23)
which the survey meter is set. *Victoreen Instrument Co.*, 5906 Hough Ave., Cleveland 3, O., designed and manufactures the tool.

DEPTH SOUNDER

Trident Products, Inc., 110 W. Alameda St., Burbank, Cal., announces a new all electronic depth sounder designed for commercial craft and yachts



of moderate size. As many as five repeaters may be connected to the master indicator and the sounder may be operated from 6, 12, 32, or 110 volts d.c. Power drain is 30 watts and depths to 100 fathoms, or 600 feet, are continuously indicated on a large indirectly illuminated scale.

PORTABLE VOLTAGE CONTROL

Completely self-contained, measuring 9 x 8 x 7 inches and incorporating a 405 watt variable auto-transformer and a 0-150 voltmeter, this new portable voltage control is suitable for laboratory control or research work. Four plug-in load receptacles eliminate the need for tedious wiring jobs which would ordinarily be necessary in improving a hook-



up of variable auto-transformer, voltmeter and load. The instrument is produced by *Andrew Technical Service*, 111 E. Delaware Pl., Chicago 11, Ill.

TEMPERATURE CONTROLS

A series of inexpensive temperature controllers has been designed recently. Only a small portion of current is allowed through the heating elements, enough to maintain definite temperatures, no resistance is used—so no cur-

rent is wasted. Available with or without pyrometers, these stepless input controllers are suitable for electric and gas furnaces, ovens, pots and similar



applications. Inquiries should be directed to the *K. H. Huppert Co.*, 6830 Cottage Grove Ave., Chicago 37, Ill.

POWDER-IRON PRODUCTS

A variety of powder-iron cores, core assemblies, coil assemblies and filter units in several types are being offered by *Lenkurt Electric Co.*, 1115 County Rd., San Carlos, Calif. The firm specializes in parts requiring extreme temperature and magnetic stabilities, emphasizing



ing production control. Parts can be supplied in any powder desired, but three standard materials are listed: they cover frequency ranges of 100 cps. to 90 kc., 50 kc. to 5 mc. and 1 mc. to 200 mc.

REGISTRATION CONTROL

A registration control for use with packaging machines using web-fed wrappers has been developed by the *Ripley Co., Inc.*, of Middletown, Conn. It is said to be so sensitive that correction in the positioning of wrapping material is possible on low color contrasts as red or brown on yellow.

The control consists of a scanner and amplifier and built-in relay with connections provided so that the cam on the feed of the packaging machine automatically corrects the position of the label whenever the web of material gets out of register due to slip-page or stretching. Because of the sensitive circuit, the same method of

scanning may be used for opaque, translucent or transparent material. The control operates at 750 per minute with correction on any sequence of registration marks such as every 5th, 10th, etc.

Protelgram

(Continued from page 11)

sealed under high vacuum: three special miniature rectifier 1Z2 diodes, transformer coil, high-voltage condensers and core pieces of "Ferroxcube," Philips' newly developed low loss magnetic material.

The triode section of the 6SR7 acts as a 1000 cycle sawtooth oscillator and drives the 6BG6G. This 6BG6G is biased near cutoff and produces 1000 cycle peak voltages in the plate circuit, which is part of the high-voltage transformer primary. The 1000 cycle 6BG6G plate pulses, which are almost equal to its maximum emission, start a 25 kc. train of damped oscillations because the transformer is tuned to approximately 25 kc. The first oscillation peaks of about 8.5 kv. charge the tripler circuit filter condensers and are rectified by the three rectifier-diodes. By connecting the 8.5 kv. output of each rectifier stage in series, 25.5 kv. is obtained.

Filaments of the three rectifier tubes, requiring 0.5 watt each, are fed by subsequent oscillation peaks from three separate secondary windings.

Part of the 25 kc. voltage is used as a negative feedback voltage which, after rectification by the two diode sections in the 6SR7, is supplied to the 6BG6G control grid. Thus, the amount of current through the high-voltage transformer primary can be controlled to improve the external 25 kv. regulation characteristic.

Three input connection wires are required for ground, filament, and 350 volt B supply.

Input requirements call for a heater supply of 6.3 v. a.c. at 1.2 a., one side grounded, and a plate supply of 350 volts at 50 ma, with 150 microamperes high voltage drain.

Typical output performance figures, with constant input supply voltages are 25.5 kv., ± 2 kv. at no load, a voltage drop of less than 600 v. at 60 microamperes drain and less than 1200 v. at 125 microamperes drain.

The high voltage unit can be mounted in various specific positions (according to manufacturer's mounting specifications for the 6BG6G) within a distance from the second-anode contact of the 3NP4 tube in the projection box, which is limited by the length (15 inches) of its insulated second-anode connection cable.

New! PALNUT SHIELD CAN FASTENER*



- Lower Assembly Cost
- Strong Positive Grip
- No tolerance problems



Live spring arch holds can tightly against chassis



Will not pull out until deliberately released

- A quick snap of the Palnut Shield Can Fastener into the chassis provides a secure job—faster, cheaper than other fastening methods. Good ground contact is maintained. May be used on any chassis thickness.
- SAMPLES and data on Palnut Shield Can Fasteners sent upon request on your company letter-head.

*Pat. Pending

The PALNUT Co.
23 CORDIER ST., IRVINGTON 11, N. J.

Television

(Continued from page 24)

and TT-6-B with a 5 kw. visual transmitter and a 2½ kw. aural transmitter, incorporating the well known phasitron modulator, for operation on television channels 1 through 13. Both transmitters meet or exceed the present FCC and RMA standards.

MULTIVISION VIEWERS

The problem of a clear, comfortable view of television at a distance has been solved by *Industrial Television, Inc.*, 359 Lexington Ave., Clifton, N.J. They have produced a unit called multivision



viewer, a large-screen viewer which can be attached to a small-screen receiver, thus avoiding the cost of a large receiver. One or more viewers can be attached, and the remote control permits the unit to be in the most advantageous position.

TV ANTENNAS

A solution to the problem of apartment house owners and their tenants who want good television reception without spoiling the appearance of the apartment house roof is offered by the Engineering Department of the Radio Manufacturers Association in a booklet released recently.

The proffered solution, the booklet explains, "has been found in a Distribution System which uses an antenna or combination of antennas, an amplifier, cables, and an outlet box for each apartment.

"The antennas are mounted on the rooftop and are oriented or 'sited' at the time of installation so as to give the best reception for each station in the vicinity. Where strong signals from the transmitter are available—such as might be the case in the center of a city—or where there are only a few receivers drawing from the system, amplifiers may not be required.

"Individual apartments are connected to the system or the amplifier, if one is being used, by means of a low-loss transmission line connected through conduit to the various apartments, each equipped with a connection box similar to an ordinary wall outlet."



NEW TUBES

RCA TUBES

SMALL ELECTRON TUBES

RCA's new "Special Red" tubes, 5691, 5692, 5693 are small type tubes specifically designed for those industrial and commercial applications requiring tube features of exceptional uniformity and stability and rigidity of characteristics to resist shock and vibration. The "girder" construction holds internal elements rigidly in adjustment, and a prolonged seasoning process minimizes changes in characteristics during operation. The tube has a minimum life specification of 10,000 hours, or about 14 months of continuous round-the-clock service.

The "Special Red" tubes are recommended, in general, as replacements for the 6SL7-GT, 6SN7-GT and 6SJ7. A technical booklet, RSB 1000, providing detailed descriptions and operating data for the tubes, is available upon request

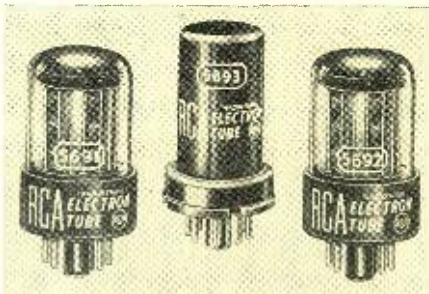

from the *RCA Tube Department, Commercial Engineering Section*, Harrison, N.J.

TUBE SOCKETS

Electronic tube sockets for transmitting and industrial tubes have been made available by the *Tube Division of General Electric Company's Electronics Department* at Schenectady, N.Y. The sockets, in a wide range of sizes, include panel-mounted and chassis mounted styles and are built to NEMA specifications. The body is molded in one piece from BM120 black bakelite, with barriers for insulation and creepage paths. Contacts are constructed from phosphor bronze, with four lines of contact for the length of the whole pin.

MINIATURE TUBES

Three new tubes, the 6AS5, 35C5 and the 50C5 are being produced by *RCA*. The 6AS5 is intended for use in the

output stage of low-cost automobile and a.c. operated receivers. It is capable of delivering 2.2 watts at the relatively

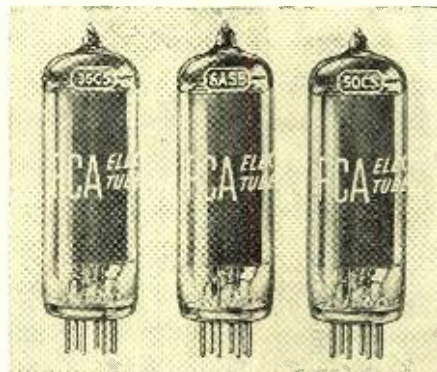

low plate and screen voltages of 150 and 110 volts, respectively.

The 35C5 and 50C5 are intended for use in the output stage of a.c.—d.c. receivers. They are designed with high power sensitivity and high efficiency, being capable of providing 1.5 watts and 1.9 watts, respectively, with 110 volts on plate and screen.

VOLTAGE-REFERENCE TUBE

The 5651 is a miniature, voltage-reference tube of the cold-cathode, glow-discharge type, designed for extreme voltage stability. Voltage fluctuation at any current value within the operating-current range of 1.5 to 3.5 milliamperes is less than 0.1 volt. The 5651 main-

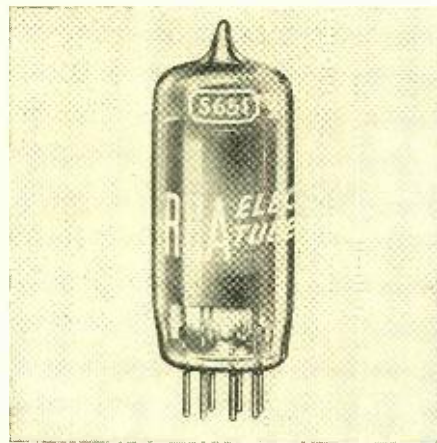

tains a d.c. operating voltage of approximately 87 volts, this characteristic being essentially independent of ambient temperature. More information can be obtained from the *RCA Tube Department*, Harrison, New Jersey.



CALENDAR



APRIL

1-3 incl.—**AIEE** Great Lakes District Meeting, Des Moines, Iowa.

7-9, incl.—**Midwest Power Conference**, Stevens, Hotel, Chicago.

17—**Chicago IRE Conference**, sponsored by the Chicago Section of the Institute of Radio Engineers; to be held at the IIT campus.

24—**Television Conference**, sponsored by the Cincinnati Section of the Institute of Radio Engineers.

26-28 incl.—**IRE-RMA Spring Meeting** on Transmitters, Syracuse Hotel, Syracuse, N. Y.

28-30 incl.—**AIEE** North Eastern District Meeting, New Haven, Conn.

MAY

11-14 incl.—**Radio Parts and Electronic Equipment Conference and Show**, Stevens Hotel, Chicago.

22—**New England Radio Engineering Meeting** sponsored by North Atlantic Region of IRE, Hotel Continental, Cambridge, Mass.

21-25 incl.—**AIEE** Summer General Meeting, Mexico City, Mex.

SEPT.-OCT.

Sept. 30-Oct. 1-2 incl.—Pacific Electronic Exhibition, Biltmore Hotel Ballroom, Los Angeles, Calif.

* * *

MONTHLY MEETINGS

Institute of Radio Engineers, Chicago Section. Don Haines, Secretary, CAPitol 6500.

Dinner, 6:00 P.M., Bolling's Restaurant, ground floor of the Engineering Building, 205 W. Wacker Drive. Price \$1.75 per plate. Call Don Haines for reservations. Program, 7:15 P.M., Engineering Auditorium, second floor of the Engineering Building.

April 17—Annual Chicago IRE Conference, see announcement above. This Conference takes the place of the regular meeting.

American Institute of Electrical Engineers, Chicago Section. F. D. Troxel, Secretary, FRAnklin 7130.

Program, 7:00 P.M., 6th floor Assembly Hall, Civic Opera Building, 20 N. Wacker Drive.

April 22—Electronics Group—"Fluorescent Lamps and Electronic Behaviour" by Charles Stover, District Engineer, Midland Sales District, G.E. Co. Lamp Dept., Chicago, Ill.



Bead-Supported Atten.

(Continued from page 14)

tolerances permit. The insert used for the 6 db. attenuator is of the continuous film design (see Fig. 4). The 20 db. unit, whose performance curves are shown on Fig. 5, is a compensated film design. All are 6" in over-all length of insert.

In order to allow widest general application of the attenuators and yet permit broad band coverage, special type N couplings were employed with a jack situated at one end and a plug at the other, as shown in Fig. 2. The couplings will mate with standard Army-Navy type $UG\ 21\ B/U$ and $UG\ 23\ B/U$ couplings, but require special bead supports in each of the mating units in order to give the desired broad band performance.

The cross-section of the "grooved" bead support is shown in Fig. 6A. For the major section of the bead length, S , the ratio of outer to inner diameter is arranged to give the same characteristic impedance for this dielectric filled line as for the standard lossless line. The outer diameter of this bead, however, is greater than the inner diameter of the outer conductor of the casing, resulting in the appearance of field distortion and added lumped capacitance² at the metallic discontinuity in the outer conductor. This is evident from an inspection of Fig. 2. These capacitive discontinuities are responsible for sizeable mismatch in the neighborhood of 10,000 mc. To compensate for this effect, grooved bead sections of thickness, d , acting effectively as inductances, are arranged to cancel the reactance produced by the discontinuity at each end of the bead. The scheme for this cancellation is shown in the admittance locus of Fig. 6B. The discontinuity capacitance represented by the length $Y_0 d$ is cancelled by a short travel, db , in the grooved section which is a transmission line of lower characteristic admittance, Y_1 . The remaining mismatch produced by the admittance Y_a is a very small fraction of the discontinuity susceptance. Since the length, $Y_0 d$, varies linearly with frequency and the length, db , nearly so, this cancellation is very broadband.

Fig. 6C illustrates the bullet used to terminate the attenuator insert. Section ab of this bullet is greater in diameter than the main line in order to permit the metallized-glass to be slipped in and soldered securely. Although the capacitive discontinuity is small, this oversized section represents a line whose characteristic impedance differs from Z_0 , the lossless characteristic impedance of the main line. Hence, a mismatch is introduced

which is especially noticeable at 10,000 mc.

Cancellation of this effect is accomplished by a neighboring reduced diameter section, bc . The admittance locus trace is shown on an exaggerated scale in Fig. 6D. The length of arc ab which is the result of the enlarged section of characteristic admittance Y_1 is cancelled by the length of arc bc resulting from the reduced diameter section of relatively low characteristic admittance Y_2 . This cancellation is also inherently broad band, since the length of traces ab and bc vary in a similar manner as the frequency changes.

The complete mechanical design of an attenuator insert and casing for the frequency band 4,000-10,000 mc. is shown in Fig. 2. The attenuations of the units designed by the procedure outlined in this paper are 3, 6, 10, and 20 db. All inserts fit interchangeably in the casing of Fig. 2.

Figs. 4 and 5 show the experimentally determined attenuation and VSWR characteristics of two of these units. The variation in attenuation for any of the units is less than 0.012 db. per db. of nominal attenuation, per cm. of wavelength band spread. In no case does the VSWR measure more than 1.30 over the entire band. It will be noted that the VSWR curves only

ZOPHAR

**WAXES
COMPOUNDS
and
EMULSIONS**



FOR
INSULATING and WATERPROOFING
of ELECTRICAL and
RADIO COMPONENTS

•

Also for
CONTAINERS and PAPER
IMPREGNATION

•

FUNGUS RESISTANT WAXES

•

ZOPHAR WAXES and COMPOUNDS
Meet all army and navy
specifications if required

•

Inquiries Invited

ZOPHAR MILLS, INC.
FOUNDED 1846
122-26th ST., BROOKLYN, N. Y.

roughly follow the theoretical shape indicated by Figs. 3B and 3D. This is mainly due to the effect of the type N couplings and bullets discussed earlier in this paper. The effect of these components is emphasized at the high frequencies where the VSWR curve shows peak values for all the units.

REFERENCES:

1. Griensmann, J.W.E., "Metallized Film Coaxial Attenuators," a paper presented at the Rochester Fall Meeting of the I.R.E.
2. Whinnery, Jamieson, and Robbins, "Coaxial Line Discontinuities," Proceedings of the I.R.E., Vol. 32, No. 11, Nov. 1944.

Delay Lines

(Continued from page 18)

L_0 and C_0 are determined from a knowledge of the required characteristic impedance, which is equal to $\sqrt{L_0/C_0}$, and the cut-off frequency, which is equal to $0.404/\sqrt{L_0C_0}$. The characteristic impedance of the line is selected so that it matches the circuit in which it is to be used. Where there is an option the characteristic impedance should be made as low as possible. This follows because the lower L is, or conversely the higher C can be made to give a particular $\sqrt{L_0C_0}$ value, the smaller the size and attenuation of the line. For generally the higher L is the greater the size and attenuation of the line, while the value of C , within reasonable limits, has very little effect upon either of these two parameters. Consequently C_0 is made as large as possible being limited, for any given f_0 , by the required characteristic impedance.

The cut-off frequency is determined from the knowledge of the pulse shape. It was shown in a previous article that a "rule of thumb" method for calculating the bandwidth or maximum frequency of a pulse is to set the maximum frequency equal to $1/2t_1$, where t_1 is the build-up time. The cut-off frequency of the network is then set at 1.33 to 2 times $\sqrt[3]{n}$ times the maximum frequency.

To review briefly, the following are the design formulae for an m -derived type of artificial line for $m = 1.275$:

$$\begin{aligned}
 T &= 0.404/f_0 \dots (a) & L_0 &= Z_0/\pi f_0 \dots (b) \\
 C_0 &= 1/\pi f_0 Z_0 \dots (c) & L &= 1.04 L_0 \dots (d) \\
 C &= 1.275 C_0 \dots (e) & M &= 0.013 L_0 \dots (f) \\
 k &= 0.12 \dots (g) & n &= T'/T \dots (h)
 \end{aligned}$$

(25)

where T' is the total delay

From experience, the following procedure has been developed for the design of this type of line.

1. A suitable value of characteristic impedance is chosen, consistent with the circuit requirements.
2. From a knowledge of the pulse shape, for which the line is to be used,

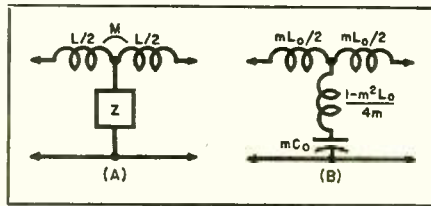

Fig. 8. Single cell of a lumped line which has mutual coupling between successive coils. Takes form of an m -derived filter.

the maximum frequency to be transmitted is determined. The cut-off frequency of a line cell is then taken to be from 1.33 to 2 times this maximum frequency.

3. From the calculated value of f_0 , the delay of one cell of the line is determined by means of Eq. (25a).

4. The number of cells necessary to provide the total delay is found from Eq. (25h). The cut off frequency of each cell must then be multiplied by $\sqrt[3]{n}$. This, of course, reduces T so that additional cells may be required. This process is repeated until a value of f_0 , consistent with bandwidth and total delay requirements, is found.

5. From Eqts. 25, the constants of the line are calculated. Since only standard values of capacitors can be used, the nearest standard value should be chosen, after which revised values of L_0 and Z_0 are calculated.

6. Both ends of the line should be terminated in a half pi section with m equal to 0.6. However, reasonably good termination may be obtained by terminating the ends with capacity equal to $C/2$.

Construction of the Line

For lines having small delay or lines with a low characteristic impedance (less than 1000 ohms), and high cut-off frequency, where physical size is not the prime consideration, the inductive portion may be made up of a single layer, continuously wound solenoid. For longer delays it may be more convenient to make up the inductance in the form of a multilayer coil usually wound in the universal manner.

The formula for the number of turns, N , necessary to provide a given inductance, L , for a single layer solenoid is:

$$N = \left(\frac{42.9L}{a} \right)^{1/2} \dots (26)$$

where L is the inductance per cell in microhenrys and a is the radius of the coil form in inches.

In order to achieve the proper coupling between coils so that k equals 0.12, the condition that l/d equals 1.7 must be satisfied, where l is the length of one cell inductance and d is the diameter of the coil form.

For multilayer coils, the number of turns may be found from:

$$N = \left(\frac{30.8L}{D} \right)^{1/2} \dots (27)$$

where D is the inside diameter of the coil, i.e., the diameter of the rod on which the coils are to be mounted. Both the width and the height of the coil winding should be equal to $D/2$. The number of turns per square inch of coil area may be found in the wire tables given in electrical handbooks.^{3,4} The wire size is chosen from these tables to fit into the required space. If the wire size given is impractical, then the value of D must be changed accordingly.

The coils should be spaced on the supporting rod in such a manner as to make the coupling coefficient between successive coils equal to 0.12. This value may be found by measuring the inductance of one coil with the adjacent one first open circuited, and then short circuited. The spacing is adjusted until:

$$\frac{L_{sc}}{L_{oc}} = 0.986 \dots (28)$$

where L_{sc} is the short circuited inductance and L_{oc} is the open circuited inductance.

When the proper spacing is determined, spacers having a thickness equal to the coupling distance may be made and used as guides for the coils to be mounted on the rod.

Attenuation in Lumped-Constant Delay Lines

The attenuation of a lumped-constant line is not an important parameter as long as the number of cells is not large. However, when the line consists of more than about fifteen cells, the attenuation may become an important factor in the design and operation of the line. Attenuation in a line may be due to several causes, i.e., losses due to wire resistance, losses in the condensers, and losses in the coil core material. At the usual pulse frequencies, the dielectric losses may be neglected, and in fact, for frequencies up to 15 mc., experience indicates that any losses that do occur are nearly entirely due to the d.c. resistance of the wire.

As in Eq. (3), the attenuation is the real part of the propagation constant, and from this we may derive that:

PHOTO CREDITS

Pages	
3.....	Altec Service Corp.
4, 6.....	Tech. Laboratories
5, 21.....	The Daven Company
7.....	Radio Corporation of America
10, 11.....	N. American Philips Co., Inc.
12.....	Polytechnic Inst. of Brooklyn
15 (top, bottom), 16, 17.....	Federal Telecommunication Laboratories
15 (lower top).....	General Electric Co.

$$\alpha = 1.91 \frac{1}{f_0} \left(\sqrt{1 + 1/Q^2} - 1 \right)^{1/2}$$

nepers per cell (29)

where $Q = 1.42 \frac{\omega L_0}{R_{dc}} = \frac{\omega L(1+2k)}{R_{dc}}$

L is the inductance of one cell and R_{dc} is the d.c. resistance of one cell.

The value of Q may be found in terms of the number of turns, N , characteristic impedance, Z_0 , and the cut-off frequency, f_0 , from:

$$Q = 1280 \frac{f_0^3 \sqrt{n} (Z_0/f_0)}{R_n} \dots \dots \dots (30)$$

where R_n is the resistance per 1000 feet of wire.

If Q is large compared to 1, which is usually the case, then Eq. (29) reduces to:

$$\alpha = 0.00106 \frac{R_n}{\sqrt{N} (Z_0 f_0^2)} \dots \dots \dots (31)$$

From this equation it can be seen that at high frequencies, where Q is large, the attenuation is constant and depends upon the wire size used.

In designing the line, a cut-and-try method is used. The values of L and C are calculated, after which a size of wire is chosen to fit the required physical dimensions of the line. The attenuation of the line is then calculated. If it is excessive, a larger wire size is chosen. To use this wire, the physical dimensions, characteristic impedance, or cut-off frequency must be changed to be consistent with the other electrical requirements of the line.

Supersonic Delay Lines

At the present time, pulse delays greater than 100 microseconds are difficult to obtain by purely electrical circuits because of the large physical size that such a line assumes. It is conceivable, however, that improvements in high dielectric materials will make the development of such long delay lines practical.

An alternative method of obtaining long delays is to transform the electrical pulse into a supersonic wave, in the form of compressional vibrations, which travels through the medium with a relatively low velocity. The delay per unit length of the medium will thereupon be relatively high.

The velocity of propagation of a supersonic wave is given by:

$$v = \sqrt{E/P} \dots \dots \dots (32)$$

where E is the Young's modulus of the medium, and P is the density of the medium.

It should be noted that an analogy exists between the electrical and acoustical lines with the inductance and capacitance being replaced by the reciprocal of Young's modulus and the density.

The acoustical lines are also analogous to the electrical ones in that the same parameters are of importance, i.e., delay time, characteristic impedance, attenuation and cut-off frequency. Unfortunately this art has not progressed to the point where complete design equations have been evolved and frequently a cut-and-try method provides the best approach.

A supersonic delay line consists of a transducer, which converts the electrical energy to acoustical energy, a medium through which the compressional vibrations travel, and another transducer which reconverts the acoustical energy to electrical energy. As may be expected, the maximum conversion efficiency is obtained when the transducer impedance matches the line impedance.

There are a number of transducers and mediums that can be used. The most common of these is the mercury-quartz combination in which the quartz transducer has a high acoustical impedance approximately equal to the mercury medium. Consequently adequate coupling is readily obtained.

The time delay of mercury lines is given by the following expression:

$$T = (17.42 + 0.0052 \text{ } ^\circ\text{C}) \text{ microsec./in.} \quad (33)$$

where $^\circ\text{C}$ is the temperature of the mercury in $^\circ\text{C}$, so that at 20°C ., the delay per inch of a mercury line is 17.52 microseconds. The variation of delay with temperature may be objectionable in some applications, in which case the mercury lines must be kept at a constant temperature by carefully controlled thermal devices.

The theoretical determination of the attenuation of mercury lines cannot be readily made since the causes of this attenuation are not completely understood. It is known, however, that the losses due to the medium alone increase as the square of the frequency. In addition, there are other effects such as the "wall effect" which increases the attenuation as the square root of frequency and inversely as the diameter of the mercury tube. In a typical 0.25" diameter mercury delay line, the attenuation is .27 nepers per foot.

The line is so constructed as to avoid reflections at the ends. This is achieved by inserting a material such as lead or ceramic at the ends of the tube containing the mercury (behind the quartz plates).

The disadvantage of mercury lines lies in the fact that an elaborate construction is necessary, and once constructed only a single value of delay may be obtained from it; that is, it cannot be tapped or shortened. Recent investigation into the use of magnetostrictive effects, i.e., contraction and

expansion of a metallic rod in accordance with a voltage applied across a coil surrounding the rod, for obtaining supersonic waves, indicates that this type of line may be more flexible. The delay of these lines can be adjusted to suit individual applications and may be tapped with ease.

BIBLIOGRAPHY

1. Moskowitz and Racker, "Pulse Amplifier Design," *Radio-Electronic Engineering* Feb. 1948, p. 14.
2. Moskowitz and Racker, "Pulse Shaping Circuits," *Radio-Electronic Engineering* March, 1948, p. 14.
3. Henney, K., "The Radio Engineering Handbook," McGraw-Hill, 1941, p. 10-13.
4. "Reference Data for Radio Engineers," Federal Telephone and Radio Corporation, 1946, p. 35, 126.
5. Moskowitz and Racker, "Pulse Techniques," *Radio-Electronic Engineering*, Jan. 1948, p. 7.
6. Saarbacher and Edson, "Hyper and Ultrahigh Frequency Engineering," John Wiley and Sons, 1944, p. 328.
7. King, Mimno, and Wing, "Transmission Lines, Antennas, and Wave Guides," McGraw-Hill Book Company, 1945, p. 13.
8. Terman, T. E., "Radio Engineers Handbook," McGraw-Hill Book Company, 1943, p. 175, 227.
9. Sharpless, T. K., "Design of Mercury Delay Lines," *Electronics*, Nov. 1947, p. 134.
10. Ridenour, L. N., "Radar Systems Engineering," McGraw-Hill Book Company, 1947, p. 667.
11. Grieg and Moskowitz, "Pulse Time Multiplex Broadcasting on V.H.F.," *Proc. of N.E.C.*, vol. 2, Oct. 1946.
12. Grieg and Racker, "Microwave Radio Links," *Signals*, Nov. 1947, p. 5.
13. Zimmermann, K. H., "Spiral Delay Lines," *Electrical Communications*, Sept. 1946, p. 327.
14. Blewett and Rubel, "Video Delay Lines," *Proc. IRE*, Dec. 1947, p. 1580.
15. DiToro, M. J., "Phase and Amplitude Distortion in Linear Networks," *Proc. IRE*, Jan. 1948, p. 24.

STOP THAT THIEF BEFORE HE STEALS!

ELECTRONIC RADIO ALARM



PROTECTS—Your Home, Factory, Warehouse, Barn, Fur Vault, Jewelry Displays, Filing Cabinets, Safes, Valuable Papers. Detects intrusion, fire, trespassing. Proven effective for over 15 years. Works on a foolproof capacity principle when protected area is approached. Used by Government agencies Service Stations, Offices, Industrial plants, Homes. Can easily be installed by any electrician or radio service man. Write for complete descriptive bulletin



1904 LINCOLN-LIBERTY BLDG.
PHILADELPHIA 7, PENNA.

An Answer to Your Needs!

RADIO TEST INSTRUMENTS

by Rufus P. Turner

Consulting Engineer, RADIO NEWS

REVISED EDITION
NOW AVAILABLE!

TELLS HOW TO CONSTRUCT, CALIBRATE, AND USE ELECTRONIC AND RADIO TEST EQUIPMENT

This well illustrated and practical manual will be an asset to any radio man's service library. It shows how to build, how to properly calibrate, how to use dozens of different types of radio and electronic testing devices. It covers briefly the theoretical explanation of radio, but only to make sure the reader first understands electrical and radio theory. The major portion of the book is devoted to technical data, which is presented in clear, understandable language. An ideal text for the practical radio man and a *must* for the radio serviceman.

Graphically Illustrated

Included are 182 informative illustrations—diagrams, charts, tables, and photographs—carefully chosen by the author to illustrate his sixteen chapters. RADIO TEST INSTRUMENTS is a unique presentation of a culmination of the author's own practices and applications. He has constructed and calibrated, tested and built, each piece of equipment described. And he shows how you can build and use these test instruments.

Covers Fully All These Test Instruments

- Multipliers
- Resistors
- Multi-Range Voltmeters
- Multi-Range Ammeters
- Ohmmeters
- Ultra-High-Resistance Meg-ohmmeters
- Volt-Ohm-Milliammeters
- Wattmeters
- Vacuum-Tube Voltmeters
- Decibel Meters
- Bridge-Type Impedance Meters
- Direct-Reading Impedance Meters
- Simple Capacitor Checkers
- Compact Capacitor Checkers
- Simple Coil Checkers
- Substitution-Type Capacitance Checkers
- Resonant Inductometers
- Precision Resistance Bridge
- High-Gain Null Detectors
- Oscilloscopes
- R.F. Test Oscillators
- and many others

Price \$4.50. Use convenient coupon with full return privilege

ZIFF-DAVIS PUBLISHING COMPANY
185 North Wabash Avenue, Chicago 1, Ill.

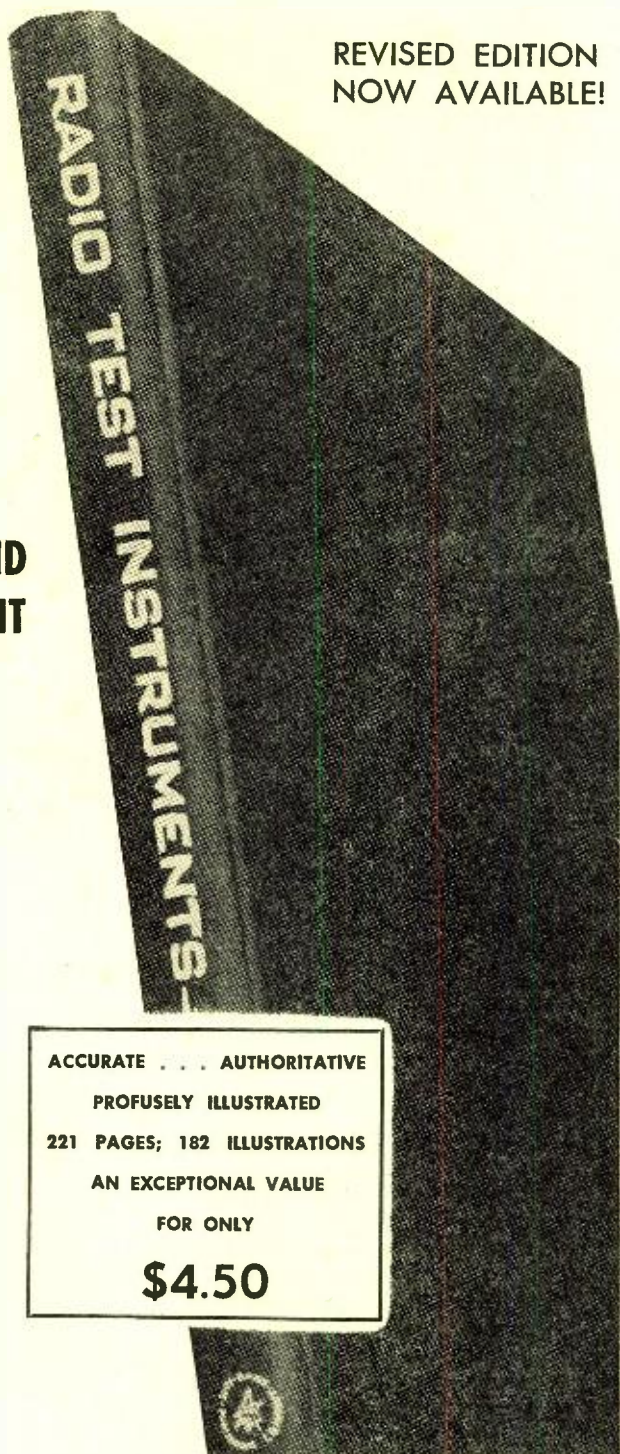

ACCURATE . . . AUTHORITY
 PROFUSELY ILLUSTRATED
 221 PAGES; 182 ILLUSTRATIONS
 AN EXCEPTIONAL VALUE
 FOR ONLY
\$4.50

MAIL THIS COUPON TODAY

Ziff-Davis Publishing Company, Dept. REE
 185 North Wabash Ave., Chicago 1, Ill.

I am enclosing \$4.50 (check or money order) for which please send me one copy of RADIO TEST INSTRUMENTS. I understand that I may return book within five days for full refund if I am not entirely pleased.

Name

Address

City State

Now! BIG RECEIVER QUALITY IN THE LOW-PRICED FIELD!!



THE NEW
NATIONAL
NC-33
\$65⁹⁵
AMATEUR NET

Here's the receiver you've been waiting for! A real communication receiver covering all frequencies from 500 kcs to 35 mcs, the brand new NC-33 offers the same fine workmanship that distinguishes National's more expensive receivers. Dollar for dollar, feature for feature, it's better built, better looking, better performing! See it — compare it — today at your dealer's. You'll decide it's the perfect choice for your shack, living room, playroom or den!

- Operates from 110-120 volts AC or DC. Ideal for shipboard and other uses where DC only is available.
- Electrical bandspread on all bands! Broadcast, amateur, police and foreign bands plainly marked.
- Automatic noise limiter assures optimum reception under all operating conditions.
- CW oscillator with pitch control provides superb CW reception.
- Lightweight — easy to carry.

TO FIND YOUR NEAREST NATIONAL DEALER SEE THE CLASSIFIED SECTION OF YOUR 'PHONE BOOK

FREE! Big New 1948 National Catalog!



NATIONAL COMPANY, Inc.
MALDEN, MASSACHUSETTS

NATIONAL COMPANY, Inc.
61 Sherman St., Malden 48, Mass.

Gentlemen: Please send me your new 1948 catalog of National receivers, components and parts.

NAME

STREET

CITY ZONE STATE

SELECT from the

Techniquality

GROUP



Bliley CRYSTALS

Many Bliley crystal units are first produced on a custom-built basis for special application. Quite often these designs contain outstanding features that are desirable in many applications and when this occurs the unit is included in our catalog listing. Our Bulletin 36 contains 22 standard crystal units, all widely used in commercial and governmental applications.

Bliley engineers are constantly utilizing

our many years of specialized experience to solve new frequency control problems. If you have a frequency control application, whether standard or specialized, we can probably come up with the right answer. Remember to specify Bliley TECHNICALITY crystals for greater accuracy, stability, quality, and advance design.

WRITE FOR YOUR COPY OF BULLETIN 36

BLILEY ELECTRIC COMPANY • UNION STATION BUILDING • ERIE, PENNSYLVANIA

Speakers
that mean
business...
FOR YOU!



TELEPHONE CHERRY 8873
The Drive-In Theatre Equipment Company, Inc.
Manufacturers of NATIONAL AUTO VOICE In-car Speaker Units

2110 2130 SUPERIOR AVENUE
CLEVELAND 14, OHIO

January 20, 1948

Mr. R. S. Fenton, Sales Manager
Parts Section, Receiver Division
Electronics Department
General Electric Company
1001 Wolf Street
Syracuse, New York

Dear Mr. Fenton:

We would like at this time to express our appreciation for your expeditious handling of our recent rush order for 5 $\frac{1}{4}$ " PM Speakers.

The speakers used in the Drive-In Theatre in-car units must meet more rigid standards than those ordinarily required commercially. The Drive-In Speaker is subjected to the most adverse weather conditions, and must be able to stand up over a period of years without appreciable impairment of its electrical characteristics. The voice coil form, and the cone proper, must be impervious to moisture or direct rainfall.

It may be of interest to you to know that after a survey of the speaker field, we chose the GE Speaker as the one best able to meet our exacting requirements. The aluminum voice coil form is ideal for our work, since there is no danger of expansion due to moisture absorption. The speakers met Navy type tests such as shock, vibration, temperature, salt spray, and frequency response requirements.

Since standardizing on GE speakers, our customer reaction has been entirely satisfactory.

Very truly yours,
DRIVE-IN THEATRE EQUIPMENT CO., INC.

E. B. Brady

President

THE LETTER reproduced here speaks for itself and —G-E Speakers. The superb engineering which makes this speaker ideal for outdoor use, also makes it ideal for replacement in home receivers, where widely varying conditions of dryness and humidity affect speaker performance.

Here is an opportunity to develop the speaker replacement market to its fullest extent and push the outdoor theatre market.

G-E Speakers are competitively priced—and in quality they are outstanding. Build speaker business now. Send us your order.

For complete information write:
General Electric Company, Electronics Department,
Electronics Park, Syracuse, New York.

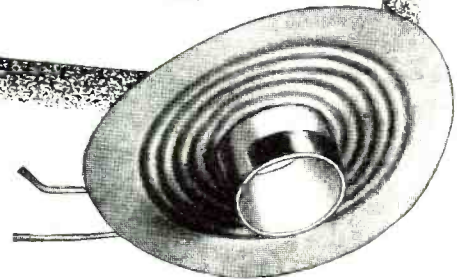

ALUMINUM FOIL BASE
VOICE COIL



GENERAL  **ELECTRIC**
169-02

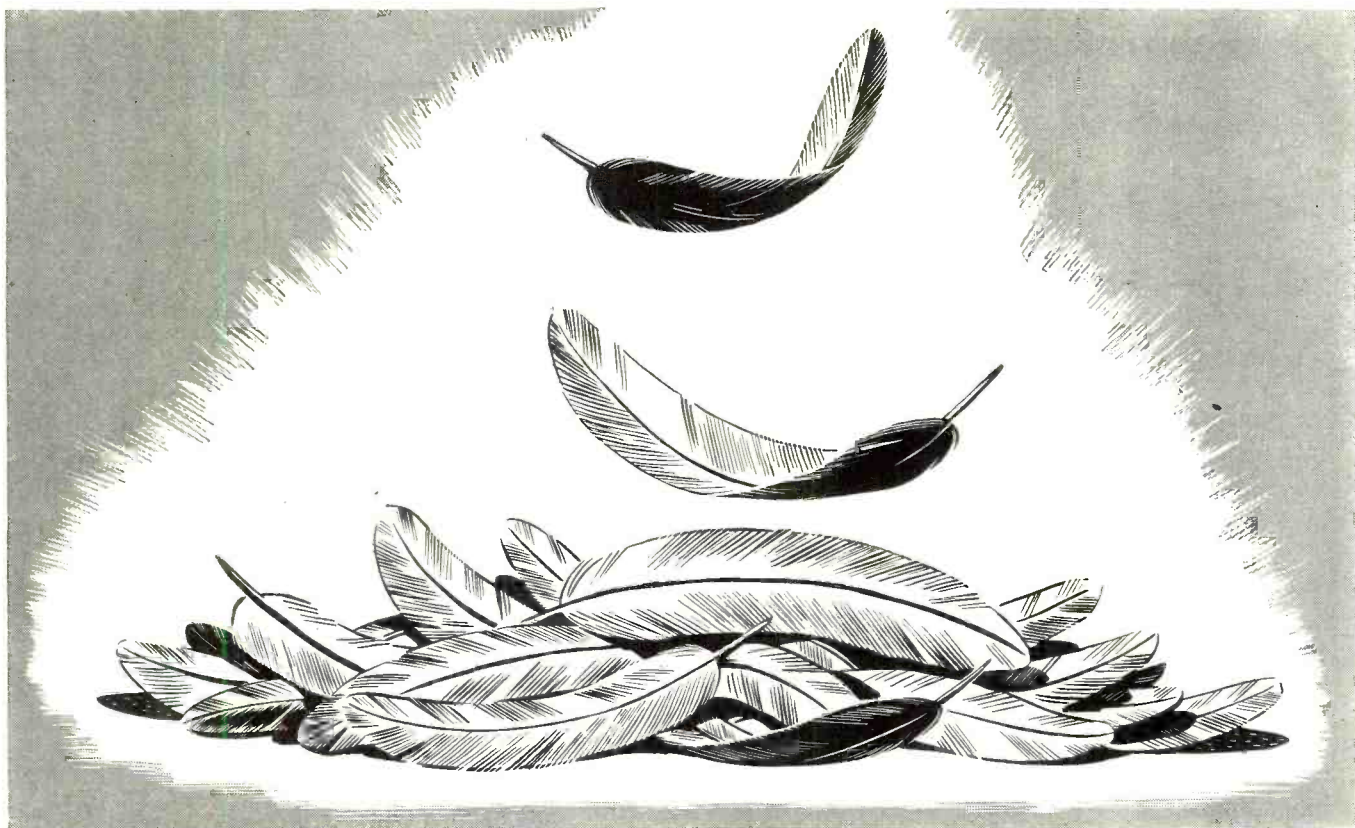

Quiet

Reputation is built alone through continued supremacy. Of the many points that help to make Radiart VIBRATORS the leader in the field, the factor of quiet, noiseless operation has reached a new point of perfection because of recent engineering developments. Here is vibrator operation at its best! Servicemen everywhere depend on the engineering skill of Radiart to serve their customers interests best. They know Radiart is always correct, electrically and mechanically for each recommended application.

It Costs No More To Get A Red Seal VIBRATOR, Radiart Includes This Important Feature . . . At Regular Low Prices

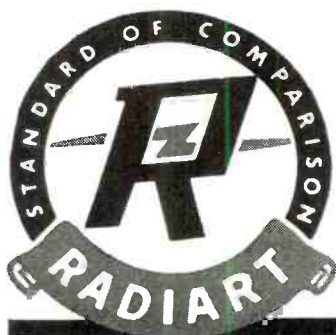

The Radiart Corp.

CLEVELAND 2, OHIO

RADIO CONTROLLED MODEL SAILBOAT



Fig. 1. Fastening antenna in position. The control unit transmitter is shown in the foreground.

By R. C. SCHMIDT, W1VDY, and
L. A. WILLIAMS
Raytheon Manufacturing Company

**Two channel operation, 51 and 53 megacycles,
provides complete 180 degree rudder control.**

SIMPLICITY is the keynote in the design of any piece of radio remote control equipment for model boats or aircraft, because light weight, low battery consumption, troublefree operation, and low cost, all hinge upon this factor.

In the radio control of the model sailboat described here, the necessary control operations are solely those of turning the rudder either to left or right at will, this operation being performed by a small permanent magnet reversible electric motor and suitable gear train. The remote radio link

must, therefore, either carry two intelligence channels or alternatively, a single channel could be used to alternately select one and then the other control operation. This "selector" system or single channel control can be made to accommodate a larger number of control operations. However, since the operations occur in a fixed sequence, it is at times a very slow and unwieldy method of control. Also, it is quite common for the receiving equipment to get out of sequence with the remote transmitter; thus some form of repositioning of the

selector is necessary in the selector system, which usually boils down to another intelligence channel. For this reason a system was chosen using two separate radio channels.

The boat used for this experiment is a "Class A" type. The hull is of mahogany planked construction with a length of 6 ft. and a beam of 14 inches. The single mast is about 8 ft. in length.

Receiver

The receiving equipment consists of two single tube receivers using Raytheon type RK61 tubes operating in the 50-54 mc. amateur band. The RK61 is a subminiature version of the prewar RK62. This tube operates in a simple superregenerative circuit, and has a small relay in its plate cir-

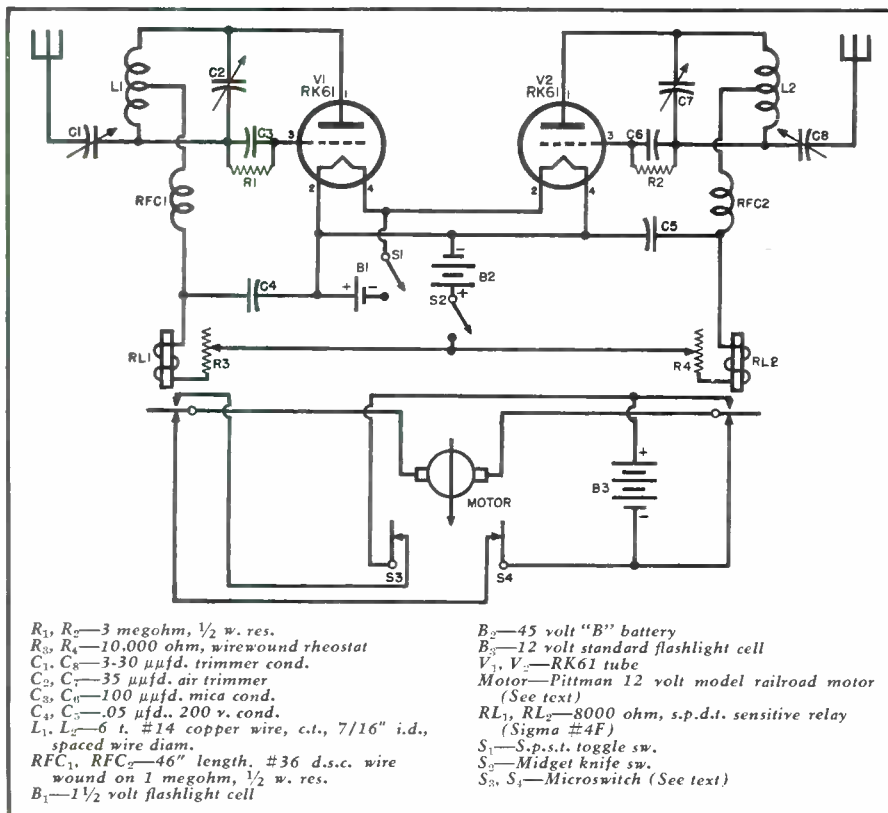

Fig. 2. Schematic diagram of receiver. Two superregenerative receivers are used as a means of reversing motor. These receivers operate on different channels.

cuit. Plate current under "the no received signal" condition is 1.5 ma., and triggers to 0.5 ma. or less depending upon signal strength. The plate circuit relay must therefore operate within this range of plate current change. The *Sigma* model 4F relay usually serves adequately here. This relay has an 8000 ohm coil, and can be adjusted to operate on as little as 0.2 ma. current change. With some

tubes the optimum relay resistance may be as low as 5000 ohms.

As regards power supply, the RK61 receiver is very economical, requiring only 1.5 volts at 50 ma. each for filament supply, and 45 volts at 1.5 ma. for the plate.

Rudder Control Mechanism

The motor used is a *Pittman* 12 volt d.c., 6000 r.p.m. model railroad

type, which can be obtained at any hobby craft store. It draws about .3 to .4 amp. under full load. In order to assure easy operation, a 3000 to 1 gear reduction was used. In length of time with the motor operating under load, the rudder may be shifted from full left to full right in about 15 seconds.

There are many ways of applying this control. The main purpose was to find a simple, positive, and variable mechanism which would be practically foolproof. The complete mechanism may be placed under the deck or above deck. The reason for placing the mechanism above deck in this case was to save hull damage in case of bad operation. The unit is enclosed in a watertight metal box with all operating parts inside (see Fig. 3). It was only necessary to drill one hole in the deck to allow for wiring. Using this method, the rudder can be moved to any position up to 90° left or right from the neutral or center point.

By the use of 2 microswitches (S_1, S_4 , Fig. 2) for limit switches the rudder cannot move beyond the 90° position.

Circuit and Construction Details

Fig. 2 includes the circuit of the receiver and associated motor drive for the rudder. The receivers are mounted on a piece of lucite which fits flush with the hatch. The tuning condensers, C_2, C_1 , and plate current adjustment resistors, R_3, R_4 are brought out through the top, along with midget knife switch S_2 . This switch affords a convenient means of inserting a 5 or 10 ma. current meter in the plate circuit for tuning purposes. The photograph of Fig. 4 shows the arrangement of component parts below decks. The sensitive relays were bolted to the metal back

Fig. 3. Aligning receiver. A 0-5 or a 0-10 milliammeter is clipped across the open knife switch (S_2) for tuning the unit.

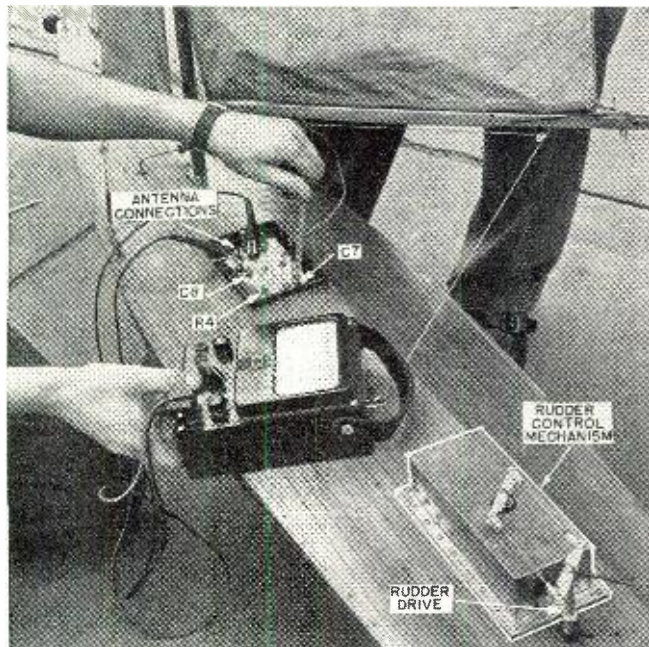
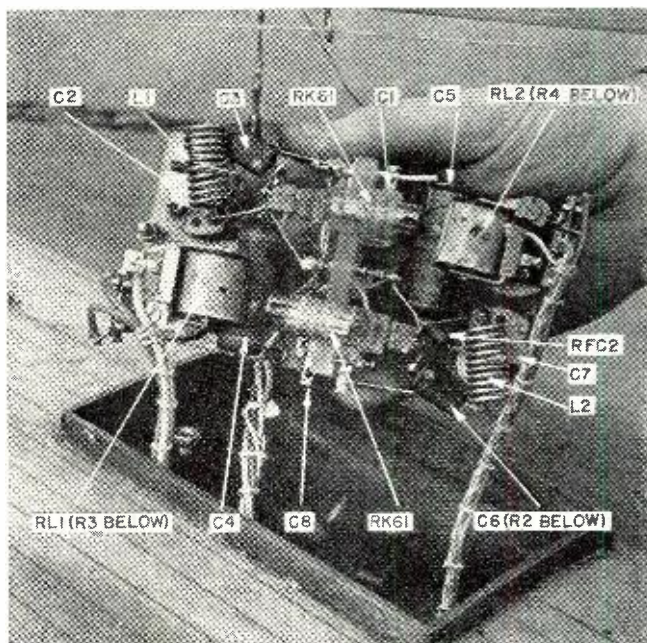

Fig. 4. Under chassis view of receiver. The two sensitive relays are mounted atop the metal covers of rheostats R, R.



covers of the control rheostats to conserve space. The RK61's are mounted horizontally in a cradle also made of lucite, and are held in place with rubber bands. The tubes have 2 inch tinned leads which may be used to wire them directly into the circuit if space is at a premium or the leads may be trimmed to 3/16" and plugged into subminiature tube sockets which are available. From the tube replacement angle, the use of sockets is better.

Connections from the receiver are cabled and brought to a common terminal board mounted in the bottom of the hull, as are all the leads from batteries, motor, and the limit switches on the motor. The limit switches, S_2 , S_1 serve to open the motor circuit when the rudder has reached the limit of its travel in either direction.

The transmitter consists of a very simple push-pull oscillator using two 957 acorn tubes with 1.5 volts on the filaments from two paralleled intermediate size flashlight cells. The plate supply is a pair of 67½ volt "B" batteries of the type used in portable broadcast radios. The complete transmitter unit is housed in an aluminum box 4½" x 4½" x 10". The control switch S_1 is a single-gang, 2-circuit, 3-position rotary switch. This switch, when turned to the left of center, connects the filaments only. When turned to the right of center, it powers the filaments, and also cuts in the padding condenser, C_1 , thus obtaining the second control channel frequency. In the interests of simplicity, it was decided to switch the filament circuit only for turning the transmitter off and on to either channel. The short time delay while the tubes are warming is unnoticeable for practical operation in this type of application. However, a separate filament switch with S_1 in the plate lead would be satisfactory also.

The photo, Fig. 6, is an internal view of the transmitter. A small subchassis partitions the batteries, and mounts the transmitter circuit components. The 957 sockets are mounted back-to-back and in a vertical position. The condensers, C_1 and C_2 , are mounted on a pillar-supported piece of lucite, so that they can be tuned from the top of the transmitter box through two appropriate holes. The quarter-wave whip antenna plugs into a feedthrough insulator also located in the top of the box.

In tuning the transmitter, S_1 is turned so that C_1 is *not* connected. Then C_2 is tuned to the *high* frequency control channel, i.e., approximately 53 mc. Then, switching over to the position which includes C_1 in the circuit, C_1 is tuned for the *low* frequency channel at 51 mc. It has been found more convenient to set the transmitter just once, and make subsequent tuning adjustments on the two receivers. Thus, having once set the transmitter well within the band, there will be no

(Continued on page 176)

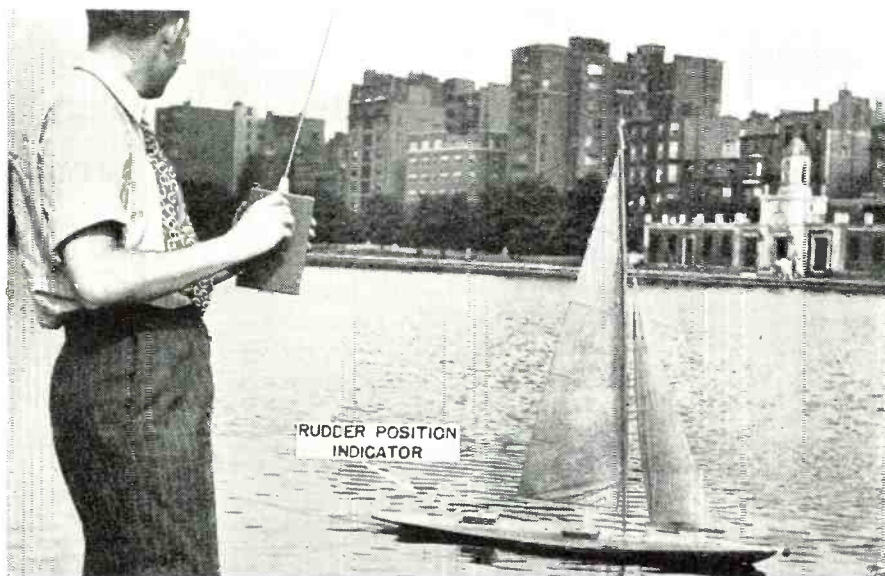

Fig. 5. "Coming about"—Boston's Back Bay section is the backdrop for this demonstration. The rudder position indicator should be visible to the operator at all times.

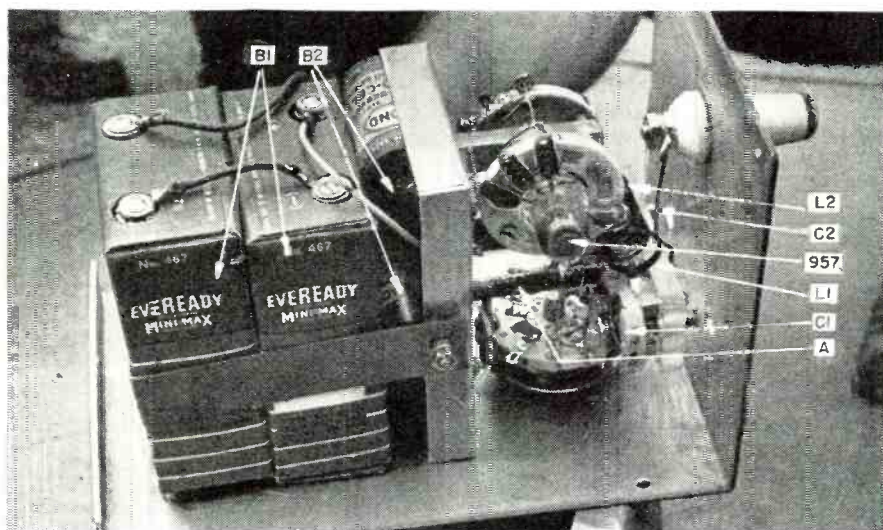
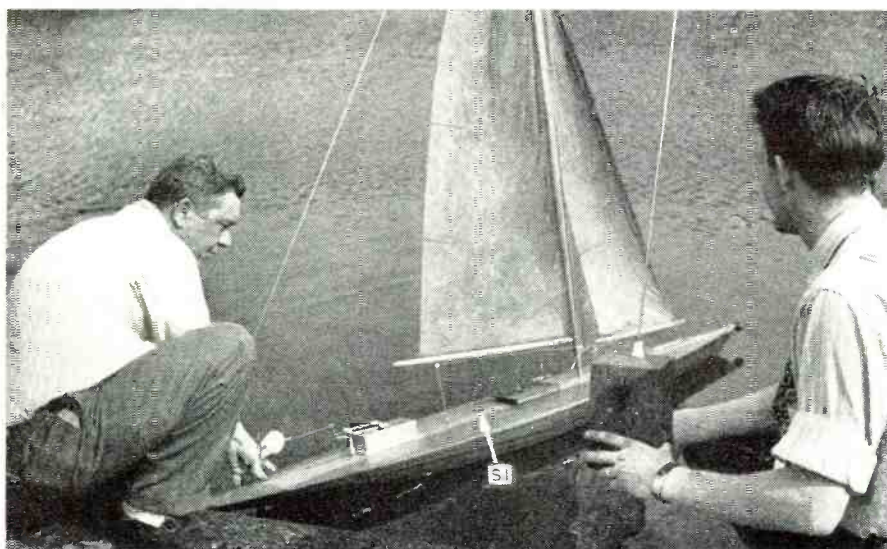

Fig. 6. Internal view of transmitter control unit. Condensers C_1 and C_2 are mounted on a polystyrene bracket supported from the subchassis by a metal rod, A .

Fig. 7. Boat carries 500 sq. in. of sail to conform with "Class A" racing standards.



MONEY—What You Need And How To Get It*

By R. W. PITMAN

Pres., The Charter Bank of Philadelphia

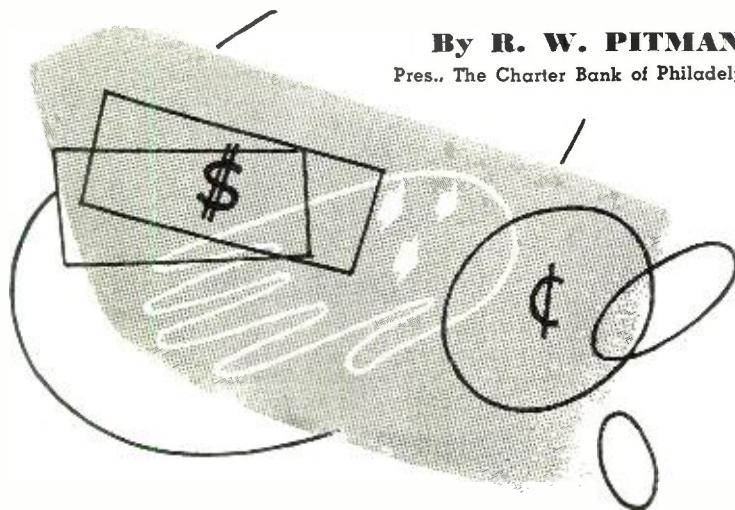

Bank credit plays an important role in your business success. Investigate the possibilities of using this service.

NOT being possessed of Aladdin's lamp, I want to confess immediately that I don't know how much money you need, and I certainly can't tell you how to get it, even if I did know how much you need. If I were possessed of such knowledge, I would apply it to my own personal use and probably would be in Florida now, instead of in Philadelphia talking to you.

In fact, I have always been impatient of these experts who visit me and explain how "intelligent" management will improve my financial condition. That "intelligence" usually means that I should buy something they have for sale. I become impatient because investigation usually indicates that they, themselves, are frequently financially worse off than I am, if that is possible.

Without previous approval from your Committee, therefore, I will take the liberty of changing the title of my remarks to "BANK CREDIT—HOW TO BUILD IT—HOW TO USE IT—AND HOW TO TREAT IT." Now like a good Methodist preacher, having stated my text, I will proceed to pay little attention to it.

During my nearly 30 years in the banking business, I have seen a number of our large industries grow from infancy to maturity, and I have seen the pioneers in those businesses who had imagination and courage grow with the industry. I have seen too many of those pioneers, however, without imagination and without courage

fall far behind the industry and finally lose out entirely.

Take the automobile industry. Many successful dealers, distributors, and factory executives today were the fellows who, 30 years ago, opened up a shop to tinker with these new contraptions in the hopes that when the toy of luxury became the necessity of today, they would be an integral part of that growth, with profit to themselves. More frequently they did not succeed because, along with their inventive genius and curiosity which attracted them to this horseless carriage, they did not have the business ability necessary to finance their growth. Nor did they have the imagination which would cause them to employ in their business the knowledge and use of financing which is a condition precedent to the growth of any business.

I have seen the same things happen, and so have you, in the early development of radio stations, the electric appliance business (such as refrigerators, washing machines, etc.), the farm implement business and, going way back, the sewing machine business—all durable goods which can only be manufactured in quantity and sold in quantity (which means service in volume) through the use of sound banking as a fixed and important part of the business.

You and I also have seen "grease

* Our thanks to Howard Browning for permission to reproduce this speech which was originally presented at the "Town Meeting of Radio Technicians" held at the Bellevue-Stratford Hotel in Philadelphia.

monkeys" with one truck develop an interstate trucking business as large as a small railroad. Too many of their companies, however, have fallen by the wayside because of their inability to envisage the essentiality of sound bookkeeping and bank credit in the growth of their business.

It seems to me that you people here today are on the ground floor of an industry which has a future potential as great or greater than most of those I have enumerated. How to keep apace with that development from a banker's viewpoint is something that we might consider for a few minutes.

In the first place, don't ever forget that the banker is as anxious to do business with you as you are to do business with him. He has money to sell just as you have service to sell. If he doesn't lend money, he can't stay in business any more than you can stay in business if you don't have customers.

Don't let the marble fronts and barred windows of banks frighten you. The banker does that to emphasize security and safety in order to attract depositors who furnish him with his raw material which is money. When you talk to your banker, get on a personal basis with him just as fast as you can. Don't withhold any of your money problems any more than you would withhold pertinent matters from your doctor, lawyer, or priest. Frequently you will find that he can advise you from his varied experience in watching other people make mistakes as well as successes, and give you information sometimes more valuable than any loan he might make to you.

Keep in mind that he is the trustee for the funds of other people—many times the lifelong savings of other people. When he tells you he can't serve you, keep in mind that he is turning away a customer who might make him money, but he is doing so because it is, in his opinion, (1) not good for you, or (2) not good for the investment of the funds which have been entrusted to him.

A banker wants to know three things before he lends you money. They are; (1) can you pay?, (2) will you pay?, and (3) can he make you pay? Let's take them up in order:

Can you pay?—In seeking an answer to this question, he wants to know just what your experience and technical ability are in your particular kind of business. He wants to know what volume of business you do and what profit you make in this business. He wants to know what sort of an employee organization you have and whether or not your customers are satisfied people. In other words, do you deliver a service which will react to your profit? If you are in the merchandising business, merchandising a concrete commodity rather than a type of service, he wants to know the source of supply, whether it is steady or not, and whether your suppliers are satisfied to do business with you.

(Continued on page 161)

HIGH FIDELITY-

Too Much Confusion Too Little Clarification

By **HARRY W. BECKER**

Chief Eng., Electronic Sound Eng. Co.

How would you define "high fidelity," "wide frequency range," and "tone quality"—are they synonymous or does each have its own connotation?

WITH so much debate and controversy raging around "high fidelity," "wide frequency range" and "tone quality," it is high time that the radio industry and the audio engineering profession carefully orient their thinking and talking about these terms. Clear definitions of meaning and function are a crying need today, because "high fidelity," "wide frequency range," and "tone quality" have now become part of our language; their misuse and misinterpretation reflect adversely on the radio industry and on audio engineers.

Popular opinion tends to interrelate the three attributes, assuming a double dose of, say, high fidelity will improve the most ordinary receiver or record player and a triple dose of the three will produce results paralleling nothing less than Gabriel's horn. Manufacturers and dealers have done little to correct such a belief, assuming that it is incorrect.

Much of the widespread confusion has arisen from irresponsible bandying of these terms by manufacturers and dealers in their consumer advertising. The listening and buying public is not only confused but also disillusioned as to the possibilities of ever owning a set that lives up to the Shangri-la of sound promised in advertising specifications.

The confusion has led to controversy. Popular writers are accusing the industry of failing to give the public what it wants and deserves in the way of fidelity and quality. Other writers are taking it out on the public, saying the listener doesn't know what he wants to hear and isn't interested at all in wide range listening. All this leaves those in the industry with an important obligation to clarify, define, and explain.

Is there a common denominator in high fidelity, tone quality, and wide frequency range? Let us ask, "What is high fidelity?" Is it quality? Is it wide-range reproduction of the original? Or is it merely faithful reproduction of a good or bad original? Most audio engineers would answer "yes" to the last question, "no" to the two preceding. If the proper definition hinges, as it must, on "faithfulness of reproduction of the original," and this implies no distortion, let us now ask whether "fidelity" and "quality" are synonymous, related, or exist independent of one another.

A moment's thought is sufficient to make it obvious that no matter how faithfully a program is reproduced, a discordant original performance remains much the

same way. So-called "tone quality" depends on the harmonics or overtones issuing forth from the resonant cavity of the originating musical instrument. Under strict laws of nature, for a musical tone to sound pleasing to the ear, the harmonic or overtone must lose strength as it goes up in pitch; or, in other words, the energy per cycle of vibration must decrease as the frequency of vibration increases. In actual practice, musical instruments do not strictly obey this rule. If they did, an oboe would sound like a violin. The characteristic sounds of the various instruments are due to a variance in the strength of these overtone vibrations and are judged either good or bad by the effect of the beats thus produced on the ear. A Stradivarius violin reproduces overtones that give it a distinguished, pleasing tone quality. Unpalatable tone quality in an inferior violin, or in one poorly played, will be unpalatable tone quality when reproduced with high fidelity. This is obvious to any student of the audio processes, but it is so often overlooked by the public. Overlooking this one point has caused as much confusion over high fidelity as anything. Wherever misconceptions on this point occur, whether in the industry or the public, every effort should be made to straighten out the misunderstanding.

What about public disappointment in wide frequency range and more specifically in FM sets? The public was told it would get "quality" in FM. Yet, there are numerous examples of obtaining much better tone quality on AM on a narrower frequency band than on FM with the highly-touted wide frequency range.

The truth of the matter is that wide range reproduction in many cases has not been pleasant from the listener's point of view. The reason for this is simple. A wide range will reproduce the overtones of a musical instrument and make possible easier recognition of the instrument, assuming the reproducing system has virtually no distortion. However, radio manufacturers have not as yet made available to the public sets capable of reproducing a wide frequency range and maintaining tone quality at the same time. In the future when sets of this type are available, we will have true high fidelity.

In many cases, the original is quality. The tonal balance is perfect, the distribution of energy is proper, the effect is pleasing, and yet the reproduction is a distinct disappointment.

(Continued on page 164)

The APS-42 RADAR

Design and operational features of a new type radar unit. It is compact, light in weight, and excels all other airborne equipment.

By

L. W. MALLACH

Project Eng., The Houston Corp.

flight while triggering and receiving a beacon.

For obstacle detection, this radar transmits a pencil beam approximately six degrees vertically and horizontally in the approximate plane of the aircraft. This is useful for detecting the position of any reflected object within the swept pattern, particularly mountains and other aircraft.

Of considerable importance, too, is the fact that the equipment also may be used for detecting areas of heavy moisture content and the accompanying turbulent areas with which they may be associated. For this service, a 2.2 microsecond pulse with a pencil beam is transmitted.

Of the two experimental units completed, one has gone to the All Weather Flying Squadron, the other to the Aircraft Radio Laboratory—both at Wright Field—for in-service testing. A total of 107 production units now are being manufactured for the Navy, for assignment to planes flown by NATS.

Tests so far indicate substantial fulfillment of the design objectives for transport-type radar navigation equipment. Problems involved consisted basically of evaluating the functions of wartime airborne radar which would seem more useful for air transport uses.

Among the functions studied were the bombing type radar's ability to map large land areas, the fighter radar's ability to detect other aircraft in the vicinity, and the paratrooper's radar equipment used for beacon navigation and more-or-less precise navigation of uncharted areas.

In looking over the field of wartime equipment, it became evident that the radar best suited for commercial use was the APS-10. But serious disadvantages were inherent. Accordingly, it was decided to utilize basic design, and add other desirable radar features, together with operational simplification and antenna stabilization.

Final design, as evolved by *The*

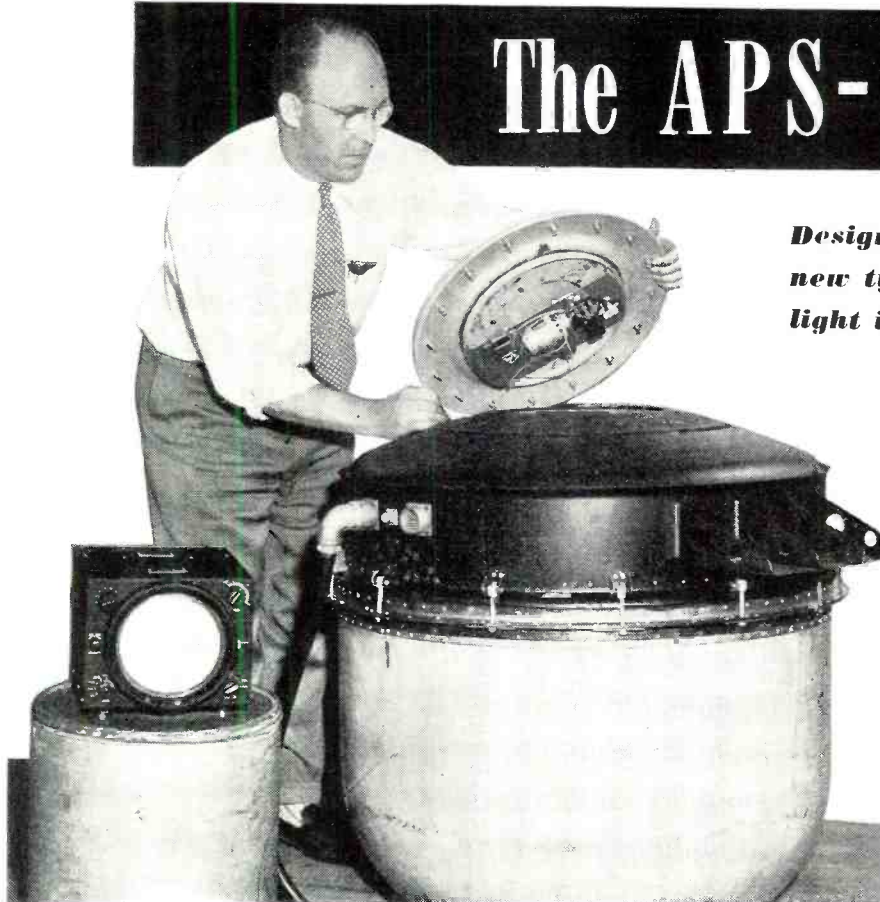

Transmitter-receiver and antenna are carried in this pressurized container made of spun magnesium and laminated fiber glass. Single cable connects unit to scope shown at left.

THIS outfit doubles the range of the well-known wartime APS-10. It weighs only 115 pounds, involves only two units, and for flexibility of operation surpasses any radar yet airborne. It is an X-band navigational radar equipment complete within itself, and provides radar mapping, responder beacon operations, obstacle detection, and weather mapping. The Army Air Forces call it the AN/APS-42 (XA-2). It is intended for service in both military and commercial aircraft, preferably in a chin or belly location. In both positions it will furnish a nominal 360° scan.

For mapping, the equipment supplies an approximate cosecant-squared pattern from the antenna, for use in mapping areas adjacent to the path of flight, to show contours and type of terrain traversed.

In responder beacon operation, it transmits a 2.2 microsecond pulse and receives on a frequency of 9310 megacycles, with automatic frequency control for picking up signals from transponder type beacons operating in this band. The antenna utilizes a cosecant-squared pattern for beacon operation to minimize any differences in altitude of the aircraft or angle of

Top view of transmitter-receiver. Gyroscope and motors keep unit approximately level during flight.



Signals and echoes flow out and in through this short radar antenna and parabolic reflector.

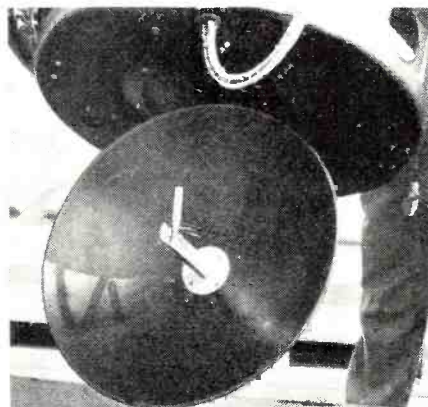

Houston Corporation on AAF contract, includes these principal features; low over-all weight; compactness; flexibility of operation, as noted in the first paragraph; higher power, in order to achieve the results mentioned more easily; stabilization of the antenna to present a better picture regardless of aircraft attitude; simplicity of operation requiring a minimum of pilot-operated controls, and reliability of operation over long periods of time by simplification of adjustments and components.

To accomplish these features, the equipment was designed so that the radar transmitter-receiver and antenna were mounted in one spherical package measuring 33 inches in diameter and 36 inches over-all height. Such a package or unit is suitable for either belly or chin mounting with approximately 21 inches of the cylinder protruding below the aircraft skin with antenna enclosed. This unit is stabilized by an internal arrangement so that the antenna is mounted on gimbal rings with servos providing automatic stabilization for 25 degrees either direction in roll and 20 degrees in pitch.

Inasmuch as the transmitter-receiver is mounted directly over the antenna, the maximum electrical efficiency is achieved through the shortening of the connecting cables. All components required for the operation of the transmitter-receiver-antenna are stabilized and mounted within this package, which is also pressurized by an integral air pressure pump actuated by an automatic pressure switch. By this means, the entire assembly is maintained at sea level pressure up to 30,000 feet, thus providing a minimum of disturbances from high voltage discharges or other high altitude phenomena.

The indicator employed is a standard 7-inch type cathode-ray tube using a PPI type display. This display is, in effect, a polar coordinate map of the surrounding area, with the plane's position being in the center of the tube and the relative angle to other

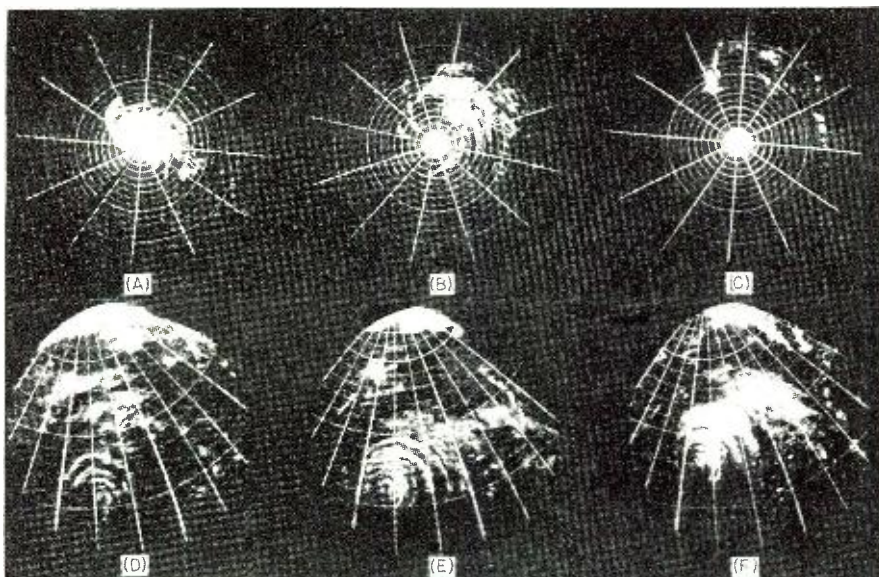

Pictures (A, B, and C) of a hurricane on a radar unit which scans complete circle around the station instead of merely an area in any one direction, as shown in D, E, and F. The storm (A) appears as a great white blob on the radar scope as the hurricane passes almost directly overhead. As the clouds travel northeast (B), the image moves from the center of the scope. In picture C only wisps of clouds remain as the hurricane moves away. Pictures D, E, and F, taken on another type of radar, were made from Army station near Orlando, Florida. In picture D, the center of the storm, at lower left, is bordered by hazy concentric arcs. These are line squalls. Above them other hazy spots are masses of rain clouds. In pictures E and F the hurricane comes closer. Position of radar unit is in the bright area at the top of the photograph.

objects being indicated by the angle in degrees from the top of the tube, the top being the straight-ahead direction.

In order to simplify the operation and make it suitable for the pilot to handle his own radar equipment with a minimum of effort, several controls are mounted on the indicator:

1. A combination "on-off" and "range" switch. In the maximum counter-clockwise position the equipment is "off," while moving the switch to any range position turns the equipment "on." Subsequent operation is automatic after an initial three-minute warm-up time-delay period. The ranges provided are 5, 15, 50, and 150 nautical miles, with five evenly spaced range marks on each range,

together with "range-in-use" lights above the indicator tube.

2. A "function switch." This provides for the versatility of operation of the equipment. The first position is "mapping," which provides for a radiated beam known as cosecant-squared or equal energy; and, as its name implies, it distributes an equal amount of transmitted power to the ground in the immediate vicinity of the ship as well as at the horizon. Therefore, all of the ground contour from immediately ahead of the plane to the horizon is reproduced on the indicator, as a contour map of the surrounding area.

In the next position, "obstacle detection," the antenna pattern is a very narrow or pencil shape beam which is

(Continued on page 178)

Electroform wave guide mixer (duplexer assembly).

Trigger generator and sensitivity time control.

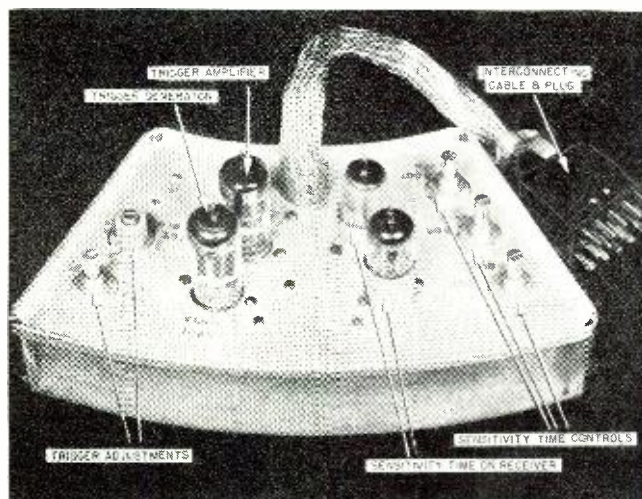
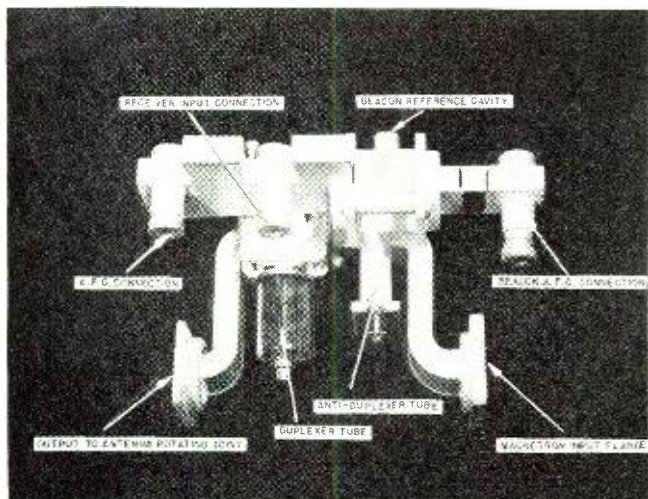

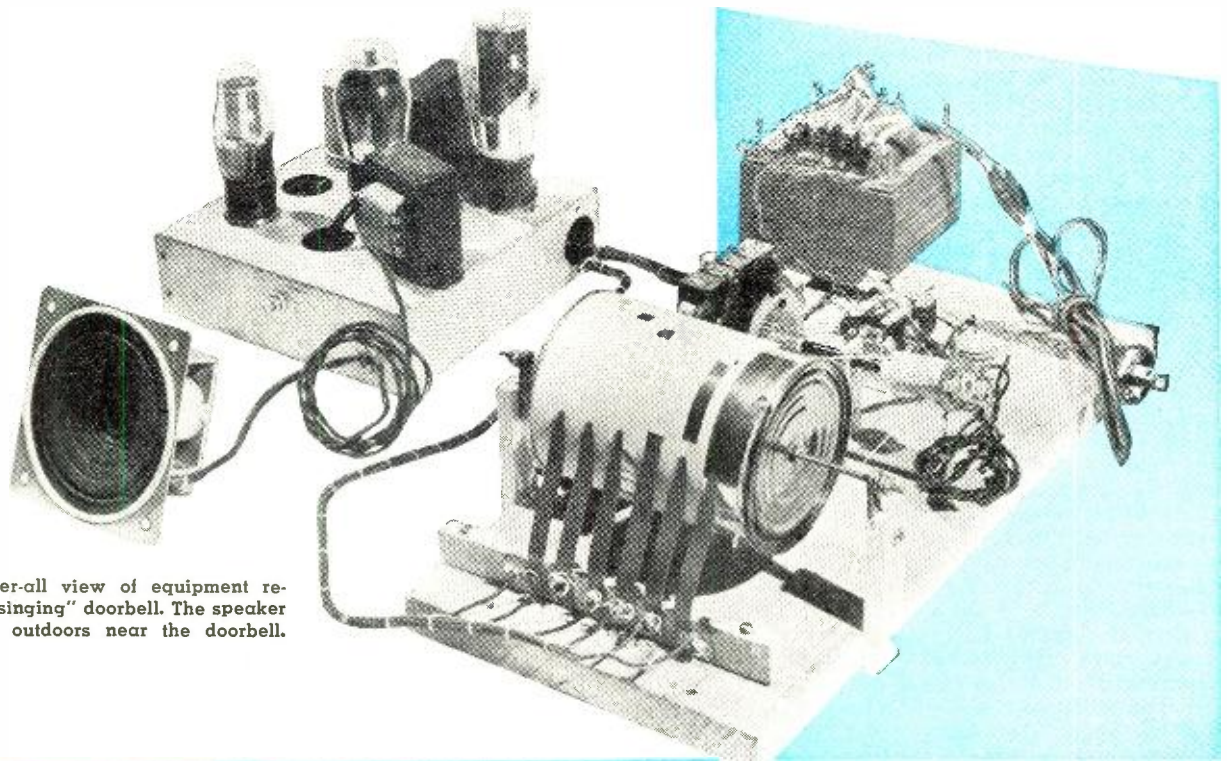

Fig. 1. Over-all view of equipment required for "singing" doorbell. The speaker is mounted outdoors near the doorbell.

A Doorbell that is Different

By RICHARD H. HOUSTON

Neon tube relaxation oscillators provide any desired series of musical notes in novelty unit.

A SHORT time ago the author was preparing for a novelty party and was stuck for a good gag to start the evening off right. This was during the short-lived reign of the erstwhile popular song "Open the Door, Richard," and that phrase was very common around the writer's house. An idea!—of course—a doorbell that would play "Open the Door, Richard"!

The device was constructed and proved to be very successful at the party (even got a plug in a local paper!). Since that time the gadget has been retuned occasionally and has provided a lot of fun by playing snatches of tunes appropriate to the season or occasion. The small amount of effort spent in building such a device will be well worthwhile for any reader who goes in for novel gadgets.

The doorbell (as we shall call it for

the sake of simplicity) was built in the best haywire tradition due to the short time available, but there is no reason why the mechanism shown in Fig. 1 could not be built more substantially and put into an attractive cabinet, rather than into a cardboard box, as was the author's unit.

The doorbell consists of an oscillator, an amplifier and speaker, a motor-driven keying mechanism, and simple control circuits. The push-button at the door operates a relay which causes the keying mechanism to play, in succession, the notes of the desired tune.

The notes are produced by a neon-bulb relaxation oscillator, consisting of N_1 and the RC combinations R_1C_1 , R_2C_2 , . . . etc. The frequency of the oscillator, and therefore the pitch of the note produced, depends upon the values of R and C . As anyone famil-

iar with such circuits knows, the exact values of R and C for any given frequency will vary quite a lot from one circuit to another. For that reason, no values are given for the RC combinations, however the following approximate values may be used as a start. R is composed of a fixed resistor and a potentiometer for tuning to different notes.

Since it is difficult to make a neon-bulb oscillator operate over a very great frequency range, the five RC combinations were chosen so that each potentiometer would cover a different range of tones. Thus the lowest frequency RC combination will handle the first three or four notes of the scale; the next highest frequency combination will handle the next three or four notes, and so on. The values of the resistors and potentiometers and those of the condensers used to produce the lowest and highest notes are as follows:

Note	Res.	Pot.	Cond
Lowest	500,000	1 meg.	.01
Highest	100,000	500,000	.005

While experimenting to find correct RC combinations, remember that increasing either the resistance or the capacitance *lowers* the tone.

The neon bulb in the original model was a type NE-16, a two-contact bulb with no series resistor in the base. A different type of neon bulb will operate just as satisfactorily if an NE-16 is not available, but the RC value approximations may not be too close. Actual tuning of the oscillator will be described later.

The output of the oscillator is coupled by C_0 to the grid of V_1 , a 6F6. No volume control was incorporated, however one could be put in the 6F6 grid circuit if desired. A

500,000 ohm control should be used with a 100,000 ohm resistor between C_1 and the top of the control to isolate the oscillator from load changes produced by varying the setting of the volume control. The arm of the control should connect to the grid of V_1 . The amplifier is strictly conventional and drives a 6-inch speaker. A .01 μ f. condenser, C_7 , is connected from the plate of V_1 to ground to eliminate some of the oscillator harmonics.

The heart of the gadget is the motor-driven switching drum. As can be seen in Figs. 1 and 5, the drum is made from a tin can with a "push-in" lid (like a paint can). The drum serves to switch the different RC combinations into the neon bulb circuit. Six strips of phosphor-bronze (or spring metal of any kind will work) are mounted so as to wipe on the can as it revolves. Five of these "brushes" (tone brushes) are connected to the RC circuits, the other one (collector brush) to the neon bulb. These six brushes enable the device to play a wide variety of tunes, however, additional tone brushes and RC combinations would make the tune selection more flexible. A sheet of paper with holes properly spaced to produce the desired notes is wrapped around the drum underneath the five tone brushes, and is held in place with a strip of Scotch tape. The collector brush rides on the can at all times. Then as the drum turns, the tone brushes make contact through the holes in the paper, keying the oscillator in correct sequence to produce the desired notes. Care must be taken to see that no two tone brushes ever touch the drum at the same time, since even an instant's double contact may cause the next note to be erratic.

The axle of the drum consists of two long 6-32 machine screws in centered holes in the ends of the drum. The screws are secured with nuts on the outside of the drum. No elaborate bearings are necessary. The end of the axle screw merely passes through a hole in a strip of metal, and the screw is prevented from sliding out by two nuts tightened together as can be seen in Fig. 5.

The lid of the can used as the drum contains another long 6-32 screw mounted like the axle, but off-center. This screw actuates a normally-closed microswitch which stops the drum after one complete revolution. The lid may be pried out and rotated to adjust the stopping point if necessary.

The drum is driven by a small 117 volt a.c. motor through a string-and-rubber-band belt. The motor circuits which were used are included in Fig. 2. The pulley sizes will depend on the speed of the motor, but should be chosen so as to make the drum revolve once in about five seconds.

The power supply is conventional and delivers about 350 volts. The power transformer mounting shown in Fig. 1 is not recommended, but is simply part of the previously-men-

tioned haywire! Don't forget the fuse, because safety demands that a piece of equipment to be operated unattended for long periods be well-fused. The reader will note that voltage for the neon bulb is supplied from a VR-105. This was done, as a deluxe gesture, to prevent sudden frequency shifts due to line surges which are numerous in an apartment, such as the one the writer is forced to occupy. Long-time drift due to changes in the oscillator components can be compensated by means of the potentiometers.

The control circuits are very simple. The push-button operates RL_1 , causing 117 volts to be applied to the coil of RL_2 . RL_1 is used merely to isolate the 117-volt line from the push-button. When RL_2 closes, 117 volts is applied to the motor. Two contacts on RL_2 act as locking contacts to hold the relay closed. When the switching drum has made one full rotation, S_1 (Fig. 2) is actuated, opening the locking circuit, releasing RL_2 , and stopping the motor.

There is practically no limit to the choice of appropriate tunes to be set up on the switching drum. One of the best and most time-resistant selections is the part of the ditty about Barnacle Bill that says, "I'll come down and let you in." This phrase will be used in the example of tuning to follow. Novelty songs like the one for which the gadget was originally built come out frequently and are good sources. On the serious side, there are songs appropriate to various

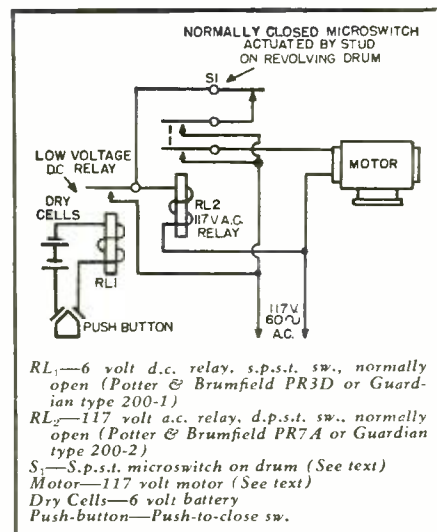

Fig. 2. Diagram for motor drive assembly.

seasons and holidays, such as Christmas and Easter, and for Halloween, we all know the spooky little phrase used on the radio as the ghost goes a-haunting. And how about leaving a musical message when you find you'll be gone overnight: "We won't be home until morning!" These are only suggestions—let your imagination take it from there.

Tuning the notes is no great trick and requires only an average musical ear. No attempt was made to tune the notes to any standard pitch since few of the writer's friends are gifted

(Continued on page 122)

Fig. 3. Schematic diagram of relaxation oscillators, amplifier, and power supply.

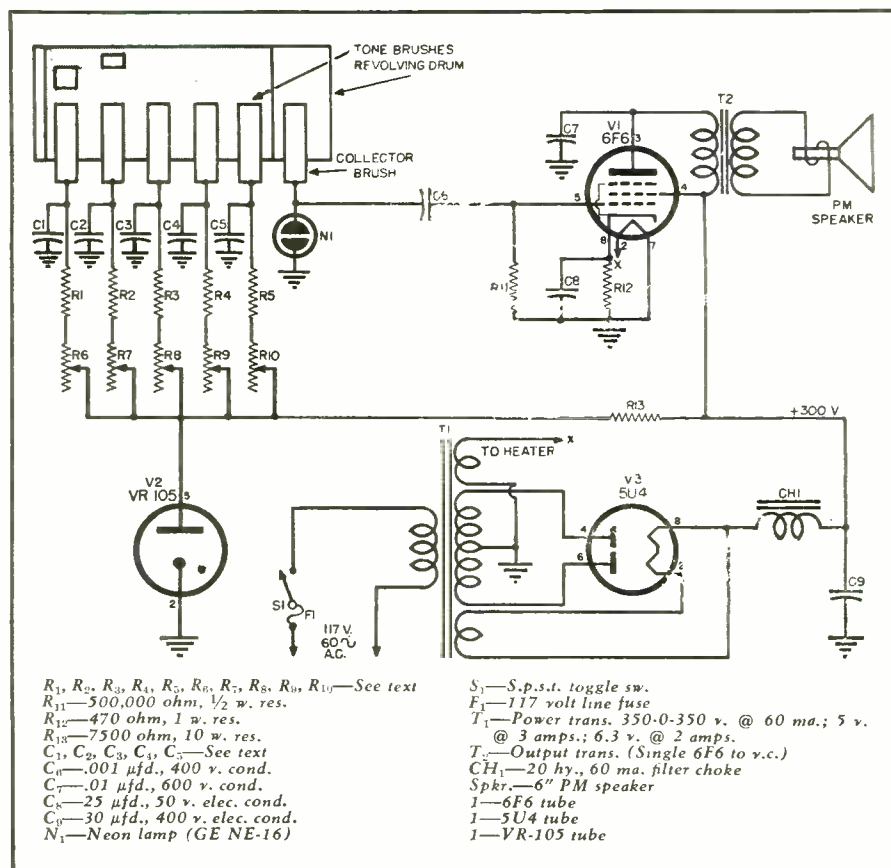

FAILURES DON'T JUST HAPPEN!

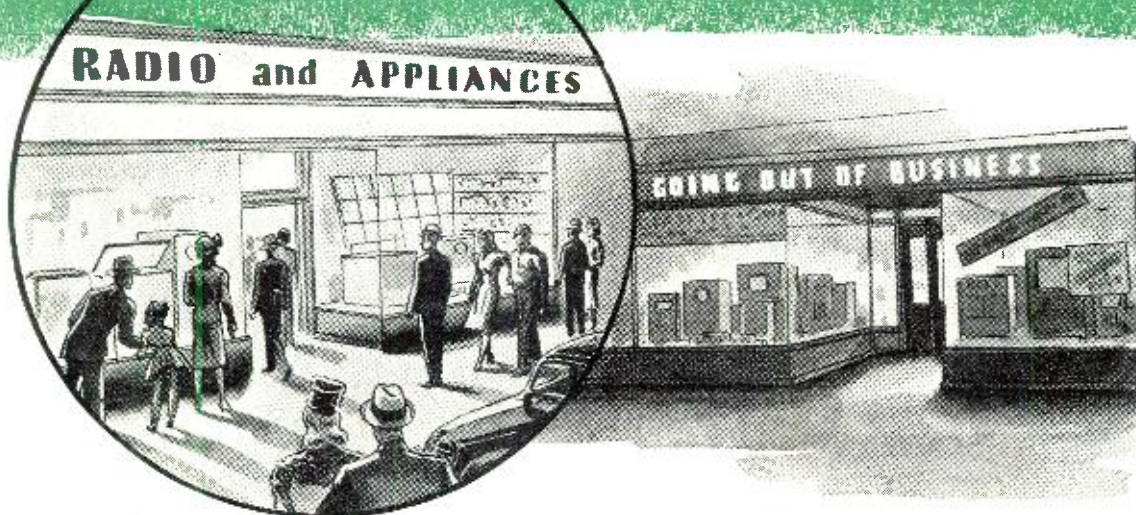

By
DR. LOUIS BADER

Assoc. Prof. of Marketing, School of Commerce, N.Y.U.

With unprecedented opportunities existing in the retail field no radio dealer needs to fail. Using tested business techniques can avert disaster.

PRIOR to World War II the death rate among retail stores was high. It was not unusual for 20 per-cent to 25 per-cent of new retail stores to close up in their first year for a variety of reasons. Within three years 50 per-cent of them closed. In some years, in the 1930's, 200 to 300 thousand small businesses closed their doors. Where small businesses closed because of failures that took the owners through bankruptcy proceedings the reasons for the failures were stated by impartial students as due to the incompetence and inexperience of the owner and lack of capital, which together accounted for roughly over 75 per-cent of the failures. Competition, fraud, failure of others, depression, and other reasons accounted for the rest. Incompetence could consist, among other things, of having too many radios in stock at the wrong time.

Since 1940 failures have been small in number and many newcomers among small business men probably do not realize that failures occur or why. Quite possibly we shall be out from under the abnormal conditions of the war and its aftermath within another year or two and many businessmen will have to look the *devil of failure* in the eye. If you are one of these men, are you going to be able to say "Get thee behind me, Satan?" Believe it or not, you can say it.

We could develop this lugubrious thesis that many small business enter-

prises cannot be successful because of the owners' incompetence, inexperience and insufficiency of capital; that these owners should not have started their businesses because they were not necessary; that the location selected was not the right one; or that the necessary investigation as to the possibility of success was not made, and so on.

Such an article would be negative and no great good would be served. We want to be constructive, and we contend that small business enterprises do not need to fail or close up shop,—especially in the radio and appliance service-dealer field except under the special circumstances that it should not have been started at all. We base our assumption on:

1. *The big market* that should exist over the next 10 or 15 years for radios, appliances, and their servicing.

2. The small businessman need not be incompetent and inexperienced and he can make his capital be sufficient to establish a business and grow into success.

Take the first of these—*the big market*. There are more than 143,000,000 people in the United States and by 1960 there will probably be about 160,000,000. This number breaks down into nearly 40,000,000 families. About 30,000,000 of these are now being served with electricity. The electric power companies will catch up to another 5,000,000 families over the next ten years. Nearly 3,000,000 of these

40,000,000 families are doubling up with other families. During the next ten years many of these and 5,000,000 more other new families will move into homes of their own. Several million of the older families will move into new homes. On top of this we now know we can reach an annual national income of more than two hundred billion dollars by 1960 if we wish. A huge sum will be spent each year for homes not now equipped, for new homes needing full equipment, and for replacement of worn and obsolete appliances, radios, and television sets. There is good reason to believe that the sum so spent will, over a period of years, average out at more than three billion dollars annually and may possibly reach five billion dollars. Look at the appliances (Table 2) that can be offered through your store to prospective customers, and think of the new devices which might come on to the market during the next 15 years. Except for radios, in the field of large appliances, we are far from the point of saturation. In fact, the market for television sets is only beginning. In addition many of the appliances in use are obsolete and should be replaced. All the while that the dealer works in this market to secure business there is a steady run of business coming along in the servicing end of this industry. All the large appliances sooner or later need servicing. An aggressive and progressive service department

will dig out and receive a substantial amount of business in this field and encourage the purchase of new products. Do you wonder, Mr. Dealer, why some people grow almost lyrical over the business possibilities in this industry? You must, too, if you want to have the right attitude toward the possibilities of growth for your business.

There is one short-run hitch to this exposition of the size of the market. Most economic analysts and a good many businessmen expect a recession in business beginning sometime in 1948. A survey among the members of the New York Credit Men's Association shows 80 per-cent of them expect this recession. They think so because prices are high, it is getting harder to sell, and inventories are piling up. Because of what followed World War I, a recession can be expected. But, even among those who expect one, many believe it will not be severe nor of long duration and that after it a prolonged period of prosperity will follow. We are inclined to be optimistic and, therefore, we do not expect much of a depression, but look for a long period of prosperity. However, we must not forget that recession or depression results largely from what men do. Quite possibly men might this time do the things that effectively put the brakes on a depression and set the wheels of prosperity whirling. Anyway, that is what I hope will happen.

Now for the second proposition, which in effect is to be a statement on how to build a successful business. Such a statement should be worth a million dollars. It is believed that ordinarily for every successful concern 20 to 25 others in the same industry are only just getting by and still others by the hundreds fail, and by the thousands just close up.

A good many small businessmen start their business adventures on an emotional basis, "they want to be their own bosses." Apparently they do not ask the questions, "Is there a real need for my business; have I something to offer customers that is distinctly to their advantage and, therefore, worth their while to give me their trade?" Many small businessmen start out hopelessly handicapped by this highly selfishly emotional basis which constitutes, in all too many cases, the main reason for opening a new business.

There is nothing dishonorable about wanting to be one's own boss, but a business to be successful in *getting and keeping customers* must be based on service—service to those whose patronage is necessary to the success of the enterprise. If you don't know what service you should give, or if you are not prepared to give it, then you should not start a business or you
(Continued on page 198)

Table 1. Fifty-nine ways to gain customers' good will as suggested by R. F. Chisholm in his book, "Your Own Store and How to Run It."

CUSTOMER RELATIONS

1. We greet as many customers as possible by name.
2. We have a personal word or two with customers, when possible.
3. We greet customers immediately when they enter the store even if we must keep them waiting before serving.
4. We take the greatest of care to assure the utmost courtesy in handling customers, even the difficult ones. Staff avoids giving a flat "no" to a request for merchandise not in stock.
5. We try to have patience in explaining official regulations to customers in a conciliatory fashion.
6. We give special consideration to the tired shopper.
7. We distribute available goods equitably among regular community customers, and also among acceptable new people in the community.
8. We avoid the patronizing phrase "we can let you have" and use instead "we will see that you get."
9. We express genuine regret when unable to supply customers' requirements.
10. We consult customers regarding ways of improving service.
11. We refer customers to a competitor when we are out of an item and are not afraid to express praise of a competitor.
12. We will do favors for customers gladly, not grudgingly.
13. We pay attention to newly married couples.

STAFF ENCOURAGEMENT

14. We are obliging over minor requests from customers.
15. We encourage clerks to take added care in personal appearance, and to smile.
16. We endeavor to work out a bonus plan for clerks which will give them an interest in the store as a whole.
17. We study the methods used by chain stores and other stores in nearby towns and cities to see what methods can be adapted to our own store.
18. We develop a complete store re-arrangement plan and then undertake one section at a time as money and material become available.
19. We modernize store front if materials are available.
20. We carry on painting of outside and inside of store more or less continuously.
21. We cut down old-fashioned, high type of shelving to present a modern streamlined appearance.
22. We clean window background, paint or renew to create best effects.
23. We remove window backgrounds wholly or partially so as to allow a view from the street right into the store—the whole store becomes a show window.
24. We departmentalize our store for easier unit stock control, and put plans into effect in at least one department by way of getting the system started well in advance.
25. We maintain spacious aisles, not crowded.
26. We arrange merchandise to encourage self-selection.
27. We move counters back to within about 2½ feet from shelving to provide maximum aisle space for customers and eliminate as many counters as possible, replacing them with modern bunks.
28. We set up a self-serve section where it is feasible.

MERCHANDISE

29. We give customers suggestions about related merchandise in other departments.
30. We keep both reserve stocks and counter stocks orderly and clean.
31. We carefully study substitute merchandise to avoid undue inventories and to make sure of timely liquidation.
32. We instruct all clerks to keep a "Want Book."
33. We review stock regularly to find out why certain lines are not selling.
34. We continue special seasonal promotions of appropriate goods.
35. We display odd and broken lines for quick sale and eliminate all old goods.
36. We add a certain amount of novelty merchandise to brighten up current offerings.
37. We maintain prominent display of free supply goods.
38. We maintain a small stock of scarce goods for emergency purposes, regardless of other demands.
39. We make a special effort to procure short-supply goods in genuine cases of emergency need.
40. We set up a desirable objective for stock turnover in each section of store.
41. We concentrate on quality merchandise and avoid buying inferior goods merely because they are available.

PRICING

42. We bring prices into line with current cash competition.
43. We maintain established special discounts for churches, etc.

DISPLAYS

44. We change window displays at regular intervals even more carefully than in normal times, in order to avoid a "tired" appearance.
45. We keep making attractive innovations in the store, featuring one section after another to give old customers something new to look at.
46. We make use of empty shelving for display purposes by use of display alcoves.
47. We create a patriotic or seasonable atmosphere in store displays.

ADVERTISING

48. We maintain local advertising.
49. We maintain direct mail promotions.
50. We donate advertising space in local papers to patriotic or charity campaigns.

COMMUNITY AFFAIRS

51. We join the organization of merchants for improvement of local merchandising, and to assist in local patriotic work.
52. We participate in local charity organizations such as Red Cross,—but avoid "trying to run things."
53. We attend meetings of farm forum radio programs to keep informed on farmers' problems.
54. We influence town officials to provide parking space for farmers and others.
55. We avoid extremes in shortening store hours, having due consideration for farmers' and workers' shopping time.

SUPPLIER RELATIONS

56. We concentrate buying with few suppliers and work faithfully with the salesmen concerned.
57. We take full advantage of ways in which reliable wholesalers can be of assistance.
58. We ask salesmen and other friends to suggest improvements which may have been overlooked.
59. We visit suppliers as regularly as possible and ask for their advice.

Bottom view of converted SCR-522 war surplus unit. All changes, as explained in the text, can be made without difficulty.

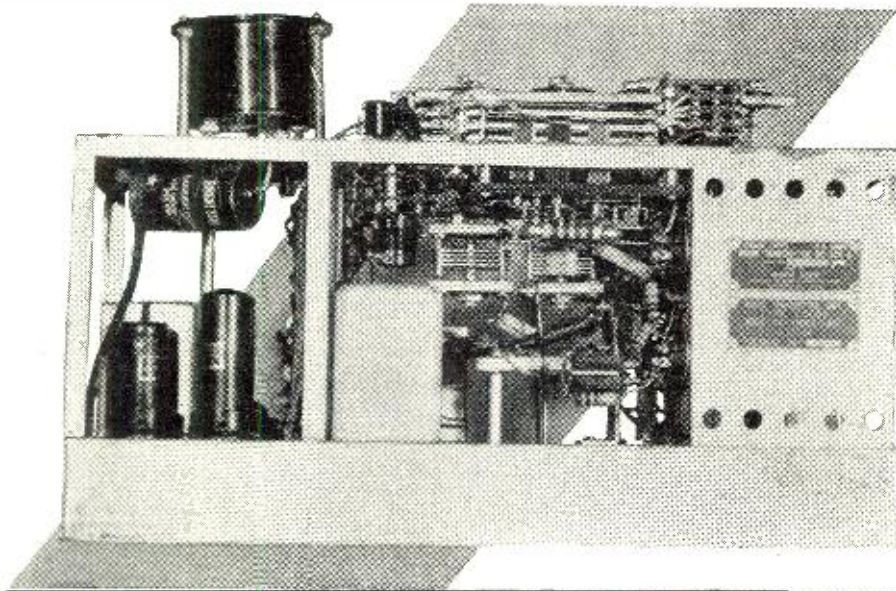

Putting the 522 TRANSMITTER on 6 and 10 METERS

By H. S. BRIER, W9EGQ

Only minor changes are required to convert this popular war surplus item into a workable ham rig.

THE "522" (625A) transmitter works as well on six and ten meters as on two meters. Its reputation on two meters makes it unnecessary to say more. The conversion is simple, and should take less than an hour to complete.

Locate the 20 $\mu\text{fd.}$ ceramic coupling condensers between the 12A6 frequency multiplier tank condenser and the 832A tripler grids. Unsolder them from the condenser and bend out of the way. Next unsolder the 20 $\mu\text{fd.}$ coupling condensers between the tripler plate circuit and the final amplifier grids from the hairpin tank.

Connect the free ends of the amplifier grid coupling condensers to the stators of the 12A6 tank condenser with two lengths of #12 wire. These leads should be exactly the same length, and are run through ventilating holes in the chassis on each side of the tripler tube socket. This removes the 832A tripler from the circuit, and the tube should be removed from the socket.

For ten meters approximately ten $\mu\text{fd.}$ of capacity must be added to the 12A6 tank circuit. Either a 3-30 $\mu\text{fd.}$ ceramic trimmer condenser, or a ceramic fixed condenser may be used. The easiest place to install it is where the #12 wires join the amplifier grid coupling condensers.

Remove the final amplifier and antenna coils. Replace them with ten-meter coils, specifications for which are given in Table 1. If a balanced feeder system is to be used, remove the jumper grounding one antenna output terminal at this time. This completes the changes required for ten-meter operation. Tuning instructions and power requirements will be given later.

For six-meter operation the 832A tripler is removed from the circuit as outlined above, and three turns are removed from the 12A6 tank coil. This coil is supported by its leads beside the tuning condenser. At first glance it appears almost impossible to remove this coil without dis-

mantling the transmitter. Actually it comes out with little difficulty. The coil contains 15 turns, tapped at the eighth turn. Remove two turns from the eight-turn end, and one turn from the other end, and re-install the coil.

The oscillator will cover almost the entire six-meter band without change; however to reach 54 megacycles, one turn must be removed from the oscillator coil. Replace the final amplifier and antenna coils (see Table 1), and unground the output link, and the 50-54 megacycle conversion is completed.

Original power requirements were 300 volts at 250 milliamperes, "B," 150 volts at ten milliamperes bias, and 13 volts at 2.35 amperes for filaments. Eliminating the 832A tripler reduces the "B" drain to 150 milliamperes, and the filament drain to 1.55 amperes. A few additional changes permit further simplification of the power requirements by eliminating the bias supply.

To do so three steps are necessary: Unground the 12A6 modulator cathodes, and return to ground through a 225-250 ohm, five watt resistor. Next remove the load from terminal four of the modulator driver transformer (part number 159) and ground the terminal to the chassis. Finally, replace the 6000 ohm grid resistor of the 832A amplifier with one of 15,000 ohms. This resistor is mounted on the partition separating the audio and r.f. sections of the transmitter, and alongside of plug 123-2.

Power connections to plug 123-2 are as follows: 300 volts to pin three or four (they are connected together); bias, if used, to pin one; hot filament to pin two; and pin eight is the common ground. A single-button carbon microphone with a three-volt battery in series connects between pin one of plug 123-1 and ground.

The transmitter is designed to use four pretuned frequencies, and while the sliders, etc., may be removed without difficulty, this feature is even more easily retained. Push the first slider home, and measure the distance from it to the protruding end of the next slider. Allow the slider to spring back to its original position. Then drill a one-eighth inch diameter hole through all four sliders. The center of this hole should be exactly one-sixteenth of an inch less than the previously measured distance from the end of the sliders. To choose a channel, the correct slider is pushed home, and a one-eighth inch metal shaft inserted in the hole through the remaining sliders; thereby holding them in position.

Tuning is simple. Connect a one milliamper meter, with an internal resistance of 100 ohms, to the meter terminals. Loosen the wing nuts on

(Continued on page 112)

New Band FM Receiver

By

J. C. Michalowicz

Dept. of Elec. Eng.
Catholic University of America

THE constant effort to obtain interference-less, high-fidelity radio reception, has resulted in the birth of the frequency modulation receiver. The rapid progression from the use of the 50 mc. band to the new FCC-allotted 100 mc. band, has shown a need for an easily constructed receiver, using readily obtainable tubes and components. Conventional circuits and practice are followed in the design of this receiver in order to keep to a minimum the need for fussy and tedious adjustments and alignment. The heterodyne high frequency section consists of a trio of the popular acorn-type tubes; a 956 for the input high-frequency amplifier, a 955 as the high frequency local oscillator, and a 954 as the frequency converter. The two stages of intermediate frequency amplification use 6AC7's followed by two limiter stages using 6SH7's. A double-diode 6H6, used for the discriminator, rounds out the frequency modulated section. The rectified plate voltage is obtained through use of a 5Y3 full-wave rectifier and a VR150/30 is used to stabilize the high-frequency plate voltages. A 6U5 tuning eye is incorporated to facilitate ease in accurate tuning. The tube complement was especially chosen to include such tubes as have been made readily available through the surplus market.

Since not only simplicity in design but also neatness in appearance is the aim in the layout of this receiver, the elimination of all but the "essentials" is effected on the front panel, as shown in Fig. 1. The main tuning condenser dial, a *National* type ACN, has the place of prominence, directly below which is the volume control knob coupled to the "on-off" switch. The tuning eye is placed as high as possible for ease of visibility, and with the audio output jack placed in line with the volume control, completes the layout of the front panel controls. The rear chassis attachments consist of (reading from left to right as shown in Fig. 4) 117 volt a.c. input receptacle, 117 volt a.c. output receptacle for auxiliary apparatus such as an audio amplifier, an optional speaker jack if the audio amplifier is mounted on the same chassis and, finally, the limiter microammeter receptacle.

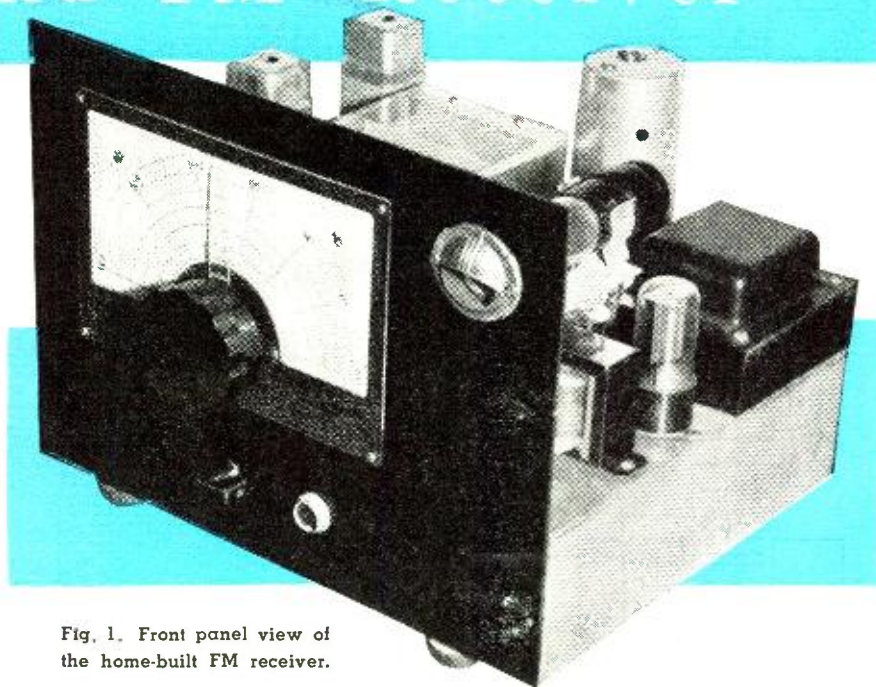

Fig. 1. Front panel view of the home-built FM receiver.

Complete construction details for building your own new band, 88-108 megacycle, home receiver.

All components, with the exception of the high frequency amplifier-oscillator-mixer stage, are mounted on a metal 12" x 10" x 3" chassis, as shown in Fig. 5. Reading clockwise around the high-frequency subchassis are the two stages of intermediate frequency amplification consisting of T_1 , V_3 , T_2 , V_4 , and T_3 ; the two limiter stages, V_5 and V_6 ; and the discriminator stage, T_4 and V_7 . The rectified power supply with its transformer, T_5 , the full-wave rectifier tube, V_{11} , the voltage regulator, V_9 , and the filter units, CH_1 , C_{11} , and C_{15} are placed as a group at the lower right.

The high frequency stage is constructed as an integral unit, primarily to provide the ultimate in interstage shielding and secondly, to allow for convenience in aligning the unit alone. This unit is shown with its top and two side plates removed in Fig. 3. It consists of an aluminum box 7" x 3 $\frac{3}{4}$ " x 3" in size. A piece of lucite is used as the top for this unit, with holes drilled directly above the air trimmers, C_1 , C_9 , and C_{13} , to facilitate ease in alignment. Three 15 μ fd. variable condensers, C_2 , C_{10} , and C_{12} , are used as the main tuning device, being ganged together by means of fiber-disc flexible couplers.

The forward compartment of the unit includes the input grid coil, L_2 and the condenser, C_2 (not visible in Fig. 3). This tuned circuit is connected

to the grid pin of the 956 amplifier tube which protrudes through the interstage shield. Antenna input is provided through a double-holed receptacle to which is connected the input inductor, L_3 . This receptacle is mounted on the top cover of the high frequency unit and is shown lying beside the sub-chassis in Fig. 3. The middle compartment houses the 956 amplifier tube, the 954 mixer and the mixer tuned circuit, L_4 and C_{10} . The plate pin of the 954 mixer passes through the bottom of the sub-chassis, thus being completely shielded from the high frequency network. The aft compartment contains the local oscillator circuit, consisting of the 955 oscillator-triode and its tuned-grid circuit, L_6 , C_{12} . Oscillator-mixer coupling is obtained by merely inserting an insulated conductor through the interstage shield from the oscillator compartment into the mixer compartment and terminating it in the near vicinity of the mixer grid. This is indicated on the wiring diagram as C_{11} . With the exception of the high frequency amplifier grid inductor, L_2 , and the antenna coupler, L_1 , all the coils are mounted on $\frac{1}{2}$ inch polystyrene forms cemented in place.

Electrical Circuit

The schematic diagram of the receiver is shown in Fig. 2. The 950-series tubes adapt themselves very

ever, if the interference resulting from the use of a single limiter stage is not objectionable, more over-all gain can be obtained by replacing a limiter stage with an additional i.f. stage, since the gain per limiter stage is usually no more than unity. But good engineering practice demands the use of two limiter stages for high quality reception, and the sacrificing of this single stage for more gain is poor economy. The time constants in limiter circuits should be relatively fast. The time constant of the grid circuit of the first limiter stage, consisting of R_{22} and C_{20} , is almost twice that of the second limiter stage consisting of R_{23} and C_{21} . Thus, whatever interference is allowed to pass the first limiter stage is made negligible by the time the signal reaches the discriminator stage. A meter jack for a microammeter is inserted in the grid circuit of the second limiter to aid in i.f. transformer and high frequency stage alignment.

The discriminator stage employs the conventional 6H6 double-diode for frequency demodulation. Here, again, the discriminator transformer was constructed by the author, but a *National Company* IFL transformer will serve as well. The output of the discriminator is terminated in an audio frequency de-emphasizer network consisting of R_{12} and C_{10} . The purpose of this network is to de-accentuate the frequency emphasis toward the upper audio frequency that is introduced in an FM transmitter. The de-emphasizer is connected to a one-megohm potentiometer and then to the audio output jack. No audio circuit is provided, although the power circuit has ample capacity to energize a single audio stage, employing, say, a 6V6 beam-power amplifier.

It must be kept in mind that since high fidelity is the aim of frequency modulation reception, good engineering should not end with the completion of the discriminator stage. The output should be terminated in an amplifier, flat within 2 db. of 1000 cycles-per-second over the audio range from 50 to 15,000 cycles-per-second. An amplifier, employing two stages of "Class A" amplification, transformer-coupled to a push-pull 6V6 stage will serve the purpose very well. Also, no compromise should be made in the physical size of the speaker. It should be at least a 12-inch model mounted within an efficient baffle.

The rectified plate voltage supply needs no explanation, emphasis being placed on good filtering, consisting here of a C-L-C network. A VR150 tube, a gaseous regulator, is incorporated to prevent any drift in the oscillator and mixer stages.

Alignment

The alignment of an FM receiver consists of practically the same tests that are performed upon an AM receiver, although certain precautions must be heeded in order to obtain the best of results. If a FM signal gen-

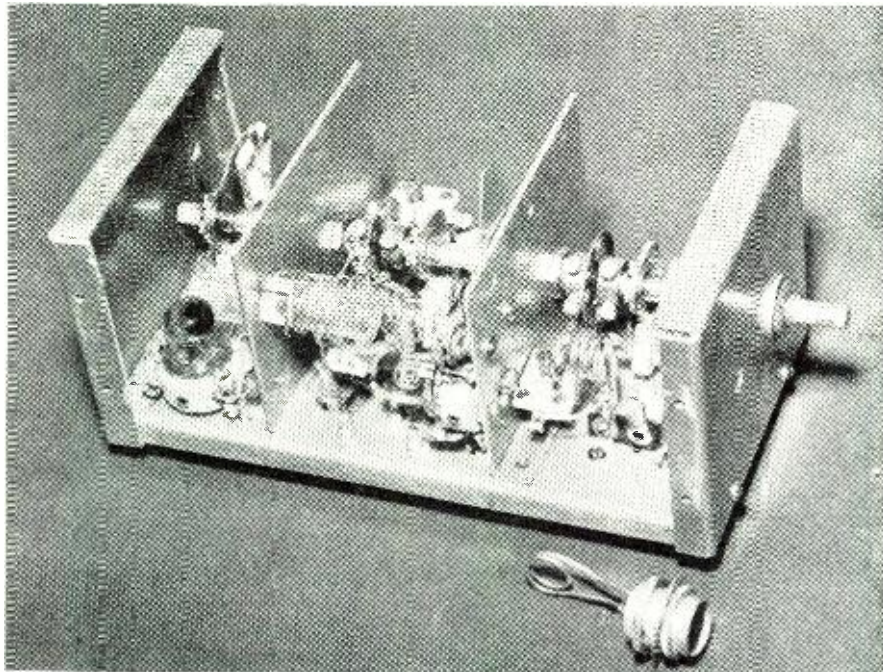

Fig. 3. Inside view of the high frequency sub-chassis assembly.

erator is available, its use is most desirable but not absolutely essential. If the conventional amplitude modulated signal generator is to be used, it must, of course, cover the 100 megacycle band. It must also generate a signal in the 10 megacycle neighborhood with good frequency spread, since the FM circuits have a bandwidth of as much as 200 kilocycles.

The best portion of the receiver in which to start alignment, is the intermediate frequency amplifier circuit. Since the limiter input voltage and the applied antenna signal strength have to bear a definite relation to each other, it is the limiter voltage that should be inspected in making the

alignment tests. An appropriate microammeter inserted in the jack, J_1 , will measure this voltage. Many persons have the habit, in aligning FM as well as AM receivers, of obtaining an over-all characteristic of the entire i.f. amplifier, rather than stage by stage. Such a procedure consists of varying, at random, all the different adjustments of the i.f. transformers until the over-all characteristic appears to be satisfactory. In narrow-band AM, this procedure may be permissible, but in broad-band FM, this technique is not conducive to the production of the best quality. Such practice generally results, when applied to FM receivers, (Continued on page 190)

Fig. 4. Rear view of receiver. See Fig. 5 for identification of components.

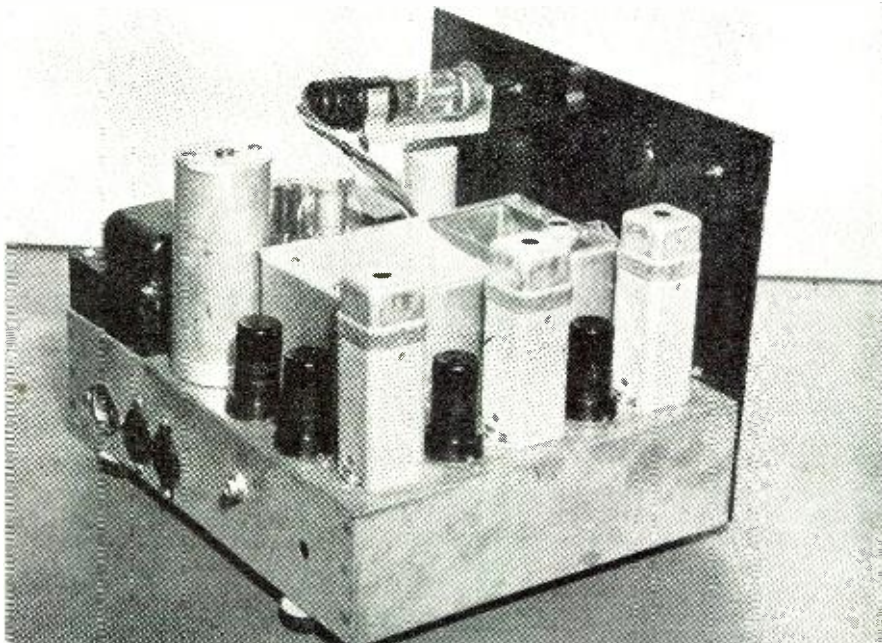

A Versatile SERVICE TEST INSTRUMENT

By
C. T. HAIST, JR.

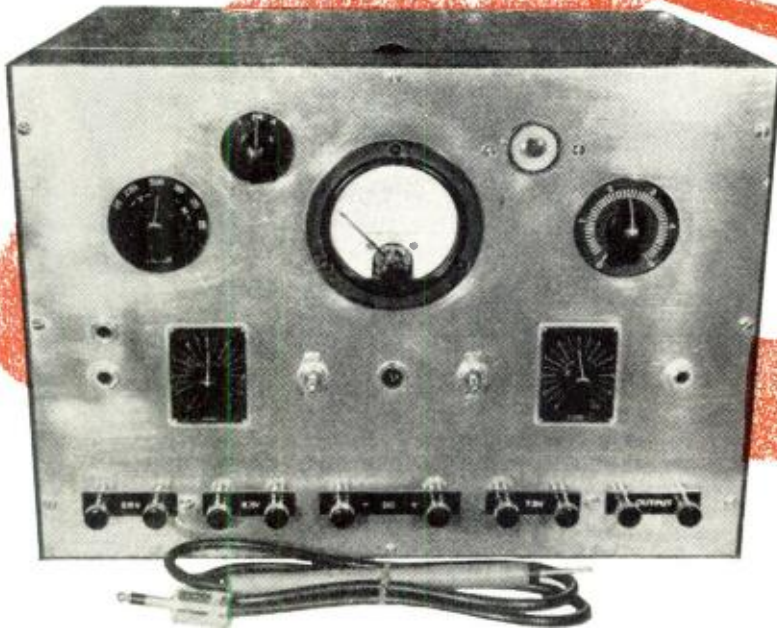

Fig. 1. Panel view of completed test instrument. For identification of various controls refer to the text.

All in one—this instrument provides a signal tracer, hi-fi audio amplifier, a variable d.c. output as well as various heater voltages.

HOW many times have you the experimenter, serviceman, or amateur wished you had a power supply at hand that would give you 2.5, 6.3, or 7.5 volts for a filament supply or a variable plate voltage supply for testing a new tube circuit; or how many times could you have used a good power supply for testing the low power stages of a new rig you just finished building? I bet you have also wished at sometime or another you had a built-up audio amplifier for testing detector and r.f. circuits, microphones, pickup units, and loudspeakers. A good public address system is also handy to have around, as well as an audio amplifier for troubleshooting a radio receiver by the audible signal method.

A piece of equipment that would do these things and then some was built for my workshop several months ago. It has really proved its worth in saving time and making tests and experiments less tiring. This unit is so simple in design and easy, as well as inexpensive, to construct, that its value was not fully appreciated. Friends that have seen this unit have commented on its value and expressed the desire to build a similar one. Because of the good results obtained and

the enthusiasm of friends this article was written so other interested parties could build up a similar unit. All parts used in this construction were found in the junk box or purchased on surplus sales. The basic unit of this device is the power supply that will deliver about 350 volts at 200 mils. The output from the 5U4G rectifier is connected to a double section filter for obtaining a low percentage of hum ripple voltage. The supply output voltage is also continuously variable from 0-325 volts and delivers up to 75 mils. (More current may be had by paralleling the regulator tube). This is accomplished by a circuit consisting of a 6H6 which is connected in such a manner as to obtain a bias voltage for the grid of a current regulator tube such as a 2A3, 6A3, 6B4G or 6A5G. By varying R_{21} or the knob on the upper right hand side of the instruments panel the voltage is made variable from zero to the maximum voltage. In Fig. 1 the terminal strip along the bottom of the panel gives 2.5v., 6.3v., and 7.5v. a.c. which are supplied from a separate universal filament transformer. Terminals on the panel marked “-” and “+” are the variable “B” voltage while the terminals

marked “Output” are for the fixed “B” voltage. The output voltage and current are indicated by a milliammeter on the front panel. A selector switch to the left of the meter selects the meter ranges of 25, 50, 250, and 500 volts and 2.5, 50, and 250 mils. These scales were chosen since the meter movement was 1 mil and the meter had a 0-25 volt scale, which saved drawing a new scale. A “50” was drawn with a numeral guide under the “25” at full scale, making interpretation of the different ranges selected easy. The metering circuit is connected to the power supply so it reads the voltage and current of the variable output terminals only. With the variable voltage control knob turned all the way up the meter reads the full output voltage of the supply.

The different range scales are achieved by adding series resistors for the voltage ranges and placing different shunts across the meter for the current ranges. The easiest and least expensive method of setting up the different ranges is to series or parallel resistors you may have on hand until the correct readings are obtained. With the power supply turned on and the voltage control set at maximum, set the meter selector switch to the 500 volt position. By means of an external voltmeter or multirange tester, measure the voltage at the “minus” and “plus” terminals. Insert the proper resistors in the meter circuit until the panel meter reads the same. This voltage will be around 375 to 400 volts, no load. With the range switch set for 250 volts, turn down the voltage control until the external meter reads

250 volts. Place the necessary resistor or resistors in the metering circuit until the panel meter reads 250 volts. The same procedure is followed for the other voltage scales.

The current shunts are low resistance. They may be wound with #28 copper magnet wire if Nichrome is not available. The shunts are also selected by cut and try. The external meter is again used in series with a dummy load such as a 50 watt adjustable 4000 ohm resistor. The resistance is adjusted until the current is proper for full scale readings. The shunts are then connected so the panel meter reads the same as the external meter. If you know the resistance of your 0-1 mil. meter and want to spend the money for multipliers and shunts, it is an easy matter to calculate the proper values. Any radio handbook gives the formula for this procedure.

The power supply switch is located just to the right of the pilot lamp in the center of the instrument. A switch to the left of the pilot lamp controls the hi-fidelity audio amplifier operation by opening or closing the filament circuit to the audio tubes. This allows the use of the power supply without the load of the amplifier when it is not needed. In order to take full advantage of the versatile performance of this unit, an exceptionally good audio system is incorporated. A type 6SL7 dual triode functions as an audio inverter and drives two 6V6's in push-pull as a final amplifier. For high fidelity operation, control R_{18} is rotated to its minimum resistance position which shorts out condenser C_7 . With this setting a small amount of the audio output is fed back to the cathode of the inverter tube thus producing inverse

feedback at all frequencies. For bass boost, resistance R_{18} is increased thus placing condenser C_7 in series with the inverse feedback lead. This allows the higher frequencies to pass as before but effectively blocks the lower frequencies, thus preventing degeneration of the bass. In the high fidelity position, the audio response curve of the amplifier is essentially flat from 60 to 15,000 cycles and an output of 5 watts with less than 5% harmonic distortion is easily attainable.

A 6C5 triode amplifier is used ahead of the 6SL7 inverter to provide sufficient voltage gain for phono pickups and crystal microphones. Two input jacks, connected in parallel, are located to the extreme left of the panel. The double jack is not necessary but was installed in case, at a later date,
(Continued on page 166)

Fig. 2. Complete schematic diagram for service test instrument. The secondary winding of T_1 must be properly polarized with relation to the feedback circuit. Should oscillation occur, it would indicate that leads should be reversed.

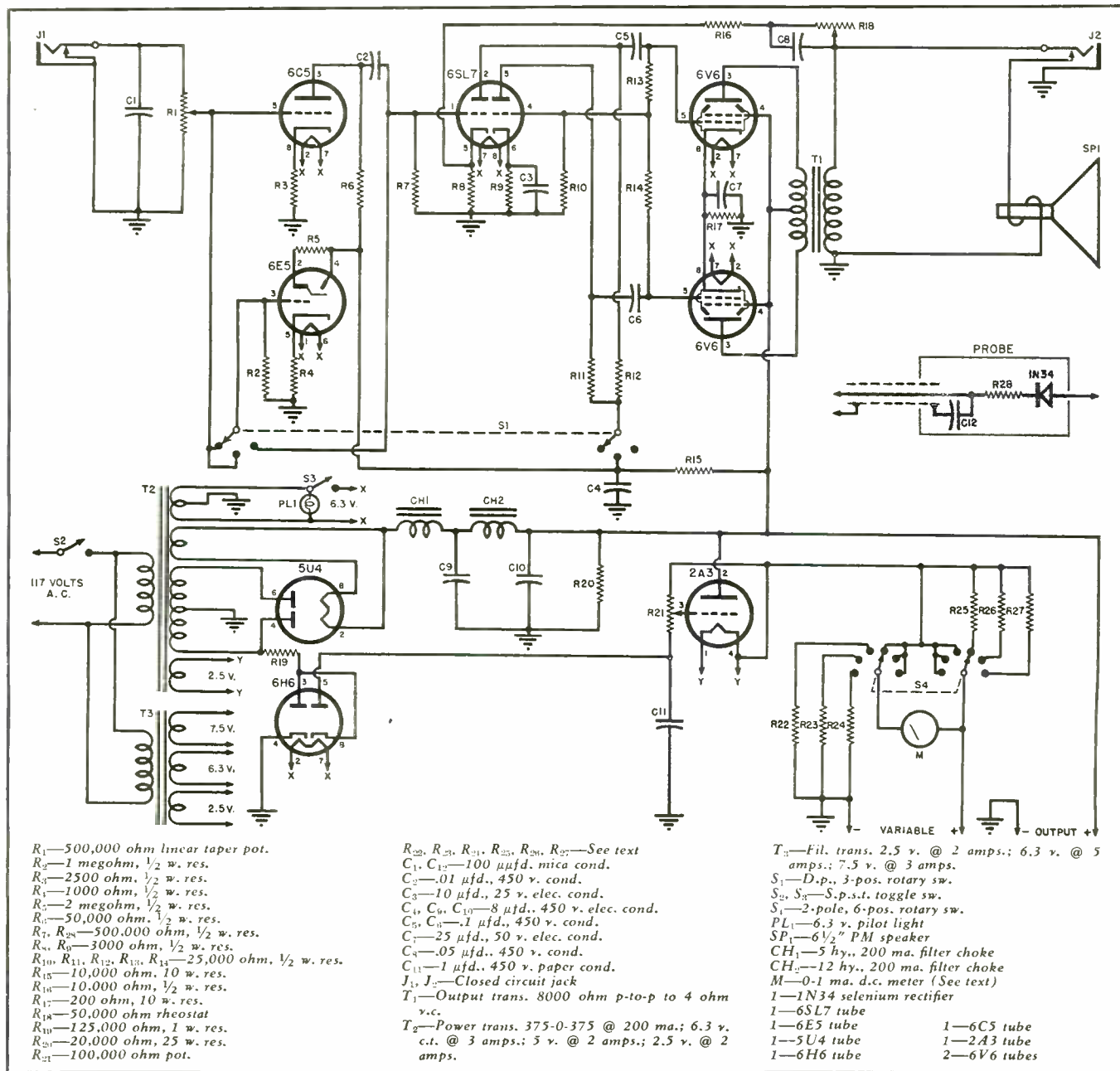

A Simple NBFM TRANSMITTER

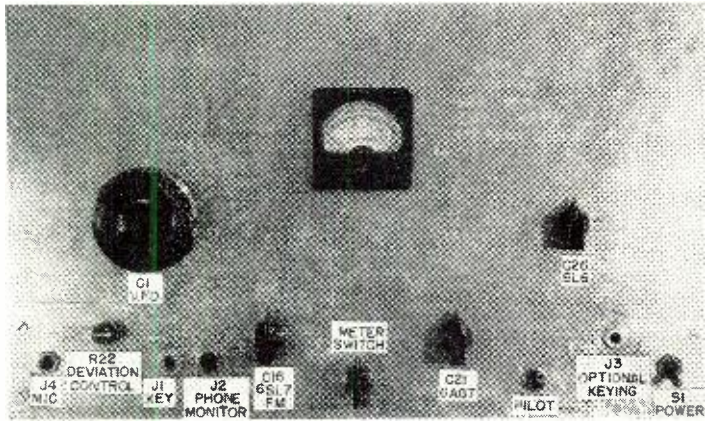

Front panel view of completed narrow-band FM transmitter.

With but two frequency multiplier stages, this unit supplies 10 watts on 10 meters and a conservative 15 watts on 20, 40, and 80 meters.

THE much discussed and often praised BCI-less NBFM has been placed on an experimental basis on 3850-3900, 14,200-14,250, 28,500-29,000 and 51,000-52,500 kcs. Therefore, some simple, v.f.o.-controlled NBFM exciter-transmitter unit is in order. The exciter-transmitter to be described was designed with the intention of seeing just what could be done with a v.f.o. combining NBFM, voltage regulated power supply on the oscillator, break-in keying, and all-band operation. In this layout, each stage, beginning with the oscillator, was completed before proceeding to the next, thereby reducing the possibility of unexpected "bugs" and eliminating any as they showed up. This plan paid dividends, as the final product required only slight changes in the number of coil turns.

The author took advantage of surplus parts to keep down the total cost. For high quality NBFM operation, an inexpensive crystal mike may be used. Ads in current issues of RADIO NEWS were utilized to full advantage in purchasing parts for this rig.

As an exciter, this unit has sufficient output to drive a high-power beam amplifier like push-pull 813's. Experience has shown that equal results can usually be obtained from a simple variable-frequency oscillator followed by an efficient quadrupler than can be realized through the use of a crystal oscillator which

doubles in its plate circuit followed by a doubler.

A glance at the schematic shows the 6SJ7 (V_1) v.f.o. operating on 80 meters. The 6AG7 (V_2) Class A r.f. amplifier serves as an untuned isolating r.f. stage. The 6SL7 (V_3) frequency modulator tunes as any r.f. amplifier, C_{16} also serving to vary the magnitude and phase angle of the R_p . Increased deviation is obtained in this FM circuit by use of a powdered iron-slug coil form. The author uses one obtained from a surplus SCR-522A crystal tuning circuit. It is $\frac{1}{2}$ inch in diameter by 2 inches long. Any powdered coil form may be used, however.

The second 6SL7 (V_4) is used as a two-stage speech amplifier. An ordinary, inexpensive crystal mike works smoothly with this duo-triode speech amplifier.

The Frequency Modulator

The only noteworthy feature of this circuit is the FM adjustment shown in the schematic diagram. The condenser (C_{15}) is nothing more than two short lengths of insulated wire twisted together for three turns. The circuit arrangement is similar to the familiar plate neutralization. Here, however, the connection is for the purpose of increasing the frequency modulation. Once installed, no further adjustment is necessary.

In tuning the condenser C_{15} , it will

By

J. P. SIMMONS, W6EBT

be found that the plates will normally be set near $\frac{1}{2}$ meshed and need hardly be touched during frequency changes of several hundred kilocycles in the v.f.o.

The phone-monitor circuit is handy for checking the quality of speech.

The Quadrupler

A 6AG7 (V_1), with the control and screen grids operating as in pentode amplification, serves as an efficient doubler, tripler, or quadrupler. The 6AG7 is capacity-coupled to the plate of the frequency modulator through C_{15} , a 100 μfd . mica condenser. This stage is biased by a 1 megohm (R_{13}) resistor in the grid return. It also has an optional keying circuit. This is sometimes desirable as it permits the v.f.o. to be shifted and monitored (in the receiver) while the key is up. The combination of the 150 ohm resistor (R_{14}) and .01 μfd . bypass condenser (C_{16}) in the cathode circuit permits the stage to double, triple, or quadruple with sufficient excitation to the next doubler and allows the oscillator to be keyed on c.w. with a resulting clean cut note.

All of the ground return connections are brought to a single ground point on a tie-post mounted alongside the isolantite socket. With the cathode bias resistor indicated, the plate current is held to a safe value when the oscillator key is up.

The 6L6 Power Doubler

The output from the 6AG7 buffer, doubler, tripler, or quadrupler is fed directly from the 6AG7 plate to the 6L6 grid through a 50 μfd . midget variable coupling condenser (C_{21}). Several values of coupling condenser were tried, however, and while the capacity was not found to be especially critical, a 50 μfd . APC type gave optimum results. Bias on this stage

RADIO NEWS

is obtained from two sources. Grid leak bias is provided by a 100,000 ohm resistor R_{17} in the grid return circuit. The tube is also biased by the use of a 400 ohm cathode resistor, R_{19} . The cathode is bypassed to ground by a .01 μ fd. paper condenser (C_{21}). A 50 ohm, 1 watt resistor in series with the grid leak and another in the plate circuit are provided for reading 6L6 grid and plate currents. The meter switch is connected directly across same. A series resistor (R_{20}) supplies the screen voltage and the screen is bypassed with C_{25} , a .02 μ fd. paper condenser. Series feed is used but the ground potential end of L_5 is bypassed to allow the plate condenser to be directly mounted on the metal panel.

Inspection of the photograph shows a large space where the 6L6 coil is located. The author has planned a bandswitching coil assembly with "end links" to be placed here.

Mechanical Details

The author's v.f.o. covers 3488-4050 kc. The photographs show the method of attaching the v.f.o. tuning

condenser. Duraluminum (galvanized iron can be used, too) brackets were bent to proper size in an ordinary bench vise. Two brackets are used, one underneath and the other in front of the v.f.o. main tuning condenser. The vernier dial (from a surplus Army coil unit) is secured to the front panel and coupled to the v.f.o. condenser via an insulated coupling. However, a metal one may be used. The v.f.o. coil form was also individually shielded to further isolate and eliminate temperature changes. (An empty rectangular spice can may be used for the v.f.o. coil shield). The v.f.o. coil was secured to the chassis with four machine screws, the coil connections being run directly through large holes in the chassis, connections being made to the screws projecting underneath.

The shield around the v.f.o. deflects heat from other tubes thereby providing additional freedom from drift caused by condenser temperature change. The author also uses shields around the doubler stages, but the one around the v.f.o. is the most important. The other two could be

eliminated to simplify the construction, especially for those not having metal bending facilities available. The chassis, and shields were made of surplus .060" thick 24SO, the panel of .091" thick 24ST. The chassis is 10"x17"x3", the panel is 19"x12". A standard manufactured chassis may be used, however. An aluminum chassis is highly recommended due to the high conductivity of this metal for grounding purposes. Shielding the v.f.o. and anchoring the oscillator coil and tuning condenser are necessary to stability.

The parts list gives the components used. The author placed tie posts near each tube socket under the chassis to provide convenient grounding points for bypasses, etc., and then interconnected all the individual grounded tie points. This provides definite grounding and eliminates uncertain grounds when using the chassis as common ground. The latter is necessary with a steel chassis. Each frequency multiplier coil is mounted adjacent to its respective tube. The 6AG7 doubler "tank" condenser is mounted approximately un-

Complete schematic diagram of the NBFM transmitter. A v.f.o. is incorporated.

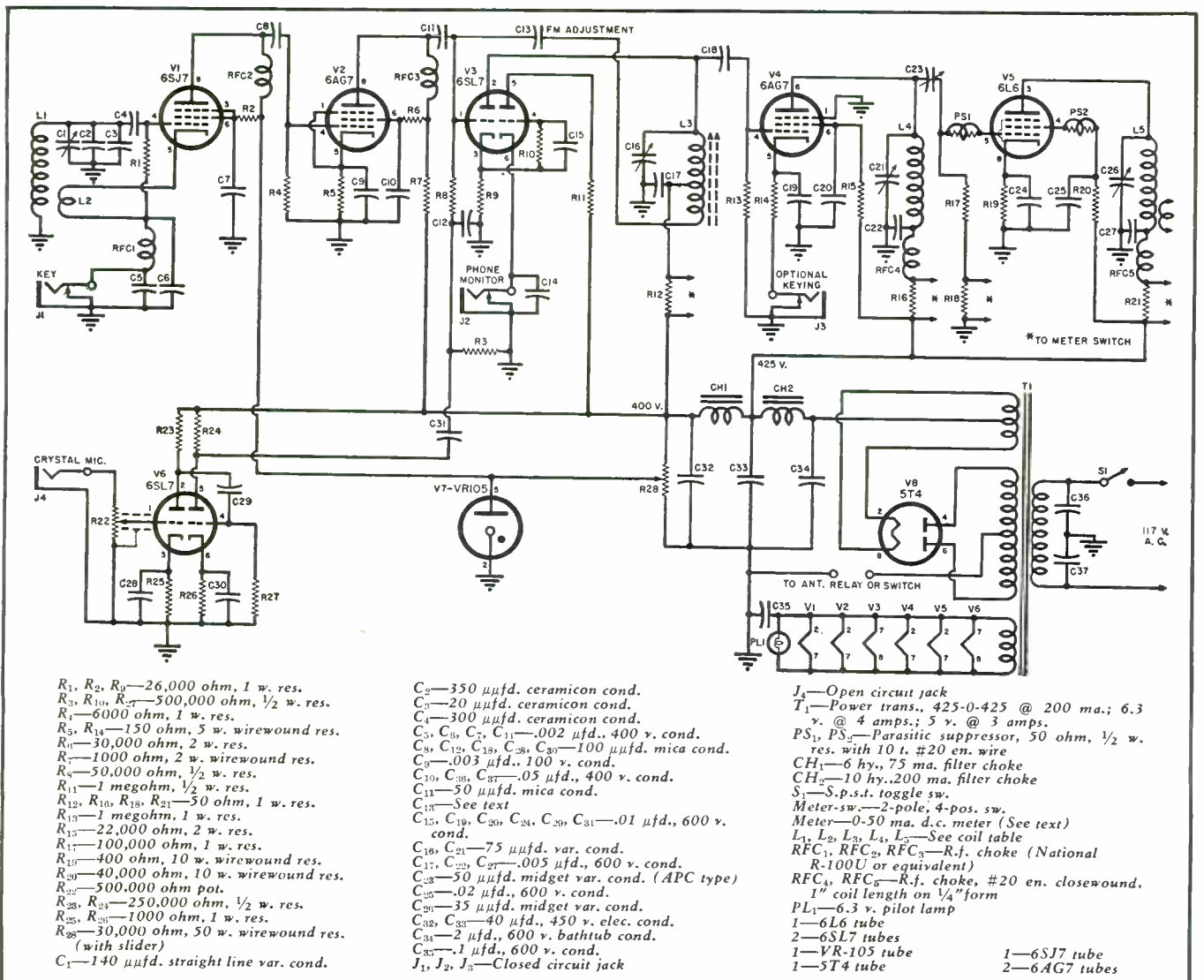

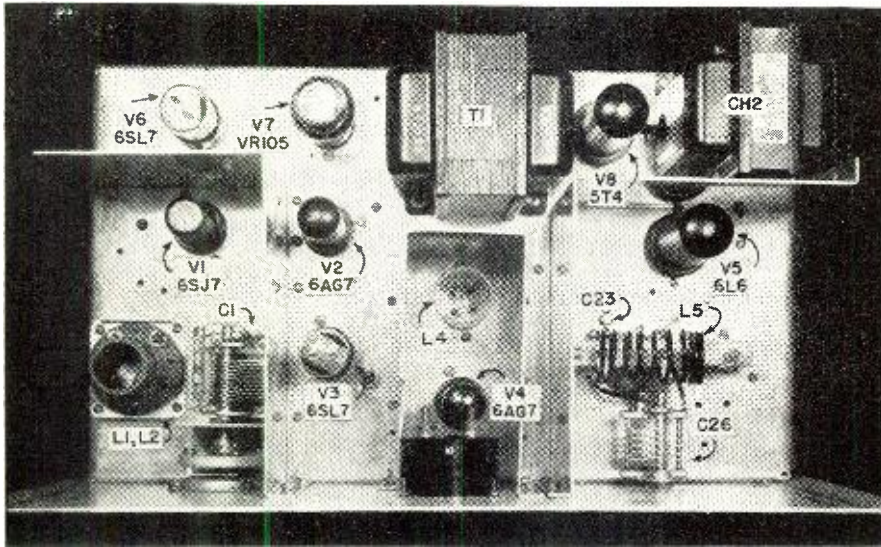

Top view shows placement of the required shield partitions.

der its inductance. The coil forms used are 4-prong polystyrene of standard make, $1\frac{1}{4}$ " in diameter. Small surplus standoff insulators are used to support the 6L6 "tank" coil. The 6L6 was wound around a 6AG7 tube as a coil form for 20 and 10 meters, spaced the diameter of the #12 wire. A jack-bar and coil strips were made from polystyrene strips, banana plugs, and jacks. For 40 and 80 meters, #20 wire is used. (Slip a thin sheet of plexiglass or strips around the 6AG7 before winding the coil). After winding the coils apply *Duco* household cement; after 5 or 6 minutes, the 6AG7 tube is withdrawn leaving neat coils. (Leave the plexiglass sheet or strips in the forms, but trim to make neat). More cement may be applied to insure rigidity for rough handling. Underneath the chassis, parts are grouped around respective tube sockets and as convenience dictates. Two terminals are provided at the left rear of the chassis for completing the "B minus" connection to ground through the separate contacts on the antenna relay. A switch may serve the same

Osc.	L_1 —10½ t. #20 en., 1¼" diam., spaced diam. of wire
Osc.	L_2 —3 t. #20 en., interwound at "ground" end of L_1
6AG7 FM	L_3 —50 t. #31 en., ½" diam. closewound, tapped at 15 t. from "ground" end (Iron core slug—see text)
6AG7	L_4 —80 m.—36 t. #20 en., 1¼" diam. closewound 40 m.—18 t. #20 en., 1¼" diam. spaced 1/16" 20m.—8 t. #20 en., 1¼" diam. 1" long
6L6	L_5 —80 m.—41 t. #20 en., 1" diam. closewound 40 m.—20 t. #20 en., 1" diam. spaced 1/16" 20 m.—12 t. #12 en., 1" diam. spaced diam. of wire 10 m.—7 t. #12 en., 1" diam. spaced ½"

Coil winding data.

purpose. The blank hole on the front panel is for the phone monitor jack.

A power supply delivering 400 volts at 200 ma. is used. However, the total plate current is only around 125 ma. under load. This insures good regulation under keying. The plate transformer also supplies the filament voltages.

Under chassis view identifies placement of major components.

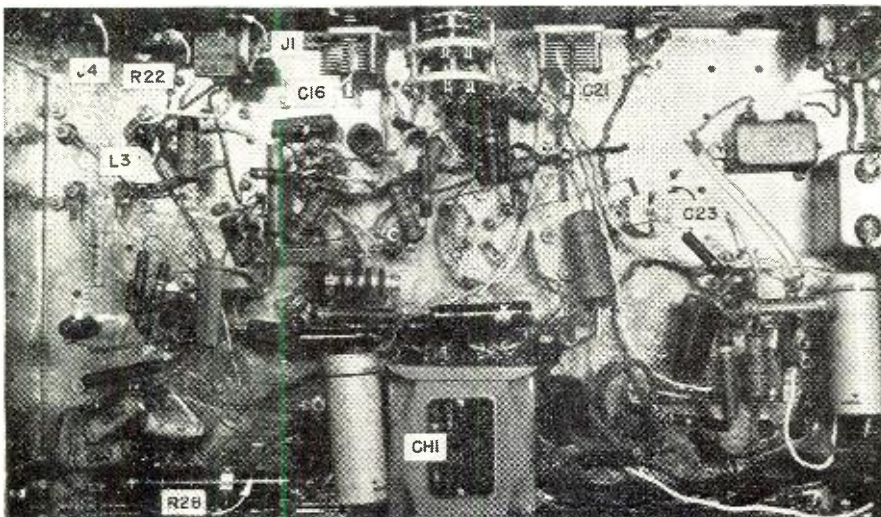

Antenna Coupling

The antenna coupling circuit consists of 3 turns fed to the #12 copper two-inch spaced transmission line feeding the 3-element rotary through the 5' 10" long RG-8-U matching transformer. Any of the capacitive, inductive, or link coupling circuits will be suitable however with other types of antennas.

Tuning Up

There is only one point that need be brought up in connection with tuning the unit. It is possible to tune the quadrupler stage to the 3rd instead of the 4th harmonic of the v.f.o. unit. This will come in handy during the Autumn of 1949 when the 21 megacycle band opens up. After coupling an antenna or final amplifier to the exciter, it will be necessary to check the amount of deviation by monitoring the 20 or 10 meter carrier, adjusting the gain or deviation control to about half open while talking into the microphone and setting C_{16} slightly off resonance. A drop in the 6AG7 grid current of about .1 or .3 ma. will be noted. On 75 meters, the maximum deviation will run around 1500 cycles or a trifle better, with the gain control well open.

The author incorporated meter switching to check the current in the various circuits. A 0-50 milliammeter, with the internal shunt removed, is used. Convenient shunts were made from what looked like #31 wire, which was wound around 1" lengths of ¼" polystyrene rod and held in place with *Duco* household cement. The individual shunts were secured directly to the meter switch and the twisted wires run from there to the individual circuits being metered. Any meter with a convenient scale may be used, however.

Final Notes

The currents drawn by the 6AG7 and 6L6 doubler stages run approximately 25 ma. and 46 ma. respectively. Under keying, they are practically unchanged, varying only a few milliamperes. This is an advantage as it does not place a large varying load on the power supply and helps keep the voltage steady for driftless v.f.o. operation on c.w. For optimum performance, the 6L6 should be loaded to 50 milliamperes. On 10 meters, the unloaded 6L6 plate current will dip to about 22 milliamperes, on 20, 40, and 80 meters proportionately lower (with excitation). The output on ten will run about 10 watts and the efficiency approximately 45 per-cent.

This exciter is the result of two other NBFM, v.f.o.-controlled units which were built up and completely dismantled before a satisfactory unit was completed. The parts totaled approximately \$37.50 less the crystal microphone, at current new and surplus prices.

If desired, an 829B with the control grids in push-pull and the plates in parallel (this allows the 829B to dou-

(Continued on page 192)

MODERN TELEVISION RECEIVERS

By
MILTON S. KIVER*

Close-up of Philco Precision Channel Selector, showing how easy it is to insert coils for various channels. This switch provides for any 8 channels of the 13 assigned by the FCC; and since a maximum of 7 stations is possible in any one metropolitan area, this Channel Selector can be used in any location in the United States.

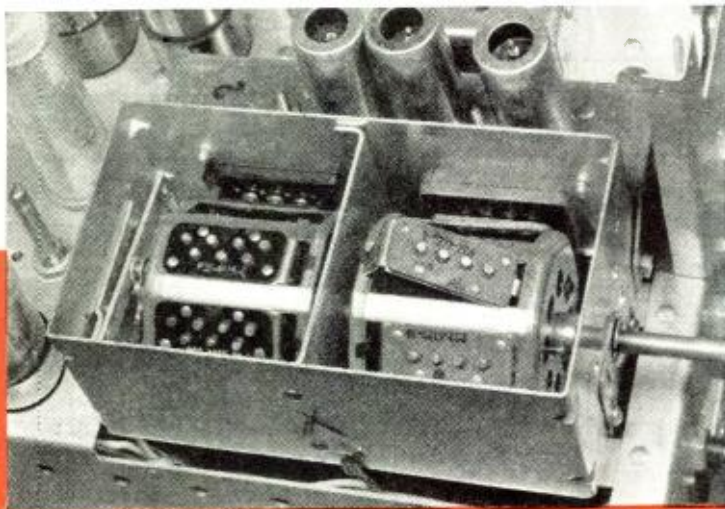

IN the last year, the status of television throughout the country has changed from "Is television commercially available?" to "How long will it take to reach my community?" The progressive serviceman, recognizing this onswEEPing trend, will now concentrate doubly hard on familiarizing himself with the operation of each television receiver as it appears on the market. As an aid toward this end, this article and those that follow will analyze various television receiver circuits, tracing the signal paths from input terminals to image tube and loudspeaker, and compare the methods employed by different manufacturers to achieve similar results.

R. F. Systems

The logical starting point in any system is where the incoming signal is received. In this respect, a television receiver is similar to the standard broadcast set. Television receivers currently being marketed are designed with an input impedance of 300 ohms. This exactly matches the characteristic impedance of the recently developed parallel-wire polyethylene transmission line and permits direct connection between the two. In addition, many of the newer wide-band antennas have impedances of 300 ohms and the erection of a completely matched antenna system is thus quite readily effected. The foregoing consideration is an important one because mismatching at any point in the antenna lead-in system results in a loss of signal power.

The television signal occupies a 6 mc. bandwidth and input circuits must be capable of adequately receiving a signal this wide. Toward this end, closely coupled and heavily loaded coils are a necessity. The ideal input

response curve is shown in Fig. 1A. However, the practical modification more closely approaches the curve shown in Fig. 1B. The dip or valley in the center is a result of the close coupling; it should, however, never exceed 30 per cent of the peak or total amplitude of the curve. The sound and video carriers, separated by 4.5 mc., are located at either end of the curve, within the 90 per-cent response region.

So much for the general requirements of the input stages of a television receiver. Now let us investigate the actual form of the circuits themselves.

Fig. 1. (A) The ideal r.f. response curve, and (B) the practical modification.

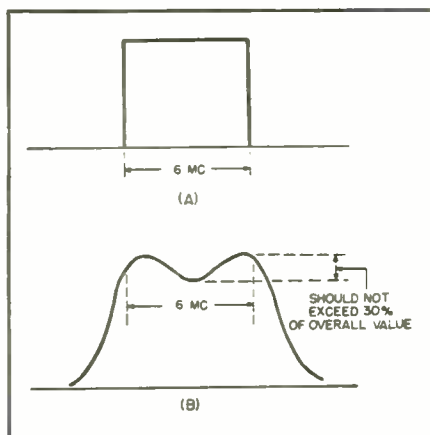

Part I. An analysis of the r.f. stages incorporated in present-day, commercially-built television receivers. In future articles of this series, the author will present a stage-by-stage comparison of all TV sets. Alignment and service techniques will also be covered.

RCA Receivers

The r.f. section of the RCA receivers (all models containing 7" and 10" direct-viewing screens) is designed around a circuit which departs sharply from so-called conventional design. In the first place, the r.f. amplifier, converter, and oscillator contain 6J6 double triode tubes and ordinarily triodes are not suitable for high-frequency use. However, the 6J6, the 6C4, and others have been specially designed for high-frequency operation. They are small in size, with interelectrode capacitances reduced to a minimum and connecting leads made as short as possible. When used in push-pull arrangement or as grounded-grid amplifiers, they function with good results. Any slight tendency toward oscillation can usually be overcome by inserting small neutralizing condensers. This is the purpose of C_1 and C_2 in Fig. 2. The input circuit is untuned, T_1 serving to short-circuit all low-frequency signals picked up by the antenna. R_1 and R_2 are the terminating resistors for the 300-ohm antenna transmission line, providing also a d.c. path for the biasing voltage from the contrast control to the grids of the r.f. amplifier.

The 13-channel tuning arrangement in the plate circuit of the r.f. amplifier is an artificial quarter-wave transmission line. The line is balanced, containing series inductances in each section of the line. Coils L_{23} and L_{24} provide the proper inductance to tune the

* Mr. Kiver is the author of "U.H.F. Simplified," "F.M. Simplified" and "Television Simplified"—all published by D. Van Nostrand Company, Inc., New York.

Manufacturer	Model No.	Picture Type		Tube Size (diam.)	Screen Size	Model Type		Tuning Method		R.F. Amplifier
		Direct	Proj.			Table	Console	Continuous	Selector Switch	
Andrea	T-VJ12	X		12	7½x10	X			X ¹	6J6
	C-VJ12	X		12	7½x10		X		X ¹	Same as Model T-VJ12
	CO-VJ12	X		12	7½x10		X		X ¹	Same as Model T-VJ12
Belmont	21A21	X		7	5½x 4¼	X		X		6AK5
General Electric	801	X		10	6 x 8		X		X	6AU6
	802	X		10	6 x 8		X		X	Same as Model 801
Motorola	VT71	X		7	4½x 6	X			X	½ of 7F8
	VT101	X		10	6¾x 8½		X		X	6AG5
Philco	48-1000	X		10	6 x 8	X			X	6AG5
	48-1050	X		10	6 x 8		X		X	Same as Model 48-1000
	48-2500		X	5	15 x20		X		X	6AG5
RCA	621TS	X		7	4½x 5¾	X			X	6J6
	630TS	X		10	6¾x 8½	X			X	6J6
	721TS	X		10	6¾x 8½	X			X	6J6
	630TCS	X		10	6¾x 8½		X		X	Same as Model 630TS
	721TCS	X		10	6¾x 8½		X		X	Same as Model 721TS
	730TV1	X		10	6¾x 8½		X		X	Same as Model 721TS
	730TV2	X		10	6¾x 8½		X		X	Same as Model 721TS
	641TV	X		10	6¾x 8½		X		X	6J6
	8TS30	X		10	6¾x 8½	X			X	Same as Model 630TS
648PTK		X	5	15 x20		X		X	6J6	
United States Television	T-502	X		10	6 x 8		X		X	6AG5
	T-507		X	5	21 x16		X		X ²	6AG5
	T-525		X	5	25 x19		X		X ²	Same as Model T-507
	T-530		X	5	30 x22½		X		X ²	Same as Model T-507
	T-621		X	5	22½x16¼		X		X ²	Same as Model T-507

¹ The Andrea receivers employ a tuner "turret" which is somewhat similar to the Philco tuner except that all 13 channels are wired into position. The r.f., modulator, and oscillator tubes, with their circuit components, are also contained within the copper-plated steel case. This reduces reradiation and protects the circuits from external fields.

² The r.f. tuning circuits of U.S.T. receivers closely resemble those employed in G.E. receivers. See explanation in article.

Table 1. A comparison of present-day television receivers. The above chart includes only those models which are on the market and which have been discussed in the article thus far. As new models become available, they will be added to chart and adequate explanation of their operation given.

circuit to channel 13, 210-216 mc. Iron-core slugs in L_{25} and L_{26} permit adjustment of each coil's inductance. L_{13} to L_{23} on one side of the line, and L_{11} to L_{21} on the other side of the line, are fixed sections which are added in series to L_{25} and L_{26} as the shorting bar is moved progressively down the line. Note that the highest frequency is obtained when the shorting bar is closest to the plates of the tubes. With each movement of the bar to the left, more inductance is inserted into the circuit.

The physical construction of each of the inductances L_{13} to L_{21} is a small non-adjustable silver strap between the switch contacts. Each strap is cut to provide a 6-mc. change in frequency. Coils L_{11} and L_{12} bridge the gap between 174 mc., channel 7, and 88 mc., channel 6. For the lower television channels, L_1 to L_6 and L_2 to L_{10} are used. These coils are constructed in the form of a "figure eight." Signal coupling between the r.f. amplifier and the mixer is achieved by C_3 , C_4 , C_5 , and a single turn of link coupling.

For servicing purposes, an open coil in either section of the tuning line will disrupt operation for that channel and all lower ones. It will not, however, interfere with the operation of higher frequency channels. If this seems puzzling, remember that the "B+" of the other section can travel through the shorting bar to the plate connected to the affected line. However, an open circuit in both sections of the line, on any channel, will disrupt all operation. Voltage or resistance checks will then reveal the open coil.

G. E. Sets

In the *General Electric* television receiver, Model 801, the r.f. amplifier employs a 6AU6 high-frequency pentode connected as a grounded-grid triode amplifier. See Fig. 3. Triodes are superior to pentodes because of their lower noise factor and in this portion of the receiver tube noise is an important consideration. In addition, the use of a triode does not noticeably reduce the gain of the set because of

the low plate load impedance employed in television receivers. To permit a 6 mc. signal to pass with uniform amplification, loading resistors reduce the impedance of the tuning circuit to a value somewhere between 2000 and 10,000 ohms.

Fig. 4 illustrates why pentode and triode tubes give comparable gains in television receiver circuits. The amplified signal divides between the plate resistance of the tube and the tuned output circuit. Since a pentode's internal resistance is considerably higher than the impedance of the tuned circuit, most of the amplified signal is lost in the tube. Consequently, the over-all gain is low and it is possible to achieve practically as much gain with a well-designed triode.

In grounded-grid amplifiers, the grid is grounded and the input signal is fed into the cathode. The grid r.f. potential is zero and the cathode potential fluctuates in accordance with the input signal. The effect on the plate current is the same as if the cathode had been kept fixed in potential and the grid voltage was varied. The chief advantage is the fact that a grounded grid acts as a shield between the input and output circuits and prevents the tube from oscillating. See page 178 for more detailed explanation.

In the *G.E.* receiver, the antenna is connected into the cathode circuit of the r.f. amplifier. The input impedance is 300 ohms, again matching the polyethylene twin-conductor transmission line. L_1 is a simple high-pass filter rejecting all low-frequency signals. The cathode chokes, L_2 to L_6 , are placed in series with the cathode resistor to prevent the input impedance from being lowered by the shunting effect of the total stray capacity to ground of the cathode of the tube. The choke value is changed with frequency. R_1 and C_1 provide cathode bias.

The r.f. amplifier is coupled to the mixer tube through a wide-band transformer. One such unit is provided for each channel. The windings are self-tuned by the distributed and tube capacities to provide maximum gain through a high L/C ratio. On channels 1 and 2, the transformer is triple-tuned to prevent the image frequencies of the 88-108 mc. FM band from causing interference. The r.f. coils for each channel are placed physically near the oscillator coils (of the same channel) in order that both voltages combine at the mixer grid.

Belmont Radio

In each of the previous circuits, the various channels were brought into position by means of a selector switch. The *Belmont* television receiver, Model 21A21, employs continuous tuning over the thirteen channels. The tuning assembly, shown in Fig. 5, is a permeability tuner in which the movable slugs of each coil are mechanically ganged together and moved in or out of the coils when the front dial is rotated.

When a station selector switch is

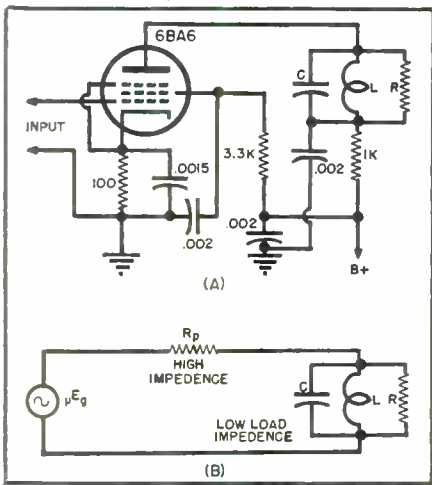

Fig. 4. A pentode r.f. amplifier (A) and its equivalent circuit (B).

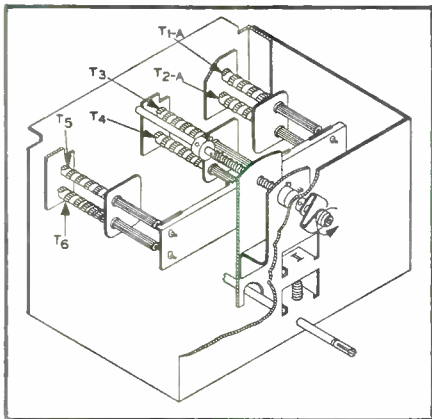

Fig. 5. Tuning assembly used in the Belmont Model 21A21 television receiver.

Fig. 6. The r.f. section of the Belmont television receiver.

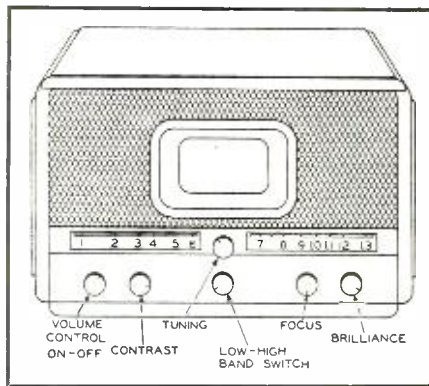
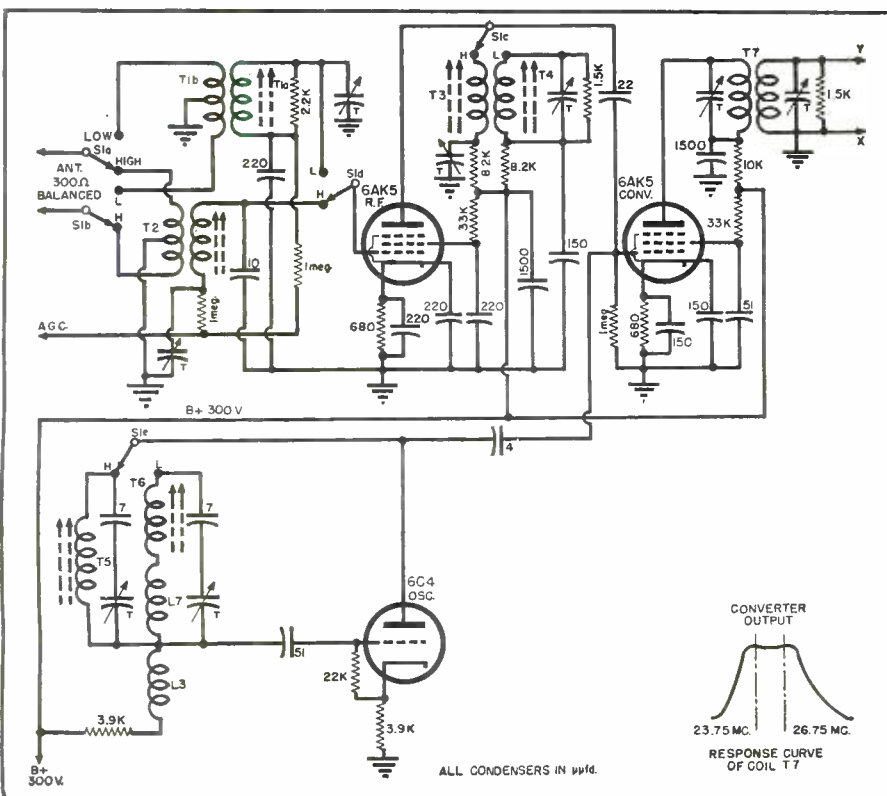

Fig. 7. Front panel layout of the Belmont Model 21A21 television receiver.

from widely separated points of the compass.

The antenna coil is coupled to the r.f. amplifier input coil through a tertiary winding. This latter resonant circuit increases the coupling between the other two circuits and produces a wide spread, double-peaked response curve. See Fig. 9B.

The r.f. amplifier itself employs a 6AG5 pentode, with a.g.c., normal cathode bias, and a small amount of degenerative feedback voltage. The latter is useful for stabilizing the circuit and reducing the effect of tube and circuit changes on signal gain. The output of the r.f. amplifier is impedance-coupled to the following 6AG5 mixer.

The tuned circuit in the r.f. amplifier output (actually the mixer grid input) is, as far as the incoming signals are concerned, a series resonant circuit. The response of this cou-

pling network is peaked, producing a curve such as indicated in Fig. 9A. If we combine this response curve with the broad, double-peaked input response curve, we obtain an over-all response curve which is fairly linear for the required 6 mc. This is shown in Fig. 9C. The oscillator coil is coupled to the r.f. amplifier output coil, thereby permitting these two voltages to combine at the mixer.

Motorola Receivers

Most television receivers currently manufactured have a 300-ohm input impedance; *Motorola* sets, however, have provision for either 75 or 300-ohm lines. This is accomplished simply by using the full primary winding of the input transformer for the 300-ohm line and half of the winding for the 75-ohm coaxial line. See Figs. 10 and 11. Inductance of a coil is proportional to the square of the number of turns. Doubling the number of turns produces four times the inductance and, at the same frequency, four times the impedance. 300 ohms is four times 75 ohms.

The secondary of the input transformer, T_1 , consists of a high and low frequency winding in series. The low frequency coil is tuned for each of the six lower channels by changing the tuning condenser across the coil. The high-frequency coils in series with the low-frequency coils do not present enough inductance to interfere with the operation of the low-frequency coils. For channels 7 through 13, condensers C_1 , C_2 , and C_3 , short out the low frequency resonant circuit. A simple short across the low-frequency coil is not the most effective method of eliminating the effect of this coil because of the switch and lead inductance present. A more effective short is obtained by developing a series resonant circuit composed of the switch and lead inductance and the condensers placed across the low-frequency winding.

To insure the proper 6 mc. bandwidth, loading resistors R_1 and R_2 are used.

The r.f. amplifier is very similar to those previously described, but the coupling circuit between the r.f. amplifier and the mixer is new. The coupling network is a critically double-tuned circuit with mutual coupling provided by C_1 and C_2 . In the simplified diagram, Fig. 11, the two variable inductances, L_A and L_B , represent each of the pairs of coils shown as L_1 through L_{2n} in Fig. 10. Each pair of coils is pretuned to the same frequency by means of a brass slug. C_A represents the output capacity of the 6AG5 plus distributed capacitances; C_B is the input capacitance of the 6J6 plus distributed wiring capacitance.

In this type of tuned circuit, the bandwidth is determined by the degree of coupling and the Q of each coil. The degree of coupling is controlled by the size of C_1 and C_2 . The smaller these capacitances, the greater the mutual impedance and the greater the bandwidth. The values C_1 and C_2 chosen

(Continued on page 142)

MAC was pleased to find his brand-new assistant waiting at the door of the shop when he came down to open up. The kid greeted him with a shy smile, his curly red hair looking like a torch in the bright rays of the Spring sun.

"Right on time, eh Barney?" Mac said as he unlocked the door of the radio shop and motioned the youth inside.

"Yes, sir. Mom was so afraid that I might be late for work the very first day that she had me eating breakfast at five-thirty."

Mac's leathery face wrinkled in a sympathetic grin as he shrugged his broad shoulders into his shop coat and fastened the belt. He waved the boy into a chair and leaned back against the desk in front of him. "Barney," he asked, "just how much do you know about radio service?"

"Not much that I'm really sure of, Mr. McGregor," Barney confessed. "I had a little radio theory in physics in high school, and I picked up some more while I was studying to get my amateur license. My transmitter and some of the other gear around the ham shack are home-built, but that was mostly a case of copying them out of books and magazines. I think you had better just figure that I am plenty dumb about radio but that I don't want to stay that way."

"Good! The less a fellow thinks he knows about anything the easier he learns. You will pick up a lot just watching and listening, but that is not enough. If we are going to make a real serviceman out of you, you must know the 'why' as well as the 'how' of fixing radios. I'll give you some books to read, and I want to hear you coming up with lots of questions. If I can, I'll answer them; and if I can't we'll dig out the answers together."

Barney nodded his head vigorously in approval of this program.

"Well," Mac said, picking up some cardboard tags from the desk, "we may as well start right now. Miss Perkins usually takes care of things up front here, but she doesn't come to work until nine o'clock. Incidentally, do not let her fool you. She likes to think that she is a sharp-tongued old sour-puss, while she really has a heart as big and as soft as they come—but don't ever let her know you know it."

Barney's blue eyes twinkled. "I think I understand, sir. Mom is a little like that."

"As I was saying," Mac went on, "there will be times, say during her lunch hour, when you will have to take sets in. When you do, *always* fill out one of these cards and fasten it to the set."

He handed one of the numbered tags to Barney and continued. "Be sure to get down correctly the name, address, and phone number of the customer. On that space on the back, write out the complaint with the set. Is it dead? noisy? distorting? cutting out? How long has it been that way? If it cuts out, how long does it take

Mac's RADIO SERVICE SHOP

By JOHN T. FRYE



MAC HIRES A HELPER

for it to do so after it has been turned on? Does it cut out entirely or just drop in volume? Does the dial lamp go out? Does anything such as jarring the set or snapping on a light seem to bring it back? Does the trouble occur at any particular time of day or on any particular station?"

Barney's eyes were beginning to look a little glazed, but Mac went on relentlessly. "Don't forget to ask the customer if he can think of any little things he noticed wrong with the receiver before this last trouble showed up, little things that did not warrant taking it to a repairman but which he would like to have corrected while it is in the shop?"

"Are we just giving him a sales line, sir?" Barney asked.

The corners of Mac's mouth twitched at that "we," but he explained gravely, "Not at all! It is true that the customer likes to have his troubles taken seriously, but those questions are to help us. Quite often a minute spent in getting information on a set's behavior will save you an hour hunting trouble. Miss Perkins is a jim-dandy at collecting this information, and often the trouble with a set can be figured out just from reading what she has down on the card. She is good."

"I suppose the fellow who reads the card has to know a little something, too," Barney ventured without a trace of a smile.

"It helps," Mac agreed, looking at him sharply.

"What do I do with the set after I get its case history?"

"That depends on whether or not it is an 'intermittent'. An intermittent is any set that has some trouble that shows up only part of the time. The trouble may be cutting out, changes in volume, distortion, and so on; but if the condition comes and goes, the set is an intermittent."

"What do I do with one of those?"

"Mostly nothing, except to carry it gently back into the shop. I want these sets disturbed just as little as possible until I get a chance to hear them misbehave. They can tell you a lot about what ails them if you can just hear them go through their routine once."

"What if the sets are not intermittent?"

"First, check to see if there is a way of knowing where the tubes belong, either in the form of a chart pasted to the cabinet or chassis or by numbers stamped on or near the sockets. If not, draw up a little tube-position chart before taking out the tubes."

"Do I check the tubes?"

"Not until I have shown you how I want it done. You just wipe them clean, using carbon-tetrachloride to remove any gum, and place them in a cardboard box together with the tube-diagram and the tag number of the set to which they belong. Come on back in the shop and I'll show you what you do then."

Barney followed Mac through the swinging-door back into the service shop. Mac went across the room and opened the door of a small closet-like compartment. Inside was a short

(Continued on page 114)



Front panel layout of completed television oscilloscope shows position and identity of all operating controls.

A TELEVISION OSCILLOSCOPE

Part 1. Covering the design problems encountered in constructing a television oscilloscope. Complete construction details will be presented next month.

By
L. H. VanARSDALE, JR.

satisfying these more complex requirements.

This series of two articles is intended for those who may be interested in knowing the design requirements for an oscilloscope suitable for general television use and also for those who may desire to construct a versatile instrument suited for both audio and television applications. The first article will discuss the requirements which such an instrument must meet to be suitable for television use, and, in addition, will describe some circuits capable of satisfying these requirements. The second article will describe a practical instrument, utilizing these circuits, which will not only permit observation of the waveforms in another television receiver, but may also be used as the picture and scanning portions of a television receiver itself.

In the television oscilloscope, the following parts of the instrument must come in for special attention:

- (1) Horizontal and vertical deflection amplifiers,
- (2) Horizontal and vertical scanning (sweep) circuits,
- (3) Video voltage connection to the cathode-ray tube,
- (4) Power supplies.

A NUMBER of very excellent articles have appeared in the literature describing various types of oscilloscopes suitable for use in connection with audio frequency work. As is well known, such work entails the use of frequencies from approximately 20 to 15,000 cycles-per-second, and the usual "garden variety"

of scope does a fine job within these frequency limits. Contrasted to these relatively simple requirements, however, an oscilloscope suited for television work must permit observation of a variety of relatively complicated waveforms over a much wider frequency range. The usual oscilloscope is, unfortunately, not often capable of

Fig. 1. Simplified block diagram of a typical deflection amplifier.

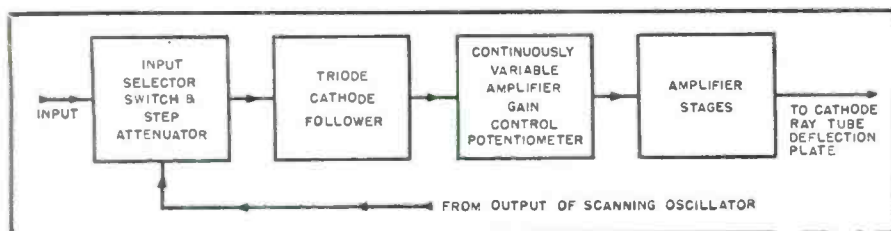

Succeeding paragraphs discuss these features in the order listed.

Deflection Amplifiers

To simplify the design of an oscilloscope, the design of both the horizontal and vertical deflection amplifiers is often made identical. This is particularly desirable in the case of a scope for television use, since the usage requirements for both are nearly identical. The comments which follow will, therefore, apply equally to both.

The deflection amplifiers should meet the following specifications:

- (a) Frequency response—flat from 20 cycles to 200 kc.
- (b) Available amplification—at least 150.
- (c) Input voltage range—0.1 volt to 200 volts peak-to-peak.
- (d) Output voltage—essentially distortionless with sufficient output to deflect the cathode-ray tube beam at least $1\frac{1}{2}$ times the screen diameter.
- (e) Gain Control—of a type which will not alter frequency response.

The reasons behind these requirements may be of interest. The lower limit of the *frequency response* has been chosen at 20 cycles-per-second simply to assure the proper performance of the instrument at low audio frequencies, in the event it is desired to use it for that purpose. The high frequency limit is determined principally by the frequency of the saw-tooth scanning voltage which the amplifier must handle without distortion. It can be shown mathematically that an amplifier must have a substantially flat frequency response to at least the 10th harmonic frequency of a saw-tooth-shaped oscillation in order to amplify this voltage without appreciable distortion. Since the frequency of the horizontal scanning voltage in a standard 525 line television picture is 15,750 cycles-per-second, the amplifier must be flat up to 157.5 kc. ($10 \times 15,750$ cycles = 157.5 kc.). The upper limit of 200 kc. was, therefore, chosen, since this gave a comfortable margin above the required limit of 157.5 kc. and permits saw-tooth scanning rates up to 20,000 cycles-per-second to be used or observed, if desired.

The *available amplification* was chosen at 150 as a minimum since it was felt that an oscilloscope should permit observation of voltages in the order of 0.1 volt. With a deflection sensitivity of 100 volts/inch, which is a not uncommon value, this would mean that a 0.1 volt peak-to-peak a.c. signal would be about $\frac{3}{16}$ " high if the gain were exactly 150.

The *input voltage range* limits were chosen as 0.1 and 200 volts peak-to-peak, since practically all voltages normally observed on an oscilloscope fall within these limits. In the instrument to be described in the next article, provision has been made for observing higher voltages by bringing out a direct connection to the deflec-

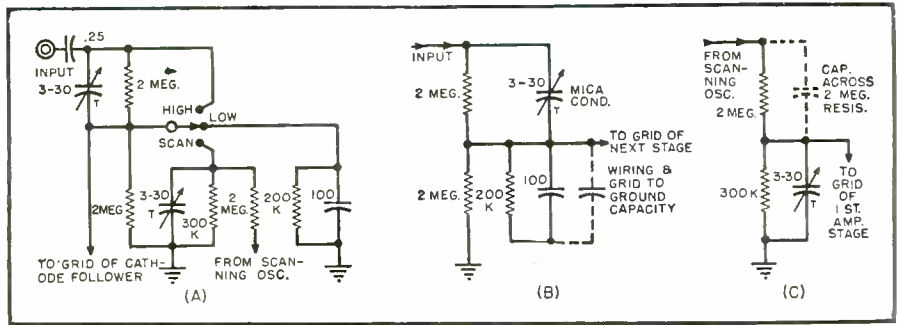

Fig. 2. (A) Wiring diagram of one form of input selector and step attenuator. (B) Diagram of "LOW" position attenuator. (C) Diagram of "SCAN" position attenuator.

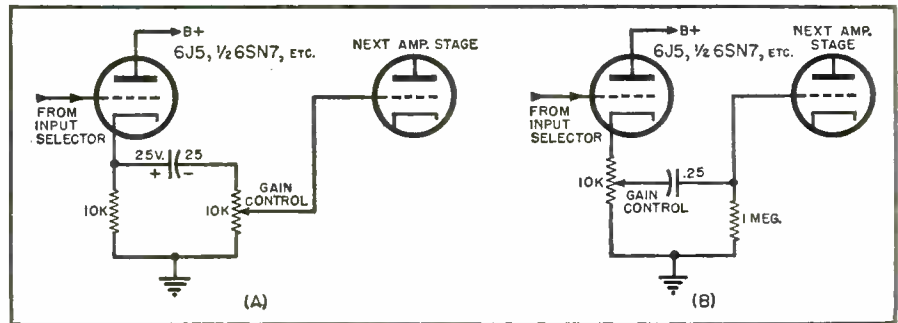

Fig. 3. (A) Diagram of a typical cathode follower stage preceding the actual amplifier stages of a deflection amplifier. (B) Alternate cathode follower circuit. This method is not preferred as momentary pattern shift occurs when gain is changed.

tion plates on the rear of the chassis.

The reason for the *essentially distortionless* characteristic of the amplifier is obvious. In addition, it is deemed essential that sufficient output voltage be available from the amplifiers to deflect the beam at least $1\frac{1}{2}$ times the cathode-ray tube screen width while maintaining the desired distortionless performance. The amplifier to be described in the second article of this series is of particular interest on this point, since it is capable of an undistorted output in excess of 400 volts peak-to-peak.

The *gain control* of a wide-band amplifier cannot be the more familiar high-resistance grid input potentiometer as used in audio work, since such a gain control discriminates very badly against the higher frequencies, principally because of the bypassing effect of the grid-to-cathode capacity at these higher frequencies. This dif-

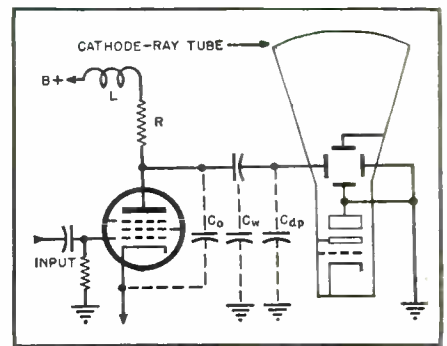
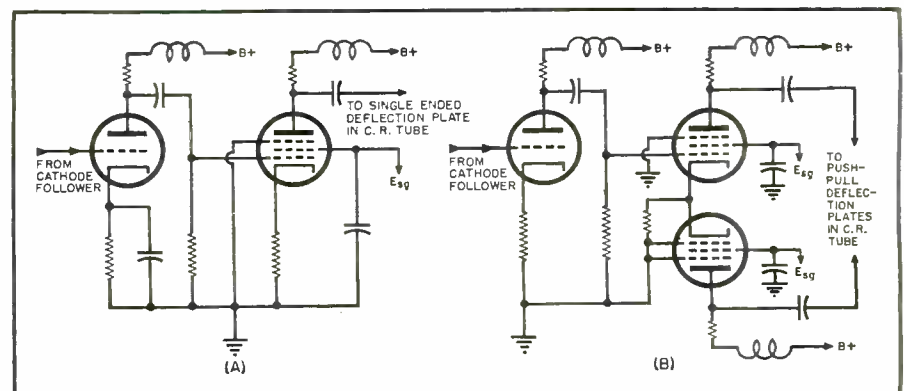

Fig. 4. Basic circuit for video-type amplifier stage. The various stray capacities affecting high-frequency response are dotted.

ficulty can be readily overcome by inserting the gain control in a cathode follower circuit output. This point will be discussed in greater detail

Fig. 5. (A) Deflection amplifier circuit suitable for single-ended deflection. (B) Deflection amplifier circuit suitable for push-pull deflection.



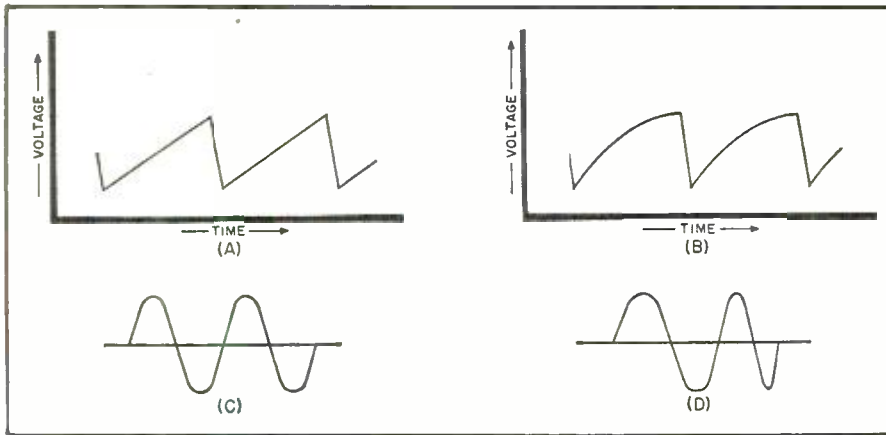

Fig. 6. (A) Linear saw-tooth scanning voltage waveform. (B) Non-linear saw-tooth scanning voltage waveform. (C) Appearance of two sine waves as seen with linear saw-tooth scanning voltage. (D) Appearance of two sine waves as seen with non-linear saw-tooth scanning voltage shown (B) above.

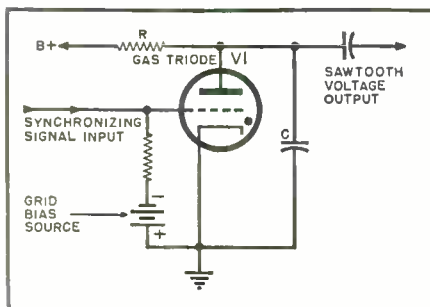

Fig. 7. Basic circuit for the gas-triode type of saw-tooth scanning oscillator.

when describing the cathode follower.

Fig. 1 is a block diagram of one complete deflection amplifier such as might be found in an oscilloscope having the previously described characteristics. Fig. 2A gives the schematic diagram of one form of input selector and attenuator which meets the bandwidth and input voltage requirements. While this assortment of condensers and resistors may seem a bit complex, they actually contribute

considerably to the proper performance of the whole circuit. Mentally rotating the selector switch to the "HIGH" position, it will be noted that the input jack is thus directly connected to the grid of the cathode follower tube through the .25 μ fd. coupling condenser. As the grid return of the cathode follower to ground is 2 megohms when the switch is in this position, the input circuit offers a very small loading effect to the circuits under test.

The switch is used in this "HIGH" gain position when small voltages are being observed. However, when it becomes necessary to view larger voltages, an attenuator must be inserted between the input terminal and the cathode follower grid to prevent the larger voltages from overloading this tube. This is accomplished by rotating the switch to the "LOW" gain position. In this position, only one-tenth (1/10) of the input voltage appears at the grid of the cathode-follower tube, thus permitting input voltages ten times greater to be observed on the oscilloscope.

Fig. 8. Complete circuit for gas-triode type saw-tooth scanning oscillator.

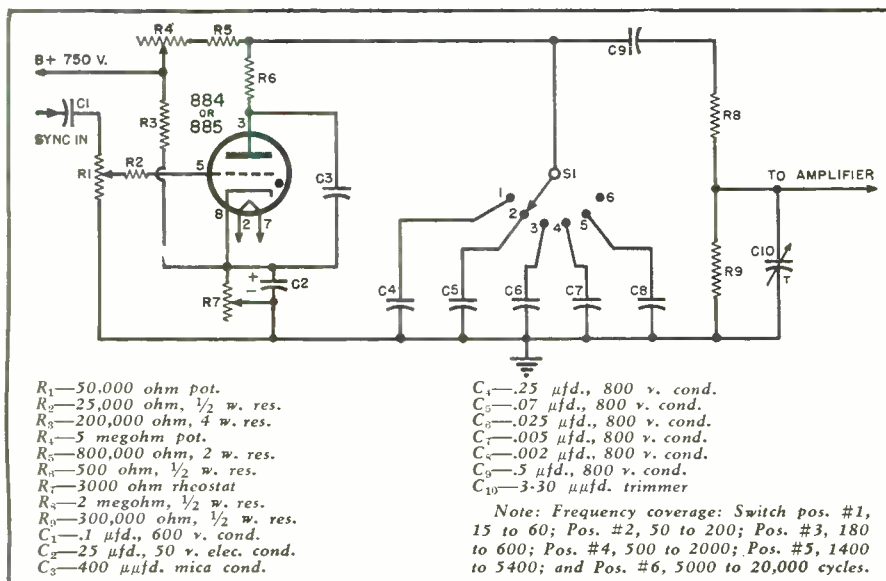

The attenuator itself is shown, without the other components, in Fig. 2B. The wiring capacity and the grid-to-ground capacity are both shown as a dotted condenser to assist the explanation. At low frequencies, the resistance portion of the attenuator would be sufficient, because the small capacity of the grid circuit, which may run around 10 μ fd. will have no appreciable effect. However, as the frequency goes higher, the reactance of this capacity gets smaller and thus has the same effect as though another resistor were added across the 200,000 ohms already there. This effect is sufficient to change the attenuation from 10:1, for which the resistors are calculated, to 20:1 at 20 kc. and 37:1 at 200 kc., using the 10 μ fd. grid-to-ground capacity figure.

To overcome this effect, an additional capacity attenuator is added in parallel with the resistance attenuator. These capacities are proportioned to assure the same degree of attenuation at the higher frequencies as the resistors alone afford at the lower frequencies, thus eliminating the frequency discriminating effects of the resistance attenuator by itself to the higher frequencies. The adjustment of the small 3-30 μ fd. trimmer to make the relationship between the resistors and condensers exactly correct is described in the second installment.

The "SCAN" position of the input selector connects the output of the saw-tooth oscillator to the input of the cathode follower through its own attenuator. The need for this additional attenuator is best explained by considering the design of a saw-tooth oscillator itself. Generally speaking, it is desirable to get the largest possible output from any saw-tooth oscillator while still maintaining the desired scanning linearity, since the waveform is more nearly a perfect saw-tooth shape at higher output voltages, and the return trace time is generally shorter. Accordingly, an attenuator is desirable to reduce the voltage from the scanning oscillator to a usable value at the grid of the cathode follower, since this output voltage is generally much larger than the deflection amplifier requires.

This scanning voltage attenuator utilizes the same principles as those described for the "LOW" position attenuator, but is adjusted in a somewhat different manner. As shown in Fig. 2C, the smaller of the two attenuator capacities is actually the capacity of the 2 megohm resistor itself, while the larger capacity across the 300,000 ohm resistor is made variable to permit exact adjustment.

Fig. 3A shows the cathode follower itself, the variable amplifier gain control, and the input grid of the first amplifier stage. One unconventional feature will be noted about this arrangement. Instead of connecting the variable control in the cathode circuit and placing a fixed resistor in the grid circuit, illustrated in Fig. 3B,

(Continued on page 192)

A Unique A.V.C. AMPLIFIER

An a.v.c. circuit providing essentially constant a.f. or r.f. output for widely varying inputs.

By J. T. GOODE

The Rollin Co.

SOON after the appearance of sensitive-type receivers, the desirability of some method of providing automatic volume control became apparent.

The first type of automatic volume control, which consisted of rectifying the amplified r.f. voltage and controlling the bias of an amplifier stage, is the most widely used a.v.c. method.

Such a method of a.v.c. control is a vast improvement over none, but does have its limitations, the limitations consisting of steadily increasing output as the input is increased.

Amplified a.v.c. control tends to correct this situation. The amplified a.v.c. control described in this article should be classed as an improvement over conventional a.v.c. amplifiers, the word "improvement" meaning an additional stage of amplification, which is used only for the purpose of increasing the voltage before rectification.

The measurements, shown in Table 1, were made on a one-stage audio amplifier with a.v.c. control (see Fig. 1). The measurements were made by increasing the input to the amplifier in one-decibel steps and measuring the db. output change of the amplifier.

On an average the a.v.c. amplifier was able to maintain the output constant within .15 db. when the input was changed 1 db. The obvious error in the output measurements was caused by inability to observe voltage measurements with such a slight change.

The measurements indicate the ability of this type of a.v.c. amplifier to maintain linear increase as the input voltage is varied. The conventional a.v.c. amplifier does not have this linear characteristic nor the ability to maintain reasonably constant output voltages when large input variations are experienced. The stability of the a.v.c. amplifier is excellent.

Tests were conducted over a period of months in a constant level audio application, and the output voltage variation was less than 1 db. During these tests no adjustment was made in any part of the circuit.

INPUT CHANGE (in db.)	OUTPUT CHANGE (in db.)
0	0
1	.1
2	.3
3	.5
4	.8
5	.9
6	1.0
7	1.1
8	1.2
9	1.3
10	1.5
11	1.7
12	1.9
13	2.0
14	2.1
15	2.2
16	2.3
17	2.5

Table 1. Actual measurements made on a one-stage audio amplifier employing the a.v.c. control described.

This type a.v.c. amplifier operates with equal stability in r.f. applications. Fig. 2 indicates circuit values for an r.f. application.

This a.v.c. amplifier requires a negative potential of approximately 75

volts. This voltage is not critical but should be maintained at a constant level. The use of a voltage regulator tube to maintain this voltage constant is desirable. The voltage regulator tube is an excellent equivalent filter condenser, producing practically pure d.c. without the use of filter chokes. The amount of current furnished by this bias supply is infinitesimal with the exception of the current drawn by the voltage regulator tube. Such being the case, one-half of the high voltage winding of a power transformer may be used and rectified for this purpose without overloading the transformer.

Another method of obtaining bias without batteries is to build a simple r.f. oscillator and rectify the r.f. This method is less desirable than the circuit indicated in Fig. 1. The r.f. bias supply has definite limitations if the a.v.c. amplifier is to be used in a receiver. Serious beat notes can result
(Continued on page 158)

Fig. 1. Diagram of a.v.c. amplifier. Note that bias voltage is obtained from one-half of transformer's high voltage winding. Balance of 5Y3 power supply is not used.

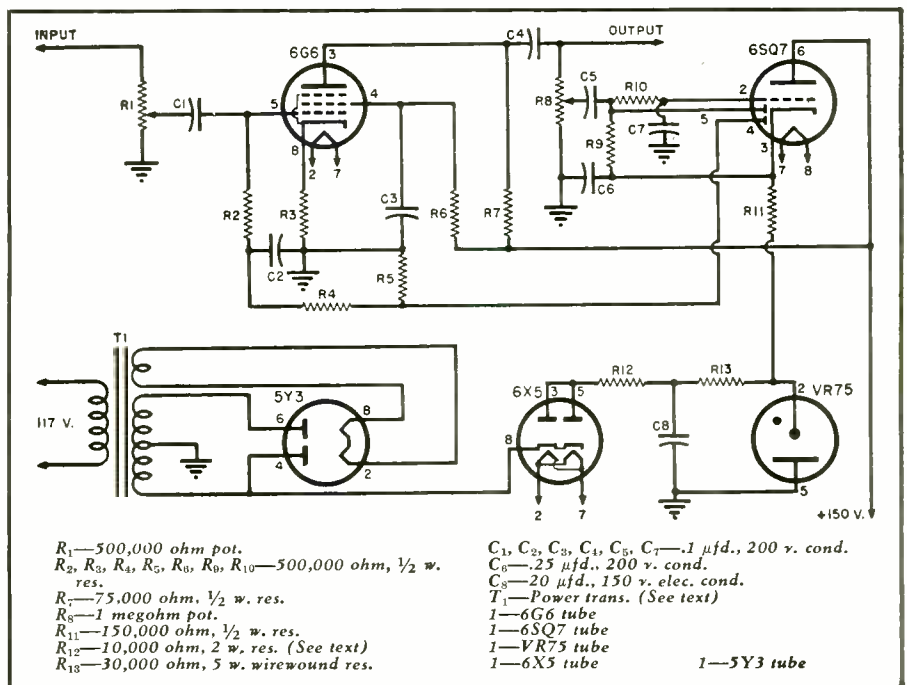

"S" Meter Calibration Techniques for Communications Receivers

The most critical phase in building an "S" meter is its calibration. Here's how it should be done.

By
ROBERT M. BERLER,
W2EPC

A LARGE variety of surplus Army and Navy communications receivers has been placed on the market since the termination of the war. Many of these units make excellent amateur communications receivers after relatively few modifications. Various articles have been written on these conversions and modifications from time to time. Of these modifications, there is one about which very little has been written, namely, the actual calibration of an "S" meter in "S" units for a given receiver.

The purpose of this article is three-fold. First, it will tell how an "S"

meter can easily be added to any receiver. Second, the method for calibrating the "S" meter will be given, and finally, some interesting and perhaps unfamiliar facts will be brought to the attention of the radio amateur about "S" meters.

Although the following calibration methods for an "S" meter were used by the author for an Army BC-348-Q receiver, the same circuit and calibration methods may be used for almost any other receiver.

One of the chief differences in the "S" meter described here and those that are commonly used in other re-

ceivers is that, in this case, the "S" meter actually measures the a.v.c. voltage rather than the change of plate current in the i.f. amplifiers. This "S" meter is incorporated in a balanced bridge vacuum tube volt-meter circuit.

Three advantages of using this type of "S" meter circuit become apparent.

1. The i.f. plate circuit doesn't have to be broken into in order to insert the meter, as is the case with the usual "S" meter and its associated resistor balancing network.

2. The sensitivity of this type of "S" meter can be tailored to fit the particular receiver to which it is being adapted.

3. Once the bridge is balanced, the "S" meter seldom has to be readjusted for zero setting or for recalibration.

A circuit diagram of the "S" meter v.t.v.m. is shown in Fig. 3A. The vacuum tube bridge consists of a 6SN7 dual triode tube. Each triode section is used as a leg in the bridge. The other two legs of the bridge consist of resistors R_3 and R_1 . R_2 is a variable meter shunt resistor and is used to fix the sensitivity of the "S" meter which is a 0-200 microammeter. The bridge is balanced for a zero meter reading by adjusting resistor R_1 , a 5000 ohm wirewound pot. Once this bridge is balanced, it seldom needs to be readjusted even though the line voltage may vary. The grid of one section of the 6SN7 is grounded while the grid of the other section is connected to the a.v.c. bus at the point where it is bypassed to ground by the a.v.c. filter condenser.

Since no official standard for the value of an "S" unit has been prescribed, it still remains a more or less arbitrary figure. Two basic "S" meter units are described in the following text. One basic unit may use each microvolt of r.f. input to the receiver as an "S" unit. Using this type of "S" unit, one may give a comparative signal strength report in microvolts increase from one value to another. Another basic "S" unit which may also be used is based on a six decibel increase in microvolts per "S" unit to the receiver. This unit represents an increase in power of four times at the transmitter.

Two pieces of equipment will be needed before the receiver can be calibrated. They are; (a) a signal generator calibrated in microvolt out-

Fig. 1. Rear view of the BC-348-Q chassis. The "S" meter v.t.v.m. and audio power amplifier tube are shown as constructed on the genemotor panel. The slotted control shaft is the zero set for the meter, R_1 . The tube at the left is the v.t.v.m.'s 6SN7GT.

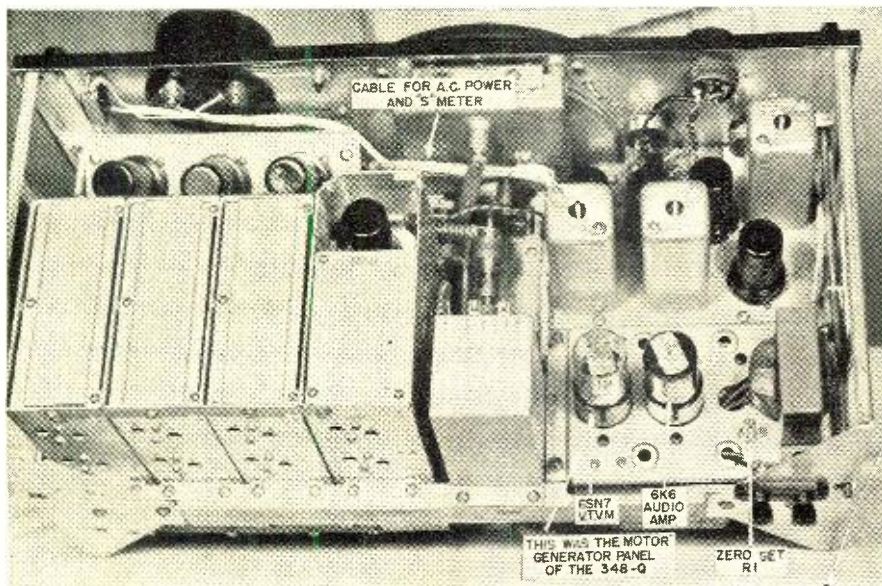

put. No modulation is used during calibration; and (b) an RMA standard dummy antenna.

A standard dummy antenna can be put together very simply as shown in Fig. 3B. It is advisable to place the entire dummy antenna inside a shielded box. Connections between the signal generator, dummy antenna, and the receiver, should be made with r.f. shielded wire.

The next step to take is to prepare a chart for the actual calibration of the "S" meter as shown in Fig. 3C. In the first column are listed the "S" units from zero to nine. In the second column is listed the calculated signal generator output setting in microvolts for each "S" unit. The value of these signal generator settings depend on what the basic "S" unit is. The third column lists the reading on the microammeter for each setting of the signal generator in "S" units.

A chart is provided (Fig. 3D) for those who desire to use a six decibel increase per "S" unit. This "Decibels Expressed as Voltage Ratios" chart uses one microvolt as a reference.

Before the actual calibration of the receiver is begun, allow both the signal generator and the receiver to warm up for at least one-half hour. In order to adjust the "S" meter to zero signal strength, short the antenna and ground terminals of the receiver together so that no outside signals will be picked up. With the r.f. gain control set for maximum, adjust resistor R_1 until the meter needle is on the zero mark. The receiver is now ready to be calibrated.

Connect the output of the signal generator through the dummy antenna to the receiver as illustrated in Fig. 5. The r.f. connecting wires should be as short as it is practical to make them so that losses and extraneous pickup will be kept to a minimum value. In fact, if possible, this whole procedure should be carried on in a shielded cage or room for best results.

Set both the signal generator and the receiver to a frequency in the center of the amateur band most frequently used. The receiver r.f. gain control is still set for maximum gain. With the signal generator microvolt output control set at its minimum setting, gradually increase this control until the "S" meter just begins to move off the zero mark. Record this setting of the signal generator in microvolts as this value will then become the reference level from which "S" units will be calibrated. Using the chart shown in Fig. 3C, fill in the "S" unit reference level just obtained in the second column opposite "S"-0. From this reference level voltage, all "S" units will be obtained by adding on the value of microvolts needed, which in turn, is decided by the basic "S" unit chosen. Next, the signal generator output control is set for an "S9" signal as taken from the second column in microvolts. Adjust the shunt resistor R_2 so that the meter



Fig. 2. Front panel view of the BC-348-Q on which the "S" meter was mounted. The panel projection type meter was used in order to avoid a large hole-drilling job.

needle reads 150 microamperes. This point on the meter will represent an "S9" signal. All other "S" units will fall in-between this point and zero. Reduce the signal generator to zero and short the receiver antenna and ground terminals together once again. Check to make sure that the meter needle returns to zero. If not, read-

just resistor R_1 slightly to make this correction. The "S" meter is now ready to be calibrated.

Record the meter readings for each value of "S" unit for which the signal generator is set, in the third column. When this chart is completely filled out, enough information will be available. (Continued on page 204)

Fig. 3. (A) Wiring diagram for "S" meter vacuum tube voltmeter. (B) RMA standard dummy antenna. (C) "S" meter calibration chart. (D) "Decibels expressed as voltage ratios" chart. The reference voltage is one microvolt.

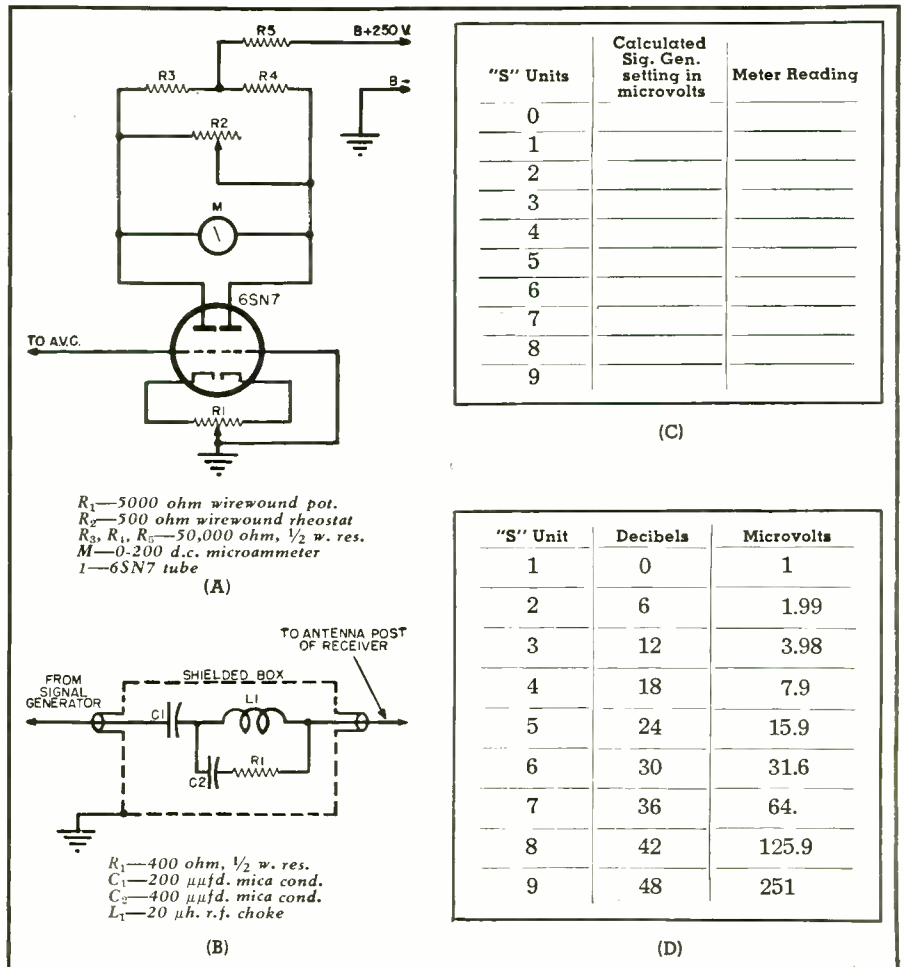

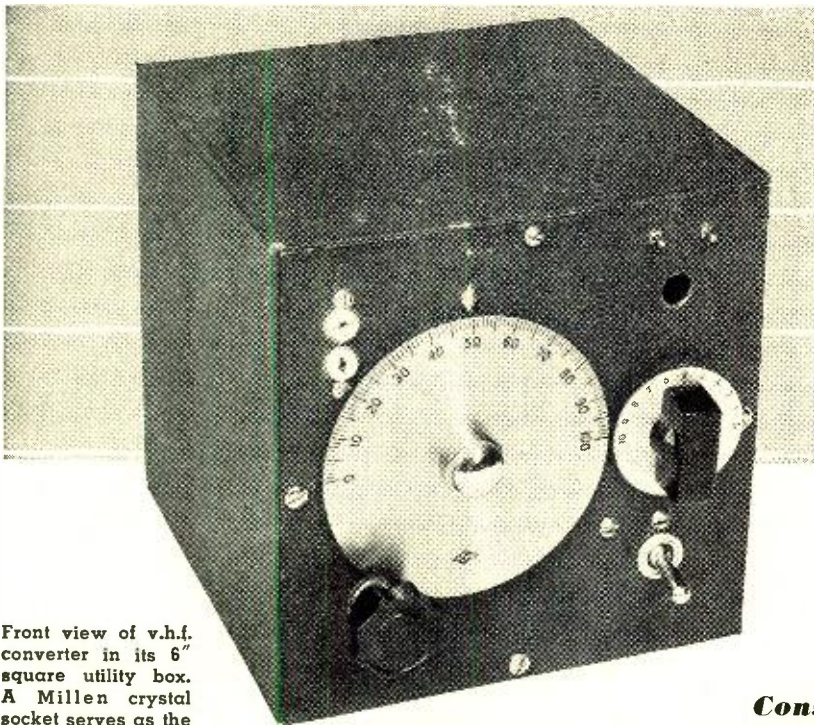

Front view of v.h.f. converter in its 6" square utility box. A Millen crystal socket serves as the antenna binding post (left). Hole on the right was left after antenna coupling device, now unused, was removed. The small dial at right is on the r.f. mixer condenser and the large dial with vernier drive tunes the oscillator condenser.

A Two-Meter Converter

By

A. DAVID MIDDLETON, W1CA

Construction details for an efficient triode, 144-148 mc. band converter, used in conjunction with a modified G.E. JFM90 "Translator," or an HRO.

SUPERHETS for the 144-148 mc. band are a "must" and many of the gang would like to have one but have hesitated because of the complications arising due to the necessity for building an i.f. system, not to mention the host of other "bugs" present in the construction of v.h.f. supers.

Since 1941, several simple superhet systems have been built and used by the writer. All of them consisted of converters fed into a ready-made i.f. system—a General Electric JFM90 "Translator." This unit is an excellent prewar-built FM tuner (41-51 mc.) with a self-contained power supply and a low-level audio output adequate for headphone reception. This output may be connected to an amplifier for speaker work, if desired. However, crystal headphones give a fine response.

Of late, this converter has been used, with excellent results, ahead of an HRO. The oscillator frequency was shifted to permit the use of a 30 mc. i.f. (on the HRO). No other changes were required and reception of "good" 144 mc. signals are now possible.

Such a simple v.h.f. converter is diagrammed in Fig. 2, and includes a pair of 955 triode acorns in both mixer and oscillator circuits. The output of the mixer feeds into a tuned circuit, link-coupled to a coax line running to the dipole antenna connection on the JFM90 FM tuner or to the HRO.

The high-C oscillator tunes the frequency range 103 to 107 mc. (for an i.f. of 41 mc.) or 114-118 mc. (for

use with a 30 mc. i.f.) and is capacitively coupled to the mixer grid. Neither complications nor difficulties arise from this sort of lashup, as "tracking" was not even considered.

The required power (150-200 volts plate and 6.3 volts filament) may be obtained from the "Translator" but at W1CA, an external power supply with a VR150 tube is normally used.

The layout of the converter can follow the dictates of purse and imagination. It is advantageous to enclose it in a metal shield. A 6" x 6" x

6" utility box houses such a unit neatly and easily. The components are mounted on a subchassis and on the front panel, and not on the inside of the can. Naturally, the L-C leads of the mixer and the oscillator should be kept short. A variable antenna pickup loop might prove useful, but, at W1CA, the loop is jammed between the turns of L_2 , adjusted until the proper coupling is obtained, and left there. The mixer tuning condenser, C_1 , is not ganged with the oscillator tuning control, thus making a "two-handed" job of tuning, but saving much work and worry in construction. The mixer, by the way, tunes sharply, especially when the point of regeneration (which is also maximum gain) is reached. A smooth-working dial is used on the oscillator condenser, C_2 . The oscillator bandset condenser is a screwdriver adjusted midget soldered directly onto the terminals of C_2 . Large size wire and sturdy construction result in a stable oscillator.

Adjusting the Converter

After building the converter, the first step in adjustment, is to set L_2-C_4 to the desired i.f. frequency. Set the JFM90 on some point near the low frequency end of the band, say 41 mc. If a suitable signal generator is available, feed a 41 mc. signal into the i.f. system via the i.f. transformer, (L_2-C_4) and adjust C_4 until the maximum response of the limiter-grid current is indicated on a meter plugged into J_2 (Fig. 1). (This meter installation will be covered later.)

If no signal generator is available, connect an antenna to the plate pin

Fig. 1. Schematic diagram of the 6SJ7 first limiter tube in the G.E. JFM90 FM "Translator" showing components added to furnish AM reception and limiter-grid current measurement. The normal low-level a.f. output of the "Translator" is used for FM reception.

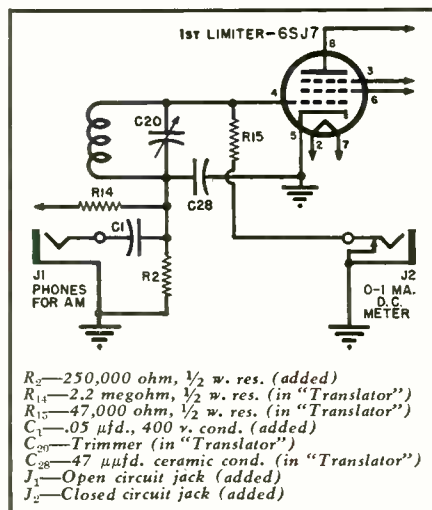

of the mixer tube socket and tune C_1 for maximum response on any available 40-50 mc. FM signal. The setting for C_1 can be changed to lower the frequency (more capacity) after hitting resonance. This procedure will serve to get a signal through the unit for checking purposes.

The next step is to spot the band, approximately 100 mc., on the oscillator. If a calibrated wavemeter is on hand, this is a simple task, but if not, the job is fairly complicated and you will have to devise some method of checking the 100 mc. point on the oscillator. At W1CA this was done with a lot of luck plus the aid of a pair of black cats, (in push-pull), as the first "two and a half" signal came in on the converter without the writer manually tuning the dial, when a station about 20 miles away "fell in" or drifted onto the spot where the oscillator was sitting. Since this is not likely to happen again, the writer will leave this problem up to the inherent ingenuity of the constructor. But—*don't* despair! You will eventually hit the *right* frequency with the oscillator. Beware of the spurious ones, however, they will only lead you down a blind alley infested with a flock of very-much-unwanted "birdies."

Just as a suggestion, try picking up the 4th subharmonic of the 100 mc. v.h.f. oscillator at 25 mc. on your calibrated low-frequency receiver. Or, if you have a receiver tuning to 33 mc., the 3rd subharmonic will be easier to locate.

The best method of hitting the right spot is, of course, to rig up a set of Lecher wires and to calibrate an absorption wavemeter covering from—say—95 to 100 mc. This will be a useful gadget around the shack if you are fooling with v.h.f. superhets and

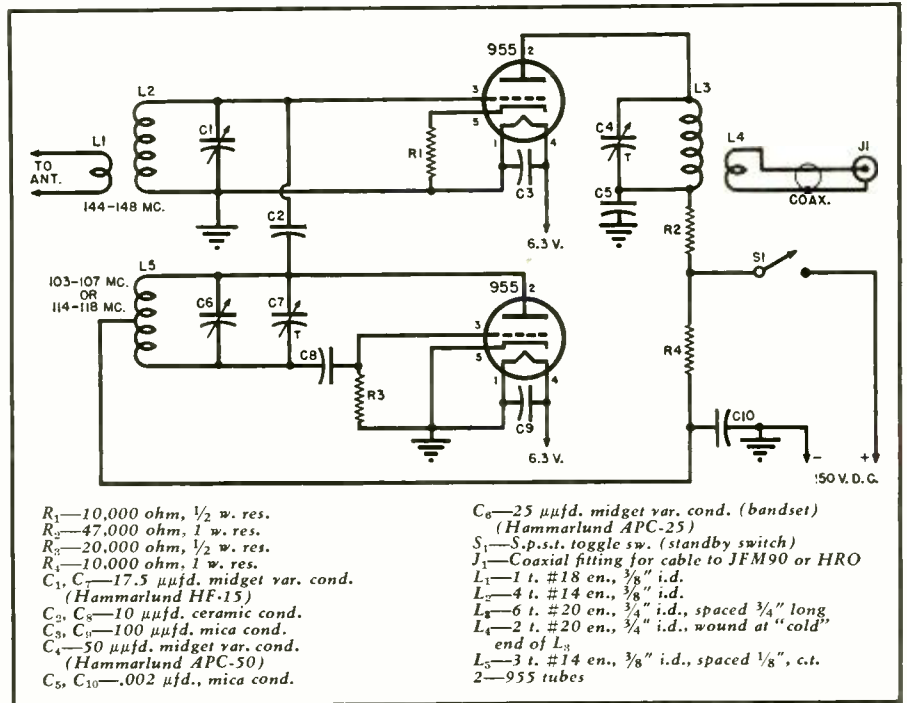

Fig. 2. Complete schematic diagram of 2-meter superheterodyne converter.

it's well worth the time and effort expended in its construction. A four-turn coil ($\frac{3}{8}$ inch i.d.) spaced about 1 inch long, tuned with a 25 μ fd. midget variable, will do the trick. Adjust the spacing to obtain a bit of bandspread in the vicinity of 100 mc.

The mixer circuit is, of course, tuned to the incoming signal frequency and the 144-148 mc. band should fall in the tuning range of L_2 - C_1 . It is necessary to have a two meter antenna connected to L_1 , during the adjustment procedure as the mixer "takes off" when unloaded.

Once the oscillator is on frequency, and the mixer is on band, reception of loud signals should be accomplished without difficulty. A local two-meter transmitter may be used, or if there are loud signals, they will suffice, except that the usual practice will be that Joe Blow will sign off *just* when you really need his signal!

After getting some sort of a signal through the converter, peak up the i.f. system (by adjusting C_1), trim up the mixer and adjust the antenna coupling plus C_1 . Keep trying until

(Continued on page 80)

(Left) Top view of the converter. The high-C oscillator is located on the right hand aluminum strip. The dial is coupled to the tuning condenser through an isolated coupling. Between the two aluminum strips may be seen the mixer-oscillator coupling condenser, a ceramic type. The mixer section is on the left hand strip. A short length of 300 ohm line connects the antenna binding posts to a one-turn antenna pickup loop jammed in between the turns of the mixer tuned circuit. The i.f. transformer's tuning condenser is a screw-adjusted midget located at the rear of the mixer section. The mixer output is terminated in the coaxial fitting shown at the bottom of the photograph. This fitting fastens to the rear panel of the cabinet. (Right) Below chassis view of the converter. The i.f. transformer is shown in the foreground. A power cable, terminated on lugs, runs through a grommetted hole in the rear panel.

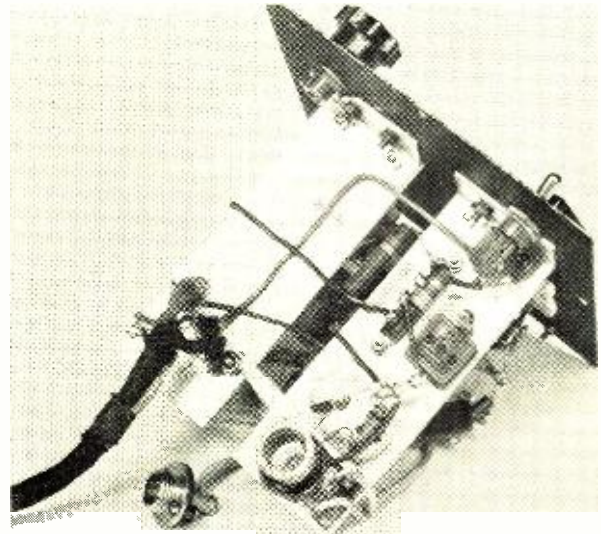
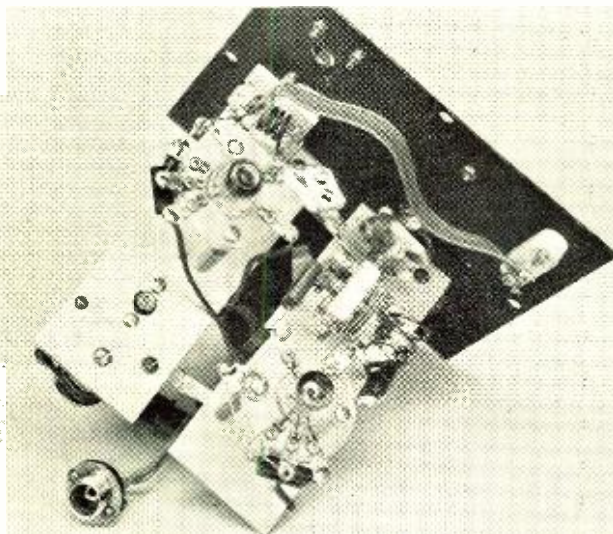

The RECORDING and REPRODUCTION of SOUND

By OLIVER READ
Editor, RADIO NEWS

Part 14. A discussion of phono pickup tracking error, groove skating, and record wear.

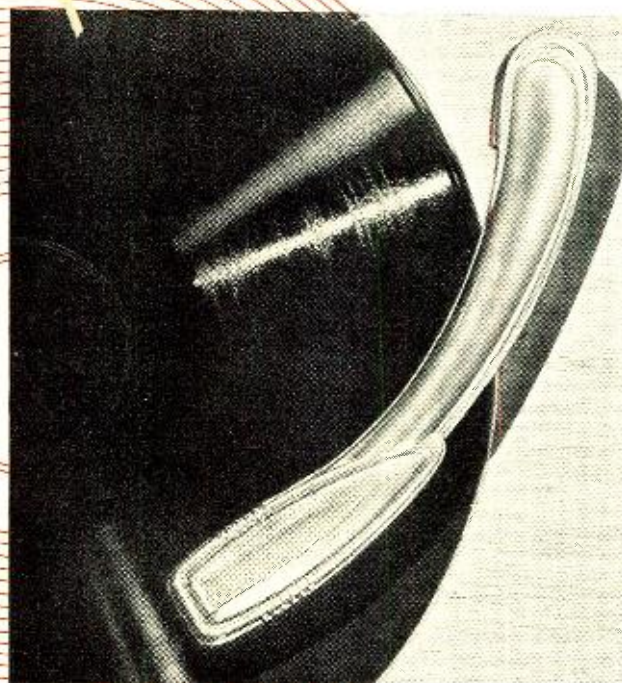

Modern offset type tone arm reduces record wear.

ENGINEERS, several years ago, realized that in order to obtain the utmost fidelity and minimum record wear, some means should be provided to offset the tendency of the pickup tone arm to "ride up" on a groove during reproduction. Many theories have been advanced regarding the effects of "tracking error," with the result that the layman is often confused when attempting to understand the fundamental rules that govern the final results.

So-called straight arm phono pickups were commonly used up until a few years ago. Little thought was given to the effects of proper "tracking" and "groove skating." The distortion caused by improperly designed tone arms meant but little as few instruments were capable of attaining high fidelity. The old conventional tone arm was designed somewhat as illustrated in Fig. 1. Note that the tone arm swings in an arc (A-B) as indicated. With this type of tone arm there is only one point on the record, that near the center of swing, where the needle or reproducing stylus will be seated correctly within the groove. At any other position of the arm travel, the stylus will either be forced to the right or to the left of that position. In other words, the pickup element or cartridge will not be at right angles to the direction of travel.

This tracking error becomes greater as the two extremes are reached by the needle as the angles become

greater with a resulting increase in distortion and record wear. At all positions except that at which the needle appears at right angles to the groove there will be a tendency for the needle to ride up on the walls of the groove. This becomes rather serious as the outside or inside grooves are reached as the action becomes more exaggerated.

Groove Skating

Groove skating results from improper tracking. Under such conditions it is impossible for the needle to reproduce properly as a great part of the applied needle pressure is from the sides or "walls" of the groove. This has a tendency to actually steer the needle away from its normal resting condition (Fig. 1C). There can be only one pivot point for the tone arm. Obviously then, the only remedy to offset the tendency of the needle to ride up on the walls of the groove is to change the straight arm design to one which will "offset" the angle thus enabling the needle to approach a closer correct angle with relationship to the groove.

Fig. 2 illustrates several offset heads of improved design. Further improvement is obtained when the point of the reproducing needle contact is swung through a lower arc, one farther from the normal hub line or center hole of the record, as illustrated in Fig. 3.

We now find that the new arc starts

below D and the needle travels approximately $\frac{3}{8}$ " below the arc shown in Fig. 1. Three possible positions for the needle are illustrated; one at the outside groove, another at point F , and the other at the inside groove of the record. Note that we approach a right angle to the groove as the arm travels throughout the record and a better average is maintained due to the offset position of the head.

Considerable record wear will result if the foregoing considerations are not met. If a needle, especially a sharp one used on commercial pressings, is allowed to ride up on the sides or walls of the groove, it can only result in continuous wear on the record material at the point of needle contact. Sound modulations are cut into the sides of *each* groove, not at only one side. Naturally then, we must take the required steps and make certain that the needle is allowed to engage both walls at the same time with even pressure or, more accurately, to see that the needle is "seated" properly.

The effects of improper tracking become even more acute with transcription and home recording blanks as the record material is considerably softer and the walls of the groove are more subject to mechanical distortion than are commercial hard shellac pressings.

An improvement can be made in the playback setup by employing pickups of the lightweight class—those

having a needle pressure of from $\frac{1}{4}$ ounce to 2 ounces. On the other hand, too little pressure is not recommended as this too can actually increase the wear on the groove walls. The pickup, therefore, must have enough point pressure to permit the needle to "seat" in the bottom of the groove and to be able to guide the complete pickup arm across the record in a horizontal plane.

The use of sapphire playback styli (needles) is recommended for all types of soft disc materials, due to the ability of the stylus to maintain a correct shape for hundreds of playings. While these are more expensive initially, the cost is offset by the saving in replacements.

As an analogy, we might point out that in early machines, such as the cylindrical record phonographs and other dictating machines, the locus of the reproducing stylus is in the straight line with perfect tangency to the groove at every point on the record. In the case of reproduction by means of the conventional pivoted tone arm, the locus (the path) of the needle point is the arc of a circle. Perfect tangency to the groove is possible at only one or two points on the record, as previously mentioned. Tracking error is the result of a pivoted tone arm and is obviously an inverse function of the length of the tone arm.

Tone Arm Length

Fig. 4 illustrates a graphical method for determining tone arm length developed by Mr. Roy Dally.¹ To arrive at the proper over-all length of a tone arm, and the included angle of offset, any shape or design of tone arm may be laid out over the backbone as long as the essential dimensions are not disturbed.

First lay out, full size, the outside groove of a twelve inch record. This averages $11\frac{1}{2}$ " in diameter. Then lay out the inside groove of a 10" record, which is about 4". The only factor that must be known beforehand is the distance from the center of the record to the lateral bearing which is usually the center of the mounting hole. This is an arbitrary distance and depends upon the space available. Let us use, for illustration, a dimension of 7". Locate this point with reference to the record center. Now construct a center groove which lies equidistant between the outer and inner grooves. Lay in line A-A which is a tangent to the center groove. Construct the arc B-B whose radius is the distance from the mounting hole to the record center. Using this same radius, locate the compass needle on tangent line A-A so that the compass point intersects the tangent point X in the center groove.

Construct an arc C-C so that both ends intersect B-B. Draw the straight line D-D which passes through the arc

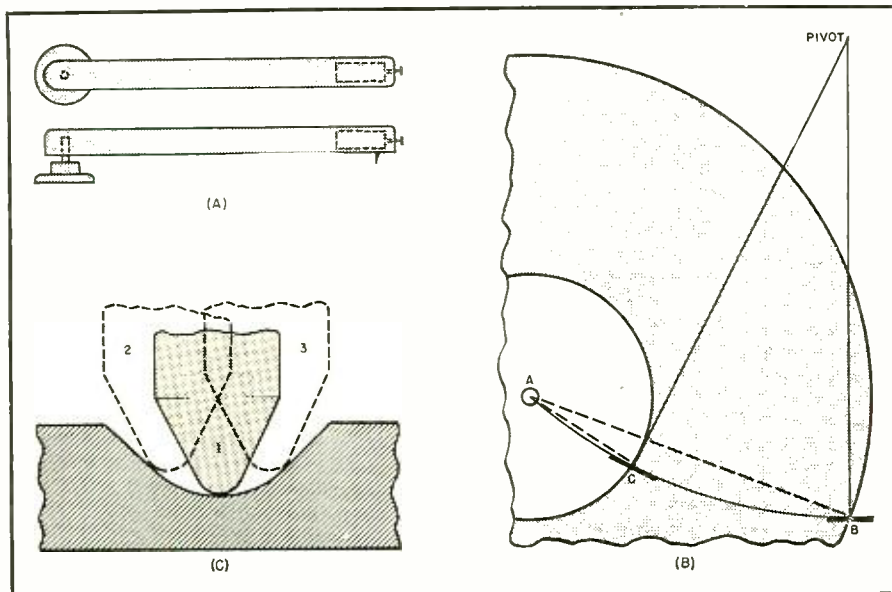

Fig. 1. (A) Straight tone arm. (B) How not to mount a tone arm. (C) Variations of groove skating.

intersections and line E-E. The point Y then represents the needle point and the distance from Y to the mounting hole center becomes $7\frac{1}{16}$ ". The $\frac{1}{16}$ " is the distance the needle point must be beyond the center of the record when the pickup is mounted in order to insure proper tracking.

Next construct the arc F-F whose radius is $11\frac{1}{16}$ ". Draw tangents G-G, H-H, and I-I, using a right triangle between the record center and intersection points of grooves and tangent lines. Then draw lines from the mounting hole center to the same points. The three included angles shown indicate the degree of offset necessary to have perfect tracking at those respective grooves.

An average included angle would be about 27 degrees which would permit an error on one side of 1 degree and on the other side $1\frac{1}{2}$ degrees. This gives the total tracking error of $2\frac{1}{2}$ degrees.

Styli and Record Wear

The perfect reproducing needle or stylus would be one which would maintain its shape throughout many thousands of playings. Regular commercial records, as purchased in music and radio stores, use a shellac base rather than the soft lacquer material used to coat the surfaces of home and transcription discs. The purpose of the shellac, other than that of a bond-

(Continued on page 116)

Fig. 2. Note the variation of offset angles on these modern tone arms.

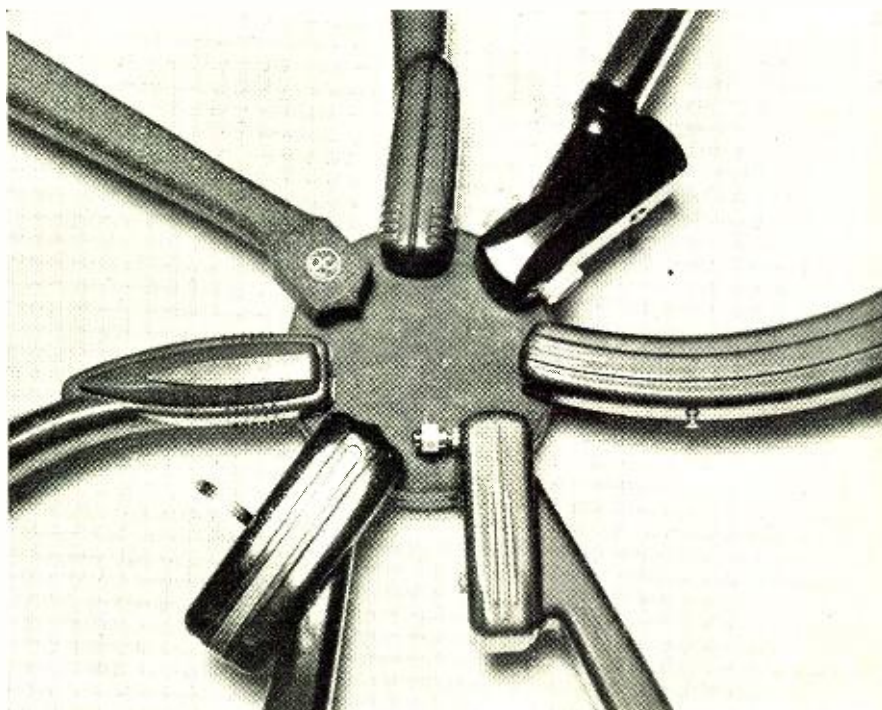

1. Dally, Roy, Consulting Eng., The Electrovox Co., Inc.: "Tone Arm Design," Radio, July, 1944.



International SHORT-WAVE



Compiled by **KENNETH R. BOORD**

IUR congratulations go to the Swedish Radio (Radiotjänst), Stockholm, on its weekly program on short-wave dedicated to DX-ers around the world. This special service is heard each Saturday at 0245*, SBO, 6.065, and SBT, 15.155; 1000, SDB-2, 10.780, and SBT, 15.155; 2000, SBU, 9.535, and SDB-2, 10.780. The scripts are prepared by Arne Skoog, president of the "International League of Short-Wave Editors," and one of Sweden's foremost authorities on international radio. They are read by Mr. Bergsten, one of Radiotjänst's *English* announcers. Mr. Skoog advises that "this new service is a tribute to international goodwill, but will also keep short-wave listeners informed regarding broadcasts from Sweden and on DX news from all over the world. The first transmission is intended primarily for the Pacific Area, but also for 'morning owls' in Europe and Africa; the second period is most suitable for listeners in Europe and Africa, but can also be heard well in America; the third transmission is intended for America. Reception reports will be greatly appreciated." (*IRC's should be used.*) A monthly program for short-wave listeners in

Sweden (presumably on the *last* Sunday of *each* month) is also being radiated over the Swedish National Network and on short-wave from SBT, 15.155, and SDB-2, 10.780, at 1700-1715; it is in Swedish although on occasion it is planned to include recordings of foreign broadcasts; it is preceded by songs of Vera Lynn.

And now some "press-time" late news:

A program in Esperanto is being broadcast on the *first* Sunday of each month at 1000 (replayed from Malmo) from Swedish outlets of SDB-2, 10.780, and SBT, 15.155; will continue until the International Congress of Esperantists in Malmo in July; consists of talks and messages concerning this Congress and lasts 15 minutes. Danska Brigaderadion (The Danish Forces' Radio) in Germany is back on 6.225 at 0400-0600, 0800-1000, 1400-1600 daily. *Radio Sumatra* is heard in Sweden on 7.210 to 0935. Reykjavik, Iceland, is definitely on the air each Sunday on 12.235 at 1115-1145. (Skoog, Sweden)

A Middle East station heard in Sydney, Australia, has been identified as an oil company's transmitter, HZZ, in Saudi-Arabia; uses 16.400, 12.200, 8.672 for communications and for the broad-

casting of aircraft movements. The British voice sometimes heard is that of the Medical Officer, although an American voice is most frequently in use. Sometimes they use Arabic when contacting Cairo. The "Radio Club of Mocambique" is anxious to receive reports from listeners on its *Sunday* transmission over CR7BJ, 9.645, at 0200-0700; QRA is P.O. Box 594, Lourenco Marques, Portuguese East Africa. Paris is using a *new* frequency of 6.120 at 0700-0830. (Radio Australia)

The station heard well in Eastern U.S. afternoons on (measured) 7.953 is *Radio Falange de Alicante*, Spain, signs off 1800; is just *above Radio Bisau*, 7.948. QRA of EAJ-43 is Radio Clube de Tenerife, Estaciones EAJ-43 y EA8AB, Apartado de Correos 225, Santa Cruz de Tenerife, Islas Canarias. (Kary)

An airmail report just in from Dorothy Sanderson, Australia, reports Makassar heard around 14 megacycles at 0730 with news in Dutch and music, fair signal. Other tips from Miss Sanderson include JBBK, 4.400, Korea, news in Russian 0530 (this one is heard in Texas and occasionally I have heard it here in West Virginia, weak at 0730); Pnom-Penh, Fr. Indo-China, on 12.36, news in Chinese at 0615; ZBW3, 9.525, Hongkong, BBC news relay 0600.

Riggle, Ohio, reports an unidentified station at 0145 on 9.54 with rooster crowing following an announcement (*not English*); sounds Middle Eastern or African; closes down shortly, so may be testing. Mozambique?

HCJB, Quito, Ecuador, informs me that its 4.107 outlet was closed down Sunday, February 8, "since we feel that 50 meters (5.995), our *new* outlet, will serve everyone who had been served by our 73-meter outlet, as well or better and should serve many new listeners at greater distances as well; unless we should get a tremendous response from listeners requesting us to return to 73 meters because they cannot receive us on 50 meters, we will no longer use the 73-meter band (which was intended primarily for listeners in Ecuador)." HCJB also advises that within some months they expect to carry on tests in the 16-meter band, and that they should have a new and

(Continued on page 146)

This well-equipped listening post and recording laboratory is that of Henry Callahan, Narberth, Pennsylvania. The receiver is a Hammarlund "Super-Pro." The unit in the left foreground is a television set. Mr. Callahan records many overseas broadcasts and sends the recordings (at his own expense) to stations abroad so engineers can "hear" how their signals come in in the Eastern United States. He has furnished many hard-to-find recordings (either originals or dubs) requested by European short-wave stations, and has long been a staunch supporter of PCJ. "The Happy Station," in Hilversum, Holland.



* (Note: Unless otherwise stated, time herein is expressed in American EST on a 24-hour clock basis; add 5 hours for GCT. "News" means in the *English* language.)

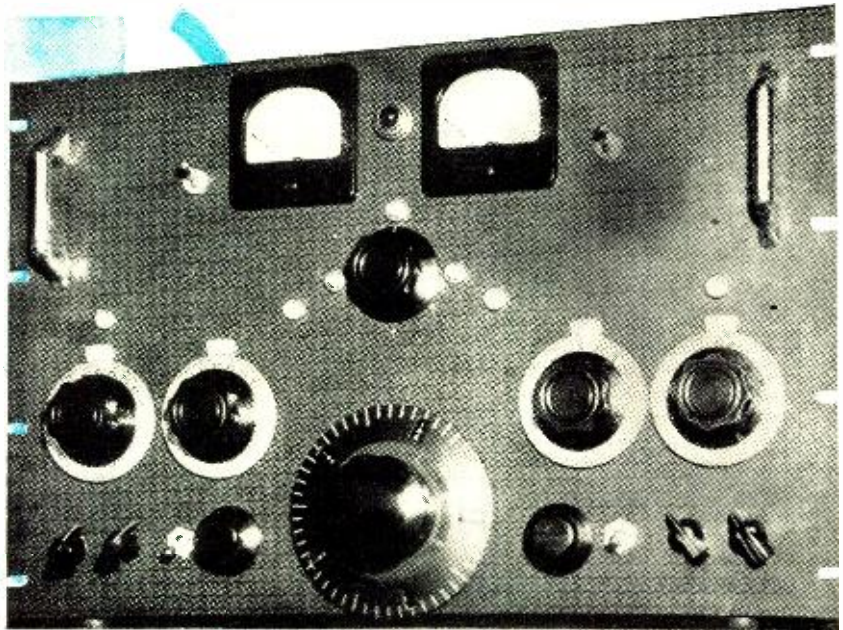

Fig. 1. Front panel view of the home-built receiver.

By **CARL V. HAYS, W6RTP**

This communications receiver, covering the 10, 20, 40, and 75 meter bands, incorporates many interesting innovations. These features will no doubt give you new ideas for improving your superheterodyne.

THE receiver in question, while an excellent one, is of quite an elaborate and expensive design. It is not intended that the reader copy it as is, but rather study its design for ideas to incorporate in supers of his own choosing. Accordingly the treatment will be confined to a discussion of the many interesting and varied innovations in design.

To begin with, the receiver is basically a double-conversion superhet, intended primarily for the reception of phone signals under the most difficult conditions. Considered as a whole it appears highly complicated; actually it is not. The tube lineup, 26 including voltage regulator and rectifiers, is misleading in that of this number, only 17 are used on any one band, certainly not an inordinate number.

The double conversion involves, of course, triple detection. This problem is simplified by having the first detector at all times fixed tuned, reversing the usual procedure in such receivers. It is not a "screwball" circuit; Collins uses the idea to excellent advantage in a contemporary design. This design differs only in that self-excited oscillators were used instead of expensive crystals. They have been highly satisfactory.

A look at the Hammarlund "Super-Pro" series of receivers will readily show where the grounded-cathode r.f. and i.f. stages were derived. This circuit is superior to all others tried for

high gain and extreme quietness, when plate voltages on the order of 200 volts and screen voltages of about 120 volts are used. Such a voltage scheme is used throughout the r.f. and i.f. sections.

Some local amateurs have noted with surprise the lack of a crystal in such an elaborate set-up. Perusal of

the schematic of the fixed i.f. will show a twelve-circuit bandpass i.f. which is the only thing we've found that gives the requisite steep-sided, flat-top characteristic absolutely necessary for really good phone reception. The wide-skirted, pinpoint peak of a crystal is simply out of the question for phone work, hence this design. The small

Fig. 2. Schematic diagram of the audio stages of the receiver.

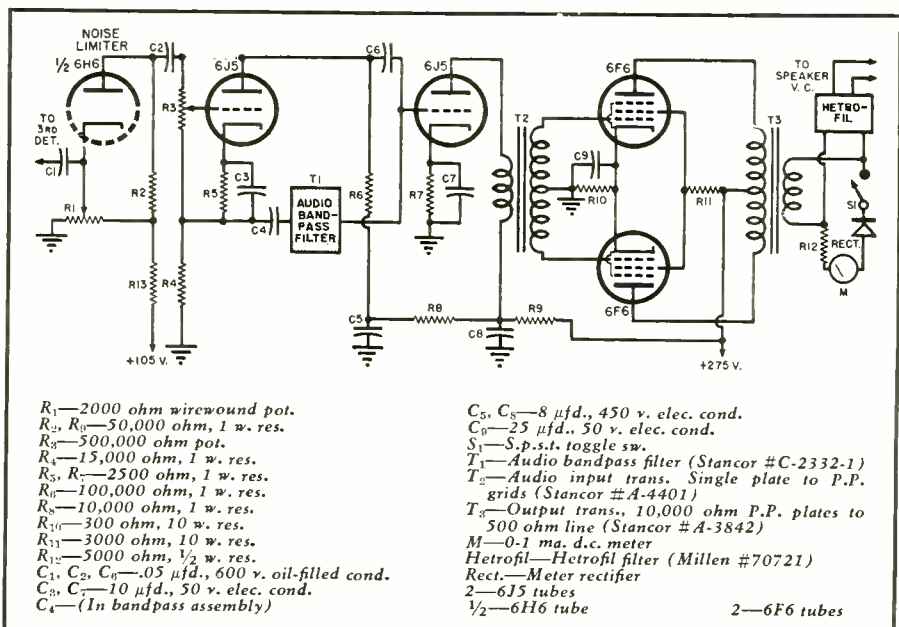

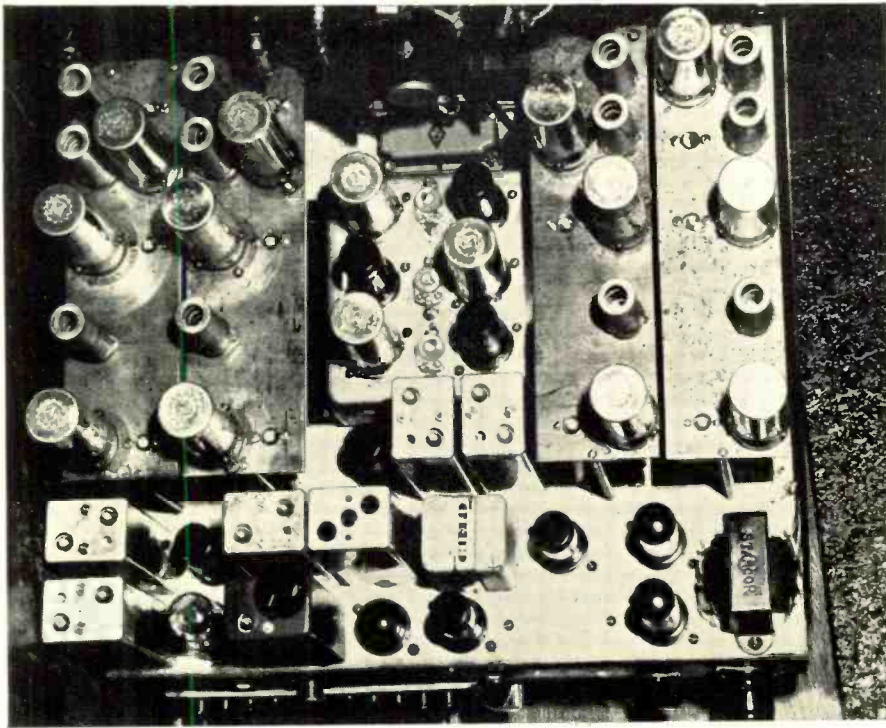

Fig. 3. Top view of chassis shows placement of various components. Four converter chassis, identical in design but covering four separate ham bands, are shown. Bandswitching is accomplished at the outputs of these sections, thus eliminating coil and condenser switching.

trimmers noted in the under chassis view are used to adjust the coupling between stages. With the aid of an oscilloscope and a "wobblator," the bandwidth has been set for just under five kc., about the optimum for phone.

In conjunction with this bandpass, a simple, effective audio bandpass has

been incorporated by use of the *Millen* "Hetrofil" across the 500 ohm output and the inclusion of the *Stancor* "Hi-Fi" treble-bass control unit in the audio input stages. They show up to good advantage when the going is tough. Audio selectivity can be adjusted from booming bass, to a "tinpany" tele-

phone sound, assuring intelligent reception under the worst of crowded conditions. The "Hetrofil" acts precisely like the phasing control of a crystal stage; heterodynes can be practically eliminated with simplicity and low-cost by inclusion of such a unit to any existent receiver. The one shown is included in the basic design, but it can be quickly and simply hooked into the output of any receiver.

A noise limiter on high frequencies is a necessity, and the one incorporated in this receiver is in the circuit at all times. If a noise limiter is needed at all, it should be in the circuit constantly, to grab off the sudden, unexpected blurts of noise that often mean missing an important call sign, etc. The limiter is of the series type, and all constants are standard. Plenty of audio gain was incorporated to preclude its dropping the output to too low a level.

The audio section is conventional, except as previously noted. Precautions were taken, such as elaborate shielding right up to the five hundred ohm output leads to the speaker, as well as thorough filtering and decoupling. Such practice is advocated in the handbooks, and needs no further comment.

The power supply, a husky utility type, utilizes two separate supplies for audio and r.f., i.f. stages. A look at Fig. 8 will show both the power supplies and the simple, relay-controlled remote circuits. The power supplies utilize transformers, chokes, and a single, husky filament transformer, mounted under the receiver chassis. The relays shown are especially selected for the purpose. RL_1 serves to

Fig. 4. Circuit diagram of the fixed frequency i.f., a.v.c. and third detector stages. Diagram for b. f. o. is shown in inset.

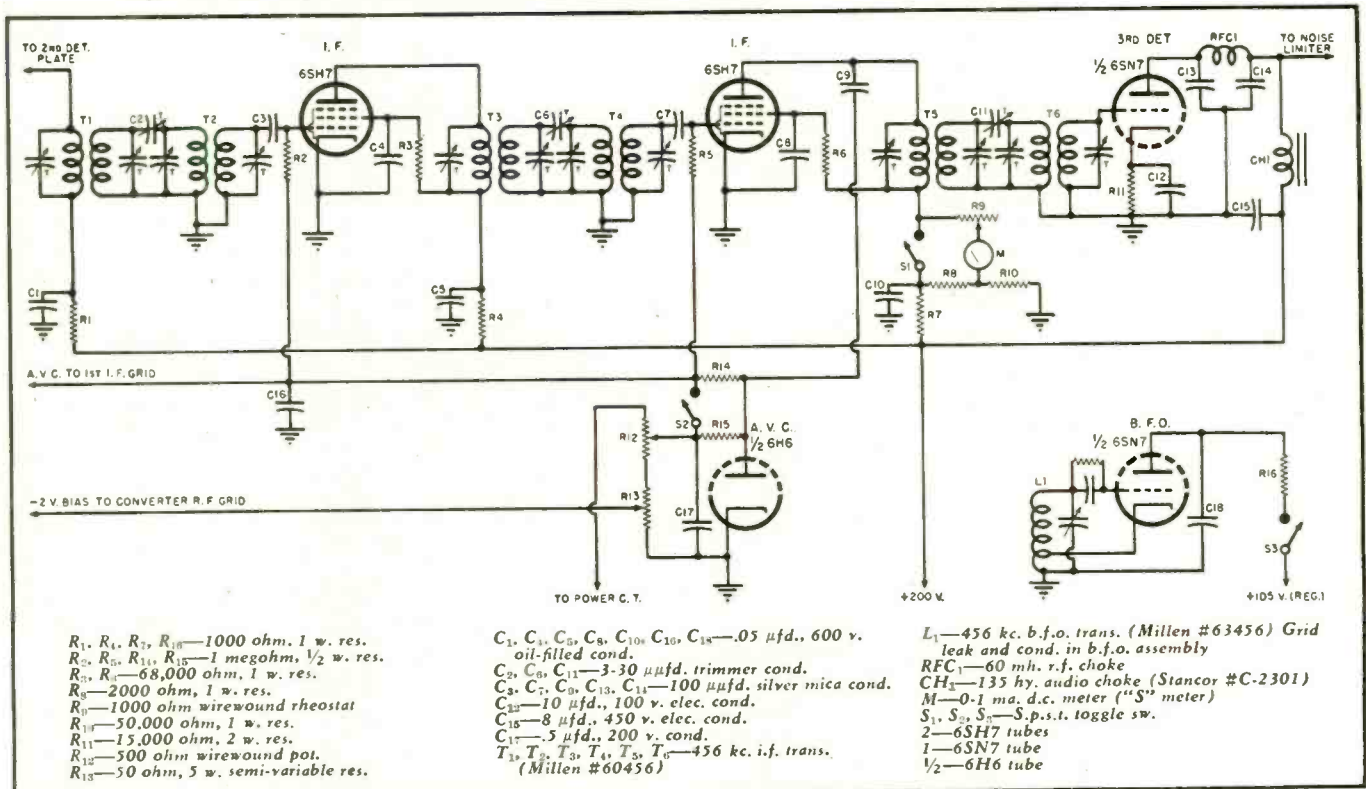

ground directly the centertap of power supply T_2 , the audio supply, and to connect the centertap of power supply T_1 , the r.f./i.f. supply, to the bias/a.v.c. circuits on the receiver chassis proper; the antenna relay (see also Fig. 10) grounds the antenna, when the transmitter is on the air, for protection.

The power supply filters are husky units as are all bypass and coupling condensers throughout. These bypasses should be noted carefully, for circuit operation is dependent on the choice of the best units obtainable. We chose 600 volt, oil-filled, metal-cased types in .05 and .01 $\mu\text{fd.}$ and silver-capped micas in 500 volt type for 100 $\mu\text{fd.}$ use. These are used for grid-blocking in the converter stages, oscillators, and tuned i.f. stages.

An inspection of Fig. 5 will show how the tunable i.f., second detectors, and oscillator operate to convert incoming 1500-3500 kc. signal-channel signals to the fixed-i.f. frequency of 456 kc. These circuits comprise the main tuning dial of the receiver, on which all actual tuning is performed. A three-gang, s.l.f. condenser of 140 $\mu\text{fd.}$ per section used in conjunction with the coils wound on Millen type 74001 shielded forms, enables the operator to calculate frequency at a glance, since each dial division of the National NPW-0 drive unit is exactly 5 kc. on all bands, and each amateur band starts at 100 on the dial. The 2000 kc. between 1500/3500 kc. is spread over exactly 400 dial divisions since perfectly linear tuning is provided by means of the s.l.f. condenser. While this dial is covering, at all times, the range 1500-3500 kc., one rapidly becomes used to thinking of it as covering the actual ham bands in use.

The tuned i.f. section is fed proper signal frequency, as desired, by the bandswitch shown in Fig. 10. By means of this device used in conjunction with separate converter chassis for each band it is not necessary to switch coils and condensers at any time. It gives bandswitching with none of the usual losses. The only leads carrying r.f. which are switched are the antenna and detector "B plus"/output leads, as shown. This has resulted in no apparent losses of any kind, since signal strength is the same through the switching arrangement as when the circuit was wired directly during experiments. The sensitivity of the tuned i.f. section is such that, trimmed to hit 75 meters and with fifteen feet of wire capacity-coupled to the hot side of the primary of the 6SG7 tuned i.f. coil, house-volume phone signals were copied from practically all districts, the "S" meter showing readings of S7/9 plus on an average. A good deal of the signal transfer to this section can be credited to the use of the excellent, quickly installed ceramic feed-throughs which show no bypass capacity effects when used for r.f.

The four converter chassis are all identical in design, with appropriate sizes of condensers (padding) used to

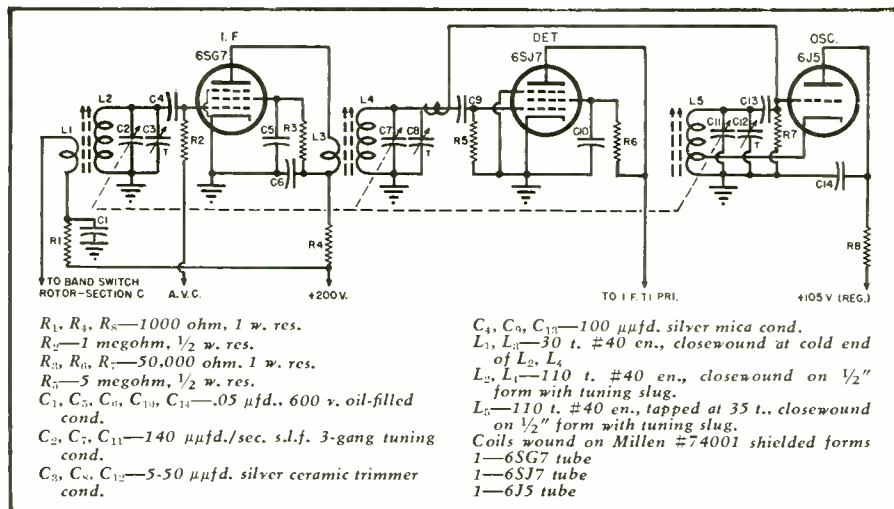

Fig. 5. Schematic diagram of tuned i.f., second detector, and second oscillator stages.

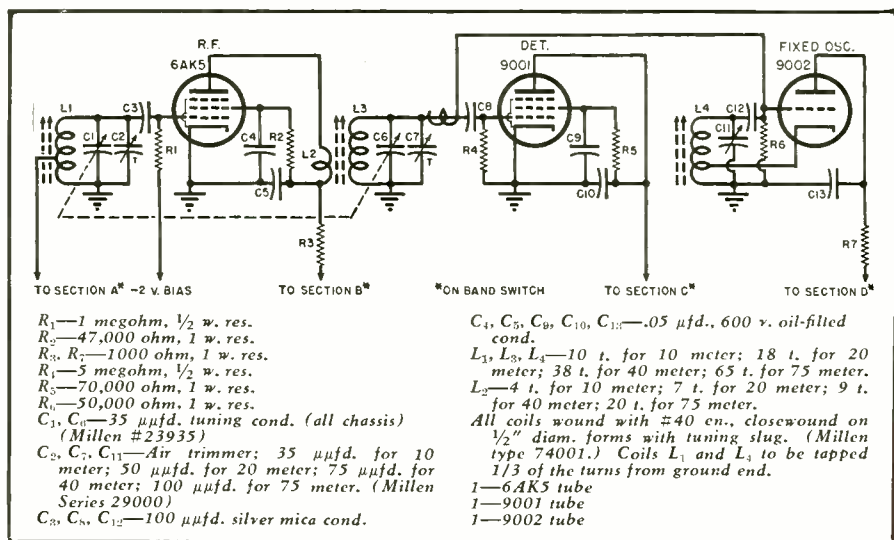
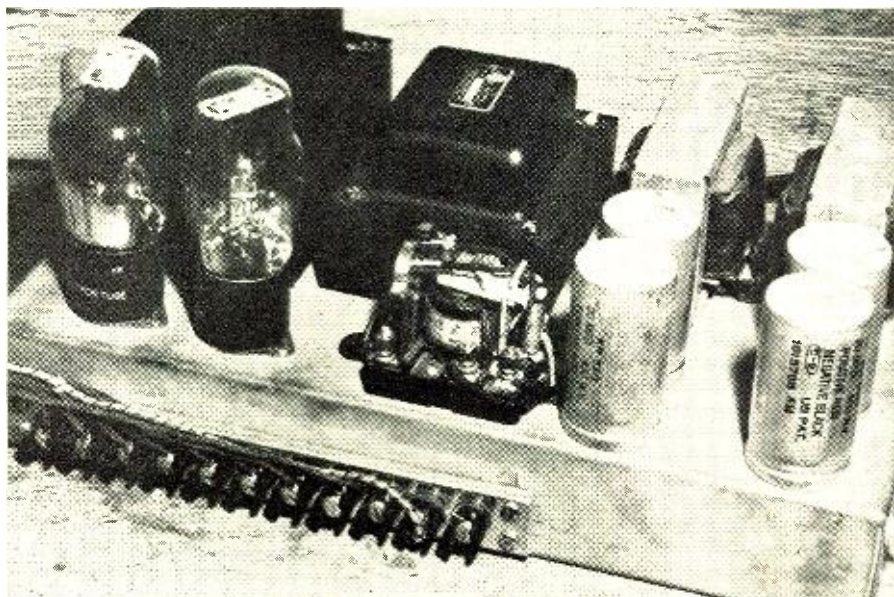

Fig. 6. Schematic diagram of r.f., detector, and fixed oscillator stages.

hit all bands. Again, as can be seen from inspection of the top chassis photograph, neat and compact high-gain coil forms in their self-contained shields have been used. It is probable that the receiver, in its present form,

Fig. 7. Top view of the power supply and control circuit unit.



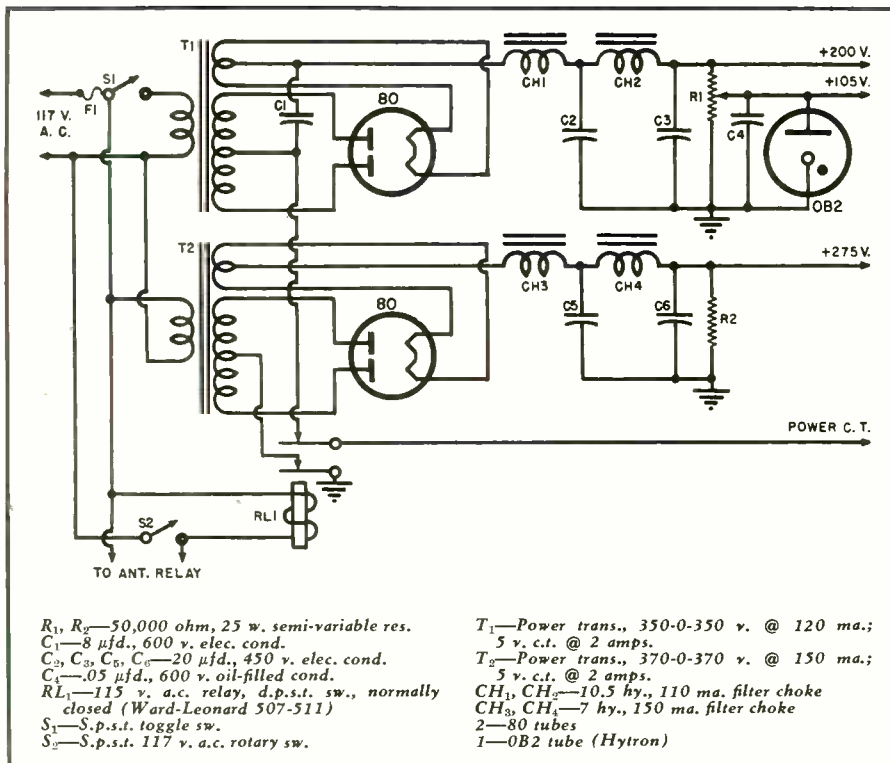

Fig. 8. Wiring diagram for the power and control circuit unit.

would not have been possible without the use of these well designed and conceived products. The tunable iron slug incorporated in them allows precise matching of inductances.

All tuning condensers on the four converter chassis are double spaced, isolantite insulated 35 μ fd. affairs, ganged by means of insulated flexible couplings, and mounted from the main chassis, directly under their respective converter sections by means of L-shaped pieces of aluminum. All trim-

ming and padding is done by silver-plated, isolantite mounted condensers, of appropriate capacity for the frequencies involved.

Actual circuits of the converter chassis duplicate those of the tuned i.f. section, being of the quiet, high-gain type made possible by the use of power-bias on r.f. and detector stages. The oscillators are conventional Hartley triode types, fixed tuned to frequencies 1500 kc. below their respective converter tubes. The tube types

Fig. 9. Under chassis view of the home-built deluxe superheterodyne receiver.

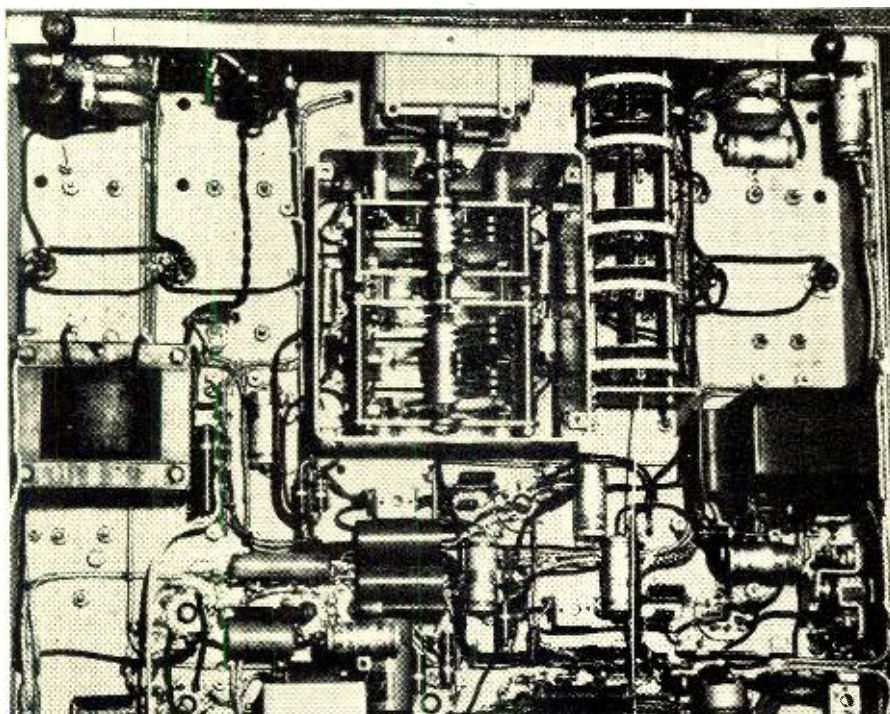

Dial drive unit	National Company Type NPW-0
Panel	Croname #27083
Pilot Light	Croname #27075
Dials	Croname #298
Knobs	Croname #6102
Ceramic feedthroughs	Millen #32150
Octal sockets	Millen #33008
Octal socket shields	Millen #33888
Miniature sockets	Millen #33307

Miscellaneous components used in construction of the deluxe receiver.

used are familiar, and excellent for the purposes. All sockets for the miniatures (6AK5, 9001, 9002) and the octal sockets for the coil forms are of steatite, thus insuring no losses from this source.

Such an elaborate and long-planned receiver needs a "front" to match the "innards," if for no other reason than vanity. A distinctive, and attractive, black anodized aluminum panel was secured for the job. A machined design surfaced on the blackened aluminum makes an extremely attractive front for the receiver, as do the four chrome planetary dials and drives. These four controls tune the ganged condensers under their respective converter chassis, and provide smooth, easy control of this critical function. The pilot light, between the two meters, is a clever device. By means of variable polaroid discs incorporated in it, the operator does not have to look at a blazing crimson eye continually—a slight twist of the bezel serves to dim the light to any desired degree.

Controls for the receiver (Fig. 1) are as follows: Top, from left to right, "S" meter switch; "S" meter; variable intensity pilot light; audio output meter; and audio meter switch. Below the meters, center, is the knob for the "Hetrofil." Below this, from left to right, are the 80, 40, 20 and 10 meter converter controls. Below these, again, left to right, r.f. gain; audio treble; a.v.c. switch; filaments and "B-plus" control switch; main tuning dial; bandswitch; standby switch, audio bass; and audio gain. Knobs visible on the back of the chassis are for noise-limiter threshold setting, and "S" meter zero.

Theory of operation, briefly, is as follows: Imagine you are tuned, and switched, to 14,000 kc. This represents the frequency the converter section (20 meter) is receiving, and converting to a suitable i.f. frequency for the tunable i.f. section to handle (Fig. 5). Now, since all fixed oscillators of the converter sections (Fig. 6) are tuned 1500 kc. lower than the bottom-edge frequency of the respective band covered, your twenty-meter oscillator is fixed-tuned to 12,500 kc., giving a frequency difference of 1500 kc. which is received on the main tuning dial of the tuned i.f. section (Fig. 5) by tuning to its lower-frequency range, namely, 1500 kc. Any signal, then, on 14,000 kc. will be received at this point. When the converter section (20 meter) is tuned to the high end of its range, 14,000/14,400 kc., an i.f. frequency-difference of 14,400 minus 12,500 kc.

(Continued on page 130)



Model VH-15 Speech Master, a new completely weatherproof 15-inch Hypex, is the latest addition to the JENSEN Hypex family, thus expanding this line of projectors to cover a wide range of sizes and prices. Designed only for speech reproduction, without compromise to music requirements, it affords greater naturalness in the low frequencies than do other Speech Masters. Model VH-15 is recommended for sound reinforcement, indoors and out, where distinct natural speech reproduction is required to carry through high noise levels.

Developed acoustic length, 36 inches. Useful response, 190 to 6,000 cps. Voice coil impedance, 8 ohms. Polar coverage angle, 90 degrees. Power rating 15 watts maximum speech signal input. Mouth diameter 15 5/8"; overall length 15".

Model VH-15 Speech Master (ST-757) List Price \$47.00

*Hypex and Speech Master are Registered Jensen Trade Marks.

NOTE THESE FEATURES

- Horn designed to JENSEN Hypex formula (Pat. 2,338,262) for improved acoustical performance.
- Non-ferrous and stainless steel rust-proof fittings. Phenolic diaphragm.
- Alnico V driver unit completely enclosed, yet replaceable without special tools.
- Rustproof, weatherproof terminal box; no exposed terminals. No soldering needed to connect.
- Trunnions adjustable through 180 degrees, lock projector in position simply by tightening two nuts with small wrench.
- Improved weatherproof finish on all metal parts. Horn finished in two-tone baked enamel.
- Power rating 15 watts maximum speech signal input.



Model VH-91 Speech Master List Price \$22.50

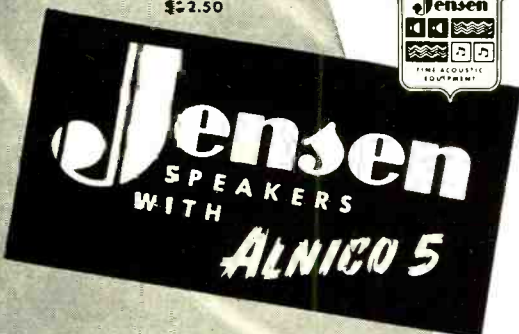

JENSEN MANUFACTURING COMPANY
6617 S. LARAMIE AVE., CHICAGO 38
In Canada: Copper Wire Products, Ltd., 11 King St. W., Toronto

Designers and Manufacturers of Fine Acoustic Equipment

TELEVISION INDUSTRIES Co.

PICTURE IF & SOUND IF STRIP and FRONT END. This sensational picture If & Sound If Strip developed by our engineering staff enables you to build a 10"-12"-15"-20" direct view or projection type receiver with FM sound. Supplied with a 13 channel RF front end unit. The front end covers channels from 44 to 88 mc/s and 174 to 216 mc/s (13 channels). Matched antenna input for 300 ohm line. Tubes: 1-6J6 RF amplifier 1-6J6 converter 1-6J6 oscillator.

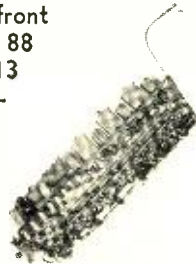
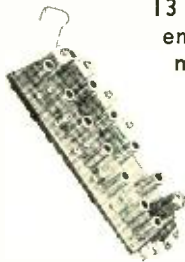

\$119.50
DEALERS NET

PICTURE IF STAGES 5 picture IF stages of amplification and second detector. **SOUND IF STAGES** 2 IF stages with limiter and discriminator. **VIDEO STAGES** 2 stages of video with a frequency response of 4.5 mc/s **ONE DC RESTORER.** IF FREQUENCY audio 21.25 — picture 25.75.

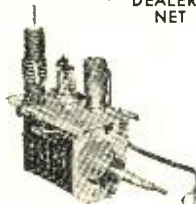

Picture IF band width 4.5 mc/s. All the above circuits and tubes are contained on one chassis. Front end unit on separate chassis. Both picture IF and sound IF delivered completely wired, tested, tubed, and matched ready for use.

DUMONT INPUTUNER

DuMont Inputuner tunes continuously from 44 to 216 megacycles without a break—covers all 13 television channels as well as FM, amateur, and aviation channels. For ease and convenience of operation no band switching of any kind is required when tuning from channel to channel with the inputuner system. Just one simple operation to reach any desired station.



\$97.90
LIST

BAUSCH & LOMB TELEVISION PROJECTION LENS



Television Industries Co. is proud to announce that they have been appointed national wholesale distributors for the Bausch & Lomb f: 1.9 Television Projection Lens. Sample orders filled immediately.



\$125.00
DEALERS NET PRICE

DEFLECTION COILS

Deflection Yoke similar to RCA part # 20 ID1



\$13.75
LIST

Contact Us for your Local Distributor

TELEVISION INDUSTRIES

540 BUSHWICK AVE.
BROOKLYN 6, N. Y.

2-Meter Converter

(Continued from page 71)

maximum signal response is obtained as indicated by the limiter-grid current. At W1CA a Lighthouse tube oscillator will push the meter up to 0.9 ma., when the converter is lined up properly. Distant signals will vary from 0.1 upward, depending on their power, antennas, polarization, and other variable factors.

AM reception is accomplished by making an addition to the JFM90 as shown in Fig. 1. A condenser, C_1 , and a resistor, R_2 are added to a conveniently-located junction of C_{25} and C_{26} and R_1 , in the "Translator." Those component numbers were obtained from G.E.'s published schematic diagram. The values of these components and the associated circuits are shown, so that no difficulty should be had in locating them in the JFM90. The addition of J_2 will permit the measurement (on a 1 ma. d.c. meter) of the limiter-grid current. This will be a most welcome addition as it permits the accurate determination of received signal levels.

To obtain maximum performance from this v.h.f. converter, it is desirable to adjust the amount of coupling between L_1 and L_2 until the mixer is just below the point of regeneration. It may be necessary to vary the resistance in the cathode (R_c) to bring the tube up to this "hot" point. At W1CA, with a four-element beam, fed with 300 ohm line, the mixer is adjusted so that oscillation does not occur in the band. What happens outside does not matter, but such a procedure will really "warm" up the unit—on the band!

The sensitivity is increased tremendously by these adjustments. For example, a signal before peaking, may be pushing the grid meter up to 0.1 or so, and after proper adjustments, this same signal will be 0.7 or 0.8 milliamperes.

Care in construction and particularly in peaking up all the circuits will really pay off. The excellent performance of this converter is surprising. The advantages of a super will be immediately apparent when you hear some of those weak signals you never heard before. Try "FM" reception on the modulated oscillators, and "AM" on the stable AM signals.

When the converter is used with the HRO, the oscillator is changed to cover the 114-118 mc. range (by decreasing capacity of C_6) and the coax output cable is connected to the HRO antenna posts. The "ground" side of the coax is grounded at the HRO. Place the HRO on approximately 30 mc. and operate the converter in the usual manner. Crystal-controlled and other stable 2-meter signals will be received as easily as those on the lower frequency bands.

Good luck!

-30-

Army BC-645 I.F.F. TRANSMITTER RECEIVER \$9.95

Brand New 450 M.C.

2 big units: all in one. A 10 tube superhet receiver for 450 Megacycle, a 5 tube 450 megacycle tuned line transmitter. Both are two channel. 4-7F7, 4-7HT, 2-7E6, 2-6F6, 2-9Z5, 1-WE316A. The tubes that come with this unit are worth more than our sale price. This unit originally designed for identification "Friend or Foe" Army BC-645. Brand new factory cartoned, weight 25 lbs. Furnished with four page conversion instructions for a CW or MCW or phone transmitter. How to build a 110 volt AC power supply, etc. 12 volt dynamotor, \$2.95 extra. WE-316A tube \$.99, BC-645. \$9.95. 2 for \$19.00.



Army BC-654 80 METER XMITTER RECEIVER \$12.95

BC-654—Two for \$25.00

Portable voice and CW transmitter and receiver for portable, mobile, and fixed station operation. 7 tube superheterodyne receiver with 3.5 microvolt sensitivity on voice and 0.5 microvolt sensitivity on CW, and 100 milliwatts undistorted power output. 157 KC IF. Uses 3-1N5GT, 1-1A7GT, 2-3Q5GT, 1-8Z6T tubes. 6 tube transmitter, with antenna tuning network, Colpitts thermal compensated oscillator, class C final with 2-307A tubes in parallel, and crystal oscillator for checking frequency every 200 KC. 25 watts output on CW and 11.2 watts output on voice. Frequency range, transmitter and receiver, 3800 to 3800 KC. Ideal for Ham's! Comes complete with cover; furnished with all tubes necessary for the operation of the trans. and rec. Less power supplies. These units are used but in good condition. Shipping weight 50 lbs. \$12.95; 2 for \$25.00. 654 Vibrator Pack 6 for 12 V.D.C. input \$4.95 extra.

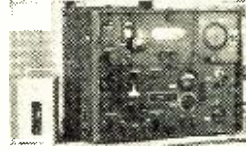

SCOOP. BC-654 Less all tubes. Net. \$7.95

MAGUIRE AUTOMATIC RECORD CHANGER \$9.95

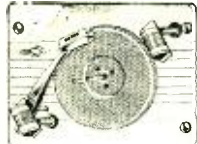

Brand new factory cartoned. This changer should sell for three times our price. Latest two-post, quick change type. Has permanent built-in needle, shuts off on the last record. Plays 12 10" or 10 1/2" records. Aero Changer, Base size 12 x 13 inches. . . . \$12.95
VM-800 Changer, Base size 13 x 14 inches. . . . \$14.95
Oak (with post changer) Base size 14 x 14 inches. 17.95
Aviola Changer, Base size 11 1/2 x 12 inches. . . . \$14.95
Detroit Changer, Base size 11 1/2 x 12 inches. . . . \$12.95. 2 for 25.00
Made to fit leatherette bases for above changers. 1.95
Specify type of changer for base.

NEW COMMAND \$5.95 XMITTERS

With each command transmitter, we furnish a schematic of the BC-458 (All command Transmitters are essentially the same; except for frequency.)

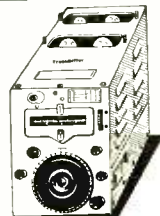

Near New BC-457, 4 to 5.3 MC with Tubes. . . . \$2.95
Brand New BC-457, 4 to 5.3 MC with Tubes. . . . 5.95
Near New BC-458, 5 to 7 MC with Tubes. . . . 2.95
Brand New BC-458, 5 to 7 MC with Tubes. . . . 5.95
Twin Pack for 2 Transmitters. 1.95
Antenna Current Meter. 1.95
Near New BC-456 Modulator, with 28 v dynamotor. 2.95

COMMAND REC. with Diagrams

Order your Aircraft command receivers from McGee. We furnish you a schematic of the BC-454 (all are the same except for frequency). Also, a diagram showing how to convert receivers for 110 volt operation.



Brand New BC-453, 200 to 500 KC with Tubes \$7.95
Near New BC-453, 200 to 500 KC with Tubes 4.95
Brand New BC-454, 3 to 6 MC with Tubes. . . . 4.95
Near New BC-454, 3 to 6 MC with Tubes. . . . 2.95
Near New BC-455, 6 to 9 MC with Tubes. . . . 3.95
Brand New BC-946, Broadcast 550 to 1500 KC, with Tubes and Instructions. 12.95
Triple Remote Control Head for 3 receivers. . . . 1.95
Triple Mounting Rack for 3 receivers.99
28 volt Rec. Dynamotor.99

ELECTRONIC MEGAPHONE SCOOP PRICE \$39.95



Only 50 of these to sell. Amplifier straps on shoulder, then just hold megaphone and speak into mike, mounted on rear of projector. These units are brand new. Amplifier is dry battery operated. Just pull trigger switch, amplifier comes on immediately. Net. . . . \$39.95

RDF RECEIVER \$19.95

MM-26-C Compass Receiver. Brand new factory cartoned. This unit covers from 150 to 1500 KC inclusive; in three bands. Complete with eleven tubes of the 5 volt type: 6SA7, 6SK7, 6F8, etc. Has 28 volt built-in dynamotor. There is no dial built on unit and no remote cables are provided. MM-26-C receiver \$19.95. Remote control \$3.95 extra.

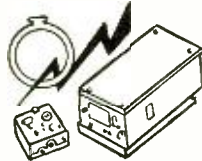

Manually operated loop. \$6.95 extra

SCR-269G A.D.F. \$39.50

SCR-269G Automatic Radio Direction Finder has 17 tubes. Frequency coverage from 200 to 1750 KC, inclusive. Receivers are in perfect condition. All of the component parts are new. Consists of receiver, remote control, relay, dehydrator, cables, dials, etc. This is a terrific value at only \$39.50. Only 50 are available.



MARKER BEACON REC. \$2.95

BC 1023 A Marker beacon receiver. Designed for reception of modulated signals of the 75 MC band. Variable tuning permits coverage of 62 to 80 MC. Brand new factory cartoned. With tubes 6SQ7, 6U6, 6SC7 and 12SN17. Operates directly from 12 or 14 volts DC. Priced for quick sale only \$2.95.



SCOOP! 110 M.C. REC. \$6.95

BC-733 D Localizer Receiver

Freq. 108-110 Mc; Tube complement; 10 tubes—1-12SQ7, 2-12SK7, 1-12AG6, 1-1A17GT, 2-12SG7, 3-117A. Now only \$6.95 NEAR NEW CONDITION. A RED HOT VALUE.

We guarantee every condenser to be of fresh stock. Made by nationally known manufacturers. No junk.

F.P. Electrolytics
40x20 MFD 150V. . . \$39 20 MFD 350V. 20x
40x20 150V 10-25V. . . .49 20 25V. . . . \$1.19
40x20 150V, 200-GV. . . .59 20x20 300V, 25-25V. . .39

Tubular Electrolytics
Exactly as you buy every day. Best National Brand. If these are not brands you prefer, your money back. All plastic covered. 1/2 the regular price.
8 Mfd 450v Aluminum Tubular. \$0.39
20 Mfd 150v Aluminum Tubular. \$0.39
10 for \$3.50

Compact Paper Tubular Electrolytics
Condensers, Flexible Leads
8x8x8 MFD 400 Volt, Long Leads. . . \$0.49; 10 for \$4.50
40x20x10 MFD 150 Volt.39; 10 for 3.50
50x30 MFD 150 Volt.49; 10 for 4.50
50x30 MFD 150 V. 25 MFD 25V.59; 10 for 5.25

HOT ITEM DELUXE
8x8x8 MFD Inverted Aluminum Can Condenser 450 Volt. Standard Screw Mounting. Made by Aerovox. Special. \$0.69; 10 for \$6.25

Buy the best 600 volt tubular condensers ever made. All plastic covered. 1/2 the regular price.
1001, .002, .005, .01, .02 at.10c
.05, .1, .15, .2, .5, 1, 2, 5, 10, 20, 50, 100.12c
Best Standard Brand. You like 'em, or money back.

3 FOR \$4.95 EACH
\$14.00

Super value. Folded DI-pole antenna, for FM and Television. Complete with 50 feet of twin 200 ohm line and 4 low-loss stand-off insulators. This folded di-pole covers frequencies 42 through 108 megacycles. Trumhome action makes exact tuning to any one weak station. Furnished with adjustable mounting bracket. Has 5 foot mast. Made for Stromberg-Carlson. Stock No. M-300—Net. \$4.95—lots of three, \$4.50 each. Weight 4 lbs. Individually packed.

SCR-518 ALTIMETER \$2950

Brand New



Famous SCR 518 A Altimeter. Brand new factory cartoned. Worth over \$900.00. Made by RCA. Complete as pictured. Has 29 tubes.

Works in the 500 MC region. This is the complete unit. Transmitter, receiver, power supply and 3" scope indicator. Reads altitude up to 30,000 ft. Operates on 28 volts. D.C. Complete with tubes, 6SK7, 2 8012, 2 6XJ7, 6C8, 6SN7, 6F8, 23D4, 6Y6, 6V6, 10 6AC7, 3 2X2, 954, 955, 956, 955 and 3 in. CR tube 1808P. A RED hot scoop at only \$29.95 complete.

ARMY \$6.95

Field Telephones



EE-8 Army field telephone. These units are used, but in good condition. Priced complete with telephone hand set, hand powered magneto and canvas carrying bag; as pictured. Net \$6.95, each.

15 TUBE SCOOP \$9.95

BRAND NEW

AM 61A Indicator Amplifier. Brand new factory cartoned. Has 28 volt DC Blower motor and fan. 2 2mfid 1000 volt cond. 2 2X .5 mfd. 1000 volt cond. and many other parts. Complete with 15 tubes, 7 6SN7, 3 VR 105, 5Y3, 3 6SL7, 8016. As a salvage item this is a RED HOT BUY The tubes are worth more than our price. Weight 30 lbs. Net \$9.95



PE 206A INVERTER—BRAND NEW \$4.95

P.E.-206A Inverter. Brand new factory cartoned. For 25 to 28.5 volts input. Output of 80 volts (plus or minus 3 volts) at 800 cycles, at 500 volt amperes. This is a perfect inverter. Has carbon pile regulator, built-in voltage control. A 20 stack selenium rectifier. Shipping weight 45 lbs.

PE-206A Net. \$4.95

PE 101C DYNAMOTOR BRAND NEW \$2.95

Dynamotor PE-101C. Input voltage 13 or 26 volts DC, at 12.6 or 6.3 amps. Output voltage 400 volts DC at 135 Mils and 800 volts at 20 Mils, 9 volts AC at 1.2 amps. Brand new factory cartoned. Shipping weight 13 lbs. PE-101C Net. \$2.95

TURBO AMPLIFIER \$1.95

Aircraft Turbo Amplifier, complete with 4 tubes, 7F7, 7Y4 and 2-7C5. Terrific salvage scoop. Ideal to wreck for parts. Priced new with tubes. \$1.95
Monthly Special. Turbo amplifier less tubes.69
Only

PULSE FORMING NETWORKS

Used in small radar modulators, available in three sizes, 67 ohms impedance. 7.5 Kilowatt rating.
H-603, one micro second, 200 pulses per second. \$1.95
H-601, three micro seconds, 200 pulses per second. \$2.95
H-602, 16 micro seconds, 60 pulses per second. . . . \$3.95
All three of above for only. \$5.95

Crystal Calibrator \$2.95

Crystal Calibrator, gives 50 KC beat note through an Xtal speed, multivibrator. Furnished complete, less 200 KC Crystal. With tubes 12SA7 and 2-12SL7. A handy item to have. Scoop price. \$2.95

PORTA-POWER

Electro Porta Power. Converts any 4, 5, or 6 tube 1 1/2 volt, 90 volt portable or farm radio to 110 volt AC operation. Multiple socket arrangement makes easy, quick connection possible. Every shop should have one of these. Regular \$9.95 value. Scoop price. \$5.95

SELSYN INDICATORS \$2.95

Selsyn indicators, 5" diameter. Will operate on from 15 to 24 volts 60 cycle AC. Model I-82A can be used as either selsyn transmitter or selsyn receiver. Scoop Price. \$2.95, 2 for \$5.40

VIBRATOR SCOOP \$1.99

Heavy Duty Vibrator—Made for 6-110 volt amplifiers. Freq. 60 CPS. Scoop price. \$1.99
135 ma 6-110 volt conventional power transformer, with all windings; will run phono motor. \$5.95
(Use with above vibrator.)

SMALL PHONO MOTOR. This 110 volt AC, 60 cycle phono motor is used on 80% of all automatic changers. Order one just to have around for replacement. Scoop price, \$1.49; Two for. \$2.79

McGEE RADIO COMPANY PRICES FOR KANSAS CITY SEND 25% DEPOSIT—BALANCE C.O.D. 1225 McGEE ST., KANSAS CITY, MISSOURI

PERSONAL PORTABLE RADIO KIT \$14.95

Size: 6 1/2" x 3 1/4" x 4 1/8"

Weights Only 3 1/2 Lbs.

- Two-Tone Ivory, Red Plastic Cab.
- Loop Aerial, Built-in Lid
- 4-Tube Superhet
- AVC.
- Looks like and is a Commercial Radio Kit
- Two-Gang Cond., Lucite Dial
- Simple Assembly and Wiring Instructions

This kit is ready for immediate delivery. The same nationally known factory that manufactures tens of thousands of this radio, is line-producing this radio kit for us. Every part, from the cabinet down to the last resistor, is matched. The chassis is ready punched; all you do, is mount the parts and wire. This radio kit will assemble into a beautiful personal radio for you, just the same as it does for the factory. We furnish you a diagram, photograph of the completed chassis and full assembly instructions so that those with a minimum knowledge of radio may wire this kit. The beautiful case is made of metal with plastic hinged lid and snap on back. The lucite face of the receiver has an inlaid gold design. The circuit is the conventional

two gang superhet type, with A.V.C. Receives the broadcast band, 540 to 1650 K.C. Uses miniature tubes; 1R5 converter, 1S3 detector A.V.C., 1T4 amplifier and 3S4 power amplifier. Alnico V P.M. speaker. The loop antenna is built in the lid. It also comes on automatically when lid opens. Operates on self-contained batteries. Priced complete with tubes and 6 1/2 volt battery and flash cell (Not AC-DC) Nothing else to buy. Model X-45. Price \$14.95. Shipping weight 6 lbs. **Complete with Batteries**



ARMCHAIR CABINET ONLY \$29.95

Beautifully made walnut armchair cabinet. Outside dimensions 24" high, 16 1/2" deep, and 27" wide. Ample room for radio receiver 14" long, 9" high and 10" deep. Will hold a changer up to 14" square. Will accommodate speaker up to 12". Has record album storage compartment. Hinged lid covers changer compartment. Cabinet Ar-15 Net \$29.95. Detrola automatic changer \$12.95 extra. Twin post Oak changer \$17.95 extra.

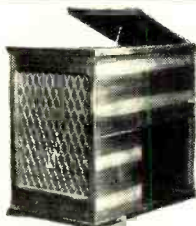

8-TUBE RADIO KIT WITH COAXIAL SPEAKER, \$37.95

A COMBINED BROADCAST SUPERHET RADIO CHASSIS AND 15 WATT P. A. SYSTEM

HEAVY DUTY 12" P.M. SPEAKER
CROW 8" SLIDE RULE DIAL. 2 GANG COND.
REC. BROAD. 550 TO 1700 KC AND 19 TO 49 METERS

PUSH PULL 6V6-TONE CONTROLS
INPUTS FOR CRYSTAL OR DYN. MIKES AND PHONO-PICKUP. WE FURNISH EVERYTHING TO BUILD THIS DELUXE CHASSIS

- WHY NOT ORDER THE ARMCHAIR CABINET WITH THIS KIT
- HAS INPUT GAIN FOR THE G.E. VARIABLE RELUCTANCE PICKUP
- CHASSIS SIZE 9 1/2 x 11 x 8" HIGH

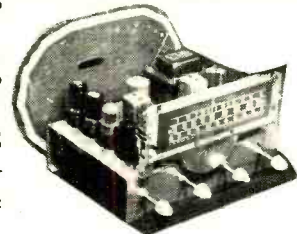

Here is something new in radio. A real 15 watt power amplifier with bass and treble controls. Has extra gain stage for crystal or dynamic mikes. And on the same chassis, a standard superhet radio receiver. We furnish all parts, knobs, escutcheon plate and tubes: 6SA7, 6SK7, 6SR7, 6SN7, 6SJ7, two 6V6 and 5Y3. No cabinet. Extra care in designing the power supply section assures low hum level, making this unit ideal for recording as well as P.A. use. We furnish everything as well as schematic diagram and photos of the completed chassis. Weight 35 lbs.

PRK-10 Radio-Amp. Kit with 12" P.M. speaker. With tubes Net

\$29.95

CPR-15. Exactly the same kit as the PRK-10 kit; except it is furnished with a 12" Cinacougraph wide range speaker. (Has built-in high frequency tweeter.) This is our finest kit. Net

\$37.95

20-WATT UTILITY AMP. KIT, \$17.95

Build this 20 watt utility 110 volt AC, 20 Watt power amplifier. Ready punched chassis, size 12 x 6 x 2 1/2 inches. Has two input circuits, one mike and one phono. Mike stage has 135 DB gain, for crystal or dynamic mike. Has bass and treble controls. Designed for use with FM speakers; former. All parts and easy-to-follow diagram furnished. Including tubes: 2-6SN7, 635, 2-6L6GA, 5Z3, Kit Model 20-LX. Net \$17.95



SMALL PORTABLE KIT, \$10.95

- 4-Tube Broadcast Superhet
- Priced Complete with Batteries
- Dynamic Speaker
- Slide Rule Dial

PORTABLE KIT MODEL K-PX. Small size leatherette covered case, 9x5x2 1/2. Easy to build. Operates on self contained B and A batteries. Rec. Broadcast 550 to 1600 K.C. Incorporates a standard superhet circuit with avc. Has 3 inch Alnico five PM speaker. Priced complete with batteries, pictorial diagram and tubes 1R5, 1S5, 1T4 and 3S4. Not AC DC, but straight battery operated. Has 2 gang cond. Everyone should have one of these personal portables. Everything furnished. Kit K-PX. Net \$10.95



3-WAY PORTABLE KIT, \$16.95

- 4 Tubes Plus Disc Rectifier
- 300 Hour Battery Pack Included
- Beautifully Built Portable Case

Build this powerful, 4-tube, 3-way portable kit. Operates on 110 volts AC or DC or self contained batteries. Receives broadcast 550 to 1650 K.C. Incorporates standard superhet circuit with AVC, and loop Ant. Has Alnico 5 PM Speaker, 2 gang condenser. All Parts and batteries are furnished including tubes, Disc Rectifier, 1R5, 1T4, 1S5 and 3S4. Has attractive leatherette portable cabinet size 7x9x9. Weight 14 lbs. Kit Model 3-ZA. Net \$16.95

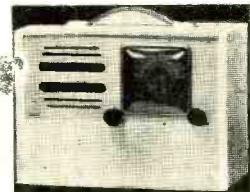

5-Tube AC-DC Broadcast Kit, \$9.95

BEAUTIFUL 10" PLASTIC CABINET
LOOP AERIAL • VERNIER DIAL
DYNAMIC SPEAKER • EASY TO BUILD

Kit Model P-85. We have finally been able to achieve our goal. Here it is. A good 5-tube broadcast AC DC superhet radio receiver for less than ten dollars. The beautiful 10 inch plastic cabinet is made of the finest material. The chassis is of the standard accepted superhet design. 456 KC. IFS AVC and 5 inch Alnico 5 PM speaker. Attractive vernier dial. Two gang tuning condenser. Loop ant. We defy anyone to offer a better working AC DC receiver kit. Priced complete with diagram, photos and tubes. 12B36, 12BA6, 12AT6, 50B5 and 35W4. Nothing else to buy. You can't go wrong on this value. Kit Model P-85. Net \$9.95



12-WATT AMPLIFIER KIT, \$10.95

PUSH PULL 6V6 OUTPUT TUBES
GAIN FOR MIKE AND PICK-UP
EVERYTHING FURNISHED. EASY TO WIRE
FINE TONE QUALITY

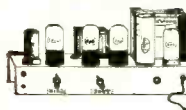

KIT MODEL AC-12. 12 watt amplifier kit. Ideal for high quality record player as well as public address or recording amplifier. Matched component parts, ready punched chassis pan. One control fades from phono to microphone. Gain enough for crystal or dynamic microphone, 100 mil power transformer, for 110 volt AC 60 cycle operation. Priced complete with tubes: 2-6V6, 6SN7, 6SH7 and rectifier. Diagrams and photos furnished. Kit AC-12. Net \$10.95. 12" Alnico 5 PM speaker \$6.95 extra; crystal microphone and desk stand \$4.95 extra.



1949 MODEL AC-DC KIT \$12.95

This is our latest and finest AC-DC radio kit. Receives Broadcast, 540 to 1650 KC. Has full length illuminated slide rule dial. Choice of Ivory or Walnut plastic cabinet. Full high efficiency 2 gang superhet circuit, with loop antenna. Ready punched chassis, full 5" PM speaker. Every part fits. Everything furnished, including tubes, 12SA7, 12SK7, 12SQ7, 35Z5 and 50L6. This kit will go together just like it would on the production line. Diagram, photos and instructions are furnished. Shipping weight 9 lbs. Kit model XA-49. Net \$12.95.

AMERICAN AND FOREIGN KIT \$14.95

550 to 1600 KC and 6 to 18 MC

This radio kit is housed in an attractive grey opalescent finished metal cabinet. Incorporates a standard 2 gang superhet circuit. Receives Broadcast (550 to 1600 KC) and foreign short wave (6 to 18 Megacycles). This kit is complete, nothing else to buy; just as all our kits. Ready punched chassis. It will go together just as it would down a production line. Has full 5" PM speaker. Complete with tubes: 12SA7, 12SK7, 12SQ7, 35Z5, 50L6. Diagram, photos and instructions are furnished. Shipping weight 10 lbs. Kit model DT-5. Net \$14.95.



WALNUT CABINET KIT \$11.95

Attractive 13" walnut cabinet AC-DC radio kit, with illuminated slide rule dial. Has made-to-fit metal front grille. Incorporates a standard 2 gang superhet circuit. Loop antenna, ready-punched chassis. This is another one of our line production radio kits. Every part is furnished. Includes tubes: 12SA7, 12SK7, 12SQ7, 35Z5 and 50L6. Diagram, photos and instructions are included. Has full 5" Alnico 5 PM speaker. Receives broadcast 550 to 1650 KC. Shipping weight 9 lbs. Model ES-6. Net \$11.95. SCOP. The above model ES-6 WIRED AND TESTED, in either Blond or Walnut cabinet. Net \$14.95.

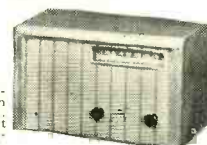

7-TUBE AC-KIT, \$19.95

KIT K-7A. Easily assembled into a line working, attractive, transformer type AC, broadcast receiver; 550 to 1700 KC. Has push-pull audio, tone control and 6 1/2" Alnico 5 PM speaker. Beautifully made 14" walnut cabinet. Incorporates a standard superhet circuit, with AVC and loop antenna. All parts, schematic and tubes 6SA7, 6SK7, 6H6, 6SN7, 2-6V6's and 5Y3 furnished. Has full 90 mil. power trans. Weight 17 lbs. Dealers Net \$19.95

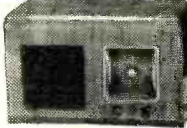

PORTABLE RADIO RECORDER KIT, \$54.95

\$90.00 value for only \$54.95. We furnish every part to build a powerful radio and dual speed recorder. The attractive leatherette case houses the sensitive superhet broadcast radio and General Industries R90L 33 1/2 and 78 RPM dual speed recorder; plus amplifier. Is all on one chassis: 12SA7, 12SQ7, 12SK7, 12SL7, mike gain; two 35L6 push-pull output; plus disc rectifier. Has plenty of gain for crystal or dynamic mikes. Has 6" heavy duty PM speaker and tone control. Kit G-31, everything complete, with tubes and diagram, \$44.95. Crystal mike and desk stand \$4.95 extra. This is without a doubt one of the best values in kits we have ever offered. Wt. 40 lbs.



McGEE RADIO COMPANY

WRITE FOR CATALOG SEND 25% DEPOSIT — BALANCE C. O. D. PRICES F. O. B. K. C. 1225 McGEE ST., KANSAS CITY, MISSOURI

PORTABLE WIRE RECORDER \$69.95



DELUXE WIRE RECORDER, \$79.95

This wire recorder incorporates all necessary circuits for recording and playbacks. Has built-in eraser circuit. The amplifier is of the AC transformer type, with push-pull 6V6 output tubes. Has tone control and fader control. Input stage for wire recording from either crystal mike, radio receiver or phono pick-up. Amplifier is wired, tested and ready to operate. This unit is classified as a kit, only because you have to mount the Webster wire recording mechanism, amplifier and speaker. Everything is furnished, including a 15 minute spool of recording wire.

Kit includes wired and tested 12 watt amplifier, expressly made for wire recording and public address use. Leatherette split type case and 10" PM speaker, furnished with regular \$52.92 Webster wire recording mechanism. Kit model GN-12. Net \$79.95. Crystal mike and desk stand \$4.95 extra.

STANDARD PORTABLE MODEL, \$69.95

Portable Wire Recorder Model GN-11

Has ready wired and tested 5 tube AC type amplifier with push-pull 6V6 tubes. Built-in eraser circuit. Input for crystal mike or phono pick-up. Diagrams show how you can record from any radio receiver. 3 position switch enables you to quickly change from record to playback or conventional P. A. system. This amp delivers 12 watts of good clean audio.

Here is what you get: Webster 79 recording mechanism, with 15 minute spool of wire, attractive leatherette covered case, 6" heavy duty PM speaker and wired and tested 12 watt AC wire recording amplifier. All you do is mount the amp, recording mechanism and speaker. Simple instructions furnished. Portable Recorder Model GN-11 Net \$69.95. Crystal mike \$4.95 extra.

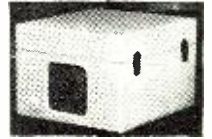

12" 3 Lb. Magnet \$9.95

12" 3 pound Alnico three magnet with 1 1/2" 8 ohm voice coil. A top quality PM speaker for public address and fine home reproduction use. You can't go wrong on this nationally known speaker value. Every speaker guaranteed brand new, factory cartoned and of latest production. A \$30.00 value. Stock No. 12P8. Net \$9.95.

15" 7 Lb. Magnet \$21.95

A \$40.00 value 15" high fidelity, super heavy duty 45 watt permanent magnet speaker. This speaker is tops. Has a 1 1/2" 8 ohm voice coil and a 7 pound Alnico 3 magnet. The 7 pound magnet in this speaker produces a force factor, that is unexcelled by any other speaker magnet. Guaranteed to be a name brand speaker. Every speaker brand new and factory cartoned. Stock No. 15P7. Net \$21.95 each. Two for \$41.95.

15" 1000 Ohm Field \$13.95

15" high fidelity dynamic speaker. Guaranteed top quality and made by a nationally known manufacturer. Latest production, brand new factory cartoned. A full 15" speaker, with 1000 ohm field and a 1 1/2" 16 ohm voice coil. This speaker will take 30 watts, with exceptional high and low frequency reproduction. Well worth twice our price. Stock No. 1517. Net \$13.95, each. Two for \$26.50. Every speaker guaranteed.

15" CINAUDAGRAPH JUKE BOX SPEAKER \$9.95

Here is without a doubt the best bargain in the whole U. S. A Jumbo 15 in. speaker made for the famous Airco Juke box. Has standard 1 1/2 in. 16 ohm voice coil and 1200 ohm field. The field may be easily excited by hooking to your radio or amplifier as a bleeder. Packed in original cartons. Fully guaranteed. Here is your chance to get a speaker that will bring out those low notes. Our scoop price, \$9.95 each.

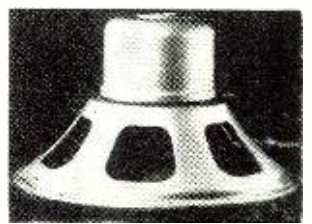

CARTONED RADIO TUBES 39c

How can you go wrong. Every tube guaranteed. Full replacement. EACH

100 "HY-VAC" ASSORTED FOR ONLY \$35.00

YOU PICK TYPES FROM THIS LIST

HY-VAC	
12SA7 GT	607 GT
12SK7 GT	6X6 GT
12SQ7 GT	6V6 GT
35L6 GT	6X5 GT
35Z5 GT	6SA7 GT
50L6 GT	6SD7 GT
6K7 GT	6SK7 GT
6A8 GT	6SN7 GT
5Y3 GT	6SQ7 GT
50B5	12K8
1T4	12A6
1L4	12SF7
1U4	6F5
1R5	6J5
1S5	6SJ7
3Q4	12SJ7
3S4	6AJ5
1B4	6SF5
6BA6	5Y4G
6BE6	5Y3G
6AT6	6A07
6X4	6C5
6BJ6	6H6
6K5	6J5
6AK5	6K7
6BH6	9001
6C5	9002
	9003
6SL7	12J5 GT
6SN7	12SG7
6SG7	12SH7
6SR7	12SJ7
6V6 GT	12SA7
6X5 GT	12SL7
6AB7	12SC7
12A76	12SQ7
12A6	12SR7
12BE6	50L6
12H6	12SK7
14Q7	14A7
14B6	25L6 GT
35L6 GT	35L6 GT
35Z5 GT	35W4
50B5	50B5
35Y4	

75% OF ALL THE TUBES YOU USE FOR 49c each

Guaranteed Standard Brands Cartonated and Uncartonated

49c Each	59c each	69c each	79c each
1 1/2 Volt Octal	1 1/2 Volt Octal	Loctal Tubes	1 1/2 Volt Loctal Tubes
IN5 GT	IN5 GT	50A5	50A5
1A7 GT	1A7 GT	35A5	35A5
1A7 GT	1A7 GT	7A7	7A7
35Z5 GT	35Z5 GT	7B7	7B7
35W4	35W4	7E7	7E7
50B5	50B5	7F7	7F7
35Y4	35Y4	7N7	7N7
		7C5	7C5
		7Y4	7Y4
		024	024

Popular P.M. Speakers

AT LESS THAN HALF PRICE EVERY SPEAKER GUARANTEED



4 in. P.M. 1 oz. Alnico V. mag.	\$0.99
6 in. P.M. 1 oz. Alnico V. mag.	\$0.99
5 in. P.M. 1.47 oz. Alnico V. mag.	\$1.19
5 in. P.M. 2.15 oz. Alnico V. mag.	1.49
6 in. P.M. 1.47 oz. Alnico V. mag.	1.49
6 in. P.M. 2.15 oz. Alnico V. mag.	1.98
6 in. P.M. 3.16 oz. Alnico V. mag.	2.95
8 in. P.M. 2.15 oz. Alnico V. mag.	2.95
8 in. P.M. 3.16 oz. Alnico V. mag.	3.45
10 in. P.M. 2.0 oz. Alnico 3. mag.	4.45
12 in. P.M. 2.0 oz. Alnico 3. mag.	4.95
12 in. P.M. 7 oz. Alnico V. mag.	5.95
12 in. P.M. 46 oz. Alnico 3. mag.	9.95

SAVE ON FIELD SPEAKERS

4 in. Dynamic. 450 ohm field.	\$1.89
5 in. Dynamic. 450 ohm field.	1.89
5 in. Dynamic. 3000 ohm field.	1.89
8 in. 2 ohm field for heavy duty auto radio use.	2.95
8 in. Dynamic. 1000 ohm field.	2.95
12 in. Dynamic. 1000 ohm field.	4.95
12 in. RCA 450 Reg. 10.00 net 14" Voice Coil. Scoop Price.	4.95

"HOTTEST PICK ME UP RADIO IN AMERICA" NO TALLER THAN A PEN NET EACH \$22.95

Model 747—3 way personal radio. Receives broadcast 550 to 1650 KC. Small size only 4x5x8 inches. However, uses full size parts with 2-gang condenser and loop. Priced complete with 4 miniature tubes and disc rectifier. These sets are only slightly larger than the smallest personal radio. Volume and tone like a big set. Kit of batteries \$11.95.



MECK PEE WEE SUPER \$11.95

Meck. 5 tube superhet; using miniature tubes. Small plastic cabinet (7x4x5 1/2), 2 gang condenser, loop antenna, Alnico 5 PM speaker. This is a red hot value in a small radio receiver; broadcast 550 to 1650 KC. Priced with tubes; ready to play.

Model 800B. Black plastic cabinet.	\$11.95
Lots of 3.	\$10.95
Model 800W. White plastic cabinet.	\$12.95
Lots of 3.	\$11.95

Weight 5 lbs. These are Dealer's Prices.

SCOOP! ON NEW C.R. TUBES

Brand New Fully Guaranteed

3 BP1	\$1.95	5 FP7	\$1.95
3 BP1	1.95	7 FP7	2.95
5 CPT	1.95	9 LD7	2.95
5 BP4	Has white screen; ideal for television. \$2.95		

2 Band coil, condenser kit. Consists of a matched 2 gang condenser, band switch and antenna and oscillator coil; for broadcast and foreign short wave. Scoop price \$1.95. Crystal hand mike, with 12 feet of cable. A handy item to have around. Scoop price; while they last. \$3.95, each.

SPEAKERS WITH OUTPUT ATTACHED

5 in. P.M. 1.47 oz. Alnico V. mag. with 50L6 output.	Special \$1.49
5 in. P.M. 1.47 oz. Alnico V. mag. with Push-Pull output trans.	Scoop \$1.69
5 1/2 in. G.E. P.M. Square with 50L6 output trans. mounts in place of regular 6 in. speaker.	\$1.95
6 in. P.M. 1.47 Alnico V. magnet with 7000 ohm primary output trans.	Special \$2.25
Heavy Duty 8" 450 Ohm Speaker with 6V6 output	\$2.95

POPULAR OVAL SPEAKERS

4x6 in. P.M. 1.47 oz. Alnico V. mag.	\$1.49
5x7 in. P.M. 2.15 oz. Alnico V. mag.	1.95
4x6 Dynamic. 450 ohm field.	1.95

PORTABLE RECORD PLAYER KITS

KIT MODEL J-41. Our leader record player kit. Fine tone, low needle scratch; includes two-tone leatherette covered portable case, rim-drive photo motor for high output crystal pick-up and 5" Alnico 5 PM speaker. 70L7 ready wired and tested amplifier. No wiring to do, just mount the parts in the case. Has the tone and volume controls. Kit Model J-41. Net \$14.95

Kit model 61-X. Has a beautifully made leatherette covered portable case; similar in appearance to our model J-41. Has an even speed 78 RPM phono motor. Light weight crystal pick-up and a powerful 4 tube transformer type wired and tested, push-pull 7C5 phono amplifier. Has separate tone and volume controls. Full 612 heavy duty PM speaker. All you do, is mount the amplifier, motor and pick-up. This is the last word in portable record players. Kit 61-X. Net \$22.95. Above kit model 61-X, with single post automatic record changer \$29.95.

POWERFUL SINGLE RECORD PLAYER KIT Z-26. Housed in an attractive leatherette covered cabinet. Latest 78 RPM rim drive motor and light weight pick-up. Ready wired and tested 60L7 type tube amplifier. Tone and volume control. 5" PM speaker (Alnico V). This kit easily slips together. Priced complete with tubes and hook-up instructions. Kit Z-26. Net \$9.95

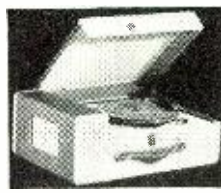

PORTABLE P.A. \$39.95

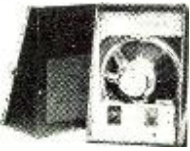

18 watt complete portable public address system. Has inputs for a crystal or dynamic mike and phono pick-up. Has push-pull 7C5 tubes in output. Attractive leatherette covered split type case. Priced complete with tubes and desk stand. Stock No. RC-18. Net \$39.95. Priced complete with crystal mike and desk stand.

G.E. Variable Reluctance Pick-up... \$4.65



Scoop—Pre-amplifier for General Electric Variable Reluctance pick-up. Easily connected to any AC or AC-DC amplifier. Wired and Tested, with 68C7 or (12SC7) tube. Diagram for connections is furnished. Specify whether you want pre-amplifier for AC or AC-DC use. Net price, 1 Pre-amp. with Tube and G.E. Pick-up—\$6.95. G.E. Variable reluctance pick-up cartridge with permanent needle. Net \$4.69.

1948 MODEL—MIKE-BROADCASTER ONLY \$7.95

Broadcasts 800 to 1500 KC from either a phonograph pick-up or a crystal or dynamic mike. Makes any radio receiver a P.A. system, record player or recording amplifier. Gives broadcast quality. Has fader control from mike to record, simulating a regular broadcast station. This is a powerful model; using 2-35L6 12SJ7 and 35Z5 tubes. Priced with tubes and connecting instructions. Wired and tested. Works on 110 volts AC-DC. Crystal mike and desk stand \$4.95 extra. Model DE-5 truly a de-luxe mike-phonoscillator.



3-TUBE PHONO OSC. ONLY \$4.95

Model DE-4—Phonograph oscillator. Broadcasts from 800 to 1500 KC. Gain for any crystal pick-up. A new powerful circuit is used to assure plenty of power. Has variable gain control for 100 per cent modulation. Priced with tubes ready to operate, two 50B5 and 34W4. Model DE-4. Net \$4.95



SUPERHET BROADCAST TUNER for connection to phono amp. or P.A. system.

Compact chassis 5x3 1/2 x 3 inches. May be mounted inside the record player cabinet. Requires only three connections to amplifier. Uses 6SA7 or 12SA7; 6SK7 or 12SK7 and crystal diode, or 12SK7 and tubes. Loop antenna, dial and instructions for connecting to any amplifier. Net \$7.95. Specify if tuner is to be used with AC or AC-DC type amplifier.



McGEE RADIO COMPANY WRITE FOR CATALOG Prices F.O.B. K.C. SEND 25% DEPOSIT—BALANCE C. O. D. 1225 McGEE ST., KANSAS CITY, MISSOURI

What's New in Radio

HICKOK OSCILLOGRAPH

The new *Hickok* Model 505 cathode-ray oscillograph utilizes the new 5UP-1 tube with a 5" screen.

The Model 505 features a wide and

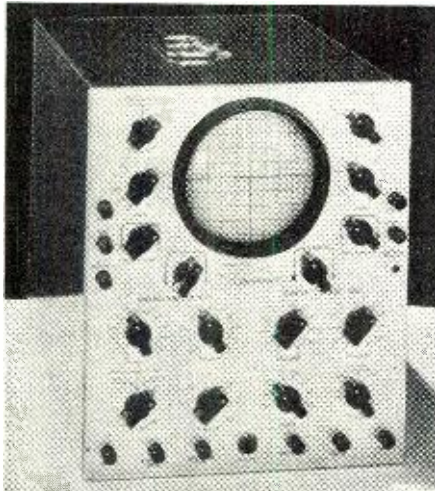

narrow band FM oscillator which makes a separate FM oscillator unnecessary; a wide-band, high gain vertical amplifier up to 1 megacycle; a modulation circuit which permits the FM oscillator to be either internally or externally modulated; a demodulator which permits any modulated r.f. signal to be viewed; a self-contained mixer circuit which permits FM output with any good signal generator; a signal tracer jack; sinusoidal sweep with phasing control; and a three-range frequency compensated attenuator network for the vertical amplifier.

For detailed literature on the Model 505 write the *Hickok Electrical Instrument Co.*, 10524 Dupont Avenue, Cleveland 8, Ohio.

"POCKETRACER"

Radex Corporation of Chicago is now marketing a pocket-sized universal signal generator which has been designed for all types of troubleshooting.

The r.f. and audio signal source of



the multivibrator type can be used for the quick analysis of circuit difficulties. The unit generates a universal frequency which can be used for alignment or test purposes, while an audio frequency is generated in addition to

r.f. and i.f. Total current consumption of the unit is only 140 ma.

A single penlite type flashlight battery is used to power the unit.

Additional information on the "Pocketracer" may be secured from *Radex Corporation*, 2076 Elston Avenue, Chicago 14, Illinois.

"MEGA-PIPPER"

Kay Electric Company is currently in production on a new instrument for the quick and accurate alignment of television receivers.

Known as the "Mega-Pipper," this unit gives four precise crystal controlled pips which are independent of the circuit under test. These pips establish the picture, sound carrier, and also the adjacent channel points. No switching or adjustment is necessary for frequency control. Since the pips are fed directly into an oscilloscope, the pips are visible at all times, even in the traps where the highest precision is required.

The "Mega-Pipper" is designed to be used with the company's "Mega-Sweep" or "Mega-Match" instruments.

Prices and additional information on this unit will be supplied by *Kay Electric Company*, Pine Brook, New Jersey.

TELE-BOOSTER

Vision Research Laboratories has developed a device which is said to



boost weak stations to a point where suitable reception is possible.

Known as the "Tele-Booster," the unit is a compact, simply-installed r.f. amplifier with self-contained power supply. It is connected to the television receiver by installing the unit in series with the receiving antenna. Since the "Tele-Booster" is a selective amplifier, it increases the strength of the desired signal and tends to reject unwanted off-channel interference. A two-position switch on the front panel of the wooden cabinet cuts the unit in and out of the circuit at will. When in the "off" position the antenna is connected directly to the television receiver and has no effect upon normal signals which require no boosting.

The cabinet, which measures 3" x 5" x 6", is available in either walnut or mahogany finish. The "Tele-Booster" is furnished in three models; Model TVL for Channels 1 through 6; Model TVH for Channels 7 through 13; and Model FM for 88 to 108 mc.

Additional information will be supplied by *Vision Research Laboratories*, 87-50 Lefferts Boulevard, Richmond Hill, New York.

SWEEP CALIBRATOR

The Model GL-22 sweep calibrator has been added to the *Browning* line of electronic equipment.

This is a pulsed timing marker oscillator designed for use with standard



oscilloscopes and synchoscopes for the measurement of time intervals on either triggered or recurrent sweeps. Variable amplitude markers of either polarity are provided with sufficient amplitude for use as intensity markers or directly on the cathode-ray tube plates as deflection markers.

Available markers include; .1, .5, 1, 10, and 100 microseconds. A positive or negative variable width gate pulse output is provided for test purposes. The duration of this pulse corresponds to the duration of the marker group. Operation of the calibrator may be by use of external synchronizing triggers or from its own trigger generator with output triggers of both polarities available at front panel connections.

Additional information on the Model GL-22 may be secured from *Browning Laboratories, Inc.*, Winchester, Massachusetts.

PORTABLE P.A. SYSTEM

The *Siltronic Company* of Pittsburgh, Pennsylvania, has developed a fully portable public address system which is particularly suited for industrial plants, carnivals, municipal agencies, crowd control, instruction, sales meetings, etc.

The PA-4 is housed in a sturdily built carrying case and is completely self-contained. The unit measures 9" x 7½" x 12" and weighs, complete with batteries, just 12 pounds.

The unit has a high gain, three-stage amplifier; crystal, high fidelity

**"REACH FOR KEN-RAD--
You'll never find a better tube!"**



Ken-Rad tubes have been built for 26 years on the idea that when you please the serviceman—you please everybody!

By actual tube experience, servicemen know Ken-Rad research and engineering are outstanding. They know Ken-Rad production is painstaking—with test after test to make doubly sure there's no higher standard of performance.

Dependability, above everything else, is why servicemen everywhere say, "Reach for Ken-Rad—you'll never find a better tube."



**LES SINGER, Singer Radio Service,
6016 Madison Road, Cincinnati, Ohio**
Like thousands of outstanding servicemen, Les Singer has been using Ken-Rad tubes ever since he started in business. He judges tubes by experience alone.

**"We build tubes to build
YOUR REPUTATION"**

Practically every radio serviceman knows Ken-Rad tubes. He depends on them.

And there's plenty of reason for this confidence. Ken-Rads are made exclusively to meet the exacting demands of servicemen. They're *quality* tubes, with *stamina* and *endurance*.

This is important. Because it takes more than good service to build repeat business.

It takes good tubes, too. Ken-Rad tubes.

Use them and you can count on customers coming back, satisfied.



**C.A. MEGUIAR, Shop Foreman,
Metal Mounting Dept.,** where grid turns are accurately aligned in beam type mounts. (Below) Aligning grid turns in special jig before welding to supports.

KEN-RAD *Radio Tubes*

PRODUCT OF GENERAL ELECTRIC COMPANY

Schenectady 5, New York

**The
Serviceman's
Tube**



NO FOOLIN'!
Federated Values
ARE UNBEATABLE!

**FAMOUS MAKE
 RF CHOKE**
 2.5 Milhenrys
 500 Ma. DC
 Brand New



Six thin universal pies, isolantite core, insulated mounting brackets. Sensational value at our low price of..... **59c**

PHANTOM ANTENNA
 A-27 Sig. Corps

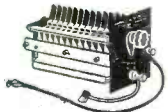

Parts alone worth twice the price! Contains high quality mycalex insulated dual spaced transmitting condenser. 150 mmfd; two heavy duty resistors, pointer knob, scale, leads, and clips. All for only **98c**

**Nationally Known
 "Velvet Action"
 VERNIER DIAL**



You'll recognize this one! We can't mention name because of terrific low price! Four-inch dial, engine-divided scale, and vernier, flush with scale. 5 to 1 planetary drive. Fits 1/4" shaft. BRAND NEW, now only..... **\$1.69**

HAND REAMER



Every service shop needs this useful tool. Made of solid, high quality tool steel, reams up to 1/2" hole. DON'T MISS THIS WONDERFUL VALUE. We've only a limited quantity at **69c**

**SOCKET WRENCH
 KIT**



Another necessary tool for every ham, repairman, experimenter. Consists of right-angle ball-bearing wrench with six interchangeable sockets from 1/2" down to 3/16. In handy metal container. A REAL BARGAIN AT..... **35c**

**TWO SPEED
 PLANETARY
 DRIVE**



Fits condenser shaft back of panel, or dial knob shaft. 5 to 1 and 1 to 1 ratios. For any 1/4" shaft. ONLY A FEW LEFT AT THIS LOW PRICE **79c**

**AIR PADDER
 CONDENSERS**



Low loss insulated padders, have screw driver adjustment and locking nut. EXCEPTIONAL VALUE!

15 mmfd
 25 mmfd

**YOUR CHOICE
 10 for \$1.90**

Please include 25% Deposit with order, Balance C.O.D. Minimum C.O.D. Order \$5.00. DEPARTMENT 28-G

Federated Purchaser
 INCORPORATED
 CABLE: FEDERPURCH
 distributors of **RADIO - ELECTRONIC**
 and **SOUND EQUIPMENT**
 80 PARK PLACE, N. Y. 7
 Phone: Digby 9-3050

microphone cased in a streamlined die cast housing; and a heavy-duty 6" PM speaker. The PA-4 uses three



tubes and three easily replaced, long life batteries.

Additional details and literature on the PA-4 are available from *The Siltronic Company*, Point Building, Pittsburgh 22, Pennsylvania.

TIRE STATIC POWDER KITS

General Cement Mfg. Co. has recently developed a tire static powder which is said to improve auto radio reception and eliminate contact shock.

The new kits include an easy-to-use injector for introducing the static powder into tire tubes without completely deflating the tires. The powder is blown into the tire's inner tube under air pressure. The tire air pressure is merely reduced 5 to 10 pounds, the injector is attached to the tube valve stem and the proper air pressure is again adjusted in the tire. The powder is automatically blown and distributed into the inner tube.

The kit includes an injector and sufficient static powder for five tires. Further information on the kits will be furnished by *General Cement Mfg. Co.*, 919 Taylor Ave., Rockford, Ill.

PIN STRAIGHTENER

The second of a series of specially designed servicemen's shop tools, a miniature pin straightener, has been announced by *Hytron Radio & Elec-*



tronics Corp. of Salem, Massachusetts.

Designed to make the serviceman's job easier and more profitable, this new tool is built of special stainless steel and aluminum for long life and trouble-free performance.

Special mounting holes are provided to permit the straightener to be fastened to the service bench. The units are priced to permit each serviceman to have one for the bench, one for the tool kit, and one for the counter near the tube tester.

Distribution of these miniature pin straighteners is being made through *Hytron* jobbers.

V.O.M.-TUBE TESTER

A combination tester which provides complete voltage, current, and resistance analyses in addition to tube testing has been announced by *The Triplett Electrical Instrument Co.* of Bluffton, Ohio.

The tube tester has a fully-balanced, multi-purpose test circuit for checking emission, short, and open elements in tubes. The company's lever switching makes possible an exclusive combination of tube testing advantages including maximum circuit flexibility, simplicity of operation, and anti-obsolescence. Only one socket is used for each tube base type thus eliminating the possibility of plugging a tube into the wrong socket. The unit tests all receiving type tubes, gaseous rectifiers, resistor and ballast tube con-



tinuity, and pilot lamps. A conveniently located roll tube chart simplifies testing.

The v.o.m. provides a.c.-d.c. voltage ranges from 0 to 1200 at 10,000 ohms-per-volt for d.c. and 2000 ohms-per-volt for a.c.; while d.c. milliamperes from 0-120; d.c. amperes from 0-12; ohms from 0-1000-100,000; and megohms from 0-1-50 may be measured with this instrument.

Additional information on the Model 3480 may be secured from *The Triplett Electrical Instrument Co.*, Bluffton, Ohio.

WIRE RECORDING HEADS

A new line of wire recording heads has been announced by *Shure Brothers, Inc.* of Chicago.

The units combine recording, playback, and erasing features in a single head. Mechanical construction permits a variety of shielding and mounting arrangements.

These new heads offer versatility of recording and playback circuits. Impedances and internal connections may be varied to suit individual needs. Other features include uniform per-
 (Continued on page 132)

The New Model 777

TUBE & SET TESTER

20,000 OHMS PER VOLT!!



TUBE TESTER SPECIFICATIONS:

- Tests all tubes including 4, 5, 6, 7, 7L, Octals, Loctals, Television, Magic Eye, Thyratrons, Single Ended, Floating Filament, Mercury Vapor Rectifiers, New Miniatures, etc. Also Pilot Lights.
- Tests by the well-established emission method for tube quality, directly read on the scale of the meter.
- Tests leakages and shorts of any one element against all elements in all tubes.
- Tests both plates in rectifiers.
- Tests individual sections such as diodes, triodes, pentodes, etc., in multi-purpose tubes.
- New type line voltage adjuster.

V. O. M. SPECIFICATIONS:

- DC Volts: (at 20,000 Ohms per Volt) 0 to 7.5/15/75/150/750/1,500 Volts
- AC VOLTS: (At 10,000 Ohms per Volt) 0 to 15/30/150/300/1,500/3,000 Volts
- DC CURRENT: 0 to 1.5/15/150 Ma. 0 to 1.5 Amperes
- RESISTANCE: 0 to 5,000/50,000/500,000 Ohms. 0 to 50 Megohms
- DECIBELS: (Based on zero decibels equals .006 Watts into a 500-Ohm line.) -10 to +18 db., +10 to +38 db., +30 to +58 db.

Model 777 operates on 90-120 Volts 60 cycles AC. Housed in beautiful hand-rubbed cabinet. Complete with test leads, tubes, charts and detailed operating instructions. Size 13" x 12 1/2" x 6".

\$59⁹⁵
NET PRICE

Distributed by the following jobbers:

ALABAMA

Bessemer Radio Supply Co., 116-118 N. 20th St., Bessemer, Ala.
Forbes Distributing Co., Inc., 1912 Fourth Ave. North, Birmingham, Ala.
Bill Erwin Radio Co., 926 First Ave., Gadsden, Ala.
Allen & Jemison Co., 620 Greensboro Ave., Tuscaloosa, Ala.

COLORADO

Western Electronic Laboratories Co., 909 Eighteenth St., Denver, Colorado

CALIFORNIA

Valley Electronic Supply Co., 1302 W. Magnolia Blvd., Burbank, Calif.
El Monte Electronics Co., 992 East Valley Blvd., El Monte, Calif.
Valley Radio Supply, 449 Blackstone Ave., Fresno 3, Calif.
Hagerty Radio Supply, 6826 San Fernando Rd., Glendale 1, Calif.
Hollywood Radio Supply Co., 5501 Hollywood Blvd., Hollywood 28, Calif.
Pacific Radio Exchange, Inc., 1407 Cahuenga Blvd., Hollywood 28, Calif.
Alvarado Supply Co., 903 S. Alvarado, Los Angeles 6, Calif.
V & H Radio & Electronic Supply, 2033 W. Venice Blvd., Los Angeles 6, Calif.
Universal Radio Supply Co., 1404-1406 Venice Blvd., Los Angeles 6, Calif.
Figart's Radio Supply Co., 6320 Commodore Sloat Dr., Los Angeles 36, Calif.
Kierulff & Co., 820 W. Olympic Blvd., Los Angeles, Calif.
Radio Parts Sales Co., 5220 So. Vermont Ave., Los Angeles 37, Calif.
Electronic Sales Co., 5559 West Adams Blvd., Los Angeles 16, Calif.
Electric Supply Co., 143 12th Street, Oakland 7, Calif.
Pasadena Radio Supply & Equipment Co., 30 W. Colorado St., Pasadena, Calif.
Sacramento Electric Supply, 711 Capital Ave., Sacramento, Calif.
Arrowhead Radio & Television Supply, 1216 D St., San Bernardino, Calif.
Electronic Equipment Distributors, 1228 2nd. Ave., San Diego 1, Calif.
San Francisco Radio & Supply Co., 1282 Market St., San Francisco 2, Calif.
Offenbach Reimus Co., 372 Ellis St., San Francisco, Calif.
Frank Quement, Inc., 161 West San Fernando St., San Jose, Calif.
E. B. Abbott Co., 345 Francisco Blvd., San Rafael, Calif.
G & M Equipment Co., 4505 Van Noys Blvd., Sherman Oaks, Calif.

CONNECTICUT

L. N. Waljhaus, 1132 Norman St., Bridgeport, Conn.

DISTRICT OF COLUMBIA

Capitol Radio Wholesalers, 2120 14th St., N. W., Washington, D. C.
Kenyon Radio Supply, 2214 14th St., N. W., Washington, D. C.
Rucker Radio Wholesalers, Inc., 1312 14th St., N. W., Washington, D. C.
Silberne Radio & Electric Co., 3523 14th St., N. W., Washington, D. C.
Sun Radio of Washington, D. C., 938 F St., N. W., Washington, D. C.

ILLINOIS

Belmont Radio Supply, 1921 W. Belmont St., Chicago 13, Ill.
Crescent Radio Components, 4324 W. Fullerton Ave., Chicago 39, Ill.
Radio Doctors' Supply House, 220 East Station, Kankakee, Ill.
Lofgren Motorola Distributing Co., 1202 4th Ave., Moline, Ill.
Homback Supply Co., 2009 30th St., Rock Island, Ill.

INDIANA

Radio Service Headquarters, 725 S. Main St., Elkhart, Ind.
Van Sickie Radio Supply Co., 34 W. Ohio, Indianapolis 4, Ind.
Clinsaman Radio, 814 W. Main St., Peru, Ind.

KANSAS

Overton Electric Co., Inc., 522 Jackson St., Topeka, Kansas

MASSACHUSETTS

Radio Shack Corp., 167 Washington St., Boston, Mass.
Harolds Radio Distributors, 46 Brattle St., Boston, Mass.
Springfield Sound Co., 147 Dwight St., Springfield 3, Mass.

MICHIGAN

Mark's Stores, Inc., 1333 Broadway, Detroit 26, Mich.
Fulton Radio Supply Co., 265 W. Cortland St., Jackson, Mich.
Electric Products Sales Co., 427 E. Michigan Ave., Lansing 29, Mich.
Orem Distributing Co., 801 E. Genesee Ave., Saginaw, Mich.

MARYLAND

Lylron Distributing Co., 1829 N. Fulton St., Baltimore, Md.

MISSOURI

Tri-State Radio & Supply, 136 Bartlett St., Poplar Bluff, Mo.
Walter Ashe, 1125 Pine St., St. Louis 1, Mo.

NEBRASKA

Arbor Co., 823 Central Ave., Nebraska City, Nebr.
Radio Supply Co., 618 Lincoln Blvd., York, Nebraska

NEW JERSEY

General Radio Supply, 207 N. Broadway, Camden, N. J.
Nidisco, Inc., 658 Anderson Ave., Cliffside, N. J.
Trade Radio, 10 Morris St., Hackensack, N. J.
Nidisco, Inc., 713 Newark Ave., Jersey City, N. J.
Variety Electric Co., Inc., 601 Broad St., Newark, N. J.
Continental Sales Co., 195 Central Ave., Newark, N. J.
William Radio Supply, 210 French St., New Brunswick, N. J.
Nidisco, Inc., 205 Madison St., Passaic, N. J.
Monmouth Radio Supply, 396 Shrewsbury Rd., Red Bank, N. J.
Nidisco, Trenton, Inc., 126 So. Warren St., Trenton, N. J.

NEW YORK

Hudson Valley Asbestos Corp., 170 Central Ave., Albany 6, N. Y.
Scheller Radio Co., 263 Oak St., Buffalo 3, N. Y.
C. A. Winchell Radio Supply Co., 37 Central Ave., Cortland, N. Y.
W. Rd. Radio Laboratory, 6 Hamilton Ave., Croton-on-Hudson, N. Y.
F. C. Harrison Co., 108 W. Church St., Elmira, N. Y.
Arace Brothers, 562 Broadway, Kingston, N. Y.
Metropolitan Elect. & Distributing Co., 42 Warren St., New York 7, N. Y.
Brooks Radio Distributing Corp., 80 Vesey St., New York 7, N. Y.
Arrow Electronics, 82 Cortlandt St., New York 7, N. Y.
General Electronic Distributing Co., 98 Park Pl., New York 7, N. Y.
Legri S. Co., Inc., 846 Amsterdam Ave., New York 25, N. Y.
National Radio Distributing Co., 899 So. Blvd., New York 59, N. Y.
Mass Electronic Distributing Co., 229 Fulton St., New York 7, N. Y.
Roy C. Stage, 265 Erie Blvd., West, Syracuse, N. Y.
Trojan Radio Co., 426 River St., Troy, N. Y.

NEW MEXICO

Supreme Radio Supply, 129 West 2nd. St., Roswell, N. M.

NORTH CAROLINA

Eastern Radio Supply, 459 Hay St., Fayetteville, N. C.

OHIO

Olson Radio Warehouse, Inc., 73 East Mill St., Akron, Ohio
Olson Radio Warehouse of Cleveland, 2020 Euclid Ave., Cleveland, Ohio
Progress Radio Supply Co., 413 Huron Road, Cleveland 15, Ohio
Whitehead Radio Co., 120 East Long St., Columbus 15, Ohio
Lifetime Sound Equipment Co., 911 Jefferson Ave., Toledo, Ohio
Steward Electric Service, 116 Seroto St., Urbana, Ohio

PENNSYLVANIA

Thompson Electric Store, 1310 12th Ave., Altoona, Pa.
Williams Auto Sales Co., Clearfield, Pa.
Kratz Bros., Kohn & Oak Sts., Norristown, Pa.
Nat Lazar Radio Co., 42-41 Lancaster Ave., Philadelphia 4, Pa.
Almo Radio Co., 509 Arch St., Philadelphia 6, Pa.
Barnett Bros. Radio Co., 145 N. 7th St., Philadelphia 6, Pa.
Radio 437 Store, 437 Market St., Philadelphia 6, Pa.
M & H Sporting Goods Co., 512 Market St., Philadelphia 6, Pa.
Warner Radio Co., 631 Market St., Philadelphia 6, Pa.
Electronic Research Laboratories, 5832 Hegerman St., Philadelphia 24, Pa.
York Radio & Refrigeration Parts, 265 W. Market St., York, Pa.
J. R. S. Distributors, 644 W. Market St., York, Pa.

SOUTH CAROLINA

Bates Radio & Supply Co., 7 South Main St., Greenville, S. C.

TENNESSEE

Chenclly Radio & Electric Co., 12 Emory Park, Knoxville 17, Tenn.
Hermitage Music Co., 423 Broad St., Nashville 3, Tenn.

TEXAS

Electronic Equip. & Engineering, 1322 1/2 S. E. Elizabeth St., Brownsville, Tex.
Electronic Equip. & Engineering, 1310 S. Staples St., Corpus Christi, Tex.
Paul Blackwell Co., 2016 Richardson St., Dallas 1, Tex.
Wilkinson Bros., 2406 Ross St., Dallas, Tex.
Car Parts Depot, Inc., 721 Texas St., El Paso, Tex.
Mission Radio, Inc., 814 S. Presa St., San Antonio 5, Tex.
The Hergis Company, Inc., 1305 Austin Ave., Waco, Texas

VIRGINIA

Ashman Dist. Co., 807 Granby St., Norfolk 10, Va.
D. R. Johnston Co., 1315 East Cary St., Richmond 19, Va.
Mattson's Radio, 519-21-23 W. Broad St., Richmond 22, Va.

WASHINGTON

White's Htg., Radio & Appliance Store, W. 908 First Ave., Spokane 8, Wash.

WISCONSIN

Valley Radio Distributors, 518 N. Appleton St., Appleton, Wis.
Standard Radio Parts Co., 1244 State St., Racine, Wis.

MANUFACTURED BY **SUPERIOR INSTRUMENTS CO.** 227 FULTON STREET NEW YORK 7, N. Y.

"ARROW" leads with Better Buys!

BRAND NEW!

TUBES

BRAND NEW!

304TL
Transmitting Tube \$195 ea.

CATHODE RAY TUBES
 5CP1 5FP7 }
 5BP1 7BP7 } **\$119 each**
 3FP7 }

5BP4
Cathode Ray Tube \$195 ea.

39c each
 lots of 50—
 10% discount

RECEIVING TUBES

954	2051	12BE6	12J5	6G6
957	12AT6	864	6AT6	Amperite
9003	12SR7	RK34	6SF7	10T1
9006	12C8	12A6	5R4	110AC
35W4	12K8	6SJ7	36	Neon Light

39c each
 lots of 50—
 10% discount

SPECIAL TUBE OFFERS

841—79c ea.	837—\$1.95 ea.	869B—\$25.00
839—\$2.95 ea.	832A—\$2.95 ea.	2C26A—49c ea.
	2J32—\$20.00 ea.	

AN/APN-9 LORAN
 BRAND NEW... R-65/APN-9 Receiver-Indicator and 115 V. 400 Cyc. power supply; complete in one chassis. With 35 tubes including 6SK7's, 2X2, etc. 3BP1 (fast screen) CR tube has magnifying lens. Factory termination, less outer case. Excellent foundation for test scope..... **\$24.95**



BIAS METER
 Brand New
 Originally used for measuring voltages and telephone equipment. Can be used for measuring DC voltages and bias voltages also checking polarity of DC voltages. Complete with a d a p t o r plug and schematic. Enclosed in metal carrying case. Requires no batteries for operation..... **\$3.95 ea.**

BC-223 AX TRANSMITTER
 801 Oscillator and 801 Power Amplifiers, 2—46 modulators and 1—46 speech amplifier; 4 Xtal Frequencies and Master Oscillator on selector switch 10 to 30 watts output. Tone voice or C.W. Mod. Ideal for Ham Use. Black wrinkle case. Tubes included, packed in original cases, less crystals, only..... **\$11.95**
 Transmitter less tubes. Tuning unit and crystal 5.95

ARC 4 TRANSMITTER and RECEIVER
 For operation VHF frequencies in range of 140-144 mc. Four channel crystal controlled, manufactured by Western Electric—24V operation. Complete with crystal and dynamotor. Used..... **\$19.95**
 Good condition.....

INTERPHONE AMPLIFIER
 Comes in an aluminum cabinet, 9"x4"x5 1/2"
 DC output at 60MA, less tubes. **95c**
 Yours for only..... **\$1.95 ea.**
 Complete with tubes.....

SCR-522 VHF COMMAND UNIT
 2-Way Radio; freq. range 100-156 MC.; complete with crystals, tubes, plugs, dynamotor..... **\$24.95**
 used, in excellent condition.....

LP-21 ADF LOOP
 Low impedance loop, good for direction finder. one Selsyn motor, one Selsyn transmitter, freq. range of loop 100 Kc to 1750 Kc.; BRAND NEW in original cartons, each..... **\$6.95**

PE-117 UNIVERSAL POWER SUPPLY
 6 or 12 volt input; output 145 volts and 90 volts; less vibrator, voltage regulator and rectifier tube; ideal mobile power supply unit; excellent condition, each..... **\$2.95**

TURBO AMPLIFIERS
 Use for parts or small phono amplifier, shipped complete with the following tubes:
 2—7C5's, 1—7Y4, 1—7F7. Each..... **\$1.65**

INTERPHONE AMPLIFIER
 Type AM-26/A1C with 28 V. DC dynamotor. Contains 2—12A6 and 2—12A7 tubes. Easily converted for phonograph or intercommunication amplifier..... **\$1.75**

RA-10 BENDIX RECEIVER
 3 band, good cond., 7 tube super heterodyne circuit, direction finder and communication receiver; freq. range 200 to 110 KC and 2 MC to 10 MC, complete with dynamotor and tubes, easily converted to operate from 110 volt
 AC-DC..... **\$14.95**

SELSYN INDICATORS
 For use with beam rotators for indication of direction of beam. Operate from 15-24V. 60 cycle AC supply. Small model, 3 inch diameter, only..... **\$2.45**
 Large model, 5 inch diameter, only..... **2.95**

GE METER
 0-10 amps, DC..... each **\$2.29**

RADIO SET SCR-AR-283
 BRAND NEW... transmitter and coil sets to cover 2.5-7 MC.; transmitter tubes 2 No. 10 special and 2 No. 45 special, receiver (less the 2 receiver coil sets), receiver tubes 1—37, 1—38, 4—39/44, shock mounts, dynamotor (24 V.), antenna switching relay, receiver control box, transmitter control box, charts, dials, and instruction manual..... **\$14.95**
 ONLY

PHANTOM ANTENNA
 Brand New
 Used with any 80 meter transmitter as a dummy load for adjusting transmitter for maximum output before going on air. Freq. range: 2MC to 4.5MC, with instruction manual, enclosed in metal case with cover..... **\$1.95 ea.**



REMOTE CONTROL BOX
 BC-450-A Remote Control Box; can be adapted to make an FT-260 local control for all command receivers..... **\$1.95**

SPRAGUE PULSE FORMING NETWORKS
 Used in small radar modulators, available in 3 sizes, 67 ohms impedance, 7.5 Kilowatt rating.
 H-603, one micro second, 200 pulses per second..... **\$1.95**
 H-601, 3 micro seconds, 200 pulses per second..... **2.95**
 H-602, 16 micro seconds, 60 pulses per second..... **3.95**
ALL THREE ABOVE FOR ONLY... 4.95

OIL-FILLED CONDENSERS
 .25 MFD at 1500 VDC..... 59c
 .25 MFD at 15,000 VDC..... **\$4.95**
 2 MFD 220 VAC..... 29c

ARROW SALES, INC.

MAIN OFFICE

SOUTH SIDE BRANCH
 8310 SOUTH HALSTED ST.

59 WEST HUBBARD ST., CHICAGO 10, ILL.

NORTH SIDE BRANCH
 1802 NORTH HUMBOLDT BLVD.

Telephone SUPERior 5575

"ARROW" leads with Better Buys!

SCR-274 MEDIUM FREQUENCY COMMAND SET

Complete installation with 2 transmitters, 3 receivers, racks, tubes, crystals, control box and plugs.
Excellent condition.....**\$19.50**

BLOWER MOTOR

24V, small portable with fan, ideal for defroster or ventilator unit, 17,000 RPM, BRAND NEW.....**\$1.95**

TEST CABLE

Coaxial cable used for correcting signal generator to receiver, complete with PL-55 on one end, 2 spare terminals on other end; shielded, 6 ft. long, NEW.....**19c**

CD-307 Phone Extension Cord PL-55 on one end and JK-26 on other end, 8 ft. long, used for extension of headsets or speaker.....**29c**

DYNAMOTOR

DM 32A. Each 95c; 3 for.....**\$2.00**

ANTENNA THERMO-COUPLE METER
BC-442; 0-10 amps, with extra relay and 50 MMFD 5000 Volt condenser. Used with command transmitters. BRAND NEW.....**\$1.95**

ARB AIRCRAFT RADIO RECEIVER
The ARB is a six tube, four band, superheterodyne Aircraft Radio Receiver with built-in dynamotor, designed for the reception of MCW (tone or voice) or CW within the frequency range 195 Kc to 9.05 megacycles. Used.....**\$15.95**

AUTOMATIC FREQUENCY CONTROL UNIT
Western Electric type used for controlling frequency for teletype and telephone work, complete with 3-68J7 and 2-6H6 tubes. Complete.....**\$4.95**

BC-604 FM 35 WATT TRANSMITTER
A-1 condition, complete with tubes, 10 channel push buttons, less crystals and power supply, each.....**\$10.95**
Set of 80 crystals for above.....\$14.95
BC-603 Receiver for above.....10.95

TRANSFORMER

High voltage scope transformer, 90V 80 cps. primary: 6400V secondary; 4 stand-off terminals.....each**\$2.95**

FILTER CHOKES—All Fully Enclosed
3.7 H. @ 145 MA. DC. 125 ohms DC. Res. 59c
4 MTG. Studs. each.....59c
100 mH.....59c

APN-1 RADIO ALTIMETER
Complete 420 MC transmitter-receiver unit, complete with all plugs, indicators. BRAND NEW.....**\$29.95**

AN/PRS-1 MINE DETECTOR—BRAND NEW
PE-103 DYNAMOTOR used.....5.95

BC-929-A
Contains power supply 110 V. 400 cycles, has 7 tubes such as 3CP1, brand new, complete with tubes. Each \$17.95; Used.....\$14.95

R-78/APS-15
Has 45 tubes, one 5" scope tube, one 2" scope tube, has 3 meters, 4 power supply units 110V 400 cycles, complete with tubes. Each.....**\$39.50**

BENDIX COMPASS RECEIVER MN-26
Remote control commercial type navigational receiver. Indicates direction of any desired transmitting station. 3 bands—frequency range: 150 Kc to 1500 Kc; has 12-6 V. type tubes. Brand new, original cost \$600.
Now.....**\$24.95**
Accessories for Above:
Loop MN-20.....\$6.95
MN-28 Control Box.....5.95
MN-52 Loop Control Unit.....1.95

COMMAND RECEIVERS and TRANSMITTERS

(274N Series)—Complete with Tubes
NEW

BC-454A; 3 to 6 MC.....**\$5.95**
BC-458; 5.3 to 7 MC.....**5.95**
BC-457; 4 to 5.3 MC.....**5.95**
BC-456 MODULATOR.
Brand New.....**2.95**

RECEIVER

Low impedance, magnetic type receiver, ideal unit for pillow receiver or small microphone, NEW.....**39c**

VHF RECEIVER BC-701

Frequency range 170-180 Mc; IF 30.5 Mc; complete with 11 tubes; self-contained power supply; brand new in beautiful wooden carrying case.....**\$9.95**

AN18/APT-10

Pre-amplifier Model K-1, designed to raise output level of magnetic type microphone, complete with 2 tubes 6SL7GT and 28D7 and hand switch, brand new in original cartons.
Each **\$1.95** 3 for **\$5.00**

VHF TRANSMITTERS

T-26/APT-2 = 450 — 710 mc = \$ 9.95
T-27/APT-3 = 85-135 mc = 10.95

Above transmitters are amplitude modulated radar transmitters. Complete with all tubes such as 829, 832, 931, 6AC7, 6AG7, 5R4GY. Also 110 volt 400 cps. power supply. Brand new in original cartons. Manuals included.

G-09

Navy type low and high frequency transmitter with power supply and tubes. Operates from 200 Kc to 18,100 kc; requires 115V, 800 cycles. Used. Complete with tubes.....**\$29.50**

RCA AVT-112A—AIRCRAFT TRANSMITTER
For radio-telephone communication: for 6, 12 or 24 volt source freq. range from 2,500 to 6,500 Kc. Small in size and wt. (wt. 6 lbs.). Complete with 6 tubes, oscillator circuit, power amplifier modulators, dual tuning indicator and amplifier, with instruction manual, less crystal. BRAND NEW in ORIGINAL CARTONS—**\$12.95**
ONLY. Each

ALTIMETER TRANSCIEVER RT-7/APN-1
Frequency 418-462 Mc FM, with 14 tubes: 3-12SJ7; 4-12SH7; 2-12HG; 1-VR150; 2-955; 2-9004; 27 V. Dynamotor, used in working condition.....**\$7.95**

RECEIVER-POWER SUPPLY UNIT

For the APN-4 indicator; complete with 18 tubes, 110 V. 400 cycles. BRAND NEW.....**\$10.95**

MONTHLY SPECIALS

Wave Meters

Each **\$7.95**
Freq. range: 22 to 30 meg.
Freq. range: 37 to 53 meg.
Freq. range: 155 to 230 meg.

AC operated, complete with carrying case and magic eye for tuning indicator, vernier tuning dial.

BC-732 CONTROL BOX

With 6 position, selective switch, volume control and toggle switch.....each**59c**

450-TH TRANSMITTING TUBE

Each.....\$9.95

AM-61 INDICATOR AMPLIFIER

15 tubes including two VR105; 6L7GT; 6SN7GT; with blower motor; brand new in original carton, with metal cover, each.....**\$9.95**

All shipments F.O.B. Chicago—20% Deposit Required on all orders. Minimum order accepted \$5.00.

REMOTE CONTROL BOX

BC-450—Triple receiver control box, can be modified to a FT-260 local control for command receivers, NEW.....**\$1.95**

SETCHELL CARLSON RADIO RECEIVER
Designed to receive A-N beam signals. 24.28 vdc 21.6 watts. Tube complement: 14I7 or 14A7, RF amplifier; 14H7 or 14I7, mixer; 14A7 or 14I7, IF amplifier; 14R7, detector and 1st audio amplifier, 28D7, output amplifier, 195 to 420 kc. 4" high x 4" wide x 6 3/4" long—wt. 3 lbs., 4 oz. BRAND NEW in original carton.....**\$5.95**

RADIO TRANSMITTER and RECEIVER APS-13

Light weight air-borne radar system, radio transmitter and receiver. APS-13; tube complement: 5-6J6, 9-6AG5, 1-VR105, 2-D21, unit is brand new, complete with tubes, the tubes alone are worth more than this LOW PRICE OF **\$10.95** ONLY

Rack for above.....\$1.95
Antenna for above.....1.95

GLIDE PATH RECEIVER R-89/ARN-5
Glide Path Receiver used in the Instrument Landing System covering the frequency range 332 to 335 mc; complete with the following tubes: 7-6AJ5, 1-12SN7, 2-12SN7, 1-28D7, and including three crystals 6497KC, 6522KC, 6457KC units.....**\$6.95**
are in A-1 condition for ONLY. Complete with Tubes and Crystals

BC-733 D LOCALIZER RECEIVER

Freq. 108-110 Mc; Tube complement: 10 tubes—1-12SQ7, 2-12SR7, 1-12A6, 1-A17GT, 2-12SG7, 3-717A; NOW ONLY.....**\$6.95**
Complete with Tubes and Crystals

VEEDER-ROOT METER AND CASE

Counts up to 1000. Each.....**59c**

WESTON OUTPUT METER No. 687

3 scales 0-50. A-1 Condition. ONLY.....\$5.95

HAND-TYPE MICROPHONE RS-38

Carbon type, with PL-68 plug, brand new.....\$1.95
Used.....1.00

BC-645 TRANSMITTER-RECEIVER

BRAND NEW..... 15 tubes interrogator-transmitter designed for airborne use, 435 to 600MC frequency range. With some modifications the set can be used for 2-way communication, voice or code, on the following bands: ham band; 420-450mc; fixed and mobile; 450-460mc; citizens radio band; 460-470mc; television experimental; 470-500mc; complete with all tubes, including WE Doorknob tube. Size 1 1/2 x 1 3/4 x 1 3/4". Net wt. only 25 lbs. Your cost.....only **\$9.95**

DYNAMOTOR FOR ABOVE Model PE-101-C.....\$2.95

RADIO PARTS

100 Resistors 1/2 to 1 watt.....**95c**
100 Tubular bypass condensers, assorted.....**\$4.69**
.01 to .1, all 600 Volt.
Electrolytic condensers.....**\$2.89**
50-30, 150 Volt.....10 for
1/2 Mex. Volume Controls.....**\$3.00**
1" shaft with switch, 10 for.....**1.95**
1/2 Mex. Volume Controls.....**1.95**
1" shaft without switch, 10 for.....**1.79**
Crystal Pick-up, new light wt.....each

400 CYCLE AUTOSYN MOTOR
Ideal for indicating direction of antenna systems—BRAND NEW.....each**\$2.95**

HEADPHONES

Signal Corps. 8000 ohms or 200 ohms, each.....used**79c**

T-17B HAND MIKE

BRAND NEW..... perfect carbon hand mikes, light wt., 200 ohms, single button, press to talk switch, 5 ft. rubber cord, plug, dust cover. ONLY.....**89c**

ARROW SALES, INC.

MAIN OFFICE

59 WEST HUBBARD ST., CHICAGO 10, ILL.

Telephone SUPERior 5575

SOUTH SIDE BRANCH
8310 SOUTH HALSTED ST.

NORTH SIDE BRANCH
1802 NORTH HUMBOLDT BLVD.

Here, and on following pages, are circuit diagrams and parts lists of many new postwar radio receivers. Radio News will bring to you other circuits as quickly as possible after we receive them from manufacturers.

RADIO NEWS, APRIL, 1948

CROSLY MODELS 68TA, 68TW

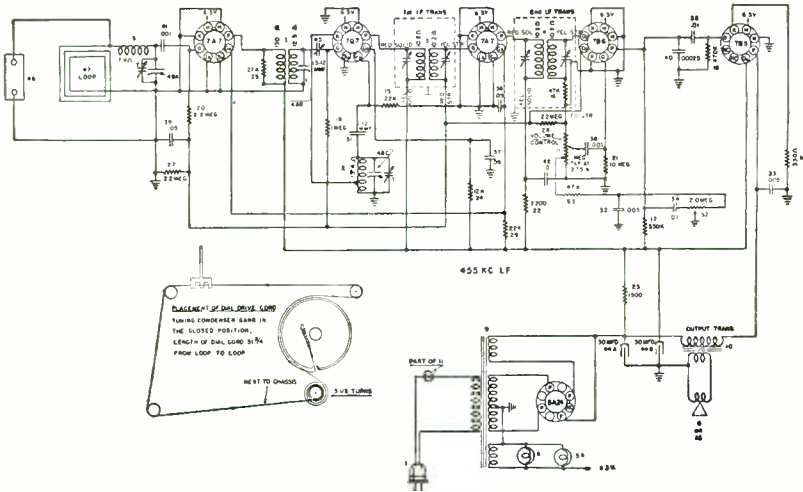

RADIO NEWS, APRIL, 1948

MECK FM CONVERTER

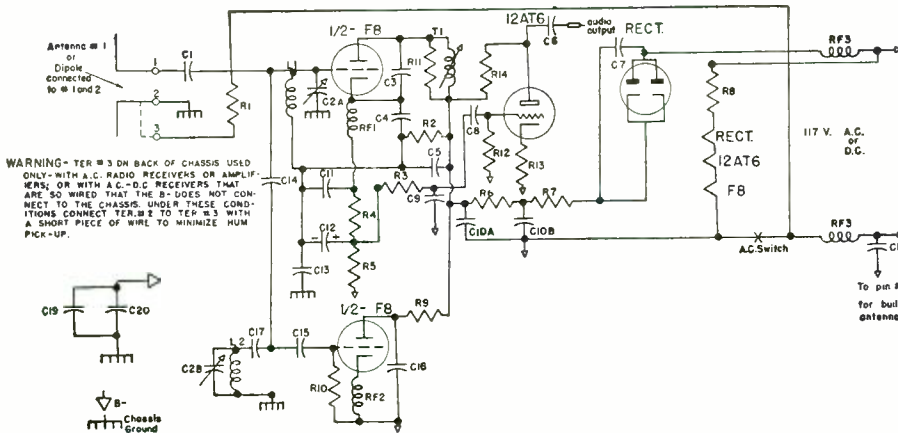

RADIO NEWS, APRIL, 1948

ZENITH MODEL 8G005

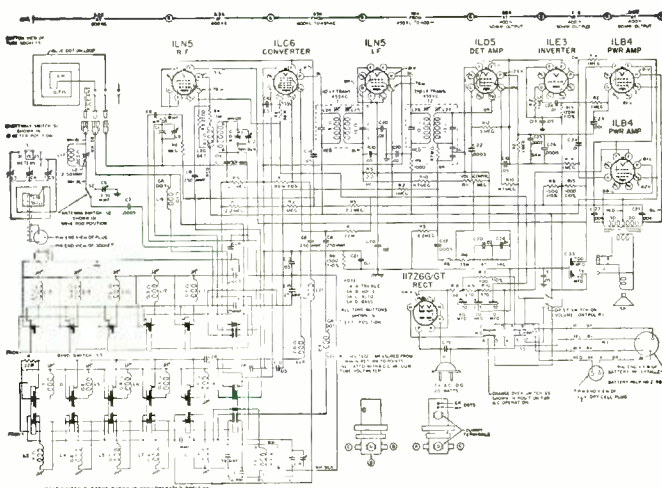

A Better Cone-Buy **LEOTONE**
 GET ON OUR MAILING LIST—
 ALWAYS SOMETHING NEW

T-30 THROAT MIKE with neckband. Excludes outside noise; leaves hands free. Requires regular carbon mike transformer & 4 1/2 V. battery. EVERY ONE BRAND NEW—SPECIAL FACTORY PRICE \$2.95
 THROAT MIKE CORD & SWITCH ASSEMBLY, complete with JK-48 jack, PL-68 plug & 9 ft. cord... \$0.39

PORTABLE A.C. AMPLIFIER
 (L.C. by W.E.)
 Here's a professional type HIGH FIDELITY unit at an amazingly low price. Wide frequency response for use with MICHAI, INSTRUMENTS, SPEECH or PIANO INPUT, FM TUNERS, etc. ALMOST any input (magnetic or crystal; vol. & tone controls). Beam power output. Beautiful, sturdy 2 tone brown leatherette case (13 3/4" x 15 3/4" x 7 1/2"). Shpg. wt. 12 lbs. \$64.50. LEOTONE'S PRICE—WHILE THEY LAST in lots of 3... \$24.95
PORTABLE AC-DC AMPLIFIER—A fine quality, low priced unit with all of the advantages of the AC-DC advantage. Attractive blue or brown leatherette case (16 1/2" x 13" x 5 1/2"). Shpg. wt. 12 lbs. \$24.95

New "Jumbo" Radio Parts Assortment
AMATEURS! SERVICEMEN! EXPERIMENTERS!—You can't afford to miss this outstanding buy in new & dismantled radio & electronic parts: 17 FULL POUNDS of COILS, TRANSFORMERS, RESISTORS, CONDENSERS, SPEAKER REPAIR PARTS, WIRE, SUB-ASSEMBLIES, ETC., ETC. All these AND MORE for only... \$2.95

FULL WAVE BRIDGE SELENIUM RECTIFIERS.
 18V. AC input at 1 amp., 20 min. duty; 600ma, continuous. O.D. 3/8" x 3/4" \$1.25
HEADBAND Special!—Sturdy fabric covered bronze spring wire. Thumb screw adjust. forks. For standard phones... \$0.39

ALNICO MAGNETS—Many sizes & shapes always in stock. Write for latest illustrated supplement.
APRIL SPECIAL—EXPERIMENTAL ALNICO MAGNET KIT. Contains 10 ass'd. magnets, Bar, "U", Circular, Block, etc. \$1.98

"GOUNCER" TRANSFORMER (7/8" x 1 1/4"). Orig. used as P.P. Osc. trans. on SCR-625. High imped. (approx. 2000 ohms) tapped double coil. to voice coil. Excellent OUTPUT for Beam Power type tubes (50L6, 50B5, etc.) 49c 12 for 250 ohm LINE TRANSFORMER to 50 ohms type equal taps, 0 to -16db. (ideal low-imp. matching to 1 or more remote speakers. Diagram incl. Ea. \$0.69c 2 for \$1.25

ALNICO V MAGNETIC PHONE UNITS
 (HS-30 headset replacement). Wide frequency response & sufficient volume for use as FM or PILLLOW SPEAKER; DYNAMIC or CONTACT MIKE. 3/4" O.D., 1/2" deep \$0.39

BARGAIN KITS FOR SERVICERS
 #2-SPEAKER CONES. 12 ass'd. 4" to 12" moulded & free-edge magnetic incl. less voice coils \$2.00
 #3-MOULDED BAKELITE CONDENSERS. 50 ass'd. .0001 to 2mf. 200-600V. Clearly marked 2.95
 #4-TUBULAR BY-PASS CONDENSERS. 50 ass'd. .001 to 2mf. 200-600V. Standard brands 2.49
 #6-DIAL SCALES. 25 ass'd. airplane & slide-rule type. metal & glass included 2.98
 #20-SPEAKER REPAIR KIT. A real time & money saver. Contains: 25 ass'd. paper rings, 25 voice coil forms, 10 spiders, 20 chamfers, leather segments, 3 yds. test strips. Kit of 16 shims & tube of speaker cement. All for... 2.49

TUBES: Perfect condition, but in unsealed cartons. Most types in stock at up to 80% off list. Every tube guaranteed 90 days.
 #20-27 or 31... \$0.29
 #75, 77, 78, 6H6 or 6K7... \$0.39
 #37, 39, 5Y4, 6C5, 6F8, 6J7, 6A8, 6SA7, 6SD7, 6SF5, 6SH7, 6SJ7, 6U7, 12SA7, 12SK7 or 12SR7... \$0.49
 #1A7, 1H5, 6U5, 6X5, 7A7, 50, 50B5 or 50L6... \$0.59
TUBE CARTONS. Plain, Miniature (1 sq. x 2 3/8") Per 100... \$0.98
 GT size (1 1/4" sq. x 3 1/4") Per 100... 1.25
 Medium (1 1/2" sq. x 4 1/4") Per 100... 1.49
 Large (2" sq. x 5") Per 100... 1.79

Prompt Service on all Speaker & Phono Pick-up Repairs. Min. order \$2.00 20% Deposit on all O.O.D. Please add sufficient postage.

LEOTONE RADIO CO.
 MAKERS OF CONES AND FIELD COILS
 65-67 DEY STREET, NEW YORK 7, N.Y.
 WORTH 2-0284-5
 12,000 SQ. FT. OF RADIO PARTS

More for Your Money R & M RADIO

Satisfaction
Guaranteed
or your
money back

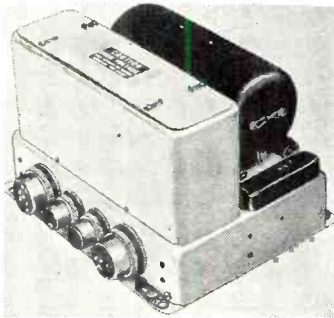

SPEECH AMPLIFIER
Modulator for Transmitter

High Volt. DC Power Supply Model unit, BC-456-A or B with dynamotor DM-33-A, plugs and tubes. Approx. wt. 17 lbs. Tube line-up, 12J5GT, 1625, VR150, and many other parts make this ideal purchase for spare parts alone. Diagram furnished. **\$2.75**

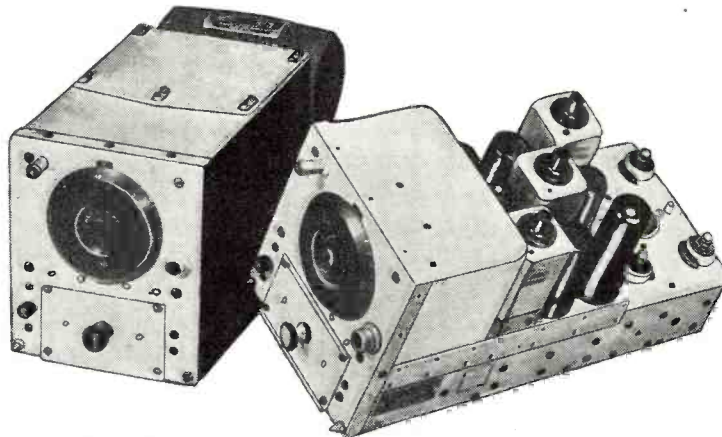

BC-453
190-550 kc.

BC-454
75 meters

BC-455
40 meters

Slight conversion
for
10 and 20 meters

\$550
(all 3 for \$15)

Proclaimed "best buy" by Hams from coast to coast
FOR PERFECT SINGLE SIGNAL RECEPTION

Says Jan. QST (p. 40, Tech. Topics): "... (BC-453A) will perk up that old broadband superhet of yours and make it cut through the QRM and pull out the desired signal like nothing you ever saw or heard." BC-455 is easily adapted to 10 and 20 meter reception as well as it works on 40 meters. Then all you need is one BC-454 to cover 75 meters and you have covered almost all of the Ham bands. Order yours today!

Be sure to write for details of our complete AMATEUR RADIO STATION

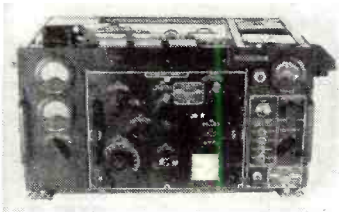

NAVY TRANSMITTER GP-7

125 watt xmtr., self-contained AC, 400 cycle power supply; uses suppressor grid modulation for phone, VFO controlled, 803 in final; built of std. parts. **\$17.50**

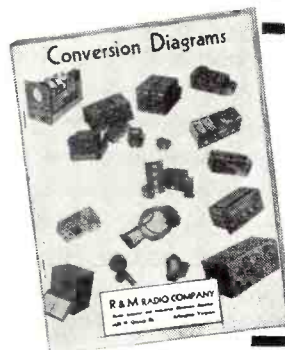

CONVERSION BOOK **\$2.00**
(with a purchase of \$5 or more, available to you at just \$1.00)

Data on conversion, with schematic diagrams, instructions, and discussion, on the following:

Diag. and Conversions: BC-348, SCR-522, BC-375, SCR-274, SCR-274-10 meter mobile.

Diagrams for: BC-221, ART-13 Collins Xmtr., APN-1, APN-4, SCR-718.

Save \$1 by ordering when you purchase \$5 (or more) worth of equipment.

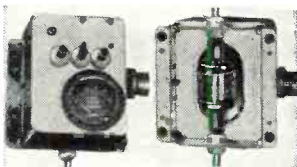

ANTENNA RELAY

BC-442-A, SWITCHING RELAY, ANTENNA CURRENT INDICATOR with 19.5 millivolt movement, current transformer and thermocouple, 50 MMFD vacuum condenser, fixed, 5000 volt rating (CAN BE USED WITH ANY RIG). **\$2.45**



**T-17
CARBON
MICROPHONE**

Brand new

\$1.85
each

Used \$1.00 each

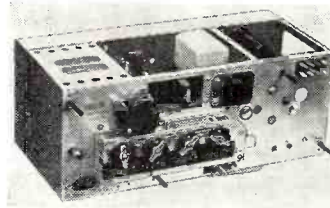

**2 or 6 METER RADIO TRANSMITTER
BC-625-A**

The famous SCR-522 transmitter only, covers from 100-156 mc., crystal control, four crystal channels, seven tubes, two of which are 832's. 8 watts power output, 100% modulation, built-in modulator. Steady, reliable, beautifully made of finest components. Can be made to furnish 50 mc. and 144 mc. Can be used as drive for any frequency above.

\$8.95

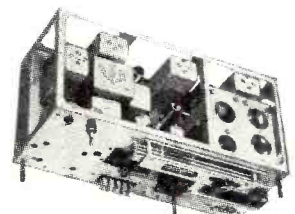

**BC-624 VHF RECEIVER
2 METER**

10 tubes, 4 crystal channels, tunes from 100 to 156 mc. Excellent receiver for the VHF experimenter. Does a fine job on 144 mc. Makes basic unit for conversion of FM or television.

\$9.95

WAR SURPLUS BC-375-E TRANSMITTER

WITH THOUSANDS OF USABLE STANDARD RADIO PARTS

(Gov't cost, \$1800) **\$24.50**
COMPLETE

It's been written about and talked about—just the thing for beginner or old-timer; has five tubes, five tuning units. Xmtr. designed to operate from 200 kc. to 12 mc. (less BC band). Equipped with antenna tuning unit BC-306-A — variometer and tap switch. Dynamotor (PE-73-C) complete with relay, fuses and filter. Diagram and instructions for its use supplied with each set. Weight: approx. 275 lbs.

Shipment from our nearest warehouse—East, Mid-West, or West Coast

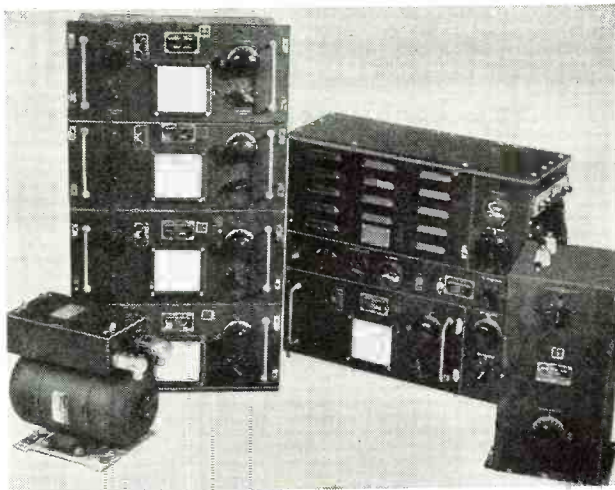

HEADPHONES

69c

HS-33 with cord and plug. 600 ohms — Used, in A-1 condition.

APN-4 RECEIVER-OSCILLOSCOPE POWER SUPPLY

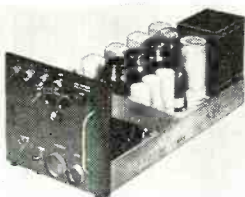

The components of this receiver are the finest money can buy. Makes excellent fixed tuner for medium frequency police calls or public address system. Has power supply for 5 inch scope—just the set to make a panoramic scope for those high frequency I.F. receivers—power transformer 400 cycle. Low voltage supply is electronically controlled and delivers 260 v.d.c. 150 mils regulated to .01%. The power supply alone is worth more than the price. Only

Has four screw-driver tuned R.F. channels selected by switch— I.F. frequency 1050 kc, I.F. band width 45 to 60 kc. R.F. frequencies 1600 kc to 2000 kc. Tube lineup: (2) 2Y2, (1) 5U4, (3) 6B4, (1) 6SU7, (1) 6SA7, (4) 6SK7, (1) 6SN7, (1) 6SL7, (1) 6H6 and (1) VR150.

\$12.50

APN-4 INDICATOR—PRECISION OSCILLOSCOPE

Special for amateurs, experimenters and repairmen; can be converted into the following:

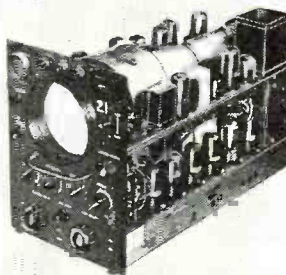

5-inch panoramic set with marker pips at 100 kc - 20 kc - 2 kc to enable you to observe crystal and V.F.O. drift and width of frequency deviation of FM; a precision sweep scope that is accurate with electronic switch for observing two signals simultaneously, and 100 kc lab. type crystal with TPTG oscillator circuit feeding six frequency divider stages. Tube lineup: (1) 5CP1, (3) 6SL7, (14) 6SN7, (6) 6H6 and (1) 6SJ7. Only

\$19.50

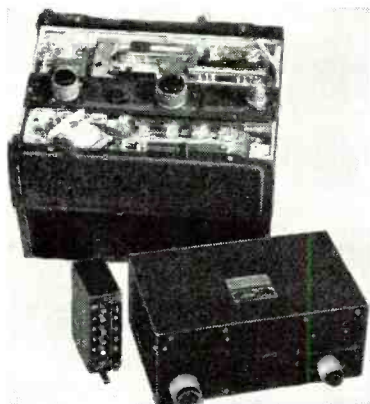

TWO METER MOBILE OR GROUND STATION

SCR-522, designed to operate from 100-156 mc. makes an ideal two-meter rig for two-way mobile radio; has one of the finest two-meter receivers ever designed. Complete trans. and rec., remote control Dynamotor PE-94 and all plugs.

\$24.50

PE-98 Dynamotor, 12 v. input, for use with SCR-522 **\$12.50**

PE-94 Dynamotor, 24 v. input **\$3.95**

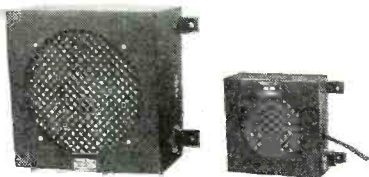

HIGH FIDELITY SPEAKERS

6-inch, 10-watt PM Speaker, ea. **\$7.95**

12-inch, 15-watt PM Speaker, ea. **\$14.50**

Brand new in Heavy Duty Steel Cabinets with beautiful black wrinkle finish.

Also has T-pad volume control and 600 ohm line to speaker transformer. Wall mounting brackets and slope front.

HEADPHONE EXTENSION CORDS...25c

Approx. 72" long, rubber cov., with JK-26 & PL-55 plugs

HEADPHONE ADAPTERS MC-385...30c

(4 for \$1)

From high to low impedance, 4000 to 600 ohms; contains matching transformer.

ANTENNA SWITCHES

- Single pole, double throw.....39c
- Double pole, double throw.....49c
- Triple pole, double throw.....\$1.25

40 WATTS OUTPUT

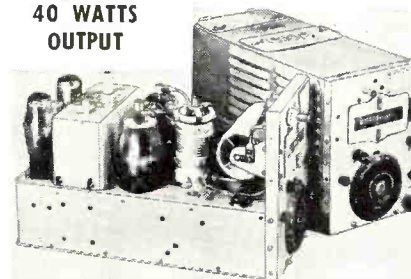

These famous VFO Drivers available:

BC-696 75 meters..... **\$8.50**

BC-457 75 meters with slight conversion. **\$6.00**

BC-458 40 meters with slight conversion. **\$6.00**

● SAVE C.O.D. CHARGES by remitting in full, or send 25% deposit with orders. Please don't send money for postage; we ship "transportation charges collect".

R & M RADIO COMPANY, Dept. RN-48, 1426 N. Quincy St., Arlington, Va.

Send Conversion Book. \$2 inclosed.

Send C.O.D. Send FREE catalogue on kits:

Xmtr. Receiver. Television.

I am a licensed amateur. Beginner.

Name.....

Address.....

City.....

Zone..... State.....

R & M RADIO COMPANY

1426 N. QUINCY ST.

ARLINGTON, VIRGINIA

**INDUSTRIAL & ELECTRONIC
POWER SUPPLY EQUIPMENT**

TRANSFORMERS

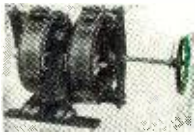

T-103—Voltage regulator Transmt. American Transformer Co. Spec. 29145 Max. KVA output 11.5, 50/60 cyc. 0-115 V. 100 amps or 230 V. 50 amps. \$75.00 Net Wt. 134 lbs. Dim. 25" W x 16" D x 17 1/2" H (Encl. 8" shaft ext.)

T-101—Plate Transformer, Amertran Spec. 29108. Primary 115 V. 60 cyc. 10.4 KVA. Secondary 17600 V. .520 amps. 35 KVA test. 8800/8800V W/center tap grounded (specify)\$65.00 Net Wt. 500 lbs. Dim. 19" W x 15 1/2" D x 41" H. O. A.



T-102 — Filament Transformer, American Transformer Co. Spec. 29106, Type WS .050 KVA, 50/60 cyc. Single phase, 35 KVA test, 12 KV D.C. operating. Primary 115 V. secondary 5 V., 10 amps with integral standoff insulator and socket for 250T, 371, 872, 5563, etc. rectifier tubes..... \$12.50 Net Wt. 15 1/2 lbs. Dim. 6 1/2" W x 6" D x 12" H. O. A.

CHOKO COIL

R-106—Amertran Disc. Type. Specification No. 29107. Line volts 15,000 V. D.C., Ripple frequency 120. 149 ohms resistance, .020 D.C. amps at 900 henrys 48% ripple, .52 amps D.C. at 25 henrys 48% ripple.....\$42.00 Net Wt. 280 lbs. Dim. 17" W x 12" D x 31 1/2" H. O. A.

CAPACITORS

C-107—G.E. Capacitor Cat. No. 14F59 or Westinghouse Inerteen, 1.0 mfd. 25,000 V. D.C..... \$36.00 Net Wt. 65 lbs. Dim. 14 1/2" W x 8 1/2" D x 15" H. O. A.

RELAY

RC-117—Westinghouse Time Delay Current Relay. Type SC-M .2 to 1 amp A.C. or D.C. .8 amp continuous rating. Rating 20-40% drop out ratio. Net Wt. 3 lbs. Dim. 3" W x 5" D x 5 3/4" H.

METERS

M-140AB—Weston Model 476—3" A.C. Ammeter. 3 amp full scale, calibrated 0-120 amps. flush mounting, with 40/1 current trans..... \$8.50 Net Wt. 3 lbs.

M-143AB—Weston Kilovoltmeter—3". Model 301. 20 KV. @ 1000 ohms per volt, flush type, calibrated for steel panel mounting, with 20 meg. 20 KV Weston resistor complete with clips and standoff insulators..... \$18.00 Net Wt. 4 lbs.

HEATERS

H-149—Chromolox strip heaters, 300 W., 115 V. (1/4 x 1 1/2 x 12") \$1.00

POWER SUPPLY

(RA-38) 115 V., 60 cyc. input, adjustable output 0-15,000 V. A.C. or D.C. @ 500 Mils. Shipping weigh. 2100 lbs. \$200.00 Can be furnished to deliver 0-7 500 V. @ 1.0 amp for \$250

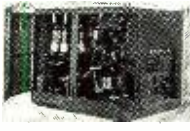

All merchandise in "as new" condition. Add approximately 20% to net weights for estimated shipping weights. Terms are 30% with order balance C.O.D. All prices f.o.b. Los Angeles Warehouse. Write to: additional detailed information on any of the above items and for special quantity discounts.

1527 E. Seventh Street

EPCO

Los Angeles 21, California

High Speed Receiver Squelch

By H. W. KLINE, W2DKE

Automatic key click eliminator with normal receiver operation characterizes this novel break-in system.

A RECEIVER silencing system has been developed and is now in continuous use at W2DKE for high speed, thumpless, break-in operation, including operation on the transmitter frequency. The system employs automatic cut-off bias developed by the transmitter to stop the first detector element of the receiver conversion system.

Over a period of years, many systems of receiver switching were tried. Some were partially satisfactory while others were found to be useless. Some of the last methods tried included the use of switching tubes, called "TR tubes" in radar language. It was found, however, that in practically every case, if the receiver gain control was adjusted for high sensitivity or for receiving signals of but a few microvolts intensity, the injection of several volts from the nearby transmitter, due to residual "TR tube" voltage drop, would cause serious blocking of the receiver, thereby preventing good break-in operation.

Unfortunately, the best "TR tubes" have an appreciable drop due to internal resistance after ionization. The loss in transmitting power due to this may be quite serious for even if a tube is placed at the current loop in a quarter-wave long stub, the power loss will be I^2 times the internal resistance of the tube. Since the current at the loop is at maximum, the amateur who is limited in the total power he has, may object to the losses incurred. He does not want to burn up twenty per-cent or more in such a device.

For radar applications, where the receiver recovery period is extremely short due to employment of a 30 megacycle intermediate frequency amplifier having low values of d.c. blocking condensers in a fast a.v.c. system, the "TR tube" performs well because the a.v.c. system can handle the residual signal drop across the TR box and return the receiver to normal operation in a period of but a fraction of a microsecond.

This condition does not occur in communications receivers where a.v.c. systems cannot operate fast enough to follow code keying. Once blocked, these receivers are sluggish in recovery. This is mainly due to the high values of the a.v.c. network bypass condensers which are necessary when intermediate frequencies are as low as a half megacycle.

Since this mode of operation is inherently normal for communications

receivers the obvious expedient was to develop a means of inactivating the receiver at its input, thus preventing its operation from the input during transmitting periods. The control circuit was to be automatic, without relays, stable, and straightforward. Thumps and clicks were to be non-detectable when listening with headphones during relay switching to monitor. Most systems caused hang-fire thumping of the receiver, extremely bothersome during relay switching from monitor to receiver. As a result of these requirements, a squelch system for fast break-in operation was developed with results more gratifying than at first anticipated. Fig. 1 shows the wiring of this system.

Referring to Fig. 1, the loop antenna for the 7 megacycle band consists of 2 turns of wire wound on a frame having an aperture one foot by two feet in dimensions, with the turns spaced one-half inch apart. It is tuned by a 100 μ fd. midget condenser. The rest of the circuit is a simple diode circuit. A high negative d.c. bias is developed across R_1 , which can be made to hold the bias constant on the first detector or cause entire cut-off, as desired, each time the transmitter key is touched. The amount of bias obtained can be regulated by turning the loop with respect to the nearby transmitter.

The operation of the system is as follows: The receiver uses a separate antenna, preferably at a greater distance from the transmitting antenna than the loop. The loop antenna is placed near the receiver which, in turn, is located near the transmitter.

Fig. 1.

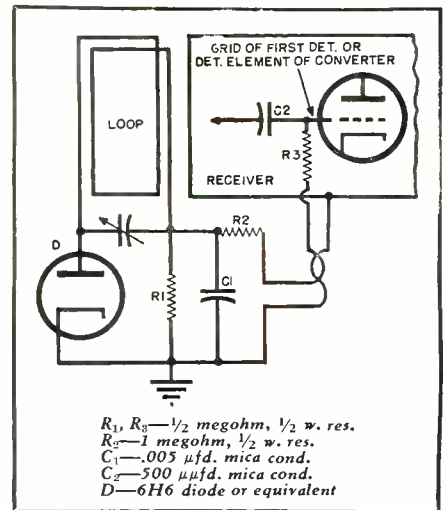

R_1, R_3 —1/2 megohm, 1/2 w. res.
 R_2 —1 megohm, 1/2 w. res.
 C_1 —.005 μ fd. mica cond.
 C_2 —500 μ fd. mica cond.
 D —6H6 diode or equivalent



Mere **BIGNESS** tells only **HALF**
the **WARD** leadership story

For every radio receiver, there's a Ward Aerial which gets more stations, gets them clearer and more dependably. You'd naturally expect that from Ward, the world's leading mass producer of radio aerials exclusively. But, large as Ward is, this organization always has believed that resting on your laurels invites rust. Especially so in the fast changing FM and television fields. Accordingly, the Ward experimental laboratory constantly is probing the electronic horizon with the fervor of the true scientist. Many aerial developments still to be unveiled would, if revealed today, cause many a raised eyebrow. Tomorrow, these new developments will mean finer performance at lower cost for the radios you build or install. This same technical know-how is available to design and mass produce custom-designed aerials for anyone needing them in quantity. If you have an aerial problem, bring it to Ward. Your inquiries are invited.



WARD AERIALS

THE WARD PRODUCTS CORPORATION
1524 EAST 45th ST. CLEVELAND 3, OHIO
DIVISION OF THE GABRIEL CO.

Export Department: C. W. Brandes, Manager, 4900 Euclid Avenue, Cleveland 3, Ohio
In Canada: Atlas Radio Corp., 560 King Street, W., Toronto 1, Ontario, Canada

AS NATIONALLY ADVERTISED IN THE SATURDAY EVENING POST, COLLIERS AND THE AMERICAN WEEKLY

April, 1948

95

In New Jersey...
...it's VARIETY
TELEVISION KITS

**TRANSVISION
 STANDARD
 MODEL
 12" KIT**



Picture size 75 square inches. 22 tubes and 12 inch picture tube. High fidelity FM sound reproduction. Advanced television circuit provides exceptionally clear pictures.

12" Standard Television Kit.....\$289.50*
 12" Deluxe Television—FM Radio Kit.....359.50*
 15" Standard.....365.00*
 15" With FM Radio.....372.95*
 7" Television Kit.....169.00*

(*Complete with tubes, less cabinet)

Cabinet for 12" Television, Receiver.....44.95*
 Cabinet for 15" Television Receiver.....59.00
 Espey Basic Television Kit, less tubes.....69.50
 Complete Line of Television Components.
 *Dealers' Prices on Request.

**SUPREME MODEL 584
 SUPER SENSITIVE
 MULTI-METER**



D.C. VOLTS 25-5000.
 20,000 Ohms per V.
 A.C. VOLTS 100-5,000,
 1000 ohms per V.
 Resistance Ranges 0-20
 megs. D B & Output
 ranges.

Net \$33.77

VARIETY RADIO KITS

5 Tube Superhet Kit complete with tubes and cabinet.....\$14.75
 Less tubes.....11.75
 FM KIT complete with cabinet and tubes. 29.95
 3-way Portable Kit complete with tubes and cabinet.....18.95

NATIONAL NC-33 RECEIVER.....\$65.95
 AC-DC 4 band superhet.
 We carry a full line of National receivers and parts.
 National NC183 Receiver complete with 10" speaker.....\$269.00

ESPEY CHASSIS AND KITS

7B-11 Tube Superhet for AM/FM.\$140.00 List
 RK14-8 tube AC, Broadcast and two short-wave bands.....106.50 List
 97A-Six tube AC-DC, short wave and Broadcast bands.....56.50 List
 Dealers Prices on Request.

**McMURDO SILVER Model 909
 FM-TV SWEEP GENERATOR**

Center freq. range 2-226 Megacycles. 5" Vernier driven calib. dial, covers 3 bands without band switching.....\$48.50

AUTO ANTENNAS, Chrome Plated, Admiralty Brass. Shielded Polyethylene Cable with Black Vinylite Cover, Slide Cowl Mount, 3 Sections—66", \$1.95 each; ten for.....\$16.95

**NEW!
 PREMIER
 Model 570
 MICROMASTER
 Band Spread Dial
 SIGNAL
 GENERATOR**



For testing and aligning BROADCAST, SHORT-WAVE, FM and TELEVISION RECEIVERS. Exclusive Band Spread Dial geared to the tuning condenser and main dial, giving a total scale length of approximately 60 inches. Three-color dial directly calibrated in Kilocycles and Megacycles. Range: 75 KC—50MC. Up to 150MC on 3rd harmonic. Size 12 1/2" x 12" x 5 1/2".

COMPLETE WITH TUBES AND CO-AXIAL CABLE. \$54.75 NET

Write Dept. RN4. 20% Deposit with order required. Please add sufficient postage. Excess will be refunded.

Variety ELECTRIC CO., Inc.
 601 Broad St., Newark 2, N. J.

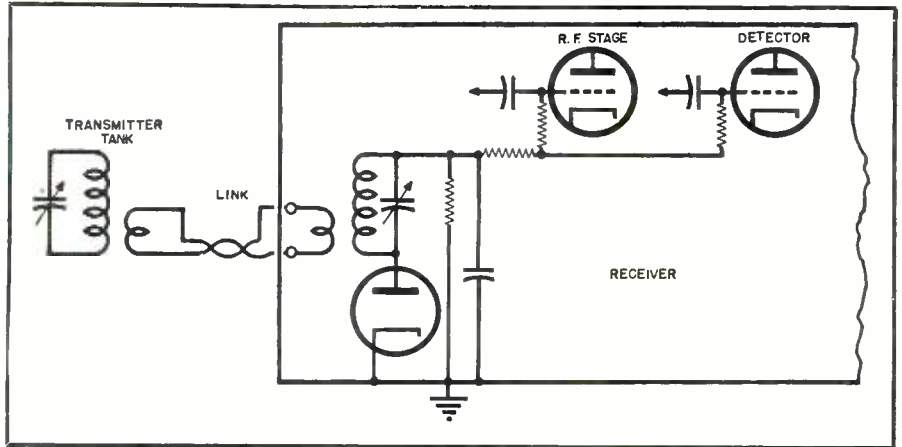

Fig. 2.

The loop is resonated to the transmitter frequency. It is oriented to pick up the necessary r.f. signal directly from the transmitter. Correct orientation can be determined immediately by listening. The receiver will be silenced as soon as the key is pressed.

It was decided to inactivate the receiver by biasing the first detector because the plate current of the first detector or the detector element of the converter is normally near cut-off. If an amplifier was suddenly cut off, a surge of plate voltage would occur causing an undesirable thump. Obviously, this system permits the holding of the detector plate current at its normal level thus preventing its operation while keying. This operation does not result in receiver paralysis. Similarly, the first r.f. stages of the receiver may be cut off, along with the detector if desired.

The only changes necessary in the receiver are the insertion of the condenser C_2 in series with the grid of the first detector and the addition of the resistor R_1 with similar treatment to the r.f. stage if desired. It is not advisable to apply this bias to other stages of the receiver as nothing will be gained by so doing.

The transmitter output power of W2DKE is 300 watts. The system was found adequate for fast break-in operation even on the same frequency as the transmitter. The bias was applied to the converter detector only. Fig. 2 shows how this system could be installed in conventional communications receivers as an additional feature.

In this instance, the loop has been eliminated and a conventional receiver coil which is loosely link-coupled to the transmitter tank substituted. The remote link coil is mounted so that the coupling to the transmitter tank circuit can be varied.

The success of this squelch system depends on having the d.c. bias developed by the transmitter equal to or exceed the peak value of r.f. signal voltage applied to the controlled tubes. This trick can only be done reasonably by the circuits shown. If the peak value of grid signal voltage at the detector is 100 volts, 100

volts of d.c. bias must be obtained to stop the detector. Voltages of this order are obtained with transmitters of several hundred watts output. 100 volt neon tubes break down when connected across receiver circuits which are tuned to the transmitter frequency. The system uses but a few milliwatts, robbed from the transmitter.

No change in the normal operation of the receiver is caused by installation of this system providing usual care is employed in installing the additional components C_2 and R_1 . The receiver alignment will not be affected. The system will follow the fastest operation of an automatic Vibroplex key.

HYTRON CONTEST

HYTRON Radio & Electronics Corp. of Salem, Massachusetts, is planning a radio serviceman's contest to start in May and run for six months.

Winners will receive valuable and worthwhile prizes. Awards will be made each month with all winners of the monthly contests being eligible to compete for the grand prize.

Entries are to be judged by Oliver Read, Editor, "RADIO NEWS"; Joseph Roche, Editor, "Radio Maintenance"; Lewis Winner, Editor, "Service"; W. W. MacDonald, Managing Editor, "Electronics"; and J. L. Stoutenburgh, Executive Editor, "Radio & Television Relating."

Full details on the contest will be announced in the company's advertisements appearing in this magazine.

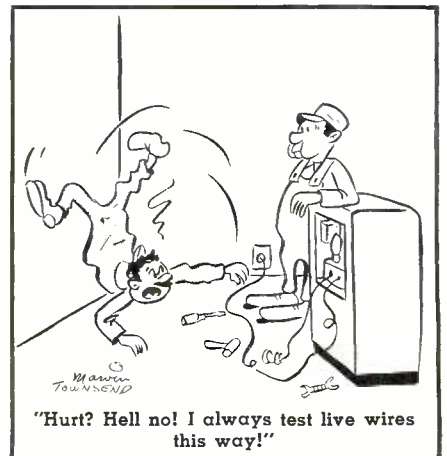



Edw. H. Guilford, Vice President

I can train you to pass your FCC License Exams in a few short weeks if you've had any practical radio experience—amateur, Army, Navy, radio servicing, or other. My time-proven plan can help put you, too, on the road to success.

Let me send you **FREE** the entire story

Just fill out the coupon and mail it. I will send you, free of charge, a copy of "How to Pass FCC License Exams," plus a sample FCC-type Exam and Catalog A, describing opportunities for you.

How to Pass

FCC Commercial Radio Operator

License Exams



FREE

Tells where to apply for and take the examinations, location of examining offices, scope of knowledge required, approved way to prepare for FCC examinations, positive method of checking your knowledge before taking the examinations.

Get your FCC ticket in a FEW SHORT WEEKS

IT'S EASY IF YOU USE CIRE SIMPLIFIED TRAINING AND COACHING METHODS AT HOME IN YOUR SPARE TIME

Look at the job opportunities you will have when you get your **FCC ticket**

- | | |
|----------------------------|------------------------|
| Forestry and conservation | Bus and truck fleets |
| Ambulances and hospitals | Police and fire depts. |
| Gas and electric utilities | Telephone companies |
| Gas and oil pipe lines | Merchant marine |
| Private automobiles | Highway Patrol |
| Street railways | Railroads |
| Taxicab fleets | Airlines |

Look at these average pay schedules for Broadcast Jobs Reported by FCC Nationwide Survey

Position	Big Stations	Little Stations
Transmitter Engineer	\$4800	\$3000
Studio Engineer	5000	3650
Chief Engineer	7700	4300

Other jobs requiring FCC commercial licenses pay similar salaries.

Get your license easily and quickly and be ready for the \$3000 to \$7500 jobs that are open to ticket holders. CIRE training is the only planned course of coaching and training that leads directly to an FCC license. Your FCC ticket is recognized in all radio fields as proof of your technical ability. Employers often give preference to license holders, even though a license is not required for the job. Hold an FCC "ticket" and the job is yours!

Look what these students say:

"Thanks to this course, I now have a very good job in a local power plant's test department. I couldn't have obtained this job without the math and basic electrical theories in the first part of Section I of this course."

Stud. #2893N12

"I have been working for Police Radio Station WPFS in Asheville for five months since getting my second-class ticket."

Stud. #2858N12

"You may be interested to know that I am employed at the local broadcast station, where I am a transmitter operator. I took and passed the FCC examinations last February."

Stud. #2754N12

Don't Waste Valuable Time MAIL COUPON TODAY!

Don't put off getting this valuable information. Good jobs in radio need men like you. You can earn higher income, have a bank account, enjoy vacations, and have easier and better living. But you must have your FCC License. Hurry! Fill out the coupon right now and mail it. There is no obligation. You owe it to yourself to get the full story NOW.

RN-4 Terminal Tower Cleveland 13, Ohio

Approved for Training under "G.I. Bill of Rights"



CLEVELAND INSTITUTE OF RADIO ELECTRONICS

RN-4 Terminal Tower Cleveland 13, Ohio

I want to know how I can get my FCC ticket in a few short weeks. Send me your **FREE** booklet "How to Pass FCC License Examinations" (does not cover exams for Amateur License) as well as a sample FCC-type exam and Catalog A, describing opportunities in Radio-Electronics.

NAME

ADDRESS

CITYZONE.....STATE.....

Veterans check for enrollment information under G.I. Bill. NO OBLIGATION—NO SALESMEN.

Why YOU SHOULD BUILD YOUR OWN TEST EQUIPMENT

1. You save two-thirds in cost. With increasing prices of most everything, labor costs are an important factor. Eliminating assembly labor costs, we can offer Heathkits at about one-third the cost of factory built equipment.
2. You have all the fun and learn while you save. Through knowledge of construction gained in assembly, better use can be made of the instruments.

Build YOUR OWN

TEST EQUIPMENT

with **HEATHKITS**

IDEAL TELEVISION and FM SERVICING COMBINATION

HEATHKIT SINE AND SQUARE WAVE AUDIO GENERATOR

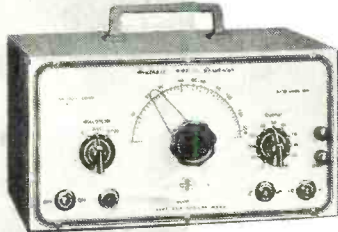

The ideal matching instrument to the Heathkit Oscilloscope for advanced service technique in television and FM servicing. Supplies sine or square wave 20 cycles to 20,000 cycles.

Excellent wave form and extremely low distortion. Everything supplied. Grey crackle cabinet, beautiful two color calibrated panel, 5 tubes, 110V power transformer, 1% calibrating resistors, all other parts and detailed blueprints and instructions.

Only \$34.50

The NEW 1948
HEATHKIT 5 INCH OSCILLOSCOPE KIT

Features

- Frequency compensated vertical and horizontal amplifiers.
- Beautiful two color panel.
- Sweep circuit supplying 15 to 30,000 cycles.
- All controls on front panel.
- Ideal for television and radio trouble shooting.
- Convenient portable size—weighs only 26 pounds.
- Cabinet dimensions 8 1/2" x 13" high by 17" deep.
- Provision for external synchronization.
- Test voltage post on front panel.
- Deflection sensitivity .65 volts per inch full gain.
- Frequency response plus or minus 20% from 50 cycles to 50 KC.
- Input impedance 1 megohm and 50 MMF.
- Tubes supplied: 2 6SJ7, 2 5Y3, 1 884, 1 5BP1.
- Operates from 110 volt 60 cycle AC.
- Power supply delivers 1100 volts negative, 350 volts positive, making 1450 volts available for the CR tube.
- All oil filled condensers used, assuring long life.

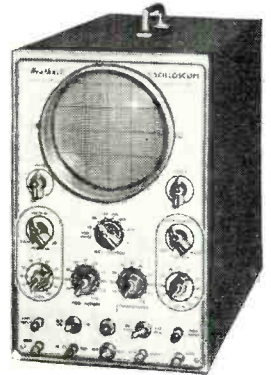

\$39.50

Nothing ELSE TO BUY...

HEATHKIT SIGNAL GENERATOR KIT

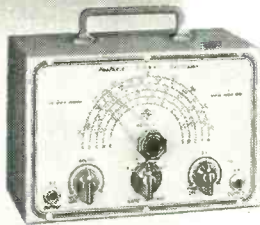

Features

- 110 Volt 60 cycle operation with transformer power supply.
- Completely isolated from power line.
- Can be used on any type receiver.
- Supplies fundamentals from 150 KC to 34 MC in five bands.
- Useful harmonics to over 100 MC.
- 400 cycle audio frequency modulation available separately for audio testing.
- Supplies either pure RF or modulated signal.
- Highly accurate calibration with calibration adjustment for exact frequency.
- Approximately 30% modulation.
- Uses 6SN7 as oscillator and audio frequency amplifier and 6X5 as transformer power supply rectifier.

\$19.50

Shipping Wt. 7 lbs.
• Convenient, portable—Dimensions 9" x 6" x 4 3/4" deep, weight 4 1/2 lbs. Complete with detailed blueprints which enable the constructor to assemble an instrument he will be proud to own.

The NEW
HEATHKIT VACUUM TUBE VOLTMETER KIT

The most essential tool a radio man can have, now within the reach of his pocketbook. The Heathkit VTVM is equal in quality to instruments selling for \$75.00 or more. Features 500 microamp meter, transformer power supply, 1% glass enclosed divider resistors, ceramic selector switches, 11 megohms input resistance, linear AC and DC scale, electronic AC reading RMS. Circuit uses 6SN7 in balanced bridge circuit, a 6H6 as AC rectifier and 6X5 as transformer power supply rectifier. Included is means of calibrating without standards. Average assembly time less than four pleasant hours, and you have the most useful test instrument you will ever own. Ranges 0-3, 30, 100, 300, 1000 volts AC or DC. Ohmmeter has ranges of scale times 1, 100, 1000, 10M and 1 megohm, giving range .1 ohm to 1000 megohms. Complete with detailed instructions. Add postage for 8 lbs.

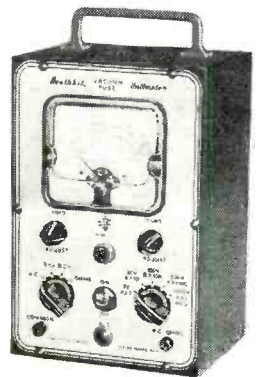

\$24.50



HEATHKIT HIGH FIDELITY AMPLIFIER KIT

Build this high fidelity amplifier and save two-thirds of the cost. Push pull output using 1619 tubes (military type 6L6's), two amplifier stages using a dual triode (6SN7), and a phase inverter give this amplifier a linear reproduction equal to amplifiers selling for ten times this price. Every part supplied; punched and formed chassis, transformers (including quality output to 3-8-15 ohm voice coil), tubes, controls, and complete instructions. Add postage for 20 lbs. 12" PM speakers for above \$6.95

\$14.95

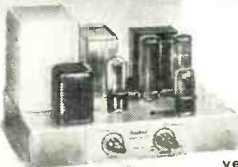

HEATH SELLS DIRECT TO THE BUILDER

Our engineers enjoy the friendly contacts with those who build Heathkit equipment, and can serve them better through direct relationships. Without the necessity for discounts to dealers, the equipment can be made available to you at the lowest possible cost. Send your order direct and we shall be glad to ship COD, or you may send cash in advance if desired.

No ORDERS UNDER \$2.00



The HEATH COMPANY

BENTON HARBOR, MICHIGAN

BEST of SURPLUS

COMMAND SET ACCESSORIES

POWER TRANSFORMER *Specials*



A wonderful buy in a new production heavy duty power transformer. Primary 117V 60 cycle. Secondaries supply 746 V.C.T at 220 MA, 6.3V. at 4.5 A., and 5V at 4 A. An ideal transformer for high quality amplifier modulator, small transmitter or quality radio. Will handle 13 tube radio receivers. Supply is limited, order early.

\$3.95 . . . 3 FOR \$9.95



FILTER CHOKE - 1.5 henries @ .100 amp. D.C. D.C. resistance, 50 ohms. No. 641.
3 FOR **\$1.00**



FILTER CHOKE - 3 henries @ .060 amp. D.C. D.C. resistance 80 ohms max. No. 642
3 FOR **\$1.00**



MODULATION AND OUTPUT TRANSFORMER - Couples 2 tubes 3000 ohms plate-to-plate 60 ma. D.C. balanced, to 1,250 ohms load at 80 ma. D.C. unbalanced and to 3.4 ohm speaker voice coil
No. 745 **\$1.00**

TRANSMITTER POWER SUPPLY KIT

For BC645, 223, 522, 274N's, etc. Ideal for powering military transmitters. Supplies 500 to 600 volts at 150 to 200 MA plate, 6.3 at 3.6A, also 9V and 12V A.C. Kit supplied complete with husky cased Acme 110V 60 cycle power transformer, 5U4 rectifier. Sprague oil filled condenser, cased choke, punched chassis, and all other parts, including detailed instructions.

Complete - nothing else to buy



\$11.95

110V RECEIVER POWER SUPPLY KIT

With 24 volt filament, no wiring changes inside set, punched chassis and volume control **\$5.95**



5" PM SPEAKER

With output transformer, matching headphone output **\$2.80**

Dual receiver rack FT277A with connecting plugs **\$1.00**

Shock mount for above rack **\$1.00**

Single transmitter rack FT234A **\$1.00**

MILITARY CONVERSION POWER TRANSFORMERS

Convert your military receivers without rewiring the filament. "A" type supplies 500 VCT at 50 MA, 5V at 2A and 24V at 1/2A. "B" type supplies 500 VCT at 50 MA, 5V at 2A and 12V at 1 amp. State whether A or B type desired. **\$2.95**

MIDGET

AMATEUR TRANSMITTER KIT

Uses Army Walkie-Talkie parts to easily assemble a 1 Watt 80 meter CW transmitter. Comes complete with 80 meter crystal, tube, chassis, tank coil, tuning condenser, all other small parts and complete instructions. The only other parts required are key and batteries listed below. Range up to 500 miles. Lowest cost ever offered. Add postage for 2 lbs.



\$3.95

ACCESSORIES

Key (add postage for 2 lbs.) **\$1.00**
Kit of batteries (add postage for 4 lbs.) **\$3.25**

SOCKET SPECIALS

Single hole mounting octal, brown, low loss, bakelite, less locking rings, **25 FOR \$1.00**

2 hole flange mounting octal bakelite 1-5/16" mounting centers. **20 FOR \$1.00**

Ceramic 2 hole flange mounting octals, 1 1/2" mounting **10 FOR \$1.00**

Ceramic acorn sockets **5 FOR \$1.00**



T32 TABLE MICROPHONE

One of the Army's best. Built by Kellogg, ideal for factory call system, public address, amateur use. Brand new in original cartons, add postage for 5 lbs. **\$2.95**



HEARING AID HEADPHONES

The Army's best - eliminate flat ears and outside noise. Complete with transformer for conversion from low to high impedance. With cord and plug complete. Add postage for 1 lb. **\$1.00**



AN/APN1 RADIO ALTIMETERS

Brand new, complete with tubes, dynamotor, antennae, indicator, switch, plugs and instruction manual. Consists of 420 MC transmitter and receiver. Converts into excellent boat radar indicating in feet, or amateur 420 MC rig. In original crate. **\$34.95**



G. E. MODEL BC-375

TUNING UNITS



\$2.49

These General Electric 150 Watt transmitter tuning units are the greatest surplus buy. Over \$30.00 worth of new condensers, coils, switches. National Velvet vernier dial, etc. Supplied complete with cabinet and two reprints of conversion articles for transmitter and receiver reprinted from RADIO NEWS. Specify TU5B, TU10B or TU26B. Add postage for 20 lbs.

DYNAMOTORS

Consists of electric motor operating generator on same shaft. Many applications - operating radios from storage battery - using as motor.

Dynamotor C - Input 28 volts, output 220 volts at 60 MA. Shipping Weight 6 pounds. **\$1.50**

Dynamotor A - Input 12 volts, output 1000 volts at 350 MA. Shipping Weight 72 pounds. **\$5.95**

Dynamotor B - Input 6 or 12 volts, output 500 volts, 160 MA. Shipping Weight 30 pounds. **\$5.95**

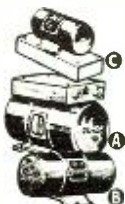

SOCKET KIT

20 beautiful octal, local and miniature sockets. **20 FOR \$1**

TRIMMER CONDENSER KIT

10 brand new variables 12 MMF to 50 MMF ceramic insulated **\$1.95**

MN26C BENDIX RADIO COMPASS

A brand new twelve tube Bendix radio compass complete with instruction manual, 12 six volt tubes, 24 volt dynamotor, power supply and shock mounting. Covers 150 KC to 1500 KC in three bands. Ideal for marine or aircraft use. **\$24.95**



BENDIX MN20E LOOP

Used with above receiver for direction finding, homing, establishing a fix, reception in snow and ice conditions, etc. 9" diameter. **\$9.95**



The HEATH COMPANY

BENTON HARBOR, MICHIGAN



A 'NATURAL' FOR RADIO MEN!

Train for Good pay in ELECTRIC MOTOR REPAIR



The busiest, most profitable electrical service of all!

ELECTRIC MOTOR REPAIR is a big, 570-page training book that can quickly help you learn this important work at home—for only \$5 for the complete course. Written especially for beginners. Tells what to do—exactly how to do it. Everything is explained simply, thoroughly and understandably. Based on what can be learned from this big book alone, you can train for prompt, profitable service on practically every electric motor in common use.

AN UNCROWDED, BIG-PAY FIELD!

The electric motor repair expert is a valuable, well-paid man. There are big opportunities for the work almost anywhere. Statistics show there are 11 electric motors in the average small American home. Big homes have many more—in oil burners, air conditioners, record players, cleaners, refrigerators, clocks, mixers, fans, washers, etc. And there are millions more in industry! Good motor repair men are scarce. Even many big appliance shops must send motors back to the factory for repair or to motor specialists! Be the man in your locality who gets this profitable business!

ELECTRIC MOTOR REPAIR book teaches you the work from the beginning. Every important step is demonstrated both in text and visually by more than 900 special illustrations. Quick reference guides show how to handle specific jobs. Widely used for training beginners and for daily reference in busy motor shops. Covers practically every modern motor type and BOTH mechanical and electrical motor control systems. Unique Duo-Spiral Binding divides book into 2 sections so that both text and related illustrations can be studied together.

BORROW IT FOR 5 DAYS

Send coupon now. Practice from ELECTRIC MOTOR REPAIR for 5 full days. See how interesting the work is—how rapidly it can be learned. Then, if not more than satisfied, return book and your money will be cheerfully refunded and no questions asked!



ALL THIS... for only \$5!

ELECTRIC MOTOR REPAIR includes complete discussions of motor parts, connections, reversing, trouble analyzing procedure, rewinding, etc. Gives full instructions on split phase motors; capacitor motors; repulsion-type; polyphase; alternating current and direct-current types; universal, shaded-pole and fan motors; d-c generators; synchronous motors and generators, etc., as well as motor control units.

Dept. RN-48, Murray Hill Books, Inc.
232 Madison Ave., New York 16, N. Y.

□ Rush me a copy of "ELECTRIC MOTOR REPAIR" for which I enclose \$5 (\$5.50 foreign); or □ send C.O.D. in U.S.A. only, for this amount and I will pay postman \$5 plus postal charge when he delivers book. If book is not what I need, I'll return it within 5 days and you guarantee to refund my \$5.

Name

Address

City & Zone State

Parts Lists

(FOR CIRCUIT DIAGRAMS APPEARING ON PAGES 90 AND 91)

WESTINGHOUSE MODELS H-164, H-166, H-167 Part No. Code and Description

- V-3305
- V-3293
- RC20AE153J
- RC20AE101M
- RC20AE153K
- RC20AE471K
- RC20AE223K
- RC20AE273K
- RC20AE224M
- RC30AE682K
- RC20AE680K
- RC20AE333K
- RC20AE474M
- RC20AE274K
- RC20AE105M
- RC20AE156M
- RC20AE332M

- RC20AE121K
- RC30AE103M
- RC20AE225M
- RC20AE330M
- RC20AE475M
- RC20AE473M
- RC20AE104K
- RC20AE224K
- RC20AE154M
- RC20AE683M
- RC41AE272K
- V-4758
- V-4759
- V-5367

- V-5323
- RCP10W4103A
- RCP10M4103A
- RCP10W6502A
- RCP10W4503A
- RCM30B512M
- RCM30C272G
- RCP10W6202M
- RCM20B101M
- RCP10W6102K
- RCM30B103M

- RCM20B271J
- RCM20B221M
- R2CC21CH150J
- RCP10M6202M
- R2CC21CH050D
- R2CC36SL221M
- R2CC21PJ220K
- R2CC26PJ470K
- R5CC21ZY471M
- V-3241
- V-4880
- V-3236
- V-3302

- V-4750
- V-4746
- V-4747
- V-4748
- V-4749
- V-5368

- V-4623
- V-4624
- R2CC21UJ100F
- V-5442-1
- V-5040-15
- V-4887
- V-4886
- V-4751
- V-4752
- V-4753
- V-5048
- V-4755
- V-4756

GENERAL ELECTRIC MODELS 354, 355

- Part No. Code and Description
- URD-089
- URD-033
- URD-133
- URD-113
- URD-017
- URF-067
- URD-057
- URD-105
- URD-1076

RRC-033

- URD-053
- URD-141
- URE-037
- URF-051
- URD-077
- URD-1045
- URD-097
- URD-049
- URF-077
- RCY-018
- UCU-004
- UCN-507
- RCW-014
- UCN-1506
- RCY-019

- RCY-017
- RCW-001
- UCU-044
- UCC-020
- UCC-040
- UCC-028
- UCC-045
- UCU-020

- RCC-040
- UCU-1040
- RCE-038
- UCC-036
- UCC-041
- RCE-039

- RCC-014
- UCC-011
- UCU-1032
- RCW-013
- UCW-1022
- UCU-060
- RCY-020
- UCC-024
- RCW-4028
- RSW-024
- RSW-025
- RTL-031
- RTL-032
- RTD-004
- RTP-028
- RTP-033

Part No. Code and Description

- C-9B1-25
- C-9B1-74
- C-9B1-34
- C-9B1-17
- C-9B1-72
- A-10A-13640
- C-9B1-37
- C-9B1-30
- C-9B1-33
- C-9B1-57
- A-2M-12618
- C-8D-10787
- C-8F3-8
- C-8F3-119
- C-8D-10770
- C-8D-10775
- C-8D-10778
- C-8D-10774
- C-8D-10785
- A-8C-11495
- A-13E-13648
- A-13D-13647
- B-13B-13643
- B-12C-13641

Part No. Code and Description

- RC-21000
- RC-21503
- RC-21003
- RC-21501
- RC-22202
- RC-22001
- RC-21001
- WP-10003
- RC-26802
- RC-24703
- RC-26801
- CC-1520
- CVP-10014
- CC-15300
- CPP-12502
- CPP-12203

R17, S3—2 megohm vol. control & sw.

- R18—1500 ohm, 1/2 w. res.
- R19, R36—6.8 megohm, 1/2 w. res.
- R22—330 ohm, 1 w. res.
- R25—1200 ohm, 2 w. res.
- R26—15,000 ohm, 1/2 w. res.
- R27—680 ohm, 1/2 w. res.
- R28, R31, R32, R27, R10—100,000 ohm, 1/2 w. res.
- R29, R1—1000 ohm, 1/2 w. res.
- R30—15,000 ohm, 2 w. res.
- C1, C5, C6—3-30/30-60/79-129 µµfd. trimmer
- C2—10 µµfd. mica cond.
- C3—3.3 µµfd. ceramic cond.
- C4—1.5 µµfd. ceramic cond.
- C7—6.8 µµfd. ceramic cond.
- C8, C9—219-269/47-83 µµfd. trimmer
- C10—Air trimmer
- C11—Ceramic cond.
- C12—470 µµfd. mica cond.
- C13—003 µµfd., 400 v. cond.
- C16, C17, C22, C11, C35—.01 µµfd., 600 v. cond.
- C18—.05 µµfd., 400 v. cond.
- C19—.05 µµfd., 600 v. cond.
- C23, C24, C45—100 µµfd. mica cond.
- C25—.01 µµfd. oil cond.
- C26, C27—330 µµfd. mica cond.
- RCE-038
- C32—8 µµfd., 25 v. elec. cond.
- C37—.002 µµfd., 600 v. cond.
- C38—.02 µµfd., 600 v. cond.
- C39A, C39B, C39C, C39D—20/15/30/30 µµfd., 25/300/350/350 v. elec. cond.
- C40—.005 µµfd. paper cond.
- C41—.05 µµfd., 200 v. cond.
- C42—150 µµfd. mica cond.
- C43—10 µµfd. ceramic cond.
- C46—56 µµfd. ceramic cond.
- C47—2200 µµfd. mica cond.
- RCY-020
- C52—86-146 µµfd. trimmer
- C54, C56—.008 µµfd., 400 v. cond.
- C55—100 µµfd. ceramic cond.
- S1—Bandswitch
- S2—Tone control sw.
- T1—First i.f. trans.
- T2—Second i.f. trans.
- T3—Dis. trans.
- T5—Power trans. (60 cycles)
- T6—Power trans. (50 cycles)

BELMONT MODEL 4B115

- Part No. Code and Description
- R1—100,000 ohm, 1/2 w. res.
- R2—10,000 ohm, 1/2 w. res.
- R3, R5, R8—3.3 megohm, 1/2 w. res.
- RC-9B1-72
- A-10A-13640
- C-9B1-37
- C-9B1-30
- C-9B1-33
- C-9B1-57
- A-2M-12618
- C-8D-10787
- C-8F3-8
- C-8F3-119
- C-8D-10770
- C-8D-10775
- C-8D-10778
- C-8D-10774
- C-8D-10785
- A-8C-11495
- A-13E-13648
- A-13D-13647
- B-13B-13643
- B-12C-13641

MECK FM CONVERTER

- Part No. Code and Description
- RC-21000
- RC-21503
- RC-21003
- RC-21501
- RC-22202
- RC-22001
- RC-21001
- WP-10003
- RC-26802
- RC-24703
- RC-26801
- CC-1520
- CVP-10014
- CC-15300
- CPP-12502
- CPP-12203

Now...

you can use it anywhere!

**Measures voltage
resistance . . . and current**

ABOUT THE HANDIEST METER in the service field! In one instrument, for one price, you get an electronic voltmeter, ohmmeter, and ammeter . . . *battery-operated* to make it completely independent of power-line sources.

Use it to test car radios, farm sets, railroad signal equipment, aircraft radio, industrial electronic devices . . . opens up hundreds of profitable new opportunities beyond the limits of power lines.

With it you can measure both a-c and d-c voltages to 1000 volts, resistance to 1000 megohms, and direct current to 10 amperes. A new low-cost, RCA crystal probe can be attached if you want to make v-h-f measurements.

Most important, this instrument is easy on batteries. They last up to 10 months in normal service. A neon pilot light flashes when the instrument is on . . . serves as a reminder to turn the instrument off when not in use.

Linearity and stability are excellent.

Here is one of the best buys in test equipment on the market today. We'll be glad to send you complete descriptive and price information on this time and money saver. See it at your RCA Test Equipment Distributor.

New **BATTERY OPERATED**
RCA VOLTOHMYST



RADIO CORPORATION of AMERICA
TEST AND MEASURING EQUIPMENT
HARRISON, N. J.

Lafayette SUPER BUYS

for the HAM and EXPERIMENTER

Save your steps, chum — you can't beat these values anywhere. Come in or write in, but get your order in fast while they last.

KIT OF 100 IRC RESISTORS

Standard types; 1/2, 1, and 2 watts. Insulated, metalized and coded. Tolerances of 5, 10 and 20%.

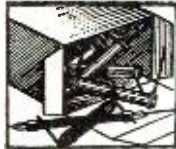

No. KPS496....Your Cost ONLY \$1.95

WEBSTER-CHICAGO WIRE RECORDER FOUNDATION UNIT

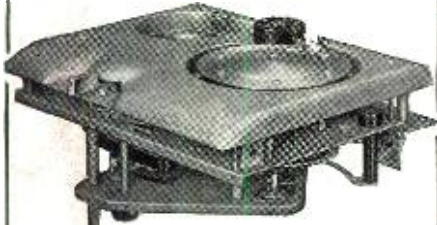

MODEL 79... Reduced to \$44.10

Now — make your own professional wire recorder at a sensational saving. It's identical to the model used in The Webster Portable Wire Recorder. It has a complete wire transporting mechanism, triple-purpose recording head; oscillator coil, 15-minute spool of recording wire plus an instruction sheet with circuit diagram. You can employ any standard Armour type recording spool and make recordings up to a full hour. 10 1/2" x 8 3/4" x 5 1/2" (3 1/2" below main plate; 2" above). Net. wt.: 10 lbs. KPS 698.

Lafayette Radio

Radio Wire Television, Inc.
100 Sixth Ave., New York 13, N.Y.
542 E. Fordham Rd. 110 Federal St. 24 Central Ave.
Bronx 58, N.Y. Boston 10, Mass. Newark 2, N.J.

ORDER NOW — MAIL COUPON

Lafayette Radio, Dept. RD-8
LAFAYETTE RADIO, Dept. RD-8
100 Sixth Ave., New York 13, N.Y.

() Send No. KPS496 @ \$1.95 ea. Quan. ()
() Send Model 79 @ \$44.10 ea. Quan. ()
Enclosed () Money Order () Check
() Rush your newest flyer C-41

Name _____
Address _____
City _____ Zone _____ State _____

- CPP-12103
- CPP-12102
- CLP-10007
- CPP-12522
- CLP-10011
- CC-15501
- CC-15200
- CC-15500
- CC-15101
- CPP-12200
- TRFP-10009
- TRCP-10010
- TSP-10016
- LG-10002
- LF-10001

- C₇, C₈—.01 μfd. paper cond.
- C₆—.001 μfd. paper cond.
- C_{10A}, C_{10B}—30/50 μfd. elec. cond.
- C₁₁—.0025 μfd. paper cond.
- C₁₂—8 μfd. elec. cond.
- C_{12A}, C₁₀, C₁₉—500 μfd. ceramic cond.
- C₁₅—20 μfd. ceramic cond.
- C₁₇—50 μfd. ceramic cond.
- C₁₈—100 μfd. ceramic cond.
- C₂₀—2 μfd. paper cond.
- L₁—FM ant. coil
- L₂—FM osc. coil
- RF₁—Choke & T₁
- RF₂—12 μh. choke
- RF₃—Line cord inductor

- 22-1426
- 22-1234
- 85-225
- 85-335
- 85-334
- 85-332
- 85-333
- 95-912
- 95-913
- 44-17
- 49-517
- S11212
- S11213
- S11214
- S11215
- S11216
- S11217
- S11218
- S11219
- S11220
- S11221
- S11222
- S11223
- S11224
- S11225
- S11226
- S11246
- S11821
- S11562
- S11591
- S11210
- S11823
- S11822
- S11211

- C_{80A}, C_{81A}, C₈₂—40/20/10 μfd., 150/150/150 v. elec. cond.
- C_{23A}, C₂₄—200/40 μfd., 10/150 v. elec. cond.
- S₁—Short-wave switch
- S₂—Antenna switch
- S₃—Band selector switch
- S₄—Tone control switch
- S₅—Changeover switch
- T₁—First i.f. trans.
- T₂—Second i.f. trans.
- J₁—Phone jack
- SP₁—5 1/4" dynamic speaker
- L₁—18 mc. osc. coil
- L₂—15 mc. osc. coil
- L₃—12 mc. osc. coil
- L₄—9 mc. osc. coil
- L₅—6 mc. osc. coil
- L₆—18 mc. det. coil
- L₇—15 mc. det. coil
- L₈—12 mc. det. coil
- L₉—9 mc. det. coil
- L₁₀—6 mc. det. coil
- L₁₁—18 mc. ant. coil
- L₁₂—15 mc. ant. coil
- L₁₃—12 mc. ant. coil
- L₁₄—9 mc. ant. coil
- L₁₅—6 mc. ant. coil
- L₁₆—Broadcast wavemagnet
- L₁₇—Wave trap coil
- L₁₈—Short-wave wavemagnet
- L₁₉—Ant. loading coil
- L₂₀—Detector coil
- L₂₁—R.f. choke coil
- L₂₂—R.f. choke coil
- L₂₃—Broadcast osc. coil
- L₂₄—First i.f. trans. pri. trimmer (on T₁)
- L₂₅—First i.f. trans. sec. trimmer (on T₁)
- L₂₆—Second i.f. trans. pri. trimmer (on T₂)
- L₂₇—Second i.f. trans. sec. trimmer (on T₂)
- L₂₈—R.f. choke
- W₁—Battery cable

CROSLEY MODELS 68TA, 68TW

- | Part No. | Code and Description |
|-------------|---|
| AW-137800 | 1—R.f. coil |
| AW-137724 | 2—Osc. coil |
| AC-137933 | 3—First i.f. trans. |
| AC-137934 | 4—Second i.f. trans. |
| AW-138546 | 5—Ant. loading coil |
| W-48858 | 6, 54—Type 47 dial bulb |
| C-132300-1 | 7—Cable and plug assembly |
| B-136597 | 9—Power trans. |
| B-136598 | 10—Output trans. |
| B-136595 | 11—1 megohm vol. control & w. |
| C-138246 | 13—Speaker |
| 39373-23 | 14—330 ohm, 1/2 w. res. |
| 39373-60 | 15—22,000 ohm, 1/2 w. res. |
| 39373-67 | 16—47,000 ohm, 1/2 w. res. |
| 39373-84 | 17—330,000 ohm, 1/2 w. res. |
| 39373-87 | 18—470,000 ohm, 1/2 w. res. |
| 39373-92 | 19—1 megohm, 1/2 w. res. |
| 39373-97 | 20—2.2 megohm, 1/2 w. res. |
| 39373-107 | 21—10 megohm, 1/2 w. res. |
| 39373-40 | 22—2200 ohm, 10 w. res. |
| 39372-7 | 23—1500 ohm, 10 w. res. |
| 39373-165 | 24—12,000 ohm, 1 w. res. |
| 39373-62 | 25—27,000 ohm, 1/2 w. res. |
| 39373-97 | 27, 28—2.2 megohm, 1/2 w. res. |
| 39373-60 | 29—22,000 ohm, 1/2 w. res. |
| 39001-11 | 32, 33—.005 μfd., 600 v. cond. |
| 39001-13 | 34, 35—.01 μfd., 600 v. cond. |
| 39001-17 | 36, 37, 39—.05 μfd., 600 v. cond. |
| 39001-7 | 38, 41—.001 μfd., 600 v. cond. |
| 39001-73 | 40—.00025 μfd., 600 v. cond. |
| 39001-13 | 42—.01 μfd., 600 v. cond. |
| B-136596 | 44A, 44B—50/30 μfd., 300/300 v. elec. cond. |
| W-132267-1 | 45—Trimmer cond. |
| AB-138584 | 46—Terminal board |
| AC-138464 | 47—Loop ant. assembly |
| AC-138595-2 | 48A, 48B, 48C—Var. cond. assembly |
| C-137727-52 | 51—12 μfd., 500 v. cond. |
| B-142857 | 52—2 megohm tone control |
| 39373-67 | 53—47,000 ohm, 1/2 w. res. |

ZENITH MODEL 8G005

- | Part No. | Code and Description |
|--------------------|---|
| 63-591 | R ₁ —22,000 ohm, 1/4 w. res. |
| 63-271 | R ₂ —1 megohm, 1/4 w. res. |
| 63-585 | R ₃ —2200 ohm, 1/4 w. res. |
| 63-590 | R ₄ —15,000 ohm, 1/4 w. res. |
| 63-600 | R ₅ —2.2 megohm, 1/4 w. res. |
| 63-594 | R ₆ —68,000 ohm, 1/4 w. res. |
| 63-654 | R ₇ —180,000 ohm, 1/4 w. res. |
| 63-254 | R ₈ —1500 ohm, 1/4 w. res. |
| 63-583 | R ₉ —1000 ohm, 1/4 w. res. |
| 63-602 | R ₁₀ —4.7 megohm, 1/4 w. res. |
| 63-1344 | R ₁₁ —1 megohm vol. control |
| 63-1093 | R ₁₂ —15 megohm, 1/4 w. res. |
| 63-771 | R ₁₃ —120,000 ohm, 1/4 w. res. |
| 63-1042 | R ₁₄ —1 megohm, 1/4 w. res. |
| 63-238 | R ₁₅ —1000 ohm, 1/4 w. res. |
| 63-592 | R ₁₆ —33,000 ohm, 1/4 w. res. |
| 63-1226 | R ₁₇ —1200 ohm, 1/2 w. res. |
| 63-1361 | R ₁₈ —88 ohm, 2 w. res. |
| 63-1343 or 63-1359 | R ₁₉ , R ₂₀ —970 ohm, 3 w. res. |
| 22-1373 | C ₁ —3-gang var. cond. |
| 22-1425 | C ₂ —Ant. wave trap trimmer |
| 22-1329 | C _{3A} , C _{3B} —31 meter and 25 meter short-wave ant. trimmer and wave booster |
| 22-1415 | C ₄ —7-70 μfd. trimmer |
| 22-1390 | C ₅ —.0005 μfd., 600 v. cond. |
| 22-1391 | C ₆ —250 μfd., 600 v. cond. |
| 22-817 | C ₇ —Broadcast ant. trimmer (on C ₁) |
| | C ₁₀ —.05 μfd., 200 v. cond. |
| | C ₁₂ —Broadcast det. trimmer (on C ₁) |
| 22-1430 | C ₁₃ —.05 μfd., 200 v. cond. |
| 22-1392 | C ₁₅ —25 μfd., 500 v. cond. |
| 22-1393 | C ₁₆ —50 μfd., 500 v. cond. |
| 22-1394 | C ₁₇ —56 μfd., 500 v. cond. |
| | C ₁₈ —Broadcast osc. trimmer (on C ₁) |
| 22-813 | C ₂₀ —.02 μfd., 200 v. cond. |
| 22-820 | C ₂₁ —.1 μfd., 200 v. cond. |
| 22-147 | C ₂₂ —.0005 μfd., 600 v. cond. |
| 22-1063 | C ₂₃ —.001 μfd., 600 v. cond. |
| 22-811 | C ₂₄ —.01 μfd., 600 v. cond. |
| 22-953 | C ₂₅ —.0002 μfd., 600 v. cond. |
| 22-470 | C ₂₆ —.00015 μfd., 600 v. cond. |
| 22-805 | C ₂₇ —.004 μfd., 600 v. cond. |
| 22-1437 | C ₂₈ —.01 μfd., 200 v. cond. |
| 22-818 | C ₂₉ —.05 μfd., 400 v. cond. |

REFERRAL SERVICE

THE Associated Radio Service Men of N.Y., Inc. has recently instituted a new service for radio customers in the form of a referral service.

Persons seeking reliable and competent technicians for the servicing of AM, FM and television receivers may contact the central distribution office of the organization from which point calls are distributed to the nearest qualified member of the ARSNY.

This is the first time that New York City has had a central distribution agency of this type. The service is offered to the public without charge and provides them with a guarantee of reliability and competence backed by the technical and ethical standards of the Associated Radio Service Men of New York.

Other cities might like to adopt such a setup for the benefit of the hundreds of persons who haven't already selected a regular radio service technician.



"No wonder it left scars on you Pa. The man says it isn't a heat pad a'tall!"

MONEY BACK GUARANTEE We believe units offered for sale by mail order should be sold only on a "Money-Back-If-Not-Satisfied" basis. We carefully check the design calibration and value of all items advertised by us and unhesitatingly offer all merchandise subject to a return for credit or refund. You, the customer, are the sole judge as to value of the item or items you have purchased.

The Model 88-A COMBINATION

SIGNAL GENERATOR AND SIGNAL TRACER



The Model 88 comes complete with all test leads and operating instructions.

Only.....

\$28⁸⁵
NET

The ultimate in signal tracing procedure is achieved by the Model 88, for the use of this model, enables you to use either the broadcast signal itself or the signal injected by the Signal Generator. This is especially useful of course when servicing "dead" or "intermittent" receivers. The Model 88 you will find is the greatest time-saver ever provided for by combining a full range Signal Generator and Signal Tracer into one unit; the set up time for interconnecting, etc., is entirely eliminated.

Signal Generator Specifications:

- Frequency Range: 150 Kilocycles to 50 Megacycles.
- The R.F. Signal Frequency is kept completely constant at all output levels. This is accomplished by use of a special grid loaded circuit which provides a constant load on the oscillatory circuit. A grounded plate oscillator is used for additional frequency stability.
- Modulation is accomplished by Grid-blocking action which has proven to be equally effective for alignment of amplitude and frequency modulation as well as for television receivers.
- Positive action attenuator provides effective output control at all times.
- R.F. is obtainable separately or modulated by the Audio Frequency.

Signal Tracer Specifications:

- Uses the new Sylvania 1N34 Germanium crystal Diode which combined with a resistance-capacity network provides a frequency range of 300 cycles to 50 Megacycles.
- Simple to operate—Clips directly on to receiver chassis, no tuning controls.
- Provision is made for insertion of phones of any impedance, a standard Volt-Ohm Milliammeter or Oscilloscope

The New Model 60-T **TUBE & SET TESTER**

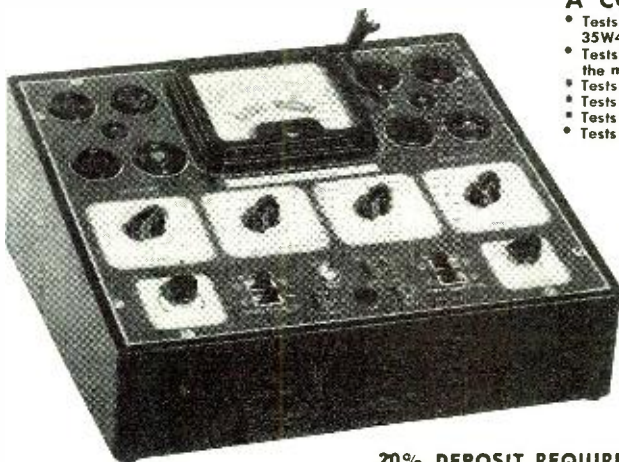

A COMPLETE TUBE TESTER

- Tests all tubes including the new post-war miniature locals such as the 12AT6, 12AU6, 35W4, 50B5, 11723, etc.
- Tests by the well-established emission method for tube quality, directly read on the scale of the meter.
- Tests shorts and leakages up to 3 Megohms in all tubes.
- Tests leakages and shorts of any one element against all elements in all tubes.
- Tests both plates in rectifiers.
- Tests individual sections such as diodes, triodes, pentodes, etc., in multi-purpose tubes.

A COMPLETE MULTI-METER

- 6 D. C. Voltage Ranges: 0 to 7.5/15/75/150/750/1,500 Volts
- 6 A. C. Voltage Ranges: 0 to 15/30/150/300/1,500/3,000 Volts
- 4 D. C. Current Ranges: 0 to 1.5/15/150 Ma. 0 to 1.5 Amps.
- High Resistance Range: 0 to 20 Megohms
- 3 Decibel Ranges: —10 to +38 +10 to +38 +30 to +58 D.B.
- 2 Medium Resistance Ranges: 0 to 20,000/200,000 Ohms
- Low Resistance Range: 0 to 2,000 Ohms (1st division is 1/10th of an ohm)

Model 60-T operates on 90-120 Volts 60 Cycles A.C. Housed in sloping leatherette covered cabinet. Comes complete with test leads, tube charts and detailed operating instructions.

Extra: We can now supply the Model 60 housed in a beautiful hand-rubbed oak cabinet. Complete with portable cover making it suitable for either bench or outside use. Only \$2.75 additional. Specify Model 60-C.

\$49⁸⁵
NET

20% DEPOSIT REQUIRED ON ALL C. O. D. ORDERS

GENERAL ELECTRONIC DISTRIBUTING CO. Dept. RN-4, 98 Park Place
New York 7, N. Y.



ESSE Specials!

Do not fail to closely examine this list of bargains. We believe that every item listed below is a sensational value. All equipment advertised herein is unconditionally guaranteed to the customer's satisfaction to this extent: Return any item advertised within five days after delivery for full refund except transportation charges (both ways).

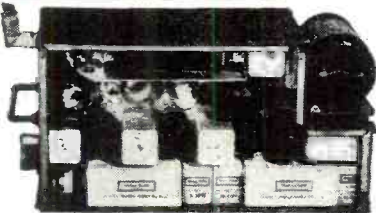

BC-733D LOCALIZER RECEIVER

A part of aircraft blind landing equipment. Operates on any one of its 6 predetermined crystal controlled frequencies in the range of 108-120 Mc. Contains 10 tubes—3 of which are W.E. 717-A's—and crystals. Ideal receiver for conversion to 144 Mc. ham band or mobile telephone bands. For 24 V. DC operation. Size, 14 1/2 x 7 x 4 5/8".

Price With Dynamotor **\$5.95**

Price Without Dynamotor **\$4.95**

ATTENTION, PROSPECTORS, MINERS, OIL COMPANIES, PLUMBERS, etc. Below is the finest metal detecting mine detector ever constructed . . .

SCR-625 MINE DETECTOR Brand New

Metallic Objects Only

Used by the Army to detect buried metallic mines. Its private use suggests the location of underground or underwater pipes, cables and ore bearing rock, the location of metallic fragments in scrap materials, logs, etc. and the screening of personnel in plants for carrying of metallic objects.

The unit consists of a balanced inductance bridge, a two-tube amp. and a 1,000 cycle oscillator. The presence of metal disturbs the bridge balance, resulting in a volume change of the 1,000 cycle tone. The tubes used are low-battery drain types such as 1G6 and 1N5. The circuit may be modified for control of warning signals, stopping of machinery etc. when metal is detected. Operates from two flashlight batteries and 103 V. "B". However, a power supply operating from 110 V. may be used. Comes complete with spare tubes, spare resonator and instruction manual—in wooden chest 8 1/4" x 28 1/4" x 16". Weight in operation is 15 lbs. New, complete in original overseas packing container. Originally sold by War Assets for \$166.00.

The U. S. Forestry Service has recommended procedure for using the SCR-625 Mine Detector to find concealed metal in tree logs and other timber products.

Price **\$79.50 ea.**

Batteries **\$4.00 extra**



AIRCRAFT RADIO RANGE FILTER FL-8-A

For helpful reduction of QRM on crowded CW bands. When attached to output of any communications receiver:

- 1—Will pass signal of 1020 CPS, eliminating others.
 - 2—Will pass voice frequencies and eliminate 1020 CPS code signal.
- Compact, light weight, with switch. Size 2 3/4" x 2 3/8" x 3 3/4".

Price **\$2.25 ea.**



SCR-274-N COMMAND SET COMPONENTS - TRANSMITTERS and RECEIVERS FOR 10 METER RIG.

Refer to "CQ" magazine for May 1946 for conversion information of these units. This outfit can be made into a sensational amateur radio station. We are featuring and pricing the components separately so as that you may buy what you want instead of what you do not need.

TRANSMITTERS:

- 4-5.3 Mc. **\$5.75**
- 5.3-7 Mc. **\$5.75**
- Modulator with Carbon Mike Input (with dynamotor) **\$5.75**
- Tuning Control Box (gang of three) **\$2.50**
- Antenna Unit with Relay 5000 V. 50 Mmfd. Condenser and Meter **\$2.25**
- Remote Control Box with Switch and Volume Control **\$1.50**
- Receiver Rack (set of three) **\$1.50**
- Transmitter Rack (set of two) **\$1.00**



RECEIVERS:

- 3-6 Mc. **\$5.75**
- 6-9.1 Mc. **\$5.75**

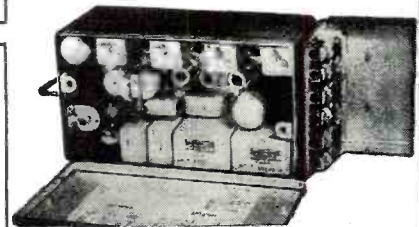

R-89/ARN 5A GLIDE PATH RECEIVER

Formerly used for blind landing but adaptable to many other uses such as receiver for new police or citizen's band. Band of operation 326-335 mc. on any of three predetermined crystal controlled frequencies. Contains eleven tubes, 6 relays and other valuable parts. For 24 V. DC operation. Size 13 3/4" x 5 1/4" x 6 3/8".

Price, complete **\$12.45**

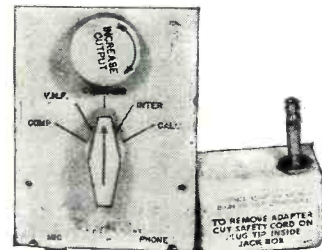

JACK BOX BC-1366

Contains 2-pole 5-position switch, rheostat, two phone jacks, etc. In aluminum case 3 1/4" x 4 3/8" x 2 1/4". Complete with headphone set adapter to match high to low impedance.

Price **\$1.25**

ANTENNA KIT 2A-264-126

Canvas bag containing 20 ceramic insulators each 3" long (1 1/4" dia. with screw-in type eye-lets), covered wires each 5' long, 10' long, 35' long, 2 each 25' long, 5 each 20' long, 150' long, (all having 1/8" thimbles and 6" connecting leads at each end and all stranded copper covered with weather proof insulation.) Brand new. Original crates. Useful to any ham, serviceman, or experimenter. Each kit

Special Price **\$4⁹⁵**



2-METER BEAM ANTENNA

Portable or fixed, manually operated or can be used with beam motor, for use in 100-156 Mc. band. Easily adapted for ham or experimental use. Contains tuning unit which matches output of transmitter to antenna, 18' steel mast with brass tube containing inside steel mast (OD color), "H" frame for holding dipoles, 3 sets (4 per set) dipole rods, compensator or sense antenna for "H" frame, 2 steel truncated cones used as antenna support and feed-through, 360 degrees bearing indicator, and hand-wheel for rotating. Brand new packed in six boxes, total weight approx. 600 lbs. Limited quantity and in much demand. Place order now

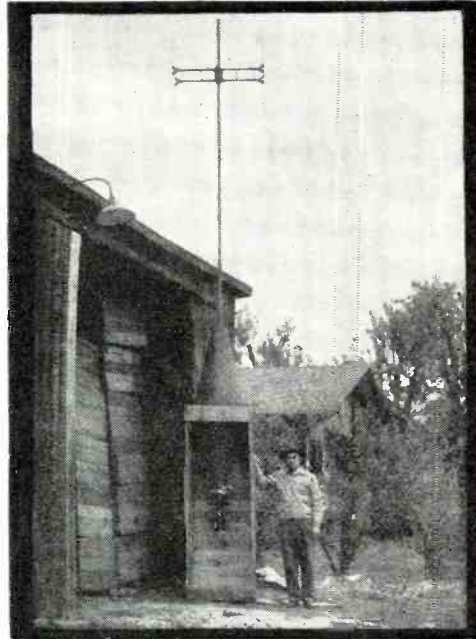

Special Price **\$79⁵⁰**

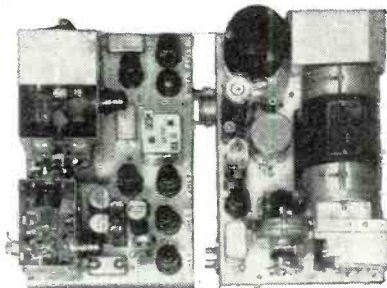

BC-966-A IFF

Approximately 2 meter frequency operation. 14 tubes, 350 V DC dynamotor, 12 V. DC input. Contains voltage regulators and many other fine parts. Worth more for parts than price asked.

\$4⁷⁵

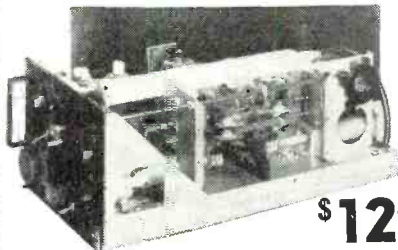

T-39/APQ-9 RADAR XMITTER

Contains many excellent parts for the VHF experimenter such as a cavity oscillator using 2-RCA 8012 tubes rated at full output to 500 Mc. Tubes are forced air cooled by 24 V. DC motor, which is easily converted for 110 V. AC operation. Other valuable parts such as a pair of 807's, 2-6AC7, 1-931 and 1-6AG7 tubes; ceramic switch, potentiometers, gears, revolution counter, etc.

\$12⁵⁰

RADIO TUBES

We're overstocked—we're unloading

- 7C5 each—**\$.35**
- 7F7 each—**.35**
- 7Y4 each—**.35**
- CW-931 each—**.35**
- 30 (VT-67) each—**.35**

(Hi-freq.-low-loss base)

- 6SN7 each—**.35**
- VT127A each—**3.75**
- OZ4 each—**.70**
- 12A6 each—**.35**
- 1625 each—**.35**
- 1629 each—**.35**

All tubes checked before shipment.

MARKER BEACON RECEIVER

Can be adapted to radio controlled devices. Was used by pilots to flash a signal lamp on aircraft instrument panel when in range of a beacon transmitter. Responds to modulated signals over a variable range of 62 to 80 Mc. Tube plates and filaments operate directly from 24 V. DC. Can be adapted for radio control of experimental apparatus, opening garage doors, etc. Circuit diagram and parts list included on either model shown below.

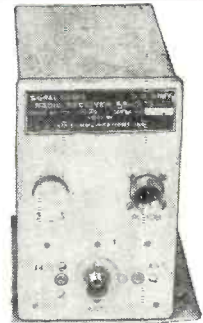

BC-357—Contains 12C8 and 12SQ7 tubes and sensitive relay (size 5 3/8"x5 1/4"x3 1/4").

Price **\$2.95**

BC-1033—Contains 6SH7, 6SL7 and 12SN7 tubes, sensitive relay (size 5 3/8"x5 1/4"x3 1/4").

Price **\$3.50**



TURBO AMPLIFIER

Used for parts — shipped complete with the following tubes:

- 2—7C5's
- 1—7Y4
- 1—7F7

Price **\$1.75 ea.**

CO-AXIAL CABLE VALUES THAT WE CAN ONLY OFFER TO CUSTOMERS WHO BUY A MINIMUM OF 100 FOOT PER TYPE.

- RG-8/U Cable, 52 ohms impedance (unmarked) \$2.95 per 100 ft.
- RG-8/U Cable, 52 ohms impedance (marked) \$3.95 per 100 ft.
- RG-29/UCO-AXIAL, 53.5 ohms impedance (marked) \$3.95 per 100 ft.
- RG-21/U Cable, 53 ohms impedance (unmarked) \$3.95 per 100 ft.

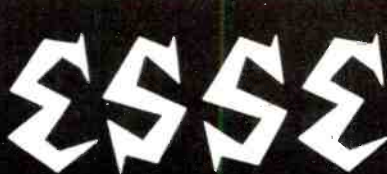

Radio Co
130 W. New York St.
Indianapolis 4, Ind.

Unless Otherwise Stated, All of This Equipment Is Sold As Used
CASH REQUIRED WITH ALL ORDERS
Orders Shipped F.O.B. Collect

Free



**NEW
Complete
Concord
RADIO
CATALOG**
160 VALUE-
PACKED PAGES

MALL the coupon below now for your copy of this great, new comprehensive Concord Catalog—a vast, complete selection of everything in Radio, Radar, Television, Test and Electronic Equipment. Featuring thousands of items . . . new, latest 1948 prices. See the new LOWER prices on finest-quality RADIO SETS, PHONO-RADIOS, RECORD CHANGERS, RECORD PLAYERS, RECORDERS—wire and disc, PORTABLES, AMPLIFIERS, COMPLETE SOUND SYSTEMS, TESTERS. See complete latest listings of all the well-known, standard, dependable lines of radio parts and equipment—all available for IMMEDIATE SHIPMENT from huge stocks in CHICAGO and ATLANTA. Whatever your needs in Radio and Electronic Parts, Supplies and Equipment—before you buy—SEE THIS GREAT NEW CONCORD CATALOG. Mail coupon for your FREE copy.

WE HAVE WHAT YOU WANT!

The new Concord Catalog displays the most comprehensive stock in years! All well-known, standard lines are fully represented. Equipment—accessories—parts for all radio and electronic use . . . for building, repair, maintenance . . . for engineer, amateur, serviceman, soundman, retailer . . . complete lines of tubes, instruments, tools, speakers, condensers, resistors, relays, etc. . . PLUS a complete radio set department . . . PLUS the exciting line of MULTIAMP Add-A-Unit Amplifiers offering many innovations in public address units obtainable only from Concord.

**RADIO PARTS
RADIO SETS
AMPLIFIERS
TESTERS
ELECTRONIC
EQUIPMENT
HAM GEAR**

Mail **COUPON**

CONCORD RADIO CORPORATION, Dept. 134
901 W. Jackson Blvd., Chicago 7, Ill.

Yes, rush FREE COPY of the comprehensive new Concord Radio Catalog.

Name _____

Address _____

City _____ State _____

CONCORD
RADIO CORPORATION
CHICAGO 7 ATLANTA 3
901 W. Jackson Blvd. 265 Peachtree St.
Downtown Chicago Branch: 229 W. Madison
Lafayette Radio Corp.

Technical
BOOKS

"RADIO RECEIVER TUBE PLACEMENT GUIDE" compiled and published by *Howard W. Sams & Co., Inc.*, Indianapolis. 192 pages. Price \$1.25.

This newest member of the "Photo-Fact" family is designed to assist the radio serviceman by cutting servicing time usually required in replacing tubes.

The book shows exactly where to replace tubes in more than 4500 receivers covering models for the years 1938 to 1947. A handy index locates the set and then refers the technician to the correct diagram covering that particular receiver. 1880 diagrams are included in this 192 page booklet which comes in handy tube manual size.

By using this manual the serviceman should be able to eliminate the time-consuming task of replacing tubes, as well as the hazards of burn-outs if hit-and-miss methods of replacement are employed.

"MOST-OFTEN-NEEDED F. M. AND TELEVISION SERVICING INFORMATION" by M. N. Beitman. Published by *Supreme Publications*, Chicago. 192 pages. Price \$2.00.

With the growing popularity of FM and television, many radiomen are faced with the problem of servicing these rather complex receivers without adequate preparation to handle this type of business.

This latest servicing book from *Supreme Publications* covers around forty of the popular 1947-1948 FM and television receivers of twenty-four different manufacturers.

The notes covering each set include a complete schematic diagram, dial stringing data, parts lists, special alignment data, information on any features of the receiver which might require specialized servicing techniques, and other pertinent data as it applies to the set in question.

Pictorial diagrams have been included on several of the sets. Diagrams accompanying text material are clear and complete.

This book should find a permanent place on many service benches in the coming months as new areas are opened to FM and television reception.

"ELEMENTS OF RADIO" by A. Marcus and William Markus. Published by *Prentice-Hall, Inc.*, New York. 738 pages. Price \$4.25. Second Edition.

The second and revised edition of this popular home-study course in basic radio has been enlarged to include a new section on radar and television in addition to a special chapter covering modern radio receivers.

As was the case with the first edition, the new book is divided into two parts, the first section dealing with basic radio while the second section



WANTED!

**Chief Engineers,
Studio Engineers,
Transmitter
Engineers**
for more than

**1000 FM* & 2250 AM
BROADCAST STATIONS**
the FCC indicates will be in
operation by the end of 1948

As of Jan. 1948:
374 FM stations
on the air.
636 FM stations
with construction
permits and
conditional grants.



**MAIL COUPON TODAY
FOR THIS 24-PAGE
FREE BOOKLET!**



Yes, Plenty of Good-Paying Jobs...

BUT Only for those Qualified

FM is actually coming into its own this year . . . more than 1000 with permits and grants now on the air, or soon to be. Over 1500 standard broadcast stations now in operation . . . 2250 on the air by the end of the year. Television receivers are on mass production lines. New TV stations are going on the air throughout the country.

Radio-electronics is not only expanding in job opportunities but it is also growing in technical complexity. Rapid developments in every branch of the field are leaving many radio technicians and engineers far behind the parade of progress. These are the men who fail to realize that their technical knowledge must grow with the expansion of the industry.

What does this mean to you? It means

you must study not only to *hold* the job you now occupy . . . but study to *qualify* for the better job you want. CREI modern technical training can (within a comparatively short time) qualify you for the better jobs and help enable you to step ahead of those who have failed to improve their ability through technical training.

Beginning *right now* CREI can provide the on-the-job training that equips you with the technical ability to go after—and GET—the important, high salaried jobs. Get all the facts today about the unprecedented opportunities that await you. Learn how CREI spare time training can help you as it has helped thousands of other professional radiomen advance to better jobs during the past twenty years.

VETERANS! CREI TRAINING AVAILABLE UNDER THE "G. I." BILL

**Capitol Radio
Engineering Institute**

An Accredited Technical Institute

Dept. RN-4, 16th and Park Road, N. W., Washington 10, D. C.

Branch Offices: New York (7): 170 Broadway San Francisco (2): 760 Market St.

Capitol Radio Engineering Institute
16th and Park Road, N. W., Dept. RN-4
Washington 10, D. C.

Gentlemen: Please send me your free booklet, "CREI training for your better job in RADIO-ELECTRONICS," together with full details of your Home Study training. I am attaching a brief resume of my experience, education and present position.

Check One Course:
 Practical Television
 Practical Radio-Electronics

Name _____

Street _____

City _____

Zone _____ State _____

I am entitled to training under the G. I. Bill.

covers the more advanced theory, antennas, transmitters, etc.

In planning this text the authors have not presupposed any previous knowledge of mathematics or physics. Three short chapters are devoted to a brief discussion of the history of communication, wave motion, and waves in ether. The student is then introduced to a simple radio receiving set. From the crystal unit the student then takes up the elements of tuning, detection, and reproduction. From this point he covers, in easy stages, the various refinements in equipment until the modern superheterodyne is discussed.

Each chapter includes a summary of the material presented, a glossary of the terms used in the text, and a series of questions and problems covering the subject matter. This type of pedagogy, plus many detailed drawings and experiments, makes this book ideally suited for the person interested in studying radio at home. The beginner should have no difficulty in grasping the subject as the book is clearly written and familiar analogies are used throughout.

"UNDERSTANDING VECTORS AND PHASE" by John F. Rider and Seymour D. Uslano. Published by *John F. Rider Publisher, Inc.*, New York. 160 pages. Price \$0.99 paper cover.

This new book has been written as an aid to understanding new technical

developments in the radio and electronic field. The text is prepared especially for the radioman without technical training, electronic engineering students, and servicemen. A minimum of mathematics has been used in presenting the material, thus any person with a simple knowledge of electronics should have no difficulty in grasping the subject.

Since more and more technical publications use vectorial representation in discussing radio and electronic circuits a working knowledge of this method of presentation is worthwhile for those in the industry.

The book is clearly written and diagrams have been used freely to illustrate the points under discussion. The book is recommended for home study.

"THE SELF ADVANCEMENT GUIDE FOR APPLIED PRACTICAL ELECTRICITY" by Coyne Staff. Published by *Coyne Electrical School*, Chicago. 47 pages.

In order to extend the benefits of technical training to those unable to study in residence, the *Coyne Staff* has prepared this first of a series of self-advancement guides which are designed to be used in conjunction with the school's courses.

This book is for use with the school's "Applied Practical Electricity" course and contains a series of twenty questions covering each section of approxi-

mately thirty pages in the corresponding volumes of the course. These "self-check" tests are divided into true and false and multiple choice questions.

Persons already owning the school's "Applied Practical Electricity" course should contact the school with regards to obtaining their copy of the guide, those buying courses in the future will be supplied copies of the guide along with the course.

"PRACTICAL AMPLIFIER DIAGRAMS" by Jack Robin and Chester E. Lipman. Published by *Os-tronic Publications*. Los Angeles. 55 pages. Price \$2.00.

This book is a practical text containing forty-five circuits covering from one to eleven-tube amplifiers with phase inversion, inverse feedback, bass boost, treble boost, compression and expansion recording amplifiers, multichannel amplifiers, preamplifiers, portable p.a. amplifiers, etc.

Available outputs cover the range from 1 watt to 75 watt units with a.c.-d.c. models described, in addition to several a.c.-battery units.

One section of the book has been devoted to a discussion of servicing amplifiers and troubleshooting techniques.

The book is presented with a spiral binding which will prove a boon to those building the equipment from the schematics in the book.

-30-

THE CORDOVER "TELLY" CHASSIS

Special Introductory Offer!

A COMPLETE 15" DIRECT VIEW TELEVISION SET

FOR ONLY **\$389⁵⁰**

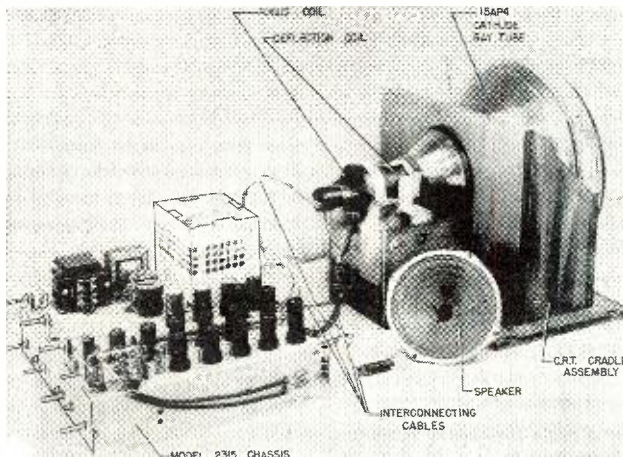

NOW YOU CAN SAVE UP TO \$500.00

BECAUSE we are selling direct to YOU!

BECAUSE we do not include a cabinet (which is easily purchased at a nominal cost, or built to suit your decorative taste, or can be supplied by us upon request).

CORDOVER "TELLY" CHASSIS FEATURES:

- ★ Chassis completely wired and tested. "ready to operate."
- ★ All 23 tubes including Dumont 15 AP4 (15" picture tube)
- ★ Jensen 8" P.M. speaker with Alnico-5 magnet.
- ★ Simple operating instructions.

ORDER YOURS TODAY!

Terms: FOB NY. Full payment (NYCity residents add 2% for city sales tax) or deposit of \$97 (25% of cost) and balance COD. *Send Check or Money Order:*

CORDOVER & CO.

20 Murray St., N. Y. 7. N. Y. DIgby 9-0023-4



NOW! BUILD 15 RADIOS \$14⁷⁵ COMPLETE KIT ONLY...

**ABSOLUTELY NO KNOWLEDGE OF RADIO NECESSARY
YOU NEED NO ADDITIONAL PARTS**

PROGRESSIVE SCOOPS!

4 TUBE TRF MIDGET RECEIVER

Regular Price\$12.75

7 1/2" x 5 1/4" x 4 1/4" Wt. only 2 3/4 lbs.
Beautiful Suede finish Cabinet (assorted colors). Uses miniature tubes 12 BA6, 12 AT6, 50 B5, 35 W4, 4" Alnico V Speaker.

Price, only.....\$11.75

ESPEY CUSTOM-BUILT AM-FM HIGH FIDELITY RECEIVERS Model No. 7-B

11 Tube AC Superheterodyne AM-FM Receiver. Folded dipole antenna for FM supplied. Wired for phonograph operation. Requires nothing but a cabinet. Ideal for custom builders.

(LIST PRICE \$140.00)

Your Price.....\$82.50
\$25.00 dep. required with c.o.d. orders.

FM COIL & CONDENSER KIT

Designed for operation on 88-108 MC (new band) contain 2 1F transformers, 1 Limiter Transformer, 1 Discriminator Transformer, 1 RF coil, 1 Variable condenser, Schematic and wiring instructions. Excellent for Schools, Experimenters and Radio Hobbyists.

Price, only.....\$4.95

40-40 MFD. 150 W.V. DC ELECTROLYTIC CONDENSERS.....45c

ANTENNA and RF COIL SET.....59c (Broadcast Band)

25000 OHM Wire Wound Pot 1/4" Shaft35c

Long Nose Pliers and Cutters \$1.45

75 Watt Soldering Iron.....\$2.40 (UL approved)

6" Alnico Slug Speaker.....\$1.69

10-10 MFD. 450 W.V. DC Electrolytic Condensers.....65c

20-20 MFD. 150 W.V. DC Electrolytic Condensers.....30c

12" Alnico Slug Speaker.....\$5.60

Selenium Rectifiers.....79c

55 Watt Soldering Iron.....\$1.90 (UL approved)

THE PROGRESSIVE RADIO KIT is the ONLY COMPLETE KIT. Operates on 110-120 volts AC/DC. Contains everything you need. Instruction Book, Metal Chassis, Tubes, Condensers, Resistors and all other necessary radio parts. The 36-page Instruction Book written by expert radio instructors and engineers teaches you to build radios in a professional manner. The first circuit built is a simple one-tube detector receiver. Each succeeding circuit incorporates new arrangements of detectors, RF and AF amplifiers. This kit is excellent for learning the principles of receiver, transmitter and amplifier design. It is used in many radio schools and colleges. All of the commonly used detectors are used, including diode, grid leak, plate and infinite-impedance. The transmitters are designed with Hartley and Armstrong oscillators, using

screen-grid and control-grid modulation. Both vacuum tube and selenium rectification are employed in these circuits. The circuits are designed to provide excellent performance. Altogether, fifteen circuits are constructed, including 11 receivers, 1 audio amplifier, and 3 transmitters. The sets start with simple circuits of 1 tube plus rectifier, gradually grow more complex, and finish with several examples of radio sets using three tubes plus rectifier.

Progressive Radio Kit, only...\$14.75

SPECIAL FREE OFFER!

Electrical and Radio Tester sent absolutely FREE with each Progressive Radio Kit. PLUS FREE membership in Progressive Radio Club. Entitles you to free expert advice and consultation service with licensed radio technicians. Write for further information or ORDER your KIT NOW!

PROGRESSIVE AMPLIFIER KIT \$15⁷⁵

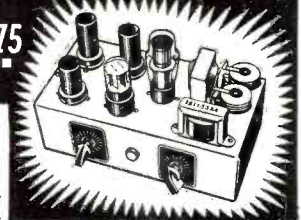

HIGH FIDELITY, HUMLESS AMPLIFIER SEVEN TUBE PERFORMANCE

This newest Progressive Kit will enable you to build a newly designed, high fidelity, humless amplifier.

Beautiful aluminum custom-punched chassis, etched tone and volume control plates.

Designed by former Western Electric engineer.

Ideal amplifier for television kit or set, FM tuner, AM tuner, microphone, phonograph, wire and instantaneous recorders.

Electrify your musical instruments by connecting them to the Progressive Amplifier by means of a contact mike.

Amplifier can be readily modified to match the GE reluctance pick-up.

Separate mike and phono input. Regulated power supply maintains constant voltage supply. DC heater supply, whether amplifier is used on AC or DC, provides humless operation by eliminating cathode-heater leakage

hum. Contains degenerative feedback for improved

frequency response, balanced phase inversion and push-pull beam power output. Every stage thoroughly decoupled to improve low-frequency response and to prevent motor boating. Tone and volume controls completely variable.

Seven-tube performance. Uses 2 selenium rectifiers, 2-beam power amplifiers, 1 high-mu pentode mike amplifier, 1 twin-triode phase inverter, and 1 voltage regulator tube.

PROGRESSIVE AMPLIFIER KIT
(less Tubes and Speaker) Only.....\$15.75

TUBES for Progressive Amplifier Kit

1-12SL7, 1-12SJ7, 1-VR75, 2-12A6's \$3.00
Complete Set, Only.....

BUILD A 5 TUBE AMPLIFIER Only...\$9.75

Ideal for phonograph, FM tuner or microphone. Has 5 tubes including rectifier. Kit is complete with tubes, chassis, volume control, tone control, radio parts, hook-up wire, solder and instructions. We can provide a 4-inch PM Speaker with

mounted output transformer to fit on chassis, priced at \$1.95. Or use this kit with your own Speaker. It has 5 watts output, more than enough to drive a 12-inch Speaker. \$9.75 ONLY.....

CONDENSER KIT

50 PAPER TUBULAR CONDENSERS

Values from .002 mfd. to .1 mfd. \$1.95
400 V. DC to 600 V. DC, Only.....

RESISTOR KIT

100 CARBON RESISTORS

1/2 Watt, RMA color-coded. Values from 120 ohms to 2.2 megohms. \$1.50

PROGRESSIVE RADIO TOOL KIT

Contains 75 Watt 110/120 Volt Soldering Iron, long nose pliers and cutters, screw-driver, insulated alignment tool.....\$3.25

MIDGET SOLDERING IRON

35 WATTS
110/120 Volts, UL approved.....69c

WRITE FOR PROGRESSIVE QUANTITY PRICES

PROGRESSIVE ELECTRONICS CO.

DEPT. RN-8 497 UNION AVENUE
BROOKLYN 11, NEW YORK

DUE TO POPULAR DEMAND WE REPEAT THESE TERRIFIC BARGAINS

- Three assorted new MICROPHONES, including push-to-talk type.....\$1.49
- Ten assorted R. F. Chokes including high frequency types.....\$.35
- Five assorted AUDIO or FILTER CHOKES.....\$.99
- One hundred assorted RESISTORS.....\$1.95
- Ten assorted JAN CABLE CONNECTORS, including SCR2T4, 522 and BC 375 types.....\$.99
- Six assorted OIL FILLED CAN TYPE CONDENSERS, all with mounting brackets.....\$1.49
- Ten assorted METAL & BAKELITE KNOBS—(no wooden knobs).....\$.39
- Six assorted VARIABLE CONDENSERS, including butterfly types.....\$1.49
- Six assorted POWER and AUDIO TRANSFORMERS, all new.....\$1.98
- Six assorted isolantite and bakelite R. F. COILS, shielded and unshielded.....\$.99

The above ten assortments totaling over \$12.00 at the unbelievable bargain prices listed can be purchased together as one lot at a super-special total price of only \$10.00. All merchandise guaranteed to be as advertised

Aluminum gear box 18x8x7 that contains two powerful electric motors and two matched gear trains, 62 gears in all varying in size from 1/4 to 4 inches in diameter. This unit is readily converted to rotate a beam antenna or any other similar usage.....\$3.00

BRAND NEW 110 V AC INPUT POWER SUPPLY, in grey enameled shock-mounted case 9" x 10" x 16". Several heavy duty resistors, 3 chokes, 4-1000 V and 600 V oil-filled condensers, 1 relay, 2-5U4's, 3 voltage regulator tubes, safety interlock, and several fuses are included in this regulated power supply at the bargain price of.....\$9.95

BC-221 FREQUENCY METERS with calibrating Crystal and calibration charts. A precision frequency standard that is useful for innumerable applications for laboratory technician, service man, amateur, and experimenter at the give away price of only \$36.95.

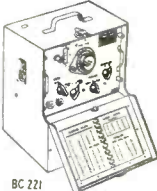

BC 221

- 100 KC crystal calibrator kit containing everything that is necessary to construct a 100 KC osc. that will supply 100 KC marker points to your receiver so that it may be used for frequency determination. The 100 KC crystal is worth far more than the price that we are asking for the complete kit.
- Kit 100K Plate and fil voltage supplied by receiver.....\$9.95
- Kit 100KA Same as above, including 110 VAC or DC self-contained power supply.....\$12.95

RT1463 7 tube amplifiers containing 3-7F7, 1-7N4, 3-7N7 4 potentiometers, numerous resistors, filter and bypass condensers, filter chokes, power and audio transformers, and six sensitive plate relays. A multi-rudder and elevator, in its original application. A control amplifier of the ordinary type would deflect the rudder by some arbitrary amount when the ship was blown off the course to port or starboard. The result would either be that the correction was insufficient and the plane continued off course, or the correction would be too great, starting a series of lockings and would greatly increase fuel consumption and elapsed time in reaching the objective. This phenomenal unit, with its 3 amplifiers and six 5000 ohm relays in bridge circuits will accurately control any 3 operations, related or unrelated, in minutely adjustable uniquely quantitative variations in either forward or reverse directions. 9"x12"x8" black crackle aluminum case. Brand new in original carton. \$9.95.

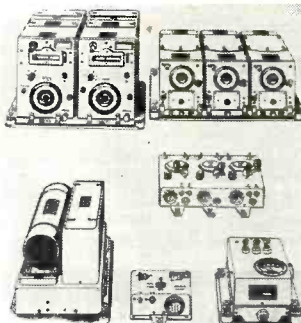

SCR-274N COMMAND SET

The greatest radio equipment value in history. A mountain of valuable equipment that includes 3 receivers covering 190 to 550 KC; 3 to 6 MC; and 6 to 9.1 MC. These receivers use plug-in coils, and consequently can be changed to any frequencies desired without conversion. Also included are two Tuning Control Boxes; 1 Antenna Coupling Box; four 28 V. Dynamotors (easily converted to 110 V operation); two 40-Watt Transmitters including crystals, and Pre-amplifier and Modulator 29 tubes supplied in all. Only a limited quantity available, so get your order in fast. Removed from unused aircraft and in guaranteed electrical condition. A super value at \$29.95, including crank type tuning knobs for receivers. Without these knobs the receivers can't be tuned, and are only useful for parts. Don't buy without knobs!

RECORDING AMPLIFIER, 3 stage, 110 V, 25 or 60 cycle high gain amplifier built by recently bankrupt manufacturer specifically for recording use. Transformer for low impedance wire recorder used or magnetic cutter included on chassis. Tone and volume controls and switches on chassis for playback, recording or use as public address amplifier. Complete with tubes—\$9.95.

14-Tube UHF Superhet Receiver — \$39.95

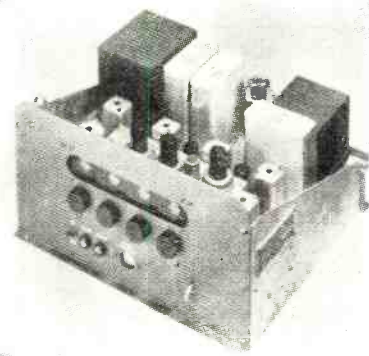

This beautifully constructed receiver was designed especially for Signal Corps communication service, and is one of the finest and most sensitive sets ever manufactured. Operating from 110V 60 cycles, this set has two tuned RF stages, tuned converter and oscillator, five I.F. stages, using iron-core IF's, a diode detector, tuning eye, and a two stage amplifier that will drive a speaker or phones. The frequency range is 158-210 Mcs. It is a simple matter to operate on other bands by making a slight alteration in the tuning coils. A complete set of tubes is included with each receiver, along with a circuit diagram and parts list. The high-voltage power supply delivers 150 milliamperes, and is well filtered by a heavy-duty choke and three 7 Mfd. oil-filled condensers. This buy of a lifetime cost the government about \$700. Amateurs and experimenters will never again be able to purchase fine equipment at such a tremendous saving! See January Radio Craft, Page 57, for complete conversion to television receiver.

GENERAL ELECTRIC 150 WATT TRANSMITTER

Cost the Government \$1800.00
Cost to you \$44.50!!!!

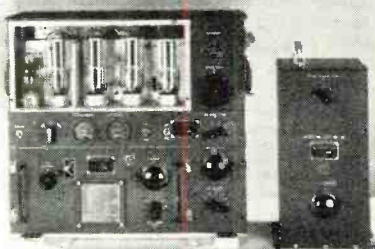

This is the famous transmitter used in U.S. Army bombers and ground stations, during the war. Its design and construction have been proved in service, under all kinds of conditions, all over the world. The entire frequency range is covered by means of plug-in tuning units which are included. Each tuning unit has its own oscillator and power amplifier coils and condensers, and antenna tuning circuits—all designed to operate at top efficiency under its particular frequency range. Transmitter and accessories are finished in black crackle, and the milliammeter, voltmeter, and ammeter are the same as used in the PE-109. These are the specifications: PE connect. This unit for 110V AC, using any supply capable of 400V DC at 135 MA. The ideal unit for use in mobile or stationary service in the Citizen's Radio Telephone Band where no license is necessary. Instructions and diagrams supplied for running the RT-1248 transmitter, either code or FM transmission or reception, for use as a mobile public address system, as on 80 to 110 Mc. FM broadcast receiver, as a Facsimile transmitter or receiver, as an amateur television transmitter or receiver, for remote control relay hookups, for Geiger-Mueller counter applications. It sells for only \$29.95 or \$52.90 if desired for marine or mobile use, the dynamotor which will work on either 12 or 24V DC and supply all power for the set is only \$15.00 additional.

meter, and RF ammeter are mounted on the front panel. 200 to 500 KC and 1500 to 12,500 KC. (Will operate on 10 and 20 meter band with slight modification.) OSCILLATOR: Self-excited, thermo compensated, and hand calibrated. POWER AMPLIFIER: Neutralized class "C" stage, using 211 tube, and equipped with antenna coupling circuit which matches practically any length antenna. MODULATOR: Class "B"—uses two 211 tubes. POWER SUPPLY: Supplied complete with dynamotor which furnishes 1000V at 350 MA. Complete instructions are furnished to operate set from 110V AC. SIZE: 21 1/2 x 23 9/16 inches. Total shipping weight 200 lbs., complete with all tubes, dynamotor power supply, five tuning units, antenna tuning unit and the essential plugs. These units have been removed from unused aircraft but are guaranteed to be in perfect condition.

BRAND NEW INVERTERS AND DYNAMOTORS

- PE 6A: A 24 to 32 V DC input, to 80 V AC regulated output converter—\$12.95.
- PE 19A: A 24 to 28 V DC input, to 80 V AC at 800 cps output—\$9.95.
- (We include a step-up transformer with each of the above so that 110 VAC is available from either.)
- 27 V DC input 285 V DC @ 75 MA output—98c.
- 27 V DC input. Output 300 V @ 150 MA, 150 V @ 15 MA and 12 V @ 5 Amp—\$5.95.
- 12 V DC input. Output 300 V @ 150 MA, 150 V @ 15 MA and 12 V @ 5 Amp—\$12.00.
- 13 or 26 V DC input. Output 800 V DC, 400 V DC @ 135 MA, and 9 V AC—\$15.00.
- By running on 6 V AC, 60 cycle input, with a small amount of DC for field excitation, the above dynamotor will provide a good source of 12, 24, 300 or 800 V DC.

GENERAL ELECTRIC RT-1248 15-TUBE TRANSMITTER-RECEIVER

TERRIFIC POWER—(20 watts) on any two instantly selected, easily pre-adjusted frequencies from 435 to 500 Mc. Transmitter uses 5 tubes including a Western Electric 316 A as final. Receiver uses 10 tubes including 955's as first detector and oscillator, and 3-7H7's as IF's, with 4 slug-tuned 40 Mc. IF transformers, plus a 7H7, 7E8's and 7F7's. In addition unit contains 8 relays designed to operate any sort of external equipment when actuated by a received signal from a similar set elsewhere. Originally designed for 12 volt operation, power supply is not included, as it is a cinch to get any amateur PE connect. This unit for 110V AC, using any supply capable of 400V DC at 135 MA. The ideal unit for use in mobile or stationary service in the Citizen's Radio Telephone Band where no license is necessary. Instructions and diagrams supplied for running the RT-1248 transmitter, either code or FM transmission or reception, for use as a mobile public address system, as on 80 to 110 Mc. FM broadcast receiver, as a Facsimile transmitter or receiver, as an amateur television transmitter or receiver, for remote control relay hookups, for Geiger-Mueller counter applications. It sells for only \$29.95 or \$52.90 if desired for marine or mobile use, the dynamotor which will work on either 12 or 24V DC and supply all power for the set is only \$15.00 additional.



SCR-284 TRANSMITTER-RECEIVER—This medium power transmitter and the accompanying 7-tube very sensitive receiver are naturals for 80 or 40 meter operation (phone or CW), on either fixed stations or mobile applications. These units are brand new and come complete with 17 tubes, key, microphone, 200 KC calibrating crystal and instructions and diagrams for use with up to 100 watts input to the final stage on 40 or 80 meters for either phone or CW, using vehicle or 110 Volt power supply. Your cost.....\$39.95

PE-109 32-VOLT DIRECT CURRENT POWER PLANT

This power plant consists of a gasoline engine that is direct coupled to a 2000 watt 32 volt DC generator. This unit is ideal for use in locations that are not serviced by commercial power or to run many of the surplus items that require 24-32V DC for operation. The price of this power plant is only \$58.95. We can also supply a converter that will supply 110V AC from the above unit or from any 16-32V DC source for \$12.95.

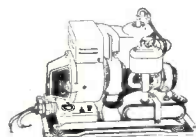

Minimum order \$3.00—All prices subject to change—25% deposit with COD orders.

RADIOMEN'S HEADQUARTERS * WORLD WIDE MAIL ORDER SERVICE !!!

BUFRAD CAR RADIO ANTENNAS

All of our car radio antennas are made of triple plated Admiralty Brass Tubing, complete with low loss shielded antenna leads and high quality fittings.

SIDE COWL—BR-1, 3 sections extend to 66". Your price—single units—\$1.50; in lots of 12—\$1.35 ea.

SKYSCRAPER—BR-2 has 4 heavy duty sections that extend to 98". Your price—single units—\$2.45; in lots of 12—\$2.25 ea.

TILT ANGLE—BR-3, may be adjusted to all body contours. 3 sections extend to 66". Single unit price—\$1.50; 12 lot price—\$1.25 ea.

VERSATILE—BR-4, single hole fender or top cowl mounting may be adjusted to conform with all body contours. 4 sections extend to 56". Single unit price—\$2.90; 12 lot price—\$2.75 ea.

THE MONARCH—BR-5, single hole top cowl mounting, 3 sections extend to 56". Single unit price—\$1.90; 12 lot price—\$1.75 ea.

BENDIX SCR 522—Very High Frequency Voice Transmitter-Receiver—100 to 156 MC. This job was good enough for the Joint Command to make it standard equipment in everything that flew, even though each set cost the Gov't \$250.00. Crystal Controlled and Amplitude Modulated—HIGH TRANSMITTER OUTPUT and 3 Microvolt Receiver Sensitivity gave good communication up to 180 miles at high altitudes. Receiver has ten tubes and transmitter has seven tubes, including two 83's. Furnished complete with 17 tubes, remote control unit, 4 crystals and the special wide band VHF antenna that was designed for this set. These sets have been removed from unused aircraft and are guaranteed to be in perfect condition. We include free parts and diagrams for the conversion to "continuously variable frequency coverage" in the receiver.

The SCR 522 complete with 24 volt dynamotor sells for only \$37.95. The SCR 522 is also available with a brand new 12 volt dynamotor for only \$42.95.

SPEAKERS—These PM speakers are the finest that are available. All have heavy oversize Alnico V magnets.

3 1/2"	\$1.15	6 for \$ 6.60
4"	\$1.15	6 for \$ 6.60
5"	\$1.10	10 for \$ 9.50
6"	\$1.50	6 for \$ 8.70
7" (Car Radio Size)	\$4.50	6 for \$21.50
8" 10 oz.	\$3.95	6 for \$20.50
8" 21 oz.	\$4.95	6 for \$26.50
10" 21 oz.	\$5.50	6 for \$30.00
12" 21 oz.	\$7.95	6 for \$42.00

AUTO RADIO DEALERS ATTENTION!

Nationally advertised brand of 1948 car radio which will fit practically any car and every pocketbook! Six tube super with three gang condenser and 6 1/2" speaker. \$32.20 for sample, or Dealer price \$29.97 each, in lots of two or more.

Here is an item that no serviceman who repairs auto radios should be without. Nationally advertised ATR battery eliminator that supplies perfectly filtered 12 VDC or 6 VDC at 14 amps, from 110 AC. \$36.00

RADIO SERVICEMEN!! Buffalo Radio Supply's lower prices mean increased profits for you. Order all of your needs from us and receive in return courteous service and first class merchandise at the lowest prices in the country.

TUBES: all types in stock, 60% off on all tube if ordered in lots of 10 or more.

TRANSFORMERS—All types in stock. **AUTO-TRANSFORMERS**: Steps up 110v to 220v, or steps down 220v to 110v—\$1.95. **FIL. TRANS.**: 6.3v, 8 Amps.—\$1.98; 5v, 10 Amps.—\$1.98; Universal Output Trans. 8 Watt—89c; 18 Watt—\$1.29; 30 Watt \$1.69. **AUDIO TRANSFORMERS**: S. Plate to S. Grid. 3:1—79c; S. Plate to P.P. Grids—79c; Heavy Duty Class AB or B. P.P. Inputs—\$1.49; Midset (output for AC-DC sets)—69c; **MIKE TRANSFORMER** for T-17 Shure microphone, similar to UTC oncuer type—\$2.00. Stancor SB or DB mike to line or grid—\$1.95.

POWER TRANSFORMERS—Half-shell type. 110V, 60 cy. Centertapped HV winding. Specify either 2.5 or 6.3V filament when ordering.
 For 4-5 tube sets—650V, 40MA, 5V & 2.5 or 6.3V.....\$1.49
 For 5-6 tube sets—650V, 45MA, 5V & 2.5 or 6.3V.....1.75
 For 6-7 tube sets—675V, 50MA, 5V & 2.5 or 6.3V.....1.90
 For 7-8 tube sets—700V, 70MA, 5V & 6.3 or two 2.5V.....2.35
 For 8-9 tube sets—700V-90MA, 5V-3A, 2.5V-3.5A.....2.85
 2.5V-10.5A.....2.85
 For 9-11 tube sets—700V, 100MA, 5V & 6.3V-4A.....2.85
 For 9-15 tube sets—600V, 150MA, 5V & 6.3V.....2.95

\$9.95 TAKES ALL THREE BIG BARGAINS

- AUDIO AMPLIFIER** Undreamed of value. Uses 6V6's. Has 4 microphone inputs brought to jacks at rear panel. Various output impedances available at rear panel connections. Steel case with chrome handles. 9" long x 6" high x 6" deep. Tubes included. New in original carton. Shipping weight 20 lbs. **SUPER SPECIAL—\$4.95** while supply lasts.
- RADIO HEADSETS** Latest supersensitive type with rubber earpieces. Every pair guaranteed perfect. **8.59 per pair OR 3 PAIRS FOR \$1.00.**
- HOME WORKSHOP AT BARGAIN PRICE** Accurate and precise 2 speed guaranteed hobby lathe, the essential machine for the home workshop. Sturdy enough for light production work or factory standby service, supplied with 56" of belt for connecting to any available electric motor or power take-off, such as on a jeep or tractor. Also included in this unbelievable offer are such accessories as a 1/2" drill chuck with specially hardened tool steel jaws, a 4" electric furnace high speed grinding wheel, a cotton buffing wheel with a large supply of buffing compound, and a 4" steel wire scratch brush. Your cost \$6.00. Sole export agent. Distributor inquiries invited.
N. C. O. D.—ORDER NOW—DON'T DELAY

Cable Address: BUFRAD

CLOSING OUT

THE FOLLOWING DESIRABLE ITEMS AT SACRIFICE PRICES TO MAKE ROOM IN OUR WAREHOUSE FOR INCOMING STOCK

LORAN INDICATOR OSCILLOSCOPE complete with 26 tubes in a five inch Cathode Ray Tube. Greatly superior to other scopes because the multivibrator circuit inc. can be used to present two traces simultaneously on screen. This input and output and amplifier stage can be viewed at same time on screen distortion is indicated conclusively by difference between input and output traces while fidelity is made evident by identical traces. Government instruction manual included. \$39.95.

47A ONE KILOWATT HIGH FREQUENCY TRANSMITTER. This relay controlled transmitter includes a 115 V, 60 cycle power supply protected by 3 magnetic circuit breakers, that alone is worth more than the price we are asking for the whole rig, even on today's surplus market. On the front panel are six 3 1/2" GE or Weston meters, including 250 MA, 50 MA, 1000 MA, 150 V AC and 1500 V DC at 1000 ohms per volt for screens and plate. The rack-type 21" x 15" x 36" unit contains six amplifier and rectifier tubes aggregating over \$60.00 at WAA current wholesale prices. Western Electric's price to the government was \$1500.00. Shipping weight 400 lbs. Your cost at lowest price as is. Formerly \$69.95, now only \$39.95

CONDENSERS—PAPER TUBULAR 600 WV—001, 002, 005—8c; 01, 05—9c; 1—10c; 25—23c; 5—36c; **ELECTROLYTICS** 8mfd 200v—20c; 10mfd 35v—20c; 30mfd 150v—23c; 20/20mfd 150v—35c; 30/20 150v—46c; 60mfd 150v—43c; 8mfd 475v—34c; 16mfd 350v—65c; **OIL CONDENSERS**: 4mfd 600v—49c; 2mfd. 600v—29c; 8X 1mfd. 600v—29c.

FILTER CHOKES: 200, 300, 400, 500 ohm light duty—59c; 200 or 300 ohm heavy duty—99c; 250 ma 35 ohm, made for U.S. Navy, fully shielded—\$1.95; 75 ohm 125 ma—25c or 25 for \$4.25; "Meisen" type tapped filter chokes—25c; 8 amp. iron core A filter—25c; Choke-condenser combination, ideal to replace any size speaker field when installing PM speakers—79c. **110 V. CIRCUIT BREAKERS** of Magnetic type: Following Current Ratings in Stock; 1, 2.5, 3, 4, 8 Amps. Please specify. \$1.95 each. Seven Assorted I.F. Transformers—\$1.98; Five Ass'd. Oscillator Coils—69c.

SELENIUM RECTIFIERS—Dry disc type 1 1/2" by 1" 1.2 Amp maximum, suitable for converting DC relays to AC, for supplying filament source in portable radios, converting DC meters to AC applications, and also may be used in low current chargers—90c.

METER RECTIFIERS—Full wave, may be used for replacement, or in construction of all types of test equipment—\$1.25. Half Wave—90c.

MICROPHONES—All nationally known brands. Bullet Crystal—\$5.45; Bullet Dynamic—\$7.45; Mike Jr.—60c; Handy Mike—90c; Lapel Mike—93c; SHURE T-17 MIKES, with push to talk switch—99c. **20 ASS'D COIL FORMS**, including 11 ceramic, 3 polystyrene, and 6 fiber. all useful sizes—50c. **VARIABLE CONDENSERS**: 350 MMFD, 5 gang—\$1.95; 4 gang—\$1.49; 3 gang—83c; 7.5 to 20 MMFD, 1750v spacing, extra long shaft Hammarlund—69c; miniature variables 25 MMFD—39c; 50 MMFD—49c; 75 MMFD—59c; 100 MMFD—69c; 140 MMFD—79c.

INTERRUPTION FREQUENCY COILS for super-regenerative receivers or the tremendously popular FM adapters for standard broadcast sets. Iron core with a resonant frequency of 50 KC—39c; Air Core, 100 KC—29c.

30 MC IF TRANSFORMERS, double slug tuned—25c. **30 MC (VIDEO) AMPLIFIER PLATE COILS**—Slug tuned—25c. **REMOTE CONTROL UNIT**: Aluminum case 4x3x2" containing 2 potentiometers, triple pole switch, 4 knobs, gear mechanism, counter and phone jacks—59c.

MODULATION TRANSFORMERS—30-watt, open-type, \$1.95; 40 watt, cast aluminum case, \$2.95; Class "B" input transformers, cast aluminum case, \$1.95; Transceiver audio transformers, 65c; Transceiver modulation transformers, 65c. Miniature Diers set contains one of each of the following: Needle nose, flat nose, parrot nose, standard nose. All contained in a leatherette case. Your cost—\$1.98.

SOCKET WRENCH SET consisting of 5 sockets ranging in size from 5/16 to 1/2" and a handle—79c.



BR1 BR2 BR3 BR4 BR5

RT-1579 consists of a three stage (cascade 6S37s and 6F6 output stage) high gain, high fidelity amplifier with 60 cycle, 110V power supply on the same 13 1/2 x 14 1/2 chassis, which is protected by a substantial steel cover over tubes and parts. Made by Western Electric with typical quality components such as a husky power transformer and oil condensers, this unit is obviously intended to give years of trouble-free service with no more need for repairs than a telephone. Disconnecting one wire each, from the special input and output filters, will result in as high a fidelity amplifier as can be obtained. Your cost with tubes, diagram and parts list included—\$14.95

We also offer the RT-1579 with a Raytheon Magnetic Voltage Regulator already installed beneath the chassis. Imagine an amplifier complete with tubes, built to Western Electric quality standards, and immune to line voltage variations besides, making it perfectly suited for the most difficult industrial, circus, carnival, or commercial installations, offered for a total price of only \$19.95, our price for both units.

AT LAST YOU CAN AFFORD A LABORATORY STANDARD MICRO VOLT

The famous Measurements Corp. Model 78B, 5 Tube Laboratory Standard Signal Generator (that sold new, FOB Bonton, N. J., for \$310.00 net), is available in perfect condition for 25 to 60 cycle, 115 V AC operation. Until now this is the sort of top-flight lab equipment that discriminating buyers have only vainly hoped would be released at a bargain price. Worth every cent the manufacturer asks but available FOB Buffalo while our limited supply lasts for only \$79.95.

Such companies as Admiral Corp. and John Meek, Inc., have ordered from us and repeated many times on these 78 generators for use in their labs and production line testing.

"REMEMBER THAT A STANDARD IS ONLY AS RELIABLE AS ITS MAKER."

deposit with C.O.D. orders

Minimum order \$3.00—All prices subject to change—25%

BUFFALO RADIO SUPPLY, 219-221 Genesee St., Dept. 4N, BUFFALO 3, N. Y. CABLE ADDRESS BUFRAD

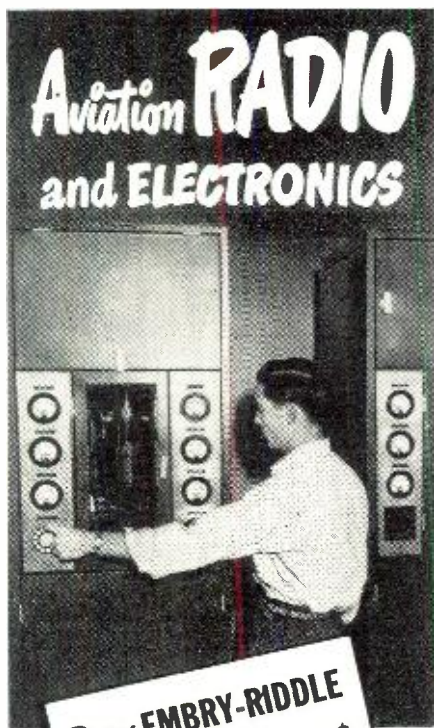

Aviation RADIO and ELECTRONICS

Pay EMBRY-RIDDLE GRADUATES \$\$\$\$
... with a real future

Emory-Riddle-trained aviation radio and electronics technicians and mechanics make top pay in important radio jobs everywhere.

The radio industry needs skilled men. Embry-Riddle has fully staffed, fully equipped laboratories and classrooms for radio and all standard aviation courses as well.

Excellent dormitories are available at Embry-Riddle. Use your opportunity for expert radio and electronics training in busy, beautiful Miami—gateway to radio opportunities and aviation hub of the Americas. Mail coupon for full information TODAY!

Authorized G. I. Training



Dean of Enrollments - Dept. 65 Embry-Riddle School of Aviation
PLEASE PRINT Miami 36, Florida

Name _____ Age _____

Address _____

City _____ State _____

I am interested in Flight Training Technical Training

Check One: Veteran Non-Veteran

STUDY IN MIAMI... AIR CAPITAL OF THE WORLD

522 Transmitter

(Continued from page 50)

the control shafts, plug in a crystal, and push home the appropriate slider. For ten meters the crystal frequency should be between 7.0 and 7.425 megacycles, or 14.0 and 14.85 megacycles (either works well). Set the oscillator tuning condenser to approximately 130 megacycles on the scale. Turn the meter switch to position five (amplifier grid current). Apply power, and tune the 12A6 tuning condenser for maximum meter deflection. Remove power and turn meter switch to position three (power amplifier plate current), apply power again and tune the final amplifier condenser for a sharp dip in the plate current. Connect the antenna and adjust the link to draw 60 to 70 milliamperes. (Full scale of the meter in this position is 100 milliamperes.) Next return the meter switch to position five and peak the exciter stages for maximum grid current.

Other crystal frequencies may be used. For ten meters 9.333 mc. to 9.9 mc. crystals will have harmonics that fall in the 28 mc. band. For six meter application 10 mc. to 10.8 mc. crystals can be used with the fifth harmonics falling in the 50 to 54 mc. band.

After tuning the transmitter on the various channels, carefully hold the controls immovable and tighten the wing nuts. After this is done it is only necessary to push in the proper slider to change frequency.

Tuning is the same on 50-54 megacycles, except that 8.3333 to 9.0 megacycles crystals are used, and the oscillator is tuned to about 150 megacycles. It is possible to pick off the wrong harmonic in the 12A6 stage, unless care is used. If three turns are

28 megacycles	
Amplifier coil:	14 t. #16 wire, 1 1/8" diam. Turns spaced wire diameter with 3/8" gap in center to accommodate antenna coil
Antenna coil:	3 t. #16 wire, 1 1/8" diam., closewound
50 megacycles	
Amplifier coil:	10 t. #14 wire, 3/4" diam. Turns spaced slightly more than wire diameter with a 3/8" gap in center to accommodate antenna coil
Antenna coil:	3 t. #14 wire, 3/4" diam., closewound

Table I. Coil winding specifications.

removed from the coil, the peak near the 150 megacycle mark on the scale is the correct one.

Power output of 12 to 14 watts is obtainable on both bands at an input of 20 watts to the final amplifier.

The unused parts were not removed from the transmitter so it might be returned to two-meter operation if desired. Furthermore, no effort was made to install switches, etc., to switch bands, because it is more satisfactory to have separate transmitters for each band. However, by converting the transmitter for 50-megacycle operation, it is possible to add enough capacity to the 12A6 stage to permit it to tune to 28 megacycles. In this case small banana plugs and jacks will permit changing the amplifier inductance.

No easy solution for including the 144-megacycle band in a rapid-change arrangement is immediately apparent, but with a soldering iron, either transmitter may be put back on 144 megacycles in five minutes.

(EDITOR'S NOTE: Regarding the meter switch, position one is plate current to the 12A6 frequency multiplier, with a full-scale range of 50 milliamperes, two is plate current to the 832A tripler, with a range of 100 milliamperes. On some transmitters position four is the carrier level indicator, while on others this position is blank, as is position six on all models.)

-30-

Top view. Coupling condensers to 832A tripler can be seen (center of photo) unsoldered and bent away from the 12A6's tuning condenser. The #12 wires connected to the tuning condenser carry excitation voltages to final amplifier. Coil which is modified for 6-meter operation can be seen, partly hidden, by the horizontally positioned tube.

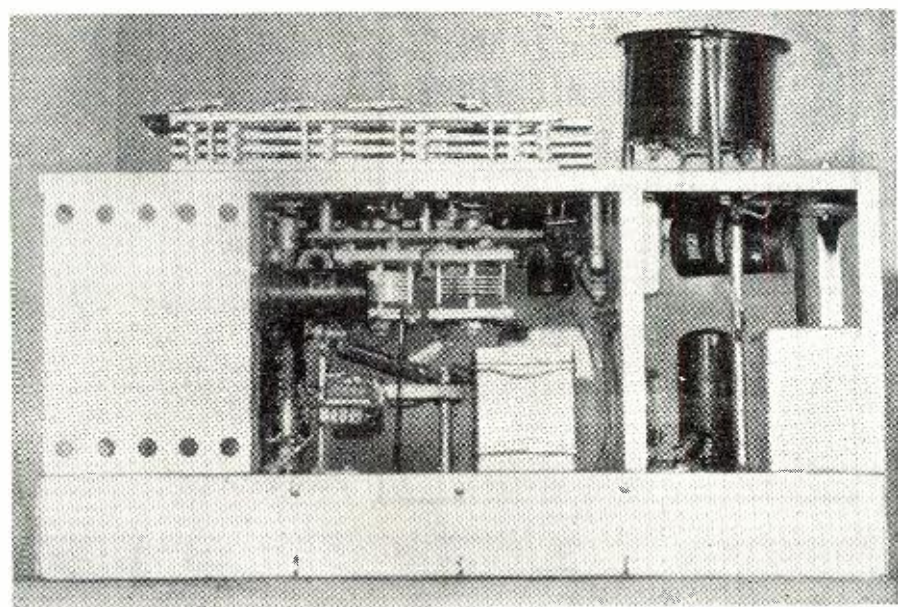

War Surplus Bargains Sold As Used Unless Otherwise Specified!



RADIO ALTIMETER APN/1

A complete 460 mc. radio receiver and transmitter which can be converted for ham or commercial use. Tubes used and included: 4-12SH7, 3-12SJ7, 2-6H6, 1-VR150, 2-955, 2-9004. Other components such as relays, 24 V dynamotor, transformers, pots, condensers, etc., make this a buy on which you can not go wrong. Complete as shown in aluminum case 18"x7"x7 1/4".

\$895

NAVY CRV-46151 AIRCRAFT RADIO RECEIVER

INCLUDING CASE

\$1950

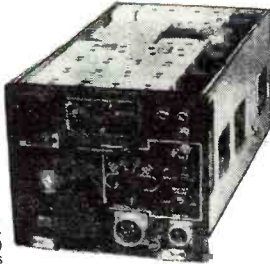

Four bands, including broadcast (195-9.050 KC). Circuit is six-tube super-heterodyne with mechanical band change or remote operated electrical band change. Remote band change and tuning controls included, making this set readily adaptable to mobile ham use. Powered from self-contained 24 V. DC dynamotor. The sets are complete with tubes, mounting rack and remote controls. No cables or plugs.

AIRCRAFT TRANSMITTER BC-475A or BC458A

Ideal to make over for master oscillator. Priced complete with tubes. Has built-in crystal for dial calibration. Used but in good condition. 5.3-7 MC or 4-5.3 MC FREE Mounting Rack with order of two or more.



\$395

3-4 MC\$5.75

INTERPHONE AMPLIFIER RL-7

Convert to high fidelity phone Amp. or speech Amp. Complete with tubes and dynamotor, for 24 V. DC operation. Used but in good condition.

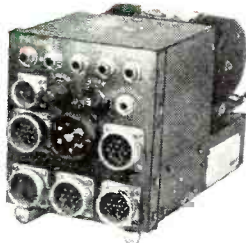

SPECIAL PRICE **\$195**

TERMS: CASH WITH ORDER

AMERICAN SURPLUS PRODUCTS CO.

537 N. CAPITOL AVE. INDIANAPOLIS, IND.

ARC-4 TRANSMITTER & REC.

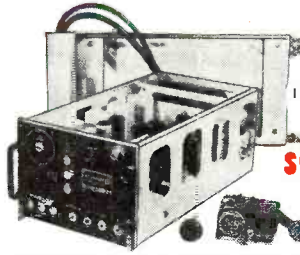

INCLUDING CASE

\$1795

Operates on any of its 4 predetermined crystal controlled frequencies in the range of 140 MC. Complete with tubes, remote control junction box, shock mounting base and connecting plugs. This unit is ideal for amateur UHF or mobile telephone. Operates from self-contained 24 V DC dynamotor.

(HRU) DC POWER SUPPLY

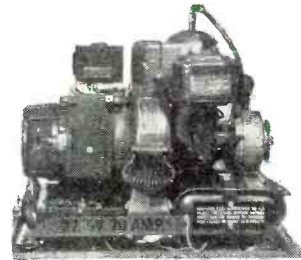

24-28 V. at 70 amp. 2000 watts gasoline engine generator with electric starter. Power supply which can be used to operate 24-28 V. equipment, start airplane engines, charge

\$7250

batteries, as a welding machine, lighting system, or for amateur radio station. 21 1/2" x 17 1/2" x 2 5/8". Wgt., 115 lbs. Includes 20 ft. plug-in cable.



BRAND NEW SCR-625 MINE DETECTORS

ATTENTION, PROSPECTORS, MINERS, OIL COMPANIES, PLUMBERS, ETC.

Used by the Army to detect buried metallic mines. Its private use suggests the location of underground or underwater pipes, cables and ore-bearing rock, the location of metallic fragments in scrap materials, logs, etc., and the screening of personnel in plants for carrying of metallic objects.

New, complete in original overseas packing container. Originally sold by War Assets for \$166.00. The U. S. Forestry Service has recommended procedure for using the SCR-625 Mine Detector to find concealed metal in tree logs and other timber products.

\$7950

SCR-274N COMMAND SET

SCR-274N Transmitter and Receiver Assembly consists of 13 pieces which are: 4 dynamotors, 1 modulator, 1 remote control box, 2 transmitters, 3 receivers and one antenna relay unit and it has its own individual dynamotor. Each receiver employs 12 V. tubes. Each transmitter contains four 12 V. tubes and has a variable frequency and crystal calibrated master oscillator, driving two 1625 final amplifier tubes, 55-watt output, with built-in silver plated variable inductance antenna matching device. Oscillator and final stage have simultaneous tuning and the dial is directly calibrated in MC. Transmitters have slugged and capacity tuning, built-in high voltage and antenna switches. Modulator furnishes plate supply for transmitters and is equipped with a dynamotor for high voltage. Also supplied is one antenna relay with built-in antenna meter. Transmitters make ideal VFO driver unit. Easily converted to 110 V. 60 cycle operation. Wt. approximately 100 lbs. PRICE

\$1995

R5/ARN-7 RECEIVER

ONLY

\$1995



control heads available

\$2.50 Each

Three bands 200 to 1750 KC. Complete with 17 tubes required. This set is ideal for conversion to home broadcast Receiver addition to ham shack, etc. Reported sold for many times the price when brand new. A Receiver that would be hard to pick up at this price.

PRICES F.O.B. INDIANAPOLIS

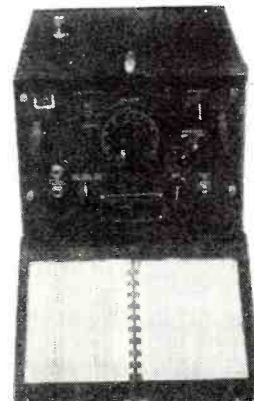

BC-221 FREQUENCY METER

Covers 125-20,000 Kc. Battery operated. Beautiful equipment.

\$4995



OXYGEN TANKS

These oxygen tanks, removed from surplus aircraft, have a capacity of 500 lbs. pressure. Type D2, with complete regulator assembly. Size of tank 22"x5". Weight 7 lbs.

\$595

TERMS: CASH WITH ORDER

AMERICAN SURPLUS PRODUCTS CO.

537 N. CAPITOL AVE. INDIANAPOLIS, IND.



Find Astatic's New "QT" Phonograph Cartridges Ideal for Practically every Replacement Demand

● For quiet, faithful reproduction, freedom from needle talk, relatively high output, and excellent tone range, the "QT" Cartridge is a modern replacement favorite. In addition, this new Cartridge is reasonably priced, simple to mount and connect, and designed for long life and record protection. Special literature is available.



Type "Q" Matched Replaceable Needles used with Model "QT" Cartridges

Precious Metal Tip

Sapphire Tip

Mac's Service Shop
(Continued from page 63)

bench with a metal hood arrangement that came down to within about eighteen inches of the top of the bench.

"Here is where you clean up the chassis and speaker of each set after you have taken them out of the cabinet," Mac explained. He snapped a switch, and there was the whir of a powerful fan accompanied by the throbbing of a small paint-spray compressor underneath the bench.

"You put the chassis on this bench and turn on that exhaust fan," Mac yelled above the noise. "Then you use these brushes to brush off all the dust and lint you can. The fan will carry it off. The compressed-air jet here will help a lot, too. Be sure and blow the dust out of the tuning condenser plates. If there is any gummy dirt on the chassis—and there usually is around the transformer—use the carbon-tet to loosen it and wipe it off. Clean the speaker, too. The main point is that I want all the dirt off. I want every chassis and every speaker to be shining clean before you set them on the service bench."

Mac turned off the switch and closed the door. From a cabinet he took out a little hand-type vacuum cleaner.

"This," he explained, "is the gadget you use to clean out the cabinets, helping things along a bit in the corners with a little brush. After the cabinet is all cleaned inside, you wipe off the outside with a damp cloth and then go over it with furniture polish."

He stopped talking to find Barney grinning broadly.

"What's so funny?" Mac asked. "I was just thinking that Mom was a little worried at first about my working in a radio shop. She was afraid I might get electrocuted. When I go home tonight I am going to tell her that the worst she has to worry about is that I'll be getting dishpan hands or housemaid's knee."

"I suppose it does sound a little that way now," Mac said, "but radio servicing is a lot more things than watching a pattern on a scope. Good preparation is half of any job. All this asking questions and this cleaning may not sound very glamorous, but they are part of the preparation. The questions tell you what to look for and where to look. You will find, too, that there is something about a bright, clean radio that makes you do your workmanlike best on it."

"I didn't mean that the way it sounded, Mr. McGregor," Barney said in quick seriousness. "I was just making a little joke for Mom."

"I realize that, Barney; and what say we drop the 'Mr. McGregor' business. I'll settle for 'Mac.'"

In a twinkling Barney's face was wreathed in its usual grin. "Okay, Mac," he said softly, "and you may as well quit fighting it and start calling me 'Red.' You know you want to!"

WELLER SOLDERING GUN
Time Saving-Money Making Features

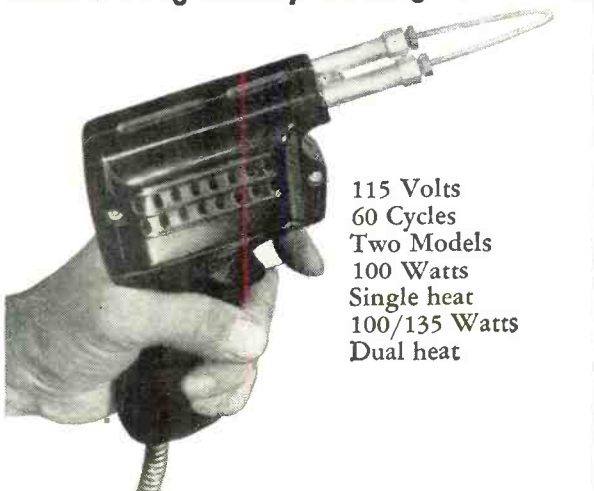

115 Volts
60 Cycles
Two Models
100 Watts
Single heat
100/135 Watts
Dual heat

See your radio parts distributor or electrical wholesaler. Or write direct for bulletin.

WELLER Mfg. Co.
810 Packer St. • Easton, Pa.

5 SECOND HEATING

ADJUSTABLE TIP

BUILT-IN SPOTLIGHT

LONG REACH

DUAL HEAT

DAVEGA COMMUNICATIONS DIVISION

Presenting the **NEW MODEL S-53**

...to give amateurs:

MORE VALUE
 Never before all these features at this price

GREATER PERFORMANCE

LOWER PRICE
\$79⁵⁰



MODEL S-53

The latest addition to the Hallicrafters Communication Receiver line exhibits performance complimentary to the most recent engineering developments. Tuning Range: 540 KC to 31 MC, 48 MC to 54.5 in five bands. No image on amateur bands. Seven tubes plus rectifier.

ONLY
\$79⁵⁰



MODEL S-51

FOR LAND . . . SEA . . . AIR COMMUNICATIONS. Tuning Range: 132 KC to 13 MC. AC-DC power, three fixed frequency channels for aircraft, ships and telephone communications. Ideal for yacht owner and landlubber. Another Hallicrafter achievement.

ONLY
\$129⁵⁰

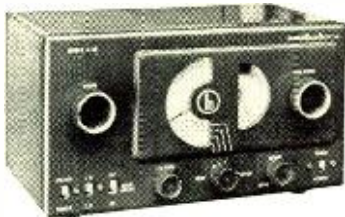

MODEL S-38

Overall frequency range from 540 KC to 32 MC in four bands. Compact and rugged. AC-DC. Built-in speaker. Tens of thousands sold. 5 Tubes plus rectifier.

ONLY
\$47⁵⁰

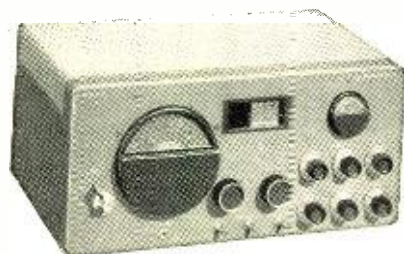

MODEL SX-43

The SX-43 offers continuous coverage from 540 KC to 55 MC and has an additional band from 88 to 108 MC. AM reception all bands. CW on four lower bands and unbelievable pure tone on the FM frequencies above 44 MC.

ONLY
\$169⁵⁰

Speaker additional\$19.50

DAVEGA

MAIL COUPON FOR DESCRIPTIVE LITERATURE

DAVEGA COMMUNICATIONS DIVISION
 63 Cortlandt Street, New York 7, N.Y.

Please send full information on Communications Receivers without obligation.

NAME.....

ADDRESS.....

CITY.....

RN-11

AMAZING NEW LOW PRICES!

7" and 10" TV "TELEKITS"

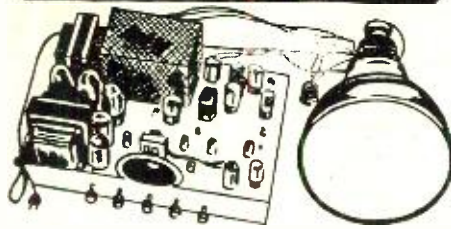

Never before have television kits manufactured by one of the country's leading firms been offered at such a low price! They're easy to assemble . . . with guaranteed performance. Each kit complete with instruction books, photos and diagrams. Ideal for beginner or experienced radio technician.

**SEVEN-INCH KIT WITH
13-CHANNEL TUNER** **59⁵⁰**
Less Tubes & Cabinet

Number 7 is the perfect set for the television beginner, and brings better picture reception than commercial receivers of its size. The new 13-Channel Tuner is pre-wired and factory aligned for the entire Television spectrum of 13 channels. The kit builder merely installs this unit into the Telekit chassis and makes 3 connections. Contains R. F. Stage, Oscillator and Mixer. High voltage transformer insures brilliant, sharply focussed pictures. Sound reception is high quality F.M.

Tube Kit Including 16 Tubes Plus 7" Picture Tube 39.50 Cabinet 21.00

**TEN-INCH KIT WITH
13-CHANNEL TUNER** **99⁵⁰**
Less Tubes & Cabinet

- Incorporation of the Telekit Thirteen Channel Tuner
- Uses the modern flyback transformer method of securing the 10,000 volt second anode supply for 10BP4 Picture Tube
- Magnetic deflection and focusing
- Ion trap electromagnet prevents burning of screen
- Uses two complete low voltage power supplies which prevent interaction between picture and sweep circuits
- Features the T.T.I. sync interlock circuits which insures stability under low signal strength and noisy conditions.

Tube Kit Including 18 Tubes Plus 10" Picture Tube 59.95 Cabinet 23.50

STEEL PARTS CABINET

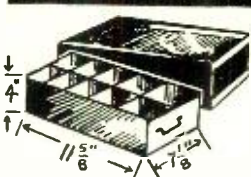

367

Heavy gauge steel. 10 partitions. Ideal for resistors, condensers and other small parts. Buy several—they can be stacked upon one another.

Radio Electric
SERVICE CO. OF PENNA., INC.

7TH AND ARCH STREETS, PHILA. 6, PENNA.
Branches 5930 Market St. and 3145 N. Broad St. in Phila.
Also in Wilmington, Del., Easton, Pa., Allentown, Pa., Camden, N. J.

Recording of Sound

(Continued from page 73)

ing material, is to make possible the inclusion of an abrasive which is added to the compound for purposes of sharpening a steel playback stylus.

The conventional sharply pointed steel reproducing needle (Fig. 5B) is familiar. When initially employed on a record, considerable hiss is present due to the sharp needle point of the stylus engaging the bottom of the groove of the record. Due to the speed and grinding action of the revolving record there will be a gradual wearing of the needle point. While initial surface noise reduces somewhat during playing, distortion will result as the reproducing stylus becomes worn. The abrasive material in the record will grind off the sharp point of the needle and the stylus will assume a rounded and somewhat distorted point. If permitted to run for any length of time, the walls of the groove will be torn and worn from improper seating, hence the necessity for changing needles, as is done with the conventional phonograph.

With the advent of *permanent* point types (sapphire, diamond, etc.) of stylus tips, this condition has been somewhat alleviated. The stylus tip is not worn due to its ability to maintain its initial shape for many thousands of playings. Such styli are less hazardous to the life of the record. Normally, looking directly from the end cross-section of a groove, we find

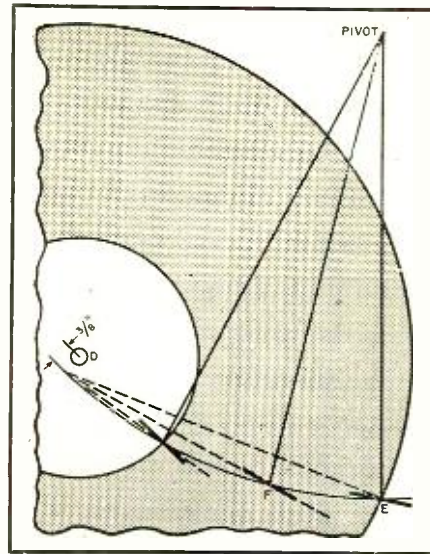

Fig. 3. Reproducing needle swings in arc below hub line.

that it is V-shaped. Obviously a sharp pointed needle, when used on a new record, engages only the bottom of this groove. Inasmuch as modulation is on the *walls* of the groove, there is no proper seating or contact with the walls of the groove for many revolutions of the disc.

Pinching Effect

A flat tool-like chisel point is used, as explained in Part 13, which cuts the groove in a revolving recording blank. The face of the *cutting stylus* cuts a groove of even width providing no sound is impressed on the cutter.

Fig. 4. Method for determining correct tone arm length and included angle of offset.

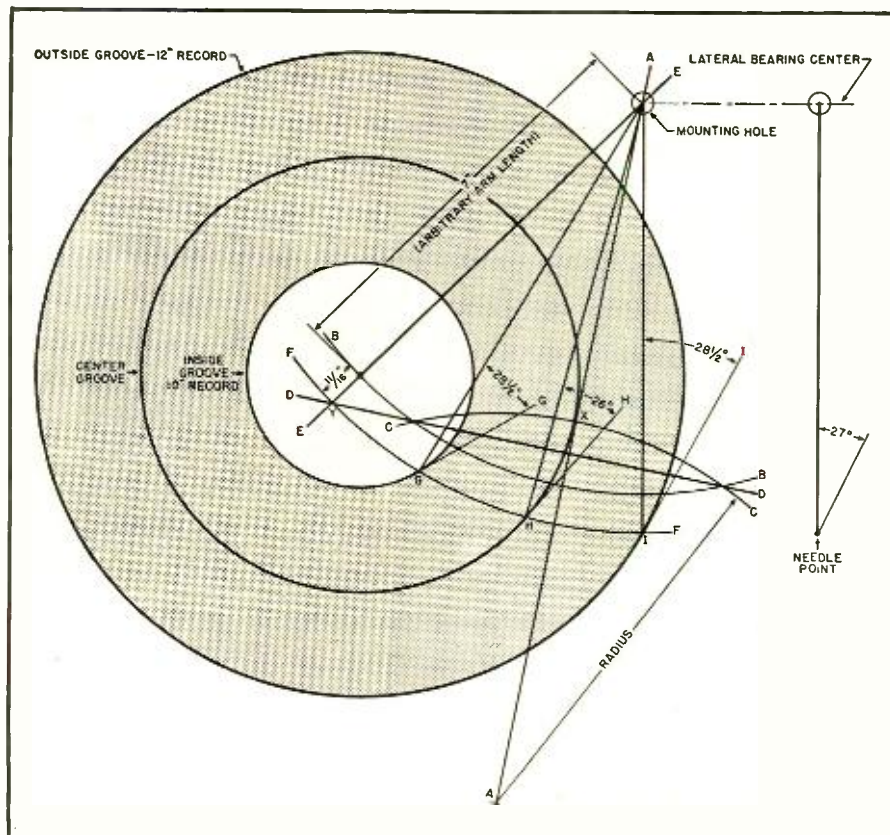

**THE
BEST BUY
IN WIRE**

GENERAL PURPOSE HOOK-UP WIRE

EVERY FOOT GUARANTEED! For all uses where a low loss dielectric is required. Every foot guaranteed to give you the best buy in wire. Buy it in hundred or hundred thousand lots.

DESCRIPTION	Per 100 Feet	Per 1000 Feet	
#12 Stranded	\$1.15	\$9.00	#22 Magnet wire, cotton covered, per lb.\$.75
#16 Stranded	.95	7.50	#22 Magnet wire, plain enameled, per lb.60
#18 Choice of Sol. or Str.	.75	6.50	"Limp" test prod wire, per 100 feet. 1.75
#20 Choice of Sol. or Str.	.65	5.50	
#22 Choice of Sol. or Str.	.55	3.75	
#24 Solid	.45	3.50	

Please specify first and second choice of colors.

**LOW PRICE AND EXCELLENT QUALITY
NEED NO LENGTHY BUILD-UP**

ITUBES



All parts included to build this unit . . . tubes: 2—35L6; 1—12SL7; 1—35Z5; Punched chassis, 6" P.M. Speaker, diagram, pictorials, output transformer, etc.

\$775

Kit Complete as Shown

HI-FI PHONO AMPLIFIER KIT

HAS 7 IMPORTANT FEATURES:

1. 4 W. Audio Output.
2. Gain, enough for Phonograph, Radio, F.M. Tuner, Carbon Mike.
3. H-Fi response, 50-20,000 C.P.S.
4. Variable Tone Control.
5. 3 section filter assures extremely low hum level.
6. Push-Pull balanced output.
7. Heavy Duty Universal Output Transformer.

MONEY BACK GUARANTEE

EVERY TUBE GUARANTEED

No "off" brands, seconds or used tubes. Money back with no questions asked if not completely satisfied.

1A5\$.50	6S850	12SH760
11C5 1.10	6SA750	12SK760
11C6 1.10	6SD750	12SN750
11H4 1.10	6SF760	12SQ760
11N5 1.10	6SG750	14A795
1N560	6SH750	14B675
1R575	6SJ750	14R775
1S575	6SK750	25Z660
1T475	6SL775	2650
2A550	6SN750	26A750
2C2650	6SQ750	2750
2C40 1.00	6SR750	35W450
2X2 1.00	6V650	35Y475
3B24 1.00	6X560	35Z560
5U450	7B660	39/4450
5Y350	7C560	50B560
5Y450	7F775	50L660
6AC795	7F860	50X675
6AG575	7G795	5650
6AK575	7H795	7550
6AT650	7N760	7650
6B495	7Q760	7750
6B895	7Y460	7850
6C450	12A650	8050
6C875	12AH775	84/6Z450
6F775	12AT650	884 1.00
6H650	12BA660	95450
6J550	12BE660	95550
6J650	12J550	95650
6J760	12SA760	900150
6K650	12SF760	900250
6K760	12SG760	900650

DEDUCT 10% from all tube orders \$20.00 or more.

SAVE ON THESE ASSORTMENTS Resistor Assortments

100 assorted 1/2, 1, 2, 5 and 10 watt resistors. All standard coded. Wide range of values. **\$1.95**

Paper Condenser Assortments
100 tubular by-pass condensers. All guaranteed, fresh stock. Wide range of useful sizes including many 600 W.V. condensers. 100 ass'd. **\$3.85**

Mica Condenser Assortment
50 mica condensers. All brand new—standard color coded. 50 assorted. **\$1.95**

Ceramic Condensers
100 assorted. **\$1.95**

25 POUNDS OF RADIO PARTS AND ASSEMBLIES

We still have plenty of good usable odds and ends and samples in our warehouse. Take advantage of the overloaded condition of our warehouse. Each kit contains 25 pounds of good and usable parts. Yours at the terrifically low price of 25 pounds for **\$3.00** Only.

ROTARY BAND SWITCHES

Furnished with Pointer Knob and Mounting Hardware.

Single pole 5 position
Single pole 12 position
Double pole 6 position
Four pole 2 position

Any 10 for \$3.15

ALL NEW - FIRST GRADE MERCHANDISE.

GUARANTEED CONTROLS

less Switch — 3/8" Shaft or longer
5,000 Ohm
10,000 Ohm
75,000 Ohm
500,000 Ohm
1,000,000 Ohm
2,000,000 Ohm
4,000,000 Ohm
5,000,000 Ohm

19c

Deduct 10% from all orders of 20 or more controls.

with Switch — 1 1/4" Shaft or longer
25,000 Ohm
250,000 Ohm
500,000 Ohm
1,000,000 Ohm
2,000,000 Ohm

39c

IRVING JOSEPH

220 S. Halsted St., Chicago 6, Ill.

50
to
18,000
C. P. S. !



THE NEW NC-108 FM TUNER-RECEIVER

Now...National offers an 88-108 Mc. band FM tuner-receiver designed to meet the most exacting demands of high-fidelity enthusiasts! Flat from 50 to 18,000 cps, ± 2 db, the new NC-108 may be connected to your amplifier or the phono input of your radio. Built-in speaker, audio output stage and tone control also permit use as separate monitoring receiver. Built to National's famous standards of quality, the NC-108 is worthy of the finest in amplifiers and speakers. Nine tubes plus rectifier and tuning eye.

\$99.50
Amateur Net

For complete specifications see the National dealer listed in the classified section of your 'phone book, or write direct to

National
EST. 1914
NATIONAL COMPANY, Inc.
MALDEN, MASSACHUSETTS

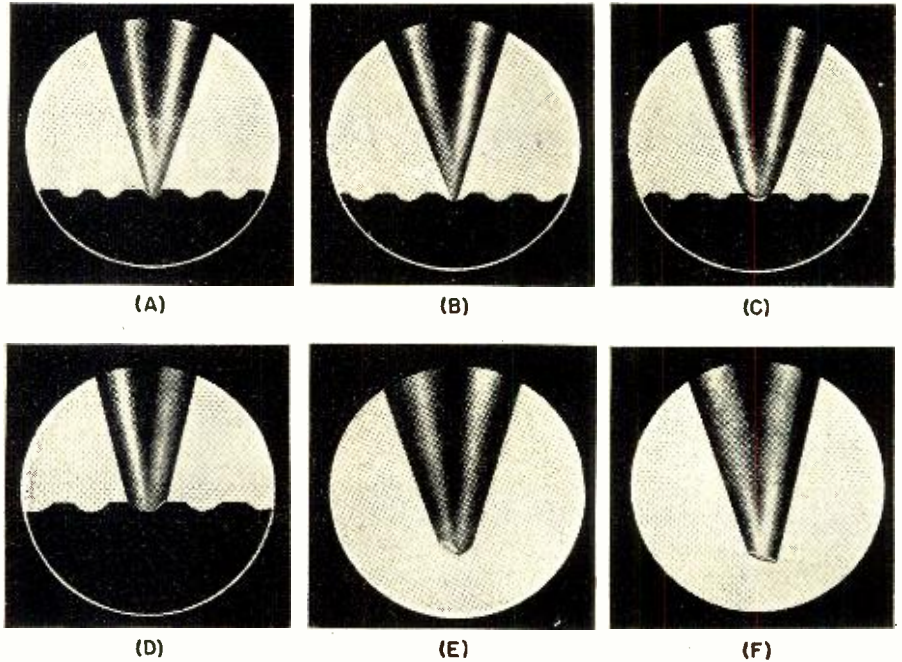

Fig. 5. Microphotographs of reproducing styli showing several conditions as met in everyday practice by the professional studio and by the home recordist. (A) a correctly seated stylus in a properly cut groove. (B) How a sharp point on the stylus can cut into the soft surface material. (C) Indicates the condition when a too rounded stylus rests on the walls of the groove. (D) A worn stylus ground to fit into the groove. (E) A chipped or defective stylus point. (F) Indicates a worn out or damaged needle point.

However, when modulation takes place the actual width of the groove varies with frequency, disc diameter, etc., as illustrated in Fig. 6.

A reproducing stylus has a rounded point, therefore, it is almost impossible for this point to seat properly in the modulated groove. The illustration, Fig. 6, serves to show the effect. Note, for example, that the width of the recording stylus at the maximum swing results in a certain dimension in the groove. Comparing this to the point of a reproducing stylus, we find that the tendency is for the point to ride out on the crest, or maximum modulation point, of that particular crest. Hence, sound vibrations are impressed on the needle at the farthest point of inertia. Actually, the point skids from side to side in the wider portions of the groove. Another possible cause of distortion, when the recording has been made with a chisel-shaped cutter and reproduced with a round point, occurs when the needle rounds a curve, as illustrated in Fig. 6.

There is no "cure-all" for the elimination of record wear and distortion. Suffice to say that the chief remedies are as follows: A perfectly level turntable free from mechanical vibration, a pickup having a tone arm with an offset head which permits a minimum degree of tracking error, and properly designed reproducing styli. By paying particular attention to these requirements, the recordists and music lovers may be assured that they have taken the necessary steps for the ultimate in reproduction.

One other important factor having an effect upon fidelity and its relation to record wear and distortion is in im-

proved design of the pickup cartridge and reproducing stylus. By employing a "knee action" as illustrated in Fig. 7 we can eliminate somewhat the pinching effect. A widening and narrowing of a groove results from a spade-like cutting point. The driving force of the record causes the stylus to move in a vertical direction and occurs at a frequency which is double that of the lateral motion of the groove. If this vertical movement of the stylus produces an electrical output (as it does in many common crystal pickups now on the market), the result is an appreciable amount of second harmonic distortion in the reproduced sound. At the same time, the pinch effect produces a mechanical reaction on the record and stylus, as previously explained. The magnitude of the pinch effect is inversely proportional to the distance from the center of the record. It may be seen by inspecting worn records that the greatest wear occurs near the center of the record. The pinch effect is undoubtedly responsible for greatly accelerating this record wear. In most of the newer pickups now used the mass of the moving parts is small enough so that the vertical inertia re-

Fig. 6. How rounded-point needle (A-A) skids like a toboggan in modulated groove.

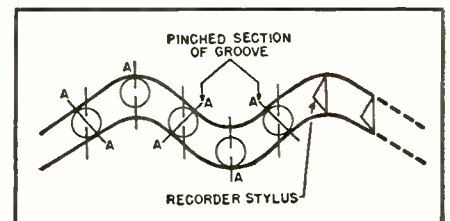

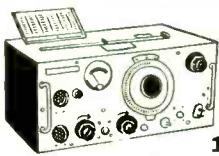

Test Set 159TPX

Measures frequency between 150 & 200 Mc. by heterodyne method. Pwr. Output of AMTR can be measured directly. Measures DC voltages up to 500 V. Operates on 110 V. 400 cy. Complete with tubes crystal, calibration chart. Conversion kit for 60 cy. \$29.95

BEST BUYS "Communications" LOWEST PRICES

CATHODE RAY TUBES

5BP1's—\$1.20

5FP7 - \$1.75
5JP2 - \$4.00

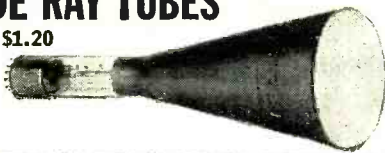

3BP1 - \$1.25
3FP7 - \$1.20

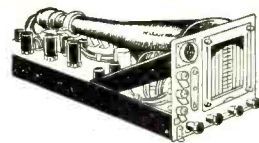

Radar Set SCR-521

Makes an excellent foundation unit for a high gain scope. Has following tubes: 4-6AC7, 3-6116, and 1-61P1 CR tube. Comes enclosed in metal shield. New, with all tubes, less power supply. With wooden carrying case \$17.50

Ceramicon Capacitors (Erie, Centralab) \$7.50 per 100

3 mmf. ±5%	67 mmf. ±20%
4 mmf. ±5%	100 mmf. ±2%
4 mmf. ±5%	115 mmf. ±2%
8.5 mmf. ±5%	120 mmf. ±5%
11 mmf. ±5%	240 mmf. ±3%
15 mmf. ±2.5%	250 mmf. —
48 mmf. ±2%	500 mmf. +15 - 30%
50 mmf. ±20%	1000 mmf. ±5%
60 mmf. ±3%	

Silver-Mica Button Capacitors (Erie, Centralab) \$9.50 per 100

185 mmf. ±2.5 mmf
175 mmf. ±2.5 mmf
500 mmf. ±10%

Sonar Sound Detection Unit

Ideal for detecting under water sounds, such as fish swimming in schools, within a 15 mile area. Using a Rochelle salt crystal, which is about 1000 times more sensitive than quartz. It is completely enclosed in a solid rubber sheath. This sound detector was originally used in harbor defense. Coupled to an audio amplifier, this can be found to have many valuable applications. It's the Model JR which contains 7 microphone units. \$12.50

Transformers (All Primaries 117 V. 60 Cycles)

No. 5102: 1080 VCT @ 55 Ma. 6.3 V. @ 1.2 Amp. \$2.35
No. 5110: 1100 V @ 70 Ma. tapped @ 550 V. (for use with H. W. rect.) \$2.75

Filament Transformers

No. 5123: 6.3 VCT @ 5 Amp. 6.3 VCT @ 1 Amp. \$2.15
No. 5109: 27 Volts @ 8.8 Amp. 6.3 V. @ 2.5 Amp. \$2.75
No. 13163: 2.5 V. @ 1.75 Amp. 5 V. @ 3 Amp. 6.5 V. @ 8 Amp. \$5.35

Doughnut Fil. Trnsr. Two 5.1 V. Windings @ 5 Amp. each. 15,000 volt test \$7.50

No. 5038: 6.3 VCT @ 2A. 6.3 VCT @ 2A. 6.3 VCT @ 2A. \$2.25
No. 5126: 5 VCT @ 3A. 5 VCT @ 3A. 5 VCT @ 6A. \$2.25
No. 5100: 6.3 VCT @ 1.2 A. 5000 V test. \$1.35
No. 5035: 6.3 VCT @ 6A. 6.3 VCT @ 1.2 A. \$1.40
No. 5056: 6.3 VCT @ 9 A. 6.3 VCT @ 2.2 A. 6.3 VCT @ 2.2 A. \$1.40
No. 5057: 6.3 VCT @ 1A. 5 VCT @ 3 A. 5 VCT @ 3 A. \$2.50
UX 6890: 5 V @ 5.5 A. 5 V @ 5.5 A. 99,000 volts Test. \$24.50

Power Chokes

6 Hy @ 150 Ma. \$1.50
6 Hy @ 300 Ma. \$2.25
1 Hy @ 800 Ma. 7.5 Ohms \$8.95
Dual Choke: 2-2 Hy @ 100 Ma. \$ 9.90
Dual Choke: 7 Hy @ 75 Ma. 11 Hy @ 60 Ma. \$1.50
2.5 h @ 125 Ma. \$1.50
2.5 h @ 65 Ma. \$1.10

ARC-5 ACCESSORIES

Conversion Coils for ARC-5 Xmttrs

M.O. Coils	P.A. Coils	Loading Coils	Freq. Range
\$1.00 Ea.	\$1.00 Ea.	\$ 8.85 Ea.	
No. 6029	No. 7247 (W.E.)	No. 6033	3-4 mc.
No. 6130	No. 9293	No. 6034	4-5.3 mc.
No. 6032	No. 6035	No. 6036	7-9.1 mc.

Kit, consisting of 1-MO and 1-PA coil in any one particular frequency range. \$1.50

Kit, consisting of 1-MO, 1-PA COIL, and 1-loading coil in any one particular frequency range. \$2.00

AIC No. 8558 variable receiving capacitor. 62 mmf./section. 3 sections. 3° spacing. Rotors. Worm drive ratio 3:1. \$1.75

ARC No. 4490, variable xmttr. capacitor. 22.4-145 mmf. 0.5° spacing. 11 rotors. Each \$1.00

ARC 5032, Var. Xmttr. capacitor. 29.2-117 mmf., .06° spacing. 16 rotors. worm drive. \$1.00

Single revr. mtg. racks \$1.50

Dual mtg. racks (revr.) \$1.50

BC band coil plus-in RF coils \$1.00

Shock mounts for rack \$ 5.50

DUAL CONTROL BOXES FOR RCVR'S \$1.00

Coax Cable and Plugs

RG9/U 51 ohm silver coated. Min 50 ft. length. per ft. .07 1/2
RG8/U 52 ohm. Min 40 ft. length. per ft. .04 1/2

Amphenol Low-Loss Series Connectors

83-1 R. Female .27c
83-1 AP. Rt. angle .27c

250 Watt Output Transformer

W. E. #K8 9496, H-I-F output. 9,000 ohm push-pull plates to 9 ohm voice coil. Freq. Response: -3 db @ 50 cps. -1.25 db @ 100 cps. 0 db @ 1,000 cps. 3 db @ 10,000 cps. 3db @ 50,000 cps. \$3.95

AN-122-A

DIPOLE ANTENNAS



MICROWAVE TUBES (Magnetrons)

Tube	Freq. Range	Pk. Pwr. Out	Price
2J31	2820-2860 mc	285 Kw	\$10.00
2J21-A (725-A)	3345-4005 mc	50 Kw	\$25.00
2J22	3267-3333 mc	265 Kw	\$15.00
2J26	2992-3019 mc	275 Kw	\$15.00
2J27	2905-2912 mc	275 Kw	\$15.00
2J31	2820-2860 mc	285 Kw	\$15.00
2J32	2780-2820 mc	285 Kw	\$15.00
2J38	PKG. 3249-3263 mc	5 Kw	\$25.00
2J55	PKG. 9345-9405 mc	50 Kw	\$25.00
3J31	24,000 mc	35 Kw	\$17.50
W. E. 700-A	680-710 mc	100 Kw	\$30.00
W. E. 720-BY	2800 mc	1000 Kw	\$25.00

MAGNETRONS for 2J21-A (725-A), 2J22, 2J26, 2J27, 2J31, 2J32, 2J32 and 3J31, each \$8.00

Field Strength (Gauss)	Distance Between Pole Pieces	Pole Face Diameter	Price
4850	3 3/8"	3 3/8"	\$8.00
1500	1 1/2"	1 3/8"	\$8.00
1000	Adjustable	2 1/8"	\$12.00
(Electromagnet) 2100	2 3/8" to 3"	2 1/8"	\$4.00

ANTENNA, AN/122-A. Used in 4-element adcock arrays for high gain and directivity; each dipole element is 12" long, made of 3/8" tubing. Excellent for that new 6 or 2-meter beam. Don't miss this great value.

ANTENNA AN/104-A. The famous ax-handle antenna, used with the SCR 522. Ideal for mobile quarter wave, because of its streamline construction; or 2 units can be used to form a dipole for 2 meters or for TV and FM reception. Consists of copper sheath 21" long moulded about a wooden support, with 83-1R coax connector. 5.75 ea., or 2 for \$11.25.

ANTENNA, ARN/1. Originally designed as radio altimeter antenna, these antennas make excellent dipoles for use on the 420 mc band. Consists of center-fed dipole, 11 1/2" long, going to 83-1R connector on mounting plate. Use four of them in array for increased directivity, and signal strength. Ea. \$1.25 or four for \$4.50.

Headsets

Dynamic mike and headset combination. A high quality, efficient unit, used in B-19 tank Xmttr. Mike & phones complete, new. \$2.75

R-15 headsets: 8000 ohms impedance, rubber cushions. Comes with 8' cord & plug PL 55. New \$1.95. Used, in good condition. \$.60

HS 30 headset. Insert type headset, cuts out background noise, and low impedance (500 ohms) assures efficiency and high fidelity. A MUST for every ham at this price. \$.85

R-2A headsets, 10,000 ohms impedance, with headband. 8' cord, and PL 55 Plug. Slightly used, in excellent condition. \$2.25

PE 73 CM Power supply for BC 375. Input: 28 VDC. Output: 1000 VDC @ 350 Ma. Starting relay, filter, etc. \$4.95

Mrs.: Write for quantity, prices & discounts on above items.

BD 77. Power supply for BC 191. Input: 14 VDC. Output: 1000 VDC @ 350 Ma. With spare fuse links, etc. \$5.95

PE 101C. Input: 13/26 VDC @ 12.6/6.3 A. Output: 400 VDC @ 135 Ma., 800 VDC @ 20 Ma. (9VAC @ 1.12 A.) \$3.49

PE 86 N. Input: 28 VDC, Output: 250 VDC @ 60 Ma. Westinghouse w/Filter. \$1.95

Without Filter. \$1.60

DM 33A. Input: 28 VDC @ 7 A. Output: 540 VDC @ 250 Ma. Power supply for modulator of SCR 274 N. \$3.95

DM 28-R. Input: 28 VDC @ 1.25 Amp. Output: 270 VDC @ 70 Ma. New, with enclosed terminal box. \$3.25

ZA/USA .0515. Input: 12/24 VDC @ 4/2 Amp. Output: 500 VDC @ 50 Ma. Compact rectangle shape, size 7 1/2 x 4 1/4 x 3". \$3.95

ZA/USA .0516. Input: 12/24 VDC @ 8/4 Amp. Output: 275 VDC @ 110 Ma. 12 VDC @ 3 Amp. Compact square, size 7 1/2 x 4 3/4 x 3". \$4.25

35X055. Input: 19 VDC @ 3.8 Amp. Output: 390 VDC @ 95 Ma. \$2.20

PE 55. Input: 12 VDC @ 25 Amp. Output: 500 VDC @ 400 Ma. (slightly used). \$4.95

MP 10 G Power supply, using 2 dynamotors. Input: 24-28 VDC. Output: 1000 VDC @ 400 Ma. 230 VDC @ 100 Ma. New, complete with relays, filters, etc. BENDIX \$40.00

B-19 power pack (dynamotor). Input: 12 VDC @ 9.4 Amp. Output: 275 VDC @ 110 Ma, 500 VDC @ 50 Ma. New, complete in metal case with 2 plugs, filters, etc. \$4.75

Inverters

PE 206-A. Input: 28 VDC @ 38 Amp. Output: 80 Volts 500 volt-amp. 800 cy. Leland Electric. New, complete with instruction book, relays, filters, etc. \$12.50

PE 218—Input: 25-28 VDC @ 92 Amp. Output: 115 volts, 1500 volt-amps. 380/500 cy. Leland Electric. New. \$15.00

A rack for complete rig, \$45.00

46" high, 24" wide, 22" deep, black crackle finish, with special receiver mounting panel. Has 3 decks and hundreds of useful parts. Listed below are just some of the components:

- 11-1" Jewels
- 4-AC Outlets
- 2-0-3 Amp RF meters
- 1-40-0-40 ammeter
- 2-Ceramic switches
- 1-Ohmite potentiometer
- 5-AC relays
- 3-Fuse blocks



- 2-115 VAC contactors
 - 1-6" AC gong
 - 7-panel-controlled circuit breakers (4-15 Amp, 2-35 Amp, 1-50 Amp)
 - 3 Large push-button switches
 - 3-Wall-type switches
 - 1-Reset push-button switch
 - 1-Microphone jack
 - 3-Meters on 5-hole meter panel
 - 5-Large Jones strips
 - 1-4" DPDT heavy-duty knife switch
 - 1-Control amplifier
- The parts alone are worth many times this special price for quick sale. \$45.00

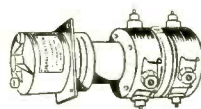

Motor Driven Switch

Switch operates at 1800 rpm, using internal 24 VDC motor. Switch is DPDT, and was originally designed for automatic switching of YAGI radar-antennae. \$2.00

All merchandise guaranteed. Mail orders promptly filled. All prices, F.O.B. New York City. Send Money Order or Check. Shipping charges sent C.O.D.

COMMUNICATIONS EQUIPMENT CO. 131 N. Liberty St., New York City 7, N. Y. Digby 9-4124

RU-16/GF-11

Introducing That Famous TRANSMITTER RECEIVER COMBINATION!

TRANSMITTER
2,000 KC—9,000 KC
RECEIVER
200 KC—13,575 KC



RECEIVER

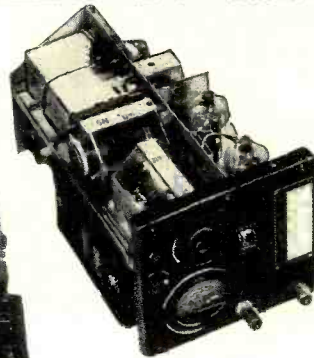

TRANSMITTER

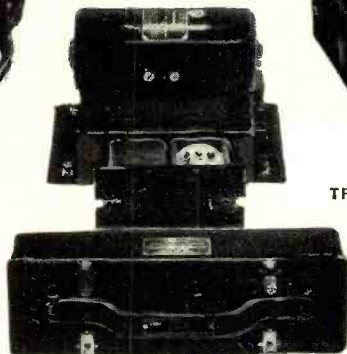

COIL DRAWER

- ★ Output on phone 15 W, much more on CW.
 - ★ Band changes by single plug-in drawer; 4 included with transmitter, 10 with receiver.
 - ★ Simple conversion for output also on 14 Mc, 21 Mc, 28 Mc!
 - ★ Dynamotor input 12 VDC, output 435 V @ 163 ma. continuous duty.
 - ★ Transmitter tube complement 89-89-837's in PP.
 - ★ Includes all accessories, filter, instruction book, remote tuning, control boxes, plugs, spare tubes, shock mounts, everything.
- We can't describe the superb appearance and design, so write for our detailed description and modification suggestions of a terrific double conversion receiver, and a beauty of a VFO transmitter that has no equal. You will hear plenty on the ham bands about this neat combination. Shipped in original crate 32 x 21 x 22 wt. 120 lbs.

25% deposit with order

A complete station, VFO operated, for

\$29⁵⁰
only

Brand new as of the manufacturer

SURPLUS RADIO, INC.

30 MUNSON ST.,
PORT WASHINGTON, N. Y.

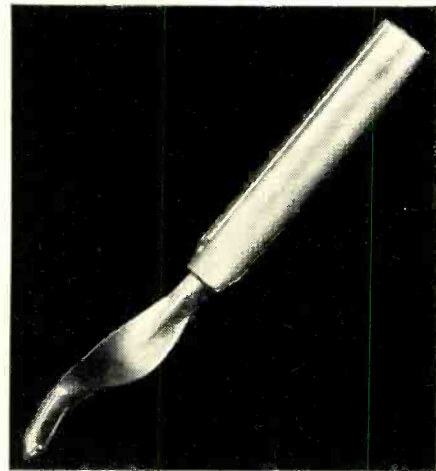

Fig. 7. Playback needle with "knee-action" feature.

action on the stylus and record due to the pinch effect is of negligible magnitude and does not contribute appreciably to record wear.

The "needle talk" is greatly reduced by employing such design. This is particularly true at the lower frequencies because of the reduced vertical reaction on the record. In relieving this reaction, the stylus and armature move vertically as a unit up to a frequency of between 500 and 800 c.p.s. rotating about a horizontal transverse axis. As the frequency increases, this axis moves closer to the armature until, at very high frequencies, the axis of rotation passes through the armature.

Record life has thus been increased considerably by careful design of pickups and their associated reproducing styli.

(To be continued)

Night view of station KDYL's super turnstile or "bat wing" antenna used for both experimental television and FM transmission. The antenna is mounted on top of Salt Lake City's highest office structure, a 20-story bank building in the business district, and towers 330 feet in the air giving coverage of the Greater Salt Lake Valley. KDYL's experimental telecasts from St. Louis to the Pacific Coast over station W6XIS, were started last month. The station which operates on channel 2 is powered at 400 watts visual and 200 watts aural. Commercial operation is expected before the end of 1948 on this circuit.

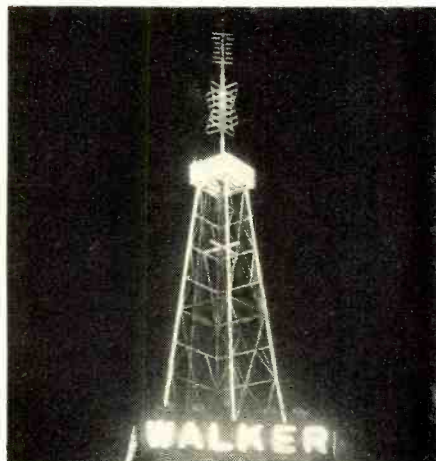

Studio Quality AMPLIFIERS

WITH CUSTOM-BUILT FEATURES

Designers and Manufacturers of Broadcast Speech Equipment, School Sound Systems and Recording Equipment.

Designed and Fabricated by the Manufacturers of High Quality Sound and Recording Equipment for the Motion Picture Industry.



Bardwell & McAlister's new line of Commercial Amplifiers answers the great demand of sound engineers for commercial amplifiers embodying the principles used in "custom-built" units which have been successful in the sound equipment of the motion picture industry. These principles result in high fidelity reproduction at any setting of volume controls up to full rated output with less than 4% distortion, versatility of application, ease of operation and the longer life found only in Bardwell & McAlister Studio Quality Amplification Systems. Manufactured by Union Craftsmen and fully licensed.

Write for our sound equipment catalog and technical bulletins. Dealer inquiries invited.



PRODUCT

ELECTRONIC DIVISION
BARDWELL & McALISTER, INC.

BOX 1310, HOLLYWOOD 28, CALIFORNIA



13

SENSATIONAL VALUES

THE NEW MODEL 247

TUBE TESTER



Model 247 comes complete with new speed-read chart. Comes housed in handsome, hand-rubbed oak cabinet sloped for bench use. A slip-on portable hinged cover is included for outside use. Size: 10 1/4" x 8 3/4" x 5 1/4".

ONLY
\$ **29⁹⁰** NET

Incorporates a newly designed element selector switch which reduces the possibility of obsolescence to an absolute minimum. Any pin may be used as a filament pin and the voltage applied between that pin and any other pin, or even the "top-cap."

The new free-point system described above permits the Model 247 to overcome the difficulties encountered with other emission type tube testers when checking Diode, Triode and Pentode sections of multi-purpose tubes, because sections can be tested individually when using the new Model 247. The special isolating circuit allows each section to be tested as if it were in a separate envelope.

The Model 247 provides a super sensitive method of checking for shorts and leakages up to 5 Megohms between any and all of the terminals. Continuity between various sections is individually indicated. One of the most important improvements, we believe, is the fact that the 4 position fast-action snap switches are all numbered in exact accordance with the standard R. M. A. numbering system. Thus, if the element terminating in pin No. 7 of a tube is under test, button No. 7 is used for that test.



The New Model 650 SIGNAL GENERATOR

RANGE:

100 Kilocycles
to
105 Megacycles

R. F. obtainable separately or modulated by the Audio Frequency.

REDUCED
FROM \$48.75

To **\$39⁹⁵**

- ★ Audio Modulating Frequency—100 cycles pure sine wave—less than 2% distortion.
 - ★ Attenuation—3-step ladder type of attenuator (T pad).
 - ★ Uses a Hartley Exciter Oscillator with a Buffer Amplifier.
 - ★ Tubes: 6J5 as R. F. Oscillator; 6AS7 as Modulated Buffer and Mixer; 6SL7 as audio oscillator and rectifier.
- Complete with coaxial cable, leads and instructions.....



SEE and HEAR the
Signal with the new
CA-12

SIGNAL TRACER FEATURES:

- * Comparative intensity of the signal is read directly on the meter—Quality of the signal is heard in the speaker.
- * Simple to operate—

Only one connecting cable—No tuning controls.

- * Highly sensitive—Uses an improved vacuum-tube voltmeter circuit. * Tube and resistor capacity network are built into the detector probe. * Built-in high gain amplifier—Alnico V speaker. * Completely portable—Weighs 8 pounds—measures 5 1/2" x 6 1/2" x 9".

Complete with self-contained batteries and instructions....

Reduced from **\$29⁹⁵**
\$34.85 to



The New Model 670 SUPER METER

A Combination VOLT-OHM-MILLIAMMETER plus CAPACITY REACTANCE, INDUCTANCE and DECIBEL MEASUREMENTS.

D.C. VOLTS: 0 to 7.5/15/75/150/750/1500/7500.—A.C. VOLTS 0 to 15/30/150/300/1500/3000 Volts.—OUTPUT VOLTS: 0 to 15/30/150/300/1500/3000.—D.C. CURRENT: 0 to 1.5/15/150 Ma.; 0 to 1.5 Amps.—RESISTANCE: 0 to 500/100,000 ohms, 0 to 10 Megohms.—CAPACITY: .001 to .2 Mfd., 1 to 4 Mfd. (Quality test for electrolytics).—REACTANCE: 700 to 27,000 Ohms; 13,000 Ohms to 3 Megohms.—INDUCTANCE: 1.75 to 70 Henries; 35 to 8,000 Henries. DECIBELS: -10 to +18, +10 to +38, +30 to +58.

The Model 670 comes housed in a rugged, crackle-finished steel cabinet complete with test leads and operating instructions. Size 5 1/2" x 7 1/2" x 3".

\$28⁴⁰ NET

AVAILABLE FOR IMMEDIATE SHIPMENT FROM STOCK—20% DEPOSIT REQUIRED ON ALL C.O.D. ORDERS

MOSS ELECTRONIC DISTRIBUTING CO.

DEPT. RN-4, 229 FULTON STREET
NEW YORK 7, N.Y.

Books that TELL YOU HOW

These books offer you valuable aid for radio and television work. Use the coupon below to see copies on approval.

1. Introduction to Practical Radio

By Tucker. All radio fundamentals very thoroughly explained, including all essential mathematics. Many problems show just how to use basic formulas in practical circuit calculations and the construction and repair of radio equipment. \$3

2. Principles of Radio for Operators

By Atherton. An easy book, with hundreds of illustrations, on the operating principles of each part of radio, including antennas. All basic commercial equipment explained and illustrated. \$4

3. Ultra-High-Frequency Radio Engineering

By Emery. The fundamentals in clear, simple terms, with worked-out examples to show how theory is specifically applied in the design of circuits and the prediction of circuit performance. \$3.75

4. An Introduction to Electronics

By Hudson. A masterly explanation in non-mathematical terms of electronic theory, the construction of electronic and phototubes, and their innumerable uses today. \$3.30

5. Principles and Practice of Wave Guides

By Huxley. The theory, construction and operating techniques of key devices, developed during the war, for high-frequency equipment. \$4.75

6. Fundamental Electronics and Vacuum Tubes

By Albert. A new revised edition of a standard work on the principles of electronic tubes and tube circuits, their analysis and use in both power and communication engineering. \$6

SEE COPIES ON APPROVAL

The Macmillan Co., 60 Fifth Ave., New York 11

Please send me copies of the books checked by number below, with the privilege of returning them within 10 days without charge.

1. 2. 3. 4. 5. 6.

Signed.....

Address.....

(Please give postal zone no.)

Singing Doorbell (Continued from page 47)

with perfect pitch! However, relative pitch is definitely important, i.e., one note must bear the right relation to all the others or the tune won't "sound right." To tune to any particular song, first consider the beginning note. Is it lower or higher than the following notes, or is it about in the middle? In any case, select one of the RC circuits which tunes to approximately the same range. For example, to set up the well-known phrase "I'll come down and let you in," the lowest RC combination should be selected for the first note, since this note is lower than all the rest. Similar reasoning will hold for each note in turn.

Tune the chosen RC circuit to some convenient pitch, which now becomes the reference pitch to which all other notes will be compared. Now hum or whistle the first two or three notes of the tune, starting with the reference pitch as the first note, then tune the next RC circuit to the second note. By continually repeating the tune, both by humming and by running through the notes already tuned, you will find it very simple to tune all the RC circuits to produce the required tones. To play the tones in this manner, a piece of paper should be slipped under all tone brushes and a short piece of wire used to short the various tone brushes to the collector brush. Remember that repeated notes required only one RC circuit, e.g., the "down" and "let" in the cited example are played on the same RC combination. To be perfectly frank, the notes for "and" and

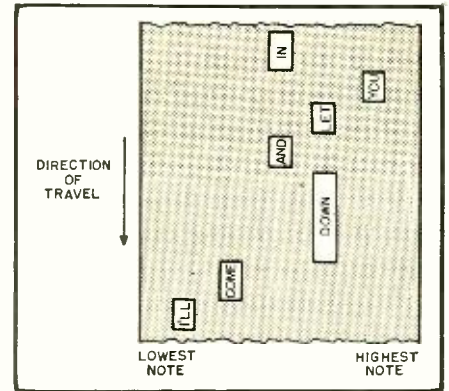
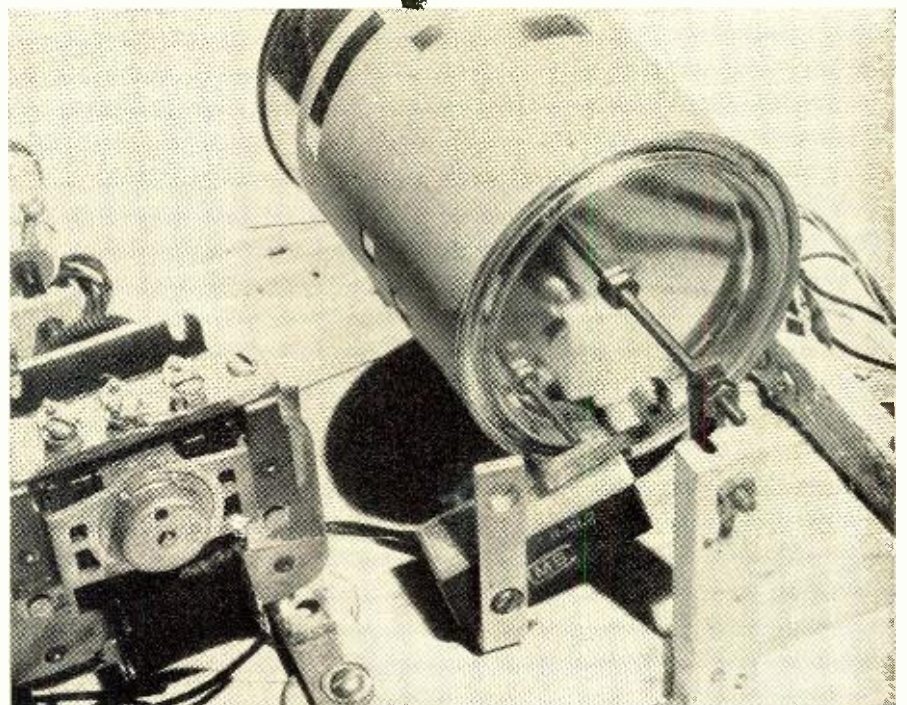

Fig. 4. Drawing shows method of cutting out paper "record" to obtain tune, "I'll come down and let you in."

"in" must also be tuned to the same pitch if only five tones are available. This leaves "and" a half-step too low, but I dare say nobody will complain!

The next step is to make the "record." Cut a piece of graph paper (or other lined paper) to fit around the drum. Mark the line of travel of each brush. The openings will be cut along these lines. Using a pencil, draw on the paper the outlines of the slots required. The position of the slot determines the note it plays and the length of the slot determines the time duration of the note. The slot position is determined from the previous RC circuit tuning. The slot length must be determined experimentally the first time. The actual length will, of course, depend on the speed of the drum and the desired note length. Once the slot length has been determined for say a quarter note, the rest will be simple. After all the slots are marked, cut them out with a sharp knife or razor blade.

Fig. 5. Closeup view shows detail of drum assembly.



BUY from America's STOREHOUSE of QUALITY PARTS

VOLUME CONTROLS



1000 ohm wire wound midgets - manufacturers close out - 1/4" shaft 3/8" long - list \$1.25 - over 90% off.

EACH
12c

SEALED
Box of 252
24.95

OUTPUT TRANSFORMERS

Clean stocks - long leads - mounting feet - made to fit where you need them.

For 6F6-6K6 - to 4 ohm voice coil - size 2" x 1 1/2" x 1 3/4".
50L6-35L6-25L6 to 4 ohm voice coil 1 3/4" x 1 3/4" x 1 3/4".
Specify quantity of each type you need at.....



49c

MULTI-USE WIRE

An old favorite - back again! Stranded No. 22 tinned wire - glass "ROCKBESTOS" 1000 volt insulation - fireproof aircraft wire - a wartime development - at this low price you can use the best.



100 feet..... **45c** 1000 feet..... **3.89**

MODEL 451A AC-DC Volt-Ohm - Meter



A dependable instrument of wide utility - sensitivity 1000 ohms per volt. Ranges: Volts AC, DC, and Output Ranges: 0-10/50/100/500/1000. Ohms full scale, 500,000. Ohms center scale, 7200.

NET complete with batteries..... **14.90**

MODEL 312 Volt-Ohm - Milliammeter



An economy pocket meter featuring a 2" moving vane meter. Reads: AC-DC volts, 0-25/50/125/250; Mills AC-DC, 0-50; Ohms, 100,000; mfd., .05-15. Jacks provide range selection.

NET Complete with cord and plug..... **6.75**

JEWELLED PILOT LIGHT ASSEMBLIES

- Miniature bayonet socket
- Mount in 1" hole
- Lamps removable from front of panel
- Available in red, green, or amber - quantities limited - order now.



List Price \$1.30
At RSE'S 85% off - you **19c** pay
Back again - by popular demand!

Pep-Up PHILCO CHANGERS

At last! All the parts you need to restore brilliant tone and volume to "sick" changers! You'll need all three items - sell your customer a 100% reconditioning job - Selenium cell only, no holder \$1.80
Sapphire needle only, no mirror..... \$1.20
Special original equipment lamp..... 27c
RECONDITIONING KIT - all three above items - postpaid - special at... **3.21**

RADIO RULE

Here is a clear 6" plastic rule - a necessity for radio students, draftsmen, hams, all who desire cleaner, more precise work. Nationally advertised at \$2.00. Order yours today postpaid only... **35c**

April, 1948

RADIO SUPPLY & ENGINEERING CO., Inc.

LOWEST PRICES

129 SELDEN AVE. DETROIT 1, MICH.

.5 mfd - 300 Volt



That's right - genuine Sprague condensers - manufacturers close out - new fresh stock - size 3/4" x 2 1/2" - tinned leads - all guaranteed.

NET EACH **10 FOR**
6c **49c**

VOLUME CONTROLS



Our own private brand - made by a nationally known manufacturer - you have this same control on your shelf now - the same kind that net for \$1.09! Standard noise-free carbon construction - 3/8" bushing - 1/4" shaft, 2" long - complete with switch. Ideal all purpose replacement control - individually boxed in our colorful carton carrying the RSE quality seal of approval.

Full range of sizes - with attached switches!

10 M ohms
15 M ohms
25 M ohms
50 M ohms
100 M ohms
250 M ohms
1 Meg. ohms
2 Meg. ohms

59c each
55.00 per 100 assorted

500 M ohms - less switch 39c ea. 100 for \$35.00

10 MEG. 1/2 WATT.

type 10 Meg. 1/2 Watt resistors - manufacturers close-out - clean stock - how can you pass them up at **1c ea.**

PANEL METERS



Panel meters by Top quality instruments - new - boxed - five popular types - priced right - your chance to get those meters you've always wanted.

- 0-150 A.C. volts - 3" round flush mounting black brass case.
- 0-150 A.C. volts - 2" round flush mounting bakelite case.
- 0-150 A.C. volts - 2" round metal case - less mounting clamp.
- 0-30 D.C. volts - 2" round flush mounting bakelite case.
- 0-400 D.C. volts - 3" round projection mounting - bakelite case.
- 0-30 A.C. amps - 3" round flush mounting bakelite case.
- 0-150 D.C. volts - 3" round flush mounting black brass case.

2.95 EACH

Supply limited - order now -

PHONO PICKUP CRYSTALS

Standard types - Set Manufacturers close-out - all Guaranteed



Nationally adv. - newest and finest - osmium tipped permanent needle - 1.8 volts output - fits standard mounting holes. List Price \$7.50. You pay us

269

Nationally adv. - pintype terminals - 3/4 oz. pressure, 1.6 volt output - 5000 cycle cutoff. List price \$5.55 - our Special..

198

new postwar design - solder terminals - 1 1/4 oz. pressure - 1 volt output - 4000 cycle cutoff. List price \$5.55 - we quote you.....

198

another new type - 1 1/4 oz. pressure - .75 volt output - 6000 cycle cutoff. List price \$5.55 - 64% off...

198

The prewar favorite - used in millions of phonographs - solder terminals - 1 1/4 oz. pressure - .6 volt output - 4500 cycle cutoff. List price \$4.45 - your cost.....

198

RESISTANCE LINE CORDS



Standard 3 terminal 135 ohm AC-DC cords - sturdy construction, flexible - 5 1/2" long complete with plug - for sets having approximately 69-75.2 volts drop in the filaments. Regular list price 1.17

Only 33c

8/8/8 - 450

Genuine triple 8 mfd. - 450 volts - inverted screw mounting - insulated aluminum can 1 1/2" x 4" - 6" insulated leads - List price \$4.25 - one time only at **89c**

OZ4 TUBES



New, guaranteed, made by the only maker of OZ4's. Buy now! Hit that car radio business hard - \$2.20 List - 60% or more off - limited quantity.



Egg crate of 100 **79.00**

In colorful RSE box at 88c ea.

PAPER TUBULARS



Genuine name brand paper bypasses! New, fresh, full capacity standard merchandise - not surplus - all guaranteed! Check the list prices - our low nets - no need to figure the discount - buy 'em now, they've hit bottom!

Mfd.	Volts	List Price	Net Each	Per 100
.01	600	30c	10c	\$ 9.15
.02	600	30c	11c	\$ 9.95
.05	600	40c	14c	\$12.95
.1	600	45c	16c	\$14.95

Quantity Prices not assorted.

SEND FOR FREE CATALOG



ORDER INSTRUCTIONS

Include full remittance with orders of \$3.00 or less. Include 25% deposit with all C.O.D. orders of \$3.00 or more. All shipments sent express collect if postage is not included. Prices subject to change without notice. BE SURE TO INCLUDE SUFFICIENT POSTAGE. EXCESS WILL BE REFUNDED.

University LOUDSPEAKERS

- can whisper, too!

And that's important because the primary purpose of any loudspeaker is to convey intelligence and not just make a loud noise. UNIVERSITY loudspeakers — with the highest conversion efficiency of any speaker of comparable size — not only give maximum sound output with minimum power input, but reproduce every detail and inflection of the voice at all levels from a whisper to a shout.

**A JOB-RATED SPEAKER
FOR EVERY APPLICATION!**

REFLEX TRUMPETS



A wide variety available for every requirement — voice, music, paging and talk-back. Weatherproof, sturdy construction for years of dependable use.

DRIVER UNITS

Several high efficiency models with continuous power capacities up to 25 watts and response to 15,000 cycles. All unconditionally guaranteed for one year.



PAGING, CALL-BACK SPEAKERS



Available in many types and power ranges. Compact design, high conversion efficiency and high sensitivity. Standard voice coil impedances permit easy installation.

SUPER POWER SOUND PROJECTORS

Many sizes — 100, 150 and 300 watts with conservative ranges to a few miles. Excellent quality even at full power. Ideal for installation in aeroplanes and church steeples.



EXPLOSION PROOF SPEAKERS



Radial and directional types for use in mines, refineries, railroads and shops. Immune to live steam, salt-spray or complete immersion. Power handling capacity 15 watts.

24 PAGE TECHNICAL CATALOG ON REQUEST



UNIVERSITY LOUDSPEAKERS · INC.

80 SO. KENSICO AVE., WHITE PLAINS, N. Y.

Wrap the paper around the drum, fasten it with *Scotch* tape, and play the record several times. Any errors in cutting will be very apparent and can be corrected by cutting a new record and changing spacing as indicated by the first trial. A finished record is shown in Fig. 4.

The laudatory comments of your

visitors and the amusement of constantly surprising your friends with new tunes will repay in short order what little work goes into building this musical "doorbell." After that, all the fun will be clear profit, and I'll give you my personal guarantee that few, if any, will cross your threshold without a *SMILE!*

-30-

A WEATHERPROOF HOUSING FOR SMALL SELSYN MOTORS

By C. F. DONBAR, W8PA

WHEN small indicating type selsyn motors appeared on the surplus market, the writer acquired a pair with the idea of placing them in service to give remote indication of the rotary antenna position.

These motors may be classed as delicate instruments, and probably would have a very short life if left in the weather, unprotected, for any length of time. Since one of the motors had to be mounted with the antenna rotating mechanism, a method of weatherproofing was devised which has been very satisfactory. The motor was recently inspected, and found in perfect condition after eight months of Michigan winter and spring weather.

A wide mouth, quart size glass jar, with a sturdy screw cover, forms the basis of the weatherproof housing for the motor. A can of similar size could be substituted, but the writer felt that it would be more convenient to use the glass jar, since the presence of moisture could be seen without opening.

A simple right angle metal bracket supports the motor and jar; this bracket is made from a strip of one sixteenth inch thick scrap metal which is approximately the same width as the diameter of the jar lid. At W8PA, a piece of heavy gauge scrap radio chassis was used for the mounting bracket.

Small sized flexible shaft is used for the mechanical connection between the selsyn motor and the antenna mechanism. This flexible shaft is of the same type as used to drive speedometers, and was used on the tuning heads of the older car radios. If an appreciable length of drive cable is needed, a used speedometer cable might be secured from a junk yard, and this could be cleaned up, relubricated, and used as is, providing the armored housing, and core are in sound condition. If a short length is required, the flexible shaft core may be secured as a radio part, and a length of soft drawn one-quarter inch copper tubing used for the housing. A word of advice concerning the method of cutting the flexible shafting: The core is made of a number of fine spring steel wires wound together under tension, and these wires have a tendency to unwind when cut; therefore it is best to clean and solder the core at the spot where the cut is to be made, and it will then saw easily without unwinding.

The motor is centrally located, and mounted about one and one-half inches below the under side of the jar lid in order to provide clearance for a brass set screw coupling which connects the flexible shaft to the motor shaft. The mounting of the motor will depend on the type of mounting flange on the motor, however most of the motors readily adapt to the use of brass mounting posts, or thin metal strips may be bent to form the supports.

Keep in mind that the finished assembly must slip easily into the jar.

Lay out the motor mounting holes on the top of the jar lid, and include a center hole which will clear the flexible shaft housing. One other hole is needed for the entrance of the electrical cable, and the size of this hole will depend on the cable and grommet used. The lid and the main supporting bracket may be clamped together and both drilled at the same time, as all holes must match identically on each piece, since the two pieces are held together with the same screws that fasten the motor mounting posts.

The jar lid, main mounting bracket, and motor supports are assembled, and the flexible shaft housing is soldered to the assembly, and the flexible core is coated with graphite grease and pushed into place, the motor, with its shaft coupling, is then mounted and the assembly is complete. Note: If the motor does not have a protruding mounting flange, the mounting posts must be fastened to the motor face with studs, before final assembly.

In cases where the motor has leads brought out instead of terminals, a small terminal strip can be mounted alongside of the motor to eliminate splicing. If the flexible shaft ends in an upright position, a thimble should be drilled and soldered to the shaft end, to prevent the entrance of water; a jar rubber is added as an extra precaution, and sealing wax is recommended around the electrical cable entrance, unless rubber covered cable is used, and a tight fit secured with the grommet. A coat of asphaltum on the exterior metal parts will prevent rust, while a half inch layer of silica gel (obtainable from refrigeration supply houses or servicemen) will take care of all internal moisture. If the entire unit is to be mounted inverted, the silica gel may be placed in a cheesecloth sack, to prevent spilling.

-30-

Weatherproofing the selsyn motor.

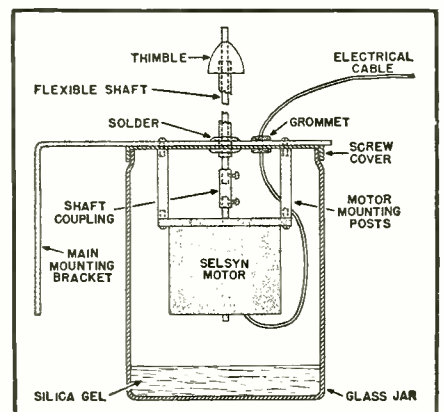



ARMY SURPLUS HEADPHONES HS23A

HS23A—Used but in A-1 electrical condition, 8000 ohms impedance. Complete with leather headband and rubber cushions. Shpg. Wt. 3 lbs.

ONLY **98c**

SAVE NOW!



SURPLUS KEY

Type J-37 Ruggedly built. 1/4" silver contacts. Bakelite base. Shpg. Wt. 2 lbs.

ONLY **98c**

ON THESE SURPLUS SPECIALS

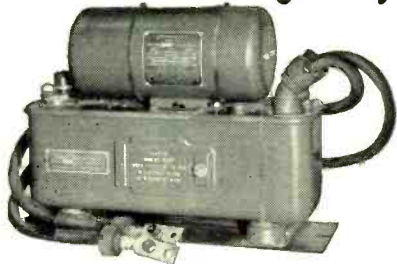

Brand New PE-103 DYNAMOTOR

Will deliver 500 VDC at 160 MA with either 6 or 12 VDC input. Complete with overload circuits, filter and connecting cable. In original overseas shipping crate. Shpg. Wt. 81 lbs.

ONLY **\$995**

Output plug for above: Cannon P8-CG-12S. Shpg. Wt. 1/2 lb.

ONLY **95c**

WITH A SURPRISE TRADE-IN ALLOWANCE ON YOUR USED TEST EQUIPMENT

For sensational trade-in values on your used Test Instruments and factory-built communication equipment, contact Walter Ashe right away. Simply tell us what you have to trade. We'll respond with an extra-liberal offer that's sure to please you. Write, wire or phone today!



ONLY **69c**

SURPLUS T-17 HANDMIKES

S. B. Carbon Mike with push-to-talk switch on handle. Complete with cord and plug. Brand New —In Original Cartons. Shpg. Wt. 3 lbs.



SURPLUS SENSITIVE RELAY
6500 ohm, 2 MA coil. SPST contacts. Shpg. Wt. 1/2 lb.

ONLY **98c**

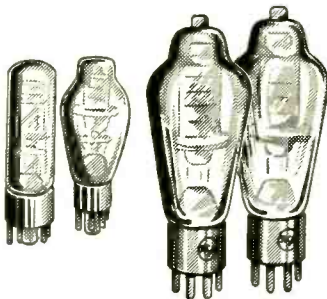

SURPLUS SPARE TUBE KIT

Complete set of spare tubes for BC-459-A or similar unit. Consists of 1—1626, 2—1625 and 1—1629. Brand new in original boxes. Shpg. Wt. 2 lbs.

ONLY **98c**



EACH **5c**

SURPLUS OCTAL SOCKETS

Similar or equal to the MIP-8. Molded in plate 8 prong socket. Shpg. Wt. 1 lb. 12 for 50c

REMEMBER . . .

your Trade-In's worth more at the Walter Ashe Store. For real money-saving get Walter Ashe's offer before you make that trade.

ALL THE BIG NAME BRANDS of Test Instruments, Receivers and Transmitters in stock . . . ready for immediate delivery.

ATTENTION RADIO SERVICEMEN . . . DEALERS, AMATEURS

For amazing bargains in top condition, slightly used Test Instruments and Communication Equipment, apply to Walter Ashe. A wide selection of good-as-new merchandise available.

CHOKES

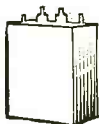

No. 5269—4.5 HY x 150 MA. 79 ohms DC Res. Shpg. Wt. 6 lbs.

Two for **79c ea.**
One only . . . **99c**

FILTER CONDENSER

3 MFD. x 400 VAC. Good for about 1500 VDC. Metal can. Shpg. Wt. 3 lbs.

ONLY **98c**

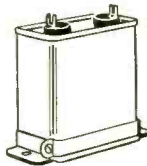

No. 2785—Dual 12 HY x 250 MA. 150 ohms DC Res. per section. Shpg. Wt. 17 lbs.

ONLY **\$4.95**



TRANSFORMER

No. 4891—1200/1400 VCT x 200 MA. PRI. 115 VAC 60 cy. Shpg. Wt. 18 lbs.

ONLY **\$7.45**



No. 6317—4 HY x 300 MA. 40 ohms DC RES. Shpg. Wt. 13 lbs.

ONLY **\$4.95**



IT'S HERE

1948
Walter Ashe
RADIO AND ELECTRONICS CATALOG

PHONE **CHestnut 1125**

ALL PRICES F. O. B. ST. LOUIS

TIME PAYMENTS AVAILABLE

WOULH W0JWD W9NRF W0WTM W0QDF W0PGI W0IYD

Use this coupon to get Walter Ashe's "Surprise" Trade-in Allowance on your used factory-built test equipment. RN4

WALTER ASHE RADIO CO.
1125 Pine St., St. Louis 1, Missouri

Am interested in the following top condition, slightly used Test Equipment. _____ (list preference)

I want to trade _____ (describe used equipment)

for _____ (show make, model of new Receiver desired or other equipment)

Rush my FREE COPY of the big, New 1948 Walter Ashe Catalog.

NAME _____

ADDRESS _____

CITY _____ ZONE _____ STATE _____

IT'S HERE! . . . The new 1948 Walter Ashe Catalog—greatest in Walter Ashe history. Nearly 150 pages. Order your free copy today!

Walter Ashe RADIO CO.
1125 PINE ST. • ST. LOUIS 1, MO.

MAIL COUPON TODAY

LETTERS

from our readers

TRUE TO LIFE

THERE is more truth than horror in the cartoon on page 181 of the January issue, only I do it one better. I have a midget radio that I rigged for headphones when the speaker went dead. Since I found I was the best available antenna I took another phone cord and ran it from the antenna lead of the set's loop antenna to a clip on my glasses. This saves me the trouble of holding the wire when I read while listening to the radio."

Paul C. Gunn
Kewanee, Illinois

That is OK providing you don't forget you are "connected" when the telephone or doorbell rings!

* * *

THE EDITORIAL

THIS letter is prompted by your editorial in the February RADIO NEWS dealing with conditions in radio servicing. As a radio serviceman with some ten years' experience, I should like to make a suggestion.

"What I suggest is an investigation sponsored by some responsible organization, and carried out by properly qualified personnel. Let each man go into a reliable shop and work with the repairman, posing as a would-be helper or apprentice, for a period of at least a month. Let him observe every detail and get as clear a picture as he can of every angle. At the end of that time, each investigator would meet with the others and compare notes, collaborating in the publishing of their findings.

"Admittedly there are certain obstacles to such a project, but I think something along this line is badly needed both for the benefit of the public as well as the serviceman. What do you think?"

Donald Kiff
Elmira, New York

NOW I am in complete agreement with you—there are too many chiselers in the radio business, also other types of business such as auto repairing, etc. But the reason for this letter is to pick some holes in your editorial.

"First you say a reliable serviceman probably would repair this set for free! Why? You cannot pay your bills working for free. Most good radio service stores have a minimum charge of approximately \$1.00 for even so simple a job as replacing a dial light. No serviceman in his right mind will do any work for free—it might build goodwill but you cannot eat goodwill.

"Next, how can a serviceman cause a short in the volume control? That

is a new one on me. Next, whoever heard of five condensers going out at once? Let's change the wording of that statement a little—change the words "going out" to the word "bad." My answer to this is, I have and you have too if you were ever in the radio service business.

"A leaky paper condenser is a bad condenser. I have found some of the sets have had to have all paper bypass condensers replaced. The customer has said the set worked better than when new!

"Now don't get me wrong, I am all for you, but I just didn't like some of the statements made in the article. RADIO NEWS is my favorite magazine."

Paul W. Curtis
Richland, Washington

* * *

SPEAKING of a racketeer—how about the radio set that is put on the market that is no good or has extremely poor design or material incorporated in it. For example during the war I saw several \$20 to \$40 auto radios put in console cabinets and sold for the sum of \$200 to \$250. I see no reason for such practice now. We have had some nationally advertised radios in our shop that cost the customer \$200 to \$300 and from a performance standpoint they were no better than \$25 set. I say this because a \$200 radio should have more than a \$20 cabinet, 5 or 6 tubes, a 7½" speaker, and an \$18 list price record changer.

"It would be nice if we could eliminate all the racketeers not only in radio service but also in the well-known automobile field and few others as well. I haven't figured that out yet.

"I am looking forward to the time when radio and electronic servicing can be a licensed profession as I believe that education is the key to better service for electronic equipment.

"I don't believe any good radio serviceman that has spent from \$12,000 to \$15,000 and 10 to 15 years of his life to learn a few things about radio would care to check and repair any radio set for fifty cents, especially a portable. With prices at their present level, this would very soon lead to certain bankruptcy. Prices for professional services in other fields are somewhat above the level you mention for the professional radio serviceman."

Wendell W. Greiner
Central Electronics Co.
Salina, Kansas

It seems like the surest way to get an immediate reaction from readers is to get 'em angry enough about something so they'll get out pencil and paper and say so. Well—our gimmick (Feb. '48 editorial) worked and as a

result, we've received a host of letters and phone calls from near and far in defense of the many thousands of honest, reliable servicemen who have been embittered by the stupid decoy radio set gag still being tossed around in the public spotlight as damning evidence that radio servicemen are all a bunch of racketeers.

We based our column on one of these "surveys," conducted by "Radio Daily" and station WOR in N.Y.C. We reported their findings almost verbatim. Purpose—to reach the many thousands of radio technicians who neither heard the air blast from WOR nor read "Radio Daily," "Time," or other publications that ran the same story.

We knew that many readers would have exactly the same reaction as we did. The most violent objection, of course, was that a qualified service technician was not on hand to carefully re-check the set after each call and to record any tampering (if any) that would put the next victim on the spot.

The public wasn't told that only one "racketeer" could have done the dirty work and he could have been stop number one on the tour.

Such surveys are usually run by those who seek the sensational. And why is it that the target is always something technical or mechanical—like radio, watches, autos, etc. We think it's because people, generally, are not technically minded and feel that they are always being taken for suckers on things mechanical or electronic.

* * *

BRITISH TV

HAVING seen in the recent editions of RADIO NEWS the great strides made by the television industry in the USA, I thought perhaps your readers might be interested in my humble efforts at television construction in this land of "much austerity."

"As you are probably aware, the only TV transmissions at present are being radiated from Alexandra Palace, London, by the BBC on a frequency of 45 mc. for vision and 41.5 mc. for sound. The vision signal has a bandwidth of 4 mc. and the sound, which is AM, of 100 kc.

"The maximum service area for this transmitter is considered to be not more than fifty miles radius from Alexandra Palace. My home is 150 miles away so it is rather surprising that I receive anything at all. I am 3 miles below line-of-sight.

"The complete receiver, which is of home construction, has been made from ex-government radar parts purchased on the surplus market at the over-all cost, including the antenna, of less than 15 pounds (\$60.00).

"The vision receiver itself is a converted naval "responder" unit which was designed to function between 200 and 250 mc. It was a superhet with 12 mc. i.f.'s that already had a 4 mc. bandwidth so only the front end had to be altered.

"The cathode-ray tube and time base

ANTENNA RELAY UNIT

0-10 Meter Weston Thermo-couple unit with 50 MMF, 5000v Vacuum condenser, and heavy duty relay...

\$198



RELAYS

Sigma No. 4RJ 2000 ohms SPDT. Can adjust to less than 1 ma.....

69¢

ATR INVERTER Model RSA

Input 12 v DC—output 110 v 60 c. 125 w Int. 100 w Cont. Special..... **\$18.95**

SELENIUM RECTIFIERS Full Wave Bridge Type

INPUT		OUTPUT		
up to 18v A.C.	up to 12v D.C.	1 Amp.	\$1.95	
up to 18v A.C.	up to 12v D.C.	5 Amp.	4.45	
up to 18v A.C.	up to 12v D.C.	10 Amp.	7.45	
up to 18v A.C.	up to 12v D.C.	15 Amp.	9.95	
up to 18v A.C.	up to 12v D.C.	30 Amp.	14.95	
up to 36v A.C.	up to 28v D.C.	1 Amp.	3.45	
up to 36v A.C.	up to 28v D.C.	5 Amp.	7.45	
up to 36v A.C.	up to 28v D.C.	10 Amp.	12.45	
up to 36v A.C.	up to 28v D.C.	15 Amp.	18.95	
up to 54v A.C.	up to 36v D.C.	25 Amp.	.98	
up to 115v A.C.	up to 100v D.C.	25 Amp.	2.95	
up to 115v A.C.	up to 100v D.C.	6 Amp.	6.95	
up to 115v A.C.	up to 100v D.C.	5 Amp.	19.95	

OIL CONDENSERS NATIONALLY FAMOUS MAKES All Ratings, D.C.

1mfd. 600v	\$0.35	2mfd. 2000v	\$1.75
2mfd. 600v	.35	3mfd. 2000v	2.75
4mfd. 600v	.60	4mfd. 2000v	3.75
8mfd. 600v	1.10	15mfd. 2000v	4.95
10mfd. 600v	1.15	1mfd. 2500v	1.25
1mfd. 1000v	.60	25mfd. 2500v	1.45
2mfd. 1000v	.70	5mfd. 2500v	1.75
4mfd. 1000v	.95	1mfd. 3000v	1.95
8mfd. 1000v	1.95	1mfd. 3000v	2.25
10mfd. 1000v	2.10	25mfd. 3000v	2.65
15mfd. 1000v	2.25	3mfd. 3000v	2.85
20mfd. 1000v	2.95	1mfd. 3000v	3.50
24mfd. 1500v	6.95	12mfd. 3000v	6.95
25mfd. 2000v	1.05	2mfd. 4000v	5.95
5mfd. 2000v	1.15	1mfd. 5000v	4.95
1mfd. 2000v	.95	1mfd. 7000v	2.95
SPECIAL 2 mfd. 3000v			\$4.45

HIGH CAPACITY CONDENSERS

2x3500 mfd.—25WVDC	\$3.45
4000 mfd.—30WVDC	2.95
1000 mfd.—15WVDC	.99
2000 mid.—50WVDC	1.95

GIBSON GIRL TRANSMITTER (SCR-578B)

Emergency life transmitter. 100% complete; includes balloon, hydrogen generator, kite, signal lamp, antenna and instruction manual. Self-powered merely by turning crank. Automatically transmits S.O.S. on 500 cycles. **FULLY GUARANTEED. \$29.95**

PORTABLE FM TRANSMITTER (SONOBUOY)

Operates on standard 67½v Minimac and 1½v Flashlight cells. Frequency 72 mc (easily doubled to 144 mc). Complete with 5 tubes and diagram. (Less batteries.) **EXCEPTIONAL BUY at..... \$12.95**

BC-375-E TRANSMITTER

Operates from 200 kc—12.5 mc complete with all tubes, dynamotor, seven tuning units and one antenna tuning unit. Like New..... **\$39.50**

CONSTANT VOLTAGE TRANSFORMER

NATIONALLY FAMOUS MAKE

Prim.: 190 to 260v 60 cyc. Sec.: 115 volts @ 1.74 amps. Rated 250 V. A.

Brand New..... **\$29.95**

PERMALLOY SHIELDS for CATHODE RAY TUBES

3" Shield	\$1.49
5" Shield	1.98

TUBES (Brand New) Army-Navy Inspected

1N21	\$0.39	371B	\$5.95
2AP1	2.25	450TH	39.95
2C40	1.19	703A	7.95
2D21	.89	715B	7.95
2V3G	1.25	721A	4.35
2X2	.84	726/AC	7.50
3AP1	3.00	801	1.49
3BP1	2.95	802	1.98
3E29	2.95	803	8.95
3GP1	3.95	804	9.95
5BP4	4.95	805	4.95
5CP1	3.95	806	14.95
5JP1	11.95	807	.95
5LP1	8.95	808	2.95
5R4GY	.98	809	1.50
5Y3	.41	810	5.95
6AB7	.99	811	3.15
6AC7	.99	812	8.95
6AG5	.99	813	4.45
6AG7	.99	814	3.95
6AJ5	.99	815	3.00
6AK5	.90	829-A-B	3.00
6AL5	.99	832	2.25
6AQ6	1.09	833A	39.50
6AR6	1.29	836	1.75
6B4G	1.29	837	2.50
6C4	.49	838	3.95
6C5	.49	861	69.50
6D4	.99	866	.75
6F6	.89	872A	2.50
6F6G	.59	884	.98
6J4	1.50	885	.98
6J5	.55	902	3.00
6J6	.89	954	.75
6L6	1.23	955	.75
6L7	.98	956	.75
6N7	1.02	957	.75
6SH7	.59	958	.75
6SL7	.89	959	.75
6SN7	.69	1005	.69
6SR7	.81	1616	2.95
7A4	.81	1619	.75
7F7	1.25	1620	1.98
7L7	1.59	1622	1.98
10Y	.98	1624	.90
15E	1.50	1625	.75
HK24C	1.75	1626	.75
28D7	.98	8001	6.49
30	.75	8003	9.95
35T/TG	3.50	8005	4.95
VR90	.75	8011	3.75
VR105	.75	8016	1.65
VR150	.75	8025A	4.95
100TH	7.95	1654	1.98
100TS	3.00	9001	1.15
211	1.25	9002	.98
75T	2.95	9003	.98
250TH	14.95	9004	.98
257B	6.49	9005	.98
304TH	9.95	9006	.98
F-127A	22.50	F-128A	75.00

GLIDE PATH RECEIVER R-89/ARN-5

Glide Path Receiver used in the Instrument Landing System covering the frequency range 332 to 335 mc; complete with the following tubes: 7—6AJ5, 1—12SR7, 2—12SN7, 1—23D7, and including three crystals 6497KC, 6522K.

Brand New..... **\$12.95**

TRANSFORMERS—115 V 60 CYC. HI-VOLTAGE INSULATION

3710v @ 10 ma.; 2x2½v @ 3A	\$9.95
2500v @ 15 ma.	6.50
2500v @ 4 ma.; 2½v @ 2A; 6.3v @ 1 amp.	9.95
2150v @ 15 ma.	6.50
1750v @ 4 ma.; 6.3v @ 3A	7.50
1700v @ 4 ma.; 6.3v @ 6A; 2½v @ 1.75A	8.50
1600v @ 4 ma.; 700v CT @ 150 ma.; 6.3v @ 9A	8.50
1600v @ 2 ma.; 6.3v @ 6A; 2½v @ 1.75A	8.50
1200v CT @ 400 ma.; 10v CT @ 10A	9.95
550-0-550 @ 150 ma.; 5v @ 3A; 2x6.3v @ 5A CT	7.95
525-0-525v @ 60 ma.; 925v @ 10 ma.; 2x5v @ 3A; 6.3v @ 3.6A; 6.3v @ 2A; 6.3v @ 1A	8.95
525v @ 35 ma.; 5v @ 35 ma.; 2½v @ 1.75A	1.98
520-0-520v @ 120 ma.; 5v @ 2A; 6.3v CT @ 5A	5.95
500-0-500v @ 25 ma.; 262-0-262v @ 55 ma.; 6.3v @ 1A; 2x5v @ 2A	4.49
500-0-500v @ 100 ma.; 5v CT @ 3A	4.95
400-230-0-230-400v @ 250 ma.; 3x5v @ 3A; 6.3v @ 5A; 6.3v @ 3A; 6.3v @ 1A	7.95
400-315-0-100-315v @ 200 ma.; 2.5v @ 2A; 5v @ 3A; 6.3v @ 9A; 6.3v @ 9A	7.50
400-0-400v @ 200 ma.; 5v @ 3A	4.95
385-0-385-550v @ 200 ma.; 2½v @ 2A; 5v @ 3A; 3x6.3v @ 6A; Pri-110/220v	9.95
375-0-375v @ 400 ma.	4.95
350-0-350v @ 150 ma.; 5v @ 3A; 6.3v @ 6A; 78v @ 1A	4.95
350-0-350v @ 45 ma.; 675v @ 5 ma.; 2½v @ 2A; 2x6.3v @ 1A; 6.3v @ 2½A	4.95
350-0-350v @ 80 ma.; 6.3v @ .6A; 6.3v @ 3.75A; 2x5v @ 3A	3.98
350-0-350v @ 150 ma.; 5v @ 3A; 6.3v @ 7.5A; 6.3v @ 3A	5.95
350-0-350v @ 35 ma.	1.49
340-0-340v @ 300 ma.; 1540v @ 5 ma.	7.50
335-0-335v @ 60 ma.; 5v @ 3A; 6.3v @ 2A; 0-13-17-21-23v @ 70 ma. Pri-110/220v	5.49
325-0-325v @ 120 ma.; 10v @ 5A; 5v @ 7A	3.49
300-0-300v @ 65 ma.; 2x5v @ 2A; 6.3v @ 2½A; 6.3v @ 1A	3.49
250-0-250v @ 100 ma.; 2x6.3v @ 4A; 6.3v @ 5A; 6.3v @ 1A	4.95
200-0-200v @ 140 ma.; 6.3v @ 4A; 5v @ 2A	1.98
120-0-120v @ 50 ma.	.98
24v @ 6A	3.50
3X10.3v @ 7A	9.95
6.3v @ 10A; 6.3v @ 1A	3.50
6.3v @ 1A; 2½v @ 2A	3.95
6.3v @ 2½A; 6.3v @ 2A; 2½v @ 2A	6.95
6.3v @ .25A; 6.3v @ 3A; 5v @ 12A; 6.3v CT @ 9A	4.95
5v CT @ 16A	\$3.49
5v—190A	17.50
6.3v CT @ 1A	.98
220v to 110v @ .75 kv.	2.98
6.3v CT @ 3A; 5v CT @ 4A	4.25

FILTER CHOKES

HI-VOLTAGE INSULATION

10 hy @ 400ma	\$4.95	10 hy @ 250ma	\$2.49
8 hy @ 300ma	3.95	10 hy @ 200ma	1.98
25 hy @ 160ma	3.49	10/20 @ 85ma	1.59
12 hy @ 150ma	2.25	15 hy @ 125ma	1.49
12 hy @ 100ma	1.39	15 hy @ 100ma	1.39
30 hy @ 70ma	1.39	3 hy @ 50ma	.29
120 hy Dual @ 17ma	1.39	30 hy Dual @ 20ma	1.49
.1 hy @ 5 amps	6.95	10/20 hy @ 85 ma	1.49
4 hy @ 600ma	5.95	10 hy @ 100ma	1.29

ATTENTION!

INDUSTRIALS—LABS—SCHOOLS—AMATEURS

Let us quote on components and equipment that you require. We have too many items to be listed on this page. Place your name on our mailing list now for new catalog.

RADIO HAM SHACK Inc.
63 DEY STREET • NEW YORK 7, N. Y.

New! New!

CHIMNEY MOUNT ANTENNA BASE

• for TELEVISION
• FM • AMATEURS

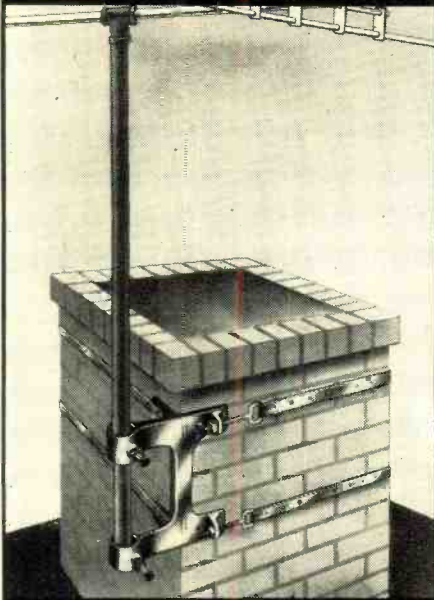

INSTALLED IN 10 MINUTES
PERMITS USE OF SEVERAL
MOUNTS ON ONE CHIMNEY

"Chimney Mount" is a brilliantly engineered new antenna base that can be installed in 10 minutes without the use of special tools or drilling of holes. Several can be strapped to one chimney—also mounts on pole, 2 x 4, side of house or to any rectangular roof extension. Fastens aerial to highest point with galvanized steel bands having a combined tensile strength of more than 3,000 pounds. Made of corrosion-resistant aircraft-type aluminum alloy. Weight: 3 lbs.

"Chimney Mount"

List Price, \$7.50

Cost to Trade, \$4.50

Available Through All Leading
Jobbers or Write to:

South River Metal Products Co.

South River, New Jersey

unit is a converted RAF indicator (similar to the U.S. indicator unit type BC704A). The CR tube itself is 6" in diameter and is electrostatically deflected. The time base generators are EF50 pentodes operating on the combined Miller-Transitron principle. They are synchronized by applying a negative going pulse to the suppressor grid and are extremely stable in operation.

"My sound receiver is an ex-RAF beacon receiver, Type 1125d, modified to the 41.5 mc. frequency. It is used as a converter to 7 mc., the latter frequency being fed into a modified USAAF Bendix radio compass receiver which serves me as a communications receiver.

"In closing I must say how much I enjoy reading RADIO NEWS and only hope that the British Treasury will allow me to invest in a further year's subscription."

Thornton N. J. Archard
Taunton, Somerset
England

Nice hearing from you, Mr. Archard. We know our readers will be interested in your comments.

* * *

SUGGESTION

A GROUP discussion at one Detroit radio school brought out several suggestions requiring long time preparation.

"Between \$35 for high school students and \$10.00 for engineers there is a demand for a tube manual selling for a \$1.00 that will show graphs on every page, show oscillograph patterns at

every stage for AM and FM, and give diagrams for FM alone and television alone.

"With more trucks and buses using two-way radio, new tube manuals should have another column showing operating readings for a storage battery power supply. Manufacturers of portables should attach a cellophane covered statistics sheet."

Steve Clamage

East Dearborn, Michigan

That is a lot of suggestions to digest at one time!

* * *

CIRCUIT DIAGRAMS

FOR many years I have been a rather consistent reader of RADIO NEWS and am now subscribing to the RADIO ELECTRONIC ENGINEERING edition.

"In reading all electronic diagrams, parts are, unless listed otherwise usually referred to as C_1 , C_2 , C_3 , etc. with separate listings of ratings and values as C_1 , C_4 , C_{12} —.01 μ fd., 600 v., etc. This leads to many exasperating minutes looking through a long list trying to find the value of C_{12} or R_{50} which may be placed at random with other parts of similar value in the column.

"Why not simplify the problem by listing and indicating all like parts as R_{1-1} , R_{1-2} , R_{1-3} , etc. in the diagrams and listings? Avoid our confusion and hair pulling when values are not given on the diagram itself. May I suggest a poll of other readers?"

Robert J. Cartwright
Boston, Massachusetts

We'll check into this idea—but off-hand don't think it too practical.—Ed.

The 3.3 billion candlepower Krypton light used in the approach line of the Westinghouse all-weather approach light system for airports is flashed alternately "on" and "off" in a predetermined sequence by means of the electronic timing system shown here installed in the rear of the weatherproof case that houses the lamp, reflector, and flasher. The electronic sequencing element is built and tested by the Control Division in Buffalo, then shipped to the Lighting Division in Cleveland where it is assembled. These early units are for the first full system that is to be installed at New York City's "Idlewild Airport."

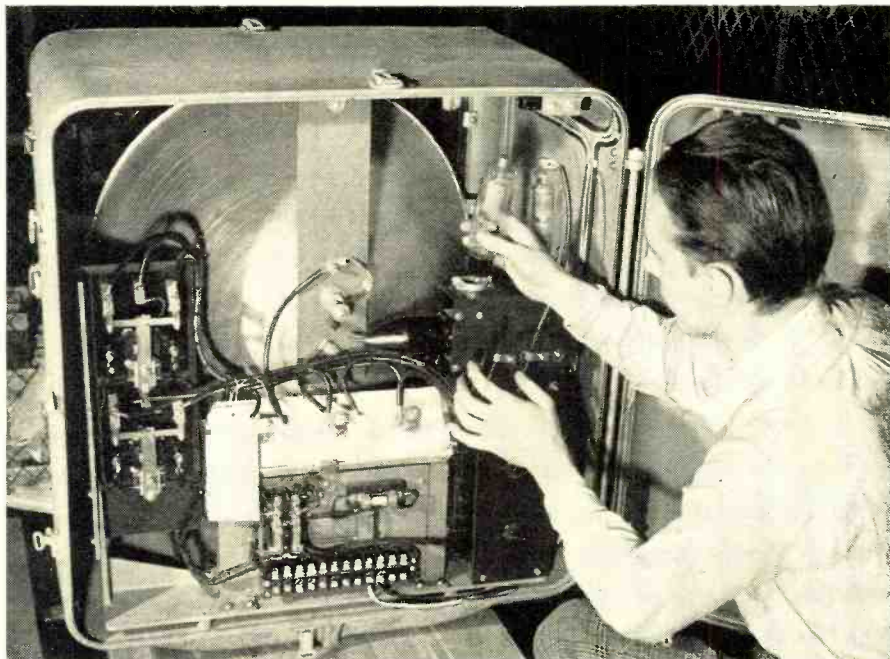



Your dollar buys more at
MID-AMERICA!

VALUES!

VALUES! VALUES!

PERMEABILITY TUNER

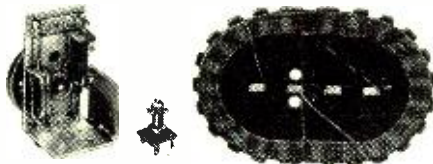

MA-2167

\$124

Build a really HOT 5 or 6 tube AC-DC superhet receiver with this compact permeability tuner. Takes the place of old-style gang condenser, rf and antenna coils; regular 455 KC intermediate frequency. Wiring diagrams supplied for making receivers with all standard parts and conventional tube line-up. Complete with permeability tuned oscillator coil, 4" x 2 1/2" x 2 1/2" diameter dial drum. Order MA-2169 Loop Antenna for use with tuner . . . 15c and MA-2914 drilled and punched chassis . . . 39c

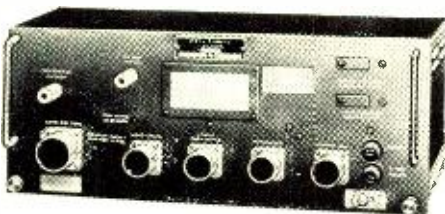

FM TRANSMITTER (APN-1)

Used as indicator for altitudes up to 4000 ft.—but readily adapted for signaling, control circuits, etc. Contains dynamotor for operation from 27.5 volts. Complete with all 14 tubes. Two antennas, altitude indicator, limit switch, connectors, instruction manual.

MA-2198

\$34.50

Miniature Tube-Pin Straightener



Steel die for straightening pins on fragile miniature tubes (1S5, 6AK5, 9002, etc). Quickly aligns pins. Simply plug tube in die. Only 1 1/4" high; 1 3/4" mounting centers for bench installation. MA-2139. . . **27¢**

ORDER FROM THIS AD!

Hurry! Get your order in quick for the big bargains listed in this ad. Minimum order we will ship is \$2.50! Send 25% deposit with order; balance COD. Mail coupon for BIG BARGAIN BULLETINS that offer latest, greatest buys that save you money! Send orders to store address.

T-17 MIKE



MA-17

49¢

Famous T-17 carbon microphone with built-in hiss filter. Push-to-talk button in handle. Has 5-foot rubber-covered cable with PL-68 plug. Slightly used, but reconditioned and in perfect shape. A great buy!

DACO TUBE TESTER



Tests performance, leakage and shorts in ALL receiving tubes, even sub-miniature and acorn. Durable construction, fully shielded. Dust-proof case. Tests every tube element. MA-2193. . . \$29.50 Portable model, MA-2194. . . \$32.50

BANTAM 1-WATTER

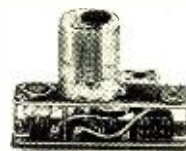

BCR-746-A tuning unit used as foundation for Bantam 1-Watter described in Jan. 1948 QST. Makes tiny, crystal-controlled CW xmitter. 3 3/4" long, 2 1/2" high, 1 1/4" wide. Requires 1 1/2 volts "A"; 30 to 90 volts "B"; draws 8 to 15 ma under load. Supplied less crystal, 1S4 tube and plug-in coil. MA-907.

24¢

Crystal Oscillator Unit

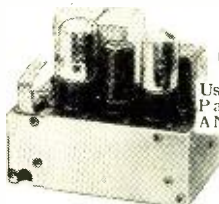

Used as frequency standard. Part of famous Collins AN/ART-13 transmitter. Unique sub-assembly utilizes one 12SL7GT twin triode as a combination 200 KC calibration oscillator and a frequency tripler, one 12SA7 as a converter, and one 12SL7GT as a signal detector and MCW audio oscillator supplying a 1000 cycle note. Regenerative frequency divider and multiplier circuit provides a 50 KC fundamental and harmonics to 18 megacycles. Shipped with tubes and schematic diagram, less 200 KC crystal. MA-OSC-3T.

\$295

CRESCENT RECORD PLAYER



Inexpensive phono amplifier (base only) and record changer with big-set features. Changer handles 10" and 12" records without jamming. Finger-tip reject button. Lightweight pick-up with Shure crystal; 78 RPM constant-speed motor; less speaker, line cord, amplifier. MA-2192.

\$14.95

FM-AM HAM ANTENNA

AN-104-B 1/4 wave at 100-156 MC. Formerly used with SCR-522, 274-N, ARC-5. A pair make an excellent broad-band dipole for FM reception. Coaxial connector in base. MA-2153.

39¢

MID-AMERICA CO. Inc.

STORE: 2412 S. Michigan Ave. Chicago 16, Ill.
WAREHOUSE: 2307 S. Archer Ave. Chicago 16, Ill.

MID-AMERICA CO., Inc.
2412 S. Michigan Ave., Dept. E-48
Chicago 16, Illinois

Please put my name on your mailing list to receive BIG BARGAIN BULLETINS that list latest, money-saving buys in radio parts, electronic equipment.

Name.....
Address.....
City..... State.....

Living Room Concerts

More Economical

Airport & Train Announcements

Cannot Tangle

Broadcast Station Monitoring

Longer Playing Time

Now Available!

8 HOURS OF CONTINUOUS PLAY ON THE MAGNETAPE RECORDER

30 Second Rewind

Conference Recording

Easy Editing

Quieter Operation

Improved Response Range

Copying Valuable Disc Records

Complete Automatic Erasing

Recorded Lectures

Industrial Factory Work Music

Passenger Entertainment

Now — on this one amazing instrument, you can record and play back with unmatched fidelity, any sound that can be heard. Enjoy complete operas and symphonies without record-changing pause, or annoying needle talk and needle chatter. Edit and rearrange your recorded material with ease. The ideal recorder-reproducer for home, office, industry and broadcast station. Also, for the first time, in one compact instrument, you have a choice of three tape speeds for high fidelity, medium fidelity, or 8-hour voice recording. Write today for illustrated technical Magnetape Recorder and accessory catalog. Send 25c for A. C. Shaney's latest booklet, "Elements of Magnetic Tape Recording—and 999 Applications."

AMPLIFIER CORP. of AMERICA

398-2 BROADWAY • NEW YORK 13, N. Y.

Deluxe Receiver

(Continued from page 78)

is obtained or 1900 kc., for the tunable i.f. to use. This means, therefore, that you tune the unit (Fig. 5) to 1900 kc., in its range of 1500-3500 kc. in order to receive signals on 14,400 kc. Since the three-gang condenser tuning the tun-

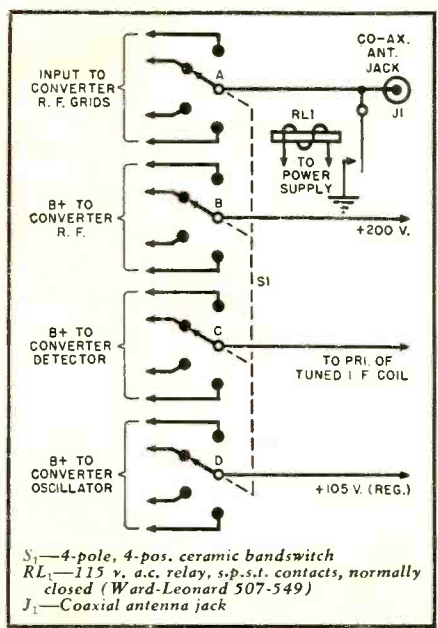

Fig. 10. Bandswitch wiring diagram.

able i.f. section is of the straight-line-frequency type, and the dial calibration is linear, tunable i.f. section must be adjusted in order that 1500 kc. falls at 100 and 3500 kc. falls at 500, thus giving exactly 400 divisions, a quarter-inch apart, with each division representing exactly 5 kc. By this means, frequency can be determined at a glance, since the bottom edge of all bands hits at 100 on the dial. All that is necessary (for instance on 20 meters) is to multiply by 5 the dial reading in excess of 100, and add this figure to 14,000 kc. in order to determine the frequency.



NESCO ELECTRONICS Presents

ANTENNA RELAY UNIT BC-442
0-10 Weston Meter and 50MMF 5000 V. vacuum condensers change over unit, with mounting PT-229. Brand New.
Ea. ONLY **\$1.95**

HANDSET—TS-13
Cradle type with butterfly switch, cord and plugs, individually boxed... NOW **\$2.25**

BC-733D
A 10-tube superhet receiver for lateral blind landing guidance (CAA type certificate) (TC-1045) Excellent condition. **\$4.95**

TU-10B or TU-5
Tuning unit for BC-375 & terrific parts value with a metal case. Brand New. ONLY **\$2.10**

BC-306
Antenna loading unit for BC-375. Brand New. Another parts value **\$1.50**

SOLDER
One pound spool, highest grade compound of tin and lead, rosin core, on metal spool, Brand New, A REAL **69¢** ea.
BUY 6 spools... **\$3.95**

RSARN/7
15-tube superhet radio compass receiver 100 to 1750KC; CW-tone-voice. Like New! **\$29.75**
AT ONLY **99¢**

SHOCK MOUNTS
4 each of 3 sizes—small, medium and large. New. ALL FOR ONLY **99¢**

FREE!
A BRAND NEW, 2 piece electrically-heated FLYING SUIT with orders of \$5.00 or more—limited quantity—for first 75 orders.

WILLARD
2 Volt Storage Battery
Brand new, spill-proof, use standard electrolyte. Suitable for all farm sets and portables. Built-in hydrometer. SPECIAL... Ea. **98c**

HEADSETS
HS-23 high impedance, Army Air Force Type, cord and plug, used... Ea. **\$1.29**

1625 TUBE
Army-Navy Standard
This is a 12 V. filament 807 tube. A tremendous buy... Ea. **39c**
3 for... **\$1.00**

CD-605
A two-foot cord with a PL-55 plug; with low to high impedance xformer for your headset... **39c**

REMOTE CONTROL UNIT RM-12
With handset, ringer circuit and built-in 3" DB meter. Used; very good condition... **\$9.95**

PLUGS and Connectors
Your choice for ONLY **49¢** each

20% deposit required on all C.O.D. orders

division of
NATIONAL EQUIPMENT & SUPPLY CO., INC.
1500 S. Western Avenue Chicago 8, Ill. MONroe 9504

EVERYTHING IN RADIO and ELECTRONICS IN ONE BOOK The Radio Data Book More Than 1000 Pages

All data and basic knowledge in radio and electronics digested into 12 sections ... in a complete, quick to find, easy to read, handbook form.

HANDSOMELY BOUND IN RED AND GOLD

Plan every operation in radio and electronics with the *Radio Data Book*. This new radio bible will be your life-long tool ... you will use it every day, on the board, at the bench, in the field! Use it for engineering, construction, troubleshooting and testing. The RADIO DATA BOOK will be your invaluable aid in design, experiment and in layout. It will help make your production better, faster and easier. In any and every operation in radio and electronics, you will use the RADIO DATA BOOK!

The RADIO DATA BOOK is a work of complete authority, prepared by engineers with many years of practical experience. They have been assisted by the Boland & Boyce staff of editors skilled in preparing electronics manuals for the U.S. Signal Corps for many years. These men have worked for several years gathering material for this book ... all the knowledge of radio principles and operation ... all the statistics ... all the newest developments in electronics ... every possible angle and detail. Eighteen months were spent digesting this material into the most concise, the clearest, and the most readable form. The result is this invaluable manual ... The RADIO DATA BOOK. Whether you use this book for general reference, for scientific instruction, or for education, one thing is certain—the practical help, the daily usefulness you will derive from it will prove to be worth many, many times its astonishingly low price!

Advance Sale ... first printing. Only 10,000 available ... To make sure to get your RADIO DATA BOOK, mail your order

NOW!

12 complete books in one only \$5.00! Less than 42c per book!

CONTENTS

Each section is a COMPLETE coverage of its subject ... 12 sections ... 12 books in ONE, 1000 pages ... Schematics ... Accurate photographs ... Specially prepared drawings ... White on black charts ... Diagrams ... Isometric projections and exploded views.

- Section 1. THE 150 BASIC CIRCUITS IN RADIO.
Every circuit is analyzed and explained in a Johnny-on-the-spot reference for any occasion.
- Section 2. COMPLETE TEST EQUIPMENT DATA.
Know more about the test instruments you now have ... Find the new ones you want to buy ... They're All in here—impartially described!
- Section 3. RECORDING.
- Section 4. ALL ABOUT ANTENNAS.
AM-FM-Television ... design, installation, characteristics, construction and feed.
- Section 5. SOUND SYSTEMS.
Planning, installing and servicing a PA System. A complete chapter on every component ... How to select and combine components ... estimating costs ... even acoustic requirements!

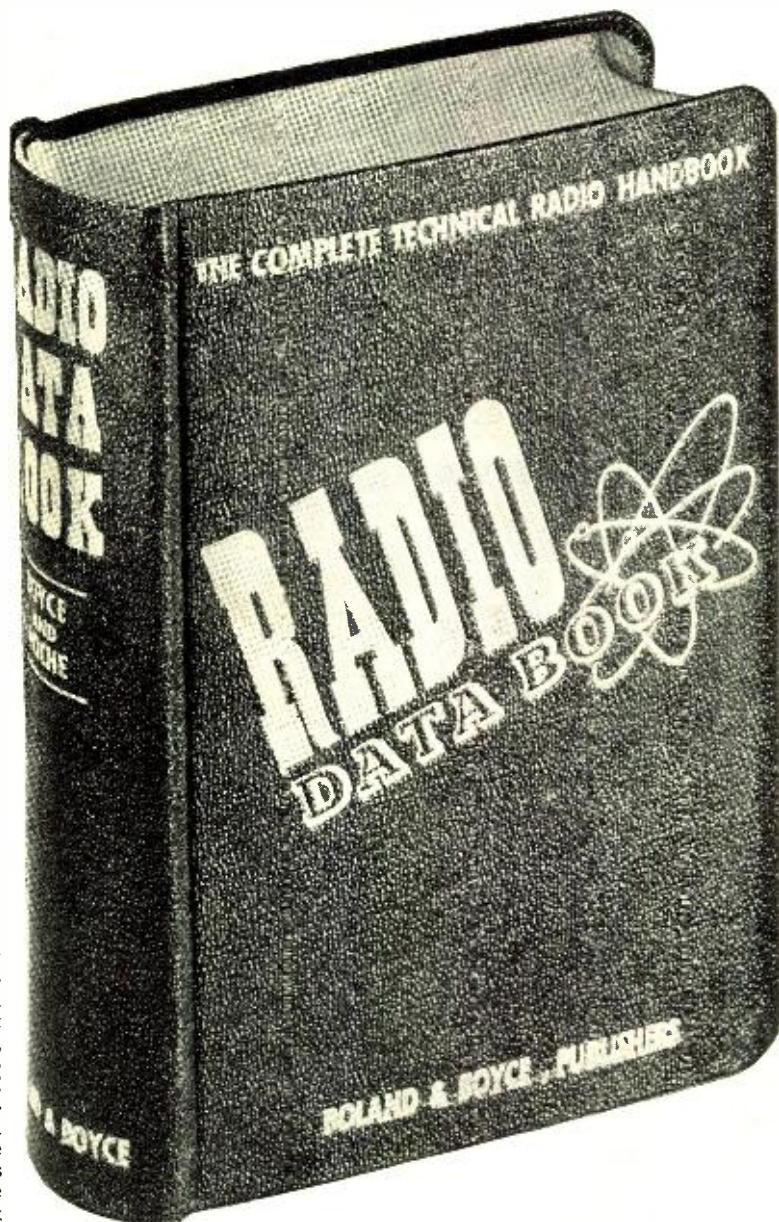

Section 6. ELECTRICAL AND PHYSICAL CHARACTERISTICS OF RADIO COMPONENTS.

Know the size, the power, the shape! A quick reference on the construction and design of any circuit or equipment.

Section 7. COMPLETE TUBE MANUAL: Receiving, transmitting and commercial.

A flick of the pages brings to you all the data and ratings of any tube made.

Section 8. CHARTS, GRAPHS AND CURVES.

Quick calculation devices ... Plotting curves, nomographs, rules and tables for speedy solutions to radio problems.

Section 9. CODES, SYMBOLS AND STANDARDS.

Handy reference to all radio symbols and abbreviations; code symbols, phrase and characters ... Where you want them ... When you want them!

Section 10. 50 TESTED CIRCUITS DESIGNED FOR OPTIMUM PERFORMANCE.

Find any circuit you want with complete parts lists and specifications ... One tube receivers to complete AM, FM and Television receiver circuits ... Amplifiers ... Transmitters ... Test Equipment and Control Circuits ... All with the latest engineering refinements.

Section 11. DICTIONARY OF RADIO AND ELECTRONIC TERMS.

Section 12. RADIO BOOK BIBLIOGRAPHY.

Mail this Coupon to Your Jobber or Direct to:

BOLAND & BOYCE INC., Publishers
460 Bloomfield Ave., Montclair, N. J.

Please send me a copy of
THE RADIO DATA BOOK Enclosed is \$5.00. (\$5.50 Foreign)

NAME.....
ADDRESS.....
CITY..... ZONE.....
STATE.....

BOLAND & BOYCE INC., PUBLISHERS

★ You can buy all these **CANNON** plugs receptacles and accessory fittings

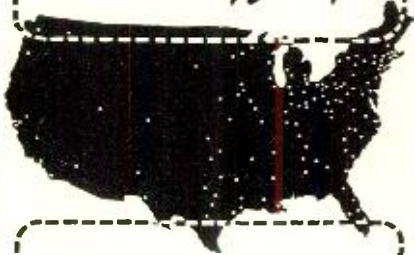

-in 6 type series from more than 200 distributors



Write for FREE new C-47 BULLETIN and list of 200 Cannon Electric Distributors.

CANNON  **ELECTRIC**

Development Company

3209 HUMBOLDT ST., LOS ANGELES 31, CALIF
 IN CANADA & BRITISH EMPIRE:
 CANNON ELECTRIC CO., LTD., TORONTO 13, ONT.
 WORLD EXPORT (Excepting British Empire):
 FRAZAR & HANSEN, 301 CLAY ST., SAN FRANCISCO

What's New in Radio

(Continued from page 86)

formance, good wear characteristics, reduced hum pickup, and controlled groove contour.

Complete information is available to firms interested in the manufacture of wire recording equipment. All requests for information must be made on company letterhead direct to *Shure Brothers, Inc.*, 225 West Huron Street, Chicago, Illinois.

DIAMOND CARTRIDGE

The *Pickering* Diamond Cartridge, the Model D-120M, is currently being placed with jobbers throughout the country.

Electrically identical with the *Pickering* Cartridge, the new unit provides

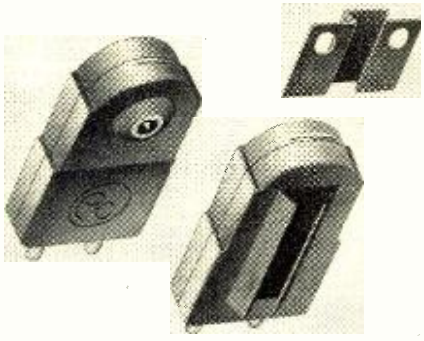

practically unlimited life, outwearing at least ten sapphire equipped cartridges, according to the company. This feature is especially advantageous when playing shellac records.

The diamond is finished to a high polish and since it does not change its shape with continued playing, it causes little wear on the records.

A new technical bulletin describing both models of the *Pickering* Cartridge and the Model 125H Equalizer-Amplifier is now available from *Pickering & Company, Inc.*, 29 W. 57th Street, New York 19, New York.

CABINET RACK ASSEMBLIES

Newcomb Audio Products Co. of Hollywood, California has announced the availability of basic elements for custom, cabinet-type rack systems suitable for various sound applications in industry, schools, churches, fairs, stadia, etc.

These new rack assemblies enable the engineer to install public address equipment designed to meet the customer's requirements. Included in this new line are the Model 595 cabinet, the Model K-60P-900 sixty watt power amplifier, the Model KX-6-900 preamplifier, Model PR-2-450 dual channel preamplifier, Model MP-450 and Model MP-900 monitor speaker panel, Model TB1-450 talk back amplifier, the Model WC-900 phonograph changer panel, and various sized blank panels.

A data sheet covering this new line

WANTED!

Articles by Radio Amateurs

2000 to 2500 words

Covering any material of genuine interest to radio amateurs, such as:

- Transmitters
- Receivers
- Antennas
- Test Equipment

Articles should be typewritten (double spaced) and accompanied by suitable diagrams, photos, and parts lists. Liberal payment will be made upon acceptance.

Address all communications to Box 419

RADIO NEWS

185 North Wabash Avenue
 Chicago 1, Illinois

INVAR SURPLUS AND OTHER BARGAINS

POWER DRIVEN ANTENNA REEL

1/4 HP, G. E. Motor—12-24 V. Removable 6" Reel. Cam worm gears, bevel gear. Solenoid clutch. In gear only when current on. Operates clockwise or counter clockwise. Ideal for power fish line, opening or closing doors, auxiliary power take-off. Can be used as buffing machine or for dozen of other uses. New. Weight 6 Lbs. \$4.50 each.

CLIPS: Rubber lined, aluminum, hundreds of uses in any shop. Assorted sizes, all new. 5 Doz. \$1. - 500 \$5.

SEND CHECK, MONEY ORDER or CASH

VOLTAGE REGULATOR

Like new. 24 V. Carbon Pyle Type. Eclipse. Westinghouse or Leece Neville Mfr. Weight 2 1/2 Lbs. \$5.50 each.

HIGH SPEED DRILL BITS

Like new! Original value over \$16.00. 25 assorted sizes & lengths \$2.50.

MICROMETER

Chrome plated, precision engineered and carefully toolled to give long life. all new. 0-1" capacity, \$2.25. 1-2" capacity, \$3.50 Each.

25% DEPOSIT REQUIRED ON C.O.D. ORDERS

TELEGRAPHERS TRANS. KEY

(J-45), with Leg Clamp or can be mounted on board. Comes with 5 Ft. detachable rubber covered cable, with jack. New. 2 sets complete \$2.95. Weight 3 Lbs.

MECHANIC'S APRON:

Made for Air Corps of long-wearing O.D. 16 Lb. duck, straps of heavy-duty webbing. 13 pockets, three with snap fasteners for holding tools and instruments, heavy stitching. \$1 each.

ALL PRICES F.O.B. CULVER CITY, CALIF.

4 in 1 SCREWDRIVER:

3 smaller screwdrivers fit compactly into hollow barrel of largest screwdriver. Sizes .6", 3", 1 1/2", and 1" overall. Fine steel bits. Solid brass knurled handles for non-slip grip. Large enough for standard screws, small enough for watches. Will handle all sewing machine screws. A handy all-purpose tool for kitchen, garage, or workshop. All New... \$1.00 per set.

AIRBORNE SALES CO., INC. DEPT. EN 418 CULVER CITY, CALIF.

A Complete Station!

Model AN/FRC-1

300 Watt Transmitter 9 TUBE SUPERHETERODYNE RECEIVER

- Amateurs • Airports
- Ship-Shore • Police • Gov't Service

Phone, CW and MCW
Band-Spread Receiver with Built-in Speaker
Complete Station — Nothing Else to Buy
Push-to-talk Relay System
CW Break-in Operation
E.C.O. With Frequency Meter Accuracy
Receiver Range 1.48 mc. to 12.5 mc. (4 Bands)
Transmitter Range 1.49 mc. to 12.5 mc. (5 Bands)
All Important Circuits Metered
Final: 1-813 Modulator: 2-811's Class B
Power Supply, Modulator, Receiver and Power Amplifier Built
in Separate Roll-Out Decks
Operates on 90 to 120 V.A.C. or 200 to 230 V.A.C.
No Modification Necessary — Ready to Operate
Universal Antenna Matching Network
Cabinet Size: 52 1/8" X 21 1/2" X 17 3/4"

Remote Control Unit and Spare Parts

Remote Phone or CW Operation up to 70 feet from transmitter
Unit Contains 5" PM Speaker and Volume Control
Remote Unit Has Primary Power ON-OFF Switch
Spare include 30 tubes (complete replacement) capacitors,
resistors, relays, fuses, etc.

Model AN/FRC-1 Transmitter-Receiver, Complete with
Speedex Key and push-to-talk microphone, ready to
operate—only \$495.00.

Remote Control Unit and Spare Parts and Tubes—
only \$39.00.

Shipped in original crates (3). All units brand new
and guaranteed. Weight 800 lbs. Prices are F.O.B.,
Chicago. \$100 with order required on C.O.D. ship-
ments.

Write for Special Listing AN/FRC-1
for Complete Details

WELLS
SALES, INC.

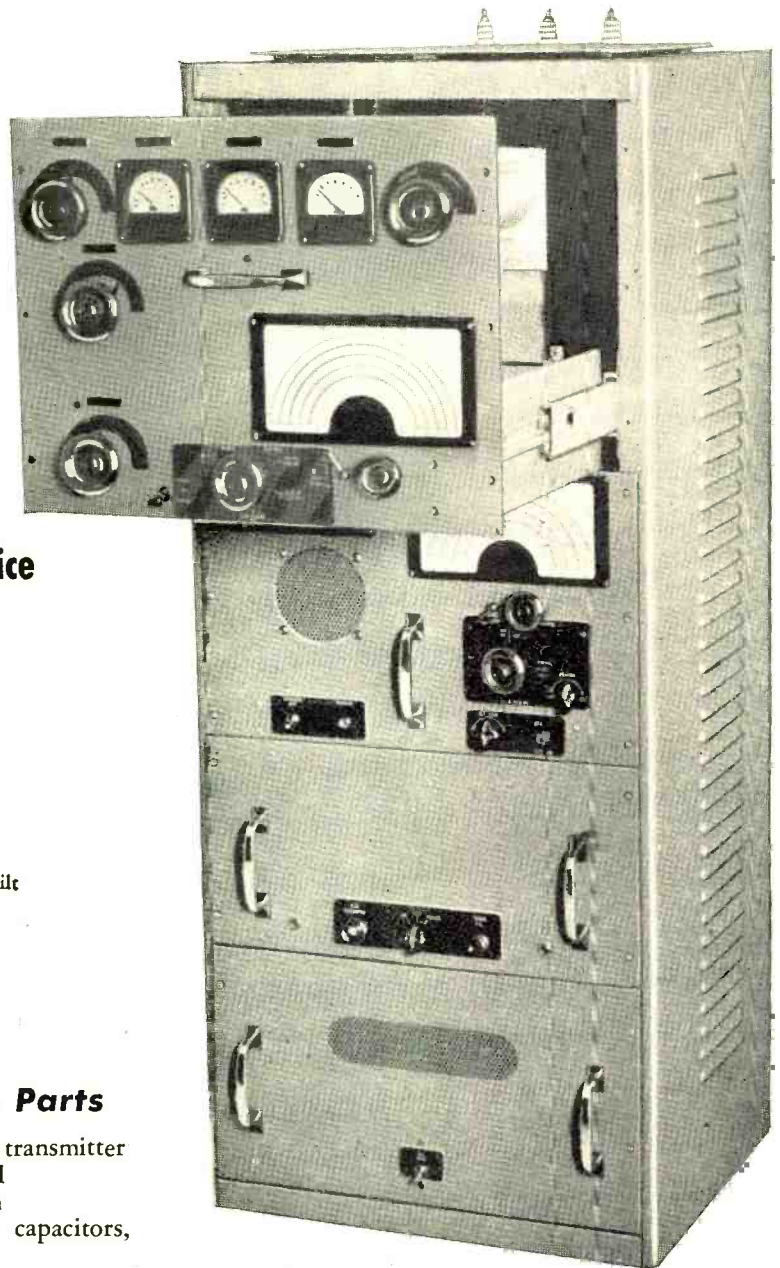

Standard Make Type 826
—60 Watt UHF Transmit-
ting Tubes at 49c each!
The growing popularity of
the higher frequency bands
makes this general purpose
tube an outstanding value.
These 826's are brand new,
inspected, and in their orig-
inal cartons. Shipped only
in boxes of 8 tubes at \$3.92.
(Add 50c for mailing any-
where in U.S.) Ceramic
Tube Sockets for 826,
829B—50c each.

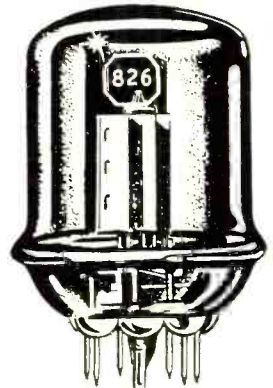

320 N. LA SALLE ST., DEPT. R-4 CHICAGO 10, ILL.

Chicago

INSTRUMENTS

Quality at Low Cost!



For years, Chicago Instruments have given radio men accurate, dependable service. And because of simplicity of design and freedom from "gadgets" we have been able to hold down prices to a fraction of what you would normally pay for instruments of similar quality.

POCKET VOLT-OHM-MILLIAMMETERS FOR ONLY \$5.25

Anyone can now own a good volt-ohm-milliammeter. There is a Chicago V.O.M.A. priced at only \$5.25. Chicago "Featherweights" that slip easily into the pocket are the original miniature radio test instruments. They are popular throughout the world.

Chicago Instruments are available in a variety of ranges and sensitivities. You may see them at your Suppliers or get the complete details by writing for Bulletin No. 10.

CHICAGO INDUSTRIAL INSTRUMENT CO., 536 W. ELM ST., CHICAGO 10, ILL.

of cabinet rack assemblies may be secured from *Newcomb Audio Products Co.*, 6824 Lexington Ave., Hollywood 38, California.

V.T.V.M.

Electronic Instrument Company, Inc. of Brooklyn, New York has announced the addition of the Model 221 vacuum tube voltmeter to its line of test equipment.

The new instrument features completely electronic operation on all



functions and ranges, accurate electronic a.c. range, a burnout-proof meter, special type electronic bridge circuit which is said to practically eliminate all zero drift after a short warm up period, two per-cent accuracy on all ranges, 26 megohms input resistance, and a 4½ inch meter with two per-cent accuracy.

The electronic a.c. and d.c. ranges measure 0-5, 10, 100, 500, and 1000 volts while the electronic ohmmeter covers the range from .2 ohms to 1000 megohms in five positions. A wide-range db. scale is also provided.

More information on the Model 221 can be obtained from *Electronic Instrument Company, Inc.*, 926 Clarkson Avenue, Brooklyn 3, New York.

DUMMY ANTENNA RESISTORS

The development of two new series of dummy antennas, Types D-101 and D-251, has just been announced by the



Ohmite Manufacturing Company of Chicago.

These new units which replace the former glass-enclosed Types D-100 and D-250, are composed of wirewound vitreous-enameled resistors connected in parallel and mounted inside a black



Better Products for the Radio Industry

NEW G-C STATIC CHASER INJECTOR and POWDER



Tire static powder kits—improve auto radio reception. Eliminates wheel static interference. New powder is blown into all inner tubes—easy to use. For every car owner!

- No. 5604—Injector for G-C Static Powder—List \$1.50
- No. 5605—G-C Static Powder Packet for 5 tires—List \$1.00
- No. 5606—Kit—One Powder Packet and Injector—List \$2.50



Have you seen the new G-C "Speedex" Wire Strippers... write for illustrated literature.

RADIO DIVISION, DEPT. H

GENERAL CEMENT Mfg. Co., Rockford, Ill., U. S. A.

Manufacturers of over 3,000 products • Sales offices in principal cities

NEW G-C TUBE PULLER



Makes it easy to remove or insert miniature tubes... simple to operate. Inserts or extracts tubes where fingers will not reach—into hard-to-reach places. Saves time and money. Ends tube breakage. Prevents burnt fingers.

- No. 5093—Miniature Puller..... List \$ 1.50
- No. 5093-D—Display of 12..... List 18.00

NEW G-C FIELD CHASS EZ



Holds almost any radio chassis in position! Has special reversible hooks for flanged type chassis or, to tilt chassis back if necessary. Made with slide adjustment—takes only 5 seconds to install. No parts to lose—will never wear out. A real convenience for the radio serviceman!

- No. 5207—Chas. Ez..... List \$2.95

G-C Products are available at leading distributors. Write for your copy of our new illustrated catalog.

"TAB"

That's A Buy

CONDENSER OIL RATED WVDC

Tapped 2 & .5 & 3mfd/200V	15 for \$1.50
CD 2mfd/330VAC/1000VWDC	5 for 1.98
5mfd/600VDC/220VAC & brackets 2 for	1.49
7mfd/600VDC/10mfd/600V	1.25
3.3mfd/225TAC \$1.25: 4mfd/600V	.49
20mfd/600V/52.50: 4fmd/330VAC/1000V	1.39
15mfd/330VAC/1000V/53: 2mfd/2000V	2.25
3mfd/2000V/53: 4mfd/3000V	5.00
2mfd/12500V/53: 4mfd/5000V	15.00
2mfd/4000V/53.75: 00025mfd/25KV	75.00
2x1mfd/400V/12 for S1: 3x1mfd/400V/10	4.95
1mfd/400V/12 for S1: 2mfd/400V/5 for	1.00
.5mfd/500V/10 for S1: 1mfd/500V/8 for	1.00
.05mfd/600V/30 for S1: 2x.05mfd/600V/25	for 1.00
3x.05mfd/600V/15 for S1: 3x.22mfd/600V/12	1.00
1mfd/600V/10 for S1: 2x.1mfd/600V/8 for	1.00
3x.1mfd/600V/8 for S1: 2x.25mfd/600V/6	for 1.00
3x.25mfd/600V/5 for S1: 5mfd/600V/8 for	1.00
2x.5mfd/600V/6 for S1: 1.22mfd/600V/8 for	1.00
1mfd/1000V/4 for S1: 25mfd/1000V/4 for	1.20

"TAB" FOR TUBES

OZ4	\$1.10	28D7	\$0.89	9006	\$0.49
1B3/8016	2.00	30	.74	902A	2.85
1E7G	.98	33Z5	.61	2A3	1.95
1L1	.98	35TL6	.74	2AP1A	4.95
1P5G	.79	50L6	.72	3AP1	3.25
2A5	.75	80	.52	3BP1	2.75
2C40	.73	83V	1.25	3DP1	2.75
2D21	.98	OC3/VR	.74	3CP7	2.75
2X2	.49	OC3/VR	.74	3CP7	2.75
2X3A	.98	OC3/VR	.74	3JP12	3.95
3A4	.75	150	.74	5AP1	2.75
3B7/1291	.95	211	.79	5BP1	3.75
3D6/1299	.95	250TH	1.80	5BP4	3.75
3S4	.90	30ATL	6.95	5CP1	3.75
3Y4G	1.40	30TA	2.25	5D1	3.95
5T4	1.53	446A	1.98	5HP1	3.95
5U4G	.69	450TH	25.00	7BP7	
5W4	.98	450TL	29.95	1813	3.95
5Y3G	.53	VL531	18.00	9JP1	3.95
5Y4G	1.00	703A	4.95	12DP7	5.95
5Z3	.80	71A	.89	1B34	2.95
5Z4	1.00	723	2.95	1B27	2.95
6AB7	.98	723AB	4.95	1P24	2.95
6AC7	.72	725	4.95	2E22	1.50
6AG5	.97	803	9.00	10Y	.35
6AG7	.98	804	8.95	15Y	1.49
6AJ5	.98	805	4.95	2C26	.39
6AK5	.81	807	1.49	2C34	
6AL5	.95	808	1.95	RK34	.49
6AR6	1.28	811	2.49	2C48	
6B4G	1.29	813	8.90	445A	.88
6B8G	.98	814	5.95	3B24	.74
6C4	.79	815	2.95	3C23	4.95
6C5	.79	816	1.15	4E24/25710.00	
6C6	.73	826	1.45	2J21	12.75
6C8G	.98	829B		2J32	16.95
6D4	.98	3E29	3.90	2J35	18.00
6D6	.74	836	1.10	2K55	4.95
6E5	.98	837	2.95	7L27	2.95
6E6/1613	69	845	4.95	63P1	3.75
6E7	1.20	860	2.49	SN4	3.75
6F8	1.20	861	9.00	CK1005	.30
6G5/8H5	.98	864	1.00	C6J	4.95
6G6	1.08	865	1.00	F127A	12.00
6H8G	.48	866	1.09	448	12.00
6H8M	.68	872A	2.20	4J47	35.00
6J4	1.98	884	1.10	2RA15	5.95
6J5	.72	922	1.49	CF215	5.95
6J6	.81	923	1.39	2RA6	3.95
6J7	.88	931A	2.49	CF206	3.95
6K6GT	.74	955	.49	1G104	14.95
6K7	.78	956	.49	1G105	16.95
6K8	1.20	958	.49	5D21	19.00
6L6G	1.24	957	.49		
6N7	1.23	958A	.49		
687	1.20	1613	.69		
68ATG	.98	1616	2.75		
68C7	.84	1619	.39		
68N7	.91	1622	.49		
68G7	.95	6L6M	1.49		
68U7	.79	1624	.79		
68L7	1.00	1625	.39		
6V6GT	.98	1616	2.75		
6V5	.87	1629	1.39		
6V6G	.88	1635	1.00		
7C5	1.00	1641	.84		
12A6	.29	2050	1.18		
12A7	1.00	2051	.88		
12K3	1.08	7108	4.09		
12S47	.79	8005	4.25		
12S67	.88	8012	3.95		
12SH7	.88	8013	3.95		
12SK7	.88	8016/1B3	2.00		
12SL7	1.08	8001	4.95		
12S87	.85	8002	.49		
12S87	.85	9002	.59		
12S87	.81	9003	.49		
15Z5	.70	9004	.49		

CONDENSER OIL or MICA rated WVDC

1mfd/1000V/3 for S1: .05mfd/1500V/2 for	\$ 1.00
2x.1mfd/500V/2 for S1.25: .5mfd/1500V	.75
1mfd/2000V/2 for S1.80: 0.1mfd/3000V	1.49
Silver Mica .02681 or .0490 W.E. 4 for	1.00
.01mfd/600V/20 for S1.20: .012/2500V	4.98

HEINEMAN 10ma, 3, 5, 10, 15, 20, 30, 35 & 40, 80, 100, 180 Amp \$1.95 @ TEN for 16.00

SQ'D & KLIXON & CH 5, 10, 20, 25, 33, 35, 60, 70 Amps 98c ea. TEN for 7.00

CERAMICONS .001 or .0001mfd TEN for 1.00

EES TELEPHONE TEST SET & RINGER 19.95

VOLTAGE REGULATOR Raytheon New 95-130V/60 cy. Out 115V/60W 10.95

V'REGULATOR Same 198-242Vinpt/50 60cy Outpt220V/500 Watts .5% regltn 29.95

WIRE 1/10/1000 ft. \$12.95; 18/1000 ft. A.N. 4.50

WEP M DRIVER 25 to 55 Watt Waterproof & blastproof \$12.95 @ 2 for 20.00

TRUMPET & WE DRIVER 35 to 55W 29.95

OSCILLOSCOPE 3" K1 tubes & pwr. Sup 15.95

TRANSFORMERS 115V/60cy INPT

2750V/ONE AMP @54. TWO for	\$99.00
5500V/1AMP/220V inpt @54. TWO for	99.00
7500V or 15000V Doubler/35ma	15.95
10800VCT or 21600V Doubler/35ma	19.95
3000V/10ma 54.50: 4000V/10ma	5.50
5000V/10ma 56.95: 2.5V/3A/20KV	4.95
1320V/375VCT/110ma, 5V/3A, 2.5V/3.25A & 6.3V/2.75A Cased Hvy Insld.	8.95
1350VCT/150ma, 6.3V/5A, 5V/2A UCT	8.95
640VCT & 8250V/250 SA.95 2 FOR	1.29
500VCT/60ma 6.3V/4A Hmtcity Csd.	6.95
1100VCT/212ma 55.95: 10V/8A/12KV	3.25
5V/115Amp 59.95: 30V/4AMP	4.95
1000VCT/45ma:795VCT/80ma: 3x5V/3A & 6.3VCT/1A, 6.3VCT/3A Hvy Hmtcity Csd.	4.95
700VCT/150ma, 10V/3.25A, 2.5V/10A & 6.3VCT/2A, 5V/3A: Hvy Insld CASED	5.50
115 or 230V/10Amp/2KW Transformer	19.95
93, 103, 112, 117 or 230V/1.6KW	14.95
115 or 230V/8AMP 1.8KW AutoTransf	14.95
115 or 230V/50-60cy/3.4Amp	4.50
110 or 220 or 220 or 412V/30W	2.95
2.5V/1.75A, 4V/6A/20KV Csd.	5.50
2.5V/1.75A, 6.3V/2A/20KV Ins GE Cased.	5.95
TRANSFORMER ONLY for Two 866A's	3.95
872A'S COMBINATION TRANS. sockets	12.00
866A COMBINATION TRANS. sockets	6.95

Transformer ONLY for Two 866A's

872A'S COMBINATION TRANS. sockets

866A COMBINATION TRANS. sockets

1320 VCT/275ma, 6VCT/3A, 2.5V/2A, 5V/4A

720/20ma, 5V/3A, 6.3V/3A CASED

220Vin/7.5V/24A Hvy-CASED

220Vinpt, 10VCT/5A or 10Vinpt/5VCT/5A

570VCT/180ma, 5V/3A, 12V/4A CSD

510VCT/125ma, 5V/2A, 6V/4A CSD

TRIPLET TUBE CHECKER TRANSF

220 to 440V-or-110 to 220V/250 Watt

AUTO TRANSF 6V/2A, 150V/1.6A, 35V/1.2A

SEL RECT TR/115V/60c, 42.5V/2A

CHOKES

15-29Hy/150ma, SWINGING CASED

12 Hy/300ma 53.95, 3Hy/40ma

15 Hy/400ma or 20 Hy/300ma/15KVins

3 Hy/400ma: 15KV/1.75, 8 Hy/200ma 2 for 2.89

8 Hy/150ma new UTC cracked blkite T'bd

0.5 Hy/100ma/4 for 98c, 50 Hy/150ma

8 Hy/110ma \$1.29: 12 Hy/275ma



AUDIO AMPLIFIER PEAK CLIPPER & LOW PASS FILTER/DEC CQ ART13 CONVERSION MODULATOR tubes L.N. Amplifier, tubes parts, diagrams, data for rewiring ART13 Amplifier INCREASE MODULATION SPECIAL \$8.25

GIBSON GIRL XMTR, ONLY NEW \$10.95

GIBSON GIRL SCR578, COMPLETE 19.95

BC103 WVEMTR 150-210mc's LN* 10.95

BC230 XMTR 2.5 to 7.7mc's LN* 5.95

COMPASS RCVR BC433/MN26 LN* 21.95

SAME Compass Rcvr LESS TUBES LN* 14.95

APS13/RCVR & XMTR less tubes LN* 6.95

ARN-5/BC733 RCVR less tubes LN* 9.95

APN-1 ALTIMETER less tubes LN* 12.95

BC457/458/459-636 Like New* ea. 5.95

MODULAT Q/R less tubes LN* 5.69

BC212 Tank Intercom & tubes & Dyn 3.95

BC191/BC375 one TU & Tubes LN* ea. 9.95

SCR211 FREQUENCY MTR LN* 38.00

USN Flashlight perspective projector & ENLARGER 16-C-168 TM 5.95

S'BAT USN HYDROMETER KIT BOXED & SPARES & THERMOMETERS NEW 1.98

F M TUNER & TEN TUBES Hignin & pwr. Supply 115V/60cy-Sens 5microV 69.95

TBY VIBRPACK & S'BATTERY 9.95

BOX KITE NYLON 2.49

BALLOON 4 ft. & Hydrogen gas Generator GIBSON GIRL HAVERSACK waterproof. STROBO FLASH AN/1503/ TWO LAMPS Inpt 12V, Complete power supply, Cables & batteries & 2 KRYPTON Hi-intensity lamps 12,000,000 lumens 98.50

STROBO FLASH AN/1503 CONVERTED to 115VAC & 3 KRYPTON lamps mtd in Reflectors & check bulbs 198.50

STROBOFLASH KRYPTON lamps & igntn Trans; 12,000,000 LUMENS/15 to 30 mds flashes, seals new. 21.00

CONDENSER STROBOFLASH GE 8mfd & 660VAC/2000WVDC/32mfd/4 units pyranol. 11.50

EXT CORD Hvy-Duty S/J 1/16" M & F plugs .98

MILLEN 150mmf/3000V Variable Condnsr. Cond Var Split Stator 90mmf per Sec. .98

BEL 115VC HOLTZER CABOT C/RN for XTALS, RECTIFIER & KITS 1.49

WRITE SigCorps TM & Tech Diagrams. SEND FOR BARGAIN "TABOGRAM." "TAB" MONEY BACK GUARANTEE. \$5 MIN. ORDER F.O.B. N.Y.C. ADD SHIPPING CHARGES & 25% Deposit.

ANT TUNING UNIT 1001A/1500 to 7000KC/1kwRF/PI-NETWORK ADJUSTABLE IN & OUTPUT CASED COMPLETE Rfmeter, COILS, CONDNR Tuning INSULATORS/Γ MANUAL, WILL MATCH & LOAD MAJORITY ANTENNAS. CAN BE ADAPTED TO HIFREQ'S SLIGHT CHANGES: NEW GTD \$11.95

HIF BL 512C tuned 10-13mc/hq 3 for 1.00

AIRCRAFT INSTS "A TAB" BUY

WESTON OIL TEMP 0-110°C e ec. 2.49

LEWIS CYL TEMP 0-350°C elec. 4.95

WESTON CARB TEMP 0-70°C elec. 2.49

U.S. OIL TEMP 60-220°C & Bulb. 2.49

Englehard 11 to .07 Fuel Air Ratio. 3.49

U.S. OIL PRESSURE 0-200 Gauge. .98

KOLLSMAN 10-50"Hg Manifo d pressure. 3.49

KOLLSMAN RPM 500-2500 Gauge. 2.49

KOLLSMAN SQ'D 0-1000 & 10000 RPM elec. 4.50

SPERRY Turn Indctr A-5 type Gyro. 7.95

SPERRY AUTO PILOT #4GYRO bank & climb 17.95

Precision Resistors FOR METERS BRIDGES, AMPLIFIERS TEST EQUIPMENT ALL STANDARD MAKES

1%	2000**	5%	4300**	10%	5100**	(Rest 1%)	12000**
2%	30000**	5%	84000**	10%	150000**	220000**	
245000**	250000	950000				1155	

ABOVE SIZES 30c each asstd... 10 for \$1.89

.116	89.5	800	2580	8500
.42	100	800	2600	9000
.7	105	812	2635	9455
1.3	107	640	2700	9710
1.3	107	700	2860	10,000
1.75	113.1	733	2900	10,500
2	120	750	3000	12,000
3	121.2	800	3100	14,460*
4	125	900	3290	14,600
4.35	150	910	3384	15,000
5	160	1000	3500	15,000
6.025	165	1030	3730	17,000
6	170	1110	4000	17,000
7	182.4	1150	4300	18,000
7.5	200	1155	4440	19,000
7.9	209.4	1175	4444	20,000
8	235	1250	4720	21,500
10	240	1260	4850	22,000
12	245.4	1322	4885	23,000
14.5	250	1350	4900	24,000
20	260	1500	5000	25,000
25	280	1510	5000	29,900
26	286	1600	5100	30,000
30	299	1640	5270	33,000
37	300	1650	5500	37,000
40	320	1800	5730	40,000
45	341	1850	6000	54,000
45.1	400	1865	6200	54,400*
49	418.8	1900	6300	60,000
50	426.9	2000	6500	65,000
55	440	2080	7000	68,000
66.7	452	2142	7500	75,000
70	480	2300	7700	80,000
71.4	487	2400	7900	84,000
75	500	2455	7950	90,000
80	520	2490	8000	91,000
81.4	540	2500	8250	95,000

ABOVE SIZES Each 45c... Ten for \$3.00

0.1meg	16675	.25meg	4.0meg	6meg
.1	175	254	402	652
.12	185	265	422	694
.15	201	268	458	7
.135	.22	.294	.478	.75
.14	.229	.314	.5	.7613
.14	.24	.333	.575	.8
.147	.245	.3335	.575	.9
.15	.25	.3535	.595	.95

ABOVE SIZES Each 60c... Ten for \$5.00

1meg.	2	4	5	11.5
1.2	2.855	4.23	9.05	

PEAK SUPER SPECIALS

SPECIALS OF THE MONTH

Western Electric Filter Choke 4.3 Henry 620 ma 42 ohms—\$4.95.

FILTER CHOKE—8 henry 160 ma—140 ohm D.C. resistance \$1.39 ea.—2 for \$2.50

APN4, 5" SCOPE INDICATOR (25 tubes)

Makes an ideal basis for 5" scope. Also can be converted into Pan-adaptor with marker pips at 100-KC-20K-C-2K-C. Has electronic switch for observing 2 frequencies simultaneously. Unit contains an accurate 100KC crystal. Tube complement: (1) 5CP1 (3) 6SL7 (14) 6SN7 (6) 6H6 (1) 6SJ7 complete with tubes and 100KC crystal. Marvellous buy at **\$24.95**



A SWELL BC 348 "S" METER

This G.E. tiny but accurate meter is only 1 1/2" sq. Basic 0-1 ma. Swell for "S" or field strength meter, etc. Only **\$3.95**



S.C. TEST SET (1-114)

In portable wood case 6"x6"x10", including cover not shown, with Weston 0-150 v. AC. Meter has 2 switching ckts and comes complete with test and line cables. **\$3.95**
A Buy at only
Same with other make meter...\$3.25



FOR GRIDS 'N' PLATES

This Westinghouse 3-inch panel meter (0-2 ma scale), complete with shunts for 20 ma and 200 ma. A Peak Special at **\$4.75**
400 ma or 500 ma shunts for above. Each **\$0.35**
Multiplier to make above 0-2000 v. DC...\$1.95



METERS (Standard Brand)

2" 0-5 ma. (amp scale)	\$1.95
2" 0-1.2 (0-100 scale)	2.49
2" 0-1 amp. R.F. (internal thermo)	3.49
2" 150-0-150 microamps Model 506 (Sperry scale)	3.49
2" 0-50 microamps. (square)	7.50
2" 0-120 Ma R.F.	4.95
2" 0-1 Ma Basic (0-3 V scale)	2.95
3" 500-0-500 microamps. (Blank scale)	3.95
3" 0-2 ma D.C.	3.95
3" 0-20 ma D.C.	3.95
3" 0-15 ma D.C. (square)	3.95
3" 0-150 volts A.C.	3.95
3" 0-200 microamps (volt-scale)	6.95
3" Running Time Meter	7.95
4" 1-0-1 ma D.C. (Blank scale)	3.95

FEDERAL SELENIUM RECTIFIER

Full wave. 36 volts input. 28 volts output at 6.1 amps. Brand new **\$7.95**

AMERTRAN TRANSTAT or Stepdown Transformer

110/220 volts 60 cycle input. Output variable plus or minus 10% of 115 volts at 8.5 amps. Also can be connected to give different voltage combinations. Brand new **\$17.50**



CONDENSERS Nationally Known

2 mfd 600 vdc	\$.39	3 mfd 3000 vdc	\$3.95
4 mfd 600 vdc	.59	1 mfd 5000 vdc	4.50
3/3 mfd 600 vdc	.79	.1 mfd 7500 vdc	1.95
14 mfd 600 vdc	1.35	.1/1 mfd 7500 vdc	2.45
2 mfd 1000 vdc	.79	.01/.01 12 KV dc	5.75
4 mfd 1000 vdc	.95	.65 mfd 12500 vdc	12.95
2 mfd 1500 vdc	1.25	.75/.35 mfd (dual) 8/16 KV dc	14.95
1 mfd 2000 vdc	1.11		

A BIG 10 BITS

Lotsa Good parts kicking around our jerrt. (Quantities too small or advertising). Dunno exactly what we'll scrape up to put into your bag, but if ya send an extra \$2.50 with your order, we promise ya won't be sorry.

If not rated, 25% with order, balance C.O.D.—Minimum order of \$3.00.

PEAK ELECTRONICS CO.

188 WASHINGTON ST., DEPT. MR
NEW YORK 7, N. Y.

wrinkle-finished perforated steel cage. The cage is equipped with legs for convenient mounting.

Two types of terminations are provided depending on whether the unit is to be used in conjunction with a coaxial cable or with a parallel transmission line.

Ohmite Manufacturing Company, 4951 West Flournoy Street, Chicago 44, Illinois will furnish full details on these units to those requesting them.

FRACTIONAL H.P. MOTORS

T. C. Smith Manufacturing Company of Springfield, Illinois is currently marketing a new fractional horsepower motor which is said to

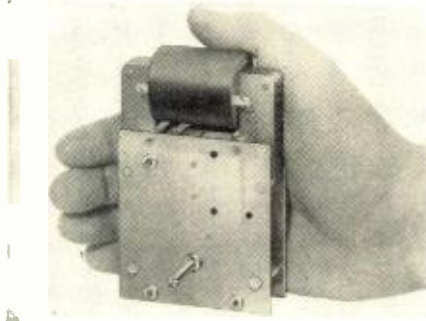

possess remarkable torque capacity for its size.

The unit, designed to be used in coin machines, directional antennas, etc., has a stalling torque of 75 inch-ounces at its rated voltage. Small enough to fit in the hand, this new motor is a shaded-pole, induction type. With 20 watts input at 115 volt, 60-cycle a.c., the no-load speed is 20 r.p.m. on the output shaft. Lower input wattages are available at correspondingly lower stalling torques, with output shaft speed at no-load substantially unchanged.

A particular feature of this motor is its magnetic clutch. With the de-energizing of the motor, this clutch prevents any over-travel of the output shaft. (This does not include gear train coast when the motor is running free.)

Performance curves and other information on the motor will be supplied on request to T. C. Smith, President, T. C. Smith Manufacturing Company, 920 Washington Street, Springfield, Illinois.

TV TEST GENERATOR

A new electronic generator which produces grill-like patterns to check the linearity and speed the precise



alignment of television picture tube circuits has been announced by the Test and Measuring Equipment Section of Radio Corporation of America.

The new "Grating Generator" (Type WA-3A) is designed to provide both television set manufacturers and television broadcasters with a means for determining the correct linearity alignment of deflection circuits for television receiver picture tubes and television camera pickup tubes.

The generator produces on the picture tube a pattern consisting of crossed horizontal and vertical bars. The horizontal bars are used for checking vertical alignment and the vertical bars are for checking horizontal alignment. Equal spacing between bars indicates perfect linearity. Crowding or spreading of the bars signifies improper alignment. Curvature of the bars reveals the effect of stray magnetic fields. Thus, by observing the grating pattern on a kinescope, it is possible to adjust the scanning velocity to produce uniform distribution of picture details.

Full details on the Type WA-3A Grating Generator will be supplied by the Test and Measuring Equipment Section, Radio Corporation of America, Camden, New Jersey.

FEATHERWEIGHT IRON

Transvision, Inc. of New Rochelle, New York has introduced a featherweight soldering iron weighing only 3 ounces but capable of doing the work of a 200 watt iron, according to the company.

The iron heats in 20 seconds from a cold start and features fingertip button control. The unit retains heat with the switch off up to one minute then needs only three seconds to reheat for



continuous operation at maximum efficiency.

An intermittent control feature prevents tip corrosion and necessity of frequent cleaning. The long, thin tip permits soldering in tight corners. Tips are interchangeable to suit the work at hand and various types of tips are available.

Transvision, Inc., 385 North Avenue, New Rochelle, New York will supply additional details on request.

VOICE-ACTIVATED RECORDER

The development of a voice-activated instantaneous start-stop clutch mechanism has been announced by the Magnephone Division of Amplifier Corp. of America.

Available as optional equipment on any of the company's "Magnetape" recorders, this new voice-clutch is activated by the voice of the speaker,

A MUST FOR FM & TELEVISION SERVICE SHOPS!

Now... AT A
SENSATIONALLY
LOW PRICE!
ECA QUALITY
FM & TELEVISION
Sweep Signal
GENERATOR
\$34⁹⁵ COMPLETE

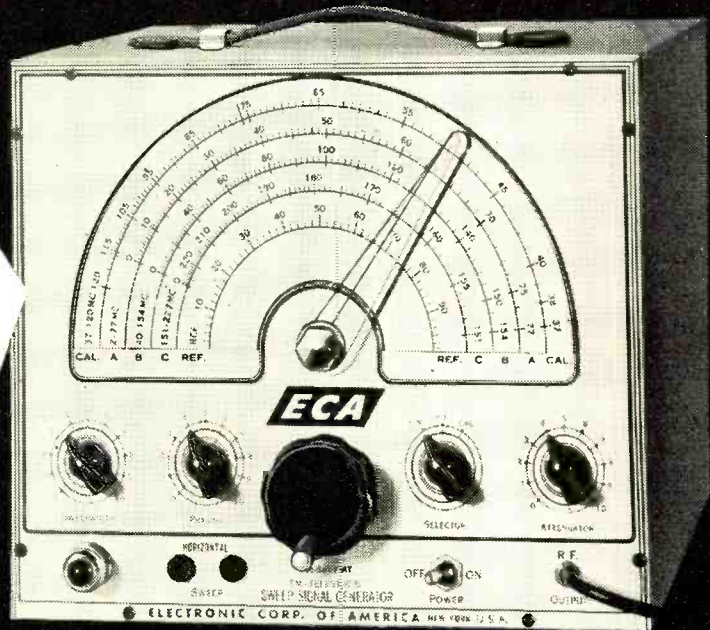

Here's great news for FM and TV Service Shops! A new, top quality sweep signal generator—product of a manufacturer with vast resources, advanced engineering "know-how", and wartime experience in producing test equipment—now available, **DIRECT FROM THE FACTORY**—at a phenomenally low price!

FRONT PANEL CONTROLS

- A — Sweep width 500 KC to approx. 10 MC
- B — Phasing control
- C — Tuning vernier control 10 to 1 ratio
- D — Selecto switch FM — RF — CAL
- E — RF Output control
- F — 60 cycle horizontal sweep output
- G — Amphenol RF output shielded connector

FREQUENCY RANGE 3 BANDS
 (No band switching necessary)
 (2 to 227 Megacycles)

- A — 2 — 77 MC
- B — 40 — 154 MC
- C — 151 — 227 MC
- D — Calibration and reference scales
- E — Dial scale length

TUBE LINEUP

- A — 6C4 — Fixed frequency modulated oscillator
- B — 6C4 — Continuously variable beat frequency oscillator
- C — 6C4 — Mixer — Cathode follower output tube
- D — 5Y3 — Rectifier tube

GENERAL INFORMATION

- A — High frequency insulation throughout
- B — Maximum output 500,000 U/V
- C — Power required 105-125 Volt 50-60 AC 35 Watts
- D — Power line filter built in
- E — Special Midline capacity tuning condenser
- F — Pilot light line indicator
- G — Generator output can be used either frequency modulated or pure RF

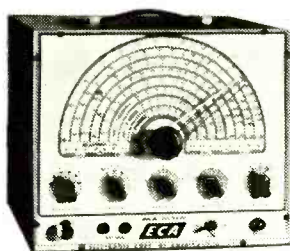

AM SIGNAL GENERATOR

8 RF bands. Frequency coverage 100KC-75MC. External modulation from 40 to 30,000 cycles. Internal modulation at 440 cycles. Phase shift audio oscillator and internal modulator. A.C. 105 to 120 volts, 50 to 60 cycles. Special Hammarlund variable condenser; 3 step RF attenuator Continuously variable RF-AF attenuator control. Ultra

stable two terminal RF oscillator. Pilot light line indicator. Cathode follower output tube. Modulator percentage continuously variable from front panel, internal or external, 0 to 100%. Heavy 16-gauge steel cabinet. Complete with 4 (standard brand) tubes. Amphenol co-axial connecting cable, ground cable, operating instructions and guarantee.

\$32⁵⁰

RADIATION LOOP AND ALIGNMENT WAND

Provides loose coupling. Checks loop-oscillator tracking. Increases efficiency of receiver's alignment or mistracking. Enables the service engineer to make gain measurements. Professional appearance and results. May be used on any signal generator. Complete with operating instructions.

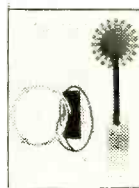

\$5⁹⁵

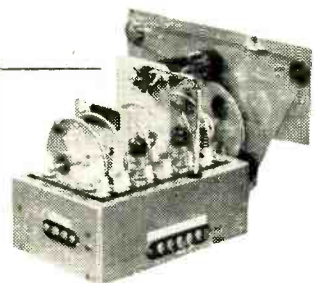

FM FRONTEND

Complete with 3 tubes, including Magic Eye. 88-108 MC.

For use with 10.7 MC I.F.S., high Q resonant tuned lines. Heavy silver overlay on lines and contacters. High frequency insulation throughout I-RF stage, detector, and oscillator. Large 7" sliderule dial. Chassis floated, non-microphonic.

\$15⁹⁵

BACKED BY ECA WITH R.M.A. GUARANTEE. WRITE FOR ECA CIRCULAR ON PARTS AND ADDITIONAL EQUIPMENT.

RUSH YOUR ORDER TODAY... TO INSURE PROMPT DELIVERY. ORDERS FILLED IN SEQUENCE AS RECEIVED. PRICES F.O.B., N. Y. C.

ELECTRONIC CORPORATION OF AMERICA

353 WEST 48th STREET • NEW YORK 19, N. Y. • PHONE: CIRCLE 6-1985 Cable Address: ECAEPLT

New! Permanent PANEL SWITCH ↓

Mounts on console panel—Eliminates groping behind radio to turn on and off.



Model 5

BATTERY ELIMINATORS

A COMPLETE LINE FOR EVERY REQUIREMENT

NEW MODEL "S" WITH SELENIUM RECTIFIER—Operates any 1.4 volt, 4, 5 or 6 tube radio from 115 volt, 60 cycle source.

MODEL "P"—Same as MODEL "S" except with tube rectifiers at lower cost.

MODEL "F"—Operates any 2 volt 4, 5, 6 or 7 tube radio from 115 volt, 60 cy. source. (0.5 amp. filament max.)

MODEL "Q"—Operates any 1.4 volt 4, 5, or 6 tube radio from 6 volt storage or dry battery, or Wincharger. Ideal for farms, camps, autos, boats, etc.

MODEL "R"—Operates 2 volt 4, 5, 6 or 7 tube radio from 6 volt storage or dry battery, or Wincharger. (0.5 amp. filament max.)

Models to convert dry battery radio to AC receivers—other models for use with 6 volt storage battery. Costs but a few cents per hundred hours of operation. Completely filtered, hum free, silent and efficient. Sturdy construction with Hammerloid finish. No liquids or moving parts. Operate in any position.

ELECTRO PRODUCTS LABORATORIES

Pioneer Manufacturers of Battery Eliminators

549 West Randolph Street

Chicago 6, Illinois

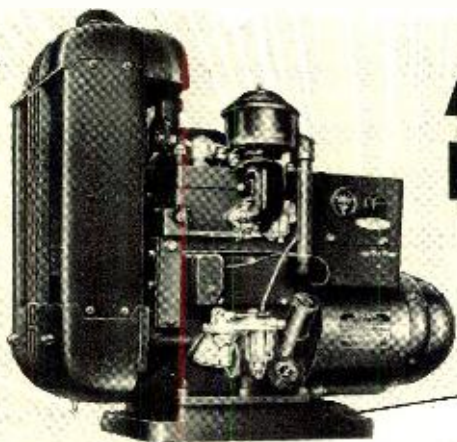

A.C. OR D.C. POWER

PORTABLE,
STANDBY OR
STATIONARY

You can simplify any power-for-electronics problem with an ONAN Electric Plant. A wide range of models and sizes makes it easy to choose the right plant for the particular application.

Lightweight one or two-cylinder air-cooled models for easy portability—A.C.—350 to 5,000 watts, D.C.—600 to 5,000 watts. Onan two, four and six-cylinder water-cooled models are built for continuous heavy-duty operation, stationary or mobile. A.C.—3,000 to 35,000 watts, D.C.—3,500 to 10,000 watts.

ONAN Electric Plants: A.C.—350 to 35,000 watts in standard voltages and frequencies, D.C.—600 to 10,000 watts, 115 and 230 volts. Battery chargers—500 to 6,000 watts, 6 to 115 volts.

D. W. ONAN & SONS INC.
4793 Royalston Ave. Minneapolis 5, Minn.

For—
Radio Station Standby
Geophysical Survey
Railroad Radio
"Spot" Recording
Mobile Radio Units
Municipal Signal Standby
Amateur Radio

Write for Folder



ONAN ELECTRIC PLANTS

singer, or by other preselected sounds. The unit so equipped continues to record as long as the sound is maintained



and for approximately five seconds thereafter, to compensate for any pause. Actually, the time the recorder will operate after the sound has ceased depends on the length of time the speech or music has been going on, and on its volume, thus, the instrument's period of expectation increases with the increased possibility of additional sounds following.

A catalogue, No. 4901, containing information about the complete line of standard and portable magnetic tape recorders and a description of the new voice-operated clutch may be secured by writing *Magnephone Division, Amplifier Corp. of America*, 398-2 Broadway, New York 13, New York.

REPLACEMENT KIT

Clarostat Mfg. Co., Inc. is now merchandising a new kit which is designed to provide servicemen with a maximum number of replacement parts with a minimum of stock.

Known as the "Han-D-Kit" No. 5, this kit contains twelve of the most popular values of plain, tapped, and slip-drive controls, together with a selection of twelve attachable shafts and four "ad-a-switches"; six most-needed ballast tubes; five "Greenohms" or 10 watt wirewound power resistors; plus a double-ended wrench, authorized service plaque, and a copy of the company's latest catalogue.

The entire assortment is packed in a green-finished steel cabinet with hinged cover which can later be used as a filing cabinet or handy box.

Additional details on the new kit may be secured from *Clarostat Mfg. Co., Inc.*, 130 Clinton St., Brooklyn, New York.

—30—

VWOA ELECTS OFFICERS

THE Chicago Chapter of the Veteran Wireless Operators Association has named Thomas Rowe to the post of chairman for the ensuing year. Serving with Mr. Rowe will be E. A. Nicolas, vice-chairman; R. Higgins, assistant vice-chairman; and E. A. Beane, secretary-treasurer.

The following members were elected to the permanent Executive Committee of the Chicago Chapter: L. W. Bear; E. A. Beane; F. Britten; L. O. Gorder; R. Higgins; W. J. Halligan; W. F. Marsh; and G. I. Martin.

—30—

RADIO NEWS

HAMS! EXPERIMENTERS! Look at these EXCLUSIVE "G & G" BUYS!



TERRIFIC VALUE!
24-VOLT STORAGE BATTERY, BRAND NEW!
 Made by Delco. 12 cells, heavy duty, very rugged. Shipped dry, uses standard sulphuric acid electrolyte.

VERY SPECIAL... **\$14.95**

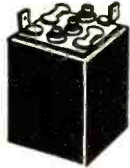

6-VOLT STORAGE BATTERY
 Navy Standard BRAND NEW. 15 ampere-hour rating. **\$4.95**

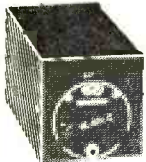

SETCHEL-CARLSON BEACON RADIO RECEIVER BC-1206-C

Receives A-N beam signals, operates on 24-28 V. DC. 5 Tubes: 3-14H7, 14R7, 28D7. Tunes 195 to 420 Kc. Size 4"x4"x6³/₈" wide. 4 lbs. Slightly used, A-1 condition. Each... **\$4.95**

Same as above, BRAND NEW, in original carton. **\$7.95**

RADIO RECEIVERS

All Brand New in Original Cartons
 BC-454A 3.1 to 6 Mc complete with tubes **\$5.95**

40-WATT VFO DRIVER

BC-457A 4 to 5.3 Mc. **\$5.95**
 BC-458A 5.3 to 7 Mc. **5.95**



PE-104-A VIBRATOR POWER SUPPLY

Works on 6 volt or 12 volt battery. Supplies 84 volts and 51 volts DC also 1.4 volts "C" bias. Size 7"x4"x3³/₈". Fits BC-654 (SCR-284) exactly. Can be used to operate many types of receivers now on market.

ALL BRAND NEW, very low price. **\$4.95**

80 VOLT A.C. INVERTER

Sig. Corps PE-206A. Terrific Value! 80 Volts AC Output, 800 cy. 28 V DC Input 6000 RPM. Complete with Filter. Value \$100.00. Your Cost. **\$6.95**

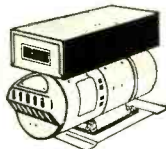

BC367 Interphone AMPLIFIER

Here's a terrific value for you! Unit comprises a 2-watt audio amplifier with input and output transformers; 600 cycle audio oscillator for signalling. Housed in compact metal case. Originally built for Signal Corps. Complete with two 6V6 tubes. Slightly used, your cost. **\$4.95**

BRAND NEW, in original carton. **\$6.95**

WILLARD 6-VOLT STORAGE BATTERY

27 amp. hrs.

3-cell battery, transparent plastic case, very specially priced. **\$4.50**

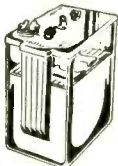
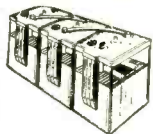

WILLARD 2-VOLT STORAGE BATTERY

20 Ampere-Hours

Exact replacement for GE portables—brand new. Each. **\$1.49**

ONE-QUART BOTTLE BATTERY ELECTROLYTE

Made by Willard, for above storage batteries. 1 quart sufficient for two 2-volt cells. Hermetically sealed. SPECIAL. per qt. bottle **95c**

7-PRONG 2-VOLT RADIO VIBRATOR for Portable and Farm Sets Replacement for GE LB 530. **\$1.65**

SPECIAL!

Delco 12-cell Storage Battery 17 ampere-hours. Only a few left at. **\$16.95**

BC-645 XMTR RECEIVER 15 TUBES 435 TO 500 MC

BRAND NEW!

\$975

2 for \$1895



The electronic equipment that saved many lives in the war. Set can be modified to use for 2-way communication, voice or code, on following bands: ham band 420-450 mc, citizens radio 460-470 mc, fixed and mobile 450-460 mc, television experimental 470-500 mc. 15 tubes (tubes alone worth more than sale price!): 4-7F7, 4-7H7, 2-7E6, 2-6F6, 2-955 and 1-WE316A. Now covers 460 to 490 mc. Brand new BC-645 with tubes, less power supply in factory carton. Shipping weight 25 lbs. PE-101C DYNAMOTOR for above BC645. **\$2.95**

UHF ANTENNA ASSEMBLY

A rare bargain for UHF experimenters! Consists of 7 aluminum rods, in calibrated lengths as follows:

- 3 rods 12" long for 200-247 Mc
- 1 rod 9¹/₂" long for 248-313 Mc
- 1 rod 7¹/₂" long for 312-400 Mc
- 1 rod 5¹/₂" long for 402-517 Mc*
- 1 rod 4¹/₂" long for 512-667 Mc

All rods in handy fabric pouch. Two UHF coaxial coupling insulators included. All BRAND NEW, in original carton, yours for only **\$2.45** *2 of these rods suitable for BC-645 Transceiver.

TU-75-B XMTR TUNING UNIT

Hams! You'll want this! Tuning unit uses 3-815 tubes. Has 5 tuning condensers, coils, all components easily converted to 2-meter rig! BRAND NEW, in original carton, with tubes, all yours for. **\$14.95**

RCA AVT-112A AIRCRAFT XMTR

2500 to 6500 Kc, 6 tubes, compact, powerful, operates on 12 volt source. Less crystal, BRAND NEW **\$12.95**

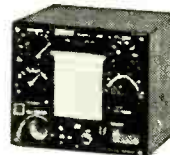

MacElroy Automatic KEYER

Suitable for keying transmitter, or for code practice. Has photoelectric cell and sensitive relay. Variable speed motor operates on 110 volts 60 cycles AC. Very Special Price! **\$14.95**

Down Come Prices! CATHODE RAY TUBES

All Brand New, in Original Cartons



- 5BP1 Lots of 4, each. **\$1.79**
- 5BP4 Lots of 4, each. **1.95**
- 3FP7 Lots of 4, each. **1.49**
- 304TL Eimac, each. **\$2.95**
- GE-211 Each. **1.22**

Western Electric Field Phone Set EE-8

Leather case, with handset, generator, ringer, etc. Requires 2 flashlight cells. Wonderful value!

As is ea. **\$4.95**
 Good Used ea. **8.50**



QUANTITY PRICES

Inquiries welcomed from institutions, wholesalers, dealers, large users. . . . Phone, write, wire for quantity prices.

Please include 25% Deposit with order—Balance C.O.D. Minimum order \$3.00. All Shipments F.O.B. Our Warehouse N.Y.C.

G & G GENUINE MAJESTIC
RADIO PARTS SERVICE
 53 VESEY STREET • NEW YORK 7, N.Y.

SENSATIONAL Smash Value!

COMPLETE I.F.F. Equipment RC-188-A

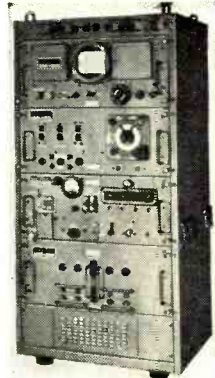

Bargain opportunity of a lifetime! This I.F.F. equipment originally cost about \$20,000. . . . now buy it for a tiny fraction of cost! Easily converted for Television. Complete assembly consists of Control unit with 5" C.R. Tube, transmitter and receiver assembly (157 to 185 Mc), Indicator unit, and Power Supply (450 watts) operating on 110 volts, 60 cycles AC. All assembled, ready to operate. 62 Tubes included: 8-6V6GT, 9-6SL7GT, 14-6SN7GT, 1-5CP1, 2-9006, 1-6Y6G, 2-6E5, 1-100TH, 2-6I5, 2-2C26, 1-3E29, 1-6H6, 7-6AG5, 3-6AK5, 1-6C4, 3-2X2, 1-6X5GT, 3-5U4GT. Overall size 55" high, 28" wide, 20¹/₂" deep. Shpg. weight 750 lbs. Your cost, complete, BRAND NEW, in original packing. **\$195.00**

HEADPHONES—All Brand New!

Individually packed, complete with phone plug. HS-33 600 ohms, in lots of 3. **\$2.45** each
 HS-23 2000 ohms, in lots of 3. **1.85** each
 HS-30, With earplugs, LOTS OF 12. **44c** each

HANDSET



Cradle-type handset with butterfly switch, unbreakable black plastic, 4-ft. 3 wire cable, BRAND NEW, individually packed, each. **\$2.75**

Same as above but slightly used, each. **\$2.25**

140 MMFD MIDGET TUNING CONDENSER
 Long shaft. Lots of 3, each. **44c**

118 MMFD TRANSMITTING CONDENSER
 Very Special Ham Value! 31 plates, Airgap .109" overall length 4³/₈", ceramic insulation, normal list price \$11.85. each **99c**

BEEDE DC METER, new, black bakelite case, 3" round 0-1000 DC Ma. Special **\$1.95**

ASTATIC CRYSTAL PICKUP, with L-26 crystal cartridge. **\$1.79**

SPECIAL 409.5 KC CRYSTAL
 Lots of six. each **29c**

FREQUENCY METER CABINET

For BC-221 Series freq. meters. BRAND NEW! 3 compartments. Massively built. 14¹/₂"x10¹/₂"x10". Value \$20.00. Yours for only. **\$2.95**

HANDMIKE T-17

Shure model T-17 mike—200-ohm carbon single button, with press-to-talk switch, 5-ft. rubber cord and plug. BRAND NEW, individually packed, in lots of 3, each. **88c**



for **QUALITY**
of Reproduction...
TAPETONE
is **TOPS!**



TAPETONE MAGNETIC TAPE RECORDING KIT

• For the Home • For Office • For Studio Experimenters. Set-Builders, Hams, Radio Engineers are all enthusiastic about the newly developed TAPETONE Magnetic Tape Recorder. These features tell you why:

- It records voice and music on tape, with quality of reproduction BETTER than that of the best platter records commercially available today!
- It plays up to 12" platter records, and reproduces from the records on to the tape.
- It records your radio reception on tape, up to 30 minutes playing time on one standard 8mm spool.

THE RECORDING-PLAYBACK MECHANISM

Comprises Heavy Duty GENERAL INDUSTRIES RM4 Recording type motor, rubber floated and turntable, for 115 Volt 60 cycle AC; Crystal Pickup with permanent stylus and reproducer arm. Complete tape drive mechanism of exclusive TAPETONE design, with separate heads for erase and playback recording, all high-precision tooled, with bronze bearings throughout for marvelously smooth, quiet operation. Lever has recording-playback, rewind, and neutral positions. Recording tape is simple to thread, and can be edited more easily than home movie film simply because it's a coated paper tape.

THE EQUALIZED AMPLIFIER

This specially designed 6-tube recording and playback amplifier is equipped with a newly engineered exciter circuit for maximum efficiency of operation with tape recorder described above. It has high impedance microphone, and phono-radio inputs, with separate gain controls on mike and phono-radio, permitting mixing. Radio input connects across any speaker voice coil. Amplifier output connects to 4 or 8 ohm speaker. Output level indicator included. For 115 Volt 60 cycle AC.

COMPLETE TAPETONE MAGNETIC TAPE RECORDING KIT

Includes—Recording-playback mechanism as described above, in component form, complete with drilled mounting board; easily and quickly assembled.

Amplifier Kit with all components, including tubes and drilled chassis, all wire, connectors, plugs, cables supplied, nothing else needed; easy-to-follow diagrams are included, NO SPECIAL KNOWLEDGE REQUIRED, to construct this exceptionally fine amplifier.

One 1/2 hour roll (1225 ft.) of the New SCOTCH HIGH FIDELITY MAGNETIC RECORDING TAPE.

Complete Kit, as described, your net cost Shipped Express Collect. Shpg. wt. 30 lbs. If C.O.D. please include 20% Deposit with order.

\$98⁵⁰

OPTIONAL ACCESSORIES

- Crystal Desk Mike with removable base and 7 ft. of cable List \$12.20
- 8-Inch Heavy Duty P.M. Speaker . . . List 8.85
- Additional 1/2 hour rolls Scotch Recording Tape, per roll \$3.06

TAPETONE MANUFACTURING CORP.

37-06 36th Street, Long Island City 1, N.Y.
Phone: ST11well 4-8380

RADIO PRODUCTION RECORDS TOPPLE

PRODUCTION of television and radio receivers, including FM, broke all industry records in 1947 according to a report recently released by the Radio Manufacturers Association.

A year-end tabulation showed a total of 17,695,677 sets produced by RMA member-companies. Preliminary estimates indicated that total production by all radio set manufacturers may exceed 18,500,000 as compared with 15,000,000 in 1946, the previous industry record.

Television sets produced during 1947 numbered 178,571 against 6476 manufactured in 1946 by member-companies. A total of 1,175,104 FM-AM receivers were produced in 1947 as compared with 181,485 in 1946. Production of both automobile and portable radios was more than double that of 1946. Auto radios numbered 3,029,637 as compared with 1,153,458 in 1946 while portables totaled 2,153,095 and 1,022,689 the year previously.

Approximately 72 per-cent of all home receivers produced by RMA member-companies were table models, while radio consoles amounted to about 13 per-cent of the output. Portables accounted for the other 15 per-cent.

A breakdown of FM-AM receivers shows 289,497 table models; 11,112 table model radio-phonograph combinations; 22,239 consoles, and 852,256 radio-phonograph consoles. Television production included 116,315 table models, including converters; 37,039 straight consoles, and 25,217 radio-phonograph consoles.

division. The little magazine is named, if you haven't guessed, "Long Lines." It reports that during 1948 "cable-laying trains will complete the placing of hundreds of miles of coaxial cable in projects already under way." New ones will also be started. Also, some coaxials will be equipped to provide new television circuits and construction will begin on two new radio relay links—between New York and Philadelphia, and between New York and Chicago. Television network now working between Boston, New York, and Washington will be extended to Richmond, Virginia. Two other television circuits over coaxial are contemplated this year between Philly and Chicago, and Chicago and St. Louis. These last will be ready for service by early 1949, AT&T predicts.

ULTIMATE GOAL in the immediate future is television terminal facilities, including operating and monitoring facilities, networking programs originating in any one of nine cities—Richmond, Pittsburgh, Cleveland, Chicago, St. Louis, New York, Philadelphia, Baltimore, and Washington. Beyond that is projected a coast-to-coast hook-up, linking big West Coast centers with the east via lines laid through Dallas, Ft. Worth, and El Paso to Los Angeles.

BY CONTRAST, turn back the clock as the Signal Corps did recently and you can get a glimpse of the incredible progress that has been made in communications within the last 85 years. On March 3, Signal Corps celebrated its 85th birthday anniversary, with special mention to a Civil War era doctor who was considered something of a crank by many of his contemporaries. Truth is, he was one of the fathers of modern communications and, through his pioneering, paved the way for modern radio. Maybe you've heard the story: The Doc was a telegrapher who finally took up medicine and wrote a thesis on how to use a sign system for deaf mutes based on the Morse code. This led him to a study of signalling generally, and he wound up during the Civil War as an assistant surgeon in the Army who insisted on messing around in his spare time with what he called "wig-wag"—a system with flags and torches which are perpetuated to this day in the insignie of the Signal Corps. The system was used for the first time during the Civil War and was so successful that on March 3, 1863, the Congress set up the Signal Corps as a separate unit. First chief signal officer was a major—later a brigadier general—named Albert J. Myer—the "crank" Doc who had developed wig-wag.

Spot Radio News

(Continued from page 20)

their entire conversation to giggles and to assuring each other that they couldn't think of a thing to say, but nothing. Often, calls are more serious. Not long ago another Tokyo ham got a message through to Chicago for an emergency shipment of streptomycin, but failed to pick up the reply. J2ROC picked it up and relayed it. Again, when a jeep accident killed a young lieutenant at Manila, J2ROC arranged for his parents to be flown to the funeral.

THE DISTANT HAMS came by their talents just like most do in the States. Tex Bowden built his first crystal set in Dothan, Alabama, and finally worked up to a ham shack in his back yard. About the same time, Stan Rodby was tinkering in his home town, Virginia, Minnesota, by cutting up his mother's pie tins, borrowing her mason jars, and somehow getting a rig that made with the voice and music. Neither one of them had a formal engineering training.

GETTING BACK to communications in the States, it is going to be improved by leaps and bounds all along the radio front this year according to word from the Long Lines Department of the American Telephone and Telegraph Company's house organ for that

IF FACSIMILE broadcasting has done nothing else, it has attracted public attention and added a word or two to the language in recent weeks. Most spectacular facsimile newspaper enterprise is one that began in mid-February in New York. The New York

Go to WESTERN for Values...

DESK STAND MICROPHONE T-32"

The perfect mike for hams and for PA work, factory call systems, etc. Single-button carbon transmitter with long, easy-acting press-to-talk switch, felt-padded base, and 6' cord terminating in PL-68. Transmitter is Western Electric 635A, 30 ohms at 1 MA, 2 MA maximum. Designed for clear, crisp speech. 4db from 300 to 3000 cps with cut-off at 265 cps. HAMS: Buy at least three while you have the chance. PA MEN: Stock up on these mikes for your speech amplifier. \$2.79 installations. ONLY

LINESMAN'S HANDSET

An ultra-sturdy handset, receiver and mike, with press-to-talk switch and 59' cord terminating in two wire-tapping clips. Clips have wire-piercing cut and alligator jaws with powerful spring on one end, and 3/8" diameter plug on other end. Handset is designed to be banged around in a tool chest. Construction is almost entirely steel. Here is a lifetime telephone unit at a once-in-a-lifetime price. New. \$4.95

EE-8 TELEPHONES

Portable field telephone in case with hand-crank ringing generator. With schematic. Highest quality at less than toy price. All you need to put it in operation is 2 flashlight batteries for each unit and 2-conductor wire to the other unit or units. Fair used, each. \$4.95
Good used, each. \$5.95

TUBE SPECIALS OF THE MONTH

All New, in Cartons

2051 Gas Tetrode Relay Tube. Use as sawtooth generator with absolute grid control of synchronizer, or as relay, or to energize relay, in photo-cell or other systems using grid-voltage triggering. Plate supply may be 115V, 60 cy, and tube will not be fired by line-voltage surges at plate. Cathode current may be as high as 375 ma peak for trigger circuits. Heater takes 4.3 v at 0.6A. **A Dream Tube For Experimenters!** \$1.47
3 for. \$1.29
5 B11. 1.95
5 B14. 1.95
304 TL. ONLY. 1.95

SCR-522 CONTROL UNIT

BC-602-B, brand new, export packed. 1 "off" push-button switch, 4 channel-selecting push-button switches, 5 pilot lamp assemblies with pilot bulbs and film dimmer, and lever switch with locking control. With Schematic. \$98

HEADSET BUYS

HS-23 (Black plug), high impedance. Used, almost like new. With rubber cushions. \$95
HS-33 (Red plug), low impedance. Used, almost like new. With rubber cushions. \$95
4' Extension Cord for either of above. \$65

AUTOSYN BEAM INDICATORS

From ADF system. Each unit comes complete with instructions and schematic. Use any two of the 3 units below as a complete system. Power the system with 15 to 24 V, 60 cy.
Recommend as Transmitter: Compensator Unit from Loop LP-21. Calibrated 0-360°. Comes with loop drive motor and gear train, may be used separately. \$2.95
Choice of Receivers: I-81, 3" dial, pilot's ADF indicator, calibrated 0-360°. \$2.45
I-82, 5" dial navigators ADF indicator, has finer divisions and has rotatable reference scale. \$2.95

RELAYS

Starting Relay: Leach, 3-contract, 20 amp cont. duty, 2 NO, 1 double-throw at 20 amp in the energized position, about 10 amp in the energized position. Coil 22-30 vdc, resistance 180 ohms. Brand new. \$98
Telegraph and Local Relay: 2 make, 1 break. Micrometer adjustment. 2 coils, each 150 ohm. For use with 115V DC. Special: 2 for \$1.29

ANOTHER LAZY Q-5'er

Use Receiver BC-1206. I. F. is 142.5 kc or slightly lower depending on the model. Tunes 200 to 400 kc, can easily be extended to 455 or 456 kc. Very compact about 4"x4"x7". Complete with all controls on the front panel. 5 tubes. Input 24 volts dc. BRAND NEW. \$5.95

THE LAZIEST Q-5'er

FL-8-A, used when flying radio range. RANGE-VOICE-BOTH switch selects 1020 cps ONLY, or voice freq. minus 1020 cps, or by-passes filter completely. Put in series with hi-impedance headset when listening to 1 kc MCW. \$95

SCR-518-A

Radar altimeter, receiver and transmitter at 515 mc. Has fast-screen CR tube, hi-voltage power supply with inverter, connectors, cables, 29 good tubes: 1-6SK7, 2-8012, 2-6S7, 1-6C8G, 1-6SN7GT, 1-6F8G, 1-23D4, 1-6Y6G, 1-6V6GT, 10-6AC7, 3-2N2, 1-954, 1-955, 1-956, 1-6J5, 1-1808P1 cathode ray tube. Brand new, in original packing. \$24.95

BARGAIN OF THE MONTH

2-METER TRANSMITTER SCOOP!

The famous AN/ARC-5 VHF Transmitter (T-23/ARC-5), brand new 100-156 mc but less tubes, crystals, and the holders for the 832A tubes. Furnished with complete schematic. 4 Xtal-controlled channels selected by 3 motor-driven turrets. Motor can be spun by hand for manual band switching or driven by low-power rectifier power pack. Tubes required are 2-1625 and 2-832A. Don't pass this up at ONLY \$4.95

COAXIAL CABLE BUYS

RG-8/U: 52 ohm coax. cable, brand new. Cut to length, min. quantity 100 feet. \$2.95
RG-7/U: Low capacity 95 ohm coax. cable, only 12.5 mmid./ft. Similar to RG-62/U. Brand new. Ideal for high-quality PA installations. Air and polyethylene dielectric, vinyl overall. O.D. 0.370". Loss at 1mc is 0.15 db/C', at 30 mc is 1 db/C'. Cut to length. Minimum quantity 100 feet. 6 1/2¢ per foot.

PANEL METER

0-1 MA, DC. 3 1/4" round bakelite case, body 2 3/4", black calibrations on large clear-reading face, calibrated 0-4KV in 40 divisions. New. \$2.49
SPECIAL AT...

SENSITIVE OUTPUT METER

BX-1140 Control Box for SCR-625 Mine Detector contains slug-tuned coils, switches, resistors etc. in addition to a panel meter with built-in rectifier, movement sensitivity 200 microamps DC full scale. 2" face. \$2.29

POWER-PANEL VOLTMETER, AC 0-300V.

Complete with external resistor. Fixed coil around moving vane. 2% accuracy. Additional multiplier resistance easily added to make it read very high voltages. Norton, Round. Flush mount. 5 1/4" flange diameter, 3 1/4" body diam. Very large, clear scale. New. Only. \$6.95

80 and 40 METERS

7-tube Superhet RA-10, Bendix DF and communications receiver. 200-1100kc and 2-10 mc. In excellent condition, inside like brand new. Complete with tubes and dynamos. Easily converted to 110V. Schematic furnished. \$14.95
Only.

ANTENNA MAST SCOOPS

Doublet Antenna Kit, used with the famous Hallcrafters BC-610, consisting of 7 steel-alloy mast sections in a handy canvas bag. Each section is 5'6" long, 1 1/2" OD with the last 6" rolled to a smaller OD to telescope into the end of the preceding section. No taper. Assemble into mast up to 35' high or shorter by any multiple of 5'. Finished in weatherproof olive drab. Ideal for erection of FM and Television Beams! Drop your coaxial cable right through the center! Brand New, export packed. \$14.95
Kit of 7 and bag.
Aluminum Mast Sections: Each 4'10 1/4" long, 2" OD, with 10" long, 2 1/4" OD tube swaged over one end. The plain end of one section telescopes into the enlarged end of the next section, so you erect mast as high as you please in multiples of 4 1/2" per section. No taper. Light and sturdy. Drop your coaxial cable through the center. Per section. \$2.39

R-89/ARN-5A

Slide path receiver. Crystal control of local oscillator. 332-335 mc complete. 7 plays 7-6A5, 1-12SR7, 2-12SN7, 1-28D7, and 3 crystals: 6497 kc, 6522 kc, 6457 kc. 90-cycle band-pass and 150-cycle band-pass filters, excellent for making an intermodulation checker. Beautiful cabinet and chassis as foundation for many interesting experimental and construction projects. Broad pass band on 20.7 mc IF's ideal for television. Schematic furnished. Used, excellent. Only. \$6.35
New, in original packing. \$8.95

BC-733-D

Localizer receiver of the blind landing system. Companion to the glide path receiver. Also contains 90 and 150 cycle band-pass filters. 108.3 to 110.3 mc. by relay selection of crystals in the local oscillator. Wide pass-band on 6.9 mc IF's ideal for output of an RF oscillator as power supply for 100 volt DC bias. With relays, crystals, and 10 tubes: 3-717A, 2-12SG7, 1-12SG7, 1-12A6, 1-12-AH7, 2-12SR7. Schematic furnished! \$6.35
Condition: Used, excellent, only.

ANTENNA SYSTEM AS-27-ARN-5

Dual antenna for the two receivers above. Two separate 1/2 wave dipoles in one mounting. \$3.95
New, export packed.

AN/ARC-4

Receiver-transmitter component. Range 140-144 mc. Xtal-controlled, 4-channel, complete with 20 tubes, 4 Xtals, and 24v dynamotor. Good used. \$17.86
A real buy at only.

VIBRATOR EQUIPMENT

Generate 60 CPS with 3H6694. Western Electric 4-pin vibrator. 12VDC input. 3 for \$1.98
3H6691-17 Vibrator, 6V in. for 150 V, 100 MA. 7-pin. 3 for \$2.49
3H6785-3. Vibrapak. Mallory. 12V in. 225VAC out at 50 MA. With transformer and input and output hash filters. Rotate vibrator in socket for either negative or positive grounded systems. \$1.89
2Z9625-33. Vibrator transformer. Pri 1.5V DC either side of CT, tapped for 122 VCT, 22 ma. Potted. 4"x2 1/4"x2 1/4". 3 for \$1.49

ATTENTION BROADCAST ENGINEERS

Aerovax capacitor type 15020, .25 MFD, 15,000 VDC. A last-chance steal at \$4.95

COMMAND SET TRANSMITTERS

BRAND NEW, with Tubes, Crystals, Schematics
T-20/ARC-5, 4-5.3 mc. \$5.95
T-21/ARC-5, 5.3-7 mc. \$5.95

TRANSFORMER AND CHOKE SPECIALS

Output: Hi-Fi used in Scott-made Navy receiver. Fully potted. Pri. 5000 ohms. output secondary 600 ohms. CT, inverse-feedback secondary 60 ohms CT. A rare buy at only \$1.49
Output: Hammarlund Super-Pro 6F6 push-pull class AB self biasing, 10,000 ohm CT primary, two secondaries: Monitoring headset output 8000 ohms and power output 600 ohms
Output: Push-Pull 6L6's, 20 watts to 50 ohm load. Impedance ratio 15,000 to 50. Fully potted. \$98
Output: 10 assorted uncouplers for \$1.89
Driver: For push-pull output. Used in Bendix radio-compass receiver. Pri. 6000 ohms. Sec. 3,000 ohms CT. Tertiary 15 ohms. \$79c
Filter Choke: Westinghouse, potted 15H at 150 MA, insulated for 300 volts. 183 ohms DC. \$1.49
Filter Choke: Navy CRV 30829, potted. 101H at 100 MA. rare buy at only \$59¢
Filter Choke or AF Filter: 3C323-145C. 3.7H at 145 MA, insulated for 1500 VDC; 125 ohms DC; enclosed case, hermetically sealed; very compact; 2 1/2"x2 1/4"x3 1/4". Last chance at this price! \$1.77
3 for.

R-5/ARN-7 RADIO COMPASS RECEIVER

Very late model ADF receiver. Includes broadcast band. Frequency 100 to 1750 kc in 4 bands. 5-gang tuning capacitor. With 15 tubes: 4-6AR5, 1-6L7, 1-6J5, 2-6B8, 2-6F6, 1-6N7, 1-6SC7, 2-2051, 1-524. SCHEMATIC FURNISHED. With shock-mount base. Like new. SPECIAL. \$19.95

LOOP LP-21. Brand new ADF loop antenna for radio compass receiver. Complete with motor, compensator, and Autosyn transmitter. In Zeppelin housing. A real buy at \$6.95

1/2 TO 3/4 KW ANTENNA TUNING UNIT

BC-939-A, used with the famous BC-610 (commercial HT-3) Hallcrafters transmitter, 1/2 KW into final. 3/4 KW output. Some of the boys use this tuning unit for a full KW into final. Brand new, complete with 0-15 RF ammeter, 2-18 mc. Two tuning controls, one coupling control. A never-to-be-repeated opportunity! Don't miss it! Only \$19.95

RT-7/APN-1

Radio Altimeter Transceiver. Transmits and receives frequency modulated signals. 418-462 mc. Complete with 14 tubes: 3-12SJ7, 4-12SH7, 2-12H6, 1-VR-150, 2-955, 2-9004. Contains 28v dynamotor. Excellent parts value. Make wobulator out of the frequency shifter. With schematic. Used, Excellent. \$7.95

DYNAMOTORS AND INVERTERS

BD-77 Dyn. Unit: 14 v in, 1000 v, 350 ma out. With relay fuse box and filters. \$5.35
BD-87 Dynamotor Unit: part of SCR- ()-183, 186, 187, 14v in, 350v, 130 ma out. Includes filter and voltage divider. \$2.75
BD-93 Dynamotor Unit: Part of SCR- ()-283 28 v in, 350v, 130 ma out. Includes filter and voltage divider. \$2.25
DM-21 Dynamotor: Part of BC-312 and BC-314, 14v in, 235v, 100 ma out. \$2.47
DM-34 Dyn.: 12v in, 220v, 80 ma out. \$2.29
DM-35 Dyn.: 12v in, 625v, 225 ma out. \$2.25
PE-55 Dyn. Unit: 12v in, either 16 or 25 amp, 500v out, either 200 or 400 ma. \$3.75
PE-73 Dynamotor Unit: Part of BC-375, 28v in, 1000v, 350 ma out with filter, starting relays etc. \$4.65
PE-206 Inverter Unit: Rotary converter. 28v in, 80v at 500 VA, 800 cy. out. \$3.95
DYNAMOTOR UNIT PE-101-C: Made for the BC-645, useful for any other mobile job. Choose 12 or 24 vdc in, get outputs of 800 v at 20 ma plus 400 v at 135 ma plus 9v at 1.1 amp. Brand new. Special at only \$2.75

SEND FOR YOUR COPY OF OUR FREE CATALOG

WESTERN RADIO CO., Inc. • 3633 South Racine Avenue
Chicago 9, Illinois

Brooks' FM Tuner

MODEL FMT-10

QUALITY—SENSITIVITY
COMPLETE

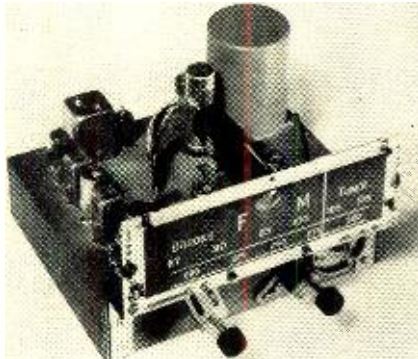

An engineered tuner for those who want the best available at reasonable prices.



Features . . .

- Completely wired and calibrated Patented Tuning Head.
- Frequency coverage: 87 to 109 MC.
- Sensitivity: 5 microvolts or less.
- Band-width: 150 KC at 6 DB down.
- High Gain Miniature Tubes.
- Ten Tubes: 4-6AK5, 6BE6, 2-9001, 6AL5, 6X4, 6G5.
- Input Impedance: 300 ohm line.
- Linear 8-inch Slide Rule Dial.
- Compact Size: 8"x10"x6 3/4".
- Self-Contained Power Supply.
- Easily assembled and adjusted.
- Rigid Non-Critical Construction.
- Compensated for Frequency Drift.
- Quality parts used throughout.
- Inductive tuning for High Q.
- Selective RF Circuits.

Model FMT-10	\$59.95
Complete with Tubes	Kit Form
Model FMT-10	\$69.95
Complete with Tubes	Wired

Completely wired and aligned Tuning Head (with tubes) \$17.50
8 inch Slide Rule Dial 2.50

Brooks Electronic Laboratories
621 Main Street
Waltham, Massachusetts

Times put out a "fax" paper, broadcasting six daily, four-page editions to fourteen department stores. The editions are produced by the New York Times staff and broadcast by the paper's FM station, WQXQ.

-30-

Television Receivers

(Continued from page 62)

provide a passband of approximately 4.5 mc. To maintain a constant bandwidth, C_1 , which is used in the lower six channels, has a value of 250 μfd . For the seven upper channels, C_1 is used, with a value of 140 μfd . This compensates for the change in coil Q 's with frequency.

The construction of C_1 and C_2 is shown in Fig. 12. The units are composed of two large circular plates with a third circular plate inserted between them and isolated by mica sheets. The two outer plates are grounded and represent one plate of the condenser. The inner plate, which is the other side of the condenser, is in two separate pieces of different thicknesses. By changing the number of mica sheets, the two capacities are obtained. C_1 and C_2 are coupling and d.c. isolating condensers.

Servicing

An indication that trouble exists in the r.f. section of the receiver is the complete absence of video and audio outputs. Absence of an image does not mean a completely dark screen, for the receiver's internal sweep oscillators continue to function. What is visible is the scanning raster. See Fig. 13.

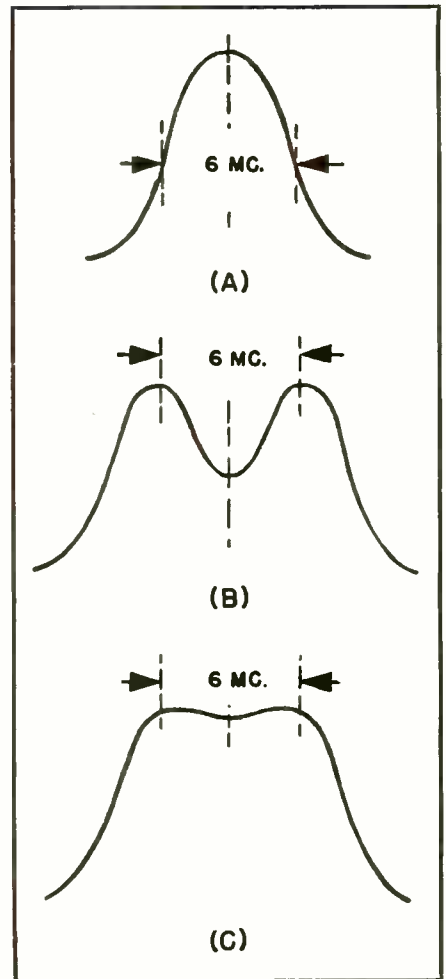
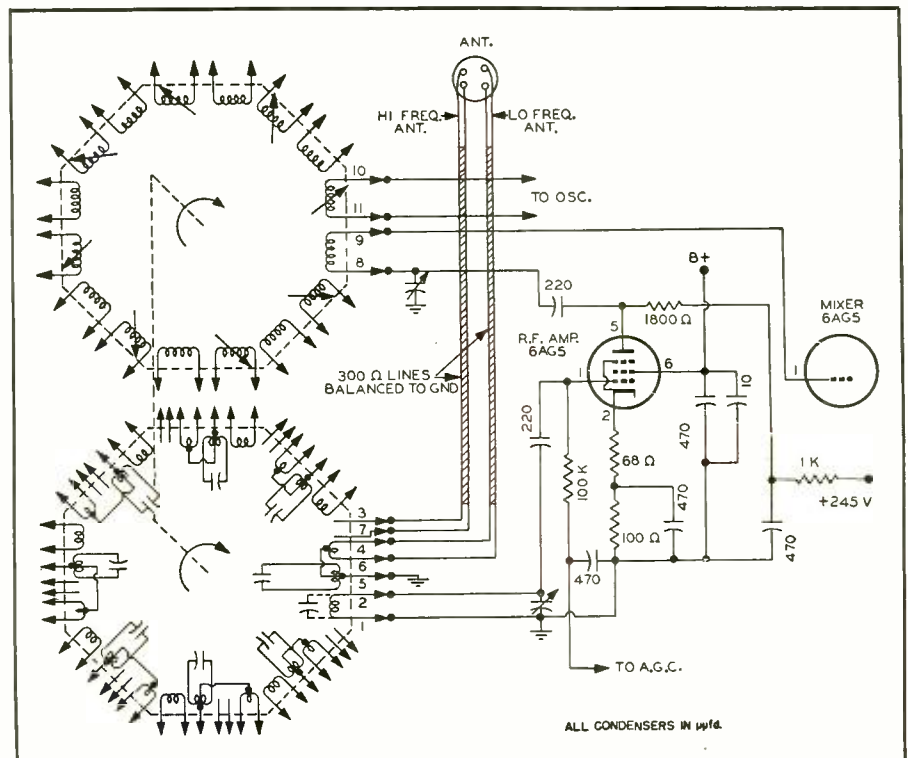

Fig. 9. Response curve for the plate circuit of the Philco r.f. amplifier (A), input circuit response (B), and their combined response (C).

Fig. 8. The r.f. amplifier used in Philco television receivers.



ALL CONDENSERS IN μfd .

KEEP YOUR EYE ON THE Special OF THE MONTH

WATCH THIS SPACE EACH MONTH

5" TELEVISION FOUNDATION KIT

This TELEVISION FOUNDATION KIT consists of the most essential (and expensive) parts needed in constructing a television receiver. Starting with the hi. volt. power supply, for the scope, right through to the antenna. This kit contains: high voltage scope transformer (for 5" or 7" tube), 2x2 filament transformer, lo. volt. transformer for receiver, cathode ray filament transformer, filter choke, 6.3 filament transformer for 16 six volt tubes along with five volt transformer for the 5u4, the two hi. volt. filter condensers, blocking oscil., transformer for all R.F.'s, sound and video I.F.'s, peaking coils and discriminator transformer. The rectifier tubes 2X2 and 5U4, the picture tube 5BP4, and an all aluminum Elin-core dipole antenna are also included.

A 26-page instruction book, including a large 12 by 18 schematic diagram, theory of television, circuit functions, explanation of scanning, preliminary volt. measurements, parts lay-out and final adjustment of the television receiver which facilitates easy alignment without the use of elaborate test equipment, comes with each unit. The only knowledge necessary to build this set is the ability to read the simple schematic diagram.

Most radio men will have many or all of the minor parts not included in the foundation kit. Special only
\$34.75
 REMAINING SET OF NECESSARY TUBES..... \$16.95
 COMPLETELY PUNCHED CHASSIS FOR ABOVE KIT 5.50

7" TELEVISION FOUNDATION KIT

This kit, which includes the famous Ray-Electron Coil Kit, gives the discriminating television experimenter an opportunity to construct a television set of excellent quality, employing a 7" electrostatic Cathode Ray Picture Tube. All the special coils required are in this kit; and these coils have been carefully designed for maximum band-width and sensitivity. This exacting design features a 4.25 megacycle IF bandwidth, which will enable video operation of any size picture tube with maximum possible resolution. By following the instructions supplied it is possible to build this quality set at home, and at low cost. The television circuit which we suggest is comparatively simple, and the home constructor will find the remaining parts readily available at most radio supply houses, after our kit is purchased. By building your own set you will teach yourself many of the technical details of television receivers which you cannot learn from a book. We place emphasis on the RF and IF design because the RF and IF coils are the heart of the television set. Regardless of circuit refinements, if the RF and IF coils are not properly designed, the pictures will not satisfy you.

CONTENTS OF KIT

This kit includes the most essential (and expensive) parts needed in the construction of a television receiver. It contains the Hi. Voltage scope transformer (for 7" tube), 2x2 filament transformer, lo. volt. transformer for receiver, Cathode ray filament transformer, filter choke, 6.3 filament transformer for 16 six volt tubes along with five volt transformer for the 5U4, the two Hi. Volt. filter condensers, blocking osc., a six channel tuner containing 1 Antenna Coil, 6 RF Tuning Coils, 1 Oscillator Tank Coil, all mounted on bakelite switch assembly plate, 5 Shielded Video IF coils, 1 Shielded Discriminator Coil, 3 Video Peaking Coils; the rectifier tubes 2X2 and 5U4, the picture tube 7EP1 and an all aluminum dipole antenna. An instruction manual containing complete assembly instructions, and circuit diagram with detailed parts list for a 20 tube, 7 inch picture tube set is also included.

This whole assortment complete is very moderately priced
 at only \$69.50
 Remaining set of necessary tubes 4.95

TUBE KITS

Complete set of tubes for SCR-522	Complete set of tubes for BC-348	Complete set of tubes for BC-312
\$17.95	\$7.95	\$7.95

Specify Model Numbers

DO YOU OWN AN SCR-522?

We have a complete power supply containing all the necessary parts down to the line cord pilot light switch & terminal blocks & delivers the following voltage—300 v. DC @ 250 mills, 150 v. of regulated bias and sufficient 12 v. to operate the tubes of both receiver and transmitter. Complete at the amazingly low price of **\$14.95**

Model 200-EA. 5-ELEMENT 2 METER BEAM KIT. Folded di-pole driven element. All-aluminum construction. Feed with low impedance coaxial cable. Amateur net price..... **\$8.40**

BC-348 Owners

CONVERTER for Broadcast Band

Convert that BC-348 without any alteration in your circuit. Our special converter takes power from receiver. Just tune your set to 450 kc. and forget it. All tuning is done on a converter panel covering 550 to 1600 kc.—double conversion means High Sensitivity. Excellent Fidelity and Higher Selectivity—complete basic kit with schematic and full instructions—less chassis dial and tuning knobs. Terrific Buy at **\$6.50**

POWER!! POWER!!

Niagara can supply a power supply kit which will completely power the ARC 5 Transmitter used as a VFO or any one of the ARC 5 receivers. All basic components included for delivering 300 v. @ 150 mills & 24 v. or 12 v. for the filaments—no rewiring of equipment necessary. This kit will also power the BC-348, BC-312, and the BC-1206. A good buy at **\$7.50**

HERE IS THE TV KIT YOU HAVE WAITED FOR—ALL GENUINE

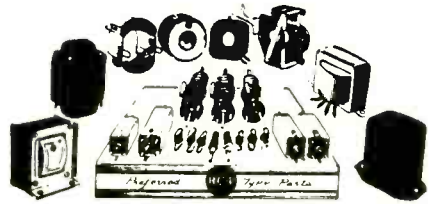

RCA PARTS

Now, for the first time you are offered a basic kit consisting of the finest essential components enabling you to build anything from a 7" to a 20" Television Receiver. These parts are the best the industry has to offer—All genuine R.C.A. Also included is a schematic diagram and a complete parts list of the minor components necessary to make up a complete TV receiver. Described and pictured below are the various components included in this sensational kit.

KIT CONSISTS OF:

- Deflection Yoke Type 201D1
- Width Control Type 201R1
- Horizontal Linearity Control Type 201R3
- Power Transformer Type 201T6
- Yoke Mounting Hood Type 201X1
- Focus Coil Type 202D1
- Vertical Output Transformer Type 204T2
- Filament Choke Type 204L1
- Television I.F. and Video Coil Kit Type 204X2
- Vert. Blocking-Oscillator Transformer Type 208T2
- Horiz. Blocking-Oscillator Transformer Type 208T3
- Horiz. Output Transformer Type 211T1

SPECIAL

\$69.50 COMPLETE

The parts in this kit, if purchased separately, would list at over \$139.00. Niagara saves you over 50%, or a big \$70.20. GET YOURS TODAY.

BUILD YOUR OWN TELEVISION SET TODAY

HI-VOLTAGE POWER SUPPLY

Hi & Low Voltage Rectifier Power Supply Model C F T—20169 formerly used with the DAQ Direction Finder. This power supply contains 2500 v. at 3 mills—325 v. at 100 mills. Also contains a sweep amplifier, voltage regulated. Power Supply can be used to power a television receiver or perfect power supply for an Oscilloscope, or General Lab. use. Unit is mounted in a cabinet with all controls including pilot lights & switches on front panel. Wt. approx. 40 pounds—

LIMITED QUANTITY **\$29.95**

New... **JUST OFF THE PRESS!**

TELEVISION CATALOG

Send for Your COPY TODAY!

TELEVISION

NIAGARA RADIO SUPPLY CORP.
 160 Greenwich St., New York 6, N. Y.

Please send copy of your Television Catalog to:

Name.....

Address..... Zone.....

City..... State.....

WRITE FOR LATEST BULLETIN 3N8. 20% deposit with all orders unless Rated. All prices F.O.B. N. Y. City

NIAGARA RADIO SUPPLY CORP.
 160 GREENWICH ST., NEW YORK 6, N. Y.

DYNAMIC REPRODUCER



HS-30 HEAD SETS

Extremely
lightweight
EMPLOYS SAME
PRINCIPLE USED
IN EXPENSIVE
HEARING AIDS

LESSENS EAR
DISCOMFORT

The impedance of these light-weight DYNAMIC headphones is 300 ohms, which fits most of the surplus ARMY and NAVY equipment. Phone plug not furnished, but may be used with any standard phone plug. Extra rubber ear inserts, and shirt clip for minimizing strain included in each package. Matching transformers for high impedance available; see price list below.

BRAND NEW

Packed in Original
Army Boxes!

SHIPPED ANYWHERE IN THE U. S.
POSTPAID AT THESE LOW PRICES

2 SETS FOR \$1
12 SETS FOR \$5

Phone Plug (PL-55).....19c
Matching Transformer for High Imp.35c
Extension Cord, with Matching Plugs.....49c

BC-348 SHOCKMOUNT BASE

Dress up your "348" with a new base—fits all models—brand new in original cartons. Shipped anywhere in U. S. for 35c. Enclose \$2.00 for each base wanted. Money Back Guarantee.

\$165
EACH

5 MFD — 3500 V. D. C. OIL-FILLED Western Electric Capacitor

Size Only:
4 3/4 in. wid. by 1 3/8 in.
thick. 4 3/4 in. high.

\$375
EACH

Mfg.: (4) 6-32 Studs.

3 FOR \$10

Shipped anywhere in U. S. A. for 60c

AUDIO AMPLIFIER

SIGNAL CORP AM-26/AIC

- Brand new with four new JAN tubes—(2) 12A6 & (2) 12J5.
- Complete with dynamotor DM-32A—Fits all 274N Sets.
- For 24 Volt operation—Easily converted to 110 AC—60 cycle.
- STANDARD phase inverter circuit.

\$345
EACH

6 FOR \$18.50

Shipped anywhere in U.S.A. for \$1.00

DM-32 DYNAMOTOR—NEW!

Fits All 274N Receivers

Input: 24V-1.1 amp.
Output: 250V-.60 amp.
Shipped anywhere in
U. S. A. for 35c

\$145
EACH

Discounts on Larger Quantities On Request
Mail Orders Promptly Filled—Your
Satisfaction or Your Money Back

ELECTRONIC SALES CO.

5559 W. ADAMS BOULEVARD
LOS ANGELES 16, CALIF.
DEPT. RN-448 PHONE YORK 8428

Get On Our Mailing List

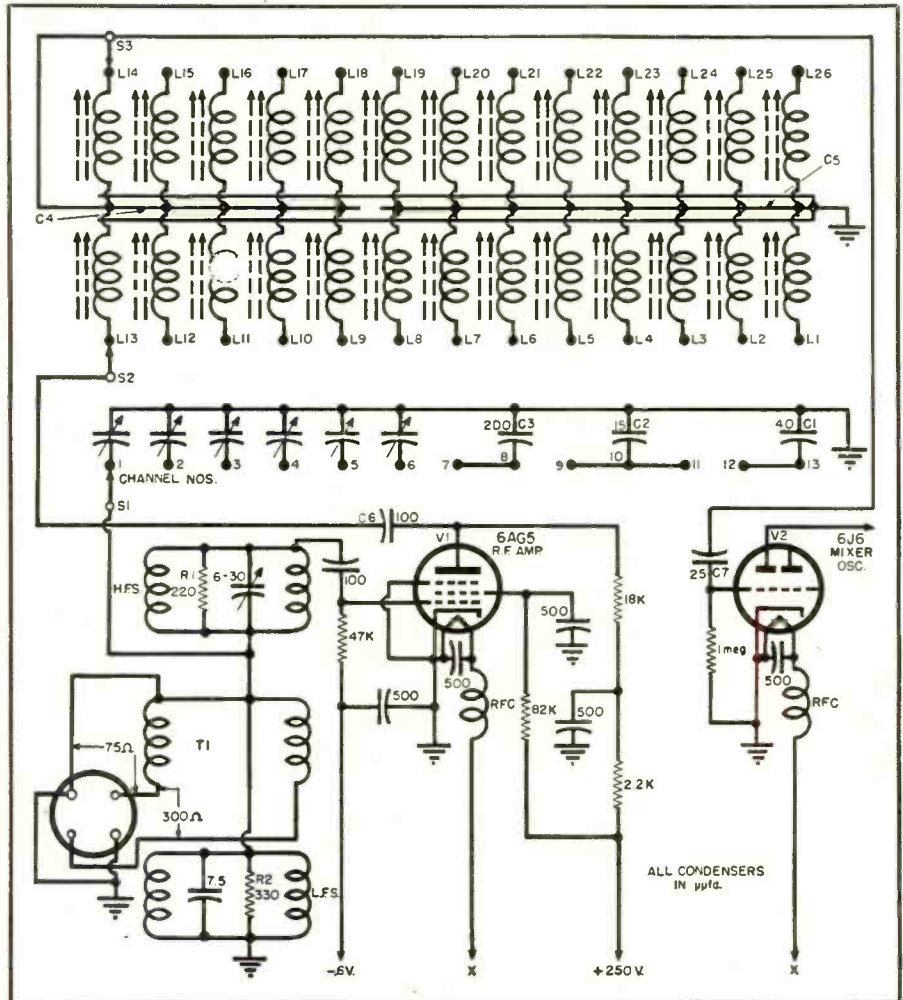

Fig. 10. The r.f. amplifier and tuning circuit for Motorola television receiver.

The entire secret of servicing television receivers lies in the proper interpretation of what appears on the screen plus what is heard from the loudspeaker. When both types of outputs are missing, the trouble obviously lies in some stage through which both signals must pass. On the other hand, if only one signal is affected, the defect is located in some portion of the system exclusively devoted to that signal. Since both signals must pass through the r.f. amplifier, here is the first place to look when neither an image nor sound is obtained. Only a

scanning raster will be visible on the screen.

Assume, then, that a scanning raster is visible, but no image or sound is obtained when the set is tuned to a station known to be operating. These symptoms indicate that the trouble lies in one of the front-end stages of the receiver. Since tubes are, by far, the greatest source of trouble, they should be tested first. This is best done by substitution, using tubes known to be good. If the set is still inoperative, the trouble lies elsewhere in this section, either in the tuned circuits or in

Fig. 11. A simplified diagram of the r.f. amplifier for Motorola television receiver, Model VT101. See Fig. 10 (above) for parts values.

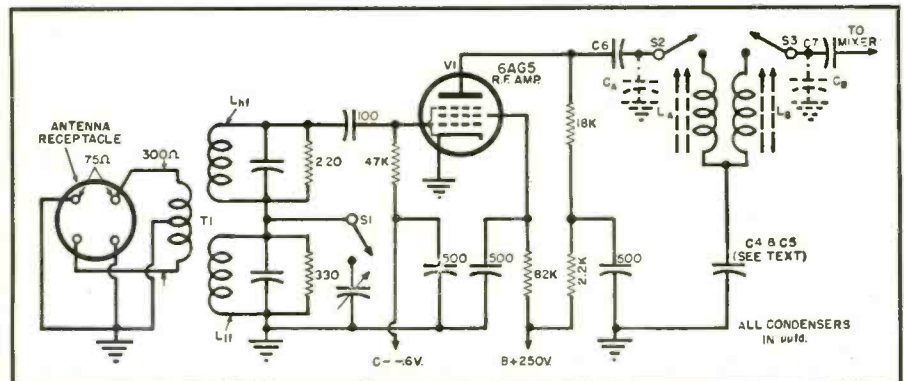

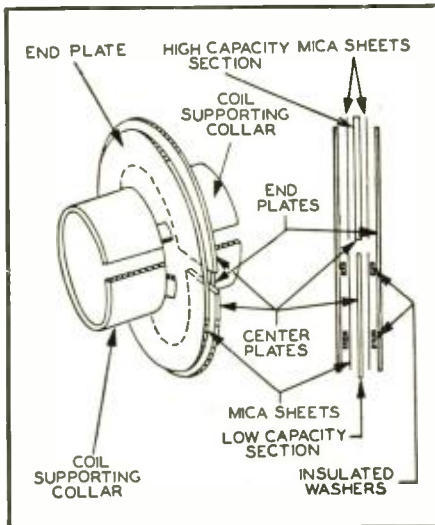

Fig. 12. Construction details of condensers C₁ and C₂ shown in schematic, Fig. 10.

the resistors and condensers. Since the tuned circuits can be checked without removing the set from the cabinet, they are tackled first.

The tuning circuits of television receivers can be classified in three ways.

1. Continuous tuning.
2. Selector switch with each channel completely separate, electrically.
3. Selector switch with each channel dependent electrically on the other channels.

To the serviceman, the foregoing information concerning the receiver to be repaired is very important because it will tell him whether or not the tuned circuits are at fault. For example, the *Belmont* receiver employs continuous tuning. However separate coils are employed for the high and low bands. Consequently, if the receiver will function on one band, but not on the other, then obviously the tuning coil of the band affected is at fault. On the other hand, if neither band is working, then it is fairly safe to assume that the trouble lies in some common component, but not in both tuning coils.

The same type of analysis can be employed for the other methods of tuning. In *G.E.* and *Philco* receivers, a completely separate tuning circuit is switched in for each channel. When all channels are affected, some common component, such as a tube, resistor, or bypass condenser must be at

Fig. 13. A scanning raster on a TV screen.

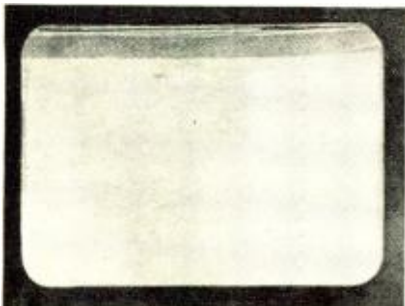

April, 1948

now WIRE RECORDER HEADS BY TURNER

MODEL TWR-1

MODEL TWR-2

After months and months of designing, testing, and perfecting—Turner Engineers, working closely with the Armour Research Foundation, have developed these superior wire recorder heads. They are of the triple-purpose type, containing record, playback, and erase heads in one single, plug-in unit. Designed for replacement and new applications, the TURNER TWR-1 and TWR-2 are way over par in performance.

OUTSTANDING DESIGN AND CONSTRUCTION FEATURES

- Maximum fidelity. Superior "Y" groove for wire accurately cut by special machine* developed exclusively for Turner.
- Hum pickup held to absolute minimum by unique double-shielding construction.
- New triple-lamination structure greatly improves magnetic circuit.
- Controlled uniformity. Advanced design and manufacturing process assures uniformity of product.
- Beautiful chrome plated die cast housing.
- Engineered for exceptional performance.

WRITE FOR BULLETIN

THE TURNER COMPANY

900 17th STREET N.E., CEDAR RAPIDS, IOWA

MICROPHONES AND OTHER ELECTRONIC EQUIPMENT

FOR A COMPLETE LINE OF MAGNETIC RECORDER HEADS TURN TO TURNER

If your manufacturing plans require magnetic recorder heads, it will pay you to consult Turner Engineers. Please write to Engineering Development, The Turner Company.

* Patent pending

**New FLEXIBILITY
New BEAUTY
New LOW COST**

CENTURY
CRYSTAL, DYNAMIC, CARBON MICROPHONES

FOR RECORDING, COMMUNICATIONS, PUBLIC ADDRESS

Heralds a new era of brilliantly engineered and superbly styled low-cost microphones! Complete adaptability permits widest use. Excellent reproduction and high output. Light weight . . . rugged.

Highest purity diecast case finished in lustrous gray-brown. The perfect answer for all economical installations. List prices from \$8.95 up. Get full details — send for Bulletin No. 137.

Authorized Distributors Everywhere

Crystal Mike licensed under Brush patents

NO FINER CHOICE THAN *Electro-Voice*

ELECTRO-VOICE, INC., BUCHANAN, MICH. Export: 13 E. 40th St., New York 16, U.S.A. — Cables: Arlab

fault. In the RCA circuit, all of the circuits are in series. However, the analysis made when the circuit was previously analyzed shows how the reasoning is modified for that particular type of circuit. Therefore, know which type of tuning the receiver employs and then check circuit operation on different channels.

Servicemen may wonder how to check channels for which there is no station available in the vicinity. A rough test, but one which will reveal whether or not a signal can get through, is to detach the transmission line from the receiver input terminals and scrape the line leads across the input terminal posts. Bursts of noise will be heard in the speaker (even with FM) and flashes of light will appear in the scanning raster. If the signal cannot pass through the r.f. section, then voltage and resistance measurements are the only remaining step to take. This requires the removal of the chassis from the cabinet.

Alignment procedure for the entire r.f. end of the receiver will be given after all of these stages have been analyzed.

(To be continued)

International Short-Wave

(Continued from page 74)

better antenna for their 19-meter outlet (15.115) in operation by this time, to give better reception to the U.S.

The new station in Honduras, HRQ, 6.125, is definitely at San Pedro Sula. CE920, 9.22, Punta Arenas, Chile, signs off 2200, good signal. ZBW3, 9.525, Hongkong, signs off 1000, fair to poor signal, can be recognized by heavy hum on carrier. *Radio Raja*, 9.360, Java, signs off (in *English*) at 1130. (Park, British Columbia)

Radio Italiana has been heard in California on 6.085 (in dual with 9.630) around 1045-1130 or later; on Sundays appears to be 1110-1130 or later, featuring "Broadcasting Throughout the World"; on alternate Sundays uses French-*English* and German-Swedish; 6.085 appears to be used as an alternate for 11.810. (Dilg)

PLA8, 8.91 (announced), *Radio Batavia*, Java, has definitely replaced the 11.440 outlet in the U.S. beam, 0930-1000; YDC, 15.15, is used in parallel yet, beamed to Australia and Malaya; PLA8 is heard in Texas but appears to be slightly *higher* than 8.91. (Stark)

CE1180, Santiago, Chile, has been measured 12.004. DAKU, Berlin, measured 15.920, has been heard with news pickups to New York at 1400 on Sunday. OAX4W, Lima, Peru, is heard evenings on measured 9.393 (is listed 9.390). HI8Z, 7.225, Santiago, Dominican Republic, is heard in West Virginia at 1800-2100. (Arthur)

Sutton, Ohio, sent these tips: XEDP, 6.135, Mexico City, *new*, "Radio Educacion," heard evenings to 2200 sign-off; CR7AA, 5.860, Lourenco Marques, Mozambique, heard 0100-0200 sign-off; HI8Z, 7.225, Santiago, Dominican Re-

HOBCO APRIL SPECIALS



PORTABLE P. A. SYSTEM

Excellent for use at Bingo Games, Sports Events, Dances, Rallies, etc. Contains all these first quality components—which may also be purchased separately.

ONLY
\$61.43

- 1 Brentwood 14 Watt Amplifier with tubes \$26.95
- 2 12" P.M. Speakers 14.22
- 1 Dual Speaker Portable Case 11.55
- 1 Crystal Mike 6.00
- 1 Microphone Plug33
- 50 Ft. Rubber Covered Wire98

Write for our Monthly Bulletins on Standard Radio Parts featuring Nationally Advertised Brands



HENRY O. BERMAN CO., Inc.

10-12 E. LOMBARD STREET
Dept. R-7 BALTIMORE 2, MD.
Electronic Equipment and Replacement Parts

Schematics and Instructions

SCR-274-N Receivers (Similar to AN-ARC-5)

BC-453 (R-23/ARC-5), BC-454 (R-21/ARC-5), BC-455 (R-22 ARC-5): Explanation of control and power circuits and plug terminals. Instructions for conversion of the front plug to a local control adapter with volume control, on-off and CW-MCW switch. Schematic and parts list for AC power pack. Complete alignment instructions. Top and bottom views showing parts location. Voltage and resistance readings. Also schematic of 3-unit rack, control box, adapters and interconnections. 12 8½x11" pages. Price **\$2.00**

Conversion of BC-946-B Broadcast-Band Receiver

Similar to R-24/ARC-5. Practical wiring diagram. Control circuit explanation. Complete conversion schematic, 106 step-by-step instructions, alignment instructions. Top and bottom views with parts location arrows. 12 8½x11" pages. Price **\$2.00**

SCHEMATICS for Other Equipment:

- BC-645 Original and conversion, fixed or mobile: \$1.00
- AN/ARC-5, Receivers, (less the VHF): \$1.00
- SCR-274-N Transmitters, Modulator, etc.: \$1.00
- AN/ARC-5 Transmitters (less the VHF), Push pull Modulator, Relay, Switching, etc.: \$1.00
- T-23/ARC-5, the VHF transmitter: \$1.00
- ARB (CRV 46151), Alignment, etc.: \$1.00
- AN/ART-13A Transmitter, Control Box, etc.: \$1.00
- SCR-522 Receiver, Transmitter, etc.: \$1.00
- BC-348-J, N, or Q, plus AC Power Pack: \$1.00
- BC-348-H, K, L, or R, plus AC Power Pack: \$1.00
- R-89/ARN-5 Glide Path Receiver: \$1.00
- RC-103-A, (includes BC-733-D): \$1.00
- AN/APN-1, (includes RT-7/APN-1): \$1.00
- MN-26-C Bendix Radio Compass Receiver: \$1.00
- R-65/APN-9 Loran Receiver-Indicator: \$1.00
- EE-8 Field Telephones: 50¢

PLEASE SPECIFY which you want. Remit with order. Print your name and complete address in the upper-left corner of the envelope.

R. E. GOODHEART

2616 N. Spaulding Ave. Chicago 47, Ill.

public, heard 0730-0800; HI2T has moved from 11.900 to 5.970, heard to 0000, located Cuidad Trujillo, Dominican Republic; YSHQ, 6.510, El Salvador, new, heard 2000-2300 sign-off; Ponta Delgada, Azores, on 11.090, signs on in Portuguese at 1500.

By this time Oslo, Norway, should be using 11.850 in parallel with 9.61 in the 2000-2100 daily beam "for Norwegians abroad" and which they say is beamed especially to North America. (Bishop, Ohio)

XORA, Shanghai, has been jumping around, varying from 11.68 to 11.700. (Hutchins, Radio Australia, via Dilg). Hutchins also reports that XGOY, Chungking, is using 15.170 (normally a summer frequency); did not give schedule but it may be for the transmission at 0500-0630 (one hour earlier in summer).

Radio Belgrano, Argentina, is back on 9.455, signs off 2200. XGPB, 6.11, China, exact location unknown, signs off at 1000, fair to poor. A Javanese outlet is heard on 7.27 to 1130 sign-off; AIR on 7.26 has news 0930 and signs off 1000; KZBU, 6.10, Cebu, Philippines, has news 1100; the USSR is using 9.48 lately in Home Service, irregularly around 0200-0600 and 0800-0900. (Balbi, California)

World-Radio Handbook

"World-Radio Handbook for Listeners" (in English) is one of the finest international radio guides I have yet seen. I heartily recommend it to every short-wave enthusiast.

It includes "Who's Who in World Radio"; a practical account of broadcasting in countries all over the world with information of benefit to listeners; a list of long- and medium-wave stations in Europe, the Near East, and North Africa with frequencies, wavelengths, and strengths; and a list of short-wave stations in all countries with frequencies, wavelengths, and strengths. It is comprehensive and highly accurate.

This guide is to be provided in two editions—the Summer Edition will be published in May, the Winter Edition in November. It may be had direct from the author for 14 International Reply Coupons. Address is O. Lund-Johansen, Lindorfsalle 1, Hellerup, Copenhagen, Denmark.

Club Notes

England—The British Short Wave League now has as its president, G. Musk; secretary, A. W. H. Wennell, 145, Uxendon Hill, Wembley Park, Middlesex; editor of its monthly house organ, "Short Wave Review," W. H. C. Jennings; council, T. Burton, L. LeBreton, E. J. Logan, S. Pearce; editorial office is at 82, Craven Park Road, London E. 15.

U.S.A.—George Jacobs, president, The Grand National Radio Society, informs us that all reports or announcements for publication in the club's monthly house organ should be sent direct to Ed Shirley, Route 1, Cassadaga, New York. This club has a fund for giving free memberships to all

BEST SURPLUS . . . BEST CONDITION . . . BEST APPEARANCE . . . LOWEST PRICES

SENSATIONAL PRICE REDUCTION!

SMALL PRECISION LATHE—110-V. A-C.

• Cancellation of a large export order for Manson Lathes forces us to liquidate our overstock immediately. Our loss is your gain—if you order IMMEDIATELY. They won't last long at these ridiculously low prices.

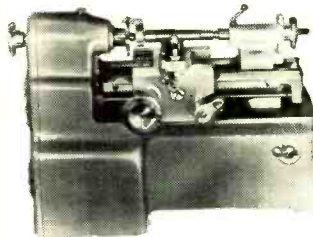

FORMERLY SOLD FOR \$60.75

NEW LOW PRICE NOW \$41.50

A small lathe for radio shops, jewelers, laboratories, dentists, hobbycrafters, model makers, machine shops, schools, etc. Automatic Feed. Work capacity 3" between centers. Swing over bed 2". Constructed of steel and cast iron. Accurately machined and finished. Fan-Cooled Motor mounted inside the base. Complete with 1 1/2" face plate, 2 lathe centers, tool post and rocker, one lathe dog, one tool-bit and test rod.

THE MANSON LATHE KIT

Former Price \$36.25. New Low Price Only \$24.50

The Manson Lathe Kit contains the following accessories, packed in a compartment box 6" long, 4" wide, with hinged cover:

- | | |
|----------------------------------|---|
| 1—4-jaw Chuck and Wrench | 1—1 1/2" Face Plate with 8 Drilled and Tapped holes |
| 1—Drill Chuck | 4—Collets—Sizes 1/4", 3/8", 1/2", 5/8" |
| 1—Center Countersink Drill | 1—Collet Chuck |
| 2—Tool Bits—Ground and sharpened | 1—Allen Wrench |
| 2—Lathe Dogs—Sizes 3/8" & 1/2" | |

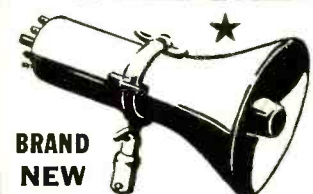

BRAND NEW

A FEW STILL ON HAND

25-Watt Re-entrant Speaker with Jensen Driver Unit and UTC Line-Matching Transformer IN ORIGINAL, SEALED FACTORY CARTONS Only \$21.60 Net

Specifications: 20" overall. Horn 13" dia. Metallic diaphragm voice-coil assembly (Jensen) Driver unit alone weighs 9 lbs. UTC Line-matching Transformer 250, 500, 1000 and 2500 ohms. Speaker is fitted with mounting swivel, lock-nut and sleeve for attachment to standard pipe stand. Unquestionably one of the best surplus buys ever offered.



BIG BARGAIN!! 6L6 AMPLIFIER

For High-Fidelity Reception with F.M. Tuners or Receivers, this Amplifier is unequalled in this Low Price! Sold for less than the net cost of parts. Complete, ready to operate, in gray crackled cabinet. Made for 24-hour continuous service. Big, husky power supply. All new parts throughout, new RCA tubes. Relay and counter (counts up to 10,000 record playings). Input for magnetic or crystal pickup, or 600-ohm phone line (for wired music systems). Separate tone, treble and bass controls. A SUPER BUY!! Only \$49.50 net. (List \$147.50.)

BC-221 Frequency Meter, with A-C Power Supply Kit and Modulation Kit and Circuit Diagram



Now—AT LAST—you can get a BC-221 Frequency Meter with a complete kit of parts for an A-C Power Supply, plus another kit of parts for a Modulator, for about half the former price of a complete modulated instrument. You can convert the BC-221 Frequency Meter in a jiffy—and use it for receiver aligning, etc. Wiring diagrams are included with each kit. This may be your last chance to buy the BC-221.

PRICES: BC-221 Frequency Meter with tubes, crystal and calibration charts, \$39.95. A-C Power Supply Kit and Diagram, \$5.85. Modulation Kit and Diagram, \$2.50.

POWER SUPPLY KIT

For 274-N Receiver

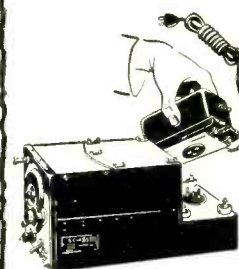

Just what you've been waiting for—a COMPLETE Power Supply Kit, containing ALL necessary parts for 110-volt AC conversion of ANY 274-N type Receiver regardless of frequency coverage. Our complete kit of parts includes wiring diagram and instructions . . . all for the LOW PRICE OF ONLY \$7.95 net. Kit includes Tuning Spline, Knobs, Plug-In Plate, black

crackle metal box, filter chokes, condensers, resistors, etc., etc. Nothing else to buy! Convert your famous 274-N into a beautiful job . . . and make it work like a "million." This same Kit is also available with an R-C Filter (instead of a choke) for only \$6.95. Better rush your order. We have a limited stock only.

R8/ARN-8 MODIFICATION "A" BEACON RECEIVER

75-Mc.

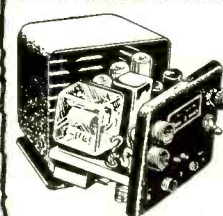

Here's a BUY! A 7-tube Beacon Receiver containing the following items: Three 25L6, Two 12SR7 and Two 12SH7 tubes, a sensitive relay (12,500 ohms) and many other essential parts—completely wired and ready to operate, but less power supply. Housed in a black crackle case, approx. 7"x7"x8", complete with shock mounts. This receiver is suitable for remote control service, such as door opening devices, turning lights on and off, starting and stopping motors or machinery from remote points, etc.

BRAND NEW—IN ORIGINAL FACTORY CARTONS . . . ONLY \$4.95 net, complete with tubes. A complete set of special plugs for this receiver available for only \$1.44.

A FEW BC-454 (3-to-6 Mc) Receivers also available. BRAND NEW . . . at our LOW-DOWN PRICE OF ONLY \$5.95 each.

Marine Receiver & Transmitter, FRC-1

Ideal 150-watt Phone or CW Ham Station! Coverage: 1.5 Mc to 12.5 Mc. Operates from 110 AC 50/60 cycles. Transmitter and Receiver completely housed in gray crackle finished metal cabinet. Requires NO conversion. Is ready to operate. Transmitter lineup: 813 final amplifier, 807 buffer, complete coverage VFO, pair of 811 Class-B modulators, standard speech amplifier with over-modulation suppressor.

SEPARATE HEAVY DUTY HIGH-VOLTAGE POWER SUPPLY FOR MODULATOR AND R-F

All decks individually removable on slides—just like filing cabinet pull-out drawers. All connections made automatically when decks slide into position. The Receiver proper is a highly sensitive 9-tube Superhet, with same frequency coverage as transmitter. Individual RF and audio gain controls, and individual power supply. A LIMITED QUANTITY ON HAND. Only \$285.00 ea.

ARN-5A 11-TUBE SUPERHET

332 to 335-MC. Fixed Tune

• This "Glide Path" Receiver, complete with 11 tubes, 7—6AJ5, 1—12SR7, 2—12SN7, 1—28D7. Frequencies: 332.6, 333.8, 335.0 mc. 6 Relays are included. Requires only 28v. Total "A" & "B" drain only 1.7 amps at 28 volts. Tubes alone worth more than price of complete receiver.

Our Price, Complete with Tubes Only \$13.95



★ 4-HOUR MAIL-ORDER SERVICE. WE SHIP ANYWHERE. 20% DEPOSIT MUST ACCOMPANY ALL ORDERS, BALANCE C.O.D.

OFFENBACH & REIMUS CO.

372 ELLIS ST., SAN FRANCISCO, CALIF.

'PHONE—ORDway 3-8551

HOT SPECIALS!!

FM TRANSMITTER

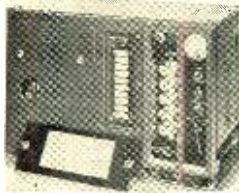

For 10 & 11 meters. BC-604, 80 watt, 20 to 30 MC, 10 channel push-button, xtal controlled. Complete with 7-1619's, 1-1624 tubes, meter, diagram, case and covers, 12 or 24 volt.

Good, used \$12.95

FM RECEIVER

For 10 and 11 meters, BC-603, 29 to 30 MC superhet, BFO, squeel; 10 push-buttons and manual tuning. Makes fine wide-band IF strip for 88-108 MC FM with converter. Includes: 10 push-button and and diagram, 12 or 24 volt. Good, used \$12.95. New, with Technical Manual \$16.95



FREE CONVERSION INSTRUCTIONS

Simple, easy change to 115 VAC. Converter diagram furnished. Complete conversion (power supply and converter) costs less than \$7.00 to build. COMBINATION OFFER, above, Rec. and Xmttr. Only \$24.95

MIDGET HEADSET



Hearing aid type HS30. Wt. ea. unit only 3/4 oz., total wt. 6 oz. Imped. 250 ohms, diam. 3/8". Fine for miniature radios, crystal sets, all around use. Can be used as low-imped. mike. Complete with headband, rubber ear plugs and shirt clip. BRAND NEW, orig. boxes. Gov't cost \$5.

YOUR COST.....2 Sets \$1.00

Please add Postage for 3 lbs. Discounts in larger quantities.

BARGAINS !!

FINAL TANK COILS for BC-610, 500W plug-in fixed link: 2-3.5 mc 89c, 4.5-5.7, 5.7-8.0, 8-11, 11-14 mc \$1.19
25 mfd or .5 mfd 600V tubular.....12 for \$1.00
7 mfd, 600V oil-filled.....\$.65
Neut. Cond. for 807, 6L6, 1" plates .5-9mmf.....\$.79
20 Meter center link 100V plug-in.....\$1.00
Var. Cond. 500 mmf Nat'l EMC500.....\$1.00
WIRE, 1/2 lb. No. 32 enam.....45c
1 lb. No. 20 enam.....60c

TRANSFORMER BARGAINS



B. 4v @ 16a. 2.5v @ 175a.....\$1.88
C. Scope 4000 vrms @ 10 ma.....\$3.65
D. Power, 315 VDC 85 ma; 5v 3a, 6.3v 2.1a No. 1159.....\$2.15
E. Power, 250 VDC 150 ma., 5v 3a, 6.3 5a. No. 1138 similar to "D".....\$2.65
CHOKE, 5h 225 ma 112 ohms GE, slick.....\$1.95

FM TRANSMITTER-RECEIVER.....\$7.88

Altimeter type RT-7/APN-1; freq. 418-462 Mc; with 14 tubes; 3-12SJ7, 4-12SH7, 2-12H6, 1-VR-150, 2-955, 2-9004. 27V dyn., dia; easily converted to communications; as shown with case; still a few left.



New.....\$7.88

ARE YOU CONFUSED?

LET US SET YOU STRAIGHT

Cross-reference tube list—Army VT Numbers to commercial types. Price.....50c
Schematic diagrams for SCR274N; ART-13; BC375; BC191; BC221B, J, O, or R; BC348C; SCR2694; SCR522; B7721 Handi-Talkie; R19A/TRC-1; T14A/TRC-1; RT7/APN-1; ARC-1; RA34; BC611 Handi-Talkie; BC312N or NX; BC324N; BC314G; BC344D; BC659; BC603; BC604. Each.....\$1.00

WRITE FOR FREE LIST

Postage extra. Minimum order \$2.00
TERMS: Net Cash, 25% deposit on C.O.D.'s

ELECTRONIC SUPPLIES

317-R East 2nd St. Tulsa 3, Oklahoma

ROTACUT Power Mowers

Gas—\$99.50 Electric—\$89.50

MAYTAG Engine 1/3 h.p. Motor

Direct Drive. Trouble FREE. Mows and trims. Lightest weight. Fully proved. Dealerships open.

FARM PRODUCTS CO.
Dept. 2064, Excelsior Springs, Mo.

"shut-ins" and disabled veterans; such persons who are interested should write *direct* to Walter Downes, R.F.D. 2, Box 328, Jeannette, Pa., stating details of the individual case.

* * *

This Month's Schedules

(Note: About this time of year many stations change to summer frequencies and/or to summer time schedules. The best way to ascertain such changes is by listening. When time changes occur, you may find many stations broadcasting one hour *earlier* than listed herein.—K.R.B.)

Albania—ZAA, 7.853, Tirana, is heard daily with news at 1515; best Sundays when has less CWQRM. (Southall, Pa.)

Algeria—Radio France, 11.835, Algiers, is heard well afternoons in East; now signs off 1800. (URDXC)

Anglo-Egyptian Sudan—Radio Omdurman informed Gillett, Australia, that its 9.700 outlet employs a standard telegraph and telephone type E.S. 4 transmitter with power output of .35 kw. to antenna, fed into folded dipoles made up for this frequency. Peddle, Newfoundland, reports the 13.32 outlet is heard there 1200-1430 daily; should have *English* on Fridays only, 1230-1300.

Angola—CR6RN, 9.475, Luanda, has recently been heard signing off at 1705 some days, other days at 1625. (Foerster, Illinois). Good signal reported in East.

Antarctica—CARA, a b o a r d the "Rancagua," of the Chilean Antarctic Expedition, uses voice on 16.595 (approx.) when they have a schedule with Punta Arenas (which probably replies on approximately 6.705), around 2055; QSO's are for talks between the officers and crew of the ship and their families; sometimes they also have special programs to station CE920, 9.200, "Radio Ejercito," Punta Arenas, and to other stations of the network "Coperativa." Schedule then is around 1930, also on 16.595; first program was heard January 9 at 1945, when the ship was in Chile Bay, Antarctica; programs are interesting—patriotic in theme; in contacts announce as "Patrulla Antarctica del Ejercito de Chile." CARA also uses the calls "X8" and "M8," when working on phone. The "Rancagua" also has available frequencies of 11.029 and 7.351; the 11.029 outlet is used mainly for c.w. contacts with CCP (Punta Arenas), CCS (Santiago), and so on, as well as with other Chilean ships. CARA sends a good signal to Brazil, but has bad QSB. Among broadcasters from Antarctica (*heard on c.w.*) are CDA, Puerto Soberania, the Chilean base at Antarctica; KICJ, Ronne Antarctic Research Expedition aboard "Port of Beaumont"; a frequency of 6.159 aboard the ice-breaker U.S.S. "Burton Island" of the U.S. Naval Antarctic Expedition for completing surveys of the last Byrd Expedition, and USFA aboard "Slava," the Russian Antarctic Whaler Expedition. (Vilella, Brazil)

Three Victoria amateurs left Perth, Australia, in early winter for Heard

Island to set up and operate base stations for the Australian Research Expedition to Antarctica; another amateur left for Macquarie Island in January. These amateurs—and possibly others—will use any of the bands allocated for amateur use; calls will include VK3OY, VK3ACD, VK3AMG, VK7AE, and others. Base stations on Macquarie and Heard Islands will be for communication with Sydney, New South Wales; call signs and frequencies allocated include these: Macquarie Island, VJM, 9.940; VJM2, 12.255; VJM3, 15.845; VJM4, 19.255; Heard Island, VJH, 9.940; VJH2, 12.255; VJH3, 15.845; VJH4, 19.255. *Radio Australia* has announced that weak signals had been reported in Perth, Western Australia, from one of the VJH outlets, no other details were given.

Argentina—LRM, 6.180, Mendoza, verified by registered airmail letter from Julio E. Pozo, director; QRA is Radio Aconcagua, E. Civit 460, Mendoza. (Cushen, N.Z.) Has been heard lately with frequency relays of *Radio El Mundo* programs. (Kary, Pa.) LRY1 has moved to 9.545; *Radio Belgrano* signs off at 2200, strong. (Balbi, California)

Australia—VLC7 has moved to 11.81 from 11.84 where it is used to East Coast (North America), in parallel with VLB, 9.54, 0800-0915 (will be one hour *earlier* in summer).

Radio Australia recently announced several changes in schedules, including: 2330-0045 to West Coast (North America), VLA7, 17.800, VLC4, 15.320, VLG10, 11.760; VLB5, 21.540 (to Africa, may be off Sat. and Sun.); 1000-1115 to West Coast (North America), VLC3, 11.760, VLB9, 9.615; 1000-1115 to Africa, VLG4, 11.840, VLA6, 15.200; 0900-1000 to British Isles and Europe, VLG10, 11.760, VLA6, 15.200; 1500-1645 to British Isles and Europe, VLA6, 15.200, VLB9, 9.615; a frequency of 15.230 appears to be in use to British Isles and Europe to 1815 closedown, probably from 2210 or earlier; 1645-1815 to Forces, VLB11, 15.160; 1645-1815 to East Coast (North America), VLA9, 21.600; 1700-1815 to South America, VLG10, 21.680. DX sessions are heard in these various beams on *Sunday*—to West Coast (North America) at 0025; to British Isles and Europe 0902; to East Coast (North America) 1800.

From Graham Hutchins, DX Editor, *Radio Australia*, come these schedules for transmitters of the Australian Broadcasting Commission in the Inland Short-Wave Service: Monday to Saturday—Melbourne, VLR2, 6.150, 1500-1715; VLR, 9.540, 1730-0330; VLR2, 6.150, 0345-0900; VLH4, 11.880, 1500-1715; VLH5, 15.230, 1830-0315; VLH3, 9.580, 0328-0900; VLG6, 15.230, 1500-1700; Brisbane, VLQ3, 9.660, 1500-0900; Perth, VLW7, 9.520, 1700-2045; VLW3, 11.830, 2230-0515, VLW7, 9.520, 0530-1100. *Sunday*—VLR2, 6.150, 1545-1715; VLR, 9.540, 1730-0215; VLR2, 6.150, 0230-0900; VLH4, 11.880, 1545-1815; VLH5, 15.230, 1830-0315; VLH3, 9.580, 0328-0900; VLG6, 15.230, 1545-1700; VLQ3, 9.660, 1500-0900; VLW7,

BIG MONEY IN RADIO

SEE THESE BRAND NEW RADIO BOOKS **FREE**

COYNE'S *New 5 Volume Set* "APPLIED PRACTICAL RADIO"

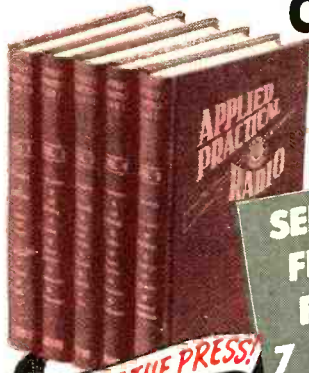

SEE IT FREE FOR 7 DAYS

JUST OFF THE PRESS!

You men who want to go places in Radio, and who know how much a solid working knowledge of the field helps to get the big money—this is IT! Over 1500 pages of down-to-earth Radio, from simplest principles to newest Television! It's all there easy to understand—how and why it works . . . how to construct, install, service. PA, short-wave, auto-radio, aviation, radio-phonographs. FM, testing instruments and trouble-shooting short-cuts, phototubes—you name it, COYNE'S got it, in "Applied Practical Radio"!

PRACTICAL! CLEAR! COMPLETE!

5 big volumes—1000 illustrations and diagrams, with step-by-step photographs which "break down" the equipment for you to show what makes it "tick". Up-to-the-minute, complete, easy to follow . . . written as only COYNE books are written!

GET THIS BOOK FREE for LOOKING AT SET



Brand New! Explains circuits of latest sets

VALUABLE BOOK FREE for Looking at 5-Volume Set

Send This Coupon NOW

You must SEE these books to know how easy it is to prepare for the big jobs in radio. Here's our special offer:—we'll send the complete 5-volume set for your 7-Day FREE Examination. And with it, we'll include our valuable, new guide for all radiomen, "150 New Radio Diagrams Explained", absolutely FREE! If you keep the 5-volume Set all you pay is \$3.00 within 7 days after the books arrive and \$3.00 per month until \$16.75 is paid—or you can pay \$15.00 cash price. If you don't want the set, return it and you OWE NOTHING. But either way you keep the "150 Radio Diagrams Book" as a gift. That book is ABSOLUTELY FREE.

EDUCATIONAL BOOK PUBLISHING DIVISION
COYNE ELECTRICAL & RADIO SCHOOL
Dept. 48-T3, 500 S. Paulina St., Chicago 12, Ill.

O. K., send me postpaid your new 5-volume set, "Applied Practical Radio" in 7 days Free Trial per your offer in Radio News. I will surely include as a gift the book of 150 New Radio Diagrams Explained, absolutely FREE.

NAME _____ AGE _____
ADDRESS _____
TOWN _____ ZONE _____ STATE _____

SEND NO MONEY REMEMBER—Coupon is not an order, just a request to see set free and get the FREE BOOK. But offer is limited, so act at once!

COYNE ELECTRICAL & RADIO SCHOOL (Founded 1899)
500 S. Paulina St., Dept. 48-T3, Chicago 12, Ill.

Talk 10 Miles! Use Flashlight Batteries! FIELD TELEPHONES



- Portable • Easy to Hook Up • Clear Reception to 10 Miles

Army Surplus Completely Reconditioned and Guaranteed

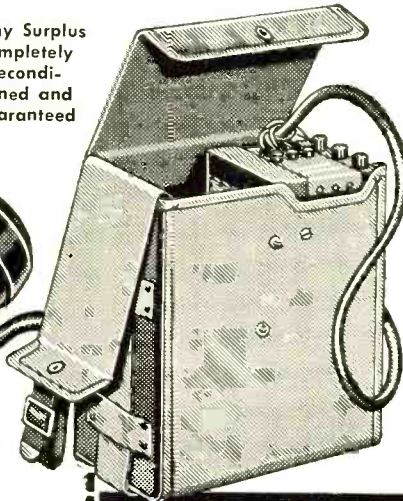

Price Per Unit Complete With Handset **\$9.95**
F. O. B. Lexington, Ky.

INCLUDES CARRYING CASE

Save time and many steps with these portable field telephones—useful wherever you need communication. Used by the Signal Corps from Nome to Naples, these Army surplus telephones are priced at a fraction of what the government paid for them. Every set tested. Every set in perfect operating condition, ready for use. Operates on 2 standard flashlight cells with easy-to-attach 2-wire connection. Weight 10½ lbs. Complete with carrying case.

MAIL THIS COUPON TODAY

SETZER HARDWARE CO.
Tate Creek Pike & Mt. Tabor Rd.
Lexington, Kentucky

- Enter order for _____
 Enclosed \$_____ Full Payment
 Part Payment (Balance C.O.D.)

NAME _____
STREET ADDRESS _____
CITY _____ STATE _____

SETZER HARDWARE CO.
TATE CREEK PIKE & MT. TABOR ROAD LEXINGTON, KY.

Now

FM-AM RECEIVER COMBINATION

DESIGNED for CUSTOM INSTALLATION

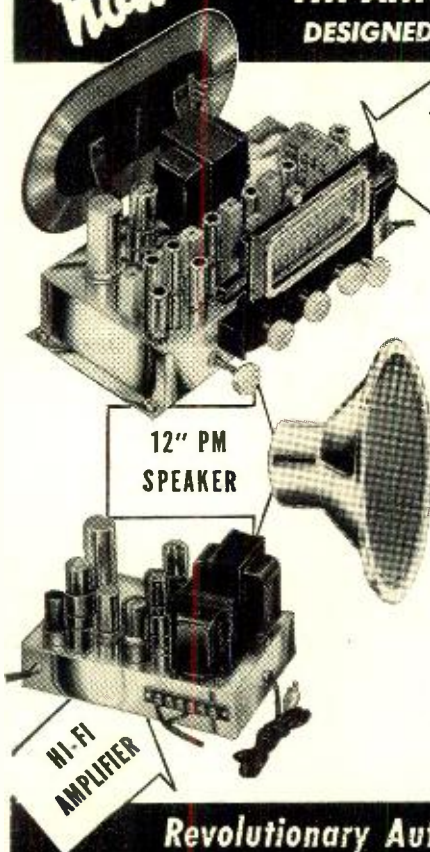

FM-AM TUNER

12" PM SPEAKER

HI-FI AMPLIFIER

A Receiver Combination you'll be proud to own or sell:

- No-drift FM-AM Receiver
- Hi-Fidelity Amplifier
- 12" PM Alnico V Speaker

FM-AM TUNER—RC-1 Features automatic frequency control, most revolutionary development in FM design—entirely eliminates drift and multiple tuning responses. Nine shielded miniature tubes plus rectifier include double limiter. Polished chrome chassis. Complete with cable, escutcheon, decals and antennae.

HI-FIDELITY AMPLIFIER—RC-2 High impedance input. 12 watts output at 1% distortion. Taps: 4, 6, 8, 15, 500 ohms. 65 db gain, including inverse feedback. Uniform frequency response from 20 to 20,000 cycles up to 8 watts output. Hum 65 db below rated output. Tubes: 6J5, 6SN7, (2) 6V6, 5Y3. Durable polished chrome chassis.

12" PM SPEAKER—RC-3 Outstanding performance. Handles up to 16 watts audio power. Alnico V 6.8-oz. permanent magnet. Voice coil 6 ohms. Completely dustproofed. Beautifully chrome plated.

Write for Descriptive Circular

The **RADIO CRAFTSMEN, Inc.**
1341 S. Michigan Ave. • Chicago 5, Ill.

Revolutionary Automatic Frequency Control

MERIT BRINGS YOU VALUES!

IT'S SENSATIONAL!

HOTTEST ITEM OUT! Make your SCR-522 Receiver operate on 144 to 148 Mc with **ONE DIAL** control, in less than 1 hour! Method is completely mechanical. Tracking is adjustable for the individual receiver. Band-spread is adjustable up to about 160 degrees. Parts and instructions..... **\$3.00**
(Please include 8c postage)

BRAND NEW SCR-522

Latest Model. Consists of BC-624-C Receiver and BC-625-AM transmitter, complete with tubes..... **\$29.95**
ARC/5 2-3 Mc Xmtr..... \$9.00
BC-454 3-6 Mc Rcvr..... 5.50
BC-455 6-9 Mc Rcvr..... 5.50

WIRE SPECIAL

7-Conductor No. 14 stranded wire, rubber-covered, color-coded. Per 100 ft..... **\$12.00**

TRANSMITTING TUBE BARGAINS!

807..... \$1.00 8025A 500 Mc Triode..... \$3.95
805..... 3.50 866A..... .75
810..... 5.95
(Minimum Tube Order \$5. All Tubes shipped Express)

SCR-522. Clean condition, with tubes. Very Special Value! \$17.50

MERIT RADIO SUPPLY CO.

471 Merrick Road Lynbrook, N.Y.

"America's Best Buy"

TUBULAR ELECTROLYTICS

Fresh Stock. Fully Guaranteed

Capacity	W.V.	Each	per 10	100
25 mfd.....	25V	\$0.17	\$1.59	\$14.95
50 mfd.....	50V	.21	1.79	16.95
100 mfd.....	50V	.24	2.29	19.98
20 mfd.....	150V	.21	1.89	17.95
30 mfd.....	150V	.22	1.95	18.95
40 mfd.....	150V	.23	2.04	18.74
50 mfd.....	150V	.24	2.14	20.45
20-20 mfd.....	150V	.29	2.49	22.98
30-20 mfd.....	150V	.32	2.95	25.98
40-20 mfd.....	150V	.36	3.25	29.95
50-30 mfd.....	150V	.39	3.49	32.98
8 mfd.....	450V	.21	1.99	19.50
8-8 mfd.....	450V	.42	3.98	35.76
16 mfd.....	450V	.39	3.74	33.78

BY-PASS CONDENSERS

.01.....	600V	\$0.06	\$0.55	\$ 4.60
.02.....	600V	.06	.55	4.75
.05.....	600V	.06	.55	4.95
.1.....	600V	.07	.65	4.49
.25.....	600V	.11	.98	8.95
.005.....	1700V	.14	1.25	9.95
.007.....	1700V	.14	1.25	9.95
.01.....	1700V	.15	1.30	10.20
.02.....	1700V	.16	1.40	10.95

An assortment of 50 of the above By-pass condensers. Fine value for the small shop or experimenter, only **\$2.98**

RESISTOR ASSORTMENT

100 assorted 1/4-1/2 watt carbon resistors. All RMA color coded. Special **\$1.29.**

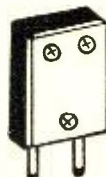

CRYSTALS 98c each

Your frequency plus or minus 10KC

- 80 Meter, 3500-4000KC
- 40 Meter, 7000-7300KC for multiplying into
- 20 Meter, 7300-7425KC
- 10 Meter, 7300-7425KC
- 6 Meter, 6250-6750KC
- 2 1/2 Meter, 8000-8222KC

Postage extra 20% deposit on COD. Write for latest bargain list featuring "America's Best Buys."

POTTER RADIO CO.

1314 McGee St., Kansas City 6, Mo.

9.520, 1545-2040; VLW3, 11.830, 2100-0515; VLW7, 9.520, 0530-0900. Many of these outlets are heard with good signals in the U.S., Canada, Africa, Britain, on the Continent, and elsewhere.

It was announced recently over VLH3, 9.580, that two new stations are planned for Australia—10 kw. each with directional antennas—to be located at Perth and Brisbane, respectively; will supplement services of VLW and VLQ; should be in operation by mid-1948, according to announcement. (Brownless, England)

Austria—Kary, Pa., reports KOFA, 7.221, Salzburg, heard in clear, but with bad fading, with news 0130-0145; announces "This is BDN, the Blue Danube Network."

Under the unusual callsign of XL2C, the Austrian Post, Telephones, and Telegraphs Dept., Vienna, has been operating a circuit with New York since September 12, 1946; on 17.600, for the exclusive use of U.S. Army and civilian personnel; station is Austrian-staffed, under American supervision; schedule is 12 hours daily—0800-2200; other frequencies available are 19.730, 9.130, 7.478 (on voice); the transmitter is 2.5 kw., and since they use single sideband, some degree of intelligibility is noted without use of b.f.o. (Kary, Pa.)

Azores—Kary, Pa., recently heard CUM, 6.925, calling CUJ, Lisbon, Portugal, at 1727, later calling Bissau, Portuguese Guinea, latter could not be found.

CSX-2, 4.845, Ponta Delgada, "Emisora Regional dos Azores," has good signal in East 1700-1900; leaves air with Portuguese National Anthem. (URDXC)

Bahrein Islands—Radio Australia's North African observer reports Manama on Bahrein Islands in the Persian Gulf as playing American, French, and German recordings, heard on frequencies from 6.910 to 7.200 but seems now to have settled down on 7.070; on the air weekdays 1000-1130, Sats. and Sun. 1000-1200; quality poor; announces in Arabic and Persian, but just before closing down, also identifies in French.

Barbados—VPO3, 10.605, Bridgetown, is often heard in Newfoundland around 1500-1615. (Peddle) Is used for special relays.

Belgian Congo—Leopoldville's frequencies have been a bit unsettled this winter, but seem to be using 9.783 and 9.745 mainly at 1300-1645, news 1530-1550, 1640-1645; 9.745 is used 1700-2300, news at 2100-2120, 2250-2300; (between 2100-2300 is beamed to North America); the 1530-1645 period is beamed to Britain and to British Colonies in Africa.

Elizabethville is heard quite well in South Africa on Sunday (only) 0800-1000 on 11.900, 150 w., and 7.145, 50 w., using the call OQ2AB; QRA is Radio Elizabethville, Box 1038, Elizabethville, Belgian Congo; verifies via letter (in French), takes several months. (Laubscher, South Africa)

Worris, Florida, received these schedules from Radio Congo Belge—

OCT3, 0000-0200 on 9.38, 6.295; 0515-0700, 11.72, 6.295; 1100-1500, 9.38, 6.295. Location is Leopoldville.

Brazil—Villega, ISW monitor in Sao Paulo, advises that "Radio Anchieta," PST-2, 7.410, has changed schedule to 1330-1530; still asks for reports to "Radio Anchieta," Secretaria da Educacao, Pateo do Colegio, Sao Paulo, Brasil; letters are acknowledged over the air at end of broadcasts.

British Honduras—Eyles, Georgia, says ZIK-2, Belize, around 10.600, is still heard at 1330 with news.

British Somaliland—New Zealand sources report *Radio Somali*, Hargeisa, is now being heard on 7.350, moved from 7.126. (Cushen, N.Z.)

Bulgaria—Radio Sofia III, 9.350, has replaced *Radio Rodina* (Military Radio) on same frequency, latter having been suspended; *English* news is scheduled daily at 1350, and for a time at 1650 to compensate for BCB 850 kcs. which is temporarily off the air. (URDXC)

Burma—The Burma Broadcasting Service has advised *Radio Australia* that it does not have calls for its transmitters; XYZ and XZZ were allocated prewar, but have not been reissued (Hutchins, Radio Australia)

Cameroons—Radio Douala, 7.950, was heard recently in Pennsylvania to 1457 sign-off; woman announced "Ici Radio Douala," and then station left the air with march (not "La Marseillaise"); surprisingly clear signal despite noise and ham QRM. (Kary) A Swedish ISW monitor lists schedule of 1300-1500, news in French at 1330, says sometimes has heavy CWQRM.

Canada—CBC's International Service now has a North American Service on Saturdays to 0000 over CKOB, 6.090, and CKLO, 9.630. (Beck, N.Y.) Official 1948 schedules for VE9AI, Edmonton, Alberta. are 6.005:—April 2130-0200; May 2230-0200; June 2300-0200; July 2300-0200; August 2200-0200; September 2045-0200; October 0815-0900, 1945-0200; November 0815-1000, 1845-0200; December 0815-1045, 1815-0200. On 9.540—April 0815-2130; May 0815-2230; June 0815-2300; July 0815-2300; August 0815-2200; September 0815-2045; October 0900-1945; November 1000-1845; December 1045-1815; power is 200 w. and the station relays medium-wave CJCA.

Celebes—According to *Radio Australia*, schedule of *Radio Makassar*, back on 9.357 and using 5.030 in parallel, is 1730-1930, 2200-0130, 0400-1000.

The 9.357 outlet sends a good signal to Britain, heard signing off 1000 with announcement, "Radio Macassar, situated on the Island of Celebes, one of the largest islands of the Eastern Archipelago and broadcasting from Macassar, capital of the State of East Indonesia." (Pearce)

Ceylon—Radio SEAC, Colombo, air-mails these schedules—Main Program, 17.82, 1930-0135, 0500-0700, 0715-1115; 15.12, 1930-0135, 0500-1115; 9.52, 1930-0135, 0500-1115; these frequencies are also used in the Sunday beam to United Kingdom, 1330-1530, and for

April, 1948

THERE'S A LOT OF PROFITS PACKED INTO THE NEW SHURE CARTRIDGE REPLACEMENT PACK



MODEL W50A

... because you only need a small parts inventory to handle most of your cartridge replacement business.

The Shure Cartridge "PACK" is the serviceman's friend in more ways than one: Shure crystal cartridges have become a standard by which quality and dependability are judged; and they will now replace over 58 cartridges being used in phonograph reproduction today. The "PACK" contains five Shure lever-type cartridges including the "Muted Stylus"* cartridge with the osmium-tip. A Shure Replacement Chart is in each pack for handy reference. It picks out the particular cartridge you should use to replace another. The "PACK" speeds up your profits: no need to order a certain type cartridge—then have to wait until your order is filled. With the "PACK" you can service your customers faster, get profits quicker.

*The "Muted Stylus" combines high output with amazing needle quietness

Model W50A (includes 5 Shure Cartridges) CODE: RUPAC, LIST PRICE \$30.80



SHURE BROTHERS, INC.

Microphones & Acoustic Devices

225 W. HURON ST., CHICAGO 10, ILL.

CABLE ADDRESS: SHUREMICRO

Here's the Cabinet Television Builders Have Been Waiting For!



Specially Designed For Your "Transvision" Kit (12" Standard Model)

A hand-crafted cabinet made of the best ¾ inch walnut, finished by expert piano polishers, for the custom-builder who seeks to give his set the advantage of commercial styling combined with exclusive construction. Dimensions: 29½ inches wide, 21 inches high, 20 inches deep.

ADD THESE UNUSUAL DE LUXE FEATURES TO YOUR SET—

- 8 inch Rola P.M. speaker for natural tone
- Conveniently located slide switch operates concealed illumination for Lucite printed dial and jewel-covered light in base.
- Specially built milk-white Lucite mask, curved to fit 12" picture tube—protected with safety glass.
- English design recessed base—felt cushioned.

AND WORTH DOUBLE TO THE COMMERCIAL BUILDER!

This highly polished cabinet comes to you completely assembled, drilled for shafts, wired and ready for your chassis. Nothing else to buy. Furnished complete with step-by-step instructions and following kit of parts to complete installation of chassis: pin jacks, plugs, pilot brackets, 6-8 volt pilot bulbs, onyx catalin knobs (6 plain, 1 with pointer), special low-loss antenna block, assembly to raise CR tube, masonite back-board drilled for ventilation, heavy stack output transformer, fuse holder, strap for CR tube, caution labels, nuts, washers, bolts, screws.

ONLY
\$79

F.O.B. Brooklyn,
N. Y.
Send 10% with
order.
Balance C.O.D.

Order direct from:

TEL-CRAFT COMPANY
108 HAVEMEYER STREET
BROOKLYN 11, N. Y.



RADIO ENGINEERING TELEVISION ELECTRONICS

Thorough training in all phases of radio and electronics, open to high school and junior college graduates. Old established school specializing in Radio training exclusively. Modern laboratories and courses. Enrollments limited. Approved veteran training.

VALPARAISO TECHNICAL INSTITUTE
Dept. RD Valparaiso, Ind.

this beam 17.77 is also listed; while 6.075 and 3.395 are *not listed* for the Sunday beam to Britain, it is believed they are being used also (for listeners in India and Pakistan, as announced); other *daily* schedules include 6.075 and 3.395, 1930-0135, 0500-1115. Ceylonese Forces Program is listed on 17.82, 0700-0715 daily. (NOTE: On Saturday there is usually an "alternate" program of sports and music at 0900 on 17.82, 6.075, and 3.395 outlets.)

Newscasts are scheduled over *Radio SEAC* at 2000 (London relay), 2200 (London relay), 0030 (world news headlines), 0130 (world news headlines), 0600 (world in review), 0730 (world and home news from Radio SEAC), 0900 (Radio Newsreel from London), 1100 (world news from London). (Park, British Columbia)

ZOH, 4.900, Colombo, runs to 1700 on Sundays; gives program summary 1055, news 1100. (Pearce, England)

China—XPPA, Kweiyang, has moved to 7.100 from 9.450. (URDXC) Now signs off at 1000 and does *not* carry XGOY news relay at 0900. (Dilg, California) Schedule is listed 1755-1900, 2330-0100, 0500-1030. (Carter, Washington)

The Communist-controlled stations in China may have gone back to former schedule; Dilg, California, recently noted that on a Sunday, XGNC, about 6.570 (drifts), remained on until 0945 when signed with "La Paloma"; should have news at either 0630 or 0730.

T. Y. Woo, director, XGOA, Nanking has informed Cushen, N. Z., that he regrets that DX reports have been acknowledged only by cards, and that cooperation of DX-ers is appreciated, but due to lack of personnel in the *English Department*, they can't hope to write each listener personally. (I have just received an attractive QSL card from this station, verifying reception of the 11.835 outlet in the portion of daily North American beam audible in East around 2230-2300.—K.R.B.)

Our observer in Western Australia, Major, sends along these details regarding XGOE, The Educational Broadcasting Station of Kwangsi, Kweilin, Kwangsi, China; director is Lu Hin Shue; station operates on 9.868 at 0500-0900 daily, using 100 watts and a crystal-controlled m.o.p.a. broadcasting transmitter; antenna is Hertz type, half-wave, 60 feet high, running E-W; civil service and *English* broadcasts were discontinued in September; prior to that time the XGOY news relay had been carried; now that period is devoted to programs of Western music. Mr. Major reports XGIO on approximately 9.99 at 0530-0630 with Western music, also heard 0800-0830; this station is listed on 8.433, location Nanking, and has been reported used chiefly for sending dispatches.

XGOY's 49-meter outlet has been measured 6.145. (Park, British Columbia) May drift. Appears to be scheduled now 0635-1145, news 0700, 0730 (at least some days) 0900, 1100. XGOY

will probably be using 15.170 shortly, watch for it on 19 meters.

XURA, Taiwan, is back on 7.220 from its 49-meter outlet (around 6.180); runs to 1000 and carries XGOY news relay at 0300. (Dilg, Calif.) Address is XURA, Taiwan Broadcasting District, Central Broadcasting Administration, Chong Sung Park, Taipeh, Taiwan, China. Schedule received from station is 0400-1015. (Carter)

Colombia—HJAP, "Radio Colonial," Cartagena, is reported moved from 4.925 to 9.895.

Czechoslovakia—Peddle, Newfoundland, heard a station on approximately 7.100 on New Year's Eve at 1500-1515 announcing in Czech and *English* between musical numbers—"Czechoslovakia wishes you a Happy New Year"; no other details. A new outlet?

OLR4A, 11.84, Prague, can sometimes be "fried out from under" CXA-19 QRM in the 1900-2000 North American transmission; usually has news commentary around 1937-1943; signs off at 2001 with Czech National Anthem. (Kary, Pa.) The 6.010 outlet is heard in Britain signing on 1130, with R8 signal. (Pearce)

Dutch Borneo—*Radio Pontianak* uses YCN, 5.480, 40 w., YCN2, 6.650, 150 w., YCN3, 8.090, 250 w., 0545-0730 (usually on YCN2). (Cushen, N. Z.)

Ecuador—HCJB, Quito, is noted at 0000-0100 on its *new* frequency of about 5.97. (Beck, N. Y.) Is officially listed 5.995; the station would appreciate reports on reception of this *new* outlet.

"La Voz de Manabi," Portoviejo, formerly 7.140, is lately reported on 4.765, evenings (EST).

HC2RL, 6.635, has been heard intermittently, from around 2100 to 2200, announcing in Portuguese, Spanish, and *English*. (Arthur, W. Va.)

England—Tommy Kneitel, New York, writes: "GKU3 verified by letter; said, 'With reference to your reception of GKU3 on 12.455 on November 1, conditions were probably exceptionally good. We normally monitor the American NSS time signals on 12.630 at 1000, 1400, 1600, 2000 GMT, and excellent reception was obtained over last weekend. SX-28 or HRO receivers are used in conjunction with a rhombic antenna, and all signal measurements are made electronically with a decimal counter chronometer.' It was stated that a 350-w. transmitter with call letters GMT is also in operation at 1000-1030 GMT each weekday; from 1000-1015 GMT an unmodulated 2-megacycle carrier is radiated and 1015-1025 a 1000 c.p.s. modulation is applied. Provisional corrections to the radiated frequencies are announced 1020-1030 GMT. These are stations of the Royal Observatory, Greenwich."

Finland—Official detailed schedules of the Finnish transmitters are: OIX2, 9.50, Lahti, 1925-1935 (*English*); 2300-0000 (Finnish), 0350-0710 (Finnish), 0715-0725 (*English*), 1000-1150 (Finnish), 1150-1230 (Finnish), 1230-1255 (French), 1255-1440 (Finnish), 1440-

Fixing Radios the Old Hard Way?

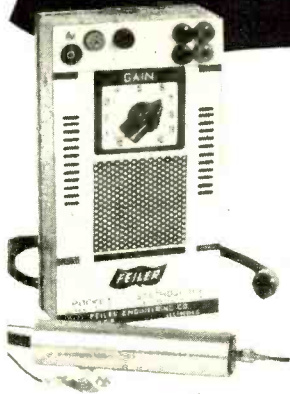

The Feiler Stethoscope does everything but make the actual repair. And the Stethoscope does it faster, better and much easier. Thousands of radio men, many with little experience, are already fixing radios and other electronic equipment this new way.

You will find that just this one low priced unit and a few basic hand tools are all you need to fix practically any radio.

Here is the new Model TS-5 "Pocket Stethoscope" built to take out on the job. It's light, compact and rugged yet performs like the bench models. Stethoscopes are available in 4 types ranging from \$9.85 to \$34.95.



The "Inside Story" of the STETHOSCOPE—how it works—how it instantly locates trouble in any circuit—is yours for the asking. The "Inside Story," a 24 page illustrated booklet, is full of practical tips and hints on radio servicing. To get your free copy, send your name and address on a penny post card today.

"MAKES RADIO REPAIRS AUTOMATIC"

Available for Export—Choice Territories Still Open



FEILER ENGINEERING COMPANY

945 George St. Dept. 4H8 Chicago 14, Illinois

The Cinaxial Speaker



YOUR ANSWER TO AN
Economical
Dual Speaker System

Used Wherever Quality Counts

Ruggedly built of finest materials — the Cinaxial Speaker will give years of trouble-free operation.

The Model Cin12A Cinaxial consists of a 12" low frequency speaker and a specially designed 3" high frequency speaker mounted within the cone of the 12" unit. Together they cover the range from 50 to 15,000 c.p.s., and will handle the output of a 10 watt wide range amplifier.

The Cinaxial Speaker is designed especially for FM use, but is equally suitable for television sound, wide range phonographs, studio monitoring, or similar installations "where quality counts."

Write for 1948 Cinaudagraph Catalog, Dept. 149B

Cinaudagraph Speakers

DIVISION OF AIREON MFG. CORP.

SALES OFFICE and FACTORY 1401 FAIRFAX TRAFFICWAY KANSAS CITY, KANSAS

April, 1948

Identify genuine TWIN-LEAD by this trade mark

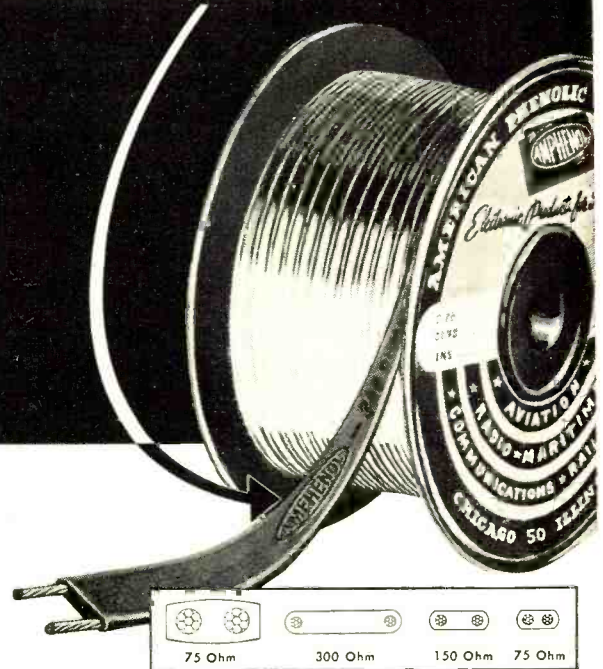

AMPHENOL

Amphenol Twin-Lead has long been recognized by the radio and electronics industry as the original Twin-Lead. It incorporates all of the improvements developed by Amphenol plastics engineers. Its polyethylene insulation is full thickness from edge to edge and is unaffected by sunlight or weather . . . remains flexible indefinitely.

Low-loss properties make Amphenol Twin-Lead ideal for television and FM transmission lines and for amateur antennas. Genuine Amphenol Twin-Lead is available in 75, 150, and 300 ohm impedances for receiving and 75 ohm impedance for transmitting.

TWIN-LEAD ACCESSORIES

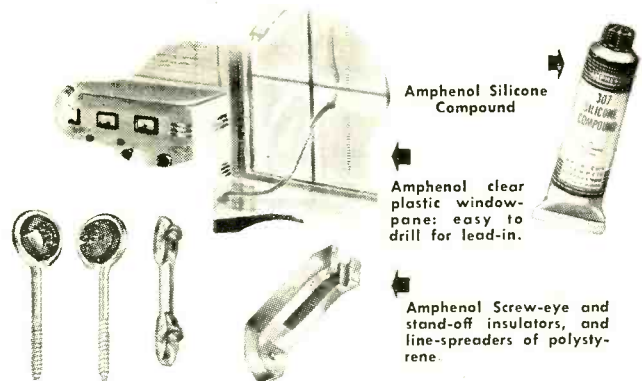

Amphenol Silicone Compound

Amphenol clear plastic window-pane: easy to drill for lead-in.

Amphenol Screw-eye and stand-off insulators, and line-spreaders of polystyrene.

AMERICAN PHENOLIC CORPORATION

1830 South 54th Street, Chicago 50, Illinois

COAXIAL CABLE AND CONNECTORS • INDUSTRIAL CONNECTORS, FITTINGS AND CONDUIT • ANTENNAS • RADIO COMPONENTS • PLASTICS FOR ELECTRONICS

153

JUST OFF THE PRESS
LATEST UP TO DATE
VIBRATOR GUIDE
 INDEXED BY
 Radio Set Model Nos.
 Radio Set Part Nos.
 Vibrator Mfg. Part No.
ORDER YOUR COPY NOW!

This vibrator replacement guide will bring you up to date on vibrator interchangeability. It is cross indexed in three ways to save your time and remove guess work. The first printing is limited so be sure to get your copy now.

Remember James vibrators work better and last longer because they feature exclusive (1) Patented Push-Pull Action (2) Frame-Mounted Cooler-Operation (3) Adjustable Contacts. Prompt shipment on all types.

Ask your Radio Parts jobber or write

JAMES VIBRAPOWR Co.

3224 W. Armitage Ave.

Chicago 47, Illinois

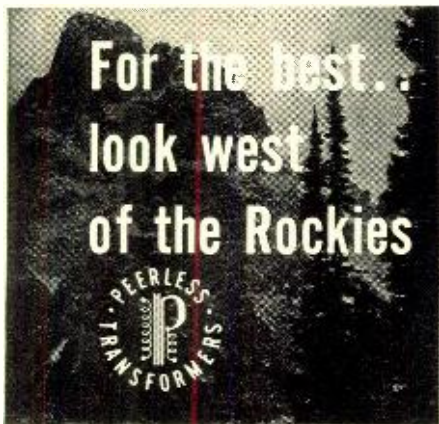

FLAT WITHIN 1DB

from 20 cycles to 20,000 cycles

Altec Lansing presents the new Peerless "20-20 Line" to meet today's need for audio transformers incorporating the admittedly superior principles of Altec Lansing design and engineering know-how, at prices attractive to present day manufacturing and replacement markets. Transportation prepaid anywhere in the U. S. on orders totaling 100 lbs. or more.



The NEW Peerless "20-20 LINE"

A new Peerless catalogue, presenting the complete line of Peerless audio, power, and special purpose transformers, will be sent on request. Write to Dept. O.

PEERLESS ELECTRICAL PRODUCTS DIV.
 6920 McKinley Ave., Los Angeles 1, Calif.
 Frazar & Hansen, Ltd., 301 Clay St., San Francisco 11,
 exclusive export agent



S & S RADIO SPECIALS

- BC 221 complete with Xtal and Calibration book \$38.50
- BC 342 Ready to plug in 110 V. 60 cycles..... 67.50
- BC 348 A few left at..... 67.50
- APS 15 Indicator 45 tubes—many 6L6's..... 32.50
- BC 929 Indicator Complete with 3" CRT..... 9.50
- SCR 522 Tr. Revr. 19.50 + Set of 6 Xtals
- 4.10/28 volt Dynamotor..... 7.50
- TS-10/APN Test set—contains approx. 450 ft. of 38 Ohm Co-ax—complete with attenuator, etc. 14.00
- Condensers, Mica .01 at 2500 v. test—25c 100 for 22.50
- 1000 for \$200.00. Famous manufacturer—new
- BC 1237 Radar Xmtr—makes good AM HF Xmtr.
- Uses 832 Push Pull Oscillator and 832 PP PA
- ID-14/APN1 Altitude indicator—contains selsyn 2.00
- AMERTRAN Xfmr. 110 v. 60 cycle primary, secondary 6200 volts center tapped—2 KVA. 55.00
- VARIAC, 2 KVA, 110 volts 60 cycle..... 32.50
- CHOKES, 20 Hy. 300 mls. 15,000 volts insulation 12.50
- Condenser, 1 mfd at 10,000 volts..... 12.50
- Condenser, 1 mfd at 6,000 volts..... 4.75
- BC 459 Xmtr unused \$9.50 slightly used..... 7.50
- BC 453 Revr the famous Q-fiver 100-550 kes... 9.50
- BC 454 3-6 megs—a good standby receiver for 75 6.50
- BC 455 6-9 megs..... 6.75
- Accessories for above receivers: 3 section rack 2.50,
- BC 450 control head 1.50, flexible shafts each 1.00,
- 28 volt dynamotor 1.50. Plugs for Xmtr or Revr any type each .50.
- Headphones, 8000 Ohms with extension and standard plug \$1.50—Phones and extension less headband 1.25.
- BC 433G Compass Revr. P/O 260, complete with inst. to convert to a superior Q-fiver and regular broadcast receiver, easily converted—complete with "S" meter and special knob 35.00 less knob and "S" meter 30.00. Covers 200 to 1750 kc in 3 bands. Has 15 standard 6 v. tubes already wired in parallel such as 6X7, 6F6 etc. Used 6B8-6F6 audio section, but has an extra 6N7 and 6F6 which can be very easily wired in for push-pull audio.
- R5/ARN7 Compass receiver—almost identical to the BC 438G except additional band 100-200 kc. Add 2.50 to BC 438G price for this unit. TIP to HAVEN, either of these units and a BC 454 receiver (1410 IP) makes a swell 75 meter recr.
- BC 375 GB Xmtr. with Ant. tuner (BC 306) and one Tuning Unit frequency range nearest your choice 20.00
- PE 73CM 28 volt dynamotor for BC 375 Xmtr. 4.75
- Though this ad was necessarily placed six weeks in advance, we have reserved sufficient quantities of these items to supply any reasonable demand at Publication time.
- All items are in a good and usable condition and are complete with tubes. P/O 260, complete with inst. 20% deposit required for COD orders—Minimum order \$5.00.
- Write for flyer—Complete inventory supplied to commercial users and dealers.

STRICKLAND-STEPHENS RADIO SUPPLY CO.

Radio Distributors
 Phone 402 and 403 Rochelle, Georgia

1000 (Finnish), 1705-1715 (French); news 1925, 0715. OIX4, 15.19, Pori, 2300-0000 (Finnish), 0350-0710 (Finnish), 0715-0725 (English), 1150-1230 (Finnish), 1440-1600 (Finnish), 1705-1715 (French); news 0715; OIX5, 17.80, Helsinki, 1925-1935 (English), 2300-0000 (Finnish) 0350-0710 (Finnish), 0715-0725 (English), 1000-1150 (Finnish), 1150-1230 (Finnish), 1230-1255 (French), 1255-1440 (Finnish), 1705-1715 (French); news 1925, 0715; OIX7, 6.12, Helsinki, 1925-1935 (English), 2300-0000 (Finnish), 0350-0710 (Finnish), 0715-0725 (English), 1000-1150 (Finnish), 1150-1230 (Finnish), 1230-1255 (French), 1255-1440 (Finnish), 1440-1600 (Finnish), 1705-1715 (French); news 1925, 0715. (Callahan, Pa.)

Helsinki programs are heard in New York after 0045 on 9.50 and 6.12. (Beck)

France—New QRA of the French Press and Information Service in New York is 610 Fifth Ave., Room 401. (Kelly, N. Y.) Latest schedules from Paris list English at 2115-2130 and French at 2130-2145 on 11.845, 9.68, 9.55. (White)

French Equatorial Africa—Latest schedules of Radio Brazzaville are 0000-0225, 17.85, 11.972, 9.984, 9.440, 7.000, 6.024, news and commentary 0030-0045; 0500-0745, 21.002, 17.850, 15.596, news and commentary, 0715-0730; 1100-1630, 17.850, 11.972, 9.984, 9.440, 6.024, 9.984 (also 21.002 to 1235 and 7.000 from 1300), news and commentary, 1345-1400, 1545-1600; 1705-2030, 11.972, 9.984, 9.440, 7.000, 6.024, news 1715-1730, 1900-1910.

French West Africa—At last report, Radio Dakar, 11.713, 6.917, was scheduled 0200-0230, 0715-0800, 1330-1700, and irregularly at 1700-1745; no English. Brehmer, Sweden, says the musical signature of this station is a French song called "Sur les Ponts d'Avignon."

Germany—Leipzig, 9.73 (may vary), now begins at 0000. (Beck, N. Y.)

Miers, ISW monitor in Berlin, says "Berlin does not operate any s.w. transmitter at present, has been off the air since February 1947; I do not know anything about a short-wave station of BFN in Germany." He lists current schedules for German s.w. outlets as Frankfurt, 6.190, 0000-1800 daily; Stuttgart, 6.180, weekdays 0500-1800, Sundays 0200-1800; Munich, 6.160, weekdays, 0000-1800, Sundays 0000-1900; Leipzig, 9.730, except Saturdays, 2300-1800, Saturdays 2300-2100 (note this one has been heard recently signing on 0000); Hamburg, 6.115, 0000-1830 daily; Baden-Baden, 6.327, 0000-1800 daily. Pearce, England, reports the BFN station formerly on 6.490 is now heard on 6.510 with strong signals afternoons (in Britain); may announce 6.513 and/or as "Radio Bumeveld."

Greece—Simonian, Mass., reports a Greek Underground Station on 7.700 at 0100-0130; begins with Greek National Anthem, then a man and woman alternate with talks in Greek; signs off with anthem; good signal.

Greenland—World-Radio Handbook, Denmark, gives this data on radio in Greenland—Normal clock time is GMT minus 3 hours; address, Radiostation Godthaab, Greenland; frequency 5.942 (50.49 m.); 1 kw.; daily program 1645-1745; weather report 1645; news in Danish 1700; ships' positions 1715; news in Eskimoan 1730; announcement in Danish is "God Aften; her Gronlands Radio"; interval signal, chimes and first movement (six bars, played twice), of the "Funeral March" by Norman Andersen which was composed for Kjell Abel's play, "Silkeborg." (Skoog, Sweden)

Guatemala—Kary, Pa., reports what appears to be a new Guatemalan on 6.660, announcing "'Radio Oriental' en la ciudad de Zacapa (?)" he is not certain of location; call is not given.

TGRB, Guatemala City, is now heard on 6.91, moved from 6.86, off 2200. (Beck, N. Y.)

Haiti—HHYM, 6.000, Port-au-Prince, a relatively new outlet, is reported by Kary, Pa., as heard signing off 2054 with anthem; announced call and frequency in English just prior to close-down, stating this was "second" broadcast of the day; slogan appears to be "Radio Phillips." Official schedule is 1200-1400, 1830-2100. (Precourt, N. Y.)

Honduras—Stark, Texas, reports a station on about 6.122 to 6.125 as HRQ; may be at San Pedro Sula; heard around 2100.

Iceland—Holmberg, Sweden, has just airmailed us that Reykjavik has announced a regular transmission on 12.235 on Sundays 1115-1145, consisting of news and Swedish music; this may be only a part of the regular transmissions that have been projected for some time by Iceland State Broadcasting. (Complete current data on s.w. schedules for this country will be appreciated.—K.R.B.)

New Zealand sources report TFI, 5.021, testing with TFN, 15.350, at 1330-1400 on December 31, in English, French, Swedish, and Icelandic. This may mean that services are to be expanded to include various languages, as forecast to me by the station some time ago.

India—Delhi's outlet on 15.160 gives program schedule for all transmissions at 0500. (Cushen, N. Z.)

Gillett, Australia, has received this data from VU7MC, Mysore—there are transmissions daily at 2030-2240, 0330-0440, 0700-1140 on 6.065 and 968 kcs.; at present the s.w. outlet uses 300 watts, while the BCB channel has only 30 watts. Plans are under way to increase power to 5 kw. on s.w. and to 10 kw. in broadcast band; it is hoped that new equipment will be installed during this year; news is listed for 2130, 0730. VU7MC belongs to the Government of Mysore, address is Akash-Vani Broadcasting Station, Mysore, India.

The Madras outlet on 4.920 has been heard with fair to good signals recently early mornings in the East; best around 0730 when relays the

ALLEN'S Money Savers on GOV'T SURPLUS ITEMS

SCR 578 TRANSMITTER (Gibson G1r) complete with tubes, 300' antenna wire on reel, all lights, handles, holding strap, hand driven generator. Brand New **\$9.95**

PARACHUTE over 70 sq. ft. orange nylon material; over 192' of 1/4" double reinforced white nylon braid; also 15' of 1 1/4" webbing, 3 safety buckles **4.95**

RUBBER BALLOON extra heavy; inflates to 4' in dia. Brand New **1.49**

HYDROGEN GENERATOR **.49**

KNAPSACK approx. 3 cubic ft. water repellent, felt lined. **1.19**

BOX KITE collapsible; 17" sq., 34" high. **1.49**

ANTENNA WIRE over 300' on reel; copper braided. **2.49**

SAVE \$3.10—buy these 7 items; Instruction manual included, for only **\$18.95**

Motor driven **GEAR BOX**; two 24v DC shunt wound motors; can be used as low voltage AC motor from 8 to 24v input; complete with micro sw'ch, 50 gears and control box. Brand New **\$3.50**

BC-733D SUPERHET RECEIVER—10 tubes, 6 xtals, 6 selector relays; operates on any one of the 6 xtal controlled frequencies; from 108.3 to 110.3 Mc. Can be easily converted to 2 meter ham or mobile telephone band. Gives both visual or aural indications of position of aircraft in respect to the runway. With dynamotor. Brand New **\$10.95** Without dynamotor **\$9.95**



STANDARD LIP MICROPHONE T-45—complete with PL291A plug; ready for use. Instruction book included. Brand New **25c**

THROAT MIKE T-30—double throat type; PL-291 plug, M199 neckband. Works into any 200 ohm impedance input circuit. Instruction sheet included. **39c**

HS-23 HEADSET—8000 ohm impedance, PL-54 plug. **98c**

HS-33 HEADSET—600 ohm impedance. **98c**

KELLOGG operator transmitter carbon microphone T-28E; adjustable swivel and extension bracket, with special 10 ft. ES2526-S cord. Brand New **\$7.95**

EARPHONE RECEIVERS R-14—high impedance, light weight, watch case type, double magnet, black bakelite cap; with PL-54 plug. **98c**

HEADSET P-19 with 2 R-15, 24,000 ohm total impedance receivers; includes 2 rubber cushions, PL-55 plug, 8 ft. cord. New **\$2.99**

HANDMIKE T17B—200 ohm, single button carbon mike, push button switch. Ideal for home transmitter or portable rig; 5 ft. rubber cord, PL-68 plug and dust cover. Brand New **89c**

HANDSET TS-13—200 ohm carbon mike, 2500 ohm earphone, 6 ft. rubber cord, 1-PL55 and 1-PL68 plugs attached. Brand New **\$2.95**

HANDSET TS-15A—200 ohm carbon mike, 2500 ohm earphone, 6' rubber cord, 1-PL55 and 1-PL68 plug attached. **\$1.98**

HANDSET TS-3AP, 75 ohm imp., 6' cord. **\$2.50**

R-57/ARN5 RECEIVER, 11 tubes, 3 xtals; 326 to 335 Mc. Brand New **\$14.95**

RC-103A RADIO AIRCRAFT receiving equipment; consists of receiver with 10 tubes, 6 xtals, 6 selective relays, 108.3 to 110.3 Mc; antenna and transmission line and plugs, indicator, etc. Complete and ready to be installed in aircraft. Brand New **\$75.00**

R-5/ARN7 RADIO COMPASS RECEIVER. Three bands 200 to 1750 Kc complete with 15 tubes. This set is ideal for conversion to home broadcast. Can also be converted to meet CAA approval for use in plane. 115v 400 cycle power supply. Brand New. Special. **\$19.85**

TRANSMITTER T-9APQ-2 **\$29.95**

TRANSMITTER T-85/APT5 **19.95**

TRANSMITTER T-28/APT1 **39.95**

DYNAMOTOR PE-94 **4.95**

TUNING UNITS, BC-746—with 2 crystals; transmits on 3655 Kc and receives 4110 Kc; includes RF coil and antenna coil with variable paddler; mounted on 1 base, wired and ready to plug in; carrying case included. Brand New **\$2.29**

WHIP ANTENNA AN-131A—Half wave 40 to 48 meg. 10 1/2 ft. long. Comes in 8 all brass sections, connected on a spring steel cable. Good for FM reception, mobile or fixed station; can be converted to fishing rod. In original sealed carton. Brand New. Only **\$1.00**

72-INCH ANTENNA—37-50 meg matching section; excellent for 10 meter band. Containing cylinder is 57" long, 3 1/2" diameter, with coaxial cable loading coil. Can be adapted for FM and Television. Good for mobile or fixed station. Brand New. Special. **\$2.45**

RADIO ALTIMETER—Transmitter Receiver RT7/APN1—complete with 14 tubes; 418 to 456 meg. 27v dynamotor. Certified by CAA; lowest Govt. \$2,000. Bargain **\$11.95**

BC-456B MODULATOR UNIT complete with tubes, 3 relays; parts worth more than our low price of **\$3.95**

BC/AL429—6 tube communications receiver and BC/AL430—4 tube transmitter, with tubes, less coils. Each **\$8.95**. Both **\$15.95**

RADIO RECEIVER BC-1023A—Ultra High Frequency, covering 62 to 80 Mc Range. An extremely sensitive relay, works on 4/10 of mill. Contains 4 tubes: 12SH7, 6SQ7, 6SC7, 6U6TG. Brand New **\$3.50**



BC-357 MARKER BEACON RECEIVER has sensitive relay; easily converted to 2.5—6 to 10 meter receiver. Complete with tubes. **\$2.50**

RECEIVER AN/CRW2 high freq., 6 tubes. Can be used for controlling purposes. Complete with tubes and dynamotor. Brand New **\$7.00**

RECEIVER AN/CRW 2A high freq.; 5 tubes and 3 sensitive relays. Used for controlling purposes. Complete with tubes and dynamotor. Brand New **\$7.00**

TBX NAVY MODEL TRANSMITTER RECEIVER, versatile because of freq. range of 2 Mc to 4.5 Mc for transmitter and 2 Mc to 8 Mc for receiver. It's adaptable for various types of power supplies, such as 6v-12v-24v dynamotor and 110v AC power-packs. This unit is excellent for ship to shore and ship to ship communication. Range 30 miles CW and 15 miles phone. Complete with tubes **\$29.95** and crystals

BC-314F RECEIVER, with 2 stages of RF; separate local and beat frequency oscillator. Frequency range 150 to 1500 Kc in 4 bands. 12v DC can be easily converted to AC. Complete with tubes. Brand New. A real buy at **\$34.95**

RA-20 POWERPACK—Converts BC-312 to AC operation; fits into dynamotor compartment. Works splendidly with BC 314-224-348-435-456-457. Primary 110v AC, 60 cycle; delivers 250v DC at 95 mls; 12v at 3 amps; 12v CT at 2 amps. Brand New **\$11.95**

CONVERTER, electronic; 110v DC to 110v AC; 250 watt cap.; complete with plugs and heavy duty vibrator **\$14.95**

MEGAPHONES anti feedback microphone and loud speaker, mounted in single unit; used with separate amplifier as a portable announcing system; self contained battery power supply. Complete and ready to use. Brand New **\$49.95**

PE-97 PLATE VIBROPACK input 6v or 12v; output 200v DC at 65 ml; regulated and well filtered. **\$4.65**

TEST EQUIPMENT IE/46B—Freq. meter 906D; Receiver 1066B; Signal generator 190B; complete with antenna, tubes, charts, etc. Brand New. All three units. **\$29.85**

FIELD TELEPHONES EE-8 with handset generator, ringer, etc., in strong leather or canvas case. **\$10.00**

FIELD TELEPHONE RM-29 with handset generator, ringer, etc., in strong steel case. Brand New **\$14.95**

TRANSFORMER and cord assembly for matching low impedance headsets to high impedance output circuit, 6' cord, PL540 plug. Brand New **30c**

G. E. 50 WATT ceramic tube sockets; for 211-83.8 250 TH and other type tubes. New, each **50c**

TRANSMITTING KEY on thigh clamp J-45—with 5 ft. cable and PL55 plug **35c**

SA-260U—Beautiful black plastic microphone switch; 2 1/2" long, 1" diameter; push button make and break, press to signal. Screw type, can be used with or without case. Good for interoffice buzzer, closet lights, doorbells, phonograph recorder. Can be mounted or used by hand. Each **26c**



Write for Quantity Discounts

Prompt Delivery—Write Dept. RNA
25% Deposit Required on C.O.D. Orders
Shipped F.O.B. New York. Minimum Order \$2.00

TOM ALLEN
564 Atlantic Ave. Brooklyn 17
Tel. Main 5-6294 New York

NOW—A REALLY HIGH-POWERED— Radio Engineering Library



NOTE:

The Library comprises a selection of books culled from leading McGraw-Hill publications in the radio field.

- especially selected by radio specialists of McGraw-Hill publications.
- to give most complete, dependable coverage of facts needed by all whose fields are grounded on radio fundamentals.
- available at a special price and on easy terms.

THESE books cover circuit phenomena, tube theory, networks, measurements, and other subjects—give specialized treatments of all fields of practical design and application. They are books of recognized position in the literature—books you will refer to and be referred to often. If you are a practical designer, researcher or engineer in any field based on radio, you want these books for the help they give on hundreds of problems throughout the whole field of radio engineering.

5 VOLUMES, 3559 PAGES, 2558 ILLUSTRATIONS
1. Eastman's FUNDAMENTALS OF VACUUM TUBES

2. Terman's RADIO ENGINEERING
3. Everitt's COMMUNICATION ENGINEERING
4. Hund's HIGH FREQUENCY MEASUREMENTS
5. Henney's RADIO ENGINEERING HANDBOOK

10 days' examination. Easy terms. Special price under this offer less than books bought separately. Add these standard works to your library now; pay small monthly installments, while you use the books.

10 DAYS' FREE EXAMINATION—SEND COUPON

McGRAW-HILL BOOK CO., Inc.
330 W. 42nd Street, New York 18, N. Y.

Send me Radio Engineering Library, 5 vols., for 10 days' examination on approval. In 10 days I will send \$2.50 plus few cents postage and \$5.00 monthly till \$27.50 is paid, or return books postpaid. (We pay postage on orders accompanied by remittance of first installment.)

Name

Address

City and State

Company

Position

news from Delhi, followed by local news.

Iran—Radio Tabriz recently verified a "harmonic" for Kary, Pa.; stated report checked with log, but that 12.180 where Kary had heard the broadcast, was a harmonic of 6.090; said appreciated report, as their technicians had since checked and had corrected this harmonic radiation. Verified by letter, divided in half, one side in English, the other in Arabic; report was sent September 8, verie mailed November 4th. received by Kary on January 26. Schedules were listed as 0500-0630 (except on Fridays when runs 0130-0600) on 11.960; 0930-1330 (daily) on 6.090, news 1300. However, Radio Australia announced more recently that Radio Tabriz has moved from 6.090 to 6.105 where it operates daily at 0900-1230, with French news 1210, English news 1220. It is believed this change was made due to a new powerful Russian outlet heard on 6.090 at 1000 in Persian and at 1100 in Arabic.

Italy—Radio Italiana recently informed Morris, Florida, that "our transmitters are located in Lombardy, at Busto Araizio near Milan, and for the moment our programs are relayed by land-line from Rome, since the short-wave center just outside Rome was destroyed by the Germans during the war and will not be back in service for some time yet." Listed power of 50 kw.

Japan—JKF, 9.655, Nazaki, is heard in Pennsylvania around 0000 and later

with strong signal. (Kary) Is heard often in Britain (announcing JOAK, medium-wave outlet) with Home Service from around 1700 when has news in Japanese; often has English lesson at 1730 by an American instructor. (Pearce)

JKE-2, Yamata, 4.860, has been heard early mornings in East in late winter with AFRS programs at 0730; JKF-2, 4.910, is also heard with relay of Home Service; AFRS outlet is best. (Kary, Pa.)

JVU-2, 11.845, is heard often working point-to-point with the U. S. on around 2340. (Park, British Columbia) Also reported heard in East.

Java—Stark, reports that Radio Batavia announced that PLC, 11.440, would be replaced by PLA on about 8.916 for the beam at 0930-1000 (to U. S.). I am still hearing a good signal on 15.145 to 15.150 in this transmission; the 19-m. outlet is beamed to Australia and Malaya.

Cushen, N. Z., airmails us these schedules for certain Indonesian outlets—Semarang, YDH, 2.510, 60 w., YDH2, 11.030, 100 w., 0730-1000; Soerabaya, YDI, 3.240, 250 w., 1800-2000, 2330, 0215, 0430-1015, YD12, 4.370, 300 w., 1830-2000, 2330-0030, 0530-0930. PMS4, 13.600, 250 w., no schedule given.

"Voice of Indonesia," 11.000, Djogjakarta, broadcasts for North America daily, 1730-1930; a transmission for the British Isles and Europe (also in English) is scheduled 1200-1300

(Continued on page 169)

REFLECTORS AND DIRECTORS

By EDWARD M. NOLL

A DIPOLE antenna (simple dipole, folded dipole, etc.) can be made uni-directional by positioning a reflector in back of, or a director ahead of, the dipole element. These elements, called parasitic because they have no direct connection to the dipole, are spaced a quarter-wave from the dipole. The reflector is 5 per cent longer, and the director 4 per cent shorter than the half-wave dipole. The dimensions are given in the chart. If both reflector and director are used, the sensitivity is still greater in a given direction but the

bandwidth is reduced to some extent. If a director or reflector is used and it is spaced a $\lambda/4$ wave from the dipole there is little change in the antenna resistance. When either type of parasitic element is moved nearer the dipole, however, antenna resistance and bandwidth is decreased. Inasmuch as the bandwidth of a folded dipole is inherently broad, a parasitic element is often moved nearer the folded dipole to reduce antenna resistance and allow it to be matched to a lower impedance line.

—30—

OUTSTANDING VALUES

Kit Model 210,
a Three Way Portable Receiver



Operating on either AC or DC or self-contained batteries . . . power switch conveniently located on front of set so that "battery" or "AC-DC" may be selected without opening case. Five-inch Alnico 5 permanent magnet dynamic speaker, and case covered with weather tested aircraft material. Price of Model 210 complete with tubes.....\$18.95

ALSO AVAILABLE

Model AC-7 Superheterodyne Receiver was designed to give the student and radio enthusiast a 110 Volt 60 Cycle receiver. Simple to build and also one of excellent performance in the broadcast band range. This kit utilizes 1 stage of tuned radio frequency amplification in combination with iron core antenna, R.F. and oscillator coils giving excellent selectivity and sensitivity over the entire tuning range. This receiver contains a full vision, 8" slide rule glass dial, a magic eye tube, and an 8" PM speaker and output transformer to match a 6V6 tube. Kit comes complete, ready for assembly.

Multitester Kit Model M-3C
A versatile, compact multitester 4" x 7" x 3" using a 3 1/2" rd. meter of 1000 ohms per volt sensitivity. Employs the following ranges: Volts AC or DC 0/5/50/150/500/1500. Milliamperes DC 0/5/50/150. Ohms 0/2000/20,000/200,000. Price Complete, \$10.95
Many other kit models available. Write for catalog M.

RADIO KITS COMPANY
120 Cedar Street New York 6, N. Y.

CHANNEL	1	2	3	4	5	6	7	8	9	10	11	12	13	L	H
$\lambda/2$ length	120	98	86	81	72	67	31	30 1/2	29 3/4	28 3/4	27 3/4	27	26 1/2	84	28 3/4
Reflector	126	103	90	85	75 1/2	70 1/4	32 1/2	32	31 1/2	30 1/2	29 1/2	28 1/4	27 3/4	88	30 1/2
Director	115	94	83	78	69 1/4	64 1/2	30 3/4	29 1/4	28 3/4	27 3/4	26 3/4	25	25 1/2	81	27 3/4
$\lambda/4$ spacing	63	51 1/2	45	42 1/2	37 3/4	35 1/4	18 1/4	18	15 3/4	15 1/2	14 3/4	14 1/4	13 1/2	44	15 1/2

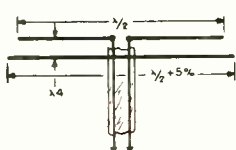

DIPOLE AND REFLECTOR

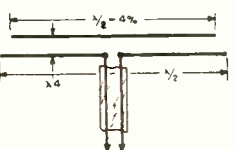

DIPOLE AND DIRECTOR

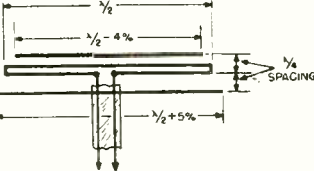

FOLDED DIPOLE
DIRECTOR AND REFLECTOR

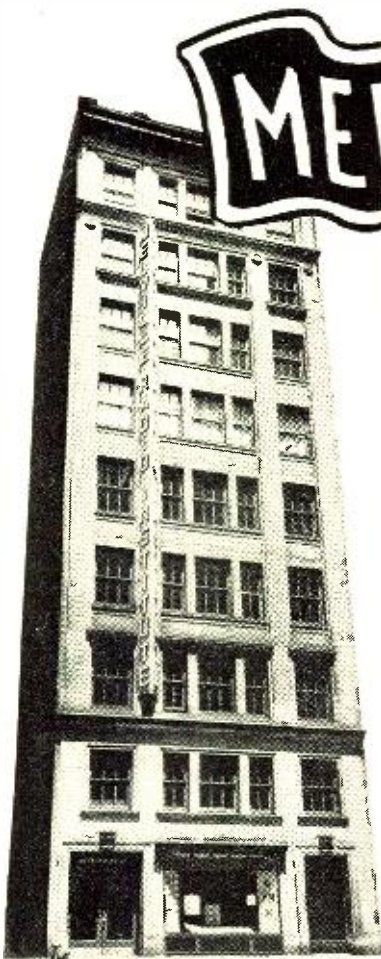

RADIO INSTITUTE

Outstanding PRE-WAR Technical Training Center for

TELEVISION & RADIO

Under the personal direction of Frank Melville, former Airlines, Merchant Marine, and Broadcast technician, you may soon qualify as:

- RADIO TECHNICIAN
- AIRLINES RADIO OFFICER
- PT. TO PT. TELEGRAPHER
- RADIO AMATEUR
- MERCHANT-MARINE RADIO OFFICER
- TELEVISION TECHNICIAN
- HOME RECEIVER REPAIRMAN
- VISUAL TELEGRAPH OPR. (SLIP TAPE)

MELVILLE RADIO INSTITUTE believes vocational training means vocational training. Thus we, like many radio schools, teach ample theory. But, unlike most schools, two-thirds of our technical students' time is spent in laboratories and shops, where, with superior equipment, they learn by doing — not memorizing.

FREE employment service is available to all MELVILLE graduates.

Visit the 10-story MELVILLE Building today as our guest and observe the school in operation.

Day and evening classes approved for veterans. Licensed by the State of New York.

MELVILLE RADIO INSTITUTE
Melville Building
15 West 46th St., N. Y. 19 LO 4-0340

MAIL THIS COUPON NOW!

MELVILLE RADIO INSTITUTE R.N.
Melville Building
15 West 46th St., New York 19, N. Y.

Gentlemen: Send me Free information about your school.

Name.....

Address.....

OUTSTANDING VALUES NOW AVAILABLE

AUTOMATIC CAR RADIO

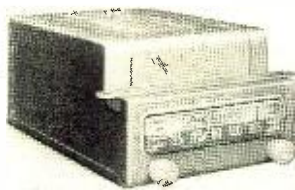

The Best Buy on the Market

Six tube superheterodyne. Two dual purpose tubes, giving 8 tube performance. Simple Universal Mounting. Equipped with G.E. 5" Speaker.

FITS ANY CAR FEATURES:

- 3 gang tuning condenser
- Beautifully finished case
- Hearing this fine radio is a thrill

Only \$39.95 includes

One 66" 2 POINT SIDE MOUNT, RUST PROOF ANTENNAS, a \$5.95 SELLER.

SPECIAL ON RECORD CHANGERS DETROLA



FEATURES:

- Plays 12-10 in. or 10-12 in. records
- Extremely smooth action
- 9" turntable
- Size 12" x 12" — 6 1/2" deep

This changer is compact enough to fit in most installations.

PRICED AT ONLY..... **\$14.95**

REGAL PORTABLE RADIO

A fine performing set, AC-DC and Battery operation. Attractive case, small and sturdily built. Slide rule dial, 4" heavy magnet speaker.

You and your customers will be pleasantly satisfied with this fine bargain.

Your Cost—\$20.95.
Price of Batteries \$2.01.



CROWE HEADS for AUTOMOBILE RADIOS

A dial to fit any radio and car 1940 thru 1948 Custom Dash Mounting Dials

Under 1940—Universal Underdash Mounting Dials. Dealers Price..... **\$3.82**

Tuning Units 706-T1 up thru 720-T1. Dealers Price **\$1.71**

Tuning Units with switch 706-T2 up thru 720-T2. Dealers Price..... **\$2.40**

Volume control units 700-V1. Dealers Price **\$0.73**

Volume controls units with switch. 700-V2. Dealers Price..... **\$1.80**

Cable kits to fit Delco-Arvin-Philco. Dealers Price **\$1.74**

When ordering, specify Make, and Model of car and make and model of radio.

Complete dial kit consists of "Head, Tuning Unit, and Volume Control Unit.

We carry a complete line of all auto radio equipment and accessories.

Radio Parts Company, 614 RANDOLPH ST., CHICAGO 6, ILL.

TUBES! TUBES! TUBES! THOUSANDS OF TUBES LOWEST PRICES

NEW, STANDARD BRANDS—DEALERS' QUANTITY PRICES ON REQUEST
MINIMUM ORDER \$5.00

TYPE	PRICE	TYPE	PRICE	TYPE	PRICE	TYPE	PRICE	TYPE	PRICE	TYPE	PRICE
1A3	\$.98	3A	.98	6SQ7	.89	35W4	.69	801A	1.10	1851	1.25
1A5	.48	6AD7	1.25	6SR7	.80	35Z3	.39	802/RK25	1.49	20A1	.90
1A7GT	1.10	6AC7	.75	6S7	.75	35Z5	.69	803	8.95	20B1	.48
1B24	2.49	6AG5	.89	6U5	.98	36	1.10	804	6.75	5514	4.75
1B38	4.50	6AG7	.99	6V6GT	.99	37	.69	805	3.75	7193	.30
1G4	.98	6AK3	.89	6V6G	.89	38	.89	807	1.25	8001	4.95
1G5	.44	6AL5	.99	6X4	.98	39/44	.59	808	2.95	8005	3.25
1G6	.98	6AQ5	.98	6X5	.99	40	.69	809	1.50	8011	2.95
1H4	.98	6AT6	.75	7AE7	.75	45	.45	810	5.95	8012	4.95
1L4	.89	6AU6	.89	7B7	.69	47	.90	811	1.95	8016	2.49
1R4/1294	1.29	6B4	1.29	7C4	1.50	50B5	.89	812	3.15	8020	5.95
1T4	.50	6B6G	.89	7C5	.89	50L6GT	.75	812H	6.90	8025	2.95
1H5	.99	6B8	.99	7F7	1.25	70L7	.89	813	5.95	9001	.89
1H5GT	1.10	6B8G	3.49	7L7GT	1.39	71A	.89	814	4.39	9002	.49
1LW5	1.10	6C4	.64	10Y	.69	71C	.89	815	2.25	9003	.49
1R5	1.10	6C3	.51	12A6	.89	75T	2.39	826	1.75	9004	.49
1S5	1.10	6C8	.75	12A7	1.10	77	.89	829A/B	2.95	9005	.98
2A3	1.39	6C21	12.95	12A7E	1.10	78	.75	830B	2.25	9006	.40
2C22	.69	6D4	.89	12BA6	.89	79	1.10	832A	5.25	EF50	.79
2C26A	.75	6D6	.75	12BE6	.89	80	.53	835A	39.50	HF100	6.95
2C34	.98	6F4	1.35	12C8	.89	82	.88	836	1.15	HV75	1.25
2C40	2.60	6F6	.51	12H6	.44	83V	.89	837	2.50	HL615	1.25
2C44	1.75	6F8	.70	12J5	.69	84	.75	838	3.75	024	1.25
2D21	.75	6F6G	.80	12K8	1.25	85	.85	841	.69	RK60	.79
2E22	1.50	6F7	.98	12SA7GT	.99	100TH	12.95	845	3.75	RK72	3.50
2E25	3.95	6F8	1.10	12S67	.89	117L7	1.89	889	3.00	T29	1.95
2E30	2.25	6G6	.89	11Z3	1.10	117Z3	.89	861	50.00	TZ40	2.95
2J32	20.00	6H6	.40	12S17	.79	11Z6GT	1.10	866A	.75	V70D	6.90
2J33	20.00	6J4	1.50	12SK7	.69	121A	2.65	922A	1.95	VR78	.75
2JB51	4.95	6J5	.49	12SL7	1.10	202B	4.50	974	1.95	VR90	.75
2X2	.69	6J6	.49	12SN7GT	.79	211	.98	884	.75	VR105	.75
3A4	.48	6J7	.89	12S7GT	.99	215A	3.00	923	.49	2E150	.69
3B7	.98	6K6	.49	12S87	.79	217C	5.00	954	.49	2225	1.95
3B22	4.95	6K7	.59	12X3	.98	250TH	17.50	955	.49	902	2.95
3B24	.98	6K8	1.25	14A7	1.10	304TL	2.49	956	.75	2AP1	1.95
3D6/1299	.89	6L6	1.25	14B7	1.10	307A	6.25	957	.40	JAPI	1.95
3E29	2.95	6L6G	1.20	14H7	1.25	316	.89	958A	.49	3BP1	1.95
3Q4	1.10	6L7	.98	14J7	1.25	371A	1.39	959	.49	4CP1	1.89
3Q6GT	.58	6L7	.89	14K7	1.10	371B	3.00	991	.59	5AP1	2.49
3S4	.43	6Q5	.98	15E	1.50	391A	4.50	1005	.39	5BP1	1.49
4C35	7.95	6Q5G	.98	23D4	.49	417A	19.95	1006	.39	5BP4	4.95
4E27/257B	4.95	6Q7	.89	23D6	.98	446A	1.25	1613	.95	3CP1	3.95
0H4GY	1.15	6R7	.98	24G	.98	450TH	12.95	1614	1.75	3FP7	4.50
5T4	1.25	6SA7	.90	25A6GT	.75	703A	7.50	1618	1.39	7BP7	2.95
6U4	1.44	6SC7	.85	25L6GT	.75	704A	16.19	1619	.98	7DP4	14.95
5V4G	.98	6SF5	.79	25Z5	.75	713A	1.65	1622	1.75	7EP4	17.95
5W4	.98	6SG7	.79	25Z6	.98	715B	4.95	1624	.90	7GP4	19.40
5Y3	.59	6SH7	.39	28D7	.75	717A	.69	1625	.49	10BP4	29.95
1Y4G	.60	6S17GT	.69	30	.78	721A	3.05	1626	.49	10CP4	42.20
5Z3	.98	6SK7	.79	31L7	1.50	73A/B	5.99	1629	.59	10FP4	42.20
5Z4	.89	6SL7	.89	35L6GT	.75	75A	12.50	1631	.49	11P1	69.00
6A6	.75	6SN7GT	.69	35Y4	1.10	800	2.25	1641/RK60	.79	15AP4	110.00
								20AP4	210.00		

20% DEPOSIT WITH ALL ORDERS UNLESS RATED

NIAGARA RADIO SUPPLY CORP.

160 Greenwich St.
New York 6, N. Y.

A.V.C. Amplifier

(Continued from page 67)

with this oscillator beating with the receiver high frequency oscillator. Adequate shielding would become necessary as well as selecting a frequency for the oscillator that would be above the tunable range of the receiver.

Careful consideration should be given to the selection of the audio amplifier tube to be used in an a.v.c. circuit.

The 6G6 tube is capable of producing 50 volts across a 75,000 ohm plate load resistor at less than 3% distortion. In some applications this high output with low distortion becomes quite desirable.

The use of a 6SK7 will give satisfactory operation with the exception of high output voltage.

The bias filter network consists of the VR75-type tube, resistors R_{12} , R_{13} and condenser C_4 . Resistor R_{12} should be adjusted to cause 10 milliamperes to flow through the VR tube. If the inverse peak voltage of the bias rectifier tube is being exceeded due to the secondary voltage of the power transformer, a resistor should be inserted between the high voltage winding and the cathode of the bias rectifier tube, reducing the voltage to a point of satisfactory operation.

Theoretical Operation

The 6G6 amplifier (see Fig. 1) is a conventional resistance-coupled stage. The output of the amplifier is connected by C_1 to the a.v.c. level control, R_8 . Condenser C_2 breaks the d.c. path to ground through R_8 . The output of the amplifier is fed into the #1 diode (Pin #5) of the a.v.c. amplifier tube where it is rectified, placing a d.c. potential on the grid of the a.v.c. amplifier tube. R_9 is the diode load resistor, and R_{10} and condenser C_7 comprise the grid filter network, which allows only d.c. voltage on the grid. Condenser C_8 completes the diode rectifier circuit as far as a.c. is concerned. Resistor R_{11} is the cathode dropping resistor. Resistor R_5 is the diode load for plate #2 (Pin #4). Condenser C_3 and resistor R_6 comprise the a.v.c. filter. Resistors R_{12} , R_{13} and condenser C_4 complete the bias filter network.

An a.v.c. voltage is fed to the 6G6 grid through resistor R_2 . Negative voltage of 75 volts is connected to the cathode dropping resistor R_{11} . 150 volts positive is connected to the plate of the a.v.c. amplifier tube. When a.v.c. control resistor R_8 is rotated to ground position, no bias is created by diode plate #1; therefore, the a.v.c. amplifier tube draws maximum current.

Consider the triode section of the a.v.c. amplifier as nothing more nor less than a variable resistor.

When the grid voltage of the 6SQ7 is zero, the plate current is maximum

SURPLUS SAVERS

*ALL PARTS NEW & STANDARD

POWER RHEOSTATS—W/Shaft*

PR-1	2500 Ohms	25 Watt	\$.75
PR-2	15 Ohms	100 Watt	1.20
PR-3	15 Ohms	75 Watt	1.00
PR-4	3000 Ohms	50 Watt	1.00
PR-5	500 Ohms	50 Watt	1.00
PR-6	25 Ohms	25 Watt	1.00
PR-7	40 Ohms	25 Watt	1.00
PR-8	60 Ohms	25 Watt	1.00
PR-9	60 Ohms	25 Watt	1.00
PR-10	15 Ohms	25 Watt	1.00

Quantities Available

POWER RHEOSTATS—Screw Driver Adjust.*

SPR-1	25 Ohm	25 Watt	} 75c each 6 for \$4.00 Quantities Available
SPR-2	50 Ohm	25 Watt	
SPR-3	60 Ohm	25 Watt	
SPR-4	60 Ohm	25 Watt	
SPR-5	150 Ohm	25 Watt	
SPR-6	25 Ohm	25 Watt	

OIL CONDENSERS—New—Famous Makes*

C-1	1 mfd.	1000 VDC (Rect)	4 for \$2.00
C-2	6 mfd.	600 VDC (Rect)	4 for \$2.50
C-3	4 mfd.	600 VDC (Rect)	4 for \$2.00
C-4	0.1 mfd.	3000 VDC (Cyl)	ea. \$.95
C-10	4 mfd.	600 VDC (Cyl)	4 for \$2.50
C-14	0.03 mfd.	7500 VDC (Cyl)	ea. \$1.05
C-18	0.1 mfd.	1500 VDC (Stub)	5 for \$1.00

SWITCHES—New—Famous Makes*

S-1	Micro-Push Butt.—125 VAC—10A	} 3 for \$1.00
	Norm. closed—W2RS13	
S-5	SPST Toggle—3A—250V	
S-18	SP11T Rotary—2 Deck	3 for \$1.00

RESISTORS—New—Famous Makes*

R-1	10,000 ohm.—120 Watt Non-Induct. W/mtg. screw, hardware, insul.,.....	3 for \$1.00
R-2	25,000 ohm. 40 watt Vitreous—Lug terminal	4 for \$1.00

AIRCRAFT KEYS—J-47—Brand New Boxed
2 for\$1.00

New Bulletin Being Prepared—Write
25% deposit required on all C.O.D. orders.
Prompt delivery assured. Write Dept. RNA.
Include postage with order.

GREENWICH SALES CO.

59 Cortland St. Digby 9-3813
NEW YORK CITY 7, N. Y.

APRIL SPECIAL

RESISTOR KITS \$1.45
100 assorted carbon and wire wound resistors 1/2 to 10 watt. Wide range of values. All standard items.

CONDENSER KITS \$1.75
50 assorted paper and mica condensers... all new... good value.

Wireless Phono Oscillator \$4.52

Operates as far as 100 ft. from radio and can be used with automatic record changer and players. Complete with 2 tubes all wired and tested. Diagram.



Mike and Phono Amplifiers \$14.95

This unit sold complete with power transformer, 3 tubes and 3 controls... all wired and tested. Diagrams supplied.

Phono Pre-Amplifier \$4.95

This unit is for G. E. Reluctance type cartridge. Completely wired, tested. Supplied with diagram, and tube 6SC7.

AC DC Radio Kits \$11.95

Super-het circuit 5 tubes. 4" alnico 5 speaker... complete with bakelite cabinet, tubes, and instructions.

BATTERY RADIO KIT \$10.50

Operates on self contained "B" and "A" batteries super-het circuit. Complete with tubes, case and instructions. Batteries extra \$1.75

RADIO PARTS

4" P M Speaker	\$ 1.15
5" P M Speaker	1.15
5" P M Speaker with 50L6 output	1.60
6" P M Speaker	1.55
8" P M Speaker with 50L6 output	1.90
5" 450 ohm dynamic speaker with 50L6 output	2.39
500 ohm Rect. Boxed 100 MA69
1 1/2" Reg. Volume Controls and Sw. long shaft35
6 ft. line cord13
Osc. Coil 128K7	1.15
Astatic Crystal Pickups	1.89
Alliance Motors and Turntables	2.50
G. I. dual speed home recording Model R90L	28.55

All Prices F.O.B. N.Y.C.—On C.O.D. 25% Dep.

THE ROSE COMPANY

88 West Broadway Dept. (N) N.Y. 7, N.Y.

and the resistance of the tube (plate to cathode) is minimum. Placing a voltmeter from ground to the cathode of the tube will indicate a positive voltage, although 75 negative volts are being applied to the cathode through resistor R_{11} . This condition is due to the plate drain of the 6SQ7, which has 150 volts positive voltage on the plate. Under these conditions the cathode is positive with respect to ground, and plate #2 is negative with respect to the cathode; therefore, there is no current flow between plate #2 and the cathode.

An input voltage is fed into the grid of the 6G6 amplifier tube and resistor R_1 is rotated, applying a.c. voltage to diode #1. Diode #1 rectifies this voltage causing a voltage drop across resistor R_2 . This, in turn, causes the grid of the 6SQ7 to become negative. The negative grid voltage reduces the amount of plate current, causing the resistance of the tube to go up. This, in turn, causes the cathode to become negative with respect to ground. Since the cathode is negative in respect to ground, diode #2 becomes positive with respect to the cathode, causing current to flow from diode #2 to the cathode. This then results in a voltage drop through resistor R_3 causing a negative voltage with respect to ground which is fed to the grid of the 6G6, and this bias reduces the gain of the amplifier stage.

Do not become alarmed if this explanation is not clear the first time it is read.

The circuit is highly sensitive and linear because the a.v.c. voltage is actually supplied by a separate source and not by the rectified audio output.

The a.v.c. amplifier simply regulates the amount of voltage required for a particular application.

Condensers C_2 and C_7 should be adjusted to cause the desired amount of a.v.c. time delay.

The operation of the a.v.c. amplifier for r.f. applications is the same as just described. Circuit values are changed as indicated in Fig. 2. In r.f. applications no controls are required.

This circuit can easily be adapted to any receiver now employing a.v.c. The use of this a.v.c. circuit would require the addition of a rectifier tube and the 6SQ7 a.v.c. amplifier tube.

For r.f. a.v.c. applications, use of a VR tube in the bias supply is not absolutely necessary. The tube could be replaced by a resistor to ground, and this resistor should be adjusted so that approximately 75 volts appear across the resistor. Slight variations caused by the elimination of the VR tube can readily be tolerated in r.f. application and in some audio applications.

A.V.C. Applications

The use of an a.v.c. amplifier which will maintain comparatively constant output when large input variations are encountered becomes highly desirable.

Airplane control towers experience

You can't beat **METROPOLITAN** FOR LOWEST PRICES and IMMEDIATE DELIVERY!

The New MODEL B-45

Battery
Operated

SIGNAL
GENERATOR



for servicing AM, FM and Television Receivers. R.F. frequencies from 150 Kilocycles to 50 Megacycles (150 Kc. to 12.5 Mc. on Fundamentals and from 11 Mc. to 50 Mc. on Harmonics). Complete with shielded test lead, self-contained batteries and instructions. Net..... **\$27.75**



The New TEST-CRAFT

COMBINATION TEST SPEAKER

A new combination test speaker, plus resistor substitutor, plus condenser substitutor, plus resistor tester, plus condenser tester, plus output meter. Substitute voice, call, output transformer and field permits testing of set speaker for shorts and opens. Field impedances 500, 1000, 1500 and 2500 ohms. Net Price..... **\$27.50**

The MODEL 689-IF WESTON OHMMETER

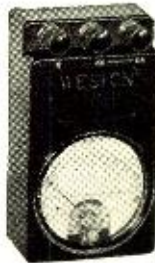

A convenient pocket size ohmmeter for checking circuits by the resistance and continuity method. The energy for the resistance readings is supplied by a self-contained 1.5 volt No. 2 standard large flashlight cell. Built to meet U. S. Army Requirements for Accuracy and Durability! This Ohmmeter also has a double range 0-10 and 0-1000, ohms for the accurate mea-

surement of low resistance values. Model 689-IF comes complete with operating instructions, test leads and LEATHER CARRYING CASE. List Price \$25.50
Our Price..... **\$14.85**



The New MODEL 111 AC-DC QUALITY MULTITESTER

A new pocket-size volt-ohm-milliammeter with features never before available in an instrument of this size and price.

DC Voltmeter: 0-5-50-250-500-2500 volts. AC Voltmeter: 0-10 100-500-1000 volts. Output Voltmeter: 0-10-100-500-1000 volts. DC Milliammeter: 0-1-10-100 milliamperes. DC Amperes: 0-1-10 amperes.

Ohmmeter: 0-500-100,000 ohms; 0-1 megohm. Decibel Meter: -8 to +55 db. The scale is calibrated for line of 500 ohms impedance. For other impedances correction charts are supplied. Model 1111, in portable case (not illustrated) including testing leads and complete instructions \$19.85 Model 111A, open face, as shown complete with instructions..... **\$16.85**

ONLY

\$89⁵⁰

IS
THE
COST!

FOR THE NEW 10 INCH (52 square inch picture)

TELEVISION KIT

LESS TUBES

\$149⁵⁰

Complete with All Tubes

★ COMPLETE ★

READY TO ASSEMBLE

WITH FULL INSTRUCTIONS

NOTHING ELSE TO BUY!

Also 7" Television Kit - Complete, less Tubes \$59.50 - Complete w/Tubes \$99.50
IMMEDIATE DELIVERY FROM STOCK

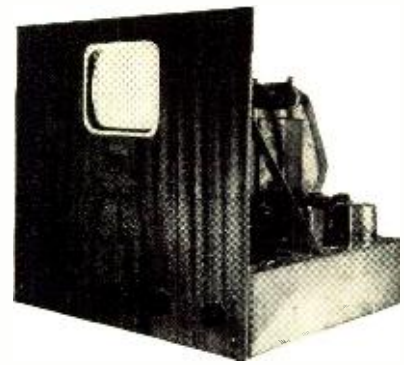

A complete Television Kit using a ten-inch tube which gives a 52-square inch picture. A well engineered piece of equipment. This receiver affords three stages of high gain video IF amplification, slug-tuned for maximum gain and efficiency. A pre-wired, pre-aligned 13 channel tuner containing an RF oscillator and mixer, affords complete television coverage in all localities. The instructions are written in an easy step-by-step system enabling accurate construction. Alignment procedure without the use of expensive test equipment is given in detail. Comes Ready to Assemble with Full Instructions!

ORDERS FILLED SAME DAY RECEIVED!

TERMS: 20% Deposit, Balance C.O.D. Or Full Payment with Order.

SEND FOR FREE CATALOG

We repair all types of testing instruments. Write for information.

Metropolitan ELECTRONIC & INSTRUMENT CO.

Dept. RN-4 42 WARREN STREET NEW YORK 7, N. Y., U. S. A.

WAR SURPLUS

BRAND NEW

A New Supply of Sperry A-5 Automatic Pilot Components

VERTICAL GYRO UNIT
Originally Cost \$2855.00
NOW ONLY \$14.95



Aluminum housing • One 400-cycle, 115-v., 3-ph. Motor Propelled Gyro • Two 24-v. DC shunt-wound motors • 2 Electronic Relays • Auto Transformer • Hundreds of precision parts • 35 lbs.

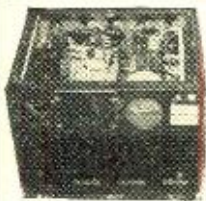

AMPLIFIER RACK
With Relays and Meters
Only \$6.95

- Mag. Cabinet • 7 DPDT Allied Relays
- 1 SPST Relay • 1 Weston 0-125 AC Volt Meter
- 1 350 to 450-cycle Frequency Meter
- 1 115-volt, 400-cyc. Transformer
- And many other parts • 25 lbs.

Special! Combination Offer!

VERTICAL GYRO and Together at AMPLIFIER RACK \$19.95

You pay shipping costs. Send check or money order to

SURPLEX RETAIL SALES INC.
2409 S. LaSalle St., Chicago 16, Ill.
Dept. RN-4 Phone CALumet 9130

Come to the Great
SHOPS OF COYNE
where you "learn by doing"



RADIO ELECTRONICS-TELEVISION
Quickly

To Succeed in Television, You Need All-Around Radio Training!

Trained Radio men needed now. Get Radio training and be ready for a real future. Learn on actual equipment at Coyne. 49 years of training experience Not "Home Study". Free employment service to graduates. Many earn while learning. If you are short of money, ask about Student Finance Plan. Now added Training in Electric Refrigeration. G.I. Approved.

SEND COUPON FOR FREE BOOK

B. W. COOKE, President
COYNE ELECTRICAL & RADIO SCHOOL
500 S. Paulina St., Dept. 4P-1K, Chicago 12, Ill.
Send Big Free Book; also details about Coyne Part-Time Employment and Student Finance Plan.

NAME AGE.....
ADDRESS.....
CITY..... STATE.....

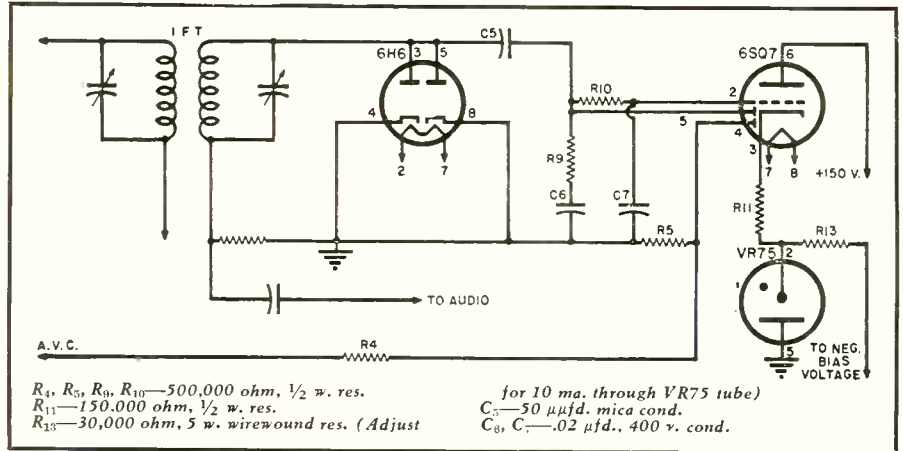

Fig. 2. Circuit diagram of a.v.c. amplifier for r.f. applications.

reception of extremely weak signals which increase in intensity many times in a matter of minutes. The use of a poor a.v.c. control system requires the operator to reduce the gain of the receiver so that loud signals can be tolerated. A sensitive a.v.c. system would allow the same operator to increase the sensitivity of the receiver, therefore improving the reception of weak signals.

The a.v.c. amplifier also has many audio applications. When used in such applications, there are limitations to the amount of control that can be tolerated. Since the function of the control is a matter of changing bias voltages, the distortion of the controlled amplifier stage will increase as control voltage is increased.

The amplifier shown in Fig. 1 is capable of maintaining a reasonably constant output voltage with less than 3% distortion when the input is varied as much as 6 db. Control in excess of 6 db. variation will cause the distortion to rise, but in certain applications this distortion increase can be tolerated.

The use of high power audio oscillators in place of frequency changers has become common practice. One of the main difficulties of this type of equipment is voltage regulation under varying loads. The a.c. voltage which causes the a.v.c. amplifier to function can be picked up from practically any stage in an amplifier circuit. By picking up this voltage at the output of the amplifier, varying loads at the output of the amplifier will cause the a.v.c. amplifier to function which, in turn, reduces the gain of the amplifier, resulting in a comparatively constant output level.

The circuit can also be used as a compressor, but as a compressor, the circuit has nothing to offer over the conventional type of compressor circuit, since both circuits simply apply negative voltage to the grid of an amplifier tube.

—30—

MONITORING C. W. SIGNALS

By HARRY L. ULYAT, W4JPW

THE idea discussed here is one which has been used successfully in the monitoring of a c.w. signal here at W4JPW.

Since I am one of those hams who likes to monitor my c.w. signal to make sure it is sounding all right, especially when I'm using a bug, I tried a number of methods, including the building of a separate oscillator, keying with a relay, etc., but all these systems had the disadvantage of keeping the family awake nights.

If I used phones, I would have had to unplug them from the oscillator to the receiver at the end of every transmission or else slip on a different set of phones.

I have found that a war-surplus BC-221 makes a very good monitor for a c.w. signal and at the same time keeps a constant check on the frequency. The only problem involved with this unit was that of switching the phones from the meter to the receiver.

Noticing that there were two phone jacks on the frequency meter, I looked into the circuit and found that the jacks are in parallel and the connection to the plug tip was made to the "B

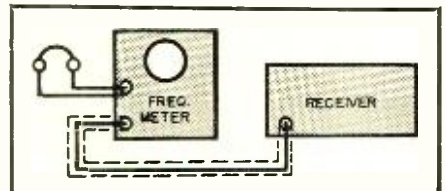

Diagram shows method of connecting BC-221 frequency meter for monitoring purposes.

plus" circuit through a condenser, thus isolating the "B plus" from the phones. I took a piece of shielded wire and connected a phone plug on either end. One end was plugged into the receiver output and the other into one of the frequency meter jacks. The phones were then plugged into the other jack in the meter.

As a result, I hear the station I am working with the same phones that are used for monitoring my own signal and at the same time I am able to keep a constant check on my frequency without keeping the neighborhood awake in the "wee sma" hours."

This Great Line of

DELCO RADIOS



DELCO MODEL R-1253-WALNUT (R-1254 MAHOGANY)—Strictly de luxe—an exquisite piece of furniture, a high-fidelity AM-FM short wave radio and an automatic record changer with balanced tone arm.



DELCO MODEL R-1409—Three-way portable radio—AC-DC and battery—with alligator-grained fabric and unique plastic front. Built-in loop antenna. Self-contained charger.

*is backed by three Great Names
General Motors • Delco
United Motors*



DELCO MODEL R-1229—Five tubes plus rectifier tube. Mahogany finish, maple grille. Built-in loop antenna.



DELCO MODEL R-1238—Handsomely designed in walnut veneer and silver-gray plastic. Four tubes plus rectifier tube. AC-DC Built-in loop antenna.



DELCO MODEL R-1236—Ivory plastic cabinet. Four tubes plus rectifier tube. Automatic tuning. Built-in loop antenna.

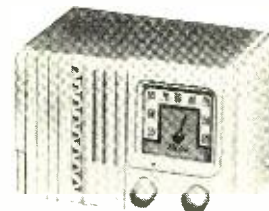

DELCO MODEL R-1230A IVORY PLASTIC (R-1231-A MAHOGANY PLASTIC)—Four tubes plus rectifier tube. Smart new plastic cabinet. Built-in loop antenna.

Looking over the current Delco line is like previewing your profits—there's a wide range of *products* and *prices* with which to interest a wide range of *prospects!* Each one of these immediately available models gives you plenty to talk about in the way of features and performance. And each one has *character* because it is backed by three great names: General Motors, Delco, United Motors.

If you want to move merchandise, get merchandise that will move! Six of the popular Delcos are shown here. There are others to round out the line. Look into this right away. Contact your nearest United Motors distributor or write to United Motors Service, General Motors Bldg., Detroit 2, Michigan.



PRINTED IN U.S.A.

DELCO RADIO A GENERAL MOTORS PRODUCT

Delco radios are distributed nationally by United Motors Service. See your United Motors distributor about the Delco Radio line.

RCA Institutes, Inc.	195
R & M Radio Company	92,93
Radiart Corp., The	38
Radio-Coin-Matic	177
Radio Corporation of America .. 13, 3rd cover,	101,209
Radio Craftsmen, Inc., The	150
Radio Development & Sales Co.	208
Radio Distributing Co.	200
Radio Electric Service Co. of Penna., Inc.	116
Radio Ham Shack, Inc.	127
Radio Hospital	194
Radio Institute of Chicago	176
Radio Kits Company	156
Radio Parts Company	157
Radio Press	193
Radio Supply & Engineering Co.	123
Radio Mart	169
Radionic Equipment Company	183
Radolek Co.	186
Ravac Electronics Corp.	174
Ray-Lectron Company	208
Reed Mfg. Co.	201
Rider Publisher, Inc., John	12
Risco Electronics	196
Rose Company	158

Sams & Co., Inc., Howard W.	22
School of Sound Recording & Transmission	
Engineering	198
Schuh's Radio Parts	176
Senco Radio, Inc.	184,189,208
Servo-Tek Products Co.	199
Setzer Hardware Co.	149
Sheffield Radio & Appliance Co.	203
Shure Brothers, Inc.	151
South River Metal Prods. Co.	130
Spellman Television Company	28
Sprague Products Company	21
Sprayberry Academy of Radio	7
Stahl, Inc., Michael	206
Standard Electrical Products	169
Standard Electronics Co.	205
Stanton Radio Supply	204
Star Measurements Co.	8
Sterling Electronic Company	201
Strickland-Stephens Radio Supply Co.	154
Sun Radio of Washington, D. C.	26
Sun Radio & Electronics Co., Inc.	190
Superior Instruments Company	87
Supreme Publications	16
Surplex Retail Sales, Inc.	160
Surplus Assets Corp.	180
Surplus Radio, Inc.	120
Sutton's Wholesale Electronics, Bill	203
Sylvania Electric	4th Cov.

TAB	135
Tapetone Manufacturing Corp.	140
Technical Radio Parts Co.	194
Tel-Craft Company	152
Telectronics Service & Supply Corp.	162
Television Industries	80
Telex, Inc.	185
Terminal Radio Corp.	171
Tradio, Inc.	178
Transvision, Inc.	165
Triplet Electrical Instrument Company	29
Tri-State College	193
Turner Company, The	145

United Surplus Materials	191
Universal General Corp.	198
University Loud Speakers, Inc.	124,172
Utica Drop Forge & Tool Corp.	164

V & H Radio & Electronic Supply	192
Valparaiso Technical Institute	152
Variety Electric Co., Inc.	96

W5CMS	205
Walmar Distributing Co.	166
Ward Leonard	179
Ward Products Corporation, The	95
Warren Distributors	203
Weber Electric	193
Weller Manufacturing Co.	114
Wells Sales, Inc.	133
Western Radio Co., Inc.	141
Western Radio Communications Institute	183
World Radio Laboratories, Inc.	177
Wright, Inc.	187

York Distributors	200
-------------------------	-----

KEEP POSTED ON ELECTRON TUBES

Use this convenient coupon for obtaining the RCA tube reference data you need.

RCA, Commercial Engineering,
 Section DW60, Harrison, N. J.
 Send me the RCA publications checked below. I am enclosing \$..... to cover cost of the books for which there is a charge.

Name _____
 Address _____
 City _____ Zone _____ State _____

Quick-Reference Chart, Miniature Tubes (Free). [A]
 HB-3 Tube Handbook (\$10.00)*. [B]
 RC-15 Receiving Tube Manual (35 cents). [C]
 Receiving Tubes for AM, FM, and Television Broadcast (10 cents). [D]
 Radiotron Designers Handbook (\$1.25). [E]
 Quick Selection Guide, Non-Receiving Types (Free). [F]
 Power and Gas Tubes for Radio and Industry (10 cents). [G]
 Phototubes, Cathode-Ray and Special Types (10 cents). [H]
 RCA Preferred Types List (Free). [I]
 Headliners for Hams (Free). [J]

**Price applies to U. S. and possessions only.*



TUBE DEPARTMENT
RADIO CORPORATION of AMERICA
 HARRISON, N. J.



ACORN ELECTRONICS

Presents HEAVY DUTY POWER TRANSFORMER \$795

PRIMARY 110/220 VOLTS, 60 CYCLES
 SECONDARY #1. 410-0-410 VOLTS AT 400 MA
 #2. 6.3 VOLTS AT 3 AMPS.
 #3. 6.9 VOLTS AT 13.5 AMPS.
 #4. 5.0 VOLTS AT 3 AMPS.
 #5. 2.5 VOLTS AT 1.75 AMPS.

Dimensions:
 6 1/2" H. x 5 1/2" D. x 6 1/2" W.
 Ship. Wt.: 30 Lbs.
 Made for Navy by General Electric



PP 6L6 OUTPUT TRANSFORMER
 Fully shielded, upright mounting output transformer to handle 25 watts from push-pull 6L6's. Mounting Centers 3 3/8", 3" H. x 2 1/2" W. x 3" D. Primary 6600 ohms to 4-8-15 ohms voice coil. Shipping weight 4 Lbs.

\$245 each
 3 for 7.00

OUTPUT TRANSFORMER
 Hermetically sealed. Made for Signal Corps by Chicago Transformer.
 Single tube to voice coil.
 Primary — 6000 Ohms
 Secondary — 8 Ohms
 Dim.: 1 3/4" W. x 1 3/4" D. x 2 3/8" H. Special Mounting Ctrs.: 1-1/16" x 1-5/16" x 2 Lbs. **69¢**



\$149 each
 3 for 4.00

Dimensions:
 3 1/2" W. x 3" D. x 4 3/4" H.
 Mounting Centers: 2 1/4" x 2 7/8". Ship. Weight: 6 Lbs.

POWER TRANSFORMER
 Primary: 110 volts, 60 cycles.
 Secondary:
 #1. 270-0-270 volts at 80 ma.
 #2. 6.3 volts at 2 amps.
 #3. 5.0 volts at 2 1/2 amps.
 Hermetically sealed. Manufactured to rigid Navy specifications.

CHOKES
 Hermetically sealed 10 Henry 70 ma choke. 420 ohms DC resistance. Mfd. to Navy specs. by Stancor. Dim.: 2 1/2" W. x 2 5/8" D. x 4 3/4" H. Shipping Weight: 5 Lbs. Mfg. Ctrs.: 1 7/8" x 2 1/8". **79¢**

CATHODE RAY TUBE CLEARANCE

5BP4
 5CP1
 5FP7
 5LP1

\$195 each

AN and UG CONNECTORS
 Every type available from stock in any quantity. Rush want list for our low quotations.

RG CO-AXIAL CABLE
 All types available from stock in any lengths. Rush want list for our low quotations.

CHOKES
 Hermetically sealed 10 Henry 250 ma choke. 110 ohms DC resistance. Mfd. to Navy specs. by G.E. Dim.: 4" H. x 3 1/2" W. x 3" D. Shipping Weight: 6 Lbs. Mounting Ctrs.: 2" x 2 1/2" **\$295**

ALL MATERIAL OFFERED IS IN BRAND-NEW CONDITION

ACORN ELECTRONICS CORP. TERMS: 20% cash with order. Balance C.O.D. All prices F.O.B. our warehouse in New York City. No orders under \$2.50.
 80 Vesey St. New York 7, N. Y.

APRIL SPECIALS

G.E. Plate Circuit Relay—10M Ohms—Operates on 8MA or 110V D.C.—S.P.D.T. 95c; 10 for \$7.50. "Penwal" Thermo Switch; 0-400, F-NC 2.5 amp @ 115V. List \$6.75. YOUR COST \$2.50; 10 for \$20.00.

OPERATES FROM A BEAM OF LIGHT

Photo-electric relay kit complete with all parts including tubes. Relay, sensitivity control and simple assembly instructions. Build your own magic eye alarm system—use light beam control. Only \$4.95.

LABS — SCHOOLS — INDUSTRIALS — GET ON OUR MAILING LIST—SEND US YOUR REQUIREMENTS.

Allied relay-24v. d.c. d.p.d.t. 10 amp. contacts. 75c; 10 for \$5.00

G. E. Solenoid operated contactor #CR820—controls 6 circuits—operates on 115V, 60CY. 4% 30%, 15 amps contacts double break each circuit. G.E. Catalog price \$25.00. YOUR PRICE \$5.95

4 mfd. @ 500V oil filled with mtg. clamp. 59c; 10 for \$ 5.00
Leach 8V de relay, 3 pole n.o. \$1.25; 10 for 10.00
UTC "S-6" input Nitr.—line or mike coil grid; dealer's price. \$3.10. Your cost. \$1.25; 10 for 10.00
Weston #476-34 1/2 Bakelite; 0-8V AC... \$3.95

Filter Chokes 10HF. @ 160MA. 1500 Ohms res. \$1.25; 10 for 10.00
Westinghouse Filter chokes—4 hy @ 90 mills, 300 ohms res. hermetically sealed 2.50; 5 for 3.00

25% deposit with order; balance COD; save COD charges; send full amount. Minimum Order, \$2.00.

RADIO DEVELOPMENT & SALES CO.

323 Atlantic Ave. Brooklyn 2, N. Y.

WE'VE MOVED!

MORE SPACE AND BETTER SERVICE

1625 Transmitting beam power, amplifier same as 807 except 12.6 volt filament medium pin base. **14c ea.**

(2) PUSH PULL Twin Beam Power Amplifier **\$1.49 ea.**

836A/3B27 Half Wave High Vacuum Rectifier **49c ea.**

2050 Hot Cathode Gas Tetrode Tube. 6.3 Filament Volts. Rect. Svc.
Pk. Forw. Volts 650 max.—
Avg. Ip. 100 ma. **69c ea.**
Pk. Inv. Volts 1300 max.
—Tube Drop 8 V

OD3/VR150 Voltage Regulator Tube. **49c ea.**

955 ACORN TUBE Detector Amplifier Oscillator Tube. **19c ea.**

25% deposit on all orders, balance C.O.D., F.O.B.N.Y.

SENCO RADIO, Inc.

Tel. Beekman 3-6498

71 West Broadway New York 7, N. Y.

HARD-TO-GET WAR SURPLUS

Free with each order over \$10.00 your choice of one new 304 TL or two HK24-G's. NILES RADIO SUPPLY NILES, MICHIGAN

BC-221-AK Frequency Meters. Like new... \$57.50

BC-454A Receiver (3-6-Mc) Includes tubes, tuning knob, speaker transformer, RA-20 power supply. New... \$15.95

Oil filled condensers. 3 Mfd. 4000 V. Replacement filter for BC-610 transmitter. Brand new... \$ 3.95

EE-8 Telephones. Like new... \$ 6.95

BC-733-D receivers with instruction booklet. Brand new. 10 tubes... \$ 4.95

Beam tubes HK 257-B. New. Similar to 813. \$ 4.75

Thordarson T70R62 Power Transformer. 700 V. @ 150 ma. 6.3 and 5 V. windings. New... \$ 3.95

TELEVISION COIL KIT

\$2350

Complete

LOOK AT THESE FEATURES!

- Video IF Bandwidth of 4.25 MC that can operate ANY size picture tube with maximum resolution.
- Five stages Video IF permeability tuned with sound and adjacent channel rejection trans in shielded cans.
- 6 Channel RF Tuner, permeability tuned mounted on switch assembly plate.
- FM Sound Discriminator for TRUE FM.
- Detailed Construction Manual & Parts List with every kit, for 20 Tube, 7 In. Television Set.

Order Direct or Thru Local Dealer—Terms Shipped Parcel Post prepaid with order, or P.P. Collect on receipt of 25% deposit, balance C.O.D.

RAY-LECTRON CO.

706 Tenth Avenue

Belmar, N. J.

208

INDEX OF

Advertisers

APRIL 1948

ADVERTISER	Page No.
A. M. Radio Sales Company	180
Abell Distributing Co.	201
Acme Electronics Co.	204
Acorn Electronics Corp.	209
Adaptol Co.	186
Aerco Sales Co.	197
Airborne Sales, Inc.	180
Allen Corp., Tom	155
Allied Radio Corp.	9
Almo Radio	200
Altec Lansing	14
Alvaradio	189,197,206
American & Foreign Associates	180
American Phenolic Corporation	153
American Radio Institute	187
American Sales Co.	198
American Surplus Products Co.	113
American Television and Radio Co.	161
Amplifier Corp. of America	130,170,202
Apex Video	191
Arrow Sales, Inc.	88,89
Astatic Corp.	114
Ashe Radio Co., Walter	125
Audel, Publishers	90
Audio Development Co.	163
Baltimore Technical Institute	206
Bardwell & McAlister, Inc.	120
Bell Telephone Laboratories	34
Berman Co., Inc., Henry O.	146
Bliley Electric Company	36
Bliss Electrical School	201
Boland & Boyce, Inc., Publishers	131
Brach Mig. Corp., L. S.	204
Bradshaw Instruments Co.	185
Brooks Electronics Laboratories	142
Brooks Radio Distributing Corp.	167
Bruce Electronics Co.	168
Buffalo Radio Supply	110,111
Burnstein-Applebee	173
Candler System Co.	197
Cannon Electric Development Company	132
Capitol Radio Engineering Institute	107
Centralab, Division of Globe Union, Inc.	32,33
Certified Television Laboratories	195
Chicago Industrial Instrument Co.	134
Chicago Transformer, Division of Essex Wire Corporation	10,11
Cinaudograph Speakers, Division of Aireon Mig. Corp.	153
Cinex, Inc.	190
Cleveland Institute of Radio Electronics	97
Clippard Instrument Laboratory, Inc.	174
Collins Audio Products Co., Inc.	161
Colortone Company	162
Columbia Wire & Supply Co.	184
Commercial Radio	206
Commercial Radio Institute	180
Communications Equipment Co.	119
Concord Radio Corporation	106
Coradio	189
Cordover & Company	108
Coyne Electrical and Radio School	149,180
Crest Corp.	198
D'Errico & Krischer, Inc.	202
Davega Communications Division	115
DeForest's Training, Inc.	19
Delco Radio	210
Delehart School of Television	196
Desert Radio	205
Dow Radio	164
Dubin Electronics Co.	192
Editors and Engineers, Limited	181
Electro Products Laboratories	138
Electronic Corporation of America	137
Electronic Vision Projection Co.	202
Electroncraft, Inc.	195,206
Electronics Institute, Inc.	202
Electronic Sales Co.	144
Electronic Supplies	148
Electronic Technical Institute	200
Electro-Voice, Inc.	146
Embry-Riddle School of Aviation	112
Epcoc	94,166
Ereco (Dick Rose)	178
Erie Supply Co.	200
Espey Manufacturing Company, Inc.	193

ADVERTISER	Page No.
Esse Radio Co.	104,105
Fair Radio Sales	207
Farm Products Co.	148
Farwest Trading Co., Inc.	179
Federal Telephone & Radio Corp.	6
Federated Purchaser, Incorporated	87
Feiler Engineering Company	153
G. & E. Equipment Supply Co.	200
G & G Radio Parts Service	139
G. & M. Equipment Co., Inc.	179
General Cement Mfg. Co.	134
General Electric	27,37, 85
General Electronic Distributing Co.	103
General Test Equipment	187
Goodheart, R. E.	146
Greenlee Tool Co.	188
Greenwich Sales Co.	158
Greylock Electronic Supply Co.	199
Hallcrafters Co.	5
Harvey Radio Company, Inc.	18
Heath Company	98,99
Henry Radio Stores	187
Hollywood Sound Institute	170
Hytron Radio and Electronic Corp.	31
Indiana Technical College	189
Interstate Radio & Parts Co.	205
Instructograph Company	199
James Vibrapower Company	154
Jensen Manufacturing Company	79
Joseph, Irving	117
Joyce Radio Distributing Co.	200
Lafayette Radio	102
Lake Radio Sales Co.	172
Lectrohm, Inc.	164
Leeds Radio Co.	163
Leotone Radio Co.	91
Lincoln Engineering School	191
Long Island Radio Co.	164
Macmillan Co.	122
Mallory & Co., Inc. P.R.	3rd Cover, 17
Martin School of Radio Arts, Don	197
Melville Radio Institute	157
Merit Coil & Transformer Corp.	20
Merit Radio Supply Co.	150
Metropolitan Electronic & Instruments Co.	159
Mid-America Co., Inc.	129,170
Midwest Radio Corporation	188
Milwaukee School of Engineering	204
Mort's Radio Shack	175
Moss Electronic Distributing Co.	121
Murray Hill Books, Inc.	30,100
McConnell's	204
McCoy Sales Company	191
McGee Radio Company	81,82,83
McGraw-Hill Book Co., Inc.	156
McMurdo Silver Co., Inc.	24
National Company, Inc.	35,118
National Equipment & Supply Co., Inc.	130
National Radio Institute	3
National Schools	23
Newark Surplus Materials Co.	195
Niagara Radio Supply Corp.	143,158
Niles Radio Supply	208
Northwestern Vocational Inst.	192
Offenbach & Reimus Co.	147
Ohmite Manufacturing Company	15
Onan & Sons, Inc., D. W.	138
Opad Green Company	207
Peak Electronics Co.	96
Peerless Electrical Products, Division of Altec Lansing	154
Permoflux Corp.	175
Photocon Sales	167
Pilot Radio Corp.	25
Plastics & Electronics Company	196
Potter Radio Co.	150,160
Progressive Electronics Co.	109
Quad Electrical Supply	168

PATENT ATTORNEYS

LANCASTER, Alwine & Rommel. Registered Patent Attorneys. Patent Practice before U. S. Patent Office. Validity and Infringement Investigations and Opinions. Booklet and form "Evidence of Conception" forwarded upon request. Suite 414, 815 15th St., N. W., Washington 5, D. C.

PATENT Attorney, registered U.S. Patent Office. I. Jordan Kunik, 75-F Pearl, Hartford, Connecticut.

CORRESPONDENCE COURSES

USED Correspondence Courses and Books bought, sold, rented, and exchanged. Catalog free. Lee Mountain, Pisgah, Alabama.

LEARN elements of radio at home. Ideal course for beginners. \$15.00. Write Waca Radio School, 1421 Sixth St., S.E., Minneapolis 14, Minn.

USED Correspondence Courses and Educational Books, bought, sold, rented. Catalog free. Educational Exchange, Summerville, Georgia.

AMATEUR radio licenses. Complete code and theory preparation for passing amateur radio examinations. Home study courses. American Radio Institute, 101 West 63rd Street, New York City 23.

MISCELLANEOUS

RADIOMEN, servicemen, beginners, make more money, easily, quickly. \$250 Weekly Possible. We show you how. Information free. Merit Products, 216-32R 132nd Avenue, Springfield Gardens 13, New York.

A FAST growing appliance and furniture business in Texas oil-booming city for sale. Owner retiring. Write: Henry A. Schaefer, Cisco, Texas.

QSLs, SWLS. Samples free. W5FAY Press, 6118 Goliad, Dallas, Texas.

BC-318-J, N, Q, OWNERS only. Special Service Manual now available. Contains Schematic, Wiring Diagrams, Alignment, etc. \$1.00. John W. Martin, 3516 Sacramento, El Paso, Texas.

PHONOGRAPH Records, 20c. Catalogue free. Paramount, NJ-313 East Market, Wilkes-Barre, Pa.

TESTING Equipment. All types and models. Expertly repaired and calibrated. Free estimates. Metropolitan Electronics, 42 Warren St., N. Y. 7, N. Y.

26 YEARS experience radio repairing at your fingertips. I've repaired 45000 radios. Have perfected simple system you can follow step by step. No calculations or formulas. Total price \$2.00 postpaid or C.O.D. Money back guarantee. Ross Radio, 14615-C Grand River, Detroit 27, Mich.

BRITISH INDUSTRIES FAIR

THE second postwar British Industries Fair, the world's largest national trade fair, is being held in England from May 3rd to 14th.

More than 3000 exhibits, representing 87 different trades will be open to an expected record crowd. The fair is being held in three big exhibition centers with the engineering industries showing their products at Castle Bromwich in Birmingham and the lighter industries at Earls' Court and Olympia in London.

-30-

ADDENDUM

Some of our readers have written in asking for the dimensions of the takeup pulley and feed spindle used in the mechanical assembly of the magnetic tape recorder ("Build Your Own Magnetic Tape Recorder," Fig. 4, page 41, February, 1948 issue).

The takeup pulley should be 3/4" in diameter while the feed spindle is 1" in diameter.

Photo Credits

Page	Credit
39, 40, 41	Walter Steinhard
44, 45 (bottom)	The Houston Corporation
48	Joe Tillotson, Staff Artist
59	Philco Corporation
72	Shure Brothers
118	Permo Products
120 (bottom)	Station KDYL
128	Westinghouse
172	Acme
174	American Airlines

FAIR APRIL SPECIALS



**BC 221A (*) FREQUENCY METERS
Crystal Calibrated**

Pictured to left, this Meter can be used as signal generator and V.F.O. Crystal calibration. Ranges: 125 K.C. to 20,000 K.C., complete with Tubes, Crystal, Original Calibration Charts. Every Meter tested and guaranteed. Slightly used but in excellent condition. **\$39.50**
Stock No. EN 4221—Price, only...
*Later Models.

OSCILLOSCOPE 3"

Complete with Conversion Parts Kit. This unit was originally used for Radar application. We have converted several for laboratory and service engineers, and have found them comparable to units selling for several times the low price of this Special Offer. Guaranteed, 110 Volt, 60 Cycle. Stock No. EN 425—**\$29.50**
Price.....

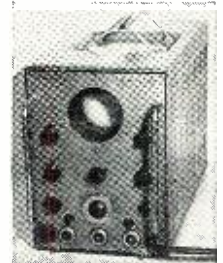

ATTENTION RADIO CLUBS
Write for complete information on our Special Club Plan.

0-500 MICROAMMETERS
0-15 and 0-600 D.C. Volt Scale with Multipliers. Brand New. Price, only**\$2.50**

BC-1023 MARKER BEACON RECEIVER

Receives 75 Mc. Modulated Signal, can be varied from 62 to 80 Mc. Operates self-contained sensitive relay that can be used to operate equipment from remote point. Needs only 12 to 14 volts DC for filament and plate voltage. Complete with 4 Tubes, instruction book. Shock mounted. Size: 5 3/4" x 5 3/4" x 3 1/4". Brand New, in original boxes. Shpg. Weight: 4 lbs. Price.....**\$3.79**

**SERVICEMAN'S SPECIALS
PM SPEAKERS**

- TS-125 4" PM Cinaudagraph P4A2—Alnico V Magnet....\$1.19 ea. 10 for \$10.90
- TS-124 5" PM Alnico V Magnet 1 oz.\$1.65 ea. 10 for \$14.95
- TS-126 6" PM Alnico V Magnet 3 oz.\$2.00 ea. 10 for \$18.50
- TS-128 10" PM Alnico V Magnet 6.8 oz.\$5.95 ea. 10 for \$49.50

- TT-115 Universal Output Transformer (Choice of 8 or 15 Watt)\$1.19 ea. 10 for \$10.95
- TC-140 Crystal Cartridge for phono pickups (American) ..\$1.39 ea. 10 for \$12.95

**WRITE FOR DEALERS CONFIDENTIAL RADIO PARTS LIST!
WE CAN SUPPLY ANY ITEM FOR B19 MARK II SETS**

MINIMUM ORDER—\$2.00

Prices are F.O.B., Lima, Ohio
25% DEPOSIT on C.O.D. ORDERS

FAIR RADIO SALES
223 S. MAIN ST. • LIMA, OHIO

**SELENIUM RECTIFIERS
FOR ALL APPLICATIONS**

FULL WAVE BRIDGE TYPES

Input	Output	Current	Price
From 0-18 V.A.C.	From 0-14 V.D.C.	1 AMP.	\$2.49
0-18 V.A.C.	0-14 V.D.C.	3 AMP.	3.49
0-18 V.A.C.	0-14 V.D.C.	5 AMP.	4.95
0-18 V.A.C.	0-14 V.D.C.	10 AMP.	7.95
0-18 V.A.C.	0-14 V.D.C.	15 AMP.	10.95
0-18 V.A.C.	0-14 V.D.C.	20 AMP.	13.95
0-18 V.A.C.	0-14 V.D.C.	25 AMP.	16.95
0-18 V.A.C.	0-14 V.D.C.	30 AMP.	19.95

HALF WAVE TYPES*

Input	Output	Current	Price
From 0-18 V.A.C.	From 0-7 V.D.C.	3 AMP.	\$2.25
0-18 V.A.C.	0-7 V.D.C.	5 AMP.	2.95
0-18 V.A.C.	0-7 V.D.C.	10 AMP.	4.95
0-18 V.A.C.	0-7 V.D.C.	15 AMP.	6.95
0-18 V.A.C.	0-7 V.D.C.	20 AMP.	8.95
0-18 V.A.C.	0-7 V.D.C.	25 AMP.	10.95

Input	Output	Current	Price
From 0-36 V.A.C.	From 0-28 V.D.C.	150 MA	\$1.25
0-36 V.A.C.	0-28 V.D.C.	2 AMP.	4.95
0-36 V.A.C.	0-28 V.D.C.	3 AMP.	5.95
0-36 V.A.C.	0-28 V.D.C.	5 AMP.	7.95
0-36 V.A.C.	0-28 V.D.C.	10 AMP.	13.95
0-36 V.A.C.	0-28 V.D.C.	15 AMP.	19.95
0-36 V.A.C.	0-28 V.D.C.	20 AMP.	25.95
From 0-120 V.A.C.	From 0-100 V.D.C.	2 AMP.	14.95
0-120 V.A.C.	0-100 V.D.C.	5 AMP.	19.95

Input	Output	Current	Price
From 0-36 V.A.C.	From 0-14 V.D.C.	3 AMP.	\$2.95
0-36 V.A.C.	0-14 V.D.C.	5 AMP.	4.95
0-36 V.A.C.	0-14 V.D.C.	10 AMP.	7.95
0-36 V.A.C.	0-14 V.D.C.	15 AMP.	10.95
0-36 V.A.C.	0-14 V.D.C.	20 AMP.	13.95
0-36 V.A.C.	0-14 V.D.C.	25 AMP.	16.95

*Use with capacitor to obtain any voltage up to twice rated output.

RAYTHEON RECTIFIER CHOKES

- .02 Henry at two amperes.....\$2.25
- .02 Henry at five amperes..... 3.25

CAPACITORS

- 1000 MFD., 15 V.D.C..... 95c
- 2000 MFD., 50 V.D.C.....\$1.98
- 100 MFD., 350 V.D.C..... 1.69

It would be impossible to give a complete listing of all our rectifier types. Our engineering staff is at your service to help you work out the application of selenium rectifiers to your specific problems. Write us for quotations or further information on capacitors and transformers to be used in conjunction with selenium rectifiers.

25% Required on all C.O.D.s—Add 10% for Parcel Post.

**OPAD GREEN COMPANY • 191 GREENWICH ST. Dept. 2
NEW YORK 7, N. Y. • Phone: BEEKMAN 3-7385**

WILCOX CW 3 (Complete) **\$12.95**
7 Tube Receiver (with Coils)



Complete with 1 set of coils—5.1 mc. to 10 mc. & additional set of tubes. Brand new in original cases. Export packed. Highly selective Superhet. 5,100 to 10,000 KC range. The i-f oscillator is xtal controlled. 110V. AC. 60 cycles 2-6K7; 1-6K8; 2-6CSG, 1-7SN7; 1-80. Single stage r-f amplifier single stage i-f, second detector, b.f.o., audio output and output limiter stage and a rectifier, less crystal. While they last at this low price of.....**\$12.95**

Prompt Delivery—Write RNA. 25% deposit required on C.O.D. order. Shipped F.O.B. N.Y.

MICHAEL STAHL, INC.
39 VESEY STREET
Tel. WOrth 4-2882-3-4 New York 7, N.Y.

EXTRA SPECIALS FROM OUR FREE CATALOG

- ★ 5 tube Kit: 50L6, 35Z5, 12SA7-K7-Q7...\$2.75
- ★ 5 tube Kit: 50B5, 35W4, 12AT6-BE6-BA6 \$2.75
- ★ Acorn tubes: Nos. 954, 955, 956, 957, 958A..... .49
- ★ Hear Aid: CK501AX to CK509AX..... .49
- ★ Proximity fuse diodes, 6.3 fl..... .49
- ★ 70L7..... .79
- ★ 024..... .89
- ★ TUBE SPECIALS: 69c each, 10 for.....\$6.00
- IR5, 1S5, 1T4, 1V3S4, 6AK5, 6AH6, 6AL5, 6AN5, 6AT6, 6BA6, 6BE6, 6C4, 6H6, 6J6, 6N4, 6N7, 6X4, 12BA6, 12BD6, 12SA7, 12BE6, 25Y5, 50B5, 717A, 9001, 9002, 9003, 9006.
- ★ Electrolytics: 20/20 @ 150..... .39
- 20 @ 150..... .25
- 8 @ 450..... .28
- (Fresh, pop. brand): 50/30 @ 150..... .49
- 16 @ 450..... .49
- 8/8 @ 450..... .59
- ★ 5" Alnico #5 PM Speaker, 16 oz. slug...\$1.39
- ★ Power Transformer, most pop. type (#P-6297). Prim. 117 V, 60 Cy. Sec. 240 V Center Tap, Rect. Fil. 5 V at 2.0 A. #1 6.3 V at 2.0 A. Center Tap ONLY.....\$2.49

Lowest Prices Anywhere — Quality Items

Write for Free Catalog.

20% Dep., Bal. C.O.D. — Min. Order \$3.00

COMMERCIAL RADIO DEPT. N1
36 BRATTLE STREET BOSTON 8, MASS.

LEARN RADIO!

IN ONLY 10 MONTHS
PREPARE FOR A GOOD JOB!
COMMERCIAL OPERATOR (CODE)
BROADCAST ENGINEER
RADIO SERVICEMAN

Television Servicing—15 Months

Veterans get \$130.00 Equipment
SEND FOR FREE LITERATURE
BALTIMORE TECHNICAL INSTITUTE
1425 EUTAW PL., DEPT. R, BALTO. 17, MD.

MOTOR GENERATORS

Brand New War Surplus Machines built by Allis Chalmers Co. to U. S. Navy Specifications.
Input: 115 V. D.C. at 14 amps., 3600 rpm. Output: 120 V. A.C., 60 CY. 1 ph. at 10.4 amps., 1000 Watts continuous duty. Ball bearings, Splashproof. Fully enclosed. Centrifugal starter. Frequency adjustable to load. Price \$87.50.
Same machine but for 230 V. D.C. input. Price \$125.00.
Spare parts kit with extra brushes, brush-holders, field coils, bearings, etc., for either machine, \$29.50.

All prices FOB Tuckahoe, New York
ELECTRONICRAFT, INC.
5 Waverly Place, Tuckahoe 7, New York

TUNING CONTROL KNOBS For Command Set Receivers

69c. ea. 3 for \$2. Postpaid in U.S.A.

BC 454, etc. series with locking sleeve. Brand new, not surplus. Makes tuning simple for fixed or mobile use.

Send for Latest Bulletin

ALVARADIO

903 S. Alvarado, Los Angeles 6, Cal.

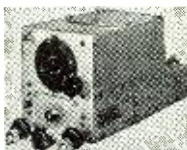

Classified

Rate 20c per word. Minimum 10 words.

RADIO ENGINEERING

RADIO Engineering Broadcasting, Aviation and Police Radio, Servicing, Marine Operating and Electronics taught thoroughly. Expenses low. Write for catalog. Valparaiso Technical Institute. Dept. N, Valparaiso, Ind.

FOR SALE

274N DIAGRAMS, original schematics and practicals on all components. 50c each. Postpaid. Specify type. Others available. Write for listing. Aerotronics Services, W6WLN, 5424 Ruthelen St., Los Angeles 37, Calif.

SHAKEPROOF tinned solder terminals, will fit #6 or #8 screw. \$2.20 per thousand, postage paid. H. Ruess, 429 E. Carson St., San Antonio 8, Texas.

BATTERY Bargains: New 24 volt 17 amp. hr. convertible to 12 volt, 34 amp. hr., in metal case with cover. Non-spillable vents. Hundreds of uses. Orig. \$57.00, now \$7.95 plus freight. Weight 52 lbs. Shipped dry. Also 24 volt, 11 amp. hr., \$6.95. Silver Creek Precision Corporation, Silver Creek, New York.

WIRE, for Webster, Sears, Air King, and other Recorders. 1/2 hour spool, \$2.90; 1 hour, \$4.95; Air King Wire Recorder, \$129.50 complete. McCoy Sales Company, P. O. Box 335, Berea, Ohio.

RADIOS. Record Players, tubes, parts. Send for free bargain list. Hallmark, 592A Communipaw, Jersey City 4, New Jersey.

MN-36A LOOPS; MN-31 Loop Director Units; MN-37A Bearing Indicators, large; MP-10 Series Power Supply Units; MP-8 Series Power Supply Units. J. D. Reed Co., Inc., Municipal Airport, Hangar 8, Houston 17, Texas.

TELEVISION diagrams, 35c each. 18 wire-wound, non-inductive, precision resistors mounted and fully wired on low-loss, wafer-type, rotary switch, ready to connect to your meter to make highest grade instrument. While they last, price, \$2.50. Radioco, 1110 Marshall Bldg., Cleveland, Ohio.

CONSTRUCT your own oscilloscope, experimental equipment, etc. New 5BP1 Cathode-Ray tube, 5-inch screen, \$2.95, plus postage. Scientific, 1026 1/2 W. 9th, Los Angeles, Calif.

TELEVISION diagrams, 35c each. "RCA," "Philco," "Viewtone," "Certified," "Transvision," "U.S.T." Any three above, \$1.00. Others available. RadioVision, 2064 Ocean Parkway, Brooklyn 23, N. Y.

RCA AUDIO Chanalyst. A complete sound system test set. Almost new. \$275.00. Rocky Mountain Radio Council, 21 East 18th Avenue, Denver 2, Colorado.

13,000 FEET RG 7/u High Frequency Cable. New. Make offer. T. & T. Tool, 317 East Third St., Tulsa, Okla.

ELECTRICAL Wiring Kit contains 30 amp. 3 pole disconnect switch, 5 fuses, 7 G.E. solderless tapeless large receptacle outlets, 65' two wire Romex cable, misc. screws, clips, everything to make complete installation in workshop, basement, barn, shed. Originally packed for Army, \$12.00 to \$15.00 in any store. Our price \$5.00 per kit. Reitz and Company, Bellevue, Ohio.

RADIO Tubes, bargains, nationally advertised radios, test equipment, etc. Address Radio Tubes, Box 108, Elizabeth City, N. C.

WURLITZER 412 Juke Box phono mechanism, good condition, \$35. Rek-O-Kut RK12 recording motor assembly with overhead feedscrew, magnetic cutter head, \$65. H. Jensen, Box 424, Route 3, Ogden, Utah.

WESTON Meters and Test Instruments. Used. Reasonably priced. McKnight, 606 Linn, Peoria, Ill.

B. C. 348 RECEIVER, excellent condition, converted to A.C., including speaker. \$90.00. S. Cavalier, 311 Columbia Blvd., Woodridge, N. J.

HQ-129-N. SPEAKER, cabinet. New and perfect. No reasonable offer refused. W2LFJ, 10 Lincoln Avenue, White Plains, N. Y.

1942 SCOTT Philharmonic, \$125.00. A. Hood, 65 Glenwood Road, Montclair, N. J.

P. M. SPEAKERS, 12-inch dual Alnico magnet, 30 watt, transformer, metal case, volume control, \$9.50 complete. Handsets, used, good, \$1.29 each. Selenium rectifier 12 v. at one amp., \$1.49. Cash with order or C.O.D. Dunn-Wright Electric, 471-7th Ave., Brooklyn, N. Y.

TELEVISION components for assembly of a modern 52-square inch screen receiver using the newest circuits and tubes. The only kit on the market featuring an aluminumized cathode ray tube, A.F.C. on horizontal sync and a wired, pre-aligned r.f. tuner covering any combination from 1 to 13 television channels. Sound and Picture IF's are on one sub-chassis using new 6AH6 miniature tubes having a gm of 9000! The IF Strip and the 9000 volt RF Power Supply are sold in kit form. The main chassis is sold with all holes punched with suggested chassis layout print. All components individually priced. Our catalog lists television components exclusively and shows parts and circuits of the "hard to find items" you have been looking for. Send for it today. It's free! Television Specialties Co., 315 Madison St., Oak Park, Ill.

RADIO Tubes. Tremendous savings. List free. Crest Corp., Dept. B-2, 3949 Forest Park Blvd., St. Louis 8, Mo.

QSLs, SWLs. Free samples! W1HJ1 Press, P. O. Box 32, Manchester, New Hampshire.

SELSYNS, 115V 60C. made from dynamotors. No rewinding or machine work. Instructions, 50c. Paul Hawkins, 1306 E. 27th, Kansas City, Mo.

6V DYNAMOTOR from 12V surplus. No rewinding. Original output. Instructions, 50c. Satisfaction guaranteed. Paul Hawkins, 1306 E. 27th, Kansas City, Mo.

PANELS, magnesium: machined, painted, engraved. Gilpin, Box 63SR4, Mt. Clemens, Michigan.

NEW and used Collins, Hallicrafters, National, Hammarlund, RME, Millen, Sonar, other receivers, transmitters, test equipment, amplifiers, etc. Lowest prices. World's best terms. Shipped on approval. Write. Henry Radio, Butler, Mo.

BARGAINS in guaranteed filter condensers. Send for free sample and price list. William H. DePeau, 1435 North 15th St., Harrisburg, Pa.

YOU can accurately align superheterodyne receivers without signal generator. Complete instructions \$1. Moneyback Guarantee! Chas. Gates, Pecos 1, Texas.

ERECO Beam Rotator. 110 VAC, heavy duty, variable speed, selsyn indicator, weather-proofed. Complete indicator and rotator ready to plug in. \$69.95. Satisfied users all over the country. Buy from your dealer or direct. Free literature. Dick Rose, Eresco, 2912 Hewitt, Everett, Washington.

WRITE Dept. RN18 for our free wholesale list of Radio parts & accessories. R. C. Radio Parts & Distributing Co., 731 Central Ave., Kansas City 6, Kansas.

LOWEST Prices. Radio Tubes, parts. Bargain lists 3c. Potter, 1314 McGee, Kansas City 6, Mo.

SELENIUM Rectifiers, full wave, 1/2 ampere, \$1.85; 1 ampere, \$2.50. Half wave 5 ampers, \$4.50; 2 ampers, \$2.25; 1.5 ampere, \$1.85. Bulletin Bursma Radio, Route 5, Grand Rapids, Mich.

CHOKES, swinging, rated 2-12 henries, 100-1000 MA. 5 1/2"x7"x10 1/2", heavy duty with porcelain insulators, \$7.50; Filament transformers, 2.5 volts. 11 amps, cased, porcelain insulators, \$2.50; with pair \$66, \$4.00. SKL Laboratory, Box 188, Lexington 73, Mass.

NEW cartoned tubes, 39c each. 100 assorted for \$35.00. 1R5, 1S5, 1T4, 1U4, 3V4, 3S4, 5Y3gt, 6A8gt, 6C5gt, 6F5gt, 6J7gt, 6H6, 6K7gt, 6Q7gt, 6V6gt, 6NA7gt, 6SD7gt, 6SF5gt, 6SK7gt, 6SQ7gt, 6X5gt, 12A7gt, 12AT6gt, 12BA6, 12BE6, 12J5gt, 12K8, 12SA7gt, 12SF7gt, 12SK7gt, 12SQ7gt, 12SJ7gt, 25L6gt, 31, 32L7gt, 35B5, 35L6, 35W4, 3Z5, 47, 50B5, 50L6, 70L7gt, 80, 89, 11L7gt. Write for bargain flyer. Henshaw Radio Supply, 3313 Delavan, Kansas City 2, Kansas.

WANTED

BRUSH Model PL-20 pick-up arm. Condition of cartridge unimportant. Charles W. Wood, 735 Wilfred Ave., Dayton 10, Ohio.

WHO can supply Tube 1 P 25? Contact Dr. Ernest Rosenthal, 18 Asylum Street, Hartford 3, Connecticut.

AN/TRC-1 Equipments T-14 Transmitters R19 Receivers TS32 Oscillators, complete or parts, any quantity. Box 458, % Radio News, 185 N. Wabash Ave., Chicago 1, Illinois.

WANTED—Lathe Work. Paul Penney, 265 West Ave., Patchogue, N. Y.

HELP WANTED

RADIO serviceman who is a licensed electrician and is a salesman. Must have own transportation. Write or call. Williams Electric, Box 357, Marquette, No. Dakota.

INSTRUCTORS in Radio-Electronics and Television. Prefer former Navy Radio Technician Instructors with Teacher Training. Must be willing to locate in Detroit, Mich. Write to Box 452, % Radio News, 185 N. Wabash Ave., Chicago 1, Ill.

change in conversion gain of a mixer tube in a receiver as the signal frequency is raised or lowered. This conversion gain tends to decrease as the frequency is increased. A second factor which can change the accuracy of the "S" unit is that as the frequency of the incoming signal is increased, the tuned circuits in each r.f. amplifier have a greater tendency to load down the tube in that stage and thus reduce its gain. If two radio carriers, one on ten meters and the other on twenty meters, have the same field strength in microvolts at a given location, a receiver may show the twenty meter signal to be "S8" while the ten meter carrier will be indicated as an "S5". To bear out these above mentioned facts, an a.v.c. voltage curve (Fig. 6) was made on the BC-348-Q receiver on two different frequencies with a changing signal strength input on each frequency. Such a.v.c. curves may be made on other communications receivers with similar results. It can be seen in Fig. 6 that a signal input of 9 microvolts on 14 mc. produced an a.v.c. voltage of .72 volt while the same signal input on 5 mc. produced an a.v.c. voltage of 1.6 volts.

Other conditions may exist which can also alter the accuracy of an "S" meter as a precise signal strength measuring instrument. The "S" meter is a very useful instrument if it is used with good judgment. However, one must bear in mind that it is primarily a comparative measuring device.

(EDITOR'S NOTE. In order to accurately calibrate an "S" meter as described herein the constructor should have access to a precision signal generator.)

-30-

RADIAL RIPS IN SPEAKER CONES

LONG rips or tears in speaker cones that project from the voice coil outward to the rim of the cone are best repaired not by cementing the edges of the tear together, but by carefully cutting the torn edges away with a razor so that an ellipse the length of the tear is formed.

If the edges of the tear were cemented together, the cone would be stiff there, and rattle. If the rip is left alone it will get longer, and the two edges will rub and make noise. Cutting the edges apart prevents this and does not appreciably reduce the efficiency of the speaker. A drop of speaker cement at each end of the ellipse will make the repair permanent. M. A.

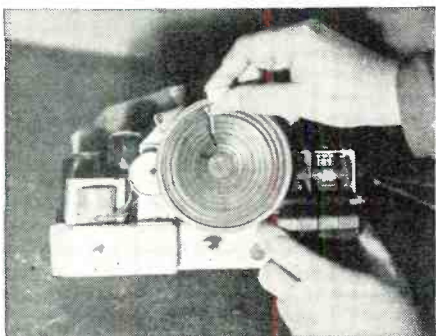

Standard Electronics

DOES IT AGAIN !!

★★★★★ SALE

A REAL AC-DC PA, RECORDING & PLAYBACK AMPLIFIER

★ Complete with Output Transformer, Changeover Switch, Separate Volume & Tone Controls, On/Off Switch for Phone Motor.

- ★ Inputs for Microphone or Phono Pickup.
- ★ Output to Speaker or Cutting

Head _____ \$3.75
(wired—less tubes)

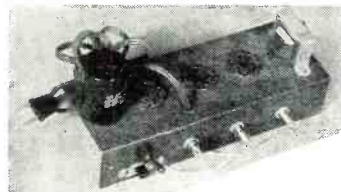

ASSESSORIES

- ★ Kit of 3 Matched Tubes.....\$1.98
- ★ 5" Heavy Duty Alnico V Speaker.....\$2.00
- ★ Heavy Duty Phono Motor & Pickup Arm.....\$5.75
- ★ Amplifier or Radio Foundation Complete with 3 Octal Sockets.....29c
- ★ Extra Octal Sockets Complete with Ring.....5c ea.—50c doz.



★ Portable Carrying Case

A Rugged Case of 3/4" Plywood Covered with Leather—Strong Handle & Catches. Motor Board Made of 1/4" Plywood.

LIST \$14.95 NET \$3.95
MANY USES FOR THIS FINE CASE

★ A REPEAT ON A SELLOUT

- 1—Class A Input Transformers No. 43009 Single Plate to Push Pull Grids with Split Secondary 25c ea., 12 or more 20c ea.
- 2—30 Watt Output Transformers Single or Push/Pull Plates to Voice Coil Ideal for 6L6, 45's, etc.
- 3—.005/400 Volt Paper Square.....05
- 4—.1/200 Volt Paper.....05
- 5—10 MFD 25 Volt.....10
- 6—10 MFD 35 Volt.....12
- 7—100 and 2000 MMFD Ceramicons.....02 \$1.85 per 100
- 8—3 Terminal Tie Points.....02 \$1.85 per 100

TERMS: 20% DEPOSIT ON COD's — ALL SHIPMENTS F.O.B. OUR WAREHOUSE

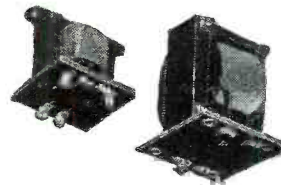

Standard Electronics Distributing Co.

INCORPORATED

1497 Main Street

Buffalo 8, N. Y.

304 TL

\$2.00 ea. Brand New! Surplus
We pay postage and insure anywhere in U. S.
1000 WATT TRIODE
Send Post Office Money Order. No C.O.D.
Packed in original shockproof shipping container.
DESERT RADIO
Box 2096, 501 P St. MOJAVE, CALIF.

BEAM MOTORS—ANTENNAS

Heavy duty 24 V. propeller motors, \$8.50 ea.
40 ft. tubular steel telescoping antenna poles suitable for long wire antenna or guyed beam support. \$14.50 ea., two for \$25.00.
Deposit on C.O.D.

W5CMS

Berryville, Ark.

SPECIAL OFFER

STANDARD BRAND TUBES INDIVIDUALLY BOXED

Type Tube	Dealers Cost	Type Tube	Dealers Cost
1R5	\$.49	12SR7	\$.48
OZ4	.79	12A6	.37
1LN5	.69	35Z5	.46

Minimum Order—10 Tubes

Send for our latest parts bulletin.

INTERSTATE RADIO & PARTS CO.
6357 So. Ashland Ave. Chicago 36, Ill.
Phone GROvehill 7588

Test-O-Lite the MODERN TROUBLE SHOOTER

THE NEON GLOW

LOCATES TROUBLE INSTANTLY in electric circuits, fuses, cut-outs, motors, radios, appliances. Tests everything electrical from 100 to 550 volts. Indicates hot or grounded wires. Tells AC from DC. Engineers prefer it because it has patented safety features.

PUTS "FINGER" ON THE TROUBLE SPOT -- QUICKLY

Far superior to ordinary clumsy test bulb. Saves precious time. Indispensable in shop or home. Vest pocket size. Lifetime guarantee. (Pat. No. 1,778,883.) Purchase through regular electrical dealers. Now only 95c.

L.S. BRACH MFG. CORP.

200 Central Ave. Newark, N. J.

FUSES

MOTORS

OUTLETS

HAM SPECIALS

Test Set 1236 for AC-DC capacity and Res. Spec. \$2.95
 Motorola FM 30-42 meg 110 AC pwr. comp. w/tubes \$37.50
 SCR-625 Mine Detector ready to operate \$29.75
 Link SFRX-FM 30-42 meg 16 tube trans & rec. comp w/110 AC and 6UV18 Pwr. Sup. NEW \$98.00
 BC-222 Walkie Talkie close out special w/tubes \$12.50
 TCS9 Collins Navy Transmitter & Receiver 1500 to 12 mc comp. w/spk. ant. coupler tubes cable. Original AC 110V supply all New. Ready to use \$98.00
 Amplifier BC908B 12 tube w/12V Dyn. easy to convert. NEW \$15.50
 Triplett 666 replacement DC volts & ohmeter. New \$4.50
 Meters RF Amp. 0-1 Weston 2" New Orig. Box \$1.95
 Meters RF Amp. 0-1 Simpson New Orig. Box \$1.50
 Mil. 0-50 Weston 2" New \$3.25; 3" sq. Simpson 0-25 New \$3.25
 Weston Mod. 155 0-40 VAC Lab. Meter. New \$25.00
 Microamp 0-500 dual monitoring Headsets. H10GR hi imp. \$3.75
 Reg. \$13.50 once in a lifetime buy. New \$1.65
 T24 Walkie Talkie Mics. with plug & headphone JK \$1.75
 T32 Press to talk Desk Mics. New \$2.50; used \$1.75
 Ampliting Tubes 833A-\$17.50; 814-\$4.25; 820-\$3.25; 803-\$6.95; 807A-\$5.50; 873-\$2.25; 834-\$2.75; 211-\$2.85; 2111-\$1.00; T125-\$4.50; 304TH-\$7.50; RK65-\$6.00; ICA Scope 902-\$3.25; 3BP1-\$2.50; 30 Sp. \$8.00.
 Condensers CD 8-8-450 orig. pack \$4.00 ea. 3 for \$1.00
 Papers 11, 05, .006, .25, .5 all 600VDC \$2.50
 Good Stock 50 2500 DC BAV18 for handie talkie, Mine Det. etc. Good Spec. \$.35
 Include postage charges on all orders.

McCONNELL'S

3834 Germantown Av. Philadelphia 40, Pa. RAS-6033

PRACTICAL TECHNICAL TRAINING FOR YOU

Specialize in Electronics, Radio, Electricity, Refrigeration, Heating and Air Conditioning, or welding. Prepare in one year for position as Technician, or in two additional years secure your B.S. Degree in Electrical Engineering with major in Machinery or Electronics. Write for booklet "Career Building"—also mention course interested in.

MILWAUKEE SCHOOL OF ENGINEERING

"A Technical Institute"

RN-448, N. Broadway and E. State, Milwaukee, Wis.

Wire, Tape, & Disc RECORDERS

Write for Our Free Catalog of Recorders and Accessories

ACME ELECTRONICS CO.

6523 Euclid Ave. Cleveland 3, Ohio

In Indiana IT'S

Stanton Radio Supply

521 State St. HAMMOND, INDIANA

"S" Meter
 (Continued from page 69)

able to permit a scale for the "S" meter face to be drawn. This new meter scale may be made with little trouble. Two methods for making this scale are available to the builder.

Draw a scale on a good grade of white paper using India ink. The size and proportion of the scale and numerals may be determined from the old meter face by using a pair of compass dividers. Obtain the meter readings from the third column of Fig. 3C for each "S" unit. Then, using the zero mark on the meter face as a reference point for the compass dividers, lay off each "S" unit on the old meter face and transpose these distances onto the new "S" meter scale being drawn. At each point thus marked, draw a line. Under each line, draw in the appropriate "S" unit number.

If a more accurate and professional looking meter face is desired, the following procedure, which incidentally, the author used, may be carried out. The original meter face is photographed and enlarged about four times. Using this enlargement for size and proportion of figures, a new meter face is drawn exactly the same size as the enlargement. The "S" units are drawn on this large face using the same procedure mentioned before except that now, everything is four times as large. Better lettering and more exact markings may be made in this way. After this face is drawn, it is photographed and then reduced back to the original size when printed. The prepared meter face, whichever method is used, is then glued to the original meter dial plate and then put back into the meter.

Many errors affecting the accuracy of an "S" meter report may come into the picture. Often, too much importance is given to such a report by a

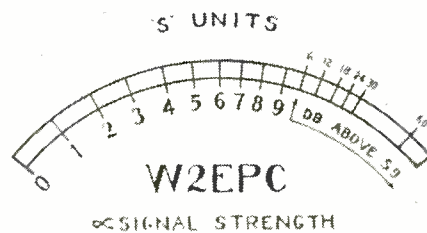

Fig. 4. An actual size print of the "S" meter dial scale for the receiver described. It is accurate for this equipment only and should not be used for any other receiver without recalibration.

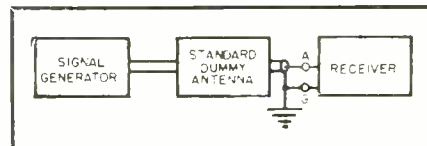
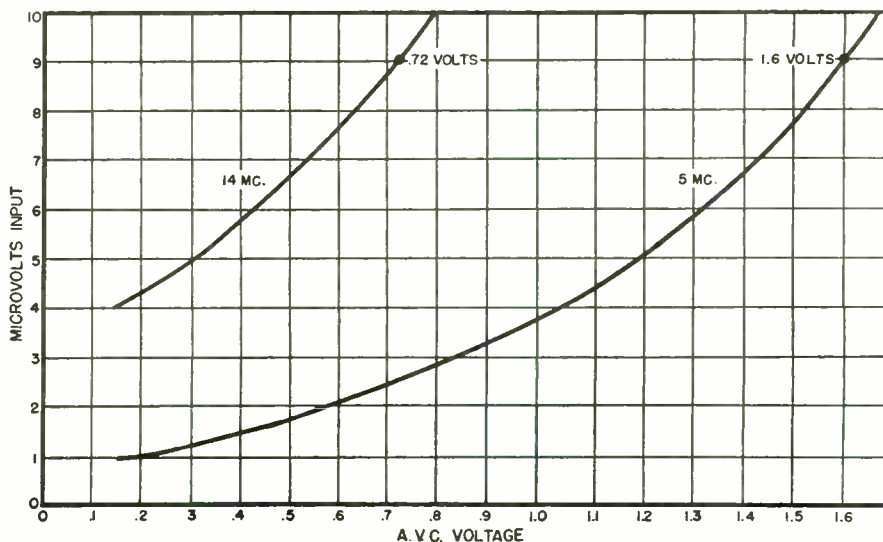

Fig. 5. Block diagram shows method of connecting signal generator to receiver.

radio amateur who "swears by the meter" on his receiver. The height and length of the receiving antenna will affect the amount of r.f. signal input to the receiver as well as the impedance match between the antenna and the receiver. A receiver situated at a given location but using two different receiving antenna locations and heights, will record two different signal strengths on the same signal. An "S6" signal using one antenna may become an "S9" signal with another antenna.

There are a number of factors which may affect the accuracy of the "S" unit in the receiver itself. There is a

Fig. 6. The r.f. signal input voltage vs. a.v.c. voltage for 5 and 14 mc.



search Products, Incorporated, and in the Specialty Products Shops before becoming a member of the Radio Division in June, 1942. He was known for his work with public address systems and theater reproducing equipment for sound motion pictures, being active in many installations.

* * *

WILLIAM W. CONE has been named Merchandising Manager of *Krich-Radisco, Inc.*, of Newark, New Jersey. In this capacity he will direct the wholesale distribution of leading American products.



Mr. Cone's business background includes 24 years' experience in the radio and television industry, five years of which were spent in the wholesale distribution end of the business. Previously he was associated with *Radio Corporation of America* in various posts, the last of which was as District Sales Manager. During the war years he was Manager of the War Service Department of the *RCA Tube Division*.

He is a member of the American Television Society and recently served as a member of the Television Broadcasting Association subcommittee which investigated the apartment house antenna problem.

-30-

PARTS SHOW SPECIALS

THE special trains headed for the Radio Parts Show in Chicago will carry a record crowd from the New York, Philadelphia, and Washington areas.

Approximately 275 persons will leave New York on Saturday, May 8th in a streamlined section of the New York Central's "Commodore Vanderbilt." The traditional free dinner, midnight supper, breakfast, playing cards, and souvenirs will again play an important role in making the hours pass rapidly for the convention-bound industry men.

The Mid-Lantic Reps Limited, in two sections of the Baltimore and Ohio, will pull out of Philadelphia at 2 p.m. on Saturday, May 8th and from Washington at 4:30 p.m. Made up in two sections to accommodate show-bound radio industry members from Eastern Pennsylvania, Wilmington, Baltimore, Washington, Richmond, Western Maryland, and Western Pennsylvania, the Washington section will leave on arrival of trains from Norfolk and Richmond, while the Philadelphia section will stop at Wilmington and Baltimore.

Perry Saftler, 53 Park Place, New York, is in charge of the arrangements for the New York Special and persons in the industry planning to make the trip should contact him at REctor 2-5334, New York.

Sam K. MacDonald, acting for the Mid-Lantic chapter of "The Representatives," is in charge of the Philadelphia-Washington Special and may be reached at his firm, 1531 Spruce Street, Philadelphia. Mr. MacDonald advises that the Mid-Lantic Specials will also feature evening dinner, midnight snack, and breakfast.

-30-

HERE THEY ARE—BIG SPRING VALUES



DeWald B-512 "Radio-Clock"

- Radio, Clock, and Musical Alarm
- Walnut, Ivory, Maple, Maroon
- Superhet. 4 tubes & rectifier.
- AC operation
- Hi-Ratio Vernier tuning
- Alnico No. 5 dynamic speaker
- Built-in Loopantenna
- Size 10" x 6" x 6 1/2"

LIST \$39.95



DeWald B-504 "Personal"

- AC/DC and Battery Operation
- Superheterodyne circuit
- 4 tubes & Selenium rectifier
- Instantaneous operation
- P.M. Alnico 5" speaker
- Size 4" x 8 3/4" x 7 1/4"

LIST \$27.95

Also available Battery Operated
LIST \$19.95



Minerva No. 410A

- Walnut Bakelite Cabinet
- Alnico V 5" PM Speaker
- 2 Hi-gain Air Core IF
- High Signal to noise ratio
- 4 tubes, selenium rect.
- 12" x 7 3/4" x 6 1/4"

LIST \$15.95



DeWald B-612 "Wireless F. M. Tuner"

- Simply plug in and play
- No wiring to radio necessary
- AC/DC operation
- Five tube & rectifier Superhet
- Balanced F.M. Detector Circuit
- Hand-rubbed walnut cabinet
- Size 11" x 6" x 7 1/2"

LIST \$39.95

**It's HERE ...
DeWALD'S BT100
DIRECT-VIEW 10"
TELEVISION
RECEIVER**
Prices on Application

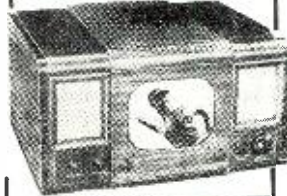

Minerva No. 702H

- 6 tube, AC-DC Superhet
- Bakelite cabinet in walnut, black & red mottled or ivory
- Beam power output
- Variable tone control
- 12" x 7 1/2" x 6"

LIST \$19.95

PARTS SPECIALS

4 Inch Permoflux Speakers, Heavy	
Alnico 5 Magnet.....	\$1.05
1/4 Meg, 1/2 Meg, 1 Meg Standard	
Brand Volume Controls, Tapped,	
with Switch, 2 1/2 Inch Shaft.....	.59 each
Nat'l Adv. 20-30 MFD at 150 Volts....	.52 each
Nat'l Adv. 30-50 MFD Condenser at	
150 Volts.....	.56 each
Nat'l Adv. 40-40 MFD at 150 Volts...	.56 each
Nat'l Adv. 50-50 at 150 Volts Plus 20	
at 25 Volts.....	.72 each
Nat'l Adv. .01, .02, .05 at 600WV...	5.75/100
Male AC Plugs, UL Approved, Bakelite	
Cap.....	4.25/100
Male AC Plugs, UL Approved, Live	
Rubber, Long Shank.....	6.75/100
Toggle Switches, Rotary or Throw Type	.14 each

Minerva No. 713A

- Superhet radio-phonograph with automatic changer
- 12, 10" or 10, 12"
- Removable radio unit
- Leatherette covered
- 5 tubes plus selenium rectifier
- 13"x9"x15"

LIST \$59.95



WE HAVE THE NEW 1948 TEMPLE AND REGAL LINES

When ordering, include sufficient amount for postage otherwise we will ship Railway Express Collect

WRITE FOR DEALER DISCOUNT SCHEDULES

WARREN DISTRIBUTORS

3145 Washington St.

Jamaica Plain 30, Mass.

Mr. Radio Service Dealer "Speed is our Motto"

One day service on all orders. None too small. Only Nationally Advertised Merchandise (No Surplus Handled). TUBES—Any quantity 50% off list.

Mail us your orders.

Illustrated list on request.

Bill Sutton's

Fifth at Commerce

Wholesale
Electronics

Fort Worth, Texas

FULLY AUTOMATIC POP-UP ELECTRIC TOASTER



Available Now!

Automatic release... no burning... adjustable to light, medium, dark... removable crumb tray for easy cleaning... all chromium—attractive design. Complete with cord. (Each \$11.37) Lots of 6—

\$11.17 ea.

25% With Order—Balance C.O.D.

Write for Our New Catalog on Fast Selling Money-Making Gifts and Small Electric Appliances.

Wholesale Distributors

1 YEAR GUARANTEE...
4 YEAR WARRANTY

SHEFFIELD RADIO & APPLIANCE CO.

916 W. Belmont Ave., Dept. D, Chicago 14, Ill.

NOW AVAILABLE!
Amplifier for GE pickup



New circuits for the first time enable you to attain full benefit from the new General Electric Model DL 1RM 6C Variable Reluctance Magnetic pickup. Employs an exclusive, humless (DC on heaters) pre-equalized pre-amplifier to produce the most satisfying musical amplifier the world has ever known. If you are a perfectionist, you are the one for whom the ACA-100GE was designed. Send for technical literature.

AMPLIFIER CORP. of AMERICA
 398-2 Broadway, New York 13, N. Y.

**A TERRIFIC
 3 BAND RADIO**

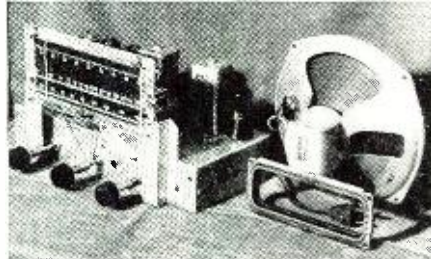

THE WORLD AT YOUR FINGERTIPS
 — BAND I—550-1600 KC. —
 — BAND II—3000-7500 KC. —
 — BAND III—7.5-21.5 Mc. —

COMPLETELY ASSEMBLED & ALIGNED
 7 Tubes—8" Speaker—Slide Rule Dial—Phono Connection—Highly Sensitive—
 Amazing Audio Fidelity—Available for All Voltages..... **\$30⁹⁵**

D'ERRICO & KRISCHER INC.
 1800 N. Humboldt Blvd. • Chicago, Ill.

**LEARN
 TELEVISION
 ELECTRONICS RADIO**

Modern Completely Equipped Laboratories

DAY AND EVENING CLASSES

G.I. Approved—Veterans Receive Subsistence

ENROLL NOW!

ELECTRONICS INSTITUTE, INC.
 21 Henry, Detroit 1, Mich.

80 Sq. Ft. Picture From Your Television Possible

Adapt your squint size picture set to project from a 6 sq. ft. home size picture up to an 80 sq. ft. hall or tavern size. Convert your set in 4 hours with our adaptation kit.

Dealers. Servicemen this is your opportunity to cash in. Territories open. Representatives wanted. Catalog of prices of kits-plans-screens, etc., \$1.00. Refundable 1st order. Circular 10c.

ELECTRONIC VISION PROJECTION CO.
 791 Jennings St. Bx., N. Y. C.

house he was assigned to small motor sales in East Springfield, Massachusetts.

In 1925 Mr. Weatherholt was transferred to the Albany, New York sales office and a year later was assigned to the New York City office. He was named eastern resale manager, in 1940, and held this position at the time of his new appointment. During the war Mr. Weatherholt served as a Lieutenant Commander in the Navy.

WILLIAM E. WILSON, who has been sales manager of the *Acme Electric Corporation*, of Cuba, New York, for the past three years, was elected to the office of Vice-President in charge of sales.



Before joining *Acme Electric*, Mr. Wilson had been in Washington with the War Production Board in charge of radio and radar transformers. Previously he was associated with *Jefferson Electric Co.*

Mr. Wilson studied electrical engineering at the *Armour Institute of Technology* and has spent much of his time in sales engineering work. In his new position he will direct the sales activities for all company products.

ZENITH RADIO CORPORATION has named A. V. Duke as assistant sales manager. Mr. Duke, who has been doing special work in the sales department since the end of the war has been a *Zenith* employee for 20 years.

Joining *Zenith* in 1928, Mr. Duke became a member of the accounting department, and in 1931 became manager of the order department for the sales division. From 1933 to the outbreak of the war in 1941, he was a member of the export sales department.

During the war Mr. Duke handled confidential work for the accounting department in connection with advance payments on Government work, material purchases, and other administrative matters.

ALAN H. BODGE, former member of *Audio Devices'* New York Sales Department, will manage the newly-established Hollywood office of the recording disc firm.



Mr. Bodge's office will be located at 844 Seward Street, in Hollywood. A Dartmouth graduate, he spent four and a half years in the radar division of the Army Signal Corps before joining *Audio Devices* in the Spring of 1946.

HOFFMAN RADIO CORP., of Los Angeles, has appointed Carlton Wasmansdorff to take over the newly-created post in charge of development engineering. Mr. Wasmansdorff is a well-known figure in code and machine communication and noise elimination

fields and for six years was superintendent of communications for the Glendale, California police department.

In the early war years he was in charge of the *Hoffman* Glendale Branch research and experimental laboratories. Formerly Mr. Wasmansdorff was associated with *Maguire Industries* as chief engineer and later spent several years in San Francisco with *Globe Wireless* as chief engineer and assistant to the vice-president in charge of operations.

BENDIX RADIO DIVISION recently announced the appointment of Horace H. Silliman as merchandising manager. In this department he will superintend liaison operations for the factory among national distributing organizations and major retail outlets.

Mr. Silliman joined *Bendix Radio* as district manager for New England and upstate New York four years ago. Last year he assumed the post of manager of distribution.

Filling Mr. Silliman's vacated position is Arthur C. Jordan. Mr. Jordan was recently the head of a national manufacturer's consumer sales organization and has served in important sales management positions with a number of leading manufacturers and distributors in Philadelphia and Washington.

CHARLES E. ANDERSON, recently appointed representative for *Snyder Manufacturing Company* of Philadelphia, augments the newly formed factory representatives' division. With his staff of three salesmen, Mr. Anderson will have Michigan, Ohio,



Southern Indiana, Kentucky, Western Pennsylvania, and the western part of West Virginia for his territory.

He will maintain headquarters in the Rockefeller Building in Cleveland and also maintain an office in Cincinnati. Mr. Anderson has a twenty-year sales background in the x-ray, photographic, radio, and electronics industries.

FURST ELECTRONICS, manufacturers of specialized electronic instruments, have more than doubled their floor space by moving to larger quarters in the same building, at 800 West North Avenue in Chicago.

PAUL T. SHERIDAN, employee of the *Western Electric Company, Incorporated*, for nearly thirty years, passed away at his home in New York following a long illness. Mr. Sheridan was in charge of engineering and field service for the *Hearing Aid Department, Radio Division*.

Mr. Sheridan joined the *Western Electric* Engineering Department in March, 1918 and later served in the Supply Department in *Electrical Re-*

Within the Industry

(Continued from page 30)

Electric and was assigned to the Test Department. For two years he worked on equipment for the armed forces at Erie, Pa., Schenectady, New York, and Syracuse. In October, 1945, he transferred to an engineering section in the Specialty Division. Mr. Rudolph is also a member of the Institute of Radio Engineers.

C. F. FAISON of *Federal Telephone and Radio Corporation*, an affiliate of *International Telephone and Telegraph Corporation*, is now representing *FTR's* broadcast and mobile communications division in the Southwest United States. Mr. Faison formerly carried on his sales operations for *Federal* in New England but will now work from Dallas, Texas. His new headquarters will be in the branch office at 301 Southland Life Building in Dallas, Texas.



Mr. Faison has spent 22 years in the radio business and during this period he aided in the designing and construction of three complete sets of plants and studios and one of the largest two-way mobile radiotelephone police installations in the Southwest.

During the war Mr. Faison was a Lieutenant Colonel in the U. S. Army and was assigned as Chief Radio Engineer of the Corps of Military Police.

TELETRAN CORPORATION, a new concern, headed by Albert J. Goldman, for the manufacture of components for the television industry has announced it would begin production on deflection yokes and horizontal h.v. transformers.

Mr. Goldman, President of *Teletran Corporation* was formerly President of the *International Transformer Corporation*. Executive and sales offices will be located at 443 Greenwich Street, New York City, with the factory located at Ramsey, New Jersey.

In charge of the factory at Ramsey will be Charles C. Hastings, formerly associated with the *R. E. Uptegraff Mfg. Co.* of Scottsdale, Pa. Production Manager will be Herbert Mark, who was previously connected with the *New York Transformer Co.*

WESTINGHOUSE ELECTRIC CORPORATION has announced the appointment of F. D. Weatherholt as assistant industrial sales manager with headquarters at East Pittsburgh.

Mr. Weatherholt has been with *Westinghouse* ever since his graduation from the University of Kentucky in 1921, where he received his Bachelor of Science degree in mechanical engineering. After completion of the Graduate Student Course at *Westing-*

SURPLUS VALUES HARD TO BEAT!

FAMOUS BC-221
CRYSTAL CALIBRATED FREQ. METER

Use this fine instrument as a signal generator or VFO. Range 125KC to 20 MC. Requires 6 V @ 1 Amp and 150 V @ 40 MA. Complete with original calibration chart, crystal and tubes. Tested before shipment. **\$37.75**

MINE DETECTOR

SCR-625 Mine Detector ideal for locating buried metal, pipes, treasure, metallic fragments. Approximate depth of detection 6 feet, depending upon soil conditions. Supplied with batteries and tubes. Tested before shipment. Shipping weight, 70 lbs.

\$49.50

100 WATT TRANSMITTER

BC-375

AM transmitter with self-contained speech amplifier and modulator. Uses 4-211's and 1 type 10 tube. Can be torn down to provide a bonanza of top quality transmitter parts: 0-500 MADC, 0-8 ARF, 0-15 VDC meters, etc. Less tubes and tuning unit. **\$14.95**
As illustrated. **\$19.95**

STURDY ALL-WEATHER INSULATED TRIPOD

Constructed of 2" phenolic tubing. Stands 11' high when assembled.

Rotating ball-bearing head. Will clamp 2" tube or shaft. Light weight, strong, does not need RF insulation. Good for rotating beams, TV, or anything else that needs rotating. Easy to assemble and install. Brand new. Shipping wgt. 100 lbs. **\$14.95**

- 1/20 H.P. Split Phase Motor. \$11.95
- 1/20 H.P. Cap. Start Motor. \$12.95
- 1/4 H.P. Motor, Cap. Start. Standard Brand. \$18.95
- RG8/U COAX, 52 ohm, ft. 6c.
- Reel 1200 ft. \$59.00

GIBSON GIRL EMERGENCY XMTR

Transmits automatic SOS signal on 500 KC emergency wave. Can be manually keyed to transmit additional information. Hand cranked.

No batteries required. **\$24.95**

ANTENNA MAST BASE

Now you can erect your tower! 15' of porcelain insulation. Galvanized cast iron. Safe load over 25 Tons. Type B comes in 3 pcs. (includes arc gap) and base. Drilled and tapped.

Type A, 1 pc. insulator. To mount—must be drilled and tapped. Shipping Wgt. 150 lbs.

Type B **\$42.95**
Type A **\$28.95**

- ARMY PORTABLE FIELD TELEPHONE EE-8** with handset generator, ringer, etc. in leather or heavy web case. Shipped with 2 flashlight batteries. Ready for use. Each \$8.75—Pair **\$15.95**
- HEADSET P-18, HIGH-Z.** w/6 cord & PL 55. \$1.95
- CABLE 19 conductor, '18 stranded 15/16" D.** 250 600 V. Ins. RC w/connectors. \$14.95
- CABLE 2 conductor, '18 stranded 600 V. 250 RC w/connectors, 1 conductor '18 shielded.** \$6.95

- TYPEWRITERS.** Standard, L. C. Smith, Remington, Underwood, Pica and elite type. Standard and Signal Corps Keyboard. Reconditioned. Satisfaction guaranteed. \$59.50
- INSULATOR ASSORTMENT**—standoff, strain, antenna, feed-thru, etc. 50 pieces. \$1.98
- SAFETY BELT,** with strap. State belt size. \$5.75
- LINEMAN'S POLE CLIMBERS.** \$4.50
- SCR 522 VHF TRANSCEIVER,** with all tubes. Excellent condition. \$22.95

ROTARY BEAM GEAR BOX

Gear train, motor mounts, enclosed in a waterproof housing. Excellent for use in constructing your new beam. Brass gears, bearings, useful hardware. Plenty of room for motor, selsyn and controls. 11"x14"x9". Two waterproof junction boxes also included. NEW. ridiculously low @ **\$7.95**

TS-13 HANDSET

Push to talk switch
6 ft. rubber cord. **\$2.95**

SOUND POWERED HANDSET

Requires no power. **\$12.95**

Mast Section **\$1.95**
5 1/2 ft. x 1 1/2" alloy tubing. 6' sleeves
Can be nested for long lengths. **\$1.95**

SEND FOR OUR FLYERS ON TRANSFORMERS, CABLE, PHOTO SUPPLIES, ETC.

TELL US YOUR WANTS.

The ABELL DISTRIBUTING CO.
5 E. BIDDLE ST. BALTIMORE 2, MD.

ROTA-BASE

NEW HANDY LAB. DIAL actually gives a "prong" picture of radio tube connections. INSTANTLY, ACCURATELY. No more valuable time lost thumbing pages or on lengthy readings. Filament, grid, plate, cathode, etc., to more than 300 tube types are shown. NOW ONLY \$1.00 postpaid, or sent C.O.D. plus postage. Order TODAY, money refunded if you are not delightfully pleased.

REED MFG. CO.
11350-P, Burbank Blvd., N. Hollywood, Calif.

ELECTRONIC VOLT-OHMMETER

\$11.85

POSTPAID

110 VOLTS AC 20 RANGES
0 / 5 / 10 / 50 / 100 / 500 / 1000 / 5000 volts DC and AC 0-1,000,000,000 ohms in six overlapping ranges. Sensitivity: over MILLION OHMS per VOLT on 5 volt range.

Complete kit includes all component parts, tubes, punched and drilled chassis and beautifully enamelled panel. Easily assembled and wired.

Special slideback circuit developed during war by scientist at the California Institute of Technology gives amazing sensitivity and flexibility while completely eliminating necessity of batteries and expensive meter. Each instrument is individually calibrated. Dial scale over nine inches long!

In addition to performing the usual volt-ohm functions, this instrument easily measures these voltages: SUPERHET OSCILLATOR, AVC, AFC, TRUE GRID BIAS AT THE GRID, BIAS CELLS without affecting the circuit. Measures the exact leakage resistance of INSULATION, TUBES, CONDENSERS. It can be used with a signal generator for SIGNAL TRACING.

STERLING ELECTRONIC COMPANY
BOWLING GREEN, KENTUCKY

ELECTRICAL TRAINING

Intensive 32 weeks' residence course in fundamentals of industrial electrical engineering, including radio, electronics. Prepares for technician, engineering aides. Approved for veteran training. 5th year. Enter July 26, Nov. 22. Catalog.

BLISS ELECTRICAL SCHOOL
7698 Takoma Avenue,
Washington 12, D. C.

RADIO VALUES

A TREASURE CHEST OF RADIO PARTS
Consists of transformers, condensers, dial controls, insulators, terminal connectors, coils, practically all types of switches. Many more useful items. Every assortment different.
No. 9650B—7 lb. Kit for only.....\$1.25

PIONEER GENE-MOTOR DYNAMOTORS
Double Shaft Dynamotor. Input volts 18, output volts 450. 1-1/16" shaft length. 1/4" shaft length with small gear. Size of motor 7 1/2" L., 4 1/4" H., 3 3/4" Dia.
No. 9626.....Each, \$3.50
Wineo Dynamotor. Input volts 12 Amps. 9.9 output volts, 400 Amps. .180. Temp. rise 40° C. R.P.M. 4200. Duty cont. Size 7" L. x 4" H. x 3 3/4" Dia. Four lead wires.
No. 9629.....Each, \$3.50



RADIO CONDENSERS
Sprague Auto Radio Condenser .5 MFD. 600 V. D.C. Size 2" L. x 1 1/16" Dia. with lead wire. No. 9631—lots of 10.....10c ea.
ROTARY SNAP SWITCH
Radio Snap Switch. Split shaft 1/4" L. Lock nuts. Approved. Rating 15 Amps. 10 V. 1/2" Single solder lugs. No. 9637.....Each, 15c
Lots of 10. Each, 15c

PIONEER GENE-MOTOR DYNAMOTORS
Same as No. 9626 Input Volts 9. Output V. 450. No. 9628.....\$5.50
BAKELITE HANDLE
Brown Marbled Bakelite Handle used for radios, luggage, etc. Size 3" L. x 2 1/2" W. with holes on each end for rings. No. 9638.....Each, 15c
Lots of 10. Each, 15c

SHUNT MOTOR
Aluminum Body Shunt Motor. Type B-9-1. 7 Amps. 27.5 volts. D.C. 5600 R.P.M. 1 1/2" shaft. Plunger Type. 3/16" shaft. No. 9639.....Each, \$2.25

SEND FOR FREE CATALOG
G. & E. EQUIPMENT SUPPLY CO.
OGDEN AT FULTON. CHICAGO 7, ILL.
We ship C.O.D. All prices F.O.B. our warehouse.

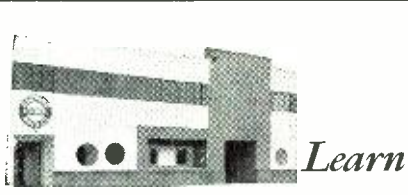

Learn

TELEVISION — FM RADIO — ELECTRONICS

BECOME A COMMERCIAL OPERATOR

Pre-F.C.C. Exam Tests.
Also AMATEUR RADIO
Sound Motion Pictures.
Laboratory Construction of
Receivers, Transmitters and TELEVISION.

ELECTRONIC TECHNICAL INSTITUTE

771 Venice Blvd. Los Angeles 15, Calif.
Phone Richmond 9573

SIGNAL - TRACER - GENERATOR

- Pencil Probe
- High Gain Tracer
- Built-In Detector
- Sig. Injector Gen.
- AC-DC Operation

ONLY \$16.50



Ready to operate—Signal Tracer with loudspeaker operation—Signal Generator—Multivibrator—Puts out strong A.F., I.F., R.F. signal 1000 cycles to 25 megacycles.

PHONO-OSC-AMPLIFIERS

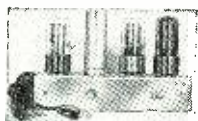

35Z5, 12SQ7, 50L6 Hi-Gain, Hi-Fi, AC DC Amp. Complete.....\$4.69

Wireless Phono-Osc. Mike. or Phono inp. Complete with tubes. Wired.. \$4.49

YORK DISTRIBUTORS
523 Knickerbocker Ave., Bklyn. 21, N.Y.

"Your Own Store and How To Run It" (Thomas Y. Crowell Co., New York). In it he listed 59 ways to gain goodwill (See Table 1). Perhaps you won't need to use all of the suggestions, but the more of them you do use, the better. Make copies of them and have all your help study them and test them out from time to time in their ability and willingness to use them.

4. Cooperate with fellow small businessmen in developing the answers to your common problems. Some of the problems that can be settled through such action follow:

a. Develop material that actually aids in operating your business more efficiently. Take as one such problem proper store layout that makes for the best flow of traffic through the store; or as another, proper lighting of the store so that merchandise stands out so invitingly that people want to buy.

b. Plan to carry on careful, continuous, and useful research into the problems of marketing, merchandising, and sales promotion of your products.

c. Develop a program of publicity and public relations which is something separate from sales promotion.

d. Study how best to work with suppliers to secure from them the right kinds of goods at prices that consumers are willing to pay, to eliminate tie-ins and other deleterious and obnoxious practices which add to the costs of distributing goods.

e. Study the consumer, his buying habits and trends so that you can guide him to your business and have on hand new, fresh, inviting, and intriguing merchandise.

f. Study how to keep prices competitive so that the largest total volume of business will always be done.

g. Study what advantage can be taken of offers by trade associations like the *Edison Electric Institute* to train sales people of small concerns in the electric appliance field.

h. Study development of materials which will help retailers of appliances and radios to advise families in their trading areas on how to buy such goods and make the best use of them.

i. Secure as much aid from government as possible to help in carrying on and extending your business enterprises.

Finally you want to know how never to have an insufficiency of capital. Space cramps this discussion so I say never try to do more business than your capital permits; don't overload with merchandise that you cannot sell in time to meet your bills; do not get tangled up in unrelated goods or enterprises; keep your business as simple as you can; stick to what you know best and develop that for all it is worth, and do not expand your business until conditions are right for it. Save something from your earnings and plow that into your business, expanding as the increased capital permits. Above all become a man of decision. As problems arise undertake to find a solution right away. —30—

PRICES SLASHED IN QUANTITY LOTS

All New, Nationally Known Brands

CONDENSERS—Metal encased, oil impregnated tubular, 600 VDC, .1 mfd
\$8.49 per 100 \$69.00 per 1000

Filter Condensers—1500 VDC 1. mfd
\$39.00 per 100 \$295.00 per 1000

PILOT LIGHT ASSEMBLY—high grade movable lens and shutter
\$11.95 per 100 \$89.00 per 1000

CRYSTALS—IN21, high frequency plug-in type
\$2.50 for 10 \$19.00 per 100

RESISTORS—Wire wound cement coated 10-Watt, 10,000 Ohm
\$8.49 per 100 \$69.00 per 1000

JACKS—Famous make, JK34A short midget phone type
\$8.95 per 100 \$79.00 per 1000

shipping extra
Write for circular—All stock must go
ERIE SUPPLY CO.
P. O. Box 907 Rochester 3, N. Y.

TRANSMITTER-RECEIVER \$9.95



BC 645 ultra high frequency transmitter receiver can be converted to operate on the 420 Mc band with few changes. It's surplus, brand new, packed in original carton—complete transmitter, modulator system and receiver. Complete with 15 tubes and conversion instructions. YOUR COST \$9.95



509 ARCH STREET PHILADELPHIA 6, PENNA.

LET'S GET ACQUAINTED!

Three 35Z5 Tubes (Std. Brand).....\$1.00
Send cash, money order or check
10 5Y3 (Std. Brand) 3.30
10 12SQ7 (Std. Brand) 4.90
All tubes in individual cartons
10 40-20, 150V. Mallory 4.90
10 Meissner I.F. Coils 455K.C. 4.90
Special: Sapphire phono needle 10,000 plays (List \$2.50)95

This Coupon Must Accompany Order
Radio Serviceman: Write for Free Illustrated Bargain Bulletin

JOYCE RADIO DISTRIBUTING CO.
Box 2068, Hollywood 28, Calif.

COUPON-OF-THE-MONTH

Tubes—5Y3GT 10 For \$3.30
Tubes—35Z5GT or 35W4 10 For 3.70
Tubes—12SA7 or 12SQ7 10 For 4.70
(Std. Brands in cartons)
Sprague Cond.—30-20 MFD. 150V. 10 For 4.70
Sprague Cond.—40-20 MFD. 150V. F.P. 10 For 4.90
Vol. Controls—5 Meg. W. SW. (2" SH.) 10 For 4.40
Trebort IF Coils 455 KC (1 1/4" x 2 1/2") 10 For 4.90
Oscill. Coils 455 KC (for 12SA7) 10 For 2.90
Loop Antenna HI Gain (5" x 8") 10 For 3.30
AC Cord & Plug Set 6 Ft. 10 For 2.20
● Combination Kit—All above items only 37.50
With This Coupon—Order At Once

RADIO DISTRIBUTING CO. PASADENA 18, CAL.

Radios	Ventilators
Television	Vacuum cleaners
Facsimile	Waxers
Hearing aids	Polishers
Washing machines	Space heaters
Irons	Room coolers
Dryers	Humidifiers
Ironers	Water supply systems
Sewing machines	Electric clocks
Refrigerators	Lamps
Electric ranges	Lighting fixtures
Dishwashers	Flashlights
Electric sinks	Fluorescent lights
Kitchen cabinets	Air conditioners
Home freezers	Razors
Grills	Massagers
Mixers	Curling irons
Toasters	Hair dryers
Waffle irons	Vaporizers
Juicers	Vibrators
Coffee makers	Electric pads
Roasters	Blankets
Water heaters	Sun lamps
Fans	Bottle warmers

Table 2. Partial listing of the most-requested electrical items for the home which can be stocked by the retail dealer.

out signs, open their doors and expect people to come to them and buy. Who are any of us that we have the right to expect this? You must work hard and consistently at persuading people that you have what they badly need and at prices that they can afford to pay. No matter what the conditions are outside your business even if they denote a depression, you go right on selling what you know people want.

Think of selling in a creative way. This means principally dealing with people in a pleasant way; tell them what *they* want to hear about your products and services. Put on a good show, make your sales act so good that people will not walk out of the store and close the door in your face. Show them what your product does for them, how it does it, the testimony of other purchasers, and how easily they may come into ownership of it.

Think of the various ways and devices you can use to attract and hold the attention of people. Use the mail or handbill method, thinking out carefully what to say and what gadgets you might use to get them to read what you write. Find out from the telephone company the many ways a phone can be used to build up business. Carefully select and train men and women to canvass homes to sell and secure leads for the future. Make good use of all the window and store display devices that leading producers of your products have developed over the years and which have proven successful.

This part might be concluded by calling attention to the *Coca-Cola Company*. Once as small as the smallest business of any reader they are today one of our most successful concerns. Recently, sales promotion experts rated them as carrying on the best sales promotion campaign. From their experience we can say:

- Sell aggressively
- Advertise tremendously (relatively)
- Use showmanship daringly
- Be an innovator in your promotional efforts.

3. Use as many ways as you can to gain the good will of customers. Robert F. Chisholm wrote a book entitled

NEW

SURPLUS GUARANTEED

Navy Ordnance Synchros

Types 1G, 1CT, 5G, 5F, 5CT, 5DG, 5HCT, 6G, 6DG, 7G, 5SG, 5HSF, 7DG, etc.

Pioneer Autodyn

AY-101D, AY-1, AY-14, AY-20, AY-54D, etc.

General Electric Selsyns

2J5HA1, 2J5DB1, 2J5FB1, 2J6F3, 2J1H1, 2J1G1, etc.



Size 5 Synchro Generator

Similar to Navy Ordnance type 5G with shaft detail per Army Ordnance Dwg. C-78414. 115 v. 60 cy. Stock #SD-43.

Price \$9.50 each net

Tachometer Generator

E.A.D. Type J-36, 2 volts DC per 100 rpm. Use to 5000 rpm. Stock #SD-130.

Price \$8.75 each net.

Servo Motor

Pioneer Type CK-2, 2 phase 400 cy. Fixed phase 26 v. Var. phase 49 volts max. 1.05 oz/in stall torque. Stock #SD-97.

Price \$4.75 each net.

Kollsman 775-01 Selsyn

Ideal for Ham use as transmitter or receiver. 6-12 volts 60 cycles. 26 volts 400 cycles. Stock #SD-57.

Price \$3.75 each net.



Remote Position Indicating System

Ideal for Ham Beam Position Indicator or industrial uses. 6-12 volts 60 cycles. 5-inch indicator with 0-360° dial. Heavy duty transmitter. Stock #SD-115.

Price \$9.95 per system.

D.C. Motor-Delco 5069466

Alnico field. 27.5 V. 10,000 rpm. 1"x1"x2". Use as motor or as tachometer generator. Stock #SD-65



Price \$1.95 each net.



Micro Wave Antenna

AS-217A/APG-15B. 12 CM dipole and 13 inch parabola housed in 16" weatherproof Radome. DC spinner motor for conical scan. Shipping weight 70 lbs. Stock #SD-95.

Price \$9.50 each net.

Phase Shift Capacitor

Four stator single rotor capacitor. 0 to 360° phase shift with circuit shown Radio News (Eng. ed. June 1947). Stock #SD-114.

Price \$4.75 each net.



SD-97



SD-119

Null Type Synchro Indicator

Precision position indicator. Uses Bendix size 5 Selsyn, rectifier tube, transformer, magic eye tube and illuminated 360° dial. Ideal for Hams, labs and experimenters. May be used with SD-43 Synchro transmitter. Stock #SD-119

Price \$6.95 each net.

Servo Motors

Pioneer Types CK-2, 10047-2-A, Kollsman 776-01, etc. for 400 cycles. Diehl FPE-25-3, FPE-25-11 (CDA-211052) and ZP-105-8 (CDA-211377) for 60 cycles.

SERVO-TEK PRODUCTS Co.

Incorporated
Surplus Division

247 CROOKS AVE.

CLIFTON, N. J.

Write for our latest flyer or call ARmory 4-2677. Open account shipments to rated concerns. Others may order C.O.D. Prices F.O.B. Clifton.

GREYLOCK

A Dependable Name in
RADIO TUBES

GT, Glass, and Miniature Types

ALL TUBES IN INDIVIDUAL CARTONS
12SA7, 12SK7, 12SQ7, 50L6, 12AT6,
12BA6, 12BE6, 35W4, 50B5 . . . each 39c
1R5, 1R5, 1T4, 384, 3Q4, 6AK5, 6AC5,
6AC7, 6AQ5, 6BE6, 6BA6, 6AU6,
6BJ6, 6X4 each 49c
32L7, 70L7, 117L7 each 59c
All Tubes Carry RMA 90-Day Guarantee

PM SPEAKERS

4" Alnico No. 5 each \$1.19
5" Alnico No. 5 each 1.29

TERMS: Net C.O.D. No order accepted for less than \$5.00
Write for Bargain Catalog N-4
GREYLOCK ELECTRONIC SUPPLY CO.
30 Church Street New York 7, N. Y.

EASY TO LEARN CODE

It is easy to learn or increase speed with an Instructograph Code Teacher. Affords the quickest and most practical method yet developed. For beginners or advanced students. Available tapes from beginner's alphabet to typical messages on all subjects. Speed range 5 to 40 WPM. Always ready—no QRM.

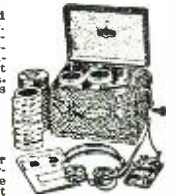

ENDORSED BY THOUSANDS!

The Instructograph Code Teacher literally takes the place of an operator-instructor and enables anyone to learn and master code without further assistance. Thousands of successful operators have "acquired the code" with the Instructograph System. Write today for convenient rental and purchase plans

INSTRUCTOGRAPH COMPANY

4711 SHERIDAN ROAD, CHICAGO 40, ILLINOIS

SAVE AT AMSCO! BUILD YOUR OWN AMPLIFIERS

20 WATT AMPLIFIER

Similar to amplifier specified on page 42 of Jan. Radio News. Uses 1 - 5U4G, 1 - 6SJ7, 1 - 6SN7, 2 - 6V6 push pull, Universal output transformer 8, 12, 16 and 500 ohms. Mike and phonograph input. Chassis 13"x10".

Complete with all parts and schematic diagram. Less tubes..... **\$14.95**

Complete with tubes..... **\$18.75**

3 TUBE PHONO AMPLIFIER

AC/DC. Uses 1 - 35Z5, 1 - 12SQ7, 1-50L6. Set complete with all parts and schematic diagram. Less tubes **\$3.95**

Now, FREE 1948 Circular Available
Now! Write Today for Yours!

AMERICAN SALES CO.
1811 W. 47th St. Chicago 9, Ill.

MIRACLE KIT VALUES!



UNIVERSAL TROUBLE SHOOTER
2 1/4 x 6 x 3 1/2" D

Locates every service trouble. All parts included case, test leads, DUG..... **\$3.95 ea.**

10 WATT 4 TUBE HI-GAIN 6L6 AMPLIFIER KIT



Separately controlled Mike & Phono Inputs. All parts including drilled chassis, hardware, solder, circuit diagrams, info., etc. Less Tubes. **\$6.95 ea.**

PHONOGRAPH OSCILLATOR KIT—Hi-Gain with microphone jack. Tubes Included. Only **\$2.75 ea.**

Write for lists of bargains in Radio and Electronic parts. Also free data, circuits designed by Robert G. Herzog.

Universal/general corp.

Dept. N
365 Canal St., New York 13, N. Y. WAlker 5-9642

AUDIO ENGINEERING SCHOOL

A practical 9 months' course in Sound Fundamentals, Recording, and Sound Transmission measurements; in a laboratory containing transmission sets, oscillators, square wave generator and intermodulation analyzer, and other equipment.

Complete recording studios assimilating broadcast, motion picture and commercial sound recording.

For information write

H. M. Tremaine, Director
SCHOOL OF SOUND RECORDING AND TRANSMISSION ENGINEERING
1655-A Cherokee Hollywood 28, Calif.

STOCK REDUCTION CLOSE-OUTS—FAMOUS BRAND NAMES

Terrific Savings! Buy at Distributor Cost!

	Your Cost
637 Jackson Tube Tester	\$67.50
640 Jackson Tube Tester	40.00
642 Jackson Tube Tester	50.00
643 Jackson Tube Tester	35.00
645 Jackson Tube Tester	60.00
650A Jackson Tube Tester	40.00
2413 Triplett Tube Tester	42.00
3212 Triplett Tube Tester	52.75
625N Triplett Volt OHM Milliammeter	35.00
2450 Triplett Volt OHM Milliammeter	80.00
A200 Oscillators	42.00

All shipments 25% deposit with order, balance C.O.D. F.O.B. St. Louis, Missouri.
CREST CORP. Dept. B-1, 3949 Forest Park Blvd., St. Louis 8, Mo.

Two choices are open in designing a high-voltage supply for the oscilloscope. If the supply is designed with "B+" grounded and "B—" hot, the grid coupling condenser must have a high-voltage rating, but the deflection plate coupling condensers may be the usual 600 volt paper condensers. The reverse is true if "B—" is grounded and "B+" is hot, but this connection is sometimes preferred as the smaller physical size of the grid coupling condenser makes it easier to keep grid-to-ground capacity of this circuit at a minimum—an important factor in the incoming video voltages.

Incidentally, an unusual power supply circuit will be discussed in the next article, which will describe an actual instrument embodying the design principles discussed herein. This circuit employs a voltage tripling connection supplying 1200 volts to the 3" cathode-ray tube in addition to the lower d.c. circuit voltages, all from a receiver-type power transformer using receiver-type rectifier tubes.

(To be continued)

Failures Don't Just Happen

(Continued from page 49)

should get out of what you are in; at least you should not whine if you are not successful.

Four things, at least, must necessarily be done by the small businessman to arrive at success. These are:

1. Know what merchandise customers want and keep it in stock in quantities that permit of the quickest possible turnover. This means marking off a trading area, doing some research in that area and stocking-up with the best known brand names in the respective lines found necessary to carry.

2. He must, as John Allen Murphy pointed out in a series of articles on failing in business in *Sales Management* in 1940, everlastingly sell and sell and sell. Murphy says that experience shows that only 25 per-cent of the concerns in an industry do the necessary selling to remain on a profitable basis. The owners of most concerns do not work hard enough at selling to be successful. Businessmen put

FOOLPROOF SEQUENCE SWITCHING

By THOMAS J. ROSENTHAL, W7IZL

MANY amateurs and experimenters have at different times had reason to use sequence switching; generally bias and filaments are turned on first, then the high voltage. In most such equipment a simple wiring circuit is used so that one switch must be turned on first, but there is no arrangement which will prevent the second switch from being on, thus allowing both circuits to become energized at the same time when the first switch is closed.

A double interlocking switch arrangement is shown in Fig. 1A which prevents such an occurrence. No matter which switch is closed first, circuit No. 1 is energized first, then when the second switch is closed, circuit No. 2 is energized, and of course no matter which switch is opened first, circuit No. 2 is de-energized first.

A similar arrangement extended for three circuits is shown in Fig. 1B. For sake of clarity, the switch arms are shown in the diagram. S_1 and S_3 are quadruple-pole, single-throw and S_2 is triple-pole, single-throw. With this system, any switch may be closed first and it will actuate circuit No. 1, either of the two remaining switches may then be closed to actuate circuit No. 2, and the third switch will give power to circuit No. 3. Opening any switch will open circuit No. 3 first and a reverse sequence is effected in de-energizing the circuits.

Using either of these circuit arrangements will give maximum protection to any set of circuits and equipment and are worth many times the extra bit of work required in wiring them.

—30—

Fig. 1

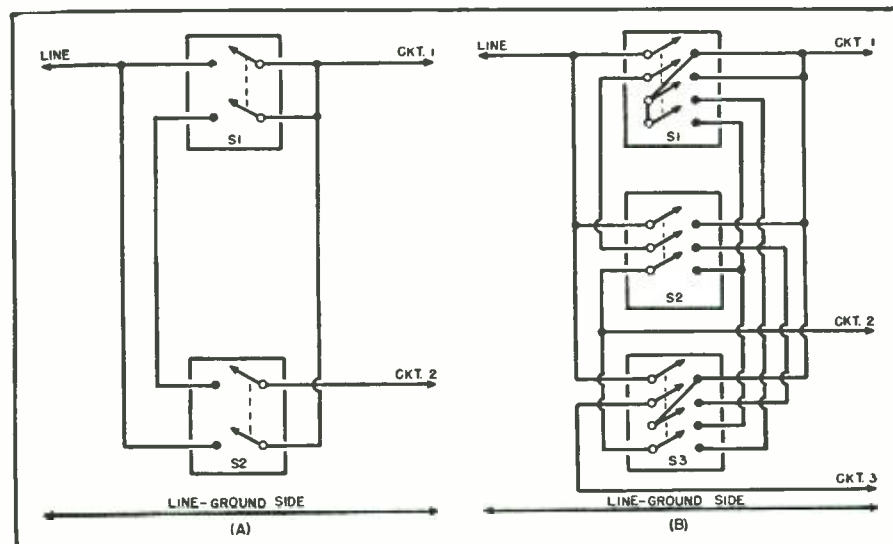

transmitter are separated in the receiver from the actual picture, or "video," information and are utilized to keep the receiver's scanning oscillators in step, or in "sync," with that of the transmitter. The actual video information is delivered to the grid of the cathode-ray tube to cause the beam to increase and decrease in intensity to correspond to the light and dark areas of the actual picture. An oscilloscope suitable for showing actual television pictures must, therefore, be provided with a connection to the grid to receive these television video voltages. Fig. 10 shows the diagram of this connection. The circuit is self-explanatory except to note that the coupling condenser must have a sufficiently high voltage rating to withstand the difference in d.c. voltage existing on each side of it, particularly in oscilloscopes having the cathode and grid at a large negative potential below ground.

Oscilloscope Power Supplies

Even though there are almost as many possible power supply circuits as there are oscilloscopes to choose from, a few generalities applying equally to all are worth noting. As for the power supply feeding the scanning oscillators and amplifiers, its primary requirement is to be very well filtered. In addition, all stages, except the output amplifiers, should have their own individual decoupling filters to prevent circuit interaction.

For the cathode-ray tubes themselves, it is important in the television oscilloscope that the high voltage source provide approximately the maximum voltage at which the tube is rated. This is because of the fact that nearly the entire cathode-ray tube screen is scanned when viewing a television picture, and under these conditions, maximum voltage is necessary to secure sufficient brightness and picture definition. In the usual oscilloscope, only one or several lines are generally viewed instead of a large screen area, and a much lower accelerating anode voltage can thus be tolerated. The high voltage supply must also be well filtered as a very small amount of high-voltage ripple will show up plainly when viewing a television picture.

Fig. 10. Circuit showing one way of connecting video voltages to grid of a CR tube.

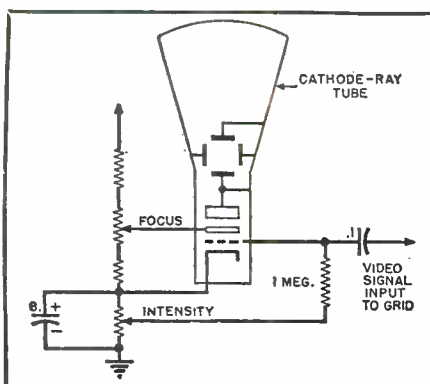

CLOSE OUT!

Never Again at This Low Price

ONLY 250 LEFT
Immediate Delivery!

25 WATT
HIGH FIDELITY
PUBLIC ADDRESS
SYSTEMS

\$29⁹⁵

INCLUDING TUBES
LIST PRICE \$100.00



Model PH25

ONLY

SPECIFICATIONS

TUBES—2—6SC7, 2—6L6, 1—5U4G, 1—6N7.
CHANNELS (3) — 2—Mic High Gain 125DB, 1—Phono 87DB.
RESPONSE — 40-12000 cycles plus or minus 7 DB.
OUTPUT IMP.—2-4-8-15-500 ohms at both "Speaker Terminals." Strip or sockets. Handles 2 microphones.
OUTPUT POWER—25 Watts 3% dist. 35 Watts peak. Hum level 57DB below output.
DUTY — Continuous—PROTECTION—Fused 2 amp. slow blow.
CASE—Steel two-tone black and silver crackle. Blue panel White letters.
CAPACITORS—Oil coupling condensers and hermetically sealed electrolytic filter condensers.
SOCKETS—Output and rectifier sockets steatite.
DIMENSION—8¼ x 10 x 14½ inches.
POWER INPUT—110-125 Volts 60 cycles.



Manufactured and Fully Guaranteed by **ATOMITE ELECTRONIC & RADIO CORP.**

TERMS: 10% Deposit with Order, Balance C.O.D., F.O.B. N. Y. C.

AERCO SALES CO.

540 BUSHWICK AVE.

BROOKLYN 6, N. Y.

Radio Technician and Announcers

A practical 15-month course in First Class Radiotelephone Operation and Announcing is offered by Don Martin School of Radio Arts. Most stations these days require combination men. We specialize in this type of training and maintain a placement bureau for our graduates. Serving the industry for 10 years, the School of Radio Arts can train you. Write for our catalogue outlining the courses offered. Classes can be arranged so you can do part time work on the side.

APPROVED FOR VETERANS

DON MARTIN SCHOOL OF RADIO ARTS
1655 North Llerokee St. Hollywood 28, Calif.

STATION CONTROL BOX



Brand New \$2 Postpaid
Contains 2 4P2T anti-cap switches, 3 jacks, 1 ST Jones strip, 2 HD Jones Plugs, 1 full wave meter rectifier, 6 cond., 3 resistors, F.B. for VFO & Trans. control, key jack & fone jack.
Send for Latest Bulletin!
ALVARADIO Dept. R-1
903 S. Alvarado
Los Angeles 6, Calif.



GET HIGH SPEED WITHOUT NERVOUS TENSION

Amazing Book shows how "crack" operators rely on something besides practice to develop high speed and proficiency. You can learn code or improve your present efficiency in sending and receiving by the same system that has made code champions and radio telegraph experts. Send for 52-page book. It is free.

CANDLER SYSTEM CO.
P.O. Box 928 Dept. 2-D Denver, Colo.

A CAREER WITH A FUTURE!

TELEVISION

Shop Work . Shop Techniques . Theory
FULLY EQUIPPED LABORATORIES

- RADIO SERVICE & REPAIR
- F. M. & TELEVISION
- TRANSMITTER COURSES
Preparing for F.C.C. LICENSES
- RADIO TECHNOLOGY
A Junior College Level Course preparing for positions in Radio-Electronic Engineering Field.

Morning • Afternoon • Evening Classes
MODERATE RATES • INSTALLMENTS

Available Under G. I. Bill

Come In and See Our Students at Work

DELEHANTY SCHOOL OF

RADIO • ELECTRONICS • TELEVISION

105 East 13 St., N. Y. 3, N. Y. • Dept. S.
LICENSED BY STATE OF NEW YORK

RISCO HAS IT

All Changers Brand New

V. M. MIXER CHANGER

PLAYS 10" and 12" Records at the same time.
DETROIT...\$13.75
MAGUIRE...10.50
STOPS AFTER LAST RECORD. PERMANENT NEEDLE. 2-POST.

Above Easily Attached to Any Radio

\$15.50

or CAN BE USED WITH AMPLIFIER BELOW

PHONO AMPLIFIER

3 TUBE AC-DC
Wired Vol. & Tone Control...\$2.75
Uses 12SQ7, 50L6, 35Z5.
Wired & Tested—Set of 3 Tubes...\$1.95
Output Trans...1.39
Alnico Spk...1.19

PHONO OSC-2-TUBE

Wired & Tested 2-Tubes...\$2.75

25% on C.O.D. orders. Orders Filled as Received. Free Catalog "R" Just Out. We Specialize in Mail Orders. Wholesale Distributors

RISCO ELECTRONICS
25 West Broadway New York 7, N. Y.
VISIT OUR NEW SHOWROOM

1" OSCILLOSCOPE

PORTABLE
MEASURES 3"x4"x5"
SPECIFICATIONS

- Focus and Intensity Controls
- X and Y Input Controls
- Internal Sweep
- Built-In 500 V. Power Supply
- Wrinkle Finish with Chrome Handle
- 110 V. AC 25 or 60 Cycle

Ideal for frequency calibration and transmitter monitoring. This basic unit can be expanded to perform virtually any laboratory oscilloscope application. Every radio service shop needs one for AM, FM and Television set alignment right on the job.

MADE FROM NAT'L. ADVERTISED PARTS

Oscilloscope complete, less RCA 913 C. R. tube \$19.95
Complete with C. R. tube...\$38.45. If you prefer to build your own 1" oscilloscope, send \$1.00 for set of plans and instructions.

PLASTICS & ELECTRONICS COMPANY
272 Northland Ave., Buffalo 8, New York

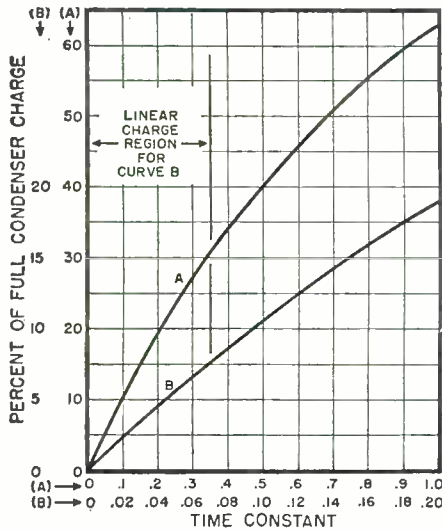

Fig. 9. Curve shows how the voltage charge on a condenser, being charged through a resistance, varies with time.

triode. This circuit will deliver linear saw-tooth oscillations at any frequency from 15 to 20,000 cycles-per-second. The output attenuator, also shown as a part of Fig. 2, is shown in Fig. 8 for the sake of completeness.

Several interesting features are worthy of note. Bias for the tube is secured by a voltage divider between "B+" and ground consisting of a 200,000 ohm resistor from "B+" to cathode and a 3000 ohm variable resistance between cathode and ground. This variable resistance may be an ordinary potentiometer arranged as a screwdriver-type adjustment within the oscilloscope, thus permitting accurate adjustment of the oscillator's ionizing point. The above values are correct if the "B+" voltage exceeds 600 volts. If less than this value, however, the 200,000 ohm resistor should be changed to 100,000 ohms to assure a sufficient range of bias adjustment.

The 5 megohm variable resistance in conjunction with the 800,000 ohm series resistance, provides a frequency adjustment of the oscillator's output for a ratio of slightly greater than 4:1 for each position of the frequency selector switch. Sufficient overlap has been provided between ranges so that charging condensers of standard commercial tolerances may be used and still give complete frequency coverage.

The highest frequency position of the charging condenser selector switch has been left open. The condenser in this position is connected directly between the plate and cathode of the gas triode, omitting even the 500 ohm discharge current-limiting resistor from the circuit. This condenser remains in the circuit at all times, but has very little effect on the circuit performance on the other frequency ranges. By connecting the condenser in this manner, the return trace time of the oscillator is considerably shorter than if the condenser were included directly at the selector switch.

Returning again to the desired linearity of the scanning trace, the following design information may be of interest to those who wish to know the design procedure for a linear scanning oscillator. Fig. 9 is the familiar curve showing how a condenser charges through a resistance. The dotted curve shows the relationship between time and the voltage across the condenser up to one RC time constant (Formula 4). The solid curve shows the same relationship but includes only the first 15% of the dotted curve. An inspection of this solid curve with the assistance of a ruler will show that its linearity is very good up to approximately 7% of RC. In other words, the scanning trace will have good linearity as long as the time for each scanning cycle does not exceed .07RC. Putting this in a formula:

$$\text{Time per cycle} = .07 RC \dots (6)$$

where:

T = Time per cycle is in seconds

R = charging resistance in megohms

C = charging condenser in microfarads

Substituting formula (5) in (6):

$$\frac{1}{f} = .07RC \text{ or } f = \frac{1}{.07RC} \dots (7)$$

Since the linearity is good at any value up to .07RC, a smaller figure than .07 may be used if desired. However, the amplitude of the saw-tooth voltage decreases as lower values than .07 are used, and the size of the charging condenser is also increased for a given frequency. Further, as previously mentioned, the waveshape from a saw-tooth oscillator may be impaired if the output voltage from it has been adjusted to be too low. It is, therefore, always desirable to design such an oscillator for the maximum possible output, and the values derived from the formula (7) will give the maximum output possible while maintaining the desired linearity.

In using formula (7), all that is necessary is to choose a convenient value of resistance, preferably corresponding to the value when the fine frequency adjustment potentiometer, such as *R*, in Fig. 8, has all its resistance in the circuit. The frequency at which it is desired to have the circuit oscillate is also chosen, and the proper value of the charging condenser, *C*, then calculated. These values of *R* and *C* are then placed in the circuit, and the bias of the oscillator is adjusted until the circuit is oscillating at the chosen frequency. Once adjusted in this manner, the gas triode oscillator is functioning at the frequency equal to .07RC, and will continue to do so without further bias adjustment at all normal values for *R* and *C* at frequencies as high as 20,000 cycles-per-second.

Video to Grid Connection

In receiving television pictures, the synchronizing pulses sent out by the

zontal scanning oscillator in a television oscilloscope. The scanning linearity of this circuit is excellent over this entire frequency range if the proper circuit constants are used, and the return trace time is less than 15% of each scanning cycle up to the maximum frequency of 20,000 cycles-per-second, which assures completely satisfactory performance on 525 line television pictures. (The standard television picture requires a 15,750 cycle linear horizontal scanning circuit having a return trace time of not over 15%.)

Fig. 7 shows the basic circuit for the gas triode type of scanning circuit. Briefly, its operation is as follows. At the start of a scanning cycle, the condenser, *C*, begins to charge through the resistance, *R*, which is connected to "B+." At this point, because the gas triode has some fixed negative grid bias and because of the small voltage at the plate of the triode, the tube is "cut-off," i.e., no plate current flows. These conditions continue to exist until the charge on the condenser, and the resultant voltage at the triode's plate, reach a certain critical value. At this point, which is determined principally by the amount of negative grid bias, the gas inside the triode suddenly ionizes, causing the tube to conduct. This causes the tube to appear as though a very small resistance were placed across the charging condenser, *C*, and the condenser quickly discharges through this resistance. Discharging the condenser causes the voltage at the plate of the gas triode to be quickly reduced to such a small value that the tube can no longer remain ionized, and the entire process just described is again repeated.

From the preceding brief description, it is evident that the actual scanning is accomplished during the time that the condenser, *C*, is being charged through the resistance, *R*, and the short return trace period occurs when the gas triode, *V*, ionizes and thus discharges the condenser through its own low internal resistance. The frequency at which this scanning process occurs depends on the time-constant of the *RC* combination. The term, "time constant," of an *RC* combination is given in the formula:

$$TC = R \times C \dots \dots \dots (4)$$

where:

TC is time in seconds

R is resistance in megohms

C is capacity in microfarads.

From this formula it may be easily seen that as either the value of *R* or *C* is increased, the length of time for each scanning cycle increases, corresponding to a decrease in scanning frequency, since:

$$\text{Time per cycle} = \frac{1}{\text{frequency}} \dots \dots (5)$$

Fig. 8 shows the circuit of a complete saw-tooth scanning oscillator utilizing either the type 884 or 885 gas

SAVE \$ ON RADIO SURPLUS

ATTENTION: Prospectors. Explorers for Hidden Treasures!

Do you seek hidden treasures or rare metallic ores? If so, construct a U.S. Army Type of Metallic Mine Detector from these U.S. Army Mine Detector Amplifiers that we are offering at a ridiculously low price. Complete Amplifier (as illustrated) (less tubes and batteries) with Battery case and cables. Cables, headphone cord and jack (no phones). Complete Army wiring diagram. U.S. Army DETECTOR SET Amplifier Type AN/PRS-1. **\$2.49** as described. Only

No. C.O.D.'s. Eveready 45 volt batteries #482. \$1.65 ea. 6 volt A. 73c. 2-1N5 tubes. 95c ea.

U.S. SIGNAL CORPS 5 METER SHORT WAVE XMTRS.

(72.2Mc) XMTRS and TUBE only, less mike, batteries and antenna. One 1½ volt dry cell and 67½ volts of B operates it. Just attach di-pole, key or mike, connect the batteries and it's ready to use. Signal Corps spec. wired with silvered wire, mica condensers, and precision inductance. Highly stable circuit with Lo-Loss silvered inductance. (Adjustable padder) Schematic supplied. Converts easily to walkie-talkie and Ham hands. **\$2.95**

SELENIUM RECTIFIERS

Lots of 12. 65c Single Lots 75c

GENUINE SIGNAL CORPS FEATHER-WEIGHT HEADPHONES WITH CORD AND PLUG 2000 OHMS—8000 OHMS IMPEDANCE **\$1.00**

OIL FILLED FILTER CONDENSERS NATIONALLY KNOWN

1.-MFD—1000 working volts. 4 for **\$1.00**

FAMOUS BRAND RECORD CUTTING HEAD

Here is your opportunity to buy a genuine HOME RECORDING CUTTING HEAD. These units are all Brand new and were made for a nationally advertised manufacturer to be in their quality Home Recording Radios. Size 13½x27½ ready to fit your cutting arm or bracket. **SPECIAL \$2.95**

3 BAND ALL-WAVE DIAL 6" DIAMETER. 75c

AMPLIFIER CHASSIS, SIZE 18"x8"x2½". BLUE CHUCKLE FINISH. DRILLED FOR CONDENSERS, TRANSFORMER AND SOCKETS. 65c

STROMBERG-CARLSON, 3 BAND ALL-WAVE TUNING KIT COMPLETE WITH TRIMMERS, BY-PASSES AND BAND SWITCH, READY TO INSTALL—DIAGRAM, etc. **\$3.75**

8 OR 9 GANG PUSH BUTTON TUNING UNIT (PLEASE SPECIFY). COMPLETE WITH BUTTONS. 25c

24 VOLT D.C. AIRCRAFT MOTOR. APPROX. ¼ H.P. ALMOST NEW **\$1.50**

U.S. AIR FORCE RESISTOR ASST. ¼-½-1 WATT—100 PIECES **95c**

U.S. AIR FORCE MICA COND. ASST. 100 PCS. **\$1.25**

Low-Loss-Short Wave Variable Condensers ¼" Shaft Type

3 Plate—12-15 MMFD.	15c
5 Plate—20 MMFD.	20c
9 Plate—35-40 MMFD.	25c
10 Plate—40 MMFD.	25c
11 Plate—45-50 MMFD.	26c
14 Plate—55-60 MMFD.	27c
27 Plate—100-110 MMFD.	45c
37 Plate—150 MMFD.	50c
38 Plate—150-155 MMFD.	50c
53 Plate—210-21 MMFD.	60c

Lock Type Air Trimmer Variable Condensers

3 Plate—12-15 MMFD.	10c
5 Plate—20 MMFD.	11c
7 Plate—28-30 MMFD.	13c
9 Plate—30-35 MMFD.	13c
10 Plate—40 MMFD.	14c
13 Plate—50 MMFD.	17c
14 Plate—56 MMFD.	20c
20 Plate—80-100 MMFD.	25c
27 Plate—100-110 MMFD.	35c

5 lbs. RADIO HARDWARE Nuts, Bolts, Screws, etc. No Junk **\$1.00**

H. & H. S.P.S.T. T O G G L E SWITCHES— 8 for **\$1.00**

100 TRIMMER & PADDER ASST. All sizes **\$1.75**

NO C. O. D. SHIPMENTS—PLEASE INCLUDE POSTAGE

NEWARK SURPLUS MATERIALS CO. 324 Plane Street, Dept. N Newark 1, N. J.

3 Band radio set chassis short wave continuous to broadcast. These chassis are incomplete. Manufacturer started them, went bankrupt. Chassis has variable condenser, filters, 6 tube super-het, all filament wiring complete. By-pass condensers, resistor, padders, hand-changing switch, tone control, volume control, all wired ready, less transformers less IF (IF 50c each, extra). This is for straight AC; may be converted for AC-DC. Limited quantities only **\$2.50** each

6 tube 3 band AC-DC chassis complete with filter condensers, volume control, dial drive, tone control, band switch, by-pass condensers, resistors, sockets, all wired ready for use with phone attachment (IF 50c each, extra) **\$2.00**

Signal Corps Flex, hook-up wire asst. contains approx. 150 ft. asst. colors, glass insulation 1 lb. Box, SPECIAL **\$2.50**

General Electric 60 cycle watt hour meters, slightly used, perfect condition, same as used in your home. 110-125 volts.

5 Ampere. **\$3.50**; 10 Ampere **\$4.50**



Philco magnetic relay tap switch. Operates on 6 V DC—15 V AC. When contact is made relay operates rotary contact switch to 20 different contacts. Brand new **89c**

Philco rotary tap tone control. 3 position, including condensers. Only 1 wire to connect to grid of audio tube. ¼" shaft. **25c**

Oil filled by-pass condenser asst. removed from Govt. apparatus—electrically perfect, dual 1-600 volt—5-600 volt. 25 piece asst. **\$1.00**

I. C. A. 30 MH RF choke **25c**

Television or Oscilloscope power transformer for use up to 5" tubes. 117 V. pri.—60 cy. 1-2½ V-25 amp., 2-5 V 2 amp., 1-470 V-10 Mi.1.—750 V-CT—60 Mi. **\$2.95**

Grind your own crystals—Pure Brazilian Quartz, all sizes and thicknesses—½ lb. package. **\$1.00**

National Velvet Vernier Dial Attachment—¼" shaft—converts any dial to slow motion vernier **75c**

340 degree dial with 10 push button attachment—¼" shaft—ideal for Xmitters—Sig Gen.—Osc. **49c**

Yaxley Band Switches— 3 gang 3 posit. 3 band **30c** 5 gang 5 posit. 4-5 band **40c**

Trimmer-Padder Asst.—all isolantite—singles, dual, triples—100 asst. pieces **\$2.25**

Signal Corps V. T I receiving tubes— 4 Drones **\$1.00** per doz.

Walkie-Talkie Telescoping Aerials—extends up to 36' **75c**

MAGNAVOX— 12"—1000 ohm Dynamic speakers **\$3.95** 8"—10,000 ohm **1.35**

P. A. System wall speaker box. 8" diameter covering screen grille for hospital, factory or school installation. Will take up to 6" speakers. Each **35c** Lots of 25, each **25c**

Radio Hardware, nuts, bolts 632-832 solid brass cadmium plated \$7.00 value. 4 lbs. for **\$1.00**

Spaghetti Insulation **75c**

RCA Institutes, Inc.

Offer thorough training courses in all technical phases of Radio and Television

WEEKLY RATES DAYS—EVENINGS

VETERANS! RCA Institutes is approved under G. I. Bill of Rights For Free Catalog write Dept. RN-48

RCA INSTITUTES, Inc.

A Service of Radio Corporation of America
75 Varick St., New York 13, N. Y.

TELEVISION RECEIVER—\$1.00

Complete instructions for building your own television receiver. 16 pages—11"x17" of pictures, pictorial diagrams, clarified schematics, 17"x22" complete schematic diagram and chassis layout. Also booklet of alignment instructions, voltage and resistance tables and trouble-shooting hints.—All for **\$1.00.**

CERTIFIED TELEVISION LABORATORIES
5507-13th Ave., Brooklyn 19, N. Y.

HIGH PRECISION 100 Kc. CRYSTALS

Price \$3.95 each

(No C. O. D.'s. Please include 25c for postage and handling.)

Brand New Surplus at about 1/10 Gov't. cost. An ideal Frequency Standard for Amateurs, Servicemen, Laboratories, etc.

Exceptional Frequency Stability ± 15 cycles from —50° to + 80° c. (.0015) 10G Vibration Test. Calibrated at 30° c. Brand New, Mounted in Sealed Cases as Shown.

ELECTRONICRAFT, Inc.
5 Waverly Place • Tuckahoe, N. Y.

JUST OUT! Hard-to-get
New Solid Brass Portable
7 FT. RADIO
ANTENNAS
 7 Exceptionally Rugged
 Sections With Handy
 Mounting Bracket

\$10 Value Only \$2.49 post paid
 Sent Postpaid Upon Receipt of
 Price or Mailed C.O.D. Plus
 Postage

FOR HOMES
BOATS or AUTOS

Same as used on Army tanks, Jeeps,
 etc. These telescopic, rustproof anten-
 nas have tremendous pickup,
 eliminate dangerous wiring. Solid
 Brass throughout, practically in-
 suring

NOISE FREE RECEPTION
 Compresses into 1 ft. 3 in.
 Handy for Camping Trips, also
 Useful for Transmitting, FM and
 Television sets.

EASY TO INSTALL ANYWHERE
 Each antenna comes securely pack-
 ed with handy mounting bracket
 ready to put up.

QUANTITY LIMITED
MAIL ORDER TODAY

Send check or money order today or
 only \$2.49 for this \$10 Value. Your
 antenna will be sent postpaid or mailed
 C.O.D. plus postage. Money back in 10
 days if not satisfied.

RADIO HOSPITAL
 442 East 86th St., Dept. R11
 New York 28, N. Y.

TECHNICAL KO's

OILED FILLED CONDENSERS		TRANSMITTING MICAS	
.05 MFD 1000 V	\$0.28	.000025 2500 V	\$0.11
.05 500 V	.14	.00005 1500 V	.12
.1 2500 V	.45	.00005 2500 V	.14
.1 7500 V	1.85	.00005 5000 V	.85
2x.1 7000 V	4.75	.000067 2500 V	.20
.12 15000 V	6.95	.00007 2500 V	.20
.25 1000 V	.35	.00025 2500 V	.25
.25 4000 V	2.75	.00025 5000 V	.87
.25 6000 V	4.00	.0004 2500 V	.22
10x.25 600 V	1.00	.0005 2500 V	.22
.5 600 V	.28	.00072 5000 V	.89
.5 1000 V	.35	.0008 5000 V	.89
.5 2000 V	.40	.001 2500 V	.22
.75 2000 V	.60	.0015 5000 V	.95
.77 330 VAC	.35	.002 1200 V	.17
1.0 1000 V	.45	.002 3000 V	.66
2.0 1000 V	.60	.0025 1200 V	.15
4.0 600 V	.55	.00275 2000 V	.28
4.0 1000 V	1.00	.003 2500 V	.30
6.0 600 V	.70	.003 3000 V	.66
6.0 1000 V	1.40	.004 2500 V	.36
8.0 600 V	.80	.005 600 V	.13
8.0 1000 V	1.75	.005 3000 V	.66
10.0 600 V	.85	.006 2000 V	.35
3x10.0 90 VAC	1.40	.008 1200 V	.15
30.0 330 VAC	2.35	.01 600 V	.13

CHOKES: 80MA-12H; 100MA-10H, 250 OHM.....\$1.59
 POTS: 20K-50K, 100K..... .16
 POTS: DUAL 1 MEG. DUAL 250K-50K..... .20
 SHIELDED WIRE #22..... .50 for .85
 RESISTOR KIT ASSORTED 1/2&1W..... .100 for 1.49
 BATHTUB KIT 3x1.1. .5. .05. ETC..... .10 for .59
 CONDENSER KIT .01-.00001..... .100 for 3.00
 MICAS .002, .005, ETC. ALL VALUES..... .08
 .01 150V PAPER (MIDGET)..... .60 for 1.00
 0.1 800V..... .8 for 1.00
 6V6 METAL...\$0.89 12Ks METAL..... 0.25

\$2.00 min. order F.O.B., N.Y.C. Add postage
 50% deposit, balance C.O.D. with all orders.
 Manufacturers' inquiries invited.

TECHNICAL RADIO PARTS CO.
 265 Greenwich St. Dept. RN-4 N. Y. 7, N. Y.

f is the upper limit of the desired amplifier frequency bandpass in cycles-per-second

C_i is the total amplifier output capacity in micromicrofarads

10^{11} is 1 with eleven zeros following it.

Step three gives the value of the "peaking" inductance, L , from the formula:

$$L = C_i \times R^2 \times 5 \times 10^{-10} \dots \dots (3)$$

where: L is the peaking inductance in millihenries

C_i is the total amplifier output capacity in micromicrofarads

5×10^{-10} is a decimal point followed by nine zeros and a 5.

Returning again to the desired high-frequency response of 200 kc. for an amplifier of this type, it will be found that the gain of a single stage having this wide bandpass is below the desired figure of 150, particularly if cathode degeneration is employed. Thus, another stage of amplification is needed. Since the desirability of the triode cathode follower at the amplifier's input has already been discussed, the remaining triode section in one of the more familiar dual triode tubes, such as the 6SN7, 7F7, etc., is most convenient for the first amplifier stage. Calculations for this first triode amplifier stage are identical to that for the output pentode amplifier with the exception that formula (1) becomes:

$$C_i = C_o + C_v + C_g + C_{gp} (1+G) \dots (1a)$$

where: C_o is the grid-to-cathode capacity of the next amplifier stage

C_v is the grid-to-plate capacity of the next amplifier stage

G is the voltage gain of the next amplifier stage.

It is apparent that the proper procedure for designing an oscilloscope deflection amplifier is to begin with the last stage, since its gain and capacities influence the design of the preceding stage. The cathode-ray tube itself, incidentally, affords an excellent means for checking the amplifier's gain. This is done by applying a 60-cycle a.c. voltage to the amplifier's grid having sufficient amplitude to deflect the cathode-ray beam over a large part of the screen diameter. The length of this deflection is measured with a ruler, then the input voltage is removed from the amplifier and applied directly to the cathode-ray tube's deflection plate, and this deflection length is measured. Dividing the first length by the second gives the gain of the amplifier. An a.c. vacuum tube voltmeter may also be used to measure the stage gain conveniently.

Figs. 5A and 5B show possible circuits suitable for use as deflection amplifiers. Fig. 5A is for single-ended deflection, and Fig. 5B is for push-pull deflection. Both amplifiers are suitable for use after the previously-discussed input cathode follower stage, and both will also meet all the requirements previously outlined as de-

sirable if the proper component values are used. These diagrams, incidentally, are not intended to be complete, but are included simply to illustrate two possible circuit arrangements.

Scanning Circuits

As is generally well-known, the scanning (sweep) circuit in an oscilloscope is one which generates a voltage having a saw-tooth wave-shape as shown in Fig. 6A. This saw-tooth voltage is usually applied to the input of the deflection amplifier. As a result of this saw-tooth-shaped voltage, a properly-operating scanning oscillator deflects the beam of the cathode-ray tube from left to right or top to bottom on the cathode-ray tube screen at a uniform rate of speed, then returns the beam in a relatively short period of time to its original starting position, where the process is repeated again.

Emphasis is placed on the word, *uniform*, above since the uniform rate of speed, or "linearity," of a saw-tooth oscillator output is one of its two most important requirements, the other being the shortness of the return-trace period. In Fig. 6A, the desired linear saw-tooth waveform is shown, and in Fig. 6C, two cycles of a sine wave are shown as they would appear on the cathode-ray tube screen if this linear saw-tooth waveform was applied to the horizontal deflection plates. Fig. 6B shows a non-linear saw-tooth waveform, and Fig. 6D shows how the same two cycles appear unevenly spaced when the horizontal deflection plates are supplied with this non-linear voltage. Were an actual television picture under observation, and such a non-linear sweep being used, the information on the left side of the picture would appear spread out, and that on the right side squeezed up. Thus, the importance of having the scanning process occur at a uniform rate can be readily appreciated, i.e., the scanning portion of the saw-tooth oscillator's cycle *must* be linear and the amplifier following it must introduce no distortion to upset it.

The author has spent considerable time working with the many variations of saw-tooth scanning oscillators, including a number utilizing the multivibrator type circuits. This rather thorough investigation has convinced the author beyond any doubt that the most satisfactory scanning oscillator for oscilloscope use, even in a television oscilloscope, is the familiar gas triode tubes known as type 834 and 885. There are several reasons for this. To begin with, the gas triode saw-tooth oscillator is extremely simple circuit-wise. In addition, it is very easy to get operating properly, requires only one tap switch and one potentiometer control to vary the frequency over its entire range, synchronizes easily and accurately, and above all, gives uniformly satisfactory performance over the wide frequency range of 15 to 20,000 cycles-per-second, as required for the hori-

tions have been written on this subject, only the highlights needed to design a suitable deflection amplifier will be given herein.

Fig. 4 shows the basic circuit of a video-type amplifier. The three dotted condensers represent the capacities which would adversely affect the high-frequency response of an amplifier due to their bypassing effect on these higher frequencies. They may be described in connection with a simple formula which is required in calculating the values for the components of such an amplifier. This formula is: $C_t = C_o + C_w + C_{ap}$(1) where:

C_t is the sum of the three "stray" capacities.

C_o is the plate-to-cathode capacity of the amplifier tube.

C_w is the capacity of the output wiring and plate coupling condenser to ground.

C_{ap} is the capacity of one cathode-ray tube deflection plate to ground.

The value of C_o and C_{ap} may be secured from the data in a tube handbook, and the value of C_w estimated to get the value for C_t , but it is preferable to wire this portion of the circuit and measure C_t directly if a suitable instrument is available. Just as in the case of the input grid capacity discussed earlier, these three stray capacities in the output circuit of the amplifier bypass the higher frequencies to ground, and a means for counteracting this effect must be employed to keep the gain of the amplifier constant to the desired high frequency limit.

Actually, two measures are taken to accomplish this purpose. First, the plate load resistance, R , is made considerably smaller than in the case of the usual resistance-coupled audio amplifier. The bypassing effect of the stray capacities across this smaller resistance does not become objectionable until a much higher frequency, thus partially correcting the trouble. Second, a suitable inductance, L , is added in series with the plate load resistance to form a broadly-tuned resonant circuit with the stray capacities at a frequency slightly higher than the upper limit of the desired frequency bandpass. When so chosen, this inductance, L , has an equal and opposite effect to the stray capacities and thus permits the gain of the amplifier to be held constant to the desired high-frequency limit.

Calculating the values for R and L in Fig. 4 is fairly simple. Three steps are required. In the first step, the value for C_t is determined by measurement, or by handbook, and estimation as previously discussed, using formula (1).

The second step is calculating the value of the plate load resistance, R , from the formula:

$$R = \frac{1.59 \times 10^{11}}{f \times C_t} \dots\dots\dots(2)$$

where:

R is the plate load resistance in ohms

ESPEY

The Custom-Built Chassis

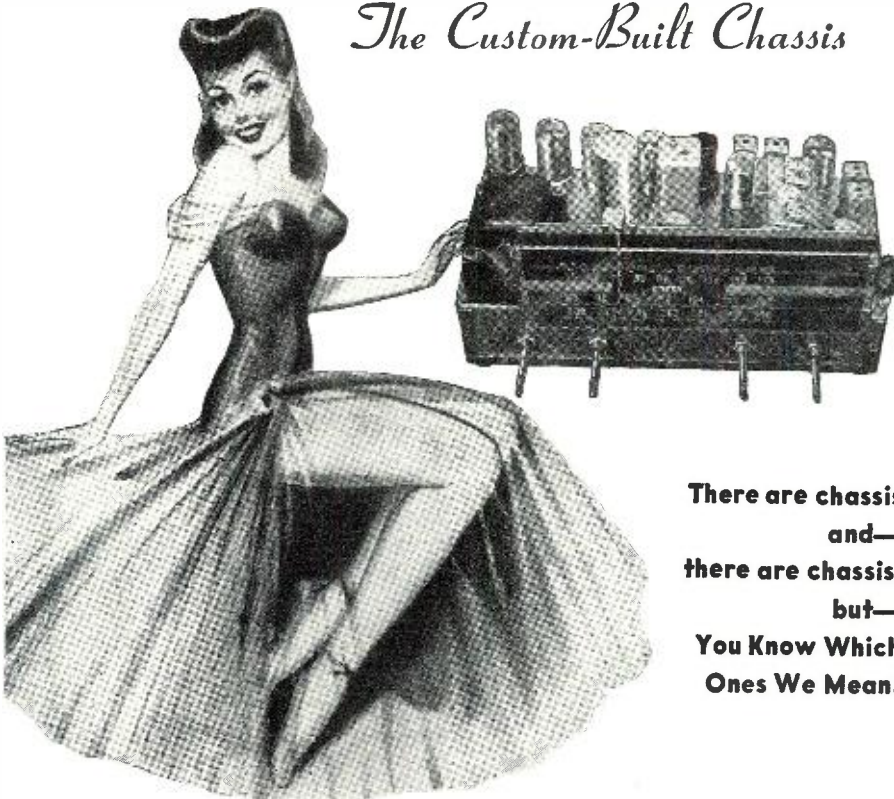

**There are chassis
and—
there are chassis,
but—
You Know Which
Ones We Mean!**

How many times have you wished you could replace that worn out AM set now housed in a beautiful, highly thought-of cabinet? At last it's possible—and at a price within the reach of everyone! The **ESPEY** line of custom-built chassis is designed for just such installations, as well as for custom-built and other special applications. Take the **ESPEY MODEL 7-B**, for instance. It's a top-quality AM-FM receiver, featuring high fidelity reception, illuminated slide rule dial, full tone control, and is wired for phonograph operation.

Its superheterodyne circuit contains 10 tubes plus a rectifier tube, and operates on 105/125 volts AC, 50/60 cycle. Furthermore, it's supplied ready to operate, with 10" speaker containing an Alnico #5 magnet, both AM and FM antennas, and all hardware needed to make the installation easy and complete.

For further details about this—and the rest of the ESPEY line—write to Department A today.

ESPEY MANUFACTURING COMPANY, INC.
528 EAST 72ND STREET-NEW YORK 21, N.Y.

RADIO ENGINEERING!

COMPLETE Radio Engineering Course. Bachelor of Science Degree. Courses also in Civil, Electrical, Mechanical, Chemical, Aeronautical Engineering, Business Administration, Accounting, Secretarial, Science. Graduates successful. 64th year. Enter March, June, Sept., Jan. Write for catalog.

TRI-STATE COLLEGE 1638 College Ave. ANGOLA, INDIANA

DEGREE IN 27 MONTHS

Serving Radio & Appliances

SERVICE DEALERS
FROM COAST TO COAST

With **4** **JOB CARDS**

ASK FOR SAMPLES **RADIO PRESS** MORGANTOWN WEST VIRGINIA

SELSYN MOTOR VALUE

115 Volts 60 Cycles



\$7.50 Per Pair

From NEW gun directional control units. Excellent for rotary beam directional control and indication. No. 5 synchro Mfg. by Bendix, Diehl, Hobart, operate as transmitter and receiver. Diameter 3 1/4", length 4 1/2". Designed for direct hook-up to 115 volt, 60 cycle, A.C. supply line.

Pair (2 units), with diagram.....\$7.50

WEBER ELECTRIC
150 Maple Ave. Dept. 4, Hershey, Penna.

WAR SURPLUS BARGAIN KIT



4 LAMPS ELECTRONIC PHOTO FLASH EQUIPMENT, THE FAMOUS "MODEL 1503" AIRCRAFT FLASH UNIT.

This powerful high quality equipment was made for the U.S. Air Corps and will be shipped to you brand new in original boxes.

- **THE POWER SUPPLY** is built into a beautiful gray finished case, with all connectors, relay control, 2 condensers each 2000 Volts, 50 M.F.D. light output 110 Watt seconds, can be used with any 12 Watt battery as a professional studio flash equipment. The power pack alone is worth more than the price we are asking for the complete unit.
- **THE FOUR HIGH SPEED FLASH TUBES** are plastic sealed, unbreakable, 12 million peak lumens light output for more than 15,000 flashes.
- **IN ADDITION TO THIS WE SUPPLY:** aluminum reflectors, transformer, connectors, connecting cords, spare parts, diagram and instructions on how to use it for battery or on how to convert the unit for 110 Volt A.C.

- **IT IS THE BEST VALUE IN WAR SURPLUS MATERIAL. WHILE THEY LAST.**

PRICE complete

\$68.00

CINEX INC. Dept. N.R.
165 West 46th St. New York 19, N. Y.

A HIT WITH AMATEURS!

"Buck" Stretcher
POWER SUPPLY KITS
500 to 3000 Volts



They contain everything you need, all parts being brand new and nationally famous, including RCA, Kenyon, Millen, etc.

#1	500 or 700 V DC @ 300 ma	\$39.50
#2	1000 or 1250 V DC @ 300 ma	\$49.50
#3	1500, 1750, or 2000 V DC @ 300 ma	\$59.50
#4	2000 V DC @ 600 ma	\$103.50
Use this one supply for double duty (600 ma CCS)		
#5	2000 V DC @ 500 ma or 3000 V DC @ 400 ma	\$119.50

Power Supply kit for the 8C-221 \$ 5.95

Complete wiring diagrams with all kits

ORDER NOW!

Prices subject to change without notice

SUN RADIO

& ELECTRONICS CO., Inc.

ESTABLISHED 1922

122-124 DUANE ST. - NEW YORK 7, N. Y. - BArday 7-1840

New FM Receiver

(Continued from page 53)

in poor alignment in one stage being compensated for by shifted alignment in another stage, thus peaking the i.f. characteristic unsymmetrically and no one stage by itself satisfies the condition for wide-band passage. Therefore, the best practice is to align each stage individually, and satisfy the requirement of phase as well as amplitude linearity for each stage as shown in Fig. 7. The output of the signal generator, whose frequency is set at the i.f. mid-frequency of 10.7 megacycles, is connected to the grid of the last i.f. amplifier tube, V₁. The transformer trimmers are so adjusted that the desired characteristic is obtained by observing the deflection of the limiter microammeter. The resulting characteristic should be as shown in Fig. 7, the two peaks appearing at about 75 kc. on either side of the i.f. frequency of 10.7 mc. The characteristic should be as "flat" as possible, which condition may be obtained by adjusting the damping resistors of the i.f. transformers. Upon successful alignment of T₃, the output of the signal generator is connected to the grid of V₂ and the transformer T₂ is aligned in a similar manner. The output of the signal generator is reduced in strength, of course, since the addition of a stage of amplification has been effected by the change. Finally, the signal is applied to the grid of the high frequency converter, V₃, and the alignment of transformer T₁ performed. It should be noted that due to the low impedance of the coil, L₁, in the grid circuit of the converter,

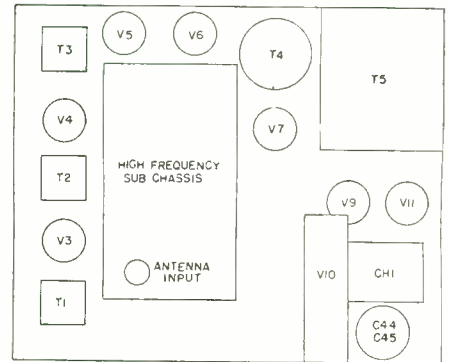
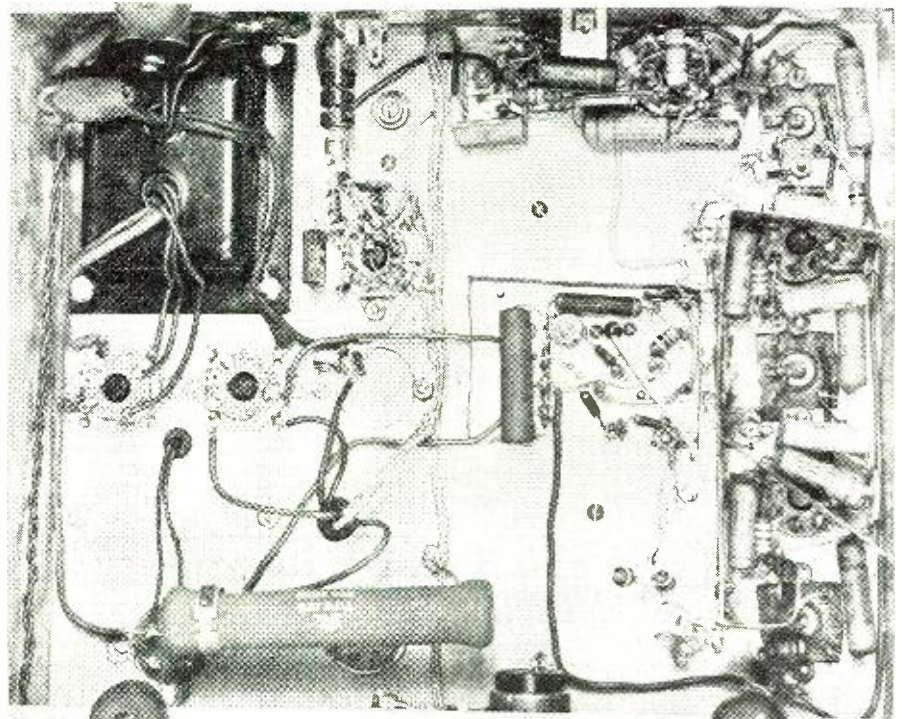

Fig. 5. Layout of receiver chassis showing location of various components.

a high resistance of, say, 100,000 ohms should be substituted for this coil, before the test is attempted.

In the alignment of the high frequency stage, customary practice is followed, the same as would be used in any other superheterodyne input circuit. A signal generator covering the FM band is connected to the antenna input terminals across L₁. Here, again, since the i.f. amplifiers have been properly aligned, the magnitude of the limiter input current is used as a guide for alignment. The signal generator is set at the high side of the band, say 105 mc., and the tuning dial, which drives C₂, C₁₀, and C₁₂, rotated until the microammeter indicates a maximum value. Then the oscillator trimmer, C₁₃, is adjusted for a still higher maximum reading and finally C₁ and C₉ are adjusted for the highest reading of the limiter grid meter. The receiver dial, at this point, is marked with the corresponding indication of the signal generator. Tracking is then checked by noting the readings

Fig. 6. Under-chassis of FM receiver features neat wiring and uncluttered appearance.



range of 40 to 9000 cycles. Wire spools of quarter, half, and full hour duration may be used. This portable unit permits dubbing in, correcting, or adding any form of sound to the original recording.

The "Musicord" provides the fun of making professional sounding records at home with the use of the Hoffman magnetic cutting head. A monitoring circuit allows you to listen to the program at the same time it is being recorded.

Many other models are also described and further information may be obtained from the Hoffman Radio Corp., Los Angeles, California.

CABINET EXHAUST FAN

The Rotron Division has recently released a catalogue sheet on an exhaust fan for flushing the air of instrument cabinets and radio transmitter cubicles. This versatile unit covers all requirements up to such high back-pressures as where a centrifugal-type fan should be used. The ball bearing motor, which is totally enclosed, can be mounted with propeller vertically-up or vertically-down or horizontal.

The propeller operates in a Venturi ring, which has been designed to obtain full benefit of the pressure-building capacity of the blades. The shape of the ring assures efficient operation for both directions of flow. A number of propellers of different pitch and opposite direction of flow are available, so that the air can either be sucked into the cabinet, or pushed out.

The motor has two accurately aligned "precision" type ball bearings with felt seals. Its diecast casing is finned for maximum heat dissipation. The motor conforms to all NEMA standards for this class. Further information on this unit will be furnished by the Rotron Division, 180 Weeden Street, Pawtucket, R. I. Ask for data sheets RP-22 and RM-15.

'SMALL BUSINESS' SERVICE

Of interest to both new and established retailers in the radio-appliance field is the booklet "The Home Appliance Business" published by the Bank of America.

If you have your own home appliance store or if you are thinking of buying or opening one, this information digest will interest you. It won't tell you how to run your business, but it may give you something to think about.

"Before the war the appliance business was very competitive and dealers sent out salesmen and arranged for demonstrations but with the war came scarcity and high prices... Today with changing conditions prewar competition is on the way back, that's why it's going to pay you to look ahead with market changes in mind."

For a copy of this publication write to Small Business Advisory Service, Bank of America, 300 Montgomery Street, San Francisco 20, California.

WE'VE MOVED! TO ENLARGED HEADQUARTERS FOR IMMEDIATE SERVICE!

HERE ARE YOUR BEST BUYS IN TUBES!

EVERY TUBE IN CARTON.		R.M.A. GUARANTEED	
Type	Each	Type	Each
1A3	45c	7A4	53c
1A5GT	59	7A7	53
1A6	36	7B6	44
1V5	45	7F7	49
1L4	55	7Y4	44
1T4	69	7X7	44
1S5	69	7A7	44
2A5	65	12A6	35
2A6	79	12A8GT	45
2X2	79	12AT6	50
3A4	69	12BA6	50
3S4	69	12BE6	50
5U4G	50	12J5GT	49
5W4GT	40	12J7GT	45
5Y3GT	40	12K7GT	45
5Y3G	42	12K8	65
5Y4G	40	12Q7GT	45
5X4G	40	12SA7GT	40
6A7	50	12SF7	39
6A8GT	49	12S07GT	40
6AC5	98	12SK7GT	45
6AC7	65	12SR7	39
6AK5	74	12SJ7GT	55
6AG7/6AK7	89	14A7	65
6B7G	55	14B6	59
6CA	29	24A	49
6C5GT	40	43	54
6C6	45	47	49
6C8G	37	57	45
6F6GT	45	58	45
6H6	45	71A	39
6H6GT	45	75	50
6J5GT	45	76	45
6J7GT	42	77	35
6K6GT	45	80	40
6K7GT	49	83V	99
6K7G	50	85	49
6L6G	79	85	49
QZ4	69	25L6GT	49
6Q7GT	47	25Z5	49
6S7	59	25Z6GT	45
6U7G	35	35W4	43
6V6GT	45	35Y4	43
6X5GT	49	35Z3	44
6SA7GT	44	35Z5GT	43
6SJ7GT	44	35L6GT	45
6SK7GT	49	35/51	49
6SL7GT	49	50L6GT	50
6SN7GT	49	117Z6GT	89
6SQ7GT	44	50B5	42
6SG7	44	32L7GT	59



Senco Special!

TURNER CRYSTAL HAND MIKE

100 feet of shielded mike cable and standard plug.

\$5.95 COMPLETE

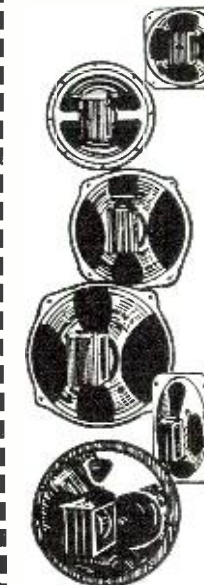

Popular Brand

12" P.M. SPEAKER with 21 oz. Magnet

6V6 push pull output transformer mounted on speaker with cord and plug attached.

\$8.95 COMPLETE

+

MORE SPEAKER VALUES

- 3 1/2" Cone 4" Sq. Frame..... **\$1.19 ea.**
- 4" P.M. Speaker... **1.19 ea.**
- 5" P.M. Speaker... **1.15 ea.**
- 5 1/2" Cone 6" Sq. Frame..... **1.55 ea.**
- 6" P.M. Speaker... **1.55 ea.**
- 8" P.M. Speaker... **2.75 ea.**
- 12" P.M. Speaker... **4.95 ea.**
- 4x6" P.M. Speaker... **1.89 ea.**

TUBULAR CONDENSERS

30 mfd. @ 150V.....	27c ea.
40 mfd. @ 150V.....	29c
80 mfd. @ 150V.....	38c
10x10 mfd. @ 50V.....	25c
16x16 mfd. @ 150V.....	33c
20x20 mfd. @ 150V 4 leads...	38c
30x30 mfd. @ 150V-20 @ 25V	40c
30x50 mfd. @ 150V.....	47c
40x40 mfd. @ 150V.....	47c
30x25 mfd. @ 300V-20 @ 25V	41c
20x20x20 mfd. @ 150V-10 @ 25V.....	40c

25% deposit on all orders, balance C. O. D., F. O. B. New York

VOLUME CONTROLS

Popular Brand
3" shaft tapped with switch.
250,000 ohms
500,000 ohms
1 meg. ohms
2 meg. ohms

39c EACH

STANDARD BRAND MOTOR AND AC CRYSTAL PICKUP

60 cycles - 115 volts with turntable.
\$4.35 COMPLETE



FREE 1 NEEDLE CUP. With motor and pick up.

VIBRATORS

6V Auto Vibrator—4 Prong..... **\$1.09 Each**
2V Vibrator for G.E. Portable Set—Model 530..... **39c Each**

SENCO RADIO, Inc.

71 WEST BROADWAY, N.Y. 7, N.Y.
TELEPHONE — BEEKMAN 3-6498



110V. AC operated. Requires only 8 MFD or larger condenser
Reversible. Appr. 1/2 RPM, hi-torque. No free swing. Easy to mount. Ideal for ham, television use. With simple instructions. Surplus—New, original boxes. \$5.95 postpaid in cont. U.S.A.

ALVARADIO, Dept. RN-1, 903 S. Alvarado, Los Angeles 6, Calif.



STEADY PROFITS

YOUR OWN BUSINESS

with CORADIO

THE COIN OPERATED RADIO

Place these specially built radios that play 1 or 2 hours for 25c in the thousands of available hotel rooms, tourists courts, etc. They yield immediate profits and steady income. Install Coradio, the finest made.

Limited capital required. Send for further information. Write today.

CORADIO Coin Operated Radio
Dept. R. N. 108 W. 31 Street, New York 1, N. Y.

RADIO ENGINEERING 27 MONTHS DEGREE IN

Intensive, specialized course, including strong basis in mathematics and electrical engineering, advanced Radio Theory and Design. Modern laboratory. Low tuition. Self-help opportunities. Also 27-month courses in Aeronautical, Chemical, Civil, Electrical and Mechanical Engineering. Gov't approved for G.I.'s. Enter June, Sept., Dec., March. Catalogue.

INDIANA TECHNICAL COLLEGE
948 E. Washington Blvd., Fort Wayne 2, Indiana

SELSYN UNITS



- 57.5 VAC 400 cycle operation
- 35-40 VAC 60 cycle operation
- Pair may be operated in series on 115V/400 cps. or in series with capacitor on 115V/60 cps. line
- Dustproof housing with lucite window over slip rings
- Brand new, unused units, 2 1/4" dia. x 3 1/2" long with 6/40 threaded shaft, nut, and tapered key.

STOCK No.
SEL-50

\$3.95

Pair Capacitor for series operation on 115VAC/60 cps line (with instructions). Stock No. CPO-48. \$0.53 ea.
Capacitor for parallel operation on 115VAC/60 cps line (38V) with instructions. Stock No. CPO-112. \$1.25 ea.

DUBIN
ELECTRONICS CO. INC.

103-02 Northern Blvd.
Corona, N. Y.

Telephone IL 8-3132 P.O. Box 58
Cable: DUBLECTRON NEW YORK

TELEVISION ELECTRONICS

LEARN RADIO THE
NORTHWESTERN WAY

- BASIC RADIO
- RADIO SERVICE
- COMMUNICATIONS
- INDUSTRIAL ELECTRONICS
- TELEVISION

Highly Trained Instructors
Modern Equipment
Spacious Building and Grounds

NORTHWESTERN VOCATIONAL INST.



745 Grand Ave.
ST. PAUL 5
MINN.

ARC-5 rcvr 190-550kc w/dyn loop or ant input, good cond. w/tubes.....\$6.95

ARC-5 2-sect rcvr or xmitter racks.....\$2.49
plugs for ARC-5 or SCR-274n..... .45

TBY xmitter or rcvr w/tubes 27-80m \$14.95

4-SECT OIL COND. 8-8-8-8 mfd 600v, new,

- L₁—2 t. #16 en. wire, 1/2" diam., self-supporting
L₂—4 t. #16 en. wire, 1/2" diam, self-supporting
L₃—1 3/4 t. #20 en. wire, 1/2" diam. polystyrene form
L₄—2 1/4 t. #20 en. wire, 1/2" diam. polystyrene form
L₅—1 1/2 t. #20 en. wire, 1/2" diam. polystyrene form
L₆—3 t. #20 en. wire, 1/2" diam. polystyrene form

Note: Maintain 1/8" spacing between turns of all coils

Primaries and secondaries of all coils should be spaced 1/8" apart.

Table 1. Coil winding data.

adjusting the input trimmer condenser of the transformer *T*.

With alignment completed, the receiver is ready for connection to an antenna system and an audio amplifier. The quality of reception depends heavily upon the design of these two additional circuits; both must be constructed with the utmost of care, for the receiver will respond with no better quality than has been incorporated in the design of these units.

-30-

NBFM Transmitter

(Continued from page 58)

ble) may be substituted for the 6L6 with higher plate voltage and output being possible. The 829B would have to have a separate power supply, but its screen could be run from the exciter unit's supply.

With the voltages shown on the schematic for the 6L6, a 25 watt lamp coupled to the 6L6 lights to 2/3 brilliance on 20 meters and 1/2 brilliance on ten meters. This exciter may be used as a composite transmitter on all bands or to excite a pentode amplifier. The unit should be link-coupled to the next stage. The author has been using the exciter with 20 watts input on 10 meters with a 3-element beam for several months. Some of the amateurs contacted found it hard to believe 20 watts input could push their S-meter so hard. Distant amateurs didn't recognize the NBFM until it was mentioned.

Television Scope

(Continued from page 66)

as might possibly seem logical, the variable control is, instead, placed in the grid circuit, and for the following reason. When the control is in the cathode circuit, as in Fig. 3B, plate current flows through the control causing a fixed d.c. voltage drop across it. This d.c. voltage will charge the grid coupling condenser to whatever voltage appears at the point where the arm of the control is set. Thus, when the arm of the control is altered, the d.c. voltage across the condenser also changes, causing a momentary shift in the pattern position either horizontally or vertically as the adjustment is made. This becomes a considerable annoyance when attempting to make a fine adjustment of a pattern, and the scheme in Fig. 3A was thus adopted. The rather unusual values of the coupling condenser and the gain control potentiometer in Fig. 3A are necessary in order to eliminate the undesirable effects of the tube input capacity, previously described. With the values shown, the various stray capacities have no detectable effect at any frequency up to 200 kc.

The amplifier proper must be designed to go with the type of cathode-ray tube being used. At present, the tendency in oscilloscope design is toward the use of push-pull deflection, i.e., a push-pull output amplifier is used to supply deflection voltage to both horizontal and both vertical deflection plates. Tubes suited for this type of deflection are the 2AP1, 3BP1, 5BP1, etc. The two principal advantages for this type of circuit lie in the fact that the output amplifier may be operated at a lower value of "B+" voltage in order to secure the desired screen deflection, and the defocusing of the cathode-ray tube spot is also minimized. These advantages are somewhat cancelled, however, by the extra tubes and circuit components required. In the case of larger tubes, the extra complexity is often justified since very large deflection voltages are needed, but in the case of the smaller tubes, particularly the 2" and 3" screen sizes, the author has always favored the "single-ended" type of deflection because of its simplicity. Single-ended deflection re-

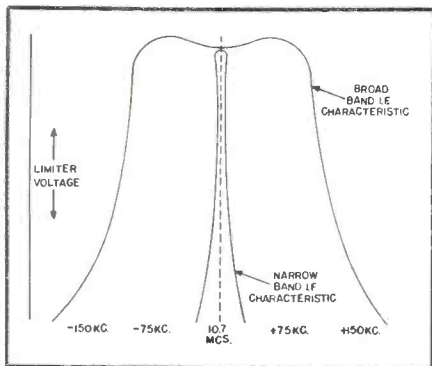

Fig. 7. Comparison of narrow-band (AM) and broad-band FM i.f. characteristics.

of the microammeter when both the settings of the signal generator and the receiver tuner are varied over the entire FM band. If the input signal is maintained constant, the microammeter should read essentially the same magnitude over the entire band, for proper tracking. If the tracking is not satisfactory, the trimmers should be adjusted, following the same practice as is employed in AM receiver alignment. Throughout the tracking procedure, the frequency of the signal generator should be noted and recorded on the receiver tuning dial in pencil and later inked in.

The discriminator circuit is adjusted next by varying the capacitances of the discriminator transformer, T_4 . This can best be done by connecting a high resistance voltmeter across the cathode end of R_{30} and ground and noting its reading as the applied intermediate frequency of 10.7 mc. is varied back and forth over this mid-frequency. The discriminator characteristic, as shown in Fig. 8, should be the resulting variation of discriminator voltage with change in frequency. Zero voltage at exactly 10.7 mc. is obtained by adjusting the output trimmer condenser of the transformer, T_4 ,—the condenser that is connected across the plates of the tube, V_7 . Equal and opposite discriminator voltages are obtained by

Fig. 8. Discriminator characteristic.



KITS

- **FILTER CONDENSER ASSORTMENT**
Electrolytics, paper, oil, etc., 100 to 1,000 V. DC. Assorted capacities. New.....10 for \$2.69
- **BATHTUB CONDENSER KIT**
.05 to 2 mfd. 200 to 600 W. DC. A Super Value! Assortment of 15.....98c
- **TRANSFORMER ASSORTMENT**
Modulation, line, mic, audio, power, etc., Like-new.....10 for \$4.95
- **HARDWARE ASSORTMENT**
Contains lugs, rivets, springs, clamps, screws, shock mounts, brackets, insulators, etc. Approx. 5 lbs.....\$1.95
- **COIL ASSORTMENT**
R.F., I.F., Osc. Ant., etc.—Shielded (some). Like-new.....10 for 98c

● MANUFACTURERS' SURPLUS RECEIVERS

Partially completed receivers. 2-16 Mc. 5 tube super-het. Less tubes and power supply. Sets in various stages of production. Include Panel, Chassis, I.F.'s, R.F., Coils, Band Switch, most Resistors and Condensers. Some have gangs and are nearly complete. As is.....\$2.29

● FREQUENCY MULTIPLIER UNIT ART-13

Less tubes. Tested and passed. Complete. New. \$1.79

● SPEECH AMPLIFIER ART-13

Less tubes. Brand new. Only a few left.....\$3.95

● FRACTIONAL H.P. MOTORS

Model AD-1. 24 V. DC 1/12 h.p. 6,000 RPM. 1/4" shaft. Square End Bell for mounting with four bolts (navy type). Size: 3" L., 2 3/4" Dia. 2 leads. For intermittent duty.

Model BX-1. Shunt. 5,000 RPM. 4 leads. Chrome-plated shell. Shaft 1/4" Dia., 3/4" L. Size: 2 1/2" x 1 1/2". New. Either type.....Just \$1.49

● TELEPHONE JACKS

Two Circuits closed when plug is inserted. New. 3 for 25c

Chock-full of Bargains...

United Surplus 1948 Catalog. Write for your FREE copy today.—You'll be sure to save money.

- Quantities are limited—Order Now. Prices subject to change without notice.
- Minimum order—\$2.00; 25% Deposit Required—Balance C.O.D. All orders shipped f.o.b. Chicago.

● TRANSFORMERS

Filament. 4 to 30 V. @ 2 A. 60 cyc. 110 V. (pri.). Well-known Brand. Completely shielded. New \$2.19
Line. 500 ohms to p.p. grids. Completely shielded. Has 4 mounting studs. 6-32 (rel. at 10-15 watts). Well-known Brand. New.....\$1.49

● DYNAMOTORS

BD-77. Input: 14 V. @ 40 A. Output: 1,000 V. @ 350 MA. For BC-375 Transmitter. New.....\$7.95
DM-33A. Input: 28 V. Output: 540 V. DC @ 250 MA. New—In original cartons.....Each \$1.79
3 for \$5.00
GN-45A. Hand Generator. Output: 6 V. DC @ 3 A., and 500 V. DC @ 140 MA. Includes legs (less cranks). Slightly used. Wt. a prox. 30 lbs. Each \$1.69

PE-103. Input: 6 or 12 V. DC. Output: 500 V. DC @ 160 MA. Like new.....Ea. \$7.95

● PUSH-BUTTON TUNING ASSEMBLY

For BC-728 Receiver 2 to 6 Mc. 4 push-buttons. 12 Variable slug tuned coils for R.F., Mixer and Osc. Completely assembled, wired and aligned. Overseas packed.....\$1.95

● ANTENNA LEAD

Coaxial for BC-728A Receiver. Approximately 5 ft. long. New.....Just 59c

● OSCILLOSCOPE POWER SUPPLY

For 7" tube. Input: 110 V. AC 60 Cyc. Output: 2300 V. DC @ 2 MA, 350 V. DC @ 155 MA. All rectifier and cathode ray filts. Completely filtered. Uses 1—2X2, 1—5U4G, 2—6Y6G, 1—6SU7 and 1—VR-105 tubes. (Tubes not included.) Size: 8" H, 14" W, 19" L. Shipping wt. approx. 75 lbs. New. A few left.....\$16.95

● FREQUENCY METERS

Vibrating Reed type. 125 V. 57 to 63 Cyc. All-bakelite case. New.....\$2.89

IT'S A WOW!!!

SURPRISE ELECTRONICS "PACKAGE"
More than 10 lbs. of assorted electronic units and parts. Worth many times this low price.....\$1.49



United SURPLUS MATERIALS
3313-19 W. OGDEN AVE.
CHICAGO 23, ILL.

BRIDGE and V. O. M. PARTS

CUT HOLES FAST IN RADIO CHASSIS



WITH A GREENLEE
RADIO CHASSIS PUNCH

• GREENLEE Punches make this tough job easy. Merely turn with an ordinary wrench . . . make accurate, clean holes in a hurry. No reaming or tedious filing. There's a GREENLEE punch for each of these sizes: 1/2"; 3/8"; 3/4"; 7/8"; 1"; 1 1/8"; 1 1/2"; 1 3/8"; 1 1/2"; 2 1/4"—for cutting holes to take sockets, plugs, etc. Also GREENLEE makes Knockout Punches and Cutters for conduit and meter holes up to 3 1/4". Write for facts. Greenlee Tool Co. 1884 Columbia Avenue, Rockford, Illinois.



NEW SERIES 16 IMPROVED NO-DRIFT FM
in the Sensational 1948
MIDWEST RADIOS

Separate Chassis Like This Powerful SERIES 16 AM-FM MODEL OR Beautiful Radio-Phono Consoles Available

The SYMPHONY GRAND RADIO-PHONOGRAPH AM-FM CONSOLE

A truly magnificent instrument that offers new, improved No-Drift FM, 5 Wave Bands, Automatic Intermix Record Changer that handles both 10" and 12" records, 14 1/2" Panasonic Speaker, and exclusive Midwest Tri-Magnadyne Coil System and Color-Ray Tone Selection. Other luxurious Console and Table Models with Series 16, 12, and 8 Chassis.

EASY TERMS
30 DAYS TRIAL

SEND FOR FREE CATALOG BUY DIRECT FROM FACTORY AND SAVE!
FILL IN COUPON AND MAIL TODAY OR JUST SEND YOUR NAME AND ADDRESS ON 1c POSTCARD

MIDWEST RADIO CORPORATION
Dept. 37-U, 909 Broadway, Cincinnati 2, Ohio

Please send me your new FREE 1948 Catalog.

NAME.....
STREET.....
CITY.....ZONE.....STATE.....

English or Spanish editions and may be obtained by writing *Sibley Machine & Foundry Corp.*, 206 East Tutt St., South Bend 23, Indiana, mentioning RADIO NEWS.

MULTIPLE ARM RELAYS

A new line of sensitive relays has been announced by *Signal Engineering & Mfg. Co.*, in their bulletin No. 50-72. This line consists of a new series of small, rugged, general purpose multiple arm relays adaptable to a wide variety of circuit arrangements.

Three styles of assembly are featured in these new relays; the octal socket with removable dust cover, the octal socket and hermetically sealed cover, and the header type container which is hermetically sealed.

The basic design consists of a relay mounted on an octal socket with the relay armature and the contact arms in a vertical position to the relay base, allowing the required mounting area to be held to a minimum. The armature is so proportioned that it is substantially balanced with respect to its axis of rotation, allowing the relay to be mounted in any position without affecting its normal action. Shock or vibration is minimized by the use of a balanced armature which might cause false opening or closing of the contacts.

Signal Engineering & Mfg. Co., 154 West 14th St., New York 11, New York, will furnish a copy of bulletin No. 50-72 on request.

NEOPRENE NOTEBOOK

The "Neoprene Notebook," recently published by *E. I. du Pont de Nemours & Co., (Inc.)*, contains articles on synthetic rubber. This booklet also contains information on laboratory results and industrial applications for Neoprene products.

Included in this notebook are abstracts from a report entitled "The Effect of Fuels Containing Aromatic Hydrocarbons on Neoprene Hose." Copies of the complete report may also be obtained from the *Rubber Chemicals Division, E. I. du Pont de Nemours & Co., (Inc.)*, Wilmington 98, Delaware.

TRANSMITTING TUBES

United Electronics Company is now offering a new 12-page catalogue, which provides a positive means for identifying transmitting tubes of latest design from war surplus.

This pamphlet presents a description of *United* electronic tubes and vacuum capacitors for radio transmission, sound amplification, and diathermy. All internal types embody the new *United* isolated getter trap which is a capsule-like device which forms a gas absorbing reservoir in which the metallic gettering substance is confined. This frees the new tubes from the mirror-like coating inside the bulb.

Contained in this pamphlet are photographs of tubes and vacuum

capacitors, with many different types of charts and tables. This catalogue, No. 1-GPW-7 is obtainable upon request by writing direct to the *United Electronics Company*, 42 Spring Street, Newark 2, New Jersey.

NEW SERVICE AID

The Friend's Record Changer Parts Company has released a sheet on its new service aid, the "Bend-R-Tool." This tool is a practical tool for bending and straightening levers in record changers.

With this tool it is possible to reach levers and parts in the changer that are inaccessible with pliers, thus making it unnecessary to lower the sub frame or main cam gear.

Further information on this tool may be obtained from *Friend's Record Changer Parts Company*, 9 North Seventh Street, Philadelphia 6, Pennsylvania by asking for sheet No. 917.

ALLIED CATALOGUE

The new 1948 catalogue called "Everything in Radio and Electronics" has been released by *Allied Radio Corporation*. This buying guide lists more than 10,000 items in its 172 pages. Complete listings of radio and electronic parts, test equipment, batteries, public address systems, radios, recording equipment, diagrams, and a wide variety of other items is to be found.

Feature items include a new low-cost television receiver, a television kit with a 12 inch viewing tube, new communications receiver, a new FM-AM console and table model radio receivers, and two chassis for custom installations.

The public address section covers equipment for sound systems from 7 to 60 watts, the latest intercom units, microphones and pickups, speakers and baffles, phono motors, cables and connectors.

A large radio amateur section includes parts and accessories to meet the requirements of all veteran and fledgling "hams." For builders and experimenters there are a wide variety of kits from the simple "one-tuber" to a 22 tube television kit, plus diagrams, accessories, and the tools and supplies necessary for the builder.

All items are arranged in clearly defined sections and are carefully indexed for speedy reference. The catalogue is available free, on request, by writing to *Allied Radio Corporation*, 833 West Jackson Boulevard, Chicago 7, Illinois.

HOFFMAN BROCHURE

Hoffman Radio Corp., recently published a 16-page brochure featuring their new line of radios and recorders.

The booklet is well illustrated with photos and descriptions of their 1948 models including the new *Hoffman* "Wirecord," a professional home recorder, and the "Musicord," a disc recorder.

The "Wirecord" is a high fidelity recorder that reproduces the full tonal

work book covering all available material, along with complete instructions on how to tie-in with FM stations. A folio of spot announcements for both AM and FM station use is provided, plus material for general publicity use.

A dealer window display is also furnished, including window streamers, window spots, and easel cards on the *Westinghouse* rainbow-tone FM. In addition, mats and proof sheets for a full page newspaper ad to be run in cooperation with the station, one for an individual dealer tie-in and three for the company's new FM receivers are provided along with 100 sixteen-page consumer brochures explaining FM and showing pictures of all *Westinghouse* FM models.

Stations installing *Westinghouse* transmitters will be provided with similar packets entitled "How to Sell Your FM Station to the Public." This material will tie-in *Westinghouse* radios and radio dealers, thereby providing a complete tool chest for FM promotion.

NEW JONES CATALOGUE

The recently published *Howard B. Jones* catalogue covering electrical connecting devices of various types, has been designed to be of maximum service to the user.

This thirty-two page catalogue includes specifications, illustrations, and suggestions for inspection, installation, etc. Each product is illustrated and, in addition, diagrammatic sketches and cutaway photographs are included for many of the items.

Copies of Catalogue #16 may be secured upon request to *Howard B. Jones Division, Cinch Manufacturing Corporation*, 2460 W. George Street, Chicago 18, Illinois.

SIBLEY DRILLING MACHINE

The *Sibley Machine & Foundry Corp.* have just issued a new catalogue, No. 67, describing their modern designed Model C-20 drilling machine.

This model is sensitive enough to handle the smaller size drills with hand feed, yet has ample power to drill 1½ inches in mild steel, or its equivalent in other metals.

The rigidity of the stationary head assures accuracy in precision work. Exact table alignment can be obtained by boring the table arm after assembly with the same spindle furnished on the machine. Table surface is held at right angles to the spindle to seven thousandths in six inches. Oil grooves in the rectangular table permit the use of a coolant. The precision ground spindle is equipped with two ball thrust bearings, with spindle speeds ranging from 65 r.p.m. to 1360 r.p.m.

The geared power feed operates in an oil reservoir and provides feeds of .003", .006", and .010" per spindle revolution. Selection of feed is made by simply turning the dial indicator.

This catalogue is available in either

April, 1948

make henry your hallicrafters headquarters

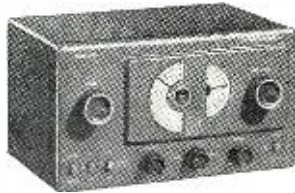

S-38 Biggest little buy on the market. Frequency range: 540 kc to 32 Mc in 4 bands. Self-contained PM dynamic speaker..... **\$47.50**

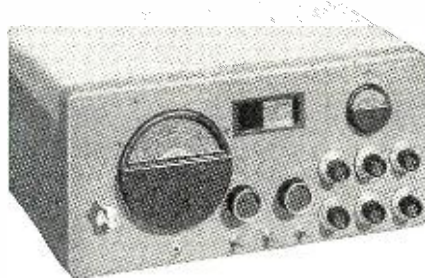

SX-43 All essential ham frequencies from 540 kc to 108 Mc. In the band of 44 to 55 Mc, wide band FM or narrow band AM, just right for narrow band FM reception is provided. **\$169.50**

COMPLETE STOCKS . . . Henry has everything in the ham field.
QUICK DELIVERY . . . Shipments 4 hours after receipt of order.

EASY TERMS . . . I have the World's Best Terms because I finance the terms myself and cooperate with you. I save you time and money. Write for details.

TEN DAY FREE TRIAL . . . Try any receiver ten days. Return it for full refund if not satisfied.

FREE NINETY DAY SERVICE . . . I service everything I sell free for 90 days. At a reasonable price after 90 days.

TRADE-INS . . . Trade-ins solicited. Big allowances made. Other jobbers say we allow too much. Write, wire, or phone. Tell me what you want and what you have to trade.

BUTLER MISSOURI **HENRY RADIO STORES** 11240 Olympic Blvd. LOS ANGELES 25 CALIF.
"World's Largest Distributor of Short Wave Receivers"

PEN-OSCIL-LITE
Extremely convenient test oscillator for all radio servicing; alignment • Small as a pen • Self powered • Range from 700 cycles audio to over 600 megacycles u.h.f. • Output from zero to 125 v. • Low in cost • Used by Signal Corps • Write for information.
GENERAL TEST EQUIPMENT
38 Argyle Buffalo 9, N. Y.

RADIO
Technician and Radio Service Courses
FM and TELEVISION
American Radio Institute
101 West 63rd St., New York 23, N. Y.
Approved Under GI Bill of Rights
Licensed by New York State

WRIGHT VERIFIED SPEAKERS
"They Glorify The Tone"
2232 University Avenue **WRIGHT** inc. St. Paul 4, Minnesota

MORE FEATURES

for your money in
this miniature

AM SUPERHET TUNER

with self-contained Power Supply
by "Adaptol"



Adaptol offers the outstanding buy in compact, efficient A.C. Superhet Tuners (540 to 1700 KC). Here are just a few of the useful applications:— Highly suitable for use in conjunction with *wire and tape recorders* . . . Installed in record player, makes *phono-radio combination* . . . Has many experimental uses . . . Tuner for custom-built radios . . . For modernizing obsolete radios and P.A. systems . . . For conversion of military, foreign, and short wave receivers to broadcast band at the flick of a switch. **CIRCUIT FEATURES:**—Self-contained power supply for 110V. AC-DC 50-60 cycles . . . Three tube circuit of conventional design, using the latest miniature and dual purpose tubes . . . Permeability tuned drift-free I.F.'s. **COMPACT:** Approximately 4 3/4" x 3 1/2" x 3 3/4".

List price \$20.00 complete with tubes. Add 5% west of Rockies. FOB Brooklyn, N. Y. See your local distributor, or write for further information to:

**ADAPTOL CO., 120 New Lots Ave.,
Brooklyn, N. Y.**

Just off the Press! 1948 Radolek RADIO PROFIT GUIDE



**NEW
COMPLETE
RADIO
PROFIT
GUIDE
FREE**

**Radio Repair Parts • Tools
Sound Systems • Tubes
Phono Equipment & Supplies
Test Instruments • Etc.**

Big, new ENLARGED complete catalog showing thousands of Radio Bargains sent to you immediately. Helpful, money-saving buying information. Send coupon today!

**BIG VALUES, LARGE STOCKS,
FAST, DEPENDABLE SERVICE.**

FREE...SEND TODAY

RADOLEK CO., Dept. B-048
601 W. Randolph St., Chicago 6, Ill.
Please send your Free Profit Guide Catalog and regular Supplements.

Name
Address
City.....Zone.....State.....

SAVE AT RADOLEK

Manufacturers' Literature

Readers are asked to write directly to the manufacturer for the literature. By mentioning RADIO NEWS, the issue and page, and enclosing the proper amount, when indicated, delay will be prevented.

TWO-WAY SPEAKER SYSTEMS

The *Colortone Company* of South Bend, Indiana have released a folder on their new 1948 line of two-way speakers.

These speaker systems are designed for sound-on-film reproduction and high quality public address systems. They employ high and low frequency speaker units and are suitable for professional uses such as playback of transcription records, auditorium entertainment, electronic organ music, and public address installation. Incorporated is a type N-300 frequency crossover network necessary for operating two-way speaker systems.

Both the high and low frequency speakers employ 25 watt permanent magnet speaker units with a combined frequency range of 50 to 9000 cycles. These speaker systems are furnished with a low and high frequency speaker unit, low frequency reflex cabinet, high frequency projector horn, crossover network, and the necessary hardware for mounting the assemblies. Side wings, which will increase the forward projection of the bass frequencies are offered in three sizes.

Further information will be furnished by the *Colortone Company*, South Bend 15, Indiana.

PACKAGED A.C. GENERATORS

"How to Apply 'Packaged' A-C Generators" is the title of a booklet recently published by the *Electric Machinery Mfg. Company*.

The "Packaged" generator consists of three main parts; a revolving-field a.c. generator, which is driven by the engine and which generates the a.c. electric power; the direct current exciter, which is connected directly to the generator shaft and furnishes excitation for the generator field winding; and the generator control cabinet. This cabinet, mounted on the generator, encloses the meter for reading the voltage, current, and "Regulelectric" circuit.

These three components are manufactured and assembled at the factory so that when the generator arrives it is ready to be connected to the engine and have the line connected. No switchboard is necessary with these units.

Protective enclosures keep drip and dirt out of the generator. Voltage selection is obtained with a built-in voltage regulator that requires no maintenance or attention.

Further information on this generator line is included in the "E-M Synchronizer," Vol. 8, No. 3a, which is

available from *Electric Machinery Mfg. Company*, 821 Second Avenue S.E., Minneapolis 14, Minn.

DIE-LESS DUPLICATING

A new edition of the 40-page *Di-Acro* catalogue has just been released by the *O'Neil-Irwin Manufacturing Company* of Lake City, Minnesota. This booklet contains illustrations and specifications on all *Di-Acro* precision machines which are now available in six different types and 18 different sizes.

These machines accurately duplicate parts making it unnecessary to make numerous dies. A simple adjustment on the *Di-Acro* machines allows changes to be made right on the job. This equipment can be readily adjusted to cover an unlimited range of duplicating requirements in a wide variety of materials, thereby making these precision machines valuable for the fabrication of a few experimental pieces or quantity production runs.

This catalogue is available from *O'Neil-Irwin Manufacturing Company*, Lake City, Minnesota.

POINT-TO-POINT COMMUNICATION

A booklet describing new point-to-point radio communication equipment is now being offered by *Westinghouse Electric Corporation*.

This 8-page booklet shows how *Westinghouse* type MV equipment can meet all radio communication demands by offering several types of service from one transmitter; on-off telegraphy, frequency shift keying, facsimile, m.c.w., and radio-telephony.

Typical applications for this equipment are ship-to-shore, between airports, and industrial communication systems such as mining, lumbering, and construction.

A center spread chart illustrates the inherent "building block" design, by which only those units needed to perform specific tasks need be incorporated in any final assembly. Copies of this booklet (B-3945) can be obtained from *Westinghouse Electric Corporation*, P.O. Box 868, Pittsburgh 30, Pa.

FM PROMOTION KIT

The Home Radio Division of *Westinghouse Electric Corporation* has prepared a complete promotion kit to give adequate material for FM promotion for *Westinghouse* distributors.

The package includes all necessary tools to meet the urgent demand for retail promotion to help build FM station audiences for new or existing stations. Materials consist of a complete

complete bands—both broadcast and overseas.

Prices and additional details on this

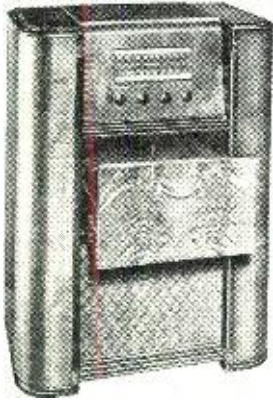

unit will be supplied on request by *Crosley Division, Avco Manufacturing Corporation, Cincinnati, Ohio.*

WIRE RECORDER

National Polytronics, Inc. has announced its entry into the wire recorder field with the Model 5-A unit.

This utility-type, ten-minute recorder comes complete with self-contained amplifier and microphone. The wire used for recording may be reused thousands of times as the machine automatically erases previous material when new recordings are made. Editing can be accomplished on this machine by either erasing unwanted portions or cutting the wire and tying with a square knot.

Designed to be marketed in the low price field, *National Polytronics, Inc.,*



2430 Atlantic Avenue, Brooklyn, New York will supply prices and additional information on this wire recorder to those requesting this data. -30-



"Psst! Better play with the toys for a while. We can figure out the max. plate rating later!"

Modern Hams Junk Old-Style "Cans"!



First basic improvement in headset design in 50 years

TELEX MONOSET

- Gives clear, crisp "near as here" reception
- Blocks outside noise
- Eliminates that "top-heavy" feeling
- Ends headachy ear pressure

Man, what relief to get rid of those pressure headaches from old-style earphones!

The TELEX MONOSET swings lightly under the chin like a stethoscope—never gets in your hair! The TELEX MONOSET delivers the signal into the ears, excludes all room noise automatically. The TELEX MONOSET gives undistorted output at maximum volume... plenty of "sock" easily adjusted with the built-in volume control.

Modernize your rig with a MONOSET—successor to the earphone! Write Department BT for information.



Canadian Distributors

Sono Film, Ltd., Winnipeg

"RANGE MASTER" MODEL 10

The 8-in-1 Service Instrument

A precision instrument for RADIO TESTING, Appliance Repairing, Service Calls, Amateur and Experimental Work.

Covers these 25 ranges.

- (1) CAPACITY .001-.1, .01-1, .1-10 Mfd.
- (2) A.C. CURRENT 0-.150, 0-.1.5, 0-15 amps.
- (3) A.C. VOLTAGE 1 10 100 500 1000 volts.
- (4) D.C. VOLTAGE 10 100 500 1000 volts.
- (5) D.C. CURRENT 1 10 100 1000 milliamps.
- (6) RESISTANCE 0 to 10,000 100,000 1 megohm.
- (7) Special High range ohmmeter to 2 megs and 20 megs.
- (8) Sensitive A.C. microammeter to 900 microamps.

TELEVISION SERVICEMEN

... why guess, measure! This is the only instrument in its class that can be used as an **OSCILLOSCOPE CALIBRATOR.**

Available in KIT form, or assembled.

- Complete KIT and Instruction.....\$17.95 net
- Bench Model (assembled)..... 23.50 net
- Foundation Meter with 3-color scale, schematic and operating instructions..... 7.85 net
- Test leads..... .85

Prices 3% higher west of the Rockies

Ask your local distributor, or write to Dept. R.N. BRADSHAW INSTRUMENTS CO. 348 Livingston Street Brooklyn 17, New York

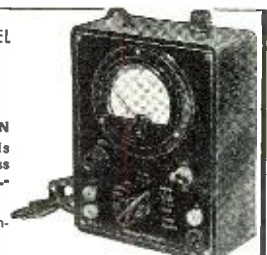

HERE'S A 5 TUBE RADIO KIT

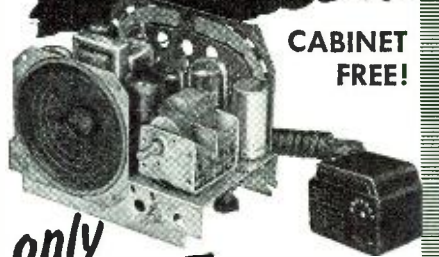

CABINET FREE!

only \$9.95 COMPLETE WITH TUBES
★
YOU GET EVERYTHING
Yes EVERYTHING YOU NEED

for the complete successful assembly of this excellent radio
• 5 Tube Superhetrodyne • Tuning from 520 KC to 1590 KC • P.M. Speaker • Built-In Antenna • 456 KC IF
• AC DC Current • All Sockets and Terminal Strip riveted into chassis • Automatic Volume Control • Tube Complement - 12SA7, 12SK7, 12SQ7, 50L6, 35W4 • Can Be Aligned Without Servicing Instruments.

DON'T DELAY — ORDER TODAY!
Prices do not include solder and wire.

Simple to Assemble!

No complicated instructions to follow. So simple you can build this 5 tube kit from only one simple diagram. No previous experience required. Yes, this is the kit you've always wanted!

25% Deposit on All Orders. Balance C.O.D. F.O.B. New York
SENCORADIO, INC.
71 WEST BROADWAY, N. Y. 7 • BECKMAN 3-6498

Columbia

APRIL SPECIALS!

Switch Replacement Cord

18 Ga. 11 foot Ivory parallel cord with feed through on and off switch inserted in cord. Non-breakable rubber male plug. An ideal replacement cord for fans, ventilators and any number of other uses. A real value. Each 60c

Microphone Cable

Flexible, stranded, all rubber shielded mike cable. Single conductor. Stock up at this low price. 100 ft. coil, \$3.95

For Radio Experimenters, "Hams", etc. Electrical Wire Assortment

Unbeatable Value!

INCLUDES: 100 ft. plastic insulating tubing and sleeving—20 ft. each of 5 sizes—400 ft. plastic insulated stranded flexible wire (insulation highly resistant to acids, water, oil, abrasions, etc.), 100 ft. each of 22, 20, 18 and 16 gauge; one 10 ft. 18 Ga. 2 conductor heavy duty round rubber extension cord set with male rubber plug and female connector on opposite end (ideal for extending power for portable equip. etc.); one 9 ft. cord set with male rubber plug and 3-way table-tap on opposite end; three 6 ft. 18 Ga. 2 conductor cord sets—1 black, 1 brown, 1 ivory (excellent as replacement for lamps, radios, etc.); one 6 ft. 18 Ga. asbestos heater cord set with rubber male plug and heavy duty connector for irons, toasters, etc.; one 100 ft. coil of 7/8 bare copper aerial wire; 3 heavy duty rubber replacement plugs . . . \$10.00 value

\$5.00

NOW ONLY
We carry in stock for immediate delivery many types of wire and cable in gauges of from 23 to 2, in addition to various types of multi-conductor cable for many uses. We also manufacture cord sets and cables to specifications. Send us your inquiries for prompt attention.

OUR NEW CATALOG IS NOW AVAILABLE FOR DISTRIBUTION
Write for your copy today!

COLUMBIA WIRE & SUPPLY CO.
5734 ELSTON AVE.
CHICAGO 30, ILLINOIS

The full-vision, straight-line dial is illuminated by two pilot lights.

The Model 77U is 10½" x 17¾" x 18¾". Engineering features include an improved automatic record changer.



er, a "Silent Sapphire" pickup, a.v.c., and built-in "Magic Loop" antenna. The receiver uses six tubes and one rectifier.

The RCA Victor Division of Radio Corporation of America will supply full information on the Model 77U upon request.

CUSTOM RECEIVER

Freedom from drift and the elimination of any need for a tuning indicator are two features being claimed by *The Radio Craftsmen, Inc.* for its new Model 1-2-3 receiving unit.

The new model incorporates an AM-FM tuner, a high-fidelity amplifier, and a 12" speaker, the whole unit being designed for custom installations.

The FM circuit of the tuner automatically compensates for drift and keeps the set in perfect tune by means of a.f.c. Besides offering flexibility in mounting arrangements, the new Model 1-2-3 has self-contained internally-switched inputs for phonograph, recorder, television sound, or microphone and multiple outputs to

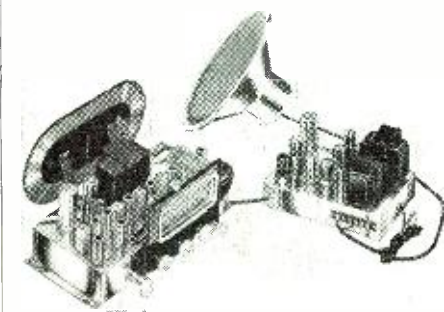

adapt to many sizes and quantities of speakers, or transmission line.

For further information and descriptive literature, write *The Radio Craftsmen, Inc.*, 1341 South Michigan Avenue, Chicago 5, Illinois.

ZENITH CONSOLE

Zenith Radio Corporation of Chicago has announced a new console radio which provides AM and FM reception as well as an automatic phonograph.

Named "The Regent," this new combination features the company's "Cobra" tone arm and "Intermix" record changer, two-band Armstrong FM, as well as AM reception. The "Radiorgan" tone control enables the listener to select any one of 64 tonal effects. A 12 inch speaker is used in this receiver. The silent-speed "Intermix" record changer automatically changes twelve 10 and 12 inch records intermixed, twelve 12" or fourteen 10" records. Storage space for record albums is also furnished.

"The Regent" is housed in a simply designed cabinet which is finished in selected American walnut veneers. The radio tilts out to a convenient, waist-high tuning position and the phonograph slides forward as the door is opened.

Additional information on this combination radio may be secured from *Zenith Radio Corporation*, 6001 West Dickens Avenue, Chicago 39, Illinois.

LOW PRICED CONSOLE

Shipment has started on *General Electric Company's* new low price ra-



dio-phonograph console, the Model 119.

The new receiver is supplied in both mahogany and walnut cabinets and is designed to provide ample space for record storage. A full lift-top covers the phonograph with its automatic record changer and the radio controls. The receiver is equipped with a 12 inch Alnico V magnet loudspeaker and has a built-in "Beamascope" antenna.

Further information on the Model 119 may be secured from the *Receiver Division, General Electric Company*, Syracuse, New York.

CROSLEY CONSOLE

A new, low-priced radio-phonograph combination, the Model 68 CR, has been announced by the *Crosley Division* of the *Avco Manufacturing Corporation*.

The new receiver features the *Crosley* "floating jewel" tone system and is housed in an American walnut cabinet measuring 36" x 27" x 14¾".

A fast, jam-proof automatic record changer plays twelve 10" or ten 12" records. The chassis is equipped with a 10" electrodynamic speaker, has continuous tone control, automatic sensitivity control, and covers two

plification for interference immunity in the picture and an r.f. stage for less interference.

The top, front, and back are removable so that the chassis may be serviced without taking it out of the cabinet. The circuits of the set are fused for safety.

Those wishing additional details on this unit should write to *United States Television Mfg. Corp.*, 3 West 61 Street, New York 23, New York.

"TELEVISION OPTIONAL"

A revolutionary idea in home receiver merchandising has been introduced by *Admiral Corporation* of Chicago.

The innovation, called "television optional," offers matching television consoles, radio-phonograph combinations, and record cabinets, which may be bought separately and matched at any time.

This new method of merchandising offers several advantages; the family of moderate income can plan on both a radio-phonograph and a television set and buy them one at a time to distribute the over-all cost and still have matched units; the family which



has been hesitating about buying a three-way set for fear of obsolescence can now protect its investment by buying the units separately, the radio-phonograph and the TV receiver may be used together, separately, or even in different rooms; as the units are styled to fit the sectional trend in furniture design, they will fit many decorative schemes.

Additional details on this new "television optional" line will be supplied by *Admiral Corporation*, Chicago, Illinois to those requesting them.

TABLE MODEL COMBINATION

A new table model radio-phonograph combination, the Model 77U, featuring the largest speaker ever employed in a comparable *RCA Victor* instrument and 50 per-cent more power output than is usual in such an instrument, has been announced by *Radio Corporation of America*.

The veneered cabinet, available in walnut or mahogany finish, is of streamlined modern design and features a cut-back lid fitted with a satin-finish, brass-plated handle for convenient lifting. The tuning and control knobs for the phonograph and standard broadcast radio units are located on the outside of the cabinet.

April, 1948

It's RADIONIC for PRICE • It's RADIONIC for VALUE • It's RADIONIC for DELIVERY

FREE RADIONIC CATALOG



It's a must for all

- Service Dealers
- Amateurs
- Experimenters
- Industrials
- Institutions
- Government Agencies

TRANSVISION'S

15" GIANT TUBE KIT
(120 sq. in.,

\$372.95 list
(includes 88-108 inc. FM)



WRITE FOR DEALER'S PRICES
SPECIAL OFFER: To see for yourself, you may order the instructions separately. Includes parts list, schematic diagrams, stage by stage drawings, etc. Send \$1.75, credit applied to your kit when ordered.

CHANCELLOR RADIO • TELEVISION KITS AND COMPONENTS • RADIOS • TEST INSTRUMENTS • PARTS AND ACCESSORIES • INTER-COMMUNICATORS • DISC AND WIRE RECORDERS • PUBLIC ADDRESS • AMATEUR EQUIPMENT • TUBES • RECORD CHANGERS • TECHNICAL BOOKS • HARDWARE

RADIONIC EQUIPMENT COMPANY

170 NASSAU STREET, N. Y. 7
Tribune Theatre Entrance
Telephone: WOrth 2-0421
Cable "CHANSLOR"

PRECISION TEST Instruments



Radionic presents the new PRECISION line of test equipment featuring...New design...New styling...New LOW prices...

PRECISION SERIES 40
Miniature, Wide range test set. 1000 o/p/v, AC and DC. 31 ranges to 6000 volts, 600 ma. +70 db, 5 megohms. Complete with batteries, test leads and instruction manual. Bakelite carrying case. \$23.26

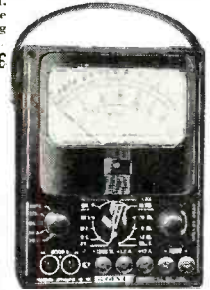

PRECISION SERIES 85
Compact, wide range super-sensitive test set. 20,000 o/p/v DC, 1000 o/p/v AC. 34 ranges to 6000 volts, 12 A. -70 db, 60 meg. Complete with batteries, test leads, operating instructions. Bakelite case. \$37.98

PRECISION SERIES 80 Physically similar to the new Series 85 but, 1000 o/p/v AC and DC. 10 megohms instead of 60. \$32.05

PRECISION SERIES 612 Up-to-the minute tube-element and short-check selection. Condenser and battery test. Portable, in hardwood case with removable cover. \$60.71

Counter Model, sloping chrome-trimmed cabinet. \$62.67

PRECISION SERIES 620
Combination tube, battery and circuit tester. A complete portable radio test lab. 1000 o/p/v AC or DC. 28 ranges to 3000 volts, 12A., +64 db., 10 megohms. Rotary switching. 4 1/2 inch 400 Ua. meter. Furnished complete with ohmmeter batteries, test leads and instructions. \$80.66

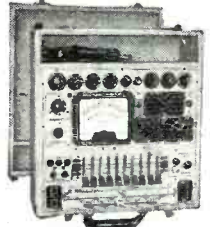

THE NEW E-200-C
Better than ever. 88 kc to 30 mc on fundamentals. 120 mc on harmonics. Maximum deviation of 1% on all bands. Vernier scale. 400 cycle audio modulates. RF up to 100%. \$62.87

Pick-up arm for Webster Mod. 56 and Mod. 70 changer to accommodate GE Variable Reluctance Pick-up. \$1.20

FREE CATALOG MAIL TODAY!

RADIONIC EQUIPMENT CO., DEPT 54
170 NASSAU STREET, NEW YORK 7, N.Y.

Send at once your free catalogs, supplements and Bargain lists as published—listing products of leading manufacturers of radio-electronic parts and equipment.
 Please send me Transvision instructions described above. I enclose \$1.75 which is returned to me if kit is ordered.

NAME.....
P.O. BOX or STREET.....
TOWN.....STATE.....

PRACTICAL TRAINING FM-RADIO-TV



Four fully-equipped laboratories provide the PRACTICAL training necessary for successful careers in Radio Communications (FCC licenses) and in Radio-Television (Technician) Servicing. Train under supervision of technical specialists—with COMMERCIAL-type equipment. Investigate why WRCI SPECIALIZED TRAINING methods are outstanding in the West; why WRCI laboratory-trained specialists are preferred for responsible positions. Read our illustrated bulletin before enrolling in any school. Approved for veteran training—non-veterans accepted. Send for free copy of Bulletin-F today.

WESTERN RADIO COMMUNICATIONS INSTITUTE
631 West Ninth Street, Los Angeles 15, California

NEW RECEIVERS for Spring Market

PORTABLE PHONOGRAPH

Audar, Inc. has just added an all-fidelity portable phonograph to its line of "Telvar" home instruments.

Known as the "Carousel," this unit is available in six color combinations



and features storage space for 10 records in a removable bottom section. The top, when removed, becomes the turntable on which either 10 or 12 inch records may be played. The unit weighs seven pounds complete.

The tone arm uses a P-89 high-fidelity crystal cartridge generating 3 volts at 1000 cycles. The unit uses a standard phonograph motor to power the turntable. The chassis is shock mounted on rubber pads to eliminate tube vibration and *Sylvania* loctals are incorporated to avoid loosening of the tubes during carrying.

Audar, Inc. of Argos, Indiana will supply full details on the "Carousel" upon request.

MEISSNER RECEPTOR

Meissner Manufacturing Division of Maguire Industries, Inc. is currently introducing the Model 8C FM receptor.

According to the company, a simple connection to any present AM radio will permit full-scale fidelity FM reception. Special features of the Model 8C include coverage of the new



FM band from 88 to 108 mc; audio fidelity, flat within plus or minus 2 db. from 50 to 15,000 c.p.s.; audio output, 3 volts r.m.s. at minimum usable signal input, 30% modulation, output

voltages as high as 15 volts r.m.s. obtained without distortion; power supply, 105 to 125 volts, 50 or 60 cycles, power consumption 35 watts; and a tube complement consisting of two type 6AG5, two type 6BA6, two type 6C4, one type 6AL5, and one type 6X5GT/G tubes.

For further information on the Model 8C write direct to the *Meissner Manufacturing Division of Maguire Industries, Inc.*, Mt. Carmel, Illinois.

CROSLLEY COMBINATION

Crosley's deluxe "Spectator," which was introduced recently to the trade, features a "Swing-a-View" picture tube which swivels over a 60 degree arc.

This all-purpose instrument provides FM, AM, and short-wave reception in addition to the automatic phonograph and television. The "Swing-a-View" picture tube mounting enables viewers to angle the screen so that they



may watch the picture directly from any point in the room within a 60 degree arc in front of the receiver.

When not in use, the picture tube swivels into a position crosswise in the cabinet and may be concealed by panels which match the mahogany cabinet.

The receiver uses seven radio tubes plus one rectifier and 23 television tubes including the 10 inch cathode-ray picture tube, plus three rectifiers. The set measures 44½" x 37½" x 18" and has storage space for records.

Further data on the "Spectator" may be secured from the *Crosley Division, Avco Manufacturing Corporation*, Cincinnati, Ohio.

G.E. TABLE TELEVISION

A compact table model television receiver, incorporating both AM and FM radio, is now in production at the *General Electric Company* plant.

Known as the Model 803, this receiver has a 10 inch direct view tube and provides reception on all 13 television channels. A separate circuit for each channel is incorporated to provide the best possible reception by merely turning the selector to the channel number on which the desired station operates.

The unit also includes the company's automatic clarifier which is said to virtually eliminate fuzzy edges



and reduce the effects of interference.

A built-in "Beamascope" is provided for AM broadcast reception. For television and FM reception convenient terminals are provided for attachment to a dipole antenna. The cabinet of genuine Honduran mahogany is designed for the home or commercial establishment where space is a consideration.

The *Receiver Division, General Electric Company*, Syracuse, New York, will supply additional details on request.

UST'S TABLE MODEL

United States Television Mfg. Corp. has entered the table model TV set field with a new 10 inch direct view unit capable of yielding a picture approximately 9 x 7 inches.

Housed in a cabinet of modern design the new receiver features four controls placed vertically for increased eye-appeal and ease of operation. The cabinet measures 22½" x 19" x 14½".

The set has a crystal picture detector which adds to picture detail. The automatic picture synchronizing controls make for easier selection in the set which has a thirteen channel tuner.

Four stages of picture i.f. amplifi-



cation and two stages of sound i.f. amplification have been incorporated along with two stages of video i.f. am-

and reradiate a certain amount of the distributed energy, and are, therefore, actually spoolers in the radiated field of the antenna.

Because it is necessary to place the parasitic dipoles in two positions, they may be turned 90 degrees against a spring by gears connecting to the antenna drive motor. The spring returns them to the non-radiating position when the power is turned off.

The antenna is mounted directly below the chassis containing the transmitter-receiver components, and is supported by a fork-type casting. Since the transmitter is fixed and the antenna rotates, a rotating joint has been arranged to transfer the energy from the magnetron transmitter to the antenna, with no change in the transmission characteristics. The antenna is driven by a 400-cycle induction motor which operates at a normal speed of 7200 r.p.m., and which is reduced by a gear train to a normal antenna rotation of 30 r.p.m.

Since not everyone in the aviation industry thinks alike it is possible that the transport industry may require modifications of this equipment, one of which might be the substitution of a 5-inch indicator, due to severe cockpit space limitations. This modification is easily accomplished and, in fact, the equipment can be operated with such an indicator, with an external control box located for easy access by the pilot. It is also probable that many of the later design aircraft are better suited to a nose installation, rather than to tolerate the drag occasioned by a belly installation, even though the nose installation reduces the radar coverage in the aft direction. The physical size of this particular unit would prohibit its installation in most of the nose areas available, but suitable modifications can be made to accomplish this. The equipment is normally able to operate with two indicators and a third could be provided, should it be required, for navigator's use.

Combining the several achievements in a single lightweight assembly has been no easy task. Now that the services have underwritten its early development, I believe the design can be produced within the economic range of the air transport industry. Coming tests by the storm-searchers, radio experts, and transport fliers should demonstrate the value of such many-in-one equipment.

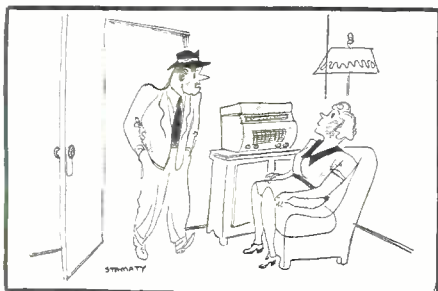

"What a gyp! They used different questions on the repeat broadcast to the West Coast!"

April, 1948

NOW READY *The only comprehensive book for the beginner!*

YOU need no other book to get your license and get on the air. Ideal for those just getting started, or getting interested, in amateur radio.

ABSOLUTELY COMPLETE

- How-to-build simple equipment for a complete station on all newcomers bands.
- Operating instructions.
- Simple theory.
- Complete section of study questions, including those needed to pass the license exams.
- U. S. A. Amateur radio regulations. Written by those masters of making-it-plain, the editors of the "Radio Handbook" and the prewar "Radio."

\$1.00 at your dealer

Please add 10c postage to mail orders.



ANTENNA MANUAL

READY—Spring, 1948

- The most comprehensive antenna book yet published, with all the old tried-and-true standards, and many a new one.

Among the new, "hot" antennas described in this book are: The BOBTAIL CURTAIN and the VERTICAL TRIAD, a couple of dx-dandies for 75 and 40. The OCTAPUSH, a single array for 40, 20, and 10! The X-CURTAIN, an improved "lazy-H." The ELECTROTATOR, an electrically rotated broadside curtain.

WRITTEN BY W. W. SMITH, W6BCX. Editor of the pre-war "Radio" and "Radio Handbook." Many of you know him as the developer or first popularizer of the Lazy-H array, the Plumber's Delight three-element rotary, the Bi-Square array, the link-coupled universal antenna coupler, and various other little gems which after many years are still helping hams snag dx, save money, avoid pink tickets for harmonics, and otherwise keep them contented.

The ANTENNA MANUAL has the same happy combination of practical how-to-build-it data and simple underlying explanations that make the "Radio Handbook" one of the largest-selling radio texts in existence.

"Sugar-coated" radiation, propagation, antenna, and transmission line theory help you understand what's going on.

Comprehensive practical data (including dimensions of course) on all the more popular antennas—and on some brand-new ones which have never before appeared in print, but about which you are going to hear a lot on the air in the near future.

A general antenna text, not exclusively for the ham. Antenna techniques and propagation data are given for all frequencies between 16 kc. and 1000 Mc. regardless of application.

\$3.50 durably clothbound

Please add 10c postage to mail orders; foreign, 25c.

More than 10,000 tubes listed!

THE WORLD'S RADIO TUBES

("Radio Tube Vade Mecum")

← NOW READY . . .

The New "1948" Seventh Edition

The Only Book of Its Kind in the World—and one of the world's largest-selling radio books.

AT YOUR FAVORITE DEALER'S

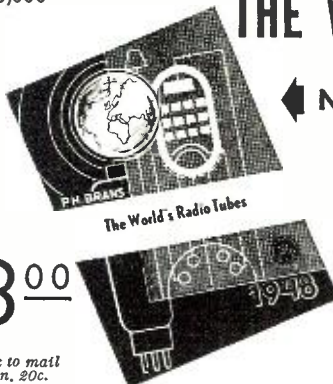

\$3.00

Please add 10c to mail orders; foreign, 20c.

Characteristic Tube Data of

- U.S.
 - BRITISH
 - FRENCH
 - CZECH
 - SWISS
 - GERMAN
 - AUSTRALIAN
 - ITALIAN
 - RUSSIAN
 - JAPANESE
 - SCANDINAVIAN
- and all other available types
- More listings than ever before • New, larger page size • Better paper and appearance

COMPLETE — In Twelve Languages

So extensive is the sale of this book, and so thorough is the coverage of tubes made in all nations, that this book is published in twelve languages!

Of the previous, smaller edition, *Electronics* said, "Here at last is the radio tube handbook radio engineers have dreamed of . . . in many carefully prepared tables and charts." "Probably the most complete and authoritative set of tube-data in existence," said *Radio Craft*.

Editors and Engineers 1302 KENWOOD ROAD Santa Barbara CALIFORNIA

BC34Q (N) R.F. UNIT Spare Part 49c ea.	NEW "FREAK" TUBES At Bargain Prices 2C261 25c 9J1 \$1.60 1223 75c 959 25c 1629 15c UX6653 25c	ANTENNA CHANGE OVER RELAYS .075 MA 24V DC 75c ea.
DN 33A DYNAMOTORS \$1.50 ea.	NEW AMPLIDYNE MOTOR GEN. \$5.00 New 24V Series Motor (AC-DC) 6000 RPM, 1/4" Shaft \$5.00	LP21A RADIO COMPASS LOOP ANTENNA NEW \$5.50 ea.
AIRCRAFT INSTRUMENTS O-150 AMP. METERS (NEW) \$2.50 AN 5531-1 G.E. TACH. GEN. \$5.00 O-40V AC VOLTMETER (400 Cycle) .. \$2.50	GI STAINLESS STEEL OXYGEN BOTTLES \$4.00 MAKE DANDY FLOATS FOR FISHERMAN ON SALT WATER	TU-5B TUNING UNIT 3000 to 1500 KC ea. \$2.00 NEW - IN ORIGINAL BOXES SHIPPING WEIGHT - 31 POUNDS
MONTHLY SPECIAL! 3/8" FRICTION TAPE 14 ROLLS \$1.00	FARWEST TRADING CO., INC. 209 1st AVE. S. SEATTLE 4, WASH. Cable Address "FARCO"	RACKS FOR COMMAND RCVRs. TYPE 453 - 4 or 5 ea. \$1.00 Also Three Channel Control Boxes for Same Complete with 3 Cannon Plugs \$1.00
		All Shipments C.O.D. Express or Parcel Post SEND 20% OR MORE DOWN.

HAMS! 80M & 40M-A1 or A3 XMTR

CAN BE ADAPTED FOR 20M — 15M — 11M — 10M; AM OR NFM.
CONTAINS ROCK-LIKE VFO-COVERS 200-500KC & 1.5-18MC.
IN ORIGINAL CASES — COMPLETE WITH TUBES — BUILT BY G-E

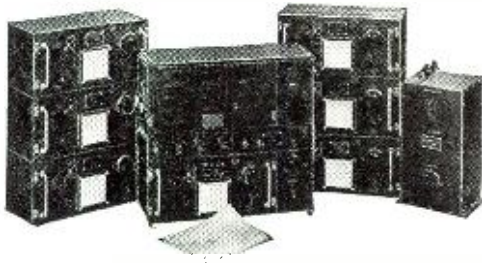

WHAT YOU GET!

- TRANSMITTER - 125 WATTS
 - ALL TUBES
 - 7 TUNING UNITS
 - ANTENNA TUNING UNIT
 - INSTRUCTION MANUAL
 - MANY REFINEMENTS
- PRICE**
\$24⁵⁰
 f.o.b. Chicago
 Shipping Weight
 275 lbs.

Hams! Here is a chance to get on the air with a fine transmitter which will operate on either 80 or 40-meters* without changes. It will provide a code (A1) or a phone (A3) unit as is when used with suitable power supply.

Contains over \$1000-worth of new radio and laboratory parts, if

it is broken up for parts, and cost over \$1800 originally. General Electric built as the BC375E.

Can be modified for NFM and for the other ham bands down to 10M without too much trouble.

RF output is in the neighborhood of 125 watts. Stability is excellent.

*Or any frequency within original range.

SURPLUS ASSETS CORP. CHICAGO 8, ILLINOIS

RADIO COURSES

Preparatory, Broadcast, Marine Operating, Servicing, Aeronautical, Television, Frequency Modulation, Radar.

Classes now forming for June 1st. Entrance Exam. May 17th.

Veteran Training. Literature.

COMMERCIAL RADIO INSTITUTE
(Founded 1920)
38 W. Biddle St. Baltimore 1, Md.

WHILE THEY LAST \$11.95

110 Volt AC Superheterodyne Receiver

This crystal fixed frequency receiver comes with full conversion instruction for variable tuning of all ham bands and broadcast. A highly selective superheterodyne receiver, 110 V.A.C. power supply built in. Uses the following tubes: 6K7—RF Amplifier; 6K8—Mixer and Oscillator; 6K7—L.F. Amplifier; 6F7—Detector and A.V.C.; 6C8—Output and Noise Suppressor; 80—Rectifier. Dimensions: —3½ x 19 x 11½ inches. Comes complete, brand new, with one set of coils and two sets of tubes. All orders will be shipped freight Collect.

AMERICAN & FOREIGN ASSOCIATES
1506A Widener Building—Philadelphia 7, Penna.
Telephone, Rittenhouse 6-4173—6-4174

SURPLUS SPECIALS—Small 110 v. AC open frame motors, ½" shaft, 2700 R.P.M., 1/70 H.P., mfg. by BARBER COLMAN CO. \$2.00 ea.
Universal Motor 115 v. AC-DC. \$6.00
 1/36 H.P. 5000 R.P.M. Mfg. by G.E.

CAPACITORS	
1100 MFD. 50 Volt	\$1.25
1500 MFD. 50 Volt	1.65
2000 MFD. 50 Volt	1.95
500 MFD. 200 Volt	1.75
SWITCHES	
Slide Switch: Stackpole DPDT	\$0.15
SPDT Momentary, Center Off Position, Long Bat Handle	.29
4 Pole DT 10A, 125 V.	.50
SPDT Center Off Position, 6A, 125 V.	.29
Toggle Bat Handle DPST	.35
CONDENSERS	
Condensers, Variable, Dual 2.5 to 10MMF	\$0.45
2 Gang 260 MMF Per Section—¼" Shaft Mycatex	1.00
Condensers, Variable, Ceramic Insul. Shaft 5/16 x ¾" L.	
C115-10-45 MMF with Coil, Tunes to 31 MCS	.50
C122-7-27 MMF with Coil, Tunes to 58 MCS	.50
C106-11-115 MMF	.35
15-330 MMF ¼" Shaft Brass Plate, Ceramic	.75
Oil Filled Condensers:	
.03 MFD. 7500 V. DC	1.15
.30 MFD. 2000 V. DC	.65
1 MFD. 2500 V. DC	1.25
1 MFD. 1200 V. DC	.85
4 MFD. 2000 V. DC	2.15
10 MFD. 1500 V. DC	3.15

No sale less than \$2.00. All prices FOB New York City. Add 25c to cover postage. 20% Deposit required with all orders—all Prices Subject to change without notice.

A. M. RADIO SALES COMPANY

345 CANAL ST. NEW YORK CITY 13, N. Y.

"A. M." Specials!

MISCELLANEOUS

PL259A Coax Connector and Socket. Silver Plated for RG8U and RG11U...	\$0.60 Pr.
3 A.G. Bakelite Fuse Post	.25
4 A.G. Bakelite Fuse Post	.25
Right Angle Adapter M359A	.30
Mica Trimmers: Variable 3-30 Mmfd 4 Gang	.20
Variable Ceramicon 4-30 mmf. 7-45 mmf.	.25
Filament Transformer: 5 volts @ 4 amp. 110 volt pri. open frame, porcelain standoffs. Mfd. by G.E.	1.50
0 to 15 DC Milliammeter, Simpson 3½" Bakelite Case	2.95
Pilot Light Assy. Ruby Jewel complete with 110 v. AC Candelabra base bulk	.50
12 v. Edwards' Buzzer complete with push button	.40
Rectifier, Copper Oxide. Full wave 110 VAC input, 100 VDC @ 1 amp. output.	3.50
Solenoid, 6VDC complete with plunger and mtg. Bracket	1.25
Microphone, T 12 with push to talk Switch Cord & Plug. Like new	.59
Sound Powered Phones, TS 10K (Unused)	25.00 Pr.

SYNCHRONOUS MOTOR
½" shaft 110 v. AC 60 cy. 4/5, 1, 1 1/5, 1 1/2 RPM 2.2 watts. Mfg. by Hayden Mfg. Co. \$1.75

the mixer unit so that the receiver is isolated from the transmitter, meaning that a common antenna-waveguide assembly is used for both transmission and reception.

Signals and other radar indications appear on a circular tube face in the conventional PPI pattern such that the zero azimuth position on top of the tube represents straight ahead, and the other azimuth positions are calibrated in a 360-degree interval around the top. Since the antenna rotates constantly, it furnishes a complete azimuth picture at all times, which continues to change as the aircraft moves. The various functions of the equipment are obtained by combinations of changes to the radar characteristics, particularly the transmitting characteristics. For instance, in switching from "search" to "weather," the transmitter pulse is lengthened by a factor of approximately three. In switching from "search" to "beacon," the transmitter pulse is likewise increased, and at the same time, the transmitted antenna pattern as well as the received antenna pattern is changed from a narrow vertical beam to a broad vertical beam, and the receiver frequency is shifted approximately 50 megacycles.

The antenna system consists of an 18-inch diameter parabolic reflector with a double dipole radiator located at the focal point of the parabola and fed from a standard X-band waveguide. In addition, a double parasitic dipole is located on top of the antenna feed, and immediately behind the normal dipole radiators. This parasitic dipole is arranged in such a manner that it can be actuated so that its dipoles are parallel to, and therefore parasitic to the radiating dipoles. The parasitic dipoles are free to rotate 90 degrees, so that they are then 90 degrees with respect to the radiating dipoles and their effect is negligible. It is by the use of such an arrangement at the frequency of 9375 megacycles that it is possible to focus nearly all the energy radiated into a very narrow beam. The beam will be approximately six degrees wide in the horizontal and vertical dimensions at the half-power points. This energy, by reason of the dipoles' horizontal position, is horizontally polarized—the most effective type of polarization on search type radar for use in detecting land and sea targets. It is also necessary that the energy be horizontally polarized for beacon operation, as the beacon antennas themselves are horizontally polarized.

When the parasitic dipole arrangement is used, a certain amount of the radiated energy is deflected downward toward the earth's surface so that there is, in effect, what amounts to a cosecant-square pattern of radiated energy. The parasitic dipoles are tilted slightly with respect to the axis so that they can radiate in a downward direction. Being located in the path of the energy being reflected to the parabolic reflector, they absorb

obtained on the equal energy path, it then becomes possible to see only those objects projecting into the flight path of the aircraft.

The third position is for "beacon operation" and it provides for the interrogation of ground radar beacons. These ground radar beacons have been established by the Army, Navy, and Coast Guard at various well-known geographical locations. It is possible for the radar to interrogate them so that they in turn show a signal on the indicator, which is suitably coded to indicate the beacon station identification and at the same time provide an accurate measure of azimuth and range to the particular beacon. Thus, precise navigation is possible through beacon operation.

The fourth position is for use in obtaining "weather information." Probably one of the most valuable assets of the transport radar is its ability to observe weather phenomena. By utilizing a pencil type of beam and tipping the antenna upwards to eliminate any reflection from the ground, it is possible to search the sky for heavy rain-bearing clouds, thunderstorms, and areas of super-cooled water. These manifest themselves by peculiar displays on the indicator which are easily recognized by an observer with practice. It is thus possible for transport aircraft to avoid such areas of possible danger. It is also possible, by mapping such areas by radar, to pick the narrowest or "softest" spot, if indeed it is not possible to avoid the weather altogether. Also, by searching in layers in a vertical direction, it is quite possible to find layers where a minimum of weather disturbances prevail so that flight altitudes may be changed to take advantage of such a situation.

The other controls to be operated by the pilot are (3) a receiver sensitivity control which, as its name implies, governs the sensitivity and hence the signal indication on the indicator. An intensity control (4) is used for governing the intensity of the display on the indicator tube primarily for adjustment under different cockpit lighting conditions. Lastly, there is a (5) trim control, which provides arbitrary displacement of the center of stabilization on the pitch axis over a range of plus or minus 7½ degrees.

Operation of APS-42 is similar to all centimeter type radar equipment, in that it transmits a high power pulse of very short duration through a waveguide assembly to an antenna which focuses the energy to a very narrow beam and rotates the beam in azimuth. Timing of the transmitted pulse is very precise, and the time required for the transmitted pulse to be sent out and reflected from a target is so measured by the equipment that the distances are recorded with good accuracy. Received echoes are picked up by the same antenna assembly, and fed into the same waveguide assembly, separation taking place at

**your
basic
3R's
for correct
current control**

Ward Leonard
RELAYS

Ward Leonard
RESISTORS

Ward Leonard
RHEOSTATS



RELAYS—provide convenient circuit control, protection, and greater operating efficiency . . . help reduce length of connecting leads. Amateur Relays available from stock: Antenna Change-Over, Antenna Grounding, Keying, Band Switching, RF Break-In, Safety, Overload, Underload, Latch-In, Remote Control, Sensitive, Time Delay. Also Industrial and General-Purpose Relays.

RESISTORS—exclusive features of VITROHM wire-wound resistors insure that *extra* performance needed in critical circuits. Fixed type in 8 stock sizes from 5 to 200 watts. Adjustable type in 7 stock sizes from 10 to 200 watts. Wide range of resistance values. Stripohm, Discohm, and Plaque types also available.

RHEOSTATS—for fixed or variable close control. Protected by tough, acid resistant, crazeless vitreous enamel. Sizes: 25, 50, 100, and 150 watts, in wide range of resistances.

Authorized Distributors Everywhere

WARD LEONARD ELECTRIC COMPANY
Radio and Electronic Distributor Division
53-N West Jackson Blvd., Chicago 4, U. S. A.

WARD LEONARD

RELAYS • RESISTORS • RHEOSTATS

Electric control devices since 1892

SEND FOR
FREE CATALOGS

Write for Amateur Relay Catalog No. D-111, and for Resistor-Rheostat Catalog No. D-2.

QUANTITY SURPLUS BUYERS

We Offer Quick Delivery On Your Largest Orders.

Our large inventory of electronic equipment and parts includes many of those hard-to-get items. Much of our stock is stored in Eastern warehouses, affording quick, low-cost delivery of large orders. Send for latest inventory lists (use your business letterhead, please). Phone and telegraph inquiries invited. Liberal quantity discounts allowed.



G. & M. EQUIPMENT CO., Inc.

4505 VAN NUYS BOULEVARD • VAN NUYS, CALIFORNIA • STATE 4-3233

BATHTUBS 5¢ EA.

3—1 MFD.—600 VDC SPRAGUE No. CP505EF104V NEW

3 MFD.—400 VDC POTTER CA259 NEW

NEON FUSE INDICATORS.....2c ea.
Lamar F-B. 0-30A. 110-220V. w/limiting resistors. Excellent RF indicator. Factory carton 150 for\$2.79

SELSYNS
MODEL No. 2J1G1. Operate from 25 to 30 volts 60 cycle OD 4½x2¼" dia. Net weight 1¼ lbs. Taken from unused equipment.

49¢ EA.

10,000 OHM PLATE OPERATED RELAY
GE No. CR2791B109P36. Opens one circuit and closes another. Can be connected for SPDT. Plastic dust shield. OD 2x1½x1½". Designed to operate in plate of 6SN7GT. Taken out of new equipment. **49c EA.**

MICA TRIMMER
18-180 MMFD. Isolantite mounting. Crysoon No. T52310. OD ¾x¾x¾". New. **5c EA.**

PE-103-A PLUG & MATCHING RECEPTACLE PAIR
3 contact plug and socket part of SCR-284. New. **69c PAIR**

Satisfaction Guaranteed or Your Money Back
HUNDREDS OF SURPLUS BARGAINS IN OUR FREE ILLUSTRATED LIST
DICK ROSE **ERECO**
2912 HEWITT AVE. EVERETT 20, WASH.

MEMO To The Radioman who wants Financial Security

Hundreds of radiomen all over the country are discovering for themselves a new and profitable adjunct to their own business in the field of coin operated radios. They've found it to be a sure-fire means of supplementing their income with a minimum investment in both time and money. And they're doing it right in their own backyards, too, by installing TRADIO and TRADIO-ETTE, the radios specifically designed for coin operation in hotels, tourist camps, restaurants, taverns, hospitals, etc.

TRADIO ★ Tried ★ Tested ★ Proven

TRADIO has pioneered in this new and flourishing post-war field. Get in on the ground floor and assure yourself of financial security for life.

 ★ TRADIO sells to operators only through franchised distributors. No routes are sold. For further information, we'll put you in touch with the distributor in your territory if you'll phone Asbury Park 2-7447 or write TRADIO, INC., Dept. P-4, Asbury Park, N. J.

TRADIO, Inc. ASBURY PARK NEW JERSEY

channels. However, two separate transmitters and transmitting antennas must then be used.

It is strongly suggested that the model sailboat enthusiast ally himself with some competent radio amateur rather than try to build his own control equipment, for though the radio gear is simple as radio gear goes, still the experience factor in the building and "de-bugging" stages of the project will count for a lot of wasted time and sleepless nights.

-30-

APS-42 Radar
(Continued from page 45)

approximately 6 degrees in width in the vertical direction. The beam is useful for detecting any obstacle, either other aircraft in flight or high ground obstacles, such as a mountain range projecting into the path of the aircraft in flight. By eliminating the reflections from the ground in the vicinity of the aircraft, such as are

GROUND-GRID AMPLIFIERS

By MILTON S. KIVER

IT is well-known by radio engineers that the simple triode tube is, in many instances, preferable to a pentode in the r.f. amplifier stage of a high-frequency receiver. This is due to its lower noise factor. In a sensitive receiver, tube and circuit noise assume greatest importance in the r.f. amplifier and mixer stages. Noise is generated in a tube because the electron current flow is not a continuous fluid but composed of a large number of separate, individual electron particles. At any one instant, more electrons are impinging on the plate than at some other moment. Over any time interval, the current is steady, but instantaneously it fluctuates quite rapidly. These instantaneous fluctuations represent the noise component. In a resistor (or other conductor) there is a random motion of electrons which also results in noise voltages. Both together are generally around 15 microvolts or less. This seemingly minute voltage is important at the front end of the receiver because the incoming signal strength may not be much greater. Hence, the tube generating the least amount of noise is desirable and the triode, in this respect is 3 to 5 times better than a pentode. However, triodes have a marked tendency to oscillate. Neutralization is not desirable because it requires the addition of several components and can, at times, be critical in adjustment.

Recently, an arrangement known as the grounded-grid amplifier has permitted the use of triode r.f. amplifiers with good results. The grounded-grid amplifier is contrasted with the conventional amplifier in Fig. 1. Note that

the grid of the tube is at r.f. ground potential and that the signal is fed to the cathode. The tube still functions as an amplifier because the flow of plate current is controlled by the grid-to-cathode potential. Instead of varying the grid potential and maintaining the cathode fixed, the grid is fixed and the cathode potential is varied. The net result is still the same. In addition, the grid, being grounded, acts as a shield between the input and output circuits, thereby preventing the feedback of energy which is so essential to the development of oscillations.

The grounded-grid amplifier also offers low input impedance, enabling the amplifier to match the antenna transmission line impedance. The low impedance provides a broader bandpass characteristic which is particularly essential to 6 mc. television signals.

A disadvantage of a grounded-grid amplifier is the inherent degeneration which is present in the circuit. When the input signal drives the cathode increasingly negative, the effect is the same as though the cathode had remained fixed and the grid was made positive.

The plate current flow increases, producing a larger current flow through the cathode circuit. A larger voltage drop is developed across the circuit in the cathode leg with a polarity as shown by the dotted lines in Fig. 1A. The result, therefore, is to produce a voltage drop which opposes the driving voltage of the signal and this opposition reduces the effect of the signal. This is detrimental to the reception of lower than normal signals.

-30-

Fig. 1. A comparison between the grounded-grid (A) and conventional r.f. amplifier (B).

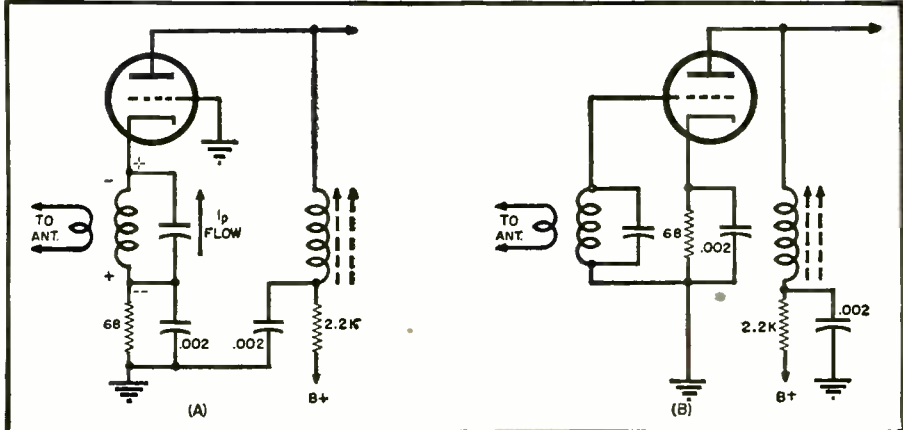

- 1 Watertight metal box
 - 1 Pittman d.c. motor (or equivalent)
 - 1 100 tooth, 48 pitch, single thread bronze worm gear with worm to match (Boston Gear G-1023)
 - 1 30 tooth, 48 pitch, single thread bronze worm gear with worm to match (Boston Gear G-1019)
 - 2 Microswitches
- No attempt was made to control the boom or vane gear as applied to this type of boat.

Parts list for rudder control mechanism.

lay chatter at the 600 c.p.s. super-regenerative quench frequency, and is quite normal. Turn the transmitter on, and vary C_2 of the receiver until the plate current takes a radical dip. Tune for minimum plate current. Repeat for the other receiver, using the other transmitter channel. It is always a good idea to walk the transmitter off 25 or 50 feet and run through a few operations before actually putting the ship in the water.

Now, just a few words about controlling the boat. In "coming about," apply full rudder until the limit switch stops the rudder in a full rudder position. The boat then heads up into the wind. Then, just as the wind carries the mainsheet boom across, use opposite rudder control to bring the rudder amidships again. After a few hours' operation the "feel" of the control will allow the operator to time his control operations nearly perfectly. However, it has been found convenient to put on some sort of rudder position indicator. This consists of some easily seen mass hung on a six inch arm to move along with the rudder. Experimentally, we used first a wad of white cotton, and then a small chromium plated vane. A ping pong ball would be ideal. With the boat under sail on a specified course, the operator will quickly recognize his greatest fault—that of over-controlling. Very short pulses of control time then suffice to keep the boat headed on course.

Variations

A considerable saving in weight is possible by the use of the new mercuric oxide batteries which should be available in quantity very soon. Also by increasing R_1 , R_2 to 50,000 ohms, the smaller size 67½ volt "B" battery can replace the larger 45 volt size. Prospective builders of this equipment should also look into the possibility of using the new ultra-small and rechargeable wet cells. Also some small electric motors by Pittman are made for 6 volt operation.

The possibility of using two channels at once should not be overlooked. Referring to the receiver circuit diagram, (Fig. 2) it will be seen that if both receivers are operating at once, the motor circuit will not be energized. Thus, if a third sensitive relay be placed in the "B+" line, and it is adjusted to open at 1.5 ma. or less, this relay will operate *only* when both receivers are signalled, but not when either one alone is. Thus, this third relay affords a third control operation through the use of only two

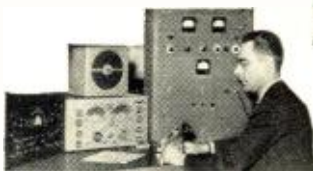

JIM NOLAND WØAWX Omaha, Nebr.

Superintendent Electronic Radio Television Institute. "We have here at the school selected both the Globe King and the Globe Trotter because after very critical inspection we decided that these two transmitters were the best for the money anywhere. Since the installation of this equipment hundreds of our students have been keenly impressed with the construction, appearance and D.X. contacts made.

IT'S A SWEETHEART

Horace M. Whittlesey, Balderas Num. 32-217, Mexico, D. F. writes: "I have been testing the GLOBE TROTTER and had the transmitter on the air for a week and have contacted New Zealand, Australia, Peru, Venezuela, Canada, all U. S. districts, and a mobile marine in Venezuela. We contacted Hawaii also all to the credit of the Globe Trotter on 10 meter band.



WRL Globe Trotter XMTR Kit

Amateurs the world over are praising the performance of this high quality, low cost rig. It's a 40 watt input kit including all parts, power supply, chassis panel and streamlined cabinet. Write for export prices. Cat. No. 70-300 less tubes.....\$59.95
Cat. No. 70-312 same as above, wired.....\$79.50
1 set of coils, meters, tubes, extra.....\$17.49



WRL Exciter Kit

From our own labs. Uses 6L6 regenerative Osc. into an 807 driver or final. Similar to unit described in A.R.R.L. Handbook. Output 35 to 40 watts. Comes mounted on standard relay rack panel 3½" x 19".
Cat. No. 70-302 less accessories.....\$19.95
Cat. No. 70-310 same as above, wired.....\$25.95
Set of coils, meter tubes.....extra.....\$10.78
Power Supply wired with tubes.....\$22.75



Leo S. Meyer WØPQA



More Watts Per Dollar

UNCONDITIONALLY GUARANTEED

The WRL 275 watt "Globe King" is a versatile advanced design transmitter kit which will give you efficient performance on 6, 10, 20, 40, and 80 meter band on phone and CW. COMPARE THESE FEATURES AND TAKE ANOTHER LOOK AT THE PRICE. Front panel control of link to final input—automatic fixed bias for good regulation—voltage controlled buffer and oscillator stages—provisions for ECO—new speech modulator circuit—modulates up to 350 watts—dual power supply for oscillator—buffer and RF stage—most compact transmitter on the market—stands 21" high. Write for complete detailed description and trade-in price on your present equipment.

WRL 275 Watt
This new WRL 275 Transmitter Kit is available as a complete unit, or individual sections may be purchased separately. Write for prices, meters, cabinet, one set of coils.

Kit Form \$366.45
Wired \$386.45

QUICK DELIVERY
It takes about a week to wire this kit

VALUES, LARGE STOCKS, FAST, DEPENDABLE SERVICE.

Hams all over the world are enjoying our personal service, fast delivery, liberal trade-ins and easy payment plan. We make it easy for you to buy and easy for you to pay. Just write and tell us what you want, the make and models you now have and I will answer your inquiry the same day giving you trade in allowances. Many times it will serve as a down payment on new gear. Dollar for Dollar you will get more at WRL. We carry a large stock of all national merchandise such as Hallicrafter, National, Hammarlund, RME, Millen, Sonar, receivers, transmitters, test equipment, beams, etc. Write me for anything you want. We can fill your order quickly.

20% DOWN—MONTHLY PAYMENTS TO FIT YOUR NEEDS! It's Easy—We Finance Our Own Paper—No Red Tape

LATEST IN HAM GEAR . . . WE HAVE IT

ST202 STANCOR	National NC 1f3	\$189.50
XMTR KIT	National NC 185	259.00
Wired by our engineers	Bud VFO 21	\$2.50
Hallicrafter HT18	Meisner Signal Shifter	99.50
Hallicrafter HT17	Gonset 6-15 Converter	75.00
Hallicrafter S 35	Gonset 10-11 meter	39.95
Hallicrafter S 33	Harvey Wells TBS-50	99.50
Hallicrafter SX 43	Sonar MB 611	72.45
RME VHF 152A	Sonar VFX-680	87.45
RME H.F. 10-20	Sonar's New CFC	59.75
National NC 33	Hammarlund HQ 129X	177.30
National NC 57	Millen 90810 H. F. Xmtr.	69.75

LOTS OF BARGAINS TOO . . .

BC458A VFO XMTR 275W series. Ideal for 40 meters—quadruples in 11 & intelligible 5.3 to 7—actually times 7.5 mc. BRAND NEW, original carton, complete with tubes & conversion instruc. \$9.95
BC458A modular for all 275W XMTRS. Brand new with 3 tubes, leaf dynamotor your eyes \$3.95

RADIO REFERENCE MAP



ONLY 25c

Just right for your control room wall. Size 2 1/2" x 4 1/2". Contains world-wide short wave broadcast station, world radio amateur prefixes, United States amateur zones, time zones, monitoring stations, etc.

GET THIS 68 PAGE BARGAIN CATALOG

World Radio Laboratories
744 West Broadway
Council Bluffs, Iowa

- Send latest free flyer with bargains
- Enclosed is 25c for radio reference map
- Send more data on "Globe King" Kit
- Send more data on Globe Trotter Kit
- Send more data on WRL Exciter Kit

Name Call letters.....
Address
City..... Zone..... State.....

COIN RADIO KITS SEPARATELY OR COMPLETE UNITS

- PLASTIC CABINET AND GRILL for table model \$ 5.75
- Richly grained brown or Ivory marble effect. No stains—no burns—No refinishing. Exceptional acoustics only equaled by this type of cabinet.
- TIMERS (Quarter 1 and 2 hour or 5c 10 Minutes) 4.95
- AC RADIO Chassis RCA 5-Tube Super-Het, Completely Wired 15.35
- METAL HINGED BASE AND BACK with No-Cheat Coin Box and Brackets..... 3.45
- MISCELLANEOUS ACCESSORIES
2 LOCKS, WING NUTS, NAME PLATES, Etc. \$ 1.80
- CONSOLE PLASTICS BASE to complete Console Model 4.25
- BEAUTY PARLOR DRYER HEAD SETS AND HOLDER..... 1.80



Deluxe Table Model. Can be screwed down or hooked to table with C Clamp. Complete kit...\$31.75

Deluxe Console, no stand needed, can be fastened to the floor. Complete kit...\$35.00



RADIO-COIN-MATIC

BOX 9465
1110 S. NORMANDIE
LOS ANGELES 6, CALIF.

More Money for You in Radio

Qualify here for your Radio Operating Engineer's Licenses

Complete instruction for
passing F.C.C. Commercial
and Amateur Radio Operator's
License Examinations.

Small classes and
individual attention

NEW CLASSES FORMING REGULARLY

G. I. Approved Training

Write for complete information

RADIO INSTITUTE OF CHICAGO

165 North Michigan Ave.
Chicago, Ill.

SCHUH DOES IT AGAIN!

**NARROW BAND F. M.
Noise Free Reception!**

Only adapter for BC-348 receiver using 915 KC IF. Also made in 455-465 KC Model 33441/2x1 1/2". Completely Chromium Plated. Easily mounted. Uses 6AK5 limiter and 6AL5 discriminator. Instructions supplied. Price (less tubes) **\$10.95**
6AL5 tubes..... 90c each
6AK5 tubes..... 90c each

Trade in your AM modulator on Sonar NBFM equipment. Liberal Allowance.

BC 610 Components... Modulator Decks Less modulation transformer. Completely wired. **\$14.95**

RA20 Powerpack
converts BC312 receiver to AC operation. Fits in dynamotor compartment. Also for external use with BC348, 314, 224, and used with BC696 and 459 as ECO. Input 110-120 VAC. 60 cycles. Output 250 VDC @ .95 MA, 12V @ .6 A, 12V CT @ .3A.
Shipping weight, 12 lbs. **\$7.95**
5W4 rectifier tube..... **.75**
5P84 White screen 5" Cathode Ray tube suitable for Television sets..... **\$ 4.50**
250TL tubes. Limited Quantity..... **12.95**
2X2 Tube..... **.70**
2500 Volt Scope transformer—Pri. 117V Sec. 2500V @ .01 amp. **2.50**
11 Hy. 1600 amp. Chokes..... **7.95**

800 Volt Power Supply Kit
All electrical components for 800VDC @ .200 amp with 117VAC 60 cycle input. 150 amp when used on 25 cycles. 2 Power transformers 800 volts each to be used in series—2—5U4 tubes and sockets, 2—10 mfd condensers and 1—8 Hy choke. **\$14.25**
10x17x3" chassis \$1.50

Swap your old receiver for a NEW NATIONAL
Let us know which model you want. Send us your old equipment prepaid and we will thoroughly inspect it and let you know how little it will cost you to own the National Receiver of your choice.
Open 5 Evenings and Saturday Afternoons!
TERMS: 30% with order. Balance C.O.D. Shipt. F.O.B. Chicago

SCHUH'S RADIO PARTS
1253 Loyola Avenue • Chicago 26, Illinois

0930; letter was signed by Fu Hwa Hau, director of the Chinese Army Radio Service; QRA is Radio Station XMPA, Chinese Army Radio Service, 10 Snake Mountain, Hanchungmen, Nanking, China. This station is heard with fair signals some early mornings in East.

XLRA, Hankow, China, operating on 11.500 at 1800-1920. 2330-0100, 0500-1030, has news at 0900 (relayed from XGOY), and signs off with National Anthem. Will verify all correct reports; QRA is Hankow Broadcasting Station, No. 168 Sheng-Li Street, Hankow, China. (Kary, Pa.)

Hanoi, 11.910, French Indo-China, is heard in Australia at 0645 with news in French and Chinese, then music. (Sanderson)

Oy. Yleisradio Ab., Helsinki, Finland, informs me that they "are just building up a new transmitter which may be one among the strongest of the world." It is presumed this will be a 100-kw. outlet.

Radio Monte Carlo, 6.13, Monaco, has been heard in New York with good level at 0130 opening; fair to poor at 0330 sign-off. (Beck)

The Director of Transmissions of Indo-China, Hotel Des Postes, Saigon, French Indo-China, has informed Major, Western Australia, that Radio France, Hanoi, 1 kw., 6.048, operates 1700-1930, 2230-0015, 0400-0830; Radio Cambodia, Pnom Penh, 1 kw., 6.035, operated 1800-1915, 2300-0015, 0500-0700. Stated Radio France ceased operation on its 9.520 channel in September and that early this year would be on 6.190.

CHNX, 6.130, Halifax, Nova Scotia (Canada) has been off the air for repairs but by this time should be back on regular schedule, listed by the station 0700-0015 (sign-on Sundays is 0900); if officials meant "local" time, then this schedule would be 1 hour ahead of EST.

Munich, Germany, relays programs from the United States over Munich I, 6.100, 1415-1700; Munich III, 6.170, 1300-1400; Munich II, 7.290, 1115-1700, and Munich IV, 9.540, 1115-1700 (all beamed on East Europe).

KRHO, Honolulu, is now using 11.890 to relay programs from the United States at 0230-0345 (carries United Nations programs beamed to China). The 9.650 channel is beamed to Philippines and South East Asia, 0400-1005.

"Voice of America relaying from Manila" is scheduled on 15.330 at 0230-0345 (except Mondays), beamed to India and Pakistan with United Nations programs; on 11.890 is beamed to Far East at 0400-1005.

ZQP, Lusaka, Northern Rhodesia, is scheduled on 9.710, 7.220, 3.914, weekdays 1000-1200; Sundays 0400-0530, 1030-1130; uses some English; has had very good signals this winter on 9.710 in California. (Dilg) I have heard this station here in East only once—on a Sunday at 1030 opening, very weak and with bad CWQRM; faded out within 15 minutes.

Model Sailboat

(Continued from page 41)

danger of getting outside of it. Incidentally, the usual FCC regulations hold in this type of service; a licensed radio amateur must be present during operation.

Operation

Receiving antennas are formed from an insulated portion of the mainmast stays. The total length of the receiver antennas should be 46" from the small rods coming up from each receiver through the hatch cover. Fahnestock clips may be used to connect the antennas to the rods.

The sensitive relays will probably need some adjustment. The back contact should be set originally for about .025" clearance between the relay armature and the winding core face. Then adjust the fore contact clearance for about .003" or the thickness of a piece of paper when the relay is open. Then, with the receiver in operation, vary the adjusting spring tension so that the fore contact closes at 1.4 ma. The plate current of the receiver may be conveniently varied for this test by means of the plate resistors, R_1 , R_2 . If the relay drops out at less than 1 ma. plate current, the relay contacts are set too wide. Optimum adjustment of the relay will yield a pull-in current of 1.4 ma., and a drop-out current of 1.1-1.2 ma.

After the preliminary adjustment of the relays, the plate current on each receiver should be set for 1.5 ma. (3 ma. total "B" battery drain). With no signal, a slight ragged-sounding audio note of about 600 c.p.s. will be heard from each relay. This is re-

Fig. 8. Schematic diagram of transmitter—a simple push-pull oscillator.

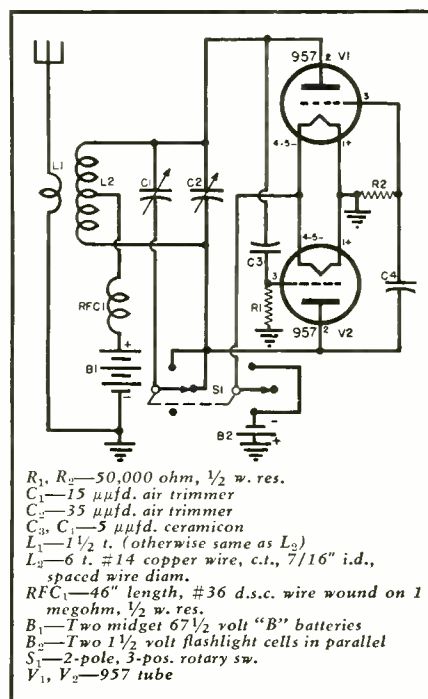

that country; still relays important Spanish broadcasts of interest, such as international matches and the like. Frequencies available are 7.080 and 14.278, although the 14.278 outlet has not been reported as having been heard; schedule given as 0800-1100, 1400-1700."

Recently, Cairo has been using SUP3, 19.765, instead of the usual 20.136 channel to New York. A recent "good three-way deal" one morning was logged while WQV, New York, was receiving pictures from GLU, 19.045, actually being relayed from Bombay, India, via London; the originating station, VW6A, in Bombay, 17.950, was picked up with very low level, but readable. PJY-19 is a new Curacao point-to-point outlet on 19.455, used to New York. (Arthur, W. Va.)

An ISW monitor in Seattle, Washington, reports that recently at night (PST), he heard a station on about 9.600 announcing as WVTM, "an all-Navy net," at Clark Field, Manila, Philippines; he says he understands this station was being reopened after having been closed for repairs during the war. (Has anyone else heard this one?—K.R.B.)

CR6RB, Radio Club de Benguela, Angola, signs on at 1230, off at 1400 on 9.165; CR6RF, 7.084, is in parallel. A station heard on approximately 9.230, in Portuguese, announces as "Radio Clube da Huilla," heard around 1300-1330; Huilla is in southern Angola, about 100 miles inland on the railway line from the port of Moasamedes. (Laubscher, South Africa)

I have received vague reports that "Radio Malaya," Singapore, is using 6.120 for relays of the (English) Home Service prior to 0600.

A new German point-to-point outlet, DFA7, Frankfurt, 7.460, is reported by Arthur, West Virginia; heard working WQM, poor level; apparently is alternate for DFA, 15.550.

Radio Martinique verified promptly via airmail from Boite Postale 136, Fort-de-France, Martinique. (Southall, Pa.)

Rabat, French Morocco, 16.666, is excellent level (in French) in Newfoundland at 0745-0815. (Peddle)

Jack Carter, Washington state, received a verie card printed on a filing card, from WLKS, Kure, Japan, station of the British Forces of Occupation; bore a Royal Crown in blue over "WLKS" in red letters and with operating data on each side of call letters; gave schedule 0630-2230 (presumably Japanese time, or 1630-0830 EST); power was listed 1 kw., frequency as 6.105.

XMPA, The Military Radio Service Station of the Chinese National Defense Department in China, at Nanking, 12.220, recently wrote Kary, Pa., that the station uses 1000 watts and a transmitter manufactured by the Central Radio Company of China, erected in Chungking and moved to Nanking three years later; gave frequency as 12.220 (24.50 m.) and a schedule of 1800-1900, 2300-0100, 0430-

April, 1948

All Mail Orders Shipped Promptly!

SAVE ON THESE MONEY-SAVING VALUES!

COMPLETE WITH 2 TUBES WIRELESS PHONO OSCILLATOR



You can't go wrong with this fine piece of equipment being sold at almost the price of the tubes alone. Uses two tubes 35W4 and 12BE6.

Limited
Quantity

\$3²⁵
Ea.

PHONO RECORD PLAYER KIT

AC Motor. Pick-up arm with cartridge.

Motor Base. Needle Cup. Complete \$495

AUTO RADIO ANTENNAS

3 Sections. Fit side cowl. Ea. 95c

DETROLA RECORD CHANGER BASE

Made of wood. Leatherette Brown Cover.

12½ x 11 x 1½". Each \$125
10 for \$10.00

REPLACEMENT PHONO MOTORS

for Detrola Changers etc. 97c

RECORDING WIRE

Standard brand for Webster, St. George, Silvertone Recorders. High quality at this low price.

1 hour spools \$3.50
½ hour spools 2.10
¼ hour spools 1.40

FREE Write
now for our big new 1948
Catalog, complete listings of
all electronic parts, equip-
ment and supplies.

All New Standard Brand FULLY GUARANTEED TUBES!

35Z5.....	50c	50L6.....	72c
12A6.....	29c	11C6.....	97c
50B5.....	59c	11N5.....	97c
25L6.....	73c	1H5.....	59c
6K7.....	60c	1A7.....	59c
117Z6.....	75c	2AP1 scope.....	\$1.50
117L6.....	98c	50A5.....	75c
1N5.....	59c	12SQ7.....	59c
12K7.....	59c	35L6.....	72c
70L7.....		35W4.....	45c
VT52.....	49c	0Z4.....	79c
7N7.....	50c	6N7.....	85c
826.....	59c	12BE6.....	59c

"ULTRA MIKE" WIRELESS MICROPHONE



This unit with your regular radio and NO extra interconnecting wires will provide superior results as a

- CALLING SYSTEM
- PUBLIC ADDRESS
- DETECTORPHONE
- BABY OR INVALID WATCHER

The "Ultra Mike" is light—economical to operate—completely self contained—no connections to power lines—portable. Complete with batteries, tubes, etc.

Special YOUR COST.. \$6.63

Retail \$18.00

25% Deposit with all C. O. D. Orders F. O. B. Chicago

Mort's Radio Shack

630 W. RANDOLPH STREET

CHICAGO 6, ILL.

Permoflux SPEAKERS



YOUR JOBBER CAN SUPPLY YOU!

Permoflux quality and dependability—the same as supplied to the major set manufacturers—is your assurance of complete customer satisfaction. You'll find Permoflux Speakers easy to install and readily available in both PM and Electrodynamic types. You'll find too, that it pays to give your customers "tops in tone" with a Permoflux Replacement Speaker.

TWO COMPLETE
FACTORIES TO SERVE YOU

PERMOFLUX

WRITE FOR
FREE BULLETIN

PIONEER MANUFACTURERS OF PERMANENT MAGNET DYNAMIC TRANSDUCERS

PERMOFLUX CORPORATION

4900 WEST GRAND AVE., CHICAGO 39, ILLINOIS
236 SOUTH VERDUGO ROAD, GLENDALE 5, CALIFORNIA

RADIO TUBES

For immediate shipment
R.M.A. Guaranteed
Below Distributor Costs
Individually Sealed Cartons

Type	Price
6K6GT	.40
6K5GT	.46
6V6GT	.46
6SA7GT	.46
6SJ7GT	.46
6SK7GT	.46
6SQ7GT	.46
6X5GT	.40
12SA7GT	.46
12SQ7GT	.46
12SK7GT	.46
12SJ7GT	.46
35L6GT	.40
35Z5GT	.32
50L6GT	.46

RATED ACCOUNTS—2% 10 DAYS
ALL OTHERS 2% C.O.D.
10% DISCOUNT ON LOTS OF 50 OR MORE

RAVAC ELECTRONICS CORP.

432—4th Avenue
New York 16, N.Y.



FASTER SIGNAL TRACING

Signallette

MULTI-FREQUENCY GENERATOR

Generates R.F., I.F. and AUDIO Frequencies, 2500 cycles to over 20 megacycles, using new electronic multivibrator radar principle. Completely self-contained—fits coat pocket or tool chest. Just plug into A.C. or D.C. LINE AND CHECK RECEIVER SENSITIVITY, AUDIO GAIN, R.F. and I.F. touch-up, auto radio aerial peaking or shielding, breaks in wires, stage by stage signal tracing, tube testing by direct comparison, etc., etc. Sturdy construction, handsome appearance! See at your distributor or write for details. Shipping wt. 13 ozs.

Clippard Instrument Laboratory, Inc.

Dept. N

1125 Bank St., Cincinnati 14, O.

PRICE \$9.95

at distributor or postpaid direct

Recognized Jobbers—wire or write for details.

is not known; may be an Underground outlet.

A station has been heard on approximately 12.1 to around 2115 with a woman speaking in what appears to be Chinese. (Foerster, Illinois) Kary, Pa., reported a Chinese-speaking station on 12.1 some time ago, early evenings (EST). (Does anyone have additional information on this station? —K.R.B.)

Bob Park, Vancouver, reports a mysterious European again—heard on Wednesday night, on 6.345, tuned in at 0245 on a special test transmission using frequent announcements in five languages (including *English*, French, and Spanish); could not get the call or location, due to weak signal and QRN. This may be HEI2 on 6.345, Park comments; was requesting reports from listeners and used excellent (Oxford) *English*. (Could this be the *Radio Venetia Julia* station

reported by Peddle, Newfoundland? —K.R.B.)

A Swedish monitor reports a Chinese-speaking station on approximately 9.640, heard to sign-off at 1000; call may possibly be XGBN, he says.

* * *

Last Minute Tips

Be on the lookout for s.w. outlets from Pakistan—due to open this summer. The Pakistan short wave station will likely be 100 kw. in strength.

SHF-1X, aboard the Swedish oceanographic ship, "Albattros," has been heard in Melbourne, Australia, on 28.450 during the evenings (in Australia), from around Hawaii. (Hutchins, Radio Australia)

Pearce, England, sends us this data about "Radio Africa," 1 kw.; "was used by Spain during her occupation of Tangier as an official Spanish outlet, having been originally set up by

AMERICAN AIRLINES SEEKING RADIOMEN

AMERICAN Airlines' newly opened school for would-be aviation radiomen is now accepting applications from servicemen under thirty-five years of age who have had at least two years' experience in operating a radio service shop, have worked for an established radio dealer for that period, or have had Signal Corps experience approximating one and a half years of actual service.

The school, which is located in Newark, New Jersey, will handle thirty-five men at a time with classes starting every three months. The company plans to be able to absorb from seventy to one-hundred such trainees yearly in their own aviation radio program.

A six months' course of instruction will include radar, facsimile, aircraft video, radio beacon and tower installation, and domestic as well as "Clipper-ship" and overseas aircraft radio installations. Courses will cover both prac-

tical and theoretical principles in equal proportions.

Classes will run from 8 a.m. to 6 p.m. daily and room and board will be furnished in addition to a salary of \$120.00 per month during the training period. Those passing the course with satisfactory ratings will be assigned to duty as radio operators aboard aircraft, as airfield radio employees, etc. After such placement, radiomen will be placed on regular assignments at specified salaries.

Inquiries about the new training program should be addressed to N. V. Gates, Director, American Airlines Radio School, Newark, New Jersey. The company is particularly interested in servicemen who are seeking employment overseas. Class members are not required to agree to work for American as a prerequisite for admission although it is assumed that the majority of the students will accept employment with the company.

-30-

One of American Airlines' training classes for aviation radiomen.



a verie from "Hunan Damas" in 47 days, report was sent in French with IRC; QRA is Republique Syrienne, Direction Generale des Postes, Telegraphes et Telephones, Damas (Damascus), Syria (Syrie).

Tangiers—Radio International verified with nice folder-type card; listed power as 1 kw.; uses 10 kw. on 1238 kcs.; schedule is 0800-1100, 1400-1900; frequency is 6.200; QRA is 34, Goya St., Tangier, International Zone, Morocco. (Kary, Pa.)

Trinidad—VP4RD, Port-of-Spain, some time ago was using 6.080 (may be as high as 6.085) at 1700-2200; badly QRM'd. Has not been reported on 49 meters more recently—so may be using 9.625 again (evenings) as it does mornings. (Stark)

U. S. S. R.—Komsomolsk, 9.565, is heard in New York 1600-1730 in Chinese; the Home Service is heard there after 1945 on 15.30 and 11.875, after 2200 on 11.89, after 2300 on 11.74, 9.54, 7.30, 6.14, and 6.02 (Kiev) (Beck)

Gillett, Australia, says Moscow's 6.18 outlet is heard in English to 0730, fair signal; also on 6.090, signing off at 0945, to return again at 1000.

A powerful new Soviet outlet is reported on 6.090 at 1000 in Persian, and at 1100 in Arabic. (Radio Australia)

Moss, Canada, reports that "despite many reports that Russian stations sign off with the 'Internationale,' this is not the case; the 'Internationale' was abandoned completely by the Soviets as of March 13, 1944, in favor of the new anthem, 'Republic of the Free'; it is with this new anthem that Soviet stations now leave the air."

Vatican—HVJ was heard recently on a new frequency of 7.670 with a special broadcast. (Beck, N. Y.) The 9.66 outlet is heard in Philadelphia with fair signal at 1315 with news. (Southall) The 15.095 channel is very good level in 1000 news.

Venezuela—YV5RY, Caracas, has moved to 4.725 from 3.380; YV2RM, 3.550, San Cristobal, is a new station heard evenings to 2130 sign-off; YV6RH, 3.450, Barcelona, is heard evenings to 2130 also.

Yemen—Radio Australia's North African correspondent reports a station on 7.385 in this small kingdom of Southern Arabia, just north of Aden; transmitter is at capital city of Sanaa; is heard in North Africa with programs in Arabic; closes down around 1215 after a newscast which begins at 1200; according to announcements, begins at 0830—but must have an irregular schedule since it has been heard signing on much later than 0830; may be off Fridays.

Yugoslavia—Radio Belgrade, 6.100, has news 1530 daily. (Pearce, England)

Unidentified—Kary, Pa., reports a station on 10.615, woman heard briefly in French at 1345, then station faded out; presumably is Madagascar which is scheduled to 1400 sign-off. Peddle, Newfoundland, reports Radio Venetia Julia on approximately 6.43; location

April, 1948



HAS THE VALUES!



HERE ARE A FEW TYPICAL OF WHAT IS TO BE FOUND IN THE BIG NEW B-A CATALOG #481

116 BIG PAGES PACKED WITH THE LATEST DEVELOPMENTS IN RADIO AND ELECTRONICS, Sets, Supplies and Apparatus For Trade—Industry—Communications—Public Utility—Experimental and Hobby Applications.

A Bargain Section Packed With OUTSTANDING VALUES in desirable WAR Surplus and other SPECIAL VALUES.

Write For Your Copy of Catalog #481 If You Did Not Receive It.

Only \$13.88 for this Quality RECORD CHANGER



A fortunate purchase from an overstocked manufacturer enables us to offer these popular UTAH Model 650 Record Changers AT A BIG SAVING.

Features: Single post, gearless construction. Quiet and fast during change cycle. Plays 10 twelve-inch or 12 ten-inch records. Rejects any record desired. Light weight balanced tone arm with quality crystal cartridge for any standard needle.

Has heavy, die cast base plate 10 3/4" x 12 1/8". Mounting size approx. 12 1/4" x 13 5/8", extends 5 3/4" above and 2" below mounting. Operates from 110 volts, 60 cycle.

No. 40A1000 Bargain Priced, Each \$13.88 Two in Factory carton, for only \$25.00

EXCITING! EXCITER BARGAIN

25 to 40 WATTS 10 to 80 METERS



FOUNDATION KIT

Engineered around the BC-610 series of plug-in tuning units. Described in the 11th edition Radio Handbook. Completed exciter uses 6AG7 crystal or electron coupled oscillator, 6L6 buffer-doubler and 807 amplifier. Kit includes four tuning units (illuminated at right above with cover removed), special 5 1/4" aluminum relay rack panel, socket for plug-in units and special hardware, together with full instructions and diagrams for assembling complete exciter.

No. 31A28, FU-40 Foundation, Special \$9.95

PARTS KIT. Everything needed to complete exciter except tubes and power supply. Includes all mica condensers, resistors, RF chokes, sockets, meter switch, 0-200 ma meter, key jack, and miscellaneous parts.

No. 31A28A, Special Per Kit, Each \$9.31

WANT RG-58/U?

Use RG-29/U—exactly the same except clear plastic cover overall. We have it!
A BARGAIN 3A105—20 Ft Coils, Each 49c
Continuous Lengths—50 ft. and over. 3 1/2c
No. ZA169. SPECIAL PER FOOT.

"Re-Mote" REAR SEAT



Car Radio Speaker

Easy to install in a few minutes—no cutting of holes required. Furnished complete with 17 ft. wire, fittings, resistor to match speaker to any standard Auto Radio and complete instructions. Consist of 5" quality PM speaker in beautiful marblod french gray plastic case, volume control built in.

No. 14A650 Your Cost Each \$6.37

80, 75 and 40 Meter CRYSTALS, 10 for \$3.95

In FT 243 holders, cut from highest quality quartz, accurately ground and acid etched. Frequency marked on each with in 2 KC. Sorry we must sell them in ass'ts. our pick of frequencies—but you can't go wrong! There are plenty of choice frequencies for 80, 75 and 40 meters or far doubling to 20 and 10 meters in each ass't. Every one guaranteed to be an active oscillator.

Stock No. 21T 3991 Assortment of TEN — ONLY \$3.95

Order direct from this ad. Our Terms: Cash With Order or C. O. D. with 20% deposit please. Radio Sets Shipped Via. Express Only.

ALUMINUM UTILITY CASE LIGHTWEIGHT DURABLE EYE APPEALING IDEAL FOR

- Radio Serviceman's parts and tool kit
- Tube carrying case
- P.A. accessory case
- Camping, Fishing, Picnics, all family use



Life time aluminum case with bakelite handle, lock and key. Size 15" long, 11" wide, 5" deep. Weight only 3 lbs. Shipping weight approx. 5 lbs.

No. 36A75—Very Handy For Everyone, NET EACH \$3.65

1000 V.—200 Ma. Power Supply FILTER KIT

Consist of Two 4 mfd. 1000 volt DC oil filled condensers size 2 1/2 x 1 1/8 x 5 1/2" high overall and One 1 Thoradson 10 Hy.-200 Ma. filter choke fully enclosed metal case size 3 3/8" sq. x 4 5/8" H.

21T3983 ONLY \$3.65

2 MFD. 2500 VOLT OIL FILLED CONDENSER

Well known brand. Ceramic pillar terminals, in hermetically sealed metal case, size overall 1 1/4 x 3 3/4 x 5 1/2" high. Comes with handy removable mfg. bracket and solder lug terminals.



No. 21T3990, Special, Each \$2.95

12 1/2 FOOT ANTENNA TELESCOPES DOWN TO 1 FOOT 4"

"Just it" for mobile equipment, portable receivers, and transmitters. Solid Brass—Ruggedly constructed—smooth telescopic action. Base is 7/8" dia.

No. 38A39, Special Each \$1.95

WEATHERPROOF WIRE at GIVE AWAY PRICES

Stranded tinned conductors (3 copper, 4 steel) flexible, yet unusually strong to stand long runs. Conductor is rubber covered with overall weather-proof saturated braid; OD 5/32".

Perfect for lead-ins, telephone, intercoms, etc. BRAND NEW in original factory wound coils.

No. 4A503, Three Conductor Per 550 Foot Coil, ONLY \$4.95

No. 4A502, As above except Single Cond. Per 900 Foot Coil, ONLY \$2.95

WRITE FOR YOUR COPY OF CATALOG No. 481 IF YOU DID NOT RECEIVE IT.



BURSTEIN-APPLEBEE Company

1012 McGEE, KANSAS CITY 6, MO.

Here's a **SOUND**
FM INVESTMENT
the new
UNIVERSITY
TWEETER



**IT PAYS BIG
 DIVIDENDS IN
 LISTENING PLEASURE!**

If you appreciate good tone quality—music that sounds *exactly* as it's played—then hook one of these inexpensive tweeters to your present cone speaker. Simple high-pass filter permits quick connection directly to the voice coil terminals of the existing speaker. Only two soldered connections and you immediately enjoy full range speaker response up to 15,000 cycles. **UNIVERSITY** tweeters are available in a handsome walnut cabinet and in single or dual unmounted types. Prices from \$20.00. Write **UNIVERSITY LOUDSPEAKERS, INC.**, 80 South Kensico Avenue, White Plains, N. Y.

University Loudspeakers

SENSATIONAL SELLER!



LAKE DELUXE CHANGER

**Revolutionizes the Industry!
 A Sensational Seller!**

11 Outstanding Features:

- Positive Intermix
- Service Adjustments Eliminated
- Minimizes Record Wear
- Single Knob Control
- Plays ALL Records
- Pick-up arm may be grasped at any time
- Completely Jam-proof
- Records Gently Lowered on Spindle—not dropped
- Automatic Shut-on on last record

Dimensions: 13 1/2" W x 12 1/4" D x 7 1/2" H. No. 116A... **YOUR NET \$28.73**

WEBSTER CHANGER, Model 56... \$26.66 Net
WEBSTER CHANGER, Model 50... 21.17 Net

FREE

DEALERS and SERVICEMEN: Write for our NEW 16-page 1948 illustrated catalog on radio parts, tubes, accessories, cabinets, sets, electrical appliances, etc. Get on our mailing list today!

Lake Radio Sales Co.

615 W. Randolph Street

DEPT. A

Chicago 6, Ill.

2345-0130 transmission. (Balbi) BBC news is scheduled for 0100. Normal operating times of the SABC network, according to latest schedules received direct via airmail from Johannesburg, are weekdays 2345-0130, 0315-0710, 0900-1605; Sundays 0055-0115, 0400-1605.

ZRB, Pretoria, the South African Air Force Station, is now using 6.210 in parallel with 9.110; former is to cover "skip" about 300 miles from Pretoria; has been heard irregularly so may not be on regular schedule with this channel yet; normal schedule on 9.110 is around 0030-1100 (may be off Sat. and Sun.); has weather report about every two hours, and fills in gaps with recorded programs and relays from SABC; the 7.445 outlet has not been reported lately but may be used in summer. Announces, "This is Radio ZRB, the S. A. Air Force station, located near Pretoria"; sometimes gives location as Waterkloof Aerodrome. (Laubscher, South Africa)

Spain—Kenneth M. Dobeson, England, of La Sociedad Espanola de Radiodifusion, informs me that future developments in Spanish radio include four 100 kw. short-wave transmitters now being built in Spain. Further details will be sent as available. He lists these schedules for present Spanish s.w. outlets:

Radio Nacional de Espana, 9.369, Madrid, 1300 French, 1330 German; 1350 Italian; 1405 Portuguese; 1420 Russian; 1500 English; 1530 Arabic; 1545 Spanish; 1600 closedown; 1845-2200 in Spanish to Latin America (news in Spanish 1915, 2100). Radio Falange de Alicante, 7.940, 1.2 kw., 0700-0900, 1400-1800. Radio Tenerife, Canary Islands, EAJ-43, 7.558, 0700-0900, 1230-1800. Radio SEU, Madrid, EBV-10, 7.190, 1 kw., 0930-1300, 1500-1830. Radio Falange de Oviedo, F.E.T.-22, 7.130, 250 w., 0730-0900, 1345-1830. Radio Falange de Cordoba,

F.E.T.-15, 7.042, 200 w., 1400-1600. Radio Mediterraneo de Valencia, 7.035, 100 w., 0700-1000, 1400-1830. Radio Nacional de Espana, Malaga, EAJ-9, 7.024, 200 w., 0830-1000, 1500-1900. Radio Nacional-Sindicalista de Valladolid, F.E.T.-1, 7.006, 0730-0900, 1500-1800. Radio Nacional de Espana, Cuenca, EAJ-7, 6.318, 200 w., 0800-1000, 1400-1900. Radio Tetuan, Spanish Morocco, 6.067, 0230-0300, 0830-1000, 1330-1800 (uses Spanish, Arabic, French). Mr. Dobeson explains that at various times news bulletins and special programs are relayed by some or all Spanish s.w. outlets with the announcement, "Radio Nacional de Espana, Madrid," giving a misleading impression; main times are 0830-0845 and 1545-1600 when news in Spanish is rebroadcast by all Spanish stations on the air at those times, and at 1800-1810 by all "Radio Nacional de Espana" outlets on medium-waves and by Cuenca and Malaga on short-wave.

Surinam—PZC (or PZX5), approximately 15.402. Paramaribo, has replaced PZR, 10.970; relays Dutch news from PCJ (Hilversum, Holland) at 1830-1845. (Balbi)

Sweden—Foerster, Illinois, reports that Sweden is to have two of its medium-wave transmitters (Gotenborg and Sundsvall) reconstructed, and that a new short-wave transmitter (probably Horby) is expected to be put in use some time this year.

Switzerland—Berne has been using 11.815 (good signal) to North America for transmissions beginning at 1730 and 2030, respectively; in latter period, 9.535 and 6.165 have been in parallel, all closing down at 2230.

Syria—Radio Damascus, 12.000, is heard in England signing at 1100, fades out before closedown; still all native except occasional Western recordings. (Pearce) Closedown is probably 1500. Block, Belgium, received

When James Caesar Petrillo permitted himself to be televised without protest during hearings before the House Labor Committee, he violated one of his own edicts. Petrillo has laid down a flat ban against any member of his union appearing on television. He is shown at right with television camera lens trained on him.



Forces Broadcasting Service, Jerusalem, stated they were closing down in January; however, this will bear checking as this station has been reported as still operating more recently.

Panama—George Williams, Panama City, long associated with broadcasting on the Isthmus, has informed Kary, Pa., that he has purchased a new transmitter in Colon for HP5J, soon to operate on 9.690; no further details were given.

Philippines—Schedules for the Commonwealth outlets are—KZRH, 9.640, Manila, 1700-1100; KZPI, 9.505, KZOK, 9.695, both Manila, 1630-1105 (according to latest schedules, KZOK is no longer an "all-nighter"); KZFM, temporarily using 11.900, Manila, reported at 1630-1830 and 0400-1105 (may not be complete schedule); "Voice of America," lately moved to 11.89 from 11.84, Manila, takes relays from the U. S. (in *English*, Korean, Chinese, Indonesian, Dutch, French, Annamese, Siamese) at 0400-1005; KZRC, 6.140, Cebu, 0400-1100; KZBU, 6.100, Cebu, new, 250 w., 0400-1105. KZRC is operated by owners of KZRH; KZBU is operated by the KZPI-KZOK company.

Poland—Warsaw seems to have settled down on about 6.215; news 1350-1610 (will be one hour earlier in summer).

Portuguese Guinea—Radio Bissau has been heard widely this winter with powerful signals in Eastern U. S. on measured 7.948; schedule appears to be 1628-1731; on with Portuguese guitar music, off with "Heroes do Mar," the Portuguese National Anthem; announces slogan of "Aqui Bissau, Estacion de ondas curtas, Emissora Regional," but also at times says "Emissora dos Reynes." Recently gave calls (in *English*) to Kary, Pa., said was operating in the 42-meter band; then in Portuguese gave call of CQM-4. Announcement of 42 meters would mean the 6.993 outlet, but a check of that frequency revealed nothing. Lists do not show Bissau on 7.948 but Berne lists do give CQM-4 on 3.973; thus, the 7.948 frequency may be a harmonic; Kary says it is definitely *not* an image. Bissau was reported some time ago by Peddle, Newfoundland, as heard on about the same schedule around 8.159 to 8.170.

Rumania—Bucharest, 9.25, has news daily 1215. (Pearce, England)

Siam—According to Malayan sources, Bangkok programs include 0500-0630 on 5.994, news 0515, 0615, talk (in *English* also) at 0545; 0700-0920 on 6.130 and 825 kcs., Home Service in Siamese; 0500-0645 on 4.754, 7.025, and 1000 kcs., Home Service in Siamese; stations on 5.994, 6.130, 825 kcs. are operated by the Siamese Publicity Dept., while those on 4.754, 7.025, 1000 kcs. are operated by the Posts and Telegraphs Dept.; callsign on 825 kcs. is HSPJ; call on 5.994 is HSPP; call for the 6.130 outlet is believed to be HS8PJ; other calls are not known. (Hutchins, Radio Australia)

South Africa—Cape Town is again using 5.877, replacing 9.608, in the

April, 1948

COMPARE THESE TERMINAL VALUES

for the **BEST TELEVISION SEMI-ASSEMBLED KITS EVER OFFERED!**
THE "Champion" WITH DUMONT INPUTUNER

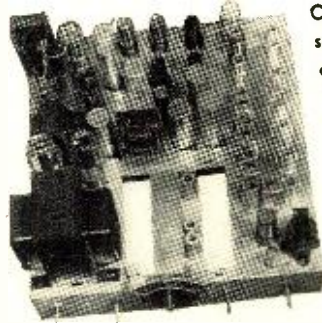

You'll be amazed with the results! The clearest television picture you've ever seen! And no adjustments or alignments required for operation on completion of assembly!

Outstanding feature of the "Champion" Television Assembly models is the exclusive Dumont Inputuner. Tunes continuously from 44 to 216 megacycles, smoothly covering all 13 television channels as well as FM, amateur and aviation bands!

Supplied completely assembled, wired, aligned and tested are the famous Dumont Inputuner and I.F. section for video and sound. You wire the power supply and audio circuits. Kit is complete with all parts, tubes, speaker, television antenna and full instructions for easy assembly.

10" Champion model, your cost	273.10
12" Champion model, your cost	303.10
15" Champion model, your cost	393.10

LONG LIFE! DEPENDABLE! TROUBLE-FREE!

TELEVISION ASSEMBLY "Standard" MODELS

Same high quality and superior television performance as with "Champion" models, but with the popular Television Assembly 13 channel R.F. Tuner front end. Both R.F. front end and I.F. sections for video and sound are supplied completely factory assembled, wired, aligned and tested.

Features include: 5 I.F. picture stages, 2 sound I.F. stages with limiter and discriminator, 4.5 Mc band-width for greatest picture definition, 10,000 volt power supply, 29 RCA tubes plus picture tube, heavy duty RCA 12" Alnico V PM speaker.

Complete with all parts, tubes, speaker, dipole antenna and full instructions for easy assembly. Remarkable life-like fidelity of picture and sound will be yours — without alignments or trimmer adjustments!

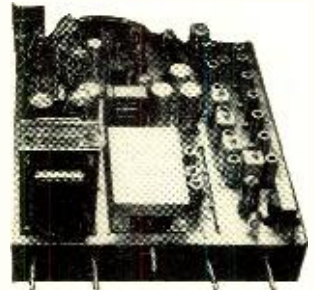

TA-10, 10" Standard model	229.50	NET
TA-12, 12" Standard model	259.50	NET
TA-15, 15" Standard model	349.50	NET

IF IT'S TELEVISION, TERMINAL HAS IT!

R.F. and I.F. ASSEMBLY — for building your own 10", 12", 15", 20" direct view or projection type television receiver. Circuit wired and aligned include 13 channel R.F. tuner, oscillator, mixer, video and sound I.F. stages. Complete **119.50** with 16 RCA tubes, your cost

BAUSCH & LOMB PROJECTION LENS — designed and made by the world-renown leader of fine lenses. A precision lens system, completely self-contained and ready for mounting in front of any 5" projection television tube. Lens speed is f/1.9, E.F. 5 inches (127.0 mm.). For bright, clear television pictures up to 6 x 8 **125.00** feet in size. Your cost

DUMONT INPUTUNER — the famous self-contained R.F. unit embodying the Mallory-Ware Inductuner and featuring continuous tuning from 44 to 216 megacycles. As used in the superb Dumont Telesets and Champion assembly kits. Complete with tubes and two-speed vernier dial. Your cost less tubes, only **58.65**

30 KILOVOLT POWER SUPPLY — an efficient and very stable 6-tube power supply, completely self-contained, for use with 5TP4 projection tube and Bausch & Lomb projection lens. May be incorporated with any set or kit for bright, clear television pictures up to 6 by 8 feet. (yes, **110.00** feet!) Your cost, complete with tubes

TERMINAL CARRIES A COMPLETE STOCK OF TELEVISION PARTS, TUBES, LENSES, ANTENNAS AND ACCESSORIES.

Make Terminal YOUR Television Headquarters

TERMINAL

RADIO CORPORATION

Distributors of Radio & Electronic Equipment

85 CORTLANDT STREET
NEW YORK 7, N. Y. — Phone: WOrth 2-4415

**Exceptional Profit Opportunity
for JOBBERS**

This famous-make FM antenna has been advertised and sold for many times the low price MID-AMERICA asks. Plenty of mark-up margin for you. DynaTenna covers both FM bands . . . delivers FM reception at its best. Complete with 60 feet of 300-ohm twin lead-in. Mounts anywhere easily . . . vertically or horizontally to match polarization of transmitting stations. Line is standard approved flat-type, solid dielectric with weather-resisting insulation. The exclusive design features and brilliant performance of this Stromberg-Carlson FM antenna makes it easy to sell. Wire, write, phone your order today! Get your share of this fast-moving item while our limited supply lasts.

MID-AMERICA Co., Inc. (Jobber Division)
2412 S. Michigan Ave. • Phone: Victory 7820
Chicago 16, Illinois

**STROMBERG
CARLSON
FM
DYNATENNA**

Only
\$3.75
Each in Lots
of 100 FOB
Chicago, Ill.

INSIDE INFO!

Get your copy today

**ELEMENTS OF
MAGNETIC TAPE
RECORDING
and 999
APPLICATIONS**

Available
For Only

25c

by **A. C. SHANEY**

Contains schematic diagrams

AMPLIFIER CORP. of AMERICA

398-2 Broadway • New York 13, N. Y.

**Learn and Earn!
TELEVISION**

**RADIO F. M.
COMMUNICATION**

offer profitable occupation for both men and women.
You learn by actual work, how to build and operate,
and fit yourself for a higher pay job. Write for catalog.

Approved for Veterans

HOLLYWOOD SOUND INSTITUTE

1040-A N. Kenmore

Los Angeles 27

QUAM *Adjust-a-Cone* **SPEAKERS**

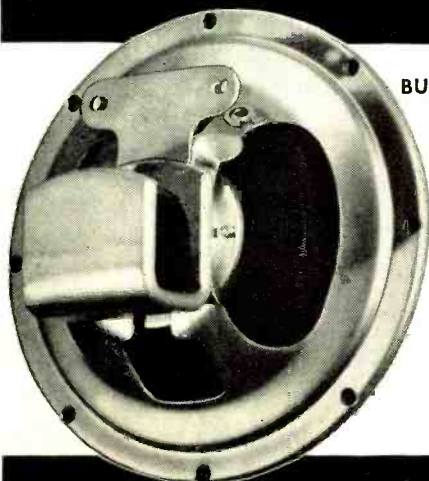

BUILDERS OF FINE SPEAKERS SINCE 1923

LOOK FOR THE
U-SHAPED
COIL POT

Electro Dynamic and P. M. Speakers
in the following sizes: 3½", 4", 4"x6",
5¼", 6½", 6"x9", 8", 10" and 12".

Write for Catalog...

QUAM-NICHOLS COMPANY, 522 East 33rd Place, Chicago 16, Ill.

Madagascar—Radio Tananarive is heard during last half-hour of the transmission closing at 1400 on 6.065 and 10.615; former outlet best; French news from 1345 to closedown. (Peddle, Newfoundland)

Malaya—The British Far Eastern Broadcasting Service, Singapore, is now using 11.770 instead of 11.735. (URDXC) The frequency has been measured 11.766.5. (Kary, Pa.)

Current schedules for programs of BFEBS are—Orange Network, 11.77, 6.77, 0030-0130, 0300-0430, 0530-1200 (at 0430-0530 these frequencies carry the Purple Network); Purple Network, 15.300, 21.720, 0030-0130; 15.300, 0300-1200; 21.720, 0300-0530; 9.690, 0530-1200. (Cushen, N. Z.) BFEBS is anxious for reports on reception of the new 21.720 outlet. (Pearce, England)

Kuala Lumpur is noted on new frequency of 6.050; heard in native to 0800, announces "Radio Malaya, Kuala Lumpur," and then takes *English* programs. (Cushen, N. Z.) Frequency may be as high as 6.055. (Balbi, Calif.)

Mozambique—Lourenco Marques has same Portuguese language program on 9.650 and about 4.825 at 1330; *English* programs are still carried on 4.925. (Gillett, Australia) The 4.825 outlet is heard in England daily from around 1300 with Portuguese programs; CR7BJ, 9.645, is heard there daily with good signal to 1500 sign-off; on Thursdays runs to 1530 with messages in Portuguese for Portugal and Angola; may be off Sundays. (Pearce)

New Zealand—By this time regular transmissions should have been started by the New Zealand-Broadcasting Service; frequencies most likely to be used are 9.54, 11.78, 15.28 (which were used in tests during early winter). James Shelley, director, has informed me that "we are pleased to receive IRC's if DX-ers are writing in asking for verification." Reports on tests were most gratifying, he adds. QRA is New Zealand-Broadcasting Service, 36, The Terrace, Wellington, C. 1, New Zealand.

Nicaragua—YNDG, Leon, has been using *English* occasionally during programs recently; frequency seems to have shifted to about 7.651, signs off around 2200. (Arthur, W. Va.)

Norway—Oslo's outlet (LLG) on 9.61 is definitely beamed to North America daily 2000-2100; still asks for reports to Norwegian State Broadcasting, Oslo Studio, Oslo, Norway. Announces in Norwegian and *English*. (Kary, Pa.) The 6.195 outlet (in parallel) is just readable in West Virginia, through bad QRM. (Arthur)

The Norwegian outlets on 6.185 and 9.540 now have increased power to 100 kw. (Holmberg, Sweden) The 9.610 outlet is heard with such good level in Eastern U. S. that some DX-ers believe it is also now 100 kw.

Friis, Denmark, reports Oslo is now on 11.855 (probably 11.850) at 0600-0730. (Kary, Pa.)

Palestine—Cushen, N. Z., reports

International Short-Wave

(Continued from page 156)

daily. (Radio Australia) (Has anyone in the U. S. picked up the 1730-1930 radiation?—K.R.B.)

Korea—The Korean Broadcasting System frequency has been measured at 7.933; is still heard well in East to 0830 sign-off; probably runs from around 0530; 2.510 may be in parallel. Cushen, New Zealand, reports XLKA at Seoul has replaced JODK on 2.510, heard 0400-0845, good signal. Reports on callsigns the new Korean stations are using are conflicting, some give "X," some "H," and still others "J" as the initial letter.

The Korean outlet on 4.400 has a good signal in Vancouver, British Columbia, 0300-1030 or 1100. (Park)

Lebanon—Radio Beirut is now on (measured) 8.017 from 8.033. (UREXC) Appears to have altered schedules; *English* programs now end at 1100, has Arabic programs to 1515, then French to 1630 (*new sign-off*); leaves the air with a French march (*not "La Marseillaise," as formerly*). (Pearce, England) Is audible some days in East near close-down, but through heavy QRM.

Libya—Sanderson, Australia, has received word from the Forces' Broadcasting Station, Benghazi, Cyrenica, M.E.L.F., that its tests on 11.850 had to be discontinued for the present, but that it hopes to be on the air soon with a regular schedule; when testing was *actually* on 11.820 although announced 11.850; watch for this one around 0500-0615, 0900-1100, 1300-1600, 1815-2100 (which were times reported testing).

Luxembourg—Announced schedule of *Radio Luxembourg* is 0600-0800, 15.350; 1130-1800, 6.090, according to Swedish sources. However, is heard in Eastern U. S. as late as 0830 when it either leaves the air or fades out, best 0700-0800. (Kary, Southall, Pa.)

(Continued on page 170)

Now Available TRANSFORMERS TO OPERATE WAR SURPLUS EQUIPMENT

New small units now available at your favorite distributor. Model F 5069 delivers 24 volts at 3 amperes — \$3.90 net. Model F 5075 delivers 24 volts at 1 ampere — \$2.40 net. Other models for 12 and 24 volt operation.

Write for your free copy of the new
STACO Relay and Transformer Catalog.

STANDARD ELECTRICAL PRODUCTS CO.
407 Linden Ave. Dayton 3, Ohio



April, 1948

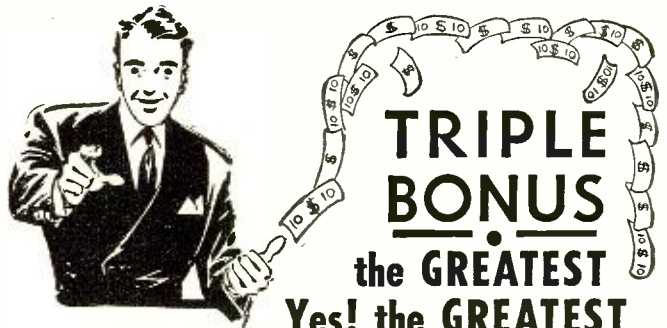

Yes! the GREATEST TEST EQUIPMENT Story Ever Told

1000 pieces of LATEST MODEL, Standard Brand Test Equipment to be sold this month. TUBE CHECKERS, SIGNAL GENERATORS, OSCILLOSCOPES, VTVM's, MULTI-TESTERS, etc.

LABORATORIES, SCHOOLS, RADIO DEALERS, SERVICE MEN, HAMS, EXPERIMENTERS, STUDENTS:

Get a TRIPLE BONUS on EACH piece of equipment valued at \$40.00 or more. Just fill out the coupon below. Act now!

Radiomart INC.

Store
149 Riverdale Ave.
Yonkers
New York

Store & Warehouse
143 West End Ave.
New York 23
New York

RADIOMART Dept. RN-4
149 Riverdale Ave., Yonkers, New York

I am interested in learning more about the greatest test equipment story ever told. Please send details of your great triple-bonus plan. I am particularly interested in buying the following equipment:

Name

Address

- | | |
|---------------------------------------|---------------------------------------|
| <input type="checkbox"/> Laboratory | <input type="checkbox"/> Service Man |
| <input type="checkbox"/> School | <input type="checkbox"/> Ham |
| <input type="checkbox"/> Radio Dealer | <input type="checkbox"/> Experimenter |

RADIO SERVICEMEN & HAMS No Army Surplus — All New

300 ohm twin lead.....\$2.75 per C; \$21.00 per M
72 ohm Coaxial Cable.....\$6.50 per C
Microphone Cable, Good.....\$6.50 per C
Car aerials, Brass Chrome, slide cowl.....\$1.67 ea
10 @\$14.7
Car aerials, Fender or top cowl.....\$2.90 ea; 10 @ \$2.70
4 Prong Universal Vibrator.....\$1.25 ea
All Mallory and Radiart Vibrators......40% off
10 Watt Wire Wound Resistors, all sizes.....27c ea.
New Tubes, RCA, Philco, Sylvania—No Surplus
Raytheon National Union......50% off, min. 10 tubes
All type Ballast tubes......59c ea.
New Condensers, Solar, Aerovox, Sprague, etc.
16 mfd tubular 450 W.V......59c ea; 10 @ 49c
40 mfd tubulars 450 W.V......79c ea; 10 @ 70c
Dual 8 mfd tubular 450 W.V......79c ea; 10 @ /uc
605-01-02-1700 V. Buffer Cond......29c ea; 10 @ 24c
10 mfd, can with nut and leads, 450 W.V......79c ea.
10 @\$1.29
16 mfd can with nut and leads, 450 W.V......89c ea.
10 @79c
30 mfd can with nut and leads, 450 W.V......99c ea.
10 @90c
40 mfd can with nut and leads, 450 W.V.....\$1.45 ea.
10 @\$1.29
40-20-20-150 W.V. tubulars......69c ea; 10 @ 63c
30-20-150 W.V. 120-25 W.V......69c ea; 10 @ 59c
001-006 mfd-600 W.V......9c ea.
01-02 mfd 600 W.V......10c ea.
05 mfd 600 W.V......11c ea.
.1 mfd 600 W.V......13c ea.
4" PM Speaker.....\$1.49
5" PM Speaker.....\$1.59
12" PM Speaker.....\$1.99
3" Cinchograph PM.....\$2.25
3" Utah 450 ohm.....\$2.95
5" Quam 6 volt field Auto Spk.....\$2.95
7 1/2" Mobar type 6 volt field Auto.....\$4.85
Phono, motor and turntable.....\$2.95
Pickup arm and L72 crystal.....\$2.10
Pickup arm and L72 crystal 3.5 output.....\$2.75
Pickup arm and Webster NS crystal.....\$1.79
Dipole Antenna FM or Telv.....\$4.95 ea; 10 @ \$4.50
Folded Dipole FM or Telv.....\$5.95 ea; 10 @ \$5.00
Centratap and IRC volume controls with switches
long shaft, 500 M and 1 meg......59c ea; 10 @ 49c
100 assorted resistors.....\$1.50
Aerial wire, No. 14—7 strand copper, 90 ft. rolls
65c ea; 10 @\$5.50
4 tube Automatic Portable Radio.....\$15.95 ea.
6 tube 8 gang Automatic Car Radio.....\$27.95 ea.

Write for special Price List on any parts you need.
\$2.00 min. order add postage
25% Deposit Balance C.O.D.

BRUCE ELECTRONICS CO.

82 Speedwell Ave.

MORRISTOWN, N. J.

RED HOT SPECIALS!



CONVERTER

Add 2 meter bands to your present receiver at low cost and little work. Now tunes 151 to 186 MC. Easily changed to 2.2 R.F. stages using 6 A K 5, 1 oscillator stage using 6C4, 1 mixer stage using 6AE5, 11 MC. output. Complete with tubes, 1 input L.F. transformer, schematic and instructions.

New \$9.95

Order now, When these are gone there'll be no more.

OUTBOARD AMPLIFIER

Add power to Your 2 meter rig. Long line tuner. Easily converted to 2. Complete with 3E29 (829B), socket, schematic, and instructions.

New \$4.95



EXTRA SPECIAL

Both units for..... \$13.50

DOLLAR TUBE SPECIAL

Three 211's or seven 1625's

Individually boxed..... \$1.00

RC-148 IFF equipment, BC-1267 Receiver Transmitter. New with tubes.....\$29.95

RA-105 Power Supply, New.....\$24.50

Both units in steel racks shipped in transport chest.....\$47.50

SOLA CONSTANT VOLTAGE TRANSFORMERS

60 watt..\$15.00, 500 watt..\$49.00, 1000 watt..\$94.50

Prices F.O.B. our warehouse.

Satisfaction Guaranteed

Write for circular. Check full of bargains!

QUAD ELECTRICAL SUPPLY

1650 N. Damen Ave.

CHICAGO 47, ILLINOIS

The particular chassis shown is a pre-punched used receiver chassis. Layout and construction may be changed to suit the individual cabinet, chassis, and parts available without affecting the operation of this

unit. The main consideration in this change would be for short and isolated grid leads to the amplifier and "eye" tubes to prevent induced hum in the amplifier.

-30-

HIGH FREQUENCY RECEPTION IN STRONG NOISE FIELDS

By I. M. BICKFORD

One of the poorest short-wave locations that can be envisioned is that area known as midtown Manhattan. Tall buildings with their partial shielding effect on radio impulses and the constant interference caused by ignition systems on cars are bad enough. The worst offender, however, is noise generated locally in the building in which radio signals are being received. If this building happens to be a newspaper office where the peak of activity is reached in the early evening hours and continues until around 4 a.m., the chances of getting consistent copy from any but the most powerful of signals is remote.

To operate a radio circuit from a city location it is usually necessary to "pipe" the signals in from a remote receiving station via leased telephone lines, and that is what is done by all commercial communication central offices.

However, there are many conditions which render the use of piped-in signals either too costly, or due to the variations in frequency at the point of origin, particularly in the case of expeditions using old type equipment with no crystal control, it is desirable or necessary to have the operator copy with one hand on the tuning dial.

This type of "slug-it-out" radio reception is now almost a thing of the past, but the high noise level in city buildings still prevents clear commercial reception by recorder tape machine, which would otherwise be possible if the locally generated noise could be eliminated, or at least cut down substantially. (Diversity reception notwithstanding.)

After many years of such "slug-it-out" reception on the third floor of one of the above-mentioned midtown Manhattan buildings, this writer, after many fruitless experiments in an endeavor to decrease the noise, finally hit the jackpot in getting clear signals through the "hell-hash," with the result that the transmission lines to the doublets atop the building no longer had a complete or partial antenna effect, and the doublets became directional again, instead of acting like electronic umbrellas, with everything electrical pelting them.

The reasoning behind this experiment was this: The chief source of noise pick-up in the receiver (locally generated noise in the building, that is) occurred in the ground or cathode side of the receiver proper. This included the power lines feeding the tubes, and even the metal shielding of the receiver itself, all such elements, of course, being in an intense field of noise in the building (elevator clicks, electrical presses, and their associated electrical equipment).

The centertap on the receiver's input coil meant nothing. The r.f. choking of the power leads had little effect, even when tuned against the received frequency. The noise still poured in. Static

shielding between the input coils was ineffective.

The conclusion was reached that since the cathode side, including the set's shielding, was acting as an antenna, with the transmission line to the doublet as its counterpoise, that in order to neutralize the transmission line as a counterpoise, an "artificial" centertap would have to be placed external to the receiver, and out of capacity relation to the set's shield.

Such an "artificial centertap" was made by using two surge resistors (Fig. 1) in each side of the transmission line in close proximity to the receiver's input terminals. One of these resistors (non-inductive) was fixed, and of about 300 ohms while the other resistor was variable, and was adjusted so that the reflections in one side of the line matched and balanced those in the other side of the transmission line.

It was found that two variable condensers, one in each transmission wire, would also function, but that they were more susceptible to external pick-up.

When suitable adjustment was made on the variable resistor a critical point was reached where the noise disappeared, the local noise that is, leaving only the static and other noise picked up by the dipole itself, such as ignition noises, signs, etc. But the continuous "mush" and roar had disappeared and the signals uncovered were surprising.

Tape recording was made of signals which previously had to be untangled by ear reception at great effort. Since this experiment was made during the war, it uncovered for monitoring, many useful interceptions.

For the variable resistor, a 1000 ohm graphite unit was used, as it was easily available and the balance point at its low end was not over critical. Each separate antenna requires its own individual balance, but the balance remains the same for all frequencies being received.

-30-

Fig. 1.

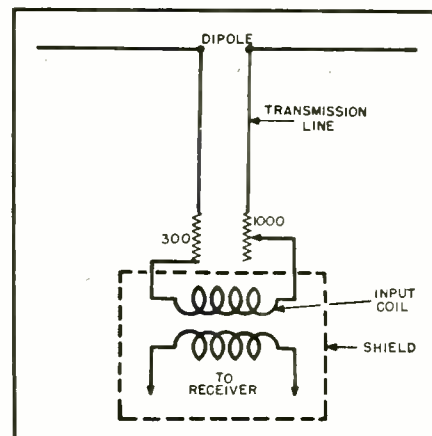

TELEVISION KIT BUILDER WRITE FOR SENSATIONAL

Offer of RCA Television Parts

- CATHODE RAY TUBE, No. 7EP4..... \$18.95
- CATHODE RAY TUBE, No. 7DP4..... 19.50
- FOLDED DIPOLE ANTENNA, list price \$14.50. 7.25
- COAXIAL CABLE, 72 ohms, per 100 feet..... 6.95
- COAXIAL CABLE, 72 ohms, per 500 feet..... 32.10
- TWIN LEAD-IN WIRE, 300 ohms, per 100 feet. 1.95
- TWIN LEAD-IN WIRE, 300 ohms, per 1000 feet 17.50
- VIEWTONE POWER TRANSFORMER..... 11.75
- ELECTROLYTIC CONDENSER, .05—3000 V.. .69

FM TUNER OR FM RADIO

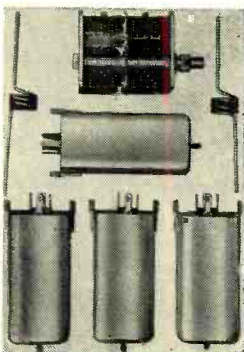

FM Condenser & Coil Kit—(88 to 108 Mc)

- Variable Condenser
- Discriminator Co II
- Oscillator Coil
- Two I.F. Coils
- Limiter Coil
- Antenna Coil
- Schematic Diagram
- Instructions

\$4.95

This kit contains the vital parts needed to build an FM Tuner or Radio and for modernizing Pre-War FM Sets; all other parts needed are standard.

RADIO TUBES KNOWN BRANDS—BULK

	Each
80, 5U4G, 5Y3GT, 5Y4GT.	\$.42
35W4, 25Z6GT, 35Z5.45
6J5, 6SA7, 6SK7, 6SQ7.49
12AT6, 12BA6, 12BE6, 12SQ7.49
12SA7, 12SK7, 12SH7, 12SR7.49
6H6, 6J7, 6K7, 6Q7, 6SN7.55
43, 6A7, 6A8, 6V6, 25L6.65
024, 6X5, 7A8, 7B7, 7N7.65
1A5, 1A7GT, 1H5GT, 1N5GT.74
1S4, 1R5, 1S5, 1T4, 3Q4, 3Q5.79
14A7, 14Q7, 14B6, 1LN5.95
6AC7, 6L6G, 25A6G, 35Y4.95
1LA6, 70L7GT, 117L7GT, 117N7GT1.35

CONDENSERS

	Per Hundred
100—Assorted, .001 to .02	\$3.95
100—.001—600 V.	3.95
100—.002—600 V.	3.95
100—.006—600 V.	4.40
100—.01—600 V.	4.40
100—.05—600 V.	4.95
100—.1—600 V.	7.20

ELECTROLYTICS

	Each
16 —150 V.	\$.24
20 —150 V.26
20-20—150 V.29
30 —150 V.32
50 —150 V.35
8 —450 V.27
10 —450 V.32
16 —450 V.36
16-16—450 V.59
20 —450 V.39
30 —450 V.47
40 —450 V.54

- G.I. AUTOMATIC RECORD CHANGER..... \$13.50
- WEBSTER NO. 50, AUTOMATIC RECORD CHANGER..... 22.75
- WEBSTER NO. 56, AUTOMATIC RECORD CHANGER..... 26.50
- BROOKS INVERTER, 50 Watts, 110 Volts, D.C. to A.C. 8.95
- ELECTRIC SOLDERING IRON, 60 Watts, list price \$2.95 1.59
- ELECTRIC SOLDERING IRON, 100 Watts, list price \$3.85 2.37
- ELECTRIC SOLDERING IRON, 150 Watts, list price \$5.95 3.57
- SELENIUM RECTIFIER, 100 ma. 1.95
- CRYSTAL CARTRIDGE, Astatic L-70. 1.55
- CRYSTAL CARTRIDGE, Astatic L-72. 1.65
- CRYSTAL CARTRIDGE, Astatic L-75. 1.25
- VOLUME CONTROLS, 1/2, 1 or 2 meg. with switches.39
- OUTPUT TRANSFORMER, match 50L6.39
- A.C.-D.C. Choke.39
- TOGGLE SWITCH, SPST.15
- TOGGLE SWITCH, DPST.25
- TOGGLE SWITCH, DPDT.40
- AUTO RADIO VIBRATOR, 4 prong, non synchronous. 1.19
- AUTO WHIP ANTENNA, 2 post, 3 section. 2.25
- I.F. COIL, 456KC.39
- OSCILLATOR COIL, 456KC.19
- VARIABLE CONDENSER, 420/162 mmd.68
- VARIABLE CONDENSER, FM (88 to 108 mc).75
- RESISTANCE CORDS, 135, 150, 180, 200, 235, 290 ohms.49
- RADIO CHASSIS, punched for 6 tubes or less.39
- LOOP ANTENNAS, oval, assorted sizes.39
- ELECTRIC PHONOGRAPH MOTOR, complete with 9" turntable. 2.95
- 4" PM SPEAKER, ALNICO No. 5 magnet. 1.19
- 5" PM SPEAKER, ALNICO No. 5 magnet. 1.39
- LINE CORD, 6 feet.14
- CRYSTAL PICK-UP ARM, includes all hardware. 1.95
- COMPLETE INTER-COMM. SYSTEM (3 tubes) master & station. 17.97
- 100—ASSORTED KNOBS, screw and push on types. 4.95
- 100—ASSORTED SOCKETS. 4.95
- 100—ASSORTED PILOT LIGHTS. 4.95
- 100—ASSORTED RESISTORS. 1.50

BROOKS RADIO DISTR. CORP., 80 VESEY ST., DEPT. B, NEW YORK 7, N. Y.

SPRING SPECIALS

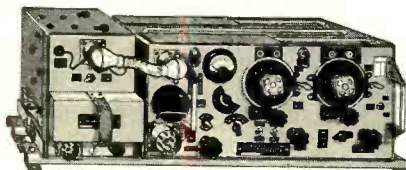

SCOP: The famous B 19; Mark II; 40 & 80' meter transmitter-receiver with tubes; dynamotor power supply instruction manual. 12 ft. ant. and base. V.I.F. antenna and base, dummy ant. mounts, 1 headset, microphone, key, junction boxes and interconnecting cables. N-1.....\$29.95
B-19 MARK II complete tank installation with all spares. Packed for export. Instruction manual, etc. N-1.....\$44.95
 Headset & Microphone used with Mark II, N-1, \$1.95.

SCR522 SPECIALS
 Two meter transmitter-receiver with tubes. U-1, \$17.95; U-2, \$14.95.
 Dynamotor—SCR522, N-1 \$3.95; Plus for SCR522 N-1, \$4.00 per set.
 BC602 Control Box, N-1.....\$1.00

BC1206-C SETCHELL CARLSON BEACON RECEIVER 28 volts D.C. 195-420 KC. 5 tubes. N-1.....\$4.95
BC733D Aircraft Glidepath Receiver N-1...\$19.95 (Approved by C.A.A.)
T-17 MIKE N-1, \$1.95; TS-13 Handsets U-1,\$2.50
APS-15 3CM Radar Transmitter complete with Magnet, magnetron Klystron and other tubes. Used.....\$14.95

BC464 TARGET RECEIVER and selector for 5 channel remote control with battery container and ant. 68-73 MC. N-1.....\$14.95

SCR284A, 3800-5800 kc.—Complete set, N-1,\$69.50
PE104A 6-12 volt vibra-pack, N-1 \$5.95; U-1 \$4.95
GN45A Handcrank Generator and stand, N-1,\$4.95
BC357J Beacon Receiver, 75 MC, tubes N-1,\$3.45
GENERAL ELECTRIC BATTERY CHARGER: Tungar 6RB6B17, 12 battery, 12 amp.; 24 battery, 6 amp. N-1.....\$67.50
TRANSFORMER 600-0-600 @ 300 MA 17 V @ 1 amp. N-1.....\$5.95

SCOP: MN26 RADIO COMPASS RECEIVER with tubes 150-1500 KC U-1.....\$18.95
 U-2.....\$14.95

SIGNAL BOX KITE, Postpaid, N-1.....\$2.50
TRIMM commercial 17,000 ohm headset, N-1,\$4.25
HS-23 8,000 ohm headset N-1 \$1.29; U-2......89c
HS-33 600 ohm headset NEW.....\$1.50
CODE: N-1 New
 U-N Used, like new
 U-1, Used, excellent condition
 U-2 Used, minor scratches
 U-3 Used

EE-8 TELEPHONE field sets with handset and ringer N-1, \$15.00 ea. \$28.00 pr.; U-2 \$10.00 ea., \$18.00 pr.; U-3 \$7.00 ea., \$13.00 pr.

TUBE SPECIALS

5PR1.....\$1.15	5RP4.....\$2.50
3AP1.....2.25	4E27.....6.00
872A.....1.75	304TL.....1.75
2N2......75	EF50......90
316......90	9002......75
726.....4.95	211.....1.00
75TL.....2.50	717-A......69

GIBSON GIRL SCR578B transmitter for sending distress signals from boats. Trans. complete with balloon, hydrogen gen., kite and inst. manuals. N-1.....\$25.00

EXTENSION CORDS, PL55 plug incl. N-1, \$.40
HS-30 Ear plug headset N-1, \$.95; U-1.....\$.50
MATCHING TRANSFORMER, HS-30.....\$.50
115 V.A.C., 1/4 h.p. motor with 250 V 600 MA ampilpyne generator, N-1.....\$24.50
200FD Johnson var. cond. dual N-1.....\$1.18

APN-1 ALTIMETER INDICATOR—basic movement 0-1 m.a. 5 ma. shunt 270° scale. An excellent basic G.E. movement for constructing your own meters. N-1.....\$1.95
METER RECTIFIER, full wave midget Selenium, 10 volts, 30 MA. N-1.....\$.29

A.C.-D.C. BUZZER, N-1.....\$.89
PL-55 PLUG, N-1 \$.29; 4 for.....\$1.00
AN-160 ANTENNA, N-1, 2,000-6,000 KC; 9 insulators and jumpers 100 ft. long.....\$1.00
 .01-300 V. mica Cap.—Ideal by-pass cond. N-1

PHOTOCON SALES

1062 N. Allen Avenue PASADENA 7, CALIF.

\$.25; 7 for \$1.00; per 100.....\$6.00
SCR-274 Remote tuning head, 3 crank \$1.50; 2 crank.....\$1.00
AS-89/ART Ant. System, N-1.....\$2.95

PE-103A DYNAMOTOR N-1.....\$9.95
CD-501A CABLE for PE-103A-BC654A N-1.....\$1.95
LS-7 SPEAKER, N-1.....\$4.95
 Frame for mobile mounting BC654A-PE-103A.....\$4.95
ANTENNA, 8 sec, 24 ft. for BC654A, Base N-1.....\$7.95

TRANSTAT 10 amp. 0-135 V. panel mtr. N-1.....\$29.50
INTERPHONE AMPLIFIER BC709, ideal for aircraft, booster for telephones, etc. 1 tube, batt. operated, N-1.....\$5.00
TSC-9 COLLINS TRANSMITTER/RECVR. 110 V. A.C. Power Supply, Cables U-1.....\$109.00
THROAT MIKE \$.50; **HAND KEY**, N-1, \$.50; U-1.....\$.25

BC-348 MNTG. BASE Postpaid.....\$2.50
BC-348 OUTLET PLUG Postpaid......80
BC-348 MNTG. BASE & OUTLET PLUG 3.00

LIONEL SPEED KEY, N-1.....\$5.95
 Crank for 274-N Receivers.....\$.60

SOUND POWERED chest set, N-1, \$3.95 ea.; pair.....\$7.50
SOUND POWERED HANDSET, TS-10, N-1, \$15.00 ea.; per pair.....\$25.00
PHOTOFLASH CAPACITOR, 23 mid., 2000 V; N-1.....\$10.00
FL-8 Range Filter, \$1.95; With cord and plug.....\$2.50
ANTENNA knife switch, S.P.D.T. \$1.00; Ant. knife switch, D.P.D.T. \$2.00
SOLA CONSTANT voltage Transformer, 80 V.A., 60 cycle, 115 V.A.C.....\$13.50

APN-4 CATHODE RAY INDICATOR, TUBES N-1.....\$24.50
APN-4 Receiver, tubes N-1.....\$17.50

PEERLESS A-4233Q Line matching transformer 50/125/200/250/500 ohms, N-1.....\$1.50
TERMS: F.O.F. Pasadena unless postpaid. No C.O.D.'s under \$5.00. 25% deposit on ALL orders. All C.O.D.'s shipped by Rail Express. Send full price with order and we will ship by fast truck, transportation collect. Minimum order \$2.00. Californians include 2% sales tax.

SEND FOR THESE SPECIALS

ALL NEW MERCHANDISE

CONDENSERS

.05 mfd. (2) 600 V. Bathtub.....	\$.09
.1 mfd. (3) 600V. Bathtub.....	.09
.1 mfd., 1,500 V. Bathtub.....	.15
2.0 mfd., 600 V. tubular oil filled.....	.45
5.0/5.0 mfd., 600 V. Rectangle oil filled....	1.05
10.0 mfd., 600 V. Rectangle oil filled w/stand off insulators.....	.95
3.5/2.5 mfd., 1,000 V. Rectangle oil filled w/ stand off insulators.....	.90
10.0 mfd., 1,000 V. Rectangle oil filled w/ stand off insulators.....	1.40
2.0 mfd., 2,500 V. Rectangle oil filled w/stand off insulators.....	2.20
.25/2.5 mfd., 6,000 V. Rectangle oil filled w/ stand off insulators.....	3.75
1.25/1.25 mfd., 7,500 V. Rectangle oil filled w/stand off insulators.....	16.95
.001 mfd., 25,000 V Rectangle Mica w/stand off insulators.....	20.00
50 mmf., 32,000 V. Tubular Vacuum.....	5.95
250 mmf/250 mmf 3,000 V. Variable .070"	
Spacing #BC-1623.....	7.95

RECTIFIERS Dry disc type—Continuous duty ratings

3.5 V.A.C.—1.8 V.D.C. @ 1.0 amp. full wave bridge.....	\$.75
6.5 V.A.C.—2.2 V.D.C. @ 3.0 amp. full wave center tap.....	1.20
36 V.A.C.—24 V.D.C. @ .2 amp. half wave.....	.75
54 V.A.C.—42 V.D.C. @ 1.6 amp. full wave bridge.....	4.40
154 V.A.C.—120 V.D.C. @ .6 amp. full wave bridge.....	6.85
180 V.A.C.—154 V.D.C. @ .4 amp. full wave bridge.....	6.90

TRANSFORMERS

Microphone input, double carbon, 18 to 6000 ohms.....	\$.70
Power, 80-110-220V., 50-1600 Cy. primary 422 V., 15m.1 C.T. and 6.3 V. @ 3.0 amp. secondary.....	.95
Power, 110 V. to 24 V. @ 1.0 A. 60 Cy. uncased.....	1.60
Transtat 115/230 V., 50/60 Cy. Input, 0-260 V. @ 2 1/2 A.....	21.50
Transtat 115 V., 50/60 Cy. input, 0-130 V. @ 10 A.....	21.50

TUBES

All new boxed and of standard mfg.

2D21 Miniature thyratron.....	\$.70
931A Photo multiplier.....	1.45
3C24/24G Transmitting triode.....	.89
872A Mercury rectifier.....	1.15
VT127A Transmitting triode.....	2.40

No Orders Under \$3.00 Please,

30% with Order - Balance C.O.D.

All shipments made Express Collect.
Write for additional information on above items
or for Special Quantity Discounts.

1527 E.
Seventh
Street

EPCO

Los Angeles
21,
California

CONDENSERS—OIL-FILLED

Type BT-14 0.012 mfd. 25,000 DC W.....	\$6.75
Type TJH 10 mfd. 1000v.....	2.15
Type TJH 8 mfd. 1000v.....	1.95
Type TJH 1 mfd. 2000v.....	1.25
Type TJH .5 mfd. 2000v.....	1.15
Bathtub Type 600v. DC W. 1 mfd. .25 mfd. .5 mfd. .05 mfd.....	.25
Bathtub Type dual 25-.25.....	.45
Mica condensers .01, .02, .03, 1000v. DC W.....	.35
Mica condensers .005 mfd 3000v. DC W.....	.45
Mica condensers .0008 mfd 5000v DC W.....	.95
Assorted condenser kits—mica-oil filled, 10 for.....	2.95

TUBES

705A.....	\$4.75	6L6C.....	\$0.99	6Y6.....	\$0.80
708A.....	4.55	6A3.....	.99	836.....	1.10
713A.....	2.75	2X2.....	.83	5HP4.....	4.95
717A.....	1.75	6A6.....	.83		
715A.....	4.95	6B7.....	.83		

TUBES JAN \$4.9

5U4	12A6	6SL7	6SG7	6H6	12SA7	2051
6K7	12H6	6SN7	6SC7	12SK7	12SQ7	6L7
884	7C7	42	43	12SL7	12SN7	7A7

TRANSFORMERS 115v. AC 50-60 cycle

Plate trans. sec. No. 1-680v. CT. - 225 MA. Sec. No. 2-1540v. @ 20 MA.....	\$4.35
Filament magnetron 7v. @ 1.5 amps. (15,000)v. insulation.....	2.95
Filament Sec. No. 1-2.6 v. - 10 amps., Sec. No. 2-6.4v. @ 3.5 amps. CT. Sec. No. 3-6.4v. @ 1 amp. CT.....	4.95
Output transformer Ratio 3000:100, max. 50 W., max. current 300 miles.....	1.10
Output ratio 5000:70 ohm.....	1.10
Output imp. ratio 9:1—works out of 6SL7.....	1.05
Output P.P. pair of 616's into 50 ohm load imp. ratio 15,000:50.....	1.98
Input transformer Ratio 3650:2500 ohm.....	1.05

RELAYS

Dunco type 115v. 60 cycle AC, contacts 115v. 30 amp. AC.....	\$2.95
Dunco type 125v. DC coil 3500 ohm, contacts 115v. 3 amps.....	2.55
Cramer time delay relay one minute.....	3.95

REOSTAT OHMITE—IRC

Cramer 500 ohm 50 W.....	\$1.35
Cramer 3000 ohm 100 W.....	1.95
Ohmite 2-0 chokes.....	1.10
Selsyn Bendix type 1-1, 115v. 60 cycle, 2 for.....	9.75
Terminal Block 12 dual contacts w/cover.....	.29

WALMAR DISTRIBUTING CO.

3002 VIRGINIA AVE. BALTIMORE 15, MD.

Test Instrument

(Continued from page 55)

another hi-gain voltage amplifier stage is added. To the extreme right of the panel is the external speaker jack. A 6½" internal speaker is connected by a closed circuit jack to the amplifier output until an external speaker is plugged in. The external jack is used for testing speakers as well as for connecting a larger speaker to the amplifier for p.a. work. The tone control is located just to the left of the speaker jack.

The 6E5 electron-ray indicator tube, visible at the upper right of center of Fig. 1, is the visual indicator of the strength of the signal made audible by the loudspeaker. It is more than this, however, since by its switch S_1 (located to the upper left of center) it may be shifted to indicate input voltage from the signal tracer probe or output voltage from the tracer amplifier. The first and third positions of the switch provide this visible voltage indication without having the signal go through the final amplifier. This is necessary since some signals measured would be so strong for a given setting of the gain control that the audible signal would blast the speaker out of its cabinet. Position #2 applies plate voltage to the inverter stage making the amplifier operative for audible as well as visual indications. The input potentiometer R_1 is intentionally provided with a linear curve rather than the usual logarithmic audio volume control curve. Thus, the user, knowing that the 6E5 electron-ray tube shadow will fully close when 3.5 volts of d.c. is applied to its grid, is potentially provided with a d.c. voltmeter. The potentiometer scale is graduated 0 to 10. A calibration curve may be made

of d.c. volts versus gain figures so the approximate voltage may be read at setting of the control. Used as a d.c. voltmeter the input resistance is that of R_1 shunted by R_2 or 333,000 to 500,000 ohms. Exactly the same process may be used to estimate a.c. voltage to quite good accuracy, but using the crystal diode to rectify the a.c. so it will properly actuate the 6E5. The input resistance will approximate 500,000 ohms on a.c. Again it is no great problem to prepare a calibration curve for the particular diode probe by applying differing a.c. voltages to it from a potentiometer connected across a 60 cycle a.c. line (instead of a d.c. voltage source as for d.c. calibration) and so determine the values of a.c. voltage necessary to just close the "eye" at the 10 successive "gain" knob settings.

This voltmeter will determine presence or absence of a.c. and d.c. operating voltages, as well as to trace signals in equipment being tested. The d.c. plate, screen, cathode, and grid voltages and polarity can be observed using it as a d.c. voltmeter.

The a.v.c., a.f.c. and other d.c. control voltages, as well as a.c. operating voltages in power, as well as signal circuits may be observed using it as an a.c. voltmeter.

The signal tracer probe shown in Fig. 1 consists of a radar type fixed crystal diode detector 1N34 with condenser C_{12} and anti-loading series input resistor R_{25} . This is all housed in a ¾ inch diameter bakelite tube, 6 inches long. A 3 foot, shielded flexible cable extending from this prod is provided with a shielded phone plug for insertion in the amplifier input jack. With this insulated probe, any r.f., i.f. and a.f. signal source points may be easily reached in any operating receiver or amplifier.

Fig. 3 illustrates the general parts layout and simplicity of construction.

Fig. 3. Top view of completed home-built servicing test instrument.

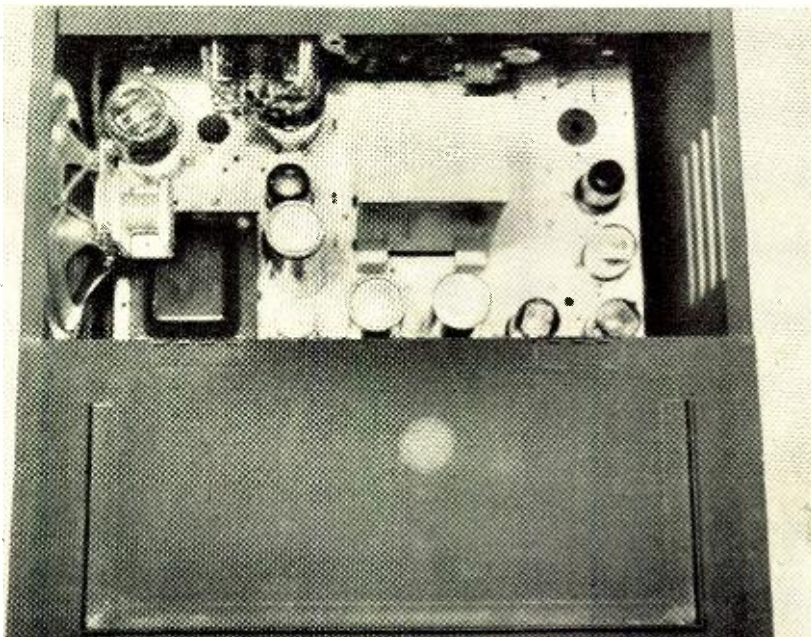

should talk clearly and intelligently about terminology that has now entered the public domain. If we let ourselves get confused, can we wonder that the public becomes confused?

Another point for the industry is to emphasize improvement in such basic factors in fidelity as the microphone, the phonograph pickup, the amplifier, and the loudspeaker. One way to raise standards of performance is to adopt realistic methods of testing audio equipment. One glaring shortcoming in our testing methods is in connection with amplifiers. While the key importance of the amplifier is recognized as a factor in high fidelity, methods of testing amplifiers are woefully inadequate.

The single frequency distortion test is now supplemented by the dual signal test and the intermodulation distortion is measured with the amplifier feeding its power into a fixed resistance load. Yet, none of these test methods comprehends intermodulation distortion with the wide variations in load impedance due to the loudspeaker and its environment. Harmonic generation, transient distortion, and intermodulation distortion rise rapidly as a mismatch occurs between the voice coil of the loudspeaker and the plates of the tubes. In addition, a severe fatigue problem develops unless the reproduction of transients is clean and no loudspeaker hangover effects are noticed.

A voice coil in motion, as is well known, reflects a very complex impedance to the amplifier. If amplifiers generally were tested while connected with a loudspeaker, we would have a more realistic appraisal of amplifier performance.

-30-

PARTS SHOW CONFAB

WAYS and means of conducting the annual Radio Parts and Electronic Equipment Conference and Show in the best interests of all groups and organizations within the industry was the subject of discussion at a recent meeting attended by leading trade press editors and publishers meeting with the Show Committee.

Charles Golenpaul, Show Corporation president, presided at the first industry press conference which was attended by Oliver Read, RADIO NEWS; S. R. Cowan, Radio Service Dealer; Nancy Mainpaugh, Radio & Electronic Jobber; Milton B. Sleeper, FM & Television; Paul S. Weil, Communications; Sidney Gernsback, Radio Craft; Alex H. Kolbe and Nat Bohlhack, Radio & Appliance Journal; Stuart J. Osten, Boland & Boyce; Mal Parks, Parts Jobber; Frank D. Thompson, Electrical Equipment; Wallace D. Morris, Radio & Television Weekly; and Rose Buss Koragren, Electronic News and TV. The Show Corporation was represented by Charles Golenpaul, Show president; Jerome J. Kahn, vice-president; William O. Schoning, treasurer; Kenneth C. Prince, general manager and general counsel; L. B. Calamaras, NEDA executive secretary; and S. I. Neiman, Show public relations counsel.

-30-

"The Kit for the Millions"

NO TECHNICAL KNOWLEDGE REQUIRED FOR ASSEMBLY!

TRANSVISION

... Tops in quality ... Tops in value!

TELEVISION KITS

BUILD YOUR OWN Custom-Quality TELEVISION SETS!

12" TELEVISION KITS—

Standard and DeLuxe Models

Picture size 1½ times larger than with 10" tube . . . A big 75 square inch picture!

Sharp, steady picture achieved with advanced Transvision television circuit. Picture has remarkable brightness even in lighted room (no darkening of room is required). IDEAL FOR HOME or COMMERCIAL INSTALLATIONS.

12" TRANSVISION TELEVISION KIT . . . Standard Model . . . **FEATURES:** 12" picture tube . . . Picture size 1½ times larger than with 10" tube . . . RF Unit designed for 13 channels: factory wired and pre-tuned for 7 channels (no areas have been assigned more than 7 channels; however if desired, up to 6 more channels may be added at very nominal cost) . . . 4 mc bandwidth for full picture definition . . . High fidelity F.M. sound reproduction . . . picture size 75 square inches . . . 9000 volts second anode potential for brightness and contrast . . . maximum picture, sensitivity (better than 50 microvolts) . . . 22 tubes and 12" picture tube, antenna, lead-in wire, etc. (Cabinet extra, if desired). **LIST \$289.00**

12" TRANSVISION TELEVISION KIT . . . DeLuxe Model with Superb Built-in F.M. RADIO. Same characteristics as the Standard Model, plus the following **ADDITIONAL FEATURES:**—50-216 mc continuous tuning . . . Covers the entire F.M. band and all 13 television channels . . . Cut-off switch eliminates unused tubes when set is used only as F.M. receiver . . . **LIST \$359.00**



12" KIT (Table Model)

ALL TRANSVISION KITS ARE COMPLETE—Nothing more to buy! . . . All Transvision Television Kits are COMPLETE with all tubes, including picture tube, wired and pre-tuned RF units and IP's, high gain folded di-pole antenna with 60 ft. lead-in cable, wire and solder.

TRANSVISION TELEVISION CABINETS Beautiful, sturdily built cabinets with handsome rubbed wood finish. Fully drilled.

12" Table Model Cabinet. . . . **LIST \$44.95**
12" Console Cabinet with compartment for record changer **LIST \$99.50**
7" Table Model Cabinet. **LIST 32.50**

FM RADIO CONVERSION UNITS: All Transvision 12" STANDARD Television Kits can now be had equipped with superb FM Radio at the following small additional charges:

For 12" KITS ALREADY ASSEMBLED, FM Conversion Unit. **LIST \$12.50**
For new 12" KITS (non-assembled), FM Conversion Unit. **LIST 7.95**



15" Picture Enlarging Lens



TRANSVISION Television Picture Enlarging Lenses

Engineered by Transvision, these lenses enlarge and clarify the picture. Have wide angle of vision. When placed about 1" from picture tube, the lens almost doubles the picture area; when placed further away, it increases the enlargement still more. Optically ground and polished; 50% greater light transmission than equivalent glass lens; ½ weight of glass lens of similar magnification power. All lenses equipped with adapter for installation on cabinets.

15" LENS (125 sq. in. picture) . . . **List \$36.95**
12" LENS (75 sq. in. picture) . . . **List 25.95**
10" LENS (52 sq. in. picture) . . . **List 19.95**

TRANSVISION ALL-CHANNEL R.F. UNIT FACTORY PRE-WIRED and TUNED . . . For use in Building your own custom-made television receiver . . . for any 7", 10", 12", 15", or 20" Kit.

TRANSVISION ALL-CHANNEL, R.F. UNIT. **LIST \$37.95**
Same R.F. Unit, plus FM Band. . . **LIST 49.95**

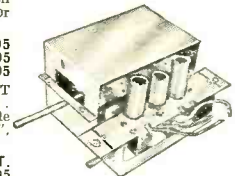

TRANSVISION FEATHERWEIGHT SOLDERING IRON

NOTE THESE NEW, REMARKABLE FEATURES: Weighs only 3 ounces (without the cord) . . . Delivers working output of 200 watt iron at fraction of current normally consumed by heavier irons . . . Heats up in 20 seconds . . . Finger-tip button control . . . Cool grip . . . Retains heat (with switch off) up to one minute . . . Featherweight permits long periods of soldering without fatigue . . . Economical—intermittent control feature prevents tip corrosion and necessity of frequent cleaning . . . Long, thin tip permits soldering in tight corners . . . Tips are interchangeable to suit work at hand . . . For operation on 110V, AC, 60 cycles. Complete with 6 volt transformer. . . . **LIST \$13.95**

All prices listed above are 5% additional west of the Mississippi. All prices are fair traded.

See your local distributor or for further information write to Dept. R.N.—



Featherweight Soldering Iron

TRANSVISION, INC.
385 NORTH AVE., NEW ROCHELLE, N. Y.

NEW! ONLY \$1495

35 Ft. Sectional ANTENNA

for one mast;

MAST OF 7 SECTIONS - 5 FEET LONG WRITE FOR QUANTITY PRICES

- 6 Stakes GP-2.
- 3 Guy Plates MP-20.
- 1 Mast Base MP-19.
- 2 Guy GY-22-A.
- 1 Guy GY-24-A
- 4 Guys GY-41.

Roll BG-176

BARGAIN WAR SURPLUS BRAND NEW "SPECIALS"

FOR HAM AND GENERAL USE

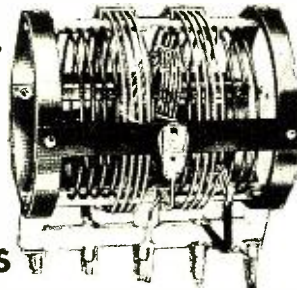

—Use The Best! SURPLUS COILS

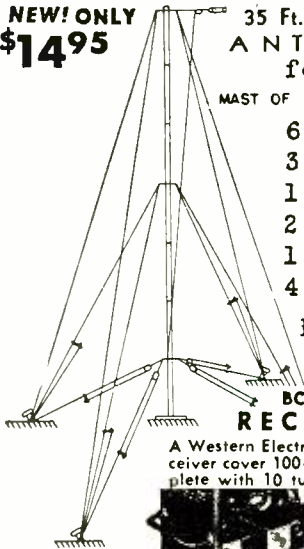

BC 733 RECEIVER

A Western Electric 10 tube receiver cover 100-120 Mc. complete with 10 tubes, crystals



Like new. \$7.95

mail orders today

DOW RADIO

1759 E. COLORADO ST. PASADENA 4, CALIF.
Pasadena Phone—SYcamore 3-1196
Los Angeles Phone—RYan 16683

B & W 3400 SERIES INDUCTORS

Frequency Range (mc)	Coil 500 watts	No. of turns on Link Coil	
2.0 - 3.5	C-387-D	12	6.5
3.5 - 4.5	C-388-C		4.5
4.5 - 5.7	C-389-C		4.5
5.7 - 8.0	C-390-C		4.5
8.0 - 11.0	C-447-B	Par Set	4.5
11.0 - 14.0	C-448-B		2.5
14.0 - 18.0	C-449-B	7.95	1.5

All prices f.o.b. PASADENA 4, CALIF. Just Out! Write for additional lists of bargains in Radio & Electronic parts.

Just keep in mind two things; (1) the banker is very anxious to be your partner in the development of your business for the simple reason that that is the business out of which he pays his living expenses just as yours is the business with which you pay yours. The other point is equally important, that is, (2) no business can develop without proper banking connections. The advice and personal and financial assistance that is available through your banker is the cheapest thing you can buy, providing you build your credit in a businesslike manner, use it intelligently, and treat it fairly; it will pay you dividends!

-50-

High Fidelity

(Continued from page 43)

Under these circumstances, the reproduction system must take the blame. Tone quality—the product of a perfect balance of vibrations between the fundamental and its harmonics or overtones of a note—must have been disturbed by additional tones generated or induced by the amplifier-speaker system, upsetting the perfect balance achieved at the point of origin.

The preference for a boom bass tone, or the so-called "juke-box bass," stems in part from the public's tendency to turn down their tone control knobs to eliminate the higher frequency sounds, which have been distorted by faulty amplification. Peculiarities in tone quality are most noticeable in wider range systems as this is where distortion has run riot on so many sets in recent years.

Popular writers are damning the public's taste by very glibly referring to listener preference tests, which indicate 5000 cycle reproduction to be much more popular, even among musicians, than 10,000 cycle reproduction. So-called experts have tossed around the findings of the *Chinn and Eisenberg* study with an amazing lack of understanding of basic audio principles. Our popular sound experts would do well to brush up a little on fundamentals and also to look at the conclusions reached by *Dr. Harry F. Olson*, who in tests with a "live" orchestra, found "it is entirely evident that users prefer full frequency range when dealing with a system with no distortion."

This significant conclusion underscores this suggestion: If we are going to furnish the public wide frequency range, let us also provide high fidelity. Then the public will hear what is really being originated. If the public then does not like the tone quality, the pressure of opinion will be felt by the performing artists and the various groups employing sound reproducing systems, such as the broadcasting industry, record manufacturers, and the motion picture industry.

In the electronic industry and the audio engineering profession, we

RADIO NEWS

UTICA TOOLS

PLIERS FOR EVERY NEED

TOOL NO. 654-6"

Ask Your Dealer

UTICA DROP FORGE & TOOL CORP.
UTICA, 4 NEW YORK

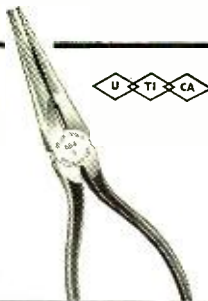

FLEXIBLE TUNING SHAFTS

MC215 Flexible Tuning Cables for remote control of SCR274N and ARC5 receivers complete with coupling nuts, ferrules, female splines, etc.

Available in following lengths:
45", 56", 79", 81", 82", 86", 91" each...\$2.75
117", 127", 135", 140", 154" each... 3.75
214", 221", 240" each... 4.25
MC211A Right Angle Drive for above, ea. .75
MC124 Flexible Tuning Cables for BC229, BC433, R5/ARN7, MN26, MN31, RA1, RA10, RU16, ARB.

Complete assembly in following lengths:
4", 72", 100" each...\$2.90
124", 139", 161", 164", 168", 189" each.. 3.50
306" each... 6.00
Right Angle Drive for above, each... 3.50
MC203A "T" Coupling for MC124 Cable, ea. 3.90
All equipment new—Prices FOB Flushing, N.Y.

LONG ISLAND RADIO CO.

164-21 Northern Blvd. Flushing, N.Y.

For those tricky Resistance Problems

—USE—

LECTROHM ADJUSTABLE RESISTORS

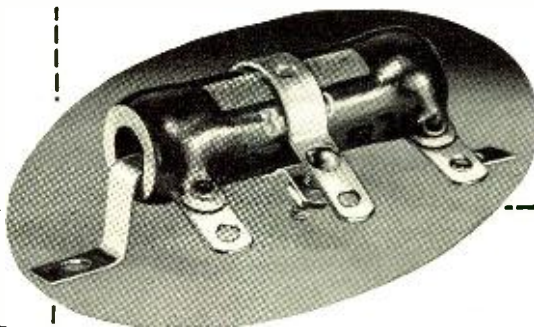

Ask your jobber or dealer for Lectrohm Adjustable Resistors—have a range of sizes on hand always for your experiments of doubtful resistances, or for those applications of varying resistances that require occasional adjustment. They are excellent too, for voltage dividers. You can get them in ratings from 10 watt to 200 watt and with one or more adjustable bands. Look for the name "Lectrohm" on all your Resistors—fixed, adjustable, ribbon-on-edge, etc.

LECTROHM INCORPORATED

4906 W. 25th PLACE, CICERO 50, ILL.
Division of The National Lock Washer Co.
Newark, N. J.

LEEDS

The Home of RADIO

In Our 25th Year
Quality -- Price -- Dependability

RADIO TRANSMITTER & RECEIVER APS 13

Tunes 410/420 megacycles; light weight airborne Radar. 17 tubes, including 5/6J6; 9/6AG5; 2/D21; 1/VE105 and 30 megacycle I.F. strip with schematic. All for \$11.95



CS—DIFFERENTIAL RELAY

Dual coil with armature pivoted between calls. All contacts normally open. Operates 220-250 Volts. 8000 Ohms each coil, contacts S.P.D.T. Controls rated 2 amps. at 110 VAC. Ideally suited for balanced or bridge type circuits where limited current or power is available. Will withstand 12 G Vibration up to 60 cycles at 35000 feet altitude.



Special low price..... 95c

STEEL CHASSIS

10 x 17 x 3	\$1.36	11 x 17 x 3	\$1.86
5 x 10 x 3	.87	13 x 17 x 3	2.22
7 x 13 x 2	.96	7 x 7 x 2	.63
10 x 14 x 3	1.35	4 x 17 x 3	.99

STEEL CANS AND BOXES

4 x 4 x 2	\$0.58	12 x 7 x 6	\$1.68
6 x 6 x 3	.78	15 x 9 x 7	2.35
8 x 8 x 6	.99	11 x 12 x 8	2.25

1/8 INCH STEEL PANELS

5 1/4 x 19	\$0.87	10 1/2 x 19	\$1.22
7 x 19	.96	12 1/4 x 19	1.46
8 3/4 x 19	1.10	14 x 19	1.62

1/8 INCH ALUMINUM PANELS

5 1/4 x 19	\$1.74	8 3/4 x 19	\$2.25
7 x 19	1.84	10 1/4 x 19	2.87

All above Black Crackle finish. Grey panels to order.

ATTENTION !!!

All SCR-522 Owners:

Remote Control Boxes for SCR 522's, Brand New in Original Packing; Consists of 5 push button switches, 5 Western Electric Pilot Assemblies, with Pilot Bulbs and Dimmer, and lever Switch all finished in Black Crackle. Order yours today for only

each \$1.25

Antenna Plug 46-PS-1 for 522A Each 15c



POWER TRANSFORMER

655-0-655 volts @ 320 mil. 110 volt AC primary. Thordarson power transformer, fully shielded. Net weight approx. 17 lbs. Special \$4.95

FILAMENT TRANSFORMERS

6.3 volts @ 8 amps. A swell buy..... \$1.50
10 volts @ 8 amps. 7500V Insulation..... 3.84

OIL FILLED CONDENSERS

1 Mfd. 600 VDC	\$0.35
2 Mfd. 600 VDC	.35
10 Mfd. 600 VDC	.98
2 Mfd. 1000 VDC	.69
7 Mfd. 330 VAC	1.25
0.1 Mfd. 7500 VDC	1.50
0.1 Mfd. 7000 VDC	2.00
0.2 Mfd. 8000 VDC	.98
SPECIAL—16 Mfd. 400 VDC W.E.	.98
1 Mfd. 5000 VDC Solar	2.95

MICA CONDENSERS

.01—600V Postage Stamp Each 5c
.03—2000V Postage Stamp 100 for \$4.75
.006—600V Postage Stamp

DYNAMOTOR 5047

D.C. input 27.0 volts at 1.75 amps. 95c
D.C. output 285 volts at .075 amps. each
Continuous Duty Rating. Brand New.

5 BPI CATHODE RAY TUBES

5" Green Screen. Brand New in original cartons. You'll want a few at this low \$1.45
Price \$1.45
832 Tubes. Brand New Guaranteed. Special \$2.15

Wire Wound Potentiometer

100,000 ohm. precision made G.R. type. 25 watt, 6" diameter. Brand new. \$1.95

Heineman Circuit Breakers 3 & 5 amp. sizes..... 95c



ITEMS YOU MAY BE LOOKING FOR

In 23A X-Tal Diodes 35c each, 3 for \$1.00
Mike to Grid Ouncer Transformer 25:1 Ratio Low to High Imp. 35c each, 10 for \$2.95
Arc-5 Silver Plated Banana Plugs per doz. 10c
De Jur Wire Wound Pot 20,000 Ohm. 12 watts. 49c
Meissner Shielded 2.5 MA RF Choke. 19c
R8-8 Octal Sockets low loss Bakelite. 8c
1/100 amp. Instrument fuses 8AG size per 12. 50c

DM-43A DYNAMOTOR

Manufactured by G.E. New. input 24v @ 23 amps. 7500 RPM; output 515/1030/2/8 v. @ 215/260 milliamps; filtered. SPECIAL \$2.95

METERS

0-1 Ma DC 2" Round Metal Case Gruen \$1.95

RESISTORS

100 watt—Ferrule Type—25,000, 30,000, 40,000, 50,000, 100,000 ohms Each 25c

FULL WAVE BRIDGE RECTIFIERS

Type B: Up to 144 VAC in, up to 96 VDC out @ 1.2 amp. Signal Corps. #9D0612B \$2.50
Type A: Up to 54 VAC in, up to 39 VDC out @ 1.2 amps. Signal Corps. #4D0238 \$1.50

If not rated 25% with order, balance C.O.D. All prices F.O.B. our warehouse New York. No order under \$2.00. We ship to any part of the globe.

LEEDS RADIO CO.

Dept. RN4
75 VESEY STREET
Cortlandt 7-2612 New York City 7

Why Leading Electronic Engineers Use ADC TRANSFORMERS For Unusual Applications

ADC engineers interpret and build transformers to fit your specific requirements:

- Frequency response
- Input and output impedances
- Power requirements
- Operating conditions
- Vacuum tubes to be used
- Mounting or casing requirements

When you need special transformer designs, send us your specifications. ADC has thousands of special transformer designs on file.

Transformer Engineering—ADC engineers design special transformers for leading electronics manufacturers. Write us your specifications when special transformer design is needed.

SEND FOR FREE CATALOG TODAY
Have the ADC catalog in your reference file.



PROMPT DELIVERY FROM STOCK OF ALL CATALOG ITEMS



Audio Development Co.

2833-13th Avenue So., Minneapolis, Minn.

Audio Develops the Finest

A PERFECT COMBINATION!

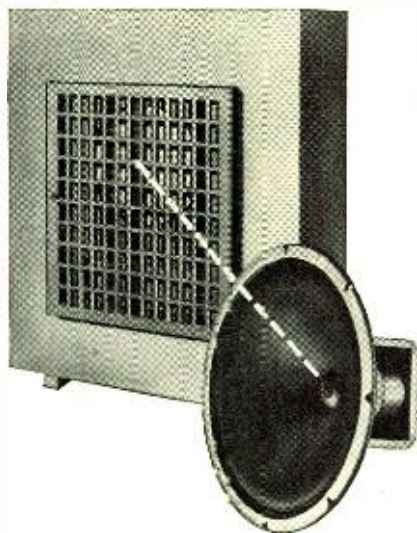

X-28 REPRODUCER

Here's the perfect combination — A high fidelity 25 watt Colortone Speaker, plus a correctly designed speaker cabinet that will please the most critical listener! Ideal for use with wired music service, disc recordings, high quality public address work and general utility demand. List Price..... **\$150.00**

COLORTONE COMPANY

1720 Mishcwoke Ave. South Bend, Ind.

TELEVISION CONVERSION



BUILD In two hours your own 15" or 20" Television Set from a new RCA 7" Television Receiver.

\$485.00

We supply Cabinet, new RCA 13 Channel Television Set complete with Tubes, 15" Picture Tube, Focusing Control plus INSTRUCTIONS for changes.

Same as above, but with 20" Tube and larger Cabinet. **\$675.00**

CONVERSIONS made BY US on request . . . additional \$50.00.

RCA 10" Receiver, Model 721TS or 8T530 also for CONVERSION — inquiries invited. Send 50c for catalog including diagrams for RCA, Belmont, G. E., Dumont, Andrea and Viewtone Television Receivers and Transvision Kits.

World's First Specialized House in Television

ELECTRONICS SERVICE & SUPPLY CORP.
264 W. 40th St. NEW YORK CITY 18, N. Y.
Phone Pennsylvania 6-8730

experience against the banker's loans without any equity. You cannot expect too much consideration on a deal of this kind because the woods are also full of bankers who are no longer in the banking business, who have been willing to furnish your capital needs as well as your financing needs—all of them.

Once you have secured your basic capital funds, it is necessary that you husband those resources. There is only one way to properly take care of your assets to intelligently keep yourself in constant position to answer the necessary questions precedent to bank financing, and that is to keep an intelligent set of books—records that tell you what you are doing, promptly and in one syllable words. The importance of accounting in any business and especially in a service business cannot be overestimated. It is so important that many automobile manufacturers furnish a complete set of bookkeeping forms for their dealers and will go so far as to cancel dealerships of those who refuse to keep books in accordance with their specified formulas.

This cannot be overemphasized because your business will not progress and your merchandise cannot be properly served or properly valued unless you know, month by month, what it costs you to do business and whether you are making money or losing money, and whether your original investment is appreciating or depreciating. If I were to make a suggestion which is gratuitous and, as such, not particularly acceptable, I would suggest that your association adopt a standard accounting system so far as possible and make it available to those members of yours who are not sufficiently experienced or equipped with personnel to select and set up their own bookkeeping system.

To get back to our original premise as to how to build your credit, how to use your credit and how to treat your credit, I think that if you will ask the above questions of yourself about your own business, the way to build your credit will answer itself.

You should use your credit only for essential and sound purposes. The use of credit is so important that I can safely say that the soundness of a loan is based to an unusual degree on the soundness of the purpose for which the loan is made. Your short term credit should be used only for short periods for purposes such as building up a receivable, the liquidation of which will pay the loan at maturity. For instance, it is sound from a business sense to purchase merchandise with borrowed money in September and October which will be sold during the Christmas season, so that the bank can be paid off and your profit can be pocketed by the year end. Such credit should not be used for the purpose of capital requirements and long term investments.

Long term credit should be used for the purpose of equipment purchases and installation of other facilities which will improve your operation or

expand your ability to do business. These funds should never be borrowed for a short term, but should be repaid over a longer period, and instead of being payable in 90 to 120 days, should be liquidated monthly while you are presumably profiting by the use of the increased facility.

There is a third use for bank credit, and that is in connection with the sale of consumer goods on the installment plan. This is really not a credit to you but is a credit to your customers and enables you to increase your sales. In this instance, you should make your connection with a bank which is experienced in the business of consumer credit to be sure that you are selling to the proper people and to insure that your customers will be handled with the proper courtesy and at proper cost to them.

You should make your selection of a banker early. You should let him handle your checking account and use whatever facilities of the bank, such as savings, safe deposit boxes, etc., that you need. This gives your banker a chance to become acquainted with you and enables him to give you much better service should your need for borrowing arise.

This last point comes under the heading of how to treat your credit. You can't expect to walk in cold to a banker who has never seen you before and ask him to determine in a few minutes whether you are a good credit risk. People are funny that way, but time and again I have seen folks come in at noon of the final day to pay their taxes and become quite disturbed because the banker who never saw them before was unable to approve their loan for the payment of those taxes in order to save them the penalty, within the next 15 or 20 minutes. In this case, the banks never heard of you before, although you knew at least a year before that you would have to pay those taxes, and you must have known at least a couple of days before that you would not have the money with which to pay them, unless you borrowed it.

Emergencies arise in practically every business, and the time to prepare for an emergency is well in advance of the occurrence. The average bank credit should not be one of emergencies, but should be well thought out by both the borrower and the lender, so that the soundness of the venture both from the standpoint of the borrower and of the lender may be established.

One more point that is obvious but might well be made in connection with the treatment of your banking relations is to keep your commitments to your banker. Of course, there will be times when what you plan does not occur. However, when that happens, see him in advance, tell him your story and give him a chance to worry with you about the liquidation of your account. If he knows what's going on, he can worry much more intelligently, and there is nothing so comforting as to have someone else help you worry.

Money—How to Get It

(Continued from page 42)

Will you pay?—Based on the information he has asked of you under question (1), he will determine your chances of staying in business. This is important in determining whether you will stay in business long enough to pay him back. He will try to determine whether you pay your bills promptly or not, what your personal reputation is outside of your business, and from that determine whether your intentions are honest or not. You will note from the questions so far that some of the questions which your banker asks you, which seem silly and irrelevant, are all couched with the intention of giving him a composite picture of you as a business man.

Can he make you pay?—This question sounds pretty harsh, and you are thinking that no banker should lend you money if he has to look forward to forcing repayment. You are absolutely correct in this thought, and no good banker would lend money under such circumstances. However, don't forget that he is lending you funds entrusted to him, and he must ask himself whether you are ultimately collectible, if conditions arise over which you or he has no control, which interfere with your repayment. In answering this question, he looks at your investment in your business, the soundness of your assets, the condition and quality of your equipment, and he looks at the soundness and satisfaction of your customers. (You will note, parenthetically, that all three of these questions are based substantially on what your customers and your suppliers think of you. The importance of public relations to a service business cannot be over-emphasized, but that is another subject.)

It goes without saying that a banker cannot be too enthusiastic about lending you money unless you have some cash in your business invested in substantial assets. The woods are full of people who are anxious to match their

(Continued on page 162)

STILL UNQUESTIONABLY THE FINEST

The COLLINS Custom Built FM/AM Tuner THE ONLY TUNER WITH WIDE RANGE AM

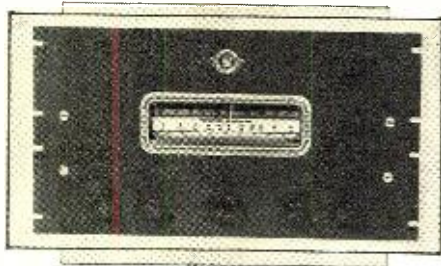

THIS tuner has received wide acclaim throughout the country as the best medium for reception of FM and AM broadcasts. Many extra, personal accessories may be ordered with the tuner to make it exactly what you want. Its 17-tube circuits employ Armstrong FM, full complement of vacuum tubes, self-contained power supply and latest circuit developments. *Write for full information about this marvelous product.*

COLLINS AUDIO PRODUCTS CO., INC.
P. O. BOX 368 Westfield, N. J.

* WE 2-4390

PLANT AT ROUTE 29, MOUNTAINSIDE, N. J.

CURRENT CONVERSION WITH **ATR** QUALITY PRODUCTS



ATR "A" BATTERY ELIMINATORS

For **DEMONSTRATING**
and **TESTING AUTO RADIOS**

New Models . . . Designed for Testing D.C. Electrical Apparatus on Regular A.C. Lines. Equipped with Full-Wave Dry Disc Type Rectifier Assuring Noiseless, Interference-Free Operation and Extreme Long Life and Reliability.

- Eliminates Storage Batteries and Battery Chargers.
- Operates the equipment at Maximum Efficiency.
- Fully Automatic and Fool-Proof.
- Type 60-ELIA . . . Rated Output 6.3 Volts at 6.5 Amperes.
- Type 120C-ELIO . . . Rated Output 6.3 Volts at 14 Amperes.



ATR AUTO RADIO VIBRATORS

Designed for Use in Standard Vibrator-Operated Auto Radio Receivers. Built with Precision Construction for longer Lasting Life.

ATR STANDARD AND HEAVY DUTY INVERTERS



For Inverting D.C. to A.C.

Specially Designed for Operating A.C. Radios, Television Sets, Amplifiers, Address Systems, and Radio Test Equipment from D.C. Voltages in Vehicles, Ships, Trains, Planes and in D.C. Districts.

Write for New ATR Catalog—Today

AMERICAN TELEVISION AND RADIO CO.
Quality Products Since 1931
SAINT PAUL 1, MINNESOTA — U. S. A.

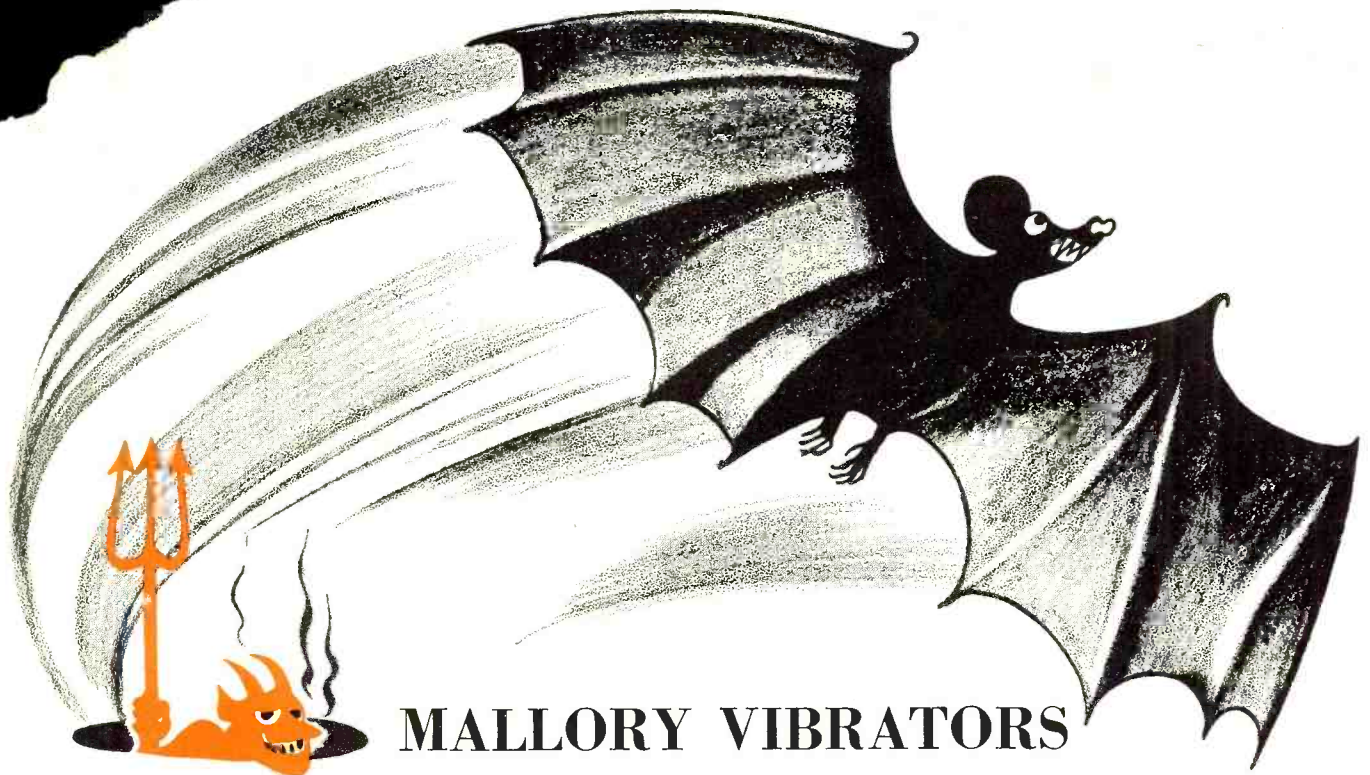

MALLORY VIBRATORS start like the proverbial bat

Mallory Vibrator contact materials are specially alloyed to resist oxidation. The design of the contact arms and their carefully controlled timing provide self-cleaning contacts. That's why you can count on Mallory Vibrators for sure starting.

THE MALLORY "GOOD SERVICE FOR GOOD BUSINESS" PLAN

will increase business and profits in your shop.

A unique follow-up file makes it easy to keep customers.

You tie in with Mallory acceptance to develop new business—ask your distributor about it.

The precision with which related parts are balanced assures accurate output and dependable service over a long life.

These are some of the reasons why more

Mallory Vibrators are used for original equipment than all other makes combined. These same reasons make Mallory the best replacement line for you to handle.

In addition to assured quality, Mallory offers the most complete line in the business. Mallory standardization permits 12 basic vibrators to meet 90% of your replacement requirements. But a complete line of 52 vibrators is available to meet virtually every vibrator need.



The Mallory Replacement Vibrator Guide is free. The Vibrator Data Book is \$1.00—from your distributor or by mail.

MORE MALLORY VIBRATORS ARE IN USE THAN ALL OTHER MAKES COMBINED

P. R. MALLORY & CO., Inc.
MALLORY

CAPACITORS . . . CONTROLS . . . VIBRATORS . . .
SWITCHES . . . RESISTORS . . . RECTIFIERS . . .
VIBRAPACK* POWER SUPPLIES . . . FILTERS

*Reg. U.S. Pat. Off.

APPROVED PRECISION PRODUCTS

P. R. MALLORY & CO., Inc., INDIANAPOLIS 6, INDIANA

Link FM Sets...
Sylvania Lock-In Tubes...
 handle emergency calls rapidly and smoothly for Morro Limousine



2-way radio permits drivers to notify central office of completion of trip.



Office can immediately advise driver of other calls in the same neighborhood.

WITH 10 of its 14 limousines equipped with 2-way Link FM, Morro Limousine Service is always ready—24 hours a day—to respond promptly to emergency calls for home-to-hospital transportation—anywhere in the entire Borough of Brooklyn. Cars are strategically located throughout the borough, to reach any point in the shortest possible time.

Since quick, *unfailing* service is the essence of Morro Limousine's business, Link Radio Corporation turns to Sylvania Lock-In Tubes to prevent communications interruptions. These tubes stay firmly in place in their sockets... have no soldered joints, few welded ones. Elements can't warp or weave. Connections are short and direct... getter located on top. Loss and leakage are reduced. See Sylvania Distributors or write Radio Tube Division, Emporium, Pa.

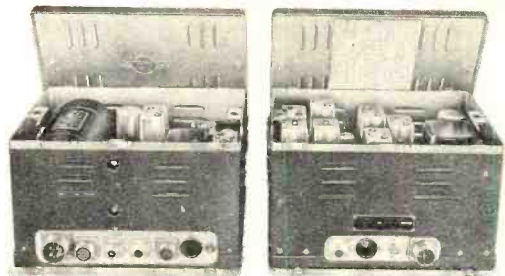

Transmitting and Receiving Units used by Morro Limousine Service, manufactured by Link Radio Corporation, New York.

The famous Lock-In Tube's superiority makes it the ideal choice for equipment on the road, in the air, on the rails, marine radar, FM and television.



SYLVANIA ELECTRIC

MAKERS OF RADIO TUBES; CATHODE RAY TUBES; ELECTRONIC DEVICES; FLUORESCENT LAMPS, FIXTURES, WIRING DEVICES; ELECTRIC LIGHT BULBS