

# RADIO NEWS

MARCH  
1948  
35¢



COMPAC

YAKIMA WASH  
1011 PLEASANT AVE  
SIDNEY M BERG  
RN-125-J27125-118

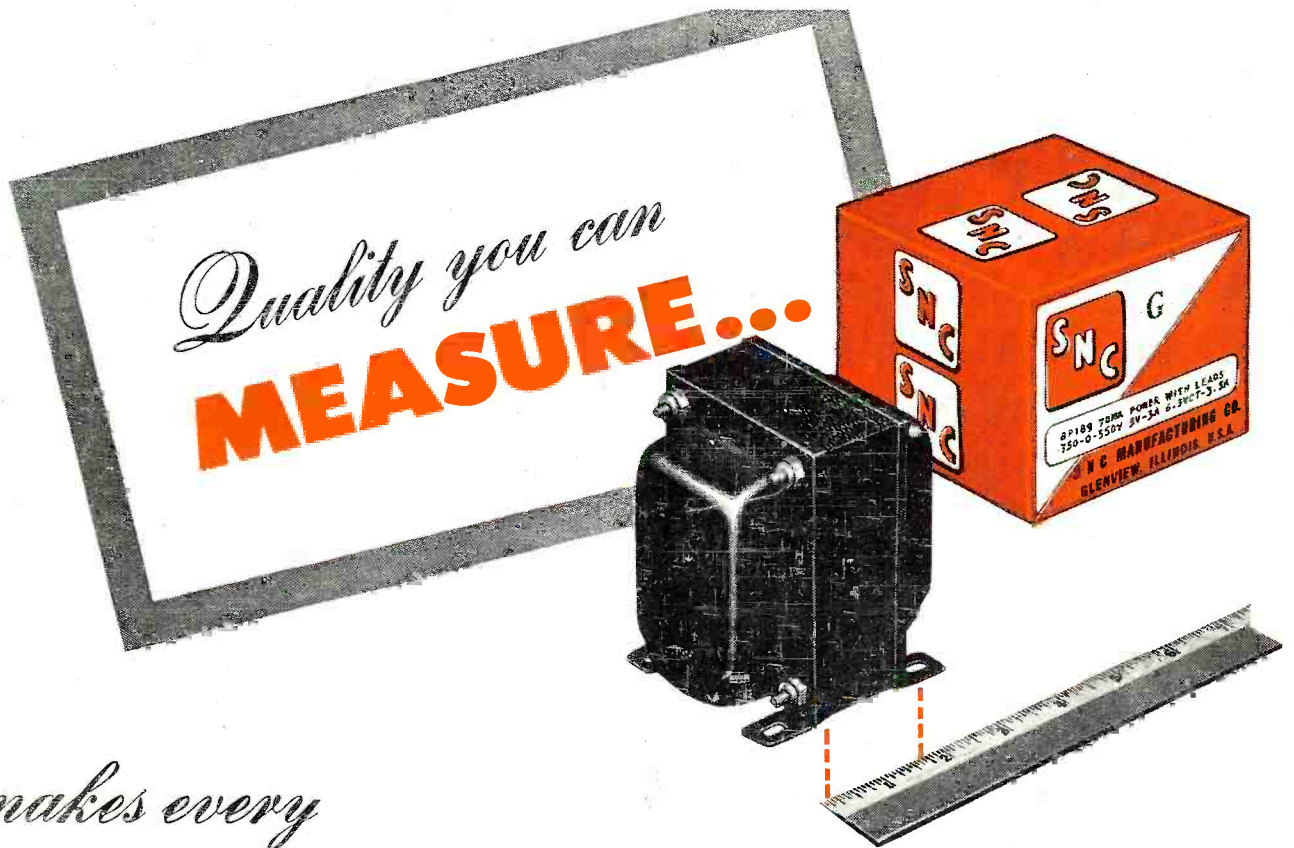

*makes every*  
**SNC TRANSFORMER** *give outstanding performance*

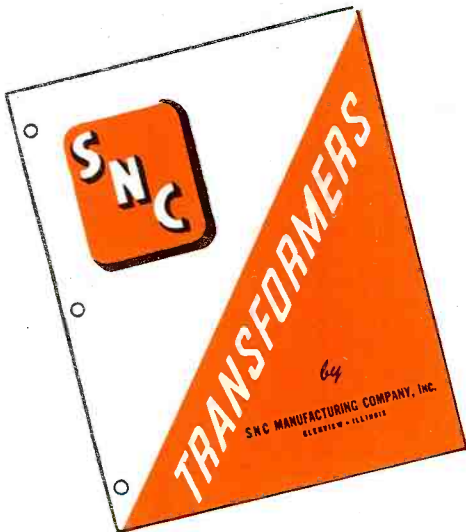

Join the increasingly large number of manufacturers, retailers, hams and other component part buyers who rely on SNC for quality, trouble-free equipment. Write for catalog today.

Place a rule against the stack of an SNC No. 8P189 transformer and the *extra* width clearly indicates the added quality built into every item in the complete SNC line.

Skillful engineering, latest production techniques and highest quality materials . . . backed by careful workmanship, exacting step-by-step inspection and rigorous final testing . . . are just a few of the reasons why SNC transformers keep rejects at a minimum and give outstanding performance.

**Remember! SNC gives MORE applications with  
 SMALLER inventories for GREATER profits!**

**SNC MANUFACTURING CO., INC.**  
*Quality Transformers*  
 WEST LAKE AVE. NEAR LEHIGH • GLENVIEW, ILLINOIS  
 Expert Department, 308 W. Washington St., Chicago 6, Illinois, U.S.A.

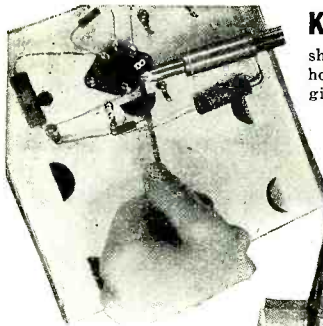

**KIT 1** (left) I send you Soldering Equipment and Radio Parts; show you how to do Radio Soldering; how to mount and connect Radio parts; give you practical experience.



**KIT 2** (left) Early in my course I show you how to build this N.R.I. Tester with parts I send. It soon helps you fix neighborhood Radios and earn EXTRA money in spare time.

## VETERANS

You can get this training in your own home under G. I. Bill. Mail coupon for full details.

# Be a RADIO Technician

## Learn by PRACTICING in Spare Time

with **BIG KITS** of **RADIO PARTS** I send you

**KIT 3** You get parts to build Radio Circuits; then test them; see how they work, learn how to design special circuits; how to locate and repair circuit defects.

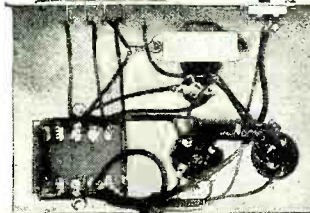
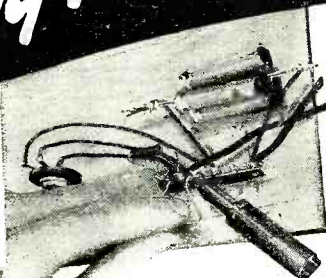

**KIT 4** You get parts to build this Vacuum Tube Power Pack; make changes which give you experience with packs of many kinds; learn to correct power pack troubles.

**KIT 5** Building this A. M. Signal Generator gives you more valuable experience. It provides amplitude-modulated signals for many tests and experiments.

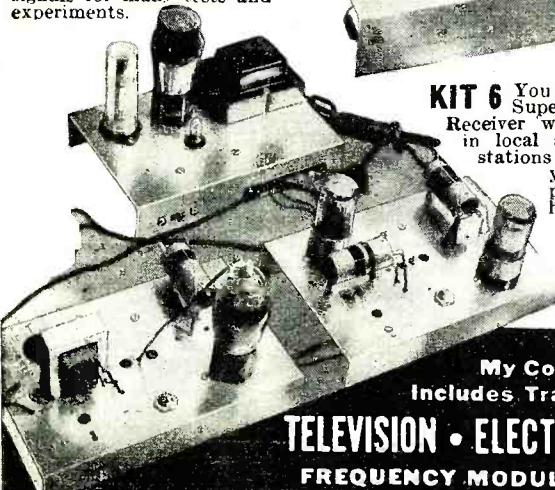
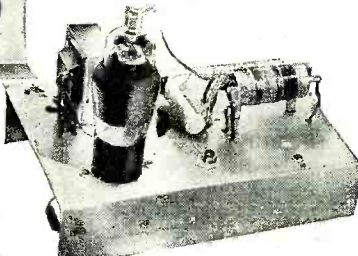

**KIT 6** You build this Superheterodyne Receiver which brings in local and distant stations—and gives you more experience to help you win success in Radio.

My Course Includes Training in **TELEVISION • ELECTRONICS** FREQUENCY MODULATION

Do you want a good-pay job in the fast-growing Radio Industry—or your own Radio Shop? Mail the Coupon for a Sample Lesson and my 64-page book, "How to Be a Success in Radio-Television-Electronics," both FREE. See how I will train you at home—how you get practical Radio experience building, testing Radio circuits with **BIG KITS OF PARTS** I send!

### Many Beginners Soon Make Extra Money in Spare Time While Learning

The day you enroll I start sending EXTRA MONEY manuals that show how to make EXTRA money fixing neighbors' Radios in spare time while still learning! It's probably easier to get started now than ever before, because the Radio Repair Business is booming. Trained Radio Technicians also find profitable opportunities in Police, Aviation, Marine Radio, Broadcasting, Radio Manufacturing, Public Address work. Think of even greater opportunities as public demand for Television, T.M. and Electronics devices continues to grow! Send for FREE books now!



### Find Out What NRI Can Do For You

Mail Coupon for Sample Lesson and my FREE 64-page book. Read the details about my Course; letters from men I trained; see how quickly, easily you can get started. No obligation! Just MAIL COUPON NOW in envelope or paste on penny postal. J. E. SMITH, President, Dept. 8CR, National Radio Institute, Pioneer Home Study Radio School, Washington 9, D. C.

Our 34th Year of Training Men for Success in Radio

Sample Lesson **FREE**  
64 Page Book

Mr. J. E. SMITH, President, Dept. 8CR  
National Radio Institute, Washington 9, D. C.

Mail me FREE, Sample Lesson and 64-page book about how to win success in Radio and Television—Electronics. (No salesman will call. Please write plainly.)

Name ..... Age.....  
Address .....  
City ..... State.....  
(Please include Post Office zone number)

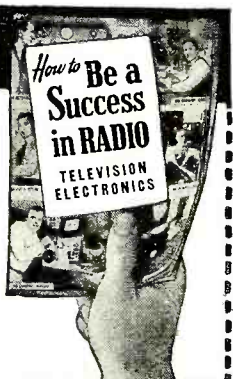

Approved for Training under GI Bill

*Editor*  
**OLIVER READ, W9ETI**  
*Managing Editor*  
**WM. A. STOCKLIN**  
*Technical Editor*  
**H. S. RENNE, EX-W9PTE**  
*Associate Editors*  
**HAY FRANK, W8JU**  
**NORMAN L. CHALFIN**  
**FRED HAMLIN**  
**GATHER LITRELL**  
**F. B. HOEFER**  
**C. M. SULLIVAN**  
*Staff Photographer*  
**ARTHUR E. HAUG**  
*Staff Artist*  
**R. S. KUPIACK**

*Advertising Manager*  
**L. L. OSTEN**  
*Midwestern Advertising Manager*  
**JOHN A. RONAN, JR.**

*Art Director*  
**HERMAN B. BOLLIN**

# RADIO NEWS

*First in radio-electronics*

Average Paid Circulation over 148,000

Trade Mark Registered U.S. Patent Office No. 378427

## CONTENTS

MARCH, 1948

Atom Smashers.....	James J. Teevan	39
A Versatile Signal Checker.....	Rufus P. Turner, W1AY	42
Bond Geddes' Report on Radio Industry.....		45
A Low Cost FM Tuner.....	J. T. Goode	46
Television—Exclusively!.....	Max Alth	48
Birth of a Service Note.....	Harry D. Hooton	50
Compact Power Supply Is Transformerless and Tubeless.....	Guy Dexter	51
A Simple B.C. Super.....	Carl V. Hays, W6RTP	52
Simplicity in a Converter.....	C. W. Roeschke, W5MLX	54
Cross Modulation—A Recurrent Factor.....	John B. Ledbetter	56
Conversion Notes on the BC-696-A.....	John T. Frye, W9EGV	57
Speech Blockade.....	C. E. Atkins	60
The Recording and Reproduction of Sound (Part 13).....	Oliver Read	62
The MiniTran.....	R. C. Amundsen, W1HYF	65
Automatic Frequency Control.....	W. H. Buchsbaum	68
Interference Traps for Television.....	Stanley N. Finley	70
Practical Radio Course (Part 60).....	Alfred A. Ghirardi	72
Direct Mail for Dealers.....	Gerald Samkofsky	96
How to Write an Ad.....	G. Edward DeNike	114
Simplified RC Bridge.....	R. L. Parmenter, W1JXF	126
A Compact Bias Supply.....	J. F. Clemens, W9ERN	180
Methods of Producing Negative Potentials.....	G. N. Carter	188

## DEPARTMENTS

For the Record.....	The Editor	8	RN Circuit Page.....	82
Spot Radio News.....	Fred Hamlin	18	What's New in Radio.....	86
Within the Industry.....		28	Manufacturers' Literature.....	136
Short-Wave.....	K. R. Boord	66	Technical Books.....	173
New Receivers.....		174		

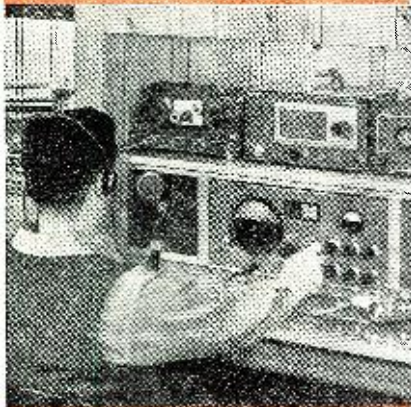

COVER PHOTO: Remote control of hi-power transmitter permits compact operating position for ham station. Rotary beam indicator, 5X-43 receiver, wire recorder, HT-18 exciter (driving a BC-610E) and Panadapter comprise this installation. (Staff Photo by Arthur E. Haug)

*Chairman of the Board and Publisher*  
**WILLIAM B. ZIFF**

*President*  
**B. G. DAVIS**

*Secretary-Treasurer*  
**ARTHUR T. PULLEN**

*Vice-Presidents*  
**GEORGE BERNER**  
*Advertising and Sales Director*

**MICHAEL H. FROELICH**  
*Editorial Director*

**H. J. MORGANROTH**  
*Production Director*

**H. G. STRONG**  
*Circulation Director*

### BRANCH OFFICES

**NEW YORK (1)**  
 Empire State Bldg., N.Y. 17-0100

*Manager, Eastern Division*  
**CHARLES R. TIGHE**

**LOS ANGELES (14)**  
 815 S. Hill St., TUrker 9211

*Manager, Western Division*  
**WILLIAM L. PINNEY**

**TORONTO**

21 King Street, East

**ASSOCIATED COMPANIES**  
 Ziff Davis, Ltd., Grosvenor Bldg.,  
 Western Gate, London, England

Ziff Davis, Patel, Ltd.,  
 190 Hornby Road, Bombay, India



COPYRIGHT 1948  
 ZIFF-DAVIS PUBLISHING COMPANY  
 185 North Wabash Ave., Chicago 1, Ill.  
 VOLUME 39 • NUMBER 3



Member  
 Audit Bureau of  
 Circulations

RADIO NEWS is published monthly by the Ziff-Davis Publishing Company, 185 N. Wabash Ave., Chicago 1, Ill. Subscription Rates: in U. S. and Canada \$4.00 (12 issues), single copies 35 cents; in Mexico, South and Central America, and U.S. Possessions, \$4.00 (12 issues); in British Empire, \$5.00 (12 issues)—all other foreign countries \$5.00 (12 issues). Subscribers should allow at least 2 weeks for change of address. All communications about subscriptions should be addressed to: Director of Circulation, 185 N. Wabash Ave., Chicago 1, Ill. Entered as second class matter March 9, 1938, at the Post Office, Chicago, Illinois, under the Act of March 3, 1879. Entered as second class matter at the Post Office Dept., Ottawa, Canada. Contributors should retain a copy of contributions and include return postage. Contributions will be handled with reasonable care but this magazine assumes no responsibility for their safety. Accepted material is subject to whatever revisions and by-line changes that are necessary. Payment made at our current rates, covers all authors', contributors', or contestants' rights, title, and interest in and to accepted material, including photographs and drawings.

# low priced ham shack \$97<sup>00</sup>

**ONLY  
hallicrafters  
COULD DO IT!**

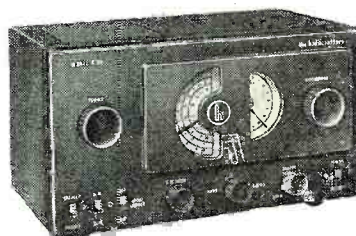

**RECEIVER**

**S-38**

Hallicrafters famous Model S-38. Recognized by hams, beginning hams and all who know the unending fascination of world wide communications, as one of the greatest receiver values on the market today. Overall frequency range from 540 kc to 32 Mc in four bands. Main tuning dial calibrated with precision accuracy. Separate electrical bandspread dial. CW pitch control adjustable from front panel, automatic noise limiter, self-contained PM dynamic speaker. 105-125 volt AC/DC. **\$47<sup>50</sup>**

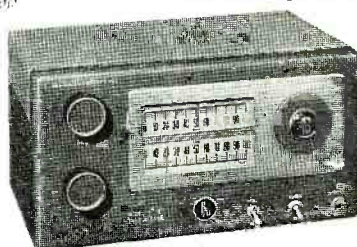

**TRANSMITTER**

**HT-17**

The Model HT-17 is a low power, high quality transmitter now available at a new low price. Real Hallicrafters performance with maximum convenience and economy. Provides an honest 10 to 20 watts of crystal-controlled CW output on the amateur 3.5, 7, 14, 21 and 28 megacycle bands. A pi-section matching network is an integral part of the plate circuit and, together with an adjustable link, provides coupling to any type of antenna or permits the HT-17 to be used as an exciter for a high power final amplifier. Take advantage of this money saving offer Now! **\$49<sup>50</sup>**  
40-meter coils included.....

**YOU SAVE \$20.00**

**BE ON THE AIR FOR LESS THAN \$100.00.** Build yourself a ham shack with the best equipment available at these low prices. Here's your chance to save money. You save exactly \$20.00 at these prices. Your nearest Hallicrafters distributor will tell you what tremendous values these pieces of Hallicrafters represent. See him for demonstration and further details.

**FOLLOW THE GATTI HALLCRAFTERS AFRICAN EXPEDITION.** Sponsored by the Hallicrafters Co. and led by famed Commander Attilio Gatti, the mobile radio equipped expedition is now on location at the Mountains of the Moon in Africa. From four separate base camps the Expedition will communicate on regular schedule with all the world via short wave. Follow this scientific safari with your Hallicrafters equipment. Get detailed information on itinerary and schedules from your distributor.

Copyright 1948, The Hallicrafters Co.

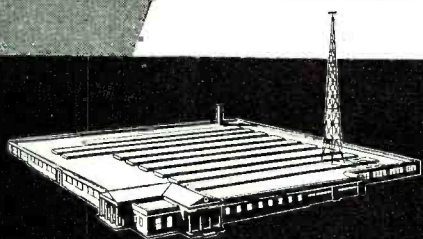

## hallicrafters RADIO

THE HALLCRAFTERS CO., MANUFACTURERS OF RADIO AND ELECTRONIC EQUIPMENT, CHICAGO 24, U. S. A.

Sole Hallicrafters Representative in Canada:  
Rogers Majestic Limited, Toronto-Montreal

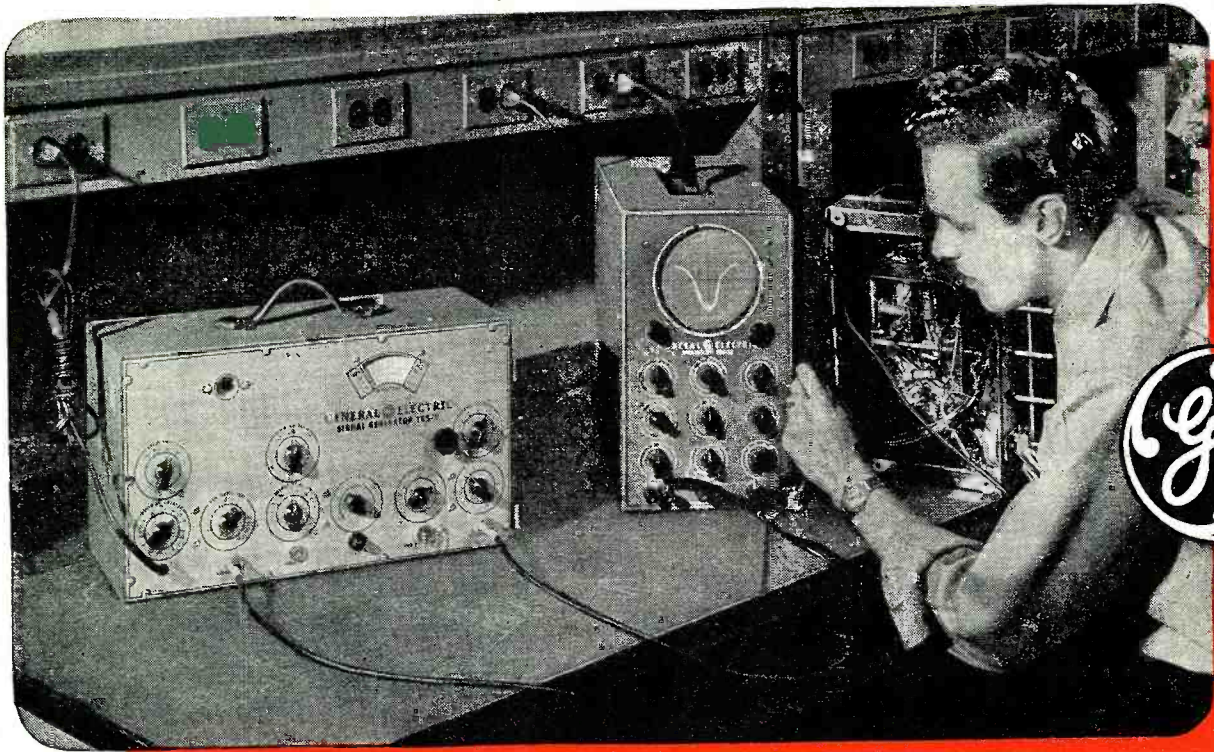

## ELIMINATE GUESSWORK!

### Speed up your FM and AM Service

**T**HE TWO General Electric units shown here are a team that will perform outstanding service feats on your bench. The Signal Generator YGS-3 and the 5" Oscilloscope CRO-5A not only eliminate guesswork but also eliminate a lot of your AM and FM service headaches.

Hook them up to the chassis on your bench—then: SEE THE PERFORMANCE OF EACH INDIVIDUAL STAGE.

The YGS-3 provides *adequate* output to operate the oscilloscope over *only one stage of I.F.* This means that each I.F. stage can be aligned separately.

This is only one of the many jobs that this versatile pair of units can accomplish for you. When you put them to work on your bench—they'll really prove to be a good right arm in your business.

RF level, AM modulation percentage and FM deviation are indicated and can be adjusted to standard levels.

#### THE CRO-5A OSCILLOSCOPE

This unit is of laboratory quality which makes it an extremely versatile unit in your shop. It has adequate sensitivity for all measurements including hum tracing.

All amplifier and sweep d-c potentials are electronically regulated to give a stable trace even under adverse power line variations. The unit is very sturdy in construction to withstand jars and vibrations. Tubes have been selected to give max-

imum amplification with minimum noise.

The 3" scope also may be used for visual alignment of radio receivers and general purpose oscilloscope work.

#### THE SIGNAL GENERATOR YGS-3 (FOUR UNITS COMBINED IN ONE)

- |                  |  |
|------------------|--|
| 1. RF Oscillator | 3. Crystal calibrator                  |
| 2. FM Oscillator | 4. Variable frequency audio oscillator |

This is really a compact job. Four basic units have been enclosed in a single cabinet to bring you one efficient, labor-saving portable equipment. Designed to simplify and speed up FM and AM receiver analysis, the YGS-3 provides:

- Extremely wide sweep deviation
- Reference level indicator for RF, audio, AM modulation percentage and FM deviation
- Constant output impedance attenuator
- Wide frequency range—100 KC to 150 MC on fundamentals for AM output and up to 200 MC for FM output
- High level output
- Lines up any FM or AM receiver, stage by stage by visual alignment methods.

Order these two units today. Let them begin to make your job easier right away.

New Booklet on FM Servicing:—Twenty-five cents (25¢).

For complete information write: *General Electric Company, Electronics Department, Electronics Park, Syracuse, New York.*

# GENERAL ELECTRIC

164-G1

RADIO NEWS



**I'll Send You 8 Big Kits of Training Equipment**  
*including*  
**TWO-BAND 6 TUBE SUPER RECEIVER**  
**AND 16 RANGE METER SET-UP**  
*for Testing*

**Learn Fast . . . Earn Fast**  
**HOME TRAINING**  
**Planned For Your Needs**  
*You Build All These*  
**TESTERS . . . and MORE!**



I give you a fine, moving-coil type Meter Instrument on Jewel Bearings—with parts for a complete Analyzer Circuit Continuity Tester. You learn how to check and correct Receiver defects with professional speed and accuracy.

**Practice Does It!**

Soldering, wiring, connecting Radio Parts . . . building circuits with your own hands—you can't beat this method of learning. When you construct this Rectifier and Filter Resistor and Condenser Tester, etc., you get a really practical slant on Radio that leads to a money-making future.

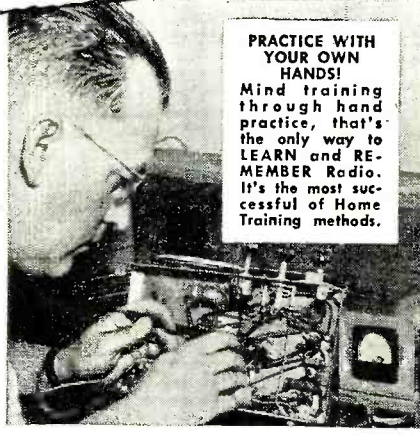
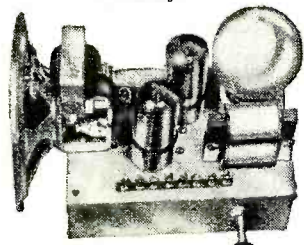

**PRACTICE WITH YOUR OWN HANDS!**  
 Mind training through hand practice, that's the only way to LEARN and REMEMBER Radio. It's the most successful of Home Training methods.

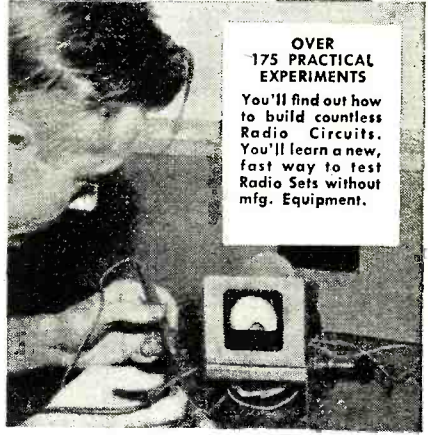

**OVER 175 PRACTICAL EXPERIMENTS**  
 You'll find out how to build countless Radio Circuits. You'll learn a new, fast way to test Radio Sets without mfg. Equipment.

**LOW COST HOME RADIO TRAINING!**  
**Easy Monthly Payments!**

My perfected Radio Training prepares you to start your own Radio Service Shop—or to land a big pay Radio job. With my help you get neighborhood Radio jobs while learning—for extra cash and rich experience. I train you RIGHT—by putting you to work with your hands in your own home during spare hours. You get 8 big kits of real professional Radio Parts and Equipment—and use them to build, test and trouble-shoot a powerful 6 tube superhet receiver, a 16 range test meter set-up and over 175 fascinating, instructive Radio experiments. My training is down-to-earth, really PRACTI-

CAL—it's the Training you need to make money in Radio. Theory is cut to the bone—you don't need any previous schooling or experience. Sprayberry Training starts you out at the very beginning of Radio—the lessons are completely illustrated, simply written and easy to understand. Get the facts about Sprayberry Training NOW. Find out what it can do for you—prepare for amazing opportunities in Radio Servicing, Television, FM, Radar and Industrial Electronics. Fill out and mail coupon for my two big Books—FREE. No obligation—and no salesman will call. Mail coupon TODAY!

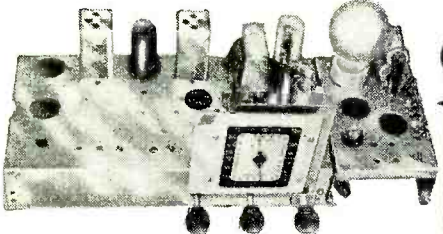

Building this Signal Generator and multi-purpose Tester will give you the kind of valuable experience and practice that is so important as a foundation for making good money in Radio. It makes a breeze out of fixing Radios, and you don't have to spend money on ready-made Equipment.

**VETERANS**  
 Approved for G. I. Training  
 under Public Laws 16 and 346

**MAIL COUPON FOR THESE 2 BOOKS!**



"How to Read Radio Diagrams and Symbols" and "How to Make Money in Radio, Electronics and Television." Immense, practical value to you — and they're yours FREE!

**SPRAYBERRY ACADEMY OF RADIO**  
 F. L. Sprayberry, President  
 Room 2538 Sprayberry Bldg., Pueblo, Colorado

Please rush my FREE copies of "How to MAKE MONEY in RADIO, ELECTRONICS and TELEVISION" and "How to READ RADIO DIAGRAMS and SYMBOLS."

Name \_\_\_\_\_ Age \_\_\_\_\_  
 Address \_\_\_\_\_  
 City \_\_\_\_\_ State \_\_\_\_\_

Check here if a Veteran.  
 (Mail in envelope or paste on penny postcard)

# University LOUDSPEAKERS

**- can whisper, too!**

And that's important because the primary purpose of any loudspeaker is to convey intelligence and not just make a loud noise. UNIVERSITY loudspeakers — with the highest conversion efficiency of any speaker of comparable size — not only give *maximum* sound output with *minimum* power input, but reproduce every detail and inflection of the voice at all levels from a whisper to a shout.

**A JOB-RATED SPEAKER  
FOR EVERY APPLICATION!**

### MODEL LH REFLEX TRUMPET



is typical of types available for every requirement—voice, music, paging and talk-back.

### MODEL SAH DRIVER UNIT

One of several high efficiency models with continuous power capacities up to 25 watts. All unconditionally guaranteed for one year.



### PAGING; CALL-BACK SPEAKERS



Available in many types and power ranges. Compact design, highest efficiency.

### SUPER POWER SOUND PROJECTOR

Many sizes—100, 150 and 300 watts with ranges up to 15 miles. Finest sound quality even at full power.

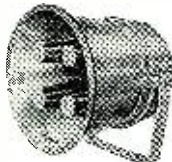

### EXPLOSION, SUBMERGENCE PROOF



for use in mines, refineries, railroads, marine, etc. Immune to live steam, salt-spray, or complete immersion.



**UNIVERSITY LOUDSPEAKERS, INC.**

30 SO. KENSICO AVE., WHITE PLAINS, N. Y.

For the **RECORD.**

BY THE EDITOR

## DEBUNKING THE POSTWAR RADIO

**W**ARTIME developments in radio-electronic equipment for our armed forces have all been incorporated in the new postwar super-deluxodyne radios. The unsurpassed beauty and tonal quality of our Model 48 will leave you gasping for breath. The entirely new postwar circuits and components guarantee long, trouble-free performance of this sensational line of compact receivers."

The above strikes a familiar (and now sour) note to many a progressive technician. Such ballyhoo in newspaper and radio commercials following the war led customers to believe that the radio set makers had hit the jackpot on something revolutionary in design and performance. Now many dealers are faced with the problem of backing up guarantees on sets that eat up any normal profit they could make if these receivers were up to par . . . but are they? From many that we have checked, they are anything but modern in design and fall far short of the tonal quality promised.

Today a serviceman stands at his bench and hunts for the socket pins of a 6C4 that are buried under a rat's nest of parts and wire and finally discovers, after 15 minutes, that someone forgot to use any solder when connecting the cathode. After correcting the situation, the chassis is reinstalled into its cabinet of rare wood (rare meaning raw) and allowed to reach its operating temperature. Some local jive is tuned in and the set is allowed to remain operating just to be sure that it is in good shape for its return to the customer. In the interim, the serviceman goes on to the testing of another set—this one was made way back in 1934 and had been giving long and faithful service up to this point.

A complete diagnosis reveals that one of the r.f. tubes had, after many thousands of hours, finally gone west and that accumulated dust had interfered with proper tuning of the receiver.

In the meantime, the reception on the first set has become progressively worse. After spending a considerable amount of valuable time, it is discovered that the heat from the rectifier tube is darned near melting the can of an adjacent i.f. and causing drift due to a drastic temperature change on the plate of the trimmer. When a time sheet is tendered, the customer hits the ceiling at the hour's time charged to labor. In the case of dealers—many absorb this cost rather

than lose a customer and profit goes down to a minimum.

The above case history is typical of the many sent to our desk every month by radio service technicians.

Numerous complaints are made against poor engineering on the part of many set manufacturers and servicemen are embittered toward them as they sweat over the haywire construction of many modern receivers. They point out, for example, that it takes much more time to service a postwar than a prewar receiver. Parts are unduly crowded and carelessly placed. Soldering, in many cases, is bad and, in others, there is no evidence of a complete inspection.

Strangely enough, some of the "horrible examples" are sets manufactured by long-established and highly responsible radio firms and not by little-known makers of unfamiliar brands.

As a case in point, we ran across an ultra-compact a.c.-d.c. battery portable recently that had better tone quality than several table model radios that were set up in a demonstration room. We were intrigued with this little receiver and removed the chassis from its case for further examination. It contained a minimum of parts and, while extremely compact, employed what we considered to be excellent engineering technique. Tubes were mounted where maximum ventilation could be had and tuning circuits were isolated by simple baffles. Every socket pin could be readily located and soldering was perfect. This receiver showed every evidence of what we might expect in a postwar radio. We can, therefore, well understand the enthusiasm of the dealer as he recommended this brand to prospective buyers.

Every manufacturer can spend only so much for any set if he is to sell it at a low price and make a profit. Thus, he is forced to cut corners whenever possible. But, progress is indicated by better quality merchandise at lower prices. Set manufacturers are regressing when all-important quality is sacrificed to the pinch-penny production technique and the use of 200 v. bypasses in 300 volt circuits.

As we see it then, the only remedy is to employ "common sense engineering." The proper placement of components can do much to offset frequency drift and other ailments, while a few more pennies should be spent for condensers—especially the hidden ones. . . . .O.R.

**RADIO NEWS**



# ALLIED'S NEW **FREE** 1948 RADIO CATALOG

**172 VALUE-PACKED PAGES**

*Send for it now!*



## The Preferred Radio Buying Guide

It's off the press—the new 1948 ALLIED Radio Catalog! Get the Radio Buying Guide that's used by thousands of expert servicemen, engineers, soundmen, Amateurs, builders and experimenters. The new ALLIED Catalog—radio's biggest book—brings you 172 pages packed with the widest selections of the newest and finest equipment, at really low, money-saving prices! Here's everything in radio for everyone in radio: new Television and home receivers, packaged Sound Systems and P. A. equipment, latest Amateur receivers and station gear, test instruments, builders' kits, thousands of parts, tubes, tools, books—the world's largest stocks of nationally-known equipment. Take advantage of ALLIED'S speedy, expert shipment and the personal attention of seasoned old-time radio men. Get the details, too, of radio's newest and most liberal Time Payment Plan. Send today for your FREE copy of ALLIED'S newest, greatest Catalog—the preferred Radio Buying Guide!

**LARGEST STOCKS • QUICK, EXPERT SERVICE**

Get your **FREE** copy of  
Radio's most complete Catalog  
Use the coupon below—**NOW!**

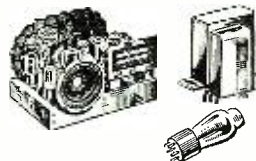

### MORE THAN 10,000 ITEMS

Everything in radio for everyone in radio! Complete lines of all leading makes of parts and equipment—all from one great, centralized source. For newest developments and best values, see your ALLIED Catalog.

### TELEVISION & HOME RADIOS

A special selection of outstanding models—table radios, consoles, combinations, FM-AM—plus new Television, offered first by ALLIED at real savings. Hand-picked models—the choice of experts!

### AMATEUR STATION GEAR

Here's heaven for the Ham! You'll find everything you need for your shack in the new ALLIED Catalog. See all the latest releases in receivers, transmitters, parts, station equipment—biggest Ham listings in radio!

### NEW P. A. EQUIPMENT

Packaged, ready-to-use Sound Systems; amplifiers guaranteed for one full year; everything in speakers, microphones, P. A. accessories, intercom and recording equipment—leading headquarters for Soundmen!

**RADIO'S LEADING  
BUYING GUIDE!**



**THE WORLD'S  
LARGEST  
RADIO  
SUPPLY  
HOUSE . . .**

**ALLIED  
RADIO**

*Everything in Radio  
and Electronics*

ALLIED RADIO CORP.  
833 W. Jackson Blvd., Dept. 1-C-8  
Chicago 7, Illinois

Send FREE New ALLIED Catalog.

Name.....

Address.....

City.....Zone.....State.....



R-1253 Walnut  
R-1254 Mahogany

A  
Masterpiece  
in design and  
engineering

*The Newest*  
**DELCO RADIO**  
*Combination*

## SPECIFICATIONS

**CIRCUIT:** Eleven tube plus rectifier superheterodyne, AM and FM reception; Short Wave Band 5.8 to 18 megacycles. Operates on 105-125 Volt 60 cycle alternating current.

**TUNING:** Automatic push-button; separate sets of five push buttons each for AM and FM.

**CONTROLS:** On lower section of instrument panel—Volume, Tone, Band Selector, Phonograph, On-and-Off Switch.

**DIAL:** Etched glass, edge-lighted.

**AUDIO:** Push-pull beam power output; 12-inch, permanent-magnet speaker.

**ANTENNA:** Separate, built-in for AM and FM. Terminals for use with outside dipole antenna on FM and Short Wave Bands.

**RECORD CHANGER:** Automatic operation, for fourteen 10-inch or ten 12-inch records. Balanced tone arm for true record reproduction.

This radio was designed and executed for those who respond to fine furniture as they do to fine music . . . it was created by experts for experts.

In this newest Delco there is no skimping of materials, no cutting of corners. An AM-FM-SHORT WAVE high-fidelity radio, with push-button tuning for both AM and FM, is combined with phono-reproducing equipment that is the product of famous audio laboratories. Period-designed cabinets of solid, hand-rubbed walnut (or mahogany) with matching veneers.

You have to see and hear this great new Delco Combination to realize how fully it provides *the best of all that's new in radio*. Ask your United Motors Service distributor for a demonstration.



## DELCO RADIO

A GENERAL MOTORS PRODUCT

*Delco radios are distributed nationally by United Motors Service. See your United Motors distributor about the Delco Radio line.*

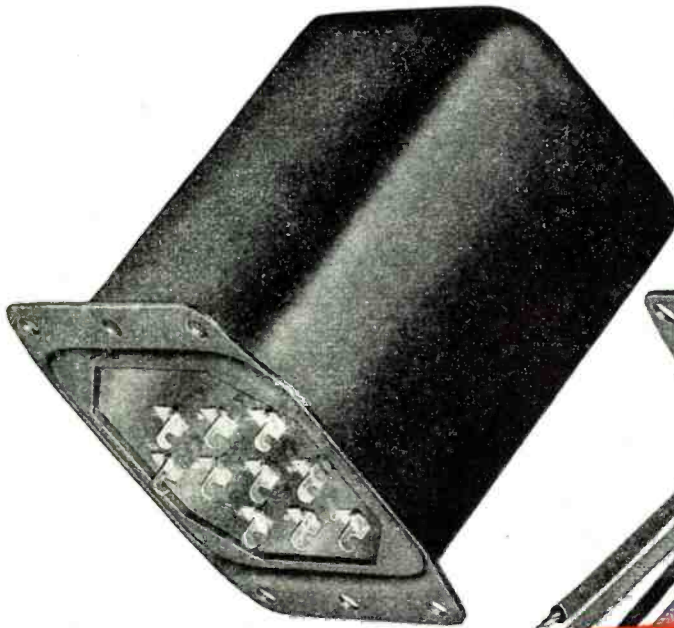

# note the New Look in Power Transformers

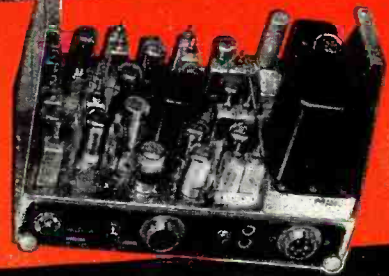

Typical Motorola FM two-way radiotelephone receiver utilizing Sealed in Steel Chicago Transformers.

## With CT's Famous Sealed in Steel Construction

The clean, streamlined appearance and compactness of CT's new *Sealed in Steel* construction contribute immeasurably to the trim, precision-like effect of any electronic equipment.

In addition, CT Transformers provide "steel wall" protection against atmospheric moisture, efficient magnetic and electro-static shielding, unsurpassed strength and rigidity to withstand shock and vibration, and unusual convenience of mounting.

Two base styles are available for most of the units in this catalog line, one with clearly identified solder lugs in a phenolic terminal board, the other with RMA color coded leads, stripped and tinned for easy soldering.

The design of these new power transformers assures maximum performance with minimum physical size and minimum temperature rise in accordance with RMA standards.

The wide range of carefully selected ratings achieves maximum flexibility of application, close matching with today's preferred types of tubes, and conformance with all industry standards.

Write direct for catalog illustrating, describing and listing the complete line, or contact your nearest radio parts jobber at once.

## PLATE AND FILAMENT SUPPLY TRANSFORMERS Primary 117 Volts, 50-60 Cycles

Catalog Number	For CAPACITOR INPUT SYSTEMS					
	HIGH VOLTAGE SECONDARY			FILAMENTS		
	A.C. Volts	D.C. Ma.	D.C. Volts Output	Rectifier Volts Amps.	No. 1 Volts Amps.	No. 2 Volts Amps.
PC-55	270-0-270	55	260	5 2	6.3CT 2	.....
PC-70	335-0-335	70	320	5 2	6.3CT 3	.....
PC-85	330-0-330	85	320	5 2	6.3CT 3	.....
PC-105	345-0-345	105	320	5 2	6.3CT 3.5	.....
PC-120	375-0-375	120	380	5 3	6.3CT 4	.....
PC-150	370-0-370	150	390	5 3	6.3CT 4	6.3CT 1
PC-200	385-0-385	200	390	5 3	6.3CT 4.5	6.3CT 1
For REACTOR INPUT SYSTEMS						
PR-55	350-0-350	55	260	5 2	6.3CT 2	.....
PR-70	425-0-425	70	320	5 2	6.3CT 3	.....
PR-85	440-0-440	85	325	5 2	6.3CT 3	.....
PR-105	445-0-445	105	325	5 2	6.3CT 3.5	.....
PR-120	500-0-500	120	400	5 3	6.3CT 4	.....
PR-150	505-0-505	150	400	5 3	6.3CT 4	6.3CT 1
PR-200	520-0-520	200	410	5 3	6.3CT 4.5	6.3CT 1
PR-300	550-370-75-0 -75-370-550	300	425	5 6	6.3CT 5	6.3CT 1

Also available in the *Sealed in Steel* constructions:  
**FILTER REACTORS** with current ratings to match power transformers above.  
**FILAMENT TRANSFORMERS** to meet a wide range of modern tube requirements.  
**AUDIO TRANSFORMERS**—Input, Output, Driver, and Modulation—that provide uniformly high fidelity response in three frequency ranges: 30-15,000 cycles, 50-10,000 cycles, and 200-3,500 cycles.

# CHICAGO TRANSFORMER

DIVISION OF ESSEX WIRE CORPORATION

3501 ADDISON STREET • CHICAGO 18, ILLINOIS





*Announcing*  
**VOL. XVII**  
**OUT IN MARCH**

1600 PAGES, PLUS THE  
 "HOW IT WORKS" book  
**\$15.00**

WITH A  
 COMPLETE SET OF RIDER  
 MANUALS YOU HAVE THE  
*World's Greatest  
 Compilation of  
 Radio Service  
 Data*

VOLUME XVII  
 PERPETUAL  
 TROUBLE SHOOTERS  
 MANUAL  
 JOHN F. RIDER

**They keep pace with the manufacturers' releases**

# Jensen

## "SECTOR" CABINET

### WITH Bass Reflex\*

for 8-inch Speakers

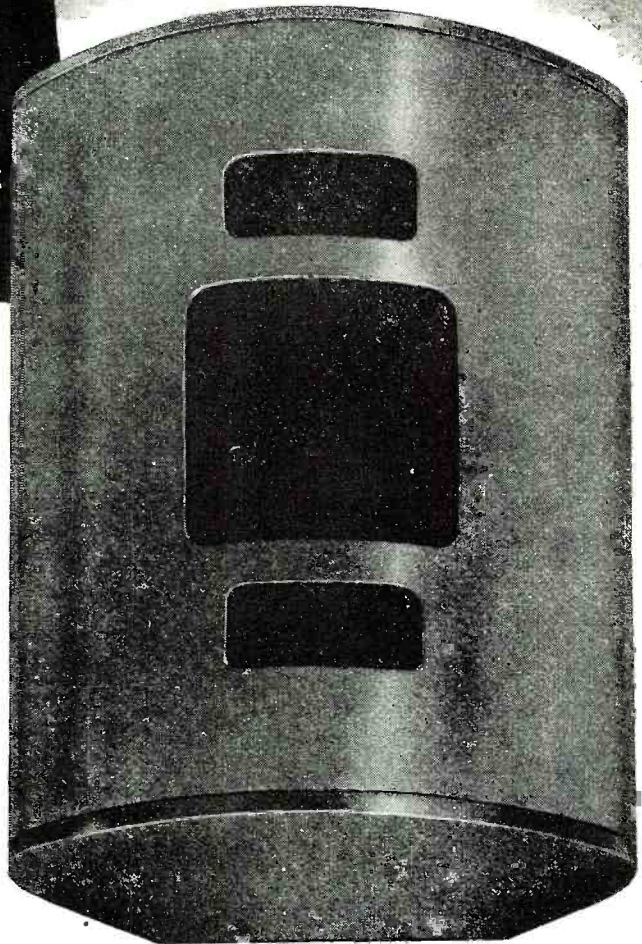
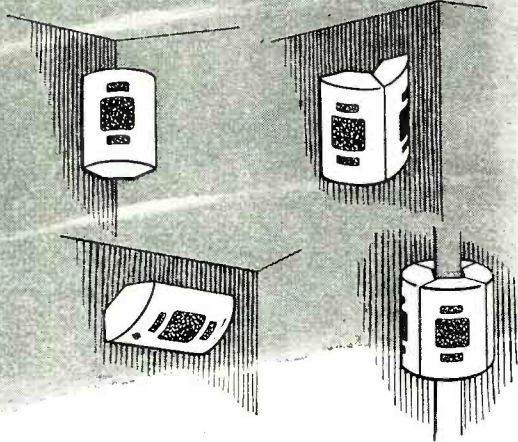

Model H-81 Sector Cabinet (ST-141) List Price \$22.50

They fit anywhere — in 90-degree corners — flat on walls — or in clusters to give wide-angle distribution. Perfectly adapted for nearly all interior sound installations, because of their economy, small size and, above all, the high quality performance of JENSEN speakers in Bass Reflex enclosures. Use with any JENSEN 8-inch speaker. Model P8-SH is recommended for high fidelity as required by many wired music installations.

Type H Sector Cabinets are built around a frame of solid wood with wood composition replacing the conventional plywood panels.

Finish is brown opaque lacquer although covering colors may be applied on the job if desirable to match environment. Size: Height 22½", width 17¾", depth 8½" Furnished with mounting brackets and screws.

**JENSEN MANUFACTURING COMPANY**  
6617 South Laramie Avenue, Chicago 38  
In Canada: Copper Wire Products, Ltd., 11 King St., W., Toronto

\*Trade Mark Registered

### OTHER Jensen CABINETS

BASS REFLEX

PERI-DYNAMIC



IMPERIAL TYPE D  
D-151 (15-inch)  
D-121 (12-inch)



UTILITY TYPE B  
B-151 (15-inch)  
B-121 (12-inch)  
B-81 (8-inch)



WALL TYPE J  
J-61 (6-inch)



# Jensen

## SPEAKERS

### WITH ALNICO 5

*Designers and Manufacturers*  
*of Fine Acoustic Equipment*

*A Few of  
the Thousands of  
Great Money-Saving  
Buys in this  
160-Page Catalog!*

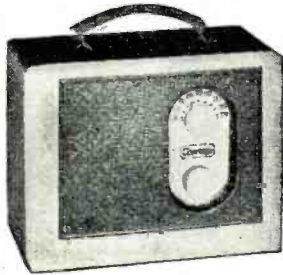

**New 3-Way Portable  
Changes From Battery to  
AC-DC Automatically**

No special switches on this modern portable, plug it into a wall socket for AC-DC operation—pull out plug—Presto—it's battery operated! Weighs only 6 lbs. Size 8 1/4 x 6 x 5 1/4". Has 4 tubes plus rectifier. Case is covered with beautiful two-tone simulated leatherette. Choice of blue and white, red and white or green and white. State color, less batteries.  
1-518 Each, in lots of 3.... \$17.95  
Each, in single lots. \$18.95  
C19882 Battery Kit..... \$ 2.79



**6 Volt Vibrator**

Replaces Mallory 294, 4-4, Radiart 5300, SO-1, Utah NP-42, Delco 5,040,000, 5,052,378, Meissner EO1.  
5B3950..... **\$1.05**



**Five-in-One Tool Set**

Cadmium-plated steel shank and knurled handle, hollow to store five snap-on tips. End of handle unscrews to remove tools. Tips are: 1/4 x 3/4" screwdriver and 3/8", 3/16", 1/8", and 1/4" socket wrenches. 7 1/4" long. Wt., 2 lbs.  
5B6548..... **79c**  
Your Cost.....

**Neutralizing Tool Kit  
12 Tools Telescope  
Into 5 Units**



This kit is composed of alligator side wrench, 6" insulated driver—metal nib, 3/8" and 1/2" nut wrench, 1/4" insulated square nut wrench, 1/4" hex metal side wrench, 2 1/2" insulated driver with metal nib, 1/4" hex slotted insulated wrench driver, 3/8" hex insulated nut wrench, 5" and 6" insulated driver.  
5B6547..... **\$2.37**  
Your Cost.....

**Combination Wire**

**Recorder-Disc Phono Unit**

A basic unit around which the builder, amateur or experimenter may build a complete unit for magnetic wire recording and playback, as well as standard disc phono playback. You may use it to record events, speech or music for reference at any future time, or you may ERASE all sound from the wire and RE-record, as many times as you wish, on the same wire. The wire recorder uses standard spools of steel recording wire (not supplied, see list below). Measures 13 x 8 x 7 3/4". Requires area 15 1/2 x 12 1/4" for playing 12" disc records. Complete with oscillator coil, circuit diagrams and instructions for building four tube amplifier and erase and bias oscillators.



C22522..... **\$47.95**  
C16311—15 min. spool.. \$1.75 C16312—30 min. spool.. \$2.55 C16313—60 min. spool.. \$4.80

*Free!*

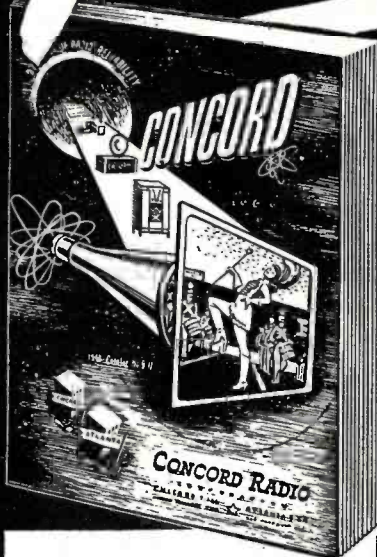

**CONCORD  
RADIO  
CATALOG**

**MAIL COUPON for FREE COPY**

The Only Complete Up-to-the-minute Catalog of  
**RADIO PARTS • RADIO SETS • AMPLIFIERS • TESTERS  
ELECTRONIC EQUIPMENT • HAM GEAR**

- Thousands of items for every need in Radio, Electronics, Television, Radar.
- Pages of Money-Saving Bargains in top-quality, standard-make Radio Parts.
- Immediate Shipment from huge stocks in Chicago and Atlanta.

**STANDARD BRAND PARTS AT LOWEST PRICES!**

**RCA • AMPERITE • SIMPSON • JENSEN • STANCOR • OHMITE • SHURE • BLILEY  
DUMONT • IRC • TRIPLETT • SPRAGUE** and hundreds of other well known brands

**CONCORD  
RADIO CORPORATION**

CHICAGO 7 285 Peachtree St.  
901 W. Jackson Blvd. Atlanta 3  
Downtown Chicago Branch: 229 W. Madison  
Lafayette Radio Corp.

Concord Radio Corporation, Dept. E-38  
901 W. Jackson Blvd., Chicago 7, Ill.

Yes, rush **FREE COPY** of the comprehensive new Concord Radio Catalog.

Name.....  
Address.....  
City..... State.....

# You've been waiting for it . . .

# HERE IT IS!



## The new **RC-15** RCA Receiving Tube Manual

Months of planning and preparation went into the new RC-15 Receiving Tube Manual to produce what is unquestionably the most complete and authoritative reference guide to receiving-type tubes ever published.

Patterned after the famous "RC-14," it has been extensively revised and expanded. Features RCA's complete receiving line including miniatures and kinescopes. The highly popular introductory section on tube and circuit theory has been increased to 55 pages and includes new reference data on FM applications. The widely used Resistance-Coupled Amplifier Charts are in entirely new form, and provide 27 combinations for each tube type. The completely revamped circuit section gives diagrams and parts values for up-to-date receiver and amplifier designs.

You'll find the new RC-15 indispensable in your work. Get your copy today from your local RCA Tube Distributor. It costs only 35 cents!

### CHECK WHY IT'S BETTER THAN EVER

- ✓ Up-to-the-minute
- ✓ Contains over 240 pages
- ✓ More data than ever before
- ✓ Abbreviated style . . . easier to use
- ✓ Tube types easy to find
- ✓ New circuit section
- ✓ Enlarged Introductory Section on Circuits and Theory
- ✓ Modernized and expanded Resistance-Coupled Amplifier Charts

THE FOUNTAINHEAD OF MODERN TUBE DEVELOPMENT IS RCA



**TUBE DEPARTMENT**

**RADIO CORPORATION of AMERICA**

**HARRISON, N. J.**

March, 1948

15

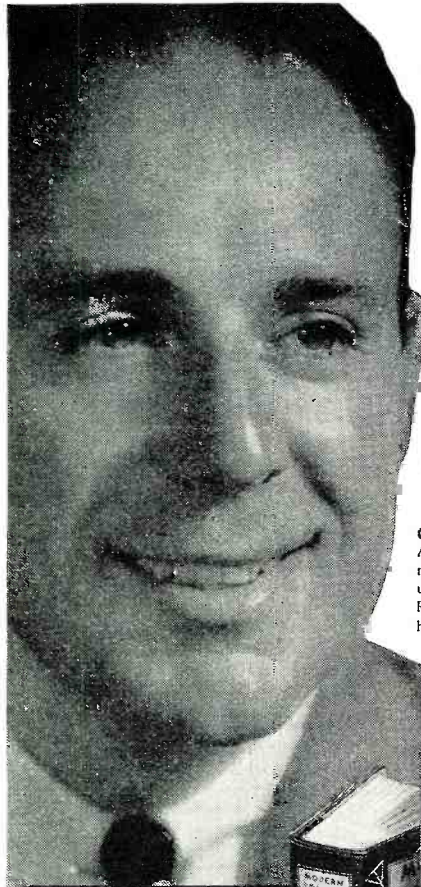

**I'll Prove That  
THE WORLD'S BEST  
RADIO-ELECTRONIC TRAINING  
Costs the Least!  
SATISFACTION or YOUR MONEY BACK!**

**1. This "AUTOMATIC TEACHER" Shows Exactly How To REPAIR OVER 4800 RADIO MODELS... IN HALF THE USUAL TIME**

A.A. Ghirardi  
Author of the most widely used books in Radio training history.

Ghirardi's Radio Troubleshooter's Handbook quickly helps you diagnose and repair common troubles in over 4800 receiver models and automatic record changers of 202 different manufacturers. Tedious testing is eliminated. This big, 4 lb. book guides you step by step in repairing almost every

radio in use today—with only a few simple tools and in half the usual time. Just look up the make and model of the radio you want to fix. 4 times out of 5, the HANDBOOK tells exactly what repairs are needed—exactly how to make them. Pays for itself in time saved on the first job! Thousands of servicemen use it every day. Enables you to repair cheap sets profitably. Ideal for training new helpers.

**ELIMINATES TEDIOUS TESTING**

But this is only the beginning! In addition, **Radio Troubleshooter's Handbook** gives you dozens of helpful charts; hundreds of pages of service data; tuning alignment information; transformer hints; tube data, color codes, tables, etc.—all designed to help you repair any radio easier and **twice as fast!** Not a "study" book! You simply look up what you need to know. Everything is carefully indexed. You can find exactly the data you need in an instant. Only \$5—on our **MONEY-BACK GUARANTEE** that protects you absolutely.

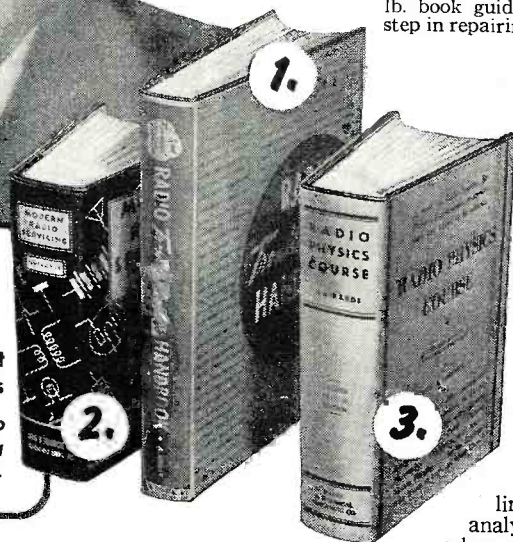

**Only \$5**  
each for these giant training course books  
Sold singly or as a group at these low prices as long as the present supply lasts.

**2. LEARN PROFESSIONAL SERVICING BY MODERN, SCIENTIFIC METHODS... for only \$5**

**Modern Radio Servicing** is A. A. Ghirardi's complete home-study guide to professional Radio-Electronic work of all kinds. It teaches you how to make preliminary trouble checks on complicated jobs; how to analyze any circuit quickly and scientifically; exactly where, when and how to use all basic test instruments; and how to interpret their readings to track down the trouble.

**3. BASIC RADIO-ELECTRONICS FOR BEGINNERS... 36 Courses in One!**  
No Lessons to Wait for... Only \$5 complete

No matter what part of **Electronics-Radio-Television** work you plan to enter, a knowledge of fundamentals is essential. Ghirardi's famous 972-page **Radio Physics Course** book gives exactly the training you need—at a price you can afford. If broken into monthly lessons and sold as a course, you'd regard it as a big bargain at \$50 or more. However, you buy it for only \$5—you complete it as fast as reading time permits.

**NO PREVIOUS TRAINING NEEDED**

Ghirardi's **Radio Physics Course** book has given more beginners their start in Radio-Electronics than any other book or course. It takes you step by step through the entire training. Nothing is omitted or condensed. It is the equivalent of 36 separate courses. Everything is explained as simply as A-B-C. Ask almost any Radio-Electronic man about it. He'll

know the book—and 9 out of 10 experts, as proved by an actual survey, recommend it as the finest, most complete Radio-Electronic book available at any price. Contains 972 pages; 508 easily understood illustrations, and 856 Self-Test Review questions. Only \$5 for the entire course in this handy, 1-volume form. **5-day money-back guarantee.**

**COMPLETE DATA ON INSTRUMENTS—TROUBLESHOOTING—REPAIR**

Nowhere else can you get this kind of professional training, faster, easier, and at less cost, than in this giant, 1300-page book. More widely used than any book of its kind. Thousands of successful servicemen got their start from it. Written so you can easily understand it at home without an instructor.

Ideal for service beginners or for men already in the business who want a real "refresher" course. Prepares you for the rich service opportunities that only those having the real "know-how" of scientific methods can hope to grasp. 706 photos, diagrams, drawings and charts make study fast and easy. Weighs over 3½ lbs. Only \$5—and you don't actually risk a cent!

**5-DAY MONEY BACK GUARANTEE**

Dept. RN-38, Murray Hill Books, Inc.,  
232 Madison Ave., New York 16, N. Y.

Enclosed find \$..... for which send me the Ghirardi Book(s) indicated below; or  send C.O.D. (no foreign C.O.D.'s) and I will pay postman this amount plus a small postal charge when he delivers my package. If the books are not entirely satisfactory, I'll return them within 5 days and you guarantee to refund my money.

- Radio Physics Course** \$5 (\$5.50 foreign)
- Modern Radio Servicing** \$5 (\$5.50 foreign)     **Radio Troubleshooter's Handbook** \$5 (\$5.50 foreign)
- MONEY SAVING COMBINATION OFFER:** Both **Modern Radio Servicing** and **Radio Troubleshooter's Handbook**, only \$9.50 for the two (\$10.50 foreign).

Name.....  
Address.....  
City & Zone..... State.....

**MONEY-SAVING OFFER!**

Get the two big Ghirardi service books for only \$9.50 (\$10.50 foreign). Let **Radio Troubleshooter's Handbook** save you time and money on common service jobs. Let **Modern Radio Servicing** train you for professional service work of all kinds! See Money-Saving Offer in coupon!





# FIRST in Quality, FIRST in Performance

You be the Judge! See why Centralab's  
**Ceramic BC "Hi-Kap" Capacitors are your best buy!**

"HI-KAP" FEATURES	DESCRIPTION	ADVANTAGES
1. Impervious to moisture	Ceramic-X is non-hygroscopic. Moisture absorption is .007% or less.	No deterioration, no shorting. Longer life even under the most adverse conditions.
2. Low mass weight	Av. Wt. .029 oz.	For unit size and weight, Centralab BC "Hi-Kaps", made with Ceramic-X, are the only capacitors on the market which provide these voltage ratings.
3. Small size	Dimensions L—.540" D—.315"	
4. High capacity	Values .00005— .00025 mfd.	
	L—.830" D—.315"	
	L—.1"	.000750— .005 mfd.
	L—1.305" D—.400"	.01 mfd.
	Rating: 600 WVDC — 1000 VDC flash test.	
5. Special insulation	Wax impregnated, lacquered, dipped in special phenolic resin, cured and wax impregnated.	Prevents any possibility of shorting to adjacent leads, chassis or components.
6. Convenient side leads	Heavy #22 gauge tinned copper.	Permit rapid, close-coupled connections. No tricky bending or fitting required.
7. Low power factor	Initial — .6%. After 100 hours, 95% humidity test — 3.0%.	More efficient circuit operation, fewer failures.
8. High leakage resistance	Initial — 5000 megohms. After humidity — 500 megohms.	Long life, more efficient performance.
9. Maximum dependability	One-piece construction. Leads soldered directly to electrodes.	Will not short or become intermittent.
10. Factory tested	For your protection, all units 100% factory tested before packaging and shipping.	Your guarantee to your customers of reliable service and performance.

PART NUMBER	VALUE (MFD.)	LIST PRICE*
D6-500	.000050	\$1.25*
D6-101	.000100	1.25*
D6-151	.000150	1.25*
D6-251	.000250	1.25*
D6-501	.000500	1.25*
D6-751	.000750	1.25*
D6-102	.001000	1.25*
D6-202	.002000	1.25*
D6-502	.005000	1.50*
D6-103	.010000	1.50*

\*PER ENVELOPE OF 5

Rating: 600 WVDC — 1000 V. flash tested. Individually color coded, inspected and insulated.

## All Capacitors Are Not Alike!

THAT'S why more and more Radio Service Dealers are turning to Centralab's *ceramic* by-pass and coupling capacitors for new dependability, permanence and convenient size. Compare the amazing low price at which Centralab is offering these *ceramic* capacitors, and you'll agree now's the time to give yourself and your service customers the newest and finest in capacitor components!

Note the wide range of *Hi-Kap* values available at left, and order a supply of these top quality capacitors from your Centralab Distributor today. For complete information, see your Centralab Distributor or write to *Centralab, Division of Globe-Union, Milwaukee, Wis.*

LOOK TO **Centralab** IN 1948!

First in component research that means lower costs for the electronic industry.

# Spot Radio News

★ Presenting latest information on the Radio Industry.

By **FRED HAMLIN**  
Washington Editor, RADIO NEWS

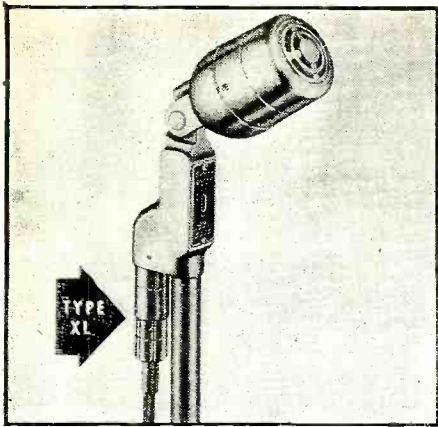

## HIGH FIDELITY EV-635 MICROPHONE USES "XL" PLUG

Electro-Voice has equipped the new EV-635 High Fidelity Dynamic Microphone for studio and remote broadcasting, with the Cannon Type XL-3-11 Plug—a quality plug for a quality microphone.

Shown at left is the new XL-3-36 Wall Receptacle (pin insert) engaged with an XL-3-11 Plug. XL-3-36 is priced at \$5.43 List; and XL-3-35 (socket insert) \$4.93 List.

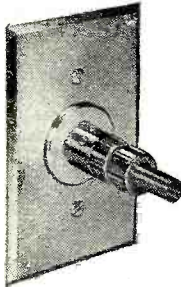

For a practical, low cost but high quality connector series having three 15-amp. contacts, choose the "XL". Four plug types and six receptacles with 3 adapter receptacles are available. Min. flashover voltage 1500 Volts.

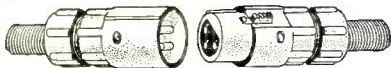

Above are the two zinc plugs (Left) XL-2-12, List \$1.20 and (right) XL-2-11, List \$1.25.

No other small electric connector has all the features of the XL, including the safety latch lock.

XL Connectors are available from more than 250 radio supply houses throughout the U.S.A.

For complete information on the XL, write for Bulletins XL-347 and XL-PR1. Address Dept. C-228.

SINCE 1915

**CANNON**  
**ELECTRIC**

Development Company

3209 HUMBOLDT ST., LOS ANGELES 31, CALIF.  
IN CANADA & BRITISH EMPIRE:  
CANNON ELECTRIC CO., LTD., TORONTO 13, ONT.  
WORLD EXPORT (Excepting British Empire):  
FRAZAR & HANSEN, 301 CLAY ST., SAN FRANCISCO

**AS WE PREDICTED** in January, Wayne Coy is the new chairman of the Federal Communications Commission. (Actually, we mentioned his name among a number of others as a possible candidate, but no Washington correspondent worth his salt remembers his mistakes, and all go to great pains to display their prophetic abilities.) Anyhow, Mr. Coy, a former fiscal expert in the Roosevelt regime and more recently manager of the Washington, D.C., station WINX, has taken over the job made vacant by hard-working Charles R. Denny last fall.

**WE HAVE INQUIRED** around since Mr. Coy took the new post, and reports are that the choice, so far, is considered good both in and outside FCC. The new chairman moved in fast and showed signs of being not only very active at hearings, but knowing what he's talking about, both from the radio standpoint and the legal. "He's showing signs of being a harder worker than Denny," are the words of one FCC observer, and a number of industry and broadcasting sources, while still keeping their fingers crossed, are equally pleased. Whether Mr. Coy will continue in the good graces of all concerned after his honeymoon on the new job is over is anybody's guess, but at least he is off to a good start.

**SO, ALSO, ARE 1948** television activities. Indeed, they are going so fast that it's difficult to keep up with them. Applications for broadcasting television are pouring into FCC at a great rate, with the tide not yet at peak. On a single day recently, eleven applications came in for television stations. Biggest interest as this goes to press is in Ohio, where town after town has asked for a license, but other areas show signs of being equally strong as the year goes forward. Those already in the field are also piling up new records. The number of television sets and viewers, according to a recent NBC progress report, shows set ownership up from 6500 in metropolitan areas on December 31, 1946, to 65,000 as of October 1, 1947—which does not, of course, include the large number of sales not yet tabulated completely, made during the Christmas season. Figuring six viewers per set, the NBC estimates

that television reached at least an audience of 600,000 by the end of 1947, and that this audience will be up to some 2,400,000 by the end of 1948.

**NOT TO BE UNDERESTIMATED** in the 1948 radio derby is another new development that shows signs of going to town much sooner than was expected, despite half a dozen obstacles that still stand in the way. This is facsimile broadcasting of newspapers. Still technically in the experimental stage, it is nevertheless working on a practical basis—and working well. *The Philadelphia Inquirer* is already broadcasting the news—with pictures—and as this went to press a number of other papers were ready to go, including *The Miami Herald* and *The New York Times*. Obstacles in the way of mass development are numerous. A receiver costs from \$600 to \$900—not exactly a modest down payment for you to make to get your morning newspaper. Broadcasters also have to ante up considerable—\$10,000 to \$15,000 to convert to facsimile. But there are assets—FM has been effective poison to bugs that used to crop up in facsimile when AM rumbled the news pages with static and newspapers are showing a lively interest in getting a running jump into the field. Don't expect it tomorrow—but, to summarize, don't be surprised within the next five years if you wake up in the morning with an 8½ x 11 inch newspaper on the floor beside you, fresh off the air.

**ONE HOT POTATO** that lit in the FCC lap early this year has cooled until, at writing, you can carry it around without asbestos gloves. That is the long-standing battle between FM stations—now represented by the Frequency Modulation Association—and the *American Telephone and Telegraph Company*, which controls the growing network of coaxial cables up and down the land. It's a complicated story at best, and after the contending lawyers got through with it, it often made more sense read backward than forward, but a nutshell summary may help. FCC granted AT&T experimental rights on the coaxial some time ago. AT&T used the coax to pipe television to and from Washington and New York. Television got the coax right for free, although

TELEVISION

RADIO

ELECTRONICS

# Stop! Do You Want More Money A GOOD JOB or A BUSINESS OF YOUR OWN...

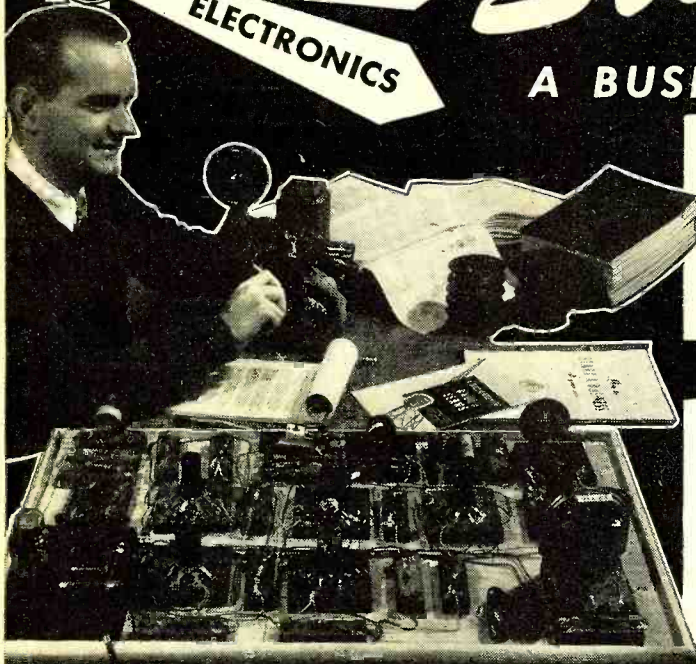

## ... Then You Can't Afford to Pass Up This OPPORTUNITY

For more than sixteen years we have been helping men like yourself... men who sought opportunity... men who wanted to get ahead. We believe we understand your problem as we have understood the problems of thousands of others.

**NO ADVANCED EDUCATION . . .**

**NO EXPERIENCE NECESSARY**

Fill in the coupon below and you will get, absolutely FREE, facts concerning our work, as well as information showing how we prepare YOU to get started in America's great opportunity field of Radio and Electronics. You'll see HOW you can tie in your future with a field that includes Television, FM Radio, Aviation Radio, Pre-Radar, Industrial Electronics, Broadcast Radio, 2-Way Train Radio, etc. You'll see HOW you may cash in on a grand opportunity to have your own business, or a real job—doing really interesting work!

As a HOME STUDENT, you receive a modern Home Laboratory that provides the practical experience you need — including 16 mm. HOME MOVIES to speed your progress.

### TAKE YOUR CHOICE

1. Our new, modern Chicago Training Center offers some of the finest RADIO-ELECTRONICS-TELEVISION training facilities in the nation. We will find comfortable living quarters for you.

2. You can get similar practical training in your spare time at home. You use 8 big kits of Radio parts and assemblies — giving you valuable practical experience at home from working out dozens of fascinating Radio-Electronic circuits. You also get instructive MOVIES RIGHT IN YOUR HOME.

**VETERANS!** Both our (1) Chicago Laboratory and (2) Home Training are accepted under the "G. I. Law."



If you choose to get your training in our new, modern Chicago Laboratory, you will work with lots of Radio-Electronic equipment under the personal supervision of some of the finest instructors in the field.

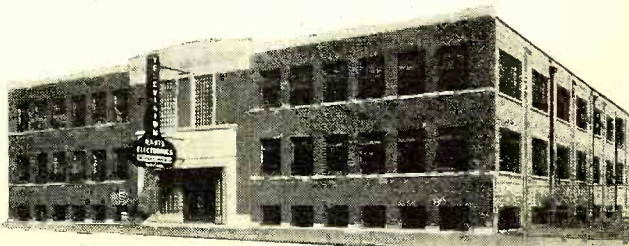

**VALUABLE EMPLOYMENT SERVICE.** When you complete either training, our effective Employment Service helps you get started toward a real Radio-Electronic future. Mail the coupon below today . . . do not delay.

### MAIL THIS OPPORTUNITY COUPON NOW

Mr. E. B. DeVry, President  
 DeForest's Training, Inc.  
 2533 N. Ashland Ave., Dept. RN-E3  
 Chicago 14, Ill.

Please show me how I may get started toward a good job or a business of my own in Radio-Electronics.

Name ..... Age.....  
 Address ..... Apt.....  
 City ..... Zone... State.....

If under 16, check here for special information.  
 If a discharged veteran of World War II, check here.

# DeForest's Training, Inc.

CHICAGO, ILLINOIS

Associated with the DeVry Corporation  
Builders of Electronic & Movie Equipment

more recently television programs have been piped containing advertising. Comes FM, wanting hook-ups via coax over the same route. AT&T says no. FM goes to FCC and asks why not. FCC says, why don't all concerned get together and talk it over? . . . Well, this happened in an informal conference in Washington recently, and the FM-AT&T representatives revealed two things—that they had not tried too hard to get together and that, differences considered, they got along pretty well. FM wants a 15,000-cycle circuit operation, and a formal request for it was made at the suggestion of the Commission after the meeting. This was on its way to FCC as we went to press. AT&T says that they can convert to FM service with proper terminal facilities, but do not want to do any expensive converting without some assurance that FM will use the service permanently. The whole matter was left on an experimental basis for the present, but every indication is that all parties involved will get together and work out a permanent solution.

**THE FMA**, incidentally, is still bursting with optimism and predictions that the new field will offer thousands of jobs to young men and women in the immediate future. New stations, the Association reports, will go on the air at the rate of 50 a month during 1948. According to Thomas F. McNulty, FM treasurer and chairman of the FMA liaison committee to the RMA, more than 380 FM commercial stations are now operating, as compared to 136 in January 1947, and 630 more have been authorized for construction this year by the FCC.

**ON THE JOB END** of the business, another FM spokesman, J. N. (Bill) Bailey, executive director of the FM Association, is equally sanguine. "The door stands wide open," he points out, "to young men and women who want to carve a career for themselves in radio." New stations on the FM circuit will offer numerous opportunities, Mr. Bailey believes, and a full share of these will appear during 1948. "This year will see the greatest expansion FM has known," he predicts, and there will be jobs accordingly all along the line, both for broadcasting talent and for technicians. We should emphasize—as we have before—that the best way to go after these jobs is neither through Mr. Bailey nor us. We do not run FM stations. See the man who owns one or—perhaps better—the man who's about to open one.

**WITH 1947 TRANSMITTER SALES** totalling around the hundred million mark and with receiver production and sale at an all-time high, far-seeing Radio Manufacturers Association is putting more and more emphasis on another war-neglected

(Continued on page 183)



*New!*

**MERIT  
HELP  
FOR  
REPAIR  
MEN**

Compact Replacement Kit containing 8 MERIT Quality Transformers for wide range of requirements. The MERIT Kit takes the place of so-called "universal replacement transformers," and brings much greater convenience to repair men. Each transformer is designed for its particular use, and individually labeled on frame with its number and data. Each kit is packed in handsome display box. For further information see your jobber, or write us.

List Price	OUTPUT TRANSFORMERS
Kit No. 1 . . . \$11.75	(2 ea.) A-2928, (1 ea.) A-2930, A-2931, A-2932, A-2934, A-2936, A-2937
Kit No. 2 . . . 12.20	(2 ea.) A-2928, A-2937, (1 ea.) A-2930, A-2931, A-2934, A-2936
Kit No. 3 . . . 11.80	(1 ea.) A-2928, A-2930, A-2931, A-2932, A-2933, A-2934, A-2937, A-2938
Kit No. 4 . . . 12.90	(2 ea.) A-2928, A-2931, A-2936, A-2937

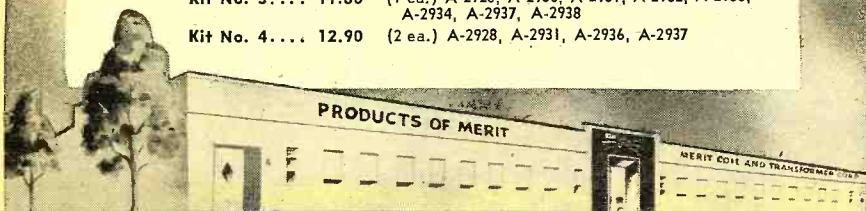

**MERIT COIL & TRANSFORMER CORP.**

TELEPHONE  
4427 North Clark St. Long Beach 6311 CHICAGO 40 ILL.

# This amazing WARD aerial sells FM better than 10,000 words!

## THE SMARTEST WAY TO MERCHANDISE FM

Every FM receiver needs an outdoor dipole aerial and, when you hear the amazing difference this new Ward Magic Wand\* makes in FM reception, you'll be sold solid. For, then you'll agree there's only one way to sell, or buy, FM . . . that's with aerial installation included. Equally efficient from all directions, this new broad band turnstile folded dipole continues to get all stations in your area regardless of how many more are yet to come on the air. Equal in signal strength to a high-gain folded dipole, it has a quarter-wave phasing loop which places elements 90 degrees apart electrically. Construction is all-metal, weather-proof. Complete fittings for installation included. Stock it, demonstrate it and sell it to present owners, and future purchasers, of FM radios!

**THE WARD PRODUCTS CORPORATION**  
1524 East 45th Street, Cleveland 3, Ohio

DIVISION OF THE GABRIEL COMPANY

EXPORT DEPT.:

C. O. Brander, Mgr., 4900 Euclid Ave., Cleveland 3, Ohio

IN CANADA:

Atlas Radio Corp., 500 King St. W., Toronto, Ontario

\*Trade mark registered

It delivers full-throated, static-free reception from every FM station in your area.

It's easy to install . . . no complicated orienting required.

Nothing else to buy . . . unit almost completely pre-assembled.

# WARD

# Magic Wand\*

NEW NON-DIRECTIONAL  
TURNSTILE FOLDED DIPOLE  
AERIAL FOR FM

BY WORDS . . . WORDS!

LARGEST PRODUCER OF AERIALS FOR CAR AND HOME

Model FMT-56  
Non-Directional Dipole

Complete with  
Magic Wand  
Aerial  
Installed

Only \$37.00

as advertised in  
THE SATURDAY EVENING  
**POST**

# HOT RADIO VALUES at SUN RADIO!

**100 WATT  
BENDIX  
TRANSMITTER  
TA12 . . . \$49.95**



**CHECK THESE VALUES:** Three 807 Tubes, four 12SK7, one 2-inch 5 amp. RF meter, four Separate Master oscillators. (These can be easily changed to cover 20-40-80 meters and by using crystal for the 10-meter band you will have a complete coverage transmitter.)

Four separate output tanks.  
One 4 position selector channel switch having seven sections which changes the ECO, IPA and output tanks simultaneously. All the controls are mounted on the front panel. The housing is cast aluminum; shields and case are sheet aluminum. Dimensions 11x12x15 inches, weight 35 1/4 lbs. Complete, simple instructions for conversion furnished. Complete with tubes. . . . . **\$49.95**

**110 VOLT AC  
SUPERHETERODYNE  
RECEIVER**



This crystal fixed frequency receiver comes with full conversion instruction for variable tuning of all ham bands and broadcast. A highly selective superheterodyne receiver, 110 V.A.C. power supply built in. Uses the following tubes: 6K7RF Amplifier; 6K8 Mixer and Oscillator; 6K7 I. F. Amplifier; 6F7 Detector and A.V.C.; 6C8 Output and Noise Suppressor; 80 Rectifier. Dimensions—3 1/2 x 19 x 11 1/2 inches. Comes complete, brand new, with one set of coils and two sets of tubes. . . . . **\$16.95**  
Extra set of coils. . . . . \$2.95

**SCR-522 VHF  
TRANSCIEIVER**

**\$24.95**

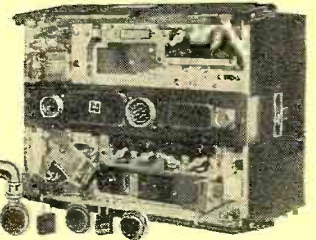

*Complete as shown*

The finest all purpose equipment on the surplus market. Tunes 100-156 MC. Don't confuse these with other incomplete and abused 522s. Sun Radio offers electronically perfect and guaranteed 522s . . . AND COMPLETE with tubes (one 10 tube superhet receiver with squelch circuit and one 7 tube transmitter), remote control box, 28 volt dynamotor (can be converted to 110V operation), 4 crystals and ALL CABLE CONNECTORS but less cables. . . . . **\$24.95**

## CRYSTALS!

IN the greatest purchase of radio transmitting crystals ever made by one wholesaler in the history of the Radio Parts Industry, Sun Radio acquired title to over a half million dollars (\$500,000.00) of Army Surplus, precision built, exactly tooled crystals in moisture proof holders which are shock mounted . . . thousands, or should we say miles, of gleaming brand new crystals in moisture proof holders manufactured by the world's finest crystal manufacturers (RCA, Biley, Western Electric, Valpey, etc.). We can't claim that we can supply every frequency, because they are offered "first come, first served," but we can supply the early birds with the below listed frequencies at the lowest prices you have ever seen.

### CRYSTALS WITH A MILLION USES

Fractions Omitted											
kc	kc	kc	kc	kc	kc	kc	kc	kc	kc	kc	kc
412	420	429	437	445	457	469	479	490	497	506	516
413	422	430	438	446	458	470	481	491	498	507	518
414	423	431	440	447	459	472	483	492	501	508	519
415	424	433	441	448	462	473	484	493	502	509	522
418	425	434	442	451	463	474	485	494	503	511	523
418	426	435	443	453	466	475	487	495	504	512	
419	427	436	444		468	477	488	496	505	515	

**49c**  
each

I.F. Frequency Standards			Crystal Frequency Standards			For Crystal Controlled Signal Generators		
kc	kc	kc	98.356kc			525kc		
450	454.166	461.111	100 kc Standard Mounted in low loss .3 prong holder.			526.388	531.944	536.111
451.388	455.556	464.815				527.777	533.333	537.500
452.777	459.259	465.277				529.166	534.722	538.888
<b>99c each</b>			<b>\$3.89 each</b>			<b>99c each</b>		

ASSORTED MISCELLANEOUS CRYSTALS					FOR HAM AND GENERAL USE				
Fractions Omitted					Fractions Omitted				
370kc	376kc	381kc	384kc	387kc	390kc	395kc	402kc	405kc	408kc
372	377	383	386	388	391	396	403	406	409
374	379				392	397	404	407	411
375	380				393	398			
priced at a fraction of the cost of their holders alone.					394	401			
<b>39c each</b>					<b>79c each</b>				

• Payments must accompany order. Enclose 20c for postage and handling. Minimum order—\$2.00 plus postage.  
• Crystals are shipped packed in cloth bags inasmuch as they are shock mounted. All shipments guaranteed.



**BC-684FM 35 WATT  
TRANSMITTER**

These units are BRAND NEW, providing 35-watt output, 10 channel push button crystal control employing NONLINEAR MODULATING COIL. This unit tunes from 27 to 38.9 mc. These units come complete with tubes less power supply, covers, and crystals. Excellent 10 meter FM transmitter for "Ham" or police use. . . . . **\$24.95**



**NAVY SPEAKERS**

Stromberg Carlson and RCA waterproof speakers. Brand New in original cartons. 25 Watt PM driver unit with projector mounted in heavy duty round metal baffle. Ideal for communication receivers and sound systems at the lowest price ever offered. **\$14.95**



**GI PORTABLE  
WIND-UP PHONOGRAPH**

A high quality sturdily built full toned windup phone originally built for armed forces as morale phono. Special triple spring motor plays 3 records on 1 winding. Speed adjustable from 33-78 revs. Brand new packed with 100 multiple play needles. . . . . **\$17.95**



**DYNAMOTOR POWER  
SUPPLY PE103**

These units are brand new in the original cartons, operate from either 6 volts or 12 volts and deliver 500 volts DC at 160 milliamps; mounted on box with circuit breakers, relays, interference filter and complete with cables. . . . . **\$9.95**



**TS13 HANDSET**

Combining a 200 ohm carbon mike and 2500 ohm earphone with butterfly switch for listen and talk. Has 6' flexible rubber cord with 1—P155 and PL68 plugs attached. Brand New. . . . . **\$2.95**



**5-GANG  
TUNING  
CONDENSER**

Brand new . . . 5 gang, 365 mmfd per section . . . a truly precision built condenser with ceramic insulation. A \$13.50 value in the greatest offering ever made in tuning condensers for only. **\$2.95**

# SUN RADIO

OF WASHINGTON, D. C.

938 F STREET, N. W. WASH. 4. D. C.

• **TERMS:** All items F. O. B., Washington, D. C. All orders \$30.00 or less cash with order. Above \$30.00 25 per cent with order, balance C.O.D. Foreign orders cash with all orders, plus exchange rate.

**WE BRING NATIONAL SCHOOLS  
TO YOU FOR  
HOME TRAINING IN  
TELEVISION & ELECTRONICS**



RADIO SHOP AT NATIONAL

BROADCAST STUDIO AT NATIONAL

Partial View of the Facilities that Stand Behind Your National Schools Home Training

TELEVISION STUDIO AT NATIONAL

Since 1905

**For Over 42 Years  
One of America's  
Leading Trade Schools**

**NATIONAL SCHOOLS SHOP METHOD HOME TRAINING WILL START YOU RIGHT**

We will train you today to get started tomorrow in one of the thousands of opportunities opening in the field of Radio, Television and Electronics. The Home Radio Service Field continues to grow. Television is here . . . Television Broadcasting facilities are being rapidly expanded. Television sales, service, installation and maintenance requirements are more and more important from day to day. Electronics is an important factor in many applications for utility, safety, accuracy and convenience. Airlines are finding new uses for Radio bringing new benefits to air transportation. Ships at sea are employing Radar together with other conventional Radio apparatus for ship-to-shore communications and safety. Frequency Modulation is modernizing Radio Broadcasting, offering static-and-interference-free reception in the home. The list of Radio applications is almost endless, and every one represents increasing opportunities in our modern world for the RADIO, TELEVISION AND ELECTRONICS TECHNICIAN WITH A SOLID TECHNICAL BACKGROUND.

**Lessons and Instruction Material  
Are Up-to-Date, Practical, Interesting**

It is not a question of opportunity but rather how to take advantage of existing opportunity. Only proper training can make these opportunities a reality. National Schools of Los Angeles, one of the oldest and largest technical trade schools in the United States, offers you Shop Method Home Training, a proved method that builds qualified technicians. Here is Home Training that BRINGS RESULTS.

Behind all training from National Schools stands a permanent faculty of experienced instructors and engineers. These men are daily teaching resident students right in our own Shops and Laboratories. From first hand experience with students here at school, our instructors understand the needs and ambitions of men like you. All of our instructors, both Home Study and Resident, have ideal facilities to make your training practical, up-to-the-minute, interesting. It takes years of experience to know how to train men, especially in the practical technical trades. Established almost 50 years ago, National Schools has a rich background of experience to help you to take full advantage of the opportunities in the Radio, Television and Electronics Industry.



**VETERANS**

During the war, National trained enlisted men under contract with the War Department. Both the Armed Forces Institute and Marine Corps Institute used our lesson texts on a wide scale. Now, we are training veterans, both resident and home study, through the Veterans Administration. If you are a veteran of World War II—and qualified for training under the G.I. Bill of Rights, check the coupon for special information.



March, 1948



**You Get All This Radio  
Experimental Equipment to  
Use and Keep at Home!**

LEARN BY DOING is the basic principle of National's Shop Method Home Training. We send you standard Radio parts for an interesting series of experiments which demonstrate the fundamentals of Radio, Television and Electronics. The very essence of this training is EXPERIENCE—you get actual experience by building many different types of circuits. You build a fine, long distance MODERN SUPERHETERODYNE RECEIVER, signal generator, low-power Radio transmitter, audio oscillator, etc. This practical work develops your knowledge of Radio step by step, makes you a practical Radio Technician.

- Here's Just a Few of the Interesting Facts you Learn with the **FREE MANUAL**
1. Routine for diagnosing Radio Troubles.
  2. Preliminary inspection of Receivers.
  3. How to Test and Measure Voltages.
  4. How to Test Speaker in Audio Stages.
  5. How to Trace the Circuit and Prepare Skeleton Diagram.
  6. Complete Reference Table for Quickly Locating Receiver Troubles.

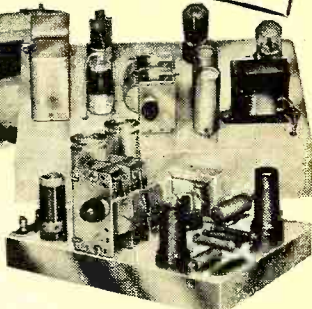

**Now! New Professional  
Multitester Included**



This versatile testing instrument is portable and complete with test leads and batteries. Simple to operate, accurate and dependable. You will be able to quickly locate trouble and adjust the most delicate circuits. You can use the Multitester at home or on service calls. It is designed to measure AC and DC volts, current, resistance and decibels. You will be proud to own and use this valuable professional instrument.

**GET THE DETAILS—SEND THE COUPON**

**G. I. APPROVED  
NATIONAL SCHOOLS  
LOS ANGELES 37, CALIFORNIA EST. 1905**

**MAIL OPPORTUNITY COUPON FOR QUICK ACTION**

NATIONAL SCHOOLS, Dept. RN-3  
4000 South Figueroa Street, Los Angeles 37, California  
Mail me FREE the two books mentioned in your ad, including a sample lesson of your course. I understand no salesman will call on me. I have checked below the plan which interests me.

NAME . . . . . AGE . . . . .

ADDRESS . . . . .

CITY . . . . . STATE . . . . .

(Include your zone number)

I am interested in home study only.

Send information on your Combined Home-Study and Modern Resident Shop Training.

Veteran of World War II.

# New SUPREME 948 and F M Manuals



## F.M. and Television

Use this giant-size manual of factory instructions for troubleshooting, repairing, and alignment of any recent **F.M.** and **Television** set. Covers every popular make, including F.M. tuners, AM-FM combinations, and all types of television receivers. Detailed circuit diagrams, theory of operation, test hints, alignment data. This is the material you need to fix any modern F.M. or Television set. Don't turn this profitable work away for lack of knowledge and information. Use this newest **Supreme** manual to save time and money on your very next F.M. job. Data presented on 192 large-size pages, 8½ x 11 in. Sturdy, manual-style binding. **\$2.00** Special price, postpaid.

## New 1948 Manual

Be prepared to repair quickly all new **1948** receivers. In this big single volume you have clearly-printed, large schematics, needed alignment data, replacement parts lists, voltage values, and information on stage gain, location of trimmers and dial stringing, for almost all recently released sets. A worthy companion to the 7 previous volumes used by over 120,000 shrewd radio servicemen. New manual covers models of 42 different manufacturers. Giant size: 8½ x 11 inches, 192 pages + index. Manual-style binding. **\$2.00** Bargain price, only...

## YOU CAN SERVICE ALL OLDER RADIOS WITH

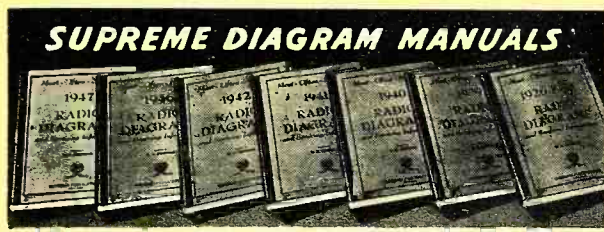

### MOST-OFTEN-NEEDED RADIO DIAGRAMS

Each manual has between 192 and 208 pages of diagrams and service hints; large size, 8½x11". Price, each **\$2.00**

DIAGRAMS 240 Pages Price \$2.50

### Post-War Automatic Record Changers

Service expertly all modern (1945-1947) record changers. Just follow simplified factory instructions to make needed adjustments and repairs. Hundreds of photographs and exploded views; thousands of test hints; service instructions for all popular makes. Large size: 8½x11". 144 fact-filled pages. At your jobber or postpaid, only **\$1.50**

### Pre-War Record Players, Changers, & Recorders

Just what you need to repair quickly thousands of pre-war automatic record changers, manual units, pick-ups, wireless oscillators, recorders, and combinations. Hundreds of mechanical and electrical diagrams. Instructions for adjustments and repairs. Most popular units of all makes. 128 large pages; size: 8½x11 inches. Price only **\$1.50**

See Your Radio Jobber or Send Coupon →

# Supreme Publications

PUBLISHERS OF RADIO BOOKS, MANUALS, AND DIAGRAMS

9 South Kedzie Ave.

Chicago 12, Illinois

## BIGGEST BARGAIN IN RADIO DIAGRAMS

Make these two new mammoth volumes your money-saving source for data on all recently released receivers. Learn about modern circuit developments, be ready to repair any new radio no matter how complex. You pay only \$2.00 for each of these large manuals. With these two volumes on your workbench there is nothing else to buy, nothing else to pay — a whole year of service data and radio diagrams yours for a couple of dollars total. Again **Supreme Publications** beats all competition and gives radio servicemen greatest bargains in service information. Read about other volumes for previous years described below at left. **No-risk** examination granted to servicemen.

## FIND ALL RADIO FAULTS DOUBLE-QUICK

You can speed-up and simplify radio repairs with **SUPREME PUBLICATIONS** Manuals. Service radios faster, better, easier; save time and money, use these **most-often-needed** diagram manuals to get ahead, earn more per hour. For the remarkable bargain price (only \$2 for most volumes) you are assured of having in your shop and on the job, needed diagrams and other essential repair data on 4 out of 5 sets you will ever service. Every popular radio of all makes from old-timers to new 1948 sets, including F.M. and Television, is covered. Clearly printed circuits, parts lists, alignment data, and helpful service hints are the facts you need to improve your servicing ability. Save hours each day, every day, begin to earn more by making repairs in minutes instead of hours. Let these manuals furnish you with diagrams for 80% of all sets. There is no need to spend large sums for bulky, space-wasting manuals, or to buy additional drawings every few weeks; be wise, use **SUPREME** Manuals to get the most in diagrams and service data for the smallest cost.

## SATISFACTION GUARANTEED

Select **Supreme** Diagram Manuals and Record Changer Books you want to examine.

See listing in left-hand column. Send the convenient no-risk trial coupon. Use the manuals in your own home or shop for 10 days at our risk. Decide for yourself that **Supreme Publications** are the greatest values in service data. You must be completely satisfied, or return manuals and receive your money back. Write today — 24-hour service.



Compiled by M. N. Beitman, radio engineer, teacher, author, & serviceman.

### Models Made by:

R.C.A., Zenith, Philco, Sears, Fada, Emerson, Belmont, Detrola, Crosley, United Motors, G.E., Westinghouse, Arvin, Majestic, Stewart-Warner, Admiral, Delco, Stromberg-Carlson, Western Auto, Spartan, Motorola, Wards, Gamble, and many others.

## NO RISK TRIAL ORDER COUPON

**SUPREME PUBLICATIONS, 9 S. Kedzie Ave., Chicago 12, ILL.**

Ship the following manuals on trial under your guarantee of satisfaction or money-back.

- New F.M. and Television Manual \$2.00
- Post-War Record Changers..... 1.50
- Pre-War Record Players & Recorders 1.50

- 1948
  - 1947
  - 1946
  - 1942
  - 1941
  - 1940
  - 1939
- PRICED AT ONLY \$2.00 EACH**

- I am enclosing \$....., send postpaid.
- Send C.O.D. I am enclosing \$..... deposit.

1926-38 — \$2.50

Name:.....

Address:.....

City:..... State:.....





**NEW!**

**MAKES YOU MASTER OF FM & TELEVISION SERVICE**



Here's what you and thousands of research and service technicians have demanded . . . a frequency-modulated FM and TV *sweep* signal generator. With this new McMurdo Silver MODEL 909 and your oscilloscope you can visually align FM and TV receivers . . . quickly and perfectly . . . for it comes with simple but complete instructions to *put you at the head of the parade* in FM and TV service.

Quality and completeness are as high as price is low . . . the regular "trademark" of Silver LCETI . . . Laboratory Caliber Electronic Test Instruments at prices you can afford.

**CENTER-FREQUENCY RANGE** 2/226 mc. — 5" vernier-driven calibrated dial. A new Silver development covers 2/77, 70/154 and 151/226 mc. in 3 bands without band-switching!

**STABILITY** is extraordinary. New u.h.f. tubes give stability such that FM and TV 'scope pictures once set up will "stay put" for hours on end.

**SIZE AND STYLE** match "VOMAX" and all Silver LCETI. Power required is 105/125V., 50/60 a.c. at 35 watts. Size 12 3/8" x 7 3/8" x 6" overall.

**CO-AXIAL OUTPUT CABLES.** 3 ft., d.c. isolated, 5/125 Ω impedance for r.f.; separate horizontal synchronizing cable. Both with clips for direct connection to receiver circuits.

**SWEEP FREQUENCY** is panel-knob variable 0/9 mc. . . . to set correct sweep for FM and TV i.f. and r.f. alignment. True electronic, not distorting and troublesome mechanical sweep.

**SYNCHRONIZATION** is either power line sine wave, or sawtooth to 'scope from 909. R.F. OUTPUT is panel-knob controllable 0/500,000 microvolts maximum. More than ample for all visual alignment with any good oscilloscope.

**MODEL 909 FM & TV SWEEP SIGNAL GENERATOR** makes you master, not victim, of today's most profitable service fields . . . at a price which is already the amazement of the industry!

**Model 909** ..... Only \$48.50 Net

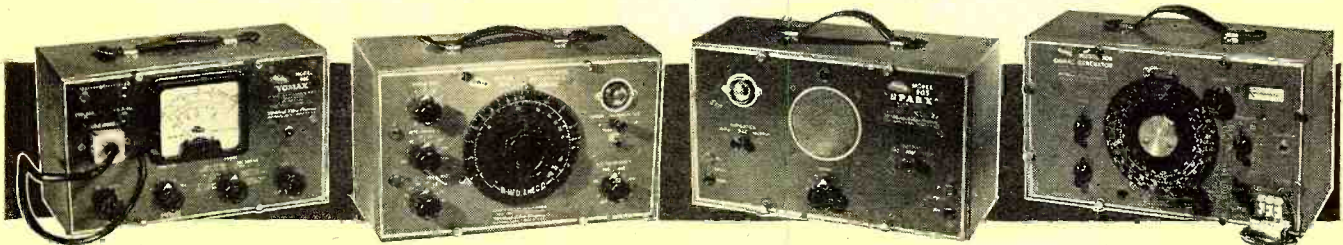

**900 "VOMAX"** 51 ranges; d.c., a.c., a.f., i.f., r.f., 20 Ω / 500 mc. 0/3000 V. d.c.; 0/1200 V. a.c., current 0/12 A. ; resistance 0/2000 meg Ω ; db.—10/+50. The overwhelming choice of wise research and service technicians. Only \$59.85 Net

**904 CONDENSER/RESISTOR TESTER.** 1/4 mmfd./1000 mfd.; 1/4 Ω /1000 meg Ω ; variable d.c. polarizing voltage leakage current; 0/50% power factor. Laboratory accuracy of ±3%. Measures all condensers with 0/500 V. rated d.c. volts applied. Only \$49.90 Net

**905 "SPARX" DYNAMIC SIGNAL TRACER/TEST SPEAKER.** Traces a.f., i.f., r.f. signals thru any receiver, tests pick ups, mikes, PA amplifiers. 20 Ω /200 mc. Saves time in receiver repairs as does no other single instrument. Only \$39.90 Net

**906 FM/AM SIGNAL GENERATOR.** 8 ranges, ±1% accurate, 90 kc./210 mc. 0/100% AM, 0/1000 kc. FM modulation. Less than 1 microvolt to over 1 volt metered output. The outstanding signal generator buy. Only \$99.50 Net

SEND FOR COMPLETE CATALOG. See these and Silver communication transmitters, receivers, "Micromatch", Xtal-controlled VFO, pretuned freq. multiplier at your jobber.

OVER 36 YEARS OF RADIO ENGINEERING ACHIEVEMENT  
**McMurdo Silver Co., Inc.**  
 EXECUTIVE OFFICES: 1240 MAIN ST., HARTFORD 3, CONN.  
 FACTORY OFFICE: 1249 MAIN ST., HARTFORD 3, CONN.

# CHASSIS • GOVT. SURPLUS • RECORDERS • INTERCOMS • CONDENSERS • TRANSFORMERS

**CUSTOM INSTALLATIONS**—Under the ECA Direct-From-Factory sales plan, our radio engineers will build to specifications or "blueprint" for approval, units to fit any cabinet design. See chassis below. Write for ECA offerings. Indicate interest in parts and equipment, home radios, chassis, recordings.

## FM-AM CHASSIS

Standard broadcast and new FM Band. Has 10 tubes plus rectifier, automatic volume control and input for phonograph. 10" Alnico V speaker, built-in antenna for AM and folded dipole for FM reception. AC. Size: 13 3/4" x 9" x 8 7/8".

**\$82<sup>50</sup>**



## \*ECA—AM CHASSIS

Ideal for "remote" areas. Standard broadcast band, Push pull audio — 3 watts undistorted output, variable tone control, Phono input. Uses 2/25L6 1/6SL7G 1/6SF7 1/6SA7 2/25Z6. Inverse feedback and automatic volume control. AC-DC. Size: 11" x 5 1/4" x 5 1/2". Complete with 7 tubes and 10 inch speaker, loop antenna.

2/25L6 1/6SL7G 1/6SF7 1/6SA7 2/25Z6. Inverse feedback and automatic volume control. AC-DC. Size: 11" x 5 1/4" x 5 1/2". Complete with 7 tubes and 10 inch speaker, loop antenna.

**\$24<sup>95</sup>**

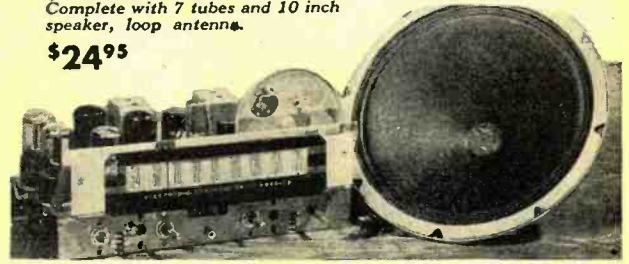

## WIRE RECORDER

Combination Wire Recorder and Record Player

Records up to one hour. Impression can be erased and wire reused. Plays 10" and 12" records with featherweight pickup. Easily wired to amplifier on radio. Operates on 110-120 AC only. Chassis complete as shown.



Stock #1005 **\$47<sup>50</sup>**

Complete recorder with amplifier. Speaker microphone mounted in portable carrying case,

Stock #1006 **\$109<sup>50</sup>**

## INTERCOM SYSTEM

2-way system, master & sub in beautiful black plastic with 50 feet of cable. Has 4" PM speaker and 3 tube amplifier. Operates on 105 to 125 volts — AC-DC. Easy to install and economic to operate!



List Price \$37.50  
**SALE PRICE \$17<sup>50</sup>**

# ATTENTION: AIRLINES AND PLANE MANUFACTURERS, HAMS

## AN/APN-1 ALTIMETER

Effective up to 4000 ft. 27 volts D.C. Compact self contained dynamometer includes external radio altitude indicator and altitude limit switch. 2 antennae all plugs and co-axial connections. Frequency 420 MC easily converted to ham communications use.

**BRAND NEW, COMPLETE, EXPORT PACKED**

Single Price, **\$34<sup>50</sup>**. Lots of 6, Each, **\$29<sup>50</sup>**

Gov't cost over \$700.



## DACO TUBE TESTER



Tests performance, leakage and shorts in ALL receiving tubes. Dust-proof case, high-visibility meter, illuminated chart. Simple, fast operation with positive contact slide-switches; tests EVERY tube element. 110 volt AC. 16 1/2" x 14".

Stock #1003 **\$29.50**

## PORTABLE DACO TUBE TESTER

Same as counter model but, enclosed in sturdy case with durable black leatherette covering. 12 1/2" x 12 1/2".

Stock #1004 **\$32.50**

## DYNAMOTOR

For Transmitters or Public Address Outfits; Mobile or Yacht Installations. Output—500 Volts at 200 MA. Continuous or 400 MA Intermittent. Input—12 or 24 Volts D.C. Made by the Randall Corp., Type DM-40AX. Price, **\$5.95**

Stock #1001



## CONDENSERS

Stock #	OIL FILLED	Price Each	Lots 10
999	Aerovox .05 mfd. 7500 volts...	\$.98	.75
1002	Pyronol G.E. .01-5000 volts...	\$.50	.45
2006	Bathub .15 mfd.-600 volts...	\$.16	.13
2007	Bathub 2 x .1 mfd.-600 volts...	\$.16	.13
2008	Bathub 2 mfd.-400 volts...	\$.22	.18
2009	G.E. upright .5 mfd.-600 volts...	\$.16	.13
2010	Bathub .01 mfd.-600 volts...	\$.16	.13
2011	Bathub 1. mfd.-400 volts...	\$.20	.16
<b>PAPER TUBULAR</b>			
2000	.1-200 volts .....	\$.06	.05
2001	.01-400 volts .....	\$.08	.05
2002	.02-200 volts .....	\$.05	.04
2003	.001-600 volts .....	\$.06	.05
<b>DRY ELECTROLYTIC TUBULAR</b>			
2004	4 mfd.-150 volts .....	\$.20	.16
<b>MICA CONDENSER</b>			
2005	.03-2000 volts .....	\$.30	.25

## 15" HIGH-FIDELITY DYNAMIC SPEAKER



Husky 25-watt dynamic speaker for use where perfect reproduction is desired. Ideal for both indoor and outdoor installations. 12,500 ohm field, 16 ohm voice coil. Regular \$40.00 list.

Stock #1021

## DC TO AC CONVERTERS



Operate your AC Receiver, Record Player, Combination, etc. from DC line. Output—110 Volts, 60 cycle, single phase. Input—115 Volts DC. 125 KVA at 2 Amp. Made by Electric Specialty. Includes built-in filter. New; individually crated. Limited quantity.

Price, each, **\$29.95** Stock #1000

## OUTPUT TRANSFORMERS

Stock #	OUTPUT TRANSFORMERS	Price
2015	Universal, will match any single or push-pull tubes, strap mounting, size 2" x 2 1/2" mtg. centers...	\$.65
2013	Single 7000-9000 ohm to 4. ohms v.c. ....	\$.59
2014	Single 50L6 output to 3.2 ohm v.c. ....	\$.39

METER 3" 0-10 MA—Scale reading, 0 to 1 M, made by De Jur Amsco. Price, each,

**\$1.95**

Stock #2012

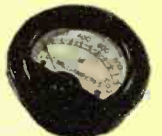

Will ship C.O.D. Minimum order \$2.00.

Attention: Manufacturers and dealers, contact us for quantity requirements in the electronic field.

**ECA**  
RADIO

**Electronic Corporation of America**

353 WEST 48th STREET • NEW YORK 19, N. Y.



# SEVERAL MILLION

**OHMITE** RHEOSTATS • RESISTORS  
TAP SWITCHES • CHOKES

*Carried in Stock  
for Immediate Delivery*

Ohmite maintains what is believed to be the largest, most complete stock of wire-wound rheostats and resistors, rotary tap switches, and chokes in the world. Available in great variety—actually in 1859 types, sizes and values.

**Rheostats**—Stocked in 25, 50, 100, 150, 300, and 500-watt sizes, each carried in at least 22 different resistance values—from 0.5 ohms to as high as 10,000 ohms.

**Resistors**—Among the stock vitreous-enameled, wire-wound, fixed resistors are 5, 10, 20, 25, 50, 100, 160, and 200-watt

sizes. Also "DIVIDOHM" adjustable resistors rated at 10, 25, 50, 75, 100, 160, and 200 watts. Both types of resistors are available in at least 24 and up to 47 resistance values from 1 ohm to 250,000 ohms. Also "LITTLE DEVIL" insulated composition resistors in all RMA values.

For experimental work or small production runs, you can get reasonable quantities of these units from Ohmite distributors in your city. Quantities not available locally can be shipped promptly from our large factory stock.

**OHMITE MANUFACTURING COMPANY**

4885 Flournoy St., Chicago 44, Ill.

Write for  
Stock Catalog  
No. 19



**OHMITE**

RHEOSTATS • RESISTORS  
TAP SWITCHES

*Industry's First Choice*

**FOR FASTER SOLDERING**  
**2 NEW WELLER**  
**SOLDERING GUNS**  
 with

*Solderlite*



**FLEXITIP**--Loop tip easy to form

**LONGER REACH**--Gets through wiring

**SOLDERLITE**--Spotlights the work

**5 SECOND HEATING**--Saves time and power

**DUAL HEAT**--35% reserve heat for chassis soldering

**S107** Single heat  
**D207** Dual heat  
 100 watts  
 110 volts  
 60 cycles

The new Weller Soldering Guns with Solderlite plus the fast 5 second heating help make service work more profitable for radio, television and appliance service men, electrical maintenance men, electric motor rewinding and repair shops automotive electrical service.

A useful and time-saving tool for laboratory workers, experimenters, hobbyists, telephone installation and maintenance men. S107 100 watts single heat, D207 100/135 watts dual heat.

See your radio parts distributor or write for bulletin direct.

**WELLER**  
**MANUFACTURING CO.**  
 810 Packer St., Easton, Pa.

*Within the*  
**INDUSTRY**

**MICHAEL SCOTT**, formerly vice-president and general manager of *Radio Wire Television, Inc.* of Boston, has been named sales manager of communications equipment division of the *Hallcrafters Co.* of Chicago.



Mr. Scott, who has been associated with the radio industry since 1926, served as officer in charge of the electronics division of the Navy disposal administration during the war. As president of the Yankee Chapter of the National Electronic Distributors Association (NEDA) he has been active in merchandising circles in New England.

He joined *Radio Wire Television, Inc.* in 1934 and served as New England chief of the WPA's radio-radar division.

**ROBERT M. KARET** has announced the formation of *R. M. Karet Associates, Inc.*, a firm of manufacturers' representatives with offices at 510 North Dearborn Street in Chicago.



Mr. Karet was formerly sales manager of the *Thorndarson - Meissner-Radiart Division of Maguire Industries* and prior to that was, for many years, sales manager of the jobber

division of the *Utah Products Company*.

John S. Margolin, formerly with *Stromberg-Carlson*, is vice-president of the new organization.

The company has been appointed to represent *Pilot Radio Corporation* in the states of Michigan, Indiana, Illinois, Missouri, Iowa, Wisconsin, Minnesota, North and South Dakota, Nebraska, and Kansas. The company is maintaining resident sales offices in St. Louis and Minneapolis in addition to the main office in Chicago.

**CARL A. STONE**, veteran manufacturers' representative, has been named president of the Los Angeles chapter of the Representative of Radio Parts Manufacturers, Inc. for the coming year.

Serving with Mr. Stone are Gerald B. Miller who was named vice-president, and M. D. Faly who was re-elected to the post of secretary-treasurer. Mr. Stone and Mr. Miller succeed Dave Marshank and George Tivy, respectively.

**OHMEGA LABORATORIES, INC.** is the name of a new corporation recently formed to specialize in research, design, and development of all types of electronic and associated equipment.

E. E. Crump, formerly of *Bell Telephone Laboratories*, is the president of the new company, while L. L. Libby, who was formerly associated with *Federal Telecommunications Laboratories*, is the chief engineer.

The new corporation is an out-

**FRANK E. BUTLER**, well-known inventor, educator, and author, passed away recently in his home in Toledo, Ohio. One of **RADIO NEWS'** best-liked authors, Mr. Butler was born in Monroeville, Ohio, only a few miles from the birthplace of Thomas A. Edison. Like Edison he started his career as a telegraph operator from the same location and at the same age, 15 years. On June 10, 1904, he resigned as a train dispatcher for the New York Central to become associated with Dr. Lee de Forest and for many years acted as his chief assistant. During this time Mr. Butler was in charge of constructing high-powered wireless stations at Pensacola; Key West; Guantanamo, Cuba; Colon, Panama; and San Juan, Puerto Rico. He then went to Manhattan Beach, Long Island, where he erected a station and sent the first wireless messages across the Atlantic. In the summer of 1906 when Dr. de Forest left American Wireless Telegraph Co., Mr. Butler also left, and in a little laboratory in the Parker Building, New York City, they worked together in developing the Audion tube. In 1908, Mr. Butler organized The American Wireless Institute, the first school in the world to teach wireless engineering. He designed numerous early radio circuits; and was sales manager of several tube companies, among them Archatron, Volutron, Arcturus, and Ken-Rad. At the time of his death, he was writing for several technical publications and was the author of books dealing with the progress of wireless, radio, and electronics. His latest and most important book, which was nearing completion, is an autobiography relating hitherto unknown facts about the birth of radio.



**FROM A LEADING RECORD MANUFACTURER**

"The pickups are proving quite the thing with the engineers here. If you ever get to New York, I'd like very much to let you hear how fine they sound."

"Recently I purchased one of the Variable Reluctance Pickups manufactured by your company. I have installed it in a . . . in conjunction with your M5C phono preamplifier and a high fidelity amplifier. The results of this installation to date have been excellent and I would like to congratulate you on this development."

**FROM A LEADING UTILITY LABORATORY**

"I have been using for the last several months a pair of your variable reluctance pickups in connection with a high fidelity play-back system with eminent satisfaction. I would in fact go so far as to say that the results when first put to use were astonishing."

*They're all talking about the*



**VARIABLE RELUCTANCE PICKUP**

**Have you sent in your order?**

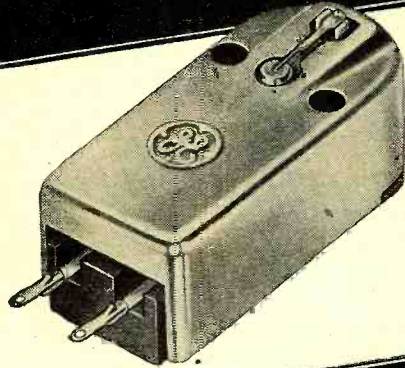

General Electric Company, Electronics Department, Electronics Park, Syracuse, New York.

**GENERAL ELECTRIC**

"Not so long ago I bought one of your DL IRM 6C variable reluctance pickups. I am completely satisfied with it. It has more than lived up to my expectations."

**FROM A LEADING STATION**  
 "Retel Nov. 27 ordered 30 G-E pickups because tests indicated that they were superior . . . and station is going to include G-E pickups in all transcription equipment."

"The release for public sale of your Variable Reluctance pickup Cartridge has made a large number of people in this neighborhood happy. Listening comparisons with other types of cartridges lead only to the conclusion that the G-E is perhaps the biggest improvement in record reproduction for the poor man in the last ten years."

"I have installed one of your DL IRM 6C Variable Reluctance type pickup cartridges in my record changer and am feeding it through a preamplifier made by you, the diagram of which is given in figure 2 of the descriptive sheet belonging to the above mentioned pickup. I find that the results I have obtained from this pickup are better than anything I have heard before."

**FROM A LEADING SET MANUFACTURER**  
 "We are rapidly approaching the day on which the G. E. Variable Reluctance Pickup will be a standard component in our instruments. May I say that I continue to enjoy immensely the results from the sample pick-ups you were kind enough to send some weeks ago. I have yet to hear their superior even at considerably higher price levels."

"I have been using a General Electric Reluctance Phonograph Pickup for the past few weeks, and am greatly impressed by the cleanness of its reproduction."

"I recently heard a demonstration of the G-E Variable Reluctance Reproducer Model DL IRM 6C, which was very impressive."

**RESEARCH AND DEVELOPMENT COMPANY**  
 "The combination of . . . G. E. cartridge, and . . . is being adopted with enthusiasm by radio stations throughout the country. National radio networks . . . are placing them on all of their transcription tables."



# HAS THE VALUES!



HERE ARE A FEW TYPICAL OF WHAT IS TO BE FOUND IN THE BIG NEW B-A CATALOG #481

116 BIG PAGES PACKED WITH THE LATEST DEVELOPMENTS IN RADIO AND ELECTRONICS, Sets, Supplies and Apparatus . . . For Trade—Industry—Communications—Public Utility—Experimental and Hobby Applications.

A Bargain Section Packed With OUTSTANDING VALUES in desirable WAR Surplus and other SPECIAL VALUES.

Write For Your Copy of Catalog #481 If You Did Not Receive It.

### "RADIO-CLOCK"



Radio, Clock and Musical Alarm—all in one, beautiful lustre Jewell Catalin Cabinet. Clock can be regulated to turn Radio on or off at the desired time . . . to wake you . . . to remember a favorite program . . . to get the news or market reports . . . to take the cake out of the oven . . . etc. Radio is a Superhet, 4 tube plus rectifier. AC operated. Easy vision slide-rule dial. High ratio Vernier tuning. AVC new Alnico No. 5 dynamic speaker, built in antenna. Well known quality make. List Price \$39.95. No. 36A67, Mahogany No. 36A68, Ivory CHOICE EACH.

\$29.95

### "WIRELESS F.M. TUNER"



F.M. on Any Radio. NO WIRING Needed. Simply Plug in and Play. 5 tube Superhet circuit AC-DC operation, utilizes 3 Iron core I.F.'s and a new balanced F.M. Detector Circuit. Capable of picking up F.M. stations in most localities without installation of antenna, and converts these signals so that any radio will reproduce F.M. without any wiring to radio. In beautiful hand-rubbed Walnut cabinet 11 x 6 x 7 1/2". No. 36A69, Complete Each \$27.85 No. 36A70, As above without cabinet for installation in consoles, etc. \$23.95

### BIG VALUE—AC-DC Superhet

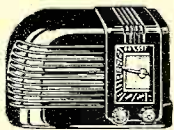

Graceful design, dependable performance anywhere. An outstanding value! Proven Superhet circuit, 5 dependable tubes (including rectifier). Full size 5" Alnico "V" PM speaker for wonderful tone. Airplane dial. Modern Plastic cabinet Ivory finish size 10 5/8 x 5 1/2 x 6 7/8". No. 31A224, SPECIAL EACH.

\$15.94

### 3 WAY "PERSONAL" AC- DC. and BATTERY OPERATED PORTABLE



Superhet circuit, 4 tubes plus Selenium rectifier. 5" Alnico PM speaker. Iron core I.F. Safety switch for operation from 110 volt AC or DC electric current or from self contained batteries (1-746 "A" and 1-467 "B") available anywhere. Beautiful dual colored Polystyrene Shatter-proof molded cabinet with plastic easy grip handle. Large slide rule dial. Vernier Hi-ratio tuning. Small: only 4" wide, 8 3/8" long, 7 1/4" high. Weight only 5 1/4 lbs. with batteries. A "Honey" for in the home or "on the go." No. 36A66 Less Batteries, ONLY \$21.95 Set of batteries (1-746 and 1-467) \$2.40

\$21.95

### "TAKE-ME-ALONG" Battery Radio—OPERATES ANYWHERE

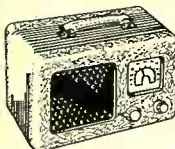

Four Tube Superhet, PM Dynamic speaker, AVC, Iron core high gain I.F. Easy vision dial. Built in antenna. Low battery drain with 2 flashlight cells and 467 "B" available anywhere. Sturdy cabinet, two tone leatherette covered, size 8 1/4 x 5 1/2". Wt. 4 3/4 lbs. complete.

\$16.62

No. 36A52 Less Batteries, ONLY SET OF BATTERIES \$2.00



LOW LOW PRICE!

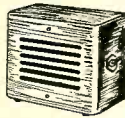

MASTER-REMOTE INTER-COMS Push button selection for 1 to 5 remote stations from this quality built 4 tube, 2 watt Master station. Several remotes can be "paged" at one time. Remote stations can originate call to Master. Very simple to install with any 3 conductor cable. Sturdy, good looking wood cabinets, walnut finished. Master 12 x 7 1/4 x 6 1/4". Remote 6 1/4 x 7 x 4". No. 32A234X, Master Station and One Remote—ONLY \$29.95 No. 32A235X, Additional Remote Stations—ONLY \$7.88 No. 2A113, 3 Conductor Cable—100 Feet \$2.60

### THE "DOUBLE TWENTY" FLUORESCENT UNIT

- Plugs in Any Outlet
- Hangs in Any Position
- Underwriter's Approved



Improved heavy steel, high reflection baked white enamel inside, gray outside. Hangs anywhere, with wire or chain, in a "jiffy." With 6 foot attached cord ready to plug in any outlet. Ideal for your hobby nook, repair shop, store, etc. Shipped complete with two 20 watt lamps. Size 25 1/4 x 9 1/4 x 5 3/4", wt. 10 lbs. No. 30A60 Spec. Each \$8.28 6 at Each \$7.73

### "2 DOOR CHIMES"

1 tone for front and 1 for rear door. Operates from either 8 dry cells or with transformer on AC. Same as electric door bell. Streamlined design with Chrome Louvre and trim strips over baked white enamel finish, size 6 3/4 x 4 1/2 x 2 1/2". Easy to install. No. 33A201, Net Each \$2.75 Transformers for bells or chimes, reduces 110 volts AC to 10 volts. No. 20A71, Net Each \$1.50



\$2.75

### "FLASH 75" SOLDERING IRON

3/8" TIP 5/16" TIP PENCIL TIP CRAFTSMAN TIP OPERATES DIRECTLY FROM 110 Volts A.C. or D.C. Quick heating. Has a natural gun grip with a cool protected plastic handle. Light weight, handy to use. Comes with Four tips as illustrated. No. 16A503, Complete with tips, Net Each \$3.28



### KRAEUTER "K" PLIER SET

Drop forged from a good grade of steel. Semi-polished heads. Blued steel handles. 1. 5" Diagonals 2. 6" Tapered jaws with cutter and slender nose. 3. 6 1/2" Electricians type, sturdy tap joint, milled jaws, hardened and tempered cutters. No. 16A533 For All THREE, ONLY \$3.87

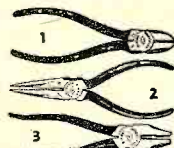

\$3.87

Order direct from this ad. Our Terms: Cash With Order or C. O. D. with 20% deposit please. Radio Sets Shipped Via. Express Only. WRITE FOR YOUR COPY OF CATALOG No. 481 IF YOU DID NOT RECEIVE IT.

growth of Kay Electric Company of Pine Brook, New Jersey, makers of the "Mega-Sweep" sweeping oscillator and the "Mega Match." Kay Electric Company will relinquish all its special development work to the Ohmega Laboratories and concentrate of manufacturing of instruments for electronic measurements. The Ohmega Laboratories, Inc. will also be located at Pine Brook, New Jersey.

V. M. GRAHAM, director of technical relations for Sylvania Electric Products Inc. of Flushing, New York, has been elected chairman of the Joint Electron Tube Engineering Council which is sponsored by the Radio Manufacturers Association and the National Electrical Manufacturing Association. The Council was established in 1944 to standardize data and engineering practice for electron tubes.



The Council includes two directors, one from RMA and the other from NEMA, and six members representing tube manufacturers. JETEC was organized largely through the efforts of Dr. W. R. G. Baker of General Electric; A. C. Streamer of Westinghouse Electric; and O. W. Pike of General Electric, the retiring chairman. The Council operates through several line committees concerned with various classes of electron tubes commonly used in radio and industrial electronic applications.

Mr. Graham has been active in the Engineering Department of the RMA and has served as an associate director of that department for twelve years. He is a Fellow and Director of the IRE and has been chairman of the IRE-RMA Rochester Fall Meeting Committee since 1929.

ROBERT A. ELLIOT, supervisor of export sales of broadcast audio equipment for the RCA International Division, has been named manager of broadcast audio sales for the company's domestic division.



In his new position, Mr. Elliot will direct national sales of RCA's complete line of broadcast audio equipment.

Mr. Elliot joined the International Division of Radio Corporation of America in 1945 and acquired extensive sales engineering experience installing broadcast equipment in many parts of the world. During the war he was in charge of studio engineering for the Radio Section of the Office of War Information.

He joined the National Broadcasting Company in 1933 and after five (Continued on page 116)



# BURSTEIN-APPLEBEE Company

1012 McGEE, KANSAS CITY 6, MO.

# Are the New SPRAGUE TM's REALLY BETTER?

**you be the judge—TRY THEM IN YOUR TOUGHEST JOBS**

We think the new Sprague type TM *molded* paper tubular capacitors are so far ahead of any other capacitors that there just isn't any comparison.

Quite naturally, we should! Not only do we make them . . . we know *how* they are made and *why* they are better.

But don't take our word for it. If you haven't already seen and used these new units, by all means get at least a few today. Try them in your toughest jobs—auto radios that get hot and are subjected to severe mechanical shocks. Use them in

portable sets and in some of those small ac-dc radios that operate at temperatures at which you normally fry eggs. Give them the kind of jobs to do that are tough on paper tubulars. Then check for performance and long life.

All we ask is that you *try* them. If you don't decide the new Sprague Molded TM's are better than any other paper tubular capacitor you have ever used, we don't want to try to convince you! We feel confident of the result because we know that *your reputation* and *your customers deserve the best!*

## **"PROOF POSITIVE!"** by Prof. Squeegee



Professor Oswald Z. Squeegee, the man who first successfully smashed the Atom in Sprague advertising back in 1938, took time out from his secret studies to wire:

HAVE JUST COMPLETED SEVERE LABORATORY TEST OF NEW SPRAGUE TM. SOAKED IT ONE WEEK IN SALINE SOLUTION (FISH BOWL, TO BE SPECIFIC). MIXED CONTENTS INCLUDING FISH AND SPRAGUE TM WITH ONE CAN DOG FOOD. HEATED TO 85° C. FOR THREE HOURS. DOGS ATE EVERYTHING BUT MOLDED CAPACITOR, WHICH WAS TOO HARD FOR CANINE TEETH. HATS OFF TO SPRAGUE! MUST HURRY BACK TO HISTORY-SHAKING EXPERIMENTS.

PROF. SQUEEGEE



CAPACITORS

# SPRAGUE

\*KOOLOHM  
RESISTORS

\*T.M. Reg.  
U.S. Pat. Off.

**SPRAGUE PRODUCTS COMPANY, North Adams, Mass.**

JOBGING DISTRIBUTING ORGANIZATION FOR PRODUCTS OF SPRAGUE ELECTRIC CO.

*Reach for a SPRAGUE  
and Know You're Right!*

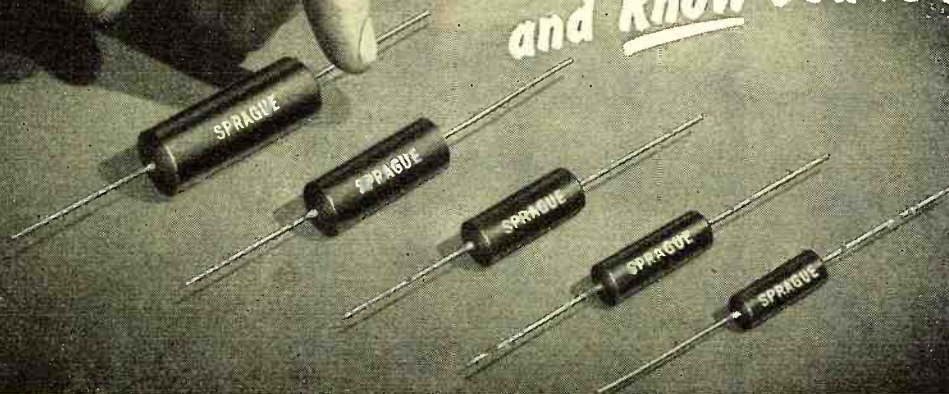

# Six Months from Today Which will YOU hold?

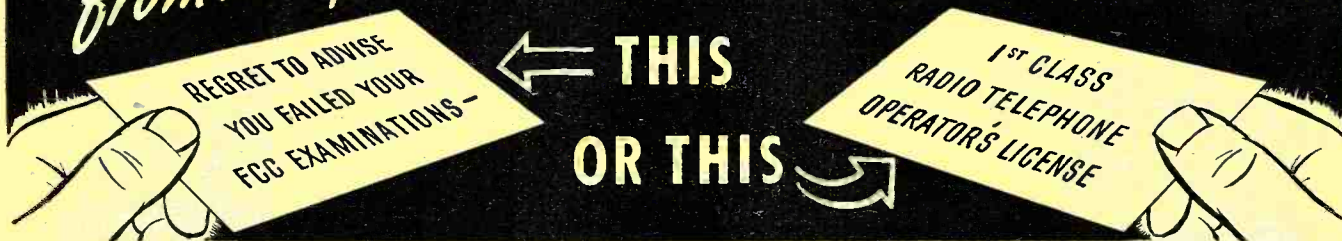

## WANT YOUR FCC COMMERCIAL LICENSE IN A HURRY?

Use CIRE Training and Coaching Service—and Get Your "Ticket" in a Few Short Weeks!

Thousands of new jobs are opening up—FM, Television, Mobile Communication Systems. These are only a few of the radio fields which require licensed radio technicians and operators.

Get your license without delay. Let Cleveland Institute prepare you to pass FCC license examinations, and hold the jobs which a license entitles you to, with CIRE streamlined, post-war methods of coaching and training.

## Your FCC Ticket Is Recognized in All Radio Fields as Proof of Your Technical Ability

More than ever before an FCC Commercial Operator License is a sure passport to many of the better paying jobs in this New World of Electronics.

Employers frequently give preference to the license holder, even though a license is not required for the job. Hold an FCC "ticket" and the job is yours!

### Hundreds of Satisfied, Successful Students

"I have taken the first class phone license examination and received my first class ticket last Saturday, May 31. In closing I must say yours is an excellent radio course, and I really appreciate your help and the fine service you have rendered me."

Student #2876N12

"I passed the FCC examination in radiotelephone 2nd class, at Detroit on June 3rd, and I want to thank you for your ready assistance as my instructor on Section I of Nilson's Master Course."

Student #2799N12

"I have had my 1st class radiotelephone license since March of this year, and plan to continue with your course since I find it a great help in studying transmitters."

Student #2779N12

"After sending in Lesson E-9 I took the commercial operator's license examination for 2nd class radiotelephone, and passed O.K. I received the license last week."

Student #2772N1

**FREE BOOKLET**—Tells you the Government requirements for all classes of FCC commercial licenses. (Does not cover Amateur License examinations.) Use coupon below for Booklet B.

## OTHER

Cleveland Institute Home Study Courses Offer Complete Technical Radio Training from Low-Level to College-Level, for the Radioman with Practical Experience!

### COURSE A—Master Course in Radio Communication

A complete course covering the technical fundamentals of radio-electronics, for the radioman who wants a general review. Includes preparation for Broadcast station employment.

### COURSE B—Advanced Course in Radio Communication Engineering

A genuine college-level radio engineering course, completely mathematical in treatment. For the advanced radioman with considerable practical experience and training.

### COURSE C—Specialized Television Engineering

An advanced college-level course for the radioman who has had formal training equivalent to A and B.

These three courses in radio-electronics offer a complete, thorough technical training for radioman who wants to cover the field. Available separately or combined.

**FREE CATALOG**—Describes all Cleveland Institute home study courses—tells of CIRE unique, post-war methods of training. Use coupon below for Catalog A.

## HOW TO PASS Commercial FCC LICENSE EXAMINATIONS...

CLEVELAND INSTITUTE OF RADIO ELECTRONICS  
Contractors to the Canadian Broadcasting Corporation

RN-3 TERMINAL TOWER

CLEVELAND 13, OHIO

How To Pass  
FCC  
LICENSE  
EXAMINATIONS

CLEVELAND INSTITUTE  
OF  
RADIO ELECTRONICS  
Terminal Tower - Cleveland, Ohio

Approved for  
Training  
Under "G-I  
Bill of Rights"

Don't Delay—  
Write Today!

Cleveland Institute of Radio Electronics  
RN-3 Terminal Tower, Cleveland 13, Ohio

Gentlemen:

Please send me your Booklet B, "HOW TO PASS THE FCC COMMERCIAL LICENSE EXAMINATIONS," and information about your home study course for preparation for FCC License Examinations. (Does not cover Amateur License Examinations.)

Please send me your Catalog A, describing all of your home study radio-electronics courses. I desire training in course  A  B  C.

Veterans check for enrollment information under G-I Bill. NO OBLIGATION—NO SALESMEN.

NAME \_\_\_\_\_

ADDRESS \_\_\_\_\_

CITY \_\_\_\_\_ ZONE \_\_\_\_\_ STATE \_\_\_\_\_



# TELEVISION ASSEMBLY CO.

INTRODUCES THE

*Champion Models*  
with

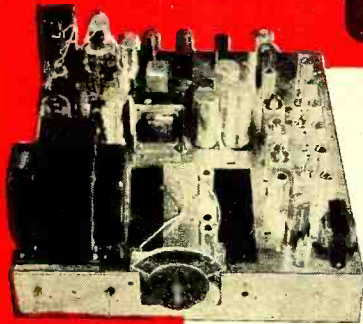

## DUMONT IMPUTUNER

The Dumont Imputuner tunes continuously from 44 to 216 megacycles without a break, covers all 13 channels as well as FM, amateur, and aviation channels. For ease and convenience of operation no band switching of any kind is required when tuning from channel to channel with the imputuner system. Just one simple operation to reach any desired station.

Assemble the Champion model of your choice, 10" flat surface screen picture, 51 sq. in. picture, 12" screen picture with 75 sq. in. picture or the 15" screen picture with 120 sq. in. picture.

All Champion Models are complete with all tubes and components including the CR Tube.

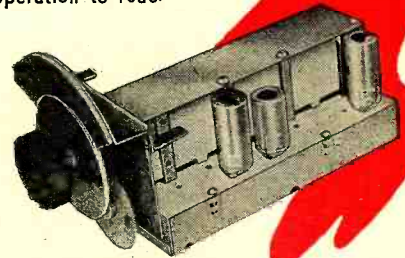

10" FLAT SURFACE

**\$ 273.10**

DEALERS NET

12" SCREEN PICTURE

**\$ 303.10**

DEALERS NET

15" SCREEN PICTURE

**\$ 393.10**

DEALERS NET

## Standard Models

NOW AVAILABLE WITH  
THE STANDARD MODELS—  
FM RADIO AT A SLIGHT  
ADDITIONAL COST OF  
\$7.95.



All Television Assemblies are complete and include: 29 RCA Tubes-1 CR Tube-Heavy Duty RCA 6.8 oz. slug 12" PM Speaker-Specially designed dipole antenna with 60 ft. lead in.

Superior performance is obtained with a new IF Video & Sound IF Strip (Pat. Pend.) aligned, wired, pretuned, tubed and tested. All circuits are contained on one chassis ready to use with the front end unit supplied. This front end will handle 13 channels and is aligned and tested, mounted on a separate chassis. Merely connect B plus filament and output IF leads to the television chassis. It is not necessary to make any RF alignments. These units utilize a clipper circuit which filters out ignition noises.

10" FLAT SURFACE

**\$ 229.50**

DEALERS NET

12" SCREEN PICTURE

**\$ 259.50**

DEALERS NET

15" SCREEN PICTURE

**\$ 349.50**

DEALERS NET

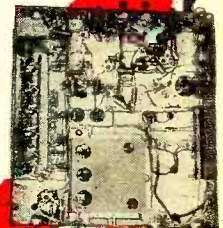

TERMS: 10%

DEPOSIT WITH

ORDER. BALANCE  
EXPRESS COLLECT.

**Guaranteed**

All Television Assemblies are guaranteed to operate to your satisfaction when simple directions are followed.

TELEVISION  
ASSEMBLY CO.

540 BUSHWICK AVE.  
BROOKLYN 6, N. Y.

Thousands of Servicemen asked us:  
**"Why Don't You Publish a Tube Placement Guide?"**



**NOTHING LIKE IT!**

Practical—like all SAMS Manuals! Complete—the only single source for tube placement data on almost 4500 models. Accurate—correct information on every model. You get 192 pages of invaluable data in a handy, sturdily-bound pocket-size book. Say goodbye to tube placement identification problems—save time—get more work done faster! Now at your local job-ber for **ONLY \$1.25**.....

**SO WE DID!**  
**AND HERE IT IS:**  
**THE NEW PRACTICAL HOWARD W. SAMS**  
**"RADIO RECEIVER**  
**TUBE PLACEMENT GUIDE"**

It's the book you'll use every single day—in the handy pocket-size you like—that shows you exactly where to replace each tube in almost 4500 models! Covers receivers from 1938 to 1947. Each tube layout is illustrated by a clear, accurate diagram, with tubes identified by large, easy-to-read type numbers. Saves you valuable time identifying tube placement, especially where the customer has removed the tubes from the set. Eliminates irritating hit-and-miss methods and risky guessing—helps you work faster, more profitably. Completely indexed for quick, accurate reference. Handy on service calls—a big help on every job—outside or in the shop. You'll want several copies for bench and outside calls. They'll pay for themselves over and over again. Order today!

**The World's Most Practical Radio Service Manuals!**

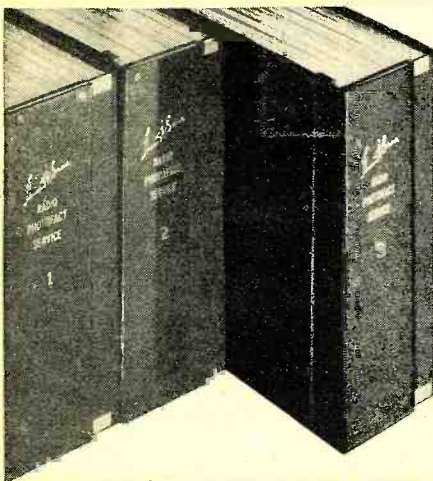

PHOTOFACT Volume 3 is ready for you—brings your post-war service data right up to January, 1948! Companion to Volumes 1 and 2—the most practical, accurate and complete Radio Data ever compiled. Here is everything you need for fast, efficient, profitable servicing of all post-war models—bound in easy-to-use volumes. Order your PHOTOFACT Volumes now—the Radio Service Data with the exclusive features that meets all your actual needs!

- Volume 1. All post-war models up to January 1, 1947.
- Volume 2. Models from January 1, 1947, to July 1, 1947.
- Volume 3. Models from July 1, 1947, to January 1, 1948.

Your Price, Each Volume, in Easy-to-Use Deluxe Binder..... **\$18.39**

**SPECIAL OFFER:** If you haven't a complete file of all PHOTOFACT Folders to date, you can trade in the individual Sets you now own for complete volumes at amazingly low cost. Write today for special offer, stating what Sets of Folders you now own (use coupon at right).

Howard W. Sams' 1947 Automatic Record Changer Manual. Only book of its kind—complete service data on all current Changers and Recorders. 400 pages. **ONLY \$4.95**



Howard W. Sams' Dial Cord Stringing Guide. No other manual like it—shows the right way to string the dial cords of models produced from 1938 through 1946. It's a "must" for Servicemen. **ONLY 75c**

**BOOST YOUR EARNING POWER!**

**Mail This Order Form**

to HOWARD W. SAMS & CO., INC. 2924 E. Washington St., Indianapolis 6, Indiana.

My (check) (money order) for \$.....enclosed.

- Send.....SAMS' TUBE PLACEMENT GUIDE(S) at \$1.25 per copy.
- Send PHOTOFACT Volume 3 (including Sets Nos. 21 through 30) in DeLuxe Binder, \$18.39.
- Send Volume 2.  Send Volume 1 (\$18.39 each).
- Send.....SAMS' 1947 AUTOMATIC RECORD CHANGER MANUAL(S) at \$4.95 each.
- Send.....SAMS' DIAL CORD STRINGING GUIDE(S) at \$0.75 per copy.
- Send FREE PHOTOFACT Cumulative Index.
- Send details of your Special Trade-In Offer

Name:.....  
 Address.....  
 City.....State.....

**HOWARD W. SAMS & CO., INC.**  
 INDIANAPOLIS 6, INDIANA

Export—Ad. Auriema—89 Broad St., New York 4, N. Y.—U. S. of America  
 Canada—A. C. Simmonds & Sons, 301 King St., East—Toronto, Ontario

**PHOTOFACT SERVICE**

"The Service that pays for itself over and over again"

# Did You Know?

Radio service men in **29** countries of the world and every state of the U. S. buy their parts and equipment from

**OLSON RADIO WAREHOUSE Inc.**

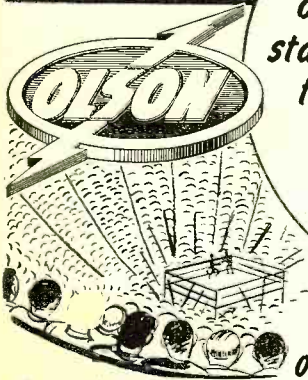

**OLSON** is hot for **SPEED!** Every order we receive is shipped

out the same day. Olson trucks, loaded with shipments, are constantly rolling to the Post Office, Express Office and Airport to keep our customers happy!

OLSON CUSTOMERS --

**46,000** of them -- would fill MADISON SQUARE GARDENS **2½ TIMES!**

OLSON is a **CRANK** on **QUALITY!**

We're fussy as old hens about everything we sell. Expert technicians, specially qualified to judge radio material, keep careful watch on the quality of all Olson tubes, parts and test equipment. No duds, no lemons from Olson!

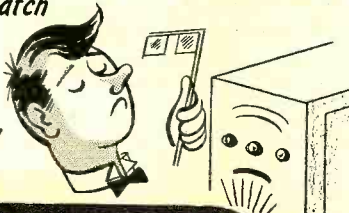

OLSON gives you an **IRON-CLAD** Guarantee with every purchase. If you are not 100% satisfied, your money will be returned without question!

## GET THIS BOOK!

**EXPLAINS FM!**

Helps you do a better FM servicing job in less time!

Shows the latest circuits and methods of alignment. Details on the oscilloscope and sweep frequency signal generator, and how to use them. A gold mine of practical information!

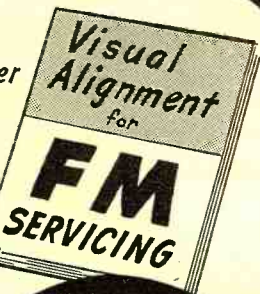

ONLY **25¢** POSTPAID

**FREE** with every FM BOOK

OLSON'S MONTHLY BARGAIN BULLETIN

OLSON gets **"ORCHIDS"** from contented customers every day. We mean thank-you letters on the quality, quick service, low prices and friendly interest they get from Olson Radio Warehouse Inc. We modestly suggest you'll like to do business with Olson, too. Try us!



## OLSON RADIO WAREHOUSE INC.

73 E. MILL ST., DEPT. 118, AKRON, OHIO

- Send me the new FM SERVICING BOOK. I enclose 25c.  
 Send me the Olson Bargain Bulletin FREE.  
 I am a Repair Man.  I am an Amateur or Experimenter.

NAME \_\_\_\_\_

ADDRESS \_\_\_\_\_

CITY \_\_\_\_\_

STATE \_\_\_\_\_

**23 DAVEGA  
RADIO STORES  
NATIONAL  
Headquarters**

# DAVEGA Communications Division

**68 YEARS OF DEPENDABLE SERVICE**

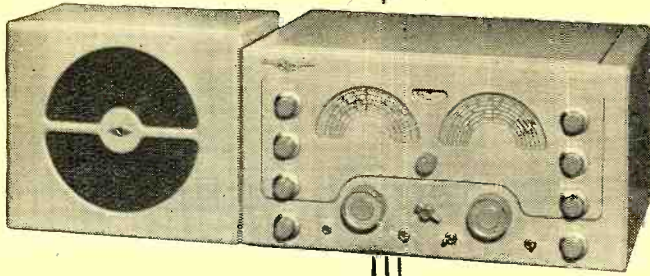

**NEW**

## NATIONAL NC-183

National's most recent development. 16 tubes including voltage regulator and rectifier. Big, husky brother of the NC-173, the NC-183 has two stages of RF, push-pull audio and a ten inch speaker. This is the job you have been waiting for! .....

**\$25500**

SPEAKER (additional) .....\$14.00



**NEW**

## NATIONAL NC-57

In the NC-57, National's engineering skill brings big receiver features and performance within reach of limited budgets. 540 kc. to 55 mc. in five bands. 1 RF, 2 IF, Automatic Noise Limiter, Antenna Trimmer, Self-contained speaker and 115 V.A.C. power supply. Matching S-meter available .....

**\$8950**

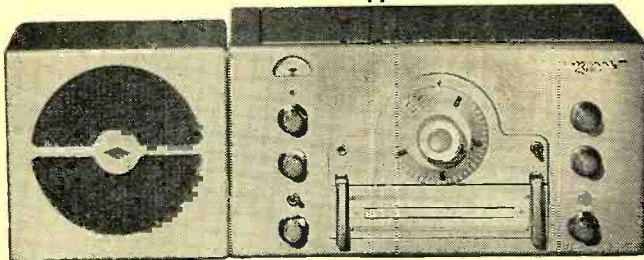

**NEW**

## NATIONAL HRO-7

Latest of the famous HRO series—way ahead of previous models. New voltage regulated HF oscillator, new effective noise limiter, new easy-to-read calibration charts, modern appearance. QRM? No DX? Poor location? Let the HRO-7 show you what a real receiver can do!

RECEIVER .....\$279.00  
SPEAKER .....\$12.00  
POWER SUPPLY .....\$20.36

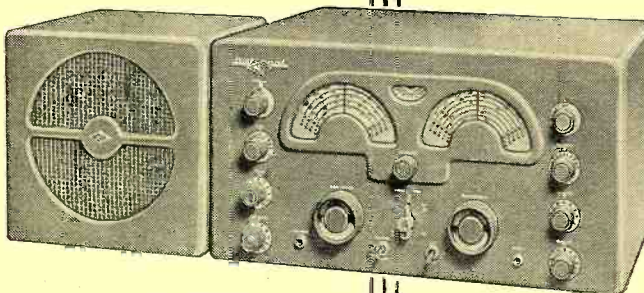

**NEW**

## NATIONAL NC-173

This set has been sweeping the country by storm since its recent introduction. Newest in radio technic and exceptional in frequency scope, 0.54 to 31 MC and 48 to 56 MC. Band switching, calibrated bandsread, 1 RF, 2 IF, antenna trimmer, effective noise limiter. .....

**\$17950**

SPEAKER (additional) .....\$10.00

**Acclaimed  
By Experts**

# DAVEGA

Downtown .....	63 Cortlandt St.	Brooklyn .....	924 Flatbush Ave.
Downtown .....	200 Broadway	Brooklyn .....	1304 Kings Highway
Near 13th St. ....	831 Broadway	Bay Ridge .....	5108 Fifth Ave.
Hotel Commodore ..	111 E. 42nd St.	Jamaica .....	163-24 Jamaica Ave.
Times Square .....	152 W. 42nd St.	Astoria .....	31-55 Steinway St.
Empire State .....	18 W. 34th St.	Flushing .....	39-11 Main Street
Madison Square Garden	825 Eighth Ave.	Hempstead .....	45 Main St.
86th St. ....	2369 Broadway	White Plains .....	175 Main St.
Harlem .....	125 W. 125th St.	Newark .....	60 Park Place
Bronx .....	31 E. Fordham Rd.	Jersey City .....	30 Journal Sq.
149th St. ....	2860 Third-Ave.	Paterson .....	185 Main St.
Brooklyn .....	360 Fulton St.		

DAVEGA COMMUNICATIONS  
DIVISION  
63 Cortlandt Street  
New York 7, N. Y.

( ) Enter my order for .....

( ) Send full information on National Communications Receivers.

Name .....

Address .....

City .....

Zone .....

State .....

RN-11

# THORDARSON



## THE MOST RADICAL IMPROVEMENT... IN POWER SUPPLY FILTER CIRCUITS...

... employing two same type universal  
chokes that provide more efficient filtering.

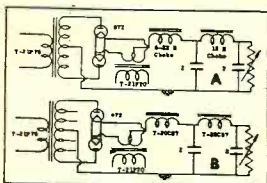
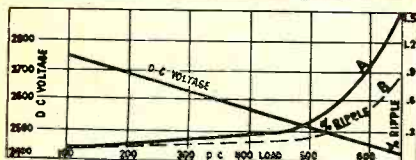

Actual Laboratory Measurements Made With The Conventional Type Filter Circuit A — (Swinging and Smoothing System) — and with the New Universal Choke Filter Circuit B Show A Decrease In Ripple Throughout The Useful Current Range of Power Supply

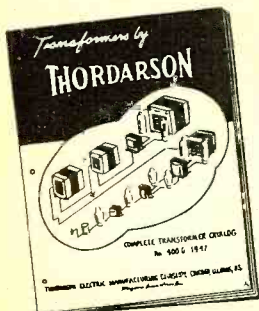

For Matched Power Supplies, see Your New 400GX Catalog Now Available. Furnished Free Upon Request.

Here again, is another triumph in Thordarson engineering skill. Thordarson engineers have developed a new universal type choke in sizes to meet all power requirements! This achievement offers the best possible filtering and regulation in a minimum size consistent with conservative design! One reactor may be used in a single section filter with all the advantages of the radically swinging type. Two similar units may be employed in a two section filter more satisfactorily than the obsolete "swinging and smoothing" system, and deliver far better performance.

Let us know how we can put these new universal chokes to work for you... Send us your requirements.

# THORDARSON

Manufacturing Quality Electrical Equipment Since 1895  
500 WEST HURON CHICAGO 10, ILLINOIS  
A Division of Maguire Industries

Export — Scheel International Inc.  
4237-39 Lincoln Ave. Chicago 18, Ill.  
Cable — (Harscheel)



## Long Life . . . . .

As the sphinx and pyramid have withstood the ravages of time over the centuries gaining their reputation for longevity, the mighty Radiart VIBRATOR has proven itself to be long lasting even beyond its normal expected effectiveness. This quality of long life helps to make Radiart VIBRATORS outstanding and cuts to a minimum expensive duplicate installation costs. This is one of the factors that brings customers back to servicemen, satisfied and asking for Radiart by name and number. Dealers everywhere know when they sell Radiart, they sell quality. On this concept, your success and ours is assured.

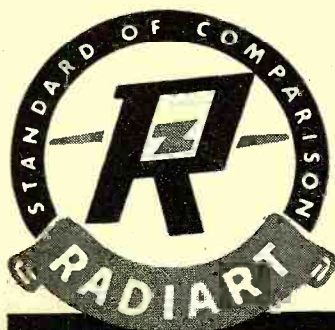
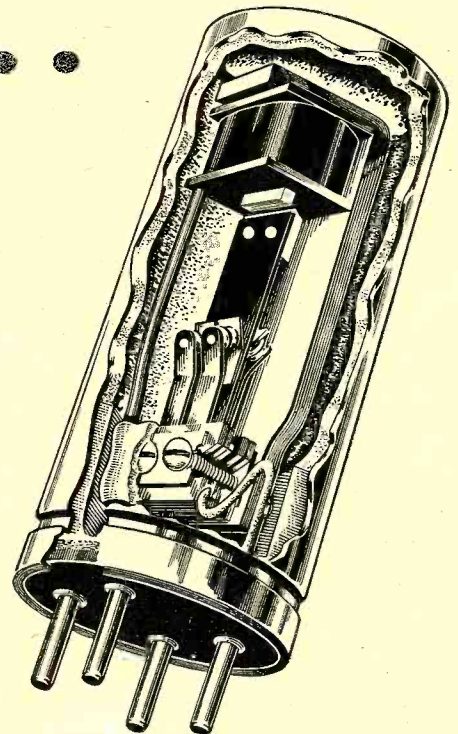

# The Radiart Corp.

CLEVELAND 2, OHIO

# ATOM SMASHERS

**Principle of operation of modern types of particle accelerators — the Betatron, Cyclotron, and the Van de Graaff Generator**

By **JAMES J. TEEVAN**

**T**HE smashing of an atom's nucleus involves a physical breaking apart or the creation of an unbalanced condition. Projectiles, be they protons, deuterons, alpha particles, positrons, or neutrons, are fired at terrific speeds at a nucleus to bring about such a condition. There is needed, then, what might be termed heavy artillery—accelerating devices that will develop extremely high voltages with a minimum of current. Scientists have at their disposal today three outstanding pieces of apparatus for just this purpose, the Van de Graaff Generator, the Cyclotron, and the Betatron. The ultimate aim in the use of each is the same, the flinging of minute particles with ever increasing energy and speed at the nucleus of the atom. It is no easy matter to score a direct hit with these pieces of artillery. Bear in mind that the largest of the atoms is about .00000001 of an inch in diameter and that in one ounce of hydrogen there are some 20,000,000,000,000,000,000,000 atoms. Fortunately a direct hit is not necessary. A near miss will induce within a nucleus electrical oscillations, oscillations that in most cases will disrupt the force of attraction holding together the protons within, a force billions of times more powerful than the earth's force of gravitation.

One of the earliest pieces of artillery developed for the creation of the high voltages necessary in the smashing of atoms was the Van de Graaff Generator.

The Van de Graaff electronic generator uses the principle of static electricity for the imparting of extremely high speeds to the particles or projectiles used. In general terms, the heart of the generator is composed of two endless belts, the bottoms of which are sprayed with opposite charges, the one negative and the other positive. Both belts reach up into metal spheres upon which the charges are deposited. When the ac-

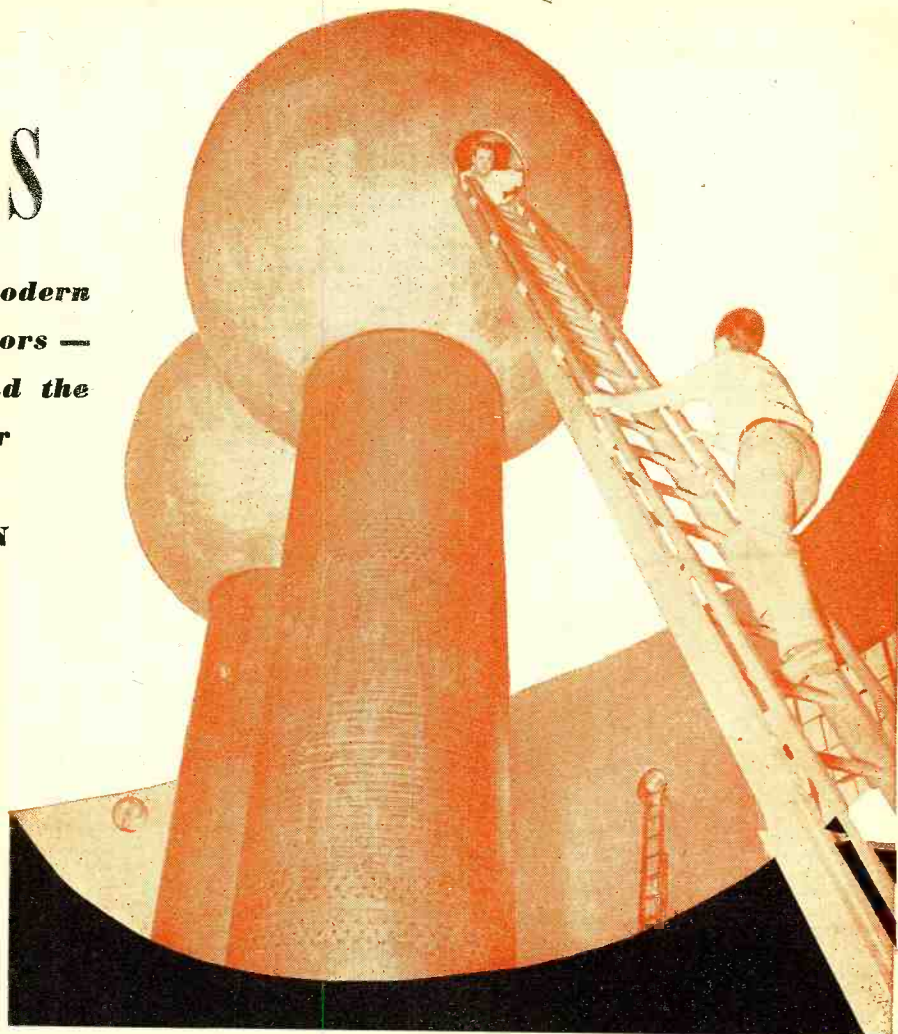

Fig. 1. The Massachusetts Institute of Technology's electrostatic generator.

cumulated charges on the spheres become great enough, in some instances as much as 5,000,000 volts, they are applied to the firing of the atomic bullets. What determines the maximum voltage that may be deposited on the spheres, which in the latest model at the Massachusetts Institute of Technology are joined, is the breakdown potential existing between the spheres and the objects surrounding them at ground potential.

Though comparatively simple in construction and operation, the Van de Graaff Generator is, to say the least, rather imposing. (See Figs. 1 and 5.) The two large hollow columns of the ten-million-volt generator at MIT are twenty-five feet high and six feet in diameter. The hollow polished aluminum sphere that surrounds the columns measures some fifteen feet across the center. The aluminum spheres, which act as reservoirs for the charge, are forty-three feet above the ground. Weighing a ton and a half each, the spheres are polished to a bright finish to eliminate projections that might cause sparking.

The wide, fast-moving belts within the columns may be either of silk or paper. Metal combs take the charges off the belts and transfer them to the

outside surface of the spheres. As more and more charge is sprayed on the belts and carried up, the potential of the individual spheres naturally increases. The potential having been raised to the desired amount, the ions produced at the positive sphere are fed into a discharge tube. Low pressure gas within the discharge tube produces further ions and from there they are shot into the accelerating tube. On their way through the accelerating tube the ions are compelled to move along lines of force created by cylinders. Effective focusing action narrows the beam of ions to a cross section of no more than half an inch.

To all purposes, the accelerating tube might be called the barrel of the atomic cannon under consideration. The ionized bullets pick up speed as they pass through it, traveling between 30,000,000 and 100,000,000 miles an hour. The structure of this tube (Fig. 4) should prove of interest. It is composed primarily of tubular "doughnuts" connected to metallic cylinders. A corona discharge is carried from doughnut to doughnut creating a uniform voltage gradient along the length of the tube. This difference of potential between the doughnuts is usually several hundred thousand

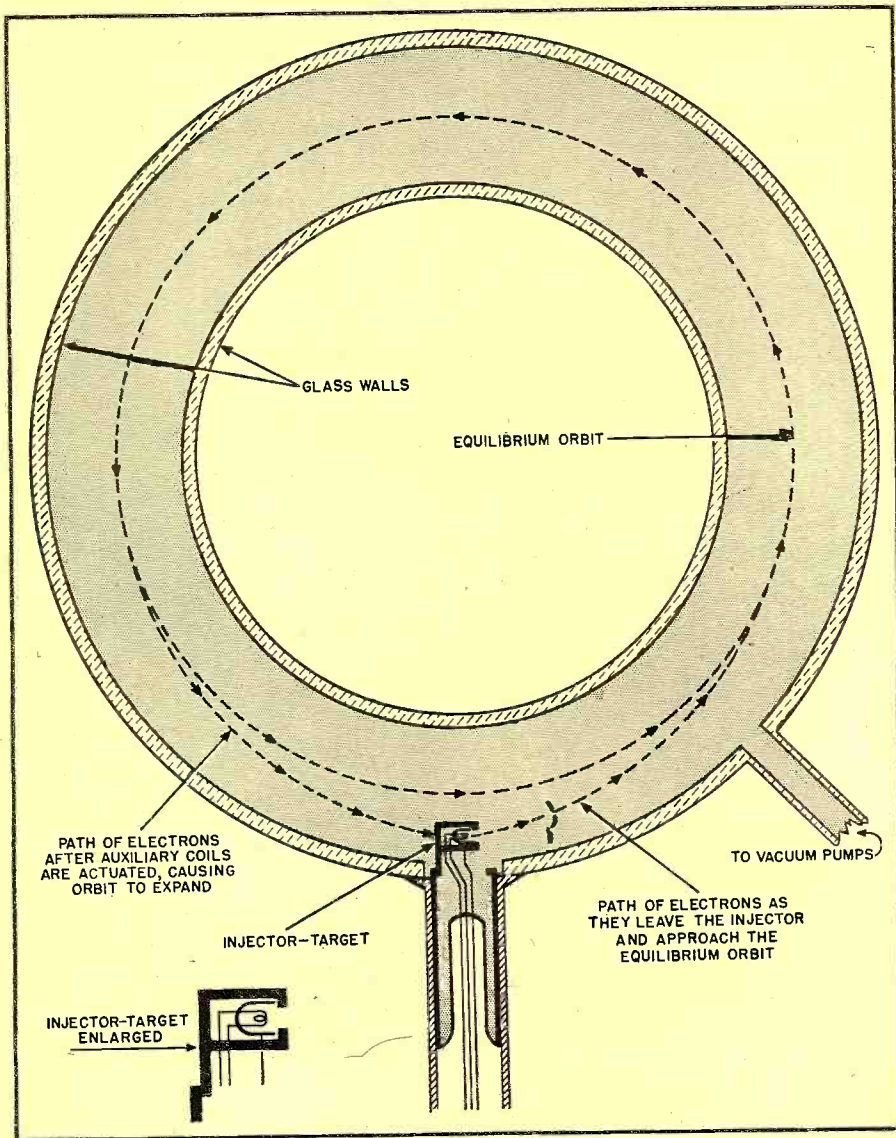

Fig. 2. A cross-sectional view of the Betatron "doughnut."

volts. The metallic cylinders act as so many lenses for the purpose of focusing the ions into the narrow beam already mentioned. As the ions move down through the tube past the cylinders they gain in energy in an amount that is proportional to the potential difference existing between the cylinders. As the ions gain in energy there is a corresponding gain in velocity ( $K.E. = 1/2 mv^2$ ), the effect desired for the smashing of the target placed at the bottom of the tube . . . an atomic nucleus. A magnet at the lower end of the tube sorts the projectiles according to their velocities and thus different beams of varying energy content are made available. Geiger counters and Wilson cloud chambers are then used to determine the results of these bombardments.

As the beam passes through the accelerating tube it is composed of two distinct types of missiles. The one is composed of single particles and the other of dumbbell-shaped double particles. It was mentioned above that a gas is fed into the discharge tube under a constant pressure. If this gas were hydrogen, the single particles

would be protons while the dumbbell-shaped double particles would be hydrogen ions. Both types would, of course, be positive in nature and the kinetic energy received by each in its passage through the tube would be of an equal amount.

The accelerating tube of the *Westinghouse* generator has an outside diameter of 17 inches and can be so completely exhausted that it contains only one seven-hundred-and-sixty millionths as many air molecules as in the normal atmosphere. Fitted with 130 electrodes, it is completely surrounded and sealed by 132 porcelain disc insulators. To prevent the premature escape of the electrical charge the tube is surrounded by a wall of compressed air, held at a pressure of 85 pounds per square inch. The air serves as an insulator and makes possible the 5,000,000 volt charges at one microampere of direct current.

The Betatron, developed by Donald W. Kerst of the University of Illinois, in some ways resembles a Cyclotron. Designed to impart high speed to electrons or Beta rays at comparatively low voltages, it is also known

as an "Induction Electron Accelerator." In function very similar to an ordinary transformer, it can impart to an electron a speed associated with a voltage of from twenty to one hundred million volts. In place of a wire secondary as in the transformer, the Betatron has as its secondary an evacuated frictionless glass doughnut but the principle is the same. (See Fig. 2.) Surrounding the doughnut is a carefully designed magnetic field intended as a focusing agent. Electrons, shot into the glass doughnut by an electron gun similar to those used in beam power tubes, are acted upon by induction as current flows in the primary. The electron gun is composed of a spiral filament, a plate, and a double plated grid. The grid concentrates the electrons in the desired definite beam.

As the a.c. cycle starts across the primary, a brief pulse of electrons is shot into the doughnut. In duration this pulse lasts but a few millionths of a second. As the a.c. builds up to maximum the electrons in the glass tube secondary are accelerated, spinning around the tube several thousand times. Moving in a circle of space, the electrons are further acted upon by the focusing magnetic field. No matter how fast the electrons move this force persists, providing the electrons remain at the same radius from the cylinder. The force itself is dependent upon the magnitude and rate of change of the magnetic field immediately surrounding each electron. When another pulse is sent through auxiliary coils surrounding the magnet the electrons leave their circular orbit and spiral inward and outward. Under this new influence the electrons now crash against a target of tungsten within the doughnut. Due to the tremendous energy with which the electrons smash against the tungsten x-rays are created. The stream of penetrating x-rays passes out of the tube and may be directed at the heart of an atom.

During this process, the current in the primary continues to flow, but it is only the rise from zero to maximum that is put to use. For the remaining three-quarters of each cycle the power is stored in a bank of condensers. A generator is needed then only to make up for the losses inasmuch as the primary coils are tuned to resonance with the condenser bank.

Theoretically, if the electric field strength exerted on an electron while in the magnetic field of the Betatron is one volt per centimeter, the electron will be accelerated to  $10^{13}$  cm. per second. In 1/1000 of a second then the electron would be accelerated beyond the velocity of light. This is impossible as the effective mass of an electron approaches infinity as its velocity approaches that of light. Thus, although the electron's velocity can never equal that of light, it can still acquire a tremendous amount of kinetic energy.

As pointed out by James Stokley in his booklet, "Atomic Artillery," Dr. W. F. Westendorp of the *General*



*Electric* research laboratory has devised a means of saving weight in the construction of the Betatron. Dr. Westendorp has devised a method of d.c. bias. This consists in applying a d.c. potential through special coils in such a way that the zero voltage line is, in effect, shifted downwards. Then, instead of accelerating the electrons only through a quarter of a cycle, nearly a full half-cycle can be used. It has been estimated that if the 100,000,000 electron-volt Betatron had been constructed in this way, it would give radiations up to 165,000,000 electron volts with no increase in size. Biasing of this kind has been used in the 50,000,000 volt Betatron in the *General Electric* research laboratory. Although this one has only half the energy of the larger ones, it is only about one tenth their physical size.

The Cyclotron (Fig. 3), invented by Ernest O. Lawrence of the University of California, is designed to apply a moderate force to particles many times. The fundamental theory in back of the Cyclotron is: (1) that the greater the velocity of the particles, the greater the radius of their path of motion, and (2) whether the particles are moving near the center or the rim of a chamber they require the same time to complete one revolution. As to physical make-up, an electromagnet, with its pole pieces but a few inches apart, constitutes the heart of the Cyclotron. Between the pole pieces of the electromagnet there is a shallow cylindrical chamber containing two smaller semicircular chambers. These semicircular segments are known as "dees." The edges of the dees facing each other are open while

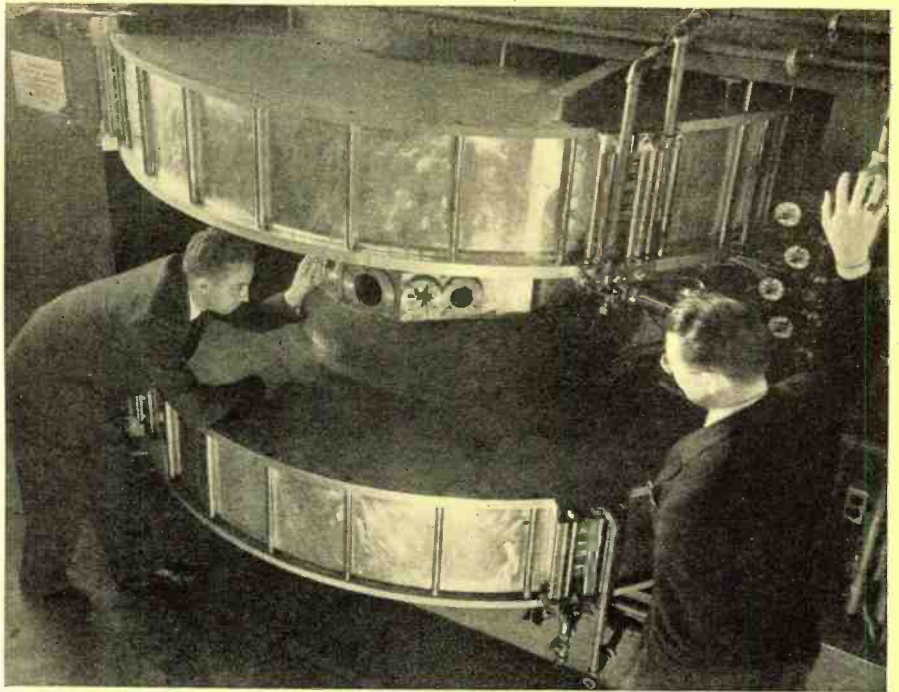

Fig. 3. The new 100 ton Cyclotron at Massachusetts Institute of Technology.

each is electrically insulated from the other. A gas fed into the two semicircular chambers is ionized in the inch and a half that separates the dees. The type of gas used will, of course, determine the nature of the projectiles. A high frequency oscillator is connected to the terminals of the dees. Just what happens to the particles of energy while in the Cyclotron may be explained briefly as follows:

Like so many of the electronic devices with which we are more familiar, the operation of the Cyclotron originates with a heated filament. The electrons emitted hit the molecules of gas in the evacuated chamber. The positive electrified particles thus produced are then acted upon by the dees. As the oscillations occur the positive particles are first attracted to the negatively charged dee. Since

(Continued on page 143)

Fig. 4. A section of the 40 foot vacuum tube used in the Westinghouse atom-smasher. The o.d. of the tube is 17 inches.

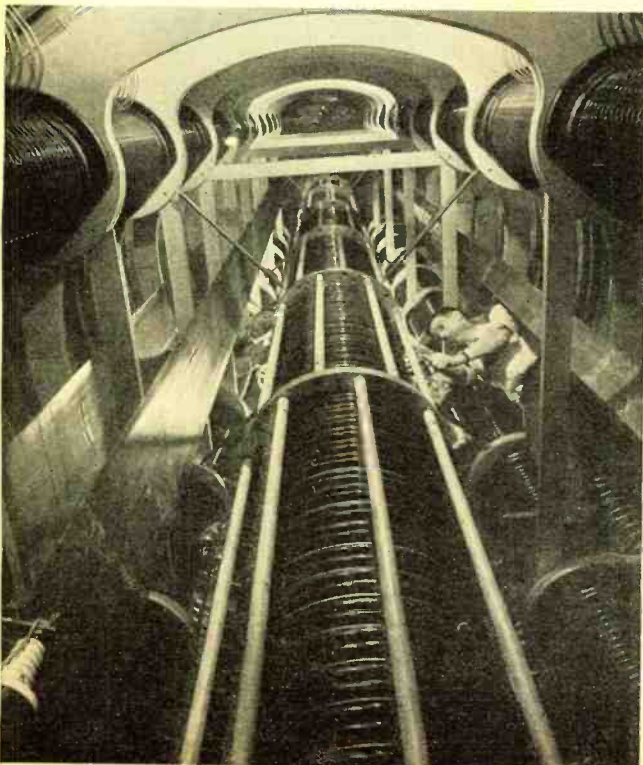

March, 1948

Fig. 5. Inside the spherical terminals of the Van de Graaff Generator installed at Massachusetts Institute of Technology.



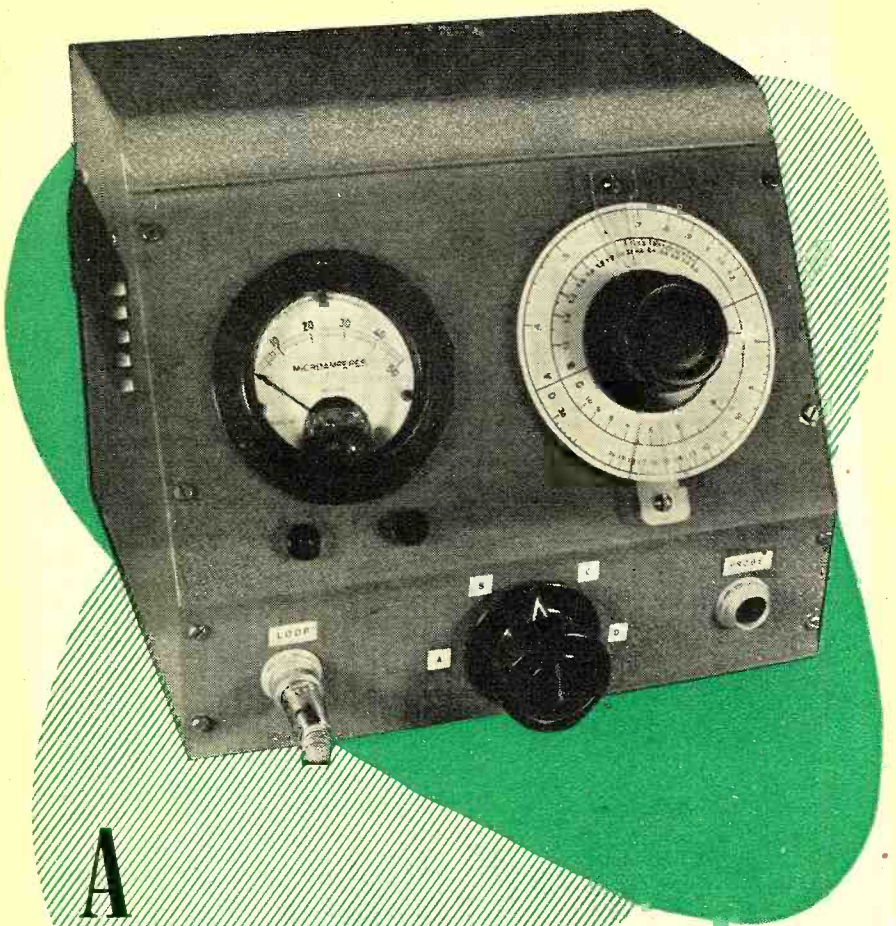

# A VERSATILE SIGNAL CHECKER

By RUFUS P. TURNER, WIAY

**A novel device which has much of the usefulness of the grid-dip meter, but uses no batteries or a.c. power supplies. In addition to its intended function as a line coupled wavemeter 1948 style, it may be employed as a monitor, field strength meter, radio receiver, and tuned signal tracer having a 4-band range of 400 kc. to 30 mc.**

**W**HAT is the frequency of my crystal oscillator? Is my oscillator doubling instead of operating straightthrough? Is my doubler tripling? Is my tripler quadrupling? Is my tank tuned to the correct frequency of a 10- or 20-meter crystal? Is my v. f. oscillator running in the broadcast band instead of on 160 meters?

Each of these questions is typical of the many which may be answered quickly and simply by the time-honored absorption wavemeter. There is no need to dwell here upon the widely-known virtues of the wavemeter which have maintained the importance of

this simple instrument over many years of more accurate frequency measurement.

Various operating disadvantages of the wavemeter, however, are not so well-known among experimenters and radio operators, and usually become apparent only when this instrument is used regularly. Paramount among these trying characteristics are the following: (1) The entire instrument must be poked into the transmitter or other apparatus under test in order to secure satisfactory coupling. This often is inconvenient or even impractical; (2) the wavemeter coil being of fixed size, it often is either too large

or too small for satisfactory coupling; (3) separate plug-in coils or separate wavemeters are necessary if a wide frequency range is to be covered; and (4) the conventional wavemeter is useless when measurements must be made at uninterruptable circuit points where no coil can be reached for inductive coupling.

The frequency checker to be described in this article, while being based upon the wavemeter principle, proposes to overcome these obstacles by (1) providing for inductive coupling a series of selectable pickup rings of different diameters operated at the end of a coaxial cable; and (2) providing a shielded and isolated probe for picking up the unknown signal from a circuit point at which a coil cannot be reached conveniently for inductive coupling.

With an instrument of this type, the operator can attach to the end of the "loop cable" whichever pickup ring will give best coupling with a coil under test or which will fit best into the available space around the coil. Since the pickup ring is attached to the end of a cable of convenient length, the instrument proper may be left on the work table.

By means of the exploring probe, the operator can couple the instrument capacitively to any r.f. circuit point where no coil can be found or where the coil, when present, is concealed by other components. Shielding and a small coupling condenser minimize body capacitance and instrument capacitance effects when the probe is used.

## Features of the Instrument

From the foregoing description, it is seen that the frequency checker essentially is a wavemeter which may be coupled either capacitively or inductively, through coaxial lines, to test points.

In order to cover a wide frequency range, bandswitching is employed. The single tuning dial of the instrument reads directly in megacycles. Frequency range of the checker is 400 kc. to 30 megacycles in four bands: 400 kc. to 1200 kc., 1100 kc. to 3.2 mc., 3.0 to 10 mc., and 8 to 30 mc.

Resonance is indicated by a d.c. microammeter which is actuated by a germanium crystal diode. No batteries or a.c. power supply therefore are required. The instrument has sufficient sensitivity to permit its use as a tuned signal tracer for radio receiver channel checking (resonance indications may be obtained even at

**RADIO NEWS**

the antenna and ground terminals of the receiver), as a sensitive field strength indicator, radiotelephone monitor and carrier shift indicator, and emergency modulated signal receiver.

The instrument may be calibrated from any r.f. signal generator or serviceman's test oscillator. This is a distinct advantage, since no elaborate instruments not available to amateurs and experimenters are required.

### Operating Principle

Fig. 2A is a simplified circuit of the frequency checker. The absorption wavemeter circuit is composed of coil  $L_2$  and tuning condenser  $C_3$ . Across this tuned circuit are connected the crystal diode and d.c. microammeter in series.

The small primary coil,  $L_1$ , with its coaxial cable provides link coupling between the pickup loop or ring and the wavemeter coil,  $L_2$ . In use, a pickup ring of appropriate diameter is plugged into the end receptacle of the loop cable, the ring is inductively coupled to the proper coil in the transmitter or oscillator under test, and  $C_3$  is tuned for maximum deflection of the microammeter.

The shielded exploring probe is employed to capacitance couple the measuring circuit ( $L_2-C_3$ ) to a source of unknown signal. In use, the prod tip of the probe simply is touched to the proper point in the circuit under test, and  $C_1$  is tuned for maximum deflection of the microammeter. When the signal strength is high, as it almost always is in transmitters, it is necessary only to point the prod tip to the circuit point in order to obtain adequate signal pickup for full-scale deflection of the meter.

Coupling condenser  $C_1$ , inside the probe handle serves also to minimize the effects of body capacitance, cable shunt capacitance, and instrument capacitance upon the device under test. Similarly; the second coupling con-

COIL	FREQUENCY RANGE	SPECIFICATIONS
A	400-1200 kc.	Primary ( $L_1$ ): 15 t. #32 en. closewound on same form as $L_2$ and separated from grounded end of $L_2$ by $1/8"$ . (See Fig 8A). Secondary ( $L_2$ ): 90 t. #32 en. on $1\frac{1}{4}"$ diam. form, closewound.
B	1100-3200 kc.	Primary ( $L_3$ ): 2 t. #24 d.c.c. closewound over grounded end of $L_4$ . (See Fig. 8B). Secondary ( $L_4$ ): 56 t. #30 en. on $5/8"$ diam. form, closewound.
C	3-10 mc.	Primary ( $L_5$ ): 2 t. #24 d.c.c. closewound over grounded end of $L_6$ . (See Fig. 8B). Secondary ( $L_6$ ): 20 t. #30 en. on $5/8"$ diam. form, spaced to winding length of $1\frac{3}{8}"$ .
D	8-30 mc.	Primary ( $L_7$ ): 2 t. #24 d.c.c. closewound over grounded end of $L_8$ . (See Fig. 8B). Secondary ( $L_8$ ): 6 t. #24 en. on $5/8"$ diam. form, spaced to winding length of $5/8"$ .

Complete details on coil construction. Coil numbers correspond to those in Fig. 6.

denser,  $C_2$  (Fig. 2A), serves also to minimize the effect of the shunt cable capacitance upon the calibration of the tuned wavemeter circuit,  $L_2-C_3$ . By choosing both  $C_1$  and  $C_2$  very small, very nearly all detrimental effects due to operator, body, and instrument capacitances are eliminated.

Fig. 2B shows the relationship of the two coupling and isolating condensers and the shunt capacitance of the coaxial cable. Note that  $C_1$ , the small condenser mounted inside the probe handle, is in series with cable capacitance,  $C_c$ . The resulting capacitance looking in from the prod tip therefore is very small when  $C_1$  is made small with respect to  $C_c$ . Actually  $C_c$  is about  $40 \mu\text{mfd.}$  for a reasonable length of cable, and  $C_1$  is only a few micromicrofarads. When  $C_1$  is  $4 \mu\text{mfd.}$ , the capacitance looking into the prod tip is only approximately  $3.65 \mu\text{mfd.}$  This total capacitance is not large enough to upset most circuits to which the tip will be touched.

Similarly; at the other end of the coaxial cable, the small condenser,  $C_2$ ,

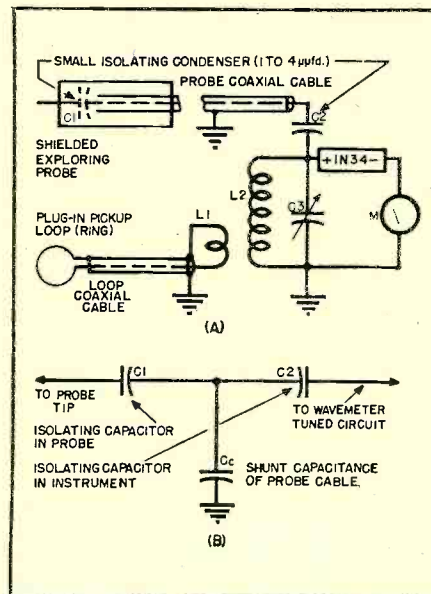
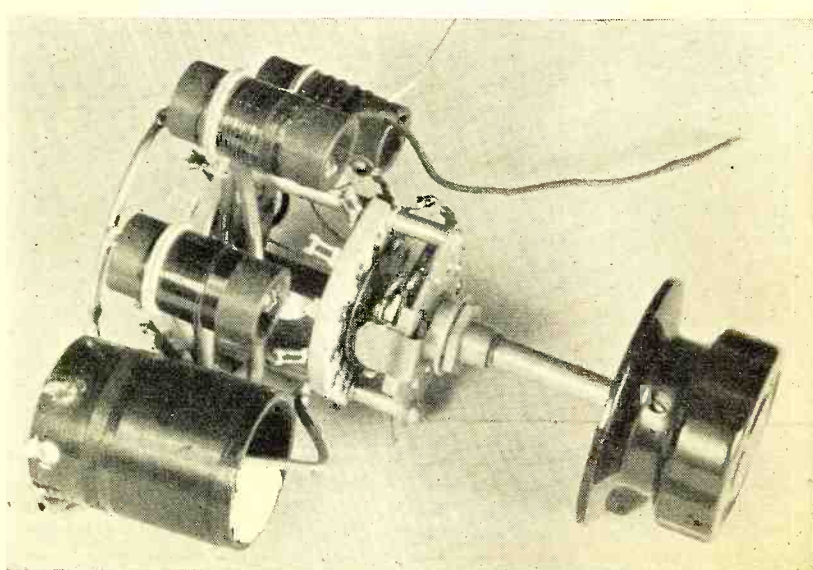
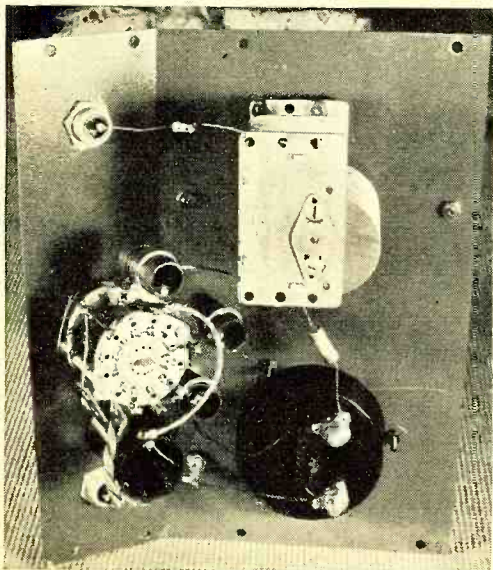

Fig. 2. (A) Basic instrument circuit. (B) Relationship between coupling condensers and capacitance of coaxial probe cable.

Fig. 3 (Left) Internal view of signal checker. Note that the crystal is hung directly between the tuning condenser and microammeter by means of the former's own long pigtailed. The  $4 \mu\text{mfd.}$  ceramic coupling condenser is similarly hung between the probe input coaxial jack and the tuning condenser stators. Fig. 4. (Right) Coil switching turrets. Coils A to D appear from bottom to top.



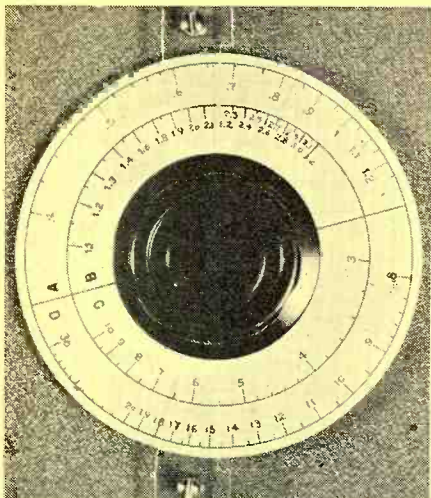

Fig. 5. Closeup of tuning dial. A standard 4" dial is used. Scales are hand-drawn on white cardboard with India ink.

is in series with the cable shunt capacitance,  $C_1$ . The capacitance introduced across the tuned circuit,  $L_2-C_2$ , by connection of the probe and its cable to the instrument, therefore is less than the small capacitance of  $C_2$  and accordingly is not high enough to interfere seriously with the calibration of the  $L_2-C_2$  circuit.

Since  $C_1$  and  $C_2$  are in series, their small total capacitance effectively isolates the wavemeter circuit from the circuit with which the probe makes contact.

By employing coil switching, any number of primary and secondary coils may be connected successively into the instrument circuit to cover a desired frequency range. The dial of the tuning condenser,  $C_2$ , may be graduated in megacycles to make the instrument direct reading.

### Complete Circuit and Accessories

The complete circuit schematic of the frequency checker is given in Fig. 6. The various sections are discussed separately below.

**Frequency Range Control.** Switch  $S_1-S_2$  (lower center in Fig. 1) is the bandswitch or frequency range control. One pole ( $S_1$ ) switches the secondary coils  $L_2, L_4, L_6$  and  $L_8$ . The other pole ( $S_2$ ) simultaneously switches the corresponding primaries  $L_1, L_3, L_5$ , and  $L_7$ . By employing a shorting-type switch, as shown in Fig. 6, all unused primaries and secondaries are automatically short-circuited and grounded, thereby preventing their interaction with the coil set in use.

**Coils and Coil Mounting.** The coils  $L_1$  to  $L_8$  are wound in accordance with specifications given in the coil table. They are wound on bakelite or polystyrene forms, as shown in Fig. 8, and are mounted around the selector switch,  $S_1-S_2$ , by soldering to the switch. The top secondary coil lugs are soldered directly to the contact lugs of  $S_1$ ; the bottom secondary lugs are soldered to a ring of

No. 14 tinned bus wire (See Fig. 4) to connect them together for grounding. Similarly, the top primary leads are soldered directly to corresponding contact lugs of  $S_2$ ; the bottom primary leads to a common lug to connect them together.

The coils are mounted in this manner to alternate switch contacts. This is done in order to provide ample space between coils and also to provide an "OFF" point (unused switch contact) between each two settings of the range switch. When  $S_1-S_2$  is thrown to any one of these "OFF" positions, the coils are disconnected automatically from the crystal and meter circuit, and the microammeter then may be used externally by connecting leads to pin jacks  $J_3$  and  $J_4$ .

**Coupling Condensers.** The coupling and isolating condensers, such as  $C_1$ , are miniature, zero-temperature-coefficient, insulated, ceramic units rated at  $4 \mu\text{fd.}$  each.  $C_1$  is connected, by means of its own pigtail leads, directly between the coaxial input jack,  $J_1$ , and the stator plates of tuning condenser  $C_2$ , as may be seen in Fig. 3. The other coupling condenser is inside the probe handle (See Fig. 7) and is also rated at  $4 \mu\text{fd.}$

**Tuning Condenser.** The tuning condenser,  $C_2, C_3$ , is a dual  $365\text{-}\mu\text{fd.}$  mid-gate broadcast unit. Its two sections are connected in parallel by running a jumper between the two stator-section lugs. The trimmer condensers built on the sides of the tuning condenser sections must be removed before  $C_2, C_3$ , is mounted in the instrument.

**Indicating Meter.** For best sensitivity, a low-range d.c. microammeter must be employed. A 0-50 d.c. microammeter is indicated in Fig. 6 and is seen on the front panel in Fig. 1. The author required a meter of this sensitivity, since the instrument was intended for use as a weak-signal tracer and field strength meter, as well as a frequency checker. Full-scale deflection of 50 microamperes is obtained with .1 volt r.m.s. input at jack  $J_2$ . However, an individual builder, if he prefers, may use a larger meter, such as a 0-500 d.c. microammeter or a 0-1 d.c. milliammeter, if he will remember that a much stronger signal will be required for a respectable deflection, and also that calibration will be somewhat more difficult with these large meters because of the correspondingly slight deflection obtained when a test oscillator is used for calibration.

**Crystal Diode.** The crystal diode is a 1N34 germanium unit. Silicon crystals, such as the 1N21 series, are not recommended for use in the signal checker, because of their lower voltage handling ability.

**Meter and Headphone Terminals.** Pin jacks  $J_3$  and  $J_4$  permit the microammeter to be used externally. In this way, the relatively expensive meter is not tied up completely in the frequency checker. When the meter

(Continued on page 164)

Fig. 6. Complete circuit diagram of signal checker. Switches  $S_1$  and  $S_2$  are ganged (note unused contacts). Jacks  $J_3$  and  $J_4$  enable use of the microammeter externally when switch  $S_1-S_2$  is set to one of the unused contact positions. Headphones may also be connected to  $J_3$  and  $J_4$  for aural monitoring of modulated signals.

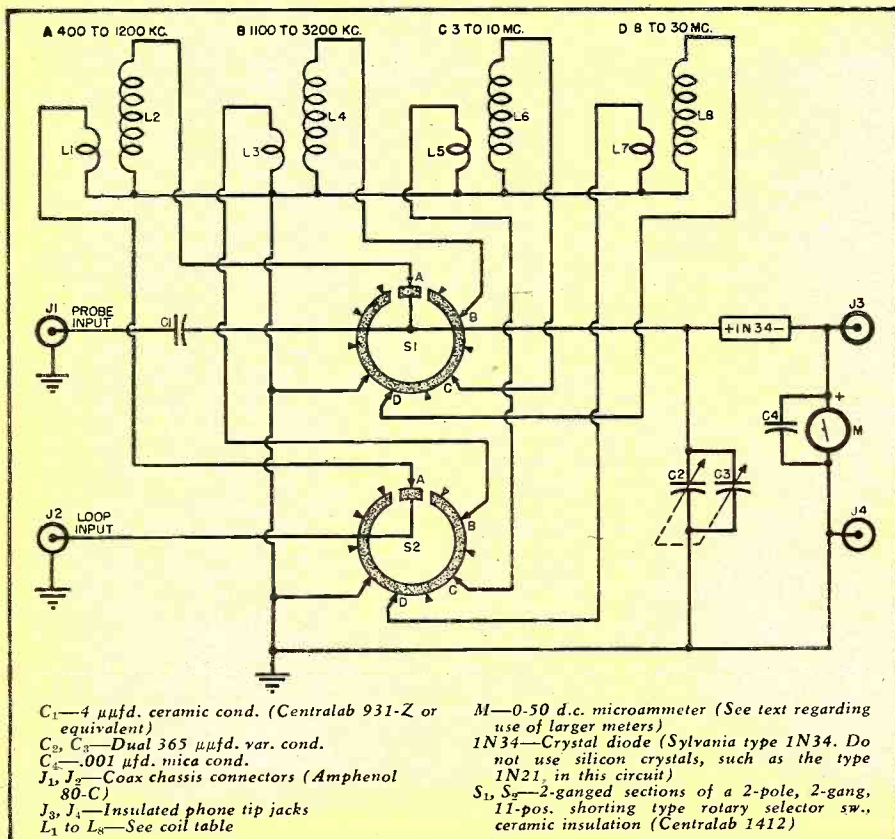

$C_1$ — $4 \mu\text{fd.}$  ceramic cond. (Centralab 931-Z or equivalent)  
 $C_2, C_3$ —Dual 365  $\mu\text{fd.}$  var. cond.  
 $C_4$ —.001  $\mu\text{fd.}$  mica cond.  
 $J_1, J_2$ —Coax chassis connectors (Amphenol 80-C)  
 $J_3, J_4$ —Insulated phone tip jacks  
 $L_1$  to  $L_8$ —See coil table

$M$ —0-50 d.c. microammeter (See text regarding use of larger meters)  
 1N34—Crystal diode (Sylvania type 1N34. Do not use silicon crystals, such as the type 1N21, in this circuit)  
 $S_1, S_2$ —2-ganged sections of a 2-pole, 2-gang, 11-pos. shorting type rotary selector sw., ceramic insulation (Centralab 1412)

# Bond Geddes' report on Radio Industry\*



**Presenting some of the most-often requested figures concerning the radio industry, its employment and its production.**

**BOND GEDDES**

Executive Vice-President &  
General Manager, Radio Manufacturers Assn.

**T**HE Radio Manufacturers Association, of which I am the Executive Vice-President and General Manager, comprises about 325 of the principal manufacturers of all types of radio-electronic equipment, including radio and television sets, transmitters, tubes, parts, accessories, and supplies. By volume the Association's member-manufacturers represent about 90 per-cent of production, although there are probably 1000 manufacturing companies in whole or part interested or allied with the industry. Included in the industry are 193 receiving set manufacturers (as compared with 57 before the war), and of these about 157 set manufacturers are in production to more or less degree, and there are about 65 major set manufacturers with all but one of these in the RMA membership. There are also thirty manufacturers of electric phonograph equipment.

The radio industry has a factory employment estimated at 300,000 workers. In addition there are about 1500 radio distributors and wholesalers, and around 35,000 to 50,000 dealers, comprising an estimated trade employment of 125,000 employees. Also there are 40,000 to 50,000 servicemen, making a total industry employment of roughly 500,000.

Factory employees in the industry include thousands of skilled and highly paid workers, largely organized in unions. The average hourly wage of member-manufacturers for October, 1947 was \$1.19 per hour, and \$47.98 weekly, the highest on record in the industry. This compares with the prewar hourly rate average of \$.68 in

1941. These figures released by the Labor Department include unskilled as well as skilled factory labor, jan-

itors, laborers, plant guards, etc. Although the aggregate industry  
(Continued on page 168)

Table 1. Summary of industry statistics covering 1940, 1941, 1942, 1946, and 1947.

FM SET PRODUCTION (1946-1947)					
Year	Units	Dollars (Retail)	Per-cent of Total Sets		
			Units	Dollars	
1946 <sup>2</sup>	181,485	61,704,900	1.4	7.06	
1947 <sup>3</sup>	1,150,000	311,000,000	6.4	24.46	
<b>Total</b>	<b>1,331,485</b>	<b>372,704,900</b>			

TELEVISION SET PRODUCTION (1940-1947)					
Year	Units	Dollars (Retail)	Per-cent of Total Sets		
			Units	Dollars	
1940	1,342	427,600	.01	.12	
1941	389	152,800	.01	.03	
1942 <sup>1</sup>	953	176,400	.02	.86	
1946 <sup>2</sup>	5,367	2,050,200	.03	.23	
1947 <sup>3</sup>	175,000	102,000,000	.97	8.00	
<b>Total</b>	<b>183,051</b>	<b>104,807,000</b>			

RADIO SETS WITH PHONOGRAPHS (Including FM and AM)					
Year	Units	Dollars (Retail)	Per-cent of Total Sets		
			Units	Dollars	
1940	1,120,674	75,000,000	9.4	21.19	
1941	1,639,176	140,300,000	11.9	29.94	
1942 <sup>1</sup>	909,151	90,500,000	21.1	44.36	
1946 <sup>2</sup>	3,081,448	354,400,000	19.2	40.56	
1947 <sup>3</sup>	2,750,000	591,500,000	15.2	46.50	
<b>Total</b>	<b>9,500,449</b>	<b>1,251,700,000</b>			

ALL SET PRODUCTION (1940-1947)			
Year	Units	Dollars (Retail)	
1940	11,855,039	354,000,000	
1941	13,664,788	468,600,000	
1942 <sup>1</sup>	4,306,085	204,000,000	
1946 <sup>2</sup>	16,019,754	873,700,000	
1947 <sup>3</sup>	18,000,000	1,271,400,000	
<b>Total</b>	<b>63,845,666</b>	<b>3,171,700,000</b>	

NOTES: <sup>1</sup> Civilian radio production halted by WPB on April 22, 1942 and not resumed until late in 1945.  
<sup>2</sup> Radio set and parts pricing under OPA control until Oct. 31, 1946.  
<sup>3</sup> Estimated totals—final reports not yet available.  
\* No records on FM set production by years prior to 1946. FCC estimated about 400,000 prewar FM sets were manufactured.

\* The figures given in this article were excerpted from Mr. Geddes' testimony before the U. S. House of Representatives' Committee on Education and Labor investigating the AFM ban on recordings.

# A LOW COST FM TUNER

By **J. T. GOODE**

The Rollin Co.

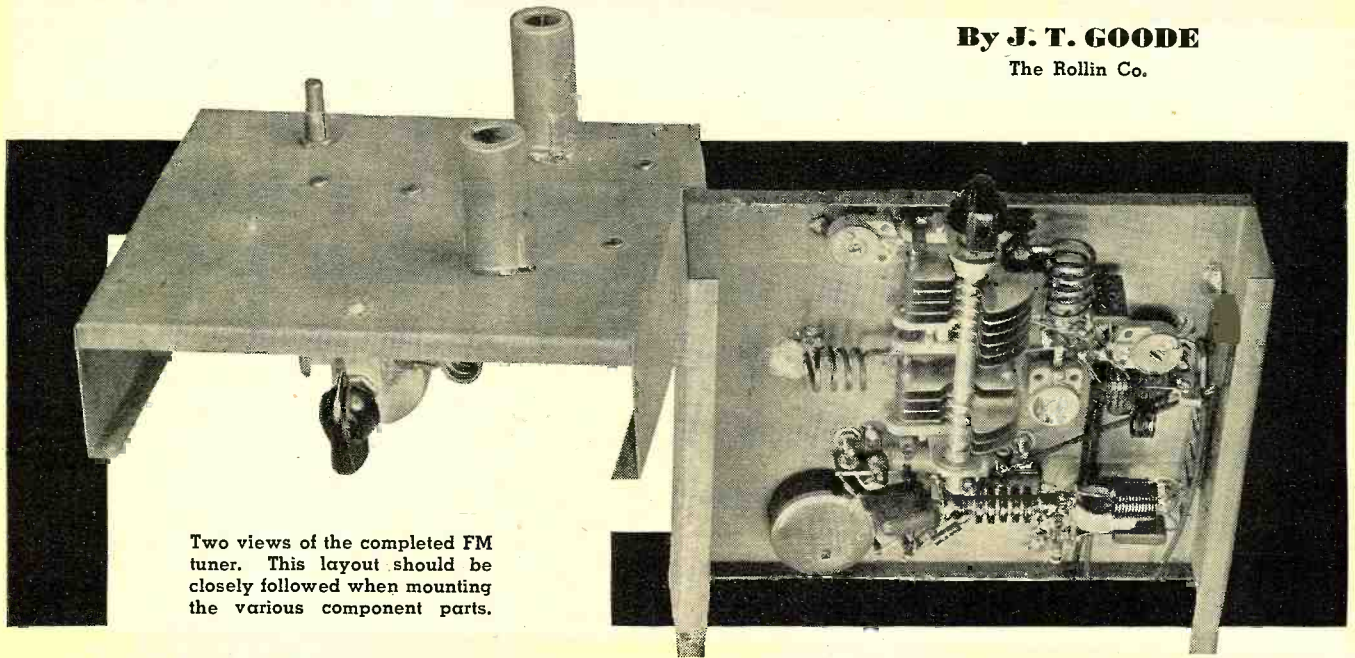

Two views of the completed FM tuner. This layout should be closely followed when mounting the various component parts.

***Operating as a sideband detector, this superregenerative FM tuner provides relatively good reception at extremely low cost.***

**N**EW FM transmitters are now broadcasting regular programs in many localities that heretofore were not served by FM.

While radio manufacturers are already well in production on FM receivers, the FM is usually incorporated in an FM-AM combination deluxe unit which is rather expensive.

Several companies are manufacturing FM tuners which can be connected to the audio amplifiers of any receiver. This reduces the expense of FM reception as these units usually consist of a complete receiver minus audio amplifier and speaker.

FM receivers and tuners are also available in kit form. To the experimenter or amateur, the kits are proving rather attractive from the economic standpoint.

All of the above-mentioned equipment is expensive when compared to the FM tuner described in this article.

A superregenerative receiver can be used to receive FM transmissions. By adding a few refinements to a superregenerative receiver, a very economical unit may be constructed from "junk box" parts. Even if all of the parts have to be purchased, the total expense would be under \$15.00. It will only take about three hours to construct this tuner.

While such a receiver does not have all the features of a true FM receiver, namely "noise elimination," on

the other hand, the sensitivity of a superregenerative receiver continually decreases as the signal strength increases, which provides a certain amount of noise reduction.

Since most FM transmitters are operating with fairly high power, such a condition insures satisfactory signal strength for most localities which are covered by FM transmission.

A straight superregenerative receiver should not be used for FM reception since such a receiver actually transmits interference on the same frequency to which it is tuned. This would cause interference to receivers operating in the same locality.

By using a superregenerative receiver as the i.f. channel of a superheterodyne, the interference possibility is eliminated. The converter of the superheterodyne provides a stage of isolation, divorcing the superregenerative stage from the antenna. The superregenerative stage is tuned to a lower frequency (approximately 31 mc.) which, in turn, gives added assurance of no interference on the receiver frequency.

Anyone who has constructed a superregenerative receiver is well aware of the difficulties encountered in maintaining good sensitivity over a wide range of frequencies. In the construction of this tuner that particular difficulty is eliminated since

the superregenerative channel can be adjusted for optimum sensitivity at one frequency.

The FM tuner consists of a 6BE6 mixer and high frequency oscillator and a 6J6 superregenerative detector. One half of the 6J6 is not used. If additional audio gain is desirable, the other half of the 6J6 can be used as an audio amplifier. A 6J5 can be used instead of the 6J6 if desired. The operation of the tuner is as follows.

The grid circuit of the 6BE6 is designed to cover the tunable range of 88 to 110 mc. The oscillator circuit of the 6BE6 is designed to tune from 57 to 79 mc. These two tuned circuits are tracked to produce a beat frequency of 31 mc. over the tunable range.

The plate circuit of the 6BE6 is tuned to 31 mc. This circuit is coupled to the tuned circuit of the 6J6 superregenerative detector which is likewise tuned to 31 mc.

Assume that a FM signal is being transmitted on 100 mc. The grid circuit of the 6BE6 is tuned to 100 mc. and the oscillator circuit is tuned to 69 mc. The received frequency will beat with the high frequency oscillator, producing an i.f. frequency of 31 mc. This signal is, in turn, detected by the 6J6 circuit producing an audio voltage. This voltage may be fed into any convenient audio amplifier. The audio amplifier in the average receiver will be adequate.

Since only one tuned circuit is involved, selectivity is extremely broad. For FM reception, the circuit is tuned so as to utilize the slope of the curve.

The circuit is tuned so the center frequency is approximately 100 kc.

down the slope of the curve. As the frequency is altered by modulation (FM), the sensitivity is increased and decreased due to the slope of the curve of the tuned circuit. This action causes an a.c. voltage to be generated by the detector and the frequency of this voltage will be that of the modulation.

Distortion will be extremely low when the straight portion of the curve is used.

This point of operation is not difficult to obtain. Simply tune the receiver for clear reception. There will be two such points, one on either side of the selectivity curve.

### Construction Notes

Considerable care should be exercised in making the chassis layout. Parts should be located in such a way that lead lengths are held to a minimum.

The variable condenser is a dual standard, 11-plate, double-spaced unit. Four plates are removed from the rear section which tunes the grid circuit of the 6BE6. Removal of these plates results in satisfactory tracking over the entire FM band.

Although the plate circuit of the 6BE6 and the grid circuit of the 6J6 are tuned to the same frequency, the coils are wound with a different number of turns. This procedure results in optimum operating conditions.

Ceramic trimmers are used throughout and are recommended. Compression type trimmers are subject to slight changes in capacity which, if encountered, will cause serious frequency drift.

It is not unusual to "hand-pick" the tubes for a superregenerative detector stage. Some tubes that operate satisfactorily in an amplifier circuit will not give the same service in a superregenerative circuit. If the FM tuner does not operate when first turned on, try changing tubes before changing component parts.

### Chassis Layout

The variable condenser is located in the center of the chassis. The 6BE6 tube socket is mounted so that lead length is divided equally between the two sections of the variable condenser. The 6J6 tube socket is mounted approximately three inches from the 6BE6 tube socket. This allows sufficient space to mount the 6BE6 plate coil and the superregenerative tank coil.

The 6BE6 oscillator coil is soldered to the front section of the variable condenser and ground, making it self supporting. The oscillator trimmer is soldered to the other side of the variable condenser and ground.

The 6BE6 grid trimmer condenser is soldered directly to the grid prong of the 6BE6 tube socket and ground. The grid coil is soldered to the other side of the back section of the variable condenser, and ground. The antenna coil consists of one turn of wire soldered to the chassis and located

near the ground end of the grid coil.

The 6BE6 plate trimmer is soldered directly to the tube socket terminal, and ground. The plate coil is supported by the plate prong and a terminal strip. The terminal strip is bypassed by a .002  $\mu$ f. condenser at this point.

The 6J6 coil and trimmer condenser are soldered directly to the plate prong of the 6J6 tube socket and the other end of the coil and trimmer connect to a terminal strip. The 6J6 grid condenser connects from the terminal strip to the grid prong of the tube socket. The r.f. choke and filter resistors are supported by another terminal strip.

Although the variable resistor in the plate circuit of the 6J6 is not absolutely necessary, it does make possible a more precise adjustment of this stage.

The connecting cable consists of two filament leads, a ground, and a "B plus" lead. Shielded wire is required to feed the audio output of the FM tuner to an audio amplifier.

Power consumption is 6.3 volts at .75 amps. and the plate drain is less than 10 ma. The plate voltage is not critical, approximately 90 volts. Filament and plate voltage for the tuner may be obtained from the audio amplifier or radio used in conjunction with this equipment. The power consumption of the tuner is sufficiently low to allow tapping into the power supply of the average 5 tube a.c. receiver without causing serious overload. At the same time the audio section of the receiver is connected to the tuner and the FM receiver is complete.

If the plate voltage of the receiver is excessive, insert a resistor in the "B plus" lead of the tuner and adjust

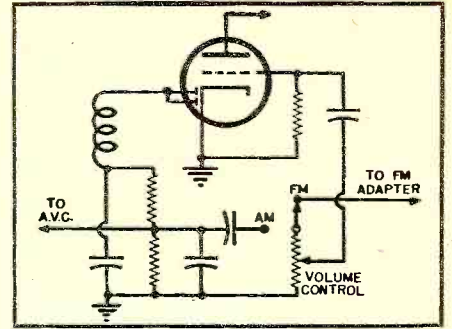

Fig. 1. Diagram shows method of connecting FM tuner to any conventional AM receiver. Receivers equipped with a phono input can be connected directly to the tuner without any circuit alterations whatsoever.

the value so that approximately 90 volts is available for the operation of the tuner.

Some receivers have a terminal available for a phonograph connection. In this case the audio connection from the tuner may be attached directly to this terminal. Receivers without this terminal will require the addition of a switch and terminal or jack.

The switch employed is of the single-pole, double-throw type. It is wired in such a manner that it is possible to transfer the audio amplifier of the receiver to either the radio or the tuner. Connections are made at the volume control of the receiver and the same control is used for AM and FM reception. See Fig. 1.

Assuming that an appropriate audio amplifier and power supply are connected to the tuner, the testing procedure is as follows. Turn on the equipment and allow a warm up period of a few minutes. If the 6J6 stage

*(Continued on page 171)*

Fig. 2. Complete schematic diagram of tuner. An external power source is required.

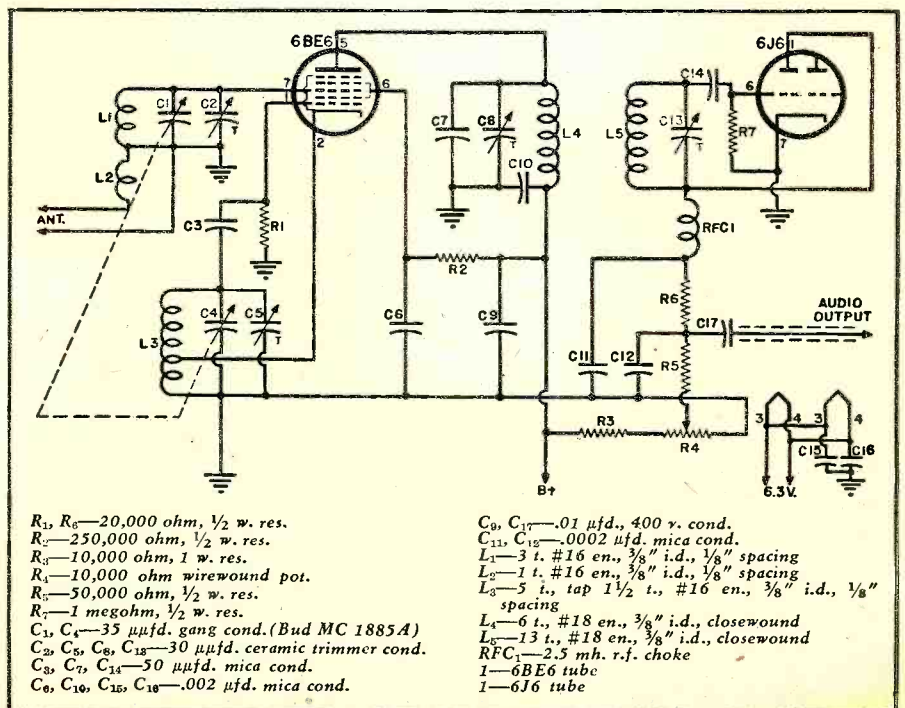

# Television-EXCLUSIVELY!

*Specialization has paid real dividends to this wide-awake firm in the New York City area.*



By  
**MAX ALTH**

next, and also rejected because of the large number of television retailers already established. Westchester County, which lies directly north of New York was considered, and chosen when *DuMont* proffered an exclusive franchise in Yonkers, which is in Westchester County.

The present site of the salon at 63 South Broadway in Yonkers was not selected. It merely happened to be the only store in the center of town that was available. Yonkers has a population of 140,000, and is within easy commuting distance of New York.

The organization rented the first floor, and basement. The entire front of the small building was painted white, and the name, "Porterfield Television" was lettered in red across the face of the building. The single color, and the lettering gives the passerby the impression that the entire three floors are used by the company.

The store proper was broken up into three rooms. One, the main showroom, opens onto the street through two show windows and a door, and has a frontage of about thirty feet. In this room the television sets are displayed. Chairs are provided, and individual sets demonstrated. The second room is connected to the first by means of an archway. This is the "theater" which seats thirty-five people comfortably for a television show. The third room is used as an office. The basement is used for storage while servicing is done at another location.

So much for the physical layout of the salon.

The opening gun of the sales attack was fired at the Westchester Home Show in the exhibition hall where many other county merchandisers displayed their wares.

Next came a series of spot advertisements, ten in all, over WFAS, a local broadcasting station. These were followed by a quarter page display ad in the *Herald-Statesman*, a leading Yonkers paper, and from then on, a continuous series of sales promotions.

JOHN R. PORTERFIELD, in conjunction with *UVX Industries, Inc.*, has just entered the retail television field in a big way. He has opened a salon in Yonkers, New York dedicated solely to selling and servicing television receivers.

The opening of this salon is not an off-the-cuff proposition, but the result of nine months of patient study. Here is the story behind the opening, and the picture to date.

*UVX Industries, Inc.* is a corporation with many years as national, factory representatives for various electrical specialities manufacturers behind them. They had a certain amount of surplus capital on hand, and were looking for the best way in which to invest this money. They decided upon retail television sales for several reasons.

Since television is a growing field, they would be working into an expanding market rather than a static, or a diminishing market. They already had retail electrical appliance merchandising know-how, and they had experienced retail merchandising sales and management personnel.

Having the general knowledge, they looked about and teamed up with John R. Porterfield, who had the specific knowledge. John Porterfield has been associated with television in one capacity or another for more than ten years.

Together they decided that the New York area was the logical place for a television sales outlet because of its high population concentration, and

the number of television broadcasting stations in operation.

However, New York City was not selected for their pilot retail outlet for the following reasons. The unreasonably high rent being asked for the available locations practically foredoomed any business that might open there. New York City is not a typical American community, and sales experienced in New York City might not be applicable to other localities, and lastly, sales while being more or less unlimited in potential numbers, are definitely limited as far as the percentage of homes is concerned.

Apartment house owners in New York City will not permit their tenants to erect individual antennas. Each tenant must hook his receiver to a common antenna, or do without.

While satisfactory multiple outlet antenna systems have been devised, and are appearing on the market, few apartment houses have them as yet, and until that occurs the number of possible television set sales in New York City will remain limited.

However, a sales office was organized, and set up at 50 Church Street, and a large crew of part, and full-time salesmen cover the city from there.

With New York relegated to a secondary position, the company looked toward the suburbs.

Long Island was considered and rejected because of its low concentration of population. It was a good location for a retail television outlet, but not the best. New Jersey was considered



Two television sets were installed in the lobby of a local movie theater. Not merely placed there, but connected to power and an antenna, and turned on every evening.

Free tickets, entitling the signer to a chance in the drawing, were placed with the box office attendant, and given to anyone requesting one. The detachable stubs of these tickets were placed in a large box in the lobby of the theater, and a drawing held at the end of one month.

Meanwhile, a two minute advertising trailer was shown at every performance during the month the television set was being offered.

An ad was also run in the theater program leaflet which the theater distributes to its patrons.

Mention of the free prize was made in the newspaper ads of both *Porterfield Television* and the theater.

A large sign in the window of the store invites the general public to come in and see a television show. In the other window the company has posted a weekly list of programs. Sometimes the windows themselves are chalked up with signs advertising the evening's program. For example, the royal wedding pictures were advertised, and drew a large crowd.

Television program schedules for the coming week are mailed to all those who show an interest, and to those who have purchased television receivers. Those people who have indicated an interest in a particular type of program, on the cards that are circulated, are invited by mail to attend whenever their particular interest is being telecast.

The public is advised that no sales pressure will be exerted, and none is—directly. At the end of each tele-show, or before, as the case may be, one of the salesmen will give a short talk on television with a view to stimulating the listeners' enthusiasm for television. No direct sales appeal is ever made. Sales leads are, of course, picked up through these public demonstrations.

The greater portion of the teletheater audience is there by invitation, the rest walk in from the street. Of the latter group a percentage is dead wood—youngsters, and the casually curious. However, there is no doubt that the teletheater more than pays its cost of operation.

The leads secured through the salon, newspaper ads, etc., are followed up by the sales force. The salesmen are in the unique position of being able to advise on television without having to push any particular brand. The company has franchises from the four major television manufacturers whose sales comprise ninety per-cent of all the television sets sold in the country, *RCA*, *Philco*, *DuMont*, and *U.S. Television*. All national advertising is to their benefit. A boost for any television set by any manufacturer is a boost for *Porterfield* salesmen. They can sell the customer any set he wants.

Because of this favorable franchise

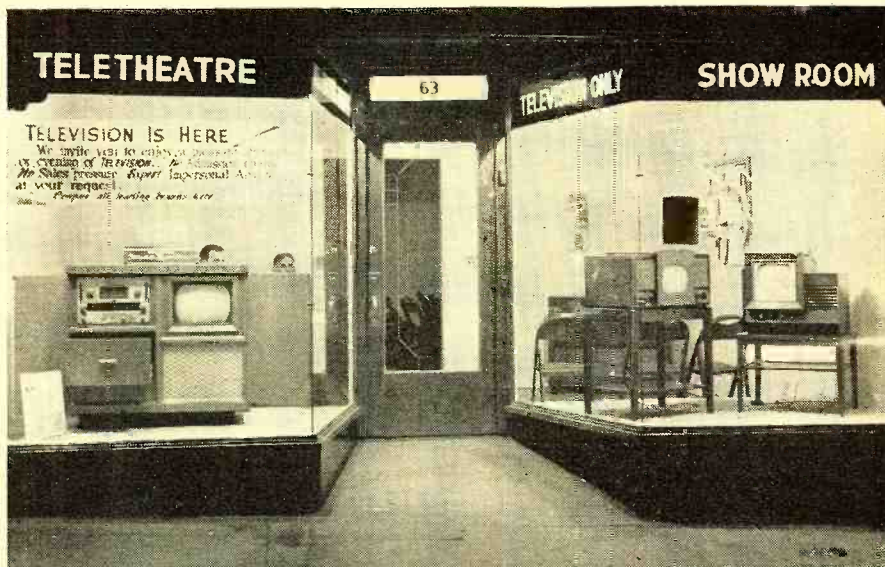

Everything about this pleasant exterior invites customers to come in and "see television."

position they organize their sales line in an advisory fashion, going to the customer's home, helping the customer select the room best suited for the set, the best location in that room, and the set best suited to the customer's needs. Thus the salesmen have an honest impartiality that gives the customer confidence in them, and all they need do is to sell television, and not any particular brand of home receiver.

Business at the end of the first month has been so good that a large crew of salesmen have been attracted. Some work part-time, others work full-time. All draw against commission.

The service department consists of a six-man crew set up on a twenty-four hour basis. They install and service the four major sets with the exception of *RCA*, which does its own servicing and repairs.

The prompt, efficient, twenty-four hour service of this group has already brought more than one customer, dissatisfied with other repairmen, into the *Porterfield* fold. The customers like the thought of twenty-four hour

service, although very few persons will actually call for service at two or three in the morning.

There have been, however, a percentage of nuisance calls. There always will be. Customers who have invited guests for dinner, for example, have wanted to make certain their new toy would perform satisfactorily—so they call the service department despite the fact that the set was working perfectly at the time of the call.

The men usually work in two-man teams, rarely going out individually unless it is a known problem which they are tackling. The charge for a two-man team, on a non-contract basis is \$7.50 per hour, plus material. The charge for one man is \$4.00. This figure is low in view of the pay a good television repairman receives. Installation charges, and the accompanying service periods are those set by the manufacturers.

Every effort is made to repair the set in the customer's home. The chassis is pulled only when it seems likely that a repair will take an inordinate

(Continued on page 124)

The "teletheater" has more than paid the cost of its operation by increased sales of sets.



# BIRTH OF A SERVICE NOTE

Those data sheets which accompany each new receiver are the result of engineering skill plus practical servicing "know-how."



Equipment engineer checking preliminary alignment of radio. Several methods are tried, but the simplest and most foolproof technique is adopted for inclusion in the service note. Voltage data on the set is also taken at this time.

By **HARRY D. HOOTON**  
 Technical Supervisor, Service Dept.  
 Westinghouse Electric Corporation

Equipment engineer conferring with draftsman after preliminary voltage and alignment data are established to be certain all essential data is included on schematic and other servicing drawings.



THE service notes and instruction bulletin sent out by every radio manufacturer with each new set are certainly not conceived overnight. As a matter of fact, service notes in their present form might not exist at all, were it not for the close cooperation of all contributing to their development.

When the engineering department designs a new model, a technician in the service laboratory receives all preliminary information regarding the circuit and any special features or innovations in the design. Receiving this material in advance, he can be fairly certain by the time the engineers have a laboratory model available what service information and alignment techniques will be required.

When the engineers complete the model, the draftsman and technician in the service department analyze it and determine what drawings will be required for the instruction booklet to be shipped with the radio. Usually, a projection drawing showing tube locations and a view with the tuning controls and dial are required; also, any special connections to accommodate a record player or an FM antenna must be shown. While they have the model, the draftsman makes measurements and rough sketches; the technician sees that all his original alignment technique and service information notes are complete and correct.

After a close analysis of the construction, the time study department breaks up the set into a number of simple operations. They make a trial run of 25 sets and then return them to the engineering department for careful checking of inherent char-

(Continued on page 169)

Engineer and technical writer checking over alignment details and voltage charts. Together they determine best service note layout to emphasize service parts in a particular receiver. Others handle work involved in the preparation of the parts lists, etc.



Proof copy from printer being checked against original dummy layout in the final step before printing of notes.

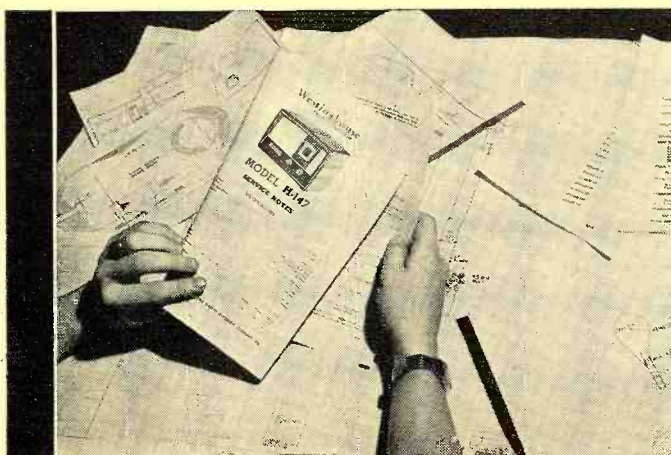

# Compact Power Supply is Transformerless and Tubeless

By GUY DEXTER

VOLTAGE multiplier circuits, such as doublers, triplers, and quadruplers, the new selenium dry-disc rectifiers offer the advantages of small size, economy, low heat dissipation, and extreme simplicity. In addition to those desirable features, a selenium voltage multiplier also has better voltage regulation than an equivalent vacuum tube outfit; is able to withstand a surprising amount of careless handling; eliminates all hum fields; and, having no filaments or heaters, can be placed into operation instantly.

Voltage multiplier circuits long have interested radio constructors and experimenters, since these circuits deliver high voltages without benefit of transformers of any kind. Composed only of diode rectifiers and condensers, a voltage multiplier circuit reduces the weight and dimensions of a power supply unit materially. The best-known voltage multiplier undoubtedly is the doubler, since that unit formerly has been employed widely in midget radio receivers and in some test instruments and electronic devices. The tripler and quadrupler, and higher-order multipliers, are not as well known except to power supply students and to high-voltage engineers.

The small-sized power supply described in this article employs a voltage quadrupler circuit. The basic portion of this unit is four selenium rectifiers and four electrolytic condensers. In addition to the basic circuit, an output filter section has been included.

The basic quadrupler circuit is shown in Fig. 2. This arrangement will be recognized as two half-wave voltage doublers connected so as to have their a.c. inputs in parallel and d.c. outputs in series. Polarities of both rectifiers and condensers are very important in this circuit. If the polarities shown in Fig. 2 are not followed exactly, the components will be damaged or the circuit will not deliver full output voltage.

Simplified operation of the quadrupler circuit corresponds to that of two doublers in combination: On alternate half-cycles of a.c. input voltage, first  $C_1$  and then  $C_2$  is charged,



Fig. 1. Two views of complete power supply. All parts are mounted underneath the metal chassis.

**This power supply, using selenium rectifiers, will deliver up to 600 volts depending on load current.**

each to a potential equal to the peak value of the a.c. input voltage minus the small drop in the rectifier (rectifier 2 charges condenser  $C_1$  when input terminal  $B$  is positive, and rectifier 3 charges condenser  $C_2$  when input terminal  $A$  is positive). Also, when input terminal  $A$  is positive; rectifier 1 conducts, charging condenser  $C_3$  to a potential equal to the peak value of the a.c. input voltage plus the charged voltage of  $C_1$  (also equal to the input peak) minus the small drop in rectifier 1. This results in a voltage across condenser  $C_3$  almost equal to twice the peak value of the a.c. input voltage ( $2.82 \times E_{ac}$ ).

Likewise, when terminal  $B$  is positive; rectifier 4 conducts, charging condenser  $C_4$  to a potential equal to the peak value of the a.c. input voltage plus the charged voltage of  $C_2$  (also equal to the input peak) minus the small drop in rectifier 4. This results in a voltage across  $C_4$  nearly equal to twice the peak value of the a.c. input voltage ( $2.82 \times E_{ac}$ ). The final result of this action is that a d.c. voltage appears across the output terminals equal to the sum of the voltages across  $C_3$  and  $C_4$ . This sum is four times the peak value of the a.c. input voltage ( $5.66 \times E_{ac}$ ).

This means that a d.c. output voltage of 650 may be obtained with an r.m.s. input voltage of 115, when low direct currents are drawn. As the output current drain is increased, the output voltage drops somewhat. Voltage regulation is improved considerably by employing large capacitances for  $C_1$ ,  $C_2$ ,  $C_3$ , and  $C_4$ . Each of these four capacitances must be equal and, for best operation, never should be lower than 20  $\mu$ fd.

From the preceding explanation of the circuit operation, it is evident that condensers  $C_1$  and  $C_2$  must have a minimum d.c. working voltage rating equal to the peak value of the

(Continued on page 184)

Fig. 2. Basic quadrupler circuit.

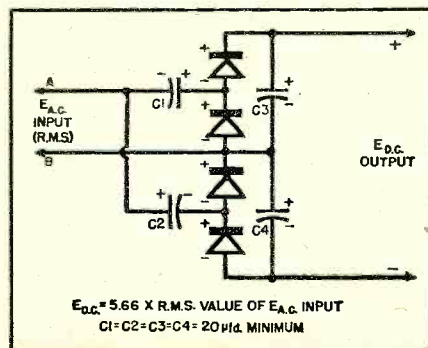



By  
**CARL V. HAYS, W6RTP**

*By popular request — a  
 conventional, easy-to-build  
 table model home receiver.*

## A SIMPLE B. C. SUPER

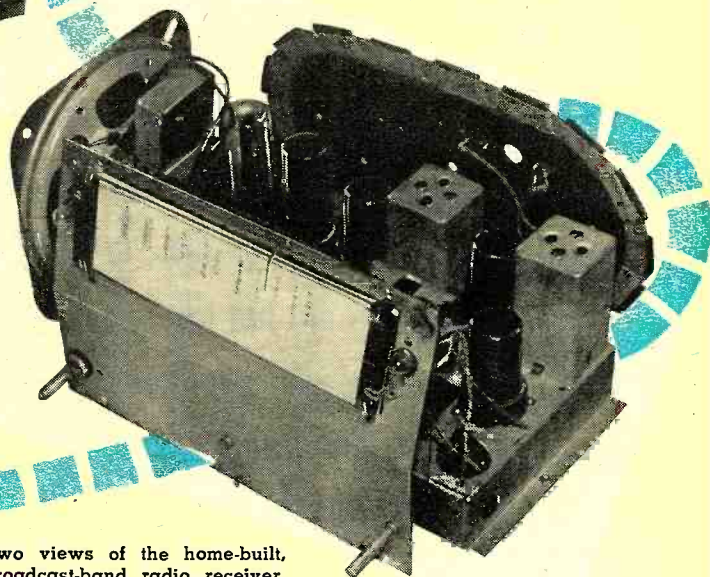

Two views of the home-built, broadcast-band radio receiver.

**O**RIGINALLY built as "something to get by on" until commercial manufacturers could again get in production, this little 5-tube, a.c. broadcast job has performed without a single component failure since 1944; has elicited favorable comment about its tonal qualities and appearance from all who have heard it; has consistently brought in Midwest stations in the late winter evenings with only its built-in loop antenna, and represents so much for so little that the author felt others might be glad to have the opportunity of duplicating this smooth performing little job.

The design is perfectly simple and orthodox—is in fact a circuit used by one of the major manufacturers for years, and consequently is completely free of bugs. Built as shown in the photographs and according to the schematic, anyone can be sure of good performance.

The only change in the model shown from the original is in the substitution of a choke in place of *R<sub>1</sub>*, but this was done only because a choke was handy—it is recommended that the circuit be copied exactly as shown in the diagram.

The 6SA7 used as the mixer-oscillator gives more than enough gain to drive the single 6SK7 455 kc. i.f. stage, using inexpensive but efficient

i.f. transformers of a standard type. A single diode-connected 6SQ7 gives adequate second detection and very nice a.v.c. action on strong signals, which are the rule on this band. The triode audio section of this same tube serves as a compact driver for the output stage which requires a low current drain 6K6GT to drive the five-inch PM speaker.

Careful duplication of parts in the bias section of the power supply will give the right grid voltage on the output stage thus insuring a minimum distortion content, even at full volume. The gain of the receiver is, incidentally, more than enough for house volume on all stations within a fifty mile radius.

The power requirements are quite modest, a small 50 mil. power transformer of the half-shell variety with a 6X5GT rectifier working into an efficient but simple filtering system will do.

Before laying out the chassis it might be wise to study the photographs in order that the layout can be followed exactly. This is recommended, since the receiver will be just that much easier to build and get going. In the top chassis photo, with the dial towards the viewer, the metal tube at the right rear of the tuning condenser is the mixer-oscillator, 6SA7; directly behind it is the first i.f.

transformer, *T<sub>1</sub>*. To the left of this is the i.f. tube, 6SK7; followed by the second i.f. transformer, *T<sub>2</sub>*, directly to the left. Next, in a straight line along the rear chassis edge, are the 6SQ7 detector-audio tube, the 6K6GT (or 6F6) audio output tube, and the 6X5GT rectifier. Directly in front of the rectifier tube is the five-inch PM speaker with the output transformer mounted on top of it. The speaker frame is bolted to the chassis by means of long 6-32 screws and spacers so that the speaker fits snugly against the cutout speaker grille on the left end of the cabinet, when the chassis is bolted in place. Directly to the right of the speaker is the power transformer, *T<sub>1</sub>*. The underchassis photographs may be followed easily by referring to the parts topside, then spotting them in their reversed position from below. Wiring is extremely simple and easy, since the chassis pan is exceptionally roomy, thus eliminating the bothersome crowding of parts. The loop, affixed to the rear of the chassis by means of spacers, is a commercial unit and is color-coded so that no trouble should be experienced in connecting it.

The dial assembly, used in this particular model, is one of the slide-rule types, but was used simply because it was available. Any type preferred by the builder will work just as well, as

long as its calibration is standard, and matches the tuning condenser used. Cabinets are now generally available, some even come complete with the dial as an integral part, so no trouble should be experienced from this angle. A home-made unit was used to house this receiver as the dial escutcheon which was originally for FM calls could be replaced by a heavy white cardboard with the typed call letters of the major local stations, thus making station selection a very simple matter.

Although the loop, as it comes from the manufacturer, is provided with a connection to permit the use of an external antenna, it has never been necessary to attach one as stations in Texas, Louisiana, Illinois, Oregon, Washington, and many other states have been received regularly in the late winter evenings with adequate volume and clarity.

The controls need no explanation. The control on the left in the front view is the a.c. switch and volume control, and that on the right is the station selector. A pulley and conventional dial-cord drive are used with this dial assembly. Operation is smooth and it has given no trouble of any kind so far.

As a matter of convenience, it is perhaps best to wire the power supply first, testing it before proceeding with the construction. Voltages are not critical, as approximately 250

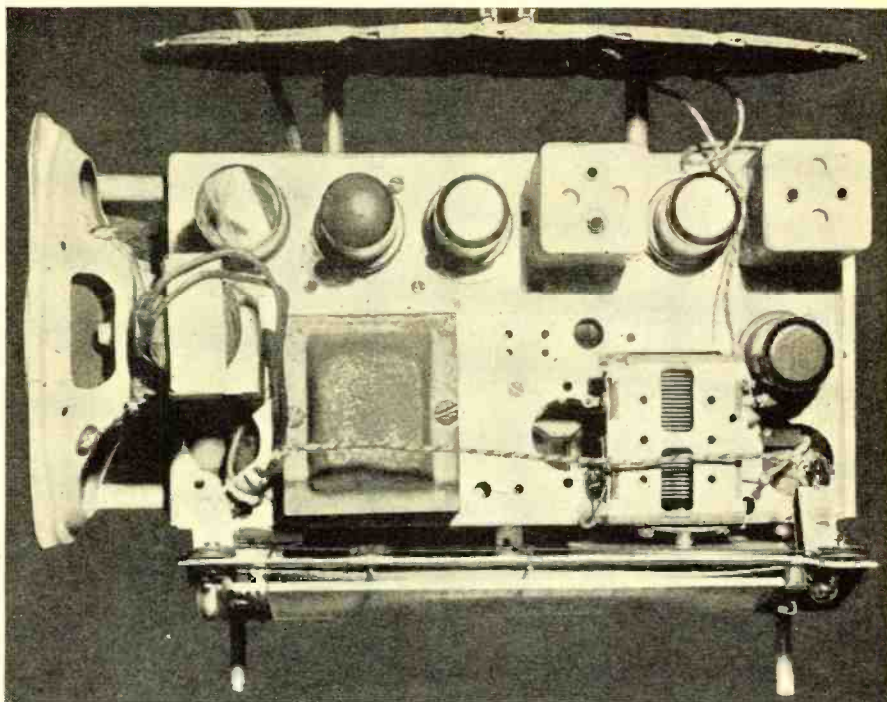

Top view of receiver shows placement of component parts.

volts (under load) will suffice. After the power supply is completed, wire all filaments in parallel, grounding one filament pin of each tube directly at the sockets. The use of the cathode-type 6X5GT eliminates the need

for a 5-volt winding for the rectifier, but if a dual filament transformer of the right size is available by all means use it—then substitute an 80 or similar tube for the 6X5GT. In this case  
(Continued on page 170)

Circuit diagram is typical of many commercially built, a.c. operated, five-tube home receivers.

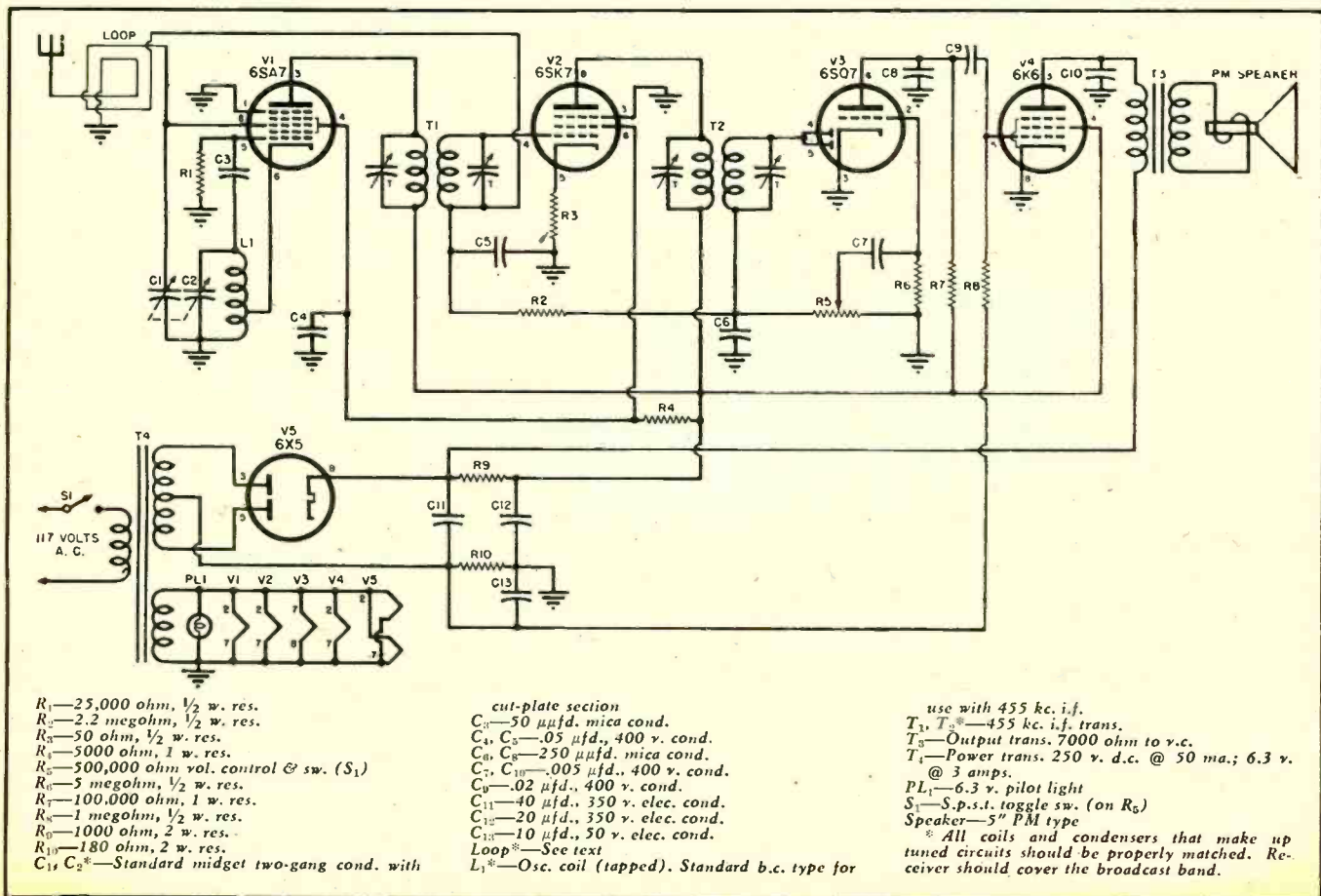

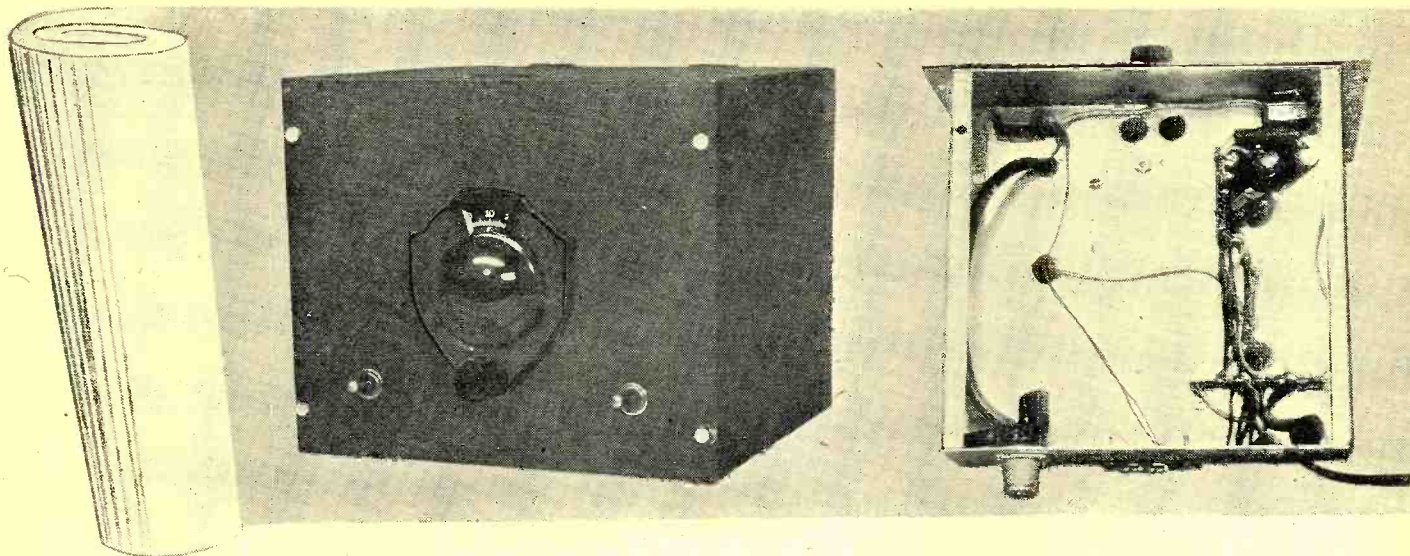

# Simplicity in a Converter

By C. W. ROESCHKE, W5MLX

**This converter makes possible complete coverage of the 6, 10, and 11 meter ham bands. It will extend the range of many surplus receivers.**

THE large number of surplus receivers available to the ham offer excellent performance at low cost, but have the disadvantage of not covering all the commonly used ham frequencies. It is particularly desirable to include the ten meter band in the receiver if at all possible, and if the six meter band can be included as well, the utility of the receiver is greatly increased.

In the desire to increase the frequency coverage of the surplus receiver in use here, many articles on converter design were examined to find one that fitted the needs. The majority of these designs used an r.f. stage, mixer, and oscillator. This required a minimum of three coils for each band to be covered, and seemed unnecessarily complicated. Spare coils have a bad habit of becoming misplaced or damaged, and the fewer needed the better.

It would be desirable to include bandswitching in a converter to eliminate the need for plug-in coils, but this introduces complications as well as losses at high frequencies.

In the examination of various literature on the subject of converters, an article was located in the *Proceedings of the IRE*<sup>1</sup> that appeared to offer promise. While this article gave no construction details, it was felt that with the information furnished, a satisfactory converter could be constructed.

To reduce the number of coils re-

quired, it was decided that the converter would use a grounded grid r.f. amplifier, followed by a mixer and oscillator. The use of a grounded grid amplifier gives a voltage gain in this application, of approximately four times, or 12 db. This type of amplifier also has the advantage of being broad-band, and is extensively used in television receivers.

The input circuit is very tolerant of various antenna impedances, with stability of the amplifier at any frequency, due to the screening action of the grid. This serves to reduce oscillator radiation to a negligible value.

As finally constructed, the converter uses a 6J6 grounded grid amplifier with the elements connected in parallel to double the transconductance. This is followed by another 6J6 as a combined mixer and oscillator. These tubes were selected as they are available at low cost in the surplus market, and give excellent

performance at the high frequencies.

As only two coils are needed, one for the mixer grid, and one for the oscillator, these two coils are combined on one base. The base used is a type supplied by *National* for use with small transmitting coils. Similar types are also made by *Millen* and can be used. A piece of lightweight copper sheet measuring 1¼ inches square is used as a shield between the two coils, and grounded.

By the use of this expedient, only one coil need be changed, and the possibility of coil misplacement is reduced. Details of the coil construction are shown in Fig. 1.

The output of the converter is tuned in the vicinity of 10 mc. and fed into the antenna and ground terminals of the receiver. The choice of a high i.f. frequency insures adequate image rejection.

It is quite common in converters to take the necessary power from the receiver. If the receiver is capable of handling the additional load this is a satisfactory method, but digging into the receiver to make the necessary connections is always inconvenient. Accordingly it was decided to make the converter self-powered.

The built-in power supply consists of a 6.3 volt transformer to supply the heaters of the 6J6's, combined with a selenium rectifier to supply the necessary high voltage. The total "B" drain of the unit is in the vicinity of 25 ma. at 100 volts for the plate, and 6.3 volts at .9 amp. for the heaters. In the event the built-in power supply is not desired,

#### Coil specifications.

L <sub>1</sub>	27-30 mc. 14 t. No. 14 en. closewound (Trimmer C <sub>3</sub> not used)
L <sub>2</sub>	27-30 mc. 8 t. No. 14 en., 5/8" long, tap at 3 t. (Trimmers C <sub>8</sub> , C <sub>10</sub> used)
L <sub>1</sub>	50-54 mc. 7 t. No. 14 en. closewound (Trimmer C <sub>3</sub> used)
L <sub>2</sub>	50-54 mc. 10 t. No. 14 en., 1" long, tap at 3 t. (Trimmer C <sub>10</sub> used, C <sub>3</sub> is not used)
L <sub>3</sub>	20 t. No. 20 en., 3/8" form, space to 7/8" length
L <sub>4</sub>	5 t. No. 20 en. closewound at cold end of L <sub>3</sub>

Note: Coils L<sub>1</sub> and L<sub>2</sub> are wound 1/2" diameter and mounted on plug-in type assembly. (See Fig. 1.)

<sup>1</sup>Sziklai, G. C. and Schroeder, A. C.; "Cathode-coupled Wide Band Amplifiers," *Proceedings of the IRE*, October, 1945.

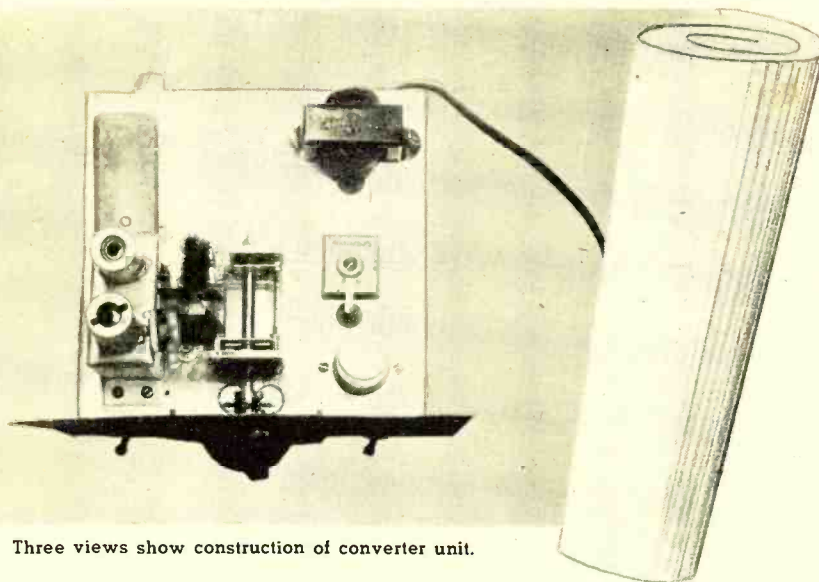

Three views show construction of converter unit.

these voltages may be obtained from most receivers.

The power supply used has one disadvantage in that the chassis is connected to one side of the a.c. line. This is no problem however, if care is taken to insert the power plug with the proper polarity, so that the grounded side of the line is connected to the chassis.

It is possible to eliminate this danger if no actual ground returns are made to the chassis, or if the chassis is insulated from the case. It was not felt however that these additional measures were necessary as, once installed, the converter would not be disturbed.

Construction details of the converter may be seen by examining the photographs. A 7" x 7" x 2" cadmium plated chassis is used, and the completed unit mounted in a 7" x 8" x 7" deep cabinet.

The tuning condenser  $C_2, C_6$  is a dual Cardwell "Trimair," with each section of 10  $\mu\text{fd.}$  maximum capacity. This condenser is centered on the chassis and mounted by means of the brackets furnished with it. The base for the plug-in coils is mounted on two inch ceramic standoffs close to the left hand side of the condenser to insure that the leads to the coil be as short as possible.

The filament transformer  $T_1$  is located at the right rear corner of the chassis. The selenium rectifier is mounted to the right of the tuning condenser, with the dual filter condenser mounted between it and the panel.

The bracket to the left of the coil mounting, is a frame from a defunct filter choke. This bracket measures  $2\frac{1}{4}$ " high,  $2\frac{1}{2}$ " long, and is  $1\frac{1}{4}$ " in width. A similar bracket may be constructed from scrap metal. Sockets for the two tubes are mounted on the top portion of this bracket, and the output i.f. transformer  $L_3, L_4$  is located on the rear vertical portion of the bracket. This method of construction insures that all r.f. leads

are of minimum length. Although tube shields are shown, their use is not necessary, and some expense may be saved by their elimination.

The i.f. transformer  $L_3, L_4$ , is constructed on the form from a defunct i.f. transformer. This transformer is one of the small type sold for replacement purposes, and uses a coil form  $\frac{3}{8}$ " in diameter. One of the ceramic trimmers used in the original transformer, plus a 100  $\mu\text{fd.}$  mica, are used to tune the primary coil  $L_3$ . Checking the original trimmer condenser on a condenser bridge indicated that the maximum value was approximately 100  $\mu\text{fd.}$  Any trimmer of this approximate value may be used in its stead.

The output winding  $L_4$  is of rela-

tively low impedance, and will give a good energy transfer to the majority of surplus receivers. In the event that one of the standard communications receivers is used, it would be advisable to increase the number of turns on  $L_4$  to give a better match to the approximately 300 ohm input circuit of most receivers.

The r.f. tube is the one located closest to the front panel. The combined mixer-oscillator is mounted to the rear to give short leads to the i.f. transformer. The tube sockets should be oriented to give the shortest leads to the tuning condenser and coil base.

An insulated flexible coupling is used between the shaft of the tuning condenser and the tuning dial. This is necessary, as the shaft of the tuning condenser is "hot" with r.f. on the six meter band. In spite of the short leads, there is considerable inductance in the condenser plates and shaft.

As the antennas used at this location for six and ten meters are both fed with 52 ohm coaxial line, the input to the cathode circuit of the r.f. stage is loaded with a 47 ohm resistor.

(Continued on page 139)

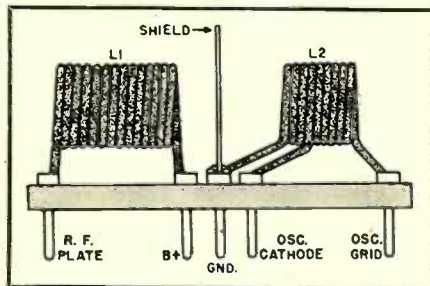
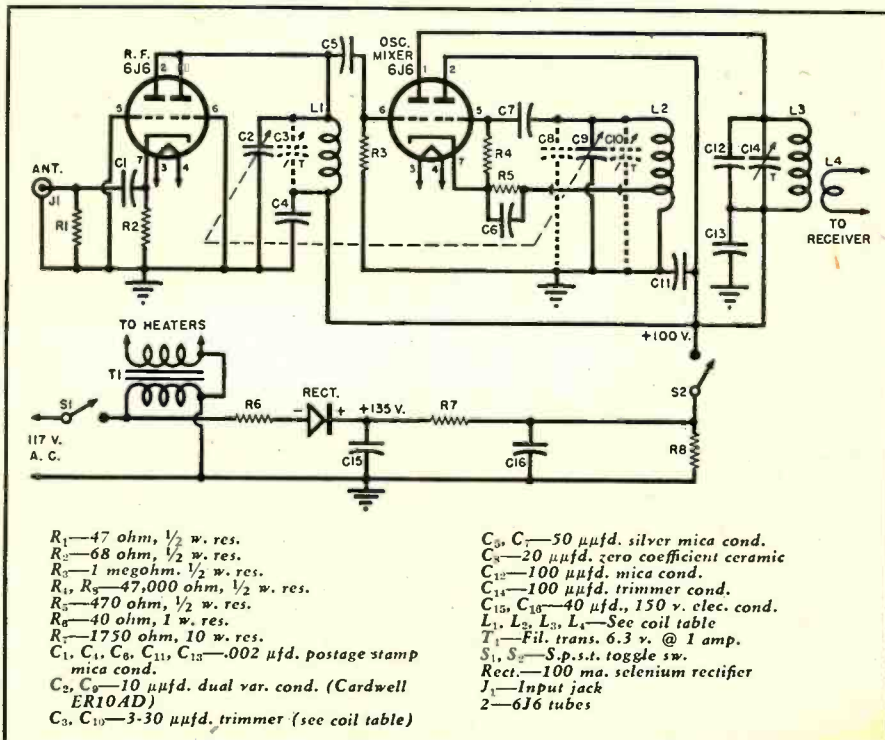

Fig. 1. Mechanical construction of coils  $L_1$  and  $L_2$ . Two sets of coils are required to cover the 6, 10, and 11 meter bands.

Fig. 2. Complete schematic diagram of self-powered converter.



# CROSS MODULATION -A Recurrent Factor

By  
**JOHN B. LEDBETTER**  
Eng., WKRC, WCTS-FM, Cincinnati

broadcast industry, however, with subsequent licensing of new stations and the granting of power increases to others, radio servicemen and station engineers will undoubtedly be faced with recurrent and increasing complaints of cross-modulation, especially in metropolitan areas where considerable amounts of exposed electrical wiring, metallic surfaces, and other rectifying media are encountered. Cross-modulation effects are also present in some rural areas, particularly those in the vicinity of high-powered broadcast transmitters. This latter condition is duplicated in metropolitan districts where the transmitter is located in or atop a business or hotel building.

## **Analysis of Cross-Modulation**

Since cross-modulation is produced by a non-linear current-voltage condition, the frequencies and side-frequencies capable of carrying cross-modulation can be found mathematically but this problem is of little more than academic interest to the serviceman.

Cross-modulation is of the same order as the fundamental, and hence may be used in locating and eliminating the source of cross-modulation. (It should be noted that these side frequencies are not developed by the presence of a second harmonic, but may be generated *without* the existence of a second harmonic of *any* kind.)

Table 1 is included in the hope that it may be useful as a reference in compiling specific interference frequencies in your own locality.

## **Sources of Cross-Modulation**

It has been stated before that cross-modulation is a product of electrolysis between two dissimilar metals. It can also be caused by corrosion or oxidation at the juncture of two *similar* metals. Any such juncture which forms a low-impedance path to ground for the radio signals is a potential source of cross-modulation. A few cases have been found wherein cross-modulation was generated within the *receiver*, being due, in some instances, to non-linear action of the tubes, and

(Continued on page 154)

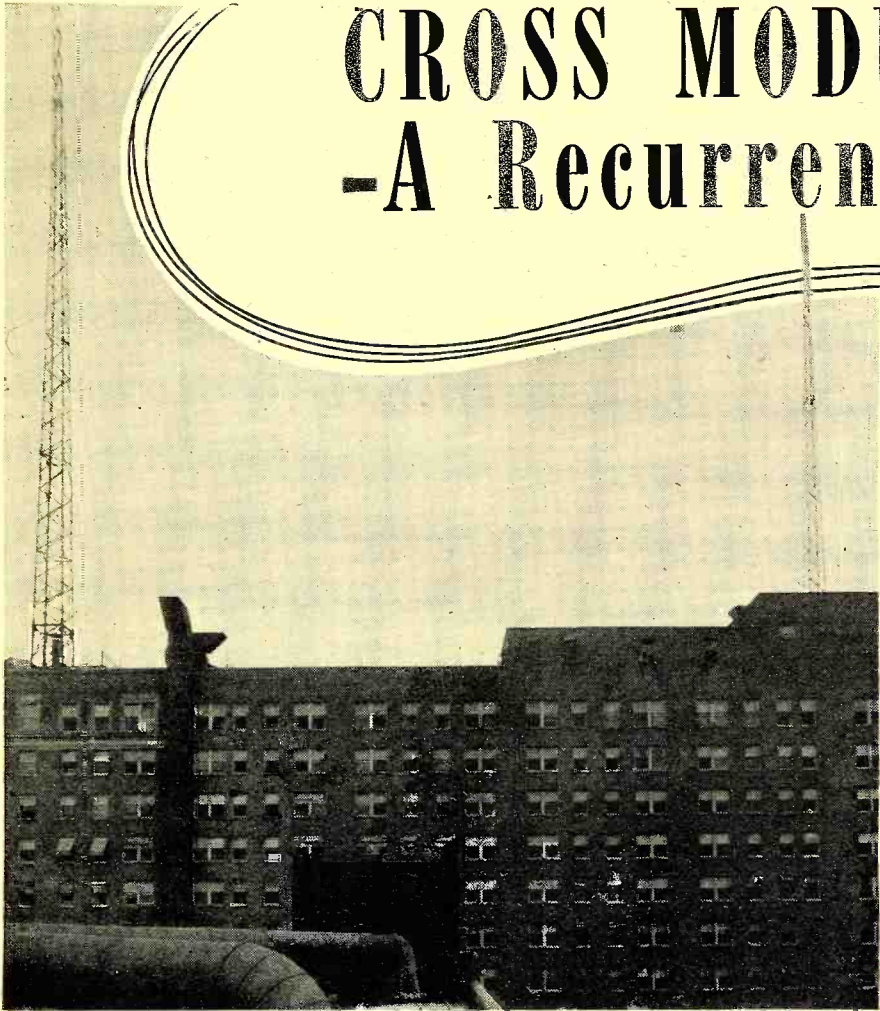

Multiple-dwelling installations, especially when located near transmitter sites, are often plagued by cross-modulation interference. One corroded connection in an installation can cause cross-modulation in a number of receivers.

***This type of interference is one of the most difficult encountered by servicemen. Here is one way of locating the source of the trouble.***

CROSS-MODULATION (sometimes called "cross-talk") is defined as "a kind of intermodulation in which there are produced frequencies equal to the sums and differences of a desired and an undesired frequency, or of their harmonics." Thus cross-modulation or "station riding" is a condition wherein two or more broadcast stations can be heard on the same frequency (or frequencies). This type of radio interference is caused by electrolytic impressions arising from special conditions and should not be confused with adjacent channel, blanketing, or heterodyne interference.

## **Cause of Cross-Modulation**

It is common knowledge that the junction of two dissimilar metals sets up a chemical reaction or electrolysis which, in turn, produces a minute voltage between the two dissimilar elements. When this voltage is the

result of electrolytic action between a suitable rectifying agent and a radio signal of sufficient field intensity, a condition of non-linearity between current and voltage is set up and cross-modulation may occur. Cross-modulation is not dependent entirely on the distance of a radio receiver from the stations involved, its action being influenced more by local conditions than by relative field intensities. In fact, many of the most prevalent cases of interference are encountered in areas of very low field strength.

Cross-modulation is not a new kind of radio interference. Detailed reports and studies were made of this phenomena as far back as 1935 and in such metropolitan areas as San Francisco, New York, Chicago, Los Angeles, and Cincinnati. Several general remedies were found and recommended, and the majority of interference complaints were eliminated. As a result of the present upsurge in the



# CONVERSION NOTES

## on the BC-696-A

By JOHN T. FRYE, W9EGV

**T**HE BC-696-A and its brother members of the 274-N family constitute some of the most popular war-surplus items with the amateur fraternity. A large part of this popularity is due to the ease with which these sturdy, frequency-stable little units may be converted to various amateur uses, such as v.f.o.'s, NBFM exciters, or complete c.w.-phone transmitters.

It is the purpose of this article to point out some of the conversion methods that have proved satisfactory and to give a detailed description of the particular method worked out by the author after extensive experiments. The reader will thus be in a position either to imitate the author's methods or to make such variations on this procedure as are dictated by his tastes and the equipment on hand.

First, let us glance briefly at the transmitter as designed by *Western Electric* for the Signal corps. Fig. 2 shows the diagram of the BC-696-A which is common to all of the transmitters of the series. The legend employs the original designation of *Western Electric* as to resistors, condensers, etc.

The transmitter consists of a 1626 master oscillator driving a pair of 1625's in parallel. Inductive coupling is used between the grid circuit of the oscillator and the grid circuit of the final. The 1625's are neutralized. Power is taken from the final tank circuit by a rotating variable link, one end of which is grounded to the chassis and the other end of which connects through a variable inductance to the antenna post.

A 1629 eye tube, in conjunction with a sealed 3500 kc. crystal, is used for checking dial calibration. When the transmitter is tuned to other than the crystal frequency, the eye shadow is narrow; but when the frequency of the master oscillator approaches the resonant frequency of the crystal, the shadow angle opens, the widest angle indicating exact resonance. A trimmer, reached through a hole in the top of the transmitter, permits the oscillator to be placed in precise calibration with the dial.

A d.p.s.t. relay,  $K_{33}$ , opens the plate

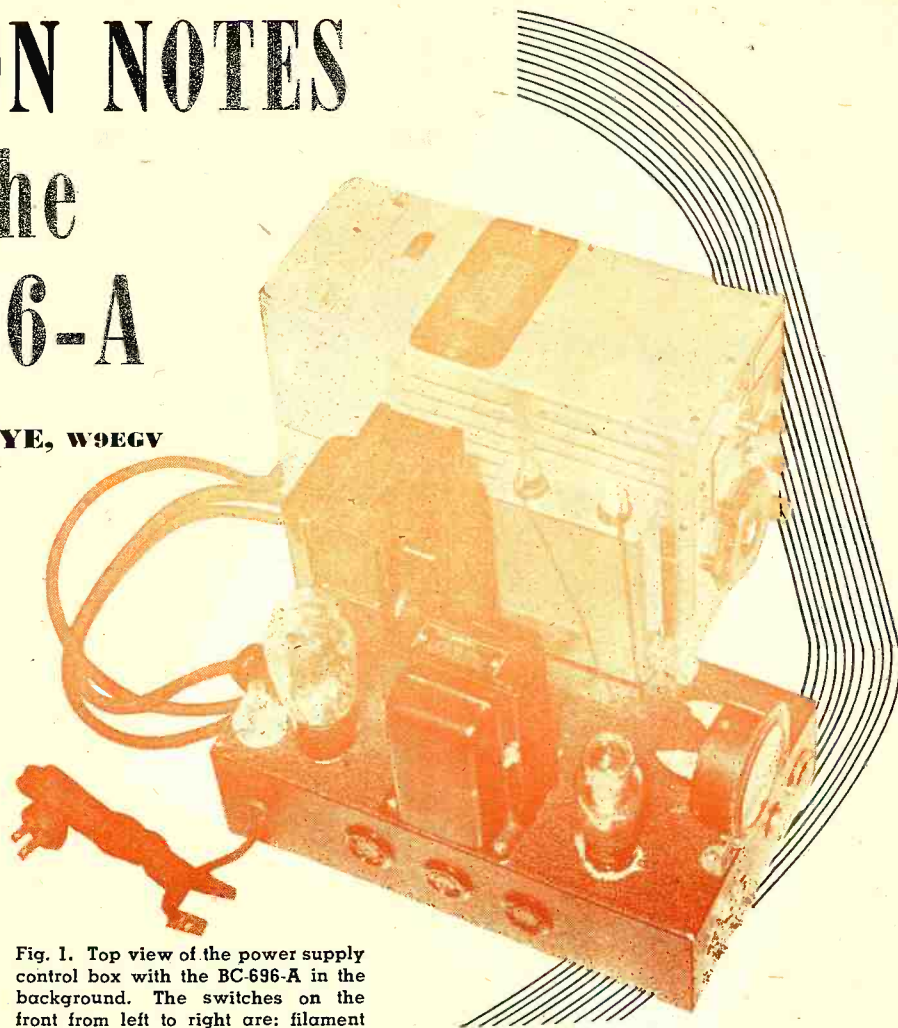

Fig. 1. Top view of the power supply control box with the BC-696-A in the background. The switches on the front from left to right are: filament control switch; the switch controlling the relay,  $K_{33}$ , used for cutting the final on and off; and the plate-power switch. Next is the key jack and to the right of this jack is the opening that gives access to the modulator jack. The shoulder-type fiber washer which serves as an insulating lining for this port can also be seen in the photograph.

**Complete details for converting a popular war surplus item. It can be used as a v.f.o., high power exciter, or as a c.w.-phone transmitter.**

lead of the oscillator and the cathode circuit of the final amplifiers—except for a 51,000 ohm resistor—when it is not energized. Another relay,  $K_{51}$ , when not energized grounds the output of the transmitter. When both of these relays are energized—they are hooked in parallel—the plate voltage is applied to the oscillator, the cathode circuit of the final amplifier is closed, and the output is connected to the antenna post.

The filaments of the two 1625's are in series across the filament supply voltage, which was 24-28 volts. This condition is also true of the filaments of the oscillator and eye tubes, although a 126 ohm resistor is added to the latter to compensate for its lower filament current rating. Total filament drain was slightly less than one ampere.

Filament voltage, final plate voltage, final screen voltage, and oscillator plate voltage were all introduced through a seven-prong socket

in the rear of the transmitter. Another lead to pin #5 permitted the relays to be energized remotely by grounding this lead. This was done so that either of two transmitters mounted in a single rack could be selected for use. All voltages were kept on both transmitters, so when the lead connected to the #5 pin of either transmitter was grounded, that transmitter was placed in action.  $K_{33}$  was not intended, as many amateurs believe, for a keying relay.

On "Phone" the 1625's were screen modulated with another 1625 by means of a modulation transformer. Under this condition, the screen voltage supply was regulated at 150 volts. On c.w. the screens were supplied with 270 volts by a series dropping resistor from the 525 volt output of the dynamotor. This full voltage was applied to the plate of the final, and a voltage divider circuit put 190 volts on the plate of the oscillator.

The transmitter was keyed in the

"B-plus" high voltage lead from the dynamotor. The keying relay thus removed all positive plate and screen voltages from the transmitter when it was opened.

Now that we know something of what the transmitter was intended to do—and no intelligent conversion job can be attempted without such knowledge—we are ready to adapt it to our use. If we convert it into a complete c.w.-phone transmitter, we will doubtless obtain the maximum benefit from the unit, for it can still function as a v.f.o. for a higher power stage. Let that be our aim.

The first consideration is what filament voltage to use. Some amateurs have used step-down transformers in conjunction with dry-disc rectifiers and filters to obtain 28 volts of d.c., but this hardly seems necessary inasmuch as a.c. works just as well on everything except the relays. If the filament circuits are left as is, around 25 volts of a.c. are needed. The filaments can be wired in parallel and a voltage of 12.5 employed. A couple of hardy souls I know substituted 807's for the 1625's, put a 6J5 in the 1626 socket, and applied 6.3 volts to the filaments wired in parallel. They

report that a small rat-tail file can be used to slot three of the holes on each 1625 socket so that an 807 can be inserted. The 1629 also works satisfactorily with only 6.3 volts on the filament, although it is a little slow in coming up to operating temperature. Of course, the 1625 sockets have to be rewired to conform with the 807 pin connections.

The author decided upon the 25 volt a.c. method and wound a filament transformer for this voltage along with another 5 volt, 3 amp. winding for a rectifier filament. The high voltage winding was figured to deliver a little more than one ampere of current. The instructions given in the June 1947 issue of RADIO NEWS in the article "Practical Transformer Design and Construction" made this a simple matter.

The power supply pictured and diagrammed (Figs. 4 and 5) was then built up. This supply delivers around 500 volts under load and has no detectable hum or ripple when used on the transmitter. The selenium rectifier is used in conjunction with the filament circuit to produce some 18 or 20 volts of d.c. for operating relay  $K_{53}$ . The resistors used for obtaining screen and

oscillator plate voltages are identical with the values originally specified for this purpose.  $J_1$  is intended for the insertion of modulation. As can be seen from the photograph, it is set back from the front panel on a little piece of bakelite and is reached through a hole that is protected from shorting by an extruded fiber washer cemented into position. This is a safety feature to protect the operator from contact with the high voltage. Other high voltage points above the chassis are heavily taped. It will be noted that when the plug carrying the modulation voltage is inserted in  $J_1$ , the screen supply as well as the plate supply of the final is modulated.

$J_2$  is a keying jack in the "B-minus" lead. It is important to note that the centertap of the high voltage transformer, one side of  $C_2$ , and one side of  $R_1$  all connect to a common point other than the chassis and are returned to the chassis only through  $J_2$ .  $PL_1$  is a #46 pilot lamp that is used as a cheap fuse. It is good protection for the rectifier and transformer. All voltages are taken out of the rear of the power supply through a large 7-prong socket whose numbering is

Fig. 2. Complete schematic diagram and parts list for the BC-696-A as they appear in their original form. Complete details for converting this unit for various amateur uses are given in the text.

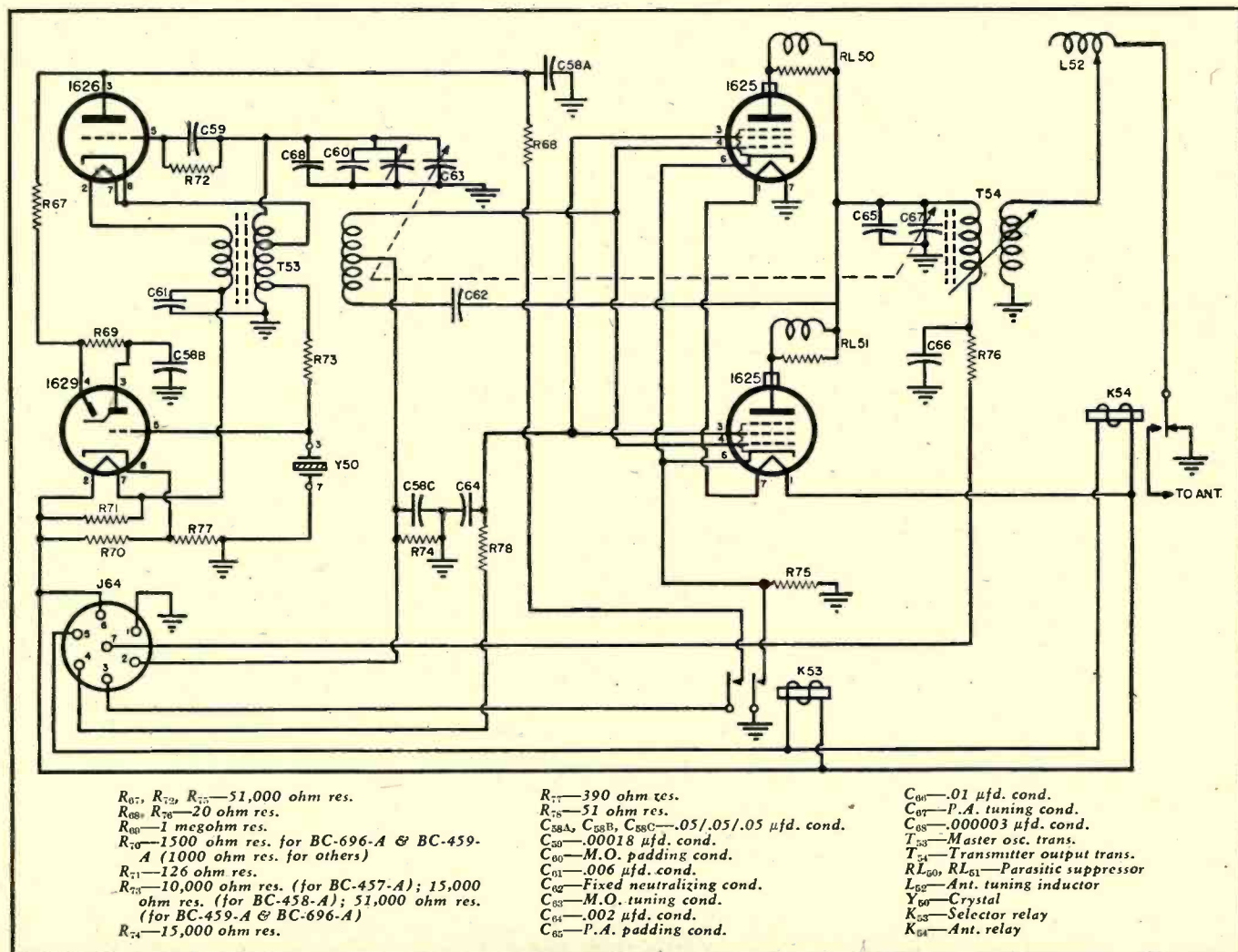

identical with that on the socket of the transmitter. This makes wiring of the cable connecting the two much more simple than would otherwise be the case.

The sockets seen along the side of the power supply are used as follows: A plug inserted in  $SO_1$  carries 117 volts a.c. to the filament and plate circuits of the modulator and speech supply. The filament primary is connected to the leads from pins 1 and 3; the plate primary from leads 1 and 2.  $SO_2$  is intended to receive a plug carrying a three-wire cable to a pair of remote switches in parallel with  $S_1$  and  $S_2$ . The filament switch goes across pins 3 and 4; the plate switch across pins 3 and 2.  $SO_3$  is intended to receive a plug carrying leads to an antenna changeover relay, a send-receive relay and a pilot lamp or other device it is desired to excite with 117 volts a.c. when the plate voltage is turned on. Leads to these relays are soldered into the plug in pairs: 1 & 6, 2 & 5, 3 & 4. Since each socket has a different prong arrangement, it is impossible to insert a wrong plug.

An OD3/VR150 can be inserted in the socket shown in dotted lines in the diagram (Fig. 5) when low output and maximum frequency stability is desired, such as when the unit is being used as a v.f.o. followed by several doubler stages; but it is not necessary when operating on 75-meter phone and should not be used on 80 meter c.w. More on this subject later.

The next step is to make necessary changes in the transmitter itself. First, take out the front window and lift the little spring carrying the antenna relay contact over the top of the portion of the antenna post jutting inside the case. The spring will hold the contact firmly down on top of this post and effectively short out the antenna-connecting contacts.

Next take off the bottom of the case. Cut off the lead going to the #2 connection of the socket on the rear of the transmitter. Simply cut it loose and tuck it back out of the way. This will give you a spare connection for future use. Cut loose from #5 connection the lead running to relay  $K_{53}$ . Leave the lead running to  $K_{53}$ , which can be seen mounted on the side of the case, connected. Change the lead that runs from  $K_{53}$  to the #1 pin of the 1625 farthest from the relay to the #7 pin of the tube nearest the relay.

Remove the lead going to one of the oscillator plate circuit contacts of  $K_{53}$  and solder it to the lead going to the opposite contact so as to prevent any opening of the plate circuit by the relay.

Remove  $R_{70}$  and  $R_{71}$ —each has one end soldered directly to lug # 8 of the eye tube socket—and solder a 2500 ohm,  $\frac{1}{2}$  watt resistor in the place of  $R_{71}$ . This will prevent the a.c. of the filament circuit from blurring the shadow angle of the eye.

Finally, solder the wires of a seven-

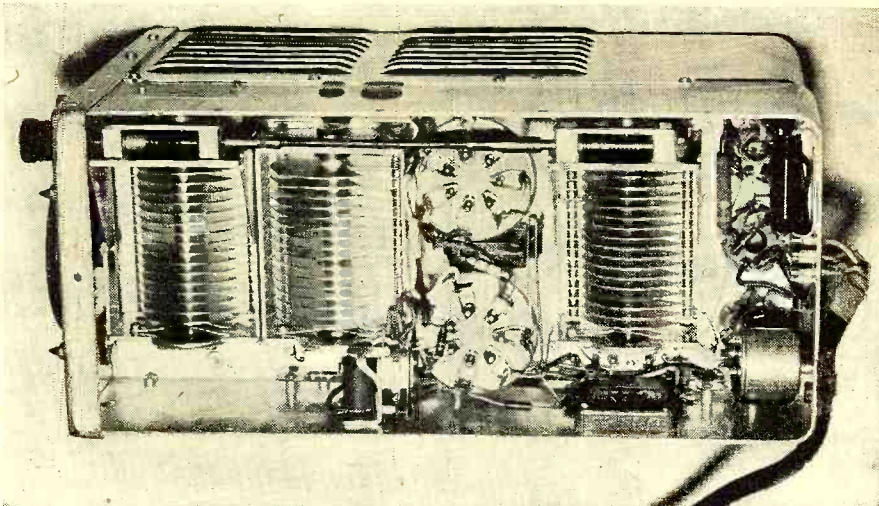

Fig. 3. Bottom view of transmitter. The cathode resistor for the eye tube is shown in front of the black wirewound resistor bolted to the rear of case. The method for attaching and securing the cable is also shown. The selector relay,  $K_{53}$ , is shown attached to the side of the case.

wire cable, each wire of which is well-insulated and the filament wires of which are #20 or larger, into the receptacle holes of the socket on the rear of the transmitter. A clamp is used to hold the cable firm against the transmitter case and to prevent any pulling on the soldered connections. On the other end of the cable, solder the wires into the corresponding-number pins of a large seven-prong plug. When this cable is plugged into the socket on the rear of the power supply, the BC-696-A is ready to function.

$S_1$ , nearest the corner of the chassis, turns on the filaments of the transmitter and that of the rectifier. When  $S_2$ , next to it is closed, relay  $K_{53}$  closes, shorting out the 51,000 ohm resistor in the cathode circuit of the final amplifier. When  $S_2$  is closed, plate current is turned on. Any time that  $S_2$

is opened it causes  $K_{53}$  to open and effectively shuts off the final amplifier, allowing the oscillator to be zero-beat with a signal.

To operate on c.w., simply insert a plug from the key or bug in  $J_2$ . Since the transmitter is dead with the key up, break-in operation can be used. Some amateurs are using  $K_{53}$  as a keying relay. The author discarded this system for the following reasons: 1. He doubted the relay would stand up long under keying; 2. he did not like the clatter the relay made with the aluminum case as a sounding board; 3. this form of keying resulted in bad clicks which could not be cured because of the lack of room for a key-click filter inside the case. After trying cathode keying of the final, plate-keying of the oscillator in conjunction with cathode keying of the final by  
(Continued on page 120)

Fig. 4. Bottom view of power supply. The filament transformer is shown bolted to the side. Beside it is the selenium rectifier. The method of insulating the modulation jack is also shown in the photograph.

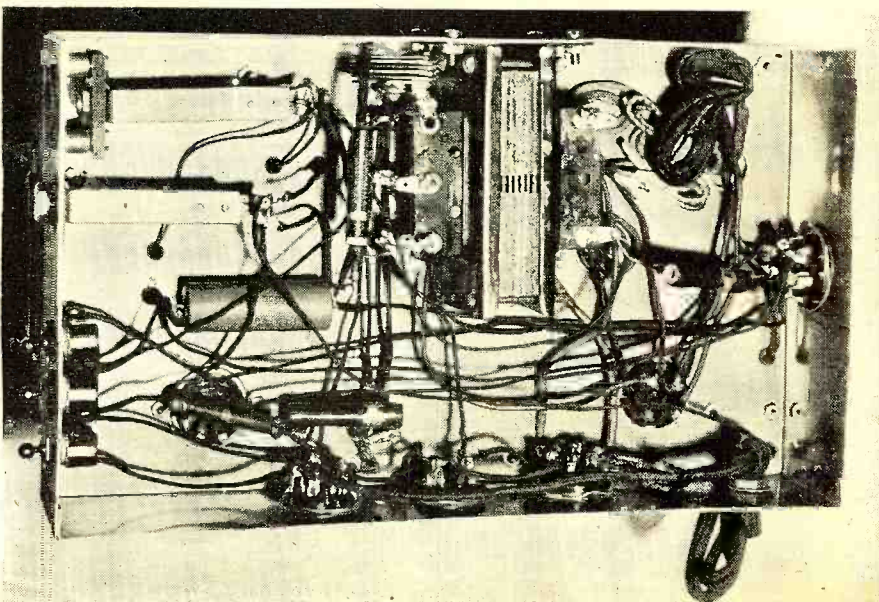

# SPEECH BLOCKADE

By  
**C. E. ATKINS**  
Tung-Sol Lamp Works, Inc.

**The design and operation of a novel gadget, ideal for  
the experimenter. Circuit permits discrimination  
between music and speech in radio programs.**

THE radio technician or service engineer with an experimental turn of mind can derive considerable pleasure from the novel control system described in this article. Frequently one desires to listen only to musical programs and to have all speech deleted. This is particularly true when one is compelled to listen to the many programs composed of occasional musical renditions separated by long commercial announcements. Under such circumstances the pleasure obtained by having the announcer's voice automatically fade out approaches ecstasy. Such pleasant results can be virtually achieved, depending in part on the experimenter's ingenuity. It must be definitely understood at the outset that the system described here is not foolproof and does not absolutely eliminate all of the speech while admitting all of the music. When properly constructed and adjusted, it will effectively reduce the quantity of talking that gets through while inadvertently removing a phrase of music now and then. This fact is probably fortunate inasmuch as a completely effective "decommercializer" would raise havoc with the economics of radio broadcasting. Nevertheless some interesting results can be coaxed out of the system and the writer presents it here in the belief that some of the more intrepid of RADIO NEWS readers might care to try their hand at it.

Fig. 1 shows, in outline form, the instrumentalities underlying almost any approach to the problem. Program material from the second detector is fed through the audio amplifier to the output transformer and the speaker voice coil while, concurrently, it is also being fed to an analyzer which determines whether it is speech or music, so as to control a relay accordingly. The contacts of this relay shunt the speaker voice coil so that when the relay is closed the voice coil is shorted and the loudspeaker is not energized. The design of the am-

plifier may be predicated on any of the known differences between speech energy and music energy. In the present system the difference in the ratio of the peak energy to average energy between speech on the one hand and music on the other is employed. This is graphically shown in Fig. 3, where *A* is an oscillogram of a typical speech passage while *B* is an oscillogram of a typical music passage. It can be seen from this figure that the music energy has a degree of continuity in marked contrast to the intermittent character of the speech energy. A circuit sensitive to this characteristic difference between speech and music energy is utilized to determine whether the relay will short circuit the speaker voice coil.

A simple and effective means for discriminating between the waveform of Fig. 3A and that of Fig. 3B is shown in Fig. 4. Audio frequency energy appearing across a load resistance,  $R_9$ , is rectified by the first diode section and appears as a pulsating d.c. potential across the network  $R_{11}-C_8$ . Both of these components have relatively low values so that the combination has a small time constant. A relatively large condenser,  $C_7$ , is charged through a high resistance  $R_{10}$ . In practice  $C_7$  may be .1 microfarad and  $R_{10}$  5 megohms.  $C_8$  is .05 microfarads while  $R_{11}$  is 100,000 ohms. Voltages between point "X" and ground can appear and disappear rapidly in responsive conformity to the program wave-

form. A voltage pattern approximating the envelope of this waveform will appear here. A voltage can develop between point "Y" and ground (across  $C_7$ ) only very slowly because of the time required to charge  $C_7$  through the relatively high resistance  $R_{10}$ . However, the voltage at point "Y" can disappear rapidly because  $R_{10}$  is shunted by a thermionic diode (second section of the 6H6) connected in a polarity such that while the charging current for  $C_7$  is compelled to flow through  $R_{10}$  the discharge current flows instead through the low resistance of the diode's cathode-anode space.

With a mechanism of this character, intermittent audio energy such as speech is incapable of producing and maintaining an appreciable potential across  $C_7$ , whereas music energy, having a more continuous character, is able to charge  $C_7$  and maintain point "Y" at a relatively high and continuous potential. Of course, the magnitude of the energies applied to the network must be kept under control and the writer has found it helpful to use a limiter ahead of the audio frequency rectifier (first section of diode tube). A simple way of doing this is disclosed in the over-all circuit diagram, Fig. 5.

In Fig. 5 audio frequency from the second detector is fed through a separate volume control, provided for the purpose, to the grid of a voltage amplifier. The output of this stage is applied to a driver which, in turn, energizes the mechanism disclosed in Fig. 4. Voltage developed at point "Y" is applied to the grid of a control tube, in the plate circuit of which is a relay. The contacts of the relay are connected across the speaker voice coil so as to short circuit it when the relay solenoid is energized. It is naturally possible to have the relay connected so as to open the voice coil circuit while disabling it if such is desired. An electrolytic condenser ( $C_9$ ) is shunted across the relay solenoid in order to stabilize its action. It may

Fig. 1. Block diagram shows principle of operation of speech blockade circuit.

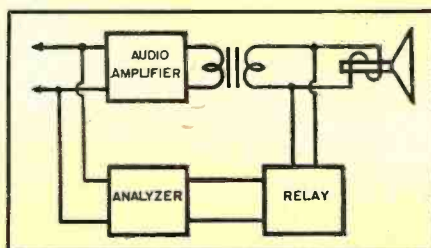

also be necessary to shunt the solenoid with a resistor in order to bring its operation within suitable range.

The choice of control tube will depend upon the relay at hand or vice versa. The writer had an old telephone relay in his junk box which would close at 15 ma. and release again at 11 ma. It is shunted by a resistance of 10,000 ohms in order to shift the operating range upward a bit. A 6AQ5, 6V6GT, or 6K6GT triode-connected was found to make a satisfactory control tube with this particular relay. If a more sensitive one is available a tube with a lower plate current, such as a 6SK7GT or even a triode such as a 6C5GT, 6J5GT, or 6P5GT may be used. In the writer's setup with a 6K6GT, approximately 20 volts is required at point "Y" in order for the relay to open and the speaker to become operative. At 9 to 11 volts the relay closes again, shorting the speaker voice coil. These voltages must be measured with a high impedance vacuum-tube voltmeter.

The diode sections can be in a single tube such as the 6H6GT or 6AL5. The driver tube in the writer's apparatus was a triode-connected 6SK7GT. A high transconductance triode would probably work just as well. Limiting action is achieved at this point by means of a resistor  $R_6$  in series with the driver grid. Positive excursions of the audio frequency waveform are clipped off due to grid current flow through the resistor  $R_6$ . This gives us limiting action on positive swings only but this is sufficient because the cathode of the first diode section is connected to the plate load of the driver tube and only negative swings are rectified by it. Because of the phase reversal in the driver tube, plus direction limiting action is satisfactory. Some a.v.c. is developed by virtue of grid rectification and the time constant of  $C_1R_6$ .

In adjusting the control circuit, an oscillograph and a vacuum-tube voltmeter are very helpful. The writer also found that phonograph records aided greatly at this point. Two turntables were set up, one playing a mu-

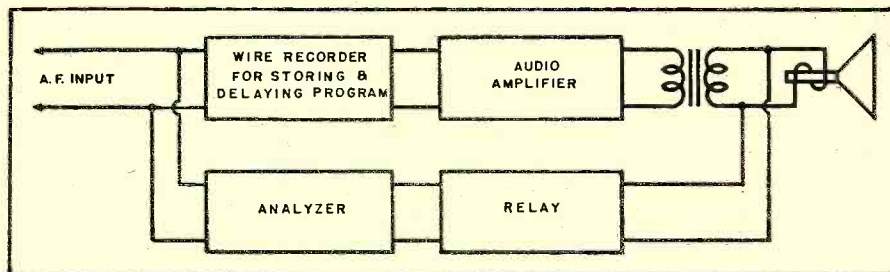

Fig. 2. Block diagram shows functional operation of a more refined circuit. Program material is stored for a more accurate analysis of its voice or music contents.

sical recording while the other was rendering a political speech. A switch was provided for quickly changing from one pickup to the other. The control unit and an audio frequency amplifier and speaker were simultaneously fed energy from one or the other of the records. By adjusting the volume control  $R_1$  while switching back and forth between music and speech, a level will be found where the music will develop a sufficiently sustained voltage at point "Y" so as to reduce the plate current of the control tube enough to de-energize the relay, thus removing the short circuit from the speaker voice coil. Speech energy, on the other hand, will not, as a rule, be sufficiently continuous in its character to do this. While the limiting action previously described helps to compensate for variations in program levels, reasonably close attention must be paid to the setting of the volume control  $R_1$ .

When using the control unit with a radio receiver, audio frequency energy may be picked up at any convenient point ahead of the output while the relay contacts are, of course, connected across the speaker voice coil. If the receiver's a.v.c. is not flat in its action a different setting of  $R_1$  may be indicated when different stations are being received. As stated in the beginning of this article, a control system of this kind is not perfect in its action, as occasional musical passages will be missed and now and then an unwanted word or phrase of speech will slip through. In the writer's ex-

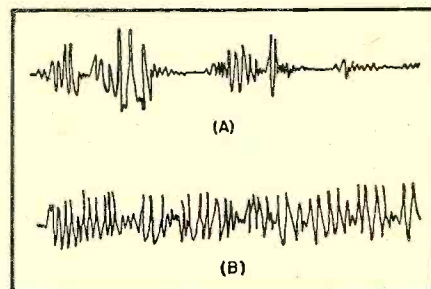

Fig. 3. The design of amplifier is predicated on known differences between speech (A) and average music energy (B).

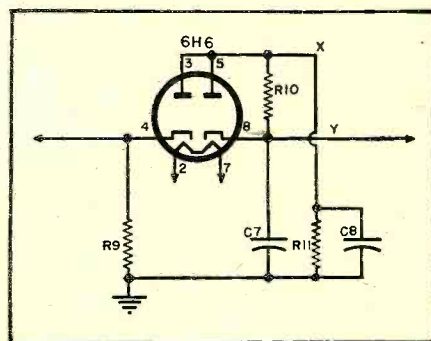
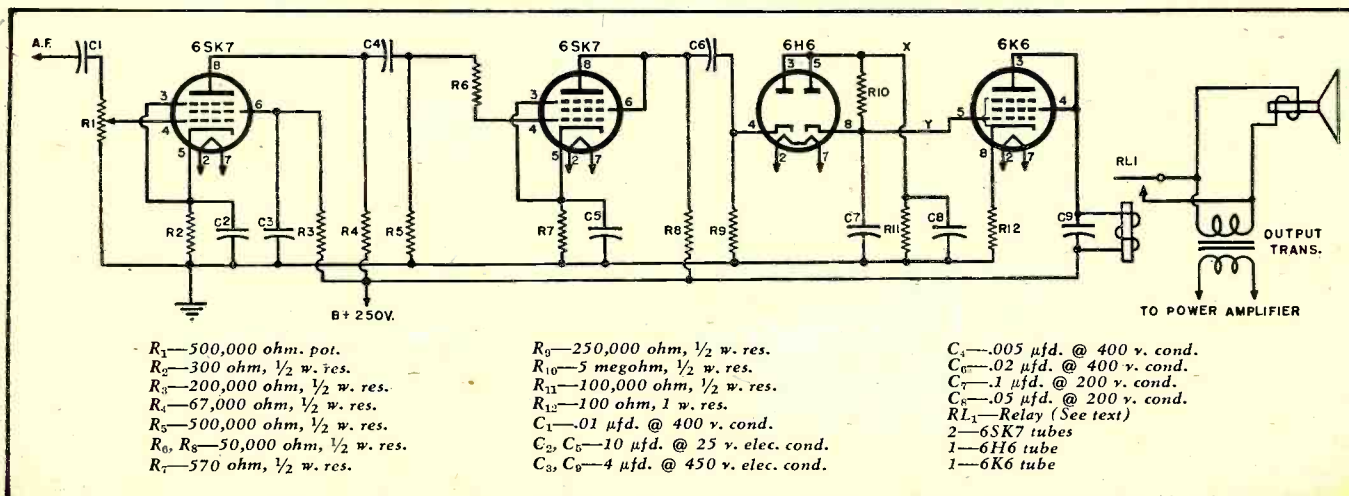

Fig. 4. Basic circuit used to discriminate between voice and music waveforms.

perience piano solos got the least favorable treatment as far as music is concerned. And, of course, the device is not very much protection against singing commercials.

Devices of this kind are capable of  
(Continued on page 191)

Fig. 5. Over-all circuit of speech blockade system incorporated in a standard home receiver.



# The RECORDING and REPRODUCTION of SOUND

By  
**OLIVER READ**  
Editor, RADIO NEWS

## Part 13. A discussion of the characteristics of cutting styli and conditions governing their proper use.



Fig. 1. "Stellite" cutting stylus for disc recording.

**T**HERE are, in general, three basic types of recording styli in present use. These are: the sapphire, alloy, and steel. The cutting stylus acts in the same manner as does the tool which cuts into material on a revolving lathe. As a matter of fact, the cutting stylus is shaped somewhat like a lathe tool. There is one basic difference, however—the tip of the stylus is the only portion of the assembly which does any actual cutting. For that reason, only the tip need be of hardened material. Normally the stylus cuts a groove in the record of approximately .003 inch in depth. Obviously only that part of the stylus within .003 inch of the tip is subjected to wear. The remainder of the stylus is known as the shank. This is the supporting and enclosing medium which serves merely as the connecting link between the cutting head armature and the portion of the stylus which does the cutting.

It is of major importance that standards be met when manufacturing a stylus for the recording of a sound track in a disc. Not only must the cutting edges of the stylus tip be extremely sharp and free from imperfections, but the sides of the tip must be polished to a very smooth surface. If the cutting edges are not sharp the chip will literally be torn from the blank instead of being cut with a clean stroke as illustrated in

Fig. 2. The result will be a groove that is noisy. If the sides of the groove and stylus tip are not polished, groove and stylus cuts will be rough and these will cause undue noise in the recording. Therefore, the groove, after being cut by the stylus, should actually shine (Fig. 4). This indicates that a properly polished and sufficiently sharp stylus has been used. A dull finish on the sides and bottom of the groove indicates that a stylus has been used which is unduly worn or which is otherwise defective.

Most recorders today, except for the inexpensive home recorders, employ a sapphire cutting stylus. These require a high degree of workmanship. If the stylus is inaccurately ground and improperly polished it will not give good results. In fact, results will be inferior to those achieved with a new steel stylus of quality manufacture.

The cutting life of a stylus depends

upon several factors; first, the hardness of the material on the blank and second, the lineal velocity of the record groove. For example, a stylus will cut longer when cutting twelve inch records at 33 $\frac{1}{3}$  r.p.m. than when cutting the same diameter at 78 r.p.m. This is because the heat generated at the stylus tip becomes greater as the speed increases.

Sapphire styli may be made from the genuine gem or from synthetic sapphire (aluminum oxide). The gem sapphire is slightly more expensive but will have longer cutting life before requiring repolishing and resharping. Both genuine and synthetic styli of this type take a high polish, a feature which is of extreme importance. They both have a low coefficient of friction and are very hard.

Sapphire styli may be resharpened many times and will give many hours of trouble-free service. Because of this long life and because they can be resharpened at a fraction of their initial cost, these styli are no more expensive to use than other types. The chief disadvantage is their fragility. The sapphire is quite brittle and very hard. This means that the tip of the sapphire can be easily chipped. A dulled sapphire can be resharpened but a chipped one cannot. When chipping occurs, the stylus must be discarded.

The tiny tip material is enclosed and mounted in a tubular metal shank. The mounting of these tiny points is extremely critical. There must be no side play, that is, the stylus tip must be firmly embedded into the shank where it cannot assume any motion other than that presented from the armature in the cutting head. The better the bond between the shank and stylus tip, the better

Fig. 2. Stylus angle adjustment.

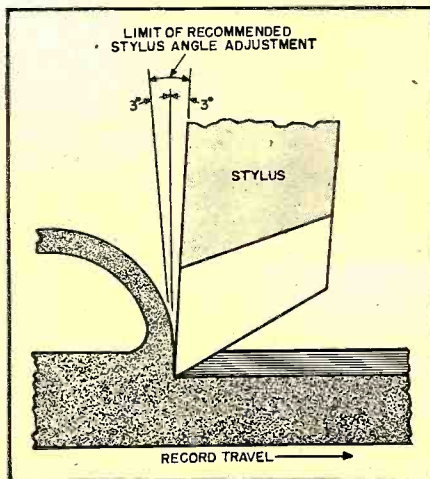

will be the high frequency response. The sapphire must, accordingly, be handled with great care. To accidentally drop the stylus onto a disc is disastrous. Chances are the tip will be ruined.

A tremendous strain is placed upon the edges of the recording stylus as it cuts the record groove. The amount of surface noise will depend largely upon the ability of the stylus to retain a sharp edge. In other words, the sharper the edge, the quieter will be the resulting recording. If the edges are dull, the result will be a tearing of the disc material in the groove and the background noise will increase materially. It is, therefore, highly important that the cutting edges be extremely sharp in order that all high frequency undulations be properly impressed on the groove walls. The humps in the vibration waves will vary according to frequency. The low notes or tones will have humps which appear farther apart within the groove than will the high frequency tones or notes. This condition is aggravated where high frequencies appear at low record groove diameters. This is still another reason for using only the best material for the cutting stylus. Furthermore, if sharp edges are not retained, the soft plastic material on the disc will tend to flow instead of being cut properly. Such a condition will result in a recording which sounds mushy or distorted.

Various attempts have been made, some with great success, to develop a cutting stylus making use of an alloy. Usually these styli have a brass or dural shank and only the tip is of the cutting alloy. Some of these styli, using hard material, will last almost as long as a good sapphire. The cost is considerably less however. The chief disadvantage is that these styli have considerably more surface noise than the sapphire and therefore most of the more popular alloy tipped cutting styli employ a metal somewhat softer than the sapphire in order to facilitate proper shaping of the tip and to thereby obtain a lower coefficient of friction. One of these is known as a "Stellite" which is tipped with a metal bearing that name (see Fig. 1). It is capable of cutting records for approximately two hours. It may be resharpened for about one-half the cost of a new unit. There is little or no danger of this type of stylus chipping, which is the main reason for its popularity. It is particularly well suited for the home recordist as the hazards of ruining a good cutting stylus are greatly reduced. There are many alloy materials employed for a cutting stylus. These are known as "precious metal tipped styli." One is about as good as another and, as previously mentioned, they are ideally suited to the home recordist.

#### Steel Styli

The most inexpensive material to use for a cutting stylus is ordinary

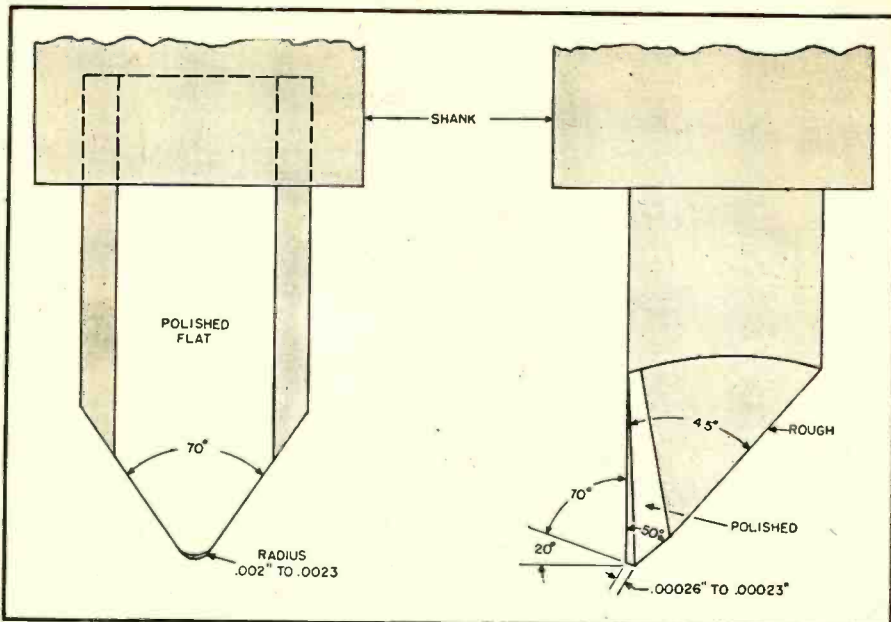

Essential dimensions of sapphire cutting stylus used for lateral recording.

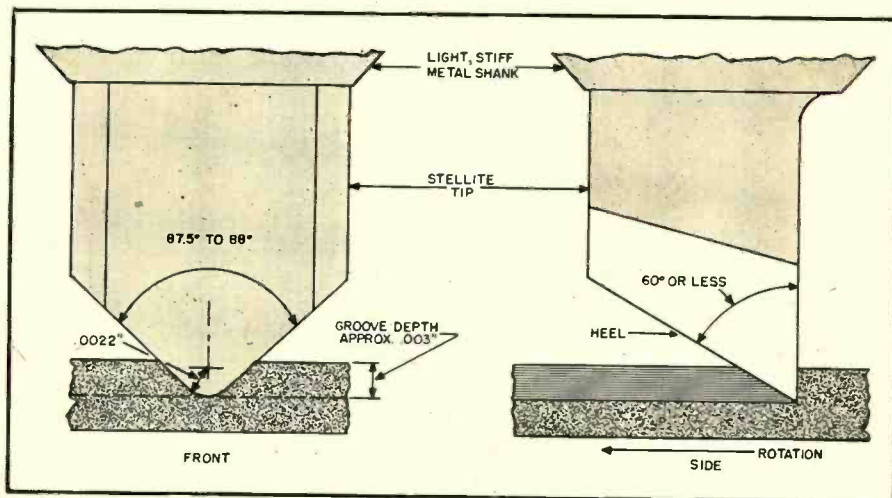

Fig. 3. Essential dimensions for steel or "Stellite" cutting stylus.

hard polished steel. There is little hazard from damage when employing such styli. Their life is extremely limited and, figured on a service-per-hour basis, steel styli are actually more expensive than sapphires. They cost from about twenty-five cents to

seventy-five cents each and have a useful life of approximately thirty minutes.

For the first few seconds they will possess a very sharp, keen cutting edge. However, they dull quickly and the recording gradually becomes quite

Fig. 4. Record cut with new stylus (left). Effects of cutter bounce (right).

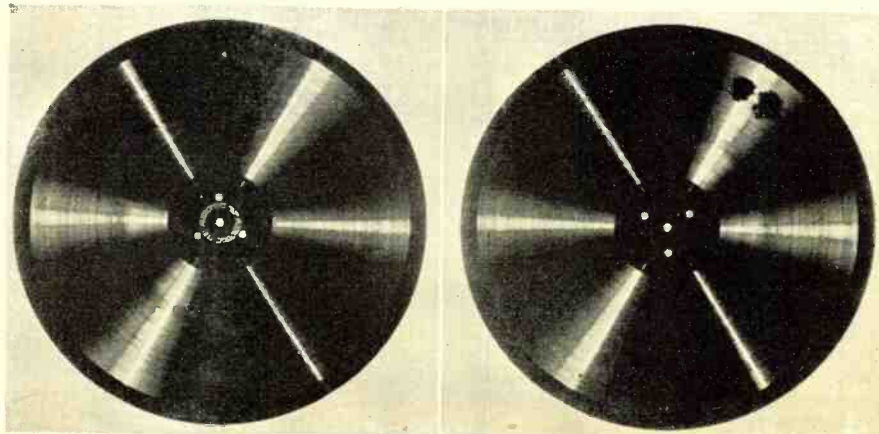

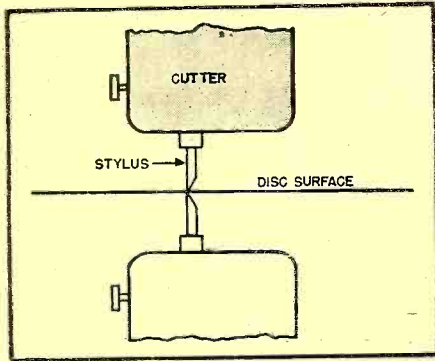

Fig. 5. Correct cutting angle of a stylus may be checked by viewing the reflection of the cutting stylus on the shiny surface of an uncut blank when the turntable is in a stationary state.

noisy. The response of a steel stylus is not as good as a sapphire and it is not capable of engraving the high notes comparable to a sapphire. However, the response is sufficiently good to handle speech and general home music where the highest overtones are not appreciated. Steel styli cannot be resharpened or polished and must be discarded after about thirty minutes of use.

#### Cutting Angle

The correct cutting angle for the stylus will depend upon the type of head used, the type of material being cut, and the angle on the face of the cutting stylus. If the cutting angle is

not correct, there will be an appreciable increase in surface noise. In addition, difficulty will be encountered in controlling the thread or chip as it leaves the record from the cutting process. The result will be high surface noise and squeaking. Many recordists prefer a slight "dig in." This means that the cutting face of the stylus leans slightly forward. Others insist the best results can be obtained only when a slight amount of "dig out" is employed, that is, when the cutting face leans slightly backward from vertical. There is no specific rule of thumb for the correct cutting angle of the stylus. The correct position can be most accurately determined only by cut and try. A test record should be cut without modulation. The unmodulated grooves should be shiny and free from any dullness when viewed in direct light. The record may be played back with a known quality reproducing stylus and the listening test will determine whether or not the cutting has been properly done. If, when played back through an amplifier, there is undue hiss, noise, or squeak on the record it will indicate that an incorrect cutting angle has been employed.

Usually, with good equipment, a correct cutting angle will be found within two or three degrees of a ninety degree vertical. The cutting angle applies whether the cutting face of the stylus leans forward or backward. It does not depend on whether the

face is turned one way or another, that is, from side to side. The cutting face of the stylus is pitched slightly as an aid in throwing the chip toward the center of the record. This pitch angle is rarely more than about two degrees. The normal tendency is for the scrap or chip material to fall to the inside of a revolving disc rather than to the outside, therefore, a slight pitch is employed as an aid in steering the chip toward the center of the disc. The cutting angle or angle which the cutting face makes with the surface of the record is checked by viewing the reflection of the cutting stylus on the shiny surface of an uncut blank (Fig. 5) when the turntable is in a stationary position. By looking directly toward the side of the cutter, an imaginary straight line is viewed from the reflection of the stylus both above and below the surface. If there appears to be a continuous straight line, chances are that the stylus is close to the proper vertical position. Any deviation from a straight line will indicate a leaning forward or leaning back of the cutter and its associated stylus. In some cases the cutting face is not parallel to the shank of the stylus. Some manufacturers vary the angle of the face of the stylus considerably. Inasmuch as there are no standards at this writing, no specific stylus can be discussed as being the best suited for general recording purposes. It is well to heed the advice of the cutter manufacturer when selecting styli.

One high quality stylus has a seventy degree angle and employs a short shank. Another has a ninety degree angle and short shank and is recommended for use with a particular cutting head when recording on acetate-lacquer blanks. If a long shank stylus is used, records will be approximately two decibels louder for the same recording level but the frequency response will be poor beyond 8000 c.p.s. and a severe high frequency peak may develop in this region.

#### High Fidelity Recording

As mentioned in earlier paragraphs, steel or even tungsten styli can be used but they have a shorter life and are not usually satisfactory for high fidelity work, since in general they produce a groove having a higher noise level. Sapphire styli are recommended for all recording except unimportant tests. A sharp cutting stylus will remove the thread quietly and smoothly. The only noise should be that of the recorder head itself which "talks" audibly during the louder passages. In other words, when test cuts or blank grooves are cut, there should be no tearing or scraping sound. By placing the ear close to the record it is possible to hear the cutting which should sound even in character and have a faint steady hiss. The stylus can be adjusted for minimum noise while operating. The amount of noise heard while cutting a blank groove is a

(Continued on page 148)

Characteristics of recorded grooves. All except (F) have been cut without modulation.

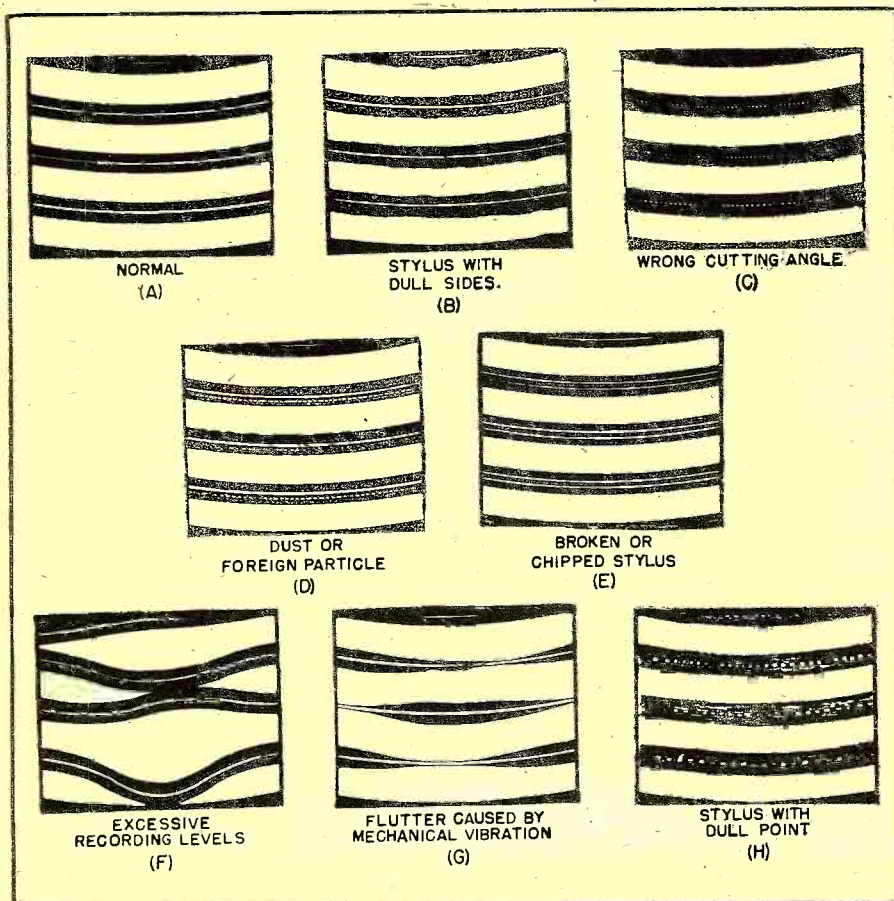



# THE MINITRAN

By  
**R. C. AMUNDSEN**  
WIHYF



Over-all view of completed unit. An external power supply is required.

**Easy to build and low in cost, this compact rig is ideal for an emergency or portable transmitter.**

**M**OST ham transmitters are not suitable for strictly portable or emergency operation. They are generally large, heavy, and, most important, inflexible as far as power supply is concerned. To satisfy the requirements for a typical portable and/or emergency transmitter the "MiniTran" was developed on paper and subsequently constructed. Previous attempts at small transmitters using one tube proved the value of a separate crystal oscillator. Too often a one tube transmitter becomes hard to adjust for proper keying, especially when used with makeshift antenna equipment. Therefore, a 6C4 is used in a Pierce oscillator driving a 6AQ5 as an amplifier or a doubler.

In place of the r.f. choke usually found in the plate circuit of a Pierce oscillator a 100,000 ohm resistor works satisfactorily. This also keeps the plate voltage down to a reasonable value. Protective bias is provided for the 6AQ5 in the form of a 330 ohm resistor in the cathode return. A standard two-circuit jack is provided for keying both cathodes simultaneously. This may also be used to connect a milliammeter to measure the total current of the entire transmitter. Shunt-feed is used in the amplifier so that "B plus" voltage is not exposed on the tank coil. It is to be remembered, of course, that in operation even this small transmitter can yield a nice r.f. burn. By using the two miniature tubes plenty of space is provided on a chassis measuring 5 1/4" x 3" x 1 3/4". In fact, there is room left to add another

6AQ5 as a one-tube modulator. A three-terminal Jones male plug is included to make power supply connections. The tank condenser is equipped with a slotted shaft and rarely has to be adjusted in practice even when shifting bands. In fact, because of the untuned Pierce oscillator circuit and just the one tuning control this little rig is capable of changing frequency and bands very rapidly.

A 5/8-inch Greenlee chassis punch is almost a necessity when building equipment using miniature tubes. A 3/4-inch punch was used to clear the center terminals of the National type AR16 coil socket. Two phone tip jacks are used for antenna link con-

nections but small feed-through insulators could have been used as well. The chassis is one of the many small meter cases which have been available from distributors for the last few years.

The power requirements for the "MiniTran" are 6.3 volts a.c. or d.c. at .6 amp and about 300 volts d.c. at about 30 ma. This can be supplied by an ordinary receiver supply or a storage battery and small vibrapack. This rig has been used both on 80 meters and 40 meters and has almost as much output on 40 meters when doubling from an 80 meter crystal as when running straight through. An-

(Continued on page 179)

Schematic diagram. A conventional Pierce oscillator is used.

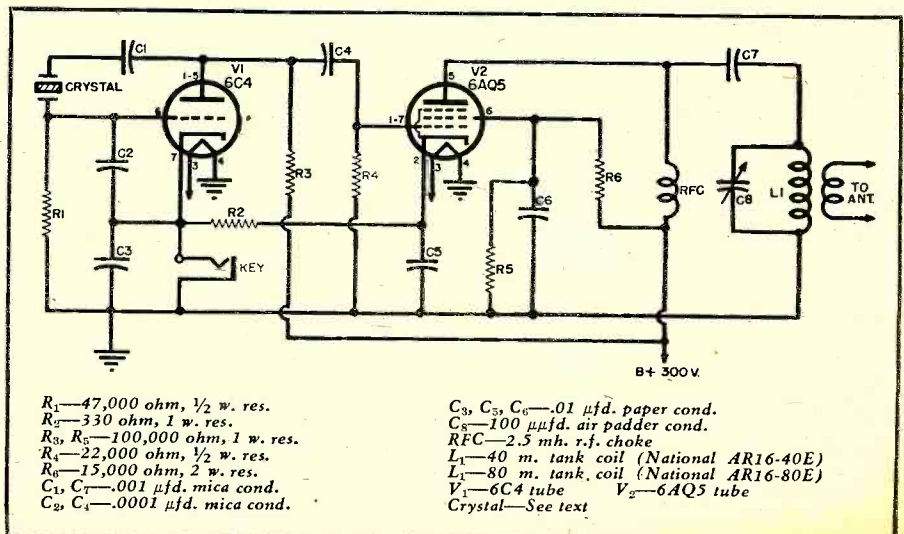



# International

# SHORT-WAVE

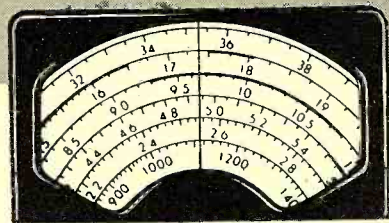

Compiled by **KENNETH R. BOORD**

**Concluding the world-wide listing of short-wave stations begun in the February issue. Stations listed cover from 9.475 through 35.000 mc.**

## WORLD-WIDE LIST OF SHORT-WAVE BROADCASTING STATIONS

- \*9.475—VONG, St. John's, Newfoundland, 300 w.  
 \*9.480—Brussels, Belgium, "Radio Nationale Belge," 5 kw.  
 9.480—Moscow.  
 \*9.480—XGOA, Nanking, China.  
 9.485—CP38, La Paz, Bolivia, "Radio Nacional," 250 w.  
 \*9.490—GWF, London, 50-100 kw.  
 \*9.490—KNBA, Dixon, Calif., U.S.A., 50-100 kw.  
 \*9.490—KNBI, Dixon, Calif., U.S.A., 50 kw.  
 \*9.490—KNBX, Dixon, Calif., U.S.A., 100 kw.  
 \*9.490—WOOW, New York, N.Y., U.S.A., 50 kw.  
 \*9.490—ZBW3, Victoria, Hong Kong.  
 \*9.500—CR6RL, Luanda, Angola, 1 kw.  
 \*9.500—OAX6D, Arequipa, Chile, 5 kw.  
 \*9.500—Paris, "Radiodiffusion Francaise," 100 kw.  
 \*9.500—XKPB, Taiyuan, China, "Shansi Broadcasting Station," 200 w.  
 9.500—XEWV, Mexico City, Mexico, "La Voz de la America Latinak," 10 kw.  
 9.500—OAX6D, Arequipa, Peru, "Radio Continental," 300 w.  
 9.500—Sverlovsk, U.S.S.R.  
 \*9.500—CR9AA, Macao, Macau, Portuguese China.  
 9.500V—OIX2, Lahti (Helsinki), Finland, 20 kw.  
 9.503—KZPI, Manila, Philippines, "Radio Philippines," 250 w.  
 9.503—Belgrade, Yugoslavia, "Radio Belgrade," 10 kw.  
 \*9.504—OLR3B, Prague, Czechoslovakia, 30 kw.  
 9.505—CP38, La Paz, Bolivia.  
 9.505—JVW2, Kawachi, Japan, "N.H.K.," 20 kw.  
 9.505—HOLA, Colon, Panama, "Radio Atlantico," 20 kw.  
 9.510—GSB, London, 50-100 kw.  
 \*9.515—XERE, Villahermosa, Mexico, 125 w.  
 \*9.515—KZFM, Manila, Philippines, "The People's Station."  
 9.515—Geneva, Switzerland, "United Nations' Radio."  
 \*9.515—ZBW3, Victoria, Hong Kong, 2.5 kw.  
 9.520—VLW7, Perth, Australia, "A.B.C.," 2 kw.  
 \*9.520—La Paz, Bolivia, "Radio Illimani," 250 w.  
 9.520—Colombo, Ceylon, "Radio SEAC," 1 kw.  
 9.520—OZF, Skamlebak (Copenhagen), Denmark, 6 kw.  
 9.520—Paris, "Radiodiffusion Francaise," 100 kw.  
 \*9.520—HEU2, Berne, Switzerland, 25 kw.  
 9.520V—OAX4K, Lima, Peru, "Radio Central," 200 w.  
 9.523—Johannesburg, South Africa, SABC (Johannesburg III), 5 kw.  
 \*9.525—Luxembourg, Luxembourg.  
 9.525—OQ2AA, Leopoldville, Belgian Congo, "Radio Leo," 50 w.  
 9.525—GWF, London, 50-100 kw.  
 9.525—JVU, Nazaki, Japan, 40 kw.  
 9.525V—ZBW3, Victoria, Hong Kong, China, 2.5 kw.  
 9.525—WGEO, Schenectady, N.Y., U.S.A., 100 kw.  
 9.527—Luxembourg, Luxembourg, "Radio Luxembourg."  
 9.530—VUC2, Calcutta, India, AIR, 10 kw.  
 \*9.530—LKC, Oslo, Norway, 5 kw.  
 \*9.530—Warsaw, Poland, "Polskie Radio," 10 kw.  
 \*9.530—WGEO, Schenectady, N.Y., U.S.A., 100 kw.  
 \*9.530—KNBI, Dixon, Calif., U.S.A., 50 kw.  
 9.530—KGEI, San Francisco, Calif., U.S.A., 50 kw.  
 \*9.530—Junglinster, Luxembourg, "Radio Luxembourg," 5 kw.  
 \*9.535—XGSG, Nanking, China.  
 \*9.535—JO2L, Nagoya; JO3G, Osaka; JO4F, Hiroshima; JO5C, Matsuyama; JO6H, Kumamoto; JO7G, Sendai; and JO8H, Sapporo, Japan; all 300 w.  
 \*9.535—JZI, Tokyo.  
 \*9.535—VPD2, Suva, Fiji Islands.  
 9.535—SBU, Motala (Stockholm), Sweden, "Radio Stockholm," 12 kw.  
 9.535—HER4, Berne, Switzerland, "Swiss Broadcasting Corp.," 25 kw.  
 \*9.539—HEI4, Berne, Switzerland, "Swiss Broadcasting Corp.," 25 kw.  
 9.540—VE9AI, Edmonton, Alberta, Canada, "Voice of the Great Northwest," 200 w.  
 9.540—Munich, Germany, 80 kw.  
 9.540—ZL2, Wellington, New Zealand, "National Broadcasting Service," 10 kw.  
 9.540—LKI, Oslo, Norway, 5 kw.  
 9.540—VLB, Shepparton, Australia, "Radio Australia," 100 kw.  
 \*9.540—VLG2, Melbourne, Australia, "Radio Australia," 10 kw.  
 9.540—VLR, Melbourne, Australia, "A.B.C.," 2 kw.  
 \*9.540—VLC5, Shepparton, Australia, "Radio Australia," 50 kw.  
 9.540—OAX5C, Lima, Peru.  
 8.540—Moscow.  
 \*9.540—XERQ, Mexico City, Mexico, "Radio Continental," 500 w.  
 9.543—Rangoon, Burma, "Radio Rangoon," 7.5 kw.  
 \*9.545—HED5, Berne, Switzerland, 25 kw.  
 \*9.545—Berlin, Germany.  
 \*9.545—MTCY, Chanschun, China.  
 \*9.545—Petropavlovsk, U.S.S.R.  
 9.547—Komsomolsk, U.S.S.R.  
 \*9.548—Batavia, Java, "Radio Batavia," 3 kw.  
 9.548—XEPF, Vera Cruz, Mexico, "La Voz de Veracruz," 250 w.  
 9.550—VUB2, Bombay, India, AIR, 10 kw.  
 \*9.550—Khartoum, Anglo-Egyptian Sudan.  
 9.550—YDD3, Batavia, Java, "Radio Batavia," 3 kw.  
 9.550—OLR3A, Prague, Czechoslovakia, 30 kw.  
 \*9.550—GWB, London, 50-100 kw.  
 \*9.550—JO9K, Tokyo, 300 w.  
 9.550—Paris, "Radiodiffusion Francaise," 100 kw.  
 \*9.550—KGEI, San Francisco, Calif., U.S.A., 50 kw.  
 \*9.550—WGEO, Schenectady, N.Y., U.S.A., 100 kw.  
 \*9.550—HVJ, Vatican City, Vatican, "Radio Vaticano," 25 kw.  
 9.553—XOPB, Hangchow, China, "Chekiang Broadcasting Station," 400 w.  
 9.557—XETT, Mexico City, Mexico, "La Hora Exacta," 500 w.
- \* Station inactive or not heard recently or additional channels of stations currently active on other frequencies.
- # Stations not on air, including transmitters under construction or installed as projected stations for which official frequency assignments have been made.
- "V" Indicates that frequency has been observed to fluctuate considerably.
- Note: Wherever possible, the power quoted is the actual operating power which sometimes differs from the licensed power.
- To convert frequency (in megacycles) to wavelength (in meters), divide 300 by the frequency.
- \*9.558—Singapore, Malaya.  
 \*9.560—VLW2, Perth, Western Australia, "A.B.C.," 2 kw.  
 \*9.560—Moscow.  
 9.560—Paris, "Radiodiffusion Francaise," 10 kw.  
 9.560—JVW4, Kawachi, Japan, "N.H.K.," 20 kw.  
 \*9.562—FHE4, Dakar, Fr. West Africa, "Radio Dakar," 12 kw.  
 \*9.562—OAX4T, Lima, Peru, "Radio Nacional del Peru," 10 kw.  
 9.565—Komsomolsk (Khabarovsk Territory), U.S.S.R., 50 kw.  
 9.565V—Vienna, Austria, "Rot-Weiss-Rot," 1 kw.  
 9.570—KWIX, San Francisco, Calif., U.S.A., 50 kw.  
 9.570—KWID, San Francisco, Calif., U.S.A., 100 kw.  
 9.570—WRUW, Boston, Mass., U.S.A., 20 kw.  
 9.570—KZRM, Manila, Philippines.  
 \*9.570—WBOS, Boston, Mass., U.S.A., 50 kw.  
 \*9.570—ZBW3, Victoria, Hong Kong.  
 \*9.575—YSPA, San Salvador, El Salvador, "Le Boz de Cuscatlan," 150 w.  
 9.575—Salzburg, Austria.  
 \*9.575—Rabat, French Morocco.  
 \*9.580—VLG, Melbourne, Australia, "Radio Australia," 10 kw.  
 9.580—VLH3, Melbourne, Australia, "A.B.C.," 10 kw.  
 9.580—GSC, London, 50-100 kw.  
 \*9.580—CR7BE, Lourenco Marques, Mozambique.  
 \*9.580V—Tonkin, French Indo-China, "Voice of Vietnam."  
 9.582V—CR7BE, Lourenco Marques, Mozambique, "Radio Mozambique," 7.5 kw.  
 9.585—CE960, Santiago, Chile.  
 9.590—VUD5, Delhi, AIR, 100 kw.  
 \*9.590—VUD3, Delhi, AIR, 5 kw.  
 9.590—VUM2, Madras, India, AIR, 10 kw.  
 9.590—PCJ, Hilversum (Huizen), Holland (Netherlands), "The Happy Station," 60 kw.  
 \*9.590—WLWL, Cincinnati, Ohio, U.S.A., 50 kw.  
 9.593—CE960, Santiago, Chile, "Radio la Americana," 1.2 kw.  
 9.595—Athlone, Ireland, "Radio Eirrean," 1.5 kw.  
 \*9.596V—Hanoi, French Indo-China.  
 9.600—GRV, London, 50-100 kw.  
 \*9.600—Khartoum, Anglo-Egyptian Sudan.  
 \*9.600—Leningrad, U.S.S.R.  
 \*9.600—JZH5, Tokyo.  
 9.604—HP5J, Panama City, Panama, "La Voz de Panama," 250 w.  
 9.605—JKE, Yamata, Japan, AFRN, 1 kw.  
 \*9.605—JLP, Tokyo.  
 \*9.605—XGSH, Nanking, China.  
 9.606—XEYU, Mexico City, Mexico, "Radio Univ. Nacional," 250 w.  
 9.608—Capetown, South Africa, SABC, 5 kw.  
 9.610—ZYC8, Rio de Janeiro, Brazil, "Radio Tamoi," 25 kw.  
 \*9.610—CBFX, Montreal, Quebec, Canada, 7.5 kw.  
 9.610—CHT.S, Sackville, Canada, "CBC International Service," 50 kw.  
 \*9.610—Algiers, Algeria.  
 \*9.610—IFD, Rome, Italy.  
 \*9.610—MCH, Luxembourg, Luxembourg.  
 9.610—XERQ, Mexico City, Mexico, "Radio Continental," 500 w.  
 9.610—LLG, Oslo, Norway, 7 kw.  
 \*9.610—Moscow.  
 \*9.610—Capetown, South Africa, SABC, 5 kw.  
 9.615—VLB9, Shepparton, Australia, "Radio Australia," 100 kw.  
 \*9.615—VLC6, Shepparton, Australia, "Radio Australia," 50 kw.

\*9.615—VLA2, Shepparton, Australia, "Radio Australia," 100 kw.  
 9.615—St. Denis, Reunion, "Radio St. Denis," 80 w.  
 9.620—TIPG, San Jose, Costa Rica, "La Voz de la Victor," 2.5 kw.  
 9.620—ETA, Addis Ababa, Ethiopia, "Radio Addis Ababa," 1 kw.  
 #9.620—Horby, Sweden.  
 9.620—HHK, Port-au-Prince, Haiti.  
 9.620—Paris, "Radiodiffusion Francaise," 25 kw.  
 9.620—CXA8, Montevideo, Uruguay, "Radio Electrica," 2 kw.  
 \*9.625—VP4RD, Port-of-Spain, Trinidad, 500 w.  
 9.625—GWO, London, 50-100 kw.  
 9.625—XEBT, Mexico City, Mexico, "Radio Pan-Americana," 500 w.  
 9.630—CP12, La Paz, Bolivia, "Radio Fides," 250 w.  
 9.630—CRLO, Sackville, Canada, "CBC International Service," 50 kw.  
 \*9.630—XURA, Tai-Pei, Formosa, 3 kw.  
 \*9.630—VUD7, Delhi, AIR, 100 kw.  
 9.630—VUD10, Delhi, AIR, 20 kw.  
 9.630—VUD2, Delhi, AIR, 10 kw.  
 9.630—VUB2, Bombay, India, AIR, 10 kw.  
 9.630—Milan, Italy, "Radio Italiana," 50 kw.  
 9.630—VP4RD, Port-of-Spain, Trinidad, 500 w.  
 9.640—COX4, Havana, Cuba, "Radiodifusora del Ministerio de Educacion," 5 kw.  
 9.640—GYZ, London, 50-100 kw.  
 9.640—KZRH, Manila, Philippines, "Voice of the Philippines," 1 kw.  
 9.640—CXA8, Montevideo, Uruguay, "Radio Real de San Carlos," 3 kw.  
 9.640—YVRC, Caracas, Venezuela, "Radiodifusora Nacional," 1 kw.  
 \*9.640—Northern Rhodesia.  
 \*9.645—LLH, Oslo, Norway, 5 kw.  
 \*9.645V—CR7BJ, Lourenco Marques, Mozambique.  
 9.645—Jaffa, Palestine, "Sharq-al-Adna."  
 \*9.648V—VP4RD, Port-of-Spain, Trinidad, "Radio Trinidad," 500 w.  
 \*9.650—CNR3, French Morocco, "Radio Maroc," 2 kw.  
 9.650—Omdurman, Anglo-Egyptian Sudan.  
 9.650—KRHO, Honolulu, Hawaii, 100 kw.  
 \*9.650—KCB, Delano, Calif., U.S.A., 50 kw.  
 \*9.650—KNBA, Dixon, Calif., U.S.A., 50 kw.  
 9.650—WCBN, New York, N.Y., U.S.A., 50 kw.  
 \*9.650—WOOC, New York, N.Y., U.S.A., 50 kw.  
 9.650—Moscow.  
 \*9.650—Manila, Philippines.  
 9.641V—CR7BJ, Lourenco Marques, Mozambique, "Radio Mozambique," 7.5 kw.  
 9.655—JFK, Nazaki, Japan, "N.H.K.," 5 kw.  
 9.655—HED6, Berne, Switzerland, "Swiss Broadcasting Corp.," 25 kw.  
 \*9.655—XGSI, Nanking, China.  
 \*9.658—HOXC, Panama City, Panama, "Radio Centroamericana," 7.5 kw.  
 \*9.660—Algiers, Algeria, "Radio Algerie," 10 kw.  
 9.660—LRX, Buenos Aires, Argentina, "Radio El Mundo," 6 kw.  
 9.660—VLQ3, Brisbane, Australia, "A.B.C.," 10 kw.  
 \*9.660—GWP, London, 50-100 kw.  
 \*9.660—HBBM, Port-au-Prince, Haiti, "National Broadcasting Co.," 1 kw.  
 \*9.660—VUD11, Delhi, AIR, 20 kw.  
 \*9.660—Jerusalem, Palestine.  
 \*9.660—Horby, Sweden.  
 9.660—HVJ, Vatican, City, Vatican, "Radio Vaticano," 25 kw.  
 9.662V—Vienna, Austria, "Radio Wien," 250 w.  
 9.663—XGOY, Chungking, China, "Chinese International Broadcasting Station," 35 kw.  
 \*9.665—VLW4, Perth, Australia, "A.B.C.," 2 kw.  
 \*9.665—HEU3, Berne, Switzerland, 25 kw.  
 \*9.666—Brussels, Belgium, "Radio Nationale Belge," 5 kw.  
 \*9.670—OLR5C, Prague, Czechoslovakia, 30 kw.  
 \*9.670—VUD2, Delhi, AIR, 10 kw.  
 9.670—VUD4, Delhi, AIR, 10 kw.  
 \*9.670—VUD11, Delhi, AIR, 20 kw.  
 \*9.670—VUD9, Delhi, AIR, 7.5 kw.  
 \*9.670—Delano, California, U.S.A., 50 kw.  
 9.670—WNRX, New York, N.Y., U.S.A., 50 kw.  
 9.673—Khartoum, Anglo-Egyptian Sudan, "Huna Omdurman."  
 9.675—GWT, London, 50-100 kw.  
 \*9.675—JVW2, Tokyo.  
 #XGSI, Nanking.  
 \*9.675V—Batavia, Java, 3 kw.  
 9.680—YDB4, Batavia, Java, 3 kw.  
 \*9.680—VLG8, Melbourne, Australia, "Radio Australia," 10 kw.  
 \*9.680—VLW6, Perth, Western Australia, "A.B.C.," 2 kw.  
 \*9.680—VLA3, Shepparton, Australia, "Radio Australia," 100 kw.  
 \*9.680—VLR2, Shepparton, Australia, "Radio Australia," 100 kw.  
 \*9.680—VLC2, Shepparton, Australia, "Radio Australia," 50 kw.  
 9.680—Paris, "Radiodiffusion Francaise," 25 kw.  
 \*9.680—VUD2, Delhi, AIR, 10 kw.  
 9.680—EQC, Teheran, Iran, "Radio Teheran," 14 kw.  
 \*9.680—XUPA (or XURA), Tai-Pei, Formosa.  
 9.680—XEQQ, Mexico City, Mexico, "La Cadena Azul," 1 kw.  
 \*9.683—HNF, Baghdad, Iraq, 5 kw.  
 \*9.687—TGWA, Guatemala City, Guatemala.  
 \*9.688—Leipzig, Germany.  
 9.690—LRA1, Buenos Aires, Argentina, "Radio del Estado," 10 kw.

\*9.690—HLCAB, Bogota, Colombia, "Radiodifusora Nacional," 2.5 kw.  
 9.690—GRX, London, 50-100 kw.  
 \*9.690—PLS, Bandoeng, Java.  
 9.690—Singapore, Malaya, "British Far East Broadcasting Service," 7.5 kw.  
 \*9.694—JVZ, Tokyo.  
 9.695—JRG, Kawachi, Japan, "N.H.K.," 5 kw.  
 9.695—Tananarive, Madagascar, "Radio Tananarive," 300 w.  
 9.695V—KZOK, Manila, Philippines, "Radio Philippines," "The Voice of the Nation," 250 w.  
 \*9.699—XUPA (or XURA), Tai-Pei, Formosa.  
 9.700—KCBF, Delano, Calif., U.S.A., 50 kw.  
 \*9.700—KCBR, Delano, Calif., U.S.A., 200 kw.  
 \*9.700—KNBI, Dixon, Calif., U.S.A., 50 kw.  
 \*9.700—WRUS, Boston, Mass., U.S.A., 50 kw.  
 9.700—WOOW, New York, N.Y., U.S.A., 50 kw.  
 9.700—WLWS2, Cincinnati, Ohio, U.S.A., 75 kw.  
 \*9.700—Khartoum, Anglo-Egyptian Sudan.  
 9.700—KZMB, Manila, Philippines.  
 9.700V—CP25, La Paz, Bolivia, "Radio Sucre," 250 w.  
 9.700V—Fort-de-France, Martinique, "Radio Martinique," 1.5 kw.  
 \*9.705—KZOK, Manila, Philippines.  
 9.710—ZQP, Lusaka, Northern Rhodesia, 250 w.  
 9.710—Moscow.  
 \*9.710—KZPI, Manila, Philippines, 250 w.  
 \*9.715—OLR3D, Prague, Czechoslovakia, 30 kw.  
 9.715—CR7BE, Lourenco Marques, Mozambique, "Radio Mozambique," 7.5 kw.  
 \*9.720—YAK, Kabul, Afghanistan.  
 9.720—PRL7, Rio de Janeiro, Brazil, "Radio Nacional," 50 kw.  
 9.720—Moscow.  
 \*9.720V—CS2MF, Lisbon, Portugal, "Emissora Nacional," 10 kw.  
 9.728—Leipzig, Germany, "Mitteldeutscher Rundfunk," 12 kw.  
 9.730—CE970, Valparaiso, Chile, "Radio La Cooperativa Vitalicia," 1.5 kw.  
 9.730—XGOA, Nanking, China, "Central Broadcasting Station," 2 kw.  
 9.736—Batavia, Java.  
 \*9.740—XGOY, Chungking, China, 35 kw.  
 \*9.740—T4NRH, Heredia, Costa Rica, "La Voz de Costa Rica," 750 w.  
 9.740—Moscow.  
 \*9.742—CRGRN, Llanda, Angola, 1 kw.  
 9.742—CS2MF, Lisbon, Portugal, "Emissora Nacional," 10 kw.  
 9.745V—OTC2, Leopoldville, Belgian Congo, "Radio Nationale Belge," 50 kw.  
 9.750—XMRA, Lanchow, China, "Kansu Broadcasting Station," 1 kw.  
 \*9.750—KCB, Delano, Calif., U.S.A., 50 kw.  
 9.750—KCBF, Delano, Calif., U.S.A., 200 kw.  
 \*9.750—KCBF, Delano, Calif., U.S.A., 50 kw.  
 \*9.750—WNRI, New York, N.Y., U.S.A., 50 kw.  
 9.760—TGWA, Guatemala City, Guatemala, "La Voz de Guatemala," 10 kw.  
 \*9.760—Pietermaritzburg, South Africa, SABC, 500 w.  
 9.760—Moscow.  
 \*9.763—Khartoum, Anglo-Egyptian Sudan, "Huna Omdurman."  
 \*9.765—OAX4K, Lima, Peru.  
 \*9.775—XOPD, Hanchow, China.  
 9.780—Moscow.  
 9.785—Leopoldville, Belgian Congo.  
 9.790—Menado, Celebes.  
 9.790—Moscow.  
 \*9.790—TGWA, Guatemala City, Guatemala.  
 \*9.800—HNF, Baghdad, Iraq.  
 \*9.810—XGOY, Chungking, China, "The Voice of China," 35 kw.  
 9.815—OAX5C, Ica, Peru, 150 w.  
 9.820—XGOE, Kweilin, China, "Kwangsi Broadcasting Station."  
 9.825—GRH, London, 50-100 kw.  
 9.830V—COBL, Havana, Cuba, "Radio Cadena Siaritos," 1 kw.  
 \*9.845—Barranquilla, Colombia, "Emisora Atlantico."  
 \*9.850—HJAP, Caragena, Colombia, "Radio Colonia."  
 \*9.860—EAQ, Madrid, Spain, "Radio Espana," 20 kw.  
 \*9.860—Sverdlovsk, U.S.S.R.  
 \*9.865—CR7BE, Lourenco Marques, Mozambique, "Radio Mozambique," 7.5 kw.  
 \*9.865—Moscow.  
 \*9.865—PLU, Dojakjakarta, Java.  
 9.870—Johannesburg, South Africa, SABC (Johannesburg IV), 1 kw.  
 \*9.880V—KWS1, Vienna, Austria.  
 9.890—HJAP, Cartagena, Colombia, "Radio Colonial."  
 \*9.895—KROJ, Los Angeles, Calif., U.S.A.  
 \*9.900V—XOPB, Hanchow, China.  
 \*9.910—Bathurst, Gambia.  
 \*9.912—Johannesburg, South Africa, SABC (Johannesburg IV), 1 kw.  
 9.915—GRU, London, 50-100 kw.  
 9.917—XDY, Chapultepec, Mexico, "Radio Mex," 20 kw.  
 \*9.920—Madrid, Spain, 40 kw.  
 9.924—XDY, Chapultepec, Mexico, "Radio Mex," 20 kw.  
 9.930—HJAQ, Cartagena, Colombia, "Radio Miramar."  
 9.935—SVM, Athens, Greece, 7 kw.  
 9.935—Barranquilla, Venezuela.  
 \*9.940—CS2MI, Lisbon, Portugal, "Emissora Nacional," 5 kw.  
 9.940—Mexico City, Mexico, "Radio Gobernacion."  
 9.943—HNF, Baghdad, Iraq, 5 kw.  
 \*9.960—ZAA, Tirana, Albania, 3 kw.

9.964—HCJB, Quito, Ecuador, "La Voz de los Andes," 1.5 kw.  
 \*9.975—HBL2, Geneva, Switzerland, 40 kw.  
 9.984—Brazzaville, French Equatorial Africa, "Poste Nationale Francaise," 500 w.  
 \*9.995—XGOL, Foochow, China, "Fukien Broadcasting Station," 20 w.  
 10.000—OPW, Washington, D.C., U.S.A., Bureau of Standards, 9 kw.  
 \*10.000—Vienna, Austria.  
 10.058—SUV, Cairo, Egypt, "Radio Cairo," 10 kw.  
 10.062—PLY, Bandoeng, Java, "Radio Omroep Bandoeng," 1 kw.  
 10.080—YVFC, Caracas, Venezuela.  
 10.100—WDF2, San Juan, Porto Rico.  
 10.105—DTSP, Germany.  
 10.120—XBHX, Mexico City, Mexico.  
 10.135—HH3V, Port-au-Prince, Haiti, "Columbia Broadcasting System," 500 w.  
 \*10.140—OPM, Leopoldville, Belgian Congo, "Radio Congo Belge," 7 kw.  
 \*10.143—Geneva, Switzerland.  
 #10.145—Geneva, Switzerland.  
 10.169—Hanoi, French Indo-China, "Radio France."  
 10.175—SUR2, Cairo, Egypt, 10 kw.  
 10.200—Hanoi, French Indo-China.  
 10.205—Moscow.  
 10.230—PSE, Rio de Janeiro, Brazil, 12 kw.  
 \*10.230—XRR, Peiping, China.  
 \*10.230—XRRA, Hankow, China.  
 \*10.230—Moscow.  
 10.258—XRR, Peiping, China, "Peiping Broadcasting Station," 10 kw.  
 10.260—PMN, Bandoeng, Java, "Radio Resmi Bandoeng," 500 w.  
 10.275—Menado, Celebes.  
 10.275V—U.S.S.R., "Espana Independiente."  
 10.280—Clandestine, "Radio Espana Independiente, Estacion Pyrenaica."  
 \*10.285—ZNR, Aden, Arabia.  
 10.300—Clandestine, "Radio Espana Independiente, Estacion Pyrenaica."  
 10.310—Clandestine Basque, "Radio Euzkadi."  
 \*10.315—HCHAC, Guayaquil, Ecuador.  
 10.330—LPC, Ushuaia, Tierra del Fuego, Argentina.  
 \*10.338—HEO4, Berne, Switzerland, "Swiss Broadcasting Corp.," 25 kw.  
 10.350—LQA5, Buenos Aires, Argentina, 10 kw.  
 10.365—PLS, Batavia, Java, "Radio Batavia," 3 kw.  
 \*10.365—HEF5, Berne, Switzerland, "Swiss Broadcasting Corp.," 25 kw.  
 \*10.395—HET4, Berne, Switzerland, "Swiss Broadcasting Corp.," 25 kw.  
 10.400—YSP, San Salvador, El Salvador.  
 \*10.405—HED4, Berne, Switzerland, "Swiss Broadcasting Corp.," 25 kw.  
 \*10.445—Moscow.  
 10.535—Tai-Pei, Formosa, 10 kw.  
 \*10.540—Johannesburg, South Africa, SABC (Johannesburg IV), 1 kw.  
 \*10.585—KUM, Tokyo, Japan.  
 10.598—ZIC2, Belize, British Honduras, 200 w.  
 10.605—VPO3, Bridgetown, Barbados, B.W.I.  
 10.615—Tananarive, Madagascar, "Radio Tananarive."  
 \*10.670—CEC, Santiago, Chile, 2 kw.  
 \*10.680—PLQ, Bandoeng, Java, 1.5 kw.  
 10.730—VQ7LO, Nairobi, Kenya, 1.5 kw.  
 \*10.770—Leningrad, U.S.S.R.  
 10.780—SDB2, Motala (Stockholm), Sweden, 12 kw.  
 \*10.810—EPA, Teheran, Iran, "Radio Teheran," 14 kw.  
 \*10.865—CRGRH, Luanda, Angola.  
 10.940—FTH, Paris, 30 kw.  
 \*10.940—Moscow.  
 \*10.953—CRGRB, Benguela, Angola, 50 w.  
 10.970—PZR, Paramaribo, Surinam, "Avros, Paramaribo," 750 w.  
 11.000—YHN, Djokjakarta, Java, "The Voice of Free Indonesia," 2 kw.  
 \*11.002—CR6RC, Luanda, Angola, "Radio Clube de Angola," 500 w.  
 \*11.010—PLQ, Bandoeng, Java, "Voice of Free Indonesia," 1 kw.  
 11.027—CS2MK, Lisbon, Portugal, "Emissora Nacional," 10 kw.  
 11.031—RWS4, Semarang, Java, "Radio Welvaart Semarang," 100 w.  
 11.035—CRGRA, Luanda, Angola, "Radio Clube de Angola," 400 w.  
 \*11.010—CS2ML, Lisbon, Portugal, "Emissora Nacional," 5 kw.  
 11.083—Soerabaya (?), Java, "Radio Omroep Soerabaya," 200 w.  
 11.084—Makassar, Celebe.  
 11.090—CS9MB, Ponta Delgada, Azores, "Emissora Regional Acores," 1 kw.  
 11.100—Semarang, Java.  
 \*11.115—MCH, Luxembourg, Luxembourg.  
 \*11.200—Clandestine Basque.  
 11.220—Makassar, Celebes.  
 \*11.250—XMG, Nanking, China.  
 11.250—Indonesia, may be Masantara, "Radio Repobliik Indonesia."  
 \*11.290V—XMG, Nanking, China.  
 \*11.315—Moscow.  
 \*11.323—PZR, Paramaribo, Surinam, 750 w.  
 11.340—Ronne Antarctic Expedition.  
 \*11.402—HRO, Geneva, Switzerland, 20 kw.  
 \*11.405—FGA, Dakar, Fr. West Africa, "Radio Dakar," 400 w.  
 11.440—PLO, Batavia, Java, "Radio Batavia," 2.5 kw.  
 11.490—XLRA, Hankow, China, "Hankow Broadcasting Station," 1 kw.  
 \*11.500—ZMB3, Apia, Western Samoa.  
 \*11.516—PZX4, Paramaribo, Surinam, "Avros, Paramaribo," 5 kw.

(Continued on page 102)

# AUTOMATIC FREQUENCY CONTROL

By  
**W. H. BUCHSBAUM**

## Theoretical operation of automatic frequency control circuits used in television receivers.

IN ANY television receiver the start of the sweep of the electron beam across the face of the cathode-ray tube is of great importance, since it has to be in exact synchronism with the sweep of the camera at the transmitter. Therefore, along with the television signal, special synchronizing pulses are broadcast to time the sweep at the receiver. We know that the vertical and the horizontal sweeping force is necessary to obtain a picture and that the vertical sweep frequency is 60 cycles-per-second while the horizontal sweep frequency is 15,750 c.p.s. This gives an interlaced picture of 30 frames a second, each containing 525 lines.

Synchronizing pulses are transmitted both at a frequency of 60 c.p.s. and 15,750 c.p.s. and they have to con-

trol the saw-tooth frequency of the vertical and horizontal sweep respectively. Moreover, the saw-tooth waves must be generated in such a manner that the longer slope develops during the time between pulses and the shorter slope during the blanking and synchronizing pulses. Fig. 3A shows the picture signal for one complete line, begun and terminated by a sharp pulse, the blanking pulse, which then has another smaller pulse, the sync pulse, superimposed. The blanking pulse drives the grid of the cathode-ray tube negative, cuts off the beam, while the sweep circuits move the beam back from the right hand edge of the screen to its starting position. If the blanking and synchronizing pulse would occur halfway during the

sweep from left to right, then the screen would show the end and the beginning of the picture, with a black space in the center, where the blanking pulses cut the tube off. As can be seen from the foregoing discussion a way has to be found to maintain exact synchronism with the incoming synchronizing pulses. This is accomplished by removing the actual sync pulse from the rest of the video signal with a clipper.

Next, the sync pulse may be amplified and finally it is fed on the grid of the multivibrator or blocking oscillator to trigger that tube. It is then necessary that this saw-tooth generator operate at a frequency very close to that of the sync pulses. This is known as direct sync and is used in most low priced, and in some of the older, television receivers. This system has the disadvantage that an incoming noise is amplified and clipped and will tend to trigger the saw-tooth generator, momentarily forcing it out of sync. The effect on the picture is that of a tear across the screen. Ignition noise and similar electrical disturbances are thus visible and ruin the picture. Another disadvantage is that the horizontal and vertical hold controls require more frequent adjustment to keep the picture stable and standing still.

Automatic frequency control was developed to overcome these disadvantages and to provide a steady clear picture with a minimum amount of adjustment by the user. Several different circuits have been used by manufacturers but they all employ the same basic idea. That basic system requires an electronic means of comparing two frequencies, that of the sync pulses and that of the local saw-tooth generator, and then a means of making a correction in the local saw-tooth generator. A method of comparing two frequencies is found by feeding both signals into a rectifier, one on the plate and one on the cathode. If they are of exactly

Fig. 1.

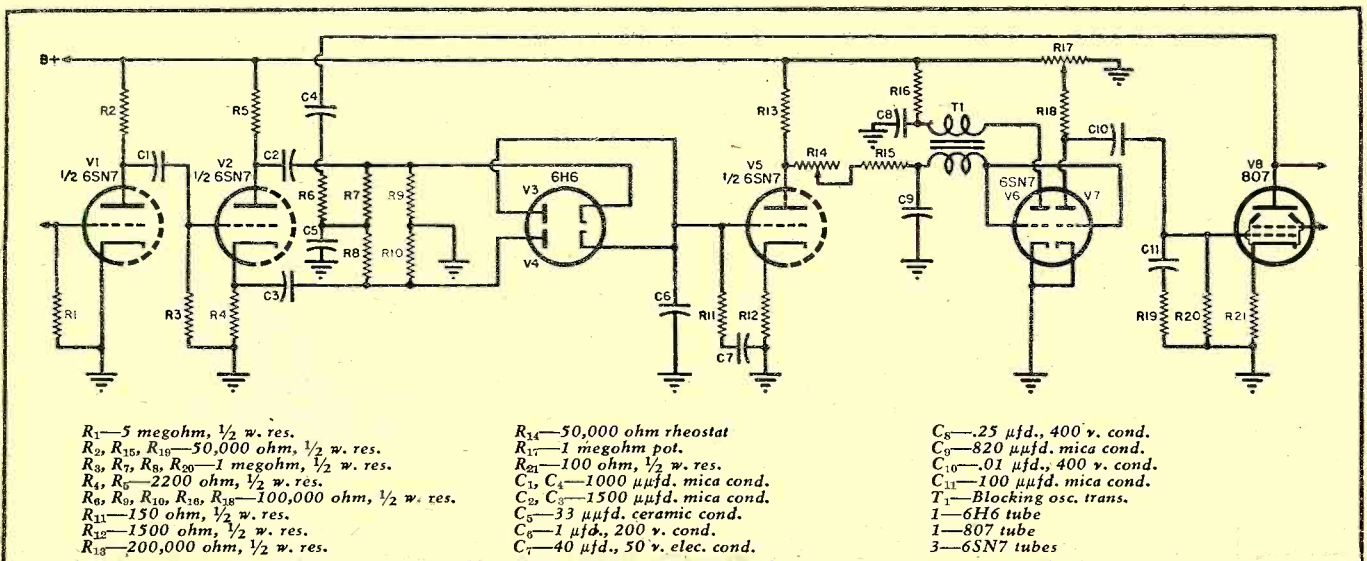

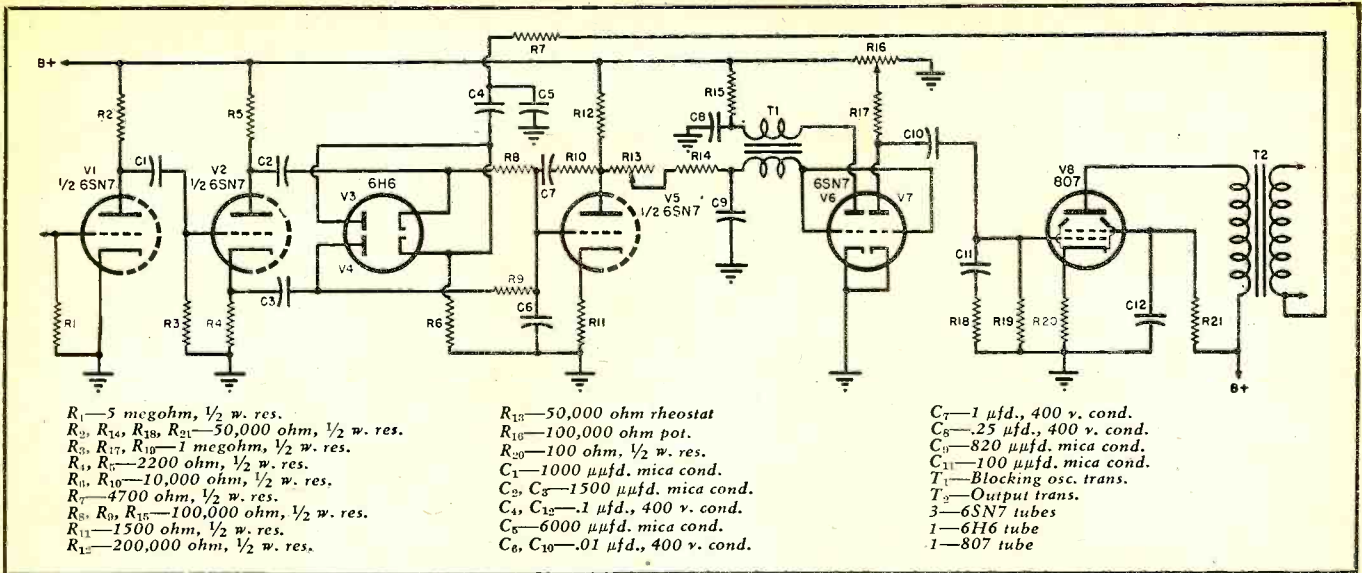

Fig. 2.

the same frequency, and provided their waveshape and amplitude is alike, no current can flow through the rectifier and no d.c. voltage is developed. If they are out of phase, then current will flow whenever the plate goes positive and a d.c. voltage will be produced. This voltage will be proportionate to the amount of phase difference as long as one signal is not twice the frequency of the other. The way phase relation of pulses might appear on an oscilloscope is shown in Fig. 3B. The d.c. voltage obtained is often called the "error" voltage and it is applied to the grid of the saw-tooth generator where it adds or subtracts from the bias and therefore has an influence on the frequency of that oscillator. A system such as the one just described has the one fault that the error voltage will be the same whether the saw-tooth generator is

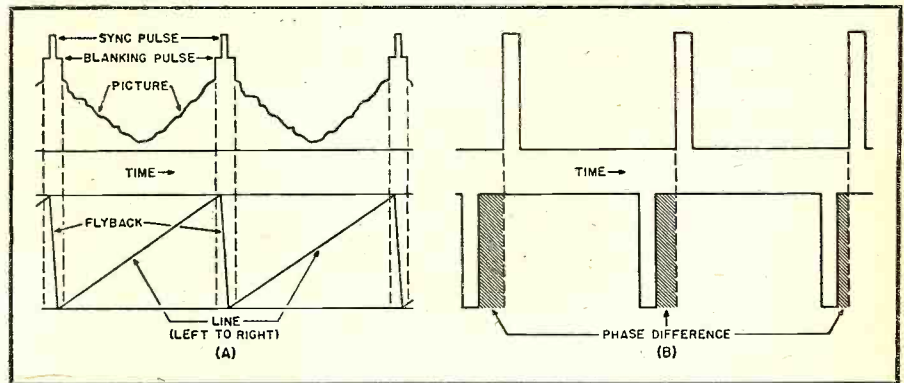

Fig. 3.

too fast or too slow, so that the correction would act in just one direction.

A practical automatic frequency

control circuit is shown in Fig. 1. Instead of using one rectifier a double diode is employed, and instead of ap- (Continued on page 146)

Fig. 4.

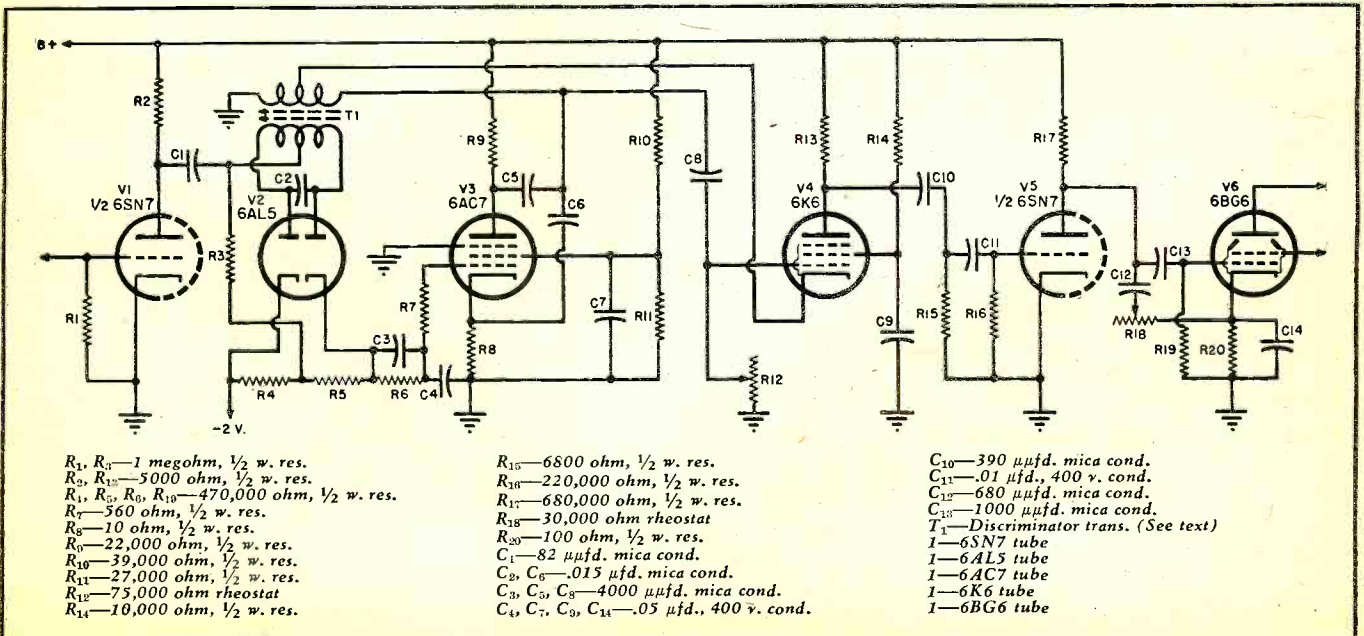

# INTERFERENCE TRAPS for TELEVISION

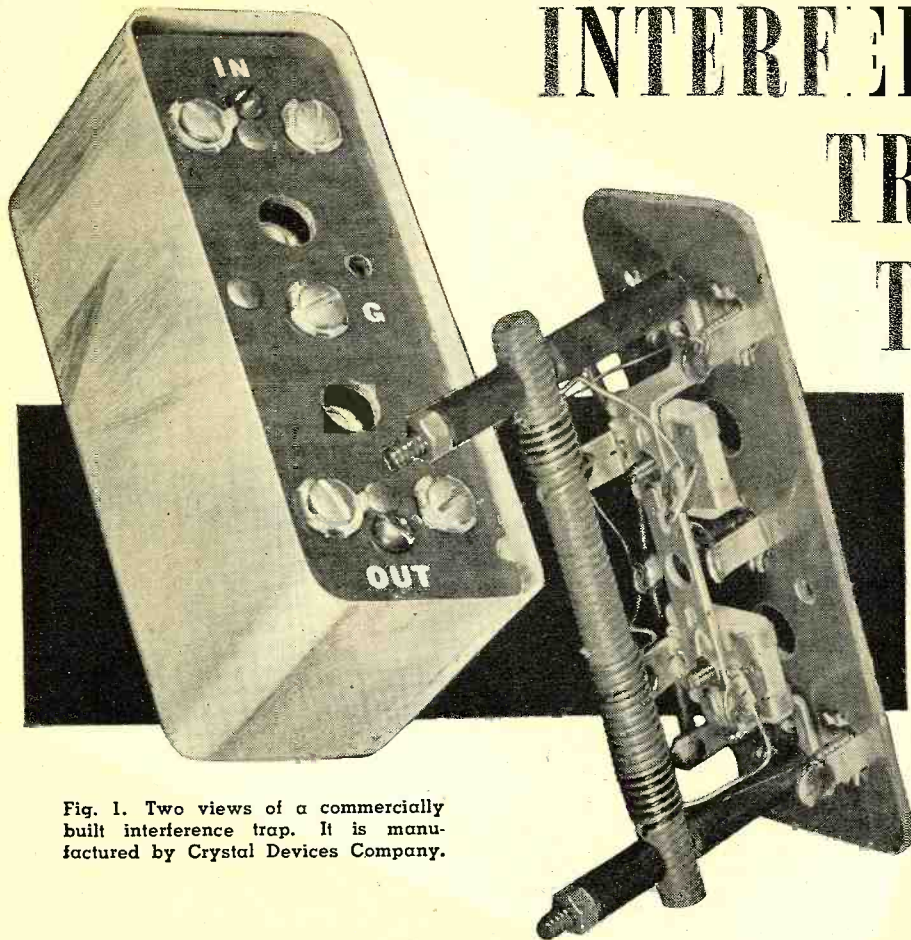

Fig. 1. Two views of a commercially built interference trap. It is manufactured by Crystal Devices Company.

By

STANLEY N. FINLEY

TELEVISION reception in some localities is disturbed by local FM broadcasts, amateur transmissions, and some commercial or police communication systems.

Interference from FM is readily recognizable because it resembles closely the parallel bars of dark and light which experienced viewers are familiar with as associated sound channel interference. The FM interference pattern can be distinguished from the associated sound channel interference because it bears no relationship to the audible sound, whereas the co-channel sound when it interferes with the picture machines matches the accompanying sound. The photograph, Fig. 5, shows the type of pattern that FM interference produces. The bars move up and down across the picture. The number of horizontal bars per frame varies according to the modulation in the FM signal causing the interference.

Interference from a fixed frequency source will give a fixed pattern, like that of a knitted tie, if it is very strong, or diagonal fine lines, or vertical bars of light and dark, if comparatively weak. An example of this type of interference is illustrated by the pattern of Fig. 7.

These patterns result from the fact that the interfering signal and the video or audio carrier, or the local oscillator mix. Either by addition or by difference this will result in a frequency which falls in the video i.f. channel.

Table 1 shows channels 2-6 of the television bands, the local oscillator frequencies for two types of receivers, and the image response ranges in which the signals from some other service can cause interference with the television image.

To determine the ranges chosen in the tables the following was employed: In Table 1 any listed frequency range when heterodyned with

**Some commonly encountered interference problems can be corrected by use of specially built traps.**

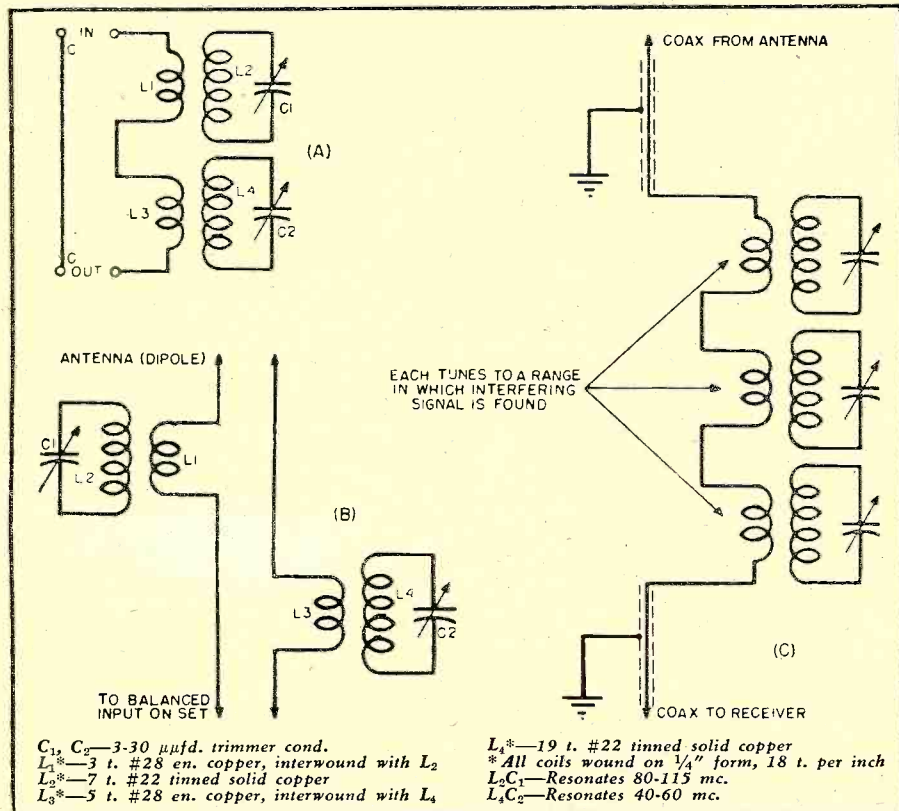

Fig. 2. Schematic diagram of several conventional types of interference traps. (A) a commercially available unit. (B) trap designed for balanced input. (C) coaxial connected trap.

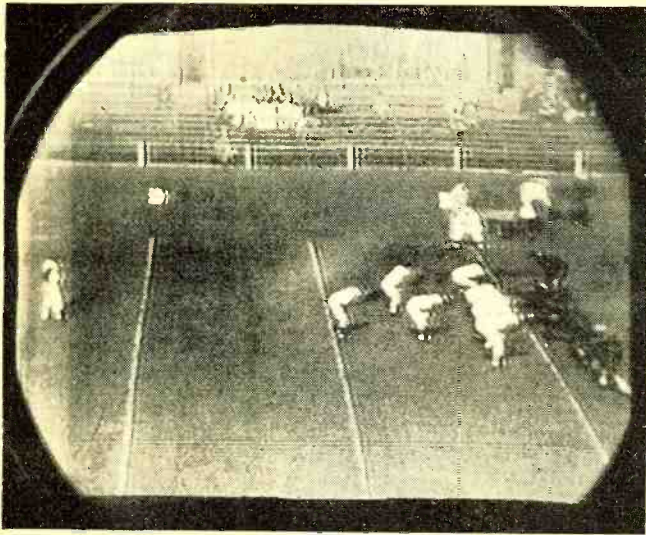

Fig. 3. The reduction of contrast due to an interfering signal. The multiple image at the right of players is due to reflected signals received by the antenna.



Fig. 4. Jose Ferrar as "Cyrano". This shot from the monitor screen shows clearly the effects of video "noise". The mottled appearance is due to "noise" voltages.

the local oscillator will result in video i.f. response. Table 2 gives frequency ranges which, when heterodyned with frequencies in the TV bands, will give a response in the video i.f. bands.

From the tables it can be seen that the most likely form of TV image interference will be that which develops from a strong nearby FM broadcasting station. For example, with a type "A" receiver, an FM station at 98.1 or 98.3 will come right in on the sound channel of a TV receiver, which is tuned to channel 4. On the same channel an FM station on any frequency between 99.1 and 102.9 will probably produce a noticeable response in the video image. Other possible combinations can be determined by referring to the table.

Radiation from the local oscillator of a neighboring television receiver will cause a reduction in contrast in your receiver. In addition, some sort of pattern will be observed on your screen which may vary from parallel vertical or horizontal stripes to a fine pepper and salt combination. Such interference, for example, will result in any type of TV receiver (A or B) when your neighbor with an "A" type receiver tunes in channel 2 while you are tuned to channel 4. Note that the local oscillator frequency for the type "A" set is 68

Fig. 5. Pattern interference caused by transmission from a nearby FM station.

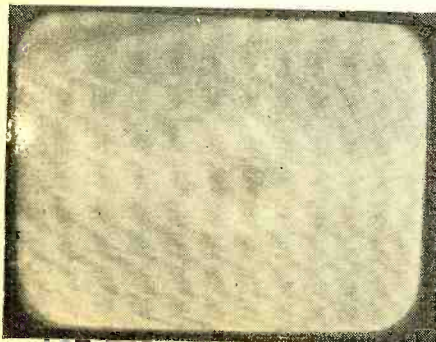

CHANNEL (mc.)	LOCAL OSCILLATOR FREQUENCY		IMAGE BANDS		SERVICES	
	A*	B**	A	B	A	B
54-60	68 mc.	81 mc.	76-82 mc.	102-108 mc.	TV	FM
60-66	74 mc.	87 mc.	82-88 mc.	108-114 mc.	TV	Comm. Relay
66-72	80 mc.	93 mc.	88-94 mc.	114-120 mc.	FM	Comm. Relay & Aviation
76-82	90 mc.	103 mc.	98-104 mc.	124-130 mc.	FM	Aviation
82-88	96 mc.	109 mc.	104-110 mc.	130-136 mc.	FM	Aviation

\* (A) for i.f. frequencies of 8.25 mc. for the audio and 12.75 mc. for the video  
 \*\* (B) for i.f. frequencies of 21.25 mc. for the audio and 25.75 mc. for the video

Table 1.

megacycles on channel 2. This is in the range of channel 4.

These conditions can be corrected by lowering the sensitivity of the input of the set at the frequency which causes the interference. This can be accomplished effectively by means of wave traps. A wave trap may be inserted in series with the antenna, or it may be built into the set as a permanent feature. In some exceptionally interference-full areas it may be advisable to employ both, as was the case in the author's experience.

Fig. 6. News photograph of Joe Louis knocking out Billy Conn. Fine pattern results from r.f. of another TV unit.

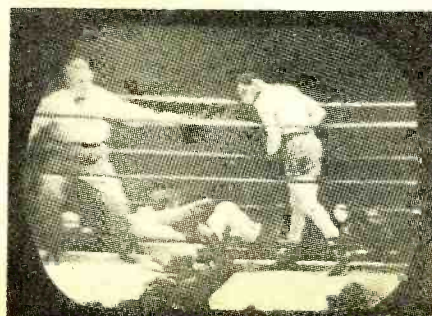

A wave trap consists of an LC circuit of fairly high "Q" which can resonate at the frequency it is desired to attenuate. A model is shown in Fig. 1 which employs two tuned circuits, each of which covers a certain range of frequencies. Fig. 2A is a circuit diagram of the dual frequency range trap pictured. A similar arrangement can be made employing several or only one tuned circuit each of which resonates over possible interference ranges.

(Continued on page 182)

Fig. 7. Beat frequency interference caused by radiation from nearby local oscillator.

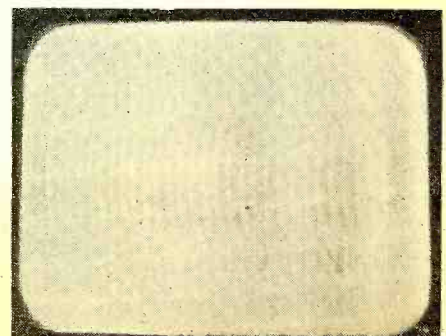

# Practical RADIO COURSE



Fig. 1. Conventional high-gain, double-tuned i.f. transformer unit for AM receiver. Note use of fiber lead spacer near bottom.

By ALFRED A. GHIRARDI

## Part 60. Concluding article of this series—covering i.f. transformers and their performance in AM, FM, and television home receivers.

MUTUAL inductive (magnetic) coupling is by no means the only method of energy-coupling together the two tuned circuits of a bandpass tuner. Several other methods are possible. Top-end capacitive coupling, as illustrated in Fig. 2A, is often employed.

With "below-critical," or "critical," value of capacitive coupling the overall frequency-response characteristics produced are much the same as for "below-critical" and "critical" magnetic coupling, respectively. This is shown by the response curves for these two conditions in Fig. 2B. However, it will be observed that with "greater-than-critical" capacitive coupling the peaks that are produced are not symmetrically displaced about the resonant frequency of the two tuned circuits. It will be seen that one peak remains approximately on the original resonance frequency for loose coupling, while the second peak appears at a different frequency below this.

### Effect of Stray Capacitive Coupling in I.F. Transformers

The conventional circuit diagram of a double-tuned i.f. transformer is as illustrated in Fig. 3A, but actually the

circuit of Fig. 3B is more representative of the true conditions which exist, since in an actual tuned transformer unit important condensers (drawn dotted here) are formed by conductors

EDITOR'S NOTE: With this article we conclude Mr. Ghirardi's popular series which had its beginnings way back in February of 1942! Ghirardi fans, of whom there are many, will be happy to know that he will continue to prepare articles for RADIO NEWS. This series is, we believe, the longest ever attempted by any national magazine—but because of the important material contained in these articles we feel that our readers were able to add greatly to their knowledge of the "why's" and "wherefore's" of radio.

that differ in i.f. potential and which are in close proximity and insulated from each other. The more important of these "stray" capacitances are shown in Fig. 3B and are labeled  $C_1$  to  $C_5$ . The photograph (Fig. 1) is that

Whether the capacitance coupling aids or opposes the magnetic coupling in a given i.f. transformer may be determined by inspection. If the coils are wound in the same direction, which is the usual case, the magnetic coupling opposes the capacitance coupling if both the plate of the preceding tube and the grid of the following tube are connected to the similar ends of the primary and secondary coils (as is the case in the i.f. transformer shown in Fig. 4). Ordinarily, the grid and plate are connected to the inside ends of the two coils, for the "production" and "electrical" reasons stated above.

of an actual i.f. transformer mounted with its two trimmer-type tuning condensers  $C_7$  and  $C_8$ , inside of a shield can, and will help to make clear just how these stray capacitances are set up.

Observe from Fig. 3B that all of the stray capacitances are really in parallel with each other so they add to form a total stray capacitance that is effectively connected from the plate end to the grid end of the transformer, exactly as is condenser  $C_6$  in Fig. 2A. This total stray capacitance acts, therefore, to couple the primary and secondary tuned circuits together capacitively.

Specifically, the total capacitance that is effective in causing this "capacitive coupling" is composed (as shown in Figs. 3 and 4) of the capacitance  $C_1$  existing between the plate and grid sides of trimmer tuning condensers  $C_7$  and  $C_8$ , capacitance  $C_2$  between the plate and grid ends of the coil windings,  $C_3$  between the plate and grid leads,  $C_4$  between the grid lead and the plate end of the primary coil, and  $C_5$  between the plate lead and the grid end of the secondary coil. The result is that the coupling between the tuned primary and secondary circuits of the i.f. transformer really consists of both normal mutual inductance and top-end capacitance coupling effective simultaneously.

This capacitive coupling is a very important part of the coupling existing in practically all i.f. transformers operating at frequencies above about 400 kc. Its importance increases as the operating frequency or the  $Q$  of the coils is increased, since it then serves to transfer more signal energy from the primary to the secondary circuit. Consequently it is very important to reduce such capacitance coupling in i.f. transformer units that are designed to operate at intermediate frequencies as high as those employed in FM broadcast receivers, television broadcast receivers, etc., by taking all practical steps possible toward that end in the physical design of the individual components, placement of leads, external leads, external shielding, etc., in the assembled coupling unit.

Double-tuned i.f. transformers may be built with the stray capacitive coupling either aiding or opposing the magnetic coupling. For reasons of production economy, both the multi-layer primary coil and the multi-layer secondary coil are usually machine-wound simultaneously (properly spaced from each other as shown in Fig. 4) on a single dowel or other insulating support. Consequently they must both be wound in the same direction. For reasons of production uniformity and to reduce the stray capacitances to minimum values, the inside end of each of these multi-layer coils is usually chosen as the "high-potential" (grid or plate) end of the coil, as shown in Fig. 4. This is done in order to keep these high-potential ends of the coils as far away as possible from;

(a) the coil-to-tuning-condenser con-



nection leads that must pass the coils on their way up to the two postage-stamp tuning condensers usually mounted above the coils near the top of the shielding can; (b) the coil-to-receiver hook-up leads that must necessarily pass each coil in order to be brought out through the base of the transformer unit for convenient connection to the tube plate, "B" supply, cathode-return and diode or grid circuits. The stray capacitances (see Fig. 3B), are reduced considerably by following this practice.

If transformers are designed so that the primary and secondary coil coupling is *below* the "critical coupling" value, variations in the stray capacitance coupling are equally important whether the capacitive coupling aids or opposes<sup>1</sup> the magnetic coupling. If they "aid," an increase in the capacitance coupling will raise the gain of the transformer; if they "oppose," an increase in the capacitance coupling will reduce the gain of the transformer (except in the very rare cases where the capacitance coupling predominates).

If the transformer coupling is at "critical coupling" value and the magnetic and capacitance couplings are "aiding," an increase in capacitance coupling will merely decrease the selectivity, while if the couplings are "opposing" an increase in capacitance coupling will increase the selectivity and reduce the gain.

In all of the above cases, the effect of increasing the stray capacitance coupling is pointed out because well-designed i.f. transformers are ordinarily built with a certain irreducible minimum stray capacitance and any changes must necessarily be additions to it.

### I.F. Transformer Construction to Maintain Capacitive Couplings Constant

Special precautions and constructions are employed in building well-designed i.f. transformers in order to keep the unavoidable capacitance coupling uniform so that transformers of uniform gain and selectivity characteristics may be provided. In the i.f. transformer unit illustrated in Fig. 1, fiber spacers are used to hold the flexible hook-up leads in the pre-determined fixed position with respect to the coils so that the capacitances between them (see Figs. 3 and 4) will remain of constant value. Some i.f. transformers use a construction employing rigid leads for maximum uniformity of capacity coupling. In each of these transformer units, the pair of small adjustable tuning condensers are mounted above the coil form and inside of the metal enclosing shield can.

In order to take advantage of the uniformity built into i.f. transformers by means of lead-spacers, it is essential that the grid and plate leads remain well spaced from each other at all points. Where the grid lead is brought out through the top of the shield (as in Fig. 1) for convenient connection to the grid cap of the asso-

March, 1948

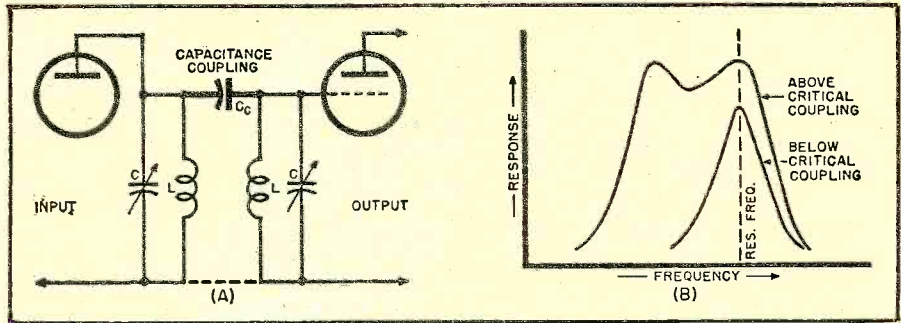

Fig. 2. Top-end capacitive coupling (A) makes the double-peaked, over-coupled resonance characteristic shown at (B) open out to one side of the resonance frequency to which both of the LC circuits are tuned.

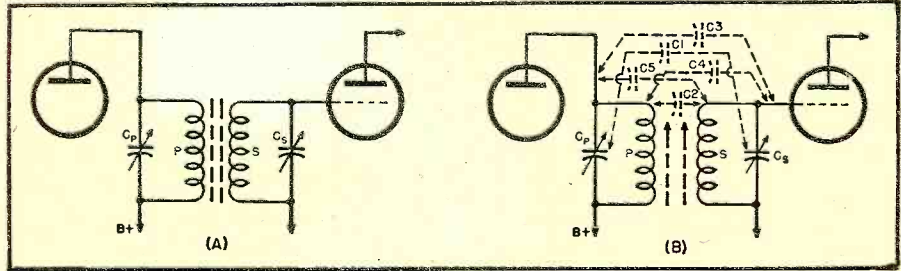

Fig. 3. (A) Typical double-tuned i.f. transformer connected between two tubes. (B) stray capacitances that cause capacitive coupling between the primary and the secondary of the i.f. transformer (see also Fig. 4).

ciated i.f. amplifier tube, this is no problem, but in the output transformer for the last i.f. stage, when the high-potential end of the secondary must be connected to a diode it is customary for both plate and diode leads to be brought out through the open bottom of the shield. In such cases, either two separate small holes in the chassis, well spaced, or one large (preferably 1" or larger) hole should be provided so that these leads may be well spaced from each other. In no case should the grid and plate leads be run through one small hole together for appreciable capacitance will then be set up between them.

### Resistance-Coupled I.F. Stage

Some AM broadcast receivers employ a two-stage i.f. amplifier but use a resistance-capacitance coupling network between the two i.f. amplifier tubes in much the same fashion as a resistance-capacitance coupled audio-frequency amplifier. Such receivers

Fig. 4. Arrangement of components and wiring of typical double-tuned i.f. transformer in shield can. Stray capacitances are indicated dotted and are lettered to correspond with those indicated in Fig. 3B.

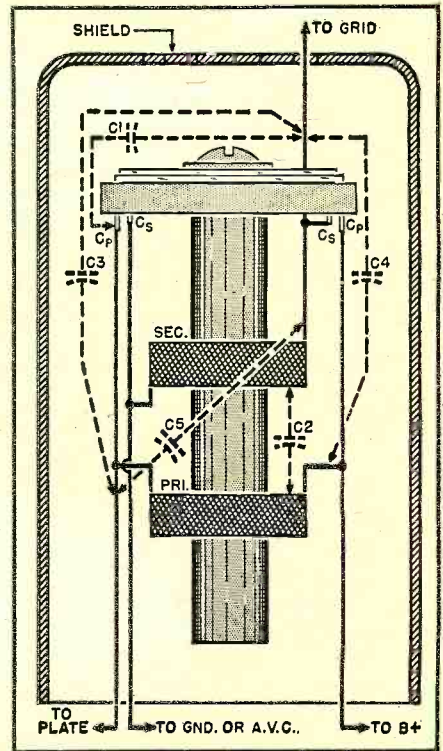
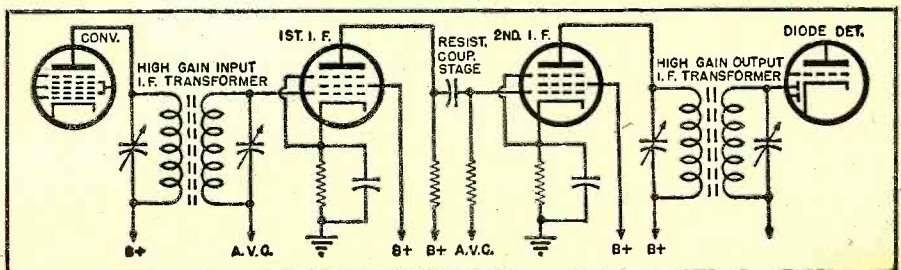

Fig. 5. Use of resistance-coupled i.f. stage in battery portables and farm radios.



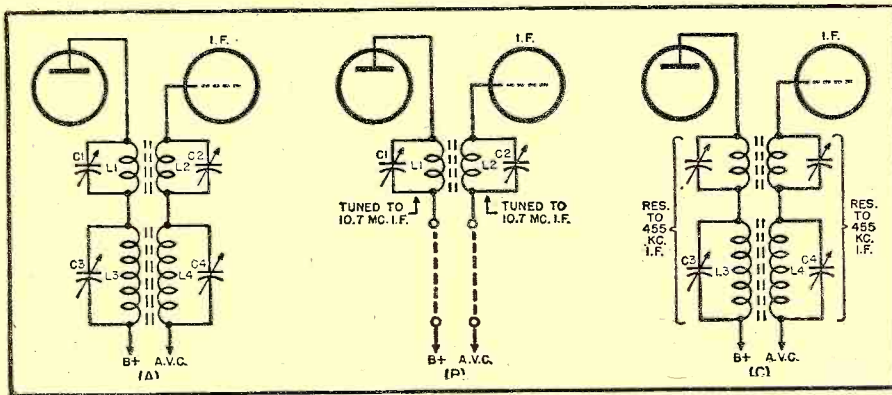

Fig. 6. Circuit and operation of AM/FM i.f. amplifier stage employing combination type AM/FM coupling transformers.

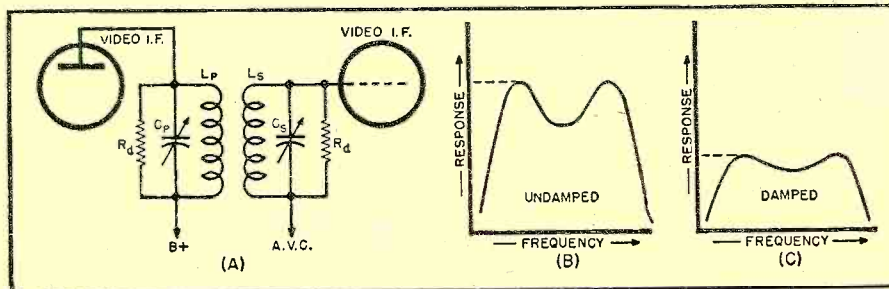

Fig. 7. Use of damping resistors ( $R_d$ ) in video i.f. amplifiers to flatten out the peaked response produced by high degree of overcoupling used in i.f. transformers.

employ high-gain, double-tuned input and output i.f. transformers. The resistance coupling contributes nothing to the selectivity of the i.f. amplifier, but the resistance-coupled stage does contribute a gain in the order of 15 to 20 times depending upon the tube used, the constants of the circuit, and the applied voltages. As this gain remains uniform over the entire tuning range of the receiver (because the carrier frequency of the signal in the i.f. amplifier does not change), it is preferable to the use of a resistance-coupled r.f. stage, whose gain would vary from one end of the tuning band to the other. (However, use of a resistance-coupled r.f. stage offers an improvement in the signal-to-noise ratio over that of a resistance-coupled i.f. stage.)

The use of a resistance-coupled i.f. stage became popular with the advent of battery portable receivers, farm re-

ceivers, and others in which added sensitivity is required to provide adequate performance in rural areas quite removed from the broadcast transmitters serving them, for in these areas such receivers are not apt to be subject to image-frequency signals of sufficient strength to cause image-frequency interference.

### Combination I.F. Transformers for AM/FM Receivers

To satisfy the widest demand, an FM broadcast receiver designed for home use should also provide for reception of AM broadcast stations over the 535-1605 kc. AM broadcast band, and those on one or more of the AM short-wave bands. The i.f. value and response characteristics desirable for receivers designed for reception of the AM broadcast stations were discussed in detail in the previous article of this series. It will be remembered that an

i.f. value of the order of 455 kc. is now the RMA standard, and a passband characteristic approximately 10 kc. wide is required for this service. These values are also satisfactory for the reception of short-wave AM broadcast signals. For FM broadcast reception an i.f. of 10.7 mc. is now the RMA standard, and a 150 kc. passband is required. How are both characteristics to be made available, at will, in one receiver?

The problem has been attacked in three different ways<sup>2</sup>. In one, independent i.f. amplifiers, each designed to provide the special characteristics required, are used for AM and FM reception and are automatically switched into the circuit by the AM/FM waveband switch. In another, either of two different sets of i.f. transformers, one for AM reception and one for FM reception, can be switched into the i.f. amplifier circuit to act as the coupling units between the single set of i.f. amplifier tubes. Of course, the switching circuits necessary in this system are objectionable.

In the third (and now most popular system for combination AM/FM broadcast receivers and AM/FM communications receivers), "combination" type i.f. transformers, each having two primaries and two secondaries, as shown in Fig. 6A, are employed. Tuned primary and secondary windings  $L_1$  and  $L_2$  constitute the FM i.f. coupling transformer designed to operate at the intermediate frequency chosen for FM reception (a 10.7 mc. i.f. is now the RMA recommended value for FM receivers, but other values, such as 4.3 mc. and 8.6 mc. have been used in some receivers). The trimmer condensers  $C_3$  and  $C_4$  used to tune the AM windings  $L_3$  and  $L_4$  are sufficiently large in value so that they act as very effective bypass condensers for the 10.7 mc. FM i.f. signal. Consequently, when FM signals are being received,  $L_1$  and  $L_2$  and their tuning condensers  $C_1$  and  $C_2$  constitute the FM transformer operating at 10.7 mc., and the circuit effectively is essentially that shown in Fig. 6B. Observe that windings  $L_3$  and  $L_4$  become effectively bypassed out of the circuit for the 10.7 mc. i.f. signal. The  $L_1C_1$ - $L_2C_2$  tuned circuits are designed to be sufficiently over-coupled so that the full wide-band 150 kc. bandpass characteristic desirable for high-fidelity FM reception is provided. The desired selectivity characteristics to prevent adjacent-channel FM station interference are also provided.

During broadcast band or short-wave AM signal reception the frequency of the intermediate carrier becomes 455 kc. Primary and secondary windings  $L_3C_3$ , which are tuned to the much higher frequency 10.7 mc. can be neglected insofar as transformer action and transfer of 455 kc. signal energy from primary to secondary is concerned. However, the impedance of 10.7 mc. tuned winding  $L_1$  acts as a loading coil for AM primary  $L_3$ , and

Fig. 8. (A) Application of degeneration to flatten frequency response of video i.f. amplifier. (B) Iron-core video i.f. coupling transformer windings tuned by distributed capacitance existing in input and output circuits (shown dotted in the diagram).

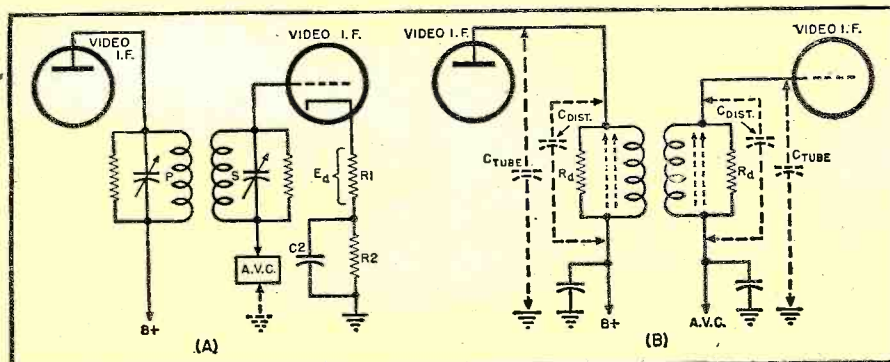

<sup>2</sup>For a discussion of AM/FM receivers see Alfred A. Ghirardi, Practical Radio Course, Part 56, (RADIO NEWS, November, 1947).

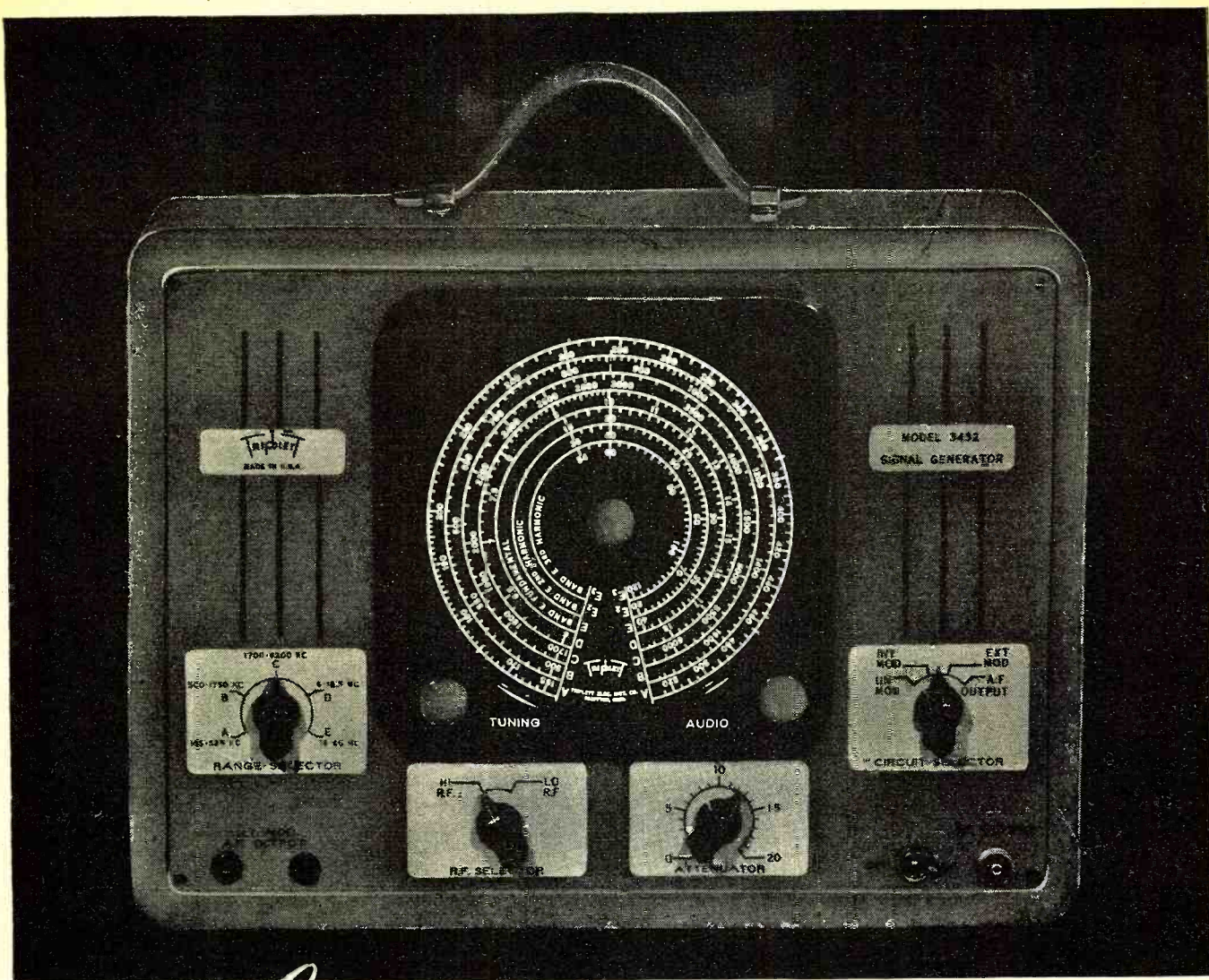

*Look at that dial!*

It's Triplet's new method of dial lighting—one of the features of Model 3432 Signal Generator. The dial is BIG (330°) and correctly illuminated . . . accurately calibrated . . . quickly readable at a glance . . . with 10 to 1 Ratio Vernier Tuning for ease of adjustment. The seven long scales on the dial of Model 3432 have five fundamental ranges 165 KC to 40 MC and two harmonic ranges directly calibrated 36 MC to 120 MC. Variable 400 cycle modulation 0 to 100%; special copper plated internal shielding, R.F. attenuation—and many other features that have to be seen—and used—to be fully appreciated. Model 3432 is a Triplet top value that's priced *right*. See it now and buy it from your distributor.

**Model 3432**  
Illuminated Dial  
Signal Generator

TRIPLET ELECTRICAL INSTRUMENT COMPANY, BLUFFTON, OHIO





## DEPENDABILITY PLUS

### THE TURNER MODEL 22X-22D

#### Crystal or Dynamic Microphone

Leading manufacturers of communications, sound, and recording equipment specify the Turner Model 22 as standard for microphone performance. Its accurate pickup and smooth, wide-range response is engineered for both voice and music. Up-to-the-minute styling adds distinction to any installation.

The Turner Model 22 is easy to handle, convenient to use. Full ninety degree tilting head permits semi- or non-directional operation. Furnished with removable 7 ft. quick-change shielded cable set.

**MODEL 22X** is engineered with a high quality, humidity protected crystal in mechanical shock-proof mounting. Equipped with wind-gag and barometric compensator. May be used indoors or out. Response:  $\pm 5$  db from 50—9000 c.p.s. Level: 52 db below 1 volt/dyne/sq.cm.

**MODEL 22D** features high quality magnets in a well balanced acoustic circuit with adequate shielding to reduce r.f. pickup. Built to withstand heat, cold, humidity. Response:  $\pm 5$  db from 50—9000 c.p.s. Level: 54 db below 1 volt/dyne/sq.cm. at high impedance.

*For thoroughly dependable performance, plus modern streamline styling—  
Turn to Microphones by Turner. Write for Complete Microphone Catalog.*

## THE TURNER COMPANY

900 17TH STREET N. E., CEDAR RAPIDS, IOWA

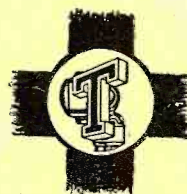

Microphones licensed under U. S. patents of the American Telephone and Telegraph Company, and Western Electric Company, Incorporated. Crystal licensed under patents of the Brush Development Company.

that of 10.7 mc. tuned winding  $L_2$  acts as a loading coil for AM secondary  $L_1$ . Therefore, the loading effects of the FM tuning circuits are included in determining the peaking of the AM tuning circuits to resonate at 455 kc. The circuit which becomes effective for AM signal reception is essentially that shown in Fig. 6C. The design of tuned primary and secondary windings  $L_3$  and  $L_4$ , and the coupling between them, is such that the usual 9.5 or 10 kc. bandpass steep-sided response characteristic required for reception of AM broadcast signals is provided. Observe that the changeover to the proper i.f. transformer windings is accomplished automatically, without need for complicated and costly switching circuits.

#### Wide-Band Video I.F. Amplifiers

The requisites<sup>3</sup> of the video (picture) i.f. amplifier of a television receiver are so much more severe than those of the sound i.f. amplifier, or the i.f. amplifier of either an AM broadcast or FM broadcast receiver, that many special and important circuit features must be employed in such amplifiers. A review of these requisites follows:

1. Briefly, the frequency-converter tube of a television receiver ordinarily changes the incoming video carrier to an intermediate frequency of between 25.75 and 26.4 mc. (postwar RMA recommended standard). The video signal bandwidth that must be handled at this extremely high carrier frequency approximates 4.5 mc. Consequently the ratio of the i.f. amplifier passband width required, to the frequency of the video i.f. carrier is approximately equal to the abnormally high value of 17.5% (contrast this with values of  $10 \times 100/455 = 2.2\%$  for the similar ratio in AM broadcast receivers,  $105 \times 100/10,700 = 1.4\%$  in FM broadcast receivers, and 0.236% in the sound i.f. amplifier of television receivers).

2. The video i.f. amplifier must also provide sharp attenuation at the low-frequency end of its passband (see bottom curve in Fig. 9) in order to eliminate the FM sound signal associated with the picture signal. In fact, this cut-off must be so sharp that such amplifiers contain special rejection filter networks<sup>3</sup> to aid in sharply attenuating this sound signal and also the sound signal of the next lower-frequency adjacent-channel television transmitter.

3. As vestigial sideband transmission (a modified form of single-sideband transmission wherein one sideband is largely suppressed at the transmitter) is employed (in the U.S.A.) for the video signal, the video carrier frequency is near the edge of the transmission band rather than in the middle. Also a special shape of video i.f. amplifier response characteristic is required in the region of the video i.f. carrier frequency (it

<sup>3</sup>See Alfred A. Ghirardi, Practical Radio Course, Part 57, (RADIO NEWS, December, 1947).

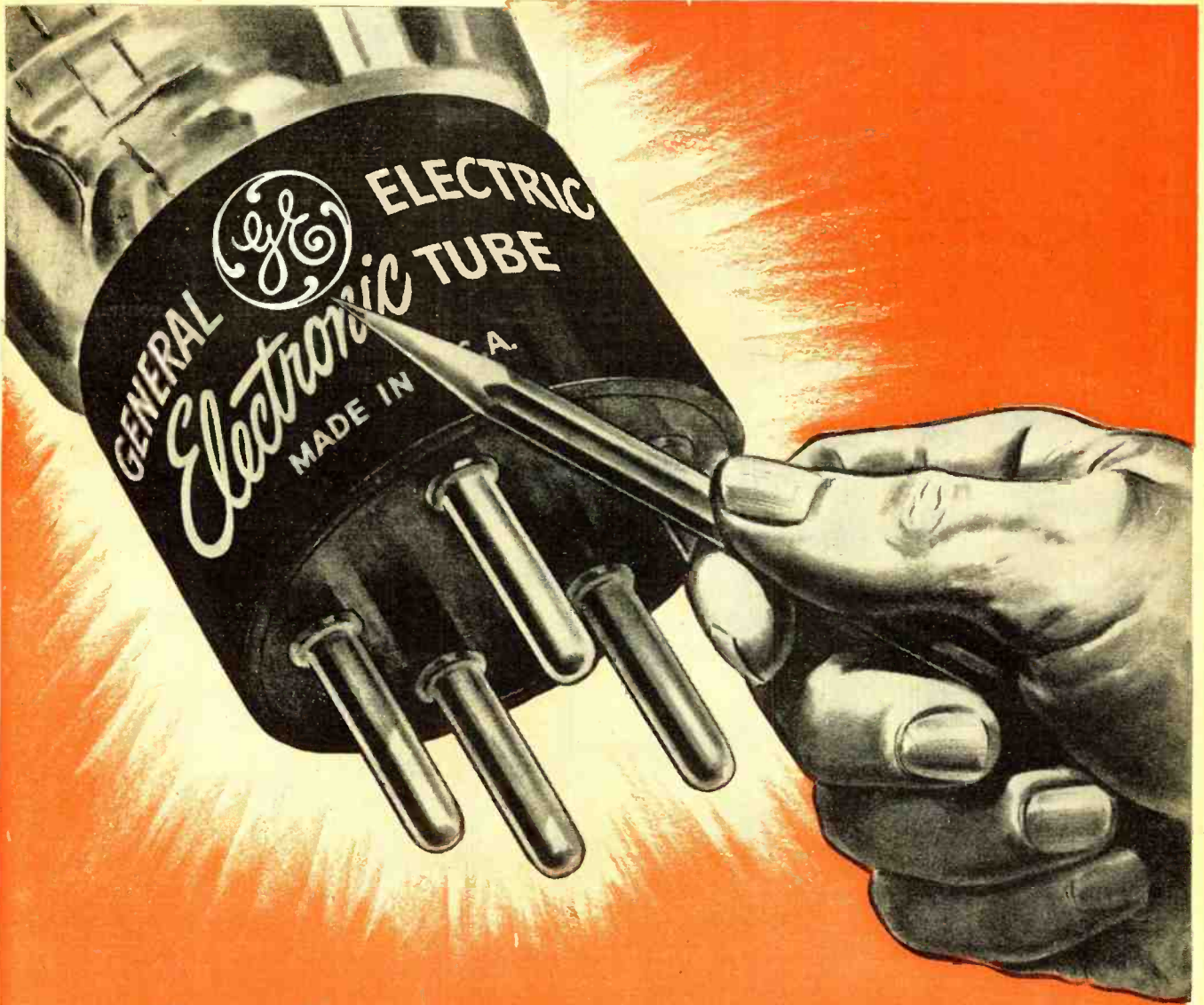

**No other name means so much!**



**GENERAL  ELECTRIC**

**FIRST AND GREATEST NAME IN ELECTRONICS**

178-GA3-8880

**For the Finest  
Phonograph Performance Ever Achieved . . .**

*Newcomb*

## ANNOUNCES 2 GREAT NEW PHONOGRAPH AMPLIFIERS

with the **MAGIC RED KNOB**

**L**OGICAL culmination of years of electronic research and engineering development continuously carried on in Newcomb laboratories, these new phonograph amplifiers, used in conjunction with suitable accessories, will produce unbelievable realism from recorded music or from AM-FM radio tuners connected to them. Their improved response at low volume, their beautifully clear, undistorted treble tones and the exclusive new "Magic Red Knob" control, which virtually eliminates surface noise and distortion from records in any condition, make these two amplifiers the best possible choice for those custom phonograph installations.

**MODEL KXLP-30:** Its ample power permits use of the famous Newcomb KX-Series dual tone control circuit, which provides tonal range and balance unattainable in less costly circuits. This circuit allows controlled emphasis of the desirable but power-consuming fundamental bass tones, avoiding emphasis of harmonic bass, so unacceptable to discriminating listeners.

**MODEL HLP-14:** Brings to music lovers an entirely new listening pleasure in a somewhat less expensive unit than the superb KXLP-30. Exceptional tonal balance at whisper volumes is a feature of the HLP-14. Its adaptability to use with the new AM-FM tuners, wide range loudspeakers and new phonograph pickups make it an ideal starting point for those increasingly popular custom installations.



Both include inputs for G.E. type pickups.



*Send for Specifications*

**AUDIO PRODUCTS CO.**

Dept. F, 6824 Lexington Avenue • Hollywood 38, California

## PRACTICAL TRAINING FM-RADIO-TV



Four fully-equipped laboratories provide the PRACTICAL training necessary for successful careers in Radio Communications (FCC licenses) and in Radio-Television (Technician) Servicing. Train under supervision of technical specialists—with COMMERCIAL-type equipment. Investigate why WRCI SPECIALIZED TRAINING methods are outstanding in the West; why WRCI laboratory-trained specialists are preferred for responsible positions. Read our illustrated bulletin before enrolling in any school. Approved for veteran training—non-veterans accepted. Send for free copy of Bulletin-B today.

**WESTERN RADIO COMMUNICATIONS INSTITUTE**  
631 West Ninth Street, Los Angeles 15, California

must be down 50% at the video i.f. carrier frequency) to compensate for the overemphasis of the lower-frequency video modulations that result from the particular video signal transmission characteristic employed in the vestigial sideband transmission.

In order to obtain the unusually wide 4.5 mc. over-all passband characteristic required in the video i.f. amplifier, heavily overcoupled double-tuned interstage i.f. transformers are usually employed. The heavy overcoupling produces a broad response characteristic that contains marked double peaks with deep dips between<sup>4</sup>, as shown at (B) of Fig. 7. The flatness of the frequency response of overcoupled double-tuned coupled circuits depends mainly upon the circuit Q's; the Q may be conveniently lowered by shunting one, or both, tuned circuits by a damping resistance of suitable value as shown at (A) of Fig. 7. This has the effect of reducing the peaks, as shown at (C). Since the gain per stage is also reduced by the damping resistors (compare the response in (B) and (C)), the flattened wideband response is obtained at the sacrifice of amplification. Because the gain per stage realized in such amplifiers is comparatively low, four stages of video i.f. amplification are usually used in television receivers in order to produce the required gain.

When heavy resistive loading is used to obtain wide, flat response it is possible to predict the value of damping resistor  $R_d$  required, by means of the approximate relation:

$$R_d = 1/6.28 \Delta f C$$

where:  $\Delta f$  = width of the passband

$C$  = circuit tuning capacitance shunting the winding to which the damping resistor is applied.

It is interesting to observe that the resistance of  $R_d$  is determined only by the required bandwidth and the circuit tuning capacitance. Because the gain of the amplifier is limited by this resistance, it can easily be seen why it is important to use as high a value of loading resistance as possible in order to realize maximum available gain. For a given bandwidth, the value of  $R_d$  will increase as the circuit-tuning capacitance  $C_s$  used decreases (since  $R_d$  varies inversely with  $C_s$ ). If the primary and secondary tuned circuits of the i.f. transformers are to be tuned to the video i.f. by use of only a small value of tuning capacitance, the  $L/C$  ratio of these tuned circuits must be made extremely high.

In order to make it possible to use a very low value of circuit-tuning capacitance (for the above reason) the primary and secondary windings of video i.f. transformers are designed to have sufficient inductance so that each is tuned to the required high video i.f. simply by the total circuit-capacitance of the circuit in which it is connected

(Continued on page 110)

<sup>4</sup>For a discussion of the response characteristics of over-coupled i.f. transformers see Alfred A. Ghirardi, Practical Radio Course, Part 58 (RADIO NEWS, January, 1948).



THE MCGEE RADIO CO. PRESENTS THE GREATEST RADIO KIT OF ALL TIMES

# PERSONAL PORTABLE RADIO KIT \$14.95

MAKES A \$32.50 RADIO

Size: 6 1/2" x 3 1/4" x 4 1/8" Weighs Only 3 1/2 Lbs.

- Two-Tone Ivory, Red Plastic Cab.
- Loop Aerial, Built-in Lid
- 4-Tube Superhet
- AVC.
- Looks like and is a Commercial Radio Kit
- Two-Gang Cond., Lucite Dial
- Simple Assembly and Wiring Instructions



Complete with Batteries

This kit is ready for immediate delivery. The same nationally known factory that manufactures tens of thousands of this radio is line-producing this radio kit for us. Every part, from the cabinet down to the last resistor, is matched. The chassis is ready punched; all you do, is mount the parts and wire. This radio kit will assemble into a beautiful personal radio for you, just the same as it does for the factory. We furnish you a diagram, photograph of the completed chassis and full assembly instructions so that those with a minimum knowledge of radio may wire this kit. The beautiful case is made of metal with plastic hinges and a snap on back. The

Lucite face of the receiver has an inlaid gold design. The circuit is the conventional two gang superhet type, with A.V.C. Receives the broadcast band, 540 to 1650 KC. Uses miniature tubes: 1R5 converter, 1R5 detector A.V.C., 1T4 amplifier and 3S4 power amplifier. Alnico V PM speaker. The loop antenna is built in the lid. Radio comes on automatically when lid opens. Operates on self-contained batteries. Priced complete with tubes and 6 1/2 volt "B" battery and flash coil (Not AC-DC). Nothing else to buy. Model X-45. Price \$14.95. Shipping weight 6 lbs.

SCOOP MODEL X-45 PERSONAL PORTABLE KIT WIRED AND TESTED WITH BATTERIES, NET \$19.95

## BUILD THIS 8-TUBE RADIO-AMPLIFIER COMPLETE KIT—ONLY \$29.95

### DELUXE CONSOLE CABINET \$49.95

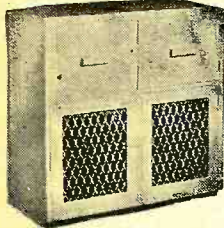

- SLIDE AWAY CHANGER COMP.
- RECORD ALBUM COMPARTMENT
- BEAUTIFUL, ALL WALNUT CONSTRUCTION

This is the first time we have been able to offer a beautiful floor model console. RADIO-PHONO cabinet. Finest all walnut construction: hand rubbed finish, 34" long, 33" high, 16" deep. Holds 12" speaker, large record

compartment. Slide away changer compartment will accommodate changer of the Webster 56 class and smaller. Receiver compartment is 15 1/2 x 7 1/2 inches. Will accommodate our Model PRK-10 radio, advertised here. Dealers, here is your chance to buy good cabinets at the right price. Convert those low-priced sets into radio-phonos combinations. Weight 50 lbs. Net, \$49.95.

Price with Two Post Oak Changer.....\$66.95 IF DESIRED, WE CAN FURNISH THIS IN BLOND MAHOAGNY AT \$49.95

### RECEIVES BROADCAST AND FOREIGN SHORT WAVE

- A COMBINED BROADCAST SUPERHET RADIO CHASSIS AND 15 WATT P. A. SYSTEM
- HEAVY DUTY 12" P.M. SPEAKER
- CROW 8" SLIDE RULE DIAL, 2 GANG COND.
- REC. BROAD, 550 TO 1700 KC AND 19 TO 49 METERS
- PUSH PULL 6V6—TWIN TONE CONTROLS
- INPUTS FOR CRYSTAL OR DYN. MIKES AND PHONO-PICKUP. WE FURNISH EVERYTHING TO BUILD THIS DELUXE CHASSIS
- WHY NOT ORDER THE CONSOLE ON THE LEFT, WITH YOUR PRK-10
- CHASSIS SIZE 9 1/2 x 11 x 8" HIGH

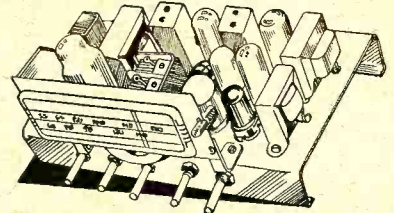

Here is something new in radio. A real 15 watt power amplifier with bass and treble controls. Has extra gain stage for crystal or dynamic mikes. And on the same chassis, a standard superhet radio receiver. We furnish all parts, knobs, escutcheon plate and tubes: 6SA7, 6SK7, 6SR7, 6SN7, 6SJ7, two 6V6 and 5Y3. No cabinet. Extra care in designing the power supply section assures low hum level, making this unit ideal for recording as well as P.A. use. We furnish everything as well as schematic diagram and photos of the completed chassis. Weight 35 lbs.

PRK-10 Radio-Amp. Kit with 12" P.M. speaker. With tubes.....Net

\$29.95

OPR-15. Exactly the same kit as the PRK-10 kit, except it is furnished with a 12" Cindagraph wide range speaker. (Has built-in high frequency tweeter.) This is our finest kit.....Net

\$37.95

### SMALL PORTABLE KIT, \$10.95

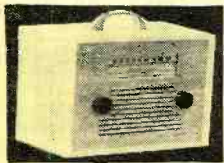

- 4-Tube Broadcast Superhet
- Priced Complete with Batteries
- Dynamic Speaker
- Slide Rule Dial

PORTABLE KIT MODEL K-PX. Small size leatherette covered case 9x5 1/2x5. Easy to build. Operates on self contained B and A batteries. Rec. Broadcast 550 to 1600 K.C. Incorporates a standard superhet circuit with AVC. Has 3 inch Alnico five PM speaker. Priced complete with batteries, pictorial diagram and tubes 1R5, 1R5, 1T4 and 3S4. Not AC DC, but straight battery operated. Has 2 gang cond. Everyone should have one of these personal portables. Everything furnished. Kit K-PX.....Net \$10.95

torial diagram and tubes 1R5, 1R5, 1T4 and 3S4. Not AC DC, but straight battery operated. Has 2 gang cond. Everyone should have one of these personal portables. Everything furnished. Kit K-PX.....Net \$10.95

### 3-WAY PORTABLE KIT, \$16.95

- 4 Tubes Plus Disc Rectifier
- 300 Hour Battery Pack Included
- Beautifully Built Portable Case

Build this powerful, 4-tube, 3-way portable kit. Operates on 110 volts AC or DC or self contained batteries. Receives broadcast 550 to 1650 K.C. Incorporates a standard superhet circuit with AVC and Loop Ant. Has Alnico 5 PM Speaker, 2 gang condenser. All parts and batteries are furnished including tubes, Disc Rectifier, 1R5, 1T4, 1R5 and 3S4. Has attractive leatherette portable cabinet size 7x9x9. Weight 14 lbs. Kit Model 3-ZA. Net \$16.95

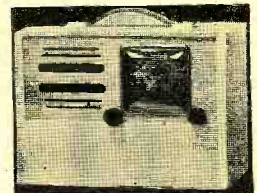

### 5-Tube AC-DC Broadcast Kit, \$9.95

BEAUTIFUL 10" PLASTIC CABINET LOOP AERIAL • VERNIER DIAL DYNAMIC SPEAKER • EASY TO BUILD

Kit Model P-85. We have finally been able to achieve our goal. Here it is. A good 5-tube broadcast AC DC superhet radio receiver for less than ten dollars. The beautiful 10 inch plastic cabinet is made of the finest material. The chassis is of the standard accepted superhet design. 456 KC ifs AVC and 5 inch Alnico 5 PM speaker. Attractive vernier dial. Two gang tuning condenser. Loop ant. We defy anyone to offer a better working AC DC receiver kit. Priced complete with diagram, photos and tubes 12B16, 12BA6, 12AT6, 50B5 and 35W4. Nothing else to buy. You can't go wrong on this value. Kit Model P-85.....Net \$9.95



### 12-WATT AMPLIFIER KIT, \$10.95

PUSH PULL 6V6 OUTPUT TUBES GAIN FOR MIKE AND PICK-UP EVERYTHING FURNISHED. EASY TO WIRE FINE TONE QUALITY



KIT MODEL AC-12. 12 watt amplifier kit. Ideal for high quality record player as well as public address or recording amplifier. Matched component parts, ready punched chassis pan. One control fades from phono to microphone. Gain enough for crystal or dynamic microphone, 100 mil power transformer for 110 volt AC 60 cycle operation. Priced complete with tubes: 2-6V6, 6SN7, 6SH7 and rectifier. Diagrams and photos furnished. Kit AC-12. Net \$10.95. 12" Alnico 5 PM speaker \$6.95 extra; crystal microphone and desk stand \$4.95 extra.

### WIRE RECORDER \$89.50



This wire recorder incorporates all necessary circuits for recording and playback. It has built-in eraser circuit. The amplifier is of the AC transformer type, with push-pull 6V6 output tubes. Has tone control and fader control. Input stage for wire recording from either crystal mike, radio receiver or phono pick-up. Amplifier is wired, tested and ready to operate. This unit is classified as a kit, only because you have to mount the Webster wire recording mechanism, amplifier and speaker. Everything is furnished, including a 15 minute spool of recording wire.

Kit includes wired and tested 12 watt amplifier, expressly made for wire recording and public address use. Leatherette split type case and 10" PM speaker, furnished with regular \$52.92 Webster wire recording mechanism. Kit model GN-12. Net \$89.50. Crystal mike and desk stand \$4.95 extra.

### 5-TUBE AC KIT, \$14.95

Model JDS AC. Has beautiful 12" walnut cabinet. All parts furnished to build a broadcast 5 tube AC transformer type, superhet. Rec. 550 to 1700 KC. Slide rule dial, 2 gang tuning cond. Loop aerial. Heavy duty Alnico V PM speaker. Everything furnished including photos, diagram and tubes. 6SA7, 6SD7, 6SQ7, 6K6 and rectifier. Kit JDS AC.....Net \$14.95



### 20-WATT UTILITY AMP. KIT, \$17.95

Build this 20 watt utility 110 volt AC, 20 Watt power amplifier. Ready punched chassis, size 12 x 6 x 2 1/2 inches. Has two input circuits, one mike and one phono. Mike stage has 135 DB gain for crystal or dynamic mike. Has bass and treble controls. Designed for use with 2M speakers; has 8-16 ohm output transformer. All parts and easy-to-follow diagram furnished, including tubes: 2-6SN7, 6J5, 2-6L6GA, 5Z3. Kit Model 20-12.....Net \$17.95



### ARMCHAIR RADIO CABINET, \$29.95

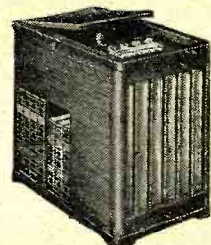

Beautifully made walnut armchair cabinet. Outside dimensions 24" high, 16 1/2" deep, and 27" wide. Ample room for radio receiver 14" long, 9" high and 10" deep. Will hold a changer up to 14" square. Will accommodate speaker up to 12". Has record album storage compartment. Hinged lid covers changer compartment. Cabinet Ar-15 Net \$29.95. Detroit automatic changer \$12.95 extra. Twin post Oak changer \$17.95 extra.

Why not order this 9 tube radio chassis kit with the armchair cabinet? Build a high fidelity broadcast receiver, 12" PM speaker. Kit has 10" slide rule dial, conventional two gang superhet circuit. Complete with tubes: 12K8, 12SK7, 12B6, 12A5, 12SL7, and 4-12AU6, in push-pull parallel. A deluxe type kit. Diagrams and photos furnished. Chassis Kit AHK-2.....Net \$19.95

**McGEE RADIO COMPANY** WRITE FOR CATALOG SEND 25% DEPOSIT — BALANCE C. O. D. PRICES F. O. B. K. C. 1225 MCGEE ST., KANSAS CITY, MISSOURI



## Army BC-645 I.F.F. TRANSMITTER RECEIVER \$995

Brand New 450 M.C.

2 big units; all in one. A 10 tube superhet receiver for 450 Megacycle, a 5 tube 450 megacycle tuned line transmitter. Both are two channel. 4-T7T, 4-7H7, 2-7E6, 2-6F6, 2-955, 1-WE 316A. The tubes that come with this unit are worth more than our sale price. This unit originally designed for identification "Friend or Foe" Army BC-645. Brand new factory cartoned, weight 25 lbs. Furnished with four page conversion instructions for a CW or MCW or phone transmitter. How to build a 110 volt AC power supply, etc. 12 volt dynamotor, \$2.95 extra. WE-316A tube \$ .99, BC-645. \$9.95. 2 for \$19.00.

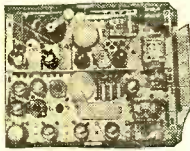

## Army BC-654 80 METER XMITTER RECEIVER \$295

BC-654—Two for \$25.00

Portable voice and CW transmitter and receiver for portable, mobile, and fixed station operation. 7-tube superheterodyne receiver with 3.5 microvolt sensitivity on voice and 0.5 microvolt sensitivity on CW, and 100 milliwatts undistorted power output. 455 KC IF. Uses 3-1N5GT, 1-1A7GT, 2-3Q3GT, 1-B5GT tubes, 6 tube transmitter, with antenna tuning network. Colpitts thermal compensated oscillator, class C final with 2-307A tubes in parallel, and crystal oscillator for checking frequency every 200 KC. 25 watts output on CW and 11.2 watts output on voice. Frequency range transmitter and receiver, 3800 to 5800 KC. Ideal for Hams! Comes complete with cover; furnished with all tubes necessary for the operation of the trans. and rec. Less power supplies. These units are used but in good condition. Shipping weight 30 lbs. \$12.95; 2 for \$25.00. 654 Vibrator Pack 6 for 12 V.D.C. input \$4.95 extra. SCOOP. BC-654 Less all tubes. Net. \$7.95



## ARC-4 \$14.95

IDEAL FOR 2 METERS  
Priced Complete With  
20 Tubes—and 12-28  
Volt Dynamotor

FOUR CHANNELS CRYSTAL CONTROLLED. ARC-4 for VHF frequencies 140 to 144 megacycles. There are 7 tubes in the transmitter: 832, two 1614, two 6V6 and two 6L6. The receiver section has 13 tubes: two 6AC7, four 6N7, three 12SQ7, two 12SQ7 and two 12A6. The unit is actually two receivers and one transmitter in one piece. One receiver is for stand-by use. Has built on dynamotor for 12 or 24 volt DC operation. Priced complete with tubes and four crystals and dynamotor. Hams convert this for two meter operation. It's a scoop at this price. Used, but guaranteed to be in good condition.

### SELSYN INDICATORS \$2.95

Selsyn indicators. 5" diameter. Will operate on from 15 to 24 volts 60 cycle AC. Model 1-82A can be used as either selsyn transmitter or selsyn receiver. Scoop Price. \$2.95. 2 for \$5.49

### 3" SELSYN INDICATOR

Works on 16 to 25v. 60 cycle

**\$2.45** Each  
**Two for \$4.45**

### CARBON HAND MIKE, 99c

Army carbon hand mike with push-to-talk switch, cord and plug. Brand new and factory cartoned. While they last. 99c each; two for \$1.89; ten for \$6.90.

### VIBRATOR SCOOP \$1.99

Heavy Duty Vibrator—Made for 6-110 volt amplifiers. Freq. 60 CPS. Scoop price. \$1.99  
135 ma 6-110 volt conventional power transformer, with all windings; will run phono motor. \$5.95  
(Use with above vibrator.)

### VEEDER ROOT METER

Counts number of feet of trailing wire antennae; number turns when winding on coil; applicable for many uses; beautiful bakelite case, jeweled dial, pilot light enclosed, 3 position switch, counts up to 1000.  
Each \$9.95

### MAGUIRE AUTOMATIC RECORD CHANGER \$9.95

Brand new factory cartoned. This changer should sell for three times our price. Latest two-post, quick change type. Has permanent built-in needle, shuts off on the last record. Plays 12 10" or 10 12" records. Fully guaranteed. Base size 16 x 13 inches. Scoop price \$9.95. Made to fit walnut base \$2.49, extra.

Aero Changer, Base size 12 x 13 inches \$12.95. Walnut base \$2.49 extra.  
Vm-800 Changer, Base size 13 x 14 inches \$14.95.. Walnut base \$2.49 extra.  
Oak Twin-post Changer, Base size 14 x 14 inches \$17.95. Walnut base \$2.49 extra.  
General Instrument Deluxe Changer, Base size 11 x 12 inches, \$17.95. Walnut base \$2.49.  
Aviola Changer, Base size 11 1/2 x 12 inches, \$14.95.. Walnut base \$2.49 extra.

Made by World's Largest Manufacturer of Vib. Heavy duty 4 prong vibrator, 6 volt non-syn. Has 3 points. Standard base connections fits 70% of all car radios. \$1.29 each, 10 for \$11.95, 50 for \$55.00, 100 for \$99.95.

## NEW COMMAND \$595

XMITTERS

With each command transmitter, we furnish a schematic of the BC-458 (All command Transmitters are essentially the same; except for frequency.)

Near New BC-457, 4 to 5.3 MC with Tubes... \$2.95  
Brand New BC-457, 4 to 5.3 MC with Tubes... 5.95  
Near New BC-458, 5 to 7 MC with Tubes... 2.95  
Brand New BC-458, 5 to 7 MC with Tubes... 5.95  
Twin Rack for 2 Transmitters... 1.95  
Antenna Current Meter... 1.95  
Near New BC-456 Modulator, with 28 v dynamotor... 2.95

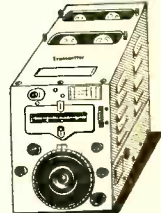

### SCR-518 ALTIMETER \$2950

Brand New  
Famous SCR 518 A Altimeter. Brand new factory cartoned. Worth over \$900.00. Made by RCA. Complete as pictured. Has 29 tubes. unit. Transmitter, receiver, power supply and 3" scope indicator. Reads altitude up to 30,000 ft. Operates on 28 volts. D.C. Complete with tubes. 6SK7, 2 8012, 2 6S17, 6CS, 6SN7, 6F8, 28D4, 6Y6, 6V6, 10 6AC7 3 2X2, 954, 955, 956, 6J5 and 3 in. CR tube 1808P. A RED hot scoop at only \$29.95 complete.

### ARMY \$695

Field Telephones  
EE-8 Army field telephone. These units are used, but in good condition. Priced complete with telephone hand set, hand powered magneto and anvas carrying bag; as pictured. Net \$6.95, each.

### 5 TUBE SCOOP \$995

BRAND NEW  
AM 61A Indicator Amplifier. Brand new factory cartoned. Has 28 volt DC Blower motor and fan. 2 2mfd 1000 volt cond. 2X .5 mfd. 1000 volt cond. and many other parts. Complete with 15 tubes, 7 6SN7, 3 VR 105, 5Y3, 3 6SL7, 8016. As a salvage item this is a RED Hot Buy. The tubes are worth more than our price. Weight 30 lbs. Net \$9.95

### AM-26 \$1.49

AM 26 interphone amplifier. This unit is nice for parts salvage and the aluminum case is usable for receiver building etc. Size 9 1/2 x 4 1/2 x 5". Has two transformers, four tube sockets, three filter condensers, three position panel switch, toggle switch, and many small parts. All are in perfect condition.  
\$1.49; 2 for \$2.49

### RDF RECEIVER \$19.95

MM-26-C Compass Receiver. Brand new factory cartoned. This unit covers from 150 to 1500 KC inclusive; in three bands. Complete with eleven tubes of the 6 volt type; 6SA7, 6SK7, 6I6, etc. Has 28 volt built-in dynamotor. There is no dial built on unit and no remote cables are provided. MM-26-C receiver \$19.95. Remote control \$3.95 extra, Manually operated loop... \$6.95 extra

## COMMAND REC. WITH DIAGRAMS

Order your Aircraft command receivers from McGee. We furnish you a schematic of the BC-454 (all are the same except for frequency). Also, a diagram showing how to convert receivers for 110 volt operation.

Brand New BC-453, 200 to 500 KC with Tubes \$7.95  
Near New BC-453, 200 to 500 KC with Tubes 4.95  
Brand New BC-454, 3 to 6 MC with Tubes... 4.95  
Near New BC-454, 3 to 6 MC with Tubes... 2.95  
Near New BC-455, 6 to 9 MC with Tubes... 3.95  
Brand New BC-946, Broadcast 550 to 1500 KC, with Tubes and Instructions... 12.95  
Triple Remot Control Head for 3 receivers... 1.95  
Triple Mounting Rack for 3 receivers... .99  
28 volt Rec. Dynamotor... .99

### MARKER BEACON REC. \$2.95

BC 1023 A Marker beacon receiver. Designed for reception of modulated signals of the 75 MC band. Variable tuning permits coverage of 62 to 80 MC. Brand new factory cartoned. With tubes 6SQ7, 6U6, 6C7 and 12SH7. Operates directly from 12 or 14 volts DC. Priced for quick sale only \$2.95.

### SCOOP! 110 M.C. REC. \$6.95

BC-733 D Localizer Receiver  
Freq. 108-110 Mc; Tube complement: 10 tubes—1-12SQ7, 2-12SR7, 1-12A6, 1-AH7GT, 2-12SG7, 3-717A. Now only...\$6.95  
NEAR NEW CONDITION. A RED HOT VALUE.

### MODULATOR SALVAGE \$2.49

Another red hot value in salvage. All kinds of good usable parts in this unit. Con. Res. Relays, Modulators, etc. and tubes VR150, 12J5 and 1625. Brand new and in factory cartoned. Originally designed to modulate the BC-457 W.E. Transmitter. You can find many uses for this BC-456 Modulator scoop. Price \$2.49; 2 for \$4.49

### PULSE FORMING NETWORKS

Used in small radar modulators, available in three sizes, 67 ohms impedance, 7.5 Kilowatt rating.  
H-603, one micro second, 200 pulses per second... \$1.95  
H-601, three micro seconds, 200 pulses per second... 3.95  
H-602, 16 micro seconds, 60 pulses per second... 3.95  
All three of above, for only... 5.95

### SCR 269G A.D.F. \$39.50

SCR-269G Automatic Radio Direction Finder has 17 tubes. Frequency coverage from 200 to 1750 KC, inclusive. Receivers are in perfect condition. All of the component parts are new. Consists of receiver, new RDF loop, remote control, relay, dehydrator, cables, plugs, etc. This is a terrific value at only \$39.50. Only 50 are available.

### PE 206A INVERTER—BRAND NEW \$4.95

P.E.-206A Inverter. Brand new factory cartoned. For 25 to 28.5 volts input. Output of 80 volts (plus or minus 3 volts) at 800 cycles, at 500 volt-amperes. This is a perfect inverter. Has carbon pile regulator, built-in voltage control. A 20 stack selenium rectifier. Shipping weight 45 lbs. PE-206A Net...\$4.95

### PE 101C DYNAMOTOR BRAND NEW \$2.95

Dynamotor PE-101C. Input voltage 13 or 26 volts DC, at 12.6 or 6.3 amps. Output voltage 400 volts DC at 135 Mils and 800 volts at 20 Mils, 9 volts AC at 1.2 amps. Brand new factory cartoned. Shipping weight 13 lbs. PE-101C Net... \$2.95  
Filament Transformer. War surplus. For 60 cycle, 110 volt AC use. Has 2.5 volts at 10 amps, 6.3 volts at 5.5 amps and 6.3 volts at 1 amp. Brand new. No. D161912. While they last, only... \$2.95  
A few BC-310 B Receivers with tubes in good condition... \$24.95

**McGEE RADIO COMPANY** WRITE FOR CATALOG SEND 25% DEPOSIT—BALANCE C.O.D. 1225 McGEE ST., KANSAS CITY, MISSOURI Prices F.O.B. K.C.

# OPPORTUNITY FOR RADIO MEN!

Think of it! The average American home has at least 11 electric motors in it. Large homes have from 15 to 25—in washers, record players, oil burners, clocks, fans, mixers, refrigerators, etc. No wonder, then, that motor repair is such a good, well-paid business! It's a real "natural" for radio men to learn—and our big new book, **ELECTRIC MOTOR REPAIR** (see below) teaches you fast—teaches you right! Send coupon today!



*I'll Make it EASY for you to LEARN*

## PROFITABLE ELECTRIC MOTOR REPAIR...

... ONLY \$5 FOR THE COMPLETE 553-PAGE COURSE!

**ELECTRIC MOTOR REPAIR**, a big book by the publishers of famous Ghirardi Radio-Electronic books is a gold mine for radio men who want to expand along logical, profitable lines in an uncrowded field. Based on this big book alone, you can train for prompt, profitable service on practically ANY TYPE OF MOTOR IN COMMON USE—from fractional horsepower motors in home appliances, to the larger industrial motors. It tells exactly how to do everything from making simple adjustments and repairs to complete rewinding. Covers AC and DC motors, synchronous motors and generators and BOTH mechanical and electrical motor control systems.

### IT PAYS TO SPECIALIZE IN "SOMETHING DIFFERENT"

Every step of the work is explained simply as A-B-C, both in text and by more than 900 specially prepared diagrams and illustrations. No guesswork! Each phase of motor repair is clearly shown so there can be no mistaking as to what should be done and why. Quick reference guides show step-by-step how to handle specific jobs. When a motor comes in for repairs, just turn to **ELECTRIC MOTOR REPAIR** and see what to do. It's an ideal book, either for beginners or for bench use in busy shops!

Unique Duo-Spiral Binding divides book into two sections with text on one side, pictures on the other. Lies flat on the bench. Both text and related illustrations are visible at the same time.

### MONEY-BACK GUARANTEE

Send coupon now! Practice from **ELECTRIC MOTOR REPAIR** for 5 full days—**AT OUR RISK**. Actually fix motors for yourself and friends. Then, if not more than satisfied, return book to us and **EVERY CENT OF YOUR MONEY WILL BE CHERFULLY REFUNDED**. No questions asked!

**"BORROW" IT FOR 5 FULL DAYS!**

**NO RISK COUPON mail today**

Dept. RN-38, Murray Hill Books, Inc.  
232 Madison Ave., New York 16, N. Y.

Send me a copy of **ELECTRIC MOTOR REPAIR** for which I enclose \$5 (\$3.50 foreign); or send C.O.D. and I will pay postman \$5 plus postal charges. If I then decide I don't want the book, I'll return it within 5 days of receipt and you guarantee to refund my \$5 and no questions asked!

Name.....

Address.....

City & Zone..... State.....



# CIRCUIT PAGE

(FOR PARTS LISTS SEE PAGE 90)

RADIO NEWS, MARCH, 1948

HOFFMAN MODEL A700

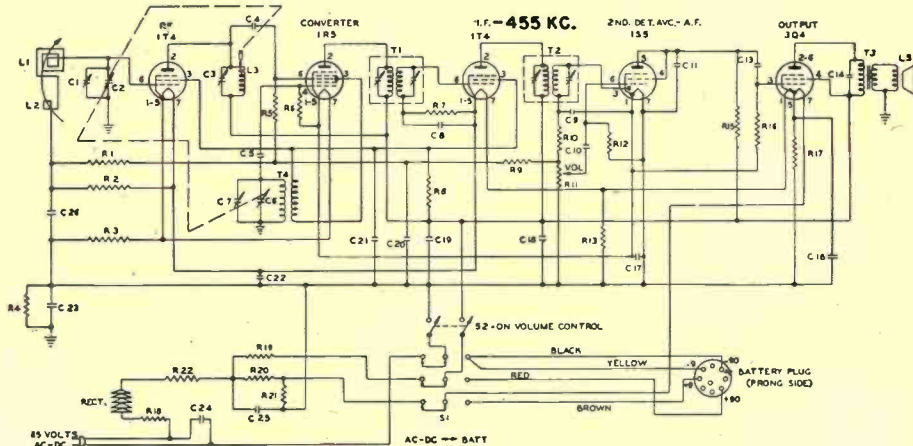

RADIO NEWS, MARCH, 1948

ZENITH MODEL 5G036

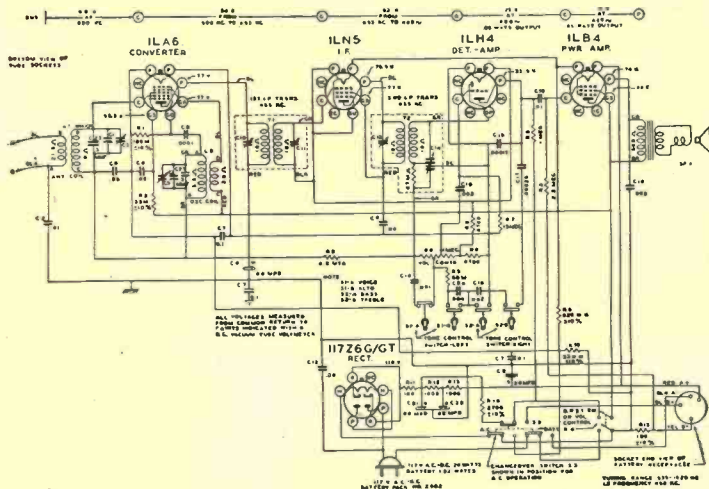

RADIO NEWS, MARCH, 1948

WARDS MODEL 74BR-2003B

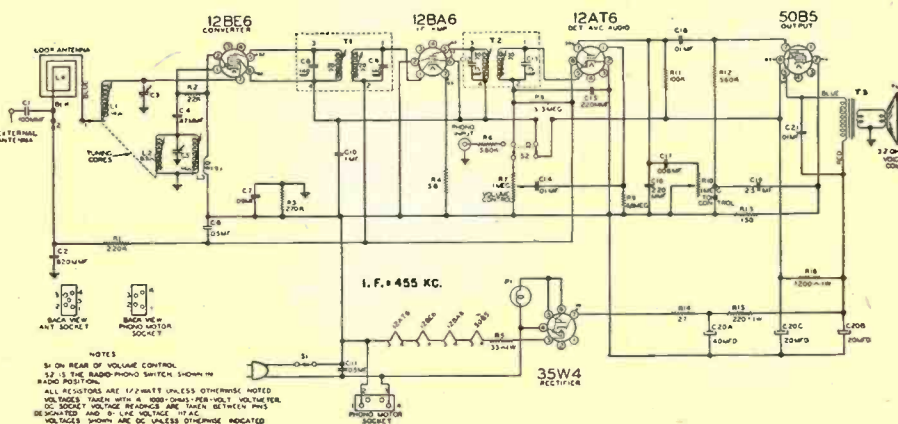

Here, and on following pages, are circuit diagrams and parts lists of many new postwar radio receivers. Radio News will bring to you other circuits as quickly as possible after we receive them from manufacturers.

RADIO NEWS, MARCH, 1948

PILOT MODEL T-601 FM TUNER

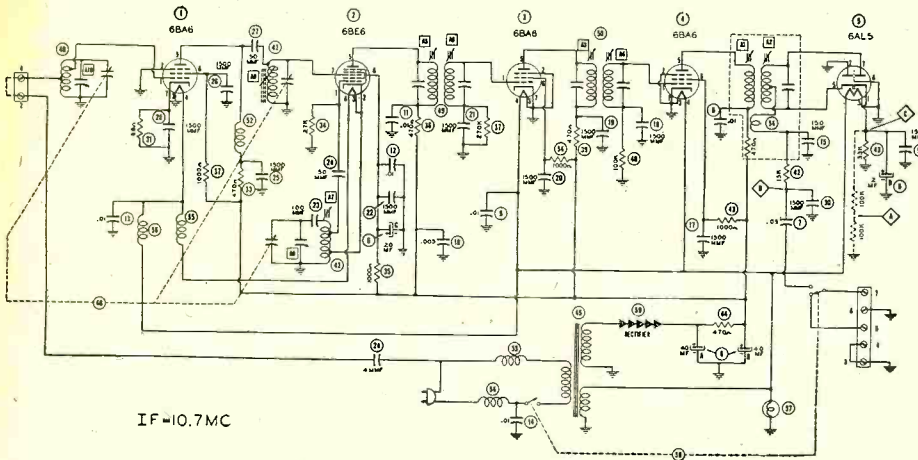

Courtesy of Howard W. Sams & Co., Inc.

RADIO NEWS, MARCH, 1948

CROSLLEY MODELS 88TA, 88TC

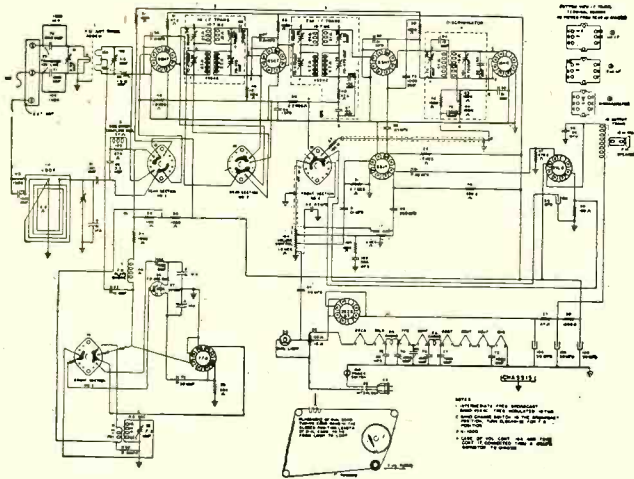

RADIO NEWS, MARCH, 1948

TRUETONE MODEL D2815

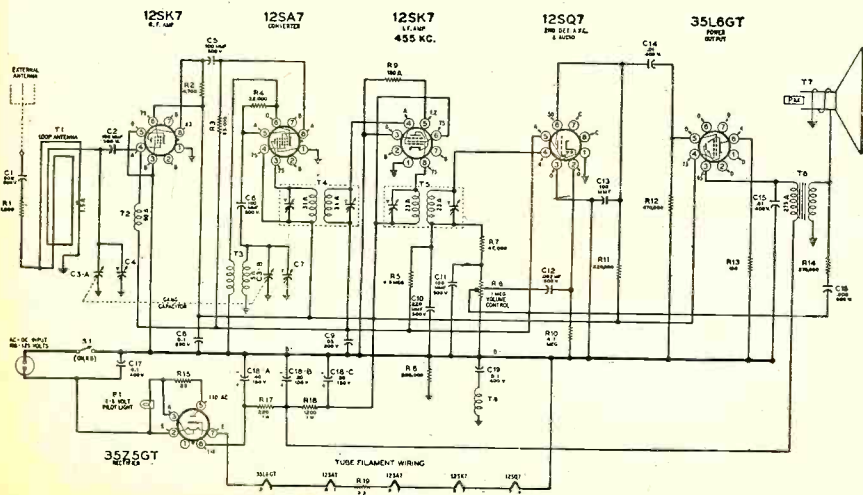

A Better Cone-Buy **LEOTONE**  
 GET ON OUR MAILING LIST—  
 ALWAYS SOMETHING NEW

**TUBES:** Perfect condition, but in unsealed cartons. Most types in stock at UP TO 80% OFF LIST. Every tube guaranteed 90 days.

#20, 26, 27 or 31	.....\$0.29
#75, 76, 77, 78, 89, 6H6 or 6K7	..... .39
#35, 36, 37, 39, 5Y4, 5W4, 5Z4, 6C5, 6F5, 6FG, 6J7, 6K8, 6U7, 6SA7, 6SH7 or 12SK7	..... .49
#1A7, 1H5, 1N5, 1R5, 6U5, 6X5, 7A7, 7C5, 7CG, 7F4, 50, 50B5 or 50L6	..... .59

**TUBE CARTONS:** Plain white

Miniature (1" sq. x 2 3/4")	Per 100.....\$0.98
GT. size (1 1/4" sq. x 3 1/4")	Per 100.....1.25
Medium (1 1/2" sq. x 4 1/4")	Per 100.....1.49
Large (2" sq. x 5")	Per 100.....1.79

**HEARING AID COMPONENTS.** Famous make miniature size units that have many applications where space is limited.

**CRYSTAL MIKE.** Sensitive diaphragm type. Small size (1 1/4" O.D., 1/4" deep) ideal for REGULAR or CONTACT MIKE or as PILLOW SPEAKER. Rubber shock-mtd. metal frame, less housing .....\$0.69



**BONE CONDUCTOR RECEIVER.** Sensitive dynamic type. Makes excellent CONTACT (musical pick-up) MIKE or MINIATURE or PILLOW SPEAKER. Low imped. 1 1/2"x3/4"x1/2" .....\$2.95  
 4 for 9.95



**ALNICO V MAGNETIC PHONE UNITS** (HS-30 headset replacements). Wide freq. response & sufficient volume for use as PM or PILLOW SPEAKER; DYNAMIC or CONTACT MIKE. 250 ohms imped. 3/4" O.D., 1/2" deep .....\$0.39



**MIDGET OUTPUT TRANSFORMER** (1 1/4" x 3/4" x 1 1/2"). One of smallest made. High imped. to voice coil. For personal & portable sets, intercoms, etc. ....\$0.49



**MIDGET AUDIO CHOKES** (3/4"x3/4"x1 1/2") 4500 ohms DC. Use in filter circuits, impedance coupling, etc. ....\$0.49

**HIGH POWER ANTENNA TUNER**

**BRAND NEW UNITS. RANGE:** 1500-7000 Kc. Easily converted to higher freq. Grey metal case contains: 20-75mh silver-plated variometer O.D. 4 1/2" x 8", edge-wound with separate induct. & coupling ticklers; hvy duty 250mmf 7000V. variable (4" sq. x 1 1/2") 2" sq. Triplett 0-8 RF ammeter & thermocouple. With instruction book. 15" x 15" x 2 3/4". Shpg. wt. 45 lbs. ....\$14.95



**BUTTERFLY TUNERS.** 240 to 1200 Mc. Silver-plated. With crystal holder. 2 3/4" O.D. ....\$1.89

**RCA VICTOR POWER TRANSFORMER** for models R-32, 43, 52 or 75. Unshielded. ....\$5.95

**PUSH BUTTON ASSEMBLY.** 5 position, D.P., circuit transfer. 5" long, 1 1/2" deep, 7/8" shafts ..... .69

With set of 5 matched bakelite knobs. .... .95

**PRECISION RESISTORS.**

± 1% wire-wound, famous makes. Ohmages: 2, 35, 11, 21.5, 100, 130, 405, 840, 1740, 2500, 3300, 5200, 7800, 30K, or 50K—ea. 35¢

3 for .....\$1.00

MEG OHMS: .1, .2, .25, .4, .5, .6, or .75 ..... .49

SPECIAL!—1 megohm, ea. .... .75

RG-8/T COAX, 52 ohm, 4 ft. lengths with two PL-259 (83-1ST) connectors. .... .39



Prompt Service on All Speaker & Phono Pick-Up Repairs  
 Minimum Order \$2.00—20% Deposit Required on All Orders. Please Add Sufficient Postage. Write RN-2.

**LEOTONE RADIO CO.**  
 MAKERS OF CONES AND FIELD COILS  
 65-67 DEY STREET, NEW YORK 7, N.Y.  
 WORTH 2-0284.5  
 12,000 SQ FT OF RADIO PARTS



# BEST of SURPLUS

Best OF SERVICE FROM HEATH

## POWER TRANSFORMER

*Special*

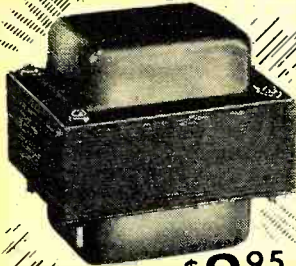

\$3<sup>95</sup>

3 FOR \$9<sup>95</sup>

A wonderful buy in a new production heavy duty power transformer. Built by a nationally known manufacturer. Primary 117V 60 cycle. Secondaries supply 746 V.C.T at 220 MA, 6.3V. at 4.5 A., and 5 V. at 4 A. An ideal transformer for high quality amplifier modulator, small transmitter or quality radio. Will handle 13 tube radio receivers. Supply is limited, order early.

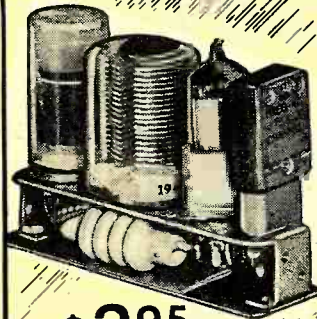

\$3<sup>95</sup>

## Midget AMATEUR TRANSMITTER KIT

The hit of the year, using army Walkie-Talkie parts. Easily assembled into a 1 Watt 80 meter CW transmitter. Comes complete with 80 meter crystal, tube, chassis, tank coil, tuning condenser, all other small parts and complete instructions. The only other parts required are key and batteries listed below. An ideal beginner's station with range up to 500 miles. Lowest cost ever offered. Add postage for 2 lbs.

### ACCESSORIES

- KEY (add postage for 2 lbs.)..... \$1.00
- KIT OF BATTERIES (add postage for 4 lbs.)..... \$3.25

## SPECIALS

- PE 104A power supplies operate from 6 or 12 volt input — output 84V plate 1.4 volt filament ..... \$4.95
- Ceramic Variable Condensers 50 MMF screw driver adj. Special 5 for \$1.00
- Lip Microphones T-45 in original sealed cartons ..... \$1.00
- Thermocouples for RF Ammeters, 3 for \$1.00
- 10 Henry 50 ma Filter Chokes ..... \$1.29
- 5BP1 Cathode Ray Tubes ..... \$2.49
- 5BP1 Socket ..... .79
- Synco Motors 5SDG Brand New, per pair \$6.95
- Kit of Screw Driver Type Potentiometers 10 for \$1.00
- Kit of Metal Tubular Bypass Condensers 20 for \$1.00
- Kit of Relays, excellent types 5 for \$2.50
- Kit of Knob Type Potentiometers carbon and W.W. 10 for \$1.95

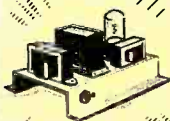

### COMMAND SET ACCESSORIES

- 110V power supply kit with 24 volt filament, no wiring changes inside set, punched chassis and volume control ..... \$5.95
- 5" PM speaker with output transformer, matching headphone output ..... \$2.80
- Dual receiver rack FT 277A with connecting plugs ..... \$1.00
- Shock mount for above rack ..... \$1.00
- Single transmitter rack FT 234A ..... \$1.00

### MILITARY CONVERSION POWER TRANSFORMERS

Convert your military receivers without rewiring the filament. "A" type supplies 500 VCT at 50 MA, 5V at 2A and 24V at 1/2A. "B" type supplies 500 VCT at 50 MA, 5V at 2A and 12V at 1 amp. State whether A or B type desired. \$2<sup>95</sup>



### BC 457 TRANSMITTER

Brand new 457's identical with unit used in January 1948 CQ for conversion to mobile rig. Also tunes 80 meter band as VFO. With tubes



\$7<sup>95</sup>

### AN/APN1 RADIO ALTIMETERS

Brand new, complete with tubes, dynamotor, antennae, indicator, switch, plugs and instruction manual. Consists of 420 MC transmitter and receiver. Converts into excellent boat radar indicating in feet, or amateur 420 MC rig. In original crate



\$34<sup>95</sup>



### T32 TABLE MICROPHONE

One of the Army's best. Built by Kellogg, ideal for factory call system, public address, amateur use. Brand new in original cartons, add postage for 5 lbs. \$2<sup>95</sup>

### OIL FILLED CONDENSERS

CAP	WVDC	PRICE	CAP	WVDC	PRICE
5	400	\$.39	1.	1000	\$.49
4	400	.49	2.	1000	.69
5	600	.59	4	1000	.90
8	600	1.00	.25	1500	.49
2.5-2.5-5	600	.95	1.5	1500	.79
5-5-5	600	1.95	.1	3000	1.20
8-8-8-8	600	3.95	.25	3000	1.30
.1	1000	.29	.05	7500	2.50
.25	1000	.39			

### DYNAMOTORS

Consists of electric motor operating generator on same shaft. Many applications—operating radios from storage battery—using as motor.

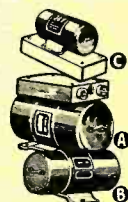

- Dynamotor C—Input 28 volts, output 220 volts at 60 MA. Shipping Weight 6 pounds. \$1.50
- Dynamotor A—Input 12 volts, output 1000 volts at 350 MA. Shipping Weight 72 pounds. \$5.95
- Dynamotor B—Input 6 or 12 volts, output 500 volts, 160 MA. Shipping Weight 30 pounds. \$5.95

### HEARING AID HEADPHONES

The Army's best—eliminate flat ears and outside noise. Complete with transformer for conversion from low to high impedance. With cord and plug complete. Add postage for 1 lb. \$1.00



### G.E. MODEL BC-375 TUNING UNITS

These General Electric 150 Watt transmitter tuning units are the greatest surplus buy. Over \$30.00 worth of new condensers, coils, switches, National Velvet vernier dial, etc. Supplied complete with cabinet and two reprints for transmitter and receiver reprinted from RADIO NEWS. Specify TU5B, TU10B or TU26B. Add postage for 20 lbs.



\$24<sup>95</sup>



# The HEATH COMPANY

BENTON HARBOR, MICHIGAN

ONE-THIRD THE COST . . . HAVE ALL THE FUN

Build  
YOUR OWN

# TEST EQUIPMENT

with HEATHKITS

Only  
**\$24<sup>50</sup>**

## TRANSMITTER POWER SUPPLY KIT

For 6C645, 223, 522, 274N's, etc.

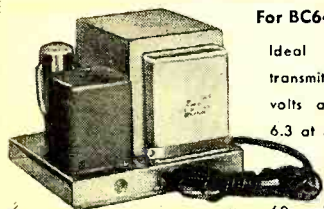

Ideal unit for powering military transmitters. Supplies 500 to 600 volts at 150 to 200 MA plate, 6.3 at 3.6A, also 9V, and 12V A.C.

Kit supplied complete with husky cased Acme 110V 60 cycle power transformer, 5U4 rectifier, Sprague oil filled condenser, cased choke, punched chassis, and all other parts including detailed instructions.

**\$11<sup>95</sup>**

Complete — nothing else to buy.

## HEATHKIT HIGH FIDELITY AMPLIFIER KIT

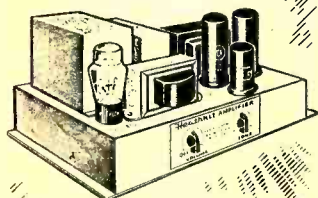

**\$14<sup>95</sup>**

12" PM speakers for above **\$6.95**

Build this high fidelity amplifier and save two-thirds of the cost. Push pull output using 1619 tubes (military type 6L6's), two amplifier stages using a dual triode (6SN7), and a phase inverter give this amplifier a linear reproduction equal to amplifiers selling for ten times this price. Every part supplied; punched and formed chassis, transformers (including quality output to 3-8-15 ohm voice coil), tubes, controls, and complete instructions. Add postage for 20 lbs.

## The NEW HEATHKIT VACUUM TUBE VOLTMETER KIT

The most essential tool a radio man can have, now within the reach of his pocketbook. The Heathkit VTVM is equal in quality to instruments selling for \$75.00 or more. Features 500 microamp meter, transformer power supply, 1% glass enclosed divider resistors, ceramic selector switches, 11 megohms input resistance, linear AC and DC scale, electronic AC reading RMS. Circuit uses 6SN7 in balanced bridge circuit, a 6H6 as AC rectifier and 6X5 as transformer power supply rectifier. Included is means of calibrating without standards. Average assembly time less than four pleasant hours, and you have the most useful test instrument you will ever own. Ranges 0-3, 30, 100, 300, 1000 volts AC or DC. Ohmmeter has ranges of scale times 1, 100, 1000, 10M and 1 megohm, giving range 1 ohm to 1000 megohms. Complete with detailed instructions. Add postage for 8 lbs.

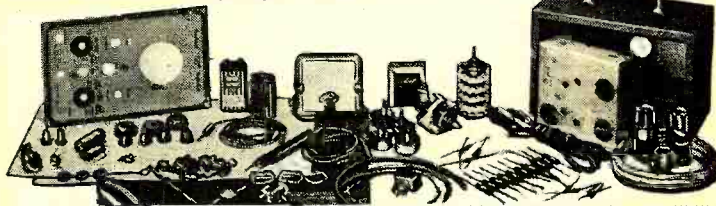
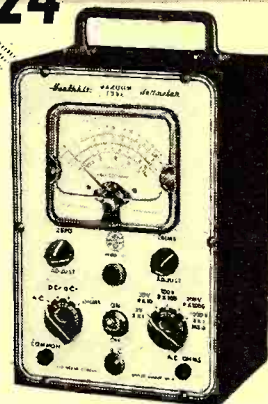

## HEATHKIT SIGNAL GENERATOR KIT

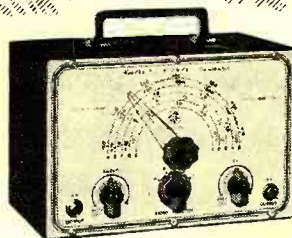

Build your own signal generator and learn while you profit. Save two-thirds the cost and have an instrument you will be proud to place on your service bench. Supplies fundamentals from 150 KC to 30 MC on large calibrated panel. 400 cy. AF modulation can be used separately for audio testing. Has transformer power supply. Furnished complete with tubes (one 6SN7, one 6X5), transformer, coils, cabinet, punched and formed chassis, blueprints and instructions, and all small parts. Add postage for 8 lbs.

**\$19<sup>50</sup>**

## The NEW 1948 HEATHKIT 5 INCH OSCILLOSCOPE KIT

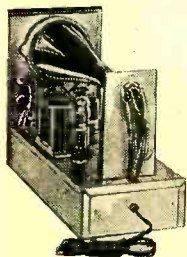

New improved model of the famous Heathkit Oscilloscope. Building an oscilloscope is the finest training for television and newer servicing technique and you save two-thirds the cost. All the features and quality of instruments selling for \$100.00 or more. Supplied complete with cabinet, two color panel, 58P1 tube, 2 5Y3 tubes, 2 6SJ7

tubes and 884 sweep generator tube. Power transformer supplies 1000V negative and 350 volt positive. Sweep generator 15 cycles to 30 M. cycles. Has vertical and horizontal amplifiers. Oil filled filter condensers for long life. Complete blueprints and instructions included.

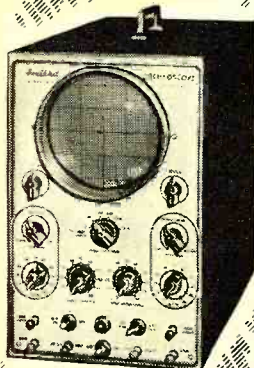

**\$39<sup>50</sup>**

Nothing ELSE TO BUY . . .

## HEATHKIT TRANSMITTER KIT

A best buy in an amateur transmitter kit. Circuit uses latest post war improvements, can be assembled to cover 80-40-20-10 meters with 25 Watt output. Comes complete with 80 meter crystal, modulator, 80 meter coil, four tubes, cabinet, beautiful panel and all additional parts needed less power supply. Blueprints and instructions included. Power supply kit \$10.00 additional. Shipping weight 20 pounds; 8 pounds for power supply.



**\$19<sup>50</sup>**

NO ORDERS UNDER \$2.00

We will ship C.O.D.

Add postage, we refund excess



The **HEATH COMPANY**

BENTON HARBOR, MICHIGAN

# What's New in Radio

## FM AND TV SWEEP GENERATOR

McMurdo Silver Co., Inc., is now shipping its new Model 909 FM and television sweep generator.

Designed to permit rapid and simple visual alignment of FM and TV r.f., i.f., and video amplifiers, this new

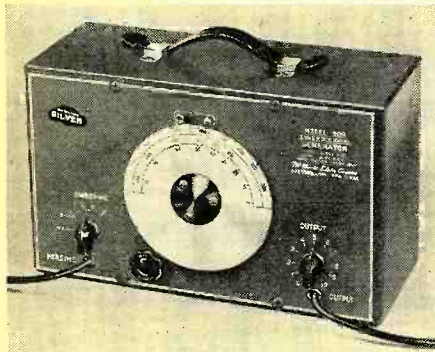

unit is especially useful to the research worker and the service technician.

The new sweep generator covers a center frequency range of 2 through 226 mc. in three bands, without usual bandswitching. Frequency modulation is adjustable from 40 kc. to over 9 mc. by a panel control, while output is adjustable by means of a second knob from 0 to 1/2 volt max. Synchronization of the oscilloscope used to visually trace alignment is at power line frequency (or selected multiples or sub-multiples thereof) or by saw-tooth synchronizing voltage provided by the Model 909 at twice power frequency.

Price and performance data will be furnished by *McMurdo Silver Co., Inc.*, 1240 Main Street, Hartford, Conn., on request.

## FEED-THROUGH TERMINALS

New, insulated feed-through terminals designed for feeding high voltages through chassis, panels, cavity walls, etc., have been placed on the

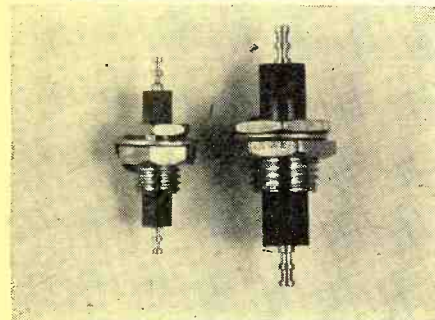

market by *Cambridge Thermionic Corporation*.

The insulating material is an approved phenolic with excellent dielectric properties. Metal parts are heavily plated and the units are con-

structed to withstand shock and vibration.

The terminals are available for 1/4" or 3/8" hole mounting, each type in two lengths. The larger of the two 3/8" models, shown in the picture, will withstand a breakdown voltage of 8000 volts at 60 cycles, a.c.

Further information may be obtained from *Cambridge Thermionic Corporation*, Department 9, 445 Concord Avenue, Cambridge 38, Mass.

## COAXIAL SWITCHES

A series of unique coaxial switches, recently introduced to the trade, is in production by *Designers for Industry, Inc.*, of Cleveland.

Possessing good voltage standing wave ratio and crosstalk characteristics, these switches can be used in many selecting and monitoring operations. These switches feature remote control, 115 v., 60 cycle solenoid operation.

One of the series, the Type D, is fully automatic with the switch ro-

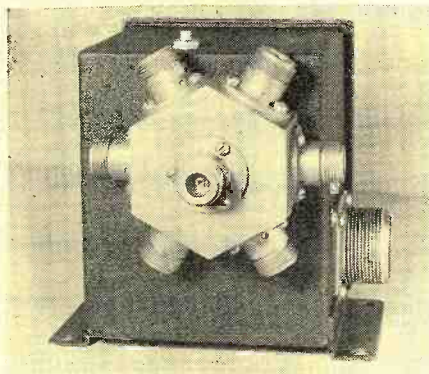

tated to positive position by the remote selector. Ideally suited for use in antenna array monitoring systems, this switch is a single-circuit, six-position unit which has been designed for use with RG-8/U cable.

*Designers for Industry, Inc.*, 2915 Detroit Avenue, Cleveland 13, Ohio, will forward a specification sheet on this series upon request.

## HOME RECORDER

*Universal Microphone Company* of Inglewood, California has just announced a new home recording unit that incorporates many professional features.

Designated the *Universal RC Recording Chassis*, this new unit offers the advantages of recording extremely close tangency; patented pantographic movement for equally spaced cutting over the entire record; visible groove depth adjustment; pantographic action keeping guide shoe at correct angle in lead screw thread; a lift lever at

side of head allowing the operator to locate the stylus in the exact groove location after the lead screw has been



engaged; recording of music and voice at commercial levels and loudness; and a recording head which automatically lifts at the end of a 10" record.

The recording unit comes complete with a crystal pickup to play back 12" records.

For further information on this home recorder interested persons should write to *Universal Microphone Company*, Centinela at Warren Lane, Inglewood, California.

## CROSSHATCH GENERATOR

A new television service instrument by means of which the serviceman can quickly and accurately check and adjust the linearity of a receiver's vertical and horizontal sweep without depending on the test charts from a television station, has been developed by *Philco Corporation* of Philadelphia.

Known as the *Philco "Crosshatch Generator"*, Model 5072, this instrument is normally adjusted to produce 12 horizontal lines and 16 vertical lines on the picture tube. Readjustment is seldom necessary, but should it be required, the number and position of the vertical lines can be changed by a trimmer while a potentiometer adjustment for horizontal lines is provided.

By means of an adapter harness, the "Crosshatch Generator" obtains the required plate power, filament power, and synchronizing voltages from the television receiver being adjusted. The harness now supplied with the adapter is for use with *Philco* TV receivers, while harnesses for other makes will be available soon.

Additional information on the Model 5072 may be secured from *Philco Corporation*, Philadelphia, Pennsylvania.

## TV CONDENSERS

*Cornell-Dubilier Electric Corporation* has added a new unit to its rapidly increasing line of condensers specifically designed for television applications.

## CAPITOL RADIO ENGINEERING INSTITUTE

Pioneers in Radio Engineering Instruction—Since 1927

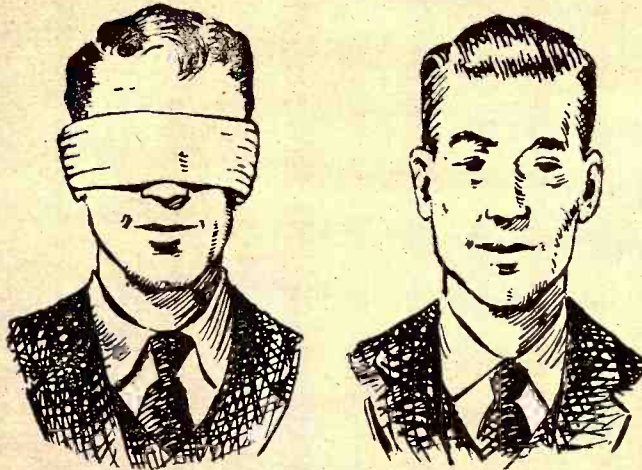

# Who Will Get the Better Job?

## The Radioman Who Looks Ahead Will Get Ahead

Don't play blind man's bluff with your future! Are you, like many other professional radiomen, so wrapped up in your present routine work that you are losing sight of where you will be tomorrow?

Look at the successful radioman. You'll find that he's the fellow who looked and *planned* ahead. Today, as a member of the great radio-electronic industry, you have opportunities that few men ever enjoyed in the past. Your future success can be assured by the plans *you* make *today*.

The radio industry is expanding so fast, that it is doubtful any radioman can truthfully say he has kept pace with all the major developments. Thousands of new men have joined the ranks of the radio industry creating new competition for you. New developments create demands for more advanced technical ability. You can't afford to be a "pre-war model". You must "re-tool" your

technical knowledge in order to keep pace.

If you are wise, you will look ahead and start now to increase your technical ability with the thorough, practical technical training for which thousands of professional radiomen have enrolled with CREI since 1927. This is real, honest-to-goodness practical engineering training that leads to better jobs presented by modern radio, electronics and television, and security in the knowledge that you are capable of coping with tough problems.

CREI courses are still available at pre-inflation prices and today give you *more thorough instruction service* per dollar than ever before—on convenient terms. It costs you nothing to read the interesting facts. Please write today.

**VETERANS:** CREI Training Is Available Under the "G.I." Bill!

### MAIL COUPON FOR FREE BOOKLET

If you have had professional or amateur radio experience and want to make more money, let us prove to you we have the training you need to qualify for a radio job. To help us intelligently answer your inquiry—PLEASE STATE BRIEFLY YOUR BACKGROUND OF EXPERIENCE, EDUCATION AND PRESENT POSITION.



## Capitol Radio Engineering Institute

An Accredited Technical Institute

DEPT. RN-3. 16TH AND PARK ROAD, N. W., WASHINGTON 10, D. C.

Branch Offices: New York (7): 170 Broadway • San Francisco (2): 760 Market St.

March, 1948

### CAPITOL RADIO ENGINEERING INSTITUTE

16th & Park Rd., N.W., Dept. RN-3, Washington 10, D.C.  
Gentlemen: Please send me your free booklet, "CREI Training for Your Better Job in RADIO-ELECTRONICS", together with full details of your home study training. I am attaching a brief resume of my experience, education and present position.

Check  PRACTICAL RADIO ELECTRONICS

Course  PRACTICAL TELEVISION ELECTRONICS

NAME.....

STREET.....

CITY.....ZONE.....STATE.....

I am entitled to training under the G.I. Bill.

The new unit, the Type TMC-187, is extremely compact and is rated at .005  $\mu$ fd., 350 volts d.c. Dimensions



are 1 1/16" in diameter and 1 3/4" in length. The unit is also available in both single and dual capacities and other voltage ratings with small physical dimensions.

The Type TMC-187 is housed in a hermetically sealed cylindrical metal container, a wax impregnated cardboard sleeve with rolled over ends insulates the case. The condenser is self-mounted on No. 18 solid tinned copper wire leads.

Additional data on the Type TMC-187 and other units in this line of television condensers may be secured from *Cornell-Dubilier Electric Corporation*, South Plainfield, New Jersey.

#### SERVICE INSTRUMENT

*Jorde Instruments Corporation* has introduced a new radio test instrument for the serviceman.

Known as the *Jorde "Master,"* the instrument incorporates fourteen needed servicing instruments into a single unit. The instrument includes a signal tracer which feeds through a high gain amplifier with the output through a 12 inch speaker; a 12 inch

test speaker which may be used as substitute for field coils, voice coils, output transformers, filter chokes or an entire speaker; an audio amplifier having two inputs with means for checking microphones and phono pickups; an electrolytic substitution bridge where any single, double, and triple capacity units can be obtained; an electrostatic substitution bridge; a resistance substitution bridge; a 6 volt d.c. power supply; a 500 volt d.c. filtered power supply; a 1 1/2 volt 90 volt power supply; a v.o.m.; an audio transformer substitution section; a voltage divider system; a condenser checker; and double duplex outlets for a.c. operation of equipment.

A pamphlet describing this instrument may be obtained on request from *Jorde Instruments Corporation*, Blytheville, Arkansas.

#### NEW UTC LINE

A new series of commercial grade components has been announced by *United Transformer Corporation* of New York.

These new transformers have been developed to meet the requirements of industrial electronics as well as those of the discriminating ham and p.a. man. The line includes audio components, input transformers, modulation, power, and filament transformers.

These new "CG" units are conservatively designed with low temperature rise and good insulation factors to assure dependability in continuous

service. All coil structures are vacuum impregnated, and cases are poured with special sealing compounds to assure stability under adverse climatic conditions.

The series includes audio components for all applications ranging from low level; humbucking; multiple alloy shielded input transformers for 600 watt "varimatch" modulation transformers. Power and filament components range up to those required for a 3000 volt, 1 ampere plate supply.

Catalogue PS-408 covering the "CG"

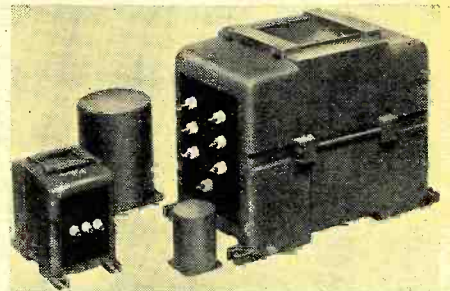

series is available upon request to *United Transformer Corporation*, 150 Varick Street, New York 13, New York.

#### RCA MAGNIFIER

An ingenious new television picture magnifier that enlarges the images received on seven or ten-inch television picture tubes to the approximate equivalent in size and brilliance of (Continued on page 160)

## "ARROW" leads with Better Buys!



#### BIAS METER Brand New

Originally used for measuring voltages and tele-type and telephone equipment. Can be used for measuring DC voltages and bias voltages also checking polarity of DC voltages. Complete with a detector plug and schematic. Enclosed in metal carrying case. Requires no batteries for operation ..... \$4.95 ea.

#### BC-223 AX TRANSMITTER

801 Oscillator and 801 Power Amplifiers, 2-46 modulators and 1-46 speech amplifier; 4 Xtal Frequencies and Master Oscillator on selector switch 10 to 30 watts output. Tone voice or C.W. Mod. Ideal for Ham Use. Black wrinkle case. \$5.95  
Less tubes, condenser and crystals.....

#### ARC 4 TRANSMITTER and RECEIVER

For operation VHF frequencies in range of 140-144 mc. Four channel crystal controlled, manufactured by Western Electric-24V operation. Complete with crystal and dynamotor. Used. \$14.90  
Good condition .....

#### GE METER \$2.29

6-10 amps., DC.....each

#### INTERPHONE AMPLIFIER

Comes in an aluminum cabinet 9 3/4" x 4 3/4" x 5 1/2". DC output at 60MA, less tubes. \$95c  
Yours for only .....  
Complete with tubes.....\$1.95 ea.

#### LP-21 ADF LOOP

Low impedance loop, good for direction finder, one Selsyn motor, one Selsyn transmitter, freq. range of loop 100 Kc to 1750 Kc.; BRAND \$6.95  
NEW in original cartons, each.....

#### PE-117 UNIVERSAL POWER SUPPLY

6 or 12 volt input; output 145 volts and 90 volts; less vibrator, voltage regulator and rectifier tube; ideal mobile power supply unit; excellent \$2.95  
condition, each.....

#### VHF Radar Transmitter

Radar unit T-85 is an amplitude modulated transmitter. Frequency range 300Mc-1500Mc. Power output 10-30 watts. Complete with two heavy duty 110 V, 60 cps. filament transformers. Tube lineup is as follows: 1-931, 2-6AC7 Video Amplifier; 1-6AG7 Video Amplifier; 1-6L6 Video Amplifier; 2-829B modulators; 1-6AG7 voltage control; 1-3C22 lighthouse oscillator, a set of lecher wires are included to measure the approximate frequency. Instruction manual included. Brand \$11.95  
new in original carton.....

#### RA-10 BENDIX RECEIVER

3 band, excellent condition, 7 tube super heterodyne circuit, direction finder and communication receiver, freq. range 200 to 110 KC and 2 MC to 10 MC, complete with dynamotor and tubes, easily converted to operate from 110 volt \$14.95  
AC-DC .....

#### I-70-D TUNING METER

Milliammeter for indicating resonance of \$49c  
tuned station, NEW.....each

#### SELSYN INDICATORS

For use with beam rotators for indication of direction of beam. Operate from 15-24V, 60 cycle AC supply. Small model, 3 inch diam. \$2.45  
eter, only .....  
Large model, 5 inch diameter, only..... \$2.95

#### PHANTOM ANTENNA Brand New

Used with any 80 meter transmitter as a dummy load for adjusting transmitter for maximum output before going on air. Freq. range: 2MC to 4.5MC, with instruc. manual, enclosed in metal case with cover ..... \$1.95 ea.

#### TUBES

6V6	12A6	6AT6
6X5	12C8	6SF7
6AG7	6SJ7	584
35W4	12SL7GT	10AC Neon
12AT6	6V6	12K8
12SR7	Amperite 10T1 36	
12Z5	12J5	6GG6
12BE5		

**49¢**  
Lots of 50-  
10% Discount

SCOPE 3AP1 3FP7.....\$1.19  
TUBES 5FP7 7BP7.....

#### SPRAGUE PULSE FORMING NETWORKS

Used in small radar modulators, available in 3 sizes, 67 ohms impedance, 7.5 Kilowatt rating.  
H-603, one micro second, 200 pulses \$1.95  
per second .....  
H-601, 3 micro seconds, 200 pulses 2.95  
per second .....  
H-602, 16 micro seconds, 60 pulses 3.95  
per second .....  
ALL THREE ABOVE FOR ONLY... 4.95

#### OIL-FILLED CONDENSERS

.25 MFD at 1500 VDC.....59c  
.25 MFD at 15,000 VDC.....\$2.95  
2 MFD 220 VAC .....29c

## ARROW SALES, INC.

MAIN OFFICE

SOUTH SIDE BRANCH  
8310 SOUTH HALSTED ST.

59 WEST HUBBARD ST., CHICAGO 10, ILL.

Telephone SUPERior 5575

NORTH SIDE BRANCH  
1802 NORTH HUMBOLDT BLVD.







# SENSATIONAL VALUES

THE NEW MODEL 247

## TUBE TESTER

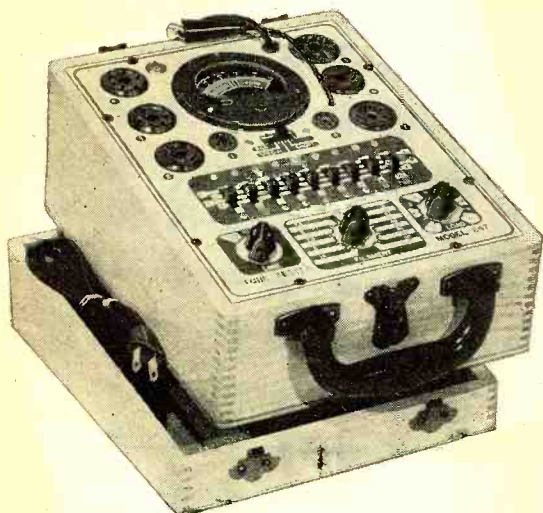

Model 247 comes complete with new speed-read chart. Comes housed in handsome, hand-rubbed oak cabinet sloped for bench use. A slip-on portable hinged cover is included for outside use. Size: 10 1/4" x 8 3/4" x 5 1/4".

ONLY  
\$ **29<sup>90</sup>** NET

**FEATURES:** The Model 247 incorporates a newly designed element selector switch which reduces the possibility of obsolescence to an absolute minimum. Any pin may be used as a filament pin and the voltage applied between that pin and any other pin, or even the "top-cap."

The new free-point system described above permits the Model 247 to overcome the difficulties encountered with other emission type tube testers when checking Diode, Triode and Pentode sections of multi-purpose tubes, because sections can be tested individually when using the new Model 247. The special isolating circuit allows each section to be tested as if it were in a separate envelope.

The Model 247 provides a super sensitive method of checking for shorts and leakages up to 5 Megohms between any and all of the terminals. Continuity between various sections is individually indicated. One of the most important improvements, we believe, is the fact that the 4 position fast-action snap switches are all numbered in exact accordance with the standard R. M. A. numbering system. Thus, if the element terminating in pin No. 7 of a tube is under test, button No. 7 is used for that test.

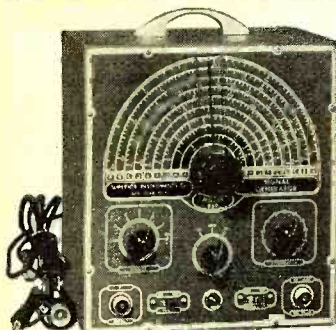

### The New Model 650 SIGNAL GENERATOR

#### RANGES:

100 Kilocycles to 35 Megacycles on Fundamentals  
25 Megacycles to 105 Megacycles on Harmonics

- ★ R. F. obtainable separately or modulated by the Audio Frequency.
- ★ Audio Modulating Frequency—400 cycles pure sine wave—less than 2% distortion.
- ★ Attenuation—3-step ladder type of attenuator (T pad).
- ★ Uses a Hartley Exciter Oscillator with a Buffer Amplifier.
- ★ Tubes: 6J5 as R. F. Oscillator; 6AS7 as Modulated Buffer and Mixer; 6SL7 as audio oscillator and rectifier. Complete with coaxial cable, leads and instructions.

REDUCED FROM \$48.75 TO **\$39<sup>95</sup>**



### SEE and HEAR the Signal with the new CA-12 SIGNAL TRACER

#### FEATURES:

- \* Comparative intensity of the signal is read directly on the meter—Quality of the signal is heard in the speaker.
- \* Simple to operate—

Only one connecting cable—No tuning controls.

- \* Highly sensitive—Uses an improved vacuum-tube voltmeter circuit. \* Tube and resistor capacity network are built into the detector probe. \* Built-in high gain amplifier—Alnico V speaker. \* Completely portable—Weights 8 pounds—measures 5 1/2" x 6 1/2" x 9".

Complete with self-contained batteries and instructions.....Reduced from \$34.85 to **\$29.95**

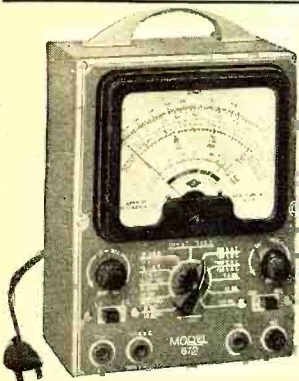

## The New Model 670 SUPER METER

A Combination VOLT-OHM-MILLIAMMETER plus CAPACITY REACTANCE, INDUCTANCE and DECIBEL MEASUREMENTS.

D.C. VOLTS: 0 to 7.5/15/75/150/750/1500/7500.—A.C. VOLTS 0 to 15/30/150/300/1500/3000 Volts.—OUTPUT VOLTS: 0 to 15/30/150/300/1500/3000.—D.C. CURRENT: 0 to 1.5/15/150 Ma.; 0 to 1.5 Amps.—RESISTANCE: 0 to 500/100,000 ohms, 0 to 10 Megohms.—CAPACITY: .001 to .2 Mfd., 1 to 4 Mfd. (Quality test for electrolytics).—REACTANCE: 700 to 27,000 Ohms; 13,000 Ohms to 3 Megohms.—INDUCTANCE: 1.75 to 70 Henries; 35 to 8,000 Henries. DECIBELS: -10 to +18, +10 to +38, +30 to +58.

The Model 670 comes housed in a rugged, crackle-finished steel cabinet complete with test leads and operating instructions. Size 5 1/2" x 7 1/2" x 3".

**\$28<sup>40</sup>** NET

AVAILABLE FOR IMMEDIATE SHIPMENT FROM STOCK—20% DEPOSIT REQUIRED ON ALL C.O.D. ORDERS

**MOSS ELECTRONIC DISTRIBUTING CO.**

DEPT. RN-3, 229 FULTON STREET  
NEW YORK 7, N.Y.

It's  
**NEW!**



**69<sup>50</sup>**

Complete,  
less tubes

## ESPEY Television Training Kit

Learn television through this unique "assembly line" procedure. Modern circuits and postwar design make up-to-the-minute training an absolute necessity. This ESPEY television training kit will help you understand and gain a working knowledge of TELEVISION—the latest development in electronics. FREE with every kit—a new type of pictorial instruction book, giving easy-to-follow, step by step method. No previous knowledge of television necessary to build—and LEARN from—this ESPEY kit.

### FEATURES

- 18 tubes, including 15 miniatures.
- 3 stage, stagger tuned pix i.f.
- 21.25 Mc sound i.f. Trap tuned.
- Balanced FM discriminator.
- Portable—weighs only 17 lbs.
- Uses 3" low-cost cathode ray tube. Magnifier makes 20 sq. in. picture.
- Can be aligned with ordinary test oscillator and V.T. Voltmeter.

**KIT INCLUDES:** All i.f., power blocking oscillator transformers, chokes, capacitors, resistors, controls, speaker, and sockets riveted into place on punched and welded chassis. All tubes are easily-obtainable types available through Distributors everywhere. \*Prices 5% higher West of Rockies.

FOR FURTHER DETAILS WRITE TO: Dept. A

**ESPEY** MANUFACTURING COMPANY, INC.

528 EAST 72<sup>ND</sup> STREET-NEW YORK 21, N.Y.

## PRE-EXAM TESTS FOR Commercial Radio Operator FCC LICENSE EXAMINATIONS

**DON'T TAKE A CHANCE—AVOID FAILURE ON FCC COMMERCIAL RADIO OPERATOR LICENSE EXAMINATIONS!**  
USE NILSON'S COMPLETE PRE-EXAMINATION TESTS AND COACHING SERVICE Enables You To

Rehearse the FCC license examinations Practice the procedure Practice the multiple-choice examination methods used by FCC Check your knowledge Locate your weak points Correct your weak points before taking the actual examination

Prepared by Arthur R. Nilson, Famous Co-author of Nilson and Hornung's RADIO OPERATING QUESTIONS AND ANSWERS  
Cleveland Institute of Radio Electronics, RN-3 Terminal Tower, Cleveland 13, Ohio

Cleveland Institute of Radio Electronics  
RN-3 Terminal Tower, Cleveland 13, Ohio  
Please send information about Pre-Exam Tests.

Name.....  
Address.....  
City..... Zone..... State.....

63-1099	R <sub>10</sub> —33 ohm, 1/2 w. wirewound res.
63-1366	R <sub>11</sub> —140 ohm, 2 w. wirewound res.
63-1239	R <sub>12</sub> —Candohm
63-439	R <sub>14</sub> —2700 ohm, 1/4 w. res.
63-627	R <sub>15</sub> —180 ohm, 1/4 w. res.
22-1216	C <sub>1</sub> —Two-section var. cond.
22-1183	C <sub>2</sub> —.01 μfd., 400 v. cond.
22-829	C <sub>3</sub> —.05 μfd., 200 v. cond.
22-162	C <sub>4</sub> —.0001 μfd., 600 v. cond.
22-827	C <sub>7</sub> —.1 μfd., 200 v. cond.
22-1027	C <sub>8</sub> , C <sub>9</sub> —20/20 μfd., 150/150 v. elec. cond.
22-1017	C <sub>12</sub> —.05 μfd., 400 v. cond.
22-470	C <sub>16</sub> —.00015 μfd., 600 v. cond.
22-196	C <sub>16</sub> —.01 μfd., 600 v. cond.
22-182	C <sub>17</sub> —.00025 μfd., 600 v. cond.
22-492	C <sub>18</sub> —.002 μfd., 600 v. cond.
22-887	C <sub>19</sub> —.001 μfd., 600 v. cond.
22-448	C <sub>20</sub> —.004 μfd., 600 v. cond.
22-1026	C <sub>21</sub> , C <sub>22</sub> —20/40 μfd., 150/150 v. elec. cond.
22-303	C <sub>23</sub> —5 μfd., 600 v. cond.
95-816	T <sub>1</sub> —First i.f. trans.
95-817	T <sub>2</sub> —Second i.f. trans.
S-11960	L <sub>1</sub> —Antenna coil assembly
S-12505	L <sub>2</sub> —Osc. coil assembly
85-284	S <sub>1</sub> —Radiorgan sw. (voice & alto)
85-288	S <sub>2</sub> —Radiorgan sw. (treble & bass)
85-254	S <sub>3</sub> —Power changeover sw.

### TRUETONE MODEL D2815

Part No.	Code and Description.
C-9B1-62	R <sub>1</sub> —100 ohm, 1/2 w. res.
C-9B1-70	R <sub>2</sub> —4700 ohm, 1/2 w. res.
C-9B1-80	R <sub>3</sub> —33,000 ohm, 1/2 w. res.
C-9B1-78	R <sub>4</sub> —22,000 ohm, 1/2 w. res.
C-9B1-34	R <sub>5</sub> —3.3 megohm, 1/2 w. res.
C-9B1-90	R <sub>6</sub> , R <sub>11</sub> —220,000 ohm, 1/2 w. res.
C-9B1-82	R <sub>7</sub> —47,000 ohm, 1/2 w. res.
A-10A-11603	R <sub>8</sub> , S <sub>1</sub> —1 megohm vol. control & sw.
C-9B1-53	R <sub>9</sub> —180 ohm, 1/2 w. res.
C-9B1-35	R <sub>10</sub> —4.7 megohm, 1/2 w. res.
C-9B1-94	R <sub>12</sub> —470,000 ohm, 1/2 w. res.
C-9B2-52	R <sub>13</sub> —150 ohm, 1/2 w. res.
C-9B1-91	R <sub>14</sub> —270,000 ohm, 1/2 w. res.
C-9B1-3	R <sub>15</sub> —22 ohm, 1/2 w. res.
C-9B2-54	R <sub>17</sub> —220 ohm, 1 w. res.
C-9B2-63	R <sub>18</sub> —1200 ohm, 1 w. res.
C-9B2-44	R <sub>19</sub> —33 ohm, 1 w. res.
C-8D-10778	C <sub>11</sub> , C <sub>12</sub> —.002 μfd., 600 v. cond.
C-8F3-8	C <sub>2</sub> , C <sub>5</sub> , C <sub>6</sub> , C <sub>11</sub> , C <sub>13</sub> —100 μfd., 500 v. mica cond.
B-8A-10827	C <sub>3A</sub> , C <sub>3B</sub> , C <sub>4</sub> , C <sub>7</sub> —Two-gang cond. assembly (including trimmers)
C-8D-10771	C <sub>8</sub> —.1 μfd., 200 v. cond.
C-8D-10770	C <sub>9</sub> —.05 μfd., 200 v. cond.
C-8F3-10	C <sub>10</sub> —220 μfd., 500 v. mica cond.
C-8D-10761	C <sub>11</sub> , C <sub>12</sub> —.01 μfd., 400 v. cond.
C-8D-10785	C <sub>16</sub> —.006 μfd., 600 v. cond.
C-8D-10760	C <sub>17</sub> , C <sub>18</sub> —.1 μfd., 400 v. cond.
A-8C-10077	C <sub>18A</sub> , C <sub>18B</sub> , C <sub>18C</sub> —40/20/20 μfd., 150/150/150 v. elec. cond.
C-201-10908-1	T <sub>1</sub> —Loop antenna assembly
A-16A-10792	T <sub>2</sub> —R.f. choke coil
A-13D-10661 or A-13D-12082	T <sub>3</sub> —Osc. coil
B-13B-10091-1	T <sub>4</sub> —Input i.f. trans.
B-13B-10092-1	T <sub>5</sub> —Output i.f. trans.
B-12C-10623	T <sub>6</sub> —Output trans. for speaker
B-18A-10647	T <sub>7</sub> —Oval PM speaker
A-16A-12164	T <sub>8</sub> —I.f. choke coil

—50—

## PRODUCTION HITS NEW PEAK

FIGURES released by the Radio Manufacturers Association on radio receiver production indicates that the industry enjoyed another record breaking month in November.

Production of FM-AM radio receivers topped all previous records with a total of 153,114 units of this type. Television receivers hit a new high for a single month with 24,135 sets reported by member-companies.

Total radio and television set production by RMA manufacturers numbered 1,615,541 in November and brought the year's eleven-month total to 15,989,759. The November FM-AM set production was at an annual rate of two million receivers and was 102.9 per cent above the previous 1947 weekly average output.

The FM-AM sets included 40,198 table models, 5660 converters and tuners, 1892 consoles, 1007 table model radio-phonograph combinations, and 104,357 radio-phonograph consoles.

—50—

TERMS: CASH WITH ORDER

# AMERICAN SURPLUS PRODUCTS CO.

537 N. CAPITOL AVE.  
INDIANAPOLIS, IND.

# WAR SURPLUS BARGAINS!

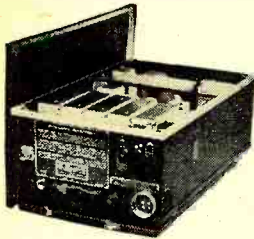

**R5/ARN-7  
RADIO  
COMPASS  
RECEIVER**

Three bands 200 to 1750 KC. Complete with 17 tubes required. This set is ideal for conversion to home broadcast receiver, addition to ham shack, etc. Reported sold for many times the price when brand new. A receiver that would be hard to pick up at this price. Control head available for above \$4.95.

Only **\$31<sup>50</sup>**



**ALTIMETER**

Sensitive Altimeter

**\$12<sup>50</sup>  
ea.**



**MAGNETIC  
COMPASS**

**\$6<sup>00</sup>  
ea.**

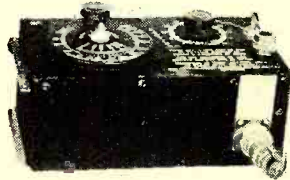

**INTERVALOMETER**

Electronic timing device for releasing bombs at preset intervals. Ideal for dark room timer, model train controller, etc. Contains relays, switches, pilot light, resistors, knobs, etc. Approximate weight, 7 lbs.

**\$1<sup>95</sup>**

**ARC-4 TRANSMITTER AND  
RECEIVER**

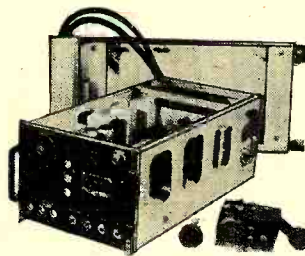

INCLUDING  
CASE

**\$19<sup>75</sup>**

Operates on any of its 4 predetermined crystal controlled frequencies in the range of 140 MC. Complete with tubes, remote control, junction box, shock mounting base and connecting plugs. This unit is ideal for amateur UHF or mobile telephone. Operates from self-contained 24 V DC dynamotor.

**MARKER  
BEACON  
RECEIVER**

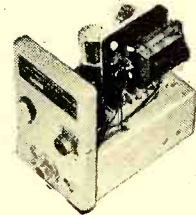

Ideal for controlling remote circuits for model aircraft, boats, etc. Operates from 75 mc. Signal easily altered to 2 meter band. Tubes used and included: 1-6SH7, 1-6SL7-GT, 1-12SN7GT. Also sensitive relay. Circuit diagram included inside case. Size 5 3/4" x 3 3/4" x 5 1/4". For 24 V. DC operation. Complete as shown. With case.

**\$3<sup>95</sup>**

**NAVY CRV-46151 AIRCRAFT  
RADIO  
RECEIVER**

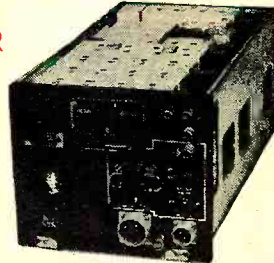

INCLUDING  
CASE

**\$19<sup>50</sup>**

Four bands, including broadcast (195-9,050 KC). Circuit is six-tube superheterodyne with mechanical band change or remote operated electrical band change. Remote band change and tuning controls included, making this set readily adaptable to mobile ham use. Powered from self-contained 24 V DC dynamotor. The sets are complete with tubes, mounting rack and remote controls. No cables.

Unless Otherwise Specified—the Advertised Equipment is Sold as Used . . .

**RADIO ALTIMETER APN/1**

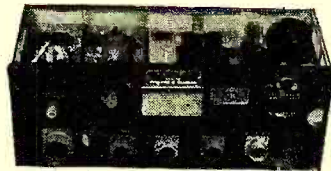

A complete 460 mc. radio receiver and transmitter which can be converted for ham or commercial use. Tubes used and included: 4-12SH7, 3-12SJ7, 2-6H6, 1-VR150, 2-955, 2-9004. Other components such as relays, 24 V dynamotor, transformers, pots, condensers, etc., make this a buy on which you can not go wrong. Complete as shown in aluminum case 18 x 7 x 7 1/4.

**\$8<sup>95</sup>**

**New WILLARD RECHARGEABLE  
STORAGE  
BATTERIES**



New 6-volt battery in spill-proof clear plastic case, housed in metal case for easy mounting. Applicable for a wide range of uses where battery power is needed. Shipped dry. Uses standard battery electrolyte available everywhere.

Price, each	.....	<b>\$4.00</b>
Lots of Ten	.....	<b>3.35</b>
Without metal case, each	.....	<b>3.00</b>
Lots of Ten	.....	<b>2.85</b>

**OXYGEN TANKS**



**\$5<sup>95</sup>**

These oxygen tanks, removed from surplus aircraft have a capacity of 500 lbs. Pressure. Type D2, with complete regulator assembly. Size of tank 22"x5".

• ALL  
PRICES  
F.O.B.  
Indianapolis

• Enclose fee for  
parcel post  
with remittance

TERMS: CASH WITH ORDER  
Address Orders to Dept. B

# AMERICAN SURPLUS PRODUCTS CO.

537 N. CAPITOL AVE.  
INDIANAPOLIS, IND.

# WAR SURPLUS WITH A MONEY BACK GUARANTEE AT R & M RADIO

**COMPLETE STOCKS  
MINIMUM PRICES  
IMMEDIATE  
DELIVERY**

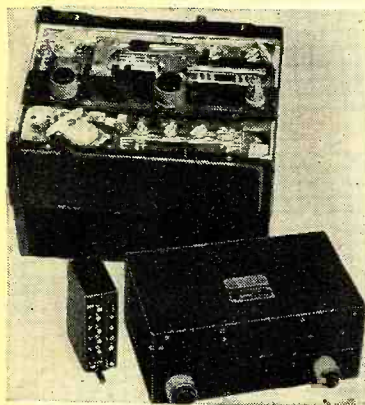

## 2 METER RIG AAF SCR-522

AAF SCR-522 designed to operate from 100-156 mc. makes ideal 2 meter rig (or 2-way mobile radio). Only two small changes incorporated converts to 6 meter operation. As mobile radio telephone unit the dynamotor can be converted to an engine-driven, self-excited generator or coupled to 1/4 hp. AC motor for ground station power supply.

Transmitter and Receiver complete with tubes. **\$17.50**

Trans-Rec., tubes, dynamotor, control box, plugs and conversion diagram book. **\$24.50**

**PE-98 DYNAMOTOR** 12-volt input for use with the SCR-522 or any 12-volt equipment, ea. **Only \$12.50**

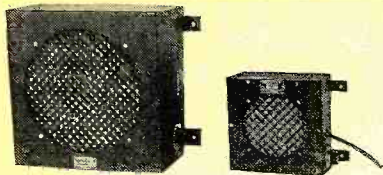

## HIGH FIDELITY SPEAKERS

6-inch, 10-watt PM Speaker, ea. **\$7.95**

12-inch, 15-watt PM Speaker, ea. **\$14.50**

Brand new in Heavy Duty Steel Cabinets with beautiful black wrinkle finish.

Also has T-pad volume control and 600 ohm line to speaker transformer. Wall mounting brackets and slope front.



## FREE CONVERSION BOOK

with each of these specials or order your copy at **\$2**

Gives data on conversion, with schematic diagrams, instructions, discussion.

Diagrams and Conversions on this War Surplus

- BC-348
- SCR-522
- BC-375
- SCR-274
- SCR-274-10 met. mobile

Also diagrams for:

- BC-221 Freq. meter
- ART-13 Collins Xmtr.
- APN-1      • SCR-718
- APN-4

Send for **FREE CATALOGUE** of radio parts and other surplus **BARGAINS**.

**SAVE COD CHARGES BY REMITTING IN FULL**

or send 25% deposit on all orders. Shipment is from nearest warehouse—East, Mid-West, or West Coast. All Orders Shipped Best Way, Prices FOB.



Cost Govt.  
Over \$600.00

*Proclaimed!! "Best Buy"  
by Hams from coast-to-coast!*

TRANSMITTERS AND RECEIVERS FOR

# 10 Meter Mobile Rig

WAR SURPLUS SCR-274-N COMPLETE FOR ONLY

Conversion Book gives details for low-cost, easy conversion to

**\$19.50**

- 10 METER MOBILE RIG
- 20—40—80 METER BANDS

This sensation of all surplus is not only an ideal 10 Meter Mobile Rig! It's a complete amateur radio station! Here are a few more ways to use the equipment included in this Command Set. The transmitter VFO driver stage gives your BC-375-E higher RF output—as high as 150 watts. Make swell standby receivers with the BC-348 on round-table "rag chews." You get all this equipment: 3 Receivers—190-550 kc, 3-6 and 6-9.1 mc; two transmitters, 4-5.3 mc, 5.3-7 mc; four dynamotors—28 volts DC input; 1 modulator with carbon mike input; two tuning control boxes; one antenna coupling box with r-f ammeter; antenna relay and 5000 volt 50 mmfd. WE vacuum condenser (antenna relay can be used with most rigs); and a complete set of tubes for each unit—29 POPULAR TUBES in all. Mechanical cables for remote tuning of receivers supplied for \$1.00 extra.

**FREE CONVERSION BOOK**

**ORIGINAL COST OVER \$600**

## LOOP LP-21

Shielded Loop Antenna Rotated by Selsyn motor. Has separate selsyn transmitter for remote indicator. Has a weather proof tear drop housing over loop.

**Price Only \$8.95**



## GASOLINE GENERATORS

32 volt DC—2000 watt.....\$74.50

115 volt 60 cy.—2500 watt.....\$250.00

## DIESEL POWERED

115-230 volt, 60 cy., 3 phase, 15 kw \$1,800

MANY OTHER TYPES. WRITE US YOUR REQUIREMENTS.

Send for **FREE Catalogue of Transmitter & Receiver Kits**

# R & M RADIO COMPANY

1426 N. QUINCY STREET, DEPT. RN-38 • ARLINGTON, VIRGINIA



**Carbon Mike T-17**  
Used, in A-1 condition  
**\$1.00**  
BRAND NEW \$1.50



**Headphones 69c**  
HS-33 with cord and plug, 600 ohms — Used, in A-1 condition.

**Headphone Extension Cords 25c**

Approx. 72" long, rubber covered, with JK-26 and PL-55 plugs.

**Headphone Adapters MC-385**

From high to low impedance, 4000 ohms to 600 ohms. Contains matching transformer.

**30c EACH**  
**4 FOR \$1.00**



**19c 29c**  
**Antenna Switches**  
Single pole, double throw (left)  
Double pole, double throw (right)



**Antenna Switch**  
Triple pole, double throw  
**75c**

# WAR SURPLUS BC-375-E TRANSMITTER

With thousands of usable standard radio parts

**\$24.50**  
**COMPLETE**  
(Gov't cost, \$1800)  
Wiring & Conversion Diagram FREE

**PARTS ALONE WORTH HUNDREDS OF DOLLARS TODAY!** Use it for parts or use it as a transmitter

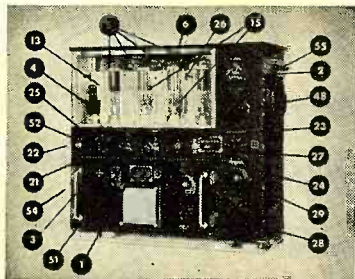

**COMPLETE BC-375-E TRANSMITTER**

- METERS**
- (1) 0-1.5V AC. DC., GE
  - (1) 0-8A RF with thermocouple, GE
  - (1) 0-500 MA. DC., GE
- TUBES**
- (1) 10Y (VT-25)
  - (4) 211 (VT-4-C)
- COILS**
- (3) RF chokes
  - (1) AF choke .5 hy .1 amp
  - (1) Parasitic Suppressor
  - (1) Tapped antenna loading coil on ceramic form
- RESISTORS**
- (1) Tapped Resistor 2.7 ohms, 36 watts — 3.7 ohms, 26 watts
  - (1) 5 ohms 2 watt, IRC
  - (2) 5 ohms 12 watt, IRC
  - (1) 50 ohms 4 watt, IRC
  - (1) 100 ohms 12 watt, IRC
  - (1) 150 ohms 8 watt, IRC
  - (1) 200 ohms 2 watt, IRC
  - (1) 200 ohms variable, Mallory
  - (1) 2500 ohms 1.5 watt, IRC
  - (2) 3000 ohms variable, Mallory
  - (1) 4000 ohms 1.5 watt, IRC
  - (3) 11000 ohms 12 watt, IRC
  - (1) 30000 ohms 1 watt, IRC
  - (1) 200000 ohms 1 watt, IRC
  - (4) 250000 ohms 1 watt, IRC
- CAPACITORS**
- (1) 22-118 mmf. variable with vernier dial
  - (1) tube thermal compensating and calibration reset capacitor
  - (2) .001-1000 V, CD, mica
  - (1) .005-2500V, CD, mica
  - (2) .001-2500V, CD, mica
  - (1) .001-4500V, CD, mica
  - (1) .02-1000V, CD, mica
  - (1) .01-1000V, CD, mica
  - (1) .01-2500V, CD, mica
  - (3) 1-300V, CD, mica
  - (1) 1-1-1 3000V GE, pyranol
  - (1) 25 mfd 25V, CD, electrolytic
- COILS (continued)**
- (1) Continuously variable antenna loading coil with dial-ceramic form
- SWITCHES**
- (1) Interlock
  - (1) Test
  - (1) SPDT Toggle
  - (2) DPST Toggle
  - (1) 3 pos. Mallory w/bar knob
  - (1) SPDT Toggle
  - (1) 4 pos., 3 sec. hi voltage band switch w/bar knob
  - (1) 5 pos. hi voltage, band switch w/bar knob



You get all this: transmitter, tubes, ant. loading unit, dynamotor, five tuning units:

**TRANSFORMERS**

- (1) Microphone trans. single button mic. to single grid
- (1) Interstage transformer single plate to push-pull grids.
- (1) Modulation transformer — class B mod. to class C plate

**MISCELLANEOUS**

- (1) 8 contact antenna relay—28V D.C.
  - (2) Ceramic insulated flexible couplings
  - (1) 6.3V dial lamp and socket
  - (1) mic. jack
  - (2) .5A-1000V Fuses
  - (3) Sockets with plugs
  - (5) Binding posts
- Plus hardware, stand-off insulators, etc.

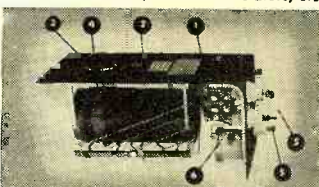

**BC-306-A ANTENNA LOADING UNIT**

- (1) 3 Gang, 5 position, high voltage band switch
- (1) Tapped inductance with variometer tuning
- (1) Vernier dial
- (1) Ceramic insulated flexible coupling
- (2) Bee-hive feed-thru insulators
- (1) Capacitor .00024-6000V SANGAMO

**SAVE C. O. D. CHARGES** by re-mitting in full direct—or send 25% deposit with all orders. Shipment made direct from whse. in Okla., Ariz., Ark. or Virginia.

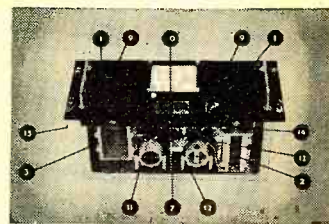

**TYPICAL TUNING UNIT**

- TU-5-B—1500-3000 KCS
- (2) Vernier dials
  - (1) Variable capacitor, 20-135 mmf.
  - (1) Variable capacitor, 20-156 mmf.
  - (1) Variable capacitor, 8-26 mmf.—neutralizing
  - (1) .00003-2000V capacitor, CD—mica
  - (3) .00009-3000V capacitor, CD—mica
  - (2) .0004-5000V capacitor, CD—mica
  - (3) .0001-3000V capacitor, CD—mica
  - (2) 4 position ceramic band switches
  - (2) 2 RF chokes
  - (1) Tank coil—ceramic form with tapped antenna coupling coil
  - (1) Tank coil—ceramic form
  - (1) Parasitic suppressor
  - (2) Ceramic flexible couplings
  - Plus banana jacks, stand-off insulators

**PE-73 DYNAMOTOR**

- (1) Dynamotor 28V DC input—1000V DC output—GE
- (1) Fuse, 30A 250V
- (1) Fuse, 60A 250V
- (1) Fuse, 1A 1000V
- (1) Relay, 24V D.C.
- (3) .005-5000V Capacitor, mica—CD
- (1) .01-1000V Capacitor, mica—CD
- (2) .01-600V Capacitor, mica—CD

## R & M RADIO COMPANY

Dept. RN-38—1425 N. QUINCY ST., ARLINGTON, VIRGINIA

R & M RADIO COMPANY, Dept. RN-38,  
1426 N. Quincy St., Arlington, Va.

- Send Conversion Book.  \$2 inclosed.  Send C.O.D.  
Send FREE catalogue on
- Xmtr. Kits.  Receiver Kits.  Television Kits.  
 I am a licensed amateur.  Beginner.

Name.....  
Address.....  
City.....  
Zone..... State.....

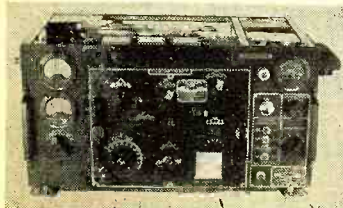

**NAVY TRANSMITTER TYPE GP-7**

Rated at over 125 watts, designed to cover from 350 to 9050 kc. with plug-in tuning units; one of the few transmitters on surplus market built of standard parts, making it a very unusual buy. Limited quantities. Transmitter, tubes and tuning unit—

**Only \$17.50**

**CATALOGUES FREE! USE COUPON**

WIRE RECORDERS?

*Resco*

HAS THEM!

**AIR KING Portable  
WIRE RECORDER  
PHONO-COMBINATION**

*The Royalty of Radio  
Since 1920*



**FEATURE FOR FEATURE  
TOPS ALL COMPETITION!**

- For home, professional, industrial and commercial use. Excellent for either voice or music reproduction.
- Records on wire directly from radio, phonograph or microphone. All three features for the price of one.
- Plays 10 or 12 inch records, is equipped with Fidelity needle.
- 5 tube amplifier (inc. rectifier).
- Compact, luggage-type carrying case.

Price complete! Includes 2 Spools of Wire; Cord for Radio Recording; Microphone and Stand.

**\$129.50**  
LIST

Write for Dealer Net Price



**RCA WIRE  
RECORDER**

*With Plug-In Recording  
Cartridge*



**\$195**

LIST

Write for Dealer  
Net Price

- Simple to operate — just plug in recording cartridge and make your recording . . . no wire-threading!
- Previous program automatically erased as new program is recorded.
- High-quality, 3-watt amplifier.
- Lightweight—only 24½ lbs. complete!
- No wire handling . . . immediate playback . . . continuous program recording . . . timing indicator.
- Includes recorder, microphone and desk stand, ½-hour cartridge.

Additional cartridges \$15.00 each list

Write for Big New Bulletin—Just Out!

Include Postage with Cash Orders

**Radio Electric**  
SERVICE CO. OF PENNA., INC.

7TH AND ARCH STREETS, PHILA. 6, PENNA.  
Branches: 5133 Market St. and 3145 N. Broad St. in Phila.  
Also in Wilmington, Del., Easton, Pa., Allentown, Pa., Camden, N. J.

# Direct Mail for Dealers

By **GERALD SAMKOFSKY**

*A direct mail campaign pays real dividends. Try some of these tested techniques on your customers.*

**I**T PAYS to advertise! This slogan has been bruited around for so many years that it has been accepted as a truism. It is time that the radio serviceman finds out just how advertising pays—and what type of advertising is best suited to his particular requirements.

By a queer quirk of fate, the writer has been engaged in both the radio servicing and the direct mail advertising field for some time. Out of the experience gleaned in both of these fields perhaps a few items might be of interest to the serviceman in evaluating his advertising budget.

There should be no disagreement among the users of the various types of advertising that the value of any particular media can only be measured by the results obtained! The ideal situation, of course, would be if each retailer could present his advertising message personally to his prospective customers, demonstrating the merchandise or service at the same time. Since this procedure is obviously impossible except to a very limited extent, the radio serviceman has to rely on other methods of telling his public of his services and capabilities.

Barring direct contact with the customer, one of the most personal approaches to selling your services or merchandise is the direct mail campaign. A carefully planned and successfully executed direct mail campaign injects a personal note into your customer relations which is hard to obtain in any other manner. In a direct mail campaign you, as a radio serviceman or dealer, can call your customer "by name" and, in effect, have a little "talk" regarding your services and merchandise.

The golden key to a successful direct mail campaign is your mailing list. An accurate and up-to-date mailing list is a valuable business asset—so much so in fact that many companies exist solely on the business derived from supplying mailing lists to other firms. If you haven't been able to assemble your own mailing list it is possible to rent suitable lists. Such commercial lists are available in an almost infinite variety of classifications ranging from major industry groups to juveniles. In renting a listing for your direct mail campaign be sure that the list you seek contains the classifications suitable to the merchandise or service you are offering.

As an example, let us assume that "Best Radio Company" in a major city

has just received a shipment of television receivers. Naturally, one of the new receivers will find its way into the company's display window—but obviously something more is needed to encourage customers to buy this item.

Not having a mailing list of their own, the "Best Radio Company" contacts a direct mail agency in its city. A suitable mailing piece is prepared telling of the arrival of the new merchandise and pointing out its advantages to the customer. Or maybe the company has decided to have a special television showing featuring a baseball game, boxing match, or movie premiere. In this case, carefully worded invitations are prepared asking the recipient to be present at the event. These invitations should not be sent haphazardly but should be forwarded to persons in the middle and upper income brackets for these are normally the people who will be in the market for television receivers.

Now assume that "Best Radio Company" has just received a shipment of small receivers closed out by a radio manufacturer. Here the problem is different. The problem is one of disposing of a large number of low priced items so the direct mail pieces are sent to a "general list" containing the names of persons in all income brackets. Since most direct mail experts can gauge the number of sales which will result from any given type of mailing, the proper coverage can be given to this sale to permit the disposal of all of the units in stock.

Direct mail can be used just as successfully in selling a service. "Black Radio Service," which specializes in radio servicing but sells no merchandise, decides on a direct mail campaign to increase its service business.

A flyer describing the servicing facilities of the company is sent to a selected list of persons in the service area of "Black Radio Service." Obviously, there is no advantage to be gained in circularizing large numbers of persons residing outside of the company's normal trading area, so the entire mailing is concentrated on a carefully selected section of the town or city. Since radio servicing is a vague sort of idea to most persons, the mailing pieces are dressed up with pictures, cartoons, etc. and written in non-technical language. In preparing such a flyer it should be remembered that to the average person money spent for radio servicing is money spent on an intangible—they can



# BIG MONEY IN RADIO

SEE THESE BRAND NEW  
RADIO BOOKS **FREE**

## COYNE'S *New 5 Volume Set* "APPLIED PRACTICAL RADIO"



You men who want to go places in Radio, and who know how much a solid working knowledge of the field helps to get the big money—this is IT! Over 1500 pages of down-to-earth Radio, from simplest principles to newest Television! It's all there easy to understand—how and why it works . . . how to construct, install, service, PA, short-wave, auto-radio, aviation, radio-phonographs, FM, testing instruments and trouble-shooting short-cuts, phototubes—you name it, COYNE'S got it, in "Applied Practical Radio"!

GET THIS  
BOOK  
**FREE**  
for LOOKING  
AT SET



Brand New!  
Explains circuits  
of latest sets.

SEE IT  
FREE  
FOR  
7 DAYS

**PRACTICAL! CLEAR! COMPLETE!**

5 big volumes—1000 illustrations and diagrams, with step-by-step photographs which "break down" the equipment for you to show what makes it "tick". Up-to-the-minute, complete, easy to follow . . . written as only COYNE books are written!

**VALUABLE BOOK FREE** for Looking at 5-Volume Set

Send This Coupon  
**NOW**

You must SEE these books to know how easy it is to prepare for the big jobs in radio. Here's our special offer:—we'll send the complete 5-volume set for your 7-Day FREE Examination. And with it, we'll include our valuable, new guide for all radiomen, "150 New Radio Diagrams Explained", absolutely FREE! If you keep the 5-volume Set all you pay is \$3.00 within 7 days after the books arrive and \$3.00 per month until \$16.75 is paid—or you can pay \$15.00 cash price. If you don't want the set, return it and you OWE NOTHING. But either way you keep the "150 Radio Diagrams Book" as a gift. That book is ABSOLUTELY FREE.

SEND NO MONEY REMEMBER—Coupon is not an order, just a request to see set free and get the FREE BOOK. But offer is limited, so act at once!

EDUCATIONAL BOOK PUBLISHING DIVISION  
COYNE ELECTRICAL & RADIO SCHOOL  
Dept. 38-T3, 500 S. Paulina St., Chicago 12, Ill.

O. K., send me, postpaid, your new 5-volume set, "Applied Practical Radio" on 7 Days Free Trial per your offer in Radio News. Be sure to include as a gift the book of 150 New Radio Diagrams Explained, absolutely FREE.

NAME \_\_\_\_\_ AGE \_\_\_\_\_  
ADDRESS \_\_\_\_\_  
TOWN \_\_\_\_\_ ZONE \_\_\_\_\_ STATE \_\_\_\_\_

**COYNE ELECTRICAL & RADIO SCHOOL (Founded 1899)**  
500 S. Paulina St., Dept. 38-T3, Chicago 12, Ill.

# NEW GOVERNMENT SURPLUS PARTS



- All Transformers 115-V 60 cycle**
- T-23—Sec. #7-6.3V-22.0 Amp.  
#2-6.3V-2.4 Amp.  
#5-6.3V-2.25 Amp.  
#4-6.3V-0.6 Amp. . . . . **\$2.95**
  - T-7—Sec. #1-25V-6A-Hi Volt Insulation  
#2-6.3V-3A. Cased—N.S. . . . . **\$2.50**
  - T-19—Sec. #1-300V-100 Mil.  
#2-22Vlt-100 Mil.  
#3-6.3V-3.5 Amp.  
#4-2.5V-10 Amp. (Hi-Insulation) . . . . . **\$1.95**
  - T-9—Sec. #1-360-0-360-350 Mil. Cased Famous Make—N.S. . . . . **\$5.00**
  - T-24—Sec. #1-438-0-438-160 Mil.  
#2-5V-3 Amp. . . . . **\$3.50**
  - T-18—Sec. #1-415-0-415-130 Mil. Cased Famous Make—N.S. . . . . **\$2.50**
  - T-15—Sec. #1-425-0-425-125 Mil.  
215V-125 Mil. . . . . **\$2.95**
  - T-14—Isolation Type Step Up 110-220-100 Watt. . . . . **\$2.75**
  - T-25—5VC 13.5 Amp.  
5VC 6.75 A . . . . . **\$2.95**
  - T-16—#1-325-0-325-25 Mil.  
#2-325-0-325-25 Mil. . . . . **\$3.00**

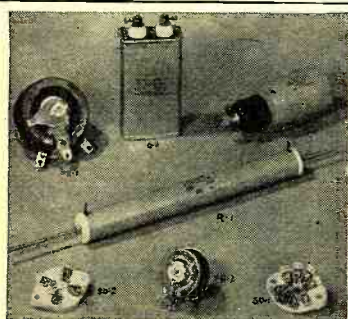

- R-1—10,000 Ohm—120 Watt Bleeder with mounting screw & insulators—3 for \$3.00
- PR-1—25,000 Ohm. WW Power Rheostat—25 Watt with 1/2" Shaft. . . . . **\$0.75**
- Each Famous Brand. 3 for \$2.00
- PR-2—15 Ohm. WW Power Rheostat—110 Watt with 1/2" Shaft. . . . . **\$1.20**
- Each Famous Brand. 10 for \$10.00
- SO-1—Stearlite Octal Socket Glazed. 3 for \$0.50
- Doz. for \$1.80
- C-1—H.V. Cond.—03—7500 VDC. . . . . **\$1.05**
- Oil filled 10 for \$10.00
- C-2—Oil filled—6 mfd.—600VDC . . . . . **\$0.65**
- 10 for \$6.00
- SO-2—Stearlite 4 prong socket. Glazed. 3 for \$0.50
- Doz. \$1.80
- 25% deposit required on all C.O.D. orders. Prompt delivery assured. Write Dept RNM. Include postage with order.

**GREENWICH SALES CO.**

59 Cortland St. Digby 9-3813  
NEW YORK CITY 7, N. Y.

- L-4—8.5 Henries—125 Mil. 120 Ohms. D.C. res. Navy Cased—Porcelain Terminals . . . . . **\$1.10**
- L-9—1 Henry—500 Mils. 30 Ohms. Open case. Grey . . . . . **\$0.50**
- L-5—20 Henries—110 Mil. 230 Ohms. D.C. res. Navy Cased—Porcelain Terminals . . . . . **\$1.50**
- L-10—1 Henry—140 Mils. 80 Ohms. Cylindrical with clamp. . . . . **\$0.35**
- L-7—12 Henries—300 Mils. 100 Ohms. Hermetically sealed—Porcelain Terminals . . . . . **\$2.95**
- L-11—12 Henries—400 Mils. 85 Ohms. Compact. . . . . **\$4.50**
- L-6—17 Henries—20 Mils. 300 Ohms. Sealed—with mtg. screws. . . . . **\$0.60**
- L-12—25 Henries—30 Mil. 850 Ohms. Navy Case—Porcelain Terminals. . . . . **\$1.05**
- L-8—13 Henries Center Tapped. 40 Mils—175 Ohms each. 2 types available . . . . . **\$0.95**
- L-14—2 Henries—100 Mil. 0.75 Ohms. Open C. . . . . **\$0.35**



# PRICES SLASHED!! BARGAINS GALORE

NEW

# SURPLUS GUARANTEED

## Navy Ordnance Synchros

Types 1G, 1CT, 5G, 5DG, 5CT, 5F, 5HCT, 6G, 6DG, 7G, 7DG, 5SG, 5HSF, etc.

## Army Ordnance Synchros

Types IV, V, X, XXI, etc.

## Pioneer Autosyns

AY-1, AY-14, AY-20, AY-30, AY-54, etc.

## General Electric Selsyns

2J5HA1, 2J5DB1, 2J5FB1, 2J6F3, etc.



Size 5 Synchro Generator

Similar to Navy Ordnance type 5G with shaft detail per Army Ordnance Dwg. C-78414. 115 V. 60 cy. Stock #SD-43.

Price \$9.50 each net

## Radio Compass Loop Type LP-21-LM

Used with SCR-269G and ARN-7. Stock #SD-99.

Price \$9.50 each net

## Sinusoidal Potentiometer

Navy. Type CFW-631539. 32,000 ohms. Provides sinusoidally and cosinusoidally varying output voltages from DC source. Used for P.P.I. deflection circuits. Stock #SD-124.

Price \$7.50 each net

## Selsyn-Kollsman 775-01

Ideal for Ham uses as transmitter or receiver. Operates 6-12 V. 60 cycle, 26 V. 400 cycle. Stock #SD-57.

Price \$3.75 each net

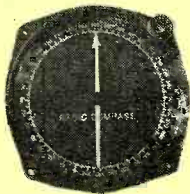

Remote Position Indicating System



6-12 volts 60 cycles. 5-inch indicator with 0 to 360° dial. Heavy duty transmitter. Stock #SD-115.

Price \$9.95 per system

## D.C. Motor-Delco 5069466

Alnico field. 27.5 V. 10,000 rpm. 1"x1"x2". Use as motor or as tachometer generator. Stock #SD-65.



Price \$1.95 each net

## Microwave Antenna

AS-217A/APG-15B. 12 Cm. dipole and 13-inch parabola housed in weatherproof Radome (not illustrated). 16" diam. DC spinner motor for conic scan. Shipping weight 70 lbs. Stock #SD-95.



Price \$9.50 each net

## Phase Shift Capacitor

Four stator single-rotor capacitor. 0 to 360° phase shift with circuit shown Radio News (Eng. Ed. June 1947). Stock #SD-114.

Price \$4.75 each net



SD-124



SD-119

## Null Type Synchro Indicator

Consists of Bendix size 5 synchro, rectifier, transformer, magic eye tube and illuminated 360° dial. Manually tuned to null. Ideal for experimenters and labs. Stock #SD-119.

Price \$6.95 each net

## Servo Motors

Pioneer Types CK-2, CK-5 and 10047-2-A, etc. Kollsman 776-01 for 400 cycles. Diehl Types FP-25-3, FPE-25-11 (CDA-211052) and ZP-105-8 (CDA-211377) for 60 cycles. Reversible DC motors, etc.

# SERVO-TEK PRODUCTS Co.

Incorporated

Surplus Division

247 CROOKS AVE.

CLIFTON, N. J.

Write for complete listing or call ARmory 4-2677

Open account shipments to rated concerns; others may order C.O.D.

## TUNING CONTROL KNOBS For Command Set Receivers

69c. ea. 3 for \$2. Postpaid in U.S.A.

BC 454, etc. series with locking sleeve. Brand new, not surplus. Makes tuning simple for fixed or mobile use.

Send for Latest Bulletin

ALVARADO

903 S. Alvarado, Los Angeles 6, Cal.

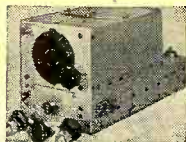

## RADIO BOOKS by mail

DOMESTIC Retail only. Same-Day Service on 95% of all orders. Order from us any radio book advertised in this magazine or elsewhere. Send stamp for catalog.

OVERSEAS We specialize in mail exports to all the world. Wholesale and retail. Send (local) stamp for details.

EDITORS AND ENGINEERS, Ltd. 1302 Kenwood Road, Santa Barbara, Calif., U.S.A.

# BLISS Electrical Training

Intensive 32 weeks residence course in fundamentals of industrial electrical engineering, including radio and electronics. Extensive laboratory, shop work, drafting. Prepares for

electrical technician and engineering aides in communications, power, manufacturing, business machines, sales, service. 54th year. Classes begin March 22; July 28. Catalog.

Electrical School

7698 Takoma Avenue, Washington 12, D. C.

98

neither see, taste, smell, or feel the results of their outlay of cash—so any spade work done in the field of educating the public with regards to radio servicing is work well done.

The flyer might show a service bench with a radio technician at work, or a comic cut depicting the "ills" of a radio receiver might be used. The idea to put across is that when the customer's radio is not working properly YOU are the outfit to do the job if the set owner really wants the job done right.

It is not always necessary to have a direct mail agency handle your campaigns for you. If you have the time and facilities for preparing mailing pieces—all well and good. Your own mailing list can be made up from sales slips, the phone book, or from lists rented from non-competitive firms operating in your neighborhood. Religious and cultural centers often have desirable mailing lists which might be for rent and often they have the machines to process such names which could be rented or the job done on a contract basis. This would cut your investment costs by eliminating the necessity for buying specialized equipment.

In case your list has been rented or purchased from a commercial outfit the first step you should take is to break down the list by classifications, if at all possible. Financial, geographical, and classifications by sex should be made so that mailings can go to persons most likely to be interested in the services or merchandise you have to offer. Once a list is so classified, the cards should be marked with colored tabs by groups to facilitate future mailings. Thus, if you as a radio dealer should happen to make a lucky purchase of say, electric razors, you could circularize your male customers without wasting time and money telling the bobby-soxers on your list of the advantages of shaving the "electric way." Similarly if you have a bargain in an inexpensive portable to offer the teen-agers you won't be insulting Mr. Big by telling him that a \$19.95 portable is just what he needs for those "jive sessions." See what we mean?

Your mailing list can be a real business-getter for you if you use care in making it up or buying it and then keep it up-to-date. If direct mail pieces are returned to you marked "Moved—Left no address" try to determine the new address—but failing this remove the card from the active file. An obsolete mailing list is as useful to you as a business man as a show window without glass. Try to avoid the "this was a good list ten years ago but—"

Don't forget that a good mailing list is good business—because if it is really up-to-date you can make a little extra cash for yourself by renting your list to non-competitive firms for them to use as their mailing list. If it is good there will be plenty of demand for it by other firms in your neighborhood.

RADIO NEWS

# Try These

## FOR BETTER PERFORMANCE

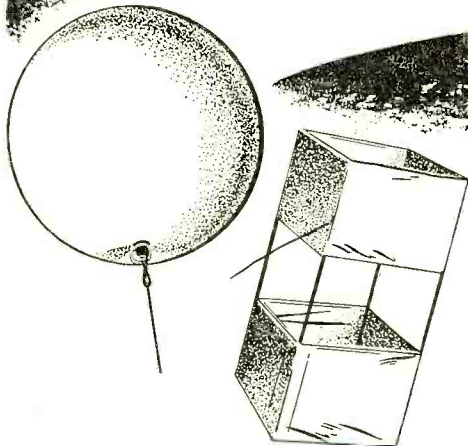

Super DX is possible with a long wire vertical antenna supported by a balloon or kite. Low angle of radiation and easy to load. A complete kit consisting of 2 heavy duty 4 foot balloons, 2 hydrogen generators, a folding aluminum frame box kite with water repellent cloth sails, and 300 feet of stranded antenna wire, packed in a tubular canvas carrying bag, is priced at only \$9.95. (Originally cost about \$75.00)

The advantages of real FM operation (less noise and QRM) can only be obtained with an FM receiver. You will be amazed at the difference in FM signals if you've heard them only on an AM receiver. The D & L FM Conversion Unit (not a kit) can be quickly wired into any receiver having an I.F. frequency between 425 and 475 KC. Price only \$15.45 complete with instructions.

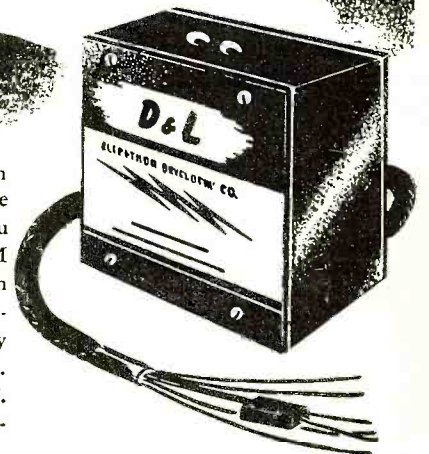

Standard Make Type 826 — 60 Watt UHF Transmitting Tubes at 49c each! The growing popularity of the higher frequency bands makes this general purpose tube an outstanding value. These 826's are brand new, inspected, and in their original cartons. Shipped only in boxes of 8 tubes at \$3.92. (Add 50c for mailing anywhere in U.S.) Ceramic Tube Sockets for 826, 829B — 50c each.

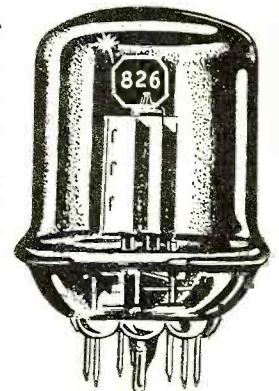

Ground Plane Antenna for 2, 6, or 10 Meters. Clamps to any vertical or horizontal support and is fed with RG8U coaxial cable directly through a connector at the base. Made to withstand extreme weather conditions. Ideal for operation at very high frequencies. Price, complete with ceramic insulated mounting, copper-plated steel elements, heavy duty chain clamp, only \$12.50. Specify frequency.

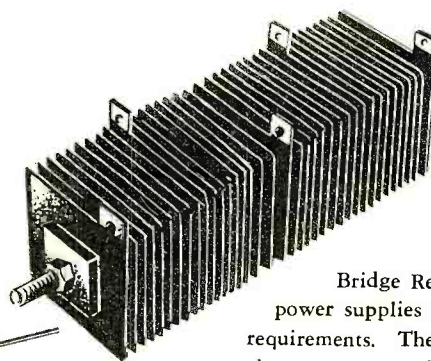

Standard Make Full Wave Bridge Rectifiers for battery chargers, power supplies and other low voltage D.C. requirements. These are the high efficiency magnesium — copper sulphide type rectifiers which are known for their long life at high output. A.C. Input — 32 volts at 9.5 amperes. D.C. Output — 14.8 volts at 7.3 amperes. Price only \$4.85 each.

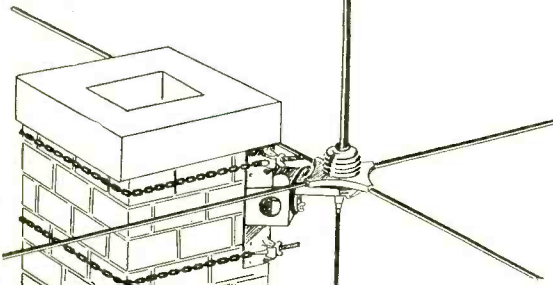

**WELLS SALES, INC.**

Order Direct From Us or Through Your Local Jobber

All Prices F.O.B. Chicago

320 N. LA SALLE ST. DEPT. R-3, CHICAGO 10, ILL.

**1948 MODEL MUTUAL CONDUCTANCE TUBE TESTER .....\$49.95**

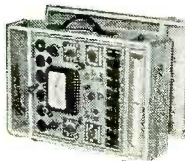

No possibility of good tubes reading "Bad" or bad tubes reading "Good" as on dynamic conductance testers or other ordinary emission testers. Attractive panel and case equal to any on the market in appearance. . . . Large 4 1/2" meter . . . Calibrated micromho scale as well as a Bad-Good scale . . . Front panel fuse . . . Individual sockets for all tube base types —voltages from .75 volts to 117 volts and complete switching flexibility allow all present and future tubes to be tested regardless of location of elements on tube base . . . Indicates gas content and detects shorts or opens on each individual section of all local, octal and miniature tubes including cold cathode, magic eye and voltage regulator tubes as well as all ballast resistors. Name of the nationally known manufacturer withheld because of special price offer.

Model "C"—Sloping front control case. . . . \$49.95  
 Model "P"—Handsome hand-rubbed portable case. . . . \$4.95  
 Built-in roll chart with either of above \$5.00 extra.

**ARMY BC-312 COMMUNICATIONS RECEIVER**

This receiver covers the frequency range of 1.5 MC to 18 MC in six direct reading bands. The dial that is driven with split gears to prevent backlash, has 4500 logging divisions per band with approximately 600 divisions on the 20 and 40 meter ham bands and 1000 divisions on 80 meters. Two stages of RF before the converter in this set give it a very high signal to noise ratio and maximum sensitivity. Outstanding features of this receiver are: BFO with pitch controls send-receive relay, jacks on the front panel for headphones and speaker output, and mike and key inputs. All tubes are standard 6 volt types. This receiver was designed to withstand rough usage in the field and for operation from vehicles while in motion, so it is ruggedly constructed and contains a dynamotor power supply—Your cost \$48.95. Conversion kit to 110 V AC is available for.....\$6.50

**PE-109 32-VOLT DIRECT CURRENT POWER PLANT**

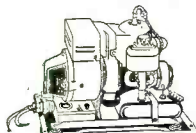

This power plant consists of a gasoline engine that is direct coupled to a 2000 watt 32 volt DC generator. This unit is ideal for use in locations that are not serviced by commercial power or to run many of the surplus items that require 24-32V DC for operation. The price of this power plant is only \$58.95. We can also supply a converter that will supply 110V AC from the above unit or from any 16-32V DC source for \$29.95.

**14-Tube UHF Superhet Receiver — \$39.95**

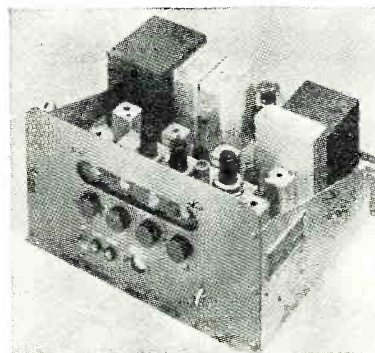

This beautifully constructed receiver was designed especially for Signal Corps communication service, and is one of the finest and most sensitive sets ever manufactured. Operating from 110V 60 cycles, this set has two tuned RF stages, tuned converter and oscillator, five I.F. stages, using iron-core IF's, a diode detector, tuning eye, and a two stage amplifier that will drive a speaker or phones. The frequency range is 158-210 Mcs. It is a simple matter to operate on other bands by making a slight alteration in the tuning coils. A complete set of tubes is included with each receiver, along with a circuit diagram and parts list. The high-voltage power supply delivers 150 milliamperes, and is well filtered by a heavy-duty choke and three 7 Mfd. oil-filled condensers. This buy of a lifetime cost the government about \$700. Amateurs and experimenters will never again be able to purchase fine equipment at such a tremendous saving! See January Radio Craft, Page 57, for complete conversion to television receiver.

**GENERAL ELECTRIC RT-1248 15-TUBE TRANSMITTER-RECEIVER**

TERRIFIC POWER—(20 watts) on any two instantly selected, easily pre-adjusted frequencies from 435 to 500 Mc. Transmitter uses 5 tubes including a Western Electric 316 A as final. Receiver uses 10 tubes including 955's, as first detector and oscillator, and 3-7HT's as IF's, with 4 slug-tuned 40 Mc. IF transformers, plus a 7HT, 7ED's and 7ET's. In addition unit contains 8 relays designed to operate any sort of external equipment when actuated by a received signal from a similar set elsewhere. Originally designed for 12 volt operation, power supply is not included, as it is a cinch for any amateur to connect this unit for 110V AC, using any supply capable of 400V DC at 135 Ma. The ideal unit for use in mobile or stationary service in the Citizen's Radio Telephone Band where no license is necessary. Instructions and diagrams supplied for running the RT-1248 transmitter on either code or voice in AM or FM transmission or Facsimile transmitter or receiver, as an amateur television transmitter or receiver, for remote control relay hookups, for Geiger-Mueller counter applications. It sells for only \$29.95 or two for \$53.90. If desired for marine or mobile use, the dynamotor which will work on either 12 or 24V DC and supply all power for the set is only \$15.00 additional.

**AT LAST YOU CAN AFFORD A LABORATORY STANDARD MICROVOLTER**

The famous Measurements Corp. Model 78B, 5 Tube Laboratory Standard Signal Generator (that sold new, FOB Boonton, N. J., for \$310.00 net), is available in perfect condition for 25 to 60 cycles, 115 V AC operation. Until now this is the sort of top-flight lab equipment that discriminating buyers have only vainly hoped would be released at a bargain price. Every cent the manufacturer asks, but available FOB Buffalo while our limited supply lasts for only \$79.95.



Model 78-B Standard Signal Generator. Two Frequency Bands between 15 and 250 megacycles.

Such companies as Admiral Corp. and John Meck, Inc. have ordered from us and repeated many times on these 78 generators for use in their labs and production line testing. "REMEMBER, THAT A STANDARD IS ONLY AS RELIABLE AS ITS MAKER."

RT1463 7 tube amplifiers containing 3-7F7, 1-7Y4, 3-7N7, 4 potentiometers, numerous resistors, filter and bypass condensers, filter chokes, power and audio transformers, and six sensitive plate relays. A military development that provided amazing stepless control proportional to correction required for altimeters, rudder and elevator, in the original application. A control amplifier of the ordinary type would deflect the rudder by some arbitrary amount when the ship was blown off the course to port or starboard. The result would either be that the correction was insufficient and the plane continued off course, or the correction would be too great, starting a series of tackings and would greatly increase fuel consumption and elapsed time in reaching the objective. This phenomenal unit, with its 3 amplifiers and six 5000 ohm relays in bridge circuits, will accurately control any 3 operations, related or unrelated, in minutely adjustable uniquely quantitative variations in either forward or reverse directions. 9"x7"x8" black crackle aluminum case. Brand new in original carton. \$12.95, or used \$9.95.

**SCR-274N COMMAND SET**

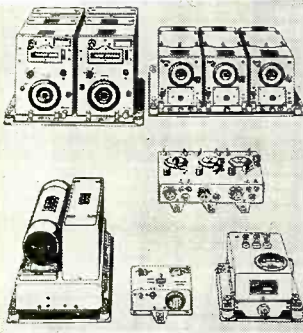

The greatest radio equipment value in history  
 A mountain of valuable equipment that includes 3 receivers covering 190 to 550 KC; 3 to 6 MC; and 6 to 9.1 MC. These receivers use plug-in coils, and consequently can be changed to any frequencies desired without conversion. Also included are two Tuning Control Boxes; 1 Antenna Coupling Box; four 28 V. Dynamotors (easily converted to 110 V. operation); two 40-Watt Transmitters including crystals, and Preamplifier and Modulator. 29 tubes supplied in all. Only a limited quantity available, so get your order in fast. Removed from unused aircraft and in guaranteed electrical condition. A super value at \$29.95, including crank type tuning knobs for receivers. Without these knobs the receivers can't be tuned, and are only useful for parts. Don't buy without knobs!

**SCR-284 TRANSMITTER-RECEIVER**

This medium power transmitter and the accompanying 7-tube very sensitive receiver are naturals for 80 or 40 meter operation (phone or CW), on either fixed stations or mobile applications. These units are brand new and come complete with 17 tubes, key, microphone, 200 KC calibrating crystal and instructions and diagrams for use with up to 100 watts input to the final stage on 40 or 80 meters for either phone or CW, using vehicle or 110 Volt power supply. Your cost.....\$39.95



ALUMINUM GEAR BOX 18x8x7 that contains two powerful electric motors and two matched gear trains, 62 gears in all varying in size from 1/2 to 4 inches in diameter. This unit is readily converted to rotate a beam antenna or any other similar usage .....\$3.00

BRAND NEW 110 V AC INPUT POWER SUPPLY, in grey enameled shock-mounted case 9" x 10" x 16". Several heavy duty resistors, 3 chokes, 4-1000 V and 600 V oil-filled condensers, 1 relay, 2-5U4's, 3 voltage regulator tubes, safety interlock, and several fuses are included in this regulated power supply at the bargain price of .....\$9.95

**DUE TO POPULAR DEMAND WE REPEAT THESE TERRIFIC BARGAINS**

- Three assorted new MICROPHONES, including push-to-talk type..... \$1.49
- Ten assorted R. F. Chokes including high frequency types..... \$ .35
- Five assorted AUDIO or FILTER CHOKES..... \$ .99
- One hundred assorted RESISTORS..... \$1.95
- Ten assorted JAN CABLE CONNECTORS, including many popular types..... \$ .99
- Six assorted OIL FILLED CAN TYPE CONDENSERS, all with mounting brackets..... \$1.49
- Ten assorted METAL & BAKELITE KNOBS—(no wooden knobs)..... \$ .39
- Six assorted VARIABLE CONDENSERS, including butterfly types..... \$1.49
- Six assorted POWER and AUDIO TRANSFORMERS, all new..... \$1.98
- Six assorted isolantite and bakelite R. F. COILS, shielded and unshielded..... \$ .99

The above ten assortments totaling over \$12.00 at the unbelievable bargain prices listed, can be purchased together as one lot at a super-special total price of only \$10.00

Minimum order \$3.00—All prices subject to change—25% deposit with COD orders.

# RADIOMEN'S HEADQUARTERS ❄️ WORLD WIDE MAIL ORDER SERVICE!!!

**RADIO SERVICEMEN!!** Buffalo Radio Supply's lower prices mean increased profits for you. Order all of your needs from us and receive in return courteous service and first class merchandise at the lowest prices in the country. Here are a few of our typical bargains.

## SELENIUM RECTIFIERS

The new miniature rectifier that more and more manufacturers are using. Order some of each type so you will be ready when these receivers require servicing. Make extra money by installing them in old sets. All types are rated at 130 V. RMS and will withstand an inverse peak of 380 v. The 25 ma unit is for phono osc and bias supplies and converting relays.

25 ma.....	\$0.45.....	10 for \$ 4.00	100 ma.....	.75.....	10 for 7.00	200 ma.....	1.05.....	10 for 10.00
75 ma.....	.70.....	10 for 6.50	150 ma.....	.80.....	10 for 7.50			

## SPEAKERS

These PM speakers are the finest that are available. All have heavy oversize Alnico V magnets.

3 1/2".....	\$1.15.....	6 for \$6.60	5".....	1.10.....	10 for 9.50
4".....	1.15.....	6 for 6.60	6".....	1.50.....	6 for 8.70

## AUTO RADIO DEALERS! ATTENTION!

A famous nationally advertised brand of auto radio which will fit any car and every pocketbook. Six tube superhet with three gang condenser and 6 1/2" speaker. Dealer price \$32.20 for sample, or \$29.97 each, in lots of two or more. Here is an item that no serviceman that repairs auto radios can be without. Nationally advertised ATR battery eliminator that supplies perfectly filtered 12 V DC or 6 V DC at 14 amperes from 10 V AC. **\$36.00**

## BUFRAD CAR RADIO ANTENNAS

All of our car radio antennas are made of triple plated Admiralty Brass Tubing, complete with low loss shielded antenna leads and have high quality fittings.

- SIDE COWL—BR-1,** 3 sections extend to 66". Your price—single units—**\$1.50**; in lots of 12—**\$1.35** ea.
- SKYSCRAPER—BR-2** has 4 heavy duty sections that extend to 98". Your price—single units—**\$2.45**; in lots of 12—**\$2.25** ea.
- TILT ANGLE—BR-3,** may be adjusted to all body contours. 3 sections extend to 66". Single unit price—**\$1.50**; 12 lot price—**\$1.25** ea.
- VERSATILE—BR-4,** single hole fender or top cowl mounting may be adjusted to conform with all body contours. 4 sections extend to 56". Single unit price—**\$2.90**; 12 lot price—**\$2.75** ea.
- THE MONARCH—BR-5,** single hole top cowl mounting, 3 sections extend to 56". Single unit price—**\$1.90**; 12 lot price—**\$1.75** ea.

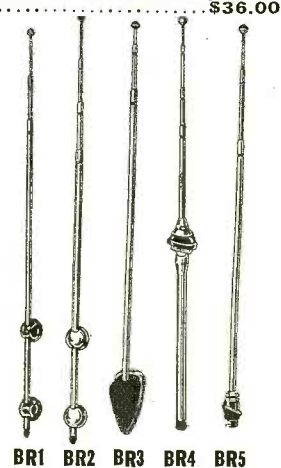

**BENDIX SCR 522—Very High Frequency Voice Transmitter-Receiver—100 to 156 MC.** This job was good enough for the Joint Command to make it standard equipment in everything that flew, even though each set cost the Gov't \$2500.00. Crystal Controlled and Amplitude Modulated—**HIGH TRANSMITTER OUTPUT** and 3 Microvolt Receiver. Sensitivity gave good communication up to 180 miles of high altitudes. Receiver has ten tubes and transmitter has seven tubes, including two 832's. Furnished complete with 17 tubes, remote control unit, 4 crystals and the special wide band VHF antenna that was designed for this set. These sets have been removed from unused aircraft and are guaranteed to be in perfect condition. We include free parts and diagrams for the conversion to "continuously variable frequency coverage" in the receiver.

The SCR522 complete with 24 volt dynamotor sells for only **\$37.95**. The SCR 522 is also available with a brand new 12 volt dynamotor for only **\$42.95**.

**BC-221 FREQUENCY METERS** with calibrating Crystal and calibration charts. A precision frequency standard that is useful for innumerable applications for laboratory technician, service man, amateur, and experimenter at the give away price of only **\$36.95**.

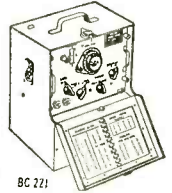

BC 221

- 100 KC CRYSTAL CALIBRATOR KIT** containing everything that is necessary to construct a 100 KC osc that will supply 100 KC marker points to your receiver so that it may be used for frequency determination. The 100 KC crystal is worth far more than the price that we are asking for the complete kit.
- KIT 100K**—Plate and filament voltage supplied by receiver... **\$ 9.95**
- KIT 100KA**—Same as the above, including 110 VAC or DC self-contained supply..... **12.95**
- DUAL METER**—one 50 uA and one 200 uA movement in the same case. This meter is ideally suited for modulation percentage and carrier shift indicator. If desired the movements may be removed from the case and used separately. All meters condition in perfect operating condition. A few have cracked glasses. This super value costs only **\$1.75**.

## CLOSING OUT

**THE FOLLOWING DESIRABLE ITEMS AT SACRIFICE PRICES TO MAKE ROOM IN OUR WAREHOUSE FOR INCOMING STOCK**

- 947A ONE KILOWATT HIGH FREQUENCY TRANSMITTER.** This relay-controlled transmitter includes a 115 V, 60 cycle power supply, protected by 8 magnetic circuit breakers, that alone is worth more than the price we are asking for the whole rig, even on today's surplus market. On the front panel are six 3 1/2" G.P. or Weston meters, including 250 MA, 50 MA, 1000 MA, 150 V AC and 1500 V DC at 1000 ohms per volt for screens and plate. The rack-type 21" x 15" x 36" unit contains six amplifier and rectifier tubes aggregating over \$80.00 at WAA current wholesale prices. Western Electric's price to the government was \$1500.00. Shipping weight 500 lbs. Your cost at close-out price as is. Formerly \$69.95, now only **\$39.95**.
- 5" "50" RADAR P.P.I. SCOPE,** complete with 9 tubes including 807 tube in final power stage that provides deflecting current for magnetic yokes. Selsyn motor and self-contained 110 V power supply designed to run on the AC supply on LST and PT boats. Various ranges from 2 to 80 miles. The most satisfactory scope available for navigational radar or panoramic television applications. Nationally advertised @ \$100.00; our price, only **\$39.95**.
- 5 INCH RECEIVER INDICATOR SCOPE.** This unit, originally sold by Western Electric for \$2500.00, includes a 13 tube receiver with 7 IP stages; 2 tube multivibrator sweep generator; 2 supply with 2x2 for high voltage. Equipped with more than 15 tubes of the 43 originally used and including a brand new scope tube in original carton. Makes a wonderful laboratory instrument as is. Formerly \$69.95, now **\$39.95**.

\$9.95

TAKES ALL THREE BIG BARGAINS

- 1. AUDIO AMPLIFIER** Undreamed of value. Uses 6V6's. Has 4 microphone inputs brought to jacks at rear panel. Various output impedances available at rear panel connections. Steel case with chrome handles. 9" long x 9" high x 6" deep. Tubes included. New in original carton. Shipping weight 20 lbs. **SUPER SPECIAL—\$4.95** while supply lasts.
- 2. RADIO HEADSETS** Latest supersensitive type with rubber earpieces. Every pair guaranteed perfect. **\$.59 per pair OR 3 PAIRS FOR \$1.00.**
- 3. HOME WORKSHOP AT BARGAIN PRICE**  
Accurate and precise 2 speed guaranteed hobby lathe, the essential machine for the home workshop. Sturdy enough for light production work or factory standby service, supplied with 36" of belting for connecting to any available electric motor or power take-off, such as on a jeep or tractor. Also included in this unbelievable offer are such accessories as a 1/2" drill chuck with specially hardened tool steel jaws, a 4" electric furnace high speed grinding wheel, a cotton buffing wheel with a large supply of buffing compound, and a 4" steel wire scratch brush. Your cost \$6.00. Sole export agent. Distributor inquiries invited.

NO C. O. D.'s—ORDER NOW—DON'T DELAY

GENERAL ELECTRIC  
150 WATT  
TRANSMITTER

Cost the Government \$1800.00  
Cost to you \$44.50!!!!

This is the famous transmitter used in U.S. Army Bombers and ground stations, during the war. Its design and construction have been proved in service, under all kinds of conditions, all over the world. The entire frequency range is covered by means of plug-in tuning units which are identical laboratory instruments and has its own oscillator and power amplifier coils and to operate at top efficiency within its particular frequency range. Transmitter and accessories are finished in black crackle, and the millimeter voice-tube sweep amplifier, video amplifier, pedestal impulse and sweep generator, and 115 volt, 60 cycle supply with dynamotor which furnishes 1000V at 350 MA. Complete instructions are furnished to operate set from removed from unused aircraft but are guaranteed to be in perfect condition.

BRAND NEW INVERTERS AND DYNAMOTORS

**PE 6A:** A 24 to 32 V DC input, to 80 V AC regulated output converter—**\$12.95.**

**PE 19A:** A 24 to 28 V DC input, to 80 V AC at 800 cps output—**\$9.95.**

(We include a step-up transformer with each of the above so that 110 VAC is available from either.)

**27 V DC input:** 28 V DC @ 75 MA output—**98c.**

**27 V DC input:** Output 300 V @ 150 MA, 150 V @ 15 MA and 12 V @ 5 Amp—**\$5.95.**

**12 V DC input:** Output 300 V @ 150 MA, 150 V @ 15 MA and 12 V @ 5 Amp—**\$12.00.**

**13 or 26 V DC input:** Output 300 V @ 150 MA, 150 V @ 15 MA and 12 V @ 5 Amp—**\$15.00.**

(By running on 6 V AC, 60 cycle input, with a small amount of DC for field excitation, the above dynamotor will provide a good source of 12, 24, 400 or 800 V DC.)

BUFFALO RADIO SUPPLY, 219-221 Genesee St., Dept. 3N, BUFFALO 3, N. Y.  
CABLE ADDRESS BUFRAD



## THE GE ELECTRONIC SWITCH

The General Electric Electronic Switch, Type YE-9, is a device which may be used with a conventional cathode ray oscilloscope for the simultaneous observation of two or more



wave phenomena on the screen of the oscilloscope. Since the cathode ray tube is essentially a single signal indicator, a device such as this is necessary for the observation of more than one signal. Thus, it permits the oscilloscope to be used as a multi-signal comparison device.

The two signals to be observed are applied to the two inputs of the Electronic Switch. The Electronic Switch then performs its function by delivering the individual signals to the output terminal, alternately. Due to the persistence of vision of the human eye, and the persistence of the fluorescent screen, the two signals appear on the oscilloscope screen simultaneously. While the employment of one Electronic Switch permits the simultaneous observation of two waveshapes on the oscilloscope screen, two switches used in tandem may be used to observe three waveshapes, etc.

The instrument requires no adjustment or calibration while in use. It is completely automatic in operation for any range of oscilloscope sweep frequencies from 10 to 12,000 cycles per second. The only controls are the individual Gain Controls for each signal and a Balance Control for separation or superposition of the two signals.

The most frequent uses to which the Electronic Switch may be put are the comparison of amplitude, waveform, phase, and frequency relationships between two signals. The signals under study may be those of an electrical or electronic device, or they may be sound or mechanical motion that are transformed into electrical functions.

### TECHNICAL DATA

Input voltage	110-125 Volts, 50-60 cycle
Power drain	45 watts
Amplifier frequency response	4 cps to 450 kc (flat within 3 db)
Oscilloscope sweep frequency range	will operate on any sweep frequency of from 10 cps to 12,000 cps, continuously variable
Input impedance	100,000 ohms
Maximum signal input	250 volts rms
Length, overall	12 1/2"
Width, overall	7 3/8"
Height, overall	8 1/2"
Weight	14 lbs.

**\$5950** Net, F.O.B., New York

Telephone: **7** **LO. 3-1800**

**HARVEY RADIO COMPANY INC**  
103 West 43rd St., New York 18, N. Y.

## International Short-Wave

(Continued from page 67)

- \*11.530—Douala, Cameroons.
- \*11.535—SPD, Warsaw, Poland.
- 11.535—VRR4, Stony Hill, Jamaica, B.W.I., 500 w.
- \*11.602—PLN, Bandoeng, Java, "Radio Omroep Bandoeng," 2 kw.
- 11.615—Teheran, Iran.
- 11.615—Clandestine, "España Independiente."
- 11.620V—Clandestine, "España Independiente."
- \*11.623—COK, Havana, Cuba, 2 kw.
- \*11.625—Berlin, Germany.
- 11.630—Leningrad, U.S.S.R.
- 11.640—Clandestine, "Radio España Independiente, Estacion Pyrenaica."
- \*11.640—PZY, Manila, Philippines.
- 11.645—OTC3, Leopoldville, Belgian Congo, "Radio Nationale Belge," 50 kw.
- 11.650—KTPA, Canton, China, 1 kw.
- 11.670—Bogota, Colombia, "Radiodifusora Nacional."
- \*11.670—OTM3, Leopoldville, Belgian Congo, "Radio Congo Belge," 20 kw.
- \*11.675—Andorra, Andorra.
- \*11.675—Moscow.
- \*11.680—PPQ, Rio de Janeiro, Brazil.
- 11.680—GRG, London, 50-100 kw.
- 11.685—HVJ, Vatican City, Vatican, "Radio Vaticano," 25 kw.
- 11.685—XGAF, ..... China, "K'ung Chun Broadcasting Station."
- \*11.687—Brazzaville, French Equatorial Africa, 500 w.
- 11.690—Bucharest, Rumania, "Radio Dacia Romana."
- 11.696—HP5A, Panama City, Panama, "Cadena Panama de Radiodifusion," 500 w.
- \*11.698V—XORA, Shanghai, China.
- \*11.700—CE1170, Santiago, Chile, "Radio Bulnes," 1.5 kw.
- 11.700—GVV, London, 50-100 kw.
- 11.700—Paris, "Radiodiffusion Francaise," 100 kw.
- \*11.705—CBFY, Montreal, Quebec, Canada, 7.5 kw.
- \*11.705—CKXA, Sackville, Canada, "CBC International Service," 50 kw.
- 11.705—SEB, Motala (Stockholm), Sweden, 12 kw.
- \*11.705—JLW3, Tokyo.
- 11.705—WLWS1/2, Cincinnati, Ohio, U.S.A., 75 kw.
- 11.705V—XORA, Shanghai, China, "Shanghai Broadcasting Station," 4 kw.
- 11.710—VLG3, Melbourne, Australia, "Radio Australia," 10 kw.
- \*11.710—VUD3, Delhi, AIR, 10 kw.
- \*11.710—Johannesburg, South Africa (Johannesburg III) 5 kw.
- 11.710—WLWR1, Cincinnati, Ohio, U.S.A., 175 kw.
- \*11.710—WLWS2, Cincinnati, Ohio, U.S.A., 75 kw.
- 11.710—Moscow.
- 11.713V—FHE3, Dakar, Fr. West Africa, "Radio Dakar," 12 kw.
- 11.715—HE15, Berne, Switzerland, 25 kw.
- \*11.715—HSP5, Bangkok, Siam, 10 kw.
- \*11.715—JLW3, Tokyo.
- \*11.717—Jerusalem, Palestine.
- 11.718V—Kiev (?), U.S.S.R.
- \*11.718—CR7BH, Lourenco Marques, Mozambique, "Radio Mozambique," 300 w.
- \*11.718—HEU4, Berne, Switzerland, 25 kw.
- 11.720—OTM4, Leopoldville Belgian Congo, "Radio Congo Belge," 20 kw.
- \*11.720—Moscow.
- \*11.720—ORY2, Ruislede (Brussels), Belgium, "Radio Nationale Belge," 5 kw.
- \*11.720—Jaffa, Palestine.
- 11.720—PRL8, Rio de Janeiro, Brazil, "Radio Nacional," 50 kw.
- 11.720—HOL, Sackville, Canada, "CBC International Service, 50 kw.
- 11.720—CRXK, Winnipeg, Manitoba, Canada, 2 kw.
- \*11.724—HNG, Baghdad, Iraq, 5 kw.
- \*11.725—XORA, Shanghai, China, 4 kw.
- 11.725—WRUW, Boston, Mass., N.S.A., 20 kw.
- \*11.725—JWV3, Tokyo.
- \*11.725—XGSK, Nanking, China.
- 11.725—Jaffa, Palestine, "Sharq-al-Adna," 7.5 kw.
- \*11.725—YVOR, Caracas, Venezuela, "Radiodifusora Nacional," 10 kw.
- \*11.728—CE1173, Santiago, Chile, "Radio Sociedad Nacional de Minería," 5 kw.
- 11.730—OQ2AA, Leopoldville, Belgian Congo, "Radio Leo," 50 w.
- \*11.730—GVV, London, 50-100 kw.
- 11.730—Paris, "Radiodiffusion Francaise," 100 kw.
- \*11.730—EQE, Teheran, Iran, "Radio Teheran," 14 kw.
- 11.730—PHI, Hilversum (Huizen), Holland, "Radio Nederland," 5 kw.
- \*11.730—KGEL, San Francisco, Calif., U.S.A., 50 kw.
- 11.730—KGEX, San Francisco, Calif., U.S.A., 100 kw.
- 11.730—WRUL, Boston, Mass., U.S.A., 50 kw.
- 11.730—WRUW, Boston, Mass., U.S.A., 20 kw.
- \*11.735—CR6RC, Luanda, Angola, "Radio Clube de Angola," 150 w.
- 11.735—Singapore, Malaya, British Far Eastern Broadcasting Service," 75 kw.
- \*11.735—XGSL, Nanking, China.
- 11.735—LKO, Fredrikstad, Norway, 8 kw.
- \*11.735—CXA7, Montevideo, Uruguay, 5 kw.
- \*11.735—Belgrade, Yugoslavia, "Radio Belgrade," 10 kw.

- 11.740—VLB10, Shepparton, Austria, "Radio Australia," 100 kw.
- \*11.740—KROJ, Los Angeles, Calif., U.S.A.
- 11.740—COCY, Havana, Cuba, "RHC-Cadena Azul," 1 kw.
- \*11.740—Athlone, Ireland, "Radio Eirrean," 1.5 kw.
- 11.740—HVJ, Vatican City, Vatican, "Radio Vaticano," 25 kw.
- 11.740—Moscow.
- 11.742—CE1174, Santiago, Chile, "Nuevo Mundo," 5 kw.
- 11.750—GSD, London, 50-100 kw.
- 11.750—Komsomolsk (Khabarovsk Territory), U.S.S.R., 50 kw.
- 11.755—HJCAE, Bogota, Colombia, "Radiodifusora Nacional," 2.5 kw.
- \*11.755—HSPP, Bangkok, Siam.
- 11.757—Minsk (Byelorussian S.S.R.), U.S.S.R.
- \*11.760—VLR8, Melbourne, Australia, "A.B." 2 kw.
- 11.760—VLG10, Melbourne, Australia, "Radio Australia," 10 kw.
- 11.760—VLB3, Melbourne, Australia, "Radio Australia," 100 kw.
- 11.760—CLB3, Melbourne, Australia, "Radio Australia," 100 kw.
- 11.760—CKRA, Sackville, Canada, "CBC International Service," 50 kw.
- \*11.760—OLR4B, Prague, Czechoslovakia, 30 kw.
- \*11.760—VUD7, Delhi, AIR, 100 kw.
- 11.760—VUD1, Delhi, AIR, 20 kw.
- \*11.762—Berlin, Germany.
- \*11.765—Colombo, Ceylon, "Radio SEAC," 7.5 kw.
- \*11.765—THA, Algiers, Algeria.
- 11.766—ZYBS, Sao Paulo, Brazil, "Radio Tupi de Sao Paulo."
- 11.767—Batavia, Java, "Radio Resmi Indonesia," 3 kw.
- \*11.767—Fredrikstad, Norway, "Radio Oslo," 8 kw.
- \*11.770—VLA4, Shepparton, Australia, "Radio Australia," 100 kw.
- \*11.770—VLB3, Shepparton, Australia, "Radio Australia," 100 kw.
- \*11.770—Colombo, Ceylon, "Radio SEAC," 100 kw.
- 11.770—GVU, London, 50-100 kw.
- \*11.770—Delano, Calif., U.S.A., 200 kw.
- 11.770—KNBI, Dixon, Calif., U.S.A., 50 kw.
- 11.770—WGEA, Schenectady, N.Y., U.S.A.
- 11.770—OTC, Leopoldville, Belgian Congo.
- \*11.775—HE16, Berne, Switzerland, 25 kw.
- \*11.775—MTCY, Chungchun, China.
- \*11.780—OIX3, Lahti (Helsinki), Finland, 15 kw.
- 11.780—ZL3, Wellington, New Zealand, "National Broadcasting Service," 10 kw.
- \*11.780—XORA, Shanghai, China.
- 11.780—HP5G, Panama City, Panama, "Radio Pan-Americana," 1.5 kw.
- 11.780—Moscow.
- 11.782—XBNN, Mexico City, Mexico, "Radio mundial," 500 w.
- 11.782—Luxembourg, Luxembourg.
- 11.783—Saigon, French Indo-China, "Radio Saigon," 12 kw.
- 11.784—Vienna, Austria, "Radio Wien."
- \*11.785—Lusaka, Northern Rhodesia.
- \*11.790—VUD3, Delhi, AIR, 100 kw.
- \*11.790—KNBA, Dixon, Calif., U.S.A., 50 kw.
- 11.790—KNBI, Dixon, Calif., U.S.A., 50 kw.
- \*11.790—KNBX, Dixon, Calif., U.S.A., 100 kw.
- 11.790—WRUA, Boston, Mass., U.S.A., 50 kw.
- \*11.790—WRUS, Boston, Mass., U.S.A., 50 kw.
- 11.790—WLWO, Cincinnati, Ohio, U.S.A., 75 kw.
- \*11.800—YSI, San Salvador, El Salvador, "Radio Intercontinental," 100 w.
- 11.800—GWH, London, 50 kw.
- \*11.800—MNL, Manila, Philippines, "The People's Station."
- \*11.800—JZJ, Tokyo, 50 kw.
- \*11.800—XGSM, Nanking, China.
- \*11.805—OZG, Skamlebak (Copenhagen), Denmark, 6 kw.
- \*11.810—VLB4, Shepparton, Australia, "Radio Australia," 100 kw.
- 11.810—Milan, Italy, "Radio Italiana," 10 kw.
- 11.810—VLG7, Shepparton, Australia, "Radio Australia," 50 kw.
- \*11.810—HOXB, Panama City, Panama, "Radio Centro-Americana," 7.5 kw.
- 11.810—KCBF, Delano, Calif., U.S.A.
- \*11.810—KCRB, Delano, Calif., U.S.A., 200 kw.
- 11.810—WGEA, Schenectady, N.Y., U.S.A., 50 kw.
- \*11.815—JVZ, Tokyo, 50 kw.
- \*11.815—HHK, Leogane, Haiti.
- \*11.815—HEU5, Berne, Switzerland.
- 11.820—GSN, London, 50-100 kw.
- \*11.820—Colombo, Ceylon.
- 11.820—XEBE, Hermosillo, Mexico, "El Heraldo de Sonora," 100 w.
- 11.820—Benghazi, Cyrenaica (Africa), "Forces Broadcasting Station."
- \*11.825—JVZ2, Tokyo, 50 kw.
- 11.825—Moscow.
- \*11.825—WCRC, New York, N.Y., U.S.A.
- 11.830—VLW3, Perth, Western Australia, "A. B.C.," 2 kw.
- \*11.830—VUD4, Delhi, AIR, 10 kw.
- \*11.830—WCBN, New York, N.Y., U.S.A., 50 kw.
- 11.830—WCDA, New York, N.Y., U.S.A., 50 kw.
- 11.830—WNRX, New York, N.Y., U.S.A., 50 kw.
- \*11.830—Moscow.
- 11.835—XGOA, Nanking, China, "Central Broadcasting Station."
- 11.835—CR7B, Lourenco Marques, Mozambique, "Radio Club de Mozambique," 300 w to 7.5 kw.

**MONEY BACK GUARANTEE** We believe units offered for sale by mail order should be sold only on a "Money-Back-If-Not-Satisfied" basis. We carefully check the design calibration and value of all items advertised by us and unhesitatingly offer all merchandise subject to a return for credit or refund. You, the customer, are the sole judge as to value of the item or items you have purchased.

## The Model 88-A COMBINATION

# SIGNAL GENERATOR AND SIGNAL TRACER



The Model 88 comes complete with all test leads and operating instructions. Only.....

**\$28<sup>85</sup>**  
NET

We're prepared for the demand we know will be created by this long overdue combination of the two units which have always been used together. The ultimate in signal tracing procedure is achieved by the Model 88, for the use of this model, enables you to use either the broadcast signal itself or the signal injected by the Signal Generator. This is especially useful of course when servicing "dead" or "intermittent" receivers. The Model 88 you will find is the greatest time-saver ever provided for by combining a full range Signal Generator and Signal Tracer into one unit; the set up time for interconnecting, etc., is entirely eliminated.

### Signal Generator Specifications:

- Frequency Range: 150 Kilocycles to 50 Megacycles.
- The R.F. Signal Frequency is kept completely constant at all output levels. This is accomplished by use of a special grid loaded circuit which provides a constant load on the oscillator circuit. A grounded plate oscillator is used for additional frequency stability.
- Modulation is accomplished by Grid-blocking action which has proven to be equally effective for alignment of amplitude and frequency modulation as well as for television receivers.
- Positive action attenuator provides effective output control at all times.
- R.F. is obtainable separately or modulated by the Audio Frequency.

### Signal Tracer Specifications:

- Uses the new Sylvania IN34 Germanium crystal Diode which combined with a resistance-capacity network provides a frequency range of 300 cycles to 10 Megacycles.
- Simple to operate—Clips directly on to receiver chassis, no tuning controls.
- Provision is made for insertion of phones of any impedance, a standard Volt-Ohm Milliammeter or Oscilloscope.

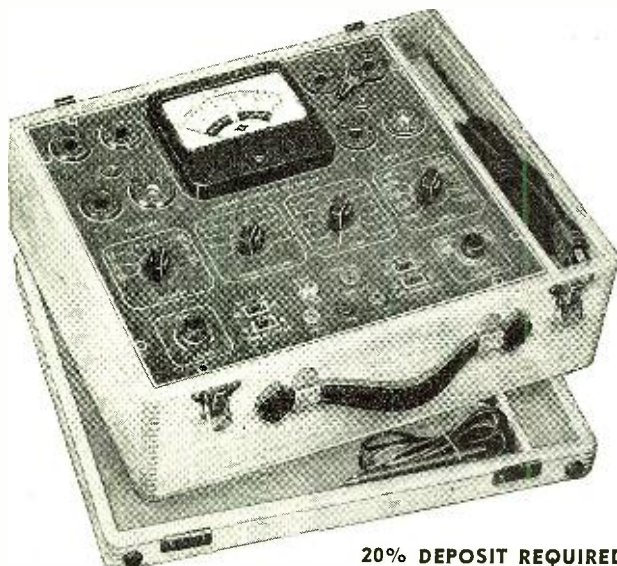

## The New Model 777 20,000 OHMS PER VOLT!! TUBE & SET TESTER

### SPECIFICATIONS:

- Tests all tubes including 4, 5, 6, 7, 7L, Octals, Loctals, Television, Magic Eye, Thyratrons, Single Ended, Floating Filament, Mercury Vapor Rectifiers, New Miniatures, etc. Also Pilot Lights.
- Tests by the well-established emission method for tube quality, directly read on the scale of the meter.
- Tests leakages and shorts of any one element against all elements in all tubes.
- Tests both plates in rectifiers.
- Tests individual sections such as diodes, triodes, pentodes, etc., in multi-purpose tubes.
- New type line voltage adjuster.

### V.O.M. SPECIFICATIONS:

- D.C. VOLTS: (At 20,000 Ohms Per Volt)  
0 to 7.5/15/75/150/750/1,500 Volts
- A.C. VOLTS: (At 10,000 Ohms Per Volt)  
0 to 15/30/150/300/1,500/3,000 Volts
- D.C. CURRENT:  
0 to 1.5/15/150 Ma. 0 to 1.5 Amperes
- RESISTANCE:  
0 to 5,000/50,000/500,000 Ohms 0 to 50 Megohms
- DECIBELS: (Based on zero decibels equals .006 Watts into a 500-Ohm line.)  
—10 to + 18 db., + 10 to + 38 db., + 30 to + 58 db.

Model 777 operates on 90-120 Volts 60 cycles A.C. Housed in beautiful hand-rubbed cabinet. Complete with test leads, tubes, charts and detailed operating instructions. Size 13" x 12 1/2" x 6".

**\$59<sup>95</sup>**  
NET PRICE

20% DEPOSIT REQUIRED ON ALL C. O. D. ORDERS

**GENERAL ELECTRONIC DISTRIBUTING CO.** Dept. RN-3, 98 Park Place  
New York 7, N. Y.

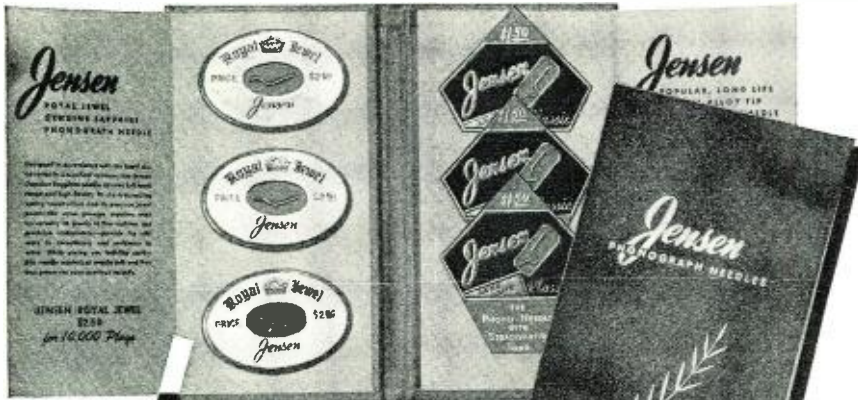

## NEW JENSEN SALES-KIT Introductory Offer

This handy, pocket-size SALES-KIT holding six Jensen phonograph needles is just the thing for Radio Servicemen to take on service calls. Contains 3 of the famous Jensen Royal Jewel Genuine Sapphire needles retailing at \$2.50, and 3 of the Jensen Classic needles at \$1.50. It helps demonstrate fine needles, sells on sight, adds \$\$\$ to your income. Needles are individually packaged in gold, red and black containers. What's more Jensen needles assure full, clear tone of the instruments you repair, make all records sound better.

Mail us your order for one SALES-KIT at \$6.00 with the name of your distributor and a \$1.50 Jensen Classic Needle will be sent to you FREE.

JENSEN INDUSTRIES, Inc., 327 SOUTH WOOD ST. • CHICAGO 12, ILL.

## REMACO BEAMS



Typical REMACO 4-6-10 Installation

### COMPARE THESE SALIENT FACTORS:

- |  |   |
|--|---|
| 1—High-Forward Gain                      | 10—Good Front to Back                     |
| 2—High Efficiency                        | 11—Mechanical Strength (Tempered Dural)   |
| 3—Ease of Assembly                       | 12—Low-Wind Resistance (Streamlined Boom) |
| 4—Ease of Adjustment                     | 13—Easily Portable                        |
| 5—Ease of Mounting                       | 14—Neat "Dual" Array                      |
| 6—Neat Appearance                        | 15—RR Express Prepaid                     |
| 7—Popular "T Match"                      | 16—Greater Dollar per Dollar Value        |
| 8—Wide Range Tuning (54—28mc or 28—14mc) |   |
| 9—DX Vertical Angle                      |   |

### ANTENNAS NOW AVAILABLE EXPRESS PREPAID IN USA

- |   |         |
|---|---------|
| REMACO 3-10-20 (3 el. 10 to 20m) NET..... | \$80.00 |
| REMACO 2-10-20 (2 el. 10 to 20m) NET..... | 54.50   |
| REMACO 4-6-10 (4 el. 6 to 10m) NET.....   | 45.00   |
| REMACO 3-6-10 (3 el. 6 to 10m) NET.....   | 40.00   |

### IF YOU BUILD YOUR OWN—

- use REMACO extra heavy tempered (ST) Dural 1/8" and 3/8" telescoping 10m elements.  
Set of 4 elements, Express Prepaid.....\$20.00  
Set of 8 REMACO clamps, Postpaid..... 2.00  
25% with order, remainder C.O.D.

Write for new REMACO literature and look for REMACO 6 and 8 element beams soon.  
Phone B. 5486 or Wire REMACO

## RESEARCH MANUFACTURING CORPORATION

P. O. Box 466, Dept. N-3 San Diego 7, California

★ ★ ★ ★ ★ ★ ★ ★ ★ ★

**"Service with a STAR"**

New **LOW Price** ... Same **HIGH QUALITY**

**THE STAR TESTER**

Volt—Ohm  
Milliammeter

**\$24<sup>25</sup>**

An all-around tester with high quality features at an amazingly low price. Built for versatility and handiness. Gives you easy, accurate reading, with a 4 1/2", 400 microampere meter. Case is metal, crackle finished. Comes complete with batteries, test leads, and instructions for use.

**DESIGN DATA**

- 5—DC Voltage Ranges—0 to 1000 volts
- 5—AC Voltage Ranges—0 to 1000 volts
- 5—Output Meter Ranges—0 to 1000 volts
- 4—DC Current Ranges—0 to 1000 ma.
- 3—Resistance Ranges—0 to 5 megohms
- Decibel Ranges— —10 to +54

You are using the best when you "Service with a STAR." Contact your dealer today, or write us direct.

Literature available on all STAR products. Write for your copies today!

**STAR MEASUREMENTS CO.**  
442 East 166th St., Dept. N-2, New York 56, N.Y.

★ ★ ★ ★ ★ ★ ★ ★ ★ ★

- 11.835—CXA19, Montevideo, Uruguay, "El Espectador," 4 kw.
- 11.836—Algiers, Algeria, "Radio Algerie," 10 kw.
- \*11.837V—Tonkin, French Indo-China, "Voice of Vietnam," 10 kw.
- \*11.840—VLQ5, Brisbane, Australia, "A.B.C.," 10 kw.
- 11.840—VLG4, Melbourne, Australia, "Radio Australia," 10 kw.
- 11.840—VLC7, Shepparton, Australia, "Radio Australia," 50 kw.
- 11.840—Manila, Philippines; "Voice of the U.S. in Manila."
- \*11.840—Rangoon, Burma, "Radio Rangoon," 7.5 kw.
- 11.840—OLR4A, Prague, Czechoslovakia, 30 kw.
- \*11.840—CXAS, Colonia, Uruguay, 3 kw.
- \*11.842—LRY, Buenos Aires, Argentina, "Radio Beltrano," 5 kw.
- 11.845—Paris, "Radiodiffusion Francaise," 25 kw.
- \*11.845—JVU2, Tokyo.
- \*11.850—VLR9, Melbourne, Australia, "A.B.C.," 2 kw.
- \*11.850—Singapore, Malaya.
- \*11.850—Tokyo.
- \*11.850—Ruislede (Brussels), Belgium, "Radio Nationale Belge," 5 kw.
- 11.850—CE1185, Santiago, Chile, "Radio El Mercurio," 3.5 kw.
- 11.850—VUD3, Delhi, AIR, 5 kw.
- \*11.850—Benghazi, Cyrenaica (Africa), "Forces Broadcasting Station."
- 11.850—VUD11, Delhi, AIR, 20 kw.
- \*11.850—LLK, Fredrikstad, Norway, "Radio Oslo," 8 kw.
- \*11.850—Saigon, French Indo-China.
- 11.851—ZPA3, Asuncion, Paraguay, "Radio Teleco," 1 kw.
- \*11.857—Tunis, Tunisia, 700 w.
- \*11.857—Rabat, French Morocco.
- \*11.860—XMHA, Shanghai, China, 1 kw.
- 11.860—GSE, London, 50-100 kw.
- \*11.860—Medan, Sumatra, "Radio Sumatra," 120 w.
- 11.865—HER5, Berne, Switzerland, "Swiss Broadcasting Corp.," 25 kw.
- \*11.870—VLC3, Shepparton, Australia, "Radio Australia," 50 kw.
- 11.870—Munich, Germany, 80 kw.
- 11.870—ZPA3, Asuncion, Paraguay.
- 11.870—VUD9, Delhi, AIR, 7.5 kw.
- \*11.870—KWID, San Francisco, Calif., U.S.A., 100 kw.
- \*11.870—WNBI, New York, N.Y., U.S.A., 50 kw.
- 11.870—WNRA, New York, N.Y., U.S.A., 50 kw.
- \*11.870—WOOC, New York, N.Y., U.S.A., 50 kw.
- \*11.870—WOOW, New York, N.Y., U.S.A., 50 kw.
- \*11.875—OLR4C, Prague, Czechoslovakia, 30 kw.
- 11.875—Moscow.
- 11.880—LRY1, Buenos Aires, Argentina.
- \*11.880—Horbj, Sweden.
- \*11.880—XGSN, Nanking, China.
- \*11.880—VLG5, Melbourne, Australia, "Radio Australia," 10 kw.
- 11.880—VLH4, Melbourne, Australia, "A.B.C.," 10 kw.
- \*11.880—VLR3, Melbourne, "A.B.C.," 2 kw.
- \*11.880—VLA5, Shepparton, Australia, "Radio Australia," 100 kw.
- 11.880—XEHH, Mexico City, Mexico, "Sal de Uvas Picot," 250 w.
- 11.880—Moscow, U.S.S.R.
- 11.885—Paris, "Radiodiffusion Francaise," 25 kw.
- \*11.885—Petropavlovsk, U.S.S.R.
- 11.885—Komsomolsk, U.S.S.R.
- \*11.890—KRHO, Honolulu, Hawaii, 100 kw.
- 11.890—KWIX, San Francisco, Calif., U.S.A., 50 kw.
- 11.890—Moscow.
- \*11.890—Manila, Philippines.
- \*11.893—WNBI, New York, N.Y., U.S.A., 50 kw.
- \*11.895—VPP2, Suva, Fiji Islands, 4 kw.
- \*11.895—EQF, Teheran, Iran, "Radio Teheran," 14 kw.
- \*11.895V—Hanoi, French Indo-China.
- 11.898—CE1190, Valparaiso, Chile, "Radio La Cooperativa Vitalicia," 1 kw.
- \*11.900—VLG9, Melbourne, Australia, "Radio Australia," 10 kw.
- 11.900—OQ2AB, Elizabethville, Belgian Congo, "Radio Elizabethville," 150 w.
- 11.900—Hanoi, French Indo-China.
- \*11.900—CKEX, Sackville, Canada, "CBC International Service," 50 kw.
- \*11.900—OLR4D, Prague, Czechoslovakia, 30 kw.
- 11.900—CXA10, Montevideo, Uruguay, "Radio Electrica," 20 kw.
- 11.900—KWID, San Francisco, Calif., U.S.A., 100 kw.
- 11.900—Moscow.
- 11.900V—KZFM, Manila, Philippines, "The People's Station."
- 11.901—HI??, Ciudad Trujillo, Dominican Republic, "La Voz del Yuna," 7.5 kw.
- \*11.910—SUW, Cairo, Egypt, 10 kw.
- \*11.913—XGOY, Chumsking, China.
- \*11.915—Brussels, Belgium, "Radio Nationale Belge," 5 kw.
- \*11.918—Moscow.
- 11.920—XGOY, Chungking, China, "Chinese International Broadcasting Station," 35 kw.
- \*11.923—LRR, Rosario, Argentina.
- 11.925V—Soerabaya, Java, "Radio Omroep Soerabaya," 200 w.
- 11.930—GVX, London, 50-100 w.



# BUY from America's STOREHOUSE of QUALITY PARTS

## IRC VOLUME CONTROLS



1000 ohm wire wound midgets—manufacturers close out— $\frac{1}{4}$ " shaft  $\frac{5}{8}$ " long—list \$1.25—over 90% off.

EACH **12c**  
 IRC SEALED Box of 252 **24.95**

# RADIO SUPPLY & ENGINEERING CO., Inc.

129 SELDEN AVE. DETROIT 1, MICH.

LOWEST PRICES

## SPRAGUE .5 mfd — 300 Volt



That's right—genuine Sprague condensers—manufacturers close out—new fresh stock—size  $\frac{3}{4}$ " x  $2\frac{1}{2}$ "—tinned leads—all guaranteed.

NET EACH **6c** 10 FOR **49c**

## OUTPUT TRANSFORMERS

Clean stocks—long leads—mounting feet—made to fit where you need them.

For 6F6-6K6—to 4 ohm voice coil—size  $2\frac{1}{2}$ " x  $1\frac{1}{2}$ " x  $1\frac{1}{2}$ ".  
 50L6-35L6-25L6 to 4 ohm voice coil  $1\frac{1}{2}$ " x  $1\frac{1}{2}$ " x  $1\frac{1}{2}$ ".  
 Specify quantity of each type you need at.....



**49c**

## MULTI-USE WIRE

An old favorite—back again! Stranded No. 22 tinned wire—glass "ROCKBESTOS" 1000 volt insulation—fireproof aircraft wire—a wartime development—at this low price you can use the best.

100 feet..... **45c** 1000 feet..... **3.89**



## MODEL 451A AC-DC

Volt-Ohm—Meter

A dependable instrument of wide utility—sensitivity 1000 ohms per volt. Ranges: Volts AC, DC, and Output Ranges: 0-10/50/100/500/1000. Ohms full scale, 500,000. Ohms center scale, 7200.



NET complete with batteries..... **14.90**

## MODEL 312 Volt-Ohm—Milliammeter

An economy pocket meter featuring a 2" moving vane meter. Reads: AC-DC volts, 0-.25/50/125/250; Mills AC-DC, 0-50; Ohms, 100,000; mfd., .05-15. Jacks provide range selection.



NET Complete with cord and plug..... **6.75**

## JEWELLED PILOT LIGHT ASSEMBLIES

- Miniature bayonet socket
- Mount in 1" hole
- Lamps removable from front of panel
- Available in red, green, or amber—quantities limited—order now.

List Price \$1.30 At RSE'S 85% off—you pay **19c**  
 Back again—by popular demand!



## Pep-Up PHILCO CHANGERS

At last! All the parts you need to restore brilliant tone and volume to "sick" changers! You'll need all three items—sell your customer a 100% reconditioning job—Selenium cell only, no holder **\$1.80**  
 Sapphire needle only, no mirror **\$1.20**  
 Special original equipment lamp **.27c**  
**RECONDITIONING KIT**—all three above items—postpaid—special at..... **3.21**

## RADIO RULE

Here is a clear 6" plastic rule—a necessity for radio students, draftsmen, hams, all who desire cleaner, more precise work. Nationally advertised at \$2.00. Order yours today postpaid only. **35c**



## VOLUME CONTROLS



Our own private brand—made by a nationally known manufacturer—you have this same control on your shelf now—the same kind that net for \$1.09! Standard noise-free carbon construction— $\frac{3}{8}$ " bushing— $\frac{1}{4}$ " shaft, 2" long—complete with switch. Ideal all purpose replacement control—individually boxed in our colorful carton carrying the RSE quality seal of approval.

Full range of sizes—with attached switches!

10 M ohms  
 15 M ohms  
 25 M ohms  
 50 M ohms  
 100 M ohms  
 250 M ohms  
 1 Meg. ohms  
 2 Meg. ohms

**59c each**  
**55.00 per 100 assorted**

500 M ohms—less switch **39c ea.** 100 for **\$35.00**

## IRC 10 MEG. $\frac{1}{2}$ WATT.



IRC type BTS 10 Meg.  $\frac{1}{2}$  Watt resistors—manufacturers close-out—clean stock—how can you pass them up! **1c ea.**

## TRIPLETT PANEL METERS



Panel meters by Triplett! Top quality instruments—new—boxed—five popular types—priced right—your chance to get those meters you've always wanted.

Model 332—0-150 A.C. volts—3" round flush mounting black brass case.

Model 231—0-150 A.C. volts—2" round flush mounting bakelite case.

Model 233—0-150 A.C. volts—2" round metal case—less mounting clamp.

Model 221—0-30 D.C. volts—2" round flush mounting bakelite case.

Model 324—0-400 D.C. volts—3" round projection mounting—bakelite case.

Model 331—0-30 A.C. amps.—3" round flush mounting bakelite case.

Model 322—0-150 D.C. volts—3" round flush mounting black brass case.

Supply limited—order now—list models you desire.

**2.95 EACH**

## PHONO PICKUP CRYSTALS

Standard types—Set Manufacturers close-out—all Guaranteed



Shure P30—Shure's newest and finest—osmium tipped permanent needle—1.8 volts output—fits standard mounting holes. List Price \$7.50. You pay us **269**



SHURE P93—W57A—pintype terminals— $\frac{3}{4}$  oz. pressure, 1.6 volt output—5000 cycle cutoff. List price \$5.55—our Special... **198**



Astatic L-70—new postwar design—solder terminals— $1\frac{1}{4}$  oz. pressure—1 volt output—4000 cycle cutoff. List price \$5.55—we quote you... **198**



Astatic L75—another new type— $1\frac{1}{4}$  oz. pressure—.75 volt output—6000 cycle cutoff. List price \$5.55—64% off. **198**



ASTATIC L40—The prewar favorite—used in millions of phonographs—solder terminals— $1\frac{1}{4}$  oz. pressure—.6 volt output—4500 cycle cutoff. List price \$4.45—your cost... **198**

## RESISTANCE LINE CORDS



Standard 3 terminal 135 ohm AC-DC cords—flexible— $5\frac{1}{2}$ " long complete with plug—for sets having approximately 69-75.2 volts drop in the filaments. Regular list price 1.17

**Only 33c**

## AEROVOX 8/8/8—450



Genuine Aerovox triple 8 mfd.—450 volts—inverted screw mounting—insulated aluminum can  $1\frac{1}{2}$ " x  $4\frac{1}{2}$ "—insulated leads—List price \$4.25—one time only at **89c**

## OZ4 TUBES



New, guaranteed, made by the only maker of OZ4's. Buy now! Hit that car radio business hard—\$2.20 List—60% or more off—limited quantity.



Egg crate of 100 **79.00**

In colorful RSE box at 88c ea.

## AEROVOX—SOLAR PAPER TUBULARS



Genuine name brand paper by-passes! New, fresh, full capacity standard merchandise—not surplus—all guaranteed! Check the list prices—our low nets—no need to figure the discount—buy'em now, they've hit bottom!

Mfd.	Volts	List Price	Net Each	Per 100
.01	600	30c	10c	\$ 9.15
.02	600	30c	11c	\$ 9.95
.05	600	40c	14c	\$12.95
.1	600	45c	16c	\$14.95

Quantity Prices not assorted.

## SEND FOR FREE CATALOG



## ORDER INSTRUCTIONS

Include full remittance with orders of \$3.00 or less. Include 25% deposit with all C.O.D. orders of \$3.00 or more. All shipments sent express collect if postage is not included. Prices subject to change without notice. BE SURE TO INCLUDE SUFFICIENT POSTAGE. EXCESS WILL BE REFUNDED.

DEMAND THIS SEAL OF QUALITY

March, 1948

105

In New Jersey...

...it's **VARIETY**

**TELEVISION KITS**

**TRANSIVISION STANDARD MODEL 12" KIT**

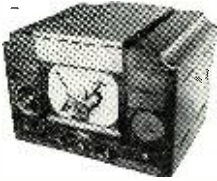

Picture size 7 1/2 square inches. 22 tubes and 12 inch picture tube. High fidelity FM sound reproduction. Advanced television circuit provides exceptionally clear pictures.

- 12" Standard Television Kit.....\$289.50\*
  - 12" Deluxe Television—FM Radio Kit..... 359.50\*
  - 15" Standard..... 365.00\*
  - 15" With FM Radio..... 372.95\*
  - 7" Television Kit..... 160.00\*
  - 7" Republic Kit..... 165.00\*
- (\*Complete with tubes, less cabinet)  
 Cabinet for 12" Television, Receiver..... 44.95\*  
 Cabinet for 15" Television Receiver..... 59.00  
 Espey Basic Television Kit, less tubes..... 69.50  
 Complete Line of Television Components.  
 \*Dealers' Prices on Request.

**SUPREME MODEL 584**

**SUPER SENSITIVE MULTI-METER**



D.C. VOLTS 25-5000, 20,000 Ohms per V.  
 A.C. VOLTS 100-5,000, 1000 ohms per V.  
 Resistance Ranges 0-20 megohms D B & Output ranges.  
**Net \$33.77**

**VARIETY RADIO KITS**

- 5 Tube Superhet Kit complete with tubes and cabinet.....\$14.75
- Less tubes..... 11.75
- FM KIT complete with cabinet and tubes. 29.95
- 3-way Portable Kit complete with tubes and cabinet..... 18.95

**NATIONAL NC57 RECEIVER.....\$89.50**  
 We carry a full line of National receivers and parts.  
**National NC183 Receiver complete with 10" speaker.....\$269.00**

**ESPEY CHASSIS AND KITS**

7B-11 Tube Superhet for AM/FM.\$140.00 List  
 RR14-8 tube A.C. Broadcast and two short-wave bands..... 106.50 List  
 97A-Six tube AC-DC, short wave and Broadcast bands..... 56.50 List  
 Dealers Prices on Request.

**VIBRATOR SPECIALS**

Standard 4-prong, replacing E.L. 1703, ATR 324, Mallory 294, Radiart 5300..... **99c each**  
 10 for..... **\$8.89**

**AUTO ANTENNAS.** Chrome Plated, Admiralty Brass, Shielded Polyethylene Cable with Black Vinylite Cover, Side Coil Mount, 3 Sections—66"  
**\$1.95 each; ten for.....\$16.95**

**NEW! PREMIER Model 570 MICROMASTER Band Spread Dial SIGNAL GENERATOR**



For testing and aligning BROADCAST, SHORT WAVE, FM and TELEVISION RECEIVERS. Exclusive Band Spread Dial geared to the tuning condenser on main dial, giving a total scale length of approximately 60 inches. Three-color dial directly calibrated in Kilocycles and Megacycles. Range: 75 KC—50MC. Up to 150MC on 3rd harmonic. Size 12 1/2" x 12" x 5 1/2".  
**COMPLETE WITH TUBES AND CO-AXIAL CABLE. \$54.75 NET**

Write Dept. RN3. 20% Deposit with order required. Please add sufficient postage. Excess will be refunded.

**Variety ELECTRIC CO., Inc.**  
 601 Broad St., Newark 2, N. J.

- \*11.940—CNR2, Rabat, Morocco, "Radio Maroc," 25 kw.
- 11.948—ZPA5, Encarnacion, Paraguay, "Radio Encarnacion," 2.5 kw.
- 11.950—Moscow.
- \*11.955—GVY, London, 50-100 kw.
- 11.960—Moscow.
- \*11.960—Tiflis, U.S.S.R.
- \*11.965—BER4, Berne, Switzerland, 25 kw.
- 11.965—Tabriz, Iran, "Radio Tabriz."
- \*11.970—JIQ2, Tokyo.
- 11.971—LRS2, Buenos Aires, Argentina, "Radio Splendid."
- 11.927—Brazzaville, French Equatorial Africa, "Radio Brazzaville, Post Nationale Francaise," 50 kw.
- \*11.980—Moscow.
- \*11.985—Andorra, Andorra.
- 11.998—CE1180, Santiago, Chile, "Radio Sociedad Nacional de Agricultura," 1 kw.
- \*11.998—CS2MO, Lisbon, Portugal, 500 w.
- 11.998—Damascus, Syria.
- \*12.00—Brazzaville, French Equatorial Africa, "Radio Club," 500 w.
- \*12.000—Vienna, Austria.
- 12.000V—Clandestine, "España Independiente."
- 12.002—Malang, Java.
- \*12.002—YDM3, Djokjakarta (?), Java, "Radio Republik Indonesia."
- \*12.010—CFCX, Montreal, Canada, 75 w.
- 12.020—OAX4Q, Lima, Peru, "Radio Victoria," 1 kw.
- 12.020—Moscow.
- \*12.020V—Tonkin, French Indo-China, "Voice of Vietnam."
- 12.024—CR6R, Benguela Angola, "Radio Clube de Benguela."
- 12.040—GRV, London, 50-100 kw.
- 12.050—VRR5, Stony Hill, Jamaica, B.W.I., 500W.
- 12.060—Moscow.
- \*12.074V—Hanoi, French Indo-China.
- \*12.080—PST, Rio de Janeiro, Brazil, 12 kw.
- 12.080—Moscow.
- 12.095—GRF, London, 50-100 kw.
- 12.110—ZIK, Pitcairn Island.
- \*12.110—H13X, Ciudad Trujillo, Dominican Republic.
- \*12.112—Moscow.
- \*12.115—ZNR, Aden, Arabia, 500 w.
- \*12.118—THA1, Algiers, Algeria, "Radio Algerie," 12 kw.
- \*12.120—Tabriz, Iran, "Radio Tabriz."
- \*12.127—Tananarive, Madagascar, "Radio Tananarive," 5 kw.
- 12.130—TPZ, Algiers, Algeria.
- \*12.150—Hanoi, French Indo-China.
- \*12.170—Moscow.
- \*12.180—Tabriz, Iran, "Radio Tabriz."
- \*12.182—OAX5C, Ica, Peru, 150 w.
- \*12.183—Soerabaja, Java, 200 w.
- 12.195—SVP, Athens, Greece.
- 12.212—Vienna, Austria.
- \*12.217—XMTA, Shanghai, China.
- 12.219—XMPA, Nanking, China, "Chinese Army Radio Service."
- \*12.230—Moscow.
- 12.235—TFJ, Reykjavik, Iceland, 7 kw.
- \*12.050—CRY4, Macao, Portuguese China.
- 12.255—WFG, Adak, Aleutian Islands, U.S.A.
- \*12.260—Moscow.
- 12.270—CE1227, Puntarenas, Chile, "Radio Ejercito."
- \*12.273—Bandong, Java.
- 12.364—..... French Indo-China, "Voice of South Vietnam."
- 12.395—Baku, (Azerbaijan S.S.R.), U.S.S.R.
- \*12.400—CS2WI, Parede, Portugal.
- 12.420—Bukit Tingi, Sumatra, "Radio Republik Indonesia."
- 12.450—ZKG, Pitcairn Island.
- 12.455—HUB, Quito, Ecuador, "La Voz de los Andes," 10 kw.
- 12.455—GKU3, Royal Observatory (Greenwich).
- \*12.495—Baku, U.S.S.R.
- 12.500—ISP, Rome, Italy.
- \*12.710—FIA, Douala, Cameroons.
- 12.725V—Tonkin, French Indo-China, "The Voice of Vietnam."
- 12.750—CS2MP, Lisbon, Portugal, "Emissora Nacional," 500 w.
- \*12.830—CNR1, Rabat, Morocco, "Radio Maroc," 12 kw.
- 12.862.5—Ronne Antarctic Expedition.
- \*12.950—VP4RD, Port-of-Spain, Trinidad.
- \*12.965—HBJ2, Geneva, Switzerland, 40 kw.
- \*13.020—Moscow.
- \*13.050—WNRI, New York, N.Y., U.S.A., 50 kw.
- 13.050V—Clandestine, "España Independiente."
- \*13.155—WLXJ, Shanghai, China.
- \*13.180—YAK, Kabul, Afghanistan.
- \*13.190—Khabarovsk, U.S.S.R.
- \*13.205—HBJ, Geneva, Switzerland, 40 kw.
- 13.250—ICA, Algiers, Algeria.
- \*13.258—VPO2, Barbados, B.W.I.
- \*13.295—Omdurman, Anglo-Egyptian Sudan, 250 w.
- 13.335—Omdurman, Anglo-Egyptian Sudan, 250 w.
- 13.400—Moscow.
- \*13.450—Moscow.
- \*13.450V—Clandestine, "Voice of Slovak Republic."
- \*13.455—HODD, Panama City, Panama.
- 13.601—PMS4, Soerabaja, Java, "Radio Resma Soerabaja," 250 w.
- \*13.610—Moscow.
- 13.625V—Clandestine, "España Independiente."
- \*13.635—SPW, Warsaw, Poland.
- 13.640—SVQ, Athens, Greece, 7 kw.
- 13.650V—Clandestine, "España Independiente."
- \*13.655—Moscow.
- 13.670—SVR, Athens, Greece, 7 kw.
- 13.712—FPE, Paris, 15 kw.
- 13.720—KLL, Bolinas, Calif., U.S.A.
- 13.725—SVS, Athens, Greece, 7 kw.
- 13.771—FSE, Paris.
- 13.825—SUZ, Cairo, Egypt, 10 kw.
- 13.870—Tiflis, U.S.S.R.
- 13.877—SUP3, Egypt, 10 kw.
- 13.950—Clandestine, "España Independiente."
- \*13.965—CNR4, Rabat, Morocco, "Radio Maroc," 2 kw.
- \*13.980—ICO, Oslo, Norway, 1 kw.
- 14.273—Nova Lisboa, Angola.
- 14.282—EAQAA, Tangier, Tangier Zone, "Radio Africa."
- 14.420—SVR, Athens, Greece.
- 14.450—DAKV, Berlin, Germany.
- \*14.461—HBZ3, Geneva, Switzerland, 40 kw.
- 14.500—XEXA, Mexico City, Mexico.
- \*14.500—CRY6, Macao, Portuguese China.
- 14.525—XDA, Chapultepec, Mexico, "Radio Mex," 20 kw.
- \*14.537—HBZ2, Geneva, Switzerland, 20 kw.
- 14.541—H2T, Ciudad Trujillo, Dominican Republic, "La Voz del Yuna."
- 14.546—YHP, Soerakarta, Java, "Radio Noesantara."
- \*14.555—HVJ, Vatican City, Vatican, "Radio Vaticano," 15 kw.
- \*14.630—Ponta Delsada, Azores, "Emissora Nacional," 1 kw.
- \*14.630—PLJ, Bandong, Java.
- 14.687—PSP, Rio de Janeiro, Brazil, 12 kw.
- \*14.717—Geneva, Switzerland.
- 14.736—IQD, Rome, Italy.
- \*14.774—Dakar, French West Africa, "Radio Dacar."
- 14.823—OQ2AB, Elizabethville, Belgian Congo.
- \*14.823—Radio Elizabethville," 100 kw.
- 14.830—Moscow.
- 14.845—OD2, Lima, Peru.
- 14.850—LPA8, Rio Grande, Argentina.
- 14.851—Ushuaia, Tierra del Fuego, Argentina, "Gobernacion Maritima."
- \*14.935—PSE, Rio de Janeiro, Brazil, 12 kw.
- \*14.950—PZ7, Paramaribo, Surinam, "Ayros, Paramaribo."
- 15.000—WWV, Washington, D.C., U.S.A.
- 15.015—VP52, Malta.
- 15.040—Moscow.
- \*15.040—Macao, Portuguese China.
- 15.050—ZLR5, Wellington, New Zealand.
- 15.053—ETA, Addis Ababa, Ethiopia, "Radio Addis Ababa," 7 kw.
- 15.070—GWC, London, 50-100 kw.
- \*15.073—ETA, Addis Ababa, Ethiopia, 7 kw.
- 15.085—ZJA6, Georgetown, British Guinea, 2 kw.
- 15.087—Moscow.
- 15.099—CBLX, Montreal, Canada, "Radio Canada," 75 kw.
- 15.095—HVJ, Vatican City, Vatican, "Radio Vaticano," 15 kw.
- 15.100—EPB, Teheran, Iran, "Radio Teheran," 14 kw.
- \*15.100—Paris, France.
- \*15.100—HCJB, Quito, Ecuador, 1 kw.
- \*15.100—HOXA, Panama City, Panama, "Radio Centro-Americana," 7.5 kw.
- \*15.103—JLG4, Tokyo.
- \*15.103—Addis Ababa, Ethiopia.
- \*15.105—Rabat, French Morocco.
- 15.105—DTSP, Germany.
- \*15.105—XG50, Nanking, China.
- 15.110—GWG, London, 50-100 kw.
- 15.110—Petropavlovsk, U.S.S.R.
- \*15.115—CE1511, Santiago, Chile, "Radio Sociedad Nacional de Minería," 5 kw.
- 15.115—HCJB, Quito, Ecuador, "The Voice of the Andes," 1 kw.
- \*15.115—JLR2, Tokyo.
- 15.120—Colombo, Ceylon, "Radio SEAC," 7.5 kw, and 100 kw.
- \*15.120—Athlone, Ireland, "Radio Eirrean," 5 kw.
- \*15.120—Warsaw, Poland.
- 15.120—CS2MS, Lisbon, Portugal, "Emissora Nacional," 10 kw.
- \*15.120—HED7, Berne, Switzerland, "Swiss Broadcasting Corp.," 25 kw.
- 15.120—HVJ, Vatican City, Vatican, "Radio Vaticano," 25 kw.
- 15.122—Milan, Italy, "Radio Roma," 50 kw.
- \*15.130—VUD3, Delhi, AIR, 5 kw.
- \*15.130—VUD1, Delhi, AIR, 20 kw.
- \*15.130—Delano, Calif., U.S.A., 50 kw.
- \*15.130—KCBR, Delano, Calif., U.S.A., 100 kw.
- \*15.120—KGEI, San Francisco, Calif., U.S.A., 50 kw.
- \*15.130—KGEX, San Francisco, Calif., U.S.A., 100 kw.
- 15.130—WOOC, New York, N.Y., U.S.A., 50 kw.
- \*15.130—WRUA, Boston, Mass., U.S.A., 50 kw.
- \*15.130—WRUS, Boston, Mass., U.S.A., 50 kw.
- \*15.130—WLWR, Cincinnati, Ohio, U.S.A., 175 kw.
- \*15.130—WLWS, Cincinnati, Ohio, U.S.A., 75 kw.
- \*15.130—XRRR, Peiping, China.
- \*15.135—XGSP, Nanking, China.
- 15.140—GSP, London, 50-100 kw.
- 15.140—JLW6, Tokyo.
- 15.140V—YDC, Batavia, Java, "Radio Batavia," 3 kw.
- 15.144—Moscow.
- \*15.145—OTM5, Leopoldville, Belgian Congo, "Radio Congo Belge," 20 kw.
- \*15.145—HBN, Baghdad, Iraq, 5 kw.
- \*15.150—CE1515, Santiago, Chile, 5 kw.
- 15.150—Munich, Germany, 80 kw.
- 15.150—KCBR, Delano, Calif., U.S.A., 50 kw.
- \*15.150—KCBF, Delano, Calif., U.S.A., 50 kw.
- \*15.150—KCBR, Delano, Calif., U.S.A., 200 kw.
- \*15.150—KNEX, Dixon, Calif., U.S.A., 100 kw.
- 15.160—WRCA, New York, N.Y., U.S.A., 50 kw.
- \*15.152—HVJ, Vatican City, Vatican, "Radio Vaticano," 25 kw.
- \*15.155—ZYE9, Sao Paulo, Brazil, "Radiofusora Sao Paulo," 5 kw.
- 15.155—SBT, Motala (Stockholm), Sweden, 12 kw.

## MICROWAVE PLUMBING

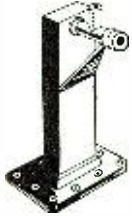

- 10 CENTIMETER**  
Sand Load (Dummy Antenna) wave guide section with cooling fins, app. 23" high..... \$28.00  
Rigid Coax Directional Coupler CU-60/UP 20 DB drop has short right angle, about 8" long..... 5.50  
Waveguide to flexible coax coupler (RG 18 U) with flange. Gold plated. App. 10" high (as shown)..... 17.50  
Rigid coax slotted section CU-60/AP..... 5.00  
Stub-supported rigid coax, gold plated, 5" lengths. Per 5" length..... 5.00  
10 Cm. McNally cavity. Silver Plated. Type SG. Each..... 3.00  
Crystal Mixer. "S" Band. Complete with Type "N" fitting and IN22 crystal..... 3.85  
16 Cm waveguide. 5.9" choke to cover. Per section..... 12.60  
Per set of 4 sections..... 45.00  
3/4" rotary coax, rotary joint..... 8.00  
Magnetron coupling to 3/4" rigid coax..... 4.00  
3/4" rigid coax, Rt. angle bend, 15" long, overall..... 2.00

### 3 CENTIMETER

- Wave Guide Sections: 2.5' long, silver plated with choke flange..... \$ 5.75  
Wave Guide 90 deg. bend E Plane 18" long..... 4.00  
Wave Guide 90 deg. bend E plane with 20DB directional coupler..... 4.75  
Wave Guide 18" long "S" curve..... 2.00  
Rotary wave guide in/out choke to choke joint..... 6.00  
3 Cm waveneter Maquire 153TPX..... 15.00  
3 Cm waveguide, 1 7/8 x 3/4". 15 ft. lengths available. Per ft..... 1.50  
Waveguide 2.5' long, silver plate, 180 deg. bend choke to cover..... 5.95  
Duplexer Section using 1B24..... 10.00  
Thermistor mount in waveguide with tunable terminations..... 8.00  
Tuner/attenuator, W.E. guide, gold plated..... 3.75  
TR/APH section with waveneter iris flange..... 4.00  
CG/APS-3, waveguide section. 10" choke to cover..... 1.75  
Right angle elbow. 5 1/2" choke to cover. 2 1/2" radius. E Plane..... 4.50  
H plane..... 5.50  
Twist, 90 deg. 6" choke to cover..... 5.00

# "Communications"

**RADAR • AMATEUR  
AIRCRAFT • INDUSTRIAL**

## DYNAMOTORS



- PE 73 CM. Power supply for BC 375. Input: 28 VDC. Output: 1000 VDC @ 350 Ma. Starting relay, filter etc. New..... \$4.95  
BD 77KM. Power supply for BC 191. Input: 14 VDC. Output: 1000 VDC @ 350 Ma. New, with spare fuse links, etc..... \$5.95  
PE 101C. Input 13/26 VDC @ 12.6/6.3 A. Output: 400 VDC @ 135 Ma., 800 VDC @ 20 Ma., 9 VAC @ 1.21 A..... \$3.49  
86N Input: 28 VDC. Output: 250 VDC @ C..... \$ 1.95  
PC77. Input: 12 VDC. Output 275 VDC 110 Ma. 500 VDC @ 50 Ma..... 3.25  
DAC 33A: Input: 18 VDC @ 3.2 A. Output: 450 VDC @ 60 Ma. Power supply for modulator for SCR 274 N..... 2.45  
DM 33 A. Input: 28 VDC @ 7 A. Output: 540 VDC @ 250 Ma. Power supply for modulator for SCR 274 N..... 3.95  
Dyn. Model 23350. Input 27 VDC @ 1.75 A. Output: 245 VDC @ 75 Ma. 92 amps. Out. DM-21: In 14 VDC 3.3 A Out 235 VDC 90 Ma. with filter 12 VDC @ 25 amp. Output: 500 VDC @ 400 ma. (slightly used, but in excellent condition)..... 2.59  
MP 10-C. Power supply using 2 dynamotors. Input: 24-28 VDC. Output: 1000 VDC @ 400 ma. 230 volts dc @ 100 ma. New, complete with enclosed relays, filters, etc..... 20.00  
MK 11 dynamotor power supply. Input: 12 VDC @ 9.4 amp. Output: 275 VDC @ 110 ma. 500 VDC @ 50 ma. New, with connecting cable and plugs..... 4.75  
**INVERTERS**  
PE 206-A. Input: 28 VDC @ 38 amp. Output: 80 volts @ 500 volt-amps, 800 cycles. Leland. New, complete with enclosed relay, filter, instruction book..... 12.50  
PE 218. Input: 25-28 VDC @ 75 amp. Output: 115 volts @ 1500 volt-amps, 380-500 cycles..... 15.00

## TRANSFORMERS

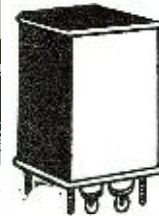

- POWER TRANSFORMERS**  
Pri. 117 V. 60 cycles. Sec. 330-0-330 V. 85 ma. 5 v. @ 2 amp., 6.3 v. @ 3 amp., 6.3 v. @ 7.5 amp. Size: 6 1/4 x 3 3/8". Weight: 8 3/4 lbs. \$1.95  
Power Pair-Transformer 470 V CT @ 60 ma., 6.3 v windings @ 1.67A and 5 V @ 2 A-Primary: 115 v 50 to 1200 Cy. PLUS a 6 Hy. 50 ma. choke..... \$1.75  
**FILAMENT TRANSFORMERS**  
All Primaries 117V, 60 Cy. No. 5126: 5 V @ 3 A. CT, 3 V @ 3 A CT, 5 V @ 6 A CT..... \$2.95  
No. 5100: 6.3 V CT @ 1.2 A. 5000 volt test..... \$1.35  
No. UX6899: 5 V @ 5.5 A, 5 V @ 5.5 A @ 29,000 V test..... 2.40  
**CHOKES**  
6 Hy @ 150 Ma..... \$1.50  
6 Hy @ 300 Ma..... 1.25  
1 Hy @ 800 Ma., 7.5 Ohms..... 0.25  
Dual Choke, 2-2 Hy @ 100 Ma..... 1.50  
Dual Choke, 7 Hy @ 75 Ma., 11 Hy @ 60 Ma. 1.50  
8.5 Hy @ 125 Ma..... 1.50  
25 Hy @ 65 Ma..... 1.10

## CATHODE RAY TUBES

- 5BP1—\$1.20 Each**  
3BP1..... \$1.25 3BP1..... \$1.60  
3FP7..... 1.20 3BP1..... 1.20  
5FP7..... 1.75 5FP7..... 4.00  
**Rectifier Tubes**  
872A..... \$1.00 705A..... \$1.25

## 12 AND 24 VOLT FILAMENT TRANSFORMERS

- (All Primaries 110 V, 60 Cycles)  
#517: Output: 12 v @ 10 amp, or 24 volts @ 5 amps..... \$2.75  
#2217: Output: 24 volts @ 3 amp. Size: 3" x 3 1/2" x 3"..... 1.50

## MICRO-WAVE ANTENNAS



- AN/TPS -3. Parabolic reflector, approx. 10" diam. Extremely light weight construction. New, in portable carrying case..... \$35.00  
Relay System Parabolic reflectors approx. range: 2000 to 6000 Mc. Dimensions: 4.5x3'. New..... 85.00  
TOD "Jam" Radar rotating antenna, 10cm. 50 db beam. 115V AC drive New..... 100.00  
50 Surface Search Radar rotating antenna, 10 cm. 24" dish complete with drive and relay motors. New..... 75.00  
3 CM ANTENNA WITH DISH. 1 1/2" Cutler Feed horizontal and vertical scan with 28V DC drive motor and drive mechanism. Complete. New..... 65.00  
AS 125/APR cone antenna, stub-supported, with type "N" connector..... 4.50  
10 CM horn, rectangular to square to circular RF assembly ending in horn, radiating circularly polarized beam. Wave-guide input, complete with flange..... 35.00

## ARC-5 ACCESSORIES

- Broadcast band R.F. coil assembly, plug-in case..... \$1.00  
Single, double mounting racks for revs..... \$1.00, 1.50  
Shock mounts for racks..... 1.00  
Dual receiver control boxes..... 1.00  
3-4 mc. conversion kit for ARC-5 Xmttrs. Consists of 1-# 6029 Oscillator coil (3-4 mc) and 1-# 7247 PA coil (3-4mc). Per set..... \$1.50  
ARC #6030 M.O. coil, 4-5.3 mc. For ARC5 Xmttrs..... \$1.00  
ARC #6032 M.O. coil, 7-9.1 mc..... 1.00  
ARC #6558. Variable capacitor, receiving type, 3 sections, 62 mmf/section. .05" spacing, 8 rotors. Worm drive ratio 33:1..... 1.75  
ARC #4490: Variable Xmtg. capacitor, 23-145 mmf. .05" spacing, 11 rotors. Each..... 1.00  
ARC #5032: Variable Xmtg. capacitor, 30-117 mmf. .06" spacing, 16 rotors. Worm drive: 96:1..... 1.00

## MICROWAVE TUBES

- (Magnetrons)  
2732 (10 CM)..... \$45.00  
Magnet for 2732..... 8.00  
2138 with magnet..... 25.00  
2155 with magnet..... 25.00  
3731 (1 CM)..... 17.50  
Magnet for 3731..... 8.00  
2121..... 15.00  
2121A..... 15.00  
2122..... 15.00  
2124..... 15.00  
2131..... 15.00  
W.E. 700A (L band)..... 45.00  
W.E. 720BY (S band) 1000 KW..... 25.00



Klystron, 2K25-723, AB 3.50

## TUNING UNITS



From BC 191 & BC 375 TU 6B 3000 kc to 4500 kc. TU 9B-7700 to 10,000 kc. TU 10B-10,000 to 12,500 kc. TU 22 B 350 to 650 kc. Will supply closest unit to specified Frequency at time of shipment. Each..... \$2.25

## SPEAKER-DRIVER UNITS

Frequency response up to 18,000 cps. Heavy duty unit, originally designed for shipboard use. Uses 2" voice coil with 1 1/2" cone. 8 ohm impedance. Makes an excellent tweeter for high fidelity reproduction. New, with spare cone..... \$9.95

## PULSE TRANSFORMERS



- All Standard Name Items  
GE No. K2731  
Repetition Rate: 625 PPS. Pri. Imp: 50 Ohms. Sec. Imp: 450 Ohms. Pulse Width: 1 Micro-sec. In. Input: 9 KV PK. Sec. Output: 28 KV PK. Peak Output: 800KV Bifilar: 2.75 Amp \$49.50  
Type G.E. K2450A will receive 3KV, 4 microsecond pulse on standard any drivers 14-KV Peak power out 100KW GE  
UX 4298E Radiation Pri 4 KV, 1 microsecond sec. 16 KV, 16 amps. Fh. pri. 115V 400 cycle. Raytheon..... 15.00  
Hi Volt input pulse transformer W.E. No. D-169271 Pulse input line to Magnetron. G.R. K2748A..... 12.00  
Utah Pulse or Blocking Oscillator Transformer Freq. limits 790-810 cy-cs windings turns ratio 1:1:1. Dimensions 10 x 1.3 x 16.1 1/8 x 1 19/32"..... 2.00

## Microwave Specials

- 10 Cm. RF Package. Consists of: (80) Xmt. - receiver using 2I27 magnetron oscillator, 250 KW peak input. 707-B receiver-mixer. \$150.00  
Modulator-motor-alternator unit for above..... \$75.00  
Receiver rectifier power unit for above..... \$25.00  
Rotating antenna using dipole feed and parabolic reflector. New Less Hood..... \$75.00  
Used..... 45.00

## POWER SUPPLY FOR SCR 522

- Power unit type 15. Input: 12 vdc @ 30 amps. Output: 300 vdc @ 260 ma. 150 vdc @ 10 ma. 14.5 vdc @ 5 amp. New, complete with starting relays, filters, wooden carrying chest..... \$7.89

## 250 WATT OUTPUT TRANSFORMER

- W. E. #KS 9496, HI-PI output, 9,000 ohm push-pull plates to 9 ohm voice coil. Freq. Response: -3 db @ 50 cps. -1.25 db @ 100 cps. 0 db @ 1,000 cps, 3 db @ 10,000 cps, 3db @ 50,000 cps..... \$3.95

## CONNECTORS

- UG 21/U, Type "N" Male..... \$0.85  
UG 86/U. Gold Plated..... .95

## COAX CABLE

- RG9U51 ohm Silver Coated..... per ft. \$0.07 1/2  
RG8U 52 ohm..... per ft. .04 1/2  
COAX Connectors, Amphenol Loss type  
831R. 831AP..... ea. \$0.27

## HEAD SETS

- P-29 Headsets, 10,000 ohm impedance. Similar to Tri-um #7045. With 8' cord PL 55 plug..... \$2.25  
Dynamic mike and headset combination. High quality, sufficient unit, used in B-19 tank Xmttrs. Mike. New..... \$1.95  
HS 30 headset. Insert type headset, cuts out background noise, and low impedance (500 ohm s) assures efficiency and high fidelity. Price..... \$0.85  
Xmt. to headset, 8000 ohms output. \$0.35

All merchandise guaranteed. Mail orders promptly filled. All prices, F.O.B. New York City. Send Money Order or Check. Shipping charges sent C.O.D.

# COMMUNICATIONS EQUIPMENT CO.

131 N Liberty St., New York City 7, N. Y.

Digby 9-4124

\*15.160—VLG7, Melbourne, Australia, "Radio Australia," 10 kw.  
 15.160—VLB11, Shepparton, Australia, "Radio Australia," 100 kw.  
 \*15.160—OLR5C, Prague, Czechoslovakia, 30 kw.  
 \*15.160—VPD2, Suva, Fiji Islands, 4 kw.  
 15.160—VUD7, Delhi, India, AIR, 100 kw.  
 \*15.160—VUD10, Delhi, AIR, 20 kw.  
 \*15.160—JVC, Nazaki, Japan, 40 kw.  
 \*15.160—JZK, Tokyo.  
 15.160—XEWV, Mexico City, Mexico, 10 kw.  
 \*15.165—OTC4, Leopoldville, Belgian Congo, "Radiodiffusion National Belge," 50 kw.  
 15.165—PRE9, Fortaleza, Brazil, "Ceara Radio Club," 5 kw.  
 \*15.165—Algiers, Algeria, listed here by NNRC.  
 \*15.165—XGOY, Chungking, China, "Chinese International Broadcasting Station," 35 kw.  
 15.165—OZH, Skamlebak (Copenhagen), Denmark, 6 kw.  
 15.170—LKV, Oslo, Norway, 5 kw.  
 15.170—TGWA, Guatemala City, Guatemala, "La Voz de Guatemala," 10 kw.  
 \*15.170—XGOY, Chungking, China.  
 \*15.170—OAX4R, Lima, Peru, "Radio Nacional de Peru," 10 kw.  
 15.170—Moscow.  
 15.175—LLM, Fredrikstad, Norway, "Radio Oslo," 6 kw.  
 15.180—GSO, London, 50-100 kw.  
 \*15.190—PRI3, Belo Horizonte, Brazil, "Radio Inconfidencia," 12 kw.  
 15.190—CKCX, Sackville, Canada, "CBC International Service," 50 kw.  
 \*15.190—ZBW4, Hong Kong, China, 2.5 kw.  
 15.190—OIX4, Pori (Helsinki), Finland, 15 kw.  
 15.190—VUD5, Delhi, AIR, 100 kw.  
 \*15.192—CBFZ, Montreal, Canada, 7.5 kw.  
 15.195—TAQ, Ankara, Turkey, "Radio Ankara," 20 kw.  
 \*15.200—VLR10, Melbourne, Australia, "A.B.C.," 2 kw.  
 15.200—VLA6, Shepparton, Australia, "Radio Australia," 100 kw.  
 \*15.200—VLB6, Shepparton, Australia, "Radio Australia," 100 kw.  
 15.200—VLC, Shepparton, Australia, "Radio Australia," 50 kw.  
 \*15.200—WOOC, New York, N.Y., U.S.A., 50 kw.  
 \*15.200—WLWL, Cincinnati, Ohio, U.S.A., 75 kw.  
 15.200—WRUA, Boston, Mass., U.S.A., 50 kw.  
 15.200—WLWS, Cincinnati, Ohio, U.S.A., 75 kw.  
 \*15.210—VLC11, Shepparton, Australia, "Radio Australia," 50 kw.  
 15.210—OQ2AA, Leopoldville, Belgian Congo, "Radio Leo," 50 w.  
 \*15.210—VUD3, Delhi, AIR, 5 kw.

\*15.210—KGEX, San Francisco, Calif., U.S.A., 100 kw.  
 15.210—WBOS, Boston, Mass., U.S.A., 50 kw.  
 15.210—PLF1, Bandoeng, Java.  
 \*15.220—CHTA, Sackville, Canada, "CBC International Service," 50 kw.  
 15.220—PCJ, Hilversum (Huizen), Holland (Netherlands), "Radio Nederland," 30 kw.  
 \*15.220—XGOY, Chungking, China.  
 15.222V—Clandestine, "España Independiente," #15.225—XGSQ, Nanking, China.  
 15.225V—JVW, Kawachi, Japan, "N.H.K.," 20 kw.  
 \*15.228V—Komsomolsk, U.S.S.R., 50 kw.  
 15.230—VLH5, Melbourne, Australia, "A.B.C.," 10 kw.  
 15.230—VLG6, Melbourne, Australia, "Radio Australia," 10 kw.  
 15.230—OLR5A, Prague, Czechoslovakia, 30 kw.  
 15.230—CR7BD, Lourenco Marques, Mozambique, "Radio Clube de Mozambique," 300 w.  
 \*15.230—WLWL, Cincinnati, Ohio, U.S.A., 75 kw.  
 15.230—Komsomolsk, U.S.S.R.  
 15.230—Moscow.  
 15.230—Colombo, Ceylon, "Radio SEAC," 6 kw.  
 15.235—JVW4, Tokyo.  
 \*15.235—XGSR, Nanking, China.  
 15.240—VLG6, Melbourne, Australia, "Radio Australia," 10 kw.  
 \*15.240—KCBA, Delano, Calif., U.S.A., 50 kw.  
 \*15.240—KNBI, Dixon, Calif., U.S.A., 50 kw.  
 \*15.240V—Belgrade, Yugoslavia, "Radio Belgrade," 10 kw.  
 15.241—Paris, "Radiodiffusion Francaise," 100 kw.  
 15.250—KRHO, Honolulu, Hawaii, 100 kw.  
 \*15.250—KNBI, Dixon, Calif., U.S.A., 50 kw.  
 15.250—KNBX, Dixon, Calif., U.S.A., 100 kw.  
 \*15.250—WBOS, Boston, Mass., U.S.A., 50 kw.  
 15.250—WLWK, Cincinnati, Ohio, U.S.A., 50 kw.  
 15.250—WLWR, Cincinnati, Ohio, U.S.A., 175 kw.  
 #15.250—Manila, Philippines.  
 15.260—GSI, London, 50-100 kw.  
 \*15.270—KCBF, Delano, Calif., U.S.A., 50 kw.  
 \*15.270—KCBR, Delano, Calif., U.S.A., 200 kw.  
 \*15.270—WBOS, Boston, Mass., U.S.A., 50 kw.  
 15.270—WCRC, New York, N.Y., U.S.A., 50 kw.  
 15.270—WCBN, New York, N.Y., U.S.A., 50 kw.  
 15.270—Sverdlovsk, U.S.S.R.  
 \*15.275V—Singapore, Malaya, "British Far Eastern Service," 7.5 kw.  
 15.276—Moscow.  
 15.280—ZL4, Wellington, New Zealand, 10 kw.  
 15.280—WNRE, New York, N.Y., U.S.A., 50 kw.

\*15.280—Moscow.  
 15.280—Brussels, Belgium.  
 \*15.280—XUPA (now XURA), Tai-Pei, Formosa.  
 \*15.290—LRU, Buenos Aires, Argentina, 5 kw.  
 15.290—VUD3, Delhi, AIR, 5 kw.  
 15.290—VUD11, Delhi, AIR, 20 kw.  
 \*15.290—KWID, San Francisco, Calif., U.S.A., 100 kw.  
 15.290—WRUL, Boston, Mass., U.S.A., 50 kw.  
 \*15.295—Belgrade, Yugoslavia, "Radio Belgrade," 10 kw.  
 15.300—GWR, London, 50-100 kw.  
 \*15.300—Rome, Italy.  
 \*15.300—Paris, France.  
 \*15.300—Horbj, Sweden.  
 \*15.300—CXA18, Montevideo, Uruguay.  
 \*15.300—HHK, Legane, Haiti.  
 15.300—Singapore, Malaya, "British Far Eastern Broadcasting Service," 7.5 kw.  
 15.305—HER6, Berne, Switzerland, "Swiss Broadcasting Corp.," 25 kw.  
 15.309—Novosibirsk, U.S.S.R.  
 15.310—GSP, London, 50-100 kw.  
 \*15.310—YDB, Soerabaja, Java.  
 \*15.310—KZRH, Manila, Philippines.  
 15.314V—Moscow  
 \*15.315—VYPX, Caracas, Venezuela, "Radiodifusora Nacional," 1 kw.  
 \*15.315—HEU6, Berne, Switzerland, "Swiss Broadcasting Corp.," 25 kw.  
 15.320—VLA5, Shepparton, Australia, "Radio Australia," 100 kw.  
 15.320—VLC4, Shepparton, Australia, "Radio Australia," 50 kw.  
 15.320—CKCS, Sackville, Canada, "CBC International Service," 50 kw.  
 \*15.320—OLR5B, Prague, Czechoslovakia, 30 kw.  
 15.320—DAKV, Berlin, Germany.  
 15.320—OZH2, Skamlebak (Copenhagen), Denmark, 6 kw.  
 \*15.320—HEI7, Berne, Switzerland, "Swiss Broadcasting Corp.," 25 kw.  
 15.320V—Moscow.  
 15.325—OQ2RC, Leopoldville, Belgian Congo, "Radio Congolia," 250 w.  
 15.325—JVW3, Kawachi, Japan, "N.H.K.," 20 kw.  
 \*15.325—JLP2, Tokyo.  
 15.325—HEU7, Berne, Switzerland.  
 \*15.326—Lourenco Marques, Mozambique, "Radio Mozambique."  
 15.330—KCBA, Delano, Calif., U.S.A., 50 kw.  
 \*15.330—KCBR, Delano, Calif., U.S.A., 200 kw.  
 15.330—KNBX, Dixon, Calif., U.S.A., 100 kw.  
 15.330—WGEO, Schenectady, N.Y., U.S.A., 100 kw.  
 \*15.330—MTCY, Changchun, China.  
 \*15.335—Brussels, Belgium, "Radio Nationale Belge," 5 kw.  
 \*15.340—KNBX, Dixon, Calif., U.S.A., 100 kw.

### OIL FILLED CONDENSERS

1 Mfd. 600 VDC.....	\$0.35
2 Mfd. 600 VDC.....	0.60
10 Mfd. 600 VDC.....	0.85
2 Mfd. 1000 VDC.....	0.69
7 Mfd. 330 VAC.....	1.25
0.1 Mfd. 7500 VDC.....	1.50
2x.1 Mfd. 7000 VDC.....	2.00
.02 Mfd. 8000 VDC.....	.98
SPECIAL—16 Mfd. 480 VDC W.E.....	.98
1 Mfd. 5000 VDC Solar.....	2.95

### 5B1 Cathode Ray Tubes

5" Green Screen. Brand New in Original Cartons. Priced so low you'll want a few. **\$1.45**

### Wire Wound Potentiometer

100,000 ohm, precision made. G.R. type, 25 watt, 6" diameter. Brand new..... **\$1.95**

Heineman Circuit Breakers 3 & 5 amp. sizes..... **95c**

### STEEL CHASSIS

10 x 17 x 3.....	\$1.38	11 x 17 x 3.....	\$1.86
5 x 10 x 3.....	.87	13 x 17 x 3.....	2.22
7 x 13 x 2.....	.96	7 x 7 x 2.....	.63
10 x 14 x 3.....	1.35	4 x 17 x 3.....	.99

### STEEL CANS AND BOXES

4 x 4 x 2.....	\$0.68	12 x 7 x 6.....	\$1.68
4 x 5 x 3.....	.78	15 x 9 x 7.....	2.35
6 x 6 x 6.....	.99	11 x 12 x 8.....	2.25

### 1/4 INCH STEEL PANELS

3 1/2 x 19.....	\$0.66	10 1/2 x 19.....	\$1.22
5 1/4 x 19.....	.87	12 1/4 x 19.....	1.46
8 3/4 x 19.....	1.10	14 x 19.....	1.62

### 1/4 INCH ALUMINUM PANELS

3 1/2 x 19.....	\$1.38	8 3/4 x 19.....	\$2.25
5 1/2 x 19.....	1.74	10 1/2 x 19.....	2.87

### FULL WAVE BRIDGE RECTIFIERS

Type B: Up to 144 VAC in, up to 96 VDC out @ 1.2 amp. Signal Corps. #9D0612B..... **\$2.50**

Type A: Up to 54 VAC in, up to 39 VDC out @ 1.2 amps. Signal Corps. #4D0238..... **\$1.50**

### RESISTORS

100 Watt—Ferrule Type 25,000, 30,000, 40,000, 50,000, 100,000 ohms. Each..... **25c**

# LEEDS

"The Home of RADIO"

### NATIONAL CO. PRODUCTS

AR-16 Exciter Coils air-spaced: For 5, 10, 20, 40, or 80 meters with end, center or swinging link. Plug in type. Each..... **\$1.15**

XB-16 Socket for Above..... **33c**

TMK-50D Condenser 50-50 mmfd. .077" spacing. 3000V Peak..... **\$4.15**

STD-50 Split Stator Double Bearing 50-50 mmfd. .026 Air Gap..... **\$2.56**

High Freq., Permeability Tuned, RF coils.

AR-2 75-220 MC.....	\$1.71
AR-5 37-110 MC.....	1.46
YR-50 Coil Form Only.....	1.01

10.7 MC Transformers for AM or FM superhets.

1FL FM Discriminator @ 1.5 DB.....	\$6.90
1FM 1F with 150 KC Band with Pass Band.....	6.45
1FN 1F with 100 KC Pass Band 1.5 DB.....	6.45
1FO FM—Ratio Discriminator.....	6.98

ACN Dial. Swell for Freq. Monitors & VFO's Dial Bezel Size 5"x7 1/4"

Five Blank Ranges for Direct Calibration..... **\$3.00**

5:1 Ratio Velvet Vernier Drive..... **\$3.00**

A most complete line of National Co. Products in Stock

### KEYING UNIT

McElroy Model G-813 complete with Tubes, 117N7GT, 1A7GT, 117Z6GT—Photo Tube, Exciter Lamp. Designed for Army Operator Training Schools. Mounted on Handsome Wooden Case. Brand New..... **\$19.95**

### CS DIFFERENTIAL RELAY

2 amp. contacts 110 VAC 8000 Ohm each coil. 8 Ma to close; will take up to 250 VDC on each coil. Swell for Balanced or Bridge type circuit where limited current or power is available. Will withstand 12G Vibration at 35,000 Ft. .... **95c**

If not rated 25% with order, balance C.O.D. All prices F.O.B. our warehouse New York. No order under \$2.00. We ship to any part of the globe

# LEEDS RADIO CO.

75 Vesey Street Dept. RN3  
 Cortlandt 7.2612 New York City 7

### Meters

0-1 Ma D.C. Gruen 2" Round Metal Case.....	\$1.95
0-30 Ma. D.C. Westinghouse 2" Round Bakelite Case.....	1.95
50 Millivolt movement 3" Round Bakelite with arbitrary scale.....	1.95

APC-25 Air Trimmers. Screw Driver adjusted 12 plates, 25 mmfd. Silver Plated 15c each. 10 for..... **\$1.25**

APC-50 Air Trimmers. Screw Driver adjusted 12 plates, 50 mmfd. Silver Plated 15c each. 10 for..... **\$1.25**

### RADIO TRANSMITTER & RECEIVER APS-13 17 TUBES

410 - 420 Mc; light weight fully enclosed. 30 Mc. IF, complete with tubes - 5-6J6; 9-6AG5; 2-2D21; 1-VR-105; Schematic supplied with each unit. Only **\$11.95**

### Real Values

832 Tubes. Brand New. Fully Guaranteed..... **\$2.15**

1N23A X-Tal Diodes 35c each; 3 for..... **1.00**

Ouncer Transformer, Mike to Grid 25:1 Ratio Low to High Impedance 35c each; 10 for **2.95**

De Jur Wire Wound 20,000 ohm Pot. 12 Watts. 49c

Arc-5 Silver Plated Banana Plugs per dozen..... **10c**

24 Volt GE Relay 200 amp. Silver Plated Contacts..... **39c**

6 Volt Bayonet Base Pilot Assemblies, with Dimmer, Red or White. Each..... **19c**

3" Telescopic Antenna..... **25c**

Octal Sockets, Low Loss Bakelite..... **08c**

### ATTENTION!!

**ALL SCR-522 OWNERS!**

Remote Control Boxes for SCR 522's. Brand New in Original Packing; Consists of 5 push button switches, 5 Western Electric Pilot Assemblies, with Pilot Bulbs and Dimmer, and a lever switch all finished in Black Crackle. Order Yours Today for only..... **\$1.25 ea.**

- 15.340—Moscow.
- \*15.345—FEH2, Dakar, French West Africa, "Radio Dakar," 12 kw.
- 15.350—XGOA, Nanking, China, "The Voice of China," 10 kw.
- 15.350—Paris, "Radiodiffusion Francaise, 25 kw.
- \*15.350—VUDS, Delhi, AIR, 7.5 kw.
- \*15.350—WRUA, Boston, Mass., U.S.A., 50 kw.
- \*15.350—WRUS, Boston, Mass., U.S.A., 50 kw.
- 15.350—WLWO, Cincinnati, Ohio, U.S.A., 75 kw.
- 15.352—Junglinster, Luxembourg, "Radio Luxembourg," 5 kw.
- 15.360—Moscow.
- \*15.360—Tokyo.
- 15.365V—Clandestine, "España Independiente."
- \*15.370—ZYC9, Rio de Janeiro, Brazil, "Radio Tamoio," 25 kw.
- 15.370—Budapest, Hungary, "Radio Budapest."
- \*15.370V—Lourenco Marques, Mozambique, "Radio Mozambique," 300 w.
- 15.370—U.S.S.R.
- \*15.375—GRE, London, 50-100 kw.
- 15.380—Moscow.
- \*15.385—FHE, Dakar, Fr. West Africa.
- 15.390—Clandestine, "Radio Espana Independiente, Estacion Pyrenaica."
- \*15.390—FHE, Dakar, Fr. West Africa, "Radio Dakar," 12 kw.
- \*15.390—KZRH, Manila, Philippines, "Voice of the Philippines."
- 15.390—Moscow.
- 15.400—Clandestine, "Radio Espana Independiente, Estacion Pyrenaica."
- 15.400—ZMB4, Apia, Western Samoa.
- \*15.405—PZC, Paramaribo, Surinam, "Avros, Paramaribo," 2 kw.
- \*15.405—PZX5, Paramaribo, Surinam, "Avros, Paramaribo," 5 kw.
- 15.408—Moscow.
- \*15.411—Santiago, Chile, "Radio Sociedad Nacional de Agricultura," 500 w.
- \*15.420—GWD, London, 50-100 kw.
- \*15.420—HBZ4, Geneva, Switzerland, 40 kw.
- \*15.420—LRA7, Buenos Aires.
- 15.425—VRR11, Stony Hill, Jamaica, B.W.I., 500 w.
- \*15.430—ZOY, Accra, Gold Coast, 5 kw.
- 15.435—GWE, London, 50-100 kw.
- 15.438—Moscow.
- 15.440—Moscow.
- 15.450—GRD, London, 50-100 kw.
- 15.484—Clandestine, "España Independiente."
- 15.490—Soerabaya, Java.
- 15.500V—U.S.S.R.
- 15.513—HDR, Quito, Ecuador, 2 kw.
- 15.530—Clandestine Polish ("Polska Walce").
- \*15.585—Salisbury, Southern Rhodesia.
- 15.595—Brazzaville, French Equatorial Africa, "Radio Brazzaville," 50 kw.
- \*15.630—ZAA, Tirana, Albania.
- \*15.660—JVE, Tokyo.
- \*15.665—SDT2, Motala (Stockholm), Sweden, 12 kw.
- \*15.692—HBZ, Geneva, Switzerland, 40 kw.
- \*15.750—Moscow.
- 15.780V—U.S.S.R.
- \*15.835—HRT5, Berne, Switzerland, 25 kw.
- \*15.855—HRO5, Berne, Switzerland, 25 kw.
- 15.860—HFB2, Frankfurt, Germany.
- 16.860—JVD, Tokyo.
- \*15.875—HEK5, Berne, Switzerland, 25 kw.
- 15.880—FTK, Paris, 30 kw.
- 15.895—CR6RL, Luanda, Angola, "Radio Clube de Angola," 1 kw.
- \*15.915—CR6RL, Luanda, Angola.
- \*15.960—PLG, Bandoeng, Java, 3 kw.
- 15.960—CUJ2, Lisbon, Portugal.
- \*16.025—THA3, Algiers, Algeria, "Radio Algerie," 10 kw.
- 16.070—VWFD, Adak, Aleutian Islands, U.S.A.
- 16.105—SUV2, Cairo, Egypt, 10 kw.
- \*16.172—CR6RL, Luanda, Angola, "Radio Clube de Angola," 1 kw.
- 16.210—Ronne Antarctic Expedition.
- 16.320—COM3, Bissau, Portuguese Guinea, "Radio Bissau," 1 kw.
- 16.373—SUX, Cairo, Egypt.
- 16.666—CNR3, Rabat, Morocco, "Radio Maroc," 2.5 kw.
- 16.737—SUX2, Cairo, Egypt, 10 kw.
- \*16.900—Tabriz, Iran, "Radio Tabriz."
- \*17.170—Geneva, Switzerland.
- 17.260—Clandestine, "España Independiente."
- \*17.290—Clandestine, "España Independiente."
- \*17.300—Brazzaville, French Equatorial Africa.
- 17.310—Ronne Antarctic Expedition.
- \*17.440—ZMB5, Apia, Western Samoa.
- 17.445—HVJ, Vatican City, Vatican, "Radio Vaticano," 25 kw.
- \*17.482—VWW3, Kirkee, India.
- \*17.530—Brazzaville, French Equatorial Africa, 800 w.
- \*17.565—Geneva, Switzerland.
- \*17.585—HFB2, Geneva, Switzerland, 40 kw.
- \*17.597—CRY7, Macao, Portuguese China.
- \*17.600—Brazzaville, French Equatorial Africa, 800 w.
- 17.630—PMW, Batavia, Java, "Radio Batavia," 2.5 kw.
- \*17.630—Moscow.
- 17.663—Shanghai (?), China, "The Chinese Broadcasting Co."
- 17.665—Clandestine, "España Independiente."
- 17.666—Paris, France.
- 17.675—Moscow.
- 17.675—Clandestine, "España Independiente."
- \*17.677—PZH, Paramaribo, Surinam, "Avros, Paramaribo."
- 17.685—GEU2, Royal Observatory (Greenwich).
- 17.690—Clandestine, "Radio Espana Independiente, Estacion Pyrenaica."
- 17.700—GVP, London, 50-100 kw.
- 17.715—GRA, London, 50-100 kw.

(Continued on page 132)

# TELEVISION INDUSTRIES Co.

PICTURE IF & SOUND IF STRIP and FRONT END. This sensational picture If & Sound If Strip developed by our engineering staff enables you to build a 10"-12"-15"-20" direct view or projection type receiver with FM sound. Supplied with a

13 channel RF front end unit. The front end covers channels from 44 to 88 mc/s and 174 to 216 mc/s (13 channels). Matched antenna input for 300 ohm line. Tubes: 1-6J6 RF amplifier 1-6J6 converter 1-6J6 oscillator.



**\$119.50**

DEALERS NET

PICTURE IF STAGES 5 picture IF stages of amplification and second detector. SOUND IF STAGES 2 IF stages with limiter and discriminator. VIDEO STAGES 2 stages of video with a frequency response of 4.5 mc/s ONE DC RESTORER. IF FREQUENCY audio 21.25—picture 25.75.

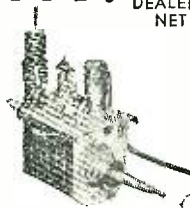

Picture IF band width 4.5 mc/s. All the above circuits and tubes are contained on one chassis. Front end unit on separate chassis. Both picture IF and sound IF delivered completely wired, tested, tubed, and matched ready for use.

## DUMONT IMPUTUNER

The Dumont Imputuner tunes continuously from 44 to 216 megacycles without a break—covers all 13 television channels as well as FM, amateur, and aviation channels. For ease and convenience of operation no band switching of any kind is required when tuning from channel to channel with the imputuner system. Just one simple operation to reach any desired station.

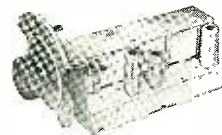

**\$97.90** LIST

## BAUSCH & LOMB TELEVISION PROJECTION LENS



Television Industries Co. is proud to announce that they have been appointed national wholesale distributors for the Bausch & Lomb f: 1.9 Television Projection Lens. Sample orders filled immediately.

**\$125.00**

DEALERS NET PRICE

## DEFLECTION COILS



Deflection Yoke similar to RCA part # 20 ID1

**\$13.75**

LIST

Contact Us for your Local Distributor

# TELEVISION INDUSTRIES

540 BUSHWICK AVE.  
BROOKLYN 6, N. Y.

# Announcing—

## Comprehensive data on BASIC RADAR CIRCUITS

Prepared by the  
radar specialists  
of the

MASSACHUSETTS  
INSTITUTE OF  
TECHNOLOGY

Now — with this single reference manual you can quickly bring yourself abreast of recent developments in radar. The first complete volume published in this important field, it covers the subject for all engineers and physicists who are concerned with electronic applications. Reflecting the broad experience of M.I.T. radar specialists, this book deals with pulse circuits and high-frequency devices common to nearly all radar equipment. The lucid explanations of circuit operation are based on physical concepts and make free use of numerical examples.



## PRINCIPLES OF RADAR

NEW  
2nd  
Edition

By members of the staff of the Radar School,  
Massachusetts Institute of Technology. 960  
pages, 6 x 9, profusely illustrated, \$5.00

Originally this book was prepared to give a sound, rapid grounding in radar principles and their wartime applications. Now, in view of the many advances of the past few years, the book has been fully revised—so that it will be helpful not only to those interested in radar but also to those concerned with ultra-high frequencies and microwaves, television, pulsetime communication systems, or pulse navigation systems. This new edition begins with a brief description of the components and functions of radar systems and continues with detailed discussion of typical system components. Expositions of circuits and devices provide an unusual combination of technically thorough and accurate treatments with minimum dependence upon mathematics. Emphasis in the discussions of circuits is on quantitative analysis directly from tube characteristics and physical principles.

Supplies timely data on:

- Timing Circuits
- Indicators
- Receivers
- Magnetrons
- Modulators
- Triode Transmitters
- Radio-Frequency Lines
- Radar Antennas and Propagation
- Wave Guides and Cavity Resonators
- Transmit-receive Devices
- Synchros and Servomechanisms

### 10 DAYS' FREE EXAMINATION

McGraw-Hill Book Co., Inc.  
330 W. 42nd St., New York 18

Send me M.I.T. Radar School-Principles of Radar for 10 days' examination on approval. In 10 days I will send \$5.00 plus few cents postage or return book postpaid. (Postage paid on cash orders.)

Name.....

Address.....

City and State.....

Company.....

Position..... RN-3-48

For Canadian price write McGraw-Hill Co. of Canada, Ltd., 12 Richmond St. E., Toronto 1

### Practical Radio Course

(Continued from page 78)

(see Fig. 8B)—without need for the use for any actual physical condensers for the purpose. This circuit capacitance is the lowest value of capacitance that could possibly be had in the circuit. It is the sum of the wiring stray capacitance, capacitance of components to ground, and capacitance of tube-element to ground. These individual capacitances are shown dotted in Fig. 8B. Since the video intermediate-frequency involved is very high, component sizes and values required in the tuning circuits of the video i.f. amplifier are very much smaller than in the i.f. amplifiers of conventional sound broadcast receivers. The stray and distributed capacitances involved in the components, wiring, plate and grid elements, etc., therefore assume relatively greater importance. To keep the total distributed capacitance down to as low a value as possible, improved tube types having exceptionally low grid-input capacitance are used in video i.f. amplifiers.

In order to produce primary and secondary windings having the required amount of inductance without having to use many turns of wire (for this would increase the distributed capacitance of the winding and also some of the stray circuit capacitances) a low-loss, high-frequency type compressed-powdered-iron slug core is used in them to increase the permeability of the magnetic flux path. By making the position of the core in the coils adjustable, the inductance of the windings can easily be altered for making any slight resonance frequency adjustments that may be required at any time.

In many manufacturers' schematic circuit diagrams of television receivers, the distributed capacitances and tube-element-to-ground capacitances which act to tune the primary and secondary windings of the video i.f. transformers are not shown, so these transformers appear to be untuned. Whenever one of these diagrams is encountered remember that these circuit capacitances are being employed to tune the coils to the video i.f., even though they are not shown.

Another method of flattening the frequency response of video i.f. amplifiers is frequently used, either alone or to supplement the damping action of damping resistors shunted across the primary and secondary windings. This consists of the application of a slight amount of degeneration in several windings (usually the first three) of the i.f. stages. One very simple and effective way of accomplishing this is by not bypassing the entire cathode bias resistor of the i.f. tube. The circuit arrangement is illustrated in Fig. 8A. Grid bias resistors  $R_1$  and  $R_2$  in series together develop the total d.c. voltage drop required for use as the fixed grid bias

for the tube. Resistor  $R_2$  is adequately bypassed by condenser  $C_2$  so no i.f. voltage drop is produced across it, and hence no degeneration is caused by it. However  $R_1$  is not bypassed, so the i.f. voltage drop  $E_a$  developed across it produces degeneration (since it is 180 degrees out-of-phase with the signal voltage variations in the grid circuit). It is evident that the amount of degeneration introduced can be easily controlled by properly choosing the resistance value of  $R_1$ .

Degeneration has another beneficial effect. Tube input capacitance is a function of the electron stream, and since the electron stream will vary with the variations in amplitude of the received video signal, this causes variations in the tube input capacitance. As the input capacitance of the tube (see Fig. 8B) represents an appreciable portion of the total distributed circuit capacitance that is effective for tuning the secondary of the video i.f. transformer to the video i.f., any variations in this capacitance may cause a sufficient variation in the resonance frequency to seriously detune the stage, with consequent reduction in gain and attenuation of the frequency-response characteristic. A small amount of degeneration serves to reduce this input capacitance variation sufficiently so that no harmful degree of frequency variation results.

### Video I.F. Stage and Over-all Frequency-Response Characteristics

The rather complicated special over-all video i.f. amplifier frequency-response characteristic that is required, see bottom curve in Fig. 9A, cannot very well be obtained in each video i.f. stage. Consequently, it is current practice to produce a number of different, readily obtainable response characteristics in the several video i.f. amplifier stages such that the over-all response for the entire video i.f. amplifier will closely approach the desired characteristic.

The individual frequency-response characteristics of the five video amplifier stages of a television receiver (Philco), and the resulting over-all response, are illustrated in Fig. 9.

When studying the shapes of such a group of individual-stage frequency response characteristics, and comparing them to the form of the resulting over-all response, it should be remembered that the over-all response at any frequency is proportional to the product of the individual-stage responses at that frequency—not to their sum.

It is also important to remember that the upper and lower cut-offs of the over-all response cannot exceed the minimum cut-offs imposed by the response characteristics of any stages in the series. For example, by referring to Fig. 9 it may be seen that the second i.f. stage is designed to have its low-frequency cut-off occur at approximately 21.7 mc. (slightly above the sound i.f. used). Now even though the low-frequency responses of the

RADIO NEWS

# Here it is War Surplus CLEARANCE!

# K T S

## KITS!

## KITS!

**TUBE KITS**  
Complete set of tubes for SCR-522  
**\$17.95**  
Complete set of tubes for BC-348  
**\$7.95**  
Complete set of tubes for BC-312  
**\$7.95**  
Specify Model Numbers

### POWER!! POWER!!

Niagara can supply a power supply kit which will completely power the ARC 5 Transmitter used as a VFO or any one of the ARC 5 receivers. All basic components included for delivering 300 v. @ 150 mills & 24 v. or 12 v. for the filaments—no rewiring of equipment necessary. This kit will also power the BC-348, BC-312, and the BC-1205. A good buy at .....**\$7.50**

### DO YOU OWN AN SCR-522?

We have a complete power supply containing all the necessary parts down to the line cord, pilot light switch & terminal blocks & delivers the following voltage—300 v. DC @ 250 mills, 150 v. of regulated bias and sufficient 12 v. to operate the tubes of both receiver and transmitter. Complete at the amazingly low price of .....**\$14.95**

Model 200-EA. 5-ELEMENT 2 METER BEAM KIT. Folded di-pole driven element. All-aluminum construction. Feed with low impedance coaxial cable. Amateur net price .....**\$8.40**

### BC-348 Owners CONVERTER for Broadcast Band

Convert that BC-348 without any alteration in your circuit. Our special converter takes power from receiver. Just tune your set to 450 kc. and forget it. All tuning is done on a converter panel covering 550 to 1600 kc.—double conversion means High Sensitivity. Excellent Fidelity and Higher Selectivity—complete basic kit with schematic and full instructions—less chassis dial and tuning knobs. Terrific Buy at.....**\$6.50**

### MODEL ATD AIRCRAFT TRANSMITTER

Covers 540 Kc. to 9050 Kc. C.W. or fone, designed for Dynamotor Operation. Power supply requirements are 380 volts and 1000 volts DC.

Separate Ant. Tuning units covering the following frequencies.

- 540—1500 Kc.
- 1500—3000 Kc.
- 3000—9050 Kc.

10 1/2" high, 12 1/4" deep, 21 1/2" long. Shipping weight 100 lbs. Price F.O.B. New York City.

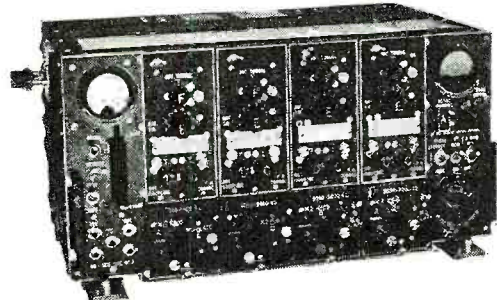

Tube line-up as follows: RF Osc. 6L6—RF Amp. 814—Audio—6SL7 Pre Amp. into 6L6 driver and side tone amplifier with pair of 6L6 modulators, screen of oscillator tube, regulated with VR 150 Tube. All circuits are metered.

**\$49.50**

FOR QUICK SALE—COMPLETE.....

### MASTER OSCILLATOR MI-19427-B

This unit was built for R.C.A. Add a final—becomes a complete transmitter with signal shifter. Perfect for Television sweep circuits for field or station use or wherever 300 v. must be maintained under varying load conditions—

#### TECHNICAL SUMMARY

<b>ELECTRICAL CHARACTERISTICS</b>	
Output Frequency.....	2 to 20 megacycles
Modulation Level, Buffer-Amplifier.....	Sufficient to drive an RCA-807
Modulation Frequency.....	650 cycles ± 150 cycles
Frequency Deviation (maximum).....	± 500 cycles
Power Consumption.....	200 watts
Power Supply.....	115 230 volts, 50/60 cycles
Oscillator Filament Current.....	0.05 ampere d-c
Amplifier and Tone Generator Filament Voltage.....	6.3 volts a-c
<b>TUBE COMPLEMENT</b>	
Electron-Coupled Oscillator.....	2 RCA-305-GT
Buffer-Amplifier.....	1 RCA-807
Tone Generator.....	1 RCA-6AB7, 1 RCA-6F6
Regulated Power Supply.....	2 RCA-5U4-G, 5 RCA-6Y6-G
	1 RCA-1852, 2 RCA-VR-150 30
<b>MECHANICAL SPECIFICATIONS</b>	
Dimensions.....	Height, 66 9/10 in.; Width, 22 in.; Depth, 17 1/2 in.
Weight.....	275 pounds
<b>TYPICAL PERFORMANCE DATA</b>	
Line voltage change, ±10 per cent.....	Frequency Change 0.0005 per cent
Temperature change, per degree Fahrenheit.....	0.0007 per cent
Relative humidity change of 1 per cent over the range of 30 to 95 at a dry bulb temperature of 110 degrees F.....	0.0003 per cent
Drift from cold start, first reading taken within 1 minute after applying power:	
Frequency deviation at the end of the first hour	a negative drift of 100-400 cycles (measured at 7 mc)

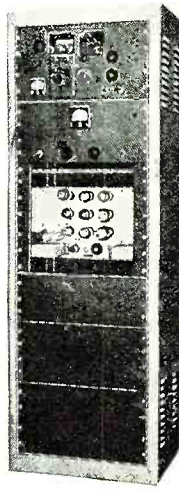

COMPLETE  
(LESS TUBES)  
**\$225.00**

### SPECIAL CLOSEOUT

#### SETCHELL CARLSON RADIO RECEIVER BC-1206-C

Designed to receive A-N beam signals. 24-28 vdc. Tube complement: 14A7, RF, 14H7, 14J7, 14H7, IF amplifier: 14R7, detector and 1st audio: 28D7, output, 195 to 420 KC 4" high x 4" wide 6 5/8" long. Weight 4 lbs. perfect receiver for "Q five" described in QST.

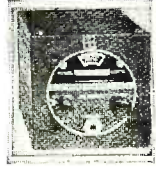

Priced At Only .....**\$198**  
(Less Tubes)  
Complete set of tubes for above \$2.89 Extra

WRITE FOR LATEST BULLETIN 2N8  
20% deposit with all orders unless Rated  
All prices F.O.B. N. Y. City

# New... JUST OFF THE PRESS!

## TELEVISION CATALOG

Send for  
Your  
COPY  
TODAY!

TELEVISION  
**NIAGARA RADIO SUPPLY CORP.**  
160 Greenwich St., New York 6, N. Y.

"TELEVISION IS HERE TO STAY." If you are thinking in terms of Television—whether you own a receiver or planning to build one—get Niagara's new giant Television catalog—all in one complete and comprehensive booklet on everything for Television. Kits, Components, Test Equipment, Antennas and miscellaneous—We have them all—Make us your TELEVISION HEADQUARTERS—you will save yourself considerable time and money. Clip this coupon.

Please send copy of your Television Catalog to:

Name.....  
Address..... Zone.....  
City..... State.....

**NIAGARA RADIO SUPPLY CORP.**  
160 GREENWICH ST., NEW YORK 6, N. Y.

ONE STANDARD  
OF QUALITY  
ONLY...THE  
HIGHEST



DEDICATED TO  
THE CONSTANT  
BETTERMENT  
OF SOUND

1161 N. VINE ST., HOLLYWOOD 38 • 250 W. 57th ST., NEW YORK 19

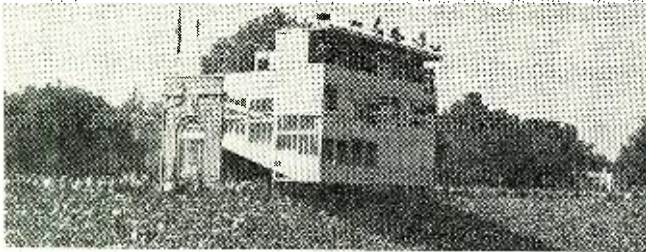

University of Michigan stadium, Ann Arbor, Mich. Altec Lansing large multicell horns driven by Altec Lansing 1/4 KW amplifier, are centralized over press stand, override noise level of 86,000 spectators. Reiss Public Address Systems, Detroit, contractors.

## LEADING ATHLETIC STADIUMS NOW CHOOSE ALTEC LANSING PUBLIC ADDRESS SYSTEMS

With million dollar "gates", sports are big business today; leading stadiums throughout the United States, both college and professional, able to afford the best, are installing Altec Lansing public address systems, or are converting previous unsatisfactory systems to Altec Lansing. Altec Lansing produces systems with sufficient power to override high crowd noises with complete intelligibility; high efficiency, directional-character multicell speakers are clus-

tered at one place, thus simplifying installation. Other stadiums using Altec Lansing systems: Griffith, Washington, D. C.; Gardens Arena, Pittsburgh; University of Utah; Briggs, Detroit; etc.

Authorized Altec Lansing stadium specialists will submit estimates and plans on your own stadium public address requirements. Address: Stadium Engineering Department C, 1161 N. Vine St., Hollywood 38, or 250 West 57th St., New York 19.

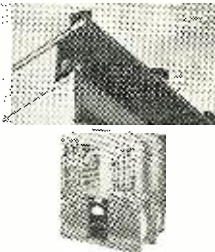

Above: large multicell Altec Lansing speakers. Below: Altec Lansing 287W 1/4 KW Industrial amplifier.

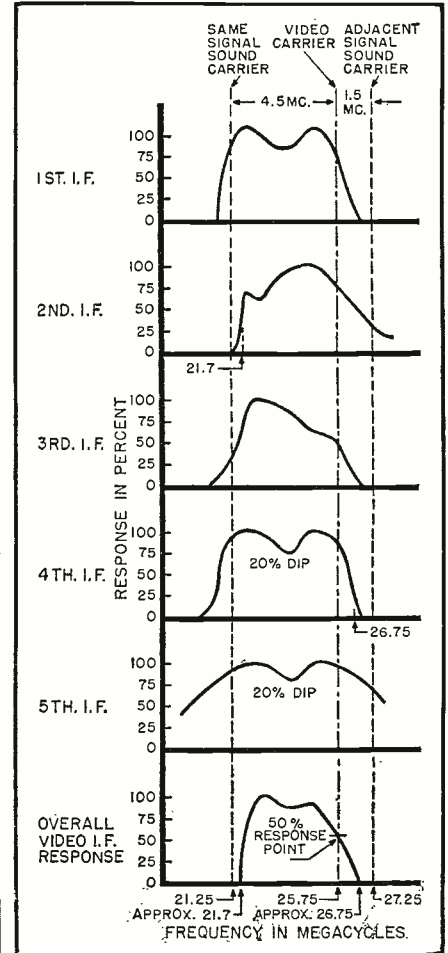

Fig. 9. Frequency response curves of each of the five individual stages, and the over-all response, for a five-stage video i.f. amplifier.

## COMBINATION Model "DYNOPTIMUM" 802-N TUBE and SET TESTER

a compact, low-priced instrument for greater profits

ONLY \$59.50



Multiply your productive service time with this completely modern, accurate tube and multi-tester. It provides maximum test operations with minimum switch settings—speeds your service checks for field and counter work. Order from your local jobber. Write direct for catalog.

### Check these features:

- Simple to operate as a tube tester or set tester—combining accuracy and speed
- Usual AC voltage errors due to frequency and temperature variations, virtually eliminated with germanium crystal rectifier
- Tests paper, mica and electrolytic condensers for leakage
- Resistance measurements through a 200 million to 1 range
- Famous Dynoptimum circuit for tube testing—giving accurate speedy tests for quality—short—leakage and noise
- Set tester includes AC-DC voltmeter—output meter—decibel meter—ammeter—milliammeter—ohmmeter—all multirange

R.C.P. INSTRUMENTS—BEST FOR EVERY TEST

RADIO CITY PRODUCTS CO., INC.

152 West 25th Street, New York 1, N. Y.

## SURPLUS

G.E.—SPRAGUE-AEROVOX oil filled condensers, 4000 Volts, 2MMF.....\$3.95  
4000 Volts, 3MMF..... 4.95  
5000 Volts, 2MMF..... 6.95  
BEACON Receiver tunes to 75 Meg., has current relay. Operates on 2 Mils.....\$1.79

### TRANSMITTERS

B.C. 457A. 4-5.3MC.....\$5.95  
B.C. 458A. 5-3.7MC..... 5.95  
B.C. 459. 7-9.1MC (VFO) New..... 7.95

### MODULATOR UNIT

B.C. 456A.....\$3.95  
Conversion diagrams furnished.  
DM-32 DYNAMOTOR..... 1.50  
B.C. 348. Receiver Mount and Plug.... 2.49  
Fil. Trans. 2 1/2-amp. 12-24 Volt..... 3.95  
F. Band Pass Filter, 1000 cycle, FL8.... 1.98

### TUBES

6AK5.....\$ .79 6AJ5.....\$ .79  
6SN7/GT..... .69 5BP4..... 4.95  
VT127A..... 2.49 5FP7..... 3.69  
304TL.....\$ .97

10-meter Receiver—New. 3-6 MC Receiver converts to 10. Diagram furnished. SPECIAL 274N-SERIES.

### (C) RECEIVERS (274N Series)

B.C. 454A. 3-6MC. New.....\$3.95  
B.C. 455A. 6-9.1MC..... 5.95

Also thousands of additional special items such as condensers, tubes, capacitors, transformers, insulators, radar equipment. Inquiries solicited. Get your name on our mailing list. Terms: Cash with order.

## ESEGE SALES, Ltd.

1306 Bond Street Los Angeles, Calif.  
TEL. RICHMOND 71162

three stages that follow this all extend much beyond this frequency, this cut-off determines the low-frequency cut-off of the over-all characteristic, which is seen to occur (bottom curve) at approximately 21.7 mc. In other words, if the second i.f. stage attenuates to zero all signal components of frequency lower than 21.7 mc., no components of frequency lower than this can possibly get through to the third, fourth, and fifth stages and appear in the output of the last stage in the amplifier.

Similarly, the third and fourth stages are both designed to have their high-frequency cut-offs occur at approximately 26.75 mc. Therefore, even though the high-frequency response of the stage which follows this (the fifth stage) extends way beyond this frequency, this cut-off determines the high-frequency cut-off of the over-all characteristic, which is seen to occur at this same frequency—26.75 mc.

Observe that the over-all frequency response characteristic shown in Fig. 9 meets the video-amplifier specifications nicely. It rejects the 21.25 mc. sound i.f. signal that is associated with the video i.f. signal; it rejects the 27.25 mc. sound i.f. signal of the adjacent-channel transmitter; its response is down 50% at the video carrier frequency.



# Why Leading Electronic Engineers Use ADC TRANSFORMERS For Unusual Applications

ADC engineers interpret and build transformers to fit your specific requirements:

- Frequency response
- Input and output impedances
- Power requirements
- Vacuum tubes to be used
- Mounting or casing requirements
- Operating conditions

When you need special transformer designs, send us your specifications. ADC has thousands of special transformer designs on file.

**Transformer Engineering**—ADC engineers design special transformers for leading electronics manufacturers. Write us your specifications when special transformer design is needed.

SEND FOR FREE CATALOG TODAY  
Have the ADC catalog in your reference file.

PROMPT DELIVERY FROM  
STOCK OF ALL CATALOG ITEMS



*Audio Development Co.*  
2833-13th Avenue So., Minneapolis, Minn.

*Audio Develops the Finest*

## RADIO PARTS COMPANY *Presents*

### RAPARCO AMPLIFIERS

*The First Amplifiers*  
With ALL These FEATURES:

- 25 watts undistorted output, Peak 31 watts.
- Separate bass and treble controls.
- 2 mike controls, 1 phono control, 1 power switch.
- Indirect lighted panel. Attractive all-steel cabinet. Hammerloid finish.
- (8 tubes) 3—6SF5, 1—6SN7, 1—6SC7, 2—6L6, 1—5U4C.
- Frequency response inverse feed back, plus or minus 1-DB 30-17,000 cycles, good at 20 cycles, also out to 20M.

RA-25—

Especially fine for FM tuners, recording work, and general purpose PA work.

**Price Only \$49<sup>95</sup>**



### OTHER FEATURE MODELS

**RA-7—7-Watt** 3 Separate controls 50-10,000 CPS. plus or minus 2DB.  
PRICE .....\$22.50

**RA-15—15-Watt** 4 Separate controls Low hum—Hi-Fi 30-17,000 plus or minus 1/2DB.  
PRICE .....\$37.60

**RA-35 35-Watt** 5 Separate controls Low hum—Hi-Fi 0 cycles 20,000 plus or minus 1 DB.  
PRICE .....\$54.95

ALL MODELS COMPLETE WITH MATCHED TUBES. ALL MODELS INVERSE FEED BACK

### PARTS SPECIALS

- 1—Aerovox Buffer condensers, .005 1600 Volt. 10 for...\$1.45
- 2—Package of 50 assorted knobs .....\$0.98
- 3—Crystal microphones, with 100 ft. of cable.....\$5.98
- 4—10" Oxford Speaker 6.8 Alnico 5 .....\$4.50
- 5—Kit of 10 Rotary switches to fit your needs.....\$2.50
- 6—40-20—150-Volt FP condensers. 10 for.....\$4.50
- 7—40—150-Volt Mallory condensers. 10 for.....\$3.50
- 8—20 x 20 400-Volt Mallory condensers. 10 for.....\$3.90
- 9—1-tube phono osc. ....\$2.75
- 10—12" PM 16 oz. Magnet Speakers .....\$5.25

SEND FOR OUR SOUND EQUIPMENT CATALOGUE SHEETS DEPT. N

**Radio Parts Company, 614 RANDOLPH ST., CHICAGO 6, ILL.**

# How to Write an Ad

**Are you paying for valuable space from which you are getting no return—make your ads pull!**

By **G. EDWARD DeNIKE**

Morris F. Taylor Company

▼ **THOUSANDS** of pages have been written on this subject and right this minute in hundreds of classrooms thousands of students are eagerly listening to instructors who are trying to instill the fine points of the art. And it is an art. It is the art of painting a picture with words, but unlike the product of the artist who uses brush and palette, the picture you paint in the wording of an advertisement must result in action on the part of the person who views it.

There is no single individual who can tell you an ad is good or bad. The resulting action of all who read the ad is the only practicable judgment of its quality. If the readers buy or expose themselves to personal sales persuasion as a result of reading your ad, it is good; if they don't, it's bad.

Naturally, as a result of the experience of reading, studying, and analyzing thousands of ads known to have been producers, certain fundamentals appear which may be considered good practice in writing an ad. By using these fundamentals, your ad has a better chance for success than if you ignored them. The use of known advertising fundamentals, however, is not an *assurance* that your ad will produce.

Again drawing the parallel between the artist and the person who paints a picture with words in an advertisement, you know that of the hundreds of thousands of persons who have learned the fundamentals of placing paint on canvas, few succeed in producing a result that is a "work of art." Nor can the theatrical producer who knows all the requirements of the show business be sure of a "hit." The comparison of advertising writing with theatrical production is even more to the point than with the painter, for the show depends for its

success on its acceptability to large numbers of people. These comparisons are drawn so that you may be fully aware of the elusiveness of the factors which make your ad good or bad, make it pay or fail.

Before you attempt to write an ad, it will pay you to leaf through your local newspaper and the magazines you have around your home in the normal way you'd go through them at any time. If an ad catches your eye sufficiently to make you stop and look at it, or if you have the sensation of glancing back at it, then feeling that you want to read it, stop right there and ask yourself why. Was it an unusual use of words in the headline? Was it an illustration which commanded your attention? Was it a combination of both? Consider the ad as critically as you would a new model radio or appliance your jobber is persuading you to stock. The ad that stopped you is a "hot number." Why?

Having stopped you does the ad make you want to read all it has to tell or would you just as soon skip the detail?

Does the ad tell you about something you have been planning to buy anyway, or does it start you wanting something you hadn't thought of acquiring?

Finally, does it ask you to buy and tell you where you can buy? Now that you've really analyzed that ad, remember *your* ad has to do the same thing.

Your ad has to stop the reader, make him believe what he's read, and then stir him into action by making him phone, write, or come into your store so he's exposed to your personal sales-closing technique.

What's going to stop the reader? In the use of small space, the best way to stop him is with a few active,

emotion-loaded words just like a newspaper headline. If there is room for a small illustration, use a device irregular in form and strong in line. Old, but always useful devices of this kind, include arrows, pointing hands, a number, an emblem; line drawing of a woman's head or photo of a woman's face expressing an emotion—joy, fear, adoration, worry, etc.; a cartoon of a person in action—running, jumping, falling, etc., a line cartoon or photo or a baby, dog, or horse. Such small thumbnail illustrations, if used, should tie in with and supplement the headline and lead the reader's eye to the body copy or descriptive wording of the ad.

The descriptive copy should be as brief as possible but sufficiently long to put across at least one idea having to do with the advantages and desirability of owning the product or securing the service advertised. Your ad should tell the reader how the product or service will accomplish one of a number of things for him, save him money, make him happier, save him work or time, protect him or his loved ones from danger, make friends, improve his social position, or entertain him.

The conclusion of the ad should never fail to ask him to buy, to ask for further details, to call, write, or visit your store. Who you are and where you're located is the final message. Have you ever been won over by an ad, only to be let down, yes, even irritated by the fact that the advertiser didn't tell you where he was located?

Study the advertising of merchants you know are successful in your town. See whether they are telling prospects some story which you can not only duplicate but improve on by making it more to the point, more interesting.

If your budget can stand large space, don't be tempted to waste it. Apply the same principles you would to a small space, but increase the factors in relation to the available space.

A most effective use of small space is to be found in the patent medicine ads. These ads, which run frequently in one, two, or three inches of space, often use no illustration or device for capturing attention other than their brief, bold headlines which play up to real or imagined human ailments and infer relief or cure. No, they're not pretty ads, but they sell merchandise. Elaborate testing precedes use of these little ads, constant checking proves they are paying out or they are stopped. Patent medicine advertisers are realistic. They don't spend money for the sheer joy of seeing their name in print. Their ads must pay dividends. View every advertising effort you make in the same cold, calculating fashion and you won't waste money.

A practical example of how you might apply the patent medicine or book selling technique is shown in Fig. 1. Let us say you have an ironer for sale. Which ad do you think would attract the most attention?

Fig. 1. Two ways of utilizing your advertising space. (1) Get the most for your ad dollar with an "eye-stopper." (2) Don't waste your money on non-pulling ads like this.

## Housewife Banishes Agonizing Blisters

New ironing method saves delicate hands

Housewives who have let us show them how to use the new Zilch ironer wonder why they stood for ironing discomfort all these years. Drop in. Let us show you this amazing new device. Free demonstration, no obligation.

Come to JONES APPLIANCE CENTER  
000 S. State St. 9 a.m. to 6 p.m. (1)

## Zilch Ironers Now in Stock

We have available the new Zilch Ironer which is finished in white enamel, has a 1/4 horsepower motor, fine duo-therm heat control, and swivel joint top lifting mechanism.

JONES APPLIANCE CENTER

000 S. State Street

(2)

Number 1 is the winner, of course. You've appealed to your most likely prospect. You've put emotion into the headline. You've suggested a way to avoid harm in the subhead. Your body copy indicates that "others are enjoying this product, you too may end drudgery." You've asked the reader to do something about it, you've calmed their fear that they may be obligating themselves. You've told them where and when they can do something about it. Number 1 is an active ad, it appeals, moves, stirs desire to do something. Number 2 is static ad. You can't afford to spend your money on static ads unless you and your family simply enjoy seeing your name in print and you don't care whether or not your advertising space pays off.

Active ads are a living, driving sales force. Static ads just fill up space.

Take the example of a stationery store which captured attention by the single word "LEBENSRAUM" as a headline. Went on to say "Space . . . extra working space is something every office needs! Here's an economical answer to the problem! This *all steel* typewriter stand is durable, attractive and practical. (Measurements are given and the two drop leaves are described as "handy" drop leaves.) Special at \$5.85." Let's look at the copy, it sells this article as an answer to a problem—"extra working space," it touts the product as an "economical" answer to the problem, it emphasizes the durability, the appearance, the practicability. Then it clinches by suggesting this is a bargain—"Special" at \$5.85. Maybe it's special and maybe it isn't, but that word connected with the price implies a worthwhile saving.

The ad concludes with the invitation to "Visit our big, new, complete Furniture Department—2nd floor, 000 S. Jones Street."

Before you try to put your ad together, spend some time analyzing a lot of ads. Do they leave you feeling "so what" or do they make you feel like buying something or at least investigating further. Ask yourself what it was about the ads that made you want to act. Be sure you get some of that "urge to act" stuff into the ad you put together.

Remember that you can't appeal to every reader, so concentrate your appeal on possible prospects. Since you are selling equipment for the home, you are talking to the ladies. Make use of the emotional appeals you know will interest them. Can your product make them more beautiful? Will it take drudgery out of their household tasks? Will it enable them to live a happier life, please their husband, win a boy friend? Will it make them the envy of their friends and neighbors? Will it save them money? If so, for goodness sake tell them. They're not interested in mechanics, construction, and drab operational details!

-30-

# GOODSELL

## Dynamic Noise Suppressor Amplifier

NET PRICE: \$248 . . . 8 3/4" standard rack panel, or removable 5" panel for cabinet installation, optional. \*With all controls electrically extended on 3" cables, \$35 net, additional.

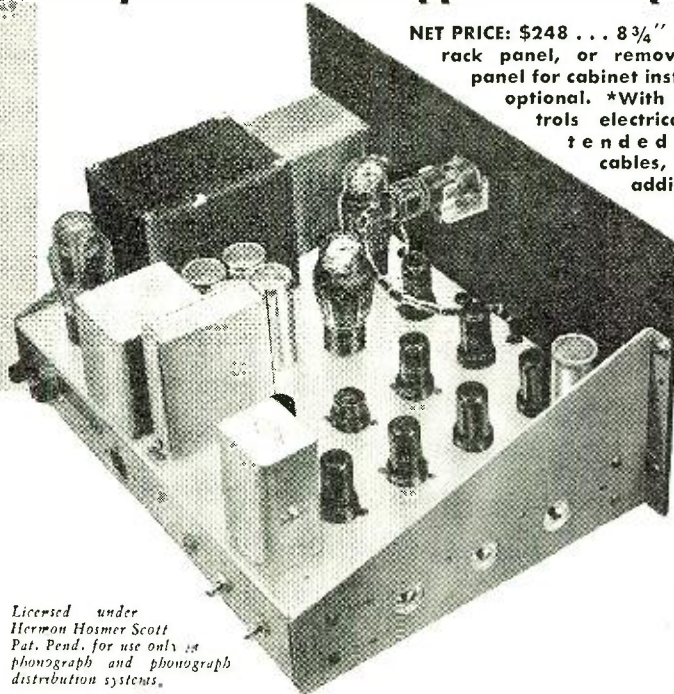

Licensed under Hermon Hosmer Scott Pat. Pend. for use only in phonograph and phonograph distribution systems.



This amplifier makes it possible for the user to obtain a maximum of music with a minimum of noise from any given recording. Recordings played through this system with a high quality pick-up and loudspeaker, provide a truly new listening experience in music reproduction.

### SPECIFICATIONS

Dynamic Noise Suppressor is six-tube version of Hermon Hosmer Scott horizontal suppression circuits incorporating one voltage amplifier stage, one d-c control voltage amplifier, one dual control voltage rectifier, one low frequency inductive reactance tube, two high frequency capacitive reactance tubes.

#### POWER OUTPUT

Eighteen watts with less than 2% harmonic distortion. (Note: Until standards are established for measuring intermodulation distortion, comparative ratings between manufacturers are not valid.) Intermodulation distortion is minimized by special circuit arrangements. Distortion at overload is "cushioned" and free of oscillatory disturbances.

#### FREQUENCY RANGE

Maximum—20 to 20,000 cycles per second. (Note: See Range Switch specifications.)

#### INPUTS

1. Built-in preamplifier, compensated for record characteristics with G.E. variable reluctance, Pickering, or other high quality magnetic pickups.  
2. Medium gain radio input. (50 to 500-ohm plug-in input transformer available.)

#### OUTPUT

Multiple voice coil and line impedances.

#### HUM LEVEL

Below audibility (—85 db below normal operating level).

#### TUBES

1—5U4G; 2—6AT6; 3—6SG7's; 3—6SJ7's; 1—6H6; 2—6J5; 2—6L6's; 1—6AL7 (eye).

#### CHASSIS DIMENSIONS

13"x17"x3", aluminum, 14 gauge.

#### PANEL DIMENSIONS

19"x8 3/4", aluminum, 11 gauge.

#### PANEL INDICATORS

Dual G.E. indicator eye tube. One section indicates the operation of low frequency gate circuit;

the other indicates the opening and closing of tandem high frequency gate circuits.

#### DYNAMIC NOISE SUPPRESSION CIRCUITS

One sloped low frequency gate type with dynamic control. Two "tandem" high frequency gate types with dynamic control. One 18,000 cycle per second sharp cut-off fixed (switch operated) filter tuneable to 10 kilocycles.

#### CONTROLS

Volume control.

Radio-phonograph switch.

Five position range switch.

(a) 20 to over 20,000 cps.

(b) 30 to 12,000 cps.

(c) 40 to 10,000 cps.

(d) 50 to 8,000 cps.

(e) 60 to 4,500 cps.

Treble control—Continuously variable. Center setting flat. Bass control—Continuously variable. Center setting flat. Both controls boost clockwise, attenuate counter-clockwise from flat electrical center setting.

Suppression—Continuously variable control of Dynamic Suppression. This control makes it possible to adjust the degree of suppression by controlling the ease with which the gate circuits will operate, to suit the surface and background noise characteristics of various records, as well as the preference of the listener.

All filter capacitors in power supply are oil filled 600 volt paper capacitors.

This is a laboratory amplifier of the highest quality, designed and constructed to provide music reproduction fidelity limited only by the available signal, and loudspeaker equipment used.

\*Amplifier may be ordered with ALL controls on 3 foot electrical extension cords with front plug-in facilities for convenience in custom cabinet installations. Special circuits compensate for added shunt capacitance in shielded cables, and no additional hum pickup is observed with these extensions.

The Minnesota Electronics Corporation • St. Paul 1, Minn.

# PROJECTION TELEVISION!

Convert your RCA 630 or Crosley 307 to this

## OUTSTANDING TELEVISION CONVERSION OF 1948!

The gigantic picture this set is capable of projecting must be seen to be believed! One set converted by a Los Angeles company, was demonstrated at the Shriner's Temple in Los Angeles, during the Rose Bowl game. It was viewed by 4800 people at one sitting! A 12x16-foot rear projection plastic screen of our type was used.

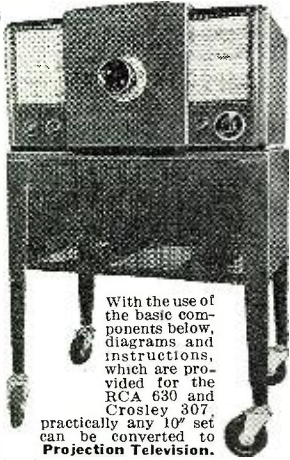

With the use of the basic components below, diagrams and instructions, which are provided for the RCA 630 and Crosley 307, practically any 10" set can be converted to Projection Television.

### F 1.9 TELEVISION PROJECTION LENS

Dimension—Length 7", Diameter 4 1/4".

F 1.9 EF. 5 in. (127 mm). This lens incorporates in barrel a corrective lens for use with a 5TP4 projection tube. It is easily removable for use with flat type tubes. Lens can be utilized to project picture sizes from several inches to 7x9 feet. Made by Bausch & Lomb Optical Co. Price, complete..... **\$125.00**  
Mounting ring available for above lens. Price **\$2.50**



### 30 KV RF POWER SUPPLY

Dimensions—Length 14", Width 11", Height 11 1/4".

This unit has a low voltage supply separate from high voltage pack. Low voltage DC supply has control which enables you to vary voltage from 12 KV to 40 KV. Unit has focus control built in for use with 5TP4 projection tube. Price, complete..... **\$99.50**



### STAND FOR PROJECTION TELEVISION SETS

Dimensions—23" High, 25" Wide, 18 1/2" Depth. For use with RCA 630 chassis or Crosley table model sets. Unit mounted on ball bearing soft tired wheels. Depth is designed to accommodate RF Power Supply. Open grill allows free circulation of air. This stand a natural for mounting scopes and other lab. equipment for easy mobility. Specify whether for Television use or shop. Stand as shown in top photo. Price..... **\$31.50**

### REAR PROJECTION TELEVISION SCREENS

The screen surface consists of a conglomerate arrangement of microscopic plastic crystals that "Pin Point" the projected image providing unexcelled angular viewing with a minimum loss of projected light. It is estimated that there is a loss of approximately 10% of light viewing the image at 45 degrees off center. Light transmission percentages are controlled to obtain the maximum efficiency of the television optical projection system. The percentage of 80% of transmission has been determined as that providing maximum efficiency. Stock sheets are available from 3x4 feet down. Specify inside dimensions of screen desired. If larger sizes are required, they can be made to order. Frames can be had on request, small sizes \$5.00—large sizes \$10.00. Price of screen, per sq. foot..... **\$4.50**

Include 25% Deposit With Order, Balance C.O.D.

Pioneers in Projection Television  
**SPELLMAN TELEVISION COMPANY**  
2898 JEROME AVENUE, NEW YORK 58, N. Y.

## Within the Industry

(Continued from page 30)

years with *NBC* joined the staff of radio station *WGY*. In 1938 he became studio engineer and night manager of station *WQXR* in New York.

\* \* \*

**E. D. A. GEGHEGAN** is the new factory manager of the Chicago plant of *Solar Manufacturing Corporation*.

Mr. Geoghegan comes to *Solar* from *Tobe Deutschmann Corp.* of Canton, Massachusetts, where he was chief engineer. He was previously connected with *Polymet Manufacturing Corporation*, *Radio Corporation of America*, and *Sprague Electric Company*, in various engineering and production capacities.



One of the nation's leading authorities on paper condensers, Mr. Geoghegan will be in complete charge of the manufacture of the company's line of paper condensers for the radio, automotive, and electrical industries.

\* \* \*

**WIRE RECORDING CORPORATION OF AMERICA** has recently been incorporated to take over the assets and manufacturing facilities of *St. George Recording Equipment Company* of New York City.

J. J. Sullivan heads the newly formed corporation which will consolidate the various manufacturing facilities of the *St. George Company* as well as sales offices in the company's new plant at 1331 Halsey Street, Brooklyn, New York.

The new company has completed plans for the manufacture and distribution of the "Wireway" wire recorder, a unit which will be available in both portable and cabinet models. Robert J. Marshall as chief engineer of the company is responsible for many of the developments which will be incorporated in the new unit.

Other officers of the new company include George F. Ryan, vice-president in charge of sales; Edward C. Gates, vice-president; and David Kestbaum, secretary-treasurer. Advertising and sales promotion will be under the direction of Ab Waxman.

\* \* \*

**KENNETH C. PRINCE**, Executive Secretary of the Association of Electronic Parts & Equipment Manufacturers and General Manager and legal counsel for Radio Parts and Electronic Equipment Shows, Inc., has announced the formation of a law partnership with his associate, Samuel Shoenberg.

The new firm, which will be known as *Prince and Schoenberg*, has offices in Suite 1016, 33 North LaSalle Street, Chicago, Illinois.

\* \* \*

**ALEXANDER WELLINGTON** heads the new *Air King Distributors Corp.* which will act as exclusive jobbers for the *Air King* line of home receivers in the New York metropolitan area.



Long associated with the industry, Mr. Wellington was most recently head of *Fada of New York*. He also traveled the entire country for *Fada Radio & Electric Co.* Prior to that he was merchandise

That servicemen are interested in television was demonstrated recently when 520 radio technicians from the Philadelphia area turned out for a video meeting sponsored by the Radio Electric Service Company of Penna. at their headquarters at 7th and Arch Streets, Philadelphia. The overflow audience heard John Meagher of Radio Corporation of America discuss the servicing of home television receivers.



RADIO NEWS

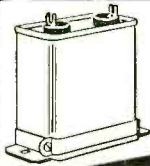

**FILTER CONDENSERS**  
3 MFD. x 400 VAC. Good for about  
1500 VDC. Metal can.  
Shpg. Wt. 3 lbs. .... **ONLY 98c**

GET YOUR FREE COPY OF  
OUR NEW 1948 CATALOG

**HV BY-PASS CONDENSER**

.002 x 3000 VDC. Bakelite  
case. Shpg. Wt. 1/2 lb. .... **ONLY 59c**

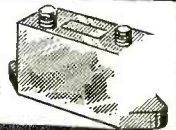

# SMASH! BARGAINS

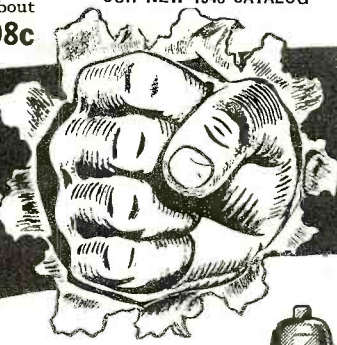

# IN SURPLUS EQUIPMENT

**ARMY  
SURPLUS  
HEADPHONES**

**HS23A**

HS23A—Used but in A-1 electrical condition  
8000 ohms impedance. Complete with leather headband  
and rubber cushions. Shpg. Wt. 3 lbs. .... **ONLY 98c**

HS-16A—Brand new. 2000 ohms impedance.  
Canvas web headband and long  
cord. Shpg. Wt. 3 lbs. .... **\$1.47**



**SURPLUS FILAMENT TRANSFORMER**

12 or 24 VAC secondary for operating any one unit  
of the SCR-274-N Type equipment such as the  
BC-459-A, BC-696-A, BC-454-A and BC-455-A,  
or any similar unit. Pri. 115/230 VAC  
60 cy. Metal Case. Shpg. Wt. 5 lbs. .... **ONLY \$1.47**

**SURPLUS SPARE TUBE KIT**

Complete set of spare tubes for BC-459-A or  
similar unit. Consists of 1—1626, 2—1625 and  
1—1629. Brand new in original boxes.  
Shpg. Wt. 2 lbs. .... **ONLY 98c**

**SEL SYN MOTORS**

No. 806—Navy surplus. Heavy  
brass case. Large continuous duty  
type. 115 VAC, 60 cy.  
Shpg. Wt. 25 lbs. .... **Per Pair Only \$12.50**

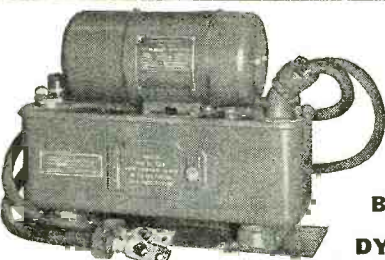

**Brand New  
PE-103  
DYNAMOTOR**

Brand new PE-103 Dynamotor. Will deliver 500 VDC at  
160 MA with either 6 or 12 VDC input. Complete with  
overload circuits; filter and connecting cable.  
In original overseas shipping crate. Shpg. Wt. 81 lbs. .... **ONLY \$9.95**  
Output plug for above: Cannon P8-CG-12S.  
Shpg. Wt. 1/2 lb. .... **ONLY 95c**

W0JWD W0WTM W0PGI W0ULH  
W9NRF W0QDF W0IYD

Remember . . . your Trade-In's  
worth more at the Walter Ashe  
Store! So get Walter Ashe's offer  
before you make that trade.

**MAIL  
COUPON  
TODAY**

**ALL PRICES  
F. O. B. ST. LOUIS**

All the Big Name  
Brands of Receivers,  
Transmitters  
and Test  
Equipment in Stock . . .  
Ready for immediate  
Delivery.  
**CHestnut 1125**

**TIME PAYMENTS AVAILABLE**

Use this coupon to get Walter Ashe's "Surprise" Trade-in  
Allowance on your used factory-built test equipment. R.N3

**WALTER ASHE RADIO CO.**  
1125 Pine St., St. Louis 1, Missouri

Am interested in the following top condition, slightly used Test  
Equipment \_\_\_\_\_ (list preference)

I want to trade \_\_\_\_\_ (describe used equipment)

for \_\_\_\_\_  
(show make, model of new Receiver desired or other equipment)

Rush my FREE COPY of the big, New 1948 Walter Ashe  
Catalog.

NAME \_\_\_\_\_

ADDRESS \_\_\_\_\_

CITY \_\_\_\_\_ ZONE \_\_\_\_\_ STATE \_\_\_\_\_

**PLATE TRANSFORMER**

No. 8931—1200/1400  
VCT x 260 MA. PRI. 115 VAC 60 cy.  
Shipping Wt. 13 lbs. .... **ONLY \$7.95**



No. 4891 — 1200/1400  
VCT x 200 MA. PRI. 115  
VAC 60 cy. Shpg. Wt.  
18 lbs. .... **ONLY \$7.45**

**FILAMENT TRANSFORMERS**

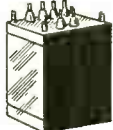

Dual 5 Volt x 5.25  
amps per section. Shpg.  
Wt. 8 lbs. PRI. 115  
VAC, 60 cy. .... **ONLY \$1.95**

**MODULATION TRANSFORMERS**

RCA 1 KW Modulation Transformer. Primary  
will match tubes up to 10,000 ohms plate to  
plate. Secondary  
No. 1. 450 MA.  
Secondary No. 2,  
80 MA for beam,  
tube, screen  
grids. Shpg. Wt.  
55 lbs. .... **ONLY \$14.95**

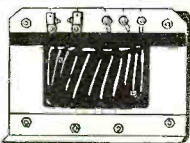

30 Watt. Primary 5000  
ohms CT. Secondary,  
1750/2000/2250. Com-  
mon B plus. Shpg. Wt.  
6 lbs. .... **ONLY \$2.00**

**Walter Ashe  
RADIO CO.**  
1125 PINE ST. • ST. LOUIS 1, MO.

# ACORN ELECTRONICS

Presents

## 10 STATION INTER-COMM

- 16 Watt Push-Pull Output.
- Standard 3 wire control system.
- Operates on 110 volt 60 cycle AC.

Price includes all tubes and 3 metal-housed sub-stations as shown. Complete instruction sheets included.

**\$79<sup>50</sup>**

BRAND NEW



## UNIVERSAL POWER TRANSFORMER

- Primary 115 or 230 volts, 60 cycles.
- Secondary
  - #1. 350-0-350 volts at 125 ma.
  - #2. 6.3 volts at 4 amps.
  - #3. 5.0 volts at 3 amps.
- Hermetically sealed.
- Size 5 1/4" H x 3 1/2" D x 4 1/2" W.
- Mounting Centers 3" x 2 7/8".
- Made for Signal Corps by Amertran.

**\$295**

BRAND NEW

## CHOKE

8 hy @ 160 ma., 135 ohms. Channel Mount. Suitable for use with universal power transformer.

**\$119**

BRAND NEW

5 for \$5.00

## RELAYS

- Pole Double Throw Clare Telephone Relay. 115VAC .....\$3.95
- Pole Double Throw Allied Relay. Type 80. 115VAC ..... 1.75
- Pole Single Throw Leach Relay. Type 1154. 115VAC ..... 1.50
- Single Pole Double Throw GE Relay. 180 ohm, 24VDC ..... .35
- ..... 3 for 1.00



## SHURE CARBON MICROPHONE

T-17-B hand mike. Single button carbon with press-to-talk switch, 5 foot rubber cord and PL68 plug. Original packing.

**79c**

each

BRAND NEW 3 for \$2.25

JK33A Jack for PL68 Plug 15c each.

## ROTARY SWITCHES

- 1 pole 12 positions. 1 bank. Non-shorting, ceramic, 1/2" shaft.....\$0.39
- 1 pole 6 positions. 1 bank. Shorting, ceramic, 5/8" shaft ..... .39
- 2 pole 3 positions. 1 bank. Non-shorting, ceramic, 3/8" shaft ..... .39
- 6 pole 3 positions. 1 bank. Non-shorting, wafer, 3/8" shaft ..... .39
- 8 pole 2 positions. 2 banks. Shorting, wafer, 3/8" shaft ..... .49

## CONDENSERS

HIGH VOLTAGE OILS		TRANSMITTING MICAS	
4 MFD 600v	\$.045	.002	5000 DC Test Volts
10 MFD 600v	\$.89	.0035	
4 MFD 1000v	\$.89	.0043	<b>49c</b> EACH
15 MFD 1000v	1.89	.0047	
.25 MFD 3000v	1.29	.005	10 for \$4.50
.1 x .1 MFD 7000v	2.29	.0002	
.1 MFD 7500v	1.79	.0005	

Brand New. Standard Nationally Advertised Makes

**ACORN ELECTRONICS CORP.**  
80 Vesey St. New York 7, N. Y.

TERMS. 20% cash with order. Balance C.O.D. All prices F.O.B. our warehouse in New York City. No orders under \$2.50

manager for a retail chain of 44 stores in the East and Middle West.

Offices and showrooms of *Air King Distributors Corp.* are located at 5302 2nd Avenue, Brooklyn, New York, from which headquarters the company will service the entire New York metropolitan area including the boroughs of Manhattan, Bronx, Brooklyn, Long Island, and Westchester.

\* \* \*

**KENNETH KENYON** has been named to the post of General Service Manager of *Philco Corporation*.

Joining *Philco* in August, 1942 as an instructor in the airborne radar school operated by the company for the Army and Navy, Mr. Kenyon was later assigned to a group of radio-radar field engineers for the Navy and served in the European and Atlantic theaters. In August, 1945, he was named television service manager for *Philco* and several months later was also placed in charge of the company's contact field service organization, including up to 535 field engineers assigned to Army, Navy, and Air Forces bases throughout the world.

In his new position as General Service Manager, Mr. Kenyon will coordinate the work of the radio and television, refrigerator and freezer, air conditioner and other departments of the *Philco Service Division*.

\* \* \*

**ALAN P. SCHREIBER** has been appointed to the sales staff of *Tracerlab, Inc.* of Boston.

In his new position, Mr. Schreiber will be in charge of sales contacts with the chemical industry for new equipment, processed radioisotopes, and for development of industrial uses for radioactivity. He will also act as Editor of "Tracerlog," the monthly technical publication of the company.

Mr. Schreiber was previously associated with the Manhattan Project at Oak Ridge as Technical Advisor on patent matters and prior to that he worked with the Chemical Bureau, War Production Board, Washington, D. C.

\* \* \*

**GILBERT C. LARSON** has been appointed chief engineer of the *Home Radio Division* of *Westinghouse Electric Corporation*, Sunbury, Pennsylvania.

A veteran of 15 years in the radio industry, Mr. Larson will be in charge of all engineering for the company's extensive line of home receivers, including FM and television units. Prior to accepting his new position, Mr. Larson was an engineering executive with *Hazeltine Electronic Corporation*.

Upon his graduation from the University of Washington with an electrical engineering degree, Mr. Larson joined the *Buckley Radio Company* in Seattle as an engineer. He held a similar post with *Colonial Radio Cor-*



## SENSATIONAL SELLER!



## LAKE DELUXE CHANGER

Revolutionizes the Industry!

A Sensational Seller!

### 11 Outstanding Features:

- Positive Intermix
- Service Adjustments Eliminated
- Minimizes Record Wear
- Single Knob Control
- Plays ALL Records
- Pick-up arm may be grasped at any time and changer will not be thrown out of adjustment
- Resonance-free ball bearing tone arm
- Easily operated—any child can do it
- Completely Jam-proof
- Records Gently Lowered on Spindle—not dropped
- Automatic Shut-off on last record

Dimensions: 13 1/2" W x 12 1/4" D x 7 3/8" H.

No. 116A..... YOUR NET **\$28.73**

FREE

DEALERS and SERVICEMEN: Write for our NEW 16-page 1948 illustrated catalog on radio parts, tubes, accessories, cabinets, sets, electrical appliances, etc. Get on our mailing list today!

**Lake Radio Sales Co.**

615 W. Randolph Street

DEPT. A

Chicago 6, Ill.

## RADIO TUBES

For immediate shipment

R.M.A. Guaranteed

Below Distributor Costs

Individually Sealed Cartons

Type	Price
6K6GT	.40
6K5GT	.46
6V6GT	.46
6SA7GT	.46
6SJ7GT	.46
6SK7GT	.46
6SQ7GT	.46
6X5GT	.40
12SA7GT	.46
12SQ7GT	.46
12SK7GT	.46
12SJ7GT	.46
35L6GT	.40
35Z5GT	.32
50L6GT	.46

RATED ACCOUNTS—2% 10 DAYS

ALL OTHERS 2% C.O.D.

10% DISCOUNT ON LOTS OF 50 OR MORE

**RAVAC ELECTRONICS CORP.**

432—4th Avenue

New York 16, N.Y.

poration, and resigned as engineer-in-charge of the *Colonial Production Laboratory* to join *Hazeltine* in 1941. He is a senior member of the IRE.

\* \* \*

**ROLAND D. PAYNE** who recently conducted a series of 33 meetings for the company at metropolitan centers covering the servicing of FM radio sets, has been appointed to the important post of Sales Manager of service test equipment for the *Specialty Division* of the *General Electric Company*.



In his new capacity he will be in charge of the sale of the division's line of radio test equipment for the serviceman and other users.

Prior to his present appointment Mr. Payne worked in the service test equipment sales section. He recently returned from a 10,000 mile, three-month tour of the country during which trip he conducted the service meetings.

Mr. Payne joined *General Electric* in April, 1945 and was assigned to the Philadelphia office of the company as district representative in charge of sales for the *Tube* and *Specialty Divisions*. He was formerly sales manager of *Danforth Company* of Pittsburgh and also managed a manufacturers' agency there for twelve years.

\* \* \*

**WILLIAM O. SPINK** has been named field engineer for the *Radio Division* of *Sylvania Electric Products Inc.* according to word received from the company recently.

Mr. Spink, who will cover the Michigan, Ohio, and Indiana territories, will report to Philip Pritchard in the *Radio Division's* Cleveland office in the Union Commerce Building. He will replace D. W. Gunn who has been transferred to the New York office where he will serve as special sales representative for the company's *Radio Division*.

-50-

The Federation of Radio Servicemen's Associations of Pennsylvania recently awarded a plaque to Howard W. Sams "in recognition of his outstanding efforts in behalf of the radio service industry." The scene of the presentation was the FRSAP's convention dinner.



March, 1948

# MEMO to:

DESIGN ENGINEERS

NO MULTIPLIER STAGES NEEDED  
 FOR CRYSTAL CONTROL DIRECTLY  
 AT FREQUENCIES UP TO 100 MC.  
 SPECIFY BLILEY FOR ACCURACY,  
 STABILITY, QUALITY, AND AD-  
 VANCE DESIGN.

*Catalog 36 describes  
 crystal units now in  
 production for commercial  
 and governmental  
 applications*

# Bliley CRYSTALS

BLILEY ELECTRIC COMPANY UNION STATION BUILDING • ERIE, PENNSYLVANIA

for **QUALITY**  
of **Reproduction...**  
**TAPETONE**  
is **TOPS!**

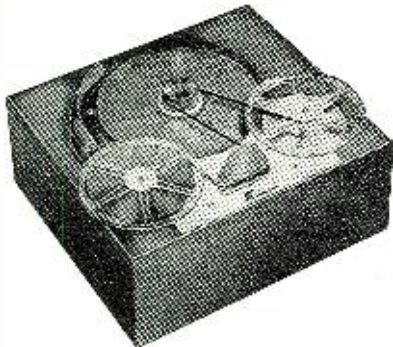

**TAPETONE MAGNETIC TAPE RECORDING KIT**

- For the Home • For Office • For Studio Experimenters, Set-Builders, Hams, Radio Engineers are all enthusiastic about the newly developed TAPETONE Magnetic Tape Recorder. These features tell you why:
- It records voice and music on tape, with quality of reproduction BETTER than that of the best platter records commercially available today!
- It plays up to 12" platter records, and reproduces from the records on to the tape.
- It records your radio reception on tape, up to 30 minutes playing time on one standard 8mm spool.

**THE RECORDING-PLAYBACK MECHANISM**

Comprises Heavy Duty GENERAL INDUSTRIES RM4 Recording type motor, rubber floated and turntable, for 115 Volt 60 cycle AC; Crystal Pickup with permanent stylus and reproducer arm. Complete tape drive mechanism of exclusive TAPETONE design, with separate heads for erase and playback recording, all high-precision tooled, with bronze bearings throughout for marvelously smooth, quiet operation. Lever has recording-playback, rewind, and neutral positions. Recording tape is simple to thread, and can be edited more easily than home movie film simply because it's a coated paper tape.

**THE EQUALIZED AMPLIFIER**

This specially designed 6-tube recording and playback amplifier is equipped with a newly engineered exciter circuit for maximum efficiency of operation with tape recorder described above. It has high impedance microphone, and phono-radio inputs, with separate gain controls on mike and phono-radio, permitting mixing. Radio input connects across any speaker voice coil. Amplifier output connects to 4 or 8 ohm speaker. Output level indicator included. For 115 Volt 60 cycle AC.

**COMPLETE TAPETONE MAGNETIC TAPE RECORDING KIT**

Includes—Recording-playback mechanism as described above, in component form, complete with drilled mounting board; easily and quickly assembled.  
Amplifier Kit with all components, including tubes and drilled chassis, all wire, connectors, plugs, cables supplied, nothing else needed; easy-to-follow diagrams are included, NO SPECIAL KNOWLEDGE REQUIRED, to construct this exceptionally fine amplifier.  
One 1/2 hour roll (1225 ft.) of the New SCOTCH HIGH FIDELITY MAGNETIC RECORDING TAPE.  
Complete Kit, as described, your net cost Shipped Express Collect. Shpg. wt. 30 lbs. If C.O.D. please include \$98.50  
20% Deposit with order.

**OPTIONAL ACCESSORIES**

- Crystal Desk Mike with removable base and 7 ft. of cable . . . . . List \$12.20
- 8-Inch Heavy Duty P.M. Speaker . . . . . List 8.85
- Additional 1/2 hour rolls Scotch Recording Tape, per roll . . . . . \$3.06

**TAPETONE MANUFACTURING CORP.**  
37-06 36th Street, Long Island City 1, N.Y.  
Phone: 5Tillwell 4-8380

**Converting BC-696-A**

(Continued from page 59)

means of  $K_{53}$ , and positive high-voltage keying, it was finally decided that keying the "B-minus" provided the best signal with the utmost safety; furthermore, it allowed the insertion of an effective click filter in the keying circuit.

Incidentally, it was found that regulation of the oscillator plate voltage alone or in conjunction with regulation of the final screen voltage resulted in a decided chirp. In addition, it was found that reducing the plate voltage of the oscillator from 190 to the 150 volts with the VR tube resulted in a noticeable reduction in drive to the final. This does not matter except when it is desired to get the maximum power from the final.

Various methods can be used to couple to the antenna. If a doublet is used, the variable inductance can be reduced to minimum and the variable link can be coupled directly to the coax, twin-lead, etc. For lengths up to thirty or forty feet, the antenna can simply be attached to the antenna post and a good ground attached to the case. Lengths to around seventy feet can be matched by placing a variable condenser of some 50  $\mu\text{mfd.}$  between the antenna post and the antenna and adjusting the variable inductance. For feeding a half-wave antenna directly on the end, a link can be run from the antenna post and chassis to a secondary tank circuit tuned to the frequency and with the end of the antenna attached to this tank circuit.

Any modulator supplying around twenty to twenty-five watts of audio

may be used. A pair of 6L6's in Class AB<sub>1</sub> will serve admirably. The secondary of the modulation transformer is attached to a cable terminating in a plug for insertion in  $J_1$  of the power supply.

I find that 100 mils. on phone and 150 mils. on c.w. are good inputs to use. This represents 50 and 75 watts respectively. At 100 mils., the modulation transformer is working into a 5000 ohm load.

Advantages of using the combination power-supply and control box are twofold: First, such a method requires a minimum of changes in the transmitter proper, and this is important in a fine piece of frequency-calibrated equipment such as the BC-696-A. Second, others may like to do as the author has done and buy a BC-459-A and equip it with a similar cable. Either transmitter can then be used by simply plugging it into the power supply; and there is no needless duplication of equipment.

This transmitter was put on 75-meter phone at the author's central Indiana location at nine o'clock in the evening, and within thirty minutes QSO's were had with a W1, a W8, and a W9. All reports were of excellent quality, good clean modulation, and S-meter readings of better than 9.

The modulator plug was then pulled out and the key plugged in. The frequency was adjusted to the 80-meter c.w. band. Within an hour the second, third, and fifth districts were worked. The weakest strength was S7, and all tone reports were T9X. Time and again the author has been politely called a liar for saying he was running only fifty watts to a BC-696-A.

The author would like to point out that the ARC-5, T-18 to T-22, trans-

Fig. 5. Schematic diagram for building power supply and control unit.

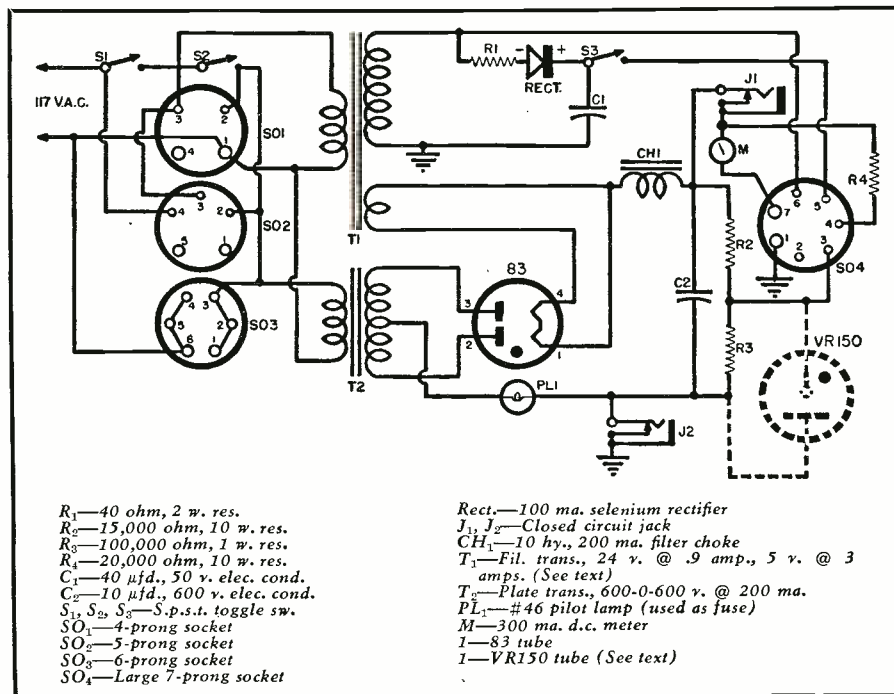



# C-1 AUTO PILOT

Complete with one each unit shown "In Box" below. Any experimenter or boat owner cannot be without this equipment which cost the Government thousands of dollars but offered you at the small price of.....

**\$3000**

## C-1 AUTO PILOT CONTROL BOX



Used for aligning control of C-1 Auto Pilot or use for parts, etc. Contains many useful pots, toggle switches, plugs, etc. Size, 11" x 6" x 4 1/2".

PRICE **\$375**

## C-1 AUTO PILOT COMPONENTS

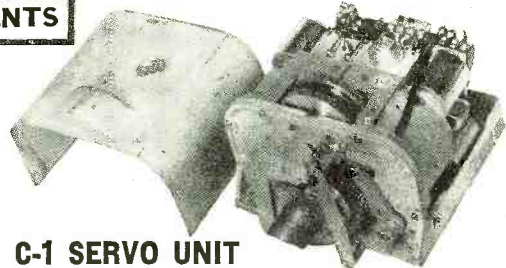
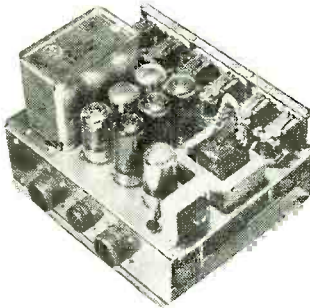

## C-1 SERVO UNIT

Use to rotate beam antenna, actuate boat rudder control, etc. Contains 24 V. motor, clutch, relays, etc. Reversible. Size overall approx. 10 1/2" x 8 1/2" x 6 1/2".

PRICE **\$1250**

## C-1 AUTO PILOT AMPLIFIER

Used to control operation of servo unit in response to signals received from gyro unit and control unit. The complete amplifier includes one rect. 7Y4, 3—7F7's for amplification and control, 3—7N7's for signal discrimination, 1 power transformer, 6 relays, 4 control pots, chokes, condensers, etc. Convert for use on radio controlled models, doors, etc. Operates from 24 V. DC. Size, 9 1/4" x 6 1/4" x 7 3/4". Complete

PRICE **\$695**

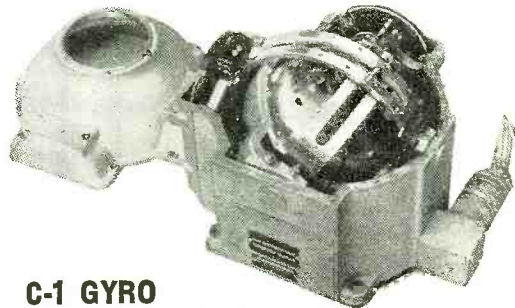

## C-1 GYRO

Part of the C-1 Auto Pilot which is sold separate and may be used to conduct many interesting and amusing experiments. Operates from 24 V. DC or may be operated for short periods on 110 V. AC. Gyro will run for approx. 15 minutes after actuating. Size—approx. 8" x 8 1/2" x 8 1/2".

PRICE **\$895**

## BEAM ROTATING MOTORS

Motor Completely Converted

PRICE **\$1795**

Used to rotate your beam antenna

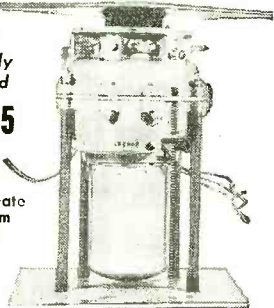

Motor Only 24-28 V.

PRICE **\$995**

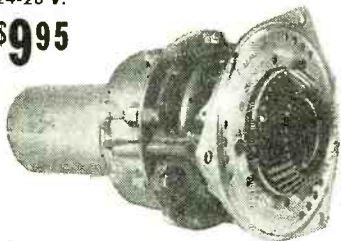

Transformer to operate 110 V.-30 V. (New) 4.95

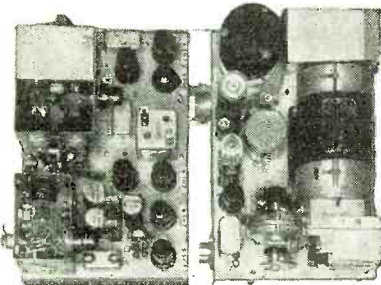

## BC-966-A IFF

Approximately 2 meter frequency operation. 14 tubes, 350 V. DC dynamotor, 12 V. DC input. Contains voltage regulators and many other fine parts. Worth more for parts than price asked....

PRICE **\$475**

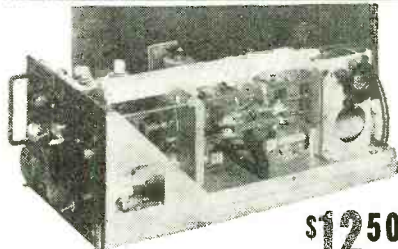

PRICE **\$1250**

## T/39/APO-9 RADAR XMITTER

Contains many excellent parts for the VHF experimenter such as a cavity oscillator using 2—RCA 8012 tubes rated at full output to 500 Mc. Tubes are forced air cooled by 24 V. DC motor, which is easily converted for 110 V. AC operation. Other valuable parts such as a pair of 807's, 2—6AC7, 1—931 and 1—6AG7 tubes; ceramic switch, potentiometers, gears, revolution counter, etc.

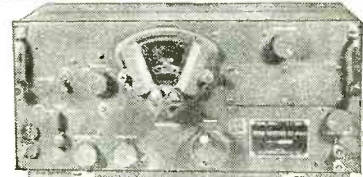

## BC-348 COMMUNICATIONS RECEIVER

PRICE **\$69.50**

6 bands, 200-500 Kc. and 1.5-18 Mc. 2 stages RF, 3 stages IF, BFO, crystal filter, manual or AVC. Complete with tubes and 24 V. dynamotor. These receivers have been thoroughly checked in our work-shop and found in excellent condition.

BC-348, 110 V. AC power supply, including simple conversion instructions. Complete with tubes.

PRICE **\$895**

## TRANSMITTER RU-19

With plug-in coils not included cover a frequency range of 3000-4525 and 6000-9050 Kc. Contains 4 tubes. Size, 6 1/2" x 6 1/2" x 11".

PRICE **\$500**

## RECEIVER RU-19

With plug-in coils not included cover a frequency range of 195-13,575 Kc. Contains 6 tubes. Size, 6 1/2" x 6 1/2" x 15".

PRICE **\$500**



**ESSE Radio Co**  
40-42 W. SOUTH STREET  
INDIANAPOLIS 4, IND.

Unless Otherwise Stated, All of This Equipment Is Sold As Used  
**CASH REQUIRED WITH ALL ORDERS**  
Orders Shipped F.O.B. Collect

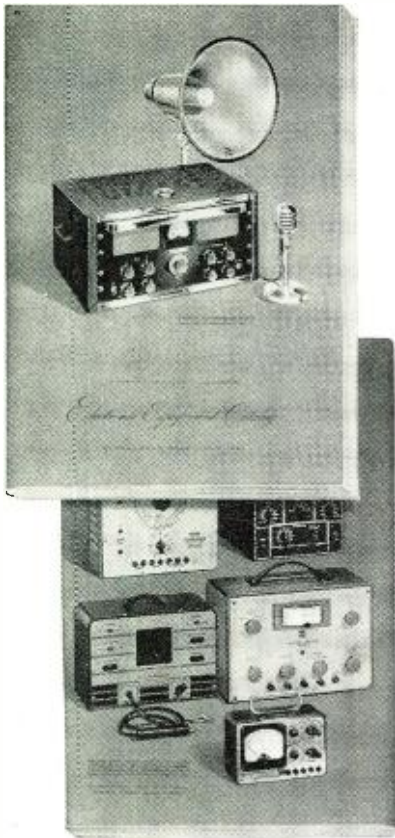

Radio Servicemen

## FREE CATALOG

Wards 1948

Electronic Equipment Catalog

Contains nationally-known set testers, analyzers, tube testers, oscilloscopes, signal generators, volt-ohm milliammeters, etc., all available on Wards Convenient Monthly Payment Plan. This new issue of the Electronic Equipment Catalog also features Amateur transmitting and receiving equipment plus a complete line of Wards Airline Sound Systems. Use Coupon below.

Mar. 48  
Mail this coupon to  
MONTGOMERY WARD, Chicago, Ill.  
Please send your free 1948 Edition of Wards  
Electronic Equipment Catalog.

Name \_\_\_\_\_  
(Please PRINT Plainly)

Address \_\_\_\_\_

City \_\_\_\_\_ State \_\_\_\_\_

mitters are not, as some think, identical with the 274-N transmitters. The ARC-5 is plate and screen modulated by a pair of 1625's in push-pull, driven straight out of a carbon-button mike transformer. The modulation transformer has separate plate and screen windings. The tank circuit of the final of the ARC-5 unit is parallel-fed instead of being series-fed, as is the BC-696-A. The input-socket connections of the ARC-5 unit are different from those of the BC-696-A. However, the numbering of

parts used in both transmitters is identical; i.e., "R<sub>n</sub>" in a BC-696-A has the same value and is used in the same place as "R<sub>n</sub>" in an ARC-5. Values peculiar to either carry a number not used in the other.

In conclusion, the author wishes to acknowledge his deep indebtedness to W9RJU, W9BRY, W9EGQ, W8EQ, and W8HB for their many suggestions and valuable bits of information in connection with the converting of this transmitter.

-50-

### THREE-ELEMENT ROTARY BEAM FOR LESS THAN \$5.00

By W. E. WHEAT, W5LYD

**T**HERE is so much controversy over how many elements a 10-meter beam should have that the writer will say nothing on the subject. The same applies to the method of feeding the driven element, suit your own tastes, use any of the standard formulas and put on as many elements as you like. You can use five elements close or wide spaced and still have a strong, light, economical efficient beam. In the drawing you will see a three-element array which was conceived and constructed at the home QTH and with this little beam on the end of my single 807 and its 60 watts I have had phenomenal success with DX, groundwave, and W contacts. The total cost of the entire array, including the rotating mechanism was less than \$5.00.

There is nothing complicated about the construction as can be seen from the drawing.

The tower or mast used in the installation was simply a piece of 8x8" cypress 16' in height. This height was selected because it would enable us to stand on the roof of the shack and work on the beam.

The boom is a cypress 2x4" with holes drilled to fit the bamboo poles. When the large end of the poles are passed through these holes about 12" they can be lashed as shown. In the event the bamboo poles are not available, any light wood strip 3/4"x3/4" about 16 1/2" long will do just as well. Right here it should be remembered that whichever type is used the poles should be attached to the beam at the exact spacing necessary

for the particular type beam to be constructed, and the insulator mounted immediately above. Next the insulators are fastened to the ends of the poles. The elements are then cut to the desired length and all pass through the eye of the insulator mounted on the boom, where they are anchored at their exact center. Next attach an 8 inch metal pulley, as shown, on the bottom of the boom at the point where the weight will be balanced. A 40-penny nail was then driven through the boom so it would pass through the hole in the center of the pulley and go down into the 8x8" far enough to hold the array steady but not tight. A rope was then put around the pulley and brought down over two bracketed pulleys mounted at right angles to the 8" pulley on the face of the 8x8". These ropes rotate the beam adequately, however, small flexible wire would do better since it would not require tightening after installation.

All the elements for the three-element array can be made from the 50' roll of aluminum clothes line wire now being sold in most grocery and hardware stores.

The insulators used on the ends of the poles were 6" Johnson Spreaders. The center insulators or anchor insulators were 1 1/2" brown porcelain with 1 1/2" screw base.

Another bamboo pole can be lashed along the ends of the beam giving it added strength so that strong winds will not affect the element spacing.

-50-

Assembly details of 3-element, 10-meter antenna.

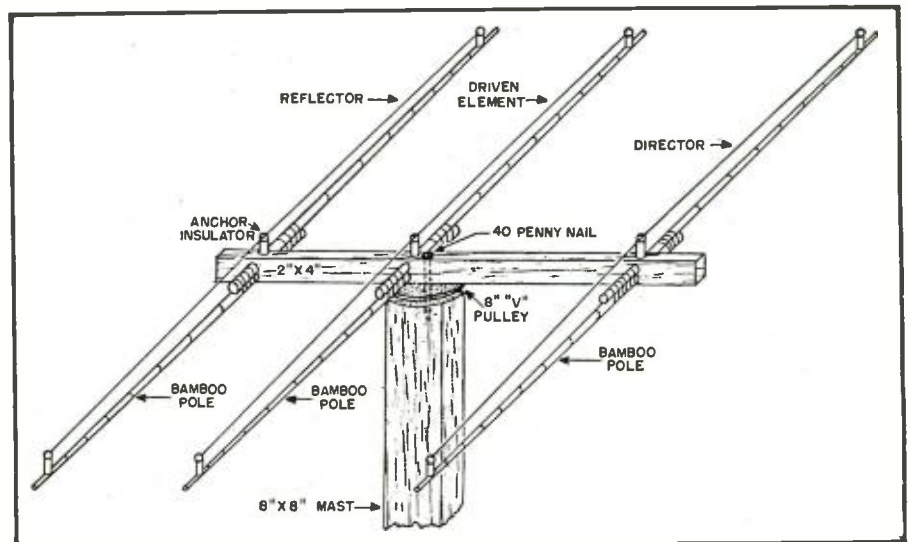

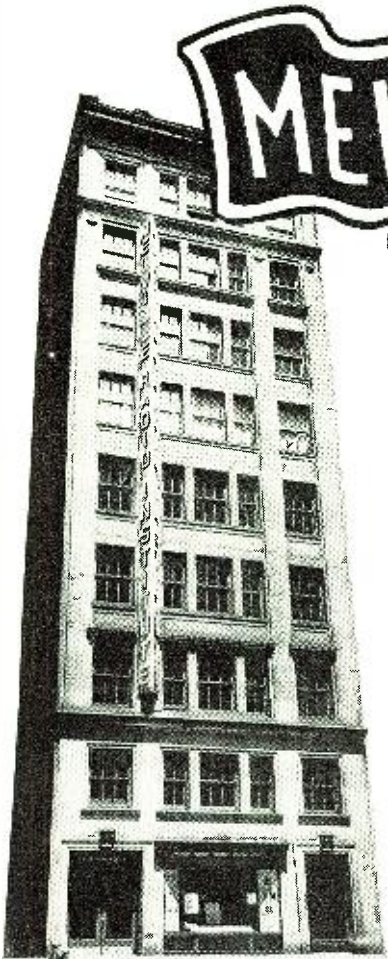

# R D O N S U E

## Outstanding PRE-WAR Technical Training Center for

# TELEVISION & RADIO

Under the personal direction of Frank Melville, former Airlines, Merchant Marine, and Broadcast technician, you may soon qualify as:

- RADIO TECHNICIAN
- AIRLINES RADIO OFFICER
- PT. TO PT. TELEGRAPHER
- RADIO AMATEUR
- MERCHANT-MARINE RADIO OFFICER
- TELEVISION TECHNICIAN
- HOME RECEIVER REPAIRMAN
- VISUAL TELEGRAPH OPR. (SLIP TAPE)

MELVILLE RADIO INSTITUTE believes vocational training means vocational training. Thus we, like many radio schools, teach ample theory. But, unlike most schools, two-thirds of our technical students' time is spent in laboratories and shops, where, with superior equipment, they learn by doing — not memorizing.

FREE employment service is available to all MELVILLE graduates.

Visit the 10-story MELVILLE Building today as our guest and observe the school in operation.

Day and evening classes approved for veterans. Licensed by the State of New York.

**MELVILLE RADIO INSTITUTE**  
Melville Building  
15 West 46th St., N. Y. 19      LO 4-0340

### MAIL THIS COUPON NOW!

MELVILLE RADIO INSTITUTE      R.N.  
Melville Building  
15 West 46th St., New York 19, N. Y.

Gentlemen: Send me Free information about your school.

Name.....  
Address.....

### BRAND NEW 5" SCOPE—BC-1266

Suitable for TV or Service Scope conversion; and I-221-A Indicator panel for rotating beams or TV arrays. Scope is a neat 15-Tube 110V 60-Cycle job, using a 5CP1 CRT and a 2X2 HV Rectifier. All power supplies self-contained except for 300V "B" voltage required for amplifiers. The indicator has a rack mount front with 3 breakers, pilots, and a removable Selsyn Unit with a glass protected illuminated dial. In addition, this Unit utilizes a 100 TH output tube and 6400V transformer to operate an external 100V AC motor. Also 8 additional tubes and assorted HV cords, relay, transformers, chokes, etc. Both units comp. w/24 tubes and schematics, in original export packed crate, for.....\$52.95

### SCR-522 VHF TRANSCEIVER

100 to 156 MC. Makes a fine economical 2-meter rig, taxicab radio, aircraft set, etc. Comp. w/17 tubes. Excellent condition.....\$22.95

### BC-375 100-WATT TRANSMITTER

For A1, A2 and A3 emission, useable from 200 Kc to 20 mc. Uses 4—211's and 1 type 10 tube. Plate, Fil and RF Meters. Antenna matching network. Comp. w/tubes, one tuning unit, wired for 24V operation.....\$18.95  
BC-191—Same as above, except wired for 12V operation.....\$19.95

### PORTABLE BURIED METAL LOCATOR

SCR-625 Army Mine Detector, will detect small amounts of any type of metal buried several feet underground. Easy to operate; both sound and meter indicators. Uses flat round light disk with 6' handle and small battery operated amplifier. Tested before shipment.....\$49.95

### EE-8 FIELD PHONES

Small portable 2-wire telephone. Generator, bell handset, etc. Excellent for farms, contractors, mines, etc. Requires only 2 flashlight batteries. Tested before shipment. Each \$8.95.....Pair \$15.95

### HANDSET TS-13

200-ohm carbon mike and 2500-ohm earphone with butterfly switch. Has 6-ft. rubber covered cord with PL 55 and PL 68 plugs.....\$2.95

### GIBSON GIRL TRANSMITTER

SCR-578, Emergency Transmitter, comp.....Each \$24.75

## GOVERNMENT SURPLUS

### WE HAVE A POWER PLANT THAT'S HOT STUFF!

Brand new! 9.4 KVA, gasoline engine power plant. Army PE-182. 115V, 230V, 440V, single or 3-phase, 60-cycle. Mounted on sturdy steel skid. Export packed, with spare parts and tools. Photo and more info upon request. Regularly \$1800.....Our Price \$699.00

### TYPEWRITERS

Standard, L. C. Smith, Remington, Underwood, 10, 11, 14 and 20" carriages, Pica and elite type. Standard and Signal Corps Keyboard. Reconditioned. Excellent. Satisfaction guaranteed.....\$59.50

### SPECIAL \$25.00 GOVERNMENT RADIO SURPLUS ASSORTMENT

Very suitable for Universities, Schools, Radio Shops and HAM'S. If you cannot get to the Government Sales of War Surplus Radio Equipment the next best thing to do is to buy our SPECIAL \$25.00 GOVERNMENT RADIO SURPLUS ASSORTMENT.

We buy large quantities of these items all over the country, divide those items we don't have in large quantities into choice assortments, for which we know you would gladly pay \$25.00 if you could see them.

On a deposit of \$5.00 we will ship you COD (balance \$20.00) freight collect, a large quantity of Government Surplus Radio Items subject to your inspection. If, after inspection you are not more than satisfied, return to us, freight collect and all it will have cost you will be freight charges one way. We will then refund your initial payment of \$5.00.

You should be able to dispose of a few of the items that you may not need for the entire cost.

### \$2.00 Minimum—PLEASE!

### PRICES SUBJECT TO CHANGE!

MAY WE SEND YOU ONE OF OUR FLYERS ON RADIO & ELECTRONIC EQUIPMENT, XFORMERS, PHOTOGRAPHIC SUPPLIES AND EQUIPMENT—TELL US YOUR WANTS!

**THE ABELL DISTRIBUTING CO.**  
7 E. Biddle St., Baltimore 2, Maryland

### BC-221 FREQUENCY METER

A heterodyne frequency meter comp. w/tubes, crystal, calibration chart. Range is 125KC to 20 MC. Can be used with 110 volts AC power pack, batteries or vibratorpack. Makes a fine signal generator or converts to VFO. These are slightly used. Tested before shipment.....\$37.75

### THE BEST ANTENNA MOUNT

We have ever seen. Rotating Ball-Bearing Head. Takes 2" OD shaft that can be clamped. Stands 11' high on 3 supports made of 2 sections of 2" phenolic tubing. Does not need guying or RF isolation.....\$14.95

### ELECTRIC MOTORS, 110V, 60 CYCLE

1/20 HP, GE Capacitor Start, 2800 RPM.....\$12.95  
1/20 HP, GE Capacitor Start, 1725 RPM.....12.95  
1/4 HP, Jack & Heintz, Capacitor Start, 1725 RPM 19.60  
1/3 HP, Jack & Heintz, Capacitor Start, 1725 RPM 27.20

### 1 1/4" ANTENNA MAST SECTIONS

5' long, with 6" extension. Can be nested to any length desired. Light alloy. Strong.....Each \$1.95

### 24' WHIP ANTENNA

Screw in 3' sections with insulated mount.....\$9.95

### 110V 1/4-WATT NEON LAMPS

Bayonet Base, T 4 1/2 bulb.....\$10 for 1.20  
Candelabra Base, T 4 1/2 bulb.....10 for 1.90

### INSULATED 90' MAST FOOTING

Lapp compression insulator with spark gap. Used by the Army to support and insulate their 90' metal towers. 15" of glazed porcelain, insulating surface, protected from snow by galvanized steel hood. 16" H. x 14" max. D.....\$44.95

### MISCELLANEOUS

Safety belt, with strap. State belt size.....\$5.75  
Lineman's Pole climbers.....4.50  
Auto Spark Plug Suppressors......50 for 2.25  
Handset Cordage, 3-conductor RC tinsel.  
Woven jacket. Minimum order 25'.  
25' to 99'.....per ft. 4c. 100 to 1000'.....per ft. 6c  
RG8/U Coax, 52 ohm, minimum order 100'.....per ft. 6c  
Cable, 3-conductor No. 18 stranded, 600V insulation 250, rubber covered. 43" OD, 1 conductor shielded. Russel Stoll connectors each end No. 8158 and 8098. Signal Corp Type CD-520.....\$5.95  
Cable, 7-conductor, No. 14 stranded, 600V insulation. Heavy duty RC, 65' long. Connectors both ends. 7/8" OD.....\$4.95  
Cable, 14-conductor, No. 15 stranded, 600V insulation. Crush-proof cotton core. Heavy duty RC 50' long connector 1 end, plug other end.....\$4.95  
12-16V Panel Lamp, 100MA, T 3 1/2 bulb, Bayonet Base. 10 for......59c  
Asbestos Gloves, Heavy Duty, suitable for welders, hot material. Sizes 10 and 11.....Pair \$1.25

# ANNOUNCING: THE TELE-SWEEP

(MODEL TSW-50)

A SWEEP SIGNAL GENERATOR FOR FM & TELEVISION PRICED WITHIN RANGE OF ALL SERVICEMEN, STUDENTS, EXPERIMENTERS

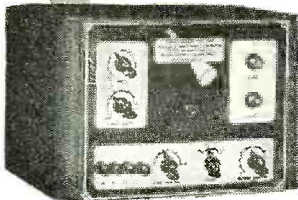

Here is a Sweep Generator for every need and pocket book. The TELE-SWEEP-TSW50 is ideal for alignment of FM and TV Receivers with a minimum of time and effort.

**CHECK THESE FEATURES**

- SWEEP WIDTH 500 KC to 10 MC
- COMPLETE FREQ. COVERAGE in four bands 3 to 100 MC and 170 to 216 MC
- TEST PROBE for point to point checking
- OUTPUT 1 Volt. Max.

See the TELE-SWEEP at your jobber's now. IT'S SENSATIONAL!

**\$68.50**  
NET

Slightly higher in the West

Plus Another  
**VISION FIRST**

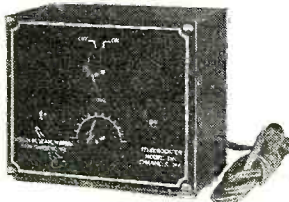

3'x4'x6'

Available in 3 models—  
TVL—Channels 1 thru 6  
TVH—channels 7 thru 13  
FM—88-108 Mc



## THE TELE-BOOSTER THREE NEW MODELS

The Vision Telebooster is a compact self powered RF Amplifier for use in improving Television and FM reception in difficult locations or where proper antenna installation cannot be made.

**FEATURES**

- Brings up weak, flat TV pictures to normal brightness
- Reduces need for outdoor antenna in many locations
- Selective circuit tends to eliminate off channel interference
- May be switched off for normal operation on stations that require no boosting
- Self contained power supply
- Simple to install & operate, just plug in and connect between antenna and receiver input terminals
- Attractive wood cabinet, mahogany or walnut finish

(Write for further information on other Vision products)

SEE THESE ITEMS AT YOUR LOCAL JOBBER

**\$26.95**  
List

Slightly higher in the West

**VISION RESEARCH LABORATORIES**  
P. O. Box No. 52, Kew Gardens 15, N. Y.

## TV Exclusively!

(Continued from page 49)

amount of time, and then the pulled chassis is replaced with a temporary unit.

So far, there is nothing to indicate that sales are being made to a particular income group, or that business would be better if a higher, or lower income bracket were concentrated upon.

Everyone who has seen a television show, wants a television set. This broad statement is substantiated by the fact that the majority of television sets are financed.

The only real limitation on sales that has been encountered so far is



Salesman explains to the "teletheater" audience why specialized installations are needed for good television reception.

the shortage of merchandise. There still aren't enough of the popular sets to meet the demand.

It should be interesting to see whether or not the rest of the retail television industry will follow John Porterfield's lead, and whether or not television will do as the automobile did, and leave the bicycle shop and move into the showroom.

-50-

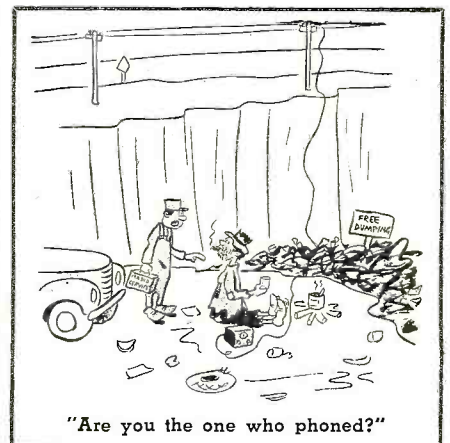

"Are you the one who phoned?"

**Precision!**  
± .0000000?%

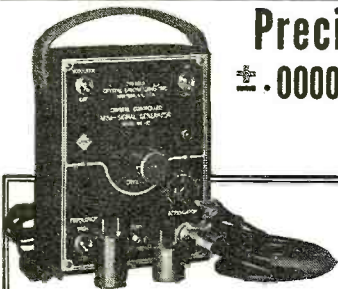

## Get the FACTS on the NEW PREMIER MODEL 117 CRYSTAL-CONTROLLED MINI-SIGNAL GENERATOR

Now you can get complete information on a signal generator that's the ultimate in accuracy: the new Premier Mini-Signal Generator. This new instrument is crystal-controlled and provided with a micrometer adjustment so you can zero-beat the crystal against standard frequency transmissions of WWV!

See how the new Premier Mini-Signal Generator serves BROADCAST STATIONS... AIRCRAFT AND AIRPORTS... LABORATORIES... RADIO EQUIPMENT MANUFACTURERS... "HAMS"... SERVICE MEN. Write for your free copy of Technical Bulletin 117 now!

**PREMIER CRYSTAL LABORATORIES, INC.**  
62 PARK ROW NEW YORK 7, N. Y.

## SENSATIONAL SALE!

Not Surplus Stock

(All fresh manufacture)

**CONDENSER SPECIALS:**

- .01
- .02
- .03
- .05 400V .....05 ea.
- .001
- .005
- .0001- 600V Tubl. ....09 ea.
- .0005- 600V Tubl. ....10 ea.
- .0005-1000V Tubl. ....15 ea.
- 40-20-150V .....45 ea.
- 40-20-20-150V .....50 ea.
- 40-20-20-150 & 25V .....50 ea.

**RESISTORS:** All Radioman numbers.  
No dead values. 100 Ass't., 1/2 & 1 Watt .....\$1.59

**50L6:** Output Transformers. Regular size. Long leads, ea. .... .35

**35Z5GT** Tubes in bulk cartons, ea...40

Terms: Remittance with order. 25% Deposit. Balance C.O.D. (Orders not less than \$3.00).

**JENSEN'S RADIO SUPPLY & SERVICE**  
176 Seneca Street Buffalo 3, N. Y.

## CODE OF ETHICS

THE Associated Radio Servicemen of New York, Inc. is distributing copies of the organization's "Code of Ethics" to member-servicemen as part of its active campaign to eliminate servicing abuses and render unnecessary the proposed legislation for licensing of servicemen now before the New York City Council.

The code, which each member is asked to read and sign, is as follows:

"1. I will at all times, without any exceptions, perform my work to the very best of my knowledge and ability. In addition, I will make a sincere effort to improve my knowledge of the technical and business requirements of my job, thereby enabling me to render still better radio service.

"2. I will conduct myself and my business in an honest and straightforward manner, meriting and inspiring the confidence of my customers.

"3. I will, whenever practicable and desirable, prefer to use original factory replacement parts. In other cases, I will use replacement parts known to be of equal or better quality, thus insuring satisfactory performance.

"4. Realizing that an extremely low price does not permit good workmanship and an unreasonably high price will prompt justifiable criticism and loss of patronage, I propose to charge a just and fair price for all my work, based upon my ability and qualifications to render satisfactory radio service.

"5. I will guarantee all radio work performed, which has been authorized and for which payment has been received, for a minimum period of not less than 90 days, and will give each customer an itemized bill.

"6. I will exercise all reasonable care in handling my customers' property.

"7. I will not engage in any unfair or unethical practices condemned or disapproved by the Associated Radio Servicemen of New York, Inc., such as misleading or untruthful advertising, making unreasonable promises or statements, unjustly criticizing a fellow man's actions or ability and such other practices as may be brought to the attention of the Associated Radio Servicemen of New York, Inc., that would lead to an unjustifiable lack of confidence in the A. R. S. of N. Y., or any of its members.

"For the mutual benefit of my customers, fellow members of the Associated Radio Servicemen of New York, Inc. and myself, I hereby subscribe to the above A.R.S. of N.Y. Code of Ethics."

-30-

## SCOTT DYNAMIC NOISE SUPPRESSOR DATA

COMPLETE details for building the suppressor into the recording amplifier (January, 1948 issue, page 54) will appear soon in Radio News. Readily available chokes and other components have been chosen for the circuit that will enable builders to duplicate the excellent performance of the laboratory model.

Other minor improvements have been made in the amplifier. These too will be shown. Many readers have requested circuits and data for utilizing other types of tubes and controls in their possession as substitutes. Generally such changes are not recommended and would result in a poor facsimile of the original.

-30-

March, 1948

- High Permeability nickel-iron cores
- Flat from 20 to 20,000 cycles  $\pm 1$  db
- Quadruple alloy-shielded
- Vacuum sealed for 100% Protection

Item Number	Application	Primary Impedance	Secondary Impedance	$\pm 1$ db from
Y-1	Interstage—Single Plate to P.P. Grid	8,000 to 15,000	60,000 C.T.	20 to 20,000
Y-2	Low Level Output to Line	8,000 to 15,000 in Two Sections	50-125-200-250-333-500	20 to 20,000
Y-3	Low Level Input	500-333-250-200-125-50	50,000 in Two Sections	20 to 20,000
Y-4	Bridging Trans.	20,000	50,000	20 to 20,000
Y-5	Repeat Coil	500/600	500/600	20 to 20,000

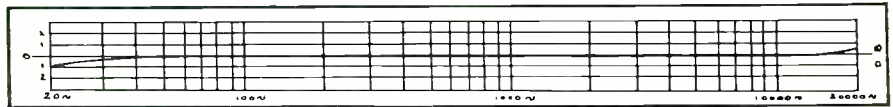

Typical frequency response curve for above units

## HIGH LEVEL OUTPUT TRANSFORMERS

Part No.	Primary Impedance	Secondary Impedance	Max. Watts	$\pm 2$ db From	Height	Width	Depth
Y-20	8500	500	15	20-20000	3 1/8"	2 3/8"	2 3/8"
Y-21	5400	4-8-15-125-250-500	35	20-20000	4 3/8"	3 1/2"	4 1/8"
Y-22	3800	4-8-15-125-250-500	50	20-20000	4 1/2"	3 3/8"	4 3/8"

These new Halldorson Transformers offer broadcasting stations, laboratories, and service engineers an opportunity to install high fidelity equipment with moderate transformer

cost. While these transformers give laboratory standards of performance, they are small in size and are equipped with convenient clamps. Try them. Ask your Radio Parts-Distributor.

For more technical information and new catalog, write The Halldorson Co., 4500 Ravenswood Ave., Chicago 40, Ill.

# Simplified

## RC BRIDGE

By R. L. PARMENTER, W1JXF

**Low-cost shop instrument provides means of measuring resistances from .1 ohm to 1000 megohms and capacitance from 1  $\mu$ fd. to 1000  $\mu$ fd.**

**K**EEPING in mind the fact that the average experimenter will steer clear of apparatus that seems to be too complicated or too difficult to construct, a resistance-capacitance bridge that has been stripped to its bare essentials is being presented. Using two or three tubes and requiring only a few easy-to-get parts the bridge retains a high degree of accuracy (comparable to a good ohmmeter) and is easy to build and operate. It is a self-powered unit and contains its own null detector, thereby eliminating the necessity of tedious hookups to put it into operation. The basic circuit as developed by Rufus P. Turner (RADIO NEWS, April, 1947) has been somewhat simplified. For the experimenter and beginner it offers a means of measuring capacitance and extending the range of resistance measurement. The average builder should find merit in this simplified version.

The ranges provided are the same as in the original version: 1  $\mu$ fd. to 0.1  $\mu$ fd., 100  $\mu$ fd. to 10  $\mu$ fd. and 0.01  $\mu$ fd. to 1000  $\mu$ fd. for capacitance and .1 ohm to 10,000 ohms, 100 ohms to 10 megohms, and 10,000 ohms to 1000 megohms, for resistance. A change-over switch is used to read either resistance or capacitance. Readings are taken directly from the main dial and multiplied by the proper factor as indicated by the range switch to achieve direct reading. It should be noted here that the upper limits of the above ranges are not usable except for relative values due to crowding on the dial. However, there is sufficient overlap on the ranges so that all intermediate values may be read accurately.

### The Resistance Circuit

A Wheatstone bridge circuit is used for resistance measurement and with it we can achieve a degree of accuracy equal to that obtainable from the average ohmmeter. While direct current is customarily used for this type of circuit it is just as feasible to use alternating current if the values in the circuit are pure resistance. Inductances cannot be measured with this bridge nor can resistances having an inductive component be measured accurately. The a.c. measuring voltage at 60 cycles is derived from a 2:1 audio transformer which is tied in with the secondary across the 110 volt line. When used in this manner the usable potential is in the neighborhood of 55 volts which is sufficient for the amplifier and detector as used.

The simplified "resistance circuit" is shown in Fig. 1A and will be recognized as the familiar Wheatstone bridge with amplifier and detector added.  $R_x$  is the unknown resistance,  $R_s$  the standard,  $R_a$  and  $R_b$  the variable values on either side of the arm of the potentiometer which are calibrated

Fig. 1. Basic circuit (A) for resistance measurement is the Wheatstone Bridge; while the familiar Wien Bridge circuit is used for capacitance measurement (B).

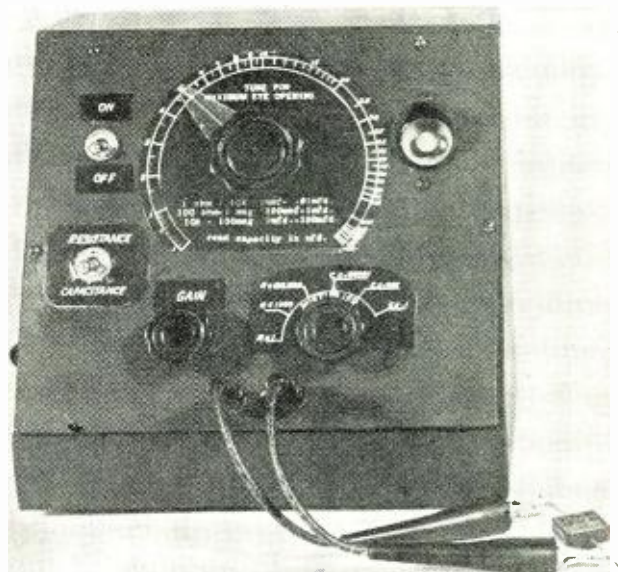
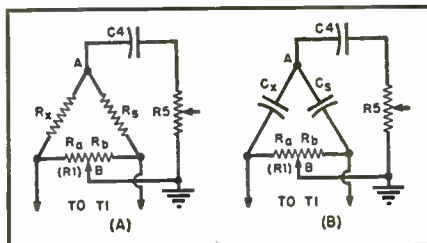

Front panel view of home-built RC bridge.

to the dial. By varying the position of the potentiometer arm the proportions of  $R_a$  and  $R_b$  are changed to arrive at the null point. Under these conditions no difference of potential exists across points A and B, no voltage is being amplified and no signal is being applied to the grid of the 6E5. The shadow on the tuning eye is opened to maximum and the proportions:

$$R_b \times R_x = R_a \times R_s, \text{ and}$$

$$R_x = \frac{R_a \times R_s}{R_b} \text{ hold true.}$$

Similarly, for the Wien bridge (Fig. 1B):

$$C_x = \frac{C_s \times R_b}{R_a}$$

In other words the position of the potentiometer arm at null is an interpretation of the above proportions and may be expressed in dial degrees. When the bridge is off null, a difference of potential exists between points A and B and a voltage is amplified and applied to the grid of the 6E5. Since this tube is a voltage measuring device any change of potential at its grid will show up as a change in its fluorescent pattern. With maximum signal the eye closes so when tuning the bridge the operator tunes for maximum eye opening. It is used in a reverse manner from that customarily used on a receiver where the eye is tuned for minimum eye opening.

The circuit as used for capacitance measurement is shown in Fig. 1B in its simplified form. In this case  $C_x$  is the unknown condenser,  $C_s$  is the standard and  $R_a$  and  $R_b$  are the same as before—the variable values of the potentiometer. The same method of operation as was used for resistance is used in this case except that the two arms of the bridge with capacitive reactance are balanced with the resistance of the potentiometer. In other words the potentiometer is calibrated for capacitance in terms of resistance. The bridge in this case is known as a Wien bridge and is in the familiar old form, long used for the measurement

**SEEING IS BELIEVING!**  
**WE INVITE YOU TO TRY A SAMPLE ORDER: IF YOU ARE NOT SATISFIED BECAUSE OF . . . QUALITY! PRICE! SERVICE! FOR ANY REASON! RETURN THIS ORDER FOR A FULL REFUND!**  
**WE WILL PROVE TO YOU THAT WE ARE ABLE TO FURNISH FINEST QUALITY AT LOW PRICES**

**25 POUNDS OF RADIO PARTS and ASSEMBLIES**  
 Our warehouses are loaded with tons of post-inventory odds and ends. We need elbow room. Take advantage of the low price we are asking for this merchandise. Buy 25 pounds of parts, including **ONE MOTOR** worth at least the total price of this assortment, for **ONLY \$300**

**Resistor Assortments**  
 100 assorted 1/2, 1, 2, 5 and coded. Wide range of values. 100 asst'd. **\$1.95**

**Paper Condenser Assortments**  
 100 tubular by-pass condensers. All guaranteed, fresh stock. Wide range of useful sizes including many 600 W.V. condensers. 100 assorted **\$3.85**

**Mica Condenser Assortment**  
 50 mica condensers. All brand new—standard color coded. 500 assorted **\$1.95**

**Ceramic Condensers**  
 100 assorted **\$1.95**

**HI-FI PHONO AMP. KIT**

- Has 7 Important Features:
1. 4 W. Audio Output.
  2. Gain, enough for Phono-graph, Radio, F.M. Tuner, Carbon Mike.
  3. H-F response, 50-20,000 C.P.S.
  4. Variable Tone Control.
  5. 3 section filter assures extremely low hum level.
  6. Push-Pull balanced output.
  7. Heavy Duty Universal Output Transformer.

All parts included to build this unit . . . tubes: 2-35L6; 1-12SL7; 1-35Z5; Punched chassis, 6" P.M. Speaker, diagram, pictorials, output transformer, etc., etc. Kit complete as shown **\$7.75**

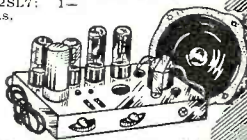

**TUBES !!**

**MONEY-BACK GUARANTEE**  
 No "Off" Brands, Seconds, or Used Tubes. Some in Cartons.

1A5	\$.50	6SJ7	\$.50	14A7	\$.95
1A7	.60	6SK7	.50	14B6	.75
1LC6	1.10	6SL7	.75	14R7	.75
1LH4	1.10	6SN7	.60	25Z6	.60
1LN5	1.10	6SQ7	.50	26	.50
1N5	.60	6SR7	.50	27	.50
1R5	.75	6V6	.50	30	.50
1S5	.75	6X5	.75	31	.50
1T4	.50	6Y6	.75	35A5	.60
2C26	1.00	7A8	.60	35L6	.60
2C40	1.00	7B6	.60	35W4	.60
3B24	1.00	7C5	.60	35Z5	.60
3Q5	.75	7C6	.60	39/44	.50
5U4	.50	7C7	.60	50B5	.60
5Y3	.50	7E5	.50	50L6	.60
6A8	.60	7F8	.50	50X6	.75
6AC7	.75	7G7	.95	50Y6	.50
6AG5	.75	7N7	.50	75	.50
6B4	.95	7Y4	.60	76	.50
6C4	.50	12AH7	.75	77	.50
6C5	.50	12AT6	.50	78	.50
6H6	.50	12BA6	.60	80	.50
6J5	.50	12BE6	.60	84/6Z4	.50
6J6	.50	12C8	.50	117L7	1.10
6J7	.60	12J5	.50	VR105	.75
6K6	.50	12SF7	.50	VR150	.75
6K7	.50	12SG7	.60	826	.50
6S8	.50	12SK7	.60	954	.75
6SA7	.50	12SJ7	.50	955	.75
6SD7	.60	12SN7	.50	956	.75
6SG7	.50	12SQ7	.60	9001	.50
6SH7	.50	12SR7	.60	9006	.50

**Deduct 10% from all tube orders \$20.00 or over.**  
 Deduct additional 5% from orders of 100 tubes of one type.

All items subject to prior sale. All prices subject to change without notice.

**6 TUBE SUPERHETERODYNE KIT**  
 Broadcast Band  
 110V AC or DC Operated

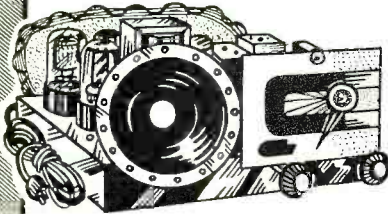

Several models built directly from this kit are now giving thoroughly dependable performance and beautiful tone. Engineered for simplicity of construction, this set will also give you the utmost in listening pleasure.

**NO FOOLING**—There's nothing weird or tricky about this set. Uses a standard superhet circuit, 6 tubes. 2 RF stages, 1 DF stage, 12SA7 converter, 12SK7, 1F amp., 12SQ7 detector, and 1st audio, 12SK7 1st IF, 35L6 output, 35Z5 rectifier.  
**KIT CONTAINS** punched chassis, 6 tubes, 2 IF's, loop antenna, 5" PM speaker, diagram, pictorials, all resistors and condensers, and every last bit of hardware required. Nothing else to buy except cabinet.

**\$995**

**KIT COMPLETE LESS CABINET**



**THIS MONTH ONLY!**

**PLAN YOUR NEXT OUTPUT APPLICATION AROUND THE 12A6.**

Can be substituted for 25L6, 35L6, 50L6, etc., in AC-DC units. Every tube brand new—JAN inspected! We can make this low price offer for one month.

**12A6 . . . only 21¢ ea.**  
 10 for . . . \$ 1.90  
 100 for . . . 17.00  
 1000 for . . . 150.00

(THESE PRICES NOT SUBJECT TO OTHER TUBE DISCOUNTS).

Minimum Order \$2.00 All Orders Shipped F.O.B. Chicago. 25% Deposit On All C.O.D. Shipments.

**IRVING JOSEPH**

220 S. Halsted St.,  
 Chicago 6, Ill.

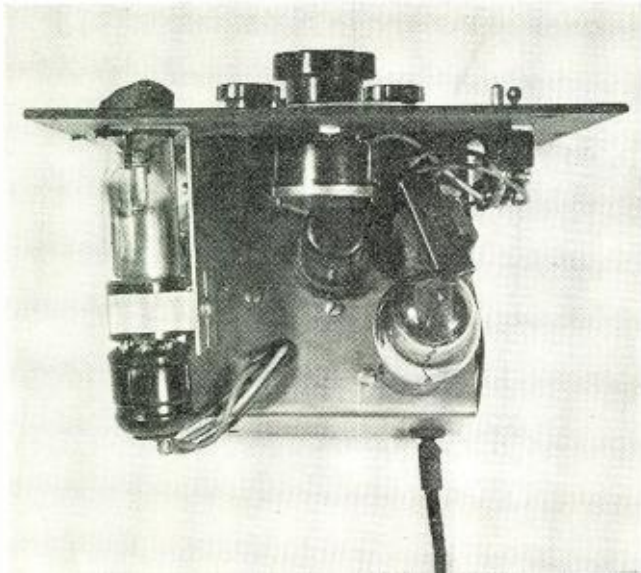

Above chassis view of RC Bridge. A linear taper potentiometer balances circuit for resistance and capacitance measurements.

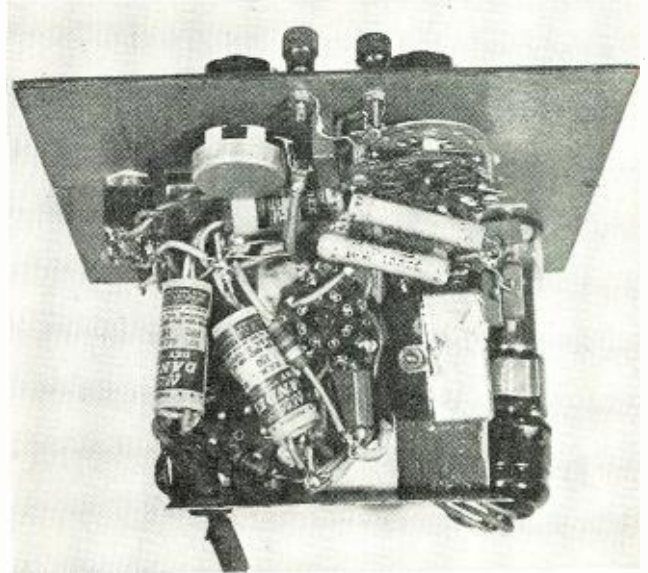

Under chassis view shows placement of component parts. Direct point-to-point wiring is advisable in construction of unit.

of capacity. The amplifier and null detector are used in the same manner as previously described for resistance measuring and the same dial calibration is used for both. Capacitance values fall in line due to the fact that equivalent values of standards and multipliers are used in both cases. In other words when the dial is calibrated for the middle resistance range ( $R \times 1000$ ) all of the other ranges, both ca-

capacity and resistance, will fall in line if the standards have been accurately picked for size.

### The Main Circuit

Fig. 2 shows the circuit diagram as used for the wiring of the bridge. It will be seen that it is merely the completed form of Figs. 1A and 1B as previously described. An a.c.-d.c. type power supply is shown using a 25Z5

or 25Z6 as rectifier. The type 25Z5 was used since one was on hand but if the builder is using new parts probably a 25Z6 or a selenium rectifier would be preferable. The power supply using a selenium rectifier is shown in Fig. 2B and this would be substituted for the tube rectifier circuit. The proper line cord resistors are shown in each case as resistors  $R_{11}$  and  $R_{12}$ . The proper polarity of the selenium rectifier must be observed as indicated in Fig. 2B. The yellow lead is minus while the red lead is plus. Sufficient filtering is achieved by the use of the 1000 ohm resistor bypassed with the two 8 or 10  $\mu$ fd. condensers since the current drain is very low. It is preferable not to connect the circuit ground to the chassis except through  $C_8$ , an .05  $\mu$ fd. paper condenser. This condenser should be placed where the line cord enters the cabinet if a metal unit is used.

Fig. 2. Complete schematic diagram of RC Bridge. Inset (B) shows alternative power supply employing a selenium rectifier in place of conventional tube.

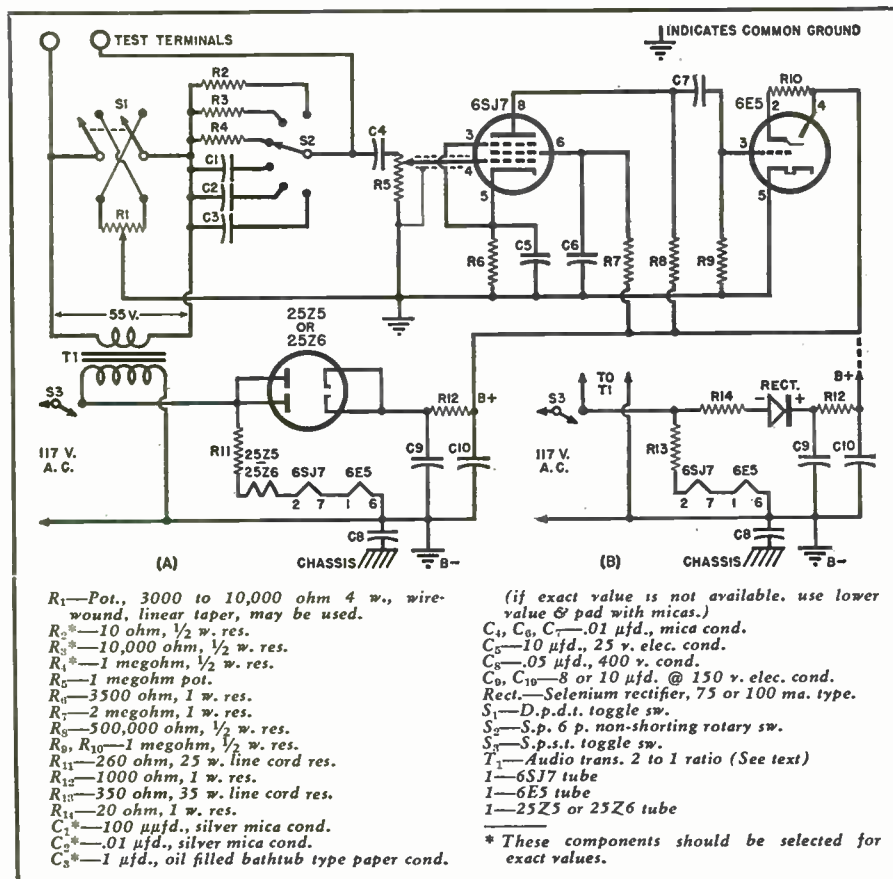

The bridge potential transformer  $T_1$  is an audio type with a ratio of 2:1 or it may be a push-pull interstage type, 1:1 ratio, in which case one half of the secondary would be used. The desirable voltage is in the neighborhood of 55 volts since this provides for sufficient sensitivity. Higher voltage than this is not necessary or desirable due to shock hazard which, while not dangerous, is not recommended. The standard resistors  $R_2, R_3,$  and  $R_4$  should be selected for greatest accuracy since upon them depend the accuracy of the bridge on resistance readings. If necessary, go through a batch of twenty or more at the radio supply store, checking them with a good ohmmeter for values nearest to those specified. The same procedure should be used for the condenser standards,  $C_1, C_2,$  and  $C_3$ , by means of a capacitance bridge. If no capacitance bridge is available it would be advisable to order these units special from the manufacturer, specifying the degree of accuracy required. At least 2% is recommended.





# NESCO ELECTRONICS Presents

**BC-733D**  
A 10-tube superhet receiver for lateral blind landing guidance (CAA type certificate) (TC-1045).  
108-110MC ..... **\$6.35**

**ANTENNA RELAY UNIT BC-442**  
0-10 Weston Meter and 50MMF 5000 V. vacuum condenser change over unit, with mounting FT-229  
Ea. ONLY **\$1.95**

**HANDSET—TS-13**  
Cradle type with butterfly switch, cord and plugs, individually boxed. ....NOW **\$2.25**

**REMOTE CONTROL UNIT RM-12**  
With handset, ringer circuit and built-in 3" DB meter. Used, very good condition..... **\$9.95**

**WIRE NO. 20**  
Solid, bare, tinned ¼ lb. spool (80 ft.). Special at..... **79c**

**1625 TUBE**  
**Army-Navy Standard**  
This is a 12 V. filament 807 tube. A tremendous buy at **39c** each. **3 for..... \$1.00**

**TU-108 or TU-5**  
Tuning unit for BC-375 with a terrific parts value case.... ONLY **\$2.10**

**BC-306**  
Antenna loading unit for BC-375. Another parts value.... **\$1.50**

**R5ARN/7**  
15-tube superhet radio compass receiver 100 to 1750KC; CW-tone-voice.  
AT ONLY **\$32.50**

**SHOCK MOUNTS**  
4 each of 3 sizes—small, medium and large. **99c** ALL FOR ONLY.

**WILLARD**  
**2 Volt Storage Battery**  
Brand new, spillproof, use standard electrolyte. Suitable for all farm sets and portables. **VERY SPECIAL BUY FEA-TURED @ ea.... 98c**

For the SCR-522 ..... PLQ-167  
For the BC-733 ..... PLQ-172  
For your 260-F Radio Compass inverter ..... PLQ-254  
Right angle 1 and 2 conductor connectors ..... PL-3108-22-4S  
3 conductor straight connector ..... PL-152  
For the SCR-274 N ..... PL-154A  
PL-258  
49c each

**PLUGS and Connectors**  
**Your Choice for ONLY 49¢**

YOUR CHOICE OF ANY OF THE ABOVE FOR ONLY **49c** each  
20% deposit required on all C.O.D. orders

division of  
**NATIONAL EQUIPMENT & SUPPLY CO., INC.**  
1500 S. Western Avenue Chicago 8, Ill. MONroe 9504

**To The Radioman who wants Financial Security**

Hundreds of radiomen all over the country are discovering for themselves a new and profitable adjunct to their own business in the field of coin operated radios. They've found it to be a sure-fire means of supplementing their income with a minimum investment in both time and money. And they're doing it right in their own backyards, too, by installing TRADIO and TRADIO-ETTE, the radios specifically-designed for coin operation in hotels, tourist camps, restaurants, taverns, hospitals, etc.

**TRADIO ★ Tried ★ Tested ★ Proven**

TRADIO has pioneered in this new and flourishing post-war field. Get in on the ground floor and assure yourself of financial security for life.

\*\*\*\*\*  
TRADIO sells to operators only through franchised distributors. No routes are sold. For further information, we'll put you in touch with the distributor in your territory if you'll phone Asbury Park 2-7447 or write TRADIO, INC., Dept. P-3, Asbury Park, N. J.  
\*\*\*\*\*

**TRADIO, Inc.** ASBURY PARK NEW JERSEY



**NOW**  
The "LITTLE KING" trade mark  
**Band Finder**  
(Pat. Pend.)

## VHF SIGNAL GENERATOR

1. Put your 2 meter rig on the air without relying on other stations!
2. Audio tone modulated.
3. Can be heard 50 feet or more with no direct coupling.
4. Use to check frequency of other stations.
5. Use for remote control purposes.
6. Accurately calibrated—wide band spread.
7. Can furnish to cover either 50-56, 144-148, 420-450 MC, or special bands.
8. Self-contained batteries—Last 1½ years!
9. Compact steel case, black wrinkle instrument finish.
10. Nothing like it at only **\$14.95.**

COD orders okay—SEND \$5.00 with order.

Postage paid if money order or certified check for full amount is sent with order.

Write or mail orders today to:

**LION PACIFIC CO. 4814 W. 98th St.**  
Inglewood, Calif., Dept. R-2

Of course it must be kept in mind that the cost of these special condensers is somewhat higher than for stock run units. When mounting these resistor and condenser standards they may be soldered right to the terminals of switch  $S_2$  in order to provide short leads. This is essential in order to hold down the distributed capacity of the circuit and should be carefully adhered to in the bridge circuit proper. This partly accounts for the poor appearance of the under chassis wiring since all of it was done point-to-point. Keep the filament wiring as far as possible from the bridge circuit in order to avoid undesirable pickup. Grounded shield braid over the lead from the grid of the 6SJ7 to the arm of the potentiometer is recommended for the same reason.

Switch,  $S_1$ , is a double-pole, double-throw unit used as a reversing switch for the potentiometer,  $R_1$ . This must be wired so that the low values of resistance will fall at the left hand end of the dial. Then by reversing the potentiometer the low values of capacitance will also fall at this end of the dial. This is explained by the fact that the reactance of condensers varies inversely as their capacitance whereas the reactance of resistors varies directly with their resistance. It might be questioned as to why an additional switch was added here when the same thing might have been accomplished by use of a two deck switch. The reason is simply one of convenience in wiring since the average builder does not like to face a complicated switching, wiring arrangement. Also perhaps single deck switches might be more available in the junk-box.

The rest of the circuit is straightforward and should present no problems, even to the beginner. In the actual construction a small metal chassis that happened to be on hand was used to good advantage, but a wood or masonite chassis could have been used equally successfully. The layout of parts is shown in the chassis photo and worked fairly well but the builder may use his own discretion about the placement of components. A slanting panel arrangement was used and the cabinet which was made of masonite and wood was made to fit the slant that seemed most convenient. Here the ideas of individual builders will vary but the slanting panel arrangement is to be recommended since it makes for the easiest reading of the magic eye.

### Making and Calibrating the Dial

The calibration of the dial is the most exacting job in the building of the bridge and care should be taken here since the accuracy of the readings will depend largely on the accuracy of the dial calibration. After the wiring is completed and the bridge "fired up," that is, tested for lighting of filaments and correct operation of the magic eye by varying the gain control potentiometer,  $R_2$ , the dial is ready to be calibrated. Attach a piece

**RADIO NEWS**

of tracing paper, somewhat larger than the finished dial, to the panel. This size will be determined by the type and size of pointer that is used but should be as large as possible to provide maximum reading accuracy. A homemade pointer was made by attaching a piece of lucite to a transmitter type knob and scratching an indicator line on it with a sharp instrument. This scratch was filled in with colored pencil. The tracing paper may be fastened to the panel by scotch tape but care should be taken not to move it after calibration is started. If a decade box is available it may be connected across the test terminals and set the range switch to "R x 1000." Now switch in 100 ohms and balance bridge for null by complete opening of the magic eye with the sensitivity control set for best control. If the null point is at right hand end of dial, throw reversing switch, S<sub>1</sub>, to other side, then mark this point 0.1 on the tracing paper. As a guide it would be well to sketch the circular sweep of the pointer onto the tracing paper to aid in placing of figures and points.

Values of resistance should be employed from 100 ohms to as high as ten megohms, using enough values to get good points in the scale. This may be quite readily done if a series of decade boxes are available. If not you will have to resort to the method as recommended by Mr. Turner for his bridge and his listing of resistors is reprinted here. Perhaps you could borrow the resistors from your radio parts jobber, or as an alternative, buy them and use them for calibration and then return them for credit expecting to be charged something for their use. The following list of resistors is reprinted from the April issue of RADIO NEWS: 100, 200, 300, 400, 500, 600, 700, 800, 900, 1000, 1500, 2000, 2500, 3000, 3500, 4000, 4500, 5000, 5500, 6000, 6500, 7000, 7500, 8000, 8500, 9000, 9500, 10,000, 11,000, 12,000, 13,000, 14,000, 15,000, 16,000, 17,000, 18,000, 19,000, 20,000, 25,000, 30,000, 35,000, 40,000, 45,000, 50,000, 55,000, 60,000, 65,000, 70,000, 75,000, 80,000, 85,000, 90,000, 95,000, 100,000, 150,000, 200,000, 250,000, 300,000, 400,000, 500,000, 1 megohm and 10 megohms. After these points have been marked on the tracing paper it is removed and the numbering is permanently applied with India ink. At the same time a title plate for the bridge and any other nameplates that are needed for identification may be drawn on tracing paper, such as the range switch plate, etc. If you are familiar with photographic processing you can use these tracing papers as positives in place of ordinary film negatives and make nameplates which present a commercial appearance. If you have no facilities for handling these take them to the nearest photo finisher and he will process them for a nominal sum. Tell him in detail just what is desired, in other words you want a solid black background with white letters. If you want to process them yourself use a high contrast pa-

**MAKE THE MOST OF THE**

**NEW**

**SHURE**

# Monoplex

**MODEL  
"737A"**

*Available Now!*

**THE *Only* SUPER-  
CARDIOID CRYSTAL  
MICROPHONE**



Here indeed is *the* crystal microphone of all time—a high-output, unidirectional microphone that ranks far, far above ordinary crystal microphones. Why? Because it is a SUPER-CARDIOID microphone. What does this mean? It means that the "Monoplex" is twice as unidirectional as the Cardioid. It has wide angle pickup across the front of the microphone but it reduces sound pickup from the rear by 15 db—over a broad range of frequencies, and reduces pickup of random sound by 73%! The "Monoplex" employs the same type of acoustic phase-shifting network used in the highest-cost Shure Broadcast microphones. New "Metal-Seal" crystal. The case is pivoted at the rear and can be pointed toward desired sound or upwards for horizontal plane pickup. The "Monoplex" is excellent for high-quality public-address, communications, recording and similar applications. It will operate under adverse conditions of background noise and reverberation where a conventional microphone would be practically useless. Make the most of the "Monoplex"—it is destined for a performance record unique in crystal microphone history!

Manufactured under Shure patents issued and pending.  
Licensed under patents of Brush Development Co.



Model "737A" CODE: RUMON List Price: \$35.50

**SHURE BROTHERS, INC.**

**Microphones & Acoustic Devices**

225 W. HURON ST., CHICAGO 10, ILL. • CABLE ADDRESS: SHUREMICRO

## FM TRANSMITTER

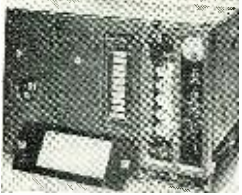

For 10 & 11 meters. BC-604, 30 Watt, 20 to 30 MC, 10 channel push-button xtal controlled. Complete with 7-1619's, 1-1624 (PA) tubes, meter, 12 or 24 v. **Good, used \$12.95**

## FM RECEIVER

For 10 and 11 meter bands. BC-603, 20 to 30 MC, superhet, BFO, squelch; 10 push-buttons and manual tuning. Makes excellent IF strip for 88 to 108 MC wide-band FM. With 10 tubes, speaker, 12 or 24 volt.

**Good, used \$12.95**  
New \$16.25



**COMBINATION OFFER, above**  
Rec. BC-603 and Xmt BC-604, Only... **\$24.95**

## J-36 SPEED KEY.....\$4.45



Sensitive movement, easy action, heavy crackle base. Made by Lionel on famous pattern of another well-known speed-key mfr.; money back if not pleased.

Very slightly used, perfect..... **\$4.45**

## EE-8 TELEPHONE.....\$4.95

With handset, generator, ringer, etc. In leather or heavy web case (please do not specify). Fine for garage extension, farm phones, warehouses, etc. For local or common battery lines. "Each phone tested before shipment."

**Used, Fair..... \$4.95**

**Used, Good \$9.95.....two for \$19.00**

**Used, Excellent, leather cases \$13.95.....two for \$27.00**

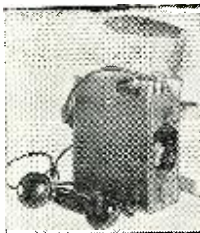

**PRECISION METERS**

**A. Ammeter, 0-10 DC W house PX14, mirrored scale..... \$9.95**

**B. Voltmeter, 0-3-15-150 DC Weston No. 1, mirrored scale; leather carrying case, key. Reg. net \$75, OUR PRICE..... 39.95**

**C. Voltmeter..... Sold out**

**D. Double-Differential Milliammeter 50-0-50 Weston No. 264..... 12.95**

## REMOTE CONTROL UNIT

**RM-12:** good for commercial or amateur stations. Has handset, ringer, generator, Weston 301 (or equiv.) db meter. Contains EE-8 phone. **Used..... \$10.95**



**"MATCHSTIX,"** Cond. C-D miniature tubular by-pass  $\frac{1}{4}$ " x 1" rated 300v.; .001, .002, .004, .01 md.; any size, ten for... **\$ .79**

**RECTIFIER,** 6 plates, input 18v, output 12vdc 220 ma fullwave... **.69**  
24 plates, input 216v, output 110vdc @ 1.57a... **3.88**

**CRYSTALS,** fit FT-243 holder or octal socket; any freq. 5675 to 8650 kc in 25kc steps (channels 270 to 380 /FC-659); 6 for \$5; each... **\$ 1.00**  
**Complete set of 120 xtals covering 5675-8650 kc in metal cabinet..... 40.00**  
Also: 3010, 3465, 3525, 3655, 3735, 3825, 3980, 3995, 4110, 4190, 4280, 4450, 4780, 4845, 5030, 5235, 5300, 5305, 5485, 5500, 5760, 5880, 5955, 6335 kc. Choice 6 for \$5; each... **1.00**

### WRITE FOR FREE LIST

Postage extra. Minimum order \$2.00  
**TERMS: Net Cash, 25% deposit on C.O.D's**

## ELECTRONIC SUPPLIES

317-R East 2nd St. Tulsa 3, Oklahoma

per such as *Velox* F-4 although F-3 may be used with good results. You will find that a fairly short interval of exposure is necessary. The nameplates, when finished, may be mounted with *Duco* cement or *Cascamite* glue works well. Some experimenting may be necessary to achieve just the results you desire but the finished product when properly handled produces nameplates which compare favorably with commercially produced plates which will cost you many times the cost of these.

A few notes are in order for the operation of the bridge. If in checking a resistor or condenser no null point is found on any range but the eye opens on the right hand end of dial it indicates a resistance or capacitance too high to read or an open. If this occurs at the left hand end of dial it indicates a value too low to read or a short. If no null point is found at first switch to the next range, higher or lower as the case may be. This sounds a bit difficult at first but you will rapidly become used to the operation and it is really quite simple.

Due to the lack of any voltage control on the bridge some change in calibration due to fluctuations in line voltage was anticipated. This did not prove to be the case, however, as was proven by powering the bridge through an autotransformer. The bridge was adjusted for null at some particular value with the sensitivity control turned up as far as possible. The line voltage was then varied from 85 volts to 125 volts and no change in the opening of the eye was noted. The brilliance of the eye changed, as was to be expected, and this would indicate a variation in sensitivity but no change in calibration was noted. This, of course, is a very desirable feature since no compensation for line voltages is necessary.

This bridge should prove to be desirable to the experimenter and beginner since it offers, for a nominal layout in parts and labor, an instrument capable of fairly precise measurement of capacitance and resistance, the degree of accuracy depending upon the workmanship and quality of parts used. Its simplicity is its main virtue and it should indicate to the beginner that it is possible to build good instruments at home with only limited facilities.

## International Short-Wave

(Continued from page 109)

- 17.720—LRA5, Buenos Aires, Argentina, "Radio del Estado," 5 kw.
- \*17.730—GVQ, London, 50-100 kw.
- \*17.732—OTC5, Leopoldville, Belgian Congo, 50 kw.
- 17.740—Moscow.
- 17.745—OTC6, Leopoldville, Belgian Congo, "Radio Nationale Belge," 50 kw.
- \*17.745—OTM6, Leopoldville, Belgian Congo, "Radio Congo Belge," 20 kw.
- 17.750—OZL Skamlebak (Copenhagen), Denmark, 6 kw.
- 17.750—WRUW, Boston, Mass., U.S.A., 20 kw.
- 17.750—Moscow.
- \*17.755—ZBW5, Hong Kong, China, 2.5 kw.
- 17.755—LKW, Oslo, Norway, 5 kw.
- \*17.755—XGSS, Nanking, China.
- 17.760—VUD3, Delhi, AIR, 5 kw.
- \*17.760—VUD8, Delhi, AIR, 7.5 kw.
- \*17.760—KWID, San Francisco, Calif., U.S.A., 100 kw.
- 17.760—KWIK, San Francisco, Calif., U.S.A., 50 kw.
- \*17.760—KUMI, Tokyo.
- 17.765—Paris, "Radiodiffusion Francaise," 100 kw.
- \*17.770—OTC5, Leopoldville, Belgian Congo, "Radio Nationale Belge," 50 kw.
- 17.770—Colombo, Ceylon, "Radio SEAC," 7.5 kw.
- \*17.770—ZL5, Wellington, New Zealand, 10 kw.
- \*17.770—Malacca, Malaya.
- \*17.770—HEDS, Berne, Switzerland, 25 kw.
- \*17.770—KNBA, Dixon, Calif., U.S.A., 50 kw.
- 17.770—Moscow; to North America, 0745-0815.
- \*17.770—Hörby, Sweden.
- \*17.775—PJCI, Willemstad, Curacao, "Radio Princess Juliana," 3 kw.
- \*17.775—HEU3, Berne, Switzerland, "Swiss Broadcasting Corp," 25 kw.
- \*17.775—Colombo, Ceylon.
- 17.776—PHI, Hilversum (Huizen), Holland (Netherlands), "Radio Nederland," 5 kw.
- \*17.780—KCBR, Delano, Calif., U.S.A., 200 kw.
- \*17.780—KNBA, Dixon, Calif., U.S.A., 50 kw.
- \*17.780—KGEX, San Francisco, Calif., U.S.A., 100 kw.
- 17.780—WNBI, New York, N.Y., U.S.A., 50 kw.
- 17.784—HER7, Berne, Switzerland, "Swiss Broadcasting Corp," 25 kw.
- 17.785—LKK, Oslo, Norway, "Radio Oslo," 5 kw.
- \*17.785—JZL, Tokyo.
- \*17.785—XGSP, Nanking, China.
- 17.790—GG, London, 50-100 kw.
- \*17.795—HE18, Berne, Switzerland, "Swiss Broadcasting Corp," 25 kw.
- \*17.795—JLU4, Tokyo.
- 17.798—OIX5, Lahti (Helsinki), Finland, 1 kw.
- 17.800—VLA7, Shepparton, Australia, "Radio Australia," 100 kw.
- \*17.800—VLE7, Shepparton, Australia, "Radio Australia," 100 kw.
- \*17.800—XGOY, Chungking, China, 35 kw.
- \*17.800—TGWA, Guatemala City, Guatemala, "La Voz de Guatemala," 10 kw.
- \*17.800—KRHO, Honolulu, Hawaii, 100 kw.
- 17.800—WLWK, Cincinnati, Ohio, U.S.A., 50 kw.
- 17.800—WLWO, Cincinnati, Ohio, U.S.A., 75 kw.
- \*17.800—Manila, Philippines.
- 17.805—LLP, Oslo, Norway, "Radio Oslo," 5 kw.
- 17.810—GSV, London, 50-100 kw.
- \*17.812—Rabat, French Morocco.
- \*17.815—HNI, Baghdad, Iraq, 5 kw.
- \*17.815—XUPA (now XURA), Tai-Pei, Formosa.
- 17.820—CKNC, Sackville, Canada, "CBC International Service," 50 kw.
- 17.820—Singapore, Malaya.
- 17.820—Colombo, Ceylon, "Radio SEAC," 10 kw.
- \*17.820—COBZ, Havana, Cuba, 1 kw.
- \*17.820—XEHH, Mexico City, Mexico, 250 w.
- \*17.820—Moscow.
- 17.820—IRU, Rome, Italy.
- 17.825—LLN, Fredrikstad, Norway, "Radio Oslo," 5 kw.
- \*17.825—Khabarovsk, U.S.S.R.
- \*17.830—LRA5, Buenos Aires, Argentina, 5 kw.
- \*17.830—OLR6A, Prague, Czechoslovakia, 30 kw.
- 17.830—VUD10, Delhi, AIR, 20 kw.
- 17.830—WCBX, New York, N.Y., U.S.A., 50 kw.
- 17.835—JVU3, Yamata, Japan, 2 kw. and 40 kw.
- \*17.835—JLP3 and JVV5, Tokyo.
- \*17.835—XGSU, Nanking, China.
- 17.838—Kiev, U.S.S.R., 40 kw.
- \*17.840—VLA10, Shepparton, Austria, "Radio Australia," 100 kw.
- 17.840—VLC9, Shepparton, Australia, "Radio Australia," 50 kw.
- 17.840—Brussels, Belgium, "Radio Nationale Belge," 5 kw.
- 17.840—Athlone, Ireland, "Radio Eirrean," 1.5 kw.
- \*17.840—HVJ, Vatican City, Vatican, "Radio Vaticano," 25 kw.
- \*17.840—XGSV, Nanking, China.
- \*17.840—JLS2, Tokyo.
- 17.840—JAG, Osaka, Japan.
- \*17.840—Hörby, Sweden.
- 17.845—Brazzaville, French Equatorial Africa, "Poste Nationale Francaise," 800 w.





**MORT**  
says



# "YOU DON'T HAVE TO BE CRAZY TO BE IN THE RADIO BUSINESS BUT IT SURE HELPS A LOT"



## WE'RE CLEANING THE SLATE FOR '48!

Mort's nuts . . . we're all nuts. Take advantage of our condition . . . we're all slaphappy—which is to your good. Everything begins new and fresh in 1948. A clean sweep . . . bring your own broom, truck, or what have you. Carry away the whole joint . . . and at the following prices, you can do it. Kiddin' aside, you'll find wonderful bargains in stuff you can always use. Wipe the slate clean so that we can serve you better in '48.

**WRITE, WIRE, PHONE OR CRAWL IN ON YOUR KNEES . . . WE FILL ALL ORDERS IMMEDIATELY . . . IT'S LOTS OF FUN**

**WE'RE CRAZY**, but you'd be crazier if you bought these 72 ohm twisted rubber pair and 300 ohm ribbon line standard brand wire if you paid more than our price of 100 feet for **\$2.95 . . . per 1000 ft. \$27.50**

**OUR CAPACITY IS REACHED** . . . must trim our shelves . . . Air Trimmers 1" shaft, 140 MMF for HF & VHF. Trim with our trimming . . . General padding, etc. . . Isolatite base . . . **39c ea. 10 for \$3.50**

**"FALL IN"** . . . we sure did. Ever get stuck for a hundred grand? Army Surplus Output Meter #146. Can be used as AC Voltmeter as well as output meter. No hot stove range, but ranges 1 1/2-6-15-60-150 volts . . . meter is 4000 ohms . . . completely baked in bakelite case with test leads. Steal 'em for **\$10.49**

**WATCH YOUR WIFE? BABIES? GIRL-FRIEND?** . . . Put "Ultra Mike" on guard. No wires, connects to hiab box . . . a terrific steal with batteries, tubes, and what have you. Super special . . . **\$6.63**. Retail \$18.00. F.O.B. Chicago.

**WE WERE TALKED INTO** these Four Tube Amplifiers . . . don't let yourself be fooled too. They're 110 volt AC, 60 Cy. A classy chassis . . . all wired and ready to go. Less tubes . . . Only a jerk would buy 'em for \$29.95 ea. when you can buy 'em for **\$12.95 ea.**

**THE BOSS SURE GOT TAKEN** when he bought these Three Tube Amplifiers at \$15.50 . . . they're 110 volts, AC, 60 Cy. . . complete, less tubes. We're giving 'em away at **\$10.95**

**DON'T FALL OFF THE ROOF** . . . we went off the deep end buying these RCA Television and FM Antennas . . . Dipole and Reflector . . . now we're climbing back on the roof and putting these items up for sale at **\$8.55 ea.**

**IDEAL FOR HANGING** . . . that's what we ought to do to the guy who made up these Antenna Kits . . . this pile of scrap has 50' of (hanging strength) copper stranded wire and 60' of rubber lead-in wire. Insulators, nail knobs, etc. With our fingers crossed . . . **69c per kit.**

**ATTENTION! ABOUT FACE** . . . and start running . . . because if you want a Signal Generator from Army Surplus, you'd better get here fast. No. 1-22-a . . . from 8 Mc to 230 Mc. Crystal Calibrated 117 Volt, 60 Cycle self contained power supply. We even furnish the tubes. Lower your sights . . . these generators are within the ranges of intermediate freqs. for FM and Television Sets. Carry 'em away with you for **\$45.95 ea.**

**WE CAN DREAM, CAN'T WE?** . . . this Army Surplus in the form of a Power Transformer 175 Ma. . . 515-0-515 Volts, 5V at 3 Amps. 2 1/2 V Cl. 5 amps. had us up in the clouds until we found out that our boss wanted us to sell them. They'll do for small transmitters and amplifiers. Used to be a good black market item . . . now you can have 'em for **\$4.95**

**WEBSTER MODEL 79 WIRE RECORDER** foundation unit. Formerly retailed at \$90. This is the first time that this quality product has ever been offered to the trade at less than **\$52.92 . . . new low price of \$44.10**

**JUMPIN' JEHOSEPHAT** . . . Some more Army Surplus! For all the Sparky boys . . . Standard Hand Telegraph Keys . . . can't go wrong at **69c**

**WE'RE LYING WHEN WE SAY** that these Bakelite House Pickup Arms were actually worth \$3.51 ea. They're standard and lightweight . . . but we're not lying at . . . **\$1.79 ea.**

**NEED SOME PILOT LIGHT BULBS?** We sure don't . . . some stupid oaf bought a train load of standard branded #13, #14, #40, #44, #46, #47, #50, #51 bulbs. Standard boxed—10 to carton. Crazy is as crazy does . . . yours per 100 . . . **\$5.00**

**HOW TO GET INTO A TIGHT SPOT** . . . Use one Pilot Light Installer . . . a handy gadget for inserting . . . lights . . . in tight places . . . **24c ea.**

**WE RAISE OUR RIGHT HANDS** when saying this . . . never in our checkered career have we found such a lovely group of hard to move Heavy Duty Phillips Screw Drivers #2 size . . . and for #10 to 16 screws . . . we were robbed for 82c ea. . . you can have 'em at **49c ea.**

**DEEP IN OUR DARK BASEMENT** we came upon these Condensers. Standard 20x20 Mfd. 150V. Tubulars. We can't sell 'em, so we'll give 'em to you at **39c ea. or 10 for \$3.50**

**HAVE YOU CONVERTED TO MORT'S** . . . Huhmmmm! We wouldn't switch to these Meek FM Converters (88 to 108 MC) either if the price was \$59.95 ea., even though they'll attach to any standard AM radio. They come in a Bakelite cabinet. You're not taking a chance at **\$15.95 ea.** A big deal at 3 for **\$44.85**

**WE CLAIM THEY'RE WORTH \$40.00**, but any darned fool would know that these Precision Resistor Kits aren't worth more than 10 for **\$1.79 . . . (plus or minus 1% standard brand).**

**SUPER OUTPUT TRANSFORMERS**, we're nuts, but they are for 50L6, 25L6 . . . you can't use them, even though they're for standard 4, 5 and 6 inch speakers. Don't even look at 'em for 79c each. How about **54c each . . . oh well! 10 for \$4.90** or we throw 'em away.

**NOW HEAR THIS** . . . the newest, the latest super-duper, Superhet Radio with Five Jumpin', jiving tubes, AC DC. Terrific cabinet can be used for a foot rest . . . a gift at **\$16.95 ea.** A triple gift at 3 for **\$47.50**

**CAN CONDENSERS THE SCREW TYPE WAY** . . . if you can use some more junk, these are 35x35x35 mfd. at 150V . . . sweeping them out the door at **89c ea. or 10 for \$7.90**

**NOISE, NOISE, NOISE** . . . filter same if shaving with an electric razor . . . radio noise filters for Filtering Line Noes. Glad to get rid of 'em at **\$1.14**

**WE'RE PRACTICALLY GIVING AWAY** these Resistor Kits. Unlucky purchase by some dumb schmoe means 100 asst. Resistors 1/4, 1/2 and 1 watt at 10%. Resistors for next to nothing. Super deal at **\$1.89 per kit.**

**THAT BOSS OF OURS** expects us to sell these brand new Volume Controls with Switch Half Meg 2 1/2 inch shafts for **\$1.17 ea. . . now you know we expect you to buy them at 49c ea. or 10 for \$4.40**

**NO ONE WANTS 'EM** at 32c each, so we're condensing a bunch of 20 Mfd. 150V Condensers into 10 for **\$1.49**

**THESE HEAVY DUTY 4" PM Speakers** with output for 50L6, 25L6, etc. . . make sound come out like your old first sergeant's voice . . . you can have 'em, we don't want 'em . . . for **\$1.79 ea.**

**MORT BOUGHT 'EM AND WE'RE STUCK** . . . sneaked these Standard 5" PM Speakers . . . Albico V. Marquet, out the back way . . . take 'em out under your coat for **\$1.45 ea.**

**WE'RE SURE NOT PROUD OF THESE** Metal Speaker Cabinets . . . don't know what you can do with 'em, but they will house a 6" Speaker and small Amplifier. Not worth \$3.75 ea. But you can't go wrong at **\$1.25 ea.**

**NOT JESS WILLARD THE FIGHTER** . . . but Willard 2-volt Storage Battery . . . a fighter nevertheless. Comes in a snazzy plastic case. Shipped dry . . . spill proof. 3 1/2" high, 3 1/2" x 3 1/2". . . Was \$6.00. The Winner at **\$1.95**

**SHOCKING!** Bare necked Copper Stranded Antenna Wire in 50' or 100' rolls . . . 50' for **28c** 100' for **34c**

**IN OUR JUNK HEAP** we found some new Auto Radio Antennas that we can't even give away for \$2.15 ea. . . maybe if we paid you to take them you could use same for flag poles . . . anyhow they come in 3 sections and fit the side cowl. Carry 'em away for **97c ea.**

**HOLD ON TO YOUR UPPERS** . . . we lost our eye-teeth when we bought these Antennas at \$2.75 . . . but because they're brass with chrome plating . . . in 3 sections, and rustproof, with side cowl mounting, you can take advantage of our stupidity for **\$1.75 ea.**

**MAYBE YOU CAN USE THESE** American Beauty Soldering Elements . . . we certainly can't . . . the boss says "give 'em away," but since they're 100 watt, and take a tip . . . you can have all you want for **\$1.85 ea.**

**WE FINALLY DUG THESE UP.** Standard Sets IF Coils 2 1/2" x 1 1/2" genuine prewar quality . . . they listed for \$3.00, but don't let that fool you . . . they're only worth **69c per set** . . . 456 Kc.

**WE'VE TRIED TO SHOVEL** these Army Surplus Utah High Impedance Earphones out the door, but they won't move . . . come in and grab a handful at **\$1.79 ea.**

**ARE YA LISTENIN'!** . . . Huhmmmm!—Microphone Floor Stands for use as hat racks . . . the durable chrome finish isn't durable and the heavy black crackle base has cracked all over the place . . . but for a hat rack they'll do . . . as a mike stand they were worth \$9.95 . . . as a hat rack . . . **\$4.75**

**USE IT FOR AN OVERNIGHT CASE** . . . A Portable Record Changer Case with inside dimensions on changer base 13"x15" with 9" depth. Will take 6" speaker. Ideal for those little intimate things . . . was \$12.95 . . . record change to **\$5.95**

**CHECK YOUR INLAYS AND RELAYS** . . . we're crazy and you will be too if you buy 10 of these assorted relays for \$25.00 when Mort's giving them away at **\$2.49**

Write for our new, FREE 1948 Catalog . . . Terms: 25% Deposit with order . . . Balance C.O.D.

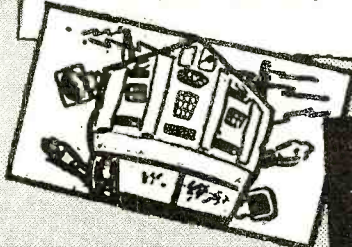

# Mort's Radio Shack

630 W. RANDOLPH STREET

CHICAGO 6, ILL.

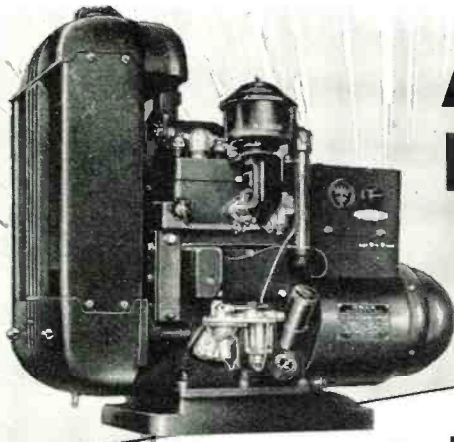

# A.C. or D.C. POWER

PORTABLE,  
STANDBY OR  
STATIONARY

You can simplify any power-for-electronics problem with an ONAN Electric Plant. A wide range of models and sizes makes it easy to choose the right plant for the particular application.

Lightweight one or two-cylinder air-cooled models for easy portability—A.C.—350 to 5,000 watts, D.C.—600 to 5,000 watts. Onan two, four and six-cylinder water-cooled models are built for continuous heavy-duty operation, stationary or mobile. A.C.—3,000 to 35,000 watts, D.C.—3,500 to 10,000 watts.

ONAN Electric Plants: A.C.—350 to 35,000 watts in standard voltages and frequencies. D.C.—600 to 10,000 watts, 115 and 230 volts. Battery chargers—500 to 6,000 watts, 6 to 115 volts.

**D. W. ONAN & SONS INC.**  
4792 Royalston Ave. Minneapolis 5, Minn.

For—  
Radio Station Standby  
Geophysical Survey  
Railroad Radio  
"Spot" Recording  
Mobile Radio Units  
Municipal Signal Standby  
Amateur Radio

Write for Folder



## ONAN ELECTRIC PLANTS

TOP NOTCH FOR  
TOP FREQUENCIES

—the new

UNIVERSITY  
TWEETER



Use It With  
Any Standard  
Cone Speaker

So you want high-fidelity? Then this tweeter is for you. A simple high-pass filter permits quick connection to your present cone speaker with only two wires. Extends the range of your existing cone speaker to 15,000 cycles. Available in several types, unmounted or in cabinet. Prices from \$20.00. For details address UNIVERSITY LOUD-SPEAKERS, INC., 80 South Kensico Avenue, White Plains, New York.

*University Loudspeakers*

### TECHNICAL KO's

OIL-FILLED CONDENSERS		TRANSMITTING MICAS	
.05 MFD 1000 V	\$0.28	.000025	2500 V \$0.11
.05 500 V	.14	.00005	1600 V .12
.1 2500 V	.45	.00005	2500 V .14
.1 7500 V	1.85	.00005	5000 V .85
2x.1 7000 V	4.75	.000067	2500 V .20
.12 15000 V	6.95	.00007	2500 V .20
.25 1000 V	.35	.00025	2500 V .25
.25 4000 V	2.75	.00025	5000 V .87
.25 6000 V	4.00	.0004	2500 V .22
10x.25 600 V	1.00	.0005	2500 V .22
.5 600 V	.28	.00072	5000 V .89
.5 1000 V	.37	.0008	5000 V .89
.5 2000 V	.40	.001	2500 V .22
.75 2000 V	.55	.0015	5000 V .95
.77 330 VAC	.35	.002	2500 V .27
1.0 1000 V	.45	.002	3000 V .66
2.0 1000 V	.60	.0025	1200 V .15
4.0 600 V	.55	.00275	2000 V .28
4.0 1000 V	1.00	.003	2500 V .30
6.0 1000 V	1.25	.004	2500 V .36
6.0 2000 V	1.75	.005	3000 V .66
8.0 600 V	.85	.006	2000 V .35
8.0 1000 V	1.75	.008	1200 V .15
10.0 600 V	1.00	.01	1200 V .16
30.0 330VAC	2.35	.02	600 V .11

NAT'L BRAND CHOKE 12H-80MA-250 OHMS.	\$1.09
NAT'L BRAND CHOKE 10H-100MA-250 OHMS	1.09
RESISTOR KIT ASSORTED 1/2&1W.....100 for	1.49
BATHTUB KIT 3x.1, .5, .05 ETC.....10 for	.59
CONDENSER KIT .01-.00001.....100 for	3.00
MICAS .002, .005, ETC. ALL VALUES.....	.08
.01 150V PAPER (MIDGET).....	.60 for 1.00
.02 1600V PAPER.....	.5 for 1.00
.1 600 V PAPER.....	10 for 1.00
12SQ7 METAL.....	\$0.32
12K5 METAL.....	\$0.25
6V6 METAL.....	.89
6L6 METAL.....	.95
POWER XFORMER 850VCT, 750VCT @ 200 MA, 5V @ 4A, 6.3V @ 5A.....	4.14

\$2.00 min. order F.O.B., N.Y.C. Add postage 50% deposit, balance C.O.D. with all orders. Manufacturers' inquiries invited.

### TECHNICAL RADIO PARTS CO.

265 Greenwich St. Dept. RN-2 N. Y. 7, N. Y.

- \*17.850—PRL9, Rio de Janeiro, Brazil, "Radio Nacional," 50 kw.
- \*17.850—COBC, Havana, Cuba, 1 kw.
- 17.850—Paris, "Radiodiffusion Francaise," 100 kw.
- \*17.850—KCBF, Delano, Calif., U.S.A., 50 kw.
- \*17.850—KNBL, Dixon, Calif., U.S.A., 50 kw.
- \*17.850—HHK, Leogane, Haiti.
- \*17.855V—Paris, "Radiodiffusion Francaise," 25 kw.
- \*17.860—Brussels, Belgium, "Radio Nationale Belge," 5 kw.
- 17.860—Moscow.
- 17.880—KGEX, San Francisco, Calif., U.S.A., 100 kw.
- 17.880—WGEX, Schenectady, N.Y., U.S.A.
- \*17.915—CR7BI, Lourenco Marques, Mozambique, "Radio Mozambique," 10 kw.
- 17.975—ZNX, St. Georges, Bermuda.
- 17.980—KQZ, Bolinas, Calif., U.S.A.
- 18.025—GRQ, London, 50-100 kw.
- 18.035—ICJ, Rome, Italy.
- 18.070—PCV, Kootwijk, Netherlands.
- 18.073—PGD, Kootwijk, Netherlands.
- 18.080—GVO, London, 50-100 kw.
- 18.115—LSD9, Buenos Aires, Argentina, 8 kw.
- 18.130—GRP, London, 50-100 kw.
- 18.135—PMC, Batavia, Java, "Radio Batavia," 3 kw.
- 18.160—WNRI, New York, U.S.A., 50 kw.
- 18.170—Moscow.
- 18.330—Paris, France.
- 18.388—FZS, Saigon, French Indo-China, "Radio Saigon."
- \*18.452—HBF, Geneva, Switzerland, 20 kw.
- \*18.480—HBH, Geneva, Switzerland, 20 kw.
- 18.600—PLA, Batavia, Java, "Radio Batavia," 2.5 kw.
- 18.750—F3A, Hong Kong.
- 18.910—JVA, Tokyo.
- \*19.046—Johannesburg, South Africa (Johannesburg III), 5 kw.
- 19.055—Bridgetown, Barbados.
- 19.080—GYBS, Royal Observatory (Greenwich).
- 19.330—IFV, Rome, Italy.
- 19.345—PMA, Batavia, Java, "Radio Batavia," 2.5 kw.
- 19.355—FTM, Paris, 30 kw.
- 19.400—LQB5, Buenos Aires, Argentina, 1 kw.
- 19.450—XGN5, Shanghai, China.
- \*19.554—HEO6, Berne, Switzerland, 25 kw.
- \*19.565—HEK6, Berne, Switzerland, 25 kw.
- 19.660—SUS, Cairo, Egypt, 2 kw.
- 19.764—SUP3, Cairo, Egypt, 10 kw.
- 20.000—WVW, Washington, D.C., U.S.A., Bureau of Standards, 8.5 kw.
- \*20.040—OPL, Leopoldville, Belgian Congo, "Radio Congo Belge," 7 kw.
- \*20.050—Cairo, Egypt.
- 20.148—SUP, Cairo, Egypt, 10 kw.
- 21.002—Brazzaville, French Equatorial Africa, "Post Nationale Francaise."
- \*21.181—Brazzaville, French Equatorial Africa.
- \*21.220—Moscow.
- \*21.350—Moscow.
- \*21.450—Brussels, Belgium, "Radio Nationale Belge," 5 kw.
- \*21.450—OLR7A, Prague, Czechoslovakia, 30 kw.
- \*21.450—XGSW, Nanking, China.
- \*21.460—LKY, Oslo, Norway, "Radio Oslo," 5 kw.
- \*21.460—KCBF, Delano, Calif., U.S.A., 50 kw.
- \*21.460—KNA, Dixon, Calif., U.S.A., 50 kw.
- \*21.460—WRU?, Boston, Mass., U.S.A., 50 kw.
- \*21.470—Colombo, Ceylon, "Radio SEAC," 7.5 kw.
- 21.470—GSH, London, 50-100 kw.
- \*21.480—PHI, Hilversum (Huizen), Holland (Netherlands), "Radio Nederland," 5 kw.
- \*21.490—Paris, "Radiodiffusion Francaise."
- \*21.490—KGEI, San Francisco, Calif., U.S.A., 50 kw.
- \*21.500—LKZ, Oslo, Norway, 5 kw.
- \*21.500—HHK, Leogane, Haiti.
- 21.500—WOOW, New York, N.Y., U.S.A., 50 kw.
- \*21.500—WGEA, Schenectady, N.Y., U.S.A., 50 kw.
- \*21.505—Moscow.
- 21.510—VUD8, Delhi, ATR, 7.5 kw.
- \*21.510—Rome, Italy.
- \*21.510—XGSX, Nanking, China.
- \*21.520—HBR8, Berne, Switzerland, "Swiss Broadcasting Corp.," 25 kw.
- \*21.520—New York, N.Y., U.S.A., 50 kw.
- \*21.520—JZM, Tokyo, Japan.
- 21.530—GSJ, London, 50-100 kw.
- \*21.540—VLR5, Melbourne, Australia, "A.B.C.," 2 kw.
- 21.540—VLB5, Shepparton, Australia, "Radio Australia," 100 kw.
- \*21.540—WBOS, Boston, Mass., U.S.A., 50 kw.
- \*21.540—Brussels, Belgium.
- 21.550—GST, London, 50-100 kw.
- \*21.550—OIX6, Lahti (Helsinki), Finland, 1 kw.
- \*21.550—XGSY, Nanking, China.
- \*21.560—Moscow.
- \*21.560—JLP4, Tokyo.
- \*21.565—OLR7B, Prague, Czechoslovakia, 30 kw.
- 21.570—WCRC, New York, N.Y., U.S.A., 50 kw.
- \*21.565—OLR7B, Prague, Czechoslovakia, 30 kw.
- 21.570—WCRC, New York, N.Y., U.S.A., 50 kw.
- \*21.580—Paris, "Radiodiffusion Francaise."
- \*21.580—Horbj, Sweden, 100 kw.
- 21.590—WGEA, Schenectady, N.Y., U.S.A., 50 kw.
- \*21.600—VLA9, Shepparton, Australia, "Radio Australia," 100 kw.
- \*21.600—VLB8, Shepparton, Australia, "Radio Australia," 100 kw.

- \*21.605—HE19, Berne, Switzerland, "Swiss Broadcasting Corp.," 25 kw.
- \*21.610—KNBA, Dixon, Calif., U.S.A., 50 kw.
- \*21.610—WNRA, New York, N.Y., U.S.A., 50 kw.
- \*21.610—JLT4, Tokyo.
- \*21.618—Colombo, Ceylon.
- \*21.620—COCY, Havana, Cuba, "RHC-Cadena Azul," 1 kw.
- \*21.620—Paris.
- \*21.620—Colombo, Ceylon, "Radio SEAC," 100 kw.
- \*21.620—JLS3, Tokyo.
- \*21.620—XGSZ, Nanking, China.
- \*21.625—OZX2, Skamlebak (Copenhagen), Denmark, 6 kw.
- \*21.630—KNBA, Dixon, Calif., U.S.A., 50 kw.
- \*21.630—New York, N.Y., U.S.A., 50 kw.
- \*21.640—OLR7C, Prague, Czechoslovakia, 30 kw.
- 21.640—GRZ, London, 50-100 kw.
- \*21.650—WLWL, Cincinnati, Ohio, U.S.A., 75 kw.
- 21.650—WLWS, Cincinnati, Ohio, U.S.A., 75 kw.
- \*21.670—LLP, Oslo, Norway, "Radio Oslo," 5 kw.
- \*21.670—HHK, Leogane, Haiti.
- 21.675—GVR, London, 50-100 kw.
- 21.680—VLC10, Shepparton, Australia, "Radio Australia," 50 kw.
- \*21.680—OTC6, Leopoldville, Belgian Congo, "Radio Nationale Belge," 50 kw.
- 21.680—TGWA, Guatemala City, Guatemala, "La Voz de Guatemala," 10 kw.
- \*21.690—Horby, Sweden, 100 kw.
- 21.690—WLWL1, Cincinnati, Ohio, U.S.A., 75 kw.
- \*21.705—HEU9, Berne, Switzerland, "Swiss Broadcasting Corp.," 25 kw.
- \*21.710—CHLA, Sackville, Canada, "CBC International Service," 50 kw.
- \*21.710—OZX, Skamlebak (Copenhagen), Denmark, 6 kw.
- 21.710—GVS, London, 50-100 kw.
- \*21.715—Brussels, Belgium, "Radio Nationale Belge," 5 kw.
- \*21.720—Horby, Sweden, 100 kw.
- \*21.720—Motala (Stockholm), Sweden, 12 kw.
- 21.720—Singapore, Malaya, "The British Far Eastern Broadcasting Service."
- \*21.730—LLQ, Oslo, Norway, "Radio Oslo," 5 kw.
- 21.730—WNRX, New York, N.Y., U.S.A., 50 kw.
- \*21.740—COCW, Havana, Cuba, "Cadena Azul," 1 kw.
- \*21.740—Paris, "Radiodiffusion Francaise," 100 kw.
- 21.750—GVT, London, 50-100 kw.
- \*22.004—ZLO, Waiouru, New Zealand, 10 kw.
- 22.225—Ronne Antarctic Expedition.
- 25.000—WWV, Washington, D.C., U.S.A., Bureau of Standards, 100 w.
- 25.600—WITX, Boston, Mass., U.S.A.
- \*25.640—HER9, Berne, Switzerland, "Swiss Broadcasting Corp.," 25 kw.
- \*25.750—GSO, London, 50-100 kw.
- 25.800—TFJ, Reykjavik, Iceland.
- \*25.800—ZL6, Wellington, New Zealand, 7.5 kw.
- \*25.900—LLA, Oslo, Norway, "Radio Oslo," 5 kw.
- \*26.020—HED9, Berne, Switzerland, "Swiss Broadcasting Corp.," 25 kw.
- \*26.020—HVJ, Vatican City, Vatican, "Radio Vaticano," 15 kw.
- \*26.070—TGWA, Guatemala City, Guatemala, "La Voz de Guatemala," 10 kw.
- 26.100—GSK, London, 50-100 kw.
- \*26.125—TGWA, Guatemala City, Guatemala.
- \*26.200—Brussels, Belgium, "Radio Nationale Belge," 5 kw.
- \*26.350—LLC, Oslo, Norway, "Radio Oslo," 5 kw.
- \*26.400—CSR, London, 50-100 kw.
- \*26.470—Brussels, Belgium, "Radio Nationale Belge," 5 kw.
- \*26.520—TGWA, Guatemala City, Guatemala, "La Voz de Guatemala," 10 kw.
- 26.550—GSS, London, 50-100 kw.
- \*27.000—CXAL1, Montevideo, Uruguay, "Radio Electrica," 2.5 kw.
- \*29.500—CXA22, Montevideo, Uruguay, "Radio Electrica," 2.5 kw.
- 30.000—WWV, Washington, D.C., U.S.A., Bureau of Standards, 100 w.
- 35.000—WWV, Washington, D.C., U.S.A., Bureau of Standards, 100 w.

(NOTE: Compiled to December 15, 1947.)

-50-



"He says he has to wait till the programs are over so he can check the signal pattern!"

TEST CRAFT Instrument Co. Proudly presents

THE NEW MODEL TC-48

# COMBINATION TEST SPEAKER

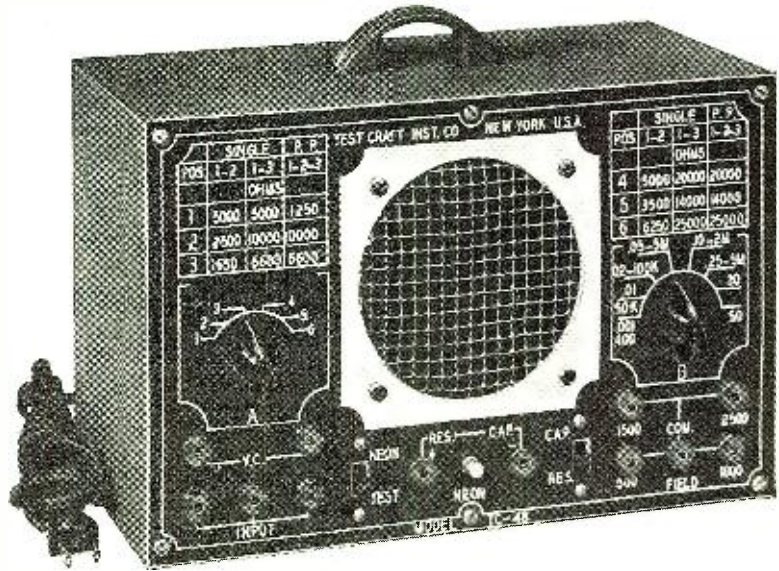

## A COMBINATION TEST SPEAKER

plus resistor tester  
plus condenser tester  
plus resistor substituter  
plus condenser substituter  
plus output meter

No need to carry the speaker to your shop in servicing any radio from the small midget to the most elaborate console. Any output tube or tubes can be matched simply by rotating input switch to tube listed and rotate field coil switch for proper impedance and proceed with testing. External voice coil connection permits testing of set speaker to determine if output transformer is open or shorted.

### SPECIFICATIONS

RESISTOR CONDENSER TESTER: 110 Volt A.C. power source for basic indications of either shorts and opens in both resistors and condensers. Leakage indication for condensers only.

CAPACITY SUBSTITUTION: 7 capacity values available. .001, .01, .02, .05, .10 at 600 volts and 30 mfd. and 50 mfd. at 150 V. Provides substitution of by-pass coupling and electrolytic condensers.

RESISTOR SUBSTITUTION: 6 resistance values available, 400, 50K, 100K, 500K, 2 meg, and 5 meg. at 1/2 w tr. Provides substitution of grid bias and other types of resistors.

OUTPUT METER: Neon type of output indicator for receiver alignment.

UNIVERSAL AND SUBSTITUTION SPEAKER: Field—500-1000-1500 and 2500 ohms at 175 ma. Speaker—Permanent magnet type. Voice Coil—2.8 ohms. Input—Single or push pull.

Available at your regular radio parts jobber. If your jobber cannot supply you, send your order directly to us.

A MUST FOR EVERY RADIO SERVICEMAN AND ENGINEER

\$ **27**<sup>50</sup> NET PRICE

THIS UNIT COMES HOUSED IN A RUGGED, BATTLESHIP GRAY, CRACKLE-FINISHED, STEEL CABINET, COMPLETE WITH FULL OPERATING INSTRUCTIONS, READY TO OPERATE ON 110-125 Volts A.C., 50-60 Cycles. SIZE: 7"x11"x5".

Now Available for IMMEDIATE SHIPMENT

TEST CRAFT INSTRUMENT CO.

42 WARREN STREET Dept. RN NEW YORK 7, N. Y.

## WALKIE-TALKIE KIT!

Operates in 144 mc. band. This amazing little unit entirely self-contained, measures only 2 3/4" x 4 1/2" x 1 1/2"! Transmitter portion of walkie-talkie has separate oscillator which may be spotted in any portion of 144 mc. band. Super-regenerative detector.

Transmitter and receiver controls brought out separately.

An ideal unit for hundreds of uses! All parts, instructions and wiring diagram included with each kit. We are offering this kit at the extremely low price of **\$19.95** only.....

Two kits for.... **\$38.50**

Set of batteries for the above..... **\$3.62**

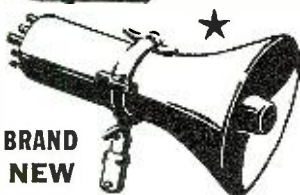

**★ ONLY A FEW STILL ON HAND**

**BRAND NEW**

**25-Watt Re-entrant Speaker with Jensen Driver Unit and UTC Line-Matching Transformer**

**IN ORIGINAL, SEALED FACTORY CARTONS**  
Only \$21.60 Net

• We have just received our final shipment of this outstanding PA Speaker. First shipment sold out in a few days. Stock up now. You will not be able to buy this Army Surplus item in future. Specifications: 20" overall. Horn 13" dia. Metallic diaphragm voice-coil assembly (Jensen). Driver unit alone weighs 9 lbs. UTC Line-matching Transformer 250, 500, 1000 and 2500 ohms. Speaker is fitted with mounting swivel, lock-nut and sleeve for attachment to standard pipe stand. Unquestionably one of the best surplus buys ever offered.

### BARGAINS FOR THIS MONTH

**Telescopic Whip Antennas.** Brand new. 7' totally extended, 9 sect. With bakelite mounting base, only \$1.75 ea.

**TU-10B Tuning Units.** Range 10 to 12.5 meg. Get this buy now while it lasts for only \$2.35 ea.

**BC-1206 Receiver.** 195 to 400 kcs. Very compact. Measures 4" x 4" x 6 1/2". Your cost only \$5.95 ea.

**4 Tube Beacon Receiver BC1023A.** Complete with tubes in sealed cartons. **WHILE THEY LAST, ONLY \$3.95 ea.**

**10 Henries at 150 ma.** fully shielded choke. **ONLY \$1.98 ea.**

**Chicago Heavy Duty Transformer!** 375v.-0-375v. @ 220 ma. 6.3v. @ 4.5a. 5v. @ 4a. Delivers 382v. d.c. A real buy at only \$4.95 ea.

**BC-221 Frequency Meter, with A-C Power Supply Kit and Modulation Kit and Circuit Diagram**



Now—AT LAST—you can get a BC-221 Frequency Meter with a complete kit of parts for an A-C Power Supply, plus another kit of parts for a Modulator, for about half the former price of a complete modulated instrument. You can convert the BC-221 Frequency Meter in a jiffy—and use it for receiver aligning, etc. Wiring diagrams are included with each kit. This may be your last chance to buy the BC-221. **PRICES:** BC-221 Frequency Meter with tubes, crystal and calibration charts, \$39.95. A-C Power Supply Kit and Diagram, \$5.85. Modulation Kit and Diagram, \$2.50. Any item sold separately if desired.

4-Hour Mail-Order Service. Write for **FREE** Catalog.

**OFFENBACH & REIMUS CO.**

372 Ellis St. San Francisco 2, Calif.  
Telephone—ORdway 3-8551

# Manufacturers' Literature

Readers are asked to write directly to the manufacturer for the literature. By mentioning RADIO NEWS, the issue and page, and enclosing the proper amount, when indicated, delay will be prevented.

### RESISTOR CATALOGUE

*Resistance Products Company* of Harrisburg, Pa., has just issued a new catalogue sheet covering its "B" type high voltage resistors.

Included is data covering dimensions, suggested mounting, ambient temperature graphs, engineering specifications, construction details, power rating figures, resistance tolerance, etc.

A copy of this publication can be secured by writing to *Resistance Products Company*, 714 Race Street, Har-

erations, such as shift mechanism for automatic resetting, frictions for manual resetting, and brake unit for instant stop.

The booklet is divided into separate sections of data sheets for each of nine different motor series manufactured, and for the various types of timing devices, such as repeat cycle and reset timers, time delay relays, interval timers, elapsed time indicators, etc.

Purchasing agents, engineers, and designers dealing with timing problems are invited to write for a copy of the catalogue. Address requests to E. B. Hamlin, *Haydon Manufacturing Company, Inc.*, Torrington, Connecticut.

### MINI-SIGNAL GENERATOR

Complete details and specifications covering the new Model 117 Crystal Controlled High Frequency Mini-Signal Generator are given in a four-page technical bulletin just issued by *Premier Crystal Laboratories, Inc.*

A complete circuit diagram and specific instructions for zero-beating the crystal by means of a unique micrometer adjustment are special features of the bulletin. Various uses for the signal generator in the aligning of AM, FM, and television receivers, as well as for testing amateur and mobile communications equipment are also suggested by the booklet.

Copies of the publication may be obtained by writing *Premier Crystal Laboratories, Inc.*, 53-63 Park Row, New York 7, New York.

### SPEAKER CATALOGUE

*The Magnavox Company* of Fort Wayne, Indiana, has announced the compilation of a comprehensive loudspeaker catalogue covering all current *Magnavox* loudspeaker models from the 4" x 6" elliptical to the 15" size.

Pertinent engineering data covering both the electro-dynamic and magneto-dynamic versions of all models is included, along with illustrations and schematic diagrams.

Copies of the new catalogue are available to any instrument manufacturer, engineer, or purchasing agent. Make your request on company letterhead direct to *The Magnavox Company*, Fort Wayne Indiana.

### KNOB CATALOGUE

*Rogan Brothers* have announced the availability of a new illustrated catalogue which lists specifications for their complete line of stock molded plastic knobs, control handles, instrument knobs, etc.

The booklet also contains useful engineering data to be used by design personnel. Copies of the catalogue may be obtained by writing to *Rogan Brothers*, 2500 W. Irving Park Boulevard, Chicago 18, Illinois.

### POWER SUPPLIES

*The Superior Electric Company* of Bristol, Connecticut, is currently offering a pamphlet describing the new "Voltbox" a.c. power supplies manufactured by the company.

Details on the "Voltbox," along with specifications, are included. The folder also gives details on the company's "Voltbase," a unit available for users who already have the company's "Powerstat" variable transformer, type 116 or 216, but require the features of the new "Voltboxes."

A copy of this pamphlet, entitled "Portable Packaged Power," will be forwarded to those requesting it from *The Superior Electric Company*, Bristol, Connecticut.

### TIMING UNITS

A 2-color, 16-page catalogue covering synchronous timing motors, timing devices, and clock movements has just been released by *Haydon Manufacturing Company, Inc.*, of Torrington, Connecticut.

The new catalogue is complete and includes photographs, profile drawings, shaft drawings, and complete listings of the speeds, voltages, frequencies, shaft sizes, and all other standard or special variations available in each motor listed.

The catalogue also lists many additional features for specific timing op-

### FM SERVICING BOOKLET

The *Specialty Division of General Electric Company* has just published a 28-page booklet entitled "Visual Alignment Techniques for FM Servicing" which should be of interest to all servicemen.

Written by Jack Najork of the Measurement Engineering Section of



### ANTENNA RELAY UNIT

0-10 Meter Weston Thermo-couple unit with 50 MMF, 5000v Vacuum condenser, and heavy duty relay...

**\$198**

# RHS

SPECIALS OF THE MONTH

### RELAYS

Sigma No. 4RJ 2000 ohms SPDT. Can adjust to less than 1 ma. ....

**69¢**

### GENERAL RADIO 566A WAVEMETER

.5 mc to 150 mc

5 PLUG IN COILS, Reg. Price \$69.50,  
BRAND NEW..... **\$39.50**

### SELENIUM RECTIFIERS

Full Wave Bridge Type

INPUT	OUTPUT	
up to 18v A.C.	up to 12v D.C.	1 Amp. \$1.95
up to 18v A.C.	up to 12v D.C.	5 Amp. 4.45
up to 18v A.C.	up to 12v D.C.	10 Amp. 7.45
up to 18v A.C.	up to 12v D.C.	15 Amp. 9.95
up to 18v A.C.	up to 12v D.C.	30 Amp. 14.95
up to 36v A.C.	up to 28v D.C.	1 Amp. 3.45
up to 36v A.C.	up to 28v D.C.	5 Amp. 7.45
up to 36v A.C.	up to 28v D.C.	10 Amp. 12.45
up to 36v A.C.	up to 28v D.C.	15 Amp. 18.95
up to 54v A.C.	up to 36v D.C.	.25 Amp. .98
up to 115v A.C.	up to 100v D.C.	.25 Amp. 2.95
up to 115v A.C.	up to 100v D.C.	.6 Amp. 6.95
up to 115v A.C.	up to 100v D.C.	5 Amp. 19.95

### OIL CONDENSERS

G. E.; AEROVOX, CD., ETC.

All Ratings, D.C.

1mfd. 600v	\$0.35	2mfd. 2000v	\$1.75
2mfd. 600v	.35	3mfd. 2000v	2.75
4mfd. 600v	.60	4mfd. 2000v	3.75
8mfd. 600v	1.10	15mfd. 2000v	4.95
10mfd. 600 v	1.15	1mfd. 2500 v	1.25
1mfd. 1000v	.60	.25mfd. 2500v	1.45
2mfd. 1000v	.70	.5mfd. 2500v	1.75
4mfd. 1000v	.95	.05mfd. 3000v	1.95
8mfd. 1000v	1.95	1mfd. 3000v	2.25
10mfd. 1000v	2.10	.25mfd. 3000v	2.65
15mfd. 1000v	2.25	.5mfd. 3000v	2.85
20mfd. 1000v	2.95	1mfd. 3000v	3.50
24mfd. 1500v	6.95	12mfd. 3000v	6.95
.25mfd. 2000v	1.05	2mfd. 4000v	5.95
.5mfd. 2000v	1.15	1mfd. 5000v	4.95
1mfd. 2000v	.95	1mfd. 7000v	2.95
<b>SPECIAL 2 mfd. 3000v</b>			<b>\$4.45</b>

### HIGH CAPACITY CONDENSERS

2x3500 mfd.—25WVDC.....	\$3.45
4000 mfd.—30WVDC.....	2.95
1000 mfd.—15WVDC.....	.99
2000 mfd.—50WVDC.....	1.95

### BC-314 RECEIVER

Used but in perfect condition. Two stages RF, separate local and beat oscillators. For 12-volt DC operation but easily converted to 110-volt AC. Frequency range 150-1500 KC, continuous in 6 bands. This unit is ideal as an airport or marine low frequency receiver, also a very excellent BC receiver. Complete with tubes, specially priced **\$29.50**

### BC-375-E TRANSMITTER

Operates from 200 kc—12.5 mc complete with all tubes, dynamotor, seven tuning units and one antenna tuning unit.  
Like New..... **\$29.95**

## SOLA

Constant Voltage Transformer

Pri.: 190 to 260v 60 cyc.  
Sec.: 115 volts @ 1.74 amps.  
Rated 250 V. A.

Brand New..... **\$29.95**

### PERMALLOY SHIELDS

for CATHODE RAY TUBES

3" Shield.....	\$1.49
5" Shield.....	1.98

### TUBES (Brand New)

Army-Navy Inspected

1N21.....	\$0.39	371B.....	\$5.95
2AP1.....	2.25	450TH.....	39.95
2C40.....	1.19	703A.....	7.95
2D21.....	.89	715B.....	7.95
2V3G.....	1.25	721A.....	4.35
2X2.....	.84	726/AC.....	7.50
3AP1.....	3.00	801.....	1.49
3BP1.....	2.95	802.....	1.98
3E29.....	2.95	803.....	8.95
3GF1.....	3.95	804.....	9.95
5BP4.....	4.95	805.....	4.95
5CP1.....	3.95	806.....	14.95
5J1P1.....	11.95	807.....	2.95
5LP1.....	8.95	808.....	2.95
5R4GY.....	.98	809.....	1.50
5Y3.....	.41	810.....	5.95
6AB7.....	.99	811.....	3.15
6AC7.....	.99	812.....	3.15
6AG5.....	.99	813.....	8.95
6AG7.....	.99	814.....	4.45
6AJ5.....	.99	815.....	3.95
6AK5.....	.90	829-A-B.....	3.00
6AL5.....	.99	832.....	2.25
6AQ6.....	1.09	833A.....	39.50
6AR6.....	1.29	836.....	1.75
6B4G.....	1.29	837.....	2.50
6C4.....	.69	838.....	3.95
6C5.....	.49	861.....	69.50
6D4.....	.99	866.....	.75
6F6.....	.89	872A.....	2.50
6F6G.....	.59	884.....	.98
6J4.....	1.50	885.....	.98
6J5.....	.55	902.....	3.00
6J6.....	.89	954.....	.75
6L6.....	1.23	955.....	.75
6L7.....	.98	956.....	.75
6N7.....	1.02	957.....	.75
6SH7.....	.59	958.....	.75
6SL7.....	.89	959.....	.75
6SN7.....	.69	1005.....	.69
6SR7.....	.89	1616.....	2.95
7A4.....	.81	1619.....	.75
7F7.....	1.25	1620.....	1.98
7L7.....	1.59	1622.....	1.98
10Y.....	.98	1624.....	.90
15E.....	1.50	1625.....	.75
HK24G.....	1.75	1626.....	.75
28D7.....	.98	8001.....	6.49
30.....	.75	8003.....	9.95
35T/TG.....	3.50	8005.....	4.95
VR90.....	.75	8011.....	3.75
VR105.....	.75	8016.....	1.65
VR150.....	.75	8025A.....	4.95
100TH.....	7.95	1654.....	1.98
100TS.....	3.00	9001.....	1.15
211.....	1.25	9002.....	.98
75T.....	2.95	9003.....	.98
250TH.....	14.95	9004.....	.98
257B.....	6.49	9005.....	.98
304TH.....	9.95	9006.....	.98
F-127A.....	22.50	F-128A.....	75.00

### GLIDE PATH RECEIVER R-89/ARN-5

Glide Path Receiver used in the Instrument Landing System covering the frequency range 332 to 335 mc; complete with the following tubes: 7-6AJ5, 1-12SR7, 2-12SN7, 1-28D7, and including three crystals 6497KC, 6522K.

Brand New..... **\$12.95**

### TRANSFORMERS—115 V 60 CYC.

HI-VOLTAGE INSULATION

3710v @ 10 ma.; 2x2½v @ 3A.....	\$9.95
2500v @ 15 ma.....	6.50
2500v @ 4 ma.; 2½v @ 2A; 6.3v @ 1 amp.....	9.95
2150v @ 15 ma.....	6.50
1750v @ 4 ma.; 6.3v @ 3A.....	7.50
1700v @ 4 ma.; 6.3v @ 6A; 2½v @ 1.75A.....	8.50
1600v @ 4 ma.; 700v CT @ 150 ma.; 6.3v @ 9A.....	8.50
1600v @ 2 ma.; 6.3v @ 6A; 2½v @ 1.75A.....	8.50
1500v @ 7 ma.; 2½v @ 1.75 A.....	7.50
1200v CT @ 400 ma.; 10v CT @ 10A.....	9.95
550-0-550 @ 150 ma.; 5v @ 3A; 2x6.3v @ 5A CT.....	7.95
525-0-525v @ 60 ma.; 925v @ 10 ma.; 2x5v @ 3A; 6.3v @ 3.6A; 6.3v @ 2A; 6.3v @ 1A.....	8.95
525v @ 35 ma.; 5v @ 35 ma.; 2½v @ 1.75A.....	1.98
520-0-520v @ 120 ma.; 5v @ 2A; 6.3v CT @ 5A.....	5.95
500-0-500v @ 25 ma.; 262-0-262v @ 55 ma.; 6.3v @ 1A; 2x5v @ 2A.....	4.49
500-0-500v @ 100 ma.; 5v CT @ 3A.....	4.95
400-230-0-230-400v @ 250 ma.; 3x5v @ 3A; 6.3v @ 5A; 6.3v @ 3A; 6.3v @ 1A.....	7.95
400-0-400v @ 200 ma.; 5v @ 3A.....	4.95
375-0-375v @ 400 ma.....	4.95
350-0-350v @ 150 ma.; 5v @ 3A; 6.3v @ 6A; 78v @ 1A.....	4.95
350-0-350v @ 45 ma.; 675v @ 5 ma.; 2½v @ 2A; 2x6.3v @ 1A; 6.3v @ 2½A.....	4.95
350-0-350v @ 80 ma.; 6.3v @ .6A; 6.3v @ 3.75A; 2x5v @ 3A.....	3.98
350-0-350v @ 120 ma.; 5v CT @ 3A; 6.3v CT @ 4.7A.....	3.95
350-0-350v @ 150 ma.; 5v @ 3A; 6.3v @ 7.5A; 6.3v @ 3A.....	5.95
350-0-350v @ 35 ma.....	1.49
340-0-340v @ 300 ma.; 1540v @ 5 ma.....	7.50
325-0-325v @ 120 ma.; 10v @ 5A; 5v @ 7A.....	3.49
300-0-300v @ 65 ma.; 2x5v @ 2A; 6.3v @ 2½A; 6.3v @ 1A.....	3.49
250-0-250v @ 100 ma.; 2x6.3v @ 4A; 6.3v @ 5A; 6.3v @ 1A.....	4.95
200-0-200v @ 140 ma.; 6.3v @ 4A; 5v @ 2A.....	1.98
120-0-120v @ 50 ma.....	.98
24v @ 6A.....	3.50
6.3v @ 10A; 6.3v @ 1A.....	3.50
6.3v @ 1A; 2½v @ 2A.....	3.95
6.3v @ 21½A; 6.3v @ 2A; 2½v @ 2A.....	6.95
6.3v @ .25A; 6.3v @ 3A; 5v @ 12A; 6.3v CT @ 9A.....	4.95
5v CT @ 16A.....	\$3.49
5v—190A.....	17.50
6.3v CT @ 1A.....	.98
220v @ 110v @ .75 kv.....	2.98
5v—115A.....	14.95
6.3v @ 6.6A.....	2.95
8v CT 1A.....	.98
10 hy @ 100ma.....	1.29

### FILTER CHOKES

HI-VOLTAGE INSULATION

10 hy @ 400ma.....	\$4.95	10 hy @ 250ma.....	\$2.49
8 hy @ 300ma.....	3.95	10 hy @ 200ma.....	1.98
25 hy @ 160ma.....	3.49	10/20 @ 85ma.....	1.59
12 hy @ 150ma.....	2.25	15 hy @ 125ma.....	1.49
12 hy @ 100ma.....	1.39	15 hy @ 100ma.....	1.39
30 hy @ 70ma.....	1.39	3 hy @ 50ma.....	.29
120 hy Dual @ 17ma.....	1.39	30 hy Dual @ 20ma.....	1.49
.1 hy @ 5 amps.....	6.95	10 hy @ 100ma.....	1.29
4 hy @ 600ma.....	5.95		

## ATTENTION!

### INDUSTRIALS—LABS— SCHOOLS—AMATEURS

Let us quote on components and equipment that you require. We have too many items to be listed on this page. Place your name on our mailing list now for new catalog.

ALL PRICES SUBJECT TO CHANGE WITHOUT NOTICE

All merchandise guaranteed. Mail orders promptly filled.  
All prices F.O.B. New York City. Send money order or check.  
Shipping charges sent C.O.D. Minimum order \$5.00.

**RADIO HAM SHACK Inc.**  
63 DEY STREET • NEW YORK 7, N. Y.

March, 1948

137

# Chicago

## INSTRUMENTS

### Quality at Low Cost!

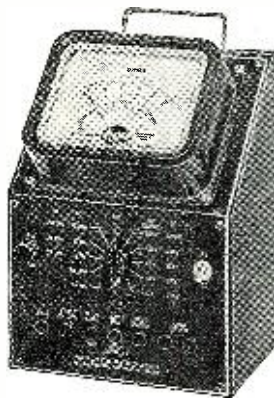

For years, Chicago Instruments have given radio men accurate, dependable service. And because of simplicity of design and freedom from "gadgets" we have been able to hold down prices to a fraction of what you would normally pay for instruments of similar quality.

Chicago Instruments are available in a variety of ranges and sensitivities. You may see them at your Suppliers or get the complete details by writing for Bulletin No. 10.

#### POCKET VOLT-OHM-MILLIAMMETERS FOR ONLY \$5.25

Anyone can now own a good volt-ohm-milliammeter. There is a Chicago V.O.M.A. priced at only \$5.25. Chicago "Featherweights" that slip easily into the pocket are the original miniature radio test instruments. They are popular throughout the world.

CHICAGO INDUSTRIAL INSTRUMENT CO., 536 W. ELM ST., CHICAGO 10, ILL.

the *Specialty Division*, the booklet includes chapters on the theory and practical applications of the cathode-ray oscilloscope and the sweep frequency signal generator, and basic FM circuits. The publication is profusely illustrated with schematic drawings, block diagrams, sketches, and curves.

Copies of the booklet (ESD-21) are obtainable from *General Electric* distributors. The price is \$0.25.

#### CORNELL-DUBILIER CATALOGUE

*Cornell-Dubilier's* new catalogue, No. 200, has been designed both as a handy reference book and complete capacitor listing in addition to offering the retailer and repairman the usual ordering service.

This 24-page catalogue, illustrated with detail drawings as well as half-tones, covers more than twenty different classes of capacitors manufactured by the company. Each type of unit is described in detail both as to construction and service. Many of the descriptions are supplemented by working drawings.

A copy of Catalogue No. 200 may be obtained by writing to *Cornell-Dubilier Electric Corporation*, South Plainfield, New Jersey.

#### MICROPHONE FOLDER

*Electro-Voice, Inc.*, is offering a copy of its colorful bulletin covering the *E-V Model 805 Contact Pickup Microphone* for stringed instruments.

Known as Bulletin No. 136, the new publication fully describes and illustrates the new product which has been designed to provide smooth, natural sound reinforcement of instrumental music including the guitar, banjo, mandolin, violin, viola, cello, harp, drum, and piano.

Complete specifications and a sketch showing the simplicity of mounting and detaching the microphone are given.

A copy of Bulletin No. 136 will be sent on request. Write to *Electro-Voice, Inc.*, Buchanan, Michigan.

#### BILEY BULLETIN

Distribution of Bulletin 36, covering crystals for all types of commercial applications, is being handled by the salesman and distributors of *Biley Electric Company* of Erie, Penn.

Included in this 9-page bulletin are crystals designed for transceivers, broadcast monitors, frequency standards, precision test equipment, communication receivers, signal generators, secondary standards, marine radio telephone, emergency service applications, vehicular and airborne equipment, etc.

Details of the company's CCO-Model 1C crystal controlled oscillator and their packaged v.h.f. crystal control unit are also given. A handy table of frequency tolerance requirements for various radio services is also given.

Copies of this bulletin covering crystals for commercial applications may be secured from the company's distributors.

**JUST OUT! Hard-to-get**  
**New Solid Brass Portable**  
**7 FT. RADIO ANTENNAS**  
**7 Exceptionally Rugged Sections With Handy Mounting Bracket**  
**\$10 Value Only \$2.49 post paid**  
**Sent Postpaid Upon Receipt of Price or Mailed C.O.D. Plus Postage**  
**FOR HOMES BOATS or AUTOS**

Same as used on Army tanks, Jeeps, etc. These telescopic, rustproof antennas have tremendous pickup, eliminate dangerous wiring. Solid Brass throughout, practically insuring

**NOISE FREE RECEPTION**  
 Compresses into 1 ft. 3 in. Handy for Camping Trips, also Useful for Transmitting, FM and Television sets.

**EASY TO INSTALL ANYWHERE**  
 Each antenna comes securely packed with mounting bracket ready to put up.

**QUANTITY LIMITED MAIL ORDER TODAY**  
 Send check or money order today for only \$2.49 for this \$10 Value. Your antenna will be sent postpaid or mailed C.O.D. plus postage. Money back in 10 days if not satisfied.

**RADIO HOSPITAL**  
 442 East 86th St., Dept. R-10  
 New York 28, N. Y.

**"America's Best Buy"**  
**TUBULAR ELECTROLYTICS**  
**Fresh Stock. Fully Guaranteed**

Capacity	W.V.	Each	per 10	100
25 mfd.	25V	\$0.17	\$1.59	\$14.95
50 mfd.	50V	.21	1.79	16.95
100 mfd.	50V	.24	2.29	19.98
20 mfd.	150V	.21	1.89	17.95
30 mfd.	150V	.22	1.95	18.95
40 mfd.	150V	.23	2.04	19.74
50 mfd.	150V	.24	2.14	20.45
20-20 mfd.	150V	.29	2.49	22.98
30-20 mfd.	150V	.32	2.95	25.98
40-20 mfd.	150V	.36	3.25	29.95
50-30 mfd.	150V	.39	3.49	32.98
8 mfd.	450V	.21	1.99	19.50
8-8 mfd.	450V	.42	3.98	35.76
16 mfd.	450V	.39	3.74	33.78

**BY-PASS CONDENSERS**

	600V	\$0.06	\$0.55	\$ 4.60
.01	600V	.06	.55	4.75
.02	600V	.06	.55	4.95
.05	600V	.07	.65	4.49
.1	600V	.11	.98	8.95
.25	1700V	.14	1.25	9.95
.005	1700V	.14	1.25	9.95
.07	1700V	.15	1.30	10.20
.01	1700V	.16	1.40	10.95
.02	1700V			

An assortment of 50 of the above By-pass condensers. Fine value for the small shop or experimenter, only \$2.98

**RESISTOR ASSORTMENT**  
 100 assorted 1/4-1 watt carbon resistors.  
 All RMA color coded. Special \$1.29.

**CRYSTALS 98c each**  
 Your frequency plus or minus 10 KC

80 Meter, 3500-4000KC
40 Meter, 7000-7300KC
for multiplying into
20 Meter, 7300-7425KC
10 Meter, 7300-7425KC
6 Meter, 6250-6750KC
2 1/2 Meter, 8000-8222KC

Postage extra 20% deposit on COD  
 Write for latest bargain list featuring  
 "America's Best Buys."  
**POTTER RADIO CO.**  
 1314 McGee St., Kansas City 6, Mo.

## Simple Converter

(Continued from page 55)

sistor,  $R_1$ , to give a close match for the line. In the event that lines of other impedance are used,  $R_1$  should be changed to correspond with their impedance.

Bias for the r.f. tube is supplied by the cathode resistor  $R_2$ . This resistor is not bypassed as the operation of this stage depends on the r.f. input being introduced into the cathode circuit. The purpose of condenser  $C_1$  is simply to act as a coupling medium between the antenna circuit and the cathode.

The plate of the r.f. stage and the grid circuit of the mixer are tuned by the combination of  $C_2$  and  $L_1$ . This LC circuit is coupled to the grid of the mixer by  $C_3$ .  $R_3$  completes the grid return for the mixer. Bias for the mixer portion of the tube is furnished by resistor  $R_4$  in the cathode circuit of the tube.

The grid leak of the oscillator portion of the tube is returned directly to the cathode of the tube, so that only the voltage developed across the grid leak in an oscillating condition, appears on the oscillator grid.

The coils are designed to give full coverage of the ten, eleven, and six meter bands, with a small overlap at each end. This requires that the necessary padding condensers be included with the coils, to provide automatic changing of condensers as the coils are changed. Details of the capacities used are given in the coil table.

In the construction of the coils, care should be taken to place the coils as far as possible from the shield plate. Sufficient coupling exists between the elements of the tube to give satisfactory mixer injection for optimum performance. Triode converters are very tolerant in the amount of oscillator voltage, and no adjustment of the injection voltage is necessary.

The oscillator for the ten meter band operates on the high frequency side of the signal, while the six meter oscillator is tuned to the low frequency side. This simplifies the method of obtaining complete band-spread on both bands, and accounts for the six meter oscillator coil having more turns than the ten meter oscillator coil.

A coaxial antenna terminal is used for the input to the converter. Resistor  $R_1$  and condenser  $C_1$  are mounted on the rear of this terminal, and a length of small diameter coaxial cable run from the junction to the cathode resistor  $R_2$ .

The output from coil  $L_4$  is brought to a terminal strip mounted on the rear edge of the chassis. Both terminals are insulated from ground to allow the converter to be used with receivers having balanced input.

Two toggle switches are mounted on the front panel. The left hand switch controls the "B" voltage for

March, 1948

# Now... a low-cost transcription quality crystal pickup!

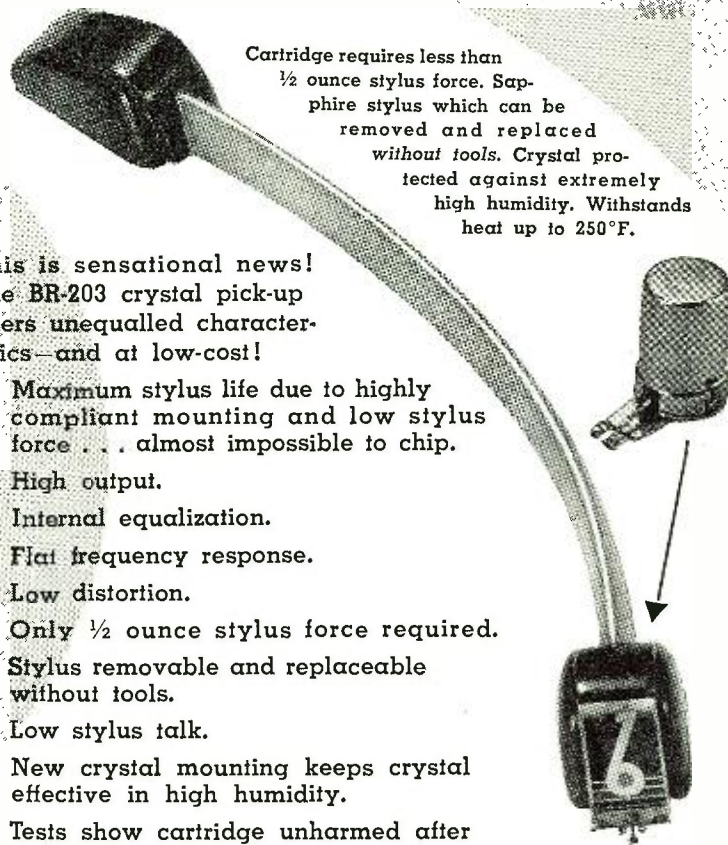

Cartridge requires less than ½ ounce stylus force. Sapphire stylus which can be removed and replaced without tools. Crystal protected against extremely high humidity. Withstands heat up to 250°F.

This is sensational news!  
The BR-203 crystal pick-up offers unequalled characteristics—and at low-cost!

- Maximum stylus life due to highly compliant mounting and low stylus force . . . almost impossible to chip.
- High output.
- Internal equalization.
- Flat frequency response.
- Low distortion.
- Only ½ ounce stylus force required.
- Stylus removable and replaceable without tools.
- Low stylus talk.
- New crystal mounting keeps crystal effective in high humidity.
- Tests show cartridge unharmed after 15 minutes in boiling water.
- New PN crystal will withstand temperatures as high as 250°F.

For the complete story on this latest  
Brush Development, write TODAY!

THE **Brush**  
DEVELOPMENT CO.

3405 Perkins Avenue • Cleveland 14, Ohio, U.S.A.

MAGNETIC RECORDING DIV. • ACOUSTIC PRODUCTS DIV.

INDUSTRIAL INSTRUMENTS DIV. • CRYSTAL DIVISION



## MORE GOOD BUYS

### BC 221A(\*) FREQUENCY METER Crystal Calibrated

Pictured to left, this Meter can be used as signal generator and V.F.O. Crystal calibration. Ranges: 125 K.C. to 20,000 K.C., complete with Tubes, Crystal, Original Calibration Charts. Every Meter tested and guaranteed. Slightly used, in excellent condition. Price, only ..... **\$39<sup>50</sup>**  
\*Later Models.

### A-27 PHANTOM ANTENNA

Dummy Antenna used for loading BC 375, BC 191 and BC 653 Transmitters. Can be used with ANY Transmitter. Calibrated Scale & Extra Leads. Brand New..... **\$1<sup>29</sup>**

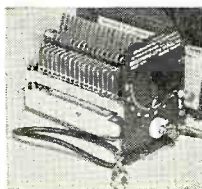

### COAXIAL CABLE

52 OHM—8 ft. lengths with connectors. 3 for..... **\$1.00**  
72 OHM—20 ft. lengths..... **\$1.00**  
72 OHM—6 ft. lengths, Male & Female Connectors. 2 for..... **\$1.25**

### HIGH-FREQUENCY METER 150 to 225 Megacycles

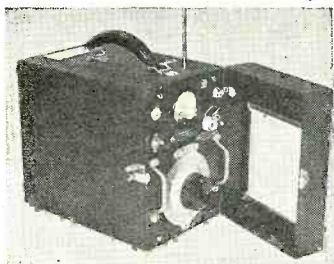

Absorption type frequency meter utilizing the DC Microammeter for frequency indication. Self-contained battery operation. Complete with Tube, Antenna, and Calibration Chart. Black metal case, size: 6 1/2" x 12" x 10". New (Less batteries) only

**\$49<sup>50</sup>**

### TRANSFORMERS

24 Volt SEC 1 Amp. Primary 110-60 cycle..... **\$2.00**  
24 Volt SEC .6 Amp. Primary 110-60 cycle..... **\$1.75**  
12 Volt SEC 1.6 Amp. Primary 110-60 cycle..... **\$1.39**  
6 Volt Vibrator Pack 220V, 60 MA output, with Tube & Vibrator. Size: 4 1/2" x 4 1/4" x 3 3/8". Brand New..... **\$5.95**

Minimum Order \$2.00. Prices are F.O.B. Lima, Ohio. 25% Deposit on C.O.D. Orders

**0-500 MICROAMMETERS**  
0-15 and 0-600 D.C. Volt Scale with Multipliers. Brand New—Only ..... **\$2.50**

**BC 375E TRANSMITTERS**  
With 7 Tuning Units and CS-48 Cases: Brand New \$29.50; Used—\$19.50. With 1 Selected Tuning Unit: Brand New—\$17.50; Used—\$10.50.

**BC 375 & BC 191 TUNING UNITS**  
With CS-48 Cases  
T.U. 5 and 6: New—\$3.00..... Used **\$1.95**  
T.U. 7, 8, 9, 10, and 26: New—\$2.50..... Used **1.50**  
BC 306: New—\$1.95..... Used **1.25**

**FABRICATED CABLES**  
BC 375 & BC 191—Set of 4 with Connectors, New—\$4.00  
BC 228—Set of 3 with Connectors, New—\$3.00  
B 19 MARK II—Set of 3 with Connectors, New—\$4.00

### WIRE

No. 20 Shielded, Stranded—100 ft. .... **\$1.50**  
No. 18 Cotton covered, Stranded—200 ft. ... **1.50**  
No. 12 Rubber covered, Stranded—75 ft. ... **1.50**  
**HARDWARE KITS**—Over 1,200 Pcs. 1 1/4 lbs. Individually packed ..... **\$7.50**  
**PHENOLIC PCS.**—9" x 11" x 1/4"—39c each, or 3 for **\$1.00**

We Can Furnish Any Item For B19 Sets!

**FAIR RADIO SALES**  
223 S. MAIN ST. • LIMA, OHIO

Prepare For A Good Job Now in  
**RADIO**  
SOUND and TELEVISION  
in a Few Short Weeks

LEARN QUICKLY IN  
THE GREAT SHOPS OF  
**GOYNE**

Get ready for a better job, bigger pay NOW in Radio. Cash in with "All-around" knowledge of Radio—Sound—Television. Train on actual equipment not by "Home-study". You learn quickest at GOYNE because it's a real SHOP course!

**G. I. APPROVED...also Finance Plan for NON-VETERANS.** Don't let lack of cash hold you back. Many earn while learning. FREE Employment Service to graduates. Get facts today!

**SEND COUPON FOR FREE BOOK**  
Send at once for Big Free Book on Radio, Sound and Television, and facts about our Finance Plan.

MAIL THIS COUPON TODAY

B.W. COOKE, Pres.,  
Coyne Electrical and Radio School  
500 S. Paulina St., Dept. 38-1K, Chicago 12, Ill.  
Please send Big FREE Book and complete details.

NAME.....  
STREET.....  
CITY.....STATE.....

## RISCO HAS IT

All Changers Brand New

### V. M. MIXER CHANGER



**\$15.50**

PLAYS 10" and 12" Records at the same time  
SEEBURG... **\$19.50**  
DETROLA... **13.75**  
OAK 2 POST 17.00  
MAGUIRE... **10.50**  
STOPS AFTER LAST RECORD, PERMANENT NEEDLE, 2-POST.

Above Easily Attached to Any Radio or CAN BE USED WITH AMPLIFIER BELOW

### SERVICEMEN'S SPECIALS

100—INSUL. RES. KIT 1/2, 1, 2w..... **\$1.65**  
25—MICA COND.—CODED..... **.89**  
15—ASST. KNOBS..... **.89**  
15—ASST. BY-PASS COND..... **.89**  
15—ASST. SOCKETS..... **.49**  
TEST LEADS, 50 IN..... **.29**  
NEON TESTERS..... **2.50**  
ALLIANCE PHONO MOTORS..... **1.79**  
ASTATIC or SHURE PICKUPS..... **1.79**



### PHONO AMPLIFIER

3 TUBE AC-DC  
Wired Vol. & Tone Control..... **\$2.75**  
Uses 12SQ7, 50L6, 35Z5.  
Wired & Tested—Set of 3 Tubes..... **\$1.95**  
Output Trans..... **.39**  
5" Alnico Spk..... **1.19**

### PHONO OSC-2-TUBE

Wired & Tested  
2-Tubes—\$1.50... **\$2.75**

25% on C.O.D. orders. Free Catalog. We Specialize in Mail Orders. Orders Filled as Received. "R" Just Out.

**RISCO ELECTRONICS**  
WHOLESALE DISTRIBUTORS  
22 Warren St., New York 7, N. Y.

standby purposes. The right hand toggle controls the primary of the heater transformer  $T_1$  and the a.c. supply to the rectifier.

When construction has been completed, the tubes and one set of coils should be put in place, the power switch turned on, and the tubes allowed to heat. It is advisable to let the unit run about fifteen minutes to reach a stable operating temperature.

The voltage should be checked at the input and output of the filter circuit, and should approximate that shown on the schematic diagram, with  $S_1$  closed.

The frequency of the oscillator should then be checked by means of an accurately calibrated receiver or frequency meter. For the ten meter coil, the range of the oscillator should be from 37 to 40 mc. with a small amount of overlap at each end. The proper procedure is to set the tuning condenser to minimum capacity and adjust the trimmer condenser across the oscillator coil to 40 mc. The tuning condenser should then be turned to maximum and the frequency again checked. The frequency will be 37 mc. if the coil is correct. However, it is probable that the coil will require some adjustment. If the overall range is too great, it is an indication that the coil has too much inductance. The inductance may be reduced by stretching the coil slightly. Too little range is caused by insufficient inductance, and may be cured by squeezing the turns together. A few adjustments will center the band on the dial.

The converter may now be connected to the receiver, and the receiver tuned to a clear spot at approximately 10 mc. The trimmer across  $L_3$  should then be adjusted for greatest noise output from the receiver, indicating that the coil  $L_3$  is tuned to the receiver frequency.

After this is done, the mixer grid coil  $L_1$  should be adjusted to track across the band when an antenna is connected to the input of the converter. If the tests are made during a period when the ten meter band is open, no difficulty will be experienced in finding plenty of stations.

It is desirable to know whether the coil has too much or too little inductance. This may be accomplished easily if a small piece of brass rod, and an iron core from an old r.f. or i.f. coil are available. These should be mounted one on each end of a piece of bakelite rod or similar insulating material. These make very useful tools for aligning purposes and are widely used in radio factories.

Inserting the brass rod in a coil will reduce the inductance, while the iron core end will increase the inductance. In this manner it may be quickly determined whether more or less inductance is needed.

This type of tool is ideal for aligning the  $L_1$  coil as it is easy to make the proper adjustment in the coil. When the coil has been properly ad-

# NOW.

## AT YOUR JOBBERS

### The Radio Data Book

More Than 1000 Pages!

HANDSOMELY BOUND  
IN RED AND GOLD

All data and basic knowledge  
in radio and electronics  
digested into 12 sections...  
in a complete, quick to find,  
easy to read, handbook form.

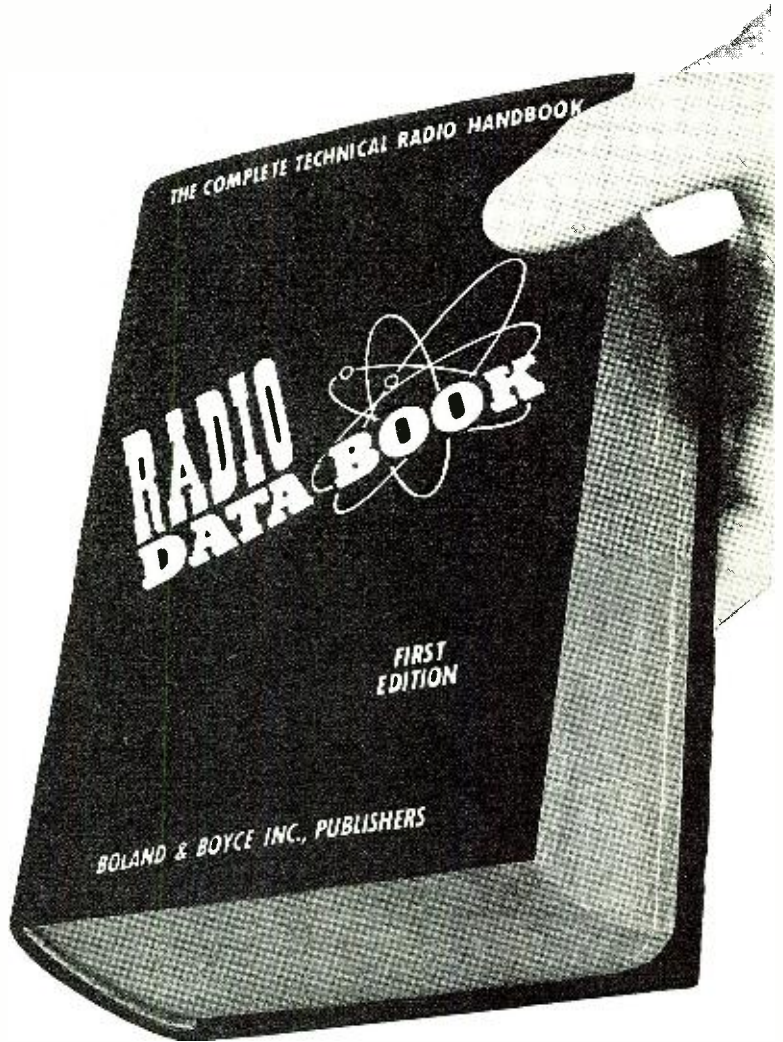

#### CONTENTS

Each section is a COMPLETE coverage of its subject... 12 sections... 12 books in ONE 1000 pages... Schematics... Accurate photographs... Specially prepared drawings... White on black charts... Diagrams... Isometric projections and exploded views.

**Section 1. THE 150 BASIC CIRCUITS IN RADIO.**

Every circuit is analyzed and explained in a Johnny-on-the-spot reference for any occasion.

**Section 2. COMPLETE TEST EQUIPMENT DATA.**

Know more about the test instruments you now have... Find the new ones you want to buy... They're All in here—impartially described!

**Section 3. TESTING, MEASURING AND ALIGNMENT.**

Simplified operation of the Oscilloscope... See what's happening inside any radio circuit... Dynamic alignment—AM, FM and TELEVISION made easy with the Oscilloscope... Scientific use of the Vacuum Tube Voltmeter, Signal Generating Equipment and other basic instruments.

**Section 4. ALL ABOUT ANTENNAS.**

AM-FM-Television... design, installation, characteristics, construction and feed.

**Section 5. SOUND SYSTEMS.**

Planning, installing and servicing a PA System. A complete chapter on every component... How to select and combine components... estimating costs... even acoustic requirements!

**Section 6. ELECTRICAL AND PHYSICAL CHARACTERISTICS OF RADIO COMPONENTS.**

Know the size, the power, the shape! A quick reference on the construction and design of any circuit or equipment.

**Section 7. COMPLETE TUBE MANUAL: Receiving, transmitting and commercial.**

A flick of the pages brings to you all the data and ratings of any tube made

**Section 8. CHARTS, GRAPHS AND CURVES.**

Quick calculation devices... Plotting curves, nomographs, rules and tables for speedy solutions to radio problems.

**Section 9. CODES, SYMBOLS AND STANDARDS.**

Handy reference to all radio symbols and abbreviations; code symbols, phrase and characters... Where you want them... When you want them!

**Section 10. 50 TESTED CIRCUITS DESIGNED FOR OPTIMUM PERFORMANCE.**

Find any circuit you want with complete parts lists and specifications... One tube receivers to complete AM, FM and Television receiver circuits... Amplifiers... Transmitters... Test Equipment and Control Circuits... All with the latest engineering refinements.

**Section 11. DICTIONARY OF RADIO AND ELECTRONIC TERMS.**

**Section 12. RADIO BOOK BIBLIOGRAPHY.**

Plan every operation in radio and electronics with the *Radio Data Book*. This new radio bible will be your lifelong tool... you will use it every day, on the board, at the bench, in the field! Use it for construction, troubleshooting and testing. The RADIO DATA BOOK will be your invaluable aid in design, experiment and in layout. It will help make your production better, faster and easier. In any and every operation in radio and electronics, you will use the RADIO DATA BOOK!

The RADIO DATA BOOK is a work of complete authority, prepared by engineers with many years of practical experience. They have been assisted by the Boland & Boyce staff of editors skilled in preparing electronics manuals for the U. S. Signal Corps for many years. These men have worked for several years gathering material for this book... all the knowledge of radio principles and operation... all the statistics... all the newest developments in electronics... every possible angle and detail. Eighteen months were spent digesting this material into the most concise, the clearest, and the most readable form. The result is this invaluable manual... The RADIO DATA BOOK. Whether you use this book for general reference, for scientific instruction, or for education, one thing is certain—the practical help, the daily usefulness you will derive from it will prove to be worth many, many times its astonishingly low price!

Advance Sale... first printing. Only 10,000 available... To make sure to get your RADIO DATA BOOK, mail your order **NOW!**

12 complete books in one only **\$5.00!** Less than 42c per book!

Mail this Coupon to Your Jobber or Direct to:

RN-3

**BOLAND & BOYCE INC., Publishers**  
460 Bloomfield Ave., Montclair 3, N. J.

Please send me a copy of  
THE RADIO DATA BOOK Enclosed is \$5.00.

NAME.....

ADDRESS.....

CITY.....ZONE.....

STATE.....

**BOLAND & BOYCE INC., PUBLISHERS**

# FM and Television Antennas by

## Have Proven Their Superiority

Premax is meeting the demand for low-cost, efficient Antennas for FM and Television reception with well-engineered dipole types that occupy little space, yet bring in the signals sharp and clear.

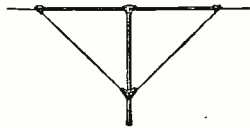

**FMTL-254**—Covers all frequencies between 44 mc. and 216 mc. An extended "V" type with elements of seamless aluminum tubing and cast aluminum fittings. Overall height 4'6", width 8', weight 4½ lbs. Complete with mounting bracket and 75' 300 ohm line.

**FML-130**—Designed for maximum response on all FM bands. Simple, light-weight and each dipole is adjustable for any angle, thus affording an adjustment of the plane of polarization for different angles of electromagnetic waves. 50" tubular support with 30" dipole arms of heat-treated aluminum, in V type. Complete with mounting bracket and 75' Twin Lead line.

**No. FML-230**—Similar except equipped with reflector and special mounting.

**No. FMTL-330**—A special dipole type for FM and Television.

**CORULITE ELEMENTS FOR HORIZONTAL ARRAYS** provide the maximum of strength and rigidity with extremely light weight. These elements are available in one to four sections, fully adjustable between their rated lengths of 5' to 17'. Especially recommended for 6, 10 and 20 meter use and for experimental work in FM and TV. Also available in kits complete with mounting insulators.

See your radio jobber. If he cannot supply you, write direct.

# Premax Products

**Div. Chisholm-Ryder Co., Inc.**

4813 Highland Ave.

Niagara Falls, N. Y.

justed, insertion of either end of the aligning tool will result in a reduction of signal strength. As before, with the oscillator coil, the inductance may be increased by squeezing, or reduced by stretching the coil. Of course it is not possible to do much squeezing on a closewound coil, but sufficient variation may be obtained for proper tracking.

When the ten meter coil has been adjusted, the same procedure should be followed on the six meter coil. In this case the oscillator frequency will be 40 to 44 mc. The output transformer need only be adjusted once, however, regardless of which coil is used. It will probably be found that the adjustment of the six meter coil is somewhat more critical than the one for ten meters. The mixer grid coil for six meters has a built-in trimmer and this should be adjusted for tracking at the high frequency end of the band.

In the event that difficulty is experienced in picking up the oscillator signal in the receiver or frequency meter, a meter of 25 ma. range may be connected in the plate lead of the oscillator section. Oscillation will be indicated by a sharp increase in plate current when the stator plates of the oscillator condenser are touched. An absorption type frequency meter may be coupled to the oscillator coil and tuned through its range. When the oscillator frequency is reached, the plate current will jump sharply. This method may be used for a quick check of the frequency.

It is very important in high frequency construction that all grounds for a particular circuit be returned to a common point. This is necessary to prevent chassis currents. Much of the trouble in high frequency equipment may be traced to failure to observe this precaution. Probably the best point for location of these grounds is one of the mounting screws of the tube sockets. In any event care in picking central ground points for the respective grid and plate circuits will pay dividends in trouble-free performance.

An attempt was made to extend the range of the converter to the two meter band but the results were disappointing. It appears that the length of the leads from the coil to the condenser are too great, with the result that the majority of the circuit inductance lies in the leads connecting the coil and condenser. However at the present time plans call for further work on this problem. Possibly the use of the butterfly type condensers will offer some improvement.

There is also the possibility of using a separate converter for each band. The low cost of the parts needed, using a common power supply, plus the better efficiency, should have considerable appeal.

Converters could be built for the 10, 6, and 2 meter bands, with a common power supply and gang tuning.

**SCHUH DOES IT AGAIN!**

**NARROW BAND F. M. Noise Free Reception!**

Only adapter for BC-348 receiver using 915 KC IF. Also made in 455-465 KC Model 3½x4½x1½". Completely Chromium Plated. Easily mounted. Uses 6AK5 limiter and 6AL5 discriminator. Instructions supplied. Price (less tubes) **\$10.95**

6AL5 tubes.....90c each  
6AK5 tubes.....90c each

**BC 610 Components... Modulator Decks Less modulation transformer. Completely wired. \$14.95**

**R-420 Powerpack**  
converts BC312 receiver to AC operation. Fits in dynamotor compartment. Also for external use with BC348, 314, 224, and used with BC696 and 459 as E.C.O. Input 110-120 VAC. 60 cycles. Output 250 VDC @ .95 MA, 12V @ .5 A, 12V CT @ 3A.  
Shipping weight, 12 lbs. **\$7.95**

**MERIT PLATE TRANSFORMERS**  
For small transmitters. DC Voltage Ratings are approx. values obtained at output of 2 section choke input filter using mercury vapor rectifier tubes. Pri. is for 115 V. 60 cy.

Type No.	Amateur Net Price	Sec. Rms. Volts	Sec. DC Volts	DC Sec. M.A.
P-3157	\$ 5.55	(660-660) (550-550)	(500) (400)	250
P-3158	7.20	(1080-1080) (900-900)	(1000) (400)	125
P-3159	6.00	(900-900) (800-800)	(750) (600)	225
P-3167	17.85	(1450-1450) (1175-1175)	(1200) (1000)	300

**MERIT MODULATION TRANSFORMERS (For Specific Applications)**

Type No.	Amateur Net Price	Ohms Impedance Pri.	Sec.	Max. MA Pri.	Sec.	Watts
A-3110	\$6.30	10000-6600CT	4000-5000 7500-10000	12000	175 150	60
A-3113	9.45	15000-6900-CT	3000-4000 5000-6000	12000	250 300	175

Write for Free Merit Catalog listing all other Transformers and Chokes! TERMS: 30% with order. Balance C.O.D. Shipt. F.O.B. Chicago

**SCHUH'S RADIO PARTS**  
1253 Loyola Avenue • Chicago 26, Illinois

For the best look west of the Rockies

**ALTEC presents**

**The NEW Peerless "20-20 LINE" of Audio Transformers**

To meet the prevalent need for audio transformers incorporating the admittedly superior performance of Altec Lansing basic design, at prices that square with market realities, Altec Lansing presents the Peerless "20-20 Line."

The frequency range will be **FLAT WITHIN 1 DB From 20 cycles to 20,000 cycles**

The "20-20 Line" will include input, output, and interstage transformers. A new Peerless catalogue, presenting the complete line of Peerless audio, power, and special purpose transformers will be sent on request. Write to Dept. I.

**PEERLESS ELECTRICAL PRODUCTS DIVISION**  
6920 McKinley Ave., Los Angeles 1, Calif.



**Atom Smashers**  
(Continued from page 41)

the vacuum chamber is between the poles of the electromagnet, the field causes them to move in a semicircular direction. By the time the particles return to the gap the oscillation has reversed the charges on the dees. The timing is well nigh perfect since the angular velocity of the particles is independent of their linear velocity. The

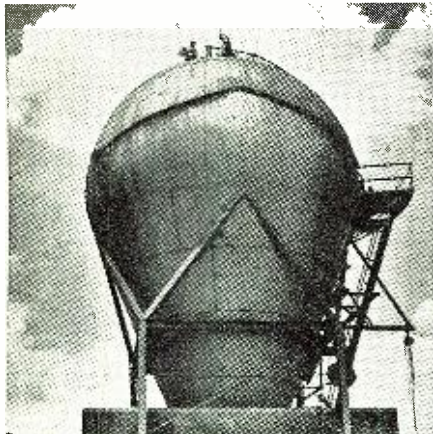

Fig. 6. The Westinghouse atom smasher.

particles are then pulled to the other dee and speeded in their flight. Once again the path of motion is a semicircle but with a greater radius. By the time they again return to the gap the charge on the dees has again reversed. Thus the path of the particles is around and around, coasting while in the dees but accelerating every time they cross the gap. As they move faster and faster their semicircular path becomes larger and larger until eventually their path is near the outer edges of the dees. A negatively charged electrode then pulls them from the dees entirely, allowing them to pass through a thin metal window.

With the atom smashers discussed in this article, scientists now have

Fig. 7. The "Giraffe"—an electronic tube used in conjunction with a Geiger counter is shown at the Westinghouse Laboratories.



**"The Kit for the Millions" NO TECHNICAL KNOWLEDGE REQUIRED FOR ASSEMBLY!**

# TRANSVISION

... Tops in *quality* ... Tops in *value!*

## TELEVISION KITS

### BUILD YOUR OWN Custom-Quality TELEVISION SETS!

#### 12" TELEVISION KITS—

Standard and DeLuxe Models

Picture size 1½ times larger than with 10" tube . . . A big 75 square inch picture!

Sharp, steady picture achieved with advanced Transvision television circuit. Picture has remarkable brightness even in lighted room (no darkening of room is required). **IDEAL FOR HOME or COMMERCIAL INSTALLATIONS.**

**12" TRANSVISION TELEVISION KIT . . . Standard Model . . . FEATURES:** 12" picture tube . . . Picture size 1½ times larger than with 10" tube . . . RF Unit designed for 13 channels: factory wired and pre-tuned for 7 channels (no areas have been assigned more than 7 channels; however if desired, up to 6 more channels may be added at very nominal cost) . . . 4 mc bandwidth for full picture definition . . . High fidelity F.M. sound reproduction . . . picture size 75 square inches . . . 9000 volts second anode potential for brightness and contrast . . . maximum picture, sensitivity (better than 50 microvolts) . . . 22 tubes and 12" picture tube, antenna, lead-in wire, etc. (Cabinet extra, if desired). **LIST \$289.00**

**12" TRANSVISION TELEVISION KIT . . . DeLuxe Model with Superb Built-in F.M. RADIO.** Same characteristics as the Standard Model, plus the following **ADDITIONAL FEATURES:**—50-216 mc continuous tuning . . . Covers the entire F.M. band and all 13 television channels . . . Cut-off switch eliminates unused tubes when set is used only as F.M. receiver . . . **LIST \$359.00**

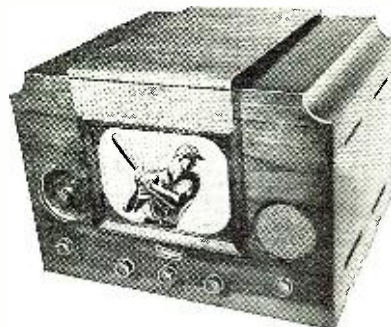

12" KIT (Table Model)

**ALL TRANSVISION KITS ARE COMPLETE**—Nothing more to buy! . . . All Transvision Television Kits are **COMPLETE** with all tubes, including picture tube, wired and pre-tuned RF units and IF's, high gain folded di-pole antenna with 60 ft. lead-in cable, wire and solder.

**TRANSVISION TELEVISION CABINETS . . .** Beautiful, sturdily built cabinets with handsome rubbed wood finish. Fully drilled.

- 12" Table Model Cabinet. . . . . **LIST \$44.95**
- 12" Console Cabinet with compartment for record changer . . . . . **LIST \$99.50**
- 7" Table Model Cabinet. . . . . **LIST 32.50**

#### FM RADIO CONVERSION UNITS: All Transvision 12" STANDARD Television Kits can now be had equipped with superb

- FM Radio at the following small additional charges:
- For 12" KITS ALREADY ASSEMBLED, FM Conversion Unit. . . . . **LIST \$12.50**
- For new 12" KITS (non-assembled), FM Conversion Unit. . . . . **LIST 7.95**



15" Picture Enlarging Lens



#### TRANSVISION Television Picture Enlarging Lenses

Engineered by Transvision, these lenses enlarge and clarify the picture. Have wide angle of vision. When placed about 1" from picture tube, the lens almost doubles the picture area; when placed further away, it increases the enlargement still more. Optically ground and polished; 50% greater light transmission than equivalent glass lens; ¼ weight of glass lens of similar magnification power. All lenses equipped with adapter for installation on cabinets.

- 15" LENS (125 sq. in. picture) . . . List \$36.95
- 12" LENS ( 75 sq. in. picture) . . . List 25.95
- 10" LENS ( 52 sq. in. picture) . . . List 19.95

**TRANSVISION ALL-CHANNEL R.F. UNIT FACTORY PRE-WIRED and TUNED . . .** For use in Building your own custom-made television receiver . . . for any 7", 10", 12", 15", or 20" Kit.

- TRANSVISION ALL-CHANNEL, R.F. UNIT.** LIST \$37.95
- Same R.F. Unit, plus FM Band. . . LIST 49.95

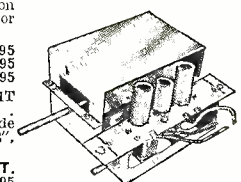

#### TRANSVISION FEATHERWEIGHT SOLDERING IRON

**NOTE THESE NEW, REMARKABLE FEATURES:** Weighs only 3 ounces (without the cord) . . . Delivers working output of 200 watt iron at fraction of current normally consumed by heavier irons . . . Heats up in 20 seconds . . . Finger-tip button control . . . Cool grip . . . Retains heat (with switch off) up to one minute . . . Featherweight permits long periods of soldering without fatigue . . . Economical—intermittent control feature prevents tip corrosion and necessity of frequent cleaning . . . Long, thin tip permits soldering in tight corners . . . Tips are interchangeable to suit work at hand . . . For operation on 110V, AC, 60 cycles. Complete with 6 volt transformer. . . . . **LIST \$13.95**



Featherweight Soldering Iron

All prices listed above are 5% additional west of the Mississippi. All prices are fair traded.

See your local distributor or for further information write to Dept. R.N.—



**TRANSVISION, INC.**  
385 NORTH AVE., NEW ROCHELLE, N. Y.

# MARCH SPECIALS

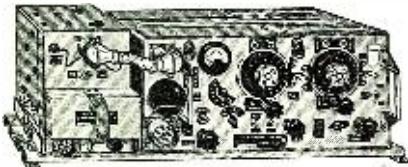

**SCOOP:** The famous B-19, Mark II, 40 & 80 meter transmitter-receiver with tubes, dynamotor power supply, instruction manual, 12 ft. antenna & base, V.H.F. antenna and base, dummy antenna, mounts, 1 headset, microphone, key, junction boxes and interconnecting cables. N-1..... **\$29.95**  
**B-19** Mark II complete tank installation with all spares. Packed for export. Instruction manual, etc. N-1..... **44.95**  
 Headset & Microphone used with Mark II, N-1..... **1.95**  
**BC348** Receivers, 200-500, 1500-18,000 KC. Complete with 28 volt dynamotor & tubes. U-N **\$54.95**; U-1 **\$49.95**; U-2 **\$44.95**.  
**BC224** Receivers, 200-500, 1500-18,000 KC. Complete with 14 volt dynamotor & tubes. N-1 **\$69.95**; U-1 **\$54.95**.  
 (NOTE: The BC224 is identical to the BC348 except input voltage.)

## SCR522 Specials

Two meter transmitter-receiver with tubes N-1 **24.95**; U-N **\$17.95**; U-1 **\$14.95**; U-2 **\$12.95**.

**BC1206-C** Satchell Carlson Beacon Receiver 28 volts D.C. 195-420 KC, 5 tubes, N-1..... **5 4.95**  
**BC474** with tubes, N-1 **\$37.50** with manual; N-2 **\$32.50**; U-1 **\$27.50**; U-2 **\$22.50**; U-3 **\$15.00**.  
**GIBSON GIRL SCR578B** transmitter for sending distress signals from boats. Transmitter complete with balloon, hydrogen generator, kite and instruction manuals. N-1..... **25.00**  
**GENERAL ELECTRIC 6RB617** Tungar Battery Charger. 12 battery, 12 amp.; 24 battery 6 amp. N-1..... **67.50**  
**EE-8** Telephone field sets with handset and ringer N-1 **\$15.00** ea., **\$28.00** pr.; N-2 **\$13.00** ea., **\$25.00** pr.; U-2 **\$10.00** ea., **\$18.00** pr.; U-3 **\$7.00** ea., **\$13.00** pr.  
**SCR284A**, 3800-5800 kc.—Complete set..... **69.50**  
**BC654A** Trans. Rec. Tubes, Xtal..... **19.95**  
**PE104A** 6-12 volt vibrapack, **\$5.95**; (U)..... **4.95**  
**PE103A** 6-12 volt dynamotor..... **8.95**  
**CD501A** cable for PE103A-BC654A..... **1.95**  
**GN45A** Handcrank Generator and stand..... **4.95**  
**BC348** Mounting Base. Postpaid..... **2.50**  
**BC348** Outlet Plug PL-Q103. Postpaid..... **.80**  
**BC348** Mounting Base and outlet plug. Postpaid..... **3.00**  
 Sound powered handset N-1 **\$15.00** ea., pr..... **25.00**  
 Trimm commercial 17,000 ohm headset N-1..... **4.25**  
**HS-23** 8,000 ohm headset N-2 **\$1.29**; U-2..... **.89**  
**HS-33** 600 ohm headset N-1..... **1.29**  
 Extension cords, PL55 plug incl. N-1..... **.40**  
**HS-30** Ear plug headset N-1 **\$0.95**; U-1..... **.50**  
 Matching transformer, HS-30..... **.50**  
**TS-13** Handsets U-1..... **2.50**  
**115 V.A.C.** ¼ h.p. motor with 250v 600MA amp-dyne generator N-2..... **18.75**  
**200FD** Johnson var. cond. dual N-2..... **1.19**  
**182A** Selsyn Compass Indicator U-1..... **1.50**  
 Companion Transmitter Selsyn U-1..... **1.50**  
**181A** Selsyn Compass Indicator U-1..... **1.50**  
 Companion Transmitter Selsyn U-1..... **1.50**  
**BC733D** Aircraft Glidepath Receiver N-1..... **19.95**  
 (Approved by C.A.A.)  
**SCOOP: MN26** Radio Compass Receiver 150-1500 KC U-1 **\$18.95**; U-2 28 V. D.C..... **14.95**  
**SCR610** FM 10 meter transmitter-receiver, 6, 12 and 24 volt power supply with tubes U-1..... **14.95**  
**T-17** Mike N-1..... **1.95**  
**Meter Rectifier**, full wave midget Selenium, 10 volts, 30MA. N-1..... **.29**  
**APS-15** 3CM Radar Transmitter complete with magnet, magnetron, Klystron and other tubes. **14.95**  
**BC464** Receiver and selector for 5 channel remote control with battery container and antenna N-1..... **14.95**

## TUBE SPECIALS

**5BP1** Cathode Ray Tube N-1..... **\$1.15**  
**5BP4** Cathode Ray Tube N-1..... **2.50**  
**3AP1** Cathode Ray Tube N-1..... **2.25**  
**304TL**..... **2.50**  
**SIGNAL BOX KITE** N-1..... **2.00**

**CODE:** N-1 New, in original boxes.  
 N-2 New, repacked.  
 N-3 New, removed from new equipment.  
 U-N, Used, like new.  
 U-1 Used, excellent condition.  
 U-2 Used, minor scratches.  
 U-3 Used, rough handled, good working condition.

**TERMS:** F.O.B. Pasadena unless postpaid. No C.O.D.'s under **\$5.00**. 25% deposit on ALL orders. All C.O.D.'s shipped by Rail Express. Save freight and C.O.D. fees by sending full price with order and we will ship by fast truck, transportation collect. Minimum order **\$2.00**. Californians include 2½% sales tax.

## PHOTOCOON SALES

1062 N. Allen Ave. Pasadena 7, Calif.

the necessary means for a more thorough study, under controlled conditions, of the transmutation of matter.

## BIBLIOGRAPHY

*Cable, Getchell, and Kadesch:* "Science in a Changing World."  
*Davis, Watson:* "Advance of Science."  
*Diets, David:* "Atomic Energy."  
*Kerst, Donald W.:* "A 20 Million Volt

*Betatron or Induction Accelerator," Review of Scientific Instruments, Vol. 13, pp. 387-394, September, 1942.*  
*Kerst, Donald W.:* "The Acceleration of Electrons by Magnetic Induction," *The Physical Review, Vol. 60, pp. 47-53, July 1, 1941.*  
*Pollard and Davidson:* "Applied Nuclear Physics."  
*Stokley, James:* "Atomic Artillery," *G. E. Review, June, 1947.*  
*Stokley, James:* "Electrons in Action."  
 -30-

## SIMPLE DIPOLE TELEVISION ANTENNA

By EDWARD M. NOLL

**T**he simple dipole, a half-wave antenna separated into quarter-wave elements and center-fed, is an effective television antenna in high-level signal areas where the signal-to-noise ratio is high. The dipole is a low impedance antenna and has an antenna resistance of 72 ohms, very conveniently matching a 75 ohm coaxial line. It can also be matched to a 300 ohm twin-wire line through a matching section or it can be attached unmatched to a 300 ohm line in which case there is attenuation but a comparatively wider frequency response.

Each element of the dipole is an electrical quarter-wavelength which is slightly shorter than a calculated quarter-wavelength in free-space. This correction has been taken into consideration in the calculation of the antenna lengths for each individual channel given in the chart. These dimensions are for peak performance on each individual channel. If antenna is cut for reception of a number of channels use the mean frequency of the channel allocations in your area to determine element length.

The mismatched dipole is only satisfactory in areas in which the signal is strong and the signal-to-noise ratio high. There is appreciable signal atten-

uation but the match between transmission line and standard 300 ohm resistive receiver input prevents line reflections. In addition the bandwidth of the antenna system is widened.

If signal is weak and noise prevalent, the antenna should be matched to obtain maximum signal utilization. A 75 ohm coaxial line matches a dipole and in addition the outer conductor acts as a shield and reduces noise pick-up. However, a 75 ohm line can only be used if the receiver has facilities to obtain a 75 ohm input. It is better to mismatch the antenna than to mismatch at the receiver termination. Some commercial receivers have means of changing over from the standard 300 ohm input to a 75 ohm input.

A simple dipole can also be matched to a 300 ohm line with a quarter-wave matching section. In this case the impedance of the matching section line is a mean between antenna resistance and the 300 ohm line, or 150 ohms. The electrical quarter-wavelength of the twin-wire matching section is considerably shorter than a free-space quarter-wave because of the lower velocity constant of the ribbon dielectric as compared to air. A .82 constant was used in the matching section lengths given in the chart.

Methods used to connect dipole antenna to television receiver. Chart gives exact dimensions of dipole elements for various television channels.

CHANNEL	λ/4 ELEMENT IN INCHES	λ/4 MATCHING SECTION 150 OHM TWIN-LEAD
1	60	51
2	49	42
3	44	38
4	40	34
5	35	30
6	33	28
7	15¾	13½
8	15¼	13
9	14¾	12½
10	14¼	12
11	13¾	11½
12	13½	11¼
13	13¼	11
MEAN HIGH CHANNELS 195MC.	14¼	12
MEAN LOW CHANNELS 66 MC.	42	36

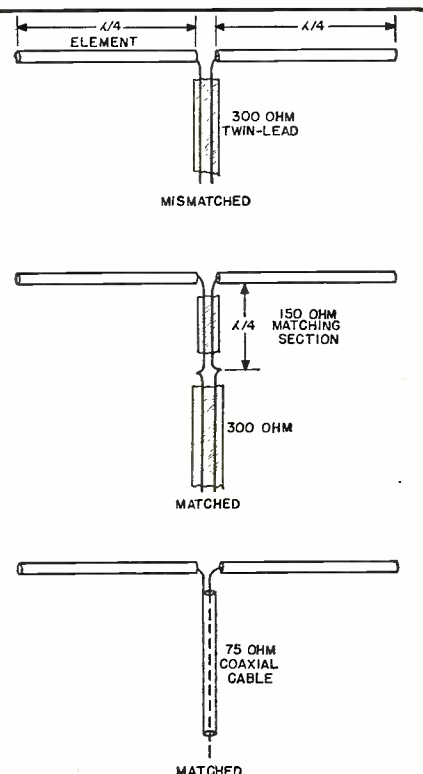



# Go To WESTERN for Values...

## BROADCAST-BAND RECEIVER

Navy ADF Receiver DZ-1, made by RCA. Continents 15 to 1750 kc in 6 bands. Gear-train tuning with vernier and coarse scales; broad or sharp band-pass; CW or MCW. All controls on front panel. Beautifully built with 5-gang tuning capacitor, shielded tubes and coil. 8 tubes: 3-6D6, 2-76, 2-6C6, 1-41. Complete with tubes, less power supply. In excellent condition. Only... **\$14.95**

## SCR-522 REC. & TRANS.

• 2-Meter Ham Rig • VHF TaxiCab 2-Way Here's the receiver, transmitter, rack, and case of the most widely used AAF VHF set. 100-156 mc, 4-channel, crystal controlled. Furnished with original schematic and with complete conversion data for 2-meter ham band. Hundreds of applications to FCC attest to its popularity for conversion to VHF NBFM 2-way taxiCab mobile. Like new, removed from aircraft with ferry time only. Complete with 17 tubes. ... **\$19.95**

## RA-10 BENDIX RECEIVER

Direction finder and communication receiver. 3 band, 7 tube superheterodyne 200-1100 kc and 2-10 mc. Excellent condition, complete with dynamotor. Easily converted to 110v AC-DC. ... **\$14.95**

## AN/ARC-4

Receiver-transmitter, range 140-144 mc, crystal controlled 4-channel. Input 12v. Complete with 20 tubes, 4 crystals, and dynamotor. Condition good used. A real buy at only... **\$17.86**

## ANTENNA EQUIPMENT BUYS

- Direct a rotary beam tower with the tower set for RC-153-B. Approximately 20 ft. high. Tripod support with aluminum tubing and two heavy-duty ball bearings for center section which has coaxial line running up through it. Brand new and complete. With spanner wrenches, level, etc. A steal at only... **\$11.95**
- AN-29. Tubular telescopic, aluminum alloy, with cap and mounting stud. 15' long collapsed, 13 ft. long when extended. 11 sections. Brand new, in original packing. ... **\$1.95**
- AN-30. Similar to above but slightly smaller. 9 sections. Brand new. ... **\$1.65**
- 2A292-7. 3-section telescopic, 8 ft. long when extended, aluminum alloy. ... **\$1.19**
- AN-109-A. 62" long solid whip antenna, very flexible, made of cad. plated silicon vanadium steel. 3/4" dia. at threaded end, tapering to 0.1" at tip end. A dandy antenna, a dandy fishing rod, a dandy price. ... **95c**  
4 to carton, per carton. ... **\$2.69**

## R-89/ARN-5

Glide path receiver. Crystal control of local oscillator. 332-335 mc, complete with relays, 7-6AJS, 1-12SR7, 2-12SN7, 1-28D7, and 3 crystals: 6497 kc, 6522 kc, 6457 kc. 90 cycle band-pass and 150 cycle band-pass filters, excellent for making an intermodulation checker. Beautiful cabinet and chassis as foundation for many interesting experimental and construction projects. Broad band on 20.7 mc IF's ideal for television. **SCHMATIC FURNISHED!** Condition: Used, excellent. Only... **\$6.45**

## BC-733-D

Localizer receiver of the blind landing system. Companion to the glide path receiver. Also contains 90 and 150 cycle band-pass filters. Has the best AVC system yet developed; can use parts or use as a model for construction. 10 tubes, crystals, relays, etc. Schematic included. Condition: used, excellent. Only... **\$6.35**

## PANEL METERS

**SUPREME** foundation meter for Model 504A tube checker. (Supreme #5532, part of 1E-19-A.) Calibrated. Bad Tube - 9. Good Tube: ohms 0-2M and infinity; volts and ma 0.50, 0-10, 0-5; AC 0-5v; good capacitor—bad capacitor. In rectangular case 4 1/4"x4", movement fits through round hole 2 1/2" dia. Face printed in black, red, green, orange. Brand new. ... **\$6.95**  
Only a few at...

**AC VOLT-METER:** 0-250, 2 1/2" face. Round, flush mount, Roller-Smith Type TA. **\$2.95**

**DC VOLT-METER:** 0-15; calibrated also 0-600 for use with external resistor. 5000 ohms per volt. Flush type, 2" face. Simpson type 125, 2% accuracy. ... **\$3.50**

## RADAR TRANSMITTERS

Amplitude-modulated radar transmitters. A gold mine of parts! Brand new, with tubes and manuals.  
T-26/APT-2, 450-710 mc. ... **\$9.95**  
T-27/APT-3, 85-135 mc. ... **10.95**

## UHF TRANSCEIVER BC-645

Brand new, in original packing. This is the UHF transceiver written up in Feb. '47 QST. 15 tubes including WE doorknob. Easily modified to ham band 420-430 mc, citizens' radio, etc. Furnished with schematic and complete conversion data for fixed or mobile voice communications using either AC power supply or dynamotor. ... **\$7.95**

**DYNAMOTOR UNIT PE-101-C:** Made for the BC-645 described above, useful for any other mobile job. Choose 12v or 24 vdc in, get outputs of 800v at 20 ma plus 400v at 135 ma plus 9v at 1.1 amp. Also brand new. Special at only... **\$2.75**

## BATTERY CHARGER RA-63-D

Heavy duty. Input 115v, 60 cy. Output 14v at 13A. Charge two 6-volt batteries in series or 12v batteries in parallel. Trickle charge switch for slow charge, 15v at 4A. New. ... **\$19.95**

## SCR-274-N COMMAND SET

### ALL THE UNITS

### With Schematics-Tubes-Crystals

Easily converted to 80-40-20 meter bands. See Jan. '48 CQ for latest conversion to 10-meter fixed or mobile. Original schematics furnished. Like new, removed from aircraft. You get all this: **\$19.50**

- BC-453 Receiver, 190-550 kc, 6-tube superheterodyne, complete with tubes and dynamotor.
- BC-454 Receiver, as above but 3-6 mc.
- BC-455 Receiver, as above but 6.9-11 mc.
- BC-457 Transmitter, 4-5.3 mc, 4-tube, crystal calibrated, with tubes and crystal.
- BC-458 Transmitter, as above but 5.3-7 mc.
- BC-456 Modulator with 4 tubes and dynamotor.
- BC-442 Antenna Relay Unit, a beauty for any transmitter, with 0-10 Amp RF meter, change-over relay, and 50 mmfd, 5 KV vacuum capacitor.
- Control Boxes: 2 transmitters, 3 receivers.

## SCR-518-A

Radar altimeter 515 mc. Fast screen CR tube, hi-voltage power supply, connectors, cables, 29 tubes: 1-6SK7, 2-8012, 2-6SJ7, 1-6C8G, 1-6SN7GT, 1-6F8C, 1-23D4, 1-6Y6G, 1-6V6GT, 10-6AC7, 3-2X2, 1-934, 1-955, 1-956, 1-6J5, 1-1808P1 cathode ray. ... **\$24.95**  
tube. Brand new.

## RADIO SET SCR-AR-283

New equipment: Transmitter and coil sets to cover 2-5.7 mc transmitter tubes 2 No. 10 special and 2 No. 45 special, receiver (less the 2 receiver coil sets), receiver tubes 1-37, 1-38, 4-39/44, shock mounts, dynamotor (24v), antenna switching relay, receiver control box, transmitter control box, charts, dials, and instruction book. What a sweet buy! Only... **\$14.95**

## BENDIX MANUAL DF

MN-26-C radio-compass receiver. Includes broadcast band, 150-1500 kc. New. With schematic. Complete with 12 tubes. ... **\$19.45**  
Control Box MN-28 for above. ... **\$3.95**  
Loop MN-20 \$6.95 Loop Control MN-52 **\$1.95**

## APA-1 RADAR INDICATOR

Amplifier with 11 good tubes: 2X2, 6H6, 6G6G, 6X5CT, 7-6SN7GT. Control unit with switches, potentiometers, etc. 3BP1 in metal case, with visor. Complete in original packing cases. With instruction book. Brand new. ... **\$19.95**

## TRANSFORMER AND CHOKE SPECIALS

**OUTPUT:** HI-Fi, used in Scott-made Navy receiver. Fully potted. Pri. 5000 ohms, output secondary 600 ohms CT, inverse-feedback secondary 60 ohms CT. A rare buy at only... **\$1.49**

**OUTPUT:** 6V6 Push-Pull, for Hammarlund Super-Pro. Good fidelity. 2 outputs: Speaker and 600 ohm headset. ... **\$1.89**

**OUTPUT:** Push-Pull 6L6's, 20 watts to 50 ohm load. Impedance ratio 15,000 to 50. Fully potted. ... **.98c**

**OUTPUT:** 10 assorted oncurs for... **\$1.89**

**DRIVER:** For push-pull output. Used in Bendix radio-compass receiver. Pri. 6000 ohms. Sec. 3000 ohms CT. Tertiary 15 ohms 79c

**FILTER CHOKE:** Westinghouse, potted. 15 H at 150 MA, insulated. 300 volts. 183 ohms DC. ... **\$1.49**

**FILTER CHOKE:** Navy CRV 30829, potted. 10H at 100 MA. A rare buy at only... **59c**

## RT-7/APN-1

Radio altimeter transceiver. Transmits and receives frequency-modulated signals. 418-462 mc. Complete with 14 tubes: 3-12SJ7, 4-12SH7, 2-12H6, 1-VR-150, 2-955, 2-9004. Contains 28v dynamotor. Excellent parts value. Make wobbulator out of the frequency shifter. ... **\$7.95**  
With schematic. Used, excellent.

## 1/2 TO 3/4 KW ANTENNA TUNING UNIT

BC-939-A, used with the famous BC-610 (commercial HT-4) Hallicrafters transmitter. 3/4 KW into final. 1/2 KW output. Some of the boys use this tuning unit for a full KW into final. Brand new, complete with 0-15 RF ammeter. 2-18 mc. Two tuning controls, one coupling control. A never-to-be-repeated opportunity! Don't miss it! Only... **\$19.95**

## ARC-5 VHF TRANSMITTER

T-23/ARC-5, brand new, 100-156 mc. As ahead of the older SCR type VHF gear as the auto is ahead of the horse and buggy! 4 Xtal-controlled channels selected by 3 motor-driven turrets. Motor can be spun by hand for manual switching. Tubes: 2-1625, 2-832A. With schematic. With tubes and crystals. ... **\$7.95**  
Less tubes and crystals. ... **\$12.95**

## SENSITIVE OUTPUT METER

BX-1140 Control Box for SCR-625 Mine Detector contains slug-tuned coils, switches, resistors, etc. in addition to a panel meter with built-in rectifier, movement sensitivity 200 microamps DC full scale, 2" face. ... **\$2.29**

## DYNAMOTORS AND INVERTERS

BD-77 Dyn. Unit: 14v in, 1000 v, 350 ma out. With relay fuse box and filters. ... **\$5.35**  
BD-87 Dynamotor Unit: part of SCR(-)-183, 186, 187, 14v in, 350v, 130 ma out. Includes filter and voltage divider. ... **\$2.75**  
BD-93 Dynamotor Unit: part of SCR(-)-283, 28v in, 350v, 130 ma out. Includes filter and voltage divider. ... **\$2.25**  
DM-21 Dynamotor: Part of BC-312 and BC-314. 14v in, 235v, 100 ma out. ... **\$2.47**  
DM-34 Dyn.: 12v in, 220v, 80 ma out. ... **\$2.29**  
DM-35 Dyn.: 12v in, 625v, 225 ma out. ... **\$3.25**  
PE-101-C Dyn. Unit: 12 or 24v in, outputs 800v, 20 ma, 400v, 135 ma, 9v, 1.1A. ... **\$2.75**  
PE-55 Dyn. Unit: 12v in, either 16 or 25 amp. 500v out, either 200 or 400 ma. ... **\$3.75**  
PE-73 Dynamotor Unit: Part of BC-375. 28v in, 100v, 350 ma out with filter, starting relays, etc. ... **\$4.65**  
PE-206 Inverter Unit: Rotary converter, 28v in, 80 v at 500 VA, 800 cy. out. ... **\$3.95**

## BC-1206

Scoop value superhet receiver! Covers approximately the same frequency as the BC-453 Command receiver, but much more compact, and is complete with tuning knob and all controls on the front panel. Entirely self contained. This is a commercial radio range receiver used by the AAF in its communications form. Complete with 5 tubes, only 4"x4"x6", wt. 3 1/4 lbs. Input 24 vdc. Used, excellent condition. ... **\$2.95**  
New. ... **\$5.95**

## AN/APN-9 LORAN

R-65/APN-9 Receiver-Indicator and 115v, 400 cy power supply, complete in one chassis. Brand new, with 35 tubes including 6SK7's, 2X2, etc. 3BP1 (fast screen) CR tube has magnifying lens. Schematic furnished. Factory termination, less outer case. Excellent foundation for test scope. ... **\$24.95**

## MISCELLANEOUS BARGAINS

Tubes: 3AP1. ... **95c** 5BP7. ... **95c**  
7BP7. ... **\$1.19** 450TH. ... **\$9.95**  
12A6. ... **10 for \$2.90**

RG-8/U: 52 ohm coax. cable, brand new. 5' cut to length, min. quant. 100 feet. ... **\$2.95**

RG-7/U: Low capacity 95 ohm coax. cable, only 12.5 mmfd./ft. Similar to RG-62/U. Brand new. Ideal for high-quality PA installations. Air and polyethylene dielectric, vinyl overall. O.D. 0.370". Loss at 1mc is 0.15 db/C'. at 30mc is 1 db/C'. Cut to length. Minimum quantity 100 feet. Per foot. ... **6 1/2c**

Loop LP-21: ADF antenna, low impedance. Brand new, complete with Selsyn transmitter, motor, and compensator. Designed for 100-1750 kc. ... **\$6.95**

**Selsyn Indicators:** Radio compass indicators, use with beam rotators. Can use one movement for transmitter, another for indicator, or use loop transmitter, described in item above for transmitter. Selsyn described in item above for transmitter. 1-81 3" dial. ... **\$2.45** 1-82 5" dial. ... **\$2.95**

**High-Voltage Capacitor:** Aerovox Type 15020 3/4 mfd at 15,000 volts dc. ... **\$4.95**

**Sharp Filter:** Band-pass or cut-off, 1020 cps. Neat compact box FL-8-A, used when flying radio range. RANGE-VOICE-BOTH switch selects 1020 pass only, or voice freq. minus 1020 cps, or bypasses filter completely. Use to make an intermodulation analyzer. An interesting experimenter's item at an interesting price, only... **95c**

**Starting Relay:** Leach, 3-contact, 20 amp cont. duty. 2 NO, 1 double-throw at 20 amp in the energized position, about 10 amp in the energized position. Coil 22-30vdc, resistance 180 ohms. Brand new. ... **98c**

SEND FOR YOUR COPY OF OUR FREE CATALOG

**WESTERN RADIO CO., Inc.** • 3633 South Racine Avenue  
Chicago 9, Illinois

# Studio Quality AMPLIFIERS

## WITH CUSTOM-BUILT FEATURES

Design of Bardwell & McAlister's New Commercial Amplifiers embodies the principles which have been proven in custom-built units developed in the Motion Picture Industry, where quality is requisite. Fully licensed.

12w. models operate up to 8 indoor speakers, effectively cover outdoor audience of 2500.

25w. models operate up to 16 indoor speakers, effectively cover outdoor audience of 8000.

Designed & fabricated by manufacturers of high quality Sound & Recording Equipment for the Motion Picture Industry. Union made.

2 to 4 high gain input channels and 2 to 4 high or low gain radio or phonograph input channels.

With or without professional "T" type bass and treble equalizers.

High fidelity reproduction at any setting of volume controls up to full rated output with less than 4% distortion.

Frequency response flat within 1/2 db from 50 to 10,000 cycles.

Output impedances 500, 250, 16 & 8 ohms. Overall gain 105 db. Hum level 85 db below full output.

Write today for informative catalog & Technical data.  
Dealer inquiries invited.

12



ELECTRONIC DIVISION  
**BARDWELL & McALISTER, INC.**

BOX 1310, HOLLYWOOD 28, CALIFORNIA

## THE "TELETRAP"

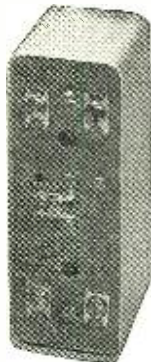

### INTERFERENCE ELIMINATOR FOR TELE SETS

Eliminates FM and amateur interference from tele image by absorption of interfering signal. Two adjustments provide for elimination of signals in 80-115Mc and 40-60Mc Ranges.  
Model 1005A List \$10

### THE SIMPLEST FM CONVERTER

Converts 40-50Mc FM Tuners and receivers to 88-108Mc operation. Simple to attach and adjust. No power required. Hundreds now in use all over U.S.  
Model 1002A List \$10.00

### CRYSTAL CONTROL FOR FM TV AND BC RECEIVERS

Send 25c (no stamps) for booklet describing applications of quartz crystal control for local oscillator of your home receivers.

See Your Local Parts Jobber or write for information

**CRYSTAL DEVICES CO.**

DEPT. N

1819 Broadway, NEW YORK 23, N. Y.

## U. S. NAVY DAQ RECEIVER

**\$79<sup>95</sup>**

Input: 115 V.A.C. 50/60 cy built-in power supply.

Complete, including 14 tubes.

Excellent Condition

### READY TO OPERATE

Now you can complete your QSO's with "HUFF-DUFF"! (Navy DAQ) superhet receiver (AM-CW-MCW-ICW) on 80-40-20-10 and new 15 mc bands. Freq. Bands: 1.5-3.1 mc: 3.1-6.6 mc: 6.6-14.0 mc: 14.0-30.0 mc.

Receiver circuit—audio output power 1.5 watts maximum undistorted into a 4-ohm loudspeaker; 100 UW maximum undistorted output into 600 ohm loudspeakers. I.F. 455 kc.

Important: This receiver has a grill in the panel for a speaker. 2 R.F. stages, 2 I.F. stages, B.F.O. for CW. Voltage regulator VR150-30 provides high stability.

Size: 18"x17"x13". Wt. 97 lbs. net.

This is the first time this amazing receiver has been offered to the amateur.

ORDER TODAY

25% deposit required on C.O.D. orders; shipped F.O.B. New York.

**WICO**

512 Greenwich St.  
New York 13, N. Y.

**A.F.C.**

(Continued from page 69)

plying the error voltage directly to the blocking oscillator it is first amplified to get more voltage and better control.

Tube  $V_1$  is the sync pulse amplifier for the horizontal pulses which are impressed on the grid of the phase-splitter,  $V_2$ . It will be noted that this tube has the same amount of resistance ( $R_4$  and  $R_5$ ) in both plate and cathode, which will produce pulses equal in amplitude but opposite in phase. The positive pulse coming from the plate of  $V_2$  is applied to the cathode of one diode,  $V_3$ , while the negative pulse from the cathode of  $V_2$  is put on the plate of the other diode,  $V_4$ . The plate and cathode of  $V_3$  and  $V_4$ , respectively, are connected together and will develop a d.c. voltage across the filter which consists of  $C_6$  and  $C_7$  and  $R_{11}$ . This will be the error voltage.

Resistors  $R_9$  and  $R_{10}$  serve as d.c. return paths to ground for the error voltage. The saw-tooth voltage from the plate of the saw-tooth amplifier is changed to a pulse by the shaping network  $C_4$ ,  $C_5$  and  $R_6$ . This pulse voltage is divided equally by the voltage divider  $R_7$ ,  $R_8$ ,  $R_9$ , and  $R_{10}$  and is superimposed on the sync pulse. When these two pulses are of exactly the same frequency, they will produce no current through the two diodes but if, for instance the locally generated pulse is faster, that will affect the current of only one diode, causing a voltage of a certain polarity to appear on the grid of  $V_5$ , the d.c. amplifier. When the local pulse is slower, the other diode will conduct and the voltage on the grid of  $V_5$  will be of opposite polarity. That is just what is necessary to control the saw-tooth generator.

A blocking oscillator is employed, followed by a discharge tube to produce a saw-tooth voltage. The frequency of this oscillator is controlled by the bias on the grid, and this bias is determined by the plate voltage of  $V_5$ , the d.c. amplifier. A rough adjustment is made by varying  $R_{11}$ , a series resistor in the grid circuit of the blocking oscillator. Condenser  $C_7$  is essential to the function of the blocking oscillator, but usually appears in series with the blocking transformer. Nevertheless, its function is still the same and its time constant has to be in accordance with the desired wave shape.

The incoming sync pulses will be of a steady frequency while the frequency of the blocking oscillator may be adjusted, for instance—too slow. Instantly the saw-tooth is fed back to the a.f.c. system and an error voltage is developed. This error voltage will charge condensers  $C_6$  and  $C_7$ , and not until the latter, a 40  $\mu$ fd. unit, is charged is the full error voltage developed on the grid of the d.c. amplifier and, in turn, not until then

has the plate voltage of that tube changed, thus changing the bias on the blocking oscillator tube. That is why the picture sometimes moves into sync visibly and gives a wavering appearance until it is finally locked in. Once the proper frequency has been reached it is rather difficult to throw the blocking oscillator out of sync, because condenser  $C_7$  retains a certain charge due to the small but constant diode current which flows regardless of signal and which keeps the grid of  $V_5$  and, in turn, of  $V_6$  at a constant potential.

Should occasional noise pulses be received, they would not be regular and frequent enough to affect the constant d.c. voltage, and, therefore, have no effect on the sync of the picture. Another advantage is that once the frequency control  $R_{11}$  is set—even though only approximately, the a.f.c. will bring the picture into sync each time unless a great change occurs in any of the circuit constants. Naturally that means less need for adjustment and many manufacturers who use a.f.c. are planning to put the hold controls on the rear of the chassis, and have them adjusted only once, at the time of installation.

The system described in this article is but one of the many possible combinations. Fig. 2, a similar system is shown, and this is slightly better adapted for manufacturing since it requires fewer components and the voltage divider does not have to be exact. Again a phase-splitter for the incoming sync pulse is employed but this time the feedback pulse is applied to the opposite plate and cathode. The principle, however, is still the same.

The error voltage is obtained through  $R_8$  or  $R_9$ , depending on whether it is positive or negative. The combination  $R_{10}$  and  $C_7$  tends to reduce the action of the d.c. amplifier and the bias for the blocking oscillator is again obtained through  $R_{11}$  and hold control  $R_{12}$ , from the plate of the previous tube. In this circuit the feedback saw-tooth is obtained from the secondary of the output transformer and a slightly different wave shaping network ( $R_6$ ,  $R_7$ ,  $C_4$  and  $C_5$ ) is necessary.

The outstanding characteristic of this last a.f.c. circuit is that the ratio of the sync pulse amplitude and the amplitude of the feedback pulse is ten to one, with the sync pulse usually being 40 volts peak-to-peak and the feedback pulse 4 volts. As long as this ratio is kept, this system performs extraordinarily well.

In Fig. 4, the a.f.c. circuit of the present RCA Model 630 TS television receiver is shown. It goes under the commercial name of "Eye Witness" sync, and is an RCA patent. It is slightly more complex than the systems hitherto discussed but the basic principle is retained.  $V_1$  is again the sync amplifier and this time no phase splitter is used, instead the sync pulse is put on the centertap of the primary of discriminator transformer  $T_1$ . This

March, 1948

# make henry your hallicrafters headquarters

## COMPLETE STOCKS

Henry has everything in the ham field



## QUICK DELIVERY

Shipments 4 hours after receipt of order

**S-38** Biggest little buy on the market. Frequency range: 540 kc to 32 Mc in 4 bands. Separate electrical bandspread dial. CW pitch control adjustable from front panel, automatic noise limiter. Self-contained PM dynamic speaker . . . **\$47.50**

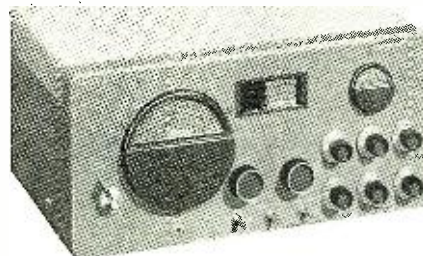

**SX-43** Hottest ham performance ever at this price. All essential ham frequencies from 540 kc to 108 Mc. In the band of 44 to 55 Mc, wide band FM or narrow band AM, just right for narrow band FM reception is provided . . . **\$169.50**

BUTLER MISSOURI

**HENRY RADIO STORES**

11240 Olympic Blvd. LOS ANGELES 25 CALIF.

"World's Largest Distributor of Short Wave Receivers"

<b>BC 348Q</b> SPARE PART R.F. UNIT 49c ea.	<b>DM 33A</b> DYNAMOTORS 24V DC to 600V DC. \$1.50 ea.	<b>NEW TUBES</b> 2C261 . . . . . \$0.35 45A . . . . . .30 9JP1 . . . . . 7.50 12Z3 . . . . . 1.00 959 . . . . . .40 1629 . . . . . .18 UX6653 . . . . .30	<b>AIRCRAFT</b> Instruments, Electrical (New) Accessories G.E. Tech. Gen. \$ 5.00 Man. Pres. Gauge 2.50 Voltage Reg. . . . 10.00 Rev. Current Relay . . . . . 5.00 Ammeter . . . . . 2.50
<b>ANTENNA</b> CHANGE OVER RELAY 95c ea.	<b>C-1 AUTOPILOT</b> Part of NORDEN Bomb Sight. \$35.00		

## MAKE MONEY CONVERTING

LP21A Radio Compass Loops to Rotating Window Display Table. LIST \$24.50. Your Cost with Materials Less than \$10.00! Complete Directions Furnished.

LP21A \$5.50, 40 mfd. condenser 40c, Cord 25c, Xformer 95c. Sell to Stores in Your Town \$24.50 completed.

**MONTHLY SPECIAL**  
STANDARD  
6 V. VIBRATOR  
\$1.50 ea.

**FARWEST TRADING CO., INC.**  
209 1st Ave., So.  
SEATTLE 4, WASH.  
Cable Address, "FARCO"

Send 20%  
Remittance with  
Order.

**PLEASE TEAR OUT THIS  
ADV. AS REMI DER**

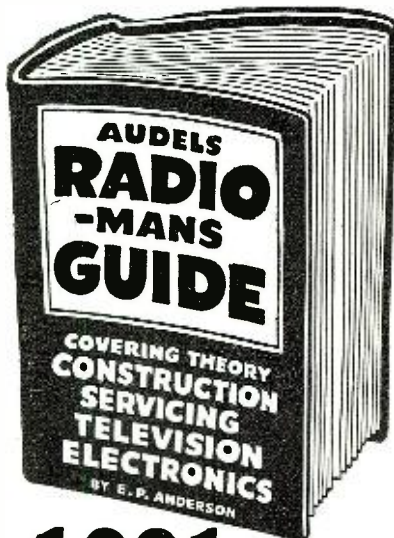

**1001 RADIO FACTS  
AND FIGURES**

**AUDELS RADIOMANS GUIDE—914 Pages, 633 Illustrations, Photos, Wiring Diagrams, 38 Big Chapters, covering Radio Theory, Construction, Servicing, including Important Data on Developments in Television, Electronics and Frequency Modulation, Review, Questions and Answers, Calculations & Testing. Highly Endorsed—Indispensable for Ready Reference and Home Study.**

**\$4 COMPLETE • PAY ONLY \$1 A MONTH**  
Step up your own skill with the facts and figures of your trade. Audels Mechanics Guides contain Practical Inside Trade Information in a handy form. Fully Illustrated and Easy to Understand. Highly Endorsed. Check the book you want for 7 days' Free Examination.

Send No Money. Nothing to pay postman.

**CUT HERE**  
**MAIL ORDER**

**AUDELS, Publishers, 49 W. 23 St., NEW YORK 10, N. Y.**

Please send me postpaid for FREE EXAMINATION books marked (x) below. If I decide to keep them I agree to mail \$1 in 7 days on each book ordered and further mail \$1 monthly on each book until I have paid price—otherwise, I will return them.

- RADIOMANS GUIDE, 914 Pages . . . \$4
- ELECTRICIANS EXAMINATIONS, 250 Pages . . . 1
- WIRING DIAGRAMS, 210 Pages . . . 1
- ELECTRIC MOTOR GUIDE, 1000 Pages . . . 4
- ELECTRICAL DICTIONARY, 9000 Terms . . . 2
- ELECTRICAL POWER CALCULATIONS, 425 Pgs. . . 2
- HANDY BOOK OF ELECTRICITY, 1440 Pages . . . 4
- ELECTRONIC DEVICES, 216 Pages . . . 2
- ELECTRIC LIBRARY, 12 vol., 7000 Pgs., \$1.50 vol. . . 1
- OIL BURNER GUIDE, 384 Pages . . . 1
- REFRIGERATION & Air Conditioning, 1280 Pgs. . . 4
- POWER PLANT ENGINEERS Guide, 1500 Pages . . . 4
- PUMPS, Hydraulics & Air Compressors, 1658 Pgs. . . 4
- WELDERS GUIDE, 400 Pages . . . 1
- BLUE PRINT READING, 416 Pages . . . 2
- SHEET METAL WORKERS Handy Book, 388 Pgs. . . 1
- SHEET METAL PATTERN LAYOUTS, 1100 Pgs. . . 4
- AIRCRAFT WORKER, 240 Pages . . . 1
- MATHEMATICS & CALCULATIONS, 700 Pgs. . . 2
- MACHINISTS Handy Book, 1600 Pages . . . 4
- MECHANICAL Dictionary, 968 Pages . . . 4
- AUTOMOBILE GUIDE, 1700 Pages . . . 4
- DIESEL ENGINE MANUAL, 400 Pages . . . 2
- MARINE ENGINEERS Handy Book, 1280 Pages . . . 4
- MECHANICAL DRAWING GUIDE, 160 Pages . . . 1
- MECHANICAL DRAWING & DESIGN, 480 Pgs. . . 2
- MILLWRIGHTS & Mechanics Guide, 1200 Pgs. . . 4
- CARPENTERS & Builders Guides (4 vols.) . . . 6
- PLUMBERS & Steamfitters Guides (4 vols.) . . . 6
- MASONS & Builders Guides (4 vols.) . . . 6
- MASTER PAINTER & DECORATOR, 320 Pgs. . . 2
- GARDENERS & GROWERS GUIDES (4 vols.) . . . 6
- ENGINEERS and Mechanics Guides . . . 12
- Nos. 1, 2, 3, 4, 5, 6, 7 and 8 complete . . . 12
- Answers on Practical ENGINEERING . . . 1
- ENGINEERS & FIREMANS EXAMINATIONS . . . 1

Name -----

Address -----

Occupation -----

Employed by ----- RN

transformer is permeability tuned and its secondary is the tapped inductance for a Hartley oscillator using  $V_1$  as the oscillator tube. The tank circuit is completed by  $C_2$  and  $C_3$ , and the capacity of  $V_2$  which is used here as a reactance tube. This oscillator circuit produces a sine wave which is changed into a saw-tooth wave by the discharge tube  $V_3$ . The frequency comparison takes place in the duodiode  $V_2$  by means of the induced signal and the center-tapped primary. The error voltage is developed across  $R_1$  and  $R_2$  which go to a  $-2$  volt tap in the power supply bleeder, and thus provides a fixed bias for the reactance tube  $V_3$ . When an error voltage is developed it adds or subtracts from the bias and therefore changes the capacity of the reactance tube. This, in turn, changes the frequency of the oscillator, producing the desired correction.

The problem of the serviceman is usually how to recognize a faulty a.f.c. system, since loss of sync is not necessarily due to the a.f.c. If, for instance, one of the sync amplifiers or the clipper is not functioning properly, no sync pulse may reach the discriminator and the a.f.c. cannot function. Usually only the horizontal sweep employs a.f.c., while the vertical works on direct sync, so that, when the picture does not seem to move up or down, it is safe to assume that the portions of the clipper and sync amplifier which contain both horizontal and vertical pulses, are all right and the trouble must, therefore, be in a section containing only the horizontal pulse. On the other hand, if it appears impossible to get either the vertical or the horizontal into sync, then obviously it cannot be the fault of the a.f.c., and the trouble is probably in the clipper or amplifier. A good oscilloscope will permit tracing the sync pulses through the circuit and thereby greatly facilitate troubleshooting. This fact has been recognized by most television service organizations which invariably possess and use suitable scopes.

In conclusion it may be said that it is very desirable to have a.f.c. in the horizontal sweep circuits of the more expensive television receivers, especially those having a screen diameter of 10 inches and up, to facilitate adjustment and prevent "tearing" and loss of sync due to noises or unstable oscillators. A disadvantage of a.f.c. is the need for at least four additional tubes, although this is usually minimized by using one duodiode and a duo-triode. However, the added number of components and necessary adjustment in production do mean added expense. Servicing problems with regards a.f.c. systems are greatly reduced when the trouble is located in one particular section by judging the symptoms and deducing their causes. Once a serviceman gets better acquainted with the appearance of sync trouble, he will have no difficulty locating and repairing it.

**Recording of Sound**

(Continued from page 64)

fairly reliable indication of how much surface noise will exist in the finished record.

**Recording Levels**

Considerable experience and skill is required in order for the recordist to obtain top quality results from his recordings. It is not practical to make an exact statement of the correct operating level for any particular recording head or setup. The correct level can be established only by experience and test. There are no fixed boundaries in disc recording representing 100% modulation. At low frequencies the groove spacing limits the possible amplitude of the cutter. At high frequencies the radius of turning of the groove is the limiting factor.

It is not difficult to find the correct operating levels for a complete installation if test cuts of speech and music are made at the same standard record speeds using the smallest contemplated groove diameters. These test cuts should be made at gradually increasing levels and the results should be noted when the records are reproduced. When the reproduction ceases to be acceptable from a quality standpoint, the maximum level has been exceeded. The presence of a very small amount of distortion is sometimes less objectionable than excessive surface noise which is one reason, from a practical commercial standpoint, for not being guided too strictly by measured distortion. It is well to keep in mind what type of equipment will be used to reproduce the recorded material. Only the most advanced type of pick-up with a diamond or sapphire stylus should be used if best quality of reproduction with low noise level is desired from acetate type recordings.

Records for 33 $\frac{1}{3}$  r.p.m. cannot be cut at as high a level as records for 78 r.p.m. because of the reduced surface velocity of the record material. It is equally necessary to reduce the recording level at least 6 db. on the 33 $\frac{1}{3}$  r.p.m. discs. A higher level is usually used for 33 $\frac{1}{3}$  r.p.m. lacquer master discs for processing than for recordings where the original is to be played back repeatedly. A high level soft lacquer original will not withstand repeated playbacks. However, the surface noise with these discs is low so that there is no need for the maximum level.

All disc recordings suffer from loss of high frequency response during playback in the area nearer the center of the disc. As the diameter of the record grooves become smaller, the condition becomes progressively worse because of the reduction in the linear speed of the recorded groove. With the slower groove speed, the actual linear distance

# Brand New Cathode Ray Tubes! as low as (3DP-1-A)

*Here's how we do it*  
Due to an unusual buy, we are now able to offer a large selection of Brand New Cathode Ray tubes at unbelievably low prices. These tubes are not just good, but guaranteed Brand New in original cartons. We are able to offer some of these tubes as low as 95c each due to the tremendous quantity purchased. See the center column below for our complete listing.

# 95¢



**Stock Up**  
WILLARD  
2 VOLT  
BATTERIES  
**ONLY \$1.25 each**  
Brand new, Compact spill proof Built-in Hydrometer. Group several together for higher voltages. Uses Standard Electrolyte Guaranteed. Add 35c to cover postage and handling.



**Radio Compass**  
R5/ARN7 or 433G, either of these Radio Compass Receivers complete with tubes. Ideal for conversion for home reception. Used but good. A real buy at only \$17.25. (Shipped express collect)



**\$17.25 each**

**Recording Wire**  
**\$1.49**  
.006 Stainless Steel recording wire. New on original spools as used by Army and Navy recorders. Each spool contains at least 1/4 mile of wire. Can be used on standard wire recorders. Add 25c to cover handling and postage.



**Cathode Ray Tube Bargains**

3CP-1 (see cut)	95¢
3DF-1A	95¢
3DP-7-A	\$1.35
3AF-1	\$1.45
3HF-7	\$1.45
3BP-1	\$1.50
908	\$1.50
(Add 25¢ to cover handling)	
5FF-7	\$1.75
5CF-1	\$1.95
5BP-1	\$2.45
5HP-1	\$2.45
5JP-1	\$2.45
(Add 35¢ to cover handling)	
7BP-7	\$2.65
7CP-1	\$3.25
(Add 40¢ to cover handling)	
9(P-7	\$3.50
(Shipped Express Collect)	

**PE-73-C  
Dynamotor  
ONLY \$2.95 each**  
PE-73-C Dynamotor. Input 28 volts at 19 amps at 5000 RPM, output 1000 volts at .55 amps. Used but good. (shipped express collect)



**Telephones  
ONLY \$1.95**  
Desk Type Telephones, will operate all flashlight cells or other small Batteries. Three of the Storage Batteries listed in this ad operate a pair nicely. Used but Excellent. (Add 40c to cover Handling and Postage)



**Aircraft  
XMTRS.  
only \$3.30 each**  
BC-457-A, 4 to 5.3 MC and BC-458-A, 5.3 to 7 MC. These transmitters are companion sets to the 453, 4, and 5 receiver series. They are used, but in excellent condition. It's really built rugged and makes an excellent 55 watt transmitter. With tubes. Shipped Express Collect



**This Month's Special!**  
**\$4.95 each**  
SCR578 Gibson Girl Transmitter complete with tubes, used but good, only \$4.95. (Shipped express collect)



**IMPORTANT!**  
All merchandise subject to prior sale, minimum order \$1.00, No C.O.D. orders accepted. Michigan residents must add 3% State sales tax.



# Better Products for the Radio Industry

## FIELD CHASS EZ—STATION INJECTOR AND POWDER—REPAIR KIT—DELUXE HARDWARE LABORATORY

### G-C FIELD CHASS EZ

Holds almost any radio chassis in position! Has special reversible hooks for flanged type chassis, or to tilt chassis back if necessary. Made with slide adjustment—takes only 5 seconds to install. No parts to lose—will never wear out. A real convenience for the radio serviceman!  
No. 5207—Servicemen's Kit ..... \$2.95



### G-C MASTER DELUXE CABINET REPAIR KIT

Complete kit in permanent metal box. Contains shellac, alcohol lamp, varnishes, glue, enamels, polish, directions, etc.  
No. 900—List ..... \$8.75



Have you seen the new G-C "Speedex" Wire Strippers... write for illustrated literature.

RADIO DIVISION, DEPT. H

### NEW G-C STATIC CHASER INJECTOR AND POWDER

Tire static powder kits... improve auto radio reception. Eliminate wheel static interference. New powder is blown into all inner tubes, easy to use. For every car owner!



- No. 5604—Injector for G-C Static Powder ..... List \$1.50
- No. 5605—G-C Static Powder Packet for 5 tires ..... List \$1.00
- No. 5606—Kit—Powder Packet and Injector ..... List \$2.50

### G-C COMPLETE HARDWARE LABORATORY

40 jars of over 2100 essential electronic hardware items, screws, nuts, lugs, parts, etc. all the items you need.  
No. 6604—List ..... \$24.00



G-C Products are available at leading distributors. Write for your copy of our new illustrated catalog.

## GENERAL CEMENT Mfg. Co., Rockford, Ill., U.S.A.

Manufacturers of over 3,000 products • Sales offices in principal cities

## ELECTRONIC SPECIALTIES

for hams for FM for TV

### MOSLEY ANTENNA ATTACHMENTS



DIPOLE CONNECTOR (Catalog 25-C)



END INSULATOR (Catalog 25-E)



ANTENNA RAINCOAT (Catalog 26)

Covers center connections and keeps them dry. Reduces change in impedance match.



CABLE PLUG (300-P)

For dead-ending 300 ohm transmission line.

These MOSLEY ANTENNA ATTACHMENTS are for 300 ohm transmission line and support antenna and feeder line securely. NO SOLDER IS NEEDED.

Also completely assembled ANTENNAS and KITS

### MOSLEY CRYSTAL HOLDER ADAPTERS



(Catalog 5-75) Fits 1/4" crystal holder to 3/4" spacing.



(Catalog 75-5) Fits 3/8" crystal holder to 1/2" spacing.

FOR SALE AT YOUR NEAREST JOBBER

## CARL E. MOSLEY

(W0FQY)

2125 LACKLAND ROAD OVERLAND PARK, MO.

## TELEVISION—F. M. TEST GENERATOR FOR \$29.75!



Does the work of sweep generators three times this price. This quality product is guaranteed and is indeed a substantial contribution to the industry. Note these features of the Model H.G.-2 signal generator.

- Frequency range: From 5 mc. thru F.M. and television bands.
- Full range attenuation control.
- Synchronizing voltage for locking in pattern on oscilloscope.
- Produces a rapid response curve of your I. F. strip or F. M. and television receiver, providing quick visual alignments at low cost.

### HI-VOLT (R. F. TYPE) POWER SUPPLY



For television and similar applications. Its small—safe—superbly engineered.

- 3000-6000 V. 4"x4"x5" Model H.V.-6 ..... \$14.95
  - Model H.V.-6 kit ..... 12.50
  - Model H.V.-6 coil ..... 5.75
  - 6000-10,000 V. 4"x6"x6" Model H.V.-10 ..... 19.95
  - Model H.V.-10 kit ..... 16.95
  - Model H.V.-10 coil ..... 7.75
- Diagram furnished with each coil.

### GOVERNMENT SURPLUS

COIL SETS for CBY receivers of RU12 equipment single range \$0.50; dual range \$0.75; specify frequency desired.  
TUBING—High grade red flexible tubing for No. 20 wire, 1500 ft. roll \$4.95.  
B.C. 423 SIGNAL GENERATOR modified for R.F. tuning of television and F.M. Pulse modulated. 54 to 106 mc. \$19.95.  
B.C. 403 RECEIVER complete with 15 tubes. Easily modified for 2 meters. \$19.95.  
FEED THRU INSULATORS—Heavy duty porcelain bell type 6"x9" \$2.50.  
CRYSTALS 1N21 and 1N23, 3 for \$1.00.  
B.C. 412 SCOPES. Easily converted to television sets, and test scopes; only a few left, \$39.50.  
CRYSTALS 100 K.C. high precision type. Frequency stability = 15 cycles from -50° to +80° C. \$4.50.  
ALUMINUM CASES 10"x14"x21" for scopes, television, mo'tor rigs, etc. with punched front panel and chassis. Well ventilated. new Duco finish \$4.95.  
25% with C.O.D. orders. Surplus F.O.B. Hempstead. \$2.00 min.

ALGERADIO 385 Jackson Street, Hempstead, N. Y.

available for a complete cycle of, for example, a 10,000 c.p.s. tone, becomes very short. The cutting stylus has a front face which is a flat plane and can record the high frequencies at the slower groove speeds without difficulty. The limiting factor becomes apparent when an attempt is made to reproduce this recording. The reproducing stylus must have a tip of spherical shape. It is obvious that this tip cannot follow a recorded groove whose radius of turning is less than the radius of the stylus tip. It is therefore desirable to confine high fidelity recording to large diameters, dividing the time on two or more discs if necessary for maximum quality. Records having extended frequency range cannot be made at a diameter of less than nine inches for 33 1/3 r.p.m. without an extreme loss of high frequency response.

In making high fidelity records, including discs for immediate playback, use can be made of what is known as complimentary compensation. Because of the energy distribution in most speech or music it is possible to accentuate the higher frequencies when making a record and then to attenuate these frequencies by a like amount in reproduction, thereby reducing the surface noise resulting from minute foreign particles in the record stock.

For high quality recordings the frequency rise should begin at about 700 c.p.s. and should increase smoothly to a maximum of 16 db. at 10,000 c.p.s. Filters, such as the RCA orthoacoustic recording filter MI-4916, have been designed for this purpose. In reproduction the inverse of this rise should be employed. Pre- and post-equalization, as this method of compensation is often called, results in a substantial reduction of surface noise. Another form of high frequency compensation involves the use of automatically variable equalizers designed specifically for 33 1/3 r.p.m. recording. With these devices the high frequency compensation is progressively increased as the recording groove diameter becomes smaller. The equalizer mounts on the rear of the recorder mechanism and is synchronized with the cutter head so that the amplifier gain is increased at the high frequencies to an amount which is considered a practical maximum.

Record playing time. Note that 17 1/4 inch blanks used for recording the "masters" should be recorded as 16 inch blanks.

Grooves Per Inch	Turntable Speed r.p.m.	Approximate Playing Time (minutes)		
		16-inch Record	12-inch Record	10-inch Record
96	78	6 1/2	4	2 3/4
112	78	7 1/2	4 1/2	3 1/4
120	78	8	5	3 3/4
136	78	9	5 1/2	3 3/4
154	78	10	6	4
96	33 1/3	14	8	4 1/2
112	33 1/3	16	9 1/2	6
120	33 1/3	17	9 3/4	6
136	33 1/3	18	10	6
154	33 1/3	20	11	6 1/2

The term "flutter" is used to describe a vertical wave or oscillation which is sometimes cut in the recorded groove. This condition can often be seen as a series of radial spokes or patterns in the record surface. These patterns are usually visible before the record is reproduced although sometimes they may be seen more plainly after playing. When viewed through a microscope, this condition appears as an alternating change in width of the cut groove. Flutter may be caused by a building vibration, low frequency turntable rumble, incorrect stylus angle or a blank having an unusually wavy surface. Hard spots in a blank will result in a condition similar to that caused by flutter. As the stylus passes over harder and softer portions of the surface, the cutter head is raised or lowered slightly, causing a variation in the depth of groove. This variation should not be mistaken for flutter or oscillation since it is the original action of a well designed and free acting recording head. A distinctive characteristic of hard spots is their prevalence near the outside of the blank. Therefore, variations in groove depth due to hard spots will be more prevalent in this region.

#### Bouncing

When a valley is encountered when cutting a disc, bouncing will occur due to lack of sufficient pressure from the cutter and stylus. The result is illustrated in Fig. 4.

#### Cutter Adjustments

It is important that the feed screw mechanism be adjusted so that the carriage supporting the recording head travels in a plane exactly parallel to the surface of the turntable in order that the depth of cut will be uniform over the entire record surface. The front face of the stylus, when in the cutting position, should be adjusted to within plus or minus three degrees of perpendicular. Some experiment may be necessary to find the most satisfactory angle for any given surface material. It is advisable not to stop the turntable with the recording head in cutting position since the stylus may cut through the acetate coating to the metal core of the blank. This will chip the cutting edge of the stylus when the turntable is moved or the head raised.

#### Tests

It is good practice to make surface noise tests from time to time with all of the cutting styli available. This will assist the operator in selecting only those cutters which produce clean, quiet grooves. Present standards require the noise level on lacquer records to be down 50 db. from normal recording level. When checking noise it is necessary to refer the noise level to some standard level. It is suggested that the 1000 c.p.s. tone band of a standard tone record be selected as a reference level.

To determine the noise level, con-



\* The greatest Radio Handbook ever published \* Larger size \* More detailed photographs \* All new equipment shown \* 32 chapters \* Other sections extensively revised.

## The greatest RADIO HANDBOOK

WE'VE EVER PUBLISHED. Our 11th edition contains the greatest array of practical radio equipment ever shown between the covers of one book—all brand-new. All newly-designed, and newly-built by practical men, for practical men; all tested in our own shop in actual use. Larger-sized, more detailed photographs, on new larger page size (same size as this magazine).

#### FEATURED IN THIS EDITION ARE:

- Dozens of transmitters for all bands, and all powers up to 1 kw.
- Six chapters on Antennas, Transmission Lines, and Propagation
- One chapter devoted entirely to rotary array construction and feed methods.
- One large chapter on the conversion of widely-distributed military surplus equipment to amateur and other practical use.
- New constructional data on beamtube amplifiers
- One chapter on determining the operational characteristics of all types of amplifiers
- New, simple FM exciter designs
- New data on transmitter control by improved methods
- New V-F-O design
- Simplified antenna tuning device and sending-wave meter
- The most extensive tube tables of any book not devoted entirely to such data.

MORE MATERIAL THAN EVER BEFORE, DURABLY CLOTHBOUND, GOLD-STAMPED, FOR ONLY

**\$3.00** per copy at your favorite dealer's in U.S.A. Mail orders, \$3.25 postpaid in U.S.A.; foreign, \$3.50 postpaid.

GET IT AT YOUR FAVORITE DEALER'S. If he cannot supply you, you may order direct from us by mail. DEALERS: "Technical" discounts allowed on this book when purchased by the radio, book, and news trades in quantities for resale.

*Editors and Engineers* 1302 KENWOOD ROAD Santa Barbara CALIFORNIA

### SPOT SURPLUS SPECIALS DELIVERY GUARANTEED!

Our buyers attend all U. S. Gov't. surplus sales. We buy in quantities that enable us to offer you the best electronic equipment including hard-to-get radar and communications sets, tubes and parts -- at the lowest prices.

SEND FOR BULLETIN "M" FOR COMPLETE UP-TO-THE-MINUTE STOCK AND PRICE LISTS.

PACIFIC COAST DEALERS: Write for special prices.

**25% CASH WITH ALL ORDERS. MINIMUM ORDER \$1.00**



## G. & M. EQUIPMENT CO., Inc.

505 VAN NUYS BOULEVARD • VAN NUYS, CALIFORNIA • STATE 4-3233

# INDUSTRIAL & ELECTRONIC POWER SUPPLY EQUIPMENT

## TRANSFORMERS



**T-103**—Voltage regulator Transstat. American Transformer Co. Spec. 29145. Max. KVA output 11.5. 50/60 cyc. 0-115 V. 100 amps or 230 V. 50 amps. \$75.00  
Net Wt. 134 lbs. Dim. 25" W x 16" D x 17 1/2" H (Encl. 3" shaft ext.)

**T-101**—Plate Transformer. American Transformer Co. Spec. 29108. Primary 115 V. 60 cyc. 10.4 KVA. Secondary 17600 V. .520 amps. 35 KVA test. \$65.00  
Net Wt. 500 lbs. Dim. 19" W x 15 1/4" D x 41" H. O. A.



**T-102**—Filament Transformer. American Transformer Co. Spec. 29106. Type WS 050 KVA. 50/60 cyc. Single phase. 35 KVA test. 12 KV D.C. operating. Primary 115 V. secondary 5 V. 10 amps with integral standoff insulator and socket of No. 371. 872. etc. rectifier tubes. \$12.50  
Net Wt. 15 1/4 lbs. Dim. 6 1/4" W x 6" D x 12" H. O. A.

**T-104**—Voltage Regulator Transstat. American Transformer Co. Spec. 29144. 115 V. 60 cyc. Max. KVA 25 single phase. voltage range control. \$59.50  
103-126 volts, max. amps 2.17 (for filament voltage control) \$59.50  
Net Wt. 15 lbs. Dim. 5" W x 11" D x 7 1/2" H. O. A.

## CHOKE COIL

**R-106**—Amertran Disc. Type. Specification No. 29107. Line volts 15,000 V. D.C. Ripple frequency 120, 149 ohms resistance. .20 D.C. amps at 900 henrys 48% ripple. .52 amps D.C. at 25 henrys 48% ripple. \$42.00  
Net Wt. 280 lbs. Dim. 17" W x 12" D x 31 1/4" H. O. A.

## CAPACITORS

**C-107**—G.E. Capacitor Cat. No. 14F59 or Westinghouse Inertene. 1.0 mfd. 25,000 V. D.C. \$36.00  
Net Wt. 65 lbs. Dim. 14 1/2" W x 8 1/4" D x 15" H. O. A.  
**C-132**—Aerovox. 10 mfd. 600 volt. D.C. Oil filled \$30.00

## RELAY

**RC-115**—R.W. Cramer Co. Time Delay Relay. Type TD2 120S. 1 min. interval. 115 V. 60 cyc. Synchronous motor drive. Contact rating 10 amp. 115 V. single pole, normally open. \$4.95

## METERS

**M-144-5**—R.W. Cramer Co. Running Time Meter—3" Type RT2H. 115 V. 60 cyc. Flush mounting. \$5.95  
Net Wt. 1 lb.

**M-141**—Weston Model 476—3". 0-130 V. A.C. volt meter. flush type, calibrated for steel panel mounting. \$4.95  
Net Wt. 1 lb.

**M-140AB**—Weston Model 476—3" A.C. Ammeter. 3 amp. full scale, calibrated 0-120 amps. flush mounting, with 40/1 current trans. \$8.50  
Net Wt. 3 lbs.

**M-146**—Weston Model 476—3". Filament voltage indicator. 0-130 V. movement with 115 V. mark. flush mounting, calibrated for steel panel. \$3.95  
Net Wt. 1 lb.

**M-143AB**—Weston Kilovoltmeter—3". Model 301. 20 KV. @ 1000 ohms per volt. flush type, calibrated for steel panel mounting, with 20 meg. 20 KV Weston resistor complete with clips and standoff insulators. \$18.00  
Net Wt. 4 lbs.

**M-142**—Weston Model 301—3". D.C. Milliammeter. 0-800 Ma., flush type, calibrated for steel panel mounting. \$4.95

## HEATERS

**H-149**—Chromolox strip heaters. 300 W., 115 V. (3/4 x 1 1/2 x 12") \$1.00

## MOTOR AND BLOWER

**MB-156**—Motor blower unit, Mfg. by Champlon Blower Co. Cat. No. O-CE, direct connected, 4" inlet, 4" exhaust, 1/20 H.P., 115 V. 60 cyc. 1750 R.P.M. Capacitor motor \$21.50

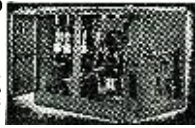

## POWER SUPPLY

(RA-38) 115 V., 60 cyc. input, adjustable output 0-15,000 V. A.C. or D.C. @ 500 Mils. Shipping weight 2100 lbs. \$200.00

All merchandise in "as new" condition. Add approximately 20% to net weights for estimated shipping weights. Terms are 30% with order, balance C.O.D. All prices f.o.b. Los Angeles Warehouse.  
Write for additional detailed information on any of the above items and for special quantity discounts.

1527 E. Seventh Street  
**EPCO**  
Los Angeles 21, California

Grooves Per Inch	Combined Width of Groove & Wall	Groove Width		Wall Width		Groove Depth			
		From	To	From	To	70° Stylus		90° Stylus	
						From	To	From	To
96	.0104	.0052	.0042	.0052	.0062	.0022	.0015	.0018	.0013
112	.0089	.0044	.0036	.0044	.0053	.0017	.0011	.0014	.0010
120	.0083	.0041	.0034	.0041	.0049	.0014	.0009	.0012	.0009
136	.0073	.0036	.0029	.0036	.0044	.0011	.....	.0010	.....
154	.0065	.0032	.0026	.0032	.0039	.0008	.....	.0008	.....

Groove dimensions.

nect a high fidelity pickup through a calibrated attenuator to the input circuit of a high gain amplifier. Insert a high pass filter, such as the one contained in the MI-4917-A variable sound effects filter by RCA, in the circuit to eliminate all frequencies below approximately 200 c.p.s. The electrical location of the high pass filter is important. If two amplifiers are used connected in cascade, the ideal electrical location for the filter is between the amplifiers. Should it be necessary to use a single unit amplifier, the filter may be connected between the pickup and the amplifier input. Be sure to provide adequate shielding for the filter when using it in this position, however, since the hum pickup may be severe. Connect the amplifier output to a loudspeaker and a volume level indicating meter. Play the 1000 cycle tone band and then the noise sample. Adjust the output of the amplifier with a calibrated attenuator until a similar indication is obtained on the volume level indicating meter. The attenuator reading indicates directly the noise level in db. below reference level.

A convenient method for determining the presence of noise or scratch consists of connecting the cutter head as a reproducer. Insert the stylus to be checked in the cutter head and connect the leads from the head di-

rectly to the input terminals of the high gain amplifier which has a loudspeaker connected to its output terminals. Cut grooves in the record material, preferably near the outside diameter. Arrange the gain of the amplifier sufficiently to hear the sound made by the cutter. A steady hiss indicates a good grade of lacquer and sharp, properly adjusted stylus. Scratching, squealing, or tearing sounds indicate a dull or improperly adjusted stylus. Clicking or banging may indicate the presence of foreign particles in the lacquer.

## Groove Spacing

The correct groove width is largely determined by the radius of the tip of the playback stylus, and by the signal level at which the recording is made. The groove should be wide enough so that the playback stylus tip contacts the side walls of the groove approximately 0.5 mil. below the surface of the record. Then ordinary light surface scratches will not be reproduced and will not add to the over-all record noise. Most lateral transcription pickups use styli which have tip radii between 2.3 and 2.5 mils. In order to obtain the proper fit, a groove width of 4.5 mils. or greater is recommended for cutting styli having either a 70 or 90 degree included angle. Fig. 6 illustrates the theoretical fit for various sizes of playback

Fig. 6. Theoretical seating of stylus in grooves of various widths. (A) Grooves cut with 70° stylus, (B) grooves cut with 90° stylus. (Tip radius .0017")

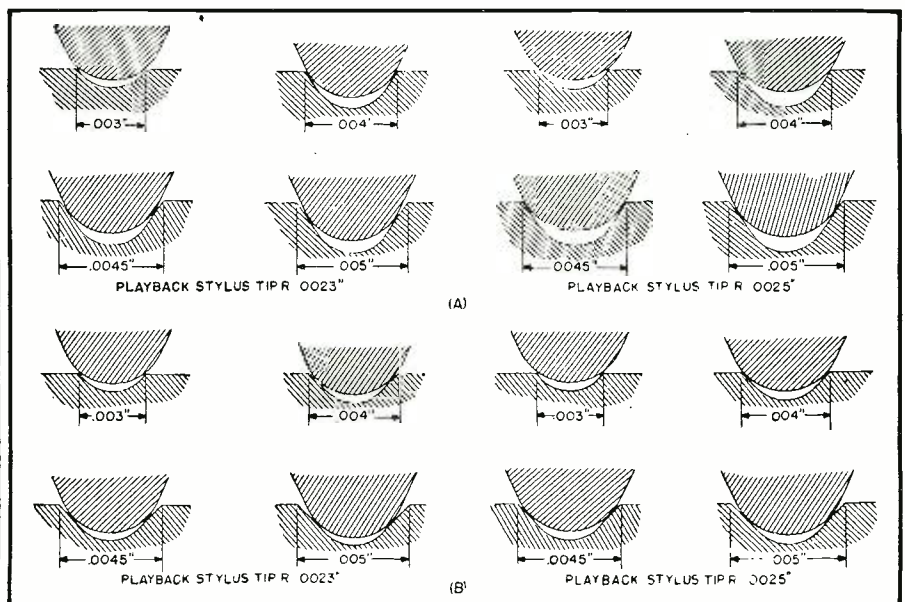



# NOW BUILD 15 RADIOS

COMPLETE KIT  
\$14.75



**ABSOLUTELY NO KNOWLEDGE OF RADIO NECESSARY  
YOU NEED NO ADDITIONAL PARTS**

THE PROGRESSIVE RADIO KIT is the ONLY COMPLETE KIT. Operates on 110-120 volts AC/DC. Contains everything you need. Instruction Book, Metal Chassis, Tubes, Condensers, Resistors and all other necessary radio parts. The 36-page Instruction Book written by expert radio instructors and engineers teaches you to build radios in a professional manner. The first circuit built is a simple one-tube detector receiver. Each succeeding circuit incorporates new arrangements of detectors, RF and AF amplifiers. This kit is excellent for learning the principles of receiver, transmitter and amplifier design. It is used in many radio schools and colleges. All of

the commonly used detectors are used, including diode, grid leak, plate and infinite-impedance. The transmitters are designed with Hartley and Armstrong oscillators, using screen-grid and control-grid modulation. Both vacuum tube and selenium rectification are employed in these circuits. The circuits are designed to provide excellent performance. Altogether, fifteen circuits are constructed, including 11 receivers, 1 audio amplifier, and 3 transmitters. The sets start with simple circuits of 1 tube plus rectifier, gradually grow more complex, and finish with several examples of radio sets using three tubes plus rectifier.

## SPECIAL FREE OFFER

Electrical and Radio Tester sent absolutely FREE with each Progressive Radio Kit. PLUS FREE membership in Progressive Radio Club. Entitles you to free expert advice and consultation service with licensed radio technicians. Write for further information or ORDER your KIT NOW!

PROGRESSIVE RADIO KIT	1 Kit	.....	\$14.75
	2 Kits	.....	28.15
	3 Kits	.....	41.50



## PROGRESSIVE AMPLIFIER KIT . . . Only \$15.75

HIGH FIDELITY, HUMLESS AMPLIFIER • SEVEN TUBE PERFORMANCE

Amplifier can be readily modified to match the GE reluctance pick-up.

Separate mike and phono input. Regulated power supply maintains constant voltage supply. DC heater supply, whether amplifier is used on AC or DC, provides humless operation by eliminating cathode-heater leakage hum. Contains degenerative feedback for improved frequency response, balanced phase inversion and push-pull beam power output. Every stage thoroughly decoupled to improve low-frequency response and to prevent motor-boating. Tone and volume controls completely variable.

Seven-tube performance. Uses 2 selenium rectifiers, 2-beam power amplifiers,

1 high-mu pentode mike amplifier, 1 twin-triode phase inverter, and 1 voltage regulator tube.

### PROGRESSIVE UNIT PRICES ON AMPLIFIER KIT (LESS TUBES & SPEAKER)

1 Kit	.....	\$15.75
2 Kits	.....	29.92
3 Kits	.....	42.51

### PROGRESSIVE UNIT PRICES ON TUBES for Amplifier Kit

(1—125L7, 1—125J7, 1—VR75, 2—12A6's)		
1 set	.....	\$3.00
2 sets	.....	5.70
3 sets	.....	8.10

This newest Progressive Kit will enable you to build a newly designed, high fidelity, humless amplifier.

Beautiful aluminum custom-punched chassis, etched tone and volume control plates. Designed by former Western Electric engineer.

Ideal amplifier for television kit or set, FM tuner, AM tuner, microphone, phonograph, wire and instantaneous recorders.

Electrify your musical instruments by connecting them to the Progressive Amplifier by means of a contact mike.

## RADIO PARTS SCOOP!

NO SURPLUS—ALL PARTS GUARANTEED BRAND NEW

**40-40 MFD. 150 W.V. DC  
Electrolytic Condensers**  
Regular Price \$1.05

Buy 1 for	\$0.45	and save	\$0.60
Buy 5 for	2.10	and save	3.15
Buy 10 for	4.00	and save	6.50

**CONDENSER KIT**  
50 Paper Tubular Condensers. Values from .002 mfd. to .1 mfd., 400 v. DC to 600 v. DC.  
Regular Price \$5.00

Buy 1 Kit for	\$1.95	and save	\$3.05
Buy 2 Kits for	3.80	and save	6.20
Buy 3 Kits for	5.55	and save	9.45

**SELENIUM RECTIFIERS**  
Regular Price \$1.10

Buy 1 for	\$0.79	and save	\$0.31
Buy 2 for	1.54	and save	.66
Buy 3 for	2.25	and save	1.05

**12" ALNICO SLUG SPEAKER**  
Regular Price \$8.00

Buy 1 for	5.60	and save	\$2.40
Buy 2 for	10.80	and save	5.20
Buy 3 for	15.95	and save	8.05

**6" ALNICO SLUG SPEAKER**  
Regular Price \$2.35

Buy 1 for	\$1.69	and save	\$0.66
Buy 2 for	3.18	and save	1.52
Buy 3 for	4.65	and save	2.40

**ANTENNA AND RF COIL SET  
(Broadcast Band)**  
Regular Price \$1.00

Buy 1 set for	\$0.59	and save	\$0.41
Buy 2 sets for	1.10	and save	.90
Buy 3 sets for	1.50	and save	1.50

**25,000 OHM WIRE-WOUND POT.**  
1/4" shaft.  
Regular Price \$1.00

Buy 1 for	\$0.35	and save	\$0.65
Buy 2 for	.66	and save	1.34
Buy 3 for	.90	and save	2.10

**MIDGET SOLDERING IRON**  
35 watts 110/120 volts UL approved.  
Regular Price \$1.00

Buy 1 for	\$0.69	and save	\$0.31
Buy 2 for	1.30	and save	.70
Buy 3 for	1.80	and save	1.20

**55 WATT SOLDERING IRON**  
Famous Make—UL approved.  
Regular Price \$2.50

Buy 1 for	\$1.80	and save	\$0.60
Buy 2 for	3.60	and save	1.40
Buy 3 for	5.10	and save	2.40

**75 WATT SOLDERING IRON**  
Famous Make—UL approved.  
Regular Price \$3.00

Buy 1 for	\$2.40	and save	\$0.60
Buy 2 for	4.60	and save	1.40
Buy 3 for	6.60	and save	2.40

**LONG NOSE PLIERS & CUTTERS**  
Exceptional quality. Hydrized for extra toughness. Diamond-tested cutters.  
Regular Price \$1.95

Buy 1 for	\$1.45	and save	\$0.50
Buy 2 for	2.70	and save	1.20
Buy 3 for	3.60	and save	2.25

**PROGRESSIVE RADIO TOOL KIT**  
A Progressive Electronics Special. Contains 75 watt 110/120 volt soldering iron, long nose pliers and cutters, screwdriver, insulated alignment tool.  
Regular Price \$5.45

Buy 1 Kit for	\$3.25	and save	\$2.20
Buy 2 Kits for	6.10	and save	4.80
Buy 3 Kits for	8.70	and save	7.65

**20-20 MFD. 150 W.V. DC  
Electrolytic Condensers**  
Regular Price 75c.

Buy 1 for	\$0.30	and save	\$0.45
Buy 5 for	1.40	and save	2.35
Buy 10 for	2.60	and save	4.90

**10-10 MFD. 450 W.V. DC  
ELECTROLYTIC CONDENSERS**  
Regular Price \$1.25

Buy 1 for	\$0.65	and save	\$0.60
Buy 2 for	1.24	and save	1.26
Buy 3 for	1.74	and save	2.01

**RESISTOR KIT**  
100 Carbon Resistors, 1/2 watt, RMA color-coded, values from 120 ohms to 2.2 megohms.  
Regular Price \$5.00

Buy 1 Kit for	\$1.50	and save	\$ 3.50
Buy 2 Kits for	2.80	and save	7.20
Buy 3 Kits for	3.90	and save	11.10

**4 TUBE TRF MIDGET RECEIVER**  
Regular Price \$12.75

7 1/2"x5 1/4"x4 1/4". Weighs only 2 3/4 lbs. Beautiful suede finish cabinet (assorted colors). Uses miniature tubes: 12BA6, 12AT6, 50B5, 35W4. 4" Alnico V Speaker.  
Buy 1 for \$11.75 and save \$1.00  
Buy 2 for 23.00 and save 2.50  
Buy 3 for 33.75 and save 4.50

**ESPEY CUSTOM-BUILT AM-FM  
HIGH FIDELITY RECEIVERS**

Model No. 7-B. List price \$140.00. Your price \$82.50. \$25 deposit required with C.O.D. orders. 11-tube AC Superheterodyne AM-FM receiver. Folded dipole antenna for FM supplied. Wired for phonograph operation. Requires nothing but a cabinet. Ideal for custom builders.

**FM COIL & CONDENSER KIT \$4.95**

Designed for operation on 88-108 MC (new band). Contains 2 IF transformers, 1 Limiter transformer, 1 Discriminator transformer, 1 oscillator coil, 1 RF coil, 1 variable condenser, schematic and wiring instructions. Excellent for schools, experimenters and radio hobbyists.

**PROGRESSIVE ELECTRONICS CO. Dept. RN-7**

497 UNION AVENUE

BROOKLYN 11, NEW YORK

# PEAK SURPLUS SPECIALS

## G.E. 2" SCOPE

This compact unit only 4 1/2 x 2 1/2 x 8 3/4" ideal for modulation indicator etc. has focus intensity and reticle brilliance controls—Uses 2A1P1 CRT and 9006 rectifier. We supply complete instructions with each scope. Rectifier built in—need only transformer delivering 350-400 v. 6.3, volts for operation. Very simple changes. Comes with 9006 but less 2A1P1.  
Only \$4.95  
2A1P1 \$2.50



## S.C. TEST SET (1-114)

In portable wood case 6" x 6" x 10", including cover not shown, with Weston 0-150 v. AC. Meter has 2 switching ckts and comes complete with test and line cables. A Buy At \$3.95 Only



Same with other make meter \$3.25

## APN 4, 5" SCOPE INDICATOR (25 tubes)

Makes an ideal basis for 5" scope. Also can be converted into Panadaptor with marker pips at 100 KC - 20 KC - 2 KC. for measuring drift and width of F.M. Has electronic switch for observing 2 frequencies simultaneously. Unit contains an accurate 100 KC crystal. Tube complement: (1) 5CP1 (3) 6SL7 (4) 6SN7 (6) 6H6 (1) 6SJ7. Complete with tubes and 100 KC crystal. Marvelous buy at \$24.95



## R.C.A. POWER TRANSFORMER

770 V.C.T. 100 ma., 6.3 volts—2.5 amp. 5 volts—2 amps—3 1/2" x 4" x 4 1/2" \$2.75

## BRUTE FORCE

A heavy duty Western Electric Filter Choke 4.3 henry 620 mill 42 ohms DC resistance 4 7/8 x 5 3/8 x 5 3/8" (Ceramic Insulators on top). A Peak Bargain at \$4.95

BC454B—3-6 MC Superhet. Complete with 6 tubes \$4.95

FILTER CHOKE—8 henry 160 mills—140 ohm D.C. resistance. \$1.39 ea. 2 for \$2.50

## METERS (Standard Brands)

0-5 ma (amp scale)	\$1.95
0-1 2 ma	2.40
0-1 amp R.F. (internal thermo)	3.40
2-150-0-150 microamps	3.40
2-0-1 ma (volt scale)	2.95
2-0-50 microamps (square)	3.95
3-500-0-500 microamps. (Blank scale)	3.95
3-0-1 ma	4.95
3-0-2 ma D.C.	3.95
3-0-20 ma D.C.	3.95
3-G.E. 0-15 ma D.C. (square)	3.95
3-0-150 volts A.C.	3.95
4-1-0-1 ma D.C. (Blank scale)	3.95

Voltage Regulated Power Supply—input 110 v. 60 cy. Delivers 150 v. DC—Well filtered (3 chokes) uses VR 150 and 6X3. Has extra 6.3 v. winding. Swell for eco's, freq. meters, etc., 16x3 1/2 x 5 with tubes. Only \$6.95

## OIL CONDENSERS

2 mfd 600 vdc	\$0.39	3 mfd 3000 vdc	\$3.95
4 mfd 600 vdc	.50	1 mfd 4000 vdc	3.75
3/4 mfd 600 vdc	.75	1 mfd 5000 vdc	4.50
4/4 mfd 600 vdc	.95	1 mfd 7500 vdc	1.95
14 mfd 600 vdc	1.35	1/1 mfd 7500 vdc	2.40
2 mfd 1000 vdc	.75	01/01 12 KV dc	5.50
4 mfd 1000 vdc	.95	65 mfd 12500 vdc	12.95
2 mfd 1500 vdc	1.25	75/375 mfd (dual) 8/16	
1 mfd 2000 vdc	1.15	KV dc	14.95

## GIZMOS

—Thousands of good parts here in quantities too limited to advertise. If you send \$2.50 for our "Gizmo Package" we promise you won't regret it.

## MISCELLANEOUS SPECIALS

2-11 mmf Butterfly Cond.	\$0.59
Millen Var. 150 mmf .077 GAP	1.69
CD 16 mfd 450 v	2.95
Kit 50 mica Cond.	2.95
CD .002 Mica 7500v. T.	.85
Kit of 5 relays	.99

If not rated, 25% with order, balance C.O.D.

**PEAK ELECTRONICS CO.**  
188 WASHINGTON ST., DEPT. MR  
NEW YORK 7, N. Y.

styli and groove widths. The tip radius of the cutting stylus should be 0.4 or 0.5 mils. less than that of the playback stylus so that the bottom of the record groove is cleared and does not form the major support for the reproducing tip.

To determine the pitch (number of grooves per inch) at which the record is to be cut, add to the groove width twice the maximum amplitude of expected stylus excursion (due to signal) plus an allowance for safety factor. Assume a normal stylus excursion of 0.626 mils. and a maximum of 10 db. above this or 1.98 mils. Twice this is 3.96 mils. plus a safety factor of 1.0 mil. added to a groove width of 4.5 mils. equals 9.46 mils., or about 109 grooves per inch. Low frequency peak amplitudes of 10 db. above normal are infrequent and it is questionable if two maximum stylus excursions will occur in adjacent grooves at such time and phase as to cut into each other. Therefore, some liberty can be taken and a slightly smaller pitch, about 7.35 mils., or 136 grooves per inch, is usually considered satisfactory when using a 70 degree cutting stylus.

The groove width should, however, never be less than 4.5 mils. when a playback stylus with a 2.3 or 2.5 mil. tip radius is used.

The tabulation (see page 152) shows the practical limits of groove and wall widths. All dimensions are in inches.

The author wishes to express his appreciation to RCA for many of the illustrations and the reference material used in this article.

(To be continued)

## Cross-Modulation

(Continued from page 56)

in others to pickup in high-gain audio stages. All such cases were located within areas of extremely high field intensities, however, and represent a very small part of interference complaints. More common sources of cross-modulation are: (1) exposed power wiring, particularly if overhead mains are used; (2) poor electrical contact between sections of metal roofing, drain pipes, metal chimneys, electrical conduit, etc., and; (3) oxidization or poor contact in the antenna or ground system, guy wires, or nearby wiring. Often such objects as a galvanized clothesline may be the source of r.f. pickup and rectification without actually coming in contact with the antenna system.

Several years ago, WLW engineers investigated almost 100 cases of cross-modulation in Cincinnati. Of these cases, the sources of interference (in the order of their appearance) were; (1) loose connections, (2) complainant's receiver, (3) vent pipes, (4) image frequency, (5) downspout, (6) radiator pipe, (7) sink drain pipe, (8) antenna dragging on a metal roof. Of the total number of cases involved, over 10 per-cent were due to loose connections which allowed oxidization or rust to occur.

## Methods of Elimination

The source of cross-modulation can best be located through the use of a portable battery receiver operated as a direction finder. The receiver

## CHANGES IN STANDARD FREQUENCY BROADCAST

**E**ffective January 30, 1948, the technical broadcast services from radio station WWV of the National Bureau of Standards were somewhat modified and improved, according to an announcement by Dr. E. U. Condon, Director of the Bureau.

Each of the eight radio carrier frequencies 2.5, 5, 10, 15, 20, 25, 30 and 35 megacycles are now being broadcast continuously day and night. Standard audio frequencies of 440 and 4000 cycles per second are transmitted on the carriers 10, 15, 20, and 25. The 440 cycle frequency, which is the standard of musical pitch (A above middle C), is also being broadcast on 2.5 and 5 megacycles. The accuracy of each of the transmitted radio and audio frequencies is better than one part in 50 million.

The attention of all users of the National Bureau of Standards time announcements is particularly called to the following change: Time announcements in International Morse Code, accurately synchronized with basic U. S. Naval Observatory time, have been advanced one minute with respect to the old announcement scheme. With the new system the audio frequencies are interrupted at precisely one minute before each hour and at each succeeding five-minute period. They are resumed precisely on the hour and each five minutes thereafter.

Under the old system, the time signals were interrupted for a minute on the hour and on each succeeding five minutes, while under the new scheme interruptions are for a minute precisely on the 59th minute, on 4 minutes past the hour, 9 minutes past the hour, etc., and resumed precisely on the hour and each five minutes thereafter. The exact moment to which the time refers is the moment of interruption of the audio frequencies of 440 and 4000 cycles per second. The audio frequencies will continue to be interrupted for one minute to allow for the time announcement, for station identification by voice at the hour and half hour, and to afford an interval for checking radio frequency measurements free from the presence of audio transmissions.

Station WWV provides six important technical broadcast services to the nation and five to the world, 24 hours a day. These are; (1) standard radio frequencies, (2) time announcements, (3) standard time intervals, (4) standard audio frequencies, (5) standard musical pitch, (6) radio propagation disturbance warning notices.

A detailed announcement of WWV broadcast services, LC886, will be provided upon request from the National Bureau of Standards, Washington 25, D. C.

## Fixing Radios the Old Hard Way?

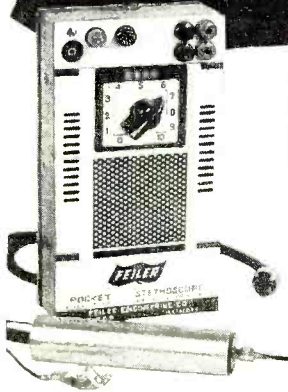

The Feiler Stethoscope does everything but make the actual repair. And the Stethoscope does it faster, better and much easier. Thousands of radio men, many with little experience, are already fixing radios and other electronic equipment this new way.

You will find that just this one low priced unit and a few basic hand tools are all you need to fix practically any radio.

Here is the new Model TS-5 "Pocket Stethoscope" built to take out on the job. It's light, compact and rugged yet performs like the bench models. Stethoscopes are available in 4 types ranging from \$9.85 to \$34.95.



The "Inside Story" of the STETHOSCOPE—how it works—how it instantly locates trouble in any circuit—is yours for the asking. The "Inside Story," a 24 page illustrated booklet, is full of practical tips and hints on radio servicing. To get your free copy, send your name and address on a penny post card today.

"MAKES RADIO REPAIRS AUTOMATIC"

Available for Export—Choice Territories Still Open



### FEILER ENGINEERING COMPANY

945 George St. Dept. 3H8 Chicago 14, Illinois

Precision Engineered for

- CONSISTENT PERFORMANCE
- HIGH FIDELITY • RUGGEDNESS

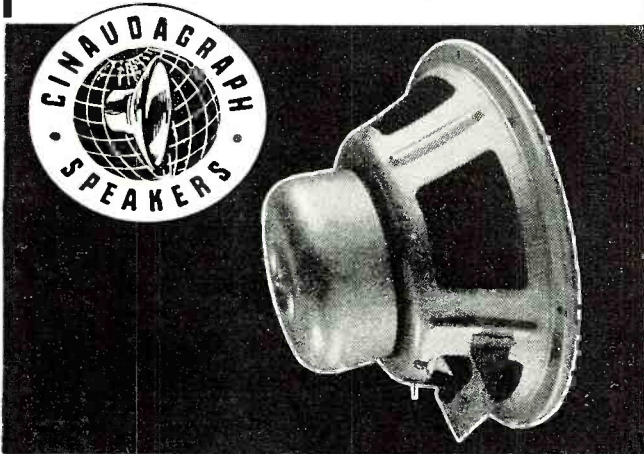

### Better Speakers for Any Purpose

From two-inch units for portable radios . . . to fifteen-inch models for commercial phonographs and public address systems . . . Cinaudagraph Speakers presents the only complete line of new 1948 model speakers in the world. Cinaudagraph Speakers has the facilities, experience and engineering ability to design and produce better speakers for any purpose. It pays to specify Cinaudagraph Speakers.

# Cinaudagraph Speakers

DIVISION OF AIREON MFG. CORP.

SALES OFFICE and FACTORY 1401 FAIRFAX TRAFFICWAY KANSAS CITY-KANSAS

March, 1948

## CURRENT CONVERSION

WITH **ATR** QUALITY PRODUCTS

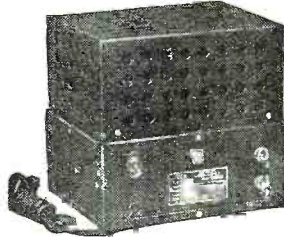

### ATR "A" BATTERY ELIMINATORS

For DEMONSTRATING and TESTING AUTO RADIOS

New Models . . . Designed for Testing D.C. Electrical Apparatus on Regular A.C. lines. Equipped with Full-Wave Dry Disc Type Rectifier Assuring Noiseless, interference-free Operation and Extreme Long Life and Reliability.

- Eliminates Storage Batteries and Battery Chargers.
- Operates the Equipment at Maximum Efficiency.
- Fully Automatic and Fool-Proof.
- Type 60-ELIA . . . Rated Output 6.3 Volts at 6.5 Amperes.
- Type 120C-ELIO . . . Rated Output 6.3 Volts at 14 Amperes.



### ATR AUTO RADIO VIBRATORS

Designed for Use in Standard Vibrator-Operated Auto Radio Receivers. Built with Precision Construction for Longer Lasting Life. Price are approximately 15% lower.

### ATR STANDARD AND HEAVY DUTY INVERTERS



For Inverting D.C. to A.C. Specially Designed for Operating A.C. Radios, Television Sets Amplifiers, Address Systems, and Radio Test Equipment from D.C. Voltages in Vehicles, Ships, Trains, Planes and in D.C. Districts.

Write for New ATR Catalog—Today!

AMERICAN TELEVISION AND RADIO CO.

Quality Products Since 1931

SAINT PAUL 1, MINNESOTA — U. S. A.

# The Perfect Combination!

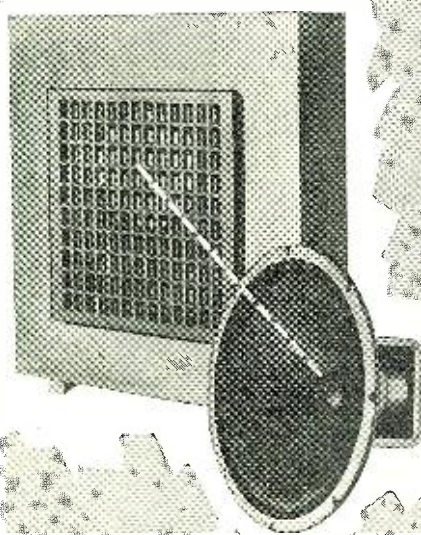

Here's the Reproducer you've been waiting for! Engineered for high quality sound reproduction and particularly designed for wired music equipment, disc recordings and high quality public address work. The 25-watt high fidelity Colortone speaker gives excellent frequency response up to 9,000 cycles—and even higher! Cabinet constructed from heavy plywood and offered in a choice of finishes.

(Circular of Colortone sound equipment mailed upon request.)

## COLORTONE COMPANY

1720 Mishawaka Avenue

South Bend, Indiana

## Learn and Earn! TELEVISION

### RADIO F. M. COMMUNICATION

offer profitable occupation for both men and women. You learn by actual work, how to build and operate, and fit yourself for a higher pay job. Write for catalog.

Approved for Veterans

### HOLLYWOOD SOUND INSTITUTE

1040-A N. Kenmore

Los Angeles 27

### 5#MFD

### 3500 V. D.C. W.E. OIL-FILLED CAPACITORS

**\$3.75**  
EACH

Size:  
4 3/4 W. by 1 3/8 Thick,  
4 3/4 Long.  
Mfg. 4 6-32 Studs.  
Shipping Weight 4 Lbs.

### ELECTRONIC SALES CO.

5559 W. Adams Blvd. Los Angeles 16, Calif.

GET ON OUR MAILING LIST

**SURPLUS SPECIAL**—Small 110 v. AC open frame motors, 1/8" shaft, 2700 R.P.M., 1/70 H.P., mfd. by BARBER COLMAN CO. **\$2.00** ea.

#### CAPACITORS

1100 MFD. 50 Volt ..... \$1.25  
1500 MFD. 50 Volt ..... 1.65  
2000 MFD. 50 Volt ..... 1.95  
500 MFD. 200 Volt ..... 1.75

#### SWITCHES

Slide Switch: Stackpole DPDT ..... \$0.15  
SPDT Momentary, Center Off Position, Long Bat Handle ..... .29  
4 Pole DT 10A, 125 V ..... .50  
SPDT Center Off Position, 6A, 125 V ..... .35  
Toggle Bat Handle DPST ..... .35

#### CONDENSERS

8 Gang Variable Condensers 50 MMFD Per Section Ceramic Insulation ..... \$0.95  
4 Gang Variable Condenser 50 MMFD Per Section Ceramic Insulation ..... .85  
Condensers, Variable, Dual 2.5 to 10MMF 260 MMF Per Section—1/4" Shaft Mycalex. 1.00  
Condensers, Variable, Ceramic Insul. Shaft 5/16 x 3/4" L.  
C115-10-45 MMF with Coil, Tunes to 31 MCS ..... .50  
C122-7-27 MMF with Coil, Tunes to 58 MCS ..... .50  
C106-11-115 MMF ..... .35  
15-330 MMF 1/4" Shaft Brass Plate, Ceramic

#### Oil Filled Condensers:

.03 MFD. 7500 V. DC ..... 1.15  
.30 MFD. 2000 V. DC ..... .65  
1 MFD. 2500 V. DC ..... 1.25  
1 MFD. 1200 V. DC ..... .85  
4 MFD. 2000 V. DC ..... 2.75  
10 MFD. 1500 V. DC ..... 3.15

No sale less than \$2.00. All prices FOB New York City. Add 25c to cover postage. 20% Deposit required with all orders—all Prices Subject to change without notice.

## A. M. RADIO SALES COMPANY

345 CANAL ST.  
NEW YORK CITY 13, N. Y.

## "A. M." Specials!

#### MISCELLANEOUS

PL259A Coax Connector and Socket. Silver Plated for RG8U and RG11U... \$0.50 Pr.  
Right Angle Adapter M359A ..... .30  
Mica Trimmers: Variable 3-30 Mmfd 4 Gang ..... .20  
Variable Ceramicon 4-30 mmf. 7-45 mmf. ..... .25  
Filament Transformer: 3 volts @ 4 amp. 110 volt pri. open frame, porcelain standoffs, Mfd. by G.E. ..... 1.00  
0 to 15 DC Milliammeter, Simpson 3 1/2" Bakelite Case ..... 2.95  
Pilot Light Assy. 1" Ruby jewel complete with 110 v. AC Candelabra base bulk ..... .40  
12 v. Edwards' Buzzer complete with push button ..... .40  
7 foot. Telescoping Antenna ..... 1.00  
Rectifier, Copper Oxide. Full wave 110 VAC input, 100 VDC @ 1 amp. output. Solenoid, 6VDC complete with plunger and mtg. Bracket ..... 1.25  
Microphone, T 17 with push to talk Switch Cord & Plug ..... .59  
Sound Powered Phones, TS 10K (Used) ..... 25.00 Pr.

#### SYNCHRONOUS MOTOR

1/8" shaft 110 v. AC 60 cy. 4/5, 1 1/5, 1 1/2 RPM 2.2 watts. Mfg. by Hayden Mfg. Co. ..... \$1.75

should incorporate high sensitivity, be well shielded, and equipped with an electrostatically shielded loop antenna. Headphones are useful where absolute quiet is desired in tracing interference in apartment buildings, hospitals, etc.

In tracing the source of interference, the best receiver should be tuned to one of the *spurious* frequencies in which the cross-modulation occurs, *not* on the fundamental. If a broadcast station is being listened to, only the *cross-modulation background* will disappear when the source is removed. When *spurious* frequencies are used, however, these artificial frequencies are removed *entirely* when the source has been eliminated. These spurious frequencies are still fairly strong when cross-modulation on the broadcast signal has been virtually eliminated. To allow tuning to these spurious frequencies, the receiver should be capable of covering a range of approximately 1500 to 5000 kc. To facilitate probing among wires, pipes, and inaccessible spots, the antenna should be mounted on a handle several feet long and connected to the receiver through shielded leads. The outside of the loop should be completely taped or insulated to prevent accidental grounds or short-circuits.

To proceed with tracing, determine first which stations are cross-modulating. This may be done by listening for call letters or by identifying a familiar program. This check should preferably be made on the complainant's receiver, since one or more of the spurious frequencies will be in the broadcast band. Once the cross-modulating frequencies are known, the chart of Table 1 may be used as a guide in finding a number of spurious frequencies which will be within the tuning range of the test receiver. The antenna, ground, and a.c. leads of the complainant's set should then be checked for presence of these spurious frequencies, first by turning the set on, then off, while listening to the spurious frequency on the test receiver. If cross-modulation appears and disappears as the set is turned on and off, the receiver itself is the source. If not, proceed by removing antenna and ground from the set and connecting together. With the test receiver's loop held near the complainant's antenna, pickup from this source can be determined. Once it has been found that the source of interference is external, the test loop should be rotated slowly in the vicinity of the affected receiver in order to determine the approximate direction or maximum strength of the cross-modulating signal. It is usually easy to trace the radiated energy to its source by listening for an increase in signal as the source is approached. All plumbing, radiator pipes, and wiring should be moved or jarred while listening to one of the spurious frequencies. As the offending object is moved, the signal will respond or disappear accordingly. Next, the down-

spouts and drain pipes should be moved, pipes and wires in basement should be checked, and telephone and power grounds examined.

All pipes touching or making intermittent contact should be either bonded and grounded, or separated and insulated from each other and from nearby objects. Antenna and ground systems, including lightning arrestors, should be checked externally, and all vent pipes, clotheslines, etc. should be cleaned and grounded if necessary, and old or faulty antenna leads removed. It is often wise to clean or examine all possible sources of interference even after the actual offender has been located, in order to prevent callbacks when and if cross-modulation occurs in these places.

Leaded joints in steam radiators and pipes are often electrically faulty; these should be cleaned and bonded if necessary. Conduit and electric switch-box junctions should be checked for good ground contacts. Poor or oxidized joints in house wiring are often evidenced when the radio increases or decreases in volume when a certain light switch is turned off and on.

Since radiation from nearby buildings, lines, etc. is often responsible for cross-modulation, it is not always possible to locate the exact source of interference. In such cases, alteration of the receiving antenna and installation of a wavetrap, tuned to the offending signal, often are helpful. In other cases, installation of an a.c. line filter may be necessary. Suitable line filters may be purchased at most radio distributors and quickly installed. In these cases, make sure the set has a good ground connection and that all connections are clean and solid.

It has been noted before that a few cases were found wherein rectification occurred in a high-gain audio stage. The grid lead, if long, should be shielded, and all low-level leads dressed away from a.c. and filament wiring. If a glass tube is used, it should be equipped with a shield or replaced with a metal equivalent. In stubborn cases, a 50 $\mu$ fd. mica condenser may be connected from control grid to ground.

Some of the trouble may be due to image frequencies. In this type of trouble, a strong station may be received at two frequencies, one its assigned frequency and the other differing by twice the i.f. frequency. A cross-modulation effect or a heterodyne "squeal" is caused when the difference or sum frequencies coincide with the frequency of another broadcast station. Several image points may be caused by local oscillator harmonics in the set. This trouble may usually be corrected by realigning or shifting the i.f. frequency so that its image frequency does not beat against that of another station. The set should also be thoroughly checked to ascertain whether r.f. is being picked up by one or more of the methods already mentioned.

# Modern Hams Junk Old-Style "Cans"!



First basic improvement in headset design in 50 years

## TELEX MONOSET

- Gives clear, crisp "near as here" reception
- Blocks outside noise
- Eliminates that "top-heavy" feeling
- Ends headachy ear pressure

Man, what relief to get rid of those pressure headaches from old-style earphones!

The TELEX MONOSET swings lightly under the chin like a stethoscope—never gets in your hair! The TELEX MONOSET delivers the signal into the ears, excludes all room noise automatically. The TELEX MONOSET gives undistorted output at maximum volume... plenty of "sock" easily adjusted with the built-in volume control.

Modernize your rig with a MONOSET  
—successor to the earphone! Write  
Department BT for information.



Canadian Distributors  
Sono Film, Ltd., Winnipeg



Deluxe Table Model.  
Can be screwed down  
or hooked to table  
with C Clamp.  
Complete .....\$31.75

### COIN RADIO KITS SEPARATELY OR COMPLETE UNITS

- PLASTIC CABINET AND GRILL for table model .....\$ 5.75
- Richly grained brown or ivory marble effect. No stains—no burns—No refinishing. Exceptional acoustics only equaled by this type of cabinet.
- TIMERS (Quarter 1 and 2 hour or 5c 10 Minutes ..... 4.95
- AC RADIO Chassis RCA 5-Tube Super-Het, Completely Wired ..... 15.35
- METAL HINGED BASE AND BACK with No-Cheat Coin Box and Brackets..... 3.45
- MISCELLANEOUS ACCESSORIES
- 2 LOCKS, WING NUTS, NAME PLATES, Etc. ....\$1.80
- CONSOLE PLASTICS BASE to complete Console Model ..... 4.25
- BEAUTY PARLOR DRYER HEAD SETS AND HOLDER..... 1.80

Deluxe Console, no stand needed, can be fastened to the floor. Complete .....\$35.00



## RADIO-COIN-MATIC

BOX 9465  
1110 S. NORMANDIE  
LOS ANGELES 6, CALIF.

**STAHL "SEZ"** if it's Radio-Electrical-Electronic Equipment - Parts - Supplies - Sets these BARGAINS must interest you.

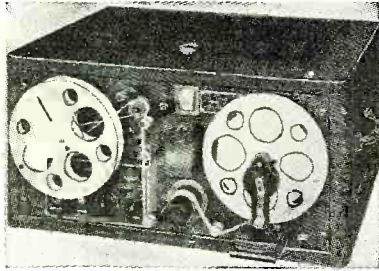

**CODE KEYSER TG-10**

An automatic unit for code practice signals, from an inked type recording. It's a self contained unit, complete with 7 tubes and electric eye tube; operates on 110-120 volts AC, 60 cycles. Size 11x24x18 1/2 inches. Weight approximately 63 lbs. Audio frequency output of 800 cycles per second. Power unit can be converted to P.A. system. Also a 78 RPM, 110 volt AC motor, can be used for turntable. Complete, only..... \$19.50

**WILCOX CW 3  
7 Tube Receiver**

**\$12.95**

Complete with 1 set of coils—5.1 meg. to 10 meg. and an additional set of tubes. Brand new in original cases. Export packed.



Highly selective Super het. operating on 5,100 to 10,000 KC frequency range. The high frequency oscillator is crystal controlled. Works on 110V. AC, 60 cycles. Tubes 2-6X7; 1-6X8; 2-6C8G; 1-7S7; 1-80. Set consists of single stage RF amplifier, single stage intermediate amplifier, second detector, bent frequency oscillator, audio output and output limiter stage and a rectifier. While they last at this low price.

**Crystal Calibrated  
Signal Generator 1-222-A**

**\$54.50**

Operation from 110-117 volts, 60 cycles, consumes 40 watts. Self-contained power supply. COMPLETE WITH TUBES.

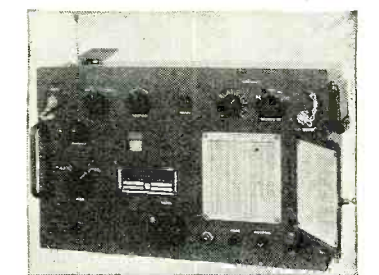

Within the i-f ranges of FM and Television sets. A combination signal generator and heterodyne wave-meter. Consists of a 5 mc crystal-controlled oscillator used as a frequency standard, a variable oscillator, an untuned detector with two stages of a.f., a sliding-rod stub antenna, a rough pi-type RF attenuator, a calibration chart and a power supply. The test oscillator covers 8 to 15 mc and 45 to 76 mc and since the third harmonic is utilized, also covers 135 to 230 mc. Cabinet measures 19 1/2" wide, 12" high, 7 1/2" deep; weight 50 lbs. Tubes in BC 1298 Power Supply—16-6SN7GT; 1-5Y3GT/G; 2-6H8; 1-6SA7; 2-6V6GT; 1-6S77. Tubes in 1-222A: 1-6J5; 2-9006; 2-6S77; 1-5Y3GT/G. An additional power supply and tubes with many other small items including cables packed in wooden chest is included in this price. Gross wght. of entire equipment 490 lbs. While they last..... \$54.50

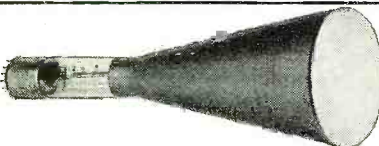

**OUR MONTHLY SPECIAL**

5 inch Cathode Ray. Type 5BP1 tubes. In their original cartons; Brand New. At this price every scope owner should buy a few, and keep in reserve. How can you go wrong for only.... \$1.95

Prompt Delivery—Write Dept. RNM  
25% deposit required on C.O.D. order  
Shipped F.O.B. New York. Min. Order \$2.00

**MICHAEL STAHL, INC.**

39 VESEY ST.

Tel. COrtland 7-5980 New York 7, N. Y.

**UNDESIRED STATION**

FREQ.	CALL	WKRC 1	WLW 2	WCPO 3	WSAI 4	WCKY 5	WKDU 6
550	WKRC	...	850	1910	2170	2510	2874
		...	1950	3010	3270	3610	3974
700	WLW	400	...	1760	2020	2360	2724
		1800	...	3160	3420	3760	4124
1230	WCPO	230	170	...	1490	1830	2194
		2330	2630	...	3950	4290	4654
1360	WSAI	260	140	1100	...	1700	2064
		2460	2760	3820	...	4420	4784
1530	WCKY	430	2760	3820	1190	...	1894
		2630	2930	3990	4250	...	4954
1712	WKDU	612	312	748	1008	1348	...
		2812	3112	4172	4432	4772	...

Table 1. Frequencies containing cross-modulation originating from six Cincinnati stations. "WKDU" is the local police frequency. The spurious side frequencies (2f<sub>1</sub>-f<sub>2</sub> and 2f<sub>2</sub>+f<sub>1</sub>) were used instead of the fundamental (f<sub>1</sub>+f<sub>2</sub> and f<sub>1</sub>-f<sub>2</sub>) since experience has shown that these spurious frequencies are more reliable in locating sources of cross-modulation. Elimination of the source completely removes all artificial frequencies, whereas only the cross-modulation background disappears when a broadcast station's fundamental frequency is used. Furthermore, these spurious frequencies are still fairly strong when cross-modulation on the broadcast station has been reduced below on audible level. However, any of the other side (spurious) frequencies could have been used in preparing this table.

The author should like, at this point, to express appreciation to R. J. Rockwell, chief engineer of WLW, for permission to reproduce the chart contained herein. WLW engineers have conducted exhaustive research in investigation and correction of cross-modulation which included preparation of the formulas as well as part of the corrective information.

Radio servicemen in the larger metropolitan areas will be called upon to correct many such cases of cross-modulation from time to time; much of it, from local experience, has been present to some extent in many receivers and simply tolerated for

years. Similar cases will be evidenced in other localities when new stations take the air or presently operating stations are granted power increases.

As long as the serviceman uses a thorough, conscientious method in tracing cross-modulation, he may be reasonably certain of eliminating it or, in the stubborn cases, of at least reducing it to a negligible degree. A considerable amount of time spent in tracing interference should by no means be considered as "lost time." It is rather a sure way of creating satisfied customers and paying the way to greater profits.

-30-

The first two-way FM radio installed on police "Servi-Car" by the Harley-Davidson Motor Co. is tested by Chief Engineer William J. Harley as Radio Engineer Victor Sierpinski looks on. The new equipment weighs only 27 pounds and operates in the 152 mc. band. It requires an antenna of 18 inches. The "talkie" cycle is expected to expedite police operations by permitting instant two-way communications with headquarters.



# *We Couldn't Do It Alone!!*



## **IT TAKES THE WORLD'S BEST RADIO WRITERS TO MAKE THE WORLD'S BEST RADIO MAGAZINE**

RADIO NEWS keeps pace with the discriminating demands of its more than 150,000 monthly readers, by providing complete and up-to-the-minute editorial material written by such top-flight radio-electronics authorities as:

**RUFUS P. TURNER**, WIAY, Consulting Engineer (Author "Radio Test Instruments")

**JOHN D. GOODELL**, Minnesota Electronics Corp.

**SAMUEL FREEDMAN** (Author, "Two Way Radio")

**TOM GOOTÉE**, Consulting Engineer

**ROBERT ENDALL**, Consulting Engineer

**ALFRED A. GHIRARDI** (Author "Radio Physics Course", etc.)

**EDWARD NOLL**, Television Instructor, Temple University

**C. W. ROESCHKE**, University of California at Los Angeles

**JOSEPH C. MICHALOWICZ**, Electrical Engineering Professor, Catholic University of America

**KENNETH R. BOORD**, authority on Short-Wave

**ARTHUR LIEBSCHER**, RCA

**J. T. GOODE**, Consulting Engineer

**CARL V. HAYS**, W6RTP, Receiver Design Engineer

This is the type of authorship RADIO NEWS has been providing consistently—month after month, year in and year out. It is the type of authorship that keeps RADIO NEWS readers well informed of the latest developments in their industry.

RADIO NEWS will not only continue to offer authorship of such high caliber, but is further expanding its scope to provide similar high grade coverage in the important fields of Television, FM, Facsimile and Sound.

This is how RADIO NEWS keeps first place by more than 50,000 readers over its nearest competitor.



**A ZIFF-DAVIS**

185 N. WABASH AVENUE



**PUBLICATION**

CHICAGO 1, ILLINOIS

RADIO-ELECTRONIC ENGINEERING • FLYING • POPULAR PHOTOGRAPHY • PLASTICS • PHOTO ARTS • BOOK DIVISION] • FICTION GROUP

**March, 1948**

**159**

# SELENIUM RECTIFIERS

FOR ALL APPLICATIONS

## FULL WAVE BRIDGE TYPES

Input	Output	Current	Price
From 0-18 V.A.C.	From 0-14 V.D.C.	1 AMP.	\$2.49
0-18 V.A.C.	0-14 V.D.C.	5 AMP.	4.95
0-18 V.A.C.	0-14 V.D.C.	10 AMP.	7.95
0-18 V.A.C.	0-14 V.D.C.	15 AMP.	10.95
0-18 V.A.C.	0-14 V.D.C.	20 AMP.	13.95
0-18 V.A.C.	0-14 V.D.C.	25 AMP.	16.95
0-18 V.A.C.	0-14 V.D.C.	30 AMP.	19.95

## HALF WAVE TYPES\*

Input	Output	Current	Price
From 0-18 V.A.C.	From 0-7 V.D.C.	3 AMP.	\$2.25
0-18 V.A.C.	0-7 V.D.C.	5 AMP.	2.95
0-18 V.A.C.	0-7 V.D.C.	10 AMP.	4.95
0-18 V.A.C.	0-7 V.D.C.	15 AMP.	6.95
0-18 V.A.C.	0-7 V.D.C.	20 AMP.	8.95
0-18 V.A.C.	0-7 V.D.C.	25 AMP.	10.95

Input	Output	Current	Price
From 0-36 V.A.C.	From 0-28 V.D.C.	2 AMP.	\$4.95
0-36 V.A.C.	0-28 V.D.C.	3 AMP.	5.95
0-36 V.A.C.	0-28 V.D.C.	5 AMP.	7.95
0-36 V.A.C.	0-28 V.D.C.	10 AMP.	13.95
0-36 V.A.C.	0-28 V.D.C.	15 AMP.	19.95
0-36 V.A.C.	0-28 V.D.C.	20 AMP.	25.95
From 0-120 V.A.C.	From 0-100 V.D.C.	2 AMP.	14.95
0-120 V.A.C.	0-100 V.D.C.	5 AMP.	19.95

Input	Output	Current	Price
From 0-36 V.A.C.	From 0-14 V.D.C.	3 AMP.	\$2.95
0-36 V.A.C.	0-14 V.D.C.	5 AMP.	4.95
0-36 V.A.C.	0-14 V.D.C.	10 AMP.	7.95
0-36 V.A.C.	0-14 V.D.C.	15 AMP.	10.95
0-36 V.A.C.	0-14 V.D.C.	20 AMP.	13.95
0-36 V.A.C.	0-14 V.D.C.	25 AMP.	16.95

\*Use with capacitor to obtain any voltage up to twice rated output.

## FULL WAVE CENTER TAP

Input	Output	Current	Price
400-0-400 V.A.C.	0-350 V.D.C.	600 Mils	\$5.95

## CAPACITORS

1000 MFD., 15 V.D.C.	98c
2000 MFD., 15 V.D.C.	\$1.69

It would be impossible to give a complete listing of all our rectifier types. Our engineering staff is at your service to help you work out the application of selenium rectifiers to your specific problems. Write us for quotations or further information on capacitors and transformers to be used in conjunction with selenium rectifiers.

25% Required on all C.O.D.s—Add 10% for Parcel Post.

**OPAD GREEN COMPANY • 191 GREENWICH ST. Dept. 2**  
**NEW YORK 7, N. Y. • Phone: BECKMAN 3-7385**

## WHILE THEY LAST

**\$11.95**

### 110 Volt AC Superheterodyne Receiver

This crystal fixed frequency receiver comes with full conversion instruction for variable tuning of all ham bands and broadcast. A highly selective superheterodyne receiver, 110 V.A.C. power supply built in. Uses the following tubes: 6K7—RF Amplifier; 6K8—Mixer and Oscillator; 6K7—L.F. Amplifier; 6F7—Detector and A.V.C.; 6C8—Output and Noise Suppressor; 80—Rectifier. Dimensions:  $3\frac{1}{2} \times 19 \times 11\frac{1}{2}$  inches. Comes complete, brand new, with one set of coils and two sets of tubes. All orders will be shipped freight Collect.

**AMERICAN & FOREIGN ASSOCIATES**  
 1506a Widener Building—Philadelphia 7, Penna.  
 Telephone, Rittenhouse 6-4173—6-4174

## Mr. Radio Service Dealer "Speed is our Motto"

One day service on all orders. None too small. Only Nationally Advertised Merchandise (No Surplus Handled). TUBES—Any quantity 50% off list.

Mail us your orders.

Illustrated list on request.

**Bill Sutton's** Wholesale Electronics  
 Fifth at Commerce Fort Worth, Texas

## What's New in Radio

(Continued from page 88)

those produced by a fifteen-inch picture tube has been developed by the Tube Department of Radio Corporation of America.

The new picture magnifier is a transparent Plexiglas lens filled with clear oil having the same optical



properties as the plastic material, thus transforming it into a true optical lens.

In use, the magnifier is positioned in front of the viewing screen of the television receiver producing a picture area nearly three times the area of the directly viewed picture on a 7" tube.

Measuring  $14\frac{1}{2}$  inches high by  $17\frac{1}{2}$  inches wide with one flat and one spherical surface and an optical aperture  $12 \times 15$  inches, the RCA 203P1 weighs approximately 24 pounds when filled. The magnifier may be used with any direct-view home television receiver.

The new magnifiers are now at RCA Tube distributors.

## TUBE SOCKETS

Amphenol has developed three new industrial tube sockets to meet the requirements for mounting industrial tubes on the face side of vertical control panels.

These new sockets of phenolic material are designed to meet NEMA requirements and feature high conductivity cloverleaf contacts to insure extremely low contact resistance at the tube base pins. Individually supported, these sockets permit spacing to allow convection air current cooling of the tubes.

Two sockets have been designed to accommodate medium 4-pin, UX based tubes, one equipped with a protective collar around the tube base and the other without. The third type is designed for use with the super jumbo and industrial 4-pin based tubes. This socket is obtainable with or without the back terminal block. With the block in place, all connection wiring

## Musical Distinction

WITH

## ABSOLUTE FIDELITY AMPLIFICATION

DESIGNED BY A. C. SHANEY

A new amplifier development now enables you to clearly identify all the instruments in a full orchestral. After 20 years of audio research and development, we can now place in your hands a new means to make the most fascinating, uplifting, and enjoyable journey into the realm of perfect sound reproduction—through the medium of the most satisfying musical amplifier the world has ever known.

If you are one of those discriminating persons for whom anything less than the best is a disappointment, you are one for whom the ACA-100DC Amplifier was designed. Send for literature.

## AMPLIFIER CORP. of AMERICA

398-2 Broadway, New York 13, N. Y.

Send 3c stamp for A. C. Shaney's new booklet "20 Steps to Amplifier Perfection." A. C. Shaney's FM-AM AMPLIFIER MANUAL is still available at 25c.



**STILL UNQUESTIONABLY THE FINEST**

*The COLLINS*  
**Custom Built FM/AM Tuner**  
**THE ONLY TUNER WITH WIDE RANGE AM**

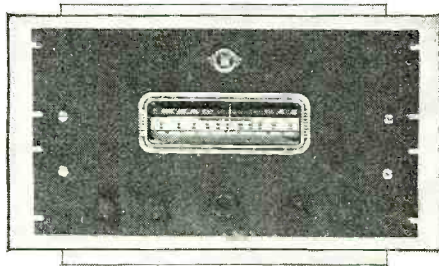

**T**HIS tuner has received wide acclaim throughout the country as the best medium for reception of FM and AM broadcasts. Many extra, personal accessories may be ordered with the tuner to make it exactly what you want. Its 17-tube circuits employ Armstrong FM, full complement of vacuum tubes, self-contained power supply and latest circuit developments. *Write for full information about this marvelous product.*

**COLLINS AUDIO PRODUCTS CO., INC.**  
**P. O. BOX 368**                      **Westfield, N. J.**  
 \* WE 2-4390 \*  
**PLANT AT ROUTE 29, MOUNTAINSIDE, N. J.**

# Signal Generator

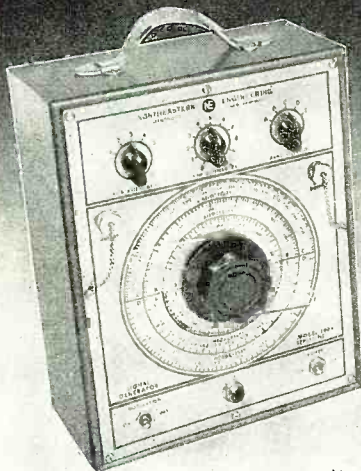

Model 700

*Designed for Radio Servicemen*

**BE PREPARED FOR 1948**  
**FM and TELEVISION**  
 with a MODEL 700 SIGNAL GENERATOR  
 Address Dept SG-6

**NORTHEASTERN ENGINEERING, INC.**  
 MANCHESTER, N. H.

# GOVERNMENT Surplus Savings

## POWER SUPPLY

Designed for nationally known transmitter:

2-807, 1-6F6, 1-6N7—Class B  
 Modulated Maximum Signal  
 Carrier Output 75 Watts.  
 Value determination — 200  
 Watts off generator — Fed  
 into 10,000 or 12,000 Ohm  
 load.

INDIVIDUALLY BOXED  
 COMPLETE WITH TUBES

**NEW \$5<sup>95</sup> EACH**

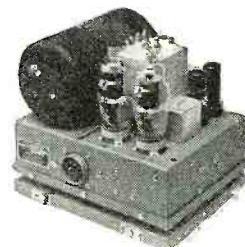

## SIGNAL GENERATOR

**1-198 A**



Frequency Range 7 to 15 mc.,  
 which multiplies into 20 and 10  
 meter band. Modulated 110 AC.  
 Can be used as frequency meter.

**NEW \$19<sup>95</sup> EACH**

## RHEOSTATS

25 Ohms, 50 Watts                      *Your choice*  
 15 Ohms, 25 Watts                      **49<sup>c</sup>**  
 20 Ohms, 1 1/2 Amps.                      **EACH**

## R. F. AMMETERS

Nationally Adver-                      **NEW**  
 tised Make.                                      **\$1<sup>29</sup>**  
 0 to 2 Amps.                                      **EACH**  
 2 1/2 Inch                                      **INDIVIDUALLY BOXED**

## 954 TUBES

Well-known                                      **NEW**  
 standard brand                                      **\$2<sup>00</sup>**  
 Individually                                      **DOZEN**  
 boxed.

## HIGH VOLTAGE TRANSFORMERS

90 V. Primary, 6400                      **NEW**  
 V. Secondary, Ap-                                      **\$1<sup>95</sup>**  
 prox. 100 Mills.                                      **EACH**

## VOLUME CONTROLS

Assortment of 12

**\$1<sup>50</sup>**

## RELAYS

110 Volt A.C.

**NEW \$1<sup>25</sup> EACH**

## I. F. F. RECEIVER AND TRANSMITTER

Complete with 14 tubes

**EACH \$5<sup>95</sup>**

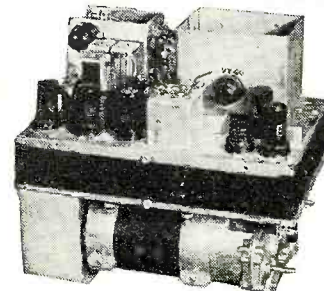

**All Orders F.O.B. DETROIT, Shipped RAILWAY EXPRESS**

*No order under \$5.00—Please send check or money order.  
 Orders shipped C.O.D. subject to 25% advance deposit.*

## RADIO CENTER

**2530 E. DAVISON AVE. DETROIT 12, MICH.**



here's a **WINDFALL**  
of **FEDERATED VALUES**  
for you!

**12" HEAVY DUTY PM**

Well-known make 12" heavy duty PM speaker, complete with output transformer for PP&Ls. Latest type construction. Ideal for P.A. work. Each... **\$8.95**

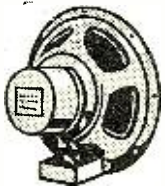

**12" PM SPEAKER**

Fine for replacement and medium duty P.A. use. Latest type construction. Made by nationally known mfr. Alnico V slug. Less transformer. Each... **\$5.95**

**150 MIL POWER TRANS.**



Upright mounting, fully shielded, with internal electrostatic shield. High quality unit, latest type construction, suitable for P.A., general replacement, construction of power supplies, etc. Primary: 115 V 60 cycles. Secondary: 700 V C.T. @ 150 Ma; 5 V @ 3 Amps; 6.3 V @ 3.2 Amps. Long flexible color-coded leads. Height 4 1/2"; Mtg. Ctrs. 2 5/8" x 3". SPECIALLY PRICED. Each... **\$3.39**

**115 MIL POWER TRANS.**



Fully shielded, made by well-known mfr., all BRAND NEW. 115 volt 60 cycle primary. Secondary: 700 V C.T. @ 115 ma; 5 V @ 3 Amps; 6.3 V @ 3.2 Amps C.T. Long tinned color-coded leads. Mtg. Ctrs. 3 1/8" x 2 1/8". VERY LOW PRICE. Each... **\$2.95**

**VOLUME CONTROL BONANZA!**

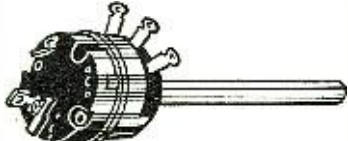

Standard replacement volume controls, complete with switches. Well-known make. 3" aluminum shaft with flat, easy cutting. Available in these ohmage:

- 10,000 ohms
- 25,000 ohms
- 50,000 ohms
- 100,000 ohms
- 250,000 ohms
- 1/2 megohm
- 1 megohm
- 2 megohms

Controls from 250,000 ohms up have extra bass-compensation tap for optional use.

YOUR CHOICE **TEN** FOR **\$4.90**

**SENSATIONAL CRYSTAL MIKE VALUE**



Never before offered at this low price! High quality crystal hand-mike, unidirectional, wide range response. Massive one-piece construction, 2 1/4" diam. by 1 1/2" thick. Complete with attached 100-ft. shielded mike cable. A truly wonderful buy, for only... **\$5.95**

**ACORN TUBES**



Types 954, 955, 957 YOUR CHOICE, Ten For... **\$2.50**  
Low Loss Sockets for Acorn Tubes, Ten For \$2.90

No C.O.D.s under \$5.00. Please Include Postage. DEPARTMENT 28-F

**Federated Purchaser**  
INCORPORATED  
distributors of **RADIO - ELECTRONIC**  
and **SOUND EQUIPMENT**  
80 PARK PLACE, N. Y. 7  
Phone: Dlgby 9-3050

may be made on the rear of the panel, and a bottom cover can be provided to totally enclose all wiring on the socket side of the panel. All three of these sockets feature solderless screw-type terminals to facilitate wiring harness maintenance.

American Phenolic Corporation, 1830 South Fifty-fourth Avenue, Chicago 50, Illinois, will supply additional information on request.

**TRANSMITTER KIT**

Standard Transformer Corporation is in production on the Model ST-202-A transmitter kit which provides transmission on 10, 11, 15, 20, 40, and 80 meter c.w.

When used with any modulator capable of 60 watts output, this unit may be used as a phone transmitter, or with a suitable FM exciter can be adapted for NBFM transmissions.

Amplifier plate power input is from 100 to 125 watts depending on the tube selected for the r.f. amplifier. The unit will operate on six bands between 3.5 and 30 mc. Internal frequency control is provided by six crystals.

The complete kit includes the cabinet with built-in chassis, appropriate panel markings, bottom plate, and all circuit and constructional components. It is also supplied with a prefabricated, cabled harness which accomplishes much of the wiring and assures a neat under-chassis construction.

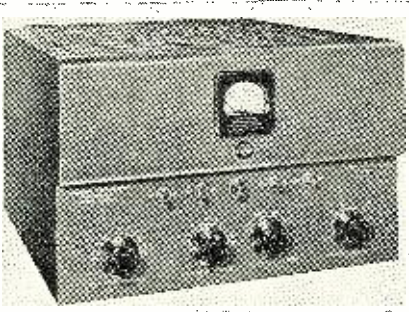

All phases of construction and operation are fully covered by a detailed instruction manual.

Further information on the ST-202-A kit may be secured from Standard Transformer Corporation, Elston Ave., Kedzie Ave., and Addison Street, Chicago 18, Illinois.

**AIR VARIABLES**

E. F. Johnson Company of Waseca, Minnesota has developed a new line of air variable condensers which are said to be the smallest ever built commercially.

The new line includes three models; single, differential, and butterfly types. Each of these three types is available in four different capacities.

The single type may be used in place of adjustable padders for trimming r.f. and i.f. oscillator circuits. The unit is available in 1.55 to 5.14  $\mu\text{fd.}$ , 1.73 to 8.69  $\mu\text{fd.}$ , 2.15 to 14.58  $\mu\text{fd.}$ , and 2.6 to 19.7  $\mu\text{fd.}$  sizes.

The differential type may be used for switching capacity from a rotor to either of two stators and for shifting

the tap on a capacity divider. This model is available in 1.84 to 5.58  $\mu\text{fd.}$ , 1.98 to 9.30  $\mu\text{fd.}$ , 2.32 to 14.82  $\mu\text{fd.}$ , and 2.67 to 19.30  $\mu\text{fd.}$

The butterfly type is applicable wherever a small, split-stator tuning



condenser is required. Four models include 1.72 to 3.30  $\mu\text{fd.}$ , 2.10 to 5.27  $\mu\text{fd.}$ , 2.72 to 8.50  $\mu\text{fd.}$ , and 3.20 to 11.02  $\mu\text{fd.}$

Full details on this new line may be secured from E. F. Johnson Company, Waseca, Minnesota.

**REPLACEMENT KIT**

Merit Coil & Transformer Corp. is currently making available a transformer replacement kit for service-men.

Designed to eliminate the need for a "universal" replacement transformer, the kit contains 8 transformers, each designed and pretested for its particular use.

Each of the transformers is labeled individually on the frame with easily readable information giving the number and all necessary transformer data. The kit is housed in a special display box with a hinged cover.

For further information apply to any Merit distributor or write Merit Coil & Transformer Corp., 4427 N. Clark Street, Chicago 40, Illinois, for the name of the nearest distributor.

**MAGNIFYING LENS**

E. L. Courmand Company of New York is now manufacturing a new plastic magnifying lens which, according to the company, will triple the screen area of most television sets.

Marketed under the tradename "Walco Tele-Vue-Lens," this unit is fitted with brackets which slide under the television receiver so that the weight of the set holds the magnifier in position. The lens may then be adjusted both vertically as well as horizontally to produce the size picture desired by the viewer.

The manufacturer will supply additional details and the name of dis-

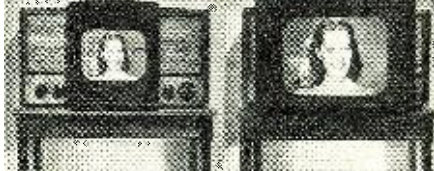

tributors where this unit may be secured. Write to E. L. Courmand Company, New York City.

**IMPROVED INPUTUNER**

A new model "Inputuner" with several refinements over the company's previous models has been announced by Allen B. DuMont Labs., Inc., of Pas-saic, New Jersey.

This packaged r.f. head is available

to television custom-built and line-production set manufacturers. The "Inputuner" is a compact, rugged, foolproof assembly as easy to install as a speaker, according to the company. It requires no aligning, adjusting, or calibrating. Built around the Mallory-Ware "Inductuner" and including all necessary components for the complete r.f. head, it provides for continuous tuning in the 44 to 216 mc. range. This feature gives coverage of all 13 television channels plus FM, amateur, aviation, telephone, and commercial services in that range without a break. Only one tuning knob is required for both coarse and fine adjustments thereby doing away with the usual switch and vernier.

Manufacturers are invited to investigate this new "Inputuner." Inquiries should be addressed to Allen B. DuMont Labs., Inc., 2 Main Avenue, Passaic, New Jersey.

### NBFM MODULATOR

Bee-Bee Electronic Co. of Los Angeles is marketing the Model 500 NBFM modulator unit which has been designed for direct coupling to the v.f.o. or crystal socket of a conventional crystal controlled pentode or triode oscillator.

The unit permits NBFM operation with existing ham rigs without ex-



pensive speech equipment, or operation of phone rigs on c.w. ratings.

Phone quality of this unit depends entirely on the microphone being used with the rig.

Prices and additional information on the Model 500 may be obtained from Bee-Bee Electronic Co., 2692 W. Pico Blvd., Los Angeles 6, California.

### PROGRAM EQUALIZER

Cinema Engineering Company has designed a new program equalizer, the Model 4031-B, which is designed to meet equalization requirements for broadcast and recording studios.

A 12 db. equalization is effected at 100 cycles and 3, 5, and 10 kc. in calibrated and detected two db. steps. High and low frequency attenuation up to 16 db. in 2 db. steps is accomplished by merely turning the same control in a counter-clockwise rotation past the center point. A constant-K circuit maintains the level and eliminates wave distortion over the entire range.

Over 1465 curve combinations may be obtained with this unit. The

March, 1948

# "IT'S REALLY A SWELL RIG"



Harry Rex, Jr.-W1QLL says... "It's a swell looking rig, well engineered and the wiring is something to be complimented." Many is one of many satisfied users. Write to Leo for the names of users in your locality.

### 10 DAY FREE TRIAL—UNCONDITIONALLY GUARANTEED

The WRL 275 watt "GLOBE KING" is a versatile, advanced design transmitter kit that will give you efficient performance on 6, 10, 20, 40, and 80 meter bands on phone and C. W. COMPARE THESE FEATURES and take another look at the price...

Front Panel control of link to final input—Voltage controlled osc and Buffer stages—Provisos for Key—New Speech Modulator circuit—modulate up to 350 watts—Dual power supply for osc—but and R.F. Stage—Most compact Xmtr on the market—Stands 28 1/2" high—275 to 200 watts input on 10 meters—All standard parts such as Stancor, National, Thordason, etc.

Write for complete detailed description and trade in price on your present equipment, all inquiries answered same day.



### WRL Globe Trotter XMTR Kit

Amateurs world over are praising the performance of this high quality, low cost rig. It's a 10 watt input kit including all parts, power supply, chassis panel and streamlined cabinet. Write for exact prices.

Cat. No. 70-300 less tubes... \$69.95  
Cat. No. 70-312 same as above, wired... \$79.50  
1 set of coils, meters, tubes, extra... \$17.49



### WRL Exciter Kit

From our own labs. Uses 6L6 regenerative Osc. into an 807 driver or final. Similar to unit described in A.R.R.L. Handbook. Output 35 to 10 watts. Comes mounted on standard relay rack panel 3 1/2" x 19".

Cat. No. 70-302 less accessories... \$19.95  
Cat. No. 70-310 same as above, wired \$25.95  
Set of coils, meter tubes... extra, \$10.78  
Power Supply wired with tubes... \$22.75

Monthly Payments  
to fit your needs.  
It's easy  
We finance  
our own paper  
No red tape  
70% Down

### Immediate Delivery

This new WRL 275 Watt GLOBE KING Transmitter kit is available as a complete unit, or individual sections may be purchased separately as priced below.

WRL 275 Watt Kit	Kit form	Wired
Complete with K. F. Speech Amplifier and Modulator.		
And Power Supply sections.....	\$295.00	\$315.00
RF Exciter section.....	44.50	52.00
Final RF section.....	59.50	65.00
Speech Amplifier, Modulator section and Power Supply.....	95.00	104.95
Dual Power Supply section.....	62.50	89.50
Above less tubes, meters, coils, and cabinet.		
3 section cabinet for complete kit, with antenna feed insulators installed. Size 28 3/16" high, 22" wide, 14 3/4" deep. Weight 38 lbs.....	\$19.50	
Tubes for Modulator... 5.80	Tubes for RF Final... \$13.90	
Meter for Modulator... 5.50	Meter for RF Final... 5.50	
Coil set for RF Exciter... 6.50	Coil set for RF Final... 6.50	
Coil set for RF Exciter... 5.50	Final, per band... 4.50	
Coil set for RF Exciter... 2.95	Tubes for Power supply, per band... 4.00	
Crating charge for complete kit.....	\$10.00	
Complete with tubes, meters, cabinet, set of coils.		
KIT FORM	WIRED	AS LOW AS
\$366.45	\$386.45	\$73.00 down
		PER MONTH
		\$25.92
		12 Months

### LATEST IN HAM GEAR WE HAVE IT

Get fast delivery from Leo.

ST 202 STANCOR XMTR KIT	\$ 91.85	Red VFO 21	\$ 52.50
Hi-Header HFIS	110.00	Meissner Signal Shifter	99.50
Hallerafter S 38	47.51	Gonset 6-15 Converter	75.00
Hallerafter S 40 A	89.50	Gonset 10-11 meter Converter	39.95
Hi-Header SX 43	100.50	Harvey Wells THS-50 XMTR	99.50
RME H.F. 125A Converter	65.50	Sonar MB 611 Mobil Xmtr	72.45
RME H.F. 10-20 Converter	77.00	Sonar VEX-680	87.45
National NC 57	80.50	Sonar's New CFC	59.75
National NC 173	150.50	Hammilland HQ-9X	177.31
National NC 183	266.10	RME JH22A Proselector	65.00
		Millen 90810 H.F. Xntr.	69.75

### Lots of Bargains too—

Kit of 4 tubes original type... \$4.95  
New Shielded transformer operates 271 for 211 XMTRS, brand new... \$1.95  
Xntr. 1-100VCT, 200 MA, 5V @ 3a  
3-11L Xntr tubes... 2.49  
6 Ft. Cable and 2 tubes to EN  
6-11 and PE103... 1.95  
New Shielded transformer operates 271 Xntr. 1-100VCT, 200 MA, 5V @ 3a  
—Pro 6.3V C.T. fil. @ 3a each series these for 12 Volts to operate Xntr... \$5.95

### RADIO REFERENCE MAP



ONLY 25c  
Just right for your control panel. Size 4 1/2" x 4 1/2". Contains 9-14-46 file sheet wave position card stations, world radio amateur prefixes, United States amateur zones, time zones, recording stations, etc.

### GET THIS 68 PAGE BARGAIN CATALOG

World Radio Laboratories  
744 West Broadway  
Council Bluffs, Iowa

Send latest free flyer with bargains  
 Enclosed is 25c for radio reference map  
 Send more data on "Globe King" Kit  
 Send more data on WRL Exciter Kit

Name \_\_\_\_\_  
Address \_\_\_\_\_ Call letters \_\_\_\_\_  
City \_\_\_\_\_ Zone \_\_\_\_\_ State \_\_\_\_\_



Leo Ferguson W1QLL

World Radio Laboratories  
COUNCIL BLUFFS, IOWA



NOW *Sounded*  
FOR YOUR SILENT PROJECTOR  
Economically

\$5995

Convert your 16mm silent projector to sound (regardless of make) with Apex sound head & radiofilm adapter. Guaranteed excellent performance. Write today for free information.

APEX VIDEO • 12209 J Branford St. • Roscoe, Calif.

### RADIO ENGINEERING!

COMPLETE Radio Engineering Course. Bachelor of Science Degree. Courses also in Civil, Electrical, Mechanical, Chemical, Aeronautical Engineering, Business Administration, Accounting, Secretarial Science. Graduates successful. 64th year. Enter March, June, Sept., Jan. Write for catalog.

TRI-STATE COLLEGE 1639 College Ave., ANGOLA, INDIANA

# VERIFIED SPEAKERS

"They Glorify The Tone"

WRIGHT  
Inc.

2232 University Avenue

St. Paul 4, Minnesota

## SAVE \$ ON RADIO SURPLUS

**ATTENTION: Prospectors,  
Explorers for Hidden Treasures!**

Do you seek hidden treasures or rare metallic ores? If so, construct a U.S. Army Type of Metallic Mine Detector from these U.S. Army Mine Detector Amplifiers that we are offering at a ridiculously low price.



Complete Amplifier (as illustrated, less tubes and batteries) with Battery case and cables. Cables, head-phone cord and jack (no phones). Complete Army wiring diagram. U.S. Army DETECTOR SET Amplifier Type AN/TRS-1, as described. Only **\$2.49**

No. C.O.D.'s. Eveready 45 volt batteries #482. **\$1.65** ea., 6 volt A. 73c. 2-1N5 tubes. **95c** ea. **U.S. SIGNAL CORPS 5 METER SHORT WAVE XMTRS.**

(72Mc) XMTRS and TUBE only, less mike, batteries and antenna. One 1 1/2 volt dry cell and 6772 volts of B operates it. Just attach di-pole, key or mike, connect the batteries and it's ready to use. Signal Corps spec. wired with silvered wire, mica condensers, and precision resistors. Highly stable circuit with Lo-Loss silvered inductance. (Adjustable paddler) Schematic supplied. Converts easily to walkie-talkie and Ham bands. **\$2.95**

No. C.O.D.'s

### SELENIUM RECTIFIERS

Lots of 12..... **65c** Single Lots..... **75c**

### BRAND NEW SENSITIVE RELAYS MICRO-AMMETERS MODEL 705

(2 1/2-0-2 1/2 0-2 range) with A.C. Rectifier. Cost Under Sam \$45.00. Our price..... **\$10.00**



GENUINE SIGNAL CORPS FEATHER-WEIGHT HEADPHONES WITH CORD AND PLUG 2000 OHMS-8000 OHMS IMPEDANCE..... **\$1.00**

### NATIONALLY ADVERTISED OIL FILLED FILTER CONDENSERS

1.-MFD-1000 working volts. 4 for..... **\$1.00**

### WEBSTER RECORD CUTTING HEAD

Here is your opportunity to buy a genuine WEBSTER HOME RECORDING CUTTING HEAD. These units are all brand new and were made for a nationally advertised manufacturer to be in their quality Home Recording Radios. Size 1 3/4 x 2 3/4 ready to fit your cutting arm or bracket. SPECIAL..... **\$2.50**

3 BAND ALL-WAVE DIAL 6" DIAMETER..... **75c**

GENERAL ELECTRIC 5 AMPERE 110-125 VOLT, 60 CYCLE WATT HOUR METERS, SLIGHTLY USED, PERFECT CONDITION, SAME AS USED IN YOUR HOME..... **\$3.50**

AMPLIFIER CHASSIS, SIZE 18"x8"x2 1/4". BLUE CRACKLE FINISH DRILLED FOR CONDENSERS, TRANSFORMER AND SOCKETS..... **65c**

STROMBERG-CARLSON, 3 BAND ALL-WAVE TUNING UNIT, COMPLETE WITH TRIAXIAL, EYE-PEAKS AND BAND SWITCH. READY TO INSTALL-DIAGRAM, etc..... **\$3.75**

8-9 GANG PUSH BUTTON TUNING UNIT (PLEASE SPECIFY). COMPLETE WITH BUTTONS..... **25c**

24 VOLT D.C. AIRCRAFT MOTOR, APPROX. 1/8 H.P. ALMOST NEW..... **\$1.50**

U.S. AIR FORCE RESISTOR AND CONDENSER ASST. 1/4-1 WATT-100 PIECES..... **95c**

U.S. AIR FORCE MICA CONDENSER ASST. 100 PIECES..... **\$1.25**

### Low-Loss-Short Wave, Variable Condensers 1/4" Shaft Type

3 Plate-12-15 MMFD.....	15c
5 Plate-20 MMFD.....	20c
9 Plate-36-40 MMFD.....	25c
10 Plate-40 MMFD.....	25c
11 Plate-45-50 MMFD.....	26c
14 Plate-55-60 MMFD.....	27c
27 Plate-100-110 MMFD.....	45c
37 Plate-150 MMFD.....	50c
38 Plate-150-175 MMFD.....	55c
53 Plate-210-21 MMFD.....	60c

### Lock Type Air Trimmer

#### Variable Condensers

3 Plate-12-15 MMFD.....	10c
5 Plate-20 MMFD.....	11c
7 Plate-28-30 MMFD.....	13c
9 Plate-30-35 MMFD.....	13c
10 Plate-40 MMFD.....	14c
13 Plate-50 MMFD.....	17c
14 Plate-50 MMFD.....	20c
14 Plate-80-100 MMFD.....	25c
27 Plate-100-110 MMFD.....	35c

5 lbs. RADIO  
HARDWARE  
Nuts, Bolts,  
Screws, etc. No  
junk..... **\$1.00**

H. & H. S.P.S.T.  
T O G L E  
SWITCHES-  
8 for..... **\$1.00**

100 TRIMMER &  
PADDER ASST.  
All sizes..... **\$1.75**

### OIL FILLED By-Pass Filter Condensers

(Bathub Type)

Removed from Gov't apparatus, but Electrically Perfect  
10-1 Dial (2-1-1600 VOLT, 1-2-2-5 MFD, 600 Volts)  
EVERY ONE GUARANTEED..... Each **15c**

### NEWARK SURPLUS MATERIALS CO.

324 Plane Street Dept. N. Newark I. N. J.

equalizer has only 14 db. insertion loss in a 500/600 ohm circuit, according to the manufacturer.

Literature on this Model 4031-B is available on request. Address inquiries to *Cinema Engineering Company*, 1510 West Verdugo Avenue, Burbank, California.

### FM & TV ANTENNAS

*JFD Manufacturing Co., Inc.* is now offering a complete, new line of FM and television antennas which incorporates the company's exclusive polystyrene "Roto-Lock" insulator.

Included in the new line is a fringe area antenna that provides extremely broad-band and high gain reception. Because of its high directivity it is said to cut out unwanted signals and improve signal-to-noise ratio.

Also included are the "Upper Band" attachable antenna for the new TV channels, the "Removable" window antenna where permanent installations are not allowed, the "Hideaway" antenna which requires no outside installation, and a 300 ohm lightning arrester which does not destroy the impedance of the 300 ohm line.

A brochure covering these new antennas may be secured upon request to Department A8, *JFD Manufacturing Co., Inc.*, 4117 Ft. Hamilton Parkway, Brooklyn 19, New York.

### MULTIPLE POWER SUPPLY

*Kepeco Laboratories, Inc.'s* new Model 103 multiple power supply was developed to meet the need for a source of power that would supply four commonly used voltages from a single compact unit.

The unit is particularly designed to be used in the study of the characteristics of vacuum and gas filled tubes as well as the characteristics of electronic circuits employing these tubes.

The power supply contains two continuously variable "B" supplies delivering from 0 to 300 volts at currents

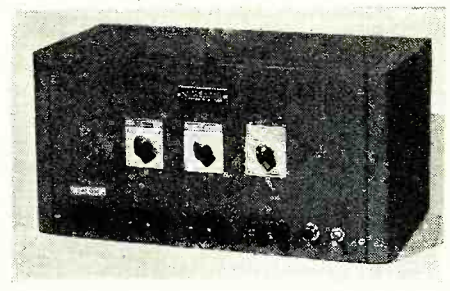

up to 120 ma., one variable "C" supply delivering from minus 50 to plus 50 volts at 5 ma., and one heater supply delivering 6.3 volts at 5 amperes. Output ripple voltages is less than 1 millivolt over the entire operating range.

A data sheet covering the Model 103 may be secured from *Kepeco Laboratories, Inc.*, 142-45 Roosevelt Avenue, Flushing, New York.

### Signal Checker

(Continued from page 44)

is to be used externally, switch S<sub>1</sub>-S<sub>2</sub> must be set to one of the "OFF" (unused contact) positions. This will disconnect the coils automatically, preventing a "short circuit" of the meter by a secondary coil and the crystal diode in series. When using the meter externally, the operator must remember that the bypass condenser, C<sub>1</sub>, is still in parallel with the meter, although this will be of no concern in most d.c. circuits in which the microammeter normally will be used.

Headphone cord tips may also be inserted into pin jacks J<sub>3</sub> and J<sub>4</sub> for aural monitoring of modulated signals or for the use of the signal checker as a crystal radio receiver. The presence of the microammeter in parallel with the headphones results in some reduction in the volume of

Charles Golenpaul, president of the Radio Parts & Electronic Equipment Shows, Inc. (right) and Kenneth C. Prince, show manager, hang out the S.R.O. sign to indicate that all 168 exhibit booths at the 1948 Radio Parts show have been allotted. The Show, to be held at the Stevens Hotel, Chicago, May 11-14, promises to be the largest in the industry's history.

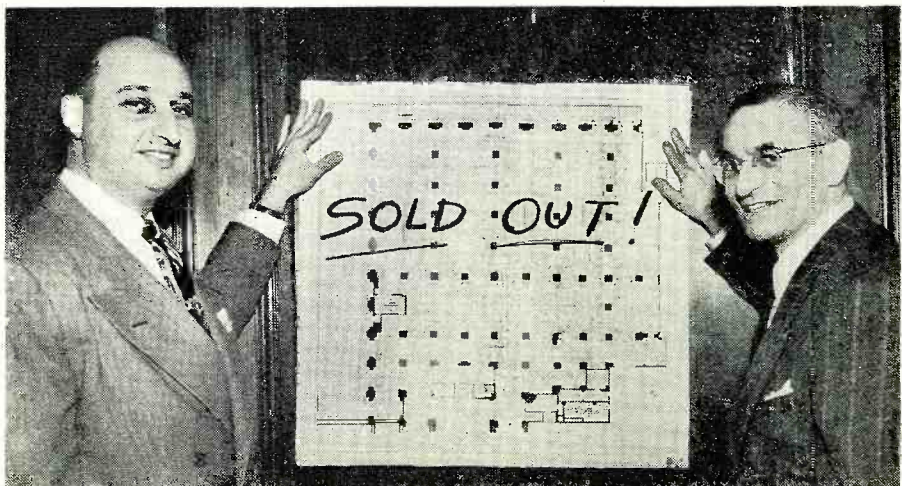

### CORRESPONDENCE COURSES IN RADIO and ELECTRICAL ENGINEERING

**ELECTRICAL ENGINEERING** Get good grasp of wide electrical field. Prepare yourself at Low Cost, for secure future. Modern course. So simplified anyone can understand quickly.

**RADIO ENGINEERING** Extra fine course in radio work. Trains you to be super-service man, real vacuum-tube technician. Servicemen needed badly. Diploma on completion. Many graduates earning big pay.

**WRITE** Send postcard for Free Copies of **\$25** Either school catalog Full details, all Course about interest, payment plan, experimental kits, etc. Lincoln Engineering School, Box 931-F111, Lincoln 2, Nebr.

the signal in the headphones. However, during the author's tests, all signals were noticed to be sufficiently good even with the meter shunting the headphones to justify this simplified connection scheme, rather than the installation of a second 2-circuit jack.

**Test Loop and Test Probe.** Constructional details of these two accessories are given in Fig. 7.

In Fig. 7A, the coaxial cable is terminated at the instrument end by a male connector for insertion into jack  $J_2$  (See Fig. 6). It is terminated at the other end by a 2-pin male connector into which may be plugged any one of several 2-contact female connectors (See Fig. 7A), each of which supports a copper wire ring to be used for inductive pickup. Several such mounted rings, covering a range of diameters, may be built.

With this arrangement, only one "loop cable" is needed, the various coupling rings being plugged successively, as required, into the end connector of the cable.

In Fig. 7B, the coaxial cable is terminated at its instrument end by a male connector for insertion into jack  $J_1$  (See Fig. 6). The other end of the cable runs as far as possible into the test probe handle in order that the outer sheath of the cable may provide shielding from the operator's hand. The 4- $\mu\text{fd}$ . ceramic isolating condenser is connected by the shortest possible pigtail leads to the prod tip on one end and to the inner conductor of the cable on the other end. A small alligator clip is connected, for grounding purposes, to the outer sheath of the cable just before it enters the probe handle. This ground connector will not be needed in most transmitter checking, where signal voltages are rather high, but it will be of definite advantage when tracing a weak signal through receiver channels.

### Mechanical and Electrical Construction

The frequency checker is a simple instrument. The only possible complication is introduced by the coil switch. The remainder of the circuit is very rudimentary and accordingly should give the builder little difficulty. Because of the simplicity of the circuit, however, there may be a temptation to forego careful checking of the wiring, and the reader is cautioned against this probability.

It is important to observe strictly the crystal and meter polarities indicated in Fig. 6.

Short, direct leads should be employed in every position. The connection between the pole of switch section  $S_1$  and the tuning condenser stators must be made with No. 14 bus wire, to prevent calibration shifts due to movement of this lead.

Bypass condenser  $C_1$  is mounted directly to the microammeter terminals and rests on the back of the meter case. (See Fig. 3.)

Layout of the instrument is shown clearly in Figs. 1 and 3. A sloping

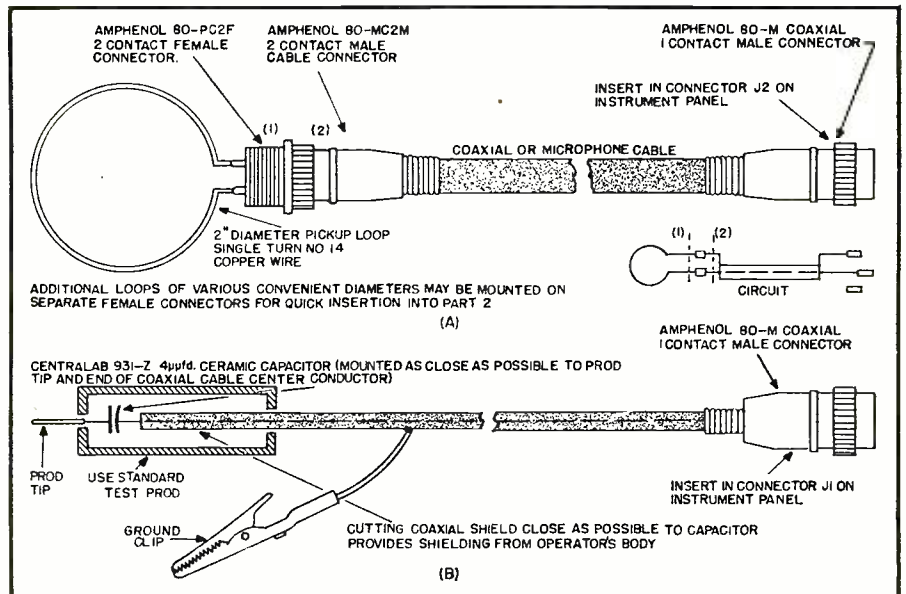

Fig. 7. (A) Pickup loop assembly. (B) Probe assembly.

front steel cabinet, 10" wide and 8" high, houses the author's instrument shown in the photograph, but this style may be varied by the individual builder. For example, a flat metal case, 10" wide, 8" high, and 4" deep, might be employed. Arrangement of the components on the front panel is shown in Fig. 1. Note that pin jacks  $J_2$  and  $J_1$  are mounted directly beneath the meter. Coaxial input jacks  $J_1$  and  $J_2$  are seen in the two lower corners of the front panel, and the range switch in the lower center portion of the panel. The range switch is shown in one of its "OFF" positions—between positions  $B$  and  $C$ .

Fig. 3 shows the arrangement of components behind the panel. All parts are mounted, as is seen, directly on the front panel, there being no need for a chassis.

The special tuning dial is made from a regular 4-inch-diameter metal-plate dial with finger grip knob. The knob is removed from the plate and a 4-inch white Bristol board disc (ruled with two circles in black India ink—one of  $1\frac{1}{2}$ " radius and the other of  $1\frac{7}{8}$ " radius) is fastened to the plate with thinly-spread rubber cement.

The knob then is replaced and the dial installed on the tuning condenser shaft. After the calibration points are marked in temporarily (See "Calibration"), the dial once again is removed, the knob taken off, and the graduations and figures rendered permanently in black India ink. After covering the drawn dial plate with a 4-inch protective disc of transparent plastic, the dial is reinstalled permanently.

A closeup of the installed dial is shown in Fig. 5. When installing the dial, the heavy radial line between the letters  $A$  and  $D$  and  $B$  and  $C$  is set flush with the indicator, with the tuning condenser set at maximum capacitance. This line is a convenient lineup point whenever the dial is removed and reinstalled.

The two dial indicators seen in Fig. 5 are cut from transparent plastic. The upper indicator is for the two top scales of the dial; the lower indicator for the two lower scales. This arrangement prevents the crowding which would result from placing all four scales above or below the knob. Dial readings are taken flush with the straight edge of each indicator.

The name plates are lettered in

Fig. 8. Mechanical details of coil construction. Winding data is given in the coil table on page 43. Construction of Coil A is shown on the left while details for Coils B, C, and D are shown at right.

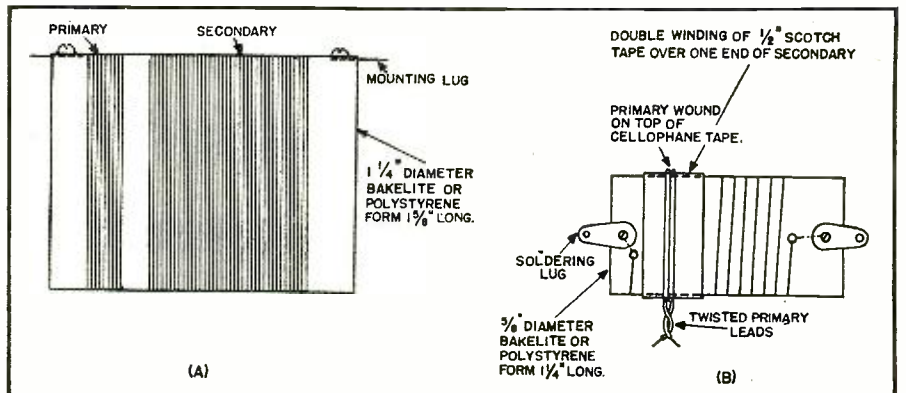

# MAKE MONEY!

## ASSEMBLING COIN RADIOS

Thousands of dollars have been made during the past year by wide awake radio amateurs who have installed coin radios in Hotels, Hospitals, Motels and Tourist Cabins. Great demand — No experience necessary.

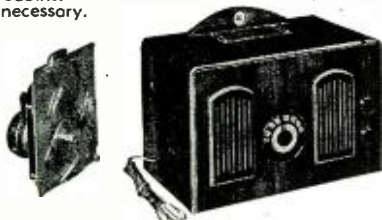

Just  
**3**  
Steps

Average Profit  
**\$25 Per Set**

If Sold Outright  
Much More If Operated on a Rental Basis!

We supply complete chassis with 6 tubes, quarter coin slot and one or two hour timer ready to place in walnut cabinet. Furnished with foolproof lock and coin box. Fill out order blank and mail to:

**EICHEL ELECTRONIC CORP.**  
EVANSVILLE 8, INDIANA

**FILL OUT... MAIL**

EICHEL ELECTRONIC CORP.  
EVANSVILLE 8, INDIANA

No.	PLEASE SHIP ME	Amt.
	Cabinets with lock @ \$6.75	
	6 Tube Chassis @ \$18.65	
	5 Tube Chassis (including plastic auxiliary case) @ \$16.50	
	Timers @ \$6.50	

I understand either of the above chassis with the timer and cabinet include all of the parts for your latest model coin operated radio.

Name .....

Street No. ....

City and State.....

## RADIO SERVICE MEN!

Headquarters for  
Nationally advertised tubes

R.C.A. • Sylvania • Tungsol • Raytheon

Receiving and Industrial types.

All standard brand components carried in stock.

Serving all counties in eastern New York State

Distributors of  RADIO EQUIPMENT

**CHIEF ELECTRONICS**

104 MAIN STREET, POUGHKEEPSIE, N. Y.  
The Square Deal Supply House

black India ink on thin white Bristol board and fastened to the front panel with thinly-spread rubber cement.

In calibrating the dial, follow this procedure:

(1) Connect a radio-frequency signal generator or test oscillator to input jack  $J_2$ . This must be a *direct* connection, not one made through a condenser, pickup coil, or probe.

(2) Set range switch  $S_1-S_2$  to position A.

(3) Set oscillator to 400 kc. and advance attenuator in oscillator to maximum output position.

(4) Tune frequency checker dial for maximum deflection of microammeter. Mark this dial setting in pencil.

(5) Advance oscillator frequency to 420 kc., tune-in with signal checker, and mark this point on signal checker dial.

(6) Repeat at as many points as possible up to 1200 kc.

(7) Turn switch  $S_1-S_2$  to position B and repeat procedure for as many frequency points as possible from 1100 to 3200 kc.

(8) Turn switch  $S_1-S_2$  to position C and repeat procedure for the 3 to 10 mc. range.

(9) Turn switch  $S_1-S_2$  to position D and repeat procedure for the 8 to 30 mc. range.

### Applications

*Absorption Wavemeter (inductively-coupled).* Plug loop cable into input jack  $J_2$ . Plug pickup ring of desirable diameter into receptacle at other end of loop cable. Set range switch  $S_1-S_2$  to range A. Place pickup ring near coil in transmitter or oscillator under test, using loose coupling. Tune dial

for maximum deflection of microammeter. At this point, read unknown frequency on instrument dial. When searching for an unknown frequency, always set range switch  $S_1-S_2$  to the *lowest* range, A, and progress to each high-frequency range until resonance is obtained. Tune the dial from the lowest to the highest frequency, and take the lowest-frequency indication encountered. In this way, a harmonic will not be spotted erroneously as the true signal. If meter deflection is excessive, reduce coupling between ring and coil in transmitter or oscillator.

*Probe-Type Wavemeter.* Plug probe cable into input jack  $J_1$ . Set range switch  $S_1-S_2$  to range A. Touch probe tip to circuit point under test and tune instrument, from lowest to highest frequency, until the resonant point is indicated by maximum deflection of the microammeter. If resonance is not found, set range switch to next higher frequency range and retune dial from low to high frequency extremes. When resonance is obtained, read unknown frequency on frequency checker dial. If meter deflection is excessive, remove test prod from circuit under test, increasing separation to reduce meter reading.

*Signal Tracer.* Use in the same manner as a tube-type channel analyzer: Connect r.f. test oscillator to antenna and ground terminals of receiver. Plug probe cable into input jack  $J_1$  of signal checker. Connect ground clip of test probe to receiver chassis. Set oscillator to some convenient frequency within receiver tuning range (say, 1000 kc.). Touch test prod tip to antenna terminal and tune-in oscillator signal with signal checker.

After three months of swishing back and forth in solution in this tank, these synthetic ethylene diamine tartrate piezoelectric crystals are now ready for "harvesting" at the Western Electric Company's Electronics Shops at Allentown, Pa. These crystals in that time have grown from tiny seeds and will now be processed into piezoelectric crystal plates which will be used as filters in long-distance telephone circuits. The process for "growing" these crystals was developed by Bell Lab scientists after ten years of investigation and research.

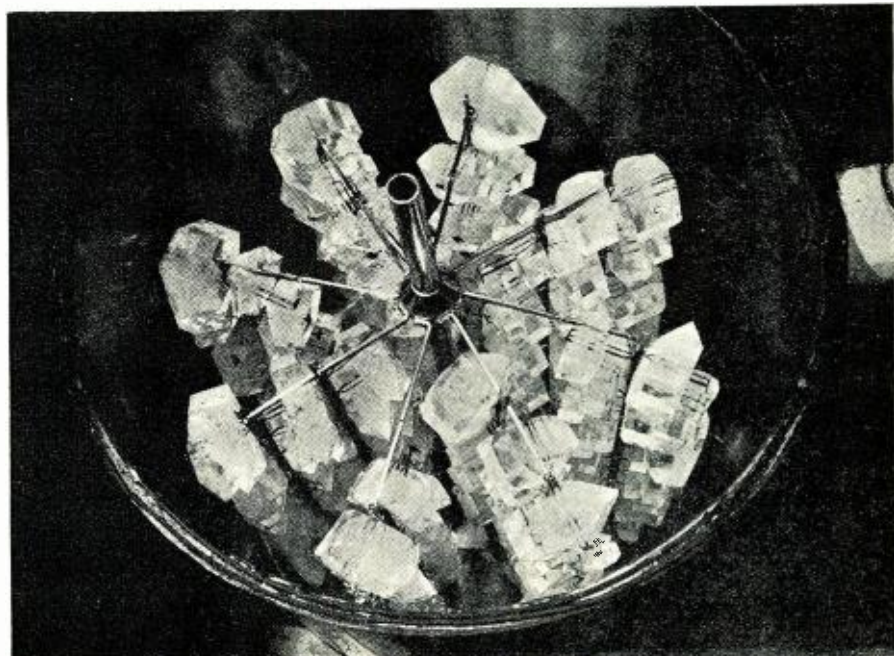

Transfer probe tip to first grid terminal and tune receiver for maximum deflection of microammeter in frequency checker. Transfer probe tip to output circuit of first receiver stage, noting meter deflection and retuning instrument if necessary. Repeat at input and output of each receiver stage, r.f., detector, i.f., and oscillator, following the signal through from antenna terminal to second detector. If meter deflection is excessive at any point, reduce test oscillator attenuator setting, noting difference between calibrated attenuator readings for determination of stage gain ratio.

**Phone Monitor.** Set up instrument as described under *Absorption Wave-meter*. Tune-in transmitter with pickup ring lying on operating table in front of signal checker (unless transmitter is extremely low powered, this will provide sufficient pickup). If meter deflection is excessive, move loop (ring) to a new position farther from the transmitter. If meter reading changes during modulation, carrier shift is indicated. Plug headphones into pin jacks  $J_3$  and  $J_4$  to monitor modulation quality.

**Crystal Radio Receiver.** Use with headphones, as outlined under *Phone Monitor*, except connect outside antenna *direct* to center terminal of input jack  $J_3$ , and ground to instrument case. Tune-in stations with instrument dial.

**Field Strength Meter.** Use as outlined under *Radio Receiver*, except remove headphones. The antenna for this application may be a short vertical rod of copper or brass, or may be a portable doublet. When the signal checker is used as a field strength meter, it will be desirable to make a direct "microvolts" calibration of the microammeter. For this purpose, set up the instrument in the manner outlined under *Calibration* and plot a curve showing microammeter deflections for various microvolts settings of the calibrated attenuator in the r.f. test oscillator or signal generator.

-30-

### "OLD TIMERS' NITE"

THE Delaware Valley Radio Association of Trenton, New Jersey, is sponsoring its Fourth Annual "Old Timers' Nite" and banquet on Saturday, March 27th.

The affair will be stag and will be held in the Terrace Room of the Stacy-Trent Hotel, West State and Willow Sts. in Trenton. A turkey dinner will be served at 6:30 p.m.

Guest speakers will include old timers in the wireless field and prominent members of the radio fraternity. Door prizes will be awarded and a special award will go to the "Grand OM" whose radio experience dates back to the earliest days of wireless.

Reservations should be made with Ed. G. Raser, W2ZI, Ticket Committee Chairman, 315 Beechwood Avenue, Trenton 8, New Jersey, before March 20th. Tickets are \$4.00 per person until March 20th with latecomers having to shell out \$5.00 for a ticket purchased at the door.

-30-

March, 1948

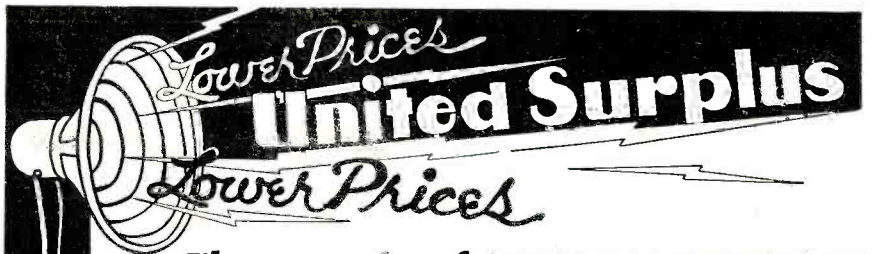

## Thousands of DYNAMOTORS!!!

• Brand New! . . . The BOSS says, "They're cluttering up the place—unload them!"

Yes, Thousands of DM-21 Dynamotors (National-known Brand) must be sold at once to make room for incoming Surplus Electronics.

These DM-21 Dynamotors are Brand New.

Input: Either 14 or 28 Volts.

Output: 235 Volts, 90 MA.

All Dynamotors in this stock-reducing sale include Filter Boxes. Prices have been slashed way down. You'll want to order some for your friends, also. Be sure to specify Voltage desired.

TAKE 'EM AWAY . . . . . Each **\$1.29**  
3 for \$3.50

### Just Arrived . . . . .

T-19/ARC-5 TRANSMITTER—V.F.O.—40 W.—3-4 Mc.  
Includes Tubes and Xtal.  
Brand New. While they last. . . . . \$10.95

### SURPRISE SURPLUS "PACKAGE"

More than 10 lbs. of assorted electronic units and parts. Worth many times this low price. \$1.49

- CONTROL BOX ASSORTMENT  
Many popular switch boxes, junction boxes, control boxes, etc. Valuable parts worth many times this close-out price. Assortment of 10 . . . . . \$3.49
- OIL-FILLED CONDENSER  
Round metal cased with mountings bracket. One MFD @ 600 V. DC.  
Brand New, 6 for . . . . . \$1.00
- CERAMIC CONDENSER KIT  
50 Assorted Values. . . . . Brand New \$1.49

### Chock-full of Bargains

United Surplus 1948 Catalog. Write for your **FREE** copy today.—You'll be sure to save money.

- Quantities are limited—Order Now. Prices subject to change without notice.
- Minimum order—\$2.00; 25% Deposit Required—Balance C.O.D. All orders shipped f.o.b. Chicago.



## United SURPLUS MATERIALS

3313-19 W. OGDEN AVE.

CHICAGO 23, ILL.

### SPECIAL!!!

## "Mallory" VIBRAPACK

"12 VOLT" with VIBRATOR

NEW!! Not Surplus

No Postage  
C.O.D.'s **\$3.50** Prepaid

Send for Radio Parts Listing

DRILLICK SALES CO.

5453 Virginia Ave. Los Angeles 27, Calif.

## -ROTA-BASE

NEW HANDY LAB. DIAL actually gives a "prong" picture of radio tube connections. INSTANTLY, ACCURATELY. No more valuable time lost thumbing pages or on lengthy readings. Filament, grid, plate, cathode, etc., to more than 300 tube types are shown. NOW ONLY \$1.00 postpaid, or sent C.O.D. plus postage. Order TODAY, money refunded if you are not delightfully pleased.

REED MFG. CO.

11350-P. Burbank Blvd., N. Hollywood, Calif.

### LEARN

## TELEVISION ELECTRONICS RADIO

Modern Completely Equipped  
Laboratories

DAY AND EVENING CLASSES

G.I. Approved—Veterans Receive  
Subsistence

ENROLL NOW!

ELECTRONICS INSTITUTE, INC.

21 Henry, Detroit 1, Mich.

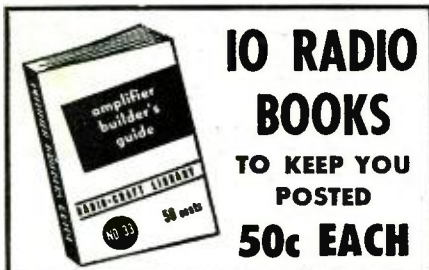

# IO RADIO BOOKS

TO KEEP YOU POSTED  
**50c EACH**

## RADIO-CRAFT LIBRARY

Why be hazy about some phases of radio construction and servicing when you can master them so easily with these low-priced books? The 10 volumes in the RADIO-CRAFT LIBRARY are the building blocks of education you need to construct a worthwhile career. They are as practical as your soldering iron and screwdriver. Written in simple language with plenty of illustrations. Large type, smart modern flexible covers. Everything about them helps to make learning a pleasure.

**No. 29—HANDY KINKS AND SHORT CUTS.** A carefully edited compilation of time savers. Kinks on Antennas—Power Supplies—Test Equipment—Servicing—In the Shop—Phonographs and Amplifiers—Coils and Transformers—Miscellaneous.

**No. 30—UNUSUAL PATENTED CIRCUITS, 1944-1946.** A selection of unusual circuits—of great value to anyone interested in electronics. Control Circuits—Detectors and Amplifiers—Power Supplies—Miscellaneous Circuits—Foreign Circuits.

**No. 31—RADIO QUESTIONS AND ANSWERS.** Answers to most frequently asked questions. Clear schematics. Amplifiers—Receivers—Transmitters—Meters and Test Equipment—Interphones—Power Supplies—Phono Amplifiers—P. A. Systems.

**No. 32—ADVANCED SERVICE TECHNIQUE.** Visual Alignment—Tracking Problems—Negative Feedback—Tone Control Circuits—Adding Microphones to Sets—Matching Loudspeakers—Remote Juke Boxes—Servicing Record Changers—Hum Elimination—FM Servicing.

**No. 33—AMPLIFIER BUILDER'S GUIDE.** Tells how to build a wide variety of amplifiers. Detailed design information on Push-Pull, Control Circuits—Bass and Treble Boosters—Volume Expanders—Resistance Coupling—Internal Feedback.

**No. 34—RADIO-ELECTRONIC CIRCUITS.** Inter-communications Systems—Power Supplies—Balancing circuits—V. T. Voltmeters—Amplifiers—Receivers—Phono Amplifiers—Short Wave Adaptors—Electronic Relays.

**No. 35—AMATEUR RADIO BUILDER'S GUIDE.** Tells you how to Build: A 2 Meter Band Acorn Tube Set—Miniature Communications Receivers—Long Line Transmitter—Beginner's Transmitter—Preselector—Rotary Beam Aerial—Power Supplies, etc.

**No. 36—RADIO TEST INSTRUMENTS. A MUST** for every radio man. Signal Tracers—Capacity Meters—Portable and Bench Multi-checkers—Signal Generators—Tube Checkers—Electronic Voltmeters—and many others.

**No. 37—ELEMENTARY RADIO SERVICING.** Planning the Service Shop—Equipping the Shop—Systematic Circuit Checks—Signal Tracing Methods—Servicing the Midget—Soldering—Servicing Volume Controls—How to Service Speakers.

**No. 38—HOW TO BUILD RADIO RECEIVERS.** This book contains a sufficient variety of sets to appeal to every radio fan. Includes: Short-Wave, Broadcast, Portable, A.C. Operated, Miniature and Standard Receivers. Complete coil-winding data.

DEALERS! WRITE FOR QUANTITY PRICES

### MAIL THIS COUPON

RADCRAFT PUBLICATIONS, Dept. RN38  
25 West Broadway, New York 7, N. Y.

Send me the volumes (50c each, postpaid) checked.  All 10 Books

I enclose \$.....  29  34  
Your Name.....  30  35  
(Print Clearly)  
Address.....  31  36  
 32  37  
 33  38

## BRIDGE and V. O. M. PARTS

Decade Unit . . . . .	0-10 ohms . . . .	\$4.50
Decade Unit . . . . .	10-100 ohms. . . .	4.50
Multiplier Unit, multiplies decade unit value by .001, .01, 1, 100, and 1000 . . . . .		5.50
V.O.M. Shunts and Multiplier unit . . . . .		5.00
Decade switch, 3-deck, 10-point . . . . .		1.00

These units are mounted on low-loss wafer-type, wiping contact, ten-point switches and with one-half hour's work and your meter can be assembled into highest grade Wheatstone Bridge and V.O.M. All of these units were made by Hickok Electrical Instrument Co. for U. S. Army Air Forces and Navy instruments to most exacting specifications and are accurate within 1/10 of 1%. The V.O.M. unit is a part of the famous Hickok 955 unit and can be used with any good high-resistance meter. Diagram furnished with units.

McCoy Sales Company P.O. Box 335, Berea, Ohio

## Radio Industry Report

(Continued from page 45)

sales volume, total employment, and plant investment are very large, radio really is a "small business" industry, composed mostly of small manufacturers. There are a half dozen large set manufacturers, but the industry actually is composed of scores of small parts and set companies and suppliers. Radio has made few fortunes, but many failures. Ours is a highly competitive, even a "cut throat" industry. It has been often said that there has been more money lost than was ever made in radio manufacturing. In 1927 there were about 290 manufacturers in the membership of our Association. Of these there have survived only 51 companies on our membership roster, and conditions today, since the entrance of many new manufacturers during the war production program, are at their competitive peak.

The American public has a large, present financial investment in millions of phonographs and combination radio-phonograph sets, both standard and the new improved FM receivers. Such public investment amounted, in the last five civilian production years, to \$1,251,700,000.

According to the annual report of the Federal Communications Commission radio set ownership among the American people is estimated at 73,000,000. There is at least one radio receiver in 91 per-cent, or in 34,800,000 of the 38,000,000, American homes. Average home ownership is about two radio receivers.

In 1947 the radio industry had an all-time record production of about 18,000,000 sets compared with a previous high, in 1946, of 16,000,000 sets of all kinds. For the information of the committee and for future reference a summary of industry statistics is given in Table 1. These figures represent production in 1940, 1941, part of 1942, and the years 1946 and 1947. The war stopped civilian radio production in April, 1942 and it was not resumed until late in 1945, so that 1946 was the first postwar year of volume production. Also, radio sets and parts were under OPA price control until October 31, 1946, and these controls interfered with normal production until finally the OPA was ended.

The new FM broadcasting was developed shortly before the war. There were only 48 FM stations on the air when civilian radio production was halted in 1942. FM had (and still has) great promise and expectations, and in 1946 FM gained impetus by the production of 181,000 sets with a retail value of \$61,700,000. FM had the official endorsement of the Federal Communications Commission and its rapid national expansion was expected. Hundreds of station applications were filed, including many from ex-service-men. But limited receivers in use at

the outset necessarily afforded FM stations limited financial advertising support and possible expenditures for musicians.

The anticipated expansion of FM was slowed down appreciably and definitely by the AFM edict prohibiting the standard broadcast networks from duplicating their music for the new, financially-weak FM stations. Thus there were no network musical programs available on FM and this substantially reduced production and sales of FM receivers and transmitters.

Just a year ago the Federal Communications Commission predicted that there would be "more than 700 FM stations on the air" by the end of 1947. Actually there are 379 such stations in operation, or about 46 per-cent less than expected by the FCC and the industry, and a large section of the nation's population is still without FM service.

Last March the radio industry had a survey made by an independent certified public accountant agency to estimate our 1947 production of FM receivers. This survey indicated that the industry would produce 2,666,000 of the new FM receivers last year. Largely as the result of the inability of the new FM broadcasters to secure network music on their programs, the industry's 1947 FM production totaled about 1,150,000 FM receivers, less than half of the anticipated 1947 production.

Industry production of television receivers in the last five years totaled 183,000 sets with a retail value of approximately \$104,800,000. A tremendous television expansion in 1948 and future years is in prospect. Competent industry estimates are that a half a million television receivers or more will be produced in 1948 with a value of possibly a quarter of a billion dollars.

-30-

One of the last official acts performed by the retiring chief of Indianapolis' Fire Department, Harry Fulmer, was the inauguration of that city's new two-way Motorola FM radiotelephone fire communications system. Incoming Fire Chief Roscoe A. McKinney and Mayor-elect Al Feeney are interested spectators as Chief Fulmer dispatches the first messages to firemen.





## Birth of a Service Note

(Continued from page 50)

acteristics. Five of the sets are then released to the service laboratory.

At this point the service technician really goes to work—he carefully records voltages, resistance, gain per stage, and other characteristics of the circuit. He develops an alignment procedure using precision laboratory equipment. This procedure must be simple. Sometimes as many as 10 separate service and alignment techniques and procedures are developed and discarded until a simple and fool-proof method of approach is found.

Once the correct method is determined, the technique is then transferred to *standard test equipment* like that generally found in the average dealer's radio service shop. If the set cannot be serviced using this type of equipment, the technician develops succeeding procedures until a satisfactory application is obtained. This cut-and-try and weeding-out process continues until a simple, straightforward service technique—one that can be performed by the *average radio serviceman* using only *average radio test equipment*—is developed for each model.

As the development of the service technique progresses, the laboratory technician makes notes concerning the location of trimmers, adjustment

screws, etc. When the essential service information has been obtained from a critical analysis of the set, the laboratory technician and draftsman work together to be certain that all pertinent information is included in laying out the necessary service schematic and other drawings. Differing from the complex shop schematic developed by the engineering department the service schematic uses a minimum of lines and crossovers, and has "sufficient air" between the parts for easy reference. Together, the technician and draftsman confer on the under chassis view and other explanatory drawings. Trimmers and test points are labeled. All parts are shown in their proper physical position and location.

If the circuit design is radically different, the laboratory technician will "bug up" the circuit by introducing troubles such as short or open-circuiting certain condensers, windings, or resistors in order to determine what effect failure of these parts will have on the performance. This information may not be included as a part of the service note; it is usually made up as a troubleshooting chart that includes all models.

Once the technician and draftsman have completed their work, all data, alignment charts, and drawings are turned over to the technical writer who arranges them in Service Note format. At this time, the laboratory technician and technical writer go

over the parts list, carefully checking the nomenclature to make certain that parts may be easily identified from the list of replacement or renewal parts, which is part of every Service Note. The technical writer is responsible for the arrangement and format of the finished product; the laboratory technician is responsible for the technical accuracy of the service data and drawings.

The "dummy" Service Note is then made up full size, with the placement of text and pictures indicated as "Fig. 1", "Copy A", "Copy B", etc. The type and style are specified for good legibility and ease in reading. Care is taken in the layout to place all drawings, particularly the schematic, near the charts so that it is not necessary to turn the page for reference.

After the printer completes a proof copy, the technical writer checks it over and may make a re-arrangement of the copy and illustrations for sake of clarity. The corrected proof is then returned to the printer and the presses roll.

So you see, from the time the engineers first conceive the idea for the "set of tomorrow" until the information for servicing the set is in the mail, the related efforts of the engineering, service, and time study departments, plus all the other people mentioned, are coordinated with one aim in mind—to have your service notes ready when you need them.

-50-

### RADIO TUBES — KNOWN BRANDS — BULK

	EACH
80, 5U4G, 5Y3GT, 5Y4GT	\$0.42
35W4, 25Z5, 25Z6GT, 35Z5	.45
6F5GT, 6J5, 6SA7, 6SK7, 6SQ7	.47
12AT6, 12BA6, 12BE6, 12SQ7	.49
12SA7, 12SK7, 12SH7, 12SR7	.49
6H6, 6J7, 6K7, 6SN7	.55
35A5, 35L6, 35Z3, 50B5, 50L6	.55
43, 6A7, 6A8, 6V6, 25L6	.59
0Z4, 6X5GT, 7A8, 7B7, 7N7	.65
1A5GT, 1A7GT, 1H5GT, 1N5GT	.74
1R5, 1S4, 1S5, 1T4, 3Q4, 3Q5	.79
50A5, 14A7, 14B6, 14Q7	.79
6AC7, 6L6G, 35Y4, 1LN5	.95
7F7, 7Y4, 117Z3, 117Z6	.95
1LA6, 70L7, 117L7GT, 117N7GT	1.35

### CONDENSERS

	PER HUNDRED
100—assorted, .001 to .02	\$3.95
.001—600 V. per hundred	3.95
.002—600 V. per hundred	3.95
.006—600 V. per hundred	4.40
.01—600 V. per hundred	4.40
.05—600 V. per hundred	4.95
.1—606 V. per hundred	7.20

### ELECTROLYTICS

	EACH
5—35 V	\$0.10
10—25 V	.14
25—25 V	.18
10—50 V	.20
8—8-200 V	.22
16—150 V	.24
20—150 V	.25
20—20—150 V	.26
30—150 V	.28
50—150 V	.28
40/40/20—150 V, 25 V	.44
8—450 V	.27
10—450 V	.32
16—450 V	.36
16/16—450 V	.59
20—450 V	.39
30—450 V	.47
40—450 V	.54

### VOLUME CONTROLS

1/2 Meg with switch	\$0.39
1 Meg with switch	.39
2 Meg with switch	.39
50 M Ohms with switch	.39

### ASSORTMENTS

KNOBBS, 100 asst.	\$4.95
SOCKETS, 100 asst.	4.95
RESISTORS, 100 assorted	1.50
PILOT LIGHTS, 100 assorted	4.95

### FM—Kit

(88 to 108 Mc)

Set of 6 matched Coils Variable Condenser Schematic Diagram Instructions **\$4.95**

### SPEAKERS

4" PM, Alnico Magnet	\$0.95
5" PM, Alnico Magnet	1.22
6" PM, Alnico Magnet	1.79
8" PM, Alnico Magnet	3.95

OUTPUT TRANS. (50L6)..... \$0.39

OUTPUT TRANS. Push Pull... .55

A.C.-D.C. CHOKE ..... .39

ZIP CORD, 20 gauge, 1000 foot spools..... \$13.75

WIRE, single stranded, 20 gauge, 1000 foot spools..... 4.95

LINE CORD, 6 Foot, complete with cap..... .14

I.F. COILS, 456Kc..... \$0.39

OSCILLATOR COIL, 456Kc..... .19

OSCILLATOR COIL SHORT WAVE..... .19

## TELEVISION

Dipole Antenna, list price \$14.50..... \$ 7.25  
Lead-in Wire, 300 ohms, 1000 feet on reels..... 17.50  
100 Feet, 300 ohms, on reels..... 2.25  
Coaxial cable, RG59U, 72 Ohms, 500 feet on reels..... 32.10

AUTO RADIO WHIP ANTENNA, rugged 3-post type..... \$2.95

AUTO RADIO VIBRATOR, 4 prong, non synchronous..... 1.19

BROOKS INVERTER, 50 Watts, 110 Volts, D.C. to A.C..... 8.95

ELECTRIC SOLDERING IRON, 60 Watts, list price \$2.95..... 1.77

ELECTRIC SOLDERING IRON, 100 Watts, list price \$3.95..... 2.37

ELECTRIC PHONO MOTOR, complete with 9" turntable..... 2.95

CRYSTAL PICK-UP ARM, includes all hardware..... 1.75

CRYSTAL CARTRIDGE..... 1.25

INTER-COMM. SYSTEM, 3 tubes complete with master and 1 station..... 17.97

PHONOGRAPH AMPLIFIER, all wired, includes 3 tubes..... 3.70

RADIO CHASSIS, punched for 6 tubes or less..... .29

LOOP ANTENNAS, oval, assorted sizes..... .39

RESISTANCE CORDS, 135, 150, 180, 200 or 290 ohms..... .29

WEBSTER AUTOMATIC RECORD CHANGER, No. 50..... 22.75

WEBSTER AUTOMATIC RECORD CHANGER, No. 56..... 26.50

## BROOKS RADIO DISTRIBUTING CORP.

80 VESEY STREET (DEPT. B) NEW YORK 7, N. Y. CORTLANDT 7-2312

# E VISION DEALERS AND SERVICEMEN

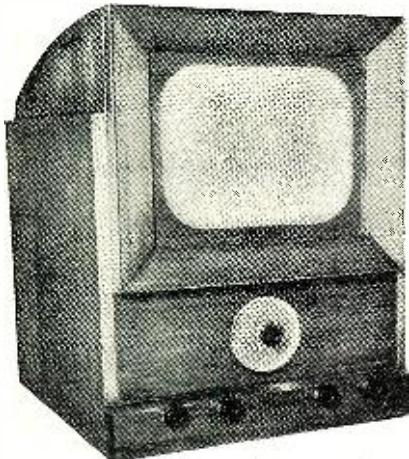

## GET IN ON THE PROFITS!

Sell the **TELECTRO Tavern-Tel** to hotels, taverns, restaurants, etc. Here are the outstanding features of the Tavern-Tel.

Television and FM . . . two speakers . . . the famous Dumont tuner . . . large 15" screen.

Sales aids, merchandising aids, and exclusive franchises available.

Write today for additional information.

**TELECTRO CORPORATION**  
385 Flatbush Avenue Extension  
BROOKLYN 1, NEW YORK

# RECORDS

## LATEST & HARD-TO-GET BACK NUMBERS

Some slightly used and some brand new—Victor, Bluebird, Columbia, Okeh, Decca, Capitol, etc. Such artists as Glenn Miller, Benny Goodman, Harry James, Bing Crosby, Frank Sinatra, Gene Autry, Duke Ellington, Fats Waller, Guy Lombardo, Andrews Sisters, Kate Smith, Ink Spots, Mills Bros., etc.

**BIG PROFITS** Your opportunity to cash in on this new field that is sweeping the country. Specify the type of music that sells best in your territory such as Swing, Sweet Music, Cow-boy, Hill-billy, Polkas, Blues, etc. Your price \$13.50 per 100 records, f.o.b. Chicago. All shipments made within 48 hours.

CHAS. HOODWIN CO.  
4419 Broadway, G-15, Chicago 40, Illinois  
World's Largest Dealers in Used Records

## B.C. Super

(Continued from page 53)

connect the 5-volt winding to the filament, and take the high voltage from that winding in the conventional way instead of from the cathode as shown. However, if parts are being purchased to build this receiver it is wise to use the circuit exactly as shown, since a saving in the purchase price will be effected.

After the filaments are wired and tested, the author advocates building the set backwards starting at the output tube, and testing each stage as built, but this is not absolutely necessary. It is merely a foolproof system to avoid the possibility of wiring mistakes which are, to say the least, a bit irritating when it comes to troubleshooting with limited test equipment. The circuit is so simple and straightforward, however, that no trouble should be experienced; years of production of this model have, as mentioned before, virtually eliminated all the "bugs."

The oscillator coil,  $L_1$ , seen soldered to the chassis lip in the extreme right top corner, is of the cathode tap variety, and should be placed in this position for best results. Shielding of any sort was found unnecessary with this layout, so adherence to it will no doubt save a possible headache or two from mutual coupling. With the coils shown, the standard type of "tracking" condenser (using a special oscillator section) works very nicely, tracking and adjustment being simplicity itself. After the entire circuit is wired, the i.f. section can be aligned, if necessary, by ear, providing the i.f. transformers have not been mis-

aligned prior to installation. Peak them, by means of the trimmers in the cans, for maximum-gain hiss, then, if no signal generator is available, tune the dial to the high end (about 1400 kc.) finding a fairly good local signal whose frequency is known. By means of the trimmer condenser on the tuning gang, next adjust the frequency until it agrees with the proper dial setting for that station. Now peak the loop (mixer grid) with its trimmer for maximum gain, and the receiver is ready to go. Of course, if the equipment is available, by all means align your receiver by the approved method, using, if possible, an output meter and a good signal generator.

In the interests of long life performance and economy the author used only components of the highest quality, and adherence to this little point will not only cost but little more, but will insure trouble-free performance for years. Incidentally, the filters shown, while not quite up to the recommended values, result in such a low hum level that no annoyance has been experienced from this score. The larger values of filter capacity that are available nowadays cheaply are, however, advisable. The ones used in this set were employed because the "big babies" just weren't to be had at the time, due to war-scarce conditions.

As a final word, while the neatness of parts layout under the chassis isn't necessary, it doesn't hurt anything, and it makes for much easier initial wiring, as well as maintenance, etc. Anyway, it's no harder to do a neat job than a haywire one, so a bit of care where it can't be seen will pay off in, at least, personal satisfaction in a job well done.

-30-

Under chassis view of completed home-built, broadcast-band receiver.

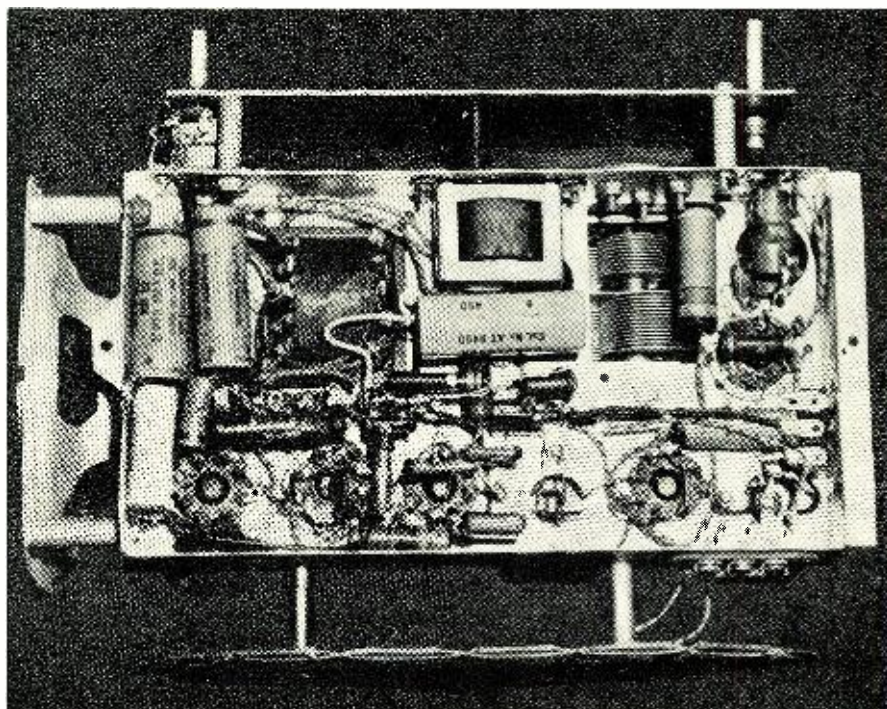

## FM Tuner

(Continued from page 47)

is superregenerating, a rushing noise will be heard in the loudspeaker. If this noise does not develop adjust the variable resistor  $R_1$  until it does.

Adjust the frequency of the 6J6 stage to approximately 31 mc. Adjust the plate circuit of the 6BE6 to the same frequency. When the 6BE6 plate circuit is tuned, a noticeable decrease in noise will result. Space the two coils so that only a slight decrease in noise takes place when this adjustment is made.

Place the variable condenser in approximately its center position. Connect a signal generator to the antenna coil, setting the frequency of the generator to 100 mc. Adjust trimmers  $C_2$  and  $C_3$  for maximum output. Adjust the variable resistor in the plate circuit of the 6J6 for optimum operation considering signal-to-noise ratio.

Condenser  $C_{11}$  and resistor  $R_1$  determine the squelch frequency. If a tube type other than the 6J6 is used it may be necessary to change the values of  $C_{11}$  and  $R_1$ . Select values that give maximum sensitivity with good signal-to-noise ratio.

As the values of  $C_{11}$  and  $R_1$  are increased the squelch frequency decreases. This can result in the production of a squelch frequency in the audible range which is highly undesirable. If such a condition does exist, a high pitched note will be heard at all times. Reducing the values of  $C_{11}$  and  $R_1$  will increase this frequency thus eliminating the whistle.

If a signal generator is not available, the following procedure can be used to align the FM tuner. Tune a receiver to 31 mc. Connect a short piece of wire to the antenna post of the receiver and place this piece of wire near the tuner. Tune the tank circuit of the 6J6 stage so that noise is heard at 31 mc., using the receiver as a monitor. Tune the trimmer in the plate circuit of the 6BE6 to a point where this control affects the rushing noise of the receiver monitor. This will indicate that the plate circuit of the 6BE6 is tuned to the same frequency as the 6J6 stage.

Use a frequency meter or wavemeter to establish the oscillator frequency at approximately 69 mc. Next adjust the 6BE6 grid trimmer for maximum noise.

Although this method is definitely on the crude side, it will place the tuner in sufficient alignment to make final adjustments on a received signal.

The antenna for the FM tuner is dictated by circumstances. If sufficient signal strength is available from a local station, a short piece of wire inside the house will give satisfactory reception. On the other hand, if the FM transmitters are located several miles distant, an outside antenna is

March, 1948

# GHOSTS



*GHOSTS* that haunt your television customers can be laid at rest. Workshop antennas, *custombuilt for television*, eliminate ghosts, fading, noise and interference. In many locations the "signal strength" of ordinary "broad-band" antennas is in-

sufficient for sharp detail and contrast. Workshop TV antennas, because of their inherent high gain and precise impedance matching, provide clear, brilliant reception. Even on adjacent channels their performance is exceptional.

## FEATURES

- Three elements for "high-gain" performance.
- Engineered for each channel, but sufficiently broad-band to cover all present channels (should be installed for the weakest channel).
- The "feed point" is completely protected from the weather by a rugged plastic head.
- Elements made of 1/2-inch duralumin tubing.
- Rigid tubular steel mast 7 1/2 feet high. No guy wires necessary. Withstands high winds and ice loading.
- Streamlined design makes clean-cut, attractive installation.

AVAILABLE AT YOUR DEALER

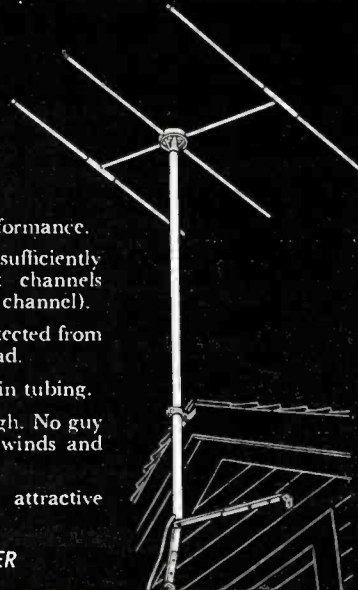

## DEALERS...

You know and we know that almost any "AM wire" will bring in TV if it is close to the transmitter. For the suburbs or out-of-town installations a Workshop TV antenna will bring in a much stronger signal. This means increased sales opportunities for you — plus superlative reception that you can sincerely recommend. Your local jobber has Workshop antennas. Get in touch with him or write direct.

## THE WORKSHOP ASSOCIATES, INC.

Specialists in High Frequency Antennas

66 Needham Street · Newton Highlands 61, Mass.



## RADIO ENGINEERING DEGREE IN 27 MONTHS

Intensive, specialized course, including strong basis in mathematics and electrical engineering, advanced Radio Theory and Design. Modern laboratory. Low tuition. Self-help opportunities. Also 27-month courses in Aeronautical, Chemical, Civil, Electrical and Mechanical Engineering. Gov't approved for G.I.'s. Enter March, June, Sept., Dec. Catalogue.

## INDIANA TECHNICAL COLLEGE

938 E. Washington Blvd., Fort Wayne 2, Indiana

## TELEVISION

KILOVOLTAGE R.F. Power Supplies  
Radio, FM & Television Coils

C-B MFG. CO.

412 West 37th St. New York, N. Y.

## Guaranteed Radio Tubes

All types for Immediate Delivery  
Send For List

Territories Still Open for  
DISTRIBUTORS

Attention Manufacturers—Large Quantities of 117L7-32L7-6F6-6K6-6SK7-70L7-1-Volt Miniature and 12-Volt Miniatures

## LE-HI ELECTRICAL COMPANY

660 Broadway Newark 4, N. J.  
Humboldt 5-3530 Humboldt 5-3531

## Here's the Cabinet Television Builders Have Been Waiting For!

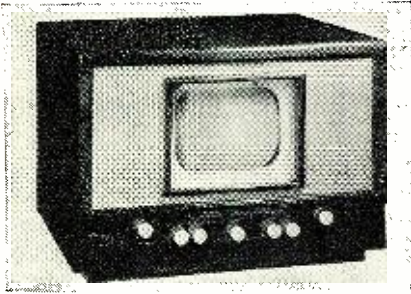

### Specially Designed For Your "Transvision" Kit (12" Standard Model)

A hand-crafted cabinet made of the best  $\frac{3}{4}$  inch walnut, finished by expert piano polishers, for the custom-builder who seeks to give his set the advantage of commercial styling combined with exclusive construction. Dimensions: 29 $\frac{1}{2}$  inches wide, 21 inches high, 20 inches deep.

#### ADD THESE UNUSUAL DE LUXE FEATURES TO YOUR SET—

- 8 inch Rola P.M. speaker for natural tone
- Conveniently located slide switch operates concealed illumination for Lucite printed dial and jewel-covered light in base.
- Specially built milk-white Lucite mask, curved to fit 12" picture tube—protected with safety glass.
- English design recessed base—felt cushioned.

#### AND WORTH DOUBLE TO THE COMMERCIAL BUILDER!

This highly polished cabinet comes to you completely assembled, drilled for shafts, wired and ready for your chassis. Nothing else to buy. Furnished complete with step-by-step instructions and following kit of parts to complete installation of chassis: pin jacks, plugs, pilot brackets, 6-8 volt pilot bulbs, onyx catalin knobs (6 plain, 1 with pointer), special low-loss antenna block, assembly to raise CR tube, masonite back-board drilled for ventilation, heavy stack output transformer, fuse holder, strap for CR tube, caution labels, nuts, washers, bolts, screws.

ONLY

**\$79**

F.O.B. Brooklyn, N. Y.  
Send 10% with order.  
Balance C.O.D.

Order direct from:

**TEL-CRAFT COMPANY**  
108 HAVEMEYER STREET  
BROOKLYN 11, N. Y.

## FREE BOOK

SHOWS **SHORT CUT** TO **CODE SPEED**



ENDORSED BY CHAMPIONS

For Amateur or Commercial Radio

Qualify at home, in spare time, by easy, simplified system. You can learn code or gain greater speed and skill in sending and receiving by the same system that has made code champions and radio telegraph experts. FREE BOOK OF FACTS explains Course. It's absolutely free. Rush your name for it today.

**CANDLER SYSTEM CO.**  
Dept. 2-C, P. O. Box 928 Denver, Colo.

desirable. The flat ribbon folded dipole antenna is economical and quite effective. Where distant reception is necessary, a beam type antenna is recommended.

The antenna connection to the tuner should be made directly to the one turn antenna coil. If a terminal strip is mounted on the chassis, both terminals should be insulated. A piece of transmission line is required to connect the antenna coil to the terminal strip.

If shielded transmission line is used for this connection, solder the shield to ground and the center conductor to the free end of the antenna coil. The ground connection should be made as close to the ground end of the antenna coil as possible.

Unshielded transmission line is connected to the antenna coil in the same manner.

The transmission line impedance will be dictated by the impedance of the receiving antenna.

The sensitivity of the tuner is in excess of one microvolt. That is, a signal intensity of one microvolt can be heard. To reduce the superregeneration rush to a desirable level, a signal of 25 microvolts is necessary. As the signal strength is increased above this level, little change in audio output is realized. There is a definite a.v.c. characteristic to a superregen-

eration stage as the sensitivity of the stage falls off radically as the signal strength increases. This effect reduces static and ignition noise.

The frequency response of this tuner is usually in excess of that found in an audio amplifier used in the average AM receiver. The first noticeable difference between AM and FM reception, using the same audio amplifier, will be a decided increase in high frequency response.

Of course the high fidelity capabilities of this unit are necessarily limited by the audio amplifier, speaker, and speaker baffle used in conjunction with the tuner.

The use of this type of tuner is not limited to broadcast FM reception. Such units can be constructed as standby receivers for emergency service, both AM and FM. Radio amateurs will find many applications for such equipment as they explore the new high frequency bands now open for ham operation. By substituting different type converter stages, adapters can be operated at extremely high frequencies with sensitivity in the order of a few microvolts.

The simplicity of the circuit is such that experimenters with a very limited amount of receiver design experience can expect to construct such a unit with satisfactory results.

-30-

The recently held convention of the Federation of Radio Servicemen's Associations of Pennsylvania found this group of chapter presidents gathered on the speakers' platform at one of the sessions. From left to right: T. L. Clarkson, Harrisburg, Vice-president, Mid State Radio Servicemen's Association; Leroy J. Link, President, Reading Radio Servicemen's Association; John Lackman, South Bend, Indiana, State Representative, Radio Electronic Technicians Association; Del Bruner, Secretary, Akron Radio Technicians Association; A. R. Guild, Williamsport, Association of Radio Servicemen of Central Pennsylvania; Dave Krantz, President, Philadelphia Radio Servicemen Association (standing at rostrum); J. A. Renville, ex-officio delegate, Luzerne County Radio Servicemen Association; B. A. Bregenzer, President, Pittsburgh Radio Servicemen Association; Max Liebowitz, President, Associated Radio Servicemen of New York; David Van Nest, President, Radio Servicemen's Association of Trenton; and H. D. Keiderling, Director, Lehigh Valley Radio Servicemen's Association and North Jersey Radio Servicemen's Association.

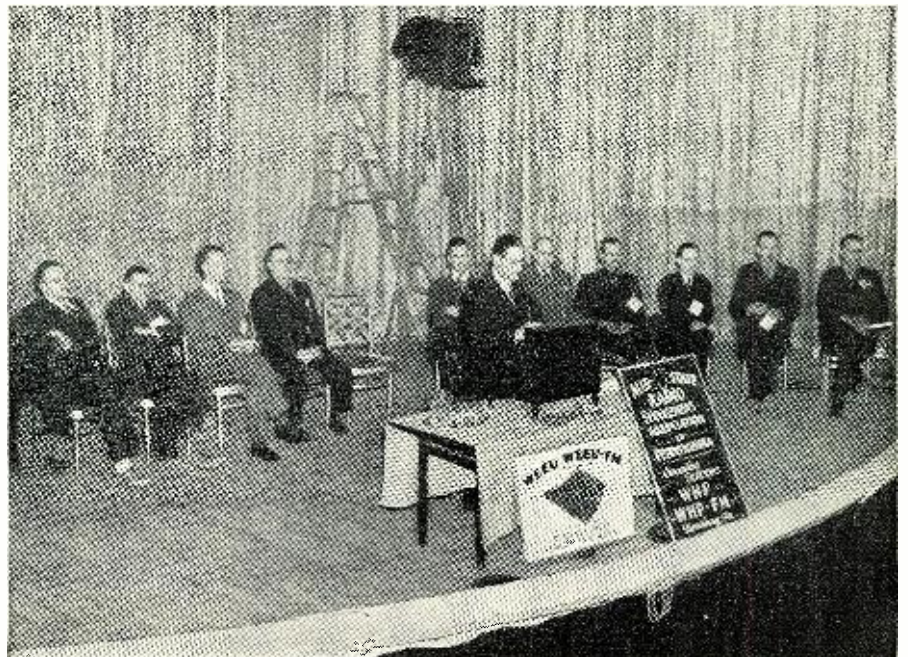

# Technical BOOKS

**"DIAL CORD STRINGING GUIDE"** compiled and published by Howard W. Sams & Co., Inc., Indianapolis, Indiana. 100 pages. Price \$ .75.

One of the most time consuming yet least profitable phases of the radio servicing business involves the repair or replacement of dial cords.

In order to eliminate costly delays in restringing dials, the authors have produced this handy-sized book which illustrates clearly and easily how to repair dial cords in radio receivers produced from 1937 through 1946.

Easy-to-follow diagrams and text show each step clearly and accurately. Hundreds of receivers of various manufacture are listed by model number and then the corresponding diagram is given for each model. The diagrams are complete and explicit and by following the step-by-step instructions even the knottiest dial cord problem should be untangled easily.

**"MOST-OFTEN-NEEDED 1948 RADIO DIAGRAMS"** compiled by M. N. Beitman. Published by Supreme Publications, Chicago. 192 pages. Price \$2.00.

This latest publication is number 8 in the series of diagram manuals published by Supreme.

The compiler has gathered together schematics, alignment data, replacement parts lists, voltage values, and information on stage gain, location of trimmers, and dial stringing for almost all of the new 1948 home receivers.

The products of over fifty radio and phonograph manufacturers are included in this new manual which should provide fairly adequate coverage of sets likely to be encountered in the radio service shop.

**"AN APPROACH TO RADIO"** by J. B. Shrewsbury. Published by Electronic Industries, Princeton, Ky. 288 pages. Price \$4.50.

This text has been designed for the layman and the beginning student of radio. The author has presented the subject of radio in an informal, easy-to-read style which is conducive to further study of the subject.

Mathematics has been purposely omitted except where absolutely necessary to an understanding of the subject. Familiar analogies have been used extensively to clarify the operation of a radio receiver.

The book is divided into eight chapters dealing with radio transmission and reception, the audio oscillator, beat note receiver, audio amplifier, receivers for modulated signals, receiver development, transmitter development, and power for transmitters and receivers.

The book is enthusiastically recommended for the layman, beginner, or the high school instructor.

• It's RADIONIC for PRICE • It's RADIONIC for VALUE • It's RADIONIC for DELIVERY •

## FREE RADIONIC CATALOG



It's a must for all

- Service Dealers
- Amateurs
- Experimenters
- Industrials
- Institutions
- Government Agencies

### TRANSVISION'S

**15" GIANT TUBE KIT**

(120 sq. in., yours for only \$365 list)



WRITE FOR DEALER'S PRICES  
SPECIAL OFFER: To see for yourself, you may order the instructions separately. Includes parts list, schematic diagrams, stage by stage drawings, etc. Send \$1.75, credit applied to your kit when ordered.

CHANCELLOR RADIO • TELEVISION KITS AND COMPONENTS • RADIOS • TEST INSTRUMENTS • PARTS AND ACCESSORIES • INTER-COMMUNICATORS • DISC AND WIRE RECORDERS PUBLIC ADDRESS • AMATEUR EQUIPMENT • TUBES • RECORD CHANGERS • TECHNICAL BOOKS • HARDWARE

**RADIONIC EQUIPMENT COMPANY**  
170 NASSAU STREET, N. Y. 7

Tribune Theatre Entrance  
Telephone: WOrth 2-0421  
Cable: CHANSLOR

## PRECISION TEST Instruments

Radionic presents the new PRECISION line of test equipment featuring...New design...New styling...New LOW prices...

**PRECISION SERIES 40**  
Miniature, Wide range test set. 1000 o/p/v, AC and DC. 31 ranges to 6000 volts, 600 ma., +70 db, 5 megohms. Complete with batteries, test leads and instruction manual. Bakelite carrying case. **\$23.26**

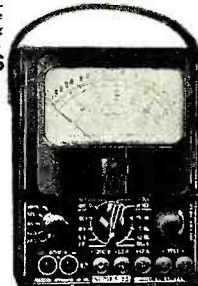
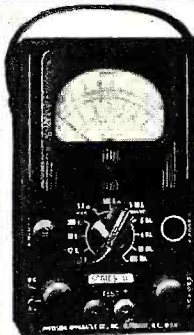

**PRECISION SERIES 85**  
Compact, wide range super-sensitive test set. 20,000 o/p/v DC, 1000 o/p/v AC. 34 ranges to 6000 volts, 12 A., -70 db, 60 meg. Complete with batteries, test leads, operating instructions. **\$37.98**

**PRECISION SERIES 80** Physically similar to the new Series 85 but, 1000 o/p/v AC and DC. 10 megohms instead of 60... **\$32.05**

**PRECISION SERIES 612** Up-to-the minute tube-tester. 4 1/2 meter. Free-point element and short-check selection. Condenser and Lattery test. Portable, in hardwood case with removable cover. **\$60.71**  
Counter Model, sloping chrome-trimmed cabinet. **\$62.67**

**PRECISION SERIES 620**  
Combination tube, battery and circuit tester. A complete portable radio test lab. 1000 o/p/v AC or DC. 28 ranges to 3000 volts, 12A., +64 db., 10 megohms. Rotary switching, 4 1/2 inch 400 Ua. meter. Furnished complete with ohmmeter batteries, test leads and instructions. **\$80.66**

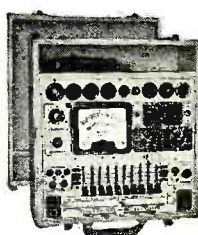

**THE NEW I-200-C**  
Better than ever. 88 kc to 30 mc on fundamentals. 120 mc on harmonics. Maximum deviation of 1% on all bands. Vernier scale. 400 cycle audio modulates. RF up to 100%... **\$62.87**

Pick-up arm for Webster Mod. 56 and Mod. 70 changer to accommodate GE Variable Reluctance Pick-up... **\$1.20**

## FREE CATALOG MAIL TODAY!

RADIONIC EQUIPMENT CO., DEPT. 53  
170 NASSAU STREET, NEW YORK 7, N.Y.

- Send at once your free catalogs, supplements and bargain lists as published listing products of leading manufacturers of radio-electronic parts and equipment.
- Please send me Transvision instructions described above.
- I enclose \$1.75 which is returned to me if kit is ordered.

NAME.....  
P.O. BOX or STREET.....  
TOWN..... STATE.....

## RADIO

Technician and Radio Service Courses  
**FM and TELEVISION**  
American Radio Institute  
101 West 63rd St., New York 23, N. Y.  
Approved Under GI Bill of Rights  
Licensed by New York State

**ELECTRONIC VOLT-OHM-METER**  
**\$11.85**  
110 VOLTS AC 20 RANGES  
0.75 / 10 / 50 / 100 / 500 / 1000 / 5000 volts  
DC and AC 0-1,000,000,000 ohms in 8 1/2 overlapping ranges. Sensitivity: over MILLION OHMS per VOLT on 3 volt range.  
Complete kit, panel, chassis, nine inch long dial scale, tubes, components. Cost is low because special slideback circuit eliminates need of expensive meter.  
**STERLING ELECTRONIC COMPANY**  
BOWLING GREEN, DEPT. 4, KENTUCKY

## EASY TO LEARN CODE

It is easy to learn or increase speed with an Instructograph Code Teacher. Affords the quickest and most practical method yet developed. For beginners or advanced students. Available tapes from beginner's alphabet to typical messages on all subjects. Speed range 5 to 40 WPM. Always ready—no QRM.



ENDORSED BY THOUSANDS!

The Instructograph Code Teacher literally takes the place of an operator-instructor and enables anyone to learn and master code without further assistance. Thousands of successful operators have "acquired the code" with the Instructograph System. Write today for convenient rental and purchase plans.

## INSTRUCTOGRAPH COMPANY

4711 SHERIDAN ROAD, CHICAGO 40, ILLINOIS

# NEW RECEIVERS for Spring Market

## LOW-COST TV RECEIVER

Distribution of the new *Motorola* table model television set is proceeding rapidly as the unit finds wide consumer acceptance in the field.

This new table model, which sells within the price range of the average buyer, has been designated the Model VT71. It is housed in either a walnut, blonde, or mahogany cabinet. Weighing only 26½ pounds complete, this new set may be easily carried about the house to provide television entertainment in any room where antenna

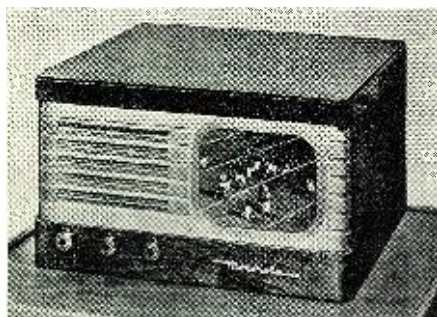

leads are available. Because of the light weight, special stands or tables are unnecessary.

The circuit uses 15 tubes, 2 rectifiers, and germanium crystal detector. The cathode-ray tube is of the 7" size giving a direct view image of approximately 26 square inches. Three controls, located on the front panel, are all that are required for the operation of the unit. There is an 8-position tuning knob and the set is adjustable to any eight of the 13 channels. The over-all cabinet dimensions are 9½" x 16¾" x 16¾".

Full information on the VT71 will be provided on request to *Motorola, Inc.*, 4545 Augusta Boulevard, Chicago 51, Illinois.

## PROJECTION TV

*General Electric Company's* Receiver Division is currently in production on a new projection television receiver, the Model 901.

This new unit projects an image 18 x 24 inches and in addition to television offers AM, FM, and short-wave coverage plus an automatic phonograph.

Using a five-inch cathode-ray tube, the image is reflected by means of the *Schmidt* optical system upon the reverse side of a translucent plastic screen. Sharp pictures are obtained by means of the company's "automatic clarifier" which virtually eliminates fuzzy edges and reduces the effects of interference interruptions, according to the manufacturer. This same cir-

cuit automatically controls picture synchronization.

Reception on all 13 television channels is assured with a separate circuit for each channel. Tuning the various channels is accomplished by turning the selector to the channel number on which the desired station operates. This feature makes it possible to move the set to any television service area in the country without having to make readjustments.

When not receiving television programs, the screen may be lowered into a concealing well in the top of the cabinet. Counterbalances make the raising and lowering of the screen effortless. The automatic phonograph is mounted on a roll-out drawer.

The Model 901 is housed in a cabinet of genuine Honduran mahogany and retails in the upper price bracket.

Further details on this console may be obtained from *General Electric Company*, Receiver Division, Electronics Park, Syracuse, New York.

## EMERSON PORTABLE

*Emerson Radio and Phonograph Corporation* has recently introduced a new self-powered portable to retail in the low priced class.

Designated the Model 567, this new set is encased in rich grained leatherette with a rugged luggage-construction base. The receiver measures 8½" x 4¾" x 7½".

A full-sized Alnico V PM dynamic

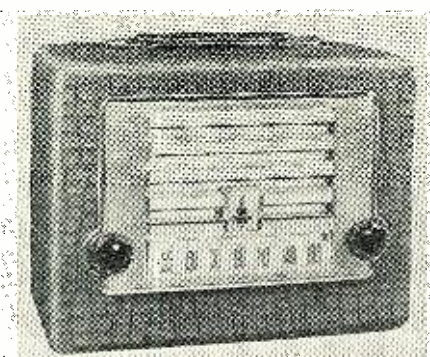

speaker, especially designed for battery use, is employed in this radio.

Additional details on the new Model 567 are available from *Emerson Radio and Phonograph Corporation*, 111 Eighth Avenue, New York 11, New York.

## PACKARD-BELL UNIT

Production on two new "top of the line" receivers which feature dual-turntables for copying of records is underway at *The Packard-Bell Company*, Los Angeles, Calif.

These "PhonOcord" combinations are available in walnut or mahogany finishes (The Wilshire) or in combed oak (The Fantasia). Both cabinets feature matched panels, a pull-out drawer containing the recording turntable, generous album storage space, and all hand-rubbed surfaces.

The "PhonOcord" includes two turntables, one a *Webster* No. 56 record-changer and the other a recording turntable. The radio circuit uses 12 tubes plus rectifier and tuning eye. FM coverage is provided by this unit along with a Hi-Q impedance loop



and FM dipole antennas. The 12" electrodynamic speaker floats on live rubber. The phonograph unit is equipped with a "Silentronic" crystal pickup, a lifetime needle, studio type wide range dynamic microphone, public address system, dual tone controls, and push-pull audio system.

Full details on either or both of these units may be secured by writing *The Packard-Bell Company*, Los Angeles, California.

## PORTABLE RECORDER

One of the new series "Magnetape" recorders made by *Amplifier Corp. of America* that is receiving a lot of attention in the industry is the portable line.

Each portable system consists of a twin set of matched carrying cases covered in brown leatherette and equipped with special handles for easy portability. One case houses the completely self-contained recording and playback unit while the second case holds a sensitive microphone, microphone cable, extension line cord in addition to providing space for 25 reels of "Magnetape," "E-Z Cue," and cleaning and maintenance accessories.

Four different models are available in the portable series depending on the frequency response desired. A simple inverter easily adapts these recorders for 6 volt automobile operation. They will operate in any position, even upside down. External vibrations have no effect on the recording and reproduction progress, according to the company.

For additional technical information, including complete specifications and performance ratings, write to *Magnephone Division, Amplifier Corp.*

**RADIO NEWS**

# TOM ALLEN Can't Keep It Secret !!! His Values TALK !!!

**GIBSON GIRL EMERGENCY TRANSMITTER SCR 578A & B**—Automatic or hand operated transmitting on 500 kc. No batteries required. Automatically transmits SOS signal. A wonderful buy at ..... **\$19.95**  
Complete with kite, parachute, lamp, extra wire, hydrogen generator etc. .... **\$29.95**



## Radio Compass Receiver R-5-ARN7

Complete with 15 tube superhet receiver, with a frequency range from 200 to 1750 kc. 115V, 400 cycles, power supply inc. Brand New, Special. .... **\$22.95**

**FIELD TELEPHONES EE-8 & RM-29**—Ideal for farm, warehouse, garage extension, or similar use; works on 2 flashlight cells. With handset, generator, ringer etc., in strong case. New only **\$9.95**  
\$14.95. Used. .... **\$9.95**



**72 Inch ANTENNA**—37-50 meg matching section; excellent for 10 meter band. Containing cylinder is 5" long, 3 1/4" diameter, with coaxial cable. Can be adapted for FM and Television. Good for mobile or fixed station. New, Special. .... **\$2.45**

**WHIP ANTENNA AN-131A**—Half wave 40 to 48 meg. 10 1/2 ft. long. Comes in 8 all brass sections, connected on a spring steel cable. Good for FM reception, mobile, or fixed station; can be converted to fishing rod. In original sealed carton. Only. .... **\$1.49**

**CABLE**—Single conductor, 7 strand #10 gauge, rubber insulated, armored with 18 strands steel wire; with heavy outside rubber cover; overall diameter 3/4"; reels contain approx. 6,000 feet; weight 3500 lbs.; has many uses in wire communication; 100 ft. min. .... 15c foot  
Discount for larger quantities.



**Standard Lip Microphone T-45**—complete with PL291A plug; ready for use. Instruction book included. New ..... 49c

**Throat Mike T-30**—double throat type; PL-291 plug, M199 neckband. Works into any 200 ohm impedance input circuit. Instruction sheet included. 39c

**HS-23 Headset**—8000 ohm impedance, PL-55 plug. .... 95c

**HS-33 Headset**—600 ohm impedance. 98c

**KELLOGG operator transmitter microphone T-28E**; adjustable swivel and extension bracket, with special 10 ft. ES2526-8 cord. New. .... **\$7.95**

**Telephone Receivers R-14**—high impedance, light weight, watch case type, double magnet, black bakelite cap, no headband. .... 59c

**MICROPHONE T-44C**—600 ohm impedance, magnetic type, with PL-179 plug and JK-26 jack; 5 foot rubber insulated and cotton covered cord. .... 98c

**HEADSET P-19** with 2 R-15, 24-000 ohm high impedance receivers; includes 2 rubber cushions, PL-55 plug, 8 ft. cord. New. \$2.39; Used. .... **\$1.79**

**HANDMIKE T-17B**—200 ohm, single button carbon mike, push button switch. Ideal for home transmitter or portable rig; 5 ft. rubber cord, plug and dust cover. Brand New. .... 89c

**HANDSET TS-13**—200 ohm carbon mike, 2500 ohm earphone, 6 ft. rubber cord, 1-PL55 and 1-PL68 plugs attached. New. .... **\$2.95**

**HANDSET TS-15A**—200 ohm, same as above; can be used in intercom., radio & telephone work. Used ..... **\$1.98**



## Write for Quantity Discounts

Prompt Delivery—Write Dept. RNM

25% Deposit Required on C.O.D. Orders  
Shipped F.O.B. New York. Minimum Order \$2.00

## TOM ALLEN CORP.

564 ATLANTIC AVE.

BROOKLYN 17

NEW YORK

All Merchandise is War Surplus and is sold as used unless otherwise specified.

**TUNING UNITS, BC-746**—with 2 crystals; transmits on 3655 KC and receives 4110 KC; includes RF coil and antenna coil with variable padder; mounted on 1 base, wired and ready to plug in; carrying case included. Brand New ..... **\$2.29**

Thigh clamp transmitting key J-45—with 5 ft. cable and PL55 plug. .... 49c

**PLUGS**—PL55 and PL68, each ..... 12c

## RADIO RECEIVER BC-1023A

Ultra High Frequency, covering 62 to 80 mc range. An extremely sensitive relay, works on 4/10 of mill. Contains 4 tubes: 12SH7, 6SQ7, 6SC7, 6U6TG. New. .... **\$3.95**

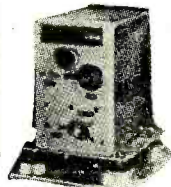

G.E. 50 watt ceramic tube sockets; for 211-838, 250T.H. and other type tubes. New, each. .... **79c**

**PARACHUTE**—12 ft. in diameter, orange color silk, nylon cord; about 70 sq. ft. of fine material; can be used for wearing apparel and many other things. Brand new, only. .... **\$4.95**

**SA-260U**—Beautiful black plastic microphone switch; 2 1/2" long, 1" diameter; push button make and break, press to signal. Screw type, can be used with or without case. Good for interoffice buzzer, closet lights, doorbells, phonograph recorder. Can be mounted or used by hand. Each ..... **26c**

Quantity prices on request.

## LARGEST WAR SURPLUS STORE IN AMERICA

## NO MAIL ORDERS FILLED FOR LESS THAN \$2.00



### SCR 522 TRANSMITTER RECEIVER

Designed to operate from 100-156 mc. Makes an ideal 2 meter rig. .... **\$14.95**

**1206B BEACON RECEIVER**  
Six tube superhet, 200 to 400 kilocycles. .... **\$4.95**

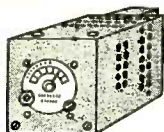

**I-82 A INDICATOR**  
Radio compass indicator. Ideal beam indicator. .... **\$2.85**

### OUTDOOR TUNING UNIT

Type CA-730 used to couple simultaneous radio range. 400 watts. 70 ohm to 1 ohm. .... **\$39.95**

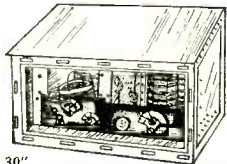

Case 43" x 32" x 30"

**ROTARY SWITCH KIT 10** switches, some ceramic and bakelite wafers. .... **\$2.49**

**MICROPHONE CORD CD318** has switch SW-141 to which are attached 7 ft. Sir. C. Cordage. CO-145 has 1.68. .... **.25**



### TL 29 PEN KNIFE

Genuine U. S. Signal Corps knife. Has one blade and one locking screwdriver. No dealers—limit one to a customer. .... **79c**



### BC 375 TUNING UNITS

TU-6B, TU-5B, (without cases) ..... **\$1.75**  
TU-7B, TU-8B, ..... **\$1.75**  
TU-9B, TU-10B, ..... **\$1.75**  
TU-26B. Will ship 5 for 8.25  
No. you indicate until sold out, after which nearest will be sent. 5 for 10.95

### TG5-B TELEGRAPH SET

Made for U.S. Signal Corps. Equipped with key, buzzer, and ringer bell in a compact metal box. FREE: Canvas waterproof case with shoulder strap. (Batteries 95c extra) .... **\$4.95**

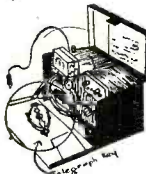

### BC 616 RELAY BOX

Contains 3-24 V relays, 1-150 MFD 50WV, 2 resistors, 1-4 terminal block, housed in aluminum box 6 1/2" x 5 1/2" x 2" ..... **\$1.79**

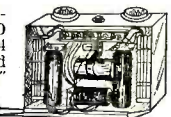

### BK 22 E RELAY BLOCK

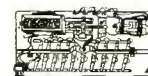

Contains 1-12 volt D.P.S.T. leach relay. 1-12 volt solenoid ratchet relay. .... **95c**

### 1147 A U.H.F. SUPERHET RECEIVER

Has 4 acorn tubes, 2 gang butterfly cond., single dial control, 2 stages of I.F. coverage 100 to 160 megacycles. .... **\$7.95**  
Less power supply.



### MICROPHONE STAND

Banquet type. Brand new. Purchased from U.S. Army. .... **\$2.95**

**MOUNTING FT 151A** aluminum plate with 6 lord, 14 lb. shock mounts. .... **.95**  
**RESISTOR KITS** 1/4 to 2 watts—50 various usable values. .... **.95**  
**25 Mica Condensers** various usable values ..... **.95**

ALL MERCHANDISE SHIPPED F.O.B. PHILA.

# JOHNSON'S FAIR

AT 8th & ALLEGHENY

PHILA. 40, PA.

NO MAIL ORDERS FILLED FOR LESS THAN \$2.

# HOBCO MARCH SPECIALS

## R.M.E. RECEIVER and SPEAKER

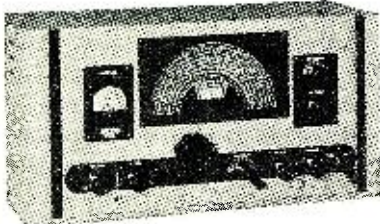

Delivers peak performance on all frequencies 550 to 33,000 K.C. Loctal tubes, short leads, temperature compensating padders, triple spaced condensers. Plenty of bandspread for ham and commercial operator. 20 meter band—14,000 to 14,400 K.C.—for instance, covers 20 divisions on translucent dial—equivalent to 72 degrees on a five inch diameter disc. In beautiful two-tone cabinet—with matched acoustically designed speaker housing.

**\$198<sup>70</sup>**

F.O.B. Balto. Md.

### LIBERAL TRADE-IN ALLOWANCE FOR YOUR OLD RECEIVER

1/2 Megohm Volume Control with switch and 1/4" brass shaft 1 1/2" long... Net **\$0.45**

High Fidelity Audio Output Transformer. Max. level 4-20 v. a., turns ratio 7-1. R.M.S. test 1.0 kv., 90c to 0.150 kc. — 1.5 vu. pri. / 20000 ohms @ 4 ma. dc., sec. 2: 500 ohms @ 0 ma. dc. zero vu = 1 mw. .... Net **\$1.95**

FERRANTI TRANSFORMER. Two identical transformers and one choke in the same can. Transformer impedances are: Pri.—6000 ohms, dc. resistance 380 ohms. Sec.—500 ohms, dc. resistance 44 ohms.

CHOKES CHARACTERISTICS: 15 henries at 300 cycles, max. dc. current 10 ma., dc. resistance 800 ohms. .... Net **\$0.95**

Write for our Monthly Bulletin on Standard Radio Parts featuring Nationally Advertised Brands



**HENRY O. BERMAN CO., Inc.**

10-12 E. LOMBARD STREET  
Dept. R-6 BALTIMORE 2, MD.  
Electronic Equipment and Replacement Parts

# TELEVISION ELECTRONICS

## LEARN RADIO THE NORTHWESTERN WAY

- BASIC RADIO
- RADIO SERVICE
- COMMUNICATIONS
- INDUSTRIAL ELECTRONICS
- TELEVISION

Highly Trained Instructors  
Modern Equipment  
Spacious Building and Grounds

**NORTHWESTERN VOCATIONAL INST.**



745 Grand Ave.  
ST. PAUL 5  
MINN.

of America, 398-2 Broadway, New York 13, N. Y.

### THE "HOLLYWOOD"

Cleervue Television Corporation's new "Hollywood" model television receiver has several eye-catching and newsworthy features that will appeal to buyers.

Housed in a modern cabinet, the new receiver features a 12" direct view swivel screen that can be focused 180 degrees in any direction. In addition, the receiver is constructed to include a five-deck chassis which is virtually five separate instruments, thus reducing servicing problems to a minimum. Each of these chassis sections are plug-in units which can be removed and replaced instantly. All repairs on the unit are performed at the service agency.

The 30-tube set is broken down into five chassis; the r.f. unit, power supply, video chassis, audio chassis, and sweep deck and high voltage. The receiver covers all 13 channels assigned to video broadcasting. There are four stages of video i.f., two stages of video amplification, and a three-stage sync separator and clipper. Five front panel controls include intensity and

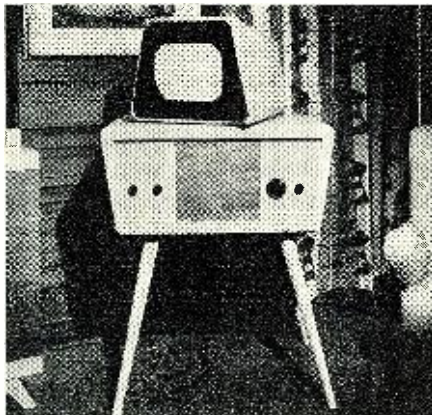

on-off switch, contrast control, volume, station selector, and vertical hold.

Additional details on the "Hollywood" will be supplied on request by Cleervue Television Corporation, 81 Willoughby St., Brooklyn 1, New York.

### RCA TABLE MODEL TV

The RCA Victor Division of Radio Corporation of America has just announced its new Model 8TS 30 table model television receiver featuring the largest speaker ever employed in an RCA Victor table model TV unit.

The unit features a 5 x 7 inch elliptical PM speaker, mounted to the cabinet which, according to the company, results in increased volume and improved tone, particularly in the bass response.

Cabinet styling includes the elimination of grille cloth and the substitution of fine louvres in a wing-like formation on either side of the 10 inch picture tube. A relief border of brass is used between the louvres and the solid portion of the cabinet front, and golden-trimmed tuning knobs are

employed. The 52-square inch picture is mounted in a light-toned frame. The set is available in mahogany, walnut, and blonde finishes.

Further details on the Model 8TS

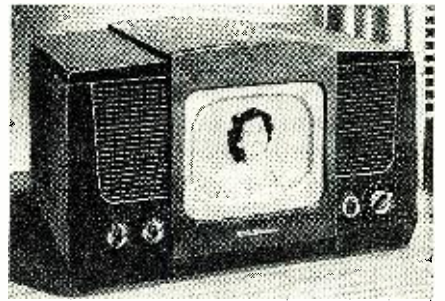

30 will be supplied on request by the RCA Victor Division, Radio Corporation of America, Camden, New Jersey.

### GAROD TV

Delivery on Garod Electronics Corporation's new "Royal" five-in-one television combination was begun recently with the instrument featuring a 12" direct viewing tube, AM, FM, short-wave, and automatic record changer, all housed in a mahogany finished 18th Century cabinet.

Garod Electronics Corporation, 70 Washington Street, Brooklyn 1, New York will supply additional details on the "Royal" upon request.

### FM-AM TUNER

Dongene Laboratories, Inc., of New York City has recently introduced a 13-tube FM-AM tuner to the trade.

The new tuner has a range of from 88 to 108 mc. for the new FM band and from 530 to 1700 kc. in the standard broadcast band. The FM section utilizes a two-tube cascade limiter for maximum noise rejection and three miniature type tubes are used in the FM front end, with a separate triode oscillator.

Temperature compensated ceramic condensers are used throughout the FM section to minimize frequency drift. The FM i.f. coils are wound on ceramic coil forms and are slug tuned.

The FM antenna input is designed for use with a 300 ohm line. No coil

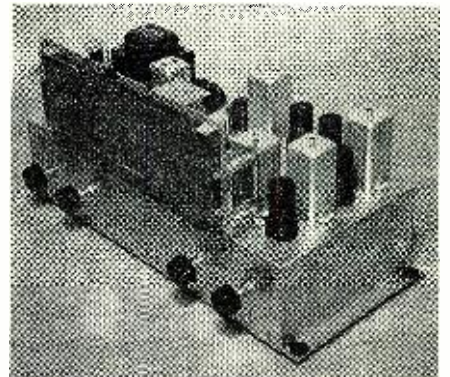

switching is utilized as separate r.f. and i.f. systems have been incorporated for FM and AM.

Further details on this tuner may be secured from Dongene Laborato-



ries, Inc., 85 Van Dam Street, New York 13, New York.

**NEW CAPEHART**

The addition of the Model 115N2 "Modern" to the Capehart line of home receivers has been announced by Farnsworth Television & Radio Corporation of Fort Wayne, Indiana.

Housed in a genuine mahogany cabinet of contemporary design, the new unit is available in either bisque or cordovan finishes.

The dual unit radio and amplifier chassis has 21 tubes plus two rectifier tubes, a tuning eye and a tuning eye amplifier. Broadcast bands are provided for AM, FM, and short-wave reception. The two speakers, a 15-inch for low frequency and a 5-inch for high frequency, are coaxially mounted.

The receiver employs the Capehart record changer which plays up to 32 selections, from 3 to 16 records, 10" and 12" intermixed, continuously and without reloading, turning them over in proper sequence or playing one side only as desired.

Further details on the Model 115N2 may be secured from Farnsworth Television & Radio Corporation, Fort Wayne, Indiana.

**PHILCO COMBINATION**

Philco Corporation has recently introduced a new radio-phonograph combination console which will retail in the moderate price class.

Featuring a powerful receiver with improved superheterodyne circuit, PM dynamic speaker for high undistorted sound output of both radio and rec-



ords, plus a quiet, smooth-action automatic record changer that plays up to 12 records, the new Model 1282 is housed in a cabinet of striped mahogany in a classic-modern design.

Prices and additional details on the Model 1282 will be supplied upon request to Philco Corporation, Philadelphia, Pa.

**TABLE COMBINATION**

Stromberg-Carlson has a new table model radio-phonograph unit in its 1948 line which includes several features usually associated with console receivers.

A three-gang condenser provides big set performance and selectivity, while the built-in loop antenna gives

**ALL YEAR ROUND it's SENCO for VALUES plus!**

**WE'VE GOT PLENTY OF TUBES!**

EVERY TUBE IN CARTON.		R.M.A. GUARANTEED	
Type	Each	Type	Each
1A5GT	59c	7Y4	44c
1U5	36	7X7	44
1V	45	7AF7	44
1L4	55	12A6	35
1T4	69	12A8GT	45
1S5	69	12AT6	50
2A5	65	12BA6	50
2A6	79	12BE6	50
2X2	79	12J5GT	49
3A4	69	12J7GT	45
3Q5GT	55	12K7GT	45
5U4G	50	12K8	65
5W4GT	40	12Q7GT	45
5Y3GT	40	12SA7GT	40
5Y3G	42	12S7	39
5Y4G	40	12SQ7GT	40
5X4G	40	12SK7GT	45
6A7	50	12SR7	39
6A8GT	49	12SJ7GT	55
6AC5	98	24A	49
6AC7	65	26	39
6AK5	74	27	42
6AG7/6AK7	89	41	40
6B7G	55	42	42
6C4	29	43	54
6C5GT	40	45	49
6C6	45	47	49
6C8G	37	56	49
6D6	45	57	45
6F6GT	45	58	45
6H6GT	45	39	39
6J5GT	45	39	39
6J7GT	42	38	45
6K6GT	45	39	35
6K7GT	49	39	35
6K7G	50	41	40
6L6G	79	69	99
6Q7GT	47	39	84/6Z4
6S7	59	48	85
6U7G	35	25	25L6GT
6V6GT	45	39	25Z6GT
6X5GT	49	39	35W4
6SA7GT	44	37	35Y4
6SJ7GT	44	37	35Z3
6SK7GT	49	39	35Z5GT
6SL7GT	49	47	35L6GT
6SN7GT	49	47	35/51
6SQ7GT	44	37	50L6GT
6SG7	44	39	117Z6GT
7B6	44	35	50B5
7B7	44	35	32L7GT
7F7	49	44	5Z3

- 1625 TRANSMITTING Beam Power. Amplifier. Same as 807 except 12.6 volt filament medium. 7 pin base. . . . . 14c ea.
- 955 ACORN TUBE. Detector Amplifier Oscillator Tube. . . . . 19c ea.
- OD3/VR150 — Voltage Regulator Tube. . . . . 49c ea.
- 836A/3B27 Half Wave High Rectifier. . . . . 99c ea.
- 829 Push Pull twin-unit. Beam power amplifier tube. . . . . \$1.49 ea.
- 4E27/HK257 BEAM POWER AMPLIFIER. Only \$1.95 each.

- VOLUME CONTROLS**
- 250,000 ohms tapped with switch, 3" shaft
  - 500,000 ohms tapped with switch, 3" shaft
  - 1 meg ohms tapped with switch, 3" shaft
  - 2 meg ohms tapped with switch, 3" shaft
- 44c each**

- STANDARD BRAND MOTOR AND AC CRYSTAL PICKUP**
- 60 cycles — 115 volts with turntable
- \$4.35 COMPLETE**
- SPEAKERS**
- 4" P.M. Speaker. . . . . \$1.19
  - 5" P.M. Speaker. . . . . 1.15
  - 6" P.M. Speaker. . . . . 1.55
  - 8" P.M. Speaker. . . . . ea. \$2.75
  - 12" P.M. Speaker. . . . . 5.49
  - 4x6 inch P.M. Speaker. . . . . 1.89

25% deposit on all orders, balance C.O.D., F.O.B. New York

**SENCO RADIO, Inc. 96A WARREN ST., N. Y. 7, N. Y. TELEPHONE BEEKMAN 3-6498**

**★ THE 14B AMPLIFIER**

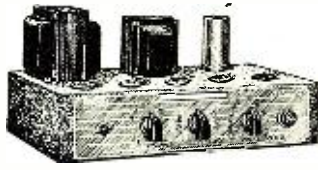

The 14B Amplifier has two input channels — 1 microphone and 1 phono. Output — 14 watts at less than 3% distortion. Peak watts — 25 watts. Five Tubes — 1 — 6SL7GT, 1 — 6SL7GT, 2 — 6V6GT and 1 — 5Y3GT Push-Pull output Class AB. Low Hum level — 67 DB below rated output. Separate control for each input allows 100% mixing. Separate Tone Control. Output impedance 4-8-15-250 and 500 ohms available at terminal strip. Microphone gain — 122 DB. Phonograph Gain — 82 DB. Frequency Response 50-12,000 cycles ± 2 DB. Operates from 50-60 cycles 105-125 volt source. Power consumption 80 watts.

**LESS TUBES. . . . . \$19.95**

**★ 5 TUBE AC SUPERHETERODYNE RADIO PHONO COMBINATION**

Featuring Angle Dial for Easy Tuning



This model is a five tube superheterodyne receiver, giving seven tube performance by the use of multi-purpose tubes, covering the frequency range of 540 to 1700 kilocycles Standard Broadcast and incorporating the features of beam power output, tone control on both radio and record player operation, super-sensitive, high efficiency, permanent-magnet dynamic speaker, automatic volume control, features producing improved performance.

loop aerial and numerous other features producing improved performance. **\$29.47 (Complete with tubes)**

**SALE! OAK RECORD CHANGER**

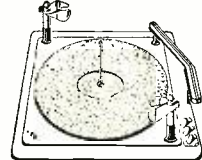

One of the most popular record changers in use today. Plays 12 — 10" or 10 — 12" records automatically — fast change cycle. Simple — foolproof — compact. 2-post — noiseless motor — feather weight — crystal pick up.

**\$15.95**

**Radio Technician and Announcers**

A practical 15-month course in First Class Radiotelephone Operation and Announcing is offered by Don Martin School of Radio Arts. Most stations these days require combination men. We specialize in this type of training and maintain a placement bureau for our graduates. Serving the industry for 10 years, the School of Radio Arts can train you. Write for our catalogue outlining the courses offered. Classes can be arranged so you can do part time work on the side.

APPROVED FOR VETERANS  
DON MARTIN SCHOOL OF RADIO ARTS  
1655 North Cherokee St. Hollywood 28, Calif.

**APPLIANCE SERVICEMEN**

Construct your signalling Iron Tester with PYRION'S thermo-electric relay, which "sounds off" when proper adjustment temperature reached. Also prevents iron overheating if forgotten! Automatic. Absolutely no attention required. Price \$6.25. Other parts available anywhere for less than \$2.00. Information on request.  
Pyrion Controls, 2215 Moore Ave., Anneton, Ala.

**IRPC**

"Try Interstate in '48"  
**THIS MONTH'S SPECIALS**  
★ ★ ★ ★ ★  
**AEROVOX — CONDENSER**  
8x8x8 MFD — 450 W.V.D.C.  
Can Type — Inverted Screw Mounting

Dealers regular net — \$2.50 each  
**SPECIAL PRICE** While they last 67c  
Each. 10 for \$6.15.

Replacement Loop Antenna — 5 1/4 x 8 inch oval. Excellent Workmanship — Minimum order — 10 for \$1.59

**Send for our latest parts bulletin**

**INTERSTATE RADIO & PARTS CO.**  
6357 So. Ashland Ave. Chicago 36, Ill.  
Phone GROvehill 7588

Get a new  
**ELECTRIC SOLDERING IRON**  
**FREE**  
... and assemble your own  
**MAGI-KLIPS**  
RADIO & ELECTRONIC EXPERIMENTER'S KIT

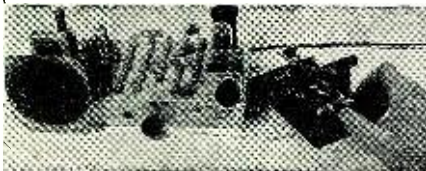

This is the same MAGI-KLIPS Kit—complete with all parts—that we sell ready assembled for \$29.75.

In knocked-down form with full instructions for assembly, it is now available at the new low price—

**\$19.75**

... complete with a new Electric Soldering Iron—the ideal iron for wiring your unassembled MAGI-KLIPS Kit.

Remember, you build 18 different experiments with your MAGI-KLIPS Kit. You actually teach yourself radio and electronics and have a lot of fun at the same time.

**RADIO RECEIVER, HOME BROADCASTER, PHOTO-ELECTRIC RELAY, CODE PRACTICE OSCILLATOR, SIGNAL TRACER, REMOTE CONTROL RELAY, Phonograph Transmitter, Intercommunication Amplifier, Code Transmitter, Radio Frequency Oscillator, Telephone Line Amplifier, Electronic Switch, Phonograph Amplifier, Temperature Control Relay, Contact Detector, Electronic Metronome, Interval Timer (one-shot), Interval Timer (repeating).**

**PHONO-AMPLIFIER KIT.** A real bargain. Uses 35Z5 and 50L6. Complete diagram and instructions for assembling. Also good for call system.

Kit Form.....\$1.85  
Wired and Tested. 2.45  
Tubes for above... 1.65

**CODE PRACTICE OSCILLATOR KIT**

Learn the code! Get your ham ticket! Uses 50L6, 35Z5, 4" PM speaker. Tone and volume controls. Ideal for classroom instruction. Complete diagram and assembly instructions.

Kit Form.....\$2.85  
Speaker and Transformer for above..... 1.95

Tubes for above..... 1.65  
Wired and Tested, with Tubes and Speaker 6.00

Terms: 20% deposit, balance C.O.D.  
Send for your copy of **FREE** booklet, "ELECTRONICS MADE EASY"

**DEER & TAYLOR COMPANY**  
Dept. N 1342 Milvia St. Berkeley 9, Calif.

**PRICES SLASHED  
IN QUANTITY LOTS**

All New, Nationally Known Brands

**CONDENSERS**—Metal encased, oil impregnated tubular, 600 VDC, 1 mfd  
\$8.49 per 100 \$69.00 per 1000

Filter Condensers—1500 VDC 1. mfd  
\$39.00 per 100 \$295.00 per 1000

**PILOT LIGHT ASSEMBLY**—high grade movable lens and shutter  
\$11.95 per 100 \$89.00 per 1000

**CRYSTALS**—IN21, high frequency plug-in type  
\$2.50 for 10 \$19.00 per 100

**RESISTORS**—Wire wound cement coated 10-Watt, 10,000 Ohm  
\$8.49 per 100 \$69.00 per 1000

**JACKS**—Famous make, JK34A short midget phone type  
\$8.95 per 100 \$79.00 per 1000 shipping extra

Write for circular—All stock must go

**ERIE SUPPLY CO.**

P. O. Box 907 Rochester 3, N. Y.

improved reception. A 5¼" permanent magnet Alnico V speaker combined with a cabinet of correct acoustical design assures excellent tone and a minimum of unwanted sounds. The receiver has three controls in-



cluding the on-off volume; phono bass, phono treble, radio treble and radio bass; and a station selector switch.

The cabinet is of hand-rubbed striped walnut veneer with an etched aluminum escutcheon grille of functional design. The over-all size is 12½" x 15¾" x 16½" inches.

The automatic record changer plays both 10 and 12 inch records intermixed and stops automatically when the last record has been played.

Stromberg-Carlson, Rochester, New York, will supply further details on the Model 1101-HPW.

**DELCO AUTO RADIO**

The outstanding feature of the new Delco auto radio is the use of an ingenious "Electro-Tuner Control" which is said to eliminate the need for push-button tuning and dial manipulation.

With the new electromechanical control, mounted on the steering column, the driver need not take his eye from the road to tune in any station desired. A touch of the finger will "trap" and tune in stations, one by one, automatically.

Designated the Delco Model R-705, this set combines sensitivity, tone, and

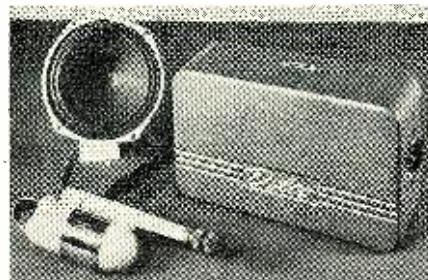

power output comparable to a home receiver, according to the manufacturers. There are 8 tubes in addition to a synchronous vibrator, a push-pull audio system, separate 7" PM speaker, and tone and sensitivity controls.

This unit can be used in all makes of cars and trucks and can be transferred from one vehicle to another with minimum of trouble.

The new receiver is being marketed by United Motors Service.

MUSKEGON, MICHIGAN, U.S.A.

**W 00ZND**

100 W. GILES RD. "DOC" DR. & W. HODGE

**RADIO PHOTO  
Q.S.O. CARD**  
from your favorite negative

**25 for \$1.00**  
postage free

Cards are glossy finished, made from your best negative. See card before you buy

Free Sample . . . send us negative with 3c return postage. We will make sample card from your negative. Negative returned with sample. No obligation whatsoever.

**VIEWCARDS**  
252 W. DELANO  
MUSKEGON HEIGHTS, MICHIGAN

**EE-8 B  
ARMY SIGNAL CORPS  
FIELD TELEPHONES**

Portable field unit, fully equipped with ringer, coils, condenser, generator and crank, can be used anywhere. Various Manufactures. Regular \$28.50 value. **OUR PRICE** (without carrying case) with handset \$10.50 each. **UNUSED. IMMEDIATE DELIVERY.**

**Maspeth Telephone & Radio Corporation**  
427 Flatbush Ave. Extension  
Brooklyn 1, N. Y.  
Telephone ULster 7-0500

**LEARN RADIO!**

IN ONLY 10 MONTHS  
**PREPARE FOR A GOOD JOB!**  
COMMERCIAL OPERATOR (CODE)  
BROADCAST ENGINEER  
RADIO SERVICEMAN

Television Servicing—15 Months

Veterans get \$130.00 Equipment  
SEND FOR FREE LITERATURE  
**BALTIMORE TECHNICAL INSTITUTE**  
1425 EUTAW PL., DEPT. R, BALTO. 17, MD.

**TELEVISION COIL KIT**  
**\$235.00**  
Complete

**LOOK AT THESE FEATURES!**

- Video IF Bandwidth of 4.25 MC that can operate ANY size picture tube with maximum resolution.
- Five stages Video IF permeability tuned with sound and adjacent channel rejection traps in shielded cans.
- 6 Channel RF Tuner, permeability tuned mounted on switch assembly plate.
- FM Sound Discriminator for TRUE FM.
- Detailed Construction Manual & Parts List with every kit, for 20 Tube, 7 In. Television Set.

Order Direct or Thru Local Dealer—Terms Shipped Parcel Post prepaid with order, or P.P. Collect on receipt of 25% deposit, balance C.O.D.

**RAY-ELECTRON CO.**  
706 Tenth Avenue Belmar, N. J.

**1" OSCILLOSCOPE**

Anyone can build the world's smallest oscilloscope for less than \$15.

- Measures 3" x 4" x 5"
- Has focus, intensity, X and Y input axis controls
- Internal sweep
- Simple, easy to understand plans and instructions \$1.00 pp.

**PLASTICS & ELECTRONICS COMPANY**  
272 Northland Ave. Buffalo 8, N. Y.

**The MiniTran**  
(Continued from page 65)

other advantage of the Pierce oscillator is that neutralization is not required in the 6AQ5.

On 40 meters the very first station called, which was located in Tennessee, was worked from Connecticut. The following week seven states were contacted on 80 and 40. Reports as high as RST589X were received up to 300 miles away.

For the one evening's time and effort spent in constructing the "Mini-Tran" it has proven very worthwhile and should fill the bill for an emergency transmitter, and also a portable for next year's vacation.

-30-

**PR SMA HANDLES COMPLAINTS**

**A** FORWARD step in the self-regulation of the service business is being taken by the Philadelphia Radio Service Men's Association.

All complaints received by PRSMA, radio stations, or the Better Business Bureau are handled by a complaint committee appointed by the Board of Governors of the association.

The investigating committee calls on the complaining customer and examines the radio equipment in question. They also examine the bill if one was given the customer and proceed to contact the serviceman or company which performed the work. If the committee finds the serviceman is at fault he is given a reasonable time in which to correct the trouble. If he does not make the correction within the allotted time, the equipment is taken to the shop of a member for proper repairs and then returned to the customer. The original serviceman is then billed for this work. If he does not pay the bill and give complete assurance of mending his ways he is dropped from PRSMA membership and notice of this action is published in the association's house organ "PR SMA News."

Whenever a complaint is received through a broadcast station, the Better Business Bureau, or any other similar organization, they are given a full report of the committee investigation as well as the action taken.

-30-



"Junior didn't like the way 'Gang Busters' turned out last night!"

	<i>More Economical</i>		<i>Cannot Tangle</i>	
<i>Longer Playing Time</i>	<b>Now Available! 8 HOURS OF CONTINUOUS PLAY ON THE MAGNETAPE* RECORDER!</b>		<i>30 Second Rewind</i>	
	<p>Now — record and play back on this amazing instrument any sound that can be heard, and many that cannot — from a concert hall symphony, to the beat of your heart. Simple interchangeable capstans provide a choice of three tape speeds for high fidelity, medium fidelity, or up to 8 hour voice recording. The ideal recorder and playback unit for home, office, industry, and broadcast station.</p> <p>Write today for our free illustrated technical catalog featuring our complete series of Magnetape Recorders, and accessory equipment. Send 25¢ in stamps or coin for our new booklet, "Elements of Magnetic Tape Recording — and 999 Applications."</p> <p>* Trademark</p>			
<i>Quieter Operation</i>				
	<i>Improved Response Range</i>		<i>Complete Automatic Erasing</i>	
<b>AMPLIFIER CORP. of AMERICA</b>				

398-2 Broadway, New York 13, N. Y.

**ORDER NOW**

- 300 ohm Amphenol ..... per C \$2.91
- 150 ohm Amphenol ..... per C \$2.62
- 75 ohm Amphenol (small) ... per C \$2.01
- 75 ohm Amphenol (heavy duty) ..... per C \$7.20
- Kilowatt 75 Ohm Amphenol Twin Lead, per 100 ft. .... \$7.20
- SCR 522 (Brand New) ..... \$18.50
- SCR 522 Dynamotors PE94C New ..... \$3.95
- SCR 522 Receiver Conversion Kit and Instructions (Less Dial) ..... \$3.50
- ACN Dial For Above ..... \$3.00
- APS 13 (Tail Warning Radar) ..... \$9.95
- 3 Gang 410 Mmfd. Per Sect. Cond. Excellent quality ..... \$2.95
- Four Gang—150 Mmfd Variable... .95
- Selsyn Indicators I-S2A ..... \$2.95
- Two for ..... \$5.49
- 4 Mfd. @ 600V—Oil—Round Can. .69
- 304 TL (New in Cartons) ..... .90
- PL 55A Phone Plugs ..... .15
- 375E Tuning Units ..... \$1.95
- 807—New—Boxed ..... \$1.49
- 2C40 Lighthouse Tube ..... \$0.95
- 2" PM Speaker (Bakelite Cased) Used in Walkie Talkie ..... \$1.95
- LM 13 Portable frequency meter boxes in canvas case (New) ..... \$1.25
- SIREN, Commercial type hand operated, very loud noise, gov't cost \$21.00. Spec. .... \$4.95
- TRANSMITTING CONDENSER, 2 mfd. @ 2500 W. V. each ..... \$2.95
- Two for ..... \$5.00

Send for Our Special Bulletin of Government Surplus Items

**DOW RADIO**

1759 E. COLORADO ST., PASADENA 4, CALIF.

Pasadena Phone—SYcamore 3-1196  
Los Angeles Phone—RYan 16683

*Columbia*  
**HOOKUP WIRE**

**Specials For March**

**Push-Back Wire**

22 ga. solid push-back wire with cotton braid and waxed cotton braid. Available in a variety of colors.  
1000 foot spool ..... \$3.50  
500 foot spool ..... 1.95

**Plastic Insulated Wire**

20 ga. flexible stranded wire with black vinylite insulation, oil and waterproof. Stock up at this low price!

500 foot coil ..... \$2.00  
Same as above but with lacquered cotton braid overall. Various colors.  
500 foot coil ..... \$2.90

**Braided Shielded Wire**

20 ga. stranded wire with tinned copper shield and lacquered cotton braid overall. White limited quantity lasts.  
250 foot coil ..... \$3.25

We carry in stock for immediate delivery many types of wire and cable in gauges of from 28 to 2, in addition to various types of multi conductor cable for many uses. We also manufacture cord sets and cables to specifications. Send us your inquiries for prompt attention.

OUR NEW CATALOG IS NOW AVAILABLE FOR DISTRIBUTION

Write for your copy today!

**COLUMBIA WIRE & SUPPLY CO.**  
5734 ELSTON AVE.  
CHICAGO 30, ILLINOIS



## SEND FOR THESE SPECIALS

ALL NEW MERCHANDISE

### CONDENSERS

203 5 mfd., 350 V. DC Electrolytics.....	\$0.29
239 .1 mfd., 1500 V. DC Bathsub.....	.15
314 15 mfd., 35 V. DC Electrolytics.....	.15
314X 3 mfd., 450 V. DC Electrolytics.....	.19
327 3—.1 mfd., 600 V. Bathsub.....	.09
343 (2) .05 mfd., 600 V. Bathsub.....	.09
1521 10 mfd., 1,000 V. oil-filled.....	1.40
2181 150 mfd., 50 V. Electrolytics.....	.40
10 mfd., 600 V. DC oil-filled.....	.95
2 mfd., 2500 V. DC oil-filled.....	2.20
25-25 mfd., Dual 6,000 V. DC 12,000 V DC oil-filled.....	3.75
2/600 V.....	.47
5/5-600 V.....	1.20
3.5/5-1000 V.....	1.05

### RECTIFIERS

12N2 6.5 V. AC, 2.2 V. DC @ 3.0 amp. Full- wave center tap.....	\$1.20
2855 Selenium 180 V., 400 ma. G.E. Full-wave bridge.....	6.90
3048 Selenium 54 V. AC 1.6 amp. DC. Full- wave bridge, G.E.....	4.40
7176 Sulphide 3.5 V. AC, 1.8 V. DC. 1 amp. Full wave bridge.....	.90
7374 Selenium, 36 V. AC, 2 amp. DC. Half wave.....	.75
7966 Selenium No. B7DBN1CM, 154 V. AC, 6 amp. DC. Full-wave bridge.....	6.85

### RESISTORS

RS20 10,000 ohm, 20 watt, wire wound.....	\$0.22
RS184 450 ohm, 5 watt, wire wound.....	.12
7404 100,000 ohm, 1 watt.....	10 for .45
2550 50 ohm, 25 watt wirewound with slider.....	.12
5219 Potentiometer, dual 1-meg.....	.60

### TRANSFORMERS

6AN2 Double carbon button, microphone input 18 ohms to 6,000 ohms.....	\$0.70
44 80-110-220 V. 50-1,600 cy. 422 V., 15 mil. CT and 6.3 V. @ 3 amp.....	.95
82 110-24 V., 1 amp., uncased.....	1.60
Transtat No. TH 2 1/2 B, 115/230 V., 50/60 cycle input, 0-260 V. @ 2 1/4 amp. output.....	21.50

### TUBES

All tubes new, boxed, and of standard manufacture.

6AC6 Miniature duodiode Hi-Mu triode.....	\$0.70
6C4 Power triode.....	.55
931A Photo multiplier.....	1.45
955 Acorn.....	.45
2D21 Miniature thyatron.....	.70
2C40 Lighthouse triode.....	2.40
750 TL Transmitting triode.....	27.00
MK-9 Microphone button, universal, carbon.....	.25
5M7 Sockets, molded mica, 7-prong miniature.....	.12
6230 Thermo switch, Fenwall —50 +400° F. 110 V. AC, 25 amp.....	1.60

### MISCELLANEOUS

Telescoping Antennae AN-75B 1'-3" to 7'-0" solid brass—clamp on.....	\$1.25
---	--------

Add approximately 20% to net weights for estimated shipping weights. Terms are 30% with order, balance C.O.D. All prices are f.o.b.

Write for additional detailed information on any of the above items and for special quantity discounts.

1527 E.  
Seventh  
Street

**EPCO**

Los Angeles  
21,  
California



## TRAIN FOR RADIO

IN MIAMI

Prepare for a radio career in one of America's most beautiful cities—busy, romantic Miami—at the crossroads of two continents.

Embry-Riddle's internationally known Government-approved School of Aviation offers a full year Radio Course, designed to qualify you for important jobs in the Radio Industry. Approved training under G.I. Bill. Immediate enrollment.

FOR FREE INFORMATION  
MAIL THIS COUPON—TODAY!

Dean of Enrollments—Dept. 55-A  
EMBRY-RIDDLE SCHOOL OF AVIATION  
Miami 30, Florida

Name \_\_\_\_\_ Age \_\_\_\_\_

Address \_\_\_\_\_

City \_\_\_\_\_ State \_\_\_\_\_

Check One  Veteran  Non-Veteran

# A Compact Bias Supply

By J. F. CLEMENS, W9ERN

*Unit will provide a 65 volt bias with a maximum grid current drain of 15 ma.*

THERE are several ways of obtaining bias for a "class C" amplifier. In transmitters using small r.f. beam pentodes such as the 807, the desired compactness or economy usually necessitates a compact bias source. Because of the ease with which cathode bias may be employed, this method is often used in combination with a grid leak arrangement. The use of cathode bias has, however, several disadvantages. For one thing, if we use the 807 as an example, the key-up plate input must be limited to the safe rating for the tube, or 30 watts and at 600 plate volts. The plate current must, therefore, be about 50 ma. Assuming the screen current is negligible, and further assuming that about -30 volts bias is required for these conditions, the value of cathode resistance is 600 ohms. Under key-down conditions the bias may become -60 volts (at  $I_b = 100$  ma.), and we have decreased our plate supply voltage by 60 volts. This operating bias may be too high to obtain maximum output since some resistance in the grid circuit is often demanded by other circuit considerations (i.e., perhaps to obtain broad tuning of the driver stage). A further disadvantage of cathode bias is the fact that the tube is in a condition of high sensitivity and there is often difficulty in securing freedom from parasitics. Also, the tube is likely to overheat at 30 watts dissipation (which occurs when the key is up) unless well-ventilated.

Fig. 2.

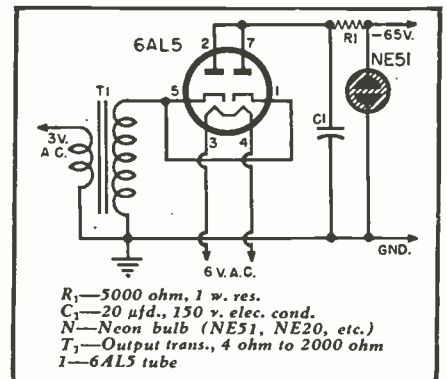
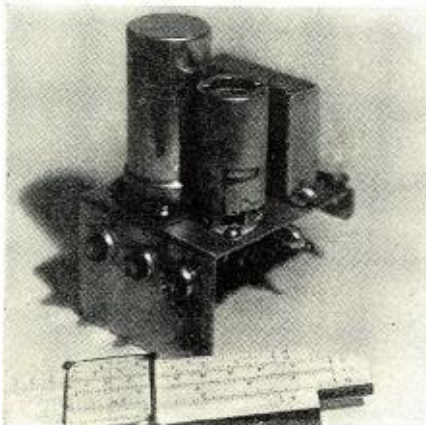

Fig. 1.

To circumvent these difficulties, fixed bias may be employed. Battery bias is ideal in all respects except for the size, weight, and cost of the batteries. Since it is usually undesirable to use a separate full-sized bias supply, a side rectifier such as a 2X2/879 is often operated from the high voltage transformer. Here, the difficulty is in obtaining a low enough bias voltage, as it is uneconomical to use a large resistor to drop the bias from 600 volts or so to the proper operating value. Also, a separate winding on the filament transformer is usually demanded for the 2X2.

A compact power supply to fit the requirements of a typical 807 transmitter, formerly operated with cathode bias, is shown in Figs. 2 and 3. The small size ( $3\frac{1}{2} \times 2\frac{1}{2} \times 2$ ) facilitates tucking the unit under the chassis of an existing transmitter. The compact size is obtained by using an audio output transformer, originally intended to match a 50L6 plate to 4 ohm voice coil, and a new miniature rectifier, the 6AL5. (See Fig. 1.)

Most of the small transformers of this type are designed to handle about 1 watt of audio @ 400 cycles. Ordinarily, it might be expected that this transformer would not be efficient at 60 cycles. It was reasoned, however, that the lack of the 50 ma. d.c. plate current in the primary (or secondary in this application) would enhance the efficiency to within reasonable limits. A test of the unit has shown it to be capable of doing the job without appreciable heating.



Fig. 3.

The voice coil of the transformer is operated at 3 volts input from the center tap to one side of the 6.3 volt filament supply. Since the turns ratio of the transformer is in the neighborhood of 20:1, the secondary delivers about 60 volts r.m.s. The condenser input circuit produces a d.c. voltage equal to the peak value of this wave, or about 85 volts.

A small resistorless neon bulb, mounted underneath the chassis, is used as a voltage regulator. Although the current through the neon bulb is somewhat less than 3 ma., a very light load in the power supply, the internal resistance of the bias supply is in the neighborhood of 200 ohms. Therefore, grid current of the "class C" stage will produce little fluctuation in the bias voltage.

The output voltage of the supply is approximately 65 volts although individual neon bulbs may vary from this value plus or minus 5 volts.

The current drain from the 3 volt source is approximately .4 amp.

*Editor's Note: The current rating for a 6AL5 is 9 ma. per plate or a total of 18 ma. As there is a drain of 3 ma. in the neon regulator, the total grid current that can be accommodated is 15 ma. In using this type of bias supply care should be taken to use only those tubes requiring not more than 15 ma. grid drive.*

-30-



"And I still say that your new checker shouldn't take it upon itself to toss out a tube!"

# HERE THEY ARE - BIG SPRING VALUES



**DeWald B-512 "Radio-Clock"**

- Radio, Clock, and Musical Alarm
- Walnut, Ivory, Maple, Maroon
- Superhet, 4 tubes & rectifier.
- AC operation
- Hi-Ratio Vernier tuning
- Alnico No. 5 dynamic speaker
- Built-in Loop antenna
- Size 10" x 6" x 6 1/2"

LIST \$39.95.....NET \$28.95



**DeWald B-504 "Personal"**

- AC/DC and Battery Operation
- Superheterodyne circuit
- 4 tubes & Selenium rectifier
- Instantaneous operation
- P.M. Alnico 5" speaker
- Size 4" x 8 1/2" x 7 1/4"

LIST \$27.95.....NET \$20.45

Also available Battery Operated  
LIST \$19.95.....NET \$16.48

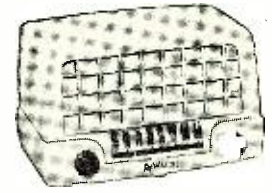

**DeWald B-506 "Handi Set"**

- Excellent performing Superhet
- Walnut, Ivory, Maple and Maroon
- Four tubes plus rectifier
- Broadcast & extended Police
- AC/DC operation
- #5 Alnico P.M. Speaker
- Size 9 1/2" x 5 1/2" x 5 1/2"

LIST \$22.95.....NET \$15.25



**DeWald B-612 "Wireless F. M. Tuner"**

- Simply plug in and play
- No wiring to radio necessary
- AC/DC operation
- Five tube & rectifier Superhet
- Balanced F.M. Detector Circuit
- Hand-rubbed walnut cabinet
- Size 11" x 6" x 7 1/4"

LIST \$39.95.....NET \$24.95

**It's HERE ...**  
**DeWald's BT100**  
**DIRECT-VIEW 10"**  
**TELEVISION**  
**RECEIVER**  
*Prices on Application*

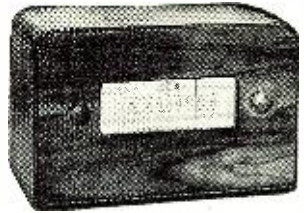

**EDWARDS F. M. "Fidelotuner"**

- Connects to any receiver
- Three IF stages
- Permeability tuned IF
- Full F-M coverage 88 to 108 Mc
- VHF insulation throughout
- Local reception antenna included
- Size 11" x 6" x 6 3/4"

LIST \$38.50.....NET \$31.50

### PARTS SPECIALS

- 4 Inch Permofoxx Speakers, Heavy Alnico 5 Magnet..... **\$1.05**
- 1/4 Meg, 1/2 Meg, 1 Meg Standard Brand Volume Controls, Tapped, with Switch, 2 1/2 Inch Shaft..... **.59** each
- Nat'l Adv. 20-30 MFD at 150 Volts..... **.52** each
- Nat'l Adv. 30-50 MFD Condenser at 150 Volts..... **.56** each
- Nat'l Adv. 40-40 MFD at 150 Volts..... **.56** each
- Nat'l Adv. 50-50 at 150 Volts Plus 20 at 25 Volts..... **.72** each
- Nat'l Adv. .01, .02, .05 at 600WV... **5.75/100**
- Male AC Plugs, UL Approved, Bakelite Cap..... **4.25/100**
- Male AC Plugs, UL Approved, Live Rubber, Long Shank..... **6.75/100**
- Toggle Switches, Rotary or Throw Type **.14** each

### TUBE SPECIALS

- 5Y3GT..... **\$0.33** each
- 35W4..... **.40** each
- 5Y4G..... **.44** each
- 6X5GT, 27, 25Z5..... **.47** each
- 1C6, 1H4G, 32, 34, 6F6GT, 6H6GT, 12AT6, 12J7GT, 12S17GT, 26, 36L6GT, 43, 45, 77, 84/8Z4, 6K7GT, 12Q7, 6SQ7GT, 12SQ7GT, 50L6GT... **.53** each
- 1A7GT, 1R5, 1U4, 3S4, 6ASGT, 1T4, 1S5, 6J7G, 7A7, 7B6, 7C6, 7C7, 7Q7, 12ASGT, 12BA6, 12BE6, 50B5, 71A, XX1, 1V, 6A7, 6C6..... **.63** each
- 1U5, 6G6G, 35Y4, 11Z6..... **.77** each
- 6L6G, 7X7, 14X7..... **.92** each

**WE HAVE THE NEW 1948 TEMPLE AND REGAL LINES—Write for CATALOG**

When ordering include sufficient amount for postage, otherwise we will ship Railway Express collect.

Write for Dealer Discount Schedules!

## WARREN DISTRIBUTORS

3145 Washington St. Jamaica Plain 30, Mass.

### MOTOR GENERATORS

Brand New War Surplus Machines built by Allis Chalmers Co. to U. S. Navy Specifications.  
Input: 115 V. D.C. at 14 amps., 3600 rpm. Output: 120 V. A.C., 60 CY, 1 ph. at 10.4 amps., 1000 Watts continuous duty. Ball bearings. Splashproof. Fully enclosed. Centrifugal starter. Frequency adjustable to load. Price \$87.50. Same machine but for 230 V. D.C. input. Price \$125.00. Spare parts kit with extra brushes, brush-holders, field coils, bearings, etc., for either machine, \$29.50.  
**All prices FOB Tuckahoe, New York**  
**ELECTRONICRAFT, INC.**  
5 Waverly Place, Tuckahoe 7, New York



### D61B CONSTANT VELOCITY FREQUENCY RECORD

Here's an indispensable guide for fast, accurate, direct checking of phono pick-ups and indirect checking of recording heads, loud speakers, p. a. equipment, etc. 12", double-faced Vinylite record, 78 RPM—recorded in 3 sections, 50-10,000 cps, 400 cps, 1,000 cps. Lists \$3.50 ea.—see your distributor or write—  
**UNIVERSAL MICROPHONE CO.**  
INGLEWOOD, CALIFORNIA.

### LEARN RADIO ELECTRONICS

APPROVED FOR VETERANS  
TELEVISION—FM—RECEIVERS—  
TRANSMITTERS—LORAN—RADAR

### Become a COMMERCIAL OPERATOR

Pre-FCC exam. tests — SOUND MOTION PICTURES — AUDIO VISUAL DEMONSTRATIONS—LABORATORY CONSTRUCTION

### ELECTRONIC TECHNICAL INSTITUTE

771 Venice Blvd. Los Angeles 15, Calif.  
Phone Richmond 9573

**NOW!**

You can get the math you need for solving everyday radio and electrical problems



Radiomen and electricians know that the language and the habit of mathematics are essential for real progress in their chosen field. They know mathematics is a tool that they are helpless without.

NOW out of the U.S. Navy Radio Materiel School at Naval Research Laboratory comes a complete home-study book that is so thorough and so detailed that any reader "who can perform arithmetical computations rapidly and accurately is capable of mastering the principles laid down in this text."

**MATHEMATICS for ELECTRICIANS and RADIOMEN**

By N. M. COOKE, Chief Radio Electrician, U. S. Navy  
604 pages 6x9, \$4.50

This book teaches you mathematics from elementary algebra through quadratic equations, logarithms, trigonometry, plane vectors and elementary vector algebra with direct applications to electrical and radio problems. It teaches you how to apply this mathematical knowledge in the solution of radio and circuit problems. In other words, it gives you the grasp of mathematics you need and then shows you how to use your knowledge.

Based on over 8 years' experience teaching mathematics to U.S. Navy electricians and radio operators, the book gives you 600 illustrative problems worked out in detail and over 3000 practice problems with answers so you can check your work.

**10 DAYS' FREE EXAMINATION**

McGraw-Hill Book Co., Inc., 330 W. 42nd St., NYC 18

Send me Cooke's Mathematics for Electricians and Radiomen for 10 days' examination on approval. In 10 days I will send you \$4.50 plus few cents postage, or return book postpaid. (We pay postage if remittance accompanies order.)

Name .....  
Address .....  
City and State .....  
Position .....  
Company ..... RN-3-48

**MERIT BRINGS YOU VALUES!**

**IT'S SENSATIONAL!**

**HOTTEST ITEM OUT!** Make your SCR-522 Receiver operate on 144 to 148 Mc with ONE DIAL control, in less than 1 hour! Parts and instructions... **\$3.00**  
(Please include 8c postage)

**BRAND NEW SCR-522**

Latest Model. Consists of BC-624-C Receiver and BC-625-AM transmitter, complete with tubes... **\$29.95**

ARC/5 2-3 Mc Xmtr. .... \$9.00  
BC-454 3-6 Mc Revr. .... 5.50  
BC-455 6-9 Mc Revr. .... 5.50

**WIRE SPECIAL**

7-Conductor No. 14 stranded wire, rubber-covered, color-coded. Per 100 ft. .... **\$12.00**

**TRANSMITTING TUBE BARGAINS!**

807..... \$1.00 8025A 500 Mc Triode.. \$3.95  
805..... 2.95 35TG..... 2.95  
810..... 5.95 866A..... .75

(Minimum Tube Order \$5. All Tubes shipped Express)

SCR-522. Clean condition, with tubes..... **\$17.50**

**MERIT RADIO SUPPLY CO.**  
471 Merrick Road Lynbrook, N.Y.

**TO COMBAT N. Y. LICENSING**

**T**HE newly organized Radio Servicemen's Association of New York has been formed for the purpose of establishing the professional standing of radio service technicians through ethical organization thus combating the proposals of City Councilman Isaacs for the licensing of radio technicians in New York City. The new group recently elected officers and established committees for the organization's activities.

Max Leibowitz of Mecca Radio and Electric Shop was named head of the new group. Norman Jacobson, Mid-City Radio and Phonograph Co., Inc., is serving as Vice-President. Jack Edel, Modern Radio Service, is the new Treasurer and Recording Secretary, while Harry Anis, of Harry's Radio Service, is the Corresponding Secretary. The attorney for the group is Gerald Nierenberg of Long Island City.

The program for the group includes the establishment of an investigation committee which will look into complaints of customers and evaluate them on a fair basis. Educational activities will include training in new radio maintenance techniques to keep members of the organization up-to-date in the field.

Emblems are being issued to member servicemen which they will display prominently in the windows of their shops. The public will be invited to look for the emblem of the association.

The members of the organization have agreed to a code of ethics which will correct many of the alleged abuses that have been attributed to the radio serviceman.

-30-

**Interference Traps**

(Continued from page 71)

The technique involved in employing these *wave traps* is that the trap circuit is *not* inserted in the antenna lead-in in the same manner as is the case with conventional traps. Note that the trap circuit is tightly coupled to the lead-in by virtue of the primary portion of each trap circuit which is actually connected in series with the transmission line. This broadens the band of effectiveness.

-30-

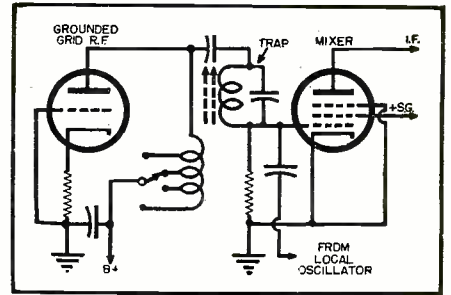

Fig. 8. Mixer grid input trap.

If the transmission line is a coaxial element then the two or more circuits can be coupled in series. (Fig. 2C). If the line is parallel, to a balanced input, then the two traps can be so wired that one circuit is in each leg and thus will not materially unbalance the antenna circuit. A considerably unbalanced condition would result in standing waves which give vertical light and dark areas that crowd up exponentially on the left hand side of the image. A detailed explanation for this phenomenon escapes this writer but it was eliminated when the line was balanced, so that the only reason that could be ascribed was the presence of standing waves in the unbalanced transmission system. The balanced line connection is shown in Fig. 2B.

Another method of connecting a trap circuit is shown in Fig. 8. This is inserted in the grid coupling system between the r.f. stage and mixer. In order to do this some means must be provided to get at the tuning element (an iron core or variable condenser). One such arrangement is possible with *National* type AR5 coils. Notice that a ground on the tuned circuit is to be avoided. If the range covered by these coils is not correct, wind your own on the type XR. They can be conveniently mounted on the chassis and will have an adjustment from the chassis top.

Employing any of the traps requires only the proper connection in the circuit and a careful study of the image while adjusting for minimum interference pattern.

Table 2.

CHANNEL (mc.)	IMAGE RANGE		SERVICES	
	A	B	A	B
54-60	40-52 mc.	27-39 mc.	Low-band FM, Amateur	Police, Amateur, Marine
60-66	46-58 mc.	33-45 mc.	Low-band FM, Amateur, TV Channel 2	Police, Low-band FM
66-72	52-64 mc.	39-51 mc.	TV Channels 2 and 3	Police, Low-band FM, Amateur
76-82	62-74 mc.	49-61 mc.	TV Channels 2, 3, and 4	Low-band FM, TV, Amateur
82-88	68-80 mc.	55-67 mc.	TV Channels 4 and 5	TV Channels 2 and 3

## Spot Radio News

(Continued from page 20)

### IT STAYS STUCK!

WITH...  
**MULTI-PURPOSE AMBROID**



If you want permanent results from an adhesive, you can't equal multi-purpose Ambroid liquid cement — for home workshop, household or factory. A quality leader for 37 years, ready-to-use Ambroid is waterproof, transparent, quick-drying, extra strong. Flexible, heat-and corrosion-resistant. For assembling, repairing or mending jobs, keep Ambroid handy. At your dealer's, or send 25¢ for big 2-oz. tube post-paid. Money back guarantee.

Also 50¢ 4-oz. tube. Pts., qts., gals., for industrial use.



310 Franklin St., Boston 10, Mass.



# STEADY PROFITS

**YOUR OWN BUSINESS**

with **CORADIO**

THE COIN OPERATED RADIO

Place these specially built radios that play 1 or 2 hours for 25c in the thousands of available hotel rooms, tourists courts, etc. They yield immediate profits and steady income. Install Coradio, the finest made. Limited capital required. Send for further information. Write today.

**CORADIO** Coin Operated Radio  
Dept. R. N. 108 W. 31 Street, New York 1, N. Y.

*Servicing Radio & Appliances*

## SERVICE DEALERS

FROM COAST TO COAST

# 4 JOB CARDS

ASK FOR SAMPLES **RADIO PRESS** MORGANTOWN WEST VIRGINIA

## RADIO COURSES

Preparatory, Broadcast, Marine Operating, Servicing, Aeronautical, Television, Frequency Modulation, Radar.

Classes now forming for June 1st. Entrance Exam. May 17th.

Veteran Training. Literature.

### COMMERCIAL RADIO INSTITUTE

(Founded 1920) Baltimore 1, Md.  
38 W. Biddle St.

aspect of the industry—servicing. The day when you had to beg a repairman on bended knees to do anything for you should disappear soonest, in RMA's view, forcefully voiced recently by Max F. Balcom, RMA president. Mr. Balcom believes that it is "an encouraging sign that the radio servicing trade is vitally interested in doing something about" servicing, "a problem that has bothered the entire industry. While the radio service trade often has been the victim of unjust attacks and exaggerated complaints," he says, "we must admit that abuses do exist in varying degrees in a number of communities." The abuses are, generally, "incompetent workmanship, unnecessary replacement of receiver parts still in good working order, and charging for work not done." "These abuses," he adds, "are confined to a small minority of radio technicians and servicing shops, but just as a rotten apple may make a whole barrel of good apples suspect, so one unscrupulous shop can impair public confidence in the entire profession." Abuses have fallen off since the end of the war, he believes, but it is still necessary "that the industry clean house before some governmental or municipal agencies try to do it for us with far less satisfactory results." That the problem can be solved by the technicians themselves Mr. Balcom does not doubt. "We believe that radio technicians are best able to rid their ranks of the men and the abuses that bring discredit upon a vocation and an industry," he says. "Manufacturers will be able and willing to help wherever and however they can." There is plenty of work for everyone in the field, and the better they are, the more the opportunities, he adds. "The day when a handyman about the house could fix a radio with a screwdriver and a pair of pliers has passed," he points out, "Proper servicing requires more skill, greater familiarity with various types of test equipment, and more technical know-how than it did before the war." But the horizons for good men in the field are unlimited. "The radio technician is today in somewhat the same position as the automobile mechanic of twenty years ago. With the widespread increase in radio sets in the home, in the car, and outdoors, plus the growing use of mobile radio communication equipment by taxicabs, buses, et cetera, radio servicing is rapidly becoming a big business."

**ALMOST SIMULTANEOUSLY**, RMA has moved against legislative regulation of the servicing groups. When New York City recently proposed laws licensing technicians and servicemen, sponsors of the new rules were persuaded to defer action until the industry got a chance to set up a plan for self-regulation. RMA experts



**It's sensational!  
Terrific!  
Amazing!**

A real 1c sale! Buy a transformer, choke, or condenser at our smashing

rock bottom prices—and as a special dividend receive another for only one penny. Buy as many as you wish. Take advantage of this stupendous bargain offer. Cannot be extended past April 30, 1948. All items subject to prior sale. So act now!

### TRANSFORMERS

Metal Cased, Ceramic Stand-Offs. Primaries are 115v. 60 cycle.	Filament Transformers
Sec. #1, 735v. 5 M.A.	Sec. #1, 6.3v. .6A.
Sec. #2, 2.5v. 3A.	Sec. #2, 2.5v. 1.75A.
for scope <b>\$2.95</b>	Sec. #3, 2.5v. 1.75A. <b>\$2.50</b>
Sec. #1, 710v. c.t. 150 M.A.	Sec. #1, 6.3v. .6A.
Sec. #2, 490v. 1.5 M.A. <b>\$2.95</b>	Sec. #2, 6.3v. 9A <b>\$2.95</b>
Sec. #1 400-220-0-220-400 125 M.A. simultaneous operation	Sec. #1, 6.3v. .9A
Sec. #2, 5.0v. 3A.	Sec. #2, 6.3v. 3.5A. <b>\$1.95</b>
Sec. #3, 5.0v. 3A.	Sec. #1, 6.3v. .6A.
Sec. #4, 5.0v. 3A.	Sec. #2, 6.3v. 6.4A. <b>\$2.45</b>
Sec. #5, 6.3v. 2A.	Sec. #1, 6.3v. .37A.
Sec. #6, 6.3v. .3A.	Sec. #2, 6.3v. 5A <b>\$2.45</b>
Sec. #7, 6.3v. 3A. <b>\$3.95</b>	Sec. #1, 5.0v. 5.32A.
Sec. #1, 1050v.c.t. 60 M.A. tapped at 925v. 10 M.A.	Sec. #2, 5.0v. 5.32A. <b>\$2.95</b>
Sec. #2, 5.0v. 3A.	Sec. #1, 6.4v. 12.0A.
Sec. #3, 5.0v. 3A.	Sec. #2, 6.4v. 10.6A.
Sec. #4, 5.0v. 3A.	Sec. #3, 5.0v. 3A.
Sec. #5, 6.3v. 2.7A.	Sec. #4, 5.0v. 3A.
Sec. #6, 6.3v. .3A.	Sec. #5, 5.0v. 3A.
Sec. #7, 6.3v. 1A. <b>\$3.50</b>	Sec. #6, 2.5v. 1.75A. <b>\$4.95</b>

### CHOKES

Single Section Chokes	
10 Henry, 85 M.A.	
330 ohms D.C. ....	<b>\$1.49</b>
59 Henry, 100 M.A.	
850 ohms D.C. ....	<b>.95</b>

### CONDENSERS

Oil Filled, Metal Cased, Ceramic Stand-Offs.		
.5 MFD.	750v. A.C.	<b>\$0.98</b>
.2 MFD.	5000v. D.C.	<b>2.49</b>
7 MFD.	600v. D.C.	<b>.59</b>
2 MFD.	1000v. D.C.	<b>.79</b>
4 MFD.	600v. D.C.	<b>.49</b>
1 MFD.	3600v. D.C.	<b>2.95</b>
7 MFD.	800v. D.C.	<b>.69</b>

**FREE CIRCULAR**—Loaded with more real bargains. 20% with order. Balance express collect. F.O.B. our warehouse.

## QUAD ELECTRICAL SUPPLY

1650 North Damen Avenue, Chicago 47, Ill.

## SCHEMATICS and INSTRUCTIONS

### SCR-274-N Receivers (Similar to AN-ARC-5)

BC-453 (R-23/ARC-5), BC-454 (R-21/ARC-5), BC-455 (R-22 ARC-5): 12 8 1/2 x 11" pages. Explanation of control and power circuits and plug terminals. Instructions for conversion of the front plug to a local control adapter with volume control, on-off switch, and CW-MCW switch. Schematic and parts list for AC power pack. Complete alignment instructions. Top and bottom views showing parts location. Voltage and resistance readings. Also schematic of 3-unit rack, control box, adapters and interconnections. Price **\$2.00**

### Conversion of BC-946-B Broadcast-Band Receiver

Similar to R-24/ARC-5. 12 8 1/2 x 11" pages. Practical wiring diagram. Control circuit explanation. Complete conversion schematic to AC use, BFO replaced by audio driver stage, gain control moved from RF to AF, delayed AVC added, and output changed for speaker operation. Includes 106 step-by-step instructions which any beginner can follow. Complete alignment instructions. Top and bottom views with parts location arrows. Price **\$2.00**

## OTHER EQUIPMENT SCHEMATICS:

- AN/ARC-5, Receivers. (less the VHF): **\$1.00**  
 SCR-274-N Transmitters, Modulator, Ant. Relay, Switch Box, and interconnections: **\$1.00**  
 AN/ARC-5 Transmitters (less the VHF), Push-pull Modulator, Relay, Switching, etc.: **\$1.00**  
 T-23/ARC-5, the VHF transmitter: **\$1.00**  
 ARB (CRV 46151), both Control Boxes, RF Alignment Chart, and interconnections: **\$1.00**  
 AN/ART-13A Transmitter, Control Box, Ant. Load Coil, Dynamotor, and interconnections: **\$1.00**  
 SCR-522 Receiver, Transmitter, Rack, Control Box, Dynamotor, and interconnections: **\$1.00**  
 BC-348-J, N, or Q, plus AC Power Pack: **\$1.00**  
 BC-348-H, K, L, or R, plus AC Power Pack: **\$1.00**  
 R-89/ARN-5 Glide Path Receiver: **\$1.00**  
 RC-103-A, (includes BC-733-D): **\$1.00**  
 AN/APN-1. (includes RT-7/APN-1): **\$1.00**  
 MN-26-C Bendix Radio Compass Receiver: **\$1.00**  
 R-65/APN-9 Loran Receiver-Indicator: **\$1.00**  
 EE-8 Field Telephones: **50c**

PLEASE SPECIFY which you want. Remit with order. Print your name and complete address in the upper-left corner of the envelope.

R. E. GOODHEART

2616 N. Spaulding Ave. Chicago 47, Ill.

## PRECISION WIRE-WOUND NON-INDUCTIVE RESISTORS FOR METERS, BRIDGES, SHUNTS, MULTIPLIERS.

1.03	5000	10500	11600	12700	
14	9500	10600	11700	12800	
20	9600	10700	11800	12900	15 cents each.
35.4	9700	10800	11900	13000	
39.5	9800	10900	12000	13100	
145	9900	11000	12100	13200	
389	10000	11100	12200	13300	10 for
439	10100	11200	12300	13400	\$1.00
550	10200	11300	12400	13500	
588	10300	11400	12500	13600	
3259	10400	11500	12600	13700	

Made by Hickok Elect. Instrument Co. to 1/10 of 1% Accuracy for U.S. Army.

## RADIOCO

1110 Marshall Bldg. Cleveland, Ohio

## AUDIO ENGINEERING SCHOOL

A practical 9 months' course in Sound Fundamentals, Recording, and Sound Transmission measurements; in a laboratory containing transmission sets, oscillators, square wave generator and intermodulation analyzer, and other equipment.

Complete recording studios assimilating broadcast, motion picture and commercial sound recording.

For information write

H. M. Tremaine, Director  
 SCHOOL OF SOUND RECORDING AND TRANSMISSION ENGINEERING  
 1655-A Cherokee Hollywood 28, Calif.

## NEW LOW PRICES

- TUBES—5Y3GT, 5Z8, 35Z5, 35W4, ea. . . . \$ 0.42  
 TUBES—6DL6, 12SA7, 12SK7, 12SQ7, ea. . . . .55  
 SPEAKER GRILLE CLOTH—6 Ass'd 6"x6" . . . . .49  
 KNOB KIT—20 Ass'd Set Screw & Sp. Types . . . .99  
 DIAL CORD KIT—100 Ft. Ass'd & 6 Springs. . . .1.35  
 RESISTOR KIT—100 Ass'd 1/2 to 1 Watt. . . . .1.95  
 BY PASS COND. KIT—35 Ass'd .005 to .1 . . . .2.99  
 COND. KIT—5 30-20 Mfd. 150 V. & 15 By Pass. . .3.39  
 COND. KIT—5 30-20 Mfd. 150 V. & 15 By Pass. . .3.39  
 SPEAKERS—5" or 3" PM, Alnico 5 . . . . .1.39  
 RADIOS—5 Tube '48 Model (Nat. Know) . . . . .14.95

Write Today for Bargain Bulletin

RADIO DISTRIBUTING CO. Pasadena 18, Calif.

under W. L. Parkinson of Syracuse, N.Y., immediately went to work and drew up various proposals for directing the public to good service shops. As this is written the program was going ahead rapidly and it looked as if it would be successful in heading off an avalanche of laws which, while catching bad servicing operators, would handicap the good with yards of red tape.

**ONE THING RMA** President Balcom overlooked in listing new radio services was a project that has gone beyond the experimental stage in Cincinnati. Station WCTS has put an FM set in a bus to amuse the customers. Last we heard, reception had proved excellent and a survey of bus riders indicates that 98 per-cent of them like the programs.

**WE CAN BELIEVE** that one about the FM reception on a moving vehicle, having recently done a little Joe Public experimenting ourselves with the new FM phone service on trains. Tried it the other day on the *Baltimore and Ohio's* "Royal Blue" from New York to Washington and the connection (from somewhere around Newark to Washington) was as clear as a bell. Making a call is almost as simple as putting in a long distance from a stationary booth. The operator on the train hooks up with the nearest mobile unit along the right of way, and from then on the call is put through in a routine fashion. Telephone numbers are different to include radio call letters—WR 02236, for instance—and some of the customers are slightly out of the ordinary, too, we learned. During the holidays there were a lot of college kids aboard and one group phoned a pal whose house was along the right of way. "Look out of the window," they yelled into the phone, "we're just about to come by on the train." Business calls are getting more and more frequent—average now on the New York-Washington run is eight—and a number of services are being worked out now that the phone is aboard. For example, B & O phones ahead from Wilmington on the Washington-Philadelphia run, so that when you get to the Philly station, if you desire, there is a taxi waiting for you in your name, eliminating battle with the guy who gets to it ahead of you. Service is done for free by the railroad, too.

**IF YOU'RE PLANNING** to do any experimenting with radar, be sure you are square with the FCC. The Commission recently issued a warning that any radar user must have both a station and an operator's license. Chief target of the warning is the college laboratory, where some radar work has been going on unlicensed. Training courses have also at times failed to sign up. The FCC precaution is to prevent interference with the transmitters of recognized radio services, particularly radio and radar navigational aids.

## Power Supply

(Continued from page 51)

a.c. input voltage ( $1.41 \times E_{ac}$ ). Condensers  $C_3$  and  $C_4$  each must have a minimum d.c. working voltage rating equal to *twice* the peak value of the a.c. input voltage ( $2.82 \times E_{ac}$ ).

The voltage quadrupler is symmetrical in configuration and therefore is comparatively easy to filter. While it has been common practice in previous literature to show these voltage multiplier circuits without output filters; the author strongly urges use of a filter, since most modern applications will not tolerate the ripple level resulting from totally unfiltered output. The current-voltage curves given in previous discussions likewise neglect the effect of voltage drop in a typical output filter. For this latter reason, the author has presented, in Fig. 4, a voltage-current curve made with a completely filtered power supply.

## Complete Circuit

The complete circuit schematic of the transformerless, tubeless power supply is given in Fig. 3.

The basic voltage quadrupler components (as illustrated previously in Fig. 2) will be recognized here as the four selenium rectifiers (REC) and condensers  $C_2$  through  $C_5$ . To this basic circuit has been added an output filter comprised of choke coil CH, and condensers  $C_6$  and  $C_7$  connected in series to withstand the high d.c. output voltage. The  $\frac{1}{2}$  megohm shunt resistors,  $R_5$  and  $R_6$ , equalize the d.c. voltage across the two filter condensers.

Resistors  $R_1$ ,  $R_2$ ,  $R_3$ , and  $R_4$  are 10 ohm, 1 watt limiting resistors in-

Fig. 3. Circuit diagram of the complete power supply unit.

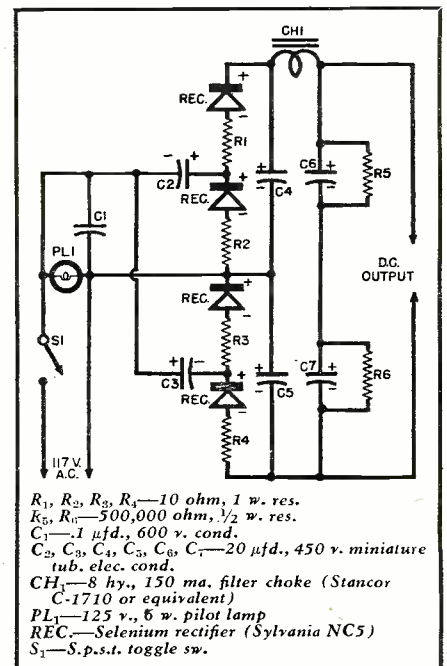

- $R_1, R_2, R_3, R_4$ —10 ohm, 1 w. res.  
 $R_5, R_6$ —500,000 ohm, 1/2 w. res.  
 $C_1$ —1  $\mu$ d., 600 v. cond.  
 $C_2, C_3, C_4, C_5, C_6, C_7$ —20  $\mu$ d., 450 v. miniature tub. elec. cond.  
 $CH$ —8 hy., 150 ma. filter choke (Stanco C-1710 or equivalent)  
 $PL_1$ —125 v., 5 w. pilot lamp  
 $REC$ —Selenium rectifier (Sylvania NC5)  
 $S_1$ —S.p.s.t. toggle sw.



## REPAIRMEN!!! LOOK!!!

Standard Parts Kits:—The parts you ALWAYS need . . . in one HANDY Kit.

	List Price	You Pay Only
Tube set—50L6, 35Z5, 12SA7, 12SK7, 12SQ7 . . . . .	\$ 7.45	\$ 2.75
Tube set—50B5, 35W4, 12AT6, 12BA6, 12BE6 . . . . .	8.05	2.75
1 Condenser 20/20 @ 150 Volts . . . . .	1.50	.45
1 Condenser 20 @ 150 Volts . . . . .	.87	.25
1 Condenser 8 @ 450 Volts . . . . .	.87	.28
1 Condenser 16 @ 450 Volts . . . . .	1.28	.49
1 each .01, .02, .05, .005 @ 600 Volts . . . . .	1.25	.36
1 Vol. Control: ½ meg. and switch . . . . .	1.15	.47
1 5-in. Alnico #5 P.M. Speaker . . . . .	4.50	1.39
1 Kit 100 carbon resistors, ½ and 1 watt . . . . .	5.00	1.79
1 AC Cord with plug . . . . .	.40	.19
1 set of 2 I.F. Trans. (456KC) and matching osc. coil . . . . .	3.50	1.19
1—50L6 Output Transformer . . . . .	1.50	.39
3 Octal Sockets . . . . .	.45	.10
	<b>\$37.77</b>	<b>\$12.65</b>

Yes, \$37.77 worth of most popular parts ONLY \$12.65 per Kit (above parts and other items may be purchased separately).

All parts new—popular brands—Guaranteed Write for Free Catalog

Send 20% deposit—Bal. C.O.D.

**COMMERCIAL RADIO**  
36 BRATTLE STREET  
BOSTON 8, MASS.

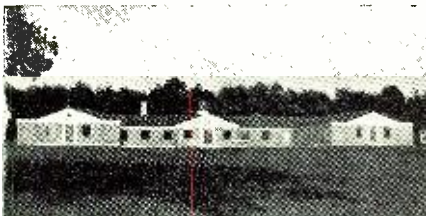

## RADIO ENGINEERING TELEVISION ELECTRONICS

Thorough training in all phases of radio and electronics, open to high school and junior college graduates. Old established school specializing in Radio training exclusively. Modern laboratories and courses. Enrollments limited. Approved veteran training.

VALPARAISO TECHNICAL INSTITUTE  
Dept. RD Valparaiso, Ind.

## GREYLOCK

A Dependable Name in  
RADIO TUBES

GT, Glass, and Miniature Types

ALL TUBES IN INDIVIDUAL CARTONS  
12SA7, 12SK7, 12SQ7, 50L6, 12AT6,  
12BA6, 12BE6, 35W4, 50B5 . . . each 39c  
1R5, 1S5, 1T4, 3S4, 3Q4, 6AK5, 6AC5,  
6AC7, 6AQ5, 6BE6, 6BA6, 6AU6,  
6BJ6, 6X4 . . . . . each 49c  
32L7, 70L7, 117L7 . . . . . each 59c  
All Tubes Carry RMA 90-Day Guarantee

### PM SPEAKERS

4" Alnico No. 5 . . . . . each \$1.19  
5" Alnico No. 5 . . . . . each 1.29  
TERMS: Net C.O.D. No order accepted for less than \$5.00

Write for Bargain Catalog N-3  
GREYLOCK ELECTRONIC SUPPLY CO.  
30 Church Street New York 7, N. Y.

## PEN-OSCIL-LITE

Extremely convenient test oscillator for all radio servicing; alignment • Small as a pen • Self powered • Range from 700 cycles audio to over 600 megacycles u.h.f. • Output from zero to 125 v. • Low in cost • Used by Signal Corps • Write for information.

**GENERAL TEST EQUIPMENT**  
38 Argyle Buffalo 9, N. Y.

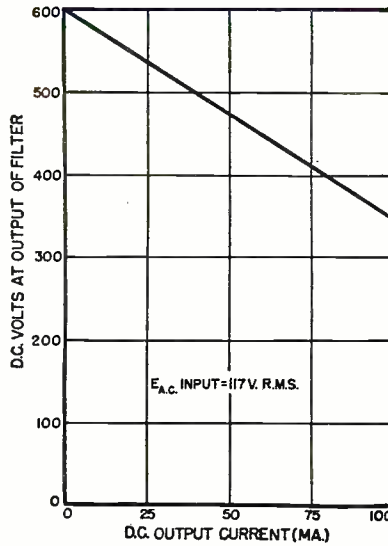

Fig. 4. Performance curve for power supply circuit shown in Fig. 3.

stalled for protection of the selenium rectifier units.

This power supply circuit delivers d.c. output voltages between 600 volts at no load (or very small load) and 360 volts at full 100 milliampere load. The variation of output voltage with load current is illustrated by the graph, Fig. 4. Close regulation of the d.c. output voltage may be obtained in a simple manner by means of gaseous voltage regulator tubes. Table 1 is a chart showing the most satisfactory combinations of series-connected VR type tubes to obtain regulated d.c. voltages of 300, 330, 360, 375, 405, and 450.

### Construction

Fig. 1 shows two views of the complete power supply unit. These photographs show clearly the arrangement of all components listed in Fig. 3.

The power supply unit is built entirely on a 9½" x 5" x 3" steel chassis. This is a standard catalogue size. All of the components are mounted underneath the chassis which serves as an enclosing case. The front lip of the chassis (See Fig. 1) holds the "ON-OFF" switch and the 115-volt pilot light bullseye. The rear lip holds the d.c. terminal post strip and admits the rubber-insulated power line cord through a grommet-lined hole.

The four selenium rectifiers are seen mounted in line with each other in the lower portion of the chassis in Fig. 1. All four rectifier units have been mounted on a 6-32 threaded rod 3¼ inches long, passed through the central mounting hole of each rectifier, which is held to the chassis by means of a small metal angle bracket on each end of the rod.

The four quadrupler condensers (C<sub>2</sub> through C<sub>5</sub>) are seen directly above the mounted rectifier stack, and the two output filter condensers (C<sub>6</sub> and C<sub>7</sub>), pilot light bracket, and filter choke at the very top of the chassis.

Assembly and wiring of this power

## MORE FEATURES

for your money in  
this miniature

## SUPERHET TUNER

by "Adaptol"



Adaptol offers the outstanding buy in compact, efficient Superhet Tuners. Here are just a few of the useful applications:—

Highly suitable for use in conjunction with *repe* and tape recorders . . . Installed in record player, makes phono-radio combination . . . Has many experimental uses . . . Tuner for custom-built radios

For modernizing obsolete radios . . . For conversion of military, foreign, and short wave receivers to broadcast band at the flick of a switch.

**CIRCUIT FEATURES**—Self-contained power supply for 110V. D.C.-A.C. 50-60 cycles . . . Three tube circuit of conventional design, using the latest miniature and dual purpose tubes . . . Permeability tuned drift-free I.F.'s. **COMPACT**: Approximately 4½" x 3½" x 3¾".

List price \$20.00 complete with tubes. Add 5% west of Rockies. FOB Brooklyn, N. Y.

See your local distributor, or write for further information to:

**ADAPTOL CO., 120 New Lots Ave.,  
Brooklyn, N. Y.**



**NEW SERIES 16 IMPROVED NO-DRIFT FM 5 WAVE BANDS**  
in the Sensational 1948  
**MIDWEST RADIOS**

Separate Chassis Like This Powerful  
SERIES 16 AM-FM MODEL OR  
Beautiful Radio-Phono Consoles Available



### The SYMPHONY GRAND

### RADIO-PHONOGRAPH AM-FM CONSOLE

A truly magnificent instrument that offers new, improved No-Drift FM, 5 Wave Bands, Automatic Interim Record Changer that handles both 10" and 12" records, 14½" Panasonic Speaker, and exclusive Midwest Tri-Magnadyne Coil System and Color-Ray Tone Selection. Other luxurious Console and Table Models with Series 16, 12, and 8 Chassis.

EASY TERMS

30 DAYS TRIAL

SEND FOR FREE Catalog

BUY DIRECT FROM FACTORY AND SAVE!

FILL IN COUPON AND MAIL TODAY OR JUST SEND YOUR NAME AND ADDRESS ON 1c POSTCARD

**MIDWEST RADIO CORPORATION**

Dept. 37-T, 909 Broadway, Cincinnati 2, Ohio

Please send me your new FREE 1948 Catalog.

NAME .....

STREET .....

CITY.....ZONE...STATE.....

## BEAM ROTATOR MOTOR



Guaranteed to Support and Rotate 100 Pound Beam

1 to 5 RPM—10 to 27 Volts AC/DC

Rotary actuator mfd. by Lear. Split field series reversible motor. Laminated field. Double spline output shaft. Adjustable limit switches. OD 8x5x4". Net weight 4 1/4 lbs. Complete instructions & drawings furnished.

\$6.95 ea. Brand New.

## PORTABLE SONAR UNIT

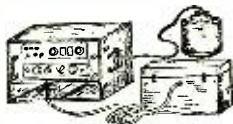

Complete QBG-1 \$79.95 Brand New

Fine for Super-Sonic Experiments—Marine Navigation 5 tube receiver, 4 tube transmitter, rochelle salt crystal projector, frequency 10 to 27 kilocycles. Automatic keying. Direct reading range knob 240 to 2600 yards. Gray leatherette carrying cases. Furnished with all connecting cables & plugs. Requires GVDC & 270VDC to operate. Shipping weight 300 lbs.

### MICRO-SWITCH SPDT



Brand New type bz-r5. ul rated 10a-125v. 2a-600vac.

10 for \$1.69 2 for .39c

### CANDELABRA SOCKET

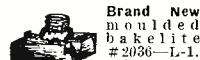

Brand New moulded Bakelite #2036—1-1. 19c ea. Screw Base 10 for \$1.49

Satisfaction Guaranteed or Your Money Back

HUNDREDS OF SURPLUS BARGAINS IN OUR FREE ILLUSTRATED LIST

## DICK ROSE—ERECO

2912 HEWITT AVE., EVERETT 20, WASH.

## APPLIANCE REPAIRMEN

MONEY SAVING PRICES — IMMEDIATE DELIVERY

## IRON REPAIR KIT



Contains a complete assortment of terminals, pins, porcelain insulators, mica, etc., that will fit most "flat" irons and appliances. Practically every part necessary in the ordinary repairing of flat irons in one handy kit. Additional supplies obtainable so that your kit can be kept replenished. Entire kit sent postpaid for only \$3.10 plus 18c postage.

### Electrical Appliance Repair Parts

Lead wire. Asbestos covered heater hook-up wire. 10 ft. \$1.00  
Heating element wire. 10 ft. coiled 1/2" O.D. #20. 2.55  
Heating element wire. 10 ft. coiled 3/16" O.D. #22. 1.77  
Ribbon element heating wire. Std. size 100 ft. .75  
Christy Electric Heating Element Welding FLUX for repairing flat iron toasters, electric stoves, etc. Enough for 50 elements. 1.00  
Hot plate bricks 5 1/2" diameter. 6 for. 1.62  
Carbon brush set. Assorted. 104 brushes. 15 Springs. Complete. 3.00  
Kerosene to Electric Lamp conversion adapters. 5 for only. 1.00

### Repair Elements for Electrical Appliances

Electric Range Elements. Fit all makes. Latest Super-high speed units. Each. \$6.30  
Renall Iron element. Guar. 1 year. Package of 6. 3.12  
Irons. Porcelain shoes for 500-600 watt. Set of 4. 1.00  
Percolator elements. Universal flat type. 1 Yr. guar. 2 for. 1.20  
Percolator element. Porcelain for new glass types. 2 for. 1.80  
Element cement. Withstands 3000° F. 1 lb. package 1.00  
Toaster element forms. Clear Mica. Fits most toasters. 10 for. 1.80

### How To Fix It Books

Modern Electric & Gas Refrigeration—928 pages. \$5.00  
Armature & Magnet Winding—270 pages. 1.50  
Practical Elec. & House Wiring—200 pages, 227 Illustrations. 1.50

Here is your opportunity to save on repairing your own appliances and to earn extra money repairing appliances for friends and neighbors.

## CHRISTY SUPPLY CO.

2835 N. Central Ave. Dept. T-756 Chicago 34, Ill.

Regulated D. C. Voltage	REGULATOR TUBES REQUIRED		
	OA3/VR75	OC3/VR105	OD3/VR150
300			2
330	1	1	1
360		2	1
375	1		2
405		1	2
450			3

Table 1. Voltage regulator combinations for the power supply unit.

supply unit is entirely straightforward and simple. Since only 60-cycle and d.c. voltages are involved in the operation of the unit, no assembly tricks are necessary. However, the 600 volt output terminals and the insulated wiring leading to them from condensers C<sub>6</sub> and C<sub>7</sub> must be kept well clear of the chassis. Terminal strips are employed liberally in construction of the unit, and wires are braided into a harness for neatness.

**WARNING:** The operator of this power supply unit must remember that it is capable of delivering an injurious electric shock. The pilot light is an important precautionary measure and should not be omitted by the builder. Because high capacitances are employed in this outfit, the output terminals are apt to be "hot" for a considerable time after the line voltage has been switched off. This is especially true when low values of output current are drawn. For this reason, it is advisable to short circuit the output terminals momentarily each time the "ON-OFF" switch has been thrown to its "OFF" position. This will discharge the condensers and protect the operator against shock.

As an additional safety measure, the chassis has not been connected to "B-minus" or to any other part of the circuit. The reader is advised to follow this scheme.

The author's power supply was built inside a small chassis for the sake of compactness. However, the individual builder may employ any housing which suits his fancy. For example, a small metal "instrument box" or cabinet might be used—or the unit could be mounted conveniently on and behind a narrow rack panel. There is no objection to using a wooden enclosure for the power supply, although it is a good idea to provide adequate ventilation, such as through a number of holes.

### Applications

The power supply described in this article may be employed in all applications in which not more than 100 milliamperes load current will be required, and in which the degree of voltage regulation indicated by the curve in Fig. 4 can be tolerated. Its range of application may be further increased by employing voltage regulation (See Table 1). While the unit is shown here as operated from the 117-volt power line, it may be operated at any voltage between 0 and 117 volts r.m.s. Also, operation is not restricted to 60 cycles, since the

## SPRING SPECIALS

**Heavy Duty Toggle Switches**  
DPST 15 A 125 V ball type handles. . . . . 49c  
DPST 12 A 125 V bat handle. . . . . 39c  
DPST 20 A 250 V ball type handle. . . . . 69c  
DPST 30 A 125 V bat handle. . . . . 39c  
SPST 5 A 125 V bat handle. . . . . 29c  
SPST 7.5 A 125 V momentary push button. . . . . 19c

**Micro Switches**  
Microswitch type YZ-3RT1 switches normally open types. . . . . 39c  
Microswitch type P.B. switches normally open types. . . . . 39c  
D.P.S.T. push button switches normally open 6 A 125 V. . . . . 39c

RCA Sapphire tipped cartridge #38610. \$2.25  
List Price, \$5.55; your cost. Lots of ten, \$1.95

RCA Replacement cartridge #31050. \$1.85  
List price, \$4.20; your cost. Lots of 10, \$1.75

**Tube Specials**  
1R 4/1294, 25c; Sylvania 1299, 25c; RCA 6B8G—\$3.20 list, your cost. . . . . 29c

10% Cash with Orders **ALM** Phone LO 3.9255  
Covers the Globe  
509 ARCH ST., PHILA., PENN.

## KEEP YOUR TOOLS AT YOUR FINGERTIPS WITH THE DAVIS WIZARD TOOLRAK



Keep your tools right where you want them—handy but out of the way— with Toolrak, save space—keep tools in order—prevent drawer damage and lost tools. With Toolrak, all your tools are out where you can use them, even when they're put away. Toolrak helps you keep your shop neat, efficient. Clear maple holders, fine natural finish; shaped, drilled, slotted to hold great variety of tools. Holders are removable, interchangeable in aluminum back-strip— you can arrange them any way you want, rearrange them to fit your changing needs. Easy to install in 2 minutes. Screws furnished.

The Wizard Toolrak "Ten" 12" long. Holds 10 tools from your jobbers\* \$1.90  
\*Jobbers— Write for Information  
If your jobber does not yet carry Toolrak, ORDER YOURS DIRECT. Add 10c to cover packing, mailing. If you prefer, SEND NO MONEY— pay postman \*2.00 plus small C.O.D. charge.

**Davis**—Development Company— 348-2 First National Bank Bldg. Colorado Springs, Colorado

## HIGH PRECISION 100 Kc. CRYSTALS

Price \$3.95 each

(No C. O. D.'s. Please include 25c for postage and handling.)

Brand New Surplus at about 1/10 Gov't. cost. An ideal Frequency Standard for Amateurs, Servicemen, Laboratories, etc.

Exceptional Frequency Stability ± 15 cycles from —50° to + 80° c. (.0015) 10G Vibration Test. Calibrated at 30° c. Brand New. Mounted in Sealed Cases as Shown.

**ELECTRONICRAFT, Inc.** 5 Waverly Place Tuckahoe, N. Y.

## SPECIAL

5 CPI—Oscilloscope and Picture Tube. New Surplus. . . . . \$1.00  
1/2 Deposit—Balance C.O.D.  
**THE WALDREF CO.**  
1615 N. Genesee, Hollywood 46, Calif.

## RCA Institutes, Inc.

Offer thorough training courses in all technical phases of Radio and Television  
**WEEKLY RATES** **DAYS—EVENINGS**  
**VETERANS:** RCA Institutes is approved under G. I. Bill of Rights  
For Free Catalog write Dept. EN-48  
**RCA INSTITUTES, Inc.**  
A Service of Radio Corporation of America  
75 Varick St., New York 13, N. Y.

quadrupler will operate satisfactorily with very little variation in performance throughout the audio frequency spectrum.

Maximum output voltage is obtained when the load current is low. A typical application of this sort is the powering of a 2-inch oscilloscope tube. The full output of 600 volts may be obtained here because of the small current drain imposed by the Type 902 cathode-ray tube.

Typical applications of the power supply include the powering of radio receivers, small transmitter stages, oscillators, and test instruments. It may also be used as a voltage breakdown tester up to the limit of 600 volts, polarizer for electrolytic condenser forming in the radio service shop, for polarizing straight capacitance bridges, and as a general experimental power supply for the test bench.

The output voltage may best be varied from zero to maximum by plugging the power supply unit into a small *Variac*, and using the latter as the output voltage control.

-30-

### TRANSMITTER EQUIPMENT SALES

SALES of transmitter equipment by RMA manufacturers totalled more than \$97 million, the majority of which was U.S. Government business, during the first half of 1947, according to a report just released by the Radio Manufacturers Association.

Manufacturers of broadcast transmitting equipment received orders for \$12,455,202 worth of transmitting and studio equipment and made deliveries on \$9,253,358 of this equipment.

Of this figure, \$3,325,570 represented orders for FM equipment with deliveries reaching \$1,820,633 by member-companies in the first half of 1947. AM transmitter equipment totaled \$2,402,768 and deliveries amounted to \$2,319,006.

AM and FM studio equipment orders totalled \$2,395,044 of which \$2,205,382 worth was delivered. Antenna equipment for both AM and FM stations aggregated \$1,597,541 in orders and \$433,767 in deliveries.

Orders for television equipment, including studio, transmitter, and antenna, totalled \$1,862,140 and deliveries amounted to \$1,354,633.

-30-

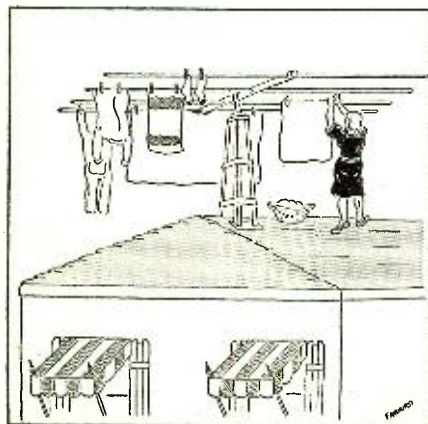

March, 1948

# TUBES! TUBES! TUBES! THOUSANDS OF TUBES LOWEST PRICES

NEW, STANDARD BRANDS—DEALERS' QUANTITY PRICES ON REQUEST  
MINIMUM ORDER \$5.00

TYPE	PRICE	TYPE	PRICE	TYPE	PRICE	TYPE	PRICE	TYPE	PRICE
1A3	\$0.98	6AG7	\$.89	6V6GT	\$.99	3525	\$.69	600	\$2.25
1A5	.49	6AQ5	.99	6X4	.98	36	1.10	601A	1.10
1A7GT	1.10	6A4	.69	6X5	.89	37	.69	602 RK25	1.10
1B2A	2.49	6AL5	.99	6Y6	.89	38	.89	603	3.49
1B38	4.50	6AD5	.98	7AE7	.75	39 44	.44	604	6.75
1B4	.98	6AT6	.75	7B7	.69	41	.69	605	3.75
1B5	.44	6AU6	.89	7C4	1.50	45	.64	607	1.25
1B6	.98	6B4	1.29	7C5	.89	46	.65	608	2.95
1B4G	.98	6BU5	.89	7F7	1.25	47	.90	609	1.50
1B5	.99	6C1	.99	7L7GT	1.39	48B5	.85	610	5.95
1L4	.89	6C4	.64	10Y	.69	50L6GT	.75	611	1.95
1L5	.92	6C5	.51	12AG	.89	50L7	.69	612	3.15
1L6GT	1.10	6C6	.75	12AV7	1.10	51A	.69	612H	6.90
1R4/1294	1.29	6C7	12.95	12AT6	1.11	52	.69	613	5.95
1R5	1.10	6C8	.89	12BA6	.89	53T	2.39	614	4.39
1S5	1.10	6E6	.75	12BE6	.89	54	.75	615	2.25
1T4	.56	6F6	1.35	12C8	.89	57	.75	620	1.75
2A3	1.39	6F5	.51	12H6	.44	58	.75	629A/B	2.95
2C22	.69	6F6	.79	12J5	.69	59	.69	630B	5.25
2C26A	.75	6F6	.80	12K6	1.25	60	.53	632A	3.25
2C34	.98	6F7	.98	12S7GT	.99	61	.98	633A	34.50
2C40	2.60	6F6	1.10	12S7	.89	62	.83V	634	1.15
2C44	1.75	6F6	1.10	12S7	.89	64	.75	637	2.50
2D21	.75	6H6	.49	12S7	.79	65	.89	638	3.75
2E22	1.50	6I4	1.50	12S7	.69	100TS	3.00	641	.69
2E25	3.95	6I5	.49	12S7	1.10	117L7	1.89	645	3.75
2E30	2.25	6I6	.49	12S7GT	.79	117Z3	1.69	650	3.00
2I32	20.00	6I7	.89	12S7GT	.99	117Z6GT	1.10	651	50.00
2I33	20.00	6K6	.49	12S7	.79	171A	2.60	666A	.75
2J851	4.95	6K7	.59	12X3	.98	205B	4.50	672A	1.95
2X2	.69	6K8	1.25	14A7	1.10	211	.98	674	1.95
3A4	.49	6L6	1.25	14B7	1.10	215A	3.00	684	.75
3B7	.98	6L5G	1.20	14H7	1.21	217C	7.50	623	.49
3B22	4.95	6L7	.98	417	1.21	250TH	1.29	654	.49
3B24	.98	6Y7	.89	14F7	1.10	341L	2.49	655	.49
3D6/1299	.89	6Q1	.98	15E	1.50	307A	6.25	656	.75
3E29	2.95	6Q2	.98	23D4	.49	316	.89	657	.49
3Q4	1.10	6Q7	.89	23D5	.98	371A	1.39	658A	.49
3Q5GT	.58	6R7	.98	24E	.69	371B	3.00	659	.49
3S4	.43	6S4	.75	25A6GT	.75	384A	4.50	661	.50
4C35	7.95	6S7	.85	25L6GT	.75	47A	18.95	1005	.39
4E27/257B	4.95	6S15	.79	25Z5	.75	446A	1.25	1006	.39
4R4GY	1.15	6S7	.79	25Z5	.98	450TH	12.95	1613	.95
5T4	1.25	6S17	.39	26D7	.75	703A	7.50	1614	1.75
5U4	.44	6S17GT	.69	30	.78	705A	1.85	1615	1.39
5V4G	.98	6S17	.79	32L7	1.50	713A	1.65	1619	.98
5W4	.98	6S17	.89	34	.98	715B	4.95	1622	1.75
5Y3	.60	6S17GT	.85	35L6GT	.75	717A	.69	1624	.98
5Y4G	.60	6S27	.85	35Y4	1.10	721A	.69	1625	.49
5Z3	.49	6SR7	.85	35W4	.69	723A/B	5.10	1625	.49
5Z4	.49	6S7	.85	35Z4	.99	725A	12.50	1629	59
6A6	.75	6S7	.75	35Z7	.85			1629	49
6A7	.49	6U5	.98					1631	1.49

NIAGARA RADIO SUPPLY CORP. 160 Greenwich St. New York 6, N. Y.

For added sales (and profits!)



demonstrate

the amazing Shockproof

nylon needle

by

DUOTONE

Actually b-o-u-n-c-e the whole tone arm on a record without effect. A spring steel shaft and nylon elbow—that is the secret!

\$2.50 LIST

\*pat. pending



## CUT HOLES FAST IN RADIO CHASSIS

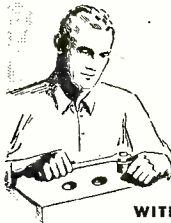

WITH A GREENLEE RADIO CHASSIS PUNCH

• GREENLEE Punches make this tough job easy. Merely turn with an ordinary wrench . . . make accurate, clean holes in a hurry. No reaming or tedious filing. There's a GREENLEE punch for each of these sizes: 1/2"; 3/8"; 3/4"; 7/8"; 1"; 1 1/8"; 1 1/2"; 1 3/4"; 1 7/8"; 2" — for cutting holes to take sockets, plugs, etc. Also GREENLEE makes Knockout Punches and Cutters for conduit and meter holes up to 3 1/2". Write for facts. Greenlee Tool Co., 1883 Columbia Avenue, Rockford, Illinois.



# PERSONALIZED RADIO KIT

with your name, a friend's name, or a business name imprinted on the dial face at no extra cost.



In New York City add 2% Sales Tax.  
Price includes imprinting of 16 letters on dial.

## MODEL 501

- P.M. Alnico Speaker
- AC-DC 105-115 Volts
- 5 tubes New Miniature 12 Volts, 50B5, 35W4, 12BA6, 12BE6, 12AT6
- Broadcast Band from 550 to 1650 KC
- All parts & Schematic included with complete instructions
- Attractive dark mahogany plastic cabinet \$1.50 extra

Send for catalogue 101 for details and prices on other personalized kits.  
Check or money order. C.O.D.'s accepted if \$2.00 accompanies order.

# RADIO TECH

523 MYRTLE AVE. BROOKLYN 5, N. Y.

**Amsco KITS!**  
**BEAT THESE PRICES**  
**IF YOU CAN . . .**

100 Resistors 1/2 & 1 Watt asst. ....	\$ 1.69
100 Mica Condensers asst. ....	2.89
100 By-pass Tubular Cond. asst. ....	5.89
25 Electrolytic Cond. asst. ....	3.29
50 Bath Tub Cond. asst. ....	2.59
20 Padder Cond. 1-2-3-4 asst. ....	.99
12 Variable Air Trimmer Cond. ....	
Gang asst. ....	1.49
20 Knobs asst. ....	1.39
25 Tube Sockets asst. ....	2.49
20 Wire Wound Resistors 5-10-25W asst. ....	1.89
6 Mike Buttons asst. ....	.89
20 R.F. Chokes asst. ....	.99
10 Volume Controls asst. ....	1.79
5 lbs. Hardware asst. ....	4.29
6 Chokes and Output Transformer asst. ....	.79

519 Items ..... \$33.35

Above Kits Sold Separately \$29.95  
... or the Entire Lot as Shown. Yours for Only

AND GET A MAGNESYN REMOTE INDICATOR **FREE!**

1 T24 Mike with Cord and Switch....\$0.79  
5BPI and 5CPI TUBES, \$2.69 ea.

New, FREE 1948 Circular Available Now! Write Today for Yours!

## AMERICAN SALES CO.

1811 W. 47th St. Chicago 9, Ill.

# Methods of Producing NEGATIVE POTENTIALS

By G. N. CARTER

Radio Service Mgr.,  
G. A. Fletcher Music Co., Ltd.  
Nanaimo, B. C., Canada

Circuits covered will supply negative potentials as high as 250 volts without requiring additional transformers.

IN SOME electronic circuits, particularly those in industrial equipment, a potential negative with respect to ground is required for biasing tubes to cut-off or beyond or in RC time constant circuits. Most servicemen are familiar with those used in receiving sets for audio tube control grid biasing from the "brute force" voltage divider circuits in the power supplies of the early days down to those in use today, such as cathode bias and "contact potential" used on the 6SQ7 and similar tubes. The two described in this article have been successfully used by the author for cut-off biasing and for RC time constant circuits. As will be noted, a minimum number of parts is used and an extra power transformer is not needed. Both systems allow the original positive supply to generate its original positive voltage in relation to ground.

In Fig. 1, on the upper side of the diagram (i.e., above ground lead), there is a conventional power supply with the voltage and polarities marked across the load resistor  $R_L$ . Coupled from one plate side of the high voltage winding of the power transformer is a diode connected as shown. The load resistors  $R_1$  and  $R_2$  are chosen so that no more than two milliamperes flows through this circuit, which current will not seriously unbalance the power supply. The voltage across the extremities of  $R_1$  and  $R_2$  will be approxi-

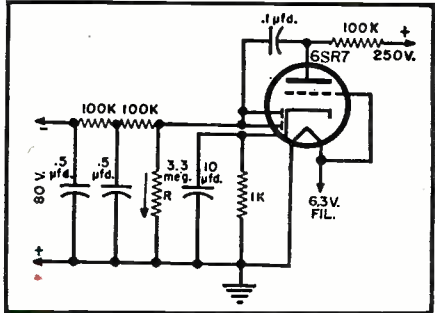
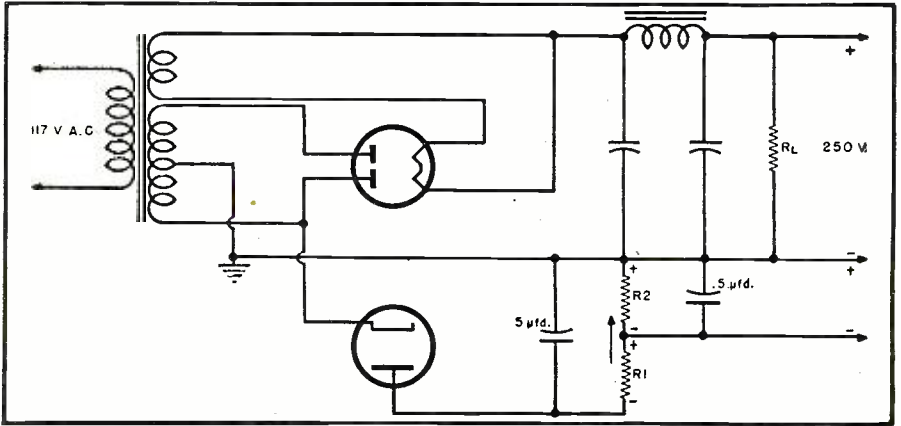

Fig. 2.

mately 250 volts with the polarities as shown, the arrow indicating electron flow. If  $R_1$  and  $R_2$  are 100,000 ohms each, 125 volts will be obtained at their junction with polarities as marked. By selecting different values of  $R_1$  and  $R_2$ , and keeping their sum at 200,000 ohms, any voltage between 0 and 250 may be obtained, negative with respect to ground. Additional RC filters may be incorporated in the negative line if hum affects the connected circuit. The diode used may be a 6H6 with plates and cathodes in parallel, with the heater connected to the 6.3 volt supply. Any of the rectifier tubes with 6.3 volt heaters could be used such as the 6Z4 or the 1V. The 0Z4 could be used if filament current was a problem, but an r.f. filter might be necessary with this gaseous rectifier. The diode may be replaced with one

Fig. 1.



# A CAREER WITH A FUTURE! TELEVISION

Shop Work · Shop Techniques · Theory  
FULLY EQUIPPED LABORATORIES

- RADIO SERVICE & REPAIR
- F. M. & TELEVISION
- TRANSMITTER COURSES  
Preparing for F.C.C. LICENSES
- RADIO TECHNOLOGY  
A Junior College Level Course preparing for positions in Radio-Electronic Engineering Field.

Morning • Afternoon • Evening Classes  
MODERATE RATES • INSTALLMENTS

Available Under G. I. Bill  
Come In and See Our Students at Work

**DELEHANTY** SCHOOL OF  
RADIO • ELECTRONICS • TELEVISION  
105 East 13 St., N. Y. 3, N. Y. • Dept. S.  
LICENSED BY STATE OF NEW YORK

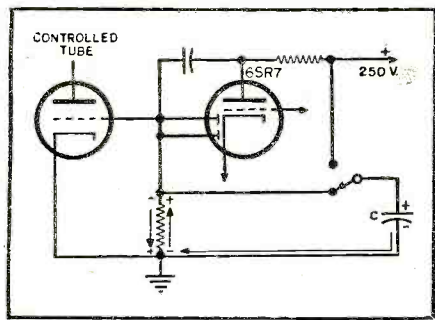

Fig. 3.

of the popular rectifiers now on the market for a.c.-d.c. receivers, provided suitable precautions are taken so that the inverse voltage on the rectifier does not exceed its specifications.

Fig. 2 shows a method of using a double diode-triode as an amplifier rectifier. The heater voltage is used as a source of a.c. applied to the grid of the triode and the amplified voltage is taken from the plate by a one-tenth microfarad condenser and applied to the two diodes connected together, the electron return path being through *R* to ground. Again, electron flow is shown by the arrow. Using a 6SR7 tube, with the optimum values shown, a voltage of 80 at the output of the filter, negative with respect to ground, may be obtained. Decreasing the value of *R* will lower this voltage. This is an ideal circuit for *RC* time delay, as *R* can be used as a condenser discharge path as shown in Fig. 3.

The discharge of condenser *C* passes through *R* in the direction shown by the right hand arrow, causing an electron flow in the reverse direction, reducing, cancelling, or reversing the voltage across the rectifier and allowing current to flow in the plate circuit of the control tube for a period related to the original voltage and the value of *R* and *C*.

Further applications of these circuits will suggest themselves to the experimenter or design engineer or for the replacement of batteries in existing equipment used to supply a negative potential.

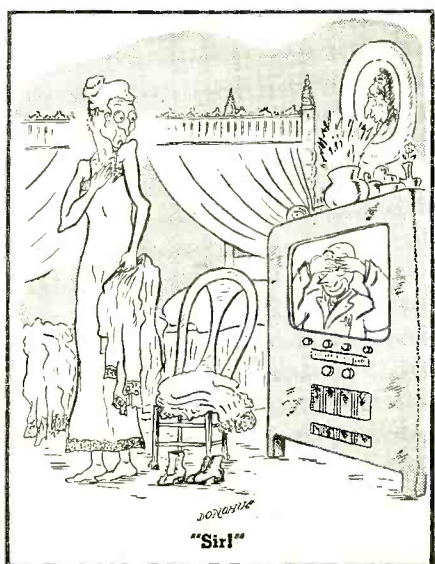

# Big XFORMER CLEARANCE SALE at Unbelievable Prices!

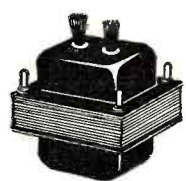

**POWER TRANSFORMERS  
at Big Savings!**

50X—50 ma.—6.3U.....	\$1.34
75X—75 ma.—6.3U.....	1.65
65A—90 ma.—2.5U.....	3.06

### CHOKES

99X—40ma.....	\$0.49
505X—50ma.....	.58
28X—85ma.....	.58
67X—125ma.....	.92
509A—160ma.....	1.32
506B—250ma.....	3.10
530A—300ma.....	4.45
74Q—Low Imp. to Hi Sec.....	7.50
78X—SB mike to grid.....	1.34
96X—Plate to grid (10,000W).....	1.40
76Q—Push Pull Input.....	8.75
82X—Class AB & B Driver (59ma.).....	2.15
9X—Class AB & B Driver (50ma.).....	1.34
35X—Tube to Line—8000CT—50/200/500.....	1.10
25X—P. P.—6L6 Output.....	1.60
28A—Single 6L6 Output.....	2.74
38Q—PP6F6 Output.....	5.60
40Q—2—6L6 AB Output.....	8.75
23X—Universal Output.....	.72
31X—50L6GT Output.....	.58

**DELUXE  
25-WATT AMPLIFIER**  
6L6s in Push Pull—2 Mike Inputs, 1  
Phono.  
A real buy at..... **\$39.95**

**WIRE**

Sv Cord—250 ft. roll.....	\$5.25
Zip Cord—250 ft. roll.....	3.50
Lead-in wire per ft.....	.01

**BC-654A TRANSMITTER  
RECEIVER**  
Buy it for tubes, parts, etc.  
A precision built instru- **A FEW LEFT AT**  
ment. **\$14.95**  
One-third deposit with or-  
der, balance C. O. D. as is less  
F.O.B. shipping point dynamotor

**G.C. Hardware Laboratory**  
A Must for the Serviceman  
1 Rack and 20 Jars of **\$7.20**  
Hardware.....

"It's D. & H. for Dependable  
Parts Service"



RADIO  
PARTS  
DIVISION

**DISTRIBUTING CO., Inc.**  
311 S. Cameron St., Harrisburg, Pa.  
31 East Lee St., Baltimore 2, Md.

## MIRACLE KIT VALUES!



**UNIVERSAL  
TROUBLE  
SHOOTER**  
2 1/4 x 6 x 3" D  
Locates every service  
trouble. All parts in-  
cluding case, test leads, plug..... **\$3.95 ea.**

**10 WATT 4 TUBE  
HI-GAIN 6L6  
AMPLIFIER KIT**

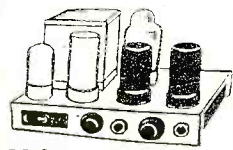

Separately controlled  
Mike & Phono In-  
puts. All parts in-  
cluding drilled chas-  
sis, hardware, solder,  
circuit diagrams,  
info., etc. Less Tubes. **\$6.95 ea.**

**PHONOGRAPH OSCILLATOR KIT—Hi-Gain** with  
microphone jack. Tubes Included. Only **\$2.75 ea.**

Write for lists of bargains in Radio and Elec-  
tronic parts. Also free data. circuits designed  
by Robert G. Herzog.

**Universal/general corp.**  
Dept. N  
365 Canal St., New York 13, N. Y. WAlker 5-9642

## SIGNAL - TRACER - GENERATOR

- Pencil Probe
- High Gain Tracer
- Built-In Detector
- Sig. Injector Gen.
- AC-DC Operation

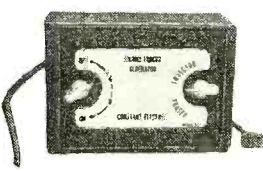

ONLY **\$16.50**

Ready to operate—Signal Tracer with loudspeaker opera-  
tion—Signal Generator—Multivibrator—Puts out strong  
A.F., I.F., R.F. signal 1000 cycles to 25 megacycles.

## PHONO-OSC-AMPLIFIERS



35Z5, 12SQ7, 50L6 Hi-  
Gain, HI-FI, AC DC  
Amp. Complete..... **\$4.69**

Wireless Phono-Osc.  
Mike or Phono inp.  
Complete with  
tubes. Wired.. **\$4.49**

**YORK DISTRIBUTORS**  
523 Knickerbocker Ave., Bklyn. 21, N.Y.

March, 1948

# FRACTIONAL MOTORS

COMPOUND WOUND—115 V DC 3/16 H.P.

Input 115 VDC—1/4 H.P. 2 amp (18 Pds) 3450 R.P.M. Oil Impregnated Ball Bearings.  
Each..... \$3.69  
4 to Case..... \$14.00

## Speaker Specials

5" PM Alnico #5 Magnet	<b>\$1.09</b>
6 for \$6.00	
6" PM Alnico #5 Magnet	<b>1.69</b>
6 for \$9.50	
8" PM Alnico #5 Magnet	<b>2.49</b>
5 for \$12.25	
10" PM Alnico #5 Magnet	<b>3.25</b>
5 for \$15.50	
12" PM 16 oz. slug	<b>5.25</b>
5 for \$25.00	

1/2 Wave Power Transformer. 3200 Volt 150 MA. 115 Volt 60 cycle (2 enough to drive K.W. Rig). Wt. 37 lbs.  
Each..... **\$8.95**

Choke T74C29 15H 150 MA. 200 ohms DC. Up-right Mounting.  
Each..... **\$1.97**  
Power Transf. 800V. CT, 200 Ma. 6.3 Volt 5 amp and 5 volt 3 amp

Each..... **\$4.59**  
G.E. Pyronol Capacitors. 23F47—2 mfd 400V. V.  
D.C. Each..... **\$4.79**  
5 for..... **\$22.50**  
Tobe Oilmite (Ral 300) 5-5 mfd 400 V.D.C. 71 OC.  
Each..... **79c**  
Tobe Filtermite 4 Frong Plug-in type 8-8 mfd.  
600V. Each..... **89c**  
500M Controls with Sw..... **49c**  
10 for..... **\$4.50**

## HARDWARE

Asst. Screws, nuts, washers, rivets, solder lugs, springs and 1000 other useful parts.  
5 pounds for..... **\$1.49**

## SOLDER

Rosin Core 50/50 Solder Size #16 or #11.  
5 lb. rolls..... **\$3.25**  
5 rolls (25 lbs.)..... **\$15.00**  
Rosin Core 60/40 Solder Size #23.  
5 lb. roll..... **\$3.25**  
5 rolls (25 lbs.)..... **\$15.00**

**FREE!** Write for R.P.D.'s latest bulletin for more sensational values.

Terms: Remittance with order plus postage or 25% deposit, balance C.O.D.

**RADIO PARTS DISTRIBUTORS**  
925 E. 55th St., Chicago 15, Ill.

# HERE'S A 5 TUBE RADIO KIT

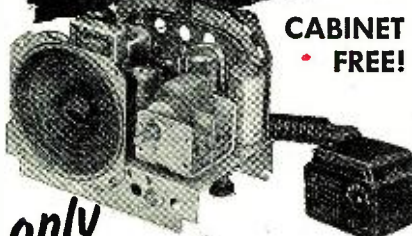

**CABINET  
• FREE!**

only **\$9.95** COMPLETE WITH TUBES  
★  
YOU GET EVERYTHING  
Yes EVERYTHING YOU NEED

for the complete successful assembly of this excellent radio  
• 5 Tube Superheterodyne • Tuning from 520 KC to 1590 KC • P.M. Speaker • Built-In Antenna • 456 KC IF • AC DC Current • All Sockets and Terminal Strip riveted into chassis • Automatic Volume Control • Tube Complement—12SA7, 12SK7, 12SQ7, 50L6, 35W4 • Can Be Aligned Without Servicing Instruments.

**DON'T DELAY — ORDER TODAY!**  
Prices do not include solder and wire.

## Simple to Assemble!

No complicated instructions to follow. So simple you can build this 5 tube kit from only one simple diagram. No previous experience required. Yes, this is the kit you've always wanted!

25% Deposit on All Orders, Balance C.O.D. F.O.B. New York

**SENCO RADIO, INC.**  
96B WARREN STREET, NEW YORK 7 • BEEKMAN 2-6498

# Classified

Rate 20c per word. Minimum 10 words.

## RADIO ENGINEERING

RADIO Engineering Broadcasting, Aviation and Police Radio, Servicing, Marine Operating and Electronics taught thoroughly. Expenses low Write for catalog. Valparaiso Technical Institute, Dept. N, Valparaiso, Ind.

## FOR SALE

ASTATIC Pick-ups, Model D9 or CL-407, brand new, regular \$5.00 value, bargain price, \$1.95. Regular \$9.00 value 20x20x150V tubular condensers, 10 for \$1.95. Write for latest 64 page bargain catalog to Leo-WOGFQ, World Radio Laboratories, Council Bluffs, Iowa.

SX-28, excellent condition, \$147.00. Jack Irwin, Candler Field Br. P. O., Atlanta, Ga.

REORDER and playback Amertype "Commando" Model A Recordgraph carrying case 110V AC 60 Cycles eight hour recording on vinylite tape. Original purchase price, \$850. Make reasonable offer. Pilot Marine Corp., 29 Broadway, New York, New York.

RADIO Line cords. Brown rubber PL-Bake: Plugs. 20c ea. Tubes, condensers. Clouse-Radio Wholesale, 820 Elmsere Place, Bronx 60, N. Y.

FM FOR under \$6.00! Build amazing one-tube super-regenerative FM tuner. Complete diagram, easy instructions, only \$1.00. G. Marsh, 6059 Waveland, Chicago, Illinois.

PANELS, magnesium: machined, painted, engraved. Gilpin, Box 638R4, Mt. Clemens, Michigan.

WIRE recorder magazine. Limited quantity, made for Army, and Air Corps. New, includes 10,000 feet stainless steel wire, spools, level-wind, brake control, automatic switches, elapsed time indicator, etc. in a fully assembled, dust-proof unit. Price, \$35.00. McCoy Sales Co., P. O. Box 335, Berea, Ohio.

D. C. METERS, new, 3 1/2". \$1.39 each, 5 for \$5.00, send for list. C2. Boutwell Electric, 203 Gilbert, Kirkwood 22, Mo.

25 WATT Jensen EP-807 full range Reproducer with 18" Woofer and horn in Bass Reflex Cabinet. Collins FM-AM Tuner in cabinet. Bogen PV-20A Amplifier with G. E. Equalization. Garrard Transcription motor. Above equipment used two hours. Must sell. Sherwin Janows, 865 Sangamon, Chicago, Ill.

Hq-129-X Hammarlund in A1 condition, \$165.00 including speaker. John M. Kriz, 784th Base Depot, Fort Eustis, Va.

MIDGET Autosyns indicator types AY1 and AY5 surplus, new condition, \$3.00 pair postpaid. W. C. Newman, 1728 Hood, Wichita 3, Kansas.

NEW and used Collins, Hallicrafters, National, Hammarlund, RME, Millen, Sonar, other receivers, transmitters, test equipment, amplifiers, etc. Lowest prices. World's best terms. Shipped on approval. Write. Henry Radio, Butler, Mo.

BARGAINS in guaranteed filter condensers. Send for free sample and price list. William H. DePeau, 1435 North 15th St., Harrisburg, Pa.

MULTICOLOR Maps. U. S. or World 50"x38", either type 75c. Both \$1.25 or on approval. Powell, 68 Lyall Road, Clifton, N. J.

RUBBER stamps etc. For sale. Cookson, Box O-RN, Puxico, Missouri.

YOU can accurately align superheterodyne receivers without signal generator. Complete instructions \$1. Moneyback Guarantee! Chas. Gates, Pecos 1, Texas.

ERECO Beam Rotator. 110 VAC, heavy duty, variable speed, selsyn indicator, weather-proofed. Complete indicator and rotator ready to plug in, \$69.95. Satisfied users all over the country. Buy from your dealer or direct. Free literature. Dick Rose, Erecos, 2912 Hewitt, Everett, Washington.

BC-455B EASILY converted to hot 10 meter receiver, fixed or mobile. Instructions, Schematics, \$1.00. Brown, 3327 Geronimo, Tucson, Arizona.

WRITE Dept. RN18 for our free wholesale list of Radio parts & accessories. R. C. Radio Parts & Distributing Co., 731 Central Ave., Kansas City 6, Kansas.

LOWEST Prices. Radio Tubes, parts. Bargain lists 3c. Potter, 1314 McGee, Kansas City 6. Mo.

CHOKES, swinging, rated 2-12 henries, 100-1000 MA. 5 1/2"x7"x10 1/2", heavy duty with porcelain insulators, \$7.50; filament transformers, 2.5 volts, 11 amps, cased, porcelain insulators, \$2.50; with pair 866, \$4.00. SKL Laboratory, Box 188, Lexington 73, Mass.

SELENIUM Rectifiers, full wave, 1/2 ampere, \$1.85; 1 ampere, \$2.50. Half wave 5 ampers, \$4.50; 2.2 ampers, \$2.25; 1.5 ampere, \$1.85. Bulletin Bursma Radio, Route 5, Grand Rapids, Mich.

WHIP Antennas, two 15 foot masts, in 5 screw-in-sections w/canvas carrying bag and heavy base insulator. New in original crates, \$14.95. Electronic Surplus Sales, 3219 Carnegie Avenue, Cleveland, Ohio.

FREE wholesale bulletin. Tubes, parts. Bargain prices. Henshaw Radio Supply, 3313 Delavan, Kansas City, Kansas.

TELEVISION components for assembly of a modern 52-square inch screen receiver using the newest circuits and tubes. The only kit on the market featuring an aluminumized cathode ray tube, A.F.C. on horizontal sync and a wired, pre-aligned r.f. tuner covering any combination from 1 to 13 television channels. Sound and Picture IF's are on one sub-chassis using new 6AH6 miniature tubes having a gm of 9000! The IF Strip and the 9000 volt RF Power Supply are sold in kit form. The main chassis is sold with all holes punched with suggested chassis layout print. All components individually priced. Our catalog lists television components exclusively and shows parts and circuits of the "hard to find items" you have been looking for. Send for it today. It's free! Television Specialties Co., 315 Madison St., Oak Park, Ill.

TELEVISION Diagrams: Transvision, Viewtone, RCA, Philco, Certified, Electrotech, others. 35c each, 3 for dollar. Transmitter kits: 80M, 40M, Ten watts. Assembled within 2 hours. Complete with power supply, xtal, tubes, instructions. Price \$11.95. RadioVision, 2064 Ocean Parkway, Brooklyn 23, N. Y.

6V DYNAMOTOR from 12V surplus. No rewinding. Original output. Instructions 50c. Satisfaction guaranteed. Paul E. Hawkins, 1306 E. 27th, Kansas City, Mo.

SELSYNS. Large, heavy duty, high torque motors. No overrun. 115 volt A.C. 60 cycle, ball bearing, precision made. Weight 6 lbs. each. \$10.95 pair. Radioco, 1110 Marshall Bldg., Cleveland, Ohio.

## WANTED

AN/TRC-1 Equipments T-14 Transmitters R19 Receivers TS32 Oscillators, complete or parts, any quantity. Box 458, % Radio News, 185 N. Wabash Ave., Chicago 1, Illinois.

TELETYPEWRITERS used or new, parts, accessories. Box 447, % Radio News, 185 N. Wabash Ave., Chicago 1, Illinois.

TRC7 RADIO Equipments. RT-53 Receiver-Transmitters, AS-12 Antennas. Box 448, % Radio News, 185 N. Wabash Ave., Chicago 1, Ill.

WESTERN Electric Carrier Telephone or Telegraph Filters, equalizers, repeating coils, etc. Also CF1 and CF2 carrier equipment and parts. Box 450, % Radio News, 185 N. Wabash Ave., Chicago 1, Illinois.

W E OR Kuthe Type 394A Grid Controlled Rectifiers. Box 451, % Radio News, 185 N. Wabash Ave., Chicago 1, Illinois.

URGENT. Nine inch dial, Zenith 8S129 or equivalent. Buy entire chassis if dial scale satisfactory. Arrow Radio, Duluth, Minnesota.

## HELP WANTED

FACTORY representatives, dealers. Hot lines. Hardware, electrical. Powered units. Farm Products Co., M-2062, Excelsior Springs, Mo.

INSTRUCTORS in Radio-Electronics and Television. Prefer former Navy Radio Technician Instructors with Teacher Training. Must be willing to locate in Detroit, Mich. Write to Box 452, % Radio News, 185 N. Wabash Ave., Chicago 1, Ill.

RAILWAY Telegraphy needs men. Complete training. Instruments furnished. Positions waiting. Bell Telegraph Railway Institute, 10 Parker Ave., San Francisco 18, Calif.

## PATENT ATTORNEYS

LANCASTER, Alwine & Rommel. Registered Patent Attorneys. Patent Practice before U. S. Patent Office. Validity and Infringement Investigations and Opinions. Booklet and form "Evidence of Conception" forwarded upon request. Suite 414, 815 15th St., N. W., Washington 5, D. C.

## MISCELLANEOUS

TESTING Equipment. All types and models. Expertly repaired and calibrated. Free estimates. Metropolitan Electronics, 42 Warren St., N. Y. 7, N. Y.

OLD established firm in Newfoundland with outlet for about 600 Radios annually seeks exclusive agency in that territory from the Manufacturer of Electric and Battery powered Radios. No dealers or jobbers need apply. Reply, Box E5191, St. John's, Newfoundland.

BC-348-J. N. Q. OWNERS only. Special Service Manual now available. Contains Schematic, Wiring Diagrams, Alignment, etc. \$1.00. John W. Martin, 3516 Sacramento, El Paso, Texas.

EXPECTING? Announce birth with new, tube-shaped "Birth-O-Gram" cleverly worded in radio motif. 60c dozen. Free sample. Birth-O-Gram Company, Madison 3, Wisconsin.

26 YEARS experience radio repairing at your fingertips. I've repaired 45000 radios. Have perfected simple system you can follow step by step. No calculations or formulas. Total price \$2.00 postpaid or C.O.D. Money back guarantee. Ross Radio, 14615-C Grand River, Detroit 27, Mich.

ELECTRIC meter laboratory. Electrical instruments, tube checkers, and analysers repaired, checked and calibrated. Prompt and reliable service guaranteed. Hazelton Instrument Co., 140 Liberty St., New York 6, N. Y. Tel. Barclay 7-4239.

MAKE more money, easily. Become independent. We show you how. Eye-opening information free. Radiomen and beginners, write: Merit, 216-32d 132nd Avenue, Springfield Gardens 13, N. Y.

PHONOGRAPH records 20c. Catalogue sent free. Paramount, NH-313 East Market, Wilkes-Barre, Pennsylvania.

QSLs, SWLS. Samples free. W5FAY Press, 6118 Goliad, Dallas, Texas.

### CORRESPONDENCE COURSES

LEARN elements of radio at home. Ideal course for beginners. \$15.00. Write Waca Radio School, 1421 Sixth St., S.E., Minneapolis 14, Minn.

USED Correspondence Courses and Educational Books sold or rented. Inexpensive. Money-back guarantee. Write for Free Catalog listing 4000 bargains. — (Courses Bought.) — Lee Mountain, Pisgah, Ala.

AMATEUR radio licenses. Complete code and theory preparation for passing amateur radio examinations. Home study courses. American Radio Institute, 101 West 63rd Street, New York City 23.

**PRACTICAL TECHNICAL TRAINING FOR YOU**

Specialize in Electronics, Radio, Electricity, Refrigeration, Heating and Air Conditioning, or Welding. Prepare in one year for position as Technician, or in two additional years secure your B.S. Degree in Electrical Engineering with major in Machinery or Electronics.

Write for booklet "Career Building"

**MILWAUKEE SCHOOL OF ENGINEERING**  
"A Technical Institute"

RN-348, N. Broadway and E. State, Milwaukee, Wis.

Page	Credit
39, 41 (top), 41 (lower right)	Massachusetts Institute of Technology
41 (lower left), 50, 143	Westinghouse Electric Corporation
45	Radio Manufacturers Association
48	Joe Tillotson, Staff Artist
49, 124	Porterfield Television
56	Station WKRC, Cincinnati
63	Audio Devices
71 (top), 71 (bottom center)	Philco Corporation
72	Meissner Manufacturing Division
119, 172	Town Meeting of Radio Technicians
158	Harley-Davidson Motor Company
164	Radio Parts & Electronic Equipment Shows, Inc.
166	Western Electric Company
168	Motorola, Inc.

### Speech Blockade

(Continued from page 61)

improvement if it is considered sufficiently worthwhile. For instance, the program material may be stored while one analyzes it and in this way some of the shortcomings of the control circuit may be corrected. The program could be recorded on a wire recorder with playback facilities arranged to deliver it to a power amplifier and speaker a minute or two later. All program material would then be heard by the listener after a predetermined lapse of time, during which the analyzer circuit could more effectively determine whether the passage being recorded consisted of speech or music. If the circuit sensed that the material was predominantly music during any interval short interruptions could be ignored by it. In like manner, if the material was predominantly speech, then the occasional word or phrase which slips through with the circuit of Fig. 5 could be blocked. Fig. 2 is a block diagram of this arrangement.

### REFERENCES

Adair, George P. U.S. Patent No. Re 21,151 July 18, 1939.  
Atkins, Carl E. U.S. Patent No. 2,421,216 July 22, 1947.

-50-

### SURPLUS SALES TO END

THE War Assets Administration has notified its agents that surplus electronic equipment sales through them will be terminated March 1st.

According to the WAA, should any inventory remain in the hands of these agencies after that date, it will be disposed of by donation to educational institutions in line with the program now applying to electronic inventories now on hand at the WAA.

While agency sales will be terminated, sale of surplus electronic equipment at the retail level will continue until stocks now in the hands of dealers are exhausted.

The WAA emphasized that there are still many types of end equipment, including components, tubes, etc., still available for sale.

-50-

"Shymo just can't stand to have anyone stare at him!"

**free radio book**

RADIOS HAM P.A.

Mail coupon for buying guide to the best values in Radio, Ham and P.A. Equipment. Send too for the newest flyer ham-packed with bargains.

**Spot-lite Values**

performs comparable to large bench type units only **\$19.95**



Pocket Size FM Signal Generator Model 720

Here's a Lafayette super-value for FM servicing and alignment. Uses 4 fixed frequencies: 10.7 mc for I.F., 88 mc for the low end, 98 mc for mid-point and 108 mc for top end of F.M. band. Complete with tubes, selenium rectifier and output cable. Hammertone grey case housing. Size: 3" x 6" x 2 3/4". Wt.: 2 lbs. No. K21479.

Model 205 Automatic Record Changer

One simple control for On, Off, Reject. Plays a full stack of 10 twelve inch or 12 ten inch records at one loading. Extremely light tangent tone arm, saves record wear. Size: 11" x 11 1/2" x 7". Wt. 12 lbs. No. K22501.

fine quality tone reproduction

only **\$16.95**

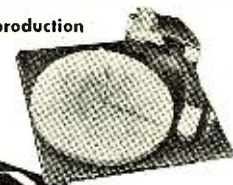

from **Lafayette**

MAIL NOW

New York  
100 SIXTH AVE.  
110 Federal St., Boston 10  
24 Central Ave., Newark 2

**Lafayette Radio**

RADIO WIRE TELEVISION, INC.  
Dept. RC-8, 100 Sixth Ave., New York 13

Rush Catalog #88  Flyer #C41   
Enclosed is check or money order for:  
 Signal Generator K21479 at \$19.95 ea.  
 Record Changer K22501 at \$16.95 ea.

Name.....  
Address.....  
City..... Zone..... State.....

# SPEAKERS SPECIAL

4" P.M. Alnico #5	\$1.15
5" P.M. Alnico #5	1.15
6" P.M. Alnico #5	1.55
7" P.M. Alnico #5	1.60
8" P.M. Alnico #5	1.90

## RESISTOR KITS \$1.45

100 assorted carbon and W.W. resistors 1/2 to 10 watt wide range of values—all standard items.

## CONDENSER KITS \$1.75

50 assorted paper by-pass and mica condensers—all new—good value.

## PHONOGRAPHS

<b>MODEL C-100</b> Plays 10"-12" records—Leatherette cabinet.	<b>MODEL C-201</b> Plays 10"-12" records. Light weight portable carrying case.
\$14.75	\$16.45

1/2 meg. vol. control with switch L shaft	\$0.35
Selenium rectifier 100 MA.	.69
6 ft. AC line cords	.13
G.I. or Alliance Motors	2.50
L-70 Crystal Pick-ups	1.89
#47 Pilot Light, 10 for	.60
40x40—150 V. solar	.45

**WIRE** Cotton on rubber covered—all colors. #20 stranded—per 1000 ft. spool. **\$4.95**

## WRITE FOR LATEST CIRCULAR

All Prices F.O.B. N.Y.C. 25% Dep. Bal. C.O.D.

# THE ROSE COMPANY

Dept. N, 88 West Broadway  
New York 7, N. Y.

## RADIO VALUES

**A TREASURE CHEST OF RADIO PARTS**  
Consists of transistors, condensers, dial controls, insulators, terminal connectors, coils, practically all types of switches. Many more useful items. Every assortment different.  
No. R6508—7 lb. Kit for only **\$1.25**

### PIONEER GEN-E-MOTOR DYNAMOTORS

Double Shaft Dynamotor. Input volts 18, output volts 450. 1-1/16" shaft length. 1/4" shaft length with small rear. Size of motor 7 1/2" L. 4 1/4" H. 3 3/4" Dia.  
No. 9626. Each **\$3.50**  
Wineo Dynamotor. Input volts 12 Amps. 9.9. output volts. 400 Amps. 180. Temp. rise 40° C. R.P.M. 4200. Duty cont. Size 7 1/2" L. x 4" H. x 3 3/4" Dia. Four lead wires.  
No. 9629. Each **\$6.50**



### CONDENSERS

Sprague Auto Radio Condenser. 5 M.F.D. 6.00 V. D.C. Size 2" L. x 1 1/16" Dia. with lead wire.  
No. 9631—lots of 10. 10c ea.



### ROTARY SNAP SWITCH

Radio Snap Switch. Split shaft 1/2" L. 2 lock nuts. Und. Rated. Rating 15 Amps. 10 V. 125 V. Single throw. 2 pole. Single throw. 2 solder lugs.  
No. 9637. Lots of 10. Each, 15c



### PIONEER GEN-E MOTOR DYNAMOTORS

Same as No. 9626 Input volts 9. Output V. 450.  
No. 9628. Each **\$5.50**

### BAKELITE HANDLE

Brown Marbleized Bakelite Handle used for radios, luggage, etc. Size 5" L. 2 1/2" W. with holes on each end for rings.  
No. 9638. Lots of 10. Each, 8c

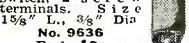

### PUSH BUTTON SWITCH

6 V. push button switch. 2 screw terminals. Size 1 3/8" L. 3/8" Dia.  
No. 9636. Each, 15c

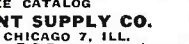

### SHUNT MOTOR

Aluminum Body Shunt Motor. Type B-9-1. 7 Amps. 27 1/2 volts. D.C. 5600 R.P.M. 1 3/4" shaft length. Plunger Type. 3/16" shaft.  
No. 9639. SEND FOR FREE CATALOG. Each. **\$2.25**

**G. & E. EQUIPMENT SUPPLY CO.**  
CORPORATION AT FULTON, CHICAGO 7, ILL.  
We ship C.O.D. All prices F.O.B. our warehouse.

In  
Indiana  
**IT'S**  
Stanton Radio Supply  
521 State St.  
HAMMOND, INDIANA

## Wire, Tape, & Disc RECORDERS

Write for Our Free Catalog of Recorders and Accessories

## ACME ELECTRONICS CO.

6523 Euclid Ave. Cleveland 3, Ohio

# INDEX OF Advertisers

MAR. 1949

While every precaution is taken to insure accuracy, we cannot guarantee against the possibility of an occasional change or omission in the preparation of this index.

ADVERTISER	PAGE NO.	ADVERTISER	PAGE NO.
A. M. Radio Sales Co.	156	Espey Mfg. Company, Inc.	92
Abell Distributing Company	123	Esse Radio Company	121
Acme Electronics	192	Fair Radio Sales	140
Acorn Electronics Corp.	118	Farwest Trading Company, Inc.	147
Adaptol Co.	185	Federated Purchaser, Inc.	162
Alger Radio	150	Felner Engineering Company	155
Allen Corp., Tom	175	G & E Equipment Supply Co.	192
Allied Radio Corp.	9	G & M Equipment Co., Inc.	151
Almo Radio Company	186	General Cement Manufacturing Co.	150
Altec Lansing	112	General Electric Company	6, 29, 77
Alvaradio	98	General Electronics Distributing Co.	103
Ambroid Company	183	General Test Equipment	183
American & Foreign Assoc.	160	R. E. Goodheart	184
American Radio Institute	178	Greenlee Tool Co.	187
American Sales Co.	183	Greenwich Sales Co.	97
American Surplus Products Co.	93	Greylock Electronic Supply Co.	185
American Television & Radio Co.	155	Hallcrafters Company	5
Amplifier Corp. of America	160, 179	Halldorson Co., The	125
Apex Video Co.	163	Harvey Radio Co., Inc.	102
Arrow Sales, Inc.	88, 89	Heath Company	84, 85
Ashe Radio Co., Walter	117	Henry Radio Stores	147
Audel Publisher	148	Hollywood Sound Institute	156
Audio Development Co.	113	Hoodwin Company, Chas.	170
Baltimore Technical Institute	178	Indiana Technical College	171
Bardwell & McAllister, Inc.	146	Interstate Radio & Parts Co.	177
Bell Telephone Laboratories	194	Instructograph Co.	173
Berman Co., Inc., Henry O.	176	Jensen Industries	104
Billie Electric Company	119	Jensen Mfg. Co.	13
Bliss Electrical School	98	Jensen's Radio Supply & Service	124
Boland & Boyce Inc., Publisher	141	Johnson's Fair	175
Brooks Radio Distributing Co.	169	Joseph, Irving	127
Brush Development Co.	139	Lake Radio Sales Co.	118
Buffalo Radio Supply, The	100, 101	Leeds Radio Co.	108
Burlington Instrument Co.	193	Le-Hi Electrical Company	171
Burstein-Applebee Co.	30	Leotone Radio Co.	83
C. B. Mfg.	171	Lincoln Engineering School	164
Candler System Co.	172	Lion Pacific Company	130
Cannon Electric Development Co.	18	Mallory & Co., Inc., P. R.	420
Capitol Radio Engineering Institute	87	Martin School of Radio Arts, Don	177
Centralab, Division of Globe Union Inc.	17	Maspath Telephone & Radio Corp.	178
Chicago Industrial Instrument Co.	138	Melville Radio Institute	123
Chicago Transformer, Division of Esser Wire Corporation	11	Merit Coil & Transformer Corp.	20
Chief Electronics	166	Merit Radio Supply Co.	182
Christy Supply Company	186	Mid-America	90
Cinaudagraph Speakers, Division of Alreone Mfg. Corp.	155	Midwest Radio Corp.	185
Cleveland Institute of Radio Electronics	32, 92	Milwaukee School of Engineering	191
Collins Audio Products Co.	161	Minnesota Electronics Corporation, The	115
Colortone Company	156	Montgomery Ward	122
Columbia Wire & Supply Co.	179	Morts Radio Shack	133
Commercial Radio	185	Mosley, Carl E.	150
Commercial Radio Institute	183	Moss Electronic Distributing Co.	91
Communications Equipment Co.	107	Murray Hill Books, Inc.	16, 82
Concord Radio Corp.	14	McCoy Sales Co.	168
Coradio	183	McGee Radio Company	79, 80, 81
Coyne Electrical & Radio School	97, 140	McGraw-Hill Book Company	110, 182
Crystal Devices Co.	146	McMurdo Silver Company, Inc.	25
D & H Distributing Co., Inc.	189	National Equipment & Supply Co., Inc.	130
Davega Stores	36	National Radio Institute	3
Davis Development Co.	186	National Schools	23
Deer & Taylor Co.	178	Newark Surplus Materials Co.	164
DeForest's Training, Inc.	19	Newcomb Audio Products Co.	78
Delco Radio	10	Niagara Radio Supply Corp.	111, 187
Delehanty School of Television	189	Northeastern Engineering, Inc.	161
Dow Radio	179	Northwestern Vocational Institute	176
Drifflick Sales	167	Offenbach & Reimus Co.	136
Duotone Company	187	Ohmite Manufacturing Co.	27
Editors & Engineers, Ltd.	98, 151	Olson Radio Warehouse, Inc.	35
Eichel Electronics	166	Onan & Sons, D. W.	134
Electronic Corp. of America	26	Opad & Green Company	160
Electronic Sales Co.	156	Peak Electronics	154
Electronic Supplies	132	Peerless Electrical Products, Division of Altec Lansing	70
Electronic Technical Institute	181	Photocon Sales	144
Electronicraft Inc.	181, 186		
Electronics Institute, Inc.	167		
Embry Riddle School of Aviation	180		
Epcoc Company	152, 180		
Ereco (Dick Rose)	186		
Erie Supply Co.	178		
Esege Sales Co., Ltd.	112		



ADVERTISER	PAGE NO.
Plastics & Electronics Company	178
Potter Radio Company	138
Premax Products	142
Premier Crystal	124
Progressive Electronics Co.	153
Pyron Controls	177

Quad Electrical Supply.....183

RCA Institutes, Inc.	186
R & M Radio Company	94, 95
Radcraft Publications	168
Radiart Corp., The	38
Radio Center	161
Radio City Products Co., Inc.	112
Radio Coin-Matic	157
Radio Corp. of America	15
Radio Distributing Co.	184
Radio Electric Service Co.	96
Radio Ham Shack, Inc.	137
Radio Hospital	138
Radio Institute of Chicago	193
Radio Parts Company	113
Radio Parts Distributors	190
Radio Press	183
Radio Supply & Engineering Co., Inc.	105
Radio Tech	188
Radio Wire Television, Inc.	191
Radionic Equipment Co.	173
Radolek Company	193
Ravac Electronics Corp.	118
Ray-lectron Company	184
Reed Mfg. Co.	167
Research Manufacturing Corp.	104
Rider Publisher, Inc., John	12
Risco Electronics Wholesale Distributors	140
Rose Company	192

SNC Manufacturing Co., Inc.	2nd Cover
Sams Company, Howard W.	34
School of Sound Recording & Transmission Engineering	184
Schuh's Radio Parts	142
Senco Radio, Inc.	177, 190
Servo-Tek Products Co.	98
Shure Bros, Inc.	131
Silverstine Co., N.	149
Spellman Television Company	116
Sprague Products Company	31
Sprayberry Academy of Radio	7
Stahl, Inc., Michael	158
Stanton Radio Supply	192
Star Measurements Co.	104
Sterling Electronic Company	173
Sun Radio of Washington, D. C.	22
Supreme Publications	21
Sutton's Wholesale Electronics, Bill	169
Sylvania Electric Products, Inc.	4th Cover

TAB	129
TapeTone Mfg. Corp.	120
Technical Radio Parts Co.	134
Tel-Craft Co.	172
Telectro Corp.	170
Television Assembly Co.	33
Television Industries Inc.	109
Telex, Inc.	157
Test Craft Instrument Co.	135
Thordarson, Division of Maguire Industries	37
Tradio, Inc.	130
Transvision, Inc.	143
Triplett Electrical Instrument Company	75
Tri-State College	163
Turner Company, The	76

United Surplus Materials	167
Universal General Corp.	189
Universal Microphone Company	181
University Loudspeakers, Inc.	8, 134

Valparaiso Technical Institute	185
Variety Electric Co., Inc.	106
View Cards	178
Vision Research	124

WICO	146
Waldref Co., The	186
Ward Products Corporation, The	21
Warren Distributors	181
Weiler Manufacturing Co.	28
Wells Sales, Inc.	99
Western Radio Co.	145
Western Radio Communications Institute	78
Workshop Associates Inc.	171
World Radio Laboratories, Inc.	163
Wright, Inc.	163

York Distributors	189
-------------------	-----



ONE OF A SERIES

## ALNICO MAGNETS

**WHY BURLINGTON PANEL INSTRUMENTS PROVIDE UTMOST RELIABILITY...**



MAGNETS OF ALNICO are standard for all DC instruments because it is the most stable magnetic material available, having greatest resistance to effects of stray magnetic fields, vibration, shock and heat. All ranges AC and DC available in 2 1/2", 3 1/2", 4 1/2", rectangular or round case styles and are fully guaranteed for one year against defects in workmanship or material. Refer inquiries to Dept. K38.



**Burlington**

**INSTRUMENT COMPANY**  
BURLINGTON, IOWA

## More Money for You in Radio

Qualify here for your Radio Operating Engineer's Licenses

Complete instruction for passing F.C.C. Commercial and Amateur Radio Operator's License Examinations.

Small classes and individual attention

NEW CLASSES FORMING REGULARLY

G. I. Approved Training

Write for complete information

**RADIO INSTITUTE OF CHICAGO**

165 North Michigan Ave.  
Chicago, Ill.

Just off the Press!  
1948 Radolek RADIO PROFIT GUIDE



**NEW COMPLETE RADIO PROFIT GUIDE FREE**

Radio Repair Parts • Tools  
Sound Systems • Tubes  
Phono Equipment & Supplies  
Test Instruments • Etc.

Big, new ENLARGED complete catalog showing thousands of Radio Bargains sent to you immediately. Helpful, money-saving buying information. Send coupon today!

**BIG VALUES, LARGE STOCKS, FAST, DEPENDABLE SERVICE.**

**FREE...SEND TODAY**

RADOLEK CO., Dept. B-038  
601 W. Randolph St., Chicago 6, Ill.  
Please send your Free Profit Guide Catalog and regular Supplements.

Name .....  
Address .....  
City.....Zone.....State.....

**SAVE AT RADOLEK**



# SEQUENCE

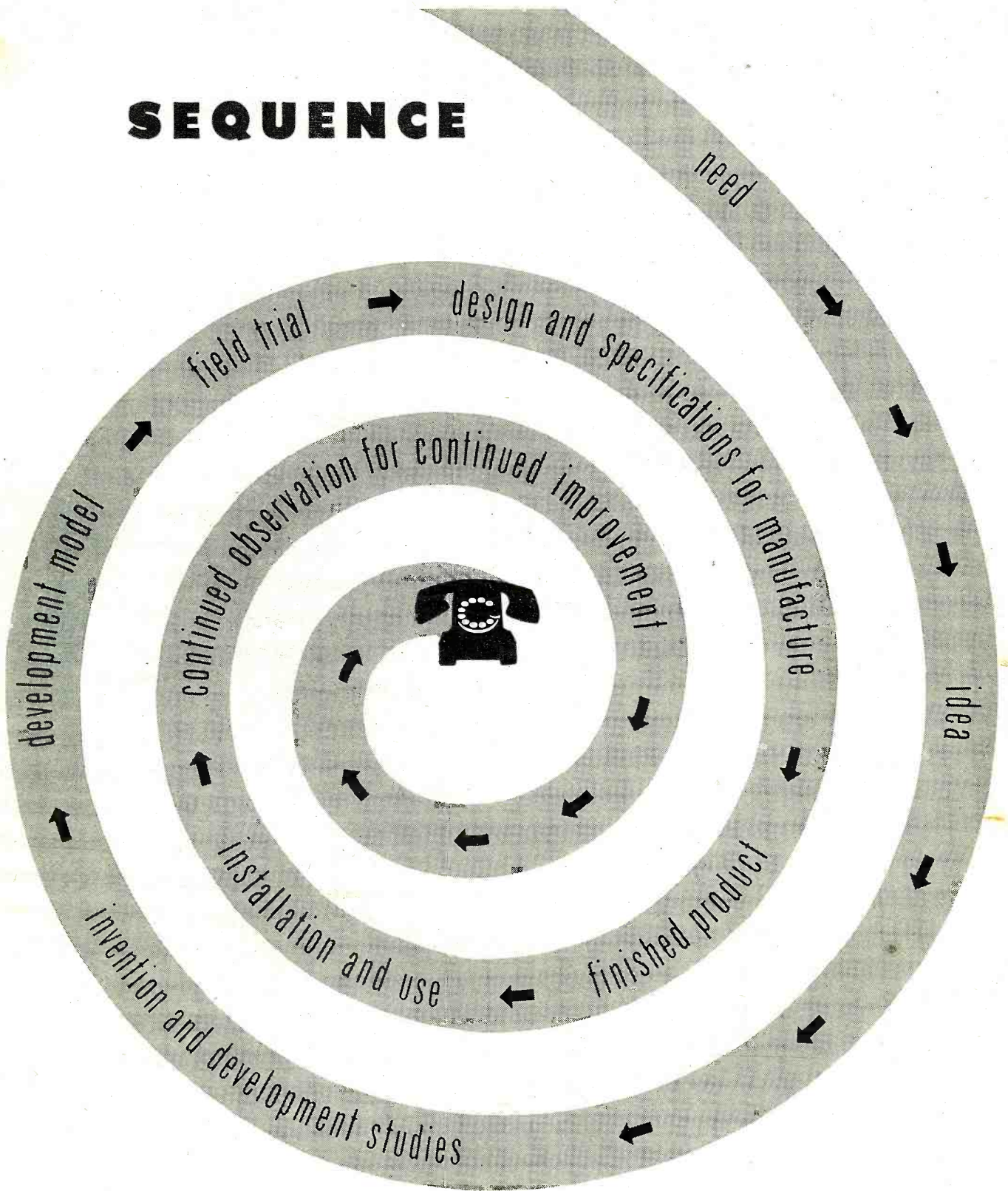

At Bell Telephone Laboratories, more than 2300 scientists, engineers, and their associates are continually exploring and inventing, devising and perfecting for improvements and economies in telephone service.



**BELL TELEPHONE LABORATORIES**

PRINTED IN U. S. A.

# Uniform Resistance

Mallory carbon controls are accurate in overall resistance value



You will find no variation in the resistance values of Mallory carbon controls. Frequent, critical inspections reject the imperfect, and pass only those carbon elements of the resistance values specified on the labels.

Recently dozens of controls from leading manufacturers were tested competitively for overall resistance value. Mallory controls averaged within 2% of specified resistance, the closest tolerance of any group in the test.



Every carbon element that goes into Mallory controls is individually inspected to be sure that its resistance value is the same as specified on the labels.

In volume controls you look for uniform

resistance, accurate tapers, silent operation and long life. Mallory gives you all four, and more, too. The Mallory trade mark is your assurance that the volume control, vibrator or capacitor you buy is the finest that can be made.

## The Mallory 1485 Control Deal

This attractive metal cabinet contains the 15 Controls and 9 Switches that will take care of 90% of your service calls. Its arrangement makes inventory control almost automatic—saves you frequent trips to the distributor's counter. It contains a rack for your Radio Service Encyclopedia. You pay only for the Volume Controls and Switches; the cabinet is included in the deal at no extra cost to you. Check your Mallory distributor on this special offer.



Visit us at  
Booths 84, 85, 86  
I. R. E. Show  
Grand Central  
Palace  
New York  
March 22-25

P. R. MALLORY & CO. Inc.  
**MALLORY**

CAPACITORS . . . CONTROLS . . . VIBRATORS . . .  
SWITCHES . . . RESISTORS . . . RECTIFIERS . . .  
VIBRAPACK\* POWER SUPPLIES . . . FILTERS

\*Reg. U. S. Pat. Off.

**APPROVED PRECISION PRODUCTS**

P. R. MALLORY & CO., Inc., INDIANAPOLIS 6, INDIANA



Conservation Officer gives detailed fire-fighting instructions to mobile unit summoned by radio.

## Motorola Units with Sylvania Lock-In Tubes Guard Michigan Forests Against Fire

Quick action in the early stages of forest fires is a vital factor in their effective control by the Michigan State Department of Conservation. A comprehensive network of two-way radio assures quick action!

Each of the 248 Conservation Officers' cars is equipped with Motorola FM, as are 19 land stations. Supplementing this equipment are 130 AM units in lookout towers, 20 in pick-up trucks, 14 in fixed stations—plus two radio-equipped airplanes. Through this equipment, fire-fighting apparatus is speedily marshaled, effectively directed!

Motorola, naturally, counts on Sylvania Lock-In tubes to help maintain uninterrupted, efficient performance of its mobile units. These tubes stay firmly in place in spite of jolting and jarring. They have few welded joints, no soldered ones. No warping or weaving of elements. Low loss, low leakage. See Sylvania Distributors, or write Radio Tube Division, Emporium, Pa.

# SYLVANIA ELECTRIC

MAKERS OF RADIO TUBES; CATHODE RAY TUBES; ELECTRONIC DEVICES;  
FLUORESCENT LAMPS, FIXTURES, WIRING DEVICES; ELECTRIC LIGHT BULBS



Conservation Officer uses his radios to summon needed fire-fighting equipment within a matter of minutes.



Chief Radio Engineer R. O. Klemm indicates how fixed land stations are in constant touch with Conservation Officers throughout the state.

Superior mechanical and electrical features of Sylvania Electric's famous Lock-In tube make it the ideal choice for equipment on the road, in the air, on the rails, marine radar, FM and television.

