

# RADIO NEWS

AUGUST  
1946  
35c  
In Canada 40c

**THE ROTARY BEAM**  
*An Important Adjunct to  
Your Ham Station*

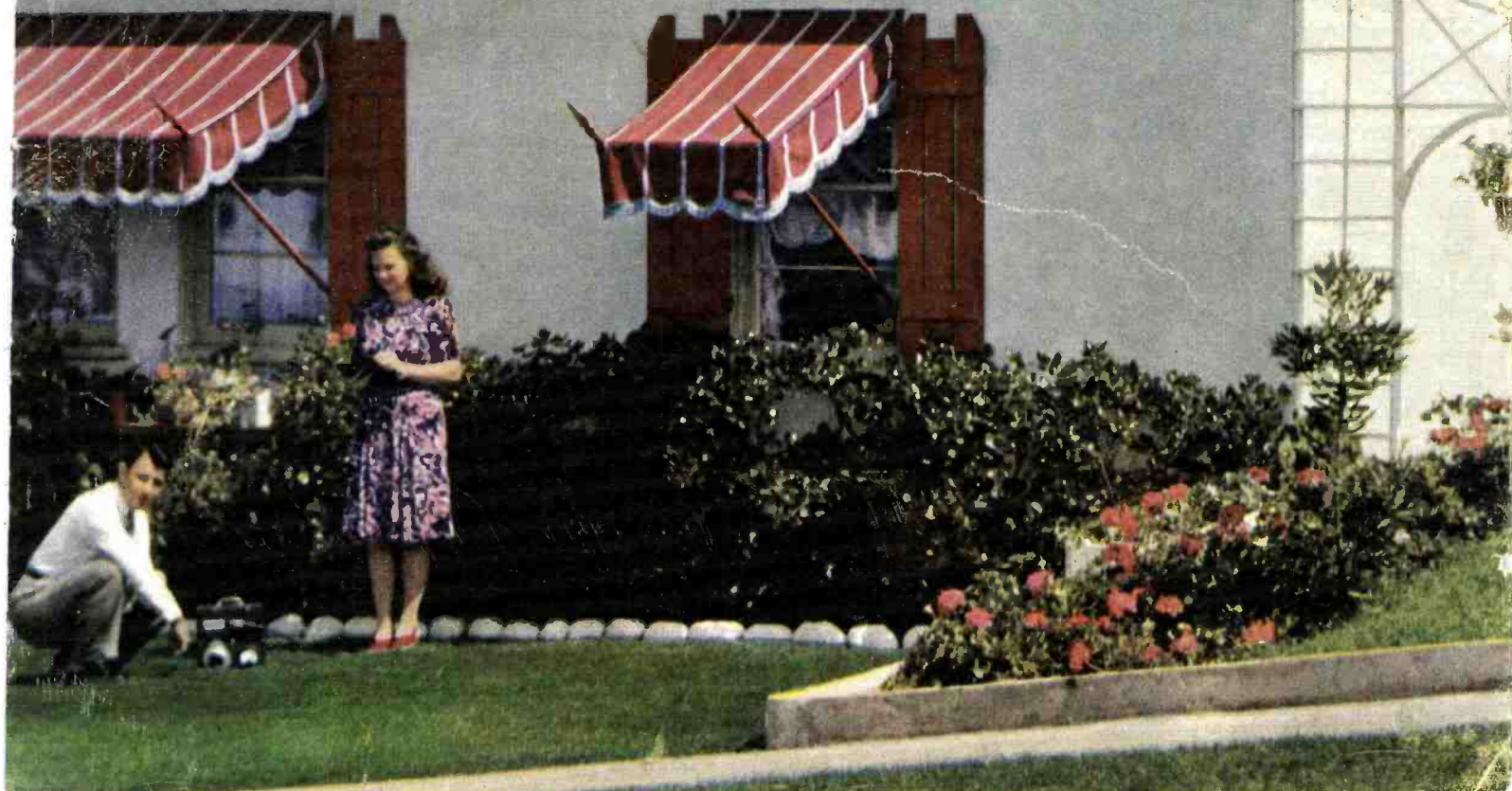

# ... And now a V.F.O. that is really engineered!

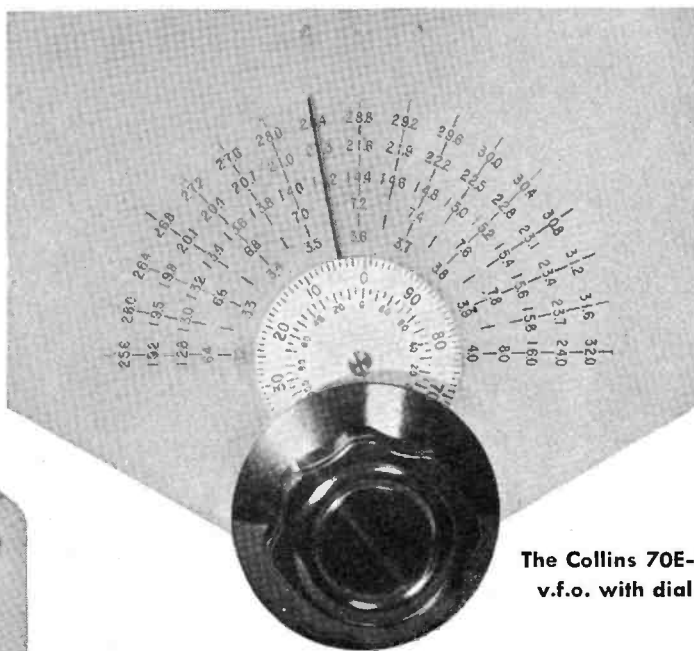
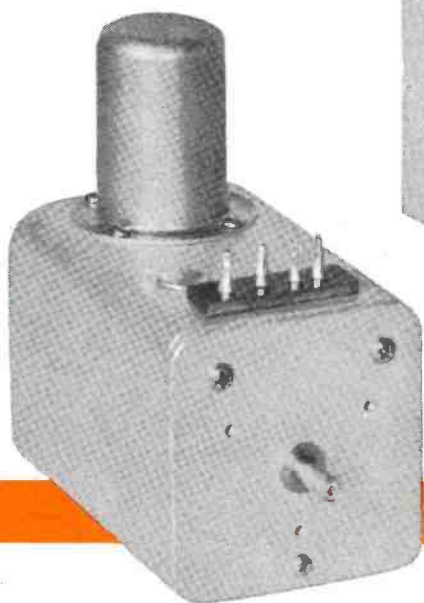

The Collins 70E-8  
v.f.o. with dial

The high stability and accurate calibration of the Collins 70E-8 variable frequency oscillator are part of the Collins program to provide amateurs with equipment that is thoroughly engineered from all angles. This unit reflects the years of successful experience at Collins in oscillator research, design, and manufacturing for commercial and military applications.

A frequency range of 1600-2000 kc is covered by the 70E-8. Each dial division represents 500 cycles on the 80 meter band. Frequency deviation and reset accuracy are within 1 dial division under all conditions. Frequency variations due to temperature changes and normal voltage fluctuations are

practically negligible. Keying is clean and crisp, without a trace of chirp.

The 70E-8 will make an ideal front end for your exciter—will give it professional performance and appearance. Its components are of the same select quality that was specified for wartime use. You can depend on it to give you long service free from trouble—and you always know your frequency.

Get one today. See your dealer, or write Collins Radio Company, Cedar Rapids, Ia. 11 West 42nd Street, New York 18, N. Y. 458 South Spring Street, Los Angeles 13, Calif.

FOR RESULTS IN AMATEUR RADIO, IT'S...





**RADIO SERVICING** pays good money for full time work. Many others make \$5, \$10 a week EXTRA fixing Radios in spare time.

Building this  
**A. M. SIGNAL GENERATOR**  
gives you valuable experience. Provides amplitude-modulated signals for test and experiment purposes.

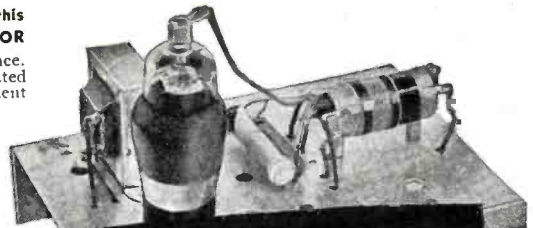

# Learn RADIO by PRACTICING in Spare Time

## with 6 Big Kits of Radio Parts I Send You

Do you want a good-pay job in Radio—or your own money-making Radio Shop? Mail Coupon for a FREE Sample Lesson and my FREE 64-page book, "Win Rich Rewards in Radio." See how N.R.I. gives you practical Radio experience at home—building, testing, repairing Radios with 6 BIG KITS OF PARTS I send!

**Many Beginners Soon Make Good Extra Money In Spare Time While Learning**

The day you enroll I start sending EXTRA MONEY JOB SHEETS. You LEARN Radio principles from my easy-to-grasp, illustrated lessons—PRACTICE what you learn with parts I send—USE your knowledge to make EXTRA money fixing neighbors' Radios in spare time while still learning! From here it's a short step to your own full-time Radio Shop or a good Radio job!

**Future for Trained Men Is Bright In Radio, Television, Electronics**

It's probably easier to get started in Radio now than ever before because the Radio Repair business is booming. Trained Radio Technicians also find profitable opportunities in Police, Aviation, Marine Radio, Broadcasting, Radio Manufacturing, Public Address work. Think of even greater opportunities as Television and Electronics become available to the public! Send for free books now!

**Find Out What N. R. I. Can Do for You**

Mail Coupon for Sample Lesson and my 64-page book. Read the details about my Course. Read letters from men I trained, telling what they are doing, earning. See how quickly, easily you can get started. No obligation! Just MAIL COUPON NOW in an envelope or paste it on a penny postal. **J. E. Smith, President, Dept. 6HR, National Radio Institute, Pioneer Home Study Radio School, Washington 9, D. C.**

**MY COURSE INCLUDES TRAINING IN TELEVISION • ELECTRONICS FREQUENCY MODULATION**



You build this  
**MEASURING INSTRUMENT**  
yourself early in the course—use it for practical Radio work on neighborhood Radios to pick up EXTRA spare time money!

You build this  
**SUPERHETERODYNE CIRCUIT**  
that brings in local and distant stations. You get practical experience putting this set through fascinating tests.

**BE A SUCCESS in RADIO I Will Train You at Home**

**Sample Lesson FREE**

Gives hints on Receiver Servicing, Locating Defects, Repair of Loudspeaker, I.F. Transformer, Gang Tuner, Condenser, etc., 31 illustrations. Study it—keep it—use it—without obligation! Mail Coupon NOW for your copy!



**GET BOTH 64 PAGE BOOK SAMPLE LESSON FREE**



Mr. J. E. SMITH, President, Dept. 6HR  
National Radio Institute, Washington 9, D. C.

Mail me FREE, without obligation, Sample Lesson and 64 page book about how to win success in Radio and Television—Electronics. (No salesman will call. Please write plainly.)

Name ..... Age.....  
Address .....  
City ..... Zone..... State.....

**APPROVED FOR TRAINING UNDER GI BILL**



REG. U.S. PAT. OFF

First in radio

AUGUST, 1946
VOLUME 36, NUMBER 2

Current Paid Circulation over 120,000

For the AMATEUR

Transmitter-Receiver for Ham Beginners... Corinne M. Sullivan 32
Flea Power Voice Transmitter... Alvin B. Kaufman 35
Crystal Controlled 2 Meter Transmitter... Wilson D. Speight, W9FST 36
Constructing A Grid Dip Meter... Howard Burgess, W9TGU 50
A Simple Method of Controlling the Beam Antenna... Edward Harris 60
The Dek-a-Xtal Holder... P. M. Oblinger 76
A Novel 2-Tube Receiver... 124

For the SERVICEMAN-DEALER

Modernize With Light... A. F. Loewe 30
Audio Oscillators... J. C. Hoadley 38
Television Receivers... R. A. Monfort 41
Hospitalization for Radios... Ormal I. Sprungman 45
Practical Radio Course... Alfred A. Ghirardi 46
Cathode Follower for Power Amplifier... Craig Stevens 52
The RN Circuit Page... 64

OF GENERAL INTEREST

Operation Crossroads... O. Read 25
Meet the Microphone... Henry J. Seitz 28
Shoran for World Mapping... 112

DEPARTMENTS

For the Record... The Editor 8
Spot Radio News... Fred Hamlin 12
QTC... Carl Coleman 49
What's New in Radio... 66
International Short-Wave... Kenneth R. Boord 55
Within the Industry... 114
Manufacturers' Literature... 118
Technical Books... 122
Letters from Our Readers... 136

COPYRIGHT 1946 ZIFF-DAVIS PUBLISHING COMPANY
185 N. Wabash Ave., Chicago 1, Ill.

BRANCH OFFICES: NEW YORK WASHINGTON, LOS ANGELES, TORONTO



B. G. DAVIS
General Manager

HERMAN R. BOLLIN
Art Director

WILLIAM B. ZIFF
Publisher

C. R. TIGHE
Asst. to the Publisher

H. G. STRONG
Circulation Director

GEORGE BERNER
Advertising Director

H. J. MORGANROTH
Production Director

EDITORIAL

OLIVER READ, W9ETI
Editor

WM. A. STOCKLIN
Asst. to the Editor

H. S. RENNE, Ex. W8PTS
Technical Editor

RAY FRANK, W9JU
Amateur Radio

FRED HAMLIN
Washington Editor

PAUL H. WENDEL
Eastern Editor

ARTHUR E. HAUG
WALTER STEINHARD
Staff Photographers

E. H. SEHNERT
Chief Draftsman

B. S. KUPJACK
Staff Artist

ADVERTISING

L. L. OSTEN
Advertising Mgr.

JOHN A. RONAN, JR.
Midwest Adv. Mgr.

WM. L. PINNEY
Western Adv. Mgr.



Cover Photo
By Kenneth Curtis

Amateur antenna installation at the home of R. L. Bedillion, Sunset Cliffs, California. This antenna, manufactured by Research Manufacturing Corporation, of Chula Vista, California is a four-element, ten-meter beam type unit.

RADIO NEWS is published monthly by the Ziff-Davis Publishing Company, 185 N. Wabash Ave., Chicago 1, Ill. Subscription Rates: in U. S. \$3.00 (12 issues), single copies 35 cents; in Mexico, South and Central America, and U. S. Possessions, \$3.00 (12 issues); in Canada \$3.50 (12 issues), single copies 40 cents; in British Empire, \$4.00 (12 issues)-all other foreign countries \$4.00 (12 issues). Subscribers should allow at least 2 weeks for change of address. All communications about subscriptions should be addressed to: Director of Circulation, 185 N. Wabash Ave., Chicago 1, Ill. Entered as second class matter March 9, 1938, at the Post Office, Chicago, Illinois, under the Act of March 3, 1879. Entered with reasonable care but this magazine assumes no responsibility for their safety. Accepted material is subject to whatever revisions and by-line changes that are necessary. Payment made at our current rates covers all authors' contributors' or contestants' rights, title, and interest in and to accepted material, including photos and drawings

Other Ziff-Davis Publications: Radio & Appliances, Radio-Electronic Engineering, Plastics, Flying, Popular Photography

NEW OFFICIAL SERVICE  
CENTERS FOR  
**hallicrafters**  
EQUIPMENT

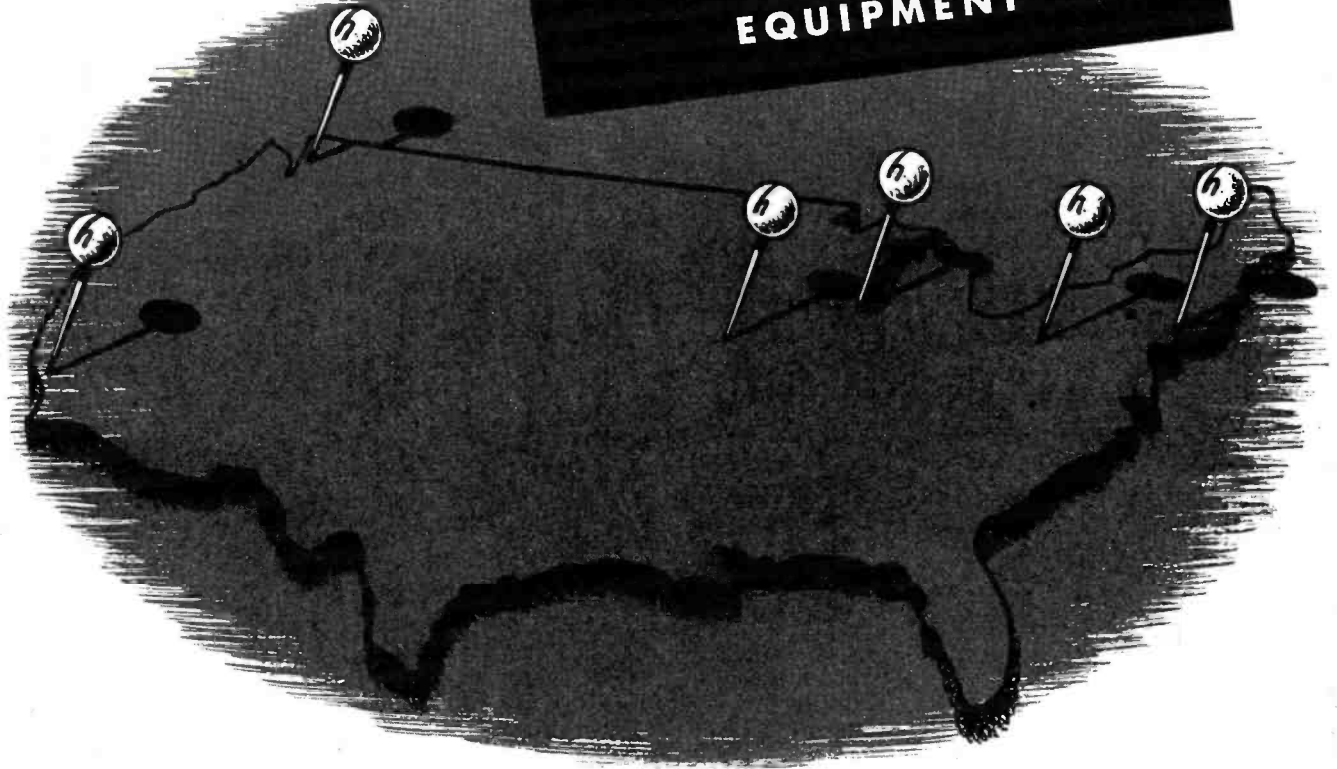

## hallicrafters establishes national network of strategically located SERVICE CENTERS

The Hallicrafters Co., Chicago, announces the beginning of a new national network of official service centers to specialize in repair and servicing of all Hallicrafters communications equipment: marine and aviation radio, ham transmitters and receivers. Service centers have already been established at New York, Pittsburgh, Kansas City, Mo., Los Angeles and Seattle. Service at these locations will be equal in every way to that offered by the Chicago factory.

As production and distribution can be increased, more such centers will be established so that Hallicrafters users everywhere will be given the fastest, most efficient service possible.

See your local Hallicrafters distributor to learn how and where you can benefit from this new service system. Your high precision Hallicrafters equipment deserves the finest care . . . put your repair and service problems in the hands of specialists: Hallicrafters official service centers.

COPYRIGHT 1946 THE HALLICRAFTERS CO.

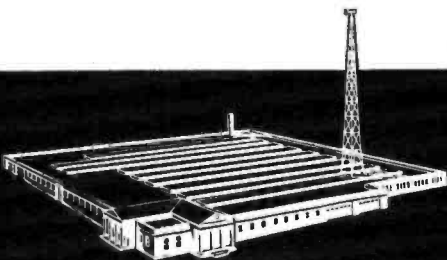

# hallicrafters RADIO

THE HALLICRAFTERS CO., MANUFACTURERS OF RADIO  
AND ELECTRONIC EQUIPMENT, CHICAGO 16, U. S. A.

# New!

## Series 200

# A RELAY BY GUARDIAN with Interchangeable Coils

### BUILT IN TWO PARTS

A.C. Coil Assemblies available for 6 v., 12 v., 24 v., 115 v.  
D.C. Coil Assemblies available for 6 v., 12 v., 24 v., 32 v., 110 v.

★ Two basic parts—a coil assembly and a contact assembly—comprise this simple, yet versatile relay. The coil assembly consists of the coil and field piece. The contact assembly consists of switch blades, armature, return spring, and mounting bracket. The coil and contact assembly are easily aligned by two locator pins on the back end of the contact assembly which fit into two holes on the coil assembly. They are then rigidly held together with the two screws and lock washers. Assembly takes only a few seconds and requires no adjustment on factory built units.

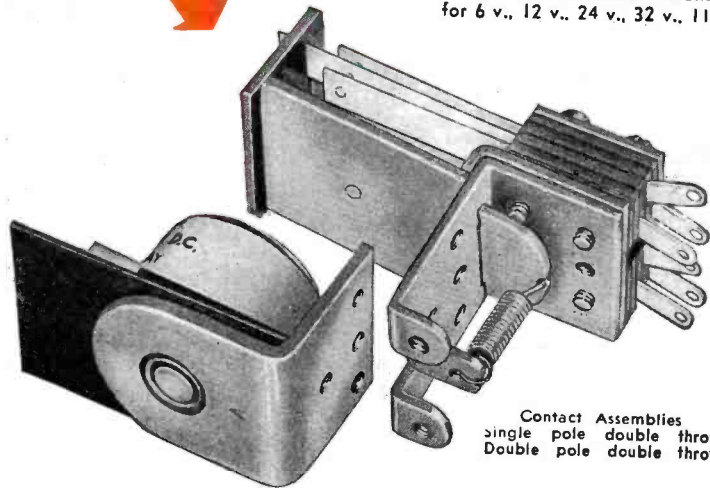

SERIES 200 RELAY

## On Sale at Your Nearest Jobber NOW!

See it today! . . . this amazing new relay with interchangeable coils. See how you can operate it on any of nine different a-c or d-c voltages—simply by changing the coil. Ideal for experimenters, inventors, engineers.

### TWO CONTACT ASSEMBLIES

The Series 200 is available with a single pole double throw, or a double pole double throw contact assembly. In addition, a set of Series 200 Contact Switch Parts, which you can buy separately, enables you to build dozens of other combinations. Instructions in each box.

### NINE COIL ASSEMBLIES

Four a-c coils and five d-c coils are available. Interchangeability of coils enables you to operate the Series 200 relay on one voltage or current and change it over to operate on another type simply by changing coils.



Your jobber has this sensational new relay on sale now. Ask him about it, Or write for descriptive bulletin.

# GUARDIAN ELECTRIC

1630-J W. WALNUT STREET CHICAGO 12, ILLINOIS  
A COMPLETE LINE OF RELAYS SERVING AMERICAN INDUSTRY

# LET ME TRAIN YOU

for RADIO ELECTRONICS & TELEVISION

# I'll Supply a FULL RADIO SET

for SIMPLIFIED INSTRUCTION — PRACTICE & TESTING

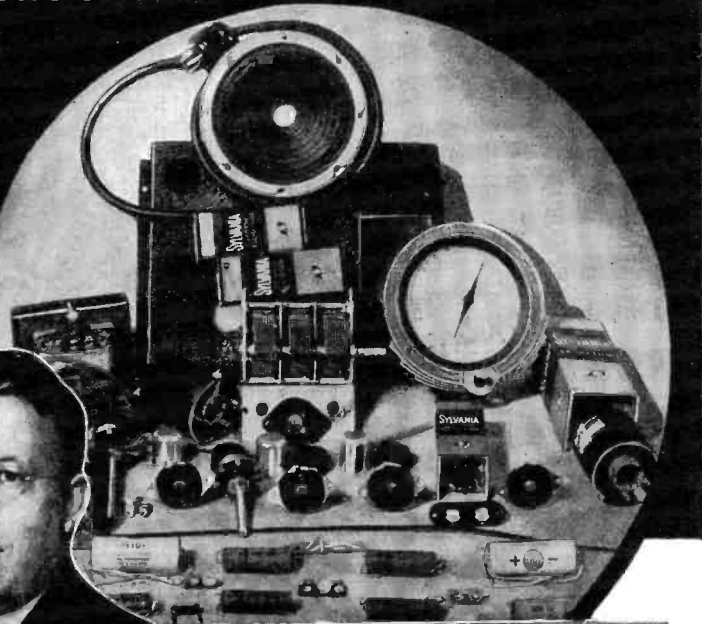
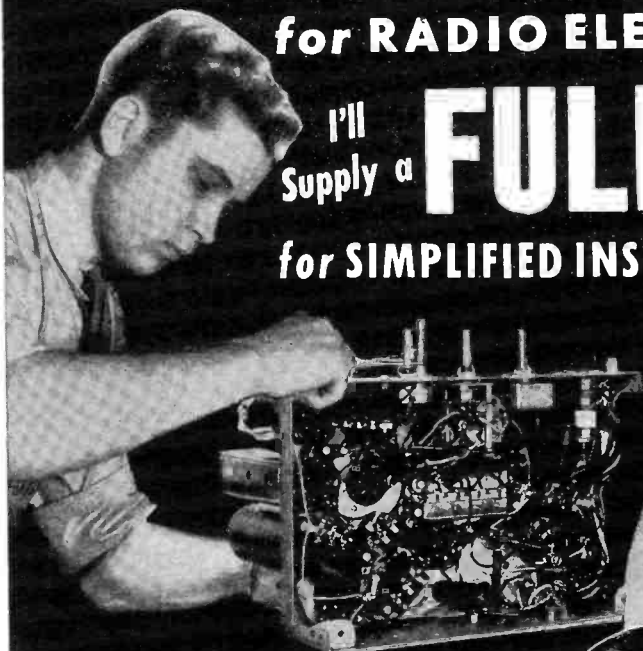

**Beginners Learn FAST**  
**START NOW! Big Developments**  
**Ahead in F. M., Radar, Television**



**MAKE GOOD MONEY IN**  
**a Business of Your Own**  
**...or a Good Radio Job.**

**M**IND training through *hand* practice with a **FULL RADIO SET** that's the interesting way I'll teach you Radio. And it's the latest, most practical method of all to fix in your head permanently the essential money-making Radio knowledge. The offer I make you here is the opportunity of a lifetime. I'll prepare you easily and quickly for a wonderful future in the swiftly expanding field of Radio-Electronics **INCLUDING** Radio, Television, Frequency Modulation and Industrial Electronics. Be wise! **NOW'S** the time to start. Opportunities ahead are tremendous! No previous experience is necessary. The Sprayberry Course starts right at the beginning of Radio. You can't get lost. It gets the various subjects across in such a clear, simple way that you understand and remember. And you can master my entire course in your spare time right at home.

**You Do Practical Experiments**

There's only one *right* way to learn Radio Electronics. You must get it through simplified lesson study combined with actual "shop" practice under the personal guidance of a qualified Radio Teacher. It's exactly this way that Sprayberry trains you... supplying real Radio parts for learn-by-doing experience right at home. Thus you learn faster, your understanding is clear-cut.

**I'll Show You a New, Fast Way to Test Radio Sets Without Mfg. Equipment**

The very same Radio Parts I supply with your Course for gaining pre-experience in Radio Repair work may be

adapted through an exclusive Sprayberry wiring procedure to serve for complete, fast, accurate Radio Receiver trouble-shooting. Thus, under Sprayberry methods, you do not have one cent of outlay for manufactured Test Equipment.

**Succeed as a Radio-Electronician**

My training will give you the broad, fundamental principles so necessary as a background, no matter which branch of Radio you wish to specialize in. I make it easy for you to learn Radio Set Repair and Installation Work. I teach you how to install and repair Electronic Equipment. In fact, you'll be a fully qualified **RADIO-ELECTRONICIAN**, equipped with the skill and knowledge to perform efficiently and to make a wonderful success of yourself.

**Read What Graduate Says**

**"One Job Nets About \$26.00"**

"Since last week I fixed 7 radios, all good-paying jobs and right now I am working on an amplifier system. This job alone will net me about \$26.00. As long as my work keeps coming in this way, I have only one word to say and that is, 'thanks' to my Sprayberry training and I am not afraid to boast about it."—**ADRIEN BENJAMIN**, North Grosvenordale, Conn.

**DON'T PUT IT OFF!**

Get the facts about my training—now! Take the first important step toward the money-making future of your dreams. All features are fully explained in my big, illustrated **FREE** Catalog which comes to you along with another valuable **FREE** book you'll be glad to own.

## FREE BOOKS

**"How To Read Radio Diagrams and Symbols"**

Here's a valuable and wonderfully complete new book which explains in simple, non-technical English how to read and understand any Radio Set Diagram. Provides the quick key to analyzing any Radio circuit. Includes translations of all Radio symbols. This instructive volume is yours for the asking—without obligation. Send for it **AT ONCE**, and along with it I will send you another big free book, describing in complete, interesting detail my Radio-Electronic training.

**RUSH COUPON for BOTH**



**SPRAYBERRY ACADEMY OF RADIO**  
**F. L. Sprayberry, President**  
**Room 2586, Pueblo, Colorado**

Please rush my **FREE** copies of "How to MAKE MONEY in RADIO, ELECTRONICS and TELEVISION," and "How to READ RADIO DIAGRAMS and SYMBOLS!"

Name..... Age.....

Address.....

City..... State.....

(Mail in envelope or paste on penny postcard)

**MAIL COUPON AT ONCE!**

August, 1946

"The Standard  
by Which  
Others  
Are Judged  
and Valued"

AUDAX has mastered wide-range so thoroughly that, today, even the lowest priced MICRODYNE has a range to 7000 cycles—(other models over 10,000 cycles). True,—wide-range makes for naturalness but,—it is highly objectionable if without quality. For example, of two singers, each capable of reaching high C, one may have a pleasing voice—the other, not at all. It is the same with pickups. To achieve EAR-ACCEPTABILITY, all other factors must be satisfied. Of these, VIBRATORY-MOMENTUM is most important. The only way to test EAR-ACCEPTABILITY of a pickup is to put it to the EAR-TEST. The sharp, clean-cut facsimile performance of MICRODYNE—regardless of climatic conditions—is a marvel to all who know that EAR-ACCEPTABILITY is the final criterion.

**Audax**  
**RELAYED-FLUX**  
*Microdyne*

Send for complimentary copy of  
"PICK-UP  
FACTS"



**AUDAX COMPANY**  
500 Fifth Avenue,  
New York 18

"Creators of Fine Electronic-Acoustical  
Apparatus since 1915"

For the **RECORD.**

BY THE EDITOR

**W**E FREQUENTLY climb out of the desk chair, descend from the ivory editorial tower and go "avisiting" with manufacturers, distributors and servicemen-dealers, attend meetings and ham fests, talk to bus drivers, cab drivers and people who just happen to sit down beside us. Naturally our interests are like yours, radio, and we keep on asking questions, snooping around to try to sense where it's all headed, based on what's going on at the moment.

One thing is certain, the radio industry has gotten out of knee pants and come of business age. We've seen some inspiring examples of scientific store layout, lighting and decoration among the distributors. The old hole in the wall, dimly lit hodgepodge which characterized the jobber's place of business seven, eight and ten years ago is rapidly vanishing. Jobbers have become full fledged business houses with an air of efficiency and modernity which does justice to the fine array of packaging and sleek new merchandise supplied by the manufacturers.

This trend toward making a store a pleasant place to enter is rapidly extending to the service-dealer outlets. It makes no difference what size a store may be or where its location, an air of orderliness, and cleanliness commends it to the customer as a successful business, inspires confidence and says more than a thousand "Thank You—Call Again" signs.

The manufacturers have done much to aid the general appearance of wholesale and retail outlets through application of the principles of modern packaging, streamlining and brightening the cases and panels of test instruments and supplying multi-drawer cabinets to house small parts purchased in bulk. Yes, the industry is definitely out of the bedraggled, dirty-faced kid stage and starting to comb its hair and wash its ears for the benefit of the public.

**B**ONANZA or mirage? Would anybody like to make any bets that we won't be up to our ears in the competitive battle of the century in radio by the first quarter of 1947? Even as early as June of this year there were definite signs that the public wasn't going to buy "just anything" to get a radio. A caution creeps into the minds of jobbers and dealers alike when they find that no "nylon lines" form to buy highly overpriced radio sets. When production actually bursts loose the distributor and dealer will be even more highly selective than the public. They will examine franchises very carefully, holding or seeking only

those brands which offer the most features, the highest quality and the best advertising and merchandising program in line with price and profit factors. The good old game of selling is due to be revitalized in the radio industry and it's stirring right now. Servicemen-dealers will do well to play the game for all it's worth for, as the supply of new radios increases there may be a lag in repair work for a time. The temporary slackening in service business should be of relatively short duration, however, as there is every indication that the public will want more and more sets per household, and that, eventually, leads to a higher average of breakdown and repair. Servicemen-dealers are in a wonderful position to play both ends against the middle by exerting their best selling efforts on new merchandise while the market is prepared to absorb it. Then, when the cycle swings, shift their weight to the service side. Never should a service-dealer neglect his service business, however. If necessary, he should hire competent help to sustain service work while attention is being given to sales of new receivers. There is no more solid foundation for any business involving technical or semi-technical merchandise than customer confidence in the dealer's service facilities.

**T**HERE may have been more harassed people in the United States than your editor preparing to wing over the Pacific to the A-bomb test and if so, they have his heartfelt sympathy.

The eleven shots in the arm, which presumably prepared me to resist the many germs which haunt the tropics, made me wonder whether having the diseases might be a more pleasant experience. Then the pages of official orders and instructions to be studied and followed in minute detail. The kind and quantity of clothing to take, the weight limitations, the restrictions which said "no cameras," etc., etc. A last minute decision to take a wire recorder meant disgorging such things as a couple of bottles of hair tonic, to stay within the weight limit. Then, alas, to discover the weight limit had been increased. Rushing to the Chicago airport to board a midnight Constellation only to discover the flight was cancelled and having to linger to 3:40 a.m. to board a Douglas. Details changed, plans upset, last minute rush, bustle, scurry, and worry plunging headlong into anticlimax. Last minute comment as the plane door was closed, "After all I've gone through, this bomb business better not be a bust." . . . . . O.R.

**RADIO NEWS**





## Communications Equipment for earliest delivery



Hallicrafters S-40

Order from  
**ALLIED**

Available on  
Time Payments

Trade-Ins  
Accepted

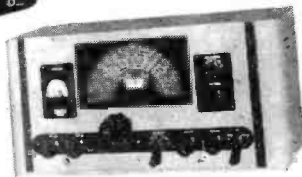

RME-45

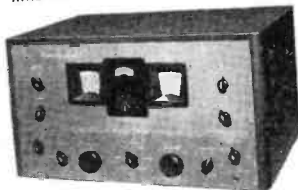

Hammarlund HQ-129X

Hallicrafters S-38	\$ 39.50
Hallicrafters S-40	79.50
National NC-46	97.50
NC-46 Speaker	9.90
RME-84	98.70
RME VHF-152 Converter	86.60
Hammarlund HQ-129X	168.00
RME-45	186.00
National HRO	197.70
National NC-240C	225.00
Hammarlund 400X	342.00
BC-610 (HT-4E Xmitter)	535.00

Net F.O.B. Chicago. Prices subject to possible change.

HAMFEST? Not exactly . . . it's just any hour of the day at the ALLIED "Ham Shack" in Chicago. Here, local amateurs as well as hams from miles around come in to chew the fat with ALLIED'S licensed lads. (Last year, the ALLIED "Ham Shack" register carried the names of amateurs from all 48 states as well as from 35 foreign countries.) Amateurs have always found a real welcome at ALLIED, a welcome based on common ham interests. Whether you visit the ALLIED "Ham Shack" in person or whether you shoot the dope to us by mail, we hope you'll always feel "at home" with us.

**OLD-TIMERS:** Whether you plan to rebuild that old rig . . . or want to try a new Ham band in the U. H. F.—you can count on ALLIED for fastest delivery on the latest available components. You know the ALLIED policy of guaranteed quality at lowest prices. That policy hasn't changed. Neither has ALLIED'S practice of preferred service for Hams.

**BEGINNERS:** For years, ALLIED has encouraged and helped thousands of beginners to become licensed radio amateurs. Get everything you need for a good start from our large stocks . . . Transceivers, Transmitter and Oscillator Kits, Code Equipment, etc. Count on us also for complete parts list service for any kit in the ARRL Handbook.

### Send for Allied's 1946 Radio Catalog FREE

Here's the latest, most complete Buying Guide to everything in radio! Includes newest communication receivers, Ham gear, code apparatus, parts, kits, tubes, tools, books, test instruments, public address and other equipment. Get your FREE copy now!



ALLIED RADIO CORP., D. L. Warner, W91BC  
833 W. Jackson Blvd., Dept. I-HH-6  
Chicago 7, Illinois

- Enter order for . . . . . Model . . . . .
- Enclosed \$ . . . . .  Full Payment  
 Part Payment (Balance C.O.D.)
- Send full information on Communication Receivers and Time Payment Plan, without obligation.
- Send FREE 1946 ALLIED Catalog.

Name . . . . .

Address . . . . .

City . . . . . Zone . . . . . State . . . . .

**ALLIED RADIO**  
*Everything for the HAM*

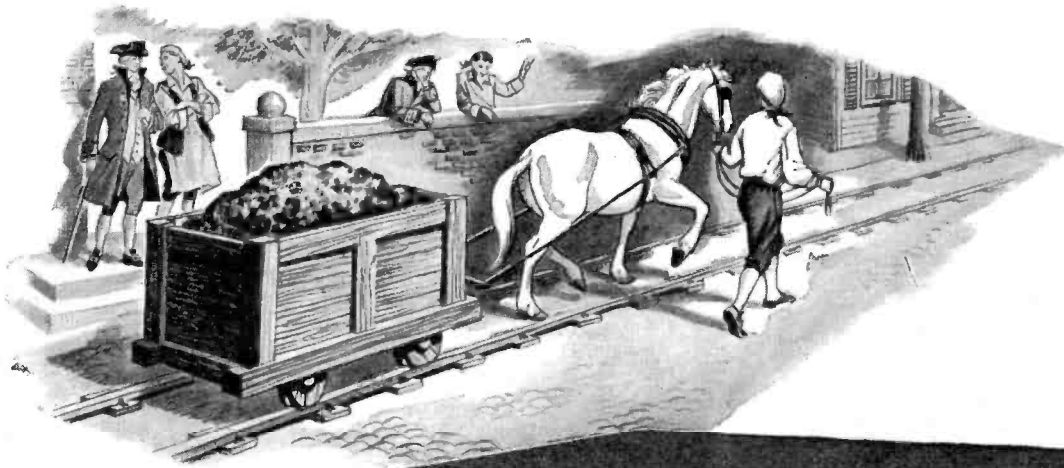

When T. Leiper raised the eyebrows of Philadelphians with his cart-on-wheels . . . he introduced our first modern network of railroads.

**PANORAMIC RECEPTION**

makes "blind" operation for the radio amateur as out-dated as stagecoach and wagon train.



**SEE** all that Panoramic Reception offers...

SEE a band up to 200 kc wide as you tune . . . SEE all activity within that band . . . phone, c.w., f.m., at a glance . . . SEE weak signals, short calls, dx. . . . SEE the characteristics of your own signal as well as others . . . SEE phone modulation or key clicks . . . SEE all these and much more with the PANADAPTOR.

**ASK THE LUCKY MAN WHO OWNS ONE!**

*New Panoramic Handbook contains complete operating, maintenance, installation and application data. Answers all questions about the PANADAPTOR. 50c at your jobber or by mail.*

Panadaptor, featuring Panoramic Reception, is the exclusive and original design of Panoramic Radio Corp.

**Panadaptor Model PCA-2**  
 now available at leading radio parts jobbers. Amateur net price, complete with ten tubes and accessories, for 115 V., 50-60 cycle operation.  
**\$99.75**  
 One Year Guarantee

**PANORAMIC**

CABLE ADDRESS  
 PANORAMIC, NEW YORK



**RADIO CORPORATION**

242-250 WEST 55<sup>TH</sup> ST. New York 19, N.Y.

Exclusive Canadian Representative: Canadian Marconi, Ltd.

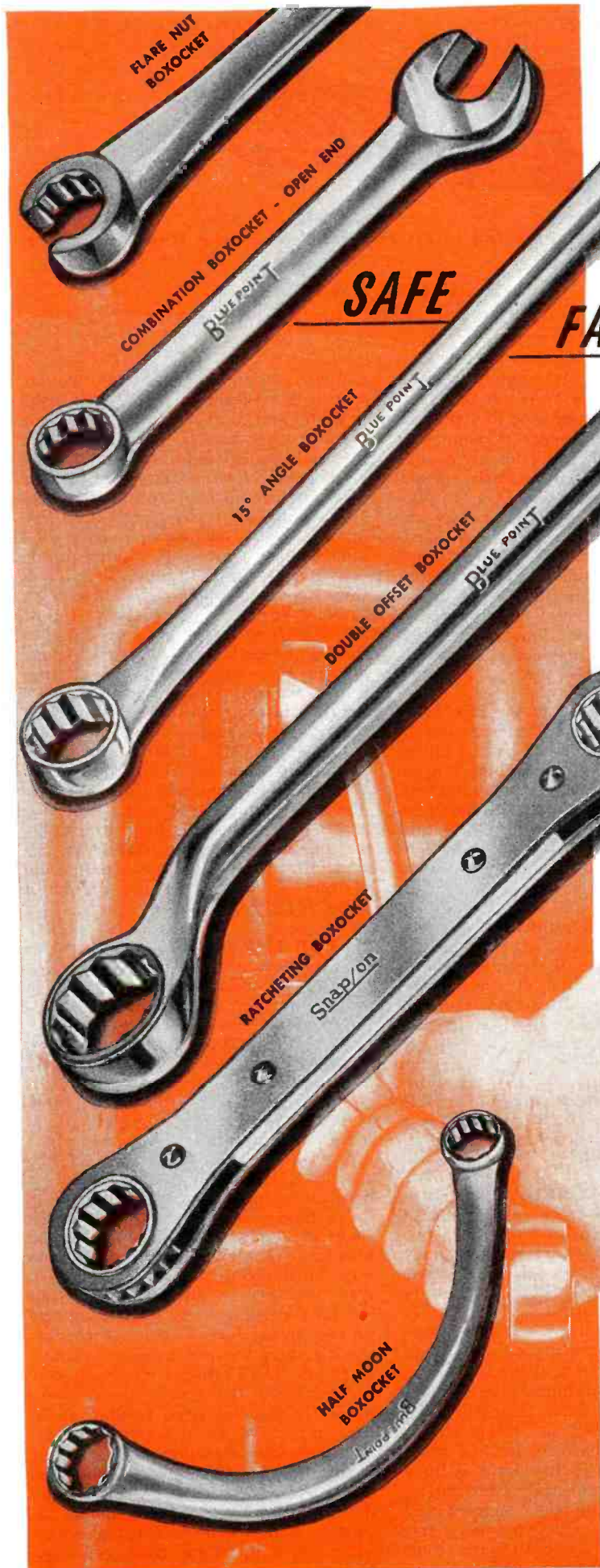

**SAFE**

**FAST**

**ADAPTABLE**

# Snap-on BOXOCKET WRENCHES

**Powerful, safe leverage that invites confident wrench speed**

Slipping handily into hard-to-get-at places . . . engaging the nut on all six corners with an encircling can't-slip-can't-spread grip . . . needing only *half the space* of an end wrench for full handle movement . . . Snap-on Boxockets are *speed* tools and *safety* tools on tough nut-turning operations. Chamfered openings slip readily over the nut. Double broaching permits operation within a 15° arc. Round handles provide comfortable grip. Snap-on Boxockets work swiftly and efficiently in many spots inaccessible to other wrenches.

For maximum usefulness on a wide range of work, Snap-on offers 13 types of its popular Blue Point Boxockets — in angled, offset, combination and flare nut heads — and in standard wrench sizes from 3/8" to 4 1/2". Available through Snap-on's nationwide direct-to-user tool service. "Ask your Snap-on man."

**SNAP-ON TOOLS CORPORATION**  
8120-H 28th AVENUE • KENOSHA, WISCONSIN

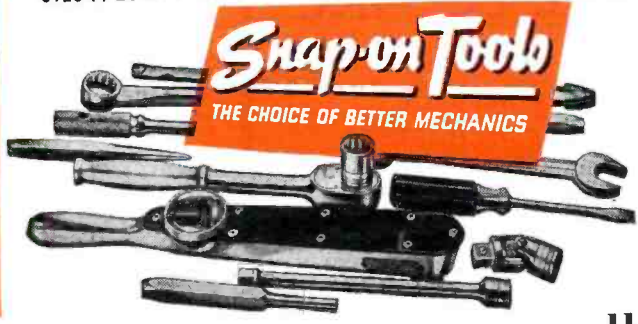

Designed for

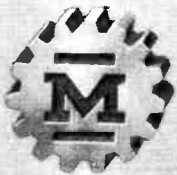

Application

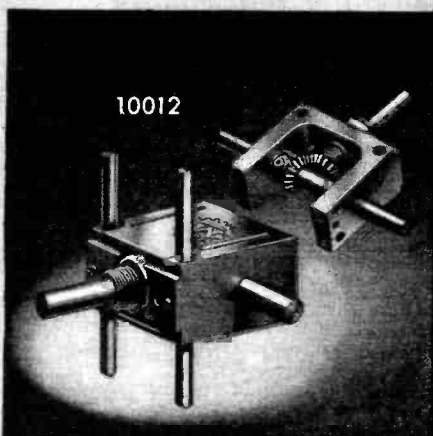

10012

### The No. 10012 RIGHT ANGLE DRIVE

"Designed for Application." Extremely compact. Case size is only 1 1/2" x 1 1/2" x 3/4". Uses bevel gears. Mounts on adjustable "standoff rods," single hole panel bushing or tapped holes in frame. Ideal for operating switches, potentiometers, etc., that must be located, for short leads, in remote parts of chassis.

## JAMES MILLEN MFG. CO., INC.

MAIN OFFICE AND FACTORY  
MALDEN  
MASSACHUSETTS



## Spot Radio News

★ Presenting latest information on the Radio Industry.

By **FRED HAMLIN**

Washington Editor, RADIO NEWS

**FCC's LAUREL** (Maryland) primary monitoring station, one of ten scattered over the nation and heart of the FCC's radio intelligence division that did such dramatic radio detective work during the war, was recently opened for the first time since VJ-Day to public inspection. Also opened was the FCC laboratory, bursting with post-war research, and between visiting both of them in one day, we, in turn, came away bursting with news. The two installations rival one another in the work they have done and are doing, and together they are a ham's paradise if we ever saw one.

**NEATEST TRICKS** of the FCC show were locating a fixed-base station at an unknown point in the United States and then locating a mobile station near the monitoring headquarters. Method used for putting the finger on the fixed station was the same that nailed an outlet at the German Embassy in Washington before it could get contact with its home station in the Reich, early in the war. FCC's RID also located numerous clandestine enemy operators here and in South America in the same fashion. In the demonstration at Laurel, the FCC experts alerted primary monitoring stations from coast to coast, told them of the "unknown" station, got dope in return by teletype and radio, and had the station located—all within five minutes. Locating the mobile station took only a little longer—eleven minutes. Adcock direction finders helped do the job.

**THAT THE LAUREL** station is a ham's paradise is true in more ways than one. Located on more than two hundred acres of what was formerly historic Collingsdale, for generations the county seat of the Collings family of Maryland, the station headquarters are in the old family mansion and are shaded by a two-century-old oak—said to be the most ancient in the state. To delight any amateur radio enthusiast are the additional facts that the old house is full of the latest equipment, and was manned, for the most part, by hams as enthusiastic as himself. Typical is George Sterling, a Maine ham since he was fourteen, now FCC assistant chief engineer and father of the RID system for rounding up illegal stations. Another at the

demonstration was Lloyd S. Quynn, who was a Brooklyn, N. Y., ham back in 1907, and in the intervening years, among other things, set up the first licensed police radio station in the country at Norfolk, Va., in 1918 and was chief radio operator on the USS Mohawk when it was sunk in three minutes by a German submarine during the last war. Other ships in the convoy picked up the survivors, among them Quynn, and brought them back to New York. He continued to follow the sea after the war was over and in the Pacific gathered a lot of radio dope on the Japs which RID pressed into service when the war began by assigning him to their monitoring station at Fairbanks, Alaska. There, Quynn helped make RID history by contacting a Jap task force and talking to them in their own code until they told him where they were going—thereby busting up one of the big Jap attacks on an American-held island. In his spare time Mr. Quynn operates his own station—W3EWW ("Every Woman's Wish"), Laurel.

**AS FOR THE GADGETS** at the monitoring station, there were so many that it was impossible to get the dope on all of them in the brief time allotted. One that you might keep an eye out for if you are interested in something unusual in the field was a "sniffer," a receiver so small that it can be held in the palm of the hand. It is used to indicate the strength of a signal audibly or visually when you are within a short distance of the transmitter. FCC sleuths found it helpful during the war when looking for a hidden outfit in a hotel—saved them the embarrassment of breaking into the wrong room. . . . Another novelty, until recently on the secret list, was the German-devised Helleschreiber for recording radio signals directly on tape in the form of printed words—the German answer to the facsimile problem. The British are using it now—coming off the air while we were around was news from London about what was going on in Washington. . . . A cathode-ray direction finder—faster than the Adcock—and a cathode-ray oscilloscope were also on display. And then there was a Boehme syphone recorder, a high-speed recording device which picks up Morse code on a tape at the rate of about 200 words a min-

A

is for the articles a good radio serviceman should read.



B

is for the business news he must keep up with.

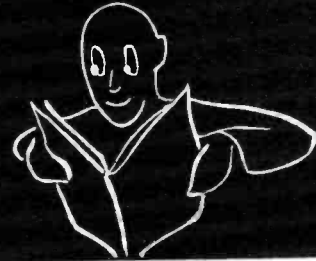

C

is for the continuous stream of new developments in the field.



and

RM

is for

# RADIO MAINTENANCE MAGAZINE

which contains all the ABC's of radio and brings a wealth of this valuable material every month.

ONLY \$3<sup>00</sup> FOR 24 ISSUES

Radio Maintenance is not sold on newsstands

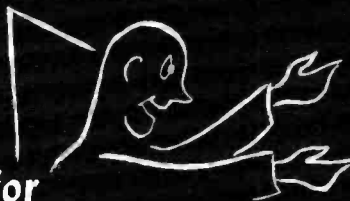

Mc Turner

YOU GET THE LATEST IN

AM • PA • FM • TELEVISION

Serviceing "Know-How"  
Lessons from military servicing.  
Short cuts and Speedups.  
Better Use of Test Equipment.  
Money in Proper Shop Layout.  
Modern Bench and Tool Equipment.  
Large, easy-to-read Schematics.  
Trouble-shooting procedures.  
Aligning new and old models.  
Contacting Prospective customers.  
News of the service profession—and many other timely, authentic subjects.

RADIO MAINTENANCE  
MAGAZINE

460 BLOOMFIELD AVE.,  
MONTCLAIR, N. J.

Please send me  
RADIO MAINTENANCE

- For 1 year 2.00
- For 2 years 3.00

- CHECK ENCLOSED\*
- BILL ME LATER

\*NOTE: By enclosing payment, thus eliminating billing expense

WE WILL ADD ONE ISSUE FREE!

*Special offer to  
Radio Servicemen*

NAME \_\_\_\_\_

OCCUPATION \_\_\_\_\_

ADDRESS \_\_\_\_\_

CITY \_\_\_\_\_

ZONE \_\_\_\_\_ STATE \_\_\_\_\_

RN-8

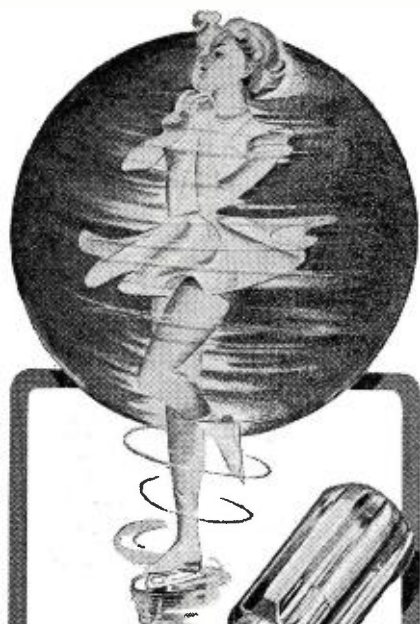

The Original  
**SPINTITE**  
**WRENCH**  
SPINS With  
Ease and Speed

Encourages nimble hands  
along the assembly line.  
Made in eleven sizes from  
3/16" to 5/8" square, hex  
or knurled . . . . .

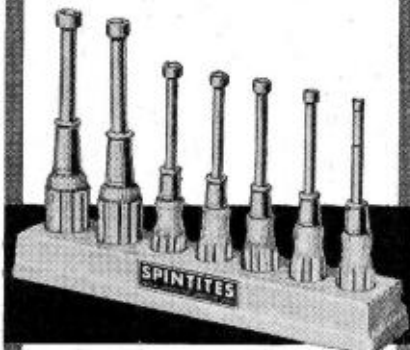

POPULAR Wood  
**SPINTITE** Handles  
**T-73 SET**

A useful Tool in every  
Radio and Electrical Shop.

Deluxe T-8 SET the same  
with Plastic Handles

Send for Catalog  
141 picturing Air-  
craft Radio and  
Automobile Tools.



**STEVENS WALDEN, INC.**  
468 SHREWSBURY STREET  
WORCESTER, MASSACHUSETTS

ute. A crack operator is good if he can get fifty.

**OVER AT THE LABORATORY** we learned that FM is here to stay and that television is coming along nicely, thank you, despite current rivalry between the black-and-white boys and the color enthusiasts. The lab approves all new gadgets in the field, but is not permitted to show something so new that somebody might want to copy it. One thing that was on display was the result of work being done to prevent diathermy apparatus from jamming nearby radio sets with heavy static. G. L. Ikelman, the engineer in charge of the demonstration, surprised everyone by the simplicity of the solution for this problem—all you have to do is put the diathermy equipment in a cage screened with regular hardware cloth—close-net wire to you—and it keeps its static to itself. New diathermy equipment is being so designed—for FCC approval—that it will need no cage. . . . The laboratory is anticipating a heavy load of work in the postwar era—so heavy, indeed, that construction of a new building, doubling its floor space, is already planned. One of the most pressing problems it expects to tackle in the near future, we learned from Charles A. Ellert, its chief, is the study of antenna structures of all kinds. Wartime antenna developments have revolutionized scientific thought concerning the relation of design to propagation of radio waves, the FCC experts point out. Finding the best antenna technique for the solution of each propagation problem is FCC's goal.

**ALTHOUGH THINGS** are comparatively slow at the Laurel FCC station now that the war's over, they manage to keep busy getting fixes for lost planes, picking off amateurs with illegal handie-talkie equipment, and making sure all licensed stations are on their right beam. Just the other day they picked up an Eastern Airlines plane, lost near Philadelphia, and guided it safely to port. We learned that RID did a lot of this work during the war, bringing in more than 300 lost Army and Navy planes to Hawaii alone. FCC also trained some three hundred radio detectives for the services, some of whom are still working in Germany rounding up stray Nazi stations that apparently don't know there's a peace on. . . . Here in this country, the Commission does a brisk business at times in catching up with race track touts who use handie-talkies to tip fellow-bookies outside the park on the results of a race. A lot of monitoring in the handie-talkie field will be necessary before it shakes down, it is expected, but it's not a job that is worrying FCC at the moment. Over at the laboratory the word was that no manufacturer had gotten around to building a handie-talkie for the mass market, and none is expected before next summer at the earliest.

**PRODUCTION OF RADIOS**, while out of the woods, has yet to get to town on a full-throttle basis, reports from the industry and Washington sources agree. With OPA difficulties out of the way (as predicted in advance by RADIO NEWS), and with the industry itself eager to meet pent-up public demands, chief barriers in the way continue to be—magnet wire and lumber. A break in the clouds was visible over both fields as this goes to press, but neither situation offers reason for hilarious optimism. Wire production, according to John D. Small, Administrator of Civilian Production, will not catch up with demand for from two to six months after settlement of the strikes, which will probably carry the shortages into the winter. Labor difficulties, plus shortages of equipment, indicate a similar if not as severe a lag in the production of lumber. . . . Perhaps the best summary of radio production at mid-summer is found in the words of R. C. Cosgrove, president of the Radio Manufacturers Association: "We are now on a fairly decent program," he said in June, "manufacturing radio sets at something over 200,000 a week, and this is almost as many as the average in our best prewar year, which was 1941. We still lack the large console models and the models with FM and some of the other new developments which we feel should have been included in sets by this time, but of course we have been operating under severe government restrictions in several directions which have confounded the industry and caused delays and confusion as well as great losses to most of the manufacturers. I hope most of these are behind us, because I think it has been demonstrated that many of these controls are not consistent with the type of enterprise we have in this country. . . . I am looking forward to this coming year with a great deal of optimism. At any event, let's get the job done in spite of all optimism."

**ON THE TELEVISION FRONT**, things are also progressing. High-spot of the telecast summer season was the Louis-Conn fight, and in the meantime indications are that, possibly by the end of the year, stations will be operating in some fifty of the nation's largest population centers. This is based on FCC figures released recently showing that there are fifteen cities where one or more stations are already operating or where permits have been issued. Most recent applications approved were for outlets in Worcester, Mass., Waltham, Mass., Providence, R. I., Cleveland, St. Paul, Richmond, Salt Lake City, Portland, and Baltimore. Other applications, already on file at FCC, point toward the half-hundred year-end figure. . . . The FM picture is even more expansive: 48 stations licensed, 5 under construction, 52 additional construction permits, and

(Continued on page 121)

# Now You can Use

## ALL OF THESE RADIO PARTS

to help You learn

# RADIO

## FASTER—EASIER AT HOME



YOU CAN BUILD **133** FASCINATING EXPERIMENTS

At home—in your spare time—you get real Radio experience from these many *interchangeable* Radio parts and sub-assemblies. DeForest's handy "Block System" eliminates unnecessary mechanical work; the convenient spring clip connections save a great deal of time. You quickly build Radio circuits that work. You experiment with Photo-Electric Cell "Magic" . . . a 5 tube Superheterodyne Receiver . . . a Radio Telephone, and scores of other fascinating projects. Little wonder learning Radio at home is so practical . . . effective and real fun—with DeForest's modern "Home Laboratory."

### YOU USE "LEARN-BY-SEEING" MOVIES!

Think of the pleasure, as well as help you get from the use of this 16mm Motion Picture Projector and exciting "movie" TRAINING FILMS. You will be surprised how much faster . . . easier . . . Home Movies help you understand Radio-Electronic fundamentals. Here's a preferred training method of tomorrow—yours today. See the principles of what you're learning—in motion . . . ANIMATED! See circuit actions otherwise hidden from the eye. You get this big Radio home training advantage—exclusively with DeFOREST'S. So act now! Mail coupon for complete details.

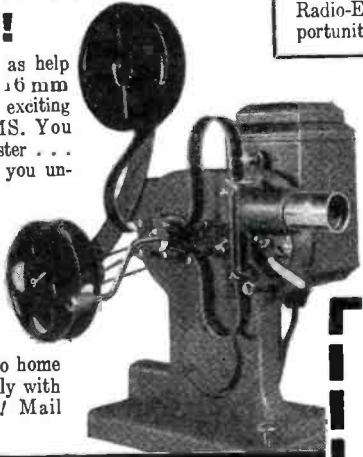

### VETERANS!

Big things are happening at DeForest's for veterans! See how you can prepare yourself WITHOUT COST for a GOOD JOB or a BUSINESS OF YOUR OWN in the vast Radio-Electronic opportunity field.

See how DeForest's fascinating SHOP METHOD Radio Training at home can help you toward a good start in the Billion Dollar Radio-Electronic Field. Write for DeForest's BIG FREE book, "VICTORY FOR YOU!" that has helped many to good pay jobs. You'll be surprised at the opportunities ahead in F.M. Radio, Aviation Radio, Broadcast Radio, a Profitable Business of Your Own, Motion Picture Sound Equipment, Electronics—plus the exciting future possibilities ahead of Television, Radar, etc.

### YOU Get "ALL THREE" With DeFOREST'S

Where else can you get such a combination of PROVED MAJOR training features as—(A) modern loose-leaf lessons prepared under the supervision of Dr. Lee DeForest, often called the "Father of Radio;" (B) the use of "Learn by Seeing" home movie films and a genuine 16 mm. home

MOVIE PROJECTOR—and (C) eight big kits of "Home Laboratory" Radio parts to give you valuable practical Radio experience—at home.

You Also Get EFFECTIVE EMPLOYMENT SERVICE . . . to help you get started toward a Radio-Electronic job or a business of your own. Residential training in our Chicago laboratories also available! DeFOREST'S TRAINING INCLUDES INSTRUCTION IN MOTION PICTURE SOUND EQUIPMENT, FM RADIO AND TELEVISION . . .

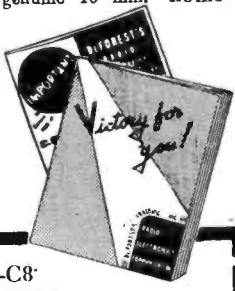

DeFOREST'S TRAINING, INC., Dept. RN-C8  
2535-41 N. Ashland Ave., Chicago 14, Illinois, U.S.A.  
Send—FREE and WITHOUT OBLIGATION—illustrated book, "VICTORY FOR YOU" and KIT SUPPLEMENT, showing how Home Movies and Home Laboratory can speed my preparation for a place in the Radio-Electronics industry.

Name \_\_\_\_\_ Age \_\_\_\_\_  
Address \_\_\_\_\_ Apt. \_\_\_\_\_  
City \_\_\_\_\_ Zone \_\_\_\_\_ State \_\_\_\_\_  
 If under 16, check here for special information.  
 If a discharged veteran of World War II, check here.

# DeFOREST'S

## TRAINING, INC.

CHICAGO, ILLINOIS

# 14 RIDER MANUALS

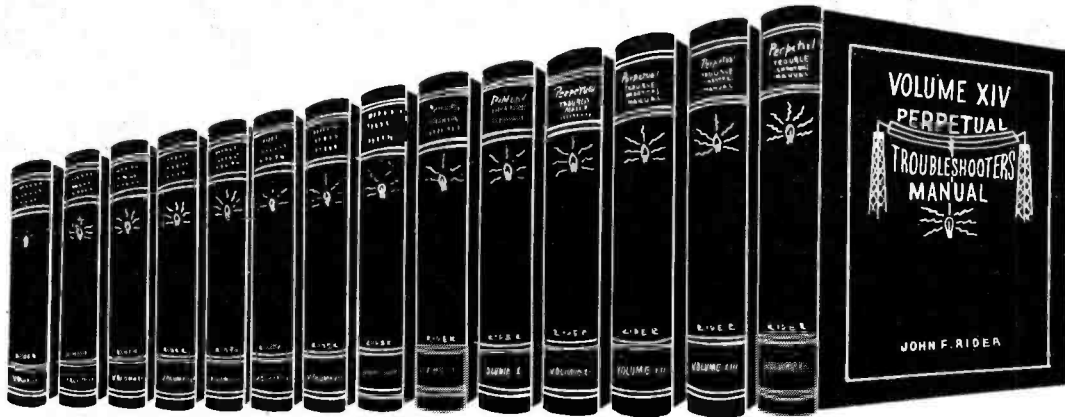

## Cover 60 million Radio Sets Now in American Homes

The fourteen volumes of Rider Manual, issued during the past sixteen years, are the only single source upon which radio servicemen can depend for authoritative servicing data on sixty million receiving sets now in American homes. These sets, all issued before 1942, are the ones most likely to develop faults.

In this connection it is significant that Rider Manuals, covering American receivers sold between 1920 and 1942, continue their unchallenged leadership in the field of radio servicing reference books.

The reason for this is that they have consistently demonstrated their reliability, their accuracy, and their completeness — their value as timesavers when localizing troubles in faulty receivers. In them will be found such vital material as receiver schematics, voltage data, alignment data, resistance values, chassis layouts and wiring, and trimmer connections.

Volume XV, now in preparation, will represent the wealth of experience we have gained from sixteen years of specialized publishing for the radio servicing industry. It will be bigger, contain ex-

panded servicing information that will save each individual service man hundreds of hours every year he uses it. This vital information will not be available from any other source.

Check the list below. Order from your jobber today.

### NOW IN FOURTEEN VOLUMES

Volumes XIV to VII.....	each volume	\$15.00
Volume VI .....		11.00
Abridged Manuals I to V.....	(1 volume)	17.50
Record Changers and Recorders.....		9.00

### GET ON THE MAILING LIST First Post-War Issue Now in the Mails

#### "SUCCESSFUL SERVICING"

This monthly publication, dedicated to the financial and technical advancement of the radio and electronic maintenance man, is yours for the asking. Just . . .

#### MAIL COUPON

JOHN F. RIDER PUBLISHER, INC.  
404 (a) Fourth Ave., New York 16, N. Y.

Name.....  
Address.....  
City.....  
State.....

## JOHN F. RIDER PUBLISHER, INC.

404 FOURTH AVENUE, NEW YORK 16, N. Y.

Export Division: Rocke-International Corp., 13 East 40th Street, New York. Cable ARLAB

### RIDER RADIO BOOKS KEEP YOU IN TOUCH WITH SUCCESS

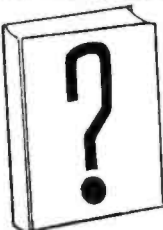

This new Rider Book, soon to be announced, will be of lasting usefulness to every maintenance man, student, instructor or engineer interested in any phase of radio.

The Cathode Ray Tube at Work  
Accepted authority on subject . . . 4.00

Frequency Modulation  
Gives principles of FM radio . . . 2.00

Servicing by Signal Tracing  
Basic Method of radio servicing . . . 4.00

The Meter at Work  
An elementary text on meters . . . 2.00

The Oscillator at Work  
How to use, test and repair . . . 2.50

Vacuum Tube Voltmeters  
Both theory and practice . . . 2.50

Automatic Frequency Control Systems  
—also automatic tuning systems . . . \$1.75

A-C Calculation Charts  
Two to five times as fast as slide rule . . . 7.50

Hour-A-Day-with-Rider Series —  
On "Alternating Currents in Radio Receivers"  
On "Resonance & Alignment"  
On "Automatic Volume Control"  
On "D-C Voltage Distribution" . . . 1.25 each



# CALRAD "hard-to-get" RADIO VALUES!

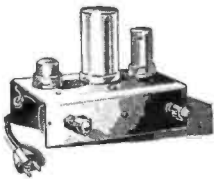

## SPECIAL

Make any record player wireless with brand new

### TWO-TUBE PHONO OSCILLATORS

Operates as far as 100 feet from a radio and can be used

with Automatic Record Changers, Players or Microphone.

Uses 1-12SH7 and 1-12H6 Tubes. Complete with tubes, \$8.75 net. Supplied in kit form with "easy-to-follow" instructions for assembly.

Complete with all parts, instructions and tubes. **\$4.95 Net**

### 4 Prong

### Universal Vibrator

Fits 80% of all replacements. Individually boxed

**\$1.25 ea.**



### CRYSTAL MIKE

Crystal Mike with 100 ft. Shielded Mike Cable.. **\$7.95 ea.**



### AUTO ANTENNAS

- 3 Section
- 66" Long
- Brass Tubing
- Triple Chromium Plated
- 2 Insulator Type Cowl Mounting with Lead Individually Boxed

24 TO MASTER CARTON **\$30.00**

LOTS OF 48 **\$55.00**

Immediate Delivery, But Quantity Is Limited

### 5 Tube Super AC-DC PARTS KIT

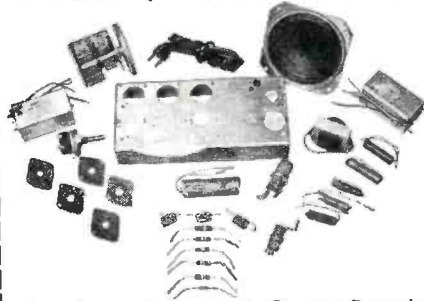

Kits include: Stamped Chassis—Dynamic Speakers—Output Transformer—Volume Control and Switch—2 Shielded I.F. Coils—Antenna and Osc. Coils—Two-gang Super Variable—50 Octal Sockets—20x20 Mfd. 150 Volt Filter—5 Tubular Condensers—3 Mica Condensers—6 Resistors—6 ft. AC Cord and Plug—Circuit Diagram.

WHILE THEY LAST **\$8.95 ea.** LOTS OF **\$50.00**

### Signal Corps TELEGRAPH KEYS



Genuine U.S. Signal Corps telegraph keys brought to you at prices below manufacturing costs! Made with switch to close contacts, polished durable enameled metal base mounted on a bakelite base; key lever is nickel-plated; contacts are brass-silver. Packed in new original boxes. **LOTS OF 60c ea.** CARTON OF **50c ea.**

### V.M. TWO POST AUTOMATIC RECORD CHANGER

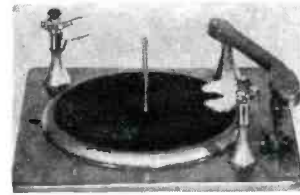

This Record Changer is a well made mechanism, will play either 10 in. or 12 in. records. The pickup uses a crystal cartridge. Size 14 in. x 14 in. Packed 2 to a factory sealed carton, factory guaranteed.

CARTON OF 2 **\$35.00** Special **\$18.95 ea.**

### WEBSTER RECORD CHANGER

Model 50 Complete



**\$19.95 ea.**

LOTS OF 3 **\$19.00**

Built to last. Fast change cycle. Simple, fool proof operation. Feather light needle pressure. Longer life for records. Quiet running shock mounted motor.

## BUY NOW! LOWEST PRICES! STOCKS LIMITED!

### Fully Shielded Power Transformers

50 Mill—6.3 Vo. @ 2 amp. C.T.—5 Vo. @ 2 amp. C.T.—650 Vo. C.T. \$2.45 ea. Lots of 10—\$2.25 ea.

### Push Pull 6L6 Shielded Output Transformer

30 Watt Peak, to 2-4-6-8-16-250 and 500 ohm line. \$3.45 ea. Lots of 12, \$3.25 ea.

### Push Pull Input Transformer, 10,000 ohm plate to push pull 6L6—\$1.10 ea. Lots of 12—\$1.00 ea.

Midget Universal Output Transformer—push pull plate to 2-4-6-8-10-16 ohm voice coil—95c ea. Lots of 10—85c ea.

10 Watt Large Universal Output—\$1.35 ea. Lots of 10—\$1.20 ea.

Single Pentode Midget Output—for 50L6, 6V6, 6F6, etc.—55c ea.

50 Mill Filter Choke 300 ohm—65c ea. Lots of 10—60c ea.

75 Mill Filter Choke 250 ohm—95c ea. Lots of 10—85c ea.

100 Mill Filter Choke 250 Ohm.....\$1.10 each Lots of 25.....\$1.00 each

### Dynamic and P.M. Speakers

4-in. 450-Ohm Dynamic—Packed 30 to Carton—\$1.75 ea.

4-in. 2500-Ohm Dynamic—Packed 30 to Carton—\$1.75 ea.

4-in. P.M. Heavy Slug—Packed 30 to Carton—\$1.70 ea.

5-in. P.M. Heavy Slug—Packed 30 to Carton—\$1.75 ea.

6-in. P.M. Heavy Slug—Packed 20 to Carton—\$2.25 ea.

### Tubular Electrolytic Condensers

10 Mfd. 50 Volt—21c ea.

25 Mfd. 50 Volt—24c ea.

50 Mfd. 50 Volt—28c ea.

100 Mfd. 50 Volt—35c ea.

16 Mfd. 150 Volt—25c ea.

20 Mfd. 150 Volt—29c ea.

30 Mfd. 150 Volt—32c ea.

50 Mfd. 150 Volt—35c ea.

20 x 20 Mfd. 150 Volt—43c ea.

30 x 20 Mfd. 150 Volt—47c ea.  
40 x 20 Mfd. 150 Volt—55c ea.  
50 x 30 Mfd. 150 Volt—65c ea.  
20 Mfd.—350 Volt }  
10 Mfd.—300 Volt } 39c ea.  
20 Mfd.—25 Volt }

### Standard Brands, Tubular By-Pass Condensers

.001-.002-.003-.005-.006-600 Volt .....\$6.75 per 100  
.025-.01-.02-600 Volt .....\$7.75 per 100  
.05-600 Volt .....\$8.50 per 100  
1-600 Volt .....\$9.50 per 100  
25-600 Volt .....\$15.00 per 100  
5-600 Volt .....\$19.00 per 100  
4 Mfd. 600 Vo. T.L.A. Oil Condenser, screw base, Upright aluminum can. 1 1/2 in. x 3/4 in.—List \$4.50, replaces 8 mfd. 600 Vo. electrolytic. 95c each

### Finest Quality Midget Micars:

.001-.0001 .005-.00005 } \$5.00 per 100  
.002-.00025 .006-.0005 } \$4.00 per 1,000

Astatic Low Pressure, curved arm, crystal pickup with Sapphire Stylus Permanent Needle, has cartridge which replaces LP6-LP21-LP23. \$3.50 ea.; Lots of 10—\$32.50.

Standard Low Pressure Crystal Pickup. \$2.25 ea.; Lots of 10—\$20.00.

Signal Corps Dual Headsets—8000 ohms high impedance, with 2 rubber ear cushions, cord and phone plug, individually boxed, \$12.50 list, net \$2.25 ea., lots of 12, \$25.

456 K.C. Antenna, Oscillator and R.F. Coils. 25c ea. 456 K.C. I.F. Coils 'nput & Output, medium size can .....59c each

Weston Volt oh. meter Model 663—\$49.50 with carrying case & leads.

Mallory #534C-6 prong, 6 Volt, Synchronous Vibrator, Equivalent to Mallory #742.....\$1.75 each Lots of 10, \$15.00

Kit of 50 assorted Bakelite Knobs for 1/4-in. shaft, with set screws.....\$2.50 per kit

Kit of 50 assorted wood knobs for 1/4 in. shaft with set screw .....\$3.50 per kit

Midget Ceramic Trimmers—3-30 mmf., \$6.00 per 100

Western Electric—0-200 Microammeter—3 in bakelite case, \$4.25 ea.

Tinned Copper Shielding—1/8 in., 1/4 in., 3/8 in. \$1.50 per 100 ft.

Rubber Sheathed "Mike" Cable, shielded, single Conductor. 100 ft. for \$25.00 500 ft. for \$5.95

Moulded Octal Sockets 1/2-in. mtg. with metal ring .....\$7.00 per 100

6 ft. A.C. Cords with plug.....\$20.00 per 100

Volume Controls, less Switch—1/2-in. shaft 250,000 ohm.

1 Meg } Lots of 100 }  
2 Meg } \$30.00 39c each

250 ft. Coil Underwriter Approved Zip Cord—\$4.75 per coil.

Transmitting type variable Condensers, Dual Double Spaced 110 Mfd. per section \$1.00 ea.

Dual Double Spaced 170 Mfd. per section—\$1.00 ea.

Single Gang Dual Spaced 440 Mfd.—\$1.00 ea.

Single Bearing Midget Condenser 14 plate—100 Mfd. 50c ea.

Midget Open Circuit Jack—Lots of 10—\$1.50

Midget Closed Circuit Jack—Lots of 10—\$2.00

Midget Double Circuit Jack—Lots of 10—\$2.00

Insulated Banana Tip Jacks, red or black. \$8.50 per 100

Insulated Banana Plugs, solderless, slide screw connection, red or black.....\$10.00 per 100

Standard Barrel Type Phone Plug.....\$20.00 per 100

Patch Cord 4 ft. with 2 P.L. 55 Plugs—49c ea.

4 Tap Midget Loop Antenna, Size 7 3/4" x 5".....35c each

500,000 Ohm Volume Control with Switch—2" Shaft .....69c each

1 Meg Ohm Volume Control with Switch—2" Shaft .....69c each

10 Watt Wire Wound Resistors, your choice of sizes 25 Ohm to 25,000 Ohm.....20c each \$17.50 per 100

Buffer Condensers (Famous Make) .005, .01, .02—1700 Volts .....19c each Lots of 50, 15c each

MAIL ORDERS FILLED:

25% deposit with order, balance C. O. D. Santa Monica & Vermont Avenues

References—Bank of America, Los Angeles, California

## CALIFORNIA RADIO & ELECTRONICS CO.

Dept. No. N. 711 No. Vermont Ave., Los Angeles 27, California

**For the Man Who Takes Pride in His Work**

**Model 2432  
Signal Generator**

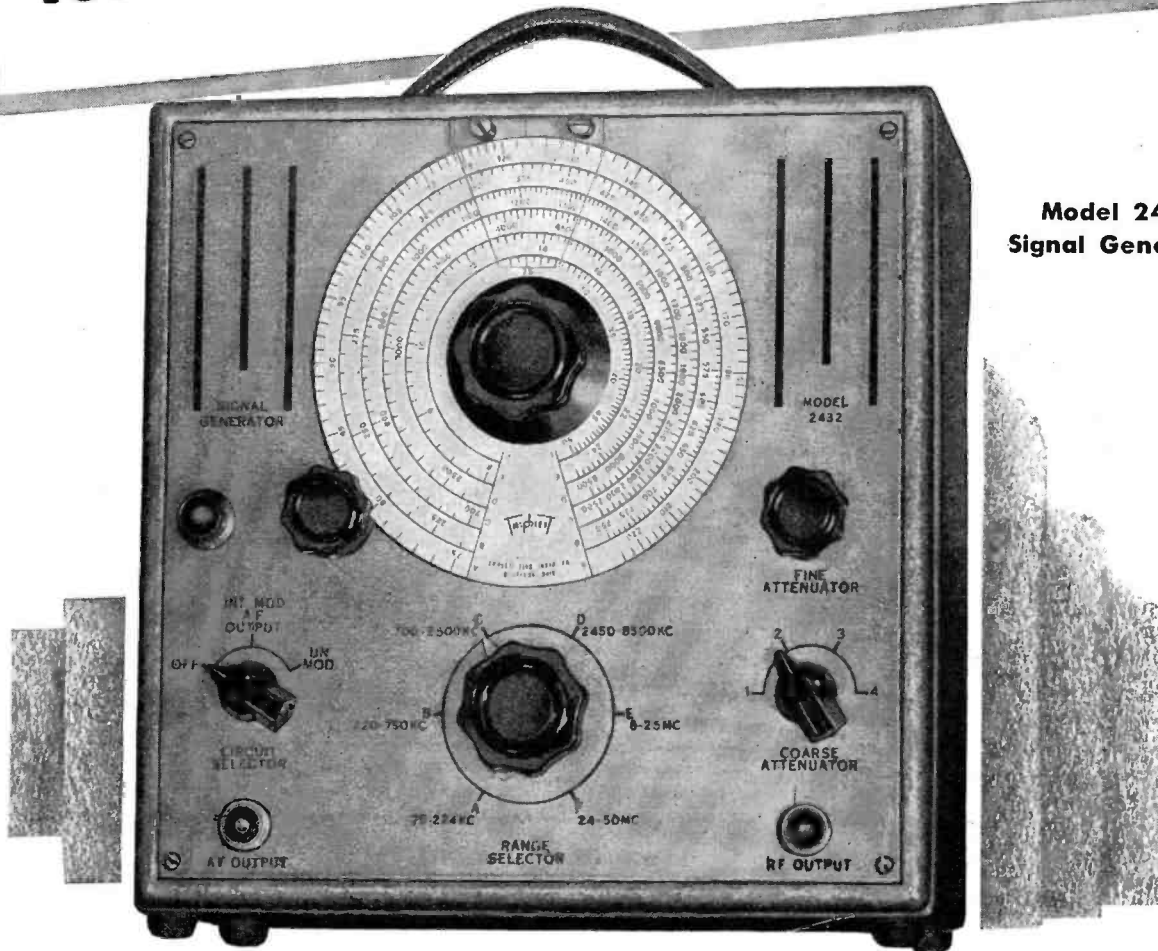

**FM AND TELEVISION BAND COVERAGE ON STRONG HARMONICS  
STRONG FUNDAMENTALS TO 50**

Another member of the Triplet Square Line of matched units this signal generator embodies features normally found only in "custom priced" laboratory models.

**FREQUENCY COVERAGE**—Continuous and overlapping 75 KC to 50 MC. Six bands. All fundamentals. **TURRET TYPE COIL ASSEMBLY**—Six-position turret type coil switching with complete shielding. Coil assembly rotates inside a copper-plated steel shield. **ATTENUATION**—Individually shielded and adjustable, by fine and course

controls, to zero for all practical purposes. **STABILITY**—Greatly increased by use of air trimmer capacitors, electron coupled oscillator circuit, and permeability adjusted coils. **INTERNAL MODULATION**—Approximately 30% at 400 cycles. **POWER SUPPLY**—115 Volts, 50-60 cycles A.C. Voltage regulated for increased oscillator stability. **CASE**—Heavy metal with tan and brown hammered enamel finish.

There are many other features in this beautiful model of equal interest to the man who takes pride in his work.



**Triplet**

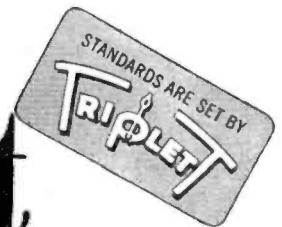

**ELECTRICAL INSTRUMENT CO. BLUFFTON, OHIO  
RADIO NEWS**

# Brother, want 3 extra hands?

Then drop a few seeds in the mailbox! C-D has them ready for you . . . punchy mailing pieces . . . to let the whole neighborhood know you're alive. And that's only one part of a complete promotional program we've prepared for you. Look around! The field is getting crowded; now is the time to promote yourself. And here is a program—complete—packaged—that'll give you three extra hands and make you "the" service shop in your community.

And watch the customers grow! You can't expect radios will break down faster to help your volume . . . but when they do get out of wack, you can bet the customers will take them to shops they've heard about. So get the ball rolling with the new C-D Sales Promotional Program that will help you grow—not only in 1946—but in 1947 and 1948.



## USE THESE C-D HELPS AVAILABLE THROUGH YOUR LOCAL JOBBER!



NEWSPAPER MATS

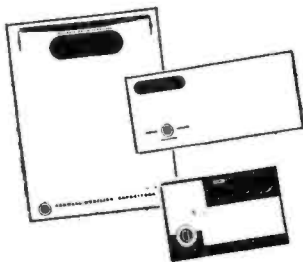

STATIONERY LABELS



DECALS



WINDOW CARDS



POSTCARDS — just address and drop in mailbox!



MATCH BOOKS —

KEEP YOUR REPUTATION GROWING WITH TOP QUALITY PARTS

C-D's "dwarf tigers" are long life units. Heat and humidity don't get them out of the picture. Real quality . . . real reputation-builders.

OF COURSE YOU'LL WANT YOUR FREE SUBSCRIPTION TO THE "CAPACITOR"

All the important radio data condensed for you. Write now: Cornell-Dubilier Electric Corp., South Plainfield, New Jersey.

NAME \_\_\_\_\_  
 ADDRESS \_\_\_\_\_  
 CITY \_\_\_\_\_  
 STATE \_\_\_\_\_  
 ZONE \_\_\_\_\_

ALL AVAILABLE THROUGH YOUR LOCAL C-D JOBBER

# Cornell-Dubilier WORLD'S LARGEST MANUFACTURER OF Capacitors



MICA • DYKANOL • PAPER • ELECTROLYTICS

# GOODBYE TO MAN-MADE RADIO NOISES!

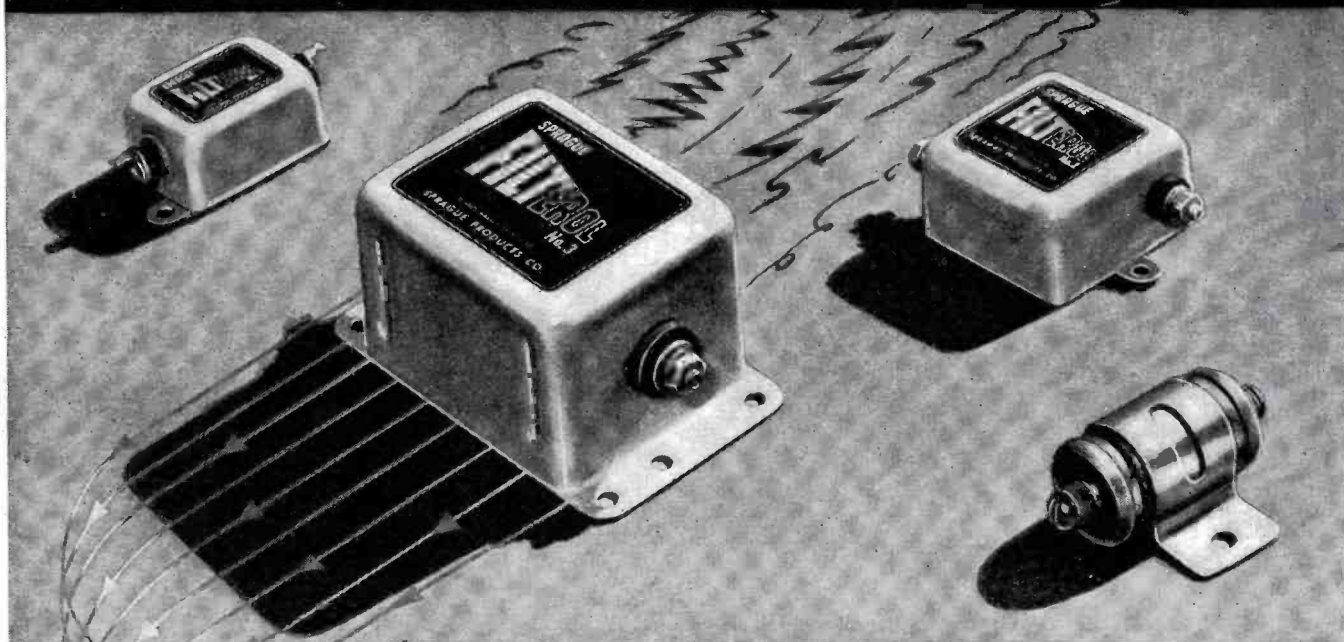

# SPRAGUE FILTEROL

The famous wartime 3-terminal network noise filter development



## GET THIS NEW CATALOG!

Contains complete details, dimensions, data, etc., on Sprague Capacitors and \*Koolohm Resistors for every radio service, amateur and experimental need.

\*Trademarks Reg. U. S. Pat. Off.

Don't waste time trying to stop man-made radio noises with plug-in filters or by other old-style, inefficient methods. Instead, install Sprague FILTEROLS directly across the line or terminals of the offending device. Do the job in the same efficient manner that made these amazing Sprague 3-terminal networks the outstanding filters for all types of war equipment!

### FILTEROL TYPES 1, 2 AND 3

These light-weight, highly compact filters are rated 1, 10 and 35 amperes respectively at 115 volts A.C. They provide effective filtering throughout the entire broadcast band. Their basic circuit is a Sprague 3-terminal network of which the can is one terminal. Selection is based on current rating, the filter used having a rating *higher* than the continuous operating current of the device being filtered. Unexcelled for all small motors, flashing signs and similar radio noise producers.

### FILTEROL TYPE 4

This unit incorporates a famous Sprague \*HYPASS Capacitor and provides exceptionally high attenuation at frequencies above 5 mc. and is effective up to 150 mc. or more. It is designed for filtering small devices having continuous current ratings up to 20 amperes.

Be the acknowledged interference expert in your locality! Get next to FILTEROLS today!

## SPRAGUE PRODUCTS COMPANY

NORTH ADAMS, MASSACHUSETTS

JOBGING DISTRIBUTING ORGANIZATION FOR PRODUCTS OF THE SPRAGUE ELECTRIC CO.

Grasp the **NEW OPPORTUNITIES** in

# RADIO ELECTRONICS AND TELEVISION NOW!

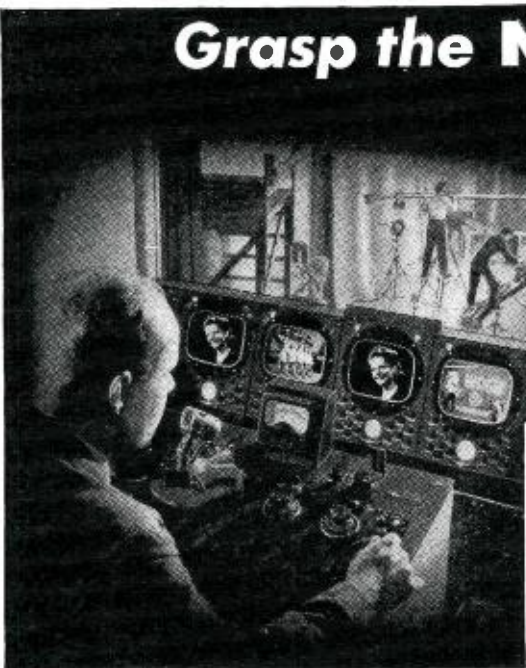

Modern Radio—FM broadcast and reception—  
Television — Radar — Industrial Electronics;  
power, control, communications — new equip-  
ment and methods demand new technical ability  
and experience. Keep up to date with the latest

## MODERN ELECTRONIC LABORATORY FOR YOU TO USE AND KEEP



The very essence of National Shop Method Home Training is EXPERIENCE. You get the actual experience by working with modern Radio and Electronic equipment—building circuits and instruments. You may build a fine, long distance MODERN SUPERHETERODYNE signal generator, miniature radio transmitter, audio oscillator—many other full sized, actual, operating pieces of equipment and instruments—conduct cathode ray and hundreds of other experiments. This experimental laboratory work advances with your training and you actually learn by doing. Send the coupon and get the full details of how such an offer can be made.

## SEE WHAT NATIONAL TRAINING HAS DONE FOR THESE MEN!

National Shop Method Home Training wins good jobs, independence and security quickly. Take the word of National men who have established records in their favorite Radio, Television, or other branches of Electronics:



Joseph Grumich, Lake Hiawatha, New Jersey writes: "My latest offer was \$5,800.00 as Radio Photo Engineer but I'm doing well where I am now engaged. I am deeply indebted to National."

Here's a statement from R. R. Wright, Blackfoot, Idaho: "Due to my training at National I was selected to instruct in the laboratory work of Navy and Marines."



Robert Adamson, Kearney, Nebraska. National graduate, has two radio jobs — makes double pay as a radio instructor and as engineer at Station KGFW. He writes: "I am proud of My National training and appreciate the cooperative spirit."



From O. K. Ivey, Washington, D. C., comes this endorsement: "I believe National offers the best course to be had... Keep up the good work."

Read what hundreds of other enthusiastic students have written about National Training. Send in your coupon today.

## SHOP METHOD HOME TRAINING

By a Great Established Resident School

Get one of the thousands of NEW JOBS that demand new techniques and methods in modern radio. Get your share of the NEW BUSINESS that servicing the new sets and equipment demands. Experts agree that Radio Television and Electronics presents the next great industrial boom! Radio is expanding farther and faster than ever with great improvements in reception. Radar is already a 2-billion-dollar-a-year business. No one knows yet how great the Television market will be. Electronics touches almost every walk of life—in industry and in the home. **TURN YOUR INTEREST IN RADIO INTO A CAREER THAT WILL ASSURE YOUR SUCCESS.** Mail the coupon below for a list of the great opportunities in this field—today and in the near future.

**Get the Proper Training**  
The good jobs in Radio Electronics now go to the men who are equipped with training and experience. National Schools, one of the oldest and best established technical trade schools in the country, makes it possible for you to get this training and experience right in your own home IN YOUR SPARE TIME. National maintains one of the biggest resident training shops and laboratories in the United States where instructors, scientists and engineers are working constantly to improve and advance training methods. SHOP METHOD HOME TRAINING is a logical extension of this practical system. A FREE lesson that shows you how practical and systematic—how sound, simple and easy this new training method is will be sent you without obligation. You may keep and use this lesson as you see fit. Fill out and mail the coupon below.

**Investigate this Proposition**  
Where do you stand today in modern industrial progress? What does the future hold for you? You owe yourself this opportunity. It may never come again. With National training YOU GET AHEAD FAST—you may step into a good position, or start a business of your own with little or no capital, even before you complete your National course.

Fit yourself for a career of independence, good earnings, a lifetime of success and security in one of the fastest growing fields in the World. But make up your own mind. Get the information first hand. Put your name and address on the coupon and mail it today.



## Get this Book FREE

This big book presents facts about the field of electronics and your opportunities in it together with full information about the advanced National Training. Read it and make up your own mind that National Training will equip you for a great future. No salesman will call on you from National. The book is FREE with your sample lesson. Send the coupon to write.



## NATIONAL SCHOOLS

LOS ANGELES 37, CALIFORNIA EST. 1905



### MAIL OPPORTUNITY COUPON FOR QUICK ACTION

National Schools, Dept. RN-3  
4000 South Figueroa Street, Los Angeles 37, California

(Mail in envelope or paste on penny post card)

Mail me FREE the two books mentioned in your ad including a sample lesson of your course. I understand no salesman will call on me.

NAME ..... AGE.....

ADDRESS .....

CITY..... ZONE..... STATE.....

Check here if veteran of World War II.

# Jensen

TYPE "RD"

## Reproducer

WITH THE NEW TYPE "H"  
ARTICULATED  
*Coaxial*

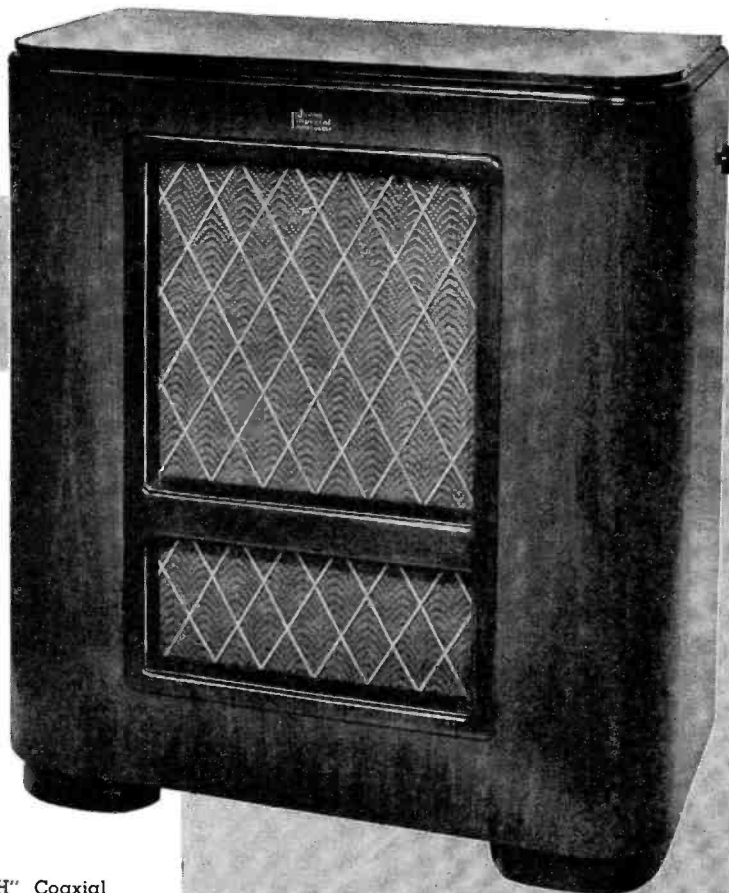

This new Reproducer, combining the Type "H" Coaxial speaker with the new Jensen Type "D" Bass Reflex cabinet, offers superior reproduction of your favorite program material and is unconditionally recommended for FM receivers, high quality phonograph reproduction, reviewing studios, monitoring, and home and public entertainment generally.

The cabinet is beautifully styled and fashioned of satin finish striped walnut. The harmonizing grillé fabric is overlaid with a protecting pattern of flat, interlaced bronzed strips.

The Type "H" Coaxial, with all *ALNICO 5* design, employs a h-f horn and l-f (15-inch) cone which are electrically and acoustically coordinated to achieve brilliant and natural response throughout the entire useful frequency range. The frequency dividing network has variable control in the range above 4,000 cycles. Nominal input impedance to dividing network, 500 ohms; maximum power handling capacity 25 watts, in speech and music systems.

Model RD-151 Reproducer complete, approximate list price \$180.

\*Trade Mark Registered

### JENSEN MANUFACTURING COMPANY

6617 S. LARAMIE AVE., CHICAGO 38, ILLINOIS

In Canada—Copper Wire Products, Ltd., 11 King Street, West, Toronto

### JENSEN BASS REFLEX

Acoustically-correct Bass Reflex Cabinet gives smoothly extended low register. Better than an "infinite" baffle . . . efficiently uses back radiation too.

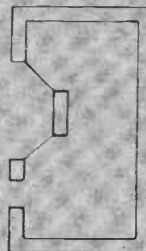

*Specialists in Design  
and Manufacture of Fine  
Acoustic Equipment*



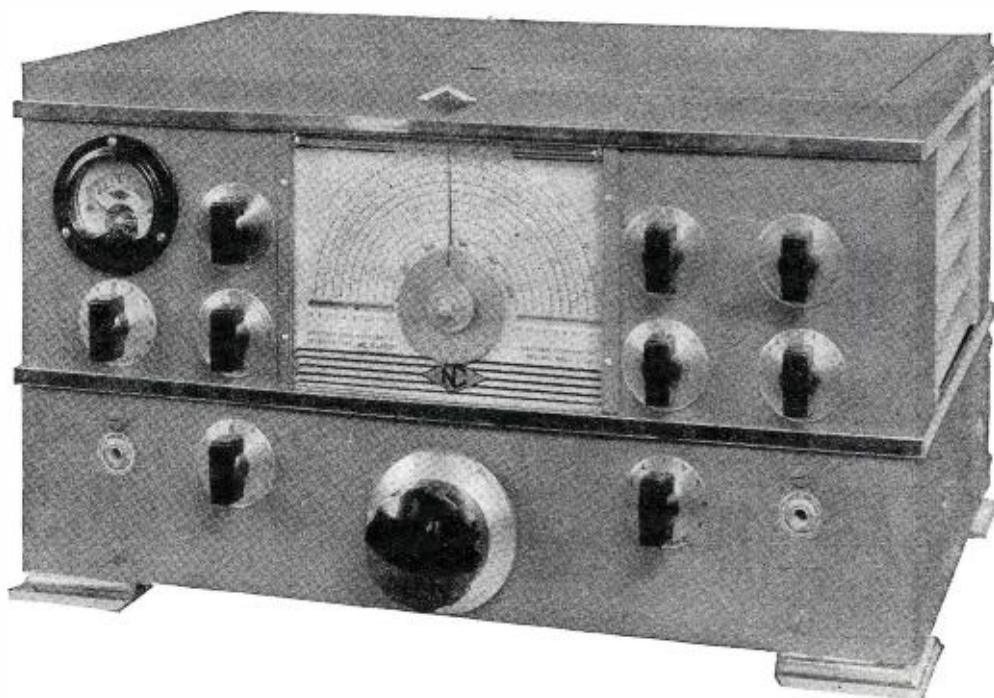

## THE NC-2-40D

*with amateur band coverage*

Every feature the amateur needs is found in the superb NC-2-40D receiver. Special expanded coil ranges for the 10, 20, 40 and 80 meter bands are included in addition to general coverage from 490 Kc. to 30 Mc. Each amateur band is spread over 80% of the dial range and the full vision dial shows your location in the band at a glance. Stability and sensitivity are outstanding. A wide range crystal filter gives optimum selectivity under all conditions. The series-valve noise limiter, the AVC, beat oscillator, tone control and S-meter are among the many auxiliary circuits that contribute toward the all-around excellence of the NC-2-40D. See it at your dealer's.



**NATIONAL COMPANY, INC., MALDEN, MASSACHUSETTS**

**FOR HAMS—  
EXPERIMENTERS—MANUFACTURERS**

**NEW PRODUCTS**

Small "butterflies" in a convenient variety of capacities for VHF and UHF.

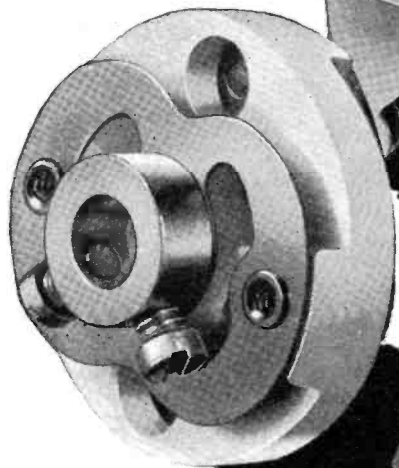
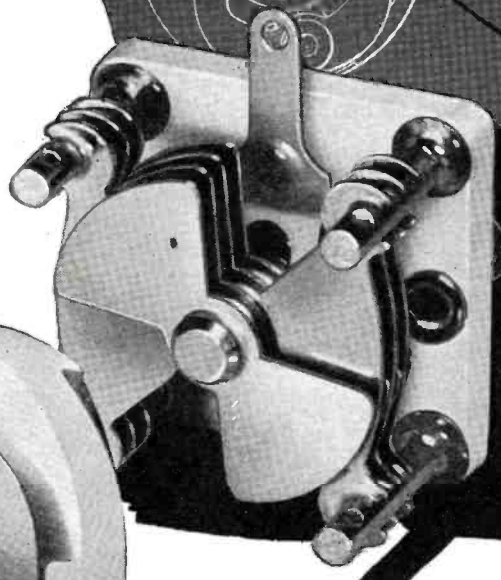

Flexible couplings in two types—insulated and non-insulated.

"RMC," a rugged midget for mobile and other uses requiring great mechanical rigidity.

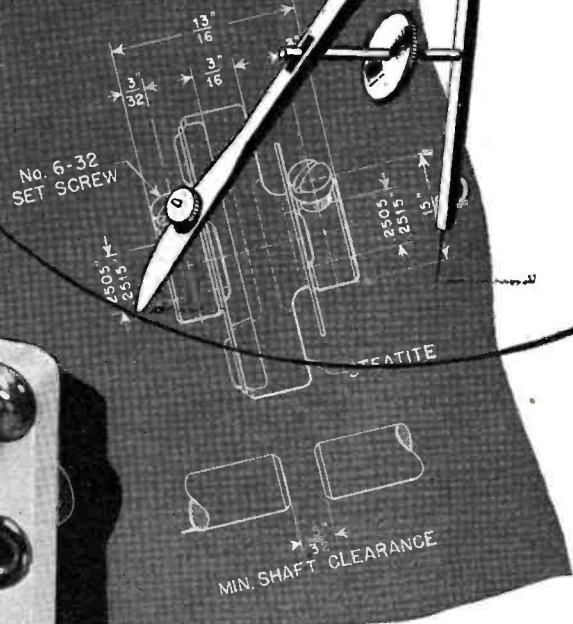
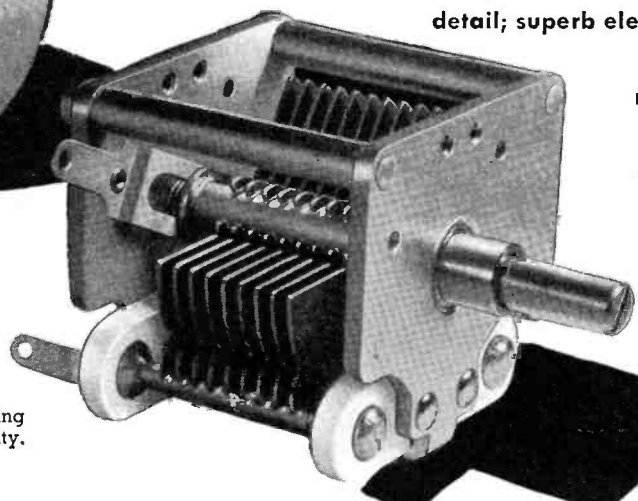

**New and improved mechanical detail; superb electrical design; precision**

**manufacturing—Three basic qualities of every**

**Hammarlund product.**

*Write for technical bulletins.*



**HAMMARLUND**

**THE HAMMARLUND MFG. CO., INC., 460 W. 34<sup>TH</sup> ST., NEW YORK 1, N.Y.  
MANUFACTURERS OF PRECISION COMMUNICATIONS EQUIPMENT**

**RADIO NEWS**



# OPERATION CROSSROADS—

## A Colossal Laboratory Test

By OLIVER READ

Editor, RADIO NEWS

*On-the-scene report of the atom-bomb test cabled to Radio News editorial offices, direct from Kwajalein.*

EDITOR'S NOTE:

*Although the final results of the atom bomb test have not come through as we go to press, we can safely say that it was the greatest laboratory experiment the world has ever seen. It brought into operation the largest number of different types of radio and electronic equipment ever assembled for a single scientific test.*

**T**HE world's fourth atomic bomb has been dropped on Bikini and the first phase of Operation Crossroads has been completed.

When, at a few seconds past 9:30 a.m. Bikini time on Monday, July 1st, the bombardier, Major Harold H. Wood, gave the signal "Bomb away," the climax to months of preparation had been reached. The atom bomb was dropping swiftly toward its target while we all awaited the conclusion to the experiment which was without parallel in the history of scientific investigation.

The whole plan began back in January, 1944, when Vice Admiral Blandy as Chief of the Bureau of Ordnance conceived the idea that after the war our obsolete ships and captured enemy ships should be reserved for determining the effectiveness of new weapons. This thinking was sustained by other high ranking officers and led to the decision to test the effects of the atomic bomb on ships which were destined for the graveyard.

The main purposes of this \$70,000,000 experiment were to test the effects of the A-Bomb against naval vessels in order to learn of possible required changes in ship design, tactical formations at sea, anchoring distance in port, number and location of future operating bases and repair yards and strategic disposition of ships.

Secondary purposes included; testing the effects of atomic weapons against aircraft, both grounded and in flight, and a wide variety of mili-

→  
Atomic cloud spews skyward over Crossroads target fleet in Bikini Atoll following bomb burst. Newsreel cameramen seen in foreground are shooting from bridge of Vice-Admiral W. H. P. Blandy's flagship.





Descending from the Air Transport Command C-54 that brought them from the mainland enroute to Bikini for the A-Bomb tests, these 20 correspondents posed at the Hickam Field ATC Terminal upon their arrival. Left to right: Commander M. O. Atkinson, USN; Alfred Klein, Air Aces Magazine; Charles H. McMurry, Associated Press; Jack Rice, Associated Press; William L. Worden, Saturday Evening Post; Robert Bennyhoff, United Press; George C. Johnson, Air Age Magazine; Lynn C. Thomas, Western Flying Magazine; James C. Chestnut, San Francisco Call-Bulletin; Paul Feltus, Western Newspaper Union; Ed. Lee Thomas, United Press; W. W. Chaplin, NBC; Tom H. Beck, American Magazine; George Dumo, International News Service; Russel MacFarland, San Francisco Argonaut. On the loading platform (top to bottom) Scholer Bangs, Aviation Magazine; Edward Rosenthal, Readers Scope Magazine; George Moorad, CBS; Bernard P. Young, Negro Newspaper Press Association; Oliver Read, Editor of Radio News.

tary weapons and equipment to learn the necessity for redesign and changes in dispersal to minimize the effect; studying the effects of atomic fission on living organisms so protection might be devised and early diagnosis and treatment provided in either war or peace; determining the relative value of A-Bomb attacks against naval vessels as compared with other types of targets and obtaining further information of general scientific value on

phenomena which accompany atomic explosions.

As far as I was concerned the A-Bomb test started officially when I left the States on June 15th bound for Hickam Field aboard the Air Transport Command's C-54.

Kwajalein seemed unreal to me in many ways. The brilliance of the tropical sun beating down on the white sandy coral makes a glare beyond that of any beach sun I have ever encoun-

tered in the U.S.A. The island has been a beehive of activity for many months, but to me it was a superb example of unparalleled teamwork.

There was a tenseness which was all-prevailing as the planes roared and circled overhead and practiced their maneuvers in the surrounding waters in preparation for the great day. Timing, down to the last flick of an eyelash, was the most important problem to these "fly-boys."

I was imbued with a great feeling of awe and admiration as I watched the completeness of integration among the cooperating service units and the extreme care evidenced, as an example, by the take-off safety devices for the plane which carried the bomb. All along the runway were set up spraying nozzles so that if the one chance in a million had occurred on the take-off, and a mechanical failure had resulted in a crash and fire, the fire would have been put out in a hurry.

Twenty-four hours before the bomb laden plane, Dave's Dream, took off for Bikini we left Kwajalein to board our assigned ships. I was stationed aboard the Navy aircraft carrier, Shangri-La, from which vantage point I watched the take-off of the Navy's drone planes as well as the detonation of the A-Bomb.

The explosion was awe-inspiring as the cloud bank rose thousands of feet into the air. From the Shangri-La we were unable to hear the explosion, but the sight was well worth the trip.

Whether the first bomb of Operation Crossroads will answer any or all of the questions asked by the Military will have to await a more thorough study of the recorded data and a closer inspection of damage sustained by capital ships and by miscellaneous military equipment.

That much of this data will be available for leisurely study is due entirely to the over 10,000 pieces of ingenious electronic equipment which recorded literally thousands of different facts

The Crossroads Press Club welcomes its first guests. Commander W. H. Grieve, USNR, welcomes Reva Hurwitz, American Red Cross Public Relations representative and Major Robert DuBose. This club served as headquarters for the press, including your editor.

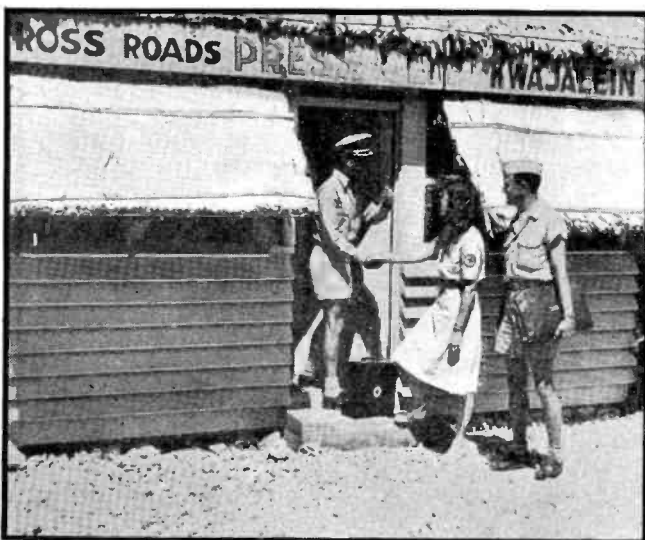

Commodore Ben H. Wyatt, USN (left) Atoll Commander, Kwajalein; discusses the Crossroads project with Lt. Gen. H. C. Wedemeyer U.S.A., Commander of U.S. Forces in China at the Press Club. The table-top chart was used by newsmen to get their bearings.

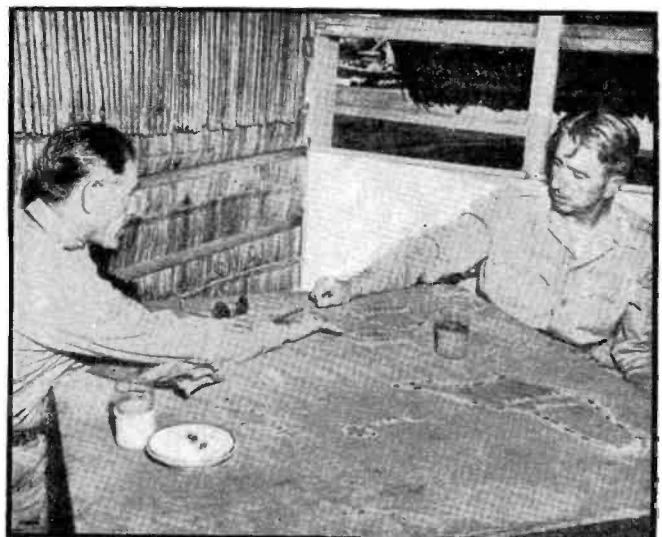

To assure ideal conditions for Able-Day, weather balloons were sent aloft daily. Forecasts were made 24 hours in advance.

View of tail assemblies of B-29 planes used in Atom-Bomb test. Planes in foreground were used for photographing the test, while plane in background (B) is "Dave's Dream," the bomb carrying craft.

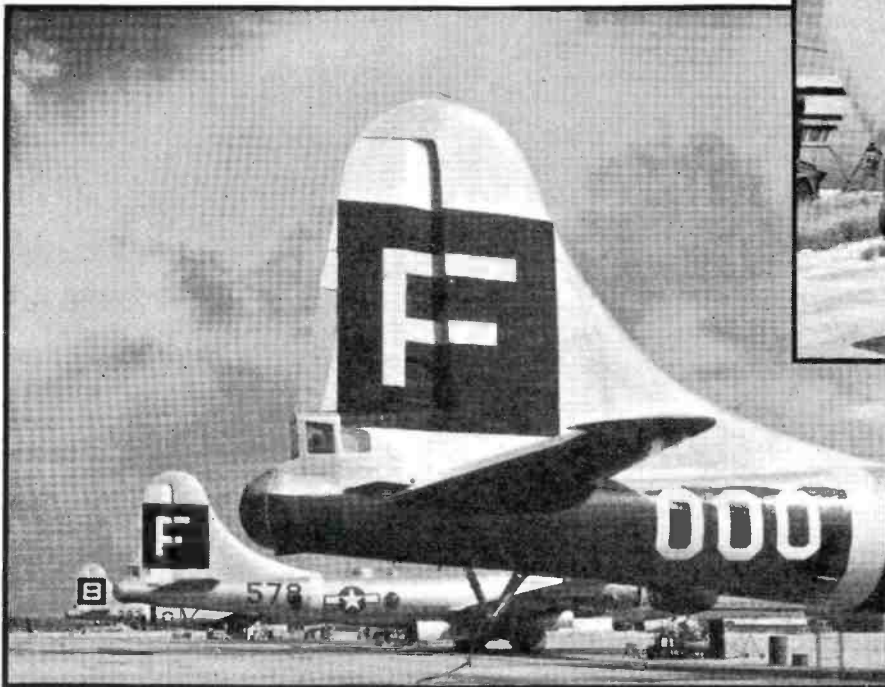

specially-built towers on Bikini Atoll. From this vantage point, these unattended cameras had an unobstructed view of the target fleet in the lagoon. The entire action was viewed by many of us on television screens located aboard the various observation ships. This gave us a "ringside" seat for the show although our actual distance from the target precluded our seeing the details which were so clearly shown on the screen.

In addition, the radio-controlled drone planes were equipped with television transmitters which enabled the "mother" ships to receive data about the inside of the atom cloud on the screens of their receivers.

Undoubtedly many of you had "eyewitness" reports of the test via radio, brought to you by a commentator viewing the action from below decks through the medium of television.

Another triumph scored by electronics and radio on Able-Day was the performance of the radio-controlled drone planes which flew through the atom cloud to bring in samples of the vapor, temperature reports, and other needed data. Before the test, no one here was willing to venture a prediction as to whether the radio-controlled planes would come through the field of high radio-activity. Only one of the four drone planes was lost and this not through the action of the bomb. The three planes which remained after the fourth crashed flew through the cloud, collected the required data and were landed safely.

Most of the equipment on these radio-controlled planes was electronically operated. And electronics came through with flying colors. Much of the electronic equipment used was war-developed and would be familiar to the readers of RADIO NEWS. The automatic pilots, radar equipment, temperature recording devices, radio equipment, and television receivers and transmitters have played a major part in the operation. Next month I will tell you of the role played by radio communications when I bring you a further report of my trip to Operation Crossroads.

for detailed scientific analysis.

It should be noted that instruments were located in a wide variety of places. All of the ships were considered as instruments in themselves or as instrument carriers. There were instruments on four of the islands of the Atoll. In addition, three of the islands were equipped with photographic towers. Various other electronic equipment and seismographical instruments were also located on the islands.

A considerable number of the one-hundred-forty planes which were in the air during the test carried instruments. Additional recording devices

were located in the water and on the bottom of the lagoon.

Many of these instruments sent their signals out by radio and the Geiger counters used in various locations recorded radioactivity, the intensity of radiation and the way in which it died down. The information was furnished instantaneously to all ships as a protective measure for those groups which entered the area after the explosion.

Of particular interest to the readers of RADIO NEWS should be the performance that television turned in at Bikini. As most of you know television pick-up cameras were housed in

Air view of the Navy area taken at Kwajalein, prior to the dropping of the first A-Bomb of Operation Crossroads, shows scope of preparation necessary for the test. The neat and orderly appearance of the island today is a far cry from the conditions which existed when the Marines made their landing at Kwajalein early in 1944.

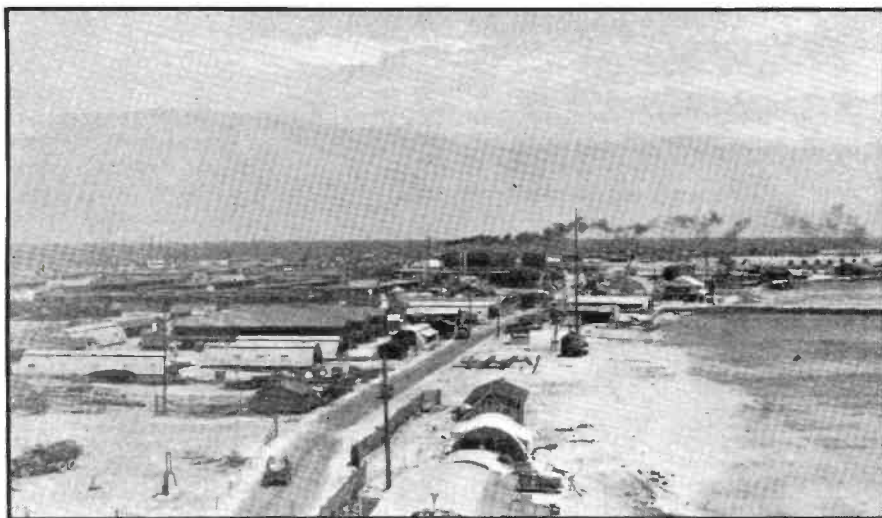

# Meet the MICROPHONE

By  
**HENRY J. SEITZ**

***A discussion of the various types of microphones, their principles of operation and the conditions under which they give the best performance.***



**I**F WE could but transport ourselves back some thirty-odd years ago into an archaic version of a modern broadcasting studio, we would undoubtedly be eager witnesses to strange and unfamiliar circumstances. Aside from the antiquated equipment strewn haphazardly about, further investigation on our part leads us to observe some form of radio frequency

generator. This would of course be coupled inductively to the antenna; be it half wave, quarter or full wave, it didn't matter very much in those good old days of radio broadcasting.

Connected in series with the aforementioned antenna is a rather crude type of carbon microphone, whose granules are enclosed in a cartridge which is then slipped into a special holder or form. In order to concentrate the sound waves a fiber megaphone was often connected to the microphone proper. Modulation of a somewhat strange and questionable nature was somehow accomplished by the performer bellowing into the above contraption.

Let us not be startled if every now and then the engineer motions the apoplectic performer into silence and reaches over to give the "mike" a few sharp raps with a screwdriver or pliers. Banging or even shaking the microphone was but one of the necessary evils of early AM transmission in order to keep the carbon granules from packing or sticking together.

Carbon microphones are today extensively used in circumstances which demand practicality rather than high fidelity transmission. This would include police, amateur and aviation use and other radiotelephone applications where the spoken word is the prime requisite.

Battery operated, these microphones

work on the principle of a varying electrical resistance between the carbon granules, when sound waves such as voice or music are impressed upon the diaphragm. Its frequency response is unaffected except as the resonant frequency of the diaphragm is approached. Considerable attenuation is the result of exceeding this factor. Stretching the diaphragm to a somewhat higher resonant point however, will easily overcome losses due to diaphragm inertia.

The sensitivity of a single button type carbon microphone is greater than that of the double button variety. As regards tonal quality, the latter type supersedes the former and has even been favorably compared to the condenser microphone which we will discuss later.

Sound waves approaching the carbon microphone and perpendicular to it have a markedly directional effect. If, however, this same source of sound is rotated horizontally about the front plane of the microphone, there exists a decided degree of attenuation insofar as the higher audio frequencies are concerned (Fig. 1).

Most broadcast engineers are familiar with the fact, that when a d.c. potential is applied between a thin metal diaphragm and a somewhat thicker stationary metal plate, both being separated by an air dielectric of .001 inches, a somewhat rudimentary de-

Fig. 1. Frequency attenuation curves of carbon type microphone due to angular displacement of sound source.

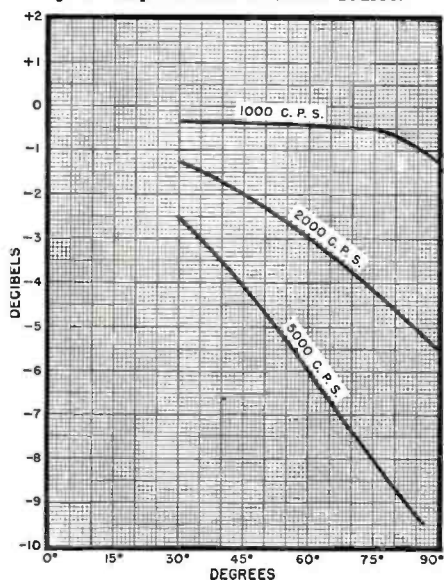

vice for converting acoustic energy into weak alternating current has been effected.

Sound pressure upon the diaphragm of the above condenser microphone obviously causes its capacity to change and vary in accordance with the characteristics of the impressed wave. This varying charge and discharge current is caused to flow through a coupling resistor which in turn develops a rather weak voltage across its terminals. Further amplification of this voltage is accomplished by the use of non-microphonic vacuum tubes.

Condenser microphones unlike the previous carbon type have a low output level but this comparative disadvantage is overcome to some extent by its absence of background noise.

Since the microphone in question is also categorized as a pressure operated device, its high frequency response will therefore be affected.

Under these conditions the microphone's output is proportional to the pressure of sound over the medium and low frequency range. However, with correspondingly higher frequencies the results are somewhat different, as increased pressure caused by these sound waves striking and rebounding off the diaphragm gives rise to pressure doubling.

Although higher voltages have been used with some success, it has been found that polarizing potentials of between 150 and 300 volts applied through a suitable resistance will usually suffice. Due to the high impedance of this device which makes it extremely sensitive to stray field pick-up, its amplifier is usually mounted in the same case or housing along with the microphone itself.

This latter aspect, from the viewpoint of the studio engineer, constitutes a grave danger as preamplifier noises and failures are often encountered while "on the air." By means of patch-cords it then becomes necessary to "lift" the microphone from its original preamp and repatch it into a spare which is usually available for emergency use. These actions must of course be accomplished quickly—which is one of the reasons why every important piece of equipment is made easily accessible to the engineer at the studio control board.

Some rather interesting results were achieved some years ago when a condenser microphone was used in conjunction with a parabolic reflector. Solo, as well as group instruments responded so well to the directivity of this device that additional means of orchestral re-enforcement were employed aside from the general coverage.

Various kinds of crystals, by virtue of their piezoelectric properties, have contributed much to the progress of radio and electronics. It is no small wonder, therefore, that small precision ground crystals appear as miniature a.c. generators in the crystal type microphone.

Unit sound cells, as they are some-

times called, usually consist of two squares of Rochelle salt, precision machined and cemented together. When subjected to sound waves a strain or stress develops across the crystal's axis. This active combination of stress and strain in turn causes a voltage to be generated. A sound cell of this type is practically non-directional in its response and is said to be capable of an output of approximately -80 db. In calibrating microphones the pressure against its moving element is sometimes expressed in dynes per square centimeter. From an open circuit point of view therefore, a microphone of -60 db. sensitivity should develop .001 volt, provided the pressure against its active element is equal to one dyne per square centimeter.

A decided advantage which the crystal microphone has over the other types previously mentioned is the fact that it does not require the use of an energizing potential or battery. In addition the frequency response is said to be quite uniform, with certain models extending their range up to and including 15,000 c.p.s.

Due to the high impedance of the crystal, the microphone's output may be fed directly into the grid of an amplifier tube—which when economical considerations are entertained is of decided advantage. Grid resistor values of about 3 to 5 megohms are generally acceptable.

Diaphragm type crystal microphones, similar to those used in hearing aid devices, consist of a crystal element mounted at three points within an air tight housing. A small actuating pin attached to the diaphragm connects to the crystal's unmounted end. The combination of crystal and diaphragm gives a much



A unidirectional crystal microphone which features wide angle front pickup but is dead in the rear. A special principle of unidirectivity provides attenuation of background noises and studio reverberation.

larger output than a single unit cell.

The grille type or crystal pile as it is sometimes called, consists of a group of either series or series parallel connected crystals. Sometimes as many as twenty crystal elements appear in a microphone of this construction. Specifications list a substantially flat response within 3 db. up to and including 15,000 c.p.s. for sounds coming from any horizontal direction.

A crystal microphone like a crystal pickup is equal to a capacitance with small internal resistance. Its capacitance however may be considered as a coupling between the voltage source and the load. Reducing the load re-

(Continued on page 72)

Fig. 2. Studio set-up for dramatic show featuring sound effects. (A) Cast and announcer's microphone, (B) sound effects turntable and microphone, (C) booth microphone (shielded against reverberation), and (D) orchestra microphone.

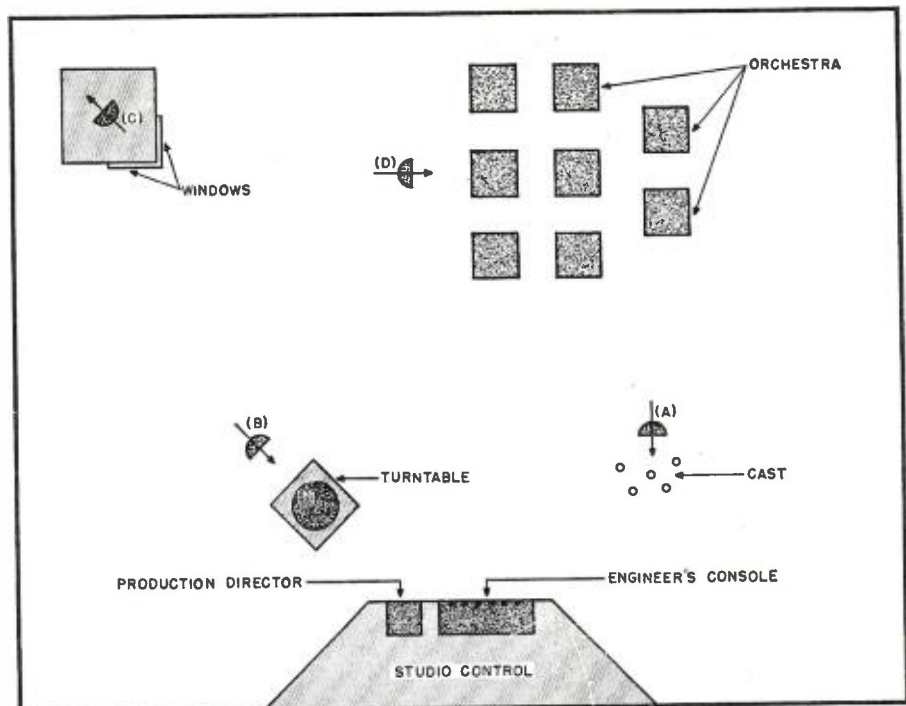

# Modernize WITH LIGHT

By A. F. LOEWE  
Lamp Dept., General Electric Co.

***Merchandising experts agree that seeing is the biggest thing in selling and that lighting is the biggest thing in seeing.***

**N**EW days call for new ways of doing business. Few radio and appliance dealers gain comfort from the knowledge that retailers in many other lines also face uncertainties, manufacturing delays and shortages of merchandise. Then, as though these problems weren't enough, there is a whole list of merchandising innovations that dealers must evaluate, rejecting some and adopting others, if

they are to meet the sterner competition ahead.

The new merchandising period just beginning will test the soundness of every dealer's advertising, promotion and sales methods. Every war-born idea and device that can be used profitably must be put to work. Newly developed or improved means of selling must be employed by the dealer who hopes to take full advantage of

the kind of market for radios that has never existed before, that may never come again.

If the dealer starts with the idea that seeing is the biggest thing in selling, he logically progresses to the conclusion that lighting is the biggest thing in seeing. Whatever modernization he may plan, whatever new equipment he may add, let him give a thought to, as well as a long look at, his lighting. Any improvement he may make may fall short of its goal unless it can be easily seen and used. For easy appraisal of merchandise and easy use of equipment, modern lighting is necessary.

Along with changes and improvements in lamps and luminaires have come advances in lighting standards and new techniques for employing recently developed light sources. Here modern lighting becomes not only a display aid but an active sales force. Note how drop ceiling reflectors have been used behind the fluorescent fixtures to direct light down to the sales floor thus avoiding wasteful dissipation on old ceiling.



In one important respect, the 1946 customer is no different from his 1941 brother. He not only wants to see, but he wants to see easily and quickly all the salient points of the merchandise that he is buying. There will be basic differences in the merchandise to be sold; design, color and value in the new appliances and radios will make a strong appeal to the customer's sense of sight. No alert salesman needs to be told that he can present the soundest possible sales arguments, yet it is "no sale" unless the customer approves the appearance of the merchandise. A customer must like a radio before he buys it, and liking is an emotional factor in which appearance plays a major part.

The competitive race between products will not, of course, be fought out as a beauty or design contest. But, new features, new appearance, improved functional value must be clearly seen to be clearly explained to

**RADIO NEWS**

the customer. The dealer and salesman will be severely handicapped unless adequate light for customer appraisal reinforces every sales effort.

A large majority of retail merchants realize that they need more effective, more modern lighting. A wartime *General Electric* survey of almost 3000 lamp, lighting equipment and electrical dealers revealed some significant figures. More than 73% of the store managers and owners interviewed planned to install fluorescent lighting when equipment became available. Some 79% of those surveyed intended to improve their interior lighting, and 84% of these wanted to install fluorescent.

This new lighting tool, because of its flexibility, efficiency and beauty, has become the spearhead of commercial lighting progress. Because of restrictions and reconversion, many retailers have not yet had the opportunity to relight their stores. However, the majority of merchants think of fluorescent as synonymous with modern lighting, and in every line of business they are planning to use this new light source in their relighting program.

The dealer can judge his need for relighting by surveying his store at a distance by night. If the front fails to stand out among the other business places in the block, regular customers are being needlessly handicapped, and an unnecessary barrier has been put in the path of new customers. Adequate sign, front and window lighting should be given first consideration.

As every modern merchandiser knows, sign, front and windows must compete at night with the brilliance of street lighting and the brightness of adjacent illumination. It is well to remember that front lighting creates a first and vital impression in the minds of every passerby.

Few retailers in any line would question the need for effective window lighting, but many who admit its importance fail to capitalize fully on the potentialities of the modern tools that can give display space maximum attraction. The proper combination of light sources, color and background can add impelling force to an invitation to stop, look and enter. More tasteful and emphatic use of exterior lighting can attract customers from distances far beyond the reach of dimly lighted stores.

While the exterior lighting is important for purposes of attraction and identification, interior lighting is vital to sales, service and atmosphere. As a customer enters any business place, he gains an immediate impression of atmosphere. He does not always attempt to analyze it, he is not often conscious of it, yet his attitude toward store, personnel and merchandise is definitely affected by atmosphere even before he looks at displays or speaks to a salesman. Dealers who want to cash in on the sales force of planned atmosphere might well take a lesson from the theater. Theater men have

long known that the response to lighting is an immediate one, an emotional as well as a visual effect.

The flexibility of the new fluorescent lamps enables them to serve in many different kinds of installations that provide functional lighting and at the same time serve definite decorative ends. Long lines or panels of light, created by recessed or flush-mounted fluorescent luminaires, interspersed with dramatic filament spot and floodlights can revitalize shelf, counter and island display, and contribute to variety in illumination that adds to pleasing atmosphere.

Displays of refrigerators, stoves or radio cabinets can be illuminated by novel overhead installations, such as artificial skylights or ceiling luminaires in geometric pattern. These provide widely diffused fluorescent lighting for both atmosphere and sales emphasis. In the larger interiors, long lines of light can be used to direct customers from one department or one display to another.

After the radio and appliance dealer has surveyed his store front and windows, he might profitably survey his interior, step by step, in an effort to see each department, each case, each individual display as the hurried customer will see, or fail to see it. Each display, each item arranged to stimulate impulse buying should be tested from the standpoint of eye-appeal.

On irons, toasters, portable radios and other similar smaller items, supplementary lighting will help to define the quality, size, finish and new service features that the manufacturer has designed to catch customer attention. When planned supplementary lighting makes easy identification and instant appraisal possible, additional sales must follow. Impulse buying accounts for as much as 50 per-cent of the sales in food, drug and department stores.



Because of their flexibility, the new fluorescent lamps are adapted to many different types of installation. In this radio and electrical repair shop, luminaires of modern design serve both decorative and functional purposes.

In the radio-appliance store, it is also recognized as a factor of major importance. Impulse items, such as auxiliary electrical equipment and radio accessories, should be arranged not only within easy reach but also within easy sight of the prospective customer with lighting positioned to catch and hold customer attention.

Along with changes and improvements in lamps and lighting equipment have come advances in lighting standards and new techniques for using recently developed light sources. New days have created new ways to solve lighting problems. Modern lighting has become not only a passive sales aid but an active sales force.

Among the new lighting applications are novel three-dimensional effects, as well as silhouette delineation in recessed case or niche display.

(Continued on page 88)

On entering any retail place of business such as this modern radio display room, customers receive an immediate impression of "atmosphere." Dealers may cash in on the sales force of planned atmosphere by installing modern lighting equipment.



# TRANSMITTER-RECEIVER



for  
Ham  
Beginners

By **CORINNE M. SULLIVAN**

Editorial Staff, Radio News

**Part 1. This transmitter-receiver, operating on a frequency band of 144-148 mc., was built by a novice. In constructing this unit, the author obtained sound, practical experience in preparation for her amateur license examination.**

**I**T'S practically impossible to work with the staff of RADIO NEWS, hearing such phrases as; "square wave analyzer," "grid bias," "ten meter band," and "terrific QRM," without taking an inquisitive interest in the story behind the stories that make RADIO NEWS.

But since I had never soldered

broken toy soldiers or wired a Rube Goldberg arrangement with an alarm clock attachment (seemingly prerequisites to radio), I approached the "ham" game with some misgivings. Another thing that put a damp wave over the picture for awhile was the fact that "hams" talk in terms of kilowatt transmitters, rotary beams,

three hundred dollar receivers, etc., which leaves the impression that the "ham" hobby is for leisure time millionaires or people that don't care if they eat or not.

We have pictures on file of ham shacks featuring four or five separate rigs with rhombic antennas, a combination that would be very impractical in a city apartment, and the talk of thousands of volts plate supply would make you wonder if it's even a safe thing to consider.

These are the problems that might tend to discourage any prospective "ham" and these are the problems that were solved or eliminated by Ray Frank, Amateur Radio Editor when he presented the SR-123 (SR meaning send and receive; 123 stands for as easy as 1, 2, 3 to build and operate), for the beginning "ham." It appeared as a very workable schematic diagram and it was up to this beginning ham to make it, and make it work.

After listening in on standard "ham" frequencies, it was decided that the traffic and interference were too heavy for a beginner to try to operate in these bands. This unit then, had to reach the high frequencies which, although they limit the beginner to local transmissions on the 144-148 mc. band, are ideal for a starting point. Since what was needed was an inexpensive unit, equipped for code and

Close-up view of the superregenerative receiver section of this unit.

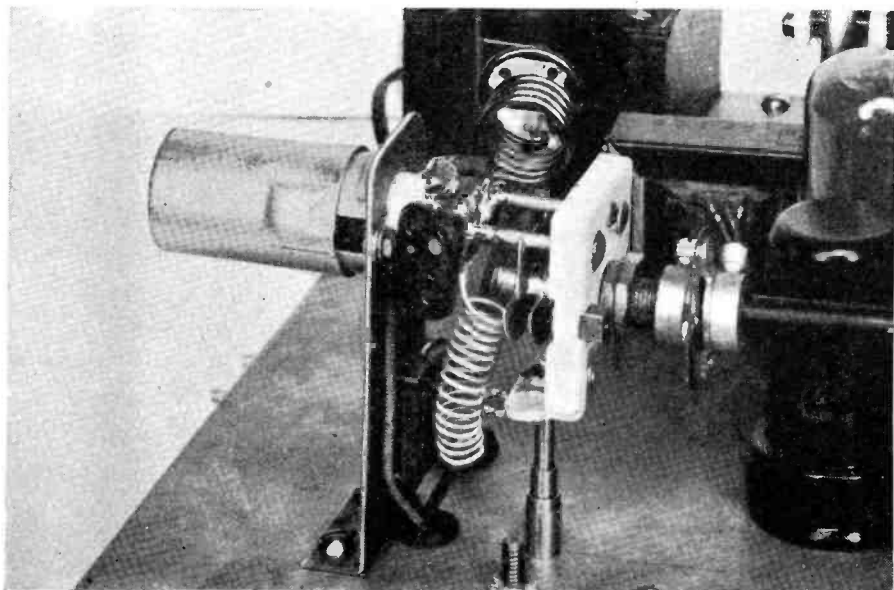



phone transmissions and with provision made for headphones, this transmitter-receiver filled all the requirements.

A couple of hours of practice with a soldering iron and an electric drill on old scraps of wire and pieces of metal were the introductory lessons to actually building the set, which satisfactorily filled in any previous lack of experience in the workshop. The entire unit should fit nicely on the corner of the desk at home and the antenna is easily put up on an apartment house roof. The highest voltage is 300 volts, well enclosed in the cabinet so your possibilities of acting as a shock absorber when operating this unit are reduced to a minimum. The cost, down to the last penny spent for sales tax, is \$27.98.

The best way to discover the workings of radio is to build a set and work with a ham to help you iron out the wrinkles and explain the operations. It's a "learning by doing" sort of procedure that serves a dual purpose since it will better equip you for the FCC examination and when you have your ticket, you'll be all set to go on the air.

The schematic diagrams, construction data, and the "reason why" were all presented to me as we have them outlined for you, in step by step procedure. Here is the first half of the story:

A transmitter and receiver both use several circuits which are similar. Each requires a power supply, audio section or modulator, and a common antenna system is preferable for convenience and maximum performance. Why not use the same components for both the transmitter and receiver wherever possible and save on both cost and size? A switching arrangement could be worked out which will permit the use of the audio section of the receiver as a modulator for the transmitter. The power requirements of both units being approximately the same, it is possible to use the same power supply for both.

For a beginner it is essential that the entire unit be as simple as possible. Conventional receivers for the high frequencies become rather involved with a multiplicity of tubes and complicated circuits. The simple superregenerative has acquired a rather bad name in the past due to the radiation from poorly designed units which caused interference over large areas. With proper design, it is possible to build a receiver of this type that will operate on very low voltage, using very loose antenna coupling, and in this way reduce radiation to a minimum.

A transmitter of simple design is a much more difficult problem. If maximum stability is desired, it is necessary to resort to one in which the frequency controlling stage is separate from the modulated stage. However, by the use of a high "C," high "Q" circuit, and the use of tubes with low interelectrode capacities, a modulated

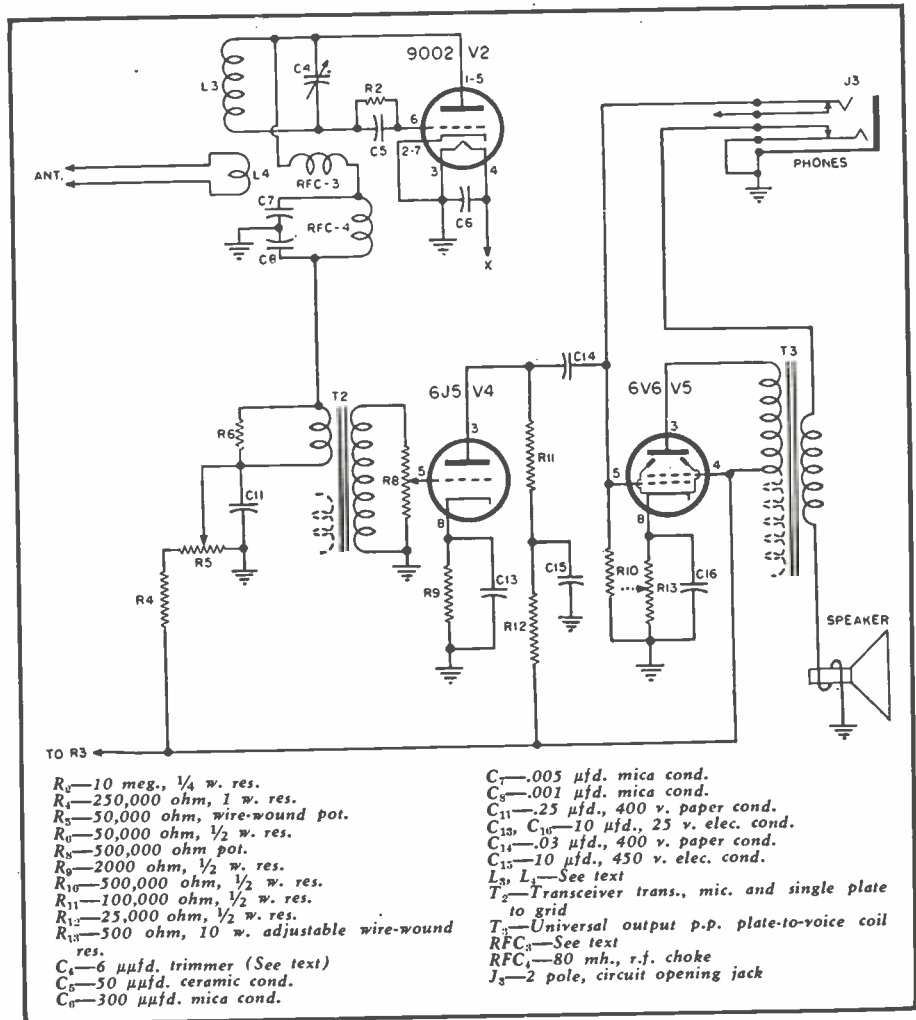
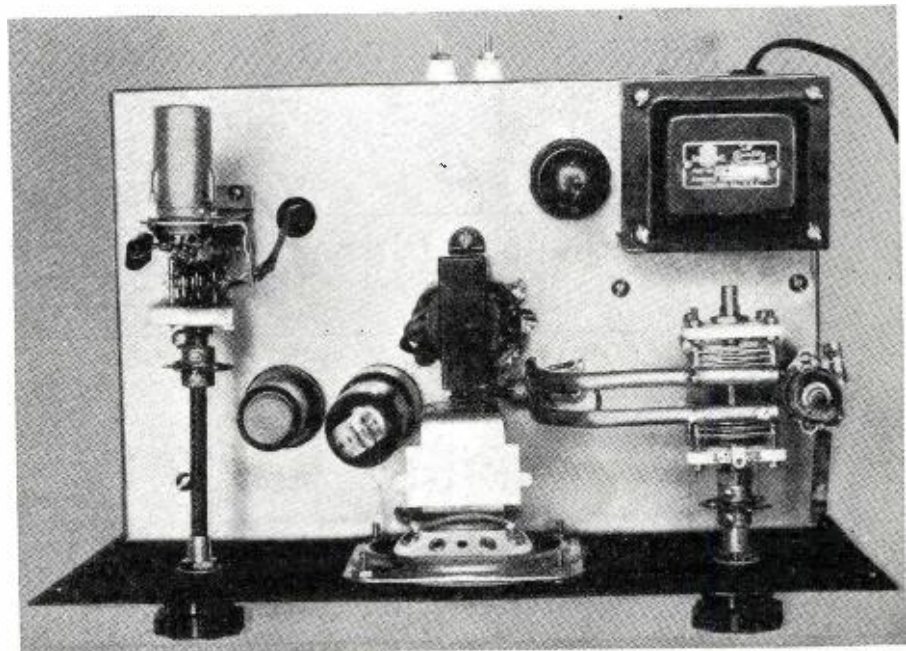

Fig. 1. Wiring diagram shows circuit and components used for the receiver. As can be seen in the complete circuit diagram, Fig. 3, some of the components serve dual purpose in that they function both for the receiver and transmitter.

oscillator of satisfactory performance may be constructed. It is essential that the modulation percentage be held to a reasonable value, to prevent

undesirable frequency modulation. The design finally decided upon was one in which the power supply and audio section were common to both

Top view of completed instrument. The heart of the receiver is shown in the upper left hand corner, while the transmitter is placed in the lower right hand corner.



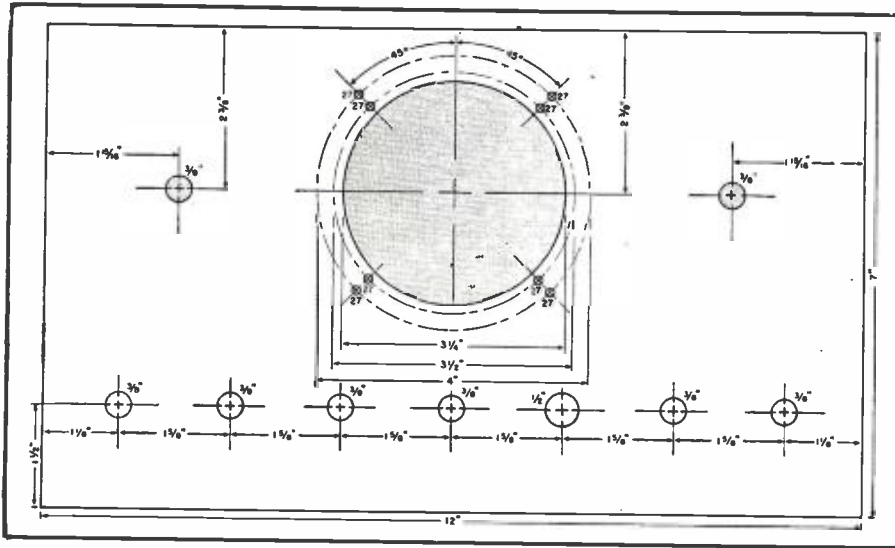

Fig. 2. Front panel showing proper layout for mounting speaker and operating controls.

the transmitter and receiver, with the audio section doing duty as a modulator in the transmit position. By the use of a multiple pole switch, it was possible to combine all the switching operations in one switch. It is rather confusing to attempt to follow the complete diagram as shown in Fig.

3 but a simple diagram of the receiver and audio portion alone are shown in Fig. 1.

Essentially, the entire unit consists of a 9002 superregenerative detector, which feeds into an audio section consisting of a 6J5 voltage amplifier, followed by a 6V6GT output stage.

Fig. 3. Complete schematic diagram of the transmitter and receiver. A simplified diagram of the receiver portion is shown in Fig. 1.

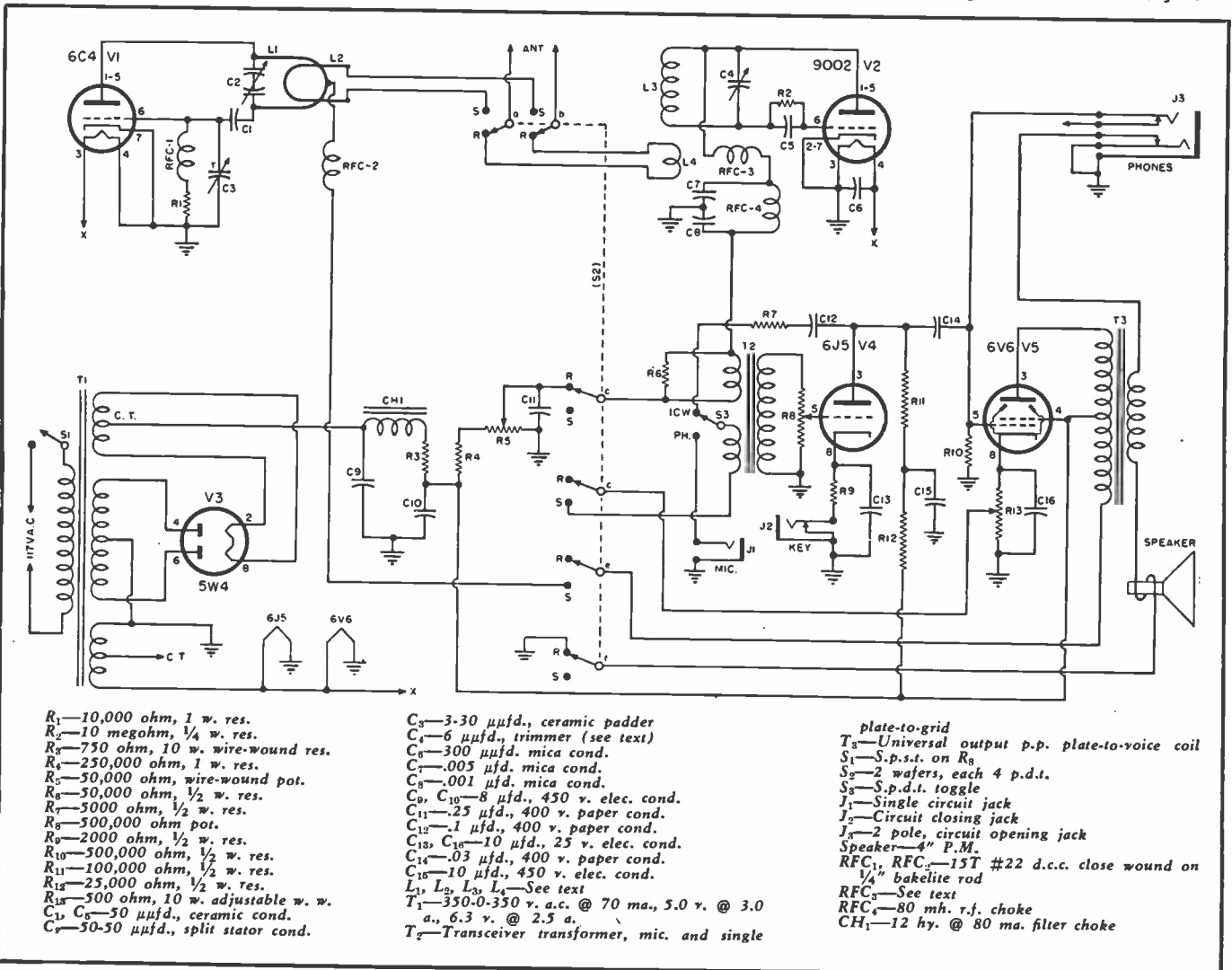

- R<sub>1</sub>—10,000 ohm, 1 w. res.
- R<sub>2</sub>—10 megohm, 1/4 w. res.
- R<sub>3</sub>—750 ohm, 10 w. wire-wound res.
- R<sub>4</sub>—250,000 ohm, 1 w. res.
- R<sub>5</sub>—50,000 ohm, wire-wound pot.
- R<sub>6</sub>—50,000 ohm, 1/2 w. res.
- R<sub>7</sub>—5000 ohm, 1/2 w. res.
- R<sub>8</sub>—500,000 ohm pot.
- R<sub>9</sub>—2000 ohm, 1/2 w. res.
- R<sub>10</sub>—500,000 ohm, 1/2 w. res.
- R<sub>11</sub>—100,000 ohm, 1/2 w. res.
- R<sub>12</sub>—25,000 ohm, 1/2 w. res.
- R<sub>13</sub>—500 ohm, 10 w. adjustable w. w.
- C<sub>1</sub>, C<sub>6</sub>—50 μfd., ceramic cond.
- C<sub>7</sub>—50-50 μfd., split stator cond.

- C<sub>2</sub>—3-30 μfd., ceramic padder
- C<sub>3</sub>—6 μfd., trimmer (see text)
- C<sub>4</sub>—300 μfd. mica cond.
- C<sub>5</sub>—0.005 μfd. mica cond.
- C<sub>8</sub>—0.001 μfd. mica cond.
- C<sub>9</sub>, C<sub>10</sub>—8 μfd., 450 v. elec. cond.
- C<sub>11</sub>—25 μfd., 400 v. paper cond.
- C<sub>12</sub>—1 μfd., 400 v. paper cond.
- C<sub>13</sub>, C<sub>14</sub>—10 μfd., 25 v. elec. cond.
- C<sub>15</sub>—0.03 μfd., 400 v. paper cond.
- C<sub>16</sub>—10 μfd., 450 v. elec. cond.
- L<sub>1</sub>, L<sub>2</sub>, L<sub>3</sub>, L<sub>4</sub>—See text
- T<sub>1</sub>—350-0-350 v. a.c. @ 70 ma., 5.0 v. @ 3.0 a., 6.3 v. @ 2.5 a.
- T<sub>2</sub>—Transceiver transformer, mic. and single

- plate-to-grid
- T<sub>3</sub>—Universal output p.p. plate-to-voice coil
- S<sub>1</sub>—S.p.s.t. on R<sub>9</sub>
- S<sub>2</sub>—2 wafers, each 4 p.d.t.
- S<sub>3</sub>—S.p.d.t. toggle
- J<sub>1</sub>—Single circuit jack
- J<sub>2</sub>—Circuit closing jack
- J<sub>3</sub>—2 pole, circuit opening jack
- Speaker—4" P.M.
- RFC<sub>1</sub>, RFC<sub>2</sub>—15T #22 d.c.c. close wound on 1/4" bakelite rod
- RFC<sub>3</sub>—See text
- RFC<sub>4</sub>—80 mh. r.f. choke
- CH<sub>1</sub>—12 hy. @ 80 ma. filter choke

Power is supplied by the transformer T<sub>1</sub>, a 5W4 rectifier, and the brute force filter consisting of CH<sub>1</sub>, R<sub>3</sub>, C<sub>9</sub>, and C<sub>10</sub>. The regeneration is controlled by R<sub>5</sub> while R<sub>8</sub> in the grid circuit of the 6J5 controls the volume. Provision is made for either headphone or speaker operation. The phone jack, J<sub>3</sub> is so wired that the speaker is disconnected when the headphones are plugged in.

The transmitter is a one tube job consisting of a 6C4 in a Colpitts oscillator and will be described in next month's article. Construction and adjustment are simple and will cause no difficulty.

It was essential that the entire unit present a pleasing appearance and be as small as practical, as well as low in cost. With this in view, a standard 7" x 12" x 7 1/2" cabinet was selected. Use of such a small size case required considerable planning to include all the components in such a restricted space.

The chassis used was a standard cadmium plated unit that measured 7" x 11" x 2" deep. The front panel layout is shown in Fig. 2, while the chassis layout will be shown in Part 2. The holes were so located in the front panel to allow the controls to be

(Continued on page 138)

# Flea Power VOICE TRANSMITTER



Front panel view of completed instrument. Note that meter has a 5 ma. movement. This is used when a 45-90 volt "B" supply is available. If a 22½ volt supply is used then the meter should be a 0-1 milliammeter movement.

By ALVIN B. KAUFMAN  
Electronic Engineer

*Novel, easy-to-construct, single tube transmitter for handie talkie, and amateur use, or in light plane aircraft service.*

**T**HE ultimate in flea power, light-weight portable transmitters may be represented in the design of the transmitter discussed in this article.

Regardless of the design, to be small and compact requires the use of one tube in either the GT series, loktal, or the newer and popular miniature types. The use of more than one tube means added components, and consequently greater bulk and weight.

Where c.w. operation is contemplated there are innumerable miniature tubes to select from, and the design and construction of such a transmitter is relatively straight-forward. The design problems of a one tube phone transmitter requires careful selection of the proper tube and method of modulation.

This article will describe the operation and design of a "flea power phone transmitter" suitable for walkie-talkie, amateur, or light plane aircraft service.

The selection of the tube depends upon the available power supply and method of modulation. For portable use it is preferable to use a tube requiring either 1½ or 2 volts d.c. for the filament source and not over 67½ volts for the plate supply. Modulation requirements indicate a system of modulation necessitating very little power from the modulation source. For these reasons, suppressor grid modulation was decided upon, and the 1LN5 tube selected as the one meeting these requirements.

A high level modulation source is the output obtainable from a carbon microphone and its associated transformer. This output is sufficient to either grid bias or suppressor grid

modulate an r.f. stage. Where modulation is produced in the oscillator or only r.f. stage, crystal control *must* be employed to prevent excessive carrier shift. Even with crystal control there is some carrier shift and it is inadvisable to operate a high power stage similarly, as excessive splatter may cause repercussions from the federal licensing bureau. With these considerations in mind, it was thought advisable to stay out of the crystal control grid circuit and instead suppressor grid modulate.

The modulation of a suppressor grid tube usually calls for the suppressor grid to be biased negatively until the plate efficiency falls somewhat less than 35%. As only reasonable voice quality is required, symmetrical mod-

ulation is not necessary. Thus the secondary of the modulation transformer has no bias supply placed between it and ground. This saves the use of an extra dry cell battery. With no bias on the suppressor grid, the negative modulation peaks are undistorted while the positive peaks are clipped off. This corresponds practically to single-ended class "B" modulation, and in actual practice produces acceptable quality for voice modulation.

The direct current for the carbon microphone is secured from the filament supply. There appears to be no interaction or feedback from the use of this common supply. The use of this low voltage source for exciting the microphone circuit limits the but-

(Continued on page 141)

Circuit diagram of one-tube transmitter which may be easily constructed by the novice.

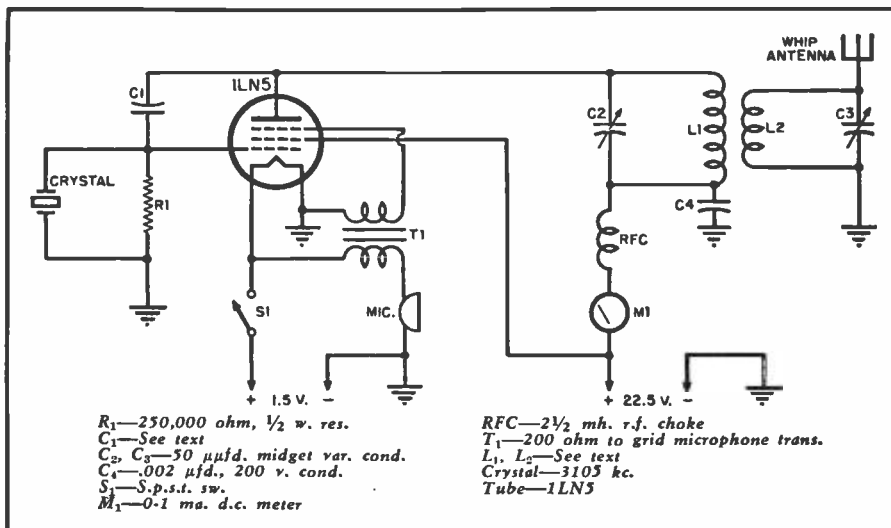

# Crystal Controlled 2 METER TRANSMITTER

By  
WILSON D. SPEIGHT,  
W9FST

*Featuring simplicity of design and availability of parts, this 144-148 mc. crystal-controlled transmitter is ideal for home construction.*

and quality. Further, the approaching marketing of factory made superheterodyne receivers for the high frequency bands will make it necessary to transmit a stable, well modulated signal or not be heard on these new receivers which will not usually receive a modulated oscillator intelligibly. This suggests use of a crystal controlled transmitter. The power in the antenna need not be large for very dependable communication within the "optical range."

The transmitter described here was the result of much deliberation with the following requirements in mind: (1) the parts should be available and easily procured (this applies particularly to crystals and tubes); (2) the number of stages necessary should be held to a minimum; and (3) the power supplies should not be large or expensive. This last requirement is governed by the fact that the 144-148 mc. transmitter is intended to be an auxiliary transmitter and should not duplicate or require use of the main, heavy power supplies of the station's lower

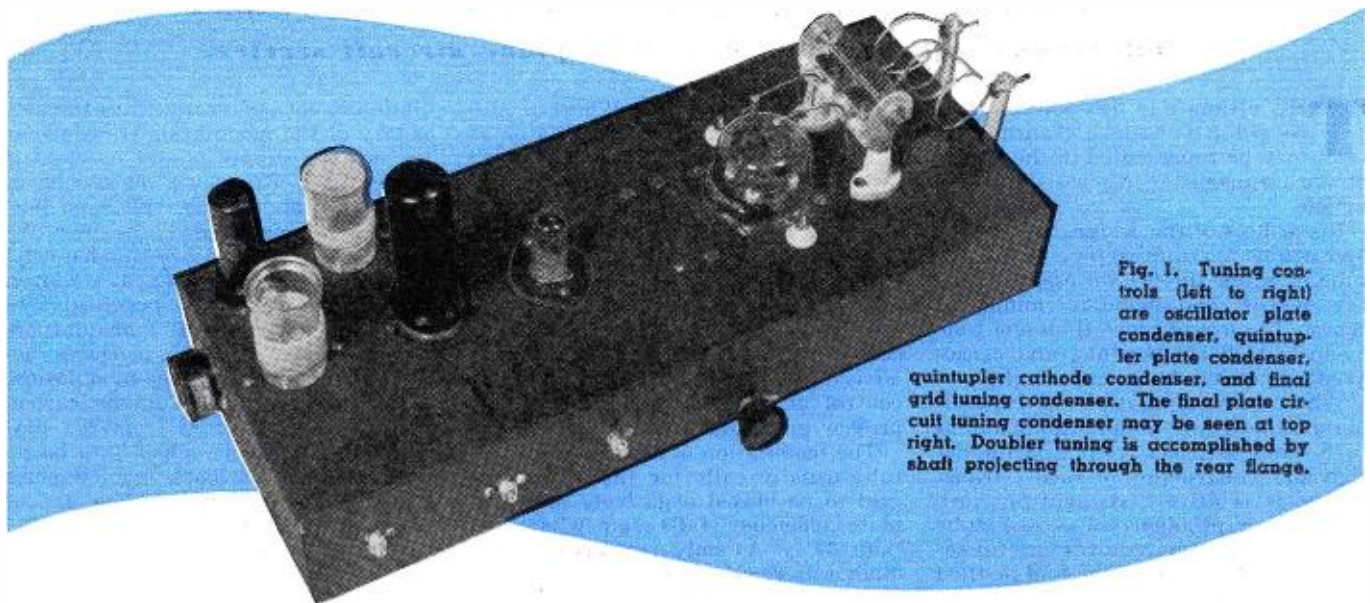

Fig. 1. Tuning controls (left to right) are oscillator plate condenser, quintupler plate condenser, quintupler cathode condenser, and final grid tuning condenser. The final plate circuit tuning condenser may be seen at top right. Doubler tuning is accomplished by shaft projecting through the rear flange.

**T**HE frontier of radio has not yet ceased its movement in the direction of the higher frequencies. Many amateurs prefer to apply their time and ingenuity to the construction of higher frequency equipment rather than travel the already well-worn road by increasing power on a much used and heavily populated lower frequency band.

There are many purposes for which the 144-148 mc. band is ideal, other than the fact that the problems encountered in equipment construction are somewhat more challenging than the construction of satisfactory equipment for lower frequency bands. For local contacts within "optical" range, the 144-148 mc. band offers an ideal method for excellent communication with low power inputs and eliminates the interference caused to and by stations engaged in long distance contacts

as, for example, on the 28 mc. band. Then too, the optimistic hope that reflection or refraction, or both, may put your two meter signal beyond the horizon should not be neglected.

The small physical dimensions of antenna arrays for the "two meter band" are a boon to antenna experimenters and also useful in insuring excellent communication with other nearby stations.

Many of the above arguments for the 144-148 mc. band apply equally to the still higher frequencies but in the case where a shift to klystron or magnetron oscillators is required, the average amateur may not be able to acquire the tubes or voltage sources needed.

In order to benefit from the advantages of the 144-148 mc. band mentioned, a transmitter should be built which produces a signal of stability

frequency transmitting equipment.

At the time of construction, no 14 mc. or 28 mc. crystals were available and, furthermore, many hams prefer to use 7 mc. crystals for frequencies higher than 7 mc., so it was decided to use a crystal in the vicinity of 7 mc. It is found that with a crystal in the range from 6 mc. to 8 mc. there are three main possibilities for multiplication into the 144 mc. band. The first is by use of a 6 mc. crystal multiplying to 144 mc. by the factor 24. This may be attained by tripling, quadrupling, and doubling. This requires three multiplying stages, two of which furnish small output with usual tubes and voltages. The second possibility is by use of a 7.2 mc. crystal and a factor of 20 to reach 144 mc. Here we may use a quintupler and two doublers. This is three stages of multiplication with only one stage of low output. The

third main possibility is by use of an 8 mc. crystal and a factor of 18 to reach 144 mc. This may be accomplished by using two triplers and a doubler, and perhaps would be a good lineup.

In order to have only one stage multiplying more than twice, the author chose the second multiplying system using crystals in the vicinity of 7.2 mc. One of the two doublers needed was incorporated into the oscillator tube, a 6N7 in the familiar oscillator and doubler circuit shown in the circuit diagram (Fig. 3). The coil  $L_1$  and its associated condenser tune to 7.2 mc. and the  $L_2C_5$  combination in the plate of the second triode in the 6N7 tunes to 14.4 mc.

In order to accomplish the quintupling at a frequency for reasonable efficiency, the 6N7 output on 14.4 mc. is multiplied in the next stage to 72 mc. A converted grid-plate oscillator circuit and a 6L6 tube were chosen for the quintupler stage in order to obtain satisfactory output on the fifth harmonic. It should be noted that the grid resistor used on this stage ( $R_1$  in Fig. 3) is 250,000 ohms, a larger value than usually specified in multiplier circuits utilizing output on lower harmonics.

The 6N7 output is coupled capacitively to the 6L6 grid through condenser  $C_5$  (Fig. 3). The plate circuit coil  $L_3$  and the condenser  $C_{10}$ , tune to 72 mc.

The remaining doubler takes the output of the 6L6 at 72 mc. and produces output at 144 mc. It was found necessary at this point to use a tube well designed for high frequencies. After unsuccessful attempts to use a 6L6 in this position, a 6C4 tube was installed and found to work beautifully. The output of the 6L6 on 72 mc. is coupled to the grid of the 6C4 through condenser  $C_{12}$  (Fig. 3). The inductance  $L_4$  in the 6C4 plate circuit is tuned to 144 mc. This tuning is accomplished by spreading or compress-

ing the turns of coil  $L_4$ , until the circuit is resonant at 144 mc.

The 6C4 plate coil is inductively coupled to the tuned grid circuit of the 832-A final amplifier stage. This grid circuit  $C_{11}L_5$  (Fig. 3) and the 6C4 plate coil are shown in the photograph (Fig. 2).

The 832-A amplifier tube is a dual beam power tube whose grid circuit and the plate circuit are both tuned to the operating frequency. The plate circuit is circuit  $C_{16}L_6$  (Fig. 3). No neutralization is required for the tube installation shown in the photographs where the grid portion of the tube is all below the chassis top surface and the plate portion of the tube is all above the chassis. The tube socket is  $\frac{3}{8}$  inch below the chassis surface.

Meters must be used, of course, in the adjustment of the transmitter, and they may be inserted at the points shown by  $X_1$ ,  $X_2$ , etc., in the circuit diagram.

#### The Crystal Oscillator

A one-turn loop containing a .15 ampere dial lamp may be used to determine when the crystal is oscillating. With plate voltage on the 6N7 only, rotate condenser  $C_1$  until the lamp lights with the one-turn loop close to the plate coil  $L_1$ .

When the lamp glows at good brilliance, shift the one-turn loop to coil  $L_2$ . Then rotate condenser  $C_2$  until the lamp lights well near this coil. This shows output on 14.4 mc. Now, a 0-100 ma. meter connected in at  $X_1$  should show approximately 75 ma.

#### The Quintupler

A .060 ampere lamp should be substituted for the .15 ampere lamp in the one-turn loop. A 0-100 ma. meter should be connected into the circuit at  $X_2$ . Condenser  $C_3$  should be set with plates disengaged. Connect the 6L6 plate voltage. Now condenser  $C_{10}$  should be rotated until the 6L6 plate current on the milliammeter shows a sharp dip to minimum value. The one-

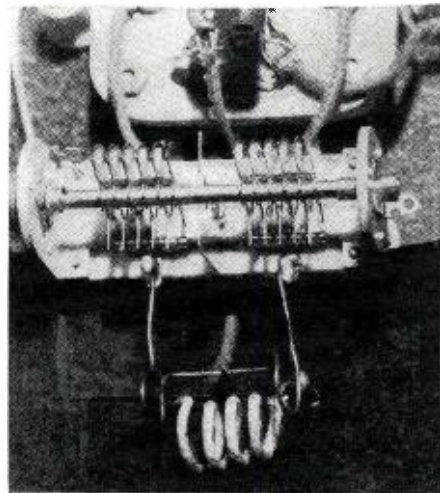

Fig. 2. Here, the four-turn 6C4 plate coil is shown as it is coupled to the 832-A tuned-grid circuit.

turn loop should now be brought close enough to the coil  $L_3$  to obtain light in the lamp. Now, remove the crystal from its circuit. If the lamp still lights, engage plates of  $C_3$  slightly, replace crystal, retune  $C_{10}$  and repeat check. Capacity of  $C_3$  should be increased until output of coil  $L_3$  ceases when crystal is removed from transmitter. At this point, maximum output will be realized without spurious oscillation.

#### The Doubler

Next, connect the plate voltage to the 6C4 and insert a 0-50 ma. meter at point  $X_3$ . Place the one-turn loop with .060 ampere lamp near coil  $L_4$ . Compress and separate the turns of coil  $L_4$ , using pieces of a good dielectric for tools, until the lamp glows the brightest and the current on the meter is minimum. This current minimum should be about 15 ma. Leave the coil in this condition exactly.

#### The Final Amplifier

With plate voltage on all tubes but (Continued on page 117)

Fig. 3. Circuit diagram of the 2-meter transmitter. An external power supply is required.

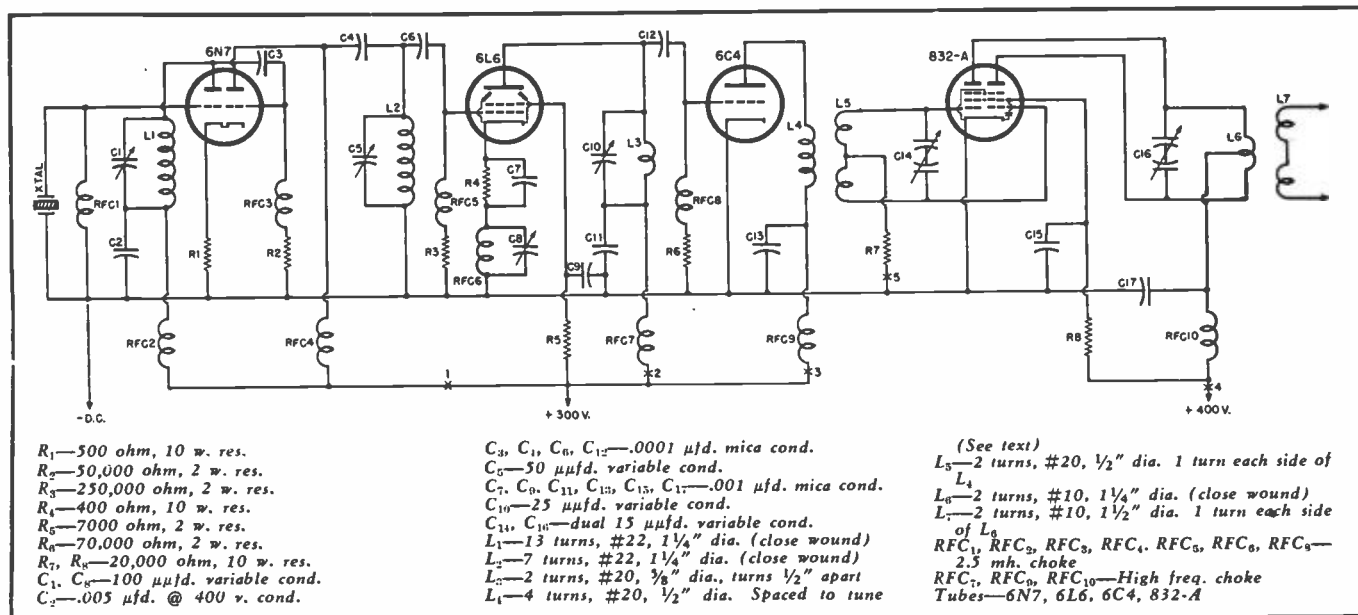

# AUDIO OSCILLATORS

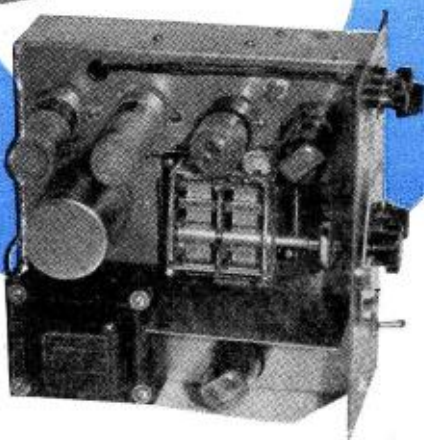
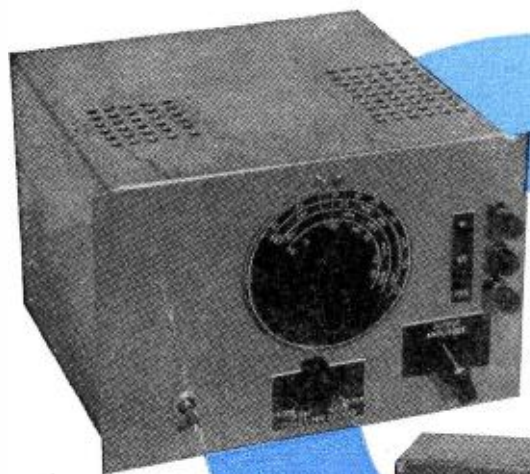

Fig. 1. Two views of the variable capacity type Wien Bridge oscillator. A standard broadcast type tuning condenser is used.

By  
**J. C. HOADLEY**

*Details for construction of two distinct versions of the Wien bridge audio oscillator. Both variable resistance and variable capacity types are covered.*

**A** SERVICE shop or experimenter's bench is not complete unless it contains an audio oscillator. With an audio oscillator we can do many things. First and foremost, we have a frequency source for calibration purposes. It is valuable for the accurate response determination of audio amplifiers and equally useful for the location of rattles in cabinets and speaker cones. When it is connected as a modulator for your r.f. signal generator, you can run response curves and measure distortion on an entire receiver from antenna to speaker. It is also useful for measuring the turns ratio of transformers, and inspecting the frequency and amplitude of tone control circuits.

As the usual commercial product is quite expensive, there are many who cannot afford one, or consider the investment too costly in light of its relative importance in the shop. These audio oscillators are not only easily built, but should not cost over fifteen dollars.

The usual audio oscillator is either a beat frequency oscillator or an RC or Wien Bridge type. The former consists of a fixed r.f. oscillator operating at about 100 kc., together with a second oscillator whose frequency may be varied from 100 kc. to 120 kc. The two oscillators' outputs are introduced into a detector which, together with a low pass filter, puts out a variable audio frequency, whose limits would be 0-20,000 c.p.s. in this case. A beat

frequency oscillator is difficult to build, due to the necessary extensive r.f. shielding and the large number of tubes.

The second type of oscillator, the RC or Wien Bridge, is simpler as it operates directly at audio frequencies. It consists of a two-stage audio amplifier and RC bridge which is at the same time regenerative and degenerative. The circuit is so adjusted that it will barely oscillate at one frequency which is determined by values of R and C.

The basic circuit is shown in Fig. 2. When  $R = R_1$  and  $C = C_1$ , then the frequency that the circuit will oscillate at is given by  $f = \frac{1}{2\pi RC}$ .  $R_2$  is

made adjustable so that the feedback may be adjusted to an optimum value.

Fig. 2. Basic diagram of the Wien Bridge. If a lower output voltage is desired, with less circuit loading, connections may be made to points "A" or "B."

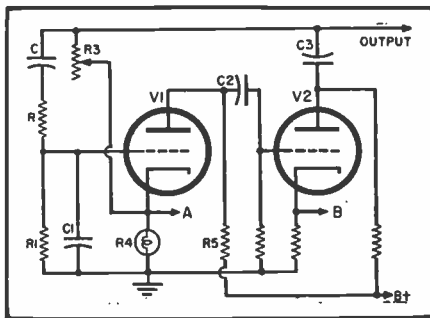

$R_1$  is a 110 volt, 3 or 6 watt lamp bulb whose resistance varies with temperature. Therefore when  $V_1$  attempts to draw more current the temperature of the lamp increases, increasing bias on  $V_1$  and increasing the degeneration. The lamp then tends to, automatically, hold the output of the oscillator constant and the distortion to a low value.  $R_2$  is so proportioned as to place the average current through the lamp on the knee of the lamp's temperature resistance characteristics. The coupling condenser  $C_2$  should be large if oscillation is to be maintained at low frequencies. Condenser  $C_3$  must be very large as it works into a very low resistance composed of  $R_7$  and  $R_8$  in series. This condenser is usually an electrolytic. Using an electrolytic as a coupling condenser looks odd but is permissible if the d.c. polarizing voltage is higher than the a.c. voltage it must handle, which it is in this case.

The frequency may be varied by varying R and  $R_1$ , or C and  $C_1$ . If C and  $C_1$  are varied, one may build an audio oscillator using a two- or four-gang .000365 broadcast tuning condenser.

In Fig. 3 is seen the circuit for a Wien Bridge audio oscillator which is extremely simple. It uses three tubes and a two-gang receiver type condenser. It has a frequency range of 25 c.p.s. to 37,000 c.p.s. Its output will remain constant within 3 db. and it will put out about twenty volts. The distortion is less than 1%. It must,

however, be carefully shielded, as it is perversely willing to lock in with multiples of 60 cycle line frequency. It will be noted from the diagram that the frame of the tuning condenser is above ground. The capacity to ground must be kept low or the frequency range will be seriously restricted. Also, a small trimmer must be connected in parallel with the upper section to compensate for this capacity to ground. This condenser should be adjusted to an average balance of  $C$  and  $C_1$  for all the ranges. The photograph, Fig. 1, shows the layout of the completed oscillator.

We may, however, vary the  $R$  in our Wien Bridge to control the frequency. By means of a dual potentiometer, we can realize a greater frequency range on one rotation of the dial and we can, if we select a linear taper on our pot, spread the range over approximately 300 degrees of dial rotations.

In Fig. 5 will be seen a circuit for a variable  $R$  audio oscillator. It will be immediately noted that we have chosen pentodes. The reason for this choice was the dual pots sections' inability to track each other. The two resistor elements will vary as much as 20% from each other. The greater gain of the pentodes allows the circuit to compensate for this discrepancy and still oscillate at a relative constant amplitude.

Also, as the 6SJ7's are metal tubes, we have the advantage of the shielding that these provide. The circuit is not nearly so susceptible to a.c. pickup and does not need to be enclosed in a metal box. The frequency ranges are selected by switching the capacitors. It will be noted that good practice is observed by not using a high resistance in the grid of a tube. The dual pot is a dual 1 meg. unit, yet the oscillator goes to the unusually low frequency of 7 cycles-per-second. If you wish to dispense with the four frequency ranges and you are satisfied with a frequency variation of 50 to about 8000 c.p.s., a two or five meg. dual pot may be used and the whole range can be crowded on one sweep of the dial. The value of each condenser used may

$$\text{be figured by } C = \frac{1}{2\pi Rf}$$

Because of the poor tracking of some dual pots, it was deemed advisable to have a panel feedback control. This control will allow the distortion to be adjusted to minimum, although the model in the photograph did not need it. The layout and parts arrangement are shown in the photographs Figs. 4, 6, and 7. Note how one of the filter condensers was so arranged to provide shielding between the bridge tubes and the power transformer. The 40  $\mu$ f. coupling condenser should be located as far from the power supply as possible. The range condensers are mounted directly on the switch and the leads should be kept short to reduce any pickup.

The values of the resistors in series with the dual pot were chosen to give

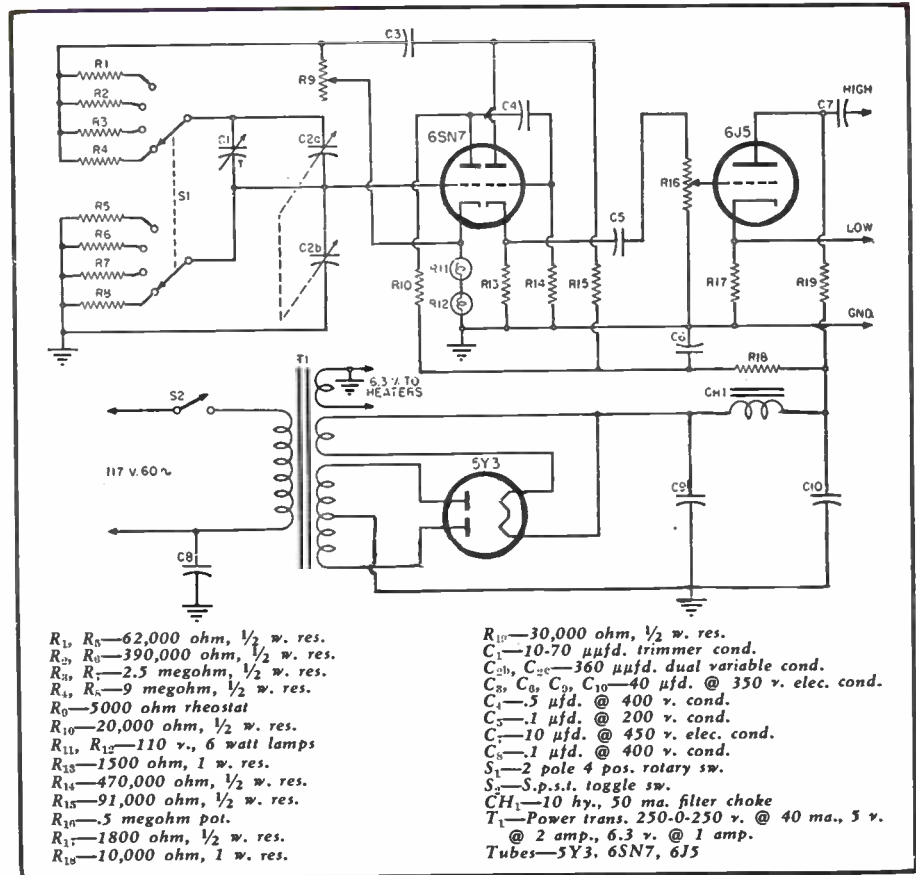

Fig. 3. Diagram of Wien Bridge audio oscillator employing a two-gang variable condenser to control frequency. Range of instrument is 25 to 37,000 cycles-per-second.

a frequency range of about ten to one. It was found that this was the greatest range the dual pot would cover without the circuit going out of oscillation. The frequency range may be increased if readjustment of the feedback control is not deemed a disadvantage.

The power supply is conventional, and any small receiver power transformer may be used. Its current out-

put should be 50 or 75 ma. Its 6.3 v. winding need not supply over 1 ampere. The choke should have 10 or more henrys inductance. Note that several ten watt resistors are used. The lamps may be soldered directly into the circuit if sockets cannot be found for them. These lamps, incidentally, are the ones used in night lights, usually found in the local ten cent store or hardware store.

Fig. 4. Front panel view of variable resistance Wien Bridge type audio oscillator. Terminals at right provide 4 volts output while those on left provide 40 volts output.

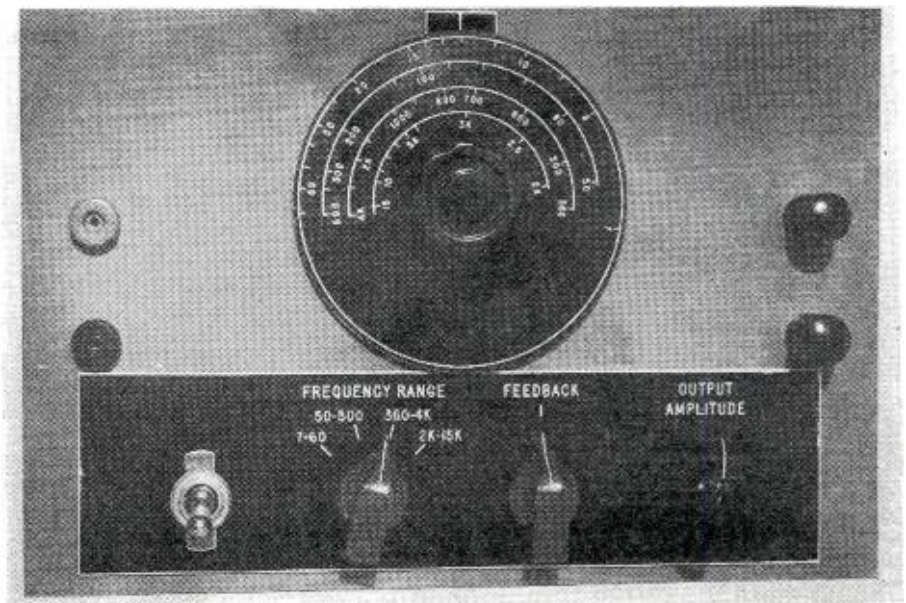

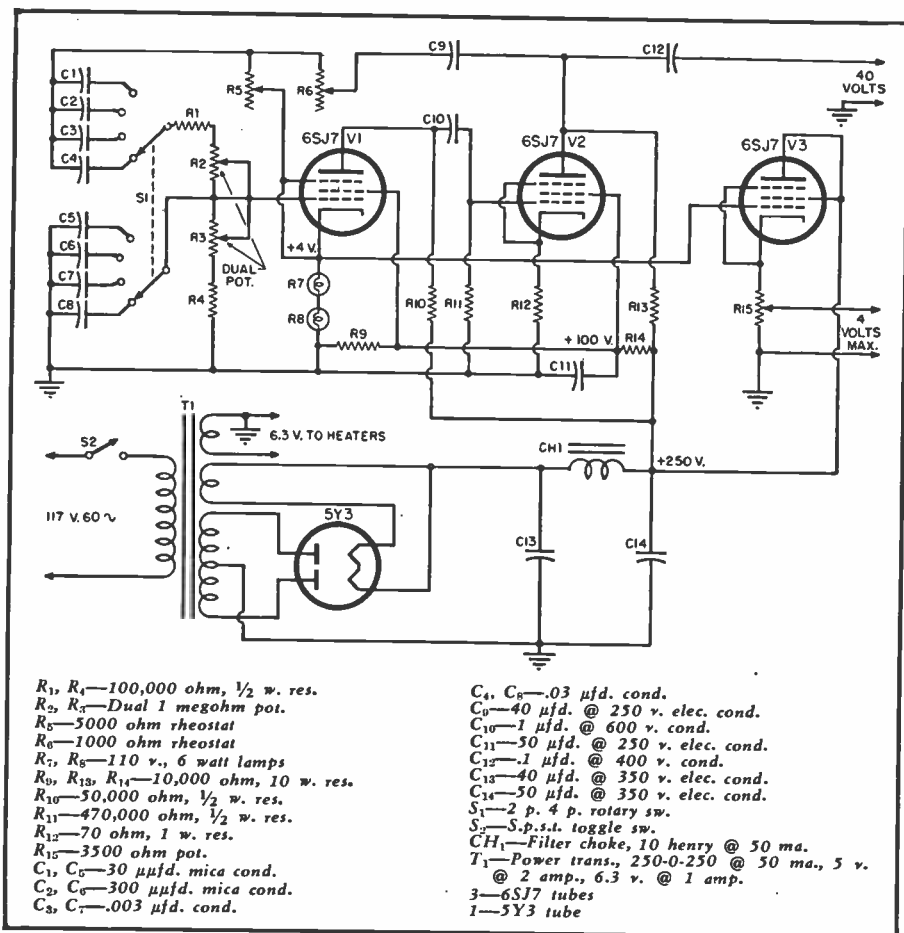

Fig. 5. Diagram of Wien Bridge. Variable resistance is used to control frequency.

This oscillator has a variable output from zero to 4 volts, which will be adequate for most work. In case you need a higher voltage, a 40 volt output is provided. This output cannot be heavily loaded. If higher output voltage is desired,  $V_2$  may be made a 6V6 amplifier with about 5000 ohms in its plate circuit or an output transformer.  $V_3$  was made a cathode follower, so as to provide an output with

a low internal resistance, and to provide a means of varying amplitude which would not be frequency discriminating.

If this output is connected to a low resistance load, a condenser should be introduced in series therewith. It will have to be large if low frequencies are being used. A large electrolytic will be satisfactory, but remember to connect the + side of it to the arm of am-

plitude control, or trouble will arise.

The author calibrated this oscillator with an oscilloscope and the 60 cycle line. Lissajous patterns were used for the lower frequencies. The frequency dial on the scope was used for the higher ranges. These higher frequencies were determined with some degree of accuracy by the following procedure:

The oscillator was calibrated by introducing the 60 cycle signal output on the scope into the horizontal amplifier. The output of the oscillator was introduced into the vertical amplifier. The lowest frequency range was calibrated by observing the Lissajous patterns starting with the circle indicating a 1 to 1 frequency ratio (see Fig. 8); switching now to the second range, 60 cycles should fall at or near the low frequency end. We now increase the oscillator's frequency until a figure eight or two loops appear. This indicates 120 cycles. We proceed until we have an eight looped figure indicating 480 cycles-per-second. As more than eight figures are very difficult to count, we resort to a different procedure. We drop back first to a five looped figure which will indicate 300 cycles-per-second. We then switch the horizontal amplifier to the scope's internal sweep and with the sync control all the way off, we adjust the sweep frequency until we get one cycle on the scope's screen. If we now increase the frequency of the oscillator until two cycles appear and stand still, we will have 600 cycles-per-second. It is feasible to count up to ten this way so we can go up to 3000 cycles-per-second in this manner. To go higher, we reduce the cycles to five, which will indicate five times 300 cycles or 1500 cycles-per-second. Then, increase the sweep frequency until five cycles are reduced to one again. The sweep frequency is now 1500 cycles-per-second. We may now

(Continued on page 98)

Fig. 6. Top view of completed instrument shows placement of component parts. Note tuning potentiometers mounted on panel.

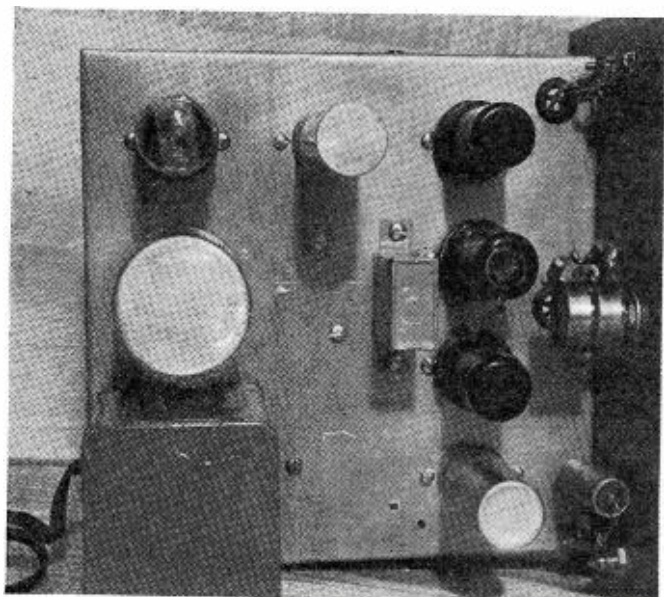
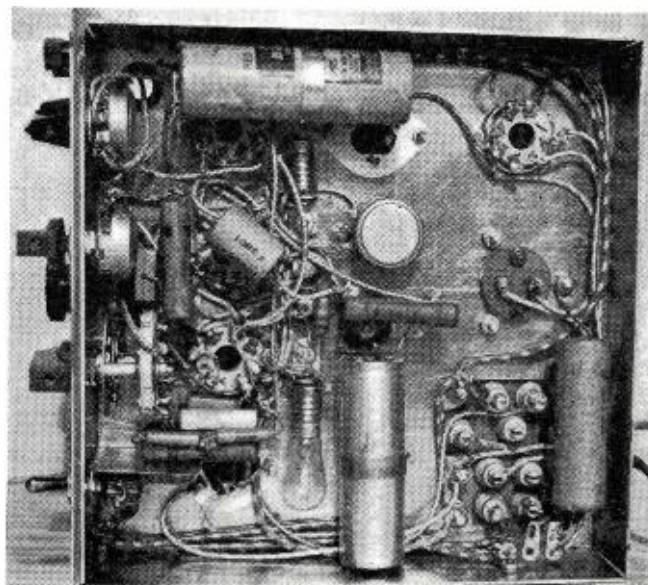

Fig. 7. Under chassis view of completed oscillator. Note that the a.c. switch is well shielded from other circuit components.





# Television RECEIVERS

By **R. A. MONFORT\***

Chief Radio and Television Eng.,  
Los Angeles Times

**Technical discussion of the operation of television receivers. Frequency modulated sound channel is now standard for black and white video transmissions.**

**T**ELEVISION receivers are inherently more complicated than the ordinary broadcast receiver. Most of the broadcast receiver techniques are used, many of them in a modified form, but in addition to these there are many unusual circuits which are entirely foreign to broadcast practice. A rigorous treatment of television receivers would require many volumes; hence a discussion such as this can do little more than touch the high spots, with only minor excursions into the more theoretical aspects.

Antennas for the reception of television signals are many and varied. They may be anything from a piece of wire two or three feet long to an elaborate array with multiple reflectors and directors, depending upon the conditions surrounding the particular installation. The short piece of wire can, of course, be used only when the receiver is very close to the transmitter, and even then the results will be only mediocre. In arriving at a decision as to what type of receiving antenna is best to use in a given installation, many factors must be considered. Among other things, the receiving antenna must be high enough and there should be no intervening objects to obstruct line-of-sight between it and the transmitting antenna.

If the distance between receiver and transmitter is very great, it may be desirable to use an antenna having a greater gain; i.e., an antenna which will deliver a greater signal voltage to the receiver terminals for a given field strength. This is where the more complicated arrays enter the picture, but it should be kept in mind that, in general, the higher the gain in the antenna system, the more directive it will be, and the narrower bandwidth it will pass. When the signals from two or more television transmitters are to

be received, the physical location of the transmitting antennas with respect to the receiving antenna, will have a profound bearing on the width of the receiving antenna beam and consequently the amount of gain that can be built into it. In addition to this, however, the carrier frequencies of the transmitters must also be considered in that the bandwidth of the receiving antenna must be kept broad enough to accept the two or more carrier frequencies which are of interest, and because this will also have a distinct effect on the maximum gain capabilities of the receiving antenna. Except in those two extremes where the receiver is located in a metropolitan area close to the transmitters and surrounded by tall buildings, or where the receiver is near the fringe of the

service area, a simple half-wave dipole antenna will usually give fairly satisfactory results, although in the final analysis, each receiving antenna installation must be individually engineered if the best possible results are to be obtained.

Most television receivers are of the superheterodyne variety, as indicated in the block diagram of Fig. 2. It will be seen that, except for the oscillator and first detector, there are actually two separate and distinct receivers; one for the sound and another for the picture. Typical carrier frequencies, both r.f. and i.f., are shown in Fig. 2, wherein the oscillator is tuned to a frequency which is 12.75 megacycles above the picture carrier, and 8.25 megacycles above the sound carrier frequency. The 8.25 megacycle sound i.f. carrier is amplified, passed thru a limiter, a discriminator, and audio gain stages to a loudspeaker in accordance with normal FM sound broadcasting practice. It may be of interest to note that at the time most of the prewar television receivers were built, television transmission standards called for an amplitude modulated sound channel. In these receivers, the i.f. pass band was quite wide (of the order of 250 kc.). When the standards were changed to specify FM for the sound channel, some receivers

Top view of television chassis shows placement of various components. Sound and video channels are incorporated into single unit to conserve space and reduce costs.

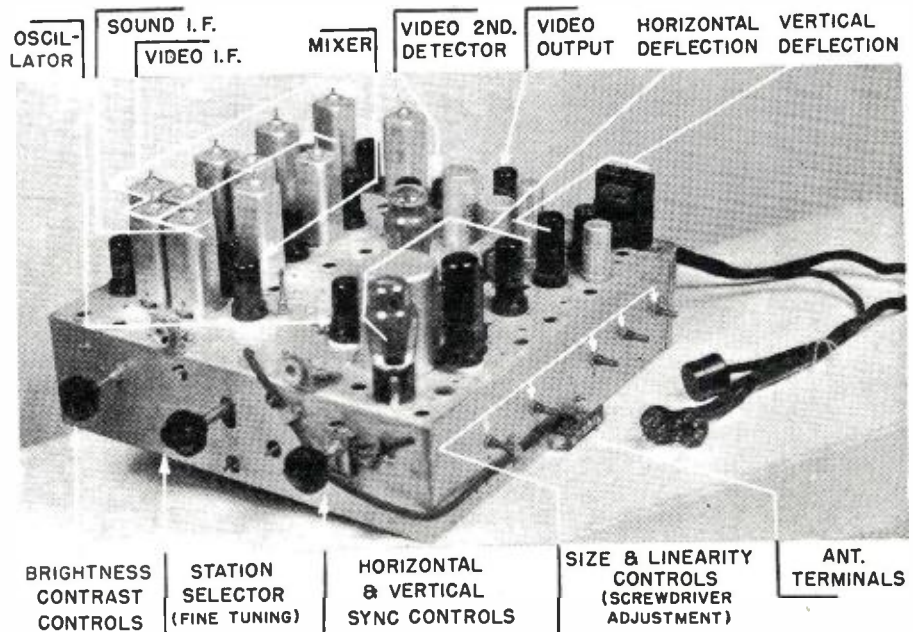

\* Formerly television engineer, National Broadcasting Company, New York, N. Y.

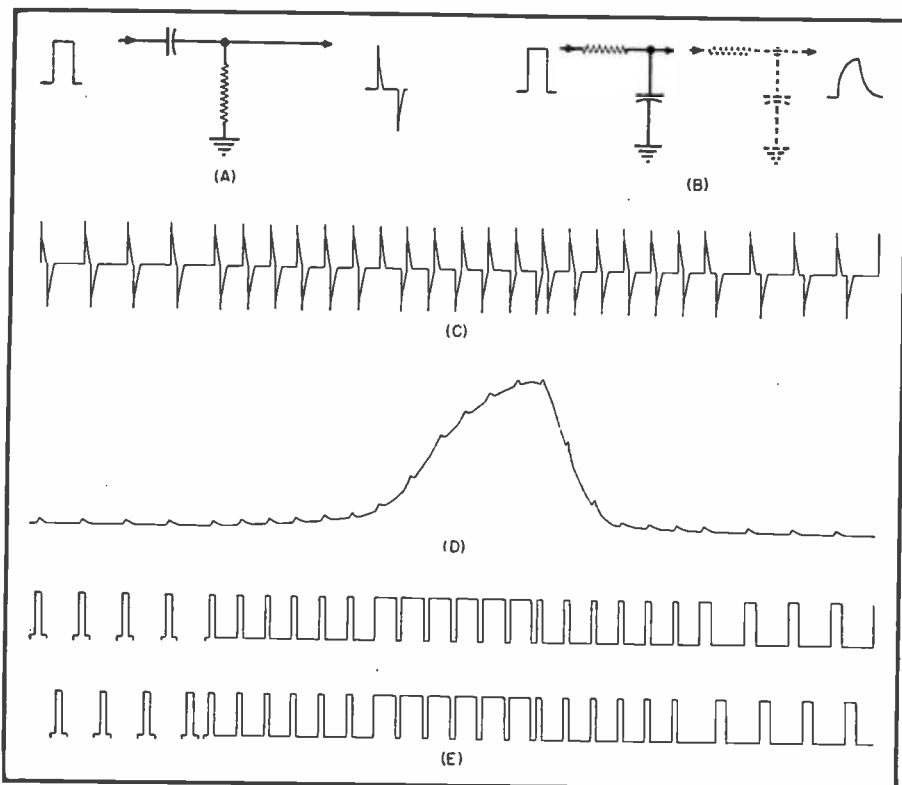

Fig. 1. (A) RC differentiation circuit, (B) RC integration circuit, additional stages may be added as indicated by the dotted lines. (C) differentiated synchronizing signal, (D) integrated synchronizing signal, (E) television synchronizing signal, with even and odd fields shown.

sion, the slope of the high frequency side of the pass band should be such that transmission is zero at 13 megacycles, and 100% at 12.5 megacycles; thus placing the carrier midway up the slope. From 12.5 megacycles down to about 8.5 megacycles, the curve should be flat, then drop to zero at 8.25 megacycles. Generally, in the first two picture i.f. stages, 8.25 megacycle and 14.25 megacycle tuned rejection circuits are to be found. The purpose of these circuits is to insure that none of the sound i.f. signal gets into the picture side of the receiver, and to avoid crosstalk into the adjacent channel. In order to obtain the unusually wide pass band characteristic in the picture i.f. stages, double tuned circuits are frequently used. The primary and secondary are deliberately over-coupled to the extent that the double peaked transmission characteristic appears, then the secondary is sufficiently loaded with resistance to flatten out the major portion of the peaks. Obviously, the gain per stage is much less under these conditions than in the ordinary broadcast receiver. It is not unusual to find five or six such stages of i.f. amplification in a television receiver in order to provide sufficient gain.

The alignment of the i.f. amplifiers in a television receiver is not simple. Of the two, the sound i.f.s are the more simple to align. Adjustment of these stages to a bandwidth of 200 to 300 kc. with the retention of a reasonable amount of gain is not too complicated, since for the most part, the technique follows broadcast practice. A sufficient bandwidth is normally allowed in the audio i.f. to permit the oscillator to be tuned for best picture re-

were modified to include a suitable discriminator, but in many cases the simple expedient of moving the i.f. pass band slightly so that the center frequency of the i.f. carrier fell in the middle of the slope of one side of the pass band was adopted. Thus, translation of the FM sound signal is accomplished as the frequency varies

up and down along the slope of the pass band characteristic. Although this is admittedly not the ideal solution, it has, for the most part, proven satisfactory.

The picture i.f. amplifier, like the video amplifiers, should have a pass band of 4.5 megacycles. Due to the single side-band method of transmis-

Fig. 2. Block diagram shows functional operation of conventional type television receiver.

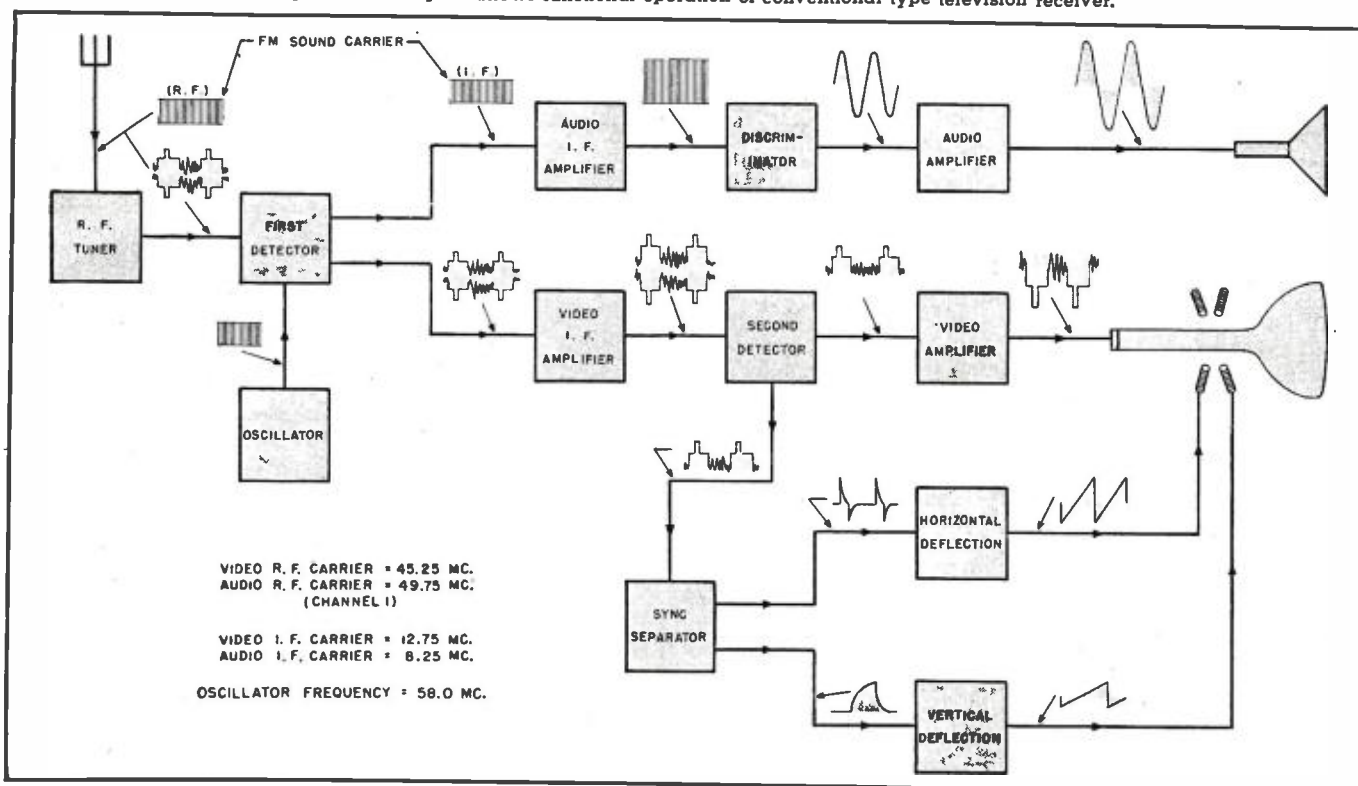

ception without seriously disturbing the sound quality. A frequency deviation of plus or minus 25 kc. is standard in the FM sound channel.

As has been previously pointed out, the gain per stage in the video i.f. amplifier is necessarily very low due to the bandwidth requirements, and consequently a greater number of stages is required than would otherwise be necessary. Also, the shape of this curve in the vicinity of the i.f. carrier frequency is of considerable importance, hence the alignment of such an amplifier must be done with a great deal of care. The tools required for this purpose are a signal generator and an indicating device. These may consist of a simple modulated oscillator which will cover the range from 7 to 15 megacycles and a meter which will read the amplitude of the demodulated signal which appears across the second detector load. However, the use of such equipment represents a rather crude approach to the problem since it involves innumerable point-by-point checks of the frequency characteristics. Quite obviously the time required to do it this way is almost prohibitive. The equipment normally used consists of a sweep oscillator, a signal generator and a cathode-ray oscilloscope. The sweep oscillator, or sweeper as it is sometimes called, is an oscillator which covers a band of frequencies, usually about 6 megacycles, which can be positioned anywhere between 7 megacycles as a lower limit and 16 megacycles as an upper limit. The frequency variable element of this oscillator may be a variable condenser which is driven by a synchronous motor or an electromagnet excited by 60 cycle a.c. so that the oscillator output frequency varies at a uniform rate over its sweep range (6 megacycles) at a repetition rate which is either 60 cycles or a multiple thereof. The output of such an oscillator, when rectified as by the second detector of a television receiver, will appear across the rectifier load resistor as a 60 cycle impulse which may be viewed on a cathode-ray oscilloscope. Since the rectifier or second detector delivers to the oscilloscope only the outline of the envelope of the input signal, the oscilloscope does not need to be a wide band device in terms of megacycles. An ordinary 100 kc. bandwidth CRO may be used. The third tool mentioned as being necessary in the alignment procedure, the signal generator, is simply another oscillator which will cover the same band of frequencies, but which can be manually adjusted to the desired frequency. When the output of this oscillator is coupled properly into the circuit which is being fed by the sweeper, the second detector output, as shown on the CRO, will show a small hump or marker signal on the previously mentioned 60 cycle impulse. With the sweep oscillator running it then becomes possible to determine what portion of the curve, or 60 cycle impulse, represents

which individual frequency by manually varying the frequency of the signal generator and noting the position of the marker with respect to the remainder of the curve and the frequency reading of the dial on the signal generator.

If there is any reason to doubt that the output from the sweeper is constant over its range, it is well to start by feeding the sweeper directly into the second detector through a 1000  $\mu$ fd. condenser if there is sufficient output voltage available from the sweeper, and sufficient gain in the CRO amplifier. The curve obtained on the CRO which is placed across the second detector load resistor should, ideally, have a perfectly flat top. If this is not the case, any deviation should be carefully noted and taken account of later on. Having checked the sweeper output in this manner, the last i.f. stage should be reconnected to the diode and the sweeper should be fed into the grid of the last i.f. stage. The coupling circuit between the last and preceding i.f. stages should have previously been disconnected so that the presence of this extra tuned circuit across the output of the sweeper will not cause trouble and the r.f. oscillator tube and the horizontal and vertical blocking oscillator tubes should be removed from their sockets so that they will not cause spurious signals by beating against the sweeper or signal generator. If the receiver contains picture a.v.c.,

the a.v.c. voltage must be replaced by a fixed bias in order to avoid misleading results. With the sweeper connected to the grid of the final i.f. stage thru a 1000  $\mu$ fd. condenser and the signal generator connected to the same grid thru a 2 to 20  $\mu$ fd. trimmer condenser, the sweeper should then be started. The trimmer should be adjusted to the lowest capacity which will give a good marker signal. A small by-pass condenser (about .004  $\mu$ fd.) may be temporarily placed across the second detector load resistor in order to improve the appearance of the marker.

By observation of the image on the CRO, the coupling circuits between the final i.f. stage and the detector should be adjusted until the characteristic shows about 90% response at 12.75 megacycles and a flat top down to about 8.5 megacycles. Having obtained such a characteristic, the grid of the final i.f. stage is then reconnected to its original position and the sweeper and signal generators are fed into the grid of the preceding i.f. stage. Adjustments are then made on the coupling circuits between the last i.f. stage and the preceding i.f. stage. This procedure should be continued, one stage at a time, until the entire i.f. system is properly aligned. In aligning these broad band transformers, the primary adjustments will, in general, have the greater effect on the frequency of the response curve. Adjustment of the secondary will have

Rear view of the RCA-TRK-12 television receiver. Video chassis, broadcast receiver chassis, kinescope, deflection yoke, speaker and power supplies are shown in picture.

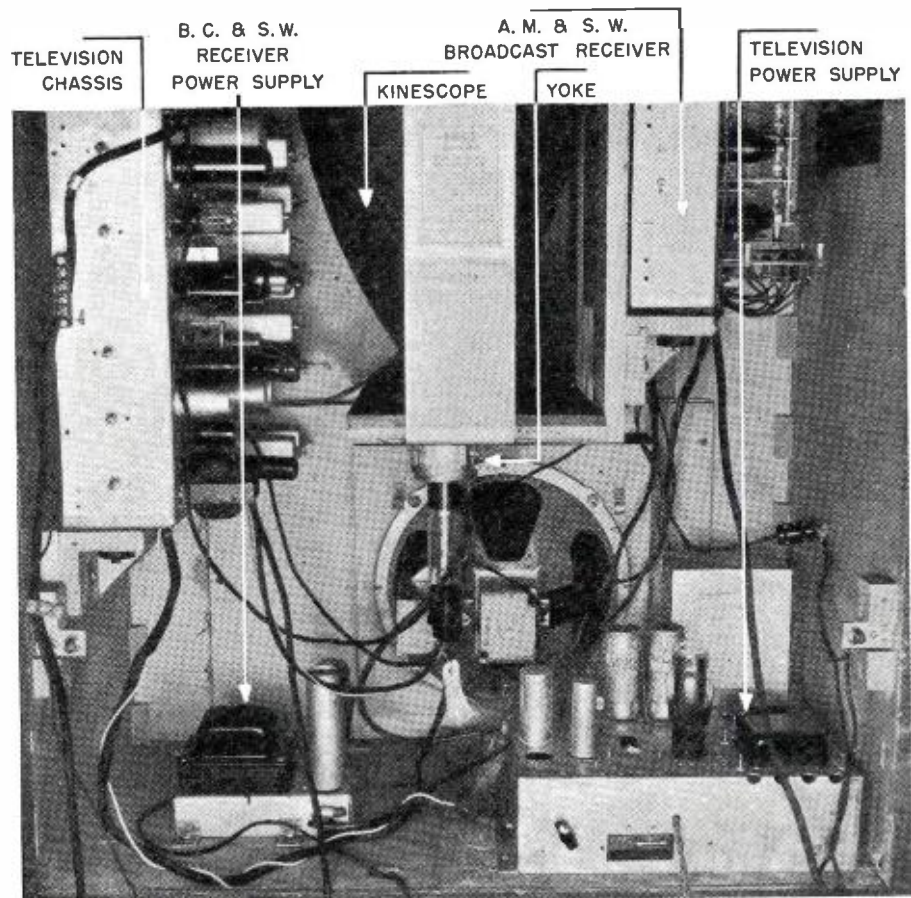

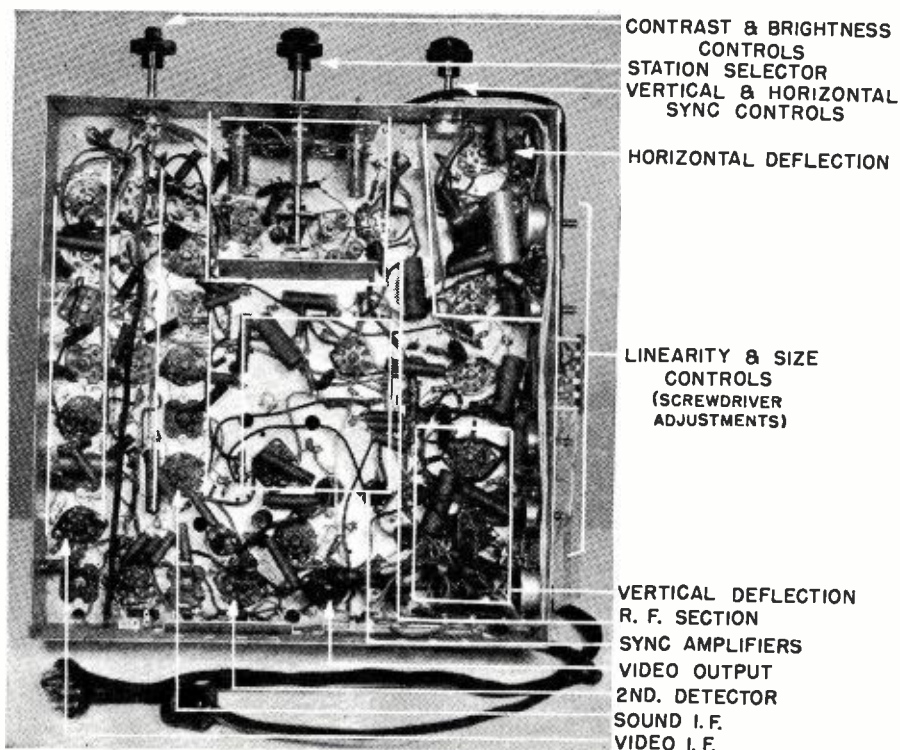

Under chassis view shows conventional stage-by-stage layout of television receiver.

signal. Since the a.c. axis is that point in the signal where the area under the curve is the same in both the positive and the negative directions, it will be seen that an increase in the amplitude of the blanking signal, without a corresponding increase in the amplitude of the picture components will cause a greater voltage to appear between the a.c. axis and the most negative portion of the signal. It is, then, this voltage which is measured or rectified and applied to the grid of the kinescope as a varying a.c. voltage, which retains the average brightness of the kinescope at the value determined by adjustments at the transmitting station, since there is no means of individually adjusting the relative amplitudes of blanking and picture components in a receiver. The brightness knob on a receiver supplies a fixed potential in series with that provided by the rectifier or d.c. setter, as it is called. This brightness control allows the user to set the average brightness of his receiver at a pleasing value and from then on, any changes in brightness are under control of the transmitting station.

The gain of the video amplifier determines the contrast of the picture on a given receiver. The greater the gain, the greater the difference between blacks and whites until that point is reached where saturation of the kinescope or "blooming," occurs. The contrast control which appears on most receivers is, therefore, merely a gain control. It may be a gain control for the video amplifier stages, or it may be a gain control for the i.f. stages, but in either case the net result is to vary the amplitude of the signal which is applied to the grid of the kinescope.

In this discussion of the video stages, no mention has been made of the synchronizing portion of the signal. The synchronizing signal remains a part of the signal which is applied to the kinescope, but since the proper setting of the brightness control is such that the top of the blanking portion of the signal is just black on the kinescope, the synchronizing signal is therefore in a voltage region which is beyond black, or blacker than black. In other words, it drives the grid of the kinescope well beyond cut-off rather than just to cut-off as does the blanking signal. The only effect that this has is to cause the d.c. setter to develop a greater voltage than might otherwise be developed, but since the amplitude of the synchronizing signal remains constant throughout, it amounts to the addition of a constant d.c. potential to the existing kinescope bias. The adjustment of the brightness control is such as to take account of the effect of the d.c. component due to the synchronizing signal; hence there is no need to remove the synchronizing signal before application of the picture and blanking components to the kinescope grid. The synchronizing signal is, however, extremely important

(Continued on page 142)

a greater effect on the shape of the response curve. Each successive stage should be aligned for progressively less and less response at the i.f. carrier frequency (12.75 megacycles in this case) until, on the over-all response curve the response at 12.75 megacycles is approximately 50% of maximum. Typical curves for a five stage i.f. amplifier are shown in Fig. 3. After the alignment of the complete i.f. system is finished in this manner, it may be necessary to make minor readjustments in various stages. A great deal of care should be exercised when aligning the i.f.s to be sure that the sweeper output is sufficiently low that none of the i.f. amplifier stages are overloaded.

The rejector circuits may be adjusted by using the sweeper and the marker signal generator to determine the point at which rejection should occur (8.25 and 14.25 megacycles), or it can be done by dispensing with the sweeper and applying audio modulation to the marker signal generator. The signal generator is set at the desired frequency and the rejector circuits are tuned for minimum output response out of the second detector. Adjustment of the r.f. and first detector circuits should be done after a satisfactory i.f. characteristic has been obtained, and is accomplished in much the same manner except that the sweeper and marker signal generator must operate in the r.f. range; i.e., frequencies in the order of 50 megacycles, rather than 12 megacycles.

The television signal which appears across the second detector load circuit has the same characteristic as that which was delivered by the studio to the transmitter. It consists of three

major portions; the synchronizing signal, the blanking signal and the picture components. At this point in the receiver circuit, this signal is directed into two entirely different types of circuits. One is the video amplifier which, as the name implies, amplifies the picture signal and applies it to the grid of the kinescope. When this signal is applied to the grid of the kinescope, it causes the beam of electrons which strike the fluorescent surface of the kinescope to be varied in intensity in accordance with the voltage variations which were obtained from the pick-up tube at the transmitting station. The brightness of the fluorescent surface of the kinescope is a function of the number of electrons which strike it and the velocity with which they strike. Hence, the variation of the beam causes the kinescope screen to be instantaneously lighter or darker at the point at which the electron beam is striking it at any given instant, in accordance with the lights and shadows in the original scene.

The blanking portion of the composite signal occurs at such a time with respect to the scanning of the kinescope beam, as to drive the grid of the kinescope to cut-off and thus extinguish the beam during the time when it is returning from right to left, or bottom to top of the picture. The amplitude of this same blanking signal with respect to the amplitude of the picture components determines the average brightness of the picture which is reproduced by the kinescope. This is accomplished by means of one of several circuits which in effect measure the voltage from the a.c. axis to the most negative portion of the

**Novel low cost plan insures a full year's service on any type receiver without additional expense.**



Busy corner of radio shop repair department where technicians inspect receivers as part of low cost "hospitalization" plan.

# Hospitalization for RADIOS

By  
**ORMAL I. SPRUNGMAN**

**T**HE newest postwar sales idea is the unique plan recently introduced by Carrillo Radio Shop, San Diego, California, to boost repair work and create customer prospects for new radios once they are available again.

It's called Radio Hospitalization, and it means just that. This is the place where sick and ailing radios, any make or model, can be repaired, renovated or rejuvenated without cost to subscribers who are members of Carrillo's Radio Maintenance Service.

Orlando Carrillo got the idea for his plan from a typewriter service station. If hospitalization can work on the health of a nation as well as a thumping-board, why couldn't it work on radio repair? He decided to try it out.

He made a list of the types of radios, figuring the average repair price of each model over a period of two years. This, then, would be the cost to a radio contract holder:

With this information at hand, he set up a schedule for each purchaser of a radio maintenance contract, which guaranteed prompt pickup and delivery, including complete maintenance and parts replacement for a period of a year.

For instance, the owner of a table radio could purchase a contract for one year for \$2.50, one-fifth the cost of

the more complex combination and recording sets. This seemed to be a better plan than charging a blanket price for all types of radios.

This does not mean that a subscriber can send in a cabinet full of spare parts and expect Carrillo Radio Shop to whip up a mellow-sounding set. The shop would do that, all right, but the usual repair charge would be made. In fact, the one and only term in the contract specified that the set must be in good working order at the time application is submitted.

This seemed reasonable enough, for the customer could feel assured that the shop would turn out the best possible repair job to avoid pickup at a later date.

When announcement of the new Radio Hospitalization Plan was made in San Diego papers, the public was so amazed and dubious about the offer that the local Better Business Bureau was swamped with more than a thousand calls in 48 hours questioning the

Premium rates for various type receivers as advertised by the shop owner.

Table Models .....	\$ 2.50
Consoles .....	5.50
Auto .....	6.00
Combination or Portable.....	7.50
Combination & Recording....	12.75

sanity of the offer and Orlando Carrillo himself. When the public was assured that all was well, contract applications began to pour in, not only from San Diego, but adjoining cities like La Jolla, Chula Vista, National City.

At present, Carrillo has 16 men in the field, soliciting new members under his Radio Maintenance Plan on a commission basis. To prevent unscrupulous solicitors from cutting in, each man carries his own identification card with picture and fingerprints, bearing credentials approved by local police.

In addition, Carrillo also works through local car dealers in servicing auto radios. The dealer covers the cost of radio repair, while the customer pays for maintenance service. A trust fund is maintained in a local bank covering the cost of every contract.

The Carrillo Radio Shop has been in operation at its present location only two years, but plans are already under way for expansion of its present repair facilities to compensate for increased business under the maintenance plan. Four experts in the back shop can turn out work in 24 to 48 hours, and prompt as well as courteous service has always been the byword at Carrillo's.

This San Diego firm already has ordered two new panel trucks for pickup service. These will be outfitted with a portable radio laboratory, including parts and tubes so that servicing can be done out on location, and only major repair jobs brought back to the shop.

Under the Radio Maintenance Plan, insurance is pro-rated when a new radio is purchased, extending beyond  
(Continued on page 151)

# Practical RADIO COURSE

By ALFRED A. GHIRARDI



Unique table model radio-phonograph manufactured by Westinghouse which features a removable midget receiver which may be used exclusive of the record player unit.

## Part 47. Theory of operation of electron-coupled, double electrode input, mixers and converters for superhets.

**T**HERE was serious need for a new superheterodyne "mixer" technique along about 1932. On one hand, there existed the demand for elimination of the separate local-oscillator tube in inexpensive midget receivers—elimination by an arrangement that would not possess the disadvantages of the autodyne<sup>1</sup> converter circuit. In addition, there appeared new demands upon the performance of the frequency converter as a result of the general progress made in radio reception and receiver design; for example, the desire for efficient and satisfactory automatic volume control, necessitating the use of variable a.v.c. bias on the mixer or converter tube as well as on the high-frequency amplifier tubes. Further, there was a trend toward popularization of multi-band receivers incorporating provisions for supplementary reception on several short-wave bands, where existing converter circuits generally behaved much less satisfactorily than at the standard broadcast frequencies.<sup>1</sup>

### Development of Special Tubes for Electron-Coupled Frequency Converters

Receiver designers were well aware of the serious disadvantages of the circuit-coupled, single-electrode input type mixers and converters then in use. However, they had to await the development, and low-cost quantity production, of the necessary new types of more complicated multi-grid tubes designed especially for electron-cou-

pled mixer and converter service before they could solve the problems confronting them. As a result of all the efforts directed toward the problem a radical new mixing technique, known as *electron coupled* mixing and employing double-electrode input (signal and oscillator voltages impressed on two separate electrodes), was developed. Because of its definite advantages, it rapidly became the most popular method of frequency conversion for superheterodyne receivers.

Several inexpensive types of multi-grid tubes designed especially for use as electron-coupled *mixers*, and as electron-coupled frequency *converters*, were developed within a comparatively short period of time. In America the *pentagrid* tube, having several grids, was developed and used in the well-known *pentagrid mixer* (6L7). In Europe, the *hexode* was developed. Then came the form of *pentagrid converter* tubes in which the first two grids, with the cathode, provided the electrode system for the local oscillator (6A8, etc.). Pentagrid tubes were manufactured (1935) in Europe under the name of *heptodes*. Then came those pentagrid converters in which the mixer portion was made up of a pentode instead of a tetrode. Such pentagrid converters are frequently called *octode converters* (7A8). *Triode-hexode* converters (6K8, 12K8, etc.) and *triode-heptode* converters (6J8, 7J7, etc.), which are in principle

simply the electrodes for a triode oscillator and a hexode or a heptode mixer, having a common cathode arrangement and enclosed in a single envelope, very soon came to be widely used. Each of these different types of tubes has certain operating characteristics that differentiate it from the others. The electrode arrangement employed in each one is illustrated in Fig. 1. The operation of each type will be explained in the next two articles of this series.

### Inner-Grid, and Outer-Grid, Oscillator Injection

First, let it be understood that the mixing action in electron-coupled mixers takes place in a manner somewhat different from that previously explained for circuit-coupled mixers.<sup>1</sup> Instead of using single-electrode input, *double-electrode input* is employed, i.e., the signal and oscillator voltages are each applied to a *different* grid placed in the same electron stream between the cathode and plate (see Fig. 1). Consequently, coupling between the oscillator and signal circuits is obtained through the medium of the *common* electron stream in which the oscillator and signal grids are located—hence the name *electron-coupled* mixer or converter.

It is apparent that the signal and oscillator grids may be positioned in the electron stream in either of two possible sequences with respect to the central cathode, i.e., the oscillator-grid may either precede, or follow, the sig-

<sup>1</sup>Alfred A. Ghirardi, "Practical Radio Course," Part 46, *Radio News*, July, 1946.

nal-grid in the electron stream. This leads to two classifications of electron-coupled frequency converters according to the grid sequence employed in the mixer section. They are:

1. Operation with the oscillator voltage impressed on an *inner* grid, the signal voltage being simultaneously applied to an outer grid. This is known as *inner-grid* (oscillator) *injection*. It is usually employed in pentagrid converters (heptodes) and hexodes.

2. Operation with the oscillator voltage impressed on an *outer* grid, the signal voltage being simultaneously applied to an inner grid. This is known as *outer grid* (oscillator) *injection*. It is the oscillator-voltage injection method usually employed in pentagrid mixers and in heptodes.

Both arrangements, as employed in various popular types of commercial mixer and converter tubes, are illustrated in Fig. 1. As we shall see presently, each produces certain operation characteristics peculiar to it.

### General Operation of Electron-Coupled Mixer Section Employing Inner-Grid Oscillator Injection

In the mixer and converter tubes designed for this operating arrangement, the alternating oscillator voltage of frequency  $f_o$  is impressed on a biased *inner* grid (usually the grid nearest the cathode) as illustrated in Fig. 2A. This oscillator voltage causes the oscillator grid potential to vary periodically at oscillator frequency about its mean (biased) value (see Fig. 3). Consequently, the oscillator grid alternately passes or reduces the flow of electrons through it, depending upon the value its potential assumes (with respect to the cathode) at each particular instant. (Its action may be visualized as being similar to that of a main electrically-operated shutter-valve, located in the main electron stream, that periodically opens and closes at oscillator frequency in accordance with the voltage variations occurring during each cycle of the applied sine-wave oscillator voltage.)

The resulting pulsating electron flow (at oscillator frequency) through the oscillator grid forms a pulsating cloud of electrons—a *virtual cathode*—between the inner portion of the screen grid and the signal grid (which are also in the electron stream—see Fig. 2A) due to the geometry of these elements and the voltages applied to them. The alternating signal voltage of frequency  $f_s$  applied to the negatively-biased signal grid controls the amount of electrons (current) that pass through it and on to the plate from this pulsating virtual cathode during each instant. Consequently, both the signal and the oscillator voltages effectively modulate the electron flow reaching the plate—i.e., modulate the plate current. As we shall presently see, this results in the production of combination frequencies in the plate circuit of the tube—among which are the “sum” ( $f_o + f_s$ ) and “differ-

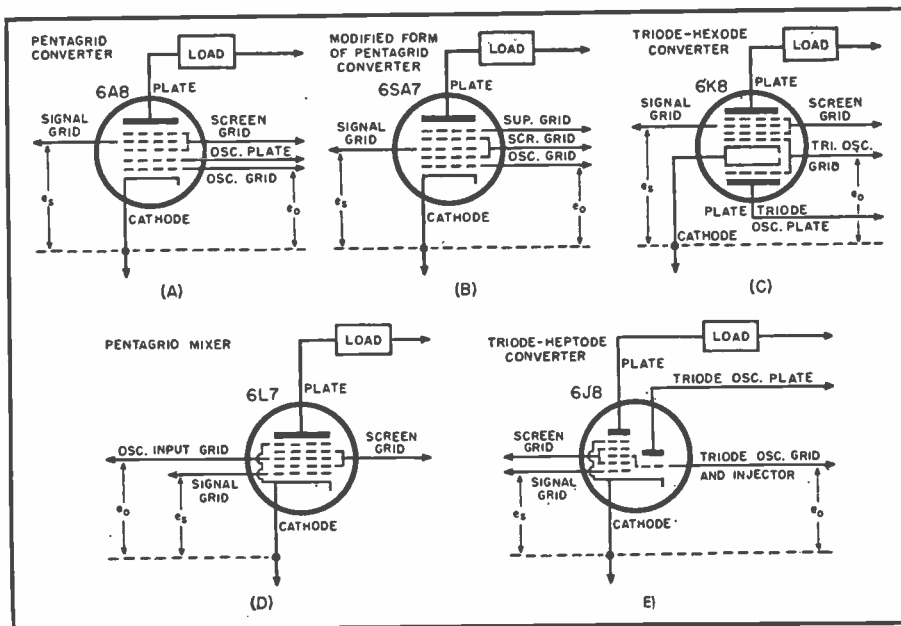

Fig. 1. Sequence of oscillator-grid and signal-grid positions (with respect to cathode) in various types of tubes employing inner-grid injection and outer-grid injection. Circuits A, B, and C show tubes using inner-grid oscillator injection. Circuits D and E show tubes using outer-grid oscillator injection.

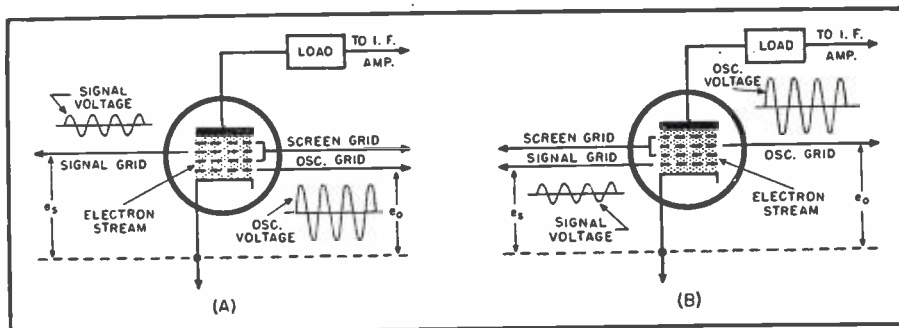
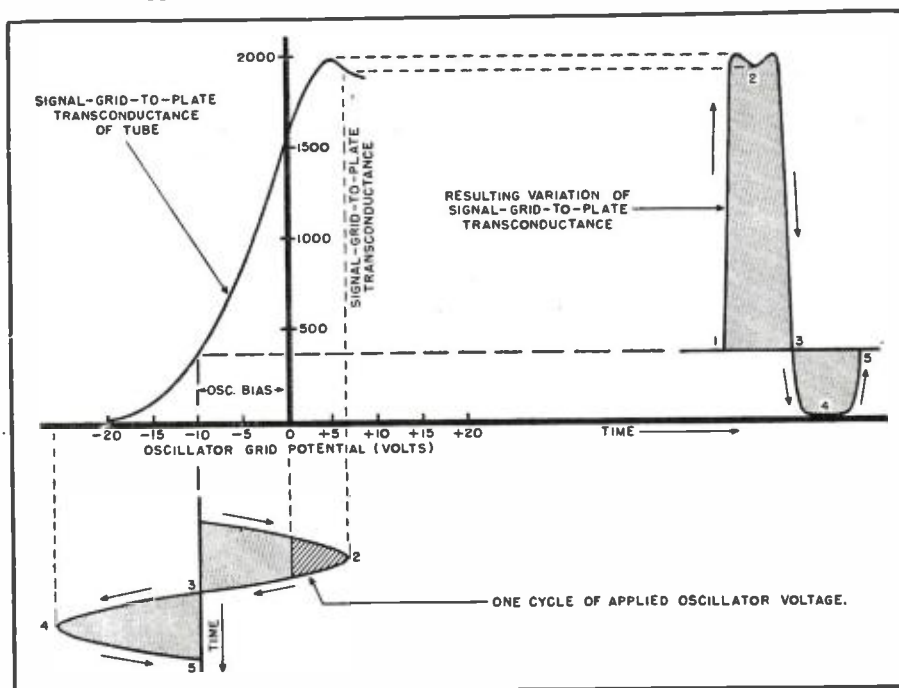

Fig. 2. How oscillator and signal voltage waves are applied to electron coupled mixer employing inner-grid oscillator injection (A), and (B) as applied to electron coupled mixer employing outer-grid oscillator injection.

Fig. 3. How signal-grid-to-plate transconductance of a typical mixer section designed for inner-grid oscillator injection varies during each cycle of applied oscillator voltage. Signal-grid bias constant at  $-3$  volts.



ence" ( $f_o - f_s$ ) frequencies. Of these, the one desired is selected by the tuned plate load circuit and passed on to the intermediate amplifier.

**General Operation of Electron-Coupled Mixer Section Employing Outer-Grid Oscillator Injection**

In the mixer and converter tubes designed for this operating arrangement, the cathode electron emission (current) is modulated by the comparatively small alternating signal voltage of carrier frequency  $f_s$  which is impressed on the negatively-biased control-grid nearest the cathode—see Fig. 2B. Since the alternating oscillator voltage, of frequency  $f_o$ , is impressed on a biased *outer* control grid, it periodically passes or reduces the flow of electrons through it and on to the plate, the number getting through at any instant depending upon the potential at that particular instant. Consequently, with this arrangement also, both the signal and the oscillator voltage variations effectively modulate the electron flow reaching the plate—i.e. modulate the plate current. As we shall presently see, this results in the production of combination frequencies in the plate circuit of the tube—among which are the "sum"

( $f_o + f_s$ ) and "difference" ( $f_o - f_s$ ) frequencies. Of these, the one desired is selected by the tuned plate load circuit and passed on to the intermediate amplifier.

**How the Signal-Grid Transconductance Is Varied by the Oscillator Voltage in Both the Inner- and Outer-Grid Injection Methods**

Because the signal grid in the inner-injection type mixer (Fig. 2A) is located in a stream of electrons whose intensity pulsates at oscillator frequency, and since the signal-grid-to-plate transconductance at any instant is a function of the intensity of the electron flow reaching the signal grid at that instant, the signal-grid transconductance also will vary at oscillator frequency. The signal-grid transconductance variation that results<sup>2</sup> in a typical mixer of this kind as a consequence of the application of each

cycle of the oscillator voltage is illustrated<sup>3</sup> at the right of Fig. 3. The signal grid is biased sufficiently negative during the whole of this action so that the applied signal voltage is not able to drive it positive. Consequently, it draws no current.

Since the peak value of signal-grid transconductance is attained when the oscillator grid swings somewhat *positive* (see Fig. 3), in the usual circuit of this kind the oscillator grid is self-biased with a low-resistance grid-leak and capacitor so that its potential swings sufficiently positive during each cycle of the applied oscillator voltage to attain this peak value of signal-grid-transconductance. Of course, the oscillator grid (inner grid) draws current during each period when its potential is driven *positive* (shown shaded (diagonal ruled lines) in the illustration).

The conversion transconductance of such a tube usually attains maximum value when the oscillator-voltage swing employed is such that it makes the tube operate past the point of maximum signal-grid transconductance in the one direction and cuts off this transconductance over slightly less than half the cycle in the other.

(Continued on page 107)

<sup>2</sup>It will be observed that this characteristic is different in shape from the corresponding curve for an r.f. pentode tube with oscillator and signal voltages applied to the same grid (single-electrode input mixer operation). See Fig. 2, Alfred A. Ghirardi, "Practical Radio Course," Part 45, Radio News, June 1946. The chief point of difference is that a definite peak in transconductance occurs.  
<sup>3</sup>Herold, "Operation of Frequency Converters and Mixers for Superhetrodyne Reception," Proceedings IRE, Feb. 1942

Fig. 4. How signal-grid-plate transconductance variation caused by osc. voltage base (left) applied to osc. grid of electron-coupled mixer causes slope of signal-grid plate current characteristic to vary during application of one cycle of signal voltage to signal grid (center). As a result, tube operates with shifting Q-point or changing path of operation (c.p.o.) during each cycle. Plate current resulting from simultaneous application of osc. and signal waves is shown at right.

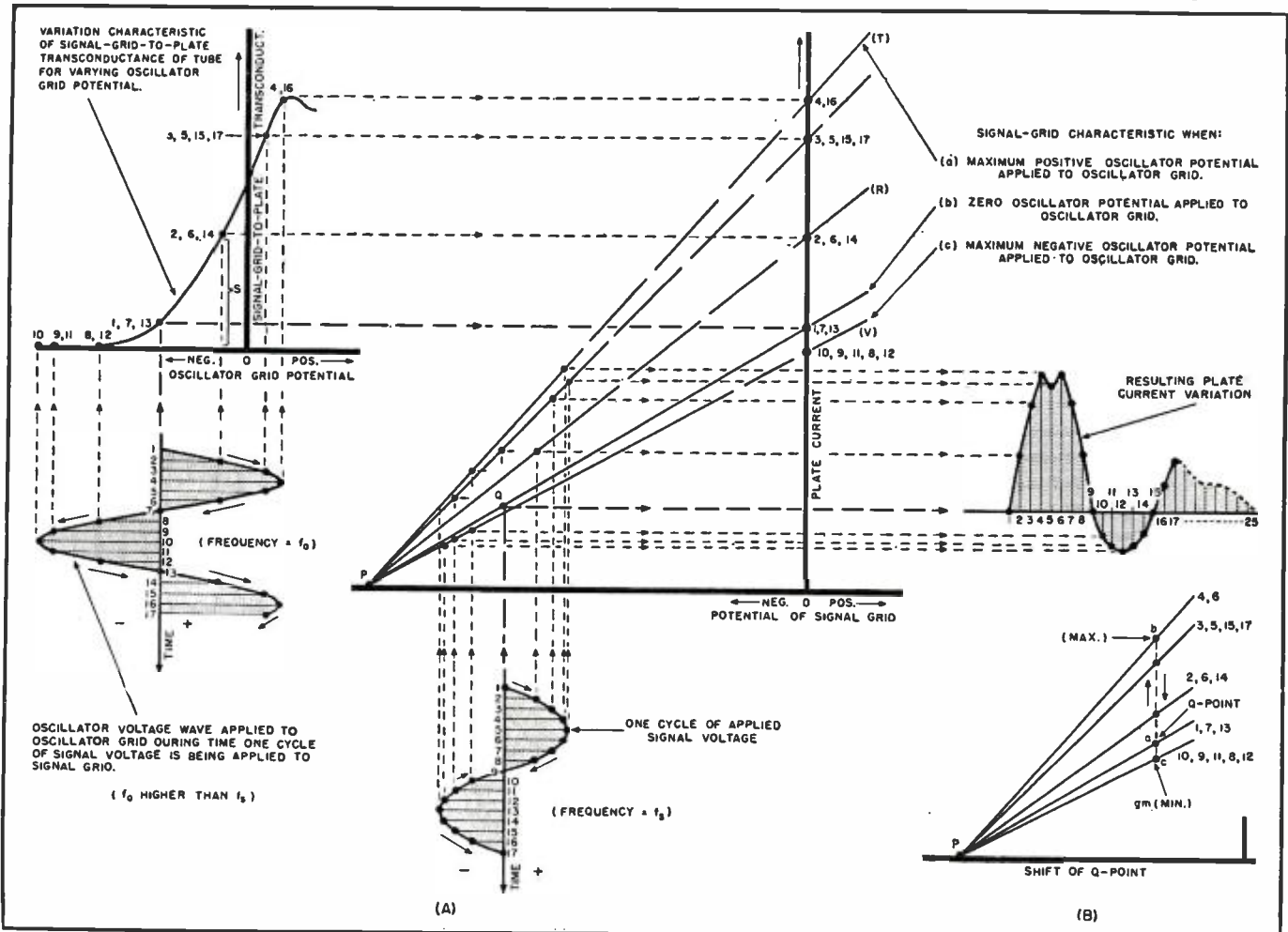



**R**USSELL A. LEWIS, a real old timer in the marine game both aboard ship and at various shore stations, arrived in New York recently aboard a Liberty and is bound for another trip across the pond. Harry Carroll recently joined the marine radio service group in New York. Ed Stetson, recently reported in Charleston, is back in New York and has been replaced by Harold Koch. T. Venis resigned his shore berth in the big town to go into his own business. . . . Frank Sergi in port for a short time recently. . . . Eugene Warren around town quite a bit recently during the recent visit here of his "Victory." . . . J. Lawless still in the sugar business. . . . Fred J. Kienzle writes from his CAA post at Allentown-Bethlehem, Pa., Fred has been with CAA for over five years now and seems to like things there and reports very interesting work and good hours combined with a swell bunch of men to work with. . . . that's what makes the job. Good luck, Fred. William Byers expecting to ship out soon—Bill was just recently discharged from the U.S. Navy. A. L. Oliveira wants to get into maintenance work ashore—"An" is late of the Army. T. L. Hopkins, ex-Coast Guard, wants to ship out with the merchant marine in the near future. N. F. Barritt of CAA wants to try sea-going brass pounding for a while. Friends of William C. (Bill) Simon, General Mgr. at Tropical Radio, will be sorry to hear he has been very ill for some time, but is now on the road to recovery.

**T**HE 127th anniversary of the American Merchant Marine (dated from the sailing of the Savannah) was celebrated May 22nd as National Maritime Day in the various ports throughout the country. It is most important that the merchant marine and its prospects be brought before the public and that it is shown to be a vital necessity to the country's well being. . . . One has only to follow the trend of the nation's welfare to determine the truth of this fact. . . . In good times the merchant marine prospers and during years of decline of the merchant marine, when it was permitted to fall into a sad state after the first World War the entire country soon followed suit. . . . We have, fortunately, possession of the strongest merchant marine in our history—or in the world's history. . . . over 54 million tons representing over 5,000 vessels which are capable of serving and competing in the trade routes throughout the world. . . . There is no maritime power in the world or combination of powers which can make such an assertion. . . . The U.S. has, on previous occasions, been so situated but has let the maritime service decline—the U.S. Government must not discriminate against the U.S. Merchant Marine if the country as a whole is to prosper in this postwar period. . . . U.S. shipping concerns should be permitted to operate supplemental aviation services in order to compete with



By **CARL COLEMAN**

foreign steamship lines—U.S. shipping must be encouraged in order for worldwide trade to prosper and for the nation itself to prosper. This cannot be accomplished with ship operating agencies in general being discriminated against in aviation circles while foreign outfits are permitted to do so and therefore stand a better chance of getting the major portion of the trade. . . . The better trade there is in the U.S. Merchant Marine the more jobs there will be for men aboard the ships . . . and better jobs.

**A**N IMPROVED version of the one-piece ship's radio station developed during the war was announced yesterday by the marine division of Mackay Radio and Telegraph Company, whose engineers originated the single unit station in 1941 for the U.S.M.C. The new model has been designed to cut costs while increasing efficiency in one third less space. We can stand the "less space" business, there is not enough room around some of the units to permit access to the various sections for cleaning, repairs, and maintenance.

**E**DWARD G. GAGE, well known New York inventor, was recently awarded a patent on a system for radionavigation of aircraft or high speed boats. The invention calls for an airport shaped in the form of a hexagon

with three direction finding receiving units at alternate vertices. An incoming airplane represents the vertex of the theoretical isosceles triangle and two sides of the triangle may be represented by the hypothetical lines formed by the path of radio reception from the aircraft to the direction finding stations. The degree of angle at the vertex of the isosceles triangle represents the distance of the plane from the center of the airport. The invention also features television apparatus at the receiving stations to give an instantaneous picture of a plane's progress toward an airport. Measurements in azimuth and altitude may be effected automatically and a plane may be located without difficulty.

**P**AN AMERICAN AIRWAYS recently opened their services to the Pacific area and New Zealand which will put a few more of the boys to work. Warren Hobwald was in port recently aboard the Liberty he has been on for some time. . . . WH expects the craft to tie up and go into the bone yard. Clyde Buckless "Victory" arrived and expects to change operating agents or also be added to the bone yard. . . . Wm. Ruocco is second with "CB" and Donald R. Daniels is third. George Mathers says he has seen enough of Portland to last him for years. . . . Pasquale Licastro announces he is the proud daddy of a daughter. . . . Ross Fraser reportedly has quit the sea going game. . . . Eugene Lemieux recently shipped out of Boston. Samuel Maged running into Baltimore for some time now. . . . Joseph Main still dicking with the local draft board. . . . Jack Forney in the Marine Hospital at Baltimore for a while. Jack Hymes in with his large craft and tied up for major repairs for about a month. Herman Meyerhoff arrived in the big town aboard his "banana" wagon and reports every-

(Cont. on page 140)

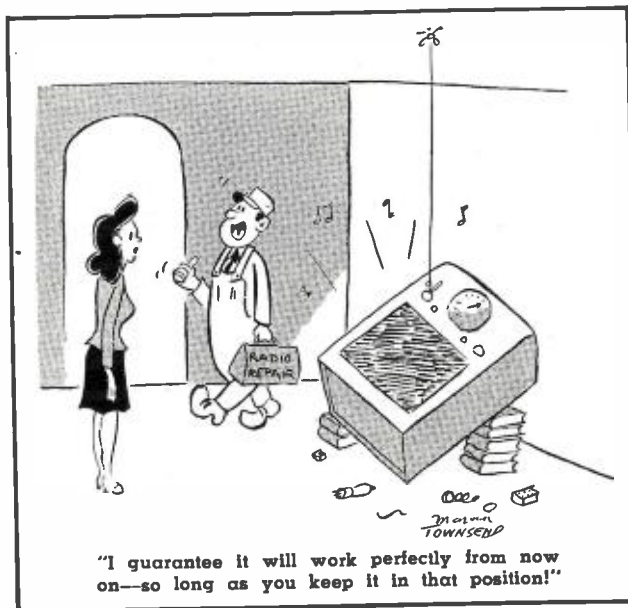



Panel view of completed instrument. A metal cabinet measuring 7" x 7" x 7" was used.

## Constructing

# A GRID DIP METER

By HOWARD BURGESS, W9TGU

*A versatile, yet simple and easy-to-construct test instrument which will find wide application in checking amateur equipment.*

**W**ITH the reopening of the amateur bands, many amateurs will want to rebuild the "old rig" completely and many newcomers to the amateur ranks will have to start at the beginning to build their transmitters. Although a very workable transmitter or receiver can be built with a volt-ohm-milliammeter as the only test equipment available, much time and trouble can be saved and more pleasure gained in the building if a few extra pieces of test equipment are available before actual construction of the new rig is begun.

Of course a small but complete testing laboratory would be the ideal but this is out of the question for most hams because of the time, space, and investment required. The following piece of equipment when properly constructed can serve several purposes.

It is known as a grid dip meter and following are a few of the uses to which it may be put.

1. Winding transmitter and receiver coils to exact frequency ranges desired.
2. Determining frequency ranges of unmarked i.f. transformers.
3. As a simple signal generator for alignment of receivers.
4. Checking resonant frequencies of antennas.

Primarily a grid dip meter is nothing more nor less than an oscillator which has a low range milliammeter inserted in the grid return lead, in series with the grid resistor. This meter reads the rectified grid current. The rectified grid current of such an oscillator will vary with any load placed upon the oscillator, decreasing as the load is increased and increasing

as the load is removed. When any external circuit is coupled to the grid dip meter and tuned to resonance on the same frequency, the meter will take a dip, the amount of dip depending upon the amount of coupling.

If the oscillator is calibrated according to frequency, the resonant frequency of any circuit which falls within the range of the oscillator can be checked. As the circuit is just a simple oscillator, the output can be used for alignment purposes on receivers.

The grid dip oscillator is constructed in a small metal cabinet which measures 7" x 7" x 7". The circuit is almost self-explanatory. The grid dip oscillator tube,  $V_1$ , is a 6J5. However a 6V6, triode connected, may be used to give greater grid current if a meter less sensitive than an 0-1 ma. has to be used. Coils  $L_1$  and  $L_2$  are wound on  $2\frac{1}{2}$ " x  $1\frac{1}{2}$ " plug-in forms, and  $L_2$  is a link consisting of several turns of heavy wire mounted self-supporting inside of the coil form. This link connects to  $PL_1$ , which is a receptacle for receiving a coaxial line plug. One end of a piece of coaxial line several feet long plugs into  $PL_1$ , and on the other end of the line is a link. This link can be coupled to the circuit under test and is more convenient in most cases than bringing it into direct coupling with the coils  $L_1$ - $L_2$ . How-

Fig. 1. Demonstrating method of coupling when checking coils and i.f. transformers.

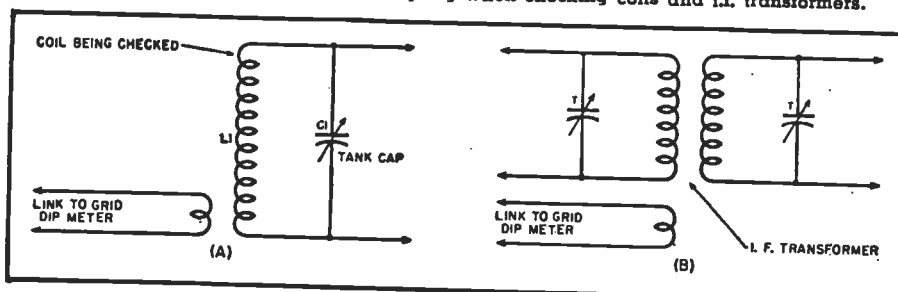

ever it should be mentioned that the dip is less when using the probe.

For those who prefer to simplify things,  $V_3$  and its circuit may be omitted but it is worth the added parts required. This is just a simple mixer circuit using a 6L7. The injector grid is supplied with a small amount of power from the  $V_1$  oscillator through  $C_3$ . A second signal may be put on the signal grid through the post marked "Signal Input."

When the  $V_1$  oscillator circuit is calibrated, a standard signal generator may be connected to  $C_5$  and, with a pair of phones connected in the plate circuit of  $V_3$ , exact zero beat can be found between the two. If no standard signal generator is available to calibrate the grid dip oscillator,  $C_5$  may be coupled to the output of a simple crystal oscillator and, with the phones plugged in, a check point can be heard at the fundamental and each harmonic of the crystal. If perhaps a crystal of 1800 kc. were used, a check point could be heard at 1800 kc., 3600 kc., 5400 kc., 7200 kc., etc.

The power supply for the instrument is of conventional design. When put into operation the resistor  $R_3$  must be reduced in value until  $V_2$  begins to glow and will hold a glow on all bands. If  $V_2$  has a tendency to oscillate or flutter at an audio rate,  $R_3$  should be reduced still more. Resistor  $R_1$  will determine the amount of grid current and reducing its value will increase the amount of grid current indicated on the meter.  $R_2$  is used to set the value as read on the meter when a sensitive meter is used (0-1 ma. or less) as the amount of grid current available will vary on some bands.

If the meter is to be used to wind coils for a transmitter or receiver it may be connected as shown in Fig. 1A.  $C_1$  is the tuning condenser to be used in the transmitter tank. The tank circuit is link-coupled to the meter with the meter oscillating on the desired frequency.  $L_1$  is then pruned until the meter,  $M$ , dips as  $C_1$  is rotated through the desired dial setting. To find the tuning range of unmarked individual i.f. transformers, the circuit of Fig. 1B can be used. One coil of the i.f. is adjusted to minimum frequency by turning the trimmer to full capacity or if slug-tuned, by turning the slug all of the way in. The other coil is adjusted to maximum frequency by placing the trimmer to minimum capacity or the slug all of the way out. If the frequency of the grid dip oscillator is varied by tuning, two major dips will be found. The frequency of these dips will be the usable limits of the transformer.

An antenna may be checked in much the same way. The system is link-coupled to the oscillator and the frequency varied. At the resonant frequency of the antenna, it will take power and the dip will occur. The approximate frequency of an antenna is usually known but this method can be used to bring one to maximum efficiency.

August, 1946

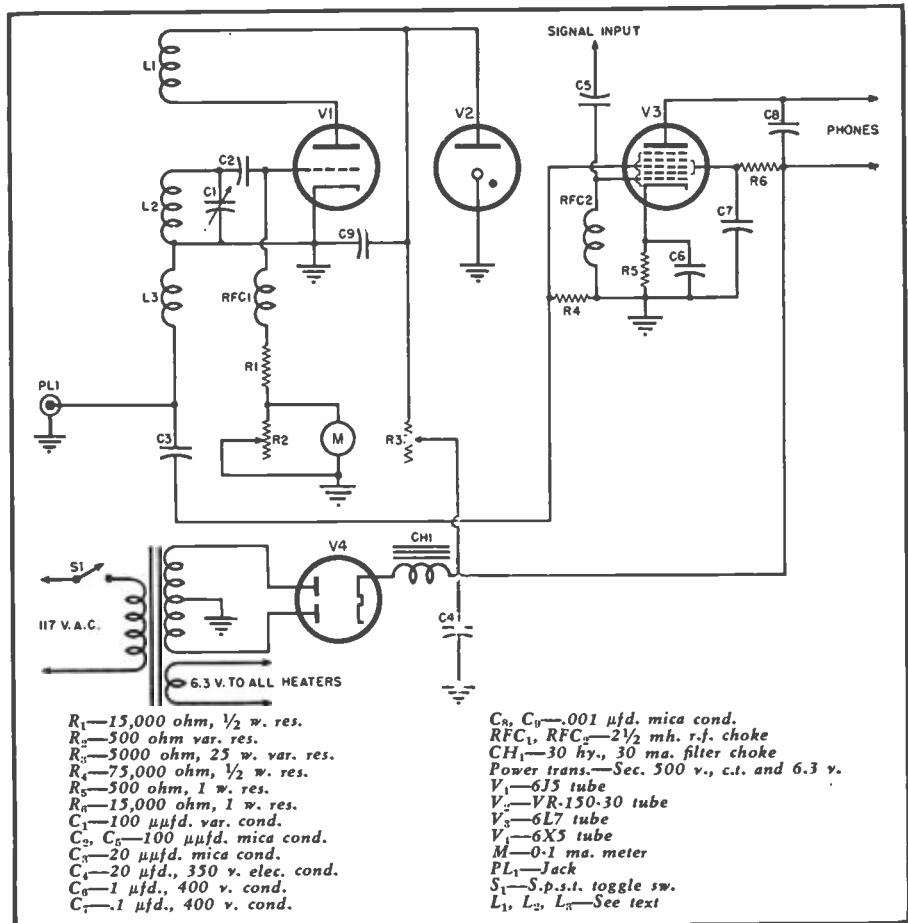

Fig. 2. Wiring diagram of 4-tube, completely a.c. operated grid dip meter.

It should be remembered, though, that the antenna is receiving power from the oscillator and that even though it is very low power, interference may result to nearby services.

The handbooks give considerable data on antenna lengths, etc., but

these are based on the theory that the antenna is operating in free space. For those who must put up antennas in limited quarters and in close proximity to surrounding objects, the use of this instrument is almost a necessity.

-30-

Top view, with cover open, shows above chassis component assembly.

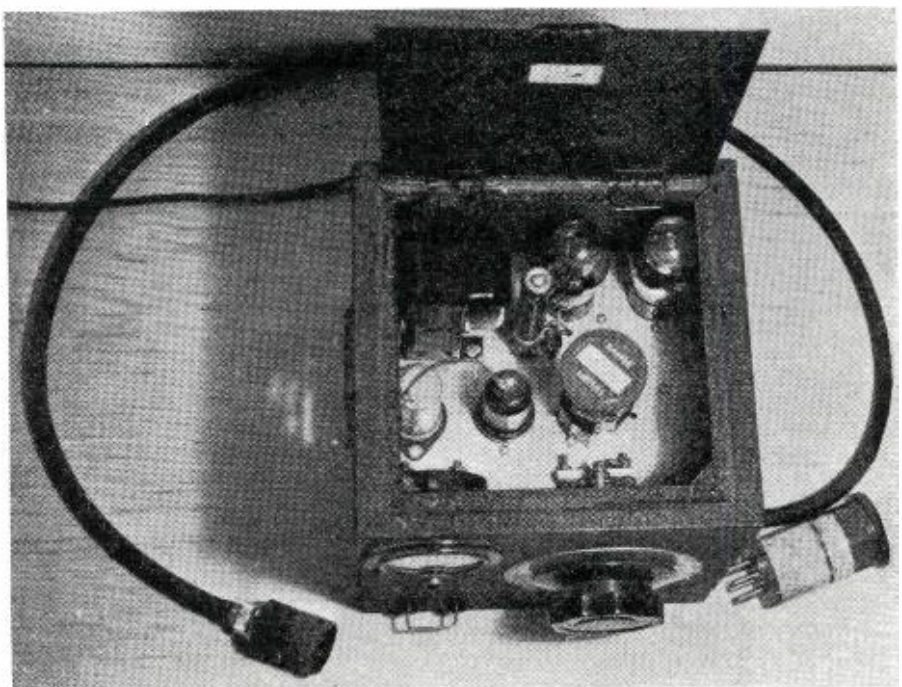

By CRAIG STEVENS

# CATHODE FOLLOWER for POWER AMPLIFIER

*Complete construction details for an audio amplifier employing cathode follower type circuit in the push-pull 6L6 output stage.*

**A**CCCELERATED electronic development during the war has brought to light many new and useful tube applications. Among these is the cathode follower. Reams of calculations, and many articles, show the usefulness of this choice item. Now we have a practical application that is well worth consideration by anyone who enjoys the high fidelity reproduction of sound, particularly those whose funds are limited.

What advantages accrue to those who use cathode follower connection of the output tubes, instead of the conventional method? What is desirable in an output amplifier when viewed from a fidelity standpoint?

There are two points which should be considered in order to meet the desired characteristics, i.e., flat frequency response, and reasonable economy. When the load is placed in the plate circuit of a tube, the impedance of this load, which is usually an output transformer and speaker, must be so proportioned as to get the maximum power from the tube, and still maintain a low level of distortion. This load impedance is usually many times the impedance of the tube for the above conditions in the case of a triode. For instance, the 2A3 has a plate resistance of 800 ohms, but the output transformer is usually designed to reflect 2500 ohms to its plate. In the case of a pentode, such as the 6L6, the

plate resistance is in the order of 35,000 ohms. A transformer which would reflect several times this impedance from an 8 ohm voice coil would be impractical, because of the enormous turns ratio involved.

The manufacture of an audio transformer becomes increasingly difficult in proportion to the turns ratio, so a lower value is chosen, usually from 3200 to 10,000 ohms, depending upon how the tube is used. A more compelling reason exists for choosing a lower output impedance for pentodes, namely, the necessity of keeping distortion down to an acceptable value.

This then, leads us to believe that the lower the output impedance of a tube used as an output amplifier, the better the result obtained with a given output transformer.

The speaker must also be considered. Speakers are usually rated as having a certain impedance, at so many cycles, say 8 ohms at 400 cycles-per-second. However, this impedance value is different for different frequencies. It might be very low at low frequencies, and very high at high frequencies, and its impedance will vary radically at such points where the cone or spider structure, or baffle resonates.

These changes of impedance are of course reflected back to the plate of the tube through the output transformer. This means, then, that the

tube does not see a constant impedance, but a variable one. If a circuit is designed that gives a certain distortion value at 400 cycles-per-second, because an output transformer with the proper turns ratio to reflect an impedance of say 2000 ohms has been provided, then 50 cycles-per-second is applied, only an impedance of 500 ohms is reflected, because of the change in speaker impedance, then the distortion value has changed.

Now, electrically the output impedance of the tube may be considered to be in parallel with the reflected impedance of the speaker output transformer combination, which simplifies to two resistances in parallel. It is fairly obvious that if one resistor is much smaller than the other, say ten times, a change in the larger, of fifty per-cent, will have a small effect on the resistance of the parallel combination. It is shown, therefore, that the lower the output impedance of the tube, the less control the speaker will have on the distortion of the circuit. Simply stated, the tube acts as a damping resistance on the speaker and output transformer. The lower the resistance of the tube in comparison with the speaker-transformer combination, the less pronounced will all the resonant peaks be, and the lower the attendant distortion. The speaker and transformer will exhibit characteristics more like a pure resistance and less like an inductance. This illustrates why pentodes are seldom used any more without some mechanism to compensate for their very high impedance which has a very small damping effect on the speaker.

The lowest plate resistance of any

Fig. 1. Rear view of complete amplifier. High and low frequency boost is provided by a negative feedback circuit



of the well known tubes is the 2A3 or 6A3 which is in the order of 800 ohms. If that resistance could be lowered or its effective impedance reduced by a large factor an improvement in reproduction would be achieved.

This can be done by hooking the tube up as a cathode follower. The effective output impedance of a 6A3 hooked as a cathode follower is in the order of 150 ohms. Furthermore, as a cathode follower has 100% degeneration, all the benefits that this provides are received, such as insensitivity to plate voltage changes, small necessary filtering in the power supply, non-critical bias requirements and insensitivity to individual tube characteristics. Furthermore, the output transformer may be much less expensive and still yield superb results. The author has actually used a small power transformer for an output, by hooking the push-pull cathode follower cathodes to the center tapped high voltage winding and connecting the speaker to the 2.5 volt filament winding! The response was reasonably flat from 50 to 8000 c.p.s. Of course a power transformer will not yield as good results as a high quality output transformer but it will still produce results quite adequate for AM radio reproduction and ordinary phonograph records.

So much for the advantages. Now there is a catch to the cathode follower, but it is not an insurmountable one. The cathode follower does not have any gain, as a matter of fact, it has a loss of a few per-cent. Therefore, driving voltage equal to 110% of the required output voltage must be provided.

If 150 volts swing are required across the output transformer to yield the wanted power output, then the cathode follower grid must be driven with 165 volts. The term "drive" is used figuratively, as really there is no power required, merely voltage. This simplifies the problem considerably, because a class "A" input transformer may be used, preferably with a step-up ratio of 1 to 2 or more.

As the driver can only swing so many volts, usually in the order of 65 to 90 volts, it is necessary to step this up to the assumed 150 volts. This problem is further simplified because a cathode follower also degenerates its input capacity to practically zero. This allows the use of an input transformer of the less expensive type which usually has a higher inherent shunt capacity across the secondary. This capacity limits the high frequency response. Of course if a high quality unit is used, a high frequency improvement will be noted.

In summation, the cathode follower as an output stage will result in improved low frequency response, improved high frequency response, will damp out all peaks in both the output transformer and speaker and have less distortion at the same power output, but requires a higher driving voltage. Let it be stated that the same power output may be obtained with given

August, 1946

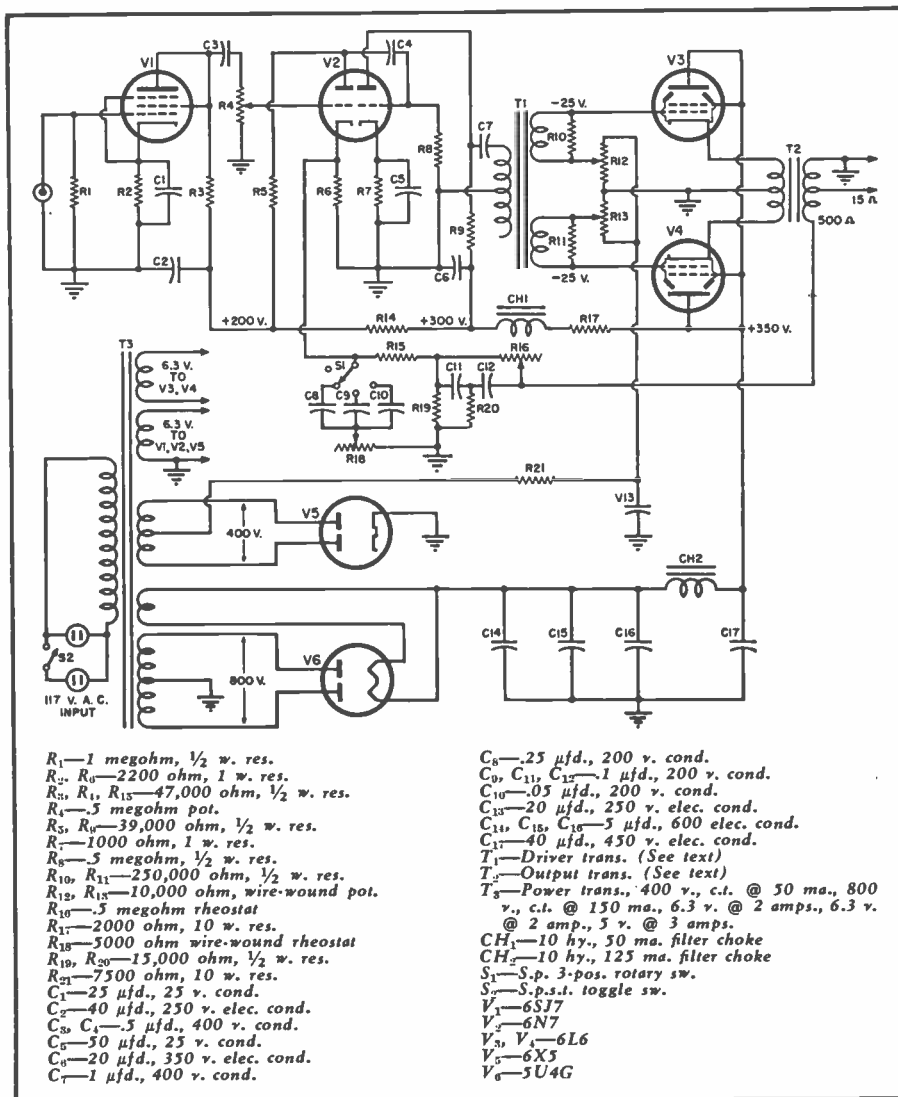
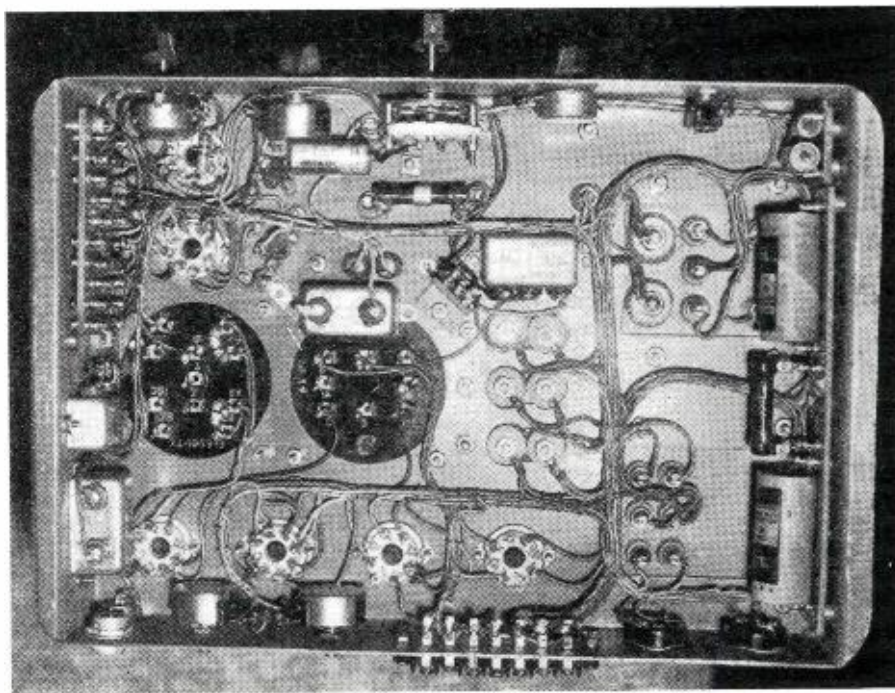

Fig. 2. Schematic diagram of completed amplifier. A total of 8 watts output is obtained.

Fig. 3. Under chassis view. Note neatness of component assembly and wiring arrangement.



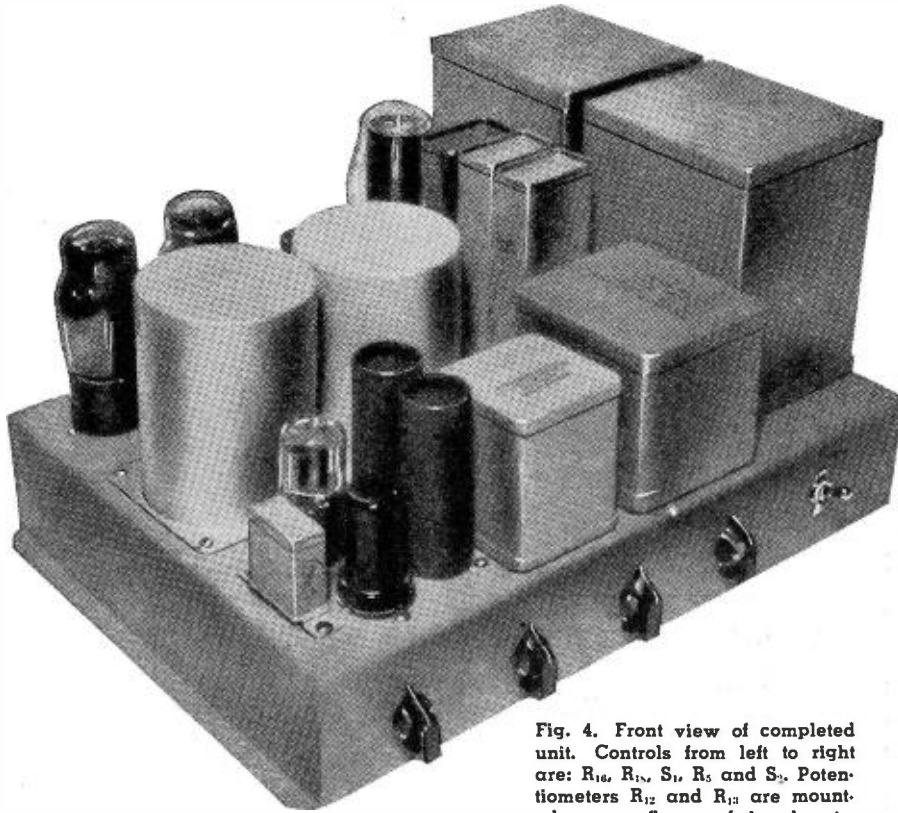

Fig. 4. Front view of completed unit. Controls from left to right are:  $R_{10}$ ,  $R_{11}$ ,  $S_1$ ,  $R_5$  and  $S_2$ . Potentiometers  $R_{12}$  and  $R_{13}$  are mounted on rear flange of the chassis.

tubes as in the conventional method of hookup.

In Fig. 2, an amplifier using triode connected 6L6's as cathode followers is shown. A pentode is disadvantageous as a cathode follower as it interposes the problem of what to do with the screen. It cannot be tied to a positive potential as the cathode is swinging up and down with the signal which would, in effect, change the screen voltage and the mode of operation of the tube. 6B4's or 2A3's would be even better but they require a separate filament supply for each tube as the filaments are connected to each side of the output transformer. A cathode type is better in this case and there is reason to believe in the near future there will be a cathode type output triode on the market similar to the 2A3 or 6B4G.

The 6L6 tubes are biased at approximately 25 volts and the plate current is approximately 60 ma. per tube at 350 volts plate potential. This is slightly higher than the rated current, but is not high enough to heat the screens and does not damage the tubes. These 6L6 tubes are driven through a push-pull input transformer with a step-up ratio of 1 to 1.5, with only half the primary used. This transformer was chosen because it was available, and not because it was ideal for the job. A higher ratio would have been desirable. The practical effect is to limit the output because of less driving voltage. No attempt was made to extract maximum power from the 6L6's and they are operated under approximately class "A" conditions. The output was eight watts. Actually as much output as in the conventional

amplifier is not needed because the distortion curve shows a very low distortion right up to the maximum output, and then a steep rise in distortion instead of a gradual rise in distortion from zero output to maximum output. It would have been desirable to drive with push-pull tubes, and if the builder has a push-pull interstage transformer this should be used.

Incidentally, the output transformer should have approximately the same impedance ratio as if the tubes were connected in the normal manner. The one the author used was 5000 ohms to 4-8 or 15 ohms; by hooking the 8 ohm speaker voice coil across the 15 ohm tap a ratio of 2500 ohms to 8 was obtained and this seemed to yield superb results.

If this power output is insufficient there is another way of increasing it, better, perhaps, than increasing the driving voltage. Merely connect more output tubes in parallel as two additional 6L6's will double the power output with the same driving voltage. Or if four 6L6's are used, parallel triode connected, then approximately the same power may be obtained with a phase inverter, and the input transformer may be eliminated. Of course the power supply will have to stand the added current drawn by the additional tubes.

The power supply in this model was rather elaborate not because it was necessary electrically but because the transformers were the only ones on hand. Actually an ordinary power transformer for 2A3's in push-pull with a bias tap will suffice. It should be capable of supplying about 350 volts at 150 ma., and a bias voltage

of 25 or 30 volts, plus the filament requirements for the rectifiers and amplifier tubes.

The photographs in Figs. 1, 3, and 4, show parts layout and wiring. The separate bias adjusting potentiometers  $R_{12}$  and  $R_{13}$  (Fig. 2) are essential only if a high fidelity output transformer is used, so that the currents of the two tubes may be balanced within the limits specified by the manufacturer (usually 5 ma. is considered permissible unbalance).

The resistors are all mounted on resistor boards which are neat, accessible, and rugged. Metal case condensers are used throughout as they provide admirable shielding.

High and low frequency boosting controls are provided in a negative feedback circuit which also reduces the distortion in the preamplifier stages.

The high frequency boost circuit allows a choice of high frequency boost points which are determined by the capacities  $C_3$ ,  $C_6$ , and  $C_{10}$ . This is useful for changing the response to suit different classes of fidelity, such as FM-AM-standard phonograph records, and short-wave. The high frequency cut-off should be reduced in the above order.

The feedback net will vary with the quality of input and output transformers.  $R_{13}$  will have to be increased when inexpensive units are used. The smallest value which does not cause oscillation is correct. As the frequency of oscillation may be above audibility a small lamp connected to the output terminals will indicate oscillation by lighting. Be sure to connect the feedback lead to the proper side of the 500 output winding. If oscillation results, then reverse the cathode leads to the two output tubes.

The 6SJ7 is triode connected and provides sufficient gain for any of the crystal pickups. The proper compensation network for the pickup used, should be inserted between the pickup and the input. If the pickup puts out too much voltage, a series resistor of from .5 to 2 megohms will reduce it. As the volume control is not located in the input tube grid circuit, it is possible to overload the first tube. The control is located in the second tube to reduce the over-all hum level of the amplifier, which it does effectively.

The hum, incidentally, cannot be heard with your ear placed several inches from the speaker. The large amount of negative feedback is instrumental in reducing it to this low level. Also, excellent filtering is provided in the power supply.

This filtering is not so necessary from a hum standpoint, but is incorporated to reduce "motorboating" because of the amplifier's excellent low frequency response.

If higher amplification is needed, the 6SJ7 may be pentode connected. Sufficient gain will result to allow the amplifier to be used with all the common types of microphones.

(Continued on page 80)



# International SHORT-WAVE

Compiled by **KENNETH R. BOORD**

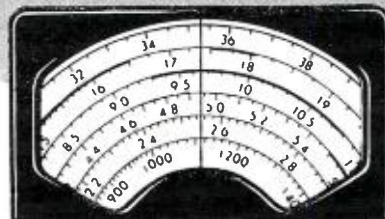

**I**N the occasion of the Fourth Anniversary of the Armed Forces Radio Service recently, the Hon. Robert P. Patterson, Secretary of War, wired congratulations to the AFRS, assuring the broadcasting service that there will be no curtailment of its activities as long as occupation forces remain overseas. Said Secretary Patterson:

"The Fourth Anniversary of the Armed Forces Radio Service gives me an opportunity to assure the American armed forces overseas that the finest entertainment and educational radio programs, and news service which the nation can provide, will continue to be brought to them just as long as they remain on occupation duty. Ten thousand miles is just as far away from home today as it was a year ago."

Officials of the Information and Education Division, operators of the Armed Forces Radio Service, estimated that AFRS will continue its present level of operations, and probably will move ahead of its past year's record. Sufficient number of transcriptions will be produced and distributed to almost a hundred overseas outlets to give each station more than eight hours of complete programs each day of the week, every week, plus enough other transcriptions to give the Armed Forces Radio Stations program material to operate as many hours longer each day as they wish. A *twenty-four hour short-wave service is also provided for overseas forces on both land and sea*, featuring decommercialized shows with practically every top network star heard in the United States, and complete news service and sports summaries from established commercial news agencies.

The Armed Forces Radio Service maintains its headquarters and broadcasting facilities in Hollywood, California.

\* \* \*

#### The Reduction of Interference

Frank E. Wooley, 37 Smith Street, Irvington, New Jersey, contributes the following on "Reduction of Interference":

"The cause of noises and unwanted signals in radio receivers is neither a new subject nor one to be dealt with in a few words. As one who has been in radio since its pioneer days (1910), I feel I am qualified to speak with some knowledge of the subject.

"The chief cause of all interference

is, of course, a spark. Originating at many sources, the spark can cause all sorts of noise troubles in a receiver. Some of the sources are d.c. motors, vacuum cleaners, bells, buzzers, sun lamps, medical and dental apparatus, x-ray machines, and so on. Among these 'criminals' you can also include series-wound a.c. motors, arcs, rectifiers, power transformers, faulty lines, movie machines and others operating on a.c. systems.

"Many are difficult to track down, especially some forms of hum or crackle that are not from spark sources but which are inductive in nature, for example: transformers and coils in alternating circuits. One way I find effective in eliminating spark noises is by applying condensers across the offending apparatus terminals. A small capacitor bridged across a bell or buzzer will cut out the rasp when it is operated. The same holds good on the 'make and break' contacts of a refrigerator. In my case, I use a 1  $\mu$ f. condenser across the contacts of my refrigerator and it very effectively eliminates the ripping sounds I used to get from it.

"Fluorescent lamps are a problem for my short-wave receivers. I over-

\*Unless otherwise stated, all times herein are in Eastern Standard Time, EST.

came this condition by installing *Aerovox* line filters. These are a combined choke and condenser arrangement of fairly high capacity which plug into the a.c. supply, your set in turn to the filter system. These are grounded also. Another excellent noise reducer is the matched antenna system. It has a coupling unit at the center of the antenna, a twisted lead into another unit at the set. Its ability is to cut out a lot of 'hash' and it causes no spreading on the dial." (Note: Mr. Wooley is a laboratory technician, Meter Division, *Westinghouse Elec. Corp.*, Newark, N. J.; he was educated as an electrical engineer at Newark (now Newark College of Engineering), but in some way, "got side-tracked into electrochemical work," he writes.)

\* \* \*

#### Late Information from Jaffa

Direct from A. W. Dean, Chief Engineer, Near East Arab Broadcasting Station, Jaffa, Palestine, comes the following information:

Studios are located in Jaffa, transmitters at Beit Jala. Frequencies are 6.135 (48.9 m.), 6.710 (44.71 m.), and 6.790 (44.18 m.). Schedule is 10:30 p.m.-12 midnight EST \* and 5:30 a.m.-1:30 p.m. EST. Broadcasts at the present time are all in Arabic. QSL

(Continued on page 100)

Following the disastrous Georgetown fire of some months ago, ZFY, 6.000 Georgetown, British Guiana, secured "The Casuarinas" as its offices and studios. This building was once the Georgetown residence of a sugar planting family, the Smellies, of Liverpool, England. ZFY is again sending out verification cards, but requires return postage in the form of an International Reply Coupon.



## AROUND THE CLOCK WITH SHORT-WAVE NEWSCASTS

EST	LOCATION	CALL	FREQ.*	EST	LOCATION	CALL	FREQ.*	EST	LOCATION	CALL	FREQ.*
7:00 a.m.	Seoul, Korea	JODK	2.510	9:00 a.m.	Chungking (At Dictation Speed)	XGOY XGOY2	7.153 9.640	11:00 a.m.	London (ES)	GWE	15.435
7:00 a.m.	Melbourne	VLC5	9.540	9:00 a.m.	Rangoon, Burma (BEC)	Radio Rangoon	11.845	11:00 a.m.	London (AS)	GSG GRP GSI	17.790 17.870 15.260
7:00 a.m.	Algiers	VANA	11.765 11.880	9:00 a.m.	Melbourne	VLC6 VLG VLA6 VANA	9.615 9.580 15.200 11.765	11:00 a.m.	Georgetown, Br. Guiana (BBC)	ZFY	6.000
7:15 a.m.	Brazzaville	FZI	15.595	9:00 a.m.	Algiers	ZOI	4.900	11:00 a.m.	Baghdad, Iraq	Y15KG	7.084
7:15 a.m.	Singapore	SEAC	11.735 7.775 6.770	9:00 a.m.	Colombo, Ceylon	VE9AI	9.540	11:15 a.m.	Montreal (Sackville) (except Sun.)	CKNC CKLK OTCS	17.820 15.090 17.770
7:15 a.m.	Lahti (Helsinki), Finland	OIK2 OIK3 OIK4	9.504 11.780 15.190	9:00 a.m.	Edmonton, Alta.	VE9AI	9.540	11:30 a.m.	Leopoldville		
7:30 a.m.	Georgetown, Br. Guiana	ZFY	6.000	9:00 a.m.	Delhi	VUD10	7.210	11:30 a.m.	Georgetown, Br. Guiana	ZFY	6.000
7:30 a.m.	Macao, Port. China	Radio Macao	7.525	9:00 a.m.	Saigon, Fr.	Radio Saigon	4.810 6.160	11:30 a.m.	Accra, Gold Coast (BBC)	ZOY	7.300 4.915 6.075 3.395
7:30 a.m.	Melbourne	VLA6 VLG10 VLG3	15.200 11.760 11.710	9:00 a.m.	Indo-China	Radio Kuala Lumpur		11:45 a.m.	Colombo, Ceylon (BBC)	SEAC	6.075 3.395
7:30 a.m.	Delhi	AIR	15.290 15.210 9.670	9:00 a.m.	Singapore (SEAC Headlines)	SEAC	11.735 6.770	12:00 noon	Jerusalem	JCKW	7.220
				9:00 a.m.	Java		9.860	12:00 noon	London (GOS)	GVO	18.080
	(Via Calcutta)	VUC2	7.290	9:00 a.m.	Honolulu	KRHO	9.650			GSO	15.180
	(Via Bombay)	VUB2	9.530 9.630	9:30 a.m.	Delhi	AIR	15.160 9.590			GSV	17.810
7:30 a.m.	Salzburg, Austria (AFRS)	KOFA	7.220	9:30 a.m.	London (FES)	GVP GSG GWE	21.675 17.790 15.435			GRF	12.095
7:30 a.m.	Moscow	Radio Centre	11.630 11.830 15.170 17.810	9:35 a.m.	Melbourne	VLC6 VLG VLA6	9.615 9.580 15.200	12:00 noon	Quarry Heights, Canal Zone	AFRS	2.390
7:30 a.m.	Java		9.415 9.860	10:00 a.m.	Chungking	XGOY XGOY2	7.153 9.640	12:00 noon	Algiers	VANA	11.765
7:30 a.m.	Colombo, Ceylon	SEAC	6.075 3.395	10:00 a.m.	Edmonton, Alta. Bombay (BEC)	VE9AI VUB2	9.540 6.150	12:05 p.m.	Frankfurt, Germany	AFN	8.565
7:45 a.m.	Melbourne	VLA6 VLG10 VLG3	15.200 11.760 11.710	10:00 a.m.	Honolulu	KRHO	9.650	12:15 p.m.	Hamburg, Germany	BFN	7.290
7:45 a.m.	Bucharest, Rumania	Radio Bucharesti	9.255 7.280	10:00 a.m.	Stockholm (or 10:05 a.m.)	SBT	15.155	12:30 p.m.	Orduрман, (Thurs. only) Anglo-Egyptian Sudan	Radio Omdurman	13.320
7:45 a.m.	London (European Service)	GWO GSN GSN GSN GWT GRT GWT GWH	9.625 11.820 7.210 9.410 11.770 7.150 9.675 11.800 11.765 11.880 9.420	10:00 a.m.	Jerusalem (Radio Newsreel)	JCKW	7.220	12:40 p.m.	Dublin (Athlone)	Radio Eireann TAP	17.840 9.465
8:00 a.m.	Algiers	VANA	11.765	10:00 a.m.	Algiers	VANA	11.765	12:45 p.m.	Ankara		9.465
8:00 a.m.	Belgrade, Yugoslavia	Radio Belgrade	9.420	10:00 a.m.	Salzburg, Austria (AFRS)	KOFA	7.220	1:00 p.m.	Nairobi, Kenya	VQ7LO	4.950 6.060
8:00 a.m.	Perth	VLW7	9.520	10:00 a.m.	London (Radio Newsreel in GOS)	GWG GSJ GSV GVP GSH CRF GSO GSD GRQ GVS CRZ	15.110 21.530 17.810 17.700 21.470 12.095 15.180 11.750 18.025 21.710 21.640	1:00 p.m.	Salzburg, Austria (AFRS)	KOFA	7.220
8:00 a.m.	Melbourne	VLC5	9.540	10:00 a.m.	Perth (Radio Newsreel)	VLW7	9.520	1:00 p.m.	Accra, Gold Coast (BBC)	ZOY	4.915
8:00 a.m.	Brisbane	VLQ2	7.215	10:10 a.m. (Sun. only)	Lourenco Marques, Mozambique	CR7AB CR7AA CR7B CR7E	3.480 5.860 15.240 9.710	1:00 p.m.	London (AS)	GSI	15.260
8:00 a.m.	Melbourne	VLC5	9.540	10:10 a.m.	Rangoon, Burma (Headlines)	Radio Rangoon	11.845	1:00 p.m.	GVW	11.700	
8:00 a.m.	Tokyo (AFRS)	WVTR	6.015	10:15 a.m.	Melbourne	VLA3 VLG8	9.680 7.280	1:00 p.m.	GRY	9.600	
8:00 a.m.	London (GOS)	GWG GRP GSV GVP GSH GRF GSO GRQ GSK GSD GVS GVO	15.110 17.870 21.530 17.810 17.700 21.470 12.095 15.180 18.025 26.100 11.750 21.710 17.730	10:45 a.m.	Delhi	AIR	15.350 11.870 11.870 11.850 9.670 9.590 7.290 6.190 4.960	1:00 p.m.	GRV	11.700	
8:00 a.m.	Victoria, Hong-kong (BBC)	ZBW	9.570	11:00 a.m.	Delhi (BBC)	AIR	15.350 11.870 7.290 6.190	1:00 p.m.	GRY	9.600	
8:00 a.m.	Delhi	VUD10	7.210	11:00 a.m.	Johannesburg, So. Africa	ZRH	6.007	1:00 p.m.	GRY	17.870	
8:00 a.m.	Akashvani, Mysore (India)		6.065	11:00 a.m.	Colombo, Ceylon (BBC)	ZOI	4.900	1:00 p.m.	GRY	17.870	
8:00 a.m.	Chungking	XGOY XGOY2 XGOA XTPA XORA XGOL XFOO XPSA XWEI XUPA	6.065 7.153 9.640 9.720 11.650 11.695 9.035 9.695 7.010 6.015	11:00 a.m.	Colombo, Ceylon	SEAC	6.075 3.395	1:00 p.m.	GRY	17.870	
8:05 a.m.	Moscow	Radio Centre	9.565 11.630 11.830 15.170 17.810	11:00 a.m.	Moscow	Radio Centre	11.830 9.565 9.615 11.840 9.620	1:00 p.m.	Edmonton, Alta.	VE9AI	9.540
8:15 a.m.	Edmonton, Alta.	VE9AI	9.540	11:00 a.m.	Addis Ababa, Ethopia (BBC)	Addis Ababa		1:00 p.m.	Prague	OLR2A OLR4A	6.010 6.010
8:15 a.m.	Singapore (or 8:30 a.m.)	SEAC	11.735 6.770	11:00 a.m.	Hamburg, Germany	BFN	7.290	1:00 p.m.	Edmonton, Alta.	VE9AI	9.540
8:30 a.m.	Macassar, (Mon., Wed., Celebes Fri.)	MCAK	9.357	11:00 a.m.	Beirut, Lebanon (Radio Levant)	FXE	8.020	1:00 p.m.	Prague	OLR2A OLR4A	6.010 6.010
8:30 a.m.	Leopoldville	OTCS	17.770	11:00 a.m.	Algiers	VANA	11.765	1:00 p.m.	Hamburg, Germany	BFN	7.290
8:30 a.m.	Colombo, Ceylon (BBC)	SEAC	6.075 3.395	11:00 a.m.	London (GOS)	GVO GSV GSF GVP GSO GRF GRQ GSD	18.080 17.810 15.140 17.700 15.180 12.095 18.025 11.750	1:00 p.m.	Madrid	RNE	9.370
8:45 a.m.	Rangoon, Burma	Radio Rangoon	11.845					1:00 p.m.	Tirana, Albania (irreg.)	ZAA	7.850

(Continued on page 90)

\*Frequencies shown are in megacycles; to convert to meters, divide 300 by the frequency in megacycles or 300,000 by the frequency in kilocycles; 1,000 kcs. equal 1 megacycle.  
 NOTES: AFN—Armed Forces Network. AFRS—Armed Forces Radio Service. AIR—All India Radio. AS—African Service. BBC—Relay of news from London. BFN—British Forces Network. ES—Eastern Service. FES—Far Eastern Service. GOS—General Overseas Service. NAS—North American Service. PS—Pacific Service. RNE—Radio Nacional de Espana. RNF—Radio Nationale Francais. SABC—South African Broadcasting Corporation. SEAC—Southeast Asia Command. VANA—"Voice of America in North Africa."  
 WIRN—West Indian Radio Newspaper.





**ALLIANCE PHONOMOTORS**  
—**POWR-PAKT MOTORS** in shaded pole induction and split-phase reversible resistor types rated from less than 1/400th h. p. on up to 1/20th h. p. for powering valves, switches, controls, driving turntables, fans, record changers and automatic devices.

**THE NEW MODEL A** shaded pole, induction-type Alliance Fan Motor for speeds from 500 to 1050 R.P.M. operates on 50 or 60 cycles at voltages up to 220, 1/30th horse power, size 4 3/4 x 2 3/4 inches. Porous bronze, oilless-type sleeve bearings. Open or fully enclosed construction. Approx. 8 to 40 oz. in. full load running torque, depending on stack length. Exceptionally quiet. For continuous or intermittent duty. Runs clockwise or counter clockwise—not reversible.

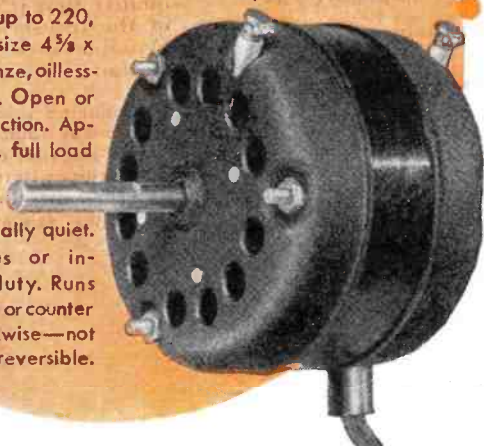

# alliance MOTORS

**SLOWER SPEEDS • LOWER CURRENT COSTS**  
**QUIETER OPERATION • SMALLER SIZE**

Here are four *big* advantages built into the new Alliance Powr-Pakt fan motors. Results are longer life — less repair — smoother performance. This new Alliance shaded pole fan motor reflects advanced engineering! Mass-produced at low cost. Write!

**WHEN YOU DESIGN — KEEP**

# alliance

**MOTORS IN MIND**

**ALLIANCE MANUFACTURING COMPANY • ALLIANCE, OHIO**  
August, 1946 57



# TURNER Model 33

meets every requirement

for a **RUGGED**

## ALL-PURPOSE MICROPHONE

Packed with power to spare — built to take rough handling and bad climate conditions — engineered for smooth response to both music and voice pickups, the Turner Model 33 is an all-around microphone for recording, P.A., call system, studio, and amateur work. A professional unit for professional results. Ask your distributor or write.

Free Turner Catalog

Write for your copy

## THE TURNER COMPANY

900 17th Street, N.E.  
Cedar Rapids, Iowa

Licensed under U.S. Patents of the American Telephone & Telegraph Company, and Western Electric Company, Incorporated.

Crystals licensed under patents of the Brush Development Company



# TURNER

Microphones

CALL  
SYSTEM



PUBLIC  
ADDRESS



STUDIO

LOOK at these  
Performance Features

### 33X Crystal

- Moisture-sealed crystal.
- 90° tilting head.
- Wind and blast-proofed.
- Barometric compensator.
- Chrome finished case.
- Level -52DB.
- Range 30-10,000 cycles.
- Removable cable set.

### 33D Dynamic

- Heavy duty dynamic cartridge.
- 90° tilting head.
- Wind and blast-proofed.
- Chrome finished case.
- Level -54DB.
- Range 40-10,000 cycles.
- Removable cable set.
- Choice of impedances.

## THE MIGHTY MIDGET

By R. V. PARRETT

OF interest to all u.h.f. fans is the tiny two-way radio brought back from Germany by a Canadian soldier. It is a self-excited transceiver with a useful range of two to four kilometers (about 1½ to 2½ miles) and covers frequencies from 320 to 380 megacycles. Complete with its throat microphone, earphones, and antenna, the set weighs only 4 pounds.

The power supply is 1.4 and 150 volts supplied from dry batteries contained in an aluminum box, 6"x4"x3½" in size. Six round cells in parallel furnish the filament voltage while small pie-shaped cells are stacked in series to total 150 volts. The batteries gave very good service and had unusually long life so were soon pressed into service by the Canadians to operate b.c. receivers.

Two midget u.h.f. tubes are used in the r.f. stages and a dual purpose standard loktal in the audio circuit. The u.h.f. tubes have bakelite insulation as have the tube sockets which indicates that good insulating materials were in short supply when the sets were built in 1944. Other materials are of good quality, however, and the set is housed in an aluminum box 2½"x6¾"x5". The tuning dial is 4½" in diameter and graduated every two megacycles. A ratchet on the tuning knob "clicks" every single megacycle. This large dial allows stations to be easily separated when tuning and the stations work quite well when close together.

Laminated 3/8" strips make up the aerial which is 65 inches long and plugs into a socket on top of the unit. It is pliable enough to fold into a small, compact bundle which can be carried in the pocket. On the microphone cord is a switch which can be clipped to the tunic. It carries a push-to-talk button and a second switch which can be left in the "on" position for long transmissions.

Resistors are mounted on bakelite panels for easy replacement and all parts are color-coded and clearly marked with the values. During tests in Canada, transmission was of such good quality that it is planned to try a pair of the transceivers for "on the spot" broadcasts over a local broadcast station.

-30-

Canadian soldier holds tiny German two-way radio set. It has a range of 2½ miles for a weight of four pounds. A clip-on throat microphone leaves both hands free when set is carried on the soldier's regular web outfit.



RADIO NEWS

# A MUST Book for Amateur and Serviceman

# TWO-WAY RADIO

By  
**SAMUEL FREDMAN**  
Commander S(E)T, USNR

## 506 Pages of Facts!

### MECHANICS — EQUIPMENT — APPLICATIONS with studies of actual installations

No radio man's technical library can be without this complete text on two-way radio. TWO-WAY RADIO covers the mechanics and applications of two-way radio for all forms of fixed, mobile and portable communication. It is written in non-mathematical form and in language easily understandable by users or intended users of this type of equipment. An excellent guide for serviceman and radio amateurs, as well as engineers, executives, and planners who are interested in a detailed analysis of the applications and equipment in this field.

#### Answers all questions

TWO-WAY RADIO gives concrete answers to your practical questions: How is it used? What are the potentialities of two-way communication? Is it efficient? Is it economical? What types are best suited for specific uses? What are the technical requirements? What are the licensing regulations? Here, in accurate, complete, and useable form is the data you need for these and a host of other pertinent questions—the basic technical information which will enable you to keep pace with the fast-coming developments in two-way radio communication.

#### Graphically illustrated

Included in TWO-WAY RADIO are 87 informative illustrations—charts, diagrams, and photographs of equipment and installations, carefully chosen by the author to illustrate his twenty chapters of text material.

The opening chapters are devoted to planning of two-way radio and details of equipment, power supply, mobile and fixed stations, and proper antenna systems. Then follows a detailed analysis of AM and FM equipment, radio and guided carrier systems, and a full discussion of microwaves. Latter chapters describe two-way radio communication as used by railroads and police, fire, highway and forestry services; also marine and aeronautical applications, and personal use by radio amateurs and private citizens. There is ample information on maintenance, repair, and trouble shooting, a full chapter on licenses and regulations, and a description of typical installations by states, communities and border patrol.

**Price \$5.00. Use convenient coupon  
with full return privileges**

**ZIFF-DAVIS PUBLISHING COMPANY**  
185 North Wabash Avenue, Chicago 1, Ill.

August, 1946

**Newly Published!**  
**Fully Illustrated!**

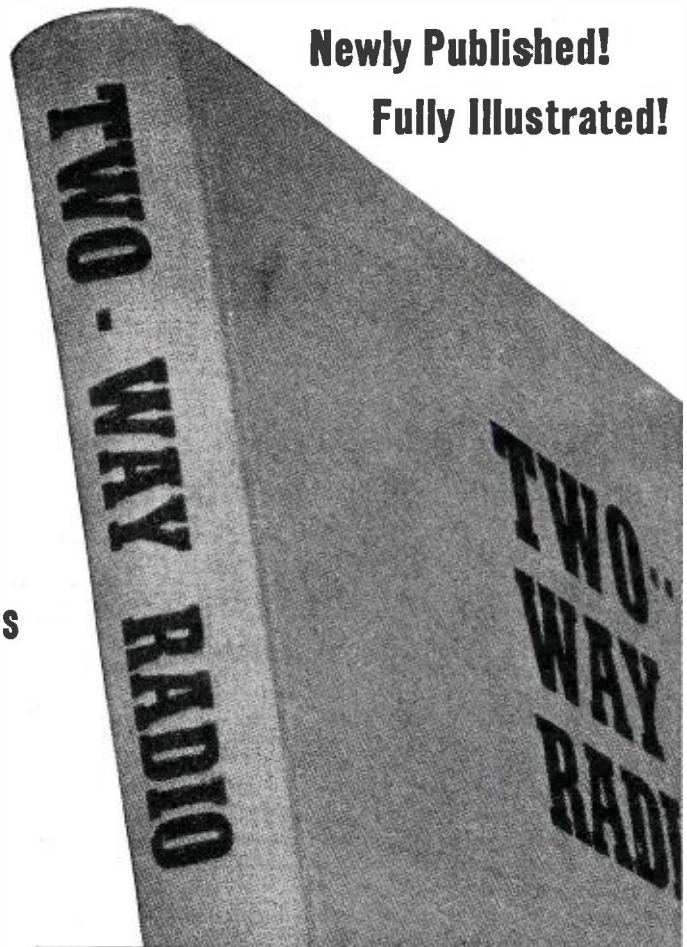

#### This Book Tells You—

- |   |  |
|---|--|
| How two-way radio functions and basic equipment used  | Advantages of microwaves   |
| How to plan for two-way radio installation  | How two-way radio is used in transportation and public services                      |
| Components and operation of mobile and fixed stations   | How it may be used in private life by amateurs, doctors, farmers, vacationists, etc. |
| Constructional and equipment details of Frequency Modulation and Amplitude Modulation Installations | How to maintain and repair two-way radio equipment.                                  |

#### MAIL THIS COUPON TODAY

**ZIFF-DAVIS PUBLISHING COMPANY**  
185 North Wabash Ave., Chicago 1, Illinois

I am enclosing \$5.00 (check or money order) for which please send me one copy of TWO-WAY RADIO. I understand that I may return book within five days for full refund if I am not entirely pleased.

Name.....

Address.....

City.....Zone.....

State.....

RN 846

# A Simple Method of CONTROLLING THE BEAM ANTENNA

By EDWARD HARRIS

*Applying the dependable Wheatstone bridge principle in controlling rotation of directional antennas.*

AS THE ham has accepted such advances in the art as the superheterodyne receiver, the crystal mike, and the use of such instruments as the cathode-ray oscilloscope, so has he accepted the rotary beam antenna. Yet, one of the greatest deterrents to the widespread use of the rotary beam antenna lies in the nature of the mechanism itself. It is a comparatively simple job to mount and feed a two or three element parasitic array and not much of a task to provide some sort of a pivot or bearing for the unit to turn on. However, when it comes to the problem of controlling the direction from a remote position, such as the operating room, and also having a positive indication of direction at all times, he runs into as neat a problem as ham radio has to offer.

Many excellent systems were offered on the market before the war and still better ones will be forthcoming. The selsyn motor, for example, is no doubt the ultimate in the position-indicating field. Yet these systems all have one negative factor in common—*high cost*—usually more than the average ham can apportion to his antenna system. If some simple, yet accurate, method were evolved to perform both the rotating and indicating functions, more amateurs would adopt the unidirectional system of transmission with a worthwhile reduction in over-all interference on the well crowded bands.

Fig. 2.

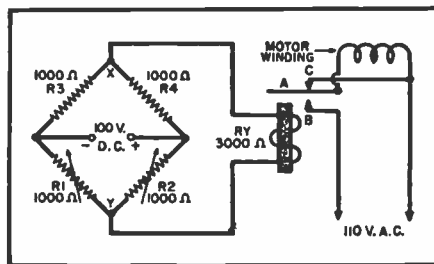
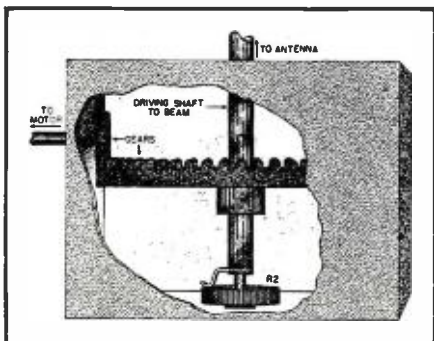

Fig. 1.

With this thought in mind, the author decided to apply a well known principle, that of the Wheatstone bridge, to act as the controlling system for the electric motor which will actually do the driving of the beam. The principle of operation is diagrammed in Fig. 1 which shows the control circuit. Details of the rotating mechanism and motor drive may be seen in Fig. 2 and Fig. 3 shows a typical adaptation of the complete system as a controlling and indicating setup. Although many variations are possible and, no doubt, will be necessary for each individual station, the basic units shown in the accompanying figures will remain essentially the same.

The control circuit shown in Fig. 1 operates as follows. If the resistance of  $R_1$  equals that of  $R_2$ , the bridge is in balance and the operating winding of relay  $RY$  will not be energized as there is no voltage output appearing at the terminals  $XY$ . Now, if the resistance of  $R_1$  is changed, the bridge becomes unbalanced and an output voltage appears across  $XY$ , causing the winding of  $RY$ , to be energized and the contacts  $AB$  to close. These contacts will remain closed until  $R_2$  is made equal to  $R_1$  and the bridge returned to the condition of balance or no output voltage. With the constants shown, the relay will operate with a very slight displacement of  $R_2$ , since it is quite sensitive.

With this basic circuit, it is quite obvious that resistance  $R_2$  can be made to follow  $R_1$ , if we cause  $R_2$  to be driven by a motor and turn the motor on and off through the contacts of  $RY$ . This

## HOW TO TEST A RADIO IN 2 MINUTES OR LESS!

Want to repair radios for neighbors and friends? Or, if you are a radio serviceman, do you want to learn how to diagnose radio troubles and fix sets TWICE AS FAST and TWICE AS PROFITABLY—without a lot of costly, hard-to-get test equipment?

Of course you do—and Ghirardi's RADIO TROUBLE-SHOOTER'S HANDBOOK is just the book that will make it possible for you to do it—for a total cost of only \$5. Send coupon on opposite page today.

## "IT'S THE BEST OUT OF 20" SAYS CHIEF ENGINEER

F. S. Bailey, Chief Engineer, Radio Operator's School, Brownsville, Texas, gives this endorsement of Radio-Electronic's greatest basic training book: "We find Ghirardi's RADIO PHYSICS COURSE the best of 20 or more books we have tried... both as a complete course in Radio Physics and for all other branches including broadcasting. It is giving our students the VERY BEST FOR THEIR MONEY." Order now—use coupon on opposite page!



THE  
ONLY BOOK  
OF ITS/  
KIND.

All the Facts on  
A Little Known Subject  
NOW AVAILABLE!

Don't buy, specify, use, or replace Capacitors blindfolded! Save time, save money, and increase your service efficiency by really knowing all about this vital subject! Actually, no Radio-Electronic component is more important or less understood than the Electrolytic Capacitor. Coming equipment will employ more of them—and in new, improved types. This new book, "The Electrolytic Capacitor" by Alexander M. Georgiev, for more than 15 years a leader in Capacitor research and development, at last explains the entire subject. Answers all the many questions servicemen, engineers, and designers have been asking about capacitors for years.

### ENDORSED BY A. A. GHIRARDI

"I heartily recommend The Electrolytic Capacitor as 'must' reading for the man who really wants to forge ahead in post-war Radio-Electronics," states A. A. Ghirardi, internationally famous technical author. "It tells what types to use and where, and how to use them to best advantage—explains the advantages and disadvantages of each—how to make emergency repairs and a host of other subjects invaluable to the man who KNOWS it pays to KNOW."

Contains over 200 pages and 80 illustrations. Price only \$3 (\$3.25 foreign).

USE COUPON! in adjoining advertisement  
MAIL TODAY!

# MAKE MONEY REPAIRING RADIOS AND OTHER ELECTRONIC EQUIPMENT

## GHIRARDI TELLS EXACTLY WHAT TO DO ... EXACTLY HOW TO DO IT

If you like to repair radios at home in spare time, Ghirardi's **RADIO TROUBLE-SHOOTER'S HANDBOOK** offers you a new, fast way that makes the work easy—without a lot of previous experience or scarce, expensive test equipment. Or, if you are a professional radio man, it helps you repair two sets in less than the time you'd normally take for one. It is the ideal book for training new helpers, for substituting tubes and parts in these days of shortages, for repairing cheap sets quickly and profitably—in short, for repairing radios better, faster and more profitably than you may have thought possible.

### 4 LBS. OF FACTUAL, TIME-SAVING MONEY-MAKING SERVICE DATA

**RADIO TROUBLESHOOTER'S HANDBOOK** isn't a "study" book. It rolls up its sleeves and goes to work for you the minute you get it. It can easily pay for itself the first time you use it! Simply look up the make, model, and the trouble symptom of the radio you want to repair ... and go to work. No useless testing! No lost time or motion! The **HANDBOOK'S** clear instructions tell you exactly what the trouble is likely to be ... and **EXACTLY** how to fix it. Actually, this big 4

pound, 744-page, manual size **HANDBOOK** brings you factual repair data for practically every radio in use today—over 4,800 individual makes and models!

In addition, there are hundreds of pages of helpful repair charts, tube charts, data on tuning alignment, transformer troubles, tube and parts substitutions, color codes, etc.—all for only \$5 (\$5.50 foreign) on an **ABSOLUTE 5-DAY MONEY-BACK GUARANTEE**.



### This "Automatic Teacher" Shows You Exactly How to REPAIR OVER 4,800 DIFFERENT RADIO MODELS

Over 400 pages of the **RADIO TROUBLE-SHOOTER'S HANDBOOK** include specific common Trouble Symptoms, their Causes and Remedies for practically every Radio Receiver in use today. **IN ADDITION**, there are hundreds of pages including i-f alignment peaks for over 20,000 superhets; a big data section on i-f transformer troubles—and the most up-to-the-minute **TUBE CHART** you've

ever seen with complete information on **EVERY TUBE TYPE** and dozens of tips on tube substitutions. Other features include plug-in and ballast resistor replacement charts; condenser charts; coil, transformer, and wire data—and a wealth of other material to save time and help you make money! **ONLY \$5 complete (\$5.50 foreign)**.

## COMPLETE BASIC RADIO-ELECTRONIC TRAINING

FOR BEGINNERS \$ **5**  
(\$5.50 foreign).

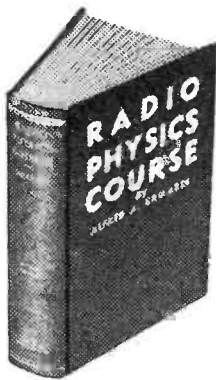

**36 COURSES IN ONE**  
Easily worth \$50 or more if broken into "course" form and sent to you in monthly lessons.

All the Basic Science of Radio-Electronics in One Big 3 1/2 lb. Book—No monthly lessons to wait for.

Start to train **NOW** for the most interesting of all futures—**RADIO-ELECTRONICS!** Ghirardi's 972-page **RADIO PHYSICS COURSE BOOK** gives you all the basic training you need—at a price you can afford to pay! Actually, this big book has started more people in Radio-Electronics than any other book or course. It is more widely used for home study—and more widely used in U. S. Signal Corps and Navy Schools and in civilian schools and colleges than any other book of its kind!

### NO OTHER COURSE LIKE IT!

Ghirardi's **RADIO PHYSICS COURSE** book with its 500 illustrations and 856 self-testing review questions makes it surprisingly easy for you to learn at home without an instructor. Nothing is omitted, nothing condensed. Everything is made as easy as A-B-C. Ask any radio man! You'll be amazed how quickly you'll master the subjects that other courses and books make seem very complicated. Begin today. Examine this truly great book for 5 full days—and get every cent of your money back if you're not more than satisfied.

August, 1946



## LEARN PROFESSIONAL SERVICE WORK AT HOME WITHOUT AN INSTRUCTOR!

Study now for a good job as a professional Radio-Electronic Service Expert. It's easy to learn from Ghirardi's big 1300-page, profusely illustrated **MODERN RADIO SERVICING** book that costs you only \$5 complete. This one big book covers all phases of the work! Explains all necessary test instruments ... even how to build your own if you prefer, how to troubleshoot all makes of radios, analyze electronic circuits, test components, make adjustments, repairs, etc., etc.—all step-by-step. Even explains how to start a successful Radio-Electronic Service Business of your own. Sold separately for \$5 (\$5.50 foreign), or see **MONEY-SAVING COMBINATION OFFER** in coupon.

### EVERY CONCEIVABLE SERVICE SUBJECT

Explains circuit and operation of all types of essential service instruments: How and when to use them; How to build your own; Preliminary trouble checks; Troubleshooting; Repairs; Obscure radio troubles; Aligning and neutralizing; Auto and Marine Radios; Interference reduction; AVC and QAVC circuits, etc., etc.

## 5-DAY MONEY BACK GUARANTEE

**MURRAY HILL BOOKS, Inc.,**  
Dept. RN-86, 232 Madison Ave., New York 16, N. Y.

Enclosed find \$..... for books checked; or  send C.O.D. (in U. S. A. only) for this amount plus postage. If not fully satisfactory, I may return the books at the end of 5 days and receive my money back.

- |  |   |   |
|--|---|---|
| <input type="checkbox"/> <b>RADIO PHYSICS COURSE</b><br>\$5 (\$5.50 foreign)   | <input type="checkbox"/> <b>RADIO TROUBLESHOOTER'S HANDBOOK</b> \$5 (\$5.50 foreign)  | <input type="checkbox"/> <b>THE ELECTROLYTIC CAPACITOR</b><br>(See advertisement in adjoining column) \$3. (\$3.25 foreign) |
| <input type="checkbox"/> <b>MODERN RADIO SERVICING</b><br>\$5 (\$5.50 foreign) | <input type="checkbox"/> <b>Special MONEY-SAVING COMBINATION:</b><br>BOTH Modern Radio Servicing and Troubleshooter's Handbook<br>\$9.50 for the two (\$10.50 foreign). |   |

Name.....  
Address.....  
City & Dist. No..... State.....  
(Please print or write plainly)

**IT'S EXCLUSIVE!  
LOW PRICED!**

**WRL GLOBE TROTTER  
TRANSMITTER KIT**

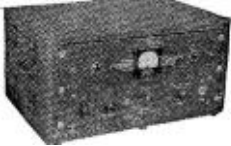

READY NOW!  
**LEO'S  
Sensation  
of the Year!**

**\$59.95**

40 WATT INPUT Cat. No. 70-300

Complete including all parts, chassis panel, streamlined cabinet, less tubes, coils, and meter.

Cat. No. 70-312 Kit same as above, wired by our engineers .....\$75.00  
All necessary Accessories .....\$13.85 extra

Here is the latest, most outstanding transmitter value on the market today. The WRL Globe Trotter is capable of 40 watts input on C.W. and 25 watts input on phone on all bands from 1500 KC through 28 Megacycles. Incorporates the Tritet Oscillator using a 20 meter X-tal and providing sufficient drive at 10 meters for the 807 final; Heising choke modulation; three bands, all pretuned; 10, 20, and 30 meters; metering provided for both oscillator and final stages; two power supplies, one for 807 final and modulator tubes, one for speech amplifier and oscillator stage.

**EXTRA SPECIAL RECEIVER BUY!**

New BC 348Q Surplus Receiver. 8 tubes, 200 to 500 Kilocycles. Weather, aircraft, and all ham bands except 10 meters. Cat. No. 35-61, less speaker, ONLY .....\$85

Here are just a few of the many well-known receivers offered by Leo:

- Hallcrafters S38 .39.50
- Hallcrafters S40 79.50
- RME 45 .....186.
- RME 84 .....\$98.70
- National NC 2-40C .....225.
- Hallcrafters SX46 ..\$115
- Hallcrafters SX42 ..\$250
- Hallcrafters S41G 33.50
- Hammarlund HQ-129X 129.

Use our Liberal trade-in and easy terms.

**SERVICE DEALER NEEDS**



**WRL MULTITESTER**  
Steel case with 30-60° angle. Cat. No. 16-491 Less Leads .. **\$1875**

Handles AC DC Voltmeter, 20 Milliammeter, high and low range Ohmmeter. 3" meter with sturdy D'Aronson movement. Size 5 1/2 x 8 x 3 1/4.

A complete stock of tools, replacement parts, test equipment, intercom and public address systems . . . everything for the progressive service dealer.

**TUBULAR CONDENSERS!  
Immediate Delivery!**

Small type, Standard Tubular By-Pass Condensers. Waterproof, Long-Life, Phenolic wrapped and Phenolic end fill. Also double waterproof seal. Manufactured to same high specifications used in the famous VT fuse. Genuine lead non-inductive foil condensers.

Unconditionally Guaranteed.

Cat. No.	Cap. 100 Mfd.		Cap. 500V	Cat. No.	Cap. 100 Mfd.		Cap. 600V
	Mfd.	Lots			Mfd.	Lots	
27-837	.002	5.40	.06	27-853	.0025	6.30	.07
27-839	.0025	5.40	.06	27-855	.005	6.30	.07
27-841	.005	5.40	.06	27-857	.01	6.30	.07
27-843	.02	5.40	.06	27-859	.02	6.30	.07
27-845	.025	6.30	.07			1000V	
27-847	.05	6.30	.07	27-861	.0025	7.20	.08
27-849	.1	7.20	.08	27-863	.0035	7.20	.08
27-851	.2	8.10	.09	27-865	.005	7.20	.08

On quantities of 500 or over condensers may be assorted to obtain an additional 5% discount with a minimum quantity of 100 of each type.

**GET OUR LATEST FLYER FREE!**



Packed with real buys in radio, electronic, and general merchandise.  
Giant Radio Map (size 3 1/2 ft. x 4 1/2 ft.)...15c  
Handy Tube-Base Calculator...25c  
Address Dept. RN-8  
Council Bluffs, Iowa

**World Radio Laboratories**  
Formerly Wholesale Radio Laboratories

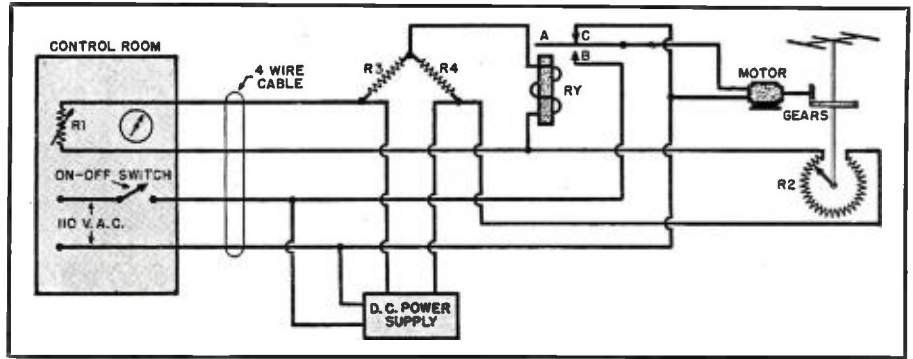

Fig. 3.

is accomplished by using two variable resistances which are identical and cover their entire range through a rotation of 360 degrees.  $R_1$  is mounted in the operating room (with a dial indicating position bearing on a map) and  $R_2$  is mounted on the beam and rotates exactly with the beam driven by the motor. Thus, when  $R_1$  is displaced from a balance setting in the room, the contacts of  $RY$ , will close causing the motor to operate. The motor drives the beam causing it to turn and  $R_2$  to vary its resistance until the bridge is once again in balance when the contacts will open and the motor will stop. Thus, the beam will stop in a position determined by the setting of  $R_1$ .

Some means of continuous rotation should be provided for in the feed system or, if preferred, the motor can be made to reverse at the end of each 360 degree rotation of the beam.

As the system stands, the beam will continue to rotate until  $R_2$  is positioned correctly when the relay contacts will open and the motor stops. But if the system is not sufficiently damped, the inertia of the system will carry it past the balance point with a resulting small error in the positioning of  $R_2$  with respect to  $R_1$ ; in the extreme case of too much inertia,  $R_2$  will be driven completely out of balance condition of the bridge and the contacts  $RY$ , will again close causing the motor to start up again and drive the beam around. In most systems, the damping caused by the high reduction gear ratio is sufficient to stop the beam immediately upon release of the contacts  $RY$ . For additional damping, the back contacts of  $RY$ , are connected as shown in Fig. 1 and Fig. 3. Thus, when the bridge balances and  $RY$ , releases, the motor windings are shorted through the back contacts. These short circuited windings act as a brake on the motor. Although unnecessary in an application of this type, it is possible that the use of a polar relay at  $RY$ , would be desirable, in order to make the motor reverse in case the system overshoots its mark.

The circuit values shown in the respective figures are for this particular setup only and may be changed at will without altering the basic circuit's operation. About all that is necessary is to make  $R_1$  and  $R_2$  iden-

tical. This may be done by purchasing two identical wire wound rheostats and altering them for 360 degree rotation or constructing the resistances entirely from material at hand. An attempt should be made to have the resistance vary linearly with the rotation of the contact arm.  $R_1$  and  $R_2$  must be identical and preferably wire wound of a value equal to the maximum resistance of  $R_1$ . The relay in this case is of the sensitive plate circuit type but almost any d.c. relay may be used provided the correct supply of voltage is available. In fact, excellent results may be obtained using relays from an automobile voltage regulator and a 6 volt supply. Of course, the resistors must be able to withstand the increased current necessary with such a system.

Now a word about the all-important item of expense. The motor and gear assembly for the drive unit and beam mount must necessarily be designed to fit the individual application. For example, a small electric motor could be purchased second hand for a few dollars and, if available, the reduction gears could be constructed from old ones. At any rate, the cost of these items depends entirely upon the Yankee ingenuity of the amateur himself.

Considering the remaining material necessary (those parts needed for the control circuit) they may be obtained from any reliable parts supply concern for less than five dollars. In fact, it is possible to construct the entire system, including the purchase of the motor, with an entire outlay of less than ten dollars.

There is nothing that can be done to the transmitter proper which would involve such a small cash outlay and yet contribute so much to the actual operating efficiency of the station as this small amount of effort expended on the antenna system.

-30-

**CLEANING  
CONDENSER PLATES**

WHEN dust lodges between variable condenser plates minute metal particles in the dust often cause crackling noises in the receiver.

An ordinary pipe cleaner run between the plates of the condenser will clean out all of the dust without bending or damaging the plates in any way.

S.G.W.

**RADIO NEWS**

**YOU name the brand—**  
(original equipment or replacement)

# PHOTOFACT FOLDERS

give you the exact  
part numbers

The manufacturers behind these and many other famous radio trademarks, including many radio set manufacturers, say that Howard W. Sams PhotoFact\* Folders offer you the most revolutionary service data ever devised. They claim—and rightly—that they can save up to 50 percent of any radio service engineer's time.

No wonder! PhotoFact Folders tell you—by data and pictures—everything you want to know about servicing every post-war radio made. Every part is listed and numbered. Every servicing shortcut and installation fact is fully set down! This at a time when receivers are more complicated than ever!

You get a set of from 30 to 50 PhotoFact Folders at a time. Each set comes to you in a handy envelope at a cost of only \$1.50 for each group. They cover all new radios, phonographs, intercommunication systems and power amplifiers as they reach the market.

Demand for the Howard W. Sams PhotoFact Folder Service is phenomenal. Paper shortages may make it impossible to send you the first sets immediately. But reprints are now being made—and you will get additional sets as fast as they are issued. Ask your distributor for full details and specimen folders. Have him put your name on his reservation list!

**HOWARD W. SAMS & CO., INC.**  
2924 East Washington Street, Indianapolis 6, Indiana

*\*Trademark Registered*

## WHAT THE PHOTOFACT SERVICE IS:

It's a new and radically different method of giving you the complete service story on every receiver manufactured since January 1, 1946.

All information is compiled by experts—from actual examination of models themselves, not from ordinary service data. No brand of product is recommended above another—all original

equipment part numbers are listed as well as competitive component part numbers. Each Folder gives you from 2 to 12 clear photos of the chassis... a keyed reference alignment procedure... complete voltage and resistance analyses... complete stage gain measurement data... plus a schematic diagram.

**PUBLICATION DATE—SET NO. 2**  
**JULY 25th—ORDER TODAY**

**HOWARD W. SAMS & CO., INC. RADIO PHOTOFACT SERVICE**



CONDENSERS INDUCTORS TUBE SOCKETS INSULATORS PLUGS AND JACKS

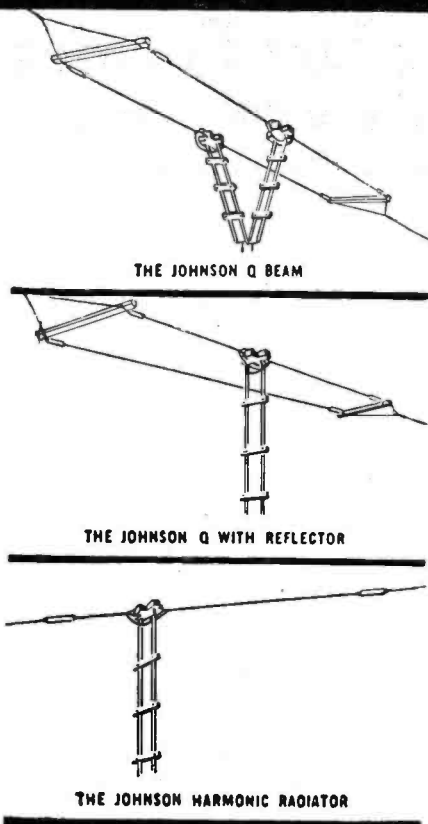

This highly efficient system is applicable to a wide variety of antennas, including the sensational "Q" Beam, Radiator-Reflector and Radiator-Director Beams, Harmonic Radiators, "V" Beams and many others. With all these the following advantages are realized:

- Matched impedances throughout with greater radiation from the same transmitting power than may be obtained with ordinary non-matched antenna feeder systems.
- Permits use of open wire line resulting in exceptionally low transmission line loss — about 1/10 that of "twisted pair" lines.
- No exact or critical overall line lengths. Line may be several hundred feet long if desired.
- Easily installed and adjusted — complete data supplied.
- Available for all the radio amateur bands from 80 to 1 1/4 meters.

**JOHNSON**  
a famous name in Radio



E. F. Johnson Co. Waseca, Minn.

RADIO NEWS, AUGUST, 1946

FARNSWORTH ET-064, ET-065, ET-066

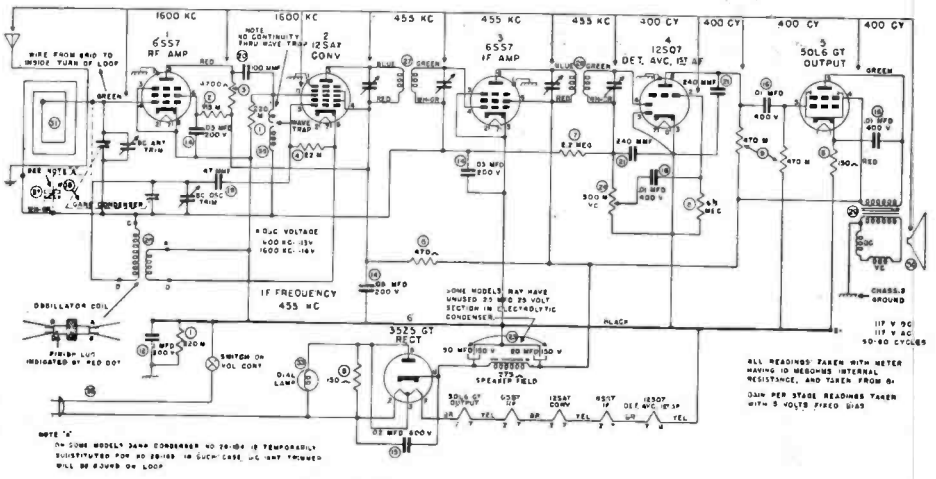

RADIO NEWS, AUGUST, 1946

RCA MODEL 56X10

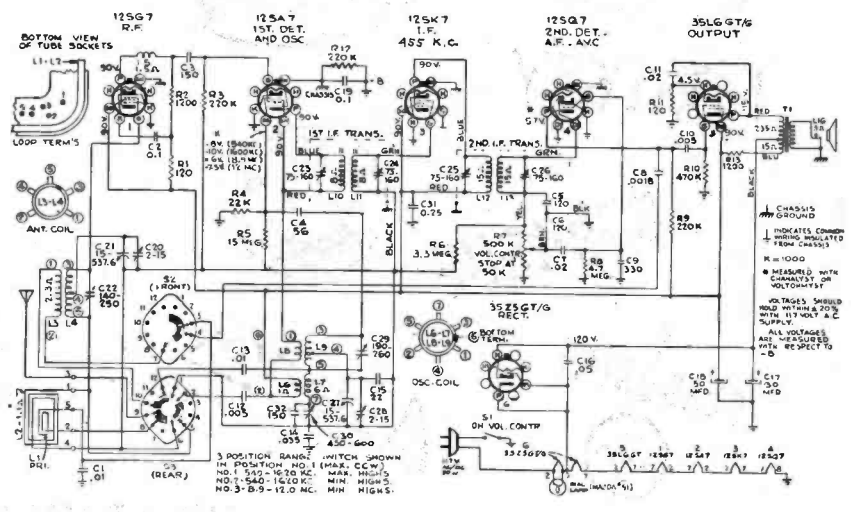

RADIO NEWS, AUGUST, 1946

WESTINGHOUSE MODEL H-125 & H-126

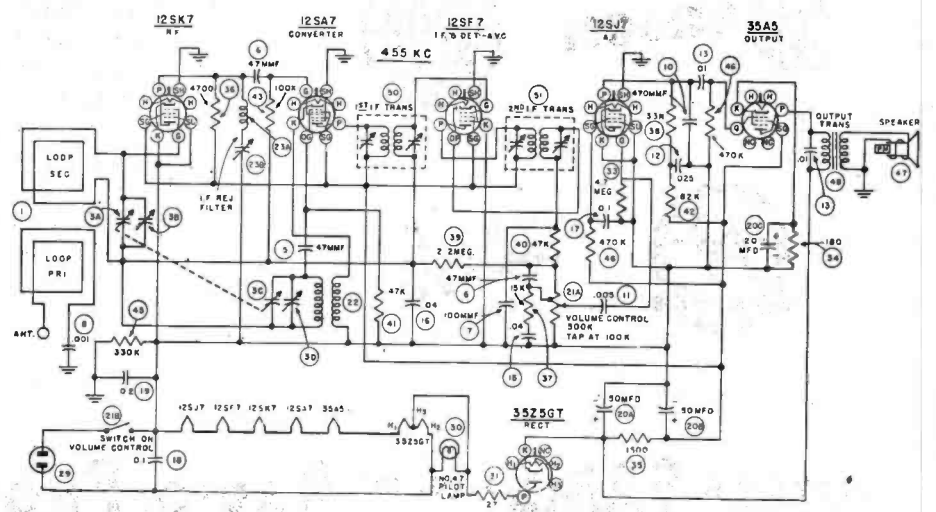



Here, and on following pages, are circuit diagrams and parts lists of many new postwar radio receivers. Radio News will bring to you other circuits as quickly as possible after we receive them from manufacturers.

# HARVEY

has greatly needed components for engineers and experimenters

We carry at all times a complete and extensive assortment of test equipment made by all the better-known manufacturers.

**IN STOCK NOW FOR IMMEDIATE DELIVERY**

**Brand New**  
**Weston Model 779-Type 1 Analyzer**

**Ranges:**  
DC Volts: 0-2.5-10-50-250-1000  
(at 20,000 or 1000 ohms per volt)  
AC Volts: 0-2.5-10-50-250-1000  
DC Current: 0-.1-1-10-50-250 ma; 0-1-10 amperes

**Decibels:** -14 to +2, -2 to +14; +12 to +28.  
+26 to +42, +38 to +54

**Ohms:** 0-3000—25 ohms center scale  
0-300,000—250 ohms center scale  
0-300,000—2500 ohms center scale  
0-30 megohms—250,000 ohms center scale

in beautifully finished antique oak case with cover, complete with self-contained batteries for all ranges, test leads and comprehensive instruction book ..... Net, \$74.70

**Weston Model 785 Industrial Circuit Tester.** Ranges similar to 779 plus AC current ranges of .5-1-5-10 amperes. A really rugged unit built to take the physical abuse it might encounter when used in field electrical shops, laboratories, broadcast stations and aboard ship. .... Net, \$101.25

**Brand New—Just released—Weston Model 798 Proportional Mutual Conductance Tube Checker.** Tests every American-made tube known, regardless of date of manufacture, or type in the receiving tube category—plus all acorns and midgets in the 9000 series, 607's, 6AK5, 6AK6, 6AD6, 6AT6, etc. All filament voltages from 1.1 to 115. Meter scale calibrated in micromhos 0-3000-6000-12,000, also red and green sections for good and bad indication and diode check. Sensitivity of tester can be varied. It also contains a volt-ohmmeter reading up to 750 volts AC or DC, 3 ranges each; reads current in 12 ranges 7.5 or 150 mils and has resistance scales 0-100,000 ohms and 0-1 megohm. Unit is supplied in grey wrinkle finish steel case with cover, test leads, instruction manual and tube charts. ... Net, \$182.65

**The ever popular Weston Model 697 Pocket Meter.** Ruggedly constructed with heavy molded bakelite case. AC/DC voltage scales 0-7.5-15-150-750; DC current 0-7.5-75 mls; resistance 0-500-5000-500,000 ohms. This unit is very compact and is just the thing to slip in your pocket for that job away from the lab. Weston high quality construction throughout, all multipliers are 1% wire wound on bobbins by Weston precision methods. This unit complete with self contained batteries and test leads at only ..... \$25.92

Do you need a small meter for that special job requiring low resistance scales such as checking DC resistance of electric motor windings, transformers of all types, etc.? This Weston 698-1F reads very accurately as low as 1/20th ohm. Two scales: 0-10 and 0-1000 ohms full scale. Very compact, measuring only 5" x 2 3/4" x 1 1/2" and almost fits a vest pocket. Specially priced at ..... \$16.22

A companion unit for the higher ranges, Weston Model 689. Two scales: 0-5000 and 0-50,000 ohms, at only ..... \$14.58

Also Weston panel meters, all types—301, 501, 517, 425—AC-DC-RF-VU—all ranges... most of them in stock right now.

Remember, HARVEY has full stocks ... same-day shipping service ... fair prices. Send us your order now!

Telephone: **hrc** LO. 3-1800

**hrc**  
**HARVEY**  
**RADIO COMPANY INC.**  
103 West 43rd St., New York 18, N. Y.

RADIO NEWS, AUGUST, 1946

HOWARD MODEL 901

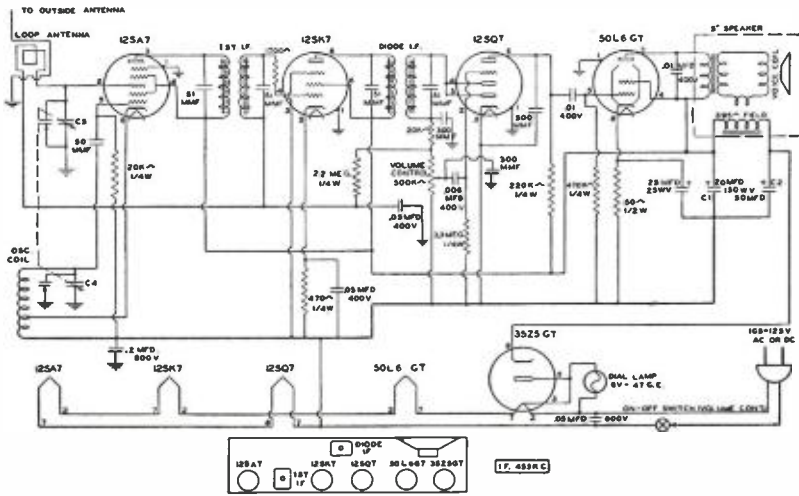

RADIO NEWS, AUGUST, 1946

CROSLY MODEL 56TX

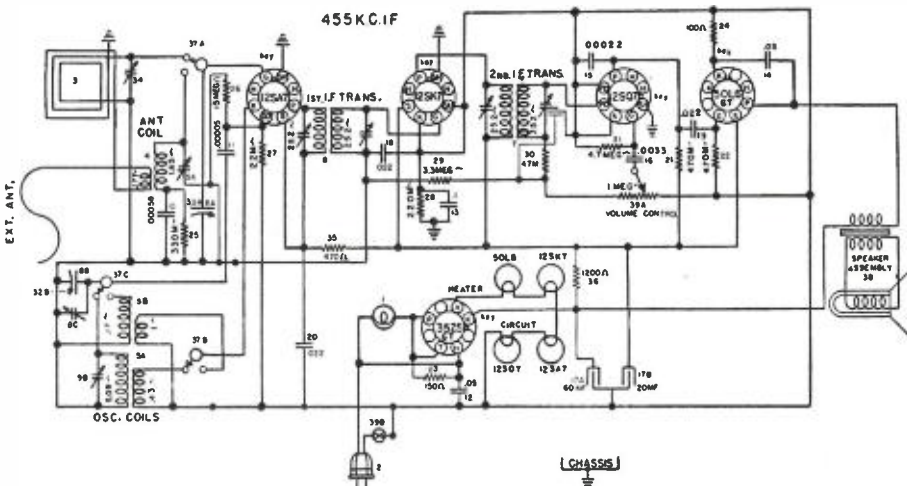

RADIO NEWS, AUGUST, 1946

EMERSON MODEL 519

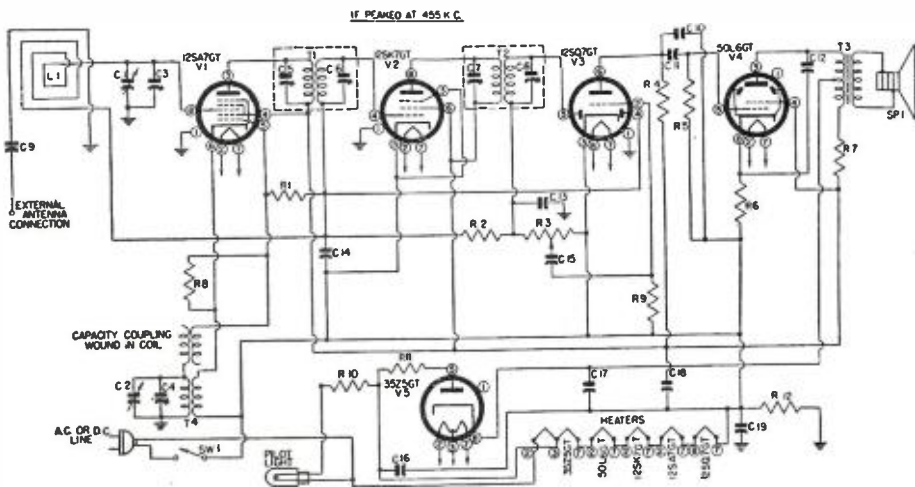

(For parts lists see page 70.)

# What's New in Radio

## COMPONENT MOUNTING STRIP

A new type of component mounting strip has been developed by *Yates Engineering Services* of Cranford, New Jersey.

By using these strips the need for soldering lugs or other metal inserts

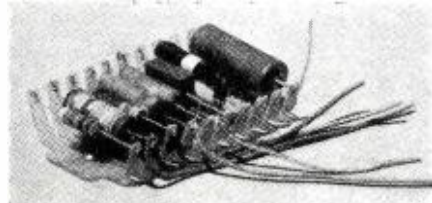

is eliminated. The mounting strips are available in glass, ceramic, rubber or laminated plastic. The choice of insulation makes these component mounting boards adaptable to virtually any type of r.f. circuit assembly as well as audio, power supply or industrial electronic applications. Heat dissipation of resistor units is good due to the free air circulation possible with this mounting.

These strips are available in both standard and special sizes. Full information will be furnished interested persons upon application to *Yates Engineering Services*, Two Hampton Road, Cranford, N. J.

## G.E. PORTABLE

A self-charging portable radio which operates for 20 hours on a penny's worth of electricity was recently demonstrated by *General Electric Company*.

Power for the new portable is supplied by a two-volt, leak-proof storage battery which operates the radio for 20 hours on a single charge. The battery can be recharged by plugging into ordinary a.c. house current. The receiver is designed to play at full volume while the battery is being charged.

This portable will be available in two models, one designed for standard



broadcast reception, the other with standard and five short-wave bands. Both will have die-cast aluminum construction throughout. The set will weigh about 20 pounds.

This receiver is now in production

at the *General Electric Company*, Bridgeport, Conn., plant.

## PLUG-IN RELAYS

A hermetically sealed plug-in relay line designed for a.c. or d.c. operation in small radio transmitters, aircraft control circuits and other applications where space is limited has been announced by *Ward Leonard Electric Company* of Mount Vernon, New York.

The unit is completely encased in a cylindrical can which provides protection against adverse atmospheric conditions such as moisture, dust, gases, corrosion, etc. The relay coil and contact connections are totally enclosed within the metal housing and are brought to the prongs of a standard octal plug base.

The line is available in contact combinations of double pole, double throw with a.c. contact ratings (at commercial frequencies of 4 amperes, from 0-115 volts and d.c. contact ratings of 5 amperes from 25 to 115 volts.

Additional information on the line

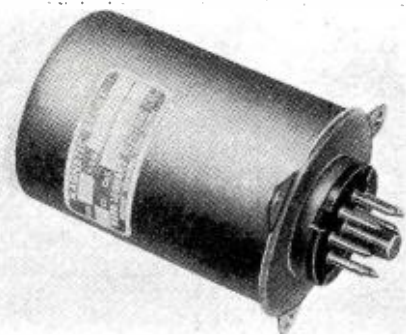

will be furnished by *Ward Leonard Electric Company*, Mount Vernon, New York.

## PICKUP HEAD

*General Electric Company* has announced a new small-sized pickup head which will be used with the new G.E. electronic reproducer.

Special features of this unit include record reproduction incredibly free from chatter, needle radiation and scratch prevalent in former systems; reduction in record wear; improved tone quality and perfect tonal balance at both high and low volumes, according to the company.

The new reproducer, of which this pickup head is a part, will be used in every automatic radio-phonograph built by the *General Electric Receiver Division* at Bridgeport, Conn.

## AIRCRAFT RADIOTELEPHONE

*Hallicrafters Company* of Chicago has recently perfected a light-weight, radiotelephone specifically designed for the personal aircraft field. This unit combines good performance with simplicity of operation.

This transmitter-receiver, known as the Skyfone model CA-2 weighs less



# OLSON CHEST

packed with  
100 Insulated Resistors

A tremendous value! This handsome Chest has twenty compartments—10 in the base and 10 in a removable tray. Walnut finish; brass hinges and fastener. Contains 100 resistors stamped with resistance values, 5 ohms to 20 megohms, ½ watt to 2 watts, color coded. Every size is popular. No war surplus resistors in this Ohm Chest!

ORDER NOW for immediate delivery.

only  
**\$4.95**  
complete  
POSTPAID

Free!

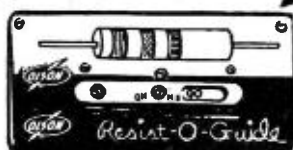

With each Ohm-Chest ordered, we send our "Resist-O-Guide" free. Revolving wheels in color show all resistance values.

CLIP AND  
Mail  
today!

This offer good  
only in U. S. A.

Write for our monthly  
BARGAIN CATALOGS  
—they're free!

## OLSON RADIO WAREHOUSE

73 E. Mill St., Dept. 32, Akron, Ohio

Send me \_\_\_\_\_ Ohm-Chests with 100 Insulated Resistors in each, @ \$4.95. "Resist-O-Guide" free with each Chest. I enclose \$ \_\_\_\_\_  Send C. O. D.

NAME .....

ADDRESS .....

# SYLVANIA NEWS

## RADIO SERVICE EDITION

AUGUST Prepared by SYLVANIA ELECTRIC PRODUCTS INC., Emporium, Pa.

1946

### "CARRY THE TUBES THAT BUILD GOODWILL" IS THEME OF SYLVANIA TUBE QUALITY STORY

**SYLVANIA  
SERVICEMAN  
SERVICE**



by  
**FRANK FAX**

Carrying the *complete* line of Sylvania receiving tubes is one of the best ways to build goodwill for your business.

You can be sure of this because of the public's recognition of Sylvania's high quality. Extensive national advertising has helped promote this recognition — and *acceptance*. **QUALITY CONTROL** backs up this story of Sylvania quality.

Before Sylvania tubes can be shipped to your distributor, they must first pass a series of stiff tests conducted by an efficient Quality Control Department. Only those tubes that are proved to be electrically and mechanically perfect ever reach you.

Sylvania makes its own tube parts — over forty-five million a month. Even the fine tungsten wire filaments for Sylvania tubes are *Sylvania-made* to safeguard the quality of this vital tube element.

As a result, Sylvania can keep a close check on every tube — from raw materials straight through to the finished product.

Remember the story of Sylvania quality! It is one reason why carrying Sylvania tubes means you will receive a lot extra in the way of *goodwill*.

#### SEE YOUR SYLVANIA DISTRIBUTOR

*For full information on the complete line of Sylvania receiving tubes — and the long list of valuable business and technical aids for you — call on your local distributor.*

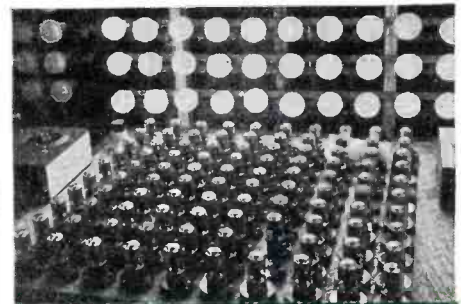

Completed tubes are being "aged" to stabilize characteristics. Then they get continuity, short and noise tests.

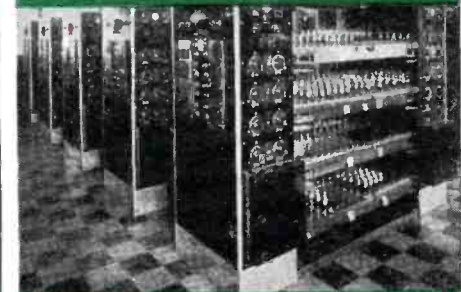

Tubes are here being given the Life Test — as another check on design, quality and dependable service.

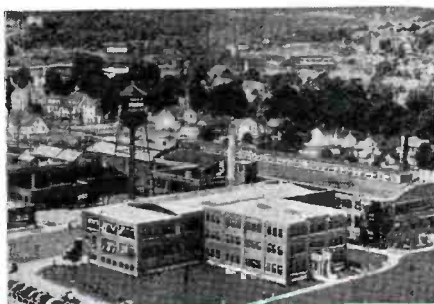

Part of the Emporium, Pa., Tube Plant, where pleasant surroundings help keep employees tuned to quality workmanship.

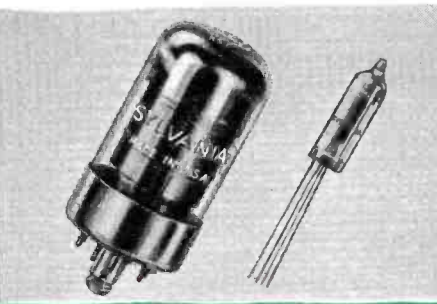

Quality products—the Sylvania Lock-In tube, and the tiny T-3 tube of proximity fuze fame.



This operation gives a percentage of all previously tested tubes a thorough going-over—just as a "double-check."

# SYLVANIA ELECTRIC

Emporium, Pa.

MAKERS OF RADIO TUBES; CATHODE RAY TUBES; ELECTRONIC DEVICES; FLUORESCENT LAMPS; FIXTURES; WIRING DEVICES; ELECTRIC LIGHT BULBS

# RADIONIC EQUIPMENT CO.

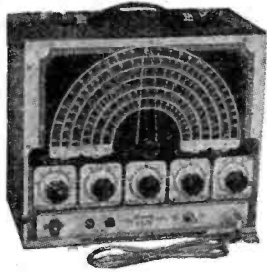

**APPROVED ELECTRONICS  
A 100 Signal Generator**

A complete instrument incorporating all the features necessary to give you a solid, dependable signal. Accurate calibration in 6 ranges covering 100 kcs to 52 mc. Provision for internal or external modulation continuously variable from 0-100%..... **\$47.00**

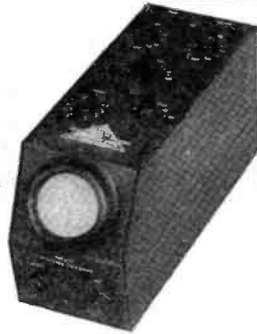

**NEW! WATERMAN  
POKETSCOPE**

An oscilloscope that has all the conventional features but in a unit 10% of the usual size. A 2" CRT that can be viewed at any angle. Hor. and ver. amplifiers with excellent freq. characteristics. Sweep circuit substantially linear from 10 to 50,000 cycles. Miniature tubes. Well designed power supply. Convenience PLUS! **\$53.90**  
4x6 1/2x10 inches. 6 lbs....

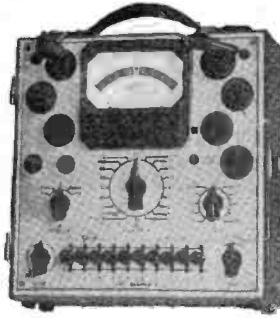

**TRIPLETT No. 2413  
TUBE CHECKER**

An ultra-modern instrument in design as well as appearance. Handles all of the newcomers. Emphasis on convenience and accuracy. Controls are arranged to provide all the information you want with a minimum of time and effort on your part. The usual Triplett quality and dependability... **\$48.50**



**WESTON 697 VOM**

A universal instrument that will measure voltages in 4 ranges—7.5, 15, 150, 750, AC and DC; current in 2 ranges, 7.5 and 75 ma; and resistance in 2 ranges 0-5000 and 0-500,000. Self-contained battery. Pocket size. Weight 1 3/4 lbs. 3 1/4 meter. 1000 ohm per volt movement..... **\$26.00**

**TRIPLETT 625-N**

A 6" two-color scale covering 32 ranges. Complete AC-DC voltage, current, resistance and output measurements, with a basic 20,000 ohm per volt movement. Multi-position selector switches for circuit and range settings. Ideal for those high resistance television circuits as well as general shop and laboratory use..... **\$44.10**



- SUPREME 3" Oscilloscope Mod. 546.....\$87.70
- SUPREME Tube and set tester Mod. 504A... 87.69
- WESTON No. 779..... 75.00
- INVERTER, 110V DC to AC, 25 Watt..... 7.15  
(Ideal for phono players)
- ASTATIC L72A..... 2.50
- MEISSNER Coil Kit, 456 Kcs..... 1.99  
(Shielded input and output, unshielded osc.)
- ANTENNA Coil..... .49
- 12" PM 20-oz. speaker..... 6.25
- MEISSNER choke coil kit (10 assorted)..... .49
- Rub-R-Light Flashlight, less bat..... 1.85
- Lots of 12..... 13.35
- CAT WHISKERS, kit of 3..... .05
- EL VIBRATORS, 1703-2041-2088-2089.... 2.09  
Auto and farm sets..... 3.50
- RIDER'S MANUALS, Vol. VI..... 11.00  
Vols. IX, XI, XIII and XIV..... (each) 15.00
- 50L6 output transformers..... .49
- ANTENNA Kit, 50 ft. ant. wire, 25 ft. leadin... .79
- 2 ground straps, 2 insul. 2 screw eyes, 2 nail knobs, Lots of 5..... .65

- STANDARD make universal output trans., 6 watt..... **\$1.20**
- STANCOR P6010, 5 tube universal power trans., 40 ma., 6V fil..... 2.65
- STANCOR P6011, 7 tube, 70 ma., 6.3 fil.... 3.38
- STANCOR P6012, 9 tube, 90 ma., 6.3 fil.... 3.82
- 5" PM SPEAKER..... 2.15
- 6" PM SPEAKER..... 2.45
- 8" PM SPEAKER..... 3.60
- WEBSTER, Record Changers Models 50 and 56

**MASCO SOUND SYSTEMS**

- 25 Watt amp. with tubes.....\$43.40
- 35 Watt amp. with tubes..... 51.77
- 50 Watt amp. with tubes..... 68.57
- 25 Watt complete portable system..... 88.74
- 35 Watt complete portable system..... 97.10
- 50 Watt complete portable system..... 168.06
- 35 Watt amplifier with record changer, top with tubes..... 89.75
- Chancellor Portable Record Player—in simulated ALLIGATOR leather....complete 36.95

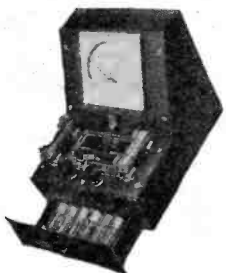

**NEW UNIQUE RENIER  
AC/DC VOLT-MIL-METER**

Shunts and multipliers are provided in cartridge form and are stored in a small self-contained drawer for selection as required. This feature permits a great variety of ranges and functions and is excellent for instructional purposes. Ideal for laboratory and school. Model 334 (illustrated) complete with 6 shunts, 6 multipliers, 2 fuses..... **\$31.85**  
Write us for descriptive literature.



**VOMAX**

The vacuum tube voltmeter that meets every measurement need. 57 ranges..... **\$59.85**



**CHANCELLOR  
RECORD PLAYER**

Shure crystal pickup; drawn aluminum case; plastic turntable; 10,000 play Precious Point needle; handsome baked brown lacquer finish; 115V AC motor; all combined with excellent design and workmanship to give you a dependable record player of first-class appearance at a remarkable price... **\$17.95**

**E-L VIBRATOR  
POWER SUPPLY**

Here's the high voltage supply for that portable, mobile, or boat job. 300 volts @ 100 ma., 6 volts @ 8 amps input. Well filtered hum-free. 6 lbs. Handsomely finished and designed for deck mounting..... **\$14.97**

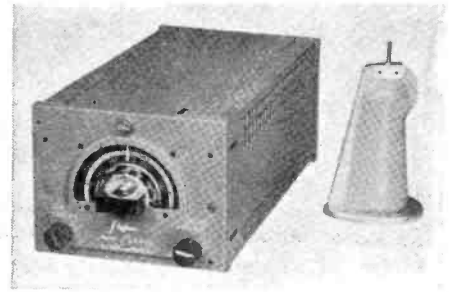

than 8 pounds but covers the frequencies of radio ranges, control towers and beacons for navigational purposes. It also includes a broadcast band.

The CA-2 is designed to operate over a wide range of temperature, humidity and vibration.

The Skyfone has only three controls and separate dial scales to avoid confusion.

Additional details on the Skyfone are available from *Hallcrafters Company*, 2611 S. Indiana Avenue, Chicago, Illinois.

**RADIO INTERFERENCE FILTERS**

Sprague Products Company of North Adams, Massachusetts has recently announced a new line of Filterol Radio Interference Filters.

These units are small, completely self-contained units and are applicable to any electrical device within their ratings. They provide noise suppression throughout all broadcast bands. Designed for installation in series with the power line or interfering device, Filterols should be mounted on the frame of the device or in a grounded junction box as close to the device as possible.

Their basic circuit is a three terminal network of which the can is one terminal. Four available types include 115 v., a.c. or d.c. ratings from 1

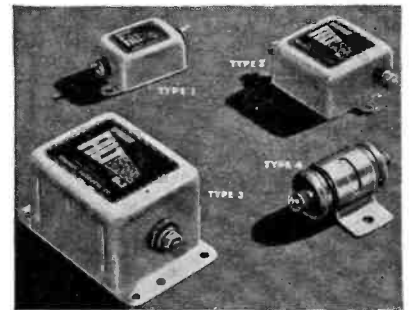

to 35 amperes, and one unit for 220 volts, a.c. or d.c. at 20 amperes.

Complete details of the new Filterol line will be furnished by *Sprague Products Company*, North Adams, Massachusetts.

**NEW SOLDERING IRON**

A patented, automatic feed, electric soldering iron, known as the "Eject-O-Matic" has recently been introduced by *Multi-Products Tool Company* of Newark, N. J.

This iron is trigger operated and ejects a measured amount of solder from a reel concealed in the handle. A special retracting feature prevents the melting of excess solder on the  
(Continued on page 80)

Terms: Full Payment with order or 25% deposit, balance COD. Include Postage  
Write DEPT W7 for FREE CATALOG of parts, sound equipment and accessories

**RADIONIC EQUIPMENT CO.**

("Chancellor Radio")

170 Nassau St., New York 7, N. Y.



# BE A TELEVISION TECHNICIAN!

## Regularly Scheduled Programs are on the Air!

Two great broadcasting corporations have entered Television and are today producing programs. Other large organizations have applied for licenses to broadcast Television in all parts of the country! The sale of home receivers is now progressing. In other words, we believe it's the beginning of a vast and exciting new business. Regular Television broadcasting is *now* a reality!

### TELEVISION AND YOU

The opportunity in Television is far greater for the properly trained man. You owe it to yourself to investigate Television and to prepare yourself to become a valued part of a fascinating new profession.

### PREPARE THE "AMERICAN" WAY

The American Television Institute is the oldest and largest training organization exclusively for Television. "American" students are trained by top Television engineers with the latest commercial equipment. You will train under actual Television studio conditions. You will learn by doing. You can qualify for your chosen field with the necessary fundamental knowledge plus real studio experience and skill.

#### VETERANS ATTENTION!

The American Television Institute has been approved for Veteran's Training under the G.I. Bill of Rights. During the war, thousands of Signal Corps men were trained under contract with the War Department. Our training methods have been developed to a high degree and our school has up to the minute facilities in every respect. If you are a veteran, mark the coupon for the G.I. Eligibility Questionnaire.

#### WHICH PHASE OF TELEVISION?

The American Television Institute's tremendous facilities offer a complete selection of Television study—broadcast studio and control, broadcast transmitter, receiver installation and service—in fact, all departments are thoroughly covered in our laboratories.

#### WHEN DO YOU START?

The best time is right now! Immediately! New classes are forming every week. Use the coupon to get further details. Mail it today!

## American Television Institute

DIVISION OF

AMERICAN TELEVISION LABORATORIES, INC.  
433 E. Erie Street Chicago 11, Illinois

**MAIL THE COUPON TODAY**

August, 1946

Studio Photos Courtesy of Television Station WCBW

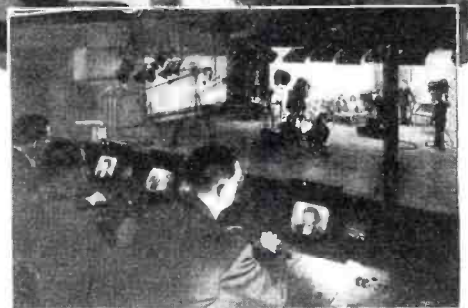

TELEVISION STUDIO CONTROL

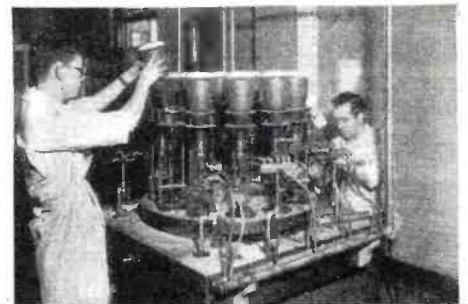

TUBE MAKING AT A.T.I.

#### REQUEST FOR FREE INFORMATION

AMERICAN TELEVISION INSTITUTE  
433 East Erie Street, Chicago 11, Illinois

- Please send me complete details of your Television training.
- I am a veteran.

NAME.....

ADDRESS.....

CITY & STATE.....

BUILD  
YOUR LINE  
AROUND

*Smooth  
Power*

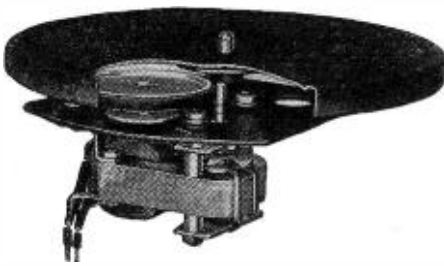

For quick starting, uniform speed and quietness, equip your new phonographs and record-changers with Smooth Power motors. From the wide and modern GI line, accurately and carefully built, you can select exactly the right motors for your needs.

Then you'll be sure of giving your customers that smooth, all 'round performance that builds good will... and sales. For motors you can always depend upon, standardize on Smooth Power.

★ ★ ★

NOTE TO INDIVIDUAL USERS:  
Smooth Power motors are sold only  
through established trade channels.



DEPT. MR • ELYRIA, OHIO

# Parts Lists

(FOR CIRCUIT DIAGRAMS APPEARING ON PAGES 64 AND 65)

## EMERSON—MODEL 519

Part No.	Code and Description
397000	$R_{13}, R_9$ —15 meg., 1/4 w. res.
321330	$R_2$ —3.3 meg., 1/4 w. res.
390010	$R_3$ —5 meg. vol. control
321130	$R_{41}, R_5$ —470,000 ohm, 1/4 w. res.
340290	$R_8$ —150 ohm, 1/2 w. res.
370490	$R_7$ —1000 ohm, 1 w. res.
310810	$R_6$ —22,000 ohm, 1/4 w. res.
340010	$R_{10}$ —10 ohm, 1/2 w. res.
397040	$R_{11}$ —15 ohm, 1 w., wire-wound res.
321050	$R_{12}$ —220,000 ohm, 1/4 w. res.
900160	$C_1, C_2$ —Two-gang variable cond. $C_3$ —Trimmer (Part of $C_1, C_2$ ) $C_4$ —Trimmer (Part of $C_1, C_2$ ) $C_5, C_6$ —Trimblers (Part of first i.f. trans.) $C_7, C_8$ —Trimblers (Part of second i.f. trans.) $C_9, C_{10}$ —0.02 $\mu$ fd., 600 v. cond. $C_{10}$ —0.01 $\mu$ fd., 600 v. cond. $C_{11}, C_{12}$ —0.2 $\mu$ fd., 400 v. cond. $C_{13}$ —0.0022 $\mu$ fd. mica cond. $C_{14}$ —1 $\mu$ fd., 200 v. cond. $C_{15}$ —0.5 $\mu$ fd., 400 v. cond. $C_{17}, C_{18}$ —30/50 $\mu$ fd., dual dry-elec. cond. $C_{19}$ —2 $\mu$ fd., 200 v. cond. $T_1$ —First i.f. trans. $T_2$ —Second i.f. trans. $T_3$ —Output trans. $T_4$ —Osc. coil

## RCA—MODEL 56X10

Part No.	Code and Description
30189	$R_1, R_{11}$ —120 ohm, 1/4 w. res.
30731	$R_2$ —1200 ohm, 1/4 w. res.
14583	$R_3, R_9, R_{12}$ —220,000 ohm, 1/4 w. res.
30492	$R_4$ —22,000 ohm, 1/4 w. res.
38785	$R_5$ —15 meg., 1/4 w. res.
12928	$R_6$ —3.3 meg., 1/4 w. res.
36242	$R_7, S_1$ —Vol. control & power sw. $R_8$ —4.7 meg., 1/4 w. res. $R_{10}$ —470,000 ohm, 1/4 w. res. $R_{13}$ —1200 ohm, 1 w. res. $C_1, C_{15}$ —0.1 $\mu$ fd., 1000 v. cond. $C_2, C_{16}$ —1 $\mu$ fd., 400 v. cond. $C_3, C_{28}$ —150 $\mu$ fd., mica cond. $C_4$ —56 $\mu$ fd. mica cond. $C_5, C_9, C_{20}, C_{28}, L_{12}, L_{15}$ —Second i.f. trans. $C_7, C_{11}$ —0.2 $\mu$ fd., 700 v. cond. $C_8$ —0.018 $\mu$ fd., 800 v. cond. $C_9$ —330 $\mu$ fd. mica cond. $C_{10}, C_{12}$ —0.05 $\mu$ fd., 600 v. cond. $C_{14}$ —0.35 $\mu$ fd., 600 v. cond. $C_{16}$ —22 $\mu$ fd., mica cond. $C_{17}$ —0.5 $\mu$ fd., 400 v. cond. $C_{17}, C_{18}$ —30/50 $\mu$ fd., 150 v. elec. cond. $C_{29}, C_{21}, C_{27}, C_{28}$ —Variable tuning cond. $C_{22}, L_3, L_4$ —Antenna coil $C_{23}, C_{24}, L_{10}, L_{11}$ —First i.f. trans. $C_{25}, C_{26}$ —190-260/450-600 $\mu$ fd. adjustable mica cond. $C_{27}$ —25 $\mu$ fd., 400 v. cond. $L_1, L_2$ —Antenna loop $L_3$ —Peaking coil $L_4, L_5, L_6, L_7$ —Osc. coil $S_2, S_3$ —Range switch $T_1$ —Output trans.

## FARNSWORTH—MODELS ET-064, ET-065, ET-066

Part No.	Code and Description
77216	1—220,000 ohm res.
77265	2—15,000 ohm res.
77211	3—4700 ohm res.
77266	4—22,000 ohm res.
77259	5—150 ohm res.
77261	6—470 ohm res.
77270	7—2.2 meg. res.
77273	8—6.8 meg. res.
77217	9—470,000 ohm res.
25215	12—1 $\mu$ fd., 600 v. cond.
25196	14—0.5 $\mu$ fd., 600 v. cond.
25195	15—0.2 $\mu$ fd., 600 v. cond.
25194	16—0.1 $\mu$ fd., 600 v. cond.
09130	18—Two-gang cond. & drive drum 19—47 $\mu$ fd. mica cond. 20—100 $\mu$ fd. mica cond. 21—240 $\mu$ fd. mica cond. 23—30/20 $\mu$ fd. elec. cond. 24—500,000 vol. control 26—Osc. coil assembly 27—First i.f. trans. 28—Second i.f. trans. 29—Output trans. 30—Speaker

## HOWARD—MODEL 901

Part No.	Code and Description
VC-0001	Vol. control & sw.
CV-0008	Tuning cond.
CE-0001	30/30/30 $\mu$ fd., 200 v. filter cond.
CE-0003	30/20 $\mu$ fd., 150 v. filter cond.
CE-0004	30/30 $\mu$ fd., 150 v. filter cond.
CE-0005	25 $\mu$ fd., 25 v. filter cond. (used with CE-0003 or CE-0004)
AN-0002	Antenna loop (for plastic cabinet)
LA-0001	Antenna loop (for wood cabinet)
LO-0014	Osc. coil
LI-0006	First i.f. assembly
LI-0007	Diode i.f. assembly

## WESTINGHOUSE—MODELS H-125, H-126

Part No.	Code and Description
V-3466	1—Loop antenna
V-3474	3—Variable capacitor 3A—Antenna tuner (Part of 3) 3B—Antenna trimmer (Part of 3) 3C—Oscillator tuner (Part of 3) 3D—Oscillator trimmer (Part of 3) 5—47 $\mu$ fd. cond. 6—47 $\mu$ fd. cond. 7—100 $\mu$ fd. cond. 8—1000 $\mu$ fd. cond. 10—470 $\mu$ fd. cond. 11—0.05 $\mu$ fd. cond. 12—0.25 $\mu$ fd. cond. 13—0.1 $\mu$ fd. cond. 15—0.4 $\mu$ fd. cond. 16—0.4 $\mu$ fd. cond. 17—10 $\mu$ fd. cond. 18—10 $\mu$ fd. cond. 19—20 $\mu$ fd. cond. 20—Electrolytic cond. 20A—50 $\mu$ fd., 150 v. elec. cond. (Part of 20) 20B—50 $\mu$ fd., 150 v. elec. cond. (Part of 20) 20C—20 $\mu$ fd., 25 v. elec. cond. (Part of 20) 21—Vol. Control & sw. 21A—Variable res. control (Part of 21) 21B—Control sw. (Part of 21) 22—Osc. coil 23—Trap coil assembly 23A—Coil (Part of 23) 23B—Trap trimmer (Part of 23) 29—Power cord 30—Westinghouse Type 47 pilot light 31—27 ohm, .5 w. res. 33—4.7 meg., .5 w. res. 34—180 ohm, .5 w. res. 35—1500 ohm, 1 w. res. 36—4700 ohm, .5 w. res. 37—15,000 ohm, .5 w. res. 38—33,000 ohm, .5 w. res. 39—2.2 meg., .5 w. res. 40—47,000 ohm, .5 w. res. 41—47,000 ohm, .5 w. res. 42—82,000 ohm, .5 w. res. 43—100,000 ohm, .5 w. res. 45—330,000 ohm, .5 w. res. 46—470,000 ohm, .5 w. res. 47—5" PM speaker 48—Output trans. 50—First i.f. trans. 51—Second i.f. trans.

## CROSLY—MODEL 56TK

Part No.	Code and Description
W-48858	1—Type 47 dial light
C-132300-1	2—Cable and power plug
AC-134618	3—Antenna loop assembly
AW-134994	4—Antenna coil assembly
AW-134993	5A, 5B—Two section osc. coil
AW-134065	6—First i.f. trans.
AW-134158	7—Second i.f. trans.
B-134995	8A, 8B—Two-section variable cond. 8C—Trimmer (Part of 8B) 9A, 9B—Two-section trimmer 10—580 $\mu$ fd., 300 v. mica cond. 11—50 $\mu$ fd., 500 v. mica cond. 12—0.5 $\mu$ fd., 200 v. cond. 13—1 $\mu$ fd., 200 v. cond. 14—0.5 $\mu$ fd., 200 v. cond. 15—220 $\mu$ fd., 500 v. mica cond. 16—3300 $\mu$ fd., 600 v. cond. 17A, 17B—60/20 $\mu$ fd., 150/100 v. elec. filter

RADIO NEWS

AS *Easy*  
AS THIS!

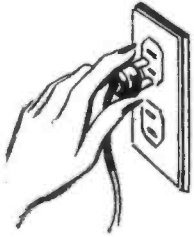

# Exclusive! New Type **CONCORD** AMPLIFIERS

with amazing  
**ADD-A-UNIT**  
features!

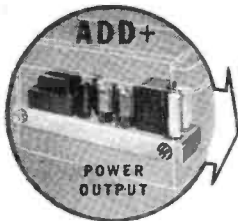
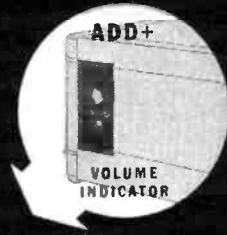
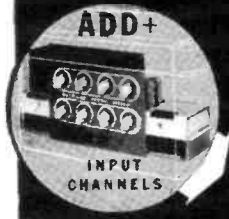

**Add any or all of these units in a SINGLE cabinet!**

Now available for **IMMEDIATE SHIPMENT**, the new, original and revolutionary Concord line of Multiamp Add-A-Unit Amplifiers and complete systems. Sets new high standards of flexibility, fidelity, performance, beauty and economy! 30 to 45 watt amplification increased, in a single cabinet, to 60, 75, or 90 watts *in minutes* with plug-in Add-A-Unit output stages—at minimum cost! Add two more input channels to total six channels if needed! Separate bass and treble tone-controls open a new world of tonal beauty and fidelity! Add a phono player, record changer, output indicator—any or all on the same Multiamp amplifier cabinet—eliminating extra space requirements and additional cabinet cost!

For every sound amplifier requirement, permanent installations or portable, the revolutionary, exclusive fea-

tures of Concord Multiamp Add-A-Unit Amplifiers, in complete systems or single units, offer the utmost in flexibility, perfection of performance and low cost.

**Immediate Shipment from CHICAGO or ATLANTA**

**Mail Coupon for New Complete Catalog — FREE!**

Your copy is ready now—featuring the exciting new Concord line of Multiamp Add-A-Unit Amplifiers and Accessories—plus Radio Sets, Phono-Radio Combinations—the latest, greatest complete selection of **RADIO PARTS, ELECTRONIC EQUIPMENT, TOOLS, AMATEUR GEAR, KITS and SUPPLIES**—every requirement for all radio and electronic use. Thousands of items—including nationally-known standard top-quality lines—money-saving prices. Mail coupon for your copy now!

# CONCORD

## RADIO CORPORATION

LAFAYETTE RADIO CORP.

CHICAGO 7  
901 W. Jackson Blvd.

ATLANTA 3  
265 Peachtree Street



CONCORD RADIO CORPORATION  
901 W. Jackson Blvd.  
Dept. E-86, Chicago 7, Ill.

Yes, rush **FREE COPY** of the comprehensive new Concord Radio Catalog.

Name.....

Address.....

City..... State.....

# AMPEREX ONE SOURCE FOR ALL TYPES

COMMUNICATION  
 INDUSTRIAL  
 RECTIFICATION  
 ELECTRO-MEDICAL  
 SPECIAL PURPOSE

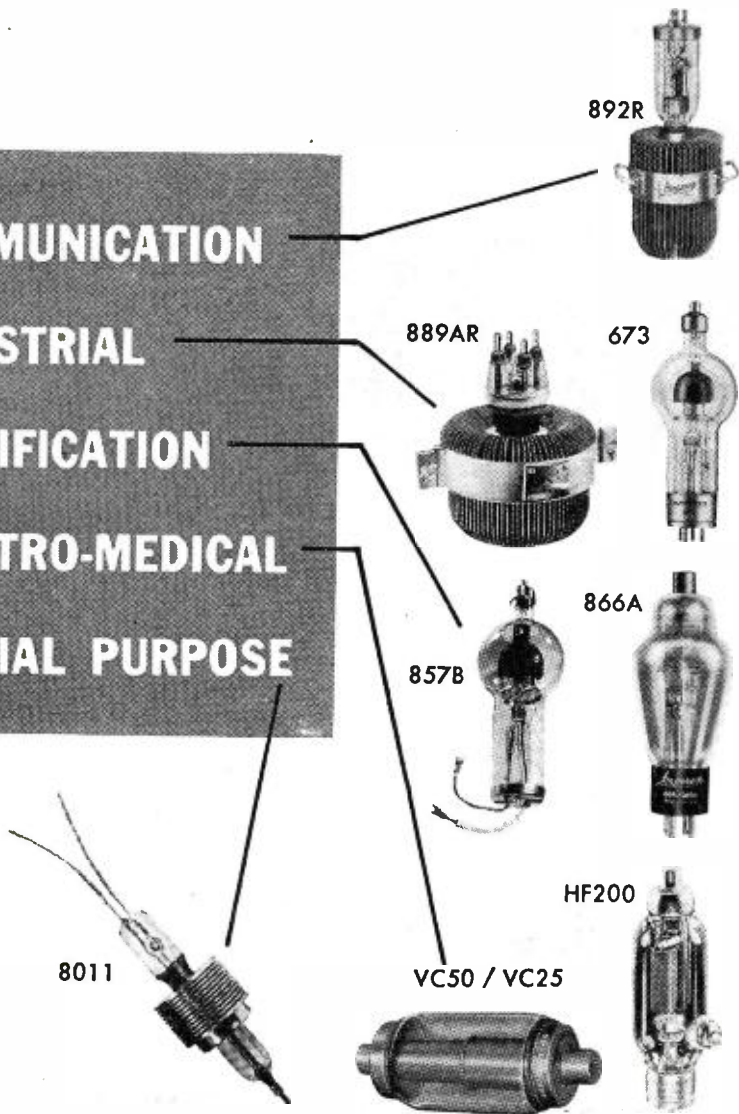

- 39001-63 18, 19, 20—.022  $\mu$ fd., 200 v. cond.
- 39281-29 21, 22—470,000 ohm,  $\frac{1}{2}$  w. res.
- 39281-8 23—150 ohm,  $\frac{1}{2}$  w. res.
- 39281-7 24—100 ohm,  $\frac{1}{2}$  w. res.
- 39281-28 25—330,000 ohm,  $\frac{1}{2}$  w. res.
- 39281-38 26—15 meg.,  $\frac{1}{2}$  w. res.
- 39281-21 27—22,000 ohm,  $\frac{1}{2}$  w. res.
- 39281-27 28—220,000 ohm,  $\frac{1}{2}$  w. res.
- 39281-34 29—3.3 meg.  $\frac{1}{2}$  w. res.
- 39281-23 30—47,000 ohm,  $\frac{1}{2}$  w. res.
- 39281-35 31—4.7 meg.,  $\frac{1}{2}$  w. res.
- 34—Antenna trimmer (Part of 3)
- 39281-11 35—470 ohm,  $\frac{1}{2}$  w. res.
- 39015-26 36—1200 ohm, 1 w. res.
- W-49772-3 37A, 37B, 37C—Three-section band change sw.
- B-134942 38—Speaker
- C-46846-6 39A, 39B—Volume control and sw.

-30-

## Meet the Microphone

(Continued from page 29)

distance results in an attenuation of the lower frequencies. For those interested, the loss in decibels for a given frequency,  $f$ , may be found from the formula:

$$10 \log_{10} \left[ 1 + \left( \frac{159,000}{fCR_c} \right)^2 \right]$$

where  $R_c$  is the load resistance in ohms and  $C$  the capacitance of the crystal together with the cable capacitance in microfarads.

Constructional features of the dynamic type microphone closely parallel those of the dynamic loudspeaker. Both utilize to good advantage a moving coil suspended within a magnetic field. In fact, amateur radio enthusiasts still continue to utilize small permanent magnet speakers as microphones.

When sound waves actuate the dynamic microphone diaphragm, causing the coil to vibrate proportionally, an alternating e.m.f. is set up in the magnetic field surrounding the entire unit. These weak voltages are then conveyed by means of special microphone cable to additional amplifying equipment.

An important factor to be considered insofar as remote broadcasts are concerned is equipment adaptability. Always a favorite with field broadcast engineers, dynamic type microphones are apt to be used for such diverse purposes as out-of-door stadium orchestral coverage; close range broadcasting including actual sound effects for emotional punch (ringside fights, hockey games, etc.) and oftentimes even with speech input equipment for portable field transmitters.

Certain types of dynamic microphones are said to have a rather uniform frequency response within the 40-9500 c.p.s. range. Furthermore, since the microphone in question is categorized as a low impedance device, it may be used, as mentioned before, with shielded microphone cable over considerable distances from its associated preamplifier. Couple this characteristic with mechanical ruggedness and you can easily see why it enjoys popularity with field personnel.

The velocity or ribbon type microphone (Page 28) as it is sometimes

## AND ALL OTHER IMPORTANT TYPES

More than two decades of creative research, precision manufacture and helpful service have given AMPEREX a unique position among specifying engineers and purchasing agents in all fields.

Distributors find this reflected in satisfactory volume and fast turnover.

Write for: Catalog; Technical Rating and Data Sheets

### AMPEREX ELECTRONIC CORPORATION

25 Washington Street, Brooklyn 1, N. Y., Cables: "ARLAB"  
In Canada and Newfoundland:  
 Rogers Majestic Limited, 672 Fleet Street West, Toronto 2B, Canada

AMPEREX



BETTER

# FM Reception

## AMPHENOL DIPOLE ANTENNAS

Amphenol Dipole Antennas and Dipole Antennas with Reflectors are engineered to provide excellent reception of FM even in zones of low signal strength.

The directional array virtually eliminates reflected signals, while building up required signal strength. The swivel feature on the mounting bracket and the mast head of the reflector types allows for tilting of the antenna plane to the optimum angle. An exclusive feature of all Amphenol FM Antennas is the Amphenol Twin-Lead low-loss transmission line from antenna to receiver.

## TWIN-LEAD TRANSMISSION LINE

A recent Amphenol innovation—a perfect parallel-line lead-in wire extruded with polyethylene dielectric. This low-loss transmission line is highly efficient, inexpensive and completely moisture-proof, and remains flexible at temperatures well below zero. Twin-Lead is manufactured in three impedances that cover requirements for all Broadcast, FM and Television reception.

- 300 OHM provides best impedance match for FM and Television.
- 150 OHM is for experimental work and other special applications.
- 75 OHM is best suited to match a 1/2 wave element and should be used where receiver input impedance is 75 ohms.

**AMPHENOL**

**AMERICAN PHENOLIC CORPORATION**  
CHICAGO 50, ILLINOIS  
In Canada • Amphenol Limited • Toronto

COAXIAL CABLES AND CONNECTORS • INDUSTRIAL CONNECTORS, FITTINGS AND

CONDUIT • ANTENNAS • RADIO COMPONENTS • PLASTICS FOR ELECTRONICS

# LEOTONE MONTHLY SPECIALS

**TUBES:** Perfect condition, but not in sealed cartons. Guaranteed for 90 days. #26, 27, 41, 46, 56 & 616, 22c; #42 & 71, 49c; #6K7, 6V8 & 6L6, 39c; #50, 120 & 6A3 ..... \$0.69

**SWITCHES:** "Acro-Snap" Momentary SPDT, 2 oz. Pressure, pin type 10A/115V. Bakelite, 2"x $\frac{1}{2}$ "x $\frac{3}{8}$ ". With external lugs ..... .39

**DPDT TOGGLES** (H & H). 6 lugs, 6A/125V. split ball ..... .39

2mmfd-1200PV bakelite mica condensers ..... .29

20mmfd-200V tubular electrolytics...6 for 1.00

**RADIOMEN'S HARDWARE;** approx. 1000 screws, nuts, lugs, washers, etc., in handy metal box ..... .49

18" N.B.C. RECORDINGS. Each contains 2 complete 15 min. programs. Such titles as: STORY AT STAVELOT, COMBAT CREW, PHILIP. FINE RETURN, GUNNERS WITH WINGS, I'LL NEVER FORGET plus numbers & others. 33 $\frac{1}{3}$  RPM ..... EACH 29c

Govt. F.M. technical manual, 49 diagrams, 86 illus., 240 pp. .... .39

**I.R.C. POWER RHEOSTATS:** wire-wound, with pointer knobs & hardware—25 watt—15, 25, 75, 130, 250, 370, 1250 or 4000 ohms ..... .69

50 watt—40, 50, 100, 250 or 550 ohms ..... .98

**EXPERIMENTAL TUBES,** varied sizes & base types. Filament tested. 20 for.... 1.00

**AC-DC Pocket Tester Multimeter.** Ranges incl.: AC volts—0/15/150; DC volts—0/30/300/1500; DC M.A.—0/150; Ohms—0/3000/300,000 meter, rectangular black crackle finish case. 5 $\frac{1}{2}$ "x3"x1 $\frac{1}{2}$ " ..... 15.95

## ALNICO MAGNETS

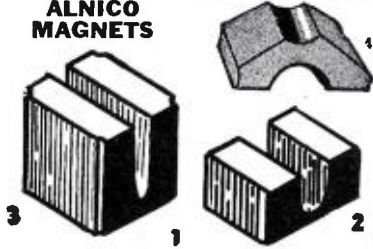

#1—Bar, 8 $\frac{1}{2}$ "x $\frac{1}{4}$ "x $\frac{1}{8}$ " ..... \$0.39

Bar in shorter lengths, per inch ..... .12

#2—Polished, 7 $\frac{1}{8}$ "x9/16"x $\frac{3}{8}$ " high ..... .35

#3—Face 3 $\frac{1}{4}$ "x5 $\frac{1}{8}$ "x $\frac{3}{8}$ " high ..... .39

#4—Face 1 $\frac{1}{4}$ "x1 $\frac{3}{4}$ "x $\frac{7}{8}$ " high ..... .98

#5—Heavy duty bar, 2 $\frac{1}{2}$ "x1 $\frac{3}{8}$ "x5/16" ..... 1.29

#6—Polished bar, 9/16"x $\frac{1}{4}$ "x $\frac{1}{8}$ "... 20 for 1.00

**SHUNTS—MULTIPLIERS,** Weston & IRC 1% precision, wire-wound: 881, 24.5, 50, 90, 3300, 3400, 3998, 8800, 13,000, 50,000 ohms ..... .35

Dual units: 5.33/9.67; 2320/2880; 2500/2500; 15K/15K; 25K/30K ohms ..... .49

Weston 1% Precision resistors: 133K, 164.5K, 226.8K, 430K, 500K, 800K; 3 & 4 meg 12 for ..... 1.50

**BAKELITE PANELS:** 1 $\frac{1}{2}$ " Glossy brown, 7"x10" ..... .59

7"x14"—69c; 7"x18"—85c; 9"x14"—1.10

1 $\frac{1}{2}$ " brown linen, 13 $\frac{1}{2}$ "x13" or 23 $\frac{1}{2}$ "x11" ..... 1.10

Output coupling coils (P.P.807a), Adj. tickler & iron core. Frequency ranges (M.C.): 1.3-2.1; 2.1-4; 4-5.3; 5.3-7; or 7-9.1 ..... Each .49

**SERVICEMEN'S KITS:** #1—10 asstd. antennas, R.F. & oscillator coils ..... \$ .98

#2—Speaker cones; 12 asstd., 4" to 12", moulded & free edge. Less voice coil ..... 2.00

#3—Bakelite mica condensers; 50 asstd., .0001 to .05mfd. Clearly marked ..... 2.95

#4—Tubular by-pass condensers; 50 asstd., .001 to 25 mfd; 200-600V. Clearly marked ..... 2.49

#5—Electrolytics; 10 asstd., including multi-section & can types ..... 2.98

#6—Dial scales; 25 asstd. airplane & slide rule (acetate & glass included) ..... 2.98

#7—Escutcheon plates; 25 asstd. airplane, slide rule & full-vision types ..... 2.95

#8—Knobs; 25 asstd. wood & bakelite, (set-screw & push-on) ..... 1.00

#9—Voltage dividers; 10 asstd. standard multi-tapped; high wattage included ..... 1.98

#10—Wafer sockets; 12 asstd. 4 to 7 prong ..... .25

Better Prices on Quantity Purchases  
Prompt Service on All Speaker & Phono Pick-up Repairs  
Minimum Order \$2.00—20% Deposit Required on All Orders  
Please Add Sufficient for Postage



MAKERS OF CONES AND FIELD COILS  
65-67 DEY STREET, NEW YORK 7, N.Y.  
WORTH 2-0284-5  
12,000 SQ. FT. OF RADIO PARTS

called, derives its name from its principle of operation which is based upon a pressure difference existing between the front and back of the microphone's ribbon. Its construction is so arranged that sound waves have easy access to this ribbon, which consists of a thin corrugated metallic strip freely suspended within a magnetic field.

This strip or ribbon must be made of very light material in order that its motion may conform to the motion of the air, even at high frequencies. With regard to the low frequencies the resonant frequency of the ribbon is made somewhat lower than the lowest audio notes to be reproduced.

Acoustical waves generate an e.m.f. by vibrating the ribbon back and forth in the magnetic field. This e.m.f. in turn appears between the opposite ends of the ribbon whereupon it is fed to a small transformer located within the microphone housing.

Perhaps the most important feature of a velocity type microphone is its bi-directional pickup characteristic. Maximum effect is therefore achieved when sound waves from either direction approach along an axis perpendicular to the plane of the ribbon. Its frequency response extends well into, and somewhat above, the 10,000 c.p.s. range.

Velocity microphones can be utilized to good advantage for over-all coverage with the aid of a microphone boom. The best response is obtained by experimentation, involving the raising or lowering of the boom with corresponding angular adjustments at the microphone itself. After positioning has been determined, both microphone and boom remain fixed for the duration of the broadcast (Fig. 2).

Acousti-mechanical features of the cardioid or polydirectional type of microphone reveals an interesting and quite ingenious arrangement of both dynamic (moving coil) and ribbon (velocity) principles of operation. A suitable combination of these elements results in a cardioid or heart shaped pickup pattern.

A microphone of this type, in addition to its cardioid characteristic, may also be used as either a dynamic or ribbon type transducer which is but another indication of its unique adaptability to the everyday demands of contemporary broadcasting. Published specifications list a frequency response



Shure Brothers "Stratoliner" dynamic microphone of rugged construction for heavy duty.

of from 40-10,000 c.p.s. with but little deviation.

With the advent of FM as a transmitting medium, together with the future possibility of its replacing AM as the public becomes increasingly aware of higher fidelity, entirely new methods of microphone technique become necessary.

For instance, in order to reduce to a minimum articulation noises, sibilance, etc., it might well be that the vocalist of the future may have to perform at greater distances from the microphone. As for orchestral shows where we often have a heterogeneity of background noise, we may as well forget it for the present and leave the problem of studio noise disposal together with a generous supply of aspirin to future FM engineers.

## REFERENCES

Hanson, O. B., "Microphone Technique in Radio Broadcasting", Acoustical Society of America Journal, July, 1931.

Ballantine, Stuart, "High Quality Broadcasting", Proceedings of the I.R.E., May, 1934.

Marshall, R. N., "A Cardioid Microphone", Bell Laboratory Record, July, 1939.

Radio Corporation of America, "Radio-tron Designers' Handbook", pages 77-80.

Terman, F. E., "Fundamentals of Radio", pages 440-444. McGraw-Hill Book Company, New York.

Note: Derivation of the chart in Fig. 1 through the courtesy of the I.R.E. The original appeared in "High Quality Broadcasting" by Stuart Ballantine, Proceedings of the I.R.E., Vol. 22, page 576, May, 1934.

-50-

Fig. 3. Open circuit frequency response of a typical 44BX velocity microphone.

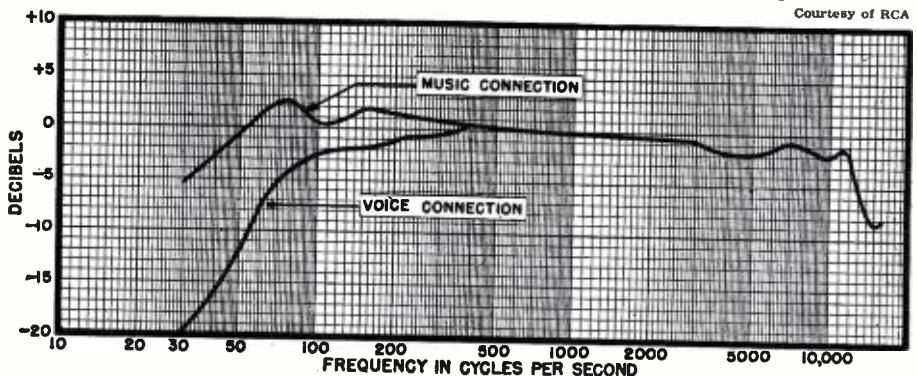

# Liberty RADIO and PHONOGRAPH Kits...

## 6 Tube "Super Het" Radio Kit

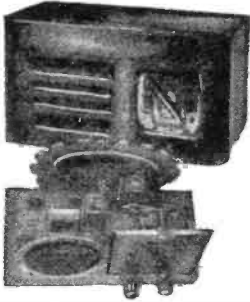

COMPLETE, INCLUDING ATTRACTIVE WALNUT CABINET  
All Parts Mounted  
To assemble, all one needs is a soldering iron and 30 minutes of your time.  
Uses one 25L6—one 25Z6—one 6SQ7—one 6SK7—two 6SJ7's or one 50L6—one 35Z5—two 12SJ7's—one 12SQ7—one 12SK7.  
YOUR COST **\$16.95** LESS TUBES WIRE-SOLDER

## 5 Tube "Super Het" Radio Kit

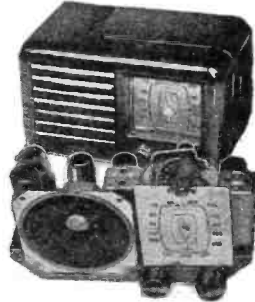

COMPLETE, INCLUDING ATTRACTIVE BROWN BAKELITE CABINET.  
All Parts Mounted  
APP SIZE 9x5x6 Inches  
Uses one 25L6—one 25Z6—one 6SA7—one 6SQ7—one 6SK7 or one 50L6—one 35Z5—one 12SA7—one 12SQ7—one 12SK7.  
YOUR COST **\$13.95** LESS TUBES WIRE-SOLDER  
Cabinet supplied in white at \$1.00 extra

## Portable Phonograph Kit



ATTRACTIVE COVERED CABINET COMPLETE WITH MOTOR — PICK-UP — AMPLIFIER  
SIZE: 14 x 7½ x 19  
TONE AND VOLUME CONTROLS  
Uses one 25L6—one 25Z6—one 6C5.  
YOUR COST **\$24.95** LESS TUBES WIRE-SOLDER

### PICTORIAL DIAGRAM FURNISHED WITH EACH KIT

We carry a complete line of Radio Parts and Equipment—Contact Department "A" for all items including the "Hard to Procure"

## IMMEDIATE DELIVERY • TERMS 10% Deposit with order. Balance C. O. D.

### SPECIAL! 5 Tube Super Heterodyne Radio Kit with SLIDE RULE DIAL

### LATEST POST-WAR APPROVED SIGNAL GENERATOR Model A 100

Here it is at last the 1946 Precision Built Instrument you've been waiting for. The Model A-100 Signal Generator is mounted in a heavy gauge steel cabinet, battle-ship grey crackle finish. Complete with 11 tubes, connecting cables and instructions — only \$47.00 F.O.B. New York City. Dimensions: 12" x 10" x 6½". Shipping weight: 18 lbs. Multicolor Frequency Dial Scales (Non-glare design). External Modulation possible at from 40 to 30,000 Cycles. Internal Modulation at 440 Cycles (same as S.W.V. Standard). Phase Shift Audio Oscillator and Internal Modulator.

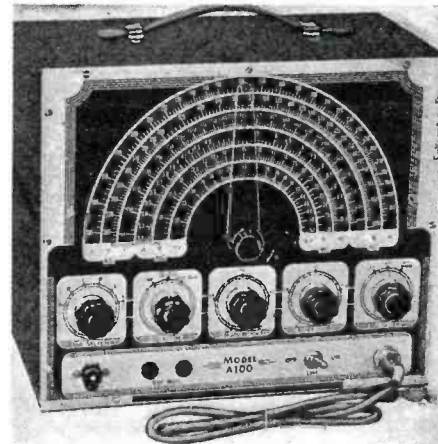

6 RF Bands  
A—100 to 310 Kc.  
B—320 to 1000 Kc.  
C—1000 to 3200 Kilocycles  
D—3.2 to 10.5 Mc.  
E—10.5 to 26 Mc.  
E2—21 to 52 Mc.  
A.C. Operation 105 to 120 Volts 50 to 60 cycles. Continuously Variable RF-AF Fine Attenuator Control. Co-Axial Output lead furnished. Pilot light indicator. Modulation Percentage continuously variable from front panel, internal or external 0 to 100%.

**\$47.00**



Chromium plated chassis—Beautiful Walnut Cabinet—Built in antenna — Dimensions: 6½" x 7½" x 12¾".

Uses the following tubes: one 12SA7 one 12SK7 one 12SQ7 one 50L6 and one 35Z5

Pictorial Diagram furnished

Your Cost **\$19.95** Less Tubes Wire Solder

### AN EXCEPTIONAL VALUE

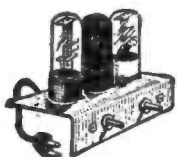

3 tube A.C. D.C. Phone Amplifier Kit—less tubes, with speaker—uses 6C5—25Z6—25L6—your cost

**\$5.95**

INVERTERS  
Converts D.C. Current to A.C. Cap. to 50 W.  
YOUR COST \$10.75 EACH

### RECORD CHANGER

Complete with motor and pick-up. Fully Guaranteed.

List, \$37.50  
Your Cost \$22.50

### AUTO RADIO ANTENNA

Chromium plated Steel  
Fits all models  
66" ..... \$3.90  
72" ..... \$4.50  
96" ..... \$6.25  
110" ..... \$7.25  
Less 40%.

### IMMEDIATE DELIVERY

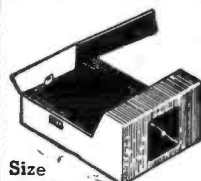

Size 7x14½x18 inches

Portable Leatherette Cabinet for Electronic Phonograph.

**\$7.75**

# LIBERTY SALES CO., INC.

115 WEST BROADWAY  
NEW YORK 13, N. Y.  
BARclay 7-6063

**NOT MERELY AS GOOD AS THE OTHERS  
... BUT BETTER THAN ALL OTHERS!**

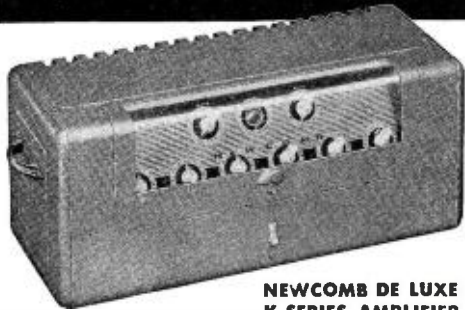

**NEWCOMB DE LUXE  
K-SERIES AMPLIFIER**

**SIMPLIFIED ... CONTROLLED OPERATION**

... The Newcomb clear-view, plastic keylock control panel cover prevents unauthorized misadjustments. An expert may adjust controls and lock them in. An outside power switch turns system on and off. No curious "dial-twister" can disturb its operation.



**T**HE KEYLOCK cover is another of the many features that make the name Newcomb outstanding in the sound equipment field. Designed for the postwar quality market, Newcomb amplifiers are unexcelled in the true reproduction of music and voice. Without reservation... Newcomb sound equipment will give finer, longer, more trouble-free service than any other system on the market today. Write for information.

T H E S O U N D O F Q U A L I T Y

*Newcomb*  
**AUDIO PRODUCTS CO.**  
MANUFACTURERS  
DEPT. F 2815 S. HILL STREET, LOS ANGELES 7, CALIFORNIA

**Available at Last!**  
**YOUR FIRST POST WAR APPROVED ELECTRONIC SIGNAL GENERATOR**

Scale readings from 100 K.C. to 52 M.C. with ultra stability. Housed in Grey Crackle Heavy Gauge Steel Cabinet with Large, Easy to read Dial Scale.

Complete with tubes, cables (including co-axial output lead), and complete operating instructions.  
Your price . . . . .

**\$47<sup>00</sup>**

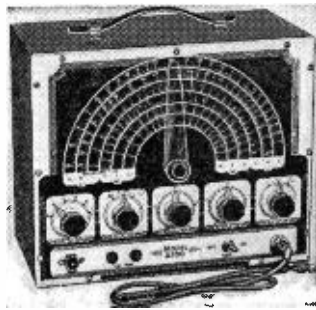

**Crowe Modern Slide Rule Dials**

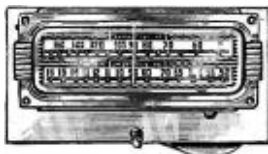

Escutcheon with Crow-glass Crystal antique bronze finish Complete with pilot light sockets.

Model 341—\$3.60 ea.	Overall Dim.
Model 339— 3.18 ea.	3 1/4" x 8 1/4"
Model 534— 1.47 ea.	3 1/4" x 6 1/4"
	2 1/4" x 4 1/4"
	Inside Dim.
Model 535—\$1.74 ea.	1 1/4" x 5 1/4"

We have in stock a complete line of radio tubes for immediate delivery. Quantity limited. All orders accepted subject to prior sale.

**Special Values!**  
**Attractive WALNUT Replacement CABINETS**

Attractive Walnut Replacement Cabinets for table model radios. Inside dimensions 14 1/4" x 7 1/4" x 6". \$3.49 each. \$3.35 in lots of 5 or more

**Standard 4 PRONG  
Universal Replacement Vibrators  
A Real Buy! While they last \$1<sup>49</sup>**

We carry a full line of Auto Radio accessories, including Aerials, Control heads, fuses, connectors and fuse holders.

Write for our new, post-war catalog

**RADIO PARTS COMPANY** 612 W. RANDOLPH  
Dept. N  
CHICAGO 6, ILLINOIS

Very little wear was evident. It would appear that an operating life of about four years of normal use could be expected.

The "Q" or figure of merit of a crystal is governed by its series resistance and capacitance at its frequency of resonance and may be determined from the formula:

$$Q = \frac{1}{2\pi f C_1 R_1}$$

where:  $f$ , is the resonant frequency of the crystal.

$R_1$  is the series resistance of the crystal.

$C_1$  is the series capacitance of the crystal.

Metallized or plated crystals possess several important advantages which make them most desirable for use with this holder as in general they have a higher "Q," higher activity, key better, and, because of the elimination of the electrodes, have less weight. The latter advantage then makes them more resistant to shock and vibration.

It is common practice to have metallized crystals conform to the Signal Corps CRAI Specifications of -40 to 70 degrees centigrade, .02 per-cent tolerance. For amateur use, metallized crystals as used in the Deka-Xtal Holder are finished to plus or minus 1 kc. in the frequency range 3500 to 9500 kc.

As metallized crystals have two separate plated surfaces on each crystal, they are supported in the holder by clips, each crystal having two clips, each clip contacting a separate plated surface. Each clip is soldered to its individual base pin which, in turn, makes contact with the two contactors of the rotary switch.

The positioning of the crystals in the clips and in the cap of the holder is such that they cannot shift about, move out of the clips and thus intermittent contact is very unlikely.

The plating of the crystals was also subjected to several severe tests including tape, boiling water, etc.

As one of the advantages gained from this holder is that of compactness, it was decided to make a comparison of the weights of the holder fully loaded with ten plated crystals and ten of the FT-type holders with crystals. It was determined that this holder weighed 1 1/2 ounces, while the ten FT-type crystals weighed 6 ounces.

It appears that this advantage of compactness and weight saving would be welcomed in aviation radio equipment.

For the amateur, the chief advantage gained from this multiple holder would be its lower cost as compared to that of ten FT-type holders and crystals.

In the commercial field, several new applications present themselves where the features embodied in this holder could simplify controls, speed up operation and aid in the general design of equipment.



# Re-new with N. U. BATTERIES



## Get Immediate Deliveries of All Types for Standard Radio and Other Replacements

Replacements for over 400 competitive types are now available in the top quality National Union Dry Battery line. The 26 N. U. Types give you *quick service coverage* for the portable and personal sets, farm radios and flashlights you will be called upon to recondition. Now is the time to display and sell N. U. Batteries—attract a flood for profitable service and parts business.

In batteries as in other products, N. U. quality helps you build for the future. The patented construction of N. U. Batteries permits more active materials—more service hours per dollar. Every N. U. Battery is engineered to the highest initial equipment standards and is designed for universal replacement.

PLACE YOUR BATTERY  
ORDER TODAY  
... WITH YOUR  
N. U. DISTRIBUTOR

Renew with N. U. ... the quality line that brings repeat sales at full profit to radio service men!

NATIONAL UNION RADIO CORPORATION, Newark 2, New Jersey

## NATIONAL UNION RADIO TUBES AND PARTS

Transmitting, Cathode Ray, Receiving, Special Purpose Tubes - Condensers - Volume Controls - Photo Electric Cells - Panel Lamps - Flashlight Bulbs

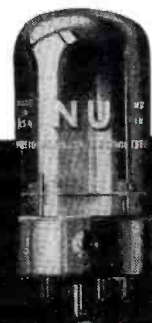

**Standard**  
HAS IT  
**IN STOCK!**  
FOR AT ONCE DELIVERY  
**ORDER NOW**

**SELSYN**  
Transmitter and Indicator Set



Indicator mounted in attractive grained wood cabinet. Furnished with 5 feet of 4 conductor cable, disconnect plug and socket and wiring diagram. Operates on 6 volts AC.

COMPLETE AS SHOWN  
**3.50**

Size 4 3/4" deep x 6" wide x 10" high

**SIMPSON**  
MODEL 260

"HIGH SENSITIVITY"  
MULTIMETER for television and radio servicing. 20,000 ohms per volt.



**33.25**

Carrying Case 4.75

**ADJUST-A-VOLT**

1/2 K. W. Isolation Transformer



- keeps AC-DC chassis neutral to ground.
- keeps AC-DC chassis neutral to grounded test equipment.
- lowers voltage to check intermittent oscillators.
- raises voltage to "pop" out stubborn intermittent parts.
- regulates voltage to service bench.
- boosts line voltage to portable P. A. systems.

115V. 70-140V

ONLY **23.50**

AC VOLTMETER  
Westinghouse 3" round flush mtg.  
0-150 Volts AC.

**4.50**

TEAR OUT AND MAIL NOW TO

**SREPCO**

STANDARD RADIO & ELECTRONIC PRODUCTS CO.,  
135 East Second Street, Dayton 2, Ohio

Please ship at once: (RN 8)

- \_\_\_\_\_ SELSYN SETS
- \_\_\_\_\_ SIMPSON MODEL 260 MULTIMETERS
- \_\_\_\_\_ ADJUST-A-VOLT TRANSFORMERS
- \_\_\_\_\_ AC VOLTMETERS

Name \_\_\_\_\_  
Address \_\_\_\_\_  
City \_\_\_\_\_ State \_\_\_\_\_

**MAIL ORDERS GIVEN PROMPT  
ATTENTION! WRITE US FOR  
INFORMATION ON ALL PARTS  
20% DEPOSIT ON ALL MAIL ORDERS**

**Cathode Follower for  
Power Amplifier**

(Continued from page 54)

The amplifier when finished should be turned on, and the bias adjusted to 25 volts with the 6L6 tubes out of the sockets. Then plug in the tubes and connect the speaker and a radio or pickup. The improvement in fidelity will be immediately noticeable. The speaker that was used was of the eight dollar, 12-inch type for light duty service, mounted in a Jensen 15-inch bass reflex baffle. It gave results comparable to a 15-inch unit because of the low output impedance of the cathode followers.

These cathode followers provide a fertile field for experimentation and even if an old power transformer is used for an output transformer the results will be gratifying, and considerably superior to one built using inexpensive transformers. A medium priced speaker will be transformed into a much better sounding one. Sounds like something for nothing, doesn't it? Well it is.

-50-

**What's New in Radio**

(Continued from page 68)

heating tip. The amount of solder deposited each time the trigger is pulled is regulated by a micrometer adjusting wheel mounted in the handle of the iron which is easily accessible to the operator's thumb.

The tool which is equipped with a



molded bakelite pistol-grip handle weighs 1 1/4 pounds loaded.

Additional information, including prices, will be furnished by *Multi-Products Tool Company*, 123 Sussex Avenue, Newark, New Jersey.

**SIGNAL TRACER**

An ingenious test unit, the Precision Electronic Model 200, has been introduced by *Radolek Company* of Chicago.

This instrument permits the serviceman to "listen in" on a signal at any point in the radio receiver. A polystyrene tipped probe feeds the signal from the r.f., i.f. or a.f. stages into a high gain amplifier, equipped with a PM speaker. A lack of signal or other abnormal condition immediately localizes the trouble.

Because extremely low capacity coupling is used in this unit, the tracer

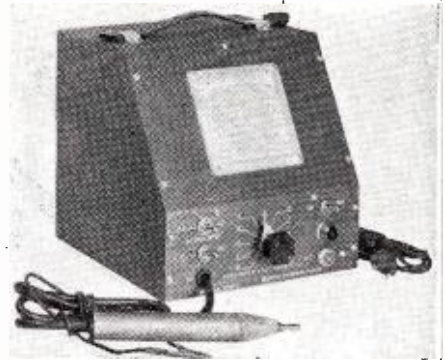

probe does not disturb the operating characteristics of the circuit.

The tracer may also be used for locating r.f. and i.f. coil troubles, for checking performance of tuning condensers, for analyzing the condition of resistors and checking paper and mica condensers. Microphonic tubes and bad speakers, defective volume controls and transformers may all be spotted with this unit.

Operation is from the regular 110-120 volt a.c. line. Additional information and price data on this unit will be furnished by *Radolek Company*, 601 W. Randolph Street, Chicago 6, Illinois.

**MICROWAVE EQUIPMENT**

Of interest to amateurs is the new lightweight microwave equipment, including an oscillator and a miniature intensity meter, which has been announced recently by the Specialty Division of *General Electric Company*.

Polarization, reflection, standing waves, refraction and other characteristics of light may be studied by means of the microwave equipment which radiates waves of about five inches. It can be used to demonstrate the fundamentals of radio and new methods of radio communication. The complete unit weighs only four pounds and utilizes the "lighthouse" tube. The unit's oscillator cavity is mounted directly on a small case containing a transformer and attenuator and bears a dipole antenna and 8-inch reflector. Completely self-contained and portable, the unit operates directly from 110 volt, 60-cycle a.c.

The microwave oscillator projects a well-defined radio beam of 2400 mc. for a distance of several feet. The intensity meter consists of a new radar-developed crystal detector and microammeter.

Additional information on this unit will be furnished upon request to *General Electric Specialty Division*, Wolf Street Plant, Syracuse, New York.

**RESISTANCE COMPARATOR**

*Clippard Instrument Laboratory, Inc.*, of Cincinnati has announced the availability of a new production electronic measuring instrument, the *Clippard Automatic Resistance Comparator* type PR-4.

Operation of this unit is extremely simple and consists of connecting a standard resistor across the "Stand-

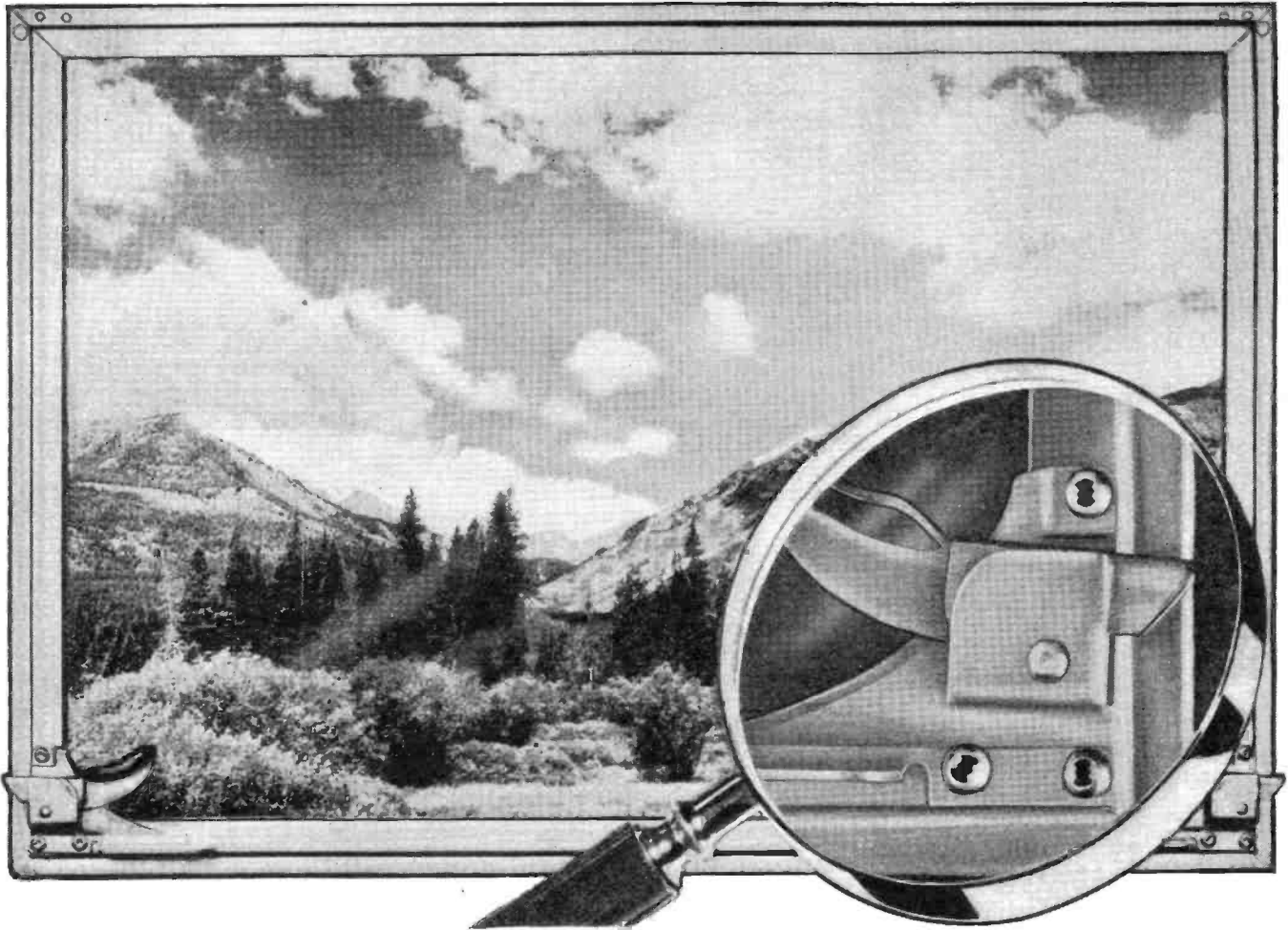

TYPE "A"  
ASSEMBLY BIT

COMMON  
SCREW DRIVER

## Clutch Head Screws

### By-pass Skid Damage for Excel Corporation

At this Elkhart, Indiana, plant the manufacture and assembly of steel window sash for Transcontinental, City, School and other types of bus transportation is on a production basis.

**Excel Corporation says:** "We have found many advantages since standardizing on CLUTCH HEAD Screws:

- We have definitely increased production.
- We have by-passed damage to the painted surface through driver slippage.
- We feel that the surer driving with CLUTCH HEADS is an important safeguard against injury to our operators.
- Simplified operation with an ordinary screwdriver has freed us from complaints regarding field-servicing difficulties.
- The longer life and easy reconditioning of the Type "A" Bit reduces tool cost and saves time."

#### Non-Tapered Driving

All-square contact of screw and bit eliminates "ride-out" for safer, easier driving. A 60-second application of the end surface to a grinding wheel repeatedly restores this Type "A" Bit to original efficiency.



#### No Servicing Problems

because CLUTCH HEAD is basically designed to operate with any common screwdriver which need only be reasonably accurate in width. Thickness of the blade is a secondary consideration.

**UNITED SCREW AND BOLT CORPORATION**

CLEVELAND 2

CHICAGO 8

NEW YORK 7

\*  
Antenn-gineered  
by  
**SNYDER**



THE  
*Cosmopolitan*

AUTO-RADIO  
ANTENNA

© COPYRIGHT 1946

**SNYDER**

MANUFACTURING CO.

PHILADELPHIA 40, U. S. A.



ard" terminals, snapping the power switch, warming up the instrument and adjusting to zero. The operator places resistances to be checked across the "Unknown" spring-tongue terminals in the center. The face of the large, inclined, easy-to-read meter at the center of the unit then illuminates and reads in per-cent of variation from the standards within the limits of -25% to +30%.

Complete details and further information on this unit will be furnished by *Clippard Instrument Laboratory, Inc.*, 1440 Chase Avenue, Cincinnati 23, Ohio.

**CAPOHMIST**

*Special Products Company* has recently developed a new capacitor and resistor substitution box for radio repair work which is known as Speco Capohmist.

According to the company this unit permits the substitution of one of 22 principal values without the need for replacing individual resistors or capacitors in diagnosing radio trouble. The operator merely locates the proper values on the dial, then clamps the ends of the lead wires from the Capoh-



mist to the radio in order to see whether the indicated part is operating or defective.

Additional information on this unit will be furnished by *Special Products Company*, Silver Springs, Md.

**RAILROAD ANTENNA**

*American Phenolic Corporation* of Chicago has recently developed a broadband 160 mc. ground plane antenna which was designed to meet the requirements of railroad service for two-way communication between trains and fixed stations, and end-to-end service.

The antenna utilizes the metal top of the car for its ground plane. It is fed by armored 52 ohm coaxial

transmission line. The radiation pattern in the horizontal plane is circular in shape and the voltage standing wave ratio is less than 1.5 to 1 from 152 to 162 mc. The gain of the antenna is .5 db. less than a dipole.

In mounting, the armored transmission line may be mounted from the top of the base or may be brought up through the car roof and antenna base.

Additional details will be furnished by the Antenna and R.F. Components Division, *American Phenolic Corporation*, Chicago 50, Illinois.

**SIGNAL GENERATOR**

Production on a new crystal controlled signal generator has begun at the Cleveland, Ohio plant of *Hickok Electrical Instrument Company*.

Designed for the radio engineer and the serviceman, this unit has a wide range of a.f. and r.f. frequencies.

The unit features complete AM coverage from 100 kc. to 110 mc. and



FM coverage from 100 kc. to 160 mc. with three variable bandwidths of sweep, 0-30 kc., 0-150 kc. and 0-450 kc.

This signal generator features frequency modulation at two self-contained modulating frequencies, 60 cycles and 400 cycles, and provision is also made for external frequency modulation to 15,000 cycles. Self-contained amplitude modulation at 400 cycles is featured along with provision for external amplitude modulation to 15,000 cycles.

Additional data on this unit will be furnished upon request to *Hickok Electrical Instrument Company*, 10523 Dupont Avenue, Cleveland 8, Ohio.

**VHF TRANSMITTER KIT**

*Hytron Radio & Electronics Corporation* has recently announced the availability of a new stable v.h.f. linear oscillator in kit form.

Known as the Hy-Q 75, this kit contains all of the components necessary and may be assembled in an hour with pliers, screwdriver and soldering iron. All parts are ready to be used and need no adjusting or testing.

A pictorial wiring diagram and an easy-to-understand instruction manual make the assembly simple. A chart permits rapid location of the amateur bands. Quick band changing from 1 1/4 to 2 meters is possible by adjusting the

**RADIO NEWS**



LARGEST STOCK OF RADIO TUBES IN AMERICA  
WE SHIP ANYWHERE IN THE WORLD

**RADIO CORPORATION**

# FLANAGAN



## RADIO TUBES

STANDARD BRANDS ALL GUARANTEED

SEND FOR PRICE LIST OF ALL AVAILABLE TUBES. WE EITHER HAVE IT IN STOCK OR CAN GET IT FOR YOU.

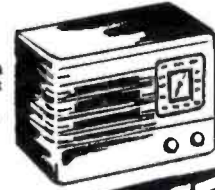

## RADIO SETS

5-TUBE SUPERHET  
BUILT-IN LOOP ANTENNA

## PHONO AMPLIFIERS

## RECORD PLAYERS RECORD CHANGERS

Beautiful Portable Case  
3 Tubes  
Volume and Tone Control



V. M.  
2-POST AUTOMATIC

Brand New—Sealed Carton. Only at Flanagan's at This Low Price.

Plays 10" & 12" Records Mixed. Crystal Pickup.

**\$21<sup>88</sup>**

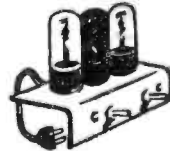

3-TUBE  
AC-DC

Completely Wired, with tubes and ready to operate. Uses a dynamic speaker. 450 ohm field. Complete with tubes, less speaker.

Only **\$7<sup>44</sup>** Including tubes 50L6-35Z5 12SQ7

## CRYSTAL PICKUPS

COMPLETE WITH HARDWARE, LATEST DATE OF MANUFACTURE **\$2<sup>50</sup>** Each

## FREE CATALOG

Send for free catalog and prices of hard-to-get Radios, Radio Tubes, Radio Parts, Pickups, Motors, Condensers, Tube Checkers, Volt and Ohm Meters, Signal Generators, Signal Tracers, etc. Write Dept. RN.

## TUBULAR CONDENSERS

EMERSON 20/20 MFD  
150 VOLTS  
Guaranteed Fresh

**55¢**

## 5-TUBE KITS

50L6, 35Z5,  
12SA7, 12SK7,  
12SQ7

**\$4<sup>88</sup>**

FOR ALL 5

## A GOLD MINE! RADIO HARDWARE

FLANAGAN CARRIES A COMPLETE LINE OF  
RADIOS, RADIO TUBES  
AND PARTS

# FLANAGAN

RADIO CORPORATION

N. E. Cor. 7th & CHESTNUT STS., Philadelphia 6, Pa., U.S.A.

for a PERFECT CONVENTION  
in Suburban Chicago - or a  
**HAPPY HOLIDAY**

**HIGHLAND  
PARK** ILLINOIS

32  
MINUTES TO  
CHICAGO  
BY  
FAST TRAIN



Conventions at the MORaine HOTEL afford the happy combination of concentrated effort and luxurious rest.

Of graceful Georgian architecture and early American appointments, in an inspiring setting of ravine woodland on the shores of Lake Michigan, the MORaine just naturally makes business a pleasure.

Our facilities conveniently accommodate groups up to 150 persons. . . . Memberships are available in our popular Beach Club. . . . Additional information will gladly be submitted upon request.

**HOTEL** *Moraine* - ON-THE-LAKE  
HIGHLAND PARK, ILLINOIS

**HOW TO PASS** Commercial Radio Operators' **FCC LICENSE EXAMINATIONS...**

How To Pass  
**FCC  
LICENSE  
EXAMINATIONS**  
CLEVELAND INSTITUTE  
OF  
RADIO ELECTRONICS  
Terminal Tower - Cleveland, Ohio

**FREE BOOKLET**

Tells you the Government Requirements for all classes of commercial licenses. Saves you many hours of random, undirected study. Assures a minimum of time in getting your ticket!

Approved for Veteran Training Under G-1 Bill of Rights

**CLEVELAND INSTITUTE OF RADIO ELECTRONICS**

Successors to Nilson Radio School, founded 1939  
Smith Practical Radio Institute, founded 1934

**RN-8 TERMINAL TOWER CLEVELAND 13, OHIO**  
MAIL THIS COUPON

**Don't Delay -  
Write Today!**

CLEVELAND INSTITUTE OF RADIO ELECTRONICS  
RN-8 Terminal Tower, Cleveland 13, Ohio

Gentlemen: Please send your FREE Booklet, "How to Pass FCC License Examinations."  
(NOTE: This booklet does not cover examinations for Amateur Licenses.)

Name .....

Address .....

City ..... Zone ..... State .....

If a Veteran check here

positions of the shorting bar and coupling loop which matches efficiently either concentric or parallel-line feeders.

Full details of this kit and prices will be furnished by *Hytron Radio & Electronics Corporation*, Salem, Massachusetts.

**FREQUENCY CALIBRATOR**

A recently developed Frequency Calibrator, the Model RH-10, has been announced by *Browning Laboratories, Inc.*

The Model RH-10 makes use of the frequency standards transmitted from station WWV and is pretuned for 5

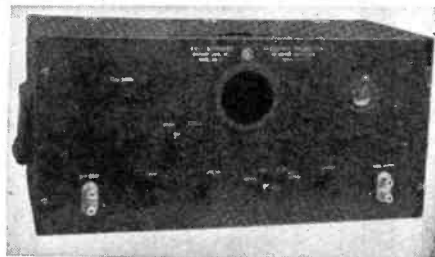

and 10 megacycles, either of which may be selected. Provisions are made for coupling secondary standards or other r.f. sources and comparing their fundamentals or harmonics with the standard frequencies transmitted by WWV. A cathode-ray indicator permits frequency comparisons to be made to at least 1/10 cycle. A dual filter allows the selection of either the 440 or 4000 cycle modulation.

The sensitivity of this unit is better than 1/2 microvolt and the image rejection

**CZECHOSLOVAKIAN  
RADIO PRODUCTION**

THE Ministry of Information, Prague, Czechoslovakia, has recently written Radio News supplying up-to-date and factual information on the radio production of that country.

This letter, which was inspired by Leon Laden's "Report on European Radio Industry" appearing in the May issue of Radio News, gives authoritative data on the production figures for the years 1935-40 and an estimate of the 1946-47 output.

According to the Ministry of Information, Czechoslovakia produced 168,872 receivers in 1935-36; 123,050 in 1936-37; 125,343 in 1937-38; and 120,502 in 1939-40. Production for the 1946-47 period is expected to reach 200,000 receivers of the so-called National Type, a six tube superheterodyne with four bands. Other types of receivers are also being produced.

Our informant also points out that crystal detectors have neither been used nor produced in Czechoslovakia for many years. At the present, high quality amplifiers are being mass produced for p.a. equipment, schools, etc.

Among the leading companies producing receivers for the 1,447,000 licensed listeners are: Telegraphia, Microphona, Radioslavia, Phillips, Telefunken, etc.

The licenses granted to listeners represent about 10% of the total population of the country, a figure which compares favorably with those for Italy, Holland, Denmark, etc.

**SILVER**

**"VOMAX"  
904 C/R BRIDGE  
"SPARX"**

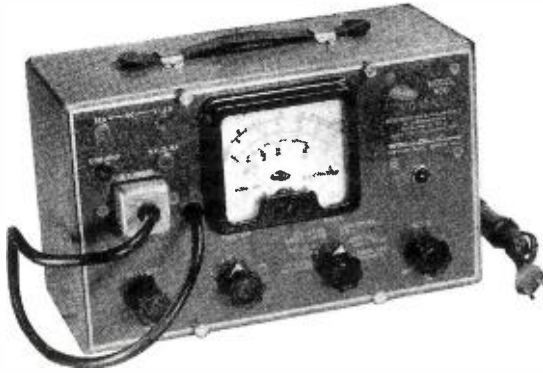

"VOMAX" is more than a multi-meter . . . more than volt-ohm-db.-milliammeter . . . more than r.f. vacuum-tube voltmeter of laboratory instrument caliber. "VOMAX" is all of these things. Born out of six years of military research and production, it is new as today. Backed by a name famous for over 35 years . . . designed by radio's only International Grand Prize winner, "VOMAX" is the standard of comparison.

RADIO MAINTENANCE engineers checked and rechecked the market for the best possible meter . . . most-used instrument in all radio service . . . to serve as heart and core of its new "Modern Test Bench." They selected "VOMAX." Your efficiency and profits will be greatest when you, too, use "VOMAX." Ou-

standing . . . tested and sworn to by thousands of serious service technicians . . . ordered and reordered by the U. S. Bureau of Standards, the Naval Research Laboratory, Western Union . . . used by Sperry, Monsanto Chemical, DuPont, F.C.C. Grand Island monitoring station, C.A.A., Naval Ordnance Depots, Lapp Insulator, Stackpole Carbon, Fairchild Aviation, etc., etc. This is positive proof that "VOMAX" is the meter you must have to top smart competition. Follow the recommendation by Bendix to all BENDIX RADIO distributors and dealers . . . "Use 'VOMAX.' It's better than we hoped." Only \$59.85

**904 C/R BRIDGE**

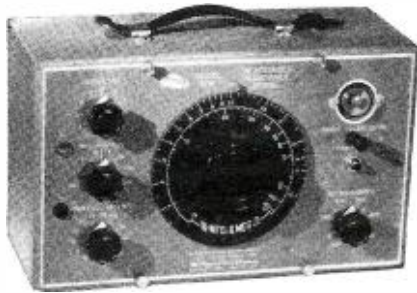

Model 904 Capacitance/Resistance Bridge. 1/4 mmfd/ohm thru 1,000 mfd./megohms; 0-50% power factor; 0-500 volt adjustable internal polarizing voltage; 0-10 and 0-100 ma. electron-ray leakage current meter; measures resistance, capacitance under actual operating voltages! Also recommended by Bendix. Only \$49.90

**"SPARX"**

"SPARX." Visual/aural dynamic signal tracer; 20~ thru 200 mcs.; new crystal rectifier r.f./a.f. probe; 65 db. a.f. amplifier; dynamic speaker. Tests speakers, phono pick-ups, amplifiers, receivers from antennae thru speakers; determines presence of operating voltages, hum. Checks individual circuits and overall performance and quality quickly and positively. Only \$39.90

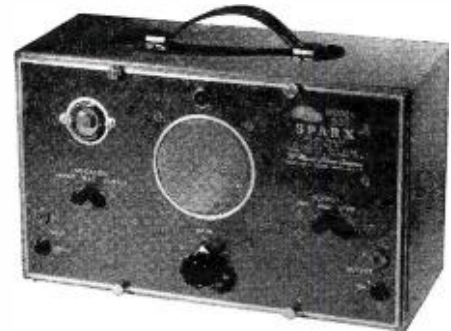

Get a copy of June, 1946 RADIO MAINTENANCE at your favorite jobber—or send 25c to 460 Bloomfield Ave. Montclair N. J., for radio's newest 100% service magazine. Read all about "VOMAX" in it. Send penny post-card for new, hot-off-the-press, catalog describing these important fresh, postwar measuring instruments, plus 3 new communication receivers, 2 new transmitters, factory built and kits, condensers, coils, sockets, new "frequency-meter" 5 thru 500 watt, 6-band transmitting inductor, keying and quality monitor, new AM and FM signal generator covering 90 kcs. thru 170 mcs. on fundamentals! See your favorite jobber at once, for demand far exceeds supply.

OVER 35 YEARS OF RADIO ENGINEERING ACHIEVEMENT

*McMurdo Silver Company*

1249 MAIN STREET • HARTFORD 3 • CONNECTICUT

In Canada—McMurdo Silver Division, General Radionics, Ltd., 465 Church St., Toronto, Ontario, Canada.

# BARGAINS

we call  
'em;  
You'll call  
'em  
GIFTS



FAMOUS BRAND  
HERMETICALLY-SEALED  
OIL CONDENSER

Finest quality oil-filled, rectangular uprights. 8 mfd. 600 volts. Size: 5 1/2" x 3 3/4" x 1 1/4". Weight: 2 lbs. WPS414 only \$1.49

## LOOK AT THIS BUY!

**TYPE TLA DYKANOL CONDENSERS**—For compact high-voltage filter applications on high-fidelity P.A. amplifiers; power supplies for short wave portable transmitters and transceivers. 2 mfd. 600 volts D.C. Size: 2 7/8" x 1 1/2". 4 mfd. 600 volts D.C. Size: 4 1/2" x 1 1/2".

XPS498 2 mfd. Only 59c  
XPS499 4 mfd. Only \$1.19

These buys are typical of what you can get from the world's largest and oldest suppliers of radio and electronic equipment, and we've got thousands more of 'em. Use coupon below; orders filled pronto!

# FREE

\*Latest Bargain Flyer C-37 gives you up-to-the-minute news on Lafayette's unbeatable bargains. Send for it today! Also, get on the mailing list for Lafayette's Super Catalog, jam-packed with dollar-saving values. Covers everything in radio and electronic equipment.

## LAFAYETTE RADIO

RADIO WIRE TELEVISION, INC.  
New York 13 • Boston 10 • Newark 2

PASTE ON PENNY POSTCARD. MAIL TODAY!

LAFAYETTE RADIO, Dept. RH-6  
100 Sixth Ave., New York 13, N. Y.

Enter my.....WPS414 oil condenser(s)  
order for.....XPS498 TLA condenser(s)  
 Check encl.  Money order  Send C.O.D.  
 Send me FREE copy of Bargain Guide C-37  
and place my name on mailing list for new Lafayette Catalog.

Name \_\_\_\_\_  
Address \_\_\_\_\_  
City \_\_\_\_\_ Zone \_\_\_\_\_ State \_\_\_\_\_

tion ratio is more than 50 db. The Model RH-10 is available in either cabinet or rack mounting.

Additional information will be furnished by *Browning Laboratories, Inc.*, Winchester, Massachusetts.

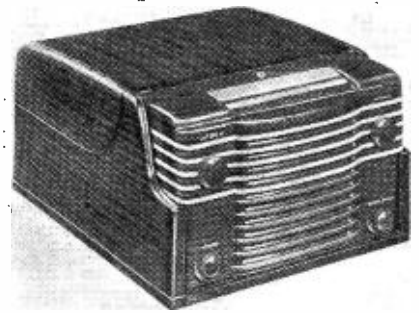

### RADIO-PHONO COMBINATION

The Home Radio Division of *Westinghouse Electric Corporation* has announced production of a new radio-phonograph combination which combines a six-tube a.c.-d.c. standard band radio receiver with a fully automatic phonograph in a mahogany veneer cabinet.

The receiver portion of this Model H-122 which forms the front section of the new unit can be removed for independent use. The automatic record changer accommodates twelve 10"

records or ten 12" records. Other features include a built-in loop antenna, a continuously variable tone control, a phase inverter tube and a push-pull output circuit for high quality reproduction.

The new model is 9" high, 14 1/4" wide  
(Continued on page 94)

## 100% "SOLID" OPERATION

By W9SXZ, W9DWP, W9QHZ

1. Never remove plate voltage from the v.f.o. when shifting frequency. This eliminates the necessity of others having to tune their receivers to determine whether or not you are on the air.
2. Always shift frequency after each QSO. This will avoid the danger of burning holes in the ether. Also it will discourage your creditors in trying to find you.
3. Do not hesitate to demonstrate at every opportunity your ability to shift frequency from one end of the band to the other. By demanding R reports at each spot, you may plot a response curve with little effort.
4. When DX is on, always QSY to the frequency of the DX station, and call him frequently and long. This will discourage others from horning in.
5. Never conduct any test off the air which by any process, however complicated, can be made on the air. This gives proof of your technical ingenuity and displays the scientific mind.
6. Never pause to retune after a shift in frequency. After all, low cost surplus tube supplies must be exhausted before reconversion can gain headway.
7. Always arrange to have non-amateur visitors "say a few words" on the air. Comments are then in order that "he handles the mike like an old timer." This establishes your reputation as a genial host.
8. Determine mike pick-up by a series of on the air tests. Vary the distance from operator to mike over a fair range, say from across the shack to the tonsils. Ask for a report on pick-up of: (a) radio in adjoining room, (b) rattle of dishes in the kitchen, (c) refrigerator, (d) oil burner or stoker, (e) junior op's electric train, (f) children practicing on piano. Also matches may be struck at varying distances from the mike.
9. If a desired station is in QSO, attract his attention by shifting the v.f.o. across the frequency of the station to which he is listening. This is sure to "get" him.
10. Always advertise the DX, if any, you have worked. If your contact recites his DX, either fail to acknowledge his prowess, or claim: (a) QRM, (b) dinner time, (c) bed time, (d) telephone, (e) chauffeuring xyl. Then sign and proceed to call CQ.
11. Always whistle into the mike once or twice before speaking. This practice permits use of the operating table lamp as a modulation indicator, thereby eliminating the expense of a meter.
12. If necessary to retune your receiver to the station with which you are in contact, always remind him that his frequency is drifting, even though your receiver was stone cold three minutes ago.
13. Never accept a report of less than R9 plus plus. A lesser report indicates that the other fellow's receiver is out of alignment.
14. Always give signal reports "on the next round." This permits you to give the other fellow a report not higher than that which he gives you. If this precaution is not taken, it might give rise to the false impression that the other fellow can and/or did build a better transmitter and antenna than yours.
15. Hold onto all DX stations as long as possible. This will tend to reduce the number of stations laying claim to having worked the same DX.
16. During Saturday night parties see to it that all participants present their views or non-views at length. To deny your guests this courtesy would be ungentlemanly.
17. When short skip is prevalent, never waste time in logging the band, but proceed to call CQ frequently and at length. Time wasted in listening may cost you many contacts.
18. After each QSO, call QRZ, then shift frequency. This one is guaranteed to fool them.
19. Always boast about the number of sheets of contacts which you have yet to copy into the log book. This proves that you operate a busy station.
20. Never use a field strength meter. The expense of this costly equipment may be avoided by making antenna adjustments while in QSO.

• Courtesy of "Ham-Gab," official monthly publication of Hamfesters Radio Club, Inc.

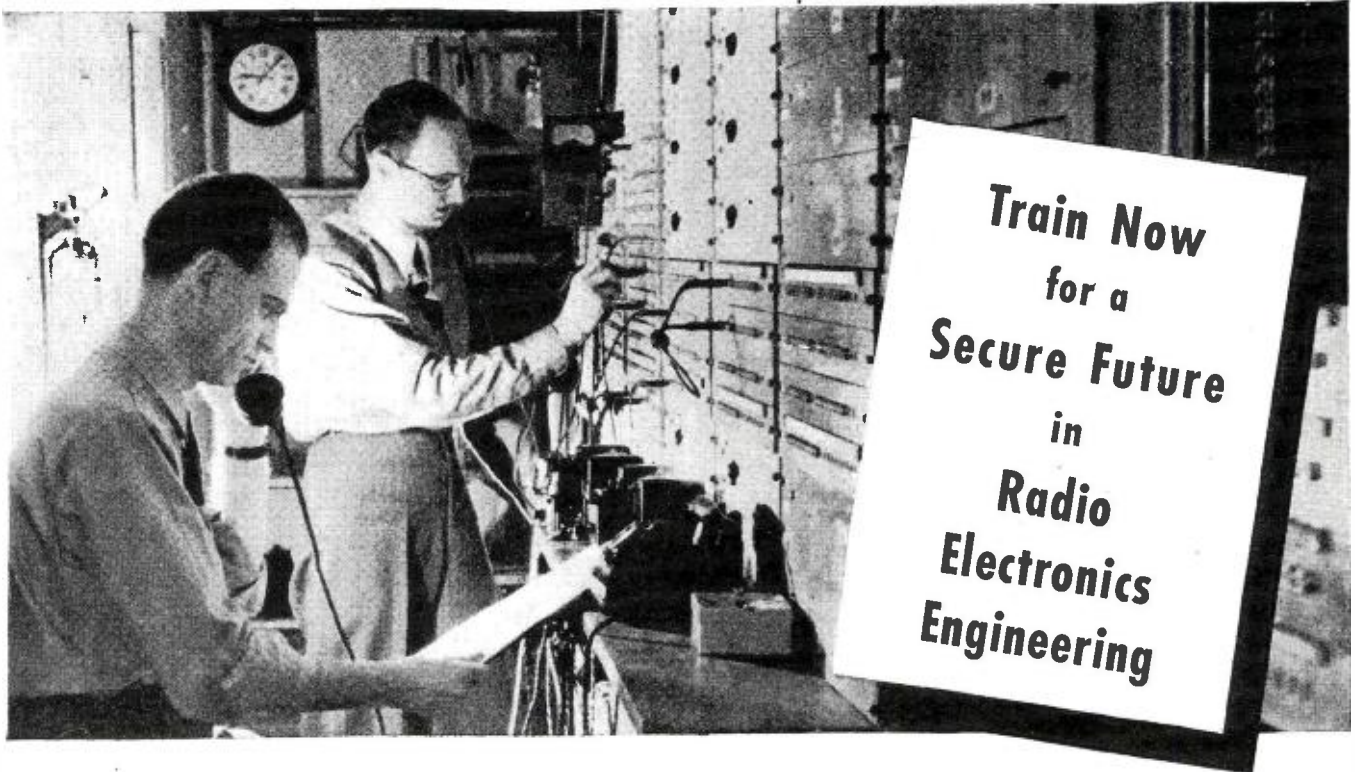

## Add CREI Technical Home Study Training to Your Present Radio Experience — Then Get that BETTER Radio Job You Want!

***CREI technical home study training prepares you for the secure radio jobs that pay good money for ability.***

Yes, YOU, can be ready to enjoy the security of an important technical position and take advantage of new career opportunities . . . if you prepare yourself now.

Join the thousands of other ambitious radiomen who have enrolled with CREI to assure themselves of secure, good-paying jobs with a planned program of advancement made possible by CREI home study training in practical Radio-Electronics Engineering. You can study at home — in your spare time — develop your technical ability — increase your knowledge to keep pace with important developments now taking place in the industry.

By adding CREI training to your present radio experience you can safeguard your future and keep pace with such new developments as U.H.F. Circuits, Cavity Resonators, Pulse Generators, Wave Guides, Klystrons and Magnetrans. Are you equipped to handle them? CREI

is equipped to help you by providing the technical background that is required.

In our proved method of instruction you learn not only how but why! Easy-to-read-and-understand lessons are provided well in advance, and each student has the benefit of individual guidance and supervision from a trained instructor. This is the basis of the CREI method of training for which many thousands of professional radiomen have enrolled during the past 19 years . . . and which has resulted in large numbers of promotions to more responsible positions.

It costs you nothing to read the interesting facts . . . to learn how CREI can help you enjoy the security you want . . . the better paying job that can be yours. Write for particulars now! (CREI training for Veterans is available under the "G.I." Bill.)

**•WRITE  
TODAY for  
FREE  
BOOKLET**



**"Your Opportunity in the  
New World of Electronics"**

If you have had professional or amateur experience—let us prove to you that we have something you need to qualify for a better radio job. To help us to intelligently answer your inquiry—PLEASE STATE BRIEFLY YOUR BACKGROUND OF EXPERIENCE, EDUCATION AND PRESENT POSITION.

## Capitol Radio Engineering Institute

E. H. RIETZKE, *President*

Dept. RN-8, 16th and Park Road, N.W., Washington 10, D. C.

**Branch Offices:**

New York City (7), N. Y.    Chicago (2), Ill.    San Francisco (2), Calif.    San Diego (1), Calif.  
170 Broadway    30 N. LaSalle St.    760 Market St.    316 C Street

MEMBER: NATIONAL HOME STUDY COUNCIL • NATIONAL COUNCIL OF TECHNICAL SCHOOLS

**Solder  
Fast**

With the **FLASH**  
TRIGGER-CONTROLLED  
INSTANT-HEATING  
**SOLDERING  
GUN**

Pats. Pending

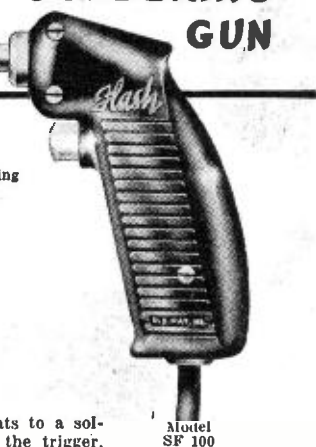

Model SF 100

**Revolutionary in Design  
Engineered for Every Type of Soldering**  
**STREAMLINED . . . PERFECT BALANCE**  
**NON-TIRING NATURAL GUN GRIP**

- **INSTANT HEATING** The Flash Instant Heating Gun heats to a soldering temperature in a few seconds following pressure on the trigger. It heats only when pressure is on trigger, while actual soldering is being done. Degree of heat is controlled by the trigger—High or Low—as desired. Correct temperature for most efficient work is easily maintained because the operator at all times has full control over such heat due to trigger arrangement and he very easily becomes expert in flowing solder for any type of work.
- **"FLASH" SAVES YOU TIME** Labor—Materials and Current. Equipped for immediate operation from our 110 Volt Transformer or from any standard storage battery or from the hot lead from any car, truck or tractor.

**MODEL SF 100 \$575** For Fine and General Type Soldering with 3/4" Tip, Pencil Point and Craftsman Tip interchangeable on this model.  
**MODEL HF 150 \$795** For Heavy Duty work with 3/8" Tip. Extra Heavy Barrel and element.  
**HD 520 \$620** TRANSFORMER with sufficient capacity for either model soldering gun.

ASK YOUR DISTRIBUTOR - - - DISTRIBUTORS WRITE - - -

**BAKER-PHILLIPS COMPANY** 3059 LYNDALE AVE. SO. MINNEAPOLIS 8, MINN.

**Modernize with Light**  
(Continued from page 31)

These novel lighting devices provide a dramatic sales appeal. An examination of his stock by the dealer or department head will reveal a wide choice of items which adapt themselves to silhouette and three-dimensional lighting treatment.

Only a few of the many jobs within the range of modern lighting can be discussed within the space limitations of this or any single article. Others will suggest themselves to the light-conscious designer of radio and electrical appliance displays.

As electrical men plan to make the most of the made-to-order market that they face today, lighting ranks as a promotional must. While lifting general levels of illumination is essential, it is clear that something more than just more light is needed. From this starting point those who plan lighting modernization may proceed in any direction dictated by their exact merchandising problems. They will not go wrong if they apply the tools and techniques of modern lighting as a flexible sales force, designed to accomplish specific display and merchandising results.

In the highly competitive era ahead many retailers will use light generously. Alert radio-appliance men can well afford to use it even more liberally, since no other device in the retail field can be used so inexpensively and contribute so much to increased sales volume.



Funds raised by the people of his home town, Potsdam, New York, have given a new life to Frank Knight, Jr., 21, a paralytic cripple who is now a patient at Park East Hospital. Aided by the \$2200 Frank Knight, Jr. Fund, the youth has gained the use of his arms and expects to walk again in a few months. He is also on his way to becoming an amateur radio operator. Since his hospitalization, he has been the pupil of Robert Gunderson, 28, a blind radio technician who volunteered to teach Frank when he heard of the youth's interest in radio. Hoping to have his FCC operator's license soon, Frank is shown in bed, with a receiver at his side and working on the transmitter he will use as an amateur.



R. C. (Dick) Hall

**R.C. & L. F. HALL, INC.**

**HOUSTON:**  
1015-17 Caroline Street Telephone C-9731  
**DALLAS:**  
2123 Cedar Springs Ave. Telephone

This month we want to call particular attention to the new receivers listed. These are all post-war models and we are delivering substantial quantities to those who have placed a \$5.00 deposit with us. Sometimes we can deliver out of stock. Deposits will be refunded upon request and your selection may be changed. We want to call attention to our new store in Dallas. If you live nearby, drop in.

Mail orders should continue to come to Houston.



L. F. (Lillian) Hall

HALLICRAFTERS		
SX-42—540 KC to 110 MC	.....	\$250.00*
SX-43—540 KC to 108 MC	.....	150.00*
SX-46—540 KC to 43 MC	.....	115.00*
S-38	.....	39.50
S-40	.....	74.50
HT-9 Transmitter (1500 KC to 28 Mega)	.....	250.00
S-37—FM/AM/CW (130 MC to 210 MC)	.....	591.75
S-36A—FM/AM/CW (27.8 to 14.3 MC)	.....	307.50
S-47—AM/FM (535 KC to 108 MC)	.....	135.00
* Speakers not included.		
SUPER PRO		
SFR-400-X (540 KC to 30 MC) rack model	.....	344.55
SFR-400-SX (1250 KC to 40 MC) rack model	.....	320.55
PS-CW-10—10 inch speaker	.....	13.20
NATIONAL		
NC-2-40 C—less speaker	.....	\$225.00
Speaker	.....	15.00
NC-2-40D—Amateur Model	.....	56.10
1-10 less tubes, speaker, and power supply	.....	19.10
5886 Power Supply for 1-10	.....	8.57
Tubes for 1-10 (534, 955, 6CS, 6F8)	.....	274.35
HRO-5T-1—4 sets coils (less speaker and power supply) table model	.....	10.95
HRO-5T-1—Speaker	.....	17.70
HRO-5T-1—Power Supply	.....	274.35
HRO-5R-1—4 sets coils (less speaker, and power supply)	.....	19.85
HRO-5R-1—Speaker	.....	33.00
HRO-5R-1—Power Supply	.....	97.50
NC/46, less speaker	.....	9.90
Speaker	.....	
RME		
RME-45 with crystal meter and speaker	.....	\$186.00
RME-84	.....	98.70
DB-20—Preselector	.....	59.30
VHF-152 (2, 8, & 10 Meter converter)	.....	86.60
Wire, write or phone your order. We will ship C.O.D. with a \$5.00 deposit. We also offer easy terms and trade-in allowances for used equipment. State Tax not included in above figures.		
"ACROSS THE OPERATING TABLE"		
A postal card to Dept. R-1 will place your name on our mailing list to receive our amateur bulletin which is just off the press.		
A FEW OF THE MANUFACTURERS WHOSE PRODUCTS WE DISTRIBUTE		
Aerovox	Clarestat	GE
Amphenol	Drake	Hallcrafters
Astac	Dumont	Hammarlund
B&W	Echophone	Hytron
Belden	Eimac	Instructograph
Bliley	Electronics Lab.	Insuline
Bud	Eric	Jensen
Centralab	Gammatron	JFD
Cinaudagraph	General Cement	Johnson
Kaal	Meissner	Pioneer
Kainer	Mullen	Precision
Kelner	Mueder	Prumex
Kwikheat	National	Radel
Leach	Newcomb	Raytheon
Lectrohm	Ohmite	RCA
Les Logan	Panoramic	Robson-Burgess
Littelfuse	Peerless	RME
John Meck	Peterson	Sangamo
Setchell-Carlson	Trimmm	
Silver	Triplet	
Simpson	Turner	
Speed-X	Vaco	
Stancor	Vibroplex	
Supreme	Waisco	
Taylor	Ward	
Thermador	Weller	
Thordarson	Weston	

**TEST EQUIPMENT IN STOCK**  
Silver Vomax V.T.M. & V.O.M. .... \$59.85  
Monitor Crystalizer, Signal Generator..... 57.50  
Robson-Burgess MT-200 V.O.M. 0-10 Mega— 22.95  
0-1500 Volts ..... 22.95  
Robson-Burgess MT-100 V.O.M. 0-1 Mega— 18.75  
0-1000 Volts ..... 18.75  
Superior Signal Tracer ..... 18.75  
Ask for other brands and models, since Test Equipment is arriving in larger shipments.

**MASCO MA-50 AMPLIFIERS IN STOCK**  
The MA-50 may be used with from 2 to 12 speakers without appreciable loss in volume. It has been designed to give high quality, high volume and long hour usage.  
Ma-50, less tubes ..... \$98.50  
Kit of Matched tubes ..... 17.50

**KWIKHEAT** has these features to offer:  
(1) patented built-in temperature control which automatically eliminates overheating.  
(2) light weight—a mere 14 oz.  
(3) 225 watts of harnessed power giving heat in 90 seconds.  
Sells for only ..... \$8.25  
Set of 4 tips ..... 4.13

"ACROSS THE SERVICE BENCH"  
is the name of our dealer bulletin, which goes regularly to our service dealer customers. This bulletin keeps you in touch with the latest information on available equipment and supplies. A postal card to Dept. R-1 will place your name on the list and will also secure a "new customer tube allocation" if you request it.

**NEW CATALOGUE IS READY**  
A new, complete catalogue giving the latest information on all types of merchandise and prices is now off the press. A card addressed to CATALOGUE—Dept. R-1 will bring it to you by return mail.

**POLICE, GEOPHYSICAL & MOBILE**  
Radio telephone equipment is available on good delivery. We welcome inquiries for your particular application.

**INDUSTRIAL ACCOUNTS**  
We have one of the largest electronic stocks in the country and we welcome the opportunity to serve you. Wire, write or phone for information.

# Our Plant

Air King Radio—in nineteen twenty only a few dollars and an ambition—is now a great manufacturing establishment. Nearly one thousand employees, in its modern plants, working with the newest and most efficient equipment can produce over five thousand sets in a single shift. Air King is one of the most completely integrated producers of radio. In addition to chassis making, it does its own metal stamping, metal spraying and finishing and has one of the largest radio cabinet plants in the New York area.

During the war all of Air King's facilities were devoted to the making of Radar and special electronic equipment. Soon Air King will have for you a complete line of AM, FM and Television receivers equal in quality, in beauty and in price to meeting the most exacting demands of your most critical customers.

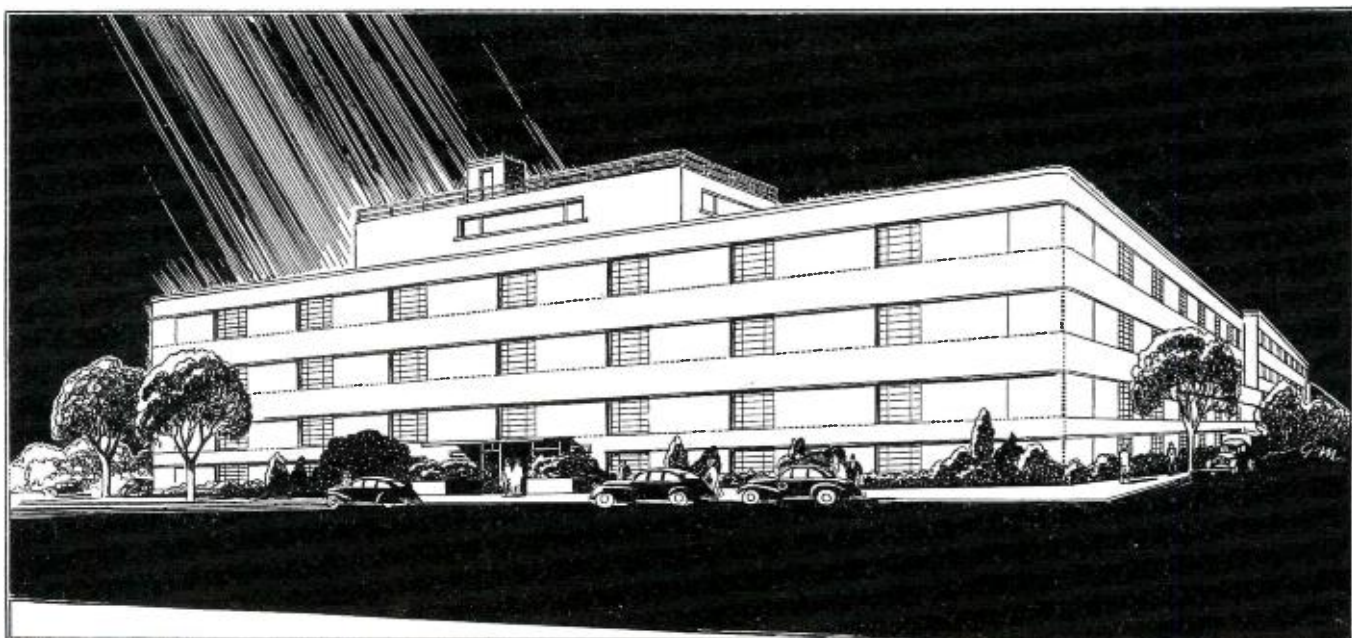

THIS NEW, MODERN AIR KING PLANT INCREASES OUR TOTAL FLOOR SPACE TO TWO HUNDRED AND FIFTY THOUSAND SQUARE FEET.



## AIR KING RADIO *Brooklyn*

*Division of* HYTRON RADIO & ELECTRONICS *Corporation*



*The Royalty of Radio Since 1920*

# BUILT-IN QUALITY

Made Our Famous

## RADIO & PHONO KITS

**A National Success!**  
**THE IDEAL KITS FOR**  
**STUDENTS • SCHOOLS**  
**HOSPITALS • SERVICEMEN**  
**AMATEURS**



Our Model S-5 uses the universally accepted superheterodyne circuit containing the following tubes: 12SA7, 12SK7, 12SQ7, 50L6, 35Z5 and tunes from 550 Kc to 1600 Kc.

Model S-5 (Illustrated) Complete Kit including tubes, Bakelite cabinet and four pages of diagrams and instructions @ **\$19.95**



### Build Your Own PORTABLE PHONOGRAPH

Ready for assembly! Beautiful carrying case, pick-up, 2-tube amplifier, volume control. Complete kit including tubes @

**\$23.95**



### Also Available! PORTABLE AUTOMATIC

**RECORD CHANGER PHONO KIT**  
 Attractively covered carrying case, 2-tube amplifier, 2-post record changer ready for assembly @

**\$43.95**



### Now! Sensational! COMBINATION RADIO & PHONO KIT

- 5-tube superheterodyne radio
- Beautiful walnut finish cabinet
- 5" Alnico V Speaker
- Astatic L-72 Pick-up

Complete Kit @ **\$34.95**

All Kits Are Furnished Complete, Less Wire & Solder  
 Direct Shipments to All Parts of the World!  
 25% Deposit on C.O.D. Orders  
 Write for FREE Catalog

## RADIO KITS COMPANY

Dept. K.  
 120 Cedar Street New York 6, N. Y.

## SHORT-WAVE NEWSCASTS

(Continued from page 56)

EST	LOCATION	CALL	FREQ.	EST	LOCATION	CALL	FREQ.
3:30 p.m.	Sofia, Bulgaria	Radio Sofia	9.350	6:30 p.m.	London (Radio Newsreel in NAS)		
3:30 p.m.	Belgrade, Yugoslavia	Radio Belgrade	6.150			GWG	15.060
3:45 p.m.	Brazzaville	FZI	9.440			GRG	11.680
			11.970			GRH	9.825
			17.530			GWH	11.800
3:45 p.m.	London (AS)	GVO	18.080	(irreg.)	(Via Georgetown, Br. Guiana)	ZFY	6.000
		GVP	17.700	6:20 p.m.	Moscow	Radio Centre	6.020
		GVW	11.700	(or 6:30 p.m.)			7.300
		GRY	9.600				7.360
		GWG	15.110				9.480
3:45 p.m.	Capetown, So. Africa (BBC)	ZRK	5.877				9.540
	Durban (BBC)	ZRD	6.170				11.880
	Johannesburg (BBC)	ZRJ	6.095		(Komsomolsk)		15.230
	Johannesburg III		3.450	6:45 p.m.	London (NAS)	GSP	15.310
3:50 p.m.	Bern	HEI5	11.713			GRG	11.800
4:00 p.m.	Warsaw, Poland	Radio	6.100			GRH	9.825
(or 4:15 p.m.)		Polskie,			(Via St. John's, Newfoundland)	VONH	5.970
4:00 p.m.	Algiers	VANA	9.610	6:45 p.m.	Melbourne	VLC9	17.840
			9.540	7:00 p.m.	San Francisco (Delano)	KCBF	17.850
4:00 p.m.	Honolulu	KRHO	17.800			KWID	17.760
4:00 p.m.	London (Radio Newsreel in GOS)	GVO	18.080			KNBX	15.340
		GVP	17.700		(Dixon)	KNBA	15.270
		GRS	7.075			KRHO	17.800
		GSF	15.140	7:00 p.m.	Honolulu	JLR	6.015
		GSG	17.790	7:00 p.m.	Tokyo (AFRS)		
		GWE	15.435	7:00 p.m.	Moscow (Moscow Newsreel)	Radio Centre	6.020
		GSO	15.180				7.300
		GSP	15.310				7.360
		GRF	12.095				9.480
4:10 p.m.	Dublin (Athlone)	Radio Eireann	9.595				9.540
4:15 p.m.	Montreal (Sackville)	CKNC	17.820		(Komsomolsk)		11.880
		CKLX	15.090	7:00 p.m.	London (Radio Newsreel in GOS)	GSB	9.510
4:30 p.m.	Ankara (Talk) (Mon., Thur.)	TAP	9.465			GSD	11.750
4:30 p.m.	London (European Service)	GRX	9.690			GRJ	7.320
		GSA	6.050	7:08 p.m.	Prague	OLR4A	11.840
		GWN	7.280	7:15 p.m.	Leopoldville	OTC2	9.741
		GRO	6.180			(Varies)	
		GWL	7.210	7:25 p.m.	Lahti (Helsinki), Finland	OIX4	15.190
		GRT	7.150			OIX2	9.504
		GWT	9.675	7:30 p.m.	Moscow	Radio Centre	6.020
		GWH	11.800				7.300
		GRK	7.185				7.360
4:45 p.m.	London (NAS)	GSP	15.310				9.480
		GWG	15.060	7:30 p.m.	Georgetown, Br. Guiana	ZFY	6.000
		GRG	11.680				
	(Via Kingston, Jamaica)	ZOI	4.700	8:00 p.m.	San Francisco (Delano)	KCBF	17.850
4:45 p.m.	Melbourne	VLA6	15.200		(Delano)	KWID	17.760
		VLC9	17.840		(Dixon)	KNBX	15.340
5:00 p.m.	San Francisco (Delano)	KCBF	17.850		(Delano)	KNBA	15.270
		KWID	17.760	8:00 p.m.	Quarry Heights, Canal Zone	AFRS	2.390
	(Dixon)	KNBI	17.340	8:00 p.m.	London (NAS)	GRG	11.680
	(Delano)	KCBA	15.270			GWH	11.800
5:00 p.m.	Quito, Ecuador (Relayed from San Francisco)	HQJB	12.455			GVZ	9.640
			15.100			GSU	7.260
			9.958		(Via St. John's Newfoundland)	VONH	5.970
5:00 p.m.	Algiers	VANA	9.610	8:00 p.m.	London (GOS)	GSF	15.140
			9.540			GSB	9.510
5:00 p.m.	Hamburg, Germany	BFN	7.290			GSD	11.750
5:00 p.m.	Honolulu	KRHO	17.800			GRJ	7.320
5:15 p.m.	Brazzaville	FZI	9.440	8:00 p.m.	Honolulu	KRHO	17.800
			11.970	8:00 p.m.	Moscow (Moscow Newsreel)	Radio Centre	6.020
			9.984				7.300
5:15 p.m.	Boston (WIRN)	WRUL	11.730				7.360
(except Sat.)	(Via Georgetown, Br. Guiana)	ZFY	6.000				9.480
5:30 p.m.	St. John's, Newfoundland	VONH	5.970	8:10 p.m.	Leopoldville	OTC2	9.741
5:30 p.m.	Edmonton, Alta.	VE9AI	9.540			(Varies)	
5:45 p.m.	London (NAS)	GSP	15.310	8:15 p.m.	Colon, Panama	HP5K	6.005
		GWG	15.060	8:30 p.m.	Melbourne	VLC9	17.840
		GRG	11.680	8:30 p.m.	Moscow	Radio Centre	6.020
		GRH	9.825				7.300
	(Via Kingston, Jamaica)	ZOI	4.700				7.360
	(Via Georgetown, Br. Guiana)	ZFY	6.000	8:35 p.m.	Bern	HEI2	6.345
	(Via St. John's, Newfoundland)	VONH	5.970	(Approx.)		HEI4	9.539
6:00 p.m.	Salzburg, Austria (AFRS)	KOFA	7.220	9:00 p.m.	Colombo, Ceylon (BBC)	ZOI	4.900
6:00 p.m.	San Francisco (Delano)	KNBA	21.610				
		KCBF	17.850	9:00 p.m.	San Francisco (Delano)	KCBF	17.850
	(Dixon)	KNBX	15.340		(Dixon)	KNBX	15.340
	(Delano)	KNBI	15.340		(Delano)	KNBA	15.270
6:00 p.m.	Tokyo (AFRS)	JLR	6.015			KWID	9.570
6:00 p.m.	Honolulu	KRHO	17.800	9:00 p.m.	Tokyo (AFRS)	JLR	6.015
				9:00 p.m.	Honolulu	KRHO	17.800
6:00 p.m.	Quarry Heights, Canal Zone	AFRS	2.390	9:00 p.m.	Quarry Heights, Canal Zone	AFRS	2.390
6:30 p.m.	Montreal (Sackville)	CKCN	17.820	9:00 p.m.	Edmonton, Alta.	VE9AI	9.540
(Sun. only)				9:00 p.m.	Paris	RNF	9.590
				9:00 p.m.	Melbourne	VLA6	15.200
						VLG6	15.230

(Continued on page 92)



# MORE SURPLUS BUYS SUPER SPECIAL

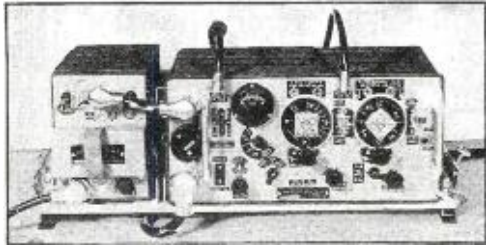

## COMPLETE TRANSMITTING & RECEIVING SETS. BRAND NEW!

3 SETS IN ONE—15 TUBES  
MADE BY ZENITH & EMERSON

**SET A**, for telephone and telegraph includes: 6-tube superheterodyne receiver and 6-tube MOPA transmitter with 807 final amplifier, frequency range 2 to 8 meg.

**SET B**, consists of 235 megacycle transceiver.  
**SET C**, a complete inter-communication system using 3 control boxes and 3 combination headphones.

**POWER SUPPLY:** This unit, including dynamotor, operates from a 12-volt battery. 2 Antennas, 1 Veriometer Resonator, Spare Set Tubes, Generator, Set of Spare Parts; 5 sets Earphones, 5 sets Microphones **\$78.50**

**NEW RECEIVERS B.C.**  
603 semi-completed, made for 603 Tank F.M. less var. cond. & front panel, no tubes. **\$5.00**

**PLATE TRANSFORMER AMERTRAN**  
115v 60cps/6200v-ct-700 ma. 11" x 14" x 10". Special price. **\$39.95**

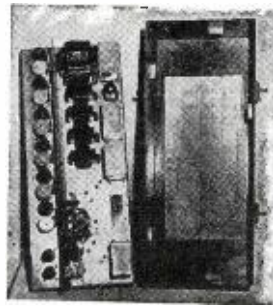

## U. S. NAVY MODEL RAK-7 SHIP RECEIVER

NEW—IN CASES

Made by R.C.A. 9-Tubes; 6 Bands; 15 kc.—600 kc., complete with power supply operating on 115v., 60 cycles. **\$77.50**

TUBES	
304TL EIMAC	\$13.95
250R EIMAC	8.95
5BP1 Sylvania	8.75
5FP7	11.00
5JP1	6.95
9JP1	9.95
723A/B Klystron, for 3cm	10.00

**CARDWELL TRANSMITTING VARIABLE AIR CONDENSER TS-800-VS.** 300 mmd. List \$40.50. OUR PRICE...\$14.95  
**I.F. CRYSTAL FILTER UNIT FOR BC-312, BC-342.** PRICE...\$9.95

**FREQ. METER BC-221** with calibrated chart & tubes 1000 Kc crystal & micro V dial. 120 Kc to 20 meg...\$82.50



## UHF RECEIVER

BC-406 from SCR-268  
Frequency range 201 mc. to 210 mc. I.F. freq. 20 mc.; 2 mc. bandwidth. 15 tubes. Operates on 115v., 60 cycles. **\$26.95**

## TRANSFORMERS

110 V./60 cycle components	
Fl. 6.3v-5a c.t.	\$ 1.00
Fl. 1.2v-4.2a/2.1v-3.05a/1.2v-4.2a	2.35
Fl. 1.5v-1.5a 30 kv insulation	2.50
Fl. 6.3v-5a c.t. 6.3v-5a c.t. 30kv insul.	3.75
Fl. 5v-115a Kenyon	8.95
Pwr. /300v-ct-20ma/5v&6v fil. sec.	1.25
Pwr. two secondaries, ea. 300v-ct 60 mils.	3.65
Pwr. /150-0-150-50ma/two 6.3 v-5a	1.25
Pwr. /330-0-330-85ma/1.3v-7.5a/5v-2a/6.3v3a electrostat. shield. case.	3.95
Pwr. Hi-V /3200-150ma oil Kenyon	9.95
Pwr. /750v-110ma/6.3v-5a/5v-3a	5.95
Pwr. H.V. plate /2750v-750ma oil Navy specs.	35.00
Choke: 1 hy-800maH.V. insulated.	12.00

## AUDIO TRANSFORMER, MODULATORS, ETC.

Modulation xfmr: typical for 211's et. A 50W	\$2.10
Modulation xfmr: 807 to pr 807's (1-3 pr)	2.65
Modulation xfmr: pr. 811's to 813.	5.00
Driver transf: 6V6 to pair 811's	3.00
Chi. transformer: P.P. Mod. & Driver 6L5's per pr.	3.30
Audio xfmr: interstage single end Z:1000:4000	1.25
Audio xfmr: interstage single end Z:560:1120	1.80
Audio input: Z120:2350 ohms 40-5000 cycles	3.20
Audio input: Z500:375,000 ohms	2.15
Audio output: Z5:1 for 12A6 to line	1.50
Audio output: 8:1 12A6 to speaker	2.15
Audio output: 6SJ7 to line	2.10
Audio line coupling: 3 sec. 150, 600, 4000 ohms, tapped at 250 ohms	.75
500 cycle tone oscillator transformer	1.00

## CECO KITS FOR HAMS

KIT 1: 1000 pcs. asstd. hardware	\$2.49
KIT 2: 100 ft. asstd. spaghetti	1.30
KIT 3: 50 mica cond. asstd.	4.65
KIT 4: 200 resistors, asstd.	5.95
KIT 5: 25 knobs, assorted	1.50
KIT 6: 25 term. strip, 1-20 terms	1.80
KIT 7: 20 ceramic coil forms	2.25
KIT 8: 10 Sprague ferrule; glass resist. 10-25 W; 500-15000 ohm	4.50

## CONDENSERS

.25 mfd 400 vdc	\$ 0.20	.25 mfd 1000 vdc	
.25 mfd 600 vdc	.30	pyr	\$ 0.40
1. mfd 500 vdc		.4 mfd 1500 vdc	
pyr	.45	W.E.	.20
.85 mfd 600 vdc	.16	1-.1 mfd 7000 vdc	5.00
6 mfd 800 vdc		C-D	
C-D	1.35	.25 mfd 20,000 vdc	12.00
8 mfd 600 vdc		C-D	
C-D	1.75	2. mfd 220 v.a.c.	.75
.05 mfd 1000 vdc		pyr	
pyr	.35	C-D	

## EXTRA!

**SPRAGUE NOISE FILTER TYPE JX-49.**  
**MALLORY NOISE FILTER TYPE 4-1.**

**\$3.95**

Lots of 10—\$2.85

## ARC-5 Navy Aircraft Set

**NEW ARC-5 SUPERHET RECEIVERS.** Tubes included: 3-12SK7; 1-12K8; 1-12SR7; 1-12A6. RANGE (specify frequency desired): .19-.55mc; 1.5-3mc; 3-6mc; 6-9.1mc. POWER: 24-28v DC. With remote control and dyn. **\$79.50**

**NEW ARC-5 TRANSMITTERS:** 25 watts CW; 15 watts phone Tubes (Included): 2-1625; 1-1629; 1-1626; 1-6200Kc xtal. RANGE (specify freq. desired): .5-.8mc; .8-1.3mc; 1.3-2.1mc; 3-4mc; 4-5.3mc; 5.3-7mc; 7-9.1mc. POWER: 24-28VDC. MODULATOR with 1-1625; 1-VR-150; 1-12J5. Price, less dynamotor. **\$109.00**

## RADAR AND MISC.

Oscilloscope, 5", BC-412, from SCR-268, operates on 115vac. with conversion dia. and instr. **\$54.50**

Signal Generator, BC-78-B made by Boonton. 15 to 55mc; 190 to 230 mc. used, perfect condition. **\$45.00**

Hi-Powered Modulator, BC-409 from SCR-268 115v60 cycle opr. Potentially useful as an induction heating unit **\$75.00**

BC-947-A; Transmitter designed to emit short pulses of UHF oscillations at 3000 mc. Has 10 amplifiers, two power rectifier circuits. **\$86.00**

SCANNER-RECORDER BC-918-B. Scans and records hand printed and upper case 6 point typewritten characters on paper tape. 12v. Less amplifier. Govt. cost \$695.00 **\$69.50**

## PULSE AMPLIFIER

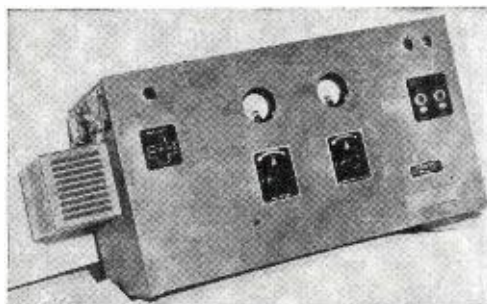

Signal Corps type BC409 from SCR-268 Radar set. Designed for 115 volts. AC 60 cycles. This unit developed the initial radar pulse and contains valuable component parts that valued individually would in sum, cost several times the selling price of this unit. Fine buy for experimental work, or for anyone who can use the component parts. Slightly used. Following are a few of the items that make up the unit. 1—304TL (Eimac) triode. 3—2 mfd. 4,000 V.V. GE Pyranol condensers. 1—3200 volt 150 MA power transformer. 1—Variac 5 amps. General Radio type CU 200. 1—5 volt 26 AMP fil. transformer (for 304 TL). 1—2.5 volt 10 Amp. fil. transformer (5000 volt insulation). 1—1 mfd. 1,000 volt GE Pyranol. 1—2 mfd. 1,000 volt GE Pyranol. 2—0 to 4,000 volt 3 inch volt meters (0.1 mil. move) and misc. chokes, resistors, condensers, etc. W-1414—Complete units only. **\$79.50**  
Your cost each.....

## Thousands of Ham Parts—Send for Our Catalog

All merchandise guaranteed. Mail orders promptly filled. All prices F.O.B. New York City. Send Money Order or Check. Shipping charges sent C.O.D.

# COMMUNICATIONS EQUIPMENT CO.

131-A LIBERTY ST., NEW YORK 7, N. Y. TELEPHONE WH 4-7658

## ALSO

LARGE INVENTORY OF 400 CYCLE TRANSFORMERS. SEND FOR LIST.



**ARMY-NAVY**  
*Official*  
**HEAD PHONES**  
**\$2.49**



**BURSTEIN-APPLEBEE**  
*Made A Lucky Buy*  
Limited quantity of these fine brand new head phones. Highly sensitive, 8000 ohms impedance. Bi-polar magnets, bakelite shell and cap. Adjustable head band, leather covered spring steel. Cord connects from one side, out of the way. Molded sponge rubber ear cushions. Our price only \$2.49 per set plus 20c postage and packing charges. Order Number 17A37.

**MAIL THE COUPON**  
**FREE CATALOG**

Latest developments in radio and electronic parts and devices, newest ham gear, gadgets, bargains, war surplus items . . . get this red hot bargain catalog FREE.

**18 YEARS**  
**IN**  
**RADIO**



**BURSTEIN-APPLEBEE CO.** Radio News  
1012 McGee St., Kansas City 6, Mo.  
\_\_\_\_\_Send me your new FREE Catalog.  
\_\_\_\_\_Send me \_\_\_\_\_pair of phones at \$2.49  
per pair plus 20c pair postage. I enclose  
\$\_\_\_\_\_in payment.  
NAME \_\_\_\_\_  
ADDRESS \_\_\_\_\_  
TOWN \_\_\_\_\_ STATE \_\_\_\_\_

**SHORT-WAVE NEWSCASTS**

(Continued from page 90)

EST	LOCATION	CALL	FREQ.	EST	LOCATION	CALL	FREQ.
9:30 p.m.	London (NAS)	GWH	11.800	1:30 a.m.	Delhi	AIR	17.830
		GRG	11.680				15.350
		GRH	9.825				15.290
		GVZ	9.640				15.190
		GSU	7.260				15.160
	(Via Leopoldville)	OTC2	9.741				11.870
	(Via St. John's, Newfoundland)	VONH	5.970	1:30 a.m.	London (Radio Newsreel in PS)	GRM	7.120
9:30 p.m.	London (GOS)	GSF	15.140			GRX	9.690
		GSB	9.510			GSN	11.820
		GSD	11.750			GSP	15.310
		GRJ	7.320			GWH	11.800
		GSC	9.580			GRE	15.375
		GSW	7.230	2:00 a.m.	Edmonton, Alta.	VE9AI	9.540
		GVX	11.930	2:00 a.m.	London (At Dictation Speed in GOS)	GRH	9.825
9:30 p.m.	Delhi	AIR	11.760			GSB	9.510
			9.670			GVQ	17.730
			7.290			GSF	15.140
			6.100			GRF	17.000
10:00 p.m.	San Francisco (Delano)	KCBF	17.850			GRS	7.075
	(Dixon)	KNBX	15.340			GSD	11.750
	(Delano)	KCBA	15.270	2:15 a.m.	London (European Service)	GSV	17.810
	(Delano)	KCBB	11.770			GWN	7.280
10:00 p.m.	Honolulu	KRHO	17.800			GSA	6.050
10:00 p.m.	Colon, Panama	KKWID	9.570			GWO	9.625
10:00 p.m.	Quarry Heights	RR5K	17.800			GRO	6.180
	Canal Zone	AFRS	2.390			GWL	7.210
10:00 p.m.	Vancouver, B. C.	CBRX	6.160			GRI	9.410
10:00 p.m.	Melbourne	VLC4	15.320			GRT	7.150
		VLA6	15.200			GWT	9.675
		VLG6	15.230			GWJ	9.525
10:00 p.m.	Montreal	CFCX	6.005	2:30 a.m.	Melbourne	VLA4	11.770
10:30 p.m.	Paris	RNF	9.550	2:45 a.m.	Colombo, Ceylon	ZOI	4.900
			11.847	3:00 a.m.	Delhi	AIR	17.760
10:30 p.m.	Delhi	AIR	17.830				15.290
			15.350				9.670
			15.190				7.290
			15.160	3:15 a.m.	Salzburg, Austria (AFRS)	KOFA	7.220
11:00 p.m.	Quarry Heights, Canal Zone	AFRS	2.390	3:30 a.m.	Melbourne	VLC8	7.280
11:00 p.m.	Honolulu	KRHO	17.800	4:00 a.m.	Tokyo (AFRS)	JRL	6.015
11:00 p.m.	London (GOS)	GRY	9.600	4:00 a.m.	Lusaka, Northern Rhodesia	ZQP	7.220
		GVW	11.700				7.285
		GVX	11.830	4:00 a.m.	Honolulu	KRHO	9.650
		GSB	9.510	4:00 a.m.	Melbourne	VLC6	9.615
		GSW	15.110			VLG10	11.760
		GSD	11.750	4:00 a.m.	Brisbane	VLO2	7.215
		GSF	15.140		Melbourne	VLH3	9.580
		GRF	12.095	4:00 a.m.	Perth	VLW3	11.830
		GSO	15.180	4:30 a.m.	Melbourne (At Dictation Speed)	VLC6	9.615
		GRJ	7.320			VLG3	11.710
		GRS	7.075	4:30 a.m.	Delhi	AIR	17.760
11:00 p.m.	Winnipeg, Manitoba	CKRO	6.150				15.350
11:25 p.m.	Macassar, Celebes	MCAK	9.357				15.190
12 midnight	Edmonton, Alta.	VE9AI	9.540				11.870
12:15 a.m.	Bern	HER5	11.865				9.670
(Tues., Sat. only, irreg.)		HEZ3	14.462	4:30 a.m.	Wellington, New Zealand	ZLT7	6.715
12:15 a.m.	Melbourne	VLC4	15.320	5:00 a.m.	Saigon, Fr. Indo-China	Radio Saigon	11.778
		VLG3	11.710				4.810
12:30 a.m.	Delhi	AIR	17.830	5:00 a.m.	Chungking	XGOY	11.920
			15.350	5:00 a.m.	Shanghai	XORA	11.695
			15.190	5:00 a.m.	Tokyo (AFRS)	JLR	6.015
			15.160	5:05 a.m.	Seoul, Korea	JODK	2.510
			11.870	5:15 a.m.	Bangkok, Siam	HSPP	6.000
12:45 a.m.	Prague	OLR5A	15.230	5:25 a.m.	Beirut, Lebanon (Radio Levant)	FXE	8.020
1:00 a.m.	Capetown, So Africa (BBC)	ZRK	5.877	5:30 a.m.	Melbourne	VLC6	9.615
	Johannesburg (BBC)					VLG10	11.760
	Durban (BBC)			6:00 a.m.	Brisbane	VLO2	7.215
1:00 a.m.	Edmonton, Alta	VE9AI	9.540	6:00 a.m.	Melbourne	VLR2	6.150
1:00 a.m.	Jerusalem	JCKW	7.220	6:00 a.m.	Algiers	VANA	11.765
1:00 a.m.	London (GOS)	GVP	17.700				11.880
		GRG	18.030	6:00 a.m.	Georgetown, Br. Guiana (BBC)	ZFY	6.000
		GRY	9.600	6:00 a.m.	Perth	VLW7	9.520
		GWG	15.110	6:00 a.m.	Shanghai	XORA	11.695
		GSB	9.510	6:00 a.m.	London (GOS)	GWG	15.110
		GSD	11.750			GRP	17.870
		GSF	15.140			GSI	21.530
		GWR	15.300			GSV	17.810
		GVP	17.700			GVP	17.770
		GSO	15.180			GWO	15.180
		GRF	12.095			GSH	21.470
		GRS	7.075	6:00 a.m.	Melbourne (or 6:10 a.m.)	VLA6	15.200
		GSV	17.810	6:15 a.m.	Capetown, So. Africa	ZRL	9.608
1:00 a.m.	London (PS)	GRM	7.120	6:30 a.m.	Chungking	XGOY2	7.153
		GRX	9.690				9.640
		GSN	11.820	6:30 a.m.	Teheran, Iran	EOB	6.155
		GSP	15.310			EPB	15.100
		GWH	11.800	6:30 a.m.	Delhi	AIR	17.830
		GVZ	9.640				15.350
1:00 a.m.	Melbourne (BBC)	VLR	9.540				15.190
	Brisbane	VLQ3	9.660				11.870
1:00 a.m.	Vancouver, B. C.	CBRX	6.160	6:45 a.m.	Montreal (Sackville)	CKNC	17.820
				(except Sun.)		CKLX	15.090

# for Modern **REMOTE** Broadcasting..

YOU'RE RIGHT ON THE SPOT WITH  
**GATES** FOR THOSE SPECIAL EVENTS!

For showmanship, efficiency, portability and compactness, these GATES Units forearm you for dependable broadcasting from right on the spot, where you must move fast, for those special events programs. They're the keynote in your success.



The **NEW FOURSOME**  
**REMOTE**  
**AMPLIFIER**

Completely assembles in rugged, handy Carrying Case as shown

A new development, and one that is bidding strongly for first place in popularity with the Dynamote is the new Foursome. It consists of three major units, a 4-channel Mixer, Amplifier and Power Supply that all fit into a trim, sturdy carrying case. The Mixer has two stages of amplification whose output plugs into the amplifier unit. On remotes where the four mixer feature is not required, just take the amplifier and power supply. A standard Cannon microphone plug fits the same receptacle as is used for the Joiner cable. The Foursome can be used for any job—large or small. Size: Mixer and Amplifier each approximately 12 in. long, 7 in. high, 4 in. wide.



Dynamote and Power Supply in Carrying Case

The **DYNAMOTE**  
**REMOTE**  
**AMPLIFIER**

This is the most popular Unit in the line of Remote units. It is a 4-stage high gain Unit containing the mixing system, VU meter and all other circuits associated with the amplifying circuit. The power supply is a separate unit assuring maximum noise reduction. The front panel is so designed to make it adaptable to any operating condition. Both the amplifier and power unit supply fit into the airplane type carrying case that is weather resistant and ruggedly built to withstand hard usage. A false bottom is provided to house cable and extra equipment always needed in remote jobs: headphones, microphones, etc. Compactness is its keynote. Size 14½ in. long; 7 in. high, 8 in. deep.

## LOOK TO GATES FOR LEADERSHIP

NEW YORK OFFICE:  
9th Floor  
40 Exchange Place

**GATES**  
**RADIO CO.**  
**QUINCY, ILL.**

SOLD IN CANADA by:  
Canadian  
Marconi Co., Ltd,  
Montreal

The **REMOTE**  
**CONDITIONER**



This Unit is a 3-stage Amplifier complete with power supply housed in one cabinet. This in itself is an accomplishment in high quality in remote amplifier design, and is the result of diligent research and experimentation. Power supply is of the full wave transformer type. Hum reduction guaranteed to a low level of minus 55 Db. below program level. Its operation is extremely simple. The only controls are the on-and-off switch and the gain control. Compact and easily portable. Size 17 in. long, 7 in. high, 4 in. deep.

EXCLUSIVE MANUFACTURERS OF RADIO TRANSMITTING EQUIPMENT... SINCE 1922

# HENRY RADIO

Do business with the biggest and one of the best in the field. Order the following or anything else you want.

Hallicrafters S38.....	\$39.50
Hallicrafters S40.....	79.50
Hallicrafters S36A.....	307.50
Hallicrafters SX42.....	Approx. 250.00
Hammarlund HQ-129X.....	173.25
Hammarlund SP-400-SX Super Pro	318.00
Hammarlund SP-400-X Super Pro	342.00
National NC-46.....	107.40
National HRO-5TA-1 Sr, (noise silencer, bandspread).....	274.35
National NC-240.....	225.00
National One-Ten.....	56.10
RME-45 complete.....	186.00
RME-84 complete.....	98.70
Pierson KP-81.....	Approx. 300.00
BC-348Q 110 V. AC model.....	85.00
Temco 75-100GA transmitter.....	495.00
Harvey 100T transmitter.....	583.00
Reconditioned BC-610 HT 4s.....	535.00
Panoramic PCA-2 panadaptors..	99.75
Other receivers, transmitters, etc. are available.	

**D**ELIVERY from the factories is improved. Some models I can ship at once from stock. By dealing with the world's largest distributor of short wave receivers you are assured of the fastest delivery and the best of service. Enter your order now. You can trade in your receiver. You can order on my own 6% terms. I will try to give you better service and cooperation. I have good buys in government surplus receivers, transmitters, parts, test equipment. Write for lists. You can depend on Bob Henry for a wide assortment and the best values in crystals, tubes, and all other amateur equipment and parts. Also test equipment. Your inquires welcomed.

BOB HENRY  
WOARA

## HENRY RADIO

BUTLER, MISSOURI AND  
LOS ANGELES 25, CALIF.

"WORLD'S LARGEST DISTRIBUTORS  
OF SHORT WAVE RECEIVERS"

94

### What's New in Radio

(Continued from page 86)

and 19" deep. Further information on this Duo-combination may be secured from the Home Radio Division, Westinghouse Electric Corporation, Sunbury, Pa.

#### TELEVISION CAPACITORS

A new line of small, light-weight capacitors designed to meet the requirements of size and weight imposed

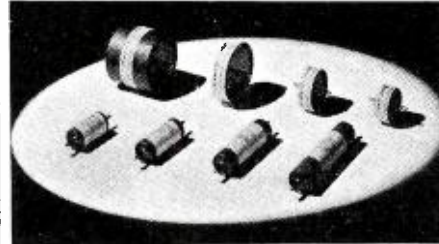

by the compact design of modern television receivers has been announced by the General Electric Company.

Developed especially for use in smoothing out the high voltage power supply in this and similar applications, these new Lectrofilm units are equipped with prong-type terminals which meet the special mounting requirements of television receiver applications.

Currently available in two designs, a flat cylinder and a tubular construction, these units are rated .005  $\mu$ fd., 5000 to 16,000 volts.

Detailed information on the new capacitors is given in Bulletin GEA-4558 which will be forwarded upon request to General Electric Company, Schenectady, New York.

#### PENTODE VOLTAGE AMPLIFIER

Sylvania Electric Products, Inc., has recently announced a new semi-remote cutoff pentode amplifier, designed for operation in portable battery and a.c.-d.c. receivers where the plate supply may drop as low as 45 volts.

Known as the type 1LG5, the tube filament is rated at 1.5 volts maximum for battery operation and has a design center of 1.3 volts for a.c.-d.c. operation. Maximum direct interelectrode capacitances when a 1 $\frac{1}{16}$ " diameter

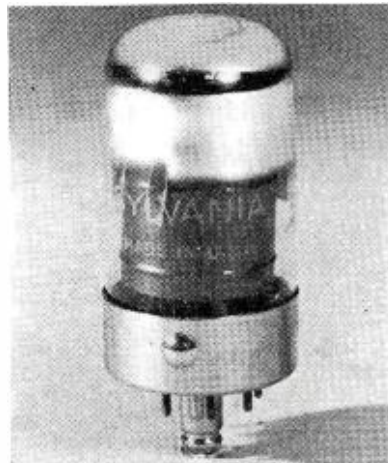

RMA standard M8-308 shield is connected to the negative side of the filament are; grid to plate .007  $\mu$ fd. max; input 3.2  $\mu$ fd., and output 7  $\mu$ fd.

Typical operating conditions and characteristics will be furnished upon request to Radio Tube Division, Sylvania Electric Products Inc., 500 Fifth Avenue, New York 18, New York.

#### MULTI-RANGE INSTRUMENT

The Marion Electrical Instrument Company has announced the production of a new foundation instrument, the Marion Multi-Ranger, which is designed to permit the user to assemble a highly accurate instrument for use as a voltmeter, milliammeter, high and low resistance ohmmeter, a.c. voltmeter and decibel meter.

The Multi-Rangers are available in 3 $\frac{1}{2}$ ", 4 $\frac{1}{2}$ " and 5 $\frac{1}{2}$ " sizes and each size is interchangeable electrically. The basic sensitivity of the instrument is 400 microamperes and the internal resistance is 500 ohms, plus or minus 1 per-cent. Alnico magnets are used. The scales are printed in three colors for quick identification and cover a full 100 degrees.

Circuits supplied with each instrument provide clear instructions for the

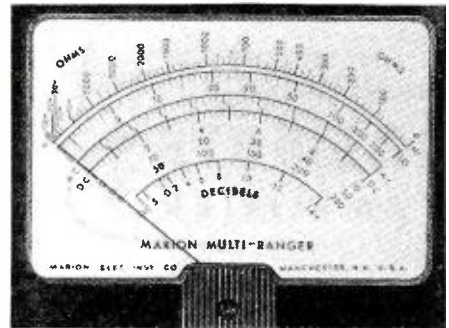

construction of single or multi-range equipment; all component values are shown on the circuits.

Further information about this instrument will be furnished by Marion Electrical Instrument Company, Manchester, New Hampshire.

#### NEW CAPACITORS

Centralab has announced the addition of four new types of capacitors to their line; transmitting capacitors, high accuracy capacitors, HDC capacitors and silver mica capacitors.

The transmitting group includes types 850S, 853S, 854S and 855S. Although designated transmitting units, these capacitors may be used for various high frequency applications. Construction features low power factor, stable retrace characteristics and maximum flashover commensurate with physical size. Plates are pure silver fired to the ceramic surface. Capacity tolerance is  $\pm 10\%$ .

The high accuracy capacitors are suitable for rigid frequency control applications and may be used to hold oscillator frequencies to close limits formerly attainable only by means of crystal control. The temperature coefficient is maintained within  $\pm 10$  parts per million. Standard working

RADIO NEWS

**JUST OFF  
THE PRESS**

# RADIOMAN'S HANDBOOK

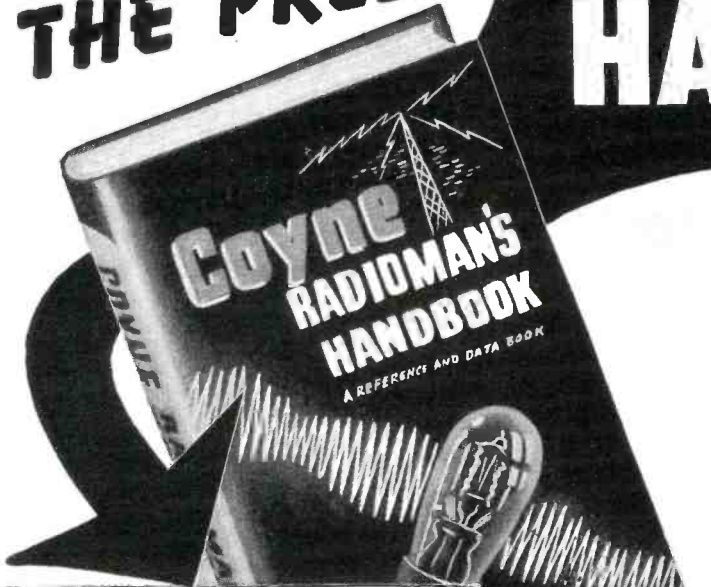

## WHAT THIS GREAT BOOK CONTAINS

- |                           |   |
|---------------------------|---|
| Radio Materials           | Radio Resistance & Insulation (wire tables, etc.) |
| Radio Abbreviations       | Capacitors & Capacitance                          |
| Radio Circuits            | Coils & Coil Winding                              |
| Power Formulas            | Resonance & Coupling                              |
| Radio Receiving Tubes     | Power Supply—A.C. or D.C.                         |
| Reactance & Energy Losses | Power Supply—Batteries                            |
| Radio Transformers        | Oscillators & Antennas                            |
| Radio Amplifiers          | Meters & Measurements                             |
| Radio Receivers           |   |
| Sound Systems & Devices   |   |
| Radio Symbols             |   |

**\$3.25**

## SEND NO MONEY SEE THIS BOOK FREE

I am not asking you to send any money—not a single penny. I am so sure this is the book you want and need that I will send it to you to examine for 7 days FREE. Then you look it over and you decide. If it isn't all I claim, then send it back and you owe nothing. If you are convinced that this book is worth many times its cost, then send \$3.25 at the end of 7 days and the book is yours. Send the coupon now, while it is before you!

SEE OTHER COYNE BOOKS IN COUPON

**COYNE ELECTRICAL SCHOOL**  
500 SOUTH PAULINA ST.  
DEPT. C6-T4 CHICAGO, ILL.

## A Brand New, Valuable Reference Book for Men Working in Radio or Electronics

This is the book that radio men everywhere have been waiting for. No matter what work you do in radio, this reference handbook will prove mighty valuable since it contains exactly the information you need. You can refer to it easily right on the job. It should help you get jobs done quicker and better—it will save you valuable time. I'm so sure that you wouldn't part with this book for many times its cost that I'm willing to send it to you for a 7 day FREE examination.

### 7 DAYS' FREE EXAMINATION

You can't expect to carry all the necessary information you need on a job in your head. But with this book at your side you will be able to make quick calculations that will help to show the boss that you certainly know plenty about radio construction, design, installation and operation. As you look through the pages of this valuable Radio Handbook you can easily see how the tables, charts, diagrams and information can help you get more money for your services. So I want you to examine this fine book at ABSOLUTELY NO COST TO YOU before you make up your mind whether or not you want it.

### A PRACTICAL REFERENCE BOOK—NOT A TEXT BOOK

You won't need to "study" this book—it is not a textbook. Every subject is indexed and condensed. It is full of valuable tables that will help you in your daily work. When you are "on a spot" just turn to the quick reference index, look up the subject you want and you'll find it thoroughly explained with helpful diagrams and tables. You lose no time. You waste no effort. The book is a day-by-day helper to you and will be of value to you on every job you undertake. It was written by competent, experienced, practical radio engineers and instructors. Every diagram has been fully tested in the great Coyne Electrical Shops. Every table is scientifically correct.

## FREE TRIAL COUPON

H. C. Lewis, President, COYNE ELECTRICAL SCHOOL, Dept. C6-T4  
500 S. Paulina Street, Chicago 12, Illinois

Send me the COYNE RADIOMAN'S HANDBOOK for 7 days' FREE examination. After 7 days I'll either return the book and owe nothing or I'll send you a check or money order for \$3.25.

Here are other Coyne Books—I'll send any or all on same 7 day Free Examination Offer.

Coyne Applied Practical Electricity—7 volume set; a complete library on everything electrical in easy to understand form. \$19.75 cash or \$21.00 on time—\$3.00 after 7 days and \$3.00 per month—1 year FREE Consultation Service and Technical Bulletins.

Coyne Electrical & Radio Trouble Shooting Manual—612 pages, over 500 wiring diagrams, hookups. Radio, P. A. systems, radio testing, refrigeration, motors and controls. \$9.00 cash—\$9.95 on time—\$3.00 after 7 days and \$3.00 monthly—1 year Technical Bulletins Free.

Coyne Electrician's Handbook—400 pages: data, diagrams, circuits, installation, wiring methods, etc. \$3.25 after 7 days.

Coyne Electronics for Radiomen & Electricians—over 400 pages: clearly explains all types electronic tubes, hundreds of diagrams, etc. \$4.95 after 7 days' examination—1 year Free Technical Bulletins.

Electrical & Radio Dictionary and Data Book—3300 electrical and radio, radar, electronic and atomic energy terms. 300 pages, vest pocket size. \$1.50 after 7 days.

Name \_\_\_\_\_ Age \_\_\_\_\_

Address \_\_\_\_\_

Town \_\_\_\_\_ Zone \_\_\_\_\_ State \_\_\_\_\_

Where Employed? \_\_\_\_\_

If you prefer to pay postman cash price indicated above when books arrive check here. Same 7 day examination and money-back guarantee of satisfaction.

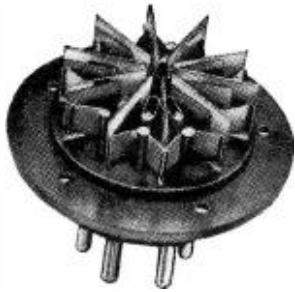

# Another SCIENTIFIC Achievement

**Compact—Ten Crystals  
in a Nutshell!**



Scientific's new DEKA-XTAL\* has ten of Scientific's fine metalized crystals arranged so any one of the ten can be connected to the base pins by rotating holder. All ten crystals in a package, no larger than a control knob. Unit plugs into standard five-prong tube transmitter socket, giving you ten frequencies with fingertip control.

Compact—rugged—sealed against moisture and dirt. The DEKA-XTAL plugged into oscillator gives you crystal control, signal shifting, at less than the cost of a good ECO. The DEKA-XTAL is useable with any number of crystals from one to ten. Order the holder with

as many crystals as you desire and add other frequencies later.

Your selection of frequencies furnished with unit, you can purchase additional metalized crystals and easily interchange them with the ones in the unit by following simple instructions.

DEKA-XTAL Holder without crystals.....\$6.95 each  
Metalized crystals furnished to plus or minus 1 KC, your specifications in the frequency range 3,500 to 9,500 KC..... 1.50 each  
\* Patents Pending



voltage is 500 volts d.c., capacity tolerance is  $\pm 5\%$ .

The HDC capacitors (high dielectric constant tubulars) may be used in ap-

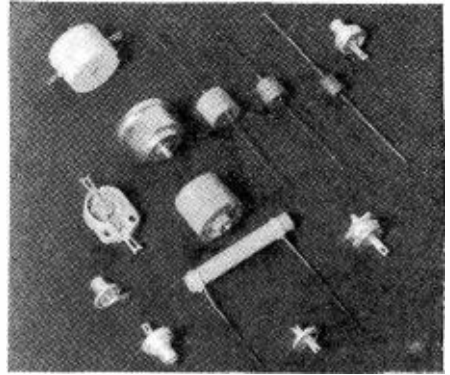

plications where temperature compensation is not necessary.

The silver mica capacitors are recommended for high frequency applications or any system requiring a unit of low losses.

More complete information on these new units is contained in Catalogue No. 25 which will be forwarded upon request to *Centralab, Division of Globe-Union Inc.*, 900 E. Keefe Avenue, Milwaukee 1, Wisconsin.

## CHANGERAK

A new Changerak, which will adjust to any size record changer and permit the changer to be locked in any position for repair is being introduced by *Aetna Radio Service* of Chicago, Illinois.

In addition to using the Changerak for repairing of record changers, the unit may be used as a display fixture or as a safe, easy holder for delivering repaired units.

Prices and additional information on this unit will be furnished those requesting it from *Aetna Radio Service*, 2846 Milwaukee Avenue, Chicago, Illinois.

## MARINE RADIOTELEPHONE

A small, compact radiotelephone which was designed specifically for small and medium sized cruisers and fishing boats, has been announced by *Islip Radio Manufacturing Corporation*.

Known as the MRT 10, the output power of this unit is 10 watts, crystal controlled for both transmitting and receiving. No tuning is required, eliminating the possibility of off-frequency operation. Individual adjustments are provided by tuning the final amplifier and antenna for full output on each channel. The receiver section is also provided with individual tuning ad-

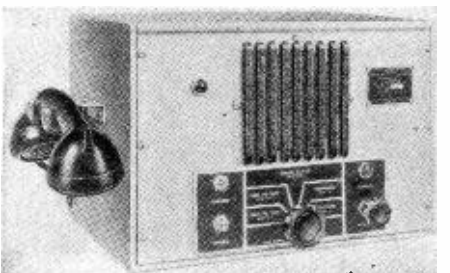

**RADIO NEWS**

# SCIENTIFIC



## RADIO PRODUCTS COMPANY

738 1/2 W. Broadway - Telephone 3-1412

MANUFACTURERS OF PIEZO ELECTRIC  
CRYSTALS AND ASSOCIATED PRODUCTS  
COUNCIL BLUFFS, IOWA

# Electricity

FOR RADIO AND ELECTRONICS USES

Model shown is from W2C series, 2 and 3-KW 60-cycle, 115 volt; powered by water-cooled, 2-cylinder engine.

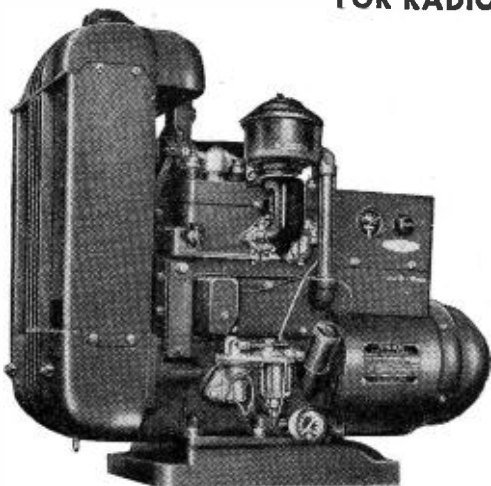

ONAN ELECTRIC GENERATING PLANTS supply reliable, economical electric power for electronics applications as well as for scores of general uses.

Driven by Onan, 4-cycle gasoline engines, these dependable plants are of single-unit, compact design and sturdy construction. Suitable for mobile, stationary or emergency service.

Onan Electric Plants are available in capacities from 350 to 35,000 watts; 115 to 660 volts A.C., 50 to 800 cycles; 6 to 500 volts D.C.; combination A.C.-D.C. types.

WRITE FOR INFORMATION OR  
ENGINEERING ASSISTANCE

## D. W. ONAN & SONS

2175 ROYALSTON AVE., MINNEAPOLIS 5, MINN.



## RADIO ENGINEERING TELEVISION ELECTRONICS

Courses in every phase of radio and electronics open to high school graduates. Thorough training, modern courses. Enrollments limited. Approved Veteran Training.

VALPARAISO TECHNICAL INSTITUTE  
Dept. RS Valparaiso, Indiana

## Ted McElroy

World's Largest Manufacturer of  
Wireless Telegraphic Apparatus

COMPLETE CENTRAL OFFICE EQUIPMENT

## McElroy Manufacturing Corp.

82 Brookline Avenue - Boston, Massachusetts

## "THIS PIONEERING EFFORT..."

*"The Chicago and North Western Railroad, always interested in technological developments which promise improvement in the efficiency and safety of railway operations, participated in the first regular use of very high frequency railway radio. This installation went into operation in our Proviso Yards in September, 1940, and continued for over a year thereafter.*

*We are happy that the technical and operating information secured from this pioneering effort was subsequently useful to the Army Ordnance Department and to the operators of the large Army Ordnance Plants in making their decision to use railroad radio in connection with the war effort.*

*The case histories provided by the use of radio at Proviso and in the large ordnance plants were later to become an important part of the railroad testimony in the Federal Communications Commission hearing which brought about the present allocation of frequencies for railway use."*



PRESIDENT,

Chicago and North Western  
Railway System



**W**hen the Chicago and North Western Railway conducted its Proviso Yards pioneering of high frequency radio for communications purposes, some of the present members of the Farnsworth Mobile Communications Division assisted in a technical capacity. These individuals, too, were largely responsible for the Army Ordnance Department's first use of radio in railway operations.

These events occurred more than five years ago, long before the Federal Communications Commission's recent allocation of frequencies for railway use—and at a time when the future of railroad radio was fraught

with doubt, and only one organization was pressing for recognition of the railroads' right to frequencies.

Today, the results of almost a decade of pioneering effort and engineering appear in the new Farnsworth 152-162 megacycle railroad radio equipment—*systematized equipment designed to guarantee maximum availability and flexibility with simplified, low-cost maintenance*—equipment meeting all of the presently-established requirements of the Federal Communications Commission and the Interstate Commerce Commission. Farnsworth Television & Radio Corporation, Dept. RN-8, Fort Wayne 1, Indiana.

# FARNSWORTH TELEVISION & RADIO CORPORATION

Farnsworth Radio and Television Receivers and Transmitters • Aircraft Radio Equipment • Farnsworth Television Tubes • Halstead Mobile Communications and Traffic Control Systems for Rail and Highway • the Farnsworth Phonograph-Radio • the Capehart • the Panamuse by Capehart

August, 1946

97

# PARDON ME!



## BUT IS YOUR SLIP SHOWING?

Sometimes much more embarrassing or disastrous results can come from slippage or unintentional movement of a dial than from having the girl friend's slip hang below her dress. The NEW BUD DIAL LOCK, DL-1947, absolutely prevents this occurrence.

DL-1947 is a new addition to the BUD line and fills a need of long standing. It is a precision unit especially designed for apparatus requiring an accurate, fast-acting dial-lock and tuning indicator.



**DON'T FAIL TO SEE IT AT YOUR LOCAL DISTRIBUTOR TODAY !!!**

**BUD Can Supply All Your Needs! . . .**

. . . with the latest types of equipment including: condensers—chokes—coils—insulators—plugs—jacks—switches—dials—test leads—jewel lights and a complete line of ultra-modern cabinets and chassis.

**BUD**  
**BUD RADIO, INC.**  
 CLEVELAND 3, OHIO

justments for each channel. The power supply may be 6 or 12 volts, d.c. or 32 volts on special order. The cabinet and chassis are steel and the entire unit is treated against moisture and corrosion.

Additional information will be furnished by *Islip Radio Manufacturing Corporation*, Islip, Long Island, New York.

#### FREQUENCY RECORD

*Universal Recording Corporation* of Chicago has announced the release of a new, double sided, non-breakable frequency record for use as a standard.

This standard is recorded 33 $\frac{1}{3}$  r.p.m. on one side and 78 r.p.m. on the other.

#### Audio Oscillators

(Continued from page 40)

calibrate our high frequency range in 1500 cycle steps by increasing the sweep frequency until one, two, three, and more cycles appear.

To obtain intermediate points, we go back and start at a different multiple of 60 cycles. By this method, as many calibration points as desired may be obtained. We may also interpolate between calibration points by ear if we so desire. The inaccuracy will not be great.

The dial can be made from a three or four inch transmitter dial with the calibration drawn with pen and India ink on paper which is cemented to the dial's face, or a *National ACN* type dial could be used with the calibrations drawn in the spaces provided for them.

Either of these oscillators, if carefully built, will provide an entirely adequate variable audio frequency source necessary for service work or any research concerned with audio frequencies. The distortion will be so low as to be considered negligible even in distortion measurements.

Voice announcements identify each frequency. Recorded frequencies include 100 cycle reference, 10, 9, 8, 7, 6, 4, 3, 2 kc., 1500 cycles, 1000 cycles, 800, 500, 300, 200, 100, 70 and 50 cycles with an additional 10 kc. band at the innermost useful groove diameter for checking tracking differential. Thirty seconds of blank grooves with a specified rumble content are included for testing playback equipment.

The records are pressed on unbreakable vinylite which gives an extremely low surface noise. Additional information on this record will be forwarded by *Universal Recording Corporation*, 7121 Ridge Avenue, Chicago 45, Illinois, upon request.

With the advent of the newer FM receivers, the audio oscillator will become as necessary as your volt-ohm-milliammeter. FM's greatest claim is its higher fidelity. Small distortions and response non-linearities not noticeable on AM will assume annoying proportions on FM. These troubles are more easily tracked down with your audio oscillator.

Just imagine trying to find an annoying rattle or distortion at 12,000 cycles-per-second with a screw driver or a multimeter. Why not build your own audio oscillator and let it show you how helpful it can be.

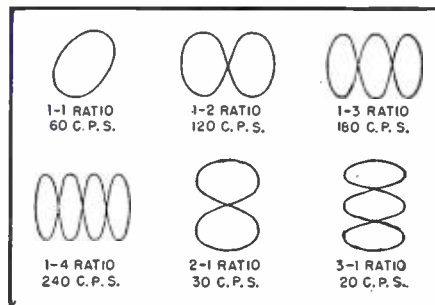
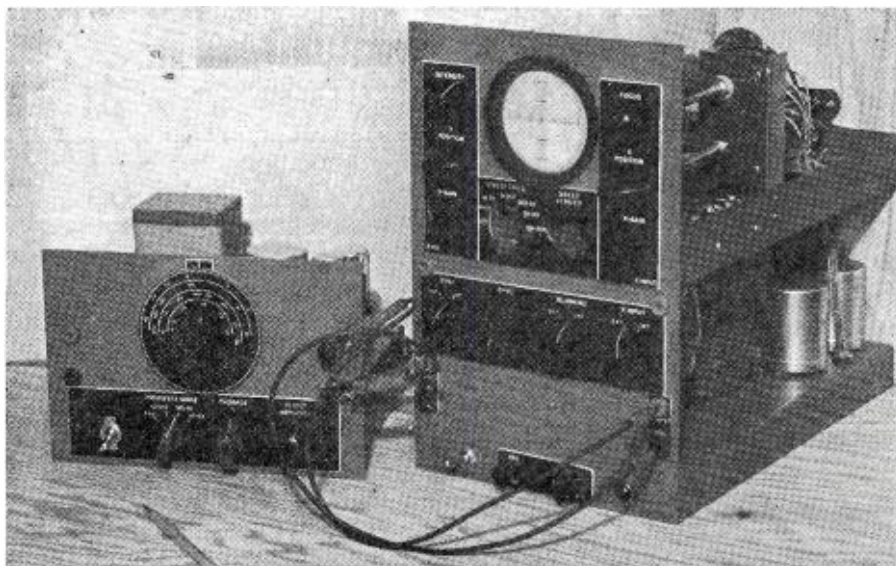

Fig. 8. Lissajous patterns were relied on for the calibration of the instrument.

Fig. 9. An oscilloscope was used by the author in final calibration of instrument.





# NOW! You Can Buy Unused Coaxial Cable

MADE TO U. S. ARMED FORCES SPECIFICATIONS

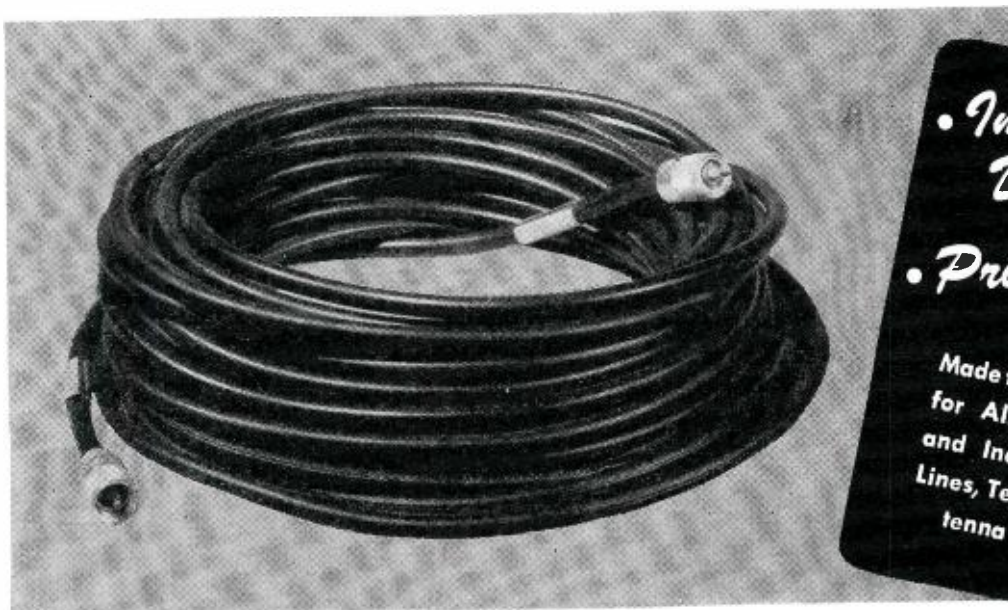

*• Immediate Delivery*  
*• Priced Very Low*

Made for the Armed Forces for All-Weather Outdoor and Indoor Transmission Lines, Test Cables and Antenna Phasing Lines

## High Fidelity Transmission Line For All Amateurs and Special Services

Now, you can have hard-to-get coaxial cable . . . made to rigid specifications . . . available for immediate delivery . . . at a price unbelievably low! This high-quality cable is government-owned surplus and was made for the Armed Forces in the same v.h.f. frequencies common to current services—F.M.: television, citizens radio, facsimile, communications, etc. It is well suited to use by police cars, railroads and all special services. Hams and all others interested in high fidelity transmission will recognize this as a "once-in-a-blue-moon" value.

Included in the types of cable we offer you at bargain prices are RG#5U, RG#8U, RG#9U, RG#25U, RG#26U, RG#29U, RG#37U, RG#55U, and RG#58U. Outstanding in this lot is the RG#5U which is offered in 60 ft. lengths with 1 conductor male plug at each end (shown in the illustration above). At our special price of \$4.00 per 60-ft. length f.o.b. Chicago it's a hard-to-beat buy. Other types listed are available in varying lengths—are coiled 500 to 2000 ft. per reel, depending on outside reel diameter.

Because this cable is in big demand, you'll be wise to order your needs immediately. Terms are 30 days approved credit . . . otherwise cash with order or C.O.D. If you live in or near Chicago, come in and see this material at our warehouse located at 3243 South Kedzie Avenue. You'll be amazed at the money-saving items displayed. Dealers will also do well to investigate our stocks and will receive special discounts on many much-wanted items. Write for detailed information—order RG#5U on the handy coupon below . . . today.

**ORDER TODAY—USE THIS COUPON**

**KELLOGG SWITCHBOARD AND SUPPLY CO.**  
 (Acting as Agent for the War Assets Administration Under Contract S1A-4-12)  
 3243 South Kedzie Avenue • Chicago, Illinois

Kellogg Switchboard and Supply Company  
 (Acting as Agent for War Assets Administration Under Contract S1A-4-12)  
 3243 South Kedzie Avenue • Chicago, Illinois

Gentlemen:  
 Send me RG#5U (60 ft. length) at \$4.00 each, f.o.b. Chicago.  
 Enclosed find check—money order—for \$.....  
 Send C.O.D.  Charge (30 days approved credit)

Name.....

Address.....  
 (If dealer, list company, your name and official position)  
 Send me information on other cable and equipment available.

# EAGLE RADIO

for better buys!

## RADIO KITS



- AC-DC 5 TUBE SUPERHET**  
12SA7, 12SK7, 12SF7, 12A6, 35Z5  
Complete with tubes.....\$16.90
- AC-DC 4 TUBE T.R.F.**  
12SK7, 12SF7, 12A6, 35Z5. Plays on Loop  
Complete with tubes.....\$13.95
- AC-DC 5 TUBE, 2-BAND SUPERHET**  
12SA7, 12SK7, 12SF7, 12A6, 35Z5. B.C.  
Band and 2000 Kc. to 10 Mc. Short  
Wave.  
Complete with tubes.....\$18.90
- 3 TUBE AC-DC AMPLIFIER**  
Designed for use with Record Player.  
Complete with tubes less speaker.\$5.95
- 2-TUBE PHONO OSCILLATOR**  
New Eagle Design.  
Complete with tubes.....\$4.49

## HIGH IMPEDANCE HEADSETS



Impedance 9200 ohms, adjustable to any size. Six ft. cord equipped with phone tips.....\$2.49 each

**REGULATION ARMY HEADSETS**  
Ear phones are equipped with a PL-54 plug.  
\$1.95 each  
6 ft. extension cord equipped with standard plug for above headsets only.....49c each

1N21B Rectifier Crystals.....59c each  
1" Dynamic Microphone can be used as a Mike or Earphone.....95c each

**COMPLETE AERIAL KITS**  
Includes—Wire, Insulators, Grounding Strip and Lightning Arrester.....98c each

**TUBES**  
813 fully guaranteed.....\$9.95 each  
866/866-A.....\$1.25 each

Write for FREE literature on complete line of kits. For all electronic equipment... try EAGLE first!

Buy with Safety

**EAGLE RADIO**  
84 CORTLANDT ST.  
Dept. N 1 New York 7, N. Y.

## International Short-Wave

(Continued from page 55)

cards are not sent, but correct reports are verified by lettermail. An illustrated, technical brochure is now being prepared for distribution.

Transmitters are two RCA ET-4750's, and two transmitters constructed in the station; all are 7½ kw. All studio equipment was designed and constructed in the station.

As to programs, Mr. Dean says, "Some artists are available in Palestine, but for the most part, recording vans are sent to Cairo, Baghdad, Damascus, and so on, to obtain local talent."

\* \* \*

### European Addresses

Sten-Stur Edberg, ABY, Sweden, has compiled for ISW readers this list of official addresses of postwar European short-wave stations, by country:

- Albania—The Albania Broadcasting Corporation, Tirana, Albania.
- Andorra—Direction del Remitente, Radio Andorra, Roch d'ells Escolls, Andorra la Vieja (Andorra).
- Austria—The Austria Broadcasting Corporation, Vienna, Austria (Osterreich).
- Azores—Emissora Regional dos Acores, Avenida Gaspar Fructuoso, Ponta Delgada, Azores (Port.).
- Belgium—The Belgium Broadcasting Corporation, Radiodiffusion Nationale Belge, Brussels, Belgium.
- Bulgaria—Radio Sofia, Information Service, Sofia, Bulgaria.
- Czechoslovakia—The Czechoslovak Broadcasting Corporation, Ceskoslovensky Rozhlas, Stalinova tr 12 Prague (Praha XII), Czechoslovakia.
- For the Slovakian short-wave station, Short-Wave Station, Bratislava, Slovakia (Slovakiet).

Denmark—Statsradiofonien, "Danmarks Radio," Rosenørns Alle 22, Copenhagen, Denmark (Danmark).

England—The British Broadcasting Corporation, Broadcasting House, London W. 1, England.

Finland—O/Y Ylesradio A/B, Fabiansgatan 15, Helsinki, Finland (Suomi).

France—Radiodiffusion Nationale Francaise, Service des Emissions vers l'Etranger, 118, Avenue des Champs Elysees, Paris, France.

Germany—(For stations in Berlin and Frankfurt), Deutsche Rundfunk, Berlin, Germany (Deutschland).

Greece—Radio Athens, The Greece Broadcasting Corporation, Athens, Greece. (A more complete address that has just come to my attention is: Cable & Wireless, Ltd., Office of Manager in Greece, Leoforos Vassilisis Sofias 2, P.O. Box 8, Athens, Greece.)

Holland—Stichting Radio Nederland in den Overgangstijd, Postbus 150, Hilversum, Holland (The Netherlands).

Hungary—The Hungary Broadcasting Corporation, Budapest, Hungary.

Iceland—Broadcasting Stations of Island, "Rikisutvarpid," Broadcast Service, Reykjavik, Iceland (Island).

Ireland—The Ireland Broadcasting Corporation, Athlone, Irish Free State (Ireland). (Or to Radio Eireann, Dublin, Eire (Ireland).)

Italy—Ente Italiano Audizioni Radiofoniche, Direzione Generale, Via Arsenale 21, Torino, Italy.

Luxembourg—Luxembourg Radio, Compagnie Luxembourgeoise de Radiodiffusion, Luxembourg City, Luxembourg G.D.

Malta—The Broadcasting Corporation in Malta, La Valetta, Malta (Mediterranean Sea).

Norway—Norsk Rikskringkasting, Stortingsgaten 24, Oslo, Norway (Norge).

The IP-25 infra-red electron-image tube which was used in the sniperscope and other vital Army-Navy equipment and manufactured by Farnsworth Television & Radio Corporation. All visible light from the carbine mounted floodlight is blocked out by an infra-red filter so that it is possible to look into the ray in the dark and not see it with the naked eye. This invisible infra-red floods the scene of activity and the reflected image is picked up by the special electron tube in the telescope mounted atop the carbine. This telescope acts as a gun sight for the sharpshooter. The infra-red technique, given impetus by the war, may be a boon to professional and amateur photographers and manufacturers of photographic film. The present construction of this electron-image tube has three essential elements, the photo-cathode, the electron optical system and the fluorescent screen. Further details of this unit will be found in the June, 1946 Radio News.

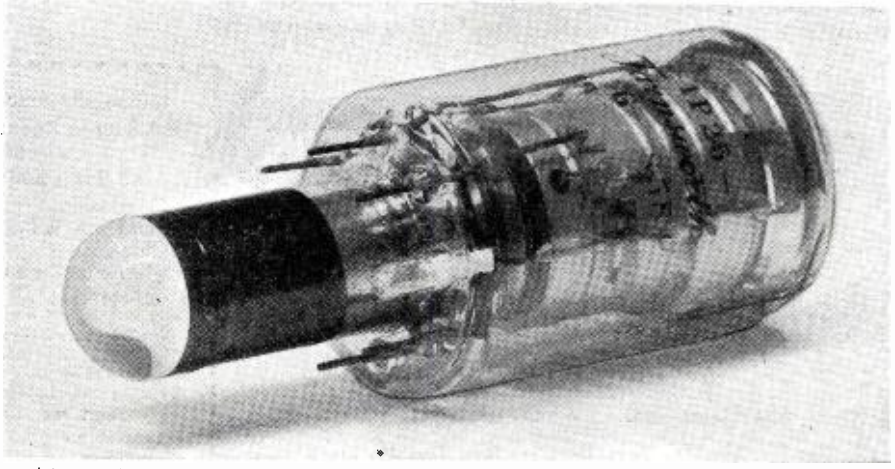

# First Again!

The New 10-11 Meter

## GON-SET CONVERTER

For Fixed—Mobile Use  
Built In Pre-Selection

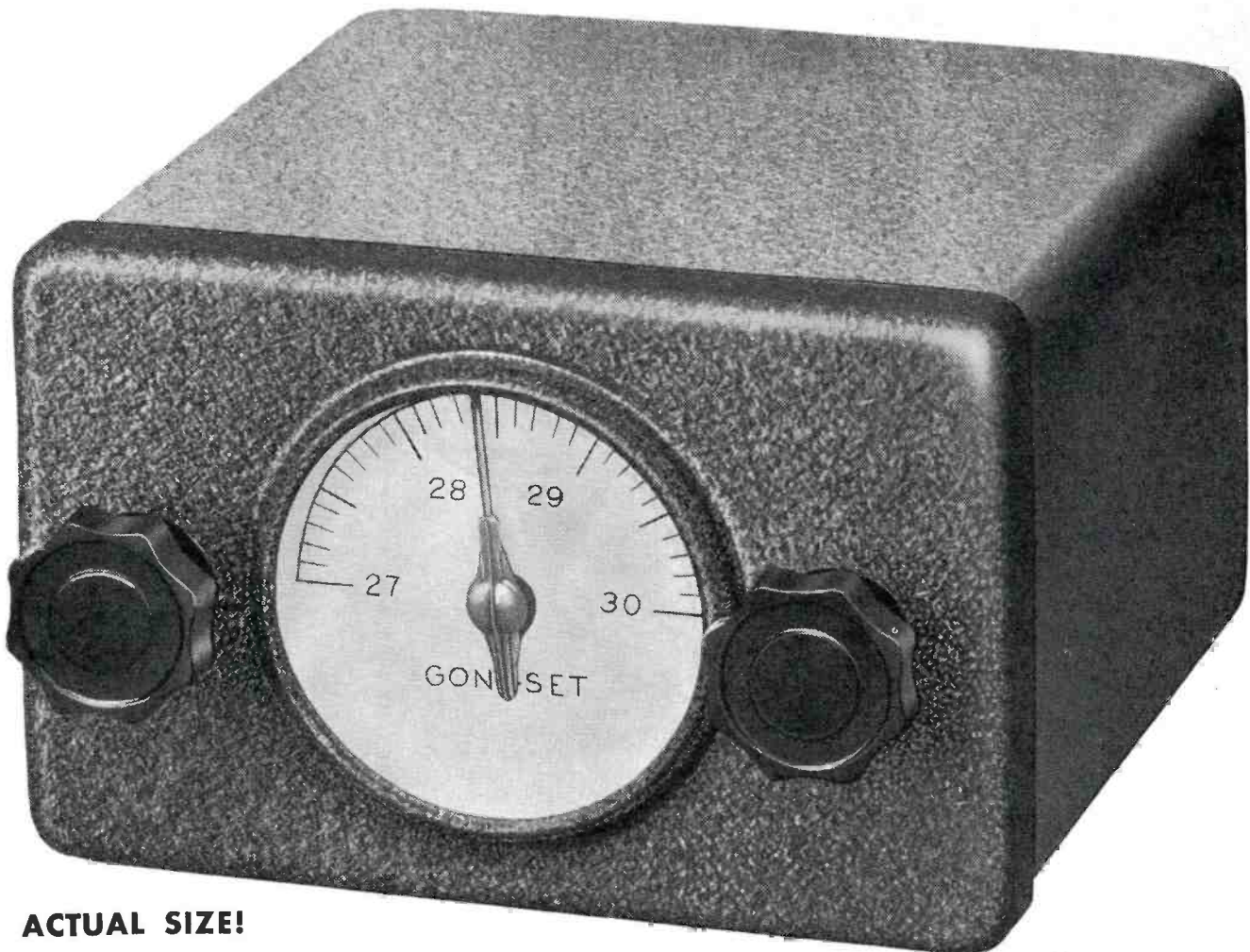

### ACTUAL SIZE!

THE new GON-SET 10-11 Meter Converter, complete with built-in pre-selection is designed for use with either broadcast, auto, or communication receivers. Attaching the converter to your present radio provides unexcelled mobile or fixed reception. GON-SET converters have been manufactured since 1938 and are used world wide. Long experience, together with precision design and construction assures a superior product. Ideal for surplus receivers.

#### IMMEDIATE DELIVERY

Price, Complete, \$39.95

Special Noise Silencer, \$8.25

High Frequency Antenna Lead Cable, \$0.08 per foot

W6YR

### WATERPROOF ELECTRIC COMPANY

70 E. VERDUGO AVE.

BURBANK, CALIFORNIA

- ★ TUBES: 6AK5, R.F.  
6AK5 Mixer-6C4 OSC.  
OB2 Voltage Regulation
- ★ COMPLETE BANDSPREAD  
27-30 MC.
- ★ OUTPUT: 1500-2000 KC.
- ★ 8-1 VERNIER
- ★ ILLUMINATED DIAL
- ★ CONNECTING CABLES INCLUDED.
- ★ WEIGHT: 2-lbs.
- ★ SINGLE DIAL CONTROL
- ★ ON-OFF SWITCH PROVIDED

O.P.A. Approved

# Attention GI JOE!

Here's Your Opportunity to be First to

## Start Your Own RADIO SERVICE SHOP

Complete Starting-in-Business  
Package Stocks of

TEST EQUIPMENT  
TUBES, PARTS, TOOLS

**\$350 up**

Act quickly! Meet the pent up demand for radio service. Turn your special service training into a profitable business of your own. No fuss. No worry. Here's everything you need—\$350 up. Details upon request! Write, wire or phone

### RCP 448

"POCKET" VOM  
A.C.—D.C. Volts  
0-5-50-250-1000  
D.C. Mills  
0-5-10-100-1000  
Ohms  
0-2,000-20,000-200,000-  
2 Meg.  
Size 3"x5 1/4"x2 1/2"

**\$24.50 net**



### RECORD CHANGERS

UTAH-DETROIT #550C ..... \$18.27  
WEBSTER-CHICAGO #56 ..... 27.20

### HALLICRAFTERS SX-28A

**\$223**



SUPER DEFIANT ..... SX25 \$94.50  
SKY CHAMPION ..... S20R 60.00  
SKYRIDER MARINE ..... S22R 74.50  
S40 NEW MODEL ..... Approximately 79.50  
SKYRIDER JR. S41 ..... 33.50

### HAMMARLUND HQ-129-X \$129



#### TRIPLETT 625-N

20000 ohms per volt D.C.  
10000 ohms per volt A.C.  
5" Scale—TOPMOST QUALITY  
(1) D.C. Volt Ranges to 5000  
(2) A.C. Volt Ranges to 5000  
(3) OHM Ranges 0-400-50000-  
10 Meg.  
(5) D.C. Current Ranges 1 Ma.  
to 10 Amp.  
PLUS OUTPUT and DB.  
RANGES  
**\$45.00** with test leads.

### PHILCO BEAM OF LIGHT

Selenium Cell only, no holder ..... **1.80**

20% deposit required on all C.O.D. orders. 2%  
transportation allowance on orders of \$25.00 or  
more accompanied by payment in full.

**RADIO SUPPLY & ENGINEERING CO., Inc.**  
129 SELDEN AVE. DETROIT 1, MICH.

Write for  
FREE CATALOG

Poland—Polskie Radio, Polskie Broadcasting Corporation, Warsaw, Poland (Polen).

Portugal—Emissora Nacional de Radiodifusao, Rua do Quelhas, Lisbon (Lisboa), Portugal.

Rumania—The Rumania Broadcasting Corporation, Bucharest, Rumania.

Spain—Radio Nacional D'España, Subsecretaria de Educacion Popular, Direccion General de Radiodifusion, Programacion-Jefatura, Madrid, Spain (España).

Sweden—The Swedish Broadcasting Corporation, "Radiotjänst," Kungsgatan 8, Stockholm, Sweden (Sverige).

Switzerland—Schweizerischer Rundsruchdienst, Direktion, Postfach Transit, Berne, Switzerland.

Vatican—Vatican Radio, Vatican City (Citta del Vaticano), Vatican State.

U.S.S.R.—Radio Centre, Moscow, Union of Soviet Socialist Republics (Russia).

Yugoslavia—Radio Belgrad, The

Yugoslavia Broadcasting Corporation, Belgrade, Yugoslavia (Jugoslavia).

\* \* \*

### More About Clubs

England—Address of the Radio Society of Great Britain is New Ruskin House, Little Russel Street, London W.C. 1, England. This organization, in the peak pre-war period, boasted a membership of somewhere around 3,650 amateurs. During the first months of hostilities, this number declined considerably, but after the critical period, the membership recovered and steadily increased until, in September, 1941, it was within some 200 of its former strength. A year later, expansion was still continuing, and the total was 4,480, including re-elected former members. By the end of 1943, the rate of intake had considerably speeded up, and the total stood at some 5,800. This figure was left far behind the following year, when in December 1944 (the last date for which figures have been furnished), the grand total

## SIGNAL CORPS FIGHTS ELECTRICAL NOISES

**A**N Army signalman, with earphones clamped over his head, sat before his radio in a camouflaged shelter. He was intently copying a military order concerning the movement of troops on maneuver. Suddenly his ears rang with scratching and hissing noises so loud that they blotted out the message.

Outside a convoy of jeeps, trucks, and tanks was moving past.

"There goes that blasted interference again," exclaimed the signalman. "How can a guy get a message through all that racket?"

The signalman was referring, not to the din made by the vehicles as they clanked along the road, but to the electrical noises emitted by the motors and treads of the rolling equipment. Every sparkplug, distributor, and generator in the convoy was a miniature broadcasting station—sending out a broadcast of noise produced by static. The radio set, tuned up high to catch weak signals, picked up the electrical noises and magnified them to a degree where it was impossible to distinguish the desired message.

Here was another problem for the Army Signal Corps. Noise interference threatened to hamper the effectiveness of the Army's vital radio communications equipment. The noise came from a thousand different sources—from motor vehicles, gasoline-driven generators, laundry power plants. It surged out from x-ray units, dentists' electrical drills, delousing plants, even from potato peelers. Something had to be done to stop it.

At the beginning of the war, the Signal Corps points out, none of the equipment manufacturers knew enough about suppression to produce vehicles and electrical units free from this form of "man-made interference." To the Detroit Signal Laboratory, Detroit, Mich., was assigned the job of designing suppression systems for all transport and combat vehicles and electrical equipment, and selling the production firms on the fact that noise suppression was as important for the success of a military mission as an engine or a gun.

For this project the Signal Corps engineers designed resistor-suppressors for the sparkplugs and distributors,

by-pass capacitors for charging circuits, and bonds and toothtype lockwashers for vehicles and metal parts. They developed, standardized, and obtained sources of supply for suppression components that could withstand Arctic cold or tropic heat and humidity.

The engineers were handicapped during the early phases of their work by the lack of suitable instruments for measuring electrical noises and determining the type of corrective measures necessary to suppress them. Noise meters were devised to determine the control limits and tolerances and the meters were installed in all plants producing war vehicles. By the time hostilities ceased a highly accurate impulse-noise generator had been developed for use as a reference standard in the measurement of radio noises.

At first, suppression equipment was provided over the range of 1.5 to 20 megacycles, but with the increasing use of radios operating on higher frequencies it was found necessary to expand the range of suppression to 40 megacycles for vehicles and even higher for power units.

Radio interference from static generated by the tracks of tanks and other track-propelled vehicles was a long-standing problem which at times appeared impossible of solution. The problem was solved, however, by the development of improved bonding devices; by bonding of the track-laying and supporting mechanisms; and by the use of conductive rubber compounds on bogie tires and on the inner surfaces of rubber tracks. The conductive surfaces, in combination with the internal bonding, permit a gradual dissipation of electric charges built up on the surfaces when the vehicles are in motion and thus overcome the sparking that occurs with non-conductive, unbonded tracks.

Suppression systems were designed for nearly every type of vehicle, engine-generator, and electrical device used in the war. And for vehicles and generators that got overseas without benefit of this treatment, suppression kits, simple to install, were sent to every theater.

—50—

RADIO NEWS

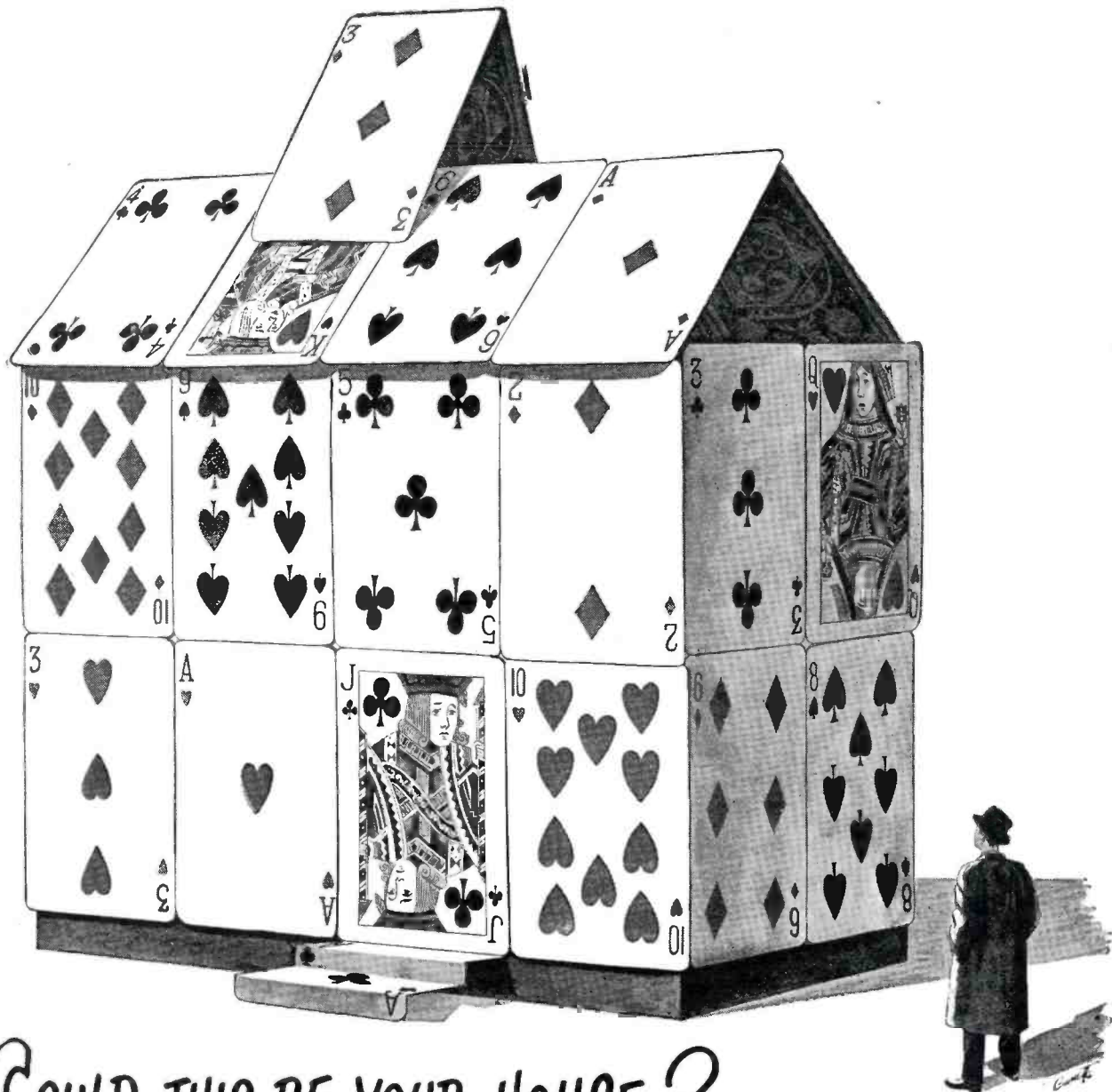

## COULD THIS BE YOUR HOUSE?

Now that the war's over and a lot more civilian goods are on the market, it's a big temptation to spend just about all you make, and not put anything aside.

But to fall for that temptation is plenty dangerous. It's like trying to live in the house above—a house that might come tumbling down about your ears at the first little blow of hard luck.

Right now the best possible way to

keep your finances in sound shape is to save regularly—by buying U. S. Savings Bonds through the Payroll Plan.

These Bonds are exactly like War Bonds. Millions of Americans have found them the safest, easiest, surest way to save. The U. S. A. protects every dollar you invest—and Uncle Sam gives you his personal guarantee that, in just ten years, you'll get four dollars back for

every three you put in!

If you stick with the Payroll Savings Plan, you'll not only guard against rainy days, you'll also be storing up money for the really important things—like sending your children to college, traveling, or buying a home.

So—anyway you look at it—isn't it smart to buy every single U. S. Bond you can possibly afford!

**SAVE THE EASY WAY... BUY YOUR BONDS THROUGH PAYROLL SAVINGS**



**ZIFF-DAVIS PUBLISHING COMPANY**

★ This is an official U. S. Treasury advertisement—prepared under auspices of Treasury Department and Advertising Council

August, 1946

★ 103

## Toroidal Coils for high "Q"

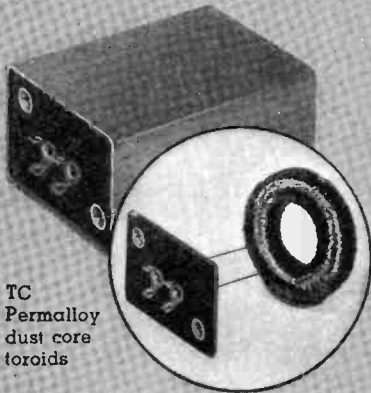

TC  
Permalloy  
dust core  
toroids

Inductance — up to 2 hys.  
Frequency—300 cy. to 30,000 cy.  
"Q"—55 at 1000 cy.; 150 at 3000 cy.  
List Price . . . from **\$4.50** to **\$7.50**  
(UNCASED)

## TOROIDAL COILS IN FILTERS

### Communications:

KF-40—Keying frequency filters providing over 60 DB attenuations at crossover points between channels. Also discriminators.

### Aircraft Radio (Personal)

BF-10—Range filters to permit separation of the 1020 cy. beam signal from voice transmission. Employs unique method of impedance matching permitting use of minimum number of components. Weighs only 10 ounces and measures 1½"x1½"x3".

### Broadcasting:

CE-20 — Transcription equalizers for lateral recordings.

CE-25 — Transcription equalizers for vertical recordings.

The above are designed in accordance with N.A.B. requirements.

### Research and Laboratory Instruments

Filters for harmonic analysis on any special type of frequency discrimination.

## Burnell & Co.

Designers and Manufacturers of  
Electronic Products

10-12 VAN CORTLANDT AVE. EAST  
BRONX 58, N. Y. SEdgwick 3-1593

was 7,744, or roughly just over twice the prewar number.

The monthly journal, first called *T & R Bulletin*, is now re-titled the *R.S.G.B. Bulletin*. The Society also issues an annual publication, known originally as the "*Guide to Amateur Radio*," later changed to "*Amateur Radio Handbook*," and to this a "*Supplement*" has recently been added. To December, 1944, some 130,000 copies of the handbook and 75,000 copies of the supplement had been sold. Throughout the war, the Experimental Section under G6HD continued to be active, and a new sub-section, the VHF (Very High Frequency) Group, has been formed. The financial position of the Society is a strong one, and a Post-War Development Fund has been built up which stood at some 5000 pounds Sterling at about war's end. (This information was furnished by the British Short-Wave League.)

New Zealand—From Merv Branks

and Bill Milne, Invercargill, New Zealand, comes this additional information on The New Zealand DX Club (incorporated), which had its beginning back in 1927 when members of the weekly radio journal, *The N.Z. Radio Record*, began to tell of their loggings in the correspondence columns of that publication.

In 1930, the club was inaugurated under the guidance of *The Record*, but in 1939, the club was taken over by the DX-ers themselves.

Headquarters of the organization are at 10 Koraha Street, Auckland, S.E. 2, while a monthly mimeographed bulletin is published at 5 Dublin Street, Invercargill. A copy of this *N.Z. DX-Tra* can be had from the latter address.

The club is an active group, with branches in the chief cities of the Dominion. Competitions are sponsored both by Headquarters and these branches. While most of these com-

## NEWLY DEVELOPED "VIBROTRON" TUBE

**R**ADIO Corporation of America recently announced the development of a tiny metal electron tube, weighing only 1/15 of an ounce, which converts mechanical motion directly into variable electron flow.

Named the "Vibrotion," this tube is expected to find wide application in future designs of phonograph pick-ups. Other fields of application are in microphones and industrial equipment where translation of mechanical motion to electron circuits is desirable for purposes of control or measurement.

Although the tube is not in production at the present, a limited number of "Vibrotions" are being made available to manufacturers of electronic equipment who are interested in experimenting with it for use in future products.

The "Vibrotion" is a metal triode only 1" in length and about ¼" in diameter. Leads for supplying voltages to the tube are brought out through a glass seal at one end. At the other end a flexible metal diaphragm permits transferring external motion to a movable electrode within the tube. This diaphragm is about half the thickness of a human hair and serves as a flexible window in the tube envelope. Through this vacuum-tight metal diaphragm,

the rod or lever is free to vibrate without distortion over a wide range of audio frequencies.

When used as a phonograph pick-up this tube is said to perform up to the highest requirements of fidelity and sensitivity. At the same time, it is said to provide for a system having low acoustic noise and needle chatter. Life tests run on this tube have indicated that it is able to withstand severe treatment over long periods of time and to be especially stable under temperature and humidity changes. The tube operates as an integral part of the pick-up head and the radio-phonograph amplifier, without the need of a preamplifier or coupling transformer.

The inset schematic of the "Vibrotion" indicates the motion of the movable electrode (E) in direction MM is transferred through a thin metal diaphragm (D) to affect the electron flow of the triode consisting of electrodes (K) cathode, (G) grid and (E) movable anode. Motion of the movable anode in direction MM produces a proportionate change in the electron flow. The triode is contained within a metal envelope (S) and has its leads (L) brought out through a vacuum-tight glass header (H) with exhaust tip (T).

-50-

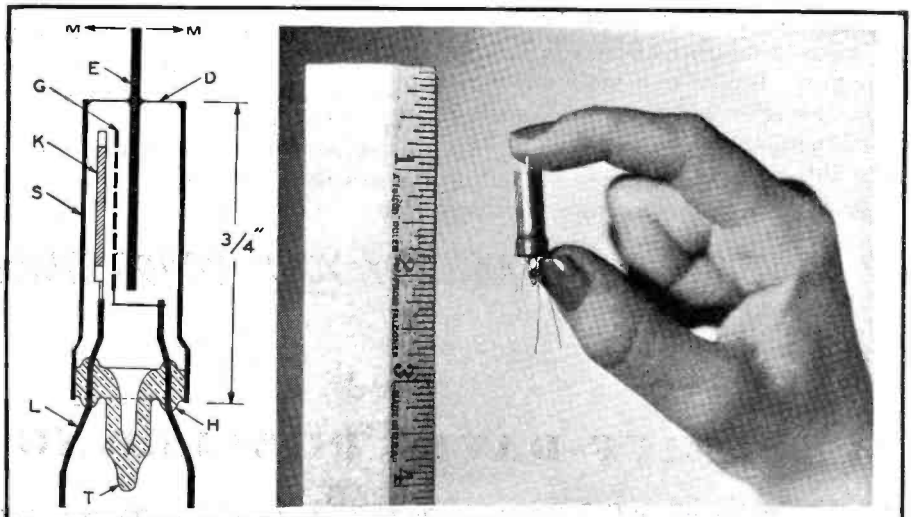

petitions are primarily for Australasian (Australia and New Zealand) members, there is a "ladder competition" run in *The DX-Tra* which should appeal to American listeners. A handsome certificate is issued and as the member's log increases and he "climbs the ladder," stickers are added to the rungs, culminating in pennants at the top. Contests are for both SW and BCB.

At present, there are 30 "financial" members of the club in the United States and Canada, while members are also found in Britain, Australia, Sweden, Italy, and so on. Dues are 8/6 for the first year and 6/6 a year thereafter. (A U. S. dollar is worth 6/1 in New Zealand currency.) The North American representative to whom membership fees may be paid is Don Trelford, 42 Old Bridle Path, Toronto, Ontario, Canada. Enrollment fee includes an enameled oval badge in the club colors of red, blue, and gold, and a membership certificate. Attractive club stationery is also available.

New Zealand appears to be a DX paradise—for in glancing through the pages of *The DX-Tra*, loggings are noted from all over the world on both SW and BCB. American BCB stations of 250 watts appear to be common loggings in New Zealand.

Messrs. Branks and Milne comment that "the N.Z.D.X.C., which is the oldest organization of its kind in the Southern Hemisphere, welcome overseas members, and by enlisting in the club, you will help your trans-Pacific log to grow."

Sweden—Gunnar Sundback, Bredgatan 6, Hyskyarna, Sweden, is editor of *Nattugglan (Night Owl)*, organ for the Huskvarna-Jonkoping DX-Club. I have just received a copy of the first issue of this mimeographed publication, thanks to Karl-Ake Bergstrom of Sweden. Our best wishes go to this club and to its new house organ.

United States—Charles WestDyke, Laguna Honda Home, San Francisco, California, is executive secretary of the *International Radio Monitors*. He will furnish particulars to anyone interested.

\* \* \*

#### Verification Tips

John T. Jones, Pennsylvania, recently received a verification from VLC7, Australia, in two months; no International Reply Coupon is necessary he writes. Address for veries of the VLA, VLC, and VLG series is Dept. of Information Short-wave Division, 375 Collins Street, Melbourne, C. 1, Australia. Mr. Jones is now attempting to get verification from Radio Centre, Moscow, by registered mail, return receipt requested, on a prepared verification. His other recent veries are VONH, CFRX, OTC, HEIZ, ZFY, FZI, and ZNS2.

Lt. Col. N. T. Norris, Washington, D. C., reports Paris verifies with a nicely-designed blue card bearing an overprint of a Dove of Peace and the Eiffel Tower. CBFW, Montreal, Quebec, Canada, verifies with a beautiful

for everything in Radio

# Get ALLIED'S 1946 RADIO CATALOG

FREE send for it now!



## LARGEST STOCKS OF RADIO AND ELECTRONICS EQUIPMENT

Get the handiest, most complete Buying Guide in Radio! Packed with the latest, finest values in parts, tubes, test instruments, tools, books, communication receivers, Ham gear, public address equipment . . . more than 10,000 items of nationally known, guaranteed quality . . . the world's largest and most complete stocks. For earliest delivery, fastest service, lowest prices, depend on ALLIED! Send for this FREE 1946 Catalog now.

**MORE THAN 10,000 ITEMS**—Largest and most complete selection of radio and electronic equipment to serve the needs of engineers, servicemen, dealers, soundmen, amateurs, and builders. All the leading makes. Guaranteed quality. Lowest prices. Everything you need from one dependable supply source!



#### HAM GEAR

Earliest delivery on latest communication receivers and transmitters. Time payment plan; trade-ins accepted.

#### HOME SETS

Parade of 1946 radios and phonoradios. Handsome styles. Wonderful performance. Today's leading values.



**NEW P. A. EQUIPMENT**—Complete Sound Systems for every public address requirement. All the newest developments. Everything in amplifiers, speakers, microphones, accessories. New intercom systems. Also the latest developments in recording and record-playing mechanisms.



#### HANDY RADIO BOOKS

Radio Formulas and Oata  
Dictionary of Radio Terms  
Radio Circuit Handbook  
Radio Builders' Handbook  
Simplified Radio Servicing  
Radio Data Handbook  
ALL SIX BOOKS No. 37-799 . . . 75c

#### HELPFUL CALCULATORS

These radio reference aids provide valuable data quickly:  
Parallel Resistance and Series Capacitance Calculator. No. 37-960. 25c  
R-F Resonance and Coil Winding Calculator. No. 37-955. . . . 25c



ALLIED RADIO CORP.  
833 W. Jackson Blvd., Dept. 1-H-6  
Chicago 7, Illinois

FREE

- Send FREE 1946 RADIO CATALOG
  - Send Six Books No. 37-799
  - Send Calculator No. 37-960
  - Send Calculator No. 37-955
- } \$.....enclosed

Name.....

Address.....

City.....Zone.....State.....

# ALLIED RADIO

Everything in Radio and Electronics



## FOR SAFETY'S SAKE

Safety first for personnel is of the utmost importance. This protection can be guaranteed through the use of G-E Interlock Switches on radio transmitters, X-ray and therapeutic machines, burglar alarms, and signal controls for fire doors. Safety first for equipment is important, too. G-E Indicator Lamps give visual evidence of what is going on inside equipment, and circuit troubles can be corrected before they become serious. Write: *Electronics Department, General Electric Company, Syracuse, New York.*

**GENERAL ELECTRIC**

100-51

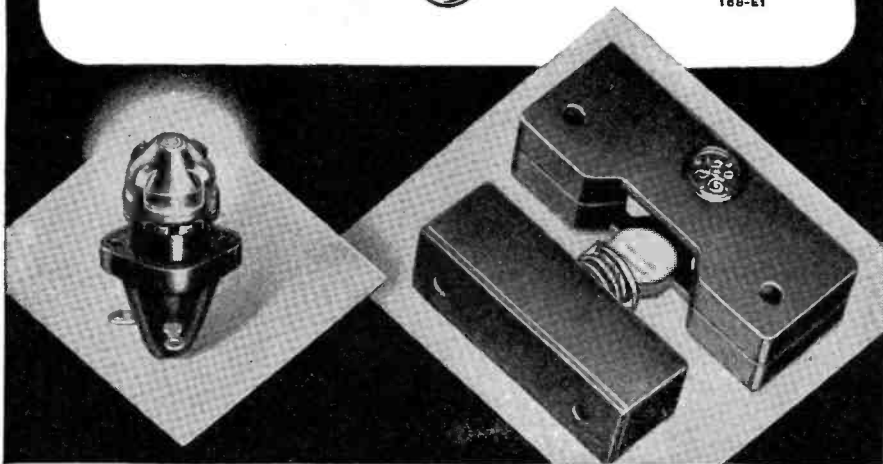

## THIS MONTH'S SPECIALS

### YOUR NET

- Two post V.M. record changer. It provides manual or automatic playing of ten standard 12" or twelve 10" discs with a minimum of waiting time between records. . . . \$18.95
- Phonograph motor for 110 volt A.C. 60 cycles and pickup that lists at \$10.00. Both for Triumph Model 333 Multirange volt ohmmeter. Instrument incorporates every desirable feature to provide a practical all purpose electrical measuring device. . . . 28.95
- Headphones, Signal Corps, 8000 ohms and 200 ohms. . . . 2.95
- Telegraph keys with cutout switch. . . . .95
- 2500 mfd. 3 volt F.P. condensers. . . . .49
- Universal 6 volt 4 prong vibrator. List \$3.95. . . . 1.69
- 100 asst. 1 and 1/2 watt resistors up to 10% tolerance. . . . 2.45
- Kit of 10 assorted toggle switches. . . . 1.89
- Kit of twenty 5, 10 and 25 watt vitreous enameled resistors. . . . 1.89
- Kit of ten bathtub condensers up to 1 mfd. 400 V. . . . 1.95
- Ten assorted volume controls less switch ranging from sizes 20M ohms to 500M ohms all with long shafts, 1" to 3". . . . 3.35
- 8" PM speakers. . . . 3.59
- 5Y3G tubes. . . . .39
- 5Y3GT tubes. . . . .39
- 6J5 tubes. . . . .48
- 6L6 tubes. . . . .98
- 46 tubes (substitute for 47). . . . 49
- 12A6GT tubes (replaces 50L6). . . . 89
- 10-12 tube power transformer, 6.3 V. winding 100 Ma. . . . 3.69

Plus shipping charges  
Dept. C.

Write for our literature featuring all types of radio parts.

**ARROW RADIO CO.**

2205 W. Division St., Chicago 22, Ill.

## RADIO CHASSIS PUNCH



Saves hours of work cutting clean, accurate holes in radio chassis—for connectors and other receptacles. Simply insert cap screw in hole to be enlarged (drill small hole if necessary), turn with ordinary wrench to force punch through the metal. No reaming or filing—hole is smooth and clean. No distortion—die supports metal. Ten sizes from 3/4" to 2 1/4"; also up to 3 1/2" for meters. Write for free folder S-119 to Greenlee Tool Co., 1888 Columbia Ave., Rockford, Ill.



card showing a map of the world, printed in silver, bearing a red and blue overprint; frequency is listed as 6.090, schedule is shown as 7:30 a.m.-12 midnight, power of 200 watts. HP5K, Colon, Panama, *La Voz de la Victor*, verifies with a light-blue card having the station call overprinted in red; frequency is given as 6.005, schedule as 7 a.m.-1 p.m. and 5-11 p.m.; address, *La Voz de la Victor*, Colon, Rep. de Panama, Apartado 33. HJDE, Medellin, Colombia, verifies with a nice black-and-white card bearing a picture of a cathedral tower; frequency, 6.1453; address, *La Voz de Antioquia*, Medellin, Colombia. CFCX, Montreal, 6.005, is sending out a yellow verification card with the station call overprinted in red; station identifies as Canadian Marconi.

John A. Znaidukas, Philadelphia, reports YV5RN, Caracas, Venezuela, verifies with a multi-colored card depicting the Venezuelan coat-of-arms on a microphone, the base of which points to Caracas on a map of Venezuela and the northern portion of South America; lists slogan as *Radio Caracas*, and operates in conjunction with YV5RA; thirteen weeks was required for verification; this station uses many American advertisements. A mimeographed letter from VLC5, Australia, states that this station is engaged on services to other countries, but reports are appreciated; no QSL cards are available as yet. CSW, Lisbon, verifies with a blue-and-green QSL showing a map of Portugal and the surrounding area; address is listed, *Presidencia do Conselho, Emissora Nacional de Radiodifusao, Rua do Quelhas, Lisboa, Portugal*; frequency is given as 9.740 (40.80), power as 10 kw., and schedule, 7-8 p.m.; a month and three weeks by ordinary mail was required. TGWA, Guatemala City, still uses QSL card with the long-plumed bird; lists its frequency as 9.790; other frequencies are 9.685, 11.760, 15.170, 17.800, all using 10 kw. and relaying TGW on 1,520 kcs. (1 kw. power).

Rex G. Gillett, Australia, reports verifies recently from HP5A, SBU, SBO, TAP, ZRH, WLWL, WCBN. Gillett has verified 50 countries.

A very fine QSL card is being sent out by the Radio Branch, Turkish Press Department, Ankara, for TAP and TAQ.

Reports to the Khartoum short-wave station can be addressed % W. F. Cottrell, Omdurman Broadcasting Station, Box 282, Khartoum, Anglo-Egyptian Sudan (Africa).

All correspondence for the SABC is handled by the main office, South African Broadcasting Corporation, P.O. Box 4559, Johannesburg, Union of South Africa.

Address for reports to *Radio Makassar* should be addressed, Radio Omroep Makassar, Telf. 43 Strandweg Zuid 2, Makassar, Celebes.

Address for reports to Northern Rhodesia is Information Office, P.O. Box 209, Lusaka, Northern Rhodesia.

**RADIO NEWS**



A letter received by a South African correspondent from G.P.O., Box 792, Salisbury, Southern Rhodesia, indicates that programs are designed for only Southern Rhodesia; probably will verify, however.

Bill Milne, New Zealand, reports verifications from VLA, VLA3, CS2WI, VUD5, Singapore (11.86, 15.46, and 9.558), Brazzaville, VLR2, VLH4, VLH5, Bern, HCJB.

Buddy Eckstein, New York, has received a letter verie from *Radio Eire*—  
(Continued on page 125)

### Practical Radio Course

(Continued from page 48)

This is the operating condition illustrated approximately with the oscillator-voltage swing shown in Fig. 3.

The signal-grid transconductance variation, as a function of applied oscillator-grid potential, that results in a typical mixer design for use with *outer-grid* oscillator injection is illustrated<sup>3</sup> in Fig. 5. It differs from that for *inner-grid* injection (Fig. 3) mainly in that approximate maximum signal-grid transconductance is reached when the oscillator-grid potential is around zero volts. The conversion transconductance of such a tube is, therefore, more accurately predicted from its normal amplifier transconductance.

It is apparent that regardless of whether the oscillator-grid precedes, or follows, the signal grid in the electron stream, it changes the tube coefficients of the signal grid and the action resulting may be expressed as a *variation in the grid-to-plate transconductance of the signal grid*.

#### Electron-Coupled Mixer Action May be Looked Upon as One of Shifting Q-Point

In electron-coupled mixers (both the inner and outer-grid injection types), since the incoming signal voltage is applied to the signal grid of a tube in which the signal-grid transconductance is simultaneously being independently varied by the alternating oscillator voltage applied to the oscillator grid, we have an amplifying system in which amplification of the applied signal voltage is not constant but periodically *varies* in value according to some definite signal-grid-to-plate-transconductance variation pattern (such as that in Figs. 3 and 5), and at the oscillator frequency. Thus, in controlling the intensity of the electron stream from instant to instant, the oscillator grid also controls the signal-grid slope ( $g_m$ ).

Both the individual, and the combined, effects of the oscillator voltage applied to the oscillator grid and the signal voltage simultaneously applied to the signal grid are illustrated in Fig. 4. The actions taking place during one complete cycle of the applied signal voltage wave are shown. Since the oscillator frequency,  $f_o$ , is assumed

The advertisement features a collection of various radio parts including cables, sockets, tubes, and components. A central graphic with a brushstroke background contains the text: "Just a few of the thousands of Radio Parts manufactured by INSULINE". Below this, there is a large image of a tube rack filled with vacuum tubes. To the right, there is a list of parts including a speaker, a transformer, a coil, a tube, a plug, a switch, and a component with three pins.

ICA is now making immediate deliveries on its entire 1946 line — everything from tiny acorn sockets to antennas; each item a vastly improved unit.

It will pay you to know the complete 1946 ICA line. Write Department B-2 today for the two new 1946 ICA catalogs— one on Antennas the other on the new ICA Parts.

**insuline**  
CORPORATION OF AMERICA  
INSULINE BUILDING • LONG ISLAND CITY, N. Y.  
More than a quarter-century of Quality production.

The logo includes the ICA logo with "INSULINE CORP OF AMERICA" and "TRADE MARK" around it, and a circular emblem with "ARMY" and "NAVY" around a central figure.

# METERS

## D. C. MICROAMMETERS GALVANOMETERS

Weston Model 301, 3/2", short scale galvanometer, 10 microamp each side of center, scale 0-20	\$ 3.95
Weston 301, 3/2", 0-200 Microamp.	7.50
General Electric, DO-41, 3/2", 0-200 microamp movement. Scale marked in volts and D. B. knife edge pointer complete with paper volt ohm milliammeter scale.	6.00
General Electric, DO-41, 3/2", 0-500 Microamp movement scale, 0-20 K. V.	4.95

## MILLIAMMETERS

General Electric, DO-41, ring mounting, 3", 0-2.5-25 MA dual range, zero center.	2.50
General Electric, DO-41, 3/2", 0-30 MA.	3.95
General Electric, DO-41, 3/2", 0-200 MA.	4.95

## D. C. VOLTMETERS

and

## KILOVOLT METERS

Westinghouse, BX, 2 1/2", dual range 0-3.5 and 0-140 volt.	1.98
Westinghouse, NX-35, 3/2", 0-15 Kilovolt, complete with 1000 ohms per volt, external wire wound resistors. List price \$160.00. Your cost	16.00
Westinghouse, NX-35, 3/2", 0-20 Kilovolt, complete with 1000 ohms per volt, external wire wound resistors. List price \$210.00. Your cost	21.00

## A. C. AMMETERS

General Electric, AO-22, 3/2", 0-5 Amp. movement, 50 Ampere scale, comes complete with external current transformer. By adding primary turns to the donut transformer, range of the meter can be made 5-10-25-50 Amps. A.C. diagram furnished with meter.	7.00
General Electric, AO-22, 3/2", 0-50 Amp. self-contained	4.50
General Electric, AO-22, 3/2", 0-80 Amps., self-contained	4.50
Weston, 476, 3/2", 0-120 Amps. complete with external current transformer.	6.50

## Weston, 528, Portable A.C. Ammeter

Dual Range 0-3 Amp. and 0-15 Amp. full scale. For use on any frequency from 25 to 500 cycles. The ideal instrument for all commercial, industrial, experimental home, radio, motor, and general repair shop testing. Comes complete with a genuine leather, plush-lined carrying case and a pair of test leads. A very convenient pocket-sized test meter priced at less than 50% of manufacturer's list. Your cost only.

12.50

## A. C. VOLTMETERS

Weston, 517, 2 1/2", ring mounted metal case, 0-15 volts	2.95
Westinghouse, NA-33, 2 1/2", 0-150 Volts	1.98
Weston, 476, 3/2", 0-150 Volts	4.50
General Electric, AO-22, 3/2", 0-150 Volts	5.50
General Electric, AO-22, 3/2", 0-300 Volts	8.00

## SPECIAL METERS

Weston, 301, Power Level Indicator, 625 Microampers, 1.2 volts A.C. movement complete with self-contained rectifier.	6.00
General Electric, DO-46, 3/2", Rectifier Type Meter. Special scale, 400 Microampers and 3 Volts A.C. movement complete with self-contained rectifier.	5.50
J.B.T. 34F, 3/2", Frequency Meter 55-65 cycle, 11 read, 100-150 Volts	6.00
Weston, 705, Sensitrol Relay, 0-100 Microampers. Solenoid reset, S.P. normally closed	7.50
Western Electric, 3/2", 100-0-100 Microampers D.C.	4.00
Western Electric, 3/2", 20-0-20 Ampere D.C.	3.00
Western Electric, 3/2", 0-500 Volts D.C. 1000 ohms per volt.	5.00
Western Electric, 3/2", 0-1 MA D.C. movement, 0-20 K. V. Scale.	3.00
Western Electric, 3/2", D. B. meter —4 +6, 1 Milliwatt in 600 ohms, full scale —1 M.A. A.C.	5.00

All meters listed above are Surplus New

Write for complete listings.  
Please add sufficient postage.  
Excess will be refunded.

## MARITIME SWITCHBOARD

336 CANAL STREET  
NEW YORK 13, N. Y.  
Worth 4-8217

to be *higher* than the signal frequency,  $f_s$ , the oscillator voltage wave (at the left) goes through slightly more than a complete cycle during this period. The "period" of the signal wave (time required to complete one cycle) has been divided into a number of equal small intervals, all numbered (from 1 to 17) so that the construction lines can be traced. The oscillator voltage (*left*) goes through slightly more than 1 1/4 cycles during this same period. It has been divided up into intervals equal to those of the signal voltage wave.

The diagram of Fig. 4 was constructed in the following manner: The ordinates of the oscillator voltage wave corresponding to the various numbered intervals were projected up to the signal-grid-to-plate transconductance variation characteristic curve for the tube (as shown by the arrowed dotted construction lines) to determine the various signal-grid-to-plate transconductance values existing at each of these instants. These points of intersection were then projected to the right to determine the signal-grid plate-current characteristic existing at each of these instants. It was assumed for simplicity that the signal-grid cut-off value remains fixed, so the lines ( $P-T$ ,  $P-R$ ,  $P-V$ , etc.) representing all

of these signal-grid plate-current characteristics were drawn through fixed cut-off point  $P$ . Furthermore, each of these characteristics was assumed to be *linear*. The reference numbers indicated on these characteristics correspond with those assigned to the corresponding instants on the oscillator-voltage wave. For example, at instant 2 on the osc.-voltage wave, the transconductance value is that given by the ordinate  $S$  on the transconductance characteristic, so the signal-grid characteristic existing at this instant is the line drawn through cut-off point  $P$  and the projection of point 2 over to the plate-current at the right—the characteristic marked  $P-R$ .

Study of the center portion of Fig. 4 will reveal how the slope ( $g_m$ ) of the plate-current signal-grid potential characteristic of the tube is shifted from instant to instant by the oscillator voltage applied to the oscillator grid—the two characteristics  $P-T$  and  $P-V$  representing the extremes of shift occurring respectively when the maximum *positive* and maximum *negative* peaks of the oscillator voltage are applied to the oscillator grid during each oscillator voltage cycle.

To determine the plate current existing at each of these instants, the signal-voltage wave ordinate (lower

## THE "HAMS" ARE WORKING THEM ULTRA-HIGH

**TWO** enthusiastic amateurs, engineers of the General Electric Company, have recently been operating experimentally in the 2300-2450 mc. band with two-way radio telephone conversation between two buildings, one-half mile apart, at the Schenectady G.E. Works.

Contact in this ultra-high frequency band was made possible by the use of "lighthouse" tubes which were developed by General Electric for radar.

The two electronic engineers who made this first entry into the new band were George H. Floyd, W6OJK/2, and Arthur R. Koch, W9WHM/2. The latter made his combined transmitter-receiver at home, using ordinary mesh screen for the parabolic reflector and the bottom of a tomato can as a reflector on the end of the radar-type antenna. Mr. Floyd developed his receiver after he was convinced that his colleague's unit would operate successfully in the new frequency band. Experimentation covered several months' time.

Since the original experimental work by Mr. Floyd and Mr. Koch, two scientists in the G.E. Research Laboratory have successfully completed operational tests with the highest amateur bands ever allocated to "hams" in the ultra-high-frequency field—21,900 megacycles.

Participating in this experiment were Dr. A. Harry Sharbaugh, Jr., WINVL/2, and Robert L. Watters, W9SAD/2. The first two-way communication with this equipment covered approximately 800 feet. One-way communication was established between the laboratory and the studios of television station WRGB, about one-half mile away.

The newly designed equipment, instead of having antennas, receives and

transmits by means of parabolas or horns. The special metal radio tube delivers the power at milliwatt level. With a wavelength of but 1.37 centimeters, radio waves are transmitted and received through a wave-guide.

The particular circuit arrangement using one high-frequency tube makes possible the use of the duplex phone and eliminates the conventional switching during two-way communication. Power supply for the tube is approximately 2000 volts. An intermediate frequency amplifier is employed for receiving.

Arthur R. Koch, W9WHM/2 and George H. Floyd, W6OJK/2 make adjustment on homemade equipment used for the first invasion by amateur radio operators of the 2300-2450 megacycle band.

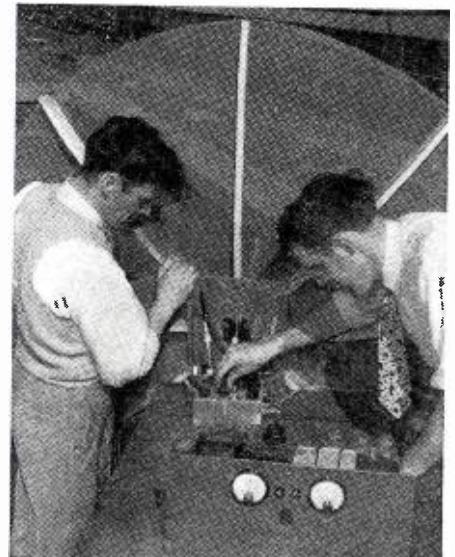

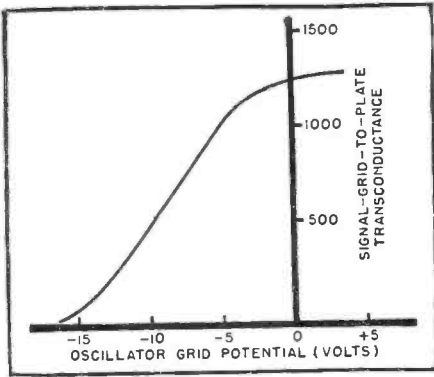

Fig. 5. How signal-grid-to-plate transconductance of a typical mixer section designed for outer-grid oscillator injection varies for various applied oscillator grid potentials. (Signal grid bias constant -3 v.)

center) at each numbered interval is projected up to the signal-grid characteristic (correspondingly numbered) existing at that instant. The ordinate of the point of intersection represents the plate current at that instant. By repeating this for each numbered interval on the signal voltage wave, and projecting the points of intersection to the right (as shown by the arrowed dotted construction lines) the plate-current wave resulting from the simultaneous application of these signal- and oscillator-voltage waves was constructed at the right. Notice that it is a complex wave, since it contains the several frequency components  $f_s, f_o, f_s + f_o, f_o - f_s$ , etc.

It is evident from this discussion, and the actions illustrated in Fig. 4, that the periodic variation of signal-grid-to-plate transconductance caused by the oscillator voltage causes the Q-point<sup>4</sup> of the tube to shift along a vertical ordinate from one signal-grid plate-current characteristic to the next, the instantaneous value of the potential on the oscillator grid at each instant determining the particular signal-grid characteristic upon which the Q-point is located at that moment.<sup>5</sup>

The manner in which the Q-point shifts during each complete cycle of applied oscillator voltage is shown in the detailed enlarged illustration of Fig. 4B. (This was drawn here separately in order to avoid further complication of the main diagram.) Notice that the different signal-grid characteristics existing at the various instants 1, 2, 3, 4, etc., have been drawn through the common cut-off point P, just as in the main diagram.

During the 1/4 cycle oscillator-voltage interval 1 to 4, the Q-point shifts upward from characteristics 1 to 4 (a to b in this illustration) as shown by the dotted line; during interval 4-7 it shifts from b back to a; during interval 7-10 it shifts down from a to c; during interval 10-13 (which completes one full cycle of oscillator volt-

<sup>4</sup>The Q-point is the (moving) point of operation on the characteristic of the tube, the position of which is determined by the locally-applied voltages. (The oscillator voltage is considered as a locally-applied voltage. The input signal voltage is the operating voltage).  
<sup>5</sup>Harry Stockman, "Superheterodyne Converter Terminology," Electronics, Nov. 1943

# SOUND VALUES at TERMINAL RADIO

*The P.A. Systems You've been waiting for!*

- TOP-NOTCH QUALITY!
- HEAVY DUTY CONSTRUCTION!
- ECONOMICAL — COMPARE!
- HUM-FREE, NOISE-FREE!
- NEW IMPROVED DESIGN!
- AVAILABLE NOW — ORDER FROM THIS ADVERTISEMENT!



Model TR-1 14 watt heavy duty system COMPLETE \$57<sup>60</sup> Net

**TERMINAL SOUND SYSTEMS** are famous for their long life and trouble-free performance. The new models here boast no superfluous fancy frills but are a new high in Sound Value — each amplifier incorporates a wealth of real, useable features for the power and tone quality heretofore unavailable in low-cost sound systems.

## 14 WATT HEAVY DUTY SOUND SYSTEM

A complete system—no extras to buy! Consists of 14 watt heavy duty amplifier, 10 inch permanent magnetic speaker in reinforced wall baffle (specify color—brown or grey), 25 ft. speaker cable, wide range crystal microphone with table stand and 15 ft. shielded microphone cable. Ready to plug in and operate!

MODEL TR-1 PA SYSTEM, as described and illustrated \$57<sup>60</sup> Net

MODEL TR-1D DUAL SPEAKER SYSTEM, (as above, but with two 10" speakers in wall baffles) \$67<sup>95</sup> Net

## 25 WATT HEAVY DUTY SOUND SYSTEM

Offers high fidelity sound reproduction with emphasis on quality and power! Consists of 25 watt amplifier, 12 inch permanent magnetic speaker in reinforced wall baffle (specify color—brown or grey), 25 ft. speaker cable, wide range crystal microphone with table stand and 15 ft. shielded microphone cable.

MODEL TR-2 PA SYSTEM, as described \$71<sup>50</sup> Net

MODEL TR-2D DUAL SPEAKER SYSTEM, (as above, but with two 12" speakers in wall baffles) \$84<sup>95</sup> Net

### 14 WATT AMPLIFIER SPECIFICATIONS

POWER OUTPUT: 14 watts normal  
 GAIN: Microphone input 110 db.; phono input 70 db.  
 FREQUENCY RESPONSE: 50 to 12,000 cps, hum -70 db. below rated output.  
 INPUTS: 1-Microphone, 1-Phono (both high impedance). Separate gain controls for mixing and fading.  
 TONE CONTROL: Full range bass and treble tone compensator.  
 OUTPUT IMPEDANCES: 2, 4, 8, 16 and 500 ohms.  
 TUBES: 1-7C7, 1-7F7, 2-7C5 and 1-5Y4G.  
 POWER CONSUMPTION: 85 watts, 117 volts 50-60 cycles. A.C. Fused primary.  
 SIZE: 13"x8 1/2"x8 1/2". Net wt. 15 lbs.

TR-1A AMPLIFIER ONLY, complete with tubes \$33<sup>81</sup> Net

### 25 WATT AMPLIFIER SPECIFICATIONS

POWER OUTPUT: 25 watts normal  
 GAIN: Microphone input 112 db.; phono input 70 db.  
 FREQUENCY RESPONSE: 40-13,000 cps, hum -65 db. below rated output.  
 INPUTS: 1-Microphone, 1-Phono (both high impedance). Separate Gain Controls for mixing and fading.  
 TONE CONTROL: Full range bass and treble tone compensator.  
 OUTPUT IMPEDANCES: 4, 8, 12, 16 and 500 ohms  
 TUBES: 1-6SL7, 1-6SL7, 2-6L6 and 1-5U4G  
 POWER CONSUMPTION: 120 watts, 117 volts 50-60 cycles. A.C. Fused primary.  
 SIZE: 17"x9"x9". Net wt. 24 lbs.

TR-2A AMPLIFIER ONLY, complete with tubes. (Similar in appearance to TR-1A, but not illustrated here) \$42<sup>63</sup> Net



### WEATHERPROOF OUTDOOR SPEAKERS

MODEL PSAH—3 1/2 ft. horn recommended for voice applications. High Efficiency, 1/2 mile sound projection, 25 watt driver unit. \$37<sup>92</sup> net

MODEL LSAH—4 1/2 ft. horn Ideal for music. Waterproof construction, 3/4 mile sound projection, 25 watt driver unit. \$47<sup>92</sup> net

### MICROPHONE FLOOR STAND

MODEL MS-4. 10" diameter, heavy base, all chrome sections adjustable from 34" to 62". Positive locking clutch. \$52<sup>25</sup> net

Above prices are FOB New York. 25% deposit required with all COD orders.

# Terminal Radio Corporation

85 CORTLANDT ST., NEW YORK 7, N. Y. • Telephone: WOrth 2-4415

# NIAGARA RADIO SUPPLY



Timely offer:

JAN 829 B/3 E29 tube and shielded aluminum socket with built in by-pass condensers. Both for the price of the tube socket.

**\$6.95**

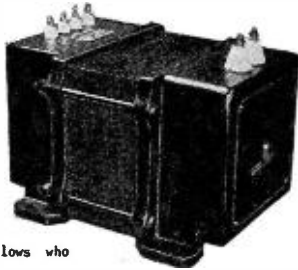

For you fellows who are planning a KW rig. 6200 Volts center tapped at 700 mils 110 Volt 60 cycle Amertran, type W frame special

**\$39.95**

For that mobile rig - Pioneer gene-motor. Delivers 500 Volts at 160 mils from a 6 or 12 Volt storage battery. 6 Volts at 21 amps input- complete with circuit breakers, in high voltage and low voltage circuits, Filter to kill hash, mounted on hard shock mounts. Here is your chance to run 75 watts or better - Mobile \$33.75

Hewlett Packard Model 200B Audio oscillator 20 to 20,000 cycles - a laboratory instrument \$74.95

400 mils swinging choke built by Langevin. A de Luxe job-swings from 9 to 60 henries. 50 to 400 mils - real regulation for only \$12.75

8½ amp Variac - General Radio, model 200C the most popular item today \$10.95

1 amp Variac General Radio 200B \$5.95

LOOK - a real buy in a very useful Transformer. 650 Volts 125 mill C.T. secondary 10 volt 6 amp and 6 volt 5 amp 110 volts 60 cycle primary - going like hot cakes at \$2.98

# NIAGARA RADIO SUPPLY

160 GREENWICH ST.  
NEW YORK 6, N.Y.  
Send for Latest Bulletin

age) it shifts from  $c$  back to the starting point  $a$ . Thus the  $Q$ -point shifts continuously from one signal-grid characteristic to another while the signal-voltage wave is applied to the signal grid—the  $Q$ -point moving periodically over a path something like  $a-b-c-a$  during each cycle of oscillator voltage. Consequently, the electron-coupled type of frequency converter is often referred to as a *shifting- $Q$ -point converter* or *changing-path-of-operation (c.p.o.) converter* to illustrate this particular action.

## Why Non-Linear Tube Characteristics Are Not Necessary in Electron-Coupled Mixers and Converters

For simplicity the signal-grid characteristic shown in Fig. 4 has been assumed to be linear (straight), which proves that rectification on the input grid is not a necessary condition, for frequency conversion by means of electron-coupled converters. Even though over-all nonlinearity within the region of operation is a primary requirement in any frequency-changing device (since the nonlinearity provides for periodic displacements in the output wave above and below the average value) a tube having a *linear* (straight) input characteristic within the region of operation will produce frequency conversion by the electron-coupling method since in this type of operation the signal-grid characteristic is periodically being shifted back and forth by the applied oscillator voltage wave, and the oscillator voltage indirectly determines the amplitude of the excursions of this continuously-changing path of operation. Thus, even though a tube having a straight-line signal-grid characteristic is used, frequency conversion will be produced. In practice, however, requirements of high

gain, a.v.c. action, etc., necessitate the use of class "C" operation with curved characteristics.

## How the Sum and Difference Frequencies Are Produced

Many students find it very helpful to look upon the mixer action occurring in electron-coupled mixers as a *multiplicative* process, for this makes possible a graphic illustration that enables a visual picture of the process to be obtained. It is apparent from what already has been said here, and from the illustrations of Figs. 3, 4 and 5, that the grid-plate transconductance for the signal control grid depends in an approximately linear manner on the potential of the oscillator grid. Thus, if a signal oscillation of instantaneous voltage  $e_s$  is applied to the signal grid, the corresponding plate-current oscillation produced will be proportional to  $e_s \times k$ , where  $k$  is a factor which depends upon the transconductance value for this grid at the instant. If, now, the voltage  $e_o$  due to the local oscillator is applied to the oscillator grid in the same electron stream,  $k$  will vary periodically in phase with  $e_o$ , i.e., the plate current will now contain a component proportional to the product  $e_s \times e_o$ . Thus, we have what may be considered as a direct multiplicative action between the two applied voltages at each instant, even though the individual tube characteristics involved are, very approximately, linear.

What happens when two such oscillating voltages are multiplied together can be illustrated graphically. In Fig. 6, a signal voltage wave ( $e_s$ ) of frequency  $f_s$  is shown at the top. Directly underneath it is drawn the oscillator voltage wave ( $e_o$ ) of higher frequency  $f_o$ . Let us assume that the time interval between points 1 and 2 is one

Fig. 6. Illustrating the multiplication of two oscillations and the production of sum and difference frequency components thereby.

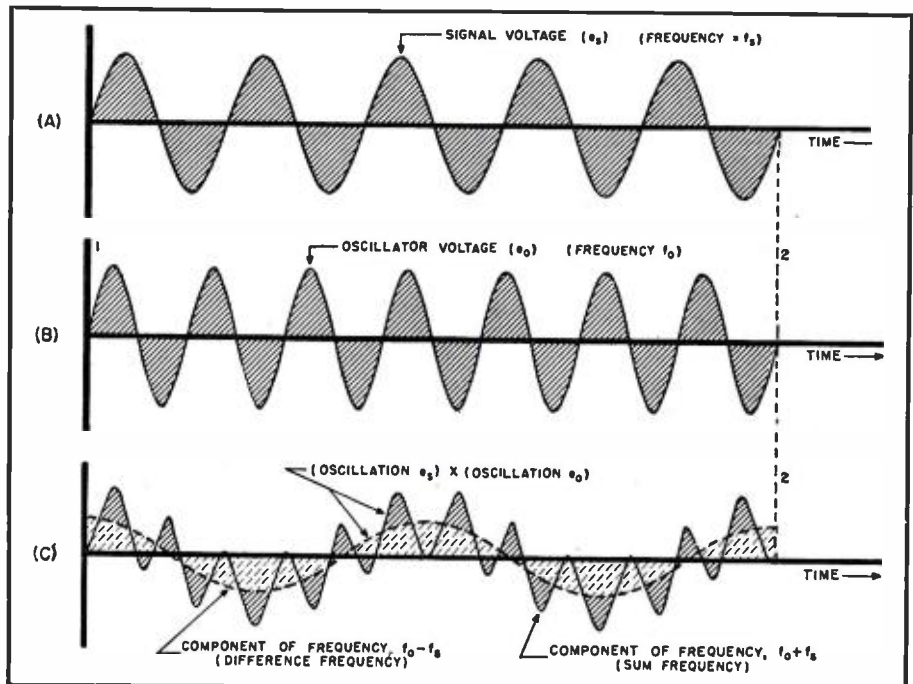

second. Then, since the signal wave as constructed here goes through 5 complete cycles (count them) during this interval, its frequency is 5 cycles/sec. Likewise, the higher frequency  $f_2$  of the oscillator wave as drawn here is 7 cycles/sec. The bottom solid wave (C) is the result (drawn to a reduced scale because of space limitations) of multiplying together the ordinates (or heights) of the other two curves at frequent small intervals.

It will be observed that the solid wave alternates above and below the dotted line, and goes through 12 complete cycles in the interval from 1 to 2. This represents the "sum frequency" component of the product, i.e.,

$$f_0 + f_1 = 7 + 5 = 12.$$

The wavy dotted line running through this bottom wave goes through 2 complete cycles in the interval from 1 to 2. This represents the "difference frequency" component of the product, i.e.,  $f_0 - f_1 = 7 - 5 = 2$ . Consequently, the "product" of the signal and oscillator voltage waves is thus indicated as containing components of sum- and difference-frequencies.

It will be observed that throughout this discussion the signal has been regarded as a single-frequency or pure sine-wave oscillation. In the reception of AM radio transmission, however, it will actually be a pure radio-frequency carrier wave modulated at one or more audio frequencies that will be changing from instant to instant according to the intelligence being transmitted. This, however, does not affect the transformation process described here in any essential way.

The electrode arrangements employed in the various popular commercial types of electron-coupled mixer and converter tubes now in general use, and the circuits employed with them, will be described in the following articles of this series.

(To be continued)

### INSULATE FRAYED WIRES

**WIRES** which pass through openings in metal sections of radio chassis or shields often have the insulation worn due to vibration or other movement.

Fiber sleeving or tubing is available at radio stores which when used as illustrated makes a neat and safe installation. H. L.

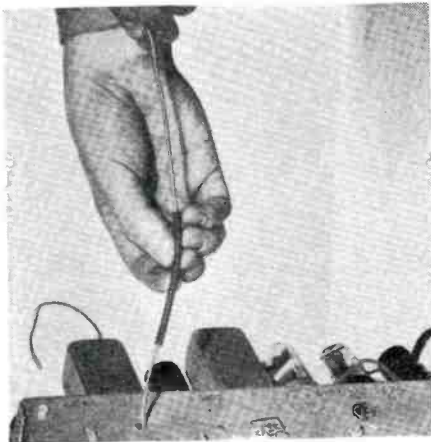

August, 1946



Is your soldering equipment **OUTDATED?**

The Kwikheat Thermostatic Soldering Iron is as modern as next year's television set. It is the *only* soldering iron on the market with a built-in thermostat for heat control plus the many other valuable features shown below. Compare your present soldering equipment with Kwikheat's fast-heating, light weight, and versatile efficiency . . . You'll agree that from tip to plug Kwikheat is in a class by itself! Ask your jobber . . . List **\$11.00**

**KWIKHEAT is modern in every respect!**



**THERMOSTATIC HEAT CONTROL**—Built-in feature automatically maintains proper heat for best soldering — prevents overheating — retains tinning longer. Saves current when idling.



**HOT IN 90 SECONDS** after plugging in. Minutes faster than any other iron of comparable power. Saves waiting time. Pays dividends in time and power. Definitely speeds production.



**HEAVY POWER — LIGHT WEIGHT** —Kwikheat is powerful enough for most soldering jobs (225 watts), yet extremely light weight (13½ ounces). Well balanced for easy handling.



**COOL PROTECTING HANDLE** of new, improved design in tough Bakelite protects the user from hot metal. Comfortable grip—does not show wear.



**SCREW-TYPE TIPS** of extra-durable copper alloy are heavy-threaded and tapered for best heat conductivity. Six styles make Kwikheat most versatile, in effect, equal to owning several tools.



Six Tip Styles . . . Each 1.25

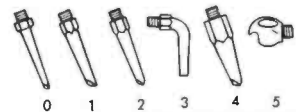

**KWIKHEAT THERMOSTATIC SOLDERING IRON**

Kwikheat Division — Sound Equipment Corp. of Calif. • 3903 San Fernando Rd., Glendale 4, Calif.

## WAR SURPLUS

We have a large quantity of Radio & Electronic Equipment purchased from the U.S. Government, which we are offering at exceptionally low prices—Wholesale & Retail. Among our fine stock of transmitting tubes are VT 127A, 836, 807, 304L, 304TL, 307A, 715A. Also a complete stock of cathode ray and oscilloscope tubes, such as 3GPI, GL-3DPI, 5BP4, 5FP7, also 12 inch, all type bases, which are going at rock bottom prices.

**RECEIVING TUBES**—954 Acorns, VR105, 0852, 6SN7, 6J5, 3Q5, 1291, and many others. We also carry a fine line of: Transformers; chokes; resistors; power packs; vibrators for power supply; volume controls; Jewel lights in assorted colors; all types of fuses and fuse holders and links; transmitting keys; flame proof with heavy bakelite knob and protector for fingers; filament transformers; all types Amphenal plugs & sockets; test equipment and meters. Insulators, porcelain stand off and lead in, all sizes, for any use—heavy duty.

Co-Axial connectors, per pr. **75c**

100 Resistors, assorted  $\frac{1}{4}$ ,  $\frac{1}{2}$ , 1 & 2 Watt sizes, RMA coded—a wonderful value at..... **\$2.75**

Tube sockets, low loss, ceramic..... **23c**

G.1 Flashlights..... **65c**

Toggle Switches, D.P., D.T. **23c**

Toggle Switches, 4-pole—D. throw..... **65c**

6L6 Tubes, metal or glass... **85c**

Pilot bulbs 6-8 V. No. 40... **5c**  
Per 100..... **\$4.00**

Spark Suppressors..... **10c**  
Per 100..... **\$8.00**

Battery, wet, G.E. Portable (27-2)..... **\$3.00**

Friction Tape,  $\frac{1}{2}$  lb. 5 rolls. **1.00**

Rubber Tape, 4 rolls..... **1.00**

TELL US YOUR WANTS AND WRIT FOR CIRCULAR

**THE ABELL DISTRIBUTING CO.**  
East Biddle Street Baltimore 2, Maryland

# SHORAN for World Mapping

**O**NE of the most significant advances in the annals of geography since the invention of the compass was recently revealed by the Army Air Forces which released information on a war-born radar development capable of locating any spot on the earth within a few feet of perfect accuracy.

Opening up vast areas of the world to mapping never before possible, the technique of electronic charting foreshadows new methods of navigation and provides the answer to extremely accurate direction of automatically controlled missiles and other weapons, according to Lt. Col. Carl I. Aslakson of the 311th Reconnaissance Wing, AAF.

Called Shoran, which literally means short-range radar, the highly elaborate system was one of the top secrets of the war and was originally developed for "through the overcast" bombing to overcome the many inadequacies of optical bombing. The first development was the result of joint cooperation between engineers of the Air Technical Service Command, AAF, Radio Corporation of America, and the Minneapolis-Honeywell Regulator Company. Recognizing long-desired possibilities inherent in the system for

a more efficient and accurate method of charting the earth's surfaces, the Army Air Forces Board assigned the 311th Wing to the task of adapting Shoran to geodetic work.

In its present stage of development, Shoran already has broken down many previous means of mathematical calculation and indicated that many locations on the earth are actually not where they are presently plotted. With Shoran it will be possible to establish a geodetic control network of the entire world and plot the distance of every point within a few feet of every other point on the globe.

The vast uncharted areas of the Amazon Valley, China, Siberia, Africa and the oceans of the world for the first time can be pinpointed and utilized in aerial and sea navigation. The economic implications of the new technique will be invaluable to the development of natural resources and to safe and efficient transportation.

Shoran, it was explained, makes use of high frequency radio waves which are transmitted and measured in terms of miles or even feet where necessary. As developed for bombing, airplanes were equipped with two transmitters which sent pulse signals to two ground stations. The latter, normally located

Diagram shows Shoran as used in reconnaissance bombing. N is point on ground directly below the airplane. Target N was photographed from reconnaissance plane and at same time the Shoran computer instrument panel was photographed. This showed exactly how far the plane was from base radio stations at time it was over the target. This information was then available for planes bombing through the overcast. H is the altitude of the reconnaissance plane. This information is also photographed on the Shoran instrument panel. R<sub>1</sub> and R<sub>2</sub> are the Shoran (radio) distances to ground stations. D is the known distance between base stations. S<sub>1</sub> and S<sub>2</sub>

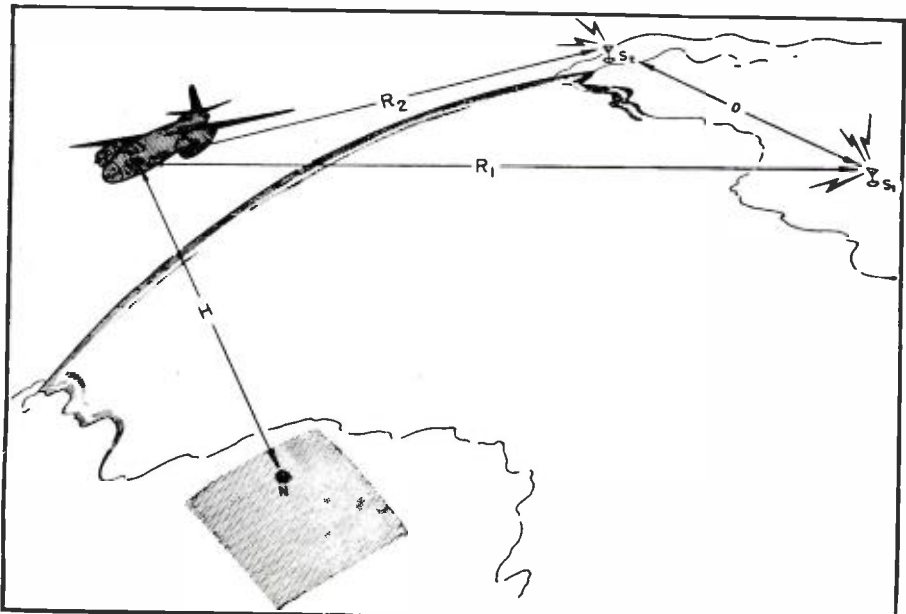

at least 100 miles apart, received the signals and re-broadcast them back to the airplane. The interval of time between the sending and receiving of the signals was measured electronically and translated into distance based on the known fact that the signals under normal atmospheric conditions travel 186,218 miles a second. Because the distance between the two ground stations was known, and because through the radio signals, the distance of the plane from each of the stations was also known, the mathematical method of triangulation located the airplane within a few feet of its actual position in the atmosphere. Through this method it was possible, during the latter part of the war, for U. S. Army planes to drop bombs on enemy targets even though the targets were completely hidden from view by a heavy layer of clouds. The triangulation is automatically computed by electronic devices so that a Shoran operator only has to watch three "pips" on a cathode ray screen and turn two dials to keep the "pips" aligned thus permitting him to read distances to both ground stations on an automobile-like speedometer.

"If a plane could determine its position with respect to two points on the ground, we assumed that the same plane also could determine the distance between two points on the earth's surface merely by flying across the line connecting them," Aslakson said, "and our present method of charting based on that premise has proven to be so accurate that through Shoran we have been able to locate a point within 10 feet in 310 miles even at this early stage of development."

For use in mapping, the new method requires that two known base points be established by existing means of location. These points can then be used to establish other points by triangulation and theoretically extended to encompass the entire world. Shoran distances currently are limited to a maximum of 500 miles because of the short-wave radio beams used, but even at that distance every point on the globe could be covered by moving portable Shoran equipment to new positions after other points have been located.

-30-



"My dear sir, we are fully aware of shortages and still are not interested in your wooden tubes!"

August, 1946

# MONITOR *Crystaliner*



TO USE  
IT ONCE  
IS TO  
OWN IT!

## A NEW SIGNAL GENERATOR FOR THE SERVICE MAN

**FINGER-TIP CONTROL.** Hundreds of exact frequencies instantly selected. No confused dial to read. No band switch. I.F., Broadcast, Shortwave, and Ultra Hi Frequencies with or without 400 cycle note.

*Fast  
Accurate  
Dependable*

**TEMPERATURE COMPENSATED.** All signals are *crystal-controlled*—not merely crystal-monitored. No stabilizing warm-up period. Laboratory accuracy the moment the set starts to oscillate. Frequency accurate to 1 of 1%. Output approximately 10 volts—enough signal to line up most I.F.'s by merely connecting to antenna post. No variable condenser to wear or coil to age. Frequency remains constant as the ageless crystal itself.

YOUR JOBBER HAS THEM IN STOCK

**\$5750**



**MONITOR PRODUCTS CO.**

815 FREMONT AVE., SOUTH PASADENA, CALIF.

113

# WAR SURPLUS RADIO EQUIPMENT

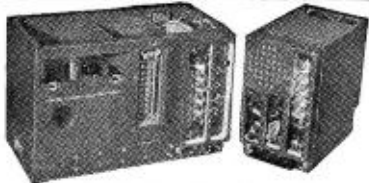

## F. M. TRANSMITTER & RECEIVER (BC683 & 684)

The BC-683 receiver operates on less than 1 microvolt, complete with 9 tubes, 10 pushbuttons, switch circuit. The BC-684 transmitter provides 35-watt output, 10 channel push button, crystal controlled, employing NONLENER MODULATING COIL, complete with 8 tubes. These units tune from 27 to 38.9 mc. These units come complete with tubes less power supplies and crystals. Excellent 10 meter band for "Ham" and Police use. **\$69.95**



**Low Frequency Receiver (BC-344)**  
Operates on 110 volts A.C. Complete with 10 tubes, 6" P.M. speaker encased in metal baffle tunes 150 to 1500 kc. a "hot" low frequency receiver at the lowest price ever offered. **\$85.60**



## WALKIE TALKIES

Operates 52 to 60 mc. . . . Used in Ham 6 meter band . . . operates portable, mobile or fixed station. Comes new complete with batteries and ready to operate. Set of Two S. C. R. #195. **\$119.00**

Extra batteries . . . . . **\$3.30** set  
Extra handset . . . . . **\$4.95**  
Extra collapsible antennae extending to 100' from 14 1/2" . . . . . **\$2.50**

## SOME OTHER SUN RADIO VALUES

WAVEMETER, tunes 150 to 210 mc, 110 V AC operation, complete with 19 tubes original Gov't cost, \$550 like new at **\$24.95**  
DYNAMOTOR, 6 or 12 volt DC Input 500 volts, DC output 160 MA Brand new in carton original Gov't cost, \$300 your cost **\$39.95**  
SIGNAL GENERATOR, Approved Electronic #A100 110 V operation 6 R.F. bands continuously variable RF-AM attenuator tunes 100 kc to 52 mc. **\$47.50**  
RADAR RECEIVER, BC-1068A, 110 V AC, tunes 174 to 210 mc ideal for Ham or experimenter comes complete with 14 tubes, excellent condition Gov't cost, \$625 **\$39.95**  
TRANSMITTER, BC-223, 25 watts C.W. or 17 phone, operates 6 or 12 volts D.C., range 2000-3000 kc 4 channels easy to change to 80 meters complete with 6 tubes less power supply and crystals. **\$49.95**  
HALLICRAFTERS, Model S36A AM-FM receiver, high fidelity receiver tuning 27.8 to 143 mc original price, \$415 net available in limited quantity first come, first served less speaker **\$307.50**

NET F. O. B. Washington D. C. 25% Deposit  
Must Accompany All C. O. D. Orders

We carry a complete stock of Hammarlund Tuning Condensers B & W Air Inductors Aerovox Condensers I.C.A. Chassis and Cabinets United Electronic & Hytron Transmitting Tubes Amphenol Cable and Connectors U.T.C. Transformers Astatic Mikes Hallicrafter & Hammarlund Receivers and many other ham & servicemen equipment.

Write For Your Radio  
Needs and the Chances Are  
SUN HAS THEM

# SUN RADIO

OF WASHINGTON, D. C.

938 F STREET, N. W. WASH. 4, D. C.

# Within the INDUSTRY

J. J. NANCE has been appointed to the president's staff of *General Electric Company*, it was recently revealed.

For the last five years Mr. Nance has served as vice-president of *Zenith Radio Corporation* in Chicago. Prior to that he was, for many years, connected with *General Motors Corporation*.

EDGAR STANTON was recently named service and advertising manager of the industrial division of the *Belden Manufacturing Company* of Chicago.



Prior to entering the Navy, Mr. Stanton represented the company in the Midwest covering the states of Mississippi,

Nebraska and Missouri.

In addition to handling all advertising problems of the industrial division, he will be responsible for the service of that division. He will report to Henry Neil, sales manager of the industrial division.

Mr. Stanton returned to *Belden* after his discharge from the Navy in October, 1945 as a lieutenant.

DEAM W. GIVEN is the new General Sales and Advertising Manager of *Aviometer Corporation*, according to a recent announcement.

Mr. Given was formerly Sales Manager of *Engineering Sales Laboratories, Inc.* of Tulsa, Oklahoma, manufacturers of gamma-ray and specialized electronic devices in the sonic and supersonic fields.

Mr. Given will be responsible for merchandising *Aviometer's* line of microphones, headsets, handsets, intercoms and specialized aircraft radio equipment.

R. FERDA has resigned as sales manager of the Sound Division, *Webster Electric Company* of Racine to become a manufacturers' agent for radio and electronic lines on the West coast.



Mr. Ferda has been connected with the development and distribution of

*Webster Electric's* paging, sound distribution, intercommunication and public address systems since 1922. He is well known in the radio-phonograph field through his activities in the merchandising of phonograph pick-ups and crystal cartridges.

Mr. Ferda has established temporary headquarters at 7422 Melrose Avenue, Hollywood 46, California.

SIDNEY L. OLSON, partner in the mail order firm of *Olson Radio Warehouse* of Akron, Ohio, has just been appointed Chief Purchasing Agent for the company.

Mr. Olson formerly served as manager of the Customer Relations Department for the North, Central and Southern Divisions.

ROGER BROWN has been added to the staff of *John Meck Industries*, Plymouth, Indiana, as new process engineer and time and job study specialist.

Mr. Brown, who has been a special radio technician in the navy, was associated with *General Electric Company* at Fort Wayne, before joining the Navy.

He is a graduate of Purdue University with a degree in trade industrial education.

MALCOLM P. FERGUSON of South Bend, Indiana, has been elected president of *Bendix Aviation Corporation*, succeeding Ernest R. Breech who has resigned to join the *Ford Motor Company*.



Mr. Ferguson's election is the culmination of over 27 years' service with *Bendix* and *Eclipse Machine Company*, a *Bendix* owned subsidiary. He is a graduate mechanical engineer, having received his degree from Syracuse University.

SIDNEY SPARKS has recently been elected vice-president and traffic manager of *RCA Communications, Inc.*

Mr. Sparks joined the company as traffic manager last September after serving for almost two years as Officer in Charge of the War Department Signal Center in Washington, D. C.

Before entering the Signal Corps in October of 1942, Mr. Sparks was superintendent and division sales manager for *Western Union* in New York.

MARSHALL R. STOECKER has been named manager of the Replacement Parts Section of the *RCA Victor Division of Radio Corporation of America*.

Mr. Stoecker will be responsible for the development and merchandise planning of all replacement parts required for equipment produced and sold by the *RCA Victor Division*. His section will also handle all customer



orders and control of finished goods inventories for the Parts Department.

He joins *RCA* after three years of service in the Navy where he was officer in charge of the Mark 5 and 6 program for the coordination of the production and procurement of components and equipment. Prior to his military service he was Manager of the Radio Department of the Chevrolet Division of *General Motors*.

**GLENN E. WEBSTER**, formerly in charge of Speech Equipment for *Collins*



*Radio Company*, has been named Chief Engineer of *The Turner Company* of Cedar Rapids, Iowa.

In his new position Mr. Webster will be in charge of the Engineering Department of the

Microphone and Electronic Division.

He is a graduate of Kansas State College with a degree in Electrical Engineering and has served as broadcast engineer for several stations including *NBC's* Chicago studio.

He is a member of the *I.R.E.* and the *A.R.R.L.*

**JOSEPH C. ELLIFF** has been named vice-president and member of the board of directors of *Scott Radio Laboratories, Inc.*, of Chicago.

Prior to his new appointment, Mr. Elliff was vice president of the *Stewart-Warner Corporation*, having joined that organization in 1939, serving as assistant general sales manager, manager of the appliance division and vice-president, in succession.

**CYRUS T. READ**, W9AA, has resigned his post on the engineering staff of *Hallcrafters* to become Supervising Buyer of Electronic Equipment for *Montgomery Ward & Company* in Chicago.

During the war, Mr. Read was a radio engineer and administrative officer with the Army Signal Corps. He was also supervisor of the Burr, Bancroft and Spry Signal Schools in Chicago, Signal Corps representative at the University of Chicago and Assistant Director of the Chicago Radar School.

Mr. Read's new appointment is in line with *Ward's* expanding electronic department.

**MAJOR APPLIANCES, INC.**, of Florida is celebrating its tenth anniversary in business with the completion of three modern buildings in Miami, Jacksonville and Tampa.

These new buildings give the company expanded warehouse and sales space for its line of radios, washers and irons, records, water heaters, ranges, refrigerators, freezers, fans, and traffic appliances.

**REX M. GAYNOR**, Treasurer and Merchandising Manager of *Walker-Jimieson, Inc.*, of Chicago, was one of the

August. 1946

The advertisement shows three different types of gauges: an 'AMPERES' gauge with a scale from 0 to 8, a 'D.C. MILLIAMPERES' gauge with a scale from 0 to 500, and a 'VOLTS' gauge with a scale from 0 to 50. Below the gauges is a large, stylized logo that reads 'PRECISION BASIC WITH Burlington INSTRUMENTS'. The logo features a lightning bolt symbol and the word 'Burlington' in a script font.

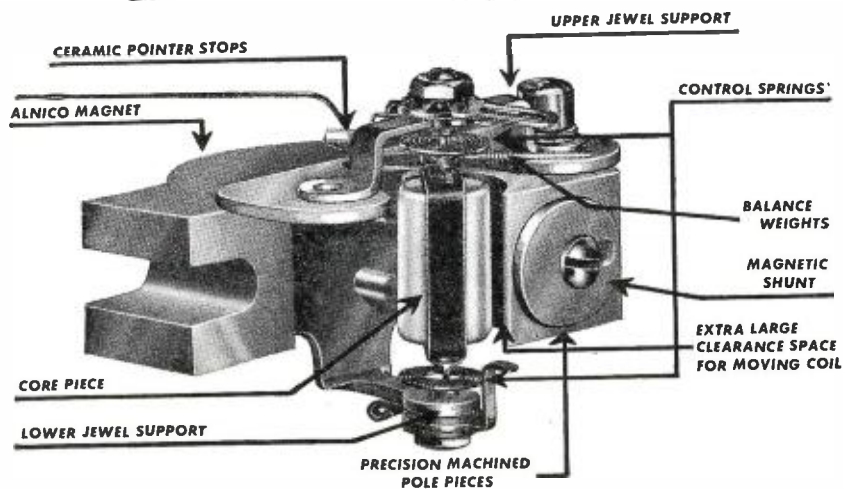

1. **MAGNETS OF ALNICO**, the most stable magnetic material available, are used in all DC instruments.
2. **LARGE CLEARANCES**, between core, moving coil, and magnet pole pieces assures freedom of movement by eliminating sticking due to moving element rubbing on adjacent parts.
3. **JEWEL SUPPORTS** are machined and assembled with aid of precision gauging fixtures to maintain perfect alignment.
4. **CONTROL SPRINGS** are fabricated from the highest quality phosphor bronze.
5. **CERAMIC POINTER STOPS** are used to prevent damage to the pointer due to accidental application of sudden overloads.
6. **BALANCE WEIGHTS** of helical type phosphor bronze are used to balance the moving element, so formed as to eliminate slipping or shifting.
7. **MAGNETIC SHUNT** is standard equipment on each DC instrument, insuring uniform damping characteristics.

All ranges AC and DC are available in 2½", 3½", 4½" sizes, both rectangular and round case styles. Inquiries for complete information and engineering service are solicited.

**BURLINGTON INSTRUMENT COMPANY**  
908 Fourth Street • BURLINGTON, IOWA

## SPEED UP REPAIRS WITH THESE G-C AIDS!

### G-C is HEADQUARTERS for RADIO PARTS and SERVICE AIDS



All Types of Radio Cements, Chemicals, Coil Dopes, Compounds.

G-C leads the field in supplying Radio-Electronic Manufacturers and Service Men with Parts, Tools, Radio Cements, Chemicals and Compounds. Insist on Genuine G-C Quality.

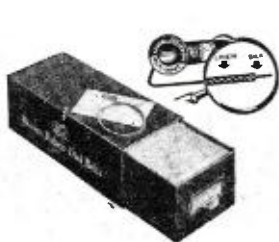

Dial Cables, Dial Belts, Packaged Hardware, Cabinet Repair Kits



Speedex Wire Strippers Alignment Tools Ne-O-Life Testers

Order from Your Jobber—Send for G-C Catalog



**GENERAL CEMENT MFG. CO.**  
ROCKFORD, ILLINOIS

## CALLING ALL HAMS and "SWL'S"... (Short wave listeners) SIGNAL CORPS COMMUNICATION RECEIVERS



**BRAND NEW only \$79.95**  
LS-3 SPEAKER & PL-55 PLUG, \$6.95

Check these features: AC operated, 110 volt, 60 cycle continuous coverage, 1,500 to 18,000 KC, vernier and speed tuning, beat frequency oscillator, with or without crystal filter, 10 tubes, 4 gang tuning, 2 RF stages, extreme sensitivity. No license needed.  
Listen to police calls, ship to shore communication, amateurs, weather forecasts, all foreign countries.

A few odd BATTERY MODELS—used but checked..... \$49.00



**EXTRA SPECIAL FOR ABOVE RECEIVERS!**  
Converter unit for complete broadcast band coverage. 100-1550 KC, connects in 30 seconds with special adapter, easy to connect (subject to O.P.A. change)....only \$15.00  
Adapter for NATIONAL NC-100 furnished upon request.  
**ATTENTION JOBBERS!** Write for special quantity price for these fast selling units.

Phono-Oscillator 76 and 6SA7 complete ready to operate .....\$6.95  
Kit form.....\$5.95

Phono-Amplifier less tubes and PM Speaker, uses 6J5, 25L6, 25Z6, completely wired .....\$4.25  
Kit form.....\$3.25

8MFD 500 volt Aerovox condenser, drawn metal can .....\$0.55

Remit 25% on all C.O.D. orders

**RELIANCE ELECTRONICS CO.**

633 Plymouth Ct.

Phone: WEBster 3692

Chicago 5, Illinois

61 persons who lost their lives in the tragic Hotel LaSalle fire in Chicago.

Mr. Gaynor, one of the founders of Walker-Jimieson, Inc., was well known in the radio parts field. He was active on several committees of the NEDA and other organizations. His home was in Elmwood Park, Illinois.

\* \* \*

**ROLLIN H. MAYER** has been elected vice-president and general manager of the newly organized St. Louis Microphone Company of St. Louis, Missouri.



The new company, which is manufacturing a line of dynamic microphones, has moved

into its newly constructed building at 2726-28 Brentwood Boulevard.

The company's line of microphones, licensed by A. T. & T. and Western Electric, include the outdoor mike, aircraft noise-cancelling dynamic, noise-cancelling differential dynamic, a dynamic mike in colored plastic as well as FM, cardioid, ham and other microphones.

\* \* \*

**JOHN A. HOLMAN** has been named business director of Westinghouse Stratovision, the new system of airborne television and FM radio transmission now under development.

Mr. Holman, a veteran radio executive who assisted in organizing the present NBC network more than 20 years ago, recently accepted an inactive status with the U. S. Signal Corps Reserve after more than five years' active service during which time he held the rank of Colonel. Mr. Holman will be in charge of all the business aspects of Stratovision, while engineering and technical development will continue under the personal direction of C. E. Nobles, 28-year old radar expert who conceived the plan.

\* \* \*

**H. C. BONFIG** has recently been promoted to the position of Vice President and Director of Sales of the Zenith Radio Corporation of Chicago.

Mr. Bonfig joined the Zenith organization in March, 1942, as Vice President in Charge of Household Radios.

\* \* \*

**SIDNEY HARMAN** has recently been appointed to the post of Sales Manager for the David Bogen Company, Inc., of 663 Broadway, New York.

Mr. Harman, who has recently returned from the Signal Corps where he served as a Lieutenant, will be in

charge of all the company's selling activities and will coordinate sales, research and promotional programs.

Mr. Harman succeeds Haskell A. Blair who has resigned to devote his time to his own company, Blair-Steinberg Company, Sales Representatives.



*New Photo Electric Unit*

**MODEL A-2**  
WITH ADDED SENSITIVITY

For numerous control applications such as burglar alarms, industrial safety controls, automatic counters, or in conjunction with a chime or bell to announce entrance of persons in stores and offices. For A.C. Complete with tubes and built-in SPDT relay.....\$11.95  
LIGHT SOURCE—Will operate up to 25 feet with above unit.....\$5.95

Write to Dept. EN

**ADSON RADIO CO.**

221 FULTON ST., NEW YORK 7, N. Y.

## PRECISION ANTENNA FM • TELEVISION • AMATEUR

Made of highest grade aluminum

Type 701A (28-44 MC) 10 meter amateur .....\$8.95  
Type 701B (44-88 MC) Television 5 meter amateur .....7.95  
Type 701C (88-148 MC) FM 2 meter amateur .....7.45

### IN STOCK ANTENNA ELEMENTS

Let us know your requirements.  
100 Ft. roll of RG 58 U. Transmission line .....\$5.45  
100 Ft. roll of parallel transmission line, 300 ohm or 150 ohm.....3.75

Immediate Shipment

Send for prices and information on our new 10 meter 3 element beam antenna and 2 meter 3 element beam antenna.

**S/C LABORATORIES, INC., Dept. R**  
20-22 Van Wagenen St. Newark 4, N. J.

Mr. Blair will continue to represent the *David Boegen Company* on the Eastern seaboard.

\* \* \*

**NORMAN B. NEELY ENTERPRISES** of Hollywood, California, has been named Western representative for the Shur Interceptor Antenna and Shur Universal Antenna Mount.

The Neely organization covers California, Arizona, Utah and Nevada, serving distributors and manufacturing accounts. The accessories and parts business of the company are under the supervision of Frank B. Koessler, a prewar employee of the company who was recently released from the Army Air Forces and has returned to his previous position with the company.

-30-

### Two Meter Transmitter

(Continued from page 37)

the 832-A, and with the milliammeter remaining in the 6C4 plate circuit, tune condenser  $C_{11}$  until the 6C4 plate current rises to about 25 ma. Now, with a 0-100 ma. meter in the 832-A plate circuit at  $X_1$ , apply plate voltage to the final stage and quickly tune condenser  $C_{10}$  until a sharp dip in plate current of the 832-A occurs. This is resonance and output will be obtained at 144 mc. Retuning of all stages may now be done, but the condenser  $C_6$  should not be moved. During retuning, a 0-10 ma. meter should be connected into the circuit at  $X_6$ . Maximum reading here indicates best performance and should be about 3 ma. The meter at  $X_1$  should read about 25 ma.

Now the antenna feeders may be connected to the ends of coil  $L_7$ . The coil  $L_7$  should be adjusted so that the current at  $X_1$ , with condenser  $C_{10}$  set for minimum current, is about 50 ma.

In practice, the crystal used is not exactly 7.2 mc. as this is the exact end of the 144-148 mc. band and a modulated signal on 144.00 mc. would be illegal. The author is using a 7.203 mc. crystal, giving 144.06 mc. output and a 7.255 mc. crystal giving 145.10 mc. output.

The modulator and speech amplifier are not explained in detail here but consist of a crystal microphone into a 6J7, resistance coupled to a 6C5, resistance coupled to a 6N7 with the two sections in parallel. This is transformer coupled to a 6N7 used as a class "B" modulator with its output transformer secondary in series with the positive lead to the 832-A plate and screen supply. This arrangement gives excellent quality and nearly 100% modulation.

Results obtained with this transmitter have been excellent, signal strength and quality of modulation favorably commented on at all points within beam antenna range. The signal has been copied on a superheterodyne receiver with great ease and receives the same excellent reports.

-30-

August, 1946

## The Difference Between "We Think So" and "We KNOW So"

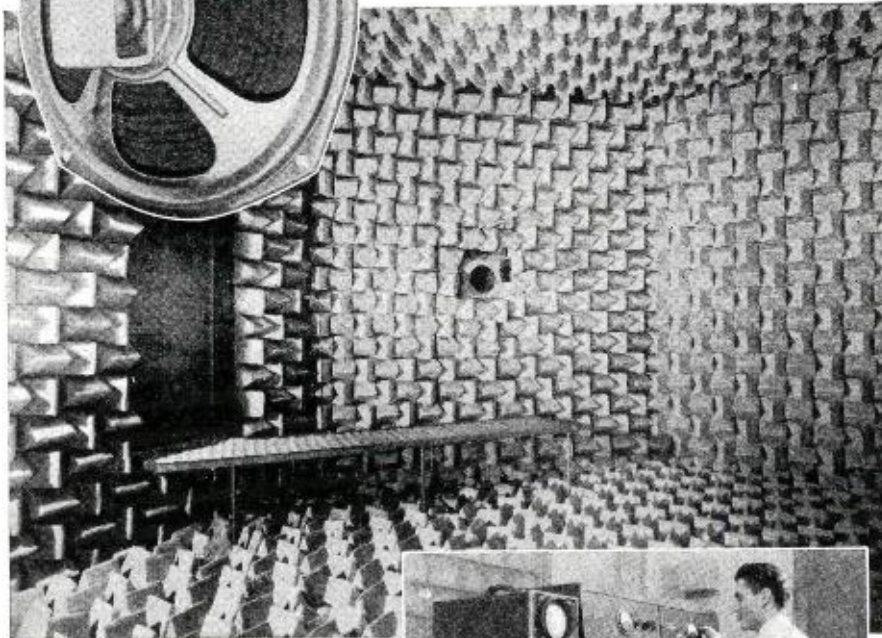
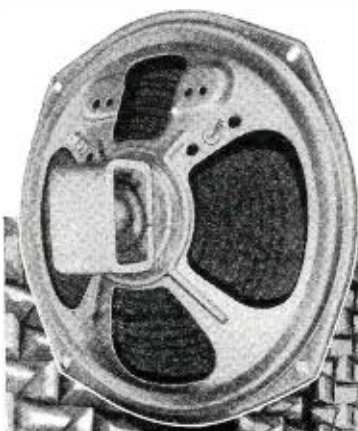

*Permoflux  
Speakers*



**...are Engineered for Application in  
this Stalactite Acoustical Chamber**

In this completely soundproof room, asymmetrical walls and carefully designed mass-interval baffles effectively reduce troublesome resonant harmonics and reflected sound to an insignificant value. Response curves are plotted which represent true performances so that Permoflux engineers can say "We Know So." Its use at Permoflux is characteristic of the many factors which make it possible to substantiate the fact that Permoflux Speakers provide the finest possible sound reproduction.

TRADE MARK  
**PERMOFLUX**  
PERMOFLUX CORPORATION  
4900 WEST GRAND AVE., CHICAGO 39, ILL.



PIONEER MANUFACTURERS OF PERMANENT MAGNET DYNAMIC TRANSDUCERS

Here's a Buy...  
**YOU MUSTN'T MISS!**  
**GENUINE EIMAC VT-127**



**HF balanced-  
 element  
 triode**

only  
**\$3.50**

Ideal for Class C and long-line oscillator service because of balanced grid and plate structure; also any RF oscillator circuit—industrial or amateur. Electrically equivalent to 100-TL (See ARRL handbook for rating). Can be used at full rating up to 300 MC; 70 watts (prox.) is ample drive for 800 watts input. A pair of these tubes will just "loaf" along at a full kilowatt input. Brand new • factory-sealed • Sig. Corps inspected • an amazing value • ORDER NOW.

And here's another  
 hot buy!

**GE  
 PYRANOL  
 XMTG  
 CAPACITOR**

4000 VOLTS—2 MFD.



Only **\$5.95**

These are just two typical Radio Shack surplus bargains. With apologies to "Schnoz" — "We got millions of 'em" Write today for current bulletin and get on our mailing list 8-A for more specials.

And there's a new catalog No. 49 of "regular" radio gear in the making. Register now — we'll send your free copy as soon as it's off the press.



**A TOOL SHOP  
 IN YOUR HAND**

Smooth, steady power for buffing scratched cabinets, metals, corroded tube and socket pins; removing burrs, sanding, etc. Grinds, drills, saws, engraves, etc. 25,000 r.p.m. AC or DC. Wt. 12 oz. In steel case with 45 accessories, \$25.00. Handee only, \$18.50.

**THE RIGHT  
 ACCESSORIES**  
 Choose them from the complete line—over 300 made right in the Handee plant.

**CHICAGO WHEEL  
 & MFG. CO.**  
 1101 W. Monroe St.,  
 Dept. RE, Chicago 7, Ill.

FREE  
 64 PAGE  
 CATALOG

**HANDEE • TOOL OF  
 1001 USES**

# Manufacturers' Literature

Readers are asked to write directly to the manufacturer for the literature. By mentioning RADIO NEWS, the issue and page, and enclosing the proper amount, when indicated, delay will be prevented.

## PANADAPTOR HANDBOOK

Of interest to amateurs is the new Panadaptor Handbook currently being offered by *Panoramic Radio Corporation*, of New York.

A copy of this handbook is being packed with each Panadaptor or copies may be secured from radio jobbers at fifty cents each.

This handbook covers the Model PCA-2, Type T-200 Panadaptor and treats such subjects as the installation, operation, circuit details, maintenance and service of the unit. Under the section on operation are listed and illustrated the various techniques for automatic visual monitoring, spotting replies to CQs, netting operations for traffic or emergency and many other items of interest to amateurs.

Distribution of the handbook is through radio jobbers, but it may be obtained from *Panoramic Radio Corporation*, 242 West 55th Street, New York 19, New York, if no jobber is handy. The price is 50 cents.

## TEST EQUIPMENT BULLETIN

An informative booklet which lists various types of testing equipment has just been published by *Metropolitan Electronic & Instrument Co.*

The booklet includes 16 pages of descriptive material on signal generators, tube testers, multimeters, combination tube and set testers, signal tracers, etc.

A copy of the booklet will be sent free of charge to radio men upon request to *Metropolitan Electronic & Instrument Co.*, 6 Murray Street, New York.

## NORTON CATALOGUE

An 18-page catalogue which lists various switchboard and portable electrical instruments has been released by *The Norton Electrical Instrument Co.*, Manchester, Conn.

Included in this descriptive bulletin are ammeters, voltmeters, wattmeters and resistor units.

A copy of the bulletin will be forwarded promptly upon request to *The Norton Electrical Instrument Co.*, Manchester, Conn.

## WALSCO CATALOGUE

Over two hundred hardware items and a complete line of adhesives, solvents, polishes and other chemicals are listed in the new *WalSCO Catalogue 46* now being distributed free of charge by *Walter L. Schott Company*.

This 16-page catalogue also lists several exclusive products developed for the radio man, including the patented Staple Driver.

A copy of Catalogue 46 will be forwarded upon request to *Walter L. Schott Company*, Department 128, Beverly Hills, California.

## FLUORESCENT GUIDE

Information on the basic principles and operating characteristics of fluorescent lamps and auxiliaries is given in the new 24-page booklet being offered by *Westinghouse Electric Corporation*.

The essential structure and operation of the mercury vapor electric discharge tube with its phosphor coating is shown diagrammatically and complete ratings are listed for important types of fluorescent lamps, including the Instant Start, Slimline and Circ-line.

In the section on operating characteristics, mortality and replacement rate curves help to explain the factors affecting lamp life and maintenance and the necessity for keeping voltage well within the recommended range is discussed. Color and stroboscopic effect, d.c. operation, a.c. frequency, power factor, the control of radio interference, noise and vibration and the effects of temperature and humidity on starting and light output are considered in detail.

A copy of Booklet A-4759 will be furnished upon application to *Westinghouse Lamp Division*, Advertising and Sales Promotion Department, Bloomfield, New Jersey.

## RESIST-O-GUIDE

*International Resistance Company* has announced the Resist-O-Guide which is now available for the radio serviceman, ham, electrical designer and electronic engineer.

This pocket sized resistor guide is used by turning its three wheels to correspond with the color code on any composition type resistor, and the standard RMA value is automatically and accurately indicated. The unit may also be used to determine the correct color coding for any standard resistor.

These Resist-O-Guides are available from *IRC* distributors only at a cost of 10 cents each. Please do not send any orders for this unit to the factory.

## AEROVOX PUBLICATION

The *Aerovox Corporation* of New Bedford, Mass., are currently offering a free subscription to the *Aerovox Research Worker* to those engaged in radio-electronic work.

A series of articles entitled "V.H.F. Primer" is being featured in the publication at the present time and will be of value to the radio man. The series

**RADIO NEWS**

started in March, 1946, and will continue through the December issue.

Requests for subscriptions should be sent to *Aerovox Corporation*, New Bedford, Mass.

**MICRO-SONIC CATALOGUES**

Two new catalogues, containing illustrations, descriptions and specifications on the company line of automatic record changers, record players and phonograph motors have just been issued by the *Micro-Sonic Corporation* of New York.

These catalogues which were introduced at the Radio Parts Show in Chicago are now available for distribution for those requesting copies.

Letters requesting copies of these catalogues should be sent to *Micro-Sonic Corporation*, 44 West 18th Street, New York, New York.

**CAPACITOR DATA**

Currently available for distribution is the new and complete catalogue of *Condenser Products Company* of Chicago.

The catalogue supplies complete technical data on *Plasticon* capacitors, silicone filled capacitors, a.c. and d.c. capacitors, glassmikes and energy storage types, photoflash and welding capacitors.

Dimensions, applications, specifications, and prices are all listed in this new catalogue which will be forwarded by *Condenser Products Company*, 1375 North Branch Street, Chicago, Illinois, upon request.

**MARION SOLDERING UNIT**

A four-page folder, covering the company's portable bench-type induction soldering unit, has just been issued by *Marion Electrical Instrument Company*.

This folder includes specifications, a description of the unit and information on various applications of this soldering unit. The unit which is de-

**FACSIMILE NEWSPAPER**

SINCE June 4th, Chicagoans have been able to witness daily newspaper publication by means of facsimile.

The *Chicago Daily Tribune* has been sent by facsimile to the downtown Public Service Office of the newspaper where its reception has been witnessed by thousands.

A feature of the second day of public demonstration was facsimile newspaper coverage of the LaSalle Hotel fire in which 61 persons died. The facsimile edition of the *Tribune* carried a news story about the fire. Between broadcasts of the edition, four-column pictures of fire scenes were transmitted and reproduced.

On June 6th, the newspaper demonstrated simultaneous reception of the facsimile edition at two widely separated sites, the *Medill School of Journalism*, Northwestern University in Evanston and at the Public Service Office.

The facsimile service is being handled by the *Tribune FM station*, WGNB in Chicago and is the first such newspaper to be so transmitted in Chicago.

# MYCONS

Higher "Q" in UHF } smaller size  
Higher Capacity }

Special purpose or standard type, oil impregnated, silvered mica capacitors. An exclusive pure silver plating method, identical to silver plating on fine instruments (not silk screened), used on the individual mica discs gives MYCONS extremely LOW inductances. Current flow is equally distributed in a 360° pattern from the center terminal, a shorter electrical path to ground. Both are standard for CRYSTALAB MYCONS.

Standard production sizes 5-100, 250, 500, 1,000 and 1,500 mmfds.	
Tolerances	2½%, 5%, 10%, 20%
<b>TECHNICAL DATA</b>	
Voltage Breakdown and Dielectric Strength	750 volts DC — Continuous
Working Voltage	1,000 volts DC — 15 min.
Overload	10,000 megohms minimum
Insulation Resistance	-50 — +100 parts/million/°C
Temperature Coefficient	1,000 for all values available
"Q" Factor	
<b>CONSTRUCTION DATA</b>	
Discs	Best available capacitor mica.
Seal	Silver plated.
Outside Rim	Correctly stacked to eliminate "book" effect.
Terminals	High vacuum transil oil impregnated.
	Silver plated brass.

Each order for MYCONS is processed to your specifications. Write for new specification and data sheets.

## CRYSTAL RESEARCH

LABORATORIES INC.

29 ALLYN ST., HARTFORD, 3, CONN., PHONE 7-3215

# FOR ALL Electricians

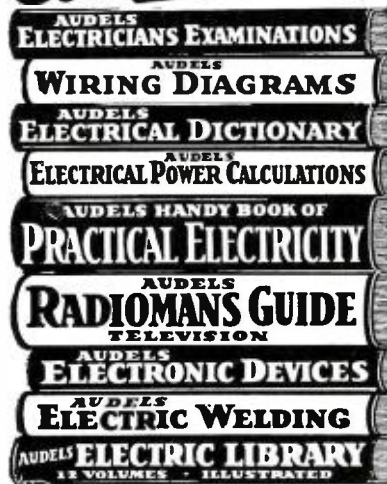

**PRACTICAL ELECTRICITY** at your finger ends. Answering your Questions and giving the facts and figures of your trade. Audels Electrical Guides contain Practical Inside Trade Information in a handy form. Fully illustrated and Easy to Understand. Highly Endorsed. Check the books you want for 7 days' Free Examination. Send No Money. Nothing to pay postman. If satisfied pay only \$1 a month until purchase price is paid.

ASK TO SEE THEM.



Get This Information for Yourself. Mail coupon today. No obligation unless O.K.

CUT HERE

## MAIL ORDER

AUDELS, Publishers, 49 W. 23 St., NEW YORK 10, N. Y.

Please send me postpaid for FREE EXAMINATION books marked (X) below. If I decide to keep them I agree to mail \$1 in 7 Days on each book ordered and further mail \$1 monthly on each book until I have paid Price.

- ELECTRICIANS EXAMINATIONS, 250 Pages . . \$1.
- WIRING DIAGRAMS, 210 Pages . . . . . 1.
- ELECTRICAL DICTIONARY, 9000 Terms . . . . . 2.
- ELECTRICAL POWER CALCULATIONS, 425 Pages. 2.
- HANDY BOOK OF ELECTRICITY, 1340 Pages . . . 4.
- RADIOMANS GUIDE, 914 Pages . . . . . 4.
- ELECTRONIC DEVICES, 216 Pages . . . . . 2.
- ELECTRIC WELDING, 400 Pages . . . . . 1.
- ELECTRIC LIBRARY, 12 vol., 7000 Pgs., \$1.50 Each

Name \_\_\_\_\_  
 Address \_\_\_\_\_  
 Occupation \_\_\_\_\_  
 Employed by \_\_\_\_\_ R.N.



### RCP Model 802N Combination TUBE-SET TESTER

Immediate Delivery from Stock.

A complete tube tester and a complete set tester. with only 5 simple switches to operate for both tube and set tester combined.

#### RANGES

- DC voltmeter 0/10/50/500/1000 at 1000 ohms per volt.
- AC voltmeter 0/10/50/500/1000.
- DC milliammeter 0/1/10/100/1000 DC Ammeter 0/10.
- Ohmmeter 0/500/5000/1,000,000/10,000,000. Low ohm center.
- D.B. Meter—8/15/15 to 20/29 to 49/32 to 55 decibels.
- Four range output meter—same as AC volts. Size: 12 1/4 x 12 x 5 1/4 inches. Weight: 11 1/4 lbs. Complete in handsome hardwood case, with test leads, self-contained batteries, ready to operate. Net. . . . . **\$59.50**

**ADSON RADIO CO.**  
221 FULTON ST., NEW YORK 7, N. Y.

signed to speed production line soldering and assembly of small metal parts is compact and easily operated.

A copy of the bulletin, complete with price, will be forwarded upon request to *Marion Electrical Instrument Company*, Manchester, New Hampshire.

#### PERCO COMPONENTS

The *Pioneer Electric and Research Corporation* of Forest Park, Illinois, has just issued a four page data sheet covering the company's line of radio components.

Included in the line are standard antenna, r.f. coils, midget antenna, r.f. coils, "Pee Wee" antenna, r.f. coils, oscillator coils, standard i.f. transformers, midget i.f. transformers, iron core i.f. transformers, etc.

The company is in production on all of these items and will forward a copy of their data sheet to those writing to the company, *Pioneer Electric and Research Corporation*, Forest Park, Illinois.

#### ELECTRICAL CODE CHART

A new chart showing changes in branch circuit wiring requirements in the 1946 National Electrical Code is being distributed by the wire and cable department of *United States Rubber Company*.

The chart indicates clearly the difference between the 1940 and 1946 codes. It is printed in two colors and furnished with a wall hanger.

Copies may be obtained from the *U. S. Rubber Company*, 1230 Avenue of the Americas, New York 20, New York.

#### SOLAR FOLDER

The *Solar Manufacturing Corporation* has recently made available their Bulletin SFF-100, covering the company's line of "Elim-O-Stat" radio interference filters for fluorescent lamps.

Three types of filters are illustrated and described in this four-page folder, the Type EF-100, Type EF-101 and the Type EF-102. Each of these filters is designed for a specific application.

Because of the increased use of fluorescent lighting fixtures in industry and the home, the radio serviceman should be interested in investigating the possibility of using some type of filter to eliminate radio interference.

A copy of Bulletin SFF-100 will be forwarded to those making their request of *Solar Manufacturing Corporation*, 285 Madison Avenue, New York 17, New York.

#### CENTRALAB SWITCHES

*Centralab*, Division of *Globe-Union Inc.*, has just issued a comprehensive catalogue covering its line of switches for electronic applications.

This 32-page book covers various types of selector switches, their specifications, dimensions and construction details; detachable shafts; clips and contacts; interstage shields; mounting straps; tone switches; medium duty power switches, lever action switches, plus details of several of the company's special type switches.

Complete engineering data about each type of switch makes this cata-

## LECTROHM RESISTORS

completely  
satisfy

ALWAYS



because—

1. Resistance wire is silver soldered to solder lugs in all Lectrohm Resistors, by special process, assuring perfect electrical bond under all conditions.
2. Lectrohm Resistors are designed and made by specialty resistor engineers—99% of Lectrohm's production is resistors.
3. Every Lectrohm Resistor is an integral unit with all parts completely embedded in vitreous enamel.
4. You will find all types and ratings in the Lectrohm Line, also power line and R.F. Plate Chokes and accessories.
5. Delivery is prompt.

Ask for the new Lectrohm Catalog and data book containing pertinent information on these Resistors and much valuable reference information.



5131 West 25th Street, Cicero 50, Illinois  
 Division of  
 National Lock Washer Co., Newark, N. J.

## NORMAN RADIO DISTRIBUTORS

"House of Bargains"

4-tube—115 Volt AC—400 Cycle Amplifiers—Brand New—in Metal Cases. Tube Complement: 2—7C5, 1—7F7, 1—744. Complete with tubes.

Worth \$15.00 in parts—can be converted to many uses. Signal Corps No. 28472A. Dim. 9x4x 4 1/2". Only **\$4.95**

3-Tube AC-DC Amplifiers—Ideal for Phono or Changer—less tubes. **\$3.95**

Army LS-3 Speaker—just a few left. Completely waterproof. 6" New **\$4.95**  
 Alnico PM—will handle 10 watts.

12" Walnut Speaker Cabinet. **\$3.95**  
 Crystal Pickup—10" or 12" records. Low pressure with 5,000 play. Per-**\$3.95**  
 manent needle. List \$10.75.

Signal Corps T175 Shure Carbon Mikes—hand type. 200-ohm input. Push-to-Talk switch with cord and plug. **\$2.49**

L Type Crystal—Cartridge. Mil-**\$2.19**  
 lions in use. Bargain at

Signal Corps Keys—Army No. J38. Special **69¢**

4-Prong Universal Type Vibra-**\$1.69**  
 tor—6 Amp. only.

100-Resistor Assortment — 1/2" **\$2.19**  
 1-2-watt sizes. Insulated types. Lists at \$12.50. Special at

All Merchandise Brand New—Perfect Condition. 25% Required on COD orders.

## NORMAN RADIO DISTRIBUTORS INC.

94-29 Merrick Road Dept. R. N. Jamaica, N. Y.

RADIO NEWS

logue of particular interest to the design engineer.

A copy of this catalogue will be furnished upon request to *Centralab*, Division of *Globe-Union Inc.*, Milwaukee 1, Wisconsin.

-30-

**Spot Radio News**

(Continued from page 14)

441 conditional grants. This is not to mention 126 applications still in hearing as we go to press, plus 261 pending applications on which there had been no action—a grand total of 885.

**EMPLOYMENT IN RADIO MANUFACTURING**, according to the Department of Labor, is substantially higher than that of manufacturers generally, according to an early-summer tabulation. Quits, both among men and women, continued high throughout industry—42 per 1000 as compared with prewar levels under ten. Government sources indicated their belief, however, that employment will continue good during the rest of the year. Bureau of Census reported it at an all-time high late in the spring—54,600,000. "Should employment rise another 2,500,000 this year—and such a rise seems certain—employment will hit the 57,000,000 mark, defined in some quarters as 'full employment' for the postwar transition period," according to the Civilian Production Administration. Speaking of jobs, the military still has a few that might appear attractive to men with radio experience. Commissions are available for men with electronic experience, the Navy has announced, if you have had the proper training at Navy schools. You must also sign up for active duty before July 1, of next year, 1947.

**PERSONALS**

From Germany comes word via **Dr. Todos M. Odarenko**, *International Telephone and Telegraph* technician, sent there by the U. S. Department of Commerce to check up on Nazi communications developments, that Germans developed adequate substitutes for copper when supplies ran short. He is also studying Nazi condensers, smaller than U. S. counterparts, which are said to be practically indestructible, since they heal themselves when a breakdown is caused by overloading. . . . New vice-presidents of the RMA are **Henry C. Bonfig** of Chicago, set division; **M. F. Balcom** of Emporium, Pa., tube division; **J. J. Kahn** of Chicago, parts division; **Fred R. Lack** of New York City, and **Allen Shoup** of Chicago. **Bond Geddes** was reelected executive vice-president, general manager, and secretary. . . . A code of industry advertising ethics is being prepared by the RMA advertising committee, under **John S. Garceau**, *Farnsworth Television & Radio Corp.*, Ft. Wayne, Ind.

-30-

August, 1946

*For the Modern, Fast-Service Shop*  
**HANDY**  
**IRC VOLUME CONTROL KITS**  
*and Resist-O-Cabinets!*

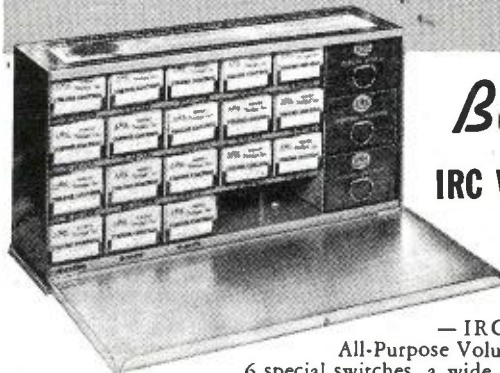

*Back Again—*  
**IRC VOLUME CONTROL KITS!**

Neat Handy Stock of Controls, Shafts and Switches. All Metal Cabinet *FREE* With Ordered Controls.

Here's a help for faster service — IRC Volume Control Kit, 18 Type D, All-Purpose Volume Controls, with 5 extra shafts and 6 special switches, a wide utility stock suited to 87% of all replacements. Kit is delivered factory-packed in an all-metal cabinet, with individual, marked compartments for controls. Three handy drawers accommodate switches and shafts. The hinged cover shuts securely. Carry the cabinet with you when required. Base is arranged for stacking where more cabinets are needed. The all-metal cabinet is *FREE* with kit of 18 controls ordered at standard control prices. It is not sold separately. Order Resistor Assortments and Volume Control Kits now.

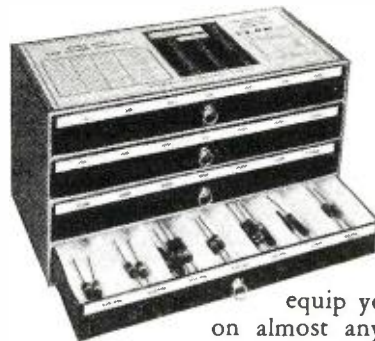

**Try These 3 IRC Balanced Resistor Assortments — Packed in FREE Resist-O-Cabinets!**

You know that modern appearance and fast service pay off. That's why you'll want one or all three IRC Resistor Assortments—factory packed in sturdy cardboard Resist-O-Cabinets—equip you for quick, easy resistor replacements on almost any job. Bases of Resist-O-Cabinets are arranged so that several cabinets may be stacked to increase stock capacity.

1. Universal Assortment. Balanced resistor assortment . . . 59 IRC Type BT Insulated *Metallized* Resistors and "universal" 10-Watt Power Wire Wound Types AB and ABA. The ABA (adjustable) type makes possible every range from a few ohms up to 10,000 ohms.
2. 1/2-Watt Assortment. 100 Type BW-1/2 and BTS Resistors. A complete assortment of most used ranges in the popular 1/2-Watt Insulated *Metallized* and Insulated Wire Wound Types.
3. 1-Watt Assortment. 83 Type BW-1 and BTA Insulated Resistors. Every dealer-service engineer should have all of these top-quality 1-watt resistance ranges at his fingertips.

----- MAIL THE CONVENIENT COUPON TODAY -----

**RADIO TELEVISION SUPPLY COMPANY, 1509 South Figueroa St., Los Angeles 15, Cal.**  
 Please make immediate delivery of . . . . . IRC Volume Control Kits with *FREE* Metal Cabinets @ \$14.97 (Dealer's Net Cost.)  
 Deliver Resistor Assortments with Free Cabinets as follows:

..... Universal Asst. #1 @ \$9.02 (Dealer's Net Cost)	Check Encl. <input type="checkbox"/>
..... 1/2-Watt Asst. #2 @ \$7.87 (Dealer's Net Cost)	Bill <input type="checkbox"/>
..... 1-Watt Asst. #3 @ \$8.47 (Dealer's Net Cost)	Send C.O.D. <input type="checkbox"/>

Dealer's Name .....

Address .....

City..... Zone..... State.....

Distributed in Western States by

**RADIO TELEVISION SUPPLY INC.**

121

## Mail Your Order Today!

We guarantee your complete satisfaction or your money back on every purchase.

Universal  
TEST  
SPEAKER  
\$24.95



Matches any field value encountered in radio servicing. Variable from 500 to 3000 ohms.

A convenient, valuable, substitute speaker. Matches any combination of output tubes . . . push-pull, single, or parallel. Voice coil input on front panel. Ideal for testing quality, distortion, and cone rattle in radio-phonographs and for shop testing of radio chassis. Operates with all types of radio and sound equipment. Complete with all required leads.

### "Can" Type Condensers



We have a large stock of 15 mfd., 375 WV Can-type Electrolytic Condensers. You save over 60% when you buy at our bargain price. Original net price...\$1.50 Our Price.....\$ .50

The  
SIGNALER  
\$24.95



### A Different, Positive Radio Tester

The New Dynamic SIGNALER is revolutionary . . . accurate . . . and quicker and easier to use! The SIGNALER puts out a continuously varying audio signal from 5000 cycles to well above short wave bands, including FM. Insert a signal at any point in the circuit. Start at the plate of the output tube. Proceed from plate to grid of every stage. Locate by lack of signal output, the defective stage . . . accurately and rapidly. Complete isolation from AC Power Line. No complicated dials to fuss with! An output jack and variable gain control do the trick. Use one probe for all tests . . . audio, intermediate, and frequency. Used with an output meter, the SIGNALER is the most modern, efficient way of servicing the most complicated radio circuits. Complete with special jack, lead, and probe, plus thorough, easy-to-understand instructions.

### MAIL THIS ORDER FOR QUICK DELIVERY

ELECTRONIC PRODUCTS CO.

662 Monroe Ave. Rochester 7, N. Y.  
Please send the following immediately. I understand my money will be refunded if I am not completely satisfied.

- Signaler Set Tester @ \$24.95
- Universal Test Speaker @ \$24.95
- Can Condensers @ 50c each
- Your complete price list (3c stamp enclosed)
- Check or Money Order enclosed  Send C.O.D.

Name.....  
Address.....  
City.....State.....

**ELECTRONIC PRODUCTS CO.**  
662 Monroe Ave. Rochester 7, N. Y.  
Designers and Manufacturers

## NEW!

## PRECISION ELECTRONIC SIGNAL TRACER

Designed for Easier and Faster  
Servicing by "Listening-in" Method

CHECKS SIGNAL STAGE-BY-STAGE in R.F.,  
I.F. AND AUDIO SECTIONS

Your No. 1 Instrument for  
Shooting Trouble in COILS,  
CONDENSERS, TRANSFORMERS,  
RESISTORS, SPEAKERS, TUBES

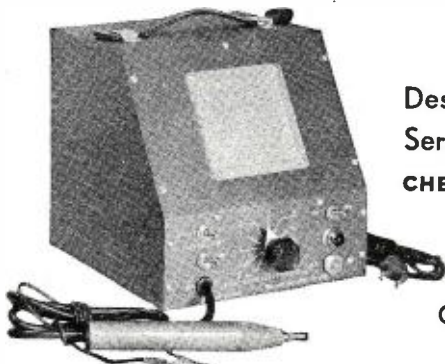

Operates on 110-120 volts—60 cycles

Only **\$29<sup>95</sup>** Complete

Radolek Stock No. G17010  
**IMMEDIATE DELIVERY**  
ORDER TODAY

Send for RADOLEK'S Radio Parts Catalog—It's FREE!

**RADOLEK CO., 601 W. Randolph St., Chicago 6, Ill.**

Probe has Polystyrene Tip—Accurate  
operation on frequencies up to 300 MC.

LOCATES INTERMITTENTS, OPENS, SHORTS, HUMS,  
NOISY CIRCUITS. CHECKS PARTS WHILE SET IS  
HOT OR COLD—BOTH IN CIRCUIT OR OUT.

## Technical BOOKS

**"A CHRONOLOGICAL HISTORY OF ELECTRICAL DEVELOPMENT."** Compiled and published by National Electrical Manufacturers Association, 155 East 44th Street, New York 17, N. Y. 106 pages plus appendix. Price \$2.00.

This book is designed as a reference work for editors, writers, commentators, libraries, and schools, as well as for industry.

The compilers have gathered together all of the important electrical dates since 600 BC and have carefully catalogued them in chronological order for easy reference. The index, which is cross-referenced, enables the student to find the correct date for some noteworthy electrical event even if the name of the inventor is the only clue, or the name of the invention itself is all that comes to mind.

We believe that this is the first attempt to catalogue such material in an orderly progression of events leading up to present-day innovations. The result is a success.

In addition to this chronology, the compilers have presented material about electrical expositions and congresses, the birth of electrical publications, engineering and trade associations, societies, foundations and institutes. The appendix contains a list of the member companies of the NEMA along with the name of the original company, date of founding, name of founder and title, and the name of the first president of the company.

**"ELECTRICAL RADIO, ELECTRONICS DICTIONARY AND DATA BOOK."** Compiled by Coyne Electrical School Technical Staff. Published by Coyne Electrical School, Chicago, Illinois. 304 pages. Price \$1.50.

This is a pocket-size reference book which will be of equal value to the serviceman, student and engineer.

In the dictionary section of the book, electrical terms are defined clearly and in easy-to-understand terminology. The data section includes symbols for wiring, radio, and electronics; insulation tables; conductor sizes; wire sizes and resistances; motor windings; wiring diagrams and various often-used wiring diagrams.

This would be a handy book to have in your pocket when you are making service calls.

**"THE RADIO AMATEUR'S HANDBOOK,"** 1946 Edition. Published by The American Radio Relay League, West Hartford, Conn. 468 pages and a 208 page manufacturers' catalogue. Price \$1.00 paper bound.

As this 23rd edition of the Radio Amateur's Handbook makes its appearance, the reviewer is a little at a

## RADIO ENGINEERING!

EX-SERVICE MEN can complete work here in shortest possible time. Courses also in Civil, Electrical, Mechanical, Chemical, Aeronautical Engineering; Business Administration, Accounting, Secretarial, Science. 63rd year. Enter Sept., Jan., Mar., June. School now filled to capacity. No applications can be accepted until further notice.

**TRI-STATE COLLEGE**

DEGREE IN  
27 MONTHS

1686 College Ave.  
ANGOLA, INDIANA

In the Rocky Mountain Region It's

## Radio & Television Supply Co.

152 Hobson Avenue, Pueblo, Colo.

P. O. Box #892

"If we don't have it, we'll get it—  
or it can't be had! Phone 5729"



loss to describe this publication adequately for it is so well known in the amateur fraternity as to need no introduction or review.

The 1946 edition is divided into three main parts. In addition to an introduction the book includes: "Principles and Design," "Equipment Construction" and "General."

The book has been revised to include up-to-date information on v.h.f. equipment.

There are 1249 illustrations in the book, including 114 charts and tables, 185 basic formulas.

The radio amateurs should welcome this new and enlarged edition of the Handbook, and all this reviewer can say is "Here it is—come and get it."

\* \* \*

**"TEACH YOURSELF RADIO COMMUNICATION"** by E. M. Reid. Published by *David McKay Company*, Philadelphia, Pa. 172 pages. Price \$1.00.

This is an American edition of a book originally published in England. The book is written for those who have no previous knowledge of radio. It covers the more elementary principles of radio communication from the theory of a current of electricity to the transmission of high-frequencies used in broadcasting.

This little book is divided into eleven chapters, dealing with theory of current, d.c. circuits, alternating current, inductance, capacity, resonance, aeri-als and radiation, properties of valves (tubes), simple applications of valves, transmitters and receivers.

The explanations in this text are clear-cut and concise and the beginning student should experience no difficulty in understanding the subject matter. The mathematics required of the student does not exceed simple arithmetic and anyone who can handle equations and various arithmetical processes should have no trouble with the problems.

This book is recommended for the beginning radio student who would like to study the subject at home.

-30-

### TEST RADIO BATTERIES

**R**ADIO dry type batteries must be tested under load—that is with the radio in operation and preferably after having operated some time.

In the case illustrated with a test as above the 45 volt "B" battery registered only 35 volts. A test made of the battery with no load showed more than 40 volts.

H. L.



August, 1946

... don't change  
the cartridge  
... change the arm  
to *Glider*

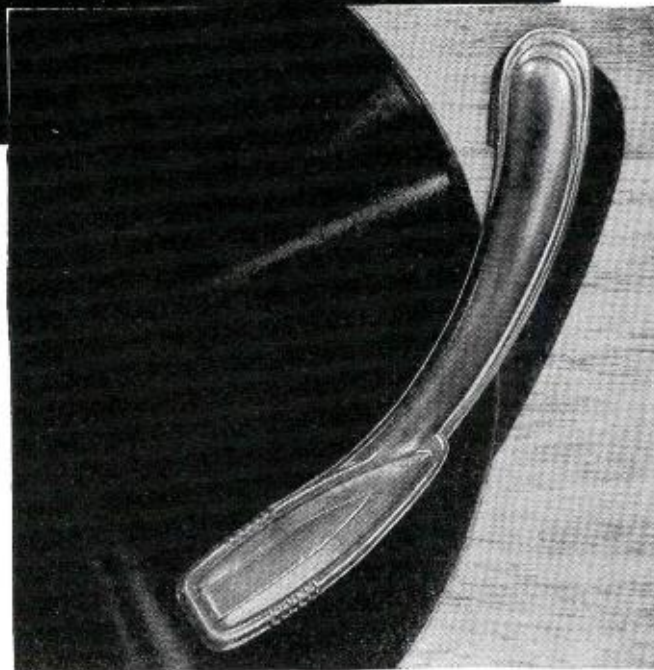

Please your customers, completely, by bringing their phonographs up-to-date . . . not by just changing the cartridge . . . but by replacing the complete arm. "Glider," the standard arm for many leading set manufacturers, is now available to the servicemen. The "Glider" has nearly two volts output—consists of the new Shure Lever-Type Cartridge and aluminum tone arm, with needle force of only 1½ ounces—reduces record wear, improves tone quality, reduces surface noise. Easy to install and a profitable bit of business for you. Model 93A . . . \$6.10 List (needle not included). Available at all Shure Distributors.

Patented by Shure Brothers and licensed under the Patents of the Brush Development Company

## SHURE BROTHERS, Inc.

Microphones and Acoustic Devices

225 West Huron Street, Chicago 10, Illinois  
Cable address: SHUREMICRO



123

## We CUSHIONED *this spindle*

### TO PROTECT RECORDS

On any single-post record changer, there's a weight of about six pounds on the spindle ledge when the changer is loaded. When the machine changes records, this weight falls on the bottom record of the remaining stock. The resulting shock ordinarily causes excessive record wear. But the exclusive Webster cushioned spindle absorbs shock—"babies" records. Webster changers effectively protect records—avoid chipped edges and excessive center hole wear.

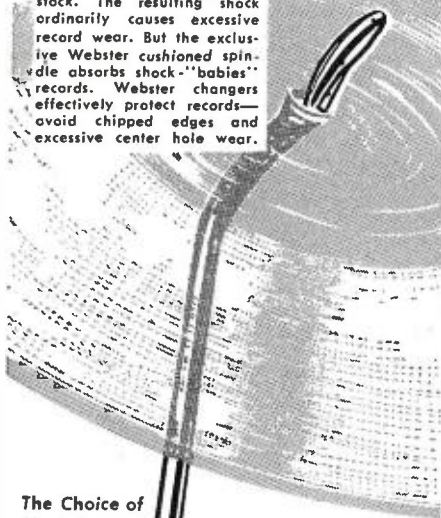

The Choice of  
Music Lovers

## WEBSTER

Automatic Record Changers



Model 50

## WEBSTER CHICAGO

5610 Bloomingdale Avenue  
CHICAGO 39, ILLINOIS

32 years of Continuous Successful Manufacturing

## E-L-E-C-T-R-O-N-I-C-S

RADIO TELEVISION RADAR

Components of all values—description—purposes  
Transmitting Tubes

H.V. transformers, resistors, condensers,  
potentiometers, relays, switches, etc. . . .

Write  
Visit  
Call

ELESKAY CORPORATION  
2503-07 No. Broad St.  
Philadelphia 32, Pa.  
BAldwin 9-7458

FREE! SYMBOLS CHART No. 7A

## SUN RADIO

& ELECTRONICS CO., Inc.

132-124 DUANE ST. NEW YORK 7, N. Y. BRaun 7-1840

# A Novel 2-Tube RECEIVER

*Details for constructing an unusual, simple two-tube receiver. Plug-in type coils are used to cover range from 1000 kc. to 23 mc.*

**L**OUDSPEAKER reception on all bands with two pentodes is a feature of a novel receiver developed by one of our readers. Here's how J. L. Dickson, Jr., of Freeport, Texas, achieved this unbeatable combination with a simple receiver of his own design.

Parts used were mainly those from the junk box with both the antenna and tuning condensers being *National* midgets while the regeneration condenser is one removed from an old b.c. receiver. A great deal of leeway is given on the antenna length with anything from a three foot piece of wire upward, giving satisfactory results. In spite of the low tuning capacity, it is possible to cover all bands simply by using the antenna trimmer and varying the regeneration condenser. The coils used are standard four-prong detector and are of the type sold by most radio parts houses.

The receiver operates in a conventional manner down to about 25 meters but below that wavelength it super-regenerates and the sensitivity is greatly increased so that almost all foreign short-wave stations may be received at full speaker volume.

While the diagram shows a 6AC7 and a 6L6 tube, one of the features of this receiver is the possibility of tube substitution. Any of the screen grid tubes will work satisfactorily as a detector by substituting appropriate voltages. The output tube may be anything handy, with the 6L6 being

preferable although a 6AG7 runs a close second.

When first tried, the receiver developed a bad parasitic in the 6L6 stage which was sufficient to light a fluorescent tube to full brilliancy.

The usual by-pass condenser across the primary of the speaker transformer is about .002  $\mu$ fd. In this particular construction it was necessary to use a .1  $\mu$ fd. to kill the parasitic. Probably the addition of a 50 ohm resistor in series with the screen would accomplish the same results and not attenuate the high frequencies as the .1  $\mu$ fd. condenser does.

As an example of the remarkable sensitivity, the audio signal at the plate of the detector tube consistently runs in the vicinity of 100 volts on most stations. A simple one tuber may be constructed easily by connecting a pair of earphones from the plate of the detector tube to ground through a small coupling condenser.

Plate voltage is not critical, with anything from 45 volts up to 450 volts providing satisfactory results. One very satisfactory version used a 4" speaker with 45 volts on the plate of the 6L6 and a total current drain of 10 ma. Care should be exercised in the choice of the 6L6 output tube as some tubes give considerably more output than others.

With a set of 5 standard plug-in coils, the frequency range of this particular unit is from 1000 kilocycles to 23 megacycles.

—30—

Schematic diagram of receiver. The 6L6 output stage may be omitted if speaker is not required. Earphones would then be connected across plate of 6AC7 and ground.

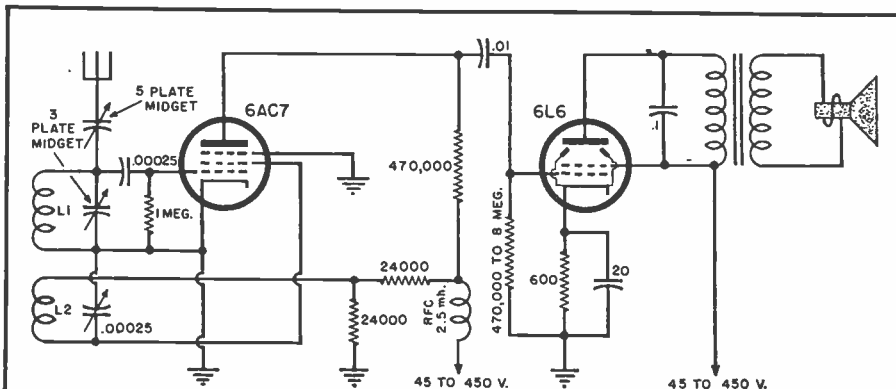

L1 and L2 are standard 4 prong plug-in type coils.

The set works efficiently with plate voltage from 45 to 450 volts.

With 45 volts on plate, the 6L6 plate current will be approximately 10 ma.

With 250 volts on plate, the 6L6 plate current will be approximately 65 ma.

Other substitute tubes may be used, however, 6L6 will give best performance.

**International Short-Wave**  
(Continued from page 107)

ann, Dublin, Eire; schedule was listed as 12:40-1 p.m. on 17.840 and 4:10-4:30 p.m. on 9.595.

Art Cushen, New Zealand, has received a letter verification from XORA, 11.695, Shanghai; address, F. Chung, Director, Shanghai Station, Central Broadcasting Administration, 7 Chung Cheng Road (Western), Shanghai, China. XORA desires reports, it was stated.

**Schedules**

Angola—CR6RA, 9.470, Luanda, is heard with an additional transmission, 1:15-2:30 a.m.

Argentina—LRR is back on 11.883 to 6 p.m. when QSY to LRR1. LRM, relaying *Radio Aconcagua* and *Radio Belgrano*, now uses 5.900.

Australia—*Radio Australia's* evening transmission to Eastern North America, 6:40-8:45 p.m., has settled on VLC9, 17.84; news continues at 6:45, 8:30 p.m. VLH4, 11.880, Melbourne, carries 3LO (Melbourne), "The State Program," every day *except* Saturday, 1:30-3:30 a.m. VLH5, 15.240, carries the 3LO programs from before 1:30 a.m. to 2:30 a.m. on *Saturdays*; VLR5 is off at 1 a.m. other days, comes back on with Chinese at 2:30 a.m. VLW7, 9.520, Perth, opens at 5:30 a.m., relays Radio Newsreel from London at 10 a.m.; is in parallel with 6WA, 6GN, 6WN (Perth), and 6GA, all Western Australia Regional Stations; closes with "God Save the King" at 10:30 a.m., *except* Saturday when sign-off is at 11 a.m. VLC2, 9.680, and VLA4, 11.770, have been heard recently carrying an experimental transmission to the United Kingdom, from 2 to around 3:15 a.m.; news at 2:30 a.m. A new Melbourne transmitter, VLB, 9.540, is reported with an experimental transmission to the East Coast (paralleling VLC9, 17.84), 6:40-8:45 p.m.

Belgian Congo—OTC2, Leopoldville, lately on 9.748, but varying, now relays the BBC's Spanish Service to Latin America for one-half hour, interrupting the North American Service relay 15 minutes longer; thus, Leopoldville's North American Service relay is now 8:15-9 p.m. and 9:30-9:45 p.m., last period being the *news*.

Belgium—Ruislede *Radio Brussels*, announcing as "*la Service Mondiale de la Radiodiffusion Nationale Belge*," is heard closing down at 11 a.m.; is on again at 12:30 p.m. with music; calls Leopoldville, Belgian Congo, around 12:55 p.m.; at 1 p.m. has a six-pip time signal, similar to the Greenwich time signal but "clipped short"; also has musical tones; news in Czech is heard at 2:45 p.m., followed at 3 p.m. with news in French. In another transmission, carrier comes on at 12:38 a.m., and opening is at 12:45 a.m. in French, with program times being given to Leopoldville. Frequency is 17.840. Belgium has now gone on Summer

August, 1946

**Highest Quality**  
**RADIO and ELECTRONIC**  
**Testing Equipment**

**Immediate Delivery from Stock Guaranteed**

**WESTON**  
**OHMMETER**  
Model 689-IF

Net Price: \$14.85



This Ohmmeter has a double range of 0-10 and 0-1000 ohms for the accurate measurement of low resistance values. This type is widely used for production testing armature and field resistances, of small motors, relay and coil testing, transform, winding tests and other similar appliances. Complete with operating instructions, test leads and leather carrying case.

**The New**  
**Model 543-S**  
**SUPREME**  
**MULTIMETER**

Net Price: \$24.75



1% WIRE WOUND PRECISION RESISTORS. Ranges at 1000 ohms per volt standard sensitivity. Full size 3" square meter with a rugged, accurate 200 microampere movement and a knife edged pointer. All ohmmeter ranges, including the megohm range are operated by batteries and contained within its durable black molded bakelite case.

**McMurdo Silver**  
**Model 904**  
**Capacitance**  
**Resistance**  
**Bridge**

Net Price \$49.90



1/4 mmd./ohm thru 1,000 mfd./megohm; 0-50% power factor; 0-500 volt adjustable internal polarizing voltage; 0-10 and 0-100 ma. electron-ray leakage current meter; measures resistance, capacitance under actual operating voltages!

**McMurdo Silver**  
**Model 905**  
**Combination**  
**"SPARX"**  
**Dynamic**  
**Signal Tracer**

Net Price \$39.90



Frequency range from 20 cycles to over 200 megacycles. Contains isolating capacitor, resistor and one of the new radar u.h.f. crystal diodes. Loads a circuit being tested with only 3 mmd. and higher than .5 megohm.

**The New**  
**Model S-10-A**  
**Pocket Size**  
**Oscilloscope**

Net Price: \$55.00



Complete cathode ray oscilloscope incorporating the cathode ray tube, vertical and horizontal amplifiers, linear time base oscillator, synchronization means and self-contained power supply. Complete with tubes and operating instructions.

**The New Model 274**  
**Dumont Five-Inch**  
**Oscilloscope**

Net Price: \$99.50



Input Impedance:  
Y Axis: Direct 5 meg., 60 uuf.  
X Axis: Direct 5 meg., 80 uuf.  
Z Axis: 10 rms. volts to blank.

Y Amplifier: 1 meg., 70 uuf.  
X Amplifier: 5 meg., 30 uuf.  
Sine wave response uniform within 20% from 20 cycles to 50 KC.  
Continuously variable frequency range from 8 c.p.s. to 30 KC. Synchronizing signal sources: internal or external.

**The New**  
**Model 705**  
**Signal**  
**Generator**

Net Price \$49.50



RANGES:  
From 95 kc to 100 mc, continuously variable. Calibration accurate to 2% through broadcast bands, within 3% for high frequency bands. Planetary drive condenser, direct reading calibration, output modulated or unmodulated. Self-contained electronic modulation 400c sine wave available for external use. Special feature provided in having two degrees of modulation at both approx. 30% and 80%.

**The New**  
**Model 802N**  
**Combination**  
**TUBE & SET**  
**TESTER**

Net Price \$59.50



D.C. Voltmeter: 0/10/50/500/1000 at 1000 ohms per volt. Four Range A.C. Voltmeter: 0/10/50/500/1000. D.C. Milliammeter: 0/1/10/1000 DC Ammeter 0/10. DB Meter: -8/15/15 to 29/29 to 49/32 to 55 decibels. Four Range Output Meter—same as AC Volts.

SUPREME Model 599 Tube and Set Tester.....	\$ 62.50
SUPREME Model 565 Vacuum Tube Voltmeter.....	\$ 63.50
R.C.P. Model 448 Pocket Multitester.....	\$ 24.50
R.C.P. Model 424 A. Volt-Ohm-Milliammeter.....	\$ 29.50
R.C.P. Model 664 Electronic Multimeter.....	\$ 45.00
R.C.P. Model 315 Tube Tester.....	\$ 59.50
R.C.P. Model 488A Ultra-Sensitive Multitester.....	\$ 71.50
R.C.P. Model 668 Vacuum Tube Volt-Ohm-Capacity Meter.....	\$ 74.50
R.C.P. Model 803 Tube and Set Tester.....	\$ 89.50
R.C.P. Model 665 A.V.T. Volt Ohmmeter.....	\$ 94.50
Insulation Tester.....	\$ 27.50
Reiner Model 333 Master Tester.....	\$ 27.50
Reiner Model 530 Squarewave Generator.....	\$ 95.00
Reiner Model 451 Vacuum Tube Volt-Ohm-Milliammeter.....	\$150.00

Superior Model CA-11 Signal Tracer.....	\$ 18.75
Superior Model 1553 Volt-Ohm-Milliammeter.....	\$ 24.75
Superior Model 680 5000 Ohms Per Volt V.O. Milliammeter.....	\$ 27.65
Superior Model PB-100 Volt-Ohm-Milliammeter.....	\$ 28.40
Superior Model 450 Tube Tester.....	\$ 39.50
Superior Model 650 Signal Generator.....	\$ 48.75
Superior Model 720 Multi Range AC Ammeter.....	\$ 49.50
Superior Model 600 Combination Tube and Set Tester.....	\$ 62.50
SHALLCROSS Decade Resistance Boxes.....	\$ 13.50
SHALLCROSS Portable Galvanometers.....	\$ 27.50
SHALLCROSS Model 630 Wheatstone Bridge.....	\$ 75.00
SHALLCROSS Model 637 Kelvin Wheatstone Bridge.....	\$100.00
RECORD CHANGER: Model VM-200.....	\$ 22.50
RECORD CHANGER: Model Maguire.....	\$ 24.50

Write for Our FREE New Post-War Catalogue!

**Metropolitan ELECTRONIC & INSTRUMENT CO.**  
Dept. R, 6 MURRAY STREET Cable Address: METRONICS  
NEW YORK 7, N. Y., U. S. A. Phone: BARclay 7-5556

# NOW—A REALLY HIGH-POWERED— Radio Engineering Library

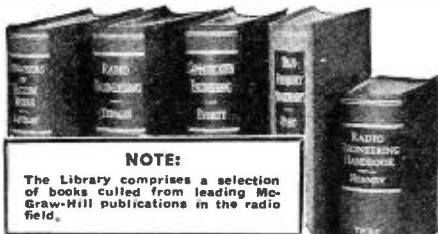

**NOTE:**

The Library comprises a selection of books culled from leading McGraw-Hill publications in the radio field.

- especially selected by radio specialists of McGraw-Hill publications.
- to give most complete, dependable coverage of facts needed by all whose fields are grounded on radio fundamentals.
- available at a special price and terms.

THESE books cover circuit phenomena, tube theory, networks, measurements, and other subjects—give specialized treatments of all fields of practical design and application. They are books of recognized position in the literature—books you will refer to and be referred to often. If you are a practical designer, researcher or engineer in any field based on radio, you want these books for the help they give in hundreds of problems throughout the whole field of radio engineering.

**5 VOLUMES, 3559 PAGES, 2558 ILLUSTRATIONS**  
1. Eastman's FUNDAMENTALS OF VACUUM TUBES

2. Terman's RADIO ENGINEERING  
3. Everitt's COMMUNICATION ENGINEERING  
4. Hund's HIGH FREQUENCY MEASUREMENTS  
5. Henney's RADIO ENGINEERING HANDBOOK

10 days' examination. Easy terms. Special price under this offer less than books bought separately. Add these standard works to your library now; pay small monthly installments, while you use the books.

10 DAYS' FREE EXAMINATION—SEND COUPON

McGraw-Hill Book Co.  
330 W. 42nd Street, New York 18, N. Y.

Send me Radio Engineering Library 5 vols., for 10 days' examination on approval. In 10 days I will send \$2.50 plus few cents postage, and \$4.00 monthly till \$26.50 is paid, or return books postpaid. (We pay postage on orders accompanied by remittance of first installment.)

Name .....

Address .....

City and State .....

Company .....

Position ..... RN-8-46

Come to the famous  
**COYNE**  
TRAINING SHOPS  
where you learn by doing

TRAIN FOR **RADIO-ELECTRONICS**  
IN A FEW WEEKS

Prepare For A Good Job Now With  
A Lifetime Future!

Trained Radio-Electronics men needed now. They will be needed too in the years to come. Don't be caught napping. Get a Radio training now and be ready. Learn by Doing. Free employment service for life after graduation. Many earn while learning. If you are short of money, I'll finance most of your tuition. Training in Industrial Electronics and Electric Refrigeration added to our course. We are also equipped to train those who qualify under G. I. Bill. We also have facilities for men with physical disabilities whether due to war or other causes. Fill in and mail coupon for details.

SEND COUPON FOR FULL DETAILS

H. C. LEWIS, Pres., Radio-Electronics Div.  
COYNE ELECTRICAL SCHOOL  
500 S. Paulina St., Dept. C6-1K, Chicago 12, Ill.  
Send Free Book and details about Coyne Part-Time Employment and Student Finance Plan.

Send G. I. Bulletin  Physical Disability

NAME ..... AGE .....

ADDRESS .....

CITY ..... STATE .....

Time, making all broadcasts from the Brussels short-wave station one hour earlier here. The former 2 a.m. broadcast has been cut to twenty minutes and is now heard, 1-1:20 a.m. A late flash from a Swedish observer says Brussels is sending on 9.665 from 3 p.m.

Borneo—West Coast listeners who seem to have a "pipeline" from Radio Balikpapan, 9.125, Borneo, will be interested to know that Rex Gillett, DX Editor of *Radio Call* (South Australia) has received a letter from 1st Lt. W. Herner of the station, stating that while the input of Radio Balikpapan is 125 watts, it is figured that the output is only about 40 watts; an original verie received by Gillett stated the power as 125 watts. Schedule is 7-9:30 a.m. Recently, Eddie Startz, m.c. of the "Happy Station Program" of PCJ, Hilversum, Holland (which program is often relayed by Radio Balikpapan), remarked that Paul Dilg, California, had listened to PCJ via Borneo, Gillett writes.

Bulgaria—Swedish observers report Radio Sofia, 9.350, is on the air, 11 p.m.-1 a.m., 5:30-7 a.m., 1-1:30 p.m., and 2-3:40 p.m., with English news at 3:30 p.m.

Burma—Latest schedule of Radio Rangoon, 11.845 (seems lower lately), is on at 8:30 a.m., news at 8:45 a.m., BBC news relay at 9 a.m., headline news at 10:10 a.m., followed by preview of next day's program; sign-off is at 10:15 a.m. with march. A further transmission on this frequency is announced for 8:15-8:45 p.m. On 6.035, the recently-revised schedule is 12:30-2-30 a.m., 6:45-8:15 a.m., and 9-9:45 p.m., mostly in native languages. On Mondays, only the 6:45 a.m. (6.035) and the 8:30 a.m. (11.845) transmissions are given.

Cape Verde Islands — The Praia broadcasting station verifies by card written in Portuguese from Oldgard B. Lisboa Santos, Services de Fazenda, Praia, and showing that the station is operated by the Radio Club of Cape Verde (*Radio Clube de Cabo-Verde*). Frequency is 6.408, but schedule is not known definitely.

Celebes—Australians report that Radio Makassar, 9.357, now runs to 9:30 a.m., and peaks at 9 a.m. Leaves the air after playing "A Perfect Day." An observer in British Columbia verifies this, and adds that sign-on is at 5:30 a.m. For the most part, programs are in Dutch.

Ceylon—Present schedules of the Ceylon transmitters are 7:30-10:15 p.m. on 11.770; 10:15 p.m.-7:30 a.m. on 15.120; and 7:30 a.m.-12 noon on 6.075. A further frequency of 88.3 meters (announced), or approximately 3.395, is used throughout these transmissions. (Gillett) Bill Cooper, British Columbia, reports a test transmission to Australia, 1:35-1:45 a.m., on an announced frequency of 17.770; asked for reports to Radio SEAC, No. 9, ABPO, Ceylon. Another Ceylon transmitter, at Colombo, recently moved to new frequencies of 11.820, 8-11 a.m., and



## MULTI-RANGE AC-DC VOLT-OHM-MILLIAMMETER WITH OUTPUT RANGES MODEL 458

### SPECIFICATIONS:

VOLTS DC: 0-5/10/50/100/500/2000—1000 OHMS PER VOLT. VOLTS AC: 0-12.5/25/125/250/1250. MILLIAMPERES DC: 0-1/10/100. MILLIAMPERES AC: 0-2.5/25/250. OHMS FULL SCALE: 1000/200,000/2,000,000. OHMS CENTER SCALE: 50/2250/22,500. OUTPUT: -5 to +55 Decibels.

This versatile instrument incorporates a large 5 1/2" rectangular meter with two-zone aluminum scale, set at a 45° angle to facilitate greater reading ease. The special-treated aluminum instrument panel is mounted on a welded steel case, finished in harmonizing brown wrinkle; equipped with rubber feet and collapsible handle for portability. Dimensions are 10 1/4" high x 6 3/4" wide x 5 1/2" deep overall. A copper-oxide rectifier is employed to insure AC range accuracy. All multipliers are bridge selected within one percent. A standard 22 1/2 volt battery, supplying testing current, is mounted within the case. Range selection is accomplished by means of polarized jacks, rotary switch and toggle switch. Potentiometer compensates for battery voltage drop. Furnished with Test Leads #1048. Shipping weight 8 lbs. Net \$26.00.

CHICAGO INDUSTRIAL INSTRUMENT CO.  
219 West Chicago Avenue  
Chicago 10, Illinois

# YOU GET MANY Extras!

Rowe No. 7  
Permanent  
Magnetic  
Driver Unit



EXTRA power, extra long life, extra freedom from break-downs, extra ease of replacement... these are but a few of the many extras you get in the ROWE No. 7 PERMANENT MAGNET... first choice of sound engineers who investigate thoroughly and analyze carefully.

The 3 lb., 4 oz. ALNICO Magnet gives power and permanency; combined voice coil and diaphragm assembly heads off trouble, provides for quick replacement if necessary. Write for circular giving complete details. Address, Dept. 846

ELECTRONICS DIVISION

**ROWE Industries**  
3120 MONROE ST., TOLEDO 6, OHIO

15.220, 12 midnight-1:30 a.m. and 3-7:30 a.m.

China—XGOL, Foochow, formerly on about 9.995, has been definitely identified by Paul Dilg, California, on 9.035. China has adopted Summer Time, and programs are now heard one hour earlier. The 8 a.m. English news now seems to originate at the capital of Nanking which is heard currently on 9.720, where signal strength is poor; relays are poor also. The Chinese Army Radio, XNPA, 6.230, has not been heard lately, and XRRRA, Peiping, seems to be off the air.

Colombia—HJCAB, 9.690, is back on the air after two months off.

Czechoslovakia—Prague recently announced on its 7 p.m. broadcast (in English) to North America over OLR4A, 11.840, that if reports of good reception in the U. S. and in Canada are received, the program will be extended in length from its present half-hour to one hour. Bill Cooper, British Columbia, flashes that OLR5A, 15.230, is being heard with surprisingly good signals; opens with repeated "bars of a tune" and the familiar "Shepherd's Horn"; announces, "Praha, Ceskoslovensky Rozhlas"; is all in Czech and music to 12:45 a.m. when English talk and news items are presented; says, "Goodnight to everyone," there is a light recording, and closedown is at 12:58 a.m.

Egypt—SUV, 10.055, Cairo, relays correspondents to the BBC and to NBC at 4:45 p.m., but usually suffers heavy c.w. interference. SUS, 19.660, is heard irregularly mornings and early afternoons relaying U. S. network correspondents from Cairo, signals are only fair.

England—Time adjustments in the BBC's North American beam make London schedules to read GVX, 11.930, 5-7 a.m.; GSP, 15.310, 6-8:15 a.m.; GVO, 18.080, 8 a.m.-6:45 p.m.; GRG, 11.680, 4:15-6:30 p.m.; GWG, 15.110, 4:15-6:45 p.m.; GSP, 15.310, 4:15-7:45 p.m.; GRH, 9.825, 5-11 p.m.; GWH, 11.800, 6:30-9:45 p.m. (to Leopoldville); GVZ, 9.640, 7-11 p.m.; and GSU, 7.260, 7-11 p.m.

French Indo-China—The Voice of Viet Nam, Hanoi, has been reported lately on new frequencies of 7.268 and 9.595 to 9:30 a.m. sign-off.

French Morocco—CNR3 has returned to its previous 9.082 from 9.650. Schedule is believed to be 1 a.m. until after 2:30 a.m. (when it fades out); also reported afternoons before 4:40 p.m. sign-off.

Germany—Australians report a British Forces Network station at Hamburg, operates on 7.290, heard at 3:30 p.m.; first announced three medium-wave outlets, but now mentions short-wave channel. Berlin has returned to 6.072, a former frequency. Leipzig, 9.688, has been heard occasionally after the usual sign-off time (6:30 p.m.) with political speeches by party leaders; once an announcement was heard that they were broadcasting from the "Leipzig Towers."

Gold Coast—Official information

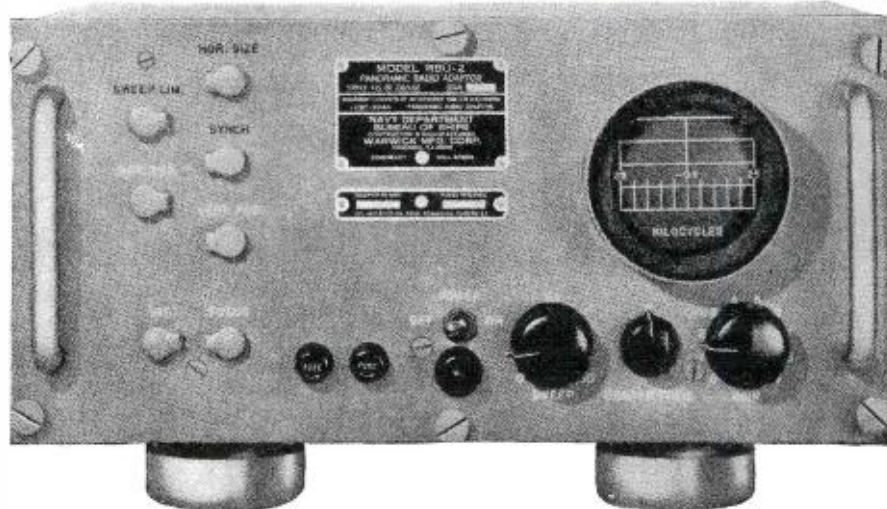

## Navy Panoramic Adaptors!

The Panoramic Adaptor tells you at a glance what is going on over a wide area of the band. When attached to your receiver, the adaptor will visually indicate whether there are signals present within the area covered. It will show the relative frequency of each signal, relative signal strength, the type and percentage of modulation. This Navy unit was built to rigid specifications without consideration of cost. It will allow you to locate "holes" in crowded bands, detect weak signals, and contribute generally to the improved operation of your station. The RBU-2 covers a continuous band of frequencies 50 Kc. wide. Operates on 115/230 V.A.C. 50/70 cycles. New and packed in original crates. Tropicalized.

PRICE **\$94.50**  
ONLY

F.O.B. Chicago

## Army Walkie-Talkies!

The BC-322 is a complete, portable radio communication set. It is light enough to be strapped on the back and powerful enough for dependable voice transmission over a range of 10 to 20 miles. Frequency band 52 to 65 Mc. These sets are new in original crates. The low price includes tubes, handset, telescopic antenna, batteries and battery adaptor, and carrying case. \$75.00 F.O.B. Chicago. Model BC-222 has two bands but otherwise the same as the BC-322. Frequencies from 28 to 38 Mc. and 38 to 52 Mc. These sets have been in service but have been renewed by the Government. New batteries. No carrying case.

PRICE **\$45.00**  
ONLY

F.O.B. Chicago

## Government Termination Material

Condensers	Transformers
Resistors	Volume Controls
Spaghetti	Vibrators
Switches	B-L Selenium Rectifiers
Transmitting Tubes	Dial Light Assemblies
Wire—Cable	Whip Antennas
Relays	
Tube Sockets	

## WELLS SALES, INC.

4717-H W. Madison St.  
Chicago 44, Ill.

USE COUPON BELOW FOR COMPLETE INFORMATION

WELLS SALES, INC., 4717-H West Madison Street, Chicago 44, Illinois

Please ship.....for which \$.....is enclosed.

Please mail free Amateur Radio Circular.

Please send prices and information on the following items:.....

NAME .....

ADDRESS .....

## FILMGRAPH PAT'D Conference Recorders

<p>UNINTERRUPTED Longtime (up to 12 hours) Conference &amp; Telephone Recordings on Safety Film Models for Dictation "TALKIES"</p>	<p>ECONOMICAL PERMANENT INSTANTANEOUS PLAY-BACK</p>
--	---

MILES REPRODUCER CO., INC. 812 BROADWAY, N.Y. 3 R.N.-3

# Vasco

SUPREME QUALITY

TRADE-MARK REG. U. S. PAT. OFF.  
ELECTRIC SOLDERING IRONS  
4116 AVALON BLVD., LOS ANGELES 11, CALIF.

## BUILD YOUR OWN RECORD PLAYER

DETROLA AUTOMATIC CHANGER — BEAUTIFUL CABINET — AMPLIFIER AND SPEAKER.



Newest in Design—Fool Proof. Plays 10" or 12" Records. Changer only. Your cost net .....\$18.27

Cabinet made to fit Changer Amplifier and 6" Speaker. Cabinet only—net. \$4.95

3 Tube AC Amplifier complete with Tubes and 6" Speaker. Can all be installed in 30 minutes. Your net. \$12.95

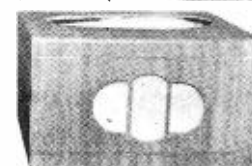

Be sure to send name for new Free Low Price Parts Circular.

McGEE RADIO CO.  
1330 BROADWAY, DENVER, COLORADO

**Sigmon's - WEST VIRGINIA'S LARGEST RADIO SUPPLY HOUSE!**

**AMPLIFIER for GUITAR OR PHONO**



★ TUBES: 6SJ5, 6J5, 6L6, 5V4G  
★ 4 Tubes—Hi Gain  
★ Two Microphone or Instrument Inputs  
★ Phone Input  
★ 1/2 Watts—Beam Power

★ Solid Wood Cabinet  
★ Aeroplane Cloth Covered  
★ Tone Control  
★ Heavy Duty 8" Speaker  
★ Complete with Tubes

Complete with Tubes—List \$59.50 **Your Cost \$37.00**

VMI BRUSH CONTROL MIKE—Net \$10.40  
MM TURNER CONTACT MIKE—Net \$ 9.45

**PHONO AMPLIFIER**  
3 Tube AC-DC  
Uses: 50L6, 35Z5, 12SR7, and 450 ohm speaker  
Net \$5.97

FOR LATEST CATALOG WRITE TO...

**Sigmon's**  
RADIO SUPPLY  
CHARLESTON, W. VA.

ALL STANDARD LINES CARRIED IN STOCK

**NOW IN STOCK!**



Quantities Limited!

**McMURDO-SILVER "VOMAX"**

Net Price .....	\$59.85
Model 904 Capacitance-Resistance Bridge..	49.90
Model 905 "Sparx"—signal tracer .....	39.90
SIMPSON 230 volt-ohm-milliammeter ....	24.75
SIMPSON 240 volt-ohm-milliammeter .....	26.50
SIMPSON 260 volt-ohm-milliammeter ....	33.25
SIMPSON 305 tube tester .....	39.50
SIMPSON 330 tube tester .....	98.50
SIMPSON 315 signal generator .....	57.50
TRIPLETT 666-H v.o.m. ....	20.00
TRIPLETT 2413 tube tester .....	49.50
TRIPLETT 625-N v.o.m. ....	45.00
TRIPLETT 2432 signal generator .....	88.50
APPROVED A-100 signal generator .....	47.00
WATERMAN 2" pocket oscilloscope .....	55.00

Also, many other instruments in stock.  
25% deposit required with C.O.D. orders.

**SCENIC RADIO & ELECTRONICS CO.**  
53 Park Place • Dept. A • New York 7, N. Y.

**LES Correspondence Courses in RADIO and ELECTRICAL ENGINEERING**

**ELECTRICAL ENGINEERING** Get good electrical field. Prepare yourself at Low Cost, for secure future, modern course. So simplified anyone can understand quickly.

**RADIO ENGINEERING** Extra fine course in radio, publishing, address, photo-electric work. Trains you to be super-service man, real vacuum-tube technician. Servicemen needed badly. Diploma on completion.

**WRITE** Send postcard or letter for Free Copies of school catalogs, full details, all about deferred payment plan, etc. **SEND NOW!** **LOW \$25** Either AS Course

**LINCOLN ENGINEERING SCHOOL, Box 981-R92, Lincoln 2, Nebr.**

from Africa states that Accra's ZOY uses 7.300, 10:45 a.m.-12:55 p.m., and 4.915, 10:45 a.m.-1:30 p.m., with no transmissions on Sunday. The majority of programs are in native Hausa, Twi, Ga, Ewo, and Fanti dialects, but BBC news is relayed at 11:30 a.m. (on both frequencies) and at 1 p.m. (on 4.915 only). (URDXC)

Greece—According to *Cairo Calling*, French news and commentaries have been inaugurated by *Radio Athens*, 7.295 (41.15 m.) at 3:30 p.m. daily; no further schedules were given in the Egyptian journal. A letter received by an Eastern DX-er from Cable & Wireless, Ltd., Office of Manager in Greece, Leoforos Vassilisis Sofias 2, P.O. Box 8, Athens, states:

"We are now broadcasting transmissions for the Ministry of Press & Information every 'evening' from 3:30 p.m. EST on 7.295, and we understand that this program will be shortly extended to 3-4:30 p.m. When the program time is extended, there will be transmissions in *English*, but at the moment the announcements are all in Greek. The program is preceded by sheep bells and a flute, repeated at short intervals. The station is announced as 'Stathmos Athinon.' We are using the same transmitters as in 1941, but unfortunately, our masts have been destroyed, and we are using temporary aerials, which will probably give a reduced field of strength. The transmitters are Marconi SWB-10's, using two CA-9 water-cooled valves in the final stage and giving 7 kw. in the aerial on telephony." SVR, 13.670, Athens, has been heard on Sunday, 11-11:30 a.m., with reports by BBC correspondents.

Holland—Australians report PCJ, Hilversum, is using 6.025 (announced) afternoons until 3 p.m., sometimes to 4 p.m., in parallel with frequencies of 9.590 (PCJ) and 11.735 (PHI). PCJ announced added programs recently, which also apply to PHI and PGD (6.025) relays: To North and South America, 10-11:30 p.m. on Wednesdays and Sundays only; Frequencies, 9.590, 11.735, 6.025; PGD on 6.025 is reported best heard due to interference on the other two. To Australia and the Pacific, 3-4:30 a.m. on Tuesday only; frequencies, 15.220, 17.776, 6.025. To the Near and Middle East, 10:30 a.m.-12 noon, Wednesday and Sunday only; frequencies, 15.220, 11.735, 6.025. To Africa and the Mediterranean Area, 4-5:30 p.m., Wednesday and Sunday only; frequencies, 9.590, 11.735, 6.025. The 9.590, 11.735, and 6.025 frequencies are also heard nightly at 5:45-6:15 p.m. with special dispatches for the BBC.

Hongkong—Australians verify that the best time to listen for ZBW, 9.570, Hongkong, is at 6:30 a.m. when KWID is off the air for 15 minutes for a beam change. ZBW takes the BBC news at 8 a.m.

India—VWW3, 17.482, Kirkee (Bombay), has been heard 3-5 p.m. testing point-to-point with a New York station; reception fair.

## WANTED!

### Articles by Radio Amateurs

2000 to 2500 words

Covering any material of genuine interest to radio amateurs, such as:

- Transmitters
- Receivers
- Antennas
- Test Equipment

Articles should be typewritten (double spaced) and accompanied by suitable diagrams, photos, and parts lists. Liberal payment will be made upon acceptance.

Address all communications to

Box 419

## RADIO NEWS

185 North Wabash Avenue

Chicago 1, Illinois

## IMMEDIATE DELIVERY!

### Automatic Players



Record changer with Crescent Model No. 100, completely assembled with amplifier, ready to play. Cabinet of brown leatherette with 3/8" seasoned pine, rubber bumpers on base. Cabinet dimensions: 16" long, 12 3/4" wide, 6 1/2" high; height with changer 12". AC amplifier with heavy duty power transformer complete with tubes 6V6, 6C5, and 6X5, tone and volume controls, cord and plug, separate AC line switch, 6" speaker. Well constructed, excellent tone quality. **\$31.50**

20% deposit required on all orders

Dept. A

**UNION RADIO CORPORATION**  
328 S. Paulina Chicago 12, Ill.

Italy—Radio Milan is heard in England at 2:30 a.m. and afternoons, a correspondent reports; frequency is 9.635. In British Columbia, Radio Milan is being heard with music to 1 a.m., then has news in Italian to closedown at 1:15 a.m.; announces, *Radio Italiana*.

Japan—Australians report a new AFRN station in Japan as WVTO in the Kyushu network. Frequency is about 3.280 (91.50 m.); heard after 5:30 a.m. Time is announced as half an hour behind South Australian time which is 14½ hours ahead of American EST. Kyushu is the southernmost island of Japan proper. They report another AFRN station on 3.070 relaying WVTR, 590 kc., Tokyo (6.015 on short-wave), with strong signals in Australia around 5 a.m. to the 9 a.m. sign-off; no call-sign other than "Armed Forces Radio Network" has been heard. A further Tokyo outlet of AFRN is reported from Australia as operating on 17.840 (probably is JAG) around 4:30-5:30 p.m. A Tokyo area station, announcing as WVDR, 5.995, AFRS, is being heard in British Columbia, with dance music and sports results of the Tokyo area, after 2 a.m.

Java—Also from Australia comes a report that a station is heard in Dutch, Indonesian, and English between 6:30-9:30 a.m. on 3.015 (99.50 m.), announcing as "The Official Dutch Station in Bandoeng." Frequency was announced; the English period was heard at 9 a.m. Rex Gillett airmails that *Radio Free Indonesia* opened in May on PLP's old



Transmitting equipment of the Radio Clube de Mozambique, Lourenco Marques, Mozambique. Two additional transmitters, a 7 kw. and a 5 kw., are now on order from RCA.

frequency of 11.000; programs are beamed to Australia in English from opening at 4:30 a.m.; at 5 a.m., Indonesian is used to the 5:30 a.m. sign-off. From the same country, stations have been heard from about 6:30 a.m. to 8:30 a.m. on (approximate) frequencies of 9.415, 9.870, and 9.882; location of these stations has not been definitely determined. Bill Cooper, British Columbia, reports the 9.415 station, location unknown, announces as *The Indonesian Broadcasting Service*, with "second English" transmission at 7 a.m.; the English news at 7:30 a.m. is read by a man and a woman, alter-

nately; *The Voice of Free Indonesia* opens at 4 a.m.; closedown is at 7:38 to 7:55 a.m.; this is probably the former PLV of Bandoeng. *The Voice of Free Indonesia* is also reported heard around 6:30-8:30 p.m. on a measured frequency of 19.350. (Bandoeng is controlled by British-Dutch now, so *Free Indonesians* must have moved the Bandoeng transmitters; some are announced as being at Djokjakarta.)

Korea—A new Korean station was heard some weeks ago on 6.590, seemed to be controlled by the Russians, but has not been reported lately.

Luxembourg—Luxembourg II, 6.090,

## Our Latest Specials for Servicemen, Amateurs and Experimenters!

**RECORD CHANGER**—Nationally advertised brand. The only changer on the market in its class that plays twelve ten or twelve inch records intermixed. Operates from 110V, 60 cy., has crystal pickup, and may be attached to any radio or amplifier. Sturdily constructed, with chrome and plastic trim. Mounted on beautiful blue leatherette case. Your price... \$24.95

**U.S. ARMY push-button unit** has ten chrome-plated buttons, which automatically set the 60 MME, high-voltage tuning condenser to any preset position; selects one of the ten 1.40 MME, variable air trimmers, and in addition, closes one of ten DPST switches, one side of which was originally used for crystal switching. Just the thing for signal-shifting excitors and transmitter. Shipped in the original carton, for a fraction of the original cost—only... \$4.75

**RELAYS:** Sigma 24RD, SPST, 2000 ohm coil. May be adjusted to operate in circuit drawing less than 1 MA. Designed for photo-cell circuits, electronic control circuits, etc. Regularly \$8.50; your cost—\$2.50. Guardian SPST relay 12-24V, DC. Has 400 ohm center-tapped coil for operation in either of two independent circuits—\$1.25. Guardian 3-make, 1-break, 12-24V, DC, extremely compact, only \$1.00 each or five for... \$3.75

**AUTO ANTENNAS**—Standard 3-section type. All of tangle chrome-plated admirably brass, complete with shielded leads. Side Cowl type sets—\$1.30. 60" (4-section)—\$2.75. "Rocket Antenna"—adjustable to any angle for rocket and torpedo bodies. 72"—\$2.75. Fender & Cowl type—adjusts from 20 to 50"—\$3.00. Underhood type—mounts either side of regular or alligator hood—no holes to drill on body of car—72"—\$2.50. HOMB ANTENNAS—12 ft. vertical mast; mounts on chimney, vent pipe, gable, etc. Ideal thing for amateur transmitters, as well as broadcast sets. Complete with lead-in, lightning arrester, heavy insulators, etc., for only \$3.50. Window type—95" long; mounts on any window sill in a few minutes. May be "focused" to any position for best reception; Only... \$2.75

**TUBULAR CONDENSER SPECIALS**—Guaranteed one year! Prices are in lots of ten, either one type or assorted. 50 Mr. 150V.—33c; 25 Mr. 35V.—23c; 20-30 Mr. 150V.—46c; 20-20 Mr. 150V.—3c; 20 Mr. 150V.—23c; 10 Mr. 450V.—32c; 10 Mr. 35V.—23c; 8 Mr. 475V.—65c; 8 Mr. 430V.—27c; 8 Mr. 200V.—20c. PAPER CONDENSERS: 600 W.V., 25 MF—23c; 100—10c; 95 MF—10c; 92 MF—9c; 91 MF—9c; 90 MF—8c. Mica Condensers—1000V, test, 600 W.V.—all standard capacities—15c.

**POWER TRANSFORMERS**—110V, 60 cy. All types have center-tapped HV winding. Specify either 6.3 or 2.5 volt filament when ordering.

For 4-5 tube sets: 650V., 40 MA, 5V. fil. and either 2.5 or 6.3V. fil. . . . . \$1.40

For 5-6 tube sets: 650V., 45 MA, 5V. fil. and either 2.5 or 6.3V. fil. . . . . 1.55

For 6-7 tube sets: 675V., 50 MA, 5V. fil. and either 2.5 or 6.3V. fil. . . . . 1.70

For 7-8 tube sets: 700V., 70 MA, 5V. fil. and either 6.3V. or two 6.3V. fil. . . . . 2.05

**FILTER CHOKES**—Cadmium plated, strap mounting. 200, 300, 400, or 500 ohms—49c. 30H, 250MA, 35 ohms DC res. Made for U.S. Navy. Fully shielded in black enameled case—\$1.98. AUDIO TRANSFORMERS: single plate to single grid—.69c. Single plate to P.P. grids—.69c. Heavy duty class "AB" or "B" P.P. output—\$1.29. Midrange output for 2-3 sets—.99c. Universal output, tapped for various impedances—.79c. Single or double-button mike transformers. . . . . .69c

**MICROPHONES**—Bullet Crystal Mike—\$5.45; Bullet Dynamic Mike—\$7.45. Shure, Model T-17, single-button carbon mike, hi-quality—complete with switch in handle, cord and plug for \$2.75. Signal Corps midrange single-button mike—has stretched duriumium. Excellent for trans. for trans. amplifiers, etc. Specially priced at 95c. MIKE STANDS: Crackle-finish base, satin-chrome tubing. Two-section type, adjusts from 3' to 7'—\$3.75. 3-section type—combination floor & banquet stand—adjusts from 23" to 6 ft. . . . . \$7.20

### Brand-New 150 Watt Signal Corps Transmitter—at a Small Fraction of the Original Cost of About \$2,000.

The amateur bands are here! This is the opportunity to get back on the air with a rig that you'll be proud to own, and at a watt-per-dollar price that can't be beat.

Originally constructed for use in aircraft, this transmitter is designed to meet rigid government specifications for dependability, frequency stability, efficiency, and ease of operation. Type 211 tubes, four of which are used in all, are employed in the final and in the class "B" modulator stage. Also featured are the highly stable oscillator stage, and the speech amplifier and driver stage.

The frequency range is 200-500 Kc. and 1500 to 12,500 Kc., all by means of seven plug-in tuning units, which are furnished with each transmitter. Each of these units has its own oscillator and amplifier coils and tuning condensers, along with antenna coupling and tuning circuits. The 12,500 Kc. unit may easily be converted to 20 meter band operation by removing a few turns from the tank coils. Plate modulation is used; thus full efficiency is realized on phone as well as CW.

Detailed instructions and diagrams for operating this transmitter from 110V., 60 cycle are furnished, although 24 to 28 V.D.C. dynamotor, which delivers 1000 volts at 350 milliamperes is supply included. Two profusely illustrated U.S. Army manuals, which contain installation, operational, and maintenance data are supplied.

The dimensions of this transmitter are 21½ x 23 x 9½"; the total shipping weight, complete with tubes, dynamotor, seven tuning units, the antenna tuning unit, and two instruction books, all in the original packing case, is 250 lbs.

While they last, the price of this magnificent equipment is only \$175 00, complete as described and illustrated.

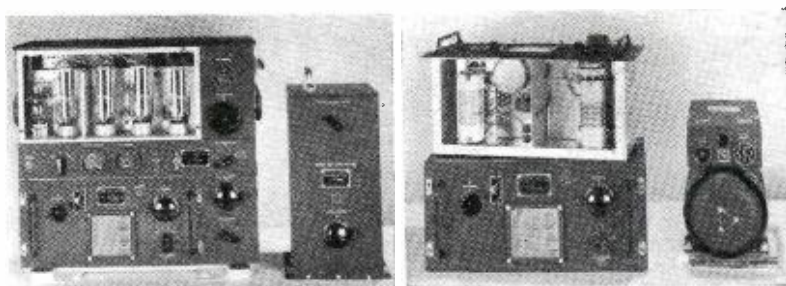

Send for our latest catalog. Include 10% deposit with all C.O.D.'s. Minimum order accepted—\$3.00.

**BUFFALO RADIO SUPPLY 219-221 Genesee St., Dept. N8, Buffalo 3, New York**

## RISCO SPECIALS Immediate Delivery

### PHONO AMPLIFIER

3-TUBE—AC-DC  
completely wired \$3.50

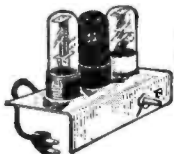

Phono kit with 3 tubes and 5" speaker \$7.95

DETROLA RECORD CHANGER \$17.50

Astatic Curved Arm L-70 Crystal pick-up.

GTC 50L6

Output Transformers only 53c

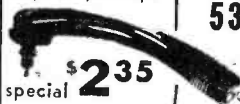

\$2.35 special



### BY-PASS CONDENSER KIT

15 assorted—all 600V 89c

### INSULATED RESISTOR KIT

100 assorted—1/4, 1/2, 1 watt \$2.25  
Emerson—20-20—150V Elect. cond. .44c  
Osc. Coils center tapped 456 kc. .19c  
25 ass't. Mica cond.—color coded. 89c  
Phosphor bronze Dial Cable, 25 ft. 25c  
Signal Corps Telegraph keys with cut-off switch 75c

25% Required on C.O.D. Orders  
Send for Free Catalog—R. N.

## RISCO SALES CO.

WHOLESALE RADIO DISTRIBUTORS  
224 E. 65th ST., NEW YORK 21, N. Y.

## MONEY-SAVING SPECIALS

### POWER TRANSFORMERS

650V 90M 5V 2 amp. 6.3V 3 Amp.  
Giveaway Price \$2.95

Output Transformers—20 watt for 6L6's, etc. 1.89

### VIBRATOR TRANSFORMERS

6 to 8 Tube Radios 2.89

### MALLORY VIBRATOR—TYPE 538C

6 prong 2.69

Electric Lab 7 prong Vibrator 2.69

A.C. D.C. Chokes 89c

### CRYSTAL PICKUP CARTRIDGES

Astatic L40 2.60  
Astatic L22 2.60  
Astatic L70 3.33  
Astatic LP 5.23  
Astatic B3 3.33  
Shure P93 2.60  
Webster D2 3.20  
Webster E4 2.60  
Webster N3 2.60  
Astatic Pickups 3.30  
Shure Pickups 3.30  
Webster Pickups 3.30  
Astatic LP Pickup permanent needle 6.90

Write for catalog listing hundreds of bargains in parts, tubes and equipment.

*Lifetime*

SOUND EQUIP. CO., Dept. 49  
911-913 JEFFERSON AVE., TOLEDO 2, OHIO

broadcasts to England to 3 p.m. *Sundays*; wants reports; English address is 2 Bishops Court, London.

Malaya—Rex Gillett, Australia, air-mails that *Radio Kuala Lumpur* on 6.160 is now announcing, *This is Radio Malaya Broadcasting from Singapore*. Has *English* news at 9 a.m.; close is believed to be 10:30 a.m. Latest official schedules of *SEAC Calling from Singapore*, are 11.735 and 6.770, 3:45-9:10 a.m.; *English* periods, 3:45-4:20 a.m., 6:30-7:30 a.m., and 8:30 a.m. to sign-off. Address for reports is Program Manager, Broadcasting, Far East Publicity Division, S.A.C.S.E.A., S.E.A.C., Singapore, Malaya.

Mozambique — CR7BE, Lourenco Marques, is currently on a measured frequency of 9.715.

Nigeria—A station for Lagos is projected—but will not materialize for some time yet, according to African sources. (URDXC)

Norway—LKJ, 9.540, Oslo, was recently heard at 11 a.m. on a *Thursday*, "concluding its weekly *English* program." (Harrison) According to an article in a Norwegian journal, the Oslo transmitter on 9.540 is located at nearby Lamberseter and uses 5 kw. power; it is intended to serve Norwegians abroad and at sea; the 6.200 transmitter is a 10-kw. station erected by the Germans at another nearby town called Kloefta, and is intended for communications purposes. It now operates as a relay beamed to Finmark, the extreme northern portion of Norway, replacing damaged or destroyed land-lines which previously carried the Norwegian Home Service to long-wave broadcasters there. The Government of Norway will in the near future receive two *Westinghouse* 7½-kw. transmitters which will be installed near Fredrikstad and which are to be used for broadcasts beamed abroad. One of these new transmitters (and possibly both) will later be built up into a 50-kw. transmitter. A 5-kw. and a 1-kw. transmitter at Jely are also available for broadcasts on special occasions.

Palestine—For the summer, JCKW, 7.220, Jerusalem, is now signing on at 10:30 p.m. instead of at 11:30 p.m. It appears that this year Palestine is the only country in the Near East to adopt Summer Time.

Peru—*Radio Central*, 9.540 (varies), is heard nightly to 12 midnight sign-off, without giving call or location; may be OAX5C.

Surinam—A new Paramaribo program and frequency is heard 4-5:30 p.m. on 14.950 in *English* and Dutch for troops; signal is just audible in the East.

Sweden—SBP, 11.705, has replaced SBC, 6.065, on the Stockholm broadcast to North America, 8-8:55 p.m.

Switzerland — Bern has replaced HEK3, 7.380, with HEI4, 9.539, in the North American beam; HEI4 is heard with good strength, and is probably the HER or HEK transmitter since HEI2, 6.345, is still in parallel. *All-English* broadcasts are now heard

## "Made for Radio"

Many Vaco Screw Drivers were created especially for fast, precision work on radio parts and receivers.

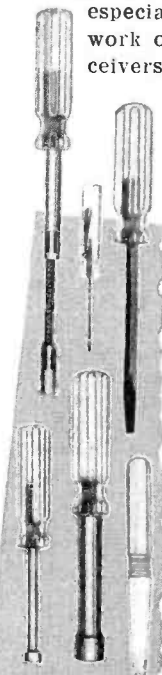

### SHOCK-PROOF BREAK-PROOF

means something too!  
Remember there are

# 173 VACO TYPES

Yes, Vaco has created more than just a variety of screw drivers. Vaco has built the exact type of screw driver to do the particular job that can be tedious and troublesome when an ordinary driver is used. No wonder mechanics who do precision work say Vacos are "tops" among all drivers. Vacos, with gleaming Amberyl handles, are shock-proof and break-proof. Write for catalog.

VACO

PATENTS MAKE JOBS

PRODUCTS CO.

317 E. Ontario St. Chicago, Ill.  
CANADA: 560 King St., W. Toronto.

## TECHNICIANS... EXPERIMENTERS HAM S

Save Money...

ON THESE RED-HOT ITEMS!

### AMPHENOL'S New U.H.F.

LOW-LOSS, TWIN LEAD  
TRANSMISSION LINE

• Efficient - Durable,  
• Weather-Resistant,  
• Easy to Install

NET PRICE PER 100 FEET  
75 ohm; 2.01; 150 ohm; 2.43; 300 ohm; 2.91

### 5 BPI CATHODE RAY TUBE

REG. PRICE \$20.50

While limited quantity lasts, a real buy \$8.95 at only ... NET

5BPI socket \$ .66 net

4 mfd. 1000 v.d.c. oil-filled capacitor, net \$1.10  
4 mfd. 600 v.d.c. oil-filled capacitor, net .85

Send check or money order for prepaid shipment; C. O. D. order F. O. B. Los Angeles. More bargains in our big monthly special circular. Write for one today. Dept. RN1

## RADIO Equipment

DISTRIBUTORS

709 S. Main St., Los Angeles 14, California



Sun.-Tues.-Thur., while on Mon.-Wed.-Fri., *English* is heard at 8:30-9:15 p.m. only, with Swiss languages being used the remainder of the period; this evening North American beam is scheduled, 8:30-10 p.m., except Saturday. HED4, used on the 2:20-2:50 p.m. beam to North America, is now being heard on its announced 10.405, but may move to a higher frequency soon. HE15, 11.715, has replaced HEF4, 9.185, in the transmission to Latin America at 6:30-8 p.m. and to South Africa at 3:50-4:25 p.m. (this is badly QRM'd by Dakar). The program for Australia is now back on its old time of 12 midnight-1:30 a.m. Tuesday and Saturday mornings, and is heard on HER5, 11.865, and HBZ3, 14.462.

Turkey—Ankara's fortnightly Tuesday program (in *English*) at 5:55-6:15 p.m. from TAP, 9.465, which was formerly for station WLW, Cincinnati, is now being announced as "especially for listeners in the United States." For August, dates should be the 13th and 27th.

Union of South Africa—Pietermaritzburg has shifted from 4.880 to 4.855. Johannesburg III, 3.450, now comes on at 10:45 a.m., has *English* news at 3:45 p.m.

U.S.S.R. — Moscow's *Espana Independiente*, 11.675, is heard in English between 9-9:50 a.m. using Spanish. Slogan is "Viva la Republica!" Leningrad on 7.430 is heard in Polish at 3:30 p.m., and the Moscow transmitter on 6.130 is heard in Czech at that hour. A Moscow station on 7.330 is heard in Yugoslav at 12:15 p.m. Petropavlovsk, 10.915, Kamchatka, is heard Sundays only, comes on at 1:50 a.m. with Red Airforce Song; all Russian to close at 2:15 a.m. Moscow is heard 7:20-8:15 a.m. to North America on 17.815, instead of its announced 17.810, and is buried under Canada's CKNC, 17.820.

United States—Among the more interesting changes are the new 13-meter beams; on 21.612, KCBA, Denalo, is scheduled, 4-5:15 p.m.; also look for KNBA, Dixon, on 21.610, may be heard later this summer, 4-10 p.m.

Uruguay—CZA13, 6.155, *Radio Carve*, Montevideo, is reported to be on the air; details have not been learned as yet.

Vatican—HVJ, 15.095, Vatican City, is being heard in British Columbia, on Tuesdays from 1:03 to 1:35 a.m., in Italian; announces *Radio Citta del Vaticano*.

Yugoslavia—Martin Harrison, England, reports the Yugoslavian stations say, "Death to Fascism, Liberty to the People" at sign-off; *English* news can be heard between 3:30-3:45 p.m. from *Radio Belgrade*, 6.150.

\* \* \*

#### Last Minute Tips

Via airmail, we have just received the following letter from KOFA, AFRS station, Salzburg, Austria:

"Our assigned call letters are KOFA. The station is one of three making up the Blue Danube Network here in Austria. The other two are KOFA, Linz, and WOFA, Vienna. All three operate

August, 1946

# GET THIS NEW BOOK FREE

Just for Examining this New 1946 Electrical TROUBLE SHOOTING MANUAL

**JUST OFF THE PRESS**

**SEND NO MONEY**

Yes, that's right! You get Coyne's sensational new book "Starting and Operating an Electrical or Radio Shop" FREE—HERE'S MY OFFER—Mail the coupon below—and I'll rush you a copy of 1946 edition of Coyne "Electrical and Radio Trouble Shooting Manual" for 10 days free trial—plus FREE copy of my "Starting a Shop" book. Examine the "Trouble Shooting Manual" 10 days, then DECIDE. IF NOT 100% pleased return the manual and owe nothing—if you keep it, pay according to terms in coupon below. But REMEMBER, whether you keep the Coyne "Electrical and Radio Trouble Shooting Manual"—or return it—the "Starting and Operating an Electrical or Radio Shop" book is yours to keep FREE.

**10 DAYS' FREE TRIAL**

"Starting and Operating a Profitable Electrical or Radio Shop" tells you how to start full or part time Electrical or Radio Shop on small capital. Explains how to finance, choose a location, how and what to buy, advertising, salesmanship, business and legal angles, record keeping. For a Limited Time this amazing new book is given absolutely FREE... just for examining the sensational new 1946 edition of Coyne's "Electrical and Radio Trouble Shooting Manual" 10 days at our expense. ACT NOW—mail the 10 days' FREE TRIAL coupon today!

**MAIL COUPON FOR FREE BOOK**

H. C. LEWIS, President, COYNE ELECTRICAL SCHOOL, Dept. C6-T3  
500 South Paulina Street, Chicago 12, Illinois

O.K.—send me your new Coyne Electrical and Radio Trouble Shooting Manual, postpaid along with my FREE COPY of "Starting and Operating a Profitable Electrical or Radio Shop." Within 10 days after the books come I'll either return the "Trouble Shooting Manual" to you AND OWE NOTHING or send \$3.00 and \$3.00 a month until a total of \$9.95 is paid. Either way I keep the "Starting and Operating an Electrical or Radio Shop" book as my free gift.

Name \_\_\_\_\_  
Address \_\_\_\_\_  
Town \_\_\_\_\_ Zone \_\_\_\_\_ State \_\_\_\_\_  
Occupation \_\_\_\_\_  
SAVE 10% OFF Send cash price, \$9.00—you save over 10%. Same 10-day free trial and MONEY BACK SATISFACTION GUARANTEE.

Sensational new 612-page Coyne "Electrical and Radio Trouble Shooting Manual." 500 shop prints and "how to use them"—plus many other practical features—all in one giant 8½" x 11" handsomely bound volume. New time saving, easy-to-follow methods of shooting trouble. Includes D. C. and A. C. Motors, Armatures, Switchboards, Electronic Controls, Radio Receivers, Auto Ignition, Refrigeration and Air Conditioning, etc. Most amazing book of its kind ever published. You get it FREE for 10 day trial plus the new book "Starting and Operating a Profitable Electrical or Radio Shop" as our outright gift to you. Rush coupon today for this amazing offer.

**... FREE with TROUBLESHOOTING MANUAL**

Act now and I'll include 1 full year of personal counsel from the Coyne Staff—technical advice by mail on any Electrical or Radio problem. A real help in your daily work.

ALSO FREE: 1 year subscription to Coyne Technical News—latest facts on Electrical and Radio Progress, illustrated and explained.

**COYNE ELECTRICAL SCHOOL**  
500 SOUTH PAULINA ST.  
DEPT. C6-T3 CHICAGO, ILL.

**RADOR** System for Automobile DASHBOARD CONTROL

of garage doors and lights uses car radio as Induction Transmitter. Conversion diagrams \$1.00. Diagram for garage Induction Relay, \$1.00. Send \$2.00 for both, plus additional diagrams and descriptions. Parts cheap. No radio license required. Patent pending.

**RADOR COMPANY**  
8237 Wilkop Avenue Niagara Falls, N. Y.

**Specify SAUERISEN**  
ACIDPROOF CEMENTS—COMPOUNDS FOR  
Tanks, Sewers, Stacks, Floors  
Technical cements for all purposes.  
Send sketches or samples  
Sauerisen Cements Company · Pittsburgh 15, Penna.

**LAST MINUTE SPECIALS!**

Iron Cord Sets, 6 ft. fine quality G.E. wire with plugs.....	Each \$0.42
Extension Cord Sets, 7 ft., with 3-way cube tap.....	.41
Pittsburgh Automatic Electric Iron.....	6.45
1 Burner Hot Plate.....	2.40
Streamlined Electric Iron.....	3.90
Sessions Mantel Electric Clock #1019.....	8.80
Key Holder Flashlights with Batteries.....	Per Doz. \$4.25

**ELECTRIC Coffee Maker Set**

Consists of a beautiful Electric Coffee Maker Stove, 8-Cup Glass Coffee Maker. Attachment for Grilling, also Attachment for making Toast..... \$6.85

(O.P.A. Retail Price \$9.98 each)

Compact, exceptionally high grain, hum-free 3-tube AC-DC Phono Amplifier..... 4.50

5" Jensen Speaker and Output Transformer..... 3.75

Write for illustrated literature featuring other merchandise. 2% discount for payment with order, otherwise shipped C.O.D. net.

**SHEFFIELD RADIO & APPLIANCE CO., Inc.**  
916 W. Belmont Ave. Dept. B Chicago 14, Ill.

## MORE SMASH BUYS at National Radio Distributors



### IMMEDIATE DELIVERY

**RECORD PLAYER KIT**, suitable for easy attachment to any radio. Consists of high polish walnut veneer ready-cut cabinet, new heavy duty self-starting phono motor with turntable, Astatic crystal pick-up arm and volume control. Instructions for easy assembling which takes about 5 or 10 minutes.

Your Net .....\$11.95 each  
Lots of 3 .....\$11.50 each



**NEW POST-WAR AC/DC 5-TUBE SUPERHET RADIO KIT** featuring built-in loop antenna, automatic volume control. Uses 12SA7, 12SK7, 12SQ7, 50L6, and 35Z3. Complete with high polish handsome brown bakelite cabinet and full instructions for assembling. Less tubes. Approximate size 9 x 6 x 5.

Your Net .....\$13.75 each  
Lots of 3 .....\$12.95 each  
Kit of 5 matched tubes for above .....\$ 4.95 each

**PORTABLE RECORD CHANGER KIT** consists of handsome brown leatherette covered portable carrying case, new Maguire ARC-1 2-post record changer, completely assembled 3-tube amplifier, 8" Alnico speaker and output transformer. Complete with instructions for assembling. Less tubes.

Your Net .....\$42.95 each  
Kit of 3 matched tubes for above (12SQ7, 50L6, 35Z3) .....\$ 2.50 each

**PHONO OSCILLATOR KIT**—separate microphone and phono inputs, individually controlled. A real broadcasting station in miniature. Complete with 3 tubes, 6SQ7, 6SA7, 6H6, and all necessary parts for assembling including full instructions.

Your Net .....\$7.95 each  
25Y5 RADIO TUBES, direct substitute for 25Z5. List. \$2.35.  
Your Net .....\$1.46 each

Please include at least 25% with order, balance C.O.D. Write for New Free Catalog NOW!

## National Radio Distributors

1029A E. 163 St., New York 59, N.Y.

### Lightweight Efficient All-Metal Beam . . .

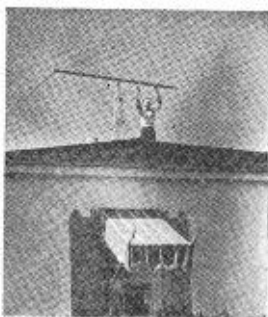

Typical Remaco 4-10 Installation (See Front Cover Photo)

Standard REMACO Beams are furnished in .14 spacing. Other spacing & element combinations will be provided to your specifications for a slight additional cost. Write for estimate.

Several new units are being presented which are designed for 2m, 6m, & FM bands. Special lightweight tower sections, with ball bearing support and shaft mounts, are to be available soon for use with REMACO or other lightweight antennas. Combination mounts for "Dual" band provision will also soon be ready.

#### ANTENNAS NOW AVAILABLE

REMACO 4-10, (4el. 10m. .14 spaced), Net. \$45.00  
REMACO 4-10A, (4el. 10m. .15" Ref.), Net 50.00  
REMACO 4-6, (4el. 6m. .14 spaced), Net. 41.00  
REMACO 4-2, (4el. 2m. .14 spaced), Net. 35.00  
REMACO 3-FM, (3el. state approx. freq.), Net 35.00

Express & repaid anywhere in Continental U.S.A. (Prices Subject to Change Without Notice.)

All REMACO Beams are lightweight and "T Match" to most any feedline. Assembly drawings, Tuning charts, & "T Match" are furnished.

PHONE: —or— WIRE:  
Bayview 5-486 WRITE REMACO, S.D.

**RESEARCH MANUFACTURING CORPORATION**  
P.O. Box 466, Dept NS,  
SAN DIEGO 7, CALIFORNIA

with 1 kw. on broadcast. The Network's short-wave transmitter is located here in KOFA, Salzburg, using a frequency of 7.220 and power of 750 watts. Two antennas are used—a vertical for local, daytime coverage, and a long wire two wavelengths long in the evenings. We operate from 2 a.m. to 7:30 p.m. All present broadcasts are in *English*, because the Network was established as a radio service for American troops stationed here in Austria. Station identification announcements are given on the half hour in *English*.

"We send QSL cards to anyone requesting same; no International Reply Coupon is necessary."

The letter was signed by Andrew J. Staiano, station engineer. A sample of KOFA's attractive QSL card was enclosed. It bears a radio mast coming up out of a map of Austria, lists the KOFA call and frequencies of 7.220 mcs. and 1,104 kcs., and states KOFA is operated by the Armed Forces Radio Service at Salzburg, Austria. Address is Armed Forces Radio Station KOFA, Salzburg, A.P.O. 541, c/o P.M., New York.

A copy of a new Indian publication, *Radio Times of India*, has just been received from D.R.D. Wadia, Bombay. It is published "fortnightly." Editor is D. D. Lakhnapal and S. R. Tikekar is the Associate Editor. In an editorial, it is pointed out that "the *Radio Times of India* does not in any way intend to displace the *Indian Listener*. On the contrary, we hope to stimulate the desire to know what is on the air all round the clock, and to act as an auxiliary to the *Indian Listener*, giving items of news which are outside their scope to deal with." One item of particular interest is that the short-wave station at Akashvani, Mysore, operating on 6.065 (49.46 m.), is scheduled daily, 9:30-10:30 p.m., 3:30-4:30 a.m., and 7:30-11:30 a.m.; relays 968 kcs. (310 m.).

An airmail letter from a Swedish correspondent gives schedule of the Oslo, Norway, transmitter on 6.200, relaying the Norwegian National Program, as 11 a.m.-5 p.m.; fixed items are weather forecasts and news at 1 and 4 p.m., and program preview after the 4 p.m. news (all is in Norwegian).

A new short-wave relay of CB97, *Radio Prat*, at Santiago, Chile, is heard on 7.820 nightly, 5:30-11 p.m.; call letters were given, but were not clear.

From William E. Duggan, Jr., C.M./RSGB (FRS104), comes word that short-wave enthusiasts are invited by Arthur E. Bear, European and Colonial Representative of the *International Short-Wave Club*, to communicate with him at 100, Adams Gardens Estate, London S.E. 16, England, for details of membership. Members receive the club's publications, "On the Air" and "Short-Wave News Letter." (Will Mr. Duggan please furnish me with his address.)

Henry Eksteen, Pretoria, South Africa, sends word that "the latest SABC transmitter is one on 11 mega-

Dealers WHY WAIT FOR YOUR RADIO?

## "BUILD YOUR OWN"

ATOMIC HEATER & RADIO CORP.  
PROUDLY PRESENTS

The Finest in Radio Kits



A COMPLETE 6 TUBE SUPERHET.  
COVERS THE BROADCAST BAND FROM  
550-1700 KC.

This set has been fully engineered and designed to make construction simple. All parts mounted, cabinet included. Tubes required—two 12SK7, one 12SA7, one 12SQ7, one 35L6 and one 35Z5. Your cost \$15.80 without tubes. Terms 10% deposit with order, balance C.O.D.

IMMEDIATE DELIVERY

## ATOMIC HEATER & RADIO CORPORATION

Dept. A

104 PARK ROW, NEW YORK 7, N. Y.

## —Special!—

Make any record player wireless with these brand new

### TWO-TUBE PHONO OSCILLATORS

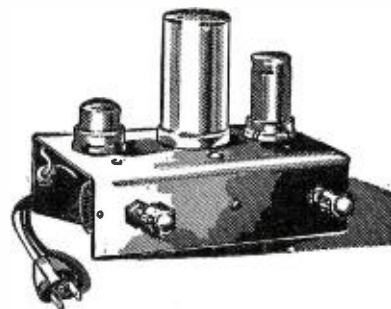

Operates as far as 100 feet from a radio and can be used with Automatic Record Changers, Players or Microphone.

Uses 1-12SH7 and 1-12H6 Tubes. Complete with tubes. **\$875** Net

Supplied in kit form with "easy-to-follow" instructions for assembly. Complete with all parts, instructions and tubes ..... **\$595** Net

Send for FREE BULLETIN

## D & D RADIO

160 Duane St., Dept. N, New York 13, N. Y.

COrtlandt 7-0371

RADIO NEWS

cycles with good reception." No details were furnished.

Bill Milne, New Zealand, flashes that *Radio Malacca*, 17.770, Malaya, is being heard after PHI, 17.776, Holland, signs off around 9:20-10 a.m.

There is still nothing definite as to whether 9.590 will be cleared by WLWO, Cincinnati, for the period that PCJ, Holland, wants for its broadcast to the Western Hemisphere, *daily* around 8-10 p.m. and *Sunday* at 10 p.m.-12 midnight.

From Sweden, via airmail, comes this schedule of HVJ on 5.970, Vatican City; headlines in French, 1:40 p.m.; headlines in Italian, 2:20 p.m.; headlines in German, 2:40 p.m.; and headlines in Spanish, 2:50 p.m.; the broadcast period ends at 3:30 p.m.

Bill Croston, Ohio, has recently been hearing the BBC news relay from *Radio Addis Ababa*, 9.620, Ethiopia, at 11 a.m. He also reports *Radio Budapest*, 3.400, Hungary, 3.400, very weak at 11:45 p.m.; and *Radio Wien (Vienna)*, 12.200, in the early evenings.

In Ontario, CS2WI, 12.405, Parede, Portugal, is being heard around 4:30 p.m. fade-in to 5:30 p.m. sign-off with National Anthem, "*Heroes Do Mar.*"

Late flashes from August Balbi, Los Angeles, are: VLC9, 17.84, Melbourne, has lately had an experimental transmission to South America, 4:30-5:30 p.m., *English* news at 4:45 p.m. VLA4, 11.77, is used to Britain daily, 2-3:15 a.m., news at 2:30 a.m., replaces VLC8, 3-4 a.m. *Radio Australia* has replaced

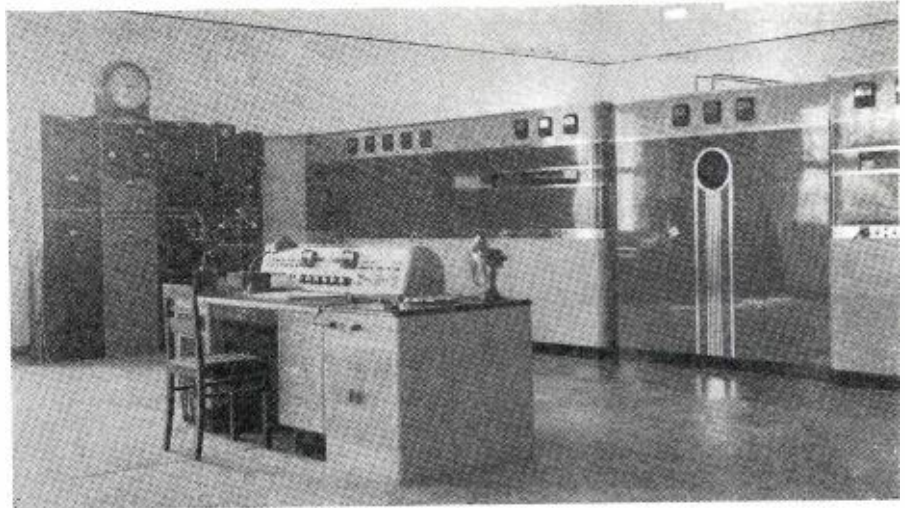

Transmitting installation of Radiodiffusion Nationale Belge at Leopoldville, Belgian Congo. This station kept Belgian nationals informed during the war.

VLG6, 15.230, with VLG3, 11.710, for the West Coast beam, 12-12:45 a.m.; VLC4 (now on 15.320) is in dual. VLR, 9.54, now signs off at 2 a.m. VLR2, 6.150, now signs on at 2:30 a.m. CKCN, 17.820, and CKLX, 15.090, Montreal (Sackville), now sign off at 2 p.m. in the European beam; CKCN, 17.820, is heard 6:30-9:30 p.m. Sunday only to South America, with *English* news at 6:30 p.m. OLR5A, 15.230, and OLR5C, 15.160, Prague, Czechoslovakia, have been heard testing irregularly, around 11 p.m. and 12 midnight. GRE, 15.375, London, is now being heard in the Pa-

cific Service along with others. XORA, 11.695 (or 11.698), Shanghai, has *English* news now at 5 a.m. XGOY, 7.153 and 9.640, now sign off at 10:40 a.m.; last *English* newscast is at 10 a.m. *Radio Saigon*, 11.778 and 4.81, now has *English* news at 5 and 9 a.m., sign-off is at 9:30 a.m.

*Radio Martinique*, 9.705, is being heard 5:30-8:30 p.m. in *French*.

Art Cushen, New Zealand, reports that in addition to the 11.778 and 4.810 transmitters, *Radio Saigon*, French Indo-China, also uses 11.850 at 7 a.m. HSPP, 6.000, Bangkok, Siam, is being

# Fahnestock Clips

## RADIO'S GREATEST CONVENIENCE



### FAHNESTOCK SPRING BINDING POST GRIPS THE WIRE BY THE ACTION OF A SPRING

No tools required to make the connection. Grips the wire with just the right pressure for good electrical contact. Simply press down, insert the wire and let go. Does not injure wire, hence connection can be made or opened as often as desired. Available in large variety of types and sizes to fit any radio purpose and any requirement as to position, space or method of attachment. You will find them in the better sets.

Positive contact; cannot jar loose. Brass or bronze—nonrusting.

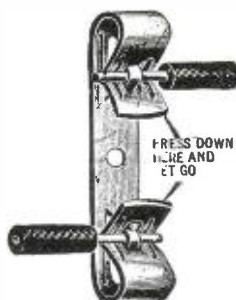
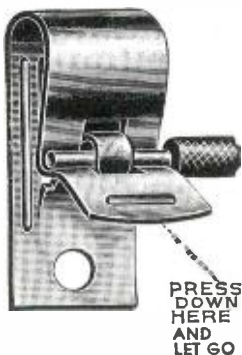

### FAHNESTOCK ELECTRIC COMPANY, Inc.

46-44 ELEVENTH STREET  
LONG ISLAND CITY 1, N. Y.

Please send us at once, Descriptive Literature, Prices and Delivery Schedule on

### FAHNESTOCK CLIPS

For .....  
Name .....  
Address .....  
City..... State:.....

## POTTER'S BARGAINS

A SPECTACULAR PURCHASE of Highest quality, famous makes, oil-filled bath-tub type condensers, enables us to offer them at these ridiculous prices:

.05	600V 10 @ \$ .99	1-1-1	600V 10 @ \$1.99
.1	600V 10 @ .99	.25	600V 10 @ 1.19
.1	1000V 10 @ 1.99	.5	600V 10 @ 1.59
2. Mfd. 600V, 49c each, 10 @ \$4.29			

0-1 Milliammeter, 3" Dejur-Amsco Model 310. Has built-in 20,000 ohm precision W.W. resistor and 20V scale. Resistor can be easily removed making a high quality 0-1 Mili. meter for test equipment, experimental and replacement use. A REAL BUY at.....\$3.98

Crystal Holders, complete with electrodes. Over 10,000 sold from our last adv. in Radio News. While supply lasts we again offer 10 assorted our choice for only 98c. Postage, 2 lbs. extra.

Mica Condenser Kit. Capacities from .002 to .00005. 400 to 600 Volt. Kit of 50 only \$1.95

Hardware Assortment. Over 1000 pieces of radio hardware. Contains nuts, bolts, screws, washers, fittings, etc. One of our most popular assortments. Shipping weight, 4 lbs. Special 89c

## SUPER WIRE ASSORTMENT

Tons of Gov't surplus wire on hand. So have made up the following deal:

5 lbs. Antenna lead-in wire. Various lengths 10-75 ft. long.

4 lbs. Cables. Each cable contains 4 or more wires. Excellent hook-up.

1 lb. short lengths of tinned hook-up wire. Stripped ready to use.

The last two items were used in building radio equipment and every piece usable. We sold same at 69c lb., but don't have time to strip the cables. Each deal should figure out over 1,000 ft. of wire. SPECIAL.....\$2.49

Your name and address on a postal card brings you our monthly BARGAIN BULLETIN crammed with page after page of real BUYS. Postage extra. 20% deposit on C.O.D.'s.

## POTTER RADIO CO.

Dept. R-N

1312-1314 McGee St. Kansas City 6, Mo.

## ALSAMS CASES

REGENCY STRIPED

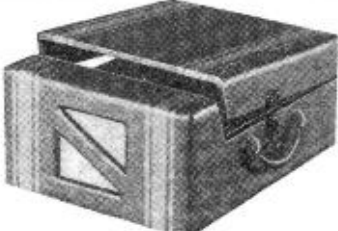

Model P-512 Portable Phonograph Case

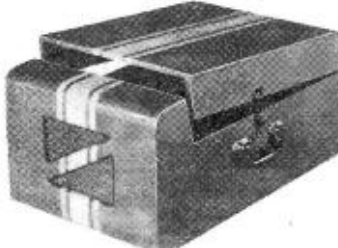

Model RC-250 Portable Automatic Phonograph Record-Changer Case

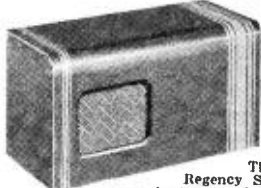

Table Model Radio Cabinets  
Model L-200  
Model L-300

The NEW Alsam Regency Striped Cases enhance the beauty of radios and phonographs. Write for illustrated literature featuring our models. Prices furnished on request.

ORDER FROM YOUR JOBBER!  
Dept. A.

ALSAM PRODUCTS COMPANY

805 MILWAUKEE AVENUE  
CHICAGO 22, ILL.

heard in New Zealand through heavy CWQRM, 5-6 a.m. (in English).

A Siberian station on approximately 8.860 is being heard daily to 9:30 a.m. sign-off; plays records; Russian is used throughout.

Direct via airmail from Athens, Greece, comes this message from S. E. Stephanou (SV1GR), president of the U.R.A.L.:

"We have the honor to announce that in 1940 we established in Greece the *Hellenic Radio Amateur League*. Unfortunately, the war came first and the occupation of our country after, so we could not be in touch with you earlier. Now that the war is over, we are glad to inform you that we are in action again. We shall be very happy to be in touch with Amateur Leagues all over the world and accept their cooperation. By the way, we request all amateurs of the whole world to send any Greek QSL card for the members of our League to the following address: Hellenic Radio Amateur League, QSL Bureau, S. E. Stephanou (SV1GR), 14 Alkmanos Street, Athens, Greece."

Also via airmail from Bratislava, Czechoslovakia, comes this message.

"It is a great pleasure and satisfaction to me that, after seven long, sad years, I can express to you, as well as to all your radio friends, my sincere greetings with restored licenses and renewed contacts here in Czechoslovakia. The address of our club, *Sektion of CAV, Brno., Czechoslovakia SW Club, Secretary, Otakar Halas, OK2RR, Brno., Krizova 44 (at this time, Bratislava 9, Postbox 34, Czechoslovakia)*. Our club organ, *Kratke Vlny*, has 12 issues per year, and there is a monthly paper *Section Clubs of Brno., QTC*, ten issues per year." Secretary Halas is the editor. He continues, "We have great interest in corresponding with other active SW radio clubs in the world; we exchange our Czechoslovakian SW periodicals (*Kratke Vlny, Short Wave*, and our Club papers, *QTC*) for other radio papers, magazines, and periodicals. Headquarters of the *Czechoslovakian Short-Wave League, Ceskoslovenski Amateri Vysilaci, CAV, Praha II, Vaclavske nam. 3/V.*" CAV stands for *Ceskoslovenski Amateri Vysilaci, Praha.*" Mr. Halas requests that all correspondence for *Section BRNO* be addressed to him at Bratislava 9, Postbox 34, Czechoslovakia—CSR.

Readers should be particularly interested in the following data just received, via airmail, from Suva, Fiji Island, which explains the absence of VPD2, Suva, from the air:

"We regret that we have no information as yet regarding future short-wave broadcasts from our station, VPD2, Suva. As already advised, the station was needed for special duties while this was a war area, and has not yet reverted to its peacetime broadcasting role. We shall be glad, however, to advise you as soon as we recommence our programs and will subsequently keep you advised of any

there is  
**NO SUBSTITUTE**

for GOOD communications  
and industrial wire. We are  
shipping you more and  
more of it now . . .



**WIRES**



**cornish**

WIRE COMPANY, INC.

15 Park Row, New York 7, N. Y.

"Made by Engineers for Engineers"

**NEW FINE POCKET SIZE RADIO!**

Slips in your pocket or purse —Wt. only 3 oz.! Complete READY TO PLAY as shown with self-contained phone for personal use. Beautiful black plastic case. Has a patented fixed Crystal —Slide Tuning Dial! NO TUBES, BATTERIES, OR ELECTRIC PLUG-IN REQUIRED. USUALLY RECEIVES LOCAL BROADCASTS without outside aerial wires.

**GUARANTEED TO WORK** when connected and used according to instructions. Can be used in homes, offices, hotels, cabins, in bed after hours, etc.

**SEND ONLY \$1.00** (cash, money order, check) and pay postman \$2.99 plus delivery fees on arrival or send \$3.99 for postpaid delivery. IDEAL GIFT FOR CHILDREN OR ADULTS ALIKE! Get your PAKETTE RADIO NOW for real enjoyment. Dealers in most cities.

PA-KETTE ELECTRIC CO., Dept. RN-2, Kearney, Nebr.

## RADIO BOOKS by mail

FAST SERVICE: 98% of all orders filled same day as received. We have one of the U.S.A.'s most complete stocks of electronic books. If you don't know the price, we'll send C.O.D., or remit sufficient and we'll refund excess.

Send stamp for catalog

EDITORS AND ENGINEERS

1302 Kenwood Rd., Santa Barbara, Calif.

## GRABREE'S WHOLESALE RADIO

2608 Ross Ave.

## DALLAS 1 TEXAS ELECTRICAL TRAINING

Intensive 8 months' residence course in fundamentals of industrial electrical engineering, including radio, electronics. Prepares for technician, engineering aides. Approved for veteran training. 53rd year. Catalog.

**BLISS ELECTRICAL SCHOOL**  
7698 Takoma Ave.  
Washington 12, D. C.



RADIO NEWS

changes." The letter was signed by F. C. Exon, Superintendent, Fiji Radio Service, Amalgamated Wireless (Australasia) Limited, Box 2516 G.P.O., Sydney, Australia. (Amalgamated Wireless (Australasia) Limited, located at 47 York Street, Sydney, operates the Wireless Station at Suva.)

\* \* \*

**Acknowledgments**

AUSTRALIA—Gillett, Maher. AUSTRALIA—Kofa. BRITISH COLUMBIA—Cooper, Park. CALIFORNIA—Dilg, Balbi, WestDyke, Foster. DENMARK—Christensen. DISTRICT OF COLUMBIA—Havlena. ENGLAND—Harrison; Cheffins, British Short-Wave League. ILLINOIS—Wajda. INDIA—Lalljee, Wadia, AIR, *Radio Times of India, The Indian Listener*. INDIANA—Green. JAPAN—Wm. Miller. LOUISIANA—Don Miller, Brennecke. MASSACHUSETTS—Harris. NEW JERSEY—Hoffman, Newark News Radio Club, Wooley. NEW YORK—Ekstein, Ballard, BBC, Taylor, Legge, Australian News & Information Bureau, The United Network. NEW ZEALAND—Milne, Cushen, New Zealand DX Club, Doyle, Sutton. OHIO—Croston, Sutton, Novak, Richardson. ONTARIO—Kennedy, Moss. OREGON—Hayre. PALESTINE—Near East Arab Broadcasting Station. PENNSYLVANIA—Jones, The Victory Radio Club, Znaidukas, Callahan. QUEBEC—Gauvreau, CBC. SOUTH AFRICA—Eksteen. SWEDEN—Edberg, Petersson, Sten Andersson, Svensson, Gustavsson, Swahn, Ekholm, Ekblom, Forsstrom, Skoog, Johnsson, Lindhe, Bergstrom, Ohrwall, Thomasson, Freis, Astrom. TEXAS—Giles. VIRGINIA—Howe, URDXC; Norris. WEST VIRGINIA—Casdorff, Rupert.

-30-

**RATTLE IN SPEAKER**

A SECTION or leg of the speaker spider sometimes develops annoying vibrations.

This condition may be remedied by applying a few coats of speaker cement as shown.

In some cases it may be necessary to cement a thin piece of leather to the spider leg. H. L.

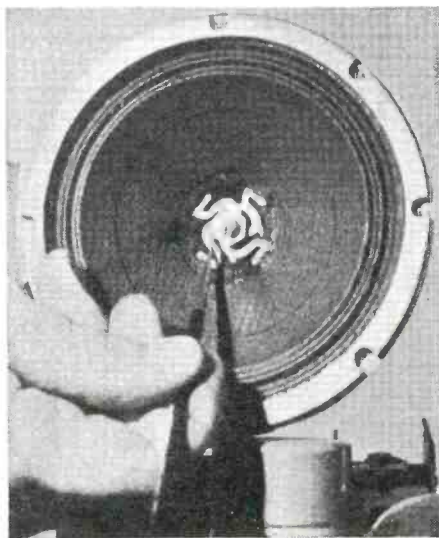

**PREPARE FOR THE**  
*New Opportunities*  
**in RADIO ELECTRONICS**

... Use Cleveland Institute home study courses for professional self-improvement.

**CLEVELAND INSTITUTE OFFERS—**

1. Mathematics for Radio and Communication Engineering.
2. Advanced Radio and Communication Engineering—  
A college-level Radio Engineering Course.
3. Master Course in Radio Communication—  
Covers fundamentals of Radio and includes complete preparation for FCC Commercial License Examinations.
4. Specialized Television Engineering—  
Including post-war Television techniques.

with

The Remarkable Workbooks of Instructional Aids, prepared by the instructing staff of Cleveland Institute.

Choose the course best suited to your needs—Start with the section you are qualified to enter—Use the economical CIRE "Pay-As-You-Go Plan."

APPROVED FOR VETERAN TRAINING UNDER G-I BILL OF RIGHTS

Write for descriptive folder.

**CLEVELAND INSTITUTE OF RADIO ELECTRONICS**

Contractors to the Canadian Broadcasting Corporation

Successors to

NILSON RADIO SCHOOL

Founded 1939

SMITH PRACTICAL RADIO INSTITUTE

Founded 1934

RN-8 TERMINAL TOWER, CLEVELAND 13, OHIO

(Mail this Coupon)

Cleveland Institute of Radio Electronics, RN-8 Terminal Tower, Cleveland 13, Ohio. Gentlemen: Please send information about your home study courses in Radio Electronics.

NAME .....  
ADDRESS .....  
CITY .....  
ZONE..... STATE.....

I desire training in.....  
I have had experience in broadcasting  servicing   
operating  mfg.  CAA  Army-Navy   
amateur  other..... I am a  
High School Grad.  College  Degree.....  
 Check here for Veteran Enrollment Information.

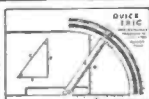

**QUICK TRIG**

Patent Pending  
EASY TO USE

This NEW IDEA in a slide rule enables you to solve QUICKLY, trig., radio, electricity, and carpentry problems. Simply set the slides. Right in front of you are the answers for All THREE sides and angles of a triangle. Gives degrees and tangents of angles. No need to figure with paper and pencil. Easy instructions included.

**SINE CIRCLE**

This completes your trig. needs. It gives all trig. functions such as sine, cos, tangent, secant, etc., for the complete 360 degrees. Both for only \$1.50 postpaid, or we will mail C.O.D. plus postage.



REED MFG. CO., 124 W. 4th St., Los Angeles 13, Calif.

**APPLIANCE TESTER \$10<sup>95</sup>**

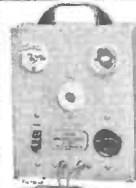

In this single unit are all the necessary tests for examining every appliance. Checks thermostats under working conditions. Tells instant it opens or closes. Controls heat on soldering irons—prevents overheating. Tests continuity, open circuits, automatic irons, vacuum cleaners, motors, coin machines, bulbs, fuses, 3-way switches, etc. Great time and money saver! Only \$10.95 complete. Shipping wt., 3 lbs. NO C.O.D.'s. WRITE FOR CIRCULAR.

Pat. Pend.

**HANLAN COMPANY**  
1419-R West Jefferson Los Angeles 7, Calif.  
FREE with each Tester. New, Complete, Practical Course in electrical appliance repairing.

# TRUONE

PREPARED ASSORTMENTS  
GUARANTEED FIRST QUALITY

Cat. No.	Quantity	Description	Price
1001	100	1/2 Watt Resistors, All Insulated.	52.98
1002	100	1/2 Watt Resistors, All Insulated.	3.98
1003	100	1 Watt Resistors, All Insulated.	4.25
1004	50	1 Watt Resistors, All Insulated.	3.98
1005	10	Wire Wound Resistors Asst'd Watts	2.98
1006	50	200 Volt Paper Condensers	2.48
1007	50	400 Volt Paper Condensers	2.49
1008	50	600 Volt Paper Condensers	2.25
1009	50	Mica Condensers	2.98
1010	20	Dry Electrolytic Filter Condensers	9.75
1011	10	Resistance and Line Cords	3.98
1012	100	Water Sockets	4.50
1013	100	Plastic and Ceramic Sockets	8.50
1014	10	25 Ft. Rolls Hookup Wire	1.98
1015	10	50 Ft. Rolls Hookup Wire	3.25
1016	10	100 Ft. Rolls Hookup Wire	6.75
1017	10	Volume and Tone Controls—No Switches	1.98
1018	50	Large Bakelite Knobs Push On	6.50
1019	50	Large Bakelite Knobs Set Screw	7.55
1020	50	Small and Medium Knobs Push On	3.50
1021	50	Small and Medium Knobs Set Screw	3.75
1022	100	Small Bar Knobs	5.50
1023	100	Large Bar Knobs	6.75
1024	100 ft.	Spaghetti and Vinylite	.98
1025	50	Padders and Trimmers	1.45
1026	10	Coils I.F., R.F. Ant. and Oec.	3.98
1027	50	Pilot Lamps	2.49
1028	20	Toggle and Slide Switches	3.98
1029	20	Wafer and Ceramic Band Switches	3.98
1030	20	Auto Generator Condensers	2.98
1031	20	Auto Suppressors	2.98
1032	25	Electrical Wiring Devices, Plugs, Caps, Bases, Heater Plugs, etc.	2.75
1033	50	Electrical Wiring Devices, Plugs, Caps, Bases, Elements, Fuses, etc.	5.00

### ELECTRICAL APPLIANCES AND PARTS

Double Burner Electric Stove	OPA \$ 7.00	\$ 9.95
Streamlined Electric Broiler Deluxe type	OPA 17.45	12.50
Fluorescent Desk Lamp, Brown, Blue or Rust	OPA 11.95	7.75
Fluorescent Kitchen Unit	OPA 18.80	6.75
Electric Phonograph	OPA 48.50	39.95
Replacement Stove Element 660 W.		.12
Replacement Electric Iron Element 550 W.		.55
Replacement Toaster Element		.75
Electric Iron Cord Set, Bakelite Plug		.45
Electric Iron Cord Set, Switch Plug		.89
3 ft. Extension Cord with Cube Top		.45
6 ft. Rubber Replacement Cord		.21

### SEND FOR TRUONE COMPLETE RADIO AND ELECTRICAL LIST

Terms: 25% deposit required with order. Balance C.O.D. Merchandise sent prepaid if full remittance accompanies order.

**TRUONE PRODUCTS CO.**

Dep., N. 303 West 42nd Street, New York (18), N. Y.

## CAPACITORS -

OIL, PAPER and  
ELECTROLYTIC



**Illinois  
CONDENSER COMPANY**

1616 N. THROOP ST.  
CHICAGO 22, ILL.

# LETTERS

from our readers

### REQUEST FOR ARTICLES

JUST a line to compliment you upon the new Circuit File Department, starting in the May RADIO NEWS.

"The circuits will be very helpful indeed, especially in the card size.

"I would like to see more articles on servicing troubles and on electronic relays as we are up against these problems all the time. Reasonably priced servicing equipment like the recent signal tracer should be very much in demand. How about an up-to-date condenser bridge?

"I feel you have a good magazine now, keep it up."

Robert W. Flory  
Los Angeles, California

Thank you for your comments. We will try to fill your order soon.

### CARD SIZES

I HAVE just subscribed to RADIO NEWS for three years after seeing the Circuit File. Great idea!

"I would prefer 4 x 6 instead of 3 x 5 cards and would like to see component values just below the circuit diagrams.

"Keep up the Turner articles on instruments."

Arnold J. Kander  
Los Angeles, California

We would like to be able to bring the circuit diagrams to our readers in a larger size but our page size would only permit 2 diagrams to a page instead of the present three if we enlarged the size of the individual diagrams.

### SHOW THE I.F.

YOUR new Circuit File in RADIO NEWS is "tops" and worth the price of the magazine alone. I appreciate your forethought in backing the circuits with advertisements.

"May I make one request? Please show the i.f. frequency. This data is very helpful."

J. E. McCarkle  
San Bernardino, California

Reader McCarkle will notice that his suggestion has been followed. Where the i.f. is not given on the manufacturer's diagram we have been adding this information for our reader's convenience in aligning receivers.

### A REQUEST AND AN OFFER

MAY I thank Mr. Moses for his timely and excellent article "A Volume Expander Compressor Pre-amplifier" which appeared in the June issue? If some one will follow up with a good p.a. system it will be much more timely than any other instrument because it is state election in most of the states and we are having a lot of p.a. work. I would like to see

a good article written on the design, operation, and servicing of p.a.'s.

"I have been reading RADIO NEWS for only about three years, to my regret, but I have enjoyed every issue and still have them.

"Here in 'T-town' we have an organization of the radio servicemen. It isn't a compulsory organization to which the servicemen must belong before servicing radios. It is called 'Tulsa Radio Service Association.' The main purpose is to promote fair competition among the servicemen, which is a good idea and a practice which benefits the serviceman and the customer.

"If anyone would like more dope on our association write and I'll do my best to help."

Paul Williamson  
3224 1/2 East 5th Street  
Tulsa, Oklahoma

Those of you who are planning some such organization of servicemen might be interested in getting some of the pointers which the Tulsa organization has available on procedure. Readers are asked to write to Mr. Williamson direct for this information.

### NO CLIPPING

I APPROVE of your RADIO NEWS circuit file very much. But as I save all my RADIO NEWS intact, I'd prefer not to cut up the magazine. So may I suggest that you do your printing on pages with the back side blank.

"I hope this will interest you for otherwise your plan will serve no purpose to me as much as I'd like it to."

Vincent Cortese  
Neptune, New Jersey

Much as we'd like to be able to print RADIO NEWS in this way, the paper shortage forbids our wasting a single inch of space on which information could be given to our readers.

### THE OPINION POLL

I AM mailing, under separate cover, my subscription to RADIO NEWS. I got my June copy last night, and found inside it a form requesting the opinions of your readers about your magazine.

"I had been meaning to write you and to subscribe to the magazine, but I am just now getting around to it.

"While I was overseas, I rarely saw a copy of RADIO NEWS, but when I could find one, I read it from cover to cover, not once, but several times.

"I hardly know how to state my interest in radio. I am to start at Georgia School of Technology in January, studying Electrical Engineering. I was an Army radio operator for about thirty months. I am interested

in ham radio, but have been unable to get the equipment together to start up. "Personally I think the articles in your magazine could hardly be improved upon. They seem to me to be pretty well balanced—something for the ham, engineer, student, experimenter and radio repairman in every issue.

"You have a fine magazine—keep up the good work."

Eugene M. Mathis  
Atlanta, Georgia

Our thanks to Mr. Mathis.

### OPERATORS' LICENSES

I AM in complete agreement with J. Victor Stout's views on the F.C.C. requiring the same of everyone desiring to operate radio equipment. He favors a radio examination every time a license is renewed."

Clarence I. Enterline  
Reading, Pa.

### ON THE CIRCUIT FILE

YOU want comments on your new department, 'Circuit File,' so here are some.

"First, I think the idea is good, and I'll use it to good advantage. However, if you intend to furnish these reprints of manufacturers schematics in 3 x 5 size, make all of them that size, not 2 1/2 x 5 or 3 x 4 or some other size as you have done in the May issue. The parts list may interest some, but I prefer the values shown on the schematic. Is it too much trouble for your editor to add these values to the print? Out of the 15 you published, only 4 had no values indicated, so it seems that your task would not be too great.

"If you do use the parts list, make it complete. As an example, what is the volume control value of the Clarion C100? I couldn't find it. I see that you are using the manufacturer's prints, but it would be nicer if they were all redrawn so as to standardize them. Maybe this is asking too much. I don't care for the way tube symbols are shown in some.

"Well anyway, I wish you luck."

James Hallock  
Electronic Servicing Eng.  
Center Moriches, N. Y.

Thanks to Mr. Hallock for his suggestions. We, too, had discussed the possibility of redrawing all of the schematics to conform with regular RADIO NEWS style, but concluded that there would be too great a possibility that errors might be made in making such a copy. A purely technical problem prevents us from making all of the diagrams exactly 3 x 5. Some of the diagrams which come from the manufacturer fill a 8 x 11 sheet while others are less than 3 inches at the largest dimension. This means that some drawings must be enlarged and some reduced in size in order to be reproduced in the 3 x 5 space and since the proportions of the diagrams are not all equal they cannot be reproduced identical in size.

-50-

# HARRISON HAS IT! HARRISON HAS IT!

## \* H S S

### 24G TUBES

- (3C24/VT204) An FB triode for VHF. 90 Watt rated Class C output. 6.3 Volt, 3 amp filament.
- Small bulb.

• Made by H & K, Gov't. inspected, fully guaranteed! Regular amateur net price was \$9.00, reduced to \$6.00. Harrison sells them in lots of **\$1.48** 3 or more for only.....each  
(Less than 3, at \$1.69 each.)

The last time we offered these popular tubes, orders and reorders came in so heavy, we had to ration them. But this time, we think we have plenty—so—order as many as you want—spares—presents, etc!

### BC-406 15 TUBE UHF RECEIVERS

- Been getting such FB reports from our customers about these swell Signal Corps Radar receivers that we just had to get more for you.
- Six acorn tube RF circuit, tuned to 205 MC; four IF stages; Thordarson heavy duty power transformer delivering 350 volts at 145 MA; four choke and oil condenser filters; 115 volt 60 cycle operation; chassis 10 1/2" x 2 1/2" in metal case. Slightly used but fully guaranteed.
- Complete with tubes: 5-954, 1-955, 4-6SK7, 2-6SN7, 3-6N7, 1-5T4.
- Instructions and diagrams for easy conversion to a hot 110 (also 6 and 2) meter superhet receiver are included. The parts alone are worth **\$21.98** much more than our low HSS Price.....
- BC-406-A. Same, but also has an 11 Watt 3/4 RPM 110 Volt motor, 1-6SN7GT, and 1-**\$29.75** 6XFS (omits 1-6N7). Like new!.....

### PRECISION RESIST.

- ORS. 1 Megohm, 1 watt.
- 1% accuracy. IRC WWVS.
- List Price \$5.25. HSS in lots of THREE at 98c each.
- (less than three—\$1.19 each)

- RCA 958-A. Acorn Tubes. New, standard, boxed stock. Reg. net price \$6.95. HSS. \$1.90

### LONG WAVE RECEIVERS

- Navy Model RAK-7. New, in original crates. A real commercial job for marine, aviation, etc., use. 15 to 600 KC. Two tuned RF stages, Band switching, precision dial. AVC noise limiter, Band pass filter, tunable audio filter. Db output meter, filament voltmeter. Six tubes plus three in 115 Volt 60 cycle regulated power supply. **\$64.50**
- Complete with tubes and instruction manual.....

Steel chest 12" x 12" x 18" containing 50 pounds of spare parts—transformers, chokes, condensers, sockets, coils, switches, etc. All new, with specifications! \$12.00.

### DYNAMOTORS

- Just the thing for that mobile amplifier, Xmitter, etc.! 12 volt input gives 680 volts at 210 ma; 6 volt input delivers 300 volts at 210 ma, or 265 volts at 300 ma. Compact, well-constructed unit for Military use. Weighs only 6 1/2 lbs. with mounting. Ball bearing for good efficiency! **\$8.95**
- Brand new, HSS Special.....

### \* HARRISON SELECT SURPLUS

- Your assurance of good, usable, guaranteed, surplus material at sensationally low prices—top value always! Come in and browse through our large, entirely separate HSS Department (Harrison Select Surplus).

## \*\* ALL STANDARD LINES RECEIVERS

As one of the world's largest distributors of Communications Equipment we are delivering plenty of receivers—right now! All makes—practically all models.

If you want your new set in the quickest possible time—send your order to HARRISON!

- NATIONAL 11R0-57A-1. New model with noise limiter metal tubes, ham broadcast coils. Complete with pack, speaker, and coils 1.7 to 30 Mc.....\$303.00
- NC-240-C.....225.00
- NC-46. AC-DC Receiver.....97.50

### HAMMARLUND

- New Super Pro. SPC-400 SX. 1.25 to 40 Mc.....\$310.05
- HQ-129-X. With speaker.....168.00

### HALLCRAFTERS

- FM-AM CW. Peak performance on 10 and 6 meters, a swell police job, a beautiful high-fidelity FM receiver (old and new bands), an excellent piece of Lab equipment—all in one! Acorn tube RF section, noise limiter, 15 tubes, 27.8 to 143 Mc. Model S 36-A. \$415.00, reduced to only.....\$307.50
- S-41. Sky rider, Jr.....33.50
- S-38. New Sky Buddy.....39.50
- S-40. 1946 Sky Champion.....79.50
- SX-28-A. Super Sky rider.....223.00
- RME 45. New, revised model with calibrated ham bandspread. With speaker.....\$186.00
- RME 84. New eight tube receiver. Complete 98.70

Literature on any receiver gladly sent upon request. Write today!

(All prices subject to change without notice.)

### ELECTRIC DRILLS

- Thor—one of the best quality makers. Compact, sturdy, a good lifetime tool. Jacobs chuck.
- 1 1/2" 2500 RPM (r.e.e. Model U14AP...\$32.50
- 1 1/2" 500 RPM, with removable dead handle for extra leverage on heavy jobs.
- Model U44.....\$59.50

Our TOOL DEPT. also has pliers, cutters, soldering irons, steel work benches, screw drivers, etc.—in stock!

### INTERCOMMUNICATION SYSTEMS

- Talk-A-Phone LP-5—Master for up to five remote stations.....\$19.95
- RS-3 Remotes (can call master).....\$7.25
- LP-10. For ten station multiple master system.....\$28.50

### BOGEN

- 12-C. For up to 12 station multiple master system.....\$28.74

(Many other models in stock)

### DUMONT Oscillograph

- Model 208-B. An excellent 5" scope for Lab., Service Bench, or Ham Shack!.....\$235.00

Our TEST EQUIPMENT DEPT. can furnish practically all makes and models of instruments, with many in stock for immediate shipment. Send in your orders NOW for best delivery!

\* We are

### FACTORY AUTHORIZED DISTRIBUTORS

for the top quality manufacturers and we now have in stock lots more new, latest improved production Ham gear! Visit our stores today, for everything you need. We promise you fresh, clean material—quicker—at the lowest current prices—and, above all, our sincere desire to be of friendly, helpful service.

MAIL ORDERS?—Certainly! Just list everything you want (items in this ad, or any ad, magazine or catalog) and include deposit.

73 de  
Bill Harrison, W2AVA

**HAM HEADQUARTERS**  
Since 1925!

**HARRISON RADIO CORPORATION**

10 WEST BROADWAY • NEW YORK CITY 7

BARCLAY 7-9854

JAMAICA BRANCH — 172-31 Hillside Ave. — REPUBLIC 9-4102

### TUBES IN STOCK

At New OPA Wholesale Schedule

11L4, 1R5, 1T4, 1S5, 3A4, 3S4, 3Q4, 2B7, 2E5, 5Y3, 5Y4, 5U4, 5Z3, 6AC7, 6AF6, 6B4, 6B8, 6C6, 6D6, 6F6, 6F8, 6H6, 6J5, 6K6, 6K7, 6L6, 6N7, 6V6, 6X5, 6SA7, 6SD7, 6SJ7, 6SL7, 6SN7, 6SQ7, 6SS7, 7A6, 7C5, 7F7, 7K8, 12H6, 12SG7, 12SK7, 12S7R7, 12SR7, 14B6, 14Q7, 38, 39, 53, 55, 76, 77, 78, 46.

1R5 & adapter to 1LA6 .....	\$1.69
1R5 & adapter to 1A7 .....	1.39
12A6 & adapter to 50L6 .....	1.69
1S5 & adapter to 1H5 .....	.98
1T4 & adapter to 1N5 .....	.98
11L4 & adapter to 1A5 .....	.98
3S4 & adapter to 3Q5 .....	.98

**HENSHAW RADIO CO.**

3313 Delavan Kansas City 2, Kansas

BE YOUR OWN BOSS — OPERATE YOUR OWN PROFITABLE BUSINESS

### HOME and INDUSTRIAL APPLIANCES

SERVICE—REPAIR—INSTALLATION

ONLY shop training course of its kind. Gives you actual shop training on washing machines, heat control systems, water heaters, toasters, vacuum sweepers, etc., etc. Learn motor rewinding, welding, plating, etc. Work on actual machines under trained instructors. Low tuition. Old established school. Most complete training course of its kind. Investigate this opportunity—its money-making possibilities and the need for trained men. Write today for details. No obligation. Veterans ask for GI plan. Act now!

**APPLIANCE TRAINING SCHOOL—Dept. 75**  
Division of Commercial Trades Institute  
6312 N. Broadway Chicago 40, Ill.

**SENSATIONAL VALUE  
at RADIO ELECTRIC!  
U. S. GOVT.  
SURPLUS **CABINET****

Only  
**\$79<sup>95</sup>**

#16 gauge steel, gray crackle finish, scratch proof. Adaptable for master installations for broadcasting, amateur, sound, ideal for school, hospital, industrial and commercial institutions. SPECS.: Height 72"—Depth 24<sup>5</sup>/<sub>8</sub>"—Width 29<sup>1</sup>/<sub>2</sub>".

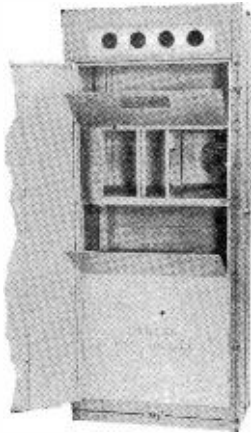

Send for Free Flyer on Radio Parts  
Mail Orders Shipped in 24 Hours

Distributors of Washer and Vacuum Cleaner Parts

**RADIO ELECTRIC  
SERVICE CO. OF PENNA., INC.**

N.W. COR. 7th & ARCH STREETS  
PHILA. 6, PA.

CAMDEN, N. J., ALLENTOWN, PA.  
WILMINGTON, DEL., EASTON, PA.

Our EXPORT Dept. Circles The Globe

**7 Days  
Free Examination**

**PRACTICAL  
RADIO  
INFORMATION**

Including Frequency Modulation—Television, etc.

Inside Radio Information for all Servicemen—Aircraft Pilots, Students. AUDELS RADIO-MANS GUIDE contains 772 Pages, 400 Diagrams & Photos is complete—gives Authentic Principles & Practices in Construction, Operation, Service & Repairs. Covers clearly and concisely Radio fundamentals—Ohm's Law—Physics of sound as related to radio science—Measuring Instruments—Power supply—Resistors—Inductors—Condensers—Transformers and examples—Broadcasting stations—Radio Telephony—Receivers—Diagrams—Construction—Control systems—Loud speakers—Antenna systems—Auto Radio—Phonograph pickups—Public Address Systems—Aircraft & Marine Radio—Radio Compass—Beacons—Automatic Radio Alarms—Short Wave—Coil Calculations—Testing—Cathode ray oscillographs—Static Elimination—Trouble Pointers—Underwriter's standards—Units and tables—Frequency Modulation—REVIEW QUESTIONS & ANSWERS, Ready Reference Index.

**\$4 COMPLETE • PAY ONLY \$1 A MO.**  
Get this practical information in handy form for yourself—Fill in and MAIL COUPON TODAY—

AUDEL Publishers, 49 W. 23rd St., N.Y.  
Mail AUDELS NEW RADIO-MANS GUIDE for free examination. If O.K., I will send you \$1 in 7 days; then remit \$1 monthly until \$4 is paid. Otherwise I will return it.

Name \_\_\_\_\_  
Address \_\_\_\_\_  
Occupation \_\_\_\_\_  
Reference \_\_\_\_\_ R.N.

**Transmitter-Receiver for  
Hams**

(Continued from page 34)

mounted a sufficient distance above the lower edge to permit ease of operation.

The controls along the lower edge of the panel from left to right are, microphone jack, volume control, phone jack, send-receive switch, phone-i.c.w. switch, regeneration control, and key jack. The large dial to the left of the speaker grille is the tuning control for the receiver, while the dial to the right of the speaker controls the transmitter tuning. An es-cutcheon from an old dial is used to improve the appearance of the speaker opening.

The first step in construction is to obtain the components and lay out the chassis following the drawing. If parts of different make and size are used, it may be necessary to relocate some of the holes. In general, most manufacturers adhere to similar dimensions for components of the same relative ratings.

The smaller holes should present no particular problem. For the socket holes either a socket punch may be used, or a series of small holes drilled and the hole filed out to the proper size. This latter procedure is recommended for the transformer cutout.

To enable the unit to stand level when removed from the cabinet, and remove strain from the front panel, small studs are mounted along the lower rear lip of the chassis. These are made by using 1/2" lengths of small tubing slipped over one inch 6-32 screws.

After all the holes have been drilled and the burrs removed with a file or chisel, the sockets should be mounted. The sockets for the 6J5 and the 6V6GT should be mounted with the key or locating slot toward the panel. The next step is the mounting of the various transformers. Any place where a wire passes through the chassis should have a grommet placed in the hole to protect the wire from shorting against the sharp edges of the hole.

It is preferable to use lock washers under all nuts to keep the nuts from loosening with vibration.

Following the mounting of the sockets and transformers, the other parts may be mounted. When all parts on the chassis have been mounted, the tube heaters should be wired. In this particular unit one side of the 6.3 volt winding is grounded while the other side is run to No. 7 terminal on both the 6J5 and 6V6GT. The center tap of this winding is not used and should be taped up and folded into a corner of the chassis. Terminals No. 1 and 2 of the 6J5 and 6V6GT are tied together and grounded directly to the chassis.

The power cord is brought in through a grommet in the rear of the chassis and one side connected directly to one side of the transformer pri-

**Aeronautical & Electronic  
Bargains for Experimenters  
and Others**

Automatic Voltage Regulator—24 volt D.C. Aeroplane generators, Westinghouse System. \$1.29 ea. or three for \$2.99.

Ingenious Waste Gate Motor—2 single phase stator windings, 200 volts, 5 W., 25 M.A. geared to a lift arm. Torque 50# per inch, timing 23 seconds, \$1.50 ea.

1/2 H.P., D.C. drive Motor from Air Force B-29 Turrets 27 volts, 4,000 rpm, Arm. V. 60, AMP 8.3 A, 2.3 F., \$5.50 ea.

Selsyn Generator and Control Transformer—2-J1G1, 2-J1F1, 115-57.5 V, 57.5-57.5 V, 400 Cycles, \$1.85 each.

Sampsel Time Control Motors—27 volts 1/5 H.P., 16 AMPS, 3,800 rpm. \$4.50 each.

Delco 27 volts D.C. Motors geared to 120 rpm #5069625 \$4.50 each.

Send money order or checks,  
shipped postpaid

**LYELL HARDWARE CO.**  
P. O. BOX No. 5 ROCHESTER 11, N. Y.



**MARINE  
RADIO  
MANUAL**

by  
**M. H. Strichartz**

"One of the best texts that has come to our attention in the past few years," says Carl Coleman in RADIO NEWS.

"This manual," says *Electrical Engineering*, "provides a detailed, comprehensive account of the duties of the ship radio officer. The text is clear and readable and covers the fundamentals and advanced duties."

Included are chapters on: laws; work in port and at sea; paper work; distress and emergency communications; operating and troubleshooting transmitters, receivers, direction finders, auto-alarms; radio medical aid; First Aid; learning International Morse Code.

528 Pages Illustrated Indexed \$4.00

At bookstores or direct  
**CORNELL MARITIME PRESS**  
241 West 23rd Street  
New York 11, N. Y.

Specializing in the design and Assembly of  
Physics Demonstration Apparatus, Electronic  
Equipment and Special Test Equipment. Consult-  
ing Service on Applied Physics and Electronics.

**CARLOCK LABORATORIES**  
of

**Applied Physics and Electronics**  
106 Tudor St. Pineville, Louisiana

**PEN-OSCIL-LITE**

Extremely convenient test oscillator for all radio servicing: alignment • Small as a pen • Self powered • Range from 700 cycles audio to over 600 megacycles u.h.f. • Output from zero to 125 v. • Used by Signal Corps • Write for information.

**GENERAL TEST EQUIPMENT CO.**  
38 Argyle Buffalo 9, N. Y.



mary, while the other side goes through the switch  $S_1$ , which is mounted on the volume control,  $R_5$ . Other windings of the power transformer are connected as indicated in the diagram.

When this unit was first tried, it was found that the "B" voltage was in the vicinity of 360 volts, more than could be safely used with the tubes in the transmitter and receiver so resistor  $R_3$  was added to reduce the voltage at the junction of  $R_3$  and  $R_1$  to approximately 300 volts.

As the switch  $S_2$  is a two-section type made from *Centralab* kit parts, each section consisting of a four pole double throw switch unit. The rear wafer of the switch was used for antenna switching to provide the shortest leads possible in this circuit and afford isolation from the balance of the unit. Connections to a switch of this nature are rather confusing to the beginner and careful examination should be made of the action of the switch before attempting wiring.

Components, such as resistors and condensers, are mounted wherever convenient with tie lug terminal strips used for support wherever necessary. No particular problems should be encountered in the wiring of this unit but care should be exercised to separate the audio circuits from the power circuits insofar as possible.

It is well to reserve the mounting of the transmitter and receiver r.f. portions until the balance of the con-

struction has been completed. The speaker is mounted directly on the front panel and it is preferable that this panel be added after the balance of the unit has been constructed.

The receiver portion may be built as a separate unit as it is necessary to have extremely short leads in this portion to obtain satisfactory operation at these frequencies. The small bracket is made of scrap 1/16" brass with a hole for mounting the tube socket. The tuning condenser for the receiver is mounted on a small brass stud directly to the chassis. This condenser consists of a 6  $\mu$ fd. midget type which has all but one stator and 2 rotor plates removed. The coil,  $L_3$ , consists of 4 turns of No. 14 enameled wire, 1/2" diameter, spaced to a length of 1/2" and soldered directly to the tuning condenser. The grid condenser,  $C_5$ , is one of the midget tubular ceramic types. If this is not available, the ordinary miniature mica may be used instead. The antenna coil,  $L_4$ , is a single turn of No. 14 enameled 1/2" in diameter mounted on a tie lug in close proximity to the grid end of  $L_3$ . This tie lug is supported by one of the socket mounting screws of  $V_2$  and the coupling between it and  $L_3$  may be adjusted by turning the tie lug on its mounting screw.

The choke,  $RFC_3$ , consists of 15 turns of No. 22 double cotton covered wire 1/4" in diameter and spaced to a length of 1 1/4". A condenser,  $C_6$ , is connected across the heater terminals

of  $V_2$  to confine the r.f. to the immediate detector circuit.

Construction of the transmitter section should be reserved until the receiver portion is completed and working in a proper manner. When wiring of the receiver portion has been completed, power should be applied and the tubes allowed to heat up. Advancing the regeneration control  $R_3$  should result in a high pitched hiss when the control is about 1/2 scale. This is the point at which the detector goes into superregeneration. It may be necessary to make some adjustments in the spacing of  $RFC_3$  to obtain smooth regeneration over the entire range of the tuning condenser  $C_4$ . It is customary in most superregenerative receivers to connect the r.f. choke to the grid end of the coil. However, in this particular model, much smoother operation was obtained with it connected to the plate end as shown.

When the operation of the receiver is smooth over the entire range of the tuning condenser, the frequency should be checked, preferably by means of an absorption wave meter. The frequency may be raised by spreading the turns of the coil  $L_3$  or lowered by squeezing them together. After the correct range has been obtained an antenna should be connected to the antenna posts located along the rear edge of the chassis and the receiver may then be calibrated by listening to stations operating in the 144-148 mc. band. If a calibrated sig-

## Presenting the "SENTINEL" by Suburban



A sensationally new medium power transmitter designed for compactness, dependability, and simplicity of operation.

The "SENTINEL" is capable of delivering 75 watts output of 100% modulated, undistorted carrier, with a frequency range covering from 3.5 to 30 megacycles.

The R F Portion consists of a 6V6 fundamental harmonic oscillator, a 6L6 doubler or fundamental oscillator for frequencies below 7 megacycles and an 8/14 in class "C" stage.

A swinging link is used for antenna loading, matching anywhere from 10 to 600 ohms, and the output is fed through two insulators at the rear of the cabinet.

The modulator consists of a 6SJ7, 6J5, 6V6, as speech amplifiers, driving a HY31Z in class "B." Any standard high impedance mike can be used. Frequency response is plus or minus 3DB from 100 to 5000 cycles.

Power is obtained from three separate supplies, consisting of a pair of 816's for the power amplifier, a 5R4GY for the oscillator and doubler, and an 83 for the modulator.

Metering is accomplished by a switch, enabling you to read; cathode current of the modulator, doubler grid, P.A. grid, and P.A. plate.

All controls are located on the front panel as well as the mike and key jacks.

An external, as well as internal, crystal jack is provided on the front panel, facilitating rapid frequency change and the use of any standard "ECO."

A switch on the gain control of the modulator is used for changing from CW to PHONE operation.

A transmit-receive switch simultaneously controls the transmitter, receiver break-in, and antenna change over, through a connector located at the rear of the chassis. (Antenna change-over relay coil must be 110 A.C. and is not included.)

A tune operate switch is provided for tuning-up, frequency check, and to prevent possible damage to the power amplifier.

The "SUBURBAN SENTINEL" is completely self-contained in a modern crackle cabinet measuring 14" high, 15" deep and 22 1/2" wide, weighing 110 pounds.

The "SUBURBAN SENTINEL" comes complete with all tubes, meter, your choice of one set of plug-in-coils, power cable and one crystal within 5 KC of your specified frequency. "All you need is a mike, key and antenna and you're on the air!"

**PRICE \$274.50 IMMEDIATE DELIVERY**

All SUBURBAN transmitters are unconditionally guaranteed, excepting tubes, for a period of ninety days after purchase.

All transmitters are F.O.B. East Rutherford, New Jersey, and require a 20% deposit in continental U.S.A., 30% elsewhere.

# SUBURBAN RADIO COMPANY

Cable Address "SUBRACO"

82 Herman Street

East Rutherford, N. J.

## RHS SPECIALS

12 volt, 12 amps. DC from 110 volts AC. Power supply for Mark 1-11-111 operates dynamotor and filament voltage. No need to tear set apart. No tubes—long life—uses heavy duty selenium rectifier. **\$32.50**  
Complete ready to plug in.....  
Get our quotations on other DC Supplies

### WIRE RECORDER—G.E. Model 20N-1

Complete with 66-minute recording wire and tubes. Operates from 24 volt DC supply. Less power supply, mike and cables. Special..... **\$85.00**  
110 v. 60 cycle supply for above..... **27.50**

### CARBON PILE REGULATORS

Built by Ieland and Bendix for Army Air Forces. Regulates up to 1000 watts. Operates from 110v 60 cycle.  
Labs and Hams: Uniform voltage to all equipment at any load.  
Servicemen: Regulates voltage to test bench and sets under test.

FARM USE: Line voltage regulator for output of gas driven generator.  
FOR RESALE: Regulates line voltage from outlets in the average home. **\$14.95**  
A BARGAIN AT.....

POWER XFORMERS FILAMENT XFORMERS  
2500v at 10ma.....\$ 7.95 2.5v at 3 amps.....\$1.80  
2300v at 2ma..... 5.95 2.5v at 2 amps 6.3v.....  
6200v at 700ma. CT. 39.95 lamp..... 2.50

SELENIUM RECTIFIERS  
28v 1 amp.....\$2.75 12v 24 amps.....\$12.50  
12v 12 amps..... 6.75 24v .5 amp..... 1.45

TUBE BARGAINS  
807.....\$1.39 8001.....\$15.00 5CP1.....\$6.95  
6C4......75 6AG7..... 1.25 127A..... 3.50  
6AL5......60 6AK5..... 1.60 1N21......65  
VR150......75 6AC7......95 6SL7..... 1.00  
Klystron 2K29/228C..... 7.50 813..... 9.95

OIL CONDENSERS ELECTROLYTICS  
4mfd 600v.....\$0.75 2400mfd 50v.....\$2.95  
1mfd 2000v......95 4000mfd 15v..... 2.25  
4mfd 2000v..... 3.95 10mfd 25v......19

1/3 with Order, Balance COD

**RADIO HAM SHACK INC.,**  
63 Dey Street New York 7, N. Y.

For Soldering in  
Tight Places...

# DRAKE

No. 400 Soldering Iron

Smallest Industrial Iron  
Ever Designed

60 Watts—1/4 in. Tip

Only 9 in. long—Wt. only 8 oz.

This mighty mite is backed by DRAKE'S 25 years of soldering iron manufacturing experience. The high quality and long service of DRAKE Soldering Irons have made them outstanding favorites with all types of radio men everywhere. The DRAKE No. 400 is an outstanding value at

Only \$4.50  
List

Drake Has an Iron  
for Every Purpose.  
Ask Your Radio  
Parts Jobber.



**DRAKE ELECTRIC WORKS, INC.**  
3636 LINCOLN AVE., CHICAGO 13, ILL.

nal generator is available, an accurate calibration of the receiver may be made.

The antenna coupling coil,  $R_4$ , should be adjusted to give the maximum gain consistent with smooth operation and selectivity of the receiver.

Superregenerative receivers described in the past, using no r.f. stage, have often been guilty of interference from a strongly radiating detector. By careful selection of components, and adjustment, it is possible to obtain satisfactory operation with low plate voltage on the detector and in this manner reduce interference.

Almost any type of high frequency antenna may be used with this unit. The particular installation in use consists of a folded dipole antenna fed by the new 300 ohm parallel transmission line.

The possibility of greatly improved results by the use of a beam antenna on the high frequencies should not be overlooked. With the use of this type of antenna, it is possible to reduce interference and increase the effective power of the transmitter by several times.

(EDITOR'S NOTE: Since this article would not have been complete without an explanation of the technical aspects of the circuit design, the staff of RADIO NEWS collaborated in making this explanation because the author, a beginning ham, was obviously not technically qualified to make this exposition.)

(To be continued)

QTC

(Continued from page 49)

thing going smoothly. D. K. Crosby reported going to the hospital for an "overhaul" job. Carl Amato back from the Army and going strong again. What became of Walter Glazer? Olaf Bottelsen and Arthur Bie both shipped out of Boston a short time ago. . . . John Milne around again after his recent illness. Admiral C. W. Nimitz in a recent address vowed that as long as the U. S. commerce moves across the seas this nation will have a powerful fleet of warships to defend its trade and its own shores.

GERALD GROSS, Vice Director of the International Telecommunications Union, said recently that reallocation of radio frequencies between broadcasting stations, shipping and flying services is essential to permit orderly international and national communication. Mr. Gross said that the present available frequencies are oversubscribed and if an international conference to redistribute them is not convened soon the situation will become critical.

AMERICAN cargo and passenger ships are slowly coming back to prewar operations. . . the various shipping companies report that WSA

# ATTENTION Radio Servicemen!

IMMEDIATE DELIVERIES ON

- Vomag V.T.V.M.
- Triplett-Hickok Volt-Ohm-Milliammeter
- Triplett Tube Checkers
- A.T.R. Battery Eliminators
- Turner Microphones
- Rider Manuals
- Write us for hard to get tubes

The POCKETSCOPE—A pocket-size complete cathode ray oscilloscope. Weighs only 5 1/4 lbs.

## RADIO ELECTRIC PRODUCTS, INC.

677 Michigan Ave., CL.6457, Buffalo 3, N. Y.

## SCOOP!!

RADIO SERVICEMEN — HAMS —  
EXPERIMENTERS — MINIATURE —  
EXTRA SENSITIVE —  
HEADPHONES

Still Available Limited Quantity

Signal Corps—Type HS-30 and matching transformer—net \$3.49

Resistor Kit—50 assorted 1/2 watt insulated resistors—RMA.....\$1.19

Condenser Kit—mica—popular sizes—standard brands.....12 for .59

Speakers—5" PM—Almico V..... 2.29

Cathode Ray Tube—3BP1—Brand New..... 5.95

Super-het coil kit—2 I.F. Coils (455 KC)—1 Oscillator coil and loop to match.....Complete 2.29

**Electronic Supply Corp.**

40-14 Greenpoint Ave., Long Island City 4, N. Y.  
Dept. B  
Stillwell 4-0231

## BARGAINS

67 1/2 Volt B Battery (Everready 467) Army Surplus. Service Date July, 1947..... 87c

10" Aluminum Base Recording Blanks (good seconds)..... 18c

TUBES GALORE. Send want list with order.

Send us your name and address for latest bulletin

**MAC'S RADIO SUPPLY**

8320-22 Long Beach Blvd.  
South Gate, Calif.  
Phone KI. 4111

## DETROLA AUTOMATIC RECORD CHANGERS

Plays 10—12" or 12—10" Records, Crystal Pickup. Fool proof—No Gears. Overall size—10 3/4" x 12 1/8". Dealers Net Price, \$18.27. WOOD BASE—Leatherette covered. Cut to fit changer—\$2.45.

**YORK RADIO DISTRIBUTING CO.**  
801-05 N. Broadway DECATUR 47, ILL.

is releasing some vessels . . . the U. S. Lines "Washington" will shortly be ready to be placed once again in the trans-Atlantic passenger service after reconditioning for this service. Grace Line reports new construction of C-2 type vessels to be placed in the Gulf-South American run (West Coast). 73.

**Flea Power Transmitter**  
(Continued from page 35)

ton current and the available voltage from the secondary of the microphone transformer. This, in turn, limits the input power to the r.f. stage if a reasonable percentage of modulation is to be obtained. Increasing the plate supply without increasing the modulation produces a stronger carrier, but at the receiving end all that is noticeable is that the noise-to-signal ratio has increased sharply. It is possible to secure the direct current for the microphone from the plate supply, through a dropping resistor. In this case higher button current may be used, with a similar increase in the r.f. input power.

A standard 200 ohm to grid transformer (Thermador I43) was used for the modulation transformer (*T<sub>1</sub>*). The better the turns ratio, the more voltage available for modulation. Although the high impedance secondary is not normally correct for this service, it is necessary to secure a higher level of modulation.

Any carbon button microphone may be used. The Air Corps hand type, which is handy and good for 75 milliamperes, is a good choice. These are available as surplus war material. A second type, made for rough handling and high button current may be purchased from Graybar, *Western Electric* distributors. This second type, the F1, as used today in all telephones (carbon button with diaphragm only) is capable of handling up to 900 milliamperes!

The crystal oscillator itself posed some interesting problems. Upon inspecting the diagram, two questions will probably arise in the mind of the reader. Why such a high value of grid leak resistance, and what about that condenser connected from plate to control grid? When the oscillator was first constructed it did not oscillate. After determining that the tank constants were proper for the crystal frequency, that the tube and crystal were in good condition, and the wiring correct it was decided to analyze the circuit. Upon investigation it was determined that the interelectrode tube capacities were so low that insufficient energy was being fed from the plate circuit back into the control grid to maintain oscillation. By trial and error 2 to 5  $\mu\text{fd}$ . was selected as being the proper r.f. bypass between the control grid and plate (*C<sub>1</sub>*). Exceeding this allowable range caused either insufficient feedback or excessive detuning of the tank circuit, resulting in failure of the circuit to oscillate.

*A Buy-word for Excellence*



**PUR-A-TONE ANTENNAS**  
Reg. Trade Mark

ALL TYPES FOR  
**• AUTOS**  
**• HOMES**  
**• MARINE**  
**A.M. — F.M. — TELEVISION**

Make pleased customers and bigger profits . . . ask your distributor for BRACH Puratone ANTENNAS.

Special-purpose transmitting antennas designed for volume production to your own specifications. Collapsible—sectional—direction finding—radar and coaxial type. All sizes, lengths and materials. Consult us on your needs.

**L. S. BRACH MFG. CORP.**  
 200 CENTRAL AVENUE NEWARK, N. J.  
 WORLD'S OLDEST AND LARGEST MANUFACTURERS OF RADIO ANTENNAS AND ACCESSORIES.

**PRE-EXAM TESTS**  
For Commercial Radio Operator  
**FCC LICENSE EXAMINATIONS**



Rehearse the FCC license examinations  
 Practice the procedure  
 Practice the multiple-choice examination methods used by FCC

Prepared by Arthur R. Nilson, Famous Co-author of Nilson and Hornung's  
**RADIO QUESTIONS AND ANSWERS**  
 Cleveland Institute of Radio Electronics, RN-8 Terminal Tower, Cleveland 13, Ohio

**DON'T TAKE A CHANCE**  
**Avoid Failure on FCC Commercial Radio Operator License Examinations!**  
 USE NILSON'S COMPLETE PRE-EXAMINATION TESTS AND COACHING SERVICE

Enables You To  
 Rehearse the FCC license examinations  
 Check your knowledge  
 Practice the procedure  
 Locate your weak points  
 Practice the multiple-choice examination methods used by FCC  
 Correct your weak points before taking the actual examination

Prepared by Arthur R. Nilson, Famous Co-author of Nilson and Hornung's  
**RADIO QUESTIONS AND ANSWERS**  
 Cleveland Institute of Radio Electronics, RN-8 Terminal Tower, Cleveland 13, Ohio

---

Cleveland Institute of Radio Electronics  
 RN-8 Terminal Tower, Cleveland 13, Ohio  
 Please send information about Pre-Exam Tests.

Name .....

Address .....

City.....Zone.....State.....

**UNIVERSAL**  
HAS IT!  
FOR IMMEDIATE  
DELIVERY!

**BRAND NEW**  
Transmitter & Receiver

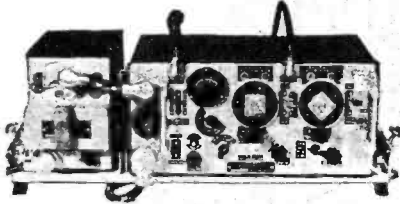

ACCESSORIES AND SPARES INCLUDED  
BUT NOT SHOWN

**FEATURES**

- Covers 2 to 8 meg. and 235 meg.
- 6 Tube Superhet. Receiver
- Phone or C. W. Operation
- Grid Modulated Phone
- Complete Inter-Com. System
- 807 Final Amp.
- 80 and 40 Meter Ham Bands Covered Without Changes

**ACCESSORIES**

- Set of 14 Extra Tubes
- Dynamotor
- 2 Antennas
- Variometer For Any Tuning
- 6 Microphones
- 6 Headsets
- 3 Control Boxes
- All Interconnecting Cables

EACH UNIT COMPLETE  
IN THREE EXPORT  
PACKING CASES  
**YOUR COST**

**\$78.50**  
F.O.B.  
LOS ANGELES



WE SPECIALIZE  
IN QUICK RESPONSE  
TO LETTERS ASKING  
ABOUT HARD TO  
GET RADIO PARTS

ROBSON-BURGESS V.O.-M	\$18.75
MILLEN 50 WATT EXCITER	37.50
PANADAPTER PC 2	99.75
24G/3C24 TUBES	1.90
VT-127A TUBES	3.50
G.E. 0-1.5 AMP R.F. 2" METER	3.45

**COMPLETE STOCKS**

**U.T.C. TRANSFORMERS**

Webster Record Changers  
Models 50-1 and 56-1

**TURNER MICROPHONES**

PETERSEN 3.5-7-14 meg. CRYSTALS  
BC-610E (HT-4E) COMPLETE FOR OP-  
ERATION ON 10-20-40-80 METERS

**UNIVERSAL**  
RADIO SUPPLY CO.  
1404 VENICE BOULEVARD  
LOS ANGELES 6, CALIFORNIA  
R C A DISTRIBUTORS

**Television Receivers**

(Continued from page 44)

As the grid current flow, due to r.f. excitation, was very low it was found necessary to go to a high value of grid leak resistance in order to develop the proper class "C" bias.

Tuning the transmitter requires the use of a 1 milliampere meter. A 5 ma. meter should be used where 45 to 90 volt operation is used. This meter is placed in the plate return so as to indicate plate current only, not screen and plate current. The tank circuit is tuned for the minimum plate current dip and then the antenna loading is adjusted for maximum plate current. A whip antenna 60 to 99 inches will be found suitable as the radiation element for this transmitter. The antenna coil and condenser should resonate at the crystal frequency in order to voltage feed the antenna system. These constants for operation at 3105 kc. are 50  $\mu$ fd. for condensers  $C_2$  and  $C_3$ . The tank and antenna coil are wound on the same  $\frac{5}{8}$  inch form 3/16 of an inch apart, with No. 32 enamel covered wire. The tank coil is wound approximately one inch long, while the antenna coil is wound only .6 of an inch long. The antenna coil should be wound at the "hot" or plate end of the tank coil.

With the use of a single flash light cell for filament power, and a miniature 22½-volt hearing aid battery for the plate supply the over-all weight and bulk of the transmitter is extremely small. Including the batteries this transmitter weighs just one and three-quarter pounds. The batteries in this small a case are secured externally to the back of the case, one inch greater depth allowing the batteries to be carried internally. This case is 2¾ by 6 by 2¼ inches deep.

-30-

and necessary in controlling the motion of the scanning beam of the kinescope. This, then, is the second channel into which the signal from the second detector is fed. These circuits are called synchronizing separation and utilization circuits. The sync separation circuits usually consist of limiter or clipper stages. These are tubes which are normally biased by either fixed bias or self bias means, well beyond cut-off. The polarity and amplitude of the signal which is applied to such a stage is such that only the synchronizing portion of the signal succeeds in driving the grid up into that range where plate current will flow, thus the output of such a stage consists only of synchronizing signal, the picture and blanking portions having been discarded.

The signal thus obtained contains both horizontal and vertical scanning frequency components. These components must be further separated in order to control the motion of the beam in the kinescope. There are several means of accomplishing this separation, and of utilizing the separated signals. In order to avoid undue confusion, one of the more common arrangements will be considered here. In the case of the horizontal utilization circuit, the synchronizing signal is passed thru an RC network which differentiates the impulses. This is simply a resistor and a condenser connected as shown in Fig. 1A, and whose time constant is very small. The impedance of the condenser at the higher frequency harmonics which go to make

Chicago Boys Club members enrolled for a new activity, a "ham" radio class, in which they will learn to operate receiving and transmitting sets formerly used by the Russian Tank Corps and turned over to them as a gift. Working the instrument are (left to right) Charles McDermott, Dick Brady, Chester Rice, George Fillipp and David Cesario.



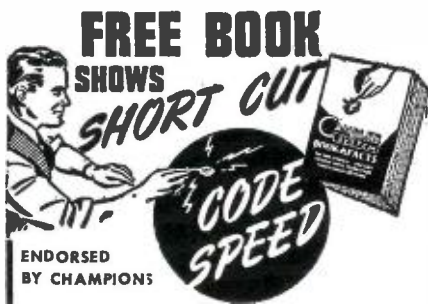

ENDORSED  
BY CHAMPIONS

Skill, speed, accuracy free of nervous tension brings big pay.

### The One and Only Candler System

Nothing else like it. It is the course that has made code champions. Will help any sincere man gain greater speed, accuracy and skill. Learn the Candler way.

### Fast, Efficient Operators Needed

If you need additional speed to be classed as an expert, try the Candler method. It is endorsed by champions. It has produced phenomenal results with a minimum of effort. Why not learn the faster and easier way. Get your copy of the Book of Facts for Code students. Telegraph and Radio Operators.

### CANDLER SYSTEM CO.

P. O. Box 928, Dept. 2-J, Denver (1), Colo.  
and at 121 Kingsway, London, W.C.2, England



### Champion Endorses CANDLER SYSTEM

T. R. McElroy, Official Champion Radiotelegraph Operator of the world with a speed of 75.2 w.p.m. claims his success is due to the Candler System.

famous for

## GREAT VALUES

### OUTSTANDING OFFERINGS OF NEW KITS

**6 Tube SUPERHET KIT**—two band complete with tubes and solid color (green, red, ivory, etc.) wood cabinet. Includes all parts, except wire and solder. Per Kit.....\$18.50

**PHONO KIT.** Consists of AC Phono-Motor, Pick up, all parts necessary for 3 tube phono Amplifier, including 5" P.M. speaker. Excludes wire, solder and tubes .....\$16.25

With PA 12 portable leatherette-covered all wood cabinet. \$7.95  
Above Kit of tubes .....\$1.85

All prices are F.O.B. New York City.

Write for our new catalogue showing new test equipment, tubes and a large variety of new replacement parts. We ship anywhere in the U.S.A. —promptly.

### RADIO DEALERS SUPPLY COMPANY

135 LIBERTY ST., NEW YORK 6, N.Y.

up the larger part of the steep leading and trailing edges of the impulses, is negligible, but its impedance at the lower frequency harmonics and fundamental is so great that these components are, for all practical purposes, lost in the process. The resultant wave form is as indicated in Fig. 1C. It will be noted that the configuration of the vertical synchronizing signal is such that there are impulses occurring during the entire vertical synchronizing period, which are in phase with the regular horizontal impulses. This explains then, the reason for the slots during the 60 cycle vertical synchronizing signal. This differentiated signal may then be used to "trigger" a relaxation type of oscillator. This may be, as is usually the case, a blocking oscillator or it may be a multivibrator, or other similar device. The fundamental or undriven frequency of the blocking oscillator should be adjustable over a narrow range and should normally be operated at a frequency only slightly below the required scanning frequency in order that it may be adequately controlled or "triggered" by the incoming signal. Since its fundamental frequency is approximately the desired scanning frequency, it is immune to the intermediate double frequency impulses which immediately precede and follow the vertical synchronizing signal. The blocking oscillator or multivibrator as used here, is a dual purpose device. When there is no synchronizing signal present to trigger the oscillator, it continues to operate at its natural frequency and thus provides a source of deflection voltage which keeps the kinescope scanning beam in motion. Were the beam to remain stationary for any appreciable length of time, a burned spot would appear on the fluorescent coating of the kinescope. Also, the oscillator acts as an amplifier in that it provides an output signal of sufficient amplitude to adequately drive the saw-tooth generating or discharge tube, although the input synchronizing signal may be of very low amplitude. The saw-tooth voltage is then amplified and applied to the deflection yoke of the kinescope in such a manner as to cause a saw-tooth current to flow in the coils of the deflecting unit.

In order to accurately reproduce the original scene, the rate at which the scanning beam moves across the face of the kinescope must be absolutely uniform. In other words, the linearity of the saw-tooth must be good. Considerable attention must be given this point in the horizontal output stage because in most cases an appreciable amount of power must be delivered by this tube to the yoke. In order to develop this required amount of power, a fairly large amplitude of saw-tooth voltage must be applied to the grid of the output stage. As is frequently the case, the amplitude of this signal may well swing the grid of the output stage beyond the limits of the straight portion of the char-

## A VERSATILE TEST LABORATORY... IN ONE COMPACT UNIT!

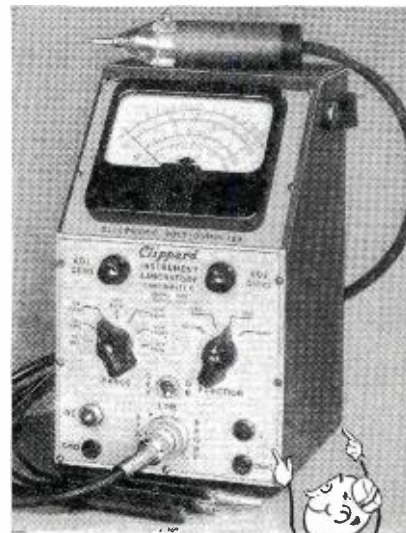

### Clippard ELECTRONIC VOLT-OHMMETER MODEL 406

**NEW BRIDGE-TYPE CIRCUIT**—fully balanced through 3 stages for maximum accuracy and stability. Tube complement: one 6X5GT rectifier, two 6SN7GT dual purpose tubes and 6AL5 dual diode in probe.

**PEN-TYPE DUAL-DIODE PROBE**—totally shielded and insulated, on detachable 36" shielded cable. High impedance, low capacity and convenient ground terminal assure accurate readings, A.F. thru U.H.F. ranges with minimum circuit disturbance.

**EXTREME RANGE**—full scale sensitivity of 0-1, 0-3, 0-10, 0-30, 0-100, 0-300 and 0-1000 volts A.C. and D.C. and 0-1,000 megohms in 7 ranges with ample overlap to eliminate guess-work. Decibel scale —20 to +51 in 3 ranges.

**INCLINED METER**—for easier, more accurate readings with less parallax.

**HANDSOME APPEARANCE**—Satin Chrome panel, etched black self-explanatory markings, convenient controls, heavy-gauge grey crackle finish steel cabinet, amply ventilated. Folding leather carrying handle. Overall size 10" x 8 1/4" x 6 1/4".

**LABORATORY ACCURACY**—calibrated to 2% accuracy at plant. 5% accuracy guaranteed in field. An instrument of laboratory quality and ruggedness priced within reach of all who want the best!

Write today for FREE bulletin  
giving Complete Details!

Electro-Magnetic Windings

R. F. Coils

Sub-Assemblies



1125 BANK ST. CINCINNATI 14, O.

# AMATEURS AND RADIO REPAIRMEN

We appreciate your bearing with us on the delay in deliveries, but hope you remember we accepted no orders for material we could not deliver.

Parts are coming in more freely now so the percentage of 100% filled orders is increasing. Thanks again.

**EXCLUSIVE DISTRIBUTORS  
FOR STROMBERG-CARLSON  
AMPLIFIERS**

*Stanton Radio Supply*

**W9PSP W9JKE  
521 State St., HAMMOND, INDIANA  
Phone 2314**

## Supreme Publications

These are the practical radio manuals you need. Improve your radio knowledge. Speed up service work. Check which manuals you want, write name below, and send this entire ad. as your order.

### MOST-OFTEN-NEEDED DIAGRAM MANUALS



1942,  1941,  1940,  1939  
Each manual has between 192 and 208 pages, 8 1/2 x 11".  
Price, each volume..... **\$2.00**



1926-1938 Radio Circuits, parts lists, hints, alignment data. 240 pages. Price, only **\$2.50**

Radio Servicing Course — Book. 22 lessons, 224 pages. Large size: 8 1/2 x 11". **\$2.50**

Record Players & Recorders. All makes, 128 pages. 8 1/2 x 11", price postpaid **\$1.50**

Practical Radio Mathematics 25c

Refrigeration Manual .....\$1.00

Encyclopedia of Television.....40c

Practical Radio & Electronics Course, 8 volumes in one, 53 lessons, for Home-Study..\$3.95

How to Modernize Radios for Profit.....\$1.00

Radio Repairing with Available Substitute Parts..25c

How to Use Diagrams in Radio Servicing.....10c



Simplified Radio Servicing by Comparison Method  
New, revolutionary different method makes radio repairing twice as easy. Introductory training included. Simple picture suggestions tell you where to look for faults and how to make the repair. No testers needed for most jobs. With job-sheets, blue prints, hints, diagrams.... **\$1.50**

**SUPREME PUBLICATIONS, 9 S. Kedzie, Chicago 12, ILL.**  
Check manuals wanted, send remittance with complete advertisement or write order in a letter. Books sent postpaid. Money back guaranteed.

Name: .....

Address: .....

144

acteristic curve. Various means have been suggested and used for improving linearity, one of which consists of an unbypassed resistor in the cathode circuit of the output stage, which, although it reduces somewhat the output voltage of the tube, does tend to straighten the tube characteristic; or the cathode resistor may be bypassed with a small condenser in order to peak the high frequency end of the pass band of the tube. In other cases, various RC networks are used in the grid circuit of the output tube or in series with the discharge condenser. Another serious cause of non-linearity of horizontal scanning is that due to the collapse of the electromagnetic field in the yoke. As this field collapses a damped oscillatory effect occurs. Obviously, such a condition would cause the rate of motion of the beam being controlled by the coil to be other than linear with respect to time. In order to eliminate this effect a damping or squelch tube is used. This is a rectifier tube which is usually connected across the secondary or output side of the horizontal deflection output transformer in such a manner that it draws current only on the negative swing of voltage which is present as the magnetic field collapses. The tube type which is used for this purpose and the resistance in series with it determines the voltage point at which it will conduct and thus absorb the back-kick from the yoke. In this way, the voltage impulse which is required in order to pass a saw-tooth current through the deflecting coils is retained as an impulse, with little or no damped oscillation following it, with the result that the scanning linearity may be maintained more accurately

Returning now to the output of the synchronizing separation tube, another branch circuit goes to the vertical synchronizing utilization circuits. Again, there have been several methods proposed for making use of the vertical synchronizing signal, but this discussion will be limited to one of the more common methods. In this circuit, the synchronizing signal is passed through a series of integrating circuits which consist of resistance and capacity as shown in Fig. 1B. In this case, it will be seen that the shunt capacities will bypass the higher frequency components of the synchronizing signal, thus the horizontal impulses will be almost, if not entirely, lost in the process. The vertical impulses, however, last for a considerably longer period of time, and contain an appreciably greater amount of energy. This greater energy content charges the condensers successively until the end of the last section of the vertical signal, when they discharge and are thus prepared for the vertical signal for the succeeding field. This process is indicated in Fig. 1D. This integrated signal then controls a blocking oscillator which in turn drives a 60 cycle saw-tooth generator or discharge tube. Following this tube are suitable amplifier stages and an output stage to feed the

# STREAMLINE

## YOUR SERVICE DEPARTMENT

with  
**4-in-1**

Job Cards - Shop Cards - Postal Notices - Storage Signals

# NOW!

## 4-in-1 offers JOB CARD STYLING

'CUSTOM TAILORED'  
SERVICE RECORDS  
STYLED TO ORDER

SAMPLES AND PRICES ON REQUEST **Radio Press** MORGANTOWN WEST VIRGINIA

**IMMEDIATE DELIVERY**

## MONITOR PRODUCTS CO.

# Crystaliner

**\$57.50 net**

**F. O. B. Los Angeles**  
Shipping Wt.—Approx.—10 lbs.

## PAPEL BROS.

**2639 E. Fourth St.  
LOS ANGELES 33, CALIFORNIA**

## MAGNETIC WIRE RECORDERS

### GENERAL ELECTRIC—MODEL 20 N-1

Built in Recording Amplifier, recording wire ready for operation on 2S volt D.C. Minor change permits playback.  
Brand new Factory sealed  
containers.....only **\$95.00**  
Power Supply for above from 110 V.A.C. line available at low cost.

### WESTERN ELECTRIC AUDIO AMPLIFIERS

Four stage High Gain Push Pull 6V6's output. Uses external power supply. Minor changes permit use as High Fidelity. P.A. AMPL. or Speech AMPL.; for Class B High Power Modulation. New sealed containers.....only **\$17.95**  
30% deposit with all COD orders.

### CLARION SOUND ENGINEERING COMPANY

363 Victory Blvd., Staten Island 1, New York

## NEW CATHODE-RAY TUBES

5CP1's in original sealed cartons, \$7.95 each. 12 pin diaphragm socket for 5CP1 when bought with tube, 45c each; otherwise, 90c each. New 5CP1 steel shields, cadmium plated, 85c each. Include shipping postage in your money order. 5CP1—5-lbs.; shield, 3-lbs. New 954 & 956 Acorn tubes in original cartons, not rejects, 89c each, postpaid in U. S.  
Write for free electronic bargain list.

### OHMEYER ENGINEERING

Fairview Blvd. Dept. C. Hempstead, N. Y.

## ELECTRONICS

Electronic Technician Training Course. Qualify for Radio Communication (Commercial Government License); Radio Repair Service; or be an Industrial Electronic Technician. Register now for new classes starting every four weeks. Approved under G. I. Bill of Rights. Residence day and evening school. Write to

### ELECTRONICS INSTITUTE, INC.

21 HENRY, DETROIT, MICH.

deflection yoke. It will be noted in Fig. 1D that each of the slots in the original synchronizing signal gives rise to a corresponding slot in the integrated signal, due to the discharge of the condenser during the short interval of time between adjacent sections of vertical synchronizing signal. These notches may be removed by adding more stages of integration. It will also be noted that due to the more rapid repetition rate of the equalizing impulses which immediately precede vertical sync, they give rise to a small increment of charge on the condenser, which adds to the much greater charge due to the larger sections of vertical sync. As has been pointed out previously, the slots in the vertical synchronizing signal are necessary in order to keep the horizontal blocking oscillator operating continuously at the proper frequency during vertical synchronizing time, since the oscillator may not recover sufficiently rapidly if this is not done. The purpose of the equalizing impulses is to improve the accuracy of interlace. They are sometimes referred to as preparatory impulses since they provide an essentially uniform set of conditions between even and odd fields for the start of the vertical synchronizing signal. Without these impulses, it will be seen from Fig. 1E, that in one set of vertical fields, call them even or odd as you will, the vertical impulse will start one full line after the last preceding horizontal impulse, while the other set of fields would start one-half line after the last preceding horizontal synchronizing pulse. Although the amount of energy obtained in the horizontal synchronizing pulse is very small, it may still be sufficient to leave some measure of charge on the integrating condenser after the passage of time represented by one-half of a horizontal scanning line. Hence, the time at which the integrated voltage reaches that point at which it will "trigger" the blocking oscillator, may be adversely affected, such that alternate fields will not be accurately spaced with relation to each other.

Linearity in vertical deflection is somewhat easier to obtain than in the case of horizontal deflection because of the lower frequency, and consequently lower impedance of the deflection coil. No squelch tube is needed on the vertical output circuit and the provisions for improving linearity seldom need be much more than provisions for adjusting the grid bias on the vertical deflection output tube, in order to insure that the saw-tooth which is applied to its grid does not over-swing the straight portion of its characteristic.

Power supplies for television receivers in the past have been fairly conventional in design. For the most part the plate supply has been merely a standard rectifier and filter. In the case of receivers, such a power supply can be adequately filtered to avoid the appearance of excessive hum

*IT'S NEW! IT'S POST-WAR*  
**SUPREME Model 565**  
**VACUUM TUBE VOLTMETER**

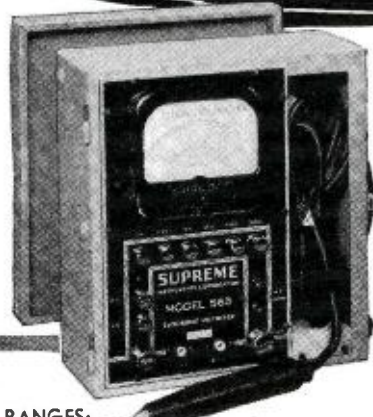

NEW PROBE Streamlined Hand Fitting. Incorporating new High Frequency Diode

**RANGES:**  
 DC 0-1, 2.5, 10, 50, 250, 500  
 AC 0-1, 2.5, 10, 50, 250  
 EXTENDED TO 5000 VOLTS BY EXTERNAL MULTIPLIERS

**FREQUENCY RANGE:**  
 Negligible frequency error from 50 cycles to 100 megacycles.

**INPUT RESISTANCE:**  
 DC—80 megohms on 1 volt range; 40 megohms on 500 volt range  
 AC—40 megohms on 1 volt range; 20 megohms on 250 volt range

**INPUT CAPACITY OF PROBE: 5 micro-micro farads**

**SUPREME INSTRUMENTS CORPORATION GREENWOOD MISSISSIPPI**



*Superior*  
**RADIO DIAL BELTS**

**ITS ROUGHNESS ASSURES SMOOTH PERFORMANCE**



This Metal Container FREE

Made of buna S rubber (#3 thin single) with smooth rubber cover on outside and rough finish on inside. Standard equipment with set manufacturers—resistant to atmospheric changes—more pliable and rougher—insuring positive grip on shafts and pulleys. Its popularity has made it the largest selling Radio Dial Belt in the U.S.A.

**FREE** Just pay for the belts and get this metal container  
 B25A Servicemans Assrt. 25 Belts  
 B50A " " " 50 "  
 B100A " " " 100 "

Ask your jobber for this handy, durable ALL METAL serviceman's sliding drawer cabinet.

Use the Belts the Manufacturers use in their original equipment.

**J · F · D · MANUFACTURING CO.**  
 4111 FT. HAMILTON PARKWAY · BROOKLYN 19, N. Y.

**IMMEDIATE DELIVERY  
OF HIGH QUALITY PRODUCTS  
FROM STOCK**

**AUTO AERIALS**

SC3, Ward antenna, 66", 3-section.....\$3.21 net  
363A1, Radiart antenna, 63", 3-section.....\$3.21 net

**VIBRATORS**

Radiart vibrators. Exact replacements for any model car radio.  
Type 5300.....\$2.41 net  
Type 5320P.....\$2.03 net  
Type 5335.....\$2.41 net  
Type 5400.....\$4.06 net  
Type 5420.....\$2.03 net

**TRANSFORMERS**

S-27, Halldorson filament, 115 v. to 2 1/2 v., 12 a.; 2 1/2 v., 3 a., C.T.; 5 v., 3 a., mtg. centers 2 1/2 x 2 1/2.....\$3.36 net  
S-25, Halldorson filament, 115 v. to 6.3 v., 4 a.; C.T.; 5 v., 3 a., mtg. centers 2 1/2 x 2 1/2.....\$3.01 net  
Also complete line of Halldorson and UTC.

**SPECIAL BARGAINS**

**VOLTMETER**

B1, Triplett, range 0-30 volts, DC.....\$2.75 net

**CORD**

6 ft. rubber AC cord with attachment cap.....\$0.21 net

**FELTEX TURNABLE REFINISHING KIT**

Contains: 18" Feltex gun, #1 antique brown Feltex, #1 antique brown Feltex adhesive, bristle brush, instruction sheet. A real profit maker.....\$3.38 net

**CORNELL-DUBILIER CONDENSERS**

EP9250, can type, lug mount, 25MFD, 450 volts.....\$1.64 net  
BR945, tubular, 8MFD, 450 volts.....\$0.51 net  
BR12215, tubular, dual 20MFD, 150 volts.....\$0.89 net  
E21645, tubular, 16MFD, 450 volts.....\$0.75 net

**METAL CHASSIS**

Budd metal chassis in all sizes. From 5x13 1/2 x 2 1/2 to 13x17x5. Send your specifications.

Send 20% deposit with order.  
Balance C. O. D.

**BARS RADIO**

AND ELECTRONIC PARTS CO.  
556 Main St. Buffalo 2, N. Y.

**WAR SURPLUS BARGAINS**

**BIG SAVINGS**  
Hundreds of specials for RADIO SERVICEMEN

- CATHODE RAY TUBES
- POWER & TRANSMITTING TUBES
- HEADPHONES, etc.
- HARD-TO-FIND TEST METERS



**7 LB. EXPERIMENTERS RADIO PARTS ASST.**

A "gold mine" for the experimenter, radio serviceman, handyman and repairman. Hundreds of valuable radio, radar and electronic parts, screw machine parts, bushings, sub assemblies, etc. More than your money's worth every time. An amazing value. Money-back guarantee.

**K130R—FULL 7 POUNDS ONLY \$179**

War Surplus Bargain Book  
Page after page of war surplus and other bargains for the radio serviceman; also specials for home, shop and outdoors.

**IT'S FREE! WRITE TO-DAY**



**STARK'S** Dept. 509 So. STATE STREET  
CHICAGO 5, ILLINOIS

components. This is contrary to transmitting equipment where it is desirable, in order to transmit a signal with an absolute minimum of hum components, to use well regulated power supplies. It is well known that any common impedance between two circuits provides a convenient path for cross-talk between these two circuits. Any power supply whose output voltage does not remain constant over its entire working range has, by definition, an appreciable internal impedance. By the addition of suitable d.c. amplifier regulating circuits to this power supply, which will maintain its voltage absolutely constant over the range of current drains demanded by the equipment which it supplies, its internal impedance can be reduced to such a low value that any cross-talk which may occur due to the fact that it is common to different circuits having widely different signal amplitudes, will be negligible. In the case of ordinary home receivers, however, such rigorous treatment of the power supply problem is not mandatory if the power handling capabilities of the plate voltage supply system are adequate and are well filtered.

The high voltage power supply may be a conventional transformer, high voltage rectifier, and filter. Since the current drain from this particular supply is extremely low, in the order of 500 microamperes, very low capacity filter condensers will suffice. Due to this low current requirement there are, however, other means of developing the high voltage required by the kinescope than with ordinary 60 cycle transformers. These include simple r.f. oscillators operating at frequencies of 100 to 500 kc. The voltage developed across the oscillator coil at the resonant frequency may be very high depending upon the "Q" of the oscillator circuit. By means of additional windings on the oscillator coil form, power for lighting the filament of a rectifier tube may be obtained as well as high voltage to be rectified by this tube, filtered, and applied to the second anode of the kinescope. Such a power supply is capable of delivering only a very small amount of power, and any demand for a greater amount of power such as would occur were the load circuit to be touched with the finger would cause the voltage to drop to a point where it would neither harm the person touching the supply, nor would it provide the accelerating potential for the kinescope. Another method of obtaining high voltage at very low power capacity is by amplification of the horizontal deflection voltage, either by tubes or transformers or a combination of both, to the point where the peak voltage obtained will be sufficient to provide the required d.c. potential for the kinescope after rectification. Both of these latter methods are safe power supplies from the standpoint of shock, but both of them require a certain amount of

*It's*  
**NEWS!**

**THE NEW  
St. Louis  
OUTDOOR RUGGED  
MICROPHONE**

One of the "Finest Line of Modern Dynamic Microphones"—engineered to fit your specific applications. This model: Range 40-9000 Cycles. Impedance output adjustable to low, 200, 500 or high, Black Lacquer, Gunmetal Gray or Olive Drab finish. Write for further information.

Licensed under patents of American Tel. & Tel. Co. and Western Elec. Co., Inc.

**St. Louis Microphone Co.**  
2726-28 Brentwood Blvd. St. Louis 17, Missouri

**PHONO CABINETS**

A plastic ebony cabinet, 1/4" thick, 13 3/4" long, 11 1/2" wide, 3 3/4" deep. Makes a streamlined mounting for phono playbacks, wireless record players, meter cases and automatic record changers. (Utah, Emerson, and others). Very sturdy; works as easily as wood. 2- or 3-tube amplifier with 3 1/2" speaker fits perfectly.

**WHILE THEY LAST:** Blanks—only \$3.69 each F.O.B. Springfield. 10% off in lots of 10. Boxes can also be ordered with motor and speaker holes already cut, and plastic grill front for an additional .50.

**VICTORIA ELECTRONICS AND SUPPLY CO.**  
1039 MEMORIAL AVE.  
WEST SPRINGFIELD, MASS.

**ELECTRONIC VOLT-OHMMETER**

**\$11.85** 110 VOLTS AC 20 RANGES

DC and AC. 0-1,000,000 ohms in six overlapping ranges. Sensitivity: over MILLION OHMS per VOLT on 5 volt range.

Complete kit includes all component parts, tubes, punched and drilled chassis and beautifully enameled panel. Easily assembled and wired.

Special slideback circuit developed during war by scientists at the California Institute of Technology gives amazing sensitivity and flexibility while completely eliminating necessity of batteries and expensive meter. Each instrument is individually calibrated. Dial scale over nine inches long!

In addition to performing the usual volt-ohm functions, this instrument easily measures these voltages: SUPERHET OSCILLATOR AVC. AFC. TRUE GRID BIAS AT THE GRID. BIAS CELLS without affecting the circuit. Measures the exact leakage resistance of INSULATION TUBES, CONDENSERS. It can be used with a signal generator for SIGNAL TRACING.

**STERLING ELECTRONIC COMPANY**  
Dept. 3  
166 N. Sierra Bonita Ave., Pasadena 4, California

**RCA Institutes, Inc.**

Offer thorough training courses in all technical phases of Radio and Television

**WEEKLY RATES** **DAYS—EVENINGS**  
**VETERANS:** RCA Institutes is approved under G. I. Bill of Rights  
For Free Catalog write Dept. RN-46  
**RCA INSTITUTES, Inc.**  
A Service of Radio Corporation of America  
75 Varick St., New York 13, N. Y.

300 ohm Amphenol twin lead, per 100 ft. \$2.90  
75 ohm Amphenol twin lead, per 100 ft. 2.00  
Navy Power Trans.—900 v. CT @ 800 ma., 2—6.3 v., 1—5 volt..... 5.95  
12' vertical army antenna with base—3 section..... 1.95

Complete line of  
RCA, TAYLOR, GE and EIMAC tubes  
Also Shure, Turner, and Astatic microphones

**DOW RADIO**  
1759 E. Colorado Pasadena 4, Calif.



**R-L** OFFERS TEST EQUIPMENT  
for IMMEDIATE delivery

**TRIPLETT**

- MODEL 2413 TUBE TESTER**  
B2806 ..... Net \$48.51
- MODEL 625N MULTI TESTER**  
**20,000 OHMS PER VOLT**  
B2800 ..... Net \$44.10
- LEATHER CARRYING CASE—Net \$5.25**
- MODEL 666H**  
**VOLT-OHM-MILLIAMETER**  
B2801 ..... Net \$19.60
- LEATHER CARRYING CASE—Net \$4.00**

**R C P**

- MODEL 668 AC-DC VACUUM TUBE**  
**VOLTMETER**  
B2847 ..... Net \$73.01

**VOMAX**

- VACUUM TUBE VOLTMETER**  
B2860 ..... Net \$59.85
- Write for Free 1946 Parts Catalog**



731 West Washington Boulevard  
Dept. N. CHICAGO 6, ILLINOIS

**Another Clark Achievement!**

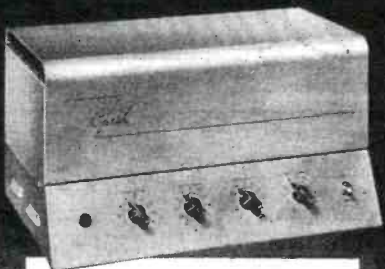

This is the 20-watt member of the Clark family of carefully engineered public address amplifiers. The PA-20 is generously rated to provide plenty of faithful volume for all except the very largest auditoriums. As in the latest radar equipment, small components are terminal strip mounted for instant accessibility.

- Inputs: 2 microphones, 1 phonograph.
- Frequency response: 30-15,000 Flat within 2 db.
- Distortion: Less than 5% over entire range.
- Hum: At least 60 db below full output.
- Output: 20 Watts (24 watts maximum).
- Output Impedance: Tapped for 4, 8, 16 and 500 ohms.

The PA-20 represents top quality engineering and performance at moderate cost. Ask your jobber or write direct for further information.

**Clark Radio Equipment Corp.**

4313 LINCOLN AVE., CHICAGO 18, ILL.

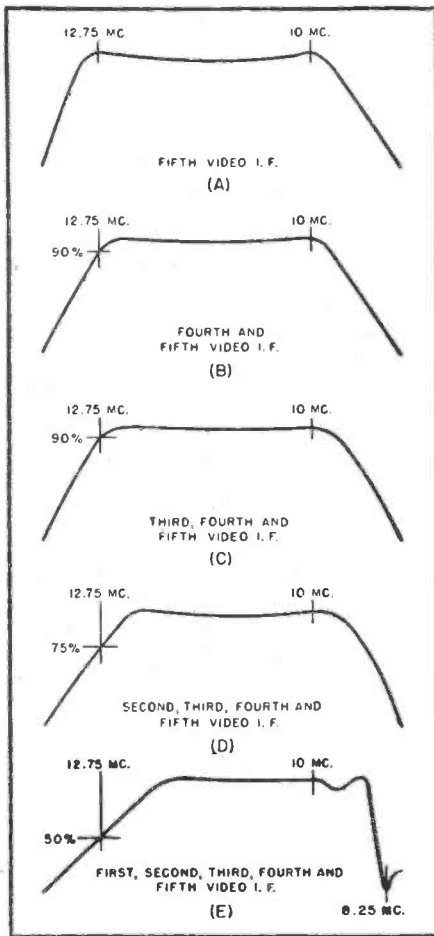

Fig. 3. Typical i.f. response curves for a receiver having five stages of i.f. amplification. The lower curve shows the effect of the sound rejector.

shielding in order to avoid cross-talk into the picture.

A slight amount of hum component from the power supplies is not objectionable in most cases. This is due to the fact that at the transmitting station the vertical deflection frequency is synchronous with the local power supply hence any hum components from the receiver power supply will result in faint stationary bars across the picture. Since these light and dark bars are stationary they will normally not be offensive; however, in those areas where the received signal originates in a power service area other than that which supplies the receiver, these hum bars may drift slowly up and down across the picture, in which case they may be extremely objectionable if the amount of hum involved is very great. The presence of power supply hum in the high voltage supply may cause bulging of the sides of the picture due to the alternate stiffening and softening of the beam of electrons as the voltage increases and decreases, and at the same time there may be a tendency for out-of-focus bands to appear across the picture, coincident with the bulges and valleys in the sides.

In any television work, whether it be with studio transmitting equipment or with receivers, the test pat-

**Order from LAKE!**  
You'll Make No Mistake!

**RADIO CABINETS & PARTS**

**NOW AVAILABLE!**  
**Postwar**  
**2 Post**  
**RECORD-CHANGER**



With luxurious brown leatherette portable case, 15" L. x 15" W. x 10" H.

D. Latest electronic developments make this modern record-changer the finest on the market today!

List price ..... \$49.95  
Dealer's net ..... 29.97

**DE LUXE RECORD-CHANGER and AMPLIFIER CASE**

De luxe changer case with ample room for amplifier. Overall dimensions: 20" L. x 16" W. x 10" H. Sturdily built of 5/8" plywood, de luxe brass hardware throughout. Inside dimensions: 15 1/2" L. x 14 1/4" W. x 9 1/2" H.

Net ..... \$12.95



**DeLuxe PHONO CABINET**

Covered in luxurious, genuine brown leatherette, has de luxe brass

hardware throughout, made completely of plywood with brown plastic handle, has padded top and bottom. Motor board 14" x 14 1/2". Overall dimensions 16" L x 15" W x 8" H. Your net price..... **\$8.95**

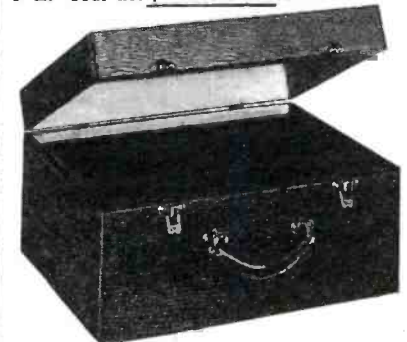

Portable Phonograph case, of sturdy durable plywood, in handsome brown leatherette finish. Inside dimensions 16 1/2" long, 14" wide, 9 1/4" high. Has blank motor board. As illustrated above. **\$6.95** specially priced at.....

Also blank table cabinets of walnut veneer in the following sizes, with speaker opening on left front side: (\*Note: #7 has center speaker grill.)  
#1 — 8 1/4" L x 5 1/2" H x 4" D \$1.95  
#2 — 10 1/4" L x 6 3/4" H x 5" D \$2.75  
#3 — 13 1/2" L x 7 7/8" H x 6 1/4" D \$3.25  
#7\* — 10 3/4" L x 7" H x 5 1/2" D \$2.50  
\*Speaker Opening in center of front side.

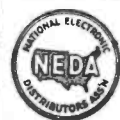

All types of radio cabinets and parts are available at Lake's Lower prices. A large stock is listed in our catalog.

**SERVICEMEN—RETAILERS**  
Join our customer list today.  
Dept. A

Write for our NEW, 12 page, illustrated elaborate catalog!

**Lake Radio Sales Co.**

615 W. Randolph Street  
Chicago 6, Ill.



**Tested and Proved  
for Accuracy and Stability**  
**Electronic  
Voltmeter Ohmmeter**

A stable bridge circuit type vacuum tube meter for measuring AC-DC voltages and ohms. Actual tests establish its superiority. Simple to operate. Hand calibration and hand calibrated multiplier resistors assure constant accuracy and stability.

Measures DC volts up to 600 with constant input resistance of 11 megohms. Resistor in the DC probe permits readings in signal-carrying circuits. Positive or negative indications through a reversal switch. Net price, \$75.00.

Meter Ranges: DC 0-3; 0-30; 0-150; 0-300, 0-600. Multiply by 4 with external probe. AC 0-3; 0-30; 0-150; 0-300. Ohms 0-1000; 0-10M; 0-100M; 0-1 Meg; 0-100 Meg.

**ELECTRONIC MANUFACTURING CO.**  
714 ROSE STREET, HARRISBURG, PA.

**RESISTORS**

**10 & 25 WATT**

A kit of 20 vitreous enameled wire wound resistors from 1 Ohm to 25000 Ohms. Also a 2 oz. jar of REVOLUTIONARY NEUTRAL SOLDER FLUX, "FORMULA B"

ALL FOR \$2.00

Limited supply—act now. Clip Coupon and Mail Postage, \$15.

BLEMAC MFG. COMPANY,  
4322 Lawrence Ave.,  
Chicago 30, Ill.

Please send immediately.....Kits.  
\$.....Money order enclosed.

Name .....

Street .....

City ..... Zone .....

State .....

tern is probably the most useful, as well as the most used tool. In standard audio broadcasting practice, tone runs provide a means of checking the performance of amplifiers; a simple 1000 cycle tone is used for routine gain measurements, and the engineer's ear (subject to checking with a CRO) detects serious distortion. The use of the test pattern provides a quick and convenient means of checking all of these conditions in a television system, as well as many others. A typical test pattern is shown in Fig. 4.

The large, heavy circle in the test pattern of Fig. 4 is so proportioned that when the scanning amplitude is adjusted so that the inner circle is tangent to the top and bottom of the picture, and the outer circle is tangent to the sides, the required 3 by 4 ratio exists. This same procedure of setting the scanning amplitude, or height and width controls, so that the inner circle is tangent to the top and bottom of the mask, and the outer circle is tangent to the sides, should be followed in the case of the receiver, otherwise the subject matter in the picture may be out of proportion.

The four tapering wedges which converge toward the center target provide a measure of the resolving power of the system. The two vertical wedges which are at right angles to the horizontal scanning lines, provide an indication of the high frequency response of the video amplifiers. That point at which the individual lines of the wedge can no longer be distinguished from each other represents the upper limit of horizontal resolution. What this resolution is, in terms of lines, may be indicated by numbers adjacent to the wedge, by concentric circles, or by dots placed along the wedge. The width and spacing of the lines in the wedge, i.e., their physical dimensions with respect to the over-all dimensions of the test pattern, are not necessarily uniform in the patterns used by all broadcasters, hence, unless the numbers appear on the pattern itself, an effort should be made to determine just what the resolution indications of a given pattern are before quoting numbers. There are indications on some test patterns which, given certain assumptions, indicate the upper limit of the pass band in terms of megacycles. A "fuzziness" or lack of sharpness of detail in the wedges, shows inadequate high frequency response. A narrow white line or transient down the right side of each of the black lines indicates excessive high frequency response or improper phase characteristic, or both. A series of short vertical lines extending off to the right of a small portion of the wedge indicates a peak within the useful range of the pass band characteristic along with attendant phase shift.

The wedges which lie in a horizontal position are used to determine vertical resolution. Obviously, the vertical resolution could never be greater than

**EASY TO LEARN CODE**

It is easy to learn or increase speed with an Instructograph Code Teacher. Affords the quickest and most practical method yet developed. For beginners or advanced students. Available tapes from beginner's alphabet to typical messages on all subjects. Speed range 5 to 40 WPM. Always ready—no QRM.

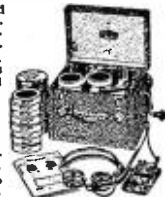

**ENDORSED BY THOUSANDS!**

The Instructograph Code Teacher literally takes the place of an operator-instructor and enables anyone to learn and master code without further assistance. Thousands of successful operators have "acquired the code" with the Instructograph System. Write today for convenient rental and purchase plans.

**INSTRUCTOGRAPH COMPANY**

4711 SHERIDAN ROAD CHICAGO 40, ILLINOIS

**Utica Tools**

**Pliers for Every Need**  
ASK YOUR DEALER

**UTICA DROP FORGE & TOOL CORPORATION**  
UTICA 4, NEW YORK

**BUFFALO'S LEADING SUPPLY HOUSE**

In the BUFFALO Area  
see DYMAC INC. for your  
radio and electronic parts and  
equipment

**Dymac INC.**

2329-31 Main Street, Buffalo 14, N. Y.

**RADIO**

RADIO Technician and Radio Communications courses. Register now for new classes starting first MONDAY of each month. Day and Evening Classes.

**AMERICAN RADIO INSTITUTE**

101 West 63d St., New York 23, N. Y.

Approved under GI Bill of Rights.

**SERVICEMEN—HAMS—  
TUBES! PARTS! METERS!**

Test Equipment in Stock!  
Kit 25-600V. By Pass Cond. \$1.95  
Write for Our Latest Bulletin!

**CHIEF ELECTRONICS**

MID-HUDSON VALLEY'S ONLY DISTRIBUTOR  
104 MAIN ST. POUGHKEEPSIE, N. Y.

**ELECTRONICS SCHOOL**

Immediate Enrollment. Technicians  
Courses in F. M. Radio P. A.  
and Television.

Approved for Veterans

For information write

**Hollywood Sound Institute, Inc.**

1040 N. Kenmore Ave., Los Angeles, Calif.

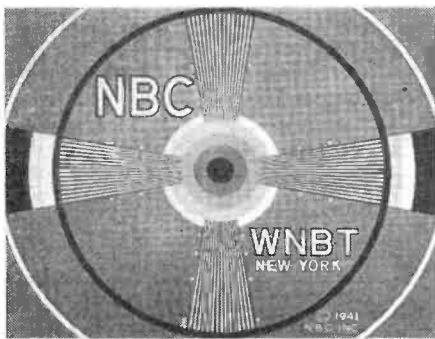

Fig. 4. Conventional type test pattern.

the number of lines in the picture (525 lines under present standards). Actually, it is invariably less since some 8% of the lines are blanked out during the vertical retrace time. An additional loss of vertical resolution may occur due to less than perfect interlace, plus the fact that there is always some doubt as to whether the position of the scanning lines with respect to the finer portion of the wedges is precisely that which will show the highest resolution. This last item, however, is not apt to seriously detract from the general picture quality.

The shading target in the center of the pattern gives an indication of saturation in the system. The center spot is black, the outer circle or the background is white, and the intermediate concentric circles represent even steps of grey between black and white. If these steps do not appear to be of uniformly increasing or decreasing density, there is saturation existing somewhere in the system.

A black or a white smear, usually following (to the right) but sometimes preceding, either a black or white object indicates improper mid-frequency response. A bas-relief effect indicates a lack of low frequency response. A second image displayed a little to the right of the main image indicates a reflection which may be in the r.f. path, or it may be due to a long unterminated cable. Egg-shaped or flattened circles indicate a lack of linearity of scanning. It will be seen that a wealth of information can be obtained from a test pattern picture, although a certain amount of experience is necessary in order to properly evaluate each of the symptoms which may appear.

The proper adjustment of a television receiver is very often misunderstood. Certain precautions are taken in the transmission of television signals to ensure the desired effect at the receiver, but in many cases, unless the receiver is properly adjusted, these effects may go wholly unnoticed or they may be distinctly disturbing to the viewer. On many receivers the controls for the adjustment of scanning amplitude, the centering of the picture within the mask, and the distribution or linearity controls, are screw driver adjustments since they normally do not require adjustment other than when repairs are made or when tubes are changed. The hori-

## PULL THE TRIGGER- START TO SOLDER

with new Transformer Type  
**SOLDERING GUN**

HEATS IN  
5  
SECONDS



Release trigger and circuit breaks automatically. Intermittent heat saves power when continuous use is unnecessary. Fast heating, SPEED IRON is always ready for use.

- SOLDER IN TIGHT PLACES—AROUND CORNERS
- PERFECTLY BALANCED—EASY TO HANDLE
- STAYS TINNED—NO TIP BURNING
- LOW VOLTAGE, HIGH CURRENT FROM BUILT-IN TRANSFORMER
- IMPACT RESISTANT PLASTIC CASE AND HANDLE—STAYS COOL

**WELLER MFG. CO.**  
512 NORTHAMPTON ST. • EASTON, PA.

\*TRADE MARK REG. U. S. PAT. OFF.



100 WATTS  
115 VOLTS  
60 CYCLES

NEW TRANSFORMER  
PRINCIPLE FOR  
FAST HEAT

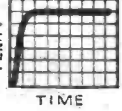

TEMP.  
TIME



SEE WHAT  
YOU SOLDER

Ask for SPEED IRON at  
your RADIO PARTS DISTRIBUTOR

## HAM HEADQUARTERS FOR Equipment and Information

### EXTRA SPECIALS

- J-38 Key with Switch...\$ .80
- TAC MS700  
Master Code Practise  
Oscillator ..... 10.25
- Aero—  
Running time meter  
60 cycle A.C. .... 3.50
- Meters 2" case  
0-150 V-AC  
0-30V-DC-5 MA Move-  
ment .....ea. 2.25
- DPDT Relay 5 V. DC... 1.75
- 2 Mfd.—  
1000 V. Round Can.... 1.50
- 3 x 3—  
600 V. oil filled..... .99
- Air Trimmers 100 MMfd. .50

Mail Orders Promptly Filled  
Amateurs to Serve You  
(20% Must Accompany All  
C.O.D. Orders)  
Write Dept. R.N.  
W6SCQ—W6UXN—W6NAT  
W6SSU

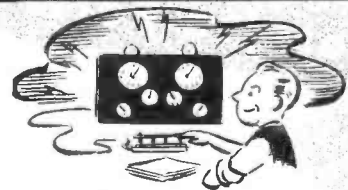

### FOR YOUR NEW RIG

We Have a Good Stock of  
All Standard Lines

### SUPER BUY!

Army BC-611F Handie-Talkie  
Complete with Tubes and Bat-  
teries ..... \$49.50

## Radio Product Sales Company

238 WEST 15TH STREET  
LOS ANGELES 15, CALIFORNIA PRespect 7471

# CAREER Radio

**FOUR INTENSIVE COURSES**

Each one a chance for ambitious men and women to increase earning capacity and promote permanent employment.

- 1. RADIO TECHNICIAN.** A general course including FM and Television. Students learn by constructing electronic and radio equipment under expert supervision.
- 2. RADIO COMMUNICATIONS.** Prepare for FCC licenses. Includes telegraphy. Leads to position as merchant marine or flight radio officer.
- 3. AIRLINE COMMUNICATOR NON-TECHNICAL.** Of special interest to YOUNG WOMEN. Prepares for employment in airport flight control offices.
- 4. RADIO & TELEVISION SERVICE.** Employment as repairman on home-type equipment including standard broadcast and FM, as well as Television receivers.

**MELVILLE RADIO INSTITUTE**  
"the radio school managed by radio men"

**CLIP THIS COUPON**  
SEND ME FREE INFORMATION

NAME \_\_\_\_\_  
ADDRESS \_\_\_\_\_  
**MELVILLE RADIO INSTITUTE**  
45 W. 45th St.  
New York 19, N. Y.

# RADOLEK

## Radio-Electronic Service Parts

Large stocks assure the finest and most complete selections of all available items at lowest prevailing prices. Thousands of active buyers depend on us for their entire Radio repair and replacement requirements. Because we understand service problems, every order is expedited for delivery in double quick time. Everything we do is planned for convenience and satisfaction to our customers. You will find it profitable to make Radolek your buying headquarters.

**FREE BUYING GUIDES**

Because of existing conditions we keep our customers right up to the minute on available merchandise by releasing supplements frequently instead of sending our regular Big Profit Guide once a year. Send the coupon now to get these Free Buying Guide Supplements as they are issued.

**FAST SERVICE!**

**RADOLEK CO., Dept. B-117**  
601 W. Randolph St., Chicago 4, Ill.

Please send FREE Buying Guide Supplements

NAME \_\_\_\_\_  
ADDRESS \_\_\_\_\_

**ORDER FROM RADOLEK**



zontal and vertical speed or synchronization controls may or may not be knobs within reach of the user. In general, these knobs need but little adjustment under ordinary conditions. The contrast and brightness knobs are the most misused of all the controls.

With the station selector knob tuned to the desired station, the contrast control should be turned fully counterclockwise, then the brightness control should be turned slowly from a clockwise position until illumination of the screen almost disappears. Then advance the contrast control until the picture appears at its best. A slight further reduction of brightness is usually desirable. The contrast control turned too far clockwise causes blurring. In addition to this effect, if the contrast control is turned up too high, an intentional reduction of blanking amplitude at the transmitting station such as would occur during a night scene will cause the screen of the receiver to go completely black. Conversely, if the contrast knob is not high enough there will appear to be a milky haze over the picture. It will appear somewhat "washed out." The common misconception in this respect is that the higher the contrast, the brighter the picture with no limitations. This is not true. The brightness of the picture, as it is usually referred to, but which is more accurately described as the contrast range of the picture, is a function of the fluorescent material in the kinescope screen and how long it has been used, as well as the accelerating voltage which is applied to the kinescope. With a given kinescope and a given accelerating voltage, the maximum contrast is limited and any increase of signal applied to the grid of the kinescope beyond this value will do no more than cause saturation and attendant loss of detail in the blacks, or the whites, or both. Proper operation of the receiver by the user is, therefore, of considerable importance if the final result is to be as intended by the producer and engineers at the broadcasting studio.

### VOICE COIL LEAD

**T**he voice coil leads or wires are very close to the speaker cone in some radio speakers and may touch or rest against the cone.

It is usually possible to bend such wires to a position where they will clear the cone. See photo. In some instances it may be necessary to shorten the wires or to tape in the desired position.

H. L.

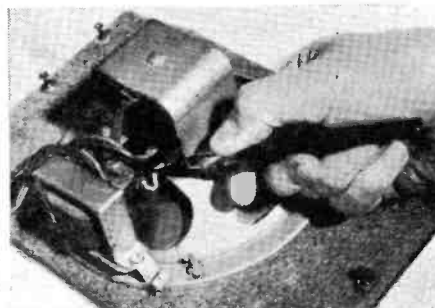

# Classified

Rate 20c per word. Minimum. 10 words

## RADIO ENGINEERING

RADIO Engineering, Broadcasting, Aviation and Police Radio, Servicing, Marine Operating and Electronics taught thoroughly. Expenses low. Write for catalog. Valparaiso Technical Institute. Dept. N. Valparaiso, Ind.

## FOR SALE

SELENIUM Rectifiers, full wave .5 ampere, \$1.85; 1 ampere, \$2.50. Half wave 5 amperes, \$4.50; 2.2 amperes, \$2.25; 1.5 ampere, \$1.85. Bulletin. Burma Radio, Route 5, Grand Rapids, Mich.

RADIO tubes, parts, wholesale. Bulletin, 3c. Henshaw, 3313 Delavan, Kansas City, Kansas.

TUBULAR paper and electrolytic condenser manufacturing equipment, consisting of 22 pieces, vacuum tanks, pumps, dryers, motor generator sets. Write Aviola Radio Corporation, Phoenix, Arizona.

CRYSTAL set, consists of coil, variable condenser, crystal, \$2.25 postpaid. Code oscillator kit, 3 tone positions. Requires key, phones, battery, \$3.00 postpaid. Used tubes: 24, 26, 71, 58, 77, 25c each. Knipe, Nampa, Idaho.

HAMMARLUND Super-Pro complete with power pack, 5 bands, perfect condition. Charles Wolosy, 136-16 Hillside Avenue, Richmond Hill 18, New York City, New York.

WAR Surplus Radio Parts—IN21 Sylvania Crystal, 98c; Condensers, Resistors. Free Bargain Lists. Erie Supply, 88 Exchange Street, Rochester, N. Y.

G.E. PYRANOL Condensers, 2MFD—4000 V. D.C., \$5.50; G.E. Pyranol Condensers, 2 MFD—1000 V. D.C., \$.95; G.E. Pyranol Condensers, 1 MFD—1000 V. D.C., \$.75; G.E. Pyranol Condensers, .05 MFD—1000 V. D.C., \$.35; 115v. A.C. DPDT relay Dunco, \$1.75; 18-28v. D.C. DPDT relay Allied, \$1.00; 20v. D.C. 4 PDT relay Allied, \$1.25; 2 section circuit breaker 8 A; 25 A; \$2.25; 866 Filament transformer, Kenyon T389, 2.5v.; 10A., \$3.95; 304 TL power tube assembly; includes tube, filaments, transformer, bypass condensers, tube socket, plate cap, wired and ready to use, \$15.00; 3"—0-4000v. D.C. meter, with external series multiplier (0-1 mil. basic movement) Roller Smith, \$5.75; Power transformer 425-0-425 @ 1.0 amp, 115v. pri., \$7.50; Linemaster foot treadle switch; step to make—step to break; 15 A. @ 125v., \$6.00; 866/866A Jan, \$1.30; 25% with order—balance C.O.D. Greenwich Sales Co., 57 Cortlandt St., New York 7.

PAN OSCILLO Receiver — (Does work of four units). Latest design 3" oscilloscope, panoramic adapter, synchroscope, receiver (when used with converter). Ideal for laboratory, television and general service work. 60 cycle transformer supplied (installed, filter reworked, tested, \$8.00 extra). New surplus originally \$1750, your cost with 21 tubes, \$97.50. Write for folder or send 50c for 80-page Technical Manual. 5G selsyn motors, 110 AC, 60 cycle. Ideal antenna or wind direction indicator, \$12.00 pair. Selected RC 406 15 tube 205 mc receiver 110 volt, 60 cycles. Easily converted 2-10 meter (Instructions furnished). FM or television bands. Complete with tubes, \$30.00. New Meters, low prices; write for list. Westchester Electronic Products, 20 Millburn St., Bronxville, New York.

SCR-211 FREQUENCY Meters, \$75.00; C-1 Auto-pilot Amplifier, 7 Locktal Tubes, 6 Plate Relays, etc., \$5.75; Free Descriptive List, Free Surplus Procurement Service. Engineering Associates, Fair Hills Branch, Box 26, Dayton, Ohio.

THREE RCA 1840 Iconoscope pickup tubes. Brand new in original wrapping. Substantial discount for quick buyer. Room 772, 11 West 42 Street, New York, N. Y., Longacre 5-1616.

NAVY Radar Oscilloscopes—ASB models. Complete with 5BP1 and 4-6AC7 tubes, high gain amplifiers, highest quality components. Tested before shipment. Special \$25. Send for list of bargains in Navy radar equipment. Seaboard Surplus, P.O. Box 719, Jacksonville, Fla.

HALLICRAFTER receiver S-20R. Like new. Write Box 203, Hodgenville, Kentucky.

WIRELESS phono-osc. transmits recordings from phono pick-up or voice from carbon mike to radio without wires up to 500 ft. AC., DC., complete with tubes, \$7.95; in kit form, \$6.50. "Constant Electric," 112 Cornelia St., Brooklyn, N. Y.

## CORRESPONDENCE COURSES

USED correspondence courses, educational and technical books bought, sold, rented. Catalog free. Educational Exchange, Henagar, Ala.

USED Correspondence Courses and Educational Books sold or rented. Inexpensive. Money-back guarantee. Write for Free Catalog listing 4000 bargains.—(Courses Bought.)—Lee Mountain, Pisgah, Ala.

CORRESPONDENCE Courses and self-instruction books, slightly used. Sold. Rented. Exchanged. All subjects. Satisfaction guaranteed. Cash paid for used courses. Complete information and 100-page illustrated bargain catalog FREE! Write Nelson Company, Dept. 2-59, Chicago 5.

AMATEUR radio licenses. Complete code and theory preparation for passing amateur radio examinations. Home study and resident courses. American Radio Institute, 101 West 63rd Street, New York City.

LOWEST Prices. Radio Tubes, parts. Bargain lists 3c. Potter, 1314 McGee, Kansas City 6, Mo.

YOU can master mathematics. Key to the Electronic Age. Write O-Universal School of Mathematics-O, 623 Walter Story Bldg., Los Angeles, Calif.

## HELP WANTED

RADIO Instructors. Receiver servicing experience. College Degree preferred. \$3600 a year to start. \$4200 after four months. Work in the heart of the Radio Industry. Write Raleigh G. Dougherty, 158 Market Street, Newark 2, New Jersey, % New York Technical Institute of New Jersey.

ONE expert radio repairman, capable of handling house and auto sets. Five years' experience desirable. Write P. O. Box 371, Aberdeen, North Carolina.

WANTED, Glassblower for research laboratory. Must be highly skilled in electronic vacuum tube work and in all types of glass-to-metal seals. Address Betatron Laboratory, Ohio State University, Columbus 10, Ohio.

INSTRUCTORS in Electronics and Radio. Prefer former Navy Radio Technician instructors willing to locate in the Detroit, Mich., area. Write to Box 431, % Radio News.

## SITUATIONS WANTED

RADIO Radar Technician. Grad. Navy Radio Materiel School. CREI student. Both FCC licenses. Desires any type radio work. Charles H. King, 483 Columbia Rd., Dorchester 25, Mass.

## PATENT ATTORNEYS

PATENTS—U.S. and Foreign Patents Secured. Trade-marks and Copyrights registered. Searches made to determine Patentability and Validity. Patent, Trade-mark and Unfair Competition Causes. Lancaster, Allwine & Rommel, Registered Patent Attorneys, Suite 414, 815 15th St., N.W., Washington 5, D. C.

PATENTS SECURED. Two valuable booklets sent free. Write immediately. Victor J. Evans & Co., 148-J Merlin Bldg., Washington 6, D. C.

## RADIO EQUIPMENT

SUPERHET Manual, \$2.50. Free electronics bookalog! Stone, Lunenburg 24, Mass.

## WANTED

WANTED: 7B4 tubes. Any quantity up to fifty. Notify at once! J. A. Schoke, 500 W. Fullerton Pkwy., Chicago 14, Ill.

## MISCELLANEOUS

ATOMITE Power Mower-Sensation. Cuts—trims. Live Agents—Dealers. Farm Products, TP-3057, Excelsior Springs, Mo.

ELECTRICAL Instrument Service, 15 Howard Ave., Vallejo, California. Send us your meters and instruments for fast and reasonable repair, calibration and conversion. Write for estimates.

BUILD your own radio 5 tube super het kit complete with all tubes and walnut cabinet using 50L6, 35Z5, 12SA7, 12SK7, 12SQ7. All major parts assembled. Easy to wire. Your cost, \$16.95. McGee Radio Co., 1330 Broadway, Denver, Colo.

AGGRESSIVE, financed company with competent technical staff wants line of Radios and Appliances for distribution in France. Agent in U.S.A. Box 434, % Radio News.

PROGRESSIVE Radio business. Exclusive territory. Central Radio Service, Goldbeach, Oregon.

## Hospitalization

(Continued from page 45)

the 90-day guarantee period which each dealer carries.

When new radios are available in quantity, Carrillo does not intend to take in old radios in trade for some time. Nor does he intend to issue blanket contracts on new sets purchased. The Radio Maintenance Plan will probably always remain voluntary on the part of the customer. In most cases, the customer will find it advantageous to participate in this special service.

Every contract sold, Carrillo points out, is a potential customer for the purchase of a new radio or electrical appliances. Hence, the Maintenance Plan is not only a good will booster, but actually boosts new sales as well as the volume of radio repair.

—50—

## PARTS SHOW BREAKS ALL RECORDS

THE 1946 Radio Parts and Electronic Equipment Conference and Show was the most outstanding event in the history of the radio industry according to figures released by Kenneth C. Prince, General Manager of the Show.

Registration reached an all-time high of 7562 individuals, 2500 of whom were affiliated with distributing firms. This number did not include radio servicemen or amateurs. The largest previous attendance at any trade show in the radio industry was 4400.

Aside from the record-breaking attendance, the 1946 Show was unique in many respects. More manufacturers exhibited their products than in any previous show. There were 169 manufacturing lines and 14 publications occupying booths. This represented an increase of 40% over the largest prior year.

Foreign representation was significant. Canada had the largest number, with Mexico a fairly close second. Other foreign countries represented were England, France, Belgium, South Africa, China, Sweden, Denmark, the Philippine Islands, Argentina, Cuba, Siam and the Territory of Hawaii.

—50—

## ERRATUM

The dual-triode tube  $V_{1-A}$  and  $V_{1-B}$  in Fig. 5, page 42, of the June, 1946 issue of Radio News was listed in error as a 6F6G. This tube is actually a 6F8G.

★ ★ ★

The Recordgraph film recorder described in the article "Embossing Sound on Film" in the June, 1946 issue of Radio News was manufactured by Frederick Hart & Company, 350 Madison Ave., N. Y. C., N. Y. This information was inadvertently omitted.

## Photo Credits

Pages	Credit
25, 26 (bottom)	Joint Army-Navy Task Force from Acme
26 (top)	Air Transport Command
28, 41, 43, 44	Radio Club de Mozambique
20	Electro-Voice, Inc.
30, 31, 108	General Electric Company
32, 33	Arthur Haug, Staff Photographer
55	J. A. V. Bourne
74	Shure Brothers
88, 142	Acme
100	Farnsworth Television & Radio Corp.
120	Radio Club de Mozambique
123	Radiodiffusion Nationale Beige
149	NBC

New Models  
Available Now!

of **ATR**

Quality Products



ATR  
"A"

## BATTERY ELIMINATORS

FOR CONVERTING A.C. TO D.C.

New Models . . . designed for testing D.C. electrical apparatus on regular A.C. lines. Equipped with full-wave dry disc type rectifier, assuring noiseless, interference-free operation and extreme long life and reliability.

- Eliminates Storage Batteries and Battery Chargers.
- Operates the Equipment at Maximum Efficiency at All Times.
- Fully Automatic and Fool-Proof.



ATR

## LOW POWER INVERTERS

FOR INVERTING D.C. TO A.C.

Another New ATR Model . . . designed for operating small A.C. motors, electric razors, and a host of other small A.C. devices from D.C. voltages sources.



ATR

## STANDARD AND HEAVY DUTY INVERTERS

FOR INVERTING D.C. TO A.C.

Specially designed for operating A.C. radios, television sets, amplifiers, address systems, and radio test equipment from D.C. voltages in vehicles, ships, trains, planes, and in D.C. districts.

WRITE FOR NEW CATALOG—  
JUST OFF THE PRESS!

AMERICAN TELEVISION & RADIO CO.

Quality Products Since 1931

ST. PAUL 1, MINN.

U. S. A.

# INDEX OF

# Advertisers

August  
1946

NAME	AGENCY	PAGE	NAME	AGENCY	PAGE
Abell Distributing Co., The	Brodix Advertising Agency	112	Maritime Switchboard		108
Adson Radio Co.	Mitchell Advertising Agency 116, 120		Melville Radio Institute	Saidel Advertising Agency	149
Aerovox Corporation	Austin C. Lescarboura & Staff	89	Metropolitan Electronic & Instrument Co.	Mitchell Advertising Agency	125
Air King Radio	Henry A. Loudon Advertising	87	Miles Reproducer Co., Inc.	Altomari Advertising Agency	127
Alliance Manufacturing Company	Foster & Davies, Inc.	87	Millen, James Mfg. Co., Inc.	James Millen, Inc.	12
Allied Radio Corporation	George Brodsky Advertising	9	Monitor Products Co.	Dennis Advertising Agency	113
Alsam Products Company	Sander Rodkin Adv. Agency	134	Moraine On the Lake	Harry Atkinson, Inc.	84
American Phenolic Corporation	Burton Browne Adv. Agency	73	Murray Hill Books, Inc.	Harry P. Bridge Company	60, 61
American Radio Institute	Sternfield-Godley, Inc.	148	McElroy Mfg. Co.	Shappe-Wilkes, Inc.	96
American Television Institute	Turner Advertising Agency	69	McGee Radio Company		127
American Television & Radio Co.	Firestone-Goodman Adv. Agency	151	McGraw-Hill Book Co.		128
Amperex Electronic Corp.	Frank H. Kaufman	72	McMurdo Silver Company	Edward Owen & Company	85
Appliance Training School	A. L. Addison Advertising	137			
Arrow Radio Co.		106	National Company, Inc.	Graydon Smith Advertising	23
Atomic Heater & Radio Corporation	W. Montague Pearsall	132	National Radio Distributors	Burke & Wayburn	132
Audak Company	Hart Lehman	8	National Radio Institute	VanSant, Dugdale & Co., Inc.	3
Audel Publishers	Grant & Wadsworth, Inc.	120, 138	National Schools	Mayers Company	21
			National Union Radio Corp.	Hutchins Advertising Agency	79
Baker-Phillips Company	Mitchell Adv. Agency, Inc.	88	Newcomb Audio Products Co.	Gail Hall Advertising	78
Bars Radio & Electronic Parts Co.	Harold Warner Company	146	Niagara Radio Supply	Sternfield-Godley, Inc.	110
Bell Telephone Laboratories	N. W. Ayer & Son	78	Norman Radio Distrib., Inc.	Mitchell Advertising Agency	120
Blumac Manufacturing Co.		148			
Bliss Electrical School	N. W. Ayer & Son	134	Ohmeyer Engineering		144
Brach, L. S. Mfg. Corp.	United Advertising Agency	141	Olson Radio Warehouse	Jessop Advertising Agency	66
Bud Radio, Inc.	Allied Advertising Agency	98	Onan, D. W. & Sons	Graves & Associates	96
Buffalo Radio Supply	International Adv. Agency	129			
Burlington Instrument Co.	Weston-Barnett, Inc.	115	Pa-Kette Electric Co.	Arrow Advertising Agency	134
Burnell & Co.	Mitchell Advertising Agency	104	Panoramic Radio Corporation	Shappe-Wilkes, Inc.	10
Burstien-Applebee Co.	Frank E. Whalen Advertising	92	Papel Brothers		144
			Permoflux Corporation	Turner Advertising Agency	117
California Radio & Electronics Co.	Mitchell Advertising Agency	17	Potter Radio Co.		134
Candler System Co.	Van DeMark Advertising Agency	143			
Capitol Radio Engineering Institute	Henry J. Kaufman Advertising	87	RCA Institutes, Inc.		146
Carlock Laboratories of Applied Physics & Electronics		138	R. C. & L. F. Hall, Inc.		88
Chicago Industrial Instrument Co.		126	R-L Electronic Corp.	R. S. Wittenberg Advertising	147
Chicago Wheel & Mfg. Co.	Weston-Barnett, Inc.	118	Radio Dealers Supply Company	H. J. Gold Advertising	143
Chief Electronics		148	Radio Electric Products, Inc.	Rozen Advertising Agency, Inc.	140
Clarion Sound Engineering Co.		144	Radio Electric Service Co.	E. L. Brown Advertising	138
Clark Radio Equipment Corp.	Turner Advertising Agency	147	Radio Equipment Distributors	Ross, Gardner & White Adv.	130
Cleveland Institute of Radio Electronics		84, 135, 141	Radio Ham Shack, Inc.	J. R. Kupsack Adv. Agency, Inc.	140
Clippard Instrument Laboratory	Kenneth H. Kolpien	84, 135, 141	Radio Kits Company	Edward Hamburger Advertising	90
Collins Radio Company	Savage & Talley	143	Radio Maintenance	Shappe-Wilkes, Inc.	13
	McCann-Erickson, Inc.		Radio Parts Company	Sidney S. Lovitt	78
			Radio Press		144
Communications Equipment Co.	Borough Advertising Agency	91	Radio Product Sales Company	Barton A. Stebbins	149
Concord Radio Corporation	E. H. Brown Advertising Agency	71	Radio Shack, The	Engineered Advertising	118
Cornell Dubilier Electric Corp.	Reiss Advertising	19	Radio Supply & Engineering Co., Inc.	Karl G. Behr Advertising Agency	102
Cornell Maritime Press	Ray-Hirsch & Waterston	138	Radio & Television Supply, Inc.		122
Cornish Wire Company, Inc.	Hart Lehman	134	Radio & Television Supply Co.	John Falkner Arndt & Co.	121
Coyne Electrical School	Phil Gordon Agency	95, 131	Radio Wire Television, Inc.	Reiss Advertising Agency	88
Coyne Electrical School	McJunkin Advertising Agency	126	Radionic Equipment Co.	Hirshon-Garfield, Inc.	66
Crabtree's Wholesale Radio		134	Radolek Co.	Turner Advertising Agency	122, 150
Crystal Research Laboratories, Inc.	Post & Johnson, Inc.	119	Rador Company		131
			Reed Mfg. Co.	Borg Advertising Agency	135
D & D Radio	Mitchell Advertising Agency	132	Reliance Electronics Co.	Paul Basinger Studio	116
DeForest's Training, Inc.	MacDonald-Cook Co.	15	Research Manufacturing Corporation		132
Dow Radio		146	Rider, John F. Publisher, Inc.	Lansford F. King Advertising	16
Drake Electric Works, Inc.	William Hoffman & Associates	140	Risco Sales Company	Diener & Dorskind	130
Dymac, Inc.	Harold Warner Co. Advertising	148	Rowe Industries	Miller Agency Co.	126
Eagle Radio	Mitchell Advertising Agency	100	S/C Laboratories, Inc.	Gallard Advertising Agency	118
Editors & Engineers		134	Sams, Howard W. & Co., Inc.	Aitkin-Kynett Co.	63
Electronics Institute, Inc.		144	Sauereisen Cements Company	McCarty Co.	131
Electronic Manufacturing Co.	Business Service Company	148	Scenic Radio & Electronics Co.	Mitchell Advertising Agency	128
Electronic Products Co.	Feldman & Lefler, Inc.	122	Scientific Radio Products Company	Allen & Reynolds	96
Electronic Supply Corp.		140	Sheffield Radio & Appliance Co.	Sander Rodkin Adv. Agency	131
Elesak Corp.		124	Shure Brothers, Inc.	Phil Gordon Agency	123
			Shure's Radio Supply	Advertising, Inc.	128
Fada Radio & Electric Company, Inc.	Sternfield-Godley, Inc.	Fourth Cover	Snap-On-Tools Corporation	Scott-Telander Adv. Agency	11
Fahnestock Electric Company, Inc.		133	Snyder Manufacturing Co.	Abner J. Gelula & Associates	82
Farnsworth Television & Radio Corp.	N. W. Ayer & Son	97	Sprague Products Company	Harry P. Bridge Company	20
Flanagan Radio Corporation	Stewart-Jordan Corp.	83	Sprayberry Academy of Radio	Harry P. Bridge Company	7
			St. Louis Microphone Co.	Altman-Gilbert Adv. Agency	146
Gates Radio Company	Ridgeway Company	93	Standard Radio & Electronic Products Co.	Hutzler Advertising Agency	80
General Cement Mfg. Co.	Turner Advertising Agency	116	Stanton Radio Supply		144
General Electric Company	Maxon, Inc.	106	Stark's	A. L. Addison Advertising	146
General Industries Co., The	Fuller & Smith & Ross, Inc.	70	Sterling Electronic Company		146
General Test Equipment Co.	Suzanne Hayman Advertising	138	Stevens Walden, Inc.	Howard Wesson Co.	14
Greenlee Tool Co.	Howard H. Monk & Associates	106	Suburban Radio Company		139
Guardian Electric	Kennedy & Company	6	Sun Radio	Kal, Ehrlich & Merrick	114
			Sun Radio & Electronics Co., Inc.	Mitchell Advertising Agency	124
Hallcrafters Co., The	Burton Browne Advertising	5	Superior Instruments Co.	Mitchell Advertising Agency	154
Hammarlund Mfg. Co., Inc., The	Roeding & Arnold, Inc.	24	Supreme Instruments Corp.	O'Callaghan Advertising Agency	145
Hanlan Company	Advertising Management Service	138	Supreme Publications	Henry H. Teplitz	144
			Sylvania Electric Products, Inc.	Newell-Emmett Company	67
Harrison Radio Corporation	Altomari Advertising Agency	137			
Harvey Radio Company, Inc.	Shappe-Wilkes, Inc.	65	Terminal Radio Corporation	Regent Advertising Agency	109
Henry Radio	Burton Browne Advertising	94	Triplet Electrical Instrument Co.	Western Advertising Agency	18
Henshaw Radio Company		137	Tri-State College	Clem J. Steigmeyer Advertising	122
Hollywood Sound Institute, Inc.	Nelson Advertising Service	148	Turner Company, The	W. D. Lyon Company	58
			Trutone Products Co.	Terrill Belknap March	136
Illinois Condenser Company	Sander Rodkin Adv. Agency	136			
Instructograph Company	Turner Advertising Agency	148	Union Radio Corporation	Sander Rodkin Adv. Agency	128
Insuline Corporation of America	S. R. Leon Company	107	United Screw & Bolt Corporation	Fred Mellis Advertising	81
			Universal Radio Supply Co.	Kemmerer, Inc.	142
J. F. D. Manufacturing Co.		145	Utica Drop Forge & Tool Co.	Devereux & Company	148
Jensen Manufacturing Company	Burton Browne Advertising	22			
Johnson, E. F. Company	David, Inc.	64	Vaco Products Company	Duane Wanamaker Advertising	130
			Valparaiso Technical Institute	Smith, Benson & McClure, Inc.	96
Kellogg Switchboard & Supply Co.	Evans Associates, Inc.	99	Vasco		127
Kwikheat	Beaumont & Hohman, Inc.	111	Victoria Electronics and Supply Co.		146
Lake Radio Sales Co.	Sander Rodkin Adv. Agency	147	Waterproof Electric Company		101
Lectrohm, Incorporated	Merchandising Advertisers	120	Webster-Chicago	William Hoffman & Associates	124
Leotone Radio Co.	Altomari Advertising Agency	74	Weller Mfg. Co.	Beaumont, Heller & Sperling	149
Liberty Sales Co., Inc.	Sternfield-Godley, Inc.	76, 77	Wells Sales, Inc.	Turner Advertising Agency	127
Lifetime Sound Equip. Co.	Miller Agency Co.	130	World Radio Laboratories, Inc.	Pfeiffer Advertising Agency	62
Lincoln Engineering School	Buchanan Thomas Adv. Co.	128			
Lyell Hardware Co.		138			
Mac's Radio Supply		140			
Mallory, P. R. & Co., Inc.	Aitkin-Kynett Co.	Third Cover	York Radio Distributing Co.		140

# HEAVY-DUTY OIL-FILLED CAPACITORS

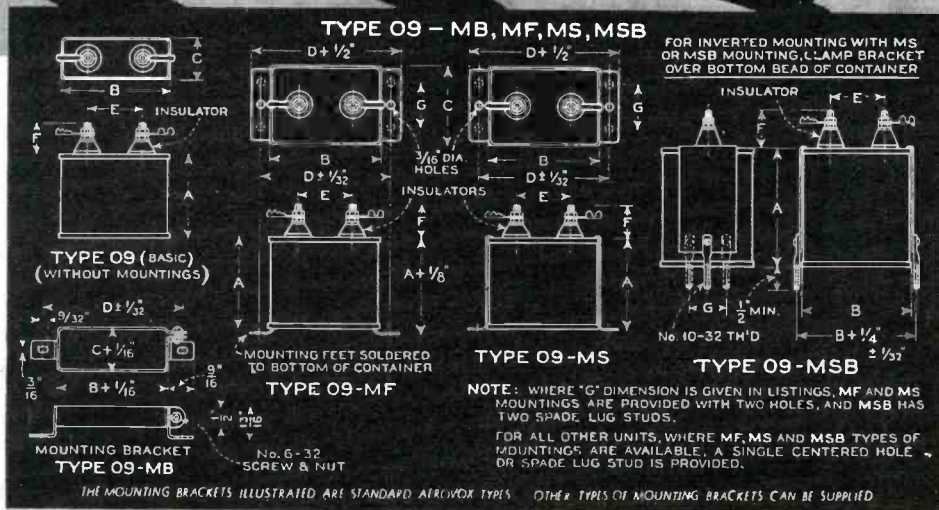
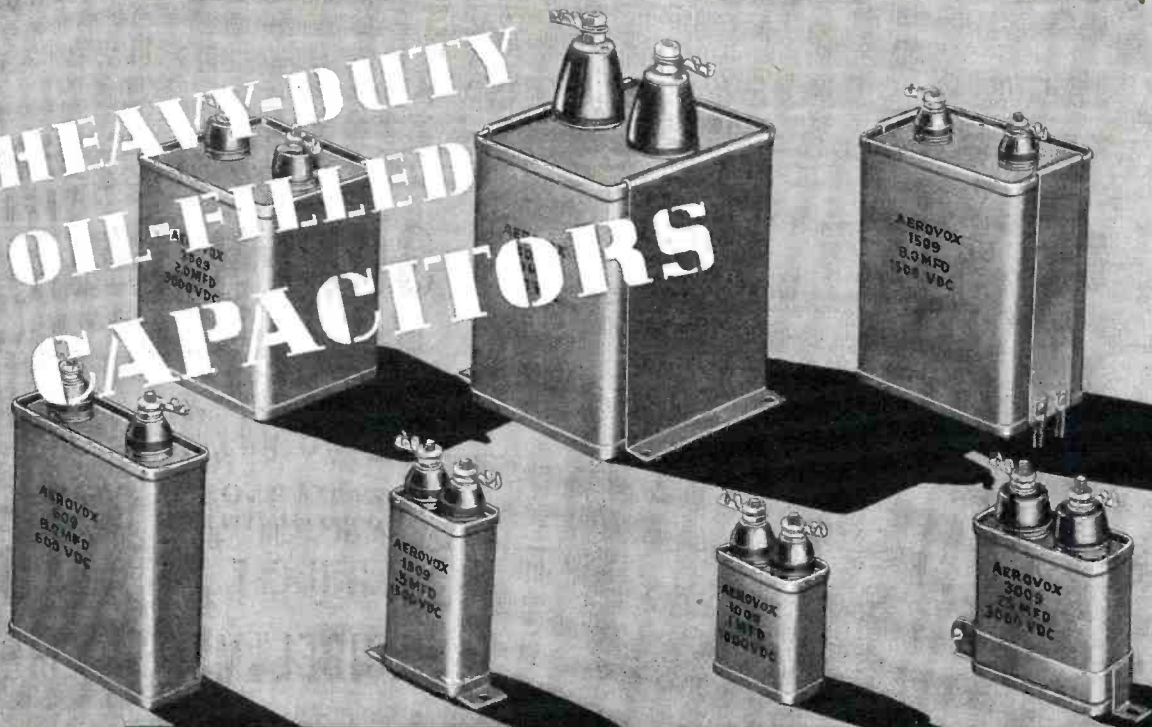

**VERSATILITY**—with economy of chassis space and assembly operations a prime factor—distinguishes Aerovox Type 09 oil-filled capacitors. Although mass-produced, this type is available in such an outstanding range of voltage and capacitance ratings, as well as mountings, that it is virtually custom-made for most high-voltage heavy-duty applications.

Note particularly the choice of mounting means. Mounting means brackets shown in drawing are Aerovox standard; other types can be supplied.

Voltage ratings from 600 to 7500 D.C.W. Widest

selection of capacitance values. Impregnants and fills available are HYVOL (Vegetable) or HYVOL M (mineral oil). The exclusive Aerovox terminal construction means units that pass the standard immersion tests required by various Governmental services. Terminal assembly is non-removable, an integral part of the capacitor.

These capacitors provide maximum capacitance at minimum cost. Widely used for continuous-service in transmitters, amplifiers, rectifier filters and similar applications.

*Literature on Request*



## FOR RADIO-ELECTRONIC AND INDUSTRIAL APPLICATIONS

AEROVOX CORPORATION, NEW BEDFORD, MASS., U.S.A.

SALES OFFICES IN ALL PRINCIPAL CITIES • Export: 13 E. 40th St., New York 16, N. Y.

Cable: 'ARLAB' • In Canada: AEROVOX CANADA LTD., HAMILTON, ONT.

PLEASE PLACE YOUR ORDER WITH YOUR REGULAR RADIO PARTS JOBBER. IF YOUR LOCAL JOBBER CANNOT SUPPLY YOU, KINDLY WRITE FOR A LIST OF JOBBERS IN YOUR STATE WHO DO DISTRIBUTE OUR INSTRUMENTS OR SEND YOUR ORDER DIRECTLY TO US.



## The New Model 670 SUPER-METER

*A Combination*  
VOLT-OHM MILLIAMMETER  
plus CAPACITY REACTANCE  
INDUCTANCE and  
DECIBEL MEASUREMENTS

### *Added Feature:*

The Model 670 includes a special GOOD - BAD scale for checking the quality of electrolytic condensers at a test potential of 150 Volts.

### *Specifications:*

**D.C. VOLTS:**  
0 to 7.5/15/75/150/750/1,500/7,500 Volts

**A.C. VOLTS:**  
0 to 15/30/150/300/1,500/3,000 Volts

**OUTPUT VOLTS:**  
0 to 15/30/150/300/1,500/3,000 Volts

**D.C. CURRENT:**  
0 to 1.5/15/150 Ma. 0 to 1.5 Amperes

**RESISTANCE:**  
0 to 500/100,000 ohms 0 to 10 Megohms

**CAPACITY:**  
.001 to .2 Mfd. .1 to 4 Mfd.

**REACTANCE:**  
700 to 27,000 Ohms 13,000 Ohms to 3 Megohms

**INDUCTANCE:**  
1.75 to 70 Henries 35 to 8,000 Henries

**DECIBELS:**  
-10 to +18 +10 to +38 +30 to +58

The Model 670 comes housed in a rugged, crackle-finished steel cabinet complete with test leads and operating instructions. Size 5½" x 7½" x 3". Net

**\$2840**

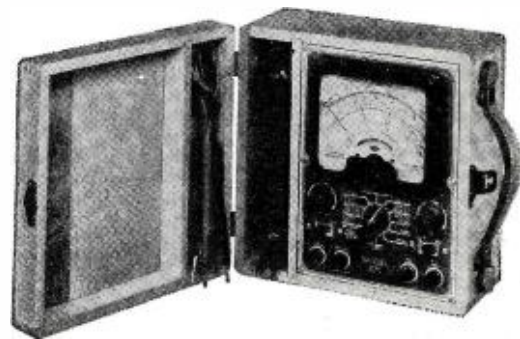

### *Model 670P*

The Model 670P is identical to the Model 670 described in detail except housed in a hand-rubbed, portable oak cabinet complete with cover.

The Model 670P comes complete with test leads and all operating instructions.

Net **\$3575**



# SUPERIOR INSTRUMENTS CO.

Dept. RN 227 FULTON ST., NEW YORK 7, N. Y.





**H**E is your Mallory parts distributor. You can depend on the products he has for sale—and on the personal service with which he backs them up. He's had a long experience in the radio business—knows that *his* success depends on yours—is willing and able to share his experience in solving any problem that may confront you. It pays to know and do business with your Mallory distributor because—

## -----> Here is What He Offers <-----

**1**

A complete line of Mallory replacement parts . . . many of them first developed by Mallory research . . . ALL of them guaranteed against premature failure by years of service in the field.

**2**

A program of standardization that meets the maximum number of application needs with the minimum number of parts . . . reduces investment, simplifies replacement, speeds up delivery.

**3**

Efficient service . . . backed by detailed information on prices, parts, catalog numbers . . . promptly applied whether orders are large or small . . . especially effective in meeting emergencies.

**4**

Technical service helps . . . bulletins, booklets, catalogs, letters with complete data on what to use and where to use it . . . special publications on radio fundamentals and new developments.

**5**

A background of personal experience . . . acquired through years of service in radio . . . helpful in solving difficult or unusual problems . . . effective in training dealer personnel.

**6**

Commercial "know how" . . . implemented by sound methods of keeping your business "on the beam" . . . with special attention to promotion devices that help sell your story to the public.

**P. R. MALLORY & CO. Inc.**  
**MALLORY**  
 VIBRATORS . . . VIBRAPACKS\* . . . CAPACITORS . . . VOLUME CONTROLS  
 . . . SWITCHES . . . RESISTORS . . . FILTERS . . . RECTIFIERS . . .  
 POWER SUPPLIES. ALSO MALLORY TROPICAL\* DRY BATTERIES,  
 ORIGINALLY DEVELOPED BY MALLORY FOR THE U. S. ARMY.  
 \*Reg. U. S. Pat. Off.

**APPROVED PRECISION PRODUCTS**

**P. R. MALLORY & CO., Inc., INDIANAPOLIS 6, INDIANA**

# FADA



Mother and Dad remember FADA from the very early days—from the very beginning of radio broadcasting. For more than a generation, the name FADA has stood for the finest in radio reception.

And—brother and sister know the name, too. We don't let them forget. No matter where they go or where they live, every family sees the FADA name again and again and again in magazines, newspapers, billboards . . . even in the heart of Times Square. That's why you can always place your faith in FADA. That's why you will find FADA radio receivers one of your fastest selling lines for this year, next year and many years to come.

PLACE YOUR FAITH IN THE

# FADA Radio

*Famous Since Broadcasting Began!*



FADA 6 tube models are equipped with the new FADA "Sensitive-Tone" . . . assuring greater sensitivity and clearer reception.

# TOPS

## in consumer acceptance

The  
**RADIO**  
of  
**TO-MORROW  
TO-DAY!**



MODEL 605W — 5 TUBES



MODEL 1000 — 6 TUBES

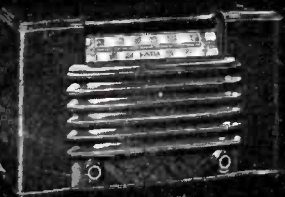

MODEL 100J — 6 TUBES

**FADA RADIO AND ELECTRIC COMPANY, INC., LONG ISLAND CITY, N. Y.**