

# RADIO NEWS

JULY  
1946  
35c

In Canada 40c

55  
25  
40  
150

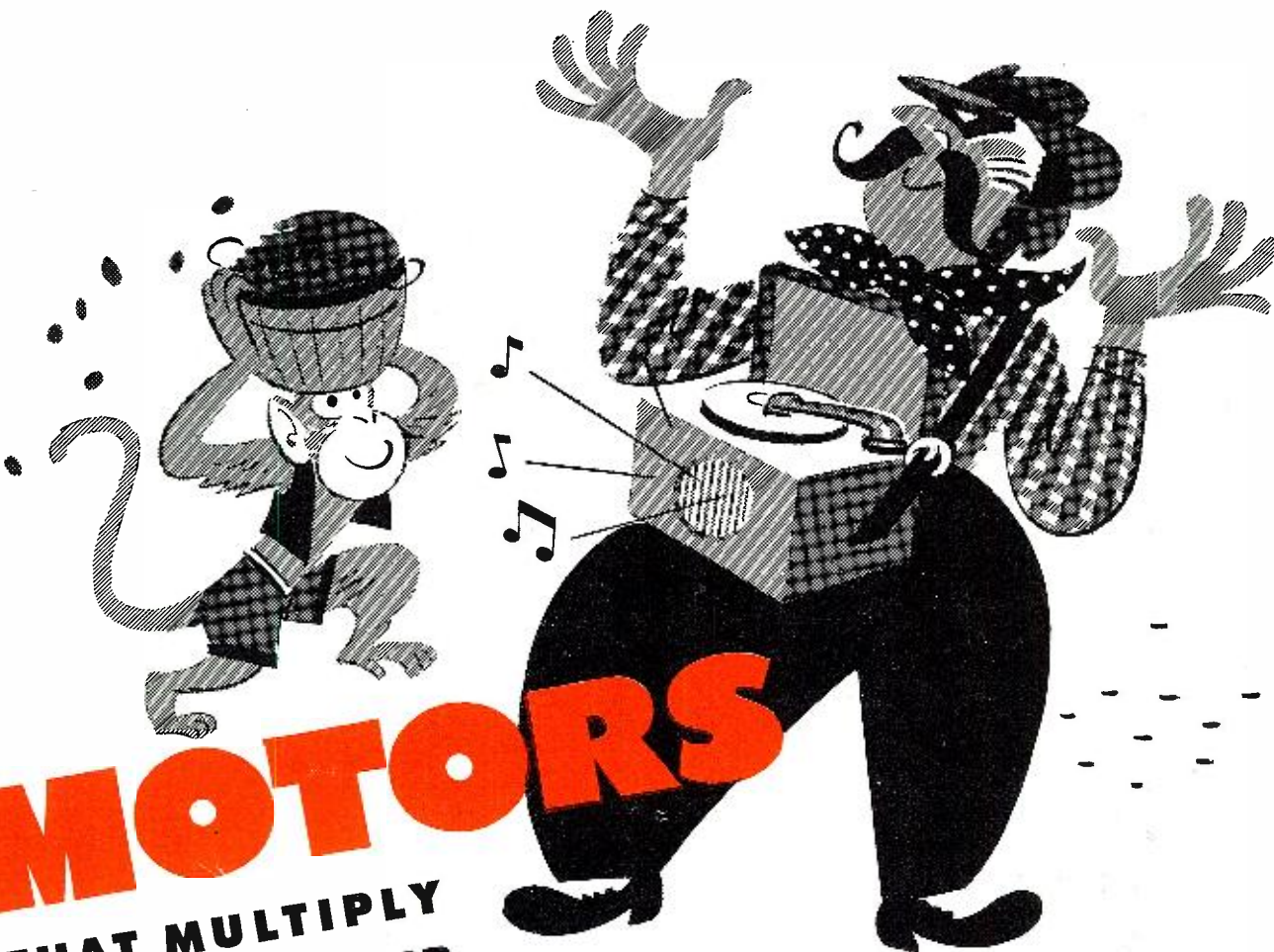

BUILDING A COMPLETE LOW-COST 144-148 mc AMATEUR TRANSMITTER-RECEIVER

An illustration featuring a monkey on the left wearing a plaid hat and a vest, and a man on the right with a large mustache, wearing a plaid jacket and a polka-dot scarf, dancing with his arms raised. Musical notes are scattered around them. The word "MOTORS" is written in large, bold, red letters across the middle of the illustration. Below it, the text "THAT MULTIPLY YOUR TURNOVER" is written in black, slanted letters.

# MOTORS

THAT MULTIPLY  
YOUR TURNOVER

Sweet music—the kind that makes satisfied customers—is yours when Alliance phonomotors drive your turntables, record changers and recorders.

Manufacturers, retailers and service shops everywhere like to “make ‘em move” with Alliance. That’s because Alliance is the recognized leader when it comes to turning out little motors in large quantities at low cost.

For original equipment or replacement the years have proved that Alliance assures trouble-free performance and long life!



WHEN YOU DESIGN... KEEP

**alliance**  
IN MIND

**THE NEW MODEL 80** “Even-speed” phonomotor is smooth, cool running and quiet. Larger bearings with ample oil reservoirs prolong life. New shock mountings almost eliminate vibration of motor and idler plate. Equipped with 60 cycle friction rim-type drive.

**NEW USES**—For automatic and non-automatic electronic control devices and the power sources to actuate mechanical or push-button controls, Alliance motors offer the most practical engineering economy in advanced designs.

**ALLIANCE MANUFACTURING COMPANY • ALLIANCE, OHIO**

ALLIANCE TOOL AND MOTOR, LTD., TORONTO 14, CANADA

# W TRAIN YOU TO S ART A SPARE TIME OR FULL TI E RADIO SERVICE BUSINESS WITHOUT CAPITAL

J. E. SMITH,  
PRESIDENT  
National Radio  
Institute  
32nd Year of  
Training Men  
for Success  
in Radio

## You Build These and Many Other Radio Circuits with 6 Kits of Parts I Supply

By the time you've conducted 60 sets of Experiments with Radio Parts I supply, made hundreds of measurements and adjustments, you'll have valuable PRACTICAL Radio experience for a good full or part-time Radio job!

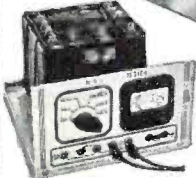
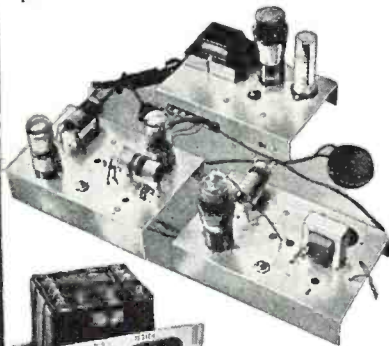

You build MEASURING INSTRUMENT above early in Course, useful for Radio work to pick up EXTRA spare time money. It is a vacuum tube multimeter, measures A.C., D.C., R.F. volts, D.C. currents, resistance, receiver output.

Building the A. M. SIGNAL GENERATOR at right will give you valuable experience. Provides amplitude-modulated signals for test and experimental purposes.



You build the SUPERHETERODYNE CIRCUIT above containing a preselector oscillator-mixer-first detector, i.f. stage, diode-detector-a.v.c. stage and audio stage. It will bring in local and distant stations. Get the thrill of learning at home evenings in spare time while you put the set through fascinating tests!

The men at the right are just a few of many I have trained, at home in their spare time, to be Radio Technicians. They are now operating their own successful spare time or full time Radio businesses. Hundreds of other men I trained hold good jobs in practically every branch of Radio. Doesn't this PROVE my "50-50 method" of home training can give you BOTH a thorough knowledge of Radio principles and the PRACTICAL experience you need to help you make more money in the fast-growing Radio industry?

Let me send you facts about opportunities in the busy Radio field. See how knowing Radio can give you security, a prosperous future... lead to jobs coming in Television, Electronics. Send coupon NOW for FREE Sample Lesson and 64-page, illustrated book. Read how N.R.I. trains you at home in spare time. Read how you practice building, testing, repairing Radios with SIX BIG KITS of Radio parts I send you.

### Many Beginners Soon Make Extra Money in Spare Time While Learning

The day you enroll I start sending EXTRA MONEY JOB SHEETS. You LEARN Radio principles from my easy-to-understand, illustrated lessons—PRACTICE what you learn by building, testing and experimenting with parts I send—USE your knowledge to make EXTRA money fixing neighbors' Radios in spare time while still learning! From here it's a short step to your own full-time Radio Shop or a good Radio job!

### Future for Trained Men is Bright in Radio, Television, Electronics

It's probably easier to get started in Radio now than ever before, because the Radio Repair Business is booming. Trained Radio Technicians also find profitable opportunities in Police, Aviation, Marine Radio, Broadcasting, Radio Manufacturing, Public Address work. Think of even greater opportunities as Television, FM, and many new, war-developed Electronic devices become available to the public! Soon there will be more Radio equipment to install, operate, maintain and repair than ever before in all history! Get the facts on all these opportunities. Send for FREE books now!

### Find Out What NRI Can Do For You

Mail Coupon for Sample Lesson, "Getting Acquainted with Receiver Servicing," and my FREE 64-page book. It's packed with facts about Radio's opportunities for you. Read the details about my Course. Read letters from men I trained, telling what they are doing, earning. See how quickly, easily you can get started. No obligation! Just MAIL COUPON NOW in an envelope or paste it on a penny postal. J. E. SMITH, President, Dept. 6GR, National Radio Institute, Pioneer Home Study Radio School, Washington 9, D. C.

### I Trained These Men

### SPARE TIME RADIO BUSINESS



"I have a spare time Radio and Electrical business of my own which has been very profitable, due to the efficient training I received from your Course. Last year I averaged over \$50 a month." —FRED H. GRIFETE, Route 3, Newville, Pa.

"I am doing radio work in my spare time, and find it a profitable hobby. My extra earnings run about \$10 a week. I certainly am glad I took your N.R.I. Course." —FERDINAND ZIRELL, Chaseley, North Dakota.



"About six months after I enrolled I started making extra money in radio. I am a farmer and just work on radio evenings and stormy days. That brought me a profit of \$600 in the last year." —BENNE L. ARENDS, RFD 2, Alexander, Iowa.

### I Trained These Men

### FULL TIME RADIO BUSINESS



"Not long ago I was working 16 hours a day in a filling station at \$10 a week. Now I have my own radio business and average over \$60 a week. The N.R.I. course is fine." —ALBERT C. CHRISTENSEN, 116-10th Avenue, Sidney, Neb.

"Previous to enrolling for your radio training I made \$12 per week in a repair store. Now I operate my own repair shop, and often clear \$35 to \$45 a week." —FREDERICK BELL, 76 Golf Ave., St. Johns, Newfoundland.



"Am making over \$50 a week profit from my own shop. Have a number to hire N.R.I. graduate working for me. I like radio." —NORMAN MILLER, Hebron, Neb.

## SAMPLE LESSON FREE

I will send you a FREE Lesson, "Getting Acquainted with Receiver Servicing," to show you how practical it is to train for Radio at home in spare time. It's a valuable lesson. Study it—keep it—use it—without obligation! Tells how Superheterodyne Circuits work, gives hints on Receiver Servicing, Locating Defects, Repair of Loudspeaker, I.F. Transformer, Gang Tuning, Condenser, etc. 31 illustrations.



My Radio Course Includes  
TELEVISION • ELECTRONICS  
FREQUENCY MODULATION

## GOOD FOR BOTH 64 PAGE BOOK SAMPLE LESSON FREE

J. E. SMITH, President, Dept. 6GR  
National Radio Institute, Washington 9, D. C.

Without obligating me, mail your Sample Lesson and 64-page book FREE. I am particularly interested in the branch of Radio checked below. (No salesman will call. Please write plainly.)

- My own Radio Service Business
- Spare Time Radio Servicing
- Service Technician for Radio Stores or Factory
- Aviation Radio
- Operating Broadcasting Station
- Industrial Electronics
- Public Address Systems
- Ship, Harbor, Gov't, Military Radio

(If you have not decided which branch you prefer—mail coupon for facts to help you decide.)

Name..... Age.....

Address.....

City..... Zone..... State.....

Approved for Training under GI Bill



**For the AMATEUR**

Compact 75 Watt Transmitter.....*Robert Lewis, W8MQU* 28  
 Super Sensitive Amateur Receiver.....*Carl V. Hays, W6RTP* 32  
 Combination Noise Limiter and Preselector.....*George and Al. Boles, W2NBU* 41  
 C. W. Break-in Monitor.....*Howard B. Bard, Jr., W6EOS* 45  
 Designing a Stable V.F.O.....*Lyle C. Tyler* 54

**For the SERVICEMAN-DEALER**

Patterns in Selling Radio Service.....*Paul H. Wendel* 25  
 Practical Radio Course.....*Alfred A. Ghirardi* 42  
 Operation and Adjustment of Television Receivers..*Edward M. Noll* 47  
 Home-Built Vacuum Tube Voltmeter....*Lt. {jg} N. M. Smith, USNR* 48  
 The RN Circuit Page..... 64  
 "For the Defense".....*Jay M. Bartels* 70

**Of GENERAL INTEREST**

Radio News to Cover—Operation Crossroads..... 30  
 Highway in the Sky.....*Andrew R. Boone* 35  
 Photo-Electronic Organ.....*Rollin E. Campbell and Lyman E. Greenlee* 36  
 Ground Control Approach System.....*Col. J. K. McDuffie* 38

**DEPARTMENTS**

For the Record..... 8      What's New in Radio..... 60  
 Spot Radio News.*Fred Hamlin* 12      Within the Industry..... 108  
 QTC.....*Carl Coleman* 44      Manufacturers' Literature... 126  
 International Short-Wave.....*Kenneth R. Boord* 50  
 Letters from our Readers..... 132

COPYRIGHT 1946 ZIFF-DAVIS PUBLISHING COMPANY  
185 N. Wabash Ave., Chicago 1, Ill.

BRANCH OFFICES: NEW YORK, WASHINGTON, LOS ANGELES, TORONTO



**WILLIAM B. ZIFF**  
*Publisher*

**B. G. DAVIS**  
*General Manager*

**HERMAN R. BOLLIN**  
*Art Director*

**C. R. TIGHE**  
*Asst. to the Publisher*

**H. G. STRONG**  
*Circulation Director*

**GEORGE BERNER**  
*Advertising Director*

**H. J. MORGANROTH**  
*Production Director*

**EDITORIAL**

**OLIVER READ, W9ETI**  
*Editor*

**WM. A. STOCKLIN**  
*Asst. to the Editor*

**H. S. RENNE, Ex. W6PTS**  
*Technical Editor*

**RAY FRANK, W9JU**  
*Amateur Radio*

**FRED HAMLIN**  
*Washington Editor*

**PAUL H. WENDEL**  
*Eastern Editor*

**ARTHUR E. HAUG**  
**WALTER STEINHARD**  
*Staff Photographers*

**E. H. SEHNERT**  
*Chief Draftsman*

**R. S. KUPJACK**  
*Staff Artist*

**ADVERTISING**

**L. L. OSTEN**  
*Advertising Mgr.*

**JOHN A. RONAN, JR.**  
*Midwest Adv. Mgr.*

**WM. L. PINNEY**  
*Western Adv. Mgr.*



Cover Photo  
By Arthur E. Haug  
(Staff Photographer)

Preparing for her amateur license, Corinne Sullivan, of Radio News, constructs transmitter and receiver. Construction of this unit will be covered in forthcoming August and September issues of Radio News.

RADIO NEWS is published monthly by the Ziff-Davis Publishing Company, 185 N. Wabash Ave., Chicago 1, Ill. Subscription Rates: in U. S. \$3.00 (12 issues), single copies 35 cents; in Mexico, South and Central America, and U. S. Possessions, \$3.00 (12 issues); in Canada \$3.50 (12 issues), single copies 40 cents; in British Empire, \$4.00 (12 issues)-all other foreign countries \$4.00 (12 issues). Subscribers should allow at least 2 weeks for change of address. All communications about subscriptions should be addressed to: Director of Circulation, 185 N. Wabash Ave., Chicago 1, Ill. Entered as second class matter March 9, 1938, at the Post Office, Chicago, Illinois, under the Act of March 3, 1879. Entered as second class matter at the Post Office Dept., Ottawa, Canada. Contributors should retain a copy of contributions and include return postage. Contributions will be handled with reasonable care but this magazine assumes no responsibility for their safety. Accepted material is subject to whatever revisions and by-line changes that are necessary. Payment, made at our current rates covers all authors' contributors', or contestants' rights, title, and interest in and to accepted material, including photos and drawings.

Other Ziff-Davis Publications: Radio & Appliances, Radio-Electronic Engineering, Plastics, Flying, Popular Photography

**HERE THEY COME!**

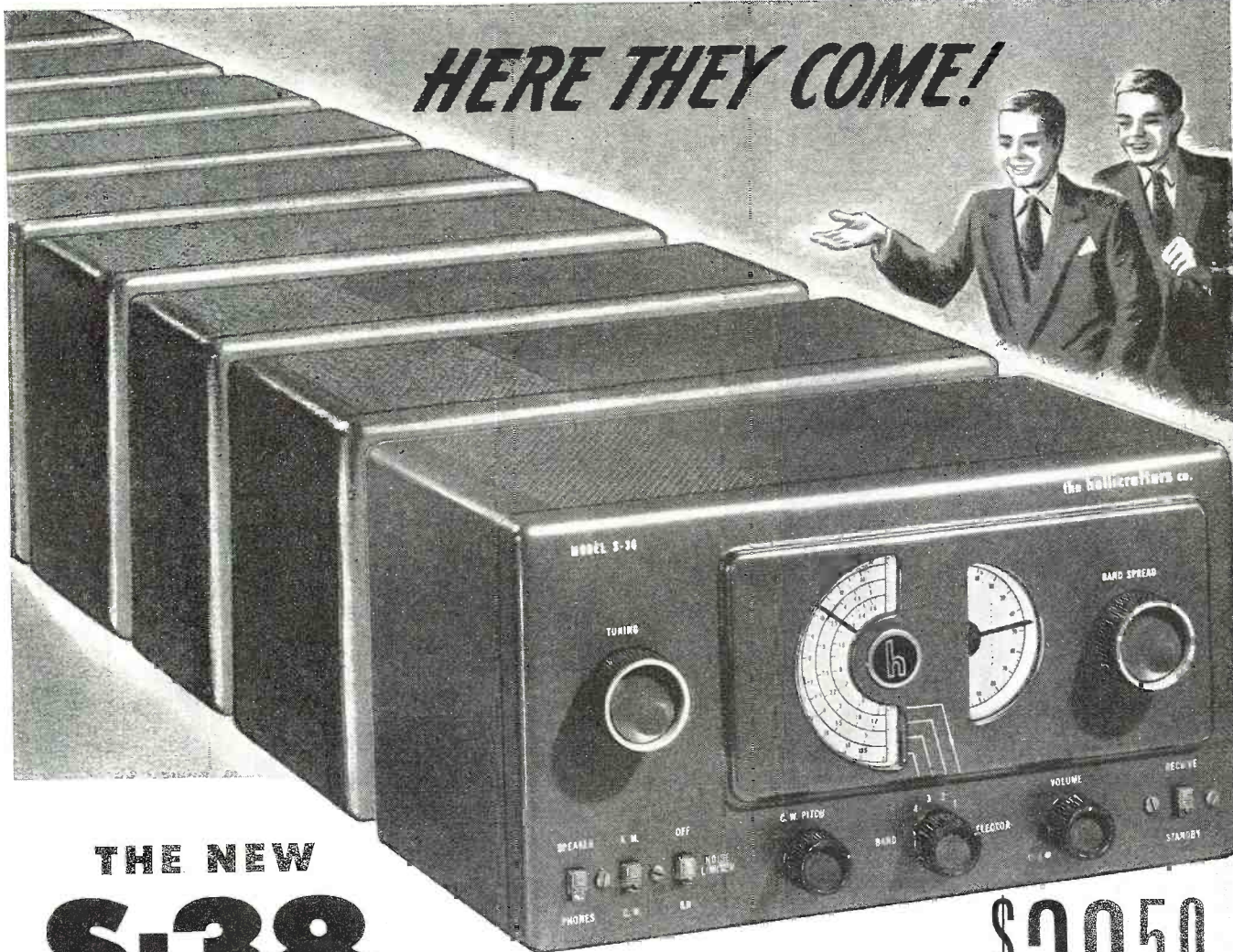

**THE NEW  
S-38's**

**4 Bands—540 kc. to 32 Mc.**

**\$39.50**  
ADD 3%  
IN  
ZONE 2

The Model S-38 meets the demand for a truly competent communications receiver in the low price field. Styled in the post-war Hallicrafters pattern and incorporating many of the features found in more expensive models, the S-38 offers performance and appearance far above anything heretofore available in its class. Four tuning bands, CW pitch control adjustable from the front panel, automatic noise limiter, self-contained PM dynamic speaker and "Airodized" steel grille, all mark the S-38 as the new leader among inexpensive communications receivers.

**FEATURES**

1. Overall frequency range—540 kilocycles to 32 megacycles in 4 bands.  
Band 1—540 to 1650 kc.  
Band 2—1.65 to 5 Mc.  
Band 3—5 to 14.5 Mc.  
Band 4—13.5 to 32 Mc.  
Adequate overlap is provided at the ends of all bands.
2. Main tuning dial accurately calibrated.
3. Separate electrical band spread dial.
4. Beat frequency oscillator, pitch adjustable from front panel.
5. AM/CW switch. Also turns on automatic volume control in AM position.
6. Standby/receive switch.
7. Automatic noise limiter.
8. Maximum audio output—1.6 watts.
9. Internal PM dynamic speaker mounted in top.
10. Controls arranged for maximum ease of operation.
11. 105-125 volt AC/DC operation. Resistor line cord for 210-250 volt operation available.
12. Speaker/phones switch.

**CONTROLS:** SPEAKER/PHONES, AM/CW, NOISE LIMITER, TUNING, CW PITCH, BAND SELECTOR, VOLUME, BAND SPREAD, RECEIVE/STANDBY.

**EXTERNAL CONNECTIONS:** Antenna terminals for doublet or single wire antenna. Ground terminal. Tip jacks for headphones.

**PHYSICAL CHARACTERISTICS:** Housed in a sturdy steel cabinet. Speaker grille in top is of airodized steel. Chassis cadmium plated.

**SIX TUBES:** 1—12SA7 converter; 1—12SK7 IF amplifier; 1—12SQ7 second detector, AVC, first audio amplifier; 1—12SQ7 beat frequency oscillator, automatic noise limiter; 1—35L6GT second audio amplifier; 1—35Z5GT rectifier.

**OPERATING DATA:** The Model S-38 is designed to operate on 105-125 volts AC or DC. A special external resistance line cord can be supplied for operation on 210 to 250 volts AC or DC. Power consumption on 117 volts is 29 watts.



**hallicrafters RADIO**

THE HALLICRAFTERS CO., MANUFACTURERS OF RADIO AND ELECTRONIC EQUIPMENT, CHICAGO 16, U. S. A.

Designed with **EXTRAS...**  
to sell that **EXTRA set!!**

# FADA

**5 EXQUISITE COLORS TO  
MATCH ANY COLOR SCHEME  
IN THE HOME OR OFFICE!**

Illustrated are two of the new exciting line of 1946 FADA Table Models. Beautifully designed in 5 scintillating colors, these FADA radio receivers provide those "extras" that make your customers anxious to buy more than one.

FADA extra sales mean extra profits!



FADA 6 tube models are equipped with the new FADA "Sensitive-Tone" . . . assuring greater sensitivity and clearer reception.



### 1000 SERIES

6 Tube A.C.-D.C. Superheterodynes . . . In Gemlike "FADA-LUCENT" Cabinets with the New Gemloid Illuminated Dial and Noise Reducing R.F. Stage.

8 tube performance with 6 full working tubes; FADA-SCOPE built-in loop ANTENNA; Beam Power Output System; Automatic Volume Control; New Wonder Speaker ALNICO V. Housed in beautiful "FADA-LUCENT" Cabinets in Five Gorgeous COLOR COMBINATIONS resembling precious stones.

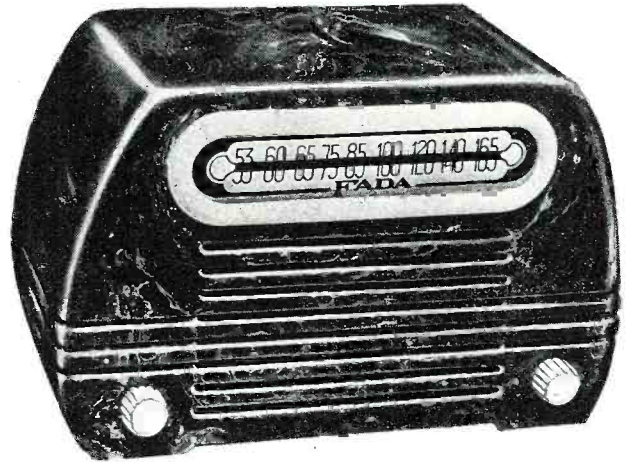

### 652 SERIES

6 Tube A.C.-D.C. Superheterodynes with the R.F. Noise Reducing Stage with Slide Rule Dial in Gemlike "FADA-LUCENT" Cabinets.

6 tube radio with 8 tube performance. Features include the new Lock in type tubes; Beam Power Output System; New Wonder Speaker ALNICO V; Automatic Volume Control and FADA-SCOPE built-in LOOP ANTENNA. Housed in beautiful "FADA-LUCENT" Cabinets in Five Gorgeous COLOR COMBINATIONS resembling precious stones.

YOU CAN ALWAYS DEPEND ON

# FADA Radio

*Famous Since Broadcasting Began!*

**FADA RADIO AND ELECTRIC COMPANY, INC., LONG ISLAND CITY, N. Y.**

# LET ME TRAIN YOU

for RADIO ELECTRONICS & TELEVISION

# I'll Supply a FULL RADIO SET

for SIMPLIFIED INSTRUCTION — PRACTICE & TESTING

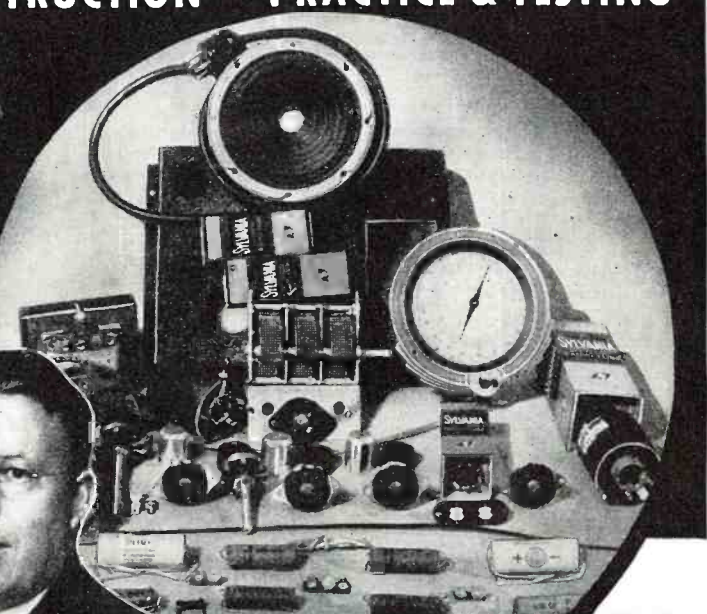
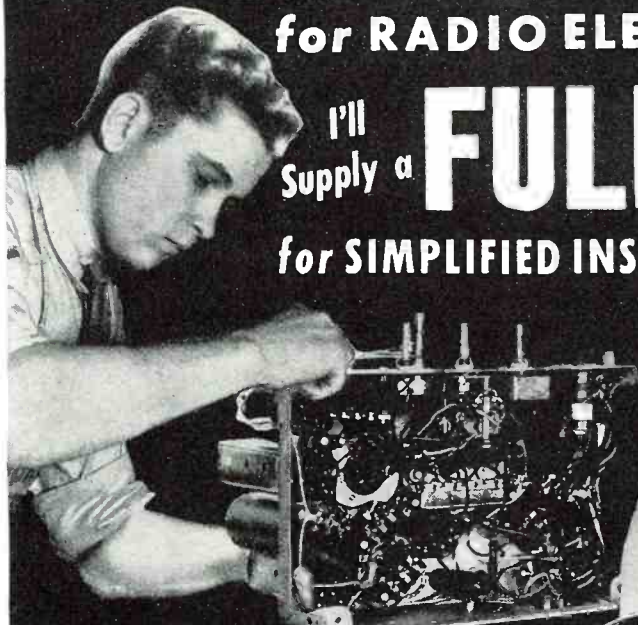

**Beginners Learn FAST**  
**START NOW! Big Developments**  
**Ahead in F. M., Radar, Television**



**MAKE GOOD MONEY IN**  
**a Business of Your Own**  
**...or a Good Radio Job.**

**M**IND training through *hand* practice with a FULL RADIO SET . . . that's the interesting way I'll teach you Radio. And it's the latest, most practical method of all to fix in your head permanently the essential money-making Radio knowledge. The offer I make you here is the opportunity of a lifetime. I'll prepare you easily and quickly for a wonderful future in the swiftly expanding field of Radio-Electronics INCLUDING Radio, Television, Frequency Modulation and Industrial Electronics. Be wise! NOW'S the time to start. Opportunities ahead are tremendous! No previous experience is necessary. The Sprayberry Course starts right at the beginning of Radio. You can't get lost. It gets the various subjects across in such a clear, simple way that you understand and remember. And you can master my entire course in your spare time . . . right at home.

**You Do Practical Experiments**

There's only one *right* way to earn Radio Electronics. You must get it through simplified lesson study combined with actual "shop" practice under the personal guidance of a qualified Radio Teacher. It's exactly this way that Sprayberry trains you . . . supplying real Radio parts for learn-by-doing experience right at home. Thus, you learn faster, your understanding is clear-cut.

**I'll Show You a New, Fast Way to Test Radio Sets Without Mfg. Equipment**

The very same Radio Parts I supply with your Course for gaining pre-experience in Radio Repair work may be

adapted through an exclusive Sprayberry wiring procedure to serve for complete, fast, accurate Radio Receiver trouble-shooting. Thus, under Sprayberry methods, you do not have one cent of outlay for manufactured Test Equipment.

**Succeed as a Radio-Electronician**

My training will give you the broad, fundamental principles so necessary as a background, no matter which branch of Radio you wish to specialize in. I make it easy for you to learn Radio Set Repair and Installation Work. I teach you how to install and repair Electronic Equipment. In fact, you'll be a fully qualified RADIO-ELECTRONICIAN, equipped with the skill and knowledge to perform efficiently and to make a wonderful success of yourself.

**Read What Graduate Says**  
**"One Job Nets About \$26.00"**

"Since last week I fixed 7 radios, all good-paying jobs and right now I am working on an amplifier system. This job alone will net me about \$26.00. As long as my work keeps coming in this way, I have only one word to say and that is, 'thanks' to my Sprayberry training, and I am not afraid to boast about it."—ADRIEN BENJAMIN North Grosvenordale, Conn.

**DON'T PUT IT OFF!**

Get the facts about my training—now! Take the first important step toward the money-making future of your dreams. All features are fully explained in my big, illustrated FREE Catalog which comes to you along with another valuable FREE book you'll be glad to own.

## FREE BOOKS

"How To Read Radio Diagrams and Symbols"

Here's a valuable and wonderfully complete new book which explains in simple, non-technical English how to read and understand any Radio Set Diagram. Provides the quick key to analyzing any Radio circuit. Includes translations of all Radio symbols. This instructive volume is yours for the asking—without obligation. Send for it AT ONCE, and along with it I will send you another big free book, describing in complete, interesting detail my Radio-Electronic training.



**RUSH**  
**COUPON**  
**for BOTH**

**SPRAYBERRY ACADEMY OF RADIO**  
**F. L. Sprayberry, President**  
**Room 2576, Pueblo, Colorado**

Please rush my FREE copies of "How to MAKE MONEY in RADIO, ELECTRONICS and TELEVISION," and "How to READ RADIO DIAGRAMS and SYMBOLS".

Name..... Age.....

Address.....

City..... State.....

(Mail in envelope or paste on penny postcard)

**MAIL COUPON AT ONCE!**

July, 1946

"The Standard  
by Which  
Others  
Are Judged  
and Valued"

AUDAX has mastered wide-range so thoroughly that, today, even the lowest priced MICRODYNE has a range to 7000 cycles—(other models over 10,000 cycles). True,—wide-range makes for naturalness but,—it is highly objectionable if without quality. For example, of two singers, each capable of reaching high C, one may have a pleasing voice—the other, not at all. It is the same with pickups. To achieve EAR-ACCEPTABILITY, all other factors must be satisfied. Of these, VIBRATORY-MOMENTUM is most important. The only way to test EAR-ACCEPTABILITY of a pickup is to put it to the EAR-TEST. The sharp, clean-cut facsimile performance of MICRODYNE—regardless of climatic conditions—is a marvel to all who know that EAR-ACCEPTABILITY is the final criterion.

# Audax

## RELAYED-FLUX

### Microdyne

Send for complimentary copy of  
"PICK-UP  
FACTS"



**AUDAX COMPANY**  
500 Fifth Avenue,  
New York 18

"Creators of Fine Electronic-Acoustical  
Apparatus since 1915"

## For the RECORD.

BY THE EDITOR

**D**RAWING a line of demarcation between radio servicemen and radio dealers has been an elusive problem to the manufacturers in the radio industry since the late 1920s when radio technicians first started to gain recognition as an important factor in the field. Those early servicemen were dealers who studied the technicalities of radio and maintained an interest in the advancement of the art.

Some have since tried to determine a dealer status on the basis that a man operates from a store. It is absurd to think, however, that working behind a large pane of glass in any way changes a man's abilities or relative position in the national economy. There are radio servicemen conducting their business in a room in their home who are responsible for the sale of more receivers than a so-called "dealer" a few blocks away who has a store. Nor can the location of the store provide a yardstick. Many manufacturers have set their distribution pattern to consider only downtown, main street stores as desirable outlets, others seek the neighborhood shopping center outlet while some also include home shop operators along with the stores.

Strictly speaking, any serviceman who is responsible for the sale of a radio receiver is a dealer. Whether he stocks radios and sells them from the floor of his place of business or whether he carries them under his arm into the consumer's home to effect the sale makes no difference. Countless thousands of radios have been sold by servicemen who had no stock but picked them up as single units from someone who did. From the manufacturers' standpoint any person in the radio business who moves a piece of merchandise which has come off his production line into the hands of the consumer is a desirable factor in the industry. What difference can it make whether a man earns a portion of his living from the application of his technical knowledge and supplements his income by effecting sales of new radios.

Manufacturers tend to place much weight on outward appearances in determining a man's standing as a dealer. A store impresses them, letterheads and business cards which say "dealer" lead them to believe it's so, yet any man is entitled to knock out the front of his house, put in a large window and call it a store (zoning laws permitting). There is no law which denies a man the right to buy stationery bearing the legend "radio dealer." True, the ranking of a dealer is determined by the number of units

he sells, his value to the manufacturer increases in direct ratio to his volume of sales, but who can say at what point a man changes rank from serviceman to dealer.

With the greatly increased number of radio brands to be marketed in the next few years it is conceivable that the distribution facilities of the radio serviceman will be given full recognition. The fact that he sells radio sets, however, will not cause him to forget or forsake his technical attributes. The fact that a man knows how to repair radios may be considered an advantage by the manufacturer whose line he is selling. Certainly manufacturers who can be sure that the retailers who sell his product are prepared to maintain it has an advantage in building his prestige at the consumer level. There are indications that the maintenance of adequate service facilities may be a requirement of some manufacturers before they assign a franchise.

There is something about the technical skill to maintain radios which gives the radio serviceman a sense of accomplishment, a nearness to radio which makes him feel that he is an integral part of the industry. Whether he moves from his home to a store, or whether he moves his bench to the back of his store so he can put a few new receivers up front for public appraisal, the man himself has not changed. He is still a technician, proud of his technical ability regardless of how many units he sells as a dealer. If he is pressed for time so he can't devote himself to work at the bench you can be sure he will see to it that the person who handles his bench work for him sustains his reputation for good service.

True, as a serviceman develops his skill at selling merchandise he will strive to improve the appearance of his store through better decoration, layout and display, he will smooth out his selling approach and learn to capitalize on manufacturers' selling helps but he will come to realize that satisfied service customers and their friends are his finest prospects for the sale of new merchandise and that a dealership is well founded on a serviceman base. The serviceman will never lose his interest in the advancements and technicalities of radio as he knows this is one of his finest business assets.

The serviceman who expands his activities as a dealer is in a far better position to weather economic storms than a dealer who knows none of the technical aspects of the business. It is natural to assume that the consumer

(Continued on page 111)



# For Earliest Delivery... ORDER YOUR NEW COMMUNICATIONS RECEIVER

Now from **ALLIED**

AVAILABLE ON  
*Time Payments*  
TRADE-INS ACCEPTED

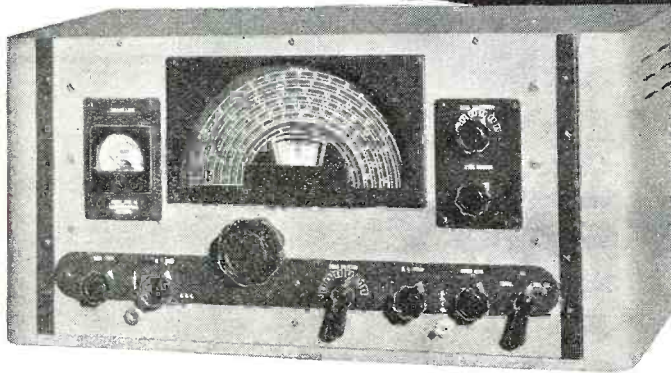

**RME 45**

The new RME 45 Receiver delivers peak reception on all frequencies—500 to 33,000 Kc. Full vision calibrated dial using one control for two-speed tuning. Five Amateur bands with ample band spread. DB calibrated signal level meter. 5 step variable crystal filter. Automatic Noise Suppression. Stable, variable pitch beat oscillator. Streamline cabinet with matching speaker. Net, with Speaker... **\$186**

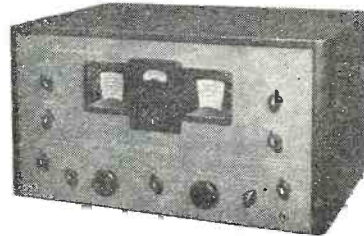

**HAMMARLUND HQ-129X**

Designed to meet the most critical demands of professional operators. Full range .54 to 31 Mc., accurately calibrated. 4 calibrated Ham bands and one arbitrary scale. Variable selectivity crystal filter. Low drift beat oscillator for code and locating stations. Antenna compensator. Voltage regulation. Compensated oscillator to reduce drift during warm-up. Automatic noise limiter. Earphone jack. 3 i.f. amplifier stages. 2 audio stages. For phone or CW. Net..... **\$129**  
Speaker, net..... **\$10.50**

**Other Communications Equipment**

Hallcrafters S-38.....	\$ 39.50	BC-610 (HT-4) Transmitter...	\$535.00
New RME-84.....	98.70	350 Watt Mod. Transformer..	21.50
Hallcrafters SX-25.....	94.50	HT-9 Transmitter.....	250.00
RME DB-20 Preselector.....	59.30	Hallcrafters S-36A.....	307.50
RME VHF-152 Converter.....	86.60	Hammalund 400X.....	342.00
National HRO-5T-A1.....	274.35	Hammalund 400SX.....	318.00
Hallcrafters SX-28A.....	223.00	Hallcrafters S-37.....	591.75

Net, F. O. B. Chicago (All prices subject to change)

**HALLICRAFTERS S-40**

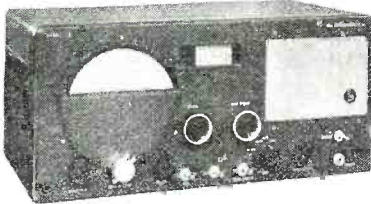

Sensational new Hallcrafters receiver! Offers many advanced design and performance features at a popular price. Simple to operate. Frequency range 550 Kc. to 44 Mc. in 4 bands. Wide vision main tuning dial accurately calibrated. Separate electrical handsread dial, inertia flywheel tuning. Beat frequency oscillator. A.V.C. switch. CW/a.m. switch. Standby/receive switch. Automatic noise limiter. Separate RF and AF gain controls. Three position tone control. "Micro-set" permeability adjusted coils in RF section. Internal dynamic speaker. Net..... **\$79.50**

Model SM-40 External "S" Meter..... **\$15.00**

**NATIONAL NC-2-40C**

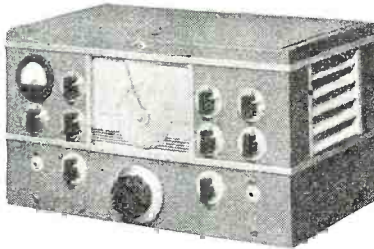

One of National's top receivers. 490 Kc. to 30 Mc. range in 6 tuning bands. Definite, accurate calibration for all bands. Actual single dial control. Stable high frequency circuits. Frequency drift reduction to a negligible value by temperature compensation. Automatic voltage stabilization. Wide range adjustable series-valve-noise limiter. Flexible crystal filter. Phonograph or high level microphone pick-up jack. Special r.f. coupling circuits maintain full sensitivity. Net..... **\$225**

Speaker in matching cabinet, net..... **\$15.00**

Free... SEND NOW FOR ALLIED'S  
**NEW 1946 CATALOG**

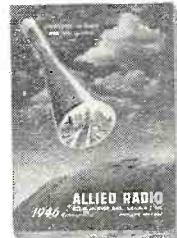

Here's your handiest, most complete 1946 Buying Guide for everything in radio! Includes latest communications receivers, Ham gear, code apparatus, parts, kits, tubes, tools, books, test instruments, public address and other equipment. 10,000 items at your finger tips... largest and most complete stocks under one roof. Nationally known makes. Fastest service—from one central source. Experienced staff of licensed radio amateurs to help you.

ALLIED RADIO CORP., D. L. Warner W918C  
833 West Jackson Blvd., Dept. 1 GG-6  
Chicago 7, Illinois

Date.....

Please enter order for

Model.....

Enclosed \$.....  Full Payment  
 Part Payment (Balance C.O.D.)

Please send full information on Communications Receivers and Time Payment Plan, without obligation.

Send FREE new 1946 Allied Catalog.

Name.....

Address.....

City..... Zone..... State.....

## ALLIED RADIO

Everything in Radio and Electronics

833 West Jackson Blvd. • Chicago 7, Illinois



The  
14 VOLUMES of  
RIDER MANUALS  
cover the 60 million  
receiving sets now  
in American  
Homes

# 16 YEARS of PROVEN LEADERSHIP

During the past sixteen years Rider Manuals have maintained their position of unchallenged leadership because they have consistently demonstrated their reliability, their accuracy and their unquestioned value as time-savers in the localizing of troubles in faulty receivers. In the fourteen volumes of Rider Manuals will be found such vital material as receiver schematics, voltage data, alignment data, resistance values, chassis layouts and wiring, and trimmer connections.

The sixty million sets issued previous to 1942 are the sets most likely to develop faults, find their way to your bench — and Rider Manuals provide the only single source upon which you can depend for accurate, complete, authoritative servicing data covering the important receivers issued from 1929 to 1942.

Volume XV is now in preparation; it will have the greatest number of pages in any volume yet issued. Its increased size will result from the in-

clusion of extra servicing information, additional data that are not ordinarily available on manufacturers' schematics. It will be necessary and useful information that will save a serviceman hundreds of hours a year.

In the meantime be sure you have all fourteen volumes. Check the list below and order from your jobber today.

## JOHN F. RIDER PUBLISHER, INC.

404 FOURTH AVENUE, N. Y. 16, N. Y.

Export Division: Rocke-International Electric Corp., 13 E. 40th Street, New York 16, N. Y.

### RIDER MANUALS (14 volumes)

*ABRIDGED VOLUMES I-V . . . . .	\$17.50
VOLUME VI . . . . .	11.00
VOLUME VII . . . . .	15.00
VOLUME VIII . . . . .	15.00
VOLUME IX . . . . .	15.00
VOLUME X . . . . .	15.00
VOLUME XI . . . . .	15.00
VOLUME XII . . . . .	15.00
VOLUME XIII . . . . .	15.00
VOLUME XIV . . . . .	15.00
RECORD CHANGERS & RECORDERS . . . . .	9.00

\*Originally published as individual  
Volumes: I, II, III, IV and V

### RIDER RADIO BOOKS KEEP YOU UP TO DATE

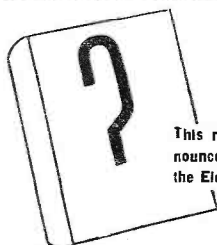

This new Rider Book, soon to be announced, will be the book of books for the Electronic Maintenance Man

**The Cathode Ray Tube at Work**  
Accepted authority on subject . . . . 4.00

**Frequency Modulation**  
Gives principles of FM radio . . . . \$2.00

**Servicing by Signal Tracing**  
Basic Method of radio servicing . . . . 4.00

**The Meter at Work**  
An elementary text on meters . . . . 2.00

**The Oscillator at Work**  
How to use, test and repair . . . . 2.50

**Vacuum Tube Voltmeters**  
Both theory and practice . . . . 2.50

**Automatic Frequency Control Systems**  
—also automatic tuning systems . . \$1.75

**A-C Calculation Charts**  
Two to five times as fast as slide rule . 7.50

**Hour-A-Day-with-Rider Series —**  
On "Alternating Currents in Radio Receivers"  
On "Resonance & Alignment"  
On "Automatic Volume Control"  
On "D-C Voltage Distribution" . 1.25 each

**RADIO NEWS**

# SPEEDS UP SERVICE and ALIGNMENT

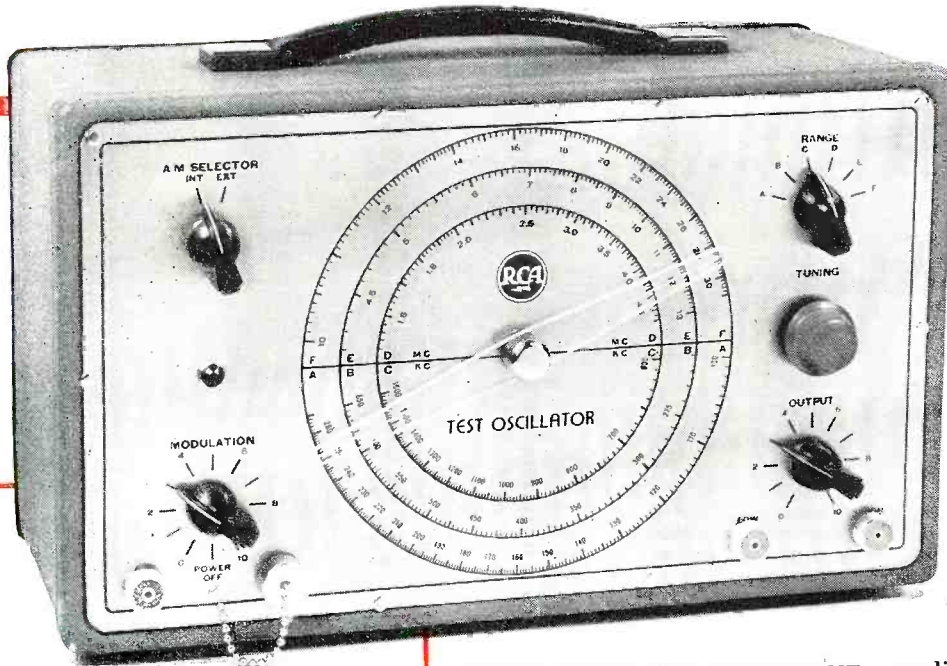

**THE NEW  
RCA TEST  
OSCILLATOR  
with  
signal-injection  
probe**

The probe shown below makes it a quick, easy matter to apply r-f, i-f, or audio test signals to any part of a receiver; also ideal for an indication of stage-by-stage gain.

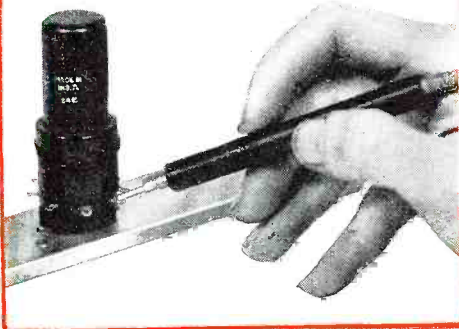

THIS BRAND-NEW INSTRUMENT (Type 167-B) is a low-cost answer to easy alignment of complex receivers. It has an extremely wide frequency range—generating fundamental signal voltages over six bands from 100 kc to 30 mc. Harmonics of the last band can be used for very-high-frequency testing.

Its high, smoothly adjustable r-f output of 1.0 volt is extremely useful for locating trouble on an inoperative or completely misaligned receiver and for single-stage alignment work. Further help is provided by an internal, 400-cycle modulation source—an r-c type

audio oscillator—adjustable up to 50 per cent.

AM and FM jacks are incorporated so that external modulation can be applied for measurements such as over-all fidelity and for visual i-f alignment using a sweep condenser.

Uses one 5Y3GT and two 6SJ7 tubes. Calibration accuracy is within  $\pm 2\%$ . Weighs only 12½ pounds.

You'll find that this low-priced instrument will quickly pay for itself in time and money saved. See your RCA Test Equipment Distributor or use the coupon below for the complete story on how it can help you.

## A QUICK WAY TO GET DETAILS



TEST AND MEASURING EQUIPMENT

**RADIO CORPORATION  
of AMERICA**

ENGINEERING PRODUCTS DEPARTMENT

CAMDEN, N.J.



Radio Corporation of America  
Dept. 70-G, Test & Measuring Equipment Section  
Camden, New Jersey

Please send me your publication on the new RCA test oscillator (Type 167-B) with signal-injection probe, designed to simplify and speed up radio repair work.

Name \_\_\_\_\_

Company \_\_\_\_\_

Street Address \_\_\_\_\_

City \_\_\_\_\_ Zone \_\_\_\_\_ State \_\_\_\_\_

Designed for



Application

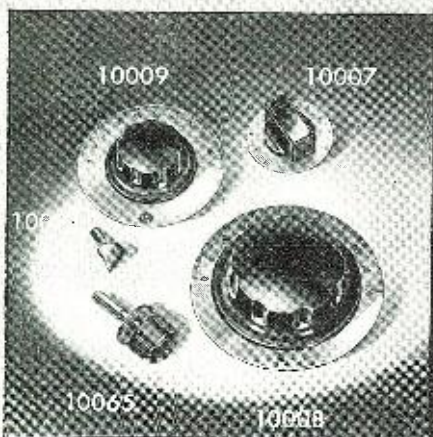

### The Millen Group of Plain Dials

The No. 10007, 8, and 9 group of nickel silver plain dials with specially designed matching knobs have accurately reamed brass bushings so as to insure concentricity. The dials themselves are insulated from the hubs by means of spacer ring molded as part of the knob. The small 10007 unit is available with either 180° standard scale or 280° for potentiometer use. No. 10065 is vernier drive device for use with No. 10008, 3 1/2" dial. The knobs are also available less dials, for other uses.

**JAMES MILLEN  
MFG. CO., INC.**

MAIN OFFICE AND FACTORY  
**MALDEN  
MASSACHUSETTS**



## Spot Radio News

★ Presenting latest information on the Radio Industry.

By **FRED HAMLIN**

Washington Editor, RADIO NEWS

**LOOK FOR FM** manufacturers, dealers, and station operators to launch an all-out sales campaign before the end of the summer. Goal, to establish FM as a national radio necessity before the end of the year. Although the drive will be more educational than spectacular, it will cover all media, concentrating on dealers and listeners. Experimental campaigns are already under way, but the big guns are being held back until enough AM-FM sets are on the market to meet the expected public response.

**AMONG OTHER THINGS**, the program will answer a number of questions raised by FCC Commissioner Clifford J. Durr early in the summer in an address before the Institute for Education by Radio. "There seems to be a disturbing inclination on the part of radio to cling to its old system of aural broadcasting rather than give free rein to a new system," Commissioner Durr declared. "Eighty-five manufacturers of radio sets have replied to a questionnaire sent to them by the Commission requesting their contemplated production of receivers during the current year. The total reported production of these manufacturers was approximately 22,000,000 sets, 9,000,000 more than the largest volume of radio receivers previously sold in any one year. Yet, according to their reported plans, of these 22,000,000 sets, only 1,800,000, or about 9 per-cent, are to contain FM bands. In the interest of the rapid development of FM, it is to be hoped that the American public . . . will continue to be dissatisfied with anything less than the newest and best. Until FM sets in substantial numbers are in the hands of the listening public, newcomers entering the field of FM broadcasting will be seriously handicapped in finding economic support for their stations. Can it be that those who already enjoy the benefits of favorable standard broadcasting assignments would like to see these handicaps against the newcomer preserved for awhile?"

**ANSWER TO THE QUESTION** is the coming campaign, plus the reasoning behind it. And most of the reasoning has been done, not by the manufacturers—having a tough time keeping up with the demand for radios, never mind what type—nor by

the dealers—able to sell anything on their shelves. Spearhead of the FM campaign, then, are the new FM station owners, acutely conscious of the need for a large listening public and determined to do something about it. But they are not as disturbed as Commissioner Durr about the FM production picture. Having for the most part waited for the duration of the war to get out of the experimental category, they are not too upset at the prospect of waiting a few months before they get into business in a big way, and they realize that in the meantime a lot of selling will have to be done before general acceptance of FM reaches a point where demand for sets will be ahead of supply.

**FM BROADCASTERS** have already gone a long way with that selling to manufacturers and dealers. Enthusiastic manufacturer cooperation is reported all along the line, with *Zenith*, *Scott*, *Philco*, *Stromberg-Carlson* and a number of others already in production on AM-FM sets, and essentially all large manufacturers reported ready to roll by mid-August at the latest. These are being urged by the broadcasters to concentrate their FM sales in the beginning on areas where stations are already prepared to go into full-panel programs as soon as an audience is available. And their cooperation is being sought by the broadcasters to concentrate on the second facet of the sales program—education of the dealer. Such educational work is even now going forward full speed at widespread spots across the nation.

Typical of the dealer-broadcaster-manufacturer teaming is a pioneer drive launched early in the summer by station KOZY, Kansas City, which has been operating on FM commercially since 1942 and fathered by Everett Dillard, a ham since he was fourteen and now general manager of the Commercial Radio Equipment Company. Dillard has been spending money on promoting KOZY since 1944, but now has intensified this work, concentrating on educating both dealers and the general public. Chief media to the dealer is a news letter, telling him the FM facilities available to the public in the Kansas City area, keeping him up to the minute on FM national news, and giving him pointers on selling the new sets. "Food for

**RADIO NEWS**



WHAT! THERE'S NO ONE  
ON THE ENTIRE FORCE  
CAN SERVICE OUR NEW  
WRIST RADIOS? WE MUST  
SUBSCRIBE TO RADIO  
MAINTENANCE  
AT ONCE!

Let  
Radio  
Maintenance  
Magazine  
help you  
keep up  
with new  
developments

"More of  
everything  
you want!"

**Articles monthly on:**

- Television — AM — FM
- Public Address Systems
- Test Equipment — Tools — Service Kit
- Shop Layout — Service Bench
- Trouble Shooting — Alignment
- Business News

**Radio Maintenance  
is not sold on newsstands**

**RADIO MAINTENANCE MAGAZINE**  
460 BLOOMFIELD AVE.,  
MONTCLAIR, N. J.

*Special offer to Radio Servicemen*  
Please send me  
**RADIO MAINTENANCE**

For 1 year 2.00     For 2 years 3.00

NAME \_\_\_\_\_

OCCUPATION \_\_\_\_\_

ADDRESS \_\_\_\_\_

CITY \_\_\_\_\_

ZONE \_\_\_\_\_ STATE \_\_\_\_\_

CHECK ENCLOSED\*     BILL ME LATER

\*NOTE: By enclosing payment,  
thus eliminating billing expense  
**WE WILL ADD ONE ISSUE FREE!**

RN-7



The Original  
**SPINTITE**  
**WRENCH**  
SPINS With  
Ease and Speed

Encourages nimble hands along the assembly line. Made in eleven sizes from 3/16" to 5/8" square, hex or knurled . . . . .

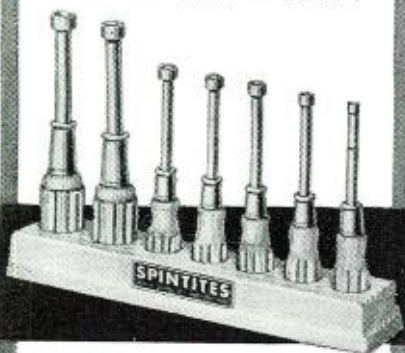

POPULAR Wood  
**SPINTITE** Handles  
T-73 SET

A useful Tool in every Radio and Electrical Shop.

Deluxe T-8 SET the same with Plastic Handles

Send for Catalog 141 picturing Aircraft Radio and Automobile Tools.

**WALDEN**  
WORCESTER  
WRENCHES

**STEVENS WALDEN, INC.**  
468 SHREWSBURY STREET  
WORCESTER, MASSACHUSETTS

thought," says one item: "What will the buyer of a set with AM only, think of the dealer that sold him when he learns that his neighbor can tune in on both AM and FM on a set purchased at the same time from another dealer." Meantime, both for Kansas City and Washington, where Dillard has another FM outlet, he is urging radio manufacturers to allocate a better-than-average share of their FM equipment as it comes off the line, since these communities have stations that will be able to serve the public, and therefore a potential public demand for FM equipment. He is appealing directly to the Kansas City public with newspaper advertising on the values of FM, warning them against buying a radio which will turn out to be a "brand new 1947 Model T." He predicts a boom season in the sets in the fall and early winter—enough to guarantee KOZY a potential listener audience in the Kansas City area "that will make FM advertising extremely interesting to the purchaser of time on the air." Manufacturer, dealer and broadcaster alike are agreed that from then on it will be only a matter of time before FM has a dominant position in the national radio picture.

**ANOTHER BOTTLENECK** that alarmed the industry was the shortage of fine copper wire, heightened by the coal strike and accentuated when the office of international trade of the Department of Commerce authorized some of the copper to be exported. This brought prompt protest from Executive Vice President Bond Geddes of the Radio Manufacturers' Association but little hope from John C. Borton, director of international trade's requirements and supply branch. "We shall continue to do everything possible to see to it that there is not a drain on the domestic supply," said Borton, blaming the current situation on "work stoppages in the copper refineries and inadequate production of the wire mills." He added that information at Commerce was that "additional capacity will be available sometime during the late summer or early fall." He held out no hope for immediate relief. "We wish it were possible for us to be of greater help to you," he told Geddes, "but under the circumstances there is nothing we can do beyond continuing our severe control of exports."

**ALL OF WHICH** is not to overlook the more immediate problem of getting the wrinkles ironed out of the general radio production program, still a major industry headache as this goes to press. With indications at OPA that most ceilings would be lifted by the end of the summer, the situation is not without its bright aspects, but it continues to be confused regardless, and probably will remain so for some weeks to come. Last bottleneck to be broken will probably be the lumber shortage, a situation in

which radio manufacturers are in the position of being innocent bystanders who are taking a beating through no fault of their own. Precious little lumber, when total production is added up, is used by radio to make cabinets, key item in the console trade, but that little—to radio—is precious, indeed. Manufacturers are willing to pay higher than the OPA ceiling to get what they need, but OPA, pointing out that lumber ceilings have already been raised repeatedly, are inclined to be stubborn, if not hostile. Officials say they cannot change ceilings to benefit a single industry, and an unimportant one at that—to the lumber industry. Another difficulty: cabinetmakers get more money turning out furniture than radio cabinets. A third: plastics make a poor substitute (they're all right in the small sets) because purchasers want a console to match their furniture, and wood gives more tone quality. All in all, until labor and other difficulties clear up in the lumber industry so that shortages can be eliminated, radio manufacturers seem faced with a more or less permanent problem.

**TECHNICALLY, THE INDUSTRY** continues to progress on all fronts. Loudest hosannas come from Frank Stanton, CBS president, saying that the last major objection to the practicability of color television as a network service has been eliminated. He bases the statement on the successful CBS 450-mile transmission of u.h.f. television over coaxial cable facilities between New York and Washington. "The evidence is plain," said Mr. Stanton, "that color television on a network basis is not only fully practicable, but also that it has an enormously greater appeal than even black-and-white pictures picked up and broadcast locally." More miraculous than this to an average ham with a set on a farm is FCC's announcement that they have granted the first construction permit for experimental radio stations in a rural telephone service. Work is going forward under direction of the Mountain States Telephone and Telegraph Company, which serves thinly populated parts of Colorado, where wire lines are not available. A central office fixed station is to be located at Cheyenne Wells, Colo., with four subscriber fixed stations at ranches within a twenty mile radius. A sixth station will operate as a portable transmitter to test the system when it gets going.

**WHICH REMINDS US**—be extremely careful about how you start your own portable radio-telephone service, even if you do it all in fun. FCC would think it very unfunny—to the point of a \$10,000 fine or imprisonment or both. The Commission announces that no licenses will be issued for the walkie-talkie and other transmitters by the general public except in the  
(Continued on page 121)

# See how readily YOU can train at home for BIGGER EARNINGS in RADIO ELECTRONICS



**FREE KIT PACKET SHOWS HOW YOU CAN GET LOTS OF "LEARN-BY-DOING" RADIO EXPERIENCE AT HOME FROM DEFOREST'S THRILLING RADIO "Home Laboratory"**

Now—you can see for yourself why DeForest's Training does such a grand job of preparing men for a bright future in one of America's most promising opportunity fields—Radio and Electronics. Send the coupon below for your free "Kit Packet" plus the big free book, "Victory For You!" that has helped so many to find the way to good pay jobs. You'll be surprised at the opportunities ahead of FM Radio, Aviation Radio, Broadcast Radio, a profitable Business of Your Own, Motion Picture Sound Equipment, and Electronics—plus the exciting future possibilities ahead of Television, Radar, etc. Train in your spare time at home—or get all of your training in our Chicago laboratories.

**133 EXPERIMENTS**  
DeForest's Kit Packets show how you can get real Radio experience from the many standard Radio parts furnished you with DeForest's Training. See how you may quickly build Radio Circuits that work... how you may experiment with Photo Electric Cell "Magic"... a 5-Tube Superheterodyne Receiver... a Radio Telephone and scores of other fascinating projects. See how you get actual "shop training" at home to give you the practical Radio experience you need.

## VETERANS!

Big things are happening at De Forest's for veterans! See how you can prepare yourself **without cost** for a **GOOD JOB** or **BUSINESS OF YOUR OWN** in the vast Radio-Electronic opportunity field.

### DeFOREST'S PROVIDES ALL 3 HOME TRAINING AIDS

- A** DeVry Movie Projector and Learn-By-Seeing Movie Film
- B** Actual Radio Parts for working out 133 experiments
- C** 90 lessons prepared under the supervision of Dr. Lee DeForest—the "Father of Radio."

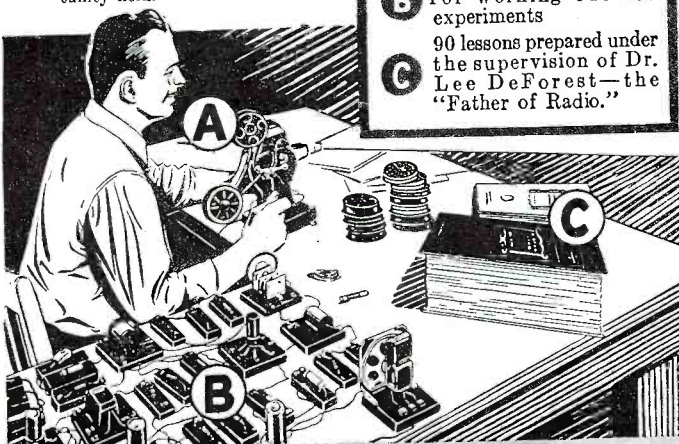

## You Also Get EFFECTIVE EMPLOYMENT SERVICE

Upon completing your training, you get the full benefit of DeForest's Employment Service that has helped so many men to get started in the Radio-Electronic field.



DeFOREST'S TRAINING INCLUDES INSTRUCTION IN MOTION PICTURE SOUND EQUIPMENT, FM RADIO AND TELEVISION... RESIDENTIAL TRAINING IN OUR MODERN CHICAGO LABORATORIES ALSO AVAILABLE—ASK US FOR INFORMATION!

E. B. DeVry, President  
DeFOREST'S TRAINING, INC.  
2535-41 North Ashland Ave., Dept. RN-C7  
Chicago 14, Illinois, U.S.A.

Send **FREE RADIO KIT PACKET** and **"VICTORY FOR YOU!"** BOOK.



Name \_\_\_\_\_ Age \_\_\_\_\_  
Address \_\_\_\_\_ Apt. \_\_\_\_\_  
City \_\_\_\_\_ Zone \_\_\_\_\_ State \_\_\_\_\_  
 If under 16, check here for special information.  If a discharged Veteran of World War II, check here.

**DeFOREST'S TRAINING, INC.**  
CHICAGO 14, ILLINOIS

# SUPPRESS RADIO NOISES FROM FLUORESCENT LAMPS!

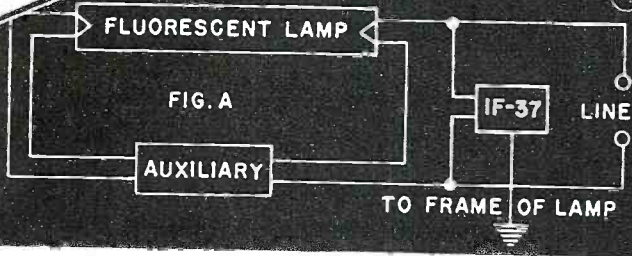
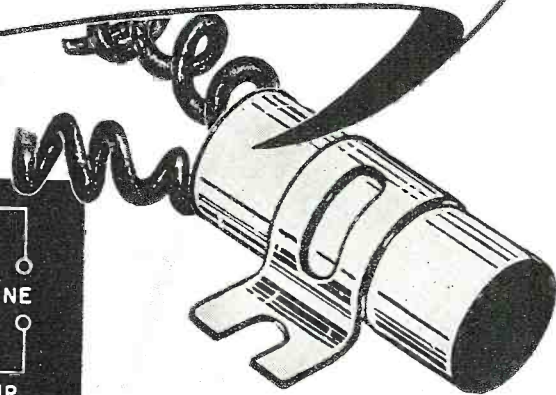

## EASILY INSTALLED — HIGHLY EFFECTIVE

The most serious radio interference from fluorescent lamps is that which is conducted down the power line to receivers at remote points. Such interference cannot be avoided merely by placing the lamp at a safe distance from the radio antenna circuit. Nor can it be avoided by using shielded lead-in wire, as in cases where interference is caused, either by direct radiation from the lamp bulb itself or by radiation to the radio antenna circuit from the electric supply lines.

Yet interference conducted down the power line to remote receivers should, and CAN, be reduced.

The really effective method is to connect Sprague IF-37 Filters directly to each fixture as indicated in the above diagram. These filters are

specifically designed for fluorescent lamp interference suppression. They are recommended for single lamp fixtures, connected as shown in figure "A". One filter is required for each auxiliary.

Type IF-37 Filters are EASY to install. Inexpensive, too—only \$1.11 each, net.

### RADIO DEALERS! REMOVE INTERFERENCE IN YOUR OWN STORE

The use of Type IF-37 Filters in your own store will help you sell more radios through better demonstration. Your sets may be perfect, but if your own fluorescent lamps interfere with reception your customers may assume the radio is at fault.

*Don't let noise spoil  
your sales!*



### WRITE

for your copy of the new Sprague Catalog No. C-306. It's the first Sprague Catalog in five years devoted to civilian radio service. In it you'll find new capacitor types and outstanding resistor improvements. Write for your new catalog today!

# SPRAGUE PRODUCTS CO.

NORTH ADAMS, MASS.

Jobbing Distributing Organization for Products of the Sprague Electric Co.



# Amphenol

provides the link in

AM

FM

TV

A complete range of electronic components to serve the entire range of frequencies in use today.

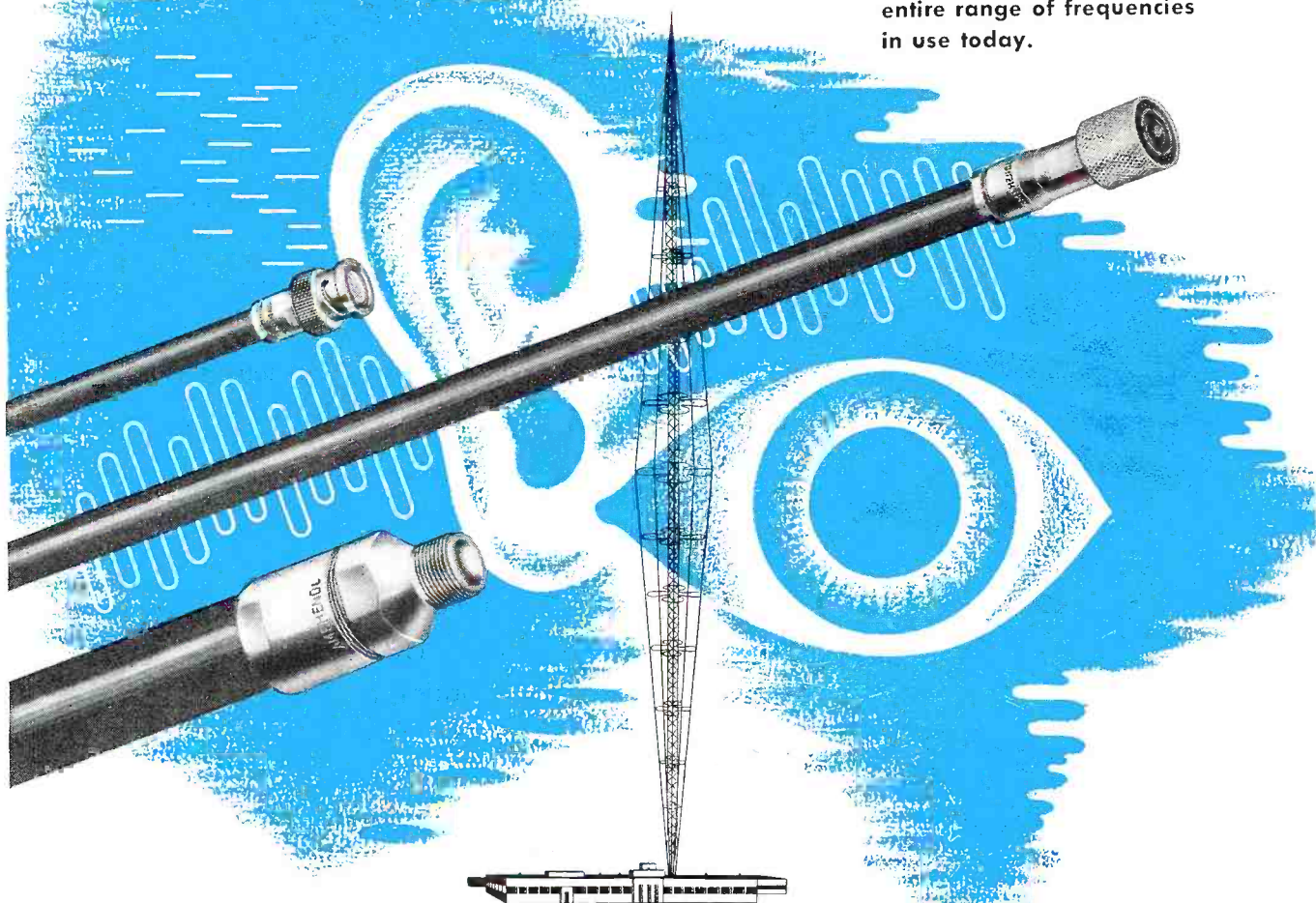

• As the emphasis in communications development shifts more and more to the higher frequencies — notably FM and Television — the electrical circuits and the component parts involved require ever greater accuracy in performance. Amphenol engineers have always worked to help push forward the frontiers of the science of electronics — the unrivalled production facilities of Amphenol have supplied the quality components required by new developments in this field.

• Among the newest Amphenol products that will be of interest to amateurs and to manufacturers of elec-

tronic equipment are: electrically better Hi-Q tube sockets, octal angle sockets for cathode ray and other tubes — Twin-Lead parallel transmission line — several FM receiving antennas — new cables, including some special ones for Television color cameras and for Facsimile work. Write for complete information.

**AMERICAN PHENOLIC CORPORATION**

CHICAGO 50, ILLINOIS

In Canada • Amphenol Limited • Toronto

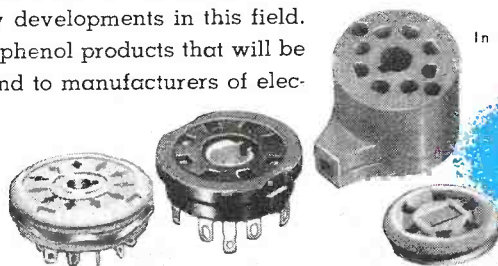

**AMPHENOL**

COAXIAL CABLES AND CONNECTORS • INDUSTRIAL CONNECTORS, FITTINGS AND CONDUIT • ANTENNAS • RADIO COMPONENTS • PLASTICS FOR ELECTRONICS

YOU CAN GIVE BETTER, FASTER SERVICE with these

3

BALANCED  
RESISTOR  
ASSORTMENTS

STURDY, HANDSOME Resist-O-Cabinet

FREE WITH EACH ASSORTMENT

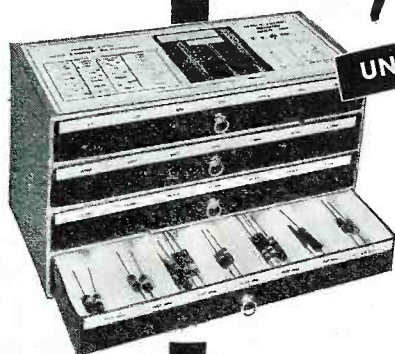

UNIVERSAL ASSORTMENT

Balanced resistor assortment. Includes 59 IRC Type BT Insulated Metallized Resistors and "universal" 10-Watt Power Wire Wound Types AB and ABA. The ABA (adjustable) type makes possible every range from a few ohms up to 10,000 ohms.

No one knows better than you that up-to-the-minute appearance and modern, efficient service pays off in your shop.

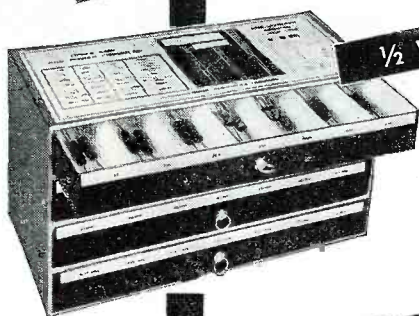

1/2 WATT ASSORTMENT

100 Type BW-1/2 and BTS Resistors. A complete assortment of most used ranges in the popular 1/2-Watt Insulated Metallized and Insulated Wire Wound Types.

That's why IRC offers three Resistor Assortments to equip you for quick, easy resistor replacements on almost any job. Any one or all three IRC assortments, arranged according to type and range, are in neat, sturdy cardboard Resist-O-Cabinets that stack firmly one on top of the other. The cabinets are supplied absolutely *free* with each assortment ordered at standard resistor prices. Get in touch with your IRC distributor *today*

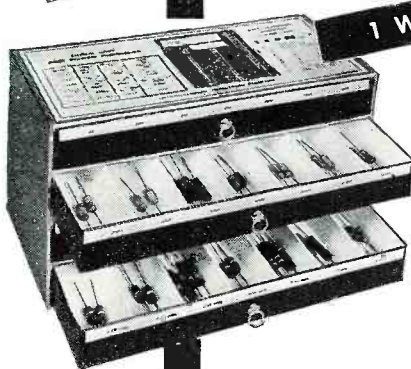

1 WATT ASSORTMENT

83 Type BW-1 and BTA Insulated Resistors. Every service engineer should have all of these top-quality 1-watt resistance ranges at his fingertips.

EASY TO STACK →

Bases of Resist-O-Cabinets are arranged for stacking so that several cabinets may be used to increase stock capacity.

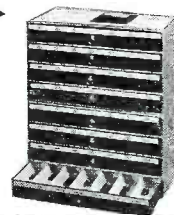

INTERNATIONAL RESISTANCE CO.

401 N. BROAD ST., PHILADELPHIA 8, PA.

Canadian Licensee: International Resistance Co., Ltd., Toronto

Grasp the **NEW OPPORTUNITIES** in

# RADIO ELECTRONICS AND TELEVISION NOW!

## MODERN ELECTRONIC LABORATORY FOR YOU TO USE AND KEEP

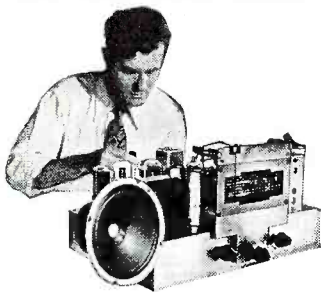

The very essence of National Shop Method Home Training is **EXPERIENCE**. You get the actual experience by working with modern Radio and Electronic equipment—building circuits and instruments. You may build a fine, long distance **MODERN SUPERHERT-ERODYNE** signal generator, miniature radio transmitter, audio oscillator—many other full sized, actual, operating pieces of equipment and instruments—conduct cathode ray and hundreds of other experiments. This experimental laboratory work advances with your training and you actually *learn by doing*. Send the coupon and get the full details of how such an offer can be made.

## SEE WHAT NATIONAL TRAINING HAS DONE FOR THESE MEN!

National Shop Method Home Training wins good jobs, independence and security quickly. Take the word of National men who have established records in their favorite Radio, Television, or other branches of Electronics:



Joseph Grumich, Lake Hiawatha, New Jersey writes: "My latest offer was \$5,800.00 as Radio Photo Engineer but I'm doing well where I am now engaged. I am deeply indebted to National."

Here's a statement from R. R. Wright, Blackfoot, Idaho: "Due to my training at National I was selected to instruct in the laboratory work of Navy and Marines."



Robert Adamson, Kearney, Nebraska, National graduate, has two radio jobs — makes double pay as a radio instructor and as engineer at Station KGFW. He writes: "I am proud of My National training and appreciate the cooperative spirit."



From O. K. Ivey, Washington, D. C., comes this endorsement: "I believe National offers the best course to be had... Keep up the good work."

Read what hundreds of other enthusiastic students have written about National Training. Send in your coupon today.

## SHOP METHOD HOME TRAINING

By a Great Established Resident School

Get one of the thousands of **NEW JOBS** that demand new techniques and methods in modern radio. Get your share of the **NEW BUSINESS** that servicing the new sets and equipment demands. Experts agree that Radio Television and Electronics presents the next great industrial boom! Radio is expanding farther and faster than ever with great improvements in reception. Radar is already a 2-billion-dollar-a-year business. No one knows yet how great the Television market will be. Electronics touches almost every walk of life—in industry and in the home.

**TURN YOUR INTEREST IN RADIO INTO A CAREER THAT WILL ASSURE YOUR SUCCESS.** Mail the coupon below for a list of the great opportunities in this field—today and in the near future.

**Get the Proper Training**  
The good jobs in Radio Electronics now go to the men who are equipped to handle them. It takes training and experience. National Schools, one of the oldest and best established technical trade schools in the country, makes it possible for you to get this training and experience right in your own home in **YOUR SPARE TIME**. National maintains one of the biggest resident training shops and laboratories in the United States where instructors, scientists and engineers are working constantly to improve and advance training methods. **SHOP METHOD HOME TRAINING** is a logical extension of this practical system.

A **FREE** lesson that shows you how practical and systematic—how sound, simple and easy this new training method is will be sent you without obligation. You may keep and use this lesson as you see fit. Fill out and mail the coupon below.

### Investigate this Proposition

Where do you stand today in modern industrial progress? What does the future hold for you? You owe yourself this opportunity. It may never come again. With National training **YOU GET AHEAD FAST**—you may step into a good position or start a business of your own, with little or no capital, even before you complete your National course.

Fit yourself for a career of independence, good earnings, a lifetime of success and security in one of the fastest growing fields in the World. But make up your own mind. Get the information first hand. Put your name and address on the coupon and mail it today.

### Get this Book FREE

This big book presents the facts about the field of electronics and your opportunities in it together with full information about the advanced National Training. Read it and make up your own mind that National Training will equip you for a great future. No salesman will call on you from National. The book is **FREE** with your sample lesson. Send the coupon or write.



## FREE LESSON

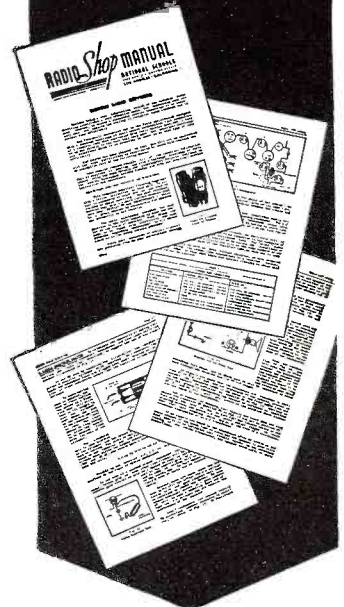

## NATIONAL SCHOOLS

LOS ANGELES 37, CALIFORNIA EST. 1905



### MAIL OPPORTUNITY COUPON FOR QUICK ACTION

National Schools, Dept. RN-7  
4000 South Figueroa Street, Los Angeles 37, California

(Mail in envelope or paste on penny post card)

Mail me **FREE** the two books mentioned in your ad including a sample lesson of your course. I understand no salesman will call on me.

NAME ..... AGE .....

ADDRESS .....

CITY ..... ZONE ..... STATE .....

Check here if veteran of World War II.

# Liberty RADIO and PHONOGRAPH Kits...

## 6 Tube "Super Het" Radio Kit

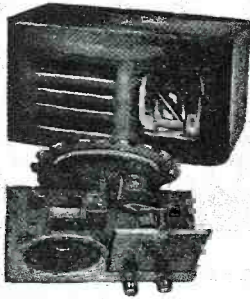

COMPLETE, INCLUDING ATTRACTIVE WALNUT CABINET  
All Parts Mounted

To assemble, all one needs is a soldering iron and 30 minutes of your time.

Uses one 25L6—one 25Z6—one 6SQ7—one 6SK7—two 6SJ7's or one 50L6—one 35Z5—two 12SJ7's—one 12SQ7—one 12SK7.

YOUR **\$16.95** LESS TUBES COST

## 5 Tube "Super Het" Radio Kit

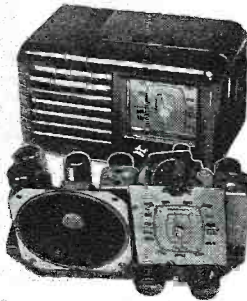

COMPLETE, INCLUDING ATTRACTIVE BROWN BAKELITE CABINET.  
All Parts Mounted

APP SIZE 9x5x6 Inches

Uses one 25L6—one 25Z6—one 6SA7—one 6SQ7—one 6SK7 or one 50L6—one 35Z5—one 12SA7—one 12SQ7—one 12SK7.

YOUR **\$13.95** LESS TUBES COST

Cabinet supplied in white at \$1.00 extra

## Portable Phonograph Kit

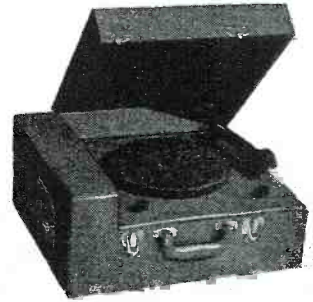

ATTRACTIVE COVERED CABINET COMPLETE WITH MOTOR — PICK-UP — AMPLIFIER

SIZE: 14 x 7½ x 19

TONE AND VOLUME CONTROLS

Uses one 25L6—one 25Z6—one 6CS.

YOUR **\$24.95** LESS TUBES COST

### PICTORIAL DIAGRAM FURNISHED WITH EACH KIT

We carry a complete line of Radio Parts and Equipment—Contact Department "A" for all items including the "Hard to Procure"

## IMMEDIATE DELIVERY • TERMS 10% Deposit with order. Balance C. O. D.

### SPECIAL! 5 Tube Super Heterodyne Radio Kit with SLIDE RULE DIAL

### LATEST POST-WAR APPROVED SIGNAL GENERATOR Model A100

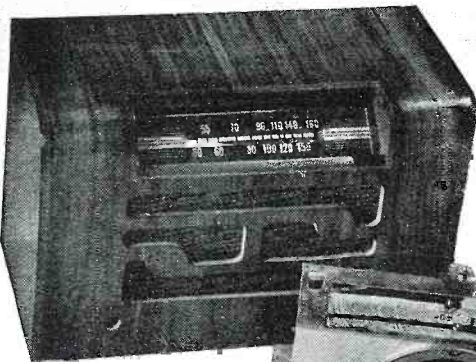

Pictorial Diagram furnished

Your **\$19.95** Less Tubes Cost

Chromium plated chassis—Beautiful Walnut Cabinet—Built in antenna—Dimensions: 6½" x 7¾" x 12¾".

Uses the following tubes: one 12SA7 one 12SK7 one 12SQ7 one 50L6 and one 35Z5

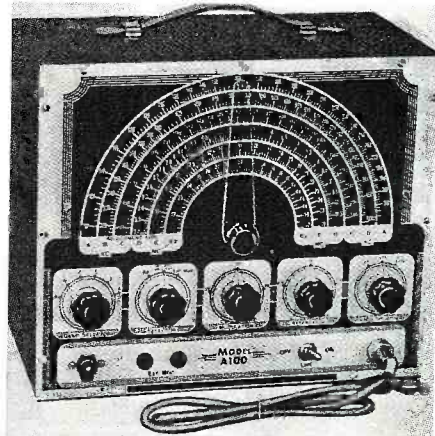

Here it is at last the 1946 Precision Built Instrument you've been waiting for. The Model A-100 Signal Generator is mounted in a heavy gauge steel cabinet, battleship grey crackle finish. Complete with all tubes, connecting cables and instructions—only \$47.00 F.O.B. New York City. Dimension: 12"x10"x6½". Shipping weight: 18 lbs. Multicolor Frequency Dial Scales (Non-glare design). External Modulation possible at from 40 to 30,000 Cycles. Internal Modulation at 440 Cycles (same as S.W.V Standard). Phase Shift Audio Oscillator and Internal Modulator.

6 RF Bands  
A—100 to 310 Kc.  
B—320 to 1000 Kc.  
C—1000 to 3200 Kilocycles  
D—3.2 to 10.5 Mc.  
E—10.5 to 26 Mc.  
E2—21 to 52 Mc.

A.C. Operation 105 to 120 Volts 50 to 60 cycles. Continuously Variable RF-AF Fine Attenuator Control. Co-Axial Output lead furnished. Pilot light indicator. Modulation Percentage continuously variable from front panel, internal or external 0 to 100%.

**\$47.00**

### AN EXCEPTIONAL VALUE

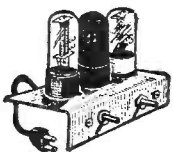

3 tube A.C. D.C. Phono Amplifier Kit—less tubes, with speaker—uses 6C5—25Z6—25L6—your cost

**\$5.95**

INVERTERS  
Converts D.C. Current to A.C. Cap. to 50 W.  
YOUR COST \$10.75 EACH

### RECORD CHANGER

2-post, complete with motor and pick-up. Fully Guaranteed.

List, \$37.50

Your Cost \$22.50

### AUTO RADIO ANTENNA

Chromium plated Steel  
Fits all models  
66" ..... \$3.90  
72" ..... \$4.50  
96" ..... \$6.25  
110" ..... \$7.25  
Less 40%.

### IMMEDIATE DELIVERY

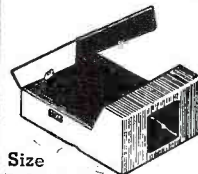

**\$7.75**

Size 7x14½x16 inches

Portable Leatherette Cabinet for Electronic Phonograph.

# LIBERTY SALES CO., INC.

115 WEST BROADWAY  
NEW YORK 13, N. Y.  
BARclay 7-6063

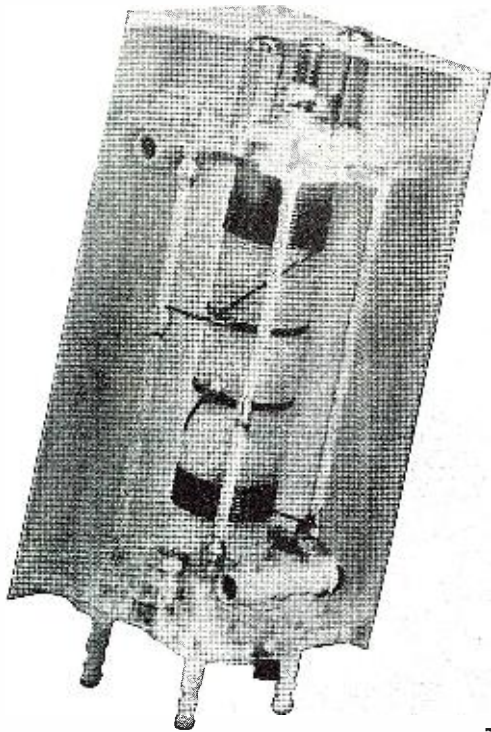

# NEW IF TRANSFORMERS

These new IF transformers are designed to meet the highest standards of performance in high frequency FM and AM. All operate at 10.7 Mc., making them ideal for the new FM band. Iron core tuning is employed and the tuning does not affect the bandwidth of 100 Kc. for the IFN or 150 Kc. for the IFM.

The discriminator output is linear over the full 150 Kc. output and remains symmetrical regardless of the position of the tuning cores.

Insulation is polystyrene for low losses. Mechanical construction is simple, compact and rugged. The transformer is 1 7/8 inches square and stands 3 1/8 inches above the chassis.



**NATIONAL COMPANY, INC., MALDEN, MASS.**

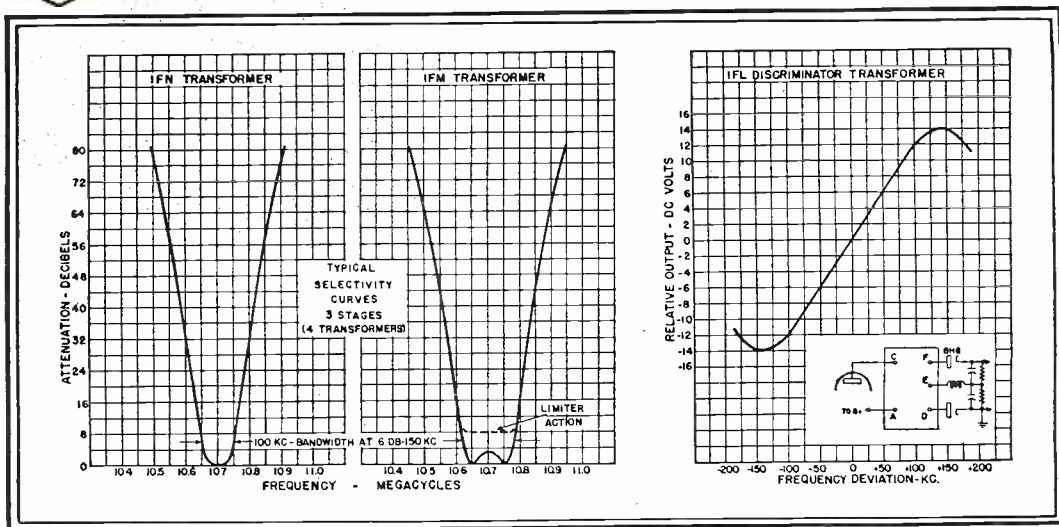

ANOTHER NEW

**Jensen**  
*Coaxial*

The most significant postwar loud speaker development yet announced is the new Jensen family of Type H Articulated Coaxial Speakers. The latest member is Model HNP-51, an all *ALNICO 5* design - in which low-frequency and high-frequency speakers are employed coaxially in an articulated assembly. The 15-inch l-f cone acts as an extension of the h-f speaker horn. The two loud speakers are electrically and acoustically coordinated into a system achieving brilliant and natural response through the entire useful frequency range (l-f performance depends upon the baffle or enclosure used). Frequency-dividing network has variable control in range above 4,000 cycles.

HNP-51 is recommended for FM receivers, high quality phonograph reproduction, television, review rooms, monitoring and home and public entertainment generally.

Coaxial Models HNP-50 and HNF-50 (for manufacturers) and HNP-51 (for general use), are now nearing quantity production. All Type J Jensen Coaxials (3 models) are now in production. Write for complete information.

**Jensen**  
SPEAKERS  
WITH *ALNICO 5*

JENSEN RADIO MANUFACTURING CO., 6617 S. Laramie Ave., Chicago 38, Ill.

In Canada: Copper Wire Products, Ltd., 137 Oxford Street, Guelph, Ontario

*Specialists in Design and Manufacture of Fine Acoustic Equipment*

### TYPE H SPECIFICATIONS

**MODEL HNP-51** (15-inch) with *ALNICO 5* in both l-f and h-f units. Power rating, 25 watts maximum in speech and music systems. Input impedance, 500 ohms. List price approximately \$125.

**MODEL HNF-50** (15-inch) *ALNICO 5* design h-f unit; field coil in l-f unit; otherwise same as HNP-51. List price approximately \$115.

**COMPLETE REPRODUCERS.** Model HNP-51 Speaker is offered in 2 cabinet models to form complete reproducers. Model "CR" Reproducer employs beautiful Jensen Imperial Walnut cabinet. Model "RA" Reproducer employs attractively finished general utility cabinet.

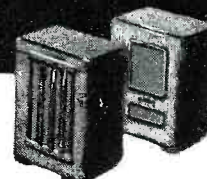

PLEASE PLACE YOUR ORDER WITH YOUR REGULAR RADIO PARTS JOBBER. IF YOUR LOCAL JOBBER CANNOT SUPPLY YOU, KINDLY WRITE FOR A LIST OF JOBBERS IN YOUR STATE WHO DO DISTRIBUTE OUR INSTRUMENTS OR SEND YOUR ORDER DIRECTLY TO US.

## The New Model CA-11 SIGNAL TRACER

Simple to operate . . . because signal intensity readings are indicated directly on the meter!

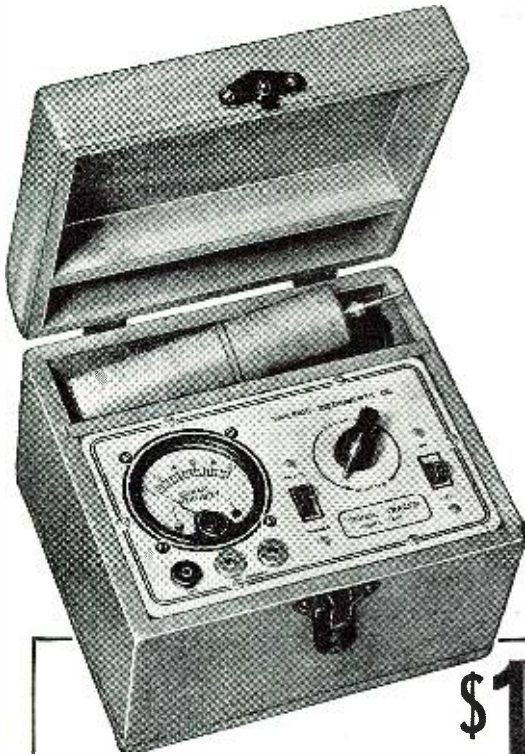

The Model CA-11 comes housed in a beautiful hand-rubbed wooden cabinet. Complete with Probe, test leads and instructions.....Net price

**\$18<sup>75</sup>**

Essentially "Signal Tracing" means following the signal in a radio receiver and using the signal itself as a basis of measurement and as a means of locating the cause of trouble. In the CA-11 the Detector Probe is used to follow the signal from the antenna to the speaker — with relative signal intensity readings available on the scale of the meter which is calibrated to permit constant comparison of signal intensity as the probe is moved to follow the signal through the various stages.

### Features:

- ★ SIMPLE TO OPERATE — only 1 connecting cable — NO TUNING CONTROLS.
- ★ HIGHLY SENSITIVE — uses an improved Vacuum Tube Voltmeter circuit.
- ★ Tube and resistor-capacity network are built into the Detector Probe.
- ★ COMPLETELY PORTABLE — weighs 5 lbs. and measures 5" x 6" x 7".
- ★ Comparative Signal Intensity readings are indicated directly on the meter as the Detector Probe is moved to follow the Signal from Antenna to Speaker.
- ★ Provision is made for insertion of phones.

## The New Model 450 TUBE TESTER



### Specifications:

- Tests all tubes up to 117 Volts including 4, 5, 6, 7, 7L, Octals, Loctals, Bantam Junior, Peanut, Television, Magic Eye, Hearing Aid, Thyratrons, Single Ended, Floating Filament, Mercury Vapor Rectifiers, etc. Also Pilot Lights.
- Tests by the well-established emission method for tube quality, directly read on the scale of the meter.
- Tests shorts and leakages up to 3 Megohms in all tubes.
- Tests individual sections such as diodes, triodes, pentodes, etc., in multi-purpose tubes.
- New type line voltage adjuster.
- NOISE TEST: Tip jacks on front panel for plugging in either phones or external amplifier will detect microphonic tubes or noise due to faulty elements and loose internal connections.
- Works on 90 to 125 Volts 60 Cycles A.C.

**SPEEDY OPERATION** assured by newly designed rotary selector switch which replaces the usual snap, toggle, or lever action switches.

The model 450 comes complete with all operating instructions. Size 13"x12"x6".  
Net weight 8 lbs. **\$39<sup>50</sup>**  
Our Net Price.....

## New Model 400 ELECTRONIC MULTI-METER

A Combination Vacuum-Tube Voltmeter and Volt-Ohm Milliammeter plus Capacity, Inductance, Reactance, & Decibel Measurements



### Specifications:

- D.C. V.T.V.M. VOLTS: 0 to 3/15/30/75/150/300/750/1500/3000 Volts
  - D.C. VOLTS: (At 1,000 Ohms Per Volt) 0 to 3/15/30/75/150/300/750/1500/3000 Volts
  - A.C. VOLTS: (At 1,000 Ohms Per Volt) 0 to 3/15/30/75/150/300/750/1500/3000 Volts
  - D.C. CURRENT: 0 to 3/15/30/75/150/300/750 Ma.  
0 to 3/15 Amperes
  - RESISTANCE: 0 to 1,000/10,000/100,000 Ohms  
0 to 1/10/1,000 Megohms
  - CAPACITY: (In MFD) .0005—.2 .05—20 .5—200
  - REACTANCE: 10 to 5M (Ohms) 100—50M (Ohms)  
.01—5 (Megohms)
  - INDUCTANCE: (In Henries) .035—14 .35—140 35—14,000
  - DECIBELS: —10 to +18 +10 to +38 +30 to +58
- The model 400 comes housed in a rugged crackle-finished steel cabinet complete with batteries, two sets of test leads, one set of V.T.V.M. probes and instructions. Size 5 1/2" x 9 1/2" x 10".....Net **\$52<sup>50</sup>**



# SUPERIOR INSTRUMENTS CO.

Dept. R.N. 227 FULTON ST., NEW YORK 7, N. Y.

# SUPER PRO

Series 400



## Less QRM---Phone or CW

When the bands are active it only takes one minute to find that you need Hammarlund's patented variable crystal filter to have a successful QSO—either phone or CW.

Look to the future! When the number of Hams doubles or triples you will need the crystal filter that weeds-out the QRM . . . If you can't hear 'em, you can't work 'em!

Price (SP-400-X)

**\$342.00**

Including Speaker



# HAMMARLUND

THE HAMMARLUND MFG. CO., INC., 460 W. 34<sup>TH</sup> ST., NEW YORK 1, N. Y.  
MANUFACTURERS OF PRECISION COMMUNICATIONS EQUIPMENT





Dealers' showrooms, decorated to equal the attractive displays of larger merchandisers, hold promise of bringing radio dealers a larger percentage of new receiver sales.

# Patterns in Selling RADIO SERVICE

**Radio News Editors interview veteran service dealers. Field surveys show dealers are alert to new postwar service business opportunities.**

**By PAUL H. WENDEL**  
Eastern Editor, RADIO NEWS

**W**HAT does the future hold for the independent radio service dealer?

Wrap up a solid answer to that question and you could do a nice business selling it across the counter. Humbly and unostensibly born a quarter of a century ago when the radio experiment swept the country with the speed of a flash flood, radio servicemen have struggled through the years to keep pace with the quickening tempo of new developments in the radio art. The serviceman, sometimes inadequately supplied with circuit and service data, oftentimes had to figure out the designer's plan in a set given him for repair. Occasionally he was able to correct the designer's mistakes.

The war threw a tremendous job on the shoulders of the country's radio servicemen. Radio had become an integral part of our way of life. To keep millions of home receivers in repair with the meager trickle of parts and tubes permitted by the serious demands of war required service ingenuity. Depending almost entirely on information picked up from their trade publications about component substitutions and circuit adjustments, radio service dealers did an admirable job of maintaining our radio life line.

War research, experiment and application are claimed to have advanced radio's newer brain children, frequency modulation and television, by many years. Now considered com-

mercially practical, these two systems for bringing entertainment into the home are expected to rapidly take their places in our lives and even eventually to replace AM radio in many sections.

More complex than AM and requiring the use of advanced testing equipment and technical knowledge, widespread sale of FM and TV receivers will pose new service problems of repair and installation.

Some commentators already are leaving the independent service dealers out of these new fields. In his place they visualize vast national service organizations maintained by radio manufacturers. This would be a costly plan for any radio manufacturer to undertake. Despite their vast re-

sources, major automobile manufacturers have never attempted such a program for supplying users service on their cars. They continue to rely on independent, franchised dealers.

But regardless of the academic discussions now current about radio service dealers' futures, the fact remains that our independent radio servicemen have always met and solved every major problem that involved radio receivers in the hands of users. It is also unfortunately true that the service dealer shared in little of the immense profits earned by the industry during the first two decades of its existence.

Out of the turbulent years of radio development there remains a group of seasoned radio service veterans who

Radios, traffic appliances, and major appliances will be handled by many radio service dealers and displayed in attractive showrooms such as this. Service dealers are anxious to pick up extra income from their store traffic but many will continue to look to their service activities for dependable operating income.



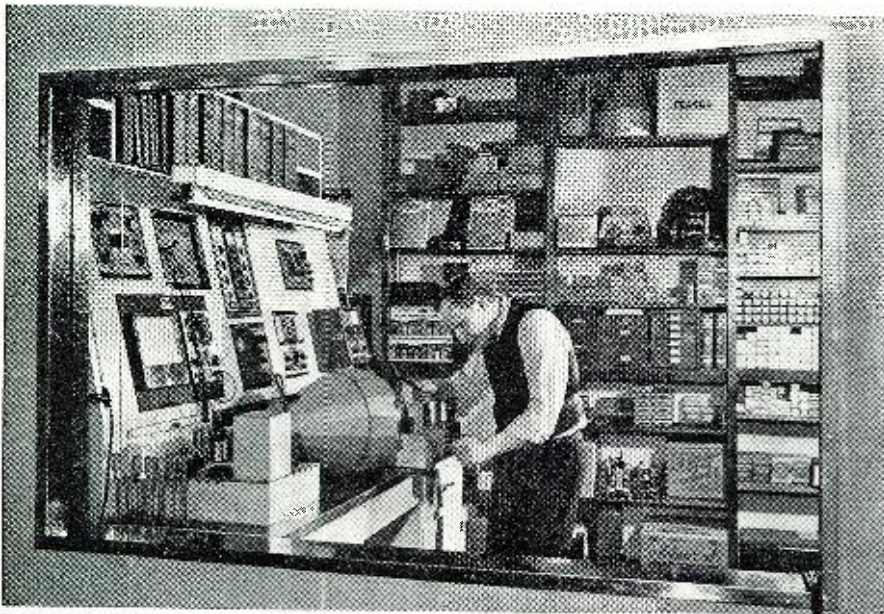

Attractively framed by the sliding plate glass window border and visible to all store customers, this shop arrangement epitomizes the use of good merchandising practices in radio service selling. Verne Wintermute, engaged here in checking the image on a video set, planned this effective arrangement when remodeling.



Automobile radio service insures a good volume of repair business for Merle Radio at Plainfield, N. J. The counter-balanced overhead door at the rear of shop permits rapid handling of cars in and out of the department. Work bench to the right of car (not visible) is completely equipped with instruments, tools and the power sources to rapidly check auto receivers.

form the backbone of the home receiver industry. From hard-won experience these men have wrung a knowledge of specialized retail merchandising that would be difficult to duplicate in a newly formed organization. This group bids fair to furnish purchasers of radio receivers and associated electronic equipment the kind of efficient service that will continue to match the technical advances of radio laboratories and factories.

Since V-J Day veteran radio servicemen have been moving ahead rapidly to establish their businesses firmly and to take advantage of all the new service opportunities the coming market will offer. Shops are being rearranged and redecored. Plans are being perfected to handle the retail sale of such new merchandise as will fit into the individual dealer's scope of operation. Allocation of floor space to either service activities or new products is being done along sound merchandising lines.

Two excellent illustrations of how seasoned radio service dealers have re-

arranged and redecored their shops in preparation for attracting a good share of the radio service business in their trade area are to be found within a few blocks of each other in Plainfield, New Jersey. One is owned by Lucien Merle and the other by Verne Wintermute, both of whom are veterans in the field of radio service.

Plainfield, a city of approximately 65,000 population, is located on the outer perimeter of commuter towns which encircle the city of New York. It is situated about 28 miles west of New York and the intervening terrain is reasonably flat, permitting line-of-sight reception of television programs radiated from the video antennas of the three New York City stations, WNBT (NBC), WCBW (CBS) and WABD (DuMont).

Commercially, industrially, and socially, Plainfield is comparable to towns of the same size located in other parts of the country, with one important exception. Situated close by one of the most densely populated areas in the U. S., local business is affected by competition from stores throughout the greater New York area. Business survival in the face of this intense competitive condition demands rare commercial acumen.

Merle Radio, located at 110 East 7th Street, utilizes a store 35 feet wide by 70 feet deep. This provides ample room for the large departmentalized service department and a generous amount of display space for new radios and appliances.

Lou Merle has set up a service department to handle repairs on five types of radio products with production line efficiency. These include (1) home radios—AM, FM, & TV, (2) automobile radios, (3) record players and changers, (4) p.a. systems, and (5) airborne radio equipment.

Minor repairs, such as tube checking, simple solder jobs, etc., are handled at one of the three service benches in the first floor service department. Major repairs are taken care of in a specially designed shop installed in an air conditioned, sound-proofed room in the basement. In this shop a signal generator can be used freely without disturbing activities in the sales room.

For ten years preceding the war Merle Radio specialized in installing radios in new automobiles. As many as twenty-five installations per day were handled by a crew of five men. In the "assembly line" technique used for auto radio installations, each set was bench-tested before installation, one man handled all interior car work, wearing a clean jumper at all times, while another mechanic took care of exterior fittings such as the antenna, suppressors and power connections.

Mr. Merle does not expect future business on auto radio installations to equal prewar levels. He is of the opinion that manufacturers will equip cars with radios at the factory, at least during the period when anxious buyers will gladly pay for fully equipped cars. However, he is main-

General layout of V. M. Wintermute Radio Service Shop in Plainfield, N. J. shows an effective utilization of display space. Radio dealers are applying good selling techniques in merchandising their various radios and traffic appliances.

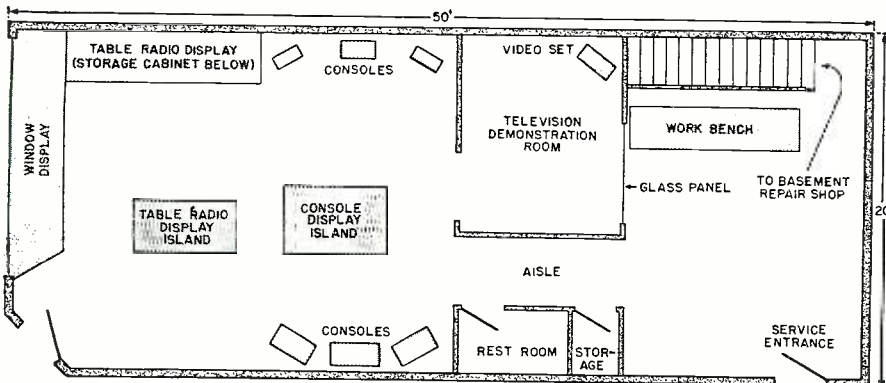

taining the drive-in service department for auto radio repairs. This type of radio service is profitable if the servicing set-up can be arranged to eliminate lost time between the car and the work-bench.

Servicing of record players and changers in the Merle shop centers in a special, home-made service rack which Mr. Merle designed to facilitate the handling of changer chassis. A large percentage of automatic record changer service involves adjustment or replacement of the mechanical parts of the changer. This ingenious changer rack, described in last month's issue of RADIO NEWS, permits the serviceman to observe the operation of the changer mechanism without handling the chassis. In thus speeding up changer repairs this department has been showing a nice profit, and an increasing volume of repair business.

Anticipating a growing demand for public address systems in the years to come, Mr. Merle keeps in close touch with new developments in this field. He keeps four portable p.a. systems for rental purposes and has had a good demand for them at a daily rental charge of two dollars. By keeping in close touch with activities in the Plainfield area Merle usually has an opportunity to bid on new installations of p.a., call and music systems and expects to receive a share of this type of business as equipment becomes available.

Many observers think that airborne radio equipment in private planes will eventually create an entirely new market for competent radio service. In anticipation of the possible potentials in this new radio field, Mr. Merle contracted to handle any plane radio service which may be required at a local private flying field. It is his plan to install a small service shop at the field whenever the volume of business warrants it and to keep a qualified radio serviceman available for airborne radio service. It is too early to make definite plans for servicing airborne radio equipment in private planes, but dealers who are on the alert for expanding service volume, should keep abreast of radio developments for use in privately owned planes.

Merle Radio currently employs five radio servicemen to take care of the present volume of repair business. The shop arrangement and organization is flexible enough to handle an increasing volume of business in any of the specialized fields it is designed to cover.

The V. M. Wintermute Radio Service shop is located at 341 Park Avenue in Plainfield. In modernizing his shop, Mr. Wintermute planned an operation that will be an exclusive radio and radio service store. The floor space, 20 feet wide by 50 feet deep, was broken up into four sections.

The first section provides shelf and island display space for table model and portable radios. The second section, designed for displaying consoles,

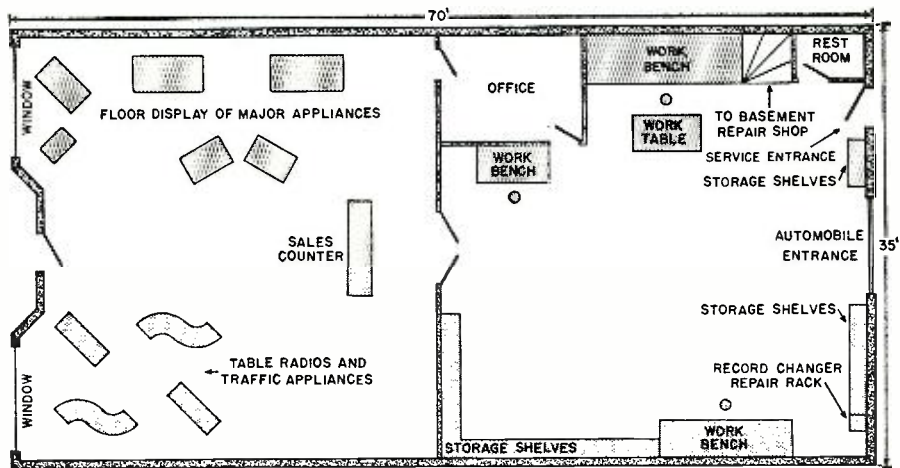

Floor plan of the Merle Radio store in Plainfield, N. J. The store space, 35 x 70 feet, is separated in the center by a wall which provides two areas 35 feet square. Display racks on the sales floor are movable, permitting frequent rearrangement of displays. Decorated in pastel shades, this showroom looks attractive from street.

is equipped with slightly raised display platforms along two sides and in the center for an island arrangement, to show off the displayed models to best advantage. A television viewing room makes up the third section. This room is attractively furnished with comfortable chairs to enable potential television receiver buyers to see video programs. Lighting of this room is controlled by a power rheostat which permits the dimming of the light to a level most convenient for viewing television programs without eyestrain.

At the rear of the store, plainly visible to all store traffic through a plate glass panel, is a neat and efficient looking work shop. Although only minor repairs are handled in this shop it provides an effective "eye-

stopper" to any customer who enters the store.

The entire basement of the store is fitted up as a workshop and ample bench room and equipment is provided to handle a number of sets simultaneously.

Mr. Wintermute has been associated with the radio industry for about a quarter of a century. During the ten years prior to the war he operated his store exclusively on radio repairs, handling radio repairs and installations for a number of department and chain stores in Plainfield.

When television receivers first became available in the early 1940's, many of the larger radio retail sales outlets shied away from selling them.

(Continued on page 122)

Successful service centers for FM and television will be completely equipped with the best of test instruments and tools. Design of work benches and the placement of test equipment must be carefully studied to provide servicing conditions of factory efficiency. Technician solders connection with a new high speed iron.

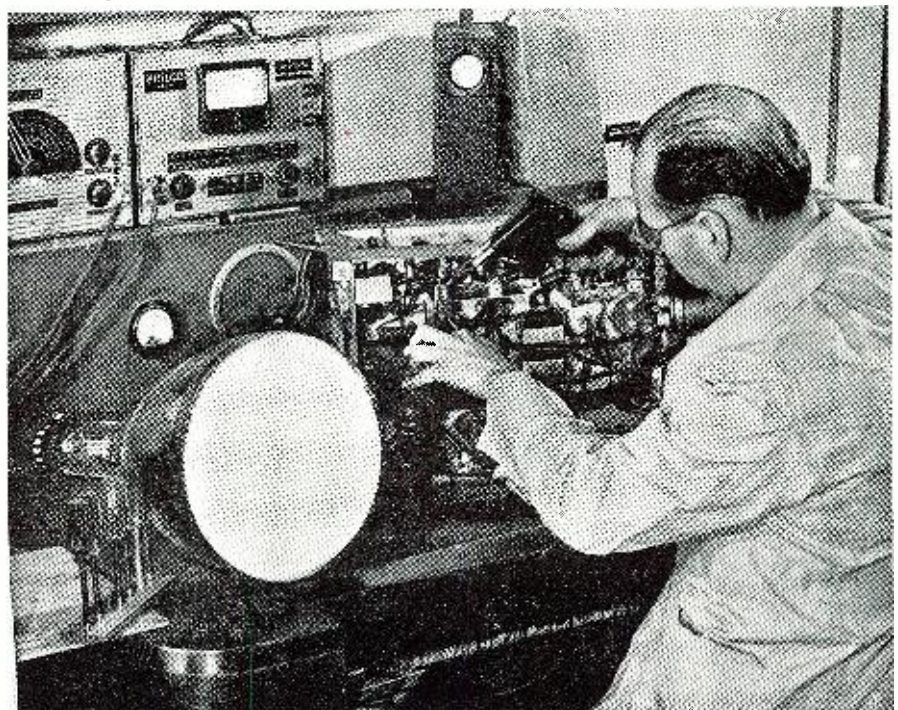

# CONTACT 75 WATT TRANSMITTER

By  
**ROBERT LEWIS, W8MQU**



Two views of the completed unit. Although home constructed its appearance compares favorably with many commercial transmitters.

**Employing plug-in type coils, an HY30Z as a final amplifier and an 807 as an oscillator—this 75-watt transmitter covers all amateur bands up to 30 mc.**

IN SPITE of all the talk and print about the revolutionary discoveries and changes in radio, most of these are in the frequencies above 30 mc. Below this, as far as amateur communications are concerned, little has been discovered or at least announced publicly, which might result in radical changes.

The transmitter described in this article was designed to cover all the amateur bands up to 30 mc. efficiently. A power input of 75 watts was chosen, which is ample for consistent communication, and economical to build and operate. In addition to that, a 75 watt transmitter can always be used to drive higher power triode amplifiers up to 500 watts, or tetrode amplifiers to the maximum legal input.

The circuit finally settled on for the transmitter being described uses an 807 tritret oscillator and an HY30Z in the final amplifier. The power supply is built on the same chassis with the r.f. section, and the unit presents a complete transmitter ready to hook up to antenna, 117 volts a.c. and key. Plug in coils were chosen for simplic-

ity. It was found that this transmitter could be shifted from one band to another about as fast as the average band switching job. The average amateur has only one antenna, and most of the time taken in changing bands is in retuning, not in shifting coil ranges. It will be seen in the schematic that the final is capacitively coupled to the oscillator, but instead of being connected directly to the 807 plate, the grid is tapped about a third of the way down the coil. This results in a better impedance match, and gives more driving power with less oscillator loading.

Only one meter is used to measure oscillator plate current, final grid and plate current by use of a rotary selector switch. It was thought that one meter would do the job of three, in addition to reducing the cost and labor. Hams who have cut meter holes in one-eighth inch steel panels with ordinary hand tools will heartily agree on the labor angle. When the author's transmitter was built, a circle cutter was tried first, but with very poor luck. Finally the meter hole was cut by

drilling a lot of small holes around the circumference of the large opening, and the job finished with a small rat-tail file, and then a large half-round file. This operation consumed the better part of one evening.

One feature of the transmitter is the final tank assembly. It uses a *Cardwell* AFU foundation unit which consists of a dual section condenser with .0001  $\mu$ fd. per section and 3000 volt spacing (adequate for plate modulating the rig). A *Barker and Williamson* BVL jack bar assembly is mounted directly to the condenser, the mounting brackets themselves being the conductors. The neutralizing condenser is also mounted directly on the side of the tank condenser. This results in extremely short r.f. leads which is desirable on the higher frequency bands. *Barker and Williamson* BVL coils plug into the jack bar, and a shaft extension permits adjustment of the variable link from the front panel. All that is necessary to change bands is to change crystals and cathode coil (unless multiplying existing crystal frequency), oscillator plate coil and final plate coil. It actually takes but a few seconds. The 807 was chosen in favor of the 6L6 because it is easier on crystals. The 6L6 tritret circuit cannot be safely operated with the plate circuit tuned to the fundamental frequency. The writer lost a good \$4.80 crystal in this manner. However, due to better in-

ternal shielding, the 807 seems to operate satisfactorily on the fundamental and it also gives good output on harmonics through the fourth. To insure long crystal life, a 60 ma. flash-light bulb is used as a fuse in the crystal circuit.

The final amplifier job was given to the HY30Z, a neat little triode which speaks well for itself. Any similar triode could be used, however, depending on the individual preference. In this particular circuit, however, the final tube should be a high  $\mu$  type which does not require fixed bias.

The power supply, which contains two Taylor 866 Jr.'s loafs along at the drain the r.f. section puts on it. You will note from the diagram that the primary circuit is fused for protection against overload. Plate voltage can be turned on and off from a remote operating position by means of a relay. Plate voltage cannot be turned on, however, until filament switch is in the "ON" position.

Keying is accomplished in the 807 cathode circuit, and no difficulty has been experienced in getting clean cut signals. With steady plate and screen voltages obtained for the 807 from the bleeder, there is no sign of chirp.

After deciding on the electrical circuit, it was found that a chassis 17 inches long, 13 inches wide and 4 inches high would accommodate all the parts without crowding. A 19 inch by 12 1/4 inch relay rack panel was used in conjunction with two mounting brackets.

Prior to purchasing any parts, a chassis layout was drawn out on paper, as well as a front panel layout. Catalogs which show accurate dimensions of each part are handy when making mechanical layouts. By this method it is possible to plan a rig without actually having any parts on hand. It is recommended, however, that actual drilling be postponed until all major components are obtained.

After all the parts for this transmitter were secured, the first step was to assemble the chassis, panel, and mounting brackets. Incidentally, the chassis, panel and brackets were purchased unfinished, so the layout could be made directly on the metal without danger of damaging a finish. This assembly job was done by first clamping the mounting brackets to the ends of the chassis, making sure all edges were even. Then the holes were drilled through bracket and chassis together, making for perfect lineup of holes. After bolting the side brackets to the chassis, the front panel was then clamped to the chassis and the holes for mounting switches and pilot lights were drilled. For the pilot lights, which are one inch in diameter, 1/2 inch holes were drilled and then reamed to 1 inch. After the drilling was completed, the foundation was then taken apart. Next step was to lay out and drill all necessary holes in the chassis for sockets, transformer and condenser mounting holes, etc. As can be noted on the sub-chassis photo-

graph, a series of holes was drilled above the location of the bleeder; for ventilation. This may have been unnecessary, however, as the bleeder seems to operate at moderate temperature. Before drilling the holes in the front panel for condensers, meter switch, and variable link shafts, these parts were mounted to the chassis and the points where shafts should come through the front panel were accurately located on the panel. These parts were mounted so that their respective control knobs would be symmetrical on the front panel. Lining up condenser shafts with holes on the front panel is a weak point in the average amateur transmitter and too much care cannot be exercised in getting them in line.

After all necessary holes were drilled in the chassis, panel and brackets, the foundation was then given a good sanding and cleaning with lacquer thinner, then sprayed with a coat of primer. Next day, a coat of gray lacquer was sprayed on. If standard

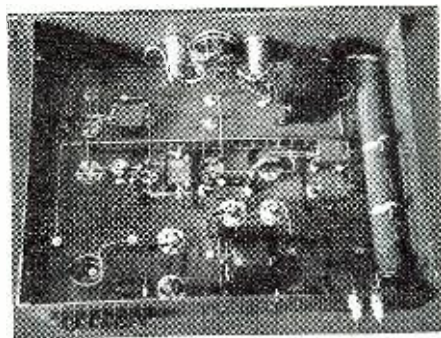

Under chassis view of transmitter.

crackle finished metal ware is used, more care is necessary during layout and drilling, to avoid damaging the finish. The writer is sold on building rigs on unfinished foundations, and then spraying with the desired finish. That does not mean that you have to own expensive paint spraying equipment either. With a little practice it

(Continued on page 96)

Schematic diagram of transmitter and its immediate power supply. Terminals 1 and 2 connect to remote relay switch, terminals 3 and 4 go to 117 volt. a.c. power source and terminals 5 and 6 are to be used for key operation.

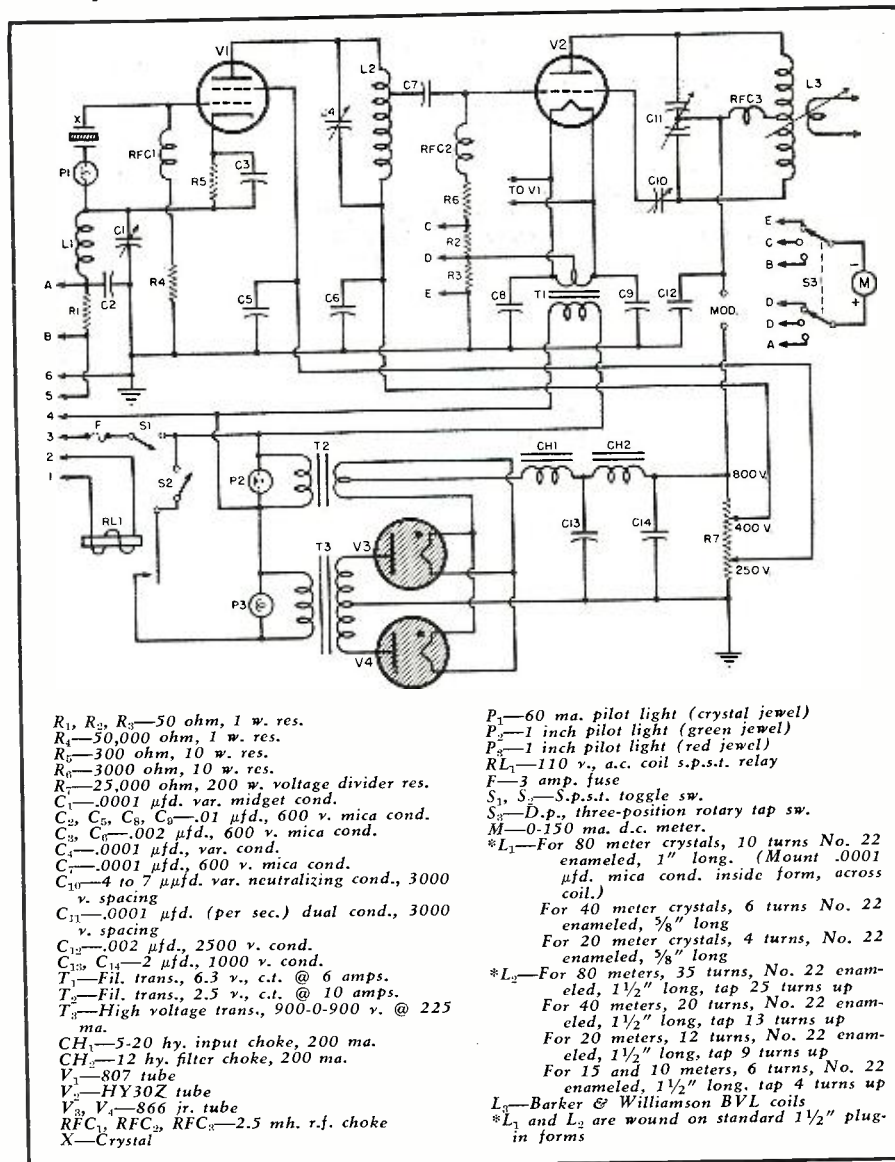

# RADIO NEWS to cover— OPERATION CROSSROADS



★ Officers of the Army and Navy Air Forces inspect part of the radio equipment that will control B-17s during rehearsal for the forthcoming Bikini Atoll atomic bomb tests. Equipment is installed in a jeep and from there will control landing and take-off of B-17 "Drone" by radio. Drone B-17s will fly through atom bomb clouds during the actual tests. Shown left to right are: Brig. Gen. Roger M. Ramey, Denton, Texas, in charge of the Army Air Forces part in the tests; Major D. H. Whittaker, Monmouth, Illinois; Col. Harvey T. Allness, Bayport, Minn. and Rear Admiral C. F. Sprague, in charge of the Navy Air group which will participate in the atom bomb tests.

★ The atomic bomb will "polish off" this vessel. Seamen swab the deck of the Japanese cruiser Sakawa in Tokyo Bay. The vessel, which was commissioned in 1944 and never saw action, has a rendezvous with a Nagasaki-type atomic bomb in the remote waters off of the Marshall Islands during the A-tests.

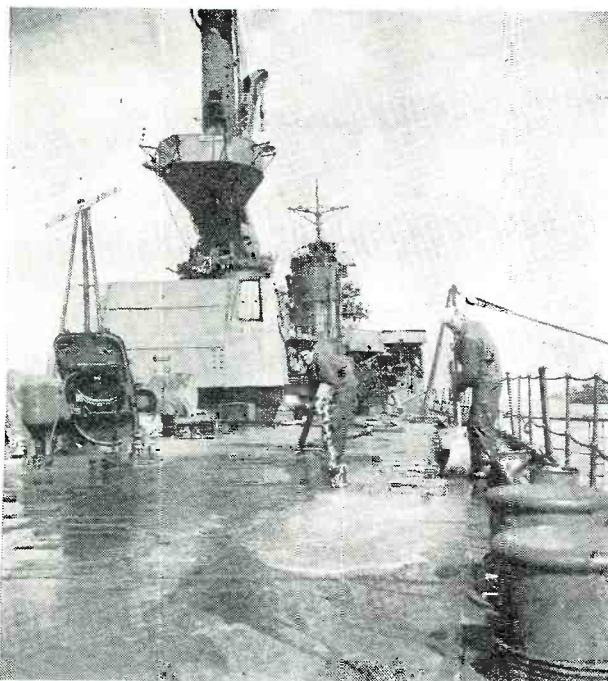

**W**HEN the "Big Show" starts on Bikini Atoll July 1st, RADIO NEWS readers will have a ringside seat for the atom bomb test through the eyes of Oliver Read, Editor of RADIO NEWS.

Because much of the emphasis has been placed on the planes and surface craft which are participating in the test, sometimes the reader loses sight of the fact that the A-bomb test is, in reality, the biggest radio and electronic show in the world. All of the remote control equipment, all of the recording equipment and much of the operating equipment will be electronically operated or radio controlled.

Mr. Read left San Francisco on June 13th by plane for Hawaii from which spot he flew to Kwajalein to make a first-hand inspection of some of the electronic equipment which will be used to record the results of this long-awaited event.

Kwajalein is to be the headquarters for all air operations and also will serve as a major staging area for the Bikini test. *(Continued on page 80)*

★ Two AAF photo lab technicians check the operation of a 24" K-18 aerial camera that will record atomic bomb results in the joint Army-Navy "Crossroads" operations over Bikini Atoll this summer. Many of the planes and their recording units will operate by remote control.



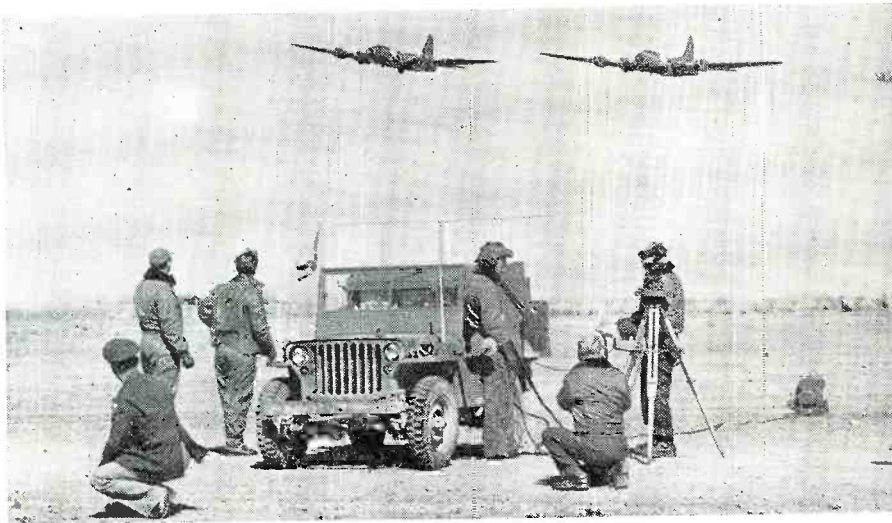

★ In an experiment in rehearsals for the Bikini Atoll atomic bomb tests, a 46,000 lb. Flying Fortress took off from the Army Air Field at Roswell, New Mexico, circled the base for more than 30 minutes, and then landed. The entire operation was done by remote control radio. The landing and take-off were controlled from a jeep on the ground, and in flight from a "Mother" plane flying to the right, above and a short distance behind the B-17 "Drone." Here radio remote control, installed in the jeep, prepares to bring in the drone, plane on right.



★ Col. H. T. Ailness, in command of remote control B-17 operations for the coming atom bomb test, is shown in nose of the "Mother" ship with television scope and control box with which "Drone" B-17 can be flown at a distance of 150 miles from "Mother" plane.

★ Eight photographers man their cameras in a demonstration of how they will work during the atom bomb tests in the Marshalls this summer. In two converted type C-54 aircraft, groups of photographers will operate twenty-one cameras of seven different types.



★ Automatic cameras, operated by remote control, will photograph the U. S. Navy atomic bomb tests this summer. The cameras will be on top of 100-foot steel towers and be housed in small rooms, each shielded against x-rays and other radioactive hazards of an atom bomb explosion. This photo shows the rear of the platform containing batteries of radio-controlled cameras.

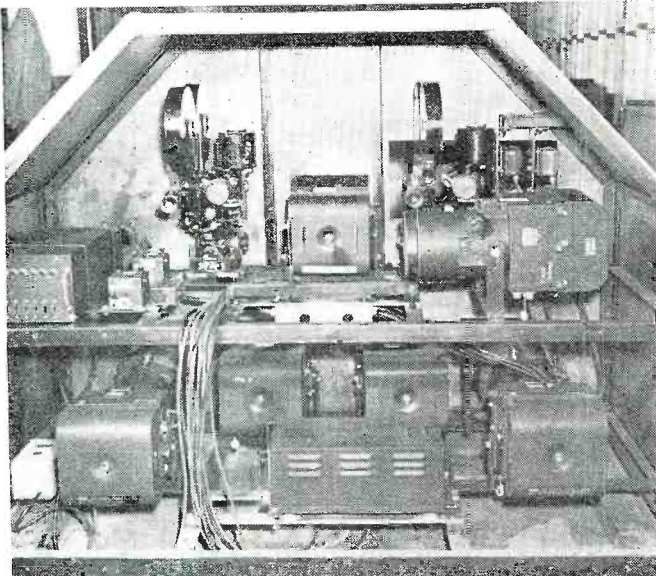

★ S/Sgt. Ivan D. Scott of Oklahoma City, Oklahoma, runs a quick test over the mechanism of the lower turret of a F-13 camera aircraft at the Roswell, New Mexico Army Air Field. The plane will be one of those used in photographing the atom bomb test results.

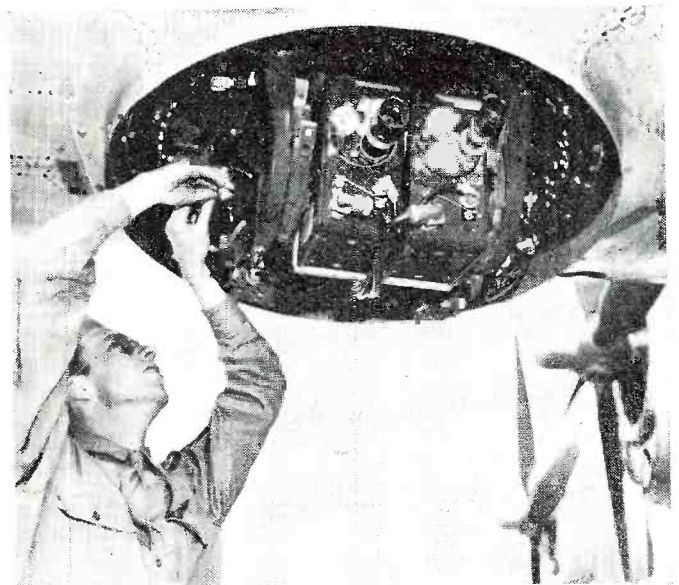

# Super Sensitive AMATEUR RECEIVER

By  
**CARL V. HAYS**  
W6RTP

*A practical discussion of design features of a home built amateur receiver that gives superior performance.*

**S**HORTLY after the 10 meter band was re-opened, the author found himself in need of a good receiver which would not exceed \$100 in cost, but would possess the highly necessary properties of sensitivity, signal-to-noise ratio, bandspread, stability, and selectivity, as well as have an S-meter, break-in switch and remote terminals, good a.v.c., c.w. oscillator, etc., that the better manufactured receivers include.

Quite an order, you will agree, but it can be done for considerably less than \$100. The receiver to be described fulfills the above listed requirements, and in some respects exceeds them.

No one "ham" can probably hope to have the information and experience at first hand to build up a receiver that will equal the average better quality communication receiver, so, not being any more brilliant than the average, the author dug deep into a good collection of sources. The search was not for a single perfect receiver, if such there be, but rather a series of excellent receivers from which representative circuits could be taken, each representing the best in its particular application. From these sources were secured (1) r.f. mixer and h.f. oscillator stages (2) i.f. stage (3) 2nd detector and b.f.o. (4) a.v.c. and S-meter (5) power supply, stabilization and audio stages.

A summary of the requirements of a really good receiver will serve to show why such pains were taken in obtaining circuits, when so many are

available that are more widely used. Briefly, a really good receiver must have a "front end" which is capable of taking (in most cases) an extremely small signal voltage, converting and amplifying it so that a very stable, high gain and very quiet i.f. section can present the maximum signal with minimum noise to a very sensitive second detector, which will provide from it a.v.c. and audio intelligence, as well as mixing the b.f.o. signal (when desired), so that an audio stage can present the "signal" to the speaker. A very complex problem, and when to this problem is added the further requisites of absolute stability and required selectivity, the problem often is apparently well-nigh hopeless of solution, if tackled in the conventional way.

A great number of circuits will not solve the problem, contrary to what one might expect, since the cost, etc., mount rapidly, as well as the grief from other causes which will be mentioned later.

Due to experience with similar layouts in the past, especially in v.h.f., the 10k $\Omega$  high-performance converter of Jones was selected to meet the requirements of (1), as listed previously. It was a fortunate choice, since it gives stability, very high gain, and sensitivity and quietness hard to equal. Some ten articles dealing strictly with i.f. design were studied in order to determine a suitable i.f. stage. The design finally chosen was a composite of several, and leaves nothing to

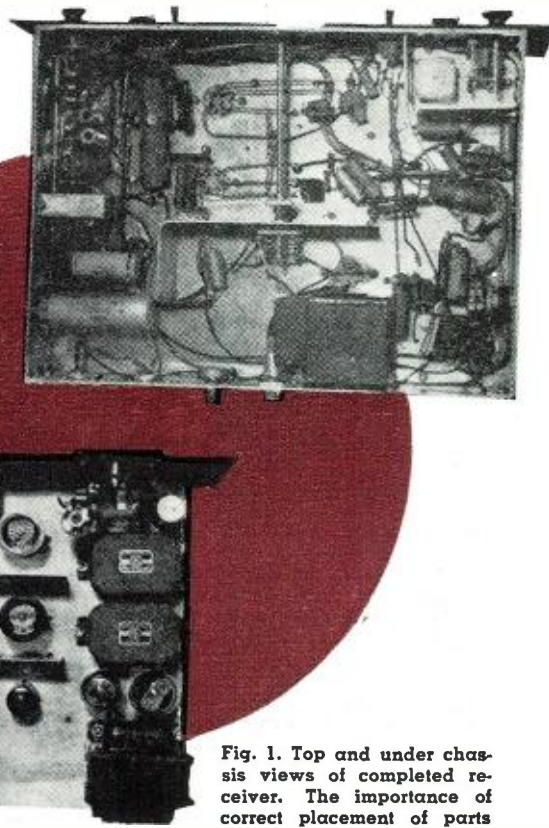

Fig. 1. Top and under chassis views of completed receiver. The importance of correct placement of parts is stressed to eliminate the possibility of inter-coupling between stages.

be desired in achieving a good i.f. section. Too little stress has been laid on i.f. design, although no other stage in the receiver is as important when maximum performance is desired. Multiple stages, to overcome inherent faults in i.f. design, are not the real answer to the problem. Several stages of i.f. are usually used in order to give sufficient signal, especially to the second detector, which is normally a diode. While a diode detector does have advantages, they are so offset by the disadvantages in communications work, that this circuit was not considered. A home constructor need not compromise so he can incorporate only the designs that are optimum for the particular job at hand. The choice of second detector will be dealt with later.

To get back to the all-important i.f. section, it was clear that a single stage, properly designed and laid out, would give more than enough gain for the purpose, since the elimination of the diode second detector cancelled the need of inordinate amounts of signal gain. Fig. 4 shows the design of mechanical lay-out, etc., which was found far superior to any other tried, since it eliminates any tendency towards regeneration, instability, noise, etc. The superior qualities of this single stage of i.f. have to be experienced to be fully appreciated; its complete lack of noise, its unusually high gain and signal-to-inherent-noise capabilities make it ideal to amplify and present the signal to the second detector, with-



## PARTS LIST

**R<sub>3</sub>, R<sub>0</sub>**—1 megohm, 1/2 w. res.  
**R<sub>2</sub>**—50,000 ohm, 1 w. res.  
**R<sub>5</sub>**—5 megohm, 1/2 w. res.  
**R<sub>14</sub>, R<sub>7</sub>, R<sub>21</sub>**—75,000 ohm, 1 w. res.  
**R<sub>15</sub>, R<sub>17</sub>, R<sub>18</sub>, R<sub>20</sub>**—2000 ohm, 1 w. res.  
**R<sub>8</sub>**—25,000 ohm, 1 w. res.  
**R<sub>9</sub>**—500,000 ohm, pot.  
**R<sub>30</sub>**—400 ohm, 10 w. res.  
**R<sub>11</sub>, R<sub>12</sub>**—100,000 ohm, 1 w. res.  
**R<sub>13</sub>**—15,000 ohm, 10 w. var.  
**R<sub>16</sub>**—100,000 ohm pot.  
**R<sub>19</sub>**—1500 ohm, 10 w. res.  
**R<sub>18</sub>**—50,000 ohm, 25 w. res.  
**R<sub>10</sub>**—1000 ohm, wire-wound rheostat  
**R<sub>22</sub>**—30 ohm, 1 w. res.  
**R<sub>25</sub>**—3000 ohm, 10 w. res.  
**C<sub>x</sub>**—Twisted wire  
**C<sub>18</sub>, C<sub>19</sub>, C<sub>10</sub>**—3-gang, 35 μfd. per sec. variable cond. (straight line frequency plate shape preferred)  
**C<sub>2</sub>, C<sub>6</sub>, C<sub>12</sub>**—See coil table below  
**C<sub>1</sub>**—1 μfd. (or larger), 400 v. cond.  
**C<sub>4</sub>, C<sub>7</sub>, C<sub>8</sub>, C<sub>9</sub>, C<sub>10</sub>, C<sub>13</sub>, C<sub>17</sub>, C<sub>18</sub>, C<sub>19</sub>**—0.05 μfd., 600 v. cond.  
**C<sub>7</sub>, C<sub>11</sub>**—0.01 μfd. mica cond.  
**C<sub>13</sub>, C<sub>14</sub>**—0.1 μfd., 600 v. cond.  
**C<sub>10</sub>**—1 μfd., 600 v. cond.  
**C<sub>20</sub>**—4 μfd. (or larger), 250 v. cond.  
**C<sub>21</sub>, C<sub>22</sub>, C<sub>23</sub>**—0.03 μfd. mica cond.  
**C<sub>24</sub>**—10 μfd., 25 v. elec. cond.  
**C<sub>25</sub>**—0.005 μfd. mica cond.  
**C<sub>26</sub>**—25 μfd. var. cond.  
**C<sub>27</sub>, C<sub>28</sub>, C<sub>29</sub>, C<sub>30</sub>**—8 μfd., 450 v. elec. cond.  
**S<sub>1</sub>**—on R<sub>10</sub>, S<sub>2</sub>, S<sub>3</sub>—on R<sub>9</sub>, S<sub>4</sub>—s.p.s.t. sw.  
**CH<sub>1</sub>, CH<sub>2</sub>**—10 hy., 100 ma. filter choke  
**CH<sub>3</sub>**—500 hy., audio choke  
**T<sub>1</sub>, T<sub>2</sub>**—Iron core, 1500 kc., i.f. trans.  
**T<sub>3</sub>**—Output trans., 5000 ohm to v.c.  
**T<sub>4</sub>**—6.3 v. fil. trans.  
**T<sub>5</sub>**—Power trans., 750 v. @ 100 ma. c.t., 6.3 v. @ 3 amps., 5 v. @ 2 amps.  
**L<sub>1</sub>, L<sub>2</sub>, L<sub>3</sub>**—See coil table  
**L<sub>4</sub>**—Iron core, 1500 kc. b.f.o. trans.  
**RFC**—2 1/2 mh. r.f. choke  
**P**—6.3 v. pilot light  
**M**—0.1 ma., 3" square meter  
**Chassis**—17" x 13" x 3" metal chassis

## COIL DATA

### 10 METERS

**Osc.** (L<sub>3</sub>)—3 turns, 1 1/4" long, bandspread tap 1 1/4 turns from ground. Cathode tap 1 turn from ground. Trimmer (C<sub>12</sub>) is 50 μfd.

**Mixer** (L<sub>2</sub>)—6 turns, 1 1/2" long, bandspread tap 1 7/8 turns from ground. Primary 4 turns closewound. Trimmer (C<sub>6</sub>) is 15 μfd.

**R.F.** (L<sub>1</sub>)—Same as mixer. Antenna tap 1 1/2 turns from ground.

### 20 METERS

**Osc.** (L<sub>3</sub>)—9 turns, 1 1/4" long, bandspread 3 turns from ground. Cathode tap 2 1/2 turns from ground. Trimmer (C<sub>12</sub>) is 75 μfd.

**Mixer** (L<sub>2</sub>)—12 turns, 1 1/2" long, bandspread 3 turns from ground. Primary 6 turns closewound. Trimmer (C<sub>6</sub>) 15 μfd.

**R.F.** (L<sub>1</sub>)—Same as mixer. Antenna 2 1/2 turns from ground.

### 40 METERS

**Osc.** (L<sub>3</sub>)—18 turns, 1 1/2" long, bandspread 6 turns from ground. Cathode tap 5 turns from ground. Trimmer (C<sub>12</sub>) is 75 μfd.

**Mixer** (L<sub>2</sub>)—23 turns, 1 1/2" long, bandspread 8 turns from ground. Trimmer (C<sub>6</sub>) is 25 μfd.

**R.F.** (L<sub>1</sub>)—Same as mixer. Antenna 6 turns from ground.

### 80 METERS

**Osc.** (L<sub>3</sub>)—20 turns closewound, bandspread 13 turns from ground. Oscillator cathode tap 7 turns from ground. Trimmer (C<sub>12</sub>) is 75 μfd.

**Mixer** (L<sub>2</sub>)—40 turns closewound, bandspread tap, 26 turns from ground. Primary 14 turns closewound. Trimmer (C<sub>6</sub>) is 25 μfd.

**R.F.** (L<sub>1</sub>)—Same as mixer. Antenna tap 10 turns from ground.

RF trimmer, C<sub>2</sub>, is panel controlled, 35 μfd. var. cond.

All coils—22 enameled on 1 1/2" receiver 5-pin forms, with trimmer self-mounted.

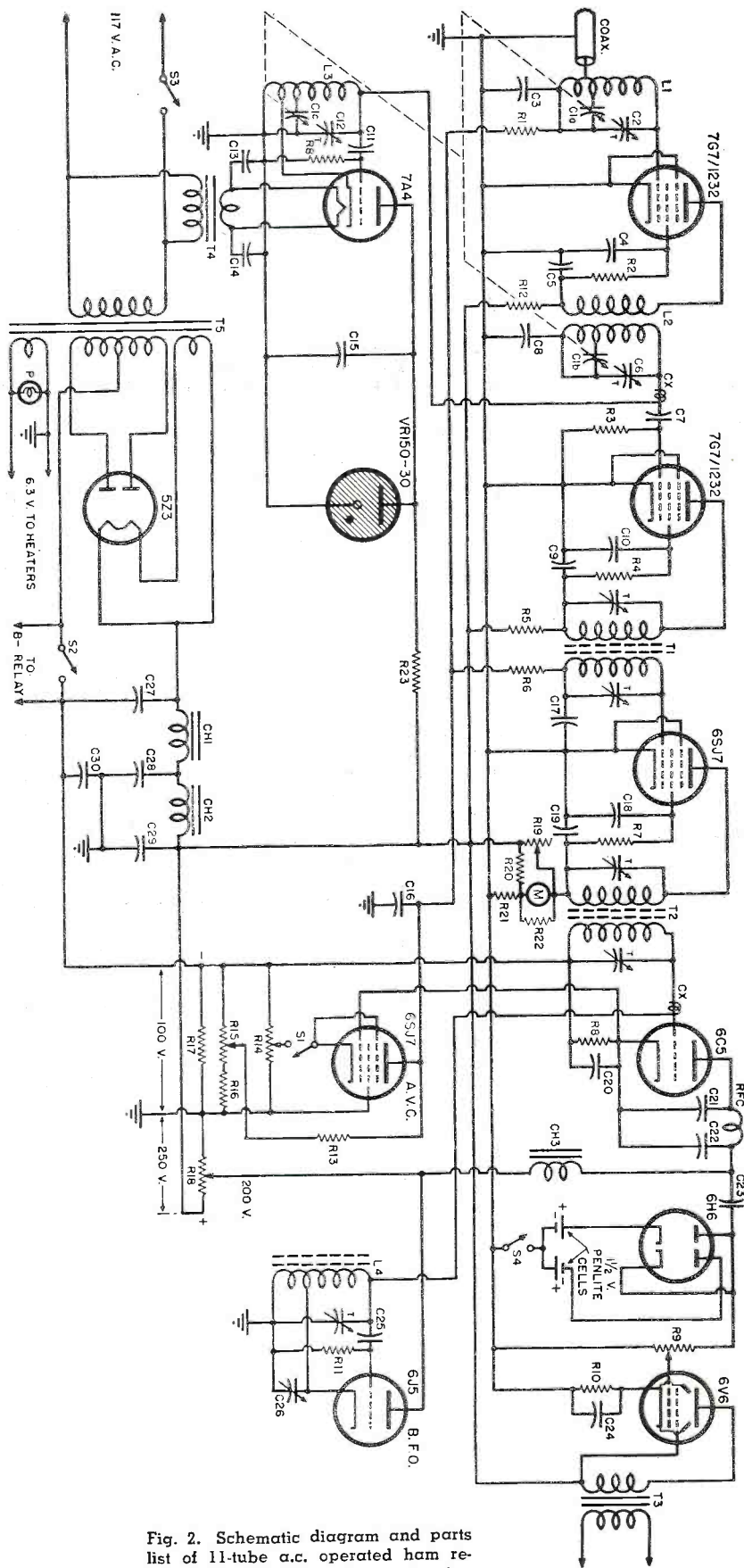

Fig. 2. Schematic diagram and parts list of 11-tube a.c. operated ham receiver. Specifications for construction of plug-in type coils are provided.

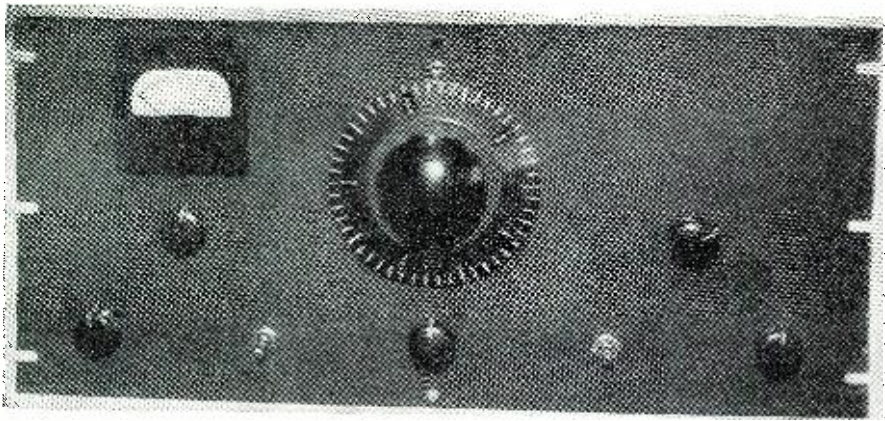
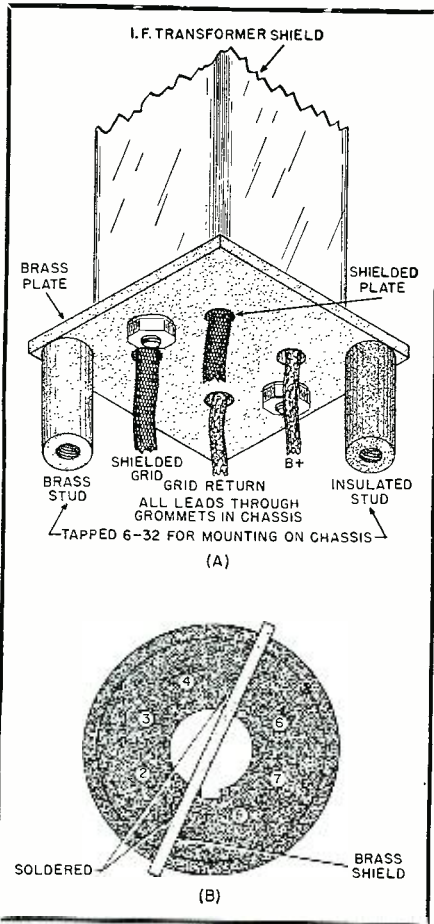

Fig. 3. Panel view of instrument. Controls left to right, bottom, are: b.f.o.  $C_{26}$ ; standby switch,  $S_2$ ; antenna trimmer,  $C_2$ ; noise limiter,  $S_1$ ; r.f. gain,  $R_{15}$ . Directly under S-meter is control  $R_{13}$  and switch  $S_1$ ; to the right of main tuning is the audio gain control  $R_9$  and switch  $S_3$ .

out any of the faults common in the i.f. stage.

Thus, a stable and quiet, high-gain front end and an equivalent stage of i.f. have been achieved. The second detector is the old faithful triode plate detector. Properly constructed, it will out-perform the usual diode on all counts, excepting cheaply obtained a.v.c. An analysis of diode a.v.c., however, indicates that it can be so vastly

Fig. 4. Details of i.f. construction. Plate voltage r.f. and i.f. stages to be adjusted to 200 v. Screen voltage r.f. and i.f. stages to be adjusted to 115 v. Filament voltages to all front-end and i.f. stages must be up to normal or slightly better. These conditions insure best signal-to-shot-noise ratio.



improved by using a triode detector and special amplifier/inverter circuit, that its loss is not serious.

The limitations of a.v.c. as usually employed are too well known to list here; suffice it to say that the system used in this receiver performs the a.v.c. function better than any diode system which has come to the author's attention and without any of the customary faults of such a.v.c. systems commonly in use. This system, in addition to ease of construction, offers positive action, no loss of sensitivity, high bias if needed, ability to handle c.w. and controlled carrier, and a flat control characteristic which is somewhat startling after the conventional response usually found in such systems. It affords a simple means of controllable bias on the grids of the r.f. and i.f. stages, thus eliminating the primary cause of noisy, unstable, insensitive receivers, the often-cursed cathode resistor and its associated bypass. The schematic diagram (Fig. 2), if studied a bit, will show how the circuit works. The a.v.c. tube, 6SJ7, is connected so it inverts as well as amplifies the voltage developed across the second detector cathode resistor.  $R_{14}$ , the cathode resistor (semi-variable) in the a.v.c. circuit, enables the "take-off" point for a.v.c. to be set as desired.  $R_{15}$ , the manual gain control, enables any bias up to about 100 volts to be applied to the r.f. and i.f. grids, in addition to the a.v.c. voltage. An initial value of about -2 volts is established by  $R_{16}$ .

The b.f.o. and audio stages are completely conventional. The b.f.o. is turned off by shorting out the cathode tap to ground. This is accomplished by bending one rotor plate of  $C_{26}$  so that it touches the stator at full mesh; this also allows the b.f.o. to maintain a constant temperature, avoiding drift of this circuit.

A speaker field, of appropriate resistance, can be used to advantage at  $R_{17}$ , thus killing two birds with one resistor, so to speak. The field-type speaker gives somewhat superior audio and may be used, but is not necessary.

The chassis employed is homemade, of  $\frac{1}{8}$ " aluminum, and with the heavy

duty cabinet, insures mechanical rigidity. Any heavy gauge chassis, 17" x 13" x 3" will be suitable.

The power supply is conventional. Heavy duty, dependable parts insure trouble free performance, as always.

Coil data is given in the accompanying table, for use with an i.f. of approximately 1500 kc. Other i.f. frequencies can be used, with appropriate changes, in the event the constructor so desires. Bandspread will be equivalent to about 10 feet, with the dial mechanism shown, and can be varied to suit individual preference by placement of  $C_{1a}$ ,  $C_{1b}$ ,  $C_{1c}$  taps.

The noise silencer shown is from the "Radio Handbook", and will be found highly satisfactory.  $S_1$  allows the silencer to be cut out of the circuit when desired. A noise silencer is almost a necessity on the high frequency bands with a receiver such as this, since its extreme sensitivity will pick up car ignition noise at distances of three and four city blocks.

Tests made on ten meters with commercial receivers indicate that the receiver described herein compares favorably with the best on the market. Incorporating a suitable crystal filter stage, while adding considerably to the expense, would give excellent results in practically all respects, but has not been found necessary for the author's particular needs.

In the interest of easy construction, the author advocates wiring all filament and power circuits first and then constructing and testing the audio stage. The other stages are then completed, one at a time and tested. This insures freedom from a possible series of circuit "bugs," which, if occurring in several places, consume time and patience to correct. This method also insures peak performance from all circuits, once completed.

After coils are wound, the receiver is aligned by setting the main tuning gang,  $C_{1a}$ ,  $C_{1b}$ ,  $C_{1c}$  at half-mesh, aligning the h.f. Osc. padder to center the band and trimming r.f. and Det. trimmers for maximum response. (The r.f. trimmer is panel controlled on all bands, enabling peak performance.) A small amount of peaking of the i.f. stage will suffice, if the circuits have been wired as advocated.

Adjustment of a.v.c. is as follows; once the receiver is aligned and operating satisfactorily, open the a.v.c. switch,  $S_1$ , and tune for a strong signal. With this signal tuned in, close  $S_1$ , and move the slider on  $R_{13}$  until the S-meter begins indicating, showing a.v.c. bias. Adjust for a full scale reading ( $S_0$ ), then open a.v.c. switch, find a weak (S-3 or so) signal, and close a.v.c. switch,  $S_1$ , re-adjusting, if necessary,  $R_{13}$ , until the meter just shows a scale reading. This setting will insure no loss of sensitivity on weak signals.

Operation of the receiver has consistently brought in house volume signals from Japan, Okinawa, Iwo Jima, Tinian, Saipan, Philippine Islands, Guam, Aleutian Islands, Hawaiian Is-

(Continued on page 107)

# HIGHWAY in the SKY

By **ANDREW R. BOONE**

**Skyroads which criss-cross the United States are masterpieces of scientific development.**

THE scientific aerial highway illustrated is one of the main reasons travelers are safer in a plane than they would be in their own bathtubs at home. Accident statistics prove this. Other reasons are thoroughly tested planes, with ample reserve power, and pilots of the highest skill and reliability. A typical result is the 1945 citation by the National Safety Council to *Western Air Lines* for flying 7,713,000 miles without an accident. Another result was the company's earlier ten-year record of no passenger fatalities.

The skyroads which cover the United States cannot be seen, for radio beams and air are invisible, but they are as plain to pilots as any highway, complete with "traffic cops" and "mileposts."

At left (Fig. 1) one of *Western's*

new Skymasters is taking off after being cleared by both the Federal Airway Traffic Control Center and the company's dispatchers. Behind it a radio range station is broadcasting a beam toward the city on the far right. The beam is divided into three parts so that pilots can "keep to the right" just as if guided by a highway's white center line.

On reaching the assigned altitude the plane proceeds straight ahead (2). Planes coming in the opposite direction fly far over to the right, and at a different altitude. The "traffic cops" (control stations) and "mileposts" (light beacons and radio markers) keep the planes ten minutes apart. The block patterns in Fig. 1 represent the various on-course radio signals. In the "twilight" zones the pilot hears the code signal for letters A or N in

addition to the steady beam tone, and knows that he is still on course. When he gets on the code signal he is drifting off course. To be on course he must hear the steady beam tone.

Approaching the city on the right the pilot is informed of clouds ahead (3). The plane continues into the overcast and a radio fan marker tells the pilot exactly where he is (4). Instructions are received from the field by radiophone and the plane descends by a series of precisely timed turns and power glides through the clouds, illustrated by the diagram (5). In these maneuvers (A to G) the pilot follows the beam, passing several times through the cone of silence which further verifies his position, and gradually descends until low enough to see the field and come in.

-30-

Fig. 1. Artist's illustration of aerial highway. Progressive improvements in ground and flight equipment provide safer air travel.

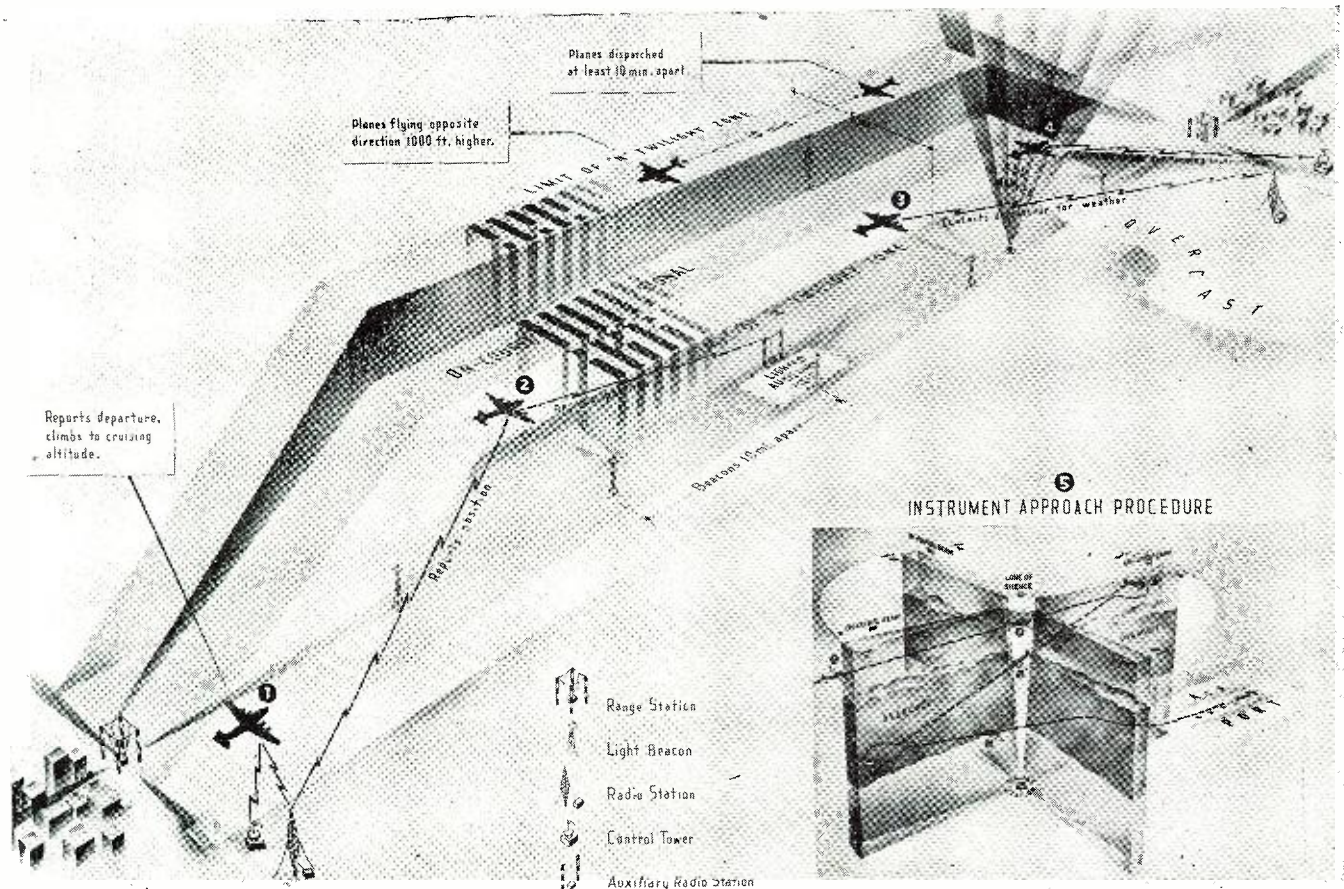

**Part 2. The organ covered herein can be entirely home constructed at a cost not exceeding 150 dollars.**

**By  
ROLLIN E. CAMPBELL  
and  
LYMAN E. GREENLEE**

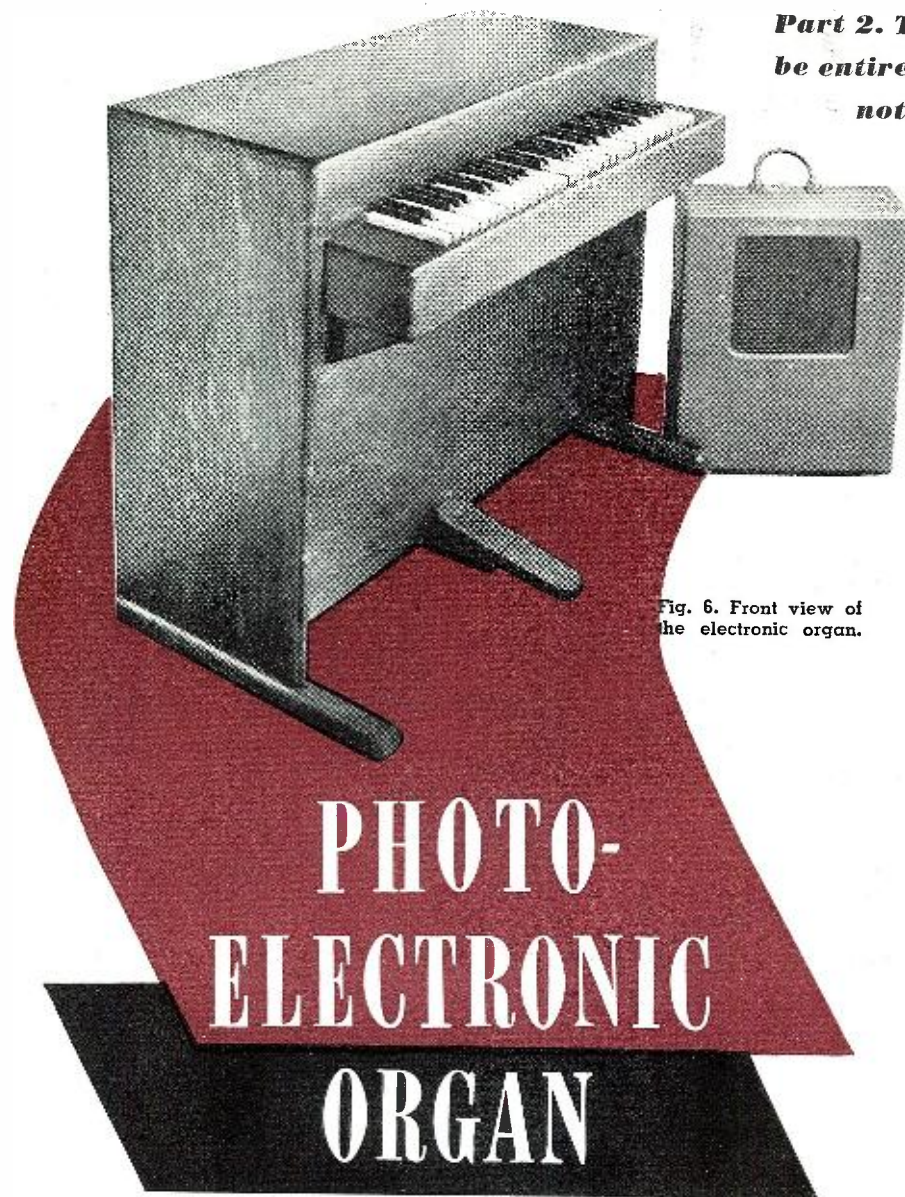

Fig. 6. Front view of the electronic organ.

# PHOTO-ELECTRONIC ORGAN

IN CONTINUING the discussion of the construction of a photo-electronic organ, it is important to note that there is very little electronic equipment employed. Assuming that an audio amplifier is available, all that is needed is a power supply and a photocell input to amplifier unit. These were thoroughly covered in last month's installment. The mechanical details involved in the construction of this unit are of utmost importance, and great care should be taken in following all minute details.

## Swell Pedal

The swell pedal actuates a movable shutter in front of the photocell. The shutter consists of a piece of photographic film shaded from light to dark. The film may be prepared from a sheet of blank film coated with an air brush, or it may be made by means of a graduated exposure obtained by focusing the camera on a diffused light and slowly withdrawing the slide

from the film holder while the exposure is in progress. A few trials may be necessary to secure the proper gradation from light to dark.

We originally used a foot pedal actuating a standard potentiometer for volume control, but we found that this type of control is sluggish, unreliable, subject to damage, and wears out very quickly. For these reasons it was abandoned in favor of the shutter type. The photograph, Fig. 7, was made before the new volume control was installed, and therefore it does not show in this picture.

Vibration of this movable shutter may be used to introduce various so-called "vibrato" effects often employed in organ music, and its very snappy action is essential when playing "hot" music.

## The Cabinet

The cabinet construction is clearly shown in Figs. 6 and 7. Material used was plywood, finished with stain and

varnish. Since this cabinet is purely functional and was designed to provide a housing for the organ with the least possible effort and expense, other constructors will undoubtedly want to design their own. However, where simplicity is important, the design shown should fill the bill very nicely. To improve the external appearance, the entire cabinet may be covered with imitation leather glued on. These materials are available in bright reds, blues, and greens, and offer the home constructor a relatively inexpensive way to secure a commercially built appearance. Mahogany or walnut veneers may also be used, if available, to enhance the external appearance. Such things are optional with the individual constructor. It is not a good idea to try to use an existing cabinet unless it can be completely dismantled and rebuilt with the dimensions altered to suit. One feature of some importance is the light weight of the entire equipment, and the design for the cabinet as shown in the pictures and drawings is an important factor in keeping the weight down to a low value. It is nice to be able to move the organ around where you want it without having to call in three or four strong men to help.

The entire inside of the cabinet must be painted a dead black, and lampblack thinned with turpentine is good for this purpose. Black glossy enamel is unsuitable. Any metal surfaces that reflect light may also have to be painted with the black paint. Note that the back is completely removable for ease in making adjustments, and that the front panel underneath the keyboard is hinged so that it may be dropped by releasing two small catches. These features will be found very important when working on the mechanism.

## Final Adjustments

With all parts assembled, mounted, and connected as shown in the drawings, it will still require considerable patience in adjusting all the various parts in order to get the instrument to operate properly. The suggested procedure is somewhat as follows:

## Lamp and Shutter Bar Adjustment

Each lamp should be mounted to run as close as possible to the tone wheel. Check each filament to be sure it is straight and tightly stretched. Discard bulbs having irregular or

**RADIO NEWS**

loose filament wires. A loose or vibrating filament in one of the lamps will spoil the music. From a position in front of and below the keyboard, look up underneath on a line with a mirror. Each shutter bar for the octave being adjusted should pass light from only one row of patterns. If more than one row is included, it will be necessary to loosen the adjusting screws and shift all the shutter bars sidewise until they are in line with the patterns on the tone wheel. This adjustment must be repeated for each octave, until the entire keyboard has been adjusted so that each shutter bar allows light to pass to the cell from one *and only one* set of patterns on the tone wheel.

The high and low frequencies will tend to be slightly weaker due to the greater distance from the photocell, but this can be taken care of by increasing the intensity of the end lamps. To do this, connect a variable resistor across the lamps for the second, third, and fourth octaves. The value of this resistor may be determined experimentally.

The actual width of the narrow band of light is  $\frac{1}{8}$ ", but this is not a critical value. The paint may be scraped off for as much as  $\frac{1}{4}$ " in width without making much difference in the operation, and if too much paint is scraped off, it is easy to repaint the bulb and try again. If facilities are available, the bulbs may be silvered in place of being painted with aluminum paint as previously suggested. The silvered surface will make a reflector superior to the aluminum paint and will not come off so easily when the bulbs get hot.

#### Keyboard Adjustment

The keys should be adjusted so they are evenly spaced and level, with the spring tension set at a value that will give a fast, snappy action with a reasonably light touch. Shims for adjusting may be cut from pieces of felt and cemented in place. Shutter bars must be fitted so that they will move freely without rattle or lost motion. The rubber bumpers should eliminate noise, however, felt pads may also be needed. A little oil applied to the proper places will limber up the action. Do not be disappointed if the action seems a little stiff at first.

A strip of felt under the keys will act as a shock absorber, and help to eliminate mechanical noise.

#### Mirror Adjustments

Adjusting the mirrors is largely a matter of trial and error. However, the procedure may be facilitated by sighting from a point very close to the photocell mounting. It should be possible to see the patterns on the tone wheel when the mirror is correctly adjusted. It is a good plan to depress the two outer keys for each octave. The mirror is correctly adjusted when both notes reproduce through the photocell, and an easy way to check this adjustment is to move the mirror to

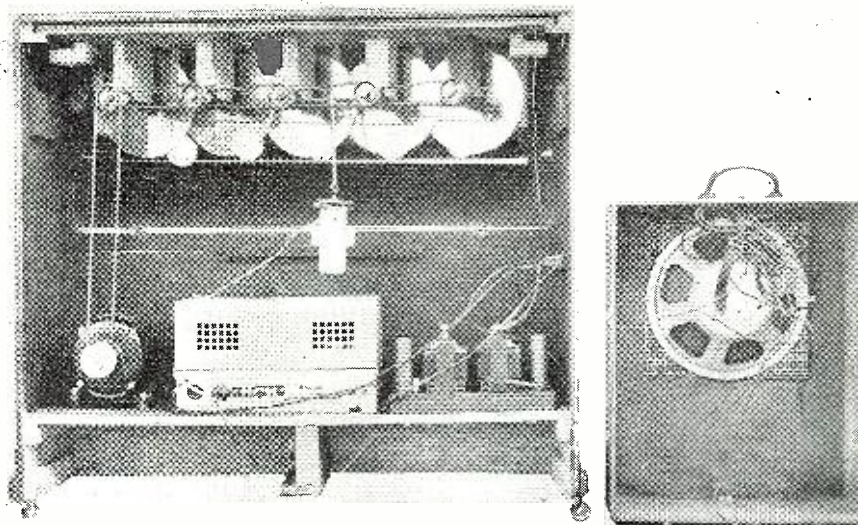

Fig. 7. Rear view of organ and speaker case. The motor should be rubber mounted.

the right until the outer note just begins to fade away, and then move it back slightly in the opposite direction, at which point the entire octave should reproduce without further adjustment. A visual observation will show if the images are properly centered in the mirrors.

#### Balancing the Tone Wheels

The tone wheels must run perfectly

true. These discs should be made from selected pieces of glass free from flaws, and the center hole should be large enough to allow the use of a paper or fibre bushing for mounting. The outside diameter should be ground to size after mounting, and small lead weights may be attached to the edges with cellophane tape for balancing. Loosen up the bearings when balancing.

*(Continued on page 99)*

Fig. 8. The tone wheel shown below is the heart of the instrument and great care should be taken in its reproduction. It is suggested by the author that this copy be taken to a professional photographer and a positive film reproduction be made. It should be enlarged to an over-all diameter of  $7\frac{1}{2}$ ". Inasmuch as the glass discs between which this tone wheel is mounted are 8" in diameter there will be  $\frac{1}{4}$ " between the tone wheel and the outer edges of the glass discs.

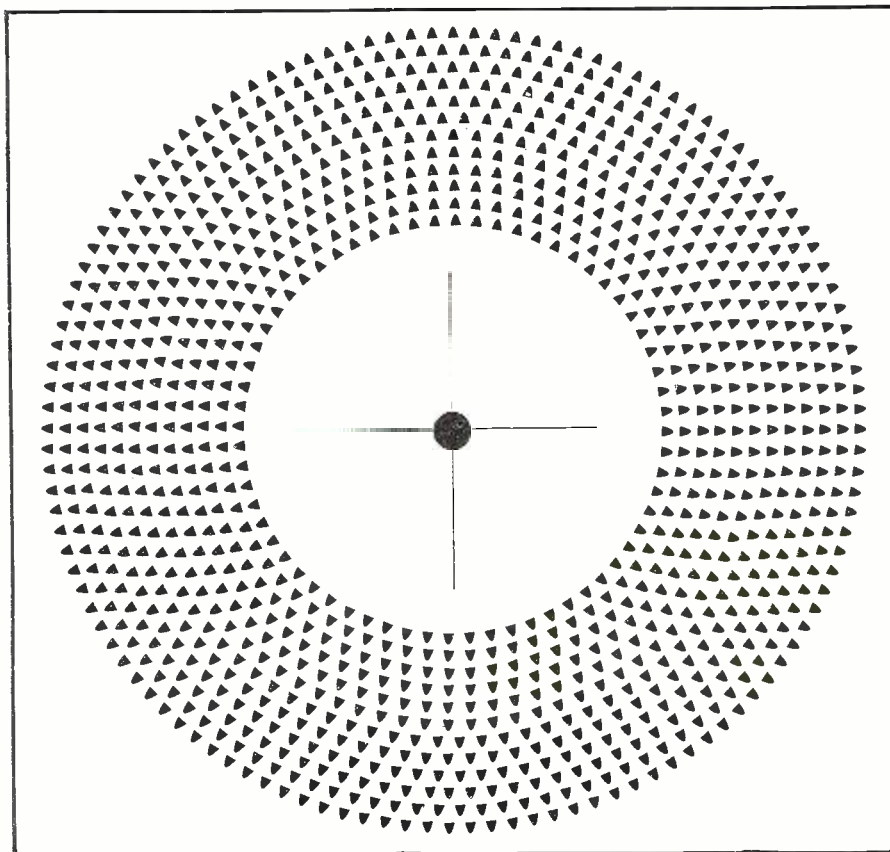

# Ground Control

## APPROACH SYSTEM

By

**COL. J. K. McDUFFIE**

Commanding Officer, 18th Base Unit, AAF



Rotating antenna for Ground Control Approach System. As it sweeps the sky, any object within range shows up on scope as pip of light.

***Operation of GCA—a combination of several radar and communications devices assembled in a single mobile unit. In peacetime, as in war, this system makes blind landing of aircraft a simple and safe operation.***

IF AN airliner in peacetime commercial service were to encounter very bad weather, with, say, visibility less than a quarter of a mile and ceiling at its destination of less than a hundred feet, the pilot would play safe. He would steer clear of the fog or rain, and turn back.

On a combat military mission, however, the pilot must keep going, and prepare to cut through the fog for a landing. Radio helps. But on a black night, the men in the tower can't see the runway much better than the pilot. Runway marker lights are a help to the pilot, but not until he gets close enough to see them. *That is the trick—finding the runway.*

The *approach* is the problem. Each day, during the war, the weather ripped its victims from the sky. Pilots would fly a thousand miles, slip through storms and flak and enemy planes to reach the home base, then grope blindly for the runway and end up knocked out in the home stretch.

Something more than ground optical devices were needed to crack the problem. More help had to be added. Finally, more help *was* added by means of a new radar method that pierces the bad weather and helps a pilot just as surely as if the nose of his plane were led down a path of light.

It is GCA (Ground Control Approach), designated as the AN/MPN1. In reality GCA is a mobile radar station designed to follow the flight of an airplane and direct a pilot through a successful approach and landing when the visibility is practically zero.

Even in thick, soupy fog the men and equipment inside a GCA trailer can spot a plane, maneuver it into position for an approach, track it in range and elevation, and "talk the pilot down" the glide path to within fifty feet above the center of the runway. In a recent training film, titled "GCA," we have shown how this is accomplished.

GCA can move wherever it's needed,

but before it's put to work, it must be correctly lined up. This requires surveying.

The GCA truck and trailer would be placed toward the windward, about 250 feet from the center of the runway, and near the takeoff end of the strip. The trailer is not set at a ninety-degree heading from the runway, as one might suppose. Because of electrical reasons, the azimuth antenna doesn't scan through the normal. That is, it doesn't see exactly what you would see if you looked out from the side of the trailer. In lining up GCA, operators need an 84° heading with respect to the runway.

The equipment faces a line parallel to the runway and covers an azimuth sector of twenty degrees, five degrees to the right of the line parallel to the runway, and fifteen degrees to the left. This gives the best close-range azimuth coverage.

After the set is pulled into position, its alignment must be checked. First it is levelled, then tilted two degrees so that the elevation scopes will get the proper scan. For the final alignment check, metal reflectors are set up. If a line were drawn from one reflector to the truck, it would be paral-

lel to the runway. Another reflector is set up at the near end of the runway center-line. When the set goes into operation, the reflectors appear as small permanent echoes, for reasons which will be explained later.

For an accurate check of the expansion angle, two additional reflectors are placed at the extremities of the sweep. Though the runway doesn't appear in the scope, the position of the reflectors shows exactly where it is.

A word about the truck and trailer. GCA needs plenty of high voltage to keep it going. Power comes from generators mounted on the truck, and is carried to the trailer through cables.

With all the electrical equipment throwing off heat, it can get pretty hot inside the trailer. So conditioned air is blown through canvas ducts to keep the trailer at a comfortable temperature while the operators are at work.

GCA is really a combination of several radar and communications devices in one composite system. There are six main parts.

1. The distant search set for the traffic director.
2. A similar set for the plane selector.
3. A precision set for close-in azimuth tracking.
4. A precision set for close-in elevation tracking.
5. These radar sets are supplemented by the error meter, a device for registering the aircraft's true position with respect to an ideal glide path.
6. Finally, a complete multi-channel radio communications system for talking to incoming planes.

Combine all these into one instrument and you have GCA.

The function of the distant search system is to locate incoming planes as they come within 30 miles of the air field.

The plane selector sees the same picture in *his* scope, but uses it to direct a selected plane into position for an approach.

The precision system then enables

Shape of GCA beam as shown diagrammatically in the AAF training film, "GCA." The beam has a sharp vertical rise which permits the radar to pick up planes close to the unit. The beam has very little ground echo and picks up aircraft flying over or near obstructions. This is shown by white lines.

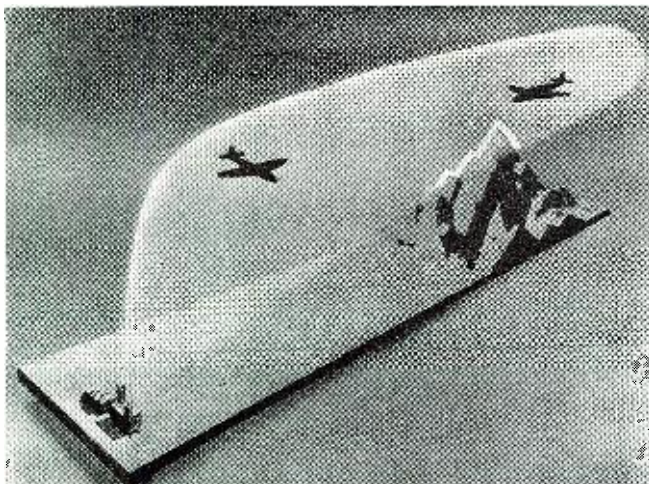

the controller to direct the plane to the runway by giving a detailed picture of the plane's position in relation to the ideal path in azimuth and completing a three-dimensional picture by also showing the plane's precise position in elevation, telling the operator exactly where it is at all times.

The information from the precision system is delivered to the error meters which are read by the approach controller who in turn relays that information to the pilot through one of the channels of the two-way communications systems.

Now, to consider these parts in more detail. As the search antenna turns, it sweeps the surrounding area. As it traverses through the entire 360 degrees of azimuth, the antenna sends out a stream of radar pulses. If a plane comes within range, some of these pulses are reflected back to the antenna.

The reflection shows up on a cathode-ray tube so that the plane's position in space can be determined. Due to the manner in which the tube is mounted, the operator can see its image combined with a map of the area. These maps are prepared for each location by the crew operating there. They show such obstructions as hills, power lines and water tanks. The obstructions normally appear on the scopes as ground echoes.

On the map is marked the approach to a glide path toward the runway. By closely watching the moving echo on this "PPI" scope (Plan Position Indicator) the operator gets all the information he needs to control the flight of the plane. If there is more than one plane, the operator can see exactly where it is. Range marks indicate how far away the planes are, up to a range of 30 miles.

The traffic director gets the planes into a traffic pattern until he can turn them over, one by one, to the plane selector, who views the plane's flight on the number two PPI scope, and directs it toward and onto the ideal glide path. With the plane clearly before



Small, portable reflectors, set at angles parallel to the runway and near the end of the runway center-line, give GCA operators final check on effectiveness of their radar before they begin operations. When GCA goes into operation, the reflectors appear as small permanent echoes on the scope, giving exact reading of the position of the radar in relation to the runway. This is a scene from the film, "GCA" produced by the AAF Motion Picture Unit.

him in a 15-mile range, the plane selector maneuvers it into the approach position. As the selected plane moves nearer to the glide path, a switch may be turned on which will magnify the range scale for more accurate observation. Now, since the plane is less than 10 miles away from the runway its echo can be tracked on the precision system. Four scopes are employed.

The azimuth tracker gets his information from two Expanded Partial PPI scopes, or Expanded Position Indicators. These are termed EPI scopes.

Were you in a GCA truck observing the standard Plan Position Indicator, you might notice three echoes at six o'clock. These circles represent range marks. On a standard indicator, it would be almost impossible to detect

Elevation and azimuth tracking centers radar beams on nose of aircraft, giving radar operators exact direction of plane's flight. Then, with any GCA, they can guide ship to safe landing in almost any weather. This is scene from AAF training film, "GCA," produced by the 18th AAF Base Unit, Culver City.

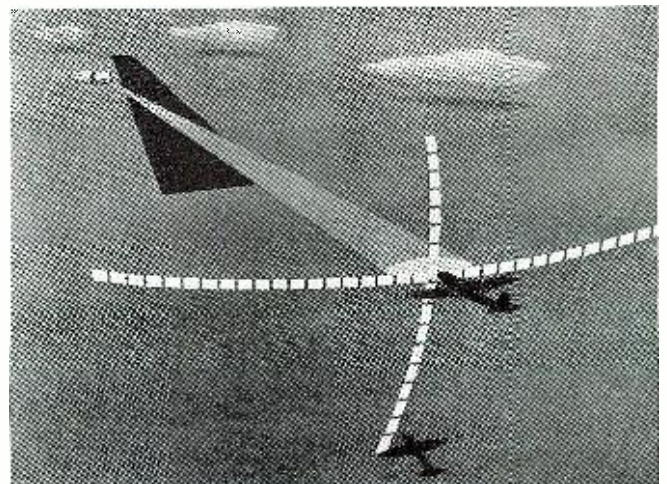



On foggy, weather closed nights, the approach of the plane to the runway is a life or death problem. Many combat planes were lost after fighting their way thousands of miles through storms, flak and enemy planes because their home base was closed in. The AAF found the solution in a new radar—GCA—which pierces bad weather and helps a pilot as surely as if the nose of the plane were led down a light path.

deviations of a few feet in the movement of those echoes. But that's just what the precision operators must do in order to track an aircraft. So a small sector in which the echoes are confined must be expanded.

Suppose the scan were changed so that it would just cover that sector. Then, if the origin of the time base were moved to the top of the tube everything would look as if it had been stretched in range. However it would be necessary to expand in another dimension by making the time base sweep through several degrees while the antenna sweeps through only one.

Finally, since deviations in linear measure are to be determined these

arcs must be converted into straight lines. This is done by employing special circuits which stretch the picture so that the range circles become straight lines. This total expansion is what appears in the EPI tubes. Even a slight shifting of the echo in the PPI tube shows up on the EPI. This greater accuracy in the expanded tube permits an operator to determine when a plane is just a few feet from the ideal glide path.

The azimuth tracker sees two such scopes. One magnifies a ten-mile section of the area. The other further expands the last two miles.

The elevation tracker follows the plane in two similar scopes, and, as in

the azimuth displays, one covers a ten-mile range and the other expands the final two miles. All the precision scopes show the position of an approaching plane relative to a predetermined glide path selected for that aircraft's characteristics.

The azimuth antenna sweeps its beam from side to side in a 20-degree space, the sector that was originally surveyed. The elevation antenna works the same way, except that its beam fans up and down, one degree below and six degrees above the horizontal. Since the two beams are pulsed, each furnishes its own range.

Now suppose a plane comes into range for an approach to the runway. The elevation beam tells the operator how high the plane is, and the azimuth beam gives the direction of the plane. The elevation antenna has found the ship, so the echo will appear on the elevation scopes. The azimuth tracker will get no echo as his antenna is scanning below the plane and he has no way of telling its height. But the elevation tracker does know the plane's altitude. So he simply lifts up his partner's antenna until both beams are properly aimed. This is done by operating foot pedals connected to an angle follower over the scope.

The elevation tracker controls the antenna movement by working the foot-pedals. This keeps the azimuth antenna lined up in elevation. In the same way, the azimuth tracker keeps the elevation antenna correctly aligned in azimuth. As they track the plane, the azimuth operator controls the elevation antenna, and the elevation operator controls the azimuth antenna.

Each beam, radiating in its turn, picks up the reflection of the incoming plane in range, azimuth, and elevation—the dimensions that are needed to guide the ship down the glide path. As the plane gets within two miles of the runway, its echo moves in to the two-mile scope. Here it shows up as a much larger pip of light. This close-up makes it much easier to guide the plane accurately.

This, then, is the job of the trackers—to follow the plane so smoothly that any small deviation from the on-course path will be revealed. Both trackers operate a handwheel which controls mechanical cursors—transparent rules mounted over the face of the precision maps. The trackers keep the cursors directly over the center of the echo. Wherever the plane moves, it is followed—whether above or below the glide path, left or right. Every deviation from the prescribed landing path is recorded.

Every movement of the cursor is also recorded in the error meters. If the pilot is flying too high or low the elevation meter will show the error directly in feet. When the plane is correctly on course, this too will be clearly indicated.

The azimuth meter works in the same manner. Every deviation shows up.

With these meter indications before  
(Continued on page 92)

Bad weather piercing radar unit for bringing planes in for safe landings is this Mobile Radar Unit, which employs new Ground Approach System.

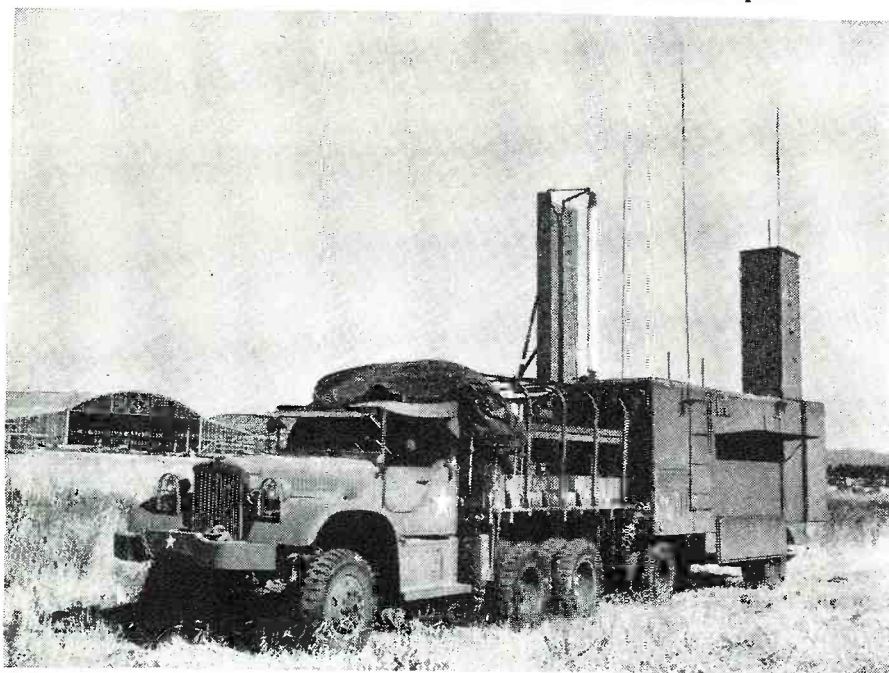



# Combination NOISE LIMITER and PRESELECTOR

By GEORGE and AL. BOLES, W2NRU

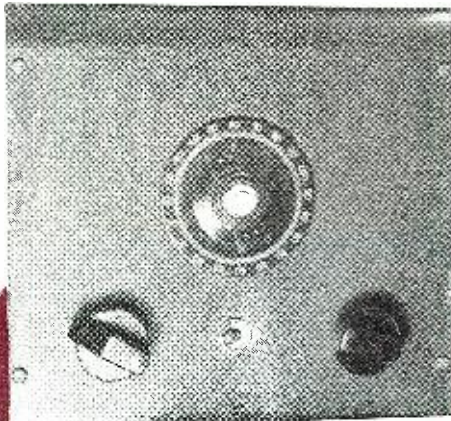

Front panel view. Condenser C<sub>1</sub> and switch S, are shown in center of panel. R<sub>1</sub> to the left and R<sub>2</sub> to the right of panel.

**Modernize those old receivers—add either, or both, of these features to improve their performance.**

LIKE many hams we are anxiously awaiting the day when new receivers will become plentiful. However, in the meantime we have to make what we have do. Thus, the receiver we're using works quite well on the lower frequencies 20, 40 and 80 but on 10 the sensitivity was pretty poor and also, like many older sets, it had no noise limiter. Our location being a particularly noisy one we decided to build a noise limiter in the receiver but found that there was not a bit of space available on the chassis. Since we were going to add a preselector to the receiver it was decided that the noise limiter circuit should be constructed on the same chassis with the preselector.

The preselector utilizes an 1851 in a conventional circuit. It is made slightly regenerative by using a tuned circuit in the plate side of the tube, instead of the usual r.f.c. This is tuned to approximately the middle of the 10 meter band. The grid of the 1851 is tapped down on the grid coil to minimize the loading effects on the tube and thus avoid spoiling both the gain and selectivity. The position of the tap was determined by the cut and try method and seemed to give the best results under our particular conditions. The grid coil was wound on a standard 1½" diameter form (five prong). The plate coil is mounted underneath the chassis and is made up of six turns wound on a ¾" diameter form. The output link to the receiver is shielded to prevent interaction between the antenna and plate circuit of the preselector. This shield also serves another and perhaps more important duty, in that it prevents the lead between the receiver and pre-

selector from picking up directly. The condenser used in the plate circuit to tune the plate coil was a *Hammarlund* Type APC which is readily available.

Under average conditions the preselector tunes quite broadly and it isn't necessary to retune constantly when the receiver is tuned. From this it might be assumed that the gain would be low but such is not the case. Just how much difference it will make depends, to a great extent, upon the receiver. In other words, if the set is one which has no radio frequency amplifier ahead of the first detector then it will probably make a very substantial difference. But, if the set has two r.f. stages then too much cannot be expected from the preselector. Provision was made only for the 10

meter band as, at the present moment, we are only interested in that particular band. On the other bands this receiver works well enough without the aid of a preselector. Of course it can be used on 20 or 40 by changing the coils. The resistors are all of the ½ watt variety and all by-pass condensers .01 μfd., 400 volts.

So much for the preselector. Now for a description of the noise limiter. It utilizes a 6H6 in the series valve type circuit. In operation the 6H6 chops off noise peaks above a certain level depending upon where the threshold control is set. This control can be advanced until the modulation sounds slightly distorted, then backed off just above this point so

(Continued on page 130)

Circuit diagram for (A) preselector and (B) noise limiter.

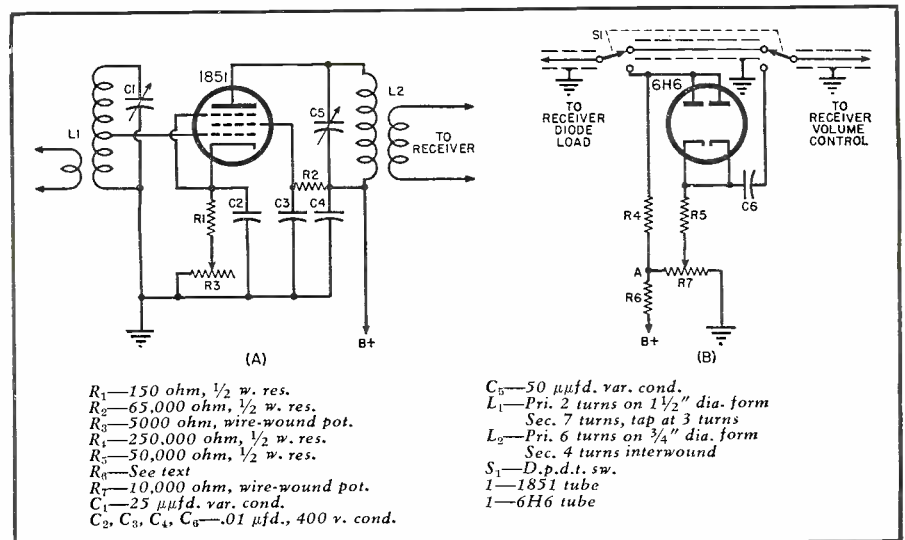

Practical

# RADIO COURSE



A new postwar table model radio-phonograph manufactured by Philco Corporation. The record is inserted in a slot beneath speaker grille. Operation of unit is automatic.

By  
**ALFRED A. GHIRARDI**

## Part 46. The application of autodyne type of single-electrode input frequency converters.

EARLY superheterodynes employed separate mixer and oscillator tubes, but from the very beginning a great deal of experimenting was directed toward reducing the number of tubes required in the frequency conversion stage from two to one. Thus, it became desirable to have a single tube (*converter*<sup>1</sup> tube) and associated circuits arranged so it would perform the dual functions of generating the necessary local oscillations and also accomplishing the "mixing."

### Autodyne Circuit Method of Combining Mixer and Oscillator Functions in a Single Tube

One early single-tube frequency converter circuit arrangement capable of performing this dual function was developed late in 1913 by H. G. Round and later became known as Round's *Autodyne*<sup>2</sup> (popularly known as the autodyne *first detector* according to old frequency-converter terminology).

An r.f. type of *tetrode* tube (such as a type 36, etc.) in which two grids are brought out to independent base terminals, can be used in either of two basic ways as an oscillator. Feedback may be employed either from the plate circuit to the *control grid* circuit, or from the plate circuit to the *screen grid* circuit, to cause the tube to oscillate at a frequency determined by the

constants of the oscillator circuit elements. The screen grid method is not widely used in practice because of the instability which results from necessarily operating the screen grid above r.f. ground potential, and because of the load imposed on the tuned circuit by the relatively low internal screen-to-ground impedance within the tube.

An r.f. *pentode* tube (such as the type 6C6, 6D6, etc.) in which three grids are brought out to independent base terminals, can be used in an additional basic way as an oscillator—by employing feedback from the plate circuit to the suppressor grid circuit.

Therefore, for purposes of analysis

<sup>1</sup> A *converter tube* is defined as an electron tube which contains the electrode system of the local oscillator as well as the electrode system of the mixer.

<sup>2</sup> So-called because the same tube elements are used as the source of the local oscillations and also as the mixer—hence the combining form "auto" meaning self. The control-grid type of autodyne frequency converter circuit was used very extensively prior to the later introduction of special multi-grid tubes (such as the popular 6A7 pentagrid converter and others) designed especially for frequency-conversion service, and the popularization of multi-band receivers. Its primary purpose was to save an oscillator tube. It became especially popular around 1930 during the early years of the depression when considerable research work was devoted to the development of small and inexpensive single-band superheterodynes in which it was necessary to cut costs by reducing the number of tubes and other components to an absolute minimum. Since many of these receivers (especially a.c./d.c. midgets) employing the control-grid type of autodyne converter are still in use, a knowledge of its circuit arrangements and mode of operation is important even though better converter arrangements now available are being used in current equipment.

we may divide all practical autodyne converter circuits into the following two basic types:

1. The *control-grid* type, in which the oscillator feedback is between the plate and control-grid circuits.

2. The *suppressor-grid* type, in which the oscillator feedback is between the plate and suppressor-grid circuits. (Since the tetrode tube does not contain a suppressor grid it cannot be used as a suppressor-grid type of autodyne converter.)

The control-grid type of autodyne converter has been the most popular of the two, mainly because of the ease with which proper oscillator amplitude can be secured. This follows because the mutual conductance between the control grid and plate is much higher than that between the suppressor grid and plate. Furthermore, the control-grid type possesses the advantage that it can employ either a tetrode or pentode type of tube. Accordingly, in each of the circuit diagrams shown in Fig. 1, a suppressor grid has been included and drawn *dotted* to indicate that either a tetrode or a pentode type tube may be used in the circuit.

As the control-grid type of autodyne circuit may be considered as a *single-electrode input* type of converter, it will be discussed here. The suppressor-grid version, being a *double-electrode input* type will be described in the later article devoted to double-electrode input converters.

### Typical Control-Grid Type Autodyne Converter Circuits

Many apparent circuit variations will be found in the control-grid type Autodyne converters employed in home receivers, but analysis of them will reveal that they differ mainly in the circuit arrangement employed for the oscillator portion of the converter.

They are all minor modifications of the fundamental mixer systems illustrated in the circuits of Fig. 1. It is important to observe that in each of the four circuits shown, a coil (or a portion of one) appears in series with the cathode-return circuit of the tube. This can well serve as a useful identifying characteristic, since it indicates that the autodyne under consideration is a control-grid type. The suppressor-grid type of autodyne does not employ a coil in the cathode circuit.

The circuit at B of Fig. 1 is an example of a control-grid Autodyne in which a tuned-plate, grid-tickler type of oscillator is employed. The circuit of A employs a Hartley oscillator arrangement. In circuit A a single tapped coil is used in the oscillator section, and a cathode tap is provided, making the lower portion,  $T$ , of the coil act as the tickler or feedback coil. This produces the same effect as the separate tickler coil,  $T$ , in the circuits at B and D. The circuit at C provides a tuned-grid plate-tickler type of oscillator section. The circuit at D illustrates the 3-coil *Meissner* type oscillator arrangement in which two tickler windings are coupled to a tank circuit. It is interesting to observe that in the oscillator circuit arrangements at A and C the "padding" capacitor cannot be connected in its usual position in series with the low-potential side of the oscillator coil because a d.c. path must be provided for the cathode current through the lower portion of the coil to ground and B—. Consequently, the padder must be placed in series between the coil and tuning capacitor  $C$ , where it will be out of the path of the cathode-circuit d.c. flow.

### Operation of Control-Grid Type Autodyne Converters

In each of the autodyne circuit arrangements illustrated in Fig. 1, the plate circuit of the converter tube contains the tuned i.f. transformer primary. The plate circuit also introduces voltage (either directly or through a shunting or coupling arrangement), at a frequency determined by the  $LC$  of the oscillator tank circuit, into the feedback or tickler coil  $T$  which is in series with the cathode circuit.

Since all the circuits in a multi-grid vacuum tube must return to the cathode, an oscillator coupling coil in the cathode circuit (and hence the voltage it introduces into this circuit) is common to the control grid, screen grid, suppressor grid and plate circuits. However, because a given voltage variation impressed on the control grid will produce a much greater change in plate current than will the same voltage variation impressed on either of the other grids or the plate, we can ignore its effects on these other elements. Accordingly, for the purpose

<sup>3</sup>This latter function is similar to that for which the oscillator-to-cathode coupling arrangements are employed in simple single electrode input type mixers. See Alfred A. Ghirardi, *Practical Radio Course, Part 41*, Radio News May 1946, Illustration (E) Fig. 2.

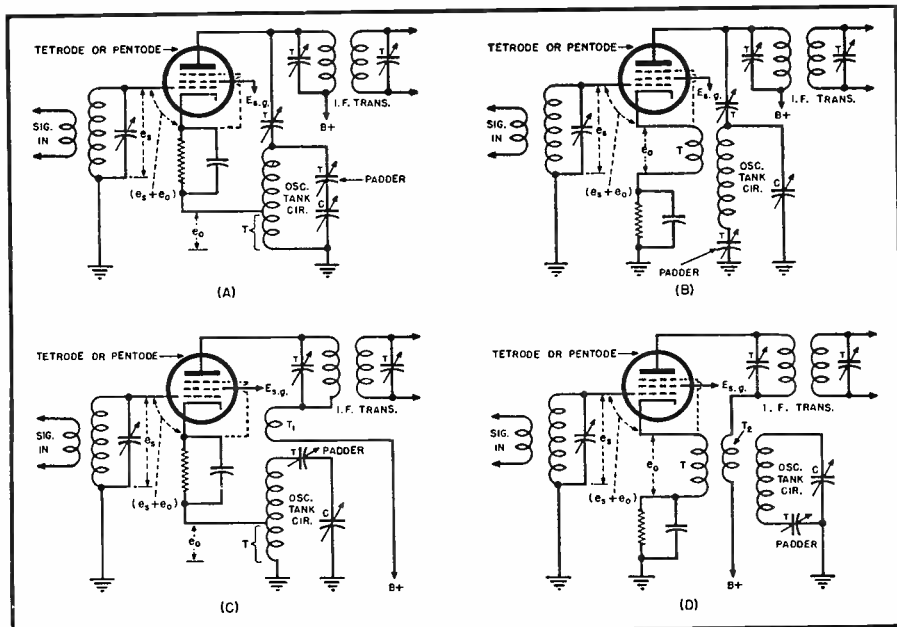

Fig. 1. Various oscillator circuit and oscillator grid coupling arrangements employed in control-grid autodyne converters.

of our explanation we may consider the oscillator feedback voltage developed in the cathode series coil as acting exactly as though it had been impressed in the control grid circuit alone. This voltage then causes the cathode to vary in potential with respect to the control grid, which is of course, the same effect as varying the control-grid voltage (at this same frequency) with respect to the cathode.

Consequently, the cathode coil serves a dual purpose. It supplies the plate-to-control-grid feedback necessary for the operation of the tube as an oscillator; it also serves to introduce oscillator voltage in series with the control-grid circuit (into which the signal voltage also is introduced) so that the required single-grid input type "mixer" action (same as that described earlier in this chapter) will take place.<sup>3</sup>

The primary advantage of the auto-

dyne frequency converter lies in the fact that it saved an oscillator tube. However, all autodyne converter circuits possess several inherent disadvantages. Among the most important of these are:

1. Low modulation gain.
2. Limited signal-frequency range (satisfactory over broadcast and police bands only).
3. Gain cannot be controlled satisfactorily by a.v.c. (automatic volume control) voltage when high-gain type tubes (6C6, 77, etc.) are used.
4. Presence of oscillator signal in grid (signal) circuit of converter tube causes tendency of osc. energy to feed back into antenna circuit and be radiated from it causing interference and whistles in neighboring receivers.

The limited high-frequency range  
(Continued on page 72)

Fig. 2. Typical single-electrode input type frequency converter circuit employing a triode-pentode type of converter tube, such as the 6F7. Inset shows electron flow in the 6F7 converter tube.

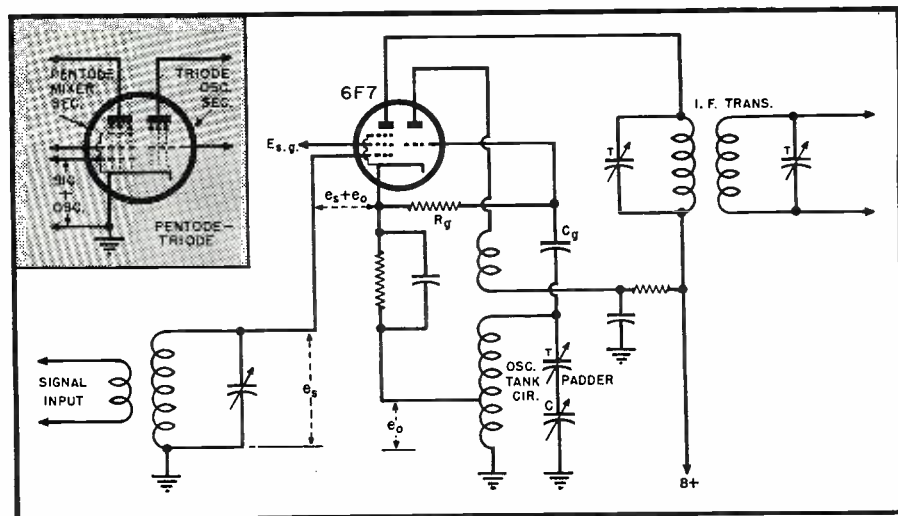



By **CARL COLEMAN**

**S**IDNEY S. MENSCHEL in recently aboard his Export Lines ship and had a brief vacation while undergoing repairs. Berge Williams in port also recently aboard his Defiance. Leslie Alt has been assigned to the Trinidad Head. J. P. McNeill who has been with UFCO in New York as marine radio serviceman has recently joined the forces of TWA with what seems to be a very bright future, good luck "Mac." Alexander Saxton out on the West Coast and still going strong—was up to Portland recently. William Whisler also out on the coast with his Chief Charlot. Another old timer, A. E. Azzopardi, is aboard the Toloa of UFCO running out of Frisco.

**D**AVID SARNOFF, President of RCA, said at a recent stockholders meeting that reconversion has been retarded by many factors and industry has been unable to reach a volume sufficient to meet the demands for goods. He also advised that RCA's new television receivers should be reaching the market this fall. Expansion by RCA already includes several plants for the manufacture of tubes, theater equipment, auto radio, etc., other expansion is expected this year, it was reported.

**T**HE War Assets Administration (controlling sale of surplus radio and radar equipment) have been requested to sell 150 used radar sets to schools to be used for instruction purposes only at the rate of one thousand dollars per unit . . . the WAA had previously tried to sell the equipment for \$18,000 each and had no purchasers, so were planning to scrap the equipment. Washington also brought out during the first of May that items on the "classified" list such as radar information had been bought in

the U. S. by foreign powers . . . component parts of these items are not restricted and agents can buy the specifications for any patented American article for a dime and purchase the parts and after study in this country can go home and assemble the unit parts into what in this country would be a restricted or "classified" article. . . . Seems as though one can buy lots of "made in USA" items in foreign lands that can not be had in this country in the electronic and mechanical lines, not to mention foodstuffs.

**T**HE American Merchant Marine Institute recently pointed out what will be good news to some of the gang, namely the "Seam" ships, while many of the "Liberty" type vessels have been laid up and others are as they arrive (not all however) if there are no assignments for them. The "Seams," the most sought after of the Libertys built by WSA during the war are bulk carriers designed to carry coal and according to the Institute have a distinct postwar advantage for areas such as the New England coal trade which is dependent upon shipping for its main supply. Since no new colliers were built in American yards since 1929 the new Liberty type are held to be a most valuable replacement—the old fleet suffered close to a fifty per-cent loss during the war. . . . The "Seams" built by Delta at New Orleans have very little resemblance to the conven-

tional Liberty with their tanker like looks. They are of about 11,000 dwt. and with the same engine as a Liberty make 13 knots. Twenty-four of these ships will provide a few jobs at least. However with the shipping situation somewhat slowed up there seems to be less ships scheduled for tie-up than a few weeks ago . . . for a time it appeared that every Liberty was headed for lay-up but many stayed only a few days and started off again.

**W**E HAVE noted that there are quite a number of the boys who have the required sea time on their licenses and who are still operating with the TLT license . . . some of these fellows have time enough for a "first" . . . get up to FCC and take the exam and get the highest grade license you can . . . we recently saw an actual case where a man who had been sailing as chief on a three man job on a cargo run was forced to take a second ops job when the ship sailed carrying passengers for the first time and it became necessary to locate a man with a "first" ticket for the chief's berth . . . the sad part was that the original chief had the necessary time on his service record to have had a first class license. Moral: Don't let it happen to you . . . it takes a little study and time to be sure but it's well worth it just in satisfaction alone. While on the subject of licenses, don't forget to post yours in the shack—FCC requirements and some are not doing same as yet—and if on a "one-man" ship be sure you have the six months' endorsement note added to the face of your license by FCC.

**R**OBERT TUCKER out Wilmington way, aboard the Oneida Victory. . . . Kliment Tistan recently returned to the West Coast aboard his Liberty after an extended trip to the Far East. . . . E. J. Anderson brought his "Knot" type craft in recently to the big city. . . . Dave Connor and D. K. Crosby, two old timers, tied up in Baltimore for some time. . . . H. J. Meyerhoff, who took out a new ship recently, has been running into Florida for a few trips. . . . Ed Stetson, well known TRS marine radio inspector, is now in charge of service in Charleston, S. C. . . . Fred Pratt in port recently for a few days. P. E. Farris tied up in Charleston for a few repairs. . . . T. Venis and George Kiessling, new men with TRS, the past few weeks.

**S**EVERAL of the major shipping lines are still in line for expansion, States Marine has now been added to the list of steamship lines operating in the African trade, Seas Shipping, American South African and Lykes Brothers already being engaged on on this run, Moore-McCormack announced the first return from WSA of one of their ships, the Mormacmoon. It is to be placed in the American Scantic service to Scandinavian and

(Continued on page 135)

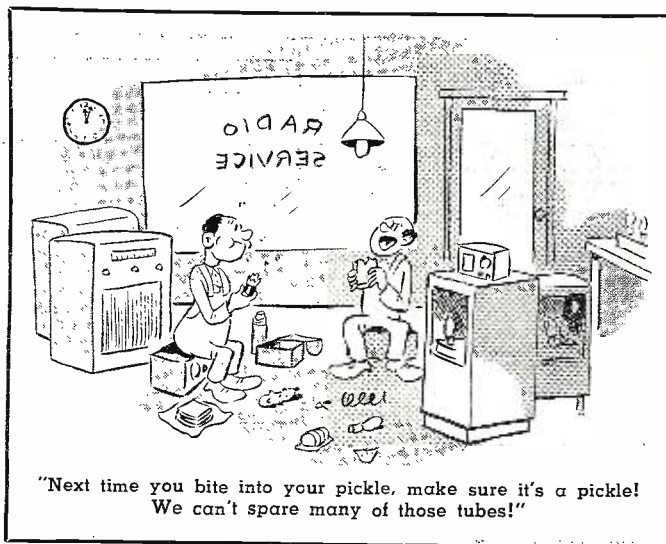

# C.W. Break-in MONITOR

By **HOWARD B. BARD, JR., W6E0S**

Radio Engineering Aide, U.S. Immigration Service

**A necessary adjunct for the traffic man and  
"brasspounder" for efficient break-in work.**

fairly constant the voltage input to the rectifier in order to avoid change in audio note of the audio oscillator or to avoid overloading of the circuits. If there is a shift from one band to another of the transmitter, the available r.f. voltage for a given coupling to the transmitter may vary, and for this reason the attenuator is used.  $L_1 - C_1$  and  $L_2 - C_2$  (Fig. 1) and other tanks if necessary, are tuned to the approximate operating frequency of the transmitter, and at resonance they offer maximum attenuation to passage of current into the rectifier circuit. As the tanks are varied off of resonance, an increasing voltage is applied to the rectifier. In this way control is afforded on the input at varying sending frequencies on the transmitter. If the transmitter is operated on one band only, this part of the circuit can be eliminated and

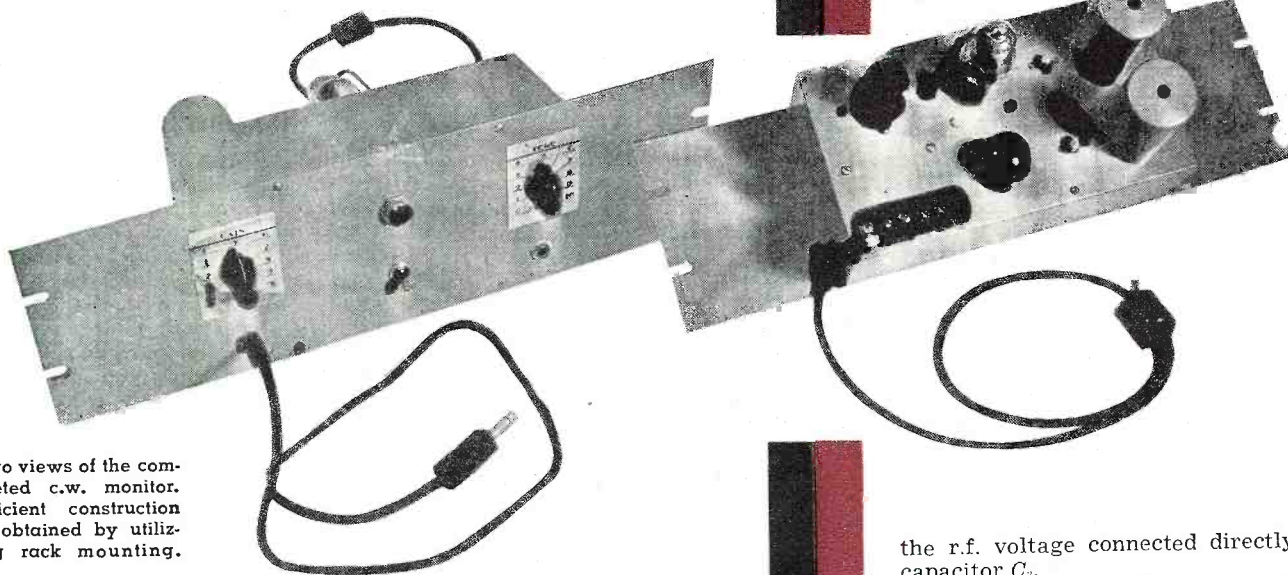

Two views of the completed c.w. monitor. Efficient construction is obtained by utilizing rack mounting.

the r.f. voltage connected directly to capacitor  $C_3$ .

The applied r.f. voltage is rectified by the half wave 6H6 tube rectifier and a d.c. voltage appears across resistor  $R_1$ . This d.c. voltage varies exactly in pulses as does the transmitted c.w. code characters.

In order to prevent the high frequency r.f. from passing to the rest of the circuit and yet allow the c.w. d.c. pulses pass, a filter consisting of  $L_3$  and  $C_4$  is inserted in the output of the 6H6 rectifier circuit.

In changing these d.c. pulses into code characters, an audio oscillator is used that depends upon these pulses as the plate voltage. A 6C5 tube is used in a conventional feedback circuit using a small audio transformer for coupling purposes. It will be noted that the plate is at ground potential and the cathode above ground, opposite of conventional circuits. This is necessitated in view of the polarity of the supply voltage relative to ground. The rectifier develops a voltage which is negative above ground, this being necessary for operation of other parts of the circuit. Actually the operation of the audio oscillator is in no way different from the con-

**S**OON the amateurs will be back on the air in even greater numbers than before the war and it can be expected that interference will be a serious problem unless some attention is given to methods of improving operating technique. It is with this in mind that the author has applied the following device for use in the amateur station.

This device, the Break-in Monitor, is an instrument that allows the operator of a station using c.w. to hear his sending as regular dots and dashes from an audio oscillator and at the same time during the silent spaces between the c.w. characters, to hear over his receiver, the station which he is working. Under ordinary operating conditions when the other station is receiving your transmissions, he will not "break" you, but should he miss a word or if interference

should start on your operating frequency, he can immediately break you and so inform you of the conditions. In this way much time can be saved and better communication maintained between the stations.

## Circuit Analysis

It will be seen from Fig. 2, showing the block diagram of the monitor circuit, that there are five separate, functional parts. The monitor depends for part of its power upon a small r.f. input from the radio transmitter. Methods of securing this will be discussed later. This r.f. voltage is first applied to a rectifier through a controlling circuit called an r.f. attenuator. This attenuator is simply a circuit consisting of several tuned tank circuits in series and is used when several transmitter frequencies are used. The function is to maintain

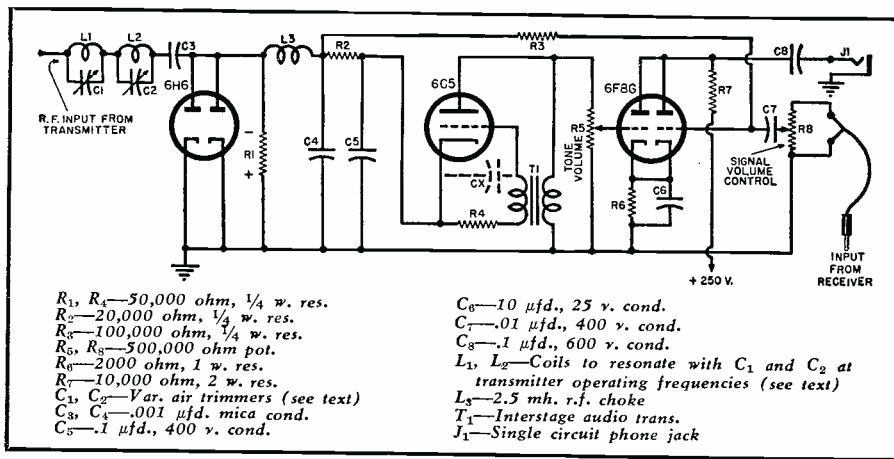

Fig. 1. Diagram of c.w. break-in monitor. A separate power supply is required.

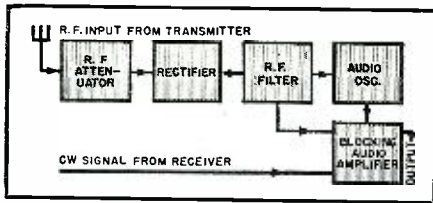

Fig. 2. Block diagram shows functions of various parts of the c.w. monitor. The r.f. attenuator is only used when certain transmitting frequencies are employed in the transmitter. Its function is to provide a means of controlling the input so as to maintain a constant r.f. voltage at the rectifier.

ventional inasmuch as the relative potentials are the same.

The output from the audio oscillator is taken from a volume control and applied to the grid of an audio amplifier-mixer tube, and then to the output or ear phones.

The circuit, as analyzed, provides an audio note each time the transmitter key is pressed. Now, in order to eliminate objectionable thumps and clicks that are always present in a receiver output near a keyed transmitter, it would be desirable that the receiver output be muted during the period that the key is pressed or when the transmitter is keyed. This is accomplished by applying the same d.c. pulses that supply power to the audio oscillator from the rectifier, to a section of the 6F8G audio mixer tube.

It will be seen in Fig. 1 that this

mixer audio tube consists of a dual triode with the plates in parallel and the grids separate. Through one section passes the audio keyed tone, and through the other section passes the radio receiver signal, both being present at the output. Now in order to mute the signal channel during the keying period, the d.c. rectifier pulses are applied to the grid of this section of the tube. This d.c. pulse is of high value and blocks the flow of plate current through this section of the dual-triode and thus mutes the signal channel.

The over-all action of the circuit then is as follows; when the key of the transmitter is pressed an audio tone is heard in the output and when the key is let up the input from the radio receiver is immediately heard. This allows the operator to hear what is on the air between his c.w. keying.

#### General Construction

As the circuit is not complicated, it is constructed either as a panel mounted unit or as a separate, cabinet unit. All parts can be mounted on a 5 x 9 x 2 inch chassis. The attenuator tanks,  $L_1-C_1$  and  $L_2-C_2$ , are so chosen that they resonate at the transmitter operating frequency. The variable condensers should be of the air type used for fixed tuning of high frequency coils, around 25 to 50  $\mu$ f. The tank can be checked for correct tuning by coupling it either to the receiver at the operating frequency or to the transmitter, a plate current

variation will indicate resonance of the tank as the condenser is varied. (Use only loose coupling)

The input from the receiver can be via a phone plug and cord from the monitor to the radio receiver. Most communications receivers have provision for use of phones and the monitor input can be plugged directly into the set in place of the ear phones. The ear phones are then plugged into the monitor output jack.

Other triodes can be substituted for the 6C5, such as 6J5, 6F5 etc., as long as the circuit will oscillate on the supplied plate voltage (usually about 35 to 60 volts).

In the model shown here, no power supply was built into the unit, its power being supplied from the communications receiver proper. The power consumption will be only about 5 ma. at 250 volts plus the heater supply, so that in most cases the unit can be connected to the receiver by a cable. Should it be desired to make the unit self-contained, a conventional, low power supply should be added to the construction.

#### Methods of Coupling

In order to secure a small r.f. voltage from the transmitter, the monitor must be coupled to the transmitter circuits or antenna feeders. Several methods of accomplishing this are shown in Fig. 3. A shows a method of coupling to either the "zepp" open wire feeders or the balanced 600 ohm line. The coupling wire may be mounted directly on the feeder spacers for a length of about 2 feet in a 300 watt transmitter and the coupling varied by sliding the coupling wire nearer the line. B shows a similar coupling except to a single wire feed line. C shows a method of coupling to the final; sometimes enough r.f. is picked up by the coupling wire by simply inserting it in the final stage compartment. When the coupling wire is placed anywhere near the dangerously high final plate voltage conductors, an isolation condenser (.0001  $\mu$ f., 5000 volt mica) should be used to prevent accidental contact and conduction to the monitor. D is a method used to couple to a low power stage provided it is keyed as well as the final. Another variation of a precautionary isolation circuit is also shown. It should be noted here that the monitor will not be checking the emitted wave when it is coupled to the lower power stages of the transmitter.

#### Operation and Adjustment

If it is desired to check the operation of the monitor before coupling it to the transmitter, a potential of about 50 volts d.c. should be applied across the rectifier load resistor  $R_1$ . This should then give a loud audio note in the ear phones. If nothing is heard, it may be that the audio transformer is connected in the circuit incorrectly. This is corrected by re-

(Continued on page 129)

Fig. 3. Methods of coupling the monitor to the transmitter or antenna feeders: (A) To 600 ohm transmission line, (B) to single wire feed line, (C) to final amplifier, (D) direct coupling to crystal or buffer stage (if keyed).

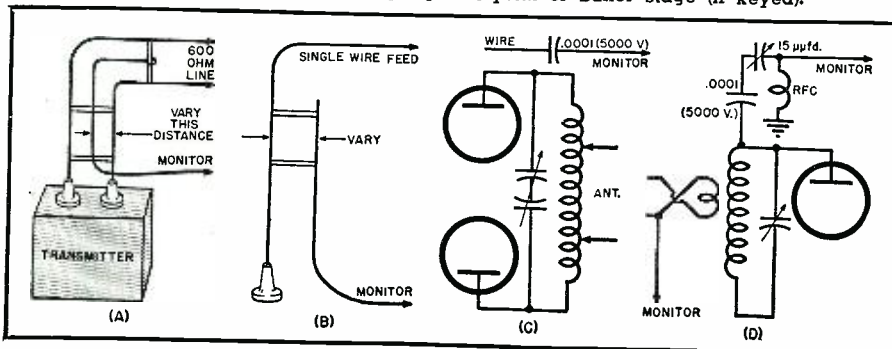

# Operation and Adjustment of TELEVISION RECEIVERS

By **EDWARD M. NOLL**  
Reading Television Labs., Inc.

## **Part 14. Adjustment of television receivers is a critical operation far removed from the customary AM and FM aligning procedures.**

**T**HE quality (contrast and resolution) of the video reproduction on the television screen is influenced greatly by the settings of the front and rear panel controls. After a television receiver is installed, the wise serviceman will not only see that the receiver is adjusted precisely but will instruct a member of the family in correct tuning procedure.

Three objectives in tuning the receiver are, to obtain a stationary pattern, an image which is sharp, properly proportioned and well-defined, and an image which has the proper light range (proper gradations, half-tones, between white and black). To assist the serviceman and home televisioner in making adjustments, the television broadcast station transmits a test chart, such as shown in Figs. 1 through 5, for fifteen minutes to one-half hour before program time. These charts, although not absolutely necessary in tuning, contain characteristic markings which can be used to advantage in setting the controls before the actual program begins.

The television receiver controls, which require adjustment in normal operation and are, in most cases, accessible on the main panel, are station selector, tuning, focus, brightness, contrast, vertical hold, and horizontal hold controls. Each of these controls will be discussed in operating sequence.

1. **Station Selector:** The station selector is a series of push-buttons labelled 1, 2, 3, 4, 5, etc., representing the various television frequency channels. Depress the push-button which represents the channel number and frequency of the station you wish to receive. The six major television channels and their frequencies are shown in Table I.

2. Before turning the power switch on, be certain the contrast and bright-

Channels	Frequency (mcs.)
1	44-50
2	54-60
3	60-66
4	66-72
5	76-82
6	82-88

Table I

ness controls are set fully counter-clockwise.

3. **Brightness:** Turn power switch on and after a few seconds bring up brightness control to the point where the fluorescent screen begins to light up. On some receivers the power switch is mechanically a part of the brightness control and comes on when the brightness control is turned from its extreme counter-clockwise position.

4. **Contrast:** Bring up contrast control until picture, or, in case of improper synchronism, a flickering unsteady pattern appears on the screen.

5. **Vertical and Horizontal Hold:** If the picture is unsteady and appears as shown in Fig. 2 or is more severely torn up, adjust the horizontal control until the picture becomes stationary

Fig. 1. Advancing the contrast control too far produces results similar to this.



horizontally. If the picture appears displaced vertically, Fig. 3, and continues to flop over, adjust the vertical hold control for a stationary vertical pattern. In a stable receiver, the vertical and horizontal hold controls are adjusted by the serviceman when the receiver is installed and thereafter only require occasional adjustment. For this reason, the vertical and horizontal hold controls for some receivers are set by screw-driver adjustments.

6. **Focus:** Adjust focus control until picture becomes sharp and well-defined. Lettering and detail should now be discernible.

7. **Brightness, Contrast, and Focus:** These three controls are now given their final fine adjustment using the station test chart.

a. Turn brightness and contrast controls fully counter-clockwise. Turn up brightness control until screen just begins to light up. Then back off slightly until screen is dark.

b. Turn up contrast control until picture seems most natural. If contrast is turned up too far, half-tones in the picture are lost. This condition is apparent in Fig. 1 which shows a

(Continued on page 102)

Fig. 2. Misalignment resulting from horizontal hold control being incorrectly set.



# Home-Built VACUUM TUBE VOLTMETER

By LT. (jg) N. M. SMITH, USNR

*Employing standard type 1 ma. meter, this easy-to-construct test instrument permits a.c.-d.c. voltage and resistance measurements.*

SEVERAL features are of primary importance when considering the construction of a vacuum tube voltmeter. Electrical features should include a high input resistance on all voltage ranges, and the ability to measure at least 100 megohms with the ohmmeter section of the instrument. Another item that must be considered is the component parts. Individual elements of the instrument should be standard parts, available at any radio supply company.

Presented here are the details of a v.t.v.m. which has these electrical features, and which was constructed entirely of parts readily available on the market at the present time. Radio experimenters and "hams" will probably find most of the parts in the junk box. Even if all components must be purchased new, the cost will be far less than the purchase price of an instrument with similar performance.

From the schematic diagram the following characteristics are obvious: (1) 11 megohms input resistance on all d.c. ranges; (2) approximately 6.5

megohms input resistance on all a.c. ranges; (3) resistance measurements up to  $R \times 1$  megohm with a 3 volt dry cell; and (4) a full scale sensitivity of 3 volts with a 0-1 milliamperemeter movement. Other characteristics which are not so readily apparent from the schematic are; (1) very low "drift" due to varying cathode temperature; (2) contact potential and current of such a low value that for all practical purposes they may be disregarded; (3) a bridge circuit with sufficient degeneration that the current change through the meter is very nearly linear, and the voltage scales may be laid out by geometric means, thus eliminating the necessity of hand calibrating the meter; (4)  $R_{15}$  may be adjusted so that the a.c. meter will give readings of r.m.s. of peak value on sinusoidal voltages, or simple peak readings of any waveform with an accuracy of 5% from 20 c.p.s. to 20,000 c.p.s.; and (5) by means of the meter zero adjustment, which is located on the front panel, the needle may be moved to center scale and both positive and negative

voltages measured without using the selector switch,  $S_2$ , or reversing test leads. This feature has been found to be helpful when tuning the discriminator stage of FM receivers.

The v.t.v.m. described here was constructed on a chassis 10" x 7" x 2", with a front panel 10" x 6½". Since the relative location of component parts is not at all critical, it is possible to construct the instrument on a smaller chassis by careful placement of parts on the chassis.

## Power Supply

Any d.c. source of approximately 300 volts, capable of delivering 20 milliamperes, will easily meet the power requirements of this meter. The power supply shown in the schematic is a full wave rectifier using a 6X5 tube, but any other similar rectifier tube may be used. A 6X5 was selected as the power rectifier in this circuit because it was desired to utilize the 5 volt heater winding of the power transformer for the 6Y6 tubes,  $V_1$  and  $V_2$ , in the bridge circuit and the 6H6 tube,  $V_3$ , used as a rectifier when making a.c. voltage measurements. By operating the heaters of these three 6.3 volt tubes at 5 volts, contact potential is reduced and the linearity of the 6H6 is increased for operation at low levels. The 6X5 rectifier,  $V_4$ , in the "B" supply and the 6H6,  $V_4$ , used as a meter protector, are then operated at their rated heater voltage of 6.3 volts. Since most "universal" power transformers have these two heater windings, the builder should have no difficulty in connecting the tube heaters to conform with this recommended arrangement.

The bleeder resistors across the rectifier should be tapped in such a manner that the plate supply is about +30 volts with respect to the chassis which is common or "ground". The cathodes of  $V_1$  and  $V_2$  are returned through the resistor network to a point about -270 volts below ground. The value of resistors  $R_{23}$  and  $R_{24}$  must be selected so that under operating conditions, the plate voltage of  $V_1$  and  $V_2$  is +30 volts and the cathode voltage is +4.5 volts with respect to ground. In the event that the values

Panel layout showing placement of various operating controls and meter.

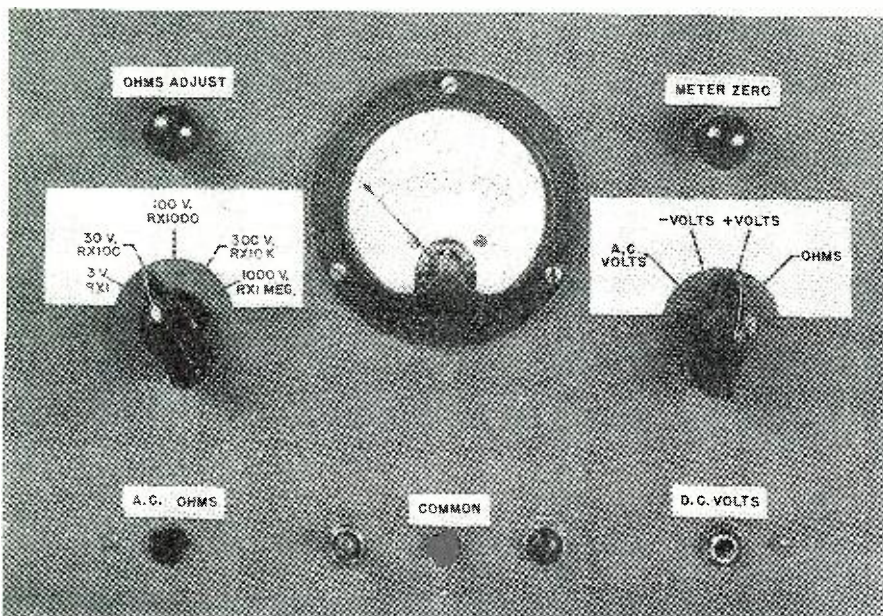



given in the parts list do not result in these operating voltages, the size of  $R_{21}$  should be increased or decreased until operating voltages very close to these recommended values are obtained.

A resistor-capacitor filter was used since it would provide adequate filtering, and the current demand of the bridge is sufficiently low that the voltage drop across  $R_{22}$  does not excessively reduce the output voltage.

### Meter Bridge

The 6Y6 type tubes were chosen for the meter circuit for two reasons; namely, (1) low contact potential and current, and (2) good linearity with low plate-cathode voltage. The plate supply is approximately +30 volts and the cathode voltage is about +4.5 volts. Thus, the plate-cathode voltage is roughly 26 volts. Under no signal conditions, the grids of both  $V_1$  and  $V_2$  are at ground potential giving a resultant grid-cathode voltage of 4.5 volts. This combination of low plate-cathode and low grid-cathode voltage is another factor in reducing the arch enemy of v.t.v.m.s, contact potential. From the characteristic curves of a 6Y6, it can be seen that under these conditions a grid swing of 4.0 volts in either direction results in a corresponding plate current change that is very close to linear.

The bridge circuit itself is a conventional one employed in many commercial meters. It consists of two cathode followers with a common cathode resistor. The common resistor in the circuit presented here is  $R_{21}$ . The 0-1 milliamper meter and a calibrating resistor are connected in series between the cathodes of the two cathode followers,  $V_1$  and  $V_2$ . When a voltage is being measured, a potential is applied to the grid of  $V_1$ . This causes a plate current change in  $V_1$ , which in turn causes a change in voltage across  $R_{18}$ ,  $R_{19}$ , and  $R_{21}$ . The voltage change across  $R_{21}$  causes an opposite change in current through  $V_2$ . But since only a portion of the voltage change across the cathode resistors of  $V_1$  affects the current flowing in  $V_2$ , the current change through  $V_2$  is very small, and the voltage change across  $R_{21}$  is reduced by the current change through  $V_2$ . It can be seen that  $V_2$  is serving merely as a low impedance source of current for operating the meter movement. The end result is that the voltage change between the cathodes of  $V_1$  and  $V_2$  is very close to one-half the amount of the voltage applied between control grid and ground of  $V_1$ . The meter movement and series calibrating resistor are shunted between the cathodes, introducing degeneration into the push-pull circuit, and further improving its linearity. Assuming perfectly linear operation, the voltage appearing between the cathodes is always the same fractional part of the voltage applied to the control grid of  $V_1$ , provided this latter voltage is within the limits of  $\pm 4.5$  volts with respect to ground. It

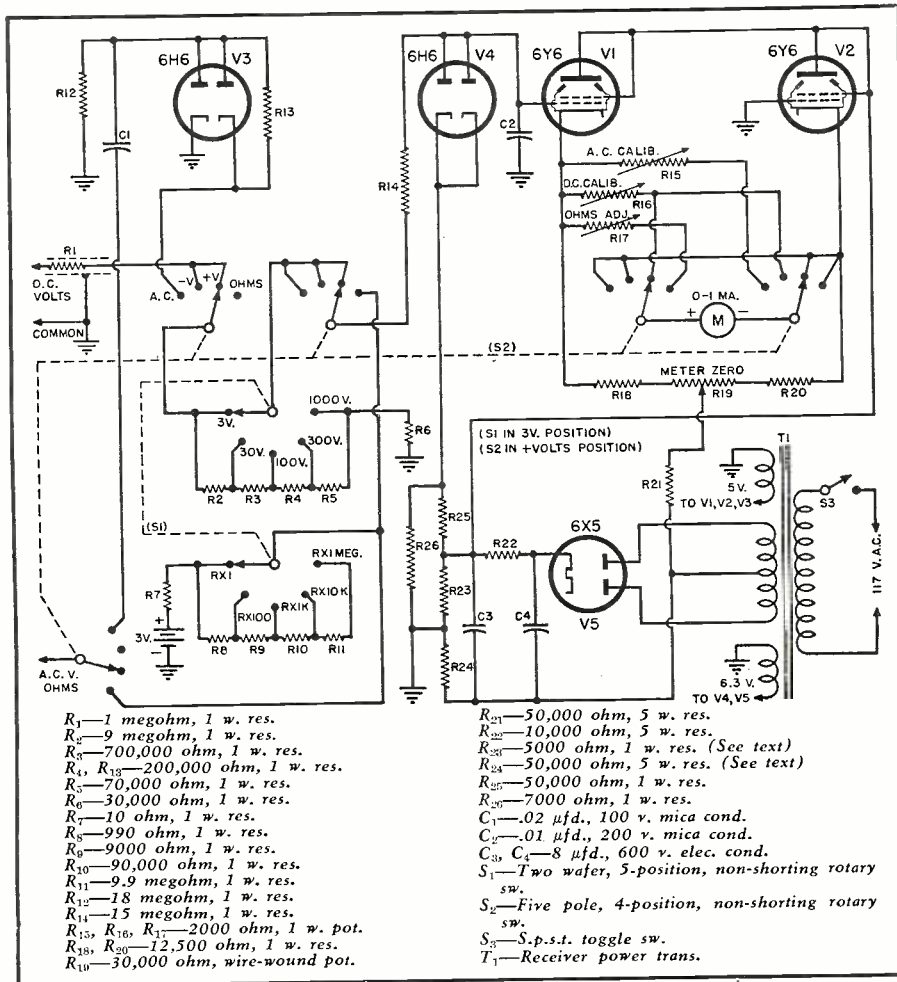

Complete wiring diagram and parts list for five tube service instrument.

can be seen that if the grid of  $V_1$  is made more positive than the cathode voltage, grid current will flow, and the applied voltage in excess of the cathode voltage will appear across  $R_{14}$ ,  $R_{15}$ , and whatever portion of the divider network is in series with the test probes and the grid. This condition is very undesirable, and fixes the limit in the positive sense at about +4.5 volts. If the grid is made more negative than approximately -4.8 volts,  $V_1$  is biased beyond cut-off, and any voltage in excess of -4.8 volts has no effect on the plate current flowing in  $V_1$ . The upper limit is the cathode voltage, or +4.5 volts, and the lower limit of usable operation is cut-off of the tube, or -4.8 volts. Allowing a margin of safety in both directions, 3 volts was selected as the minimum voltage for full scale deflection, and the divider network designed accordingly.

Resistor  $R_{14}$  serves two very important functions in this circuit. It can be seen that without this resistor in the circuit, the resistance in the grid circuit of  $V_1$  would vary from 10 megohms to 30,000 ohms as  $S_1$  is switched from the 3 volt position to the 1,000 volt position. This would cause an appreciable change in contact current through  $V_1$ , and it would be necessary to zero the meter each time a new voltage range might be selected. The

addition of  $R_{14}$  to the circuit reduces the percentage resistance change in the grid to ground circuit of  $V_1$ , as  $S_1$  is rotated from one limit to the other. A resistance change from 25 megohms to 15 megohms has a negligible effect on contact current, while a change from 10 megohms to 30,000 ohms will produce a prohibitive change in contact current. The exact value of  $R_{14}$  is not critical, but its value should be between 10 and 15 megohms.

The second function of  $R_{14}$  is that of a filter reactance. To measure an a.c. voltage with this instrument, the a.c. voltage is first converted to a unidirectional current by  $V_3$ . It is next filtered; then applied to the bridge circuit as a d.c. voltage.  $R_{14}$  and  $C_2$  form this necessary filter.

$C_2$ , in addition to being a filter condenser, is also an a.c. by-pass condenser for the grid circuit when the selector switch,  $S_3$ , is on either of the d.c. positions. Since the grid circuit is a high impedance circuit, it readily picks up stray a.c. voltages from other circuits in the unit. The amplitude of these undesired a.c. voltages may be greater than the 3 volt maximum of the desired voltage. If these extraneous voltages are not by-passed, grid rectification will occur, resulting in an erroneous meter reading. For best results,  $C_2$  should be a mica condenser,

(Continued on page 123)



# International SHORT-WAVE

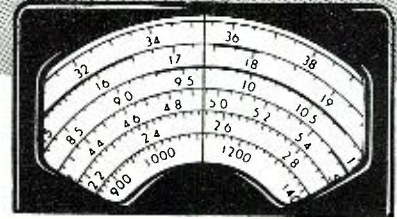

Compiled by **KENNETH R. BOORD**

LBANIA, Austria, Czechoslovakia, Denmark, Germany, Hungary, Great Britain, Poland, Portugal, Spain, Spanish Morocco, Canary Islands, Azores, Iceland, and the Near East have adopted Summer time. In general, broadcasts from these countries which are domestic relays are received one hour earlier EST\*. Certain transmissions beamed abroad will be found at the same EST as previously, including BBC's North American beam.

### "Operation Crossroads" Coverage

From Lt. William E. Miller, Jr., Tokyo, comes word that WVLC, aboard the U.S. Army communications ship, "Spindle-eye," at anchor in Honolulu as of April 30, will probably cover the Bikini atoll atomic bomb tests in the Marshall Islands during July and August.

"KU5Q on Guam will also be in on the big affair," he advises. "Following the atomic bomb tests, KU5Q will probably be dismantled and WVLC will return to the States for decommissioning." According to Lt. Miller, WVLC works KKL, KES-2, KBE, and KGT-5 occasionally on 18.530 or 9.065; the 13.970 frequency is rarely being used.

KU5Q, operated by the U.S. Navy on Guam, is at present relaying news programs from Shanghai to the Amer-

ican networks. Frequencies listed by Lt. Miller are:

17.820 and 15.930 — Work KKL (RCA, San Francisco) occasionally about 6 p.m.

13.360 and 9.280 — Work WLXJ, Shanghai, nearly every day from 6:30 to about 8 a.m.

9.670 and 7.645—Work KES-2 (RCA, San Francisco) nearly every day from 6:30 to about 8 a.m.

He reports that WLXJ, operated by the U.S. Army in Shanghai, broadcasts news programs to American networks. "These are often relayed by KU5Q on Guam, and occasionally by JVU-2 (11.845), JLU-2 (9.525), or JVT (6.750), Tokyo. Occasionally also, WLXJ works KES-2 (RCA, San Francisco) direct." Frequencies used by WLXJ are: 8.040, used almost daily, 6:30-8 a.m.; 5.500, used occasionally in place of 8.040. Power of WLXJ is 2 kilowatts.

Lt. Miller is with the Signal Section, 8th Army.

\* \* \*

### Additional Data on Clubs

British Short-Wave League — A. Chas. Cheffins, secretary, BSWL, Headquarters, 17 Bedford Road, Alexandra Park, London, N. 22, England, sends us the following information about that organization:

The BSWL was founded in 1935 and before the war had members in 25 countries. "We are now building up

our overseas membership again and would welcome new friends from all countries," Mr. Cheffins advises. "We have, of course, members in America including the famous Dorothy Hall, W21XY, who is BSWL105. All members are issued a BSWL number for use on SWL cards and we have a bureau for the distribution of QSL cards to members. The official organ, the 'Short Wave Review,' is published monthly and is sent to all members. The annual subscription is 4/- (four shillings) which provides for a number of services in addition to the monthly 'Review.' Attractive certificates are issued to members for listening achievements."

Editorial offices of the "Short Wave Review" are located at 53 Madeley Road, Ealing, London, W. 5, England. Norman Stevens is editor.

The BSWL Council is made up of Mr. Cheffins, Mr. Stevens; Sidney Pearce, president; R. Aish Clee, assistant secretary; George Musk, vice-president; and E. J. LeBreton, E. J. Logan, C. Overland, E. A. Strowbridge, T. L. Stevens, and C. G. Tilly.

Mr. Cheffins points out that "the British Short Wave League is a non-profit organization founded to meet the requirements of short-wave listeners. The League's aims are to promote and foster the 'ham spirit; to bring together the s.w. listeners of the world, through the medium of its official organ, to mutual benefit; and to provide these listeners with facilities for enjoying their hobby to its greatest extent." Slogan is: "Organized by the Listener for the Listener."

The Grand National SWL Club—The GNSWLC is a SWL-card swappers club, according to George H. Jacobs, president of the group. "We are not in competition with any radio club," he tells me. "Dues are \$1 per year. The club issues a high-quality bulletin each month. The GNSWLC was organized in 1939 and membership is international — with members throughout the United States, England, Australia, New Zealand, Canada, Cuba, South America, and many other countries." John W. Zonner is vice-president of this club; the Membership Director and Radio Editor-in-Chief is Edward F. Shirley, P.O. Box 98, Cassadaga, New York. Address of

\*(Unless otherwise indicated, all times herein are given in Eastern Standard Time (EST).)

Ulric Gouveia, assistant announcer is shown at the "mike" in Studio B, with part of the control room in the background at station ZFY, 6.000, "The Voice of Guiana," Georgetown, British Guiana. This station is widely heard, even on the West Coast, and latest schedule received direct from Georgetown is 5:45-7:45 a.m., 9:45-11:45 a.m., 2:45-7:45 p.m.; BBC news is relayed at 6 a.m., 11 a.m., 3 p.m. and 5:45 p.m. and the Caribbean news is heard at 7:30 and 11:30 a.m. and 7:30 p.m., all daily. Gerard V. de Freitas is the chief announcer. After spending some months in the U.S. with the "West Indian Radio Newspaper," he is now back on duty at ZFY. The station is operated by The British Guiana United Broadcasting Co., Limited.



You have these Advantages  
in selecting

# OHMITE

RHEOSTATS • RESISTORS  
TAP SWITCHES

Wide Variety of Types and Sizes!

Stock and Special Units!

Time Proved Performance!

Experienced Engineering Cooperation!

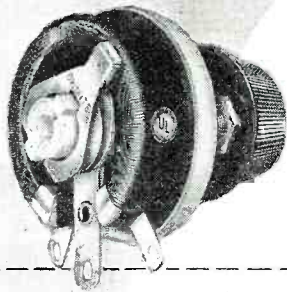

#### Close Control RHEOSTATS

10 Wattage Sizes from 25 to 1000 Watts, from 1 1/8" to 12" Diameter, with Standard or Special Features, with Uniform or Tapered Windings, in Stock or Special Resistances, in Single, Tandem, or Concentric Units.



#### Wire Wound RESISTORS

Widest Range of Types, Sizes and Ratings in Stock and Made-to-Order Units. Fixed, Adjustable or Tapped. General-Purpose, Non-Inductive or Precision. Standard or Special Windings. Variety of Terminals and Mountings. Also Hermetically Glass-Sealed Resistors.

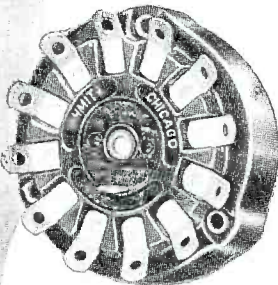

#### High Current TAP SWITCHES

Compact, enclosed, all-ceramic, rotary, non-shorting, multi-point Selector Switches. 5 Sizes rated at 10, 15, 25, 50 and 100 Amperes 150, 300 V.A.C. As few as 2 or as many as 12 taps. Sizes from 1 3/4" to 6" Diameter. Single or Tandem units. Also Open Type Tap Switches in "shorting" (commutator) and "non-shorting" units. In Stock or Made-to-Order.

Send for Stock-Unit  
Catalog No. 18

Write for this quick, helpful reference. Gives valuable data and information on the wide variety of Ohmite Stock Rheostats, Resistors, Chokes and Tap Switches.



The complete service available to you at Ohmite assures you of the *right* control units for your specific needs. From the many Ohmite stock types, you can often make a quick, economical selection. On special requirements, Ohmite experience with unusual applications can be of real help to you. What's more . . . you can always rely on the knowledge that Ohmite design and construction have long been proved in the most critical applications under severest operating conditions. Yes, there's good reason to prefer Ohmite Rheostats, Resistors, Tap Switches in your products or equipment.

**OHMITE MANUFACTURING COMPANY**  
4883 FLOURNOY STREET • CHICAGO 44, U. S. A.

Be Right with

# OHMITE

RHEOSTATS • RESISTORS  
TAP SWITCHES

**FREE**

# New! Complete! CONCORD Radio Catalog



**NEW RADIO SETS**

**NEW AMPLIFIERS**

**NEW RADIO PARTS**

**Electronic Equipment**

**HAM GEAR**

## STANDARD LINES! LARGEST STOCK! IMMEDIATE SHIPMENT!

For the newest, the latest, and the best in radio sets, radio parts, amateur kits, and test equipment, mail coupon below for your free copy of Concord's first post-war Catalog. It offers a huge storehouse of everything that's new in radio and electronics . . . including the sensational, talked-about line of exclusive Concord Multiamp ADD-A-UNIT amplifiers. It contains thousands of items . . . all standard lines . . . war-born discoveries and improvements . . . all ready for same-day shipment direct to you from CHICAGO or ATLANTA.

### History-Making ADD-A-UNIT Line of Amplifiers

Typical of Concord leadership is the completely revolutionary line of Multiamp ADD-A-UNIT Amplifiers, designed and engineered by Concord, sold only by Concord. Built on entirely new principles, these Amplifiers offer startling innovations not available elsewhere . . . new high standards of flexibility, fidelity, power, economy, and all-round performance almost beyond belief. Mail coupon now for Concord's New Complete Catalog showing full amplifier line . . . and complete assortments of "everything that's new in radio and electronics."

**CONCORD**  
RADIO CORPORATION  
LAFAYETTE RADIO CORPORATION  
CHICAGO 7 ATLANTA 3  
901 W. Jackson Blvd. 265 Peachtree Street

CONCORD RADIO CORPORATION  
901 W. Jackson Blvd., Dept. E-76, Chicago 7, Ill.  
Yes, rush FREE COPY of the comprehensive  
new Concord Radio Catalog.

Name.....

Address.....

City..... State.....

the GNSWLC is P.O. Box 781, Ft. Wayne, Indiana.

International Round Table — The IRT is "a society founded on the principles of good fellowship among those interested in short-wave radio." Its house organ is the "International Round Table," published monthly; subscription rate is \$1.85 per year *anywhere*. President of the club is Warren H. Stark, 2117a N. 64th street, Wauwatosa 13, Wisconsin; Bernard D. Kierski, 2011a, So. Jefferson avenue, St. Louis 4, Missouri, is editor of IRT.

Wireless Institute of Australia—Federal Headquarters is Box 2611W, G.P.O., Melbourne, Victoria, Australia. Federal officials include: President, R. Marriott (VK3SI); treasurer, T. D. Hogan (VK3HX); secretary, A. H. Clyne (VK3VX); councilors, A. R. Williams (VK3WE) and C. C. Quin (VK3WQ). Address of the New South Wales Division (VK2WI), located at 21 Turnstall Avenue, Kingsford, is Box 1734, G.P.O., Sydney, New South Wales, Australia; address of the Victorian Division (VK3WI), located at 191 Queen Street, is Box 2611W, G.P.O., Melbourne, Victoria, Australia; address of the Queensland Division (VK4WI) is Box 1524V, Brisbane, Australia; address of the South Australian Division (VK5WI) is Box 284D, Adelaide, South Australia; address of the Western Australian Division (VK6WI) is Box N. 1002, G.P.O., Perth, Western Australia; address of the Tasmanian Division (VK7WI) is Box 547E, Hobart, Tasmania.

Gladesville District Radio Club (VK2ADY) — Secretary is Charles Fryar (VK2NP), 113A Tennyson Road, Gladesville, New South Wales, Australia.

New Zealand Radio Hobbies Club—Headquarters address is Electric Lamphouse, Wellington, C.1, New Zealand. Monthly bulletin is "Radiogram." Arthur S. Cushen, 105 Princes Street, Invercargill, New Zealand, compiles the DX notes and an annual log.

*(Information on Australian and New Zealand clubs listed above is by (Continued on page 82))*

### JOB OPPORTUNITIES

ACCORDING to a recent memorandum from the Headquarters of the Air Communications Service, Army Air Forces, the commercial airlines of the United States offer excellent opportunities to personnel trained in the field of communications. Many service men have during their tour in the Armed Forces received training which qualifies them for placement in communication positions.

The chances of obtaining employment with the airlines are greatly increased if at the time of application the service man holds a 2nd class radio telephone, 2nd class radio telegraph, or a license of higher rating.

For further information concerning examinations, and where they may be taken, contact the Federal Communications Commission, Washington, D.C.

—30—

RADIO NEWS

# New!

## Series 200

# A RELAY BY GUARDIAN with Interchangeable Coils

### BUILT IN TWO PARTS

A.C. Coil Assemblies - available for 6 v., 12 v., 24 v., 115 v.  
D.C. Coil Assemblies available for 6 v., 12 v., 24 v., 32 v., 110 v.

★ Two basic parts—a coil assembly and a contact assembly—comprise this simple, yet versatile relay. The coil assembly consists of the coil and field piece. The contact assembly consists of switch blades, armature, return spring, and mounting bracket. The coil and contact assembly are easily aligned by two locator pins on the back end of the contact assembly which fit into two holes on the coil assembly. They are then rigidly held together with the two screws and lock washers. Assembly takes only a few seconds and requires no adjustment on factory built units.

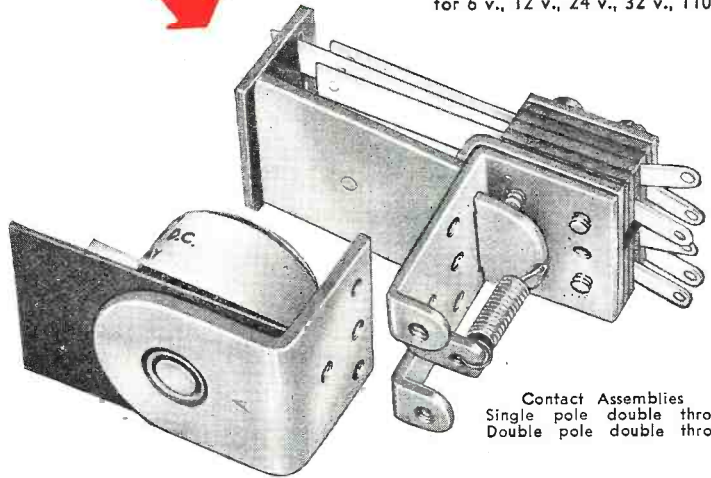

SERIES 200 RELAY

Contact Assemblies  
Single pole double throw  
Double pole double throw

## On Sale at Your Nearest Jobber NOW!

See it today! . . . this amazing new relay with interchangeable coils. See how you can operate it on any of nine different a-c or d-c voltages—simply by changing the coil. Ideal for experimenters, inventors, engineers.

### TWO CONTACT ASSEMBLIES

The Series 200 is available with a single pole double throw, or a double pole double throw contact assembly. In addition, a set of Series 200 Contact Switch Parts, which you can buy separately, enables you to build dozens of other combinations. Instructions in each box.

### NINE COIL ASSEMBLIES

Four a-c coils and five d-c coils are available. Interchangeability of coils enables you to operate the Series 200 relay on one voltage or current and change it over to operate on another type simply by changing coils.



Your jobber has this sensational new relay on sale now. Ask him about it. Or write for descriptive bulletin.

**GUARDIAN**  **ELECTRIC**  
1630-H W. WALNUT STREET CHICAGO 12, ILLINOIS  
A COMPLETE LINE OF RELAYS SERVING AMERICAN INDUSTRY

# MONTHLY LEOTONE SPECIALS

- 2 TUBE PHONO OSCILLATOR, 110V. AC-DC. freq. 1450-1550 KC; 6"x3 3/4"x2". With tubes..... \$5.95
- BAKELITE PANELS: 1/4" glossy brown, 7"x10", 59c; 7"x14", 69c; 7"x18", 79c; 9"x15", 85c; 9"x18", 95c; 7"x18", 1.05
- 1/2" brown linen, 7"x10", 65c; 7"x14", 75c; 7"x18", 85c
- 1/2" brown linen strips, 1 1/2"x13" or 2 1/4"x11", 1.10
- EXPERIMENTAL TUBES, varied sizes & base types. Filament tested. 20 for..... 1.00

RADIO HARDWARE: Approx. 1000 asstd. screws, nuts, washers, etc., in metal container..... \$0.49

- Standard switch mounting nuts, hexagonal, brass, 100 for..... \$1.25
- Tuning condenser pulleys (with setscrew), 3" O.D., 1/4" or 3/8" shaft hole..... .19
- 6" O.D., 3/8" shaft hole..... .29
- 5 TUBE PUNCHED CHASSIS & COVER FOUNDATION; Black crackle finish, all-round louvre ventilation; 12"x9"x9". Per set..... 1.29

I.R.C. WIRE-WOUND POWER RHEOSTATS, all with pointer knobs & hardware: 25 watt—5, 20, 50, 100, 500, 2500 or 5000 ohms. Each..... \$0.69

50 watt—4, 15, 50, 100, 250 or 550 ohms..... .98

- I.R.C. 1% precision meter shunts: 1.02, 65, 90, 425 or 840 ohms. Each..... \$0.35
- 1% precision multipliers: 170, 330, 3300, 4K, 5290, 5993, 11K, 18K, 35.8K, 227K or 400K ohms..... .35
- Weston 1% precision resistors: 99K, 135K, 164.5K, 500K, 750K, 800K; 1.2, 3, 4, & 15 meg. 12 for..... 1.50
- Short-wave ceramic tuning coils, slider & iron-core adjust. Specify freq. range (MC): 1.3-2.1, 2.1-3, 3-4, 4-5.3, 5.3-7, or 7-9.1..... .49

## ALNICO MAGNETS

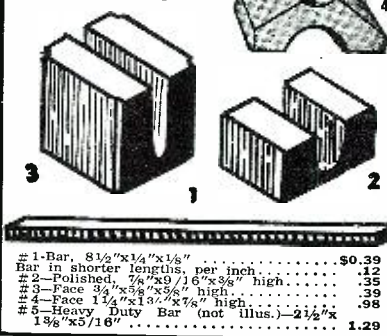

- #1—Bar, 8 1/2"x1 1/2"x1 1/4"..... \$0.39
- Bar in shorter lengths, per inch..... .12
- #2—Polished, 7/8"x9/16"x3/8" high..... .35
- #3—Face 3/8"x3/8" high..... .39
- #4—Face 1 1/2"x1 3/8"x7/8" high..... .98
- #5—Heavy Duty Bar (not illus.) 2 1/2"x1 3/8"x5/16"..... 1.29

TUBES: Perfect condition, but not in sealed cartons. Guaranteed for 90 days. #26, 27, 46, 56, 41 & 6F6, 29c; #42, 6AS, & 77, 49c; #6V6, 6K7, & 6L6, 39c; #250, 120 & 6AS..... \$0.69

- 3 TUBE PHONO AMPLIFIER (50L6, 35Z5, 12SQ7); 110V. AC-DC, volume and tone controls; 6"x3 3/4"x2"; with output transformer and tubes..... 7.95
- SERVICEMEN'S KITS: #1—Speaker Repair; contains 12 asstd. paper rings, 8 spiders, felt strips for four 12" spkrs., kit of 16 shims, 12 chamois segments, and tube spkr. cement..... \$2.25
- #2—Speaker Cones: 12 popular sizes, 4" to 12", moulded & free edge. Less voice coil..... 2.00
- #3—Bakelite mica condensers; 50 asstd. capacities and voltages..... 2.95
- #4—Tubular bypass condensers; 50 asstd. .001 to .2 mfd. 200-600V, clearly marked..... 2.49
- #5—Electrolytics: 10 asstd. including multi-section and can types..... 1.95
- #6—Voltage Dividers: 20 asstd. multi-tapped high wattage..... 3.95
- #7—Dial Scales: 23 asstd. airplane & slide rule (acetate & glass included)..... 2.98
- #8—Escutcheon Plates: 25 asstd. airplane, slide rule & full-size types..... 2.95
- #9—Knobs: 25 asstd. wood & bakelite (setscrew & push-on)..... 1.00

WRITE FOR BETTER PRICES ON ALL QUANTITY PURCHASES

PROMPT SERVICE ON ALL SPEAKER AND PHONO PICK-UP REPAIRS

MINIMUM ORDER—\$2.00

20% DEPOSIT REQUIRED ON ALL ORDERS

PLEASE ADD SUFFICIENT AMOUNT FOR POSTAGE

**LEOTONE RADIO CO.**  
MAKERS OF CONES AND FIELD COILS  
65-67 DEY STREET, NEW YORK 7, N.Y.  
WORTH 2-0284-5  
12,000 SQ. FT. OF RADIO PARTS

# Designing A STABLE V.F.O.

By LYLE C. TYLER

**Important facts to remember when designing your own stable variable frequency oscillator.**

A VARIABLE frequency oscillator with very good frequency stability can be constructed if sufficient care is used in the design and construction. This article will discuss some of the problems encountered in such a design, and as an example, suggest a circuit for an oscillator which will be suitable for use as an exciter for a transmitter, or as a basic oscillator for a heterodyne frequency meter.

Frequency instability of an oscillator may be caused by variation of electrode voltages thus causing variations in plate resistance and mutual conductance, variations in temperature of the LC circuit, geometrical variation of the tube elements, and variation of the load.

We know that the frequency actually generated in an oscillator differs slightly from the resonant frequency of the tuned circuit, a condition which, of course, is necessary to sustain oscillation. That difference depends on several factors, mainly the plate voltage, the filament voltage, the r.f. resistance of the tank circuit, and the load resistance. The greater that frequency difference is, the greater will be the effect on the output frequency

when those factors are varied. With some thought given to the design of the tank circuit, much can be done toward eliminating the effects of varying line voltage, temperature, etc.

The methods for frequency stabilization to be considered include:

1. Adjusting the grid excitation by means of a tapped inductance. This reduces the frequency difference between frequency generated and tank resonant frequency, thereby reducing the effects of varying tube electrode voltages.
2. Use of low power. It can readily be seen that high power output and frequency stability simply cannot go together.
3. Plate voltage regulation.
4. Temperature compensation or temperature control of the tank circuit.
5. The tank circuit Q is made as high as possible.
6. Electron coupling to the load and additional isolation from any varying load.
7. Very rigid mechanical construction.
8. Use of the best possible variable capacitor and other component parts. Of course the methods used here may

Fig. 1. Schematic diagram of oscillator and untuned buffer.

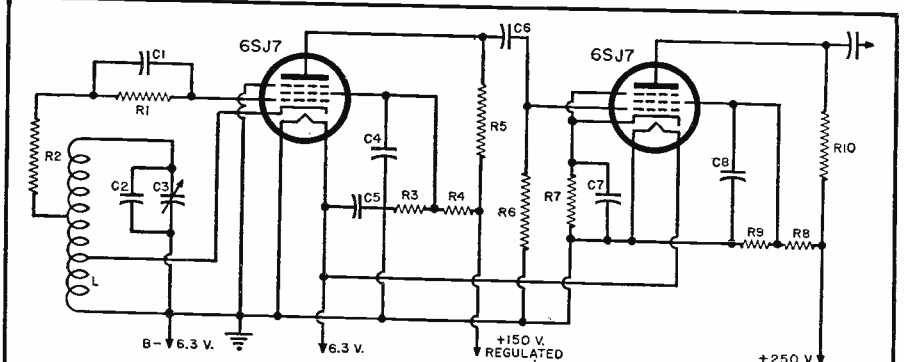

- R<sub>1</sub>—150,000 ohm, 1/2 w. res.
- R<sub>2</sub>—200 to 300 ohm, 1/2 w. res. (See text)
- R<sub>3</sub>—30,000 ohm, 1 w. res.
- R<sub>4</sub>—20,000 ohm, 1 w. res.
- R<sub>5</sub>—10,000 ohm, 1 w. res.
- R<sub>6</sub>—1 megohm, 1/2 w. res.
- R<sub>7</sub>—200 ohm, 1 w. res.
- R<sub>8</sub>—75,000 ohm, 1 w. res.
- R<sub>9</sub>, R<sub>10</sub>—50,000 ohm, 1 w. res.
- C<sub>1</sub>, C<sub>6</sub>—50 μfd. mica cond.
- C<sub>2</sub>—300 μfd. cond. (for 1.7 to 2 mc.)
- 210 μfd. cond. (for 3.5 to 4 mc.) (See text)
- C<sub>3</sub>—200 μfd. max. cond. (for 1.7 to 2 mc.)
- 150 μfd. max. cond. (for 3.5 to 4 mc.) (See text)
- C<sub>4</sub>, C<sub>5</sub>, C<sub>7</sub>, C<sub>8</sub>—.01 μfd. mica cond.
- L—18 μh. osc. coil (for 1.7 to 2 mc.)
- 6 μh. osc. coil (for 3.5 to 4 mc.) (See text)
- V<sub>1</sub>, V<sub>2</sub>—Type 6SJ7 tube

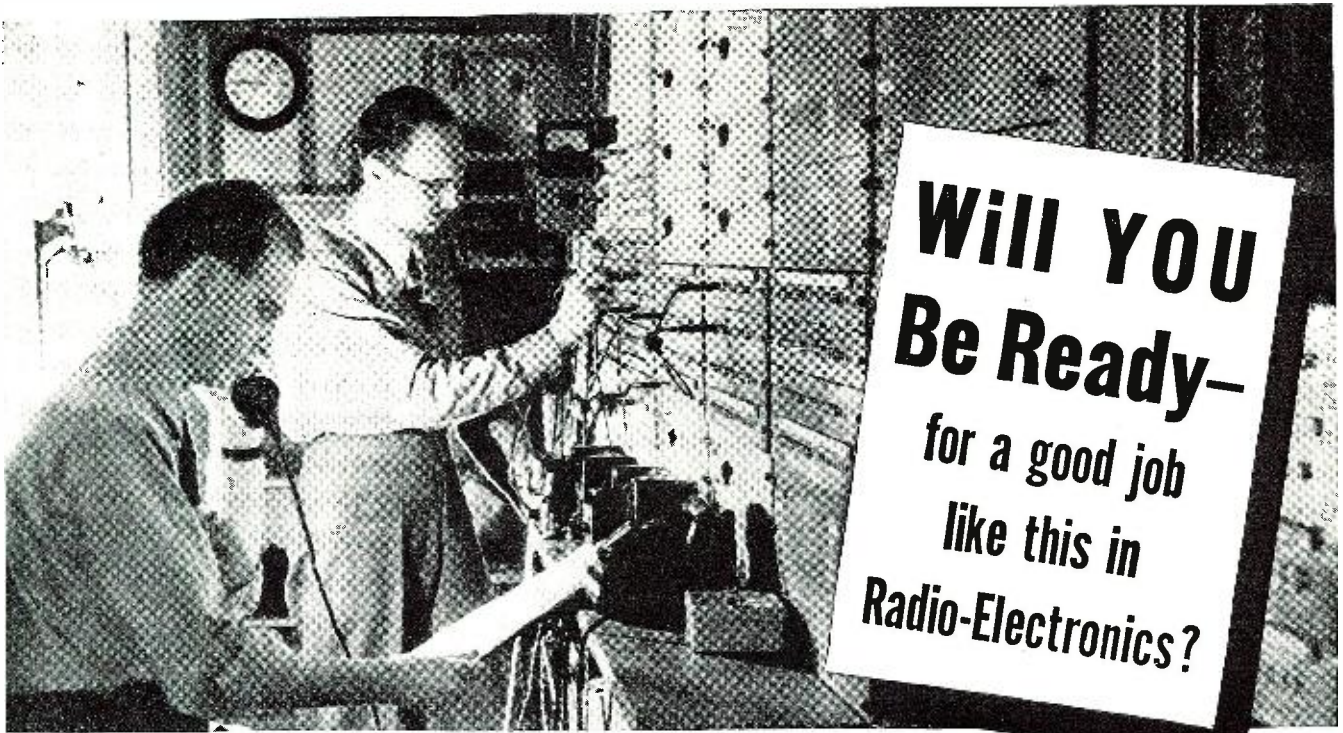

## CREI Home Study Training Can Equip You to Step Ahead of Competition and Gain the Confidence Born of Knowledge

**CREI technical home study training prepares you for the secure radio jobs that pay good money for ability.**

Yes, YOU, can be ready to enjoy the security of an important engineering position and take advantage of new career opportunities . . . if you prepare yourself **now**.

Join the thousands of other ambitious radio-men who have enrolled with CREI to assure themselves of secure, good-paying jobs with a planned program of advancement made possible by CREI home study training in Practical Radio-Electronics Engineering. You can study at home—in your spare time—develop your technical ability—increase your knowledge to keep pace with important developments now taking place in the industry.

By adding CREI training to your present radio experience you can safeguard your future and keep pace with such new developments as U.H.F. Circuits, Cavity Resonators, Pulse Generators, Wave Guides, Klystrons, Magnetrons and other tubes. Are you equipped to handle them? CREI is equipped to help you, by provid-

ing the know-how and ability that is required.

In our proved method of instruction you learn not only how but why! Easy-to-read-and-understand lessons are provided well in advance, and each student has the benefit of individual guidance and supervision from a trained instructor. This is the basis of the CREI method of training which many thousands of professional radio men have completed during the past 19 years . . . training similar to that which CREI used in training thousands of radio technicians during the war for the U. S. Signal Corps, U. S. Navy and U. S. Coast Guard.

It costs you nothing to read the interesting facts . . . to learn how CREI can help you enjoy the security you want . . . the better paying job that can be yours. Write for particulars now! (CREI training for Veterans is approved under the "G.I." Bill.)

• **WRITE TODAY for FREE BOOKLET** 

"Your Opportunity in the New World of Electronics"

If you have had professional or amateur experience—let us prove to you that we have something you need to qualify for a better radio job. To help us to intelligently answer your inquiry—PLEASE STATE BRIEFLY YOUR BACKGROUND OF EXPERIENCE, EDUCATION AND PRESENT POSITION.

## Capitol Radio Engineering Institute

E. H. RIETZKE, *President*

Dept. RN-7, 16th and Park Road, N.W., Washington 10, D. C.

*Branch Offices:*

New York City (7), N. Y.  
170 Broadway

Chicago (2), Ill.  
30 N. LaSalle St.

San Francisco (2), Calif.  
760 Market St.

San Diego (1), Calif.  
316 C Street

MEMBER: NATIONAL HOME STUDY COUNCIL • NATIONAL COUNCIL OF TECHNICAL SCHOOLS

# JUST RECEIVED! ARMY-NAVY SURPLUS OUTSTANDING VALUES

## COMPLETE TRANSMITTING & RECEIVING SETS

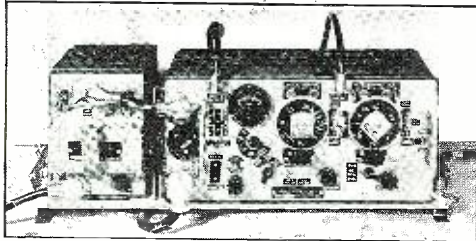

## BRAND NEW! 3 SETS IN ONE—15 TUBES MADE BY ZENITH & EMERSON

SET A, for telephone and telegraph includes: 6 tube superheterodyne receiver and 6-tube MOPA transmitter with 807 final amplifier. Grid modulated for telephone. Specialized circuits make this set ideal for network operations. The frequency range of 2 to 8 megacycles includes the 80 meter and 40 meter amateur bands.

SET B, consists of 235 megacycle transceiver that can be shifted to the 144 or 225 megacycle amateur bands.

SET C, a complete inter-communication system using 3 control boxes and 3 combination headphones—push-to talk microphone, providing inter-communication in 3 different locations.

or remote control operation in an extremely flexible arrangement in 3 different locations.  
POWER SUPPLY: This unit, including dynamotor, operates from a 12-volt storage battery. These sets are ideal for mobile or marine installations. 2 Antennas, 1 Variometer Resonator, Spare Set Tubes, Generator, Set of Spare Parts; 5 sets Earphones, 5 sets Microphones.....

**\$78<sup>50</sup>**

## U. S. NAVY MODEL RAK-7 SHIP RECEIVERS NEW—IN CASES

Made by R. C. A. 9 tube TRF; 6 bands; 15 KC - 600 KC complete with power supply operating on 115 v/  
60 cps .....

**\$77<sup>50</sup>**

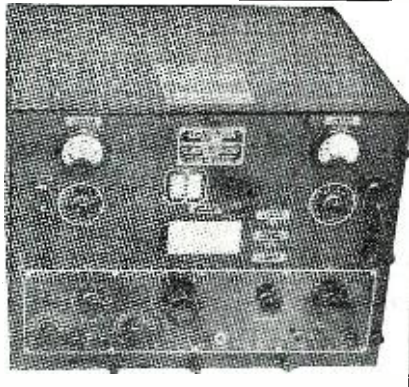

## PULSE AMPLIFIER

Signal Corps type BC409 from SCR-268 Radar set.

Designed for 115 volts, AC 60 cycles. This unit developed the initial radar pulse and contains valuable component parts that valued individually would, in sum, cost several times the selling price of this unit. Fine buy for experimental work, or for anyone who can use the component parts. Slightly used. Following are a few of the items that make up the unit.

- 1—304TL (Eimac) triode.
- 3—2 mfd. 4,000 W.V. GE Pyranol.

**\$79<sup>50</sup>**

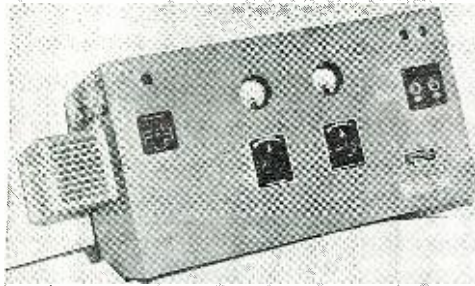

- 1—3200 volt, 150 MA power transformer.
- 1—Variac 5 amps. General Radio type CU 200.
- 1—5 volt, 26 AMP fil. transformer (for 304 TL).
- 1—2.5 volt, 10 Amp. fil. transformer (5000 volt. insulation).
- 1—2 mfd. 1,000 volt. GE Pyranol.
- 2—0 to 4,000 volt, 3" volt. meters (0-1 mil. move) and misc. chokes, resistors, etc.

NEW RECEIVERS B.C. 603 semi-completed, made for 603 Tank F.M. less var. cond. & front panel, no tubes. In lots of 25.....  
Tech. Book & Hook-up .....

Driver 6v6 to pair of 811's.....  
Modulation Transformer 811's to 813 .....

NEW BATTERY BOX BX-4, +90 v., +67½ v., -3 v., -1½ v., common, +A Terminals; with Cable. All wired, ready for use. Black wrinkle finish. Will hold 2 Bell-ringer "A" batteries, 2¼ dia. 4—22½ v. "B" Batteries; 3¾ x 2¼ x 2¾. 1—4½ v. "C" Batteries; 1¼ x 3 x 4. Ideal for portable set. Each.....

All merchandise guaranteed. Mail orders promptly filled. All prices F.O.B. New York City. Send Money Order or Check. Shipping charges sent C.O.D. Send for Flyers.

**COMMUNICATIONS EQUIPMENT CO.**  
131-A LIBERTY ST., NEW YORK 7, N. Y. TELEPHONE WH 4-7658

be used in many other type oscillators including the Colpitts circuit, where the grid tap would be made on the capacitors across the inductance instead of the inductance itself.

In selecting a tube for an oscillator, an extremely high gain tube, such as a 6AC7 should not be used, as the close spacing of the elements causes wider variation of characteristics during shock or aging. A load resistance much less than the plate resistance of the tube should be used. This minimizes the effect of any change in plate resistance. A plate voltage of 150 volts is recommended as it is much lower than the maximum rated value and it is easy to regulate with a single VR-150-30 voltage regulator tube.

The variable capacitor used should be extremely well built with good spacing between the plates, and the plates should be well centered. Mounting should be made at the front only, with the rest of the capacitor left free.

In designing the tank circuit, the frequency range must first be determined, and the values of  $L$ ,  $C_2$ , and  $C_3$  (Fig. 1) determined accordingly. The value of  $C_2$  plus the minimum value of  $C_3$  should be much greater than the input capacity of the tube. This will help minimize frequency changes due to changes of tube element spacing caused by shock, aging, changing tubes, etc. Suggested values for given frequencies are given in Fig. 1, but for those who would prefer to work out values for their particular application, a suggested method is as follows:

Assume a reasonable value of  $(C_2 + C_{3 \text{ min.}})$ .

This should not be so large as to require the use of an unreasonably large variable capacitor,  $C_3$ , to cover the desired frequency range. The value of  $L$  can be found from the expression:

$$f = \frac{10^9}{2\pi\sqrt{LC}}$$

and solving for  $L$ ,  $L = \frac{(10^9)^2}{C}$

where  $L$  is the inductance in microhenrys.

$f_2$  is the highest frequency in cycles to be used.

$C$  is  $(C_2 + C_{3 \text{ min.}})$  in micromicrofarads.

More will be said on the actual construction of the coil  $L$  later. The value of  $(C_2 + C_{3 \text{ max.}})$  can be found by:

$$C_2 + C_{3 \text{ max.}} = \frac{(10^9)^2}{L}$$

where  $f_1$  is the lowest frequency in cycles to be used.

The capacity change required in the variable capacitor will then be:

$$(C_2 + C_{3 \text{ max.}}) - (C_2 + C_{3 \text{ min.}})$$

The value of  $C_{3 \text{ max.}}$  should then be this difference plus the actual minimum capacity and enough to allow for circuit capacities. Usually the choice of the next standard size larger will be



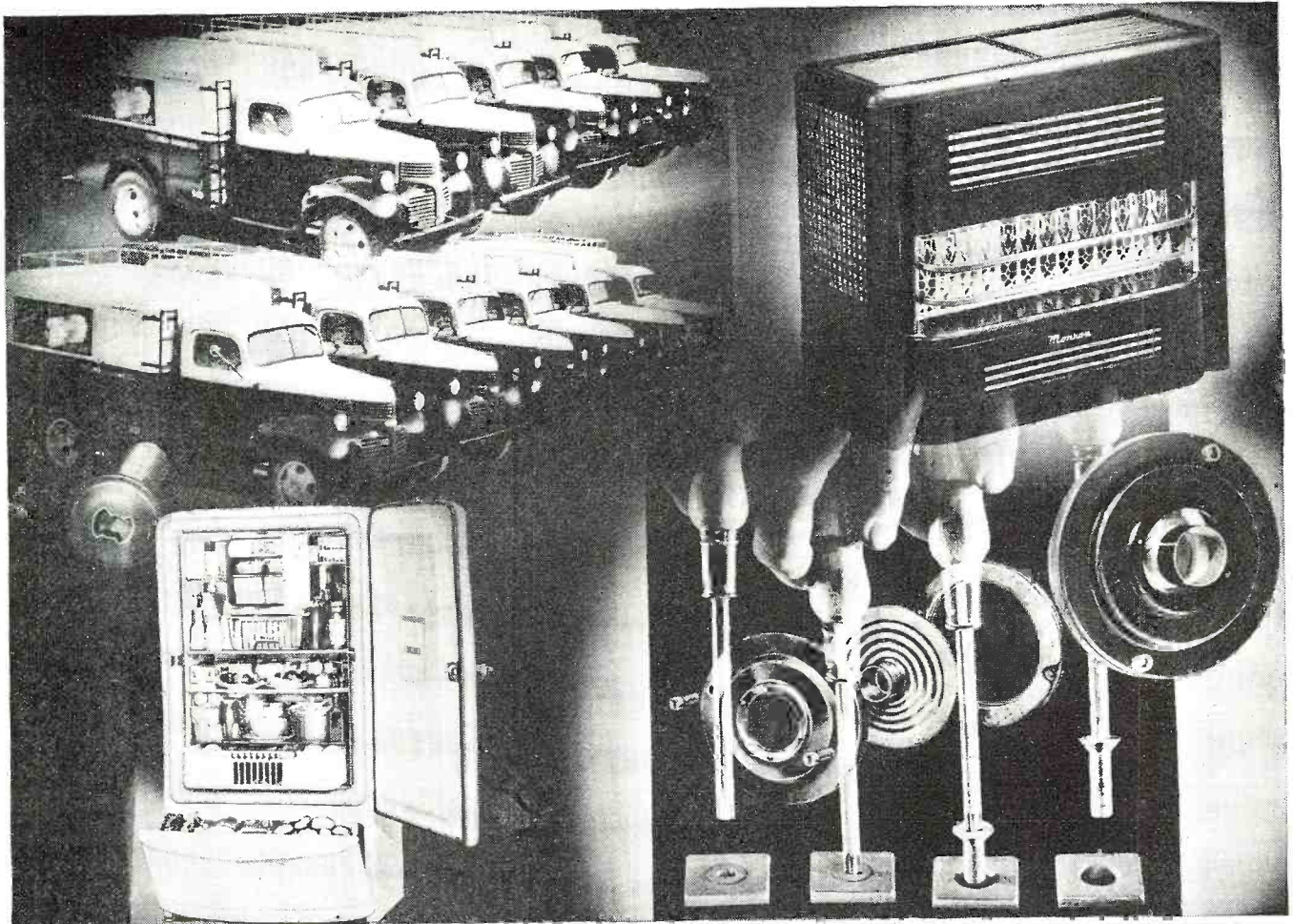

COMMON  
SCREWDRIVER

TYPE "A"  
ASSEMBLY BIT

## Clutch Heads Will Cut Your Assembly Costs Too

Just four typical examples telling what you may expect to gain by adopting the most modern screw on the market today...in lowered costs, safer, faster, smoother operation; plus simplified service.

**The Lindsay Corporation, CHICAGO**—"SIX instead of FIVE truck body assemblies"...this increase in production as compared with the use of other recessed head screws.

**Dearborn-Monroe Company, CHICAGO**—"Change-over to CLUTCH HEADS (from other recessed head screws) cut our Gas Heater assembly costs 22%...Your Type "A" Bit outlasts other bits 5 to 1...easy field service with flat blade is an important advantage."

**Norge Refrigerators report**—"Stepped-up production and elimination of cabinet damage"...tribute to CLUTCH HEAD'S protection against driver slippage.

**Quam-Nichols Company, CHICAGO**—"Adjust-a-Cone" Speaker Units—"A 20% increase in assembly operation...damage from driver slippage went to zero...service problems simplified by screwdriver operation."

*These and other exclusive CLUTCH HEAD advantages are available for every type of assembly line production. Investigate and con-*



*vince yourself. Send for package assortment of CLUTCH HEAD Screws, sample of Type "A" Bit, and illustrated Brochure.*

**UNITED SCREW AND BOLT CORPORATION**

CLEVELAND 2

CHICAGO 8

NEW YORK 7

**Order from LAKE!**  
**You'll Make No Mistake!**

**RADIO CABINETS & PARTS**

**NOW AVAILABLE!**  
**Postwar 2 Post RECORD-CHANGER**



With luxurious brown leatherette portable case, 15" L. x 15" W. x 10" H.

D. Latest electronic developments make this modern record-changer the finest on the market today!

List price ..... \$49.95  
 Dealer's net ..... 29.97

**DE LUXE RECORD-CHANGER and AMPLIFIER CASE**

De luxe changer case with ample room for amplifier. Overall dimensions: 20" L. x 16" W. x 10" H. Sturdily built of 5/8" plywood, de luxe brass hardware throughout. Inside dimensions: 15 1/2" L. x 14 3/4" W. x 9 1/2" H.

Net ..... \$12.95



**DeLuxe PHONO CABINET**

Covered in luxurious, genuine brown leatherette, has de luxe brass

hardware throughout, made completely of plywood with brown plastic handle, has padded top and bottom. Motor board 14" x 14 1/2". Overall dimensions 16" L. x 15" W. x 8" H. Your net price..... **\$8.95**



Portable Phono-graph case in brown leatherette covering. Inside dimensions 17 1/2" long, 13" wide, 7 1/2" high. Has blank motor board and opening for speaker. As illustrated at left, specially priced at.....

**\$7.95**

Also blank table cabinets of walnut veneer in the following sizes, with speaker opening on left front side: (\*Note: \*7 has center speaker grill)

#1	8 1/4"	L x 5 1/2"	H x 4"	<b>U \$1.95</b>
#2	10 1/4"	L x 6 3/8"	H x 5"	<b>D \$2.75</b>
#3	13 1/2"	L x 7 5/8"	H x 6 1/4"	<b>D \$3.25</b>
#7*	10 3/4"	L x 7"	H x 5 1/2"	<b>D \$2.50</b>

\*Speaker Opening in center of front side.

All types of radio cabinets and parts are available at Lake's Lower prices. A large stock is listed in our catalog.



SERVICEMEN—RETAILERS  
 Join our customer list today.

Dept. A

**Order our new catalog today!**  
**Get on our mailing list!**

**Lake Radio Sales Co.**  
 615 W. Randolph Street  
 Chicago 6, Ill.

suitable. The value of  $C_{3 \min}$  should then be determined by measurement or manufacturer's stated value. The value of  $C_2$  is then:

$$(C_2 + C_{3 \min.}) - C_{3 \min.} - C_c$$

where the expression  $(C_2 + C_{3 \min.})$  is the original value assumed in determining the value of  $L$ , and  $C_c$  is the value allowed for circuit capacities.

If these calculations do not result in a convenient value of  $C_3$ , assume a different value of  $C_2$  and repeat the process.

Having determined the value of  $L$ , the winding can be calculated by:

$$N = \sqrt{\frac{(9a + 10b)L}{a^2}}$$
 for single layer winding

where  $N$  is the total number of turns.

$L$  is inductance in microhenrys.

$a$  is the radius of winding in inches.

$b$  is the length of the winding in inches.

The values of  $a$  and  $b$  should be chosen to give a good form factor. A value of 1 to 2 for the ratio  $b/2a$  is generally considered good practice. The wire size should be as large as possible to fill out the winding length. For frequencies of from 1 to 4 megacycles, a 1 inch diameter coil form is recommended. A coil much smaller would necessitate the use of wire so small as to adversely affect the  $Q$  of the coil, while a coil very much larger would result in mechanical and shielding difficulties, for the reason that the magnetic and electrostatic fields become larger as the coil gets larger and are more easily affected by surrounding components, thus affecting frequency stability.

A grooved ceramic coil form should be used if possible, and the wire wound using a firm uniform tension throughout the entire winding. If it is not possible to use a grooved form, the winding should be well cemented using a good grade coil cement.

For optimum performance, the coil taps will have to be determined by experiment. Wind the coil with the calculated number of turns. With the grid connected (through the grid condenser and resistor) to the "high" end of the coil, adjust the cathode tap until the tube oscillates readily. Do not go any further from the ground end than necessary. The correct tap will be about one fourth the total number of turns from the ground end. Now insert  $R_2$  in the grid lead. This resistor is used to prevent oscillation at a higher frequency than the one to which the tank circuit is tuned and should not be any larger than necessary. A value of 200 to 300 ohms should be satisfactory. Using some method of varying the filament voltage plus and minus 10%, adjust the grid tap until the least change in frequency is noted as the filament voltage is varied. Of course oscillation will cease before complete stability is reached and the r.f. voltage output will decrease as the tap is lowered. An optimum point can be found giving good stability with sufficient r.f. out-

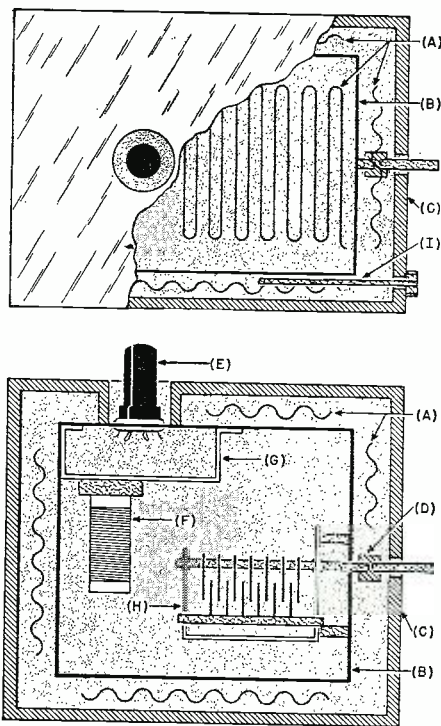

Fig. 2. Suggested arrangement of components in oven. (A) Card type heater units, (B) heavy gauge aluminum inner box, (C) heat insulated outer box, (D) non-metallic shaft coupling, (E) oscillator tube, (F) inductance, (G) heavy gauge chassis for mounting coil and other parts, (H) variable capacitor,  $C_3$ , and (I) mercury type thermostat.

put to drive the untuned buffer. The output of the buffer will be about the same as that of the oscillator with full excitation. The grid tap will be about 1/2 to 2/3 the total number of turns from the ground end. It may be necessary to adjust the total number of turns for correct frequency range. This should be done at the "high" end of the coil, and before the final adjustment is made on the grid tap. Of course the coil should be mounted in place with shield in place when final adjustments are made.

A better job can be done if the coil is temporarily wound for the adjustment of the taps and the exact number of turns, then when all data is obtained, rewind the coil permanently.

Now as to varying ambient temperature and its effect on the frequency. It will be found that the circuit will have a positive temperature coefficient, that is, as the temperature increases, the inductance and the capacity in the circuit increases, thus lowering the frequency. There are two methods of compensating for this effect, first, by the use of temperature compensating capacity, and second by the use of temperature control of the tank circuit.

Considering the first method, it is extremely difficult to completely compensate for all circuit changes taking place due to changes in temperature. In the first place, very few variable capacitors have a zero temperature

(Continued on page 101)

# THE WORLD'S MOST FAMOUS BOOK FOR RADIO-ELECTRONIC BEGINNERS (No previous training necessary)



**A. A. GHIRARDI**  
Let Radio's most widely known technical author help you start training NOW for a fascinating, profitable future.

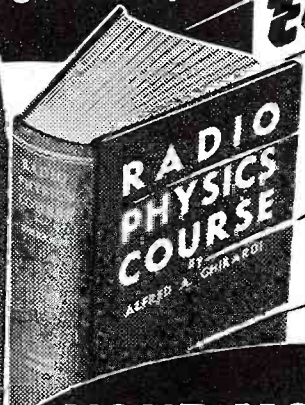
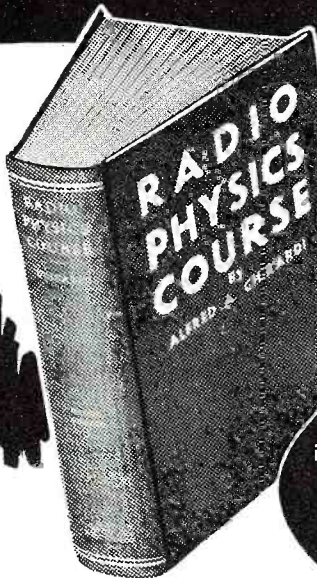

**LEARN RADIO-ELECTRONICS EASIER BETTER FASTER for Only \$5.**

## YOUR MONEY BACK

in 5 Days if Ghirardi's 972-page RADIO PHYSICS COURSE Book doesn't teach you Radio-Electronic fundamentals EASIER, FASTER and at LESS COST than any other book! That's how sure we are that Ghirardi's RADIO PHYSICS COURSE is the very best in the field!

## HERE'S HOW TO REPAIR RADIOS THE EASY WAY!

### A Definite Guide for Diagnosing, Locating and Repairing Radio Receiver Troubles

Radio servicemen everywhere say that this big 3rd edition of A. A. Ghirardi's RADIO TROUBLESHOOTER'S HANDBOOK helps them turn out twice as much work in a given time! Radio "troubleshooters" and beginners who like to fix their own home sets and those of friends find this big book a quick, easy way of locating and repairing receiver troubles without extensive shop equipment! Nine times out of ten, it tells exactly how to make the necessary repairs—without any elaborate testing whatever!

#### NOT A "STUDY" BOOK

Actually, this big, 744-page manual-size RADIO TROUBLESHOOTER'S HANDBOOK is a complete guide to the trouble diagnosing, locating and repairing of PRACTICALLY EVERY TYPE OF RADIO RECEIVER NOW IN USE. It isn't a "study" book! You simply turn to it whenever you want to fix a particular type of trouble in a particular make of radio. Its 404-page Case History Section gives full details on common

trouble symptoms, their causes and remedies for OVER 4,000 DIFFERENT RADIO RECEIVER MODELS. It describes the trouble exactly—tells exactly how to repair it. It eliminates extensive testing—helps you do two jobs in the time normally required for one—repair cheap sets at a profit—substitute tubes and parts profitably—train new helpers, etc.

In addition, hundreds of other pages are devoted to the most modern tube chart you've ever seen; tube and parts substitution data; I-F alignment peaks for over 20,000 superformer troubles—and dozens of charts, graphs, helpful hints and data compilations—all carefully indexed so you can find exactly what you need in a JIFFY.

This big, beautifully bound HANDBOOK is only \$5 (\$5.50 foreign)—on our UNRESERVED 5-DAY MONEY-BACK GUARANTEE. You cannot lose!



#### SAVE MONEY!

See coupon for special combination offer on Modern Radio Servicing and Troubleshooter's Handbook—over 2040 pages of helpful service data!

## HERE'S HOW TO LEARN MODERN RADIO SERVICE WORK

... without an instructor!

A. A. Ghirardi's MODERN RADIO SERVICING is the only simple, inexpensive book that gives a complete, easily understandable course in modern radio repair work in all of its branches. Written so simply you can understand it without an instructor! Read from the beginning it takes you step by step through all phases of the work—or, serves as a beautifully cross-indexed work for "brushing up" on any type of work that may puzzle you.

Included is a thorough explanation of all Test Instruments, telling exactly how they should be used and why; (it even gives all necessary data you prefer to make their own!); Receiver Troubleshooting Procedure and Circuit Analysis; Testing and Repair of Components; Installations; Adjustments, etc., etc.—also How to Start a Successful Service Business—1,300 pages; 720 Self-Testing Review Questions; 708 helpful illustrations and diagrams. Only \$5 complete (\$5.50 foreign) on our 5-Day Money-Back Guarantee.

## Complete, Easy-to-Understand Basic Training

Ask the men who KNOW what's good in Radio Training—the men who had to learn Radio quickly and from scratch, in the Armed Forces; the men who already have obtained good-paying Radio-Electronic jobs in industry! Nine out of ten of them (as proved by a recent survey) will tell you that Ghirardi's famous RADIO PHYSICS COURSE is their first choice as the easiest-to-study, most thorough and inexpensive Radio book on the market.

### MOST POPULAR FOR ARMY-NAVY AND CIVILIAN RADIO TRAINING

This same inexpensive book has given more people the first basic Radio-Electronic training than any other ever published. It is more widely endorsed by men who know. Because of its sheer merit, it is more universally used for home study, and more widely employed in U. S. Army Signal Corps, Navy and civilian schools and colleges than any other book on the subject. Would you want any better proof than this?

### EVEN IF YOU DON'T KNOW ANYTHING ABOUT RADIO!

Even if you've had no previous Radio or Electrical training or experience, it's easy to learn from Ghirardi's RADIO PHYSICS COURSE! Everything that can be done to make learning easy has been done for you. It painstakingly explains everything in detail so you cannot fail to understand. Over 500 specially prepared illustrations help you to visualize every action. You don't have to know a single thing about Radio in advance. All you need is a little spare reading time and a desire to get started RIGHT for a profitable future in any of Radio-Electronics' many branches—from service work

to aviation, military, broadcasting, manufacturing, public address and many others.

### SCOPE OF 36 COURSES IN ONE

Actually, RADIO PHYSICS COURSE gives you the scope of 36 different courses in one convenient, inexpensive big book. Nothing is omitted. Nothing is condensed. Nothing is left to chance. You learn all you need to know. You don't need to wait for monthly lessons. You progress as rapidly as you wish in your spare time and in the comfort of your own home.

### A \$50 VALUE FOR \$5 COMPLETE

RADIO PHYSICS COURSE is acclaimed everywhere as the "biggest bargain" available in Radio-Electronic training. If it were broken into sections and sold as a course, you'd regard it as a bargain at \$50 or more—but you actually buy it all here complete in one big \$5 book, handsomely bound book for only \$5 (\$5.50 foreign) and with our absolute 5-Day MONEY-BACK GUARANTEE. Get the book and see for yourself. Compare it with any other book or course on the market—it may price. See how much more complete it is, how much better illustrated, how much easier to understand! You be the judge! You cannot lose!

**WARNING!** Paper shortages may make it impossible for us to continue meeting the tremendous demand for all Ghirardi Radio Books. Don't take chances! Order yours today while they're still available. Use this Order Form.

MURRAY HILL BOOKS, INC.  
Dept. RN-76, 232 Madison Ave., New York 16, N. Y.

Enclosed find \$\_\_\_\_\_ for books checked; or  send C.O.D. for this amount plus postage. If I am not fully satisfied, I may return the books within 5 days and receive my money back.

RADIO PHYSICS COURSE \$5.00 (\$5.50 foreign)

3rd Edit. RADIO TROUBLESHOOTER'S HANDBOOK \$5.00 (\$5.50 foreign)

Special "MONEY-SAVING" Combination MODERN RADIO SERVICING with the HANDBOOK \$9.50 (\$10.50 foreign)

MODERN RADIO SERVICING \$5.00 (\$5.50 foreign)

Name \_\_\_\_\_

Address \_\_\_\_\_

City \_\_\_\_\_ City Dist. No. \_\_\_\_\_ State \_\_\_\_\_

# REPAIR ANY KIND OF RADIO EQUIPMENT PREPARE YOURSELF FOR A BETTER JOB AT HIGHER PAY IN THE RADIO-ELECTRONIC FIELD

# HENRY RADIO

Do business with the biggest and one of the best in the field. Enter your orders for the following:

Skyrider Jr. S41.....	\$ 33.50
Hallicrafters S38 complete.....	39.50
Hallicrafters SX-25.....	94.50
Hallicrafters SX-29A.....	223.00
Hallicrafters S36A.....	307.50
Hallicrafters S37.....	591.75
Hallicrafters S40.....	79.50
National N-2-40C.....	225.00
National One-Ten.....	56.10
National HRO Sr.....	197.70
RME-45.....	186.00
Hammarlund HQ129X.....	129.00
Hammarlund SP-400-SX Super Pro complete.....	318.00
Hammarlund SP-400-X Super Pro complete.....	342.00
HT-9 transmitter.....	250.00
Harvey 100T transmitter.....	583.00
Temco 75/100GA transmitter..	495.00

SOME models are available for immediate shipment. As more and more receivers become available Bob Henry will be able to serve you better and better. By dealing with the world's largest distributor of short wave receivers you are assured of the fastest delivery possible and the best of service.

Enter your reservation now. You can trade in your present receiver. You can order on our 6% terms. You can depend on Bob Henry also for a wide assortment and the best values in crystals, transmitting tubes, microphones, test equipment, etc. Your inquiries welcomed.

BOB HENRY  
W9ARA

## HENRY RADIO

BUTLER, MISSOURI AND  
LOS ANGELES 25, CALIF.

"WORLD'S LARGEST DISTRIBUTORS  
OF SHORT WAVE RECEIVERS"

60

## What's New in Radio

### SIGNAL GENERATOR

A new signal generator, Model 2432, has been added to the *Triplet* "Square Line" of matched test equipment.

Frequency coverage is continuous and overlapping from 75 kc. to 50 mc. in six bands, all fundamentals. The unit also features six-position turret type coil switching with complete shielding. The coil assembly rotates

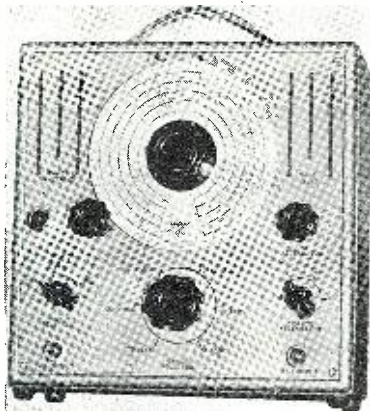

inside a copper-plated steel shield.

The use of air trimmer capacitors, electron coupled oscillator circuit, and permeability adjusted coils adds to the stability of this unit. The internal modulation of this signal generator is approximately 30% at 400 cycles. The unit operates on 115 volts, 50-60 cycles a.c. and is voltage regulated for increased oscillator stability.

The case is heavy metal with tan and brown hammered enamel finish. Complete details and prices will be furnished by *The Triplet Electrical Instrument Company*, Bluffton, Ohio.

### COMPACT RECORD CHANGER

A compact, low-cost automatic record changer has been added to the regular line of record changers made by *Webster-Chicago Corporation*.

The new unit, known as the Model 50, is compactly designed for use in the smaller radio-phonograph com-

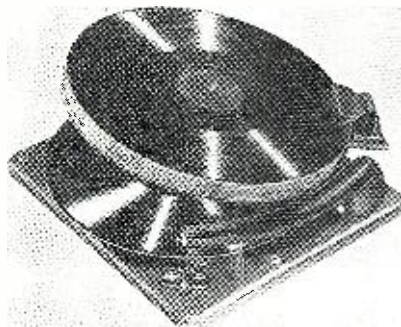

binations and may also be used as a replacement for outmoded changers.

The over-all dimensions are 12" x 12 $\frac{7}{8}$ " x 9", 6 $\frac{1}{2}$ " of which are above the main plate and 2 $\frac{1}{2}$ " below. The unit

can be completely installed from the top on a standard  $\frac{5}{8}$ " mounting board. The record changer features a fast change cycle—about 4 seconds—and will play ten 12" or twelve 10" records.

Distribution will be through *Webster* distributors. Additional information can be secured from distributors or from the company, *Webster-Chicago Corporation*, 3825 W. Armitage Avenue, Chicago, Illinois.

### FM TRANSMITTING TUBE

*General Electric Company* has announced the development of a new three-electrode transmitting tube, Type 7C29, for FM service.

Designed for application as a class "C," r.f. amplifier, this tube is well adapted for use in an open line circuit. Fernico seals for grid and filament terminals provide excellent mechanical strength.

Maximum ratings on the new 7C29 apply up to 110 mc. The anode is forced-air-cooled and capable of dissipating 500 watts. The cathode is a thoriated tungsten filament. Tests at 110 mc. in an open line circuit under class "C" conditions and at a d.c. plate voltage of 2800 volts show a typical power output of 600 watts per tube.

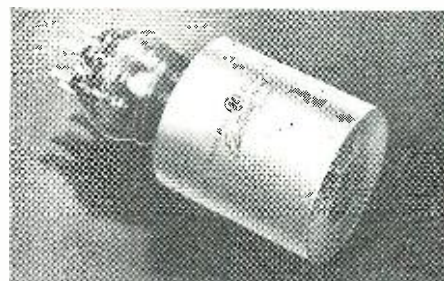

Technical information on this tube may be obtained from the Tube Division, Electronics Department, *General Electric Company*, Schenectady, New York.

### PIPE LOCATOR

The Model 112 Pipe Locator, developed by Hugo Wahlquist, is now being manufactured commercially by *Nilson Electrical Laboratory, Inc.* of New York.

The transmitter and receiver units are contained in walnut cabinets which are equipped with carrying handles. In both units the apparatus is fastened to the top panel and can be withdrawn from the case by removing two wood screws. The transmitter measures 4" x 5 $\frac{1}{2}$ " x 6" and weighs 4 pounds. The receiver measures 3" x 7" x 8" and weighs 4 pounds. A pair of headphones is furnished with each receiver.

The transmitter unit is used to supply a test signal to the pipe or conduit and remains stationary. The receiver

RADIO NEWS

**1 1/4**  
METERS

**2**  
METERS

# The easy sure-fire way

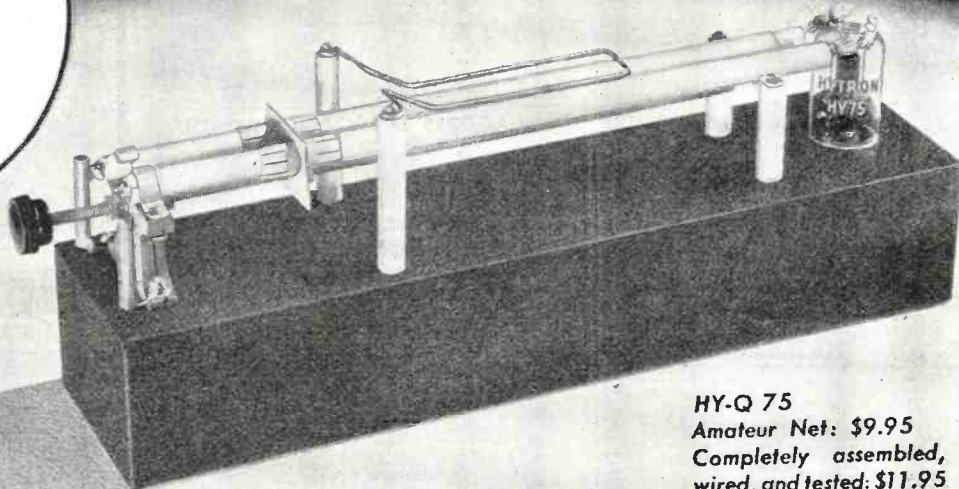

**HY-Q 75**  
Amateur Net: \$9.95  
Completely assembled,  
wired, and tested: \$11.95

**ASSEMBLE THIS EFFICIENT HY-Q 75 KIT IN AN HOUR**

Like most amateurs you may prefer to "roll your own." If your leisure time is limited, however, you will welcome the HY-Q 75. Long hours of engineering have ironed out the "bugs"—have assured easily reproducible maximum efficiency on 1 1/4 and 2 meters with the popular HY75. Fancy "plumbing" and tricky parts are prefabricated. With screwdriver, pliers, and soldering iron, you can quickly put this efficient linear oscillator on the air. Check the many features. Ask your jobber to let you see the HY-Q 75.

### HY-Q 75 KIT HAS MANY FEATURES

**CAREFULLY ENGINEERED** to make it easy for you to duplicate results on 1 1/4 and 2 meters.

**NO CUT AND TRY**—chart assures quick location of amateur bands.

**MICROMETRIC TUNING** (135 mc to 250 mc) by finely adjustable lead screw.

**SILVER-PLATED TANK CIRCUIT** means permanently low r-f losses.

**PRECISION-MACHINED SHORTING BAR** with multi-fingered silver-plated contacts for low resistance.

**LOW-LOSS INSULATORS** with extremely long leakage paths.

**SPECIAL R-F CHOKES**—filament, plate, grid—assure peak operation of HY75 at vhf.

**NON-INDUCTIVE PLATE BLOCKING CONDENSER** is concentric with the plate line.

**QUICK BAND CHANGING** from 1 1/4 to 2 meters by adjusting the positions of shorting bar and coupling loop.

**ADJUSTABLE ANTENNA COUPLING LOOP** matches efficiently either concentric or parallel line feeders.

**BETTER FREQUENCY STABILITY** is obtained from the rugged parallel-line construction.

**COMPLETE VHF TRANSMITTER**—a-c or d-c, fixed or mobile. Add only tube, power supply, and a-f unit.

**LABORATORY POWER OSCILLATOR** for special measurements and classroom vhf demonstrations.

**USEFUL POWER TO LOAD** at 144 mc (less at 225 mc) is 14 w on c-w; 11 w on phone.\*

**PEAK PERFORMANCE OF HY75**—but readily adaptable to other vhf tubes.

**PICTORIAL WIRING DIAGRAM** and easy-to-understand instruction manual.

*\*Useful power output equals total power output minus radiation losses, circuit losses, and grid drive.*

SPECIALISTS IN RADIO RECEIVING TUBES SINCE 1921.



**HYTRON**  
RADIO AND ELECTRONICS CORP.



MAIN OFFICE: SALEM, MASSACHUSETTS



R. C. (Dick) Hall  
W5EIB

## R. C. & L. F. HALL, INC.

1015-17 Caroline St.  
Telephone C-9731  
Houston 2, Texas

This is written in Chicago just after the close of the Annual Radio Show. We have seen many new items that will appeal to you. Delivery will probably be good in July on all items listed. Silver has a very interesting new line for prompt delivery and we suggest you ask for his complete catalog.



L. F. (Lillian) Hall  
W5EUG

**"THE HAM SHACK"**  
Panadapter PCA-2 complete ..... \$99.75  
**HALLCRAFTERS**  
S-38 ..... \$ 39.50  
S-40 ..... 79.50  
S-22R Marine ..... 74.50  
S-37 (130-210 MC) FMAM ..... 53.75  
S-36A (28-143 MC) FMAM ..... 307.50  
Speaker for S-36, S-37 (PM 23) ..... 15.00  
HT-9 transmitter (less coils, crystals, mike) ..... 250.00  
**HAMMARLUND**  
HQ-129X, less speaker ..... \$168.00  
Speaker ..... 10.50  
**SUPER PRO**  
SPC-410-X (540 KC to 30 MC) cabinet model ..... \$334.05  
SPC-410-SX (1250 KC to 40 MC) cabinet model ..... 310.05  
SPR-410-X (540 KC to 40 MC) rack model ..... 344.55  
SPR-410-SX (1250 KC to 40 MC) rack model ..... 320.55  
PS-CW-10, 10 inch speaker ..... 13.20  
**NATIONAL**  
NC-2-40C, less speaker ..... \$225.00  
Speaker ..... 15.00  
NC-46, less speaker ..... 97.50  
Speaker ..... 9.90  
1-10, less tubes, speaker, power supply ..... 56.10  
5886 power supply for 1-10 ..... 19.50  
Tubes for 1-10 (834, 855, 8C5, 6F6) ..... 8.57  
HRO-5TA ..... 197.70  
HRO-5RA ..... 211.20  
**RME**  
RME-45 with crystal, meter & speaker ..... \$186.00  
RME-34 with self-contained speaker ..... 98.70  
DB-20 preselector ..... 59.30  
VHF-152 (2, 5, & 10 meter converter) ..... 86.60  
Wire, write or phone your order. We will ship C.O.D. with a \$5.00 deposit. We also offer easy terms and trade-in allowances for used equipment. State Tax not included in above figures.  
**"ACROSS THE OPERATING TABLE"**  
A postal card to Dept. N will place you on our mailing list to receive our amateur bulletin which is just off the press.

### A FEW OF THE MANUFACTURERS WHOSE PRODUCTS WE DISTRIBUTE

Aerovox	Clarostat	GE	Kaar	Meissner	Pioneer	Setchell-Carlson	Trimm
Amphenol	Drake	Hallcrafters	Kainer	Millen	Precision	Silver	Triplet
Astastic	Dumont	Hammarlund	Kelner	Mueller	Premax	Simpson	Turner
B&W	Echophone	Hytron	Kwikheat	National	Radel	Speed-X	Vaco
Belden	Eimac	Instructograph	Leach	Newcomb	Raytheon	Stancor	Vibroplex
Bliley	Electronics Lab.	Insuline	Lectrohm	Ohmite	RCA	Supreme	Walisco
Bud	Erie	Jensen	Les Logan	Panoramic	Robson-Burgess	Taylor	Ward
Centralab	Gammatron	JFD	Littelfuse	Peerless	RME	Thermador	Weller
Cinaudagraph	General Cement	Johnson	John Meck	Petersen	Sangamo	Thordarson	Weston

### "ACROSS THE SERVICE BENCH"

is the name of our dealer bulletin, which goes regularly to our service dealer customers. This bulletin keeps you in touch with the latest information on available equipment and supplies. A postal card to Dept. N will place your name on this list and will also secure a "new customer tube allocation" if you request it.

### SPECIAL ATTENTION

is being given to ex-servicemen entering business who need complete stocks. Such inquiries should be marked "for personal attention R. C. Hall."

### PANEL METERS

A complete stock of DC Milliammeters, DC Microammeters, AC Voltmeters, DC Voltmeters made by General Electric, Marion, Supreme, Simpson, Triplet

2", 3" & 4" in all ranges in square or round cases.

### TEST EQUIPMENT IN STOCK

Silver Vomax, V.T.V.M. & V.O.M. .... \$59.85  
Monitor Crystallizer Signal Generator ..... 57.50  
Robson-Burgess MT-200 V.O.M. 0-10 Megs ..... 22.95  
0-1500 Volts .....  
Robson-Burgess MT-100 V.O.M. 0-1 Meg ..... 18.75  
0-1000 Volts .....  
Superior Signal Tracer ..... 18.75  
Ask for other brands and models, since Test Equipment is beginning to arrive in larger shipments.

### MARINE EQUIPMENT

We are able to give good delivery on marine radio-telephones. Phone, write, or wire for information.

### POLICE, GEOPHYSICAL & MOBILE

Radio telephone equipment is available on good delivery. We welcome inquiries for your particular application.

### INDUSTRIAL ACCOUNTS

We have one of the largest electronic stocks in the country, and we welcome the opportunity to serve you. Wire, write or phone for information.

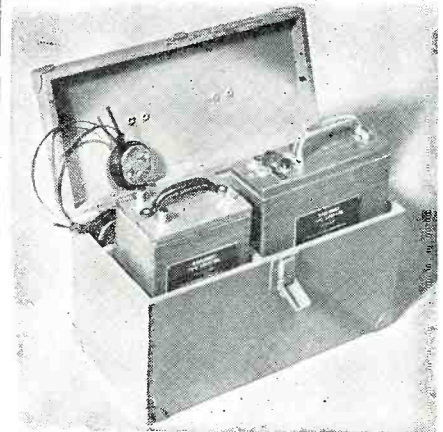

unit consists of an internal pickup coil and battery operated, three-stage amplifier delivering its output into headphones. The pipe is traced by the signal picked up in its vicinity.

Full details of the pipe locator will be furnished by *Nilsson Electrical Laboratory, Inc.*, 103 Lafayette Street, New York 13, New York upon request.

### DELCO HOME RADIO

The *Delco Radio Division of General Motors Corporation* has announced production of the first models of their new line of home radios.

Included in the line are seven models, three six-tube models, two five-tube models and two of the models which are available in different colors.

Models 1236 and 1238 have auto-

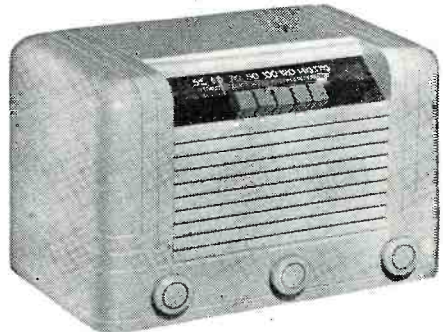

matic tuning and volume control. The cabinets range in size from a width of 13½", height 8¾" and depth 7" to the smallest with a width of 8¾", height 5¾" and depth of 6".

The line is being distributed nationally by United Motors Service.

### PROFESSIONAL RECORDERS

The *Radiotone* line of professional recording machines are currently in production at *Ellinwood Industries*, Los Angeles, California.

Included in the present production are two portable recorders, the RA-116 and the R-116 and the D-116 dubbing table.

The RA-116 is a 16" dual speed recorder with "Duo-Chromatic" equalizers in the amplifier to give a high fidelity to recordings. The amplifier incorporates phase inversion, inverse feedback and complete tone equalization, plus simplicity of control. The

(Continued on page 76)

**NOT MERELY AS GOOD AS THE OTHERS  
... BUT BETTER THAN ALL OTHERS!**

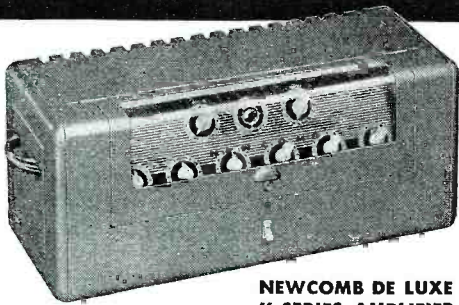

NEWCOMB DE LUXE  
K-SERIES AMPLIFIER

### SIMPLIFIED ... CONTROLLED OPERATION

... The Newcomb clear-view, plastic keylock control panel cover prevents unauthorized misadjustments. An expert may adjust controls and lock them in. An outside power switch turns system on and off. No curious "dial-twister" can disturb its operation.

**T**HE KEYLOCK cover is another of the many features that make the name Newcomb outstanding in the sound equipment field. Designed for the postwar quality market, Newcomb amplifiers are unexcelled in the true reproduction of music and voice. Without reservation... Newcomb sound equipment will give finer, longer, more trouble-free service than any other system on the market today. Write for information.

THE SOUND OF QUALITY

*Newcomb*  
**AUDIO PRODUCTS CO.**  
MANUFACTURERS

DEPT. F 2815 S. HILL STREET, LOS ANGELES 7, CALIFORNIA

from **RADIO NEWS**

*For the* **RECORD.**

BY THE EDITOR

**MUCH** has been said and reams have been written about the necessity for the service engineer to apply modern scientific techniques and sound business practices to assure his success in the post war era. It takes no crystal gazer to predict that with the tremendous increase in varieties of radio models the need will be acute for some new short cut to accurate well organized service data. In the past the serviceman needed information on the products of only 36 receiver manufacturers whereas more than 1000 models of 212 radio and phonograph manufacturers will soon be on the market.

One company has already taken cognizance of this complex problem and is producing a radically different, high efficiency technical reference service. The radio service engineer who acquires this service will be provided not only with exhaustive technical data on 30 radio receivers but will have access to the knowledge of a board of 30 specialists in radio, radar and radio servicing to help him solve problems relating to parts selection, shop operation, promotion, accounting and business methods.

The forward thinking of this organization assures servicemen of a pipeline to the two springs of knowledge requisite to their business success; practical well organized technical information and sound business practices. O.R.  
JUNE ISSUE RADIO NEWS

Here's  
**YOUR**  
problem

Here's  
**OUR**  
answer

# Save Up to 50% in Servicing Time!

**In Each  
PHOTOFACT FOLDER  
You Get:**

- ✓ From 2 to 12 clear photos of the chassis, identifying each component part for immediate checking or replacement.
- ✓ Complete specifications on each component, including manufacturer's part number, available replacement type or types and valuable installation notes.
- ✓ A keyed reference alignment procedure for the individual set, with adjustment frequencies and recommended standard connections.
- ✓ Complete voltage analysis of receiver.
- ✓ Complete resistance analysis of receiver.
- ✓ Complete stage gain measurement data.
- ✓ Schematic diagram.



If you think it's going to be easy to service the 1,000 or more radio sets soon to come off production lines, read no further! The Sams PhotoFact\* Service is designed for men who *know* there's a tough time ahead—who need and *want* better service information.

The Sams PhotoFact Service provides such information in the form of reliable, fact-filled, illustrated folders that can save as much as 50% of your servicing time. Every post-war radio is visualized in photographs . . . every part listed and numbered . . . every servicing shortcut and installation fact fully set down! No matter how complicated the set, or how new the components, you have the whole story right in front of you.

You get a set of from 30 to 50 PhotoFact Folders at a time. Each set of folders

comes to you in a handy envelope at a cost of only \$1.50 for each group. They cover all new receivers as they reach the market.

Think of it! An absolutely fool-proof visual method of giving you the exact information you want, where you want it, when you want it, for as little as three cents per new radio model! And every bit of information is compiled by experts from an examination of the actual receiver itself — *not from standard service data!* PhotoFact Folder Set No. 1 is being published June 15. Others will follow closely. Reserve yours now!

*Also, Membership in*  
**HOWARD W. SAMS INSTITUTE**

Answers to hard service problems! Economical shop practices! How to get more customers! These and many other subjects covered by 30 top notch specialists! Complete facts with PhotoFact Set No. 1.

*\*Trade Mark Registered*

Cut This Out and Mail It to Your Distributor! If you do not know his name and address, send it directly to Howard W. Sams & Co., Inc. 2924 East Washington Street, Indianapolis 6, Indiana, and we will see that your nearest distributor gets it.

CHECK ONE SQUARE

PLEASE PRINT

Yes, by all means reserve every issue of the Sams PhotoFact Folder Service for me.

Send complete information and reservation card.

My (check) (money order) (cash) for \$1.50 is enclosed for PhotoFact Folder Set No. 1. (Publication date, June 15, 1946). (If you send cash, be sure you use registered mail.)

Name \_\_\_\_\_ Address \_\_\_\_\_

City \_\_\_\_\_ Zone \_\_\_\_\_ State \_\_\_\_\_

Company Name \_\_\_\_\_

My Distributor's Name \_\_\_\_\_ City \_\_\_\_\_

**HOWARD W. SAMS & CO., INC. RADIO PHOTOFACT SERVICE**





Here, and on following pages, are circuit diagrams and parts lists of many new postwar radio receivers. Radio News will bring to you other circuits as quickly as possible after we receive them from manufacturers.

RADIO NEWS, JULY, 1946

RCA VICTOR MODELS 56X, 56X2, & 56X3

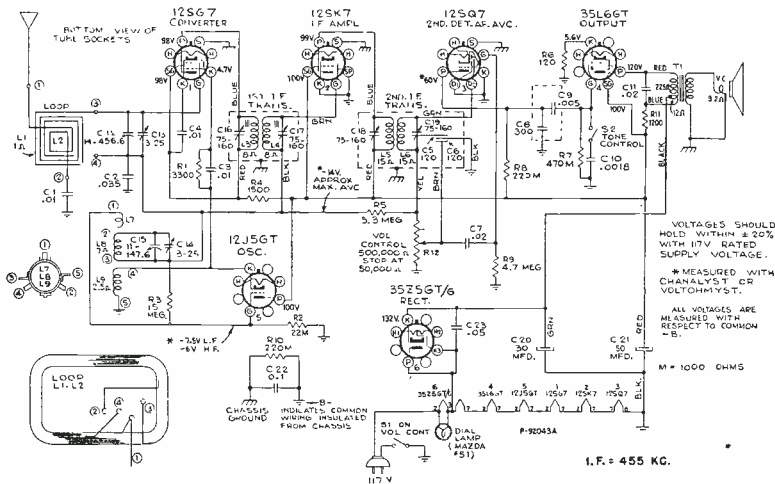

RADIO NEWS, JULY, 1946

GAROD MODEL 5A2

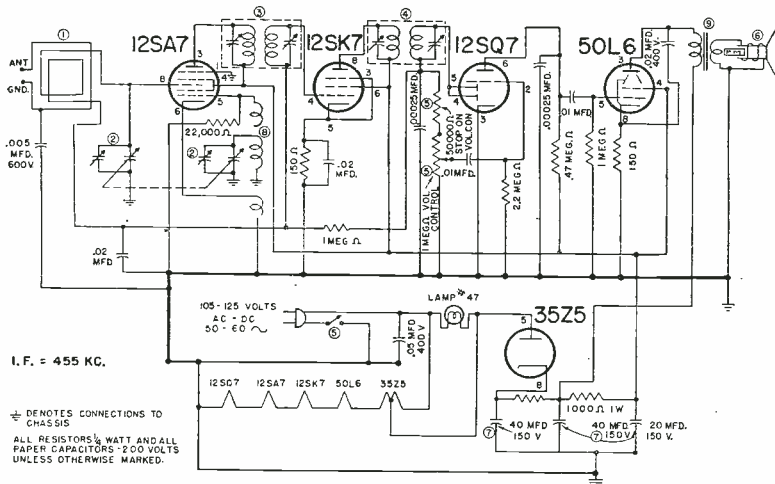

RADIO NEWS, JULY, 1946

CLARION MODEL C101

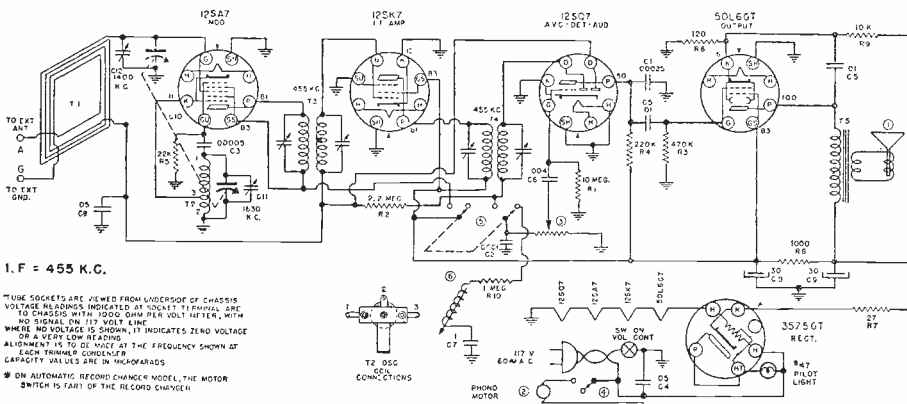

**SUPREME**

TESTING INSTRUMENTS

AFTER A GREAT WAR RECORD

**BACK AGAIN!**

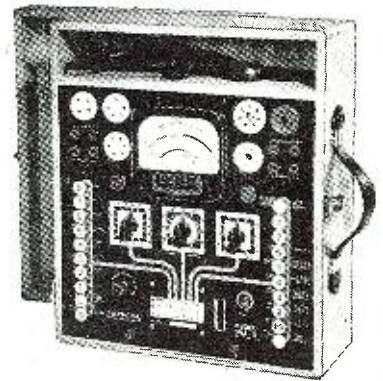

**SUPREME 504B TUBE AND SET TESTER**

SUPREME regrets that war necessitated an interruption of service to its customers and friends. We are genuinely glad to get back into peacetime production—production for YOU.

**MANY SUPREME INSTRUMENTS NOW AVAILABLE**

—But not enough to take care of all orders at one time. Demand for accurate, dependable SUPREME equipment is such that we suggest you make arrangements for your needed new SUPREME models without delay.

**SEE YOUR NEAREST SUPREME JOBBER NOW!**



**SUPREME INSTRUMENTS CORP. GREENWOOD, MISS. U. S. A.**

Export Department: THE AMERICAN STEEL EXPORT CO., Inc. 374 Madison Ave., New York 17, N. Y.

(For parts lists see page 68.)

**Standard**  
**HAS IT**  
**IN STOCK!**  
**FOR AT ONCE DELIVERY**  
**ORDER NOW**

**SI PSON**  
**MODEL 260**

"HIGH SENSITIVITY"  
 MULTIMETER for tele-  
 vision and radio servic-  
 ing. 20,000 ohms per  
 volt.

**33.25**

Carrying Case 4.75

**AT ONCE  
 DELIVERY**



**"A" BATTERY ELIMINATOR**

**ATR STANDARD  
 MODEL**

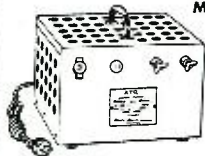

Use for demon-  
 strating and test-  
 ing auto radios on  
 105 to 125 volts,  
 50 to 60 cycle  
 lines. Eliminates  
 storage batteries  
 and battery charg-  
 ers. Uses full-wave  
 dry disc rectifier.  
 Delivers pure di-  
 rect current.

**21.60**

**ADJUST-A-VOLT**

**1/2 K. W. Isolation Transformer**



- keeps AC-DC chassis neutral to ground.
- keeps AC-DC chassis neutral to grounded test equipment.
- lowers voltage to check intermittent oscillators.
- raises voltage to "pop" out stubborn intermittent parts.
- regulates voltage to service bench.
- boosts line voltage to portable P. A. systems.

115V. 70-140V.

**ONLY 23.50**

**TEAR OUT AND MAIL NOW TO**

**SREPCO**

**STANDARD RADIO & ELECTRONIC PRODUCTS CO.**  
 135 East Second Street, Dayton 2, Ohio

Please ship at once: (RN-7)

\_\_\_\_\_ SIMPSON MODEL 260 MULTIMETERS

\_\_\_\_\_ "A" BATTERY ELIMINATORS

\_\_\_\_\_ ADJUST-A-VOLTS

Name \_\_\_\_\_

Address \_\_\_\_\_

City \_\_\_\_\_ State \_\_\_\_\_

**MAIL ORDERS GIVEN PROMPT  
 ATTENTION! WRITE US FOR  
 INFORMATION ON ALL PARTS  
 20% DEPOSIT ON ALL MAIL ORDERS**

**Improvements in PORTABLE  
 GENERATOR DESIGN**

**E**XPERIENCE gained under gruelling war conditions has resulted in notable improvements for portable engine-driven electric generators, which will have important commercial applications, according to an announcement by the Army Signal Corps.

New engines have been designed that will be less liable to failure from chemical compounds built up by combustion of high octane gasoline and deterioration of cylinder oil. The Signal Corps has reduced for military use the numerous and widely varying types of commercial power plants and propose to further reduce those types by standardizing six sizes of engines employing only four different sizes of cylinders and pistons.

The production and procurement of engine-driven generators assumed enormous proportions during the war. A total of 320,000 units, representing an aggregate of over one million kilowatts of power, were supplied. The portable plants ranged in size from small, single-cylinder, air-cooled engines coupled to generators developing only a few watts, to large, multicylinder, fluid-cooled engines driving generators with a capacity of 15 kilowatts.

Hardly any phase of the war could have been carried on without electric power. No radio, radar, telephone, telegraph, or teletype could have been operated, no airplane flown, and no motor vehicle driven. For small radios, flashlights, and the like, batteries were used, literally by the billions. But to provide power in larger quantities the Army in the field had to rely principally on the portable power plants.

In procuring these power units in the pyramiding numbers required, the Signal Corps was confronted with immense problems. Before the war only a few firms manufactured portable engine-driven generator sets for such use as farm lighting, electric welding, and emergency standby units. Most of this equipment utilized commercial-type engines. They were not built with any concern for weight or size, and they were generally intended only for intermittent duty.

Existing facilities for manufacturing the needed units were almost hopelessly deficient. This was due to the huge requirements and the fact that other types of military equipment having higher priority were absorbing the facilities. It was necessary therefore to set up new engine and power unit manufacturing sources. To meet military requirements it was mandatory to procure every available type and start fabrication by many inexperienced firms. This procedure led to innumerable types and combinations, and, while unavoidable under the circumstances, created an exceedingly difficult problem with respect to supply of maintenance parts.

It was soon found that available engines were not giving satisfactory service under military field conditions. This was due chiefly to two causes: the all-purpose military gasoline and lubricating oil had a very serious effect on the operating life of the engines, and units

intended for intermittent duty were operated on a continuous schedule under various weather conditions.

Engines most commonly used for portable power units were of the 4-cycle, L-head type. The most frequent cause of early engine failure was the 80-octane military gasoline, a fuel primarily designed for use in vehicles with high-compression engines. It was not the high octane that caused the trouble, however, but the tetra-ethyl lead used to obtain the high octane. The all-purpose gasoline contained up to three cubic centimeters of tetra-ethyl lead compound per gallon.

When this fuel burns, the lead forms a compound with the carbon and leaves a gray deposit within the combustion chamber and on the valves and valve stems. Under constant operating conditions these deposits build up rapidly and cause the valves to stick and burn. The material is of an abrasive nature, causing rapid wear on cylinder walls and piston rings, and unless the lubricating oil is changed frequently it will become thickened, resembling gray paint.

In addition to these difficulties, the heavy-duty lubricating oil used as a military standard contains cleansing materials which are considered helpful for vehicle motors. However, the metallic soaps used by some refiners combine with engine deposits to form bridges across spark plug electrodes, causing the engine to stop.

In attempting to overcome the effects of leaded fuel, considerable improvement was made by using better materials in engine construction and by modifying valves and valve guides, employing valve rotators, and other devices. However, the 4-cycle engines continued to present serious maintenance problems. It was found that 2-cycle engines can be designed so that they are able to burn leaded fuel without the damaging effects suffered by 4-cycle engines. This is because the 2-cycle engines contain no valves and the fuel is introduced in the crankcase, then transferred to the combustion chamber, thus keeping the crankcase and cylinder walls washed clean of the abrasive products.

These difficulties revealed the necessity, not only for developing better power units, but for standardization on a minimum number of types, and although this was realized early in the war, it was impossible to do more than gradually eliminate the worst unit components. Nevertheless many improvements were made during production and the experience thus gained points the way for the development of greatly improved power units.

Plans of the Signal Corps call for the development of a series of new units powered by liquid-cooled, 2-cycle engines incorporating such features as vapor-phase constant temperature cooling, fuel injection, electric governing, a new type of non-fouling ignition system, suppression of radio interference, and silencing for mechanical and exhaust noise.

**SILVER**

**"VOMAX"  
904 C/R BRIDGE  
"SPARX"**

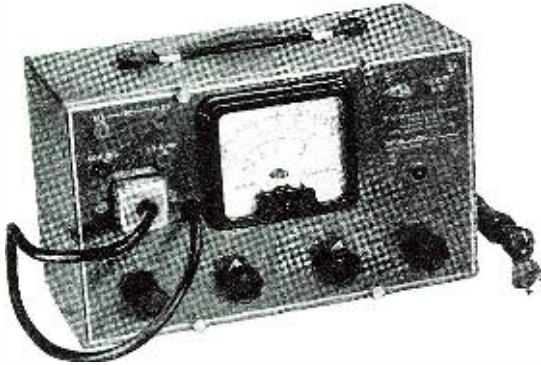

"VOMAX" is more than a multi-meter . . . more than volt-ohm-db.-milliammeter . . . more than r.f. vacuum-tube voltmeter of laboratory instrument caliber. "VOMAX" is all of these things. Born out of six years of military research and production, it is new as today. Backed by a name famous for over 35 years . . . designed by radio's only International Grand Prize winner, "VOMAX" is the standard of comparison.

RADIO MAINTENANCE engineers checked and rechecked the market for the best possible meter . . . most-used instrument in all radio service . . . to serve as heart and core of its new "Modern Test Bench." They selected "VOMAX." Your efficiency and profits will be greatest when you, too, use "VOMAX." Our-

standing . . . tested and sworn to by thousands of serious service technicians . . . ordered and reordered by the U. S. Bureau of Standards, the Naval Research Laboratory, Western Union . . . used by Sperry, Monsanto Chemical, DuPont, F.C.C. Grand Island monitoring station, C.A.A., Naval Ordnance Depots, Lapp Insulator, Stackpole Carbon, Fairchild Aviation, etc., etc. This is positive proof that "VOMAX" is the meter you must have to top smart competition. Follow the recommendation by Bendix to all BENDIX RADIO distributors and dealers . . . "Use 'VOMAX.' It's better than we hoped." Only \$59.85

**904 C/R BRIDGE**

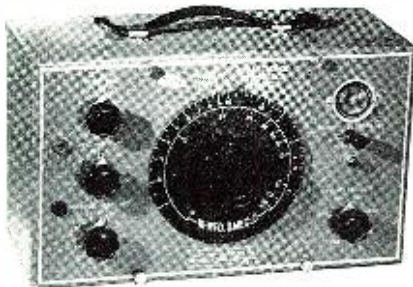

Model 904 Capacitance/Resistance Bridge. 1/4 mmfd/ohm thru 1,000 mfd./megohms; 0-50% power factor; 0-500 volt adjustable internal polarizing voltage; 0-10 and 0-100 ma. electron-ray leakage current meter; measures resistance, capacitance under actual operating voltages! Also recommended by Bendix. Only \$49.90

**"SPARX"**

"SPARX." Visual/aural dynamic signal tracer; 20~ thru 200 mcs.; new crystal rectifier r.f./a.f. probe; 65 db. a.f. amplifier; dynamic speaker. Tests speakers, phono pick-ups, amplifiers, receivers from antennae thru speakers; determines presence of operating voltages, hum. Checks individual circuits and overall performance and quality quickly and positively. Only \$39.90



Get a copy of June, 1946 RADIO MAINTENANCE at your favorite jobber—or send 25c to 460 Bloomfield Ave. Montclair N. J., for radio's newest 100% service magazine. Read all about "VOMAX" in it. Send penny post-card for new, hot-off-the-press, catalog describing these important fresh, postwar measuring instruments, plus 3 new communication receivers, 2 new transmitters, factory built and kits, condensers, coils, sockets, new "frequency-meter" 5 thru 500 watt, 6-band transmitting inductor, keying and quality monitor, new AM and FM signal generator covering 90 kcs. thru 170 mcs. on fundamentals! See your favorite jobber at once, for demand far exceeds supply

OVER 35 YEARS OF RADIO ENGINEERING ACHIEVEMENT

*McMurdo Silver Company*

1249 MAIN STREET • HARTFORD 3 • CONNECTICUT

In Canada—McMurdo Silver Division, General Radionics, Ltd., 465 Church St., Toronto, Ontario, Canada.



**ARMY-NAVY**  
*Official*  
**HEAD PHONES**

**\$2.49**

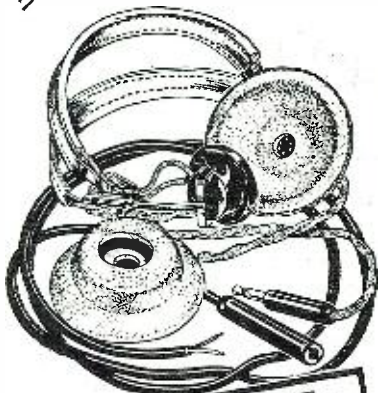

**BURSTEIN-APPLEBEE**  
*Made A Lucky Buy*

Limited quantity of these fine brand new head phones. Highly sensitive, 8000 ohms impedance. Bi-polar magnets, bakelite shell and cap. Adjustable head band, leather covered spring steel. Cord connects from one side, out of the way. Molded sponge rubber ear cushions. Our price only \$2.49 per set plus 20c postage and packing charges. Retail value \$13.50. Order Number 17A37.



**MAIL THE COUPON**  
**FREE CATALOG**

Latest developments in radio and electronic parts and devices, newest ham gear, gadgets, bargains, war surplus items . . . get this red hot bargain catalog FREE.

**18 YEARS**  
**IN**  
**RADIO**



BURSTEIN-APPLEBEE CO. Radio News  
1012 McGee St., Kansas City 6, Mo.

Send me your new FREE Catalog.  
Send me \_\_\_\_\_ pair of phones at \$2.49  
per pair plus 20c pair postage. I enclose  
\$\_\_\_\_\_ in payment.

NAME \_\_\_\_\_  
ADDRESS \_\_\_\_\_  
TOWN \_\_\_\_\_ STATE \_\_\_\_\_

# Parts Lists

(FOR CIRCUIT DIAGRAMS APPEARING ON PAGES 64 AND 65.)

## GENERAL ELECTRIC MODELS 100, 101, 103, 105

Part No.	Code and Description
URD-145	R <sub>1</sub> —470 ohm, 1/2 w. res.
URD-081	R <sub>2</sub> —10 megohm, 1/2 w. res.
URD-113	R <sub>3</sub> —22,000 ohm, 1/2 w. res.
URD-129	R <sub>4</sub> , R <sub>12</sub> , R <sub>18</sub> —470,000 ohm, 1/2 w. res.
URD-041	R <sub>5</sub> —2.2 megohm, 1/2 w. res.
URD-089	R <sub>6</sub> —470 ohm, 1/2 w. res.
RRC-002	R <sub>7</sub> —47,000 ohm, 1/2 w. res.
URD-049	R <sub>8</sub> , S <sub>1</sub> —2 megohm vol. control & sw.
URD-139	R <sub>9</sub> —1000 ohm, 1/2 w. res.
URD-029	R <sub>10</sub> —5.6 megohm, 1/2 w. res.
URD-015	R <sub>11</sub> —150 ohm, 1/2 w. res.
URE-007	R <sub>12</sub> —39 ohm, 1/2 w. res.
RCT-001	R <sub>13</sub> —18 ohm, 1 w. res.
UCC-045	C <sub>1a</sub> , C <sub>1b</sub> , C <sub>2</sub> , C <sub>8</sub> —Tuning capacitor assembly.
UCC-048	C <sub>3</sub> , C <sub>11</sub> —.05 µfd., 600 v. cond.
RCU-110	C <sub>4</sub> —1 µfd., 600 v. cond.
RCU-115	C <sub>5</sub> —47 µfd., 500 v. cond.
RCU-112	C <sub>6</sub> —330 µfd., 500 v. cond.
RCU-113	C <sub>7</sub> —100 µfd., 500 v. cond.
RCC-040	C <sub>14</sub> —150 µfd., 500 v. cond.
UCC-013	C <sub>15</sub> , C <sub>17</sub> , C <sub>18</sub> —.01 µfd., 600 v. cond.
RCC-045	C <sub>16</sub> —1 µfd., 200 v. cond.
RCE-001	C <sub>20</sub> —.05 µfd., 600 v. cond.
UCC-039	C <sub>21a</sub> , C <sub>21b</sub> , C <sub>21c</sub> —50/50/150 µfd. @ 150 v./150 v./25 v. elec. cond.
UCC-040	C <sub>22</sub> —.005 µfd., 600 v. cond.
RTL-001	C <sub>25</sub> —.01 µfd., 600 v. cond.
RTL-002	T <sub>1</sub> —First i.f. trans.
RTO-001	T <sub>2</sub> —Second i.f. trans.
RLC-001	T <sub>3</sub> —Output trans. T <sub>4</sub> —Osc. coil assembly.

## CLARION—MODEL C101

Part No.	Code and Description
18-266	R <sub>1</sub> —10 megohm, 1/4 w. res.
19-177	R <sub>2</sub> —2.2 megohm, 1/4 w. res.
82 32	R <sub>3</sub> —470,000 ohm, 1/4 w. res.
10-394	R <sub>4</sub> —220,000 ohm, 1/4 w. res.
10-369	R <sub>5</sub> —22,000 ohm, 1/4 w. res.
10-370	R <sub>6</sub> —120 ohm, 1/4 w. res.
80-212	R <sub>7</sub> —27 ohm, 1/4 w. res. R <sub>8</sub> —1000 ohm, 1/2 w. res. R <sub>9</sub> —10,000 ohm, 1 w. res. R <sub>10</sub> —1 megohm, 1/3 w. res. C <sub>1</sub> —.00025 µfd., mica cond. C <sub>2</sub> —.0001 µfd., mica cond. C <sub>3</sub> —.00005 µfd., mica cond. C <sub>4</sub> —.05 µfd., 400 v. cond. C <sub>5</sub> —.01 µfd., 400 v. cond. C <sub>6</sub> —.004 µfd., 400 v. cond. C <sub>7</sub> —1 µfd., 400 v. cond. C <sub>8</sub> —.05 µfd., 200 v. cond. C <sub>9</sub> —30/30 µfd., 150 v. elec. cond. C <sub>10</sub> , C <sub>11</sub> , C <sub>12</sub> —Two-gang var. cond. T <sub>1</sub> —Loop antenna T <sub>2</sub> —Osc. Coil T <sub>3</sub> —First i.f. trans. T <sub>4</sub> —Second i.f. trans. T <sub>5</sub> —Output trans.

## GAROD—MODEL 5A2

(See circuit diagram for component values)

## VOGUE—MODELS 553R, 554R

(See circuit diagram for component values)

## EMERSON

### MODEL 510, CHASSIS MODELS, 120000, 120029

Part No.	Code and Description
397000	R <sub>1</sub> , R <sub>6</sub> —15 megohm, 1/4 w. res.
3212330	R <sub>2</sub> —2.3 megohm, 1/4 w. res.
390010	R <sub>3</sub> —5 megohm vol. control.
321130	R <sub>4</sub> , R <sub>5</sub> —470,000 ohm, 1/4 w. res.
340290	R <sub>7</sub> —150 ohm, 1/2 w. res.
370490	R <sub>8</sub> —1000 ohm, 1 w. res.
310810	R <sub>9</sub> —22,000 ohm, 1/4 w. res.
340010	R <sub>10</sub> —10 ohm, 1/2 w. res.
397040	R <sub>11</sub> —15 ohm, 1 w. wire-wound res.
321050	R <sub>12</sub> —220,000 ohm, 1/4 w. res.
900170	C <sub>1</sub> , C <sub>2</sub> —Two-gang var. cond. (120,000 chassis)
900290	C <sub>1</sub> , C <sub>2</sub> —Two-gang var. con. (120,029 chassis)
	C <sub>3</sub> , C <sub>4</sub> —Trimmer (Part of variable cond.)
	C <sub>5</sub> , C <sub>6</sub> —Trimmer (Part of first i.f. trans.)
	C <sub>7</sub> , C <sub>8</sub> —Trimmer (Part of second i.f. trans.)
920010	C <sub>9</sub> , C <sub>15</sub> —.002 µfd., 600 v. cond.
920170	C <sub>10</sub> —.001 µfd., 600 v. cond.
920020	C <sub>11</sub> , C <sub>12</sub> —.02 µfd., 400 v. cond.
910000	C <sub>13</sub> —.00022 µfd., mica cond.
920040	C <sub>14</sub> —.1 µfd., 200 v. cond.
920030	C <sub>16</sub> —.05 µfd., 400 v. cond.
925000	C <sub>17</sub> , C <sub>18</sub> —30-50 µfd., 150 v. dual dry. elec. cond.

920050	C <sub>10</sub> —.2 µfd., 200 v. cond.
720000	T <sub>1</sub> —First i.f. trans.
720100	T <sub>2</sub> —Second i.f. trans.
734000	T <sub>3</sub> —Output trans.
716010	T <sub>4</sub> —Osc. coil
807000	Pilot light
507100	Pilot light socket
520019	Dial backplate (120000 chassis)
520500	Dial backplate (120029 chassis)
525010	Dial pointer assembly
520080	Dial crystal
280103	Drive shaft

## RCA—MODELS 56X, 56X2, 56X3

Part No.	Code and Description
30733	R <sub>1</sub> —3300 ohm, 1/4 w. res.
30492	R <sub>2</sub> —22,000 ohm, 1/4 w. res.
38785	R <sub>3</sub> —15 megohm, 1/4 w. res.
30654	R <sub>4</sub> —1500 ohm, 1/4 w. res.
12928	R <sub>5</sub> —3.3 megohm, 1/4 w. res.
30189	R <sub>6</sub> —120 ohm, 1/4 w. res.
30648	R <sub>7</sub> —470,000 ohm, 1/4 w. res.
14583	R <sub>8</sub> , R <sub>10</sub> —220,000 ohm, 1/4 w. res.
30931	R <sub>9</sub> —4.7 megohm, 1/4 w. res.
6134	R <sub>11</sub> —1200 ohm, 1 w. res.
36242	R <sub>12</sub> , S <sub>1</sub> —Vol. control & power sw.
70652	C <sub>1</sub> , C <sub>3</sub> , C <sub>6</sub> —.01 µfd., 800 v. cond.
70635	C <sub>2</sub> —.035 µfd., 500 v. cond.
70412	C <sub>5</sub> , C <sub>8</sub> , C <sub>18</sub> , C <sub>19</sub> , L <sub>5</sub> , L <sub>6</sub> —Second i.f. trans.
70711	C <sub>7</sub> , C <sub>11</sub> —.02 µfd., 700 v. cond.
37359	C <sub>8</sub> , C <sub>9</sub> —.00031, .005 µfd., 200 v. cond.
70712	C <sub>10</sub> —.0018 µfd., 800 v. cond.
36226	C <sub>12</sub> , C <sub>13</sub> , C <sub>14</sub> , C <sub>15</sub> —Var. tuning cond.
70411	C <sub>16</sub> , C <sub>17</sub> , L <sub>3</sub> , L <sub>4</sub> —First i.f. trans.
39152	C <sub>20</sub> , C <sub>21</sub> —30/50 µfd., 150 v. elec. cond.
70617	C <sub>22</sub> —.1 µfd., 400 v. cond.
70615	C <sub>23</sub> —.05 µfd., 400 v. cond.

—30—

## RADIO DIAL LIGHT EXTENSION

AN efficient trouble shooting lamp may be made by using the radio dial light on an extension, as illustrated.

A flashlight socket insulated with rubber and connected to a cord with insulated clips on the opposite end is all that is required.

In use the clips are connected across the dial lamp terminals, or as illustrated from one terminal to chassis, and the lamp screwed into the extension socket.

In case the radio uses a bayonet type socket, use another lamp of the "screw in" type of the proper voltage. H.L.

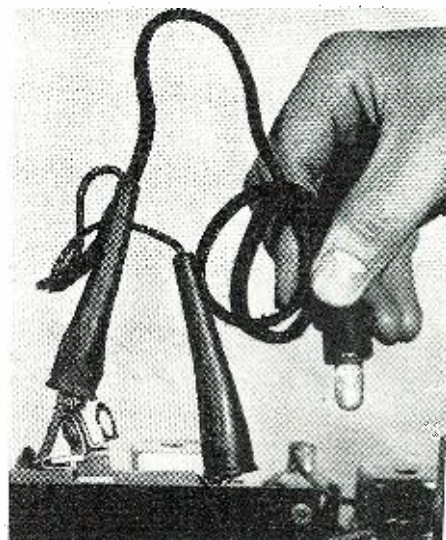

RADIO NEWS

# It's Collins!

# It's new!

# It's ready!

... the Collins 30K—a NEW transmitter for amateur radio—thoroughly engineered for the continuous exacting requirements of "ham" operation. Check this partial list of features against your desires:

**5 band operation • 500 watts input on CW • 375 watts input on Phone • Push-to-talk • Clean, sharp keying • Speech clipper • Bandswitching • Fully metered • Break-in operation • Vfo controlled**

The high efficiency of the 30K assures a strong signal. In addition, the speech clipper circuit assists in maintaining a high modulation level, with no danger of overmodulation. Speech clipping also improves intelligibility. Brass pounders will proudly note the clean keying at any speed.

The exciter unit, built into a receiver type cabinet, may be placed on the operating desk. A highly accurate and stable variable frequency oscillator, the product of years of research and manufacturing experience, is calibrated directly in frequency. The frequency can be varied considerably without retuning the final.

The attractive appearance of this up-to-the-minute transmitter will improve any "shack." Its smooth, easy operation will please you.

Write today for complete details. Collins Radio Company, Cedar Rapids, Iowa; 11 West 42nd Street, New York 18, N. Y.

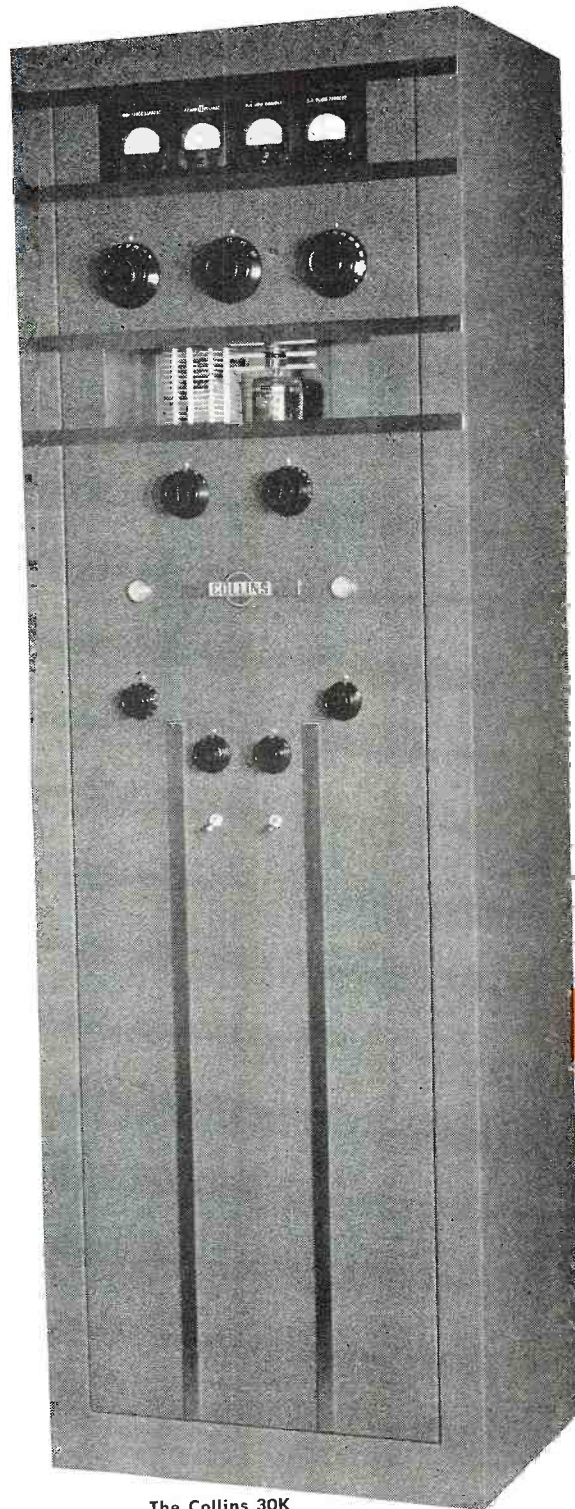

The Collins 30K



FOR RESULTS IN AMATEUR RADIO, GET...



# HARVEY

has greatly needed  
components for  
engineers and  
experimenters

Full line of

## Shallcross Instruments

Harvey has Shallcross Measuring Instruments, well known in both laboratories and classrooms, in stock for immediate delivery. Listed are a few of the more popular numbers:

**No. 630 Wheatstone Bridge**—Measures resistance from .1 to 11,100,000 ohms. Accuracy between 10 and 1,000,000 ohms normally better than 1 per cent. With built-in galvanometer having sensitivity of 1 microampere per millimeter division. In carrying case with removable cover.....\$75.00

**Portable Galvanometers**—Sensitive galvanometer housed in sturdy case with binding posts on panel for external connection. Movement has lock to prevent free swinging. No. 310, in oak case...\$27.50

### Series 500 Decade Resistance Boxes

Accuracy 0.1% to 1%

No.	Ohm Steps	Ohms Total Resistance	Price
543	0.1	1	\$13.50
544	1.0	10	13.50
545	10	100	13.50
546	100	1,000	13.50
547	1,000	10,000	15.00
548	10,000	100,000	17.50
549	100,000	1,000,000	27.50
550	1,000,000	10,000,000	45.00

## Test Equipment

Now available—a complete selection of test equipment, including millivoltmeters, micro- and milliammeters, AC and DC voltmeters, and RF meters, produced by Weston, Westinghouse, and other quality manufacturers.

## Voltage Regulating Transformers

Harvey can supply the Sola constant-voltage, self-regulating transformers. No moving parts, no ballasts, no tubes. Output voltage maintained within —1% for a total primary variation of 30%. Eliminates manual voltage adjustments; results in better operation, less trouble, longer life for important parts. May be operated in parallel for greater output. Regularly supplied in single phase, but also available for 3-phase. Stock models provide output voltages of 6.3, 115, or 230 volts. Input voltages range 95-125, 190-250, 95/190-125/250, and 190/380-250/500. Power rating ranges from 15 VA to 10,000 VA. Typical types, all 95-125 volt input: No. 301002—15 VA, 6.3 v. output.....\$18.50  
No. 30806—120 VA, 115 v. output.....\$32.00  
No. 30807—250 VA, 115 v. output.....\$52.00

Remember, HARVEY has full stocks  
...same-day shipping service...fair  
prices. Send us your order now!

Telephone:  LO. 3-1800

# HARVEY

RADIO COMPANY INC.

103 West 43rd St., New York 18, N. Y.

# “For the Defense”

## The People vs. Servicemen

By Jay M. Bartels

**A layman carries on his own investigation of radio servicemen and discovers that the average are honest.**

**O**CCASIONALLY a newspaper or periodical carries an article dealing with the so-called vices of the radio repairman, exposing him as a highway robber or cunning racketeer who rakes in huge profits on business transactions with his “sucker victims” who, knowing nothing of the technicalities involved, are at his “complete and ruthless mercy.” Such sparks of illusion which generally seem to fly thicker and faster than those of facts and reason were probably kindled by cranks, spread by a poorly informed public and accelerated by some of the radio repair shop’s competitors themselves. The latter, never having been allied into a common brotherhood as other highly skilled technicians in older established trades, have been apt to vie with each other to the detriment of both and even indulge in maligning one another because of petty business jealousy.

In prewar times the tendency to knock the radio serviceman existed as a kind of undercurrent but flared up into violent criticism during the war when the shortage of parts, materials and skilled help in non-war industries gave some justification for complaints of slow, inferior, and high priced workmanship. That the radio repair business should have been singled out above other lines in this respect, however, is a fact that should be listed among the paradoxes of these times. Even certain city officials gave warning that a substantial number of “these offending concerns” would be severely dealt with if such “racketeering” continued. The irony of this matter is that quite a few of these establishments which were actually unable to subsist on the “crooked deals” and “excessive profits” made on radio repairs and parts which they were not even able to obtain (except possibly through high priced black market) due to government priorities, were obliged to close shop and discharge employees.

Until about two years ago this writer was among those individuals who, when confronted sooner or later with the inevitable breakdown of his radio, suspiciously eyed each of the radio repair shops in his vicinity wondering which one would be likely to “do” him the worst. Personal experiences and hearsay from the next door neighbor who had been unable to get an estimate of his radio repairs without leaving the old set at the shop

for a check over and finally paying \$15 for goodness knows what and believing that good parts were probably replaced with inferior ones led this “sorely wronged” person to what he considered the best solution, “learn radio myself and avoid these preying cut-throats.” That was the beginning of quite an eye opening on the subject and at this point the writer would like to offer his services to the council for the defense of the average radio repairman, barring, of course, the comparative minority found in about every business, who resorts to unethical practices.

An intensive course during spare time covering a year and a half acquainted the writer with Basic Electricity, Electronics and Fundamentals of Radio with some lab work including theoretical and practical analysis, also radio trouble-shooting with the use of standard test equipment. This “cooling off period” was followed by another year in which several hundred hours of spare time were spent in repairing different makes and models of radios, of various vintages covering the past fifteen years, none of which followed any standard plan regarding assembly or placement of parts and all internally mellowed with a thick coat of dust, carefully concealed from the eyes of the most critical housewife.

Bearing down on the dull facts of radio repairing, the task of rejuvenating sick sets can vary from the sweet to the sour. A faulty set may only need a new tube which scarcely requires more time to fix than to state the trouble. Tubes are generally suspected first and are tested, bad ones being replaced with new ones. But if the “invalid” is what is technically called “an intermittent case” after tube trouble has been eliminated then the repairman may have a real job on his hands, whether he has been in the game for two or twenty years. With the myriad of parts in a radio, each of which alone could be the source of the same disturbing condition, he would be lucky to put his finger on the cause immediately without methodically checking through the various suspected parts with instruments, as a doctor does a patient suffering from a hidden ailment. This takes time which is a large item in the operation of a business and in such cases a repair bill of several dollars is not un-

**electrical pipe-line** →

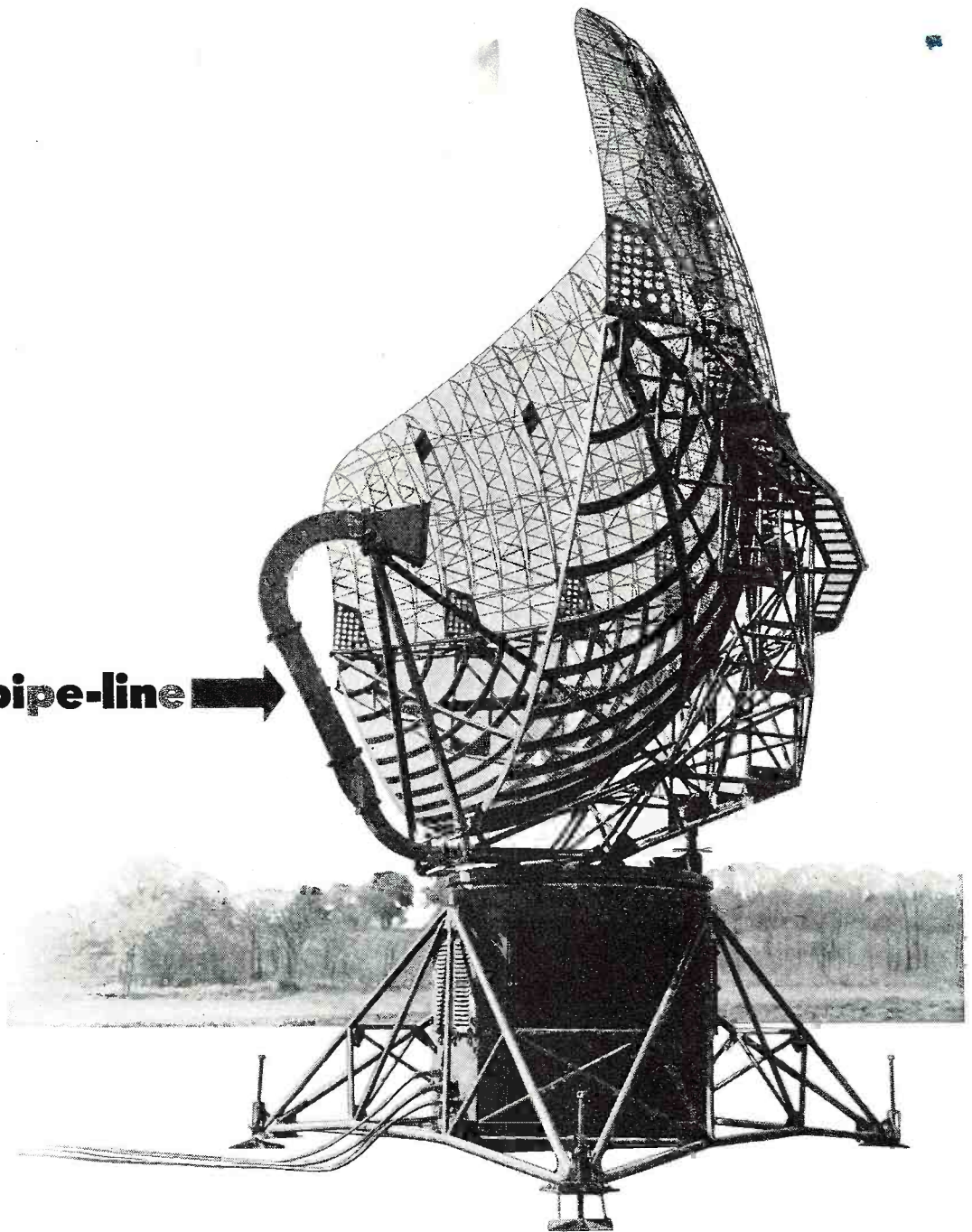

Microwaves make their journey from apparatus to antenna not by wire, cable, or coaxial — but by waveguide.

Long before the war, Bell Laboratories by theory and experiment had proved that a metal tube could serve as a pipe-line for the transmission of electric waves, even over great distances.

War came, and with it the sudden need for a conveyor of the powerful microwave pulses of radar. The metal waveguide was the answer. Simple,

rugged, containing no insulation, it would operate unchanged in heat or cold. In the radar shown above, which kept track of enemy and friendly planes, a waveguide conveyed microwave pulses between reflector and the radar apparatus in the pedestal. Bell Laboratories' engineers freely shared their waveguide discoveries with war industry.

Now, by the use of special shapes and strategic angles, by putting rods

across the inside and varying the diameter, waveguides can be made to separate waves of different lengths. They can slow up waves, hurry them along, reflect them, or send them into space and funnel them back. Bell Laboratories are now developing waveguides to conduct microwave energy in new radio relay systems, capable of carrying hundreds of telephone conversations simultaneously with television and music programs.

EXPLORING AND INVENTING, DEVISING AND PERFECTING FOR CON-

TINUED IMPROVEMENTS AND ECONOMIES IN TELEPHONE SERVICE

July, 1946



**BELL TELEPHONE LABORATORIES**

## COMPLETE TRANSMITTING & RECEIVING SETS

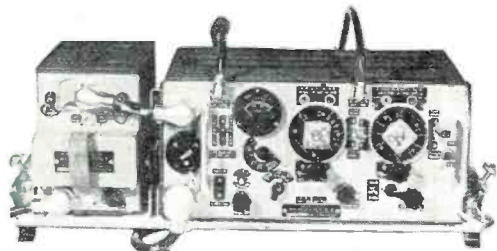

\$**78.50**  
NET

F.O.B. LOS ANGELES

**BRAND NEW!**

### 3 SETS IN ONE—15 TUBES MADE BY ZENITH & EMERSON

**SET A**, for telephone and telegraph includes: 6 tube superheterodyne receiver and 6-tube MOPA transmitter with 807 final amplifier. Grid modulated for telephone. Specialized circuits make this set ideal for network operations. The frequency range of 2 to 8 megacycles includes the 80 meter and 40 meter amateur bands.

**SET B**, consists of 235 megacycle transceiver that can be shifted to the 144 or 225 megacycle amateur bands.

**SET C**, a complete inter-communication system using 3 control boxes and 3 combination headphones—push-to talk microphone, providing inter-communication or remote control operation in an extremely flexible arrangement in 3 different locations.

**POWER SUPPLY:** This unit, including dynamotor, operates from a 12-volt storage battery. These sets are ideal for mobile or marine installations.

**ADDITIONAL EQUIPMENT:** This set includes the following equipment not shown in photograph: 2 Antennas, 1 Variometer Resonator, Spare Set Tubes, Generator, Set of Spare Parts; 5 sets Earphones, 5 sets Microphones...

The equipment included in the set fills three large packing cases. A complete description of every part covers three printed pages. Experts will be present at our store to describe all the equipment that is included. The sets go direct to you from the storage depot in the original export packing cases.

These sets are ideally suited to licensed radio amateurs. They are also excellent for schools and colleges in need of fine laboratory equipment. Small commercial stations may buy this equipment at a fraction of its original cost.

## RADIO EQUIPMENT DISTRIBUTORS

709 S. MAIN STREET

LOS ANGELES 14, CALIFORNIA

PHONE: TRINITY 8068

# THE BEST RADIO DEAL IN 3 YEARS



*Coming!* Olson Radio Warehouse will soon announce a most unusual plan to give the radio service-man more for his money and something besides. Details will be sent FREE to all radio men on our mailing list. Don't miss out! If you are interested in making more money, clip the coupon and mail it to us right away.

MAIL  
TODAY



**OLSON RADIO WAREHOUSE**

73 E. MILL ST., Dept. 28, AKRON, OHIO

OK, put us on your mailing list. (No obligation.)

NAME .....

ADDRESS .....

just even if the offending part when finally located is only a ten cent resistor or a fifty cent condenser.

A factor which might lead to the elimination of misapprehensions about the radio repair trade would be the organizing of radiomen into local and national groups as are found in other trades. A pioneer and fine example of such a movement is the RETA (Radio Engineers & Technicians Association) of Indiana which issues certificates of qualification to its members who have passed a written examination consisting of questions which a capable radio technician should be able to answer. In a sense this would not be a movement necessary to cleanse the business of foul play or shady deals as about nine out of every ten radio "doctors" have earned their place in business the hard way. But certainly a neatly framed certificate bearing a recognized seal and hanging conspicuously in his shop would tend to put many non-trusting customers at ease and give the repairman a prestige befitting one who, of necessity, must be adept in such a highly technical field in order to carry on successfully.

-30-

### Practical Radio Course

(Continued from page 43)

of the autodyne is due to the tendency of the signal-circuit to "pull in" to the frequency of the oscillator (especially on weak signals), making tuning unstable and difficult on high-frequency signals. The reason for this becomes clear if we examine typical autodyne converter circuits (Fig. 1). Since the oscillator frequency appears across the tuned grid (signal) circuit, if the impedance of this circuit to the oscillator frequency is appreciable (as it is at high signal frequencies) appreciable voltage of oscillator frequency will be built up across it and appear on the signal grid. This is one of the main reasons why the autodyne converter circuit is not suitable for the higher signal frequencies and is not used in multi-band receivers.

A compromise is necessary in the choice of tube. A sharp cut-off tube (such as the 6C6, 77, etc.) provides more gain and a better signal-to-noise ratio than a super-control or logarithmic type tube (6D6, 78, etc.), but the latter type enables a.v.c. (automatic volume control) to be applied.

For the foregoing reasons, the autodyne frequency converter has lost popularity among receiver designers (although thousands of them are still in use in old receivers—especially the less expensive midgets). The autodyne system is the sort of thing that one gets by with until a better idea comes along. The better idea is definitely the more recent double-electrode input converters that employ electron coupling between the oscillator and signal grid circuits and utilize the superior, more recent types of tubes (pentagrid converters, etc.)





*The Victrola\*, made exclusively by RCA Victor, gives higher fidelity and longer record life through its jewel-point pickup.*

## **Your Victrola's jewel-point pickup**

### ***floats like a feather on water—***

Instead of an ordinary, rigidly mounted needle, your Victrola radio-phonograph has a moving sapphire playing tip that fairly floats over the record.

It follows the groove with effortless ease, achieves new clarity of tone, adds longer life to records, and acts as a filter against surface noise.

Such a feather touch reduces "needle chatter," gives you all the rich warm flow of the pure music . . . the highest tones, the lowest tones, the overtones. Truly, your Victrola's jewel-point pickup brings you the ultimate in recorded music pleasure.

This pickup was perfected at RCA Laboratories—a world center of radio and electronic research—where RCA products are kept at the top of the field.

And when you buy an RCA Victor radio, television receiver, Victrola, or even an RCA radio tube replacement, RCA Laboratories is your assurance that you are getting one of the finest products of its kind that science has yet achieved.

*Radio Corporation of America, RCA Building, Radio City, New York 20 . . . Listen to The RCA Victor Show, Sundays, 4:30 P. M., Eastern Daylight Time, over the NBC Network.*

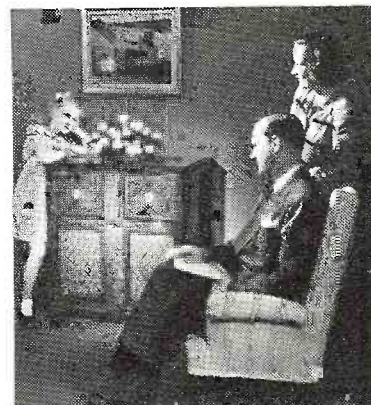

New Victrola radio-phonograph, with Chippendale-style cabinet, priced at approximately \$275. "Rollout" record changer handling twelve 10-inch, or ten 12-inch records. Permanent jewel-point pickup—no needles. American and foreign radio reception. An outstanding radio-phonograph combination—thanks to research at RCA Laboratories.



**RADIO CORPORATION of AMERICA**

\*Victrola T.M. Reg. U. S. Pat. Off.

July, 1946

73

TIME WILL TELL!

33 Years of Experience

• THE HALLDORSON COMPANY has continuously manufactured for industry since 1913. Since inception, this firm has been and is still an individual firm . . . not a subsidiary or branch of another company. Each and every HALLDORSON transformer is backed by 33 years of experience, research and actual field knowledge. A new and more complete line of transformers is now being developed in the HALLDORSON laboratories. Soon . . . we hope, in the very near future . . . these transformers will be available.

JOBBERS: Get on our mailing list today!

THE HALLDORSON COMPANY  
SINCE 1913  
4500 Ravenswood Avenue • Chicago 40, Illinois

HALLDORSON Vacuum Sealed TRANSFORMERS

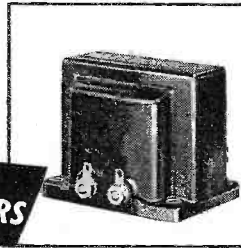

which were especially designed to serve the dual function of oscillator and mixer. These will be described in the next article of this series.

### Triode-Pentode Converter

Another single-tube, single-electrode input type of frequency converter arrangement that deserves mention employs a combination triode-pentode tube in which the electrodes for a triode oscillator and a pentode mixer are combined within a single envelope—a common cathode being used. Fig. 2 illustrates a converter circuit of this kind employing a typical triode-pentode tube such as the 6F7.

Examination of this circuit shows that a plate-tickler fed Hartley oscillator circuit is employed. The method of coupling the oscillator voltage into the cathode-return circuit by means of a cathode coil is similar to that used in the autodyne circuit illustrated at C of Fig. 1. Since the oscillator section of the tube operates as an ordinary triode oscillator, the grid leak  $R_g$  and capacitor  $C_g$  are employed in its grid circuit.

This circuit was a considerable improvement on previous forms of single-tube frequency converters of the single-electrode input type, and it provided good sensitivity. However, due to the cathode coupling employed, it still contains inherent faults. Since comparatively large voltages of oscillator frequency appear across the signal grid circuit, there is a tendency toward "pulling" or "locking-in" on weak signals and on the higher frequencies. Similar remarks concerning this apply as for the autodyne converter. Hence, the operation is satisfactory only on the broadcast band. Also, the possibility of modulation hum, particularly on a.c./d.c. receivers, is increased, due to the fact that the cathode is "floating."

(To be continued)

### TELEVISION SOCIETY REVIVED

THE Lawrence Tech Television Society which was discontinued in 1941 "for the duration" has again resumed its regular sessions.

This society which was organized in Highland Park, Michigan in 1938 was formed for the purpose of providing the place and means for those interested in television to meet and study the art. The meeting room which is also the laboratory has been provided by the Lawrence Institute of Technology. Monthly dues are used to purchase parts for the members to build into various pieces of television equipment.

An associate grade of membership is provided for those wishing to attend meetings but who do not care to take an active part.

Meetings are held twice a month. At the reorganization meeting E. S. Lansing was named chairman of the group for the coming year; John McCoy was elected secretary-treasurer while C. E. Quinn will serve as project co-ordinator.

Other groups interested in television might wish to organize a similar group for mutual assistance and education.

-30-

# JFD NEW "BIG 4" SERVICEMEN'S BASIC KIT!



A Great New **TIMESAVER**  
For Radio Servicemen!  
FOUR Basic Radio Service  
Kits in ONE Package

COMBINATION List Price \$33.35

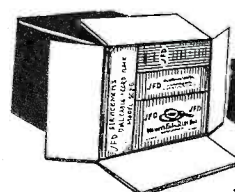
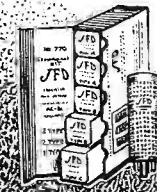
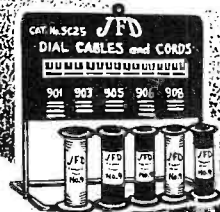

**\$10.00 SPECIAL**  
NET COST



### JFD "BASIC-KIT"

For Radio Servicemen  
Starting a Repair Business

For Established Radio  
Servicemen Who want to  
Save Time and Energy

These 4 Popular JFD Kits have everything needed for 25% of all radio service work.

- **B25A Belt Kit.** Assortment of 25 Dial Belts in Metal Container. Includes FREE 64-page JFD Servicemen's Manual, listing belts for more than 1500 set models.
- **770 Ballast Kit.** Contains five JFD Improved Aircooled AC-DC Adjustable Ballasts. Suitable for more than 95% of a ballast tube replacements.
- **5C25 Dial Cable & Cord Rack.** Contains 5 Metal Spools of fast-moving dial cables and cords.
- **BP-100-MC Plug Assortment.** 100 radio battery plugs, in 25 different popular types. Sturdy Metal Container. Includes FREE Battery plug folder with technical data and schematic diagrams of all plug types.

J.F.D. MANUFACTURING CO.  
4109-4123 FT. HAMILTON PARKWAY, BROOKLYN 19, N. Y.

# CALRAD "hard-o-ge" RADIO VALUES!

## V.M. TWO POST AUTOMATIC RECORD CHARGER

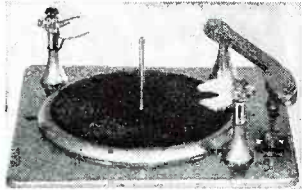

This Record Charger is a well made mechanism, will play either 10 in. or 12 in. records. The pickup uses a crystal cartridge. Size 14 in. x 14 in. Packed 2 to a factory sealed carton, factory guaranteed.

CARTON OF 2 **\$35.00** Special **\$18.95** ea.

## Signal Corps TELEGRAPH KEYS



Genuine U.S. Signal Corps telegraph keys brought to you at prices below manufacturing costs! Made with switch to close contacts, polished durable enameled metal base mounted on a bakelite base; key lever is nickel-plated; contacts are brass-silver. Packed in new original boxes.

LOTS OF 10 **75c** CARTON OF 50 **60c** ea.

## 5 Tube Super AC-DC PARTS KIT

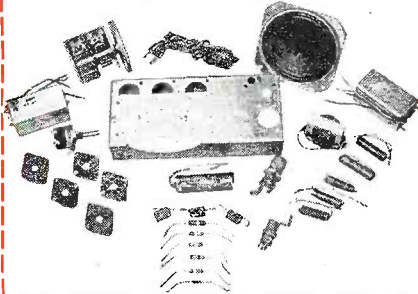

Kits include: Stamped Chassis—Dynamic Speakers—Output Transformer—Volume Control and Switch—2 Shielded I.F. Coils—Antenna and Osc. Coils—Two-gang Super Variable—50 Octal Sockets—20x20 Mfd. 150 Volt Filter—5 Tubular Condensers—3 Mica Condensers—6 Resistors—6 ft. AC Cord and Plug—Circuit Diagram.

WHILE THEY LAST **\$8.95** ea. LOTS OF 6 **\$50.00**

## AUTO ANTENNAS

- 3 Section
- 66" Long
- Brass Tubing
- Triple Chromium Plated
- 2 Insulator Type Cowl Mounting with Lead Individually Boxed

24 to Master Carton

**\$30.00**

LOTS OF 43

**\$55.00**

Immediate Delivery But Quantity Is Limited

## Approved SIGNAL GENERATOR

Model A-100

Complete **\$47.00**

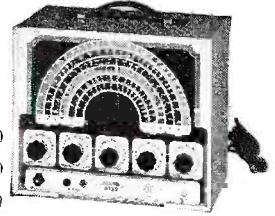

A-100 to 310 Kilocycles  
B-320 to 1000 Kilocycles  
C-1000 to 3200 Kilocycles  
D-3.2 to 10.5 Megacycles  
E-10.5 to 26 Megacycles  
E2-21 to 52 Megacycles  
440 Standard Audio Frequency (same as WWV) Internal modulation at 440 cycles (same as WWV). External modulation possible from 40 to 30,000 cycles.

## WEBSTER RECORD CHANGER

Model 56



Complete **\$26.45** ea.

Built to last. Fast change cycle. Simple, fool-proof operation. Automatic shut-off. Feather light needle pressure. Longer life for records. Quiet running Webster 4 Pole motor-cushion mounted.

Webster Model 50, ea. **\$20.95**

# BUY NOW! LOWEST PRICES! STOCKS LIMITED!

### Fully Shielded Power Transformers

50 Mill-6.3Vo. @ 2 amp. C.T.-5Vo. @ 2 amp. C.T.-650Vo. C.T. \$2.45 ea. Lots of 10.....\$2.25 ea.

### Push-Pull 6L6 Shielded Output Transformer

30 Watt Peak. to 2-4-6-8-10-250 and 500 ohm line. \$3.45 ea. Lots of 12.....\$3.25 ea.

Push Pull Input Transformer. 10,000 ohm plate to push pull 6L6. \$1.10 ea. Lots of 12.....\$1.00 ea.

Midget Universal Output Transformer—push pull plate to 2-4-6-8-10-16 ohm voice coil. 95c ea. Lots of 10.....85c ea.

10 Watt Large Universal Output. \$1.35 ea. Lots of 10.....\$1.20 ea.

Single Pentode Midget Output—for 50L6, 6V6, 6FG, etc. 55c ea. ....60c ea.

50 Mill Filter Choke 300 ohm. 65c ea. Lots of 10.....60c ea.

75 Mill Filter Choke 250 ohm. 95c ea. Lots of 10.....85c ea.

### Dynamic and P.M. Speakers

4 in 450 Ohm Dynamic—Pkd. 30 to Carton.\$1.75 ea.

4 in 2500 Ohm Dynamic—Pkd. 30 to Carton.\$1.75 ea.

4 in. P.M. Heavy Slug—Pkd. 30 to Carton.\$1.70 ea.

5 in. P.M. Heavy Slug—Pkd. 30 to Carton.\$1.75 ea.

6 in. P.M. Heavy Slug—Pkd. 30 to Carton.\$2.25 ea.

### Tubular Electrolytic Condensers

10 Mfd. 50 Volt—Lots of 25.....21c ea.

25 Mfd. 50 Volt—Lots of 25.....24c ea.

50 Mfd. 50 Volt—Lots of 25.....28c ea.

10 Mfd. 150 Volt—Lots of 25.....25c ea.

20 Mfd. 150 Volt—Lots of 25.....29c ea.

30 Mfd. 150 Volt—Lots of 25.....32c ea.

50 Mfd. 150 Volt—Lots of 25.....35c ea.

20x20 Mfd. 150 Volt—Lots of 25.....43c ea.

30x20 Mfd. 150 Volt—Lots of 25.....47c ea.

40x20 Mfd. 150 Volt—Lots of 25.....55c ea.

50x20 Mfd. 150 Volt—Lots of 25.....65c ea.

20 Mfd.—350 Volt—Lots of 25.....39c ea.

10 Mfd.—300 Volt—Lots of 25.....36c ea.

20 Mfd.—25 Volt—Lots of 25.....39c ea.

### STANDARD BRANDS. TUBULAR BY-PASS CONDENSERS

.001-.002-.003-.005-.006-600 Volt.....\$ 6.75 per 100  
.025-.01-.02-600 Volt.....7.75 per 100  
.05-600 Volt.....9.75 per 100  
1-600 Volt.....12.00 per 100  
25-600 Volt.....18.00 per 100  
5-600 Volt.....22.00 per 100  
4 Mfd. 600 Vo. T.L.A. Oil Condenser. screw base. Upright aluminum can. 1 1/2 in. x 3 3/8 in. Replaces 8 mfd. 600 Vo. electrolytic. List.....\$4.50  
Carton of 40.....\$38.50

### Finest Quality Midget Micacs:

.001-.0001. .002-.00025.....\$5.00  
.005-.00005. .006-.0005.....per 100

Astatic Low Pressure, curved arm, crystal pickup with Sapphire Stylus Permanent Needle, has cartridge which replaces LFG-LP21-LP23. \$3.75 ea.; Lots of 10.....\$33.50

### STANDARD LOW PRESSURE CRYSTAL PICKUP

\$2.50 ea.; Lots of 10.....\$22.50

456 K.C. Antenna, Oscillator and R.F. Coils.25c ea.

456 K.C. I.F. Coils Input & Output, medium size can.....\$45.00 per 100 asst.

Weston Volt ohm meter Model 603—with carrying case & leads.....\$49.50

Universal 4 Prong Electronic Vibrator.....\$1.75 ea.

6 Prong Synchronous Mallory Vibrator.....\$1.75 ea.

Kit of 50 assorted Bakelite Knobs for 1/4 in. shaft, with set screws.....\$2.50 per kit

Midget Ceramic Trimmers—3-30 mmf.....\$6.00 per 100

Western Electric—0-200 Microammeter—3 in bakelite case.....\$4.25 ea.

Tinned Copper Shielding—1/4 in. 3/4 in. 1 in. Per 100 ft.....\$1.50  
Rubber Sheathed "Mike" Cable, shielded, single Conductor. 100 ft. for.....\$ 5.95  
500 ft. for.....25.00  
Moulded Loctal Sockets 1 1/2 in mtg. with metal ring.....\$7.00 per 100  
6 ft. A.C. Cords with plug.....\$20.00 per 100  
Volume Controls, less Switch—1 1/2 in. shaft 250,000 ohm. 1 Meg.....Lots of 100  
2 Meg.....\$30.00

250 ft. Coil Underwriter Approved Zip Cord.....\$4.75 per coil

Turner Juke Box Type Crystal Microphone with 100 ft. shielded mike cable.....\$9.95 ea.

Transmitting type variable Condensers. Dual Double Spaced 110 Mfd. per section.....\$1.00 ea.  
Dual Double Spaced 170 Mfd. per section.....\$1.00 ea.  
Single Gang Dual Spaced 440 Mfd.....\$1.00 ea.  
Single Bearing Midget Condenser 14 plate—100 Mfd.....50c ea.

Midget Open Circuit Jack—Lots of 10.....\$1.50

Midget Closed Circuit Jack—Lots of 10.....2.00

Midget Double Circuit Jack—Lots of 10.....2.00

### Signal Corps Jacks

Signal Corps Jacks, fits all standard plugs. Open circuit, Mallory type SC-1 equivalent of Signal Corps Jack #JK 24A.....\$12.00 per 100  
\$100.00 per 1000

Insulated Banana Tip Jacks, red or black.....\$8.50 per 100

Insulated Banana Plugs, solderless, side screw connection, red or black.....\$10.00 per 100

Standard Barrel Type Phone Plug.....\$20.00 per 100

Sterling #44 Pocket Volt-Amp meter with carrying case.....\$1.00 ea.

Patch Cord 4 ft. with 2 P.L. 55 Plugs.....49c ea.

MAIL ORDERS FILLED: 25% DEPOSIT WITH ORDER, BALANCE C.O.D. REFERENCES—BANK OF AMERICA, SANTA MONICA & VERMONT AVE., LOS ANGELES, CAL.

CALIFORNIA RADIO & ELECTRO ICS CO.

Dept. No. N. 711 No. Vermont Ave., Los Angeles 27, California



## Bud Transmitting Coils are dependable!



When you need a radio frequency coil that can be depended upon to give you the utmost in service and quality, make your selection from the BUD line.

Since one of the most effective means of varying the loading of an R.F. stage is by the use of a variable link to the plate tank, this line of inductances has this feature incorporated in it.

These coils are distinguished by their rigid construction, attractive appearance, convenient mounting base and conservative power rating. The ceramic mounting base permits easy removal without disturbing the winding.

Ask your local distributor to show you these coils. He can explain them in detail to you.

### BUD

Can Supply All Your Needs! . . .

. . . with the latest types of equipment including: condensers — chokes — coils — insulators — plugs — jacks — switches — dials — test leads — jewel lights and a complete line of ultra-modern cabinets and chassis.



**BUD RADIO, INC.**  
CLEVELAND 3, OHIO

### What's New in Radio

(Continued from page 62)

instrument will produce professional acetate recordings which may be used as masters for pressings or for instantaneous playback. The recording

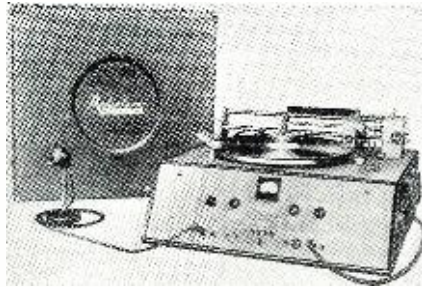

drive mechanism is the overhead lathe used only in professional studio recording equipment.

Additional information regarding this line will be furnished upon request to *Ellinwood Industries*, Los Angeles, California.

#### PREMIER RADIO

*Premier Crystal Laboratories, Inc.* of New York have recently introduced the first of the new Premier line of radios.

The Model 15 is a five tube a.c.-d.c. superheterodyne housed in a hardwood cabinet. Harmonizing with the cabinet is the three dimensional, three



color, inclined dial with edge lighting. The receiver employs a 5 inch PM speaker.

Details of the line may be secured by writing *Premier Crystal Laboratories, Inc.*, 53-63 Park Row, New York 7, New York.

#### HOME RECEIVER

*Hallcrafters Company* of Chicago is introducing a new six-tube superheterodyne table model capable of receiving standard broadcasts as well as foreign and domestic short-wave stations.

The new receiver, known as the S-38, provides continuous coverage in four frequency ranges from 540 kc. to 30 mc. All amateur bands are clearly indicated on the main tuning dial scale, with provision made for fine tuning of short-wave stations.

A special feature of the receiver is the automatic noise limiter. A beat oscillator is provided for the reception

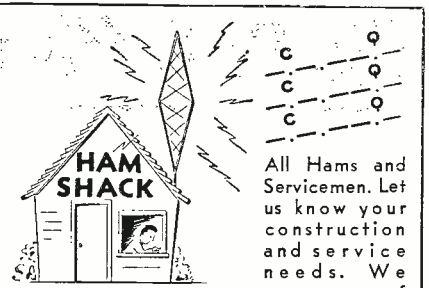

All Hams and Servicemen. Let us know your construction and service needs. We carry one of

the largest stocks in the west. All inquiries given prompt attention.

BUY IN THE WEST  
THE FUTURE ELECTRONICS CENTER

#### WHILE THEY LAST SPECIALS

832A Tubes .....	\$6.95
Dual 4MFD 1500 WVDC Oil Filled Cond., Metal Case, Insulated Screw Terminals .....	1.19
10½ ft. Collapsible Whip Ant., All Brass, Folds to 17" .....	1.49
O-20; O-300 MA DC Meters, 2½" Round, Flush Mount, G.E. ....	2.49
500k Volume Controls, Well known make, Less Switch .....	.59
With Switch .....	.89

ALL ORDERS FILLED SUBJECT TO PRIOR SALE

#### THE HAM SHACK

1244 2nd AVE., SAN DIEGO 1, CALIF.



## TELEVISION!

Prepare now for a fascinating new profession. At **Television Center** on the shores of beautiful Lake Michigan, you will train under top television engineers using up-to-the-minute commercial equipment. Every phase of Television is thoroughly covered—studio, control room, transmitter and receiver. Highly developed techniques through wartime training of thousands of Signal Corps men assure rapid advance.



New classes are forming every week. Don't wait! The best time to start your training is right now!

**Government  
Approved  
for G.I. Training**



**AMERICAN  
TELEVISION  
INSTITUTE**

433 E. Erie Street  
Chicago 11, Ill.

#### MAIL THE COUPON TODAY

**AMERICAN TELEVISION INSTITUTE**  
Division of American Television Laboratories, Inc.,  
433 E. Erie Street,  
Chicago 11, Illinois.

Please send me free information regarding Television Training.

NAME .....

ADDRESS .....

CITY & STATE .....

**RADIO NEWS**

# CRONAME *Facilities*

FOR ELECTRONIC COMPONENTS  
AND FINE METALCRAFT

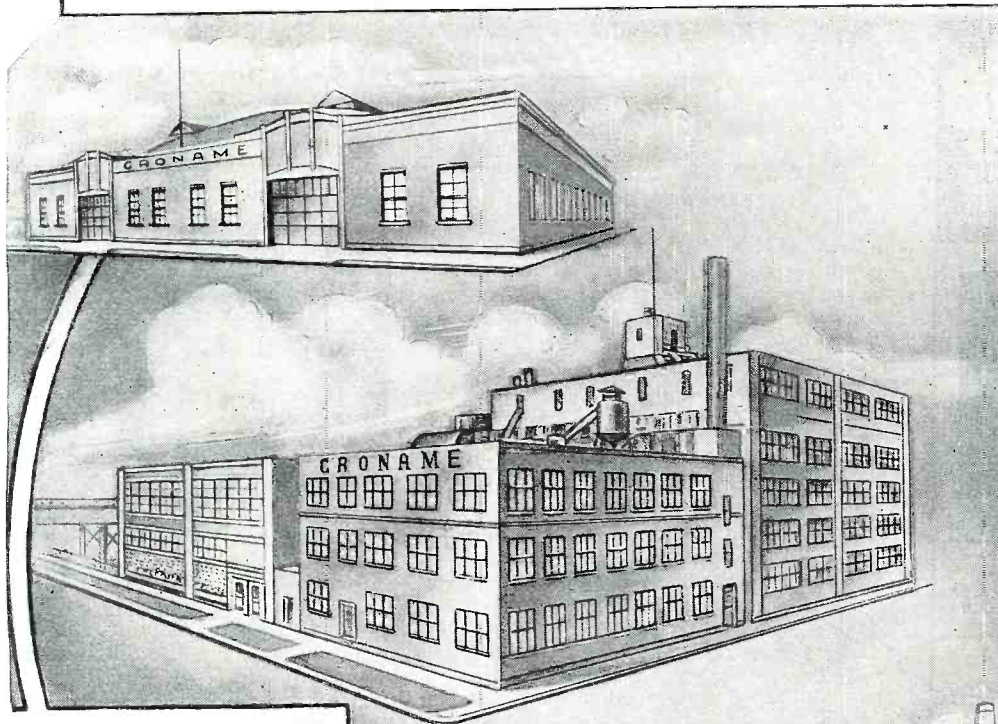

ENGINEERING  
ETCHING  
LITHOGRAPHING  
EMBOSSING  
ENGRAVING  
STAMPING  
ALUMINUM WELDING  
& HEAT TREATING  
ASSEMBLIES  
SOLDERING  
METAL FINISHING  
PLATING

ANODIZING  
PARKERIZING  
OXIDIZING  
FLUORESCENT  
PHOSPHORESCENT  
DECORATED GLASS  
GLASS DIALS  
DECORATED PLASTICS  
FORMED PLASTICS  
RADIO TUNING UNITS  
REMOTE CONTROLS

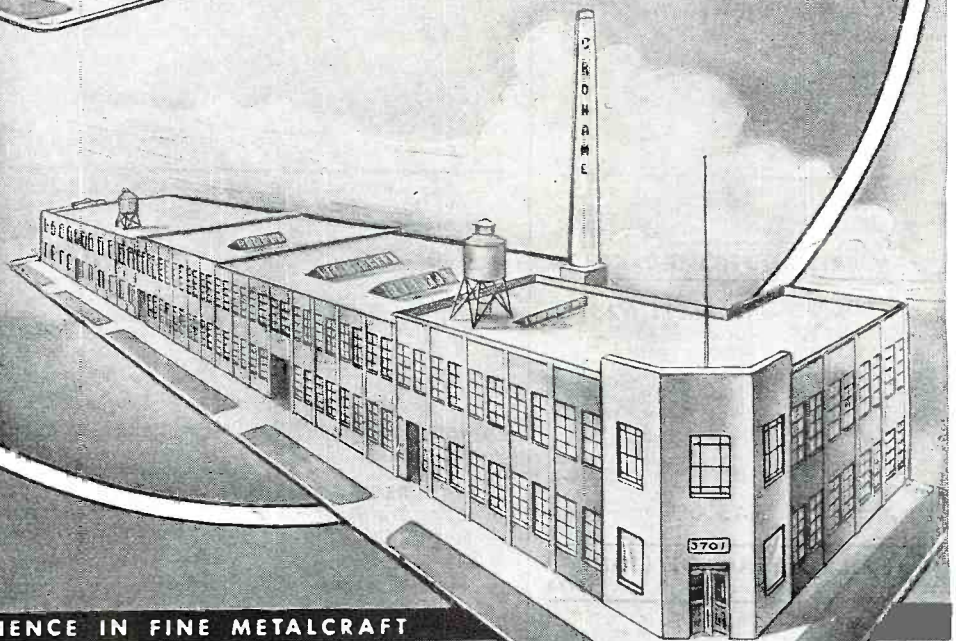

OVER 40 YEARS EXPERIENCE IN FINE METALCRAFT



**CRONAME**  
INCORPORATED

3701 RAVENSWOOD AVENUE  
CHICAGO 13, ILLINOIS

**Attention  
GI JOE!**

Here's Your Opportunity to be First to  
**Start Your Own  
RADIO SERVICE  
SHOP**

Complete Starting-in-Business  
Package Stocks of

**TEST EQUIPMENT  
TUBES, PARTS, TOOLS** **\$350 up**

Act quickly! Meet the pent up demand for radio service. Turn your special service training into a profitable business of your own. No fuss. No worry. Here's everything you need—\$350 up. Details upon request! Write, wire or phone

**RCP 448**

**"POCKET" VOM**

A.C.—D.C. Volts  
0-5-50-250-1000  
D.C. Mills  
0-5-10-100-1000  
Ohms  
0-2,000-20,000-200,000-  
2 Meg.  
Size 3" x 5 1/4" x 2 1/2"

**\$24.50 net**



**RECORD CHANGERS**

UTAH-DETROLA \* 550C ..... **\$18.27**  
WEBSTER-CHICAGO \* 56 ..... **27.20**

**HALLICRAFTERS SX-28A**

**\$223**

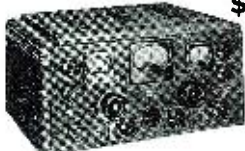

SUPER DEFIANT ..... SX25 **\$94.50**  
SKY CHAMPION ..... S20R **60.00**  
SKYRIDER MARINE ..... S22R **74.50**  
S40 NEW MODEL ..... Approximately **79.50**  
SKYRIDER JR. S41 ..... **33.50**

**HAMMARLUND HQ-129-X \$129**

**TRIPLETT 625-N**

20000 ohms per volt D.C.  
10000 ohms per volt A.C.  
5" Scale-TOPMOST QUALITY  
(12) D.C. Volt Ranges to 5000  
(6) A.C. Volt Ranges to 5000  
(3) OHM Ranges 0-400-50000-  
10 Meg.  
(5) D.C. Current Ranges 1 Ma.  
to 10 Amp.  
PLUS OUTPUT and DB.  
RANGES  
**\$45.00** with test leads.



**PHILCO BEAM OF LIGHT**

Selenium Cell only, no holder ..... **1.80**

20% deposit required on all C.O.D. orders. 2% transportation allowance on orders of \$25.00 or more accompanied by payment in full.

**RADIO SUPPLY &  
ENGINEERING CO., Inc.**  
129 SELDEN AVE. DETROIT 1, MICH.

Write for  
**FREE CATALOG**

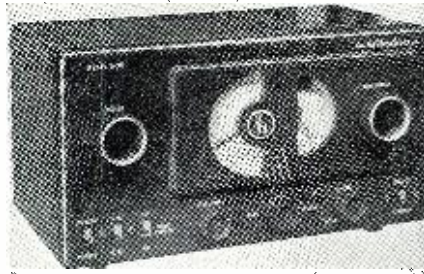

of code signals from both amateur and commercial stations.

The S-38 chassis is housed in a ventilated sheet metal cabinet which provides mechanical strength and minimizes electrical interference.

Additional information on the S-38 will be furnished by *Hallicrafters Company*, 2611 S. Indiana Avenue, Chicago 16, Illinois.

**PANADAPTOR**

A new system of reception has been announced by the *Panoramic Radio Corporation* of New York. Known as "panoramic reception" because it shows visually a wide panorama of frequencies simultaneously, the system is available for use by means of an instrument called the "Panadaptor." This instrument may be attached to any good communications receiver having an i.f. of 450-470 kc.

A band of frequencies 100 kc. on either side of the frequency to which the receiver is tuned is visible at all times. The bandwidth may be changed instantly by an adjusting knob on the panel, so the band covered is from 200 kc. to any width down to zero. In the latter case, the signal characteristics of the station to which the set is tuned may be studied in detail.

This instrument has many applica-

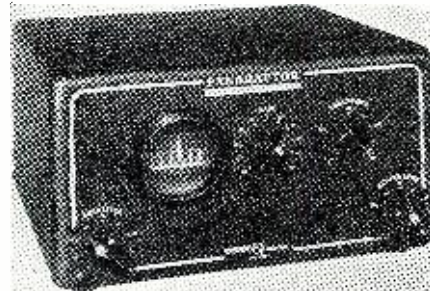

tions in the amateur and short-wave field and full details will be furnished by *Panoramic Radio Corporation*, 242 West 55th Street, New York 19, New York, upon request.

**DIRECT-COUPLED AMPLIFIER**

The *Amplifier Company of America* has announced their new Model ACA-100DC direct-coupled amplifier which is designed for all amplifier applications requiring a wide pass-band and low inherent amplitude and cross-modulation distortion.

This unit is particularly adapted for studio monitoring, record evaluation, microphone and speaker measurements as well as fidelity amplification of FM and AM radio programs and all types of recording.

The model utilizes a new signal self-

balancing and current drift-correcting direct-coupled output circuit. The response is 20 to 20,000 cycles at  $\pm 1$  db. It develops 23 watts with less than 1% total distortion. The over-all gain is 96 db. and the hum and noise level is -40 v. u. Two independent inputs of 500,000 ohms each are provided. Balanced output terminals are provided for 4/8/16 and 500 ohms. In-between terminals provide the addition output impedances of 1/2/5/10/12/83/100/125/150/166/175 ohms.

Full details of performance will be furnished upon application to *Amplifier Company of America*, 398 Broadway, New York 3, New York.

**WIDE-RANGE SIGNAL GENERATOR**

A new wide-range signal generator for AM and FM has been announced by *Simpson Electric Company*.

This instrument features, in addition to wide-range, closeness of con-



trol, constancy of output and completeness of attenuation. Known as the Model 415, the new signal generator is designed to be practically independent of line voltage fluctuation, with calibration stable regardless of wide variations in line voltage. Control of the r.f. output through its entire range eliminates the necessity for a separate connection for high output.

The model features modulation from 0 to 100% using either the 400 cycle internal sine wave or an external source, high fidelity modulation up to 100% from below 60 c.p.s. to over 10 kc. with no unwanted frequency modulation.

Additional information and prices on this unit will be furnished by *Simpson Electric Company*, 5200 West Kinzie Street, Chicago 44, Illinois.

**MIDGET CAPACITOR**

The *Hammarlund Mfg. Company, Inc.* has announced a new "RMC" midget capacitor which is particularly designed for use in applications where strength and solid construction are important. The frame consists of 3/32" aluminum end plates reinforced by three horizontal bars or pillars which hold the assembly rigid.

Two low loss silicone treated ceramic insulating bars are used to support the stator. Bearings are hand-fitted sleeve in the front and single ball thrust in the rear. Contact to the rotor is made through a silverplated beryllium forked spring bearing on a wide disc on the rotor shaft. Brackets are provided for mounting either side

*Adaptability*

**. . . JOHNSON  
COMPONENTS PICKED  
FOR USE IN AIRLINE  
TRANSMITTER !**

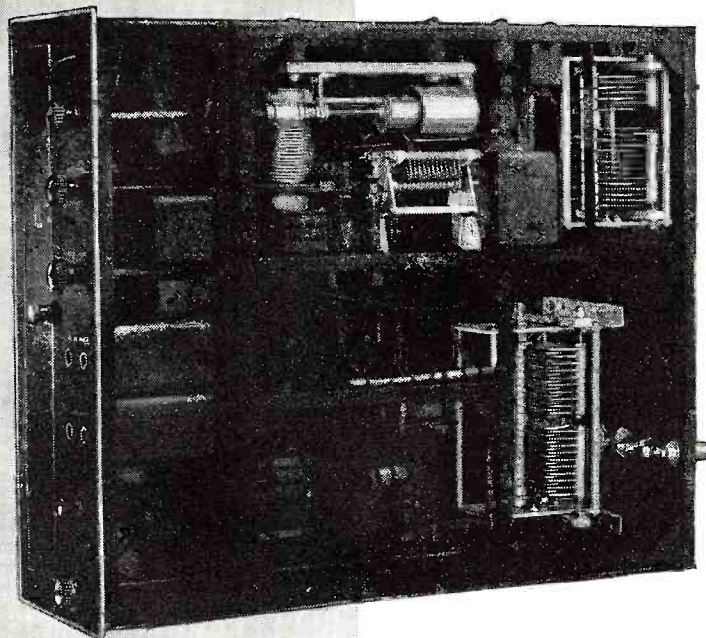

The new Wilcox 99A, medium power, transmitter designed primarily for airline fixed communication service, is provided with features including four removable radio frequency channels in the low, high and very high frequency ranges.

Shown above is one of the r.f. channels with Johnson components highlighted . . . Type D dual condensers in the antenna tuning and final amplifier stages, Type F condenser in the r.f. amplifier, Type N neutralizing condenser, "Hi-Q" plug in inductor, shaft coupling, cone insulators and thru-panel insulators with jack connections. Not visible in the photograph are Johnson 211 and 273 tube sockets, lead-in bushings and panel bearings.

The use of Johnson components in the Wilcox 99A is

further proof of the reliability of Johnson products. In a transmitter of this type, designed for flexible and trouble-free service, components must meet the highest standards of quality and adaptability.

The adaptability of Johnson products results in great savings to Johnson customers by minimizing the need for specially designed components. For example, the Type D dual condensers used in the assembly shown above are standard models reduced in overall size and supplied with special mounting brackets to meet chassis design. The standard Type D used in the final amplifier has been furnished with dual sections of different capacitances, thus eliminating the need for a special condenser.

Whether you are working on a "ham rig," electronic heating equipment, commercial transmitter or any other radio electronic device, you will be sure of top performance with components by Johnson. Send us your special problems and we will first try to adapt our standard products to meet your special requirements.

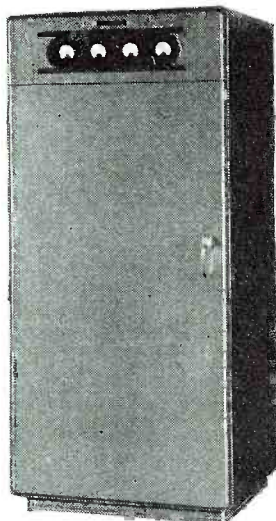

WILCOX 99A  
TRANSMITTER

**R. F. CAPACITORS AND INDUCTORS • TUBE SOCKETS • INSULATORS  
CONNECTORS • PILOT LIGHTS • HARDWARE ITEMS**

**WRITE FOR SPECIFIC INFORMATION  
OR GENERAL PRODUCTS CATALOG 968Z**



**E. F. JOHNSON COMPANY • WASECA • MINNESOTA**  
July, 1946

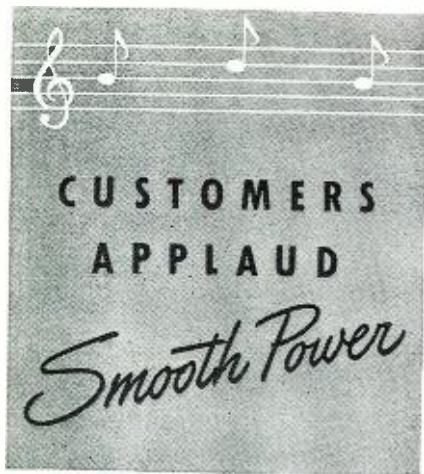

• Build your line of new phonographs and record-changers around *Smooth Power* motors and you'll get that quietness, uniform speed and smooth-as-velvet operation that your customers will approve.

That's because these qualities are engineered and built into every motor and assembly in the wide GI line. It's the result of many years of successful experience in the production of phono motors.

You'll win your markets faster and gain more applause from customers when you *standardize on Smooth Power motors.*

★ ★ ★

**NOTE TO INDIVIDUAL USERS:**  
Smooth Power motors are sold only through established trade channels.



DEPT. MR . ELYRIA, OHIO

down or to a front panel with spacing pillars, threaded mounting holes are provided for panel mounting.

Complete details on the "RMC" capacitor will be furnished upon request to *The Hammarlund Mfg. Company, Inc.*, 460 West 34th Street, New York 1, New York.

-30-

### Operation Crossroads

(Continued from page 30)

As most of you know, 133 ships of war, ranging from the 33,100 ton battleship *Pennsylvania* to a squadron of LSTs, will be used in this test of the effectiveness of seapower vs. airborne atom bombs. It is believed that many of the ships will come through the test unscathed, while others will be repairable.

Witnessing this test of atom power will be hundreds of trained observers, as well as thousands of electronic devices which will record results and weigh the effectiveness of the A-bomb. Movie cameras, television pick-up cameras and photographic equipment, housed in concrete towers on Bikini Atoll will make a permanent history of the event for future study and experimentation. Pilotless planes, equipped with ingenious recording devices, will fly through the area.

The target ships themselves will carry devices which will automatically transmit by FM, information to receivers on "mother" ships. The first test recordings will be made of the air pressure exerted on two target ships by the explosion of the atomic bomb detonated in the air. The second test will be made during the explosion of the second atomic bomb on the water's surface and will measure the pressure created at six positions around the target ships.

In addition to tests being made at the site of the explosion, recordings will be taken in the stratosphere at various points around the globe to determine what effect, if any, the A-bomb explosion has on the radio-activity of the stratosphere. After the explosion of the bomb, sound balloons carrying Geiger counters will be sent up at various points.

Present plans also call for the setting up of super-sensitive microbarographs at Guam, Midway, Wake and Honolulu to see whether the shock wave from the air burst of the bomb will register at points up to 2000 miles away.

The group of observers at the A-bomb test have been divided, the largest group will witness the explosion from two ships some distance from the site. The balance of the group will observe from a plane in flight during the explosion. Your editor will be one of the airborne observers and from this vantage point it is his hope to bring RADIO NEWS readers a complete and vivid report of the test.

He will have approximately two weeks from the time of his landing

## ALSAMS CASES

REGENCY STRIPED



Model P-512 Portable Phonograph Case



Model RC-250 Portable Automatic Phonograph Record-Changer Case



Table Model Radio Cabinets  
Model L-200  
Model L-300

The NEW Alsam Regency Striped Cases enhance the beauty of radios and phonographs. Write for illustrated literature featuring other models. Prices furnished on request.  
**ORDER FROM YOUR JOBBER!**  
Dept. A.

### ALSAM PRODUCTS COMPANY

805 MILWAUKEE AVENUE  
CHICAGO 22, ILL.

## SCOOP!!

**RADIO SERVICEMEN—HAMS**  
**IMMEDIATE DELIVERY**  
**MINIATURE EXTRA-SENSITIVE HEAD PHONES**

You can now get those miniature extra sensitive headphones at less than one-tenth their original cost to the government!

Features—Wide Frequency Response.

Can be connected to high or low impedance outputs.

Featherweight-Adjustable Headband. The extreme in wearing comfort.

Signal Corps Type HS-30 and matching transformer.

Complete—Net \$3.49

Webster Lightweight Crystal Pickup. Streamlined Bakelite Arm. **\$.275**

Astatic Crystal Pickup..... **3.23**

Precision Carbon Resistors—1 meg —2 meg designed for meter multipliers, special ..... **.12**

Resistor Assortment—RMA— $\frac{1}{2}$  watt insulated carbon—25 for... **.59**

Condenser assortment—mica—popular sizes and brands—12 for... **.59**

IR5-3Q4-1S5-1T4. Each..... **.85**

Resistors—insulated  $\frac{1}{2}$  watt—RMA—all sizes. Each..... **.04**

Send check or money order for postpaid shipment.

### Electronic Supply Corp.

40-14 Greenpoint Ave., Long Island City 4, N. Y.  
Stillwell 4-0231



*New! Exclusive! Ready Now!*

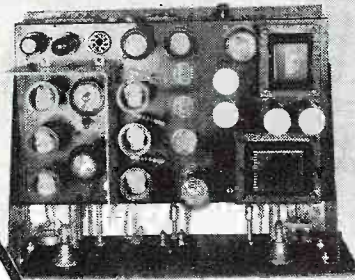
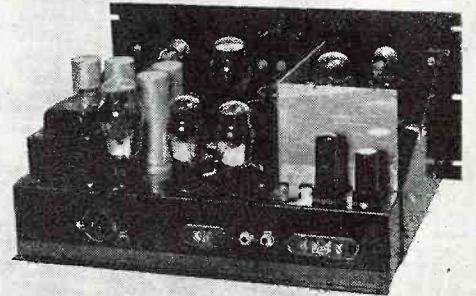

**WRL**  
**Globe Trotter**  
 40 WATTS INPUT  
**TRANSMITTER**  
**KIT**

*The Sensation  
 of the Year!*

Transmitter kits are almost impossible to get, but Leo, W9GFQ, now offers amateurs the new WRL Globe-Trotter, destined to become one of the most popular kits on the market. The WRL Globe-Trotter is capable of 40 watts input on C.W. and 25 watts input on phone on all bands from 1500 KC through 28 Megacycles. Incorporates the proven Tritet Oscillator using a 20 meter X—Tal and providing sufficient drive at 10 meters for the 807 final. Heising choke modulation is incorporated and gives excellent results and good tonal quality. Look this over! It has everything! Three bands are all pretuned and available at the turn of a switch, 10, 20, and 80 meters. Metering is provided for both oscillator and final stages. The transmitter uses two power supplies, one furnishing power to the 807 final and modulator tubes, and the other supplying the speech, amplifier and oscillator stage. Tube Line Up: RF—6L6 OSC, 807 final amplifier; Audio—6SJ7, 6N7, 2-6V6S—Rectifiers, 2-5U4G.

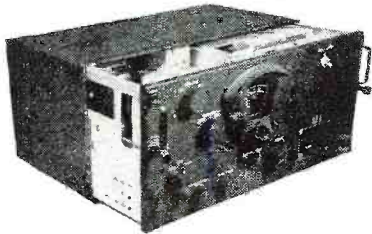

**NEW**  
**BC 348Q**  
**RECEIVERS**  
 Original government price over \$200.  
**\$85.00**  
 Including steel case, Speaker furnished at small added cost. Cat. No. 35-61.

Here is one of the hottest war-surplus receivers that will be available, 9 tubes, 2 tuned RF stages, 3 stages of IF amplification. Frequency range, 200 to 500 kilocycles; 1½ to 18 MC in four bands. Tunes weather and aircraft bands, and all ham bands except 10 meters. Ask about our special converter for 10 meter operation.

**BC-610 (Hallicrafters HT-4E) TRANSMITTERS**

Counterpart of the famous SCR-299. 825 watts input on CW, 540 watts input on phone; 3 sets of coils. Range of 1½ to 18 Meg. Completely reconditioned, Cat. No. R70-202, \$510.00—New Cat. No. 70-202, \$760.00. Reconditioned or new sets converted to 10 meters, \$25 extra.

Giant Radio Reference Map with time and amateur zones, standard and short wave stations, and other valuable information. Printed in colors. Size 3½x4½ feet. . . . . Only 15¢

Write for our latest flyer of radio parts. FREE

Complete kit including all parts, chassis, panel, streamlined cabinet less tubes, coils and meters. **\$59.95**

Cat. No. 70-300

Kit Same as above. Wired by our engineers  
 Cat. No. 70-312. . . . . **\$75.00**

**ACCESSORIES**

- Complete kit of 8 Tubes
- Cat. No. 70-314. . . . . \$5.95
- 3 in. Meter Cat. No. 70-318. . . . . 4.95
- Coils per set (any band)
- Cat. No. 70-316. . . . . 2.95
- Cry'sals-40-80 Meters Mts.
- Cat. No. 70-322. . . . . ea. 2.65
- Quality Crystal Mike and Stand
- Cat. No. 70-320. . . . . 9.45



Formerly Wholesale Radio Laboratories

Address Dept. RN-7, Council Bluffs, Iowa

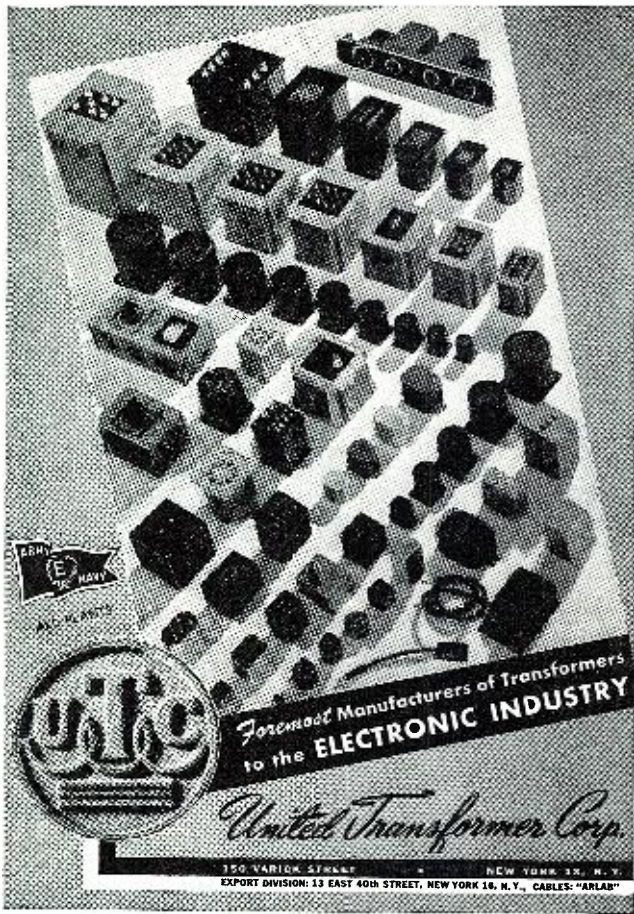

## BUY THE NIAGARA WAY!!

### SPEECH AMPLIFIER

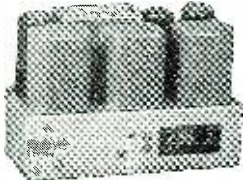

This is a complete speech amplifier minus tubes and power supply working from dynamic or carbon microphone to Class B grids. Noise level less than -55 db. Designed for use in Collins A R T X/13 Auto-tune transmitter. Uses 2 6V6G's and one 12SJ7..... **\$7.95**

### SWINGING CHOKE



Swings from 60 to 9 Henries. 50 to 400 mils. Built by Langevin. A marvelous choke for class B modulators — while they last..... **\$12.75**

### DYNAMOTOR

12 volts DC input—delivers 235 volts at 90 mils. Complete with filter — mounted in can. 6¼x5¼x3¼ with cover. **\$2.95**



### AMERTRAN TRANSTAT

Designed for adjusting filament voltages. 20 amp. up to 50 volts AC. Adjustment may be locked after setting. Terminates in an aircraft Amphenol plug mounted in a black crackle case with air louvres..... **\$3.95**

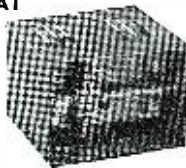

### ADDITIONAL ITEMS

Class B Modulation transformer used with the Collins auto-tuned transmitter. Modulates an 813 tube both plate and screen from 811 modulators. Good for as much as 150 watts of audio at ..... **\$4.95**

Western Electric class B driver transformer will match 6L6 tubes push-pull to grids of any class B tubes. Limited quantity..... **\$3.95**

General Electric 10 Henry, 250 mils, smoothing choke. These chokes made to very rigid Govt. specifications ..... **\$3.50**

Class B 599 watt Transformer made by N. Y. Transformer Co. Ratio 1.58:1 primary 7200 ohms, secondary 2650 ohms. For you KW boys. Come and get them for..... **\$23.75**

Signal Generator. Navy type OAN covers from 200 kc. to 2 mc., M.O.P.A. Will operate on batteries or 110 volts, 60 cycles. Comes complete with 15 feet Ant. RF can be taken from Probe or sectional ant. Special..... **\$42.50**

Cramer running time meter, 110 Volts, 60 cycles —reads to 9999.9 hrs..... **\$4.95**

Choke—150 MA—10 Henry—20 Ohms..... **\$1.49**  
807 Tubes, JAN. .... **\$1.49**

Filament transformer, 866's 2-2½ V. windings —open core—at 10 amps each. Wonderful buy ..... **\$1.35**

# NIAGARA RADIO SUPPLY 160 GREENWICH ST. NEW YORK 6, N. Y.

Send your QSL card for our latest Bulletin

in Kwajalein until the test, during which time he will have the opportunity to see in operation the various electronic instruments which will be used in the test. As far as military security will permit, he will bring our readers details of this equipment.

If present plans materialize, the second of the atomic bombs, the one to be exploded at the waterline, will be dropped in approximately three weeks after the first is detonated. In this case, it is probable that your editor will remain in the South Pacific to cover this event for you. The results of these tests will be reported for our readers as soon as possible after the event, by means of photographs and an eyewitness report.

-30-

## International Short-Wave (Continued from page 52)

courtesy of Cleve Maher, Gladestville, N.S.W., Australia.)

\* \* \*

### Broadcasts from Prague

A letter from The Czechoslovak Broadcasting Corporation, "Ceskoslovensky Rozhlas," Prague, gives this information with regards the Czech Radio:

"Owing to conditions that prevailed in our country during the German occupation, we have so far only one short-wave station in operation. Our regular short-wave transmissions in the 49.92-meter band (6.010) are as follows:

"For Lusatian Serbs, 12:45-1 p.m.; for U.S.S.R., 1-1:30 p.m.; for Yugoslavia, 1:20-2 p.m.; for Poland, 2-2:30 p.m.; for Bulgaria, 2:30-3 p.m.; in English, 3-3:30 p.m.; in Spanish, 3:30-4 p.m.; in French, 4-4:30 p.m.; and in Esperanto, 4:30-4:45 p.m.

"News in Czech is being transmitted in the 25.34-meter band (11.840) at 1-1:20 a.m. on weekdays and at 4-4:15 a.m. on Sundays.

"Our call letters are OLR3A; the address is Praha XII, Stalinova Trida 12. Our news is broadcast in the above-mentioned transmissions.

"So far our verification cards have not yet been reprinted, but as soon as we will have them, we will not fail to send them to listeners who are good enough to let us have reception reports."

(NOTE: Although not listed by the Czechoslovak Broadcasting Corporation, a transmission on 11.840 is reported by East Coast listeners as heard 7-7:30 p.m., directed to North America, including English news at approximately 7:08 p.m., and music.)

\* \* \*

### The "Voice of the Great North West"

VE9AI, relays CJCA, "Voice of the Great North West," 4th Floor, Birks Building, Edmonton, Alberta, Canada, and lists itself as "Foothills Network" and basic station of the Canadian Broadcasting Corporation. CJCA operates on 930 kcs.; VE9AI presently

# Insert Trouble-



**Just like plastics used to have!**

**Plastics buyers** used to find some metal inserts a lot like a loose tooth—necessary in function, but unstable, liable to wander, and very apt to produce sharp pains (in the pocketbook). Incidentally, so did we custom molders.

But now Heatronic molding (using radiofrequency pre-heating) has changed all that, and very defi-

nately for the better. Heatronics gives much greater plasticity to the material in the mold and at the same time reduces the amount of pressure required. This easier flow, on the identical jobs in which inserts used to shear or float at times, today cuts rejects down to the vanishing point.

You'll find plenty of other reasons, too, why Heatronics is considered

the greatest forward stride made by plastics in many years. Come to Kurz-Kasch for practical information—on them and their application to your molding problems. Why? Because Kurz-Kasch *pioneered* Heatronics for plastics—because we have one of the *finest installations* in the industry—and because we know Heatronics *right now* just as thoroughly as we know custom molding.

## Kurz-Kasch

*For Over 29 Years*

*Planners and Molders in Plastics*

Kurz-Kasch, Inc., 1429 S. Broadway, Dayton 1, Ohio. Export Offices: 89 Broad Street, New York, New York.  
Branch Sales Offices: New York • Chicago • Detroit • Los Angeles • Dallas • St. Louis • Toronto, Canada.

# For IMMEDIATE DELIVERY

14 Watt Heavy Duty Sound System, 1—18 Watt Amplifier, 2—12" PM Speakers 21 oz., 1 Dual Speaker Case, 2—25 Ft. Speaker Cable, 1 Desk Mike, 1 Mike, 1 Phono Input, 2 Gain and 1 Tone Control, Tubes 1—7C7, 1—7F7, 2—7C5, 1—5Y4, special. . . . . **\$84.95**

25 Watt Heavy Duty Sound System, 1—25 Watt Amplifier, 2—12" PM Speakers (21 oz.), 1 Dual Speaker Case, 2—25 ft. Speaker Cable, 1 Desk Mike, 1 Mike and 1 Phonograph Input, 2 Gain Controls and 1 Tone Control, Fused, Tubes 1—6SJ7, 1—6Y7, 2—6L6, 1—5Y3, special. . . . . **\$99.50**

3-Tube AC-DC Phono Amp., uses PM Speaker, less tubes, output and AC Cord with Volume and Tone Control, uses 12SQ7, 50L6, 35Z5 tubes, **\$4.25 ea.** In lots of 10. . . . . **4.00 ea.** In lots of 25. . . . . **3.75 ea.**

1 Tube, AC-DC Phono Amp., with 117L7 Tube, less Volume Control, Output and AC Cord. . . . . **\$4.95**

Phono Kit, Open Base, 12 x 12 x 6" Cutout for 5" Speaker, Phono Motor Pickup, special. . . . . **\$11.95**

Portable Kit, Case, Phono Motor Pickup, Cutout for 6" Speaker. Cases have slight defects in covering, special **\$15.95**

3 1/2" Square Meter, Scale 0-10. Shunt for 0-1 Volt in Meter, extra spec. **\$1.98**

0-1-DC Mill Meter, 3" Panel Mounting, NEW, not War Material, special **\$5.95**

Meter Scales for Meters, Weston 301, Triplett 321. Also Model 88, reads Ohms, Volts 0-50, 0-250, 0-1000, **14c ea.** In lots of 100. . . . . **9c ea.**

Special, Musical Amplifiers, 18-Watt size in portable case, 12" Speaker, Case size 18 3/4" high, 15 1/4" wide, 8 1/4" deep, uses tubes, 1—6SN7, 1—6Y7, 2—6V6, 1—5U4G. Has 3 input stages for guitars, gain control and tone control, only 30—while they last, each. . . . . **\$44.95**

**Extra Special**, Astatic Desk Mike and Stand, brand new original carton, each. . . . . **\$4.95**

Special, 5-Tube Chassis Pan, size 8 x 3 1/2 x 1 1/2, new clean chassis dipped for 5" speaker, only 1000 of these in stock, each. . . . . **28c**

Special New V.M Changer, mixes 10" and 12" records, each. . . . . **\$20.95**

18-Watt Amp. PP 6V6 Output, tube lineup 1—6SJ7, 2—6Y7G, 2—6V6, 1—80, 1 mike and 1 phono input with standard 8-ohm voice coil, black base, slanting front, size 14" long, 10" deep 3" high with blue lid, cover 5" high, each as is. . . . . **\$22.95**

*AV items subject to prior sale. 20% deposit with order*

Write Dept. RC-1a

## R. C. RADIO PARTS & DISTRIBUTING CO.

Makers of Radio and Portable Phonograph Cabinets

1827 Grand Avenue, Kansas City 8, Mo. Phone, Victor 1726

Factory and Plant at 731-33 Central Ave. Kansas City 6 Kansas Phone. Drexel 751j

operates on 9.540, but, as in the past, may operate part-time on 6.005 with the coming of winter, station officials report.

"We are on the air at 6:15 a.m. (8:15 a.m. EST) in the morning, and continue broadcasting until 12 midnight (2 a.m. EST). This applies Monday through Friday. On Saturdays, we usually stay on the air until 1:30 a.m. (3:30 a.m. EST) with our 'Hello, the North' broadcast. We do not sign on until 8 a.m. (10 a.m. EST) Sundays, and sign-off at 12 midnight (2 a.m. EST). 'Hello, the North' broadcast from 12 midnight Saturday until 1:30 a.m. Sunday (2-2:30 a.m. Sunday EST), is a special CJCA feature for listeners in the Northwest Territories, Yukon, and Alaska. All our broadcasts are in English. News-casts are at 6:15 a.m., 7 a.m., 8 a.m., 12:30 p.m., 3:30 p.m., 5:25 p.m., 7 p.m., 10 p.m., 11 p.m., and sign-off news at 12 midnight (8:15 a.m., 9 a.m., 10 a.m., 2:30 p.m., 5:30 p.m., 7:25 p.m., 9 p.m., 12 midnight, 1 a.m., and 2 a.m. EST).

"We send verifications in the form of a letter. International Reply Coupons are appreciated, but are not necessary."

\* \* \*

### Radio Fade-Outs

During the first fortnight of February, 1946, listeners to long-distance short-wave broadcasts must have noticed that their radio reception was, on occasions, wholly or partially interrupted, a phenomenon which, in technical language, is known as radio fade-out.

What was this fade-out due to? If listeners had gotten hold of a smoked glass screen and looked through it at the sun during this period, they would have noticed another equally remarkable phenomenon—a group of dark spots on the sun's disc. These spots were, then, associated with the frequent interruptions in your radio reception.

Scientific research has established that these radio fade-outs are brought about in two different ways by violent upheavals on the sun, which are usually manifested by the appearance of dark spots and bright "flares" on the sun's disc. During these eruptions, the sun, it is believed, pours out enormous quantities of energy in the form of ultra-violet radiations, which travel with the speed of light, i.e., 186,000 miles per second. These radiations, because of their great speed, reach the outer atmosphere of the earth within a few seconds and produce an unusually high "ionization" or electrification of the atmosphere, at a level of about 40 miles above the surface of the earth. This extra ionization at this low level causes complete or partial absorption of radio waves, thus bringing about a radio fade-out.

These fade-outs are known as Dellinger Fades, after the radio engineer who first proved that they were caused by the sun. Their onset is very sudden, almost simultaneous with the

occurrence of disturbances on the sun, but they affect only those radio circuits which pass through the sunlit hemisphere.

During a fade-out of this kind high frequencies are affected less than lower frequencies used for short-wave transmission and when the fade-out starts clearing, high frequency stations start coming in earlier than those operating on lower frequencies. The duration of a fade-out ranges from a few minutes to an hour, sometimes more, and its effects are more pronounced in that region of the earth where the sun's radiation is perpendicular, i.e., greater at noon than at other times of the day and greater in equatorial than in higher latitudes.

Simultaneously with the ultra-violet radiations, the sun, during periods of disturbances, is also believed to give out certain kinds of charged and uncharged high speed particles which travel at about 1000 miles per second. These approach the earth's outer atmospheric layer in about 20 to 30 hours and are then diverted by the earth's magnetic field to the polar regions. There, colliding with particles of atmospheric gases, they produce that wonder of variegated lights called the Polar Aurorae.

The exact manner in which these particles from the sun affect radio reception is not fully understood. They do, however, cause a radio fade-out which is different from the Dellinger type—inasmuch as it may affect the entire earth. These fade-outs are described as being due to ionosphere storms and occur considerably after a solar disturbance. The storms affect the higher frequency stations more than those operating on lower frequencies. They often last for several days and their effects are more pronounced in high latitudes.

Both the Dellinger and the ionosphere storm type of radio fade-out give rise to unusual fluctuations in the normal magnetic field of the earth. Such abnormal variations in the earth's magnetic fields are called magnetic storms. Magnetic storms associated with the two different types of fade-outs also partake of their peculiar characteristics. It is seen that magnetic storms produced by Dellinger fade-outs occur only in the sunlit hemisphere. The onset of the magnetic disturbance is very sudden and is more pronounced in lower latitudes than higher latitudes. Likewise, magnetic storms associated with ionosphere storms are world-wide in their occurrence and are more severe in higher latitudes than in lower latitudes.

From what has been said above it would be natural to expect that all these phenomena would tend to follow the sun's activity. It has, for instance, been ascertained that some of them have a tendency to recur after 27 days, which is the period of rotation of the sun on its axis. They are also known to be more frequent and prominent during periods of high sun-spot activ-

*A Triumph in*  
**COMMUNICATIONS ENGINEERING**



*The New Improved*  
**KP - 81**  
*Receiver*

**D**ESIGNED by Karl E. Pierson, creator of the famous PR series of receivers, the new KP-81 is now in production. We promise you this receiver will establish new standards of excellence in the field of radio communications. KP-81 incorporates many of the advanced features born of wartime research, and is years ahead in design, engineering and performance.

*We are making every effort to meet the heavy demand for the new KP-81 receivers. However Pierson Electronic Corporation will adhere to their policy of precision construction, and suggest that you place your order well in advance.*



New Automatic Noise Silencer  
Two Pre-Selector Stages  
Turret Band Change  
Four Gang Tuning and Band Spread Condensers  
Series Parallel Crystal Filter  
Calibrated Band Spread  
Built-In Crystal Calibrator  
Single Signal At All Times  
Variable Hi and Lo Pass Audio Filters  
550 Kilocycles to 40 Megacycles

**PIERSON ELECTRONIC CORP.**

533 EAST FIFTH STREET • LOS ANGELES 13, CALIF.

*Manufacturers of Communication and Commercial Radio Equipment*

# DID YOU GET YOUR FREE BARGAIN GUIDE?



**RADIO BARGAINS BY THE HUNDREDS  
PACKED INTO THIS LATEST RWT FLYER!**

Who but the largest name in Radio Values would bring you bargains like these NOW! For twenty-five years we've been scouring the markets for you engineers, servicers, hams and experimenters. Send for this bargain flyer and see the values RWT has for you in nationally known merchandise. Clip convenient coupon NOW!

## SPECIAL!!!

Another RWT achievement! Use this versatile xmitter tube as a modulator-oscillator-amplifier! Filament voltage: 5 or 10 volts. Plate: 3,000 volts. Plate current: 900 ma. Plate dissipation: 300 watts. Limited quantity only.

**304TH**  
Xmitter tube now  
being sold at  
\$50 elsewhere

RWT's price  
to you, only... **\$9.95**

**USE  
COUPON  
TO  
ORDER!  
MAIL  
TODAY!**

**Radio Wire  
Television Inc.**

• NEW YORK 13 • BOSTON 10 • NEWARK 2

Originators and  
Marketers of  
the Famous

**Lafayette Radio**

RWT Dept. RG6

100 Avenue of the Americas, New York 13.  
Gentlemen: Enter my order for  xmitter  
tube(s).

Check enclosed.  M. O.  Send C.O.D.  
 Send me FREE copy of your latest BARGAIN  
GUIDE C37 and place my name on list for your  
NEW SUPER CATALOG.

NAME.....

ADDRESS.....

CITY.....ZONE.....STATE.....

Paste on Penny Postcard.

ity and thus follow the 11-year sun-spot cycle.

(This information was contributed by a member of the Research Department, All India Radio, New Delhi, India, "The Indian Listener.")

\* \* \*

### Broadcast Schedules

Albania—Swedish monitors report ZAA, 7.850, Radio Tirana, now opens at 1:30 p.m., new sign-off is reported at 4:15 p.m.

Algeria—"The Voice of America in North Africa" has revised its schedules to 11.880 at 6-8:30 a.m.; 11.765 at 6 a.m.-2:15 p.m.; 9.610 at 2:30-5:15 p.m.; and 9.540 at 12:15-5:15 p.m. Both 6-megacycle frequencies have been dropped for the summer.

Anglo-Egyptian Sudan—Latest reports on Omdurman Radio, 13.320, come from Australia where this station is heard best around 12 noon with wailing-type music typical of the Near East. On Thursdays only, this station carries an English program at 12:30 p.m. Khartoum, 9.220, also operated by the Sudan Broadcasting Service, may be in parallel at times.

Argentina—A new relay of Radio El Mundo is heard on 5.900 nightly with poor to fair signals. No call letters have been reported as yet. Rosario's LRR has moved from 11.880 to a new frequency of 6.142 where it is heard with much less strength and with interference from HJDE, 6.145. The Argentine government has banned relay of Radio Belgrano by CXAS/CXA14. LRY, 9.455, carries Radio Belgrano programs, 6 a.m.-6 p.m., when it is replaced by LRY1, 6.087.

Australia—The First Daily Transmission from Radio Australia, beamed to the Eastern U.S. and Canada, is now heard from 7-8:15 a.m. sign-off with news at 7:01 and 8:01 a.m. The VLC5, 9.54, Shepparton, transmitter is still being used, and sends the best signal from Australia to Eastern North America. For the summer, Radio Australia's evening transmission to Eastern North America is being heard over VLC9, 17.84, 6:40-8:45 p.m., with news at 6:45 and 8:30 p.m. This is the longest single broadcast period yet effected by Radio Australia to North America. VLA6, 15.200, has replaced VLA, 7.280, in the Asiatic beam, 7:45-9:45 a.m.; English news is now heard, 8:30-8:45 a.m. The transmission to Britain over VLA3, VLC8, and VLG is now extended, 10-10:58 a.m. In the midnight and 1 a.m. transmissions to Western North America and Tahiti, respectively, VLC4 now uses 15.320, but still uses listed 15.315 on all other transmissions. VLC4, 15.315, heard at 10:20 p.m. (for Australian Forces), has requested reports of reception. VLC2, 9.68, is being heard in Britain now, 2-3 a.m., replacing VLC8, 7.28; change in time is due to Summer Time change in Britain; news is heard at 2:30 a.m. VLA6, 15.200, is being heard on West Coast with good signal at 6:10 a.m. in a news period; sign-off is at 7 a.m.

Austria—The short-wave station

## TOWARD NEW HORIZONS

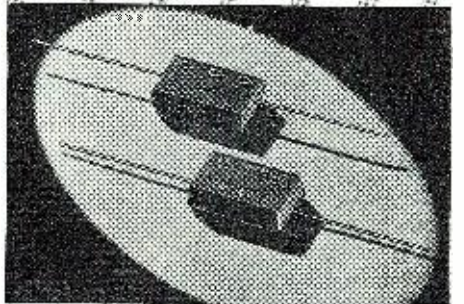

Tested and proved in every important theatre of war, El-Menco Capacitors are now serving with equal merit in the products of peace. Insure the correctness of this important part of your product by specifying El-Menco Capacitors.

Write on your firm letterhead for our catalog. Foreign Radio and Electronic Manufacturers communicate direct with our expert department, at Willimantic, Connecticut for information.



**THE ELECTRO  
MOTIVE Mfg. Co., Inc.**  
Willimantic, Connecticut

*Announcing*  
**NEW PUBLICATION  
DATE FOR**

**RADIO  
NEWS**

Beginning with the August issue of RADIO NEWS, the sales date will be the 30th of each month preceding month of publication, instead of the 25th. There is a shortage of copies each month; we suggest, therefore, that you reserve your copy at your newsdealer, or subscribe today.

**RADIO NEWS**  
A ZIFF-DAVIS PUBLICATION

185 NORTH WABASH AVENUE  
CHICAGO 1, ILLINOIS



# WE SPECIALIZE IN "Specials"

**FOR NEARLY 20 YEARS**, the Kenyon Transformer Company has done an outstanding job of satisfying the demand of large manufacturers for "special units" to fit exactly their most critical needs, with the same care that other manufacturers could provide items of their standard catalog lines.

**THIS ACHIEVEMENT** is a tribute to the skillful engineering ability of the Kenyon Pioneers who have maintained a leading place in the development of outstanding transformer equipment.

**WE INVITE INQUIRIES** from manufacturers of electronic and other types of equipment, and from industrial and commercial users of transformers.

**KENYON PREDICTS** that the small additional cost of "specials" will be more than offset by the superior product—streamlined to fit each manufacturer's requirement.

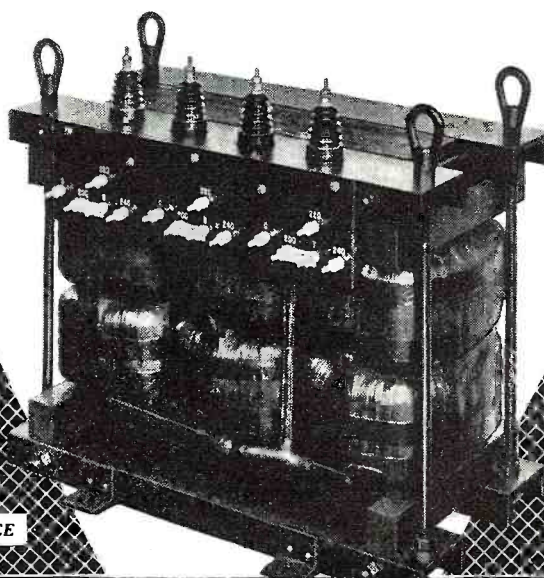

THE MARK OF

EXCELLENCE

**KENYON TRANSFORMER CO., Inc.** 840 BARRY STREET  
NEW YORK, U. S. A.

*Better*  
**ATLAS SOUND**  
**Equipment**  
*Ready for YOU*

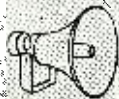

**DOUBLE REENTRANT PROJECTOR**

Many sizes. From 15 in. air column to 6 foot air column.

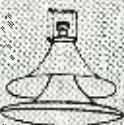

**360 RADIAL, CHANDELIER PROJECTORS**

Double Reentrant. For driver units. 3 and 4 foot air column lengths.

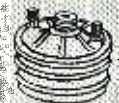

**DRIVER UNITS**

Various Power Handling Capacities. Newest types of Indestructible Phenolic Diaphragms.

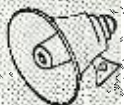

**MINIATURE TYPE RE-ENTRANT PROJECTORS — BOOSTER SPEAKERS**

High-efficiency. Weather-proof. Complete with Driver Unit and Universal Bracket.

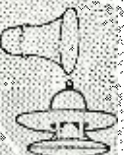

**CONE TYPE PARABOLICS and CHANDELIER BAFFLES** for all size cone speakers. Wooden and Metal Cone Speaker Enclosures, Baffles, Carrying Cases, Loud speaker Support Stands and Brackets.

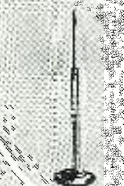

**MICROPHONE SUPPORT STANDS**

20 types and sizes. All Fittings, Adaptors and Accessories. Floor Stands, Desk Stands, Banquet Stands, Boom Stands.

Write for New Illustrated Catalog Sheets.

**ATLAS SOUND CORPORATION**

1447 39th St., Brooklyn 18, N. Y.

first reported as "Dornbirn" has been identified as being in the French occupation zone of Germany rather than of Austria, and in the city of Baden-Baden, not Dornbirn. (See Germany.) Radio Vienna is reported heard on 9.875, 7-8:30 p.m., paralleling 12.210. KOFA, 7.215, AFRS, Salzburg, is reported with good signal around 3:45 p.m.

Bahamas—ZNS2 will most likely return soon to 6.090 after ZNS has completed tests for its frequency change; ZNS has been testing on 1540 kcs. in parallel with the regular medium-wave outlet on 640 kcs. to 10 p.m., this probably being the reason the short-wave transmitter (ZNS2) has "temporarily" disappeared.

Belgian Congo—OTC2, 9.738, now relays the BBC to North America, 8:15-9 p.m. and 9:15-9:45 p.m., not to 11 p.m. as the BBC says. News is heard on this frequency at 7:15 p.m. and at about 8:10 p.m., just prior to going over to BBC; the BBC news is relayed at 9:30 p.m. The experimental Leopoldville relay on 9.352 has been discontinued.

Belgium—Brussels has changed the frequency of its 2-4:30 p.m. broadcast to Leopoldville from 9.667 to 9.480 and of its 4:45-5:30 p.m. test on 7.300 to 11.850, both new channels being heard poorly and with severe interference. An additional transmission, also beamed to Leopoldville, is now heard, 2-3 a.m.

Bolivia—A Bolivian station on 6.026 (measured) is heard nightly with poor signal strength, 8:30-11 p.m. sign-off; call letters are given as CP37, and the station identifies as Radio Oruro at Oruro.

British Somaliland—Radio Somali, 7.126, Hargeisa, is scheduled currently, 8:30-10 a.m., peaks last 15 minutes on West Coast. Australians report that some days a BBC feature is relayed just prior to closing.

Bulgaria—The correct frequency of Sofia's short-wave outlet is now reported as 9.355, heard only 2:30-3:40 p.m., with English news at 3:30 p.m. Canadians, however, report Sofia at 11:30 p.m. with a fine signal.

Burma—Rangoon has interchanged its Sunday and Monday schedules so all transmissions are now given on Sunday, while only one transmission—8:30-10 a.m. on 11.840—is broadcast on Monday. Listeners in the East report Radio Rangoon, 6.035, around 6-7 a.m., in native languages.

Canada—The new Montreal, Quebec, outlet, CBFZ, 15.19, signs off at 10 p.m. CKRX, 11.720, Winnipeg, Manitoba, is being widely heard in the East afternoons and evenings. The European Transmission of the International Service, CBC, is now scheduled on CKNC, 17.82, and CKLX, 15.09, Monday through Saturday, 6-8 a.m. and 11 a.m.-5:03 p.m., and Sundays only, 6 a.m.-5:03 p.m. English news is heard at 6:45 a.m., 11:15 a.m. (except Sunday), and at 4:15 p.m. French news is scheduled for 11:45 a.m. (except Sunday when L'Actualité Région-

**THIS MONTH'S SPECIALS!**

**YOUR NET**

Two post V.M. record changer. It provides manual or automatic playing of ten standard 12" or twelve 12" discs with a minimum of waiting time between records . . . . .	\$18.95
Phonograph motor for 110 volt A.C. 60 cycles and pickup that lists at \$10.00. Both for Triumph Model 333 Multirange volt ohmmeter. Instrument incorporates every desirable feature to provide a practical all purpose electrical measuring device . . . . .	28.95
Headphones, Signal Corps, 8000 ohm and 200 ohms . . . . .	2.95
Telegraph keys with cutout switch . . . . .	.95
2500 mfd. 3 volt F.P. condensers . . . . .	.49
Universal 6 volt 4 prong vibrator. List \$3.95 . . . . .	1.69
100 ass't. 1 and 1/2 watt resistors up to 10% tolerance . . . . .	2.45
Kit of 10 assorted toggle switches . . . . .	1.89
Kit of 20, 5, 10 and 25 watt vitreous enameled resistors . . . . .	1.89
Kit of ten bathtub condensers up to 1 mfd. 400 V. . . . .	1.95
Ten assorted volume controls less switch ranging from sizes 20M ohms to 500M ohms all with long shafts, 1" to 3" . . . . .	3.35
8" PM speakers . . . . .	3.59
5Y3G tubes . . . . .	.39
5Y3GT tubes . . . . .	.39
6J5 tubes . . . . .	.48
6L6 tubes . . . . .	.98
46 tubes (substitute for 47) . . . . .	.49
12A6GT tubes (replaces 50L6) . . . . .	.89
10-12 tube power transformer, 6.3 V. winding 100 Ma. . . . .	3.69

Plus shipping charges  
 Dept. C  
**ARROW RADIO CO.**  
 2205 W. Division Street  
 Chicago 22, Ill.

**CAPACITORS — OIL, PAPER and ELECTROLYTIC**

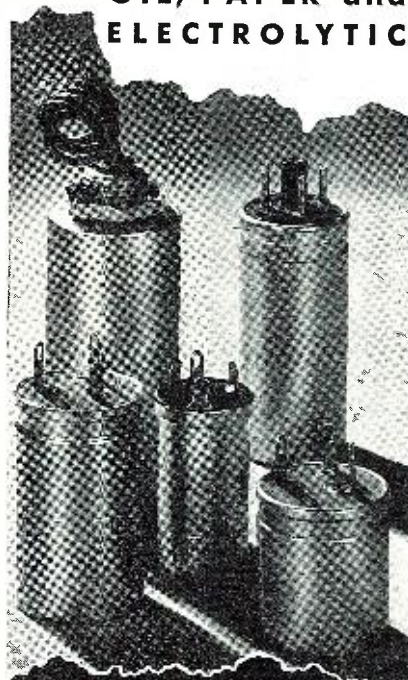

**Illinois CONDENSER COMPANY**

1616 N. THROOP ST.  
 CHICAGO 22, ILL.

RADIO NEWS



*Highest Quality*

# RADIO and ELECTRONIC Testing Equipment

**IMMEDIATE DELIVERY FROM STOCK GUARANTEED!**



The New Model 680  
**5000 OHMS per VOLT  
VOLT-OHM  
MILLIAMMETER**

Net Price **\$2765**

A single scale is used for all voltage (both A.C. and D.C.) and current ranges. Thus all readings are plain and obvious. Radio servicemen will be delighted with this time-saving innovation. Measures: **D.C. VOLTAGES** to 1500 volts; **A.C. VOLTAGES** to 1500 volts; **RESISTANCE** to 2 megohms; **OUTPUT VOLTS** to 1500 volts; **D.C. CURRENT** to 150 MA; **DECIBELS** to +58 D.C. Housed in hand-rubbed oak, portable cabinet. Complete with self-contained battery, test leads and instructions.

The New REINER Model 333

**MASTER TESTER**

Net Price **\$2750**



Lifetime guaranteed meter is at the optimum angle for easy reading and visual accuracy. Meter is hermetically sealed—positively dustproof and moisture-proof. Includes 2 meter fuses.  
**6 D.C. VOLTAGE MULTIPLIERS 1% ACCURACY:** 0-5-10-25-100-250-300 volts.  
**6 D.C. CURRENT SHUNTS:** 0-5-10-25-100-250-500 milliamps. Basic ranges of 0-120 millivolts and 0-1 milliampere.

The New REINER Model 334 MASTER TESTER

Identical to 333 but has in addition **SIX AC Voltage** ranges. Each AC and DC range is at a sensitivity of 1000 ohms per volt. AC measurements free from temperature and frequency errors throughout a range of 25 cycles to 1 megacycle. New Germanium rectifier used. Basic motor sensitivity 400 micro-amperes full scale.

Net Price **\$3250**

## NEW McMURDO SILVER TESTING EQUIPMENT



McMurdo Silver Model 905  
**"SPARX"  
Dynamic  
Signal Tracer**  
Net Price **\$39.90**

Frequency range from 20 cycles to over 200 megacycles. Contains isolating capacitor, resistor and one of the new radar u.h.f. crystal diodes. Loads a circuit being tested with only 3 mmd. and higher than .5 megohm.

McMurdo Silver Model 904  
**CAPACITANCE  
RESISTANCE  
BRIDGE**

Net Price **\$49.90**

1/4 mmd/ohm thru 1,000 mfd./megohms; 0-50% power factor; 0-500 volt adjustable internal polarizing voltage; 0-10 and 0-100 ma. electron-ray leakage current meter; measures resistance, capacitance under actual operating voltages!



McMurdo Silver Model  
**"VOMAX"  
Vacuum Tube  
Voltmeter**

Net Price **\$59.85**

D.C. Volts at 51 and 126 megohms. A.C. and r.f. volts at 6.6 megohms. Resistance 2 ohms to 2,000 megohms. D.C. current 1.2 ma. through 12 amperes. B.D.-10 through +50. Plus visual dynamic signal tracing.

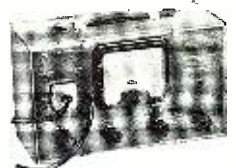

The New SUPERIOR Model 400  
**ELECTRONIC MULTI-METER**

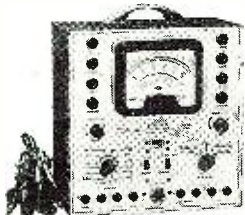

Net Price **\$5250**

DC V.T.V.M. Volts: 0 to 3/15/30/75/150/300/750/1500/3000 volts.  
DC Volts: (at 1000 ohms per volt) 0 to 3/15/30/75/150/300/750/1500/3000 volts.  
AC Volts: (at 1000 ohms per volt) 0 to 3/15/30/75/150/300/750/1500/3000 volts.  
DC Current: 0 to 3/15/30/75/150/300/750 Ma. 0 to 3/15 amps.  
Resistance: 0 to 1,000/10,000/100,000 ohms. 0 to 1/10/1,000 megs.  
Capacity: 0.001-2, .05-20, .5-200 mfd.  
Reactance: 10 to 5M ohms, 100-50M ohms, .01-5 megs.  
Inductance: .035-14, .35-140, 35-14,000 henries.  
Decibels: -10 to +18, +10 to +38, +30 to +58.

The New SUPERIOR Model CA-11  
**SIGNAL TRACER**



Net Price **\$1875**

- Signal intensity readings indicated directly on meter.
- Only one connecting cable—No tuning controls.
- Highly sensitive—uses an improved vacuum tube voltmeter circuit.
- Tube and resistor-capacity network are built into the Detector Probe.
- Weighs 5 lbs. Measures 3"x5"x7".
- Provision is made for insertion of phones.

The New Model 802N Combination  
**TUBE &  
SET TESTER**

Net Price **\$5831**

D.C. Voltmeter: 0/10/50/500/1000 at 1000 ohms per volt.  
Four Range A.C. Voltmeter: 0/10/50/500/1000.  
D.C. Milliammeter: 0/1/10/1000.  
DC Ammeter 0/10.  
DB Meter: 8/15/15 to 29/29 to 49/32 to 55 decibels.  
Four Range Output Meter—same as AC Volts.



The New Model 705  
**Signal Generator**

Net Price **\$4851**



RANGES:

From 95 kc to 100 mc, continuously variable. Calibration accurate to 2% through broadcast bands, within 3% for high frequency bands. Planetary drive condenser, direct reading calibration, output modulated or unmodulated. Self-contained electronic modulation 400 sine wave available for external use. Special feature provided in having two degrees of modulation at both approx. 30% and 80%.

R.C.P. Model 448 Pocket Multitester.....	\$ 24.01
R.C.P. Model 424A Volt-Ohm-Milliammeter.....	28.91
R.C.P. Model 461A Sensitive Multitester.....	45.00
R.C.P. Model 664 Electronic Voltmeter.....	70.71
R.C.P. Model 488A Ultra-Sensitive Multitester.....	87.71
R.C.P. Model 805 Tube and Set Tester.....	92.61
R.C.P. Model 665A V.T. Volt Ohm Megger Insulation Testers.....	95.00
Reiner Model 530 Squarewave Generator.....	135.00
Reiner Model 450 Vacuum Tube Volt-Ohm-Milliammeter.....	24.75
Superior Model 1553 Volt Ohm Milliammeter.....	28.40
Superior Model PB-100 Volt Ohm Milliammeter.....	39.50
Superior Model 450 Tube Tester.....	48.75
Superior Model 650 Signal Generator.....	

Superior Model 720 Multi-Range Ammeter.....	\$ 49.50
Superior Model 600 Combination Tube & Set Tester.....	62.50
SHALLCROSS Decade Resistance Boxes.....	13.50
SHALLCROSS Portable Galvanometers.....	27.50
SHALLCROSS Model 630 Wheatstone Bridge.....	75.00
SHALLCROSS Model 637 Kelvin-Wheatstone Bridge.....	100.00
SHALLCROSS Model 638-2 Kelvin Wheatstone Bridge.....	120.00
VM-Model 200-R Record Changer. List Price, \$37.50. Net.....	22.50
Maguire ARC-1 Record Changer. List Price, \$47.41. Net.....	24.50
Lots of 6 or more. Each.....	22.90
Monitor Crystalline Signal Generator.....	57.50
Supreme Oscilloscope Model 516.....	87.95

**WRITE FOR OUR FREE NEW POST-WAR CATALOGUE!**

*Metropolitan* ELECTRONIC & INSTRUMENT CO.  
Dept. R, 6 MURRAY STREET Cable Address: METRONICS  
NEW YORK 7, N. Y., U. S. A. Phone: BARclay 7-5556

# HEXACON ELECTRIC SOLDERING IRONS

## ..tagged for the big jobs!

TYPE P-150  
(illustrated)

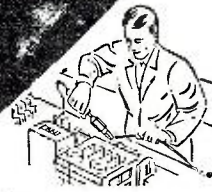

Follow the leaders—and use HEXACON! For rugged, heavy duty work or for light intricate work . . . here's the answer. One reason is "Balanced Heat"—dissipating excessive element-impairing heat—and minimizing element burn-outs and tip replacements. Another is their lightweight. Literature is available describing the complete HEXACON line of screw tip and plug tip irons from 40 to 700 watts, and with tip diameters ranging from 1/4" to 1 3/4".

**HEXACON ELECTRIC CO.**  
119 W. Clay Ave., Roselle Park, N. J.

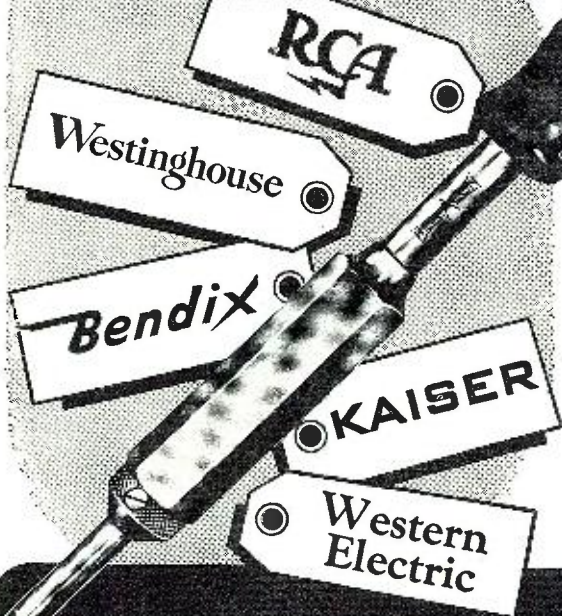

HIGH-QUALITY, LONG-LASTING SOLDERING IRONS

# HEXACON

**CATHODE RAY SCOPE KIT**

5CP1—C.R. TUBE JAN.	Each	\$7.95
SOCKET FOR 5CP1, WIRING		1.98
ANODE BUTTON FOR 5CP1		.35
X F O R M E R—1700v., —6.3v., —6A., —2.5v., —1.75A.		5.00
CONDENSER 1 mfd-2000v.		.95
2x2 TUBE		.95
CERAMIC SOCKET FOR 2x2		.25
CERAMIC PLATE CAP.		.20

Order separately or  
**COMPLETE KIT...\$14.95**

Per-cent Modulation Meter  
Weston No. 301 Rectifier Type **\$3.95**

**MODULATION STAGE KIT**  
DRIVER XFORMER MOD. XFORMER  
Pri.—Z-600 ohms Pri.—Z-15000 ohms  
Sec.—Z-00000 ohms Sec.—Z-4250 ohms  
Ratio—1:13 1KV Test at 235 ma. Test 5KV  
Will drive pair of 813's

**SPECIAL FOR PAIR.....\$6.95**

**NATIONAL DRIVE PW-O**  
LESS DIAL **\$2.95**

**HEAVY-DUTY RESISTORS**

30000 ohms 75W..\$0.89	30000 ohms 115W..\$1.39
6300 ohms 115W.. 1.09	30000 ohms 120W.. 1.49
10000 ohms 115W.. 1.29	7000 ohms 160W.. .99
15000 ohms 115W.. 1.29	35000 ohms 160W.. 1.69
20000 ohms 115W.. 1.29	7500 ohms 200W.. 1.29

CHRAMER TIME DELAY RELAY  
Mod. 45S2; 110v., 60cyc., 2 Pole 10A. \$9.95

**CERAMIC  
1KV BAND SWITCH**  
4 Deck, 9 Pos. **\$9.95**

**RESISTOR KIT—100 Asstd. Popular Sizes.....\$4.95**  
**CONDENSER KIT—100 Asstd. Popular Sizes.....\$6.95**

806.....\$1.19	6AK7.....\$1.25	5CP1.....\$6.95
6C4......75	6AK5..... 1.60	10T1S..... 3.50
6AL5......70	6AC7......95	6SL7..... 1.00
VR150......75	8001.....15.00	1N21......69

RCA #813 Extra Special \$9.95

**ONE OF THE WAR'S GREAT SECRETS  
NOW RELEASED--FOR THE FIRST TIME!**

# THE SONOBUOY

**PORTABLE F.M. TRANSMITTER**  
This equipment was successfully used by the Army Air Forces to detect enemy submarines.

**COMPLETE WITH  
5 TUBES**  
(less batteries) **\$17.50** Special

Weight 13 1/2 lbs. (with batteries). Completely equipped with parachute, quarter wave collapsible whip antenna, and magneto-striction hydrophone (underwater microphone).

**Set of batteries—\$2.50**

**Easily convertible to:**  
—Portable Amplifier (P.A.). —Transmitter.  
—Receiver. —Tranceiver (Walkie-Talkie). No changes necessary to use as F.M. Wireless phono. Excellent for schools, geologists, explorers, campers, etc.

SONOBUOY is thrown from patrol plane. Parachute lowers it into the water. Underwater microphone picks up submarine sounds which are relayed by the radio transmitter in the buoy to the patrol plane or a ship.

ale (Regional Actuality) is given in the French language.

Celebes—Radio Macassar, 9.357, is scheduled 5:30-9:30 a.m. daily; can usually be heard with level of at least S-6 here in the East around 6-7 a.m.

Ceylon—The new Radio SEAC station at Colombo is scheduled as follows: 7:30-9:30 p.m. on 11.77; 9:30 p.m.-7:30 a.m. on 15.12; and 7:30 a.m.-12 noon on 6.075. West Coast listeners report the 6.075 is heard with fine level from sign-on at 7:30 a.m. to around 9:30-10 a.m. when the signal usually fades out. This is a 100-kw. transmitter. Reception reports are requested, addressed to Radio SEAC, A.D.P.O. No. 9, Ceylon. It is believed the less powerful transmitter on 11.765 is still in regular service.

Chile—CE1227, 12.270, Radio Ejercito, Punta Arenas, has been sending a nice signal to the East around 7:15 p.m.

China—XGOY, 9.64, Chungking, is being heard with a good signal here in the East from sign-on at 6:35 a.m. to around 7:15-7:30 a.m. fade-out. XGOY's 11.920 frequency is coming through to the East with fine level around 6-6:25 a.m. sign-off; English news is scheduled for 5 a.m., but recently I have been hearing Chinese at that time. XGOA, Chungking, has changed frequency from 5.917 to 9.480; schedule remains around 5-10:40 a.m.; reception is good on West Coast. XGOA carries the 9 a.m. English news period. XORA, Shanghai, is currently on about 11.695/8, relaying medium-wave XORA, 900 kcs., to 10:30 a.m. sign-off; English news is relayed by XORA at 9 a.m.; reception reports are desired by F. J. Chen, Director of the Shanghai Broadcasting Station, Central Broadcasting Administration, 7 Chung Cheng Road (Western), Shanghai, China. (NOTE: This station was used originally by the Germans under the call, XGRS, but on May 25, 1945, the Japanese took over the station after Germany's surrender, at which

## CEMENT VOICE COIL LEADS

**I**f you are repairing a receiver in which the voice coil leads terminate in the speaker cone, they should be carefully cemented to the cone in order to prevent rattling. The method for performing such an operation is illustrated in the picture. Care must be exercised when performing this task in order to prevent puncturing of the speaker cone.



20% DEPOSIT REQUIRED WITH ALL ORDERS

# RADIO HAM SHACK, Inc.

63 Dey St., New York 7, N. Y.—BO 9-6875

LARGEST STOCK OF RADIO TUBES IN AMERICA  
WE SHIP ANYWHERE IN THE WORLD

**RADIO CORPORATION**

# FLANAGAN

## RADIO TUBES

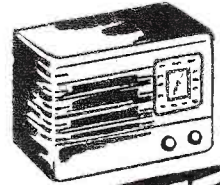

STANDARD BRANDS ALL GUARANTEED AVAILABLE FOR IMMEDIATE DELIVERY

71A(O1A) \$ .54	6SA7 . . . \$ .76	1C5 . . . \$1.09	1N5 . . . \$1.27
26 . . . . .55	6SK7 . . . .76	1H5 . . . 1.09	2A3 . . . 1.27
5Y3 . . . .55	6SQ7 . . . .76	6U5 . . . 1.10	35Z3 . . 1.27
80 . . . . .55	5W4 . . . .76	47 . . . . 1.10	35A5 . . 1.27
76 . . . . .60	6R7 . . . .90	6E5 . . . 1.10	7B7 . . . 1.30
78 . . . . .60	5X4 . . . .99	0Z4 . . . 1.20	25Z6M . 1.30
6SF5 . . .67	7A4 . . . 1.00	1R5 . . . 1.20	7A8 . . . 1.30
5Y4 . . . .75	7A5 . . . 1.00	154 . . . 1.20	12K8 . . 1.30
39/44 . . .76	7A6 . . . 1.00	155 . . . 1.20	11N5 . . 1.41
30 . . . . .76	7A7 . . . 1.00	114 . . . 1.20	616 . . . 1.41
5Z3 . . . .76	7B4 . . . 1.00	354 . . . 1.20	50A5 . . 1.41
5U4 . . . .76	7B6 . . . 1.00	6A8M . 1.21	14Q7 . . 1.41
6C6 . . . .76	6A7 . . . 1.00	6K8 . . . 1.21	14A7 . . 1.41
6D6 . . . .76	7C6 . . . 1.00	XXL . . . 1.21	3Q5 . . . 1.51
6F6 . . . .76	12K7 . . 1.00	XXD . . . 1.21	117Z6 . 1.59
6H6 . . . .76	14B6 . . 1.00	6F7 . . . 1.21	117L/M7 2.27
6K7 . . . .76	1A5 . . . 1.09	1A7 . . . 1.27	117N/P7 2.27



## RADIO SETS

5-TUBE SUPERHET  
BUILT-IN LOOP  
ANTENNA

## PHONO AMPLIFIERS

## RECORD PLAYERS RECORD CHANGERS

An Exceptional Value!

Beautiful Portable Case  
3 Tubes  
Volume and Tone Control



V. M.  
2-POST AUTOMATIC

Brand New—Sealed Carton. Only at Flanagan's at This Low Price.  
Plays 10" & 12" Records Mixed. Crystal Pickup.

**\$23<sup>88</sup>**

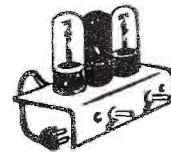

3-TUBE  
AC—DC

Completely Wired, with tubes and ready to operate. Uses a dynamic speaker. 450 ohm field. Complete with tubes, less speaker.

Only **\$7<sup>44</sup>** Including tubes 50L6—35Z5 12SQ7

## TUBULAR CONDENSERS

EMERSON 20/20 MFD  
150 VOLTS  
Guaranteed Fresh

**55¢**

## 5-TUBE KITS

50L6, 35Z5,  
12SA7, 12SK7,  
12SQ7

**\$4<sup>88</sup>**  
FOR ALL 5

## A GOLD MINE! RADIO HARDWARE

Transformers . . . Coils . . . Sockets of all types . . .  
Screws, all sizes . . . Nuts . . . Bolts . . . Grommets  
. . . Angles . . . Wire . . . Resistors . . . Portable Battery  
Plugs . . . Connectors . . . Terminal Strips . . . Insula-  
tors . . . Lugs . . . Spaghetti, etc.

A \$25.00 Value—Don't Miss It **\$2<sup>00</sup>** Size 3 1/2" x 6" x 9" Loaded

## CRYSTAL PICKUPS

COMPLETE WITH HARDWARE, LATEST DATE OF MANUFACTURE **\$2<sup>50</sup>** Each

## FREE CATALOG

Send for free catalog and prices of hard-to-get Radios, Radio Tubes, Radio Parts, Pick-ups, Motors, Condensers, Tube Checkers, Volt and Ohm Meters, Signal Generators, Signal Tracers, etc. Write Dept. RN.

# FLANAGAN

RADIO CORPORATION

N. E. Cor. 7th & CHESTNUT STS., Philadelphia 6, Pa., U.S.A.

# PULL THE TRIGGER- START TO SOLDER

with new Transformer Type  
**SPEED IRON\***

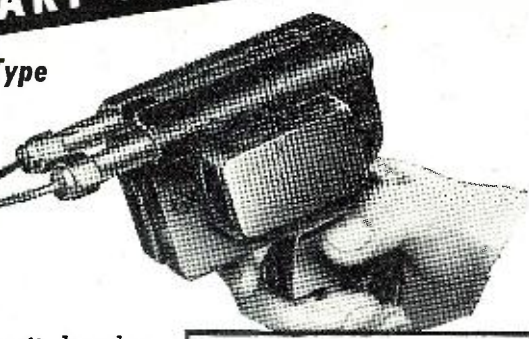

Release trigger and circuit breaks automatically. Intermittent heat saves power when continuous use is unnecessary. Fast heating, SPEED IRON is always ready for use.

- SOLDER IN TIGHT PLACES—AROUND CORNERS
- PERFECTLY BALANCED—EASY TO HANDLE
- STAYS TINNED—NO TIP BURNING
- LOW VOLTAGE, HIGH CURRENT FROM BUILT-IN TRANSFORMER
- IMPACT RESISTANT PLASTIC CASE AND HANDLE—STAYS COOL

**WELLER MFG. CO.**  
512 NORTHAMPTON ST. • EASTON, PA.

\*TRADE MARK REG. U. S. PAT. OFF.

100 WATTS  
115 VOLTS  
60 CYCLES

NEW TRANSFORMER PRINCIPLE FOR FAST HEAT

TEMP. TIME

SEE WHAT YOU SOLDER

Ask for SPEED IRON at your RADIO PARTS DISTRIBUTOR

## Ground Control Approach (Continued from page 40)

him, the approach controller is able to instruct the pilot in concrete terms, telling him exactly what course to fly in order to make an instrument approach to the runway. Moreover, when the approach controller turns a sound transmitting switch on, every azimuth deviation can be heard in the plane. The pilot hears a tone which varies in pitch and coding in accordance with direction of the plane. Controlling this tone is an aural signal device which is automatically controlled by the azimuth cursor. It is transmitted to the pilot through the communications channel. If the ship is off to the right or left, the pilot hears a continuous, high-pitched signal. The pitch rises as the error increases. A short pip assures the pilot he's on course.

A two-way radio system keeps the GCA operators in constant communication with the pilot. The pilot uses whatever radio equipment happens to be standard in his particular plane. This is one of GCA's advantages; no modifications are necessary to any planes for them to communicate with and use this system.

Each radio system on the ground is comprised of six transmitters and six receivers. Three complete units are operated in the v.h.f. band. But, since many aircraft are not equipped with v.h.f., three units can be operated in the h.f. band.

It's a three-channel communication system, which may be used as local conditions indicate. For example, Channel A—traffic director to pilot. Channel B—plane selector to pilot. Channel C—approach controller to pilot.

Each one of the GCA operators is a member of a six-man team. Success of a GCA landing depends on perfect coordination between the five men on the ground and the sixth man—the pilot.

Suppose we examine a typical situation to get the operational picture. Two airplanes are heading toward the airfield. The pilots face a final approach through skies that are dark and heavy with overcast. On the ground, it's just as bad. Yet those planes must be landed, quickly and safely.

The pilots contact the tower and report their position. The tower checks their bearing. Both planes are on the beam. The tower calls the planes: "We're notifying GCA to pick you up in a few minutes. . . They'll bring you in all right."

Now GCA is looking for them, sweeping the sky, reaching out for them with radar, ready to lead them in.

Suddenly three blips appear on the PPI scope. The traffic director speaks: "Hello, Baker George 2, this is Jonah. Are you receiving me? Over."

Pilot: "Hello, Jonah, this is Baker

## LOCATE RADIO TROUBLE FAST with FEILER SIGNAL ANALYZER

Permits following signal directly as it progresses through any radio set or amplifier using latest type of high gain miniature vacuum tube (1T4) that allows direct connection directly across r.f. circuits with minimum detuning.

Is portable and self-contained, has own batteries. So compact that it can be carried in palm of hand. In sturdy, brown-metal finished case measuring 6 3/4" x 4 3/4" x 3 3/4" weighing 4 pounds complete with batteries.

Has special built-in network reducing input capacity from 8 to 10 times that of other instruments. Probe is of smallest size measuring 1" in diameter by 4 3/4" long with non-breakable bakelite and extra-heavy 3 ft. rubber covered cable.

Has high input impedance and can be used with any pair of magnetic phones of 1000 ohms or more. Requires no changing of switches, controls or test leads to receive r.f., i.f. or audio signals at any point in radio sets.

- Model TS-1 Complete with Tube, but less batteries and phones . . . . .Net. \$9.85  
67 1/2 Volt Battery . . . . . \$1.60  
Flashlight Cell . . . . . \$ .06  
2,000 Ohm Dual Headset . . . . . \$2.25



Only \$9.85

### Crowe Modern Slide Rule Dials



Escutcheon with Crow-glass Crystal. antique bronze finish. complete with pilot light sockets

- Overall Dim.  
Model 341—\$3.60 ea. . . . . 3 1/4" x 8 7/8"  
Model 339—\$3.18 ea. . . . . 3 1/4" x 6 5/8"  
Model 534—\$1.47 ea. . . . . 2 7/8" x 4 1/4"  
Model 535—\$1.74 ea. . . . . 1 1/2" x 5 1/2"

### \$30.00 HEAD-SET

Model HS-30-U specially developed for U. S. Army. Eliminates ALL outside noises, fits inside ears like doctor's stethoscope. \$59.50 ea. Now available for only . . . . .

#### SPECIAL

Outside aerial kits consisting of:  
Antenna wire—Lead-in wire—Glass insulators—Nail knobs—Lead-in strip—Ground clamp—Screw eyes—79c ea.  
Lots of 10 or more . . . . . 69c ea.

We Have in Stock a Complete Line of Radio Tubes for Immediate Delivery  
Quantity limited. All orders accepted subject to prior sale.

We have the complete line of Simpson Test Equipment.

Write for Latest Catalog

# RADIO PARTS COMPANY 612 W. Randolph Dept. N Chicago 6, Ill.



# *Our Mark*

Beginning in 1920 and growing with the growth of Radio itself, Air King has seen its sets go into service on every continent and on all the seven seas. Not all these sets have borne the Air King mark. Many have been made for other successful merchandisers of radio and have been sold under many respected brands, but all have had the benefit of Air King standards, Air King experience and Air King production efficiency.

During the war these high standards were raised still higher, more experience was gained and the efficiency and scale of production greatly increased. Soon new AM, FM and Television receivers bearing the Air King mark will be ready for you. These sets will have the advantage of Air King wartime experience and of Air King economy—an economy made possible by a daily schedule of over five thousand sets in its plants equipped for efficient modern production. Under its own mark, or any other, Air King will always be the industry's greatest value.



**AIR KING  
RADIO**

*Brooklyn*

*Division of* **HYTRON RADIO & ELECTRONICS Corporation**



*The Royalty of Radio Since 1920*

**IN STOCK**  
**For Immediate Delivery**  
**RADIONIK**  
**AUTO ANTENNAS**

- Admiralty Brass • Sparkling Chromium • Noiseless Reception
- Rattle-Proof Construction

**Side cow!**

**THREE SECTION**

- No. 203L—With low loss lead (26" to 66" extension).....**\$1.89**
- No. 243L—With low loss lead (36" to 96" extension)..... **2.47**

**FOUR SECTION**

- No. 244POL With "Poly" low loss lead (30" to 90" ext.)... **3.20**

**cow! under hood—bracket mount**

**THREE SECTION**

- No. 203XL—With low loss lead (26" to 66" extension)..... **2.30**
- No. 243XPOL With "Poly" low loss lead (26" to 96" ext.)... **2.60**

**3-Tube Phono-Amplifiers**

Adaptable any type Phono and Record Changer Cabinet. With volume Control and Tone Control.....Ea. **\$4.25**  
 Lots of 3.....ea. **3.95**

**PM Speakers**  
**Limited Quantity**

- 5" with 50L6 Output.....**\$2.95**
- 5" less 50L6 Output..... **2.40**
- 6" less 50L6 Output..... **2.65**
- 8" less 50L6 Output..... **3.25**
- 12" with 20-oz. Slug..... **6.25**

**Meissner Choke Coil Kit**

10 Chokes in each Kit. Any two Chokes worth price of entire Kit. Per Kit...**49c**  
**ANTENNA KITS**.....ea. **79c**  
 Lots of 3.....ea. **65c**

RIDER'S MANUAL No. 14.....**\$15.00**  
 RIDER'S MANUAL No. 13..... **15.00**

**MODEL 900 "VOMAX"**  
 Vacuum Tube Voltmeter

Vomax makes possible reliable voltage measurements in television... photo-electric cell... a.v.c.... FM limiter and discriminator... a.f.c.... resistance-coupled amplifier... and a host of other specialized and load sensitive circuits.....**\$59.85**

**E-L Vibrators**

These 4 Models service 95% of all Auto Radio Replacement Needs.

- Model 1703 Services 738 Auto Radios.....**\$2.09**
- Model 2041 Services 75 Auto Radios..... **2.09**
- Model 2089 Services 237 Auto and Farm Radios..... **3.50**
- Model 2088 Services 72 Auto Radios..... **2.09**

A complete auto radio replacement guide will be sent with every order for 4 E-L Vibrators. This information will tell you at a glance what E-L Vibrator Model to install in any auto radio model.

**TERMS: 25% Deposit; Balance C. O. D. F. O. B. Our Warehouse (when paying in full please include postage)**

For Free Radio Parts and P. A. Catalog—Write Dept. W7

**RADIONIK EQUIPMENT CO.**  
 "Chancellor Radio"  
 170 NASSAU ST., N. Y. 7, N. Y.  
 Cable Address: "CHANSLOR"

George 2, receiving you loud and clear. Over."

"Baker George 2, this is Jonah. What is your approximate range, elevation and heading? Over."

"Jonah, this is Baker George 2. Approximate range 25 miles. Elevation 3500. Steering course 135. Over."

"Roger, Baker George 2, we have you in contact. Check gyro. Over."

"Roger. Checking gyro. Out."

Seconds later: "Baker George 2, this is Jonah. Left turn, vector 095. Left turn, vector 095."

"Roger. Out."

The traffic director, by watching which of those two targets turns can tell which of the two planes is Baker George 2. Then, maintaining communication with both planes on Channel A, he directs Baker George 2 toward the field for a landing while controlling the flight of the other plane until he's ready to bring him in. One plane is at approximately 8 o'clock at a range of eight miles; the other plane at approximately 8:30 o'clock at range of 17 miles and orbiting.

Another few minutes elapse, when the traffic director talks again: "Baker George 2, this is Jonah. Your range now 8 miles southwest of field. Left turn, vector 050. Left turn, vector 050. Over."

"Roger. Turning left to vector 050. Out."

The traffic director moves the strobe mark dial out from the center of the scope and places it on the plane at 8-mile range. Again: "Baker George 2, this is Jonah. Over to Channel B, Baker. Channel B, Baker. Over."

"Roger. Over to B, Baker. Out."

No. 2 PPI scope is now on the 15-mile range. Only one plane is visible, as the other is outside range of this scope. The plane at 8 miles is flying easterly, with the strobe mark quite evident.

Here the plane selector takes over: "Hello, Baker George 2. This is Jonah... Channel B. Are you receiving? Over."

"Loud and clear. Over."

From the scope, the plane selector knows the exact position and heading of the plane and continues giving approach instructions:

"Prepare to land. Reduce speed, lower undercarriage, partial flaps. Over."

As he follows the echo and No. 2 PPI scope, the plane selector continues: "Baker George 2. Left turn, vector 355. Vector 355. Over."

"Roger. Out."

Now the plane moves toward the glide path at the proper elevation and ready to land, moves nearer, until finally, there it is, a pip of light in the ten-mile elevation scope.

A pip of light moves in from the left side at 7 miles in the 10-mile elevation scope. The cursors center on it. An echo is seen at 7-mile range on the 10-mile azimuth scope. The cursors center on it.

"Baker George 2. This is Jonah. Left turn, vector 315. Left turn, vector 315. Over."

**TOP SECRET**

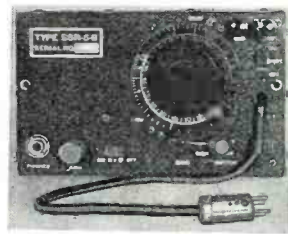

This famous portable receiver designed for and used by the U. S. Secret Service overseas is available to you for the first time in Kit form. 6 tubes included. Small, compact, ultra-efficient. No drilling or punching required. Complete wiring diagram supplied.

- Uses 6 miniature tubes 1R5, etc.
- Superhet operated
- 2-12 megacycles
- Operates from 90 Volts B & 1 1/2 Volts A
- Iron core I.F. transformers

QUANTITY LIMITED. SHIPPING WEIGHT, 4 LBS.

YOUR COST.....**\$19.95**

Less Phones & Hookup Wire  
 Additional Information on Request

**CODE OSCILLATOR KIT**

Includes 1000 cycle note tone generator U. S. Signal Corps telegraph key—hookup wire—hardware—Fahnestock clips. Requires only headphones and two flashlight cells.....**\$2.89**

**RESISTOR KITS**

100 insulated, assorted sizes, 50 ohms—**\$1.98**  
 10 meg. Mica Cond. Kits (25) asstd. sizes.....**98c**

**20% DEPOSIT ON ALL ORDERS ADD POSTAGE**

Bargains Galore • Send for Catalogue  
**KELVIN ELECTRONICS**  
 74 Cortlandt Street, New York 7, N. Y.

**CAMCO**



"Way out front" with the most outstanding line of antennas. Besides critical engineering, Camco Antennas are also "Easy to look at" because they are superbly designed in true modern taste.

An antenna for every type of installation... and all have this in common—rattle proof, Admiralty brass, rustproof, smart styling and handsomely packaged.

Multi-colored dealer sales display helps sell Camco antennas. Write for complete line and prices.

In Canada: The Astral Electric Company, Scarborough Bluffs, Ontario.



**CAMBURN, Inc.**  
 32-40 57th St. Woodside, N. Y.

"Roger. Turning left to 315."  
"Baker George 2. This is Jonah. Your range 7 miles. Over to Channel C. Channel C as in Charlie. Over."

"Roger. Over to C, Charlie. C t."  
And now, the last stage: "Hello, Baker George 2. This is Jonah. Are you receiving Channel C? Over."

"Roger. Receiving Channel C, loud and clear. Over."

"Roger. Baker George 2. This is the final controller . . . remain on 'receive' for the remainder of this transmission. Maintain your present elevation and continue vector 315. Your range just under 7 miles."

The approach controller watches the error meters closely. "Azimuth is fair," he continues, "Maintain your present elevation, fly left three degrees . . . azimuth correcting nicely . . . now fly right three degrees. Azimuth now very good. Maintain your present heading."

"You are cleared for this approach. You are on course. Azimuth very good, indeed. Continue to hold elevation. Range now six miles. Azimuth still very good. Your present heading is holding you on course nicely. Maintain your present heading. Azimuth still good. Hold your elevation."

"You are on course, and approaching the glide path slowly."

The azimuth tracker turns the cursor wheel.

"Fly right two degrees," corrects the approach controller.

"Azimuth not correcting . . . fly right two degrees."

"You're drifting off to the left of course. Fly right four degrees. . . ."

"Azimuth now correcting. You are approaching course nicely . . . now left two degrees . . . azimuth improving . . . an additional two degrees left . . . azimuth now good. Maintain elevation. Range just under 5 miles."

"Azimuth very good. Maintain your present heading. You're almost at the glide path. Begin your rate of descent at 500 feet per minute."

The plane starts down through the soup.

"You are starting down the glide path," says the approach controller. "Rate of descent is good. Range now four miles. You are drifting slightly to the right. Fly left two degrees. The solid tone means 'fly left.' Decreasing pitch indicates azimuth correcting."

"You are now 50 feet too low. Decrease your rate of descent slightly. You are 75 feet too low. Azimuth correcting nicely. Range three miles. Fly right two degrees. You are a hundred feet too low. Decrease your rate of descent. You are still below the glide path."

The elevation meter starts moving up. Quickly the approach controller's voice relays the news: "Elevation improving . . . 75 feet too low . . . 50 . . . 25 feet too low. Ease your rate of descent. Elevation now good. Very nice correction. Azimuth also good. You're now receiving the encore signal."

*Doughnuts ...  
or Life Preservers*

A drowning man doesn't want a doughnut—he wants a life preserver. When a radio man wants a special transformer—a special transformer is as useless to him as the doughnut is to the drowning man.

Realizing the radio industry needs a broad choice of transformers of many different types, we at Stancor have adhered through the years to our policy of manufacturing a complete line.

This has not been easy, with material and labor shortages and endless restrictions dogging us at every turn. But we have managed—by limiting the quantity of any one type of transformer in order to make the broadest variety—to fit all the different needs of the industry.

Our customers have told us they understand and appreciate our policy. They point out we could "skim off the cream" by putting all our materials and facilities into several simpler types of transformers that currently are represented as fulfilling the major requirements. We have avoided this short-sighted course.

Yes—adhering to our firm policies of a complete line and equal distribution, Stancor will continue to serve you for many years after this crisis has passed. We are making every attempt to meet current needs, and like to feel it can't be much longer before Stancor is in a position to fill your largest transformer requirements . . . quickly, efficiently and economically.

*Jerome J. Kahn*  
PRESIDENT

**STANDARD TRANSFORMER CORPORATION**  
1500 NORTH HALSTED STREET • CHICAGO 22, ILLINOIS

# "TAB"

That's a Buy

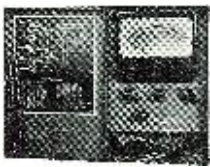

**ELECTRONIC VOLT-OHM-METER BRAND NEW U. S. ARMY TYPE I-107-F PRECISION UNIT.** Rugged design housed steel case 6" x 9 1/2" x 4 1/8" leather carrying handle. Contains Simpson 4" highly damped 300 micro-amp Alnico meter. Clear visible scale, large numerals, easily readable at all points. All voltage ranges ten megohms sensitivity; reads 0-3 volts in .05 v steps; 0-10 volts in .2 v steps; 0-30 volts in .5 v steps; 0-100 volts in .2 v steps; 0-300 volts in 5 v steps—OHMS Rx1 from .02 to 1000 ohms; Rx10 from 2 to 1000 ohms; Rx100 from 20 to 100,000 ohms; Rx1000 from 200 to 1 megohm; Rx10,000 from 2000 to 10 megohms (center scale is 10). Unit complete with 3 test leads; batteries and instructions. Cost gov't \$65. "TAB" special \$29.70. Additional V.T.V.M. Loctal tube 1 Lc 3/SP Sig C \$1.15.

- F.M. Television Rotable UHF coupler..... \$ 3.95
- CATHODE Ray Tube new g't. ins. 3BP1... 6.95
- CATHODE Ray Tube new 5A1P-BP1-BP4, ea. 9.95
- RECTIFIER GE 872A new G'Ins. (L.P. \$7.50) 4.50
- EIMAC or H.K. VT-127A with connectors... 4.95
- RCA 6AC7-1852 new Gvt. Ins. (L.P. \$1.75)... .65
- G.E. Neon 1/4 W NE 16 (L.P. 42c) 4 for..... 1.20
- RCA 866A new Govt. Ins. 2 for..... 2.80
- 807 new Gov. Ins. with Millen cap. .... 1.95
- RCA 614 new Gov. Ins. (L.P. \$8.35) \$2.49, 2 for 4.75
- TUNGOSOL miniature 3A4 G'Ins. (\$1.55), 2 for 1.10
- EIMAC 304TL used, L.N., tested, guaranteed 13.95
- JOHNSON Socket No. 213 for 304TL..... .90
- SPAGHETTI ass'tment 10 lengths 3' each size .50
- Impedance Ouncer Jefferson 100 Hy. 3100Ω... .69
- Crystal Det. JANIN 21 Sylvania Sil. C. 3 for 1.00
- Resistors 100 ass't. 1/2 & 1 W BT 50 to 2 megΩ... 2.50
- G.E. R.F. Thermo-mtr 0-5A 2 1/2" B'case. 3.50
- RES'R pres. WE % accy. 1000-5000-10000 ohm @ ..... -25
- 30,000 ohm @ .35; 200,000 @ .55; 500,000 @ .65 ..... .65
- G.E. DW44 R.F. Thermomtr. 0-1A 2 1/2" B'case 3.95
- SOCKET amphenol octal S8TN, 25 for..... 1.50
- DAVEN switch 13 circuits 25 amp ets, 2 for. .98
- JEFF. ouncer impd 100 Hy 3100 ohms, 2 for. .98
- EXT'OR Fuse posts takes 3AG&4AG, 4 four... .98
- Lacing Cord mildew resistant #6 treated, lb. 1.90
- Micro-Switch leaf type 10A125V SPNO., 3 for 1.25
- CONDENSER WE new uprt. mtg. 500MFD-60WV .95
- CONDENSER WE oil 16MFD-400V, 2 for..... 2.35
- CONDENSER KIT 24 midget oil Cornell Dub. 8 ea. size 1&2&3 x .05MFD-300WV Gvt. ins. 2.40
- COND. GE pyranol 4MFD-600VDC wkg. 2 for 1.90
- CONDENSER TUB. DUAL 40mfd 150WV, 10 for 3.50
- COND. Wsths 2MFD-5500VDC wkg (LP\$75) 12.50
- SOCKET amphenol safety UX 77A-ATN, 10 for 3.00
- CRYSTAL diode IN21 & holder, 2 sets ea. 1.25
- WE 115V60Cpri. 650VCT300ma: 5V3A: 6V5A 3.95
- CRYSTAL & HOLDER LO DRIFT cut any freq. 2to9MCS active osc. etd @ \$1.49, 4 for 5.70
- CRYSTAL mid aircast 1000KC Std. 02% acc 7.20
- Jenning VC50 air condenser 50 mmf-20,000V 3.50
- HEINEMAN ma. circuit bkr. 20A or 3A or 0.5A ..... .97
- RELAY sen. sigma 5AH 200 ohm 3.5 ma SPDT 2.25
- Relay Sensitive WE. 3500 ohms. SPDT 5A... .97
- RELAY 105 Ward L. 115V60CY 20A.Cts..... 1.90
- CHOKE G.E. 4HY 1/2A.30 ohm wt. 10 lbs..... 2.95
- RadioNoise Filter MALLORY oil cond&chokes .49
- DC.VOLTMTR. DW41GE 2000V 1000 ohm 2 1/2" 8.95
- DC.VOLTMTR. 301 Weston 4000V 1000 ohms 10.95
- DC.VOLTMTR. 301 Weston 10000V 1000 ohm 12.95
- AC.VOLTMTR. NA33 Wsths 150V 2 1/2" B.C. 2.95
- GE DC DNI miniature ma. G'Insp. 1/2" B.C. 3.25
- COND. GE pyranol 3MFD 1000VDCWkg. 2 for 2.50
- CONDSR Aerovox oil 1MFD10000VDC wkg. 36.00
- CO-Axial 52&72ohm RG8&11u cable 100 ft... 7.95



## Autosyns Bendix

Brand new gov't sealed and inspected, packed in overseas cans, synchro-transmitters AC, 115V, 60 cy. operation. Continuous heavy duty. Precision accuracy made for gun-fire control. Cost gov't \$90 each. 5 lbs. "TAB," special two for \$18.

\$1 Min. orders FOB, N.Y.C. Add Postage all orders and 25% deposit. Write to: 3-3557. Send for catalog 300. Don't wait, rush orders as quantities are limited. Buy thru "TAB" and save.

"TAB," Dept. N7

Six Church Street, New York 6, N. Y.

Out in the murk, the pilot manipulates the flap lever. The echo appears on the two-mile scope, strong and brilliant. A click of the azimuth scope's scan speed switch, and the beam's scan increases. The echo appears even brighter. The slightest variation in the plane's movement becomes instantly visible. The two-mile elevation scope comes on. Together, they show the plane coming down the glide path.

The approach controller goes on the air:

"Fly right three degrees. The broken tone means 'fly right.' Elevation is good. Azimuth correcting nicely as indicated by the decreasing pitch. Now fly left three degrees. Range one mile. Azimuth good. Elevation good. Nice flying, indeed. You're on the glide path and on course. Azimuth and elevation both good at one-half mile. Maintain your heading. On course. On the glide path. Very good. Now over the end of the runway. Azimuth and elevation both perfect. Touchdown in four seconds. Take it over, Baker George 2. It's all yours from here. . . ."

Well, that's GCA. It brings 'em down in all weather. In time, perhaps soon, the same system will aid the commercial airlines to better their already excellent record of safety.

-30-

## 75 Watt Transmitter

(Continued from page 29)

is possible to do a professional job with a fly sprayer.

When the lacquer had become sufficiently dry, the transmitter was completely assembled. A good practice, if using the "locking ring" type socket, is to mount the sockets first, as it is rather difficult to hold socket in hole and apply locking ring after other parts project up from top of chassis.

John V. L. Hogan points to monitor recorder which is part of the scanning equipment recently demonstrated to leading broadcasters who cooperated in the development of the Faximile System of Radio Printing. The revolving cylinder at Mr. Hogan's right is used to scan copy to be broadcast; the recorder to which he is pointing shows the operator how the copy is being received in the home of a set owner.





cabled without any detrimental effects to the performance of the rig. The wire should have good insulation for the voltages encountered, however. No r.f. wiring should ever be cabled, as high losses, feedback, parasitics, and all kinds of troubles will result. To put it briefly, the job probably will not work at all, if r.f. wiring is cabled.

For r.f. wiring, it is best to use No. 12 or 14 bare copper, tinned, or enameled wire, and run leads direct and short as possible. A few neat right angle bends are permissible if they do not increase the length of the lead appreciably. Mica condensers are preferable to paper for r.f. circuits, and they really pay for themselves in time because they seem to last longer. For supporting r.f. wiring or parts, or high d.c. voltage, small ceramic stand-off insulators were used in the job. Ceramic feed-through insulators were used to pass r.f. through the chassis. Fiber terminal strips were used to anchor d.c. and 60 cycle wiring and associated parts. Black rubber grommets seem to be satisfactory for passing insulated wire through chassis.

A glance at the front panel photograph will show unusual calibrations on each control. These were made by drilling a semicircle of 11 evenly spaced holes corresponding to 0 10, then after the gray finish had been applied and dried, a small drop of white lacquer was dropped in each hole. Of course the holes were not drilled through the panel, just enough to confine the paint to a neat, round dot.

The wiring being completed, our transmitter was ready for testing. The first step was to trace all the circuits with an ohmmeter to determine if any mistakes had been made. Everything being OK, the tubes, a crystal, and coils for one band were inserted. Taps on the bleeder were set at points estimated to give 400 volts to the 807 plate and 250 v. to the screen. The 117 volt a.c. line was then connected to the terminal strip and keying connections made. Plate connection to HY30Z was purposely left off by leaving the jumper off the two feed-through insulators on the back of the chassis marked for modulator connections.

Filaments were allowed to remain on for a few minutes until all mercury in the rectifiers had vaporized. When plate voltage was applied, a voltmeter was used to adjust plate and screen voltages on 807 to exact value. These adjustments were made with oscillator operating normally and putting out r.f. Of course the next step was to neutralize the HY30Z. With the oscillator putting out power, the meter was set on the final grid current position, and the plate tank condenser tuned through resonance, indicated by jump in grid current. Neutralizing condenser was adjusted until no change was observed in grid current at any position of final tank condenser. This setting was checked on higher frequencies than the original test frequency, and found to be the same on

**NEW and**  
*Ready for you!*

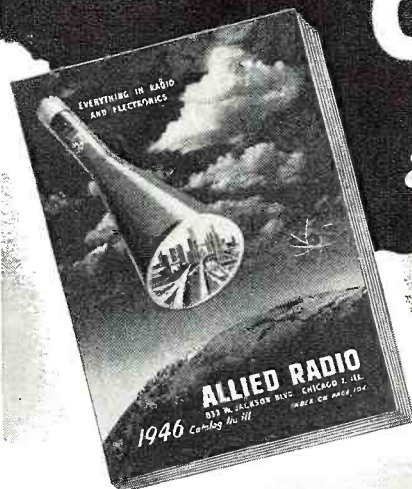

# ALLIED'S 1946 CATALOG

*of Radio and Electronic Supplies*

**FREE**  
Send for it Now!

## LARGEST AND MOST COMPLETE STOCKS

Today's handiest, most complete *Buying Guide!* Brings you latest, finest values in parts, tubes, kits, tools, books, test instruments, communications receivers, Ham gear, public address and other equipment. Places at your finger tips over 10,000 items of nationally known guaranteed quality. Makes available to you the world's largest and most complete stocks under one roof . . . ready for rush delivery. Enables you to get everything you need in radio and electronics from one dependable, central source. Send for this new 1946 Catalog now. Save time, work and money!



### NEW RADIO SETS

Parade of new 1946 models, including phonoradios, and latest communications receivers covering broadcast, short-wave and amateur bands. Beautiful styles! Wonderful performance! Outstanding values!



### HANDY RADIO BOOKS AND CALCULATORS

Radio Formulas & Data, Dictionary of Radio Terms, Circuit Handbook, Radio Builders' Handbook, Simplified Radio Servicing, Radio Data Handbook.  
Six Books No. 37-799...75c  
Parallel Resistance and Series Capacitance Calculator. No. X37-960...25c  
R-F Resonance and Coil Winding Calculator. No. 37-955...25c

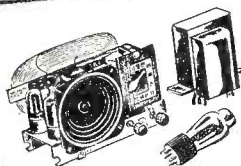

### OVER 10,000 ITEMS

Biggest section of quality parts and equipment for engineers, dealers, servicemen, soundmen, amateurs, builders. All leading makes, at lowest prices. Send for Free Catalog now.



### NEW P.A. EQUIPMENT

Sound systems for every public address requirement. Complete listing of amplifiers, speakers, microphones, accessories. Newest developments with many exclusive features.

**ALLIED RADIO CORP.**  
833 W. Jackson Blvd., Dept. 1-G-5  
Chicago 7, Illinois

Date.....

- Send FREE New 1946 Catalog.  
 Send Six Books—Calculator No..... } \$..... Enclosed  
Calculator No..... }

Name.....

Address.....

City..... Zone.....

# ALLIED RADIO

*Everything in Radio and Electronics*

**RCA HIGH AND LOW VOLTAGE  
COMPLETE-IN-ONE-UNIT**

**TELEVISION POWER  
SUPPLIES**

**\$90<sup>00</sup>**

**Cathode Ray Tubes  
NEW, FACTORY SEALED, FOR**



**Television and Oscilloscopes**

Dumont 5BP1	} with special wired	{	\$15.00
RCA 5BP4			15.00
N.A. Philips 5CP1	} sockets	{	15.00
Dumont 7EP4			29.90
RCA 9AP4			62.50
RCA 12AP4			75.00
RCA, new type, 5TP4 Projection			70.00
NA-ALD 11 pole magal socket with H.V. wiring			2.40
14 pole Di-heptal Cinch socket with H.V. wiring			2.40
RCA Television 5 bands switch with 5 Antenna transformers			5.60
G.E. or power transformer 1700 V., 6.3 V., 2.5 V.			9.90

**SPECIAL TUBES,  
FACTORY PACKED**

6J6	\$1.00
6AG5	1.00
6AG7	1.00
6AL5	.75
6AC7	.90
6CA	.75
9002	1.00
9003	1.00
9006	1.00
2V3G	1.50
2X2	1.00
6SN7GT	.70
6SL7GT	.75
6L6	1.00
7F7	.90

**CAPACITORS**

2 MFD 750 V. SPRAGUE, oil filled Capacitor	1.50
1 MFD 1500 V. SPRAGUE, oil filled Capacitor	1.80
.02 MFD 2500 V. SPRAGUE, oil filled Capacitor	.90
.5 MFD 3000 V. AEROVON, oil filled capacitor	2.40
.1 MFD 3500 V. CORNELL-DUB., oil filled Capacitor	1.80
.03 MFD 7500 V. G.E., oil filled Ca- pacitor	3.75
.1 MFD 7500 V. G.E., oil filled Ca- pacitor	7.50
2 x .1 MFD 7000 V., G.E., oil filled Capacitor	9.00
2 x .15 MFD 8000 V., SPRAGUE, oil filled Capacitor	9.00
.05 MFD 16000 V. SPRAGUE, oil filled Capacitor	9.00

Send 50c for complete catalog including dia-  
grams for RCA, G.E., DUMONT and  
ANDREA Television Receivers; free with  
your order. No order less than \$10.00.

RCA Parts and Equipment Distributors.  
World's First Specialized House in  
Television.

**Teletronics Service and Supply Corp.**  
264 W. 40th St. New York 18, N. Y.

all bands. After neutralization was complete, the modulator terminals were jumped, putting about 800 volts on the final plate, which was immediately tuned to resonance. At resonance, final plate current, without load, was only about 20 mills. A low impedance load (100 watt light bulb) was then connected to output of link, and link coupling increased, keeping final tank at resonance at all times, until final plate current of 100 ma. was indicated. With a pure resistive load, of course, the resonant point of the final tank did not change with increase in loading. The output of the link of this transmitter can be connected directly to a 70 ohm twisted pair fed antenna or concentric line fed antenna. With higher impedance feed, however, an auxiliary tank circuit should be used for proper transfer of energy.

Oscillator plate current runs from 30 ma. on lowest frequency to about 50 ma. on highest. Final grid current should be in the vicinity of 30 ma.

No specific mechanical dimensions have been included in this article as most hams like to make their own variations. It is believed that sufficient information can be obtained from the photographs and diagram and text.

Plans are under way to build a companion modulator a little later on for this rig, which has been designed to permit full 100 per-cent plate modulation.

A high power amplifier can be added at any time, but it is doubtful if any increase in signal strength would be noted unless power were increased several times. In other words, adding a 150 watt amplifier to a 75 watt driver would hardly be worth while in terms of signal strength. Better to put the money into a beam or good flat-top. If power could be increased to 500 watts, however, it would be definitely worthwhile.

-30-

**ELIMINATING  
MECHANICAL HUM**

**M**ECHANICAL hum often originates in the power transformer because the laminations or thin plates of the transformer become loose.

The transformer mounting or holding screws should first be tightened. If this does not stop the vibrations, then thin flat pieces of steel may be driven between the loose laminations as illustrated.

H.L.L.

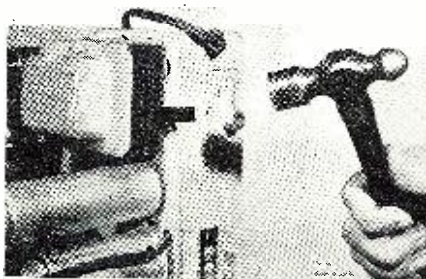

**MORE SMASH BUYS at  
National Radio Distributors**



**IMMEDIATE DELIVERY  
NEW POST-WAR SCOOP**

5 tube AC/DC Superheterodyne Radio Kit featuring built-in loop antenna, using 12SA7, 12SK7, 12SQ7, 50L6, 35Z5 tubes. All parts brand new and perfectly matched. Absolute satisfaction guaranteed. Including cabinet and full instructions for assembling.....\$13.75  
In lots of 3.....\$22.95  
Kit of 5 matched tubes.....\$4.95  
Hook-up wire, solder, nuts and bolts not included in above kit.

**SPECIAL-NEW MAGUIRE ARC-1 RECORD CHANGERS**, precision engineered, single control knob, plays 10-12" or 12-10" records, stops automatically after last record is played. Extra light-weight pick-up arm, features spring mounting and heavy duty rugged motor.....\$22.95  
**PAC 100 PORTABLE RECORD CHANGER CASE**, dark brown leatherette covered. Will accommodate above or any other make changer. Mounting panel 15 3/4" square...NET \$8.95



**NEW POST-WAR PORTABLE RECORD PLAYER KITS**. Model RP100 player including beautiful alligator or leatherette covered portable carrying case, motor, completely assembled 3 tube amplifier using 12SQ7, 50L6, 35Z5. Crystal pick-up arm, 1/2" PM speaker with output transformer. Will play 12" records with lid closed and 4 features separate tone and volume controls.

Your cost, \$24.50 less tubes  
Kit of 3 matched tubes.....\$2.95

Model RC300 Same as above with New Maguire Record Changer and 2-toned leatherette portable carrying case to match. Will take 10-12" or 12-10" records with lid closed.

Your cost.....\$44.95 less tubes  
**COMPLETE INSTRUCTIONS FOR ASSEMBLING**  
Hook-up wire, solder, nuts and bolts not included in above kit.

**EXTRA SPECIAL! BY-PASS CONDENSER KIT**. Consists of 100 Tubulars (all 500 Volts) in the following sizes: .001, .002, .006, .01, .02, .03, .05 and .1 Mfd. All fresh stock; fully guaranteed. Per Kit \$5.95

Please include at least 25% with C.O.D. orders.  
Write for New Free Catalog Now!

**National Radio Distributors**

1029<sup>A</sup> E. 163 St., New York 59, N. Y.

**Dealers WHY WAIT FOR  
YOUR RADIO?**

**"BUILD YOUR OWN"**

**ATOMIC HEATER & RADIO CORP.  
PROUDLY PRESENTS**

**The Finest in Radio Kits**

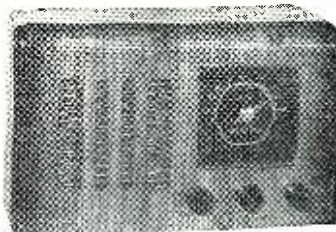

A COMPLETE 6 TUBE SUPERHET.  
COVERS THE BROADCAST BAND FROM  
550-1700 KC

This set has been fully engineered and designed to make construction simple. All parts mounted, cabinet included. Tubes required—two 12SK7, one 12SA7, one 12SQ7, one 35L6 and one 35Z5. Your cost \$15.80 without tubes. Terms 10% deposit with order, balance C.O.D.

IMMEDIATE DELIVERY

**ATOMIC HEATER  
& RADIO CORPORATION**

Dept. A

104 PARK ROW, NEW YORK 7, N. Y.

## Photo-Electronic Organ

(Continued from page 37)

ing, and then tighten carefully, being sure the bearings run free and true without binding or jumpiness. If the bearings do not run smoothly, try re-grinding with fine emery paste. Dirt or scratches on the tone wheels will cause noise in the amplifier, so be very careful to handle the discs in such a way as to avoid scratches and finger marks.

We tried lucite and plexiglas discs, which are easily formed but also scratch easily and tend to soften from the heat of the lamps. For these reasons glass was chosen as being the most desirable material in spite of the fact that it is hard to work with.

Be sure that the positive film is exactly centered. If the film is off-center, the tone patterns will not reproduce properly. A small drop of coil dope will help to hold the film in place to permit exact centering. Centering may be checked by depressing a key while observing the pattern as it passes the shutter opening. If any portion of the pattern is cut off during part of a revolution of the tone wheel, the pattern is off center and must be shifted to correct this condition. A reproduction of the tone wheel is shown in Fig. 8. This should be taken to your photographer and five positive films of it made to the exact size indicated. Be sure to check the film for distortion if the images cannot be made to center up properly. Some camera lenses will give a distorted image. A photo-engraving camera should be used if possible, as the images will be much more accurate.

### Speed Adjustments

These adjustments are preferably made with a stroboscopic light. When properly adjusted, there is a uniform speed ratio between each disc of 2:1. If a disc is moving too fast or too slow, the speed may be altered by making the proper change in size of the pulleys. A temporary adjustment may be made by using adhesive tape to build up pulleys when too small. After the proper sizes have been determined by trial, the pulleys may be turned to their final diameters on a lathe. Wood pulleys may be used at first for experimental purposes, until the exact size wanted has been determined. There is some stretching and slippage that will occur normally and this must be compensated for by varying pulley diameters. The rubber belts we used are rubber packing rings manufactured for packing cream separator bowls. They may be obtained from dealers in farm implements. Leather may be used if the rubber is unavailable.

All five discs must be running at a uniform speed ratio of 2:1 if the instrument is in tune. When this adjustment has been properly made, the discs will all appear to stand still or

July, 1946

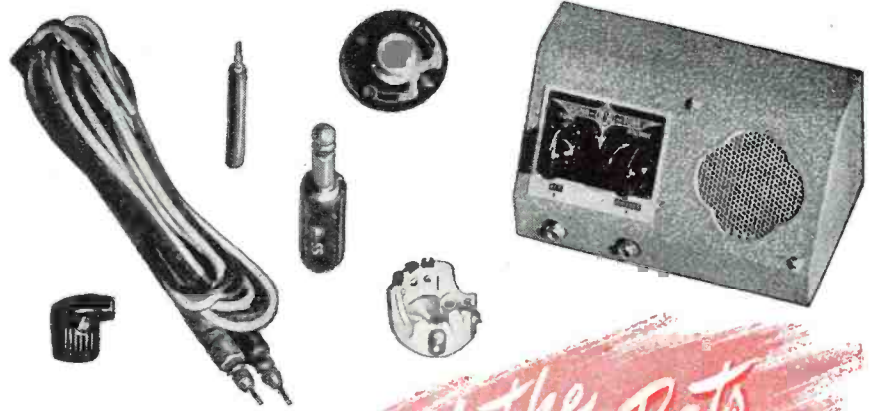

*Just a few of the thousands of Radio Parts manufactured by INSULINE*



ICA is now making immediate deliveries on its entire 1946 line — everything from tiny acorn sockets to antennas; each item a vastly improved unit.

It will pay you to know the complete 1946 ICA line. Write Department B-2 today for the two new 1946 ICA catalogs—one on Antennas the other on the new ICA Parts.



**insuline**  
CORPORATION OF AMERICA

INSULINE BUILDING • LONG ISLAND CITY, N. Y.  
More than a quarter-century of Quality production.



Model shown is from W2C series. 2 and 3-KW 60-cycle, 115 volt; powered by water-cooled, 2-cylinder engine.

# Electricity

FOR RADIO AND ELECTRONICS USES

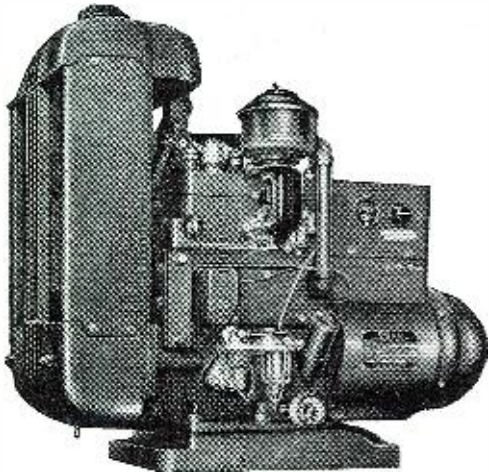

ONAN ELECTRIC GENERATING PLANTS supply reliable, economical electric power for electronics applications as well as for scores of general uses.

Driven by Onan, 4-cycle gasoline engines, these dependable plants are of single-unit, compact design and sturdy construction. Suitable for mobile, stationary or emergency service.

Onan Electric Plants are available in capacities from 350 to 35,000 watts; 115 to 660 volts A.C., 50 to 800 cycles; 6 to 500 volts D.C.; combination A.C.-D.C. types.

WRITE FOR INFORMATION OR ENGINEERING ASSISTANCE

**D. W. ONAN & SONS**  
2174 ROYALSTON AVE., MINNEAPOLIS 5, MINN.



EDITOR'S NOTE: Because of our limited page size, it is impossible for us to print the mechanical drawings pertaining to the construction of this organ in sufficient size to be practical. We have, therefore, made arrangements to provide a complete set of original blueprints for those interested in constructing this unit. These blueprints will be available at our cost of \$1.00. All requests are to be forwarded to The Editor, Radio News, 185 N. Wabash, Chicago 1, Ill.

move with uniformity in one direction under the strobe light.

When properly adjusted, if the key for middle "C" is depressed, the note should correspond to that of a standard tuning fork or oscillator set for 256 vibrations per second. If this frequency is off, the speed of all five octaves should be altered. Then if the speed ratios have been correctly adjusted, the entire instrument will be in tune and no further speed adjustments will be necessary. Remember that increasing the speed increases the frequency, while decreasing the speed lowers the frequency. An ordinary neon bulb lighted from 60-cycle current is useful in making these adjustments if no strobe light is available. The neon bulb will show errors in speed between successive discs.

A cathode-ray oscilloscope may be used to check speed, tuning, waveform, distortion, hum pickup, noise, vibration, etc. With the vertical deflecting plates connected to the amplifier output through the proper coupling condensers, the pattern may be viewed on the screen and when corresponding keys are depressed, notes should mix together from separate octaves. The fundamental of one octave is equivalent to a harmonic of an octave below, and if these patterns do not mix together perfectly on the screen of the oscilloscope, the speed of the discs should be altered until these patterns do blend perfectly.

The oscilloscope is also useful in checking for noise and hum. The pattern of the linear sweep should be as nearly a straight line as possible when no keys are depressed. By covering all the mirrors but one with cardboard, noise, hum, and distortion may be traced to the particular octave causing the difficulty. Sometimes an unwanted reflection from one of the glass discs will cause interference and noise. The remedy is usually to apply a little black paint to stop the reflection. A cardboard shield can also be used to advantage to cut off unwanted light, especially for checking purposes.

If radio, phono, and microphone pickups are provided, it will be easy to compare the patterns of the Photo-Electronic Organ tones with the tones of recorded music, or music picked up from radio broadcasts, or directly through the microphone from other musical instruments. A comparison of the tone patterns will show where the differences occur, and what makes various musical notes different and individual for each separate musical instrument.

**WALSCO PRODUCTS**  
help the radioman

**NEW LOW PRICED FLOCK FINISHING KIT**

**Includes:**

- Flock Spray Gun and Brush.
- 2 Colors of Flock, Undercoats, Thinner and Instructions.

Flock Gun and Flocking Material  
Also Available Separately  
For full information write Dept. RN3

**WALTER L. SCHOTT CO.**  
BEVERLY HILLS, CALIFORNIA • CHICAGO 5, ILLINOIS

**ATTENTION HAMS!**

**THE IDEAL MIKE FOR THAT PORTABLE RIG**

A good quality moving coil dynamic Microphone, designed especially for communications work. Ideal for Hams, Police equipment, and some P.A. work. Output -50 db. HI-impedance, semi-directional. Hand type rugged black acetate plastic case 3 1/4" x 2 3/8" x 1" deep. Weighs only 8 oz. Complete with 7 ft. of tough, flexible, long lived, vinylite cord.

**ONLY \$5.00**

Plus 5% excise tax

**O & S LABORATORIES**

3831 N. FREMONTCHICAGO 13, ILLINOIS

Since the Photo-Electronic Organ is still in the experimental stage, the authors feel that its construction is an interesting and worthwhile project for any engineer, amateur, or experimenter interested in electronic musical instruments. This field is wide open for experimental development. The description of the organ has been made rather general to allow the prospective constructor considerable leeway in developing ideas of his own. The authors are especially anxious to hear from anyone interested in this sort of an instrument, and they will be more than glad to answer questions concerning it or any problems that may arise in its construction.

**REFERENCE:**

Goodell, John D. "Electronic Composition of Music," *Radio-Electronic Engineering Department of RADIO NEWS*, July 1945, p. 12.

-50-

**Stable V.F.O.**

(Continued from page 58)

coefficient, although some precision variable capacitors do have this characteristic. If a capacitor having a positive temperature coefficient is used, it can be seen that if, for instance, compensation was obtained with the variable capacitor set at mid-capacity, over compensation would result at minimum capacity and under compensation at maximum capacity. It is also difficult to completely compensate for inductance changes with capacity. If, however, a zero temperature coefficient variable capacitor can be obtained, good results are possible. The value of negative temperature coefficient capacity used will have to be determined by experiment and will make up part of the value of  $C_2$ . The balance of the value of  $C_2$  will, of course, be of zero temperature coefficient.

If however, a zero temperature coefficient variable capacitor is not available, and if a compromise in compensation is acceptable, any good grade variable capacitor with adjustable stator or rotor plates can be used if it is electrically centered. This can be done as follows:

Connect the capacitor in the circuit and arrange a means of checking frequency change. Adjust the stator or rotor plate assembly backward or forward until a point is reached so that when the assembly is moved either backward or forward, the capacity is increased (frequency is lowered). Check this at three or more points, that is, at maximum capacity, mid-capacity and near minimum capacity. When the capacitor is so adjusted, an increase in temperature will cause an increase in capacity at any setting and therefore make compensation easier to control, even though complete compensation cannot be obtained.

Considering the use of temperature control of the tank circuit, mechanical construction becomes more compli-

# SOUND VALUES at TERMINAL RADIO

*The P.A. Systems You've been waiting for!*

- TOP-NOTCH QUALITY!
- HEAVY DUTY CONSTRUCTION!
- ECONOMICAL — COMPARE!
- HUM-FREE, NOISE-FREE!
- NEW IMPROVED DESIGN!
- AVAILABLE NOW — ORDER FROM THIS ADVERTISEMENT!



**\$57<sup>60</sup>** Net

Model TR-1 14 watt heavy duty system COMPLETE

**T**ERMINAL SOUND SYSTEMS are famous for their long life and trouble-free performance. The new models here boast no superfluous fancy frills but are a new high in Sound Value — each amplifier incorporates a wealth of real, useable features for the power and tone quality heretofore unavailable in low-cost sound systems.

**14 WATT HEAVY DUTY SOUND SYSTEM**

A complete system—no extras to buy! Consists of 14 watt heavy duty amplifier, 14 inch permanent magnetic speaker in reinforced wall baffle (specify color—brown or grey), 25 ft. speaker cable, wide range crystal microphone with table stand and 15 ft. shielded microphone cable. Ready to plug in and operate!

MODEL TR-1 PA SYSTEM, as described and illustrated **\$5760** Net

MODEL TR-1D DUAL SPEAKER SYSTEM, (as above, but with two 10" speakers in wall baffles) **\$6795** Net

**25 WATT HEAVY DUTY SOUND SYSTEM**

Offers high fidelity sound reproduction with emphasis on quality and power! Consists of 25 watt amplifier, 12 inch permanent magnetic speaker in reinforced wall baffle (specify color—brown or grey), 25 ft. speaker cable, wide range crystal microphone with table stand and 15 ft. shielded microphone cable.

MODEL TR-2 PA SYSTEM, as described **\$7150** Net

MODEL TR-2D DUAL SPEAKER SYSTEM, (as above, but with two 12" speakers in wall baffles) **\$8495** Net

**14 WATT AMPLIFIER SPECIFICATIONS**

POWER OUTPUT: 14 watts normal  
 GAIN: Microphone input 110 db.; phono input 70 db.  
 FREQUENCY RESPONSE: 50 to 12,000 cps, hum —70 db. below rated output.  
 INPUTS: 1-Microphone, 1-Phono (both high impedance). Separate gain controls for mixing and fading.  
 TONE CONTROL: Full range bass and treble tone compensator.  
 OUTPUT IMPEDANCES: 2, 4, 8, 16 and 500 ohms.  
 TUBES: 1-7C7, 1-7F7, 2-7C5 and 1-5Y4G.  
 POWER CONSUMPTION: 85 watts, 117 volts 50-60 cycles. A.C. Fused primary.  
 SIZE: 13"x8½"x8½". Net wt. 15 lbs.

TR-1A AMPLIFIER ONLY, complete with tubes **\$3381** Net

**25 WATT AMPLIFIER SPECIFICATIONS**

POWER OUTPUT: 25 watts normal  
 GAIN: Microphone input 112 db.; phono input 70 db.  
 FREQUENCY RESPONSE: 40-13,000 cps, hum —65 db. below rated output.  
 INPUTS: 1-Microphone, 1-Phono (both high impedance). Separate Gain Controls for mixing and fading.  
 TONE CONTROL: Full range bass and treble tone compensator.  
 OUTPUT IMPEDANCES: 4, 8, 12, 16 and 500 ohms  
 TUBES: 1-6SJ7, 1-6SL7, 2-6L6 and 1-5U4G  
 POWER CONSUMPTION: 120 watts, 117 volts 50-60 cycles. A.C. Fused primary.  
 SIZE: 17"x9"x9". Net wt. 24 lbs.

TR-2A AMPLIFIER ONLY, complete with tubes. (Similar in appearance to TR-1A, but not illustrated here) **\$4263** Net



**WEATHERPROOF OUTDOOR SPEAKERS**

MODEL PSAH—3½ ft. horn recommended for voice applications. High Efficiency, ½ mile sound projection, 25 watt driver unit. **\$3792** net

MODEL LSAH—4½ ft. horn ideal for music. Waterproof construction, ¾ mile sound projection, 25 watt driver unit. **\$4792** net

**MICROPHONE FLOOR STAND**

MODEL MS-4. 10" diameter, heavy base, all chrome sections adjustable from 34" to 62". Positive locking clutch. **\$525** net

Above prices are FOB New York. 25% deposit required with all COD orders.

*Terminal Radio Corporation*

85 CORTLANDT ST., NEW YORK 7, N. Y. • Telephone: WOrth 2-4415

## Real Values at LEEDS RADIO

Measurements Corp. Model 62  
VACUUM TUBE VOLTMETER



R.M.S. of Sine Wave or .707 of peak of complex wave.  
A.C. Volts—0-1/3/30/100  
D.C. Volts—0-30/300

Brand New .....\$110.00

## SELSYN INDICATORS

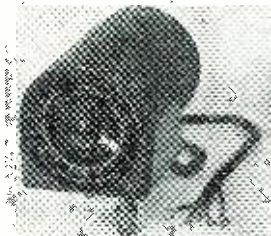

Type II—1  
Ideal for rotary Antenna  
Pair \$18.00

## CHECK THESE CONDENSER VALUES!

G.E. Pyranol	4 mfd.	600 V.D.C.,	\$0.95
	10 mfd.	1500 V.D.C.,	3.50
	7 mfd.	330 V.A.C.,	1.25
Aerovox	0.1 mfd.	7500 V.D.C.,	1.50
		oil filled,	

## WESTON ANALYZER

Model 772, type 6. Equipped with televerter, model 766, type Z.  
D.C. volts 20,000 or 1000 ohms per volt 0-2.5/10/50/250/1000  
With televerter range can be extended to 10,000 volts at 20,000 ohms per volt.  
A.C. volts 0-2.5/10/50/250/1000.  
Ohms— $\frac{1}{4}$  ohm to 30 megohms.  
Current—Eight D.C. ranges 100 microamps to 10 amps.  
Decibels—DB range from -14 to +54 in 5 steps.  
Housed in wooden carrying case. Complete with leads and instructions.

BRAND NEW .....\$74.95

Signal Corps Telegraph Key.. .89  
7" Porcelain Strain Insulators .10

## NAVY TS 182/UP SCOPE

Has vertical and horizontal amplifiers, 12 tubes including 2 API cathode, housed in gray crackedle watertight cabinet measuring 10 $\frac{1}{2}$  x 16 x 16 $\frac{1}{2}$  inches; supplied with complete kit of spare parts consisting of transformer, choke, resistors, condenser and 22 tubes, including 2 extra cathode tubes. Kit of parts in metal box measuring 9 $\frac{1}{2}$  x 19 $\frac{1}{4}$  x 16.  
Price complete with spare parts.....\$60.00

SIGNAL CORPS A-E2 (Phantom) ANTENNA  
Consists of variable inductance, variable capacitor, 2 fixed resistors. Use in place of antenna to tune transmitter without radiating strong signal.  
Complete with instructions.....\$50

A deposit of 25% must accompany all orders.  
All prices F.O.B. our warehouse New York.

## LEEDS RADIO CO.

75 Vesey St., Dept. 40  
COrtland 7-2612 New York City 7

cated, but very good stability may be obtained if a good oven that will maintain a constant temperature under conditions of varying ambient temperature and line voltage is used. An oven satisfactory for this purpose was described in the October, 1945 issue of RADIO NEWS. In using an oven to control the temperature of the tank circuit, the tube should not be mounted within the controlled chamber, as the heat dissipated by the tube makes good heat control difficult. Fig. 2 shows how the tube may be mounted outside the heat controlled compartment, while the rest of the circuit component parts are mounted within.

For best results, even when using temperature control, a zero temperature coefficient or electrically centered variable capacitor should be used.

Even though electron coupling is used in the oscillator shown, an untuned buffer is recommended to completely isolate the oscillator from any variation in the load, such as a tuned amplifier or multiplier. The r.f. voltage output of the buffer may be controlled, if desired, by using a 50,000 ohm potentiometer in the place of  $R_s$ , thus controlling the screen voltage.

It should be emphasized that every consideration should be given rigid mechanical construction of the oscillator. Any shielding used should be of heavy gauge material as should be the chassis on which the unit is constructed. A cast aluminum chassis and shield is ideal although very good results can be had by using  $\frac{1}{8}$  inch aluminum, well bolted or riveted.

Frequency stability in the order of 8 to 10 cycles per megacycle under conditions of widely varying ambient temperature and line voltage is possible using the methods discussed herein. No specific type of mechanical construction or layout is discussed as that is left to individual requirements, although something similar to the layout as shown in Fig. 2 is suggested

if oscillator is to be constructed in an oven. The untuned buffer stage may then be constructed on a chassis attached to the outside of the oven.

-50-

## Television Receivers

(Continued from page 47)

receiver test pattern with all controls adjusted properly except the contrast control that has been advanced a bit too far. In the test pattern, the very center should be black and there should be a definite increase in intensity in the second concentric area and a further increase in the third. With the contrast advanced too far the center and the second area blend together, the second area becoming almost as dark as the center. If the contrast control is not turned up far enough the picture has a dull appearance with greyish looking white areas and weak blacks.

c. Adjust focus carefully for a sharp picture. When the focus control is properly set there is a sharp, definite separation between the vertically and horizontally fanned lines all the way into the intersection points where they meet the outer concentric circle. Since focus and brightness adjustments react on each other, it is sometimes necessary to touch up each one just a bit more to obtain the best picture possible.

## Installation Adjustments

When the radio serviceman installs the television receiver, he not only explains and demonstrates the previously discussed operational procedures but also makes a number of other adjustments. These adjustments are screw-driver adjustments and, once properly set, are not to be disturbed by the customer. The remainder of the controls are horizontal linearity, vertical linearity, width,

Five veteran hams whose amateur experience totals 117 years, look at a 1915 crystal receiver at a recent meeting of the Hamfesters Club of Chicago. Left to right are: John S. Reed, W9LUT, 14 years in ham radio; Ollie Read, W9ETI, Editor of Radio News, 27 years; Cy Read, W9AA, 30 years; T. J. Reid, W9AAJ, 23 years; and Major E. O. Reid, W9SI, transportation officer of the Chicago Quartermaster Depot, 23 years.



height, horizontal centering, and vertical centering. After the serviceman has gone through the operating procedures, he makes the following adjustments:

1. *Width and Height Controls:* The width and height controls are adjusted until the picture occupies adequately the fluorescent area of the picture tube screen and has the proper aspect ratio. The transmitted test chart is helpful in making these adjustments. Thus the chart in Fig. 4 is compressed horizontally and the width control must be tuned to spread the picture out. Likewise, the height control is tuned until the chart is properly proportioned vertically. When the picture has the proper aspect ratio, the rings on the test chart are a perfect circle as shown in Fig. 1 and not elliptical as shown in Fig. 4.

2. *Vertical and Horizontal Centering:* It is also possible that the entire picture, although it has the proper aspect ratio, is displaced from center of fluorescent screen as shown in Fig. 5. In this example, the horizontal centering control requires adjustment to move the entire picture horizontally to the center of the screen. Likewise, a vertical centering control properly centers the picture vertically. Proper centering and aspect ratio are shown in the chart of Fig. 1.

a. Perfect inner circle indicates proper aspect ratio.

b. Outer circle just touches very edge of scanning raster on right and left sides. Inner circle just touches very edge of scanning raster at top and bottom. This indicates proper aspect ratio, proper centering, and correct width and height adjustment.

3. *Vertical and Horizontal Linearity Controls:* The linearity controls are adjusted for proper proportioning of the picture. Thus if the picture is crowded on the right side of the scanning raster, the horizontal linearity control requires adjustment; if crowded at the bottom of the scanning raster, the vertical linearity control requires adjustment. Here, again, the object is to tune for a perfect circle with the aid of the test chart. The effect of incorrect linearity setting is evident to a certain extent in Fig. 5. Notice how the half-circle of the inner ring extends out further on the left side of center than the half-

Fig. 3 Illustrating results obtained when vertical hold control is incorrectly set.

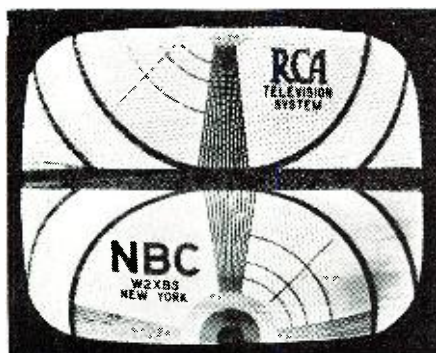

July, 1946



Marion Glass-to-Metal Truly Hermetically Sealed Electrical Indicating Instruments are 100% guaranteed for six months. After this period we will replace any 2½" or 3½" type, ranging from 200 microamperes upward, for a flat fee of \$1.50, regardless of whether the instrument has been overloaded, burned out, or in any way mistreated, provided the seal has not been broken. We will replace, for a flat fee of \$2.50, any 2½" or 3½" instrument, with sensitivity greater than 200 microamperes, under similar circumstances.

### An important blanket guarantee . . .

For the user of electrical indicating instruments, this guarantee is highly significant. It precludes the need for him to maintain his own repair department, and it minimizes the correspondence and red tape that formerly enmeshed most replacement transactions. Moreover, he is assured of receiving his replacement within a reasonably short period at a saving of considerable time and money. It is our faith in the quality and performance of Marion "hermetics" that prompts us to make this guarantee which is offered to customers in all parts of the world. You can buy and use them with confidence.

### Marion Glass-to-Metal Truly Hermetically Sealed 2½" and 3½" Electrical Indicating Instruments

Note: Marion "hermetics" cost no more than most standard unsealed instruments—and they are positively interchangeable. Write for the new Marion Catalog.



IN CANADA: THE ASTRAL ELECTRIC COMPANY, SCARBORO BLUFFS, ONTARIO

# Portable A.C. Ammeter

Surplus New  
Weston Model 528



Dual Range 0-3 Amp. and 0-15 Amp. full scale. For use on any frequency from 25 to 500 cycles. The ideal instrument for all commercial, industrial, experimental home, radio, motor, and general repair shop testing. Comes complete with a genuine leather, plush-lined, carrying case and a pair of test leads. A very convenient pocket-sized test meter priced at less than 50% of manufacturer's list.

Your Cost **Only \$12<sup>50</sup>**

## Panel Meters

Weston Model 517, 2 1/2", round flush, Flange mtd., bake case, 0-150 Volts, A.C. . . . . . **\$2.95**

Weston Model 517, 2 1/2", round flush ring mtd., metal case, 0-75 Volts, A.C. . . . . **\$2.50**

## VARIACS

General Radio Type 200 CU, 860 Volt-Ampere rating, 115 Volt A.C. Input; Output variable from 0 to 135 volts A.C. at a maximum current of 7 1/2 amperes. Shipped complete with knob, less dial, in original G. R. carton.

**Only \$12<sup>00</sup>**

## MARITIME SWITCHBOARD

336 Canal St., New York 13, New York  
Worth 4-8217

circle does to the right of center. Since the linearity, height, and width controls interact on each other, all four adjustments must be touched-up slightly as a final tuning step.

### Antenna Orientation

Another task encountered by the serviceman when he installs a television receiver is proper orientation of the antenna to secure maximum signal. The more elaborate and directional the antenna array becomes, the more critical it is to orient.

The actual positioning of the antenna is not difficult although it is a bit awkward unless you and your helper are on hand. The antenna is slowly rotated about in the general direction of the station by one man, while the second observes the picture tube screen to locate the maximum signal position (indicated by darkest picture). Some means of voice communication is necessary between receiver and roof so that the antenna may be set precisely. This is particularly the case in congested areas where reflections are prevalent and can sometimes be eliminated completely by proper antenna positioning. To remedy this defect, the serviceman observing the receiver checks for the antenna position which removes all secondary images.

A small portable telephone set is a time-saver and lung-saver in positioning the antenna. The citizens' radio band can be used to advantage by the servicemen in the installation of television and FM antennas. It can be a convenient method of orienting antennas with the man on the roof and the serviceman in the house both equipped with small portable citizens' frequency transceivers. Another gadget which the wise serviceman could use is a compass for if he knows the relative bearings about his city and the location of the television transmitter, he can do a precise job of orienting the antenna on the first trip to the roof. In fact, the serviceman located in an outlying city or town twenty or more miles from the transmitter location can set his compass up permanently by taking the relative bearing of the transmitter from his town with the assistance of a map, and permanently marking the transmitter bearing on the compass. He can then use this compass in any part of town to position antennas on the distant transmitter. Be careful to compensate for the fact that the compass is attracted toward magnetic north, and the map is probably based on true north.

### Technical Analysis of Controls

It is important that the serviceman knows not only how to adjust each control but what goes on technically when each control is turned. If he does, and there is any malfunction when a particular control is turned, he is well on the way to diagnosing the trouble.

1. *Wave Selector*: The wave selector switches change the resonant cir-

# ELECTRON TRACER



- A VACUUM TUBE VOLTMETER
- AN AUDIBLE SIGNAL TRACER
- AN ELECTRONIC OHMMETER

A Complete 6 Tube Service Laboratory

### RANGES:

DC Volts: 5/10/100/500/1000; + or -3%.  
DC Input resistance: 26 megohms  
AC Volts: 5/10/100/500/1000.  
AC Input resistance: Over .5 megohms.  
OHMMETER: From .2 ohm to 1000 megohms.

See your local jobber. If he does not carry the ELECTRON TRACER, write us.

**\$89<sup>50</sup>** NET

## ELECTRONIC INSTRUMENT CO., Inc.

926 CLARKSON AVENUE BROOKLYN 3, N. Y.

## IMMEDIATE DELIVERY!

### ARNOLD SHURE Phonographs



#### THE VIVITONE MODEL 4RP2

Fully portable, self contained, all electric Phonograph.

3 Tubes (7C5, 5Y3, 7N7 or 7F7) 2 Watt output, 6" P.M. Speaker, fast change (3 1/8 second cycle) Milwaukee Erwood Changer. Inverse

feed back for perfect tone control. Handsome shark grained leatherette covered carrying case with post handle. Size: 9 3/4" x 16" x 18". Net weight 26 lbs. 2 oz. Shipping weight 29 lbs. 7 oz. RETAIL PRICE (O.P.A. Ceiling) \$68.75\*

#### THE STANDARD MODEL 4RP1

Fully portable, self contained, all electric Phonograph. 3 Tubes (7Y4, 6B4, 7N7 or 7F7) 2 Watt output. Inverse feed back. Sturdy hardware. 5" P.M. Speaker. Attractive leatherette covered carrying case with post handle. Size: 15" x 15" x 9". Net weight 19 lbs. Shipping weight (2 units packed to carton) 46 lbs.

RETAIL PRICE (O.P.A. Ceiling) \$50.35\*

#### THE USE-A-TONE MODEL OR2

Wired record changer, Milwaukee Erwood Unit (same as used on Model 4RP2). Mounted on handsome leatherette covered base. Makes a Phono Combination out of any radio, utilizing its full tone quality. Appr Size: 14" x 14" x 9". Appr. Weight: 8 lbs Packed: 10 lbs.

RETAIL PRICE (O.P.A. Ceiling) \$30.50\*

\* Plus 5% in Zone 2

All units 110-120 Volt, AC only  
Sold by leading Department, Music,  
and Radio Stores

DEALERS write, wire, or phone for prices

**NATIONAL ACOUSTIC PRODUCTS**  
120 N. GREEN ST. CHICAGO 7, ILL.  
PHONE HAYMARKET 6522

RADIO NEWS



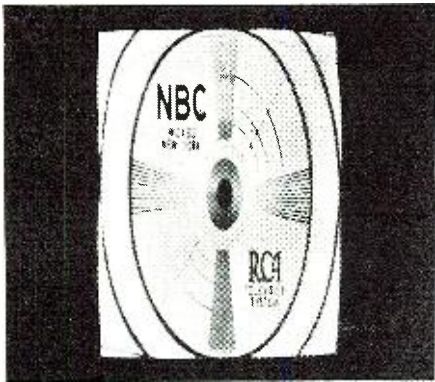

Fig. 4. When the horizontal width, or size, control is incorrectly set, this is the result.

cuits of the r.f. amplifier, mixer and local oscillator by a substitution process. Each channel has its individual tuned circuits.

2. *Tuning*: The fine tuning control changes only the frequency of the local oscillator over a limited range. With this control the local oscillator is precisely tuned so that its difference frequency with respect to the incoming signals is the exact i.f. frequency.

3. *Brightness*: Brightness control changes the fixed bias on the cathode or control grid of the picture tube. Consequently, the number of electrons reaching the fluorescent screen is varied, causing the degree of illumination to vary. Changing the grid bias on the picture tube has the same effect on beam current as changing the grid bias on an ordinary vacuum tube has on plate current.

4. *Focus*: Focus control changes the voltage relation between first and second anodes of the picture tube by varying the first anode voltage. This control acts as an electronic lens for it causes the beam to come to a pin-point focal point on the fluorescent screen. When improperly adjusted, the beam focal point is in front of or behind the fluorescent screen and the image on the screen is blurred. A similar condition exists when you try to read with another person's glasses which have not been made for your eyes. Since the focus control also changes voltage relation between first anode and control grid, there is some interaction between the focus and brightness controls.

5. *Contrast*: The contrast control

Fig. 5. Distortion which results when horizontal centering control is incorrectly set.

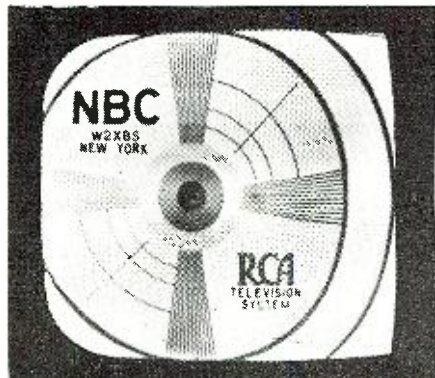

July, 1946

## HARRISON HAS IT!

### ★ H S S

#### Stromberg-Carlson DYNAMOTORS

Compact, well-constructed unit, excellent for mobile transmitters, amplifiers, etc. Ball bearings, good efficiency. Made for military use.

INPUT		OUTPUT	
12 V	at 16.8 A	680 V	at 210 Ma
6 "	" 16 "	300 "	" 210 "
6 "	" 21.5 "	265 "	" 300 "

3 3/4" dia. x 6 1/2" long. 6 lb. 12 oz., with mounting plate. Brand New. HSS **\$8.95**  
SPECIAL.....

#### Beachmaster POWER AMPLIFIER

250 Watts Class B 805's to 9 ohm load. Delivers 1500 Volts DC at 320 MA and 300 Volts DC at 150 MA; 10 and 6.3 Volts AC. On heavy chassis 12 1/2" x 19". Has blower fan to cool tubes. Excellent for P.A. booster, modulator, or power supply. Less HSS tubes—HSS... **\$44.75**

#### HSS TUBES

Raytheon RK-63. Regular price \$22.00. Special **\$9.85**.  
RK-38—\$5.95  
RK-39—1.75  
Navy tested and accepted 805's—\$6.90.  
807's—\$1.29.  
Eimac 304-TL. Handle a KW cool! Slightly used in radar pulsing, tested and guaranteed OK. Reg. net \$50.  
HSS..... **\$7.50**  
Special.....

#### ROTARY COAXIAL COUPLING

Having trouble coupling to your rotary beam? Feed it efficiently through this constant impedance slip-ring coupling. Made for Signal Corps by Lapp Insulator Company, one of the best antenna system manufacturers. Surge impedance of 52 ohms will match most coaxial cable.

Head, 1 7/8" dia. finely machined from brass. Copper feed line 7/8" dia. is 51" long..... **\$7.75**

#### LONG WAVE RECEIVERS

##### Navy Model RAK7

15 to 600 Kilocycles. 6 Tube Receiver with AVC, Noise Limiter—Band Pass Filter—Tuneable Audio Filter—Band Switching—Precision Dial—3 Tube Voltage Regulated Power Supply for 115 V—60 cycle A.C. Optional Battery Operation. Excellent for Marine and Aviation work.

Brand New in original crate, complete with Power Supply, Steel Chest full of spare tubes and parts, full instructions..... **\$79.50**

#### HAM XTALS

Here is the value in ham band crystals that tops anything you have ever seen! Carefully manufactured to exacting Signal Corps specifications. Very active oscillators. Stainless steel electrodes. Neoprene gasket seals out moisture and dust. Calibration accuracy. .01% over full temperature range!

40 meters—in DC-35 holder. (1/2" Pin spacing.) Fits into Millen 33202 socket.

80 meters—in DC-34 holder. (3/4" Pin spacing.) Fits into Amphenol 33-3 socket.

Specify frequency desired with acceptable limits. Quantity limited..... **90c**  
(Three or more—postpaid.)

**PHOSPHOR BRONZE ANTENNA WIRE**  
Strong, won't stretch. 7 strands No. 18 (10 ga) 100 foot coils. List price \$6.00. HSS—\$2.39.

#### 1N34 CRYSTAL DIODE

This is the germanium rectifier crystal specified in recent articles for noise limiters, field strength meters, etc..... **\$1.80**

#### HSS TUBES

All new, fully guaranteed. HK24G (3C24/VT204), an FB Tube for VHF. 90 watts Class C output. Gov't inspected. Regular Amateur Net Price was \$9.00, reduced to \$6.00; but Harrison sells them for only **\$1.69** (3 for \$4.45)

#### HAND MIKES

High impedance dynamic microphones, used in the SCR-299 mobile transmitter. Excellent voice response. Push-to-talk button to close relay. Complete with 9-foot cable and Amphenol MC3M plug. Tested and guaranteed. HSS..... **\$9.75**

#### \* HARRISON SELECT SURPLUS

Your assurance of good, usable, guaranteed surplus material at sensationally low prices—top value always! Come in and browse through our large, entirely separate HSS Department (Harrison Select Surplus).

## HARRISON HAS IT!

### ALL STANDARD LINES

#### NEW SKY CHAMPION

By special chartered cargo-plane, we obtained our initial stock of the new Hallicrafters S-40 Sky Champion receivers! They're going **\$79.50** fast so rush in your order. Complete..

⌈ We'll do everything possible to give you the very best service on all makes and models of receivers, transmitters, etc.—Keep sending in your orders. ⌋

#### Test Equipment

Shipments are getting bigger and better! Send us your order now for quickest delivery.

Dumont—GE—Hickok—Precision—RCP—RCA—Shallcross—Simpson—Supreme—Triplet—Weston.

#### TWIN

##### RIBBON CABLE

Amphenol's sensational new transmission line. In stock in 75, 150 and 300 ohm surge impedance. Per foot... **3c**

##### PLASTICS PLIERS

New SPECO all plastic long nose pliers. Light, strong, very handy..... **89c**

### ☞ CQ—L. I. HAMS! ☜

Our JAMAICA BRANCH is the most handy place on the Island to get your Ham and Service material. Right at the bend in Hillside Ave. Complete stocks—plus direct lines to make our N. Y. store and warehouse stocks immediately available. Drop in—often!

#### BOAT OWNERS!

Immediate delivery of Islip Model MRT-10 Marine Radio Telephones. 10 Watt carrier output. 5 channel selector switch. Push-talk handset. For 6 or 12 Volt operation, 8 1/2" x 8 1/2" x 12", complete! Well engineered and constructed. With six crystals for three channels. **\$195**

Coast Guard vertical rod antenna \$45. Real radiation efficiency!

#### Record Changers

Garrard..... \$65.85  
Webster No. 56-1 26.66  
Webster No. 50. 21.17

#### STEEL ??

It's scarce, but we've just received shipments of several truckloads! Chassis—racks—panels—cabinets—boxes—brackets—etc., all sizes. Parmet—Bud—Mid-dietown—ICA. Get yours now!

#### 10L DIPOLE

Made by S.C. Labs. Light-weight, all aluminum adjustable elements and mounting pole. Machined center coupling insulator. Good value for little money! Complete with instructions... **\$6.75**

PREMAX Antennae and elements in stock!

### We are

FACTORY AUTHORIZED DISTRIBUTORS for the top quality manufacturers and we now have in stock lots more new, latest improved production Ham gear! Visit our stores today, for everything you need. We promise you fresh, clean material—quicker—at the lowest current prices—and, above all, our sincere desire to be of friendly, helpful service.

MAIL ORDERS?—Certainly! Just list everything you want (items in this ad, or any ad, magazine or catalog) and include deposit.

73 de

Bill Harrison, W2AVA

**HAM HEADQUARTERS**  
Since 1925!



**HARRISON RADIO CORPORATION**

10 WEST BROADWAY • NEW YORK CITY 7

BARCLAY 7-9854

JAMAICA BRANCH — 172-31 Hillside Ave. — REPUBLIC 9-4102

**SPEED UP REPAIRS WITH THESE G-C AIDS!**

**G-C is HEADQUARTERS for RADIO PARTS and SERVICE AIDS**



All Types of Radio Cements, Chemicals, Coil Dopes, Compounds.

G-C leads the field in supplying Radio-Electronic Manufacturers and Service Men with Parts, Tools, Radio Cements, Chemicals and Compounds. Insist on Genuine G-C Quality.



Dial Cables, Dial Belts, Packaged Hardware, Cabinet Repair Kits

Speedex Wire Strippers Alignment Tools Ne-O-Lite Testers

Order from Your Jobber—Send for G-C Catalog



**GENERAL CEMENT MFG. CO.**  
ROCKFORD, ILLINOIS

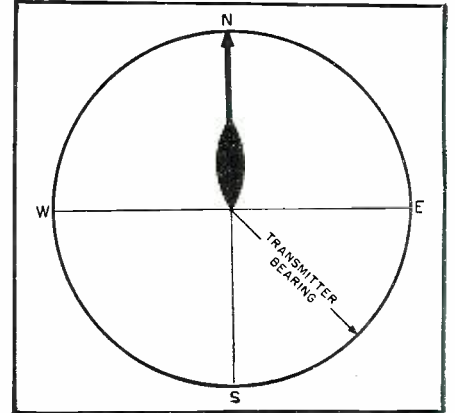

Fig. 6. Calibrated compass, transmitter bearing with respect to magnetic north.

varies the peak-to-peak amplitude of the picture signal applied to the control grid of the picture tube. It does this either by varying the gain of the i.f. amplifier (similar to r.f. gain control in conventional broadcast receiver), or by varying the gain of the video amplifier (similar to audio volume control in conventional broadcast receiver). Just the proper amount of signal must be applied to the picture tube to vary the illumination from black to peak illumination with the proper relative half-tones in between.

6. *Hold Controls:* The hold controls, vertical and horizontal, determine the free-running frequency of the saw-tooth oscillators. When the free-running frequency of the saw-tooth oscillator is brought within a certain frequency range by the hold controls, the oscillator is locked in synchronism and held precisely on the correct frequency by the sync pulse, horizontal and vertical. The hold control varies the free-running frequency of the oscillator by changing the time constant of a resistor-capacitor discharge network which is the frequency determining elements of a relaxation oscillator.

7. *Width Control:* The width control varies the amplitude of the horizontal saw-tooth. This is done by increasing the rate with which the capacitor charges, across which the saw-tooth voltage is developed. Thus, when the control is advanced, the capacitor charges to a higher level in a given amount of time, before it is discharged by conduction of a tube. It is evident the frequency remains the same, but the saw-tooth amplitude has increased. Consequently, the deflection voltage, in the case of a picture-tube with electrostatic deflection, and the deflection current, in the case of a picture-tube with electro-magnetic deflection, is increased. The beam, therefore, is deflected over a greater area horizontally, producing a wider picture.

8. *Height Control:* The height control exerts the same influence over the amplitude of the vertical saw-tooth, changing the vertical area over which the beam is swept.

9. *Vertical and Horizontal Centering Controls:* The centering controls, in

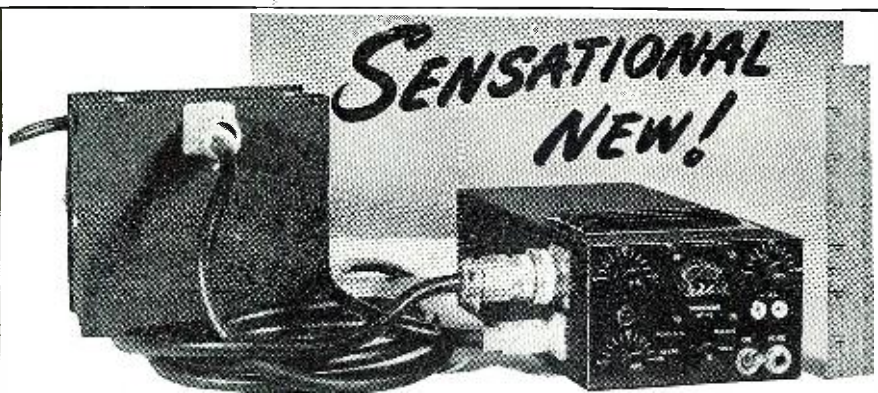

**SENSATIONAL NEW!**

**MOBILE TRANSMITTERS by Suburban**

Styled for Universal dashboard mounting facilitating rapid frequency change and eliminating cumbersome cable arrangements.

The SUBURBAN MT-15 is capable of delivering 15 watts output of 100% modulated, undistorted carrier, with a frequency range covering from 27 to 31 megacycles.

The dynamotor unit is designed for engine wall mounting either inside or out, providing maximum efficiency and minimum mechanical and electrical disturbances.

**PRICE \$149.50** All units complete, including all tubes and cables (Price subject to OFA Approval)

**IMMEDIATE DELIVERY**

All units unconditionally guaranteed for a period of ninety days, excepting tubes. A 20% deposit required on all orders. All units f. o. b. East Rutherford, N. J. Technical information regarding these units will be promptly forwarded on request.

**SUBURBAN RADIO COMPANY**

82 Herman Street, East Rutherford, N. J.

**Photo Electric Unit**

For numerous control applications such as burglar alarms, industrial safety controls, automatic counters and in conjunction with a chime or bell to announce entrance of people in stores and offices. For AC. Complete with all tubes and SPDT control relay.

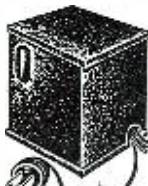

\$9.45

LIGHT SOURCE—Up to 15 feet. For use with above unit.

\$5.95

Write to Dept. RN

**ADSON RADIO CO.**  
221 FULTON ST., NEW YORK 7, N. Y.

**LOCATES TROUBLE INSTANTLY IN ALL ELECTRICAL DEVICES**

**HANLAN APPLIANCE TESTER**

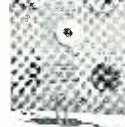

In this single unit are combined all the necessary tests for examining every appliance. Checks thermostats under actual working conditions. Tells instant it opens or closes. Controls the heat on soldering irons—prevents overheating. Tests continuity, open circuits, etc. Checks automatic irons, vacuum cleaners, motors, shavers, bulbs, fuses, appliances with 3-way switches, etc. Great time, effort and money saver! Only \$10.95 complete. WRITE FOR CIRCULAR.

**HANLAN COMPANY**

1419-R West Jefferson Los Angeles 7, Calif.  
FREE with each Tester. New, Complete, Practical Course in electrical appliance repairing.

the case of a picture tube with electrostatic deflection, vary the d.c. component of voltages applied to the horizontal and vertical deflection plates. With a picture-tube using electromagnetic deflection, the centering controls vary the d.c. component of deflection current flowing through the vertical and horizontal deflection coils.

10. *Vertical and Horizontal Linearity:* The linearity controls alter the top portion of the sweep waveforms by one of two methods. The more linear the sweeps become, of course, the better the relative picture proportion is on all sides of center. One method of correcting linearity is to pass the saw-tooth through a stage which is biased on the non-linear portion of its characteristic. Another method is to develop the waveform across an impedance which has a rising impedance to the very high frequency components of the sawtooth waveform.

### Installation of Picture Tube

Many receivers, particularly those using the larger picture tubes, are shipped with the picture-tube as a separate item. The serviceman must then install the picture-tube. A number of precautions are to be observed in handling these tubes:

1. Wear gloves and goggles when installing the picture tube. Since it is large and evacuated it is incapable of withstanding a high pressure, and a jar may cause it to break.

2. Do not handle picture tube along the outer periphery of its face because it is here that it must withstand the greatest pressure.

3. Do not, under any circumstances, try to force the picture tube into its position. If it binds, locate and remove the obstacle.

(To be continued)

### Amateur Receiver

(Continued from page 34)

lands, Johnston Island, Alaska, Canada, Mexico, Brazil, Argentina, Chile, Cuba, Porto Rico, Australia, etc., at times when reception alone of the places mentioned was quite a feat for several good commercial products.

Signal-to-noise ratio is a bit startling. A house shaking S9 signal will leave the receiver dead quiet, once the S9 carrier is cut and no change made in tuning adjustments. Ground wave work shows almost complete freedom from the annoying "rush" noise common to such reception.

Excellence of a.v.c. is discernible from the fact that the usual 50,000 ohm resistor at  $R_{21}$ , with a 0-1 ma. meter, gave off-scale readings on practically any signal! Increasing  $R_{21}$  to 75,000 ohms, and inserting a shunt of 30 ohms at  $R_{22}$ , gives about optimum S report readings.

Carefully constructed, of quality parts, the receiver will leave nothing to be desired.

-50-



Chart compares heating time of KWIKHEAT to the average of 7 other soldering irons of comparable power.

### CHECK THESE MANY IMPORTANT FEATURES

- ✓ FAST! Hot in Only 90 Seconds
- ✓ COOL New Protecting Handle
- ✓ SAFE! Will Not Overheat
- ✓ POWERFUL (Full 225 Watts)
- ✓ SAVES TIME—Less Retinning
- ✓ BALANCED! Easily Handled
- ✓ DEPENDABLE—Longer Lasting
- ✓ LIGHT WEIGHT (Only 13½ oz.)
- ✓ THREADED TIPS For Best Contact
- ✓ ECONOMICAL In Operation
- ✓ THERMOSTAT Is Built In
- ✓ SIX TIP STYLES Interchangeable

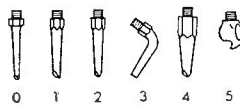

YOU'LL FIND  
KWIKHEAT  
*is best*  
BY TEST!

Plug in a Kwikheat Thermostatic Soldering Iron and any other soldering iron of equal power simultaneously. See for yourself how much faster Kwikheat heats up—only 90 seconds! Check the 12 features at the left against *any* soldering iron. You'll find that Kwikheat wins every time. Ask your dealer.

Complete with #1 tip... **\$11.00**  
Extra Tips—Six Styles, each 1.25

"FROM TIP TO

PLUG...IN A CLASS BY ITSELF"...!



VANATA  
**KWIKHEAT**  
THERMOSTATIC SOLDERING IRON

A Division of  
Sound Equipment Corporation of California  
3903 San Fernando Rd., Glendale 4, California

# Now! Get COPIES of Anything, in a Jiffy!

... Right in your own office or plant! New, low-cost, error-proof method saves typing, drafting, checking—TIME!



Photo-Copyer  
**\$55**  
Copies up to  
18" x 22"

Also continuous cabinet models for prints of any length, up to 42" wide.

Quickly, Easily copy

**BLUE PRINTS, TRACINGS, WIRING DIAGRAMS, SPECIFICATIONS, DRAWINGS, GRAPHS, CHARTS, LETTERS**  
(over 100 others)

Make accurate permanent copies of anything at 1-a-minute speed—for less than the price of a phone call! No darkroom or technical knowledge needed. Anyone can operate APÉCO—"America's Most Widely Used Photocopy Equipment." Get full information, TODAY!

**MAIL COUPON NOW for this FREE book**



American Photocopy Equipment Co.  
2849 N. Clark St., Dept. HK76  
Chicago 14, Ill.

Send, without obligation, your 20-page illustrated book on Photocopying and its savings in time, money and labor.

NAME.....

COMPANY.....

TITLE.....

ADDRESS.....

CITY & STATE.....

**LESLIE LINCOLN ENGINEERING SCHOOL** Correspondence Courses in **RADIO and ELECTRICAL ENGINEERING**

**ELECTRICAL ENGINEERING** Get good electrical held. Prepare yourself at Low Cost, for secure future. Modern course. So simplified anyone can understand quickly.

**RADIO ENGINEERING** Extra fine course in radio, public address, photo-electric work. Trains you to be super-service man, real vacuum-tube technician. Servicemen needed badly. Diploma on completion.

Send postcard or letter for Free Copies of school catalogs, full details, all about deferred payment plan, etc. **SEND NOW!**

**LOW AS \$25** Either Course

**LINCOLN ENGINEERING SCHOOL, Box 931-R91, Lincoln, 2 Nebr.**

300 ohm Amphenol twin lead, per 100 ft.	\$2.90
75 ohm Amphenol twin lead, per 100 ft.	2.00
Navy Power Trans.—900 v. CT @ 300 ma., 2—6.3 v., 1—5 volt.	5.95
Advance Ceramic insulated antenna relay—	
1 KW vertical army antenna with base—3 section	5.40
BC312 or BC348 Receivers	1.95
(write for prices on conversion to 110 V AC)	59.95
Clare DPST relays 6 volt coil	1.25
<b>DOW RADIO</b>	
1759 E. Colorado	Pasadena 4, Calif.

# Within the INDUSTRY

**GEORGE M. SOLOMON** has been appointed service manager for the *Hamilton Radio Corporation*, makers of Olympic radios and radio - phonograph combinations.



During the war, Mr. Solomon was with the U.S. Army Signal Corps as an instructor in radar schools. In 1945 he was transferred to the Panama Canal Department where he supervised installation and maintenance of microwave aircraft warning, I.F.F. and beacon radar equipment for defense of the Canal.

Prior to his enlistment in the Armed Forces, Mr. Solomon was associated with *Vim Radio and Electric Company*, and *George's Radio Company* in Washington, D. C.

**KENNETH H. BAKER** has been named Director of Research for the *National Association of Broadcasters*.

Mr. Baker was formerly a member of the faculty at Ohio State University and joined NAB on April 1st. He has had considerable experience in the field of research, having made studies of listening habits, market surveys and panel studies.

Mr. Baker was also a member of the faculty at Northwestern University and Ohio Wesleyan University where he was associated with the psychology departments. He received his doctorate from Ohio State and did further graduate study at Northwestern University. He served in the Army during World War II where he established and directed OSS training. He served thirteen months overseas in special operations and intelligence.

**L. H. MINGINS** has rejoined the sales organization of the *Webster Electric Company* of Racine, Wisconsin, after serving almost four years with the Army Air Forces.



Mr. Mingins will represent the company in the metropolitan New York, New York State and New Jersey areas.

Major Mingins was in the Air Service during the first World War as a pilot. Upon re-entering the service he took the O.T.S. refresher course at Miami Beach and was then stationed in New York City where he was in charge of the Cadet Boards of the Second Service Command.

His overseas service included duty

in Calcutta and Shanghai. Major Mingins returned to the United States in February of this year and rejoined *Webster* shortly thereafter.

**RICHARD H. WANN**, Director of Purchases of the *International Detrola Corporation* of Detroit has announced his resignation.

Mr. Wann was associated with the company since its inception and was previously a radio buyer for *Sears Roebuck and Co.*

After a brief rest, Mr. Wann plans to participate in the organization of a new corporation for the manufacture of specialized products in the field of heat-transfer and thermoelectric devices.

**ROBERT H. BISHOP** was recently named Director of Sales of all divisions and subsidiaries of *Sylvania Electric Products, Inc.*



Mr. Bishop joined *Sylvania* in 1936 and in his new post will be responsible for the coordination of selling policy in all divisions of the company as well as its subsidiaries, *Colonial Radio Corporation* and *Wabash Corporation*. He will also have direct responsibility for the sales organization of the lamp, fixture, radio tube and electronics divisions.

**HOWARD W. SAMS & COMPANY, INC.** of Indianapolis has announced the distribution of their new *Radio Encyclopedia Service*.

This service which will provide servicemen with complete servicing data on new radio receivers includes an individual "PhotoFact" folder covering each receiver model. The folders will vary in size from 4 to 12 pages and include, in addition to schematic diagrams and parts lists, detailed engineering data and voltage and resistance analyses.

Analysis of each radio receiver will be made by the company engineers from samples obtained as soon as the unit goes on the market.

Howard W. Sams, who heads the new organization, was an executive of the *P. R. Mallory & Company* for many years.

**JOHN L. BROWN**, recently discharged from the U. S. Navy, has been named sales manager of the replacement tube department of *Raytheon Manufacturing Co.* of Newton, Massachusetts.

During the past three years, Mr. Brown served as a Lieutenant Com-

mander in the Navy and was electronic ship superintendent in the New York Navy Yard, supervising inspection, installation and testing of electronic gear aboard Navy vessels in the Yard.

Prior to his service with the Navy he was with *Zenith Radio Corporation* in charge of regional activities at Dayton, Ohio, and he also served as contact engineer with the radio division of Bureau of Ships.

**C. A. CLINTON** has been named General Manager of the *Ansley Radio Corporation* of Trenton, New Jersey. Recently he has had charge of purchasing, expediting and material control and has worked closely with the factory in conjunction with production



scheduling. Prior to this Mr. Clinton was Director of Sales for the company in the New England States with headquarters in Albany, New York.

Before joining the *Ansley Radio Corporation*, he was Eastern Representative for the *Phansteihl Chemical Company* and prior to that had been Sales Manager of the *Strube Piano Company* of Chicago.

In addition to his assignment as General Manager, Mr. Clinton will visit *Ansley Dealers* regularly.

**RAYMOND DEVOE HUTCHENS**, Editor of *RCA Communications'* publication "Relay" died recently of a heart attack in Polyclinic Hospital, New York.

Mr. Hutchins was 41 years old at the time of his death. He was a long-time contributor to *RADIO NEWS* and other trade publications.

He joined the staff of *RCA Communication, Inc.* in 1928, working under Dr. R. H. Ranger on facsimile development, having served previously as a radio operator aboard ships of the Ward and United States Line.

**JULIUS HABER** has recently been named Advertising and Sales Promotion Manager of the Tube Department, *RCA Victor Division* of *RCA*.



Prior to this appointment Mr. Haber was engaged in special advertising and promotion assignments in the

company's Public Relations department. He will be located in Harrison, New Jersey, headquarters for *RCA's* tube activities.

Mr. Haber joined *RCA* in 1923 and has continued with the company ever since with the exception of a two-year period starting in 1930 when he joined the staff of *Lord & Thomas Advertising Agency* to organize and direct its publicity department. During this period he directed publicity activities not only for the *Victor Company* and *RCA*



## Largest Producers of CRYSTAL CARTRIDGES FOR PHONOGRAPH PICKUPS



**T**HAT The Astatic Corporation is the world's largest producer of Crystal Phonograph Pickup Cartridges is, in itself, actual testimony of their outstanding service and high operating efficiency. That they are preferred and used by a majority of the leading manufacturers of electrical phonographs and automatic record changers, is convincing evidence of their expert engineering and construction. Astatic Crystal Cartridges are manufactured to meet today's exacting standards of performance and are individually tested and approved for output voltage before being released for shipment. Astatic Cartridges are extensively used in an ever-growing field of new product applications, as well as for replacement purposes or the improvement of existing equipment.

*Astatic Crystal Devices  
manufactured under Brush  
Development Co. patents*

**THE**  
*Astatic*  
**ASTATIC CORPORATION**  
CONNEAUT, OHIO

IN CANADA - CANADIAN ASTATIC LTD, TORONTO, ONTARIO



*Shuts Itself off*

**AFTER THE LAST RECORD HAS PLAYED**



**MODEL 56**

**WEBSTER**  
*Automatic Record Changer*

An outstanding convenience for the owner of Webster 56 is the automatic shutoff. The machine automatically stops after the last record has been played... this is another reason why Webster 56 performs so simply and smoothly, assuring fullest record enjoyment. Makers of finer radio phonograph combinations have accepted it for use in their instruments.



Velocity trip — changes more kinds of standard records than the usual changer.

Fool-proof operation — pickup arm can be moved without damage while machine is in change cycle.

Protects finest records, but it will change many old, badly worn — yet cherished — records.

Feather-touch pickup. Fast change cycle.

The Choice of Music Lovers Everywhere

**WEBSTER CHICAGO**  
5610 BLOOMINGDALE AVE.  
CHICAGO 39, ILLINOIS  
32 years of Continuous Successful Manufacturing

**A TOOL SHOP IN YOUR HAND**



Smooth, steady power for buffing scratched cabinets, metals, corroded tube and socket pins; removing burrs, sanding, etc. Grinds, drills, saws, engraves, etc. 25,000 r.p.m. AC or DC. Wt. 12 oz. In steel case with 45 accessories, \$25.00. Handee only, \$18.50.

**THE RIGHT ACCESSORIES**  
Choose them from the complete line—over 300 made right in the Handee plant.

**CHICAGO WHEEL & MFG. CO.**  
1101 W. Monroe St.  
Dept. RE, Chicago 7, Ill.

FREE 64 PAGE CATALOG

**HANDEE** • TOOL OF 1001 USES

but also for the radio programs of several nationally known consumer products.

\* \* \*

**JAMES R. S. MILLAR** has rejoined the Radio & Appliance Division of *Sparks-Withington Company* of Jackson, Michigan, after serving thirty-one months in the Army.



Mr. Millar will resume his former position in the Advertising Department of the company where prior to his service he edited two house organs, in addition to his activities in the advertising field.

Mr. Millar was stationed in Hawaii as a Staff Sergeant during the war.

\* \* \*

**ARTHUR M. LINICK, W9FXB**, of 3750 Lake Shore Drive in Chicago, has been selected to set up an organization of Illinois amateur radio operators prepared to furnish organized emergency communication in time of disaster.

The announcement of Mr. Linick's appointment comes from the A.R.R.L. who announced that his assignment will carry the title of Emergency Coordinator.

In addition to use of normal station equipment working from commercial power, amateur stations using self-powered radio transmitters and receivers are needed.

Mr. Linick will call local meetings of amateurs, establish common operating procedures and arrange regular drill periods when the hams' personal stations may be mobilized under simulated emergency conditions. His duties will also include liaison planning with the local chapter of the American Red Cross and other relief agencies.

\* \* \*

**HARRY E. WARREN** has been appointed New York Manager of the *Ralph H. Jones Company Advertising Agency*.



Mr. Warren comes to his new post from *Hotpoint*. He was associated with the *Hotpoint* organization for eight years, holding positions as manager of three national sales divisions, and for the last three years of his service was in charge of advertising and coordinating merchandising activities for twelve lines of home appliances.

\* \* \*

**JOSEPH E. RUDER** has been named director of purchases of the *Detrola Radio Division of International Detrola Corporation* of Detroit.

Mr. Ruder succeeds Richard H. Wann who resigned. Mr. Ruder has more than eleven years' experience in purchasing radio material. He joined *Detrola* in September of 1945 as general purchasing agent.

His new assignment places him in charge of all procurement for *Detrola's* production of radio receivers,

**OUTSTANDING VALUES**

at Greenwich Sales

**POWER TUBE KIT**

Eimac 304TL, tube socket, filament transformer (10v. @ 13 amps or 5v. @ 26 amps) and high voltage mica bypass capacitors,  
wired ..... **\$15.00**

**G. E. PYRANOL CONDENSERS**

2 MFD 4000 V. DC.  
2 for ..... **\$11.00**

**KENYON POWER TRANSFORMER**

PRI-115V. 60 cycle Sec. 3200V 150 mil. Ultra conservative current rating. Use pair in series or parallel to get double voltage or current.  
Each ..... **\$6.00**

**HEINEMAN 2 SEC. CIRCUIT BREAKER**

15 amps 115V AC—25 amps 230V AC ..... **\$2.50**

**CADMIUM PLATED STEEL CHASSIS**

Punched for power supply, amplifier, transmitter section #1—16 1/4" x 6" x 3"; #2—16 1/4" x 13 1/4" x 3".  
Each ..... **\$0.75**

**RECTIFIER KIT**

Kenyon Filament transformer (2.5V @ 10 amps, 10,000V insulation) 866A tube, socket and plate cap  
wired ..... **\$5.00**

Porcelain Low Loss Octal Sockets with Standard Value Resistors and Mica Bypass wired (all parts brand new). In dozen ..... **\$1.00**  
lots.....

25% deposit required on all orders.  
Prompt delivery assured.

**GREENWICH SALES CO.**

59 Cortlandt St.—Whitehall 3-3052  
New York City 7, N. Y.

**RADIO MFGRS. & WHOLESALERS**

Government Surplus

**CONDENSERS**

Aerovox	Cornell Dubilier
Tobe Deutschman	Gudeman
Westinghouse	Sprague
	Solar Fast
125,000	All Capacities

**Jones Terminal Strips**

Fuses  
Resistors Knobs  
Micro Switches  
G. E. Switchettes  
Potted Filter Chokes  
Octal Sockets—ceramic & mica  
4 contact Ceramic Sockets

We Sell Wholesale ONLY

**CLARK-REISS DISTRIBUTORS**

32 Broadway  
DIgby 4-6891 New York City 4

automatic phonographs and other products which are marketed under trade names. The *Detrola* brand line is sold only in Michigan.

\* \* \*

**GARRARD MOUNTJOY** was named president of the corporation by the Board of Directors of *Electronic Corporation of America* at a recent meeting of that group.



Samuel Novick who has been serving in that capacity was elected chairman of the board.

Mr. Mountjoy has been vice-president in charge of engineering of the company. Previous to his association with *ECA* he was in charge of engineering for *Lear, Inc.*, and *Sparks-Withington Co.* He is also a former chief of the license consulting section of the *RCA License Laboratories* and holds more than thirty foreign and domestic patents in the electronic field.

\* \* \*

**R. W. BIGGS** has been named works manager of the Ambridge Pennsylvania plant of *National Electric Products Corporation*, succeeding Neil C. Lamont who has retired.

The new works manager is a graduate of Ohio Northern University. His first production responsibility was in the Lorain, Ohio, works of *National Tube Company*.

Mr. Biggs has been in the Pittsburgh general offices of *National Electric* for five years, serving in an administrative capacity.

-30-

**For the Record**  
(Continued from page 8)

who purchases a radio from a technical expert will have greater confidence in the product in the assurance that it will be properly maintained.

Yes, a serviceman is a dealer when he disposes of a new receiver to a consumer and what serviceman has not been responsible for a substantial number of such sales.

RADIO NEWS recognizes the desire of many thousands of our servicemen readers to study modern business methods, sales, advertising and business techniques. To render a greater service to these readers we plan to supplement the articles dealing with the practical technical phases of radio, television and electronics with one or two authoritative articles on business subjects. We, too, are unable to draw a line of demarcation between the technician and the merchant and feel that if we can provide this additional service to our vast technical readership we will further add to RADIO NEWS' value as the universal reference book for all radio men. If this innovation is pleasing to you we will be glad to have your comments. If you would prefer to have us adhere strictly to technicalities tell us so. O.R.

July, 1946

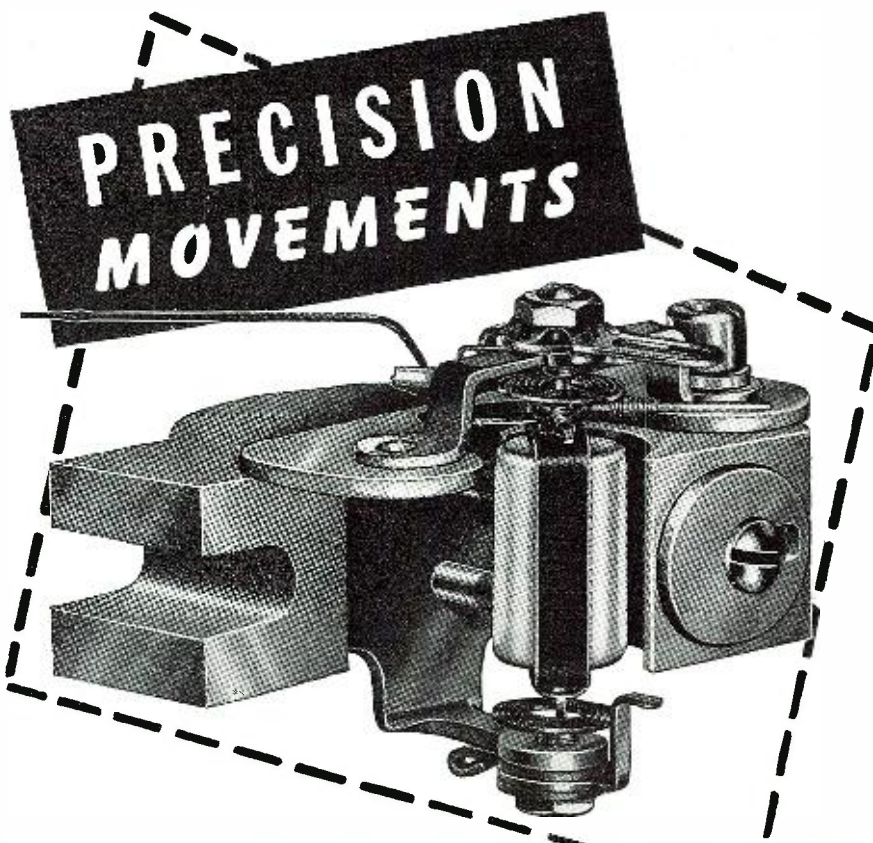

**Burlington**  
**PANEL INSTRUMENTS**



The heart of every Burlington Instrument — and the reason for its high degree of dependability — is the Burlington Precision Movement.

Design, material, and manufacturing processes are selected in such a manner that Burlington gives you a rugged instrument — which may be subjected to rough usage — and still retain its original calibration characteristics. All DC instruments employ Alnico magnets which are known to be more highly resistant to shock, heat, vibration, and stray fields than any other magnetic material.

All ranges AC & DC are available in 2½", 3½" and 4½" sizes, both square and round, flush mounting.

*Engineering Service Furnished for Specialized Applications. No Obligation. Write Today for Further Information.*

**BURLINGTON INSTRUMENT CO.**

907 FOURTH STREET BURLINGTON, IOWA

**PANEL INSTRUMENTS • VOLTAGE REGULATORS • AUTOMATIC SYNCHRONIZERS • FREQUENCY REGULATORS**



# FOR ALL Electricians

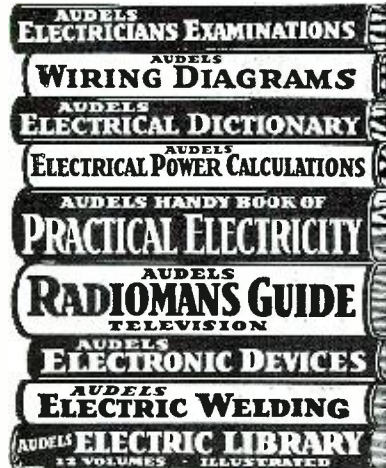

**PRACTICAL ELECTRICITY** at your finger ends. Answering your Questions and giving the facts and figures of your trade. Audels Electrical Guides contain Practical Inside Trade Information in a handy form. Fully illustrated and Easy to Understand. Highly Endorsed. Check the books you want for 7 days' Free Examination. Send No Money. Nothing to pay postman. If satisfied pay only \$1 a month until purchase price is paid.

ASK TO SEE THEM.



Get This Information for Yourself. Mail coupon today. No obligation unless O.K.

-----CUT HERE-----

## MAIL ORDER

AUDEL, Publishers, 49 W. 23 St., NEW YORK 10, N. Y.

Please send me postpaid for FREE EXAMINATION books marked (x) below. If I decide to keep them I agree to mail \$1 in 7 days on each book ordered and further mail \$1 monthly on each book until I have paid price.

- ELECTRICIANS EXAMINATIONS, 250 Pages . . . \$1.
- WIRING DIAGRAMS, 210 Pages . . . 1.
- ELECTRICAL DICTIONARY, 9000 Terms . . . 2.
- ELECTRICAL POWER CALCULATIONS, 425 Pages. 2.
- HANDY BOOK OF ELECTRICITY, 1340 Pages . . . 4.
- RADIOMAN'S GUIDE, 914 Pages . . . 4.
- ELECTRONIC DEVICES, 216 Pages . . . 2.
- ELECTRIC WELDING, 400 Pages . . . 1.
- ELECTRIC LIBRARY, 12 vol., 7000 Pgs., \$1.50 Each

Name \_\_\_\_\_  
 Address \_\_\_\_\_  
 Occupation \_\_\_\_\_  
 Employed by \_\_\_\_\_ R.N.

### IMMEDIATE DELIVERY!

APPROVED MODEL A-100

### SIGNAL GENERATOR

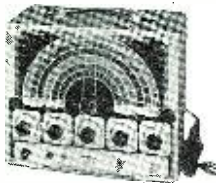

Complete with all tubes, connecting cables, instructions, etc. Battleship gray crackle finish. Size: 12 x 10 x 6 5/8".

- 6 R.F. BANDS  
100 Kc.-316 Kc., 316 Kc.-1000 Kc., 990 Kc.-3200 Kc., 3200 Kc.-10.6 Mc., 10.6 Mc.-26 Mc., 21.2 Mc.-52 Mc.
  - CONTINUOUSLY VARIABLE RF-AM attenuator control.
  - EXTERNAL MODULATION FROM 40 to 30,000 cycles.
  - INTERNAL MODULATION AT 440 cycles.
  - NEGLIGIBLE HARMONIC OUTPUT.
- NET Price. . . . . **\$47.00**

#### OTHER INSTRUMENTS IN STOCK!

- McMURDO-SILVER "Vomax" . . . . . \$ 59.85
- SIMPSON 260 Volt-Ohm-Milliammeter . . . . . 33.25
- SIMPSON 240 "Hammer" . . . . . 26.50
- TRIPLETT 2413 Tube Tester . . . . . 45.00
- TRIPLETT 625-N Volt-Ohm-Milliammeter . . . . . 45.00
- RADIO CITY 802-N Tube & Set Tester . . . . . 59.50
- DUMONT 208-B-5 Oscilloscope . . . . . 235.00
- RADIO CITY 665-A Vacuum Tube V.M. . . . . 89.50

— Circular on Request —

C.O.D. orders should be accompanied by 25% deposit.  
**SCENIC RADIO & ELECTRONICS CO.**  
 53 Park Pl., Dept. J, New York City 7

## International Short-Wave (Continued from page 90)

time the call was changed to XGOO. The station continued to operate under this call-sign even after the Japanese surrender, but when the Central Broadcasting Administration (Chungking) of the National Government of the Chinese Republic took over, on November 11, 1945, the call was changed to XORA; the transmitter is 5-kw. and is xtal-controlled.) XRRR, 6,090, Peiping, has not been reported lately by West Coasters who say the 10.280 summer frequency has not been heard yet, either. XUSA, 4,760, Chungking, operated by the Signal Corps, is heard 9:45-11 a.m. or later in Australia, with request programs; has poor signal through heavy CWQRM. XGNC, 9.625, Kalgan, has good signals usually around 6-7:30 a.m. (all Chinese), and is heard on West Coast, in the Eastern United States and Canada, and in Sweden. XGOL, 9.995, Foochow, usually can be heard around 4-7 a.m., or later; in some parts of the world it suffers interference from WWV, 10,000, U.S. Bureau of Standards station in Washington, D.C.

Colombia—Radio Continental de Bogota, 4.835, is being heard irregularly evenings, 7-10 p.m., after more than a year off the air; it relays HJCS, 920 kcs., but no call letters are announced for the s.w. outlet.

Cuba—COCD, 6.130, Havana, verifies with a beautiful card; address, P.O. Box 2294. COKG, 8.955, Santiago de Cuba, "La Cadena Orientale de Radio," relays BCB station CMKW; at 11:55 p.m. sign-off identifies in both Spanish and English. COCW, 6.325, Havana, "RHC Cadena Azul," relaying CMCW, can be heard almost every night with good to fair signals; Canadians report this as one of the most reliable Cubans this summer.

Curacao—PJCL, 7.250, Willemstad, still reported to sign-off at 9:30 p.m.

Czechoslovakia—Listeners report Prague's North American broadcast is now heard well, on 11.840, 7-7:30 p.m., with English news at about 7:08-7:15 p.m. Wants reception reports; address, Ceskoslovensky Rozhlas, Prague, Czechoslovakia.

Denmark—A letter just received from the Chief of Press Department, Statsradiophonien, Copenhagen, says: "At present, we are only transmitting our ordinary program from 12:35 to 5 p.m. over our short-wave transmitter at Skamlebaek, call sign is OZF, wavelength is 31.51 m. (9.520). All broadcasts are in Danish. On Sundays, from 8 a.m. to 1 p.m., we are transmitting on 19.58 m. (15.320). As these transmitters have only a power of 6 kw. and 5 kw., respectively, reception in America may be rather bad. We have a new short-wave transmitter under construction, but it will not be finished until the spring of 1947." A report received a few days later by airmail from a new Copenhagen correspondent

For Soldering in Tight Places . . .

# DRAKE

No. 400 Soldering Iron

Smallest Industrial Iron Ever Designed

60 Watts—1/4 in. Tip

Only 9 in. long—Wt. only 8 oz.

This mighty mite is backed by DRAKE'S 25 years of soldering iron manufacturing experience. The high quality and long service of DRAKE Soldering Irons have made them outstanding favorites with all types of radio men everywhere. The DRAKE No. 400 is an outstanding value at



Only \$4.50 List

Drake Has an Iron for Every Purpose. Ask Your Radio Parts Jobber.



## DRAKE ELECTRIC WORKS, INC.

3656 LINCOLN AVE., CHICAGO 13, ILL.

## SIGNAL CORPS SURPLUS UHF SUPER-HET

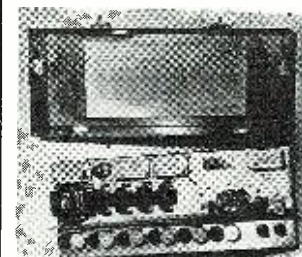

BC-406. Freq. range 201-210 mc. 20 mc IF freq. 2 mc bandwidth. 15 tubes.

\$2995

### I.F. CRYSTAL FILTER FOR \$995

- BC-312, BC-342 . . . . .
- ARC-5 Receivers, complete . . . . . \$ 79.00
- ARC-5 Transmitters, compl., less Dyn. . . . . 109.00
- BC-221 Frequency meter, complete . . . . . 82.50
- BC-603 Receiver, 85% compl. with manual . . . . . 5.00
- 947-A Magnetron Transmitter from SCR-547 . . . . . 86.00
- MC-363-A Range converter, 10 ampl. from SCR-547 . . . . . 85.00
- BC-937-A Receiver Indicator from SCR-547 . . . . . 155.00
- RA-58-A Power unit from SCR-547 . . . . . 116.00
- BC-412 Scope from SCR-268, with tubes . . . . . 59.50
- BC-409 Pulse Ampl. from SCR-268 with tubes . . . . . 59.50
- G.E. Synchroscope, new, complete . . . . . 240.00
- Selsyns, Diehl, 115v/60cps per pair . . . . . 7.75
- Klystrons 723A/B, new . . . . . 10.00
- 5CP1, 5CP4 with tube socket . . . . . 10.95
- Modulation Transformer 807 to pair 807's . . . . . 2.65
- Power xmftr 115v-60cps/300v-ct 20ma/6v & 5v . . . . .
- Stearite miniature coil forms 1 1/2 x 1/2 dia. . . . . 2.25
- Ceramic coil forms, adj. base 2 1/2 x 1 1/2 dia. . . . . .45

### SEND FOR PARTS LIST

All merchandise guaranteed. Mail orders promptly filled. All prices F.O.B. New York City. Send Money Order or Check. Shipping charges sent C.O.D.  
**WORLD-WIDE COMMUNICATIONS**  
 Dept. D, 88 Cortlandt St., N.Y.C., BA-7-4260



reports, however, that as of May 1, 1946, OZF, 9.520, was to extend its service to 12:35-6:30 p.m., and that OZU, 7.260, is now operating between 12:35 and 3 p.m.

Dutch Borneo—Radio Balikpapan, 9.125, announces its power as 125 watts, and the announcer gives his name as Franz Miller. All announcements are in Dutch and English and reception is frequently good on the West Coast. It has not been definitely reported in the East as yet. Is scheduled to relay PCJ, Holland, between 8:30-9:30 a.m. or later (including the Happy Station Program (in English) on Sunday at that time), but lately seems to have been experiencing trouble in so-doing. This station occasionally carries music past its regular sign-off time, 9:30 a.m., to as late as 10:30 a.m. Radio Balikpapan usually has a "warm-up" period prior to 7 a.m. sign-on, including music. English announcements are generally heard on the quarter hour; sign-off is with the playing of the Good-Night Song.

Ecuador—HC1AC has returned to the air on a new frequency of 6.210 (was formerly on 7.200); signs on about 6 p.m., sign-off is at 11 p.m. HC2ET, 4.712 (lists itself on 9.200), transmits daily, 7:30-9 a.m., 11:45 a.m.-1 p.m., 3:45-6 p.m., and 6:45-10:30 p.m.

Egypt—SUX, 7.863, Cairo, is reported heard in Canada at 3:20 p.m., with a weak signal through heavy CWQRM.

El Salvador—YSR has returned to 6.270 from 9:250; schedule remains 1-11 p.m.

England—The BBC's North American Service summer schedule is listed, GVX, 11.93, 5-6 a.m.; GSP, 15.31, 6-8:15 a.m.; GVO, 18.08, 8 a.m.-4 p.m.; GSP, 15.31, 4-6 p.m.; GWG, 15.06, 4:15-6:45 p.m.; GRG, 11.68, 4:15-9:45 p.m.; GRH, 9.825, 4:15-11 p.m.; GVZ, 9.64, 4:15-11 p.m.; GSU, 7.260, 7-11 p.m.; and via Leopoldville, 9.747 (actually 9.738), 8:15-9 p.m. and 9:15-11 p.m. (actually, sign-off is at 9:45 p.m., according to listeners). In the evening beam, BBC news is read at 4:45, 5:45, 6:45, 8, and 9:30 p.m., with Radio Newsreel now on at 6:30 p.m. GSL, 6.11, has been eliminated from the evening North American beam for the summer. A spurious frequency of the BBC's Latin American Service is reported nightly on 7.360 with the Portuguese program, where it interferes with an unidentified station on the same frequency (may be Moscow).

Ethiopia—The English period of Radio Addis Ababa, 9.620, is heard 10:15-11:15 a.m. Swedish listeners report Radio Addis Ababa on a new frequency of 6.920, Mondays between 4:30-5 p.m.

Fiji Islands—Australians report that VPD2, 6.130, Suva, is back on the air, 1-5 a.m., but is weak even in Australia.

Finland—OIX2, 9.503, Helsinki (transmitter is located at Peri), has English news to North America at 7:15 a.m.

French Equatorial Africa—Brazza-

# - YOU can hold a New, Better Job in RADIO ELECTRONICS

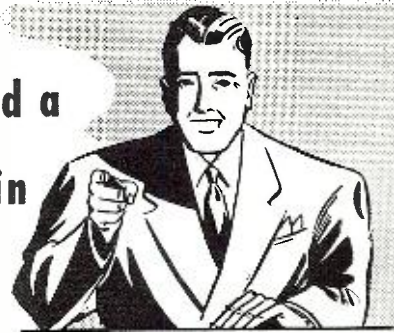

Use Cleveland Institute home study courses for professional self-improvement.

THIS NEW WORLD OF ELECTRONICS promises exciting opportunities for employment in new applications of new electronic developments. FM broadcasting, micro-wave relay systems, television, mobile communication systems for railroads, automobiles, busses, and trucks—these are only a few of the post-war possibilities for new employment. BRAND NEW JOBS IN BRAND NEW FIELDS!

ARE YOU QUALIFIED FOR THESE NEW JOBS? That is the first question you will face. Practical experience is only a partial answer—the field has plenty of such men. Practical experience PLUS technical training is the best answer—the answer that will bring that better job and more pay.

YOUR FIRST STEP TOWARD THAT BETTER JOB in this New World of Electronics is your resolution to acquire a sound basic knowledge of the technical side of radio-electronics. Add this knowledge to your practical experience and place yourself ABOVE the competition of the "average" radioman. Cleveland Institute courses of supervised home study training are planned to do just that job.

LET CLEVELAND INSTITUTE TAKE OVER YOUR PERSONAL UP-GRADING PROBLEM. Qualified, competent instructors, ample, personalized instructional aids, orderly, progressively arranged study assignments in recognized, approved technical texts—these are only a few of the many superior advantages of Cleveland Institute's plan of personalized spare-time home study training for professional self-improvement.

Many Cleveland Institute students of advanced engineering courses today are broadcast chief engineers. Graduates of Cleveland Institute courses are eligible for the top jobs in radio-electronics.

CLEVELAND INSTITUTE HOME STUDY COURSES COVER THE FIELD OF RADIO-ELECTRONICS—TELEVISION, ULTRA-HIGH FREQUENCY TECHNIQUES, AM AND FM BROADCASTING, COMMUNICATION ENGINEERING—from simple treatment of fundamentals, through preparation for FCC commercial radio operators' license examinations, up to and including complete high level quantitative treatment of advanced radio-electronics and communications engineering. Choose the course best suited to your needs, and start with the section you are qualified to enter. You pay for only the section or sections you need. Use the "Pay-as-you-go plan" patterned after ethical, educational practice. These features are

unique with Cleveland Institute, and represent the best in the modern, post-war concept of home study training.

Write today for free, descriptive booklet — "THIS NEW WORLD OF ELECTRONICS HOLDS OPPORTUNITY FOR YOU." No obligation — no salesmen.



Approved for Veteran Training Under "G-1 Bill of Rights"

## CLEVELAND INSTITUTE OF RADIO ELECTRONICS

Contractors to the Canadian Broadcasting Corporation  
Successors to

NILSON RADIO SCHOOL  
Founded 1939

SMITH PRACTICAL RADIO INSTITUTE  
Founded 1934

RN-7 TERMINAL TOWER, CLEVELAND 13, OHIO

(Mail this Coupon)

Cleveland Institute of Radio Electronics, RN-7 Terminal Tower, Cleveland 13, Ohio.  
Gentlemen: Please send information about your home study courses in Radio Electronics.

NAME .....

ADDRESS .....

CITY .....

ZONE..... STATE.....

I desire training in.....  
I have had experience in broadcasting  servicing   
operating  mfg.  CAA  Army-Navy   
amateur  other..... I am a  
High School Grad.  College  Degree .....

Check here for Veteran Enrollment Information.

## PRE-EXAM TESTS

For Commercial Radio Operator

## FCC LICENSE EXAMINATIONS



Rehearse the FCC license examinations  
Practice the procedure  
Practice the multiple-choice examination methods used by FCC

## DON'T TAKE A CHANCE

Avoid Failure on FCC Commercial Radio Operator License Examinations!

USE NILSON'S COMPLETE PRE-EXAMINATION TESTS AND COACHING SERVICE

Enables You To

Check your knowledge  
Locate your weak points  
Correct your weak points before taking the actual examination

Prepared by Arthur R. Nilson, Famous Co-author of Nilson and Hornung's  
RADIO QUESTIONS AND ANSWERS

Cleveland Institute of Radio Electronics, RN-7 Terminal Tower, Cleveland 13, Ohio

Cleveland Institute of Radio Electronics  
RN-7 Terminal Tower, Cleveland 13, Ohio  
Please send information about Pre-Exam Tests.

Name .....

Address .....

City..... Zone..... State.....

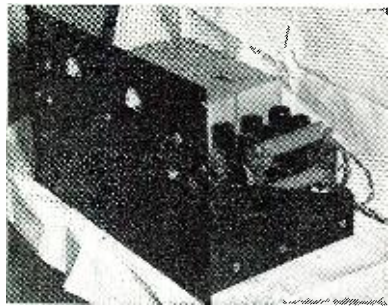

## ELECTRONIC REGULATED

### POWER SUPPLY

Limited Quantity—Immediate Delivery  
Type A:—Variable from 210 to 350  
V.D.C. at 400 M.A.

Type B:—Variable from 535 to 915  
V.D.C. at 125 M.A.

Built for the U. S. Army as part of RA-57-A,  
but never used.

Adapted to civilian use by mounting on  
12 1/4" x 19" panel, & installing meters,  
brackets, chassis, etc.

Fits any standard 19" rack or cabinet. Com-  
plete with tubes and ready to plug in.

All Units Unconditionally Guaranteed

#### Specifications:

Input: 115 V. 60 ~

Regulation: Less than 1/10 V. change in output  
voltage with change from 85 to 145 V.A.C.  
input voltage & from no load to full load (at  
center of variable range—See graph).

Ripple: Less than 5 Millivolts at all loads and  
voltages.

Tubes used in Type A: 2-836; 6-6L6; 2-6SF5;  
1-VR150; 1-VR105.

Tubes used in Type B: 2-836; 2-6L6; 2-6SF5;  
1-VR150; 1-VR105.

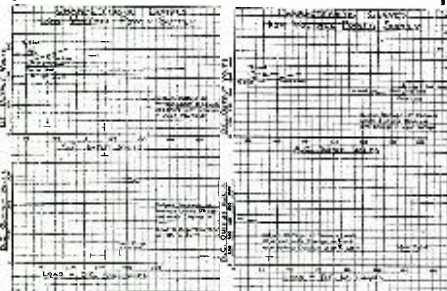

Component parts alone list for more than \$500

NET PRICE:

Type A—\$138 F.O.B. Baltimore

Type B—\$135 F.O.B. Baltimore

### NATIONAL RADIO SERVICE CO.

Reisterstown Rd. & Cold Spring Lane  
Baltimore 15, Md.

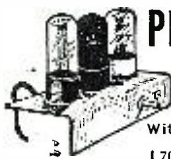

## PHONO AMPLIFIER

### 3-TUBE AC-DC

Complete Kit and 5" speaker, only \$5.95

With Tubes \$7.95, 12SQ7, 35Z5, 50L6.

L70 Crystal Pickup special... \$2.50

25% required on C.O.D. orders.  
FREE CATALOG.

IMMEDIATE  
DELIVERY

RISCO SALES COMPANY

224 East 65th St. Dept. R. N. New York 21, N. Y.



## RCA Institutes, Inc.

Offer thorough training courses  
in all technical phases of  
Radio and Television

WEEKLY RATES DAYS—EVENINGS

VETERANS: RCA Institutes, Inc. is approved  
Under G. I. Bill of Rights

For Free Catalog write Dept. RN-46

RCA INSTITUTES, Inc.

A Service of Radio Corporation of America  
75 Varick St., New York 13, N. Y.

ville's transmitter on 17.530 has re-  
turned to the air and is heard well to  
5 p.m. sign-off; it carries most Brazza-  
ville transmissions, but not the 5:05-8  
p.m. period. West Coasters report  
Brazzaville is heard 12 midnight-2:25  
a.m. on 11.97, the new 9.984 frequency,  
and 9.44. The 9.984 frequency is also  
heard evenings in the North American  
beam, with English news at 5:15 and  
6:30 p.m.

French Indo-China—Radio Saigon,  
11.778 and 4.81, now signs off at 9:30  
a.m. and has English news at 5 and  
8:30 a.m. Usually, French news dicta-  
tion immediately precedes the sign-off.  
Radio Hanoi, 12.150, has French news  
at 7 a.m., English news and com-  
mentary at 8 a.m., with a fair signal  
but heavy CWQRM, Oceania listeners  
write. Another outlet of Radio Hanoi,  
9.660, is heard in Australia at 6:30 a.m.

French Morocco—CNR3, 9.080, Ra-  
dio Maroc, Rabat, is heard irregularly  
on the Pacific Coast around 1:30-2  
a.m., usually with CWQRM. Swedish  
monitors list this station for 1-2:15  
a.m., 12:30-5:45 p.m.

French West Africa—Radio Dakar,  
now on 11.715, opens at 2 a.m. with a  
continuous three-note signal on a flute-  
like instrument; news in French is  
read at 2:15 a.m. Usually sends a fine  
signal to East.

GERMANY—The new French sta-  
tion in Germany at Baden-Baden re-  
lays "Suedwestfunk" and Paris, and is  
varying in frequency from 6.308 to  
6.320. Since the time change in Ger-  
many, it has been heard signing on at  
11:45 p.m. This station was previous-  
ly reported as located at Dorbirn, Aus-  
tria. A short-wave relay of the "Brit-  
ish Forces' Network in Germany" with  
studios at Oldenburg is heard well  
signing on at 11:30 p.m., but has poor  
signal at 5 p.m. sign-off. The mea-  
sured frequency is 7.290. West Coast  
DXers report this station is heard  
there, 11:30 p.m.-1 a.m. Berlin's recent  
wanderings took it to 5.898 and lately  
back up to 5.919. This transmitter  
signs on at 11 p.m. since the German  
time change. Leipzig, 9.688, is being  
heard, 11-11:50 p.m., after which GRX  
(9.690) interferes.

Gibraltar—A point-to-point broad-  
cast from Gibraltar was heard by  
Australians a few weeks ago at 2:10  
a.m. on 6.335; the station being con-  
tacted was at Merida, Yucatan, Mex-  
ico, probably XAM, on the same fre-  
quency.

Gold Coast—Australians report ZOY,  
Accra, has been heard at 1:30 p.m. on  
5.865 with music.

Greece—Radio Athens, 7.295, has  
been heard recently in Ohio, 3-3:30  
p.m.

Guam—KU5Q, 13.360, was heard  
with recorded musical program until  
7:30 a.m. when they carried a news  
relay; announced they would continue  
the program in two hours, or at 9 a.m.  
The chief engineer at KU5Q reports  
that the 13.360 and 9.280 channels are  
beamed to Shanghai, China.

Haiti—HH3W, 10.135, Port-au-  
Prince, has French news at 8 p.m.; I

## Electronic Voltmeter Ohmmeter



Aold  
Etched  
Panel

Model  
100

For

## ACCURACY \* STABILITY

A stable bridge circuit type vacuum  
tube meter for measuring AC-DC voltages  
and ohms by electronic means. Hand  
calibration and hand calibrated multiplier  
resistors assure constant accuracy and sta-  
bility. The "know how" obtained from  
years of war production enables us to of-  
fer high price quality at a moderate price.

Measures DC volts up to 600 with con-  
stant input resistance of 11 megohms. Re-  
sistor in the DC probe permits readings  
in signal carrying circuits. Positive or  
negative indications through a reversal  
switch. Net price \$75.00.

ELECTRONIC MANUFACTURING CO.

140 E. HCOND STREET, HARRISBURG, PA.

## POTTER'S SPECIAL BARGAINS

### DYNAMIC MICROPHONE



10 ft. Cable  
High Impedance  
Good Quality

Gun Metal Finish  
\$7.49

Chrome Finish  
\$7.95

### MICROPHONE STAND

A beautiful Streamlined Banquet Stand. 9"  
Tall. Plastic base weighs 2 lbs.

ONLY \$1.49

Shipping wt., 3 lbs. Postage extra.

### TUBES

New Surplus. 5R4G @ 95c

807 @ \$1.49. Gammatron 54 @ \$5.95

1614 @ \$1.49. 1621 @ 69c. 1622 @ 79c

### EDISON THERMAL RELAYS

Placed in Primary of 866 Filament, turns on  
plate supply after proper delay. \$10.00 list.

Our SPECIAL Price \$1.79

While we have large quantities of above, all  
are offered subject to prior sale. Prompt re-  
fund if sold out.

Send for our current Bargain List—It's FREE.

## Potter Radio Co.

1312-14 McGee St.

Kansas City 6, Mo.

have also heard this station lately with fine level, early mornings, usually with music and French announcements.

Hawaii—Excellent signals are heard from KRHO, 9.650; latest schedule is reported as 4 a.m.-12 noon.

Holland—PCJ, 15.220, and PHI, 17.775, Huizen, have been reported with recent test broadcasts for Australia, 6-7:45 a.m., with good signal strength. The regular schedule of PCJ and PHI, as reported by Swedish observers, is 8-9:30 a.m. on PCJ, 15.220, and PHI, 17.775, beamed to the Far East; 2-3:30 p.m. on PCJ, 9.590, and PHI, 11.730, beamed to South Africa; 8-9:30 p.m. on PCJ, 9.590, and PHI, 11.730, beamed to the Dutch West Indies. PCJ is using 30 kilowatts, PHI, but 5 kw.

Hongkong—The 9.57 transmitter (first reported as approximately 9.572/3) was not heard for some days recently, but was later reported heard again on the West Coast, in native languages to 8 a.m. when it takes the news and other features in English from the BBC. I have been hearing this station on occasion lately here in the East between 6:30-6:45 a.m. when KWID leaves the air for a beam change; the Hongkong transmitter is using Chinese at that time.

Hungary—Radio Budapest, 3.400, was recently heard by an Ohio monitor at 12 midnight (may open daily transmission at that time).

Iceland—TFJ, 12.235, Reykjavik, is still heard Sundays only, 9-9:30 a.m.; the approximately 25.800 frequency reported a few weeks ago proved to be erroneous.

India—West Coasters report Radio Bombay, VUB-2, 9.630, as heard 8-10 a.m. sign-off, but I have been hearing this station here in the East as early as 7:15 a.m. when it announces in English; a relay of the English news from Delhi is heard at 7:30 a.m., at which time the same broadcast can be heard direct from Delhi on 9.670. From the West Coast we learn that Madras' VUM2 is heard on approximately 7.260, rather than its listed 7.255, being on the sigh side of JWV, 7.258, Tokyo; Australians list this station as 7.257. VUM2 is not on this frequency between 7:30-9:15 a.m. as scheduled, but probably uses one of its lower frequencies, 7:45-9 a.m. Identification is occasionally heard which sounds like Radio Nepal, suggesting this may be another station relaying Madras. An English (Children's Hour) program is scheduled for Saturday at 6 a.m. VUC2, Calcutta, is now heard on 9.530, 5:30-8 a.m. with mostly native program; also on 4.840, 8:15-11.30 a.m. (Note: Address for verification from AIR is Director of News and External Services, All India Radio, 15 Alipore Road, New Delhi, India.)

Italy—Rome, 6.030, is reported, 6-6:30 p.m. Radio Milan, 9.630, is reported heard in Australia at 9:30 a.m. Swedish correspondents say that Radio Milan, 9.630 and 11.810, carry the

**Crystalab**  
TRADE MARK REG. U. S. PAT. OFF.

SPECIALISTS IN  
SPECIAL CRYSTALS

*Light Weight*  
**COMPACT**  
**DEPENDABLE**

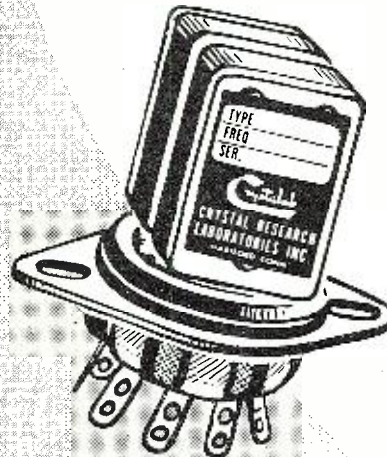

2,000KC—15,000KC Crystal mounted in  
Crystalab CRL-16 holder . . . STABLE—BX  
rated (-30° C to +60° C at .01% fre-  
quency deviation) . . . LIGHT WEIGHT—  
17.5 grams . . . COMPACT—overall height  
1.59" width .812" depth .438" holder  
height 1.125" . . . pin spacing .486" on  
centers . . . TWO CRL-16 holders fit a  
standard octal socket. Low temperature  
coefficient cut crystal clamped in a  
humidity sealed holder by heavy spring  
action. Especially adaptable to Aircraft,  
Marine, and Mobile units.

Our Develop-  
ment Laboratory  
invites your diffi-  
cult control or ul-  
trasonic crystal  
problems.



**CRYSTAL RESEARCH**  
LABORATORIES INC.

29 ALLYM ST., HARTFORD, 3, CONN., PHONE 7-3215

# NOW!

150-WATT SOUND SYSTEM  
NEEDS LESS THAN  
2½ SQUARE FEET...

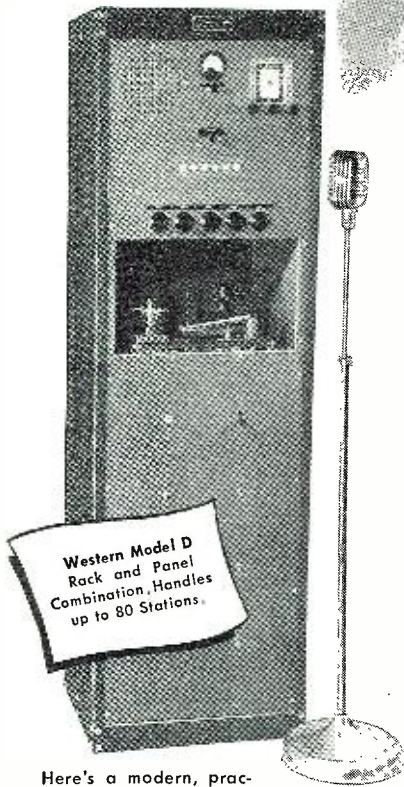

Western Model D  
Rack and Panel  
Combination. Handles  
up to 80 Stations.

Here's a modern, practical sound system for industrial plants, schools, institutions, where floor space is at a premium. WESTERN Rack and Panel Combinations providing high powered, high fidelity sound distribution, need only 2½ sq. ft. of floor space or less. Include custom-built AM radio tuners, automatic record changer, visual level indicator, tone control and many other features typical of WESTERN experience and engineering skill.

Completely enclosed in an attractive all-steel fireproof cabinet, they are available in single or dual channel with or without talk-back. Two general models: Model D, 150 watts, handles up to 80 stations; Model E, 50 watts, handles up to 25 stations.

**DEALERS!**

for Ready PROFIT Today,  
Sell and Install WESTERN  
Custom-Built and Stock  
Sound Systems. Available  
NOW. Write for details.

**WESTERN** SOUND & ELECTRIC  
LABORATORIES, INC.

Milwaukee, Wisconsin

Pioneer manufacturers of Centralized, Portable  
and Recording and Inter-Communication Systems

same programs, but schedule was not given.

Japan—JVT, 6.750, JVP, 7.510, and JLS, 9.655, are not the former Japanese higher-powered transmitters but a group of 3-kw. transmitters located on a ship in Tokyo harbor and operated by the U. S. Army Signal Corps. KU1M, 10.585, or 17.760, is used by the United States ABC for relays from Tokyo to this country. EOU, 7.645, Tokyo, was reported recently around 6:30 a.m. carrying the Japanese Home Service in parallel with JLG4, 7.552, and JWV, 7.258.

Java—The Free Indonesian Radio on 6.720 and 12.275 has not been reported for several weeks, but a new "Voice of Free Indonesia" is being heard by West Coasters on about 9.860 to 9:30 a.m. sign-off; programs are mostly music, with announcements in Dutch and English; location was announced and may have been Jokjakarta; it is possible this transmitter has replaced PLFI, 15.210, which also has not been reported as heard recently. A station announcing as Radio Indonesia, thus locating it at Batavia, is heard nightly on 14.947, 5:5:45 p.m. sign-off, and with another transmission, 6:30-8:30 p.m.; programs are in Dutch, Hindustani, and English. The transmitter has a bad hum, and CW interference is generally heavy on the earlier transmission. This may be a new frequency for the Radio Indonesia transmitter which formerly was heard on 18.135. Another new Javan frequency reported from Oceania is 15.957, transmitting around 5:30-8:35 a.m.

Kenya—VQ7LO, 6.060, Nairobi, reported moved here from 6.114, is listed 5-6 a.m., 11 a.m.-2 p.m.; VQ7LO, 10.730, Nairobi, verified by letter in 5 months; address, Cable & Wireless, Ltd., P.O. Box 777, Nairobi, Kenya Colony.

Korea—JODK, 2.510, Seoul, is American-operated, according to New Zealand monitors; has dance music after 8 a.m., peak strength is at 6:30 a.m., signs off at 8:30 a.m., at which time it has been heard contacting Shanghai and Tokyo.

Labuan—The 500-watt station on Labuan (an island off the N.W. coast of Borneo), was used only from October 1 to November 11, 1945; used a BC610 (Hallicrafters) with a half-wave, center-fed Zepp antenna; was replaced by a BCB station on 980 kcs.

Lebanon—FXE, 8.020 (officially listed by Middle Forces' Times as 8.11), Radio Levant, Beirut, is using 3 kw. and is heard in Sweden on a schedule of 12:15-1:15 a.m., 7-7:20 a.m., and 10 a.m.-4 p.m.; signs off with "La Marseillaise." Verifies.

Luxemburg—Radio Luxemburg, 6.090, is reported now heard on Sunday to 3 p.m. with a special request musical program.

Malaya—Radio SEAC in the Far Eastern Service Calling From Singapore, 11.635 and 6.770, now signs off at 9:05 a.m., has English news at 7:15 and 8:30 a.m. From Oceania, DXers

## IMMEDIATE DELIVERY



### ON RADIO AND ELECTRONIC SUPPLIES

Radio Electric Service Co. of Penna., Inc. is an old established house with the newest in parts and equipment from the finest lines in the country.

- ★ SOUND EQUIPMENT
- ★ INTERCOM SYSTEMS
- ★ TEST EQUIPMENT
- ★ INDUSTRIAL ELECTRONIC EQUIPMENT
- ★ AMATEUR EQUIPMENT

MAIL ORDERS SHIPPED  
IN 24 HOURS

## RADIO ELECTRIC

SERVICE CO. OF PENNA., INC.

N. W. COR. 7TH & ARCH STREETS  
PHILADELPHIA 6, PA.

CAMDEN, N. J., ALLENTOWN, PA.  
WILMINGTON, DEL., EASTON, PA.

Our EXPORT Dept. Circles the Globe

### IMMEDIATE DELIVERY

Packet Voltahn Meter McClintock No. 3240 range 0-1000 ohms x 10x100x1000 0-3/30/300/600 volts D.C. 100 micro emp. movement, 1000 ohms per volt, less batteries and test leads \$14.95  
Beede Meter—Movement 425 Micro-Amps., 4½" sq. scale 0-60 V.A.C. 0-3/15/60 V.D.C. plus mills. Make your own voltahn milliammeter with this unit furnished with separate half wave rectifier..... 5.85  
Above Meter Only..... 4.85  
Half Wave Rectifier Only..... 1.35  
Weston 425 R.F. Meter 0-50 Milliamps with internal vacuum thermo-couple 3½ rd. flush bakelite case..... 24.95  
Gen. Elec. Meter Same as Above..... 22.95  
Manufacturers, dealers, etc. write for special prices on these meters.  
Weston 772 Analyzer New—not shipped prepaid. 68.15  
Material shipped C.O.D. or prepaid if you remit with order.  
ERIC WENDSTREND, 4317 Dayton St., Chicago 13, Ill.

**NEW TINY POCKET SIZE RADIO!**

Slips in your pocket or purse—We only 3 oz.! Complete READY TO PLAY as shown with self-contained phone for personal use. Beautiful black plastic case. Has a patented Exact Crystal - Slide Tuning Dial! NO TUBES. BATTERIES OR ELECTRIC PLUG-IN REQUIRED. U.S. PAT. 2,141,141 RECEIVES LOCAL BROADCASTS without outside aerial wires.

**GUARANTEED TO WORK** when connected and used according to instructions. Can be used in homes, offices, hotels, cabins, in bed after hours.

**SEND ONLY \$1.00** (cash, money order, check) and I'll pay postage. \$2.99 plus delivery fees on arrival or send \$3.99 for postpaid delivery. IDEAL GIFT FOR CHILDREN OR ADULTS ALIKE! Get your PA-KETTE RADIO NOW for real enjoyment. Dealers in most cities.

PA.KETTE ELECTRIC CO., Dept. RN-7, Kearney, Nebr.

### ELECTRONICS

Electronic Technician Training Course. Quality for Radio Communication (Commercial Government License); Radio Repair Service; or be an Industrial Electronic Technician. Register now for new classes starting every four weeks. Approved under G. I. Bill of Rights. Residence day and evening school. Write to

**ELECTRONICS INSTITUTE, INC.**  
21 HENRY, DETROIT, MICH.

report Radio Malacca at 9 a.m. announcing as "the Far Eastern Service of Radio SEAC," with interference from PHI, 17.775, Huizen, Holland. Frequency of Radio Malacca is believed to be 17.770. It may be possible to log this station after PHI leaves the air around 9:30 a.m. (Note: Inasmuch as Singapore's Far Eastern Service signs off now at 9:05 a.m., Radio Malacca must carry an independent service, or perhaps beams the Red or Blue Network to the Far East. Radio Kuala Lumpur, 6.163, is reported to have English news (relayed from the BBC) at 8 a.m.; schedule is 5:30-10:30 a.m.

Martinique—Radio Martinique, 9.705/8, Fort-de-France, signs off at 8:32 p.m.

Mexico—Call letters announced for the new short-wave relay of XERH on 11.880 are XEHH ("X-E-doble H"); this station is heard 8 a.m.-1 a.m. (next day) sign-off, identifies with the slogan, "Sal de Uvas Picot."

New Britain—VJZ, 9.310, Rabaul, is back on the air; first reported to me by Australians, it is now being heard by Eastern DXers calling Sydney point-to-point around 6:30 a.m.

New Caledonia—Radio Noumea in a recent letter to a New Zealand correspondent listed its schedule as 2-4 a.m. and 7-8 p.m., a slight curtailment of time.

New Zealand—ZLR5, 15.050, a commercial frequency at Wellington, has been heard in the East with strong

signals, testing late evenings and early mornings. Several recent reports from New Zealand and Australian DXers indicate that ZLT, 10.940, Wellington, has lately been carrying a description of the cricket matches between New Zealand and Australia, around 1:15 a.m.

Northern Rhodesia — ZQP, 3.900, 7.220, and 7.285, Lusaka, has an English period, 10 a.m.-12 noon daily, and on Sunday at 4-5:30 a.m.

Norway — Swedish correspondents list the schedule of Oslo, 6.200, as 4-6 a.m., 9 a.m.-12 noon, and 3-6 p.m.

Palestine—JCKW, 7.220, Jerusalem, leaves the air at 4 p.m.

Panama—HOB, Panama City, Radio Panamericana, is now heard regularly on 6.070 where interference from WLWK, 6.080, is extremely annoying. This station parallels HP5G, 11.780, and medium-wave HOA; schedule is believed to be 6:30 a.m.-10:30 p.m.

Pitcairn Island—A Pennsylvania DXer reports picking up Pitcairn Island on approximately 12.130 at 1:25 a.m. EST on April 20, 1946; he reports, "I understood perfectly the 'Pitcairn Island,' but no call was given; sounded like an emergency transmission as medical supplies were mentioned."

Poland—Radio Warsaw, 6.100, has English news at 4-4:15 p.m.

Portugal—Radio Renascenca, 6.155, Lisbon, is scheduled, 2:30-7 p.m.; uses 5. kw.; Swedish monitors have received verification from Rua Capelo 5, Lisbon; this is Emissora Catholicá

Portuguesa (Portuguese Catholic Radio Station).

Portuguese China—Radio Macau, 7.530 (listed), has not been reported lately; was good on West Coast during the winter months.

Rumania—Radio Bucharesti, 9.255, has French news at 7:45 a.m., heard in Sweden. Another Swedish observer, listing the frequency as 9.259, and location as Dacharomina, reports an hour's program between 7:30-8:30 a.m., with 15 minute news periods in English, French, and German.

Siam—Bangkok, 6.000, is reported to 8:58 a.m. sign-off; but on Sunday, they return almost immediately with chimes interval signal repeated several times, then a man talks in Siamese until after 9:20 a.m.; this station is again being heard on the West Coast. Oceania reporters say English announcements are given by a lady announcer, and that reception is poor there, 5-6 a.m., with heavy interference. Eastern DXers wishing to log this station should try for it after ZFY, 6.000, Georgetown, British Guiana, signs off at 7:45 a.m.

South Africa—The Johannesburg V transmitter on 4.377 (measured) is heard with weak signal strength in the Southeast at 11:45 p.m. opening with the relay of the SABC English program; power is only 200 watts. Best signals in the East from South Africa are those from ZRK, 5.877, Capetown III, 11:45 p.m.-1:30 a.m., with BBC news relay at 1 a.m. Jo-

# Fahnestock Clips

## RADIO'S GREATEST CONVENIENCE

### FAHNESTOCK SPRING BINDING POST GRIPS THE WIRE BY THE ACTION OF A SPRING

No tools required to make the connection. Grips the wire with just the right pressure for good electrical contact. Simply press down, insert the wire and let go. Does not injure wire, hence connection can be made or opened as often as desired. Available in large variety of types and sizes to fit any radio purpose and any requirement as to position, space or method of attachment. You will find them in the better sets.

Positive contact; cannot jar loose. Brass or bronze—nonrusting.

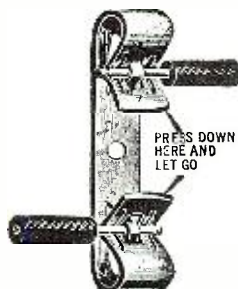
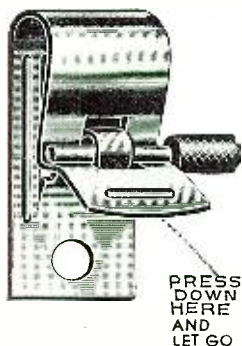
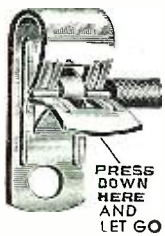

### FAHNESTOCK ELECTRIC COMPANY, Inc.

46-44 ELEVENTH STREET  
LONG ISLAND CITY 1, N. Y.

Please send us at once, Descriptive Literature, Prices and Delivery Schedule on

### FAHNESTOCK CLIPS

For .....  
Name .....  
Address .....  
City..... State.....

hannesburg III, 3.450, is being heard in Australia mainly in Afrikaans, but the BBC news is relayed at 3:45 p.m. with good level.

Southern Rhodesia — The second harmonic of Bulawayo, 3.800, is being heard in Europe on 7.600 in the early afternoon.

Spain—Radio Falange de Alicante, 7.940 (listed as 7.950), Alicante, using 1.2 kw., is heard in Sweden, 2-6 p.m.

Suriname—PZH5, 5.845, Paramaribo, verifies promptly with a card; this is definitely the correct call; uses 325 watts in a dipole; schedule is usually 6-8:30 p.m. PZR, 11.322, Paramaribo, contacts PJY, 9.738, Curacao, around 8 a.m.

Sweden—Just received from Sweden is this revised list of the Motala 12-kilowatt short-wave stations: SDT-2, 15.665; SBT, 15.155; SBP, 11.705; SDB-2, 10.780; SBU, 9.535; SDT, 9.4425; SBO, 6.065; SDB, 5.7325. "The best heard here in Sweden is SBO between 1 and 5 p.m." The North American beam is officially listed over SBT, 15.155, and SBP, 11.705, 10-11 a.m. Address for verification is Aktiebolaget Radiotjänst, Kungsgatan 8, Stockholm 7, Sweden (Sverige).

Switzerland—HER5, 11.865, Bern, is heard Tuesdays and Saturdays, 12 midnight-1:30 a.m., beamed to Australia.

Tangiers—EA9AA, 7.095, Tangiers, is heard in Sweden as early as 2:45 p.m.

Turkey—Best signals from TAP,

9.465, are the English broadcasts, 4:30-4:45 p.m., Sunday (Postbag), Monday and Thursday (to Britain); on this same frequency, TAP has a later program in English, 6-6:15 p.m., now on only every other week (probably Saturday *only*). Verifies; address the Turkish Radio Department, Radio Branch, Ankara, Turkey.

U.S.S.R.—A new Moscow frequency heard 11 a.m.-3:15 p.m. is 15.412; programs beamed to Europe in English, German, French, Spanish, and Polish. A new Home Service frequency heard with weak signal after 10 p.m. is 9.739. From the West Coast we learn that Moscow's Home Service is being heard now only on 15.17, 15.27, and 15.32 from 10 p.m., and that the 11.63 frequency is seldom heard near midnight. Moscow's big seasonal shift of frequencies, affecting practically all transmissions, with many adjustments in hours of broadcast, has resulted in this schedule to North America (including Kiev and Komsomolsk transmitters): Transmission One—7:20-7:45 a.m., 11.630, 11.830, 15.170, and 17.810 (new), and 7:45-8:15 a.m., 6.070, 9.565, 11.630, 11.830, 15.170, and 17.810. Transmission Two — 6:20-7:30 p.m., 6.020, 7.300, 7.360, 9.480, 9.540 (new), 11.880, 15.230, and 7:30-9:00 p.m., 6.020, 7.300, 7.360, 9.480, and 9.540. English news in the evening transmission is at 6:30, 7:30, 8:30 p.m.; Moscow Newsreel is heard at 7 and 8 p.m. Moscow's Latin American broadcast is now heard 7:30-10 p.m. on 7.430, 9.610, 9.710, and 11.890, 6.980 and 7.200 have been dropped.

United States — Due to European change to Summer Time, the East Coast schedules have been extensively changed; sign-on in most cases is at 4:45 a.m. instead of 5:45 a.m., with sign-off at 5:15 p.m., rather than 6 p.m.; transmitters will be found in all the popular s.w. bands.

Vatican — Apparently affected by the Italian time change, HVJ, 11.740, has been heard in a special broadcast recently, 1:15-1:25 a.m., by West Coast listeners.

Venezuela — Latest listed schedules of Caracas stations are: YVKO, 4.980, 5:30-10:30 p.m.; YV5RN, 4.915, 6:27 a.m.-10:30 p.m.; YV5RU, 4.860, 5:55-8 a.m. and 9:55 a.m.-10:30 p.m.; YV5RM, 4.970, 5:25-7:30 a.m.

and 10:29 a.m.-10:30 p.m.; YV5RD, 3.570, 10:30 a.m.-1:20 p.m. and 3:30-11:30 p.m.; YV5RS, 3.530, 10:25 a.m.-12:30 a.m. (next day); YV5RX, 3.505, 9:25 a.m.-2 p.m. and 3:25-10:30 p.m.; YV5RW, 3.400, 5:30-8 a.m., 9:55 a.m.-1:30 p.m., and 2:55-10:30 p.m.; and YV5RY, 3.380, 9:30 a.m.-10:30 p.m.

Yugoslavia—Australians write me that VLR-2, Melbourne, 6.150, has been interfered with by Radio Belgrade, prior to VLR-2's sign-off at 4:10 p.m. After the Australian signs off, Radio Belgrade is heard with a fair signal on 6.150; foreign language programs are punctuated by an interval signal of four chimes; programs of music have been heard at good level around 12:30 p.m. English news is scheduled for 3:30 p.m.

\* \* \*

### Last Minute Tips

By the time you read this, Radio Australia will have replaced VLC9, 17.84, by VLC4, 15.320, Shepparton, for the evening transmission to Eastern North America, 6:40-8:45 p.m.; English news will remain on the same schedule, 6:45 and 8:30 p.m. VLC4 (but on 15.315) was used last year for the evening transmission, 9:55-10:45 p.m. and sent powerful signals to the East; in tests I have just heard on this frequency, VLC4 has been sending a better quality signal to the East than VLC9, and strength will likely increase as summer advances, which was the case in 1945.

Radio Warsaw, 6.100, Poland, is heard in Australia as early as 12:30 p.m.

Radio Teheran, EPB, 15.100, Teheran, is reported heard in New York at 1 p.m. with an excellent signal.

A letter verification received by Lennart Ekblom, Sweden, from Kenya Colony, states that this station is on the air daily, except Sunday, from 5-6 a.m. and from 11 a.m.-2 p.m. On Tuesdays and Thursdays, they also broadcast at 7:30-8:30 a.m., and on Sundays, from 10:30 a.m.-1:30 p.m. All programs are broadcast on 810 kcs. and 6.060 and, in addition, after 11 a.m., 4.950 is also in use. Another Swedish correspondent reports the 4.950 frequency has English news at 1 p.m.

From another Swedish observer, we learn that PCJ, Hilversum (Huizen), Holland, has been heard on about 6.310, 8-8:30 a.m., with news; also that OIX2, 9.503, Finland, is heard in Sweden at 10 a.m.

Still another Swedish reporter lists a "new Chinese station heard at 7-8:30 p.m. on 12.200, announcing at XXGA." (This may be listed XLPA, 12.220, Hunan Broadcasting Station, at Changsha.)

VUB-2, 6.15, Radio Bombay, has English news (from the BBC) at 10 a.m. VLR, 9.54, Melbourne, has English news at 1 a.m. In a letter from WVLC regarding two reception reports, it was stated that the communications ship "Apache" had been decommissioned. (Milne, New Zealand.)

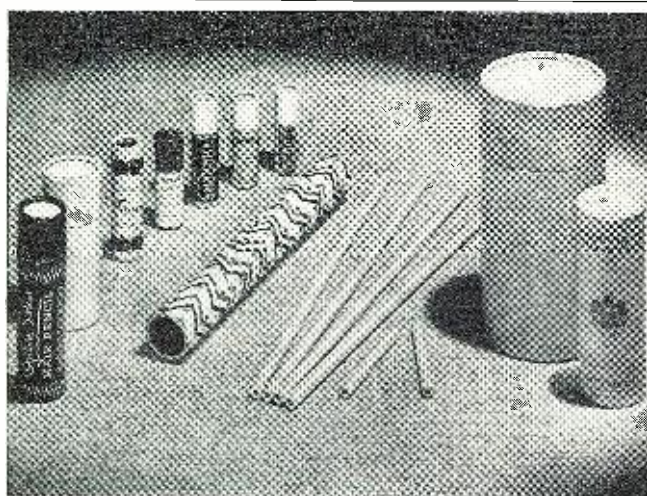

## PAPER and TRANSPARENT TUBES for the RADIO and ELECTRICAL FIELD

Spiral wound—diameters 1/16" to 3". Exacting specification work in large quantity lots. Prompt delivery on Condenser Tubes, Socket Liners, Etc., Etc.

**DIAMOND STRAW & MACHINE CO.**

114-116 East  
New York



16th Street  
N. Y.

Australians report a station heard on 7.750 at 6:45 a.m. has been identified as KW3U, Tientsin, China; has been heard contacting KU5Q, Guam.

A new outlet of Radio Indonesia is reported from Australia, on 7.470; at 6:45 a.m., a program of American-type dance recordings was being played; announcements were in native languages. This is likely the unidentified station reported by West Coasters for this spot.

In Sweden, XGOY, 9.64, Chungking, is being heard at 10-10:30 a.m. with news in English at dictation speed (probably press dispatches).

Of widespread interest are the following excerpts from a letter recently received by Paul Dilg, Monrovia, California, from Radio OMROEP Station, Telf. 43 Strandweg Zuid 2, Macassar, Celebes:

"According to your observations, our signal improved from weak to good towards the end of February; this fits in with some improvements we performed on our transmitter, bringing its strength from about 3.5 kw. to some 6 kws. The English program you happened to tune in on Mondays, Wednesdays, and Fridays is a "For the Forces and By the Forces" feature, which is being broadcast for the benefit of the members of the British occupation troops in these parts of the Netherlands East Indies. As a matter of fact, the first half of the show, 7:30-8 a.m., is in Hindustandi (for the Dogras, Gurkas, and other Indian troops), while the second half, 8-8:30 a.m., is in English. . . . It may interest you to know that yours is the first report from the U.S.A. granting our audibility program value, which is nice to know for ourselves, too, and ever so encouraging." It was pointed out that Radio Macassar was "created by the Japs and did not exist before the war." The letter was signed by Bert Garthoff, Program Editor, R.O.M. The program sheet enclosed listed Radio Macassar, 9.357 (36.06 m.), strength, plus or minus 6 kw., daily transmissions, 11 p.m.-1:30 a.m., with news in English at 11:25-11:30 p.m.; and 5:30-9:30 a.m. The "For the Forces and By the Forces" feature is heard Monday, Wednesday, Friday, between 7:30-9:30 a.m. On Sundays, there is an additional transmission of two religious services: Protestant, 8-9 p.m.; Catholic, 9-10 p.m., followed by a classical concert on records between 10-11 p.m.

A late flash from the West Coast reports Radio SEAC, Ceylon, announcing an additional outlet, 88.02 meters (probably the 3.395 channel), paralleling 6.075 to 10 a.m. sign-off.

Consistently good signals continue to be received here in the East from ZLT7, 6.715, Wellington, New Zealand, around 4:30 a.m. when English news and sports results are broadcast for approximately 10-15 minutes. At the end of the transmission, the usual announcement is that "ZLT7 will now cease transmission until 9:30 tomorrow night" (4:30 a.m. EST). The

July, 1946

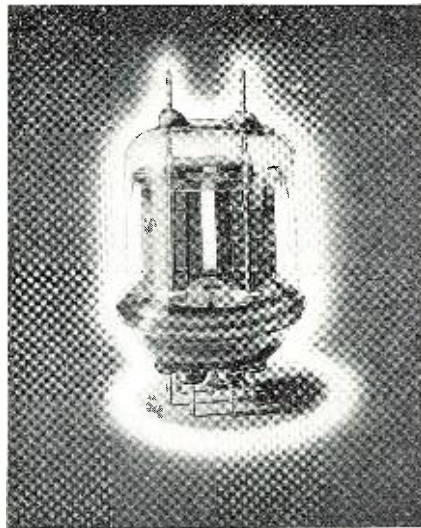

## Transmitting Tubes at WELLS

We have a fine selection of medium power transmitting tubes of the most popular types. These are all brand new standard makes packed in their original sealed cartons and fully guaranteed. All tubes are government contract termination material and have been approved by JAN inspection. The following are priced far below actual value and we suggest that your order include spares as quantities are not unlimited: 829B (Illustrated), 807, 803, 811, 8025, 832, 832B, 304TL, 3C24 and 7193. Wells Special—Type 813 Tube—Only \$9.75 net.

### Wells' New Amateur Radio Division

Tom Kosti, W9OPU, heads the new Amateur Radio Division. He has carefully selected a wonderful list of parts and equipment just released by the Government. You can save a big share of the cost of your new rig by writing Tom for his new Amateur Radio Circular. Wells' Amateur Radio Division, 4715-D West Madison Street, Chicago 44, Illinois.

#### Government Contract Termination Material

Wells' tremendous stock of radio and electronic components has been hand picked from contract termination sources. Everything is new and of the highest quality. Quantities and prices are attractive even to the largest users. This is only a partial list of categories.

##### CONDENSERS

Oil Filled Bathtubs  
Electrolytics  
Mica and Silver Mica  
Moulded Bakelite  
Oil Filled Transmitting  
Tubulars  
Trimmers and Padders

##### RESISTORS

Carbon  
Precision  
Wire Wound

##### SPAGHETTI

Varnish Cambric  
Extruded Vinylite

##### SWITCHES

H & H Toggles

##### C-H Toggles

G-E Push Type  
G-E Switchettes  
Square D Breakers

##### WIRE—CABLE

2-Conductor Telephone  
Field Wire  
Coaxial Cable 50 and 70 Ohm  
Coaxial Connectors

##### RELAYS

Allied  
Automatic Electric  
Clare  
Guardian  
Potter and Brumfield  
Struthers-Dunn

##### TUBE SOCKETS

Composition Octal  
Steatite Octal  
Moulded Bakelite Octal  
Johnson Ceramics  
Miniatures

##### TRANSFORMERS

Navy Type Power  
UTC "Ouncers"  
Amertran Step Up or Down  
Chicago Transformer Audio  
Chokes

##### VOLUME CONTROLS

##### VIBRATORS

B-L SELENIUM RECTIFIERS  
DIAL LIGHT ASSEMBLIES  
WHIP ANTENNAS

WELLS SALES, INC., 4717-D W. Madison St., Chicago 44, Illinois

USE COUPON BELOW FOR COMPLETE INFORMATION

WELLS SALES, INC., 4717-D West Madison Street, Chicago 44, Illinois

Please ship..... 813 Tubes at \$9.75 each for which check (or M. O.) for \$..... is enclosed.

Please mail free Amateur Radio Circular.

Please send prices and information on the following items:.....

NAME .....

ADDRESS .....

## HOPP Plastic RADIO DIALS

DIAL WINDOWS,  
NAME PLATES,  
SCALES, GAUGES,  
CHARTS,  
CALCULATORS, ETC.

PLASTIC RADIO DIALS combine the beauty of radiant color with the utility of perfect light transmission. The possibilities of design, size, shape and color combination are limitless.

Whether your problem is dials, or any of hundreds of allied applications, let Hopp artists and engineers "sit in" on your designing problem.

Send us your blueprints or samples for quotation.

ESTABLISHED 1893  
**THE HOPP PRESS, INC.**  
460 W. 34th STREET, NEW YORK 1, N. Y.

# R-L SPECIALS

for IMMEDIATE delivery

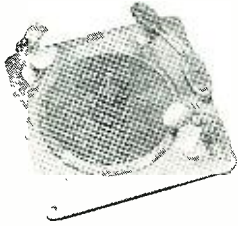

**V-M**  
RECORD CHANGER

With two posts  
as illustrated.

**\$22<sup>05</sup>**

**DETROLA**  
SINGLE POST RECORD CHANGER

**\$18<sup>26</sup>**

**PORTABLE CASE**

Fits either changer.

**\$14<sup>95</sup>**



**WOOD BASE FOR DETROLA \$3<sup>60</sup>**

Write for Free 1946 Parts Catalog



731 West Washington Boulevard  
DEPT. N CHICAGO 6, ILLINOIS

**SIMPLIFY YOUR SYSTEM . . .**

with the

## "RADIO SERVICE STANDARD RATE BOOK"

A manual designed  
for the

Radio Service Dealer

- to assist him in determining charges for service work
- as a convenient guide for ordering replacement parts
- outlining step-by-step general servicing procedures

**INCLUDES:**

Radio Tube Prices

Radio Parts Prices

Crystal Cartridge Digest

Registry of Electronic Manufacturers

Auto Radio Installation and Service

Price Formula for Repairs of  
Radio Equipment

General Servicing Procedures for  
Radio and Record Changers

**Price: \$1.00 per copy**

Available at Your Radio Parts Jobber

**OELRICH PUBLICATIONS**

1627 South Keeler Ave., Chicago 23, Ill.

station can be heard, however, as early as 4:15 a.m. when music is usually relayed from one of the Wellington medium-wave stations.

An Indiana DXer reports FZI, 15.595, Brazzaville, French Equatorial Africa, has English news at 7:15 a.m.

William E. Miller, Jr., 1st Lt., Signal Corps, Technical Supervisor, Japanese Voice Radio Circuits, Tokyo Signal Office, Headquarters U.S. 8th Army, Tokyo, flashes us the following information concerning Tokyo short-wave broadcasting stations. All of these stations are owned by the *International Tele-communications Company of Japan* and are operated by the Company personnel (Japanese) under supervision of the U.S. 8th Army.

JVA, 18.910, 20 kw., 5:30 p.m. to about 3 a.m., works KNY, KWN-2 (A.T. & T. San Francisco).

JLP-3, 17.835, 15 kw., 5:30 to about 6:30 p.m. (dual with JZK), works KKL (RCA, San Francisco), KBE (P.W., Los Angeles).

JVD, 15.860, 20 kw., about 3-5 a.m., works KWU, KWN-4 (A.T. & T., San Francisco).

JZK, 15.160, 20 kw., same schedule as JLP-3, and works same stations.

JIQ-2, 11.970, 20 kw., irregularly about 3 a.m., works KWV, KWN-6 (A.T. & T., San Francisco).

JVU-2, 11.845, 15 kw., irregularly about 3 a.m., works KKL, KES-2 (RCA, San Francisco).

JLU-2, 9.525, 20 kw., 6:30 to about 7:30 a.m. (dual with JVT), works KES-2 (RCA, San Francisco), KGT-5 (P.W., Los Angeles).

JVT, 6.750, 15 kw., same schedule as JLU-2, and works same stations.

JGF, 7.780, 20 kw., about 5 to about 10 a.m., works KMI-2, KWN-7 (A.T. & T., San Francisco).

JLR, 6.015, 20 kw., 4:30 p.m.-4 a.m., relays AFRS programs to Japan and Korea.

JZC, 3.075, 10 kw., 3-9 a.m., relays AFRS programs to Japan and Korea.

(Note: Beginning sometime in May, JVU-2 and JLU-2 were to be operated dually for the 6:30 a.m. transmission, after which time JVT was to be used only occasionally, if at all, until fall. JVA, JVD, JIQ-2, JGF carry telephone conversations inverted at 3000 cycles. Transmitters are double side-band. JLP-3, JZK, JVU-2, JLU-2, and JVT transmit news broadcasts by network commentators which are re-broadcast by American networks.)

Lt. Miller comments: "Reception reports are most welcome and should be addressed to this office. Verifications will be furnished."

Radio Australia has recently been conducting test broadcasts to Eastern U.S. and Canada between 6:40-8:45 p.m. on the new VLB transmitter on a frequency of 9.54 (announced), as well as on VLC4, 15.32 (announced), and VLA9, 21.600 (announced). Reception reports are requested and should be addressed simply, "Radio Australia, Melbourne, Australia," according to announcement. This "long"

**THE BUY OF A LIFE-TIME!**

## BRAND NEW GENUINE U. S. SIGNAL CORPS SHORT-WAVE TRANSMITTERS

72.2 M.C. Approx. 5 meters  
COMPLETE WITH TUBE

Operates on 1 Dry cell 1½ volts—67½—90 V.B. Ready to use—attach di-pole—antenna—keying or mike—connect batteries and you have it. Wired with silver wire, silver mica condensers, precision resistors, seatite socket. Circuit is completely stable and has low loss silver wire inductance (adjustable padder). Guaranteed to work, and it weighs less than 1 lb.

This outfit can be converted easily into a walkie-talkie. Schematic diagram furnished. No C. O. D. accepted.

Express Shipments only. Sacrificed at \$2.95—Postal or Express Money Order or Certified Check.

**NEWARK SURPLUS MATERIALS CO.**  
324 Plane St. Newark 2, N. J.

# RECORDS

**LATEST & HARD-TO-GET BACK NUMBERS**

Some slightly used and some brand new—Victor, Bluebird, Columbia, Okeh, Decca, Capitol, etc. Such artists as Glenn Miller, Benny Goodman, Harry James, Bing Crosby, Frank Sinatra, Gene Autry, Duke Ellington, Fats Waller, Guy Lombardo, Andrews Sisters, Kate Smith, Ink Spots, Mills Bros., etc.

**BIG PROFITS** Your opportunity to cash in on this new field that is sweeping the country. Specify the type of music that sells best in your territory such as Swing, Sweet Music, Cow-boy, Hill-billy, Polkas, Blues, etc. Your price \$13.90 per 100 records, f.o.b. Chicago, 2% off for cash with order. All shipments made within 48 hours

CHAS. HOODWIN CO.

4419 Broadway, P-15, Chicago 40, Illinois  
World's Largest Dealers in Used Records

## PRECISION ANTENNA

FM • TELEVISION • AMATEUR

Made of highest grade aluminum

Type 701A (28-44 MC) 10 meter amateur	\$8.95
Type 701B (44-88 MC) Television 5 meter amateur	7.95
Type 701C (88-148 MC) FM 2 meter amateur	7.45

### IN STOCK ANTENNA ELEMENTS

Let us know your requirements.	
100 Ft. roll of RG 58 U. Transmission line	\$5.45
100 Ft. roll of parallel transmission line, 300 ohm or 150 ohm	3.75

Immediate Shipment

Send for prices and information on our new 10 meter 3 element beam antenna and 2 meter 6 element beam antenna.

S/C LABORATORIES, INC., Dept. R  
20-22 Van Wagenen St. Newark 4, N. J.

## ELECTRICAL TRAINING

Intensive 3 months' residence course in fundamentals of industrial electrical engineering, including radio electronics. Prepares for technician, engineering aides. Approved for veteran training. 53rd year. Catalog.

**BLISS** ELECTRICAL SCHOOL  
7698 Takoma Ave.  
Washington 12, D. C.

## Post War Resistor Chest

100 factory selected ½-1 watt Continental Carbon resistors from 50 ohms to 20 megohms in beautiful 6 drawer WOOD chest—\$12.49.

Distributors for Sylvania, Halldorson, Bogen, Ohmite, Cinaudagraph, G.C., J.F.D., Alliance, Central, and other leading brands.

*Mission Radio Distributors*

114 Main Plaza San Antonio, Texas



nightwave to Eastern North America, with English news at 6:45 and 8:30 p.m., will likely soon settle on one, or possibly two, of these frequencies, rather than continue to use VLC9, 17.84, which had been used first this spring.

\* \* \*

#### Acknowledgments

ALBERTA — VE9AI, Edmonton. AUSTRALIA—Gillett, Maher; *Radio Australia*. CALIFORNIA—Dilg, Balbi, Foster, Curtiss, Harris, Teague. COLORADO—Woolley. CONNECTICUT—Farmer. CZECHOSLOVAKIA—The Czechoslovak Broadcasting Corporation. DENMARK—Statsradiofonien; Jensen, Christensen, Friis. DISTRICT OF COLUMBIA—Havlena, Norris. ENGLAND—Cheffins, BSWL. FLORIDA—Mohr. HOLLAND—Edward Startz, PCJ; Koelmans. ILLINOIS—Johnson, Wajda, Vidoloff. INDIA—All India Radio. INDIANA—Jacobs, The Grand National SWL Club; Green, Hoiermann. JAPAN—Miller. KENTUCKY—Harvey. MASSACHUSETTS—French, Harris. MISSOURI—Kierski, IRT. NEW JERSEY—Potts, NNRC. NEW YORK—Bishop; BBC; Eckstein, Weaver, Shirley, Reamy, Viteri, Barry, Taylor, Ballard. NEW ZEALAND—Coombe, Sutton, Milne; Cushen, N.Z. DX-TRA. NORTH DAKOTA—Steinmetz. OHIO—Sutton, Riggle, Croston. ONTARIO—Brook, Kennedy, Bromley. OREGON—Hayre. PENNSYLVANIA—

Znaidukas, Black, Callahan; VRC. QUEBEC—CBC's International Service; Gauvreau. SOUTH AFRICA—Eckstein. SWEDEN—Hansson, Olsson, Skogsberg, Frick, Dahlstedt; Skoog, Kortvags-Lyssnaren; Ohrwall, Mattsson, S. Andersson, Ekblom. TEXAS—Giles. VIRGINIA—Mayo; Howe, URDXC. —50—

#### Spot Radio News

(Continued from page 14)

Amateur Service, until the Citizens Radiocommunication Service, designed to govern such use, is put into effect. And without a license you are subject to the big fine. The Citizens Service will not be opened to the public for some time, FCC adds. It also warns that when it is open, don't count on using a surplus Army walkie-talkie. They aren't built to operate in the 460-470 mc. band which is reserved for the Citizen Service. Reason for the ban on walkies without license is because tragic interference to the aviation, marine, police, fire, and military radio communications can result.

**ROSEL H. HYDE**, who succeeds the late Governor William H. Wills as a Commissioner of the FCC, has been its general counsel for more than a year. It is probably news, things being what they are in Washington these days, to

add that he's not from Missouri. He was born in Banock County, Idaho, in the year 1900. He is a graduate of Utah Agricultural College and George Washington University, D. C., where he completed his law course in 1929, and is a member of the bar of both the District and of the Supreme Court of the United States. His association with government radio bureaus dates back to 1928, when he worked with the old Federal Radio Commission, and he graduated from that to the FCC when it was created. Thus he has a background of nearly twenty years of legal service in radio matters for the Federal government.

**BUT TWENTY YEARS'** experience will be needed to keep up with the load of work now on the FCC schedule. From a low of thirty-nine new licenses granted for AM stations during the year ending June 30, 1939, the Commission has so far in 1946 licensed 143 AM stations and, since last October, has granted conditional licenses to 426 FM stations. This is not to mention the load of applications for ham licenses—so numerous that FCC hasn't had time to add them up—nor the coming flood of licenses for the Citizens Radiocommunication Service, estimated roughly at a million. It will probably go to more than that, the rising post-war interest in radio being what it is.

—50—

**For the Man Who Takes Pride in His Work**

### MODEL 2432 SIGNAL GENERATOR

Another member of the Triplett Square Line of matched units this signal generator embodies features normally found only in "custom priced" laboratory models.

**FREQUENCY COVERAGE**—Continuous and overlapping 75 KC to 50 MC. Six bands. All fundamentals. **TURRET TYPE COIL ASSEMBLY**—Six-position turret type coil switching with complete shielding. Coil assembly rotates inside a copper-plated steel shield. **ATTENUATION**—Individually shielded and adjustable, by fine and coarse controls, to zero for all practical purposes. **STABILITY**—Greatly increased by use of air trimmer capacitors, electron coupled oscillator circuit and permeability adjusted coils. **INTERNAL MODULATION**—Approximately 30% at 400 cycles. **POWER SUPPLY**—115 volts, 50-60 cycles A.C. Voltage regulated for increased oscillator stability.

**CASE**—Heavy metal with tan and brown hammered enamel finish.

There are many other features in this beautiful model of equal interest to the man who takes pride in his work.

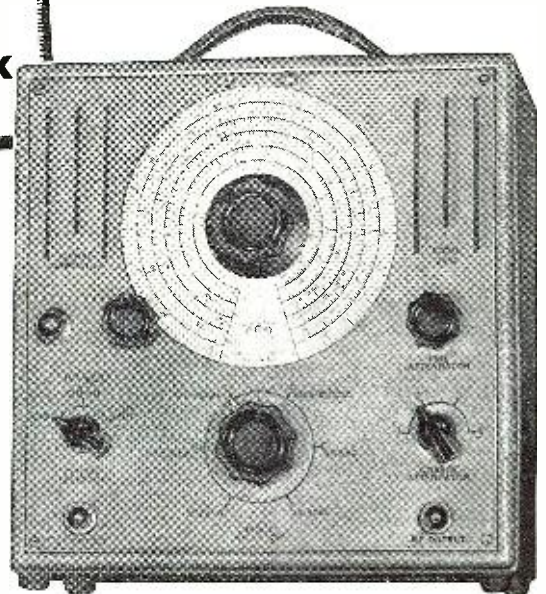

# Triplett

ELECTRICAL INSTRUMENT CO. BLUFFTON, OHIO



**FREE BOOK SHOWS SHORT CUT TO CODE SPEED**

ENDORSED BY CHAMPIONS

Skill, speed, accuracy free of nervous tension brings big pay.

**The One and Only Candler System**

Nothing else like it. It is the course that has made code champions. Will help any sincere man gain greater speed, accuracy and skill. Learn the Candler way.

**Fast, Efficient Operators Needed**

If you need additional speed to be classed as an expert, try the Candler method. It is endorsed by champions. It has produced phenomenal results with a minimum of effort. Why not learn the faster and easier way. Get your copy of the Book of Facts for Code students, Telegraph and Radio Operators.

**CANDLER SYSTEM CO.**

P. O. Box 928, Dept. 2-H Denver (1), Colo and at 21 Kingsway, London, W. C. 2, Eng.



**Champion Endorses CANDLER SYSTEM**

T. R. McElroy, Official Champion Radiotelegraph Operator of the world with a speed of 75.2 w.p.m., claims his success is due to the Candler System.

**CAREER Radio**

**FOUR INTENSIVE COURSES**

Each one a chance for ambitious men and women to increase earning capacity and promote permanent employment.

- 1. RADIO TECHNICIAN.** A general course including FM and Television. Students learn by constructing electronic and radio equipment under expert supervision.
- 2. RADIO COMMUNICATIONS.** Prepare for FCC licenses. Includes telegraphy. Leads to position as merchant marine or flight radio officer.
- 3. AIRLINE COMMUNICATOR NON-TECHNICAL.** Of special interest to YOUNG WOMEN. Prepares for employment in airport flight control offices.
- 4. RADIO & TELEVISION SERVICING.** Employment as repairman on home-type equipment including standard broadcast and FM, as well as Television receivers.

**MELVILLE RADIO INSTITUTE**  
"the radio school managed by radio men"

CLIP THIS COUPON

SEND ME FREE INFORMATION

NAME .....

ADDRESS .....

**MELVILLE RADIO INSTITUTE**  
45 W. 45th St.  
New York 19, N. Y.

**Selling Radio Service**

(Continued from page 27)

After being approached by several prospective purchasers, Mr. Wintermute arranged to sell the video receivers of one of the major manufacturers. Until the war stopped all home radio production, Mr. Wintermute sold quite a number of TV receivers in the Plainfield area and has continued to service them during the intervening years.

In the light of his close association with television receivers in the hands of users it is interesting to note that Mr. Wintermute entertains no fears about the future of television. With a large number of orders on hand for sets as soon as they are available, he confidently expects that television receiver sales and installations will prove a boon to the qualified, independent radio service dealer. He is of the opinion that department and chain stores will be unable to get qualified TV technicians who will give purchasers service equal to that available from the specialized radio dealer.

As in the case of other dealers who have been servicing video home receivers for a number of years, Mr. Wintermute thinks that alert radio specialists will set up service and installation departments geared to the needs of television users. This would

include among other things, service available during the evening hours when families nominally would gather around the home TV set to watch a performance. Many dealers consider the answer to this to be a staggered shift which would provide for a man on duty from 4 p.m. to midnight.

It is interesting to observe that among seasoned radio men all planning of merchandising activities revolves around the maintenance of an efficient service department. The prevailing opinion is that the future of the independent service dealer hinges on his ability to keep abreast of new developments in the industry and to conduct his service department profitably.

**REPAIR HINT**

**T**O start screws in those almost inaccessible spots around a radio chassis, nothing lends itself better to the purpose than a doctor's applicator or swab stick. (The little round stick that has the cotton on the end.)

Just trim the end of the stick slightly wider than the screwdriver slot in the screw, force the screw on the end, put the screw in place and start the screw. The stick can then be removed and the screw tightened with a screwdriver.

To remove screws from tight positions the procedure can be reversed. These sticks can be obtained at any drug store and the cost is negligible. They are a handy addition to your regular tool kit. L.J.S.

**TELEVISION SETS ON DISPLAY**



"It's one of the most realistic models put out, Sir."

**Home-Built V.T.V.M.**  
(Continued from page 49)

so that its leakage resistance will be high; and it should be mounted directly on the grid pin of the socket of  $V_1$ .

$R_1$  is located in the tip of the d.c. test probe. Its purpose is that of an isolating resistor. For example, if it is desired to measure the grid voltage of an oscillator tube,  $R_1$  isolates the capacity associated with the test leads from that of the grid circuit under test. Thus, the grid bias of oscillators, r.f. amplifiers, and other high impedance circuits may be tested under actual operating conditions.

A meter movement with a full scale deflection of less than one milliamperere may be used by simply increasing the size of the series calibrating resistors,  $R_{15}$ ,  $R_{16}$ , and  $R_{17}$ . Thus, if a 200 micro-ampere movement is to be used, the

$$\text{series rheostat} = \frac{1.5 \text{ volts}}{.002 \text{ amperes}} =$$

7500 ohms. In this manner the size of the series resistors may be computed for any meter movement. It is not recommended that a meter movement requiring a greater current than one milliamperere for full scale deflection be used in this circuit.

On the front panel of the v.t.v.m. the following items are mounted: meter movement,  $S_1$ ,  $S_2$ ,  $S_3$ ,  $R_{17}$ ,  $R_{18}$ , and the tip jacks for the three test leads. To further reduce stray a.c. pickup, a shielded lead should be used for the d.c. probe. To accommodate this shielded lead, a standard phone plug and jack may be used. An instrument panel jewel light also should be included on the front panel as a reminder to turn off the power when you have finished using the meter.

$R_{15}$  and  $R_{16}$  are screwdriver adjustments, and may be mounted anywhere on the chassis or front panel. It is suggested that they be mounted on the chassis since they need be adjusted only when one or both of the tubes in the bridge circuit are changed.

The two rotary switches in the meter,  $S_1$ , and  $S_2$ , are mounted on the front panel. The "pies" or wafers of  $S_1$  labeled  $S_{1A}$  and  $S_{1B}$  on the schematic are mounted on the same shaft. In like manner, the different sections of  $S_2$  are labeled  $S_{2A}$ ,  $S_{2B}$ , etc., and are also ganged to a common shaft.

**Divider Networks**

The resistors in the voltage divider and those in the ohms multiplier network must be selected within 1% of the values specified in the parts list if accuracy is to be maintained. In fact, the accuracy of the divider networks determines the accuracy of the v.t.v.m.

Resistors of 1% tolerance may be purchased from most dealers; however, 1% resistors of high ohms values are quite expensive.

One less expensive source of resistors with which to make the dividers is 5% or 10% resistors, select-

**TECHNO-CRAFT  
RECORDING MECHANISM**

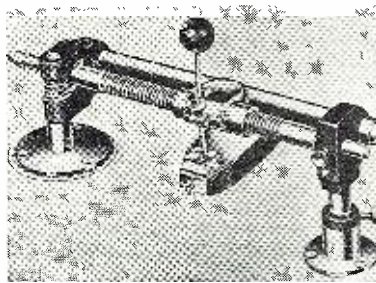

**INCLUDING CUTTER**

Professional type overhead record cutting mechanism. Cuts 110 lines per inch. Provided with either crystal X26 astatic or magnetic M41 astatic cutting head.

Two sizes—12" and 16" Black crackle finish with chrome bars.

Head locks on UP position. Infinite adjustable pressure on cutting head. List 12", \$75.00. List 16", \$89.50.

12" \$45<sup>00</sup><sub>NET</sub> • 16" \$55<sup>00</sup><sub>NET</sub>

**PORTELEC 16" TRANSCRIPTION PLAYERS**

We have been fortunate in obtaining a quantity of high grade 16" Transcription Players. Original price \$200.00.

PORTABLE • 5-TUBE HIGH FIDELITY AMPLIFIER 15 Watt  
1 OZ. PICK-UP • 12" JENSEN SPEAKER • HEAVY DUTY  
MOTOR • MICROPHONE JACK • 78 & 33 1/3 R.P.M.

Extra Plug for Additional Speaker

**\$176<sup>66</sup>** Net Price

Weight 40 lbs.

Size 20"x13"x14"



**MICROPHONES—AT GREAT SAVINGS**

- |  |                |                    |
|--|----------------|--------------------|
| Electro-Voice, Model V-2.....                        | List, \$41.05. | Our Price, \$24.63 |
| Electro-Voice Cardiaia, Model V-1, #950 Crystal..... | List, \$37.00. | Our Price, \$22.20 |
| Shure Crystal Mike 707A.....                         | List, \$13.50. | Our Price, \$ 8.10 |
| Shure Cardiaia Dynamic 55C.....                      | List, \$34.20  | Our Price, \$32.52 |

*Inquiries Invited on Products Not Advertised*

**Heins & Bolet**

68 CORTLANDT STREET, NEW YORK 7, N. Y.  
RECTOR 2-7600

RADIOS  
CAMERAS  
JEWELRY  
APPLIANCES

**BE YOUR OWN BOSS — OPERATE  
YOUR OWN PROFITABLE BUSINESS**

**HOME and INDUSTRIAL APPLIANCES**  
SERVICE—REPAIR—INSTALLATION

ONLY shop training course of its kind. Gives you actual shop training on washing machines, heat control systems, water heaters, toasters, vacuum sweepers, etc., etc. Work on actual machines under trained instructors. Low tuition. Old established school. Most complete training course of its kind. Investigate this opportunity—its money-making possibilities and the need for trained men. Write today for details. No obligation. Veterans ask for GI plan. Act now!

APPLIANCE TRAINING SCHOOL—Dept. 65  
Division of Commercial Trades Institute  
6312 N. Broadway Chicago 40, Ill.

**NEW!**  
4-in-1  
**Job Card**

Designed for Service Dealers

Provides: 1. Radio or Appliance Tag;  
2. Customer Claim Check;  
3. Guarantee;  
4. Job Ring Card.

SAMPLE AND PRICES ON REQUEST Radio Press MORGANTOWN WEST VIRGINIA

# RADIO CHASSIS PUNCH



Saves hours of work cutting clean, accurate holes in radio chassis—for connectors and other receptacles. Simply insert cap screw in hole to be enlarged (drill small hole if necessary), turn with ordinary wrench to force punch through the metal. No reaming or filing—hole is smooth and clean. No distortion—die supports metal. Ten sizes from 3/4" to 2 1/4"; also up to 3 1/2" for meters. Write for free folder S-119 to Greenlee Tool Co., 1887 Columbia Ave., Rockford, Ill.



REGISTERED TOOLS

## GREENLEE

FOR THE CRAFTSMAN

## New 5" Oscillograph

POST-WAR  
DUMONT  
DESIGN

Especially suitable for schools and laboratories.

Five (5") Dumont Model 274-EM, at remarkably low cost of

**\$99.50**

(available after July 1)

ORDER NOW TO HEAD THE LIST FOR FALL DELIVERY

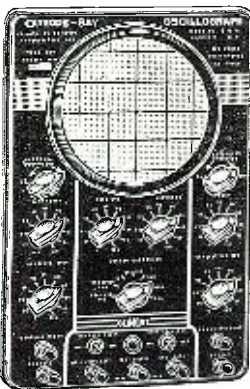

### Supplied Free

60 PAGES OF ELECTRONIC DEMONSTRATION EXPERIMENTS

To help you get the most out of your class-room Demonstrations, these practical directions are illustrated in complete detail. Available to school purchasers of test equipment, at no extra cost.

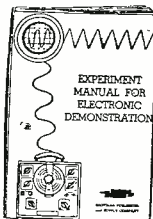

BY  
SOL D. PRENSKY

• For DEMONSTRATION EXPERIMENT MANUAL—EMS ONLY, enclose \$2.00, which is refunded when any test equipment is ordered.

• Write for Latest Bulletin DSN, on Dumont scopes and educational test equipment of other mfrs. (Please indicate school address.)

## Radiolab Publishing & Supply Co.

652 Montgomery Street, Brooklyn 25, N. Y.

ing two whose sum equals the value desired. The value of the individual resistors may be determined accurately by the use of a Wheatstone bridge or an ohmmeter which is known to be accurate.

Another method of "hedging" on the expensive 1% resistors is to use one of the old style carbon resistors, choosing one whose value is about 10% below that required. Then as a groove is filed in the body of the resistor, its resistance will increase with the depth of the groove. In this manner the resistor may be changed to the correct value. Needless to say, this groove is filed across the body of the resistor, not along its length. After filing, the resistor should be given a coat of varnish to prevent it from absorbing moisture and changing value. In addition to increasing its resistance, filing also reduces the wattage rating and mechanical strength of a resistor. For these reasons, a resistor should not be filed over one third through. Another point to be remembered is that these old style resistors have a tendency to change value as they age.

### The Ohmmeter

When the selector switch is in the "measure ohms" position, the circuit is still essentially a voltmeter. A voltage divider is formed by placing the unknown resistance in series with a known one. The meter then measures the portion of the 3 volts from the internal battery appearing across the unknown resistance. This voltage reading is calibrated on the meter face directly in ohms. When the unknown resistance equals the internal known resistor, the needle is at half scale. In this circuit, half scale is 10 ohms, full scale is infinity, and no deflection is a short circuit, or zero resistance. When the meter is switched from volts to ohms, the needle swings to the full scale position. The zero position for volts and the zero resistance position are both on the left side of the meter face.

From these three known points, zero, half scale, and full scale, the other divisions in the ohms scale may be filled in by graphical or mathematical means.

Reading from left to right, the marked divisions of the fundamental or R x 1 ohms scale are: 1, 2, 3, 4, . . . etc. to 10, which is half scale. From 10 it is marked 20, 30, 40, . . . etc. to 100. Then it is marked 200, 300, . . .

Chassis layout of test instrument.

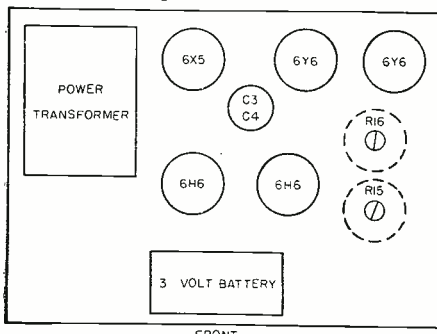

## RCP Model 802N Combination TUBE-SET TESTER

Immediate Delivery  
from Stock.

A complete tube tester and a complete set tester, with only 5 simple switches to operate for both tube and set tester combined.

### RANGES

DC voltmeter 0/10/50/500/1000 at 1000 ohms per volt.  
AC voltmeter 0/10/50/500/1000.  
DC milliammeter 0/10/100/1000 DC Ammeter 0/10.  
Ohmmeter 0/500/5000/1,000,000/10,000,000. Low ohm center.  
D. B. Meter—8/15/15 to 29/29 to 49/32 to 55 decibels.  
Four range output meter—same as AC volts.  
Size: 12 3/4 x 12 x 5 1/4 inches. Weight: 11 1/2 lbs.  
Complete in handsome hardwood case, with test leads, self-contained batteries, ready to operate. Net **\$58.31**

**ADSON RADIO CO.**  
221 FULTON ST., NEW YORK 7, N. Y.

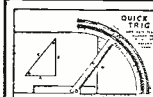

## QUICK TRIG

Patent-Pending  
EASY TO USE

This NEW IDEA in a slide rule enables you to solve QUICKLY trig., radio, electricity, and carpentry problems. Simply set the slides. Right in front of you are the answers for ALL THREE sides and angles of a triangle. Gives degrees and tangents of angles. No need to figure with paper and pencil. Easy instructions included.

### SINE CIRCLE

This completes your trig. needs. It gives all trig. functions such as sine, cos., tangent, secant, etc., for the complete 360 degrees. Both for only \$1.50 postpaid, or we will mail C.O.D. plus postage.



REED MFG. CO., 124 W. 4th St., Los Angeles 13, Calif.

## DETROLA AUTOMATIC RECORD CHANGERS

Plays 10—12" or 12—10" Records, Crystal Pickup. Fool proof—No Gears. Overall size—10 3/4" x 12 1/8". Dealers Net Price, \$18.27. WOOD BASE—Leatherette covered. Cut to fit changer—\$2.45.

**YORK RADIO DISTRIBUTING CO.**  
801-05 N. Broadway DECATUR 47, ILL.

## RADIO

RADIO Technician and Radio Communications courses. Register now for new classes starting first MONDAY of each month. Day and Evening Classes.

### AMERICAN RADIO INSTITUTE

101 West 63d St., New York 23, N. Y.  
Approved under GI Bill of Rights.

## SERVICEMEN—HAMS TUBES! PARTS! METERS!

Test Equipment in Stock!  
100 Resistor Kit Special \$1.75  
Write for Our Latest Bulletin!  
**CHIEF ELECTRONICS**  
MID-HUDSON VALLEY'S ONLY DISTRIBUTOR  
104 MAIN ST. POUGHKEEPSIE, N. Y.

Specify **SAUERISEN**  
ACIDPROOF CEMENTS—COMPOUNDS  
FOR

Tanks, Sewers, Stacks, Floors  
Technical cements for all purposes.

Send sketches or samples  
Sauerisen Cements Company · Pittsburgh 15, Penna.

etc. to 500. No divisions are made between the 500 mark and full scale or infinity mark.

Another satisfactory way of completing the ohms scale is by using a decade resistance box or other known resistors. After the construction has been completed and the instrument fully calibrated according to instructions, the ohmmeter is carefully calibrated by adjusting  $R_{17}$  and  $R_{18}$ . The test leads of the ohmmeter are connected in turn to the different resistors and the proper divisions marked on the meter face.

The resistance ranges built into this meter are  $R \times 1$ ,  $R \times 100$ ,  $R \times 1000$ ,  $R \times 10,000$ , and  $R \times 1$  megohm. These ranges were selected as the ones most used in ordinary radio servicing.

#### Calibrating the Meter

A simple procedure is followed in calibrating this unit. Before the power is turned on, the mechanical zero of the meter needle should be adjusted so that the needle is exactly on zero when the instrument is resting in operating position. The line power is now turned on, and the selector switch,  $S_2$ , is placed in the "+volts" position. For accurate calibration, a warm-up period of 15 to 20 minutes should be allowed. During this warm-up period, the meter needle is kept on zero by adjusting  $R_{18}$ . It is suggested that the instrument be calibrated on the 30 volt or 100 volt range.

$S_1$  is turned to the 30 volt range po-

sition and the d.c. test leads are connected to a voltage source of exactly 30 volts d.c. This voltage is measured with another voltmeter whose accuracy is known.  $R_{16}$  is now adjusted for full scale deflection. Remove the voltage source from the d.c. test leads and readjust  $R_{19}$  for zero meter reading. These two adjustments are repeated until the needle rests squarely on the full scale mark with 30 volts applied, and squarely on the zero position with the test probes free.

When these adjustments have been made, the selector switch is moved to the "AC volts" position, and  $R_{18}$  adjusted for meter zero, if necessary. The a.c. test leads are connected to a 60 cycle source of exactly 30 volts r.m.s., and  $R_{18}$  is adjusted for full scale. In the same manner that was used on d.c., these two adjustments are repeated until the meter reads zero and full scale.

When the above adjustments have been made, the instrument is fully calibrated, and with the exception of the ohms adjustments, need not be repeated until a tube or major component is replaced.

With  $S_1$  in any position,  $S_2$  is switched to the "Ohms" position, and the same procedure followed for calibration of the ohmmeter as was used on a.c. and d.c. except that  $R_{17}$  and  $R_{18}$  are used.  $R_{17}$  is set for full scale with the test leads free, and  $R_{18}$  is set for zero with the leads shorted together. This set of two adjustments is a front

panel calibration and is repeated each time the instrument is switched to the "Ohms" position. This one zero adjustment will hold for all positions of switch  $S_1$ .

-30-

## LONG DISTANCE FM COMMUNICATIONS

FROM A. G. Kovach of Winnipeg, Canada comes an item of interest regarding FM.

On March 8, 1946, while operating an FM transceiver, used for service communication in local areas by the Winnipeg (Canada) Electric Company, operator R. M. Simister suddenly found himself carrying on a conversation with Ensign G. D. Melville aboard the USS LCI 1000, located 200 miles southwest of Jamaica in the Caribbean Sea. The time was 1 p.m.

The contact was made on a frequency of 33.7 mc. Other operators of the Winnipeg Electric communications system, located at Great Falls, near Winnipeg, also talked with Ensign Melville, who spoke of a rough sea, stated that his ship was two days out of Panama, and wondered where Winnipeg was. H. Shaver, in a cruiser car of the Winnipeg Electric Company, listened to the whole performance over the small receiver in the car.

Ensign Melville said that he was talking over a regulation Navy walkie-talkie set with a supposed maximum range of 15 miles. The distance is actually about 2700 miles.

Winnipeg is situated 60 miles north of the U.S. border, above the state of Minnesota.

-30-

## IMMEDIATE DELIVERY ON THESE SUPER-SPECIALS IN TEST EQUIPMENT!

### MODEL 431

AC-DC Volt-Ohm-Milliammeter  
Volts DC: 0-30/300/1500, at 2000 ohms-per-volt  
Volts AC: 0-15/150, at 1000 ohms-per-volt  
Milliamperes DC: 0-150  
Ohms: 3000/300,000  
Employs sensitive 425 microampere square meter, on aluminum panel. Two jacks are used for all ranges, by means of rotary selector switch. In handsome steel case, with snap-on carrying strap, complete with test leads. Shipping weight, 4 lbs.

YOUR COST, \$15.00

### MODEL 433 SUPER-HIGH SENSITIVITY VOLT-OHMMETER

Volts DC: 0-3/30/300/600  
Ohms: 5000/50,000/500,000/5,000,000  
This instrument features a 50 microampere, 3-inch meter, and has a sensitivity of 20,000 ohms-per-volt, a feature usually found on only the highest-priced instruments. Furnished complete with test leads. Shipping weight, 4 lbs.

YOUR COST, \$22.90

### SIMPLEX VOLT-OHM-MILLIAMMETERS

These two instruments are housed in bakelite cases, and employ 2-inch meters.

#### MODEL 371

Volts DC: 0-2/15/30/300  
Milliamperes DC: 0-25  
Ohms: 0-10,000

With self-contained battery.

YOUR COST, \$4.55

#### MODEL 312

Volts AC and DC: 0/25/50/125/250  
Milliamperes AC and DC: 0-50  
Ohms: 0-100,000

Capacity Meter: —.05 to 15 Mfd.  
This instrument operates from any 110V AC or DC outlet. Shipping weight, 2 lbs.

YOUR COST, \$5.85



### MULTI-RANGE AC-DC VOLT-OHM-MILLIAMMETER WITH OUTPUT RANGES

### MODEL 458

Volts DC: 0-5/10/50/100/  
500/2000, 1000 ohms-  
per-volt

Volts AC: 0-12.5/25/125/  
250/1250

Milliamperes DC: 0-1/10/  
100

Milliamperes AC: 0-2.5/  
25/250

Ohms: 0-1000/200,000/2,000,000

Output: —5 to +55 Decibels

Overall Accuracy: —1%



### 5 1/2 INCH RECTANGULAR METER

with two-tone aluminum scale, set at a 45° angle for easiest reading. Special-treated aluminum panel, mounted on a wrinkle finish welded steel case, equipped with rubber feet and collapsible handle for portability. Complete with self-contained battery and test leads.

Shipping weight, 8 lbs.

YOUR COST, \$25.45

### FEATHERWEIGHT MINIATURE MODELS

Just slightly larger than a pack of cigarettes, though they feature high accuracy, large, easily readable scales, and rotary-switch range selection. Average weight, only 12 oz.; shipping weight, 2 lbs.

### MODEL 450

Volts DC: 0-5/10/50/  
500/1000, at 1000  
ohms-per-volt

Milliamperes DC: 0-1

Ohms: 5000/50,000/  
500,000

YOUR COST, \$9.95



### MODEL 451

Volts DC: 0-10/50/100/  
500/1000

Volts AC & Output: 0-  
10/50/100/500/1000

Ohms: 0-500,000  
1000 ohms-per-volt on  
all ranges

Condenser is built-in  
for output ranges

YOUR COST, \$13.35

### MODEL 452

Volts DC: 0-10/50/100/500/1000

Ohms: 200/20,000/200,000/2,000,000  
10,000 Ohms-per-volt on all ranges

Has sensitive 100 microampere meter

YOUR COST, \$13.35

We also have complete stocks of tube testers, oscillators, etc., for immediate delivery. Send for our catalog on radio parts and test equipment.

Prices subject to change without notice. Include 10% deposit on all C.O.D.'s.

**BUFFALO RADIO SUPPLY, 219-221 GENESEE STREET, BUFFALO 3, N. Y.**

## Another Clark Achievement!



This is the 20-watt member of the Clark family of carefully engineered public address amplifiers. The PA-20 is generously rated to provide plenty of faithful volume for all except the very largest auditoriums. As in the latest razor equipment, small components are terminal strip mounted for instant accessibility.

Inputs: 2 microphones, 1 phonograph.

Frequency response: 30-15,000 Flat within 2 db.

Distortion: Less than 5% over entire range.

Hum: At least 60 db below full output.

Output: 20 Watts (24 watts maximum).

Output Impedance: Tapped for 4, 8, 16 and 500 ohms.

The PA-20 represents top quality engineering and performance at moderate cost. Ask your jobber or write direct for further information.

**Clark Radio Equipment Corp.**

4313 LINCOLN AVE., CHICAGO 18, ILL.

## A TELEVISION

### HOME STUDY COURSE

For the Radio Technician and Serviceman

Television is not an incomprehensible subject—instead, it is a giant orientation study which a well-organized, clearly-written home-study course can very clearly present. An understandable, practical presentation has been a paramount consideration in the preparation of Reading Television Laboratories' television course.

The television text consists of three major sections as follows:

**Section One—Radio Review, Slanted for Television.**

**Section Two—Television I, The Complete Television System and General Functions**

**Section Three—Television II, Transmitter and Receiver Television Circuit Details.**

Write Today for Literature!

**READING TELEVISION LABORATORIES, INC.**

1328 CHESTNUT STREET  
SUITE 622, PHILADELPHIA, PA.

# Manufacturers' Literature

Readers are asked to write directly to the manufacturer for the literature. By mentioning RADIO NEWS, the issue and page, and enclosing the proper amount, when indicated, delay will be prevented.

### ALUMINUM ALLOYS CATALOGUE

Of interest to design engineers is the new catalogue recently issued by *Aluminum Alloys Corporation* of Detroit.

This fully illustrated catalogue describes the company's complete facilities for the production of sand or permanent mold aluminum castings. The book also contains tables on the chemical and physical properties of aluminum alloys, plus a section on the general characteristics and uses of aluminum.

A copy of this catalogue will be forwarded upon request to *Aluminum Alloys Corporation*, 7447 St. Aubin Avenue, Detroit 11, Michigan.

### VARI-SPEED LATHE

*Precise Products Company* has just released a new bulletin covering their Vari-Speed Lathe.

Bulletin E-3 lists 12 features of this new unit in addition to giving technical information on its operation and application.

This bulletin, which is free of charge, will be forwarded promptly upon request to *Precise Products Company*, 1328 Clark Street, Racine, Wisconsin.

### POWERSTAT TRANSFORMERS

Bulletin 30, describing the Powerstat line of variable transformers, has just been made available by *Superior Electric Company* of Bristol, Conn.

The line described in the bulletin feature covered input and output terminals, and fuse for overload protection. Some models feature a third wire for grounding the Powerstat frame.

A revised price list is also included with the bulletin. A copy of Bulletin 30 will be forwarded to those making their request direct to *Superior Electric Company*, Bristol, Conn.

### G. E. MYCALEX

The Chemical Department of the *General Electric Company* has released a new 24-page booklet on G.E. Mycalex, a stone-like product composed of mica and special glass.

The booklet describes in detail both the technical and manufactured data compiled by General Electric in its 23 years of Mycalex production. Included is information regarding properties, available types, molded parts, fabricated parts, machining practice and a properties chart of six grades of Mycalex of both the compression and injection molded types.

A copy of this booklet will be furnished by writing News Bureau,

Chemical Department, *General Electric Company*, Pittsfield, Massachusetts. Please specify the Mycalex booklet.

### CARDIOID MICROPHONES

A colorful, illustrated 4-page bulletin covering the new Model 950 Cardax Microphone has just been issued by *Electro-Voice, Inc.*

Included in the bulletin is a complete description of the model, technical data, frequency response curves, specifications and application information on this cardioid unidirectional crystal microphone.

A copy of the Cardax Bulletin will be forwarded upon request to *Electro-Voice, Inc.*, 1239 South Bend Avenue, South Bend 24, Indiana.

### SPRAGUE CATALOGUE

*Sprague Products Company* of North Adams, Massachusetts has just issued a 40-page catalogue designed for the radio serviceman, the amateur and the experimenter.

The catalogue contains information on the company's line of resistors, capacitors, test equipment and radio interference filters. Among the new units catalogued for the first time are the Sprague Type LM universal vertical chassis mounting replacement capacitors; Filterol; a complete line of mica capacitors; and new transmitting capacitor developments, etc.

A copy of the catalogue will be forwarded upon request to *Sprague Products Company*, North Adams, Massachusetts.

### JFD BELT MANUAL

A 64-page booklet which contains valuable information on the replacement of woven fabric radio dial belts for over 1500 models has just been released by *JFD Manufacturing Company*.

Complete and detailed listings, specifications and interchange data makes the book of value to the radio serviceman as a reference. A special section on radio drive cable and cord has been included and is supplemented with full coverage of rubber drives and dial springs.

This 1946 edition of the Belt Manual is offered free to any serviceman or dealer by the *JFD Manufacturing Company*, 4111 Fort Hamilton Parkway, Brooklyn, New York.

### OHMITE BULLETIN

Bulletin 126, just issued by *Ohmite Manufacturing Company* of Chicago, provides detailed information on the complete line of Ohmite Riteohm ½

**RADIO NEWS**

watt and 1 watt, non-inductive, pie-wound,  $\pm 1\%$  precision resistors.

This fully illustrated bulletin contains electrical, mechanical and dimensional data on the various types and sizes and shows various mountings and terminals as well as lists all the values available from stock and those custombuilt.

For a copy of Bulletin 126 write to *Ohmite Manufacturing Company*, 4835 W. Flournoy Street, Chicago 44, Illinois.

#### W.E. MAGAZINE

The third issue of *Western Electric Company's* illustrated magazine, the "Oscillator" is just off the press and contains several articles of interest to the radio man.

Included in the list of articles is a new antenna designed for FM broadcasting; the application of a warplane radio to peacetime airways operation; a new microphone for better pickup fidelity and a metal lens which focuses microwaves as a magnifying glass focuses the rays of the sun.

A copy of this issue of the "Oscillator" will be forwarded upon request to Information Department, *Western Electric Company, Inc.*, 195 Broadway, New York 7, New York.

#### NEW HAM PUBLICATION

The Tube Division of *General Electric Company's* Electronics Department has announced the publication of a bi-monthly magazine for radio amateurs, "The G.E. Ham News."

George H. Floyd, W60JK/2, a G.E. employee and a ham since 1936 will edit the four-page publication.

The "G.E. Ham News" will include a construction article in each issue plus a section devoted to questions and answers on ham equipment, tricks and topics consisting of hints on tricks about building amateur rigs and technical data on new amateur electron tubes.

Contributors to this publication are being sought. Additional information on this publication may be secured by writing Electronics Department, *General Electric Company*, Thompson Road Plant, Syracuse, New York.

#### SOLAR MAGAZINE

The *Solar Manufacturing Corporation* of New York is publishing a monthly magazine which will be of interest to those in the radio and electronic fields.

This publication contains much technical information which will be of value to technicians including data on the new RMA color code for mica capacitors.

The current issue of the publication also contains information on the proximity fuze which is of interest inasmuch as the techniques used in developing this instrument of war can be adapted to the manufacture of midget electronic equipment for peacetime applications.

To get on the mailing list for this publication which appears six times a

# HAM

## HEADQUARTERS FOR Equipment and Information

### EXTRA SPECIALS

- Dual-Vibro pack 550 V.—160MA 6 volt input—\$12.00
- G-E 4MFD-600—\$1.75
- C.D. 8MFD-600—\$1.50 Solvonia Crystals IN23—50c IN27
- Mic-mold Capacitor .002-0000 V. working—\$2.40 Complete 25 Tube F.M. Transmitter and Receiver, 2 channel job. Will Tune from 27 MC to 28.9 MC—\$35.00
- Port-Mobile Equipmt. Complete 10 Meter Converter Kit, ready to wire, with Tube—\$13.50

Mail Orders Promptly Filled  
Amateurs to Serve You

(20% Must Accompany All C.O.D. Orders)

Write Dept. R.N.  
W6SCQ—W6UXN—W6NAT  
W6SSU

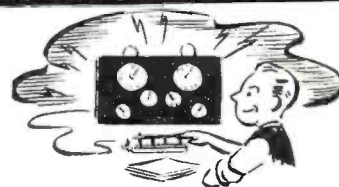

## FOR YOUR NEW RIG

We Have a Good Stock of  
All Standard Lines

### WATCH FOR THE NEW

Port-mobile Xmtrs, from 5 to 60 watts. All in Kit form, chassis Punched. Complete with Tubes. Ready to wire.

## Radio Product Sales Company

238 WEST 15TH STREET

LOS ANGELES 15, CALIFORNIA

PRospect 7471

**DIG SAVINGS**  
Hundreds of specials  
for RADIO SERVICEMEN

- CATHODE RAY TUBES
- POWER & TRANSMITTING TUBES
- HEADPHONES, etc.
- HARD-TO-FIND TEST METERS



#### 7 LB EXPERIMENTERS RADIO PARTS ASST.

A "gold mine" for the experimenter, radio serviceman, handyman and repairman. Hundreds of valuable radio, radar and electronic parts, screw machine parts, bushings, sub assemblies, etc. More than your money's worth every time. An amazing value. Money-back guarantee.

K130R—FULL 7 POUNDS ONLY \$179

War Surplus Bargain Book

Page after page of war surplus and other bargains for the radio serviceman; also specials for home, shop and outdoors.

IT'S FREE! WRITE TO-DAY

**FREE  
CATALOG**

**STARK'S** Dept. 509 So. STATE STREET  
CHICAGO 5, ILLINOIS

## 7 Days Free Examination

# PRACTICAL RADIO INFORMATION

Including Frequency Modulation—Television, etc.

Inside Radio Information for all Servicemen—Aircraft Pilots, Students, AUDELS RADIO-MANS GUIDE contains 772 Pages, 400 Diagrams & Photos is complete—gives Authentic Principles & Practices in Construction, Operation, Service & Repairs. Covers clearly and concisely Radio fundamentals—Ohm's Law—Physics of sound as related to radio science—Measuring Instruments—Power supply—Resistors—Inductors—Condensers—Transformers and examples—Broadcasting stations—Radio Telephony—Receivers—Diagrams—Construction—Control systems—Loud speakers—Antenna systems—Auto Radio—Phonograph pickups—Public Address Systems—Aircraft & Marine Radio—Radio Compass—Beacons—Automatic Radio Alarms—Short Wave—Coil Calculations—Testing—Cathode ray oscillographs—Static Elimination—Trouble Pointers—Underwriter's standards—Units and tables—Frequency Modulation—REVIEW QUESTIONS & ANSWERS. Ready Reference Index.

**\$4 COMPLETE • PAY ONLY \$1 A MO.** Get this practical information in handy form for yourself—Fill in and MAIL COUPON TODAY

AUDEL Publishers, 49 W. 23rd St., N.Y. Mail AUDELS NEW RADIO-MANS GUIDE for free examination. If O. K., I will send you \$1 in 7 days; then remit \$1 monthly until \$4 is paid. Otherwise I will return it.

Name \_\_\_\_\_  
Address \_\_\_\_\_  
Occupation \_\_\_\_\_  
Reference \_\_\_\_\_ R.N.

## IMMEDIATE DELIVERY

**Stephens Tru-Sonic Co-Axial Speakers**  
 PM 15".....List Price \$205.00  
 Field Coil Type—  
 1600 & 2500 Ohms.....List Price \$175.00

### ATR 110 to 6.3 Volt "A" Battery Eliminator

Standard 6.5 Amp.....List Price \$36.00  
 Heavy Duty 14 Amp.....List Price \$59.00

100 Assortment 1/2 Watt Carbon Resistors  
 Your Cost \$1.80

Standard 1 Meg. Ohm Vol. Controls—  
 Your Cost 33c

Wright 5" Alnico V PM Speakers.....\$3.80 List

### Two-Tube AC-DC Radio Kits

Complete with Tubes.....Your Cost \$7.95  
 Crystal Set Kit.....Your Cost .87

Standard Discounts Given to  
 Dealers, Servicemen & Amateurs  
 on All List Prices

WRITE For our bulletin NOW, for  
 other available merchandise

Complete Stock of Parts & Equipment  
 Two Stores to Serve You

## RADIO & TELEVISION EQUIPMENT CO.



207 Oak Street, Dept. L.  
 Santa Ana, California

Long Beach, Calif., Store: 709 Cherry Ave.

## IMMEDIATE DELIVERY SUPERIOR MODEL PB-100 VOLT-OHM MILLIAMMETER \$28.40

**RANGES**  
 DC Volts: 0 to 5/25/50/250/500/2500.  
 AC Volts: 0 to 10/50/100/500/1000.  
 Output Meter  
 Ranges: 0 to 10/50/100/500/1000 volts.  
 DC Current: 0 to 10/250 Ma. 0 to 2.5 Amp.  
 Resistance: 0 to 10,000/100,000 ohms. 0-1 Meg.  
 Decibels: -10 to +15; 0 to +35; +30 to +55.

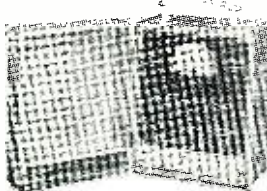

**New SUPERIOR  
 Model CA-11  
 SIGNAL TRACER  
 Net Price \$18.75**



Only one connecting cable  
 no tuning controls.  
 Highly sensitive... uses  
 an improved vacuum tube  
 voltmeter circuit.

Signal intensity readings are indicated directly  
 on meter.  
 Provision is made for insertion of phones.  
 Tube and resistor capacity network are built  
 into the Detector Tube.  
 Portable. Measures only 5 x 6 x 7". Weighs  
 only 5 lbs.

### Write for Catalog

Equipment, parts, supplies... hundreds of new and  
 wanted items for service men and dealers. Ask for  
 latest bulletin.

**Lifetime**  
**SOUND EQUIP. CO., Dept. 48**  
 911-913 JEFFERSON AVE., TOLEDO 2, OHIO

year, address your requests to *Solar Manufacturing Corporation*, 285 Madison Avenue, New York 17, New York.

### SYMBOL CHART

A condensed chart of graphical symbols for electronic diagrams has been prepared by *Sun Radio & Electronics Co., Inc.*

The value of the two page chart lies in the fact that it reproduces the symbols as standardized by the RMA and includes such information as data on the magnetron, split magnetron, single and double cavity envelope and single and double cavity velocity modulated tubes.

Thousands of copies of the chart have already been distributed to radio schools and clubs and such requests are invited.

A free copy of this chart will be forwarded upon request to *Sun Radio & Electronics Co., Inc.*, 122-124 Duane Street, New York 7, New York. Make your request on your company letterhead and mention RADIO NEWS in writing for your copy.

### W-L RELAYS

Bulletin 130, which describes the company's line of relays has just been released for distribution by *Ward Leonard Electric Company* of Mount Vernon, New York.

Included in the bulletin are single pole, double pole, three and four pole relays, double throw, one, two and three pole relays; mechanical latching relays, with and without interlock contacts; and double throw transfer relays; coil and contact data.

A copy of Bulletin 130 will be forwarded upon request to *Ward Leonard Electric Company*, Mount Vernon, New York.

### RELAY INFORMATION

*Potter & Brumfield Sales Company* is currently distributing a new 24-page catalogue which gives detailed information on *Potter & Brumfield Manufacturing Company's* complete line of standard relays and electrical timing devices.

Full data on applications, selection and capacities is included for each model relay illustrated and discussed.

Copies of the new catalogue may be obtained by writing to *Potter & Brumfield*, Department 223, 549 West Washington Boulevard, Chicago 6, Illinois.

### TUBE BOOKLETS

Two new publications on the essential characteristics and important ratings of *General Electric* and *Ken-Rad* receiving tubes have been announced by the Tube Division of *General Electric Company*.

Each of these publications is a 40 page booklet, complete with characteristics and ratings of receiving tube types. The company recommends their use to radio servicemen, radio technicians and electronic engineers who work or experiment on receiving tubes.

These new booklets are divided into

## EASY TO LEARN CODE

It is easy to learn or increase speed with an Instructograph Code Teacher. Affords the quickest and most practical method yet developed. For beginners or advanced students. Available tapes from beginner's alphabet to typical messages on all subjects. Speed range 5 to 40 WPM. Always ready—no QRM.



### ENDORSED BY THOUSANDS!

The Instructograph Code Teacher literally takes the place of an operator-instructor and enables anyone to learn and master code without further assistance. Thousands of successful operators have "acquired the code" with the Instructograph System. Write today for convenient rental and purchase plans.

## INSTRUCTOGRAPH COMPANY

4711 SHERIDAN ROAD CHICAGO 40, ILLINOIS

## ELECTRONIC VOLT-OHMMETER

\$11.85

110 VOLTS AC 20 RANGES

0.5/10/50/100/500/1000/5000 volts DC and AC. 0-1,000,000,000 ohms in six overlapping ranges. Sensitivity over MILLION OHMS per VOLT on 5 volt range.

POSTPAID

Complete kit includes all component parts, tubes, punched and drilled chassis and beautifully enameled panel. Easily assembled and wired.

Special slideback circuit developed during war by scientist at the California Institute of Technology gives amazing sensitivity and flexibility while completely eliminating necessity of batteries and expensive meter. Each instrument is individually calibrated. Dial scale over nine inches long.

In addition to performing the usual volt-ohm functions, this instrument easily measures these voltages: SUPERHER OSCILLATOR AVC. TRUE GRID BIAS AT THE GRID. BIAS CELLS without affecting the circuit. Measures the exact leakage resistance of INSULATION, TUBES, CONDENSERS. It can be used with a signal generator for SIGNAL TRACING.

STERLING ELECTRONIC COMPANY

166 N. Sierra Bonita Ave., Pasadena 4, California

SUPREME QUALITY  
**Vasco**

TRADE-MARK REG. U. S. PAT. OFF.

ELECTRIC SOLDERING IRONS  
 4116 AVALON BLVD., LOS ANGELES 11, CALIF.

## RADIO ENGINEERING TELEVISION ELECTRONICS

Courses in every phase of radio and electronics open to high school graduates. Thorough training, modern courses. Enrollments limited. Approved Veteran Training.

VALPARAISO TECHNICAL INSTITUTE

Dept. RS

Valparaiso, Indiana

## PEN-OSCIL-LITE

Extremely convenient test oscillator for all radio servicing; alignment • Small as a pen • Self powered • Range from 700 cycles audio to over 600 megacycles u.h.f. • Output from zero to 125 v. • Used by Signal Corps • Write for information.

GENERAL TEST EQUIPMENT CO.

38 Argyle

Buffalo 9, N. Y.

## GRAB REE'S WHOLESALE RADIO

2608 Ross Ave.

DALLAS 1 TEXAS

## ELECTRONICS SCHOOL

Immediate Enrollment. Technicians  
 Courses in F. M. Radio P. A.  
 and Television.

Approved for Veterans  
 For information write

Hollywood Sound Institute, Inc.

1040 N. Kenmore Ave., Los Angeles, Calif.



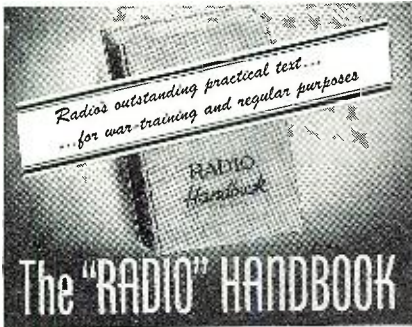

Basic electrical and radio theory in the simplest possible language, written especially for those without mathematical or technical training.

Dozens of complete how-to-build-it descriptions of many types of receiving, transmitting, and test equipment show practical applications. Hundreds of diagrams and large photographs.

Over 700 pages, durably clothbound, gold-stamped. From your favorite dealer, or from us, postpaid; please add any applicable taxes.  
\$2.00 in Continental U.S.A. Elsewhere, \$2.25

**RADIO AND ELECTRONICS BOOKS**  
Immediate Shipment on Mail Orders Anywhere

We stock nearly all radio and electronics books, and can furnish any other currently-published one on short notice. Send stamp for catalog. Currently popular books include:

- U.H.F. Radio Simplified, Kiver, \$3.25\*
- "Practical Radio Communication," Nilson, 6.00\*
- "Principles of Radio," Henney, 3.50\*
- "Mathematics for Radiomen," Cooke, 4.00\*
- "Radio Physics Course," Ghirardi, 5.00\*
- "Radio Engineering Handbook," Henney, 5.00\*
- "Radio Engineers' Handbook," Terman, 6.00\*
- "Theory and Appl. of Vacuum Tubes," Reich, 5.00\*
- "Electronics," Millman and Seelev, 5.00\*
- "Radio Engineering," Terman, 5.50\*
- "Microwave Transmission," Slater, 3.50\*
- "Basic Elec. for Communications," Timble, 3.50\*
- "Understanding Radio," Watson and others, 2.80\*
- "Prim. Aeronautical Rdo. Eng.," Sondretto, 3.50\*
- "Modern Radio Servicing," Ghirardi, 5.00\*
- "Hyper and U.H.F. Engineering," Sarbacher, 8.00\*
- "Standard Handbook for Elec. Engrs.," 5.50\*
- "Cathode-Ray Tube at Work," Rider, 4.00\*
- "Frequency Modulation," Rider, 2.00\*
- "Radio Manual," Sterling, 6.00\*
- "Measurements in Radio Engineering," Terman, 4.50\*
- "U.H.F. Techniques," 4 authors, 4.50\*

\* Add 4% for domestic postage (including A.P.O.'s); foreign, 10%; in Calif. add 2 1/2% sales tax.

**EDITORS AND ENGINEERS**

1420 North Highland Ave., Los Angeles 28, Calif.

**AMATEURS  
AND  
RADIO REPAIRMEN**

We appreciate your bearing with us on the delay in deliveries, but hope you remember we accepted no orders for material we could not deliver.

Parts are coming in more freely now so the percentage of 100% filled orders is increasing. Thanks again.

**EXCLUSIVE DISTRIBUTORS  
FOR STROMBERG-CARLSON  
AMPLIFIERS**

**Stanton Radio Supply**

W9PSP W9JKE  
521 State St., HAMMOND, INDIANA  
Phone 2314

July, 1946

four sections, the interpretation of ratings and technical data; recommended types; characteristics and ratings; and outline drawings and basing connections of the tube types.

A copy of either or both of these booklets may be obtained by writing Tube Division, Electronics Department, General Electric Company, Schenectady, New York. Please specify publications ETR-15 and ETR-16 when making your request.

**BURLINGTON CATALOGUE**

A 20-page catalogue which lists the company's complete line of indicating instruments and auxiliary equipment is being offered by the Burlington Instrument Co.

The line includes panel instruments, voltage regulators, automatic synchronizers, frequency regulators and other control equipment. The catalogue offers a detailed illustration of the precision movement used in these instruments, together with a complete explanation of operating advantages, dimensional drawings and panel layouts.

Catalogue 46 may be secured by writing to Burlington Instrument Co., Box 589, Burlington, Iowa

-30-

**C.W. Break-in Monitor**  
(Continued from page 46)

versing the terminal wires of one winding of the transformer. If the audio tone heard is not of the correct pitch, it may be varied by connecting condensers of varied capacity at point marked C, in the diagram.

Application of this d.c. to R<sub>1</sub> (plus to ground) should also mute the signal coming from the radio receiver.

With the equipment in place and plugged into the receiver, a coupling wire is run to the transmitter and the induced r.f. is adjusted by varying the coupling of this wire. Sufficient voltage should be induced to completely block any receiver signal when the transmitter key is pressed. Variation of the coupling will also vary the pitch of the audio note.

If it so happens that several bands are used by the transmitter, correct operation of the monitor is secured on the band that gives the least induced voltage to the monitor. The transmitter is then shifted to the other bands and the L, C, etc., tanks adjusted to attenuate the r.f. until comparable operation is secured. Variation in induced r.f. at different frequencies is a result of variation of inductive impedance between the transmitter and the coupling wire, and variation of actual voltage present in the transmitter or on the feeders at different frequencies.

It will be observed that smoothest operation can be obtained with the signal volume control set low and the audio volume control on the receiver set high.

Operation of this monitor has been successful with varied types of com-

**A VERSATILE TEST  
LABORATORY...IN  
ONE COMPACT UNIT!**

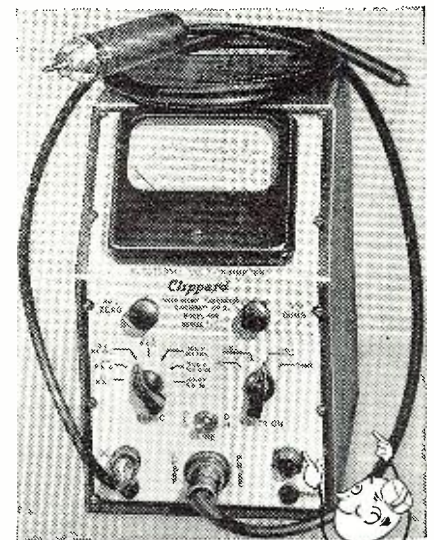

**Clippard**  
**ELECTRONIC  
VOLT-OHMMETER  
MODEL 406**

**NEW BRIDGE-TYPE CIRCUIT**—fully balanced through 3 stages for maximum accuracy and stability. Tube complement: one 6X5GT rectifier, two 6SN7GT dual purpose tubes and 6AL5 dual diode in probe.

**PEN-TYPE DUAL-DIODE PROBE**—on detachable 36" shielded cable. High impedance, low capacity and convenient ground terminal assure accurate readings, A.F. thru U.H.F. ranges with minimum circuit disturbance.

**EXTREME RANGE**—full scale sensitivity of 0-1, 0-3, 0-10, 0-30, 0-100, 0-300 and 0-1000 volts A.C. and D.C. and 0-1,000 megohms in 7 ranges with ample overlap to eliminate guess-work. Decibel scale -20 to +51 in 3 ranges.

**INCLINED METER**—for easier, more accurate readings with less parallax.

**HANDSOME APPEARANCE**—Satin Chrome panel, etched black self-explanatory markings, convenient controls, quarter-sawed oak case, folding leather carrying handle. Overall size 10" x 8 1/2" x 6 1/4"

**LABORATORY ACCURACY**—calibrated to 2% accuracy at plant, 5% accuracy guaranteed in field. An instrument of laboratory quality and ruggedness priced within reach of all who want the best!

Write today for FREE bulletin giving Complete Details!

Electro-Magnetic Windings

R; P; Coils

Sub-Assemblies



129

## Sensational Value!

### T-17B MICROPHONE (NEW)



These Signal Corps inspected and approved microphones were constructed for the Army during the war. Sales price to the Army was more than double your low purchase price. Made of durable plastic. Complete with 5 ft. rubber coated cord and plug PL-68. Press-to-talk button. Can be used with most radio sets as home broadcaster mike for entertainment. Will serve as standard equipment in planes and other facilities requiring T-17 mike.

#### SUPPLY IS LIMITED! ACT QUICKLY

to take advantage of this exceptionally low offer to consumers only. We are confident that you cannot be at this price anywhere.

ONLY \$2.09

WHILE THEY LAST TO CONSUMERS ONLY plus 2% Sales Tax in Illinois

#### MAIL THIS COUPON

**SHURE APPLIANCES & RADIO, Dept. E**  
120 N. Green Street, Chicago 7, Illinois  
Send me.....Signal Corps inspected and approved T-17B Microphones at \$2.09 ea.

- Money Order or Check enclosed.  
 I will pay Mail-man on arrival \$2.09 ea. plus postage & C.O.D. charges.

NAME .....  
ADDRESS .....  
CITY ..... STATE .....

PLUS 2% SALES TAX IN ILLINOIS

## Supreme Publications

These are the practical radio manuals you need. Improve your radio knowledge. Speed up service work. Check which manuals you want, write name below, and send this entire ad. as your order.

### MOST-OFTEN-NEEDED DIAGRAM MANUALS

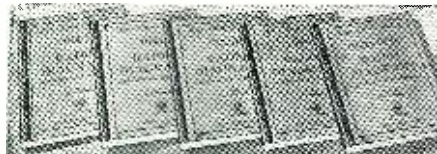

1942.  1941.  1940.  1939  
Each manual has between 192 and 208 pages. 8½x11".  
Price, each volume.... **\$2.00**

- 1926-1938 Radios  
Circuits, parts lists, hints, alignment data. 240 pages.  
Price, only **\$2.50**

- Radio Servicing Course — Book. 22 lessons. 224 pages. **\$2.50**  
Large size: 8½x11".  
 Record Players & Recorders. All makes, 128 pages. 8½x11", price postpaid **\$1.50**  
 Practical Radio Mathematics 25c  
 Refrigeration Manual .... \$1.00  
 Encyclopedia of Television.....40c

- Practical Radio & Electronics Course, 3 volumes in one, 53 lessons, for Home-Study. \$3.95  
 How to Modernize Radios for Profit.....\$1.00  
 Radio Repairing with Available Substitute Parts. 25c  
 How to Use Diagrams in Radio Servicing.....10c

- Simplified Radio Servicing by Comparison Method  
New, revolutionary different method makes radio repairing twice as easy. Introductory training included. Simple picture suggestions tell you where to look for faults and how to make the repair. No testers needed for most jobs. With job-sheets, blue prints, hints, diagrams.... **\$1.50**

**SUPREME PUBLICATIONS, 9 S. Kedzie, Chicago 12, ILL.**  
Check manuals wanted, send remittance with complete advertisement or write order in a letter. Books sent postpaid. Money back guaranteed.

Name: .....

Address: .....

130

munications receivers and with radio transmitters of power up to 500 watts on frequencies up to 10 mc.

In addition to providing break-in operation, the monitor also gives a continuous check on the emission of the transmitter, bringing to the attention of the operator any irregular operation such as clicks or tails on the note. Both of these operational techniques are a necessity to future amateur operation.

-30-

### Noise Limiter and Preselector

(Continued from page 41)

that any noise peaks above this level will not override the signal. Just how effective the limiter will be depends to a great extent upon the type of noise. For instance, this circuit works quite well on auto ignition interference but, if the noise is of the continuous type created by a badly arcing motor, it is ineffective. Fortunately, the latter type of noise is not as prevalent as auto ignition interference so the outfit is worth adding to any receiver which does not now contain one. Of course this limiter will also reduce the audio gain when it is switched in but most receivers have enough reserve gain to compensate for the difference. However, improved reception is well worth a slight reduction in signal volume. We certainly don't claim that it will completely remove all noise but it does reduce it to such an extent that it is possible to copy stations that would ordinarily be impossible to hear. Another advantageous feature of a limiter is that it keeps the audio output of the receiver practically constant. Every ham will appreciate this feature if he has ever had to copy a fairly weak signal through the QRM

Bottom view of completed unit. The 6H6 socket is shown in the upper left hand corner. The r.f. coil  $L_2$  is mounted between the 6H6 and the 1851 sockets while coil  $L_1$  is mounted on stand-off insulators on top of chassis.

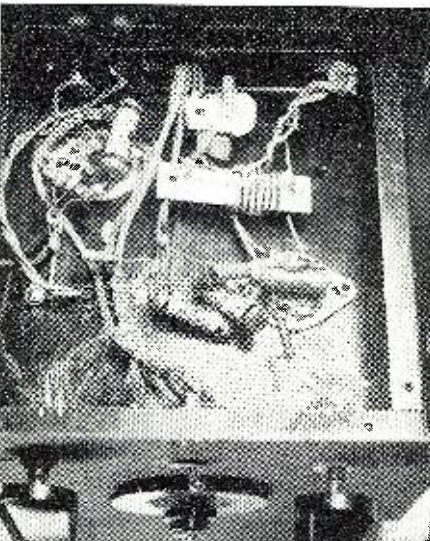

## PAPER AND MICA CONDENSERS

100 assorted paper and mica condensers .....\$1.00 cash, check or money order.

**PETER BALIZER**

19 Micieli Place

Brooklyn 18, N. Y.

## RADIO & ELECTRONIC PARTS TUBES & EQUIPMENT

**STANDARD ELECTRONICS CO.**

1497 Main St.

Buffalo 8, N. Y.

Write for New Catalogue

## FILMGRAPH PAT'D Conference Recorders

UNINTERRUPTED Longtime (up to 12 hours) Conference & Telephone Recordings on Safety Film Models for Dictation "TALKIES"

ECONOMICAL PERMANENT INSTANTANEOUS PLAY-BACK

MILES REPRODUCER CO., INC. 812 BROADWAY, N.Y.3 RN-7

## In the Rocky Mountain Region It's Radio & Television Supply Co.

152 Hobson Avenue, Pueblo, Colo.

P. O. Box #892

"If we don't have it, we'll get it— or it can't be had! Phone 5729"

## IN NEW MEXICO

AND THE SOUTHWEST IT'S

## Radio Equipment Company

Albuquerque, New Mexico

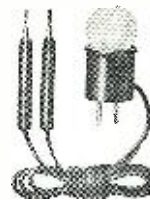

### PLUG-IN TEST LAMP

Tests Everything Electrical Speeds Up Trouble-Shooting

Used by Radio Men, Electricians, Mechanics and Experimenters. Tests continuity, open circuits, etc. ALWAYS READY! PLUGS INTO ANY OUTLET! Only \$1.95 Postpaid. FREE CIRCULAR. (Pat. Pend.) HANLAN CO., 1419-R, West Jefferson, Los Angeles 7, Calif.

## RADIO ENGINEERING!

EX-SERVICE MEN can complete work here in shortest possible time. Courses also in Civil, Electrical, Mechanical, Chemical, Aeronautical Engineering; Business Administration, Accounting, Secretarial, Science. 63rd year. Enter June, Sept., Jan., Mar. School now filled to capacity. No applications can be accepted until further notice.

**TRI-STATE COLLEGE** 1576 College Ave. ANGOLA, INDIANA

DEGREE IN 27 MONTHS

Reserve Your Copy of

## RADIO NEWS

at your newsdealer. There is a shortage of copies each month

## Ted McElroy

World's Largest Manufacturer of Wireless Telegraphic Apparatus

COMPLETE CENTRAL OFFICE EQUIPMENT

**McElroy Manufacturing Corp.**

82 Brookline Avenue • Boston, Massachusetts

RADIO NEWS



**PREPARED ASSORTMENTS  
GUARANTEED FIRST QUALITY**

Cat. No.	Quantity	Description	Price
1001	100	1/2 Watt Resistors, All Insulated.	\$2.98
1002	100	1/2 Watt Resistors, All Insulated.	3.98
1003	100	1 Watt Resistors, All Insulated.	4.45
1004	50	2 Watt Resistors, All Insulated.	3.98
1005	10	Wire Wound Resistors Ass'd	
		Watts	2.98
1006	50	200 Volt Paper Condensers	2.48
1007	50	400 Volt Paper Condensers	3.48
1008	50	600 Volt Paper Condensers	4.25
1009	50	Mica Condensers	2.98
1010	20	Dry Electrolytic Filter Condensers	6.75
1011	10	Resistance and Line Cords	3.98
1012	100	Wafer Sockets	4.50
1013	100	Plastic and Ceramic Sockets	8.50
1014	10	25 Ft. Rolls Hookup Wire—	
		Ass'd Colors	1.98
1015	10	50 Ft. Rolls Hookup Wire—	
		Ass'd Colors	3.25
1016	10	100 Ft. Rolls Hookup Wire—	
		Ass'd Colors	6.75
1017	10	Volume Tone Controls—No	
		Switches	1.98
1018	50	Large Bakelite Knobs Push On	6.50
1019	50	Large Bakelite Knobs Set Screw	7.85
1020	50	Small and Medium Knobs Push On	3.50
1021	50	Small and Medium Knobs Set	
		Screws	3.75
1022	100	Small Bar Knobs	5.50
1023	100	Large Bar Knobs	6.75
1024	100	ft. Spigetti and Vinylite	.98
1025	50	Padders and Trimmers	1.45
1026	10	Coils I.F., R.F. Ant. and Osc.	3.98
1027	50	Pilot Lamps	2.49
1028	20	Toggle and Slide Switches	3.98
1029	20	Wafer and Ceramic Band Switches	3.98
1030	20	Auto Generator Condensers	2.98
1031	20	Auto Suppressors	2.98
1032	25	Electrical Wiring Devices, Plugs,	
		Cns. Bases, Heater Plugs, etc.	2.75
1033	50	Electrical Wiring Devices, Plugs,	
		Cns. Bases, Elements, Fuses,	5.00
		etc.	

**ELECTRICAL APPLIANCES AND PARTS**

Double Burner Electric Stove	Streamlined	OPA \$ 7.00	\$ 5.95
Electric Broiler Deluxe type		OPA 17.45	12.50
Fluorescent Desk Lamp, Brown,			
Blue or Rust	OPA 11.95	7.75	
Fluorescent Etch Unit	OPA 10.80	6.75	
Electric Phonograph	OPA 48.50	39.95	
Replacement Stove Element 660 W.			12
Replacement Electric Iron Element 550 W.			.55
Replacement Toaster Element			.75
Electric Iron Cord Set, Bakelite Plug			.45
Electric Iron Cord Set, Switch Plug			.89
8 ft. Extension Cord with Cube Top			.45
6 ft. Rubber Replacement Cord			.21

**SEND FOR TRUTONE COMPLETE RADIO AND ELECTRICAL LIST**

Terms: 25% deposit required with order. Balance C.O.D. Merchandise sent prepaid if full remittance accompanies order.

**TRUTONE PRODUCTS CO.**

Dept. N, 303 West 42nd Street, New York (18), N. Y.

**IMMEDIATE DELIVERY!**

**2-POST RECORD CHANGER**



**Automatically Intermixes**

Record changer completely assembled with amplifier ready to play. Dimensions 8" H x 15 1/2" x 15 1/4" D. Grilled speaker front, acoustic chamber 15" W. x 4" D. with rear louvre for eliminating cabinet resonance. Genuine walnut cabinet with decal trim, nickel plated mounting hardware, tone and volume control mounted on changer. 6" Heavy duty dynamic speaker. AC amplifier with power transformer. AC power cord and plug. 3 tubes 1—6V6, 1—6C5 and 1—5Y3. \$44.50 Net.

Cabinet less changer and amplifier \$9.50 Net. Accommodates Webster and V-M Changers.

20% Deposit required on all orders. Dept. A

**UNION Radio Corporation**

328 S. Paulina • Chicago 12, Ill.

created by someone starting a car nearby.

To connect the limiter to the receiver first locate the audio coupling condenser which usually is connected from some point on the diode load resistor to the high side of the volume control, then this lead should be opened (the connection running to the volume control) and using shielded wire throughout, connections made to terminals on the double-pole, double-throw switch which turns the limiter on and off. This is indicated on the diagram. The value of resistor  $R_c$  should be adjusted so that point A on the diagram assumes a value of about 30 volts positive, with respect to ground. In this the value proved to be 75,000 ohms but it will probably be best to determine individual values by experimentation. All resistors can be of the 1/2 watt variety, but the threshold control should be of the wire wound type since a carbon resistor may get quite noisy after operating for a while.

Power for the entire outfit is taken from the receiver since the total current drain is relatively small. A convenient place for connecting the preselector to the set is the screen of the output tube. Filament power can be taken from the same tube.

This little preselector will make quite an improvement in an old receiver, while the noise limiter makes it possible to pull weak DX signals through heavy ignition interference. This is a pretty reasonable way to improve your present receiver until you can pick up that new set you have your eye on.

-30-

**SOLDERING IRON AS TEST UNIT**

A soldering iron which is connected to the wall outlet and then the tip touched to the grid or plate of the detector tube will give an indication as to the condition of the audio section.

If this section is operating a loud humming noise will be heard. H.L.

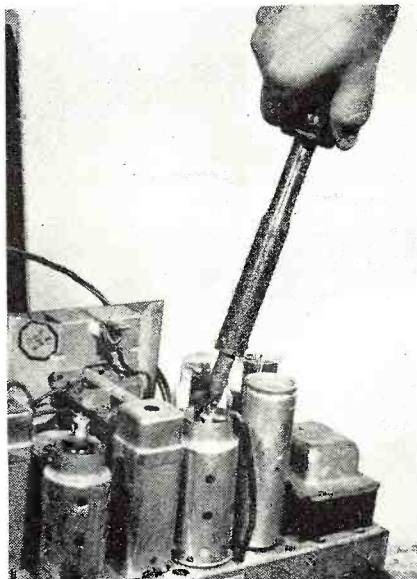

**Antenn-gineered**  
*by*  
**SNYDER**

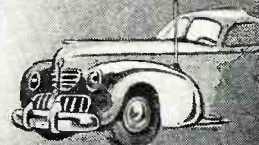

THE  
*Cosmopolitan*  
AUTO-RADIO  
ANTENNA

© COPYRIGHT, 1946

**SNYDER**

MANUFACTURING CO.

PHILADELPHIA 40, U. S. A.

**The New REINER  
 LABORATORY**

**VOLT  
 METER**

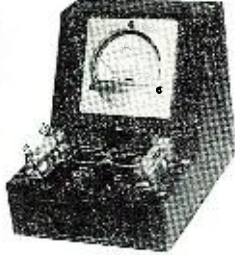

Model 333  
 Size: 6"x7 1/2"x6 1/2"  
 Weight: 4 3/4 lbs.  
**\$27.50**  
 Net

Revolutionary design makes this instrument ideal for Laboratories, Schools, and Service Benches. Note these outstanding features:

- Lifetime Guaranteed Meter Hermetically Sealed
  - Visible, Accessible and Removable Multipliers and Shunts—Individually Calibrated to an Accuracy Within 1% on All Ranges.
  - Meter Has Extra Long Scale and Is Fused Against Burn-out.
  - Attractive Silvered Bezel, Heavy, Durable Crackle Finish Steel Cabinet.
  - Heavy Duty Insulated Binding Posts with Non-back Off Heads.
  - Handy Slide Drawer Contains Spare Fuses, Complete Assortment of 12 Shunts and Multipliers and Shorting Connectors All Individually Mounted in Spring Snap Holders. Includes 2 Meter Fuses.
  - DC Voltage Multipliers—0-5-10-25-100-250-500 Volts.
  - DC Current Shunts—0-5-10-25-100-250-500 Milliamps.
- Additional Shunts and Multipliers Are Available.  
 \* In Addition Instrument Has Basic Ranges of 120 Millivolts and 0-1 Milliampere.

**Model 334**

Identical to Model 333, but has in addition 6 A.C. Voltage Ranges.  
 • Each A.C. and D.C. range has a sensitivity of 1000 Ohms per Volt. A.C. measurements are free from temperature and frequency error throughout a range of 25 cycles to 1 megacycle. The new Germanium rectifier is used.  
 • Basic meter sensitivity is 400 Micro-ampere full scale **\$32.50**  
 Net

**Federated Purchaser**  
 INCORPORATED  
 DISTRIBUTORS OF RADIO—ELECTRONIC  
 and SOUND EQUIPMENT  
 80-R PARK PLACE, NEW YORK 7

**ELECTRONIC  
 SURPLUS  
 BARGAINS**

All perfect—Original package

- |  |        |
|--|--------|
|  | Each   |
| 1,500 Regulator, generator voltage control 24 volts system by Westinghouse.... | \$0.50 |
| 1,000 Amplifiers, 115 Volts, 400 Cycles with 2 7C5—one 7Y4—one 7F7 tubes.....  | 4.75   |
| 800 Waste Gate Motors, turbo supercharger control, AMPL Volts—400 C.....       | .50    |
| 1,000 Turbo Governor, Supercharger control, 2780 rpm.                          | .50    |
| 900 Nacelle Junction Boxes, Turbo supercharger regulator, 400 Cy 115 Volts...  | .25    |
- Parcel Post—Prepaid—send cash or money order to—

**M.F.S. Mfg. Corporation**  
 P.O. Box 5      Rochester 11, N. Y.

**WE GUESS YOU LIKE IT**

**M**AY I congratulate RADIO NEWS on its new Radio Circuit Page? It is an excellent idea. . . .

"Why not extend the idea to 'pre-view' new test equipment as it comes out. It is just a suggestion. Thanks for a splendid magazine."

Kenneth C. MacGregor  
 Detroit, Michigan

\* \* \*

**C**OMMENTING on the 'Circuit Section' recently included in RADIO NEWS, I, for one, welcome it heartily. I feel that it fills in the gap and makes the publication complete. In addition, this service is something of especial interest to the servicemen who have a definite need for the information and its value as a time-saver cannot be estimated.

"I know there are thousands who will agree with me but may not find the time to write and tell you so. For them and for me, keep it coming and the more circuits, the higher will be the appreciation."

Raymond W. Cobb  
 Brentwood, Missouri

\* \* \*

**I** LIKE your RN Circuit Page published in your last issue. I noticed that circuits were not put on the backs of technical pages. By way of suggestion this would be all that I would offer, unless a way could be figured out to have the parts list for each set with the drawing and still publish as many diagrams."

E. van Rossum  
 Pensacola, Florida

\* \* \*

**T**HE May issue in which you published the new circuit diagrams has arrived and I wish to thank you for running the circuits on the back of advertising pages so that it is possible to cut out the circuits without cutting into editorial matter.

"I have begun to cut them out and mount them on my file cards.

"Thank you for the service and I hope that you will continue to publish interesting 'build it yourself' equipment."

Roger Mayrand  
 Montreal, Canada

\* \* \*

**T**HE Circuit File beginning in RADIO NEWS is a wonderful help. We have already started a file for them and since you have asked for suggestions, here's one that we think would be of big help to the serviceman. Why not print the parts lists in the 3 x 5 outline like the circuits are printed? In pasting the parts list as they were printed in this month's issue it was necessary to cut the lists in half and it would make a much neater

file if they were printed in the 3 x 5 space to begin with.

"Our opinion is that this file box idea is going to be easier for the serviceman than the book form. With the file card there will be no need to have a book in your way while you work."

C. J. Whitton  
 Texoma Radio Company  
 Denison, Texas

\* \* \*

**B**EING a regular subscriber to RADIO NEWS, I thought I'd drop you a few lines on my thoughts and opinions of your magazine.

"I think the features and articles in the magazine are swell, especially the new RN Circuit Page which you inaugurated in the May, 1946 issue. Being a professional radio serviceman I follow all radio articles with interest, especially those on servicing."

Sid Wolfson  
 Bronx, New York

\* \* \*

**I** THINK your idea of the service schematics in the May issue is good for the repairman. I would suggest that if you could print the parts lists which are on the other pages, in small size they could be cut out and pasted on the back of the same card the schematic is on. This would be a big help to the repairman."

U. S. Vess  
 Refugio, Texas

\* \* \*

**C**ONGRATULATIONS on your new feature, 'Circuit File Department.' It is something that has been needed a long time. I hope it expands each succeeding month. Once again, thanks!"

F. W. Luecker, Jr.  
 Milwaukee, Wisconsin

\* \* \*

**I** THINK your new idea of printing radio circuits in your magazine each month as you receive them from the manufacturer is a swell idea. I hope you will keep it up each issue."

Harry Olson  
 Chicago, Illinois

\* \* \*

**W**E RECEIVED our copy of the May issue of RADIO NEWS and were deeply impressed with the fine way you started a series of radio circuits for filing, along with the parts list.

"We have just finished cutting out the 15 different radio circuits and pasted them on 3 x 5 cards, with the parts list on the back and have placed them in a neat little filing box for handy reference.

"Do continue with this circuit data. They are most worthwhile to the radio service and repair man.

"We have done a crack-up job of putting out 95% of the radios brought in for repair all through the war as

# ATTENTION Manufacturers!

## War Time Knowledge

of Electronics & Radar  
Applied to Manufacturing  
Problems Including  
INSPECTION, GRADING  
and  
CONTROL SYSTEMS

300 yrs. of Engineering  
Experience at your Service

**Electronic Associates, Inc.**  
Long Branch, N. J.

famous for

# GREAT VALUES

## OUTSTANDING OFFERINGS OF NEW KITS

**PHONO KIT.** Consists of AC Phono-Motor, Pick up, all parts necessary for 3 tube phono Amplifier, including 5" P.M. speaker. Excludes wire, solder and tubes.....\$16.25

With the Above { PA 12 portable leatherette-covered all wood cabinet .....\$7.95  
Kit of tubes.....\$1.85

**5-Tube SUPERHET** ..... \$15.50

Complete with Cabinet and Tubes, but excluding wire and solder.

All prices are F.O.B. New York City

Write for our new catalogue showing new test equipment, tubes and a large variety of new replacement parts.

We ship anywhere in the U.S.A. —promptly.

**RADIO DEALERS  
SUPPLY COMPANY**

135 LIBERTY ST., NEW YORK 6, N.Y.

we were very fortunate in being able to obtain tubes and parts for repair jobs on practically all radios. I have been in the repair business for 25 years and am still going strong. Your articles on FM are splendid but I would like to see a well-designed FM antenna, 75 feet high, that can be adjusted to any FM frequency, also more information on various FM and television stations springing up all over the country, their range, frequency and reception conditions."

Warren R. Davee  
West Point, Nebraska

\* \* \*

**T**HIS is just a line to tell you how much I appreciate RADIO NEWS.

"I don't write very often about such things, RN has been improving by the month. I await each copy with the expectation of new and interesting articles.

"The circuit file which is in the May issue is swell and I hope you keep it up. I am not a serviceman but like to service radios as a hobby.

"The articles on ham radio are very nice and I hope to be back on the air soon myself."

E. A. McCall  
Kansas City, Missouri

\* \* \*

*Our sincere thanks to all those who wrote in commenting on the New RN Circuit Page. Your suggestions have been noted and discussed by the Editorial Staff. The parts lists do present a problem as we would like to print them in a 3 x 5 box which would match the circuit itself. Most of you have probably noticed that the parts lists of various manufacturers vary in length from no formal parts list to one containing many items. In making up our master file we found that all of the parts lists could be fitted on the back of the 3 x 5 card, although at times it was necessary for us to divide the list in half. If we printed the parts lists in the 3 x 5 outline it would be necessary to waste considerable space, especially where the parts lists were short, which would detract from the appearance of the pages. We have adopted one suggested improvement made by one of our readers. You will notice that now each circuit diagram includes the i.f. of the receiver. We hope that this will be a help . . . ED.*

-50-

## Photo Credits

Pages	Credit
25, 26, 27, . . .	Walter Steinhard, Staff Photographer
30 (top, bottom left), 31 (top left and right, bottom left) . . . . .	Acme
30 (bottom right), 31 (center and bottom right) . . . . .	Acme Photo from Joint Army-Navy Task Force
38, 39, 40, . . . . .	A.A.F.
42, . . . . .	Philco Radio Corporation
47, 102, 103, 105, . . . . .	NBC
50, . . . . .	British Guiana United Broadcasting Co., Ltd.
96, . . . . .	Radio Inventions, Inc.
102 . . . . .	Hallcrafters

# ATTENTION!

## Introducing Our First POST-WAR RADIO KIT

Ideal for Use By

- STUDENTS
- SCHOOLS
- HOSPITALS
- SERVICEMEN
- AMATEURS



Our Model S-5 uses the universally accepted superheterodyne circuit containing the following tubes: 12SA7, 12SK7, 12SQ7, 50L6, 35Z5 and tunes from 550 Kc. to 1600 Kc.

Model S-5 (Illustrated)—Complete Kit, including tubes, Bakelite Cabinet and four pages of diagrams and instructions @ .....\$19.95

## The Buy of the Season! BUILD YOUR OWN PORTABLE PHONOGRAPH



Beautiful carrying case, pick-up, 3 tube amplifier, motor, tone and volume controls. Complete kit, including tubes, ready for assembly @ .....\$25.95

### ALSO AVAILABLE

Automatic Record Changer Phono Kit with Amplifier . . . ready for assembly @ \$43.95

### Special for This Month!

Maguire's Automatic 2-post Record Changer. Plays ten 12" records or twelve 10" records @ .....\$21.95

In addition, our previous models of meters and radio kits are still available.

Radio Kit Model TRF-4A, complete with tubes @ .....\$10.95

Ohm-Volt Milliammeter Kit M-3A (A.C.-D.C.) @ .....\$16.95

Radio Kit Model S-6, less cabinet, complete with tubes @ .....\$17.95

Exporters: Write for Details!

25% Deposit on C.O.D. Orders

Write for FREE Catalog

# RADIO KITS COMPANY

Dept. K 120 Cedar St. New York 6, N. Y.

# Classified Advertising

Rate 20c per word

Minimum, 10 words

## RADIO ENGINEERING

RADIO Engineering, Broadcasting, Aviation and Police Radio, Servicing, Marine Operating and Electronics taught thoroughly. Expenses low. Write for catalog. Valparaiso Technical Institute, Dept. N. Valparaiso, Ind.

SLIDE Rule Short Cuts. 2,500 words of Real Information for Radio Technicians. One dollar, postpaid. W. P. Miller, 536 "F" St., San Diego 1, Calif.

## FOR SALE

RECTIFIERS—Halfwave, 5 Amperes, \$4.50; 2.2 Amperes, \$2.25; 1.5 Amperes, \$1.85. Fullwave, 1 Ampere, \$2.50; 5 Ampere, \$1.85. Maximum 18 volts input. List free. Milton Burma, Route 5, Grand Rapids, Mich.

RADIO tubes, parts, wholesale. Bulletin, 3c. Henshaw, 3313 Delavan, Kansas City, Kansas.

PAN OSCILLO Receiver — (Does work of four units). Latest design 3" oscilloscope, panoramic adapter, synchroscope, receiver (when used with converter). Ideal for laboratory, television and general service work. 60 cycle transformer supplied (installed, filter reworked, tested, \$8.00 extra). New surplus originally \$1750, your cost, with 21 tubes, \$97.50. Write for folder or send 50c for 80-page Technical Manual. 5G selsyn motors, 110 AC, 60 cycle. Ideal antenna or wind direction indicator, \$12.00 pair. Selected BC 406 15 tube 205 mc receiver 110 volt, 60 cycles. Easily converted 2-10 meter (Instructions furnished). FM or television bands. Complete with tubes, \$30.00. New Meters, low prices; write for list. Westchester Electronic Products, 29 Millburn St., Bronxville, New York.

SELSYN motors, large size. Write for illustrations, description, etc. J. A. Weber, 150 Maple, Hershey, Pa.

RCA Electronic Controla, body capacity. Complete in boxes. Ready to use. Reasonable. Electrical Service, 699-6th Ave., New York, N. Y.

200 WATT Audio Amplifier, built for Signal Corps, automatic volume control, high gain, built-in power supply. Complete with 15 tubes, \$150.00. White Sound Service, 151 West 63rd St., New York, N. Y.

EXCELLENT Serviceable Surplus: SCR 211 Frequency Meters, Original tubes and Xtal for perfect calibration. Contains Spare matched tubes to maintain calibration, \$59.95. 100 KC Xtals, \$5.00. Loran Indicators—Complete with 26 6.3V Tubes and 5" Ray Tube, has 100 KC Xtal, Hi-voltage Condensers, resistors, controls, all in a steel cabinet, \$49.95. Loran Tuners—Complete with 16 tubes. Channel fixed tuner. Transformers, chokes, 2500V condensers, etc., \$39.95. Dandy Dynamotors 1000V at 350ma, \$7.50. 375V at 150ma, \$5.00. Quantity Limited; first come, first served. Cyril F. Hoffman, Box 762, Uvalde, Texas.

NEW Signal Generators-Oscillators, \$19.50. Variable 125 KC to 625 KC. Five day delivery. Cash or \$5.00 with order—balance C.O.D. All sales final. Letronic Mfg. Co., 722 No. Hamline, St. Paul, Minn.

HERMETICALLY Sealed Filament Transformers: #1—2.5V., 12 Amp., \$3.50; #2—7.5V., 12 Amp., \$3.50; #3—6.3V., 12 Amp., \$3.75; #4—Dual, Two 6V. Sec., 12 Amps. each, \$5.00; #5—2.5V., 14 Amp., Uncased, \$3.50; #6—Power Transformer (3x3 1/2 x 1") 390V.—140 Mil. & two 6V. Fil., \$3.75; #7—Wired power packs with above pwr. transf. wired for 2-6x5's, uses two C.D. 16 mfd., 450V. can filters (6 1/2 x 9 x 3 1/2), \$5.95. Oil Filled Condensers: #8—10 mfd. 600 V., Westinghouse (4 1/2 x 2 7/8 x 1 3/4"), \$2.50; #9—2 mfd., 5000V., C.D. (3 3/4 x 6 x 4 1/2"), \$5.95; Electrolytics (4 1/2" H., 2" Dia.), #10—500 mfd., 125V., 75c; #11—4000 mfd., 25V., 75c. Complete stock of Barker & Williamson coils, Middletown Chassis & Cabinets; Greenlee punches, at standard prices. Miscellaneous: a. Chassis punched for 8 tubes (16x8 1/2 x 2 1/2"), 69c; b. Metal cabinet to fit above chassis with panel, 79c; c. Bud, OLS-40, 40 meter, 50 watt, Oscillator & Buffer Coil, 69c; d. Roller-Smith meter, 3 1/2" round, 0-4 Kil. V., 0-1 Movement, \$4.35; e. Amphenol, tan, low loss mica-filled Bakelite sockets, 4, 5, 6, or 3 prong, 12c each; f. 72 Ohms Amphenol Coaxial cable, 12c ft.; g. Two-tube chassis with two Amphenol sockets, 19c. Belmont Radio Supply, 1921 Belmont Avenue, Chicago 13, Illinois, and 325 S. Chicago St., Joliet, Illinois.

PHONO Amplifiers, completely wired, uses 50L6, 35Z5, 12SQ7. \$4.50 less tubes. Ten for \$42.50. Tubular electrolytics, standard brand, 20-20 mfd, 150 volts. 48c each. Ten for \$4.45. 25% required on all C.O.D. orders. Howard Supply Co., 490 Claremont Parkway, Bronx 57, New York.

VOLTMETER, Milliammeter, Fluorescent Light, Microammeter, \$3.00 each. Wire Recorder, 30 Warrington, Providence 7, R. I.

CLOSING out! Brand new GE Selsyns (ideal for remote control—loops, tuning, etc.), \$4.00 each; \$7.50 pair. Few Selsyn Differential Generators, \$4.50 each. Hal Davidson, 164 4th St., N.E., Atlanta, Ga.

## WANTED

I NEED Test Equipment, New or Used, Signal Tracing, UHF, etc. Let me know what you have. Jos. A. Long, Box 234, Menomonie, Wisconsin.

WANTED—Amplifier and speakers for Midwest Royale Receiver. Northern Radio, Standish, Michigan.

POWER Transformer, Model 181 Majestic. Koon Radio Service, Harrison, Arkansas.

GENERATORS, 10-15 volt, compound wound up to 500 watts. Rectifiers also, similar capacity. Delosh Brothers, 3508—105th St., Corona, New York.

INSTRUCTORS in Electronics and Radio. Prefer former Navy Radio Technician instructors willing to locate in the Detroit, Mich., area. Write to Box 431, % Radio News.

COIL Winder—Exp. R.F., OSC, Loops—Capable set-up. Box SX, 614 West 49th St., New York, N. Y.

## RADIO EQUIPMENT

SUPERHET Manual, \$2.50. Free electronics bookalog! Stone, Lunenburg 24, Mass.

## CORRESPONDENCE COURSES

USED correspondence courses, educational and technical books bought, sold, rented. Free catalog. Educational Exchange, Henagar, Ala.

USED Correspondence Courses and Educational Books sold or rented. Inexpensive. Money-back guarantee. Write for Free Catalog listing 4000 bargains.—(Courses Bought.)—Lee Mountain, Pisgah, Ala.

CORRESPONDENCE Courses and self-instruction books, slightly used. Sold. Rented. Exchanged. All subjects. Satisfaction guaranteed. Cash paid for used courses. Complete information and 100 page illustrated bargain catalog FREE! Write Nelson Company, Dept. 2-59, Chicago 5.

AMATEUR radio licenses. Complete code and theory preparation for passing amateur radio examinations. Home study and resident courses. American Radio Institute, 101 West 63rd Street New York City.

LOWEST Prices. Radio Tubes, parts. Bargain lists 3c. Potter, 1314 McGee, Kansas City 6, Mo.

YOU can master mathematics. Key to the Electronic Age. Write O-Universal School of Mathematics-0, 623 Walter Story Bldg., Los Angeles, Calif.

## PATENT ATTORNEYS

INVENTORS—Before disclosing your invention to anyone, send for Form "Evidence of Conception"; "Schedule of Government and Attorneys' Fees" and instructions. Sent free. Lancaster, Allwine & Rommel, 414 Bowen Building, Washington 5, D. C.

PATENTS SECURED. Two valuable booklets sent free. Write immediately. Victor J. Evans & Co., 148-H Merlin Bldg., Washington 6, D. C.

## HELP WANTED

RADIO Instructors. Receiver servicing experience. College Degree preferred. \$3600 a year to start. \$4200 after four months. Work in the heart of the Radio Industry. Write Raleigh G. Dougherty, 158 Market Street, Newark 2, New Jersey, % New York Technical Institute of New Jersey.

WANTED: 2 Production Executives, Production manager; also Head Production Control Department with several years' experience in Electronic Equipment Manufacturing and Assembly. Salary Brackets—5,000 to 8,000. Write for interview describing background and experience, especially peace time production responsibilities before the war. Box 433, % Radio News.

## MISCELLANEOUS

POWER Mower—Sensation. Cuts and trims Dealers wanted. Prompt shipment. Farm Products, TP-3050, Excelsior Springs, Mo.

ELECTRICAL Instrument Service, 15 Howard Ave., Vallejo, California. Send us your meters and instruments for fast and reasonable repair, calibration and conversion. Write for estimates.

SAVE time, expense, worry. If you have a personal or business matter to attend to in Chicago we can do it for you. Write Denserve, 30 W Washington, Chicago, Ill.

# WANTED!

## Articles by Radio Amateurs

2000 to 2500 words

Covering any material of genuine interest to radio amateurs, such as:

- Transmitters
- Receivers
- Antennas
- Test Equipment

Articles should be typewritten (double spaced) and accompanied by suitable diagrams, photos, and parts lists. Liberal payment will be made upon acceptance.

Address all communications to

Box 419

## RADIO NEWS

185 North Wabash Avenue

Chicago 1, Illinois

# YOU GET MANY Extras!

Rowe No. 7  
Permanent  
Magnetic  
Driver Unit



**E**XTRA power, extra long life, extra freedom from break-downs, extra ease of replacement . . . these are but a few of the many extras you get in the ROWE No. 7 PERMANENT MAGNET . . . first choice of sound engineers who investigate thoroughly and analyze carefully.

The 3 lb., 4 oz. ALNICO Magnet gives power and permanency; combined voice coil and diaphragm assembly heads off trouble, provides for quick replacement if necessary. Write for circular giving complete details. Address, Dept. 746

## ELECTRONICS DIVISION

**RUHE Industries**  
3120 MONROE ST., TOLEDO 6, OHIO

# RADOLEK

Radio-  
Electronic  
Service Parts

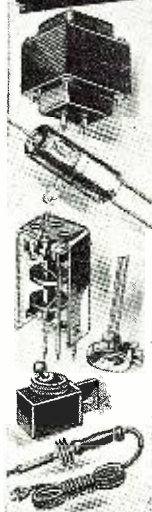

Large stocks assure the finest and most complete selections of all available items at lowest prevailing prices. Thousands of active buyers depend on us for their entire Radio repair and replacement requirements. Because we understand service problems, every order is expedited for delivery in double quick time. Everything we do is planned for convenience and satisfaction to our customers. You will find it profitable to make Radolek your buying headquarters.

### FREE BUYING GUIDES

Because of existing conditions we keep our customers right up to the minute on available merchandise by releasing supplements frequently instead of sending our regular Big Profit Guide once a year. Send the coupon now to get these Free Buying Guide Supplements as they are issued.

**FREE!**



### FAST SERVICE!

RADOLEK CO., Dept. B-116  
601 W. Randolph St., Chicago 6, Ill.  
Please send FREE Buying Guide Supplements

NAME \_\_\_\_\_  
ADDRESS \_\_\_\_\_

**ORDER FROM RADOLEK**

July, 1946

## QTC

(Continued from page 44)

Baltic ports soon . . . New and what were prewar are slowly opening up in marine shipping which will mean additional work for marine radio oprs. . . . New openings ashore are getting few and far between, it seems, with a condition of more men than jobs coming about where a short while ago it was more jobs than men. There are a few jobs left, however, for the men with experience in air and marine radio.

**D**URING 1945, while materials for the radio industry in the U. S. were under war-time restrictions and frozen, over \$88,000,000 worth of transmitting and receiving equipment moved to foreign countries . . . 84 of them getting materials that were "out" as far as the American market was concerned. . . . Russia got over \$23,000,000 in transmitters in 1945. And some items are still hard to get in the USA.

**L.** L. SHINDLER was in recently aboard his Liberty and had a vacation while undergoing repairs. . . . A. H. Ashley in recently. T. Hardy is probably due for a trip with his craft to New York, it's reported. Jack Edwards aboard his new craft was headed north but diverted below again. . . . Where is C. H. Lawrence these days? Still with the Iriona? Joe Long and E. J. Murar both newly married—congrats boys . . . same also goes for W. W. Draper and A. Klein. . . . Ed Sittler, ex-Marine radio serviceman, has actually gone into business we hear, following in the steps of R. K. Davis, apparently, but not however in the same business. . . . W. Boyette, P. Trolloff and J. C. Oblinger all recently resigned from the sea going brass pounding gang and are getting established elsewhere. . . . 73

## PHONOGRAPH REPAIRING HINTS

**I**F the bracket on your RCA electric record player becomes cracked it may be repaired by adjusting the arm to the correct height and then applying a small amount of solder along the top of the supporting swivel arm thus supporting the front part of the arm to scrape on the record.

To connect the machine to an old type radio, merely fasten one wire from the pickup to the chassis of the radio and the other wire to an .01  $\mu$ fd. paper condenser, the other end of the condenser being wired to the grid input of the first stage of audio amplification, or to the plate of the detector stage preceding the first stage of audio.

Slip a sleeve over the center post of the record player in case the records have a hole that is so large that the record does not center properly. A record that does not run true causes the reproduction to be uneven and causes excessive record wear. E.C.D.

Now . . . new help for radio men

# 2 NEW-McGRAW-HILL BOOKS

## 1. ELECTRONICS DICTIONARY

A well-illustrated, up-to-the-minute dictionary containing clear, expert definitions of nearly 6500 terms used in radio, television, industrial electronics, communications, facsimile, sound recording, etc. The most comprehensive guide to electronics terms available. Over 600 diagrams and sketches illustrate the principles and equipment described. By N. Cooke, Executive Officer, Radio Materiel School, Naval Research Laboratory, and J. Markus, Asso. Editor, **Electronics**. 433 pages. \$5.00.

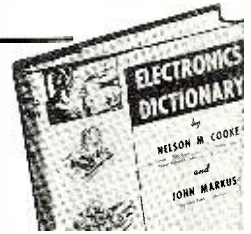

## 2. ELECTRONICS FOR ENGINEERS

A handy reference manual containing many of the latest engineering aids relating to design of circuits, equipment and individual parts for radio, electronic, television, facsimile, radar, sound, and related vacuum-tube apparatus. The material has been condensed into graphs, charts, and concise articles to supply you with short cuts to more and better reference data in your field. Edited by J. Markus and V. Zeluff, Asso. Editors, **Electronics**. 390 pages, 488 figures. \$6.00.

### 10 DAYS' FREE TRIAL—Mail coupon

McGraw-Hill Book Co., 330 W. 42 St., N.Y.C. 18  
Send me the books checked below for 10 days' examination on approval. In 10 days I will pay for books, plus few cents postage, or return them postpaid. (Postage paid on cash orders. Same return privilege.)

- Cooke & Markus—Electronics Dictionary . . . \$5.00  
 Markus & Zeluff—Electronics for Engineers . . . \$6.00

Name \_\_\_\_\_  
Address \_\_\_\_\_  
City and State \_\_\_\_\_  
Company \_\_\_\_\_  
Position \_\_\_\_\_ R N 7-46  
For Canadian prices write Embassy Book Co.  
12 Richmond St. E., Toronto 1

Come to the famous

**COYNE**  
TRAINING SHOPS

where you learn by doing



TRAIN FOR  
FOR  
**RADIO-  
ELECTRONICS**  
IN A FEW WEEKS

Prepare For A Good Job Now With  
A Lifetime Future!

Trained Radio-Electronics men needed now. They will be needed too in the years to come. Don't be caught napping. Get a Radio training now and be ready. Learn by Doing. Free employment service for life after graduation. Many earn while learning. If you are short of money, I'll finance most of your tuition. Training in Industrial Electronics and Electric Refrigeration added to our course. We are also equipped to train those who qualify under G. I. Bill. We also have facilities for men with physical disabilities whether due to war or other causes. Fill in and mail coupon for details.

### SEND COUPON FOR FULL DETAILS

H. C. LEWIS, Pres., Radio-Electronics Div.  
COYNE ELECTRICAL SCHOOL,  
500 S. Paulina St., Dept. B6-1K, Chicago 12, Ill.  
Send Free Book and details about Coyne Part-Time Employment and Student Finance Plan.  
 Send G. I. Bulletin  Physical Disability

NAME \_\_\_\_\_ AGE \_\_\_\_\_  
ADDRESS \_\_\_\_\_  
CITY \_\_\_\_\_ STATE \_\_\_\_\_

NAME	AGENCY	PAGE	NAME	AGENCY	PAGE
Adson Radio Co.	Mitchell Advertising Agency	106, 124	M.F.S. Mfg. Corporation		132
Aerovox Corporation	Austin C. Lescarbours & Staff	137	Mallory, P. R. & Co., Inc.	Aitkin-Kynett Co.	Third Cover
Air King Radio	Henry A. Loudon Advertising	93	Marion Electrical Instrument Co.	Shappe-Wilkes, Inc.	103
Alliance Manufacturing Company	Foster & Davies, Inc.	Second Cover	Maritime Switchboard		104
Allied Radio Corporation	Henry H. Teplitz	9, 97	Melville Radio Institute	Seidel Advertising & Pub. Co.	122
Alsam Products Company	Sander Rodkin Adv. Agency	87	Metropolitan Electronic & Instr. Co.	Mitchell Advertising Agency	89
American Phenolic Corporation	Burton Browne Advertising	17	Miles Reproducer Co., Inc.	Altomari Advertising Agency	130
American Photocopy Equipment Co.	Arthur Meyerhoff & Company	108	Millen, James, Mfg. Co., Inc.	James Millen, Inc.	12
American Radio Institute	Sternfield-Godley, Inc.	124	Mission Radio Distributors		120
American Television Institute	Turner Advertising Agency	76	Murray Hill Books, Inc.	Harry P. Bridge Advertising	59
American Television & Radio Co.	Firestone-Goodman Adv. Agency	64	McElroy Manufacturing Corp.	Shappe-Wilkes, Inc.	130
Appliance Training School	A. L. Addison Advertising	123	McGraw-Hill Book Co.		135
Arrow Radio Co.		86	McMurdo Silver Company	Edward Owen & Company	67
Asatic Corporation, The	Wearstler Advertising, Inc.	109	National Acoustics Products	Paul Basinger Studio	104
Atlas Sound Corporation	Burke & Wayburn	88	National Company, Inc.	Graydon Smith Advertising	21
Atomic Heater & Radio Corporation	W. Montague Pearsall	98	National Radio Distributors	Burke & Wayburn	98
Audak Company	Hart Lehman	8	National Radio Institute	Van Sant, Dugdale & Co., Inc.	3
Audel Publishers	Grant & Wadsworth, Inc.	112, 127	National Radio Service		114
Balizer, Peter		130	National Schools	Mayers Company	19
Bell Telephone Laboratories	N. W. Ayer & Son	71	Newark Surplus Materials Co.	DePerri Advertising Agency	120
Bliss Electrical School	N. W. Ayer & Son	120	Newcomb Audio Products Co.	Gail Hall Advertising	62
Bud Radio, Inc.	Allied Advertising Agency	76	Niagara Radio Supply	Sternfield-Godley, Inc.	82
Buffalo Radio Supply	International Adv. Agency	125	O & S Laboratory	Paul Basinger Studio	100
Burlington Instrument Co.	Weston-Barnett, Inc.	111	Oelrich Publications	Sander Rodkin Adv. Agency	120
Burstein-Applebee Co.	Frank E. Whalen Adv. Co.	68	Ohmite Manufacturing Company	Henry H. Teplitz	51
California Radio & Electronics Co.	Mitchell Advertising Agency	75	Olson Radio Warehouse	Jessop Advertising Agency	72
Camburn, Inc.	Mitchell Advertising Agency	94	Onan, D. W. & Sons	Graves & Associates	100
Candler System Co.	Van De Mark Advertising, Inc.	122	Pa-Kette Electric Co.	Arrow Advertising Agency	116
Capitol Radio Engineering Institute	Henry J. Kaufman Advertising	55	Panoramic Radio Corporation	Shappe-Wilkes, Inc.	138
Chicago Wheel & Mfg. Co.	Weston-Barnett, Inc.	110	Pierson Electronic Corp.	Brooks Advertising Agency	85
Chief Electronics		124	Potter Radio Co.		114
Clark Radio Equipment Corp.	Turner Advertising Agency	110	RCA Institutes, Inc.		114
Clark Reiss Distributors	Mitchell Advertising Agency	126	Radio Corporation of America	J. Walter Thompson Co.	11, 73
Cleveland Institute of Radio Electronics	Kenneth H. Kolpien	113	R. C. & L. F. Hall, Inc.		62
Clippard Instrument Laboratory	Savage & Talley	129	R. C. Radio Parts & Distributing Co.	R. S. Wittenberg Advertising	120
Collins Radio Company	McCann-Erickson, Inc.	69	R-L Electronic Corp.	H. J. Gold	133
Communications Equipment Co.	Borough Advertising Agency	56	Radio Dealers Supply Company		130
Concord Radio Corporation	E. H. Brown Advertising Agency	52	Radio Equipment Distributors		72
Coyne Electrical School	McJunkin Advertising Agency	135	Radio Electric Service Co.	E. L. Brown Advertising	116
Crabtree's Wholesale Radio		128	Radio Ham Shack, Inc.	J. R. Kupsick Adv. Agency	90
Croname, Incorporated		77	Radio Kits Company	Edward Hamburger Advertising	133
Crystal Research Laboratories, Inc.	Post, Johnson & Livingston, Inc.	115	Radio Maintenance	Shappe-Wilkes, Inc.	13
DeForest's Training, Inc.	MacDonald-Cook Co.	15	Radio Parts Company Magazine	Sidney S. Lovitt	92
Diamond Straw & Machine Co.	Halpern Advertising Agency	118	Radio Press		123
Dow Radio		108	Radiolab Publishing & Supply Co.		124
Drake Electric Works, Inc.	William Hoffman & Associates	112	Radio Products Sales Company	Barton A. Stebbins	127
Editors & Engineers		129	Radio Supply & Engineering	Karl G. Behr Advertising	78
Electro-Motive Mfg. Co.	Cory Snow, Inc.	88	Radio & Television Equipment Co.		123
Electronics Associates, Inc.		133	Radio & Television Supply Co.		133
Electronics Institute, Inc.		116	Radio Wire Television, Inc.	Reiss Advertising Agency	86
Electronic Instrument Company	Mitchell Advertising Agency	104	Radiconic Equipment Co.	Hirshon-Garfield, Inc.	94
Electronic Manufacturing Co.	Business Service Company	114	Radolek Co.	Turner Advertising Agency	135
Electronic Supply Company		80	Reading Television Labs., Inc., The		126
Fada Radio & Electric Co., Inc.	Sternfield-Godley, Inc.	6	Reed Mfg. Co.	Borg Advertising Agency	124
Fahnestock Electric Company, Inc.		117	Rider, John F., Publisher, Inc., The	Lansford F. King Advertising	10
Federated Purchaser, Incorporated	Altomari Advertising Agency	132	Risco Sales Company	Diener & Dorskind	114
Flanagan Radio Corp.	Stewart-Jordan Corp.	91	Rowe Industries	Miller Advertising Agency	135
General Cement Mfg. Co.	Turner Advertising Agency	106	S./C. Laboratories, Inc.		120
General Industries Co., The	Fuller & Smith & Ross, Inc.	80	Sams, Howard W. & Co.	Aitkin-Kynett Co.	63
General Test Equipment Company	Suzanne Hayman Advertising	128	Sauerisen Cements Company	McCarty Company	124
Greenlee Tool Co.	Howard H. Monk & Associates	124	Scenic Radio & Electronics Co.		112
Greenwich Sales Co.	Mitchell Advertising Agency	110	Schott, Walter Co.	Ross, Gardner & White	100
Guardian Electric	Kennedy & Co.	53	Shure Appliances & Radio	Paul Basinger Studio	130
Haldorson Company, The	Sander Rodkin Adv. Agency	74	Snyder Manufacturing Co.	Abner J. Gelula & Associates	131
Hallcrafters Company, The	Burton Browne Advertising	5	Sprague Products Company	Harry P. Bridge Advertising	16
Hammarlund Mfg. Co., Inc., The	Roeding & Arnold, Inc.	24	Sprayberry Academy of Radio	Harry P. Bridge Advertising	7
Ham Shack, The		76	Standard Electronics Co.	Suzanne Hayman Advertising	130
Hanlan Company	Adv. Management Service	106, 130	Standard Radio & Electronic Products Co.	Hutzler Advertising Agency	66
Harrison Radio Corporation	Altomari Advertising Agency	105	Standard Transformer Corporation	Burnet-Kuhn Advertising	95
Harvey Radio Company	Shappe-Wilkes, Inc.	70	Stanton Radio Supply		129
Heins & Bolet	Sternfield-Godley, Inc.	123	Stark's		127
Henry Radio	Burton Browne Advertising	60	Sterling Electronic Company		123
Hexacon Electric Co.	George Homer Martin	90	Stevens Walden, Inc.	Howard-Wesson Co.	14
Hollywood Sound Institute, Inc.	Nelson Adv-tising Service	128	Suburban Radio Company		106
Hoodwin, Chas. Co.	J. L. Stewart Agency	123	Superior Instruments Co.	Mitchell Advertising Agency	23
Hopp Press, Inc., The	Gallard Advertising Agency	119	Supreme Instruments Corp.	O'Callaghan Advertising Agency	65
Hytron Radio & Electronics Corp.	Henry A. Loudon Advertising	61	Supreme Publications	Henry H. Teplitz	130
Illinois Condenser Company	Sander Rodkin Adv. Agency	88	Tab	Mitchell Advertising	96
Instructograph Company	Turner Advertising Agency	128	Telectronic Service & Supply	Burke & Wayburn	98
Insuline Corporation of America	S. R. Leon Co.	99	Terminal Radio Corporation	Regent Advertising Agency	101
International Resistance Co.	John Falkner Arndt & Co.	18	Triplett Electrical Instrument Co.	Western Advertising Agency	121
J.F.D. Manufacturing Co.	Bergman Jarrett Adv. Co.	74	Tri-State College	Clem J. Steigmeyer	130
Jensen Radio Manufacturing Co.	Burton Browne Advertising	22	Trutone Products Co.	Terrill Belknap March	131
Johnson, E. F. Company	David, Inc.	79	Union Radio Corporation	Sander Rodkin Adv. Agency	131
Kelvin Electronics	Sternfield-Godley, Inc.	94	United Screw & Bolt Corporation	Fred W. Mellis Advertising	57
Kenyon Transformer Co., Inc.	Jasper, Lynch & Fisher, Inc.	87	United Transformer Corp.	Shappe-Wilkes, Inc.	82
Kurz-Kasch, Inc.	Kircher, Helton & Collett	83	Valparaiso Technical Institute	Smith, Benson & McClure Co.	128
Kwikheat	Beaumont & Hohman, Inc.	107	Vasco		128
Lake Radio Sales Co.	Sander Rodkin Adv. Agency	58	Webster-Chicago Corporation	William Hoffman & Associates	110
Leeds Radio Co.	Mitchell Advertising Agency	102	Weller Manufacturing Co.	Beaumont, Heller & Sperling	92
Leotone Radio Co.	Altomari Advertising Agency	54	Wells Sales, Inc.	Turner Advertising Agency	119
Liberty Sales Co., Inc.	Sternfield-Godley, Inc.	20	Wendstrend, Eric		116
Lifetime Sound Equipment Co.	Miller Agency	128	Western Sound & Electric Laboratories, Inc.	Morrison Advertising Agency	127
Lincoln Engineering School	Buchanan Thomas Adv. Agency	108	Weston Electrical Instrument Corp.	G. M. Basford	Fourth Cover
			World Radio Laboratories, Inc.	Pfeiffer Advertising Agency	81
			World-Wide Communications	Borough Advertising Agency	112
			York Radio Distributing Co.		124



### AEROVOX Electrolytic Capacitors

INSULATED MOUNTING CAPACITORS  
SCREW-MOUNTING WIRE-LEAD CAPACITORS  
SLIT-CONTACT SPACER CAPACITORS

### AEROVOX TEST INSTRUMENTS

Of course you remember those precision test instruments. They were essential equipment with the more successful servicemen and maintenance workers. These Aerovox instruments were also found in many laboratories, and physics instruments were also found in many laboratories.

They are coming back again. These Aerovox test instruments - just as soon as production can be resumed on such civilian items. The post-war types of these instruments will be better than ever before. New features will be incorporated. The post-war models however mostly distinguished themselves will be still more useful in your daily work.

AEROVOX CAPACITANCE AND RESISTANCE BRIDGE

### AEROVOX Paper Capacitors

CONSUMER TYPE  
COMMERCIAL TYPE  
INDUSTRIAL TYPE



**AEROVOX Capacitors**

**RESISTORS AND TEST INSTRUMENTS**

"The Sign of the Vindicator"

• This latest AeroVox catalog contains the outstanding postwar selection of capacitor types, sizes, mountings, terminals, voltages and capacities. • Be sure you have a copy in your working library. • Ask your AeroVox jobber for this catalog—or write us direct.

### AEROVOX Mica Capacitors

"POSTAGE-STAMP" HIGH-VOLTAGE MICA CAPACITORS  
MILITARY-BATTERY MICA CAPACITORS  
PORCELAIN-CASED MICA CAPACITORS

### AEROVOX Paper Capacitors

WAX-PAINT FILLED "MILITARY" CAPACITORS  
MILITARY WAX-CASED "MILITARY" CAPACITORS  
METAL-CASED UNICASED PAPER CAPACITORS  
UNCASED PAPER CAPACITORS

### AEROVOX Filters and Auto-Radio Condensers

AUTO-RADIO CONDENSERS  
SUPPRESSOR CONDENSERS  
MOTOROLA Replacement Condensers  
SUPPRESSOR CONDENSERS FOR JODD AUTO RADIOS  
WASH CONDENSER  
CONE LIGHT CONDENSER  
OIL & SMOKE FILTER



## FOR RADIO-ELECTRONIC AND INDUSTRIAL APPLICATIONS

AEROVOX CORPORATION, NEW BEDFORD, MASS., U.S.A.

SALES OFFICES IN ALL PRINCIPAL CITIES • Export: 13 E. 40th St., NEW YORK 16, N. Y.

Cable: 'ARLAB' • In Canada: AEROVOX CANADA LTD., HAMILTON, ONT.

S. WILLARD BRIDGES  
293 SUMMER STREET  
BOSTON 10, MASSACHUSETTS

April 9, 1946

Panoramic Radio Corp.  
242 West 55th Street  
New York 19, N.Y.

Attention: Mr. Bernard Schlessel

Gentlemen:-

It is seldom that I have purchased a piece of radio equipment and found it far superior to my expectations, but the Panadaptor that I purchased from the Radio Shack in Boston about two weeks ago has certainly out-performed anything I had hoped for.

I have used the Panadaptor primarily as a monitor for the 10 meter band in conjunction with an NC 200 Receiver, and I find it priceless for band coverage between transmissions. Today I discovered I was paying no attention whatsoever to the receiver dial but was controlling my receiver entirely from the scope screen where I could see the field both sides of the frequency to which I was tuned.

This is a fine unit and I know you will sell a great many of them.

Yours very truly,

*S. Willard Bridges*  
S. Willard Bridges

swb:k

# "PRICELESS"

FOR BAND COVERAGE . . .

CONTROLLING RECEIVER ENTIRELY . . .

Letters arrive daily . . . all enthusiastic

. . . all agree that PANADAPTOR

.. out-performs anything hoped for..

To fully appreciate ALL that this amazing instrument offers, you must SEE

## PANORAMIC RECEPTION

"Blind" operation is now a thing of the past . . . as outdated as the kerosene lamp for illuminating your home. Some radio amateurs may continue to "rough" it without a PANADAPTOR . . . but all modern shacks will have it.



**PANADAPTOR Model PCA-2**  
Now Available at Leading Radio Parts Jobbers. Ask for demonstration. Amateur Net Price, complete with ten tubes and accessories for 115 V., 50-60 cycle operation.

**\$99.75**

**ONE YEAR GUARANTEE**  
against defects in parts or workmanship (excluding tubes). Panoramic Handbook with full installation, operating, application and maintenance instructions furnished with each PANADAPTOR.

PANADAPTOR is the "EYE" of your rig. It lets you SEE holes in busy bands, SEE the signal characteristics of your own and other stations, SEE short calls. It shows you 200 kc of any band instantly, helps you locate your sked and avoid annoying QRM. PANADAPTOR makes radio more fun for you, by making operation of your station more efficient . . . smoother . . . easier. You owe it to yourself to see the PANADAPTOR — now on display at leading radio jobbers.

Exclusive Canadian Representative: CANADIAN MARCONI, Ltd.

PANADAPTOR, featuring PANORAMIC RECEPTION, is the exclusive and original design of PANORAMIC RADIO CORPORATION

## PANORAMIC

CABLE ADDRESS  
PANORAMIC, NEW YORK



## RADIO CORPORATION

242-250 WEST 55th ST. New York 19, N.Y.

# You Expect More—and Get More—from MALLORY!

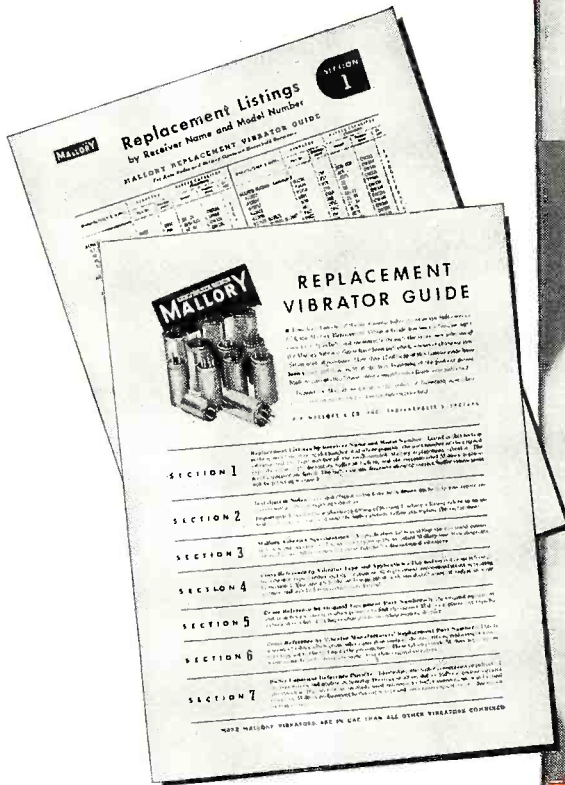

Ask for

## This Invaluable Replacement Vibrator Guide

### Plus These Other Helps

Work goes smoother—often costs less to do—with Mallyory publications like these to help you. Many others are in preparation:

1946 Fifth Edition Radio Service Encyclopedia

Replacement Vibrator Guide

Mallyory Technical Manual

Approved Precision Parts Catalog

MALLYORY gives service beyond the sale. That's why it backs up its products with complete technical information—helpful literature like this Mallyory Replacement Vibrator Guide.

Bigger and better than ever before, this Vibrator Guide lists replacements for all prewar auto radios and is sectionalized for quick reference. It includes a new section on buffer capacitor circuits . . . another section on servicing old radios that need obsolete or discontinued types of vibrators . . . even information on vibrator power supplies.

Depend on Mallyory to continue its policy of furnishing timely, comprehensive, easily digested service data. As new auto radios appear on the market, Mallyory will issue supplementary bulletins covering proper vibrator replacements. Meanwhile, if you don't have a copy of this Replacement Vibrator Guide, get one from your Mallyory Distributor.

P. R. MALLORY & CO., Inc.  
**MALLORY**

VIBRATORS...VIBRAPACKS\*...CAPACITORS...VOLUME CONTROLS  
... SWITCHES . . . RESISTORS . . . FILTERS . . . RECTIFIERS . . .  
POWER SUPPLIES. ALSO MALLYORY TROPICAL\* DRY BATTERIES,  
ORIGINALLY DEVELOPED BY MALLYORY FOR THE U. S. ARMY.  
\*Reg. U. S. Pat. Off.

**APPROVED PRECISION PRODUCTS**

P. R. MALLORY & CO., Inc., INDIANAPOLIS 6, INDIANA

200

THE NEW, COMPACT  
SUPER-SENSITIVE

*Analyzer*



# Weston

## MODEL 779

*Model 779 is designed for use with WESTON Socket Selectors which facilitate checking tube circuit conditions — and with WESTON Televerters for DC voltage measurements up to 10,000 volts.*

Extreme compactness and lightweight—dual DC voltage sensitivity of either 1000 or 20,000 ohms per volt—five AC and DC voltage ranges, seven DC current ranges, four DC resistance ranges, and five decibel ranges—all carefully selected to meet the broadest requirements of testing and maintenance—precision WESTON resistors throughout—large 50 microampere WESTON meter—temperature compensated including AC ranges—size only 6 $\frac{3}{8}$ " x 9 $\frac{1}{8}$ " x 4 $\frac{7}{8}$ "—furnished in rugged, solid oak carrying case.

NOW AVAILABLE . . . see Model 779 at the Radio Parts and Electronic Show . . . Stevens Hotel . . . Booth No. 75. Weston Electrical Instrument Corporation, 658 Frelinghuysen Avenue, Newark 5, New Jersey.

**Weston** *Instruments*

Albany · Atlanta · Boston · Buffalo · Chicago · Cincinnati · Cleveland · Dallas · Denver · Detroit · Jacksonville · Knoxville · Los Angeles · Meriden · Minneapolis · Newark · New Orleans · New York · Philadelphia · Phoenix · Pittsburgh · Rochester · San Francisco · Seattle · St. Louis · Syracuse · In Canada, Northern Electric Co., Ltd., Powerlite Devices, Ltd.