

JUNE
1946

35c

In Canada 40c

RADIO NEWS

★



LIFE TESTING OF MICA AND PAPER CAPACITORS

A TESTED job record card...

- FOR CUSTOMER SATISFACTION
- FOR REPEAT BUSINESS
- FOR BUSINESS-LIKE OPERATION

This Raytheon Bonded Electronic Technician job record card enables you to follow each customer's repair *all the way* through. It gives the customer a written guarantee and an itemized statement. It provides an automatic mailing list—in fact, it has every element *dealers themselves* found essential in actual tests.

This proved job record card is only one of the dozens of dealer-helps designed to build a substantial, money-making radio service business. For all the facts, see your Raytheon distributor today to find out how you can qualify.



BONDED ELECTRONIC TECHNICIANS
FRANK'S RADIO SERVICE
100 S. MAIN STREET
CITYVILLE, OHIO
TEL. MAIN 1000

ORDER
N^o 49
 Inventory

Name _____
Address _____
City _____ State _____ Zip _____
Phone _____

Notify if repairs will be over \$ _____ Order Number _____
We use and recommend Raytheon Tubes

Date _____
Mth. _____
Model _____
Serial _____
Promised _____

MERCHANTISE and PARTS

Total Material	
Diode	<input type="checkbox"/> Changer
Triode	<input type="checkbox"/> Pick Up
Activity	<input type="checkbox"/> Dial Cable
Radio Hark	<input type="checkbox"/> AC Card
	Time _____ Statement _____

14 Dial Cable _____
15 General Changer _____
16 Miscellaneous _____
17 _____

G U A R A N T E E

The service work completed on your radio as specified is guaranteed against defective workmanship and material for 90 days from date of delivery, providing all charges have been paid in full. This guarantee is void if damage results from accidents or attempted repairs by anyone else.

Signature _____ Delivery Date _____
Customer _____ Service Engineer _____

Name _____ N^o 49
Address _____
Article _____

BONDED ELECTRONIC TECHNICIANS
FRANK'S RADIO SERVICE
100 S. MAIN STREET
CITYVILLE, OHIO
TEL. MAIN 1000

We use and recommend Raytheon Tubes

Repairs Promised _____ AM PM
ARTICLE _____
No Radios Delivered Without This Claim Check

Another reason why it pays to qualify as
a Raytheon Bonded Electronic Technician



Excellence in Electronics

RADIO RECEIVING TUBE DIVISION
NEWTON, MASS. • NEW YORK • CHICAGO

COPYRIGHT 1946 RAYTHEON MANUFACTURING COMPANY



I Will Show You How to Learn RADIO by Practicing in Spare Time

**I Send You
6 Big Kits
of Radio Parts**

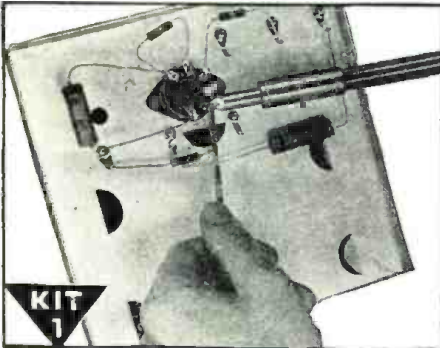

KIT 1
I send you Soldering Equipment and Radio parts; show you how to do Radio soldering; how to mount and connect Radio parts; give you practical experience.

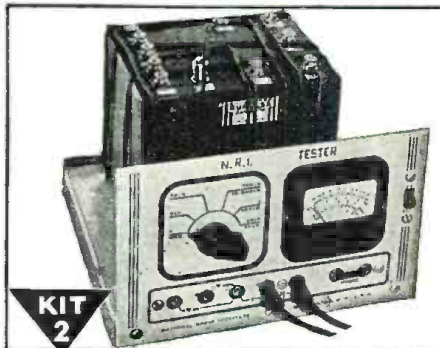

KIT 2
Early in my course I show you how to build this N.R.I. Tester with parts I send. It soon helps you fix neighborhood Radios and earn EXTRA money in spare time.

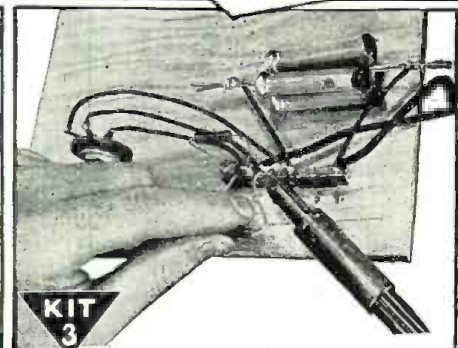

KIT 3
You get parts to build Radio Circuits; then test them; see how they work; learn how to design special circuits; how to locate and repair circuit defects.

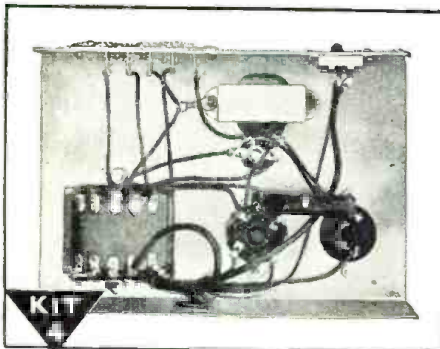

KIT 4
You get parts to build this Vacuum Tube Power Pack; make changes which give you experience with packs of many kinds; learn to correct power pack troubles.

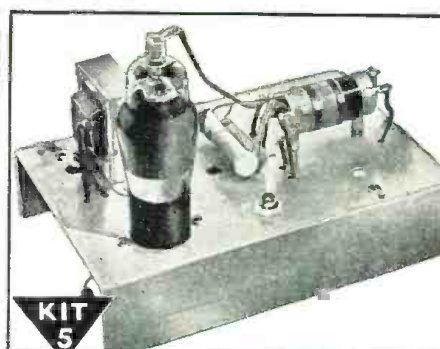

KIT 5
Building this A. M. Signal Generator gives you more valuable experience. It provides amplitude-modulated signals for many tests and experiments.

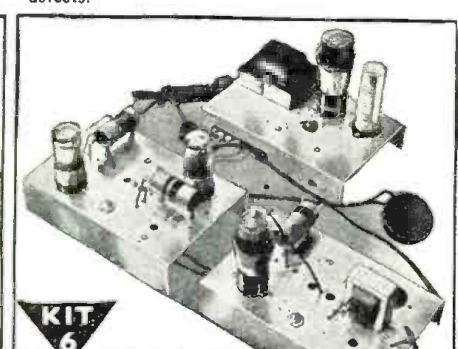

KIT 6
You build this Superheterodyne Receiver which brings in local and distant stations—and gives you more experience to help you win success in Radio.

I Will Train You at Home - SAMPLE LESSON FREE

Let me send you facts about rich opportunities in Radio. See how knowing Radio can give you security, a prosperous future. Send the coupon for FREE Sample Lesson, "Getting Acquainted with Receiver Servicing," and my FREE 64-page book, "Win Rich Rewards in Radio." See how N.R.I. trains you at home. Read how you practice building, testing, repairing Radios with SIX BIG KITS of Radio parts I send you.

Future for Trained Men is Bright in Radio, Television, Electronics

The Radio Repair business is booming NOW. There is good money fixing Radios in your spare time or own full-time business. Trained Radio Technicians also find good pay opportunities in Police, Aviation, Marine Radio, in Broadcasting, Radio Manufacturing, Public Address work, etc.

Think of the boom coming now that new Radios can be made! Think of the backlog of business built up in ALL branches of Radio! Think of

even GREATER opportunities when Television and Electronics are available to the public! Send for free book now.

Many Beginners Soon Make \$5, \$10 a Week EXTRA in Spare Time

The day you enroll I start sending EXTRA MONEY JOB SHEETS to help you make EXTRA money fixing Radios in spare time while learning. You LEARN Radio principles from my easy-to-grasp Lessons—PRACTICE what you learn by building real Radio Circuits with Radio

parts I send—USE your knowledge to make EXTRA money in spare time.

Find Out What N.R.I. Can Do for YOU

MAIL COUPON for Sample Lesson and my FREE 64-page book. It's packed with facts about opportunities for you. Read the details about my Course. Read letters from men I trained, telling what they are doing, earning. Just MAIL COUPON in an envelope or paste it on a penny postal. J. E. SMITH, President, Dept. 6FR, National Radio Institute, Pioneer Home Study Radio School, Washington 9, D. C.

Our 32nd Year of Training Men for Success in Radio

Good for Both - FREE

MR. J. E. SMITH, President, Dept 6FR
National Radio Institute, Washington 9, D. C.

Mail me FREE, without obligation, Sample Lesson and 64-page book about how to win success in Radio and Television—Electronics. (No salesman will call. Please write plainly.)

Age.....

Name.....

Address.....

City..... State..... 4FR

(Please include Post Office Zone Number)



**My Radio Course Includes
TELEVISION • ELECTRONICS
FREQUENCY MODULATION**

APPROVED FOR TRAINING UNDER GI BILL



REG. U.S. PAT. OFF.

First in Radio

JUNE, 1946
VOLUME 35, NUMBER 6

Current Paid Circulation over 120,000

For the AMATEUR

Transmitter for 2 Meters... E. F. Crowell, W1FEC and R. L. Parmenter, W11XF 28
Motor-Driven Antenna... Rowland J. Long, W9NLP 38
LCR Meter for Amateur Use... W. B. Bernard, W4ELZ 40
All Purpose Transmitter Remote Control System... Philip Johnson, RT2/c 68
The "Super-3"... 76
Make Those "Ham Fests" Interesting... John E. Hubel 90

For the SERVICEMAN-DEALER

A Volume Expander Compressor Preamplifier... Robert C. Moses 32
Constant 6 volt D.C. Supply... Lt. Curtis C. Springer 44
Recent Developments in Heavy Duty Vibrator Type Power Supplies... Martin R. Williams 46
Television Voltage Circuits... Edward M. Noll 50
Analysis of Radio Interference Phenomena... 54
Practical Radio Course... Alfred A. Ghirardi 55
The RN Circuit Page... 62
Simple Rack Speeds Record Changer Repairs... 86
The Multivibrator as a Service Instrument... Wayne M. Ross 120

OF GENERAL INTEREST

Photo-Electronic Organ... Rollin E. Campbell and Lyman E. Greenlee 25
Electronics in Processing Foods... S. R. Winters 31
Invisible Light Aids Marksman... 35
Embossing Sound on Film... Stanley Kempner 36
A Non-Electrical Phonograph... Edwin N. and Alvin B. Kaufman 53

DEPARTMENTS

For the Record... The Editor 8
Spot Radio News... Fred Hamlin 12
QTC... Carl Coleman 43
What's New in Radio... 64
International Short-Wave... Kenneth R. Boord 49
Technical Books... 104
Manufacturers' Literature... 126
Letters from our Readers... 130
Within the Industry... 138

COPYRIGHT 1946 ZIFF-DAVIS PUBLISHING COMPANY
185 N. Wabash Ave., Chicago 1, Ill.

BRANCH OFFICES: NEW YORK, WASHINGTON, LOS ANGELES, TORONTO



WILLIAM B. ZIFF, Publisher
B. G. DAVIS, General Manager
HERMAN R. BOLLIN, Art Director
C. R. TIGHE, Ass't to the Publisher
H. G. STRONG, Circulation Director
GEORGE BERNER, Advertising Director
H. J. MORGANROTH, Production Director



Cover Photo
By Arthur E. Haug
(Staff Photographer)

Life testing of mica and paper capacitors at the Sangamo Electric Company's Springfield, Ill. plant. Production samples are taken from each day's run.

RADIO NEWS is published monthly by the Ziff-Davis Publishing Company, 185 N. Wabash Ave., Chicago 1, Ill. Subscription Rates: in U. S. \$3.00 (12 issues), single copies 35 cents; in Mexico, South and Central America, and U. S. Possessions, \$3.00 (12 issues); in Canada \$3.50 (12 issues), single copies 40 cents; in British Empire, \$4.00 (12 issues); all other foreign countries \$4.00 (12 issues). Subscribers should allow at least 2 weeks for change of address. All communications about subscriptions should be addressed to Director of Circulation, 185 N. Wabash Ave., Chicago 1, Ill. Entered as second class matter March 9, 1938, at the Post Office, Chicago, Illinois, under the Act of March 3, 1879. Entered as second class matter at the Post Office Dept., Ottawa, Canada. Contributors should retain a copy of contributions and include return postage. Contributions will be handled with reasonable care but this magazine assumes no responsibility for their safety. Accepted material is subject to whatever revisions and by-line changes that are necessary. Payment, made at our current rates, covers all authors', contributors', or contestants' rights, title, and interest in and to accepted material, including photos and drawings.

Other Ziff-Davis Publications: Radio & Appliances, Radio-Electronic Engineering, Plastics, Flying, Popular Photography

HERE THEY COME!



**THE NEW
S-38's
4 Bands—540 kc. to 32 Mc.**

\$39.50
ADD 3%
IN
ZONE 2

The Model S-38 meets the demand for a truly competent communications receiver in the low price field. Styled in the post-war Hallicrafters pattern and incorporating many of the features found in more expensive models, the S-38 offers performance and appearance far above anything heretofore available in its class. Four tuning bands, CW pitch control adjustable from the front panel, automatic noise limiter, self-contained PM dynamic speaker and "Airodized" steel grille, all mark the S-38 as the new leader among inexpensive communications receivers.

FEATURES

1. Overall frequency range—540 kilocycles to 32 megacycles in 4 bands.
Band 1—540 to 1650 kc.
Band 2—1.65 to 5 Mc.
Band 3—5 to 14.5 Mc.
Band 4—13.5 to 32 Mc.
Adequate overlap is provided at the ends of all bands.
2. Main tuning dial accurately calibrated.
3. Separate electrical band spread dial.
4. Beat frequency oscillator, pitch adjustable from front panel.
5. AM/CW switch. Also turns on automatic volume control in AM position.
6. Standby/receive switch.
7. Automatic noise limiter.
8. Maximum audio output—1.6 watts.
9. Internal PM dynamic speaker mounted in top.
10. Controls arranged for maximum ease of operation.
11. 105-125 volt AC/DC operation. Resistor line cord for 210-250 volt operation available.
12. Speaker/phones switch.

CONTROLS: SPEAKER/PHONES, AM/CW, NOISE LIMITER, TUNING, CW PITCH, BAND SELECTOR, VOLUME, BAND SPREAD, RECEIVE/STANDBY.

EXTERNAL CONNECTIONS: Antenna terminals for doublet or single wire antenna. Ground terminal. Tip jacks for headphones.

PHYSICAL CHARACTERISTICS: Housed in a sturdy steel cabinet. Speaker grille in top is of airodized steel. Chassis cadmium plated.

SIX TUBES: 1—12SA7 converter; 1—12SK7 IF amplifier; 1—12SQ7 second detector, AVC, first audio amplifier; 1—12SQ7 beat frequency oscillator, automatic noise limiter; 1—35L6GT second audio amplifier; 1—35Z5GT rectifier.

OPERATING DATA: The Model S-38 is designed to operate on 105-125 volts AC or DC. A special external resistance line cord can be supplied for operation on 210 to 250 volts AC or DC. Power consumption on 117 volts is 29 watts.

hallicrafters RADIO

THE HALLICRAFTERS CO., MANUFACTURERS OF RADIO AND ELECTRONIC EQUIPMENT, CHICAGO 16, U. S. A.



FADA

sparkles in Times Square



FADA 6 tube models are equipped with the new FADA "Sensitive-Tone" . . . assuring greater sensitivity and clearer reception.

In the heart of Times Square a new FADA "spectacular," one of the most dramatic electric signs in all America, blazons the name FADA to millions of people, every day of the year. More such signs are planned throughout the United States to spotlight FADA'S reputation as "the radio of tomorrow—TODAY."

And—this is just one of a long list of FADA sales promotion activities designed to augment the universal consumer acceptance enjoyed by FADA "since broadcasting began."

For sales—this year and next year and the years to come—you, too, can depend upon FADA, "the radio of tomorrow—today"!



YOU CAN ALWAYS DEPEND ON

FADA

Radio

Famous Since Broadcasting Began!



652 SERIES
ONE OF FADA'S
NEW TABLE
MODELS

6 Tube A.C.-D.C. Superheterodynes with the R.F. Noise Reducing Stage with Slide Rule Dial in Gemlike "FADA-LUCENT" Cabinets.

6 tube radio with 8 tube performance. Features include the new Lock in type tubes; Beam Power Output System; New Wonder Speaker ALNICO V; Automatic Volume Control and FADA-SCOPE built-in LOOP ANTENNA. Housed in beautiful "FADA-LUCENT" Cabinets in Five Gorgeous COLOR COMBINATIONS resembling precious stones.

FADA RADIO AND ELECTRIC COMPANY, INC., LONG ISLAND CITY, N. Y.

LET ME TRAIN YOU

for RADIO ELECTRONICS & TELEVISION

I'll Supply a FULL RADIO SET

for SIMPLIFIED INSTRUCTION — PRACTICE & TESTING

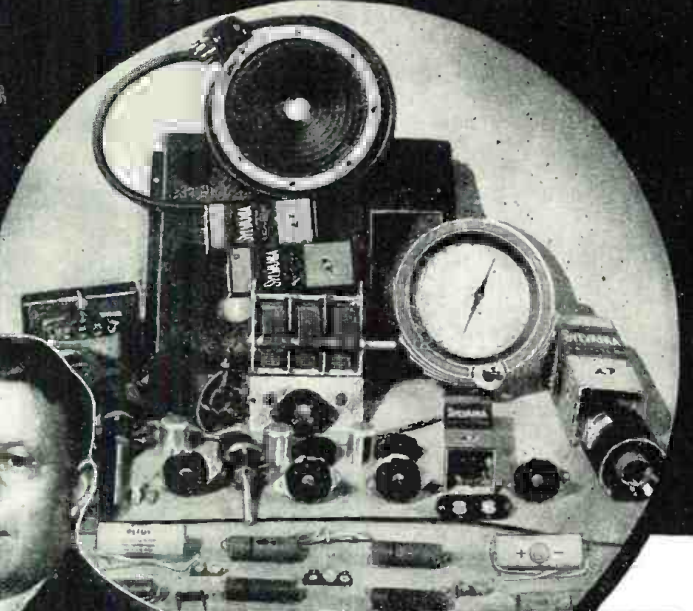
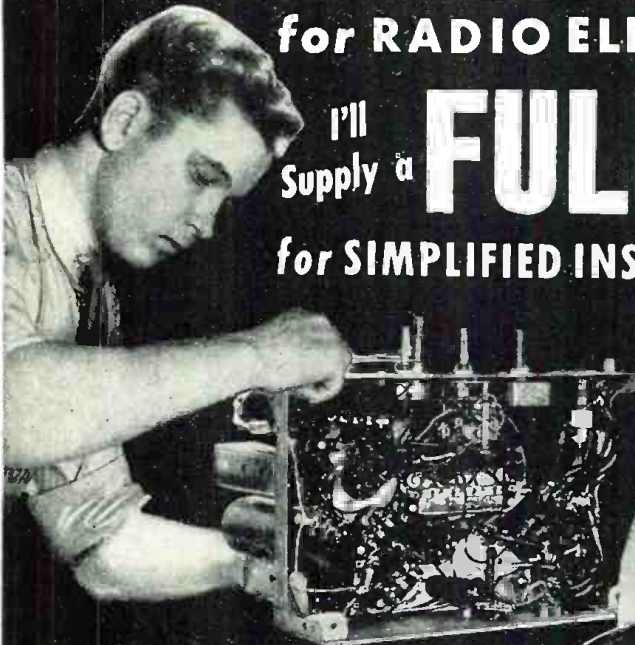

Beginners Learn FAST
START NOW! Big Developments
Ahead in F. M., Radar, Television



MAKE GOOD MONEY IN
a Business of Your Own
...or a Good Radio Job.

MIND training through *hand* practice with a **FULL RADIO SET** . . . that's the interesting way I'll teach you Radio. And it's the latest, most practical method of all to fix in your head permanently the essential money-making Radio knowledge. The offer I make you here is the opportunity of a lifetime. I'll prepare you easily and quickly for a wonderful future in the swiftly expanding field of Radio-Electronics INCLUDING Radio, Television, Frequency Modulation and Industrial Electronics. Be wise! **NOW'S** the time to start. Opportunities ahead are tremendous! No previous experience is necessary. The Sprayberry Course starts right at the beginning of Radio. You can't get lost. It gets the various subjects across in such a clear, simple way that you understand and remember. And you can master my entire course in your spare time . . . right at home.

You Do Practical Experiments
 There's only one *right* way to learn Radio Electronics. You must get it through simplified lesson study combined with actual "shop" practice under the personal guidance of a qualified Radio Teacher. It's exactly this way that Sprayberry trains you . . . supplying real Radio parts for learn-by-doing experience right at home. Thus, you learn faster, your understanding is clear-cut.

I'll Show You a New, Fast Way to Test Radio Sets Without Mfg. Equipment

The very same Radio Parts I supply with your Course for gaining pre-experience in Radio Repair work may be

adapted through an exclusive Sprayberry wiring procedure to serve for complete, fast, accurate Radio Receiver trouble-shooting. Thus, under Sprayberry methods, you do not have one cent of outlay for manufactured Test Equipment.

Succeed as a Radio-Electronician
 My training will give you the broad, fundamental principles so necessary as a background, no matter which branch of Radio you wish to specialize in. I make it easy for you to learn Radio Set Repair and Installation Work. I teach you how to install and repair Electronic Equipment. In fact, you'll be a fully qualified RADIO-ELECTRONICIAN, equipped with the skill and knowledge to perform efficiently and to make a wonderful success of yourself.

Read What Graduate Says
"One Job Nets About \$26.00"

"Since last week I fixed 7 radios, all good-paying jobs and right now I am working on an amplifier system. This job alone will net me about \$26.00. As long as my work keeps coming in this way, I have only one word to say and that is, 'thanks' to my Sprayberry training, and I am not afraid to boast about it."—ADRIEN BENJAMIN, North Grosvenordale, Conn.

DON'T PUT IT OFF!
 Get the facts about my training—now! Take the first important step toward the money-making future of your dreams. All features are fully explained in my big, illustrated **FREE** Catalog which comes to you along with another valuable **FREE** book you'll be glad to own.

FREE BOOKS

"How To Read Radio Diagrams and Symbols"

Here's a valuable and wonderfully complete new book which explains in simple, non-technical English how to read and understand any Radio Set Diagram. Provides the quick key to analyzing any Radio circuit. Includes translations of all Radio symbols. This instructive volume is yours for the asking—without obligation. Send for it **AT ONCE**, and along with it I will send you another big free book, describing in complete, interesting detail my Radio-Electronic training.

RUSH
COUPON
for BOTH



SPRAYBERRY ACADEMY OF RADIO
F. L. Sprayberry, President
Room 2566, Pueblo, Colorado

Please rush my **FREE** copies of "How to MAKE MONEY in RADIO, ELECTRONICS and TELEVISION," and "How to READ RADIO DIAGRAMS and SYMBOLS".

Name..... Age.....
 Address.....
 City..... State.....
 (Mail in envelope or paste on penny postcard)

MAIL COUPON AT ONCE!

June, 1946

*"The Standard
by Which
Others
Are Judged
and Valued"*

AUDAX has mastered wide-range so thoroughly that, today, even the lowest priced MICRODYNE has a range to 7000 cycles—(other models over 10,000 cycles). True,—wide-range makes for naturalness but,—it is highly objectionable if without quality. For example, of two singers, each capable of reaching high C, one may have a pleasing voice—the other, not at all. It is the same with pickups. To achieve EAR-ACCEPTABILITY, all other factors must be satisfied. Of these, VIBRATORY-MOMENTUM is most important. The only way to test EAR-ACCEPTABILITY of a pickup is to put it to the EAR-TEST. The sharp, clean-cut *facsimile* performance of MICRODYNE—regardless of climatic conditions—is a marvel to all who know that EAR-ACCEPTABILITY is the final criterion.

Audax

RELAYED-FLUX

Microdyne

Send for complimentary copy of
"PICK-UP
FACTS"



AUDAX COMPANY
500 Fifth Avenue,
New York 18

"Creators of Fine Electronic-Acoustical
Apparatus since 1915"

For the **RECORD.**

BY THE EDITOR

REAL trouble for the ham looms on the horizon unless individually he recognizes the fact that there are those among us that "stick our necks out" by violating rules and regulations that govern our conduct. We know, for example, that the RID is having its hands full in tracking down the illegal stations that add further to our problems. Many 80 meter boys "jumped the gun" and were heard many hours before the band opened officially. Several could be identified by their voices alone—others by the technique employed. No—they didn't use their call letters, but they were dopes to think they could conceal their identity.

The problem becomes so complex that no single organization can, by itself, solve these existing problems or take the entire responsibility for guiding amateur radio's future destiny. It is the duty of every amateur to help maintain a "dignified" hobby. If he fails—he will encourage the newcomers to be careless, selfish—yes, even reckless with his operations. He must face the fact that our ham bands will become even more overcrowded as thousands of new licenses are issued. We have no legal or moral right to discourage these new members by pointing to the "overcrowded" bands as a sample of what they're in for. It would be the same as telling new prospective car purchasers that the highways were so crowded that no more drivers licenses could be issued.

We think the most logical solution is to encourage the use of the higher frequencies. Here—new hams could "get their wings" and learn the ropes. Furthermore—equipment could be purchased or constructed for these frequencies that would be inexpensive to the newcomer. In addition—less power is required and directional antenna systems may be employed to get maximum coverage-per-watt. It should be stressed that, like any development, new techniques will be found and new equipment designed that will increase the effectiveness of the higher frequencies as time goes on.

Finding a solution to a problem is not difficult. But finding a solution to a problem that does not introduce other problems is difficult.

We must recognize the importance of cooperating with the FCC if we are to, in future years, demand more space on the air for the many hundreds of new hams. In numbers there is strength. This numerical strength

must, however, be augmented by our ability and willingness to conduct our hobby on a "prestige basis."

As reported in this column last month, the Radio Manufacturers Association has its own Amateur Radio Activities Section under capable leadership and with the "brainpower" needed to tackle the many problems facing the committee.

Being non-political and non-fraternal, the Amateur Committee can give its wholehearted attention to the task of establishing better standards for ham gear and to acting as a clearing house of information concerning new products needed by the amateur.

The main objective is to demonstrate the importance of amateur radio to the public and to promote the welfare and continued prosperity of ham radio.

The success of the Committee can, in our opinion, make a priceless contribution to the security of amateur radio as it "mushrooms" in years to come.

MUCH has been said and reams have been written about the necessity for the service engineer to apply modern scientific techniques and sound business practices to assure his success in the post war era. It takes no crystal gazer to predict that with the tremendous increase in varieties of radio models the need will be acute for some new short cut to accurate well organized service data. In the past the serviceman needed information on the products of only 36 receiver manufacturers whereas more than 1000 models of 212 radio and phonograph manufacturers will soon be on the market.

One company has already taken cognizance of this complex problem and is producing a radically different, high efficiency technical reference service. The radio service engineer who acquires this service will be provided not only with exhaustive technical data on radio receivers but will have access to the knowledge of a board of 30 specialists in radio, radar and radio servicing to help him solve problems relating to parts selection, shop operation, promotion, accounting and business methods.

The forward thinking of this organization assures servicemen of a pipeline to the two springs of knowledge requisite to their business success; practical well organized technical information and sound business practices. O.R.

For Earliest Delivery... **ORDER YOUR NEW COMMUNICATIONS RECEIVER**
Now from **ALLIED**

AVAILABLE ON
Time Payments
TRADE-INS ACCEPTED



RME 45

The new RME 45 Receiver delivers peak reception on all frequencies—500 to 33,000 Kc. Full vision calibrated dial using one control for two-speed tuning. Five Amateur bands with ample hand spread. DB calibrated signal level meter. 5 step variable crystal filter. Automatic Noise Suppression. Stable, variable pitch beat oscillator. Streamline cabinet with matching speaker. Net, with Speaker... **\$186**



HAMMARLUND HQ-129X

Designed to meet the most critical demands of professional operators. Full range .54 to 31 Mc., accurately calibrated. 4 calibrated Ham bands and one arbitrary scale. Variable selectivity crystal filter. Low drift beat oscillator for code and locating stations. Antenna compensator. Voltage regulation. Compensated oscillator to reduce drift during warm-up. Automatic noise limiter. Earphone jack. 3 i.f. amplifier stages. 2 audio stages. For phone or CW. Net..... **\$129**
 Speaker, net..... **\$10.50**

Other Communications Equipment

Hallicrafters S-38.....	\$ 39.50	BC-610 (HT-4) Transmitter....	\$535.00
New RME-84.....	98.70	350 Watt Mod. Transformer..	21.50
Hallicrafters SX-25.....	94.50	HT-9 Transmitter.....	250.00
RME DB-20 Preselector.....	59.30	Hallicrafters S-36A.....	307.50
RME VHF-152 Converter.....	86.60	Hammarlund 400X.....	318.00
National HRO.....	197.70	Hammarlund 400SX.....	318.00
Hallicrafters SX-28A.....	223.00	Hallicrafters S-37.....	591.75

Net, F. O. B. Chicago (All prices subject to change)



HALLICRAFTERS S-40

Sensational new Hallicrafters receiver! Offers many advanced design and performance features at a popular price. Simple to operate. Frequency range 550 Kc. to 44 Mc. in 4 bands. Wide vision main tuning dial accurately calibrated. Separate electrical Beat frequency oscillator. A.V.C. switch. CW/a.m. switch. Standby/receive switch. Automatic noise limiter. Separate RF and AF gain controls. Three position tone control. "Micro-set" permeability adjusted coils in RF section. Internal dynamic speaker. Net..... **\$79.50**

Model SM-40 External "S" Meter..... **\$15.00**

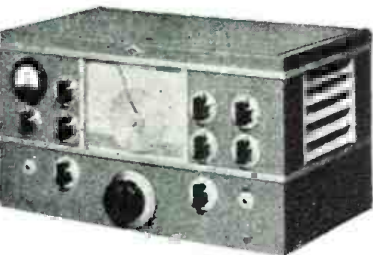

NATIONAL NC-2-40C

One of National's top receivers. 490 Kc. to 30 Mc. range in 6 tuning bands. Definite, accurate calibration for all bands. Actual single dial control. Stable high frequency circuits. Frequency drift reduction to a negligible value by temperature compensation. Automatic voltage stabilization. Wide range adjustable series-valve-noise limiter. Flexible crystal filter. Phonograph or high level microphone pick-up jack. Special r.f. coupling circuits maintain full sensitivity. Net..... **\$225**

Speaker in matching cabinet, net..... **\$15.00**

Free... **SEND NOW FOR ALLIED'S NEW 1946 CATALOG**



Here's your handiest, most complete 1946 Buying Guide for everything in radio! Includes latest communications receivers, Ham gear, code apparatus, parts, kits, tubes, tools, books, test instruments, public address and other equipment. 10,000 items at your finger tips... largest and most complete stocks under one roof. Nationally known makes. Fastest service—from one central source. Experienced staff of licensed radio amateurs to help you.

ALLIED RADIO CORP., D. L. Warner W9IBC
 833 West Jackson Blvd., Dept. 1-FF-6
 Chicago 7, Illinois

Please enter order for Date.....

Model.....

Enclosed \$..... Full Payment

Please send full information on Communications Receivers and Time Payment Plan, without obligation.

Send FREE new 1946 Allied Catalog.

Name.....

Address.....

City..... Zone..... State.....

ALLIED RADIO
Everything in Radio and Electronics
 833 West Jackson Blvd. • Chicago 7, Illinois

**THE NEW, COMPACT
SUPER-SENSITIVE**

Analyzer

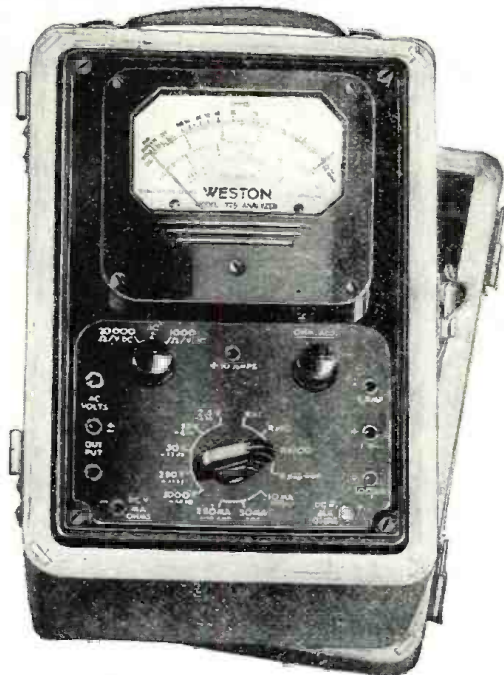

Weston

MODEL 779

Model 779 is designed for use with WESTON Socket Selectors which facilitate checking tube circuit conditions – and with WESTON Televerters for DC voltage measurements up to 10,000 volts.

Extreme compactness and lightweight—dual DC voltage sensitivity of either 1000 or 20,000 ohms per volt – five AC and DC voltage ranges, several DC current ranges, four DC resistance ranges, and five decibel ranges – all carefully selected to meet the broadest requirements of testing and maintenance – precision WESTON resistors throughout—large 50 microampere WESTON meter – temperature compensated including AC ranges – size only 6 $\frac{3}{8}$ " x 9 $\frac{1}{8}$ " x 4 $\frac{7}{8}$ " – furnished in rugged, solid oak carrying case.

NOW AVAILABLE . . . see Model 779 at the Radio Parts and Electronic Show . . . Stevens Hotel . . . Booth No. 75. Weston Electrical Instrument Corporation, 658 Frelinghuysen Avenue, Newark 5, New Jersey.

Weston Instruments

Albany · Atlanta · Boston · Buffalo · Chicago · Cincinnati · Cleveland · Dallas · Denver · Detroit · Jacksonville · Knoxville · Los Angeles · Meriden · Minneapolis · Newark · New Orleans · New York · Philadelphia · Phoenix · Pittsburgh · Rochester · San Francisco · Seattle · St. Louis · Syracuse · In Canada, Northern Electric Co., Ltd., Powerlite Devices, Ltd.

New!

Series 200

A RELAY BY GUARDIAN with Interchangeable Coils

BUILT IN TWO PARTS

A.C. Coil Assemblies available for 6 v., 12 v., 24 v., 115 v.
D.C. Coil Assemblies available for 6 v., 12 v., 24 v., 32 v., 110 v.

★ Two basic parts—a coil assembly and a contact assembly—comprise this simple, yet versatile relay. The coil assembly consists of the coil and field piece. The contact assembly consists of switch blades, armature, return spring, and mounting bracket. The coil and contact assembly are easily aligned by two locator pins on the back end of the contact assembly which fit into two holes on the coil assembly. They are then rigidly held together with the two screws and lock washers. Assembly takes only a few seconds and requires no adjustment on factory built units.

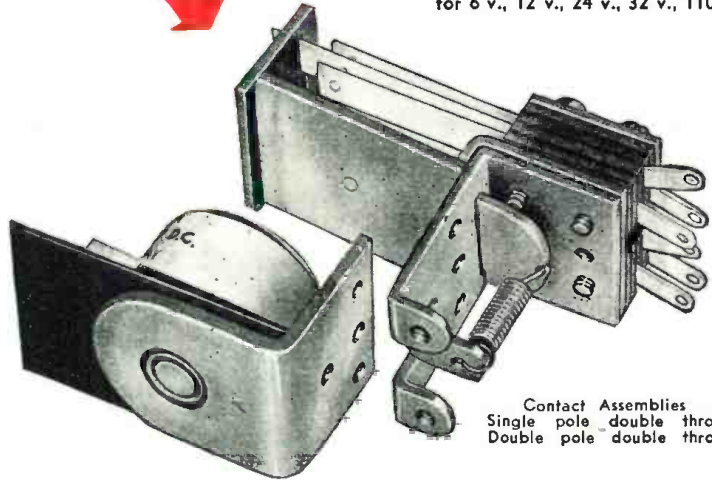

SERIES 200 RELAY

Contact Assemblies
Single pole double throw
Double pole double throw

On Sale at Your Nearest Jobber NOW!

See it today! . . . this amazing new relay with interchangeable coils. See how you can operate it on any of nine different a-c or d-c voltages—simply by changing the coil. Ideal for experimenters, inventors, engineers.

TWO CONTACT ASSEMBLIES

The Series 200 is available with a single pole double throw, or a double pole double throw contact assembly. In addition, a set of Series 200 Contact Switch Parts, which you can buy separately, enables you to build dozens of other combinations. Instructions in each box.

NINE COIL ASSEMBLIES

Four a-c coils and five d-c coils are available. Interchangeability of coils enables you to operate the Series 200 relay on one voltage or current and change it over to operate on another type simply by changing coils.



Your jobber has this sensational new relay on sale now. Ask him about it. Or write for descriptive bulletin.

GUARDIAN ELECTRIC

1630-G W. WALNUT STREET CHICAGO 12, ILLINOIS
A COMPLETE LINE OF RELAYS SERVING AMERICAN INDUSTRY

Designed for



Application

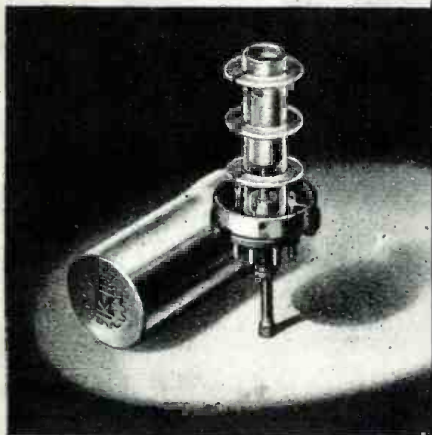

The No. 74001 Tunable Coil Form

Another new Millen "Designed for Application" product is the No. 74001 permeability tuned, shielded plug-in coil form. Standard octal base of low loss mica-filled Bakelite, polystyrene 1/2" diameter coil form, heavy aluminum shield, iron tuning slug of high frequency type, suitable for use up to 35 mc. Adjusting screw protrudes through center hole of standard octal socket. Special extension terminals facilitate connection to base pins.

**JAMES MILLEN
MFG. CO., INC.**

MAIN OFFICE AND FACTORY
**MALDEN
MASSACHUSETTS**



Spot Radio News

* Presenting latest information on the Radio Industry.

By **FRED HAMLIN**

Washington Editor, RADIO NEWS

RETURNED VETERANS planning to build FM stations were rightly disturbed by the recent Civilian Production Administration's ruling that you must get an okay from them before building any radio housing at a cost of more than a thousand dollars. Despite a prompt Federal Communications Commission statement saying that the CPA ruling was no cause for alarm, the fact remains that the CPA order will lead, at best, to a lot of trouble and red tape. Gravity of the situation was underlined when transmitter manufacturers immediately protested. They pointed out that unless the ban is modified to allow station construction up to \$15,000, as is permitted by CPA for so-called industrial enterprises, FM station construction will receive a body blow. Thousands of employees engaged in the manufacture of transmitting equipment will also be hard hit. Said Bond Geddes to CPA Administrator John Small: "Radio Manufacturers Association, representing virtually the entire industry, urgently requests a modification of the order which, in effect, stops all construction of radio broadcast stations and the development of regular broadcasting, as well as FM and television services." The National Association of Broadcasters also put in a strong protest.

FCC's COMMENT on the situation, while in part reassuring, did not eliminate the construction difficulties raised by CPA. FCC went on record favoring as many new stations as quickly as possible and added that "except for the actual housing structures and facilities, the construction of radio stations would have no adverse effect on the Veterans' Housing Program." CPA limitations, the FCC pointed out, do not halt building of radio towers, panel boards, transmitters, and the like, and the erection of new buildings can go forward even if exceeding a thousand dollars by getting the approval of the nearest CPA office. Ominous, however, were the closing sentences of the FCC statement. "By limiting the housing plans for radio stations to absolutely essential construction," the Commission advised, "a considerable number of permittees will be able to operate satisfactorily until material for more elaborate structures becomes avail-

able. Therefore, the FCC proposes to continue processing applications with the understanding that *the final decision as to whether construction will be authorized remains with the CPA*. The CPA wishes it emphasized that the issuance of a permit by the Commission does not mean that the required construction will be authorized. The FCC also stressed that requests for the interpretation of (the) Housing Order (limiting construction) should be addressed to the nearest Civilian Production Administration construction office and not to the Commission."

NEITHER AGENCY OFFERED an opinion on how much—or how little—housing could be built in the current high market under the low CPA thousand-dollar limit. The situation would seem to leave the potential small station builder with only two alternatives; build a shack under the CPA ceiling, tear it down when supplies become plentiful, and then build a permanent structure; or go to CPA and seek permission to spend more than a thousand dollars and do the job right in the first place. But as this goes to press, your chances of getting a CPA permit are poor. "We cannot say what policy the regional offices are going to follow regarding radio structures," a Civilian Production Administration spokesman told RADIO NEWS, "but we see no reason why they should make an exception for any broadcasting stations, FM or otherwise."

BRIGHTER OUTLOOK FOR VETERANS and small business men is found in a recent report by the Senate Small Business Committee on opportunities in the FM broadcasting field. The Committee recommended that FCC make all provisions necessary to encourage "modestly financed newcomers" and provide ample opportunity for expansion. Also recommended was "that the Commission undertake to keep the public fully informed of the development of new communications devices, that it encourage the widest possible participation in their development, and that it provide information and assistance to prospective applicants, both in Washington and in its various field offices." FCC's reaction to the Senate report was one of full

RADIO NEWS

Advanced international service demands advanced airborne radio

AS FAST as they are being delivered by the manufacturer, TWA's giant Constellations are writing a brilliant new performance chapter in the history of commercial aviation.

With an easy cruising speed of 300 miles per hour they are flying 51 passengers across the nation in 10 hours.

With a non-stop range of more than 5,000 miles they are speeding 41 passengers from New York to Europe in less than fourteen hours.

In point of time, TWA has suddenly reduced the earth's surface approximately fifty per cent in the last few months!

"This new standard of air travel is safe because it is not isolated," says TWA. "Besides exhaustive checks of equipment and flying conditions which precede all flights, the planes are in direct communication with land throughout. The principal means of long range communication is the Collins 17H-2 Autotune transmitting equipment. Duplicate sets of these transmitters are being installed in all TWA Constellations and DC-4's to be used in international service."

We will be glad of an opportunity to advise and quote on your requirements.

Collins Radio Company

Cedar Rapids, Iowa; 11 West 42nd Street, New York 18, N. Y.



IN RADIO COMMUNICATIONS, IT'S...





**WORKS LIKE A
SCREW DRIVER
Speeds Production!**

Standard
Sizes, Hex,
Square or Knurled,
Chuck Type with many
Tools for many uses
Radio and Electrical Shops
Need them

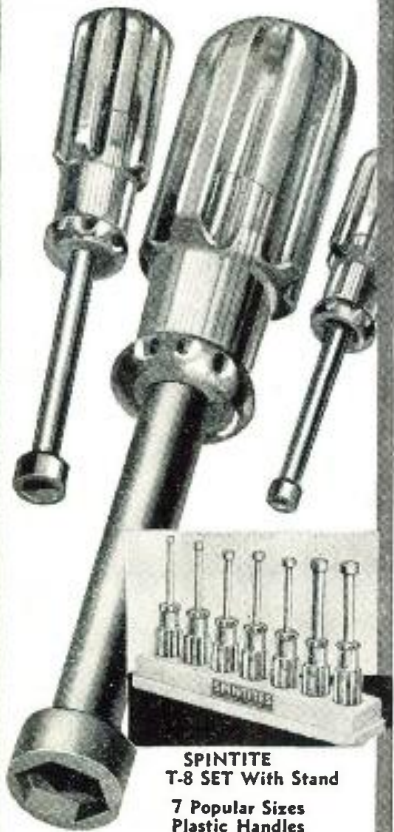

**SPINTITE
T-8 SET With Stand
7 Popular Sizes
Plastic Handles**

Send for Catalog No. 141 picturing a full line of Automobile Aircraft and Radio Tools

**WALDEN
WORCESTER
WRENCHES**

STEVENS WALDEN, INC.
468 SHREWSBURY STREET
WORCESTER, MASSACHUSETTS

agreement, and in connection with the last recommendation, called to the attention of anyone wishing to get into the FM field a recent FCC booklet, "How to Apply for an FM Broadcast Station Permit," available at FCC headquarters, Washington.

SPRING FORECASTS and reviews seemed otherwise to put the industry just around the corner from prosperity. E. A. Nicholas, president of the *Farnsworth Television and Radio Corp.*, pointed out that the industry now faces "a pent-up consumer demand for radios and radio-phonographs . . . estimated variously as high as 27 million sets." So eager are the customers going to be for new equipment that he warned dealers to take care to see that purchaser financing goes forward on "a sound financial basis." In this way, instead of "putting a customer into debt," the dealer actually "enhances the owner's individual assets and capital value." . . . Paralleling the Nicholas estimate of an eager general consumer market is the estimate from W. J. Halligan, president of *Hallcrafters Co.*, Chicago, and chairman of the RMA Amateur Activities Section, that the number of radio amateurs in this country may well grow from more than 60,000 to 250,000 or more within the next few years. He estimated that the job of providing amateurs with radio equipment may develop into a \$60,000,000-a-year business as contrasted with the pre-war high of only \$20,000,000.

A BATTLE IN COLOR seems indicated in the television-casting field following a late spring campaign led by Frank Stanton, president of the *Columbia Broadcasting System*, in which the values of black-and-white television were challenged. American advertisers and advertising agencies, Stanton declared, have indicated that they believe that "black-and-white cannot hope to survive against color's greater appeal." The statement followed a showing of color television at *CBS New York* headquarters. "The dwindling opponents of *CBS* television are hoping that the time consumed in FCC processes will postpone advent of color," Mr. Stanton declared. "I am confident that no one will fall prey to delaying tactics." FCC responded promptly that no "delaying tactics" would be tolerated, but that before color television can reach the public, hearings will have to be held and engineering proof furnished by the color partisans that they can give an adequate service in the 480-920 mc. band reserved for them. Following hearings, applicants can then apply for stations—but not until service in the band has been approved. FCC added that, as we go to press, no request for color hearings had been made by *CBS* or anybody else. *CBS* believes that such hearings will be requested "within the next few months." Rival black-

and-white, meantime, with its band already established, is going ahead with applications and sizable advances in service to the general public are predicted before the end of the year. Observers say it seems unlikely that color will become active in the field before that time, but that when it does begin operations, competition will be keen.

A TELEVISION ADVENTURE story which began twelve years ago was told in all its dramatic detail in Washington the other day when the Navy for the first time publicly demonstrated its war-time applications of airborne television. The story begins in the spring of 1934, when Dr. V. K. Zworykin, director of the electronic research laboratory of the *Radio Corporation of America*, learned that the Japanese were organizing Kamikaze (suicide) squadrons to control aerial weapons. Believing that the U. S. answer to such tactics in case of war should not commit American personnel to certain death, Dr. Zworykin proposed to explore the possibilities of a radio-controlled torpedo with an electric eye. The idea introduced "an entirely new principle in ballistics," the *RCA* engineer pointed out, "since in all (then) existing methods the operator has no way of controlling the projectile once it has been released." Work had progressed by the end of 1935 to the point where he and his associates were able to report the possibility of developing a radio-controlled magic-eye plane as well as a torpedo. As early as 1937, television research engineers at *RCA* under the direction of R. D. Kell made flight tests with airborne television transmitting equipment, and Waldemar J. Pock, an *RCA-Victor* development engineer, had solved many of the problems involved in reducing the size of the television equipment. Aerial television units weighing as little as 113 pounds were ready to go before we entered the war, and applications during the fighting, especially in the Pacific, more than offset the Jap Kamikaze squadrons. In sum, while we may have been caught flatfooted at Pearl Harbor, scientific vision was at work creating safeguards long before the shooting began.

ANTI-KAMIKAZE WAS NOT the only use for the airborne equipment, as the recent demonstration clearly illustrated. Perhaps the most dramatic use was in directing aerial battles. Planes equipped with transmitting units capable of sending high-quality television pictures up to 200 miles picked up battlefront scenes and action and transmitted them instantly to a bank of receivers at headquarters, where the command could not only see what was going on but, by means of radio, could give orders and issue warnings although many miles from

(Continued on page 98)

RADIO NEWS

See how readily YOU can train at home for BIGGER EARNINGS in RADIO ELECTRONICS



FREE KIT PACKET SHOWS HOW YOU CAN GET LOTS OF "LEARN-BY-DOING" RADIO EXPERIENCE AT HOME FROM DEFOREST'S THRILLING RADIO

"Home Laboratory"

133 EXPERIMENTS

DeForest's Kit Packets shows how you can get real Radio experience from the many standard Radio parts furnished you with DeForest's Training. See how you may quickly build Radio Circuits that work... how you may experiment with Photo Electric Cell "Magic"... a 5-Tube Superheterodyne Receiver... a Radio Telephone and scores of other fascinating projects. See how you get actual "shop training" at home to give you the practical Radio experience you need.

Now—you can see for yourself why DeForest's Training does such a grand job of preparing men for a bright future in one of America's most promising opportunity fields—Radio and Electronics. Send the coupon below for your free "Kit Packet" plus the big free book, "Victory For You!" that has helped so many to find the way to good pay jobs. You'll be surprised at the opportunities ahead of FM Radio, Aviation Radio, Broadcast Radio, a profitable Business of Your Own, Motion Picture Sound Equipment, and Electronics—plus the exciting future possibilities ahead of Television, Radar, etc. Train in your spare time at home—or get all of your training in our Chicago laboratories.

VETERANS!

Big things are happening at De Forest's for veterans! See how you can prepare yourself **without cost** for a GOOD JOB or BUSINESS OF YOUR OWN in the vast Radio-Electronic opportunity field.

DeFOREST'S PROVIDES ALL 3 HOME TRAINING AIDS

- A** DeVry Movie Projector and Learn-By-Seeing Movie Film
- B** Actual Radio Parts for working out 133 experiments
- C** 90 lessons prepared under the supervision of Dr. Lee DeForest—the "Father of Radio."

You Also Get EFFECTIVE EMPLOYMENT SERVICE

Upon completing your training, you get the full benefit of DeForest's Employment Service that has helped so many men to get started in the Radio-Electronic field.



DeFOREST'S TRAINING INCLUDES INSTRUCTION IN MOTION PICTURE SOUND EQUIPMENT, FM RADIO AND TELEVISION RESIDENTIAL TRAINING IN OUR MODERN CHICAGO LABORATORIES ALSO AVAILABLE — ASK US FOR INFORMATION!

E. B. DeVry, President
DeFOREST'S TRAINING, INC.
2535-41 North Ashland Ave., Dept. RN-C6
Chicago 14, Illinois, U.S.A.

Send FREE RADIO KIT PACKET and "VICTORY FOR YOU!" BOOK.

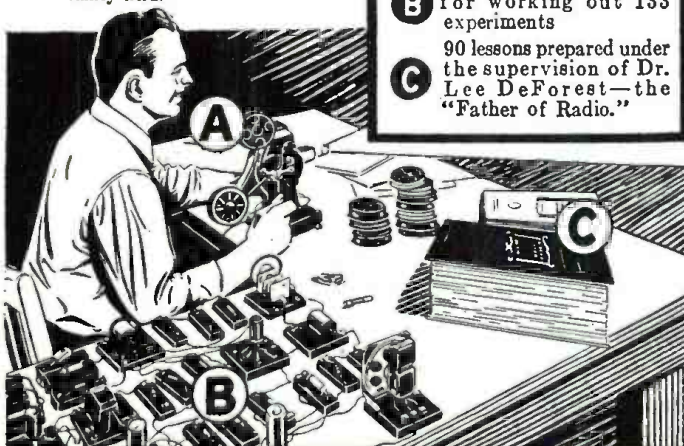

Name _____ Age _____
 Address _____ Apt. _____
 City _____ Zone _____ State _____
 If under 16, check here for special information. If a discharged Veteran of World War II, check here.

DeFOREST'S TRAINING, INC.
CHICAGO 14, ILLINOIS



Techniquality

Every product that enjoys the full confidence of those who use it has its "priceless ingredient." In Bliley crystals it's "techniquality."

Cutting, grinding, and finishing alone do not transform raw quartz into a sensitive frequency control device. Behind these operations there must be a background of technical skill and creative engineering that is gained only through years of experience.

Bliley crystals have a reputation for "techniquality" that started fifteen years ago. Today, the fact that Bliley crystals are used in practically every phase of radio communications is tacit proof that leading engineers have found it is best to specify Bliley "techniquality" crystals.

Bulletin 27 describes the crystal units engineered for the needs of today. Write for your copy.



Bliley
CRYSTALS

New! Exclusive! Ready Now!

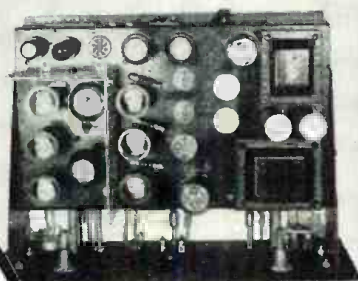

*The Sensation
of the Year!*

WRL
Globe Trotter
25 WATT OUTPUT
TRANSMITTER
KIT

Transmitter kits are almost impossible to get, but Leo, W9GFQ, now offers amateurs the new WRL Globe-Trotter, destined to become one of the most popular kits on the market. The WRL Globe-Trotter is capable of 25 Watts output on all bands from 3500 KC through 28 Mega-cycles. Incorporates the proven Tritet Oscillator using a 40 metal X-Tal and providing sufficient drive at 10 meters for the 807 final. Heising choke modulation is incorporated and is capable of 100% modulation with good tonal quality. Look this over! It has everything! Three bands are all pretuned and available at the turn of a switch, 10, 20, and 80 meters. Metering is provided for both oscillator and final stages. The transmitter uses two power supplies, one furnishing power to the 807 final and modulator tubes, and the other supplying the speech, amplifier and oscillator stage. Tube Line Up: RF—6L6 OSC, 807 final amplifier; Audio—6SJ7, 6N7, 2-6V6S—Rectifiers, 2-5U4G.

NEW
BC 348Q
RECEIVERS

Original government price over \$200.

\$85.00

Including steel case. Speaker furnished at small added cost. Cat. No. 35-61.

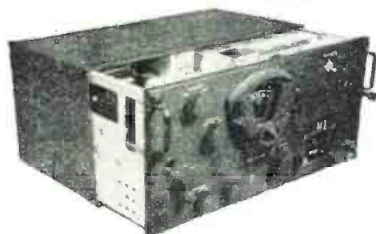

Here is one of the hottest war-surplus receivers that will be available. 9 tubes, 2 tuned RF stages, 3 stages of IF amplification. Frequency range, 200 to 500 kilocycles; 1 1/2 to 18 MC in four bands. Tunes weather and aircraft bands, and all ham bands except 10 meters. Ask about our special converter for 10 meter operation.

BC-610 (Hallicrafters HT-4E) TRANSMITTERS

Counterpart of the famous SCR-299. 625 watts input on CW, 540 watts input on Phone; 3 sets of coils. Range of 1 1/2 to 18 Meg. Completely reconditioned, Cat. No. R70-202, \$510.00—New Cat. No. 70-202, \$760.00. Reconditioned or new sets converted to 10 meters, \$25 extra.

Giant Radio Reference Map with time and amateur zones, standard and short wave stations, and other valuable information. Printed in colors. Size 3 1/2 x 4 1/2 feet. Only 15c

Write for our latest flyer of radio parts. FREE!

Complete kit including all parts, chassis, panel, streamlined cabinet less tubes, coils and meters. **\$59⁹⁵**

Cat. No. 70-300

Kit Same as above. Wired by our engineers
Cat. No. 70-312. **\$75.00**

ACCESSORIES

- Complete kit of 8 Tubes
Cat. No. 70-314. \$5.95
- 3 in. Meter Cat. No. 70-318. 4.95
- Coils per set (any band)
Cat. No. 70-316. 2.95
- Crystals-40-80 Meters Mts.
Cat. No. 70-322. ea. 2.65
- Quality Crystal Mike and Stand
Cat. No. 70-320. 9.45



Formerly Wholesale Radio Laboratories

Address Dept. RN-6, Council Bluffs, Iowa

SIX NEWSWORTHY RADIO ITEMS

VOLUME XV RIDER MANUAL

Now in Preparation

For sixteen years Rider Manuals have been recognized for their leadership in practical presentation of servicing data. In Volume XV, this leadership reaches new heights and will result in the offering of material elsewhere unavailable. Our laboratories are developing data on the new sets that will save hundreds of hours of servicing time for loyal users of Rider Manuals. In the meantime check the list below—place your order for any missing volume today—to assure earliest possible delivery.

RIDER MANUALS (14 VOLUMES)

Volumes XIV to VII . . . \$15.00 each volume
Volume VI \$11.00
Abridged Manuals I to V (I Vol.) . . . 17.50
Record Changers and Recorders . . . 9.00

Shipments of Rider Manuals
are increasing Each Month

**RIDER MANUALS
MAKE SERVICING
EASIER**

INSIDE THE VACUUM TUBE

This typical Rider Book offers a new approach and technique that makes its message easy to understand. Here is a solid, elementary concept of the theory and operation of the basic types of vacuum tubes.

Many diagrams and graphs are repeated to minimize the turning of pages in reading text and drawings. Anaglyphs give "three-dimensional" pictures of phenomena heretofore seen only in two dimensions.

Although an elementary book on a fundamental subject, therefore a goldmine for the student; it is a must for the libraries of servicemen, amateurs and engineers.

JUST OUT

425 pages \$4.50

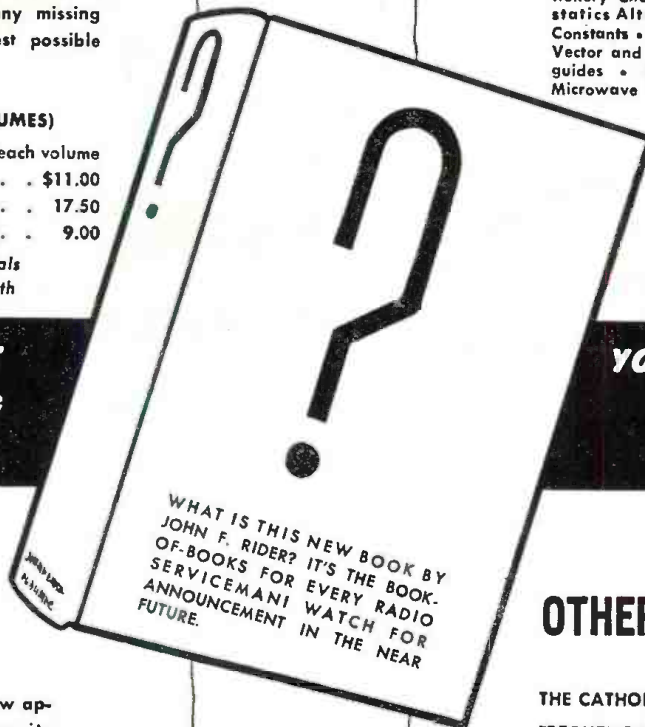

Publication Resumed with June Issue!

Get on the Mailing List for "Successful Servicing"

A monthly paper, dedicated to the financial and technical advancement of the electronic and radio maintenance man. Free distribution—Just

MAIL COUPON

JOHN F. RIDER PUBLISHER, INC.
404 (a) FOURTH AVE., NEW YORK, N. Y.

NAME _____
ADDRESS _____
CITY _____
STATE _____

UNDERSTANDING MICROWAVES

For those who have not previously considered radio waves shorter than 10 centimeters. Provides foundation for understanding various microwave developments of past five years. To simplify explanations, mathematics are placed in footnotes wherever possible.

CHAPTER HEADS

The Ultra High Frequency Concept • Stationary Charge and its Field • Magneto-statics Alternating Current and Lumped Constants • Transmission Lines • Poynting's Vector and Maxwell's Equations • Waveguides • Resonant Cavities • Antennas Microwave Oscillators • Radar and Communication • Section Two is devoted to descriptions of Microwave Terms, Ideas and Theorems.

JUST OUT

Over 400 pages \$6.00

**YOU MUST STUDY
TO KEEP
UP TO DATE**

OTHER RIDER BOOKS

THE CATHODE RAY TUBE AT WORK \$4.00
FREQUENCY MODULATION . . . \$2.00
SERVICING BY SIGNAL TRACING . \$4.00
THE METER AT WORK \$2.00
THE OSCILLATOR AT WORK . . . \$2.50
VACUUM TUBE VOLTMETERS . . . \$2.50
AUTOMATIC FREQUENCY
CONTROL \$1.75

AN-HOUR-A-DAY-WITH-RIDER SERIES —
on "Alternating Currents in Radio Receivers," on "Resonance & Alignment," on "Automatic Volume Control," on "D.C. Voltage Distribution." Hard bindings \$1.25 ea.

JOHN F. RIDER, Publisher Inc. 404 Fourth Ave., New York 16, N.Y.

EXPORT DIVISION: ROCKE-INTERNATIONAL CORP. • 13 E. 40th St., New York City • Cable: ARLAB

Where will you be when the **GOLD RUSH** is over?

The answer to that question will be decided by the way you promote your service business now! The farther you fall behind in your service calls, the more important sound promotion of your business becomes. That is why Cornell-Dubilier has developed for you a 1946 sales promotion program that looks ahead to 1948. Here is a plan—written for you—by people who know your problems! It is just as you would prepare it if you had the time and money. That is why we urge you to see your local C-D jobber today. He has the full details on this hard-hitting sales program—designed especially for you! **GET THEM NOW!**



**HERE ARE YOUR NEW 'LEGMEN'—
AVAILABLE THROUGH YOUR LOCAL C-D JOBBER**



NEWSPAPER MATS—all ready—just deliver to your local newspaper.

WINDOW CARDS—sell you as a reliable service shop to the community.

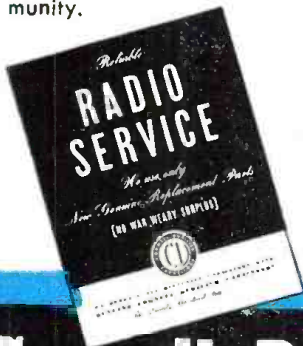

POST CARDS—with your name! Will keep your regular customers sold on your shop!

DECALS—identify you as a user of top quality replacement parts.



LET YOURSELF GROW WITH A QUALITY LINE!



Here's a capacitor you should get acquainted with. These E-Z's are the most practical, all around replacement units available. They incorporate C-D's superior features which give them C-D's longer lasting quality.

KEEP UP-TO-DATE WITH THE "CAPACITOR"



The one and only pocket-sized encyclopedia of radio technical data. Keep up to date on new condensed, easy-to-read style. **FREE**, every month. Get on the mailing list now. Write: Cornell Dubilier Electric Corp., South Plainfield, New Jersey.

Cornell-Dubilier WORLD'S LARGEST MANUFACTURER OF Capacitors



MICA • DYKANOL • PAPER • ELECTROLYTICS



Yes, or alike as two telephone handsets made by the same process. Yet, pins or handsets — no two could ever be made exactly alike. Dimensions, weight, performance—all vary every time due to variables in manufacture. How can these variables be controlled?

Back in 1924, Bell Laboratories' mathematicians and engineers teamed up to find out, forming the first group of quality-control specialists in history. They invented the now familiar Quality Control Chart, designed inspection tables for scientific sampling. They discovered that test data mathematically charted in the light of probability theory were talking a language that could be read for the benefit of all industry.

Western Electric, manufacturing branch of the Bell System, applied the new science to its large-scale production. In war, it was used by industrial and government agencies of the United Nations in establishing and maintaining standards for military matériel. A Quality Assurance Department, a novelty back in the nineteen-twenties, has come to be indispensable to almost every important manufacturer.

Scientific quality control is one of many Bell Laboratories' ideas that have born fruit in the Bell System. The application of mathematics to production helps good management all over the industrial world — and furthers the cause of good telephone service.



BELL TELEPHONE LABORATORIES

EXPLORING AND INVENTING, DEVISING AND PERFECTING FOR CONTINUED IMPROVEMENTS AND ECONOMIES IN TELEPHONE SERVICE.

Grasp the **NEW OPPORTUNITIES** in

RADIO ELECTRONICS AND TELEVISION NOW!



Modern Radio—FM broadcast and reception—
Television—Radar—Industrial Electronics;
power, control, communications—new equip-
ment and methods demand new technical ability
and experience. Keep up to date with the latest

MODERN ELECTRONIC LABORATORY FOR YOU TO USE AND KEEP

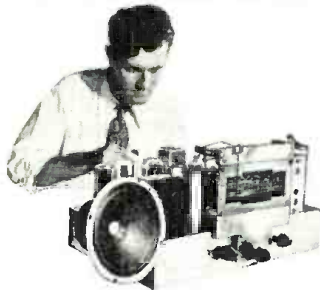

The very essence of National Shop Method Home Training is **EXPERIENCE**. You get the actual experience by working with modern Radio and Electronic equipment—building circuits and instruments. You may build a fine, long distance **MODERN SUPERHETERODYNE**, signal generator, miniature radio transmitter, audio oscillator—many other full sized, actual, operating pieces of equipment and instruments—conduct cathode ray and hundreds of other experiments. This experimental laboratory work advances with your training and you actually *learn by doing*. Send the coupon and get the full details of how such an offer can be made.

SEE WHAT NATIONAL TRAINING HAS DONE FOR THESE MEN!

National Shop Method Home Training wins good jobs, independence and security quickly. Take the word of National men who have established records in their favorite Radio, Television, or other branches of Electronics:



Joseph Grumlich, Lake Hiawatha, New Jersey writes: "My latest offer was \$5,800.00 as

Radio Photo Engineer but I'm doing well where I am now engaged. I am deeply indebted to National."

Here's a statement from R. R. Wright, Blackfoot, Idaho: "Due to my training at National I was selected to instruct in the laboratory work of Navy and Marines."



From O. K. Ivey, Washington, D. C., comes this endorsement: "I believe National offers the best course to be had. Keep up the good work."

Robert Admisen, Kearney, Nebraska, National graduate, has two radio jobs—makes double pay as a radio instructor and as engineer at Station KGFV. He writes:

"I am proud of my National training and appreciate the cooperative spirit."



Read what hundreds of other enthusiastic students have written about National Training. Send in your coupon today.

SHOP METHOD HOME TRAINING

By a Great Established Resident School

Get one of the thousands of **NEW JOBS** that demand new techniques and methods in modern radio. Get your share of the **NEW BUSINESS** that servicing the new sets and equipment demands. Experts agree that Radio Television and Electronics presents the next great industrial boom!

Radio is expanding farther and faster than ever with great improvements in reception. Radar is already a 2-billion-dollar-a-year business. No one knows yet how great the Television market will be. Electronics touches almost every walk of life—in industry and in the home.

TURN YOUR INTEREST IN RADIO INTO A CAREER THAT WILL ASSURE YOUR SUCCESS. Mail the coupon below for a list of the great opportunities in this field—today and in the near future.

Get the Proper Training

The goal jobs in Radio Electronics now go to the men who are equipped to handle them. It takes training and experience. National Schools, one of the oldest and best established technical trade schools in the country, makes it possible for you to get this training and experience right in your own home **IN YOUR SPARE TIME**.

National maintains one of the biggest resident training shops and laboratories in the United States where

instructors, scientists and engineers are working constantly to improve and advance training methods. **SHOP METHOD HOME TRAINING** is a logical extension of this practical system.

A **FREE** lesson that shows you how practical and systematic—how sound, simple and easy this new training method is will be sent you without obligation. You may keep and use this lesson as you see fit. Fill out and mail the coupon below.

Investigate this Proposition

Where do you stand today in modern industrial progress? What does the future hold for you? You owe yourself this opportunity. It may never come again. With National training **YOU GET AHEAD FAST**—you may step into a good position or start business of your own, with little or no capital, even before you complete your National course.

Fit yourself for a career of independence, good earnings, a lifetime of success and security in one of the fastest growing fields in the World. But make up your own mind. Get the information first hand. Put your name and address on the coupon and mail it today.

**Learn right!
Get the latest short cuts, trade secrets, straight information.**



Get this Book FREE

This big book presents the facts about the field of electronics and your opportunities in it together with full information about the advanced National Training. Read it and make up your own mind that National Training will equip you for a great future. No salesman will call on you from National. The book is **FREE** with your sample lesson. Send the coupon or write.

FREE LESSON

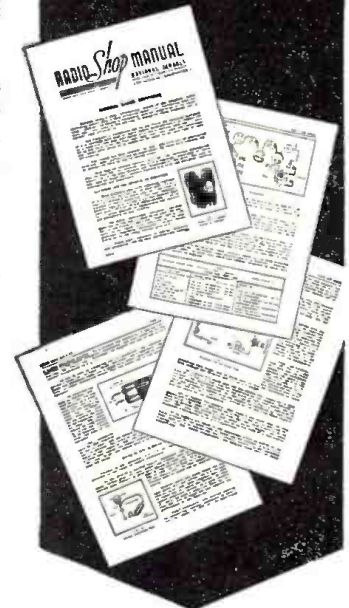

NATIONAL SCHOOLS

LOS ANGELES 37, CALIFORNIA EST. 1905



MAIL OPPORTUNITY COUPON FOR QUICK ACTION

National Schools, Dept. RN-6

4000 South Figueroa Street, Los Angeles 37, California

(Mail in envelope or paste on Penny post card)

Mail me **FREE** the two books mentioned in your ad including a sample lesson of your course. I understand no salesman will call on me.

NAME AGE

ADDRESS

CITY STATE

Include your zone number

A STAR PERFORMER.



PROVED BY THE YEARS

NOW BETTER THAN EVER

- ★ INTEGRATED DESIGN
- ★ IMPROVED CIRCUIT
- ★ MOTOR TUNING
- ★ SHOWMANSHIP

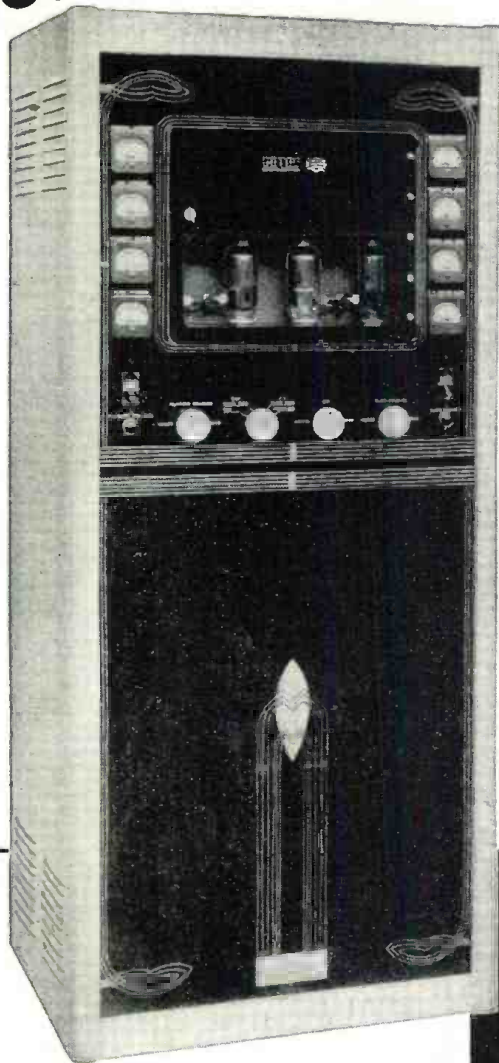

Broadcasting Stations Everywhere Applaud Its Stellar Dependability

The test was the crucial years just past when sheer dependability was paramount—when even normal maintenance and spare parts were in direct ratio to prevailing shortages. This Unit won the applause of Stations everywhere for dogged, trouble-free service, and we are proud to offer it now with added improvements that further distinguish its super performance and GATES superior engineering.

THE Gates

250-C TRANSMITTER — 250 WATTS

—gives your Station a new efficiency in broadcasting technique. Its proved design assures that It is superior for its INTEGRATED DESIGN embodied in the new, structural layout rendering visibility and accessibility an easy procedure. Engineers will like this GATES achievement. The Front Panel is also designed to contribute a maximum effect to "showmanship"—another must for broadcasting stations.

Engineered to Meet Modern Demands

The Schematic Diagram at the right shows the fundamental circuits of this Unit—straightforward—properly applied—to obtain the best operation. Added is the distinguishing feature of MOTOR TUNING for the tuning adjustments of the final stage and loading to the antenna—another EXCLUSIVE for the GATES 250 C. Also, there are but TWO controls for the entire tuning procedure, for simplicity. These are only a few of its outstanding superiorities in engineering design.

WRITE FOR COMPLETE SPECIFICATIONS

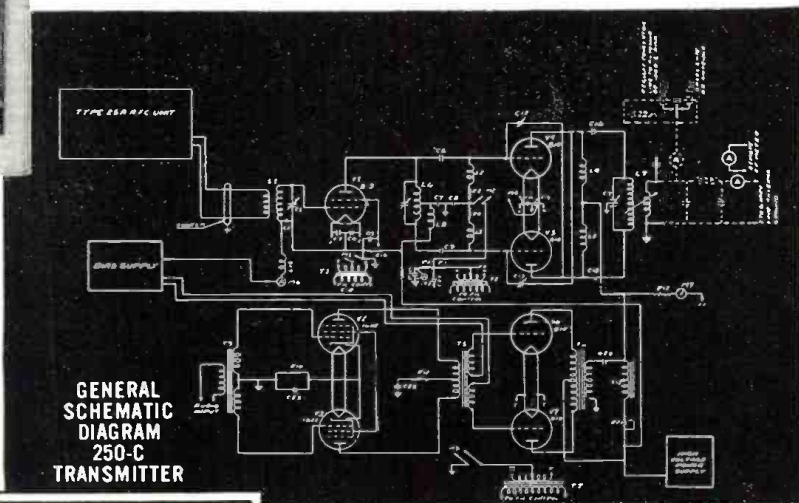

GENERAL SCHEMATIC DIAGRAM 250-C TRANSMITTER

NEW YORK OFFICE:
9th Floor • 40 Exchange Place

GATES
RADIO CO.
QUINCY, ILLINOIS

SOLD IN CANADA BY:
Canadian Marconi Co.,
Ltd., Montreal

EXCLUSIVE MANUFACTURERS OF RADIO TRANSMITTING EQUIPMENT... SINCE 1922

PLEASE PLACE YOUR ORDER WITH YOUR REGULAR RADIO PARTS JOBBER. IF YOUR LOCAL JOBBER CANNOT SUPPLY YOU, KINDLY WRITE FOR A LIST OF JOBBERS IN YOUR STATE WHO DO DISTRIBUTE OUR INSTRUMENTS OR SEND YOUR ORDER DIRECTLY TO US.



The New Model CA-11 SIGNAL TRACER

Simple to operate . . . because signal intensity readings are indicated directly on the meter!

Essentially "Signal Tracing" means following the signal in a radio receiver and using the signal itself as a basis of measurement and as a means of locating the cause of trouble. In the CA-11 the Detector Probe is used to follow the signal from the antenna to the speaker — with relative signal intensity readings available on the scale of the meter which is calibrated to permit constant comparison of signal intensity as the probe is moved to follow the signal through the various stages.

Features:

- ★ SIMPLE TO OPERATE — only 1 connecting cable — NO TUNING CONTROLS.
- ★ HIGHLY SENSITIVE — uses an improved Vacuum Tube Voltmeter circuit.
- ★ Tube and resistor-capacity network are built into the Detector Probe.
- ★ COMPLETELY PORTABLE — weighs 5 lbs. and measures 5" x 6" x 7".
- ★ Comparative Signal Intensity readings are indicated directly on the meter as the Detector Probe is moved to follow the Signal from Antenna to Speaker.
- ★ Provision is made for insertion of phones.

The Model CA-11 comes housed in a beautiful hand-rubbed wooden cabinet. Complete with Probe, test leads and instructions.....Net price

\$18⁷⁵

The New Model 450 TUBE TESTER



Specifications:

- Tests all tubes up to 117 Volts including 4, 5, 6, 7, 7L, Octals, Loctals, Bantam Junior, Peanut, Television, Magic Eye, Hearing Aid, Thyratrons, Single Ended, Floating Filament, Mercury Vapor Rectifiers, etc. Also Pilot Lights.
- Tests by the well-established emission method for tube quality, directly read on the scale of the meter.
- Tests shorts and leakages up to 3 Megohms in all tubes.
- Tests individual sections such as diodes, triodes, pentodes, etc., in multi-purpose tubes.
- New type line voltage adjuster.
- NOISE TEST: Tip jacks on front panel for plugging in either phones or external amplifier will detect microphonic tubes or noise due to faulty elements and loose internal connections.
- Works on 90 to 125 Volts 60 Cycles A.C.

SPEEDY OPERATION assured by newly designed rotary selector switch which replaces the usual snap, toggle, or lever action switches.

The model 450 comes complete with all operating instructions. Size 13"x12"x6". Net weight 8 lbs. **\$39⁵⁰** Our Net Price.....

New Model 400 ELECTRONIC MULTI-METER

A Combination Vacuum-Tube Voltmeter and Volt-Ohm Milliammeter *plus* Capacity, Inductance, Reactance, & Decibel Measurements



Specifications:

- D.C. V.T.V.M. VOLTS: 0 to 3/15/30/75/150/300/750/1500/3000 Volts
 - D.C. VOLTS: (At 1,000 Ohms Per Volt) 0 to 3/15/30/75/150/300/750/1500/3000 Volts
 - A.C. VOLTS: (At 1,000 Ohms Per Volt) 0 to 3/15/30/75/150/300/750/1500/3000 Volts
 - D.C. CURRENT: 0 to 3/15/30/75/150/300/750 Ma. 0 to 3/15 Amperes
 - RESISTANCE: 0 to 1,000/10,000/100,000 Ohms 0 to 1/10/1,000 Megohms
 - CAPACITY: (In MFD) .0005—.2 .05—20 .5—200
 - REACTANCE: 10 to 5M (Ohms) 100—50M (Ohms) .01—5 (Megohms)
 - INDUCTANCE: (In Henries) .035—14 .35—140 35—14,000
 - DECIBELS: —10 to +18 +10 to +38 +30 to +58
- The model 400 comes housed in a rugged crackle-finished steel cabinet complete with batteries, two sets of test leads, one set of V.T.V.M. probes and instructions. **\$52⁵⁰** Size 5½" x 9½" x 10".....Net



SUPERIOR INSTRUMENTS CO.

Dept. R.N. 227 FULTON ST., NEW YORK 7, N. Y.

FULLY SHIELDED



The "Super-Pro's" high-fidelity amplifier provides excellent broadcast quality — fine for use with record players when DX isn't coming through.

"SUPER PRO"

Series 400

.54-30 MC.

If you are troubled with spurious beats and images from powerful stations, you need a "Super-Pro." Complete shielding right up to the antenna terminals is one of the many features of the new Series 400 "Super-Pro."



ESTABLISHED 1910

HAMMARLUND

THE HAMMARLUND MFG. CO., INC., 460 W. 34TH ST., NEW YORK 1, N. Y.
MANUFACTURERS OF PRECISION COMMUNICATIONS EQUIPMENT

Photo-Electronic Organ

By
ROLLIN E. CAMPBELL
and
LYMAN E. GREENLEE

THE authors devoted more than a year to working out this design, mostly by a process of trial and error, and in building the model in its final form. The results have been very gratifying in every respect. In its present form, the instrument is simple and easily built and works surprisingly well. It will stand a lot of punishment and hard knocks. Furthermore, the authors feel that the design is sufficiently off the beaten path that it may well open up a whole new field of research and development in music to be reproduced from recorded or hand drawn tone patterns. The tone may be changed by altering the pattern, and this field is limitless in its scope. We are now working on several new designs for tone wheels designed to reproduce various types and kinds of musical notes, and some of these contain combinations of fundamentals and overtones that have never been heard before. At least they do not resemble the notes of any existing musical instrument that we have heard.

As to the tone quality of the Photo-Electronic Organ—it is different from that of any other existing musical instrument. While it may be described as an organ-tone, that description is inadequate, because there are certain fundamental differences between existing organs and this new instrument. Because of these differences, the Photo-Electronic Organ has an individuality of tone quality all its own. This does not mean, however, that the tone quality is either more or less pleasing than that of other musical instruments. Such things are usually a matter of individual preference anyhow.

Most amateurs and radio engineers who have planned to build some sort of electronic musical instrument, have been discouraged by the expense and effort involved. Here is a design that is fairly simple and cheap to build. Parts may be obtained from the junk box, local hardware stores, and regular radio parts jobbers. The cost of parts will vary, depending on how much salvaged material can be used, but should not exceed \$150.00. Anyone who has a small lathe and drill press, and who is reasonably handy with tools, should have no serious difficulty in making the instrument and



Fig. 1. Finished model of the Photo-Electronic Organ.

Part 1. With proper equipment, leisure time, and mechanical ability, this electronic organ is within the reach of the average home.

getting it to work properly. The principles involved are simple and only an elementary knowledge of radio and electronics is needed to understand them; in fact, the Photo-Electronic Organ can be built by any good mechanic regardless of previous knowledge of the subject. The results, as measured in terms of the satisfaction of being able to build and own such an instrument, far outweigh the expense and effort involved in its construction.

Basic Principles Involved

The fundamental principles involved are well known. A beam of light shining through a rotating wheel having a tone pattern printed thereon, passes through a simple shutter and is reflected by a mirror onto a photocell. The secret of the success of the Photo-Electronic Organ is in the design and construction of the tone wheel and associated mechanism. Actually, the construction of a suitable tone wheel is the most important

and most difficult part of the whole project.

A study of the photographs and drawings will show the basic simplicity of the design. Fig. 1 shows the finished model of the Photo-Electronic Organ as it appears while in use in the home. Figs. 2 and 5 show the octave unit assembly which includes the keyboard, the shutter action, the lights, tone wheels, driving belts and pulleys, mirrors, and photocell mounting. This self-contained unit, which is mounted on a piece of plywood $\frac{5}{8}$ " x 15" x 38", comprises all the working parts of the organ with the exception of the power supply, driving motor, swell pedal control, amplifier and speaker. The tones are generated by means of the five wheels shown in Figs. 2 and 5. There are five of these tone wheels in the completed organ, and each wheel reproduces one octave or twelve notes of music. A slightly modified scale is used, and the frequencies differ slightly from those employed in other instruments. No

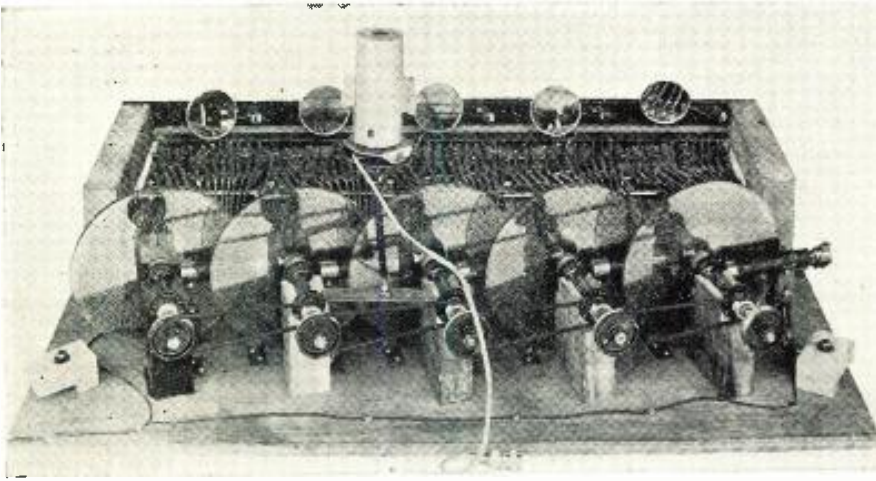

Fig. 2. The five octave unit assemblies can be clearly seen in this photo.

musician who has listened to the organ has been able to detect these differences in frequency.

The block diagram of Fig. 4 will also help to illustrate the principles involved. Each tone wheel is driven at the required speed by a motor, and the speed of rotation determines the frequency (number of vibrations per second) of the notes being played. Light from the specially prepared lamp shines on the tone wheel through a narrow slit and is stopped by a shutter bar until a key is depressed. Depressing a key, lifts the shutter bar to allow light to pass through the tone wheel to the mirror and from there to be reflected to the photocell to be translated into electrical impulses

capable of amplification and reproduction through the loudspeaker. The volume control is unique and consists of a diffusing disc. This disc controls the volume by limiting the light reaching the photocell. Such a control has the advantage of fast action without mechanical noise or wear. This control is used to supplement the regular control on the amplifier, and is attached to a swell pedal mounted on the front of the organ.

The Tone Wheel

The heart of the Photo-Electronic Organ is the tone wheels shown in Figs. 2 and 5. Each wheel will reproduce one octave of music, since there

Fig. 3. Schematic diagram of the electronic organ. It is simple and uses a minimum of parts. (A) diagram of power supply, (B) photocell wiring. An audio amplifier is not shown as it is assumed that constructor has such a unit available.

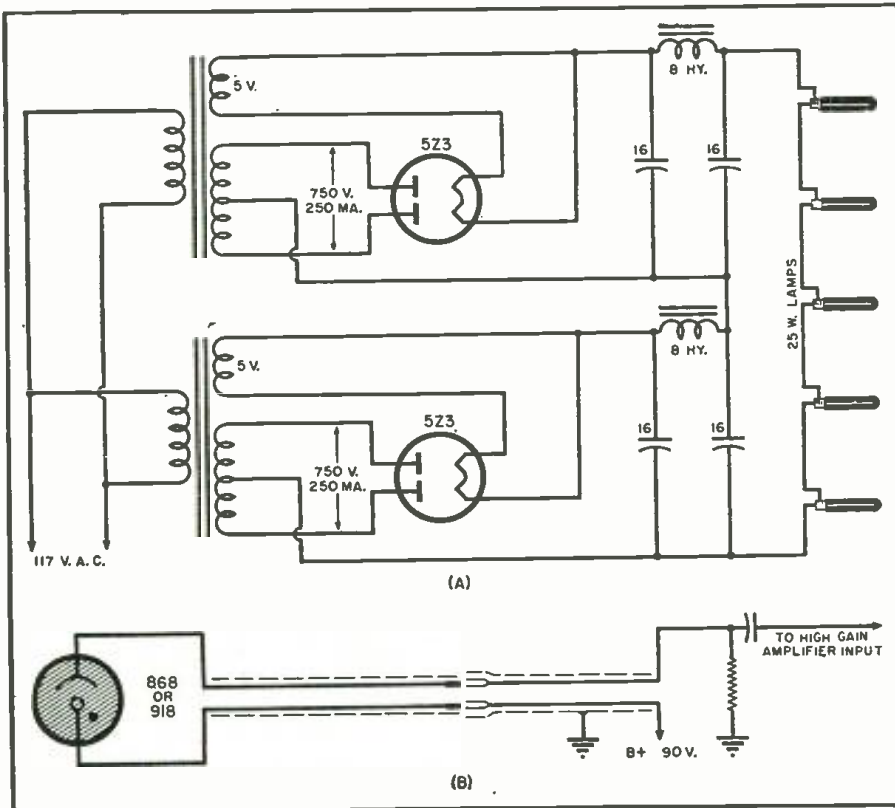

are twelve rows of tone patterns arranged in proper sequence. The five tone wheels are exact duplicates, but when one is run at twice the speed of its predecessor, another octave is produced in perfect sequence. Tuning is accomplished by adjusting the speed of the combination until it is correct for the range wanted. Any number of octaves within the audible range could be operated together, but five is the best number for an instrument of this type. Since each octave is treated as a unit, there is no difficulty in designing the instrument to play anywhere from one to eight octaves as might be required.

Each tone wheel consists of two pieces of glass with a positive film mounted in between them. The positive photographic film carries the tone patterns, and these patterns make the music. To make the original of this tone wheel, we used a sheet of wall-board 4' square. It was first given two coats of white casein (water) wall paint, and then ruled lightly with pencil into the correct number of divisions. Individual patterns were then cut from black paper using a metal template, and these tone patterns were then glued to the wall-board background to form the design. The master pattern was then reduced to an 8" circle photographically, using an 8" x 10" camera and process film to secure maximum contrast. A set of five positive film prints were made from the negative, and these were used as tone wheels in the completed instrument. We found that either the negative or positive could be used, but the positive prints gave superior results when used as tone wheels, probably due to the fact that the positive film admits more light to the photocell. It is beyond the scope of this article to go into details as to the calculations involved and reasons for the size, shape, and arrangement of patterns. The making of the original involved a tremendous amount of painstaking detail work, so we suggest that anyone who wishes to duplicate this tone wheel should do so by making a photographic negative of it. A reproduction of this wheel will be shown in Part 2 of this article.

Octave Unit Assembly

Each octave assembly is made up as a unit. These individual units are mounted together as shown in Fig. 5. Each tone wheel consists of two glass discs with the positive film containing the tone patterns mounted in between them. This tone wheel assembly is mounted on a bicycle wheel front hub, which is supported on a wooden block attached to the chassis base. Select front hubs carefully to secure those having good threads and smooth bearing action. To improve on the smoothness of the bearings, run them for an hour or so packed with fine grinding compound and then take apart and thoroughly clean out and repack with clear vaseline or light cup grease. In order to

mount both pulleys, it will be necessary to run the thread down on the axle with a die, or this work may be done on a lathe if one is available. Since each succeeding octave requires that the disc run at twice the speed of its predecessor, pulley diameters must be chosen to give the proper speed ratios. These pulleys were turned from small cast pulleys obtained from the hardware store. They are sold for use with clotheslines and awnings. Rubber belts were used to couple the various pulleys together, and they can be seen clearly in Fig. 2. To allow for belt slippage and stretch, it was found necessary to turn each pulley to its final diameter after the instrument was completed and in operation. Final checking for correct speed of operation should be made with a stroboscopic light or 'scope.

Since any conventional socket would occupy too much space, the lights are mounted on clamps. Each bulb was given a coat of aluminum paint, followed by a coat of black on the outside. The paint must be scraped off along a narrow line about $\frac{1}{4}$ " wide and for a length of about $2\frac{1}{4}$ ". This narrow band of light shines through the tone wheel and is stopped by the shutter bars. Shutter bars are formed from $\frac{1}{8}$ " x $\frac{3}{4}$ " h.r.s. stock and each bar, when lifted, admits light from the bulb through one row of tone patterns to the mirror, and is reflected to the photocell. One mirror is used for each octave. These mirrors are rear-view mirrors sold for use on bicycles. Their ball-and-socket mounting permits turning in any direction for adjustment. Ends of the shutter bars are flattened and ground to size so that the assembly completely fills the space, forming a solid light-tight barrier, but at the same time tolerances must be sufficient to allow for free movement up and down. The coil springs used to hold the keys in position were removed from mousetraps. Mounting was accomplished by drilling a small hole in each key to allow insertion of the spring with a pair of pliers.

The keys were made of hardwood and their tops were covered with white plastic trim strip. This plastic strip is now being sold for use with linoleum or for trim around kitchen sinks, etc. It may be applied with airplane glue or celluloid cement, and may be worked down with fine sandpaper. The keys are mounted together on a common bar of $\frac{1}{4}$ " drill rod, $32\frac{1}{2}$ " long and spaced with washers. Felt bumpers may be glued to the keys to quiet the action. Coupling between keys and shutter bars is an ordinary 8-32 machine screw which engages a small brass finger attached to each key with two small wood screws. This type of coupling is simple and allows for adjustment to absorb all lost motion in the assembly. After final adjustments are made, nuts may be coated with shellac to prevent loosening. This whole mechanism is so simple, that there is

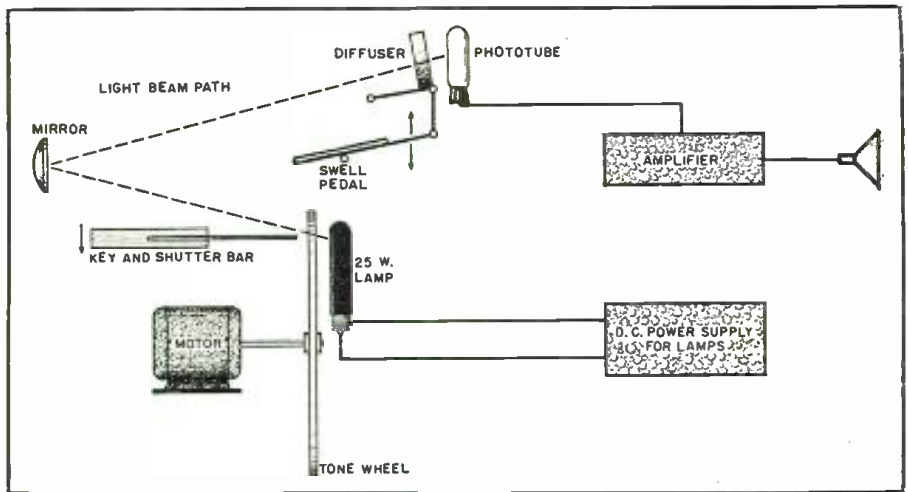

Fig. 4. Block diagram illustrates principle of photocell operation.

really nothing to it. Construction of saddles and rubber bumpers for the shutter bars is simple. The only critical measurement is the width of the flattened ends of the shutter bars.

EDITOR'S NOTE: Because of our limited page size, it is impossible for us to print the mechanical drawings pertaining to the construction of this organ in sufficient size to be practical. We have, therefore, made arrangements to provide a complete set of original blueprints for those interested in constructing this unit. These blueprints will be available at our cost of \$1.00. All requests are to be forwarded to The Editor, Radio News, 185 N. Wabash, Chicago 1, Ill.

This width should be carefully held to .156" for each bar.

The photocell socket is mounted on a ball-and-socket support obtained by removing the mirror from one of the bicycle rear view mirrors. This type of mounting allows for adjustment of the cell in any direction as may be required. The cover over the cell is an old style aluminum tube shield with a hole cut in one side. The inside of the tube shield was lined with

black paper to exclude unwanted light. It is very important to exclude all light except that coming directly through the shutters. Light falling on the cell or mirrors from any other source will cause an unwanted disturbance in the amplifier.

It is advisable to build one octave and assemble it in working order before proceeding with the construction of the others. Errors can thus be eliminated and much extra effort avoided. As with any mechanism of this type, the completed instrument will be no better than its component parts, and for this reason each part should be carefully made and fitted.

At the time the photographs were taken, we were using an ordinary $\frac{1}{4}$ -h.p. motor, mounted on rubber, to drive the discs. This was because it happened to be easily available, but a smaller motor would be better. The motor chosen should be one that runs with the least possible noise and vibration. A small round leather belt was used to drive the tone wheels, but

(Continued on page 108)

Fig. 5. Under chassis view of keyboard. Each tone wheel controls one octave. These tone wheels are made up of two glass discs with the tone pattern film enclosed.

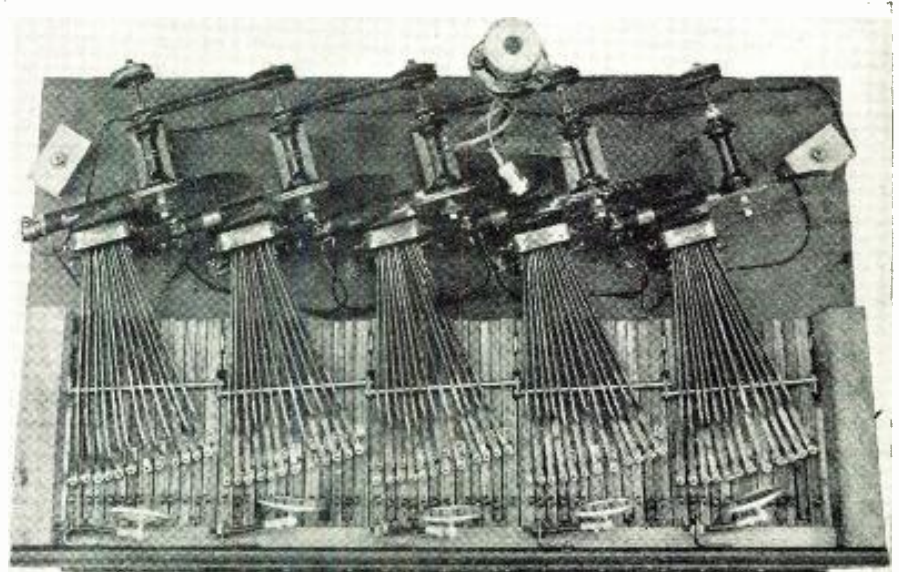

Transmitter for 2 Meters

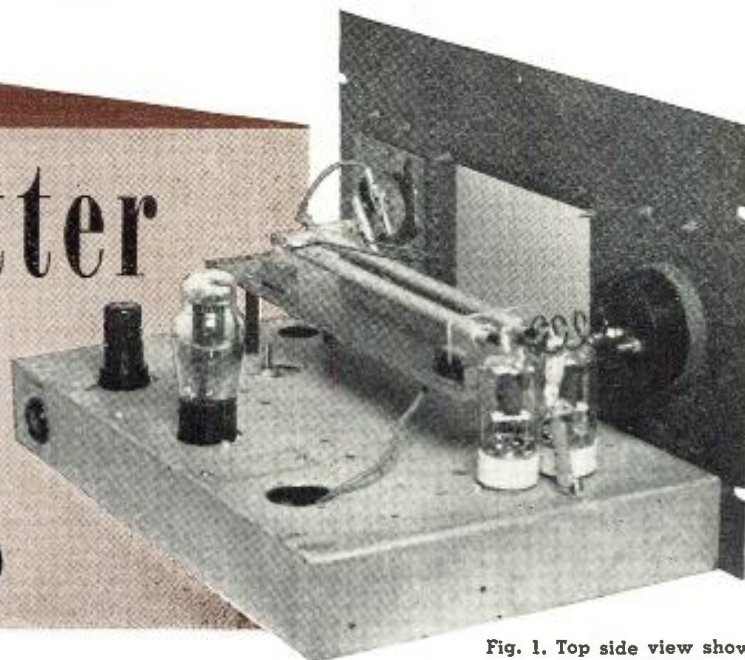

Fig. 1. Top side view showing position of HY-75 tubes and plate tank assembly.

BY

E. F. CROWELL and R. L. PARMENTER
W1FEC W1JXF

Simplicity of design, ease of construction, and the use of readily-available parts, makes this rig ideal for the beginner.

AMATEUR radio is now well under way and with the reopening of the 5 meter and 10 meter bands and the assignment of the new 2 meter band considerable activity has been noted. While hams are all looking forward to new things to do, new ways of transmission, new transmitters and new developments that will come out of war experience, there is still a dearth of some materials and that brand new transmitter cannot be constructed as easily as might be expected.

With that in mind here is a transmitter for the new two meter band which uses mostly equipment that is fairly available to the newcomer to ham radio or that which is to be found in most any old-timer's junk box. It is not new as this circuit has been used a lot on five and two and one-half meters and has worked out well on both. It is fairly simple and easy to get lined up.

One word about general construction on very high frequencies. If possible to do so, it is worth while to take the utmost precaution to keep losses down. In the oscillator, keep all leads as short as possible and use polystyrene or steatite where support is necessary. Sockets for the HY-75s and supports for the tank rods should be of these materials. Polystyrene was used as it was available and is somewhat more flexible to use. The results were very satisfactory.

The oscillator is a two-tube, push-pull arrangement using a pair of HY-

75s (see Fig. 2). The circuit is, in reality, a tuned-plate, tuned-grid type with a linear tank in the plate circuit for better efficiency. In the grid circuit an untuned coil was used principally to conserve space. This has the disadvantage of not making for very flexible frequency variation, but experience with this unit has indicated that once a fair transmitting frequency has been found, most hams prefer to stay in one spot on the dial, so to speak. At any rate, if a small change in frequency is desired the grid coil may be expanded or compressed slightly if care is used to maintain the same spacing of the grid caps.

The plate rods are cut from $\frac{7}{16}$ " brass or copper tubing to a length of 10 inches (Fig. 5). These rods or tank, as it is generally called, are supported by two small pieces of polystyrene $1\frac{1}{4}$ " x $2\frac{1}{2}$ " x $\frac{1}{8}$ " thick. The top corners were rounded off for appearance sake, as shown in Fig. 5. $\frac{7}{16}$ " holes are drilled in these pieces to accommodate the rods and these holes must be accurately drilled as spacing of the rods is a determining factor for frequency adjustment. These polystyrene pieces are placed on the rods in the position shown in Fig. 5 and the shorting bar which may be made of two thin strips of brass or copper is put on. Two short pieces of flexible wire or braid may be used to attach the caps to the ends of the tank. These are regular, small size grid caps and make connection to the

plates of the HY-75s. This assembly makes a complete tank unit which may be removed or inserted without disturbing the frequency adjustment. Another unit could be made up for a different frequency if desired, using somewhat longer (or shorter) lengths of tubing.

The tank support is made out of $\frac{1}{4}$ " bakelite but some other material, such as plywood, might be used. This is shown in Figs. 1 and 5. The base is cut 3" wide by 12" long. Small pieces of bakelite are cut out for the holders, $\frac{3}{4}$ " by $1\frac{1}{2}$ ", and the ends are rounded off to match the polystyrene pieces previously made. Slots are cut out $\frac{1}{8}$ " wide by $\frac{3}{8}$ " deep to accommodate the polystyrene holders. The bakelite holders are drilled and tapped on the bottom for 6-32 machine screws and the base is drilled to clear these screws. The holders are then secured to the base. This complete assembly is mounted on the chassis by means of three bakelite dowels but dry wood dowels could have been used. Avoid the use of long or large machine screws in the radio frequency field if possible since any metal, grounded or not, will cause r.f. losses. These dowels are $1\frac{1}{4}$ " long which makes the base secure on the chassis and gives the correct height so that the plate rods align properly with the plate caps of the tubes.

The grid coil, L_1 , is made of No. 14 enameled or bare wire, wound on a $\frac{1}{2}$ " form and pulled apart to extend 1" over-all. Four turns are used, which seemed to hit the band at about center with the tubes used. Some variation may be necessary here as only a slight difference in the inter-electrode capacities of the tubes will change the values. A small variation in frequency may be effected by compressing or extending the grid coil.

At the electrical center of the grid coil one end of the 5000 ohm, 10 watt grid resistor is soldered securely and the other end is grounded. The coil is made self-supporting by soldering small grid caps to the ends and the tubes themselves act as the support.

Small filament chokes are used in the oscillator although these may not be necessary. If the oscillator does not function well, i.e., the no load mils seem too high, it is advisable to use them. These were constructed with No. 18 enameled wire wound on a $\frac{5}{8}$ " dowel, 10 turns being used, spaced the diameter of the wire. These are soldered to the filament connection at the tube sockets since both filaments are in parallel. The oscillator grid return is made through the 5000 ohm grid leak to ground, the filament circuit being connected to a 75 to 100 ohm center-tapped resistor in the power supply chassis.

The Modulation Equipment

A suitable modulator for use with this transmitter should be capable of delivering at least 10 to 12 watts of audio power. With this particular rig a conventional class "B" arrangement employing a 6N7 as modulator driven by a single stage of speech using a 6J5 was used. High plate efficiency is realized from the 6N7 and the single stage of speech seems sufficient when a single button microphone was used. The oscillator load will vary depending upon the plate current, the value may be figured by dividing the plate voltage by the plate current.

When using i.c.w. or tone modulation, the speech amplifier is made to oscillate when the 4-pole, d.t. rotary switch, S_2 , is thrown to the i.c.w. position. In this position the primary of the mike transformer is cut into the plate circuit of the 6J5, thus acting as a tickler coil to provide feedback for oscillation. A change in tone may be obtained by varying the cathode resistor, R_2 , and the gain control, R_1 . Two flashlight cells in series were used for mike current and should be disconnected from the circuit by switch, S_1 , when the transmitter is not in use. The speech and modulation stages draw at least 35 milliamperes and, when the oscillator is fired up, the total plate current should be about 90 milliamperes at a plate potential in the neighborhood of 450 volts.

The layout of the modulator is not particularly critical and will depend upon individual preference. In this layout the class "B" transformer and the tube sockets are in line across the rear of the chassis. The i.c.w. key jack is mounted on the front panel near the bottom along with the i.c.w.-phone change-over switch and mike jack. Ordinary push-back hook-up wire was used in this wiring. The customary precautions about short, direct leads are in order here, especially in the grid circuits. If any trouble with undesirable feed-back is experienced, the use of shielded wire in the grid leads is advised. Color-

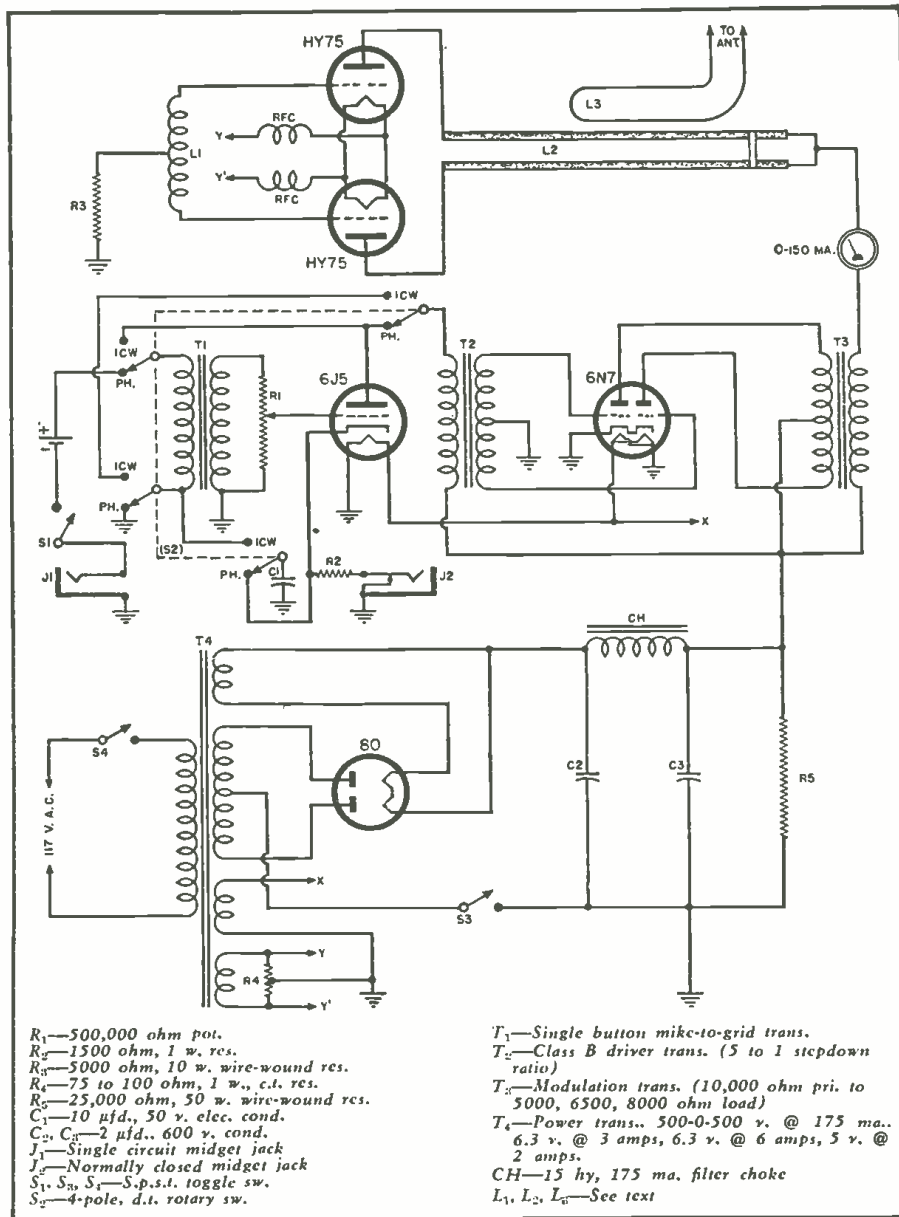
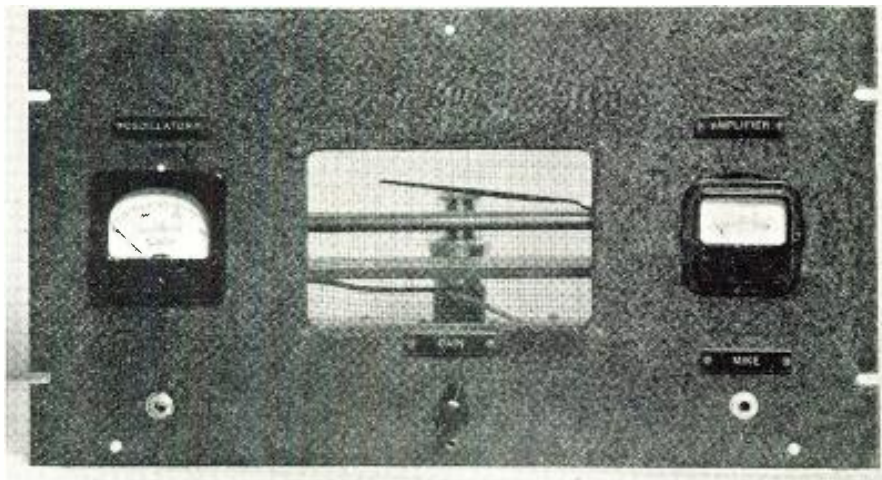

Fig. 2. Wiring diagram of the completely a.c. operated 5-tube transmitter.



Fig. 3. Front panel view showing placement of operating controls and meters.



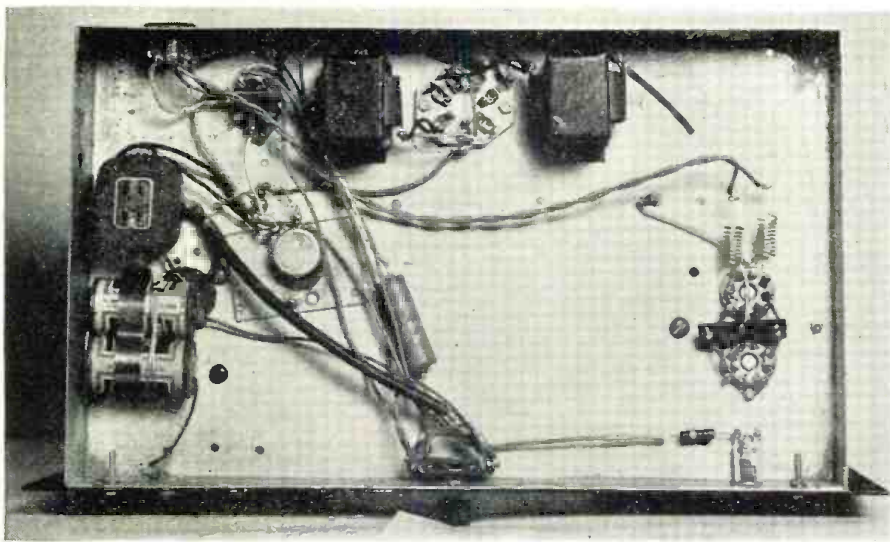

Fig. 4. Bottom view of the completed transmitter. Note simplicity of wiring.

coding of filament and high voltage leads is always advisable and was used in this case to facilitate trouble shooting.

Power Supply

The power supply used for this outfit was a separate unit which was already constructed and was connected to the transmitter by a color coded cable. Only the usual precautions need be observed in the construction of this unit as the voltages are quite low. It is always advisable to use

good quality components in this item to avoid breakdown later on. This power supply delivers 475 volts at about 15% regulation. If choke input were used the output voltage would be reduced considerably and the regulation would be improved but this is not really needed since the modulation equipment does not impose too heavy a drain on modulation peaks. The power supply was built on a 7" x 9" x 2" chassis and no special arrangement of parts need be followed as a conventional set-up is entirely satis-

Fig. 5. Mechanical details of radio frequency plate tank assembly.

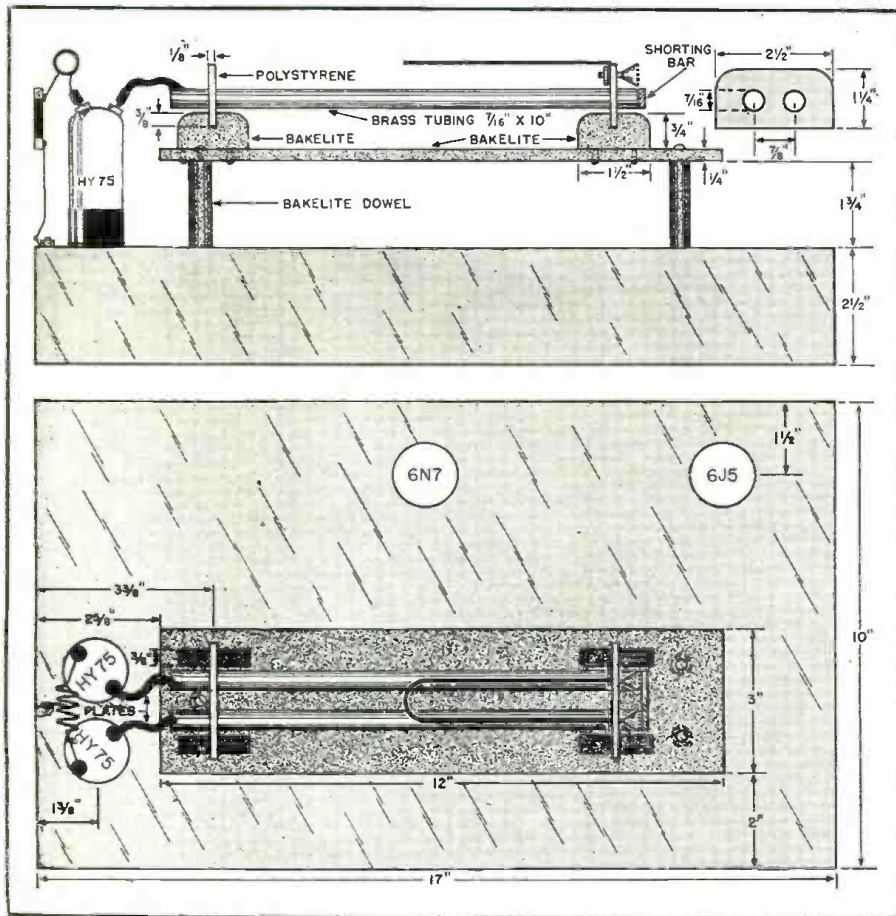

factory. The output voltages were brought out to a 6-prong socket at the rear of the chassis to connect to the color-coded cable. It is advisable to use color-coding here to coincide with whatever system was used in modulator wiring as here again it will facilitate trouble shooting. The switch S_1 is the main power switch and the switch S_2 is the stand-by switch. These were both mounted in the power supply chassis but if it is desired to have the power supply as a separate unit S_2 might be brought up to the modulator chassis through the interconnecting cable to make change-over easier.

Antenna Coupling

The method of coupling the antenna to the transmitter is a fairly simple procedure and is accomplished by means of a loop. Two holes to clear a 6-32 machine screw are drilled in the polystyrene rod holder which is at the far end of the rods (i.e., away from the tubes). Two binding posts or two machine screws are used here to support a hairpin loop L_a , which is merely a piece of bus bar bent back on itself to form a hairpin six inches long. This should parallel the tank rods along their length and should be separated from them by about an inch to start. This is shown in Fig. 1, the side view of the chassis. This spacing should be varied in accordance with the load the antenna will take and the amount of loading the oscillator will take and still remain oscillating well.

Tuning Up the Transmitter

The filament power should be turned on first by means of S_1 (see Fig. 2). Note if the tubes are all lighted. If all is well, the plate power may be applied by means of S_2 and the milliammeter reading then noted. Now the milliammeter reading should be adjusted for lowest value by varying the shorting bar on the plate rods and by compressing or expanding the grid coil. When adjusting the grid coil make the changes so that both sides of the center tap will be equal since a small discrepancy here will cause one tube to load more than the other. If one tube seems to load more heavily than the other, adjust the grid coil by compressing or expanding on one or the other side of center tap to compensate for differences in inter-electrode capacities in the tubes or the slight unbalance of the center tap. When the point of resonance is determined by the minimum reading of plate current, the frequency should be checked by an absorption type frequency meter or a well shielded receiver. At resonance a value of from 80 to 90 milliamperes should be satisfactory with a plate voltage near 450 volts. At these values the plates of the tubes show slightly pink and seem to work well. The antenna may now be attached to the hairpin coil and the milliammeter should show an in-

(Continued on page 144)

Electronics in

PROCESSING FOODS

By
S. R. WINTERS

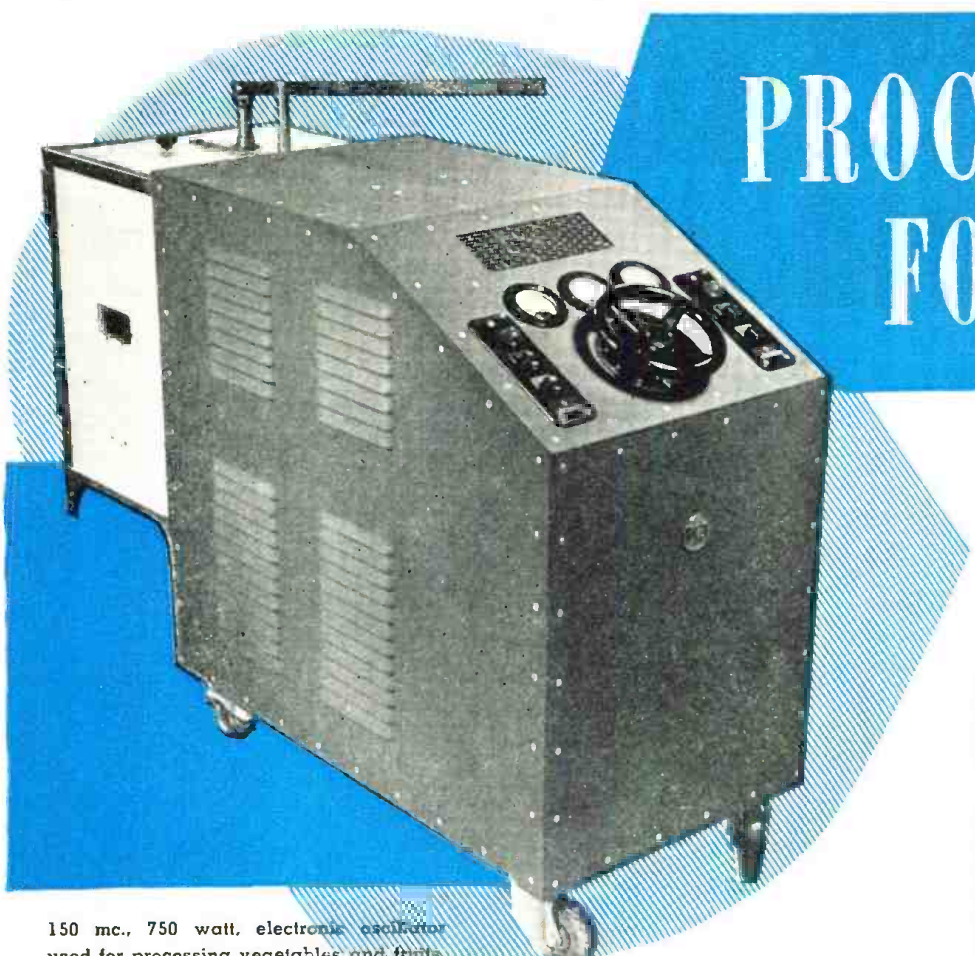

150 mc., 750 watt. electronic oscillator
used for processing vegetables and fruits.

**Report on some of the experimental work being
carried on in the electronic heating of foods.**

THE use of electronic equipment, tuned to a frequency of 150 megacycles, may displace steam or boiling water as a time-honored method of preserving vegetables, fruits, and other foodstuffs. In freezing or dehydrating vegetables, for example, they are momentarily exposed to flowing steam or boiling water as an agent in rendering inactive the enzymes, or chemical ferments, which would otherwise cause an impairment of flavor and destroy such food constituents as ascorbic acid and the vitamin-A-producing carotene.

From time immemorial however, blanching of vegetables has been achieved by the steam or hot-water processes but not without the loss of vitamin C and members of the vitamin B complex through leaching. Then, too, scientific investigations in food-processing laboratories have shown that these old heating agencies not infrequently impair the texture of vegetables, rendering them undesirable.

June, 1946

ably soft. The ideal heating process would be one that raised the temperature uniformly and yet did not sacrifice any of the food constituents.

As scientific bellwethers in the field of electronic heating as applied to food preservation, Professors James C. Moyer and Elmer Stotz of the Division of Food Science and Technology of the New York Agricultural Experiment Station pondered the results of diathermy equipment in producing high artificial temperatures in the human body and thus ameliorating or curing certain bodily afflictions. They also contemplated the war-necessitated successes of aircraft manufacturing companies in binding layers of wood in the making of airplane plywood through the magic of high-frequency radio waves. In this instance, electronic oscillators, instead of serving the customary purpose of oscillating millions of cycles-per-second as a carrier current for radio messages, introduced heat slowly in both wood and

plastic material, thus curtailing the ordinary required time for the setting of glue in plywood from hours to a few minutes.

Having deliberated the marvels of electronics in generating artificial fevers and in the manufacture of airplane plywood, the scientists at Cornell University inquired into the possibilities of removing the outer skins or other coatings from vegetables and bleaching carrots, cabbage, etc., by means of high radio frequencies. It did not seem a far cry from heating wood and human bodies to that of shooting ultra-high radio waves into peas, diced carrots, and diced potatoes.

In these pioneering experiments of preserving vegetables and fruits by means of electronics, the food technologists of the New York Agricultural Experiment Station sought the assistance of the Princeton (New Jersey) Laboratories of the *Radio Corporation of America*. As a result, electronic generators were installed in the food-processing laboratory at Geneva. Each has a capacity of generating radio currents alternating 7,000,000 to 10,000,000 times per second. By the trial-and-error procedure, a necessary method in blazing new trails of science, it was realized that when enough current was applied to boost the temperature of the vegetable rapidly that arcing between the electrodes resulted and, consequently, the cabbages or carrots being preserved by radio heat were burned. The tests were repeated in a modified form, the electronic field alternating 28,000,000 to 29,000,000 times a second, thus reducing the arcing effect somewhat. Then it was logically assumed that the tendency to burn the vegetables, when preserving

(Continued on page 121)

A Volume

EXPANDER COMPRESSOR PREAMPLIFIER

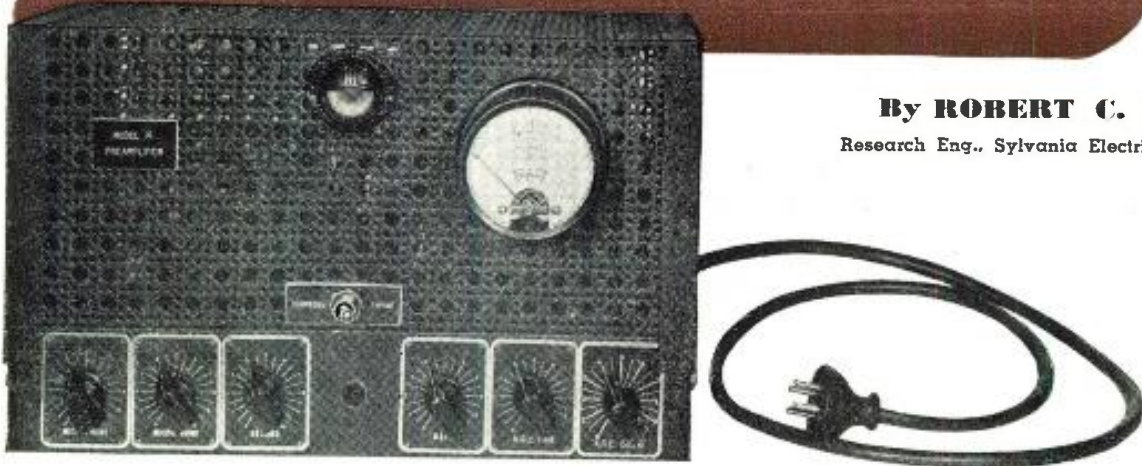

By **ROBERT C. MOSES**

Research Eng., Sylvania Electric Products, Inc.

Fig. 1. Front view of preamplifier with dust cover in place. Controls from left to right are; channel 1 gain, channel 2 gain, channels 3 to 4 fader, master gain, a.g.c. time constant and a.g.c. amplitude. Input and output connectors, not visible in the photograph are located at the ends of the chassis.

IN THE past, many systems have been devised for automatic volume expansion and compression for application to phonograph playback and recording amplifiers. In the process of sound recording, the high-volume-level passages in musical selections are attenuated or compressed in order to prevent overcutting of the record groove and consequent distortion. When the records are played back on conventional systems, the discriminating listener misses a great deal of the aesthetic sense of the selection. It is the purpose of automatic volume expansion to restore, as nearly as possible, the original dynamic volume range, thus recreating to a great extent the original studio presentation. The means employed to effect this must satisfy two important requirements; first, it must not introduce objectionable amplitude or frequency distortion, and second, the volume changes must be as nearly instantaneous as possible, so that there will be a minimum of time delay in the system. To the writer's knowledge, most expanders now in use fall short of both of these aims, and it is felt that in the amplifier to be described, a definite improvement has been made. Although the basic circuit is not new, several refinements have been added to achieve these improvements. This unit is also useful

Complete details for construction of preamplifier employing a novel volume expander-compressor.

as a volume compressor in phonograph recording, where the above features are equally important.

Although originally designed for phonograph and recording purposes, the preamplifier has a second broad application. In radiotelephone communication, particularly on the crowded amateur bands, a high percentage of modulation of the carrier makes the signal more intelligible. Unfortunately, however, on the signal peaks, distortion is caused by overmodulation when too high an average percentage modulation is employed. By reducing the peaks with

a volume compressor before the signal is fed to the transmitter, a higher average percentage modulation is feasible since the average level can be increased. Thus, the ratio of signal to interference is materially improved without danger of overmodulation plus distortion. In practice 85 or 90 per-cent average modulation can be realized instead of the 70 per-cent maximum without compression. Gains of as much as 2 db. in the received audio signal may result. In the same manner, when compression is applied to a recording amplifier, the effect of noise is reduced, because the average audio level can be increased without overcutting.

While this is intended to be a descriptive rather than a "how to build it" article, it is hoped that the reader can gain sufficient information from the following to enable him to duplicate the original unit, if he so desires. The most interesting feature of this amplifier is the automatic gain control (hereafter termed "a.g.c.") and a relatively large amount of space is devoted to a discussion of the a.g.c. circuits.

Since it was originally designed for

Fig. 2. Block diagram showing automatic volume expander and compressor operation.

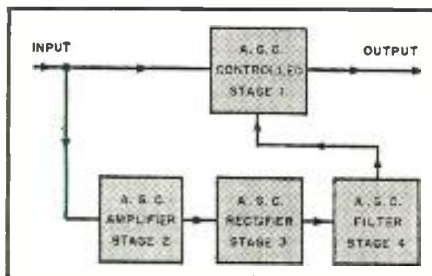

Fig. 3. Complete wiring diagram and parts list for the preamplifier, including the volume expander and compressor circuit.

operation with a remote 30 watt power amplifier stage, the preamplifier was constructed to be one unit of a larger installation. Provisions for local monitoring and low impedance line connection were provided. The power stage was used either as a recording and playback booster amplifier or as a driver for a high power class "B" modulator. As some degree of versatility was thus required, four high-impedance input channels and three individual gain controls, together with a master gain control, were included. The preamplifier output matches into either a 500 ohm line or 10,000 ohm monitoring headset, and both outputs can be used simultaneously. A volume level indicator across the 500 ohm output provides a means of visual monitoring.

As all stages, with the exception of the mixing stages, are balanced push-pull circuits, even-order harmonic distortion is minimized, with the result that the total harmonic distortion at full output is of the order of 4%. The frequency response is flat to $\pm 1\frac{1}{2}$ db. from 35 to 15,000 c.p.s. The maximum undistorted power output is 120 milliwatts corresponding to 13 db. above zero level. The over-all gain from the two low gain inputs is 85 db. and from the two high gain inputs, 110 db. This provides an adequate gain reserve for virtually any type of microphone. A panel control for the a.g.c. time constant is provided so that the system may be readily adapted to almost any type of program material.

Before proceeding with a detailed discussion of the circuits used, it might be well to review briefly the principle upon which automatic volume expanders and compressors operate. Consider first the simplified block diagram of Fig. 2.

Block 1 is a normal signal amplifier stage, the gain of which is made to vary in accordance with the average input level so as to expand or compress the signal. Often it contains a super-control pentode. This gain control is accomplished by a small d.c. voltage fed into the grid from the a.g.c. circuit of blocks 2, 3, and 4. This d.c. voltage, which is proportional to the average signal, varies the effective d.c. operating point on the plate current-grid voltage characteristic. Consequently the mutual conductance and the stage gain vary automatically. The control voltage will be either positive or negative, depending on whether expansion or compression is desired. As is clear from the figure, the control voltage is obtained by rectifying and filtering an amplified portion of the input signal.

The filter prevents the gain from changing at an audio rate, and causes the control voltage to follow average changes rather than instantaneous changes in input level. It is in this filter that the objectionable time delay,

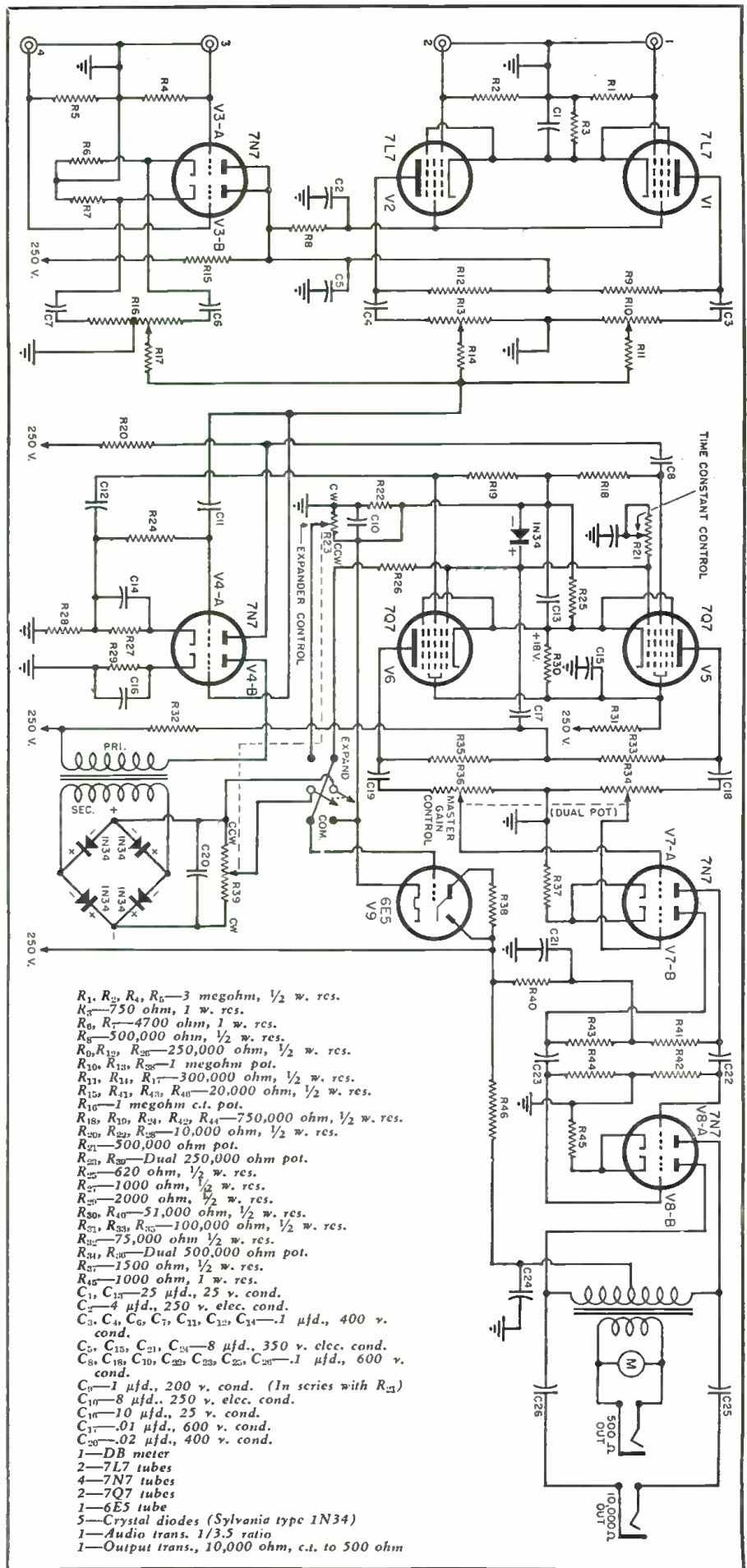

- R₁, R₂, R₄, R₅—3 megohm, 1/2 w. res.
- R₃—750 ohm, 1 w. res.
- R₆, R₇—4700 ohm, 1 w. res.
- R₈—500,000 ohm, 1/2 w. res.
- R₉, R₁₀, R₁₁, R₁₂—250,000 ohm, 1/2 w. res.
- R₁₃, R₁₄, R₁₅—1 megohm pot.
- R₁₆, R₁₇, R₁₈—300,000 ohm, 1/2 w. res.
- R₁₉, R₂₀, R₂₁, R₂₂—20,000 ohm, 1/2 w. res.
- R₂₃—1 megohm c.t. pot.
- R₂₄, R₂₅, R₂₆, R₂₇—750,000 ohm, 1/2 w. res.
- R₂₈, R₂₉, R₃₀—10,000 ohm, 1/2 w. res.
- R₃₁—500,000 ohm pot.
- R₃₂, R₃₃—Dual 250,000 ohm pot.
- R₃₄—620 ohm, 1/2 w. res.
- R₃₅—1000 ohm, 1/2 w. res.
- R₃₆—2000 ohm, 1/2 w. res.
- R₃₇, R₃₈—51,000 ohm, 1/2 w. res.
- R₃₉, R₄₀, R₄₁, R₄₂—100,000 ohm, 1/2 w. res.
- R₄₃—75,000 ohm, 1/2 w. res.
- R₄₄, R₄₅—Dual 500,000 ohm pot.
- R₄₆—1500 ohm, 1/2 w. res.
- R₄₇—1000 ohm, 1 w. res.
- C₁, C₂—25 μfd., 25 v. cond.
- C₃—4 μfd., 250 v. elec. cond.
- C₄, C₅, C₆, C₇, C₈, C₉, C₁₀, C₁₁, C₁₂, C₁₃—1 μfd., 400 v. cond.
- C₁₄, C₁₅, C₁₆, C₁₇, C₁₈—8 μfd., 350 v. elec. cond.
- C₁₉, C₂₀, C₂₁, C₂₂, C₂₃, C₂₄, C₂₅, C₂₆—1 μfd., 600 v. cond.
- C₂₇—1 μfd., 200 v. cond. (In series with R₂₃)
- C₂₈—8 μfd., 250 v. elec. cond.
- C₂₉—10 μfd., 25 v. cond.
- C₃₀—0.1 μfd., 600 v. cond.
- C₃₁—0.2 μfd., 400 v. cond.
- 1—DB meter
- 2—7L7 tubes
- 4—7N7 tubes
- 2—7Q7 tubes
- 1—6E5 tube
- 5—Crystal diodes (Sylvania type 1N34)
- 1—Audio trans. 1/3.5 ratio
- 1—Output trans., 10,000 ohm, c.t. to 500 ohm

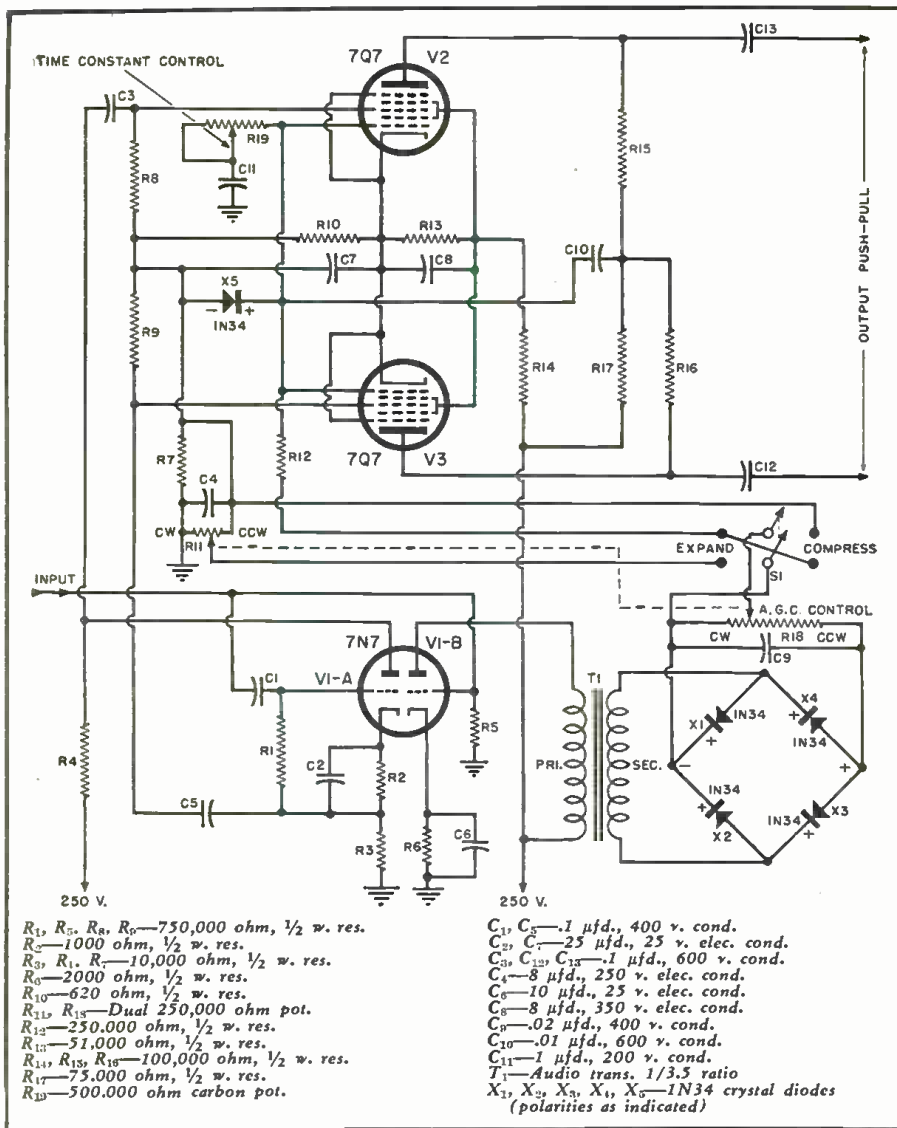

Fig. 4. Schematic diagram of volume expander and compressor.

inherent in almost all expander-compressors, is developed. In the amplifier to be described, a special filter design and a novel differential feedback system are employed. The time delay is greatly reduced and the operation of the automatic gain con-

control circuit is almost instantaneous.

The schematic diagram of the whole unit appears in Fig. 3, but the heart of the device, the expander circuit itself, is shown in Fig. 4. The stage whose gain is automatically controlled consists of the push-pull-con-

Fig. 5. Bottom view of chassis with base plate removed. Connectors at left are the four channel inputs, and jacks at the right are the line and monitoring outputs. The crystal bridge is clearly visible at the rear of the chassis behind the dual master gain control potentiometer. The clipper diode, X_5 , is not visible as it is mounted on terminal strip underneath the board on which crystal bridge is mounted.

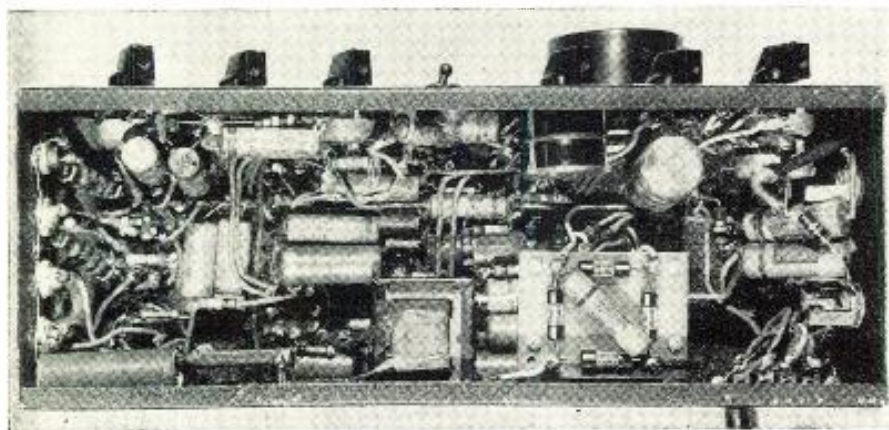

nected 7Q7 tubes, V_2 and V_3 (Fig. 4). They are fed by the 7N7 phase inverter, V_{1A} . The amplifier of the a.g.c. circuit is tube V_{1B} , the other half of the 7N7. The a.g.c. rectifier consists of four Type 1N34 crystal diodes, X_1, X_2, X_3 , and X_4 , connected in a bridge circuit. The a.g.c. filter network consists of the condensers C_9, C_{10} , and C_{11} , and the resistors R_{15}, R_{16} , and R_{17} . (C_{10} is also in the feedback circuit).

Now to consider each section in detail.

In the schematic diagram in Fig. 4, V_{1A} is a conventional single tube phase inverter with its load impedance split equally between the plate and cathode circuits. Resistors R_4 and R_5 are the load resistors across which the out-of-phase voltages are developed. A grid swing in the positive direction causes the instantaneous plate potential to decrease, and the instantaneous cathode potential to increase, thus producing two signals having 180° phase difference. The two signals are balanced to within 5% and the stage gain is approximately 0.8 to each output. The two out-of-phase signals are fed through C_3 and C_5 to the push-pull #3 grids of the a.g.c. controlled tubes V_2 and V_3 .

The A.G.C. Controlled Stage

The a.g.c. controlled stage itself is a balanced push-pull circuit using two Type 7Q7s. The out-of-phase signal voltages from the phase inverter are applied to the #3 grids, and the a.g.c. voltage is impressed on the parallel connected #1 grids. While this method of connection is a bit unconventional, it has been found that the #3 grid, having a sharper cut-off characteristic, will handle a large range of input signal voltages without running into the curved portion of the grid-plate characteristic. Furthermore the #1 grid is more suitable for application of relatively large negative control voltages, since there is less tendency to plate current cut-off at advanced settings of the expansion-compression control. Resistors R_7, R_{10}, R_{13} , and R_{14} set the operating conditions on the a.g.c. controlled tubes such that the voltage at the junction point of the grid resistors R_7 and R_9 is 25 volts, the voltage at the common cathode point is 27 volts, and the common screen voltage is 80 volts, all measured from ground. With the expansion-compression control $R_{15}-R_{11}$ (ganged) in the extreme counterclockwise position, these tubes operate in the normal manner, delivering equal and out-of-phase voltages across the plate load resistors R_{15} and R_{16} . The stage gain under these conditions is approximately 10. Since the circuit is essentially balanced, very little audio voltage resulting from amplified #3 grid voltage changes is developed across the common plate resistor R_{17} , and as far as the signal voltages are concerned, the junction of the three resistors R_{15}, R_{16} , and R_{17} is essentially at ground potential.

(Continued on page 146)

INVISIBLE LIGHT Aids Marksman

Infrared light used in recently revealed wartime development makes possible full visibility on darkest nights. Peacetime applications are promising.



Top photograph shows the sniperscope as it appears in conjunction with the .30 caliber carbine. Mounted on the carbine, this unit permits the sniper to locate the enemy and then fire. The snooperscope shown at the right is used for signalling and as a detection device. Fire control officers used this unit to direct the battery barrages.



ONE of the many secret weapons developed by the U. S. Army during the war has now been released. This device, employing invisible light, made it possible for U. S. Infantrymen and Marines to locate infiltrating troops during the hours of total darkness. This seemingly impossible feat is accomplished by means of an infrared light beam and an electronically operated telescopic sight which together convert an invisible image into a clearly discernible "picture".

This infrared instrument was used in two different ways, the specific application being more or less indicated by the name applied to each unit, i.e., the sniperscope and the snooperscope.

The sniperscope was mounted on a .30 caliber carbine and was used to locate the enemy for direct annihilation by the user. Under infrared radiation the target became clear, enabling the sniper to fire on the enemy who had the misfortune to be in the area scanned by the scope.

The infrared source resembles a fog light in appearance. The glass face of the unit looks like it is painted black. This part of the device is mounted below the barrel of the carbine. The

other integral part of the instrument, the telescope, is mounted above the rear sight of the carbine. The entire unit, both infrared source and telescope, is connected by means of a cable conductor to a small power supply which is carried on the sniper's back in a canvas case.

The field operation of the sniperscope is extremely simple. A fighter armed with a carbine equipped with this device has only to aim in the general direction of the infiltrating enemy, sight through the telescope and turn on the power supply. He then moves the weapon back and forth across the field like an invisible search-

light until the enemy is sighted. Through the sniperscope the enemy appears to be spotlighted in a light beam of greenish hue. (Through the telescope all objects appear in various shades of green regardless of their natural color). The soldier focuses his telescope to give the clearest image and then presses the trigger of his carbine and another Jap has gone to join his "honorable ancestors".

The snooperscope is similar to the sniperscope but the unit is not used in conjunction with a carbine.

The telescopic device is mounted on a hand grip with the infrared unit mounted directly below the telescope. This unit is similarly powered by a portable power supply carried on the back. The snooperscope was used to direct gun fire and for signalling.

The operating principle of this "night sight" is a combination of electronics and optics and depends on phototubes with associated filters to cut out visible light and transmit only the infrared portion of the spectrum. The telescope receives reflected invisible infrared images at the front end and converts this radiation into visible images which are received at the eyepiece.

For the eye to view the scene illuminated by infrared, a specially constructed electronic tube, similar to the 1P25 image tube, is used. It operates as a combination "iconoscope-kinescope." The optical system pro-

(Continued on page 128)

Artist's illustration of the type 1P25 image tube similar to that used in this unit.

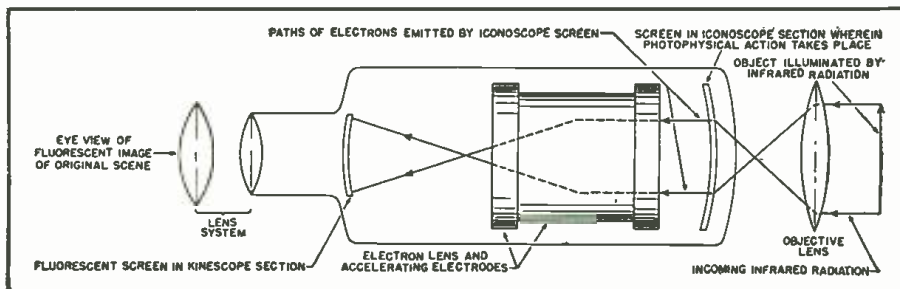

Embossing Sound on Film

By
STANLEY KEMPNER

FROM the War Crimes Trial in Nuremberg, Germany, from airports dotting the United States, from radio testing stations of famous railroads and from remote Navy radio stations around the world, reports have been coming in of post-war applications of instantaneous recording on film by embossing, requiring no processing. A few of the multitude of current uses of these film recorders which made history throughout the war, are to be found in police and fire departments, public utilities, Federal bureaus, newspapers, control centers and other spots where recording speech and sound is essential. The many unusual features of this instrument are proving themselves in these installations.

During the war the film recorders brought brilliant word pictures and the actual sounds of battle from Normandy, Holland, robot launching bases in France, from Paris, Guam, Saipan, Peleliu, the Philippines, Japan, and elsewhere, to radio listeners throughout the world.

Undoubtedly the most publicized and probably the best-on-the-spot reporting during the invasion of France on D-Day was the recording on film made by George Hicks, Blue Network announcer. Throughout the blaze of the anti-aircraft batteries and the heavy firing from both ships and planes, the correspondent kept up a running commentary on the action. From the deck of an Allied warship, the flagship of a U.S. naval task force, Hicks described the action along the coast and the attack on the convoy by JU-88 bombers.

Gun 42, a 40 mm. twin-barrel anti-aircraft gun beside the microphones, succeeded in downing one of the Junkers. The recording caught not only the sound of the firing but the plane

falling into the Channel, and also the cheers and shouts of the men at the gun positions as they gloated over their first "kill."

All four major networks played the recording back at least six times and individual radio stations rebroadcast it innumerable times. One station played it 17 times. The British Broadcasting Company included the Hicks recording in its home report and short-wave and armed-forces broadcasts. The Canadian Broadcasting Company also put it on the air.

The machine used by Hicks was the *Recordgraph*, a film recorder which operates on the same principle as the familiar record or transcription machine except that its recording needle embosses grooves in parallel lines on a 50-foot film belt instead of on a disc. The film itself becomes the record and, without processing, can be played

back, as on a dictaphone or phonograph, by running a pickup needle along the embossed groove. One film belt can record about 97 minutes (one hour and thirty-seven minutes) of sound at 60' per minute on a single side.

Use of a film recorder for combat purposes was no accident. Through earlier tests, the navy had found that film recorders, rather than disc or wire machines, would be best suited for the invasion operation.

Recording machines were borrowed by the networks from the Navy, and technicians thoroughly drilled in the use of the sets by the Naval engineers.

A few days before D-Day, correspondents and technicians were called with full equipment and put through final rehearsal. Just before the push-off they were sealed in ships with the troops. Each network team carried

Nelson Wells, engineer, explains to Russell Maguire, president of Maguire Industries, operation of the recorder unit included in a radio installation for Reading Railroad.



This war-proven recorder employing 35 mm. cellulose acetate film will find many peace-time applications.

two recording kits weighing 50 pounds, about the size of a portable typewriter. Spare parts were supplied by the Navy.

In contrast to the mechanical process of recording sound on film as used in the *Recordgraph*, recording on wire is done with an outfit that translates sound waves into fluctuations of a magnetic field and records the fluctuations in the form of altered molecular patterns in a fine wire passed through the field.

Still different is the process of making the sound track on motion picture film, in which the sound waves are transformed electrically into light rays and photographed and reproduced by photoelectric cells. This means costly photographic development methods and time delay.

Recordgraph film recorders operate on 110-volt a.c. When this is not available, transformers, generators, or batteries may be used. Use of recorders to cover fighting on land was thus somewhat restricted since it would be difficult to lug the power supply from foxhole to foxhole. In Normandy when the recording machines were taken from the boats to the beaches, mobile generators supplied the power.

The combat recorders proved they were sturdy enough to stand the strain imposed upon them. Charles Collingwood, of the Columbia Broadcasting System, carried his apparatus from an LST to an LCPV and went right up on the beach. During the journey the recorder was doused repeatedly with spray and salt water. The announcer was certain it would not work. In fact, in this recording he stated that "it looks like we owe the Navy Department one recorder."

Other correspondents reported that the recording sets jumped as high as six inches off the deck during gunfire while crossing the channel from England. One commentator took the film recorder on a bombing mission in a B-26 Marauder and made one of his

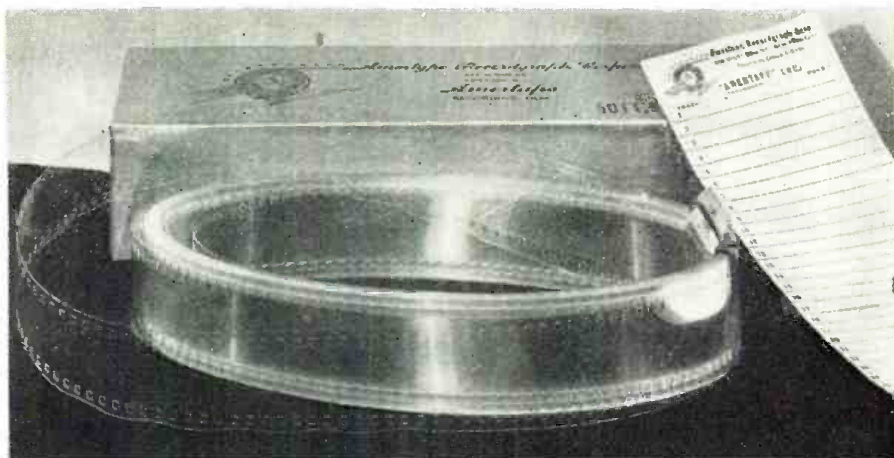

Fifty foot roll of 35 mm. cellulose acetate film on which sound is embossed.

best broadcasts. Some sets were caked with dust when used to cover landings. Yet all the sets came out of the operation in good condition.

Censoring was done by running off the original film and re-recording its contents on copy, or dub, film. The copy which is just as good as the original is used for actual broadcasting. When a censorable word, sentence or phrase is noted, monitors simply switch off the dub machine until the objectionable content is passed. So precise is the process that words and sometimes infinitives can be split.

The *Recordgraphs* are the result of more than eight years of intensive research and development, together with a comprehensive study of the widely varying requirements of the many governmental and civilian agencies.

The portable unit is a compact completely self-contained unit with no extraneous equipment and weighs 50 pounds. It is furnished in a valise-like case, making it relatively easy to handle and transport. Its over-all size is 18 3/8" x 13 1/2" x 9 1/2".

This machine records in any position and recordings can be made even though the machine may be upside

down or subjected to extreme vibration. Upon completion of any recording, the same machine immediately plays back.

Either manual or automatic control of the machine may be selected at will. The automatic device for starting and stopping is called Audio-trol. When using this, the voice or sound signal is used to "trigger off" the starting clutch. This is accomplished by having the output of the amplifier operate a thyatron tube (2050) which in turn energizes the clutch relay. Delay time to start is 1/10 second and the hold over time is from 4 to 6 seconds. Thus the loss of sound is negligible.

The *Recordgraph* film is a 50 foot continuous belt with a recording capacity of 5750 feet on one side. If desired, both sides of the film may be used in which event, the footage is doubled. For recording at a 40 foot per minute film speed a continuous (one side) recording of 2 3/4 hours may be had, while at 20 foot speed, using both sides, 9 1/2 hours recording of a satisfactory monitoring or reference quality may be obtained. With the

(Continued on page 106)

Rear view of the portable recording instrument.

Front view shows path of film through Recordgraph.

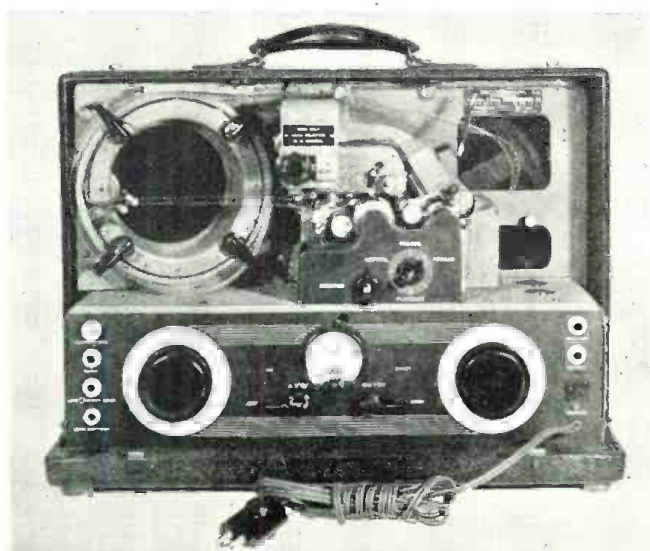
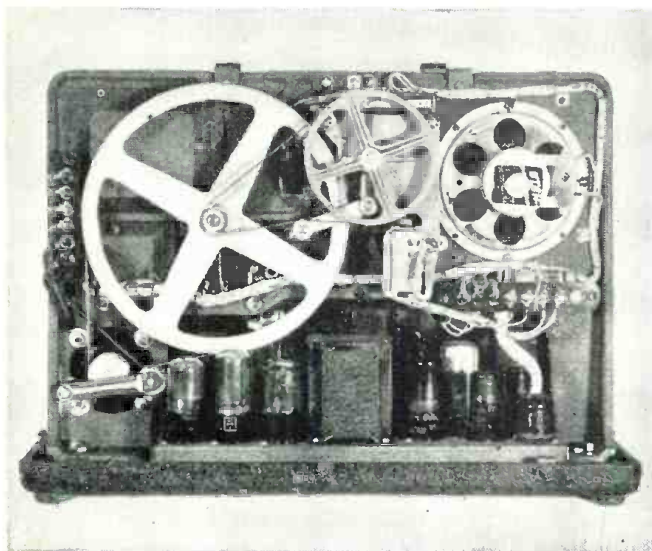

MOTOR-DRIVEN ANTENNA

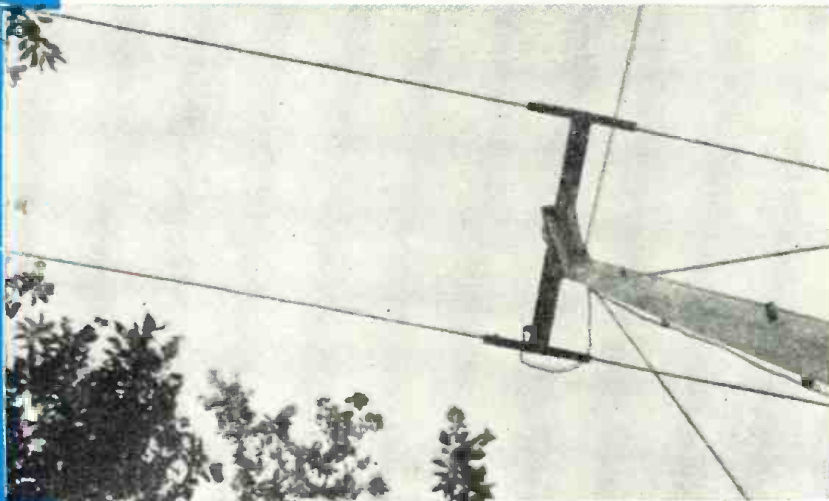

The motor-driven array proved to be more useful in receiving than in transmitting.

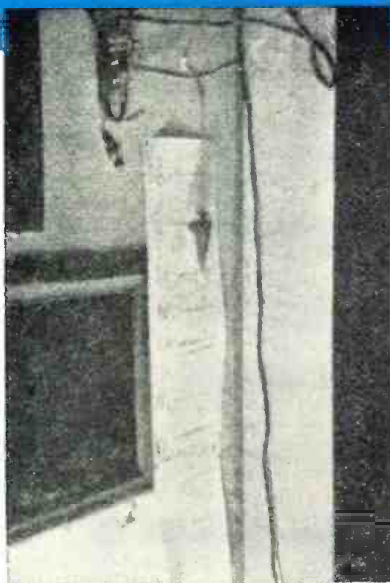

Plumb-bob indicates the direction of the beam. The gadget is foolproof.

MANY hams are located in large cities and in congested districts where a very limited space is available for the erection of antennas. The development of the close-spaced array greatly simplified the problems of these hams, since antennas of the reflector radiator type are often too bulky for some locations. I had been operating in a QRA of limited space, using the doublet type of antenna, when I decided to experiment with a rotary beam antenna using a close-spaced array. My chief problem was to develop an efficient method of rotating the antenna, and to cut down the heavy cost of similar special factory-made equipment. I designed this rotating equipment for my own particular need, but the entire assembly can be used for mounting close-spaced antennas of either the director-radiator doublet type or the 8-JK beam type. I have been using this rotating beam antenna for some time, and find it to be very practical and efficient. It has an extreme degree of selectivity making it very adaptable for receiving purposes.

By **ROWLAND J. LONG, W9NLP**

as told to Tom Gootée in 1938

Experience has proven that a directional antenna will help eliminate inter-station interference. This directional system provides power gain of 4.

The rotating equipment consists of two principal parts, the fixed main pole and the top movable "header" on which the antenna rods are mounted. The "header" revolves on the wooden shelf plate mounted at the top of the main pole, and is driven by a motor and gear assembly located in the radio shack. The main pole and the "header" can be constructed separately, making the assembly of parts comparatively simple. The entire antenna and rotating equipment should be completely assembled on the ground before permanently mounting.

For the main pole I used a forty foot 6" x 6". This pole was later mounted five feet in the ground, placing the antenna array rods the usual one-half wave above ground. The wooden support shelf 10" x 24½" x 2" was permanently mounted at the top of the main pole. The hub of a front automobile wheel (the wooden spoke type) was then set in the top center of the shelf. I decided on this type of hub rotator because of the two roller bearings that are spaced approximately six inches apart and result in a strong rotating support for the movable top element.

The surface of the axle (at the point where the "king pin" fastens to the shaft) was milled off, and to this an iron plate ¾" x 6" x 31" was securely fastened. A 14 inch gear flywheel replacement ring was then bolted to the iron plate. It was quite a tedious job to find the exact center before drilling. This gear ring was also attached to the steel plate above it for aligning the gear teeth.

A 5/8" drive shaft is used to turn a small gear which meshes with the large 14 inch flywheel gear. This drive shaft goes through the stationary wooden plate, and a Bendix starter gear was attached to this drive shaft by setting in a support bearing. This bearing support consisted of a 1" pipe flange and close nipple into which a bronze bearing was pressed and then adjusted so that the starter gear meshed properly with the flywheel gear, both as to height and depth in teeth. The used automobile hub, ring gear, starter gear, and iron plate completely assembled and ready to fasten to the stationary shelf cost only \$12.00 (as of 1938), which included the time required by the machine shop to do the work.

EDITOR'S NOTE: In view of the scarcity of commercially constructed equipment along this line, we are republishing this article which originally appeared in the October, 1938 issue of Radio News. Since we have had many requests from our readers for a directional antenna constructed from junk box parts, we feel that a reprint of this article should prove invaluable. May we point out to our readers that Tom Gootée who reported on this antenna in 1938 is still a regular contributor to Radio News. Most of his recent work has been in the radar field.

The $\frac{5}{8}$ " drive shaft was then extended down one side of the main pole, supported about $1\frac{1}{2}$ " away from the pole by means of small angle iron brackets. At about three feet above the ground surface the drive shaft changes direction and enters the shack. To make this turn I used an awning right-angle gear box which had a ratio of about ten to one. The drive shaft then continued horizontally for about ten feet, and was terminated with another 10 to 1 gear box in the shack. The drive motor was attached directly to this gear box. For my purpose I used an old-style player-piano motor, having a speed of about 800 r.p.m. and approximately 0.5 hp.; these motors have starting leads brought out so that they can be easily reversed. Almost any other similar type of reversible motor could be used to drive the turning shaft. The gear ratio is 12 to 1 at the top of the "header," 10 to 1 at the first gear box, and 10 to 1 at the second gear box, making the "header" travel one revolution per minute.

The actual antenna array and mounting supports were constructed separately and then mounted on the large movable iron plate. I used a wooden piece 2" x 10" x 7'6" in length which I bolted over the iron plate; it was necessary to bore a large hole in the center of this mounting board to allow the axle and mounting nut to protrude from above the iron plate. Two holes were drilled on each side of the center axle mounting for bolting the iron plate to the wooden mounting piece. The actual antenna mounting support pieces were next attached to each end of the wooden center cross-piece. For my purpose I used two forty inch 2" x 4" pieces, one bolted to each end of the 7'6" cross-piece.

The antenna rods were mounted on these 2" x 4" mounting pieces. I used steel tubing prepared for my use at a local machine shop. Two 16'1" rods (tapered out: $\frac{7}{8}$ " to $\frac{1}{4}$ ") were mounted on the 2" x 4" pieces, and were connected together by means of a loading coil at the center. These two rods formed the radiator. I used two mineralx insulator clamps, spaced 15 inches apart, on each half of the radiator. The loading coil was about 8 inches in length, $2\frac{1}{2}$ " in diameter, and consisted of 10 turns of $\frac{1}{8}$ " copper tubing spaced $\frac{1}{8}$ " apart. When finally completed the radiator side of the directive array measured exactly 32'10". The rods extended well out over the end of the 2" x 4"s.

The antenna director rods were mounted on the other side in the same manner as for the radiator rods, except that the director rods are cut longer—the total combined length of the director being 33'6". There is no loading coil in the director. The same type of steel tubing was used for the directive rods.

There are several other types of tubing which can be used for the radiating elements. Shelby steel tubing,

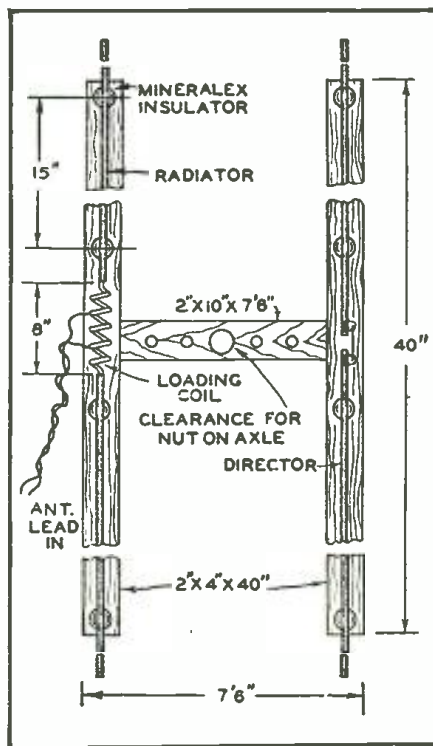

Construction of the beam supports.

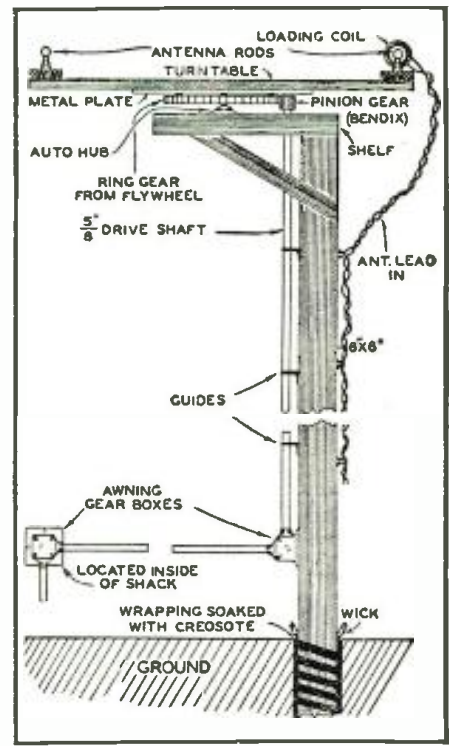

Details of the array assembly.

thin wall conduit, even bamboo and No. 10 copper wire in bridge form can be employed. The choice will depend largely upon the amount of money to be spent on the actual radiating elements.

I used EO-1 cable as a feeder for this antenna array, but other types, such as Bassett cable, could also be used. I mounted the feeder cable on the side of the 6" x 6" main pole opposite the drive shaft by means of glass stand-off insulators. Before the entire assembly was permanently mounted the radiating and director rods were properly tuned. The proper points for tapping on each of the rods to the loading coil can be easily determined by means of a field strength meter. The feeder was not securely attached to the antenna until the entire assembly was permanently mounted in an upright position.

The wooden shelf is attached directly to the main pole, and two wooden supports (about 2" x 2" x 1'6") were used to brace the shelf against the main pole, as shown in illustration. The automobile hub should be filled with water pump grease, and

the hub screwed on the bottom side, to give permanent lubrication. I used aluminum paint applied over red lead as a protection for the exposed metal pieces on my rotating array. Ordinary outside paint was used on all wooden surfaces. Stove-bolts and heavy wood screws were used for all of the construction. Lubricating oil can be used on the meshing gears at the top of the main pole, but if properly painted this may not be necessary.

Since the rotating array was to be a permanent part of my rig I had to give some thought to the preservation of that part of the main pole embedded in the ground. I wrapped upholstery tape on the bottom of the pole as a preservative, forming a wick on all four sides extending from the bottom to about one foot above ground. The tape was folded over and tacked down, making sort of a tube duct. Before filling in the earth around the pole I soaked the tape in creosote, and after filling in I used a small "squirt-gun" to pump more creosote into the ducts to fill the wicks. The tape absorbs the creosote, and

(Continued on page 82)

An auto flywheel ring gear engaged by a Bendix starter gear turns the antenna.

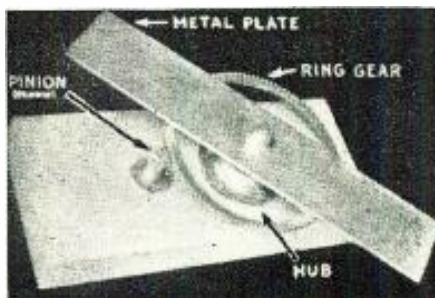

Motor turns array by means of flexible coupling to gear box. $\frac{1}{2}$ hp. is used.



LCR METER

for Amateur Use

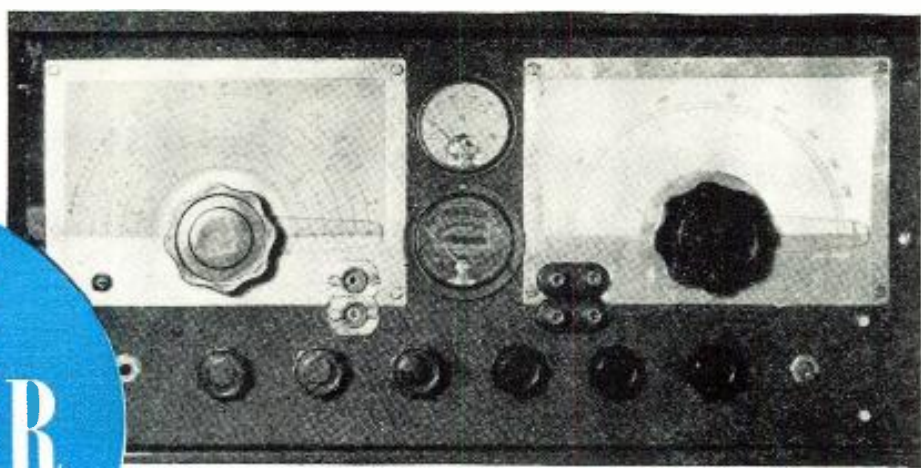

Fig. 1. Front panel view of completed unit.

Eliminate cut and try methods — construct this LCR instrument and measure various circuit constants accurately on the first test.

By **W. B. BERNARD, W4ELZ**

HAVE you ever spent hours winding coils for your transmitter or receiver by the cut and try method? If you have and if you want to do it an easier way next time, the LCR meter is the instrument that you want around your shack. The oscillator section of the meter can be used as a signal generator and as a grid-dip oscillator, each application of which has many uses. The oscillator uses coil and condenser switching to cover the frequency range from 90 kc. to 36 mc. Measurements of r.f. components may be made anywhere within this range.

Operation as a LCR meter allows the measurement of the following:
 Inductance.
 Q of an inductor (within the range of 10 to 600).

Capacities up to 350 $\mu\mu\text{fd.}$ (this range may be extended by use of additional standard capacitors of 250 to 300 $\mu\mu\text{fd.}$).

By use of the LCR meter and necessary calculations, measurements of radio frequency properties of resistors, r.f. chokes and other components may be made.

With a lesser degree of accuracy the grid-dip oscillator will measure the following:

Inductance.
 Capacitance from 250 $\mu\mu\text{fd.}$ to 1 $\mu\text{fd.}$ (without disconnecting the condenser from its circuit unless it is shunted by a low resistance.)

Resonant frequency of tuned circuits, antenna and feeder systems, and crystals.

When operated as a signal genera-

tor the oscillator may be used to align receivers or as a generator for making radio frequency measurements which require one watt or less of power. It is also useful as a low power oscillator for use in the adjustment of directional antenna arrays.

A 7C5 tube is used as the radio frequency oscillator. The tuned circuits are of the high-C type. It was found that the current through the measuring circuit was more constant over a wide tuning range with high-C circuits. When the instrument is used as a grid-dip oscillator or as a power oscillator the output is drawn from link circuits inductively coupled to the tuned circuit. When it is used as an alignment oscillator the output is taken from the plate circuit of the oscillator tube which operates as an electron coupled oscillator for this service. The oscillator may be operated unmodulated, with internal modulation, or with external modulation.

For use as an LCR meter S_1 (Fig. 5) selects the proper coil and condenser combination for the desired frequency; S_{2a} connects the oscillator output through M_1 to R_3 ; S_{2b} connects M_2 to the plate of the Q-meter voltmeter tube V_{1A} ; and S_{2c} completes a radio frequency path from the plate of the oscillator tube to ground. The inductance under test is connected between terminals P_1 and P_2 . The radio frequency output current through R_3 is set to a value I , then C_{11} is tuned to resonate the LCR circuit to the applied frequency. The current I flowing through R_3 causes a voltage drop e to exist between terminal P_1 and

Table 1. Construction details of the various coils used in this unit.

FREQUENCY	L ₁	L ₂	L ₃	TUNED WITH
90-300 kc.	324T #20 dcc bankwound. 9 deep. 1 3/8" long	2T	4T	C ₁ , C ₂ , C ₃ , C ₄
260-900 kc.	135T #20 dcc bankwound. 3 deep	2T	4T	C ₁ , C ₂ , C ₃ , C ₄
700-2300 kc.	45T #20 dcc closewound	2T	3T	C ₁ , C ₃ , C ₄
1800-5800 kc.	25T #20 dcc closewound	2T	*	C ₁ , C ₂
4500-13,000 kc.	11T #18 enamel. 1/2" long	2T	*	C ₁
13,000-36,000 kc.	5T #14 enamel. 1" o.d., 5/8" long	2T	*	C ₁

The first three coils listed are wound on 1 1/2" coil forms, the next two are wound on 3/4" coil forms and the last coil is self-supporting.
 * L₂ is wired to the switch points so that it operates as both L₂ and L₃.

ground. The resistance of R_s is very low so that in the calculations to follow the oscillator may be represented as a generator which has a negligible internal impedance.

Referring to Fig. 4B, when R , L , and C form a resonant circuit the current i through R , L , and C will equal e/R .

$$\text{By definition } Q = \frac{\omega L}{R}$$

Multiplying the top and bottom of this fraction by i we have: $Q = \frac{i\omega L}{iR}$

$$\text{But } i = \frac{e}{R} \text{ so } Q = \frac{i\omega L}{e}$$

Under the condition of resonance

$$\omega L = \frac{1}{\omega C} \text{ and } i\omega L = \frac{i}{\omega C} = E$$

$$\text{Therefore } Q = \frac{E}{e} = \frac{E}{IR_s}$$

Since R_s is fixed, for any given current I , Q is proportional to E which is measured by the vacuum tube V_{1A} and indicated by M_2 . By selecting an arbitrary value of I for all measurements, the dial of M_2 can be directly calibrated in values of Q . For this instrument R_s is .05 ohms and I is set at .4 amperes so one volt applied at the grid of V_{1A} represents a Q of 50. Full scale deflection of the meter requires an input of six volts. This allows direct reading of values of Q up to 300. By setting the current through R_s to $I/2$ (0.2 ampere) the readings of the meter are doubled, thereby extending the range of the instrument to measure Q up to a value of 600.

C_{11} is directly calibrated in μfd s. so that by the use of a reactance chart or by means of calculations the inductance of L_r can be accurately determined. Small capacitors can be measured by connecting them between terminals P_2 and P_1 , after an inductance has been tuned to resonance by C_{11} . After the capacitor is added, C_{11} is again varied to produce resonance. The unknown capacity is then determined by the difference between the second and first settings of C_{11} .

A further discussion of the theory and operation of the LCR meter may be found by referring to material on the Q -meter in the "Proceedings of the I.R.E." for November 1942 and in Terman's "Radio Engineers' Handbook."

For use as a grid-dip oscillator S_{2a} disconnects M_1 and R_s from the circuit to prevent them from consuming radio frequency power; S_{2b} connects M_2 to the plate of the grid-dip voltmeter tube V_2 and S_{2c} maintains the radio frequency ground on the plate of the oscillator tube. A coupling cable is connected to J_1 if inductive coupling to the load is desired or a test lead is connected to J_1 , if capacitive coupling is desired. R_s is adjusted until M_2 indicates somewhere within the lower fourth of the scale. As the oscillator is tuned through the resonant frequency of the circuit being tested the power taken by the circuit from the

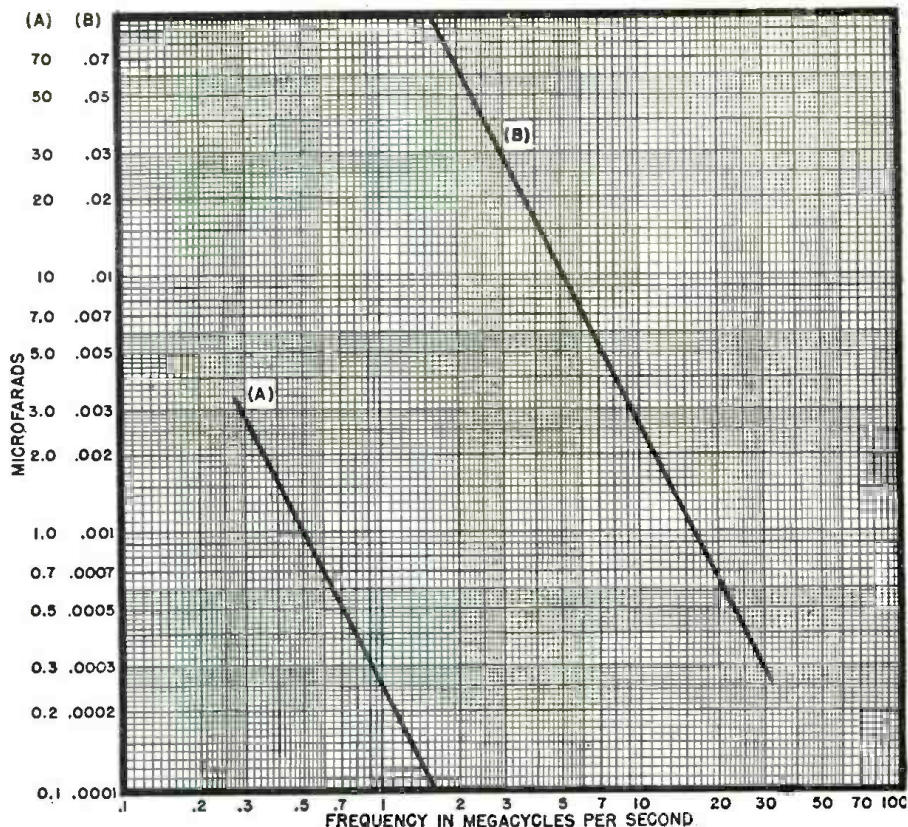

Fig. 2. Capacity vs. frequency—chart used for checking capacity of condensers.

oscillator is increased, thereby decreasing the oscillator grid voltage and the rectified d.c. voltage appearing across the grid leak. As the oscillator grid becomes less negative the grid of V_2 becomes less negative and the plate current drawn by V_2 increases. This increase is registered by M_2 , and this increased reading of M_2 means that the oscillator is tuned to the resonant frequency of the circuit coupled to it.

By use of the grid-dip oscillator and a single turn inductance, the capacity of a condenser within the range of 250 μfd . to 1 μfd . can be measured

without disconnecting it from the circuit unless it is shunted by a low resistance, as in the case of a cathode bypass condenser.

The coupling cable may be inductively coupled to almost any unshielded tuned circuit or current fed antenna system. The capacity coupling is used for shielded circuits, crystals, and voltage fed antenna systems.

The same setting of S_2 is used to operate the instrument as a power oscillator. Power is taken from J_2 and the output is adjusted by R_s . All measurements must be made by external instruments.

Fig. 3. Rear view of completed instrument showing placement of component parts.

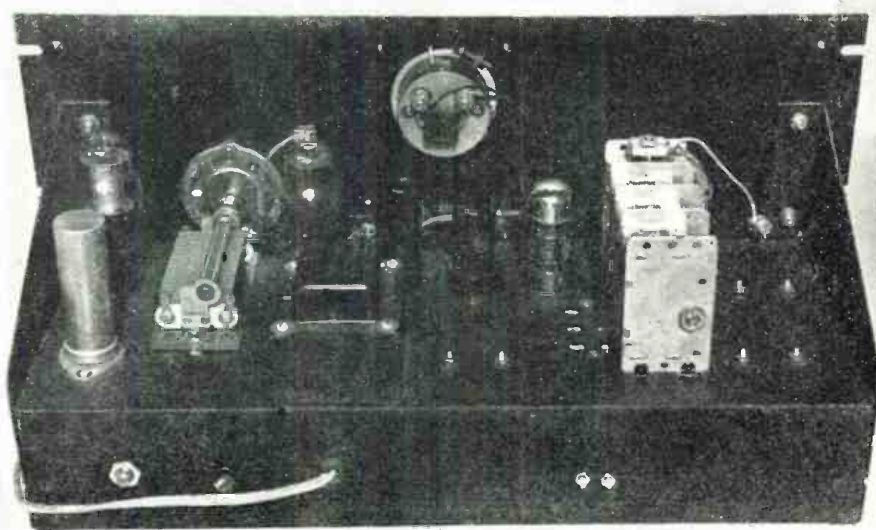

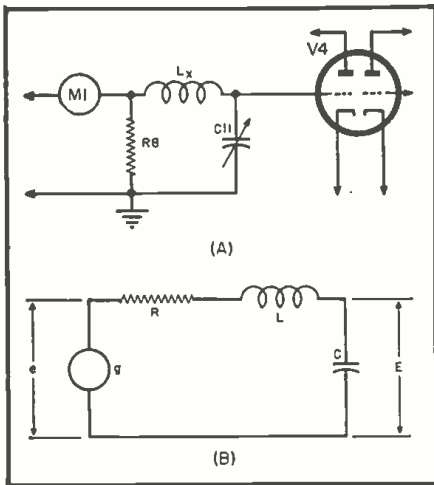

Fig. 4. Circuits used to illustrate mathematical procedure discussed in the text.

When used as an alignment oscillator S_{2a} connects R_8 and M_1 to L_2 , S_{2b} connects M_2 to the plate of V_{4A} and S_{2c} is open, allowing a radio frequency

voltage to develop across R_8 and R_{13} . The radio frequency output is controlled by R_{13} . M_1 and R_8 are left connected so that the frequency calibrations will be correct.

S_3 controls the modulator circuit. When no modulation is desired the cathode circuit of the modulator section of V_{4B} is opened. When external modulation is desired V_{4B} is connected to amplify any audio signal fed into J_4 . T_1 acts as a modulation transformer and superimposes the amplified audio voltage upon the direct current plate supply to V_1 . When internal modulation is used V_{4B} is connected as an audio oscillator and T_1 is employed as both an oscillation transformer and a modulation transformer. C_{14} is used to tune the transformer to a suitable audio frequency.

V_5 furnishes a regulated supply of 150 volts to the voltmeter circuits. R_{14} and R_{15} are used to balance the static plate current of V_{4A} which allows M_2 to read zero when there is no voltage impressed on the grid of V_{4A} .

The vacuum tube voltmeter can be calibrated with 60 cycle a.c. if a 25 μ f. 25 volt condenser is connected in parallel with C_{13} . For the original calibration of the meter R_{15} is set to maximum resistance, R_{16} is set to give no balancing action (maximum meter reading), and R_{16} is adjusted until V_{4A} draws about .25 ma. plate current. This current is then balanced out by adjusting R_{15} . Six volts r.m.s. are then applied between terminals P_2 and P_4 . R_{15} is adjusted to give full scale deflection of M_2 . The voltage is then removed and the zero reading of M_2 is reset with R_{15} . One more adjustment of R_{15} for full scale deflection of the meter should be sufficient to effect the calibration. Intermediate values are then marked on the meter scale. One volt equals a Q of 50, two volts a Q of 100, etc. During subsequent calibrations it is necessary only to adjust R_{15} so that six volts r.m.s. gives full scale deflection of the meter.

The unit is constructed on a 7 x 17 x (Continued on page 123)

Fig. 5. Circuit diagram of complete instrument. The oscillator has a frequency range of from 90 to 36,000 kilocycles.

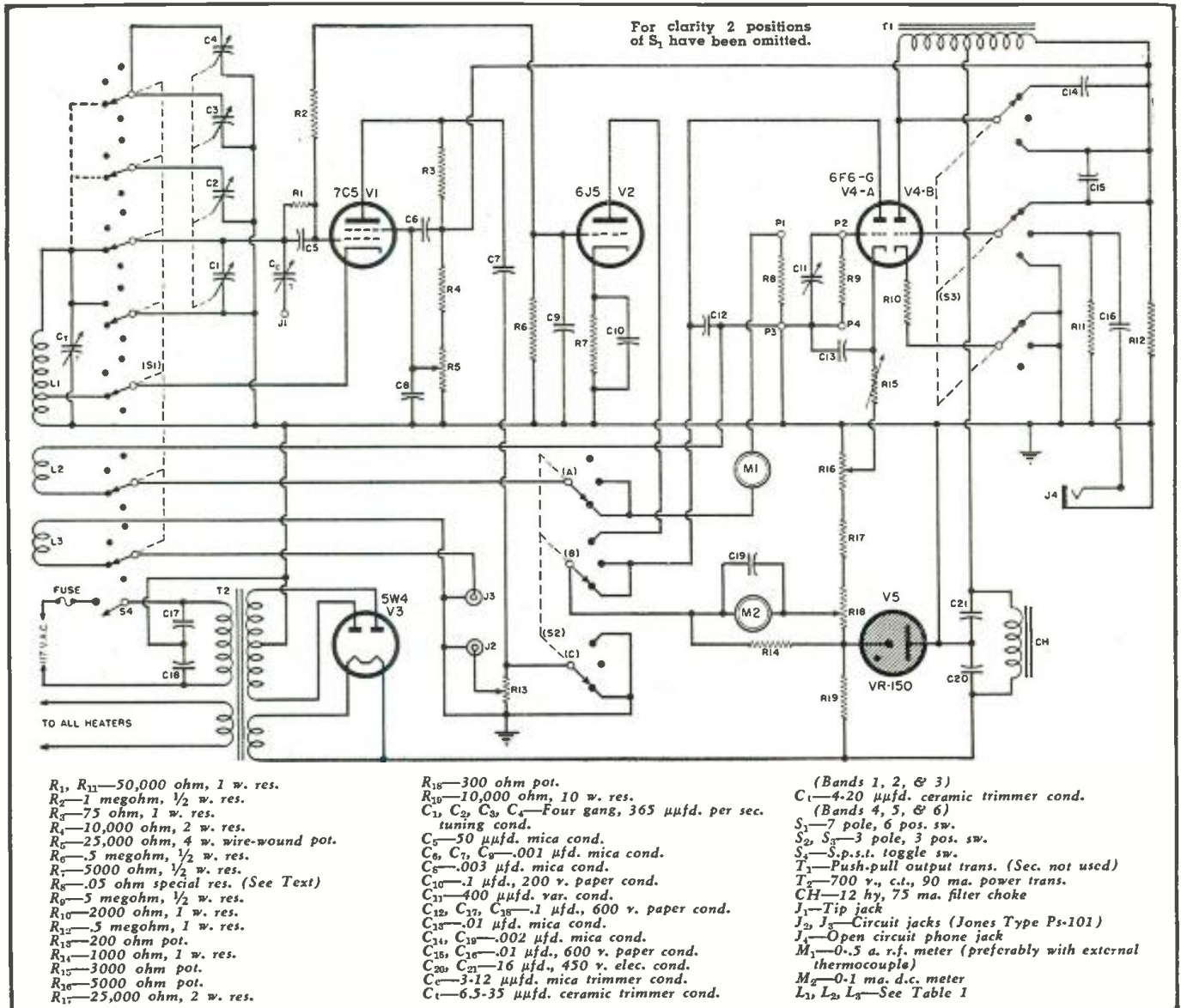

W. T. BACKUS, of Honolulu, sends along a very fine letter and some information which may be of interest to those hunting a position in radio operating ashore. "The Pacific Area, otherwise known as the Ninth Region of the Civil Aeronautics Administration, has need of fifty experienced communications men (famously known as 'operators') at starting salaries ranging from \$2900 to \$3300 per year. The jobs are fixed base (beachside if you like) with, in general, the possibility of family accommodations. Being in the Pacific Area rather than in the Continental United States, the Civil Service restrictions as to veteran employment do not apply in this case. Anyone with the desired qualifications can be appointed." Those interested should address their inquiries to the United States Civil Service Commission, San Francisco, California, with a request for information about openings with the CAA in the Pacific Area; qualifications should be stated in the letter of inquiry. "W. T." says that there is a great job to do out there and plenty of opportunity for advancement. This information we hope will be of some value to those with such experience in getting a shore berth.

THE War Shipping Administration recently announced that nearly five hundred vessels operated under government charter during the war have been returned to their owners. Additional shipping in both cargo and passenger types are being steadily returned to the prewar owners, some of whom have already started operation of their former cargo and passenger services. Cargo carrying has also been authorized by WSA aboard fast passenger liners on the north Atlantic run. . . . First of these cargo carriers was the United States Lines "Washington" which started the schedule in early April. There will be six vessels on this run of the passenger-cargo type. At this writing the Grace Lines have launched five of their new fleet of "Santa" vessels, four more will follow shortly. . . . The new ships are combination cargo-passenger ships and will join the regular runs of the company.

U. S. MARITIME COMMISSION reported the delivery of eleven merchant ships during March which made a total of thirty-four new vessels delivered during the first three months of this year—four were for the Netherlands Government, the remainder were USMC "C" types. The U. S. Maritime Service has also announced the opening of a radar school of USMS members at Sheepshead Bay whereby students are paid out of USMS funds. A suggestion by several organizations has been made that the various electronic equipment aboard ship including sounding gear, radio direction finder, loran, radar and public address systems, etc., be under



By **CARL COLEMAN**

the complete care of the radio officer—and that its repair should only be permitted by those who hold radio licenses.

IN THE marine field, beach lists generally have lengthened during the past few months as was to be expected with the tie-up of many of the older types of ships such as the greater number of the old Liberty class. However new construction by many shipping lines, to replace overage and others lost during the war, will give new permanent employment to a large number of marine radiomen. Among the new tonnage will be four new ore carriers—to be the largest and fastest afloat, about 24,000 tons each with a speed of from 16 to 18 knots—three of these craft have already been launched.

THE American South African Line has launched two of six new ships which will enter service on the company's South Africa run. United Fruit Company has traded nine of its older vessels in to the Maritime Commis-

sion on nine new ships for the fleet, several of which are already launched and in addition new passenger construction is also believed under consideration. UFCO is expected to operate to the U.K. and Europe points in addition to its regular South and Central American runs . . . and West Indies trade. Prudential Line also reported opening cargo runs to Europe which should provide additional berths.

DR. D. H. Andrews of Johns Hopkins University recently announced a device, some phases of which are still classified as secret, using an infra-red "eye" which can see in the dark for ten to fifteen miles. The equipment, known as a superconducting bolometer, was the invention of a group of Johns Hopkins University chemists, headed by Dr. Andrews. It was explained that the superconducting bolometer "saw" rather than detected, it being possible to get an actual outline of the object observed if the instrument is used in conjunction with a suitable scanning

device such as a cathode ray oscilloscope. . . . Unlike radar which can be traced by the wave it sends out, the infra-red "eye" does not disclose its position. It merely receives rays from infra-red sources and anything which is warm in relation to its surroundings is an infra-red source. The announcement came after almost complete silence throughout the war on American infra-red research. The "eye" was not developed in time to be put to wartime use, most likely as a short range substitute for radar. It might also be the answer to iceberg warnings and very short range operations for the safety
(Cont. on page 74)



*Constant 6 volt D.C. Supply

For the Service Lab.

By Lt. Curtis C. Springer

Asst. Sup., Police Radio & Comm.,
Indianapolis Police Department

Although originally designed for police radio labs this battery charger and automatic regulator unit can be well adapted to auto radio servicing.

IN THE modern Police Radio System, a large percentage of service repairs involve equipment which must operate from a 6-volt d.c. supply. A storage battery in the lab fills the bill nicely, except that it must be regularly replaced with a fresh one, recharged when low, or floated across a trickle charger. In all such cases, the net result is a varying input voltage from time to time to the unit under test, which is roughly equivalent to making linear measurements with a two-way stretch yardstick.

This problem has long been recognized at WMDZ, and only recently met satisfactorily with a semi-automatic

control on a heavy duty charger rectifier. The prefix "semi" represents the desirability of adjusting the charging rate to meet the load. The "automatic" part is nicely handled by a 2050 tube, which turns the charger off when the battery voltage exceeds a predetermined value, and turns it on when the voltage tends to drop below that value. We still have to give the battery a drink about once a year.

There is nothing complicated or expensive about the layout. The "innards" of the charger itself had been in use for some years for the same purpose, but with different results. Too often the human element entered

in, causing a dead battery, or one boiled dry.

Naturally, while a battery is being charged faster than it is being discharged, the voltage increases slightly. If the charging rate is considerably higher, the voltage may go up several tenths of a volt, and such a condition happens often in a lab where the load may vary considerably. This would take place, for instance, when a mobile transmitter, with its 18 amp. load, is being turned on and off while under test. If the charger remained "ON" between operations, and kept on charging at a rate equal to the maximum load, the battery before long would develop over seven volts between its terminals.

What was needed was a method for putting back into the battery (in ampere hours), exactly what was being taken out. Maintaining the proper battery voltage will give this result, and that is exactly what happens in this circuit.

The 2050 tube (a thyratron gas tetrode) is very sensitive, but will operate a mine-run relay in a "yes or no" manner, no "maybe" to it. No other tubes are required, as a.c. is necessary for its plate supply and in this circuit, the battery in question is part of its bias.

Basically, here are the fundamentals: About 70 volts a.c. is fed to the plate of the 2050 through the solenoid of a relay. This relay controls the a.c. input to the charger. The full six volts from the storage battery is applied as grid bias in the usual manner. However, six volts is far too much to allow the tube to conduct, so a small a.c. voltage is borrowed from the heater winding and applied in series with the battery bias. The positive peaks of this a.c. voltage ef-

Complete wiring diagram for automatic regulator and battery charger.

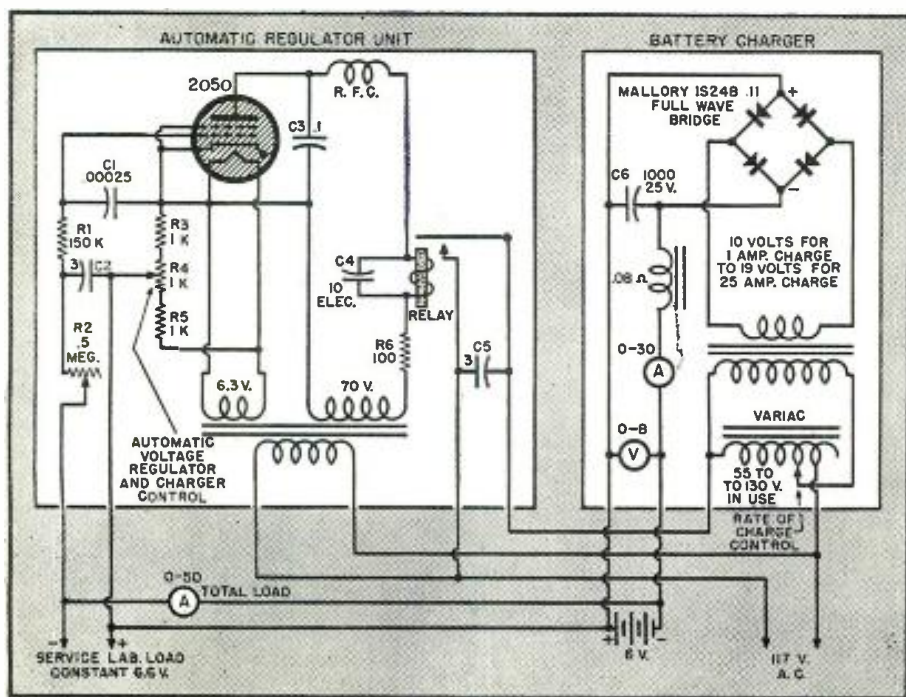

* Reprinted from the February, 1946, issue of "The APCO Bulletin."

fectively reduce the actual bias to the conducting point of the tube when the peak a.c. voltage is equivalent to the amount of d.c. bias beyond "cut-off." Therefore, with the proper effective combined negative bias to allow the grid to ride just beyond the point where the plate conducts, any drop in battery voltage will reduce the bias enough to allow full conduction. Therefore, changing the amount of a.c. in the grid circuit will allow conduction to start at a different battery voltage, and the charger can be caused to turn on automatically at any desired battery voltage from 5 to 7.5 volts. However, line voltage variations do not change the adjustment, because they also cause proportional changes in the plate voltage in the same direction.

The 2050 is an ideal tube for such an application. It has high sensitivity so a small variation in grid voltage will trigger conduction in the plate circuit with a minimum of "backlash," or sluggishness, and the plate circuit will handle enough current to operate a relay which is made for real work. Conduction in the plate circuit takes place over a large portion of the positive cycle, and, providing a sufficiently large by-pass is used across the relay coil, no hum or chattering is encountered.

The 2050 tube ratings are: Peak forward plate volts, 650; peak inverse, 1300; peak plate current, 500 ma.; average plate current, 100 ma.; heater 6.3 volts at .6 amp.

None of these ratings is likely to be approached in such an application as this except the peak plate current. The relay coil, regardless of its resistance, does not present much impedance to the peak current when the coil is by-passed with such a condenser as ordinarily is necessary. Therefore, a series resistor of 100 ohms is included in the plate supply to limit the peaks.

A simple r.f. filter is necessary in the plate circuit to prevent r.f. radiation. A .1 μ fd., 200 volt paper condenser from plate to cathode, and a small r.f. choke in series with the plate supply are all that are necessary to cure the hash completely.

The tube manufacturer states that the impedance in the grid circuit should be between one tenth and ten megohms. The action definitely becomes sluggish unless at least one tenth megohm is in the circuit right next to the grid (R_1). Even a .01 mica condenser directly from grid to cathode causes sluggishness. However, a .00025 in this position (C_1) causes no noticeable effect, and will prevent a strong r.f. carrier from effecting operation. Without a small r.f. by-pass here, the plate circuit relay will follow a nearby c.w. transmitter at 40 w.p.m.

A total of more than .25 megohm in series with the grid-cathode circuit also brings on sluggishness. "Sluggishness" refers to a tendency for the tube to start conducting at one value

of grid bias, with a noticeable increase in negative bias necessary to stop conduction. A little of this condition is desirable to keep the charger from turning on and off too often, and is easily regulated with a variable series resistor in the grid circuit (R_2 , adjusted to about .1 megohm). The large paper condenser C_2 is added to form a time-delay circuit with R_2 , to also assist in keeping the charger from turning on and off rapidly in case the charger is left at a high rate with no load on the battery.

The other important parts of the automatic control circuit are the three resistors R_3 , R_4 and R_5 , which form a voltage divider across the 6.3 volt heater winding to provide the a.c. for feeding into the grid circuit. No power is involved, so R_3 and R_5 are half-watt, 1000 ohm resistors. R_4 is also 1000 ohms, but must be variable, because this is the control which determines the battery voltage at which the charger turns on. The range of two to four volts a.c. which appears across R_4 is more than enough to spread the point of conduction in the 2050 from 5 to 7.5 volts battery voltage. This spreads the usually desired range of 6 to 6.6 volts over a convenient portion of the control.

As would be expected, the a.c. fed to the plate circuit should be in phase with the a.c. in the grid circuit. Otherwise, on that part of the a.c. cycle when the plate is positive, the grid is negative 9 to 12 volts (d.c., plus a.c. peaks added), and when the grid becomes low enough for conduction (d.c. minus the positive peaks), the plate is negative and cannot conduct. The simple expedient is to reverse either

the plate winding at the transformer, or the a.c. going into the voltage divider from the filament winding. They must be properly phased.

Our charger was built for a maximum of 30 amperes d.c. into the battery, which means that the controlling relay must handle considerable power, and because of the automatic feature it naturally must be expected to operate pretty often as compared to a switch. This calls for generous contact surface. The relay is an "Advance," with $\frac{1}{4}$ " contacts. It is similar to many keying relays, but the coil happened to be wound for operation on 110 volts a.c., and has a d.c. resistance of 250 ohms. In operation, there is an effective drop of 17 volts d.c. across the relay. As previously mentioned, a condenser is necessary across the relay solenoid. We use a 10 μ fd. electrolytic.

Also, a 3 μ fd. paper condenser was installed across the relay contacts to reduce flashing. This passes some a.c. into the transformer primary, but not enough to do any charging of the battery.

At a glance, it might seem simpler to dispense with the a.c. in the grid circuit, and use a "volume control" across the battery, with the grid connected to the rotating arm. However, as the arm approached the "off" end of the control, less and less of the available voltage variations would be fed to the grid. As the available bias is divided, the variation voltage is also divided. Less than one volt of the available six volts d.c. is all that can be used, so such a circuit would take advantage of only one sixth of the

(Continued on page 145)

In the photograph below, "A" is the voltmeter which indicates the "6 volt" supply voltage at the test bench. The battery is beyond the wall, in the garage. "B" is the control which determines the point at which the charger turns on. The size of the control unit chassis, which mounts behind this panel, is indicated by the four screw heads above and below this control knob. "C" is the "rate of charge" meter, and "D" is the variac dial which determines the rate of charge. Behind panel "E" is the charger rectifier, which is 5"x6"x7 1/2". The test two-way control unit, shown in photograph, is mounted on the front of this panel for convenience.

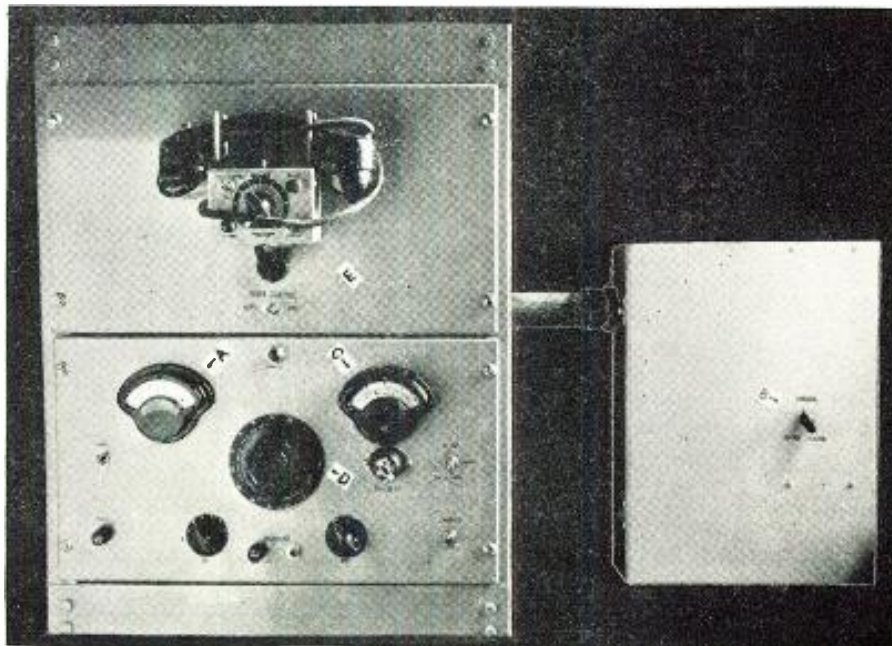

Recent Developments in

Heavy Duty Vibrator Type

POWER SUPPLIES

By **MARTIN R. WILLIAMS**
Field Eng., Electronic Laboratories, Inc.

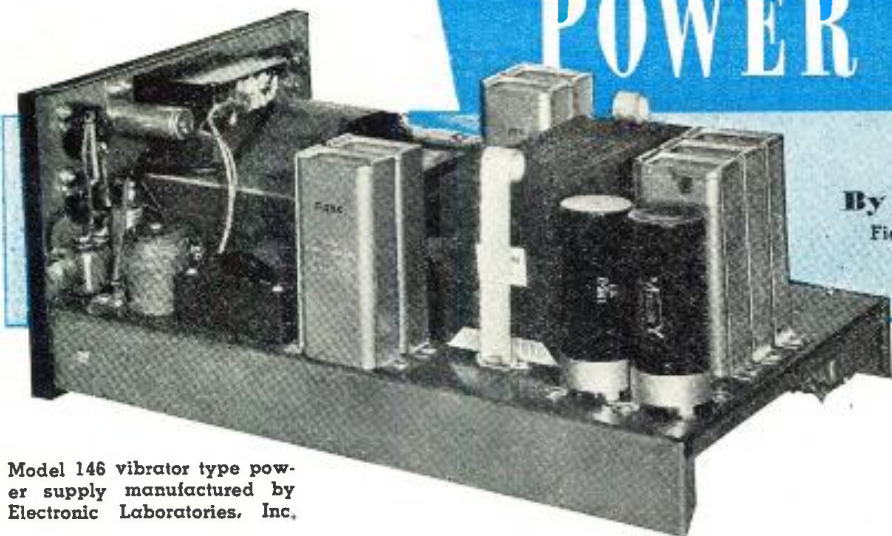

Model 146 vibrator type power supply manufactured by Electronic Laboratories, Inc.

The vibrator supplies a convenient means of converting d.c. to a.c. power. Covered in this article are many new features that have been incorporated in a commercially designed vibrator type power supply.

INASMUCH as the mechanical, vibrator-type, voltage and frequency changer power supply will find wide acceptance in postwar applications, an article describing such type of available apparatus should be most timely.

It is generally appreciated that the present day vibrator unit has not only been highly developed but has been successfully war proven in all branches of the Armed Services.

Because of the increased efficiency afforded, and the possibility of hermetic sealing, the mechanical vibrator method has, in many instances, proven to be the only practical one of providing power with the necessary voltage and current characteristics from the source at hand.

A vibrating circuit breaker in conjunction with an inductive transformer is theoretically a simple means of converting a direct current to one in which the current alternately flows first in one direction and then in the other.

In order to actuate the vibrating element, or armature, of such a vibrator unit (Fig. 3A) it is first necessary that an auxiliary electromagnet be provided, arranged in such a way that upon the application of the d.c. voltage, the free end of the armature

is attracted away from its position of rest. The core of this electromagnet is usually a continuation of the iron framework, to which the metal reed armature is attached, thereby providing a short magnetic gap to the free end of the armature. The structure is arranged electrically so that a pair of contacts, one welded on the armature, and the other on, but insulated from, the frame, are normally together when the armature is in the rest position.

The d.c. source is then connected to the electromagnet coil with the pair of contacts in series. Upon closing the battery circuit with this arrange-

ment, the coil is energized, pulling the armature towards itself, thereby opening up the coil circuit, allowing the armature to return to its former position. Upon returning to this position, the contacts close once again and the cycle is repeated, the armature continuing to open and close the contacts so long as voltage is applied and the setup is not otherwise disturbed.

In early types of vibrators, advantage was taken of this opening and closing of the circuit by winding the actuating coil with a wire of sufficient size to carry the power load, and by then inserting the primary winding of a transformer directly in series. Through the rise and fall of magnetic lines of force resulting over the primary, an a.c. voltage, determined by the turns ratio, was induced into the secondary winding.

Analysis of this original method (Fig. 3B) will disclose that, for every complete cycle of armature movement, starting from the point of maximum displacement, back to the point of maximum displacement, one pulse of current or electron flow had taken place in the primary winding, and this, of course, in but one direction.

Modern practice dictates that a reversal of current, equal in amplitude, take place recurrently in the primary winding. Hence a center tapped primary winding and auxiliary contacts, independent of those of the armature drive circuit, are used to connect the ends of the primary winding alternately to the source of power (Fig. 3C).

It follows that with this arrangement, there will be developed across the primary winding an a.c. voltage having close to a square or rectangular waveform and of equal amplitude on each side of the cycle.

In speaking of a square waveform, if the voltage appearing across the

Fig. 1. Wave shape of vibrator pulses.

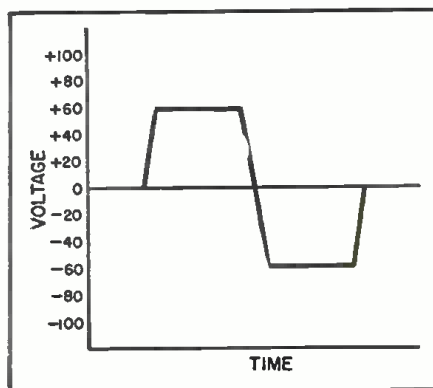

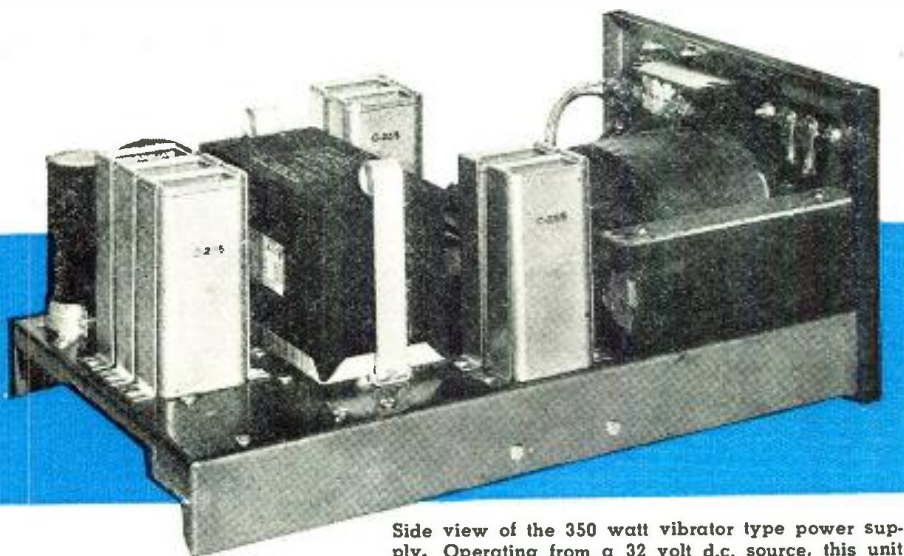

Side view of the 350 watt vibrator type power supply. Operating from a 32 volt d.c. source, this unit supplies an output of 110-120 volts at 60 cycles.

primary winding were represented on graph paper, using the horizontal to represent time and the vertical to represent relative voltage amplitude, the line starting at zero, upon making contact, would proceed almost directly upward, and would level off and run horizontal until the breaking of the contact. At this time it would almost instantly return to, and cross the zero line and proceed to a downward vertical distance equal to that of the upward side. The line would then run horizontally until, upon the next opening of the contact, it would return to zero, representing the completion of one voltage cycle.

If the vibrator armature were designed to vibrate 60 times per second, this number of cycles, or 120 alternations would take place over a duration of one second's time. From this it follows that during each cycle the vibrating armature has required .00333 seconds for travelling time between contacts and maintains contact closure, first on one side and then on the other, for a period of .00667 second each, or a total of .0134 sec.

During this .00667 second period while the contacts are closed (represented by the horizontal lines on the graph, Fig. 1) it should be remembered that voltage is being applied across an inductance, the inherent property of which is to retard any change in current taking place within itself, and therefore in its associated external circuit.

In other words, unlike the current resulting when voltage is applied to a resistor, the current flow through an inductance builds up in a comparatively slow fashion and does not reach a maximum value until an instant after the application of the voltage.

Therefore, during this period of constant primary voltage, the current continues to change, and, as a result, the strength of surrounding magnetic flux is changing. With the change of magnetic flux over the secondary winding, current is induced, causing a

voltage to appear across the transformer output terminals.

At all times during the cycle, the amplitude of the transformer secondary current is in step with that of the primary, from which it follows that secondary and primary voltages are also relative. Should a graph be drawn of the secondary voltage, it would also present the rectangular pattern of a square waveform.

As long as the r.m.s. values are proper and the alternations take place at a rate for which the various power appliances have been designed, it makes little difference in operating efficiency as to how the current progresses from the start, through maximum amplitude, and to the end of each half cycle.

The vibrator type power supply obviously may be designed to change any form of current and voltage to that of any other form within the frequency range or mechanical vibrational ability of the vibrator armature. The single unit vibrator may be designed to handle up to approximately one kilowatt.

One of the more popular *E-L* power supplies using the vibrator principle is the 350 watt, Model 146. This unit has been specifically designed to make possible the operation of standard 110-120 volt, 60 cycle equipment such as radio receivers, transmitters, phonographs, public address systems,

motors, and other standard electrical appliances from a 32-volt d.c. source.

The voltage regulation of this model is 27% at the rated load (Fig. 2). An efficiency of 75% is attained at the rated load as shown in the graph of Fig. 5.

The momentary pulsations of current, occasioned upon breaking a d.c. circuit containing inductance and capacity takes place at a rate which, if not suppressed, would cause severe interference with radio receivers used with or in the vicinity of the power supply. Such interference has been suppressed to a satisfactory degree in the Model 146 by the installation of proper condensers across the various current breaking contacts, and secondly, by preventing disturbing line surges from following the power source supply wires to the outside of the shielding case. These components are shown in the schematic diagram (Fig. 4).

They consist of eight .25 μ fd. condensers and the coil assembly with its two associated .5 μ fd. condensers. All of these components are shown on the left side of schematic diagram, Fig. 4.

The power handling capacity of the vibrator unit is determined by the cross section area of the metal armature or reed, and by the ability of the contacts to carry the applied current. Normally the largest cross-sectional area possible is used for the reed, consistent with its ability to vibrate at the frequency desired. At the standard power frequency of 60 cycles, the permitted cross section area has carrying capacity much greater than that of the contact, and therefore does

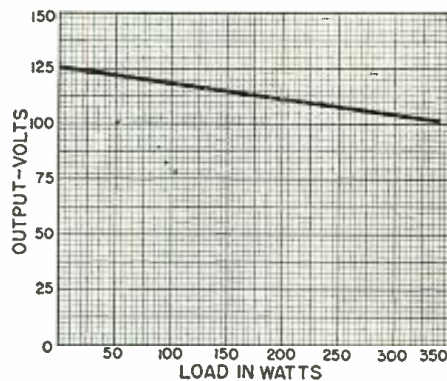
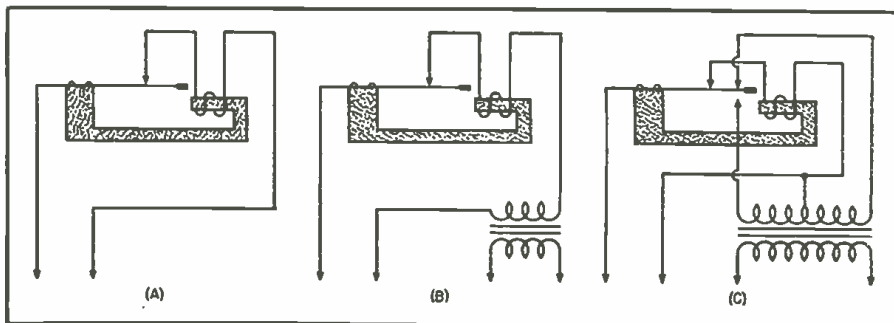
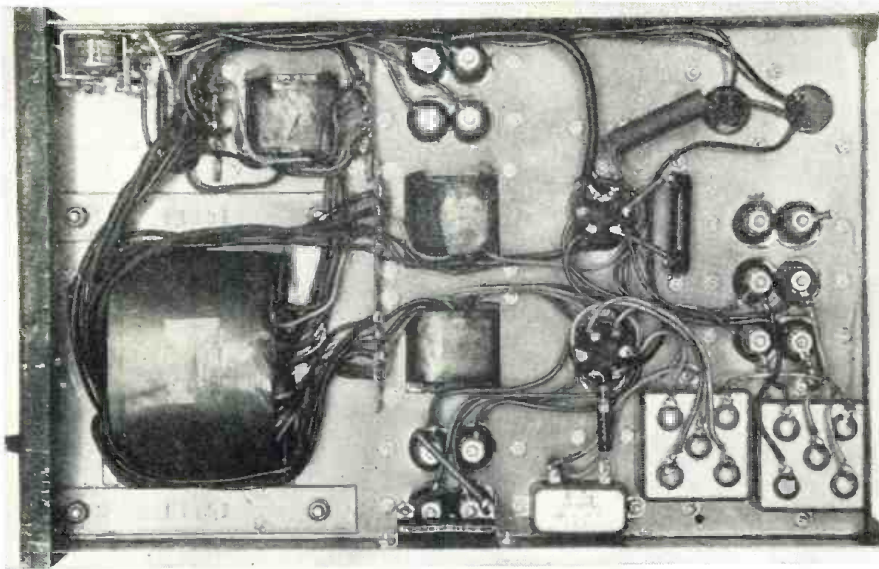

Fig. 2. Voltage regulation curve of vibrator type power supply pictured above.

Fig. 3. Illustrating mechanical and electrical operation of vibrator type circuit breaker.





Under chassis view shows neatness of assembly and absence of extraneous components.

not become a source of trouble.

Should simply two or more contacts be paralleled for handling an increased current, it would be impossible to maintain mechanical alignment whereby both contacts would close at the same instant.

However, through the use of an inductive dividing network arranged to equalize the current applied to each

contact, it becomes no longer necessary for all contacts to close simultaneously.

The reader may recall that in driving a dual 110-220 volt motor or transformer on a supply voltage of 220, one section of the winding must be series connected in proper phase relation to the other, or the magnetic field of one will cancel that of the

other, leaving only the d.c. resistance of the copper wire, and that this would present practically a short circuit to the supply voltage.

Advantage is taken of this principle in the case of the multiple contact type dual or tandem reed vibrator used with Model 146. An inductance is connected in series with each of two contacts, magnetically related in such a way that when equal current is passing through each, the reactances are cancelled, thus leaving only the negligible d.c. resistance of the windings.

Referring to the *E-L* Model 146 power supply schematic diagram (Fig. 4), upon closing the switch, the armature actuating coil is energized, attracting the armature. After travelling so far, the armature contact makes with the lower left-hand stationary contact.

This allows current to flow from the left-hand terminal of the power source, through inductance S_1F_1 , through transformer primary winding $P_{1-1}-P_{1-2}$ through inductance 4-3, and back to the other side of the supply terminal.

At this point, it is obvious that the current flow is retarded by the inductance S_1F_1 .

The movement of the armature continues and contact is made with the second contact from the lower left, (Continued on page 150)

Fig. 4. Complete wiring diagram of the Model 146 vibrator type power supply.

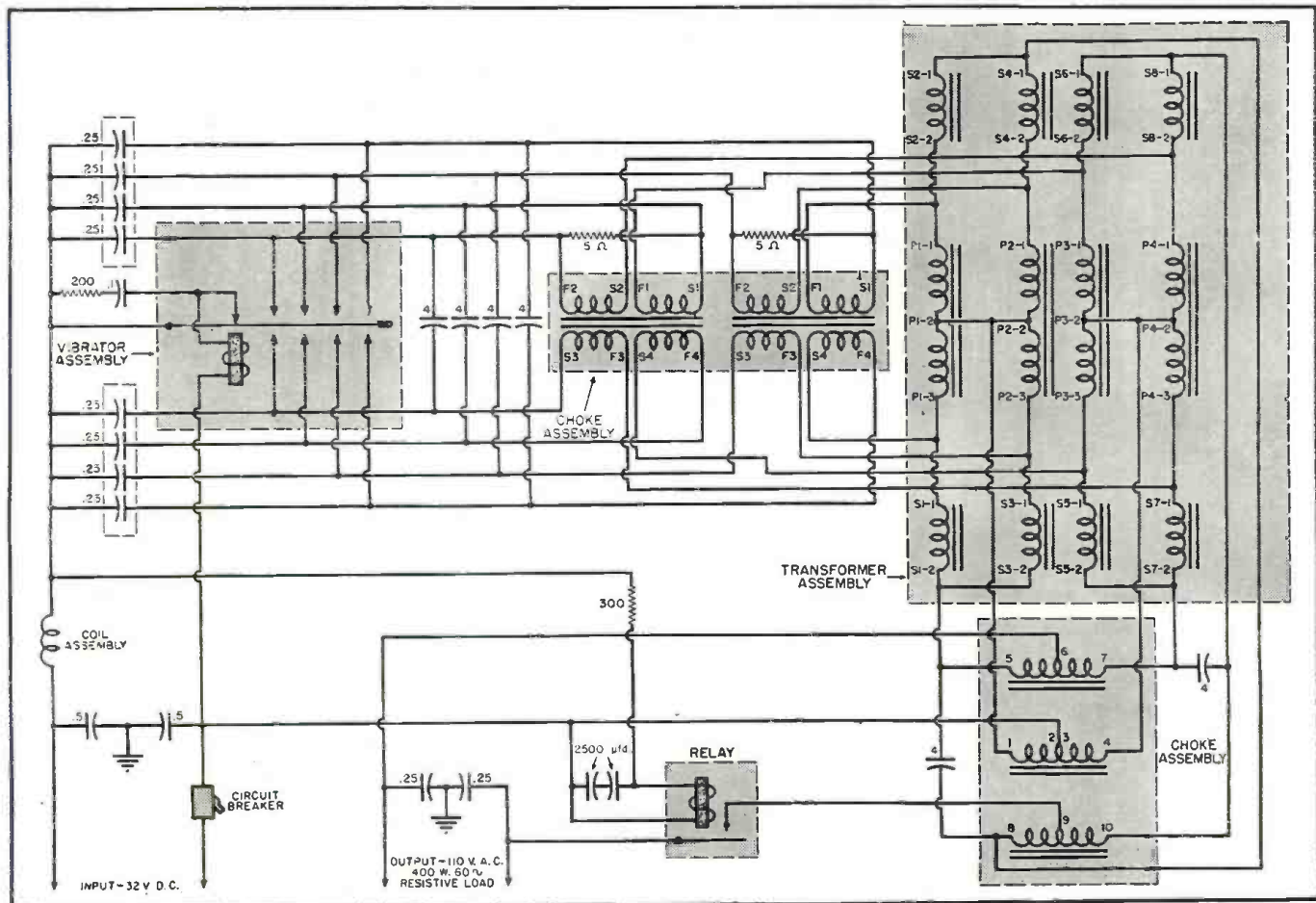



International SHORT-WAVE

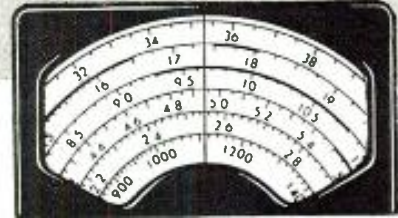

Compiled by **KENNETH R. BOORD**

FROM W. H. Erholm, ex-W2JWW, chief engineer, Radio Services, Ministry of Posts, Telegraphs and Telephones, Empire of Ethiopia, comes word that Radio Addis Ababa operates on 9.620 with 1 kw. power.

"We hope to shortly go on higher power with worldwide broadcasts," Mr. Erholm says. He also reports that several c.w. circuits have been created in the past year and that they hope to increase their direct circuits, such as the one now in operation between *Mackay Radio* in New York and Addis Ababa.

On 9.620, Radio Addis Ababa has local Amharic news and music on Monday, Wednesday, Saturday, 6-7 a.m.,* and Tuesday, Thursday, Friday, Sunday, 6-6:30 a.m.; world news in Amharic is heard daily, 8:45-9:30 a.m.; Amharic programs are also heard Saturday only, 12:30-2 p.m., and Sunday only, 3-3:30 a.m.

Arabic programs are carried 9:30-10:15 a.m. daily, with world news in that language at 9:45 a.m.

The English program begins at 10:15 a.m. daily and the BBC news is relayed from London between 11-11:15 a.m. (atmospherics permitting). Although not so stated, the station presumably closes down at 11:15 a.m.

* * *

Northern Rhodesia Calls

According to the Information & Public Relations Officer, P.O. Box 209, Lusaka, the Northern Rhodesia Broadcasting Station, ZQP, operates on frequencies of 7.220 (41.19 m.), 7.285 (41.55 m.), and 3.900 (76.91 m.) with programs for Africans in the Chibemba, Chinyanja, Chitonga, and Si-lozi dialects, and in English, between 10 a.m.-12 noon, daily, and in English to Europeans on Sundays only between 4-5:30 a.m.

Verification cards are being printed and International Reply Coupons are not required. Address ZQP, Northern Rhodesia Broadcasting Station, % Information Office, P. O. Box 209, Lusaka, Northern Rhodesia.

* * *

Radio Clube De Mozambique

We are indebted to A. Goncalves, manager, Radio Clube de Mozambique, at Lourenco Marques, Mozambique, for the following information regarding broadcasts from that country:

* All time herein is Eastern Standard Time (5 hours ahead of GMT), unless otherwise indicated.

CR7BK, 759 kilocycles (395 m.), 300 watts; CR7AB, 3.49 (85.96 m.), 600 watts; CR7AA, 5.86 (51.15 m.); CR7BD, 15.24 (19.69 m.), 300 watts; CR7BE, 9.71 (30.89 m.), 10 kw. Location is Lourenco Marques, Colony of Mozambique in Portuguese East Africa.

"Schedule for all except CR7BE is 12 midnight-1 a.m., 4:30-6:45 a.m., and 11:45 a.m.-3:30 p.m. daily; CR7BE comes on at 2 p.m. until closedown at 3:30 p.m.; on Sunday, all stations operate 4-7 a.m. and 10 a.m.-2:30 p.m. Our transmissions are bilingual, that is, in Portuguese and English, with English news at 10:10 a.m. and 2:50 p.m., preceded by the news in Portuguese. On Sundays, our programs are divided into A and B, the latter being talks of a religious nature."

* * *

Harmonic or Image?

Many good receivers show images occasionally on very strong signals. Whenever you hear something like that of which you are suspicious, it can be checked merely by tuning your receiver 912 kcs. higher. If you don't find the same thing, then your station is not an image but a bona fide signal.

Images frequently show on certain receivers on the low side of the 19-, 25-, and 31-meter bands, to mention the popular s.w. broadcast bands.

Example: A short time ago I heard the BBC with a fair level on about 8600 kcs. and wondered if it were an image or a harmonic. I asked a good friend about this and he explained "to be a harmonic, this would mean the

BBC would have to be on 4300 kcs. or 2150 kcs., or 1075 kcs., none of which are BBC channels. Undoubtedly, you heard the image of GSB, 9510 kcs. Images occur at twice the intermediate frequency of your receiver less—or rather, below—the fundamental of the station being heard. Your i.f. is nominally 456 kcs., doubled equals 912 kcs., subtracted from 9510 kcs., equals 8598 kcs. You only hear images of strong signals usually and they are the result of insufficient r.f. pre-amplification in your receiver."

* * *

Radio Clubs "Down Under"

Rex G. Gillett, DX Editor of "Radio Call," South Australia, has furnished the following list of active radio clubs in Australia and New Zealand:

Australian DX Radio Club (Victoria)—Ted Tinning, 7 Weir Street, Kew, Melbourne, Australia.

All Wave All World DX Club—Les Keast, 23 Honiton Avenue W., Carlingford, New South Wales, Australia.

Short Wave League of West Australia—Roy Matthews, P. O. Box P1179, Perth, Western Australia.

New Zealand DX Club, H. Barr, 10 Koraha Street, Remuera, Auckland, S.E.2, New Zealand.

New Zealand DX Radio Association—Joe Saunders, 20 Marion Street, Wellington, C.2, New Zealand.

New Zealand Radio-Hobbies Club, 11 Manners Street, Wellington, New Zealand.

Ted Whiting, 16 Loudon Street, Five
(Continued on page 110)

English and South American sections of Radiodiffusion Nationale Belge, Leopoldville, Belgian Congo. Transmissions of OTC2, approximately 9.471, are directed to North America nightly between 5-9:45 p.m. with English newscasts at 7:15 and 8:10 p.m.



Television VOLTAGE CIRCUITS

By **EDWARD M. NOLL**
Television Tech Enterprises

Part 13. Theoretical analysis of the various voltage circuits used in television receivers.

DANGER lurks in the high voltage supply of the television receiver. Be certain the chassis is grounded at all times to prevent the development of high floating potentials by a defective high-voltage transformer. Caution owners not to attempt any internal repairs. Do not make *any* internal repairs with high voltage turned on.

There will be unnecessary casualties unless manufacturers design a completely shielded, foolproof, high voltage supply, or use a voltage circuit, the output of which drops to a low ineffective value upon contact. Some circuits, such as an oscillator voltage supply or a transient voltage supply,

could be used for television applications.

A typical high voltage circuit for supplying various potentials to the electrodes of a picture tube is shown in Fig. 1. Actually, there is very little current drawn from the supply (a fraction of a milliamperere is drawn by the high resistance bleeder) and the transformer and rectifier can be reasonably small as long as they can withstand the high voltage without breakdown. When a tiny current is drawn the high voltage can be adequately filtered with a simple resistor-capacitor combination. Thus, the time constant of resistors R_1 and R_2 , and capacitors C_1 and C_2 is suf-

ficiently long to filter the ripple, and still the voltage drop across the large resistors is not excessive because only a small d.c. current is drawn through them. Consequently, the capacitors maintain an essentially constant voltage across them for the current is not drawn off of them excessively during the negative alternations of the input cycle when the rectifier is non-conducting.

Picture Tube Voltage Circuit

Picture tube voltage and operating circuits of the GE Model 90 receiver are shown in Fig. 2. The anode of the electromagnetic deflection picture tube requires a top voltage of 6500 volts. To obtain this potential with a reasonably small transformer winding, a voltage doubler circuit is employed. Capacitor C_1 charges to peak value on one alternation of the transformer high-voltage output; capacitor C_2 , to peak on the other alternation. The direction of the electron flow in the charging circuit is indicated by arrows. Since very little current is drawn, the series capacitors remain charged to essentially double the peak value of the high-voltage sine wave. This voltage is satisfactorily filtered by the RC filter.

The remainder of the picture tube electrodes, except control grid and cathode, receive their potentials off the high-resistance bleeder divider, which shunts the high-voltage output. Potentiometer R_1 serves as a focusing adjustment, changing the voltage ratio between first and second anodes. Grid bias, as covered thoroughly in an earlier installment, is the summation of the voltage drop across the video output plate resistor R_2 and the voltage across a portion of the bleeder network of the low-voltage power supply.

To properly center the image on the picture tube screen, there must be a certain amount of d.c. current flowing through the deflection coils. The necessary current is derived from the

CBS, advocate of full color television, has recently carried on extensive experiments with this ultra-high frequency service. Photograph shows the ten inch horizontal bar of the receiving antenna with a section of its parabolic reflector in the background. This antenna eliminates "ghosts" or unwanted reflections.

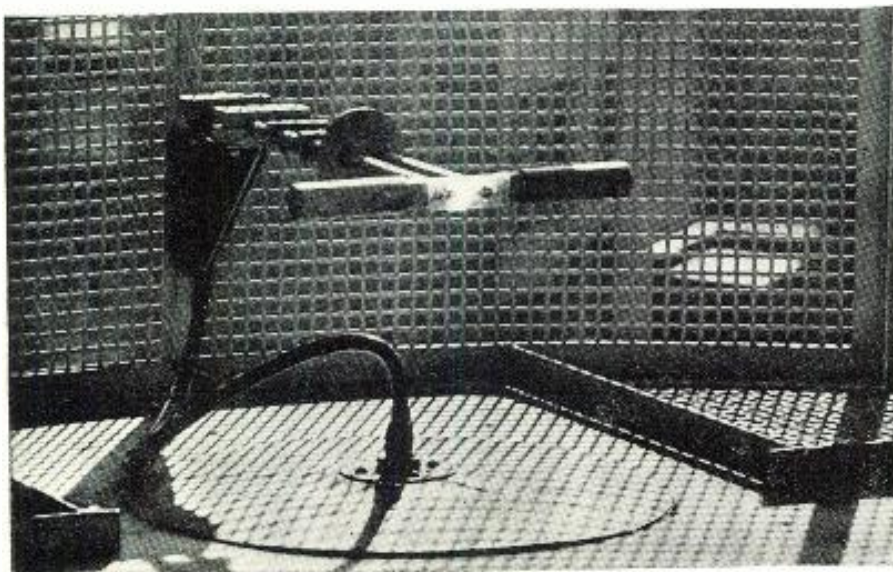

negative side of the low voltage bleeder resistor. A certain voltage appears across the low value resistors R_3 and R_4 , connected in series with R_2 between the negative side of the low voltage output and ground, which is used to cause a d.c. current flow through the deflection coils. The amount of current flowing through the deflection coils and transformer secondary depends on the position of the rotor arm with respect to the fixed connection. Final adjustment is made with the scanning raster on the screen.

Signal Paths

To assist in obtaining a clearer over-all picture of the complete receiver operation, the following discussion, used in conjunction with Fig. 3, traces the signal paths through the complete video section of the GE Model HM-171 receiver, which uses a five-inch, electrostatically deflected picture tube. Functions of various components are pointed out in numerical order. For a more complete discussion of individual topics mentioned, refer to previous installments of this series.

The input circuit to the receiver (1) is a wave filter which blocks undesired signals, reducing image response and interference. An input transformer (2) is used which properly matches the antenna and has the required broad band-pass characteristics. The r.f. section of the receiver consists of a triode mixer and triode oscillator to obtain the best conversion efficiency. Local oscillator generates a frequency of 12.75 mc. above the frequency of the picture carrier received. Fine adjustment is made by tuning the oscillator over a limited range (3) with the small capacitor C_1 . A series-resonant wave trap (4) is used to present a low impedance to the i.f. frequencies, preventing oscillations at the i.f. frequency. Local oscillations are grid-injected (5) through capacitor C_2 .

The i.f. signal (12.75 mc. on almost all postwar receivers) appears across the double-tuned (6) transformer. The transformer windings (tuned with movable iron cores) resonate with the distributed circuit capacities at the correct i.f. frequency. The wide bandwidth is obtained by having the correct value of mutual coupling between windings, and by loading the tuned circuits with low-value resistors (7) to flatten the response of the tuned circuits. The i.f. tubes have a high figure of merit (high g_m and low input and output capacities) to obtain sufficient gain with broad response. Gain of the mixer and the first three i.f. stages is set by the contrast control (8) which varies the cathode bias on each stage. This, in turn, varies the gain of the stages and determines the amplitude of the signal applied to the control grid of the picture tube. Since this signal determines the light range limits between which the grid is varied, the control is called a contrast control.

In the output circuit of the first i.f. stage, picture and sound are separated by two rather sharply tuned resonant circuits. The plate circuit (9) is resonant to the picture i.f. carrier frequency of 12.75 mcs.; the suppressor-screen (10) to the sound carrier frequency. It should be pointed out that with a small five-inch picture tube, the band-pass of the picture i.f. channel is narrower than with a receiver which has a larger picture tube, because the small tube is not capable of fully utilizing the very high frequency components of the picture signal. Inasmuch as the bandwidth requirements are not as strict, fewer i.f. stages with a greater gain per stage can be used, and wave traps to block out the associated sound channel are not necessary. Neither is it necessary to use a wave trap to compensate for the partial side-band suppression of the transmitted signal with a wave trap; instead, the i.f. amplifier is just slightly detuned so the carrier amplitude, 12.75 mc., is just a bit off the end of the flat-top of the characteristic.

The adjacent channel sound is nearer the picture carrier and a parallel resonant trap (set on 14.25 mc.) is used to block adjacent channel sound and prevent it from appearing on the picture tube screen. This trap (11) serves as the mutual coupling between primary and secondary of the third i.f. transformer, passing the picture carrier and blocking, if it is present, the adjacent channel sound. The fourth i.f. amplifier is zero-biased (cathode grounded) with no signal applied. When signal is present, the signal peaks of the modulated envelope (sync tips in particular) draw a small amount of grid current

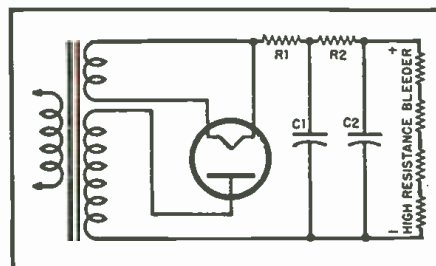
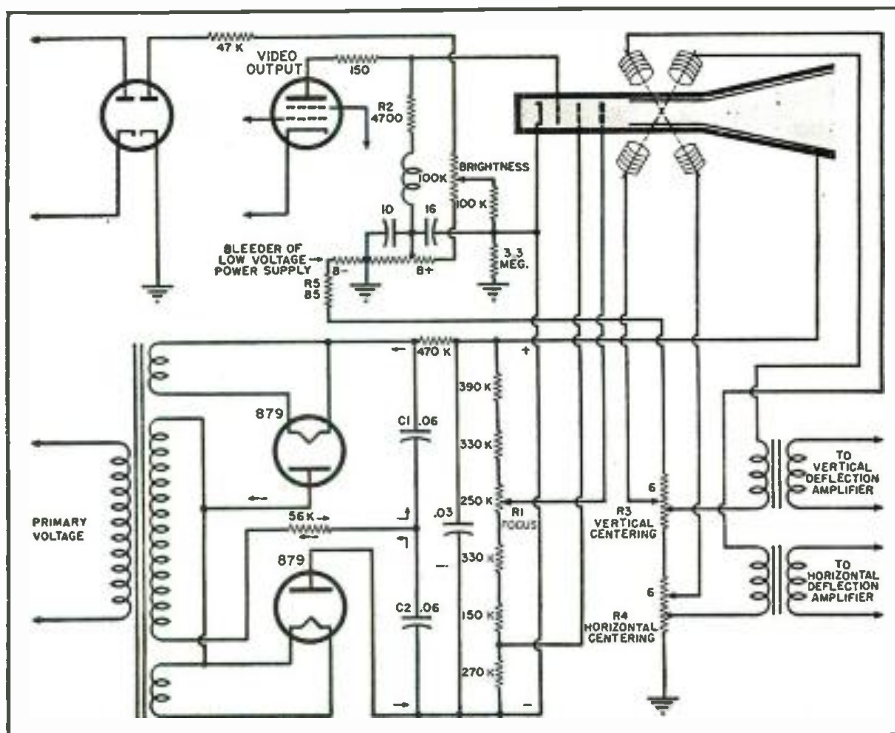

Fig. 1. Conventional high voltage supply.

through resistor R_1 . The voltage drop across the resistor is sustained by capacitor C_2 of the combination (12), setting up an average bias on the i.f. amplifier grid proportional to the peak amplitude of the modulation envelope. This limiting action keeps the carrier output of the fourth i.f. essentially constant after the signal exceeds a certain value, preventing overload of the succeeding stages and picture tube.

Fourth i.f. amplifier output is transformer-coupled to the video detector which develops a negatively polarized composite signal across the low-value diode load resistor (14). High frequency components of the detected signal are maintained by the series peaking coil (13). This composite signal is direct-coupled to the first video amplifier and, consequently, the voltage variation across the diode load resistor serves as the excitation to the grid of the video amplifier. The advantage of this connection is, of course, the fact that the blanking level represents a fixed modulation percentage which will still be maintained as a constant grid voltage level regardless of shifts in average signal content. In turn, the plate output of

Fig. 2. Picture tube voltage circuits of General Electric Model 90.



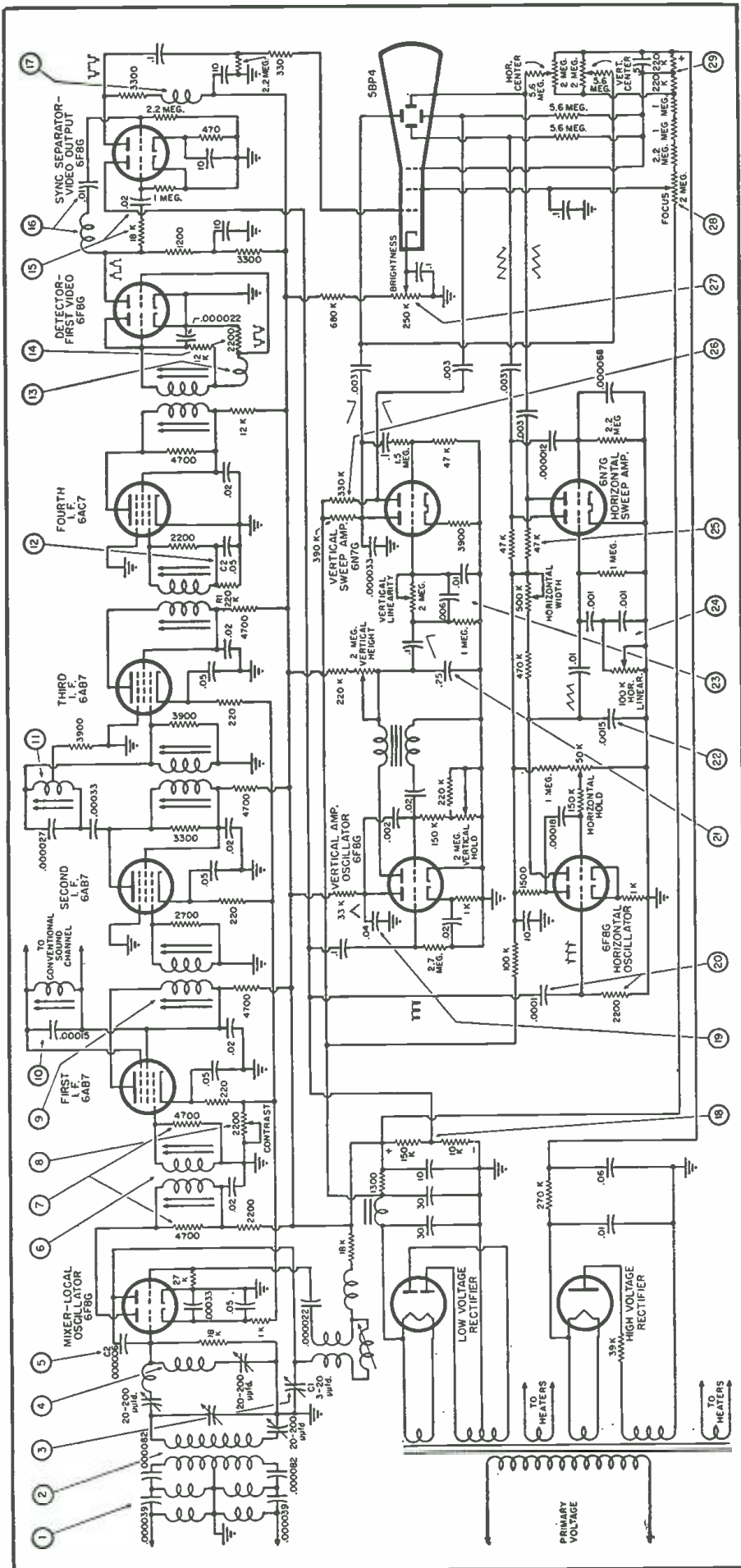

Fig. 3. Wiring diagram of the picture channel employed in General Electric Model HM-171.

the first video amplifier has a constant blanking level regardless of changes in average brightness. Although this signal is capacitively coupled to the video output stage and, then, capacitively coupled to the picture tube, there is not sufficient shift in the established blanking level through these capacitors to seriously upset the light range of the picture tube presentation with changes in average brightness.

Two outputs are taken off the plate of the first video amplifier; one output is coupled through a series resistor and capacitor (15) to the sync separator, and a second output through a series peaking coil and capacitor (16) to the grid of the video output stage. The video output stage steps up the amplitude of the picture signal to the required level to excite the picture tube grid. High frequency components of the picture signal are sustained by the shunt peaking coil (17).

The sync separator is zero-biased and only a few volts from the power supply bleeder (18) is applied to its plate. Consequently, an average bias is set by the grid circuit resistor-capacitor combination by the flow of grid current during the sync pulse intervals. This set level holds the composite sync blanking level of the tube, and only the positive swing of the sync pulses develops negative sync pulses in the output. The composite sync output of the separator also follows two paths, one to the horizontal oscillator; the other, the vertical pulse amplifier. Both horizontal and vertical pulses excite the grid of the amplifier; however, only the longer duration and close-spaced vertical pulses accumulate a charge across the capacitor (19) of the plate circuit RC combination. When the charge reaches sufficient amplitude, it syncs in the vertical oscillator. The greater spacing between horizontal pulses permits the capacitor to completely discharge before the next horizontal pulse arrives and, consequently, no charge accumulates. Composite sync is also applied through a differentiating network (20) to the grid of the horizontal oscillator. On the grid of the oscillator sharp negative pips appear which represent the leading edges of all the sync pulses. It is these leading edges which maintain continuous horizontal synchronism throughout the entire frame.

The vertical oscillator is of the blocking oscillator type, developing a saw-tooth of voltage (21) across the output capacitor. Likewise, the horizontal oscillator, multivibrator type, develops a saw-tooth (22) across the output capacitor. Both of these saw-tooth voltages are capacitively-coupled to the final sweep amplifiers. On the grid circuit (23) and (24) of each amplifier there is a linearity network which corrects the sweep output of

(Continued on page 80)

A Non-Electrical PHONOGRAPH



By
EDWIN N. and
ALVIN B. KAUFMAN

Another version of this type of record player employs an electrically operated motor.

Known as the Phonocone, this non-electrical record player is ideal for portable operation.

REVOLUTIONARY design and construction changes in the last few years have made the mechanical phonograph a sought for item by the public instead of a has-been.

Years ago the only method of reproducing sound recorded on a record was with means of a mechanical system. These mechanical means were refined to a great extent, but were still vastly inferior at that time to the newly developed electrical methods of reproduction. Due to these reasons the mechanical method of record reproduction has almost vanished from the scene except as a child's toy and in farm homes where no electric power exists.

The mechanical reproducer, as developed in the 1920's, consisted of a number of basic parts. These parts, the reproducer head and arm (usually called a tone arm), and an exponential horn attached to the tone arm, formed the mechanical system. The reproducer head usually consisted of a thin disc of glass, approximately $\frac{1}{32}$

of an inch thick, mounted in a circular metal ring. A phonograph needle, secured in a needle chuck, was displaced mechanically by its movement in the record groove and this displacement was amplified and applied to the glass diaphragm by a pivoted arm, as shown on page 142. As the glass diaphragm is secured to the pivoted arm it vibrates at the rate and to the amplitude impressed upon it by the phonograph needle. The modulated side of the glass diaphragm was left open to the air. The other side of the diaphragm was sealed into a chamber (the head) and the resultant air flow was conducted through the tone arm to the exponential horn. Although the shape and size of the tone arms and exponential horns varied greatly, the fundamental operation of each system was as described above.

The main reasons for the mechanical system of reproduction falling out of favor with the public may be stated briefly. Probably the two main objections to this system, by the public,

were the size of the equipment and the comparatively poor quality as compared, even then, with the new battery radio receivers. It is true that some mechanical reproducers were made with very small horns, but this limited both the low frequency response and the volume. If any reproduction was desired to somewhat approach the quality of the electrically operated reproducer, then a large horn was used. The low frequency response of an exponential horn is definitely limited by the diameter of the mouth of the horn. Secondly a large horn must be used to amplify the sound if any reasonable amount of needle pressure on the record is to be maintained. The quality of reproduction is seriously affected by needle pressure, excessive pressure causing rapid record wear and distortion. The poor quality of the mechanical phonograph was caused by distortion and lack of frequency response. Mechanically operated systems are notorious for their lack of low frequency response. Due to the tone arm and exponential speaker characteristics the average low frequency cut-off is in the frequency range of 200 to 400 cycles-per-second. The frequency response above this range was distorted

(Continued on page 142)

ANALYSIS OF RADIO INTERFERENCE PHENOMENA

Character, Cause, Type Receivers Affected, Where Prevalent, and Service Remedies

(Reprinted from February 1946 issue "RCA Radio Service News," Tube Department, Radio Corporation of America, Harrison, N. J.)

Type of Interference	Character of Interference	Cause	Type Receivers Affected	Where Prevalent	Suggested Service Remedies
IMAGE RESPONSE	Heterodyne whistle or second signal when tuned to certain stations.	Strong signal at a frequency $2 \times$ i.f. above desired station.	Superhet only. (1) With limited number tuned circuits ahead first detector. (2) With low impedance, high frequency resonant antenna primary circuits.	Locality strong i.e. stations near high end of band. Vicinity 1610-1750 kc. Police Stations. Vicinity 1700-2000 kc. amateur band.	(1) Wave trap tuned to interfering station. (2) Band elimination antenna such as RCA Magic Wave. (3) Re-align i.f.
HARMONIC OF I.F.	Heterodyne whistle when tuning a station having same frequency as a harmonic of the i.f.	Second harmonic of station combines with oscillator fundamental forming a spurious i.f.	Superhet only. Selectivity does not affect.	Vicinity of station operating at twice i.f.	(1) Wave trap tuned to station. (2) Wave trap tuned to station second harmonic in mixer grid circuit. (3) Re-align i.f.
DIRECT I.F. RESPONSE	Non-tunable code with intensity increasing toward low frequency end of band.	Commercial shore-to-ship code signal having frequency in i.f. range, reaching input to i.f. system.	Superhet only. (1) With limited selectivity ahead of i.f. input and relatively high i.f. gain. (2) With high impedance, low frequency antenna system.	Coastal areas near location of commercial stations.	(1) RCA Magic Wave antenna. (2) I.f. wave traps. (3) Re-align i.f. (4) Orient loop for minimum interference.
HARMONICS OF OSCILLATOR	Reception of short-wave code or broadcast signals at points in standard broadcast band.	Oscillator harmonics combine with short-wave signals producing the required i.f. Especially prevalent on loop receivers due to secondary resonances of loop.	Superhet only. (1) With loop antenna. (2) Having oscillator rich in harmonics.	Rurally or where s.w. signals of proper frequency are intense.	(1) Use wave trap on interfering station. (2) Orientation of loop. (3) Re-align loop circuit. (4) Reduce oscillator excitation.
COMBINATION OF I.F.	Whistle or second station(s) heard on practically all carriers.	Differences in frequency of two strong stations equal to i.f. of receiver; the two stations mixing within receiver to form a constant spurious i.f.	Superhet only; having limited selectivity ahead of first detector.	Metropolitan areas, generally.	(1) Check by tracking of r.f. and antenna circuits. (2) Reduce size or effectiveness of antenna. (3) Install wave trap and tune to frequency of one of interfering stations. (4) Shift i.f.
HETERODYNE OSCILLATOR RADIATION	Whistle on a particular desired station, disappearing or changing frequency at random.	Radiation of receiver's heterodyne oscillator, due to oscillator strength, unusual coupling, resonant antenna, or transmission via power line.	Superhet only. (1) Without good shielding. (2) Without r.f. stage.	Metropolitan areas, generally.	(1) Filter power line. (2) Use RCA Magic Wave antenna. (3) Reduce oscillator grid leak. (4) Shift i.f.
CROSS MODULATION WITHIN RECEIVER	Second station(s) appearing in background, when tuned to desired station	Strong interfering station modulating carrier of desired station within a nonlinear circuit or element of the receiver; or pickup and detection taking place in audio system.	T.r.f. and superhet. (1) With limited or no selection ahead of first tube. (2) With exposed grid circuits and wiring associated with early tuned stages. (3) Without variable-mu input tubes.	Metropolitan areas. Vicinity of very strong stations.	(1) Wave trap in antenna tuned to station causing trouble. (2) Filter power line. (3) Install RCA Magic Wave noise reducing antenna. (4) Shield exposed grid leads and wiring of first stages.
CROSS MODULATION EXTERNAL TO RECEIVER	Second station(s) in background on or between other stations.	Detection within, and re-radiation from, power lines, telephone lines, and other aerial metallic structures.	All types of receivers are affected regardless of selectivity or design.	Vicinity of unusually strong stations, especially where open-wire power lines are prevalent. Generally changes with weather.	(1) See that power line and telephone grounds are secure. (2) Ground conduits solidly. (3) Use RCA Magic Wave antenna. (4) Orient loop antenna for minimum interference.
SAME CHANNEL BEAT	Flutter, waver, or growl heard in background when tuned to desired station.	Second station assigned to same channel, but differing very slightly in carrier frequency.	Receivers with high sensitivity and extended bass response.	In areas remote from a usable assortment of strong stations. Wherever signals of two stations on same channel are comparable in strength.	(1) Use directive or loop antenna. (2) Reduce sensitivity of set. (3) Reduce bass response.
ADJACENT CHANNEL BEAT	Steady 10,000 cycle note or whistle.	Adjacent channel carrier beating with carrier to which receiver is tuned.	T.r.f. and superhet; especially those with limited selectivity and wide range of audio response.	Localities where adjacent channel location is strong compared to desired station.	(1) Suppress adjacent station with sharply tuned wave trap. (2) Re-align receiver carefully. (3) Reduce high-frequency response. (4) Use directive antenna.
MONKEY CHATTER	Unintelligible modulation superimposed upon desired station, having character of "inverted speech."	Side band of adjacent channel overlapping side band and combining with carrier of desired station. Also caused by harmonics from over-modulation of adjacent station.	T.r.f. and superhet; having wide band selectivity and audio response.	Localities where adjacent channel station is strong. Also aggravated by extended high frequency response of transmitter.	(1) Precisely re-align receiver to make more selective. (2) Reduce high frequency audio response.

BEFORE continuing with the study of the action of the single-input type mixer, it will be well to understand what happens when two oscillating voltages are simultaneously impressed upon a simple linear electrical circuit. As this is a topic that many writers have confused, incorrect statements concerning it will be found in many magazine articles and even in some text books of fairly recent origin.

Result Obtained by Pure Addition of Signal and Oscillator Voltages

Assuming that a suitable coupling circuit arrangement¹ is being employed to introduce the oscillator voltage e_o (of frequency f_o) in series with the signal voltage e_s (of frequency f_s) in the grid-cathode circuit of the mixer, let us see what happens if the two voltages are simply added together.

The two voltages are illustrated separately in graphical form at A and B in Fig. 3. For simplicity, the signal voltage is shown here as being unmodulated. Also, the frequency of the oscillator voltage is considered to be higher than that of the signal voltage, as is the case in most broadcast-band superheterodynes. (During the time interval between points 1 and 2, the signal voltage is shown as going through 8 cycles. During this same interval the oscillator voltage goes through 10 cycles).

At C, both voltages are shown acting together in the common linear circuit and combining by pure addition. Their resultant, obtained as the algebraic sum of the individual instantaneous values at each instant of time, is indicated by the *sum pattern* (drawn dotted). For clarity this sum pattern is shown again alone, with its envelope, at D. It is important to observe that the sum pattern varies in amplitude, rising periodically to a "maximum" of amplitude. Notice that during the time interval between points 1 and 2, two such maximums are produced. (In connection with this, observe that the *difference* between the two frequencies is $f_o - f_s$, or $10 - 8 = 2$.) However, although the cycle of this "maximum" occurs $f_o - f_s$ times a second (assuming f_o to be a frequency higher than f_s), no additional

frequency has been developed because the sum pattern is *symmetrical* about the zero axis and consequently its *average* value over a significant period of time is zero. Consequently, it is incorrect to say (as some writers do) that this sum pattern contains a "difference frequency" component. It is merely the sum of two varying voltages, and no additional new frequency has been developed. This is important, and it is summarized herewith for emphasis:

"The mere simple addition in the same circuit of two oscillating voltages of different frequencies leaves each frequency completely unaffected and produces no new frequencies whatsoever."²

Why a Non-Linear Device is Necessary in the Single-Electrode Input Type Mixer

The foregoing statement is important in any discussion of frequency conversion, for it explains why it is *not* sufficient to simply add, or linearly "mix," the signal and oscillator voltages together in an electrical circuit in order to produce the i.f. signal—as so many writers state. Something more is required!

In the single-electrode input (circuit-coupled) type mixer we are discussing, a non-linear device³ (an instrument whose output is not directly proportional to the input) must be employed if a "difference" frequency is to be obtained and passed on to the i.f. amplifier. When the sum pattern of the signal and local-oscillator voltages is applied to this non-linear device, it loses its symmetry and becomes rectified. The rectified sum pattern thus represents a distorted output, which contains several *new* frequency components in addition to the original ones f_s and f_o .

In the *electron-coupled* type of mixers and converters to be described in the next article of this series the "addition" device employed is a multi-grid tube whose action in the circuit will be explained.

Action of Single-Electrode Input (Circuit-Coupled) Type Mixers

The actions that take place in the single-electrode input (circuit cou-

Practical RADIO COURSE

By
ALFRED A. GHIRARDI

Part 15. Theory of single electrode input frequency converters for superhets.

pled) type of mixer may be explained in several ways but, unfortunately, most of these explanations prove rather confusing to beginners. Even graphic illustrations of the signal, oscillator and i.f. waveforms existing in the various parts of the circuit prove

¹ Alfred A. Ghirardi, Practical Radio Course (Part 14), RADIO NEWS, May 1946, Fig. 2.

² This is not only true, but extremely fortunate, for if it were untrue our systems of radio and television broadcasting would be practically impossible. The space surrounding our earth is full, at almost all times, of a multitude of electric oscillations of different frequencies—all emitted simultaneously by the transmitting antennas of the numerous broadcasting stations. These are all added to each other in the above sense, but it is a fact of experience that they do not interact, or cross-modulate, or produce new frequencies at all (with the exception of those special interactions that take place in the ionosphere). A tuned circuit or an aerial can be adjusted (tuned) to respond to each and every such oscillation, (signal) individually, just as though all the others were absent, and the actual instantaneous currents or potentials induced in the aerial will simply be the sum of the contributions from each oscillation. The resulting oscillation pattern will, of course, be more or less complicated in form, and will depend upon the frequencies involved.

³ The non-linear device may be a crystal diode, or multi-electrode tube. Crystal mixers are desirable because of their high signal-to-noise ratio and are employed in many u.h.f. receivers.

Fig. 1. Skeleton circuit diagram, (A), and grid voltage, plate-current characteristics, (B), for mixer operating with single-electrode input.

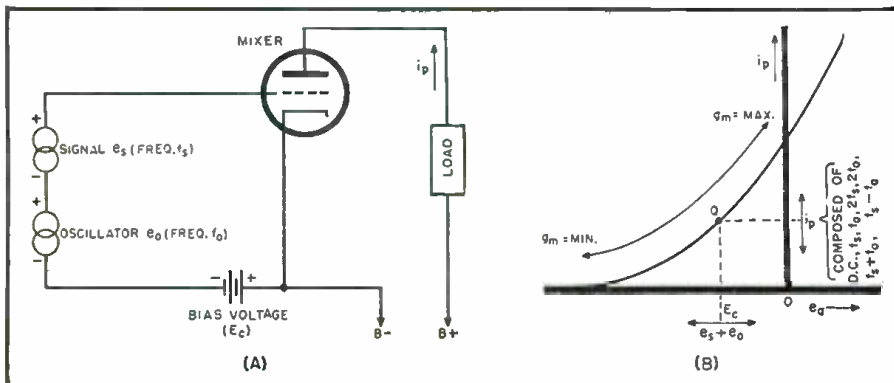

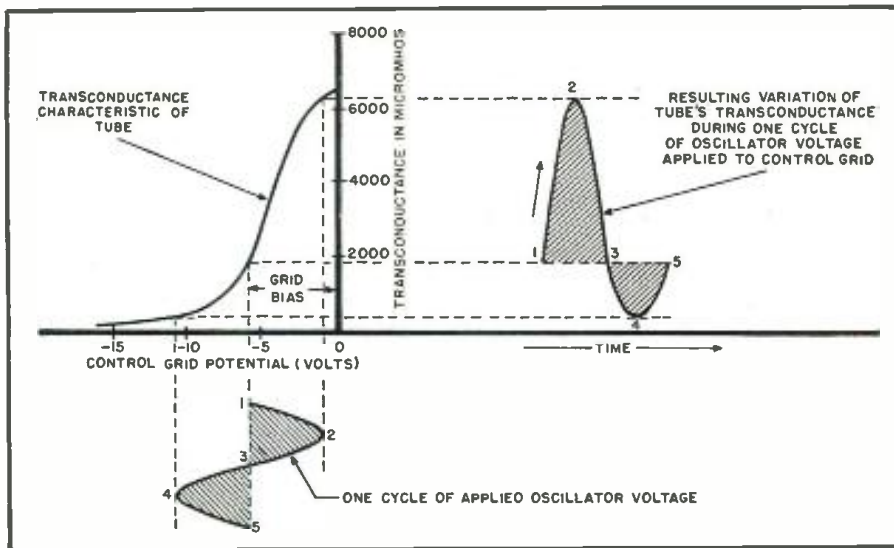

Fig. 2. How transconductance of typical variable- μ r.f. pentode varies during one cycle of oscillator voltage applied to control grid. Large oscillator voltage is applied so that non-linear operation is obtained.

rather confusing because several actions take place simultaneously and it is not possible to show all of them in a two-dimensional illustration. It is hoped that the following explanation, based on a recent contribution⁴ toward clarification of the subject will help the reader to visualize the rather complicated actions from the viewpoint of simple vacuum tube action.

The action may be understood if we

look upon this type of mixer as a device of variable transconductance and imagine the signal and oscillator voltages as being applied in series and to the grid circuit of an r.f. amplifier tube having a curved grid-voltage plate-current characteristic as illustrated at A of Fig. 1, and if we assume further that there is no interaction between these two voltage sources. The oscillator voltage is purposely made

Fig. 3. Demonstrating the addition of signal and oscillator voltages of differing frequencies. As explained in the text, no new frequencies are added.

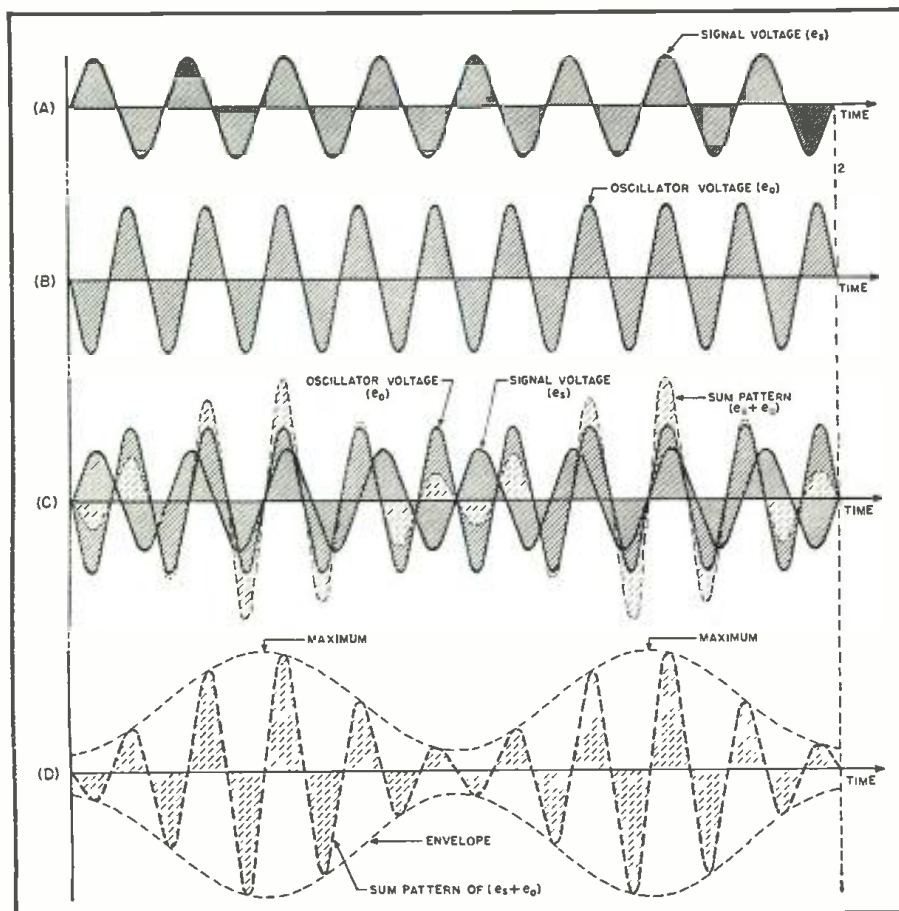

sufficiently large to result in non-linear operation of the mixer tube. The negative bias voltage used must always be such that the positive peak of each cycle of the large oscillator voltage does not drive the grid positive (see Fig. 2)—otherwise grid current would flow and undesirable damping of the signal-tuning circuit would result. The actions which take place are then as follows:

1. Since the *local-oscillator voltage*⁵ is sufficiently large, it causes a periodic variation⁶ (at local-oscillator frequency) of the instantaneous control-grid transconductance and hence the amplification of the tube (the *conductance* or admittance in the case of a crystal or diode). A typical transconductance versus control-grid potential curve for a variable- μ radio-frequency pentode tube is illustrated in Fig. 2. Thus, the large oscillating *oscillator voltage* may be visualized as sliding the original *Q-point*⁷ of the device periodically back and forth at local-oscillator frequency along the current-voltage characteristic for the device,⁸ thus producing a periodic variation of the instantaneous control-grid transconductance or transadmittance (see B of Fig. 1).

2. The signal voltage is not a controlling variable since the conversion conductance, in the same manner as the mutual conductance, is not affected by the comparatively small signal voltage applied to the control-grid under normal operating conditions. However, since the transconductance or transadmittance is varying periodically at the oscillator frequency (see Fig. 2), the signal wave appearing at the output of the non-linear tube will have been periodically expanded and contracted, i.e. it becomes *amplitude modulated*. As a consequence of this, all the various components given by the classical modulation theory appear in the modulator output. The desirable modulation output contains, among others, the carrier and the two side frequencies ($f_o + f_s$) and ($f_o - f_s$) (*sum* and *difference* frequencies). Usually, the lower side frequency (*difference* frequency) only, is of interest and is passed on to the intermediate amplifier, all other components being bypassed by the sorting-out mechanism (the tuned load) on the output side of the frequency converter. In some receivers only the *upper* side frequency is used—all other components being by-passed by the load.

If the incoming signal is modulated by speech or music this modulation appears in the output (the i.f. signal) of the device.

⁴ Harry Stockman, "Superheterodyne Converter Terminology," *Electronics* Nov. 1943. Harry Stockman, "Frequency Conversion," *Communications*, April 1945.

⁵ (which may be practically a pure sine wave) (usually non-sinusoidal)

⁷ The (moving) point of operation on the characteristics of the tube, the position of which is determined by locally-applied voltages. The oscillator voltage is here to be considered as a *locally-applied* voltage. The input signal voltage is the *operating* voltage.

⁸ Because of this action, such a converter is often referred to as a *sliding-Q-point converter* or, as the path of operation remains essentially the same during operation, as a *fixed-path-of-operation* (f.p.o.) converter.

OHMITE

OFFERS THE WIDEST, MOST COMPLETE
RANGE OF TYPES AND SIZES IN

CLOSE CONTROL Rheostats

10 Wattage Sizes from 25 to 1000 watts,
from 1-9/16" to 12" Diameter, with Standard or
Special Features, with Uniform or Tapered
Windings, in Stock or Special Resistances,
in Single, Tandem or Concentric Units.

Only Ohmite provides such a wide range of types
and sizes . . . to give you a quick and correct answer
to your Rheostat needs. Stock models in 25, 50,
100, 150, 300, and 500 watt sizes in a wide range
of resistance values.

All models have the time-proved features of Ohmite
design—the pioneer design that revolutionized
rheostat construction. Every Ohmite unit assures
permanently smooth close control . . . under every
operating condition.

Get the benefit of Ohmite experience in countless
applications. Let Ohmite engineers cooperate in
solving your rheostat control problems.

OHMITE MANUFACTURING COMPANY
4885 FLOURNOY STREET, CHICAGO 44, U.S.A.

* * *

AUTHORIZED DISTRIBUTORS EVERYWHERE

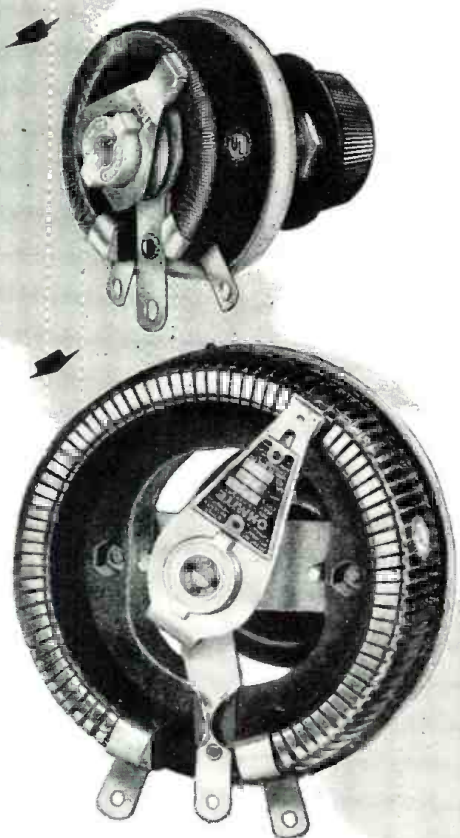

Send for Stock-Unit
Catalog No. 18

Write for this quick, help-
ful reference. Gives valu-
able data and information
on the wide variety of
Ohmite Stock Rheostats,
Resistors, Chokes and Tap
Switches.



Be Right with **OHMITE**
RHEOSTATS • RESISTORS • TAP SWITCHES

New! Spectacular! Complete!

CONCORD RADIO CATALOG



RADIO SETS

AMPLIFIERS

RADIO PARTS

ELECTRONIC EQUIPMENT

Mail
Coupon for
FREE
Copy!

WE HAVE WHAT YOU WANT!

The new Concord Catalog displays the most comprehensive stock in years! All well-known, standard lines are fully represented. Equipment—accessories—parts for all radio and electronic use . . . for building, repair, maintenance . . . for engineer, amateur, serviceman, soundman, retailer . . . complete lines of tubes, instruments, tools, speakers, condensers, resistors, relays, etc. . . PLUS a radio set department offering latest postwar models . . . PLUS the exciting line of MULTIAMP Add-A-Unit Amplifiers offering many innovations in public address units exclusive with Concord

Your Copy of the
Complete, New Concord
Catalog is Ready!

It offers you the latest, greatest selection of guaranteed quality RADIO SETS, PHONO-RADIOS, RADIO PARTS, TEST INSTRUMENTS, BOOKS, TOOLS, AMPLIFIERS AND ACCESSORIES, AMATEUR KITS AND SUPPLIES, ELECTRONIC EQUIPMENT . . . page after page of post-war-engineered equipment and parts you have long been waiting for. All standard, top-quality lines. Thousands of items. Money-saving prices. And fast service, direct from our two centrally located warehouses in CHICAGO and ATLANTA.

See the first peacetime line of Concord Radio Sets in new, modern cabinets with a host of post-war features. See the thrilling MULTIAMP Add-A-Unit Amplifiers, brand new in the field, with sensational new flexibility, fidelity, and power—EXCLUSIVE with CONCORD.

See the vast stock of everything you need in equipment and parts . . . see them in the new, comprehensive Concord Catalog, just off the press. Your copy is ready . . . and it's FREE. Rush coupon today.

CONCORD RADIO CORPORATION
901 W. Jackson Blvd.
Dept. E-66, Chicago 7, Ill.

Yes, rush FREE COPY of the comprehensive new Concord Radio Catalog.

Name.....

Address.....

City..... State.....

CONCORD
RADIO CORPORATION
LAFAYETTE RADIO CORPORATION

CHICAGO 7 ATLANTA 3
901 W. Jackson Blvd. 265 Peachtree Street

Early superheterodyne receivers employed a detector type of circuit as the mixing device. This led to the widely adopted belief that a detector type of circuit has to be used for this function. Therefore, to prevent confusion with the real detector following the i.f. amplifier (which is the *true* detector or demodulator in the receiver), the latter was given the name "second detector" and the mixer was given the name "first detector." These names will be found in old literature on the subject and on the manufacturers' schematic diagrams of many superheterodyne receivers.

Although correct for the original circuit, the term "first detector" now causes confusion and should not be used, for it leads to the belief that the first detector necessarily performs detection. We now know that this early rectification is by no means essential or axiomatic, and was only a consequence of the particular tubes and type of mixing (single-electrode input) then being used. To facilitate the understanding of the fact that the mixer portion of the frequency converter provides a *frequency shift* and does not necessarily produce detection,⁹ it is recommended that the terms *first* and *second* detector not be used. The conventional superheterodyne for sound program reception then has one detector (demodulator) only, like any other simple radio receiver.¹⁰ It also contains a frequency converter (modulator).

Conversion Transconductance of a Frequency Converter

It will be remembered from a previous article of this series devoted to a discussion of vacuum tube amplifiers, that the *mutual conductance* or control-grid-to-plate transconductance of the tube is a measure of how effectively it converts a change in control-grid voltage into a change in plate current—both changes occurring at the *same* frequency. In connection with frequency converter systems, we are concerned with the conversion transconductance of a tube instead of the ordinary mutual conductance or control-grid-to-plate transconductance. The *conversion transconductance* of a frequency converter is a measure of how effectively the frequency converter converts a change in grid voltage at the *signal* frequency to a change in plate current at the *intermediate* frequency (i.f.). Consequently, the *conversion transconductance* (*g_c*) of a frequency converter (mixer or converter) is defined as the *ratio of an increment of the i.f. component of current in the i.f. transformer primary to the increment of r.f. component of signal voltage applied to the signal electrode required*

⁹ As we shall learn in a later article of this series (Part 47), mixers need not necessarily involve a rectifying action. In the modern electron-coupled type of mixer there is no rectification in the ordinary sense of the word.

¹⁰ The conventional *television* superheterodyne receiver employs two detectors (demodulators)—one for the audio channel and one for the separate video channel.

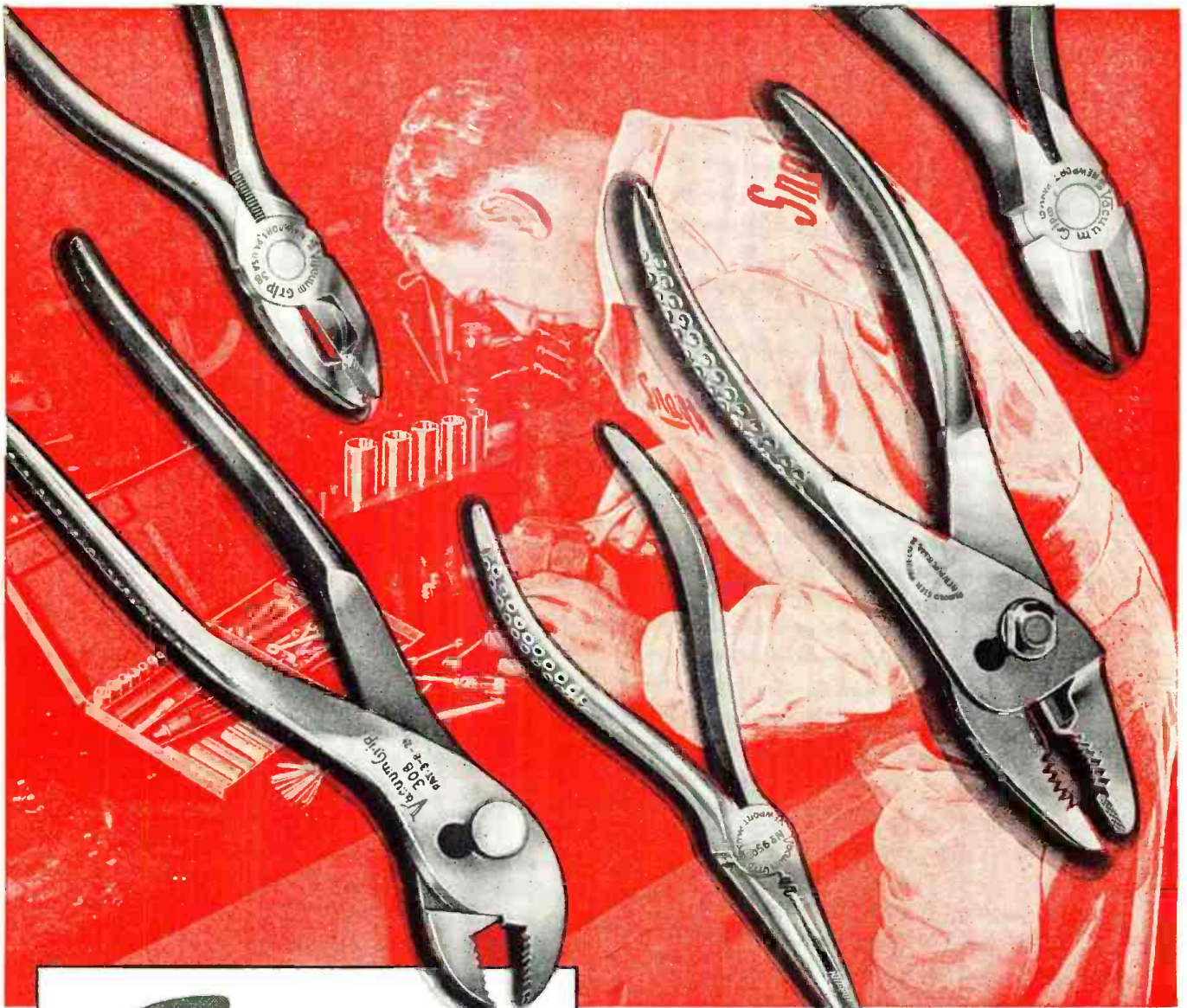

Snap-on

Vacuum Grip
REG. U.S. PAT. OFF.
Pliers

A complete line . . . engineered for performance

Pliers are basic tools in an extremely wide and varied range of operations. The *right pliers for the job* can make a tremendous difference in speed and workmanship. The Snap-on pliers illustrated are typical of the many types of Vacuum Grip pliers . . . each type *job-engineered* for peak performance on the work for which it is designed.

Snap-on builds Vacuum Grip pliers in a modern plant devoted exclusively to the production of the finest, most efficient pliers that can be produced. Vacuum Grip pliers are hammer forged from special high car-

bon chrome-silico-manganese alloy tool steel, hardened and tempered through and through. Light in weight, perfectly balanced. Smooth, easy riding joints, sharp, deeply milled teeth. Hand filed, perfectly aligned cutters. Spring-tempered, "Vacuum Grip", non-slip handles.

A famed name in Snap-on's complete line of more than 3,000 tools for production and service, Vacuum Grip pliers are available everywhere through Snap-on's nation-wide direct-to-user tool service.

SNAP-ON TOOLS CORPORATION
 8120-F 28th AVENUE KENOSHA, WISCONSIN

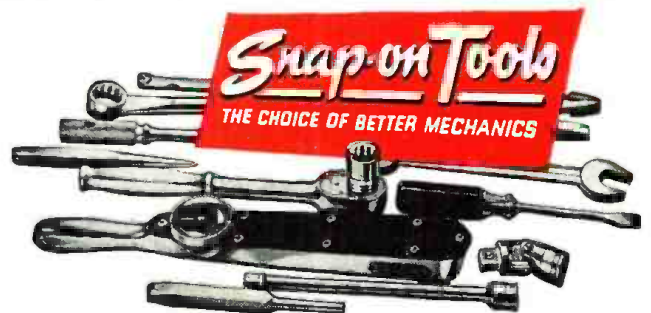

NEW and
Ready for you!

ALLIED'S 1946 CATALOG

*of Radio and
Electronic Supplies*

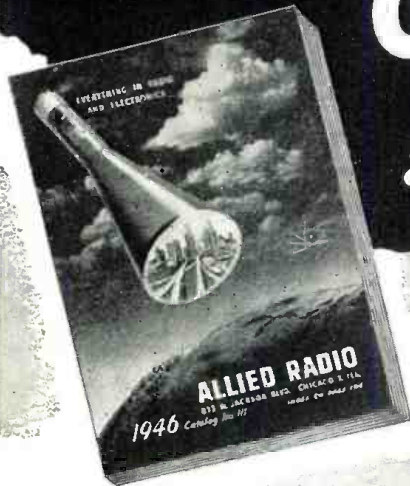

FREE

Send for it Now!

LARGEST AND MOST COMPLETE STOCKS

Today's handiest, most complete *Buying Guide!* Brings you latest, finest values in parts, tubes, kits, tools, books, test instruments, communications receivers, Ham gear, public address and other equipment. Places at your finger tips over 10,000 items of nationally known guaranteed quality. Makes available to you the world's largest and most complete stocks under one roof . . . ready for rush delivery. Enables you to get everything you need in radio and electronics from one dependable, central source. Send for this new 1946 Catalog now. Save time, work and money!



HANDY RADIO BOOKS AND CALCULATORS

Radio Formulas & Data, Dictionary of Radio Terms, Radio Circuit Handbook, Radio Builders' Handbook, Simplified Radio Servicing, Radio Data Hand-book.
Six Books No. 37-799.....75c
Parallel Resistance and Series Capacitance Calculator, No. X37-960.....25c
R-F Resonance and Coil Winding Calculator, No. 37-955.25c

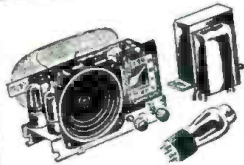

OVER 10,000 ITEMS

Biggest section of quality parts and equipment for engineers, dealers, servicemen, soundmen, amateurs, builders. All leading makes, at lowest prices. Send for Free Catalog now.



NEW RADIO SETS

Parade of new 1946 models, including phonoradios, and latest communications receivers covering broadcast, short-wave and amateur bands. Beautiful styles! Wonderful performance! Outstanding values!

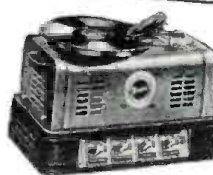

NEW P. A. EQUIPMENT

Sound systems for every public address requirement. Complete listing of amplifiers, speakers, microphones, accessories. Newest developments with many exclusive features.

ALLIED RADIO CORP.

833 W. Jackson Blvd., Dept. 1-F-6
Chicago 7, Illinois

Date.....

- Send FREE New 1946 Catalog.
 Send Six Books—Calculator No..... } \$.....Enclosed
Calculator No..... }

Name.....

Address.....

City..... Zone..... State.....

ALLIED RADIO

*Everything in Radio
and Electronics*

to produce it.¹¹ Since this is a current/voltage ratio, the value is expressed in *micromhos* (conductance unit). In connection with the performance of a frequency converter, it is employed in the same manner as mutual conductance is used in single-frequency amplifier computations.

Conversion Gain of a Frequency Converter

The gain obtained in a frequency converter may be treated in exactly the same manner as the gain in an ordinary amplifier stage. The *conversion gain, G*, of a frequency converter (mixer or converter) is defined as *the ratio of the i.f. voltage developed across the load (primary of the 1st i.f. transformer) to the r.f. signal voltage applied to the signal electrode of the converter or mixer tube.* When the conversion transconductance and the other required tube and circuit constants are known (see tube data charts), and the plate load consists of a single parallel-tuned circuit, the conversion gain of a frequency converter may be calculated by means of the equation:

$$CONVERSION GAIN = \frac{g_c \times r_p \times R_L}{r_p + R_L}$$

where g_c is the conversion transconductance in μmhos , r_p is the internal a.c. plate resistance of the tube in megohms, and R_L is the effective series dynamic resistance of the tuned plate load circuit at resonance, in megohms. When coupled tuned circuits (ordinary i.f. transformers) are used as the plate load, the value of R_L should be the dynamic resistance of the primary with the secondary coupled under normal conditions (i.e. impedance reflected to primary of the first i.f. transformer), in megohms.

Examination of this equation for conversion gain shows the desirability of using a mixer or converter tube having a high transconductance and a high plate resistance. In most converters, the conversion gain realized ranges approximately from 10 to 60. A low conversion gain in a frequency converter is not necessarily indicative of poor design, for in many receivers, a slight sacrifice of conversion gain (particularly during reception on short-wave bands) is deliberately made by reducing the oscillator signal strength, thereby reducing the variation in signal-grid-to-plate transconductance of the tube caused by each cycle of the oscillator voltage. This makes it possible to achieve a lower noise level and therefore a better signal-to-noise ratio. The conversion gain can also be reduced by increasing the negative bias applied to the signal grid. To facilitate this for control purposes, the signal grid of most con-

(Continued on page 70)

¹¹ The value of transconductance that can be expected from most tubes operated as frequency converters is approximately equal to 28% of the maximum zero-bias grid-plate transconductance (mutual conductance) of the tube, when the oscillator associated with it is operated at its fundamental frequency. When the second harmonic of the oscillator is employed (second-harmonic superheterodyne operation), this is reduced to about 14%.

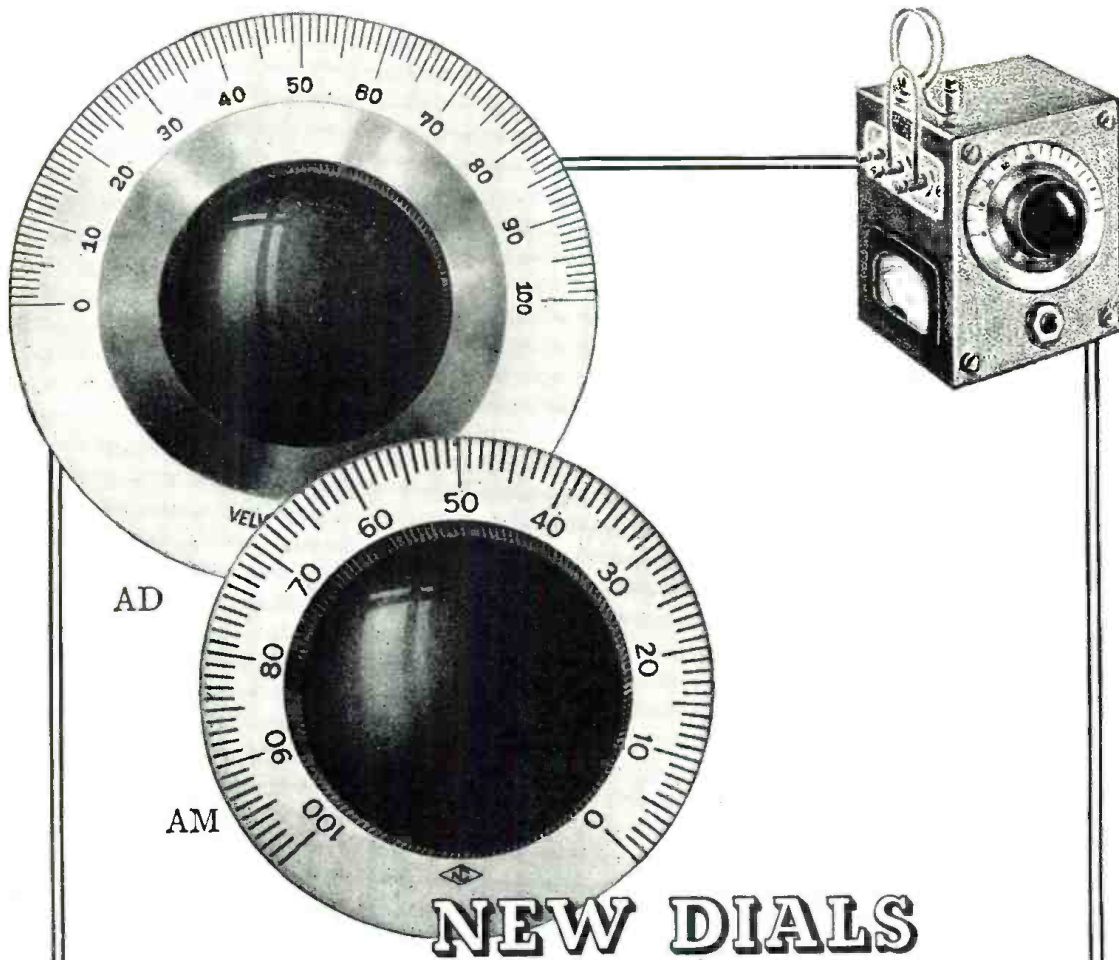

NEW DIALS

Wartime requirements for accurate smooth-working dials resulted in the design of these two new models. Both make use of the time-tested "Velvet Vernier" drive unit which for more than twenty years has been a favorite because of its incomparably smooth action and sensitive control. The Type AM Dial is three inches in diameter and is available with 2, 3, 4, 5 or 6 scale. The four-inch Type AD Dial is made with 2, 3, 4 or 5 scale. Both are handsome in appearance and moderate in cost.

DIAL SCALES			
Scale	Divisions	Rotation	Direction of Condenser Rotation for increase of dial reading
2	0-100	180°	Counter Clockwise
3	100-0	180°	Clockwise
4	150-0	270°	Clockwise
5	200-0	360°	Clockwise
6	0-150	270°	Counter Clockwise



NATIONAL COMPANY,  INC., MALDEN, MASS. U.S.A.

for U. H. F.

CONDENSERS
INDUCTORS
TUBE SOCKETS
INSULATORS
ANTENNAS

JOHNSON 122-101 SOCKET



FOR TOP PERFORMANCE FROM 826-829 832 TRANSMITTING TUBES

Latest addition to the famous line of JOHNSON Tube Sockets is the 122-101. A ceramic wafer socket with aluminum base shield and JOHNSON superior contacts—the 122-101 is designed to really "take it".

Socket is designed so that by-pass capacitors may be mounted directly on the tube socket base. Button mica capacitors are available in a range of capacitances enabling the tube to be used of its highest frequency.

Grid terminals are designed so that connecting wires may be isolated from other circuits.

Grid terminals are specially constructed to permit small grid coils to be mounted directly on the terminal ends, thus eliminating connecting leads.

Holes are provided for adequate ventilation of the tube.

Built-in retainer springs hold tube securely in place under conditions of heavy vibration and shock.

Your JOHNSON Distributor has, or soon will have the JOHNSON 122-101.

Shown at left are JOHNSON 228 and 275 tube sockets. The 228 socket is ideal for many tubes including the "Tuf-20", and the 275 socket is designed for tubes including the 4-125A, RK28, 125M, 803 and X404. See these sockets and other outstanding JOHNSON products of leading radio-electronic distributors everywhere.



There is a JOHNSON Tube Socket for every stage of the "hom" transmitter many of these sockets are being widely used in commercial communication and industrial electronic equipment. JOHNSON means the ultimate in amateur, industrial and broadcast components.



WRITE FOR CATALOG 968Z

JOHNSON
a famous name in Radio



E. F. Johnson Co. Waseca, Minn.



CIRCUIT PAGE

RADIO NEWS, JUNE, 1946

HOFFMAN MODEL A302

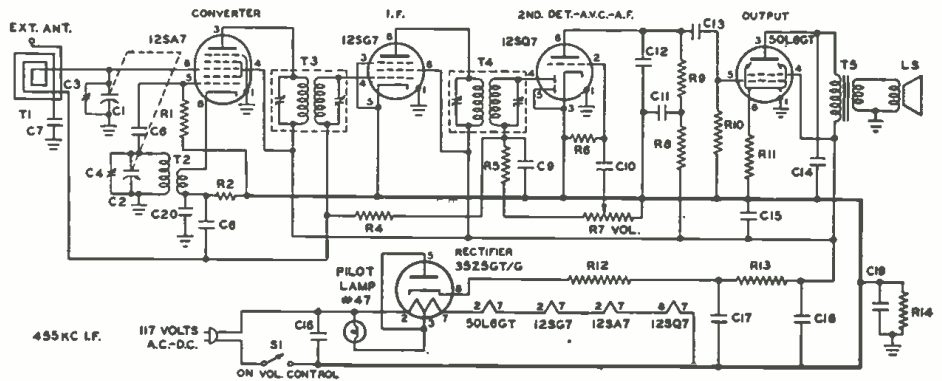

RADIO NEWS, JUNE, 1946

BENDIX MODELS 526A, 526B, 526D, 526E

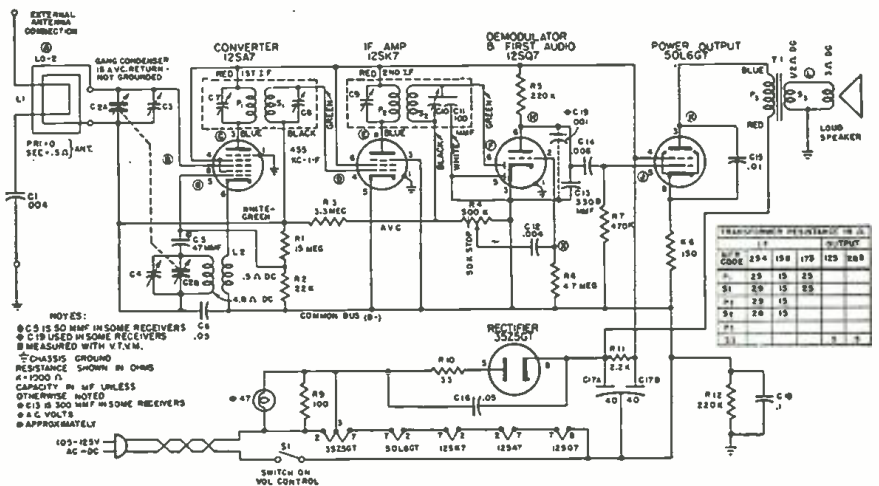

RADIO NEWS, JUNE, 1946

STROMBERG CARLSON MODEL 1100, SERIES 10

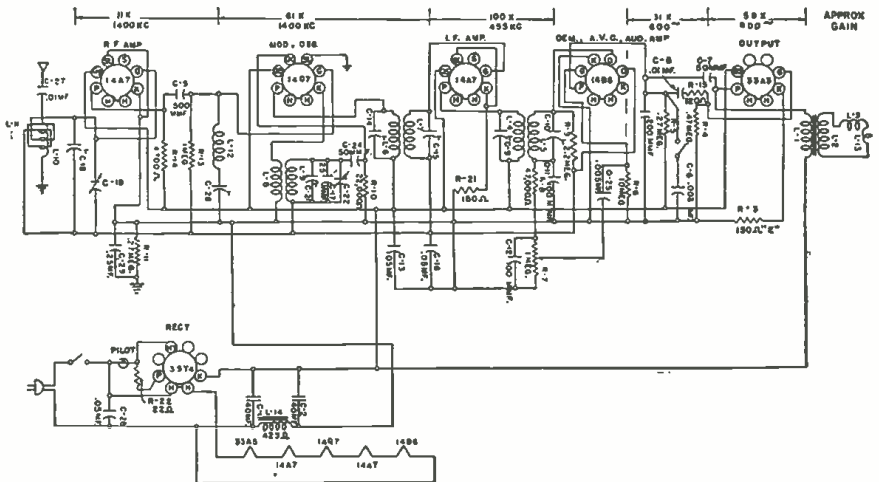

Here, and on following pages, are circuit diagrams and parts lists of many new postwar radio receivers. Radio News will bring to you other circuits as quickly as possible after we receive them from manufacturers.

RADIO NEWS, JUNE, 1946

AUTOMATIC MODEL 611

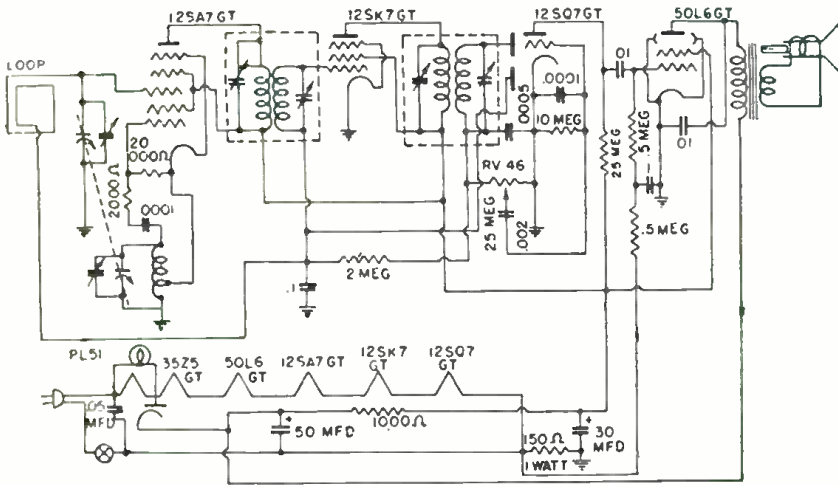

RADIO NEWS, JUNE, 1946

WESTINGHOUSE MODELS H-122, H-130

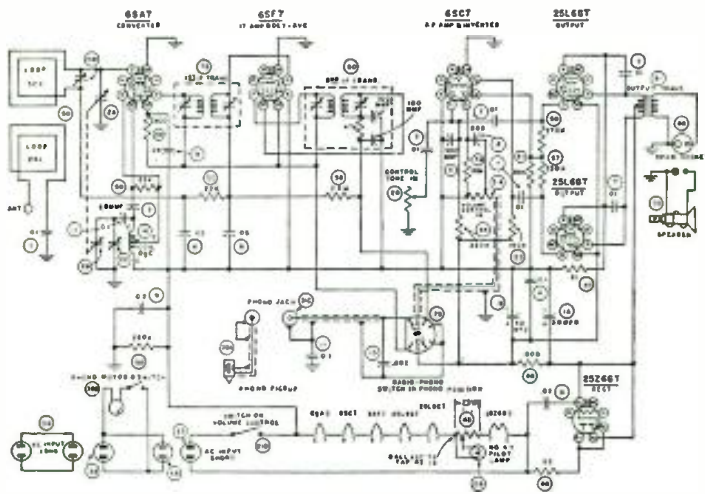

RADIO NEWS, JUNE, 1946

STEWART-WARNER MODEL 9014-E

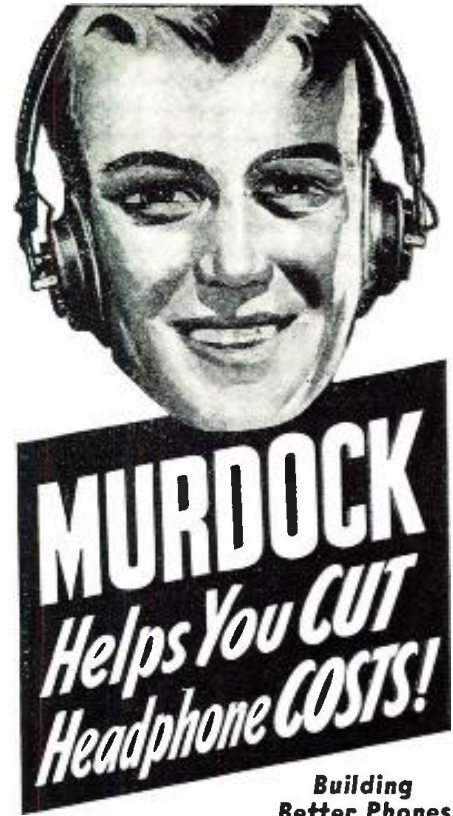
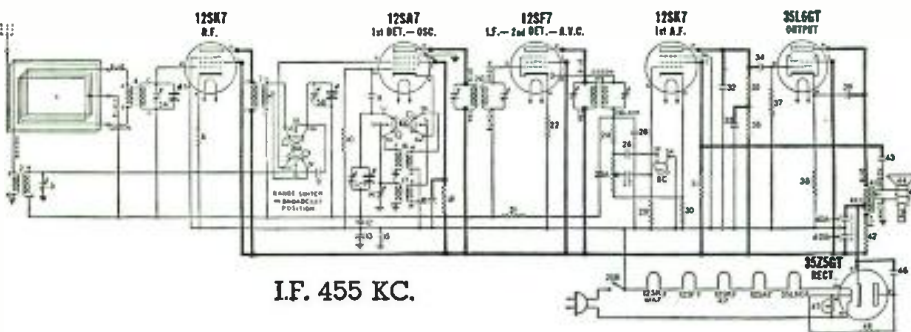

Building Better Phones Since 1904

"Put it up to MURDOCK" when you're stopped by a tough, obstinate Headphone problem!

Through the years, MURDOCK craftsmen, "know-how," and research have combined to produce the answer to many perplexing headphone problems. MURDOCK engineers have "rolled up their sleeves" and designed highly specialized headphones to meet many exacting requirements.

MURDOCK pioneered in the first Solid-Built Headphone 42 years ago. Ever since then, MURDOCK has been closely identified with progress in better headphones for clearer, easier listening. Benefit from our long experience and save time and money. Write today—no obligation, of course.

Write for Catalog!

COMPLETE STOCKS FOR JOBBERS

Send for information, terms, and prices on MURDOCK'S extensive line of Headphones. Quick stock shipments now available.

WM. J. MURDOCK CO.
206 Carter St., Chelsea 50, Mass.

(For parts lists see page 72.)

**Attention
GI JOE!**

Here's Your Opportunity to be First to

**Start Your Own
RADIO SERVICE
SHOP**

Complete Starting-in-Business
Package Stocks of

**TEST EQUIPMENT
TUBES, PARTS, TOOLS** **\$350 up**

Act quickly! Meet the pent up demand for radio service. Turn your special service training into a profitable business of your own. No fuss. No worry. Here's everything you need—\$350 up. Details upon request! Write, wire or phone

RCP 448

"POCKET" VOM
A.C.-D.C. Volts
0-5-50-250-1000
D.C. Mills
0-5-10-100-1000
Ohms
0-2,000-20,000-200,000-
2 Meg.
Size 3" x 5 7/8" x 2 1/4"

\$24.50 net



RECORD CHANGERS

UTAH-OETROLA #550C **\$18.27**
WEBSTER-CHICAGO #36 **27.20**

HALLICRAFTERS SX-28A

\$223



SUPER DEFIANT SX25 **\$94.50**
SKY CHAMPION S20R **60.00**
SKYRIDER MARINE S22R **74.50**
S40 NEW MODEL Approximately **79.50**
SKYRIDER JR. S41 **33.50**

HAMMARLUND HQ-129-X \$129

TRIPLETT 625-N

20000 ohms per volt D.C.
10000 ohms per volt A.C.
5" Scale-TOPMOST QUALITY
(12) D.C. Volt Ranges to 5000
(6) A.C. Volt Ranges to 5000
(3) OHM Ranges 0-400-50000-
10 Meg.
(5) D.C. Current Ranges 1 Ma.
to 10 Amp.
**PLUS OUTPUT and DB.
RANGES**
\$45.00 with test leads.



PHILCO BEAM OF LIGHT

Selenium Cell only, no holder **1.80**

20% deposit required on all C.O.D. orders. 2% transportation allowance on orders of \$25.00 or more accompanied by payment in full.

Write for
FREE CATALOG

**RADIO SUPPLY &
ENGINEERING CO., Inc.**
129 SELDEN AVE. DETROIT 1, MICH.

What's New in Radio

PORTABLE POWER SUPPLY

Electronic Laboratories, Inc. has announced a new portable-mobile power supply, Model 2606.

This vibrator type power supply was designed to meet the needs of experimenters and amateurs. Portable radio transmitters and receivers, by using this "Hampack", can be operated



from any 6 volt battery source. In addition, commercial receiving equipment normally operated from 110 volt lines can be converted to mobile operation by the use of this pack and batteries.

The input of the unit is 6.3 volts, input current at rated output, 8.2 amperes. Output is 300 volts d.c. at 100 milliamperes. The unit has been designed to incorporate complete hum filtering and r.f. noise suppression for the high frequency band. Regulation is 38% between no and full load. The "Hampack" is 4 3/16" x 5 1/2" x 5" and weighs 6 1/2 pounds.

Full details of this new power supply will be furnished by writing to *Electronic Laboratories, Inc.*, Indianapolis, Indiana.

PROGRAM EQUALIZER

A new program equalizer, built for use in the broadcast or recording field, has been announced by *Cinema Engineering Company* of Burbank, California.

This equalizer provides a wide variety of controls for equalization, attenuation or sound effects filtering. Graduated in 2 db. steps, both high and low ends of the sound spectrum can be regulated over a range of 16 db. attenuation and 12 db. equalization.

Attenuation is peaked at 100 cycles on the low end. A key selector per-



mits switching high frequency peak equalization to 3 kc., 5 kc., or 10 kc. A cut-out key, enabling pre-setting, is

provided with a fixed pad to compensate for insertion loss in the "out" position, permitting the equalizer to be cut in or out at will with no change in the over-all level.

The unit is designed with a constant "K" circuit, resulting in no change of impedance, signal level or wave distortion over the entire range of the instrument.

The line or program equalizer is supplied with a 3 1/2" panel to fit a standard relay rack, but can be furnished in a multiple channel installation to fit specifications.

Details of this Type 4031 Equalizer will be furnished by writing *Cinema Engineering Company*, 1510 W. Verdugo Avenue, Burbank, California.

THERMOCOUPLE TUBE

Sylvania Electric Products Inc., has announced a new tube for the direct microammeter measurement of vacuum and low gas pressures.

Used with a microammeter, this thermocouple tube will record pressures of 10⁻¹ to 10⁻⁵ millimeters with a plus or minus 5% accuracy.

Operated in a simple three volt battery and resistance circuit, it may be sealed directly into evacuating apparatus by means

of tabulation provided on top of the bulb. Direct measurement may be made with a 0-250 microammeter which may be calibrated for each gas measured. Maximum accuracy is assured by shielding the equipment from sources of radiant heat.

The tube is 4 7/16" long over pins and the maximum bulb diameter is 1 9/16". The tube is supplied with a small 4-pin base and may be operated in any position.

Electrical ratings and full details of possible applications will be furnished by *Sylvania Electric Products Inc.*, Electronics Division, Boston 15, Massachusetts.

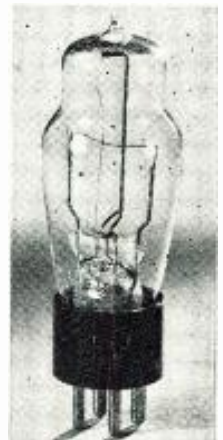

SOUND PRESSURE STANDARD

A precision acoustic instrument developed to facilitate absolute sound pressure measurements throughout the audible frequency range is currently available from *Massa Laboratories, Inc.*

Known as the *Massa Model M 101* Sound Pressure Measurement Standard, this unit incorporates high mechanical impedance, small physical

RADIO NEWS

PACK PUSH BUTTON

POWER

INTO YOUR PRODUCT
WITH
alliance
MOTORS

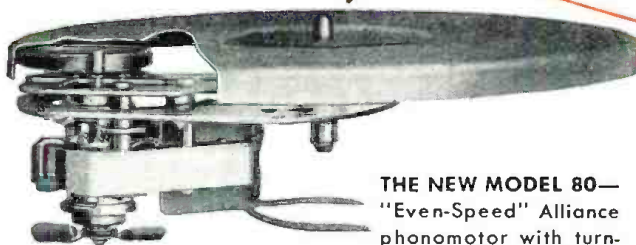

THE NEW MODEL 80—
"Even-Speed" Alliance
phonomotor with turn-
table. More Alliance

phonomotors are used in the radio industry than any other kind.

ALLIANCE POWR-PAKT MOTORS are made in both shaded pole induction and split-phase resistor types. Ratings range from less than 1/400th on up to 1/20th horsepower.

NEW USES FOR THE POWR-PAKT LINE! Radio, electronic and electric controls, opening and closing valves and switches, rotating fans, operating signals, automatic dispensers, turntable drives, tuning devices, shutters, heating controls, and action displays.

Hook up your radio, electronic and remote controls with Alliance Powr-Pakt motors. They'll spark your product with greater flexibility and all-around utility.

MILLIONS of Alliance Phonomotors are driving turntables, record changers, and radio tuning devices for the radio industry. With a few design variations Alliance is now mass producing Powr-Pakt motors at the same low prices. They'll actuate all kinds of moving parts and controls. Write for information.

WHEN YOU DESIGN—KEEP

alliance

MOTORS IN MIND

ALLIANCE MANUFACTURING COMPANY • ALLIANCE, OHIO

ALLIANCE TOOL AND MOTOR LTD., TORONTO 14, CANADA

SOUND VALUES at TERMINAL RADIO

*The P.A. Systems You've
been waiting for!*

- TOP-NOTCH QUALITY!
- HEAVY DUTY CONSTRUCTION!
- ECONOMICAL — COMPARE!
- HUM-FREE, NOISE-FREE!
- NEW IMPROVED DESIGN!
- AVAILABLE NOW — ORDER FROM THIS ADVERTISEMENT!



Model TR-1 14 watt heavy duty system COMPLETE \$57⁶⁰ Net

TERMINAL SOUND SYSTEMS are famous for their long life and trouble-free performance. The new models here boast no superfluous fancy frills but are a new high in Sound Value — each amplifier incorporates a wealth of real, useable features for the power and tone quality heretofore unavailable in low-cost sound systems.

14 WATT HEAVY DUTY SOUND SYSTEM

A complete system—no extras to buy! Consists of 14 watt heavy duty amplifier, 10 inch permanent magnetic speaker in reinforced wall baffle (specify color—brown or grey), 25 ft. speaker cable, wide range crystal microphone with table stand and 15 ft. shielded microphone cable. Ready to plug in and operate!

MODEL TR-1 PA SYSTEM, as described and illustrated \$57⁶⁰ Net

MODEL TR-1D DUAL SPEAKER SYSTEM, (as above, but with two 10" speakers in wall baffles) \$67⁹⁵ Net

25 WATT HEAVY DUTY SOUND SYSTEM

Offers high fidelity sound reproduction with emphasis on quality and power! Consists of 25 watt amplifier, 12 inch permanent magnetic speaker in reinforced wall baffle (specify color—brown or grey), 25 ft. speaker cable, wide range crystal microphone with table stand and 15 ft. shielded microphone cable.

MODEL TR-2 PA SYSTEM, as described \$71⁵⁰ Net

MODEL TR-2D DUAL SPEAKER SYSTEM, (as above, but with two 12" speakers in wall baffles) \$84⁹⁵ Net

14 WATT AMPLIFIER SPECIFICATIONS

POWER OUTPUT: 14 watts normal
GAIN: Microphone input 110 db.; phono input 70 db.
FREQUENCY RESPONSE: 50 to 12,000 cps, hum —70 db. below rated output.
INPUTS: 1-Microphone, 1-Phono (both high impedance). Separate gain controls for mixing and fading.
TONE CONTROL: Full range bass and treble tone compensator.
OUTPUT IMPEDANCES: 2, 4, 8, 16 and 500 ohms.
TUBES: 1-7C7, 1-7F7, 2-7C5 and 1-5Y4G.
POWER CONSUMPTION: 85 watts, 117 volts 50-60 cycles. A.C. Fused primary.
SIZE: 13"x8½"x8½". Net wt. 15 lbs.

TR-1A AMPLIFIER ONLY, complete with tubes \$33⁸¹ Net



WEATHERPROOF OUTDOOR SPEAKERS

MODEL PSAH—3½ ft. horn recommended for voice applications. High Efficiency, ½ mile sound projection, 25 watt driver unit. \$37⁹² net

MODEL LSAH—4½ ft. horn ideal for music. Waterproof construction, ¾ mile sound projection, 25 watt driver unit. \$47⁹² net

Above prices are FOB New York. 25% deposit required with all COD orders.

25 WATT AMPLIFIER SPECIFICATIONS

POWER OUTPUT: 25 watts normal
GAIN: Microphone input 112 db.; phono input 70 db.
FREQUENCY RESPONSE: 40-13,000 cps, hum —65 db. below rated output.
INPUTS: 1-Microphone, 1-Phono (both high impedance). Separate Gain Controls for mixing and fading.
TONE CONTROL: Full range bass and treble tone compensator.
OUTPUT IMPEDANCES: 4, 8, 12, 16 and 500 ohms
TUBES: 1-6SJ7, 1-6SL7, 2-6L6 and 1-5U4G
POWER CONSUMPTION: 120 watts, 117 volts 50-60 cycles. A.C. Fused primary.
SIZE: 17"x9"x9". Net wt. 24 lbs.

TR-2A AMPLIFIER ONLY, complete with tubes. (Similar in appearance to TR-1A, but not illustrated here) \$42⁶³ Net

MICROPHONE FLOOR STAND

MODEL MS-4. 10" diameter, heavy base, all chrome sections adjustable from 34" to 62". Positive locking clutch. \$52²⁵ net

Terminal Radio Corporation

85 CORTLANDT ST., NEW YORK 7, N. Y. • Telephone: WOrth 2-4415

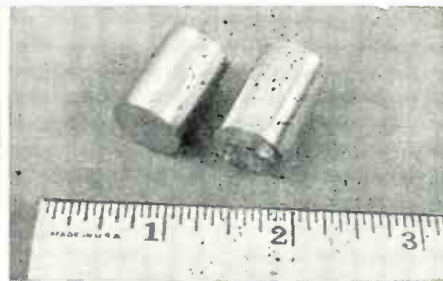

size, wide dynamic range and flatness of response. The vibrating system is stiffness-controlled to well beyond 30 kc. which results in a pressure sensitivity independent of frequency throughout the entire audible range.

A technical bulletin giving complete specifications of the unit will be sent upon request to *Massa Laboratories, Inc.*, 3868 Carnegie Avenue, Cleveland 15, Ohio.

NEW INTERCOM LINE

A completely redesigned line of intercommunication equipment is now in production at the *Operadio Manufacturing Company's* plant in St. Charles, Illinois.

The new "Flexifone" line features a 10-station master, a 20-station master, a 6-station "Supervisor" master, and a remote speaker station with or without call-switch.

Several new features have been incorporated in the design of this line of "Flexifones"; self-clearing, gravity-assisted piano type keyboard for station selector switches; selector keys and controls of plastic; "Finger-tip



Touch" talk switch; die-cast metal housings and gray-tan Hammerloid finish.

Details of individual units in the line will be furnished upon request to *Operadio Manufacturing Company*, St. Charles, Illinois.

RECORD CHANGER

A complete line of record changers, record players and phonograph motors are currently available according to *Micro-Sonic Corporation* of New York.

The record changer incorporates several new features not previously used in similar types of equipment. The unit can be sharply tilted without interfering with the operation. Ten

(Continued on page 92)

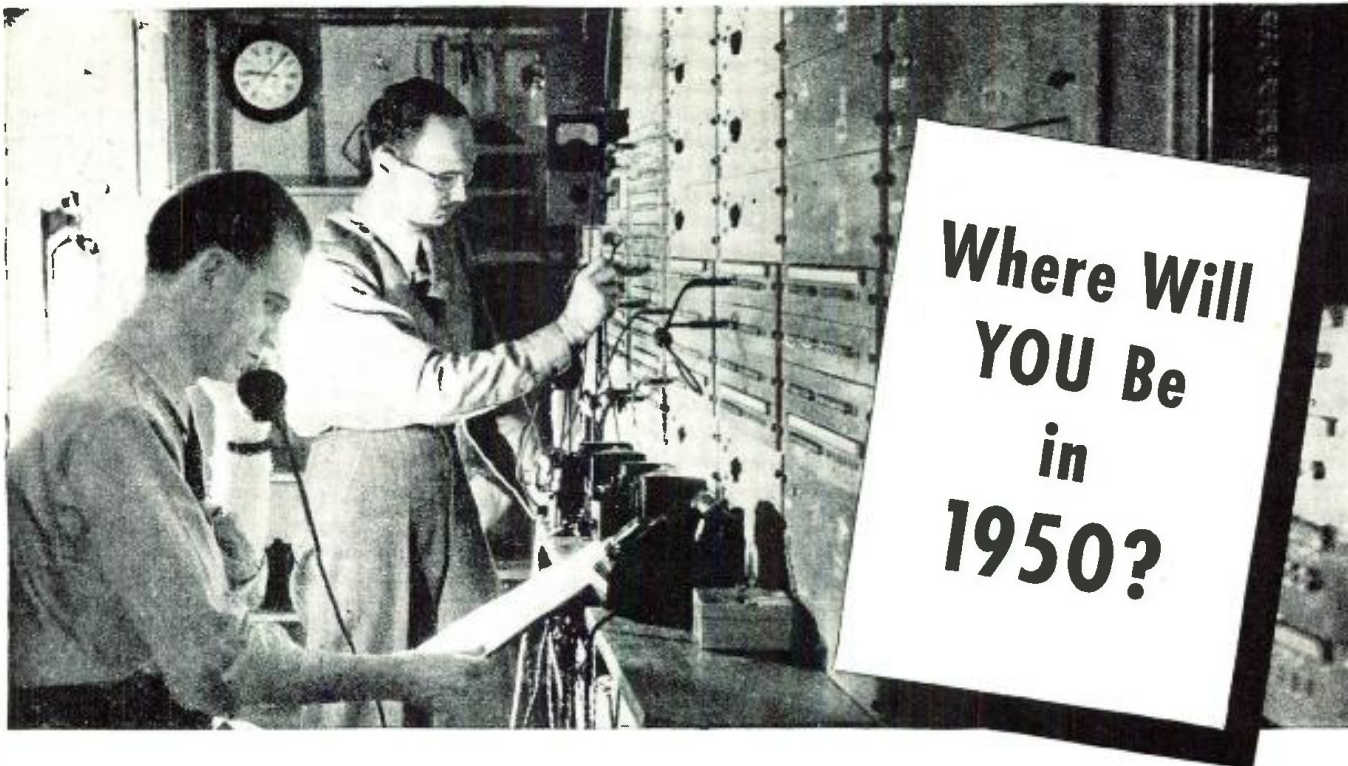

Enjoy Security and Good Pay! Step Ahead of Competition Into A Better Radio Job by Preparing Now With CREI Technical Home Study Training — CREI Offers You a Proved Program of Self-Improvement to Keep Pace With Modern U. H. F. Advancements and Get That Radio Engineering Job You Want

Yes, there are **GOOD JOBS . . . for GOOD men!** The easy jobs are gone and once again knowledge and ability are the requirements to **HOLD** good jobs —to **SECURE** better ones. Employers once again can afford to be "choosey" . . . to select the best man for the best job. In the face of this show-down situation—*where do YOU stand?*

CREI home study training in Practical Radio-Electronics Engineering can equip you to meet the requirements to hold your job—or advance to a *better* one. CREI graduates are recognized throughout the Radio-Electronics industry. Your CREI diploma is the best recommendation for a better job. By adding CREI training to your present radio experience you can safeguard your future and keep pace with such new developments as U.H.F. Circuits, Cavity Resonators, Pulse Generators, Wave Guides, Klystrons, Magnetrons and other tubes. Are you equipped to handle them? CREI is equipped to *help you*, by providing the know-how and ability that is required.

In our proved method of instruction, you learn not only *how* but *why!* Easy-to-read-and-understand

lessons are provided well in advance, and each student has the benefit of individual guidance and supervision from a trained instructor. This is the basis of the CREI method of training which many thousand professional radio men have completed during the past 19 years. CREI courses were used during the war to train thousands of Army and Naval radio technicians during the war for the U. S. Signal Corps, U. S. Navy and U. S. Coast Guard.

It's up to you now to decide your course. What you do today will be the answer to where you will be in 1950 and the years after. It costs you nothing to read the interesting facts . . . to learn how CREI can help you enjoy the security you want . . . the better-paying job that can be yours. Write for particulars *now!* (CREI training for Veterans is approved under the "G.I." Bill.)

• **WRITE TODAY for FREE BOOKLET**



"Your Opportunity in the New World of Electronics"

If you have had professional or amateur experience—let us prove to you that we have something you need to qualify for a better radio job. To help us to intelligently answer your inquiry—PLEASE STATE BRIEFLY YOUR BACKGROUND OF EXPERIENCE, EDUCATION AND PRESENT POSITION.

Capitol Radio Engineering Institute

E. H. RIETZKE, *President*

Dept. RN-6, 16th and Park Road, N.W., Washington 10, D. C.

Branch Offices:

New York City (7), N. Y. 170 Broadway Chicago (2), Ill. 30 N. LaSalle St. San Francisco (2), Calif. 760 Market St. San Diego (1), Calif. 316 C Street

MEMBER: NATIONAL HOME STUDY COUNCIL • NATIONAL COUNCIL OF TECHNICAL SCHOOLS



**DON'T BE A VICTIM
OF**

T.B.D.*

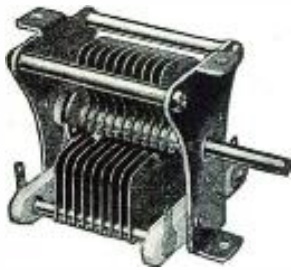

Why take chances? Use condensers that you can depend on for steady, long-range, serviceable performance. The BUD variable condenser line consists of tuning, neutralizing and padder condensers that are designed to give maximum service at moderate cost. See your local distributor for information on the complete BUD condenser line. Ask him to show you the differences that make this line so outstanding!

* Transmitter Break-Down

BUD

Can Supply All Your Needs! . . .

. . . with the latest types of equipment including: condensers — chokes — coils — insulators — plugs — jacks — switches — dials — test leads — jewel lights and a complete line of ultra-modern cabinets and chassis.



All Purpose TRANSMITTER REMOTE CONTROL SYSTEM

By **PHILIP JOHNSON,**
RT 2/c

Staff EE & RM USNTS

WITH the hams again *pounding brass*, most of them are either designing and building new rigs or modernizing their prewar rigs.

In postwar radio gear, as in prewar radio gear, control methods are important because individual switches and dials often handle very-high voltage which is dangerous to the life and safety of the operator and because it is often inconvenient or impossible to locate all equipment within easy reach of the operator.

Radio equipment may be controlled directly, by means of switches and dials located on the front panel of the equipment, or it may be indirectly

controlled. When it is indirectly controlled, it is said to be *remotely controlled*. This is advantageous to the operator because it increases the safety of the operator by removing all high-power circuits from the reach of his hands and allows cumbersome equipment to be located away from the operating desk and convenient to power and antenna connections.

The illustrated remote control system is one with which the radio operator may turn on the transmitter, operate it, and then turn it off. All steps are done by pressing the single telegraph key.

The operator may energize the transmitter by pressing the telegraph

Fig. 1

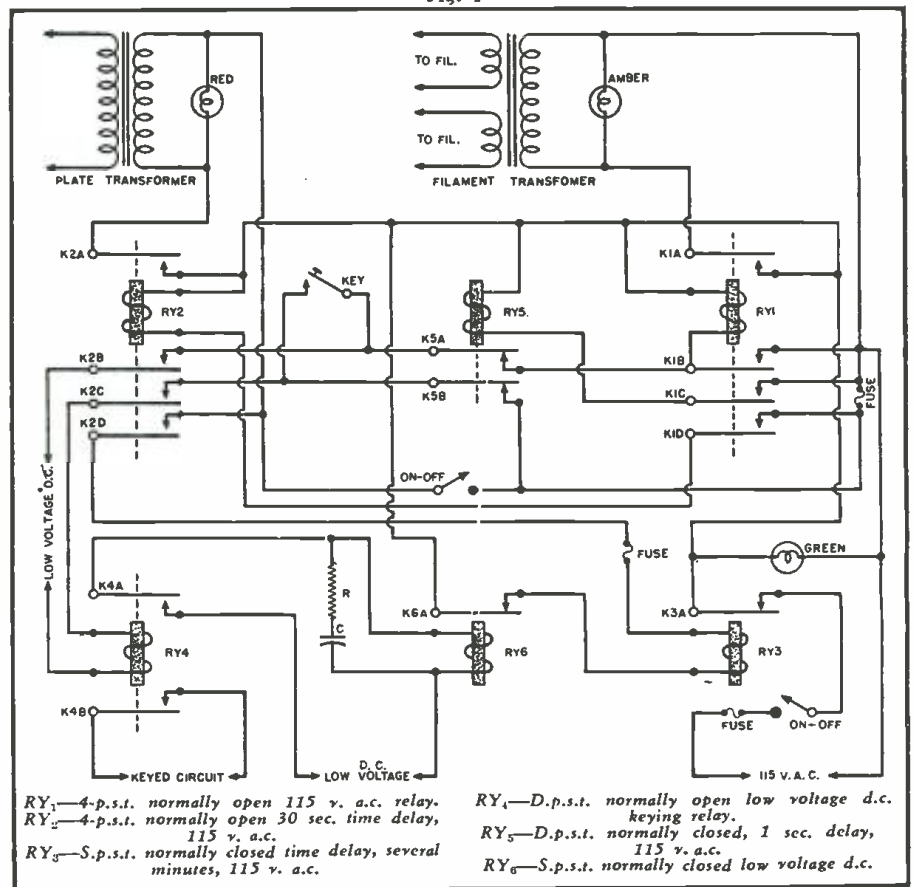

NOW YOU CAN

SEE!



PANADAPTOR Eliminates "Blind" Operation

The PANADAPTOR brings a revolutionary change in amateur techniques. It provides "eyes" for your receiver. Panoramic Reception allows you to see not only the one signal heard through your receiver, but *simultaneously* every signal in the 200 kc portion of the band surrounding that signal. Through the use of another sense — sight — the PANADAPTOR introduces new methods, new efficiency. . . .

USE YOUR EYES

- TO** find holes in those crowded bands . . . locate weak signals . . . to find your sked among the QRM and tell him where to shift frequency . . . to see quick answers to your CQs. . . .
- TO** facilitate netting operations . . . see the station which is off frequency in the net (instead of being absent) . . . to see break-ins . . . to see calls from auxiliary nets. . . .
- TO** observe signal characteristics, your own and others . . . to measure percentage modulation, to detect splatter . . . to sort 'phone and CW. . . .
- TO** aid your ears . . . use all your faculties to improve your station operation and efficiency . . . to enhance the pleasure you get from radio.

THE PANADAPTOR IS YOUR SEEING EYE, use it and you'll find you get more out of any phase of radio operation be it traffic handling, DXing, experimenting. . . .

You must **SEE** the Panadaptor in operation to realize how it can revolutionize, simplify and improve the operation of your rig. Contact your radio parts jobber, **NOW!**

Write to us for a free descriptive booklet.

PANADAPTOR Model PCA-2
Now Available at Leading Radio Parts Jobbers. Ask for demonstration. Amateur Net Price, complete with ten tubes and accessories for 115 V., 50-60 cycle operation.

\$99.75

ONE YEAR GUARANTEE against defects in parts or workmanship (excluding tubes). Panoramic Handbook with full installation, operating, application and maintenance instructions furnished with each PANADAPTOR.

PANORAMIC

CABLE ADDRESS
PANORAMIC, NEW YORK



RADIO CORPORATION

242-250 WEST 55th ST. New York 19, N.Y.

A VERSATILE TEST LABORATORY...IN ONE COMPACT UNIT!

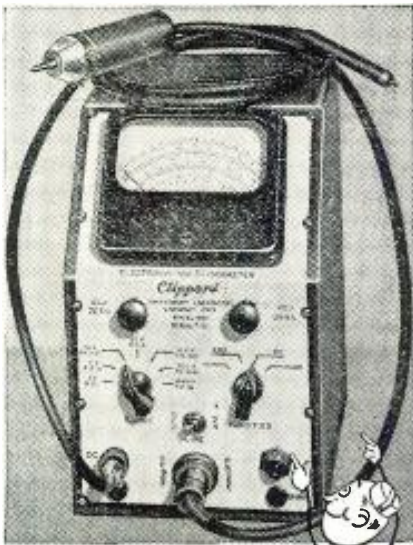

Clippard ELECTRONIC VOLT-OHMMETER MODEL 406

NEW BRIDGE-TYPE CIRCUIT—fully balanced through 3 stages for maximum accuracy and stability. Tube complement: one 6X5GT rectifier, two 6SN7GT dual purpose tubes and 6AL5 dual diode in probe.

PEN-TYPE DUAL-DIODE PROBE—on detachable 36" shielded cable. High impedance, low capacity and convenient ground terminal assure accurate readings, A.F. thru U.H.F. ranges with minimum circuit disturbance.

EXTREME RANGE—full scale sensitivity of 0-1, 0-3, 0-10, 0-30, 0-100, 0-300 and 0-1000 volts A.C. and D.C. and 0-1,000 megohms in 7 ranges with ample overlap to eliminate guess-work. Decibel scale -20 to +51 in 3 ranges.

INCLINED METER—for easier, more accurate readings with less parallax.

HANDSOME APPEARANCE—Satin Chrome panel, etched black self-explanatory markings, convenient controls, quarter-sawn oak case, folding leather carrying handle. Overall size 10" x 8 1/2" x 6 1/4".

LABORATORY ACCURACY—calibrated to 2% accuracy at plant. 5% accuracy guaranteed in field. An instrument of laboratory quality and ruggedness priced within reach of all who want the best!

Write today for FREE bulletin
giving Complete Details!

Electro-Magnetic Windings

R. F. Coils

Sub-Assemblies

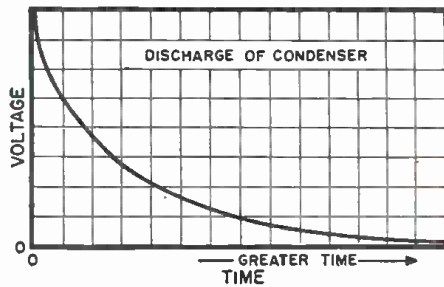

Fig. 2.

key and holding it down for about one second. After the normal 30 second warmup period, he may start keying the transmitter, using the same telegraph key. If he does not key the transmitter, the transmitter will automatically de-energize itself after a predetermined space of time. Both the plate and filament circuits will be de-energized.

Operation

The circuit is made up of six relays, including three time delay relays. There is also one large condenser and a resistor in the circuit. The relays are all shown in their normal de-energized positions. Relay RY_1 has four normally open contacts— K_{1A} , K_{1B} , K_{1C} , and K_{1D} . The time delay relay, RY_2 , has four normally open contacts— K_{2A} , K_{2B} , K_{2C} , and K_{2D} . Relay RY_3 , also a time delay relay, has one normally closed contact, K_{3A} . Relay RY_4 , the keying relay, has one normally open contact in addition to its contacts in the keying circuit of the transmitter. The key switch relay, RY_5 , is a time delay relay with two normally closed contacts, K_{5A} and K_{5B} . Relay RY_6 has one normally closed contact, K_{6A} . The on-off switches are all emergency switches. They may be left permanently in the on position.

When the key is pressed and held down for about one second, the following sequence of operations will take place. Relay RY_1 is immediately energized and its four normally open contacts close. The transmitter filaments are then energized, due to the closing of the K_{1A} ; the key is short-circuited due to the closing of K_{1B} ; and the two time delay relays, RY_2 and RY_3 , are energized because of the closing of K_{1C} and K_{1D} . In one second, the key switch relay, RY_5 , trips, opening contacts K_{5A} and K_{5B} . These contacts remove the telegraph key from the circuit of relay RY_1 . In another 29 seconds, relay RY_2 trips, closing its four contacts. The closing of contact K_{2A} causes the high voltage circuits to be energized. The closing of contacts K_{2B} and K_{2C} put the telegraph key in series with the key relay, RY_4 . The transmitter may now be keyed. Relay RY_3 is energized by the closing of contact K_{3A} . Relay RY_3 is a time delay relay set to trip after a certain number of minutes and, after that time period is up, relay RY_3 trips, opening contact K_{3A} . Opening of contact K_{3A} de-energizes the entire circuit. Relay RY_4 is prevented from tripping during

operation by relay RY_6 . Relay RY_6 is energized by closing of contact K_{6A} of the key relay. The energizing of relay RY_6 opens contact K_{6A} which de-energizes relay RY_3 . Relay RY_6 stays energized during the short space of time between dots and dashes by the discharge of condenser C through its coil. The discharge of condenser C is illustrated in Fig. 2.

The entire circuit may be built on one of the shelves of the relay rack holding the transmitter to be controlled. The only wires necessary between the relay rack and the operating desk are the two leads of the telegraph key.

In choosing the relays, care should be taken to see that the relay contacts are large enough to handle the current they control. If 4-pole relays cannot be obtained, two 2-pole relays connected in parallel may be used in place of the 4-pole relay. Relay RY_4 may be any type of delay relay capable of handling the load of the complete transmitter with a delay period the operator finds convenient.

The circuit may be used on a radio-telephone transmitter by short-circuiting the telegraph key with a switch.

The value of condenser C is determined from the following formula:

$$C = \frac{t}{R \log_e E/IR}$$

C —in farads

t —.2 sec. (the longest time between a dot or dash)

I —.9 the maximum current through RY_6 .

R —Resistance of coil of RY_6 plus any added resistance to keep value of C reasonable

E —Value of the d.c. voltage across RY_6 .

—30—

Practical Radio Course

(Continued from page 60)

verter tubes is provided with a variable-mu characteristic.

Diodes or Crystal as Mixers

A simple diode tube, or a crystal, can serve as the non-linear element in a single-electrode input type mixer. In fact, during the past few years such mixers have become appreciated for the advantages they possess for operation in the region of ultra-high signal frequencies where ordinary multi-electrode types of mixer tubes (even the electron-coupled types) cease to operate satisfactorily. Consequently they have become popular for use in ultra-high frequency and microwave receivers.

A discussion of diode and crystal mixers for these applications will be deferred to Part 50 of this series, after the causes for the high-frequency limitations of the various commercial types of electron-coupled mixer and converter tubes have been completely covered.

(To be continued)

RADIO NEWS



CABLES

For Use in Transmission of High Frequencies

CONNECTORS

• Amphenol Twinax and Coax RG cables, produced to standards that surpass the high Army-Navy specifications for critical wartime uses, are ideal for the myriad of peacetime applications in all phases of the rapidly expanding electronic industries. Rigid laboratory tests and notarized affidavits on every shipment give final assurance of extra quality and dependability.

• Amphenol special low-loss V.H.F. connectors are available in a complete line for all practical applications of RG cables and other uses. Mechanically efficient and electrically correct, these easily assembled connectors and adapters provide the utmost efficiency in circuits in which they are used.

AMPHENOL ASSEMBLY SERVICE

An important part of Amphenol service to users of cables and connectors is a complete Assembly Service. Rigid specifications and performance requirements, plus thorough scientific testing of each part and process, assures users of satisfactory service. For cables, connectors and complete assembly service, look to the world's largest producer — Amphenol.

AMERICAN PHENOLIC CORPORATION
CHICAGO 50, ILLINOIS
IN CANADA
AMPHENOL LIMITED • TORONTO

AMPHENOL



ARMY-NAVY
Official
HEAD PHONES
\$2.49



BURSTEIN-APPLEBEE
Made A Lucky Buy

Limited quantity of these fine brand new head phones. Highly sensitive, 8000 ohms impedance. Bi-polar magnets, bakelite shell and cap. Adjustable head band, leather covered spring steel. Cord connects from one side, out of the way. Molded sponge rubber ear cushions. Our price only \$2.49 per set plus 20c postage and packing \$13.50. Order Number 17A37.



MAIL THE COUPON
FREE CATALOG

Latest developments in radio and electronic parts and devices, newest ham gear, gadgets, bargains, war surplus items . . . get this red hot bargain catalog FREE.

18 YEARS
IN
RADIO



BURSTEIN-APPLEBEE CO. Radio News
1012 McGee St., Kansas City 6, Mo.

Send me your new FREE Catalog.
Send me _____ pair of phones at \$2.49 per pair plus 20c pair postage. I enclose \$_____ in payment.

NAME _____
ADDRESS _____
TOWN _____ STATE _____

Parts Lists

(FOR CIRCUIT DIAGRAMS APPEARING ON PAGES 62 AND 63.)

WESTINGHOUSE—MODELS H-122, H-130

- V.3311 45—Ballast res.
RC20AE220M 46—22 ohm, 1/2 w. res.
RC30AE910J 47—91 ohm, 1 w. res.
RC40AE152M 48—1500 ohm, 2 w. res.
RC10AE332M 49—3300 ohm, 1/4 w. res.
RC10AE223M 50—22,000 ohm, 1/4 w. res.
RC10AE823K 51—82,000 ohm, 1/4 w. res.
RC20AE184K 53—180,000 ohm, 1/2 w. res.
RC20AE224K 54—220,000 ohm, 1/2 w. res.
RC10AE224M 55—220,000 ohm, 1/4 w. res.
RC10AE274K 56—270,000 ohm, 1/4 w. res.
RC10AE334K 57—330,000 ohm, 1/4 w. res.
RC10AE223M 58—2.2 megohm, 1/4 w. res.
RC10AE106M 59—10 megohm, 1/4 w. res.
V.3304 1—Elec. cond.
1A—30 μ f. cond.
1B—50 μ f. cond.
2—Var. two-gang cond.
2A—Loop tuning cond.
2B—Osc. tuning cond.
2C—Osc. trimmer cond.
3—68 μ f. cond.
5—300 μ f. cond.
6—.005 μ f. cond.
7—.01 μ f. cond.
8—.05 μ f. cond.
9—.2 μ f. cond.
10—.002 μ f. cond.
11—.1 μ f. cond.
20—Osc. coil
21—Tone control
22—Vol. control & sw.
21A—Var. res. control
70—6" PM Speaker
79—First i.f. trans.
80—Second i.f. trans.
81—Output trans.

V-3535

- RCM20A680M
RCM20A301M
RCP10W6502A
RCP10W4103A
RCP10W4503A
RCP10W4204K
RCP10W6202A
RCP10W4104A
V.3382
V.3303
V.3298
V.3291
V.3328
V.3329
V.3297

STROMBERG CARLSON—MODEL 1100, SERIES 10

- 26323 R_{31}, R_{21} —150 ohm res.
26365 R_4 —470,000 ohm res.
26362 R_5, R_{11} —270,000 ohm res.
26381 R_6 —10 megohm res.
31694 R_7 —1 megohm pot.
26353 R_8 —47,000 ohm res.
26373 R_9 —2.2 megohm res.
26349 R_{10} —22,000 ohm res.
26369 R_{13} —1 megohm res.
26341 R_{14} —4700 ohm res.
26322 R_{15} —120 ohm res.
41580 R_{17} —22 ohm res.
34506 C_{11}, C_{12} —40/40 μ f. elec. cond.
27101 C_{13} —200 μ f. cond.
29371 C_{14} —500 μ f. cond.
27646 C_{15} —0.02 μ f. cond.
24560 C_{17}, C_{24} —50 μ f. cond.
25485 C_{18}, C_{27} —.01 μ f. cond.
33208 $C_{29}, C_{10}, C_{11}, C_{12}, L_1, L_2$ —Second i.f. trans.
29891 C_{28}, C_{29} —.05 μ f. cond.
31686 C_{34}, C_{35}, L_3, L_7 —First i.f. trans.
40632 C_{16} —.05 μ f. cond.
24166 C_{17} —25 μ f. cond.
31698 C_{19}, C_{22} —Var. cond. and pulley
27760 C_{25} —.005 μ f. cond.
27921 C_{28} —Aligning cond.
28002 C_{29} —.25 μ f. cond.
33206 L_9, L_7 —Osc. coil
33205 L_{10}, L_{11} —Loop
33249 L_{12} —Wave trap
34505 Speaker assembly

AUTOMATIC—MODEL 611

See circuit diagram for component values

HOFFMAN—MODEL A302

- 4501 R_1 —22,000 ohm, 1/2 w. res.
4524 R_2 —68 ohm, 1/2 w. res.
4502 R_3 —2.2 megohm, 1/2 w. res.
4504 R_4 —47,000 ohm, 1/2 w. res.
4505 R_5 —10 megohm, 1/2 w. res.
4802 R_6 —.5 megohm pot. with sw.
4511 R_7 —.1 megohm, 1/2 w. res.
4500 R_8 —.22 megohm, 1/2 w. res.
4506 R_{10}, R_{14} —47 megohm, 1/2 w. res.
4510 R_{11} —150 ohm, 1/2 w. res.
4508 R_{12} —47 ohm, 1/2 w. res.
4700 R_{13} —500 ohm, 5 w. wire-wound res.
4401 C_1, C_2 —Two-section var. (388-180 μ f.)
 C_3, C_4 —Trimmer cond. (part of var. cond.)
4000 C_5 —100 μ f. mica cond.
4102 C_7, C_{10}, C_{13} —.005 μ f., 600 v. tub. cond.
4100 C_8, C_{11}, C_{15} —.05 μ f., 200 v. tub. cond.
4001 C_9, C_{12} —270 μ f. mica cond.

- 4106 C_{14} —.02 μ f., 400 v. tub. cond.
4103 C_{16} —.01 μ f., 600 v. tub. cond.
4201 C_{17}, C_{18} —30/50 μ f., 150 v. elec. cond.
4111 C_{19}, C_{20} —.1 μ f., 200 v. tub. cond.
9003 L_2 —5" PM loudspeaker
5207 S_1 —On-off sw. on vol. control
5208 T_1 —Antenna loop
5205 T_2 —Osc. coil
5206 T_3 —Input i.f. trans. (455 kc.)
5101 T_4 —Output i.f. trans. (455 kc.)
 T_5 —Audio output trans.

STEWART-WARNER—MODEL 9014-E

- 502140 6—390 ohm, 1/4 w. res.
502130 10—22,000 ohm, 1/4 w. res.
502133 15—220,000 ohm, 1/4 w. res.
502291 19—4700 ohm, 1/4 w. res.
502269 21—3.3 megohm, 1/4 w. res.
502264 22—47 ohm, 1/4 w. res.
502131 24—47,000 ohm, 1/4 w. res.
502145 25A, 25B—500,000 ohm vol. control with sw.
502136 29—10 megohm, 1/4 w. res.
502128 30—2200 ohm, 1/4 w. res.
502135 31—2.2 megohm, 1/4 w. res.
502133 35-36—220,000 ohm, 1/4 w. res.
502134 37—470,000 ohm, 1/4 w. res.
502138 38—130 ohm, 1/4 w. res.
502469 42—1500 ohm, 1 w. res.
502574 48—33 ohm, 1/2 w. res.
502172 3, 14—25 to 100 μ f. trimmer cond.
502123 5A, 5B, 5C—Variable gang (with drum)
502162 9—315 μ f., 500 v. cond.
502159 11—50 μ f., 500 v. mica cond.
502155 12—.1 μ f., 200 v. cond.
502158 13—.2 μ f., 200 v. cond.
502262 18—.25 μ f., 200 v. cond.
502470 26—0008 μ f., 400 v. cond.
502453 27—.002 μ f., 400 v. cond.
502160 28, 32—110 μ f., 500 v. mica cond.
502153 33—.05 μ f., 200 v. cond.
502156 34—.004 μ f., 400 v. cond.
502151 39—.01 μ f., 400 v. cond.
500256 40A, 40B—A-40 μ f., 150 v.; B-20 μ f., 400 v. elec. cond.
502152 43—.02 μ f., 400 v. cond.
502157 46—.05 μ f., 400 v. cond.
502503 1—Loop antenna
502740 2—S.W. antenna coil
502121 4—Antenna coupling coil
502142 7—BC, r.f. coil
502198 16—BC osc. coil
502197 17—S.W. osc. coil
502102 20—First i.f. trans.
502103 23—Second i.f. trans.
502998 45—5" dynamic PM speaker

BENDIX—MODELS 526A, 526B, 526C, 526D, 526E

- RC1H76 R_1 —15 megohm, 1/4 w. res.
RC1H40 R_2 —22,000 ohm, 1/4 w. res.
RC1H68 R_3 —3.3 megohm, 1/4 w. res.
RV0S00 R_4 —500,000 ohm pot. with sw.
RC1H54 R_5, R_{15} —220,000 ohm, 1/4 w. res.
RC1H70 R_6 —4.7 megohm, 1/4 w. res.
RC1H58 R_7 —470,000 ohm, 1/4 w. res.
RW1B14 R_8 —150 ohm, 1 w., wire-wound res.
RC3H12 R_9 —100 ohm, 1 w. res.
RW1A06 R_{10} —33 ohm, 1 w., wire-wound res.
RC4G28 R_{11} —2200 ohms, 2 w. res.
CP6T16 C_1, C_{12} —.004 μ f., 600 v. cond.
CV0B01 C_{23}, C_{24} —25 μ f. max. (per sec.) var. cond.
 C_3, C_4 —25 μ f. max. var.
 C_5 —47 μ f. mica cond.
 C_6 —.05 μ f., 400 v. cond.
 C_7, C_8 —In can with first i.f.
 C_9, C_{10} —In can with second i.f.
 C_{11} —100 μ f., mica cond.
 C_{13} —330 μ f. mica cond.
CP4T20 C_{14} —.006 μ f., 400 v. cond.
CP4T31 C_{15} —.01 μ f., 400 v. cond.
CP6T40 C_{16} —.05 μ f., 600 v. cond.
CE2A00 C_{17A}, C_{17B} —40/40 μ f. 150 v. elec. cond.
 C_{18} —.1 μ f., 400 v. cond.
 C_{19} —.001 μ f. 500 v. mica cond.
 L_1 —Antenna loop assembly
 L_2 —Osc. coil
First i.f. trans.
Second i.f. trans.



**WITH
CLUTCH HEAD
SCREWS**

Norge

**“Steps Up
Production
and
Eliminates
Cabinet
Damage”**

TYPE "A"
ASSEMBLY BIT



COMMON
SCREWDRIVER



Here Are Results computable in dollars and cents on the profit side of production... results obtainable only with CLUTCH HEAD Screws because they have exclusive features for safety and speed unmatched by any other screw on the market.

In the great Norge Plants, where the drive of screws runs into millions, safeguarding the beauty of an immaculate cabinet ranks in importance as a cost factor with speed of assembly.

With CLUTCH HEAD Screws, costly damage caused by driver slippage is eliminated:

- 1 Because the Center Pivot Column on the driver guides the bit into deep dead-center of the Clutch recess for automatically straight driving free from canting.
- 2 Because the driving engagement is all-square, eliminating the need for strenuous end pressure to combat "ride-out" as set up by tapered driving... one of the major causes of driver slippage.

The step-up in driving tempo logically results from the roomy easy-to-hit Clutch target, the positively centered entry, the sureness of the torque grip, and the effortless drive home. CLUTCH HEAD also contributes unmatched tool economy with the rugged Type "A" Bit that drives thousands more screws without interruption.

Note how simple it is to recondition this bit. It may be repeatedly restored to original efficiency by a 60-second application of the end surface to a grinding wheel. No "back-to-the-factory" shipment necessary... No delay. No expense.



Norge too, in common with all users of CLUTCH HEAD, enjoys the benefit of simplified field service because this screw is basically designed for operation with the ordinary screwdriver or any flat blade reasonably accurate in width.

UNITED SCREW AND BOLT CORPORATION

CLEVELAND 2

CHICAGO 8

NEW YORK 7

TWO COMPLETE LINES
of Newcomb Quality
AMPLIFIERS

Newcomb now offers the first truly post-war amplifiers... the result of advanced electronic engineering, backed by experience and a strict insistence upon perfection.



Deluxe K Series



Standard H Series

DELUXE K-SERIES: designed to fill a growing demand for the finest possible amplification equipment. The superb operation of K-Series amplifiers signals an outstanding achievement of modern electronic research... **STANDARD H-SERIES:** offers characteristic Newcomb quality for applications in which economy must be considered, but dependability and performance cannot be sacrificed... Both series feature the exclusive hum-free, plug-in transformer for instant conversion from high to low impedance... both offer quality heretofore not available to the public address field.

"NOT MERELY AS GOOD AS THE OTHERS... BUT BETTER THAN ALL OTHERS."

THE SOUND OF QUALITY

Newcomb

AUDIO PRODUCTS CO.

MANUFACTURERS

DEPT. F 2815 S. HILL STREET, LOS ANGELES 7, CALIFORNIA



FOR SAFETY'S SAKE

Safety first for personnel is of the utmost importance.

This protection can be guaranteed through the use of G-E Interlock Switches on radio transmitters, X-ray and therapeutic machines, burglar alarms, and signal controls for fire doors.

Safety first for equipment is important, too. G-E Indicator Lamps give visual evidence of what is going on inside equipment, and circuit troubles can be corrected before they become serious. Write: *Electronics Department, General Electric Company, Syracuse, New York.*

GENERAL  ELECTRIC
100-E1

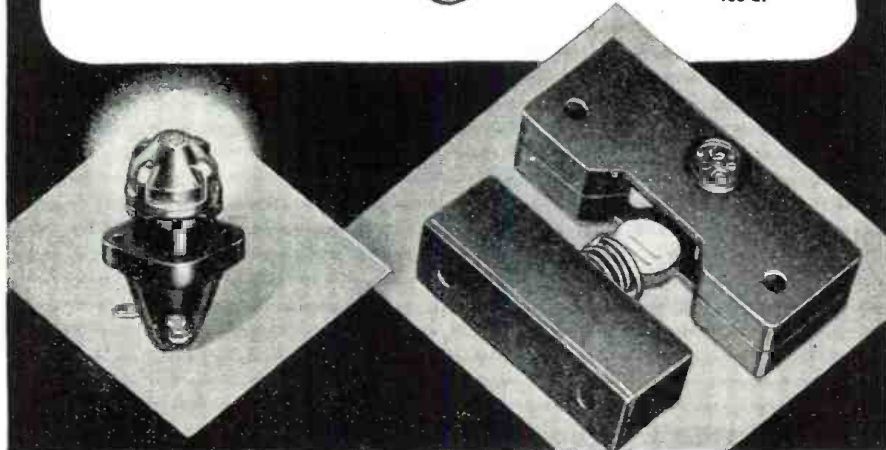

QTC
(Continued from page 43)

of maritime navigation. Possibly this is the final answer to the present delay in docking vessels during heavy fog and in entering and leaving port during conditions of poor visibility. Another item, developed by *General Electric*, will be of interest to those in television—an aluminum "skin" which is about 1500 times thinner than a sheet of paper which is being used to produce approximately three times greater clarity and brilliance of images on a television screen. The skin is the principal improvement in a cathode ray tube recently developed by *GE* which is described as coated on fluorescent powder (just inside the face of the tube) the skin permits a beam of electrons shot from the rear of the tube to penetrate it. However, the light created when the electrons cause the powder to fluoresce is unable to penetrate the skin and instead is reflected outward. Without light being lost or dissipated toward the rear of the tube the brilliance of the reflected light is judged to have been increased three times... In other words, the aluminum skin will pass electrons yet because it is shiny it reflects light.

FRANK KRUSHINA in recently aboard his "Black Warrior." Old timer Cliff Folsom still chief aboard the *Sedalia Victory* on the north Atlantic run, in recently. Bob Erskine, Jr., in port recently aboard one of the "Knot" type ships of *UFCO*. Joe Faraca from up Beantown way arrived in for an extended stay aboard his *Victory* (Matson Line) and managed a short vacation home. Tropical Radio (*UFCO*) has the real Sparks aboard one of their vessels, Charles E. Sparks on the "Golden Eagle" who was in the East Coast recently.

JOE BELLEZEA, old timer in the New York area died recently after a long illness... Bill Halleran hooked up with Pan American we understand, Alva Swomley leaving the deep blue to open a gas station. Bob Willits, Bob Myhre and Dave Unger in town recently. Harold Koch and Charlie Shanholtzer have been seen inquiring about additional insurance since J. P. McNeill recently purchased a new motorcycle... Claude Goodwin and Rehn Mathers both in town on a visit a short while ago. Congrats to B. R. Jones, recently married... he will soon be in the same class with Norman Foster and Henry Hayes, two proud fathers of baby girls... Louis Pinkerton, Francis Bearse, Denton McMullen and Olaf Bottlesen all visitors up Boston way recently. John Egan on the beach again down Baltimore way. Robert Chun back in Nola recently after over three years aboard his "Philip P. Barbour".....73.

CALRAD "hard-to-get" RADIO VALUES!

Auto ANTENNAS

- 3 Section
- 66" Long
- Brass Tubing
- Triple Chromium Plated
- 2 Insulator Type Cowl Mounting with Lead Individually Boxed

24 to Master Carton

\$30

Lots of 96

\$105

Immediate Delivery But Quantity Is Limited

5 Tube Superhet AC-DC PARTS KIT

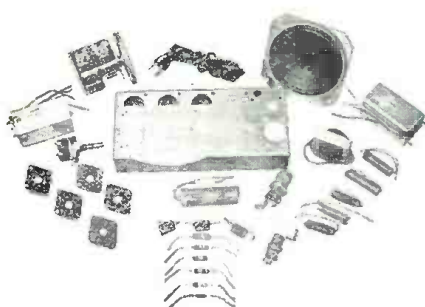

These Special Kits include: Stamped Chassis—Dynamic Speakers—Output Transformer—Volume Control and Switch—2 Shielded I.F. Coils—Antenna and Osc. Coils—Two-gang Super Variable—5 Octal Sockets—20x20 Mfd. 150 Volt Filter—5 Tubular Condensers—3 Mica Condensers—6 Resistors—6 ft. AC Cord and Plug—Circuit Diagram.

While They Last **\$8⁹⁵** ea.

(Lots of 6—\$50.00)

Signal Corps TELEGRAPH KEYS



Genuine U. S. Signal Corps telegraph keys brought to you at prices below manufacturing costs! Made with switch to close contacts, polished durable enameled metal base mounted on a bakelite base; key lever is nickel-plated; contacts are brass-silver.

Packed in new original boxes.

Lots of 10

75c ea.

Carton of 50

60c ea.

MICROMETER

Western Electric—0-200 Microamps D.C.—Zero adjustment, Bakelite Case, 3 inch meter, individually boxed.

Each **\$3⁹⁵**



V.M. TWO POST AUTOMATIC RECORD CHANGER

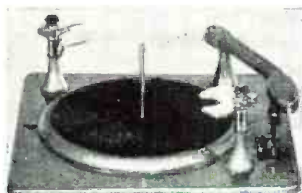

Carton of 2 **\$3800**

This Record Changer is a well made mechanism, will play either 10 in. or 12 inch records. The pickup uses a crystal cartridge. Size 14 in. x 14 in. Packed 2 to a factory sealed carton, factory guaranteed. Special each

\$20⁹⁵

Approved SIGNAL GENERATOR

Model A-100

- A—100 to 310 Kilocycles
- B—320 to 1000 Kilocycles
- C—1000 to 3200 Kilocycles
- D—3.2 to 10.5 Megacycles
- E—10.5 to 26 Megacycles
- E2—21 to 52 Megacycles

440 Standard Audio Frequency (same as WWV) Internal modulation at 440 cycles (same as WWV). External modulation possible from 40 to 30,000 cycles.

\$47⁰⁰

Complete



BUY NOW! LOWEST PRICES! STOCKS LIMITED!

Guaranteed Filter Condensers (Tubular Type)

10 mfd. 50 Vo.	\$21.00 per 100
16 mfd. 150 Vo.	\$25.00 per 100
20 mfd. 150 Vo.	\$28.00 per 100
30 mfd. 150 Vo.	\$30.00 per 100
50 mfd. 150 Vo.	\$33.00 per 100
20x20 mfd. 150 Vo.	\$39.00 per 100
30x20 mfd. 150 Vo.	\$45.00 per 100
40x20 mfd. 150 Vo.	\$50.00 per 100
50x30 mfd. 150 Vo.	\$55.00 per 100
Standard Brands, Tubular By-Pass Condensers	
.001—.002—.003—.005—.006—	
600 Volt	\$ 6.75 per 100
.025—.01—.02—600 Volt	\$ 7.75 per 100
.05—600 Volt	\$ 9.75 per 100
.1—600 Volt	\$12.00 per 100
.25—600 Volt	\$18.00 per 100
.5—600 Volt	\$22.00 per 100
4 Mfd. 600 Vo. T.L.A. Oil Condenser, screw base, upright aluminum can, 1 1/2 in. x 3 3/4 in. \$4.50 list, replaces 8 mfd. 600 Vo. electrolytic.	
Carton of 40	\$38.50

SPEAKERS

4 in. 450 ohm Dynamic Speaker Packed 30 to factory carton	\$1.70 ea.
4 in. P.M. Speaker Alnico V slug Packed 30 to factory carton	\$1.65 ea.
5 in. P.M. Speaker Alnico V slug Packed 30 to carton	\$1.70 ea.
5 in. 450 ohm Dynamic Speaker Packed 20 to carton	\$1.75 ea.

6 in. P.M. Speaker, Heavy Slug Packed 20 to carton.....\$1.95 ea.

Rubber Sheathed "Mike" Cable, shielded, ghsite Conductor.....100 ft. for \$ 5.95
500 ft. for \$25.00

456 K.C. Antenna, Oscillator and R.F. Coils.....25c ea.

456 K.C. I.F. Coils Input & Output, medium size can.....\$45.00 per 100 ass't.

6 ft. A.C. Cords with plug.....\$20.00 per 100

Astatic Low Pressure, curved arm, crystal pickup with Saphire Stylus Permanent Needle, has cartridge which replaces LP8-LP21-LP23.....\$3.75 ea.; lots of 10, \$33.50

Standard Low Pressure Crystal Pickup.....\$2.50 ea.; lots of 10, \$22.50

Signal Corps Jacks

Signal Corps Jacks, fits all 11 standard plugs. Open Circuit, Military type SC-1, equivalent of Signal Corps Jack #JK 34A.....\$ 12.00 per 100
\$100.00 per 1000

Volume Controls, less Switch — 1 1/2 in. shaft 250,000 ohm. 1 Meg. Lots of 100, \$27.50
2 Meg

Kit of 50 assorted Bakelite Knobs for 1/4 in. shaft, with set screws.....\$2.50 per kit

2000 ft. Spool #16 Solid Push Back Wire.....\$9.00 per spool

Standard Barrel Type Phone Plug.....\$20.00 per 100

Midget Ceramic Trimmers—3-30 mmf.....\$6.00 per 100

Moulded Locol Sockets 1 1/2 in. mtg. with metal ring.....\$7.00 per 100

Mazda Pilot Bulbs #44—

Packed 10 to box.....\$ 4.25 per 100

1000 to Carton.....\$38.50 per 1000

#40 & 46, packed 100 to carton.....\$ 4.25 per 100

Single Pentode Midget Output Transformers for 50L6, 95Z6, etc.....Lots of 25, 55c ea.

Insulated Banana Plugs, solderless, side screw connection, red or black.....\$10.00 per 100

Insulated Banana Tip Jacks, red or black.....\$ 8.50 per 100

Finest quality Midget Micars:

.001—.0001 \$5.00

.002—.00025 } per 100

.005—.0005 }

.006—.0005 }

Timed Copper Shielding—1/4 in., 1/4 in., 3/8 in. \$1.50 per 100 ft.

Filter Choke—75 Mill.—250 ohm—3/4 in. Core.....85c ea.

Filter Choke—50 Mill.—300 ohm—3/4 in. Core.....85c ea.

MAIL ORDERS FILLED: 25% DEPOSIT WITH ORDER, BALANCE C.O.D. REFERENCES—BANK OF AMERICA, SANTA MONICA & VERMONT AVE., LOS ANGELES, CAL.

CALIFORNIA RADIO & ELECTRONICS CO.

Dept. No. N. 711 No. Vermont Ave., Los Angeles 27, California

**Order from LAKE!
You'll Make No Mistake!**

RADIO CABINETS & PARTS



**NOW AVAILABLE!
Postwar
2 Post
RECORD-
CHANGER**

With luxurious brown leatherette portable case, 15" L. x 15" W. x 10"

D. Latest electronic developments make this modern record-changer the finest on the market today!

List price \$49.95
Dealer's net 29.97

**DE LUXE RECORD-CHANGER and
AMPLIFIER CASE**

De luxe changer case with ample room for amplifier. Overall dimensions: 20" L. x 16" W. x 10" H. Sturdily built of 5/8" plywood, de luxe brass hardware throughout. Inside dimensions: 15 1/2" L. x 14 1/2" W. x 9 1/2" H.

Net \$12.95



**DeLuxe
PHONO
CABINET**

Covered in luxurious, genuine brown leatherette, has de luxe brass

hardware throughout, made completely of plywood with brown plastic handle, has padded top and bottom. Motor board 14" x 14 1/2". Overall dimensions 16" L. x 15" W. x 8" H. Your net price.....

\$8.95



Portable Phono-graph case in brown leatherette covering. Inside dimensions 17 1/2" long, 13" wide, 7 1/2" high. Has blank motor board and opening for speaker. As illustrated at left, specially priced at.....

\$7.95

Also blank table cabinets of walnut veneer in the following sizes, with speaker opening on left front side: (* Note: *7 has center speaker grill.)

- #1 — 8 1/4" L x 5 1/2" H x 4" D \$1.95
- #2 — 10 1/4" L x 6 3/8" H x 5" D \$2.75
- #3 — 13 1/2" L x 7 7/8" H x 6 1/4" D \$3.25
- *7 — 10 3/4" L x 7" H x 5 1/2" D \$2.50

* Speaker Opening in center of front side.

All types of radio cabinets and parts are available at Lake's Lower prices. A large stock is listed in our catalog.



SERVICEMEN—RETAILERS
Join our customer list today.

Dept. A

Write for our NEW, 12 page, illustrated elaborate catalog!

Lake Radio Sales Co.
615 W. Randolph Street
Chicago 6, Ill.

The "SUPER-3"

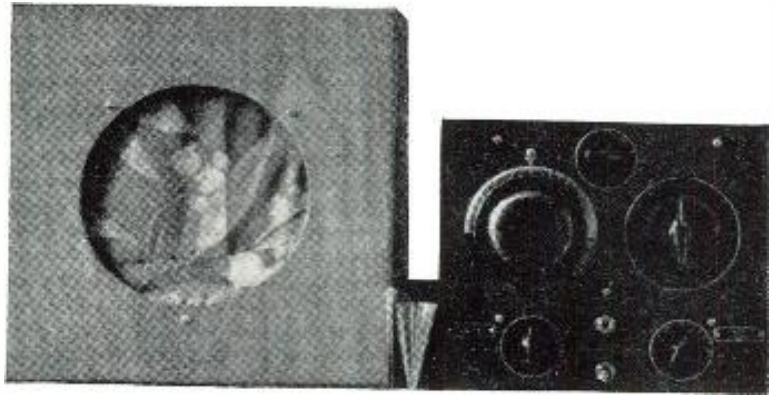

Panel view of the receiver. Speaker housing is shown at left.

A three-tube regenerative type short-wave receiver that is simple in design and easy to construct.

WE HAVE occasionally received requests from our readers for circuit diagrams covering a small, inexpensive short-wave receiver which will give maximum coverage without a large outlay of cash.

A 3 tube, short-wave receiver which meets all of the above requirements has been designed and built by an avid DXer, Jean-Marie Gauvreau of Quebec City, Canada. In the hopes that this design will meet the requirements of other short-wave fans, Jean-Marie has made construction details and circuit diagrams available to our readers through this article.

Mr. Gauvreau, who is now 22, built his first receiver in 1940 and tore it down two years later. In September,

1945, he "got the bug" again and decided to build this receiver which he calls "The Super-3". Within three months of its completion, he had successfully DXed all continents with this receiver.

The chassis is 7 1/2" x 5" x 3" and was salvaged from an old receiver, then cut to size. The front and side panels are of black masonite, 1/8" thick. The inside of the front panel is covered with a thin sheet of tin to minimize body capacity which is quite annoying on 25 and 19 meters. An all metal panel would help to eliminate this disturbance, but no such panel was available at the time this receiver was built.

A notch is cut in the top of the front panel in order that the shaft of

Wiring diagram—if only phone operation is desired last stage can be omitted.

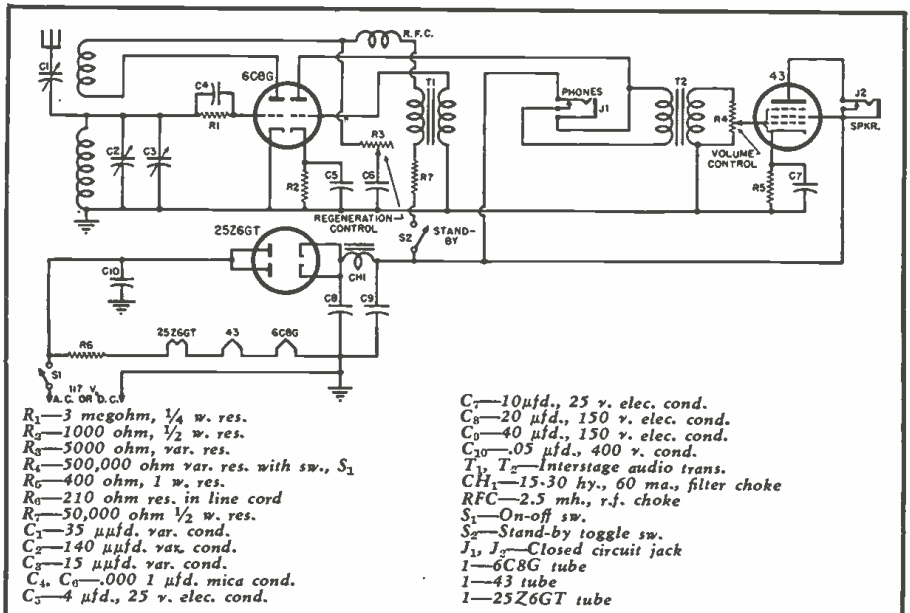

- R₁—3 megohm, 1/4 w. res.
- R₂—1000 ohm, 1/2 w. res.
- R₃—5000 ohm, var. res.
- R₄—500,000 ohm var. res. with sw., S₁
- R₅—400 ohm, 1 w. res.
- R₆—210 ohm res. in line cond
- R₇—50,000 ohm 1/2 w. res.
- C₁—35 μfd. var. cond.
- C₂—140 μfd. var. cond.
- C₃—15 μfd. var. cond.
- C₄, C₆—000 1 μfd. mica cond.
- C₅—4 μfd., 25 v. elec. cond.

- C₇—10 μfd., 25 v. elec. cond.
- C₈—20 μfd., 150 v. elec. cond.
- C₉—40 μfd., 150 v. elec. cond.
- C₁₀—.05 μfd., 400 v. cond.
- T₁, T₂—Interstage audio trans.
- CH₁—15-30 hy., 60 ma., filter choke
- RFC—2.5 mh., r.f. choke
- S₁—On-off sw.
- S₂—Stand-by toggle sw.
- J₁, J₂—Closed circuit jack
- 1—6C8G tube
- 1—43 tube
- 1—2526GT tube



Keep Your Name in Front with N. U. BUSINESS-BUILDERS

One of the largest and finest assortments of dealer helps and sales promotional material ever offered to radio service dealers is now available from National Union Distributors. Here are business-builders for practically every need of the radio service engineer. All are smartly designed in the most modern styles. Many are offered with personalized imprint of your name and address. Let N. U. help you advertise *your* business, find new customers and increase your sales.

Ask Your N. U. Distributor Today

National Union Radio Corp.
Newark 2, New Jersey

NOW AVAILABLE

- | | |
|---|--|
| <ul style="list-style-type: none"> • BUSINESS BUILDERS • Window Decals • Book Matches • Dummy Cartons • Stationery • Job Tickets • Embosograf Signs • Newspaper Ad Mats • Telephone Ad Mats • Cartoon Cards | <ul style="list-style-type: none"> • Trouble Finder Folders • Battery Cross-Indexes <p>TECHNICAL HELPS</p> <ul style="list-style-type: none"> • Electronic Engineers Reference Manuals • Service Engineering Bulletins • Uniballast Manuals • Visual Aid Vacuum Tube Charts |
|---|--|

COMING

- | | |
|--|--|
| <ul style="list-style-type: none"> • Window Displays • Outdoor Signs • Indoor Signs | <ul style="list-style-type: none"> • Imprinted Scotch Tape • 4 Purpose Tube Decals • Shop Coats |
|--|--|

GOV'T SURPLUS AT BARGAIN PRICES!

CONDENSERS

.25 Mfd 400 vdc can Spr.	\$ 0.45
.25 Mfd 600 vdc can Sol.	1.60
1 Mfd 500 vdc (pvt. G. E. 233303)	1.00
.85 Mfd 600 vdc rd can aero. (55850) 1 1/2 x 1 3/4	.30
5.5 Mfd 400 vdc th rect can	1.60
4 Mfd 600 vdc C-D Oil	1.75
8 Mfd 600 vdc C-D Oil	2.88
15x15x15-450 V. Dry.	1.25
.05 Mfd 1000 vdc inv. mtg. GE pyr 1 1/2 x 1 3/4	.70
.25 Mfd. 1000 vdc inv. mtg GE Pyr 1 1/2 x 1 3/4	.80
4 Mfd 1500 vdc WE Oil	7.50
11 Mfd 7000 vdc GE pyr	7.50
.25 Mfd 20000 vdc C-D	15.00
Mfd 220 Vac C-D	2.25
500 Mfd 200 vdc rd 2x1 1/2 bakel case	2.95

TEMP COMPENSATED COND.

.25 Mfd 200 vdc WE oil 0 to +55 C.	\$.50
.535 Mfd 200 vdc WE oil 0 to +55 C.	.50
1 Mfd 200 vdc WE oil -40 to +65 C.	1.00
2.16 Mfd 400 vdc WE oil 0 to 55 C.	1.00
.4 Mfd 1500 WE oil -50 to +85 C.	.70

TUBES

Acorn tubes 954, 955, 956, etc.	\$ 1.15
304 TI perfect.	13.95
250 TI perfect.	10.00
5 BPF 571	9.95
5 FP7	14.50
Mag Foc & def. Coils for 5 FP7.	SET 12.00
KLYSTRONS 725 A-B.	10.00
Klystrons. UHF CONVERTER 3 CM. with 3-6ac7's	10.00
Micro-wave fittings, all types.	

RADAR COMPONENTS FROM SCR-268

BC 406 15 tube UHF RCVR. 301-210 Mc easily converted to television bands with tubes WE	\$35.00
BC-435 III Pwr Modulator with 8-304 TL 2-250 TI Tubes.	99.00
BC-436 Iltank Units.	35.00
BC-412 5" Oscilloscope WE 115 Vopr with conversion dia. & instr.	59.50
BC-78-B-Boonton Sig Gen--15 to 55 Mc 190 to 230 Mc used.	55.00
COLLINS ART-13 new XMTR used on B-29 XTal Calib. CW-225 Watts; Phone 180 watts; freq 1.8-18 Mc.	\$25.00
Navy Herr New RB1-3 freq 15-600 KC7 tubes, 115 V opr.	59.00

TRANSFORMERS

H. V. Plate Xfms.	
215 V/860 vct 510 Ma oil	\$7.50
115 V/2750 v 750 M. A. oil U. S. N. spec.	\$45.00
115 V/750 vct 110 31/8. 3N -5A/5V 3A	\$6.95
KENYON FIL 115 V/5 V-115A.	\$8.95
GE Modulation Xfmr-Pair 811's to 813's	\$ 5.00
3"x4" GE Driver 6V6 to Pair 811's.	3.00
Pwr. Transformer 400 2400 cps 118/630 vct 4A/6.3 V-6A/6.3 V-.9A/5V-6A.	5.00
118 V 3600 V-5 MA./2.5-175	7.00

MISCELLANEOUS

CO-ax RG-8U. 72 ohms per ft.	\$0.10
500 New Horrs B C 603 with manual semi compl. less variable cond and pwr unit--\$4.50 lots of 25	4.00
Relays; 115 Vac/10A DI'PT ISOLANTITE 1x1 1/2x2	2.00
Throat mike buttons, gold plated	.75
Lip mike buttons, gold plated.	1.75
Visors, leather, for 5 inch scopes.	1.00

ASSORTED RADIO HARDWARE

1000 pieces assorted screws such as 632, 832, various lengths, nuts, washers, lugs, brackets, insulation washers--everything for the builder and serviceman. \$2.49

200 RESISTORS

Assorted mixture in 1/4, 1/2, and 1 watt range from 100 ohms to 1 meg. \$6.25

50 MICA COND. KIT 400 and 600V

In 12 sizes such as .0005-.0008-.001-.01 etc. \$4.65

SEND FOR PARTS LIST

All merchandise guaranteed. Mail orders promptly filled. All prices F.O.B. New York City. Send Money Order or Check. Crating and shipping charges sent C.O.D.

COMMUNICATIONS EQUIPMENT CO.

131 LIBERTY ST., N. Y. C. (7)
TELEPHONE WH 4-7658

condenser C_1 might be free (not grounded). The fact that the antenna condenser is on the front panel adds to body capacity effect so, if possible, this condenser should be mounted at the rear of the unit.

The front panel is held by means of four angle brackets, installed at the top and bottom. The sides and panel provide a strong construction which will allow the set to be carried without bending of the panel.

Any 4-prong, plug-in coils with tickler and grid winding will do. In practice, the tickler coil is wound at the ground end of the grid coil.

The jacks, J_1 and J_2 , are two normally closed circuit jacks. J_1 accommodates the phones and when the phones are inserted in this jack, the output stage is disconnected and the speaker is silenced. When both plugs are removed from the jacks, the jacks are closed. This feature is important in the plate circuit of the 43 tube, because operating the set without the plate circuit closed would damage the screen grid of the tube.

The speaker is an 8" permanent magnet speaker with a 20 ounce magnet. The speaker represented the largest single item of cost in this receiver. Mr. Gauvreau built the speaker enclosure himself and covered the sides with leatherette. The front of the housing is of plywood which has been varnished. A smaller speaker could have been substituted here, at a sacrifice of tonal quality.

The antenna is, at present, a temporary affair consisting of a 29 foot span of wire, running E-W, plus 10 feet of wire for lead-in and located 20 feet from the ground. This antenna is to be replaced by a permanent structure when warmer weather makes it practical to work out of doors for longer periods of time.

The tubes selected for this receiver, a 6C8G, a 43, and a 25Z6GT, can be replaced by equivalent 6F8, 25A6, and 25Z5-25Z6, etc. without changing the values of any of the components.

There are several features of this receiver which perhaps need explain-



Rear view of the completed receiver.

ing. Resistor, R_1 , in the plate circuit of the detector tube is used to smooth out the operation of the regeneration control, but may be eliminated if desired. The value of 5000 ohms for the regeneration control gives very quiet operation.

The detector tube, 6C8G, is shielded, as is the grid wire from cap to grid leak. This gives hum free operation.

The variable condenser, C_1 , can be replaced by a small padder, 3-30 μ fd., if desired but this condenser was used because it was easier to adjust the set for different antennas without the use of a screwdriver.

The filter choke and transformer, T_1 , are placed on top of the chassis. T_2 is on the underside, while the output transformer is mounted on the speaker.

The bandsread condenser, C_2 , gives full bandsread on all bands. This bandsread condenser has a large black bakelite dial which is easy to tune. The main tuning dial is an ordinary flat, engraved metal dial with pointer knob.

The regeneration control is not conventional and those building the receiver should study the diagram carefully.

It should also be noted that both jacks are hot with d.c. and when an all metal panel is used it is important that C_1 , R_1 , J_1 and J_2 be insulated.

(Continued on page 88)

Mechanical layout of receiver housing. Location of panel controls are shown.

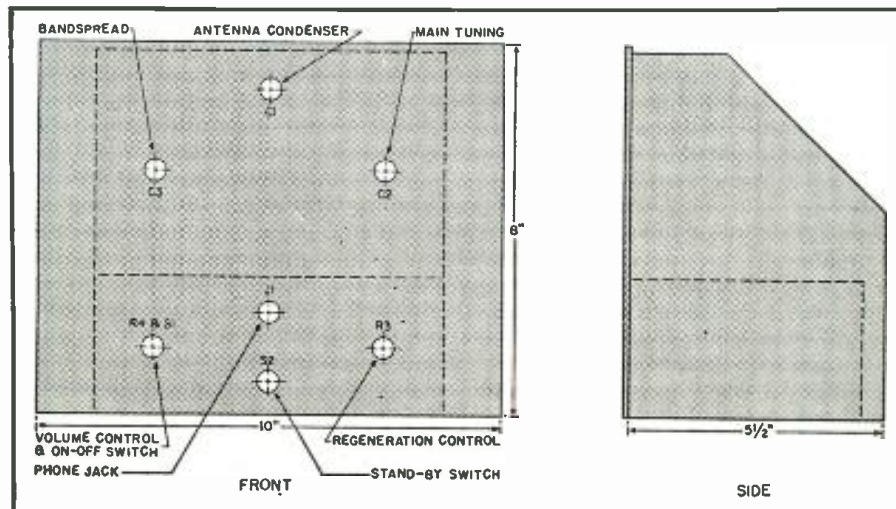

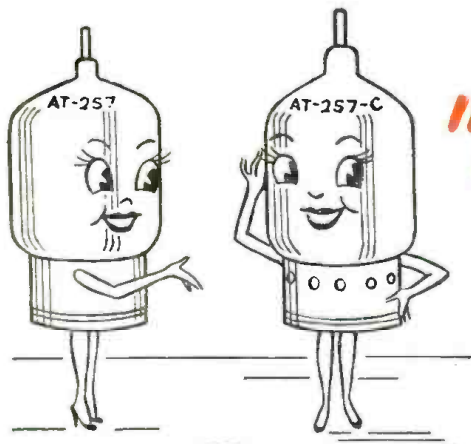

"Meet my Sister"

THE *New* LEWIS
AT257-C

BEAM POWER PENTODE

NOTE TO DESIGN ENGINEERS—With all the advantages of the Lewis AT-257 (4E27) — enormous power gain, great circuit flexibility—the new AT-257C has a “plus” factor you will be interested in. The addition of Zirconium coating to the anode has enabled Lewis Electronics to re-announce this versatile 75 watt beam pentode in the 125 watt class.

By nearly doubling the plate dissipation of the 4E27, the usefulness of this already popular tube is further extended. May we recommend that you consider the use of the Lewis AT-257C in fixed or mobile radio equipment you are now designing? A note to Lewis Electronics, Los Gatos, California, will bring further particulars.



Lewis Electronics at Los Gatos, California, is prepared to build transmitting, rectifying, industrial or special purpose vacuum tubes to your specifications.

Filament Voltage 5 Volts

Plate Dissipation 125 Watts

Filament Current 7.5 Amps.

Jumbo 7-pin Metal Sleeve Bayonet

Lewis ELECTRONICS

LOS GATOS • CALIFORNIA

Subsidiary of **Aireon** MANUFACTURING CORPORATION

REPAIR RADIOS THIS FAST, EASY WAY!

Complete, easy instructions for diagnosing and repairing common troubles in practically every home and car radio in use today

NOT A STUDY BOOK!

You don't have to be an expert! You don't have to have a lot of costly test equipment in order to repair most radios—NOT when you have A. A. Ghirardi's famous **RADIO TROUBLESHOOTER'S HANDBOOK** at your finger tips. Bothered with "fading" on a certain model? "Noises" on another? "Poor volume?" A "dead" set or whatnot? Just look up the receiver's make and model in the 404-page Case History Section of the **HANDBOOK**. Nine times out of ten, it will tell you **EXACTLY** what the trouble is—and **EXACTLY** how to fix it. No lost time! No needless tedious testing! The **HANDBOOK** tells you—automatically!

Over 300 additional big manual-size pages contain other invaluable radio service data—Color Codes, Tube Data, Tube and Part Substitutions, I-F alignment and Transformer information and literally dozens of charts, graphs, diagrams, data and helpful hints that will help you repair any radio ever made **EASIER, BETTER and TWICE AS FAST!** Weighs over 4 lbs. Only \$5—and you actually don't risk a cent. **5-DAY MONEY-BACK GUARANTEE.**



PAYS FOR ITSELF Pronto!

RADIO TROUBLESHOOTER'S HANDBOOK will pay for itself in time saved the first time you use it! "Thanks to the **HANDBOOK**, I repaired my radio an hour after it had been returned as 'unrepairable' by a local radio shop," writes J. L. Fizzell of Kansas City. "The Case Histories take you right to the trouble and save hours of testing," says Julius Siske, Jr., of Maryland.



Prepare for a Real Future in PROFESSIONAL RADIO-ELECTRONIC REPAIR WORK

LEARN AT HOME . . . without an Instructor

Who will service the millions of new radios and complicated television, F-M and facsimile equipment to be sold within the next few years? Who will install and service the countless electronic devices now going into industry? Never before has there been such a demand for professionally-trained technicians who know their stuff—and this means training of exactly the type that A. A. Ghirardi gives you in his big 1300-page, profusely illustrated **MODERN RADIO SERVICING**. It is the ideal book for home study! Explains all types of service test instruments—how to use each one; how to make preliminary trouble checks; how to analyze circuits scientifically; how to troubleshoot; how to repair or replace parts or make substitutions; how to install equipment—and literally hundreds of additional subjects including **How to Start and Operate a Successful Service Business of Your Own**. Sold on **5-DAY MONEY BACK GUARANTEE**. You can't lose. Send coupon today!

GET WHERE THE BIG MONEY IS!

Ghirardi's **MODERN RADIO SERVICING** is the only single, inexpensive book giving a complete course in electronic servicing by scientific professional methods. Contains over 706 clear illustrations. Quick to read—easy to understand.

MAIL ORDER . . . Rush Coupon Now!

Murray Hill Books, Inc., Dept. RN-66
232 Madison Ave., New York 16, N. Y.

- Enclosed find \$ for books checked; or
 send C.O.D. (no foreign C.O.D.'s) for this amount plus postage. It is understood I may return the books for refund within 5 days if not satisfied.
- RADIO TROUBLESHOOTER'S HANDBOOK \$5** (\$5.50 foreign) **MODERN RADIO SERVICING \$5** (\$5.50 foreign)
- MONEY-SAVING COMBINATION OFFER:** Both big books, over 2040 pages of the finest service data—only \$9.50 for the two (\$10.50 foreign).

Name
Address
City & Dist. State

GET BOTH BOOKS AT A BARGAIN

SPECIAL OFFER!

Let Ghirardi's **RADIO TROUBLESHOOTER'S HANDBOOK** save you time and money on common radio service jobs—let **MODERN RADIO SERVICING** train you for complete professional, electronic service training!—Get **BOTH BIG BOOKS** at the special price of only \$9.50 for the two. Use coupon today. Check "**MONEY-SAVING COMBINATION OFFER.**"

5-DAY MONEY-BACK GUARANTEE

Television Voltage Circuits (Continued from page 52)

the sweep oscillators and compensates for other frequency response failings. This method of correcting linearity differs from those previously discussed because it depends on the frequency response characteristic of an impedance network. The composition of the saw-tooth is such that the frequency of the change in voltage becomes increasingly higher as the voltage apex of the saw-tooth is approached. It is here that the frequency response drops off and the waveform begins to round off. Another source of distortion is low value coupling capacitors which must be used to couple deflection amplifiers to deflection plates without excessive d.c. leakage. In this case some of the lows are lost. Thus, at the proper frequencies the linearity networks apply a greater voltage to the grid of the deflection amplifiers to compensate for losses in other portions of the sweep amplifiers.

The deflection amplifiers have push-pull output connections with equal but out-of-phase saw-tooth voltages developed across the equal value load resistors (25) and (26). Since the picture tube uses electrostatic deflection it is only necessary to apply a saw-tooth voltage to the deflection plates. Consequently, the outputs of the deflection amplifiers are capacitively-coupled to the deflection plates and no output transformer is necessary. The input of the deflection amplifiers are single-ended, the output of the first triode section excites one of the deflection plates as well as applying a small grid voltage to the second section. Output of the second section excites the other plate. Values of component parts are carefully chosen to have approximately equal outputs from both triode sections of each deflection amplifier.

The brightness control is a potentiometer which, in series with another resistor, shunts the low-voltage power supply. The required voltage is taken off the divider and impressed on the cathode of the picture tube.

The remainder of the picture tube operating voltages are taken off a high-resistance divider which shunts the series connected low and high voltage supplies. Proper focusing potential reaches the first anode of the picture-tube through a variable potentiometer (28) in the divider. Second anode potential is taken off almost at the most positive point (29) on the divider; some variation about this point is necessary to obtain proper centering.

The high-voltage supply for the small five-inch tube consists of a single rectifier and an RC filter. A small resistor is inserted between rectifier plate and transformer to protect the high-voltage winding in case of a tube or filter circuit short.

The final part of the review is a list

of definitions. Some of these are definitions which have been expanded upon, but which appear basically in the FCC "Standards of Good Engineering Practice for Television Broadcast Stations."

1. *Amplitude Modulation (AM)* means a system of modulation in which the envelope of the transmitted wave contains a component similar to the waveform of the signal to be transmitted. The picture carrier is amplitude modulated.

2. *Frequency Modulation (FM)* means a system of modulation of a radio signal in which the frequency of the carrier wave is varied in accordance with the signal to be transmitted, while the amplitude of the carrier remains constant. The sound carrier is frequency-modulated.

3. *Aspect Ratio* means the numerical ratio of the frame width to frame height as transmitted. The standard ratio is four units horizontally to three units vertically.

4. *Black Level* means the amplitude of the modulating signal corresponding to the scanning of a black area in the transmitted picture. When the received signal reaches this level the picture-tube control grid is biased to a level which blacks out the picture-tube screen.

5. *Frame* means one complete picture. Thirty complete pictures are transmitted each second.

6. *Frame Frequency* means the number of times per second (30) the picture area is completely scanned.

7. *Field Frequency* means the number of times per second (60) the frame area is fractionally scanned in interlaced scanning.

8. *Interlaced Scanning* means a scanning process in which successively scanned lines are spaced an integral number of line widths and in which the adjacent lines are scanned during successive cycles of the field frequency scanning. In the standard system there are two fields per frame—one field covers even-numbered lines; second field, odd-numbered lines.

9. *Negative Transmission* means that a decrease in initial light intensity causes an increase in the transmitted power. The darker the background of the transmitted scene is, the higher the average power output. Dark spots in the transmitted scene are represented by high instantaneous power output.

10. *Synchronization* means the maintaining of one operation in step with another. The picture tube beam is maintained in synchronism with the pickup tube beam which is scanning an image of the televised scene.

11. *Vestigial-side-band Transmission* means a system of transmission wherein one of the generated sidebands is partially attenuated at the transmitter and radiated only in part. In the standard system, only approximately $1\frac{1}{2}$ megacycles of the low-frequency sideband of the picture signal is transmitted.

12. *Visual Frequency*, commonly

**"THIS EASY, INEXPENSIVE BOOK
WILL GIVE YOU a Complete Mastery
OF BASIC RADIO-ELECTRONICS"**

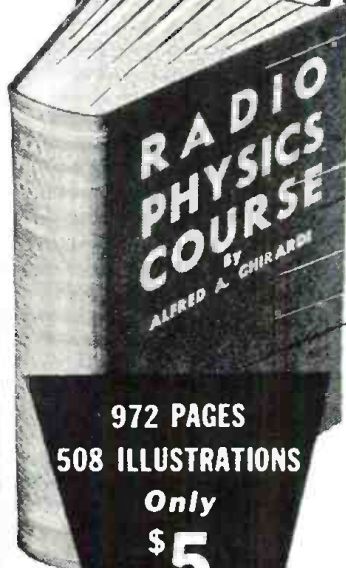
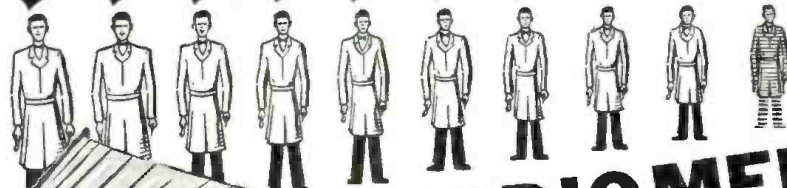

**972 PAGES
508 ILLUSTRATIONS**

**Only
\$5**

**FOR BEGINNERS
... 36 Courses
in One**

EVERYTHING ABOUT RADIO, SOUND, ELECTRICITY, ELECTRONICS: RADIO broadcasting Systems; Sound, Speech and Music; Electron Theory; Electric Current; Electrical Units; Ohm's Law; Resistance; Electrical Circuits; Batteries; Electromagnetism; Electro-magnetic Induction; Inductance and Inductors; Capacitance and Condensers; Alternating Current Circuits; Electric Filters; Electrical Measuring Instruments; Electromagnetic Radiations; Radio Transmission; The Broadcasting Station; The Receiving Station; Elementary Study of the Vacuum Tube; Vacuum Tube Detector & Amplifier Action; Tube Characteristics; Radio-Frequency Amplification; Superheterodyne Receivers; Amplifier and Tuning Coils; Audio Amplification; Battery & Electric Operated Receivers; Auto-Radio; Aircraft Radio; Phonograph Pick-ups; Public Address Systems; Short-Wave Receivers; Photo-Electric Cells; Television; Testing and Servicing; Sound Motion Pictures — and dozens of other subjects.

IMPORTANT!

There is no guess work when you buy Ghirardi's RADIO PHYSICS COURSE. Sales records prove that this big book with its tested instruction material is more widely used for home study, and by more Signal Corps, Navy, and civilian schools and colleges than any other of its kind!

**9 OUT OF 10
Can't be Wrong!**

Train now for a successful career in RADIO-TELEVISION-ELECTRONICS! Before spending a lot of money, however, it pays to find out what training the successful Radio-Electronic men of today themselves prefer. What training do they recommend—and is it possible that a single big, 972-page book at only \$5 can do as much or more for you than a lesson course selling for ten times this amount? Let a mixed group of 817 industrial electronic experts, radio repair men, instructors, and students give you the answer:

724 OUT OF 817

When we asked them to tell us exactly what they thought of the various radio-electronic books and courses, 724 of these men—9 OUT OF 10—answered that Alfred A. Ghirardi's RADIO PHYSICS COURSE book is their choice as the best buy on the market—the easiest to understand—and far better than any other book or course they had ever seen! What better proof could you ask than this?

Read the book yourself for 5 full days. Compare it page for page with any similar instruction of which you have ever heard. If not more than satisfied, return the book. EVERY CENT OF YOUR MONEY WILL BE REFUNDED!

LEARN AS FAST AS YOU CAN READ!

You'll understand every word of Ghirardi's RADIO PHYSICS COURSE without previous training. You'll be pleasantly surprised how quickly you'll master subjects that other courses make seem very complicated.

RADIO PHYSICS COURSE is the most complete training money can buy. Starting with BASIC ELECTRICITY, it takes you step by step through the entire field. Everything is

made crystal clear. You buy it for only \$5 complete—and you progress as fast as your spare reading time permits. Many students have completed it in a few weeks!

If you're anxious to get off to a flying start in the fascinating, big-paying field of RADIO-ELECTRONICS-TELEVISION, this is the book for you! Our 5-Day Money-Back Guarantee is your absolute protection.

Alfred A. Ghirardi

**I'LL TRAIN YOU AT HOME
FOR A PROFITABLE FUTURE
IN THE FASTEST
GROWING INDUSTRY IN
THE WORLD!**



5 DAY MONEY-BACK GUARANTEE

Murray Hill Books, Inc., Dept. RN-66
232 Madison Ave., New York 16, N. Y.

Enclosed find \$..... for which please rush a copy of Ghirardi's 972-page RADIO PHYSICS COURSE book, or send C.O.D. (no foreign C.O.D.'s) for this amount plus postage. It is understood I may return the book in 5 days for full refund if not more than satisfied.

Name

Address

City & Dist. No. State

HENRY RADIO

Do business with the biggest and one of the best in the field. Enter your orders for the following:

Skyrider Jr. S41	\$ 33.50
Hallicrafters S22R	74.50
Hallicrafters S39	110.00
Hallicrafters SX-25	94.50
Hallicrafters SX-28A	223.00
Hallicrafters S38	39.50
Hallicrafters S40	79.50
National N-2-40C	225.00
National One-Ten	56.10
National HRO Sr.	197.70
RME-45	166.00
Hammarlund HQ129X	129.00
Hammarlund Super Pro	318.00
HT-9 transmitter	250.00
HT-6 transmitter	110.00

Some models are available for immediate shipment.

AS MORE and more receivers become available Bob Henry will be able to serve you better and better. By dealing with the world's largest distributor of short wave receivers you are assured of the fastest delivery possible and the best of service.

Enter your reservation now. You can trade in your present receiver. You can order on our 6% terms. You can depend on Bob Henry also for a wide assortment and the best values in crystals, transmitting tubes, microphones, test equipment etc. Your inquiries welcomed.

BOB HENRY
W9ARA

HENRY RADIO

BUTLER, MISSOURI AND
LOS ANGELES 25, CALIF.

"WORLD'S LARGEST DISTRIBUTORS
OF SHORT WAVE RECEIVERS"

called video frequency, means the frequency of the signal resulting from television scanning. This represents truly a video frequency for it is a signal which is conveying light information. An amplifier which passes the visual signal is called a video amplifier. Video amplifiers also amplify pulses and other non-sinusoidal waveforms because of their ability to pass very low and very high frequency components of a waveform.

(To be continued)

Motor-Driven Antenna

(Continued from page 39)

protection is thus afforded the pole. I plan to apply the creosote to the wicks about every six months to prevent any possibility of rotting.

I erected the main pole at the rear of my residence, as shown in the illustration, using the roof angle of the house as a means of bracing the main pole. Actually only about fifteen feet of the main pole is free to move with the wind. I used several guy wires to strengthen the main pole, but they are not absolutely necessary as the movable array is very well balanced. When it is not possible or convenient to mount the main pole against a part of the house or building I would suggest that the completed structure be very well guyed with heavy wire, preferably at about one-third and two-thirds of the main pole height above ground. This is necessary due to the weight of the entire top structure. The weight of the header is about 20 to 25 pounds.

After the main pole was erected and in place I used a temporary pulley to raise the "header" to the top of the pole. Two eye-bolts in the main pole (one 6" from the top, the other 2'0" from the top) were used to receive a three foot heavy rod. This rod was bent at the top in a V shape, and was inserted in the eye-bolts for the raising process. It was later removed when the "header" had been

permanently mounted. The eye-bolts were left in for possible future use.

After the "header" had been attached I connected the lead-in wires to the antenna rods and loading coils. The feeder was left in a loose loop, and was connected to the main pole about three feet below the top of the main pole. Sufficient slack was thereby allowed to permit one full revolution of the antenna unit on the "header." After one full revolution it is necessary to stop, and reverse the motor to obtain other desired directions. Some type of indicating device was therefore needed to show the exact position of the directional array. Such a device should be located in the radio shack for convenience.

After quite a bit of experimentation I decided upon a mechanical indicating device. The vertical drive shaft on the main pole makes 12 revolutions for each complete revolution of the antenna "header." I attached one end of a piece of copper dial cable to this vertical drive shaft, and then brought the dial cable through copper tubing into the house and directly to my shack—a distance of about twelve feet. I fastened a plumb bob to the free end of the dial cable (in the shack) and then marked a position scale on the wall of the shack to correspond with various positions of the antenna "header." The exterior end of the dial cable was wound around the drive shaft. As the shaft turns the plumb bob on the other end of the dial cable travels up and down a distance of about three feet for the compass circle of 360 degrees. An illustration of this gadget is shown. All motor starting and reversing switches are located on a panel in the shack.

As to cost and obtaining parts, I think this type of directive array can be constructed very economically. The automobile hub, ring gear, starter gear and iron plate were obtained completely assembled for about \$12.00. The cost of shafting, with all necessary couplers, amounted to \$4.00.

Ordinary awning gear boxes are used to turn the corner and give proper driving turn ratio.

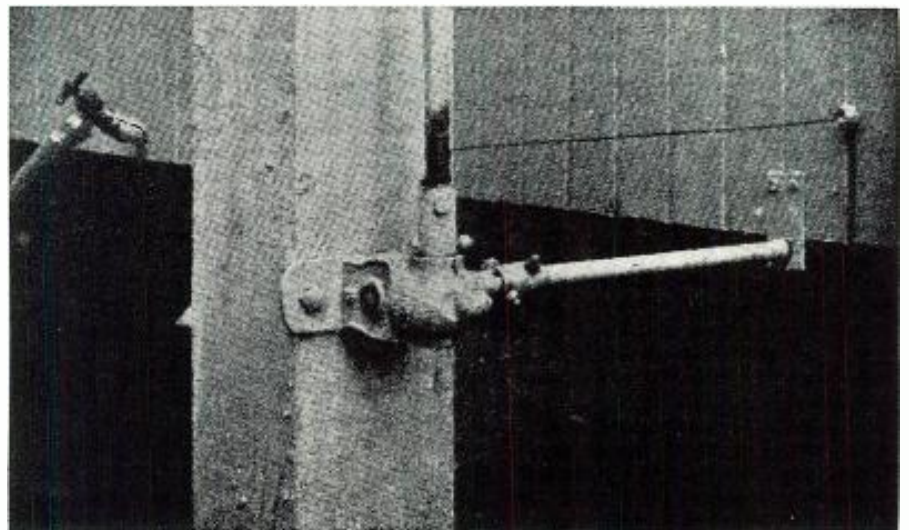



NEW...
HANDY...
QUICK...
ACCURATE...

THE
Resist-O-Guide
 10¢ at all IRC Distributors

RESISTANCE RANGES RIGHT AT YOUR FINGERTIPS
EASY TO TELL AT A GLANCE!

HERE'S SOMETHING NEW—The RESIST-O-GUIDE, a practical aid in resistor range identification for every Radio Serviceman, Ham, Electrical Designer and Electronic Engineer.

To use the pocket size RESIST-O-GUIDE simply turn its three wheels to correspond with the color code on any composition-type resistor—the standard RMA range is automatically and accurately indicated. Readings are direct... no cumbersome calculations! Or, turn the wheels to indicate any desired standard range, and you are immediately shown the correct color coding.

The RESIST-O-GUIDE is convenient and accurate—and varnished for durability. To get the RESIST-O-GUIDE contact your IRC distributor—it's not sold elsewhere.



INTERNATIONAL RESISTANCE CO.

401 N. BROAD ST., PHILADELPHIA 8, PA.

Canadian Licensee: International Resistance Co., Ltd., Toronto

for everything in
ELECTRONICS
 and **EQUIPMENT**
 follow
ARROW!

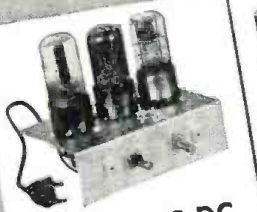

3 Tube AC-DC PHONO AMPLIFIER

Completely wired, with tubes and ready to operate. Uses a dynamic speaker 450 ohm field.

Complete with tubes, less speaker.

Only **\$7.95** Net

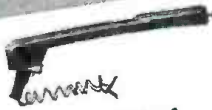

CRYSTAL PICKUP

Accommodates 10" or 12" records. Has crystal cartridge. Pickup arm curved for correct tangent. Low needle pressure on records. Beautifully finished in brown.

Special **\$2.75** Net

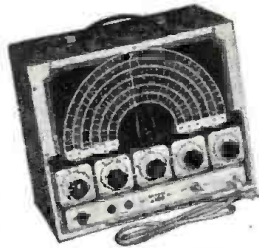

The Model A-100 SIGNAL GENERATOR

• Latest Open Face Multiple Frequency Dial Scales (non-glare design).

- 6 RF Bands:
 100 to 310 KC
 320 to 1000 KC
 1000 to 3200 KC
 3.2 to 10.5 MC
 10.5 to 26 MC
 21 to 52 MC

Complete with tubes, cables and instructions.

\$47.00 Net

ARROW
ELECTRONICS COMPANY
 82 CORTLANDT ST., NEW YORK 7, N. Y.
 Dept. No. 206 Whitehall 3-2696

Write to us for anything in **ELECTRONIC PARTS and EQUIPMENT**. Get on our mailing list and keep informed as merchandise becomes available.

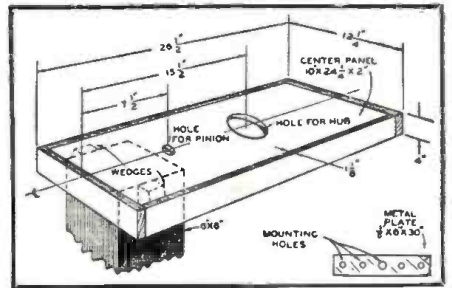

Constructional details of the header.

Used awning gear boxes were obtained for only \$2.50. The 6" x 6" main pole cost approximately \$12.00. A suitable driving motor can be obtained for \$5 or less. The antenna radiating rods will be an additional cost, depending upon the type desired.

I have used this type of rotating device for some time now and have found it very practical and faultless in operation. Although I use it for transmitting I find its greatest use in receiving DX. By merely rotating the antenna I can get selectivity far greater than I could expect from any make of receiver.

My 800 watt rig has put out a good signal with this type of antenna. It uses 2—250T's in the output, driven by T55's; a 47 crystal and 801 buffer-doubler complete the tube line-up.

This type of rotating device can also be used with any kind of close-spaced array antenna system, it being only necessary to alter the dimensions of the 2" x 4" mounting pieces which are attached to the movable "header." With reasonable care in construction I believe any ham can enjoy a really selective directional antenna array.

The most important work that the array accomplishes is to receive weak, badly QRM'd signals. The old adage, "You can't work 'em, if you can't hear 'em" still holds true. By swinging the array towards the incoming signal, the interfering signals drop down farther and farther and sometimes even completely out. Meanwhile the station you want to hear comes up out of the background noise until it seems that it is the only signal on the band. The advantages of this have been so marked that I have been able to work stations I have only had the luck to work when one or more of the interfering stations were off the air. It has increased my DX quota over a 1000% since its erection.

-30-

DRY BATTERY TESTER

IF IT is necessary to test dry batteries when no commercial tester is obtainable, a 15 or 20 mil. meter may be used (any cheap meter will do). Connect a resistor in series with the meter to give approximately a 3/4 scale reading with a new battery. You can now compare old batteries against this reading. This tests the battery under a fair load and thus gives a good indication of the battery's condition.

-30-



brings you the amazing new time-saver tool...

Philco's No. 1 Wiring Secret!

No change in grip—No other tools needed

The experts use these all-purpose Pliers for faster, easier, better wiring. Try it—the perfect "all in one" tool for cutting wire, removing insulation, wrapping wire, trimming excess. You'll say it's a crackerjack!

GRIP-TOOTH ENDS

BROAD CRUSHER JAWS

WIRE CUTTER BLADES



PRICED ONLY

\$1.95 POSTPAID

FOR WIRING JOBS!

Write for our monthly BARGAIN CATALOGS They're free!

This offer good only in U. S. A.

Order Yours TODAY

OLSON RADIO WAREHOUSE

73 E. Mill St., Dept. 24, Akron, Ohio

Stock X-33

Send me.....All-Purpose Radio Pliers @ \$1.95 postpaid. I enclose \$..... (No C.O.D. Orders.)

NAME

ADDRESS

*timely!
authentic!
comprehensive!*



Save Up to 50% in Servicing Time!

In Each PHOTOFACT FOLDER You Get:

- ✓ From 2 to 12 clear photos of the chassis, identifying each component part for immediate checking or replacement.
- ✓ Complete specifications on each component, including manufacturer's part number, available replacement type or types and valuable installation notes.
- ✓ A keyed reference alignment procedure for the individual set, with adjustment frequencies and recommended standard connections.
- ✓ Complete voltage analysis of receiver.
- ✓ Complete resistance analysis of receiver.
- ✓ Complete stage gain measurement data.
- ✓ Schematic diagram.

If you think it's going to be easy to service the 1,000 or more radio sets soon to come off production lines, read no further! The Howard W. Sams PhotoFact Service is designed for men who *know* there's a tough time ahead—who need and *want* better service information.

The Sams PhotoFact Service provides such information in the form of reliable, fact-filled, illustrated folders that can save as much as 50% of your servicing time. Every post-war radio is visualized in photographs . . . every part listed and numbered . . . every servicing shortcut and installation fact fully set down! No matter how complicated the set, or how new the components, you have the whole story right in front of you.

You get from 30 to 50 such PhotoFact Folders at a time. The Folders come to

you in handy folios at a cost of only \$1.50 for each group! They cover all new sets as they reach the market.

Think of it! An absolutely fool-proof visual method of giving you the exact information you want, where you want it, when you want it, for as little as three cents per new radio model! And every bit of information is compiled by experts from an examination of the actual receiver itself—not from standard service data! The Howard W. Sams PhotoFact Service starts June 15. Reserve your PhotoFact service now!

Also, Membership in HOWARD W. SAMS INSTITUTE

Answers to hard service problems! Economical shop practices! How to get more customers! These and many other subjects covered by 30 top notch specialists! Complete facts with PhotoFact Folio No. 1.

Cut This Out and Mail It to Your Distributor! If you do not know his name and address, send it directly to Howard W. Sams & Co., Inc. 2924 East Washington Street, Indianapolis 6, Indiana, and we will see that your nearest distributor gets it.

CHECK ONE SQUARE

PLEASE PRINT

- Yes, by all means reserve every issue of the Howard W. Sams PhotoFact Folio Service for me.
- Send complete information and reservation card.
- My (check) (money order) (cash) for \$1.50 is enclosed for PhotoFact Folio No. 1. (Publication date, June 15, 1946)

Name _____ Address _____

City _____ Zone _____ State _____

Company Name _____

My Distributor's Name _____ City _____

**MAIL THIS
COUPON
TODAY**

Howard W. Sams

Radio PhotoFact Service

Better
ATLAS SOUND
Equipment
Ready for YOU



DOUBLE REENTRANT PROJECTOR

Many sizes. From 15 in. air column to 6 foot air column.



360 RADIAL, CHANDELIER PROJECTORS

Double Reentrant. For driver units. 3 and 4 foot air column lengths.



DRIVER UNITS

Various Power Handling Capacities. Newest types of Indestructible Phenolic Diaphragms.



MINIATURE TYPE RE-ENTRANT PROJECTORS — BOOSTER SPEAKERS

High-efficiency. Weather-proof. Complete with Driver Unit and Universal Bracket.



CONE TYPE PARABOLICS and CHANDELIER BAFFLES for all size cone speakers. Wooden and Metal Cone Speaker Enclosures, Baffles, Carrying Cases, Loud speaker Support Stands and Brackets.



MICROPHONE SUPPORT STANDS

20 types and sizes. All Fittings, Adaptors and Accessories. Floor Stands, Desk Stands, Banquet Stands, Boom Stands.

Write for New Illustrated Catalog Sheets.

ATLAS SOUND CORPORATION

1447 39th St., Brooklyn 18, N. Y.

Simple Rack Speeds Record Changer Repairs

MANY radio service dealers frown upon some types of repair jobs brought to them because the time required in checking and handling the job is less profitable than straight radio repairing. This is especially true in the case of record changers and players where repair or adjustment is required in the mechanical or non-radio part of the unit.

What radio serviceman hasn't cussed mentally (and many times vocally) when trying to check the operation of an automatic record changer out of its cabinet and propped up on his workbench?

An excellent solution to the problem of handling record player repairs is this simple and easily built repair rack developed by Lou Merle, owner of the *Merle Radio Company* in Plainfield, N. J.

The rack is made up of four pieces of scrap 1" x 1" angle iron. Two pieces 18" long are required for the side arms. These two lengths, each originally 24" long, are cut and bent to form the side arms and back support.

Before bending the 24" lengths, holes should be drilled in the six inch section to accommodate the screws or bolts which will hold the rack to the wall and the 3" slots should be cut in the forward end of the 18" section. Fig. 1C shows a 24" section with segment removed for bending and Fig. 1D pictures the section bent to provide the side arm and back support with bar to hold the section rigid.

The completed assembly is shown in Fig. 2. Here it will be noticed that the movement of the front arm, provided by the three inch long slots, permits the changer to be locked in place between the front and rear arms.

It was discovered that the pickup



Fig. 2. Under chassis observation of the changer's operation is convenient with this repair rack. Lou Merle uses neon handlamp to adjust record player.

arms on some automatic changers would not clear the 1" vertical section of the rear arm. To provide the necessary clearance a 1/4" wood square strip was fastened in the rear arm as shown in Fig. 1A.

In the Merle shop the rack is mounted in a corner of the shop about 68" above the floor. A small, movable platform 8" high, is kept under the rack. When checking a changer in operation the repairman can observe the mechanism underneath the changer table while standing on the floor and, by stepping on the platform, can quickly see the components on the top side of the unit.

To conserve time and steps a small but complete workbench is within reach of the rack. This bench is completely equipped with tools and test instruments.

Fig. 1. Mechanical details for constructing record changer rack. 1"x1" angle irons are used.

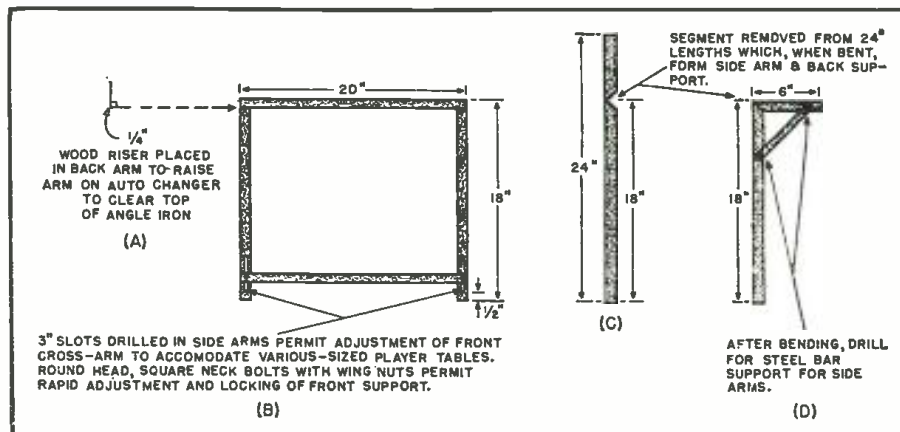

BUILT TO ORDER

Designers of mobile equipment and amateur vhf enthusiasts asked for this driver tube. The 2E30 (outgrowth of the Hytron development type HD59) is a filamentary-type beam tetrode. Standby current is eliminated. Yet the 2E30 is ready to operate a second after electrode potentials are simultaneously applied.

In vhf equipment, the 2E30 is ideal as a class C oscillator, frequency multiplier, or audio frequency amplifier. Important to you—the 2E30 is a transmitting tube—not just a re-hashed receiving type.

Check its versatility and its many features. Quite possibly you will discover that the 2E30 was built to order for you too.



HYTRON TYPE 2E30

Instant-Heating Miniature Beam Tetrode
GENERAL CHARACTERISTICS

Filament	Oxide coated
Potential, a-c or d-c	6.0 ± 10% volts
Current	0.7 ampere
Grid-plate capacitance	0.5 mmfd
Input capacitance	10.0 mmfd
Output capacitance	5.0 mmfd
Max overall length	2 5/8 in.
Max diameter	3/4 in.
Base	T-5 1/2 min button 7-pin

ABSOLUTE MAXIMUM RATINGS

D-c plate potential	250 volts max
D-c screen-grid potential	250 volts max
D-c plate current	60 ma max
D-c screen-grid input power	2.5 watts max
Plate dissipation	10 watts max

OUTPUT—TYPICAL OPERATION

Output, class A1 power amplifier	4 watts
Output, class C oscillator	7.5 watts†
Output, class C doubler (80 to 160 mc)	3 watts†

†Useful power output delivered to load under normal circuit efficiency. Total plate power output (including power actually lost in circuit and by radiation) is at least two watts higher.

FEATURES THE 2E30 OFFERS YOU

- Designed, manufactured, and tested for transmitting
- Special testing controls assure interchangeability*
- Oscillator, frequency multiplier, or a-f amplifier
- Filament power is fully adequate for transmitting
- 1/10 watt driving power for 4 watts output at 80 mc
- 10 watts plate dissipation—surplus reserve for vhf
- Miniature bulb saves space and has low base losses
- Low lead inductance and capacitance—ideal for vhf
- High efficiency at low plate potential—250 volts
- Instant-heating filament—approximately one second

*For example, characteristics are tested at positive grid potentials.

TYPICAL CIRCUIT FOR VERSATILE HYTRON 2E30

Extremely Compact Driver Giving 3 Watts to Load at 160 Mc

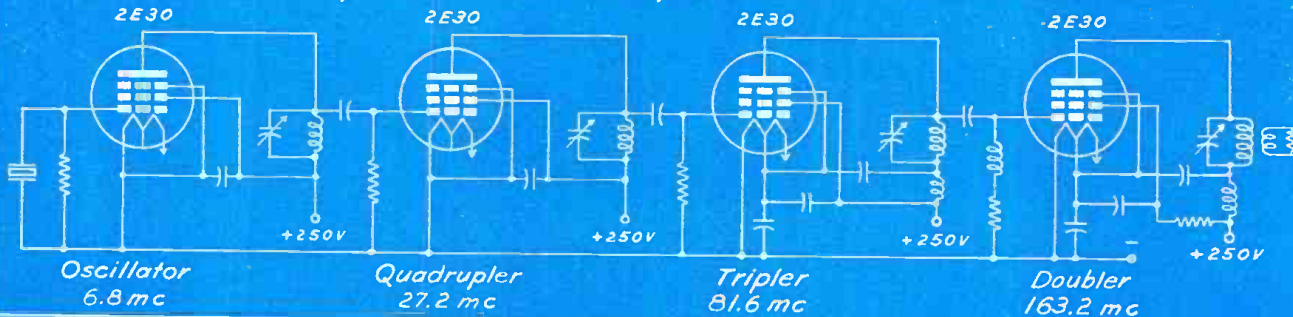

OLDEST MANUFACTURER SPECIALIZING IN RADIO RECEIVING TUBES



HYTRON

RADIO AND ELECTRONICS CORP.



MAIN OFFICE: SALEM, MASSACHUSETTS

Transformer Type **SPEED IRON**

**FOR SOLDERING
IN TIGHT PLACES**

HEATS IN
5 SECONDS



Short pistol length and slender loop type tip permits working in close quarters and around sharp corners. Tip easily formed by hand to fit the job.

- BUILT-IN TRANSFORMER PRINCIPLE FOR FAST SOLDERING HEAT
- 115 VOLT - 60 CYCLE - 100 WATTS
- ALWAYS READY TO USE
- STAYS TINNED - NO TIP BURNING
- INEXPENSIVE TIPS EASY TO REPLACE
- IMPACT RESISTING CASE

WELLER MFG. CO.

517 NORTHAMPTON ST. • EASTON, PA.

TRADE MARK REG. U. S. PAT. OFF.

LOW VOLTAGE →



HIGH CURRENT →



← SPEEDS UP WORK

PERFECTLY BALANCED
EASY TO HANDLE →



The "Super-3"

(Continued from page 78)

In his first three months of winter DXing with the "Super-3," Mr. Gauvreau logged HH3W, 10.135, Port-au-Prince, Haiti; H12G, 9.13, Trujillo, Dominican Republic; HCJB, 9.958, Quito, Ecuador; HEK3, 7.38, Bern, Switzerland; RNF, 9.52, Paris; RNE, 9.37, Madrid; VONH, 5.97, St. John's Newfoundland; VLC5, 9.54, Shepparton, Australia; GSL, 6.11, London; HJDE, 6.145, Medellin, Colombia; RNB, 9.745, Leopoldville, Belgian Congo; TGWA, 9.79, Guatemala City, Guatemala; PRL7, 9.72, Rio de Janeiro, Brazil; FZI, 9.44, Brazzaville, French Equatorial Africa; XEWW, 9.50, Mexico City; GSP, 15.31, London; CSW7, 9.735, Lisbon, Portugal; XEQQ, 9.68, Mexico City; GSB, 9.51, London; RNF, 11.845, Paris; GRH, 9.825, London; FZI-2, 11.97, Brazzaville; GSU, 7.26, London; GRJ, 7.32, London; GVZ, 9.64, London; HEF4, 9.185, Bern; GRI, 9.41, London; HJCAB, 9.69, Bogota, Colombia; Radio Algiers, 6.04, Algeria; ZYC8, 9.61, Rio de Janeiro, Brazil; HJCD, 6.16, Bogota; GSA, 6.05, London; GRR, 6.07, London; HJCX, 6.018, Bogota; GRY, 9.60, London; GWO, 9.625, London; GRU, 9.915 London;

FREQ. RANGE	GRID COIL	TICKLER
1.7-3.2 mc.	56T.. #22E.	10T.. #24E.
3.0-5.7 mc.	32T.. #22E.	8T.. #24E.
5.4-10.0 mc.	18T.. #22E.	7T.. #24E.
9.5-14.5 mc.	10T.. #22E.	7T.. #24E.

Tickler coils all close-wound, spaced 1/8" from bottom of grid winding. 1.7 mc. grid coil close-wound, others spaced to occupy a length of 1 1/2". All coils wound on 1 1/2" diameter coil forms.

Coil data for short-wave receiver.

GSC, 9.58, London; GWB, 9.55, London; VLC6, 9.615, Shepparton, Australia; ZFY, 6.00 Georgetown, British Guiana; GRG, 11.68, London; HCJB, 12.445, Quito; HJCT, 6.18, Bogota; HH2S, 5.95, Port-au-Prince; COCX, 9.27, Havana, Cuba; VUD7, 9.63, Delhi, India; VLA, 7.28, Shepparton, Australia; LRS, 9.317, Buenos Aires, Argentina; HI1N, 6.243, Trujillo, Dominican Republic; VUD10, 7.21, Delhi; 44 stations in the United States; and 7 stations in Canada.

Verifications received include those from VONH, WGEA, WGEO, CFRX, CJCX, W1AW, XEWW, KCBA, KCBF, with reports out to France, Switzerland, Spain, Belgian Congo, French Equatorial Africa, Colombia, Australia, British Guiana, the United States, and Canada.

Considering this receiver cost approximately \$8.00 to build, exclusive of the speaker and using junk box parts, this log is an impressive one. Readers whose junk boxes are not too well furnished could build this set for approximately \$30.00 (Canadian dollar value) according to this avid DXer.

-30-

**LOCATE RADIO TROUBLE FAST
with FEILER SIGNAL ANALYZER**

Permits following signal directly as it progresses through any radio set or amplifier using latest type of high gain miniature vacuum tube (1T4) that allows direct connection directly across r.f. circuits with minimum detuning.

Is portable and self-contained, has own batteries. So compact that it can be carried in palm of hand. In sturdy, brown-metal finished case measuring 6 3/4" x 4 3/4" x 3 3/4" weighing 4 pounds complete with batteries.

Has special built-in network reduces input capacity from 8 to 10 times that of other instruments. Probe is of smallest size measuring 1" in diameter by 4 3/4" long with non-breakable bakelite and extra-heavy 3 ft. rubber covered cable.

Has high input impedance and can be used with any pair of magnetic phones of 1000 ohms or more. Requires no changing of switches, controls or test leads to receive r.f., i.f., or audio signals at any point in radio sets.

Model TS-1 Complete with Tube, but less batteries and phones.....Net. \$9.85
67 1/2 Volt Battery.....\$1.60
Flashlight Cell.....\$.06
2,000 Ohm Dual Headset.....\$2.25



Only
\$9.85

Crowe Modern Slide Rule Dials

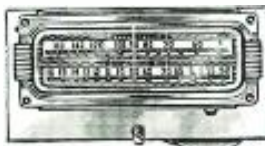

Escutcheon with Crow-glass Crystal. a n t i q u e bronze finish. c o m p l e t e with Pilot light sockets.

Overall Dim.
Model 341—\$3.23 ea. 3 3/4" x 8 7/8"
Model 330—\$2.85 ea. 3 3/4" x 6 5/8"
Model 534—\$1.33 ea. 2 7/8" x 4 1/2"
Model 535—\$1.56 ea. 1 1/8" x 5 1/2"

AUTO ANTENNAS

1. Seamless Brass Tubing
 2. High Polished Chromium Plating
 3. Stainless Steel "Snap Back" Top Rod
 4. Heavily Insulated Shielded Loom Lead
 5. 100% Low Loss Construction
 6. Sturdy Quality Design and Workmanship
- 96" \$3.49 ea. 10 or more \$3.25 ea. Lots of 100 \$3.00 ea.
66" \$2.75 ea. 10 or more \$2.50 ea. Lots of 100 \$2.25 ea.

SPECIAL

Outside aerial kits consisting of:
Antenna wire—Lead-in wire—Glass Insulators—Nail knobs—Lead-in strip—Ground clamp—Screw eyes—79c ea. **69c ea.**
Lots of 10 or more.....

**WE HAVE IN STOCK A COMPLETE LINE OF RADIO TUBES
FOR IMMEDIATE DELIVERY**

Quantity limited. All orders accepted subject to prior sale.

We have the complete line of Alsam cabinets shown in this issue.

RADIO PARTS COMPANY 612 W. Randolph
Chicago 6, Illinois

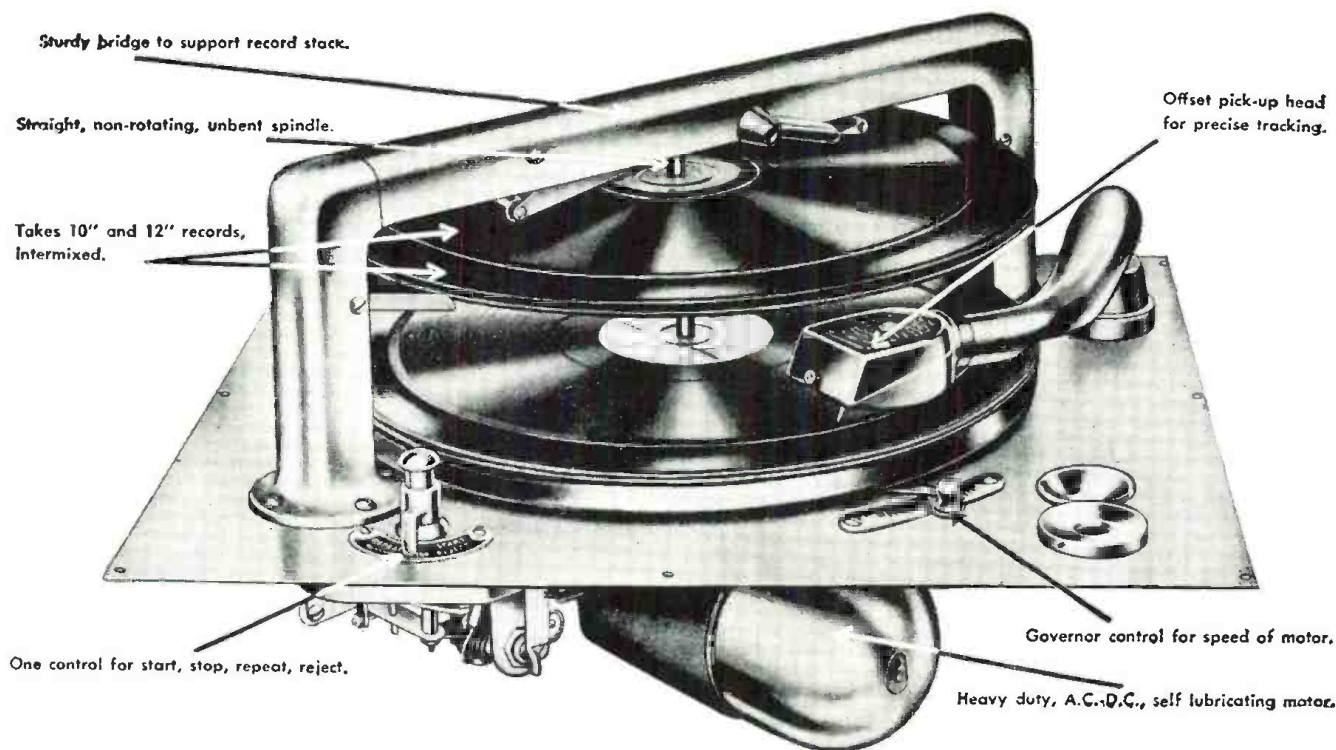

MICRO-SONIC PRESENTS THE **TOPS** IN RECORD CHANGERS

No other record changer compares with Micro-Sonic's British-built, automatic record changer. Feature by feature, Micro-Sonic's record changer leads all competitors in the field, according to the findings of a firm of impartial engineers.

Micro-Sonic's record changer is completely automatic; its action, fool-proof. For instance: restraining the tone arm while a record is being played cannot possibly damage the mechanism. And there are dozens of other features that set Micro-Sonic's record changer apart from all competition.

You owe it to yourself to see this record changer. You will agree that it is "built like a battleship and has the precision of a fine watch." Micro-Sonic's record changer is being demonstrated at the showrooms of the Micro-Sonic Corporation, 44 West 18th Street, New York, N. Y. Be sure to see it!

*"Built like a battleship...
with the precision of a fine watch."*

MICRO-SONIC
CORPORATION



Distinctive FEATURES

1. Records of different sizes, 10" and 12", may be played intermixed.
2. Offset pick-up head insures precise tracking.
3. Pick-up does not fall into place; it is gently placed, mechanically, into the outermost record groove.
4. Restraining the movement of the tone arm by force, while the changer cycle is in operation cannot damage the changer.
5. Extreme simplicity in loading and unloading.
6. Positive and fool-proof selection of 10" and 12" records by two selecting mechanisms. Micro-Sonic is the only unit with two; all others have one.
7. A straight non-rotating, unbent spindle, prevents record chewing and distortion.
8. Record drops by automatically controlled mechanism on a cushion of air.
9. Tilting does not interfere with performance. Records remain parallel to turntable, and to each other, at all times.
10. Automatically stops at the end of the last record, with pick-up off the record.
11. Repeat, reject, start, and stop incorporated into one control... convenient, simple.
12. Playing may be stopped at any point on the record, with no possibility of needle biting into record. Pick-up lifts off record when stop button is pushed.
13. Extremely low scratch level.
14. Super heavy-duty motor has the highest torque of any changer motor on the market.
15. A governor regulates speed of motor, insuring accurate reproduction.
16. A heavy 12" turntable.
17. Plated changing mechanism remains rust-proof, jam-free, and silent throughout its unusually long life.

44 West 18th Street • New York 11, N. Y. Phone: WAtkins 9-5486

June, 1946

LOOK!

BEAM POWER TUBES

829-B push-pull R-F beam power amplifier. Exceptionally efficient, with full input at frequencies up to 200 Mc. Max. ratings are: 750 plate volts, 60 watts plate dissipation. While they last...
\$4.95 (Stock Number) WPS416.

R. W. T. BARGAINS of the MONTH

LOOK!

ACORN TUBES

Government Released. Sensational offer. Normally \$1.85-\$5!
 Stock No. WPS 422: Type 954.
 Stock No. WPS 423: Type 955.
 Stock No. WPS 424: Type 956.
 Stock No. WPS 425: Type 955.
 Socket for above.
 W8464, price 49c

69¢

FREE! Latest Bargain Flyer includes test instruments, record changers, communication receivers, ham transmitting tubes and many other electronic items you need today. Big new catalog coming! Get your name on our list!

Radio Wire Television Inc.
 NEW YORK 13 BOSTON 10 NEWARK 2

Originators and Marketers of the Famous **Lafayette Radio**

Cut out coupon, paste on penny post card, mail today.

R. W. T. Dept. RF6
 100 AVENUE OF THE AMERICAS, NEW YORK 13

Gentlemen: Send me FREE copy of your Latest Bargain Flyer and put my name on list for your Big New Catalog

NAME _____
 ADDRESS _____
 CITY _____ ZONE _____ STATE _____

Make those "HAM FESTS" Interesting

By
JOHN E. HUBEL

MOST of us who are members of a group of men know how difficult it is to get good attendance at meetings, even if such meetings are only held once a month. Not so with the meetings of the Milwaukee Radio Amateurs' Club. These are held once a week and members look forward to the day when they can get together and compare notes of their accomplishments. Perhaps the fact that interesting speakers are on hand to talk shop is the drawing card, these often being men from radio manufacturing establishments in this area, engineers from local broadcasting stations, the electric utility or telephone company. Then, too, the Club itself has engineers among its members, who frequently give extemporaneous talks, which are sometimes illustrated with lantern slides and movies. The interest shown in technical matters pertaining to radio brings up many questions at every meeting of the Club, discussions often becoming spirited at the end of the talks.

There is also a clearing house for the members' radio troubles, as, with the large attendance at the meetings, some member is sure to know and give the answer, permitting another to go home happy, after having had a problem solved that could not readily be found in books on the subject. As the attending membership changes, many lasting friendships are made at these meetings. At almost every Club meeting some member, having recently been honorably discharged from the armed forces, will recite his experiences in radio and telephone operation on the front, some recent talks on such subjects as radar, microwaves, manufacturing and testing of radio tubes, as well as propagation of radio waves, beam antennas, etc., having kept the entire audience listening for almost an entire evening.

Getting newcomers to keep up their interest in amateur radio is easy when you apply the method used at the meetings of the Milwaukee club. Becoming a ham is encouraged by a code class which is conducted at the weekly meetings of the Club. From one-half to one hour before the regular meeting students have access to a key and an oscillator for code practice. Such code classes start in September of each year and by the following spring individuals have gained a sufficient knowledge and speed (13 words a minute) to pass a code test at the examinations. At present the Club has no theory class, but one was held before the war, a continuation being looked

for in the near future. Of course, all members of the Club have a license and are members of the A.R.R.L., but those who have no license are termed associates. At this writing the Club has 140 members, who have paid an initiation fee of 50 cents and annual dues of \$2.25.

The Club meetings, held each Thursday, are conducted according to parliamentary law and Roberts' "Rules of Order," for the routine business part of the meeting. After the formal part of the meeting is over, a speaker for the evening takes over, or a film, having to do with U. S. Signal Corps radio and radar training, etc., is shown. These programs are of such interest, secretary Erwin W. Kreis of the Club says, that the breaking up time comes all too soon for the members present.

Before the war, the Club held an annual QSO party, a six-hour affair with dinner and stag entertainment, on at least one occasion about 450 being present, coming from sections as far as St. Paul, St. Louis, Chicago and Michigan. On such occasions the Club has had the A.R.R.L. central division director as speaker. A QSO party was talked of for this year, but so far it has not been possible to obtain a hall large enough to hold the crowd that would be expected. A Saturday in May is the time desired by the Committee, but if no hall is obtainable for such a date, it may be necessary to hold the affair next fall. There has been no lack of room for the regular weekly meetings of the Club, as they are held in the Conference Room at the Milwaukee Public Library from September to May. The attendance at weekly meetings has been good—from 60 to 100 members showing up each week, the average being around the 90 mark, which is high, considering that the total active membership of this Club is 140 at this writing.

The Milwaukee Radio Amateurs' Club was founded in 1917, becoming an incorporated group in March, 1923, having become affiliated with the A.R.R.L. in December, 1919, the seventh club in the United States to become so affiliated. The Club claims to be the oldest continuously existent radio amateur club in the world. The officers of the Milwaukee group are John Scarvaci, president; Ralph O. Koenig, vice president; Emil R. Felber, treasurer and Erwin W. Kreis, secretary.

If enthusiasm is what keeps a club active and together, the Milwaukee Club has it.

77 RADIO SET MANUFACTURERS DEPEND ON

OXFORD SPEAKERS

Why?



- ★ Because we are fully tooled from 2" to 12" units . . . (We have our own tool and die shop.)
- ★ We maintain rigid quality control.
- ★ Constant research and development.
- ★ Modern assembly methods and facilities — now being expanded for greatly increased production.
- ★ Prompt delivery of pre-production samples.
- ★ 13 years of manufacturing speakers for the trade.

OXFORD RADIO CORPORATION
3911 South Michigan Avenue
Chicago 15, Illinois

SUPREME

TESTING INSTRUMENTS

AFTER A GREAT
WAR RECORD

BACK AGAIN!

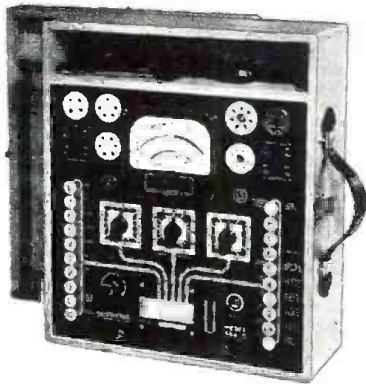

SUPREME MODEL 504-A TUBE AND SET TESTER

SUPREME regrets that war necessitated an interruption of service to its customers and friends. We are genuinely glad to get back into peacetime production—production for YOU.

MANY SUPREME INSTRUMENTS NOW AVAILABLE

—But not enough to take care of all orders at one time. Demand for accurate, dependable SUPREME equipment is such that we suggest you make arrangements for your needed new SUPREME models without delay.

SEE YOUR NEAREST SUPREME JOBBER NOW!

SUPREME

SUPREME INSTRUMENTS CORP.
GREENWOOD, MISS.
U. S. A.

Export Department:
THE AMERICAN STEEL EXPORT CO., Inc.
374 Madison Ave., New York 17, N. Y.

What's New in Radio

(Continued from page 66)

and twelve inch records may be loaded intermixed and the tone-arm automatically compensates for the differences in diameters. A single control unit stops, starts, changes, repeats and rejects. The tone-arm may be restrained during the change cycle without causing damage. R.p.m. is controlled by a heavy-construction, self-lubricating motor, regulated by a manual governor.

Complete details of this line will be furnished to those addressing their requests to *Micro-Sonic Corporation*, 44 West 18th Street, New York, New York.

AIRCRAFT RANGE RECEIVER

A lightweight aircraft range receiver, the Model ARR-1, is now in production at the Electronics Division of *Maguire Industries, Inc.*

This receiver was originally designed for permanent installation as the sole radio equipment in light aircraft, or as a standby emergency receiver for larger airplanes which are equipped with two-way radio. It can be adapted for portable installation in all types of planes as the batteries are contained in the same case as the receiver and there is only one external plug-in connection necessary to place the set in operation.

The set, complete with tubes and batteries weighs 3 pounds, 10 ounces and measures 4½" x 4½" x 6¾". The batteries are readily replaced and give exceptionally long service. Since low battery drain miniature tubes are used in the receiver the "A" battery will supply more than 30 hours of fly-

RECEIVER PRODUCTION SURVEY

The FCC has recently released the results of its survey of radio receiver manufacturers which was made to ascertain the probable production of various types of broadcast receivers in 1946.

A total of 85 manufacturers have indicated their probable production in 1946. It is believed that this 85 includes all but four of the companies which are expected to be substantial producers.

The report shows that 79.2% of receiver production will be for the AM band only, while .4% was indicated as the number of receivers for the FM band only. 8% of the total set production will be combination FM and AM receivers.

Receivers designed for the exclusive reception of television on channels 1-13 inclusive will represent .2% of the manufacture, while combinations which will include AM, FM and television will account for .3% of the production. 11.7% of the companies did not specify the type of receivers that would be manufactured.

The report further indicated that a production of 21,129,760 units is planned for 1946.



ing service while the "B" battery will last more than 50 hours.

In addition to weather and tower, the ARR-1 will receive all radio ranges in the 190 to 420 kc. band.

Complete information about the ARR-1 will be furnished by *Maguire Industries, Inc.*, Bridgeport, Conn.

TWO-WAY PLANE RADIO

A two-way personal plane radio designed to utilize both low frequency and v.h.f. airway facilities has just been announced by *Raytheon Manufacturing Co., Inc.* The units are being manufactured by the *Belmont Radio Corporation Division* of the company.

The new two-way radio weighs 14 pounds and its dimensions are 5" x 5¼" x 14¼". By incorporating a fixed tuned v.h.f. channel on 75 mc. for receiving fan and Z markers, and con-

Another Clark Achievement!

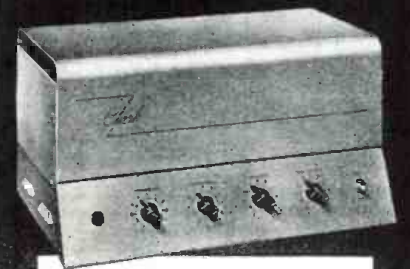

This is the 20 watt member of the Clark family of carefully engineered public address amplifiers. The PA-20 is generously rated to provide plenty of faithful volume for all except the very largest auditoriums. As in the latest radar equipment, small components are terminal strip mounted for instant accessibility.

Inputs: 2 microphones, 1 phonograph.
Frequency response: 50-10,000 Flat within ±2 db.
Distortion: Less than 5% over entire range.
Hum: At least 55 db below full output.
Output: 20 Watts (24 watts maximum).
Output impedance: Tapped for 4, 8, 16, and 500 ohms.

The PA-20 represents top quality engineering and performance at moderate cost. Ask your jobber or write direct for further information.

Clark Radio Equipment Corp.

4313 LINCOLN AVE., CHICAGO 18, ILL.

RADIO NEWS

SYLVANIA NEWS

RADIO SERVICE EDITION

JUNE

Prepared by SYLVANIA ELECTRIC PRODUCTS INC., Emporium, Pa.

1946

SYLVANIA SERVICEMAN SERVICE

by
FRANK FAX



RADIO SERVICE MAGIC

The trick is to find yourself on top of the world, happy, successful—enjoying increased profits as well as the goodwill of your community.

Also—to be accepted as *the* expert in your field, have a host of satisfied customers, a fast-growing business that will keep you on top of the world.

HERE'S HOW IT'S DONE

This *radio service magic* is done with Sylvania national advertising—pages of it—that builds goodwill and does a lot of selling for you.

It's done with impartial, Sylvania coast-to-coast surveys that find interesting facts about the radio market, tell you what the public wants.

It's done with valuable business and technical aids for the radio serviceman—finger-tip data to help streamline your business, assure accurate servicing.

And for the *final touch*: Sylvania's *complete* line of receiving tubes. They mean satisfied service customers—the best source for bigger profits.

Your Sylvania Electric distributor has these famous tubes, plus a long list of aids to your business. Let him tell you more about this Sylvania *magic*, and the wonders it will do for you.

MONEY-SAVING BUSINESS AIDS

WORK-SAVING TECHNICAL AIDS

SALES-ASSURING RADIO TUBES

FACT-FINDING NATIONAL SURVEYS

GOODWILL-BUILDING ADVERTISEMENTS

SYLVANIA ELECTRIC

Emporium, Pa.

MAKERS OF RADIO TUBES; CATHODE RAY TUBES; ELECTRONIC DEVICES; FLUORESCENT LAMPS, FIXTURES, WIRING DEVICES; ELECTRIC LIGHT BULBS
June, 1946

93

SMOOTH YOUR
SELLING ROAD WITH
Smooth Power



When you equip your new phonographs and record-changers with Smooth Power motors, you're adding a definite asset to your line. That's because every motor in the wide GI line has built into it that quick pick-up, quietness and smooth-as-velvet performance that users demand.

Then too, their modern design and accurate manufacture gives them long, trouble-free life . . . to add reliability to your products.

You can smooth your selling road if you *standardize on Smooth Power motors.*

NOTE TO INDIVIDUAL USERS:
Smooth Power motors are sold only through established trade channels.

THE GENERAL INDUSTRIES CO.

DEPT. MR. • ELYRIA • OHIO

tinuous tunable coverage from 195 to 410 kc. and 540 to 1600 kc., satisfactory communications and navigation are available in one unit. A loop antenna may be added to provide radio d.f. navigation. Transmitter operation is on the standard interient private aircraft frequency of 3105 kc.

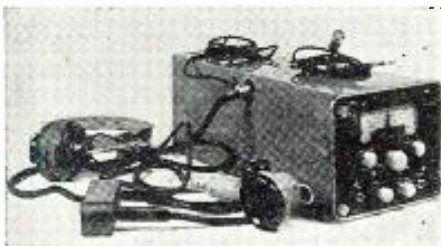

Incorporated in the receiver is a range filter permitting filtering out of voice transmissions from "A" and "N" quadrant identification signals when using the standard simultaneous type CAA radio ranges. This is a valuable feature when reading scheduled weather broadcasts sent out on almost all range stations.

This radiophone will be available in three different models to operate from a d.c. input of either 6, 12, or 24 volts. Two independent vibrators are included with a selector switch on the front panel in the event of failure of either unit.

Additional details of this personal plane radio will be furnished to those requesting them from *Belmont Radio Corporation Division of Raytheon Manufacturing Company, Inc.*, 60 East 42nd Street, New York 17, New York.

CONSTRUCTION KITS

Radio Kits Company has announced the availability of the first of their post war line of model radio kits designed for use in schools, etc. The S-5 which is currently available, contains complete building instructions, wiring and pictorial diagrams, voltage and current charts. The instructions are given in a series of progressive stages, showing the wiring step by step.

In addition to this kit, t.r.f. and six tube superheterodyne kits are available. Multi-tester kits are also included in the line.

Catalogues and full details of the available kits will be furnished upon request to *Radio Kits Company*, 120 Cedar Street, New York, New York.

FREQUENCY METER

A new frequency meter, the Model S-4, which will cover specified frequencies in the range from 1.5 to 100 mc. has been developed by the *Browning Laboratories, Inc.* of Winchester, Massachusetts.

This meter may be used to check the frequency of either AM or FM transmitters to an accuracy of .0025%. A 100 kc. crystal is used as a secondary standard. Its frequency may be checked against WWV, assuring an accuracy of 5 cycles in 10,000,000.

Checks of the crystal against the ECO may be obtained by means of a cathode-ray indicator to better than

1 part in 1,000,000. A machine cut dial with vernier is employed for tuning the ECO. A telescoping antenna allows convenient coupling to the transmitter.

This unit weighs 15 pounds and measures 13 $\frac{1}{2}$ " x 7 $\frac{1}{2}$ " x 6 $\frac{1}{2}$ ". Full details of Model S-4 Frequency Meter will be furnished upon request to *Browning Laboratories, Inc.*, Winchester, Massachusetts.

TABLE MODEL TELEVISION

Belmont Radio Corporation Division of Raytheon Manufacturing Company, Inc. has currently introduced the first of its line of new television receivers priced to retail at approximately \$150.00

The table model television receiver employs a direct viewing 7" picture tube which is sufficiently brilliant to be viewed in the home during daylight hours.

The over-all dimensions of the cabinet are 14 $\frac{1}{2}$ " x 21" x 16". Compactness and light weight enable the receiver to be moved around the house.

The manufacturers have emphasized ease of operation and claim that this receiver is as easy to tune as a conventional broadcast set. Two tuning bands are employed which cover the entire spectrum of assigned television channels, making it possible to view all the stations on the air.

Power consumption of this receiver is no more than that of the average broadcast receiver. Total tube complement is limited to 20 standard *Raytheon* tubes. Interior design is relatively simple and all components of the set are readily accessible, enabling easier and faster servicing.

Delivery on the first of these receivers is expected to start in July.

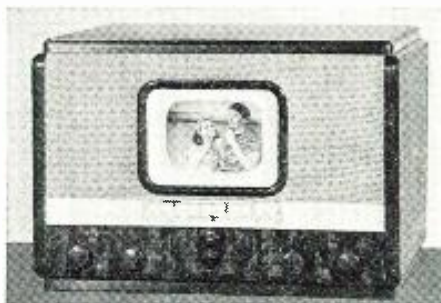

Further information on this table model television set will be furnished by *Belmont Radio Corporation Division of Raytheon Manufacturing Company, Inc.*, 60 East 42nd Street, New York 17, New York.

AUDIO FREQUENCY METER

General Electric Company's Electronics Department is announcing a new audio frequency meter, Type YE-5.

This unit has been designed for use in FM and AM transmitter monitoring, in the manufacture of all types of electronic devices and in many industrial applications.

The audio frequency meter gives a direct indication of the frequency of an audio voltage applied to its input,

RADIO NEWS

Simpson gives new meaning to



Mutual Conductance Tube Testing

Tube manufacturers consider that a radio tube has reached the end of its usable life when it falls to a certain percentage of its rated value. There has never before been an instrument to test tubes in percentage terms.

But now here *is* such an instrument. The new Simpson Model 330 tests tubes in terms of percentage of rated dynamic mutual conductance—a comparison of the tube under test against the standard rated micromho value of that tube. The colored zones on the dial coincide with the micromho rating or the percent of mutual conductance, indicating that the tube is good, fair, doubtful or definitely bad. Thus, at a glance, you can check the tube against manufacturers' ratings. If, for any reason, it becomes desirable to know the actual value in micromhos, the percentage reading may be easily converted.

Besides this revolutionary new method, Simpson offers you an equally revolutionary switching arrangement. The circuit is so arranged that, even though there are numerous combinations possible, very few switches require moving to test any one tube. Many of the popular tubes are tested in the "normal" position without moving any of the nine tube circuit switches:

There are fourteen push button switches and nine rotating switches of six positions each. These switches provide infinite combinations in tube element and circuit selection. Only a few settings are necessary for the most complicated tube. The tube chart provided is arranged for quickly identifying the tube and setting the controls.

When you have finished a tube test, the Automatic Reset takes over to speed and simplify the next test. Just press the reset button and instantly all switches, both push button and rotary, return to normal automatically!

SIMPSON ELECTRIC COMPANY
5200-5218 West Kinzie St., Chicago 44, Ill.

Simpson

INSTRUMENTS THAT STAY ACCURATE

SIMPSON MODEL 330 MUTUAL CONDUCTANCE TUBE TESTER

1. Size—15½" x 9½" x 7".
2. Case—Sturdy plywood construction, with heavy fabricoid covering, corners trimmed in leather, rustproof hardware — removable cover with slip type hinges.
3. Panel—Heavy molded bakelite, beautiful satin grained finish. All characters, numerals, and dial divisions are engraved and filled in white, insuring long wearing qualities.
4. Meter—4½" rectangular of modern design with artistic four-colored dial indicating good, fair, doubtful, and bad—also "Percentage of Mutual Conductance" scale.
5. Sockets provided for all types of tubes including acorn tube.
6. Neon glow tube incorporated to indicate shorted tubes.
7. New simplified revolutionary switching arrangement (see description at left).
8. The tube chart provided is arranged for quickly identifying the tube and setting the controls.
9. Tests tubes with voltage applied automatically over the entire operating range and under conditions approximating actual operation in a radio set.

Price\$98.50

ASK YOUR JOBBER

NIAGARA RADIO SUPPLY

AMATEURS Still a few left at \$4.95

Class B modulation transformer used with the Collins auto-tuned transmitter—modulates an 813 tube both plate and screen, has separate screen winding. Primary will handle 2 811 plates. Good for as much as 150 watts of audio.

Western Electric Class B driver transformer will match 6L6 tubes push pull to grids of any class B tubes. Limited quantity.....\$3.95

General Electric 10 Henry 250 Mill smoothing choke. These chokes made to very rigid Gov. spec.....\$3.50

Class B 599 Watts transformer. Made by N. Y. Transformer Co. Ratio 1.58:1 Primary 7200 ohms, Secondary 2650 ohms. For you KW boys—come and get them for.....\$23.75

Signal Generators Navy type OAN—covers from 200Kc to 2 Megs M.O.P.A. Will operate from batteries or 110 volts 60 cycles—comes complete with 15 foot ant. Very special.\$42.50

NIAGARA RADIO SUPPLY

160 GREENWICH ST., NEW YORK 6, NEW YORK

BOWLING GREEN 9-7993

SEND FOR BULLETIN B1

Remarkable Buy!!! BEAT FREQUENCY OSCILLATOR

Limited
Quantity
First come
First served



HUNDREDS OF USES

Can be used as C.W. OSC. Basic OSC for Frequency Meter, signal generator. Original Frequency 372.6 to 415.7 with one Padder cut-out becomes 456 or 465 KC. Comes complete with schematic, hardware and 6J5 tube. **3.95**

500 Mill 15 Henry smoothing choke. 72 ohms D.C. resistance. New York Transformer Co.\$12.00

500 Mill Swinging choke 14 Henries at 150 mills—7 Henries at 570 mills 45 ohms D.C. Resistance. New York Transformer Co.\$12.00

600 ohms mike in-put transformer to single grid. New York Transformer Co.\$3.50

over a range extending from very low pulses up to 50,000 c.p.s. A range switch is provided permitting the maximum accuracy on any one of eleven ranges within the above limits. Over a range of 105 to 125 volts, power line variation in the frequency reading will not vary more than plus or minus 1 per-cent.

Further information and a specification sheet on this unit is available on request to *General Electric Specialty Division*, Syracuse, New York. Please specify Audio Frequency Meter, Type YE-5.

FACSIMILE UNITS

Finch Telecommunications, Inc. of Passaic, New Jersey has announced the development of two new types of duplex facsimile units, designed for point-to-point, mobile and other commercial communication services.

One of the new units, the FRS 141-A, is a high-speed duplex unit which sends and receives messages by radio at a speed of 30,000 words per hour, or 2760 sq. inches of picture copy. The second of the new *Finch* units is designated the FRS 140-A. This facsimile machine is a medium-speed duplex with a speed of 9600 words per hour or 918 sq. inches of picture copy. This unit will operate on any communication channel which will handle a subcarrier frequency of 1.3 kilocycles (300-2300 c.p.s.). Both units are identical in size and appearance and have push buttons for automatic framing and ejection of messages.

Each model weighs approximately 75 pounds and measures approximately 16" x 16" x 12". Both are designed



for either 110 v., 60 cycle a.c.; 200 v., 60 cycle a.c., 110-220 v. d.c., or battery power, as required for any particular installation.

Technical data and other detailed information on these two units is contained in a new leaflet which will be forwarded upon request to *Finch Telecommunications, Inc.*, Passaic, New Jersey.

THERMAL DELAY RELAY

The Instrument Division of *Thomas A. Edison, Incorporated* is announcing a new Thermal Delay Relay, the Model 501. This relay provides a reliable means of delaying the control of heavy current circuits for a predetermined time interval and also for

RADIO NEWS

La Salle

a better camera at a better price... complete with carrying case



An Excellent
Candid Type Camera
for this New
LOW PRICE

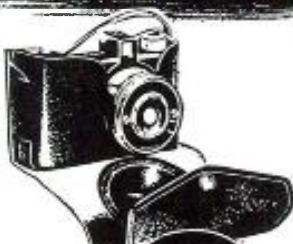

ONLY
\$3.29

CAMERA AND CARRYING CASE

Look no further for the camera that takes pictures any time... keeps your happy occasions in picture form for memories... easy to operate... fun for the whole family... Ideal for gifts or personal use... Order "La Salle Camera" at this unbelievably low price.

These Features Include:

- * Takes 16 pictures on standard No. 127 film
- * Takes pictures in full color (with color film)
- * Genuine Ground Polished Lens
- * Exact Level View Finder
- * Simple to Work, fun to use
- * Full sized candid

ROLL FILM

SATISFACTION GUARANTEED OR MONEY REFUNDED If Returned Within Five Days

Rush This Coupon Today!

JAYE PRODUCTS, INC., 618 South Dearborn Street, Chicago 5, Ill., DEPT. C423

Please RUSH my La Salle Camera, with shoulder strap carrying case as checked below:

- La Salle Cameras ONLY \$3.29 each (postage prepaid) or
 Enclosed find \$ (postage prepaid) or
 Send C.O.D. I will pay postman \$ plus postage.

- Roll Film No. 127-5 for \$1.50
 Roll Film No. 120- No. 620-4 for \$1.50
 Roll Film No. 116 No. 616-3 for \$1.25

Price of film includes postage and handling

NAME _____

ADDRESS _____

CITY _____ ZONE _____ STATE _____

For the Man Who Takes Pride in His Work

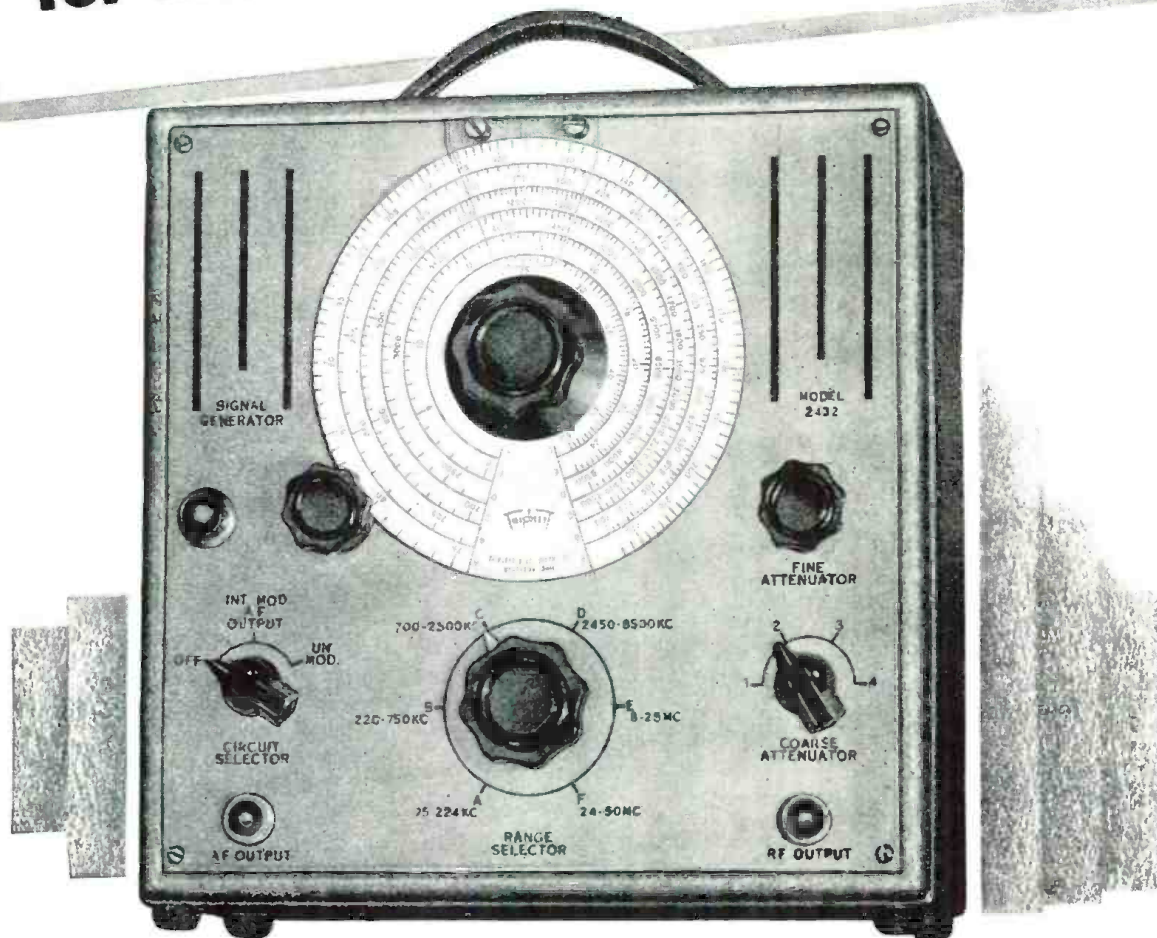

MODEL 2432 SIGNAL GENERATOR

Another member of the Triplet Square Line of matched units this signal generator embodies features normally found only in "custom priced" laboratory models.

FREQUENCY COVERAGE—Continuous and overlapping 75 KC to 50 MC. Six bands. All fundamentals. **TURRET TYPE COIL ASSEMBLY**—Six-position turret type coil switching with complete shielding. Coil assembly rotates inside a copper-plated steel shield. **ATTENUATION**—Individually shielded and adjustable, by fine and course

controls, to zero for all practical purposes. **STABILITY**—Greatly increased by use of air trimmer capacitors, electron coupled oscillator circuit, and permeability adjusted coils. **INTERNAL MODULATION**—Approximately 30% at 400 cycles. **POWER SUPPLY**—115 Volts, 50-60 cycles A.C. Voltage regulated for increased oscillator stability. **CASE**—Heavy metal with tan and brown hammered enamel finish.

There are many other features in this beautiful model of equal interest to the man who takes pride in his work.

*Precision first
...to last*



Triplet

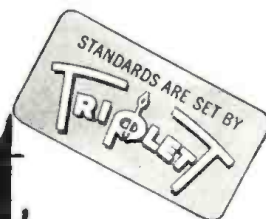

ELECTRICAL INSTRUMENT CO. BLUFFTON, OHIO

June, 1946

97

JUNE SPECIALS

In stock for immediate delivery.

New Model Oscillograph.
5 inch Oscillograph. . . . 2 only **\$235.50**
3 inch Oscillograph. . . . 2 only **\$107.50**
Vacuum Tube Portable Voltmeter with battery pack, also one spare tube **\$26.50**

Record Changers **\$19.95**
Cabinet to hold Changers, open style Blank. Also cut for Webster 50 and 56 models. **\$3.75**
High-Fidelity cabinet for bass, size 30" high, 19" wide, 10½" deep, leatherette covered, colors brown, maroon and tan. each **\$11.80**

Musical Amplifiers in portable case, 11¾" high, 12¼" wide, 7½" deep, brown and tan covered, uses tubes 6SL7—6J5—6V6—5Y3. Has input for 2 guitars and gain control, spec. **\$34.50**

Musical Amplifiers, large size, in portable case, 17¾" high, 14¾" wide, 8¼" deep, covered in leatherette covering. Uses tubes 1—6SN7, 1—6Y7, 2—6V6, 1—5Y3, gain and tone controls, special. **\$39.95**

18 Watt Amplifiers PP 6V6 Output each as is. **\$22.95**
35 Watt Amplifiers PP 6L6 Output each as is. **\$28.50**
These amplifiers are slightly damaged, paint is chipped. Both models have tops and covers.

Power Supply Chassis with transformer cutout 2¾" by 3" with 4 socket holes in sides with strip cutout 3½" with top cover, blue crackle finish, 9¼" long, 5½" wide, 1¾" high, special while they last. **\$0.49**

Thordarson Plate Supply Transformer 750—750, 300 mills, these transformers are slightly used, special at each **\$4.95**

Cabinet cutout for Webster Model 56 Changer, open face top, and cutout for 6" speaker and cutout for radio dial, also with blank top. each **\$7.95**
Also cutout for Miessner Kits 15" square, 8¼" deep.

Cabinet for Webster Changer Model 56, cutout for 6" speaker in center and amplifier 17" x 15" x 8¼" **\$8.95**

Bargain beginners Volt and Continuity Tester with 3½" square meter 125 ohms per volt reads 0-10, 0-100, 0-1000 volts. Ideal for testing shorts in wires, testing batteries, etc. with plywood case, leatherette covering, size 6 x 8 x 2½. each **\$8.95**

Write Dept. RC-18

R. C. RADIO PARTS & DISTRIBUTING CO.

Makers of Radio & Portable Phonograph Cabinets

1827 Grand Avenue, Kansas City 8, Mo.
Phone, Victor 1726

Factory & Plant at 731-33 Central Ave.
Kansas City 6, Ks. Phone, Drexel 7510

eliminating chatter from delicate instrument contacts.

Designed for continuous operation with its heater energized, the relay combines both time delay and control functions in one unit with no danger of false operation caused by heat from the heater affecting the ambient temperature compensation.

Among its uses is the protection of gas filled rectifiers and thyratrons by delaying the application of plate voltage until the cathode reaches operating temperatures; as a guard against the effects of transient currents in control circuits; to perform functions usually served by other relay types; and as an over-current or over-voltage warning or controlling device. A series of these relays can be appropriately timed to perform sequence operations.

The relay is sealed in an inert atmosphere to prevent arcing and burning of the contacts. It is mounted in

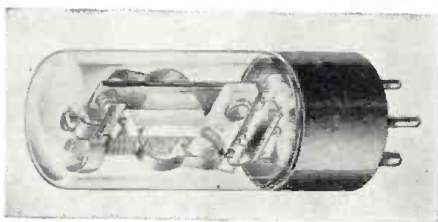

a T-9 tube envelope with an octal or 4-prong base for mounting in standard sockets. The relay is supplied with either normally open or normally closed contacts. It is rated at 6 amperes and will make or break this current up to 450 volts a.c. or 250 volts d.c.

A detailed discussion of the characteristics of this unit and a summary of the more common uses are contained in Publication No. 3007 which will be forwarded by *Thomas A. Edison, Incorporated*, West Orange, New Jersey, upon request.

BROAD RANGE ANALYZER

A new super-sensitive analyzer, compact and light in weight, has been announced by the *Weston Electrical Instrument Corporation* of Newark, New Jersey.

The Model 779 has five completely overlapping a.c. and d.c. voltage ranges, seven d.c. current ranges, four



d.c. resistance ranges and five decibel ranges. Each d.c. voltage range is available at a dual sensitivity of 1000 or 20,000 ohms per volt.

The Model 779 is mounted on a solid molded bakelite panel in an oak carrying case. All readings are taken on a standard 4" rectangular 50 micro-ampere instrument and a.c. measurements are made possible through a special temperature-compensated, full-bridge, copper oxide rectifier, so designed that all a.c. readings are made on a single scale arc.

Details of this unit will be furnished by *Weston Electrical Instrument Corporation*, Newark, New Jersey.

-30-

Spot Radio News

(Continued from page 14)

the scene of the conflict. The "eyes" were, as has been indicated, also applied to remote-control aircraft loaded with high explosives, crash boats, and aerial torpedoes. Other uses included observation of gunfire, reconnaissance in connection with amphibious landings, map making, for reading meters, gauges and other instruments in connection with tests during aircraft design, and, to quote an *RCA* engineer, "for obtaining the equivalent of eyewitness information under conditions of space, speed, or peril which would preclude the gathering of the required information by personal observation or by other means." . . . Another thing we picked up—Navy, true to form, didn't let the superman equipment hang around long before they tagged it with sea-going lingo. A remote-control television-equipped glider filled with high explosives was dubbed a "Glomb," a crash boat with the same equipment became a "Campbell," and the television system for guiding bombs was dubbed "Roc."

NOR DOES THE STORY OF airborne television end with the cessation of hostilities. According to David Sarnoff, president of *RCA*, scores of projects are already under way to apply the equipment to peacetime needs. He predicts, for instance, that it will be used for "revolutionary" television news coverage over short and long distances from cars, boats, planes, and helicopters, enabling the public to sit in their living rooms and see screened a fire, flood, sports event, or anything else you want to imagine from the best possible angle. Another application anticipated is the "walkie-lookie," with which a reporter might cover news events of the man in the street as readily "as he does now" (it says here) "with a Speed Graphic." Test-pilots will be saved the perils of flying a dangerous experimental plane through the use of airborne television equipment focused on the instruments and the testing gear. Even explorers have not been forgotten in the peacetime plans of the equipment. Before going into a hazardous area, they may



The Mark of Quality

With the dawn of the new electronic era CENTRALAB again dominates the scene. The "CRL IN THE DIAMOND" identifies a group of QUALITY components engineered to the exacting requirements of the new electronic age . . . always specify CENTRALAB.

Centralab

Division of GLOBE-UNION INC., Milwaukee

PRODUCERS OF



Ceramic Trimmers
Bulletin 695



Variable Resistors
Bulletin 697



Tubular Ceramic
Capacitors
Bulletins 630 and 586



Selector Switches
Bulletin 722



Ceramic High Voltage Capacitors
Bulletin 814

HARVEY

has

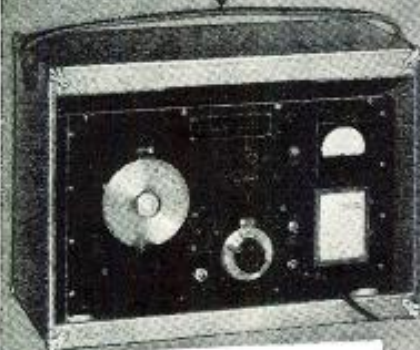

SC-I-112-A LABORATORY STANDARD SIGNAL GENERATORS

...ideal for servicemen and
development laboratories!

SPECIAL!

\$79⁵⁰

- Range: 34 to 134 Megacycles
- 117 Volt, 50/60 cycle Input
- Internal modulation at 400 or 625 cycles
- Zero drift after brief warm-up
- Piston attenuator
- Vacuum tube voltmeter
- Calibrated output indicator
- Output impedance 38 ohms
- Coaxial connector for audio output
- Shock mounted in hardwood case
- Thoroughly shielded
- Parts silver-plated
- Output: 0.1 volt.

Watch HARVEY'S
ads for real values!

Our service is prompt... efficient!
Our prices are reasonable!
And... we deliver!

HARVEY
RADIO COMPANY INC.
103 West 43rd St., New York 18, N. Y.

now get a televised view of it. And an adaptation is also being considered to probe areas far beneath the surface of the ocean to locate sunken treasures or survey regions heretofore inaccessible owing to high sea pressures.

TECHNICALLY, THE EQUIPMENT has been developed to a maximum efficiency for a minimum weight. Television pickup and transmitting equipment that once might have filled a large room was redesigned, modified and built to suitcase compactness, one unit weighing but fifty pounds. Other special requirements were met with equal success, enabling the equipment to operate satisfactorily with the small antennas practicable for airplanes, on airplane power supply, and under unusual handicaps of noise and vibration. Making tubes was another tough problem that was solved and some adaptations of the airborne system built toward the close of the war made use of the super-sensitive Image Orthicon tube, extending the usefulness of the equipment in twilight hours and under adverse light conditions. Pictures obtained in the so-called Navy "Block" equipment—Block being a code word for the lightest unit developed during the war—are viewed by the control operator on the screen of a special kinescope in a monitoring receiver. The kinescope has a face seven inches in diameter and is somewhat similar to that used in home television receivers, one important difference being that in Block the phosphor used on the screen produces a green image—a color to which the human eye has maximum response. The unit produces 40 frames a second in sequential scanning, with 350 lines on the receiving screen. Its transmitter has a peak power output of 60 watts at 264 to 372 megacycles, and special transmitting antennas have been designed for each of its ten workable channels. The receiver unit has two broad-band antennas. . . . The Block is the most compact system devised during the war. Another unit, the Ring, is more elaborate and efficient, and will be used for most of the applications anticipated in the peacetime world. NBC plans to use it any day now in covering news events.

INTERNATIONAL RADIO PROBLEMS are a long way from solution, according to word from inside the State Department, but plans are going steadily ahead toward world cooperation in the field. Latest word on the pipeline is of a five-power conference in Moscow, attended by representatives of the United States, Britain, Russia, France and China, to be held "as soon as possible." This, we are told, will be followed by a full-dress World Communications Conference late this year or early next year near Washington. Crowded conditions at the capital will make it necessary to hold the big meeting elsewhere. All phases of telecommunications will be reviewed at both the Big-Five and the

world meetings, and it is expected that actions of the 1932 Madrid conference and the 1938 conference at Cairo will be revised. Spotlights in the revision program will be allocation of radio frequencies. . . . International progress is already going forward on schedule in the Western Hemisphere following the Second North American Regional Broadcasting Conference in February, State reports. The third of these conferences is already scheduled for an undesignated place in Canada in mid-September of next year.

EMPLOYMENT OPPORTUNITIES, especially for returned veterans, was one of the main topics discussed at a two-day conference of the Radio Manufacturers Association Industrial Relations Committee in New York May 21-22. G. W. Thompson of *Noblitt-Sparks Co.*, was chairman of the RMA group, and F. D. Wilson of the *RCA Victor Division* was chairman of the committee on veteran employment. Statistics and information were being assembled by his organization on veteran reemployment, seniority and similar problems toward making detailed reports to all RMA members. Estimates are that the radio industry had about 35,000 employes in uniform at the peak of the war, and information on the number returning to the industry are being gathered. . . . Interest is also high among RMA membership in the annual convention

**ATTENTION! STUDENTS • SERVICEMEN
• HOSPITALS**

INTRODUCING OUR FIRST POST-WAR

RADIO KIT

Our model S-5 uses the universally accepted superheterodyne circuit, containing the following tubes: 12SA7, 12SK7, 12SQ7, 50L6, 35Z5 and tunes from 550 Kc to 1600 Kc.



Model S-5 (Illustrated), Complete kit, including tubes, Bakelite Cabinet and four pages of diagrams and instructions. . . . @ \$19.95
Our Kits are Professionally Engineered, Professionally Designed and Professional Looking.

MULTI-TESTER KIT

5 voltage ranges,
3 current ranges,
3 ohm ranges.

Volt Ranges: 0-5-
50-150-500-1500
volts.

Current Ranges:
0-50-150-500 Ma.

Ohm Ranges:
0-2000-20,000-
200,000 ohms.

Model 120 (Illustrated) Complete Kit @ \$9.95



SPECIAL FOR THIS MONTH!

Electrolytic Condensers

10 mf—450 volts.10 for \$2.50
20-20 mf—150 volts.10 for 2.50

We carry a complete stock of parts.
Export Inquiries Invited.
25% Deposit on C.O.D. Orders.

Write for FREE Catalog

RADIO KITS COMPANY

Dept. K, 120 Cedar St., New York 6, N. Y.

"CATS AND DOGS" SALE

The listings below represent stock we have on hand at the lowest prices prevailing. All items are boxed, clean merchandise. Every item is guaranteed by us and the manufacturer.

METERS		
N1—3 1/2" Westinghouse	0-150 Volts AC.....\$4.95	
N2—2 1/2" Gruen	0-50 ma DC.....3.45	
N3—2 1/2" Gruen	0-100 ma DC.....3.45	
N4—2 1/2" Gruen	0-250 ma DC.....3.45	
N5—2 1/2" Burlington	0-150 Volts AC.....4.45	
N6—Superior P8-100 Combination Volt-Ohm-Millimeter:	DC—Volts to 2500, Output Volts to 1000, AC—Volts to 1000, DC current to 2.5 amperes, Resistance to 1 megohm, Decibels to plus 55 DB. (In handsome oak case with test leads).....\$28.40	
N7—Superior SIGNAL TRACER complete with probe, meter. Follows signal from antenna to speaker of any set.....\$18.50		
N8—Radio City Volt-Ohm-Millimeter—ranges as above.....\$17.85		
N9—SIGNAL TRACER with probe—has 5 tubes with magic eye and speaker... external probe with volume control.....\$39.95		
N10—G.E. NEON GLOW LAMP—two contact standard base......25¢		
N11—40 pilot bulbs Mazda—box of 10......50¢		
N12—44 pilot bulbs Mazda—box of 10......50¢		
N13—46 pilot bulbs Mazda—box of 10......50¢		
N14—47 pilot bulbs Mazda—box of 10......50¢		
N15—41 pilot bulbs Mazda—box of 10......50¢		
N16—Complete CRYSTAL SET with earphone ready to assemble—no soldering required—in attractive case.....\$1.98		
N17—Complete two-way telegraph set with Blinker, key, light and sounder and 50 feet of wire.....\$2.75		
N18—Toy Microphone with built-in switch, ready to connect to any radio......60¢		
N19—Aerial Kit—50 ft. tinned aerial wire, 20 feet rubber covered ground wire, staples, ground clamp, nail knobs and insulators complete......75¢		
TUBES		
6D6......50¢	0Z4......90¢	6SK7......60¢
954......45¢	12SK7......60¢	6SQ7......60¢
955......45¢	1R5......90¢	6X5......90¢
956......45¢	5U4A......54¢	6SN7......70¢
957......45¢	6C6......60¢	7H7.....\$1.00
959......45¢	39......50¢	6D6......60¢
N21—3-tube Amplifier for 12SQ7, 35Z5 and 50L6—all wired—ready to operate—less tubes.....\$4.95		
N22—17-watt Amplifier with cover and with tubes: one 7C7, one 7F7, two 6L6, one 5Y3. Tapped output, 2 channels.....\$30.30		
N23—25-watt Bell Sound Amplifier with cover and case and tubes: two 6SJ7, one 6SF5, one 6N7, two 6L6, one 5U4. Three separately controlled channels, tapped output, less than 5% distortion at 30 watts peak.....\$58.92		
N24—Master Communicator and substation with 50 feet of 3-wire cable, two watts output, with tubes: 12SL7, 35Z5, 50L6, "silent" feature with ringing on master and sub).....\$26.15		
N25—2" PM Speakers.....\$1.58		
3" PM Speakers.....1.80		
4" PM Speakers.....1.80		
5" PM Speakers.....1.80		
6" PM Speakers.....2.98		
8" PM Speakers.....3.75		
10" PM Speakers.....5.98		
12" PM Speakers.....7.50		
4" 450-ohm Speakers.....2.00		
5" 450-ohm Speakers.....2.00		
5" 2750-ohm Speakers.....2.00		
6" 1800-ohm Speakers.....3.00		
8" 450-ohm Speakers.....3.00		
8" 1000-ohm Speakers.....4.00		
8" 2500-ohm Speakers.....4.00		
10" 2000-ohm Speakers.....5.00		
10" 2500-ohm Speakers.....5.00		
12" 2000-ohm Speakers.....6.00		
12" 2500-ohm Speakers.....6.00		
12-watt Inverse Trumpet—waterproof—high efficiency.....\$18.00		
25-watt Inverse Trumpet and unit—high efficiency—3 1/2 ft.....\$33.00		
MICROPHONES		
N26—Hand Crystal Mike—with 6-ft. cord.....\$3.95		
N27—Astatic Model JT-30 Crystal Mike with handle and base.....\$10.00		
N28—Astatic N-30 Crystal Mike.....11.00		
N29—Electro-Voice Model V2 ribbon high quality Mike.....\$24.00		
N30—Electro-Voice Cordak Mike (latest release).....22.00		
N31—Turner Cardoid—101 high impedance.....39.00		
N32—Turner U9S—fills impedance needs—50, 200, 500 and high.....\$22.00		
N33—Turner 33X Crystal Mike.....13.00		
N34—Turner 33D Dynamic Mike.....13.00		
N35—Turner 22X Crystal Mike.....12.00		
N36—Turner 22D Dynamic Mike.....14.00		
N37—Cartridge to repair any Crystal Mike.....4.00		
N38—Third Hand to hold any Mike and leave hands free.....\$3.00		
N39—Universal Dynamic Mike, high impedance.....9.75		
PICKUPS		
N40—Astatic Pickup Model D9.....\$3.00		
N41—Astatic Pickup Model SL8.....3.00		
N42—Astatic Pickup Model S8.....6.60		

N43—Astatic Pickup Model AB8M.....\$7.50	
N44—Astatic Pickup Model FP-8.....9.70	
N45—Astatic Pickup Model FP-1B.....9.70	
N46—Astatic Pickup Model S-12.....7.50	
N47—Webster Pickup Model AJ-1 with permanent needle.....\$3.90	
N48—30 Transcription Needles......15¢	
N49—5 Cutting Needles......60¢	
N50—Jensen Permanent Needle......60¢	
N51—Sapphire Cutting Needle.....\$3.60	
N52—Adjustable Floor Stand (chrome base).....5.25	
N53—Bonquet Stand.....1.35	
N54—Boom Stand.....33.00	
N55—Adjustable Bonquet Stand.....3.00	
N56—ARRL 1946 New Book.....1.00	
N57—Circuit Diagrams 1926-1942 (5 volumes).....10.30	
N58—Ghirardi's Radio Service Course.....5.00	
N59—Rider's Automatic Record Changers and Recorders Book.....\$9.00	
N60—Kaar Engineering KE23-A Communications Receiver—with speaker—signal squelch circuit—9 tubes.....\$13.17	
N61—Antenna Coils—new small type......35¢	
N62—RF Coils—new small type......35¢	
N63—3-Tap Oscillator Coils—new small type—456 I. F......35¢	
N64—4-Tap Oscillator Coils—new small type......45¢	
N65—465 Input I. F. Coil—shielded with trimmers......78¢	
N66—465 Output I. F. Coil—shielded with trimmers......78¢	
N67—Peterson Plug-in Crystals—all frequencies.....\$3.43	
N68—Galena Crystals—for crystal sets......18¢	
N69—Signals Corps Magnetic Pair Phones.....\$1.98	
N70—Acme 2000-ohm Pair Phones.....1.35	
N71—Brandes 2000-ohm Pair Phones.....1.89	
N72—Moguire Industries two-post Changers, with automatic stop last record. Encased in mahogany cabinet with 6-ft. attachment cord and standard plug-in.....\$24.19	
N73—Cabinets—with removable cover for record changers.....\$10.90	
N74—Dual 12" speaker carrying case with room for amplifier.....\$1.85	
N75—Leatherette covered cabinets for portable radios.....\$14.90	
N76—5" wall baffles.....\$1.95	
N77—6" wall baffles.....2.45	
N78—8" wall baffles.....2.95	
N79—10" wall baffles.....3.45	
N80—12" wall baffles.....3.95	
N81—Cabinets for Emerson 301.....1.65	
N82—Cabinets for portable phono with 5" speaker hole—motor board and cover.....\$9.75	
N83—100 Insulated Marked Resistors in four drawer cabinets—complete.....\$7.95	
AUTO AERIALS	
N84—3-Section Side Cowl with plain lead......99¢	
N85—4-Section Side Cowl with shielded lead.....\$2.50	
N86—Flexmount—3-section—shielded lead.....2.50	
N87—Disappearing Antenna—4-section—shielded lead.....\$2.95	
N88—Offset Vibrators for Delco.....1.78	
N89—Standard 4-prong Vibrators.....1.78	
N90—Buick Standard Vibrators.....3.00	
N91—Kit of 4 Vibrators to fit most cars—with chart.....9.99	
N92—4 Auto Aerials—1-3 Section with Shield } 1-4 Section with Shield } 1 Flexmount }.....\$9.99 1 Fender } 1 Display Board }	
N93—10-watt Fixed Resistors—all sizes.....20¢	
N94—25-watt Fixed Resistors—all sizes.....35¢	
N95—DPST—Toggle Switch (H & H).....25¢	
N96—Jewel Light with socket—straight mount—with adjustable lite opening.....50¢	
N97—Battery Eliminator—supplies 6 volts D.C.—14 amps. from 110 A.C.....\$39.50	
N98—Battery Eliminator—supplies 6 volts and 180 volts for portable from 110 A.C.....\$9.60	
N99—1 1/2-Volt "A" Batteries—plug-ins—portables.....40¢	
N100—6-Volt "A" Batteries—plug-ins—portables.....40¢	
N101—4 1/2-Volt "A" Batteries—plug-ins—portables.....35¢	
N102—6 1/2-Volt "A" Batteries—plug-ins—portable.....\$1.25	
N103—45-Volt "B" Batteries—plug-ins—portable.....1.00	
N104—4 1/2-Volt "C" Battery......25¢	
N105—22 1/2-Volt "C" Battery......75¢	
N106—1 1/2-Volt Flashlight Battery......6¢	
N107—Combination 1 1/2-Volt plus 90 Battery.....\$1.68	
N108—Acorn Tube Sockets......60¢	
N109—4 Flashlights: (1) Swivel Head (2) Industrial (1) Redhead with 48 cells.....\$9.72	
N110—Trusonic Coaxial Speaker—permanent magnet complete—overall diameter 1 1/2"—weight 30 pounds—2-inch metal diaphragm—1 1/2" voice coil—B-cell multicellular horn for high frequency.....\$123.00	
N111—Pair Test Leads—with insulated handles......60¢	
N112—6-foot extension cords with cap and cube top.....36¢	
N113—All-purpose Neon Tester for A.C. and D.C.....30¢	
N114—Vibrator Puller to extract vibrators from auto sets......25¢	
N115—Pilot Light Puller to extract any type pilot light from set......24¢	
N116—20,000-Rpm—motor with 22 attachments for polishing, grinding, etc.....\$12.95	
N117—Sun Lamps—Infra-Red—Standard Socket.....1.02	

N118—Metal Bases—brown crockle to fit Detrol Record Changers.....\$2.95	
N119—Knobs—1/4" shaft—1/4" diameter......7¢	
N120—Telephone Switches—DPDT......99¢	
N121—On-Off-On Toggle Switches......5¢	
N122—STEEL STOOLS—24"—all welded—guaranteed 10 years.....\$2.50	
Back Extra.....1.00	
N123—STEEL STOOLS—30"—all welded—guaranteed 10 years.....\$3.00	
Back Extra.....1.00	
N124—Small Parts Drawer Units—18 Metal Drawers in Metal Cabinet 34x17x11. Three dividers provided for each drawer.....\$19.95	
N125—Speed SOLDER IRON—7 seconds—gun type (6 volts).....\$3.95	
N126—Transformer for Solder Gun from 6 Volts to 110.....\$3.25	
N127—Weller Solder Gun—transformer type—7 seconds.....\$12.95	
N128—Circle Cutter (cut holes in steel, brass, aluminum, wood, etc.) from 1/8" to 4".....\$1.50	
N129—Circle Cutter—from 1 1/2" to 8" diameter.....4.95	
N130—Hond Soldering Iron—1/4" tip—6" length.....1.90	
N131—Dry Battery Tester—0-10 D.C. Volts and 0-150 D.C. Volts (pocket type).....\$2.75	
N132—Kraeter Diagonal Cutting Pliers—4 1/2-inch.....\$1.50	
N133—Kraeter Diagonal Cutting Pliers—5-inch.....1.60	
N134—Kraeter Nose and Cutting Pliers—7-inch.....1.90	
N134A—Kraeter Nose and Cutting Pliers—6-inch.....1.75	
N135—Kraeter Pliers and Cutting—7 inches.....2.20	
N136—Clorostat Volume Controls—Carbon—all sizes.....60¢	
N137—Clorostat Volume Controls—Carbon Tapped.....90¢	
N138—Clorostat Switches—DPST or SPST.....30¢	
N139—Clorostat Wire Wound—all sizes.....60¢	
N140—Transformer—6.3V—.06 A, 45V—60 ma, 50-1800 cycles.....49¢	
N141—Ballasts—RL45 Amperite—Universal.....60¢	
N142—J. F. D.—Universal—A. B. C.....90¢	
N143—K49B—K55B—L55B—100-70—100-77—100-79—All Sizes.....49¢	
N144—Resistance Cords—135—160—180—200—220—250—300—350.....49¢	
N145—560 and 960 Resistance Cords.....59¢	
N146—Universal Tapped Resistance Cords.....75¢	
N147—Rubber Lamp Cord—per 100 feet.....\$1.50	
N148—Rubber covered, stranded, tinned copper wire—per hundred feet......50¢	
N149—Vacuum Cleaner Wire—per 100 feet.....\$2.50	
N150—20 Conductor Plastic Covered Wire with heavy Plastic outer coat—per hundred feet.....\$10.00	
N151—Transmission Wire—Outdoor—Twisted—Black—per 100 feet.....\$1.50	
N152—8 Conductor—Coded—with grey outer wrap—per 100 ft.....\$7.50	
N153—7/26 Tinned Aerial Wire—per 100 feet.....40¢	
N154—DIPOLE ANTENNA.....\$1.75	
N155—DIPOLE ANTENNA with reflector and 50 feet coaxial cable.....\$4.75	
N156—Amphenol Dipole Antenna with cable.....5.40	
N157—Universal Output Transformers—4 watt.....1.00	
N158—Universal Output Transformers—8 watt.....1.50	
N159—Universal Output Transformers—12 watt.....1.75	
N160—Universal Input Transformers.....1.50	
N160A—Push-Pull Input Transformers.....90¢	
N161—POWER TRANSFORMERS. Latest fully shielded construction. Upright mounting. Best values in the country.	
40 mill 6.3.....\$1.79	125 mill 6.3.....\$3.19
50 mill 6.3.....1.99	200 mill 6.3.....3.95
60 mill 6.3.....2.19	50 mill 2.5.....2.19
75 mill 6.3.....2.39	75 mill 2.5.....2.49
90 mill 6.3.....2.79	120 mill 2.5.....3.29
N162—AEROVOX—8 mfd. 450 Volts Tubular.....50¢	
16 mfd. 450 Volts Tubular.....75¢	
20 mfd. 450 Volts Tubular.....80¢	
40 mfd. 450 Volts Tubular.....\$1.00	
N163—AEROVOX—20 mfd. 150 Volts Tubular.....50¢	
30 mfd. 150 Volts Tubular.....55¢	
40 mfd. 150 Volts Tubular.....57¢	
20/20 mfd. 150 Volts Tubular.....90¢	
N164—CAN TYPES—8-450.....90¢	
16-450.....\$1.25	
20-450.....1.40	
30-450.....1.60	
40-450.....1.90	
80-450.....3.30	
N165—TUBULAR PAPER—	
600 Volts—.01—.02—All Sizes.....14¢	
.05.....18¢	
.1.....20¢	
1600 Volts—.01.....30¢	
N166—Phone Plugs......24¢	
N167—Phone Plugs—Shielded......60¢	
N168—Phone Jack—Open Circuit......15¢	
N169—Phone Jack—Closed Circuit......19¢	
N170—Amphenol Mike Connector......33¢	
N171—Amphenol Female Mike Connector......30¢	
N172—Red & Black Tips, Jacks, Plugs, etc......9¢	
N173—Chassis or Record Changer Holder.....\$4.95	
N174—Staple Gun with 250 staples: feeds one at a time.....\$3.70	

TERMS: All prices shown are net. All items subject to prior sale. Please do not make remittance for total amount of order. If check is sent, mark it not good for more than amount of order and we will fill in the correct amount. This eliminates necessity of making refund if we are unable to completely fill order. C. O. D. shipments made if 10% remittance accompanies order. Please include postage or express in remittance.

LOUIS M. HERMAN CO. INC., 885 Boylston Street, Boston 16, Mass.
 June, 1946

A Handy SALESKIT FOR RADIO SERVICEMEN

A real saleshelp exclusively for Radio Servicemen... the Jensen Phonograph Needle Saleskit is just the thing for demonstrating fine needles. What's more, Jensen needles augment your work, assure full, clear tone of the instruments you repair, make all records sound better.

Colorful, convenient, compact... the Saleskit slips easily into your pocket. Take it on service calls. It contains 3 Jensen Concert Needles retailing at \$1 each and 3 Jensen Genuine Sapphire Needles at \$2.50 each.

Available NOW at your jobber. WRITE TODAY for complete details and our better than usual discount to servicemen.

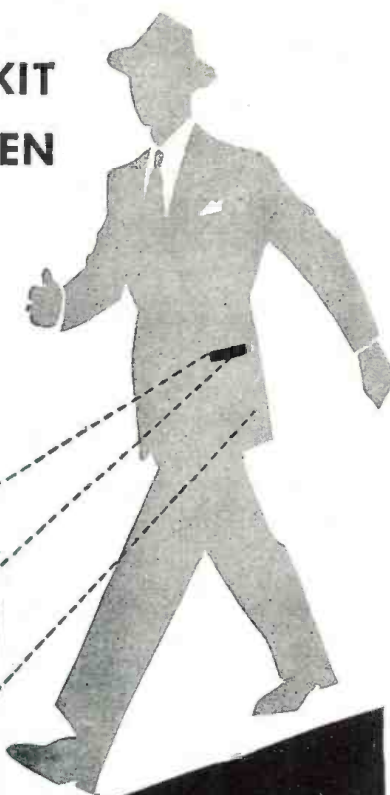

JENSEN INDUSTRIES, INC.
331 SOUTH WOOD STREET
CHICAGO 12 ILLINOIS

HAM HEADQUARTERS FOR Equipment and Information

EXTRA SPECIALS

- Low loss Antenna Change Over Relay 6 v. D.C. D.P.D.T. \$1.75
- 3C/24G Tubes \$1.90
- 3-3 MFD. 600 V Oil Filled \$0.99
- 8 MFD. 600 V Oil Filled Round Can any Mounting \$1.50
- 2 MFD.—2000 CD \$3.50
- Ceramic Caps for 807-866 etc. \$0.19 ea.

Mail Orders Promptly Filled
Amateurs to Serve You
(20% Must Accompany All COD Orders)
Write to Dept. RN
W6SCQ—W6UXN—W6NAT
W6SSU

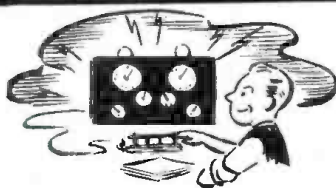

FOR YOUR NEW RIG

We Have a Good Stock of
All Standard Lines

SUPER BUY

For 10 Meter F.M. Mobile Operation BC 1335 COMPLETE TRANSMITTER and RECEIVER from 27.5-38.9 MC READY TO GO with 3 Crystals for FM Portion of 10 Meters and Shure T17B Hand Set.\$53.00

Radio Product Sales Company

238 WEST 15TH STREET
LOS ANGELES 15, CALIFORNIA PRespect 7471

and membership meetings scheduled for Chicago, June 10-13, which will include an RMA industry banquet on the evening of June 13, the first since before the war. Officers and directors will be elected the same day.

THAT STATIC YOU MAY REMEMBER having encountered on your radio late in March—and which may bother you again from time to time—isn't caused by the sun, as has been popularly supposed, but rather by speeding clouds of electrically charged gases hurtling from the sun into upper layers of the earth's atmosphere. At least that is the explanation offered recently by H. W. Wells, J. W. Watts and D. E. George of the Washington, D. C., Carnegie Institution staff, after studying the disturbances of March 25-26. The scientists report that the sun clouds bounce around in the so-called F-layer of the earth's ionosphere, or electrically charged region of the earth's atmosphere, causing a fading or disappearance of radio signals. Long distance broadcasting is hardest hit. Nothing much you can do about it, either—the sun clouds move at about a mile a second and seldom get closer to the earth than 180 miles.

RADIO NEWS WAS INVITED a few days ago—along with more gold braid than we've seen together around these parts since V-J Day—to an exhibition of captured enemy equipment under the joint auspices of the Corps of Engineers and the Publication Board of the Department of Commerce. The show started with a short speech by Secretary of Commerce Wallace, and continued at Ft. Belvoir, treasure-house of the captured stuff. But we have to report that there wasn't a single radio in the entire collection—not even a crystal set. . . . Checking back with the Publication Board, we learned that captured radio and allied equipment has been turned over to the Signal Corps. It may be that they will have an exhibition, too, one of these days, but most of the stuff captured was either inferior to ours in quality or so far behind radio developments here that it would be of little interest. About the only thing that Commerce has on hand that might interest you right now is a selenium rectifier captured from the Germans, along with the process for making it. It was used by the Nazis for converting alternating current into direct current for battery-charging devices and radio and radar sets. U. S. experts think it may meet American needs for accurately controlled sources of direct electric current. A detailed analysis of the rectifier and how it is made may be had from Report No. 425 of the Commerce Publication Board, price 25 cents. The Board is making public all scientific data from enemy sources, but very little of it concerns radio and allied fields, for the reasons cited above. . . .

REPLACE CAPACITORS Faster... Better... at Less Cost



NEW UNIVERSAL MOUNTING TYPE
 Sprague Type LM Atoms for vertical chassis mounting. Replace any screw type can mounting. Fit any chassis hole from $\frac{3}{16}$ " to $\frac{1}{8}$ ". Have separate positive and separate negative leads.

with SPRAGUE ATOMS



NEW CATALOG—JUST OUT!

The finest, most complete and most helpful Sprague catalog ever issued! Contains complete details, dimensions, data, etc. on Sprague Capacitors and *Koolohm Resistors for every service, amateur and experimental need.
 *Trademark Reg. U. S. Pat. Off.

SEE US AT BOOTH 132—CHICAGO SHOW!

- Use them universally for ALL dry electrolytic replacements.
- A small supply equips you for ANY job — any voltage, capacity or capacity combination.
- Order them by name — be sure of getting genuine, factory-fresh Sprague Atoms — the kind that will not let you down.

SPRAGUE PRODUCTS COMPANY
 North Adams, Mass.

JOBGING DISTRIBUTING ORGANIZATION FOR PRODUCTS OF THE SPRAGUE ELECTRIC CO.

June, 1946

103

The model handbook
on technical
broadcasting



By
KINGDON S. TYLER

Construction Engineer of CBS

MODERN RADIO

An extensive and detailed picture of radio from the studio and studio design to such advanced topics as colored television and radar.

This book has the answers to questions like these:

- What is a parabolic reflector?
- Who actually puts a program on the air?
- How can one simulate the sound of marching men?
- Why must a radio tower mast be a certain height to broadcast on a specific wave length?
- Why can a dog hear sounds you can't?
- How can a television camera seem to make a standing-still train move?

These and hundreds of other fascinating topics are clearly explained in MODERN RADIO. Essential reading for everyone in (or who wants to be in) radio.

CBS MAGAZINE: "An outstanding example of the very difficult art of making technical information easily understood."

RADIO CRAFT: "The details of sound conditioning and reverberation control are distinctly interesting to the technician who has not had an opportunity to familiarize himself with broadcasting practice."

JOURNAL OF THE AIR: "The best description available of the physical aspects of radio as perceived in studios."

Illustrated with 28 drawings and 38 photographs \$2.50

ORDER YOUR COPY TODAY!

To **Harcourt, Brace & Co., Publishers**
383 Madison Ave., New York 17, N. Y.

Please send me _____ copies of MODERN RADIO at \$2.50 each.

- I enclose check or money order (we pay postage)
- Please send C. O. D. (plus postage)

NAME _____

ADDRESS _____

Technical
BOOKS

"MATHEMATICAL AND PHYSICAL PRINCIPLES OF ENGINEERING ANALYSIS" by Walter C. Johnson. Published by McGraw-Hill Book Company, Inc., New York. 336 pages. Price \$3.00.

This book is a compilation of material which the author has used during the last six years in his engineering classes at Princeton University.

The book presents the essential physical and mathematical principles and methods of approach that underlie the analysis of practical engineering problems. The text emphasizes basic physical principles and physical reasoning. Considerable attention has been devoted to methods of attack, the use of assumptions, procedures in setting up equations, the use of mathematics as a tool in accurate and quantitative reasoning, and the physical interpretation of mathematical results.

A reasonable knowledge of elementary college physics and mechanics, and mathematics through calculus will be required of the student in order to fully understand the subject matter of this text. The senior engineering student or graduate engineer should derive considerable benefit from this book.

* * *

"CALCULUS REFRESHER FOR TECHNICAL MEN" by A. A. Klaf. Published by McGraw-Hill Book Company, Inc., New York. 421 pages. Price \$3.00.

This book represents a new approach to the study of calculus inasmuch as the "question and answer" method is used to convey the information.

While the text is designed as a refresher for persons with a knowledge of calculus, the book might be used by the student attacking the subject for the first time.

The book is divided into three sections, the first dealing with differential calculus, the second covering integral calculus while the third section outlines the applications of calculus to various fields of technology.

Each chapter includes test problems which the student may work and then check his answers against those given in the appendix. A second appendix supplies much valuable mathematical material in ready reference form.

* * *

"A BUSINESS OF MY OWN" by Arthur E. Morgan. Published by Community Service, Inc., Yellow Springs, Ohio. 167 pages. Price \$1.00.

With the end of the war many persons are considering starting their own businesses and achieving financial independence. That a certain percentage of such ventures should end disastrously is, unfortunately, a foregone conclusion.

This book, which is 100% practical, presents a new approach to the problem. Instead of giving a step-by-step outline of the physical operation of a business, this author has approached the problem from the human angle—which in the last analysis is the reason a business succeeds or fails.

Mr. Morgan deplors the fact that too many people use their business as a toy to be enjoyed and then dropped. He makes a strong plea for a sense of responsibility on the part of the owners.

He has outlined many types of businesses which could be profitable because they render a needed service in an uncrowded commercial field. Too many would-be business men gravitate to overly crowded ventures which are doomed to failure because the community in which the business is located cannot comfortably support several similar enterprises.

The fact that Mr. Morgan spent five years surveying the business opportunities in all parts of the country before writing this resume has enabled him to bring out many important and seldom considered points.

-30-

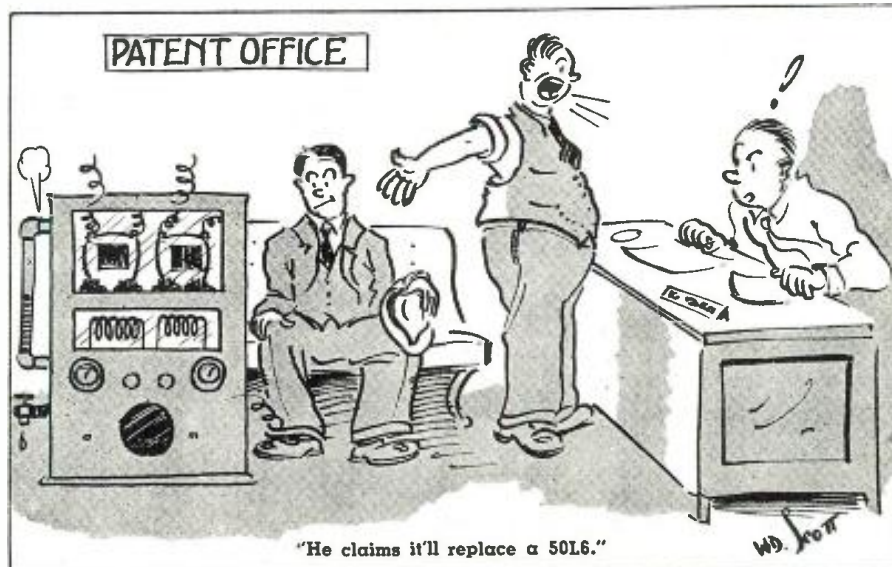

Liberty RADIO and PHONOGRAPH Kits...

6 Tube "Super Het" Radio Kit

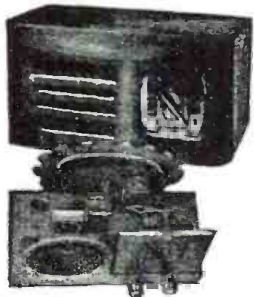

COMPLETE, INCLUDING ATTRACTIVE WALNUT CABINET
All Parts Mounted

To assemble, all one needs is a soldering iron and 30 minutes of your time.

Uses one 25L6—one 25Z6—one 6SQ7—one 6SK7—two 6SJ7's or one 50L6—one 35Z5—two 12SJ7's—one 12SQ7—one 12SK7.

YOUR **\$16.95** LESS
COST TUBES

5 Tube "Super Het" Radio Kit



COMPLETE, INCLUDING ATTRACTIVE BROWN BAKELITE CABINET.
All Parts Mounted

APP SIZE 9x5x6 Inches

Uses one 25L6—one 25Z6—one 6SA7—one 6SQ7—one 6SK7 or one 50L6—one 35Z5—one 12SA7—one 12SQ7—one 12SK7.

YOUR **\$13.95** LESS
COST TUBES

Cabinet supplied in white at \$1.00 extra

Portable Phonograph Kit



ATTRACTIVE COVERED CABINET
COMPLETE WITH MOTOR — PICK-UP —
AMPLIFIER

SIZE: 14 x 7 1/2 x 19

TONE AND VOLUME CONTROLS
Uses one 25L6—one 25Z6—one 6C5.

YOUR **\$24.95** LESS
COST TUBES

PICTORIAL DIAGRAM FURNISHED WITH EACH KIT

We carry a complete line of Radio Parts and Equipment—Contact Department "A" for all items including the "Hard to Procure"

IMMEDIATE DELIVERY • TERMS 10% Deposit with order. Balance C. O. D.

SPECIAL! 5 Tube Super Heterodyne Radio Kit with SLIDE RULE DIAL



Chromium plated chassis—Beautiful Walnut Cabinet—Built in antenna—Dimensions: 6 5/8" x 7 7/8" x 12 3/4".

Uses the following tubes: one 12SA7 one 12SK7 one 12SQ7 one 50L6 and one 35Z5

Pictorial Diagram furnished

Your **\$19.95** Less
Cost Tubes

LATEST POST-WAR APPROVED SIGNAL GENERATOR Model A100

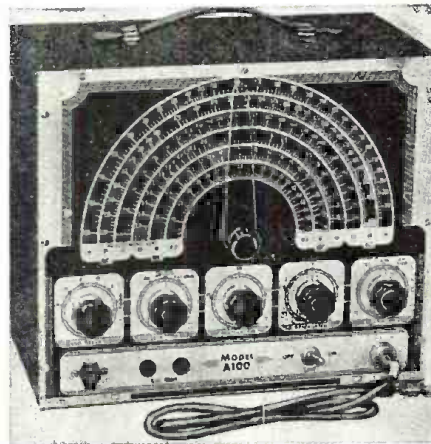

Here it is at last the 1946 Precision Built Instrument you've been waiting for. The Model A-100 Signal Generator is mounted in a heavy gauge steel cabinet, battleship grey crackle finish. Complete with all tubes, connecting cables and instructions — only \$47.00 F.O.B. New York City. Dimensions: 12" x 10" x 6 5/8". Shipping weight: 18 lbs. Multifactor Frequency Dial Scales (Non-glare design). External Modulation possible at from 40 to 30,000 Cycles. Internal Modulation at 440 Cycles (same as W W V Standard). Phase Shift Audio Oscillator and Internal Modulator.

6 RF Bands
A—100 to 310 Kc.
B—320 to 1000 Kc.
C—1000 to 3200 Kilocycles
D—3.2 to 10.5 Mc.
E—10.5 to 26 Mc.
E2—21 to 52 Mc.

A.C. Operation 105 to 120 Volts 50 to 60 cycles. Continuously Variable RF-AF Fine Attenuator Control. Modulation Percentage continuously variable from front panel, internal or external 0 to 100%. Co-Axial Output lead furnished. Pilot light indicator. **\$47.00**

AN EXCEPTIONAL VALUE

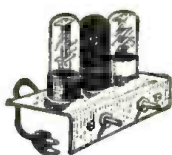

3 tube A.C. D.C. Phono Amplifier Kit—less tubes. with speaker—uses 6C5—25Z6—25L6—your cost

\$5.95

RECORD CHANGER

2 post complete with motor and pick-up
FULLY GUARANTEED
LIST \$37.50
YOUR COST \$22.50

INVERTERS
Converts D.C. Current to A.C. Cap. to 50 W.
YOUR COST \$10.75 EACH

• IMMEDIATE DELIVERY •

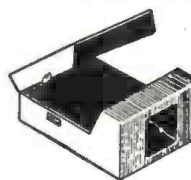

Portable Leatherette Cabinet for Electronic Phonograph. Your cost

\$7.75

Size 7x14 1/2x18 inches

LIBERTY SALES CO., INC.

115 WEST BROADWAY
NEW YORK 13, N. Y.
BARCLAY 7-6063

NEW MODELS
Available Now!
of **ATR**
QUALITY PRODUCTS



ATR
"A"

BATTERY ELIMINATORS

FOR CONVERTING A.C. TO D.C.

New Models . . . designed for testing D.C. electrical apparatus on regular A.C. lines. Equipped with full-wave dry disc type rectifier, assuring noiseless, interference-free operation and extreme long life and reliability.

- Eliminates Storage Batteries and Battery Chargers.
- Operates the Equipment at Maximum Efficiency at All Times.
- Fully Automatic and Fool-Proof



ATR

LOW POWER INVERTERS

FOR INVERTING D.C. TO A.C.

Another New ATR Model . . . designed for operating small A.C. motors, electric razors, and a host of other small A.C. devices from D.C. voltages sources.



ATR

STANDARD AND HEAVY DUTY INVERTERS

FOR INVERTING D.C. TO A.C.

Specially designed for operating A.C. radios, television sets, amplifiers, address systems, and radio test equipment from D.C. voltages in vehicles, ships, trains, planes, and in D.C. districts.

WRITE FOR NEW CATALOG—
JUST OFF THE PRESS!

AMERICAN TELEVISION & RADIO CO.
Quality Products Since 1931
ST. PAUL 1, MINN. U. S. A.

Embossing Sound on Film
(Continued from page 37)

Audiotrol feature operating, this recording time is further extended to many hours or even days of intermittent recording on one 50 foot film.

The sound is permanently embossed on 35 mm. cellulose acetate film which is manufactured to specification by the *Eastman Kodak Company*. The base material is fire resistant, free of abrasive, tough and good for a surprising number of playbacks. It sells for \$1.50 per roll which brings the recording cost down to 15.6c per hour for 9½ hours. No processing of the film is necessary by the user. The film is supplied in a box 10" x 3" x 2" and is usually returned to the box after use for safe storage. It should be noted that permanent storage of the record therefore, presents a simple problem.

The machine has the following structural features:

1. Selection: flip of the switch selection of public address, recording, playback or threading.

2. Continuous recording with automatic track over from groove to groove in the film as required. 115 tracks are permissible on one side of the film.

3. A means is provided for the recording and also the locating of a particular track when desired for playback.

4. A 114 db. gain high quality amplifier is used. Frequency response is 2 db. from 300 cycles to 10,000 cycles. Various input circuits automatically give desirable gains for intended uses. Output impedance 6 ohms. The input and output circuits are listed below.

Input circuits—(not simultaneous) are as follows:

- (a) Microphone—½ megohm impedance, 114 db. gain.
- (b) Radio—½ megohm impedance, 85 db. gain.
- (c) Line Input—1000 ohms impedance, 90 db. gain (d.c. impedance infinity).
- (d) Carbon Microphone—1000 ohms impedance (for 100 or 200 ohm carbon microphones) with self contained batteries.

Output Circuits—

- (a) Self-contained 5 inch permanent magnet speaker.
- (b) 6 ohm jack (interrupting signal to speaker).
- (c) Monitor—Direct connection from playback head.

Volume meter is provided for easy adjustment to correct recording level. Automatic volume control is optional by flip switch and is designed to accommodate 30 db. input signal variation.

The Audiotrol, described above, has a sensitivity control permitting operation on an input signal from 0 to -13 db. based on the required average recording level. This means that the

IMMEDIATE DELIVERY!

2-POST RECORD CHANGER

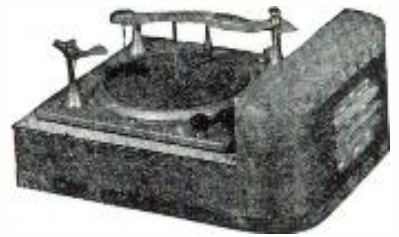

Automatically Intermixes

Record changer completely assembled with amplifier ready to play. Dimensions 8" H x 15½" x 15¼" D. Grilled speaker front, acoustic chamber 15" W. x 4" D. with rear louvre for eliminating cabinet resonance. Genuine walnut cabinet with decal trim, nickel plated mounting hardware, tone and volume control mounted on changer. 6" Heavy duty dynamic speaker. AC amplifier with power transformer. AC power cord and plug. 3 tubes 1—6V6, 1—6C5 and 1—5Y3. \$44.50 Net.

Cabinet less changer and amplifier \$9.50 Net. Accommodates Webster and V-M Changers.

20% Deposit required on all orders.

UNION Radio Corporation

328 S. Paulina • Chicago 12, Ill.

AMATEURS AND RADIO REPAIRMEN

We appreciate your bearing with us on the delay in deliveries, but hope you remember we accepted no orders for material we could not deliver.

Parts are coming in more freely now so the percentage of 100% filled orders is increasing. Thanks again.

EXCLUSIVE DISTRIBUTORS FOR STROMBERG-CARLSON AMPLIFIERS

Stanton Radio Supply

W9PSP W9JKE
521 State St., HAMMOND, INDIANA

Phone 2314



JOE MACJERK'S
STICKING HIS
FINGERS IN HOT
TELEVISION SETS
AGAIN!

LAST TIME
THE BOSS SWORE
HE'D CUT JOE'S
SALARY AND BUY
"RADIO
MAINTENANCE"
FOR HIM!

VIC TURNER

For
optimum
performance
in the
service
field
USE
Radio
Maintenance
Magazine.

*Special offer to
Radio Servicemen*

Articles monthly on:

- Television — AM — FM
- Public Address Systems
- Test Equipment — Tools — Service Kit
- Shop Layout — Service Bench
- Trouble Shooting
- Business News

**Radio Maintenance
is not sold on
newsstands**

**RADIO MAINTENANCE MAGAZINE
460 BLOOMFIELD AVE., MONTCLAIR, N. J.**

Please send me
RADIO MAINTENANCE

- For 1 year 2.00
- For 2 years 3.00

NAME _____

OCCUPATION _____

ADDRESS _____

CITY _____

ZONE _____ STATE _____

- CHECK ENCLOSED*
- BILL ME LATER

*NOTE: By enclosing payment,
thus eliminating billing expense
WE WILL ADD ONE ISSUE FREE!

RNS

MID-AMERICA COMPANY

RADIO SHOW Stevens

**RADIO DEALERS
JOBBER
WHOLESALE
PURCHASING AGENTS
MANUFACTURERS
QUANTITY BUYERS**

Don't miss the BIG SHOW at Radio Bargain Headquarters—the Mid-America Company—just a few minutes ride from the Stevens Hotel! Come in and see 50,000 square feet of floor space jammed to the ceiling with top quality Radio Parts, Supplies and Equipment of every kind—Tubes, Condensers, Resistors, Meters, Transformers, Controls, Switches, Relays, Filters, Generators, Microphones, Speakers, Test Equipment, Tools and thousands of Radio needs. All standard lines are here for your selection including nationally-known makes and brand names that have been famous in radio for over a quarter of a century... and all at amazing low BARGAIN PRICES!

WHOLESALE ONLY

Come on Over and See Thousands of Values Like These

Volume Controls.....\$5.00 per 100 and up
 5-Watt Resistors.....\$4.00 per 100 and up
 10-Watt Resistors.....\$7.00 per 100 and up
 25-Watt Resistors.....\$15.00 per 100 and up
 Push Button Switches, Gang Type.....\$9.00 per 100
 Deck Switches.....\$9.00 per 100
 Micro Switches, Ass't'd sizes and types, \$21.00 per 100
 Power Rheostats.....25c and up
 F. P. Can Condensers, 15-15, 450 Volts.....55c each
 F. P. Can Condensers, 30-15-10, 250 Volts.....58c each
 Tubular Condensers, .001 to .004.....\$4.25 per 100
 Meters, nationally-known makes.
 Antennas, variety of sizes and types.

TUBES

Transmitting Tubes

HK24G	15E	957	1624
HY615	15R	958A	1625
RK34	114B	9002	1635
2X2/879	211	9003	1960
3D21A	801A	9004	VR90
5CP1	803	1201	VR150-30
3BP1	830B	1203A	1H20 Ballast
6C4	955	1613	

Receiving Tubes

1S5	688	12C8	12SJ7
6AC7	6H6	12H6	12SH7
6AG7		12SG7	6J5

OPEN 8:00 A.M. TO 5:00 P.M.

Easy to get to by taxi or southbound Archer Avenue street car. Visit us whenever in town—or write, wire or phone us anytime for anything in radio.

MID-AMERICA CO.

2309 S. Archer Avenue

Phone VICTory 7820 • Chicago 8, Illinois

signal to noise ratio of the incoming signal should be 20 db. for really good operation.

5. Frequency Response—input-to-recording-to-output-on-playback 300 to 4500 cycles on the standard machine. 5000 cycle and other special machines have been produced to order.

6. Recording Head—balanced magnetic type, sealed against dirt, having an impedance of 9000 ohms at 1000 cycles-per-second.

7. Playback Head—balanced magnetic type, sealed against dirt, having an impedance of 9000 ohms at 1000 cycles-per-second.

8. Stylus—both Playback and Recording styli are of special design and are of the permanent sapphire type.

9. Mechanical—design is such that permits of ready accessibility for replacement and service.

(a) Bearings—Oilite.

(b) Motor drive — self-aligning sleeve bearings, shaded pole induction motor with dynamically balanced rotor.

(c) Machine divided into three main parts, carrying case, mechanical frame and amplifier. Simple and easy to separate.

10. Monitor — the monitoring method in the *Recordgraph* is greatly appreciated by all professional recording men, for the actual recording as embossed in the film belt is played back as against the usual method of tapping directly across the recording head. Thus a true picture of the actual recording is had.

The recorder is currently being used for police communications recording.

Rack model with multiple mixer and dual *Recordgraph* units which will record continuously for 19 hours and intermittently for many days without supervision.

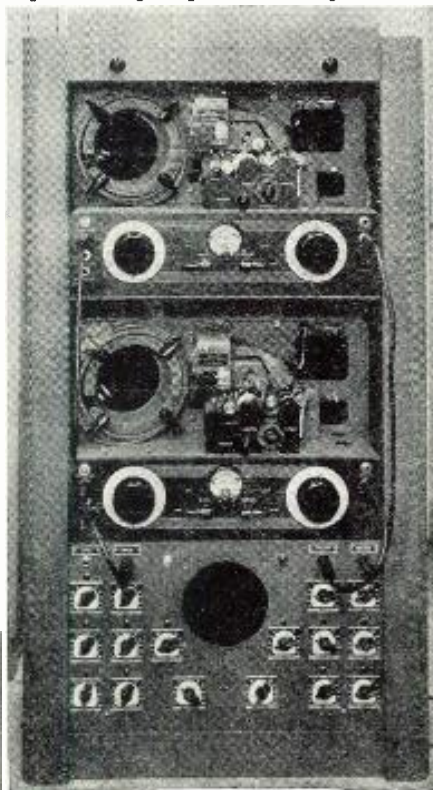

authorized telephone recordings, investigations, conferences, radio interception, sound analysis, training purposes, narration, at control centers, on ships, for mobile equipment, and wherever else permanent recording of sound, speech or code may be wanted.

-50-

Photo-Electronic Organ

(Continued from page 27)

a rubber belt or endless V belt would also work. If a leather belt is used, the splice should be sewed with thread, as this will be found more satisfactory than a wire splice.

The octave assembly and keyboard slides into the cabinet along two supports and is held in place by tightening two bolts attached to wood clamps. See Figs. 2 and 5. This type of construction facilitates removal for service and adjustments.

Speakers were mounted in separate cases, but they could easily be mounted in the cabinet if desired. There is a disadvantage in mounting them in the cabinet; trouble may be experienced from feedback, and for this reason it is desirable to mount them separately. Most commercial installations of instruments of this type require separately mounted speakers.

Almost any high-gain amplifier with a power output of 15 watts or more may be used with the Photo-Electronic Organ. The connections from photocell to amplifier are standard practice and are shown in Fig. 3B. Voltage on the 868 or 918 phototube must be kept at 90 volts or below by means of a suitable voltage divider network which can usually be coupled to a screen voltage circuit. It is desirable to include provision for radio and phono pickup in case these are not already included in the mixer circuits of the amplifier used. Of course, a home constructed amplifier can be used, and perhaps some advantage gained, since the construction of a suitable amplifier presents no special problems. One thing to avoid in the amplifier is microphonics, and, to avoid the possibility, it is desirable to mount the entire amplifier on a piece of sponge rubber rather than to fasten it directly to the cabinet.

As will be noted by referring to the diagram, Fig. 3A, the power supply for the lights really consists of two separate supplies wired in series. In building this power supply, use power transformers and chokes that will carry the heavy current, as the output requirements are 250 ma. at 575 v.d.c. to light the five 25 w. 115 v. lamps. Using bakelite for the chassis base rather than metal will help to prevent shorts and unwanted grounds. Since one power supply is to be operated at a high potential from ground, it is also well to use caution in touching any of the parts when the current is turned on. Filtering, as shown, was found to be adequate to suppress hum,

A MUST Book for Amateur and Serviceman

TWO-WAY RADIO

By
SAMUEL FREEDMAN
Commander S(E)T, USNR

506 Pages of Facts!

MECHANICS — EQUIPMENT — APPLICATIONS
with studies of actual installations

No radio man's technical library can be without this complete text on two-way radio. TWO-WAY RADIO covers the mechanics and applications of two-way radio for all forms of fixed, mobile and portable communication. It is written in non-mathematical form and in language easily understandable by users or intended users of this type of equipment. An excellent guide for serviceman and radio amateurs, as well as engineers, executives, and planners who are interested in a detailed analysis of the applications and equipment in this field.

Answers all questions

TWO-WAY RADIO gives concrete answers to your practical questions: How is it used? What are the potentialities of two-way communication? Is it efficient? Is it economical? What types are best suited for specific uses? What are the technical requirements? What are the licensing regulations? Here, in accurate, complete, and useable form is the data you need for these and a host of other pertinent questions—the basic technical information which will enable you to keep pace with the fast-coming developments in two-way radio communication.

Graphically illustrated

Included in TWO-WAY RADIO are 87 informative illustrations—charts, diagrams, and photographs of equipment and installations, carefully chosen by the author to illustrate his twenty chapters of text material.

The opening chapters are devoted to planning of two-way radio and details of equipment, power supply, mobile and fixed stations, and proper antenna systems. Then follows a detailed analysis of AM and FM equipment, radio and guided carrier systems, and a full discussion of microwaves. Latter chapters describe two-way radio communication as used by railroads and police, fire, highway and forestry services; also marine and aeronautical applications, and personal use by radio amateurs and private citizens. There is ample information on maintenance, repair, and trouble shooting, a full chapter on licenses and regulations, and a description of typical installations by states, communities and border patrol.

**Price \$5.00. Use convenient coupon
with full return privileges**

ZIFF-DAVIS PUBLISHING COMPANY
185 North Wabash Avenue, Chicago 1, Ill.

June, 1946

Newly Published!
Fully Illustrated!

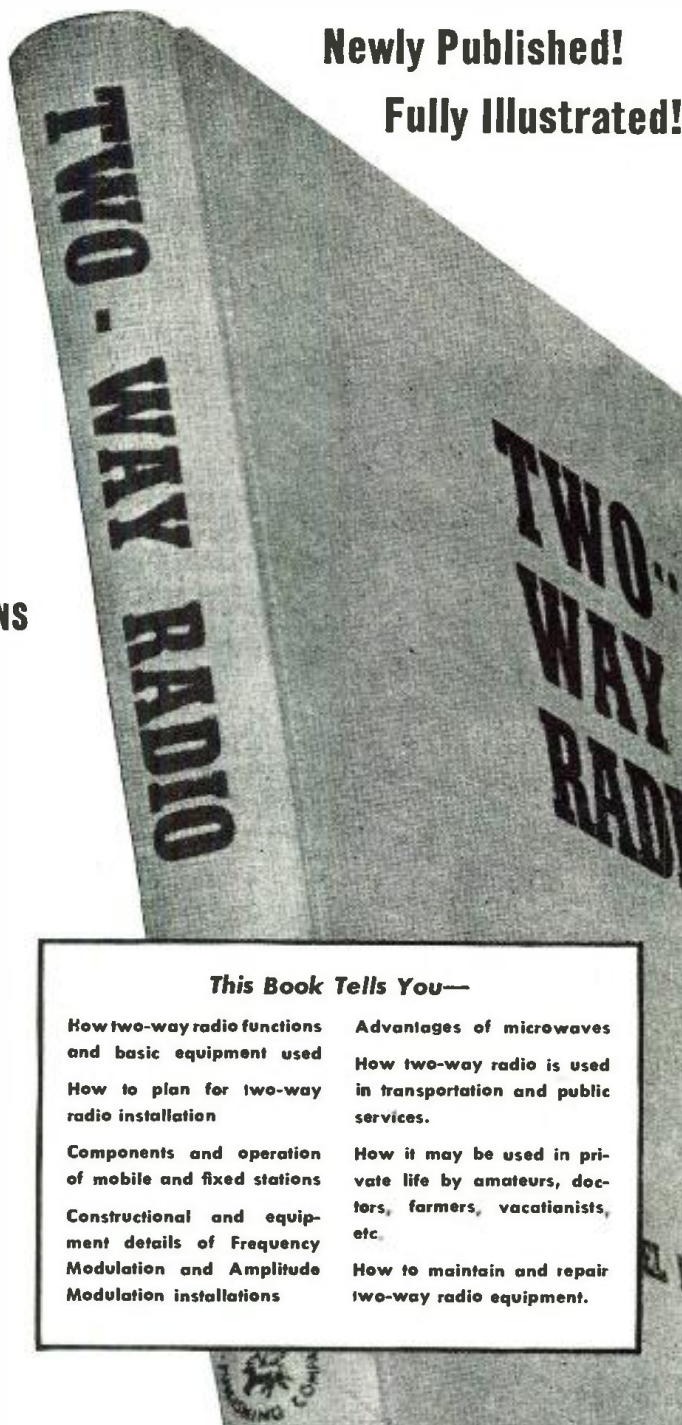

This Book Tells You—

- | | |
|---|--|
| How two-way radio functions and basic equipment used | Advantages of microwaves |
| How to plan for two-way radio installation | How two-way radio is used in transportation and public services. |
| Components and operation of mobile and fixed stations | How it may be used in private life by amateurs, doctors, farmers, vacationists, etc. |
| Constructional and equipment details of Frequency Modulation and Amplitude Modulation installations | How to maintain and repair two-way radio equipment. |

MAIL THIS COUPON TODAY

ZIFF-DAVIS PUBLISHING COMPANY
185 North Wabash Ave., Chicago 1, Illinois

I am enclosing \$5.00 (check or money order) for which please send me one copy of TWO-WAY RADIO. I understand that I may return book within five days for full refund if I am not entirely pleased.

Name.....

Address.....

City.....Zone.....

State.....

R N 646

ELECTRICITY

FOR RADIO AND ELECTRONIC APPLICATIONS



• ONAN ELECTRIC GENERATING PLANTS supply reliable, economical electric service for electronics applications as well as for scores of general uses.

Driven by Onan-built, 4-cycle gasoline engines, these power units are of single-unit, compact design and sturdy construction. Suitable for mobile, stationary or emergency service.

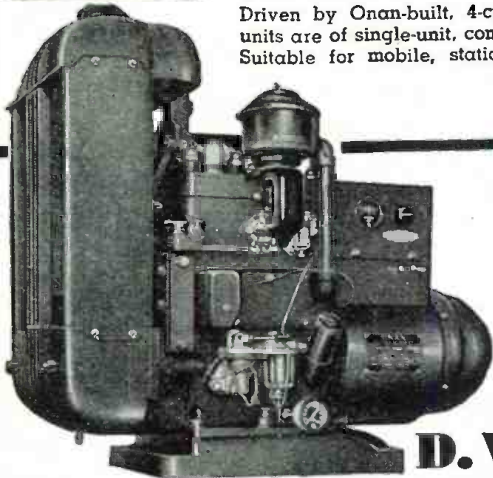

Models range from 350 to 35,000 watts. A.C. types from 115 to 660 volts; 50, 60, 180 cycles, single or three-phase; 400, 500 and 800 cycles, single phase; also special frequencies. D.C. types range from 6 to 4000 volts. Dual voltage types available. Write for engineering assistance or detailed literature.

Model shown is from W2C series, 2 and 3-KW, 60-cycle, 115 volt, powered by water-cooled 2-cylinder engine.

D. W. ONAN & SONS

2173 Royalston Avenue

MINNEAPOLIS 5,

MINN.

UNIVERSAL Model 501 RADIO TUBE TESTER

PRECISION ELECTRONIC INSTRUMENTS

Advanced Styling — Finest Quality Materials and Workmanship.

Designed to give lasting service and priced to **SAVE YOU MONEY.**

WRITE TODAY for SPECIFICATIONS and PRICES.



Please rush me full details and specifications on UNIVERSAL Radio Service Instruments.

Name.....

Street.....

City.....

UNIVERSAL INSTRUMENT CO.

306 E. McMILLAN STREET

CINCINNATI 19, OHIO

Photo Electric Unit

For numerous control applications such as burglar alarms, industrial safety controls, automatic counters and in conjunction with a chime or bell to announce entrance of people in stores and offices. For A.C. Complete with all tubes and SPDT control relay.

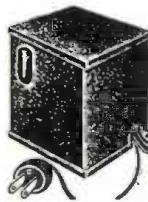

\$9.45

LIGHT SOURCE—Up to 15 feet. For use with above unit.

Net

\$5.95

Write to Dept. RN

ADSON RADIO CO.

221 FULTON ST., NEW YORK 7, N. Y.

PRE-EXAM TESTS for FCC COMMERCIAL RADIO OPERATOR EXAMINATIONS

Determines your weak points—Enables you to brush-up before taking the FCC exam. Prepared by A. R. Nilson, famous co-author Nilson & Hornung's RADIO OPERATING QUESTIONS AND ANSWERS.

CLEVELAND INSTITUTE OF RADIO ELECTRONICS
RN-6 Terminal Tower Cleveland 13, Ohio

Specify SAUERISEN ACIDPROOF CEMENTS—COMPOUNDS FOR

Tanks, Sewers, Stacks, Floors
Technical cements for all purposes.

Send sketches or samples

Sauereisen Cements Company · Pittsburgh 15, Penna.

but a single choke and two filter condensers may be adequate if suitable high-voltage condensers are available, such as 10 μ fd., 1500 volts. The voltage drop across the lights should be 575 volts, and it may be necessary to add a series resistor if voltages are too high. However, in the model we built, no series resistance was necessary. There is a lot of voltage drop due to the heavy load and filter condensers and other parts must be able to withstand the high voltages developed in case the load is suddenly removed when one of the bulbs burns out or for some other cause. The open-circuit voltage may go as high as 1100 volts so the filter condensers should be rated at 550 volts peak, 450 w.v. Connections to the lamps should be carefully made with wire having adequate insulation (do not use ordinary pushback wire), and special precautions should be taken to avoid any possibility of shock. It is well to cover exposed parts with a heavy coating of insulating varnish or paint. No specific details are given for mounting parts as this will depend largely on what is available. Since considerable heat is developed, it is well to arrange for ventilation and also to allow sufficient spacing between parts to insure adequate cooling. A good rule to follow is to pull the plug before making any adjustments on the lights. This precaution may save getting a serious shock or bad burn.

(To be concluded next month)

International Short-Wave

(Continued from page 49)

Dock, New South Wales, Australia, is short-wave editor of "Radio and Hobbies," and Roy Hallett, 36 Baker Street, Enfield, New South Wales, Australia, is the BCB editor.

* * *

AFRS Network in Japan

Upon his recent arrival from Japan, Jack Hartley, ex-2LMX, Hawthorne, New Jersey, formerly a transmitter man at WVTR, Tokyo, sent your short-wave editor this information on the AFRS Network in Nippon:

"WVTR and the 15 other AFRS stations are on the air continuously from 6:30 a.m. to 11 p.m. Tokyo time (4:30 p.m.-9 a.m. EST). All programs are the same, and are relayed on 6.015 from 4:30 p.m. to 2:30 a.m. EST, and are on 3.075 from 2:30 a.m. to 9 a.m. EST. Here is a complete list of calls, locations, and frequencies of this network:

"WVTR, Tokyo, 590 kcs., 6.015 (daytime in Japan), and 3.075 (nights in Japan); WLKF, Kumamoto, 1400 kcs.; WVTQ, Osaka, 1310 kcs.; WLKE, Sendai, 1370 kcs.; WVTC, Nagoya, 1340 kcs.; WLKD, Sapporo, 1420 kcs.; Tsuruga, 1180 kcs.; Okayama, 1480 kcs.; Matsuyama, 750 kcs.; WLKH, Kure, 1440 kcs.; WVTO, Omura, 1450 kcs.; WLKI, Fukuoka, 1360 kcs.; WLKB, Niigata, 1430 kcs.; WVTH, Hackinohe,

720 kcs.; WLKA, Kanoya, 1490 kcs.; and Aomori, 1440 kcs.

"While in Tokyo, I had other contacts with both Army and commercial set-ups, and several other interesting stations to listen for are:

"F3A, 18.75, Hongkong, American Broadcasting Company relay to San Francisco; KWQ3, 15.925, Tokyo, SIG-PAC relay to Manila; KU-1-M, 17.760, Tokyo, ABC relay to San Francisco; KU-1-M, 10.585, Tokyo, ABC relay to Los Angeles (on from 9-11:30 p.m. EST daily).

"Whenever the ABC network wishes to relay programs to the United States from Japan, they use the above set-ups. Also of unique interest is the SSB circuit which runs 24-hours-a-day from Tokyo to San Francisco. It is operated by the 4025th Signal Service Group and terminates at A. T. & T., San Francisco. They, naturally, have a return circuit back to Japan. SSB means 'single side-band,' which the amateurs are just now hearing about. I feel that, in time, SSB circuits for hams will be commonplace. Over this circuit (KWN is the Tokyo call), seven teletype messages and two clear channels for radiophoto or voice are sent out simultaneously. If the band-spread is used and the signal tuned out at the h.f. end, you can invariably pick up the conversations. You can tell an SSB signal since it resembles a vacuum cleaner in noise on a regular receiver. You'll hear signals like that all over the bands. There are only two stations in the Pacific—Tokyo and Manila—other than terminals at San Francisco, and they operate 24 hours a day, using various frequencies. At 4 p.m. EST, 18.490 is used; at 1 a.m. EST, we changed to 7.465, and at 6 a.m. EST, we used 12.870. In case of any of these were noisy, alternate frequencies of 10.065 or 15.050 were used.

"One series of stations mentioned in your January ISW is also operated by the Signal Corps. JVT, 6.750, JLS, 9.655, and JVP, 7.510, are operated by a group of men living on a 75-ft. ship docked against a seawall outside Tokyo. The circuits are known as the *Green Hornet* series and are 3-kw. set-ups. In the January issue of *RADIO NEWS* there was an article ("The Signal Corps On-and In-the Air") about our unit entering Japan, and Lt. F. Russel Hyde, Elmira, New York, was mentioned. He started the *Green Hornet* and received his direct commission for action in the Leyte invasion in October, 1944. Another D-C was Lt. Paffenberg, and he now operates the *Green Hornet*.

"The SSB circuit is also located on these 75-ft. ships; they are W.E. 1-kw. units and employ a 55-foot vertical (with arcs all over the metal railings of the ships)."

* * *

International Short-Wave Schedules

ALASKA—WXFG, 12.555, Adak, Aleutians, relays irregularly, 7:55 p.m.-1 a.m.

ALBANIA—ZAA, 7.852, announcing

June, 1946

Scoop!

BRAND NEW STANDARD R M A 4 PRONG REPLACEMENT VIBRATOR

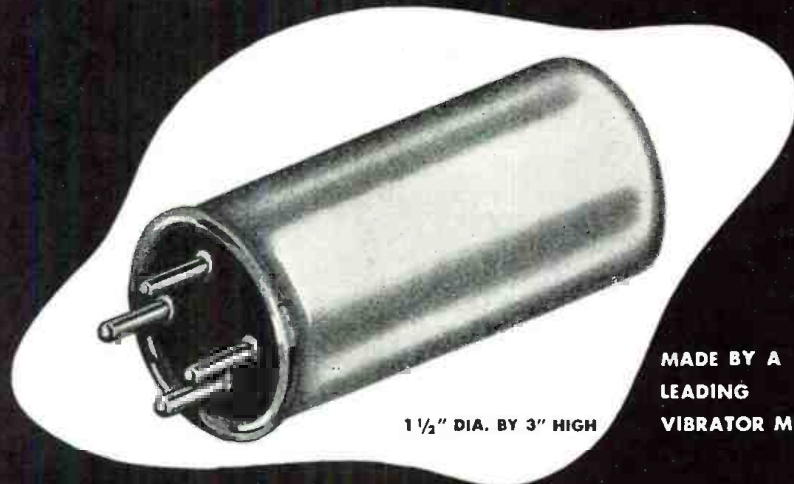

1 1/2" DIA. BY 3" HIGH

MADE BY A
LEADING
VIBRATOR MFR.

NOW... FILL YOUR SUMMER
REQUIREMENTS AT THIS LOW PRICE

\$1.19
each

\$1.10
each } in lots
of 25

EXTRA SPECIALS

STANDARD
TUBULAR CONDENSERS
JOHN FAST & CO.

.02 mfd - 600 VOLTS

Only \$9.00 per 100

STANDARD MOLDED
BAKELITE PAPER
CONDENSERS
MICAMOLD

.01 mfd - 400 VOLTS

Only \$9.00 per 100

Standard RADIO & ELECTRONIC
PRODUCTS COMPANY

135 E. SECOND STREET • DAYTON 2, OHIO

MAIL ORDERS GIVEN PROMPT ATTENTION

WRITE US FOR INFORMATION ON ALL PARTS

20% DEPOSIT ON ALL MAIL ORDERS

Cyclohm

POWER PLANTS



An opportunity
for
**DISTRIBUTORS
AND DEALERS**

- PORTABLE
- ALL-PURPOSE

Cyclohm Power Plants, which proved their dependability and popularity with the Armed Forces of the Allied Nations, are now available for civilian use. Valuable distributorships and dealerships are open which offer a fine opportunity to sell these plants . . . powered by Briggs & Stratton air-cooled gasoline engines . . . embodying the most advanced features of power unit design . . . known for their efficient, dependable performance as LIGHTING PLANTS (portable or stationary) for homes, boats, fisheries, farms, mines, camps, etc. . . . BATTERY CHARGERS for mechanized equipment, industrial works, radio, farms, boats, mobile repair plants, truck fleets, etc.

When you sell Cyclohm units, you sell the best . . . powerful flywheel-blower air cooling . . . moisture-proof and dust-proof ignition . . . easy output control over a wide range . . . Formex insulation . . . and many other features. Write for details on exclusive representation in your territory.

ATLAS AIRCRAFT PRODUCTS CORPORATION
5-17 Forty-Sixth Road, Long Island City 1, N. Y.

AMAZING 12 FOOT PORTABLE

RADIO ANTENNAS

Real \$15 value now only \$3.95 POST PAID

FOR HOMES, BOATS or AUTOS

Just released Government surplus same as used on Army tanks. These telescopic RUSTPROOF antenna have a tremendous pickup and eliminate dangerous wiring. Made of Solid Brass throughout which practically insures

NOISE FREE RECEPTION.

12 exceptionally rugged sections
compress into 1 ft. 4 in.

Handy for Camping Trips, also Useful
for Transmitting Sets, FM Sets and
Television Receivers

Each antenna comes with clamps, nut, lug, and
wire. Easy to install anywhere.

QUANTITY LIMITED.

ORDER TODAY. A real \$15 value for only
\$3.95 Postpaid.

Send check or money order now.
Money back in 10 days if not satisfied.

RADIO HOSPITAL

1113 LEXINGTON AVE., DEPT. R NEW YORK 21, N. Y.



as *Radio Tirana*, has recently been audible in the East from fade-in around 3 p.m. (with S. European languages) to new sign-off at 4:15 p.m. (with anthem); uses about 12-note interval signal. Reaches Australia with fair level.

ALGERIA—THA (announced), 12.116, Algiers, 11:23 p.m.-1:30 a.m. and 12 noon-6 p.m.; good signal in East; this was formerly *Radio France* and is reported as announcing now as *Radio Algerie* as well as THA. "The Voice of America in North Africa," 11.765, is scheduled 6 a.m.-12 noon, usually with English news on the hour; good signal in East; the 6.025 frequency usually has good signals afternoons, schedule is 1:20-6 p.m.

ANDORRA—*Radio Andorra*, 11.985, is heard on this new frequency in parallel with 5.997, 9 a.m.-2:30 p.m.

ANGLO-EGYPTIAN SUDAN—*Radio Omdurman*, 13.320, heard best in Arabic, 2-2:30 p.m., but with severe interference; is also heard with recorded music and English announcements to sign-off at 4:04 p.m.; QRM is from carrier-shift station. Has English at 12:30 p.m. Thursday only.

ARGENTINA—The Argentine returned to Standard Time in February, making all schedules one hour later here, *except* the Friday broadcast for abroad, sponsored by the government at 4-4:30 p.m. over LRA5, 17.720. A station heard on 6.180 at 11:55 p.m. is reported as LRA2. LRX1, 6.120, Buenos Aires, is good early evenings.

AUSTRALIA—North American transmissions are: First Transmission (East Coast beam)—VLC5, 9.54, Shepparton, 8-8:45 a.m., news at 8:01 and 8:35 a.m. Second Transmission (West Coast beam)—VLC6, 9.615, Shepparton, 11-11:45 a.m., news at 11:01 and 11:35 a.m. Third Transmission (East Coast beam)—was resumed on March 18 and is being carried this year on VLC9, 17.84, Shepparton (instead of VLC4, 15.315, Shepparton), and is heard 6:40-8:45 p.m. (from 6:30 p.m. in tone), with news at 6:45 and 8:30 p.m.; signals in the East are best towards end of program; tested for a few nights on VLA4, 11.77, and VLC7, 11.84 (inaudible in most parts of the East and on West Coast), then returned to 17.84. Fourth Transmission (West Coast beam)—now comes on 10 minutes earlier than before, is heard 12 midnight-12:45 a.m. over VLC4, 15.315, Shepparton, and VLG6, 15.23, Melbourne, replacing VLC7, 11.84, Shepparton, and VLG3, 11.71, Melbourne; news is at 12:15 a.m.; good signals both West and East. VLR2, 6.150, Melbourne, is scheduled to 8:30 a.m. daily *except* Saturday when sign-off is at 9 a.m.; carries news at 8 a.m.; is poor to inaudible in East. VLH3, 9.58, Melbourne, usually has a good signal in English news at 7:30 and 8 a.m. VLQ2, 7.215, Brisbane, is good around 7-8 a.m. VLA6, 15.20, and VLG3, 11.71, broadcast an all-Japanese program to Japan now, 2:30-3:30 a.m. VLW7, 9.52, Perth, Western Australia, one of Eastern listeners' most distant s.w. stations, is still coming through nicely mornings here in the East, is heard 5-10:30 a.m., *except* Saturday when sign-off is at 10:45 a.m.; news is scheduled for 6, 8, and 10 a.m.

AUSTRIA—"Voice of Vienna," 6.002, is reported to be an AFRS station heard with English news at 6:30 p.m. through bad QRM. KOFA, the AFRS at Salzburg, has shifted to 7.221 and now identifies with medium-wave stations (sometimes the call heard is KOSA) as the Blue Danube Network; is heard well at sign-off at 6:33 p.m. and sign-on at 1 a.m. *Radio Vienna* has shifted its 30-meter relay to 9.911 and the 24-meter relay to 12.200.

AZORES—Australians report *Emissora Nacional*, 7.017, Ponta Delgada, 3-4 p.m., but it may be off by this time in favor of a summer schedule on 11.090, 3-4 p.m.

BAHAMAS—ZNS2, 6.095, Nassau, is currently off the air; its medium-wave outlet (ZNS) will move from 640 kcs. to 1540 kcs., no date for move has been set. ZFO, 6.250, Cat Cay, was heard Friday at 12 noon testing.

BECHUANALAND—H. Eksteen, Pretoria, South Africa, reports ZNB, 5.88 (listed as 5.900 with 200 watts power), Mafeking, 1:55-2:30 p.m., with good strength in South Africa. (Bechuanaland is a British protectorate between the Transvaal and S. W. Africa.)

BELGIAN CONGO—OTM2, 9.350, Leopoldville, was being heard to 9:45 p.m., from 8:15 p.m. with BBC relay, but has not been reported with this service lately; OTM2, however, has been reported at 9 p.m., announcing as OTM and

referring to the transmission as a test. OTC2, 9.741 (listed by the BBC as 9.745), Leopoldville, opens its English broadcast to North America at 7:15 p.m. with English news; further news is scheduled for 8:10 p.m., then relays BBC's North American Service from 8:15-9:45 p.m. sign-off; signals are good in most parts of the Western Hemisphere. A good signal is received daily from OTC5, 17.770, Leopoldville, scheduled 5-9:30 a.m., 11:30 a.m.-1 p.m., with English news at 8:30 and 11:30 a.m.

BELGIUM—Swedish sources report Brussels on a new channel, 9.670/9.675, at 12 noon. In the East, it is reported that Brussels has been heard weakly with a new transmission to Leopoldville daily, 2:30-4:30 p.m. on this new frequency (reported in U. S. as 9.667).

BORNEO—Australians report *Radio Balikpapan* on an announced frequency of 9.125, heard opening at 7 a.m., takes the relay from PCJ, 15.22, Hilversum, Holland, at 8 a.m. Recorded music is played until time of relay, closes at 9:30 a.m. This 125-watt is fair level in Australia and New Zealand.

BRAZIL—PPQ, 11.680, Rio de Janeiro, is reported heard at 7 p.m. with network pickup for New York. The following are official schedules of Brazil's domestic short-wave stations (exclusive of the international outlets, PRL7, 9.720, 4:30-6 a.m., 3:10-9:30 p.m.; and PRL8, 11.720, 1:15-3:10 p.m., and to North America in English, 9:30-9:52 p.m., except Saturday and Sunday, news at 9:35 p.m.): PRJ4, 4.825, Parnaiba, 500 watts, 3-10 p.m.; PRC5, 4.865, Belem, 2 kw., 6-7, 9-11:30 a.m., 3:30-8 p.m., except Sunday; PRF6, 4.895, 250 watts, irregular schedule; PRI3, 6.000, 5 kw., 5:45 a.m.-12 noon, 3-9 p.m.; PRA8, 6.016, Recife, 5 kw., 8 a.m.-12 noon, 2-10 p.m.; ZYB7, 6.095, Sao Paulo, 25 kw., 4-9:30 p.m., is interchangeable with 11.765; PRE9, 6.105, Fortaleza, 2 kw., 9 a.m.-12 noon, 3:30-9 p.m., and irregularly on 15.165; ZYC8, 9.610, Rio de Janeiro, 25 kw., 3-10 p.m.; ZYB8, 11.765, Sao Paulo, 25 kw., 8-11:30 a.m. ZYC8 and ZYB7 are heard best in the U. S.

BRITISH GUIANA—ZFY, 6.000, Georgetown, is scheduled 5:45-7:45 a.m., 9:45-11:45 a.m., and 2:45-7:45 p.m., with BBC news relay at 6 a.m., 11 a.m., 3 p.m., and 5:45 p.m., and Caribbean news at 7:30 a.m., 11:30 a.m., and 7:30 p.m.; signal is excellent in the East, but there is usually a bad hetrodyne; is heard fair on West Coast, especially mornings.

BRITISH SOMALILAND—*Radio Somali*, 7.126, Hargeisa, signs off some days at 10:30 a.m., others at 10 a.m.; sign-on is 8:30 a.m.; peak is around 9:45 a.m.; has English and dialect programs, announces as "Radio Somali," occasionally as "Radio Somaliland."

BULGARIA—*Radio Rodina*, 9.345, Sofia, may have replaced 9.330 which has not been reported lately; due to fine signal strength, comparable to Belgrade, it is believed to have in-

DIELH HEAVY DUTY PHONO MOTORS. 110 V. 25 cycle, 78 RPM, self-starting, 3 3/8" below mtg. plate, less turntable. Shpd. Wt. 8 Lbs... \$5.95



MONTHLY SPECIALS

VICTOR POWER TRANS. for mods. R-32, 45, 52 & 75 (un-shielded)... \$5.95

SELSYN MOTORS, 115V. 60 cycle synchro-transmitters only (3/4 x 5/2")	\$3.95
Selsyn pick-up assembly	.49
RELAYS, 115V. DC, D.P.S.T., 50MA, 425 ohm coil, norm. closed	.98
115V., DC, D.P.S.T., 25 amp. contacts, 3500 ohm coil, norm. open	.98
115V. DC, D.P.S.T., 3 amp. contacts, 8000 or 170 ohm coil	.69
YAXLEY CONTROLS, 100,000 ohm	.39
400 ohm, W.W. with switch	.49
YAXLEY SWITCHES, 2 gang. 2pt, shorting	.39
WESTON mod. 301; % modulation (0-50V, rect. type), 1000 ohm/V. 3/2" bakelite	5.95
WESTON SHUNTS-MULTIPLIERS, 90 ohms	.39
6M, 10.8M, 12.5M, 18M, 100M, 150M, 375M, 400M	.39
RESISTORS, Weston 1% Precision, 135M, 180M, 200M, 250M, 450M, 500M, 600M, 750M, 800M, 1, 3, and 4 Meg.	12 for 1.50
120 ohm—25 watt, W.W., slider	.29
450 ohm—100 watt	.49

CQ AMATEURS, bakelite coil forms, 15 assorted sizes	\$1.00
Wafer sockets, 12 asstd. (4 to 7 prong)	.25
Trim 2000 ohm earphones	1.75
W.E. platinum point key & buzzer	1.75
W.E. platinum point key only	.49
Ceramic coil forms, ribbed & grooved, 5" or 6" L., O.D. 2", 3/16 wall	.19
Magnavox carbon mike, single button, press-to-talk	1.49

CRYSTAL SET KIT, compl. with slider coil & isolantite base det.	\$1.95
Coil only (1 1/4" x 5/4")	.69
Brass bar & slider for coil	.39
Isolantite Base-detector with galena crystal	.79
EXPERIMENTAL TUBES, 20 asstd. sizes & base types, filament tested	1.00
16" N.B.C. RECORDS, (33 1/3 RPM), ea. record contains 2 compl. 15 min. "Voice of The Army" programs, music & drama. Titles such as: "Career of Alice Blair" with Martha Scott, "Someone to Watch Over Me" & "Report from Overseas," etc.	.29

ALNICO MAGNETS, #1-bar, 8/2" x 1/4" x 1/8" \$0.39
 In shorter lengths, 9c per inch
 #2 High Polished, 7/8" x 9/16" x 3/8" .39
 #3 1 1/16" x 9/16" x 9/16" .39

PHONO PARTS; Crosley tone arms for crystal or mag. pick-ups	\$0.98
8" turntables, 3/8" shaft hole, flocked 89c, unflocked	.49
12" turntable felts	.23
TUBES, perfect condition, but not in sealed cartons. Guaranteed 90 days: #27, 46, 56, 66	.29
#50, 120, 6A3	.69

Write Dept. RN-6
PROMPT SERVICE ON ALL SPEAKER AND PHONO PICK-UP REPAIRS
MINIMUM ORDER \$2.00

LEOTONE RADIO CO.
 MAKERS OF CONES AND FIELD COILS
 65-67 DEY STREET, NEW YORK 7, N.Y.
 WORTH 2-0284-5
 12,000 SQ FT OF RADIO PARTS

20% DEPOSIT REQUIRED ON ALL ORDERS
WRITE FOR BETTER PRICES ON ALL QUANTITY PURCHASES

Power Transformer: 2.5V, C.T.; two 5V, C.T.; 7.5V, C.T.; 300V, C.T. at 150 MA. Fully shielded, upright mtg. 3/4" x 3/4" x 4 3/8"	\$1.95
WIRE, #30, 31 & 32 enameled, on fibre spools of approx. 1 lb., 89c; 1/4 lb. (Wd. Spool)	.35
#36 D.C.C. per lb., \$2.25; 1/4 lb.	.89
Single shielded for phono pick-ups, etc., 100 ft.	2.49
2 cond. twisted, vinylite insul. line cord O.D. 1/4", .031/2 per ft.; 250 ft.	5.00
10 ft. extension cords, vinylite jacket with male & female plugs	.69
2 cond. rubber insul. in 25" lengths	.05
6 cond. shielded, overall rubber insul., 27" lgt.	.10
AUTO REMOTE CABLE, .150 gauge, swaged (less sheath, 8c per ft.; 100 ft.)	6.45
Brand New R.C.A. UX-200 tubes in sealed cartons (det. & ampl.)	8 for \$1.00

RADIO HARDWARE, approx. 1000 asstd. screws, nuts, washers, etc., in metal cont.	\$0.49
Battery clips, 2 1/2" long	8 for .50
Rosette screws, 8/32, 1/4, 1"	100 for .75
1/4" to 1/2" shaft extensions 2", 1"	7 for 1.00
Philco lightning arrestors (doublet)	.15
9" x 13" sheep aluminum (.025)	.19

ELECTROLYTICS, 8 mfd/200V.	\$0.29
16 mfd/200V.	.39
8mfd/350 V. (can)	.39
20mfd/200V.	.6 for 1.00
8-8-8-8 mfd/475V.	1.25
Hi-voltage paper wound, multi-section filter blocks, suitable for gen'l replacement or new set building	.6 for 2.49
SPEAKER ACCESSORIES, set of 16 centering shims in leather case	.29
Plastic sq. louvre grille for 5" spkr.	.15
RND. 12" hvy steel mesh grille	.29
Grille cloth, silver or gold weave	sq. ft. .15
S-W CERAMIC TUNING COILS, with adj. tickler & iron core; Freq. Ranges (M.C.): 1.3-2.1, 2.1-3, 3-4, 4-5.3, 5.3-7, 7-9.1	.49

SERVICEMEN'S KITS, #1—ten asstd. ant. R.F. & osc. coils	\$0.98
#2—12 popular speaker cones, moulded 5" to 12" & free edge, less voice coil	2.00
#3—25 asstd. wood & bakelite knobs (set screw & push-on)	1.00
#4—25 asstd. dial scales, air-plane & slide rule (acetate & glass incl.)	2.98
#5—25 asstd. escutcheon plates, incl. air-plane, slide rule & full vision types	2.95
#6—20 asstd. voltage dividers, multi-tapped Hi-wattage	3.95
#7—10 asstd. electrolytic condensers (single, multi-section & can types)	1.95
#8—18 asstd. bakelite mica condensers	1.00
#9—SPEAKER REPAIR KIT: contains set of 16 spkr. shims, 8 spiders, 12 rings, 4 felt strips (ea. for 12" spkr.), 12 leather segments for free edge cones and 3 oz. spkr. cement	2.25

BAKELITE, 1/8" glossy brown panels, 7" x 10"	\$0.59
7" x 14"—69c; 7" x 18"—79c; 9" x 15"	.85
1/8" brown linen strips, 1 3/4" x 13"	.10
MEISSNER OCTAL SOCKETS, bakelite with saddle 1 3/8" mtg, 100 for \$4.50; 15 for	1.00
Govt. F.M. tech. manual, 86 illus., 49 diagrams, 240 PP.	.39
Loop antennas, oval (11" x 7 1/2") or round (O.D. 9")	.49

SPEED UP REPAIRS WITH THESE G-C AIDS!

G-C is HEADQUARTERS for RADIO PARTS and SERVICE AIDS



All Types of Radio Cements, Chemicals, Coil Dopes, Compounds.

G-C leads the field in supplying Radio-Electronic Manufacturers and Service Men with Parts, Tools, Radio Cements, Chemicals and Compounds. Insist on Genuine G-C Quality.



Dial Cables, Dial Belts, Packaged Hardware, Cabinet Repair Kits



Speedex Wire Strippers Alignment Tools Ne-O-Lite Testers

Order from Your Jobber—Send for G-C Catalog



GENERAL CEMENT MFG. CO.
ROCKFORD, ILLINOIS

Announcing SOMETHING NEW!

"HAM" TRANSMITTERS by Suburban



Suburban transmitters are designed, custom built, and tested by experts for efficiency, dependability and simplicity of operation.

These transmitters incorporate low drive tubes necessitating only a minimum of controls and are as compact as

the average commercial ham receiver.

All units are symmetrically balanced and come encased in a modern black crackle chrome trimmed cabinet complete with tubes, crystal, and your choice of one set of coils.

Every transmitter is unconditionally guaranteed, excepting tubes, for a period of ninety days.

Suburban can give you immediate delivery on the smaller models up to 200 watts. On higher power models delivery from ten to thirty days.

We also carry a complete line of mobile equipment.

Technical information regarding these units will be promptly forwarded you upon request.

SUBURBAN RADIO COMPANY

82 Herman Street, East Rutherford, N. J.

LOCATES TROUBLE INSTANTLY IN ALL ELECTRICAL DEVICES



HANLAN APPLIANCE TESTER

In this single unit are combined all the necessary tests for examining every appliance. Checks thermostats under actual working conditions. Tells instant it opens or closes. Controls the heat on soldering iron—prevents overheating. Tests continuity, open circuits, etc. Checks automatic irons, vacuum cleaners, motors, shavers, bulbs, fuses, appliances with 3-way switches, etc. Great time, effort and money saver! Only \$9.50 complete. WRITE FOR CIRCULAR.

HANLAN COMPANY

1419-R West Jefferson Los Angeles 7, Calif.
FREE with each Tester. New, Complete, Practical Course in electrical appliance repairing.

RADIO ENGINEERING!

EX-SERVICE MEN can complete work here in shortest possible time. Courses also in Civil, Electrical, Mechanical, Chemical, Aeronautical Engineering; Business Administration, Accounting, Secretarial, Science. 63rd year. Enter June, Sept., Jan., Mar. School now filled to capacity. No applications can be accepted until further notice.

DEGREE IN 27 MONTHS

TRI-STATE COLLEGE 1666 College Ave. ANGOLA, INDIANA

In the Rocky Mountain Region It's Radio & Television Supply Co.

152 Hobson Avenue, Pueblo, Colo.
P. O. Box #892

"If we don't have it, we'll get it... or it can't be had! Phone 5729"

creased power as reported ready to do some time ago; schedule of 11 p.m.-1 a.m. is best transmission.

BURMA—Radio Rangoon, 11.85, latest weekday schedule reported as 7:30-9 a.m., with news at 7:45 and 8:55 a.m.; Sundays is reported heard only between 8:30-9:10 a.m. sign-off, usually with short sermon at 9 a.m.

CANADA—CKLO, 9.63, Sackville, N. B., has been dropped from the CBC's European beam; this European transmission is currently heard over CKNC, 17.82, 7 a.m.-3:15 p.m., CKCX, 15.19, 7 a.m.-6:05 p.m., and CHOL, 11.72, 3:30-6:05 p.m., news at 7 a.m., 12:15 p.m., 5:15 p.m.; these stations have an operational break now from 8:45 a.m. to 12 noon, except Sunday. VE9AI, Edmonton, Alberta, has dropped 6.005 and is using only 9.540, heard to 2:05 a.m. sign-off weekdays, may run to 4:15 a.m. on Sundays, has news at 1, 2 a.m.

CANARY ISLANDS—EAJ43, Santa Cruz de Tenerife, appropriately dubbed "the great wanderer," has moved lower in frequency to 7.558 where it is still heard 5-6:05 p.m., but with interference from Moscow's 7.560 channel.

CELEBES—Radio Makassar, 9.358, is now heard daily, 5:30-9:30 a.m.; mostly in Malay and Dutch, but "The British Forces' Program from Makassar" is heard Monday, Wednesday, Friday, concluding at 7:20 a.m.; heard well on West Coast and comes in fair to good some mornings in East.

CEYLON—Colombo on 3.395 is heard in New Zealand to 11 a.m. sign-off, uses English; poor signal reported. On 15.12, Colombo is heard around 6:25 a.m. in English with a good signal in New Zealand, sign-off is 7:30 a.m.

CHILE—CE1227, 12.270, Punta Arenas, "Radio Ejercito," opens at 6:30 p.m. with good signal.

CHINA—XGOY, Chungking, is using a new frequency of 9.645 (announced as 9.635), 6:35-10:40 a.m., continues to use 6.155 (listed as 6.135) from 10:45-11:30 a.m.; the 7.153 frequency is in dual during the entire period; English news is at 9 a.m. On about 11.920, XGOY is reported with good signals on the West Coast around 5-6 a.m., with English news at 5 a.m.; this frequency is also scheduled 7-8 p.m., with news at 7:30 p.m. XORA, Shanghai, is currently operating on 11.705 (although listed as on 11.78), from about 5 to 10 a.m., has English news at 6 a.m. and relays XGOY news from Chungking at 9 a.m. XTPA, 11.650, believed to be Canton (is listed by Australians yet as Shanghai), has been sending a good signal to the East mornings, relays Chungking news at 9 a.m., peaks around 7:30 a.m. The Chinese station on 6.235, believed to be located at Changchow, was off the air for several days, but has returned again, is heard mornings; call letters sound like XNTA, but others have been heard, so is apparently a relay station; no English has been reported. XGOL, 9.99, Fochow, is now one of best heard Chinese on West Coast,

may have increased power; is heard some mornings in East; signs off at 10 a.m. now. XGNC, Kalgan, on 9.623/5 is scheduled 5-9:15 a.m. and 11:30 p.m.-12:40 a.m.; is being heard (entirely in Chinese) some mornings in East; relays XNCR, Yen-an, around 6 a.m., which call is heard then. Australians report KW3U, 7.750, Tientsin, at 6:45 a.m. calling KU5Q, Guam, and WLXJ, Shanghai; also on 8.040 (announced) calling KU5Q at 8 a.m.; on approximately 13.115, WLXJ is heard irregularly in Australia calling PY-11, Manila, and KGT-7, Los Angeles, around 8:30 a.m. Australians report XPSA, Kweiyang, seems nearer 7.020 than 7.010 as reported in the U. S. WLXJ, 5.510, Shanghai, announces program schedule at 5:30 a.m., giving wavelengths of 54.9 and 99.29 meters which are 5.470 (presumably this is actually 5.510) and 3.020 (which may refer to an AFRN station reported on 3.007); has been heard at 9:15 a.m. calling KU5Q, and announcing WXJ, not WXLJ. XRRR, 6.090, Peiping, is now heard on this channel instead of 6.100, leaving Delhi's 6.100 outlet in the clear; XRRR is believed to carry the Chungking news at 9 a.m., and is not heard after 10:30 a.m. XNCR, 7.048, Yen-an, signs off between 6:05-6:15 a.m.; this station usually has an hour of solid Chinese in this transmission; the announcer is a woman.

COLOMBIA — HJFB, 6.225, Manizales, verifies with Spanish letter; listed schedule is 5-10:35 p.m. HJDE, 6.145, Medellin, usually has American music, 9-9:30 p.m.

CUBA — COCY, 11.74, Havana, is scheduled 6:30 a.m.-12:30 a.m.; verifies, address is Apartado Postal 770-799.

CURACAO — PJCI, 7.250, Willemstad, "Princess Juliana Sender," is scheduled 7-9:30 p.m. and 11:30 a.m.-12:30 p.m., irregularly, 4:30-9:45 p.m. Swedish listeners report PJCI, 17.775, Willemstad, 6-7 a.m.

CZECHOSLOVAKIA — Evening transmission of OLR4A, 11.84, Prague, is now scheduled one hour earlier, 6:50-7:30 p.m.; signals are usually quite good in the East; to 7 p.m. uses the French horn identification; also reported with good signals, 12:55-1:20 a.m. There may be an afternoon transmission also, since late reports from Australia list English news on this frequency at 4:30 p.m.

DOMINICAN REPUBLIC — H12T, Monsenor Noeul, "La Voz del Yuna," has changed frequency from 6.480 to 6.466 (measured); reception excellent. H11Z, 6.310, Ciudad Trujillo, is heard 4-9:40 p.m., sometimes later; was heard a recent Sunday morning at 6:20 a.m. with music, followed by broadcast of national lottery drawings.

ECUADOR — HC1AC, 7.200, Quito, is scheduled 7-9 a.m., 11 a.m.-4 p.m., and 5-11 p.m., reported recently heard at 4:10 p.m., later than usual sign-off of second transmission. HCJB, 12.455, Quito, is heard irregularly from 6 a.m.

Can a Leopard *Change his Spots?*

It's generally agreed that he can't. If he could, however, he would no longer be a leopard. For one of the first principles is that nothing can undergo a fundamental change and still retain its lineage.

We, at Stancor, apply this principle to our product . . . quality transformers. For we realize that any change in Stancor transformers, enabling us to capitalize on the peak demands, would mean a sacrifice in quality.

We're convinced, too, that this is your choice; that you, as a transformer user, in sustaining your valued position in the industry, endorse the Stancor policy of quality. In a sense, then, you dictate Stancor policy.

Like you, we are expending every effort to surmount today's knotty production and delivery problems, that we may soon be able to supply the same quality transformers . . . in ever increasing quantities.

Until that time Stancor's engineering facilities and industrial resourcefulness are available for the solution of your most urgent transformer problems.

Jerome J. Kahn
PRESIDENT

STANDARD TRANSFORMER CORPORATION
1500 NORTH HALSTED STREET • CHICAGO 22, ILLINOIS

EAGLE RADIO

for better buys!

RADIO KITS

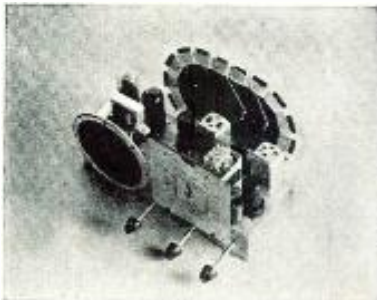

- AC-DC 5-TUBE SUPERHET.**
12SA7, 12SK7, 12SQ7, 12A6, 35Z5.
Complete with tubes.....\$16.90
- AC-DC 4-TUBE T.R.F.**
12SK7, 12SQ7, 12A6, 35Z5. Plays on Loop. Complete with tubes.....\$13.95
- AC-DC 5-TUBE, 2-BAND SUPERHET.**
12SA7, 12SK7, 12SQ7, 12A6, 35Z5. B.C. Band and 2000 Kc to 10 Mc. Short Wave. Complete with tubes.....\$18.90
- 3-TUBE AC-DC AMPLIFIER**
Designed for use with Record Player. Complete with tubes.....\$5.95
- 2-TUBE PHONO OSCILLATOR**
New Eagle Design. Complete with tubes.....\$4.49

Approved SIGNAL GENERATOR

- 6 RF BANDS
- 100 to 310 Kc
- 320 to 1000 Kc
- 1000 to 3200 Kc
- 3.2 to 10.5 Mc
- 10.5 to 26 Mc
- 21 to 52 Mc
- Net **\$4700**



ELECTRONIC DESIGNS V.T. V.M. VOLTMETER- OHMMETER



DC Ranges: 0 to 3-10-30-100-300 and 1,000 volts. All ranges have a constant input resistance of 11,000,000 ohms. Accuracy 3% ±.
AC Ranges: 0 to 10-30-100-300 and 1,000 volts. Sensitivity: 1,000 ohms per volt. Accuracy 5% ±.
Electronic Ohmmeter Ranges: 0-1,000 ohms, 0-10,000 ohms, 0-100,000 ohms, 0-1 megohm, 0-10 megohms, and 0-1,000 megohms. Net, **\$4750**

Pocket Size VOLT-OHM MILLIAMMETER

An Approved Electronic Instrument
RANGES:
DC Volts: 15-150-300-1500.
AC Volts: 15-150-1500.
Milliamperes: 1.5-15-150.
DC Resistance: 3000-300,000 ohms. Net, **\$1875**

ARMY SURPLUS KEYS

J38 Slightly Used.....49c
Brand New and Boxed.....89c

Write for FREE literature on complete line of kits. For all electronic equipment... try EAGLE first!

Buy with Safety

EAGLE RADIO
84 CORTLANDT ST.

Dept. N New York 7, N. Y.

to 10 p.m., relays news from San Francisco at 5 p.m.; the 15.095 and 9.958 frequencies are usually in parallel with 12.455; on 6.280, HCJB is scheduled 6-10 p.m.; the 4.105 frequency is scheduled weekdays, 6-10:30 p.m., signs off at 9:45 p.m. Sunday.

EGYPT—The Cairo Forces' transmitter on 7.192 ceased operations on December 29, but according to Major Ken Ellis of the F.B.S., "a new Service will be starting on 49 meters shortly" (presumably from Cairo). "Radio Cairo." official bulletin of Egyptian State Broadcasting, lists short-wave service from Cairo as Arabic program on SUX, 7.867, 1:30-3:30 p.m., and recitations from the Koran and Prayer, Friday only, on SUV, 10.055, 4:30-5:45 a.m.

EIRE—Radio Eireann, 17.840, Dublin, expects to increase power soon; is heard with English news and sports summary daily at 12:40-12:55 p.m.; asks for reception reports from U. S. listeners to Radio Eireann, Chrysler Building, New York City, Canadian reports to Radio Eireann, 140 Wellington Street, Ottawa, Ontario. On 9.595, is scheduled 4:05-4:35 p.m. daily, with sign-off at 4:17 p.m. Sunday; English news is scheduled at 4:15 and 4:30 p.m.; has not been reported as heard in U. S. recently.

ENGLAND—North American Service is GVO, 18.08, 8-9 a.m., 9:15-10 a.m., 10-10:45 a.m.; GSP, 15.31, 10:30-11 a.m., 11-11:15 a.m., 12 noon-4 p.m., 4:15-6 p.m.; GRG, 11.68, 4:15-8:15 p.m.; GRH, 9.825, 4:15-9:45 p.m.; GSU, 7.26, 6-9:45 p.m.; and GSL, 6.11, 8:30-9:45 p.m., all to North America, Mexico, North Caribbean Area, with GVZ, 9.64, beamed to West Coast, 4:15-9:45 p.m.; news at 4:45, 5:45, 6:45, 8, and 9:30 p.m., with Radio Newsreel at 7:30 p.m. The North American beam in the General Forces Program (incorporating the General Overseas Service) is heard on GVX, 5-7 a.m.; GVO, 18.08, 6-8 a.m.; GSP, 15.31, 11:15 a.m.-12 noon and 4-4:15 p.m.; GSL, 6.11,

9:45-11 p.m.; GSU, 7.26, 9:45-11 p.m.; and GVZ, 9.64, to West Coast, 9:45-11 p.m.

ETHIOPIA—Radio Addis Ababa, 9.620, has BBC news relay daily at 11 a.m. (conditions permitting); music with English announcements is scheduled 10:15-11 a.m.

FINLAND—An announcement at 7:25 p.m. heard on OIX4, 15.190, Lahti, stated that the evening broadcast for North America, 7:15-7:45 p.m., is a transcription of the morning period heard at 7:15-7:35 a.m. over OIX2, 9.504, OIX3, 11.780, and OIX4, 15.190, Lahti. Reception on 15.190 in evening period has been generally improving.

FRANCE—FFE, 13.712, Paris, has been relaying Radiodiffusion Française to New York regularly, 2:15-2:45 p.m., signal excellent. The evening North American beam from Paris is heard over 9.55 and 11.845, 8:55-10:45 p.m., English news at 9 and 10:30 p.m. Paris is heard on West Coast, 11-11:45 p.m., 12 midnight-12:45 a.m., and 1-1:45 a.m. on 11.845 (measured as 11.847), is usually also good in East during these transmissions. A new transmission beamed to Brazil is carried by Paris on 15.240, 15.350, and 17.852, and irregularly by Brazzaville on 15.595, 10-10:30 a.m. The 9.550 Paris frequency has added a broadcast to Tahiti, 12 midnight-12:45 a.m.; the 9.560 Paris frequency has dropped the 6:30-7 p.m. transmission, has added 9:15-9:30 a.m.; 9.620 has added 5-5:15 p.m., may be on 11-11:45 p.m. but this is not listed. Paris on 11.705 is heard 1-1:40 a.m. Complete schedules of the Paris 11.886 frequency are 5:30-5:45, 6:30-8, 9:15-10:30 a.m., 11:45 a.m.-1:15 p.m., 1:30-4:45 p.m., 6:25-8:40 p.m., heard irregularly, 5:30-6:30 p.m. The Paris 15.240 frequency is now off, 12 midnight-12:45 a.m.

FRENCH EQUATORIAL AFRICA—FZL, 9.440 and 11.970, Brazzaville, heard with good signals afternoons and evenings; English news is scheduled for 1:45, 3:45, 5:15, 6:30 p.m.; the

The listening post of Charles S. Sutton, Toledo, Ohio, is equipped with a RME-LF90 Low Frequency Inverter, RME-DB20 Preselector, and a Hallicrafters S20R Sky Champion receiver (with S-meter). Charles uses Brush crystal phones. His antenna is a 100 ft. "L". "I have never collected veris," he comments, "but just DX for pleasure I receive from it. I have logged 2500 s.w. stations in 96 countries. Best catches include XNEW, 8.690, Kunming, China; Radio Bissau, 7.095, Portuguese Guinea; Salisbury, 15.605, Southern Rhodesia; Radio Congola, 15.320, 50-watter in the Belgian Congo; Ajaccio, 7.830, Corsica; and Battle of two Jima from U.S. Flagship Turner."

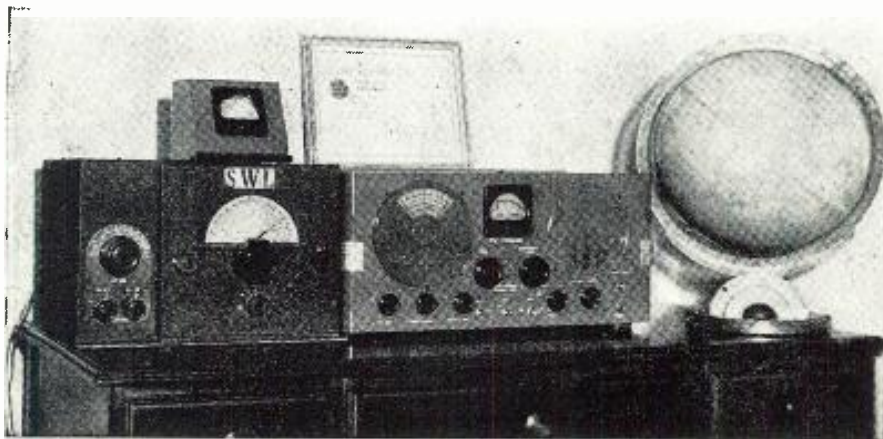

11.970 transmitter has been heard signing on in French at 12 midnight lately. The 17.530 transmitter has been off the air recently. The new 9.984 frequency is scheduled 11 a.m.-5 p.m. and 12 midnight-2:25 a.m.; sends good signal to East. The 6.024 frequency is reported heard in parallel with 9.440 and 11.970 from around 5:06 to 8 p.m. sign-off.

FRENCH INDO-CHINA—Radio Saigon, 11.778 and 4.810, heard 4-10:30 a.m. (new) sign-off, sometimes goes to 10:30 a.m.; has English news at 5:30, 8:30 a.m.; usually sends a good signal to East on 11.778. Hanoi, 12.165, has English news at 8 a.m., but usually suffers heavy interference from an adjacent radiotelephone station.

FRENCH MOROCCO—Radio Maroc, CNR3, 9.080 (measured), Rabat, is heard well opening its daily transmission at 1 a.m.; frequency sometimes jumps to 9.109.

FORMOSA—XUPA, 9.695 and 6.015, Tai-Pei (formerly Taihoku), is heard mornings, 5-9:20 or 10 a.m.; XGOY English news at 9 a.m.

GERMANY—The Berlin relay on 9.688, announced as part of the Central German Radio, probably at Leipzig, is scheduled 12 midnight-7:40 p.m., Saturday to 9 p.m.; the piano interval signal is *not* the same as used by the former Nazi radio. Berlin short-wave is currently using 6.063, reception is usually poor, schedule is believed to be 9 a.m.-3:45 p.m.

GOLD COAST—ZOY, 7.299, Accra, is scheduled 12 noon-1 p.m.

GREECE—Radio Athens, 7.295, is scheduled 3-3:30 p.m., according to Swedish correspondents; has also been heard in Australia where it was first believed to be ZOY, 7.299, Accra, Gold Coast.

GUADELOUPE—Radio Guadeloupe, 6.192, Pointe-a-Pitre, is scheduled 11:30 a.m.-12:45 p.m. and 6-7:30 p.m.

GUAM—KU5Q now has four transmitters in operation; announcement on 9.670 around 7:30 a.m. gave 9.280, 7.645, and 13.360 as in parallel. On 12.265, KU5Q has been reported as heard frequently around 2 a.m. with relays of the Guam medium-wave AFRS station, WXLI, reception fair. KU5Q now verifies with a card in white with call in black at top; power on 9.670 is listed as 2 kw. The 15.920 and 17.820 frequencies are still reported as heard *daily* in evenings.

GUATEMALA—TGLA, originally 6.276, is now on 6.295 and is heard with fair signal, 7:30-10:30 p.m., irregularly to 11 p.m.; location is announced as Ciudad Rotalhuleu, and it relays medium-wave TGL, "La Voz del Pacifico."

HAITI—HH3W, 10.135, Port-au-Prince, signs off at 9:15 p.m. on Monday, Tuesday, other days at 10 p.m. HH2S, 5.947, Port-au-Prince, has evening transmission, 5:30-9:40 p.m., Saturday to 10:05 p.m., signs off at 8 p.m. on Sunday.

HAWAII—KRHO, Honolulu, is now off 6.120 and is heard instead on 9.650,

COMPARE KWIKHEAT WITH ANY OTHER SOLDERING IRON

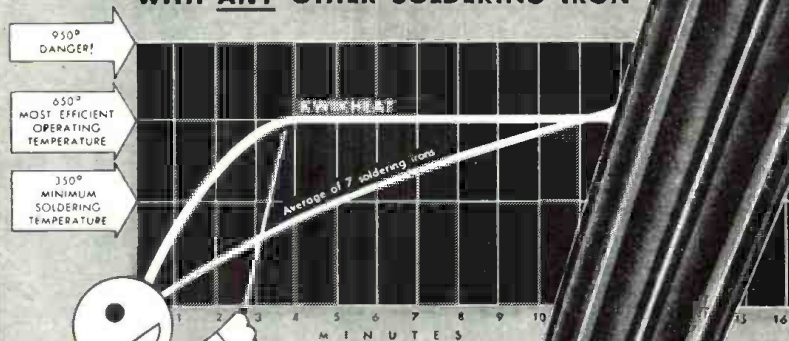

Chart compares heating time of KWIKHEAT to the average of 7 other soldering irons of comparable power.

CHECK THESE MANY IMPORTANT FEATURES

- ✓ FAST! Hot In Only 90 Seconds
- ✓ COOL New Protecting Handle
- ✓ SAFE! Will Not Overheat
- ✓ POWERFUL (Full 225 Watts)
- ✓ SAVES TIME—Less Retinning
- ✓ BALANCED! Easily Handled
- ✓ DEPENDABLE—Longer Lasting
- ✓ LIGHT WEIGHT (Only 13 1/2 oz.)
- ✓ THREADED TIPS For Best Contact
- ✓ ECONOMICAL In Operation
- ✓ THERMOSTAT Is Built In
- ✓ SIX TIP STYLES Interchangeable



**YOU'LL FIND
KWIKHEAT
is best
BY TEST!**

Plug in a Kwikheat Thermostatic Soldering Iron and any other soldering iron of equal power simultaneously. See for yourself how much faster Kwikheat heats up—only 90 seconds! Check the 12 features at the left against any soldering iron. You'll find that Kwikheat wins every time. Ask your dealer.

Complete with #1 tip... **\$11.00**
Extra Tips—Six Styles, each 1.25

"FROM TIP TO

PLUG...IN A CLASS BY ITSELF"....!



VANATTA
KWIKHEAT
THERMOSTATIC SOLDERING IRON

A Division of
Sound Equipment Corporation of California
3903 San Fernando Rd., Glendale 4, California

WALSCO PRODUCTS
help the radioman

NEW LOW PRICED FLOCK FINISHING KIT

Includes:

- Flock Spray Gun and Brush.
- 2 Colors of Flock, Undercoats, Thinner and Instructions.

Flock Gun and Flocking Material Also Available Separately
For full information write Dept. RN2

WALTER L. SCHOTT CO.
BEVERLY HILLS, CALIFORNIA • CHICAGO 5, ILLINOIS

MINIATURE, EXTRA-SENSITIVE HEADPHONES!

IDEAL FOR Amateurs, Servicemen, Commercial Operators, etc.

Manufactured especially for Infantry and Armored Forces; cost the Government approx. \$35.00 per headset. Extremely sensitive phones, with good fidelity characteristics, with matching transformer built-in so that phones work into any hi-impedance output and at the same time are protected from any DC component. Practically indestructible Light and Compact! Features: adjustable headband; flexible rubber phone cord to provide many years of wear and to guard against moisture; rubber spring clip for fastening to clothing; soft, flexible rubber ear-tips fastened to each phone for comfort and to remove extraneous noises, etc. Supplied with standard phone plug.

PRICE, COMPLETE \$5⁹⁵

Send check or money order for postpaid delivery.
Dealer and Distributors inquiries invited on quantity.

TAYBERN EQUIPMENT CO.
118 GREENWICH ST., NEW YORK, 6, N. Y.

RCP Model 802N
Combination
TUBE-SET
TESTER

Immediate Delivery from Stock.

A complete tube tester and a complete set tester, with only 5 simple switches to operate for both tube and set tester combined.

RANGES

DC voltmeter 0/10/50/500/1000 at 1000 ohms per volt.
AC voltmeter 0/10/50/500/1000.
DC milliammeter 0/1/10/100/1000 DC Ammeter 0/10.
Ohmmeter 0/500/5000/1,000,000/10,000,000. Low ohm center.
D.B. Meter—8/15/15 to 29/29 to 49/32 to 55 decibels.

Four range output meter—same as AC volts.
Size: 12 3/4 x 12 x 5 1/4 inches. Weight: 11 1/2 lbs.
Complete in handsome hardwood case, with test leads, self-contained batteries, ready to operate. Net. **\$59⁵⁰**

ADSON RADIO CO.
221 FULTON ST., NEW YORK 7, N. Y.

RADIO ENGINEERING TELEVISION ELECTRONICS

Courses in every phase of radio and electronics open to high school graduates. Thorough training, modern courses. Enrollments limited. Approved Veteran Training.

VALPARAISO TECHNICAL INSTITUTE
Dept. RS Valparaiso, Indiana

NEW TINY POCKET SIZE RADIO!

Slips in your pocket or purse—We only 3 ozs! Complete READY TO PLAY as shown with self-contained phone for personal use. Beautiful black plastic case. Has a patented "Fixed Crystal-Slide Tuning Dial" NO TUBES, BATTERIES, OR ELECTRIC PLUG-IN REQUIRED. USUALLY RECEIVES LOCAL BROADCASTS without outside aerial wires.

GUARANTEED TO WORK when connected and used according to instructions. Can be used in homes, offices, hotels, cabins, in bed after hours, etc. (cash, money order, check) and pay postman \$2.99 plus delivery fees on arrival of send \$3.99 for postpaid delivery. **IDEAL GIFT FOR CHILDREN OR ADULTS ALIKE!** Get your PA-KETTE RADIO NOW for real enjoyment. Dealers in most cities.

PA-KETTE ELECTRIC CO., Dept. RN-6, Kearney, Nebr.

4-10 a.m., with good signal; English news on the hour. On 17.80, KRHO is scheduled 4 p.m.-12 midnight, with English news on the hour.

HOLLAND—PCJ, 15.22, Huizen (studios in Hilversum), is scheduled daily, 8-9:30 a.m., and is relayed by PHI, 17.775, Huizen; on Wednesday and Sunday, the Happy Station Program of a Friendly Nation is heard between 8:30-9:30 a.m. with pre-war m.c. Eddie Startz at the microphone; this broadcast is relayed also by *Radio Balikpapan*, 9.125, Borneo. PCJ's 9.590 frequency is scheduled 2-3 p.m. and 8-9 p.m. daily, with PHI's 11.730 frequency relaying; neither frequency is good in the United States due to terrific interference from powerful American stations. A recent announcement stated PCJ broadcasts to America mornings on 16-, 19-, and 49-meters; for Africa, afternoons, on 25-, 31-, and 49-meters; and for North America, evenings, on 25- and 31-meters.

HONDURAS—HRN, 5.875, Tagucigalpa, "La Voz de Honduras," is heard with good signals, evenings.

HONGKONG—ZBW3, 9.525, Victoria, is no longer being heard, but instead, ZBY, 9.573, Victoria, is on the air 5:30-10 a.m., in native to 8 a.m. then features BBC relays and local English thereafter; can be heard with weak level even in the East, but has bad QRM.

HUNGARY—Radio Budapest, 3.400, is reported at 12 midnight by Swedish observers.

ICELAND—The 9-9:30 a.m. Sunday only broadcast of TFJ, Reykjavik, formerly on 12.235, is now heard on approximately 25.800, a new channel; signals are only fair; uses c.w. thereafter; the 9-9:30 a.m. radiation is all Icelandic; also reported irregularly as early as 8:30 a.m. Sunday. Verifies in English on an attractive, illustrated card.

INDIA—Items of most interest to U. S. DXers from All India Radio current schedules (effective April 1) include All Forces Program (90 min.), 8:30 p.m., 9.630, 6.100; English News (15 min.), 9:30 p.m., 11.760, 9.670, 7.290; Far East Program Summary (15 min.), 10:15 p.m., 17.830, 15.350, 15.190, 15.160, 11.870; English (15 min.), 10:30 p.m., 17.830, 15.350, 15.190, 15.160, 11.870; English (30 min.), 12:30 a.m., 17.830, 15.350, 15.190, 15.160, 11.870; English (15 min.), 1:30 a.m., 17.830, 15.350, 15.290, 15.190, 15.160, 11.870; All Forces Program (90 min.), 2:30 a.m., 9.590; English News (10 min.), 3 a.m., 17.76, 15.290, 9.670, 7.290; English and Program Summary (15 min.), 4:30 a.m., 17.76, 15.350, 15.190, 11.870, 9.670, 7.290; English, "Voice of Britain Calling the Far East" from Delhi (30 min.), 6:30 a.m., 17.830, 15.350, 15.190, 11.870; English News (10 min.), 7:30 a.m., 15.290, 15.210, 9.670, 7.290; All Forces Program (270 min.), 8 a.m., 7.210; Troops—India and Ceylon—(45 min.), 8:30 a.m., 7.290, 4.960; Program Summary (30 min.), 9 a.m., 15.350, 15.160, 11.870, 9.590; English News (15 min.), 9:30 a.m.,

15.160, 9.590; Western Music (30 min.), 15.350, 11.870, 11.850, 9.670, 9.590, 7.290, 6.190, 4.960; BBC News Relay (10 min.), 11 a.m., 15.350, 11.870, 11.850, 7.290, 6.190; Troops (45 min.), 12:30 p.m., 15.350, 11.870, 9.590, 6.190. (Frequencies in italics indicate 100-kw. transmitters.) VUM2, Madras, now operates on 7.255, 6 a.m.-12 noon, heard best on West Coast around 10 a.m., programs mostly native Telugu, but on Saturdays has Children's Program in English at 6 a.m.; VUM2 now uses only 500 watts power and currently has two other transmissions on 9.565, 2:30-5 a.m., and on 6.085, 9-10:30 p.m.

IRAN—EQB, 6.155, Teheran, reported heard in Sweden at 12 noon with EQC, 9.680, also Teheran.

IRAQ—YI5KG, 7.084, Baghdad, is scheduled 8 a.m.-5:35 p.m. with news at 11 a.m.; is heard some mornings on West Coast with weak signal around 9 a.m.; Australians report native-type program at 9 a.m., sends out good signal.

ITALY—Changed time recently, making broadcasts from Rome and Milan one hour earlier here. Rome on 6.030 is reported 6-6:30 p.m. Rome on 9.610 now uses the call letters IFD and carries only commercial traffic. Rome's IQD has changed frequency from 14.370 to 14.736. ISP, approximately 12.675, Rome, has been reported testing with WLK at 3:45 p.m.

JAMAICA—ZQI, 4.700, official schedule is 4:30-6:30 p.m., uses English; studios are in Kingston.

JAPAN—JLG3, 11.705, Tokyo, is heard in Home Service from 1 a.m., with JVV in parallel. JLU2, 9.525, and JVT, 6.75, Tokyo, are used to RCA, San Francisco, for pickups early mornings. JZH, 6.095, Tokyo, was carrying the Home Service in parallel with JLT/JVV around 7:30 a.m., but has not been reported recently. JLG4, 7.55, Tokyo, is heard some mornings in East around 7 a.m., also in Home Service. Tokyo is now using 7.645 in Home Service, in parallel with 7.55 and others, heard around 6:30 a.m. on West Coast. New Zealanders report AFRN, 3.100 (listed as 3.075), with news in English at 4 a.m.; schedule is 2:30-9 a.m.

JAVA—The Free Indonesia Radio on 6.72 and 12.273 has not been reported lately, may be off the air. Gillett, Australia, reports two new Javanese stations on 7.465 about 7:30 a.m. and on 15.960 with English news at 5:15 a.m. Jakarta is the location of the latter; the former's location is not known as yet. The 7.465 frequency has been heard very weak on West Coast. Australians also report a new Bandoeng frequency of 15.210 with a four-letter call, not yet identified; announcements as "The Voice of Free Indonesia," and has English news at 7:15 a.m., closes at 7:30 a.m.

LEBANON—According to the Forces' RADIO TIMES, Cairo, Radio Levant, 8.11 (37 meters), Beirut, has news between 5:25-5:30 a.m.; Records (Continued on page 131)

Highest Quality RADIO and ELECTRONIC Testing Equipment

Immediate Delivery from Stock Guaranteed

The New SUPERIOR
Model CA-11
SIGNAL TRACER
Net Price **\$18.75**



- FEATURES:**
- * Signal intensity readings are indicated directly on the meter.
 - * Only one connecting cable
 - * Highly sensitive—uses an improved vacuum tube voltmeter circuit.
 - * Tube and resistor-capacity network are built into the Detector Probe.
 - * Completely portable—weighs 5 lbs. Measures 5x 6 1/2 inches.
 - * Provision is made for insertion of phones.

The New
McMurdo Silver
Model 904
**CAPACITANCE
RESISTANCE
BRIDGE**
Net Price **\$49.90**



1/4 mmfd/ohm thru 1,000 mfd./megohms; 0-50% power factor; 0-500 volt adjustable internal polarizing voltage; 0-10 and 0-100 ma. electron-ray leakage current meter; measures resistance, capacitance under actual operating voltages!

The
New SUPERIOR
Model 400
**ELECTRONIC
MULTI-METER**
Net Price **\$52.50**



RANGES:
DC V.T.V.M. Volts: 0 to 3/15/30/75/150/300/750/1500/3000 volts.
DC Volts: (at 1000 ohms per volt) 0 to 3/15/30/75/150/300/750/1500/3000 volts.
AC Volts: (at 1000 ohms per volt) 0 to 3/15/30/75/150/300/750/1500/3000 volts.
DC Current: 0 to 3/15/30/75/150/300/750 Ma. 0 to 3/15 amps.
Resistance: 0 to 1,000/10,000/100,000 ohms. 0 to 1/10/1,000 meks.
Capacity: .0005-.2 .05-20. 5-200 mfd.
Reactance: 10 to 5M ohms. 100-50M ohms. .01-5 meks.
Inductance: .035-14. 35-140. 35-140,000 henries.
Decibels: -10 to +18 +10 to +38 +30 to +58.

The New
Model 802N
**COMBINATION
TUBE & SET
TESTER**
Net Price **\$58.31**

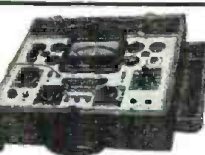

RANGES:
DC Voltmeter: 0/10/50/500/1000 at 1000 ohms per volt.
Four Range AC Voltmeter: 0/10/50/500/1000.
DC Milliammeter: 0/1/10/1000 DC Ammeter 0/10.
DB Meter: -8/15/15 to 29/29/ to 49/32 to 55 decibels.
Four Range Output Meter—same as AC Volts.

R.C.P. Model 448 Pocket Multitester.....	\$ 24.01
R.C.P. Model 424A Volt-Ohm-Milliammeter..	28.91
R.C.P. Model 461A Sensitive Multitester....	38.71
R.C.P. Model 664 Electronic Voltmeter.....	45.00
R.C.P. Model 705 Signal Generator.....	48.51
R.C.P. Model 488A Ultra-Sensitive Multitester	70.07
R.C.P. Model 805 Tube and Set Tester.....	87.71
R.C.P. Model 665A V.T. Volt Ohmeggler Insulation Testers.....	92.61
Reiner Model 530 Squarewave Generator.....	95.00
Reiner Model 450 Vacuum Tube Volt-Ohm-Milliammeter.....	135.00
Superior Model 1553 Volt Ohm Milliammeter	24.75
Superior Model PB-100 Volt Ohm Milliammeter	28.40
Superior Model 450 Tube Tester.....	39.50

The New
MONITOR
Crystaliner
SIGNAL
GENERATOR
Net Price **\$57.50**

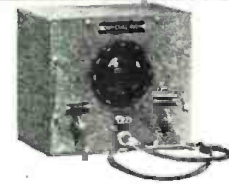

A New Type Signal Generator designed for the Finger-Tip Control. Frequency instantly selected. No confused dial to read. No hand switch. I.F. Broadcast, Shortwave and Ultra High Frequencies with or without 400 cycle note. Frequency accurate to .1 of 1%. Output approximately 10 volts.

The New
McMurdo Silver
Model "VOMAX"
**VACUUM TUBE
VOLT METER**
Net Price **\$59.85**



D.C. Volts at 51 and 126 megohms.
A.C. and r.f. volts at 6.6 meks.
Resistance: 2 ohms to 2,000 meks.
D.C. current 1.2 ma. through 12 amperes.
D.B. -10 through +50.
Plus visual dynamic signal tracing.

The New Model 668
**VACUUM TUBE
VOLT OHM
CAPACITY METER**
Net Price **\$73.01**



RANGES:
D.C. Vacuum-Tube Voltmeter: Direct Reading. Sensitivity: 160 to 16 megohms. Six ranges: 0/5/30/150/600/1500/6000 volts. Voltmeter readings can be taken without affecting circuit constants.
A.C. Vacuum-Tube Ohmmeter: Direct reading. Input capacity: 0.00005 mfd. at terminals of instrument. Input resistance: 160 to 16 megohms. Seven ranges: 0/3/5/30/150/600/1500/6000 volts. Measures signal and output voltages from 10 cps to 10000 cps.
Vacuum-Tube Ohmmeter: Direct readings. from 0.1 ohm to 1000 megohms. Seven ranges: 0/1000/10000/100000 ohms. 1/10/100/1000 megohms.
Capacity Meters: Accurate measurements from 0.00005 to 2000 mfd. Seven ranges: 0/0.002/0.02/0.2/2/20/200/2000 mfd.

The New Model 680
**5000 OHMS PER VOLT
VOLT-OHM
MILLIAMMETER**
Net Price **\$27.65**



D.C. Voltages to—1500 volts.
A.C. Voltages to—1500 volts.
Resistance to—2 Megohms.
Output Volts to—1500 Volts.
D.C. Current to—150 Ma.
Decibels to—+58 D.C.

Superior Model 650 Signal Generator.....	48.75
Superior Model 720 Multi-Range AC Ammeter	49.50
Superior Model 600 Combination Tube and Set Tester.....	62.50
SHALLCROSS Decade Resistance Boxes.....	13.50
SHALLCROSS Portable Galvanometers.....	27.50
SHALLCROSS Model 630 Wheatstone Bridge	75.00
SHALLCROSS Model 637 Kelvin-Wheatstone Bridge.....	100.00
SHALLCROSS Model 638-2 Kelvin Wheatstone Bridge.....	120.00
VM-Model 200-13 Record Changer.....	135.00
List Price: \$37.50. Net.....	22.50
Maguire ARC-1 Record Changer.....	27.50
List Price: \$47.41. Net.....	25.00
Lots of 12 or more. Each.....	25.00

Write for our FREE new POST-WAR CATALOG!

Metropolitan

Dept. R, 6 MURRAY STREET
NEW YORK 7, N. Y., U. S. A.

ELECTRONIC & INSTRUMENT CO.

Cable Address: METRONICS
Phone: BARclay 7-5556

HAM SUPER SPECIALS

BC 344 FARNSWORTH Standard Band Radio RECEIVER

8 STAGE, 10 TUBE SUPER HET. WITH A.V.C. CIRCUIT AND—C.W. OSCILLATOR NO CONVERSION

Operates on your regular 110V AC line.

Check these FEATURES:

- Ship to Shore receiving
- International distress Frequency
- Air craft beacons
- Weather reports
- High speed code nets
- Vernier and speed tuning
- LF to MF
- 150—1500 KC
- 6F6 Output Tube
- SIZE: 18" x 10³/₄" D x 9¹/₄" H

COMPLETE with LS 3—8" Speaker. Plugs and line cord.

Only **\$88⁰⁰**

Super Special BC-683—10 Tube FM RECEIVER

COMPLETE WITH TUBES

All you need to build is an inexpensive power supply. While They Last ONLY \$25.00 COMPLETE Send your order today

LEONARD ASHBACH
Company

ELECTRONICS DISTRIBUTORS
Phone Whitehall 2065
152 W. HURON ST. • CHICAGO 10, ILL.

LEARN Correspondence Courses in RADIO and ELECTRICAL ENGINEERING

ELECTRICAL ENGINEERING Get good grasp of wide electrical field. Prepare yourself at Low Cost, for secure future. Modern course. So simplified anyone can understand quickly.

RADIO ENGINEERING Extra fine course in radio, public address, photo-electric work, Triodes you to be super-service man, real vacuum-tube technician. Services needed badly. Diploma on completion.

WRITE Send postcard or letter for Free Copies of school catalog, full details, all about deferred payment plan, etc. **SEND NOW!** **LOW AS \$25** Either Course

LINCOLN ENGINEERING SCHOOL, Box 531-R96, Lincoln, 2 Nebr.

Electronic Volt-Ohmmeter, \$9.85

21 ranges; 6000 V. AC; 6000 V. DC; Billion Ohms

Complete Kit, tubes, punched and drilled chassis and panel, full instructions on construction and use. Instrument easily measures these voltages: SUPER-HET OSCILLATOR, A.V.C., TRUE GRID BIAS, BIAS CELL. Checks leakage resistance of insulation, tubes, condensers. Signal tracing with oscillator.

RADIOCRAFTERS

166 N. Sierra Bonita Ave., Pasadena 4, California

The MULTIVIBRATOR as a service instrument

By WAYNE M. ROSS

ALTHOUGH the multivibrator has long been known to radio engineers, its usefulness in radio equipment manufacturing and particularly radio servicing has not been fully appreciated.

The usefulness of the instrument lies in the fact that, when it is made to oscillate at, say 600 cycles, harmonics of this frequency are generated up to and beyond 18 or 20 mc. These harmonics spaced at 600 cycles provide a continuous, flat, modulated signal covering any band used in the standard broadcast receiver.

In the production testing of receivers the signal may be applied either directly or by radiation, and an output meter connected to the receiver under test. If the receiver is then tuned across the band, any dead spots or peaks in the response will be shown immediately.

The time consuming operation known as "rocking the condenser" to insure alignment at 600 kc. is accomplished, when using a multivibrator, by first adjusting the trimmers for maximum gain at 1500 kc. with a standard oscillator, then setting the receiver to 600 kc., applying the multivibrator signal, and adjusting the oscillator padder for maximum gain. No "rocking" or readjusting is necessary.

The instrument shown is inexpensive and may be constructed as a small, compact unit. Almost any two triode tubes or a dual triode will work satisfactorily. The 6SN7 tube used in this instrument was chosen for compactness and single ended wiring. The .1 meg. controls are used to vary the

fundamental frequency and may be roughly calibrated. The 5000 ohm potentiometer in the cathode circuit is used to lock the signal to some harmonic of the line voltage. This provides a purer tone. The arm of this control should be set at the ground end, the multivibrator set to approximately 600 cycles and the control slowly turned up. The note will be heard to lock in, or appear to be more of a pure tone. This is the proper setting; if the control is turned further it will successively lower the fundamental frequency and lessen the harmonic output.

The audio and intermediate frequency filters are necessary to prevent interaction and misleading results. The audio filter may be any choke shunted by a .0005 or .001 μ fd. condenser, or when a fixed frequency is used the filter may be resonated at this fixed fundamental frequency.

The intermediate frequency filter must be tuned to the i.f. of the receiver under test. Where one type of receiver is being tested this tuning may be fixed. If the instrument is to be used on all types of receivers, the frequency must be variable. In the model shown the filter was tunable between 450-470 kc., using a small variable condenser. The most commonly used frequencies were calibrated. If necessary, a second coil could be switched in for intermediate frequencies of 260 kc.

The audio output has, of necessity, a distorted waveform but will be found quite useful for checking audio "continuity" and other uses.

—30—

Diagram of multivibrator circuit. An external power supply is required.

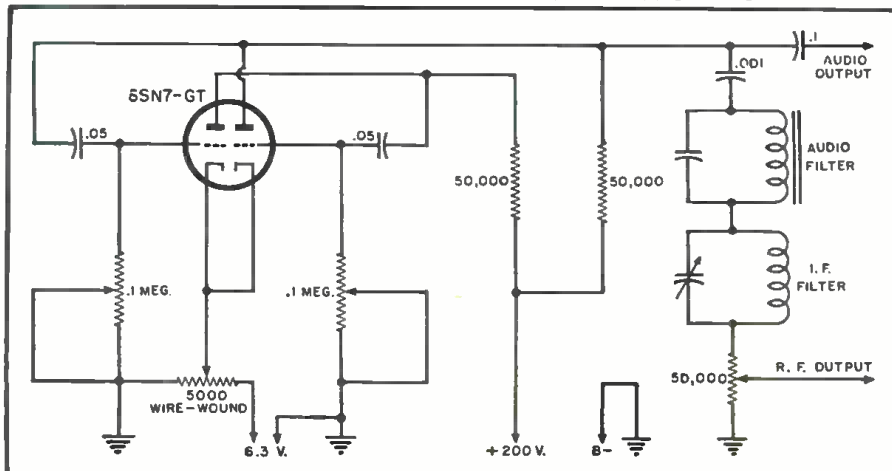

Electronic Processing

(Continued from page 31)

them was the ultimate aim, could be minimized by stepping up the frequency of the radio field in which the food product was to be blanched.

The electronic oscillator employed in the preliminary food-preserving experiments had a capacity for delivering 750 watts of energy at a frequency of 150,000,000 cycles-per-second. The heat from this electronic "power machine" was applied to a variety of vegetables and fruits, ranging from shredded cabbage to diced carrots. At the outset, the bands of radio frequencies from 7 to 10 and 28 to 29 megacycles were employed but, as previously indicated, when adequate radio-frequency power was applied at these frequencies there was arcing between the electrodes with the consequent burning of the vegetable tissue. Moreover, individual pieces of carrots, potatoes or peas were scorched due to the arcing effect.

It then became evident that additional experimentation was needed in order to find the correct formula for high frequency heating of foods.

Then, comparable to the assigning of "clear channels" to certain broadcasting stations for effectual radio coverage, the Cornell University scientists discovered that the frequency of 150 megacycles was the ideal wavelength for heating cabbage. When the oscillator was generating on this frequency, with a power output of 750 watts, there was little or no tendency toward arcing with the undesirable effect of scorching the cabbage, if the vegetable was tightly packed in a container. Therefore, if flippancy is permitted, to tune in on Jiggs' fabled corned beef and cabbage it is necessary to adjust your receiver to the wavelength of 150 megacycles.

Without levity, in determining how effective dielectric heating is, the heads of cabbage were sliced in an eighth of an inch thickness and the shredded material was packed into conventional cartons ordinarily used in preserving vegetables by freezing. The carton of finely pulverized cabbage was inserted between two copper electrodes, mounted in an electric-air oven. As a means of tuning the cabbage to its ideal frequency of 150 megacycles, stubs were attached to the electrodes, also as a means of eliminating standing waves and as an aid in the coupling of the power load to the electronic oscillator. An oven temperature of 100 degrees Centigrade was employed to avoid the forming of moisture on the electrodes and also to counteract heat losses from the carton container by radiation. A heating period of two to three minutes was enough to boost the temperature of 180 grams of cabbage to 99 degrees Centigrade as shown by a spirit-filled thermometer inserted in the carton of vegetables.

HARRISON HAS IT!

ALL STANDARD LINES

We are Factory Authorized Distributors for the top quality manufacturers and we now have in stock lots more new, latest improved production Ham gear! Visit our stores today, for *everything* you need. We promise you fresh, clean material—quicker—at the lowest current prices—and, above all, our sincere desire to be of friendly, helpful service. MAIL ORDERS?—Certainly! Just list *everything* you want and include deposit or full amount. (Please add postage if you want parcel post shipment)

73 de

Bill Harrison W2AVA

TEMCO 75-GA TRANSMITTER

A post war transmitter of exceptional quality and dependability, incorporating many features of advanced design. High stability VFO for crystal like output in any part of every Amature band covered. Single dial tuning to simplify operation. Band switching of factory tuned exciter stages. Crystal selector switch—voltage regulated oscillator power supply—etc. Conservatively rated output of 75 Watts phone and 100 Watts CW.

Engineered and constructed to highest standards of performance this TEMCO Transmitter is a sound investment for the discriminating Amateur.

Complete, with tubes, VFO, and coils for five band (10, 15, 20, 40, and 80) **\$495**

Place your order now for delivery in May (Literature supplied upon request)

NEW SOLDERING TOOLS

Kwickheat—Built-in thermostat—225 watt element—heats in 90 seconds. Net price, with tip. **\$8.91**

Weller Speed Gun—Trigger control gun type iron—5 second heating—wire loop tip. **\$12.95**

Met-Elec Soldering Gun—For operation on 6 volt battery or transformer. **\$2.94**

With transformer for 115 V. AC. **\$6.43**

ABBOTT TR-4A

New improved 144 Mc transmitter-receiver in stock. Less accessories. **\$43.00**

PANADAPTOR

Panoramie tuning adaptor. Easily attached to any standard communications receiver.

Harrison has it! In stock. **\$99.75**

A POST CARD will put your name on our mailing list to receive new catalogs, bulletins, additional HSS bargains, and details of how you may obtain a copy of "Electronic Parts and Equipment," our new 800-page Buyers' Guide. Please send it today!

MILLEN ECO

No. 90700. Compact, low drift, frequency shifter that plugs in, in place of crystal. Accurately calibrated. Built-in good regulation power supply. Complete with tubes. **\$32.50**

Corlab GROUND PLANE ANTENNA

Still the best made job for 2 meters! Solid, sturdy adjustable, proven in service. Model GP-144. **\$8.82**

Shur Antennae, Beams, and Mounts IN STOCK.

MILLEN 50 WATT TRANSMITTER-EXCITER

No. 90800. Output on four bands with one crystal or ECO. 6L6—807. Compact, versatile. Less tubes. **\$37.50**

TELESCOPING ANTENNA

Signal Corps AN20-C. Sturdy, lightweight, brass antennae. Extends to 12'10", closes to 15". 3/4" base diameter. Weighs only 30 oz. Good for mobile or rotary beams with elements. HSS **\$1.98**

Subject to prior sale or price change without notice.

HARRISON HAS IT!

HSS—HARRISON SELECT SURPLUS

Your assurance of good, usable, guaranteed surplus material at sensationally low prices—top value always! Come in and browse thru our large, *entirely separate* HSS Department (Harrison Select Surplus).

SIGNAL CORPS RECEIVERS

Here's one of the hottest jobs to come out of the war—the BC-342! Two RF stages—two IF stages—exceptionally low noise level—high sensitivity—ten tubes—crystal filter—AVC—BFO—calibrated precision dial—4500 division vernier bandspread—beam power output to phones or speaker—9 1/2" x 18" panel—metal cabinet. Covers 1500 KC to 18 MC. (Use with 2, 5 and 10 meter converter for top efficiency on all bands.)

Complete with tubes, speaker in metal cabinet and instruction manual—ready to operate on 115 volt 60 cycle AC.

A darn good, dependable, modern communications receiver at a sensationally low price. Slightly used, but checked by the factory and fully guaranteed. (AND WE HAVE THE GOOD ONES, WITH ALL THE BEST FEATURES!)

HSS **\$69.75**
For mobile, marine, etc. or emergency service—Model BC-312, operates on 12 Volt Battery. **\$49.25**

Just a few left—

HALLCRAFTERS

BC-610

TRANSMITTERS

Complete with coils for 10, 20, 40 and 80 meters, speech amplifier, tubes, etc. Factory converted for 10 and fully checked. **\$535.00**

(See our May Radio News AD PAGE 137)

FIELD STRENGTH METERS

Signal Corps 1-149 Indispensable for tuning up beam antennae. Also can be used as foundation for 50,000 ohm per volt multimeter.

Westinghouse NX-36 3 1/2" case 0-30 DC microammeter, tube, battery, low-high sensitivity switch; all in sturdy metal case 6" x 6" x 3", with carrying handle and plug-in pick up antenna. Operates on all frequencies. Complete ready to use. **\$13.90**

REVERSIBLE MOTORS—FB for UFH Beams

Totally enclosed motor and gear box. 3 RPM right angle drive shift with ball thrust bearing. Runs on 24 to 30 volts AC or DC. Single wire reversing. Light weight aluminum construction. 3 1/2 lbs., 5 1/2" x 3 1/2" x 5" overall. Plenty power for 2 or 5 meter beam. Surplus Navy **\$14.90**
material—brand new! Autotransformer for 115 Volt AO. **\$2.25**

MORE!—15 TUBE UHF RECEIVERS

We have just secured more of those FB Signal Corps Model BC-406-A 205 Mc. receivers. These are all brand new, and sealed (also contain an 11 watt .65 RPM motor).

Six acorn tube RF circuit, four IF stages, 115 volt 60 cycle operation. Chassis 10 1/2" x 25 1/2", in metal case. Complete with tubes: 5—954, 1—955, 4—6SK7, 2—6SJ7, 2—6N7, 1—5T4.

Full instructions and diagrams for easy conversion to a hot 10 (also 6 and 2) meter superhet receiver are included.

Parts alone are worth much more than our low HSS price **\$29.75**

HSS RECEIVERS

NATIONAL model NC 100-ASD. Brand new, in original crates, complete with tubes, speaker in cabinet, and spare parts **\$115.00**

HAND MIKES

Made for Signal Corps by Shure. Model T-17. 200 ohm high sensitivity single button microphone, push-talk switch to close mike and relay circuits, five foot cable, plug, hang up hook on handle. Just the thing for mobile rig! Brand new. **\$2.75**

HSS CONDENSERS

Oil filled, compact cylindrical type, mounts in 3/4" hole. Just the thing for transmitters, amplifiers, etc. Guaranteed at full rated DC working voltage. 2 MFD.—1000 Volt—FOUR for \$2.34. (Regular price of one)

Standard rectangular type, with stand off insulator terminals. Oil filled. 4 Mfd.—1000 Volt—3 for \$3.47. 8 Mfd.—1000 Volt—3 for \$2.80. Lug terminals, oil filled. 2 Mfd.—600 Volt—FOUR for \$2.12.

FILTER CHOKES

10 Henry; 260 Ma. General Electric. Metal cased, potted, ceramic stand-off insulators. 3 1/2" x 3 1/2" x 5" high. 8 1/2 lbs. **\$3.23**

HAM HEADQUARTERS
Since 1925!



HARRISON RADIO CORPORATION

10 WEST BROADWAY • NEW YORK CITY 7
BARCLAY 7-9854
JAMAICA BRANCH — 172-31 Hillside Ave. — REPUBLIC 9-4102

NOW—A REALLY HIGH-POWERED— Radio Engineering Library

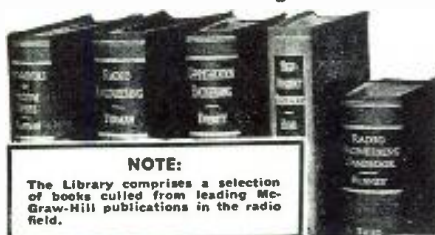

NOTE:

The Library comprises a selection of books culled from leading McGraw-Hill publications in the radio field.

- especially selected by radio specialists of McGraw-Hill publications.
- to give most complete, dependable coverage of facts needed by all whose fields are grounded on radio fundamentals.
- available at a special price and terms.

THESE books cover circuit phenomena, tube theory, networks, measurements, and other subjects—give specialized treatments of all fields of practical design and application. They are books of recognized position in the literature—books you will refer to and be referred to often. If you are a practical designer, researcher or engineer in any field based on radio, you want these books for the help they give in hundreds of problems throughout the whole field of radio engineering.

5 VOLUMES, 3559 PAGES, 2558 ILLUSTRATIONS

1. Eastman's FUNDAMENTALS OF VACUUM TUBES
2. Terman's RADIO ENGINEERING
3. Everitt's COMMUNICATION ENGINEERING
4. Hund's HIGH FREQUENCY MEASUREMENTS
5. Henney's RADIO ENGINEERING HANDBOOK

10 days' examination. Easy terms. Special price under this offer less than books bought separately. Add these standard works to your library now; pay small monthly installments, while you use the books.

10 DAYS' FREE EXAMINATION—SEND COUPON

McGRAW-HILL BOOK CO.

330 W. 42nd Street, New York 18, N. Y.

Send me Radio Engineering Library, 5 vols., for 10 days' examination on approval. In 10 days I will send \$2.50 plus few cents postage, and \$4.00 monthly till \$26.50 is paid, or return books postpaid. (We pay postage on orders accompanied by remittance of first installment.)

Name

Address

City and State

Company

Position RN-6-46

Come to the famous
COYNE
TRAINING SHOPS
where you learn by doing

TRAIN FOR **RADIO-ELECTRONICS**
IN A FEW WEEKS

Prepare For A Good Job Now With
A Lifetime Future!

Trained Radio-Electronics men needed now. They will be needed too in the years to come. Don't be caught napping. Get a Radio training now and be ready. Learn by Doing. Free employment service for life after graduation. Many earn while learning. If you are short of money, I'll finance most of your tuition. Training in Industrial Electronics and Electric Refrigeration added to our course. We are also equipped to train those who qualify under G. I. Bill. We also have facilities for men with physical disabilities whether due to war or other causes. Fill in and mail coupon for details.

SEND COUPON FOR FULL DETAILS

H. C. LEWIS, Pres., Radio-Electronics Div.
COYNE ELECTRICAL SCHOOL
500 S. Paulina St., Dept. A6-1K, Chicago 12, Ill.
Send Free Book and details about Coyne Part-Time Employment and Student Finance Plan.
 Send G. I. Bulletin Physical Disability

NAME AGE

ADDRESS

CITY STATE

The losses of food value from electronic blanching is well-nigh negligible. To be more explicit, only three per-cent of ascorbic acid was lost when electronics was employed, as contrasted with a 40 per-cent loss when vegetables to be preserved were exposed to boiling water. "The nearly negligible loss of ascorbic acid, during electronic blanching," point out Professors Moyer and Stotz, "in contrast to the 30 to 40 per-cent losses occurring in the steam and water processes points the way to production of processed vegetables of higher nutritive value. Other vegetables have been successfully blanched by electronics, and more extensive studies of the value of dielectric heating for the inactivation of enzymes in fruits and vegetables are in progress and will include storage trials."

The operation of this, the first, electronic equipment in preserving vegetables was beset by difficulties; what these were and how they were overcome are lessons in applied electronics. Inasmuch as radio high frequencies penetrate only the vegetables between the electrodes, some of the heat generated in the mass of vegetables is lost to the surrounding air, which permits the outer portion of the vegetable to be heated at a reduced pace. However, this needless sacrifice of heat is a problem that has been overcome by mounting the electrodes in an air oven with a temperature comparable to boiling water. Another snag encountered was that of transferring radio energy from the point of origin in the giant electronic tubes of the oscillator to the electrodes in the air oven. At the ultra-high frequency of 150,000,000 cycles-per-second, interfering radio fields were established around the extensive bands of copper connecting the oscillator to the electrodes. Unless this opposing force is overcome, the quantity of radio energy delivered to the electrodes is reduced appreciably, with a consequent drawing out of the required period for blanching. Ingeniously enough, Cornell University scientists skirted this problem by use of loops of copper wire, these serving to short-circuit the electrodes and consequently eliminate the undesirable effect of conflicting and opposing radio fields. Still another scheme of adding to the efficiency of power transmission is to elevate or lower the upper electrode.

In the original blanching experiments by electronics, the washed fruits and vegetables were deposited in rectangular, end-opening cartons with cellophane liners. The containers are then slid along glass rods so that the carton was centered precisely between the upper and lower electrodes. The temperature of the cabbage or other vegetable to be blanched electronically was obtainable throughout the preserving period by means of a thermometer poked part way into the vegetable or fruit carton. Inasmuch as the vegetable or fruit is heated throughout simultaneously, the

Roehr Distributing Company

St. Louis' Radio
Mail Order House

ANTENNAS (Auto and Home)
CONDENSERS
RESISTORS
MICROPHONES
TUBES

PHONO MOTORS
BATTERIES
(All Types—
AB Packs)

PHONO NEEDLES
TRANSFORMERS (All Types)
VOLUME CONTROLS
(Complete Stock Carbon
and wire wound)

ALL R. M. S. CABINETS IN STOCK

Write for our list of tubes,
catalog package, and in-
formation on how to secure
a Speedex Tube Base Chart
free of charge.

ST. LOUIS 3, MISSOURI

YOU GET MANY Extras!

Rowe No. 7
Permanent
Magnetic
Driver Unit



EXTRA power, extra long life, extra freedom from break-downs, extra ease of replacement . . . these are but a few of the many extras you get in the ROWE No. 7 PERMANENT MAGNET . . . first choice of sound engineers who investigate thoroughly and analyze carefully.

The 3 lb., 4 oz. ALNICO Magnet gives power and permanency; combined voice coil and diaphragm assembly heads off trouble, provides for quick replacement if necessary. Write for circular giving complete details. Address, Dept. 646

ELECTRONICS DIVISION

Rowe Industries
3120 MONROE ST., TOLEDO 6, OHIO

RADIO NEWS

heating periods ordinarily employed in the steam or boiling-water processes cannot be accepted as the suitable guide for electronic blanching. Necessarily, therefore, similar samples of vegetables were heated dielectrically to varying temperatures for varying periods of time. Comparable specimens of vegetables were preserved in steam or boiling water for the usual periods of time and these acted as reference standards for judging the appearance and flavor following periods in storage, say, at 10 degrees Fahrenheit. To determine the thoroughness of the new blanching method, portions of samples were employed to measure the residue of chemical ferments (enzymes) active after applying the science of electronics. Vitamin analyses were also conducted on fresh, blanched, and frozen batches of vegetables and fruits after they were taken from the food warehouse or storage.

As the inventors of a patented device who seek broad allowable claims, Cornell University food scientists avoid imposing narrow limitations on the applications of electronic heat. Certainly they would not limit it to the blanching of vegetables and fruits, but would insist that the "allowable claims" be all-embracing in the entire sphere of processing foods. Electronics would range far afield, "wherever there is a problem of uniform heat penetration or when it is desirable to heat a food without exposure to moisture."

-50-

LCR Meter
(Continued from page 42)

3 inch chassis mounted on an 8 3/4 inch relay rack panel. An 8 x 17 x 3 inch chassis would have been preferable but at the time none was available. The oscillator circuit components are located at the right end of the chassis (Fig. 3), the power supply in the center, and the LCR meter components at the left end of the chassis. Fig. 1 shows the arrangement of the front panel. The dials are homemade using National Type A vernier movements and are similar to the type ACN dials which were not available when the unit was built. The left hand dial operates the oscillator tuning condenser. The right hand dial is connected to C₁₁. The two meters are placed between the two dials, M₁ is placed in the lower position to keep the r.f. leads as short as possible. J₁ is at the lower left corner of the oscillator dial and J₂ and J₃ are at the lower right corner of the same dial. P₁ and P₂ are on the lower left corner of the LCR meter dial and P₃ and P₄ are just below.

The remainder of the controls are placed below the dials from left to right as follows; S₁, S₂, R₁₂, R₃, S₃, and R₁₈. J₁ is to the left of the knobs and S₄ is to the right of them. These may be seen in Fig. 1.

The tuning coil for the highest fre-

June, 1946



FLANAGAN RADIO CORP.

America's Largest Stock of Radio Tubes

WE SHIP ANYWHERE IN THE WORLD

STANDARD SEALED CARTON TUBES

Your Money Back If Not Satisfied

0Z4 ... \$1.20	2A7 ... \$.76	6J5 \$.60	6X5GT .. \$.76	12Q7 ... \$.82	50 \$1.41
1A5 ... 1.09	3Q5 ... 1.51	6J790	7A4 1.00	14A7 ... 1.41	5576
1A7 ... 1.27	354 ... 1.20	6K576	7A5 1.00	14B6 ... 1.41	5860
1C5 ... 1.09	5T4 ... 1.41	6K676	7A6 1.00	24A65	6E5 1.10
1H5 ... 1.09	5U476	6K776	7A8 1.30	25L6G .. 1.30	71A(01A) .54
1LA4 .. 1.90	5W476	6K8 1.21	7B4 1.00	25Z5 ... 1.00	7585
1LA6 .. 2.27	5X499	6L576	7B6 1.00	25Z6M .. 1.30	7660
1LB4 .. 1.90	5Y355	6L6 1.41	7B7 1.30	2655	7760
1LC6 .. 2.27	5Y475	6L7 1.20	7C6 1.00	2742	7860
1LH4 .. 1.90	5Z376	6N5 1.20	7G7 1.41	3076	79 1.20
1LN5 .. 1.41	5Z4 ... 1.09	6N6 1.90	7H7 1.41	35/5176	8055
1N5 ... 1.27	6A7 ... 1.00	6Q790	7Y4 1.00	35Z480	84/6Z4 .. 1.00
1Q5 ... 1.20	6A8GT . .98	6R790	12A6 ... 1.41	39/4476	117L/M7 . 2.27
1R5 ... 1.20	6C576	6SA776	12A8 ... 1.00	35A5 ... 1.27	117N7 ... 2.27
1S4 ... 1.20	6C676	6SF567	12SF7 .. 1.21	35Z3 ... 1.27	117Z6 ... 1.59
1S5 ... 1.20	6D676	6SK776	12F576	43 1.10	XXL 1.21
1T4 ... 1.20	6F596	6SQ776	12J576	4580	
1T5 ... 1.20	6F676	6U5/6G5. 1.10	12J7 ... 1.00	45Z3 ... 1.10	
2A3 ... 1.27	6F7 ... 1.21	6V6GT76	12K7 ... 1.00	45Z580	
2A576	6H676	6X5 1.20	12K8 ... 1.21	47 1.10	



SUPERIOR MULTI-METER

Complete with hand-rubbed oak portable cabinet, cover, self-contained battery, test leads and instructions. It is speedy . . . has push button operation. It measures A. C. Volts, D. C. Volts, D. C. Current, Low Resistance, High Resistance, Low Capacity, High Capacity, Decibels. SPECIFICATIONS: 5 A. C. Voltage Ranges; 5 D. C. Voltage Ranges; 5 Output Meter Ranges; 4 D. C. Current Ranges; 2 Capacity Ranges; 3 Decibel Ranges; 4 Resistance Ranges.

FLANAGAN CAT. #740

MODEL
PB-210
NET PRICE
\$35⁷⁵

5 TUBE KITS

50L6, 35Z5,
12SA7, 12SK7,
12SQ7
\$488
FOR ALL 5

CRYSTAL PICKUPS

COMPLETE WITH
HARDWARE, LATEST
DATE OF MANUFACTURE
\$287 Each

TUBE SPECIALS FOR RADIO HAMS

307 ... \$1.70	829B ... \$8.90	2AP1 .. \$4.90
807 ... 1.90	9001 .. 2.45	58P1A .. 12.45
866 ... 1.45	9002 .. 1.95	5FP7 .. 9.95
954 ... 4.90	9003 .. 2.45	5R4GY .. 1.80
955 ... 2.90	9004 .. 1.95	6AK5 .. 1.69
8005 .. 4.90	9006 .. .94	7BP7 .. 14.90
8025 .. 8.90		VR-105 .. 1.37

EMERSON

TUBULAR CONDENSERS

WITH LEADS GUARANTEED
FRESH 20/20 MFD—150 Volts
FLANAGAN CAT. #272 ea. **55¢**

And Hundreds of other items. Send postal for FREE Complete Catalog of Radio Parts, Tubes, Batteries, Record Players, Radios, etc. Orders filled as received. We ship anywhere. We do not back order. Write Dept. R. N.

A GOLD MINE RADIO HARDWARE

Transformers...Coils...Sockets of all types
...Screws, all sizes...Nuts...Bolts...
Grommets...Angles...Wire...Resistors
...Portable Battery Plugs...Connectors...
Terminal Strips...Insulators...Lugs...
Spaghetti, ETC.

A \$25.00 VALUE—DON'T MISS IT!

3 1/2 x 6 x 9" LOADED **\$200** Box

PHONO-AMPLIFIERS



3 TUBE AC-DC
TONE CONTROL
VOLUME CONTROL
LESS SPEAKER

\$744 Net

Completely wired, ready to operate. Uses a dynamic speaker, 450 OHM Field.

INCLUDING TUBES
50L6 • 35Z5 • 12SQ7

FLANAGAN RADIO CORP.

N. E. COR. 7th & CHESTNUT STREET • PHILADELPHIA 6, PENNA.

FOR ALL Electricians

- AUDELS
ELECTRICIANS EXAMINATIONS**
- AUDELS
WIRING DIAGRAMS**
- AUDELS
ELECTRICAL DICTIONARY**
- AUDELS
ELECTRICAL POWER CALCULATIONS**
- AUDELS HANDY BOOK OF
PRACTICAL ELECTRICITY**
- AUDELS
RADIOMANS GUIDE
TELEVISION**
- AUDELS
ELECTRONIC DEVICES**
- AUDELS
ELECTRIC WELDING**
- AUDELS
ELECTRIC LIBRARY
12 VOLUMES ILLUSTRATED**

PRACTICAL ELECTRICITY at your finger ends. Answering your Questions and giving the facts and figures of your trade. Audels Electrical Guides contain Practical Inside Trade Information in a handy form. Fully illustrated and Easy to Understand. Highly Endorsed. Check the books you want for 7 days' Free Examination. Send No Money. Nothing to pay postman. If satisfied pay only \$1 a month until purchase price is paid.

ASK TO SEE THEM.



Get This Information for Yourself. Mail coupon today. No obligation unless O.K.

-----CUT HERE-----

MAIL ORDER

AUDEL, Publishers, 49 W. 23 St., NEW YORK 10, N. Y.

Please send me postpaid for FREE EXAMINATION books marked (x) below. If I decide to keep them I agree to mail \$1 in 7 Days on each book ordered and further mail \$1 monthly on each book until I have paid price.

- ELECTRICIANS EXAMINATIONS, 250 Pages . . . \$1.
- WIRING DIAGRAMS, 210 Pages 1.
- ELECTRICAL DICTIONARY, 9000 Terms 2.
- ELECTRICAL POWER CALCULATIONS, 425 Pages. 2.
- HANDY BOOK OF ELECTRICITY, 1340 Pages . . . 4.
- RADIOMANS GUIDE, 914 Pages 4.
- ELECTRONIC DEVICES, 216 Pages 2.
- ELECTRIC WELDING, 400 Pages 1.
- ELECTRIC LIBRARY, 12 vol., 7000 Pgs., \$1.50 Each

Name: _____

Address: _____

Occupation: _____

Employed by: _____ RN



NEW!
4-in-1
Job Card

Designed for Service Dealers

Provides: 1. Radio or Appliance Tag;
2. Customer Claim Check;
3. Guarantee;
4. 3-5 Filing Card.

Radio Press MORGANTOWN WEST VIRGINIA

SAMPLE AND PRICES ON REQUEST



RCA Institutes, Inc.

Offer thorough training courses in all technical phases of Radio and Television

WEEKLY RATES **DAYS—EVENINGS**

VETERANS: RCA Institutes is approved under G. I. Bill of Rights

For Free Catalog write Dept. RN-46
RCA INSTITUTES, Inc.

A Service of Radio Corporation of America
75 Varick St., New York 13, N. Y.

quency band is soldered directly to the proper terminals of S_1 . The coils for the next two bands lower in frequency are wound on one form and are mounted very near to S_1 . The other three coils are placed in the corners of the oscillator section of the chassis since the length of leads at these frequencies is not of great importance. The six trimmer condensers are mounted on a bakelite sub panel and are placed just to the right of S_1 . The holes in the chassis which allow the adjustment of the trimmers are just towards the center of the chassis from the tuning condenser.

Particular care should be taken to select good insulation for use in the oscillator and LCR circuits. Steatite or polystyrene should be used wherever possible. Short heavy leads should be used in the LCR circuit to hold to a minimum the internal inductance of the instrument. Any excess of internal inductance will cause a decrease of accuracy of measurements made at high frequencies.

All grounds for each circuit are made at one point only because any radio frequency currents flowing in the chassis may cause stray voltages to appear at points where they will effect the accuracy of the instrument.

Although in the instrument described the coils for the two lower frequency bands were bank wound, it is thought that a sectionalized layer winding of the same number of turns would give satisfactory results. Liquid collodion was used to hold the end turn of each bank of the winding until the next bank could be wound against it. Although collodion is not recommended as a low-loss coil dope it was used because it dries very rapidly. Because of the small amount of the winding covered by it and because it was used only on the low frequency coils it is thought that it did not materially effect the losses of the coils. After the coils were completed they were thoroughly coated with polystyrene coil dope.

Because of the large amount of overlap of the tuning ranges of the low frequency coils a three gang condenser should have a sufficiently high maximum capacity to allow the same over-all frequency coverage. It would of course be necessary to increase the inductance of the coil for the lowest frequency band if coverage to 100 kc. is desired.

Special precautions are necessary to reduce the inductance of R_s in order to allow operation at 30 mc. R_s was constructed as a double coaxial resistor consisting of two branches of #38 Advance resistance wire connected between a piece of #18 enameled copper wire and a block of brass serving as the common ground point for the LCR circuit. Another brass block fits over the top of the resistor to totally enclose it. The two brass blocks were faced and bolted together and a hole to pass the #18 copper wire was drilled between them. At one end of the blocks small grooves were cut to hold

!SURPLUS! Navy Transmitter Tuning Units

EACH UNIT CONSISTS OF—

- 1 Gear-Driven Dial, Vernier 3 Place
- 1 Velvet Vernier Dial Assembly
- 3 Pointer Knobs
- 2 Dial Locks
- 3 Ceramic Insulated Shaft Couplers
- 1 Tapped Oscillator 25 Watt Coil With Triple Ganged 2 Position Switch
- 1 Ceramic Insulated 150 mmfd .030" Variable
- 1 Micalex Insulated 100 mmfd Fixed Padder
- 1 Micalex Insulated 30 mmfd Variable
- 1 Mica-Filled Tapped Variometer
- 1 Continuously Variable Coil 21 Turns With Calibrated Dial Assembly
- 1 Ceramic Insulated 100 mmfd Variable Heavy-Duty With .175" Spacing
- 1 Cornell-Dubilier Type 639-15L .00005 mfd 3000 volts
- Assorted Brackets, Hardware & Chassis

YOUR COST \$ **5** 95

Limited Quantity
ORDER NOW

UNIVERSAL
RADIO SUPPLY CO.
1404 VENICE BOULEVARD
LOS ANGELES 6, CALIFORNIA

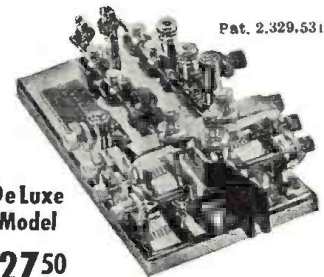

De Luxe Model

\$2750

THE MELEHAN VALIANT

Automatic Dots PLUS Automatic Dashes

- Permits sustained high speed transmission • Fifteen to eighty WPM • No vertical play in handle unit • Eliminates "glass arm" condition • Length and speed of dots and dashes individually adjustable • Handle elevation, leverage action and spring tension fully adjustable • Purely mechanical in operation, self-contained and self-sufficient • Outstanding in design and craftsmanship • Massive base and cradle unit • Light, balanced working parts assure that precision movement and split-second response so essential to true super-speed sending • Completely chromed • Base 4x1/2x7 • Shipping weight 7 1/2 pounds •

MELVINE E. HANSON
(W6MFY)
MELEHAN RADIO 821 Main Street
HUNTINGTON BEACH, CALIFORNIA

RADIO NEWS

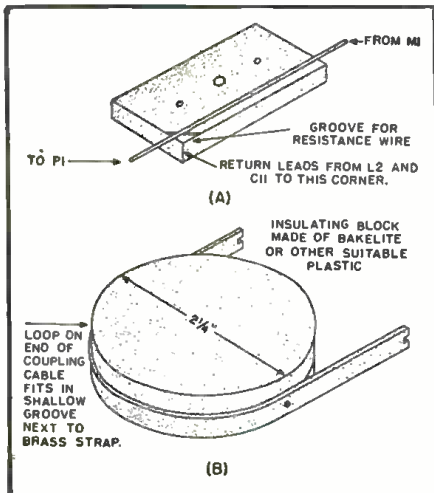

Fig. 6. (A) Construction of resistor. R. (B) Details of construction of test inductor. used for checking capacitors with the grid-dip oscillator.

the #38 Advance wire. Details are shown in Fig. 6A. Perhaps the precautions taken to reduce the inductance of R_s were excessive; it may be possible to construct the resistor on the face of the bottom block with no necessity of a cover if sufficiently small resistance wire is used. Two legs of #40 Advance wire about $\frac{1}{2}$ inch long should give about the proper resistance. If the resistance wire is enameled it is much easier to confine the solder to the areas where it is desired. It is essential that the return lead from the coupling link and the return lead from C_{11} be connected to the brass ground block as closely as possible to the points where the resistance wires are soldered to the block. Any path common to these two leads will add an inductive reactance in series with the voltage developed across R_s and will cause errors in the readings of the instrument. The chassis should not be used as a return for either of these circuits.

It is desirable that M_1 be an external thermocouple type meter since with an internal thermocouple meter there may be an inductive field of considerable strength in front of the meter. If it is necessary to use a meter with an internal couple care should be taken to keep coils under test from being placed immediately in front of the meter. Before the power switch, band change switch, or the instrument use switch (S_2) are operated, R_s should be turned fully counter-clockwise to prevent accidental burnout of M_1 .

Fig. 6B shows the test inductor for checking capacitors with the grid-dip oscillator. The loop of the coupling cable is placed next to the brass strip and the ends of the brass strip are firmly held against the leads of the capacitor. The oscillator frequency is then varied until the resonant frequency of the capacitor and the inductor is crossed. Then by reference to Fig. 2 the capacity of the capacitor is found.

-50-

Burlington

'DONUT' TRANSFORMERS



These transformers are designed for use with vane type ammeters which are used on frequencies from 25 to 133 cycles.

Maximum accuracy is obtained at 70% of full scale value and is dependent upon the number of primary turns used. Accuracy is directly proportional to the number of primary turns.

These transformers are designed for a capacity of two volt-amperes and the secondary windings are of such size as to allow in excess of 800 CM/ampere at maximum rating.

Insulation resistance is such that 4500 volts can be applied without breakdown.

*Burlington Bulletin DT gives full information.
Write for a copy today.*

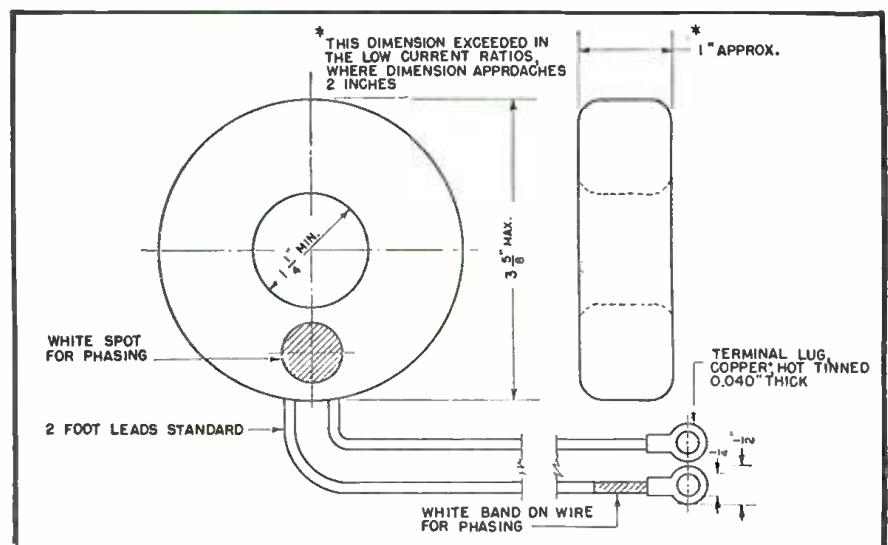

BURLINGTON INSTRUMENT COMPANY
906 Fourth Street
Burlington, Iowa

R-L AND WARD AUTO RADIO ANTENNAS



SIDE COWL MOUNT

5675 (as illustrated) 3 section 66". 2 stanchion mounting, rust-proof finish with 36" moisture-proof leadin. Shipping Wt. 2 lbs.
NET\$2.25

UNIVERSAL FENDER MOUNT

5681—3 section 56". Single stanchion mount. Fits all cars. With 48" HI-Q low loss detachable lead. Shp. Wt. 3 lbs.
NET\$4.67

UNIVERSAL FENDER OR COWL MOUNT

5684—3 sections 68". Fits all cars. Shipping Wt. 2 lbs.
NET\$3.20

Write for Free 1946 Parts Catalog



731 West Washington Boulevard
DEPT. N CHICAGO 6, ILLINOIS

**MORE SMASH BUYS at
National Radio Distributors**

IMMEDIATE DELIVERY

NEW POST-WAR SCOOP



5 tube AC/DC Superheterodyne Radio Kit featuring built in loop antenna, using 12SA7, 12SK7, 12SQ7, 50L6, 35Z5 tubes. All parts brand new and perfectly matched. Absolute satisfaction guaranteed. Complete, including cabinet and full instructions for assembling. \$13.75

In lots of 3 12.95
Kit of 5 matched tubes 4.95

SPECIAL—NEW MAGUIRE ARC—1 RECORD CHANGER, precision engineered, single control knob, plays 10—12" or 12—11" records, stops automatically after last record is played. Extra light-weight pickup arm, features spring mounting and heavy duty rugged motor \$22.95

PAC 100 PORTABLE RECORD CHANGER CASE, dark brown leatherette covered. Will accommodate above or any other make changer. Mounting panel 15 1/2" square. NET \$8.95

EXTRA SPECIAL!—BY-PASS CONDENSER KIT. Consists of 100 Tubulars (all 600 Volt) in the following sizes: .001, .002, .006, .01, .02, .03, .05 and 1 Mfd. All fresh stock; fully guaranteed. Per Kit \$5.95

A GREAT BUY—INSULATED RESISTOR KIT. Contains 100 1/2, 1 and 2 Watt New BT (Type Metalized Insulated Resistors. Approximately 60 different popular sizes. Some Gold Band. Per Kit \$2.69
In lots of 10 each \$2.25

AERIAL KITS—Contains everything necessary to put up a good broadcast aerial. Individually boxed. Each 75c
In lots of 25. Each 71c

Please include at least 25% with C.O.D. orders.
Write for New Free Catalog Now!

National Radio Distributors

1029 A E. 163 St., New York 59, N.Y.

Manufacturers' Literature

Readers are asked to write directly to the manufacturer for the literature. By mentioning RADIO NEWS, the issue and page, and enclosing the proper amount, when indicated, delay will be prevented.

NEW OHMITE BULLETIN

Bulletin No. 127 has recently been released by *Ohmite Manufacturing Company* of Chicago in which are described the new "Little Devil" resistor line made by the company.

Included are the 1/2 watt, 1 watt and 2 watt insulated composition resistors. Construction and performance data, dimensional drawings, lists of stock items and the RMA color code are also given.

A copy of this bulletin will be sent without charge upon application to *Ohmite Manufacturing Company*, 4835 Flournoy Street, Chicago 44, Illinois. Please specify Bulletin No. 127.

PHOSPHOR BOOKLET

North American Philips Company, Inc., has recently issued a 16-page booklet entitled "Phosphors and Their Behavior in Television," which is being distributed without charge to interested persons.

The text material was written by Irving Krushel, Chemical Engineer, who describes in detail the intricate chemical processes involved in the manufacture of cathode-ray tube screens.

The booklet covers such subjects as the general theory of fluorescence, manufacturing problems, the chemistry of various fluorescents used, types of cathode-ray tube screens, essential C-R tube elements, building of the screens, properties of phosphors, effects of milling and temperature, gas absorption, efficiency and phosphor objectives for projection television.

A copy of the booklet will be forwarded upon request to *North American Philips Company, Inc.*, 100 E. 42nd Street, New York 17, New York.

W-L CATALOGUE

A new bulletin, Catalogue D-2, which gives complete data on the W-L line of wirewound vitreous enamel resistors, has been issued by *Ward Leonard Electric Company* of Mount Vernon, New York.

The catalogue which has been specifically designed for the electronic industry contains listings of hundreds of fixed and variable resistors in several different forms.

Copies of this catalogue are free upon request. Write *Ward Leonard Electric Company*, 31 South Street, Mount Vernon, New York. Please specify Catalogue D-2.

SUPPLY TIMETABLE

As a service to the industry, the *New York Journal of Commerce* has just published a new supply timetable

which enables manufacturers to keep abreast of raw material stocks.

The probable end of acute scarcities and the eventual date when supply and demand will be balanced is spotlighted in the timetable.

Copies of "Scarce Materials Timetable" may be secured at a cost of 25 cents from *New York Journal of Commerce*, 63 Park Row, New York 15, New York.

VERTROD DATA

Vertrod Corporation has recently issued a specification sheet covering their Model 103 antenna kit.

This particular model consists of a 3-section, 9-foot hard aluminum mast mounted on a patented rotary base. The transmission system of this unit is capable of piping r.f. signals of frequencies 500 kc. to 30 mc. from rod to the radio set input. This antenna is suitable for communications, broadcast and short-wave receivers.

Full information on this kit is included in the data sheet which may be obtained by writing *Vertrod Corporation* at 60 East 42nd Street, New York 17, New York.

CONCORD CATALOGUE

A 112-page, postwar catalogue has been issued by *Concord Radio Corporation* of Chicago and Atlanta.

Containing information on radio receivers and radio-phonograph combinations, this catalogue makes a handy buying guide for the radio dealer. In other sections of the catalogue are listed amplifiers, parts, equipment, supplies and accessories, tubes, meters, condensers, transformers, resistors, controls, switches, relays, generators, microphones, test equipment, tools, and amateur kits and supplies.

A free copy of this new catalogue may be obtained by writing *Concord Radio Corporation*, 901 West Jackson Boulevard, Chicago 7, Illinois.

FM EQUIPMENT BULLETIN

A complete description of various types of FM equipment has been issued by *Federal Telephone and Radio Corporation* for those interested in establishing a frequency modulation station.

The booklet includes information on the 1 kw., 3 kw., 10 kw., and 50 kw. transmitters; antenna arrays; control consoles; station accessories (transcription tables, microphones, studio recorders, monitor speakers); tubes; support towers; and transmission line.

The bulletin entitled "Complete FM Radio Broadcast Equipment" is being distributed by *Federal Telephone and*

Radio Corporation, 67 Broad Street, New York 4, New York.

CORNING BOOKLETS

The Corning Glass Works has issued three new four-page booklets which are of particular interest to the electronics industry.

Entitled "Glass Components for the Electronic Industry," "Silica Glass for the Electronic Industry" and "Metalized Glassware for the Electronic Industry," these booklets outline glass characteristics which are favorable for electronic usage.

Any or all of these booklets will be forwarded to those interested in the subject. Address all requests direct to Corning Glass Works, Corning, New York.

EQUIPMENT CATALOGUE

A new 35-page catalogue which lists hundreds of industrial and laboratory items has just been made available by Precision Equipment Company of Chicago.

Of particular interest to the radio serviceman are the listings for portable electric tools, tool boxes and storage bins, voltage regulators, inverters, voltboxes, soldering irons, etc.

A copy of this booklet will be sent to those requesting it from Precision Equipment Company, 32 North State Street, Chicago 2, Illinois.

WESTON MAGAZINE

Weston Electrical Instrument Corporation has begun the publication of a bi-monthly magazine entitled "Weston Engineering Notes."

This magazine will serve as a me-

T.I.I.C. REQUEST

THE Technical Industrial Intelligence Committees have asked for the co-operation of American industry in making known the subjects about which the industry would like information from German and other enemy sources.

The Office of the Publication Board and the War Department are about to begin a complex and difficult operation, i.e., the selection and the microfilming, in Germany, of data that may be valuable to American science and industry. Since it is difficult for a government agency to determine what items of material may be of value to some American business or research group, the OPB has asked for assistance in this matter.

The OPB would like to have industries and scientific groups suggest specific information that should be sought by the Technical Industrial Intelligence Committees. Any suggestions as to where valuable documents might be found and what industries in Germany might possess information would be appreciated.

The need for qualified technicians to help carry on this work is still great and persons knowing of individuals who might qualify for these expert classifications are asked to communicate with the OPB.

All communications should be addressed to John C. Green, Executive Secretary, Department of Commerce, Office of the Publication Board, Washington 25, D. C.

-50-

The Difference Between "We Think So" and "We KNOW So"

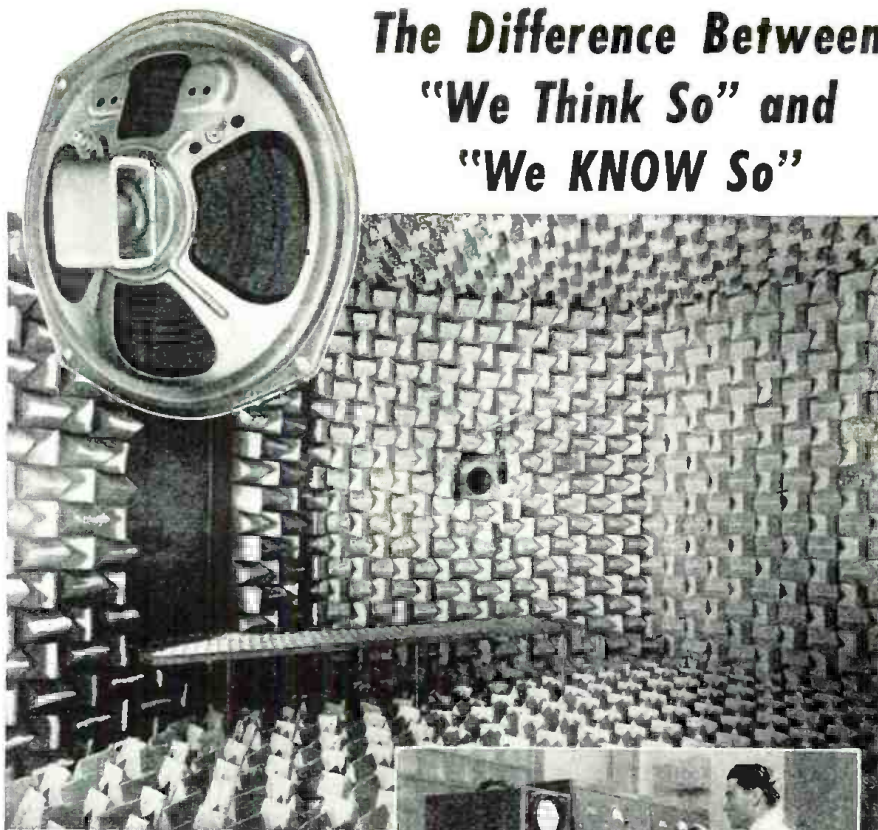

Permoflux Speakers

... are Engineered for Application in this Stalactite Acoustical Chamber

In this completely soundproof room, asymmetrical walls and carefully designed mass-interval baffles effectively reduce troublesome resonant harmonics and reflected sound to an insignificant value. Response curves are plotted which represent true performances so that Permoflux engineers can say "We Know So." Its use at Permoflux is characteristic of the many factors which make it possible to substantiate the fact that Permoflux Speakers provide the finest possible sound reproduction.

SEE US AT THE CHICAGO TRADE SHOW—BOOTH 32

TRADE MARK
PERMOFLUX

PERMOFLUX CORPORATION
4900 WEST GRAND AVE., CHICAGO 39, ILL.



PIONEER MANUFACTURERS OF PERMANENT MAGNET DYNAMIC TRANSDUCERS

ALSAMS CASES

REGENCY STRIPED



Model P-512 Portable Phonograph Case



Model RC-250 Portable Automatic Phonograph Record-Change Case



Table Model Radio Cabinets
Model L-200
Model L-300

The NEW Alsam Regency Striped Cases enhance the beauty of radios and phonographs.

Write for illustrated literature featuring other models. Prices furnished on request.

ORDER FROM YOUR JOBBER!

ALSAM PRODUCTS COMPANY

805 MILWAUKEE AVENUE
CHICAGO 22, ILL.

WAR SURPLUS BARGAINS

WAR SURPLUS BARGAINS

BIG SAVINGS
Hundreds of specials
for **RADIO SERVICEMEN**

- CATHODE RAY TUBES
- POWER & TRANSMITTING TUBES
- HEADPHONES, etc.
- HARD-TO-FIND TEST METERS



7 LB. EXPERIMENTERS RADIO PARTS ASST.
A "gold mine" for the experimenter, radio serviceman, handyman and repairman. Hundreds of valuable radio, radar and electronic parts, screw machine parts, bushings, sub assemblies, etc. More than your money's worth every time. An amazing value. Money-back guarantee.

K130R—FULL 7 POUNDS ONLY \$179

War Surplus Bargain Book
Page after page of war surplus and other bargains for the radio serviceman; also a special for home, shop and outdoors.

IT'S FREE! WRITE TO-DAY

FREE CATALOG

STARK'S Dept. RN646 509 So. STATE STREET
CHICAGO 5, ILLINOIS

dium for providing pertinent application engineering information for users of electrical indicating instruments.

The first issue features articles covering the galvanometer and the bridge, and copper oxide rectifiers as used in measuring instruments.

Anyone interested in instrumentation problems will be placed on the mailing list to receive this publication regularly. Requests for this service should be addressed to John Parker, Editor, *Weston Electrical Instrument Corporation*, Newark 5, New Jersey.

NEWCOMB CATALOGUE

A 24-page catalogue listing the company's complete line of audio products has just been issued by *Newcomb Audio Products Company* of Los Angeles, California.

Included in the listings are a new line of audio amplifiers, pre-amplifiers and accessories. The line features two distinct series, the K-series deluxe models with plastic keylock control cover, volume and overload indicator, and master volume control, and the H-series standard models designed for applications where lower cost must be considered.

Portable systems built around all models of both K- and H-series amplifiers are also included in the catalogue.

Inquiries about the line, or requests for the catalogue should be addressed to *Newcomb Audio Products Company*, 2815 S. Hill Street, Los Angeles 7, California.

-30-

Invisible Light

(Continued from page 35)

jects the incoming infrared radiation upon a photo cathode in the "iconoscope" end of the tube. As this screen is sensitive to the infrared light, it emits electrons upon being exposed to such radiation (a photo physical reaction). These electrons, in an electronic image of the scene illuminated by the infrared, pass through a series of electrodes of varying potential and strike a fluorescent screen in the "kinescope" section of the tube in such a manner that the human eye can see a greenish picture of the original scene. The electron lens systems and the accelerating electrodes increase the sensitivity of the tube, and cause the picture on the fluorescent screen to be brighter and to have greater definition.

This equipment, when available for civilian purposes, will have several interesting applications. It can be used as a navigation device for ships and other surface craft thus permitting officers and lookouts to see a considerable distance with less eye fatigue on the darkest nights. Obstacles may be detected at sufficiently great distances to prevent collisions. Other vehicles can also be operated in complete darkness with safety. During the war the Army tested this equipment in connection with the operation of locomo-

BARGAINS IN RADIO PARTS

PHONOGRAPH PICKUP



List Price \$4.95.
Astatic, Crackle
finish, 12" Cartridge,
Brand New, Guaranteed.
In Lots of 12.....\$2.09 ea. Net 95%
In Lots of 100.....1.89 ea. Net
In Lots of 500.....1.79 ea. Net on All Orders

SURPLUS ARMY BATTERIES

ALL PERFECT—ALL GUARANTEED Manufactured

45 volt Z30N "B" (screw terminals)	.49	AUG. '44
67 1/2 volt Personal (clip terminals)	.89	AUG. '45
6 volt Eveready 718 "A" (Jumbo)	.29	OCT. '44
90 volt Burgess X60BP (screw terminals)	.59	AUG. '43
90 & 3 volt Pack, Small, same size as small 45v "B" Uses 3 pr. 45 volt Std. Plug	.69	AUG. '44
In lots of \$50.00	20%	off
In lots of \$100.00	25%	off

25% Deposit on all orders

DYNAMIC MIKE

List Price, \$24.60. Astatic Model DN-M2. High Impedance. Flat response from 10 to 7000 cps. Brand New—Boxed.

In lots of 10.....\$8.99 ea. Net	
In lots of 24.....3.50 ea. Net	
In lots of 50..... 8.30 ea. Net	

25% Deposit on all orders.

BIGG
RADIO STORE
1506 W. WASHINGTON BLVD
LOS ANGELES CALIF

Post-war ELECTRONIC TRAINING



Classroom
Demonstrations
with
Modern
Test
Equipment

BY
SOL D. PRENSKY
60 PAGE EXPERIMENT MANUAL—FREE

60 pages of up-to-date, educationally sound, electronic demonstrations; illustrated in complete detail. Available to school purchasers of test equipment at no extra cost.

As a specialized agency for schools and colleges, we obtain speediest possible distribution of equipment selected as most suitable for school purposes:

- Signal Generators
- Oscillographs
- Demonstration Multi-meters
- Sound Systems
- Vac. Tube Voltmeters
- Radio Kits

Write for **DEMONSTRATION EXPERIMENT MANUAL-EMR**, enclosing \$2.00, which is refunded when any equipment is ordered by the school. (Indicate school connection).

Write also for bulletin **DRN** on Brand New Dumont Model Five (5") Oscillograph, to be available after July, for about \$99.50 (giving school address).



Radiolab Publishing & Supply Co.
652 Montgomery Street, Brooklyn 25, N. Y.

RADIO NEWS

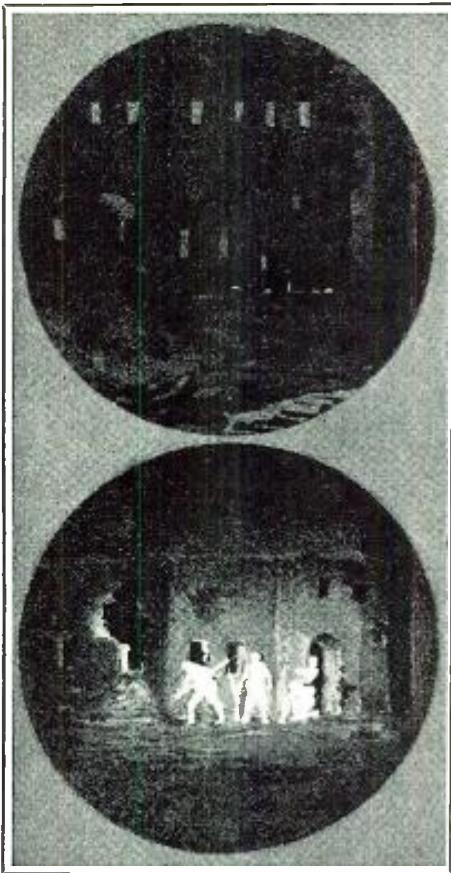

Top picture shows a street scene as viewed by the naked eye during the night hours. The bottom picture shows the same scene as viewed through the sniperscope. The figures which appear white in the picture actually have a greenish cast when viewed by the sniper. Clarity of details enables sniper to score direct hit.

tives during the hours of darkness.

In spite of the fact that this equipment was revealed to the public only a short time ago, several police departments have expressed an interest in the infrared "night sight" as a crime detection and prevention device.

Undoubtedly other peacetime uses for this unit will be found, where it will augment or replace certain radar applications, but until more extensive civilian tests are made, this weapon stands as a tribute to American ingenuity and "know-how".

-50-

EUROPEAN TUBE DATA

THE Office of the Publication Board, Department of Commerce, has announced the availability of data on European radio tubes, both military and commercial.

Tube characteristics, photographs, base diagrams, lists of equivalent tubes and other information is tabulated in a report compiled by the U. S. Army Signal Intelligence service to assist in identification, replacement, and evaluation of radio tubes. The report, PB-15055, is available on order from the OPB. The price for photostats is \$5.00, for microfilm, \$1.00.

One section of the report lists RCA equivalents of many of the foreign tubes.

-50-

New CANNON Plug

FOR ALL LOW LEVEL SOUND TRANSMISSION CIRCUITS

AMPLE VOLTAGE AND AMPERAGE CAPACITIES

COMPRESSION GLAND WITH CABLE RELIEF SPRING OR CABLE CLAMP

LATCHLOCK FOR CONVENIENT QUICK DISCONNECT

PIN CONTACTS MACHINED OF SOLID BRASS—SILVER PLATED

15 AMP CONTACT

POLARIZING BOSS

9/32" CABLE ACCOMMODATION

EXTREMELY LIGHT WEIGHT AS LOW AS 1 1/2 OUNCES

XL 3 11 PLUG LIST PRICE \$1.25

STREAMLINED ZINC SHELL DESIGN BRIGHT NICKEL FINISH

THREADS TAPPED IN METAL FOR INSERT RETAINING SCREW

HIGH QUALITY MOLDED INSULATION

TYPE XL

Type XL is the new low-price "radio universal" Precision Cannon Connector. Born of the demand for more compact fittings, the Type XL connector is a precision product of the highest Cannon quality. And its design is based on sound engineering... for Cannon Plugs have a 15-year background as standard equipment on the finest of broadcast equipment.

The Type XL is a balanced design: It contains all the features that spell convenience and utility...and it is a product of precision craftsmanship. Illustration above points out the features that establish Type XL as a typical Cannon product.



XL-3-14N RECEPTACLE



XL-3-14 RECEPTACLE



XL-3-13N RECEPTACLE



XL-3-12 PLUG

CANNON ELECTRIC

Cannon Electric Development Co., Dept. F-228, Los Angeles 31, Calif. • Canadian Factory and Engineering Office: Cannon Electric Co., Ltd., Toronto, Canada • Representatives in Principal Cities... Consult Your Local Telephone Book



..... LETTERS FROM OUR READERS

THIS MONTH'S SPECIALS!

6 Volt 4 prong universal vibrator, List \$3.95	Your Net \$1.69
10-12 tube power transformer 6.3 V. winding 100 Ma.	3.69
4" speaker case only for talk back or P.A. systems	.69
100 asst. 1 and 1/2 watt resistors up to 10% tolerance	2.45
Headphones, Signal Corps, 8000 ohms, List \$10.00	2.95
Telegraph keys with cutout switch	.95
2500 mfd. 3 volt F.P. condensers	.49
Tubular electrolytic condensers	
20 mfd. 150 W.V.	.32
20-20 mfd. 150 W.V.	.55
50-30 mfd. 150 W.V.	.73
Tubular bypass condensers	
600 W.V.	
.01 and .02	.07
.05	.08
.1	.10
.25 mfd.	.15
5 mfd.	.22
12A6GT-replaces 50L6	89¢
46 tube (substitute for 45)	.49
8" P.M. speaker	3.59
New GL6 metal tubes in original cartons	.89
Plus shipping charges	

Write for our illustrated literature featuring all types of radio parts. Order from your jobber or write direct: Dept. C

ARROW RADIO CO.
2205 W. Division Street
Chicago 22, Ill.

ATTENTION HAMS!

Lee Kimberling—W8ESN—is now in charge of our amateur supply department and is here to help you solve your problems as well as to fill your orders. Send him your orders and ask him for any information you wish. He knows the answers.

TUBE SPECIALS

6 AK5 \$ 1.74	5BPIA \$12.50
5 R4GY ... 1.85	8005 4.95
VR-105 ... 1.41	8025 8.95
9002 2.00	829B 8.95
9003 2.50	5FP7 10.00
9004 2.00	955 2.95
900699	7BP7 14.95
307 1.75	9001 2.50
807 1.95	954 4.95
866 1.50	955 2.95

Many other tubes coming in daily. We carry a complete line of Ham equipment and parts . . . crystals, condensers, chokes, wires, cables . . . everything you need. If it's available LIFETIME can supply you. Write for latest bargain bulletin.

Lifetime
SOUND EQUIP. CO., Dept. 47
911-913 JEFFERSON AVE., TOLEDO 2, OHIO

SECOND CLASS TICKETS?

TONY WAYNE in his article on aircraft radio servicing says 'if it takes only a 3rd class phone to operate the plane radio, why should the radio mechanic have to get a 2nd class ticket?'

"Tch, Tch, Tony. All operators know the answer to that one. If you get your radio home from the serviceman and an hour later it goes out, you cuss him out and take it back tomorrow. If a pilot has his transmitter tuned up and an hour later in a peaspout fog he tries to contact the ground and the rig doesn't work—he may not be able to get back to give the serviceman hell—because he's dead or has a broken back. The fact that a pilot has only a 3rd has nothing to do with it. The pilot isn't allowed to even test a tube from the transmitter—and neither should the unlicensed serviceman.

"One out of three servicemen work fine with manuals but don't know basic radio theory. There is a lot of difference between licensing aircraft R.M. and licensing home radio servicemen. The aircraft R.M. is responsible to the FCC and may have his license suspended for careless work. The serviceman is responsible to no one. The serviceman's license, is designed, in most cases, to stifle competition and save the consumer's pocketbook (I don't believe it). The R.M. 2nd class is designed to qualify men and save the consumer's life. And it does. Right, ED?"

John V. Lavery
Colonial Service
Rolla, Missouri

Right!—ED.

WORD FROM BUENOS AIRES

AS AN Argentine radio amateur and a lover of North America, especially of the 'hams,' I wish to send you, on behalf of all the radio amateurs, radio technicians and operators of all the services of telecommunication, my best wishes and heartiest greetings. Now, after the victory, we, all the 'hams' united, send best wishes for a lasting peace and hope that the manipulators and broadcasters may convey messages not of destruction but of hope, peace and increasing prosperity for America and for the entire world.

"I only regret that I do not yet have a license to broadcast, because I was at one time with the Merchant Marine of my country, it was not possible to set up a small station. Now, we will see, in spite of the fact that the cost of materials is still prohibitive, if it is possible to make transmission through the ether, even though it may be on c.w. only, because the construction of a transmitter for c.w. is more economical. This will be seen later.

"I do not wish to burden you with this letter, presuming that you understand the Spanish language. I write in Spanish because, although I understand English very well, I do not want to impose on you with my many mistakes. I assure you that I love to hear the North Americans speak Spanish. They are formidable, 'excellent' as we Argentinians say. I have several merchant marine friends from the United States and some of them know only four or five Spanish words, as for instance, 'Yes, Argentine girls is very pretty,' which is as if I would say 'American girls is very good.'

"With kindest regards, I am"

Jose Maria Francisco
Calle Viamonte 332
Buenos Aires, Argentina

It is nice to hear from some of our Good Neighbors!

* * *

ANOTHER COUNTRY HEARD FROM

ON THE same latitude as Nome, Alaska, far up north in Sweden lies Umea, the place where this letter is written. I wish to extend my sincere thanks and congratulations for the articles and features in your magazine. I have been reading RADIO NEWS for many years and ever since I have been a subscriber every copy has arrived safely except the January, 1946 issue.

"Your magazine is of great interest to all radio technicians in Sweden and Europe, as a whole. You see, there are few instructive and popular radio magazines in Europe and of course none that can compete with RADIO NEWS. It is, in fact, a real radio bible.

"I am particularly interested in amateur short-wave and here in Umea we have started an amateur short-wave club and hope to start broadcasting next year. In the future, I hope you will publish more diagrams and features on DX transmitters and receivers.

"I started monkeying around with radio in 1928 while in America and I am a graduate of the NRI in Washington, D.C., and a member of the NRI Alumni Association.

"May I add that I would greatly appreciate it if some readers of RADIO NEWS would like to drop me a line some day. Having lived in America for some time and being a lover of American life, it would certainly make me very happy if some letters came my way."

Rueben Nilsson
Box 511, Obbola
Umea, Sweden

Here is a chance for some of our readers to strike up a pen friendship in Sweden.

—30—

International Short-Wave
(Continued from page 119)

at Random at 10:45 a.m.; News and Evening Serenade at 11 a.m.; and music between 11:15-11:45 a.m.; some afternoons, however, FXE can be heard weakly here in the East to sign-off at 4:10 p.m. with "La Marseillaise"; carries French news at 4 p.m.; frequency appears to be actually 8.015/30.

KENYA—VQ7LO, 4.950, Nairobi, is reported heard in Sweden with English news at 1 p.m.; the 6.060 frequency has been moved there from 6.114, is listed 5-6 a.m., 11 a.m.-2 p.m.; the 10.730 frequency verified by letter in 5 months, address is Cable & Wireless, Ltd., P. O. Box 777, Nairobi, Kenya.

LUXEMBOURG—Luxembourg II, 6.090, is scheduled 12 midnight-3:30 a.m., 5-8:30 a.m., and 12 noon-5 p.m.; identifies as *Radio Luxembourg*. Australians report English recordings from 4 p.m.

MADAGASCAR—Subsequent listings of *Radio Tananarive* indicate that the 3.400 transmission formerly listed as 9-10 a.m. is *actually* on 4.300 at 10-11 a.m. The 6.140 transmitter power is 1.2 kw. *Radio Tananarive* on 12.126 is scheduled 6-9 a.m., signs off with "La Marseillaise"; uses native and French languages; signals are usually poor.

MALAYA—The 25-meter transmitter in the "Far Eastern Service of *Radio SEAC*, calling from Singapore" is now heard well in the East on its announced frequency of 11.735, 4:15-8:30 a.m.; the parallel frequency of 6.770 is still fair to inaudible in East; English news is at 7:15, 8:15 a.m. The Malayan formerly on 6.090 and 6.180, now using 6.163, is located at Kuala Lumpur; is heard mornings, mostly in native languages; Oceania listeners report BBC news is carried at 8 a.m. Singapore, 11.858, is heard to India in English around 9-10:30 a.m., irregularly later.

MARTINIQUE—*Radio Fort-de-France*, 9.705, is again coming through well, frequently at 5:30-8 p.m. in areas where WRUS, 9.700, Boston, is not too strong; news on Tuesday, Saturday, 6:15 p.m.

MEXICO—XEBT, 6.000, *Radio Pan-americana*, uses 10 kw. power. XEBT, 9.625, Mexico City, is now heard after midnight with QRM from GWO, London, same frequency. XERH, 11.880, Mexico City, is now heard to sign-off at 1 a.m., irregularly later.

MOZAMBIQUE—CR7AB, 3.49, CR7AA, 5.86, and CR7BD, 15.24, Lourenco Marques, 12 midnight-1 a.m., 4:30-6:45 a.m., and 11:45 a.m.-3:30 p.m. *daily*; CR7BE, 9.71, Lourenco Marques, comes on at 2 p.m. and runs to closedown at 3:30 p.m.; on Sundays *all* stations operate 4-7 a.m. and 10 a.m.-2:30 p.m.; English news at 10:10 a.m. and 2:50 p.m.; usually, CR7BE is good in the U. S. afternoons.

NEW BRITAIN—VJZ, 9.310, Raul, is heard well in Australia on this

June, 1946

CHANGING TIMES SHOULD BE SUCCESSFUL TIMES FOR EXECUTIVES!

Today, war worries have been succeeded by an atomic turmoil. Far-reaching changes have always followed wars—and the man who has kept pace always comes out on top.

Come what may, one need is never completely filled—the need for competent executives to direct business and industry. In tumultuous times like those of today, this demand multiplies. Right now, the outlook for ambitious men is brighter than ever before—if they have the training to take advantage of opportunities.

The training needed is not narrowly specialized, but goes broad and deep, probing the basic principles that underly *all* business. It provides the knowledge that enables men to direct the activities of others not in one department or one kind of business, but in *any* business. It supplies the "know how" that enables top executives to manage *any* business.

How to get such executive training

Training of this kind is provided by the Modern Business Course and Service of the Alexander Hamilton Institute. The Course covers the four major functions of business—Production, Marketing, Finance and Accounting. It turns out not accountants, or salesmen or production men, but *executives!*

Takes months instead of years

This knowledge takes years to acquire by ordinary methods. Through Institute training, the process is concentrated and thus finished in a matter of months. It does not interfere with a man's present position, being taken at home, during spare hours. More than 430,000 men have subscribed; many call it "a turning point in their lives."

Many prominent contributors

One reason why the Institute Course is so basic, thorough and scientific is found in its list of prominent contributors. Among them are such men as Thomas J. Watson, President, International Business Machines Corp.; Frederick W. Pickard, Vice President and Director, E. I. du Pont de Nemours & Co.; Clifton Slusser, Vice President, Goodyear Tire & Rubber Co., and Herman Steinkraus, President, Bridgeport Brass Company.

"Forging Ahead in Business"—FREE!

You can read the Institute's stimulating story in the 64-page booklet "Forging Ahead in Business." Convenient, time-saving, it is offered without cost or obligation. Simply fill in and mail the coupon!



Fill in and mail this coupon today, and a free copy of "Forging Ahead in Business" will be mailed to you:

ALEXANDER HAMILTON INSTITUTE
Dept. 423, 71 West 23rd St.
New York 10, N. Y.

In Canada: 54 Wellington Street, West,
Toronto 1, Ont.

Please mail me, without cost, a copy of
the 64-page book—"FORGING AHEAD
IN BUSINESS."

Name.....
Firm Name.....
Business Address.....
Position.....
Home Address.....

Alexander Hamilton Institute

CAREER

Radio

FOUR INTENSIVE COURSES

Each one a chance for ambitious men and women to increase earning capacity and promote permanent employment.

1. **RADIO TECHNICIAN.** A general course including FM and Television. Students learn by constructing electronic and radio equipment under expert supervision.

2. **RADIO COMMUNICATIONS.** Prepare for FCC licenses. Includes telegraphy. Leads to position as merchant marine or flight radio officer.

3. **AIRLINE COMMUNICATOR NON-TECHNICAL.** Of special interest to **YOUNG WOMEN.** Prepares for employment in airport flight control offices.

4. **RADIO & TELEVISION SERVICE.** Employment as repairman on home-type equipment including standard broadcast and FM, as well as Television receivers.

MELVILLE RADIO INSTITUTE

"the radio school managed by radio men"



CLIP THIS COUPON
SEND ME FREE INFORMATION

NAME

ADDRESS

MELVILLE RADIO INSTITUTE
45 W. 45th St.
New York 19, N. Y.

LIGHTWEIGHT—ROTABLE BEAM ANTENNA REMACO 4-10

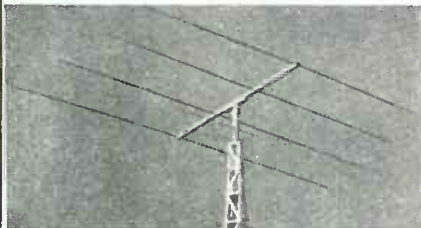

REMACO
4-ELEMENT BEAM
AT W60ZH

Have You Heard
Him Lately?

The Remaco 4-10 Antenna

Is a four element, close spaced, ten meter antenna. It is lightweight and easily adapted to most any form of rotating mechanism. The elements and supporting boom are of durable aluminum alloy, and are easily assembled. They are furnished complete with "T Match" feed system and instructions.

(LESS TOWER) \$40.00 (NET) F.O.B. FACTORY
25% WITH ORDER, REMAINDER C.O.D.

WATCH NEXT MONTH FOR
BUTTERFLY TUNED CIRCUITS

PHONE: — or — WIRE:
C.V. 1362 WRITE REMACO

RESEARCH MANUFACTURING CORPORATION
BOX 757, DEPT. N6
CHULA VISTA, CALIFORNIA

announced frequency at 6:30 a.m. calling Sydney.

NEWFOUNDLAND—VONH, 5.970, St. John's, relays VONF, 9 a.m.-2 p.m., 3-10 p.m.; has frequent English newscasts (some relayed from BBC), generally at 5:30, 6:45, 8, 9 p.m.; good signals in East.

NEW ZEALAND—ZLT7, 6.715, Wellington, is widely heard from either 4:15 or 4:30 to 4:45 or 4:50 a.m. daily with English news and sports summary, some days also has musical interlude; will verify. ZLN10, 9.205, Wellington, has been heard on West Coast testing nightly at 2:45 a.m. with c.w. and calling KQJ at 3 a.m.

NICARAGUA — YNWW, *Radio Sport*, at Granada, has been shifting frequency increasingly lower, and has lately settled at 6.877.

NORTHERN RHODESIA — ZQP, 7.220, 7.285, 3.900, for Africa is heard daily, 10 a.m.-12 noon, in Chibemba, Chinyanja, Chitonga, Silozi, and English; on Sunday only has special English transmission for Europeans, 4-5:30 a.m.

NORWAY — According to Swedish sources, Oslo, 6.200, uses 10 kw. power and has no call sign; relays the Norwegian National Program, 11 a.m.-5 p.m., with antenna beamed northward; location is Klofta, near Oslo. Will verify.

PALESTINE—JCKW, 7.220, Jerusalem, has abandoned Saturday tests to 8 p.m.; scheduled now is 11:30 p.m.-1:30 a.m. and 4 a.m.-4 p.m.; can easily be identified during first hour of 11:30 p.m. transmission by frequent time checks which are 7 hours ahead of EST. *Sharq el Adna*, 6.710, Jaffa, is heard best between 11:30 p.m.-1 a.m., in parallel with 6.790 and 6.135, in native (Arabic) language; at beginning of this transmission, setting-up exercises are featured; sends good signal to East.

PANAMA—A station identifying as "This is Panama City" has been heard around 9-9:30 a.m. on 9.575 by West Coast listeners, with heavy interference from KWIX, San Francisco, and ZBY, Hongkong; may be HP5J, listed on 9.607, off-frequency. HP5K, 6.005, Colon, Canal Zone, has English news at 8:15 and 10 p.m. The AFRS, 2.390, Quarry Heights, Canal Zone, sends out a mimeographed verification card, states they do not have call letters; schedule is 5:30-7 a.m., 10 a.m.-11:05 p.m., with news at 12 noon, 6, 8, 9, 11 p.m. Uses 400 watts power. Return postage is not required for a veri. Address is Headquarters Panama Canal Department, Office of the Department Special Service Officer, Radio Section, APO 825, % Postmaster, New Orleans, Louisiana.

PARAGUAY—ZPA3, *Radio Teleco*, Asuncion, has moved up in frequency to 11.871 where it is nearly buried under New York on 11.870; schedule remains 4:55-9:15 p.m. ZPA5, 11.950, Encarnacion, has been heard leaving the air on Saturdays at 7 p.m., is scheduled 5:45-11 p.m.

PERU—OAX4Z, 5.895, Lima, veri-

IMMEDIATE DELIVERY

All Types—1946—Auto Radio

AERIALS

Radiant

Ward

Rad-El

RECORD CHANGERS:—

V/M Miller Automatic
(List Price \$37.50)

Standard Discounts Given to
Dealers, Servicemen, & Amateurs

WRITE For our bulletin NOW, for
other available merchandise

Complete Stock of Parts & Equipment
Two Stores to Serve You



RADIO & TELEVISION EQUIPMENT CO.

207 Oak Street, Dept. L.
Santa Ana, California

Long Beach, Calif., Store: 709 Cherry Ave.

there is NO SUBSTITUTE

for GOOD communications
and industrial wire. We are
shipping you more and
more of it now . . .



WIRES



cornish

WIRE COMPANY, INC.



15 Park Row, New York 7, N. Y.

"Made by Engineers for Engineers"

RADIO NEWS

fies. OAX1A, 7.120, Chiclayo, has not been heard on this channel lately. OAX4J, 9.330, Lima, *Radio Colonial*, is back on the air, schedule is 6 p.m.-1 a.m.

POLAND—*Radio Warsaw*, 6.100, is scheduled 4-8 p.m., uses foreign and English languages; has English news, 4-4:20 p.m.; reported with fair signal *daily* in Australia.

PORTUGAL—CS2WI, 12.400, Parcede, is scheduled 6:45-9 a.m. and 2:30-6:30 p.m. CUJ2, 15.960, Lisbon, is reported with tests at 9-10:20 a.m. with New York in preparation for relays from Portugal to the United States. CSW6, 11.04, Lisbon, reported 1-3 p.m., beamed to Mozambique, closes with 8-stroke gong and National Anthem, has frequent identification in Portuguese. CSW7, 9.730, Lisbon, heard to North America, 7-8 p.m., has news in Portuguese at 7:45 p.m., closes with "My Prayer"; good signal.

PORTUGUESE CHINA—*Radio Macau*, 7.525, has been one of the most consistent of the weaker Asiatics the past several months; is heard around 7-9 a.m. on West Coast; while there is a weakening of signal during the reading of English news at about 7:30-7:40 a.m., the phono-input is usually fairly good; peaks on West Coast around 8:35 a.m., earlier in East.

PORTUGUESE GUINEA—*Radio Bissau* is reported now slightly higher on 7.105, heard as late as 6:30 p.m., reception poor. A frequency of 16.310 (18.39 m.) is also listed by Lisbon

communication officials, but no schedule is given.

SALVADOR—YSI, 7.040, San Salvador, is now off the air; not heard on new channel as yet.

SIAM—*Radio Bangkok*, 6.000, is heard on West Coast, 6-8:45 a.m., may run later on Sunday. From Oceania, HSPP, 11.755, Bangkok, is reported operating 9-11 a.m. Siamese is the language chiefly used.

SOUTHERN RHODESIA—Salisbury, 7.600, reported on this channel, 2:50-3:10 p.m.

SPAIN—Madrid's wandering *Radio SEU* is now heard on 7.093 to sign-off at 6:30 p.m.; transmitter is still characterized by a bad hum. *Radio Nacional de Espana*, 9.370, is scheduled 3-5, 6:30-9:15 p.m., Sunday from 3:45 p.m.; news is at 3 p.m. weekdays, at 3:45 Sunday.

SURINAME—PZH5, 5.844, Paramaribo, is correct call according to veri, power is 325 watts, and schedule is 6-8:25 or 8:30 p.m.

SWEDEN—SBT, 15.155, Stockholm, Sunday and holidays, Home Service, 2:45-9 a.m.; to North America in English, 10-11 a.m.; Home Service, 11:05-12 noon; reading of names of refugees, 12 noon-12:30 p.m.; Home Service, 12:30-1:15 p.m.; weekdays, Home Service, 6-6:50 a.m.; to North America in English, 10-11 a.m.; Home Service, 11:05-12 noon; reading of names of refugees, 12 noon-12:30 p.m.; news in German, English, Swedish, 12:30-12:55 p.m.; Home Service, 1-1:15 p.m. SBP,

11:705, Stockholm, Sunday and holidays, Home Service, 2:30-7 a.m.; to North America in English, 10-11 a.m.; weekdays, Home Service, 1:40-2:10 a.m., 6-6:50 a.m., and 8:45-9:30 a.m. SDB2, 10.780, Stockholm, Sunday and holidays, Home Service, 11 a.m.-12 noon; reading of names of refugees, 12 noon-12:30 p.m.; Home Service, 12:30-1:15 p.m.; weekdays, Home Service, 11 a.m.-12 noon; reading of names of refugees, 12 noon-12:30 p.m.; news in German, English, Swedish, 12:30-12:55 p.m.; Home Service, 1-1:15 p.m. SBU, 9.535, and SBO, 6.065, Stockholm, Sunday and holidays, Service for Swedes Abroad, 8-9 p.m.; Home Service, 1:30-4:30 p.m.; Service for Swedes Abroad, 4:30-5 p.m.; weekdays, same, *except* Home Service runs 1:30-5 p.m. (These schedules were furnished by Göte Olsson, Sagmyra, Sweden, who says all communications should be addressed to the headquarters for Swedish Broadcasting, Aktiegolaget Radiotjänst, Kungagatan 8, Stockholm, Sweden.)

SWITZERLAND—North American "Short Edition" is heard daily *except* Saturday, 2:20-2:50 p.m. over HED4, 10.405, Bern, English news at beginning. North American "Full Edition" is still beamed, 8:30-10 p.m., over HEI2, 6.345, and HEK3, 7.380, both Bern with news at 8:35 p.m. HEK4, 11.960, Bern, is reported good to Latin America, 3:45-4:15 p.m. HEI5, 11.713, Bern, is scheduled Tuesday and Friday, 10-11:30 a.m., on Saturday, 10

Fahnestock Clips

RADIO'S GREATEST CONVENIENCE

FAHNESTOCK SPRING BINDING POST GRIPS THE WIRE BY THE ACTION OF A SPRING



No tools required to make the connection. Grips the wire with just the right pressure for good electrical contact. Simply press down, insert the wire and let go. Does not injure wire, hence connection can be made or opened as often as desired. Available in large variety of types and sizes to fit any radio purpose and any requirement as to position, space or method of attachment. You will find them in the better sets.

Positive contact; cannot jar loose. Brass or bronze—nonrusting.

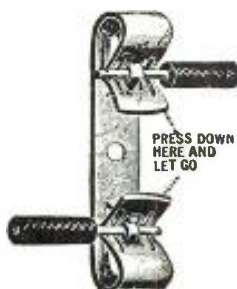
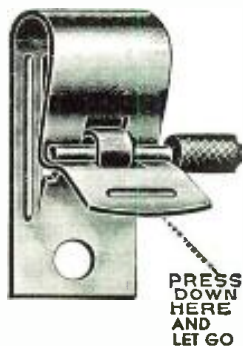

FAHNESTOCK ELECTRIC COMPANY, Inc.

46-44 ELEVENTH STREET
LONG ISLAND CITY 1, N. Y.

Please send us at once, Descriptive Literature, Prices and Delivery Schedule on

FAHNESTOCK CLIPS

For
Name
Address
City..... State.....

New Army and Navy Surplus Material

TUBES 75c ea.



As Listed Below

6C4	6AC7	125N7
6AL5	6V6	6N7
6B4	1625	6AG5
2X2	125L7	VR150/30

836...\$3.50; 866...99c; 257B...\$15.00

1N21B Crystal69c
Klystron 736C/2K29\$7.50
Popular United 812-H & V-70-D in stock	

CONDENSERS: Aerovox, C-D, Solar, etc.

2 Mfd.—600 Vdc.	\$.60	8 Mfd.—1000 Vdc.	\$1.80
4 Mfd.—600 Vdc.	.75	10 Mfd.—1000 Vdc.	2.00
8 Mfd.—600 Vdc.	1.10	6 Mfd.—1500 Vdc.	2.56
10 Mfd.—600 Vdc.	1.75	1 Mfd.—2000 Vdc.	.95
4 Mfd.—1000 Vdc.	1.00	8 Mfd.—2000 Vdc.	3.75

COAXIAL CABLES

72 Ohm RG 11/U10c per ft.
53 Ohm RG 58/U9c per ft.

Power Transformers: 110 V ac 60 Cycle.

880V 150 Ma.; 5.0V 3.0A; 6.3V 6.25A, Special.	\$.45
665V CT 125 Ma.	5.0V 2.0A
10V CT 6.5A	2.5V CT 10.0A
6.3V 2.8A	
Special\$4.50
1912V CT 230 Ma.7.50

Step-Up 110—220 or Step Down 220-210 800 Watt. Special\$17.50

Johnson Tube Sockets. **50c ea.**
No. 210. Special

MAIL ORDERS: ONE THIRD WITH ORDER BALANCE C.O.D.

RADIO HAM SHACK

63 DEY ST. NEW YORK 7, N. Y.

For Soldering in Tight Places...

DRAKE

No. 400 Soldering Iron



Smallest Industrial Iron Ever Designed

60 Watts—1/4 in. Tip

Only 9 in. long—Wt. only 8 oz.

This mighty mite is backed by DRAKE'S 25 years of soldering iron manufacturing experience. The high quality and long service of DRAKE Soldering Irons have made them outstanding favorites with all types of radio men everywhere. The DRAKE No. 400 is an outstanding value at

Only \$4⁵⁰ List

Drake Has an Iron for Every Purpose. Ask Your Radio Parts Jobber.



DRAKE ELECTRIC WORKS, INC.

3656 LINCOLN AVE. CHICAGO 13, ILL.

a.m.-12 noon. South Africans report HEF4, 9.185, Bern, 3:50-4:30 p.m., beamed to South Africa, with weak signals, close is in French, HBF, 18.450, Geneva, reported heard weakly in East on a Sunday at 12:30 p.m.

TURKEY—TAP, 9.645, Ankara, broadcasts in English to England at 4:30-4:45 p.m. Monday and Thursday; has Postbag, in English, at same time Sunday; and broadcasts 15-minute news periods daily from 11 a.m. to 1:15 p.m. in the following language order: Urdu, Serb/Croat, Arabic, Persian, Turkish, Greek, Bulgarian, English (12:45 p.m.), French. TAQ, 15.195, Ankara, is scheduled 12 midnight-2 a.m. and 4:15-8:15 a.m., Saturdays to 10:30 a.m., in E. European and Eastern languages.

UNION OF SOUTH AFRICA—ZRK, listed as 5.878, Capetown 3, is still coming through nicely in the East on about 5.885, 11:45 p.m.-1:30 a.m.; carrier comes on at 11:40 p.m., has bugle call at 11:45 p.m., followed by English sign-on; then goes into Afrikaans with 15 minutes of setting-up exercises characterized by piano accompaniment; clock strikes 7 a.m. their local time at 12 midnight EST; BBC news is relayed from London at 1 a.m. ZRH, 6.007, Johannesburg 3, and ZRJ, 6.094, Johannesburg 4, are scheduled in parallel. ZRL, 9.608, Capetown 3, is scheduled 3:15-7, 9-10:30 a.m., and 11:30 a.m.-4 p.m.; reported heard in Canada around 1:45-2 p.m. with weak signal, interference from GRY, 9.600, London. Durban 2, 6.170, is scheduled 11:45 p.m.-1:30 a.m., 3:15-7 a.m., and 9 a.m.-4 p.m., probably parallels Capetown and Johannesburg transmitters.

U.S.S.R.—Radio Tbilisi at Tiflis, on measured frequency of 7.489, has been heard nightly at 9:30 p.m. signing on; Moscow's Home Service is relayed at 10 p.m. to sign-off which is 11:30 p.m. some days, or to fade-out at 12 midnight. The Moscow Home Service is reported opening at 10 p.m. also on 12.260, 12.170, 12.112, 11.780, and 9.710, still good at 12 midnight; the Kha-

barovsk (Siberia) Home Service is heard at the same time on frequencies of 11.885, 9.565, and 8.820. The Moscow broadcast to Latin America on 7.210, scheduled 6-11 p.m., has been moved to 7.200; to make 10 kcs. separation, London has moved its GWL to 7.210. Petropavlovsk, 6.070, Kamachka Peninsula, comes on the air at 3:30 a.m.; Moscow on 7.560 comes on the air at 5 p.m., and 7.430 is in parallel at 6:20 p.m. Moscow was heard to announce recently it will use 17.840, probably at 7:30 p.m. to North America (they may have meant 17.18). Leningrad on 7.430 is reported heard in Canada at 9:45 p.m. in Spanish. Latest announced schedules of Radio Centre, Moscow, to America are 7:20-8:15 a.m. on 17.18, 15.17, 11.83, 11.63, adding 6.07 and 9.56 (probably is Komsomolsk in relay) at 7:45 a.m.; 6:20-9 p.m. on 15.23 (probably Komsomolsk in relay), 11.88, 9.54, 9.48, 7.03 (I believe they mean 7.300 since I have been hearing this one with English news at 8, 9 p.m.), and 6.02, dropping 15.23 and 11.88 at 7:30 p.m.; also announce further broadcast daily except Tuesday, 11-11:25 a.m. on 9.48, 11.83, and 15.75, beamed to America.

UNITED STATES—WNRX, 7.250, New York carries news up to 6:45 p.m. when U.N.O. is in session. KWID, 7.230, San Francisco, is off. KWIX, 7.230, San Francisco, is heard 4-11 a.m. KNBI, 9.490, San Francisco, is off. KWIX, 9.570, San Francisco, is reported off, but on that frequency KWID is scheduled 7:30 p.m.-12 midnight, 12:15-1:45, 2:15-6:30, 6:45-11 a.m., and 11:15 a.m.-1 p.m. WOOC, 9:650, New York, is same as 7.250. KCBF, 9.700, Delano, off the air. WNRA, 9.750, New York, same as 9.650. KWID, 9.855, San Francisco, is off. WBOS, 9.897, Boston, is off. KNBX, 9.490, San Francisco, off 11 a.m. KGBI, 11.730, San Francisco, is off. KCBR, 11.770, Delano, is off the air. KNBX, 11.790, San Francisco, has new schedule of 11:15 a.m.-3:30 p.m. KGEI, 15.130, San Francisco, add 1-4:45 p.m., off 8 p.m.-

Northern Rhodesia Broadcasting station ZQP. Lusaka, Northern Rhodesia, uses frequencies of 7.220, 7.285, 3.900. This station will verify correct reports.

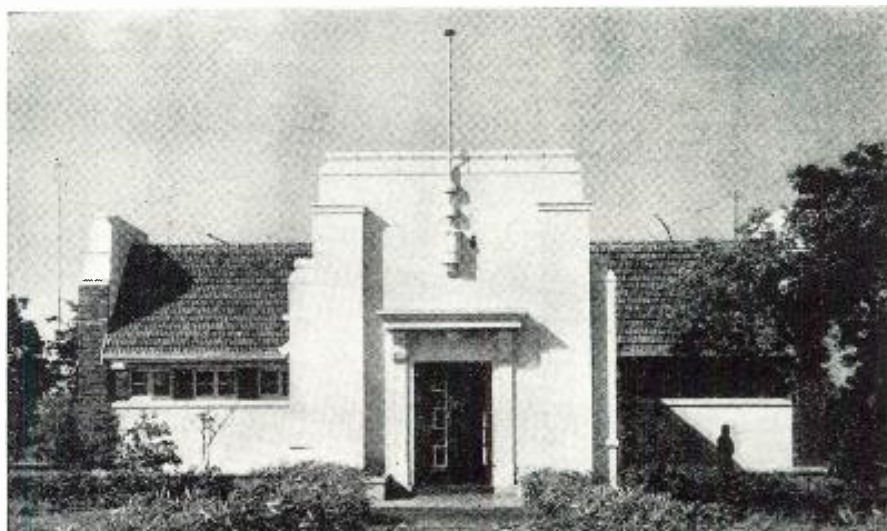

12 midnight. KNBI, 15.340, San Francisco, add 1:15-3:45 a.m. KGEI, 17.780, San Francisco, is heard 8 p.m.-12 midnight, replaces 15.130.

URUGUAY—Official schedules and addresses of Uruguay s.w. broadcasters are CXA30, 6.035, 18 de Julio 1764, Montevideo, 11 a.m.-1 p.m., 4-9 p.m.; CXA14, 6.055, Av. Gral Flores 30, Colonia, 9 a.m.-1 p.m., 3-8 p.m.; CXA3, 6.075, 18 de Julio 1277, Montevideo, 7 a.m.-11 p.m.; CXA21, 6.170, 18 de Julio 965, Montevideo, 6-9 p.m.; CXA6, 9.620, Mercedes 823, Montevideo, 11 a.m.-1 p.m., 4-10 p.m.; CXA8, 9.640, Av. Gral Flores 30, Colonia, 11 a.m.-1 p.m., 4-9 p.m.; CXA19, 11.835, 18 de Julio 1393, Montevideo, 7 a.m.-2 p.m., 4-10 p.m.; CXA10, 11.900, Mercedes 823, Montevideo, 6:30-9:15 p.m.

VATICAN CITY—HVJ has added a second frequency in its European beam of 6.190, paralleling 5.971, 2-3:15 p.m., but is not audible in the U.S.; the 6.190 frequency is also scheduled 1:45-2 p.m. on Tuesday, Thursday, Saturday, and 4:15-5:30 a.m. Sundays only. HVJ, 15.095, comes on with chimes at 5:25 a.m. and has Holy Mass to 6 a.m.

VENEZUELA—YV2RN, 4.830, San Cristobal, "La Voz del Tachira," relays YV2RB, 980 kcs.; verified with letter, address is Apartado 37.

YUGOSLAVIA—Radio Ljubljana has shifted frequency to 6.537 from 6.506, and it is heard best at present around 12:30 a.m. when it has fair strength in East. Radio Belgrade, 9.420, is scheduled 12:15-2:45 or 4:15 a.m., 5-10 a.m., 10:15-11:25 a.m. or to 12:25 p.m.; news at 8 a.m.; is heard in East with weak signal around 12:30 a.m. In the East, a new afternoon transmission is reported, 3:45-4:30 p.m., fading towards close.

Last Minute Tips

A late flash from Paul Dilg, California, reports Radio Balikpapan, Borneo, was picked up at 8:45 a.m. recently on an announced frequency of 9.125; popular American recordings; signal was fairly good; sign-off at 9:30 a.m. was with playing of Ted Lewis' recording, "Goodnight" song. At a later date (a Sunday), Radio Balikpapan was heard as early as 6:50 a.m. playing Western music and announcing at 32.88 meters (did not give frequency). There was a pause, then a march was played 6:57-7 a.m., when they made announcements in Dutch and English. Signal was fairly good, with some c.w. QRM. Paul believes their sign-off is 7 a.m. and that the musical selections before that hour are merely a "warming up" process. (The Dutch East Indies—even under the Japanese—made a practice of doing this.) At 9:35 p.m. sign-off it was stated they would be back "tomorrow at 8 o'clock" local time. (Borneo Standard Time is 12½ hours ahead of EST.) The program between 7-8 a.m. was recordings of popular music, mostly with vocal choruses. At 8 a.m. announced in both Dutch and English that they would have news in Dutch, sounded somewhat like a relay, until

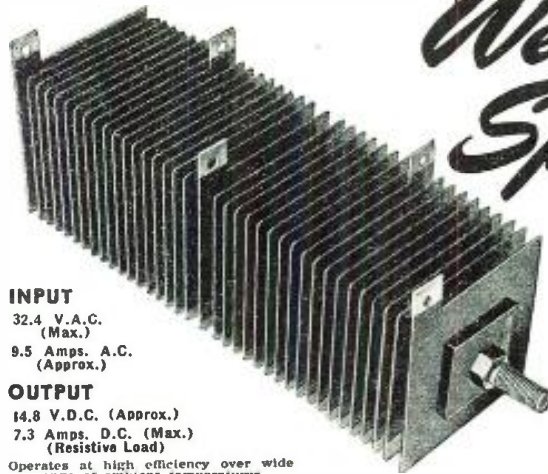

Wells Specials!

Mallory Standard Rectifiers

We have fortunately obtained several thousand Type 36B7 Mallory Standard Single Phase, full-wave bridge rectifiers. These are the famous magnesium-copper sulphide rectifiers which are noted for long life at high output. They are used in battery changers, battery substitutes, power supplies for electro-chemical, magnetic and arc devices or wherever a source of low D.C. voltage is required. These rectifiers are new, unused and guaranteed. List price is \$18.50. Wells' special price, \$4.85 net F.O.B., Chicago. (Minimum order—5.)

INPUT

32.4 V.A.C.

(Max.)

9.5 Amps. A.C.

(Approx.)

OUTPUT

14.8 V.D.C. (Approx.)

7.3 Amps. D.C. (Max.)

(Resistive Load)

Operates at high efficiency over wide range of ambient temperatures.

Government Termination Material

The following list is just a hint of our vast stock of components. Everything is new, unused and unconditionally guaranteed. Prices, in many cases, are below the cost of manufacture. Send us your requirements.

CONDENSERS

Oil Filled Bathtubs
Electrolytics
Mica and Silver Mica
Moulded Bakelite
Oil Filled Transmitting
Tubulars
Trimmers and Padders

RESISTORS

Carbon
Precision
Wire Wound

SPAGHETTI

Varnish Cambric
Extruded Vinylite

SWITCHES

H & H Toggles
C-H Toggles
G-E Push Type
G-E Switchettes
Square D Breakers

TRANSMITTING TUBES

803	832	7193
807	837	8025
811	955	3C24
813	1148	304TL

WIRE—CABLE

2-Conductor Telephone
Field Wire
Coaxial Cable 50 and
70 Ohm
Coaxial Connectors

RELAYS

Struthers-Dunn
Allied
Guardian
Potter and Brumfield
Automatic Electric
Clare

TUBE SOCKETS

Composition Octal
Steatite Octal
Moulded Bakelite Octal
Johnson Ceramics
Miniatures

TRANSFORMERS

Navy Type Power
UTC "Ouncers"
Amerfran Step Up or Down
Chicago Transformer
Audio Chokes

VOLUME CONTROLS

VIBRATORS
B-L SELENIUM RECTIFIERS
DIAL LIGHT ASSEMBLIES
WHIP ANTENNAS

WELLS SALES, Inc., 4717-C W. Madison St., Chicago 44, Illinois

USE COUPON BELOW FOR COMPLETE INFORMATION

WELLS SALES, INC., 4717-C West Madison St., Chicago 44, Ill.

Please ship Mallory Rectifiers type 36B7 at \$4.85 each F.O.B. Chicago for which check (or M.O.) for \$..... is enclosed. (Minimum order—5)
Please send prices and information on the following items:

.....

.....

.....

Name

Address



PLUG-IN TEST LAMP

Tests Everything Electrical
Speeds Up Trouble-Shooting

Used by Radio Men, Electricians, Mechanics and Experimenters. Tests continuity, open circuits, etc. ALWAYS READY! PLUGS INTO ANY OUTLET! Only \$1.50 Postpaid. FREE CIRCULAR. (Pat. Pend.) HANLAN CO., 1419-R, West Jefferson, Los Angeles 7, Calif.

Ted McElroy
World's Largest Manufacturer of Wireless Telegraphic Apparatus
COMPLETE CENTRAL OFFICE EQUIPMENT
McElroy Manufacturing Corp.
82 Brookline Avenue • Boston, Massachusetts

RECORDS

LATEST & HARD-TO-GET BACK NUMBERS

Some slightly used and some brand new—Victor, Bluebird, Columbia, Okeh, Decca, Capitol, etc. Such artists as Glenn Miller, Benny Goodman, Harry James, Bing Crosby, Frank Sinatra, Gene Autry, Duke Ellington, Fats Waller, Guy Lombardo, Andrews Sisters, Kate Smith, Ink Spots, Mills Bros., etc.

BIG PROFITS Your opportunity to cash in on this new field that is sweeping the country. Specify the type of music that sells best in your territory such as Swing, Sweet Music, Cow-boy, Hill-billy, Polkas, Blues, etc. Your price \$13.90 per 100 records, f.o.b. Chicago, 2% off for cash with order. All shipments made within 48 hours.

CHAS. HOODWIN CO.

4419 Broadway, N-15, Chicago 40, Illinois
World's Largest Dealers in Used Records

FREE BOOK
SHOWS
SHORT CUT
TO
CODE SPEED

ENDORSED
BY CHAMPIONS

Skill, speed, accuracy free of nervous tension brings big pay.

The One and Only Candler System

Nothing else like it. It is the course that has made code champions. Will help any sincere man gain greater speed, accuracy and skill. Learn the Candler way.

Fast, Efficient Operators Needed

If you need additional speed to be classed as an expert, try the Candler method. It is endorsed by champions. It has produced phenomenal results with a minimum of effort. Why not learn the faster and easier way. Get your copy of the Book of Facts for Code students, Telegraph and Radio Operators.

CANDLER SYSTEM CO.

P. O. Box 928, Dept. 2-G, Denver (1), Colo.



**Champion Endorses
CANDLER SYSTEM**

T. R. McElroy, Official Champion Radiotelegraph Operator of the world with speed of 75.2 w.p.m., claims his success is due to the Candler System.

**CAPACITORS -
OIL, PAPER and
ELECTROLYTIC**



**Illinois
CONDENSER COMPANY**

1616 N. THROOP ST.
CHICAGO 22, ILL.

8:30 a.m. At 8:30 a.m. had male chorus followed by church chimes and a "new" announcer stated, "You are listening to Netherlands PCJ, the Happy Station of a Friendly Nation," and from that time to 9:30 a.m., PCJ's Happy Station Program with Eddie Startz as m.c. was relayed. *Radio Balikpapan's* signal built up to a "strong"; Paul writes, "I cannot conceive that they use only 125 watts." At 9:30 a.m. there was a short pause, and at 9:35 a.m. a woman sang "Goodnight, Wherever You Are." (Incidentally, during the last 15-minutes of PCJ's Happy Station Program while Eddie Startz was acknowledging communications from various parts of the world, he sent thanks to your editors of *RADIO NEWS* for the article about PCJ which appeared in the March issue of *ISW*. Paul comments, "Your name was broadcast from Holland, picked up in Borneo, and rebroadcast to me here in California. 'Ain't' radio wonderful? I see no reason why you cannot bring in Borneo there in the East, since their signal was actually strong during the relay. You should catch at least the opening of the relay of PCJ at 8:30 a.m. EST.")

Although not listed in official schedules for English news at 7:30 a.m., the 9.63 transmitter of All India Radio, Delhi, is being heard with fine level here in the East with such a newscast at that time. (The 9.67 frequency is scheduled, but is not heard here.)

A late flash indicates that *Radio Australia* may soon replace VLC9, 17.84, with VLC4, 15.315, Shepparton, in the 6:40-8:50 p.m. transmission to Eastern North America; VLC4 was used last summer with great success.

Radio Vienna, 12.200/12.210, Austria, is good evenings again and is also heard early mornings to 2:15 a.m. sign-off.

Brussels, 7.300, reported testing recently to Latin America for a few days around 5-5:30 p.m.; not reported since.

Sofia on 7.410 has English at 4:10-4:20 p.m. on this channel, according to officials of the station; has not been heard yet, may be a misprint by the authorities, but is worth tuning for. *Radio Rodina* (listed in schedules as 9.345), Sofia, is reported back on 9.330, heard well nights, and 2:15-3:40 p.m. sign-off; has French, 3:20-3:30 p.m., English news, 3:30-3:40 p.m.; announces as *Radio Sofia* of the Bulgarian Broadcasting System, and asks for reports.

Rangoon, Burma, schedules have recently been advanced one hour, making those of *Radio Rangoon*, 11.85, 10-10:30 p.m., 2:15-2:45, 8:30-10 a.m., Sunday, 9:30-11 a.m. only; news at 2:30, 8:45, 9:55, 10 a.m.

XMHA, 11.860, Shanghai, is reported back on the air at 5:45 a.m. as "Your Armed Forces Radio in Shanghai."

SUV, 10.055, Cairo, is heard relaying news correspondents some afternoons around 4:20-4:30 p.m.; poor signal. A station heard in French recently at 1:15 a.m. with woman and

**ATTENTION
DEALERS & RADIO MEN**

★ **Changerak**

HERE AT LAST—JUST WHAT YOU NEED
MAKES RECORD CHANGER REPAIR
SIMPLE, FAST, & LABOR SAVING

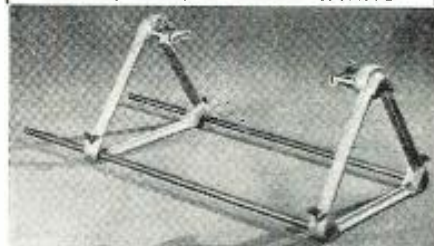

\$11.95

F.O.B. Los Angeles • Shipping Wt. 7 Lbs.

D-61 Constant Velocity Frequency
Record with Data Sheet **\$1.80**
Net

T-305 Throat Microphone Complete
with 6 Ft. Ext'n Cord & **\$1.35**
Plug Net

Send Us Your Name & Address
for Monthly Bulletin

**RADIO EQUIPMENT
DISTRIBUTORS**

709 S. Main St.
LOS ANGELES 14, CALIF.
Phone Trinity 8068

★ Pat. Applied For

CAMCO
AUTO
ANTENNAS

• **COMPLETE NEW LINE**

"Way out front" with the most outstanding line of antennas. Besides critical engineering, Camco Antennas are also "Easy to look at" because they are superbly designed in true modern taste.

An antenna for every type of installation . . . and all have this in common—rattle proof, Admiralty brass, rustproof, smart styling and handsomely packaged.

Multi-colored dealer sales display helps sell Camco antennas. Write for complete line and prices.



CAMBURN, Inc.
32-40 57th St. Woodside, N. Y.

man calling New York is believed to have been SUZ, 13.820, Cairo.

A late tip confirms that *Radio Athens*, 7.295, Greece, now signs off at 3:30 p.m.

Swedish correspondents report HAT4, 9.125, Budapest, Hungary, has returned to the air, heard signing off at 7:40 a.m. after English news period. In the East, it is reported still heard evenings in c.w.

Radio Milan, 11.805, Italy, is heard from 3:45 p.m. to 7:30 p.m. sign-off; status of the 9.630 station is not known.

West Coast listeners report a new Tokyo station on 9.680, comes on at 2:30 a.m. with theme sounding like "Kimagayo"; may be in parallel with 7.275 and 7.285.

A station heard in Hawaii on 5.780 in French and English, 9:15-9:30 a.m. is believed to be Port Louis, Mauritius.

A station on 13.710 is reported from Australia as believed to be Moratai; heard at 8:30 and 11 a.m.

The stations of *Sharq El Adna*, Jaffa, Palestine, on 6.135, 6.710, 6.790, want reception reports, will verify.

Madrid on 14.950, has been heard contacting New York for network pickups at 1 p.m.

Saba, 9.046, St. Martin, St. Eustatius, Netherlands West Indies, reported with tests at 8:20-9:30 a.m. and 1 p.m., and on 11.900, verified report of an Eastern DXer recently; airmail letter in English was received from C. Peter-son, Landsradio en Telefoondienst.

* * *

Acknowledgements

AUSTRALIA—Gillett, Maher, BRITISH COLUMBIA (CANADA)—Cooper. BRITISH GUIANA—de Freitas, ZFY. CALIFORNIA—Dilg, Balbi, McCarthy, Teague, Foster. CONNECTICUT—Farmer. DISTRICT OF COLUMBIA—Harris, WIRN; Eaton, Norris. EGYPT—Forces' Radio Times, Cairo Calling, Ellis. ETHIOPIA—Erholm, Radio Addis Ababa. FRANCE—Radiodiffusion Francaise. HOLLAND—Koelmans. ILLINOIS—Norton. INDIA—Wadia, All India Radio. INDIANA—Green, Siskel, Cossell. KANSAS—Seckler. KENTUCKY—Harvey. MASSACHUSETTS—Hudson, Harris. MEXICO—Butcher. MOZAMBIQUE—Radio Clube de Mozambique. NEW JERSEY—Hartley. NEW YORK—Taylor, BBC, Ballard, Ekstein, Bogdan, Australian News & Information Bureau, Bishop. NEW ZEALAND—Milne, N.Z. DX-Tra. NORTHERN RHODESIA—Information and Public Relations Office, Lusaka. OHIO—Riggle, Banfield, Richardson, Hamilton, Sutton. OKLAHOMA—Walker. ONTARIO (CANADA)—Kennedy. PENNSYLVANIA—VRC, Callahan. QUEBEC (CANADA)—Gauvreau, CBC, Dolbec. SOUTH AFRICA—Eksteen. SWEDEN—Olsson, Skoog, Ekblom. VIRGINIA—Mayo, Howe, URDXC. WEST VIRGINIA—Rupert, Casdorff.

—30—

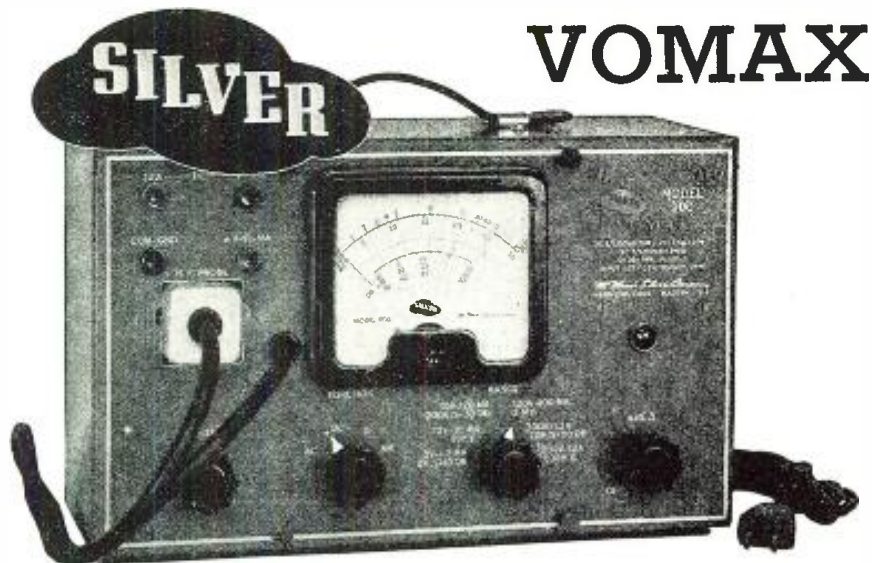

Nothing we can say about overwhelmingly popular "VOMAX" equals what its competent buyers say:

"Will increase your profits . . . measuring every type of receiver voltage. 'VOMAX' speeds work to give you more profit." That's mighty sound advice from such experienced distributors as R. G. Scell & Co., Hartford, Conn., Welch Radio Supply of St. Petersburg, Florida, Radio Products Sales Co., Denver, Colorado.

"Only with 'VOMAX' can you measure every type of voltage in receiver servicing . . . no other instrument gives you this exclusive advantage." So state Arrowhead Radio & Television Supply Co., San Bernardino, Calif., Northwest Radio, Duluth, Minn., Continental Sales Co., Newark, N. J.

"All those vital measurements you've never been able to make before . . . you can now directly measure r.f., i.f., a.f., a.c. . . visual dynamic signal tracing on operating receivers." So state Universal Radio Supply Co., Louisville, Ky., Radio Parts Co., Milwaukee, Wis., Ware Radio Supply Co., Brockton, Mass., Evans Radio, Concord, N. H.

"Instantly acclaimed as the standard of comparison . . . carrying our highest recommendation." What more can you ask . . . when it comes from Stan-Burn Radio & Electronics Co., New York and Brooklyn, Carolina Radio Equipment Co., Raleigh, N. C., Metropolitan Electronics and Instruments Co., New York, Harvey Radio Co., New York, N. Y.

"Value far above \$59.85 cost . . . superb quality of parts, husky construction . . . give-away price," carries conviction when Mattson's of Richmond, Va., say it.

These and over 500 more SILVER jobbers can supply your "VOMAX" promptly—the instrument the factory recommends to all BENDIX RADIO distributors and dealers—the instrument the authorities use.

"VOMAX"

Measures EVERY Voltage

1. Brand new post-war design . . . positively not a "warmed over" pre-war model.
2. More than an "electronic" voltmeter, VOMAX is a true vacuum tube voltmeter in every voltage/resistance/db. function.
3. Complete visual signal tracing from 20 cycles through over 100 megacycles by withdrawable r.f. diode probe.
4. 3 through 1200 volts d.c. full scale in 6 ranges at 51, and in 6 added ranges to 3000 volts at 126 megohms input resistance. Plus-minus polarity reversing switch.
5. 3 through 1900 volts a.c. full scale in 6 ranges at honest effective circuit loading of 0.6 megohms and 8-mfd.
6. 0.2 through 2000 megohms in six easily read ranges.
7. -10 through +50 db. (0 db. = 1 mw. in 600 ohms) in 3 ranges.
8. 1.2 ma through 12 amperes full scale. 6 d.c. ranges.
9. Absolutely stable—one zero adjustment sets all ranges. No probe shorting to set a meaningless zero which shifts as soon as probes are separated. Grid current errors completely eliminated.
10. Honest, factual accuracy: ±3% on d.c.; ±5% on a.c.; 20% through 100 megacycles; ±2% of full scale, ±1% of indicated resistance value.
11. Only five color-differentiated scales on 4 1/4" D'Arsonval meter for 51 ranges (including d.c. volts polarity reversal) eliminate confusion.
12. Meter 100% protected against overload burnout on volts/ohm/db.
13. Substantial leather carrying handle. Size only 12 3/4" x 7 3/4" x 5 3/4".

Send postcard for free catalog of measurement and communication equipment.

OVER 35 YEARS OF RADIO ENGINEERING ACHIEVEMENT

McMurdo Silver Company

1240 MAIN STREET, HARTFORD 2, CONNECTICUT

BUFFALO'S LEADING SUPPLY HOUSE

In the BUFFALO Area
see DYMAC INC. for your
radio and electronic parts and
equipment

Dymac INC.

2329-31 Main Street, Buffalo 14, N. Y.

BE YOUR OWN BOSS — OPERATE
YOUR OWN PROFITABLE BUSINESS

HOME and INDUSTRIAL APPLIANCES

SERVICE—REPAIR—INSTALLATION

ONLY shop training course of its kind. Gives you actual shop training on washing machines, managers, heat control systems, water heaters, toasters, vacuum sweepers, etc., etc. Work on actual machines under trained instructors. Low tuition. Old established school. Most complete training course of its kind. Investigate this opportunity—its money-making possibilities and the need for trained men. Write today for details. No obligation. Veterans ask for GI plan. Act now!

APPLIANCE TRAINING SCHOOL—Dept. 55
Division of Commercial Trades Institute
6312 N. Broadway Chicago 40, Ill.

The ROBERTS TUBE and CIRCUIT ANALYZER

WITH the aid of a new patented SWITCH, World Rights, we are able to offer the Radio Engineer and repair men an analyzer that locates faults in Radio and like apparatus and tests tubes at the same time.

Our company alone holds this patent and no other firm will be manufacturing them. It is the COMPLETE ANALYZER, easily carried, overall size being 12"x12"x7" in a handsome box with leather handle, approx. weight some 8½ lbs. It is complete with the necessary adaptors you require, some nine being stowed away in the lid of the analyzer, ready wired in their respective sockets, and plugs. It has two good calibrated meters that give you instantaneous accurate readings whether you are testing the tubes or the circuit, simple to use and the greatest time saver ever offered in radio repairs.

The ANALYZER can be used for outside tests as a volts-ohms-milliammeter and volts up to 500 A/C & D/C be read, this range can be increased by the insertion of suitable series resistors across the switch.

We have left enough space for the repair man to carry a set of tubes and spare tools he might require on an outside job, in the lid.

Write us today for bulletin giving complete details to . . .

JOHN AMBLER

330 6th Ave., Verdun, P. Q., Canada

7 Days

Free Examination

PRACTICAL RADIO INFORMATION

Including Frequency Modulation—Television, etc.

Inside Radio Information for all Servicemen—Aircraft Pilots, Students. AUDELS RADIO-MANS GUIDE contains 772 Pages, 400 Diagrams & Photos is complete—gives Authentic Principles & Practices in Construction, Operation, Service & Repairs. Covers clearly and concisely Radio fundamentals—Ohm's Law—Physics of sound as related to radio science—Measuring Instruments—Power supply—Resistors—Inductors—Condensers—Transformers and examples—Broadcasting stations—Radio Telephony—Receivers—Diagrams—Construction—Control systems—Loud speakers—Antenna systems

—Auto Radio—Phonograph pickups—Public Address Systems—Aircraft & Marine Radio—Radio Compass—Beacons—Automatic Radio Alarms—Short Wave—Coil Calculations—Testing—Cathode ray oscillographs—Static Elimination—Trouble Pointers—Underwriter's standards—Units and tables—Frequency Modulation—REVIEW QUESTIONS & ANSWERS, Ready Reference Index.

\$4 COMPLETE • PAY ONLY \$1 A MO. Get this practical information in handy form for yourself—Fill in and MAIL COUPON TODAY—

AUDEL Publishers, 49 W. 23rd St., N.Y. Mail AUDELS NEW RADIO-MANS GUIDE for free examination. W.O.W., I will send you \$1 in 7 days; then remit \$1 monthly until \$4 is paid. Otherwise I will return it.

Name _____
Address _____
Occupation _____
Reference _____ R.N.

138

Within the INDUSTRY

L. K. ALEXANDER has been appointed manager of the Ken-Rad Division of *General Electric Company's* Electronics Department with headquarters in Owensboro, Ky.



In his new position, Mr. Alexander will be in charge of the operations of the G.E. Ken-Rad plants at Owensboro and Huntingburg, Ind., and will also be responsible for the management of the government-owned G.E. plants at Bowling Green, Ky., and Tell City, Ind.

Mr. Alexander has been associated with *General Electric* since 1933.

* * *

L. E. OSBORNE has recently been named senior operating vice-president of the *Westinghouse Electric Corporation*.

Mr. Osborne joined *Westinghouse* at the age of 16 as a clerk in the tool room of the East Pittsburgh Works from which post he advanced steadily until just before Pearl Harbor he became manager of the Steam Division. His latest promotion is a culmination of 36 years' service to *Westinghouse*.

* * *

ILLINOIS CONDENSER COMPANY which was formerly located at 1160 North Howe Street, in Chicago, has recently moved their offices and plant to a new building located at 1616 North Throop Street, Chicago 22, Illinois.

The company manufactures a line of oil, paper and electrolytic capacitors.

* * *

J. ERNEST SMITH has joined *Raytheon Manufacturing Company* as head of the Microwave Communication Engineering Department.



During the past 12 years Mr. Smith was associated with *Radio Corporation of America*, working up from student engineer to research division head of *RCA Laboratories*. He is a graduate of Jamestown College, and holds a degree of Master of Electrical Engineering from Polytechnic Institute of Brooklyn.

Mr. Smith is the author of "Simplified Filter Design" and has been granted numerous patents on modulation systems, radio relay control systems, frequency modulation systems, etc.

Raytheon is now operating an experimental microwave communication

circuit between New York and Boston as the first link of the company's system.

* * *

E. RALPH HAINES, assistant manager of Distributor Sales for the *Raytheon Manufacturing Company* of Newton, Massachusetts, has resigned his position with the company.

Mr. Haines started with *Raytheon* in 1935 in their Midwest territory. In 1941 he became assistant manager of Distributor Sales. During the war he handled contact on bids, contracts and negotiations with the Army and Navy. He also represented the company on the Radio Tube Advisory Committee of the WPB.

The future plans of Mr. Haines have not been announced.

* * *

R. M. COBURN has been named sales manager of *Panoramic Radio Corporation* of New York.

Mr. Coburn, recently resigned from the National Association of Manufacturers where he was engaged in marketing research was formerly general sales manager of *National Union Radio Corporation*. He also spent several years as Professional Marketing Consultant.

Mr. Coburn's experience in the field of radio and electronics dates back to World War I when he was a Radio Operator in U. S. Naval Aviation. In the early 1920's he operated his own retail radio store, later becoming district manager for *Kolster Radio*.

* * *

THE SIGNAL LEAGUE, a civilian association of wartime communications officers and manufacturers was recently organized in Chicago. The League was established to encourage postwar application of wartime research, development and training in communications.

Major General James A. Code, Jr. (ret.), wartime assistant Chief Signal Officer of the army and now vice-president of *Automatic Electric Company* was elected chairman of the Board of Governors; William J. Halligan, president of *Hallcrafters Company* was chosen president of the League; S. I. Neiman, wartime director of public relations for the Signal Corps in the Chicago area was elected executive secretary. The following men were named to the Board of Governors; Edward W. Shepherd, *Philco Corporation*; Jerome J. Kahn, *Standard Transformer Corporation*; Leslie F. Muter,

RADIO NEWS

Radar-Radio Industries of Chicago, Inc.; Frank J. O'Brien, *Galvin Mfg. Co.*; Oliver Read, *RADIO NEWS, U. A. Sanabria, American Television Laboratories*, and Horace M. Carleton, *E. B. Mathewson Company*.

The Signal League has established headquarters in the One North La-Salle Building as an Illinois not-for-profit corporation. The League took over quarters formerly occupied by the Signal Corps' Commanding General of the Sixth Corps area during the war. In a ceremony formally closing the Signal Corps offices, the Corps banners which had been presented by members of the industry during the war were turned over to the City of Chicago. The Mayor's office, represented by Fred V. Maguire, in turn gave the insignia to Mr. Halligan to be placed in the Signal League archives as a memento of Chicago's contribution to wartime electronics production.

The League's charter permits manufacturers who made "a significant contribution" to production for the Armed Forces, civilians who contributed time, services or support to the communications branches and former members of the Armed Forces who contributed leadership or helped expedite production to be admitted as members.

TRAV-LER KARENOLA RADIO & TELEVISION CORPORATION of Chicago has announced a change in the corporate name to *Trav-Ler Radio Corporation*. This move was designed to stream-

line identification of the company's products. The products and management of the company remain the same. The firm's general offices are located at 571 W. Jackson Boulevard, Chicago 6, Illinois.

FRITZ FRANKE, former chief engineer in charge of research and design, has been promoted to the post of assistant sales manager of *Hallicrafters Company* of Chicago.

Mr. Franke joined *Hallicrafters* in 1940 and was one of the original group of engineers who produced the SCR-299, army mobile communications unit. He previously operated his own airline ground equipment and special electronic devices business.

Mr. Franke is a member of the Institute of Radio Engineers; chairman of the marine section, transmitter division of the Radio Manufacturers Association; and a member of the Illinois Ham Club.

C. MURRAY LEEDS, formerly associated with *Thomas A. Edison, Inc.*, and the *Wright Aeronautical Corporation*, has joined the staff of the Mobile Communications Division of the *Farnsworth Television and Radio Corporation*.

Mr. Leeds served as test equipment

design engineer for the *Wright* organization until his entry into the Navy as a Lt. (jg.). He was released from service as a lieutenant on March 1st of this year after 26 months' service.

While in service, he was assigned to the Electronic Division of the Bureau of Ships and was later transferred to the Marine Corps radio section where he was placed in charge of the design of mobile radio equipment used by the Marines.

METROPOLITAN ELECTRONIC AND INSTRUMENT COMPANY has announced the removal of their firm from 258 Broadway to 6 Murray Street, New York 7, New York.

The company produces a line of tube testers, pocket model V-O-Ms, multi-testers, vacuum tube voltmeters, tube and set testers, etc.

L. HARRISS ROBINSON has resigned his commission as major in the Army to accept a position as radio communications engineer for the *Galvin Mfg. Corporation*.

Mr. Robinson received his B.S. degree in electrical engineering from the University of Illinois in 1941 and prior to the war worked for *Stewart-Warner Corporation* and the *Texas Company*.

When called to active service by the Signal Corps on July 1, 1941, he was the second radio engineer assigned to radar work in the Hawaiian Islands. He was later made Acting Signal Offi-

TWO MORE STUPENDOUS BARGAINS IN SURPLUS RADIO NOW AVAILABLE!

In line with our past policy of being "The first with the best for the least," we announce two more of our bargains in government surplus electronic equipment. These two were procured after a careful survey of many different types of equipment available, and selected on the basis of their ease of adaptability to civilian use, for their conventional design, and, most of all, to avail our customers of the greatest saving in dollars and cents that is possible.

The first is the famous BC-654 transmitter and receiver, also known as the SCR-284A. This set consists of a 7-tube superhet receiver, and a 25 watt transmitter, constructed on separate chassis, and mounted together in one cabinet. Designed especially for semi-portable and vehicular operation, weighing 45 lbs., and operating on phone or CW from 3750 to 5825 Kc, this set is a "Natural" for amateur use, for aircraft, marine, police, as well as for experimental and instructional purposes. Due to its construction, it is very easy to adapt this equipment to operate on other frequencies.

The receiver employs an RF stage, a mixer-oscillator stage, two 455 Kc. IF stages, a second detector, and two stages of audio amplification. Also featured are AVC, a beat frequency oscillator, and a high ratio geared vernier dial drive. Due to the low drain tubes employed, the receiver operates from small portable batteries (1½V and 90V). A small electronic supply may be used, and operated from 110V, 6 or 12 volts DC. Either a speaker or headphones may be used in the output circuit.

The transmitter consists of a stable, thermal-compensated electron-coupled oscillator, a buffer,

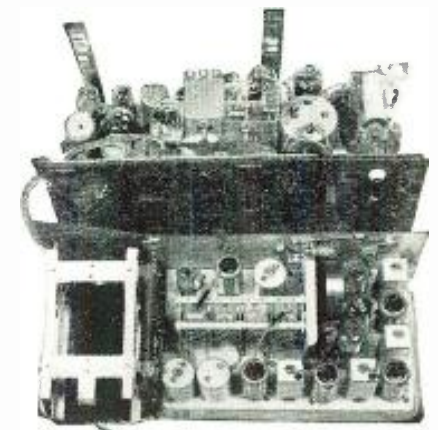
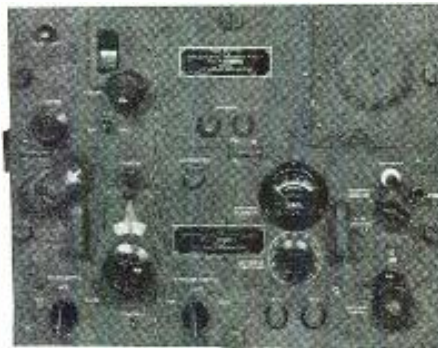

and a pair of 307-A or RK-75 class "C" power amplifiers. Two more tubes comprise a modulator and a 200 Kc crystal calibrator circuit. This calibrator insures crystal accuracy in transmitter oscillator setting. A built-in antenna tuning circuit, including a thermo-couple R.F. ammeter matches the transmitter to a wide range of antenna lengths. The transmitter requires 6 or 12V filament voltage, 45 volts bias, and 500V plate supply. These voltages may be obtained from a 110V power supply, or from the dynamotor described below.

These sets have been slightly used, but outside of slightly scratched cases, are in "like new" condition, both electrically and mechanically. Each set includes circuit diagrams, instructions, crystal, and a complete set of 13 tubes.

Also available is a dynamotor unit (PE-103) which was designed especially for this equipment. This unit operates from 6 or 12V D.C., and delivers 500V DC at 100 MA. Its base contains filters, circuit-breakers, switches, and relays necessary for operation, and is supplied complete with cable.

The price of the complete set is \$39.95. A dynamotor, if desired, is \$19.95. Both units purchased together, \$54.95.

Our other special is one of particular interest to those who are working on Ultra-High frequencies. This is a 14-tube receiver, operating from 157 to 212 Megacycles. All controls and illuminated tuning dials are on the front panel. Dimensions are 15x16½x9", and shipping weight is 75 lbs.

This fine piece of equipment, which is complete except for phones or speaker, plugs right into any 110V 60 Cycle line, has 2 RF stages, a 6AB7 detector, a 6B5 oscillator, 6VE 4F stages, using 6AT7's and 6AB7's, second detector, two audio stages and a 6E5 tuning indicator. This receiver is typical of the kind of equipment recently used to receive reflected radar signals from the moon, and undoubtedly is far more sensitive than any set used by anyone not previously engaged in similar work. Government cost was almost \$700. While our limited quantity lasts, your cost for this super bargain, complete with tubes, is \$39.95.

RECORD CHANGERS, 110V 60 cy. With crystal pickup. This modern two-post changer plays twelve 10 or 12 inch records INTERMIXED! —The only changer on the market with this feature in its price range. Now specially priced at \$22.50.

10% Deposit must accompany all C.O.D. orders.

BUFFALO RADIO SUPPLY

219-221 GENESEE ST., DEPT. 6N, BUFFALO 3, N. Y.

TRUTONE

**PREPARED ASSORTMENTS
—GUARANTEED FIRST QUALITY**

Cat. No.	Quantity	Description	Price
1001	100	1/4 Watt Resistors, All Insulated	\$2.98
1002	100	1/2 Watt Resistors, All Insulated	3.98
1003	100	1 Watt Resistors, All Insulated	4.45
1004	50	2 Watt Resistors, All Insulated	3.98
1005	10	Wire Wound Resistors Ass't'd	2.98
1006	50	200 Volt Paper Condensers	2.48
1007	50	400 Volt Paper Condensers	3.49
1008	50	600 Volt Paper Condensers	4.25
1009	50	Mica Condensers	2.98
1010	20	Dry Electrolytic Filter Condensers	6.75
1011	10	Resistance and Line Cords	3.98
1012	100	Wafer Sockets	4.50
1013	100	Plastic and Ceramic Sockets	6.50
1014	10	25 Ft. Rolls Hookup Wire—	1.98
1015	10	50 Ft. Rolls Hookup Wire—	3.25
1016	10	100 Ft. Rolls Hookup Wire—	6.75
1017	10	Volume and Tone Controls—No	1.98
1018	50	Large Bakelite Knobs Push On	6.30
1019	50	Large Bakelite Knobs Set Screw	7.85
1020	50	Small and Medium Knobs Push On	3.50
1021	50	Small and Medium Knobs Set	3.75
1022	100	Small Bar Knobs	5.50
1023	100	Large Bar Knobs	6.75
1024	100 ft.	Spaghetti and Vinylite	.98
1025	50	Paddlers and Trimmers	6.45
1026	10	Coils I.F., R.F. Ant. and Osc.	3.98
1027	50	Pilot Lamps	2.49
1028	20	Toggles and Slide Switches	3.98
1029	20	Wafer and Ceramic Band Switches	2.98
1030	20	Auto Generator Condensers	2.98
1031	20	Auto Suppressors	2.98
1032	25	Electrical Wiring Devices, Plugs, Caps, Bases, Heater Plugs, etc.	2.75
1033	50	Electrical Wiring Devices, Plugs, Caps, Bases, Elements, Fuses, etc.	5.00

ELECTRICAL APPLIANCES AND PARTS

Double Burner Electric Stove	OPA \$ 7.00	\$ 5.95
Streamlined Electric Broiler	OPA 17.45	12.50
Fluorescent Desk Lamp, Brown, Blue or Rust	OPA 11.95	7.75
Fluorescent Kitchen Unit	OPA 10.50	6.75
Electric Phonograph	OPA 48.50	39.95
Replacement Stove Element 660 W		.12
Replacement Electric Iron Element 550 W		.15
Replacement Toaster Element		.75
Electric Iron Cord Set, Bakelite Plug		.45
Electric Iron Cord Set, Switch Plug		.39
8 ft. Extension Cord with Cube Top		.45
6 ft. Rubber Replacement Cord		.21

SEND FOR TRUTONE'S RADIO AND ELECTRICAL LIST
Terms: 25% deposit required with order. Balance C.O.D. Merchandise sent prepaid if full remittance accompanies order.

TRUTONE PRODUCTS CO.

303 West 42nd Street
New York (18), N. Y.



TELEVISION!

Prepare now for a fascinating new profession. At Television Center on the shores of beautiful Lake Michigan, you will train under top television engineers using up-to-the-minute commercial equipment. Every phase of Television is thoroughly covered—studio, control room, transmitter and receiver. Highly developed techniques through wartime training of thousands of Signal Corps men assure rapid advance.



New classes are forming every week. Don't wait! The best time to start your training is right now!

Government Approved for G.I. Training

AMERICAN TELEVISION INSTITUTE

433 E. Erie Street
Chicago 11, Ill.

MAIL THE COUPON TODAY

AMERICAN TELEVISION INSTITUTE
Division of American Television Laboratories, Inc.,
433 E. Erie Street,
Chicago 11, Illinois.

Please send me free information regarding Television Training.

NAME

ADDRESS

CITY & STATE

cer of the 8th Army Area Command in the Philippines, with the rank of major.

Mr. Robinson will work as an engineering consultant for *Motorola* two-way radiotelephone communication systems.

* * *

KARL KRAMER has been transferred from the engineering to the sales department of *Jensen Radio Manufacturing Company* where he will now serve as Technical Service Engineer for the company's line of acoustic equipment.



Mr. Kramer joined the *Jensen* company in 1935 and has served since that time as senior development engineer and applications engineer. In this capacity he was responsible for all direct-radiator loud speaker development and for the design and development of enclosures.

Mr. Kramer is a senior member of the I.R.E. and a member of the executive committee of the Chicago Section. He is also a member of the Acoustic Society of America and the Radio Engineers Club of Chicago.

* * *

ELECTRONIC CORPORATION OF AMERICA has moved all manufacturing and sales operations to the company's new plant at 170 53rd Street, Brooklyn, New York.

The company, which manufactures a complete line of radio receivers, formerly was located at 45 West 18th Street, New York 11, New York.

* * *

PIERRE BOUCHERON has been named general manager of the broadcast division of *Farnsworth Television and Radio Corporation* and placed in charge of Station WGL at Fort Wayne, Indiana.



Mr. Boucheron's duties will entail the management of *Farnsworth's* Fort Wayne AM station, WGL, as well as a proposed FM station, if the license now pending is granted by the FCC. By late spring it is anticipated that he will be operating Fort Wayne's first television station to which the experimental call letters W9XFT have been assigned.

Mr. Boucheron began his radio activities in 1912 as a wireless operator with the *Marconi Wireless Telegraph Company*. In 1917 he enlisted in the Navy and after World War I he served as managing editor of *RADIO NEWS* until 1920, at which time he became associated with *Radio Corporation of America*.

He joined *Farnsworth Corporation* in 1939 as General Sales Manager. He served as a Captain in the Navy during World War II and performed many important communications tasks over-

You Get **TOPS** in Accuracy in the Electronic Voltmeter Ohmmeter



Because it has a stable bridge circuit type vacuum tube meter for measuring AC-DC voltages and ohms by electronic means.

Because it is hand calibrated.

Because it has hand calibrated multiplier resistors.

Because we have the "know how" obtained from years of war production.

Measures DC volts up to 600 with constant input resistance of 11 megohms. Resistor in the DC probe permits readings in signal carrying circuits. Positive or negative indications through a reversal switch. Net price \$75.00.

ELECTRONIC MANUFACTURING CO.
140 S. Second Street—Harrisburg, Pa.

HIGH PRICE QUALITY IN THE MEDIUM PRICE FIELD

SPECIAL INTRODUCTORY OFFER

WHILE THEY LAST

Famous Signal Corps

LS3 SPEAKER



\$4.95

Features

- 6" PM Alnico 5
- Waterproof Cone
- Water Sealed Case
- Handles 10 Watts Audio
- Input Jack
- 6 Ohm Voice Coil Output or 10,000 Ohms
- Ideal for Public Address Speakers
- Auto Speakers
- Extension Speakers
- 4 Mounting Bolts on Back of Cabinet
- Case 8"x8"x4 1/2"

PL68 PLUGS FOR SPEAKER 29c ea.

Norman Radio Distrib., Inc.
94-29 Merrick Road Jamaica, 5, N. Y.

Please RUSH me LS3 Speakers.

Terms M.O. or Check payment in full.
 Deposit 20%. Balance C.O.D.

Name

Address

seas during the war. He rejoined *Farnsworth Corporation* in July of 1945.

ROBERT L. WOLFF has been named Chief Radio and Electronics Engineer for the *Centralab, Division of Globe-Union, Inc.*, of Milwaukee.



Mr. Wolff is a 1927 graduate of the University of Chicago where he received his bachelor of science degree. Before joining *Centralab* in 1937, Mr. Wolff was employed for four years on engineering development design at the Hawthorne plant of *Western Electric Company* and four years on r.f. design at *Wells-Gardner* of Chicago.

W. H. McKNEW has been named service manager of the *Westinghouse Home Radio Division*, with headquarters in Sunbury, Pennsylvania.

Mr. McKNew, a lieutenant commander in the U. S. Naval Reserve, recently transferred to inactive status, served from 1942 to 1945 as Resident Inspector of Naval Material at the *Westinghouse Industrial Electronics* and *X-ray Divisions* in Baltimore.

He is a graduate of Baltimore Polytechnic Institute and studied electrical engineering at Johns Hopkins University. Mr. McKNew was formerly employed by *Western Electric Company* where he worked on the development of sound movies, and by the *General Electric Company* where he held several sales and engineering positions.

MICHAEL SCOTT who served as a Lieutenant Commander in the Navy has returned to *Radio Wire Television, Inc.*, of Boston, Massachusetts, as vice-president and general manager of the firm.



Mr. Scott served as Officer-in-Charge of the Electronic Division of the Navy's Disposal Administration where he initiated and administered policy, procedures and operations for the disposal of the Navy's surplus electronic material.

Before entering the service, Mr. Scott served for 18 months as the Regional Chief of the WPB's Radio and Radar Division. He has been with *Radio Wire and Television, Inc.*, since 1934 and on a leave of absence from the company since 1942.

LESTER R. BELMUTH, an ex-captain in the U. S. Army Air Forces, has been appointed Sales Representative of the *Insuline Corporation of America*.

Mr. Belmuth will serve the New York, Eastern Pennsylvania and Virginia areas.

He was recently released from the Air Corps after four years' active duty, during which he was awarded the Pur-

PUR-A-TONE

Reg. Trade Mark

ANTENNAS



Masterpieces of

DESIGN AND
CONSTRUCTION

A. M. — F. M. — TELEVISION

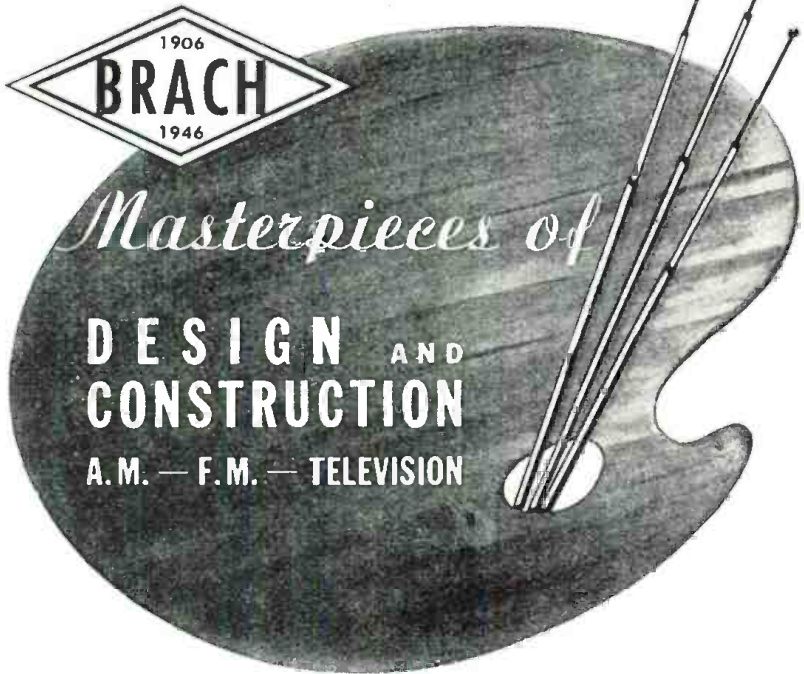

for AUTOS • HOMES • MARINE

Brach Pur-a-tone Antennas have long been recognized as the standard by which all others are judged. They're a byword for Quality and a buy-word for Satisfaction. Please your customers and increase your profits—ask your distributor for BRACH ANTENNAS.

Special-purpose transmitting antennas designed for volume production to your specifications. Collapsible — sectional — direction-finding — radar — and coaxial type. All sizes, lengths and materials. Consult us on your needs.

L. S. BRACH MFG. CORP.

200 CENTRAL AVENUE NEWARK, N. J.



WORLD'S OLDEST AND LARGEST MANUFACTURERS OF RADIO ANTENNAS AND ACCESSORIES.

RADIO COURSES

- RADIO OPERATING • CODE
- RADIO SERVICING — ELECTRONICS
- REFRIGERATION SERVICING

Personal Counselling Services for Veterans
Write for Latest Trade & Technical Catalog
Y.M.C.A. TRADE & TECHNICAL SCHOOLS
7 W. 64th Street New York City

RADIO BOOKS by mail

FAST SERVICE: 98% of all orders filled same day as received. We have one of the U.S.A.'s most complete stocks of electronic books. If you don't know the price, we'll send C.O.D., or remit sufficient and we'll refund excess.

Send stamp for catalog
EDITORS AND ENGINEERS

1420 North Highland Ave., Los Angeles 28, Calif.

WAR SURPLUS RADIO PARTS

New, top quality, at a fraction of original cost

CONDENSERS—Famous make. Filter, oil filled, rectangular cans—

1500 VDC 1. mfd., \$1.09 ea., 10 for \$10.40
750 VDC 2. mfd., \$1.13 ea., 10 for \$10.80
600 VDC 2.2. mfd., \$1.15 ea., 10 for \$11.00

Bath tub type—

600 VDC .1.1.1 mfd., 63c ea., 10 for \$6.00
600 VDC 1. mfd., 59c ea., 10 for \$5.50

Tubulars—

600 VDC .1 mfd. 1500 V test, metal encased, oil impregnated, 19c ea., 10 for \$1.85.

CRYSTALS—Sylvania type IN21, high frequency, plug-in type receiving crystals (make a fine meter rectifier). 98c ea.

JACKS—Signal Corps type JK34A, short phone Jack. 21c ea., 10 for \$1.85.

Shipping extra

Many other outstanding values—Write for Circular.

ERIE SUPPLY CO.

88 Exchange Street

Rochester 4, N. Y.

famous for
GREAT VALUES

OUTSTANDING OFFERINGS OF NEW KITS

PHONO KIT. Consists of AC Phono-Motor, Pick up, all parts necessary for 3 tube phono Amplifier, including 5" P.M. speaker. Excludes wire, solder and tubes **\$16.25**

With the PA 12 portable leatherette-covered all wood cabinet **\$7.95**
 Above Kit of tubes **\$1.85**

KIT #2. Easy-Built 1-tube radio. Operates on AC, DC or battery current. **\$7.05**
 All prices are F.O.B. New York City

*Write for our new catalogue showing new test equipment, tubes and a large variety of new replacement parts.
 We ship anywhere in the U.S.A. —promptly!*

RADIO DEALERS SUPPLY COMPANY
 135 LIBERTY ST., NEW YORK 6, N.Y.

Supreme Publications

These are the practical radio manuals you need. Improve your radio knowledge. Speed up service work. Check manuals you want, write name below, and send this entire ad. as your order.

MOST-OFTEN-NEEDED DIAGRAM MANUALS



1942. 1941. 1940. 1939
 Each manual has between 192 and 208 pages, 8 1/2 x 11".
 Price, each **\$2.00**

1926-1938
 Radio Diagram Manual, 240 pages.
 Price, only **\$2.50**

- Radio Servicing Course — Book.** 22 lessons, 224 pages. **\$2.50**
 Size: 8 1/2 x 11"
- Record Players & Recorders.** All makes, 8 1/2 x 11". **\$1.50**
 128 pages
- Practical Radio Mathematics** 25c
- Refrigeration Manual** \$1.00
- Cyclopedia of Television** 40c

- Practical Radio & Electronics Course.** 3 volumes in one. 53 lessons, for Home-Study. \$3.95
- How to Modernize Radios for Profit.** \$1.00
- Radio Repairing with Available Substitute Parts.** 25c
- How to Use Diagrams in Radio Servicing.** 10c
- Simplified Radio Servicing by Comparison Method**
 New, revolutionary different method makes radio repairing twice as easy. Introductory training included. Simple picture suggestions tell you where to look for faults and how to make the repair. No testers needed for most jobs. With job-sheets, blue prints, hints, diagrams. **\$1.50**

SUPREME PUBLICATIONS, 9 S. Kedzie, Chicago 12, ILL.
 Check manuals wanted, send remittance with complete advertisement or write order in a letter. Books sent postpaid. Money back guaranteed.

Name:
 Address:

ple Heart, Distinguished Flying Cross and the Air Medal with two clusters. He is a graduate of the Ft. Knox Engineering School, the Army Radar School and other military technical training institutions.

-30-

A Non-Electrical Phonograph
 (Continued from page 53)

with volume peaks of great magnitude, and the quality was distorted by the resonant frequencies producing harmonics.

This system also had considerable directive effect due to the use of the exponential speaker, particularly so at the high frequency end of the response.

The size and clumsiness of the tone arm, besides detracting from the appearance, caused the reproducer needle pressure to be between five and ten ounces which is conducive to fast record wear and poor reproduction. Counter-balancing the tone arm was rarely done as the excessive pressure did produce high output volume.

During the past few years a well known Western phonograph manufacturer has been experimenting with the possibility of producing an improved mechanical reproducer with sufficient merit to appeal to the public over that of an electrical reproducer based on price and reproduction quality. That he has succeeded has been proven by large purchases of this item by retailers.

The Pacific Sound Equipment Company under the trade name of *Portelec* is now producing the equipment, with either an electric or spring driven turntable. The phonograph is sold under the name of "Phonocone."

The design engineer carefully considered all the factors involved. Light weight, small size and portability, as well as the reproduction quality demanded, determined that no amplifying or exponential horn could be used. If only a tone arm were used there would be no volume, and the same distortion attended upon the glass diaphragm pickup would be present. An original idea was needed and it was forthcoming. It was thought that

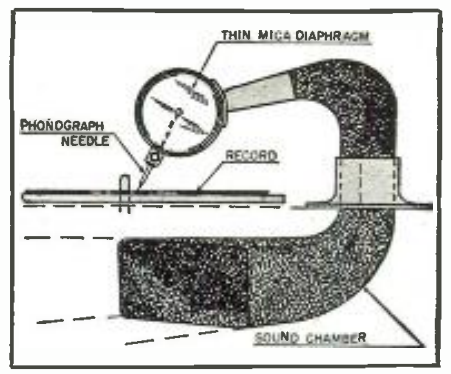

Old type mechanical reproducer.

if a small paper speaker cone was mounted in place of the glass disc, of the previously mentioned tone arm, that good volume could be attained without the exponential horn. Investigation determined that some volume did exist. From here it was a logical step to advance to larger diameter speaker cones. Further investigation determined that about a five inch diameter speaker cone gave the best results, giving the best volume and frequency response. The cone sizes tried were from one inch to eight inches in diameter. The volume increase from a three inch cone to a five inch cone was considerable. Above this size little additional volume was noticed. Logically, the lever arm from the needle to the cone center was lengthened and shortened and it was determined that the length of the lever should remain the same length as that of the old style mechanical reproducer from which it was borrowed.

It was also determined, by suitable investigation, that heavy paper cones gave the best low frequency response and volume, slightly limiting the high frequency response as compared with a light weight cone. It was discovered that the thickness of the cone material was extremely important; when making frequency characteristics checks with a *Columbia* tone record, it was noted besides over-all volume changes that this thickness caused definite changes in the frequency response. The thin cones gave a better frequency response, so that a compromise was

Two relatively new types of sound reproducers.

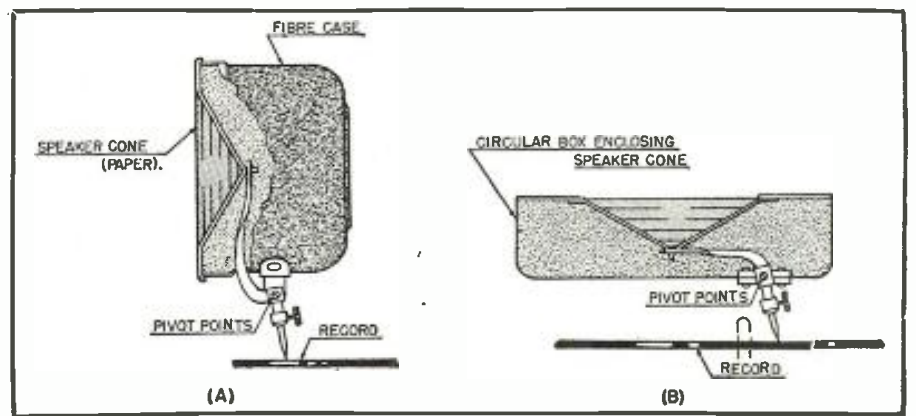

made, giving good volume and fair frequency response.

While these experiments were going on, it was decided to turn the position of the speaker cone from a vertical to a horizontal position so as to make a more compact and better looking model. With the cone turned, facing up, it was immediately noticeable that a better distribution of sound occurred in the room. The diameter of the box the speaker cone was in was increased to about eight inches, forming a baffle and a small bass reflex cabinet which, although not correctly proportioned, aided the low frequency response considerably.

As the drawings show quite plainly, this assembly can be used with either hill and dale recordings or with the standard lateral commercial recordings depending upon the way the tone head is mounted above the turntable. If the pivot plane is in line with the record grooves, then the lateral movement of the needle will pull and push on the cone through the lever system. With the pivot plane at right angles to the record grooves, the lever system is only capable of responding to a hill and dale motion of the phonograph needle. At the present time the "Phonocone" is being produced for use with standard lateral recordings, and is being assembled accordingly.

The frequency response of this new mechanical system does not approach that of an electrically operated reproducer, but is still very pleasing to the ear and is very competitive to the electric reproducer in the low price field.

The needle pressure of this system is under three ounces and it has been determined that a pressure of one and one-half ounces is quite satisfactory, providing full volume and frequency response. Rather than add weight to the assembly, for counter-balancing the pickup arm, a spring was used to lower the needle pressure.

The volume produced by this novel reproducer is very good. It compares favorably with any standard type 45 or 6F6 output stage. In a normal room the volume is loud, but not excessive. Volume control may be added by using one of the following systems. One method tried consisted of closing off all the speaker outlets at one time, thus lowering the volume in one step and also altering the frequency response. Of course attempting to control the volume by a variable area outlet from the speaker does not work, due to the well known acoustical law that a crack lets through as much sound as a large hole (for any practical purpose). One method of possibly controlling the volume is by the use of a rubber snubber on the lever arm between the pivot and speaker cone. If by the use of a rotary motion of a knob, the rubber would clamp down on the lever, it would dampen the amplitude of the lever and thus lower the volume output. This method would un-

READING
PRONOUNCED REDDING

ANNOUNCEMENT

TO

RADIO SERVICEMEN AND TECHNICIANS

EDWARD M. NOLL

television and radio science writer and engineer, former instructor in television engineering at Temple University, former member Philco radar department, etc.

wishes to announce the formation of a scholastic service organization and laboratory,

THE READING TELEVISION LABORATORIES, INC.

offering a twelve months' CORRESPONDENCE course in television service, operation and maintenance for radio servicemen and technicians . . . those now possessing a basic knowledge of radio equipment and those who are the natural heirs of television servicing and repairs.

BE PREPARED—TELEVISION IS HERE!

Write for a Brochure Today!

THE READING TELEVISION LABORATORIES, INC.

1328 Chestnut Street

Suite 622

PHILADELPHIA 7, PA.

EASY TO LEARN CODE

It is easy to learn or increase speed with an Instructograph Code Fechner. Affords the quickest and most practical method yet developed. For beginners or advanced students. Available tapes from beginner's alphabet to typical messages on all subjects. Speed range 5 to 40 WPM. Always ready—no QRM.

ENDORSED BY THOUSANDS!

The Instructograph Code Fechner literally takes the place of an operator-instructor and enables anyone to learn and master code without further assistance. Thousands of successful operators have "acquired the code" with the Instructograph System. Write today for convenient rental and purchase plans.



INSTRUCTOGRAPH COMPANY

4711 SHERIDAN ROAD, CHICAGO 40, ILLINOIS

TEST EQUIPMENT

SHIPPED FROM STOCK!

SIMPSON 260-volt-ohm-milliammeter. \$33.25
SIMPSON 240 "Hammer" 26.50
SIMPSON 305 tube tester 39.50
TRIPLETT 2413-tube tester 45.00
TRIPLETT 2432 signal generator 49.75
RADIO CITY 705-signal generator 49.50
RADIO CITY 802 N tube & set tester 59.50
McMURDO-SILVER "Vomax" 59.85
APPROVED R.F. signal generator 47.00
DuMONT 164-E-3" oscilloscope 105.00

Also many, many others available.
WE ALSO STOCK AMPLIFIERS!

Amplifiers and complete sound systems available from \$29.99 up. Write to us on your specific needs. Orders shipped C.O.D. upon receipt of 25% deposit.

SCENIC RADIO & ELECTRONICS CO.

53 Park Place • New York 7, N. Y.

CUT HOLES

3/4" TO 3 1/2"



in radio chassis

Punch cuts through chassis, die supports metal to prevent distortion, cap screw is turned with wrench to cut clean, accurate holes for sockets, plugs, and other receptacles. Saves hours of work — no reaming, filing or drilling! 3/4" to 3 1/2" sizes. Get complete data now from Greenlee Tool Co., 1886 Columbia Ave., Rockford, Illinois.

WRITE FOR FREE FOLDER S-119



desirably lower the high frequency response, but might be suitable because of the ease of construction. One method now used to control the volume to different range levels is the use of a loud, medium, or soft playback needle.

Where pivot point screws are employed in the needle to speaker cone lever assembly, it is important that these screws be taken up snugly without being tight. Tightness will reduce the volume level while insufficient snugness will cause considerable rattle and distortion. It is possible to remove the pivot screws and put through a pivot bar (by drilling the pivot arm) which does away with any adjustments, little side play being present because of already close tolerances.

The lever arm at the start of manufacturing was secured to the paper speaker cone by an extremely small machine screw placed through the paper cone and screwed into a tapped hole on the lever arm. After experimentation it was found possible to merely glue the lever arm to the paper cone, which speeded up production considerably.

The phonographic device described herein was the development of an original invention by Robt. G. Metzner. Application for this invention is on file at the U. S. Patent Office.

-50-

Two Meter Transmitter

(Continued from page 30)

crease of from 10 to 15 milliamperes. Generally speaking, it is well not to load the antenna too heavily with these tubes as they seem to operate better and give a better signal with fairly light loading. A matched impedance antenna was used with this transmitter and gave very satisfactory results, but other types may well be employed. Reference to the A.R.R.L. handbook here is advised as there are many types that may be used and it will be optional with the individual.

In describing this transmitter an attempt has been made to present an outfit which would be suitable for the newcomer to the ultra-high frequencies as well as for the ham who wants a compact rig for local phone work. It has worked well at its present location and R8 and R9 reports are received consistently from 15 to 25 miles away. Modulation reports are good and the quality with a single button carbon microphone is fair. It is possible to use i.c.w. by merely throwing S₂ to its proper position and plugging a key into J.

All in all, this is an ideal rig for low power on the new 2 meter band and should appeal to the average ham who likes a local ragchew.

-50-

NEW RULES GOVERNING AMATEUR RADIO SERVICE

Scope of operator authority. Amateur operator licenses are valid only for the operation of licensed amateur stations; and, on a temporary basis, for the operation of experimental stations (except class 2 stations) in the experimental service licensed for operation exclusively on a frequency or frequencies above 450 mc. if such services are performed without compensation, direct or indirect, paid or promised.

Renewal of amateur operator license. An amateur operator license may be renewed upon proper application showing that within the last six months of the license term the licensee has lawfully operated an amateur station or stations licensed by the Commission, and has thereby communicated by radio telegraphy with at least three other such amateur stations in the United States. The applicant shall qualify for a new license by examination if the requirements of this section are not fulfilled. Application for renewal of an amateur operator license shall be filed not more than 120 days prior to date of expiration of such license and not later than the date of expiration.

Examination credit. An applicant for any class of amateur privileges will be given credit for examination element one if within five years prior to the receipt of his application by the Commission he held a radio-telegraph first or second class operator license. No examination credit for other classes of licenses or privileges shall be allowed.

Eligibility for reexamination. An applicant who fails examination for amateur op-

erator privileges may not take another examination for such privileges within 30 days, except that this limitation shall not apply to an examination for class B operating privileges following an examination for class C privileges.

License period. The license for an amateur station is valid normally for a period of 5 years from the date of issuance of a new, renewed, or modified license.

Transmission of call signals. When telephony is used, the call of the station shall be preceded by the words "this is" or the word "from" instead of the letters "de," followed by an announcement of the geographical location in which the portable or mobile station is being operated. When using telephony phonetic aids to identify the call of the station may be employed. To avoid confusion, however, the names of countries or cities shall not be used for this purpose.

Allocation of frequencies. The band of frequencies 420 to 450 mc. is allocated for use by amateur stations (and temporarily by other services for special air navigational aids) subject to the limitation of 50 watts peak antenna power. The band of frequencies 235 to 240 mc. is allocated for use by amateur stations until January 1, 1949; the frequency band 220 to 225 mc. is allocated for use by amateur stations beginning January 1, 1949. Amateur stations may be operated with types A-O, A-1, A-2, A-3, A-4 and special emission for frequency modulation on the frequency band 27.185-27.455 mc. (allocated for operation of scientific, industrial and medical apparatus).

-30-

RCA TRK 90 TELEVISION CABINET with 11 tube all wave radio receiver slightly used complete with 12" speaker Less Television Chassis and Kinescope \$199.00
RCA TELEVISION 50/60 cycle Power Supply \$90.00

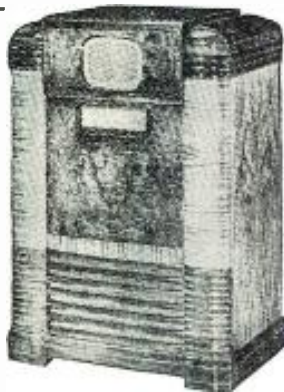

RCA TELEVISION Magnetic Deflection yoke with hardware..... 19.50
G.E. TELEVISION Magnetic Focusing Coil..... 9.00
RCA TELEVISION Switch with 5 Antennae Transformers..... 5.60
Capacitors .03 mfd 7500 V.w..... 3.75
Pyranol..... 7.50
Capacitors .1 mfd 7500 V.w..... 1.80
Pyranol..... .90
Capacitors .02 mfd 2500 V.w. tubular.....

NEW SEALED CATHODE-RAY TUBES
RCA 5BP4 \$18.00 Dumont 5BP1 \$15.00
RCA 5AP4 27.50 Philips 5CP1 15.00
RCA 9AP4 62.50 Dumont 5JP4 27.00
RCA 12AP4 75.00 Dumont 7EP4 29.90

Send 50c for complete catalog including diagrams for RCA, G.E., Dumont and Andrea Television Receivers, free with order \$5.00 and more.

RCA Parts and Equipment Distributors
World's First Specialized House in Television

ELECTRONICS SERVICE AND SUPPLY
266 West 40th Street, New York 18, N.Y.

6 Volt D.C. Supply
(Continued from page 45)

total available sensitivity of the 2050 tube.

For the charger, we use a husky transformer with a 20 volt secondary, and a large *Mallory* magnesium-copper-sulphide dry-disc bridge rectifier rated at 30 amps. A filter is used, consisting of a 1000 μ fd., 25 volt input condenser across the rectifier, and a choke of .08 ohms resistance. The choke is wound on a core having cross-sectional dimensions of 2 1/4" x 1 1/2". Two paralleled windings of 110 turns each of No. 12 wire keep the resistance at this low value. The filtering action is sufficient to eliminate all hum. The resistance could have been kept just as low with a single winding of No. 9 wire, but this would have been awkward on such a core. The battery itself is equivalent to a condenser of such a value across the output of the filter, that the inclusion of another condenser here is a reflection on the character of the battery.

Most chargers introduce some hum or hash, but we are unable to know when ours is on without watching a pilot light. Naturally, a choke of low resistance is of prime importance to pass 25 amps. at low voltage.

A major factor in the success of this control unit is the variable a.c. input to the charger, nicely handled by a 5 amp. variac. Obviously, the objective is to replace only the amount of power taken from the battery, and the logical way to do it is to match the charging current to the load. It could be done by taps on the transformer, but the variac gives a stepless variable input. If the charging rate is left considerably higher than the load current, no harm results, except that the charger will turn on and off quite often.

Note in the diagram that the 6-volt d.c. feed to the grid circuit of the 2050 is tapped-on at the load terminals, rather than at the battery. This takes advantage of the drop in the battery cable, because the actual battery voltage variation and the drop in the cable are added. In practice, with optimum adjustment of the controls, even a two or three amp. load will cause the charger to turn on as soon as the load is applied, and turn off when it is removed.

Unfortunately, a voltage control unit such as this would not be very practical with a tube rectifier charger, unless the filament could be left on while the control unit controlled the plate circuit alone.

Our heavy-duty *Mallory* dry-disc rectifier has been extremely satisfactory, although it has been used eight years without replacement. The ambient temperature is a prime factor in the life of these rectifiers, so we have ours mounted behind a panel, but exposed to the free circulation of air.

We consulted an engineer of a well known battery company on the ad-



THIS NEW WORLD OF ELECTRONICS promises exciting opportunities for employment in new applications of new electronic developments. FM broadcasting, micro-wave relay systems, television, mobile communication systems for railroads, automobiles, busses and trucks—**BRAND NEW JOBS IN BRAND NEW FIELDS!**

WHAT ARE YOUR QUALIFICATIONS FOR THESE JOBS? That is the first question. Practical experience is only a partial answer—the field has a sufficiency of such men. Practical experience plus technical training is the more desirable answer—employers want these men.

YOUR FIRST STEP TOWARD SUCCESS in this New World of Electronics is your resolution to acquire a sound basic knowledge of the technical side of radio-electronics. Add this knowledge to your practical experience and place yourself ABOVE the competition of the "average" radioman.

LET CIRE TAKE OVER YOUR PERSONAL UP-GRADING PROGRAM! Qualified, competent instructors, ample, personalized instructional aids, orderly, progressively arranged study assignments in recognized, approved technical texts—these are only a few of the many superior advantages of CIRE's plan of personalized spare-time home study training for professional self-improvement.

Graduates of CIRE courses are eligible for the top jobs in radio-electronics. Write today for free, descriptive booklet, "THIS NEW WORLD OF ELECTRONICS HOLDS OPPORTUNITY FOR YOU." No obligation—no salesmen.

APPROVED FOR VETERAN TRAINING UNDER "G-I BILL OF RIGHTS."

CIRE HOME STUDY COURSES COVER THE FIELD OF RADIO-ELECTRONICS—TELEVISION, ULTRA-HIGH FREQUENCY TECHNIQUES, AM AND FM BROADCASTING, COMMUNICATIONS ENGINEERING—from simple treatment of fundamentals, through preparation for FCC commercial radio operators' license examinations, up to and including complete high-level quantitative treatment of advanced radio-electronics and communication engineering. Choose the course best suited to your needs, and start with the section you are qualified to enter. You pay for only the section or sections you need.



Use the "Pay-as-you-go plan" patterned after ethical, educational practice. These features are unique with Cleveland Institute, and represent the best in the modern, post-war concept of home study training.

CLEVELAND INSTITUTE OF RADIO ELECTRONICS

Contractors to the Canadian Broadcasting Corporation

Successors to

NILSON RADIO SCHOOL, Founded 1939

SMITH PRACTICAL RADIO INSTITUTE, Founded 1934

RN-6 TERMINAL TOWER, CLEVELAND 13, OHIO

(Mail this Coupon)

Cleveland Institute of Radio Electronics, RN-6, Terminal Tower, Cleveland 13, Ohio.

Gentlemen: Please send information about your home study courses in Radio Electronics.

NAME

ADDRESS

CITY

ZONE..... STATE.....

I desire training in.....

I have had experience in broadcasting servicing

operating mfg. CAA Army-Navy

amateur other..... I am a

High School Grad. College War Veteran

I hold a degree in.....

GRAB REE'S
WHOLESALE RADIO

2608 Ross Ave.

DALLAS 1 TEXAS

RADIO

RADIO Technician and Radio Communications courses. Register now for new classes starting first MONDAY of each month. Day and Evening Classes.

AMERICAN RADIO INSTITUTE

101 West 63d St., New York 23, N. Y.

Approved under GI Bill of Rights.

A TOOL SHOP
IN YOUR HAND

For buffing scratched cabinets, metals, corroded tube and socket pins; removing burrs; sanding, etc. First small portable tool and today's finest—uses 300 accessories to grind, drill, polish, saw, sand, engrave. 25,000 r.p.m. AC or DC. Wt. 12 oz.

In compact steel carrying case with 45 practical accessories, \$25.00 Post Paid. Handle only with 7 accessories. \$18.50.

CHICAGO WHEEL & MFG. CO.

1101 W. Monroe St., Dept. RE, Chicago 7, Ill.

FREE 64 PAGE CATALOG

HANDEE • TOOL OF 1001 USES

LECTROHM RESISTORS

completely
satisfy
ALWAYS



because—

1. Resistance wire is silver soldered to solder lugs in all Lectrohm Resistors, by special process, assuring perfect electrical bond under all conditions.
2. Lectrohm Resistors are designed and made by specialty resistor engineers—99% of Lectrohm's production is resistors.
3. Every Lectrohm Resistor is an integral unit with all parts completely embedded in vitreous enamel.
4. You will find all types and ratings in the Lectrohm Line, also power line and R.F. Plate Chokes and accessories.
5. Delivery is prompt.

Ask for the new Lectrohm Catalog and data book containing pertinent information on these Resistors and much valuable reference information.



5131 West 25th Street, Cicero 30, Illinois
Division of
National Lock Washer Co., Newark, N. J.

MATHEMATICS FOR RADIO AND COMMUNICATION

by GEORGE F. MAEDEL, A.B., E.E.

To master the technicalities of radio—to read engineering literature intelligently—you must have the mathematical groundwork covered by these absorbing books prepared for home study. Book I (314 pp.) covers the algebra, arithmetic, and geometry; Book II (329 pp.) covers the advanced algebra, trigonometry, and complex numbers necessary to read technical books and articles on radio.

MAEDEL PUBLISHING HOUSE Room 109
593 East 38 Street, Brooklyn, New York
Send me MATHEMATICS FOR RADIO AND COMMUNICATION as checked below. I enclose payment therefor with the understanding that I may return the book(s) within 5 days in good condition and my money will be refunded.

Name.....

Address.....

- Book I at \$3.75 plus 3c postage.
 - Book II at \$4.00 plus 3c postage.
 - Books I and II at \$7.75 postage prepaid.
- Foreign and Canadian prices 25c per volume higher.

visibility of maintaining a constant terminal voltage (disregarding gravity readings), and also on the ideal voltage to maintain. We were informed that there is no kinder treatment for a battery than to maintain a proper voltage, regardless of some radio experts' opinion on the subject. Also, we were somewhat surprised to learn that constant terminal voltage of 7.2 volts is not necessarily too high for "automobile" type batteries. Excessive gassing or evaporation seems to indicate too high a voltage better than any other means. Some special batteries purposely have a maximum gravity of 1.220, and maximum desirable terminal voltage of 6.3 volts.

We settled on 6.6 volts as a good average terminal voltage (at the battery) usually encountered in the field on mobile equipment, and which is also satisfactory for keeping the laboratory battery "new" in its old age.

We know of nothing more universally needed in police radio service-labs than a good, constant, standard 6 volt d.c. supply. You cannot do without it, if you are going to bench-test and preadjust receivers and transmitters so they are ready for immediate installation in the field. This unit has proven very satisfactory and worthwhile.

—50—

Expander Compressor Preamplifier

(Continued from page 34)

Depending upon the position of the expand-compress switch S_1 , the paralleled #1 grids are returned either to the low end of the #3 grid resistors, or to a variable voltage point negative with respect to the cathodes. The d.c. return for these grids is through one unit, R_{12} , of the ganged expansion-compression control. This resistor is the load for the a.g.c. rectifier, and is shunted by a small condenser, C_5 , in order to make the d.c. output approximate the peak of the impressed a.c. voltage. With the expansion-compression control R_{11} - R_{12} full off, the resting bias on the #1 grids is essentially equal to that on the #3 grids.

A.G.C. Amplifier and Rectifier

V_{1B} (Fig. 4) is a conventional transformer-coupled amplifier with its control grid effectively in parallel with the grid of the input phase inverter. The output of this amplifier is coupled through T_1 to the a.c. side of the 1N34 bridge rectifier X_1 , X_2 , X_3 and X_4 . The input impedance of the bridge with the load resistor of 250,000 is approximately 170,000, and for all practical purposes is purely resistive. This impedance is sufficiently high so that a conventional step-up audio transformer can be used to work into the rectifier, without the former being seriously loaded down. The over-all rectification efficiency is such that with a transformer ratio of 1 to 3.5, the d.c. output measures 3.2 volts with an input of one volt to the trans-

NEW PRECISION ANTENNA NEW

F-M TELEVISION COMPLETELY AMATEUR ADJUSTABLE

Enjoy the Finest in Radio Reception
Made of Highest Grade Aluminum

Complete with 5 ft. Aluminum Mast and all necessary mounting hardware. Designed for complete adjustment to any frequency within the required band. Incorporates a broad-band feature ideal for television and FM reception. Electrically and mechanically superior to standard fixed type Di-Pole.

Type 701A (28-44MC) 10 Meter Amateur **\$8.95**

Type 701B (44-88MC) Television 5 Meter Amateur..... **\$7.95**

Type 701C (88-148MC) FM 2 Meter Amateur **\$7.45**

(All Prices Less Transmission Line)

Send for particulars on our Special 2 and 10 Meter Adjustable 3 Element Beam.

Immediate Deliveries

S. C. LABORATORIES, INC.
20-22 Van Wagenen St., Newark 4, N. J.
Please send me Postpaid; C.O.D.
Type 701A; 701B; 701C

Name

Address

City..... State.....

SPEAKERS RECONED!

4" — \$1.15	6" — \$1.35	10" — \$2.25
5" — \$1.25	8" — \$1.85	12" — \$2.50

Plus Transportation
Prompt Service—Expert Workmanship

York Radio
DISTRIBUTING COMPANY
Quality Parts for the Radio Profession
Central & Broadway DECATUR 47, ILL.

SUPREME QUALITY

Vasco

TRADE-MARK REG. U. S. PAT. OFF.

ELECTRIC SOLDERING IRONS
4116 AVALON BLVD., LOS ANGELES, CALIF

ELECTRICAL TRAINING

Intensive 8 months' residence course in fundamentals of industrial electrical engineering, including radio, electronics. Prepares for technician, engineering aids. Approved for veteran training. 53rd year. Catalog.

BLISS ELECTRICAL SCHOOL
7698 Takoma Ave.
Washington 12, D. C.

WESTON R. F. METER

0 to 50 milli-amp. vacuum thermocouple. R. F. meter Weston model #425, 3 1/2" round, bakelite, flush mounting case. New stock, not war surplus. List price \$50.00, special \$24.95. Write for quantity discounts. Shipped C.O.D., prepaid if remittance accompanies order.

ERIC WENSTREND
4317 Dayton Street, Chicago 13, Illinois

WAR RADIO MATERIAL

- New Western Electric 1N23B Fixed Crystal Detector. Cost \$6.00. Prepaid..... **\$1.20**
- Paratroop All-Metal folding Antenna, same as landing troops used. For Radio, Auto, Boats. Extends to 128". Worth \$10.00. Prepaid..... **1.49**
- Signal Corps Telegraph Key. Prepaid..... **.99**

Write for free bargain list "RN"

RADIO CITY LABS
30 Church St. New York 7, N. Y.

former primary. For best efficiencies, the 1N34 units should have back resistances of greater than 300,000. Most units measure well over this figure so that selection should not be necessary. Exact matching of crystals is not required as variations of as much as 20% in the forward or back resistances will have but little effect upon the operation of the bridge. One advantage in the use of crystals, instead of the more conventional double diodes in the rectifier, is that the conducting resistance of the crystal bridge is very much lower than in any equivalent vacuum tube circuit. Hence, the charging time of the filter condenser following the bridge is materially reduced and the action of the whole a.g.c. circuit is more rapid.

Feedback Circuit and Other Features

It has been previously mentioned that this circuit contains a novel feedback arrangement that quickens the response of the a.g.c. circuit. The operation is as follows: Consider the action of the circuit when adjusted for volume expansion. With S_1 in the expand position, a partially filtered positive d.c. control voltage, proportional to the mean signal amplitude, is applied to the paralleled #1 grids through the filter resistor R_{15} . Since the resulting plate current changes in V_2 and V_3 are in the same direction and upward in both tubes, the voltage

Over-all gain, high gain channels:	110 db.
Over-all gain, low gain channels:	85 db.
Frequency response: $\pm 1\frac{1}{2}$ db:	35 c.p.s. to 12,000 c.p.s.
Total harmonic distortion; a.g.c. off:	4%
Total harmonic distortion; 18 db. of a.g.c.:	5.5%
Maximum a.g.c. at 10% total harmonics:	23 db.
High gain input overload voltage:015 volts r.m.s.
Low gain input overload voltage:	1.2 volts r.m.s.
Maximum output voltage at 4% total harmonic distortion:	7.7 v. in 500 ohms
A.g.c. rise time, milliseconds:	3.0 minimum
A.g.c. decay time; milliseconds:	500 maximum

Major electrical operating characteristics of preamplifier.

at the junction point of R_{15} and R_{16} drops. In other words, a positive excursion of the #1 grid voltage will result in a negative change in the d.c. potential at the junction of the plate load resistors. As mentioned previously, the control voltage on the #1 grids is only partially filtered so that there is an appreciably large a.c. component present. An amplified and inverse a.c. component is therefore present across the common plate load resistor R_{17} . This a.c. component is applied to the #1 grids through the feedback condenser C_{10} in such a way as to cancel the a.c. component already present. The end result is that, due to the feedback action thus obtained, very small time constants can be used in the a.g.c. circuit, and the action of the circuit in response to a control voltage can be made almost instantaneous. In the experimental unit, the rise time of the #1 voltage

was made as short as 3 milliseconds, and the overshoot of the control voltage pulse in response to a square wave input was negligible.

The resting grid bias for the #1 grids is determined by the setting of the control R_{11} . This control is ganged with the potentiometer R_{18} across the rectifier output. With the compression-expansion control R_{11} - R_{18} in the "off" position, this bias is essentially the same as that on the signal grids and the gain of the stage is normal. As the control is advanced, the resting #1 grid bias is made progressively more negative, the gain decreases, and the positive a.g.c. control voltage is increased. The distribution of voltage on the control R_{11} is such that these grids will not swing positive with any normal level of signal applied to the input of the amplifier. However, to prevent any extremely strong impulse from overloading these

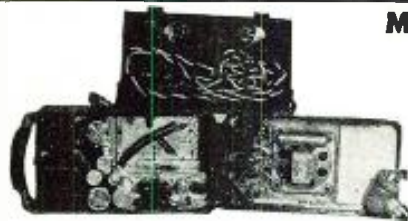

ARMY SALVAGE SPECIAL— 2-Volt Power Supply

The above unit has a multitude of valuable parts. Included are: 4" Alnico 5 P.M., 2-7 prong 2-volt sync. vibrators, 2-4-prong 6-volt vibrators, handy carrying case, 2 relays, mike trans. condensers, etc. Price complete, **\$9.95**
Less the 4 Vibrators, **\$5.95**

B.C. 1068A RADAR RECEIVER

Very H. F. receiver, 157 to 212 MC., for 110 volt AC operation. Has 150 mill 250 volt power supply contains 14 tubes. 2-6SH7, 6J5, 9006, 3-6AC7, 2-6AB7, 6H6, 6SH7, 6SX17, 6E5 and 5V4. An excellent receiver for hams and covers Television band—slug tunnel coils 2RF & 5 IF stages. Original Government cost, \$625.00. Size 15x16x9. Weight, 67 lbs. Price, **\$31.50**

RECORDED CHANGERS—IMMEDIATE DELIVERY

Latest single post type with wrinkle finished metal bases **\$19.95**
AC-DC 2 tube phono oscillator, high output type with tubes easily fits inside metal face of above changer **\$3.69**
3 tube model with extra gain stage for crystal mike; has volume control. A new item and will be a fast seller **\$4.95**
Portable case for automatic changers. Has cut-out for speaker, plenty of room for amplifier. Will accommodate most any changer. Brown leatherette covered **\$11.95**
Price complete with single post changer, **\$29.95**

AUTO AERIAL

Standard 66" side cowl type with 36" unshielded lead. All brass, chrome plated construction. Very special at **\$1.49** each
Top cowl, single hole mounting, all brass, chrome plated construction, similar to 41 and 42; original equipment; has 36" shielded lead. Only **\$1.59** each

McGEE'S BARGAINS FOR JUNE

RADIO TUBE SPECIALS

War surplus marked Jan. Cartoned and uncartoned.			
6SD7	6K6gt	76	77
6SH7	12SL7	6V6	78
6SK7	6C5	46	6D6
6SA7	12SJ7	6SN7	6K7M
6SQ7	12SG7	12SC7	6K7g
6SG7	12SH7	12SN7	6N7gt
6SH7	6B8G	1631	6SL7
6C5	6V6	1632	6SC7
6F6	6K6gt	6H6	6J5

Each **49c**
We have 1000 6L6 metal RCA tubes to sell. A real value if we ever had one. Marked RCA electronic tubes. Latest production.

99c each; 10 for **\$9.50**

TUBES AND ADAPTERS TO REPLACE TUBES STILL SCARCE AT ABOUT PRICE OF TUBES

1R5 & Adapter to 1A7.99c	1L4 & Adapter to 1A5.69c
1S5 & Adapter to 1H5.69c	3S4 & Adapter to 3Q5.69c
1T4 & Adapter to 1N5.69c	3S4 & Adapter to 1Q5.69c

GOOD SUBSTITUTES FOR THOSE IMPOSSIBLE 2V TUBES

3A4 & Adapter for 33.69c	1S5 & Adapter for 1H6.69c
3A4 & Adapter for 1G5.69c	1S5 & Adapter for 1B5.69c
3A4 & Adapter for 1F4.69c	1T4 & Adapter for 30.69c
A34 & Adapter for 1F5.69c	1R5 & Adapter for 1C7.99c
1T4 & Adapter for 1D5 1E5.....69c	

We have sold many thousands of these adapters and Servicemen report that in most cases the substitution is as good or better than original.

VIBRATORS

Standard 4 prong.....	\$1.49
Delco off set 4 prong.....	1.59
Standard 6 prong sync. Made by Mallory—a very popular type at a ridiculous price.....	\$1.98
Midget sync. vibrator made by Radiart; can size 1 1/2" x 2 1/2". Small enough to fit in most any original case, the vibrator with a hundred uses, no buffers.....	\$1.49
General Electric 2 volt vibrator and transformer as used in the G E self charging portable.....	\$1.98

SYNC. VIBR. UNIT

Save Yourself Money
Latest producing. With leads easily fits in any case. 6-Volt. A hot replacement item. Only **\$1.69**

1946 INTER-COMM. SETS

Selective control panel enables operator to communicate with one to four sub-stations, individually or two at once. Designed for 3 wire circuit enabling sub-stations to call in at any time. Three gain stages



assure plenty of volume even on remote installations.

MODEL EX 4 tube MASTER, complete (net) **\$16.95**
SUB-STATION, small cased Alnico 5 speaker with call-in switch (net)..... **\$4.95**

NAVY RECEIVER

Model RAK. A finely constructed Navy receiver for 110 volt AC operation. Covers from 15 to 600 KC. Offered complete with spare parts and voltage regulated power supply. 5 cartons of material in all. The spare parts are in a handy metal box, size 14x14x24; the spares alone are said to be worth \$37.50; has 3 complete sets of tubes. New; factory packed. Ideal for receiving airport signals and can be revamped for many other uses. Shipping wt., 150 lbs. Price, **\$7.95**

4" P.M. with 2 1/2 oz. of "Alnico 5" magnet. Has hard surface cone especially adapted for intercomm sets. Will double the output of your intercomm. **\$2.29**

Army PM Speaker Model LS-3—latest 6 1/2" P.M. with 2 1/2 oz. of the new super magnet "Alnico 5." Has Universal line transformer housed in a square metal case 8x8x5—felt lined interior. We have tested this speaker and it will play just as loud as the average 12" speaker. Ideal for Intercomms, auto sets and ham use..... **\$6.95**
Immediate delivery on the following test equipment:

Vonax, net	\$ 59.85
Meissner Analyst	109.50
Universal Instrument Tube Checker....	45.00
Rosin Core Solder—38-62, the finest solder being delivered today.	

49c per lb.; 10 for **\$4.50**
Include 20% Deposit with Order
Balance Sent C.O.D.

McGee Radio and Electric Co. 1225 McGee St., Kansas City, Missouri

Dealers WHY WAIT FOR YOUR RADIO? "BUILD YOUR OWN"

ATOMIC HEATER & RADIO CORP.
PROUDLY PRESENTS

The Finest in Radio Kits



A COMPLETE 6 TUBE SUPERHET.
COVERS THE BROADCAST BAND FROM
550-1700 KC.

This set has been fully engineered and designed to make construction simple. All parts mounted, cabinet included. Tubes required—two 12SK7, one 12SA7, one 12SQ7, one 35L6 and one 35Z5. Your cost \$15.80 without tubes. Terms 10% deposit with order, balance C.O.D.

IMMEDIATE DELIVERY

**ATOMIC HEATER
& RADIO CORPORATION**

Dept. A

104 PARK ROW, NEW YORK 7, N. Y.

BARS Radio & Electronic Parts Company

DISTRIBUTORS
FOR

American Amphenol
Phenolic
Bud Radio Products
Burgess Batteries
Clarostat Controls
Cornell Dubilier Condensers
Halldorson Transformers
Hytron Tubes
Insuline Corp. of Amer.
Jackson Test Equipment
Masco Amplifiers
Radiart Aerials & Vibrators
Sprague Condensers
Trimm Headsets
Universal Microphones
University Speakers
UTC Transformers
Ward Aerials

Write for prices; or order C.O.D.
including 20% deposit with order.

BARS 956 Main St.
Buffalo 2, N. Y.

grids and blocking the system, the 1N34 crystal diode, X_6 , is reverse-connected into the #1 grid line to act as a clipper, in conjunction with the resistor R_{12} . The back resistance of this unit should be as high as possible, as any low impedance at this point will load down the grid circuit and decrease the amplitude of the control voltage.

When the circuit is used as a volume compressor, the polarity of the control voltage is reversed by S_1 , so that the #1 grids swing in the negative direction. The resting bias on the #1 grids is, in this case, fixed at the same value as that of the signal grids, and is constant at all settings of the expansion-compression control. There has been no tendency for the tubes to cut off with the expansion-compression control at maximum, even with signals as large as two volts applied to the input of the phase inverter.

Time Constants

There has been considerable controversy as to the correct time constant values in a.g.c. circuits, possibly due to the fact that no two types of program material react in the same manner in such systems. It is generally conceded that the rise time of the control voltage should be considerably shorter for speech and fast dance music, than for slow symphonic material. In any case however, the decay time should be very much longer than the rise time, and a time constant of from 0.3 to 0.5 seconds has been more or less accepted as a standard. In general, the time constants for both expansion and compression should be about the same, so that the same time constant filters can be employed for both types of operation. In this unit, a minimum rise time of three milliseconds, and a maximum decay time of 0.5 seconds were found to be about the optimum range required for most types of program material, and the filter circuits were designed around these figures. As a large degree of flexibility in a.g.c. time constant is desirable, it was felt that a panel control for this purpose is a worthwhile refinement, and the potentiometer R_{10} provides the required range of adjustment. The network R_{10} and C_{11} controls primarily the a.g.c. decay time, although there is some interaction with the charging circuit, and the rise time is also affected when the value of R_{10} is made very small. It is possible, by the addition of rather complex circuits, to make the rise time constant and decay time constant of the control voltage entirely independent of each other, but for any ordinary application, such circuits are not usually necessary.

The Complete Amplifier

Having discussed the automatic gain control circuits, let us now consider the complete amplifier, the diagram of which appears in Fig. 3. Four input channels are provided, three of

Utica Tools

U T I C A

Pliers for
Every Need

ASK YOUR DEALER

UTICA DROP FORGE & TOOL
CORPORATION
UTICA 4, NEW YORK

IMMEDIATE DELIVERY

SPECIAL VALUES

PHONO AMPLIFIER—3 Tube AC-DC. Complete with Tubes & 5" Speaker. \$5.55
PASS COND. KIT—20 Ass'td.99
RESISTOR KIT—50 Ass'td. 1/2 to 1 Watt.99
DIAL CORD KIT—100 Ft. Ass'td & 6 Springs.1.19
LOOP ANTENNA (High Gain).99
ANT. & OSCIL. or ANT. & RF. COIL SETS.99
OUTPUT TRANS.—2000-3 or 7000-3 Ohms.99
CRYSTAL PICKUPS—1/2 Oz. 2.79
Write Today for Bargain Bulletin

RADIO DISTRIBUTING CO., Pasadena 18, Cal.

PEN-OSCIL-LITE

Extremely convenient test oscillator for all radio servicing alignment. Small as a pen & self powered. Range from 700 cycles audio to over 500 megacycles u.h.f. Output from zero to 125 v. Used by Signal Corps & Write for information.

GENERAL TEST EQUIPMENT CO.

38 Argyle

Buffalo 9, N. Y.

RADIO & ELECTRONIC PARTS TUBES & EQUIPMENT

STANDARD ELECTRONICS CO.

1497 Main St. Buffalo 8, N. Y.

Write for New Catalogue

FILMGRAPH PAT'D Conference Recorders

UNINTERRUPTED
Longtime (up to 12 hours) Conference
& Telephone Recordings on Safety Film
Models for Dictation "TALKIES"

ECONOMICAL
PERMANENT
INSTANTANEOUS
PLAY-BACK

MILES REPRODUCER CO., INC. 812 BROADWAY, N.Y.3 R-6

ELECTRONICS

Electronic Technician Training Course. Quality for Radio Communication (Commercial Government License); Radio Repair Service; or be an Industrial Electronic Technician. Register now for new classes starting every four weeks. Approved under G. I. Bill of Rights. Residence day and evening school. Write to

ELECTRONICS INSTITUTE, INC.
21 HENRY; DETROIT, MICH.

300 ohm Amphenol twin lead, per 100 ft. \$2.90
75 ohm Amphenol twin lead, per 100 ft. 2.00
Navy Power Trans.—300 v. CT @ 300 ma. 2—6.3 v. 1—5 volt. 5.95
Advance Ceramic insulated antenna relay—1 KW 5.40
12" vertical army antenna with base—3 section 1.95
Pioneer Dynamotors Input 12/14 volt output 225 volt @ 90 ma. 6.95
Clare DPST relays 6 volt coil. 1.25

DOW RADIO

1759 E. Colorado Pasadena 4, Calif.

ROTA-BASE

NEW HANDY LAB. DIAL. Simply turn the movable dial to the tube number desired on the ROTA-BASE and, complete, correct connections are instantly indicated on the "prong" diagram. Filament, grid, plate, cathode, etc. to more than 300 tube types are given. No more valuable time lost on lengthy reading or thumbing of pages. ROTA-BASE actually gives a "prong" picture of the connections. PRICE NOW ONLY \$1.00. Postage prepaid or sent C.O.D. plus postage. Money back if not delightfully pleased. (Dept. A.)

R&E MFG. CO., 124 W. 4th St., Los Angeles 13, Calif.

which can be used simultaneously. In Fig. 3, tubes V_1 , V_2 , and the two halves of the double triode V_3 are arranged as an electronic mixer having two high-gain channels for microphone and two low-gain channels for tuner or pickup. The high-gain channels are conventional pentode stages with a voltage of approximately 125. The low-gain channels are cathode-follower isolating stages arranged in such a way that the channel gain control is separated from the input circuit. The purpose of these stages is to allow adjustment of the gain from one or two crystal pickups, without having the gain control act as the load resistance for the crystal element. Direct connection of a crystal pickup to a gain control potentiometer has a serious effect upon the frequency response of the pickup when the control is set to an intermediate position. The outputs from the cathode followers are connected to a 1 megohm fader which allows either channel to be faded in at will. It was not considered necessary to provide for electronic mixing of the two low-gain channels, as simultaneous operation of these was not desired.

The arms of the three channel gain controls are joined through isolating resistors to the paralleled grids of the phase inverter V_{1A} and the a.g.c. amplifier V_{1B} . The purpose of the isolating resistors is to prevent one control from short-circuiting the others when that control is turned to the "off" position.

Tubes V_{1A} , V_{1B} , V_5 and V_6 constitute the a.g.c. circuit, whose operation was described in a previous section. The 6E5 eye tube serves as an a.g.c. indicator and provides a rough check on the operation of the expansion-compression circuits. The grid of this tube is so connected that the shadow angle increases with expansion and decreases when the circuits are arranged for compression.

The master gain control is in the grid circuit of the push-pull 7N7 resistance coupled amplifier V_{2A} and V_{2B} , immediately following the expander-compressor stage. This control is a 500,000 potentiometer, and for best results the two sections should be reasonably well matched. Decoupling from the plate supply in this stage assists in eliminating low frequency feedback and instability.

The output amplifier is also a 7N7 with the two sections in push-pull. The output of this stage works into a push-pull plate-to-line transformer to provide the low impedance line connection. Plate supply decoupling is also provided in this stage. The volume level indicator is a rectifier type voltmeter with suitable multipliers to read from 0 to +16 db. A high impedance output directly from the plates of the output stage permits audio monitoring, and the d.c. component is blocked out, allowing the use of crystal phones.

-30-

Where stability takes top priority...

SNYDER

Antennas

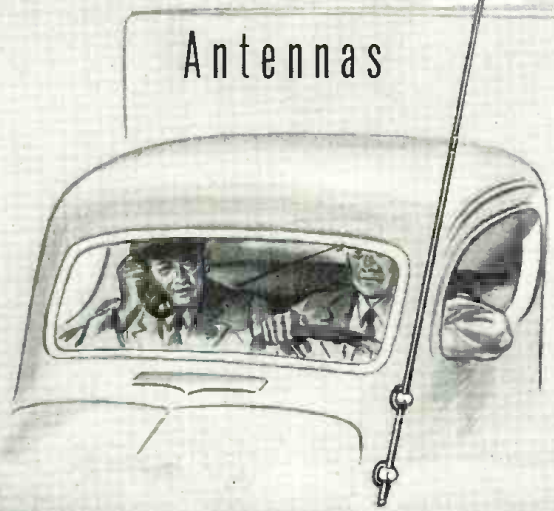

SNYDER MFG. CO.
PHILADELPHIA
MANUFACTURERS... START TO FINISH

R. C. & L. F. HALL, INC.
1015-17 Caroline St.
Telephone C-9731
Houston 2, Texas

Our stock is at a new all time high although some items are still relatively scarce. We are delivering many communications receivers to those who have placed a \$5 deposit with us. Your attention is called particularly to the Hallcrafters S-38; the Robson-Burgess V-O-M - at \$18.75 and the splendid value in the crystal control, 8 channel, Aircraft transmitter T-67/ARC-3, 100-156 mc. and our splendid stock of amateur and replacement components.



R. C. (Dick) Hall
W5E1B



L. F. (Lillian) Hall
W5EUG

"THE HAM SHACK"
Panadaptor "CA-2 complete, \$99.75
NATIONAL

NC-2-40C less speaker.....	\$225.00
Speaker.....	25.00
1-10 less tubes, speaker & power supply.....	56.10
5886 power supply for 1-10.....	19.50
Tubes for 1-10 (6X4, 955, 6C5, 6F6).....	8.57

HRO-5TA; HRO-5RA

HAMMARLUND

HQ-129X less speaker.....	\$129.00
Speaker.....	10.50

Super-pro

SPC-410-X (540 KC to 30 MC) cabinet model	
SPC-410-SX (1250KC to 40MC) cabinet model	
SPR-410-X (540 KC to 30 MC) rack model	
SPR-410-SX (1250KC to 40MC) rack model	
PS-CW-10 10 inch PM speaker.....	

(O.P.A. prices not determined at this time)

HALLCRAFTERS

S-38.....	\$ 39.50
S-40.....	approx. 79.50
S-41 Snyder Jr.....	33.50
S-22B Marine.....	74.50
SX-25 Super Defiant.....	94.50
SX-28A Super Skywider.....	223.00
S-37 (130-210MC) FMAM.....	591.75
S-36A (28-143MC) FMAM.....	307.50
Speaker for SX-25, SX-28, S-36, S-37.....	15.00
HT-9 transmitter (less coils, crystals, mike).....	250.00

RME

RME-45 with crystal, meter & speaker.....	\$186.00
DR-20 preselector.....	59.30

VHF-152 (2, 5, and 10 meter converter)
Wire, write or phone your order. We will ship C.O.D. with a \$5.00 deposit. We also offer easy terms and trade-in allowances for used equipment.
State Tax not included in above figures.

"ACROSS THE SERVICE BENCH"
A postal card will place you on our mailing list to receive our amateur bulletin.

A FEW OF THE MANUFACTURERS WHOSE PRODUCTS WE DISTRIBUTE

Aerovox	Djarostat	GE	Kaer	Melssner	Pioneer	Setchell-Carlson	Trim
Amphenol	Drake	Hallcrafters	Kalner	Millen	Precision	Silver	Triplott
Astac	Dumont	Hammarlund	Kelner	Mueller	Premaix	Simpson	Turner
B&W	Echophone	Hytron	Kwikheat	National	Radel	Speed-X	Vaco
Belden	Eimac	Instructograph	Leach	Newcomb	Raytheon	Stancor	Vibroplex
Bill	Electronics Lab.	Insuline	Lectrohm	Ohmite	RCA	Supreme	Walsco
Boji	Erie	Jensen	Les Logan	Panoramic	Robson-Burgess	Taylor	Ward
Centralab	Gammatron	JFD	Littelfuse	Peerless	RME	Thermador	Welter
Cinaudagraph	General Cement	Johnson	John Meck	Petersen	Sangamo	Thordarson	Weston

"ACROSS THE SERVICE BENCH"
is the name of our dealer bulletin, which goes regularly to our service dealer customers. This bulletin keeps you in touch with the latest information on available equipment and supplies. A postal will place your name on this list and will also secure a "new customer tube allocation" if you request it.

SPECIAL ATTENTION
is being given to ex-servicemen entering business who need complete stocks. Such inquiries should be marked "for personal attention R. C. Hall."

SPECIALS
SUPREME PANEL METERS, ALL RANGES
Aircraft transmitter T-67/ARC-3 8 channel crystal control, 1 e s s crystals, 100-156 MC.....\$47.50

TEST EQUIPMENT IN STOCK
Silver "Vomax".....\$59.85
Monitor "Crystalizer" Signal Generator.....\$7.50
Robson-Burgess V-O-M MT-100.....\$8.75
Ask for other brands and models, since we carry practically all of them and are getting shipments from time to time.

MARINE EQUIPMENT
We are able to give good delivery on marine radio-telephones. Phone, write or wire for information.

POLICE, GEOPHYSICAL & MOBILE
radiotelephone equipment is available on good delivery. We welcome inquiries for your particular application.

INDUSTRIAL ACCOUNTS
are welcomed. Wire, write or phone. We have one of the largest electronic stocks in the country.

WANTED!

Articles by Radio Amateurs

2000 to 2500 words

Covering any material of genuine interest to radio amateurs, such as:

- Transmitters
- Receivers
- Antennas
- Test Equipment

Articles should be typewritten (double spaced) and accompanied by suitable diagrams, photos, and parts lists. Liberal payment will be made upon acceptance.

Address all communications to
Box 419

RADIO NEWS

185 North Wabash Avenue
Chicago 1, Illinois

RADOLEK

Radio-Electronic Service Parts

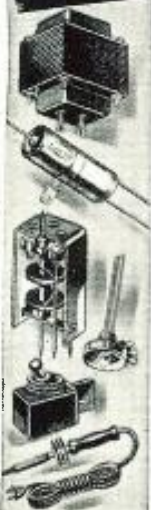

Large stocks assure the finest and most complete selections of all available items at lowest prevailing prices. Thousands of active buyers depend on us for their entire Radio repair and replacement requirements. Because we understand service problems, every order is expedited for delivery in double quick time. Everything we do is planned for convenience and satisfaction to our customers. You will find it profitable to make Radolek your buying headquarters.

FREE BUYING GUIDES

Because of existing conditions we keep our customers right up to the minute on available merchandise by releasing supplements frequently instead of sending our regular Big Profit Guide once a year. Send the coupon now to get these Free Buying Guide Supplements as they are issued.



FAST SERVICE!

RADOLEK CO., Dept. B-115
601 W. Randolph St., Chicago 6, Ill.

Please send FREE Buying Guide Supplements

NAME _____

ADDRESS _____

ORDER FROM RADOLEK

Heavy Duty Power Supplies (Continued from page 48)

current is caused to flow from the source, through the latter contacts, through inductance S_3F_1 , through transformer primary P_{3-3} , P_{3-2} , through inductance 4-3, thence back to the supply source.

At this point, it may be seen that the inductance of S_1F_1 is less effective in retarding the current flow in this branch of the circuit on account of the opposing action of the changing magnetic field still about S_3F_1 .

Moreover, as the field continues to build up on S_3F_1 , the effective inductance of S_3F_1 becomes less and less as a result, until eventually the inductance of both S_1F_1 and S_3F_1 entirely cancel each other. During this interval, the current through the associated circuits, including the contacts, has become completely equalized.

It will be noted that the vibrator of the Model 146 unit has eight moving and eight stationary contacts. Therefore, besides equalizing the current between each contact of a pair, it also becomes necessary to equalize that between contact pairs on the same side of the armature.

Reference to the schematic (Fig. 4) will show that this is accomplished between the lower two contact pairs by inductances 3-4 and 1-2. Advantage is taken here of the fact that both upper and lower contacts are not energized at the same time and the same inductance is used for equalizing both between the two upper contact pairs, and between the two lower pairs.

In reference to the individual contacts of each pair and the two pairs of contacts shown on the top side of the vibrator, an examination of the print will disclose that equalization is taken care of in exactly the same way as that of the lower contacts.

The fact that both sides of the vibrator are not operating at the same time allows the use of a common core for reactances S_3F_1 , S_1F_1 , and F_2S_2 , F_1S_1 .

The power transformer is a multiple winding autotransformer with primary input terminals P_{1-1} , P_{2-1} , P_{3-1} , P_{4-1} , P_{1-3} , P_{2-3} , P_{3-3} , P_{4-3} , and with centertaps P_{1-2} , P_{2-2} , P_{3-2} and P_{4-2} . One

Photo Credits

Pages	Credit
31RCA
32, 34Sylvania Electric Products, Inc.
35, 46, 47, 48, 129Electronic Laboratories, Inc.
36Maguire Industries
37, 108Frederick Hart & Co., Inc.
45"The APCO Bulletin"
49Radiodiffusion Nationale Belge
50CBS
53Pacific Sound Equipment Co.
86Walter Steinhard, Staff Photographer
134Northern Rhodesia Broadcasting Co.

Classified

Rate 20c per word, Minimum, 10 words

RADIO ENGINEERING

RADIO Engineering, Broadcasting, Aviation and Police Radio, Servicing, Marine Operating and Electronics taught thoroughly. Expenses low. Write for catalog. Valparaiso Technical Institute, Dept. N. Valparaiso, Ind.

FOR SALE

BEAM Antennae—Direction Indicator. Remote Indicating, Selsyn type. Morse Engineering Co., Fullerton Bldg., St. Louis 1, Mo.

RADIO tubes, parts, wholesale. Bulletin, 3c. Henshaw, 3313 Delavan, Kansas City, Kansas.

BEAUTIFUL ebony plastic phono cabinets, as advertised in April issue (Pg. 122) of Radio News. 18 1/2 x 11 1/2 x 3 1/2, \$3.89, F.O.B. Springfield, Mass. Victoria Radio & Sound Co., 1039 Memorial Ave., West Springfield, Mass.

SEND 20c for telephone plug brass, short type, worth 49c. Electric tester with neon light, check circuits, electrical devices, 110-550 volts, prepaid 39c. Big Ham-Experimenter list free. John Barron, 662-85th St., Brooklyn 9, N. Y.

NEW Hallicrafters SX-25 and matching speaker. Perfect condition. Bought recently. A. Ogawa, Adams B-47, Cambridge 38, Mass.

A LARGE number of new Hallicrafters SX-28, \$179.50, used SX-28's less. No trade-ins accepted. All sets guaranteed. Send for list. Orman Wanamaker, 608 Buchanan, Topeka, Kansas.

REACTORS, 280, UTC ounce series, type 0-13, uncased, brand new, sell at small fraction of cost. A Trunk, 1748 First Ave., New York 28, New York.

LAFAYETTE Recorder, \$25.00 or swap for communications receiver. E. L. Self, Box 1426, Clemson, South Carolina.

USED radio parts and equipment. List 3c. Milo Burston, 808 River, Alpena, Michigan.

RCA DYNAMIC Demonstrator III. Never used. Perfect condition. Will sell at less than cost. Box 430, % Radio News.

GOV'T Surplus Amplifier, in 4"x4"x8" black wrinkle finished case, brand new with tubes, input to 7F7, Output 2-7C5's full wave rectifier 7Y4, with transformer, all mica condenser coupling. Shipped in Original carton, Parcel Post, prepaid, \$4.95. Lyell Hardware & Lumber Co., Inc., 1451 Lyell Avenue, Rochester, New York.

PAN OSCILLO Receivers—latest design 3" oscilloscope, panoramic adapter, synchroscope, receiver (when used with converters). Ideal for laboratory, television, general service work (such as I.F. alignment). 60 cycle transformer supplied (installed and tested \$8.00 additional). Originally \$17.50. Your cost with 21 tubes \$97.50. Write for descriptive folder or send 50c for eighty-page technical manual. 5G synchronous motors 110 a.c. 60 cycle; perfect for antenna or wind direction indicator, \$12 per pair. Selys converted BC 406-15 tube, 205 mc receivers. Easily converted UHF and ten meter bands, FM or Television. See February "CG" for conversion instructions. Complete with 15 tubes plus two spare 954 tubes and instructions—\$30.00. Write for surplus list. Westchester Electronic Products, 28 Milburn St., Bronxville, N. Y.

NEW Voltage Tester—3 Neons, automatically indicates 110-220-440 volts A.C. or D.C. No guessing. Free circular. Agents wanted. Dellab, 224 St. Marks Ave., Brooklyn, N. Y.

FIVE Army surplus frequency meters. BC221, 125 to 20,000 Kilocycles. Less tubes, \$20.00 each. One less case, \$10.00. \$90 for lot as is. Box 1472, Jacksonville, Texas.

RECTIFIERS—Halfwave. 5 Amperes, \$4.50. 2.2 Amperes, \$2.25; 1.5 Amperes, \$1.85. Fullwave, 1 Ampere, \$2.50; .5 Ampere, \$1.85. Maximum 18 volts input. List free. Milton Bursma, Route 5, Grand Rapids, Mich.

LOWEST Prices. Radio Tubes, parts. Bargain lists 3c. Potter, 1314 McGee, Kansas City 6, Mo.

CORRESPONDENCE COURSES

USED correspondence courses, educational and technical books bought, sold, rented. Free catalog. Educational Exchange, Henagar, Ala.

RADIO NEWS

USED Correspondence Courses and Educational Books sold or rented. Inexpensive. Money-back guarantee. Write for Free Catalog listing 4000 bargains.—(Courses Bought.)—Lee Mountain, Pis-rah, Ala.

CORRESPONDENCE Courses and self-instruction books, slightly used. Sold. Rented. Exchanged. All subjects. Satisfaction guaranteed. Cash paid for used courses. Complete information and 100 page illustrated bargain catalog FREE! Write Nelson Company, Dept. 2-59, Chicago 5.

AMATEUR radio licenses. Complete code and theory preparation for passing amateur radio examinations. Home study and resident courses American Radio Institute, 101 West 63rd Street New York City.

SITUATIONS WANTED

EX-CHIEF radio technician, graduate of Navy school. Hold first class radio telephone license and amateur. 16 years' experience. Desires job with future. Age 37; presentable. H. D. Renfro, Route 8, Box 392, Fort Worth, Texas.

HELP WANTED

ONE expert radio repairman. Must be absolute tops on Auto Radios, Home Radios, Sound Systems and Inter-Com. At least five years' active experience necessary. Salary open. Munroe's Radio Service, 215 Commerce St., Kingsport, Tennessee.

RADIO Instructors. Receiver servicing experience. College Degree preferred. \$3600 a year to start. \$4200 after four months. Work in the heart of the Radio Industry. Write Raleigh G. Dougherty, 158 Market Street, Newark 2, New Jersey, % New York Technical Institute of New Jersey.

PATENT ATTORNEYS

INVENTORS—Before disclosing your invention to anyone, send for Form "Evidence of Conception"; "Schedule of Government and Attorneys' Fees"; and instructions. Sent free. Lancaster, Allwine & Rommel, 414 Bowen Building, Washington 5, D. C.

PATENTS SECURED. Two valuable booklets sent free. Write immediately. Victor J. Evans & Co., 148-G Merlín Bldg., Washington 6, D. C.

RADIO EQUIPMENT

CODE set! Sends real wireless signals! Shipped complete with telegraph key-high frequency buzzer and instructions. Now only \$1.00. For two-way communication or practice order two sets. Satisfaction Guaranteed! Immediate shipment! Please include 20c postage. Rathert Electric Co., Dept. N1, Cresco, Iowa.

WANTED

USED testers, books, manuals. Ketelaar, 208 West North, Kalamazoo, Michigan.

INSTRUCTORS in Electronics and Radio. Prefer former Navy Radio Technician instructors willing to locate in the Detroit, Mich., area. Write to Box 431, % Radio News.

MISCELLANEOUS

SAVE time, expense, worry. If you have a personal or business matter to attend to in Chicago, we can do it for you. Write Denserve, 30 W. Washington, Chicago, Ill.

ELECTRICAL engineer with business experience wants a good radio to distribute in Puerto Rico. Sufficient capital available. Write. R. Schae-ning, Box 184, Quebradillas, Puerto Rico.

AGENCIES wanted for Canada; radio; electrical parts and equipment. Aggressive and reliable representation. Inquiries, Box 432, % Radio News.

AVAILABLE NOW

JUNE, 1946

Television

8 pages of television information **25c**

Ziff-Davis Publishing Co., Dept. C
185 North Wabash Ave., Chicago 1, Ill.

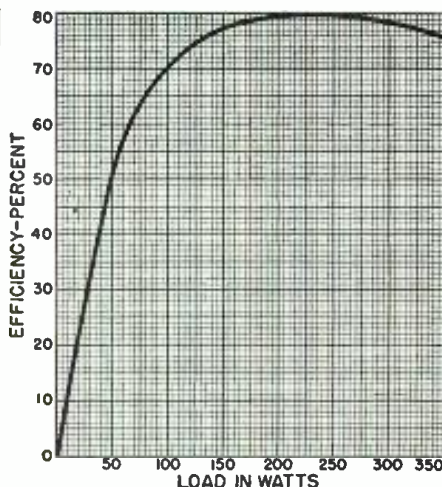

Fig. 5. Efficiency vs. load in watts of Model 146 vibrator type power supply.

end of the secondary winding is represented by S_{2-1} , S_{1-1} , S_{6-1} , S_{7-1} and the other by S_{1-2} , S_{2-2} , S_{5-2} and S_{7-2} .

Reference to reactor 5—7, with centertap 6, will disclose that each end is connected to one terminal of a secondary winding section. This reactor, again, is an equalizing arrangement allowing equal drain of output current from the two lower secondary sections of the power transformer. Similar to that previously described, this equalization takes place in the following manner.

Assume that at the beginning of a cycle, current begins to pass through this reactor from terminal 5 to terminal 6. The full inductive reactance of this half of the reactor will immediately come into play, hence the current flow to the load will be greatly reduced. In sequence (after another contact has been successfully made), the other half of the transformer section becomes energized, causing current to pass through from terminals 7 to 6. With this flow of current through 7—6, the reactance of 5—6 is cancelled, allowing, in effect, the load to be connected equally to S_{2-2} and S_{5-2} as though either reactance 7—6 or 5—6 were not present.

Reactor 8—10 with centertap 9 performs a like function for the opposite two sections of the secondary winding.

It will be noted, as previously mentioned, that since the contact currents are automatically equalized, it is no longer required that all contacts close simultaneously or in any particular recurrent sequence.

All of the 4 μ fd. capacitors, (Fig. 4), are for the purpose of buffering. The value of each is so chosen that the swing of the current cycle across the primary winding is timed to be of correct voltage and polarity, for the subsequent closing of the contact on alternate sides of the vibrator.

The time delay relay automatically allows the vibrator to assume normal operation before the external load is applied. This relay also removes the load each time the control switch is returned to the "off" position.

—30—

...here's a TIP for You!

In fact there are four interchangeable tips adapted to the Ungar Soldering pencil... each designed to do speedy precision work on hard-to-reach jobs!

No. 537 Pencil Tip, made from Elkaloy A, Tip $\frac{1}{8}$ " dia.

Ruggedly built, the Ungar Soldering tool weighs only 3.6 ozs., is perfectly balanced and handles like a fountain pen. Heats in 90 seconds. Draws only 17 watts. Unit complete with any one tip sells at less than \$2. Please order from your Electronics distributor.

No. 538 Chisel Tip, made from Elkaloy A, Tip $\frac{1}{8}$ " dia.

No. 536 Standard Tip, made from Hard Drawn Copper

No. 539 Extra Hot, made from Tellurium

Ungar
Electric Tools, Inc.
Formerly Harry A. Unger, Inc.
LOS ANGELES 54, CALIF.

That hour-after-hour steady grind calls for

PERFORMANCE INSURANCE

as provided by

AEROVOX *Rating-plus* CAPACITORS

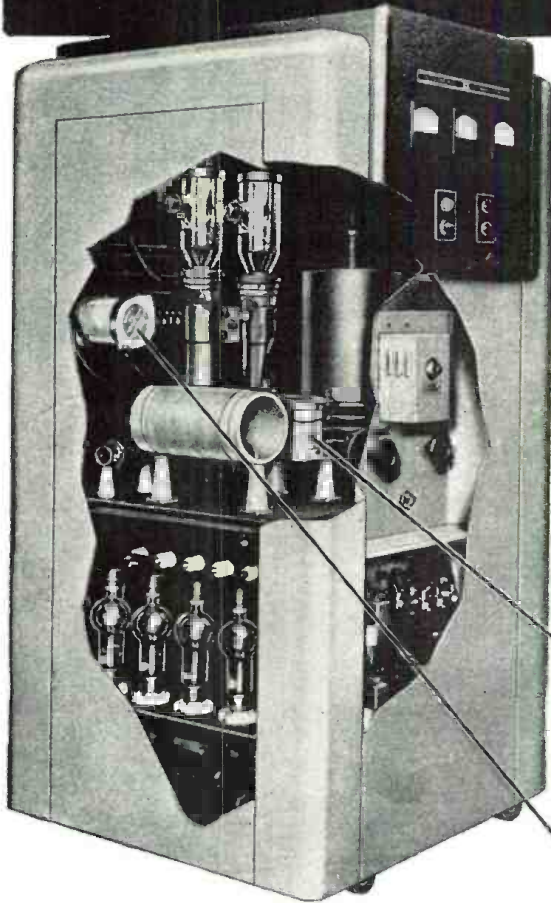

• This induction heating unit bears the name of a world-famous manufacturer. A great reputation is at stake. Such equipment must stand up—hour after hour, day in and day out, for months and years to come.

None but outstandingly dependable components can be risked in such equipment. And the selection of Aerovox Series 1940 stack-mounting capacitors is based on two good reasons:

First, Aerovox are *rating-plus* capacitors. A comparative study of specifications is invited. Second, Aerovox provides *Continuous Service Rating Data* for all its current-handling capacitors. The equipment designer knows precisely what such capacitors can and cannot do. These two points alone can write a performance insurance policy.

Continuous Service Rating Data
TYPES 1940-1950-1960-1970-1980
 Maximum Current in Amperes at an Ambient Temperature of 60° C.
 Barometric Pressure 28 to 32 inches Mercury and Relative Humidity 10 to 80%. Maximum Ambient Temperature 70° C.

TYPE 1940						
Cap. Mfd.	Test Volts ER.	Catalog Number	7000 kc.	1000 kc.	300 kc.	100 kc.
.000075	35,000	1940-236	7.5			
.0001	35,000	1940-203	10.	4.5		
.00015	35,000	1940-204	13.	6.	1.8	.6
.0002	35,000	1940-205	16.	8.	2.2	.8
.00025	35,000	1940-206	17.	12.	3.	1.2
.0003	35,000			13.	4.	1.5
.00035	35,000				5.	2.0
.0004	35,000				5.	2.4
.0005	35,000				6.	2.8
.0006	35,000				7.	3.3
.0007	35,000				8.	4.
.0008	35,000				10.	4.5
.001	35,000				12.	5.
.00125	35,000				12.	6.
.0015	35,000				14.	8.
.002	30,000				15.	8.
.0025	25,000				18.	10.
	25,000				21.	11.5
	20,000				22.	12.
					25.	13.
					30.	

• Interested in performance insurance protection for your assemblies? Then insist on *rating-plus* specifications and continuous service rating data—or simply specify AEROVOX. Literature on request.



FOR RADIO-ELECTRONIC AND INDUSTRIAL APPLICATIONS

AEROVOX CORPORATION, NEW BEDFORD, MASS., U.S.A.

SALES OFFICES IN ALL PRINCIPAL CITIES • Export: 13 E. 40th ST., NEW YORK 16, N. Y.

Cable: 'ARLAB' • In Canada: AEROVOX CANADA LTD., HAMILTON, ONT.



Model A-81 Cabinet

Model A-121 Cabinet

Model A-151 Cabinet

THE FAMOUS

** Bass Reflex*

REPRODUCERS IN NEW, BETTER-THAN-EVER DESIGNS

True high-fidelity reproducers with the famous and exclusive *Jensen Bass Reflex* principle of design are now available in improved postwar cabinets. *Jensen Bass Reflex* reproducers give crisp, extended range reproduction... no back-side radiation... full bass with no boom.

Bass Reflex Reproducers are widely used in broadcast monitoring and in recording work. They are ideal for ham shack use and are in much demand for phonographs, FM reception, and general sound reinforcement applications.

Jensen Bass Reflex Reproducers are available in sizes for 8-inch, 12-inch and 15-inch loud speakers and are designed for floor or wall installation. The 15-inch cabinet is designed for both Type J and Type H *Jensen Coaxial Speakers* and for single-radiator 15-inch speakers.

Write for complete literature.

* Trade Mark Registered

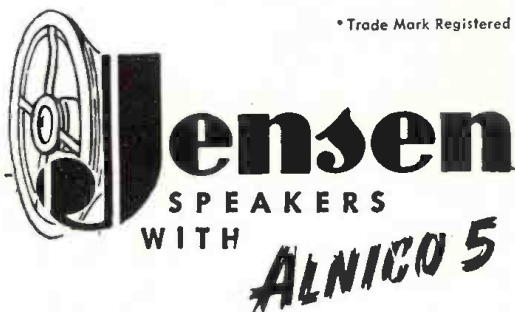

The *Jensen* exhibit will be in Booth 68 at the 1946 Radio Parts Show in Chicago's Stevens Hotel, May 13th through 15th. Old and new friends alike are cordially invited to see the 1946 line of *Jensen* fine acoustic equipment.

JENSEN RADIO MANUFACTURING COMPANY
6617 SOUTH LARAMIE AVENUE • CHICAGO 38, ILLINOIS
In Canada: Copper Wire Products, Ltd., 137 Oxford Street, Guelph, Ontario

Specialists in Design and Manufacture of Fine Acoustic Equipment

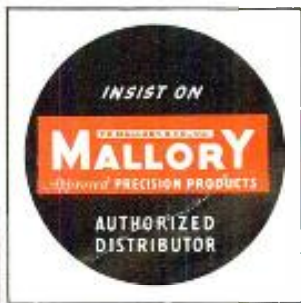

Where you see
THIS SIGN

You can count on
SERVICE

YOUR distributor wouldn't have the Mallory franchise if he were *merely* a distributor of Mallory parts. He was selected because he has a thorough knowledge of the business . . . because he has the *ability* to be of real help . . . because there is no question about his *willingness* to give it.

That's why your Mallory distributor is a good man to know and do business with. Call on him for *any* help within his province—from problems of procurement to problems of management—and you'll find him glad to respond. He's the right man, in the right place, with the right kind of service to save you time and money.

Here's What Your MALLORY Distributor Will Do For You:

1

A complete line of Mallory replacement parts . . . many of them first developed by Mallory research . . . ALL of them guaranteed against premature failure by years of service in the field.

2

A program of standardization that meets the maximum number of application needs with the minimum number of parts . . . reduces investment, simplifies replacement, speeds up delivery.

3

Efficient service . . . backed by detailed information on prices, parts, catalog numbers . . . promptly applied whether orders are large or small . . . especially effective in meeting emergencies.

4

Technical service helps . . . bulletins, booklets, catalogs, letters with complete data on what to use and where to use it . . . special publications on radio fundamentals and new developments.

5

A background of personal experience . . . acquired through years of service in radio . . . helpful in solving difficult or unusual problems . . . effective in training dealer personnel.

6

Commercial "know how" . . . implemented by sound methods of keeping your business "on the beam" . . . with special attention to promotion devices that help sell your story to the public.

P. R. MALLORY & CO. Inc.
MALLORY

VIBRATORS . . . VIBRAPACKS* . . . CAPACITORS . . . VOLUME CONTROLS . . . SWITCHES . . . RESISTORS . . . FILTERS . . . RECTIFIERS . . . POWER SUPPLIES. ALSO MALLORY TROPICAL* DRY BATTERIES, ORIGINALLY DEVELOPED BY MALLORY FOR THE U. S. ARMY.

*Reg. U. S. Pat. Off.

APPROVED PRECISION PRODUCTS

P. R. MALLORY & CO., Inc., INDIANAPOLIS 6, INDIANA



Accurate **LONG RANGE** Navigation... anytime... in all weather

With Sperry Loran the navigator has at hand a quick and accurate means of determining a ship's position at any time, in all kinds of weather. This system involves the reception of accurately timed radio pulses from shore-based transmitting stations, usually 200 to 400 miles apart.

The *difference in time of arrival* of signals from a pair of transmitting stations is measured and the time difference is then used to determine, from special charts or tables, a line-of-position on the earth's surface. When two lines-of-position from two different pairs of Loran stations are

crossed, you have a "*Loran fix.*" Fixes are obtainable at distances from shore stations up to 1400 miles at night, 700 miles in daytime.

In your consideration of Loran, note particularly that Sperry's equipment is easy to operate. A Time Difference Meter (see illustration above) greatly simplifies the operator's

work and prevents errors in readings.

Sperry Loran is backed by a world-wide service organization and meets the usual high standards of test and performance of all Sperry products. *Loran equipments in limited quantity are ready for immediate delivery.*

**The Time Difference Meter, giving position references directly, is a Sperry exclusive.*



Sperry Gyroscope Company, Inc.

EXECUTIVE OFFICES: GREAT NECK, NEW YORK • DIVISION OF THE SPERRY CORPORATION
 LOS ANGELES • SAN FRANCISCO • NEW ORLEANS • HONOLULU • CLEVELAND • SEATTLE
 GYROSCOPICS • ELECTRONICS • RADAR • AUTOMATIC COMPUTATION • SERVO-MECHANISMS