

# RADIO NEWS

Sealing glass to copper anode of water-cooled transmitting tube.

OCTOBER  
1944

25c

In Canada 30c



# A + B = X

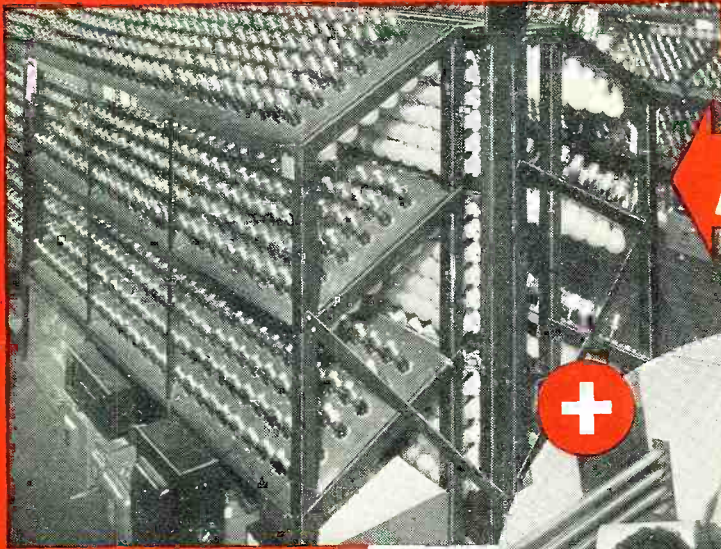

**A**

### RECEIVING TUBE TECHNIQUE

Oldest manufacturer specializing on radio receiving tubes — the originator of the now standard BANTAM GT — Hytron has been developing skill in high-speed, soft-glass receiving tube technique since 1921.

**+**

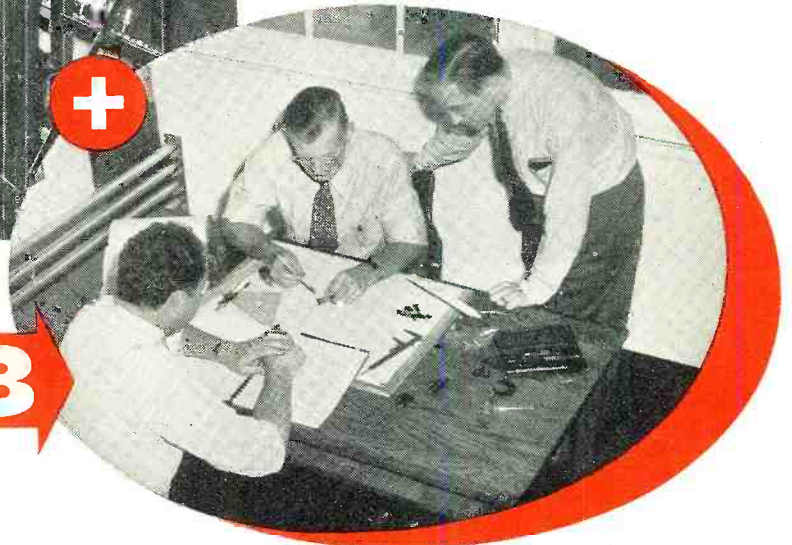

**B**

### SPECIAL PURPOSE ENGINEERING

Hytron engineers originated BANTAM JR. hearing-aid tubes — popular U-H-F types HY75, HY114B, HY615 — instant-heating beam tetrodes HY65, HY67, HY69, HY1269 — and numerous other special tubes.

**= X**

### THE ANSWER

Add A to B, and you have the answer Hytron is able to give the Services when they demand special purpose and transmitting tubes in staggering quantities and at economical prices.



**1616** Consider a few examples. Substituting soft for hard glass, a mesh for a ribbon filament, Hytron beat the promise by months on requirements for the high-voltage thermionic type 1616 rectifier — through application of mass production methods. Result: The Navy's, "Well done!"



**HY65** Typical of Hytron's instant-heating beam tetrodes for mobile communications, the HY65 combines high-speed techniques with a thoriated tungsten filament and special r.f. design features which gave the Services a rugged, power-conserving, all-purpose beam tetrode. (Cf. JAN-1A spec.)



**OD3/VR-150** Hytron engineering refinements include new starting electrode, lower starting voltage, painstaking processing. Add to these still-increasing high-speed manufacture. Result: "When we think of the OD3/VR-150, we think of Hytron."\*

\*Quotation from expeditor for one of largest electronic equipment manufacturers.



**2C26** Hytron solved a problem for the Services by designing a tube capable of performance and high ratings never before achieved in soft glass. Produced at receiving tube speed and priced at less than a fourth of the cost of tubes replaced, the little 2C26 delivers 2 KW of useful r.f. power under intermittent operating conditions.

**WHAT ABOUT POST-WAR?** Hytron design, development, and production facilities now serving our fighting men, will be yours to command. The A plus B of Hytron's know-how will supply answers to your special tube problems.

OLDEST EXCLUSIVE MANUFACTURER OF RADIO RECEIVING TUBES

# HYTRON CORPORATION

ELECTRONIC AND RADIO TUBES

SALEM AND NEWBURYPORT, MASS.



**BUY ANOTHER WAR BOND**



J. E. SMITH, President, National Radio Institute Our 30th Year of Training Men for Success in Radio

# I WILL SEND A SAMPLE LESSON FREE to PROVE I can Train You at Home in Spare Time to BE A RADIO TECHNICIAN

## I Trained These Men

### \$200 a Month in Own Business



"For several years I have been in business for myself making around \$200 a month. Business has steadily increased. I have N.R.I. to thank for my start in this field." **ARCHIE J. FROEHLNER**, 360 W. Texas Ave., Goose Creek, Texas.

### \$5 to \$10 Week in Spare Time

"I am engaged in spare time Radio work. I average from \$5 to \$10 a week. I often wished that I had enrolled sooner. All this EXTRA money sure does come in handy." **THEODORE K. DUBREE**, Horsham, Pa.



### Chief Operator Broadcasting Station

"Before I completed your lessons, I obtained my Radio Broadcast Operator's license and immediately joined Station WMPC where I am now Chief Operator." **HOLLIS E. HAYES**, 327 Madison St., Lapeer, Mich.

### Communication Station Operator

"Am with the Civil Aeronautics Administration at the Shreveport Airways Communication station. Have a lifetime position, with pension after retirement." **JESSE N. ROBERTS**, Box 1076, Shreveport, La.



## Big Demand Now For Well Trained Radio Technicians, Operators

I will send you my Lesson, "Getting Acquainted with Receiver Servicing," FREE, to show you how practical it is to train for Radio at home in spare time. It's a valuable Lesson. Study it—keep it—use it—without obligation! And with this Lesson I'll send my 64-page, illustrated book, "Win Rich Rewards in Radio" FREE. It describes many fascinating jobs Radio offers, tells how N.R.I. gives you practical Radio experience at home with SIX BIG KITS OF RADIO PARTS I supply!

## Many Opportunities Open for Trained Radio Technicians and Operators

There's a shortage today of capable Technicians and Operators. The Radio Repair business is booming. Profits are large. After-the-war prospects are bright too. Think of the new boom in Radio Sales and Servicing that's coming when new Radios are again available—when Frequency Modulation and Electronics can be promoted—when Television starts its postwar expansion!

Broadcasting Stations, Aviation Radio, Police Radio, Loudspeaker Systems, Radio Manufacturing all offer good jobs to trained Radio men—and most of these fields have a big backlog of business that built up because of the war, plus opportunities to expand into new fields opened by wartime developments. You may never see a time again when it will be so easy to get a start in Radio!

## Many Beginners Soon Make \$5, \$10 a Week EXTRA in Spare Time

The day you enroll for my Course I start sending you EXTRA MONEY JOB SHEETS that help show how to make EXTRA money fixing Radios in spare time while still learning. I send you SIX big kits of Radio parts as part of my Course. You LEARN Radio fundamentals from my illustrated, easy-to-grasp lessons—PRACTICE what you learn by building real Radio Circuits—PROVE what you learn by interesting tests on the circuits you build!

## Mail Coupon for FREE Lesson and Book

The opportunity war has given beginners to get started in Radio may never be repeated. So take the first step at once. Get my FREE Lesson and 64-page illustrated book. No obligation—no salesman will call. Just mail Coupon in an envelope or pasted on a penny postal.—J. E. SMITH, President, Dept. 4KR, National Radio Institute, Washington 9, D. C.

## You Build These and Many Other Radio Circuits with 6 Kits of Parts I Supply

By the time you've conducted 60 sets of Experiments with Radio Parts I supply, made hundreds of measurements and adjustments, you'll have had PRACTICAL Radio experience valuable for a good full or part-time Radio job!

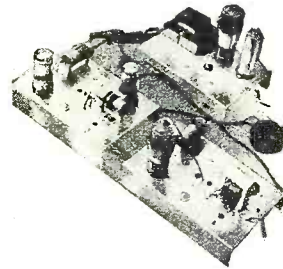

You build the SUPER-HETERODYNE CIRCUIT (left) containing a preselector oscillator-mixer-first detector, i.f. stage, diode detector-a.v.c. stage and audio stage. It will bring in local and distant stations. Get the thrill of learning at home evenings in spare time while you put the set through fascinating tests!

You build MEASURING INSTRUMENT (right) early in Course, useful for Radio work to pick up EXTRA spare time money. It is a vacuum tube multimeter, measures A.C., D.C., R.F. volts, D.C. currents, resistance, receiver output.

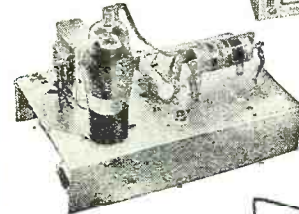
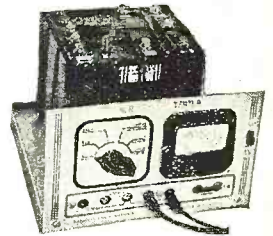

Building the A.M. SIGNAL GENERATOR at left will give you valuable experience. Provides amplitude-modulated signals for test and experimental purposes.

## SAMPLE LESSON FREE

Mail coupon for your FREE copy of Lesson, "Getting Acquainted With Receiver Servicing," to see how practical it is to train for Radio at home in spare time. Study it—keep it—use it—without obligation! Tells how Superheterodyne Circuits work, gives hints on Receiver Servicing, Locating Defects, Repair of Loudspeaker, I. F. Transformer, Gang Tuning Condenser, etc., 31 illustrations.

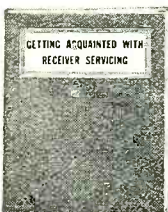

## GOOD FOR BOTH 64 PAGE BOOK SAMPLE LESSON FREE

J. E. SMITH, President, Dept. 4KR National Radio Institute, Washington 9, D. C.

Mail me FREE, without obligation, Sample Lesson and 64-page book, "Win Rich Rewards in Radio." (No salesman will call. Write plainly.)

Name..... Age.....

Address.....

City..... State..... 4KR



My Radio Course Includes TELEVISION • ELECTRONICS FREQUENCY MODULATION

**CONTENTS**

**FEATURES**

Communications Score D-Day Triumph.....*Kenneth R. Porter* 23  
 Radio Intelligence.....*Oliver Read* 25  
 End to End Communications for Trains.....*Ernest A. Dahl* 29  
 Design Tips for Rewinding Your Own Transformers.....  
 .....*James E. Dolan* 32  
 Master Tube Tester.....*Harry G. Burnett* 34  
 The Great Spiderweb.....  
 .....*Pvt. H. D. Colson and S/Sgt. R. C. Fleischman* 37  
 "Limits Bridge" for Production Testing.....*McMurdo Silver* 40  
 Radio Communications in the Field.....*Lt. Col. Steve Gadler* 42  
 Theory of Wave Analyzers.....*Rufus P. Turner* 44  
 Noise Suppression on Small Boats.....*Henry B. Davis* 47  
 Advanced Radio Theory for FCC Operator's Exams.....  
 .....*Carl E. Winter* 50  
 Latest in Telephone Toll Service.....*P. Glanzer* 53  
 Signals in Britain's Army.....*Capt. A. Reid* 56  
 Theory and Application of U.H.F.....*Milton S. Kiver* 58  
 Practical Radio Course.....*Alfred A. Ghirardi* 66  
 Code Practice Oscillator.....*Clayton Cool, Jr.* 95

**DEPARTMENTS**

For the Record..... 8  
 Spot Radio News..... 12  
 QTC .....*Carl Coleman* 52  
 International Short-Wave.....*Kenneth R. Boord* 54  
 Within the Industry..... 107  
 What's New in Radio..... 143

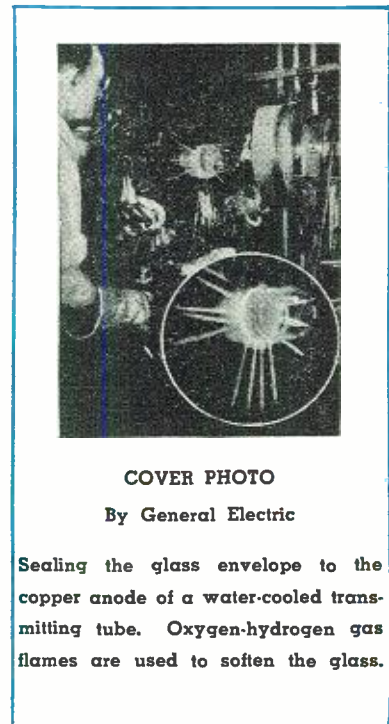

**COVER PHOTO**

By General Electric

Sealing the glass envelope to the copper anode of a water-cooled transmitting tube. Oxygen-hydrogen gas flames are used to soften the glass.

**WILLIAM B. ZIFF**  
*Publisher*

**B. G. DAVIS**  
*Editor*

**C. R. TIGHE**  
*Ass't to Publisher*

**OLIVER READ, W9ETI**  
*Managing Editor*

**WM. A. STOCKLIN**  
*Associate Editor*

**HAROLD S. RENNE**  
*Technical Editor*

**JOE MARTY, JR.**  
*Field Editor*

**FRED HAMLIN**  
*Washington Editor*

**E. H. SEHNERT**  
*Chief Draftsman*

**HERMAN R. BOLLIN**  
*Art Director*

**K. R. PORTER**  
*War Correspondent*

**FRANK ROSS**  
*Staff Photographer*

**GEORGE BERNER**  
*Advertising Director*

**S. L. CAHN**  
*Advertising Mgr.*

**R. B. FRANK, W9JU**  
*(on leave)*

**J. M. ECKERT**  
*Midwest Adv. Mgr.*

**H. G. STRONG**  
*Circulation Director*

**H. J. MORGANROTH**  
*Production Director*

Copyright, 1944  
**ZIFF-DAVIS PUBLISHING COMPANY**  
 Editorial Offices: 540 N. Michigan Ave., Chicago 11, Ill.  
 Member of the Audit Bureau of Circulation

RADIO NEWS is published monthly by the Ziff-Davis Publishing Company at 540 N. Michigan Ave., Chicago 11, Ill. New York Office, Empire State Building, New York 1, N.Y. Washington, D. C., Office, Earle Bldg. Los Angeles Office, William L. Pinney, Manager, 815 S. Hill St., Los Angeles 14, Calif. Subscription Rates: In U. S. \$3.00 (12 issues), single copies, 25 cents; in Mexico, South and Central America, and U. S. Possessions, \$3.00 (12 issues); in Canada \$3.50 (12 issues), single copies 30 cents; in British Empire, \$4.00 (12 issues); all other foreign countries \$6.00 (12 issues). Subscribers should allow at least 2 weeks for change of address. All communications about subscriptions should be addressed to: Director of Circulation, 540 N. Michigan Ave., Chicago 11, Ill. Entered as second class matter March 9, 1938, at the Post Office, Chicago, Illinois, under the Act of March 3, 1879. Entered as second class matter at the Post Office Department, Ottawa, Canada. Contributors should retain a copy of contributions. All submitted material must contain return postage. Contributions will be handled with reasonable care, but this magazine assumes no responsibility for their safety. Accepted material is subject to whatever adaptations, and revisions, including "by-line" changes necessary to meet requirements. Payment covers all authors, contributors or contestants rights, title, and interest in and to the material accepted and will be made at our current rates upon acceptance. All photos and drawings will be considered as part of material purchased.



# COVERED WAGON...



## ... 1944 STYLE

**BLAZING NEW TRAILS TO FREEDOM** . . . The covered wagon 1944 style is the SCR-299 — the famous piece of mobile radio equipment built by Hallicrafters. It is blazing new trails to freedom in all corners of the world, wherever men fight; and by extending Allied lines of communications, it is playing an important part in saving American lives and in shortening the war. Just as the pioneers faced new frontiers with courage and strength, the men and women who make Hallicrafters equipment face the post war period solid in the conviction that they are helping to stake out exciting new territories.

You can win yourself a share of these new lands with short wave communications equipment. Hallicrafters were famous before the war as the makers of the ham's "ideal radio." They earned a reputation for the development of "the radio man's radio" and that reputation was solidified in war time. In peace, out of this intensive experience and realistic know-how they will continue to make the finest that can be made. There will be a Hallicrafters set for you in our post war line.

 **hallicrafters RADIO**

THE HALCRAFTERS COMPANY, MANUFACTURERS OF RADIO  
AND ELECTRONIC EQUIPMENT, CHICAGO 16, U. S. A.

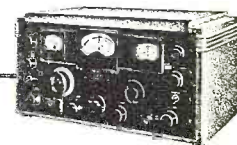

Hallicrafters short wave communications receivers like this will help push back the horizons of tomorrow and make new radio history. This is a 15 tube, 6 band receiver of amazing range and performance.

**BUY A WAR BOND TODAY!**

# WHAT FREQUENCY RANGE

## DO WE NEED FOR HIGH FIDELITY REPRODUCTION?

"Frequency Range and Power Considerations in Music Reproduction" is the title of number three JENSEN Monograph, now ready for mailing. With the approach of FM, Television, High Quality Recording and other advances in the audio electric art, calling for new and increased emphasis on the requirements of High Fidelity Sound Reproducing equipment, this subject is both timely and pertinent.

Do you know the maximum, useful audio frequency ranges under actual listening conditions? Do you know how frequency range is limited even if perfect transmission, reception and reproduction were possible? Or how much change in high frequency cut-off is required to be just noticeable to the listener?

All of these questions, and many more, are answered in this latest JENSEN Monograph. Based on an extensive examination of authoritative work in this field, treatment of the subject is such that it will be found valuable by professionals, the trade, educators and the public.

If you are interested in sound reproduction, you need this up-to-the-minute information. Get your copy today from your JENSEN distributor or dealer, or send 25c to:



### Series So Far Issued

- No. 1. Loud Speaker Frequency-Response Measurements.
- No. 2. Impedance Matching and Power Distribution.
- No. 3. Frequency Range in Music Reproduction.

Watch for the next issue!

Free to men in the Armed Services and to Colleges, Technical Schools and Libraries.

# Jensen

JENSEN RADIO MANUFACTURING COMPANY  
6617 South Laramie Avenue  
Chicago 38, Illinois

Send me  Loud Speaker Frequency-Response Measurements  
 Impedance Matching and Power Distribution  
 Frequency Range in Music Reproduction  
(Check one, two or three. Send 25c for each book ordered.)

NAME \_\_\_\_\_

ADDRESS \_\_\_\_\_

CITY \_\_\_\_\_

ZONE \_\_\_\_\_ STATE \_\_\_\_\_

*Farewell*  
TO  
ARMS...



The tools of war have no place in a soldier's picture of peace. And yet, the perfections that have made his battle equipment the finest in the world will have an immediate and practical application to the postwar way of life for which he is fighting. Radio, especially, will reflect the amazing advances made to meet the precise and varied requirements of modern warfare. From these exciting and expanded frontiers, FADA engineers already are planning the radio and television sets of tomorrow. These expert technicians will be responsible for creations that you will appreciate. You can safely place your faith in the FADA of the future.

PLACE  
YOUR FAITH  
IN THE

**FADA**  
*Radio*

OF THE FUTURE

*Famous Since Broadcasting Began!*

**FADA RADIO AND ELECTRIC COMPANY, INC., LONG ISLAND CITY, N. Y.**

# AUDAX

RELAYED-FLUX  
Microdyne

Long before this war began . . .  
AUDAX PICKUPS were in . . .

## SELECTIVE SERVICE

Since pickups first became important commercially, the distinguished products of AUDAX have been SELECTED wherever and whenever the requirements were exacting.

Today AUDAX magnetically powered pickups are SELECTED for War contracts that demand the highest standards of performance, regardless of climatic variations or severe handling.

Our stern peacetime standards, maintained for so many years, have proven comfortably adequate to meet government specifications.

The sharp, clean-cut *facsimile* reproduction of MICRODYNE is a marvel to all who have put it to the only test that really matters . . . the EAR TEST.

### AUDAX COMPANY

500-N Fifth Ave., New York 18, N. Y.

Creators of High Grade Electrical  
and Acoustical Apparatus Since 1915

Send for your copy of our informative  
"PICK-UP FACTS"

★ BUY  
WAR BONDS

"The Standard by Which Others  
Are Judged and Valued"



# FOR THE RECORD

by the editor

ONE of the best arguments at the moment in favor of immediate production of television sets at the termination of the war (using prewar standards) is the potential employment of some 500,000 people. Many of these jobs could be filled by returning servicemen. It is now a generally accepted fact that when Germany is licked there will, of necessity, be a sudden shutdown in many war plants. The radio-electronic industry will be no exception. Thousands of skilled workers will find themselves without jobs. Many of their wartime skills could be used for the production of television transmitters and receivers. To find immediate employment for these workers would solve one of our greatest postwar problems—that of unemployment.

Leaders in our industry feel that the potential market for television receivers will be as great as radio itself. If the growth of television follows in the footsteps of its predecessor, the radio receiver, it is quite possible that within a period of but a very few years the rate of employment could increase tenfold. That's a lot of jobs! But—how will television receivers be sold and serviced in the postwar period?

A modern television set will include about 25 tubes to fill requirements for adopted standards. A maze of new circuits will offer considerable trouble to many servicemen unless they have the opportunity to preview some of the many refinements that have been made during the war.

Up to the present time practically no information has been released by the leading manufacturers of television receivers. Many have refused to divulge the circuits, etc. which will be used in their postwar models. This "hush hush" works advantageously for the *manufacturer* as he is able to protect many design features which would otherwise be copied by his competitors.

On the other hand, this technique works to the disadvantage of those who are to be responsible for the sale and maintenance of television. If established radio-service dealers are to sell television to the public, and they are the logical choice, they must be given a "preview" of the products that they must sell.

Many radio dealers and servicemen are still up to their necks in keeping radio sets in operating condition and

have had little time to even consider the sale or servicing of television sets. Many of them feel that they will have their hands full in meeting the demands of their customers for new radio sets and for the servicing of existing sets at the end of the war.

We find that the average serviceman knows absolutely nothing about television receivers and furthermore, that many are not the least bit excited about adding television to their line of merchandise. They point out that if they do not understand what they are selling, they will run into all sorts of grief.

The sale and servicing of radio receivers has followed a natural course of development. Most servicemen started out originally by building their own sets. Complete constructional data and other necessary information was furnished to them by the various radio trade magazines and through bulletins sent out by many manufacturers. The experience gained by constructing their own receivers made it comparatively easy for them to recognize failures in factory-made receivers. As sets became more complicated, they found the need for more complete technical data. They got it. With this information they were able to tackle any make or model of set.

But what about television? There is no background or groundwork laid. The average serviceman is completely in the "dark" in his knowledge of video subjects. He would not be able to even consider taking on a service job on a complicated television set with any degree of confidence.

If the television manufacturers hope to get the support of the radio serviceman, and they haven't at this point, it will be necessary for them to "take off the lid" now and show the serviceman what they have to offer. Wiring diagrams for television sets are not "military secrets." They could be submitted to radio publications and be accompanied by factual information which would serve as a basic guide for the serviceman and would enable him to understand the functions of a television set.

Television is receiving a terrific public build-up and we are in favor of it. But why not give the radio serviceman a picture of what he is expected to sell and service in the future? Yes—television is ready for the public but, is the radio serviceman-dealer ready for television? . . . . . O. R.



# Delco Radio products are proved in use

Delco Radio products—millions of units—are proving themselves in use. In motor cars Delco auto radios have been serving dependably for years. In tanks, ships, aircraft, mobile artillery and field units, Delco radio and electronic equipment is meeting the stern tests of battle. Doubly important today is Delco Radio's ability to combine engineering vision with manufacturing precision.

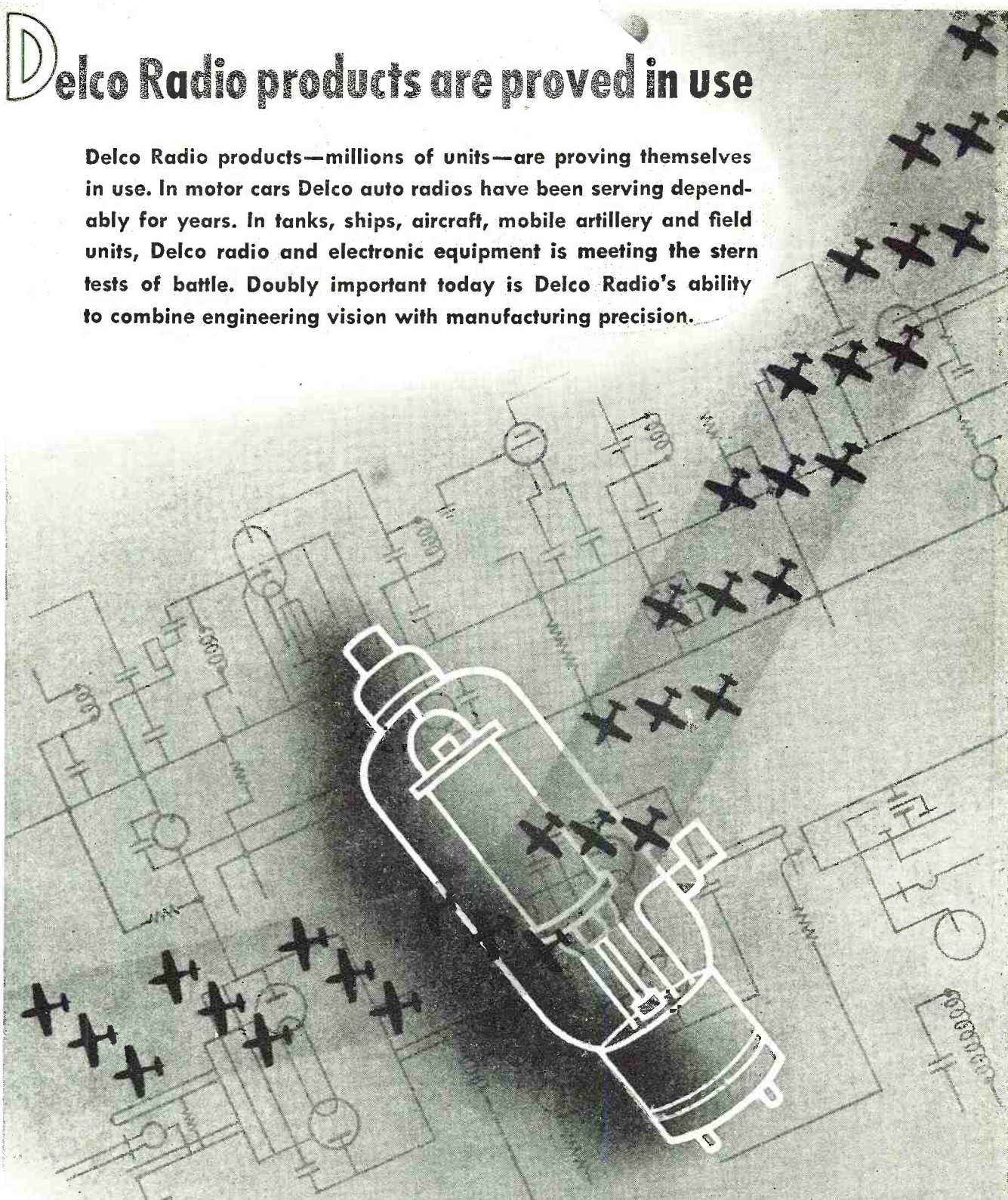

*Put Your Dollars In Action*  
**BUY MORE WAR BONDS**

**Delco Radio**  
DIVISION OF  
**GENERAL MOTORS**

# Federal

Low Frequency Transmitters Used

# Inside the

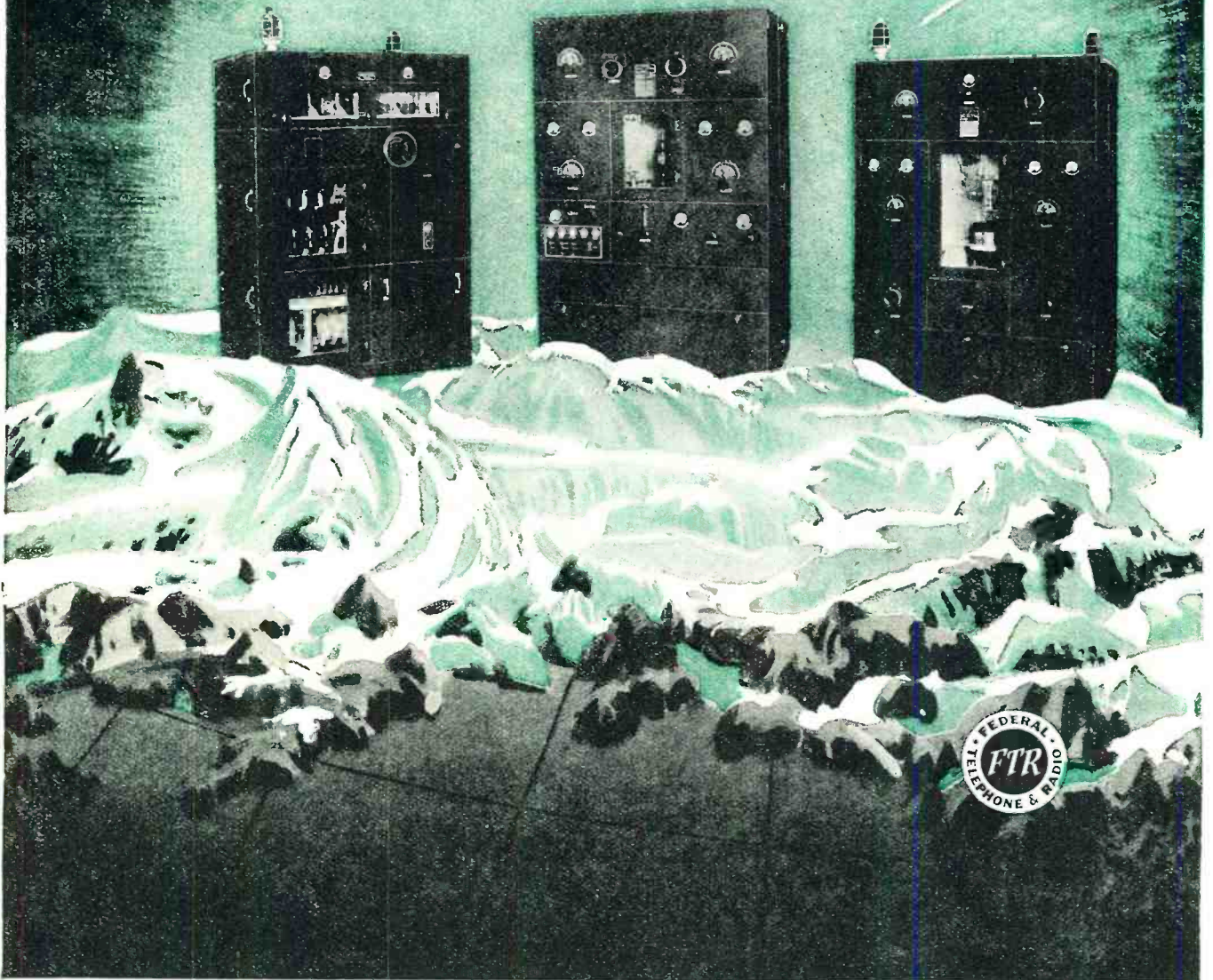

# Arctic Circle

To maintain unfailling communication between airports and from field to plane inside the Arctic Circle, requires the use of low frequency transmitters that will operate reliably far from service facilities.

Federal, pioneer in both low and high frequency radio communication, provides the solution with its 10 KW low frequency transmitter, consisting of an exciter, rectifier, RF transmitter and antenna tuning equipment, housed as separate units. Compact, light in weight, they may be transported in a cargo plane without dismantling.

Through blinding storms and almost perpetual night, pilots in the Far North stake their lives on the dependability of these Federal radio transmitters.

Your transmitting equipment may never be called upon to meet such rigorous demands. But, whatever your requirements are in low or high frequency transmission, Federal, with its technical experience and leadership in radio communication, is prepared to solve your problem.



Intelin High Frequency Power and Coaxial Cables, manufactured by Federal, meet every construction and performance requirement of the most exacting specifications.

*Federal Telephone and Radio Corporation*

Newark 1, N. J.



Designed for



Application

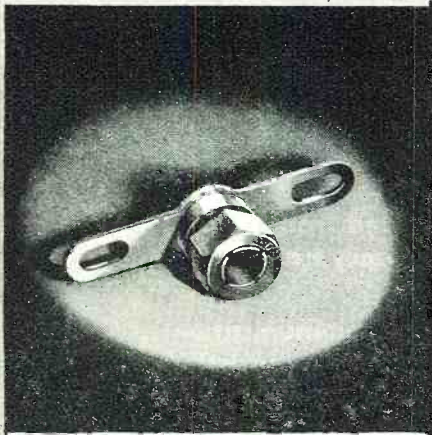

### The No. 10060 Shaft Lock

Another exclusive Millen "Designed for Application" product is the No. 10060 shaft lock. This differs from the self-mounting No. 10061 unit in that it is mounted on a cross arm which can readily be attached to variable condenser frames, brackets, etc., for "behind the panel" applications.

**JAMES MILLEN  
MFG. CO., INC.**

MAIN OFFICE AND FACTORY  
**MALDEN  
MASSACHUSETTS**



## Spot Radio News

By RADIO NEWS Washington Correspondent

Presenting latest information on the Radio Industry.

**WHEN GERMANY SURRENDERS** it should be possible to resume civilian production of receivers, WPB vice-chairman C. E. Wilson told members of the radio industry advisory committee in Washington, recently. He said that a Nazi armistice would probably reduce the over-all war production program about forty per cent and the radio-radar program from twenty-five to thirty per cent. The latter figure, of course, is variable and depends on just what products may be necessary in the war against Japan. Ray C. Ellis, WPB director of the radio and radar division, advised the members of the committee that cut-backs appearing after the Nazi collapse might afford enough materials to provide civilian production without quota restrictions. Both Mr. Wilson and Mr. Ellis emphasized, however, that there will be no civilian production until Germany surrenders.

The WPB officials also reminded the committee that the Signal Corps still has in effect a huge radio and electronic program calling for the expenditure of over two-billion dollars worth of equipment. The present program began on July 1st and will end on June 30th, 1945. Over a billion dollars will be spent for airborne radio and electronic equipment to be completed by March 31st, 1946. The remaining sum will be spent for Army Ground Force, Army Air Force (ground activities), and Lend-Lease. The minimum military program, therefore, will continue upward through December at a general increase of over sixteen per cent over that produced in July.

Notwithstanding the WPB restriction statements, the OPA has already prepared a temporary postwar price scheduling plan which indicates that the prices of receivers may be up from fifteen to twenty-five per cent over prewar prices. The price schedule that previously governed manufacturers' maximum prices for receivers and phonographs has been revoked. The OPA officials state that the price schedules prepared in 1942 do not now and can not apply to future problems. In 1942, they say, conditions were very acute, demanding the very severe price policing schedule. The OPA has asked the radio industry advisory committee to assist them in formulating a definite new price schedule.

The WPB also met with members of the Electronic Distributors Industry Advisory Committee in Washington a few weeks ago to discuss tube and component distribution problems. The major project discussed was that

of tube distribution. It was felt generally that the present method of distribution is operating reasonably well, particularly in view of the fact that military requirements are keeping civilian supplies below demand, and the demand for replacement tubes is naturally higher now because we have had no new sets since April, 1942. Incidentally, the present tube distribution system is quite unique. Tubes are interchanged among manufacturers so that each manufacturer has a stock of all types. Thus the manufacturer can supply their distributors with tubes on a pro rata system, based on the purchases of these distributors of tube types in 1941.

An optimistic report on increased tube production was issued by Arthur Stringer of the National Association of Broadcasters in Washington. He estimated that at least one hundred to two hundred per cent more tubes would be delivered in the fall and winter of this year.

Batteries were also discussed at these meetings. It was learned that every effort is being made to produce sufficient hearing-aid batteries to accommodate all needs during the fall. In the first and second quarters of this year total production averaged about twelve-million cells per quarter. This was between six and seven times the estimated prewar production rate. Two manufacturers have been permitted to increase their production in view of curtailment by two other manufacturers. This balance should provide for an equitable adjustment of production and distribution. It is expected that production of other types of batteries for farm radios will also be maintained on a basis consistent with the current demands.

**THE RECENT RELAXATIONS** of the WPB manufacturing rulings brought little relief to the radio industry, except for the automatic phonograph producers. And here the problem was a bit complicated since many components such as pickups, motors, and amplifiers are still in the essential classification and thus difficult to obtain. Thus far, no specific solutions to the problem of obtaining these parts have appeared. However, according to WPB spokesmen, this relaxation of L21A may eventually provide for the release of the required accessories. The rules may also be applied to the production of these specific units. This relaxation which introduces an industry conversion program has been fostered by Donald Nelson. Mr. Nelson

**RADIO NEWS**

**MEMO TO Purchasing Dept.**

In our postwar radio sets, recommend you buy Solar Sealdtite Tubular Capacitors - they're the best we've ever tested - the only way - waxed units - superior protection against moisture.

E.M.

**ENGINEERING  
SPECIFY  
SOLAR  
DEPARTMENT**

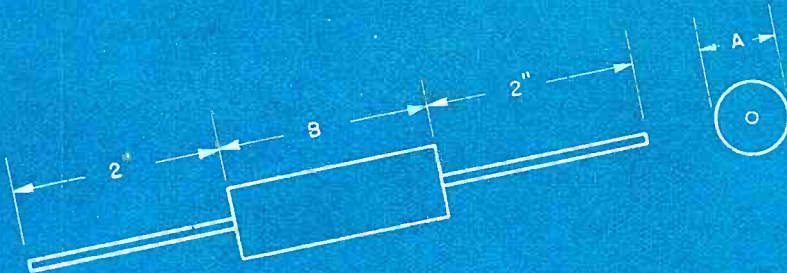

**LEADING MANUFACTURERS  
EVERYWHERE**

ART NO.	SOLAR PART NO.	CAP'Y MFD.	WKG VOLTS	DIMENSIONS		DATE
				"A"	"B"	
9A40-1	S-0211	.001	600	3/8	1-3/16	8/15/44
9A40-2	S-0215	.005	600	3/8	1-3/16	DWG. No. 49A40
49A40-3	S-0221	.01	600	7/16	1-3/8	ISSUE
49A40-4	S-0224	.02	600	7/16	1-5/8	
49A40-5	S-0230	.05	600	9/16	1-5/8	
49A40-6	S-0240	.1	600	9/16	2-1/8	

**DRAWN** E.O.H.  
**TRACED** M.  
**APPROVED** J.C.

Prominent engineers consistently show their preference for Solar Capacitors. Solar pledges continued production of superior quality capacitors to merit that preference. Solar Manufacturing Corporation, 285 Madison Avenue, New York 17, N. Y.



**CAPACITORS &  
ELIM-O-STATS**



**SPEEDIER!**

**SPINTITES ARE REAL SPEED UP TOOLS.** This is the **WRENCH** that works like a **SCREW DRIVER**

Standard sizes for Hexagon nuts or headed screws . . . special SPINTITES for square or knurled nuts. Handles are either fixed or chuck type

**SPEED-UP design by makers of WALDEN WORCESTER WRENCHES**

**STEVENS WALDEN, INC.**  
465 SHREWSBURY STREET  
WORCESTER, MASSACHUSETTS

said that the plan should decentralize some of the operations which will be necessary to take up a slack as men and materials cease to be needed for war purposes. The field officers of the WPB will have complete authority on authorization of materials. Preference ratings of AA5 are being assigned for the production of some electrical items. Thus far, this rating has not been allocated to phonograph production. However, a move to provide this rating to phonograph manufacturers is expected soon.

**THE FREQUENCY ALLOCATIONS**

that we may have in the postwar era were revealed at a special conference called by Adolf A. Berle, Jr., assistant Secretary of State, in Washington recently. Before a distinguished group of government and industry specialists, Secretary of State spokesman Francis C. deWolf, who is chief of the telecommunications division, declared that the Interdepartment Radio Advisory Committee (IRAC) has prepared a postwar allocation proposal for study by members of industry and government and for eventual submission to the next international telecommunications conference which will be held as soon as the war is over. These proposals may also be submitted before a regional conference of nations in this hemisphere which is expected to be held in Brazil during the spring of 1945.

In the proposals, frequency modulation and television are treated quite kindly, for approximately sixty-one per cent of the 42 to 1000 megacycle spectrum is allocated to these services. The region between 42 and 54 mc is set aside for FM and the 54-108 and 158-218 mc region is allocated for television. In the latter instance nine 6-megacycle channels between 54 and 108 megacycles are set aside for television. Between 158 and 218 mc, three 12 megacycle or six 6 megacycle channels are proposed. It appears possible, too, that television may receive thirty 16 megacycle channels between 460 and 956 megacycles and an additional 16 megacycle channel between 508 and 524 megacycles, provided navigational aids do not require these channels. The higher frequencies would be used for high definition television. Some government and industry specialists indicated that there was every possibility that high power high frequency television broadcasting would be available. One former prominent government official, who is now associated with a midwestern radio chain, stated that 400-to-900 megacycle transmission on high power will be plausible and that, accordingly, his organization is making plans for the use of these higher frequencies. A member of a large eastern chain concurred in this view. However, several members of other eastern chains stated that high frequency, high power transmission will not be practical for many years, unless, of course, military developments, not as yet available, accelerate such development and production. It

was generally felt that this problem would receive an intense analysis, providing many of the necessary solutions before the proposals were finally put into effect.

International broadcasting did not fare so well in the proposed allocation plan, the committee citing that there are too many stations at the present time on too limited a group of bands, causing interference and complicating transmission schedules. Representatives of one international broadcasting unit severely criticized this proposal, stating that international broadcasting was a necessity. These officials said that proposed allocations of bands must be modified to accommodate international broadcasting. They cited some of the proposals which allowed bands for services which could use narrower bands, and less frequencies. The IRAC proposal called for a point-to-point transmission system. This was also criticized, the critics citing that such a procedure would throw the broadcast at the mercy of the individual governments receiving these programs. Interviews with members of the government and industry specialists at the conclusion of the conference indicated that some method of international broadcasting may have to be instituted because other nations will probably require such facilities.

Broadcast, aviation and amateur fields were treated well by IRAC. The broadcast band was expanded downward to include the 540 kc band. An aviation band was also expanded to accommodate postwar developments. Amateurs receive a host of bands on the very high frequencies for experimental operation. Some of these bands are located in the 200, 1,100, 2,500, 5,000, 10,000, and 21,000 megacycle regions.

The FM allocation would provide for sixty 200-kilocycle channels, eighty 150-kilocycle channels, or one hundred and twenty 100-kilocycle channels. Commenting on this proposal, the engineering director of an eastern chain said that this extension offers only a partial solution to the problem. He cited that in the congested metropolitan areas additional channels will be necessary. The reservation of adjacent channels assigned to lower frequency television stations until such time as television was firmly established in the higher frequencies, was offered as a possible solution.

Dr. J. H. Dellinger, chief of the radio section of the Bureau of Standards and chairman of the State Department special committee on communications, presided over the technical sessions covering allocations. Cmdr. T. A. M. Craven, former FCC commissioner who is now associated with the Cowles interests, played a key role in the IRAC recommendations. Cmdr. Craven exhibited a chart explaining the procedure applied in the design of the proposed allocations. He said that relaxation of military restrictions will probably facilitate allocation decisions. He expressed the belief that

# SPRAYBERRY RADIO TRAINING

*Gives you Both*



**FULL RADIO SET SUPPLIED FOR SHOP PRACTICE!**

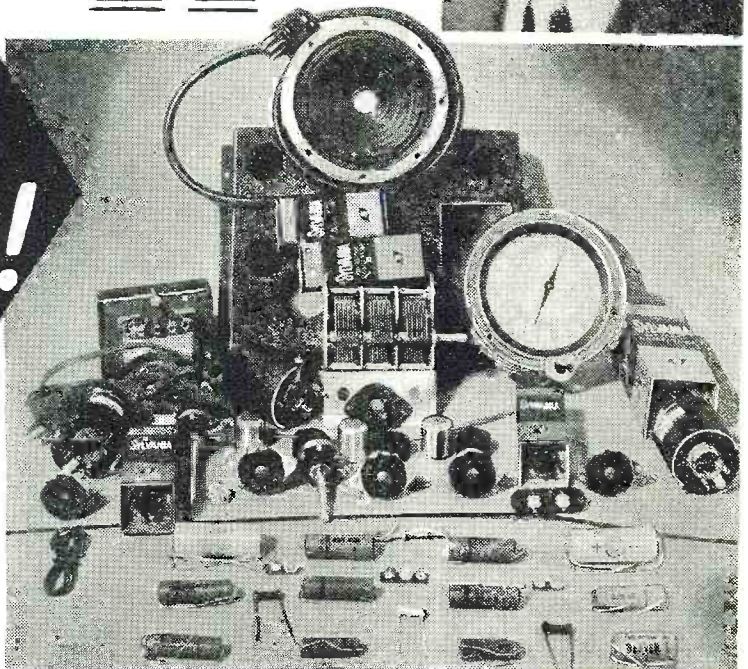

## HERE'S THE ONE PRACTICAL WAY TO TRAIN FOR BIG EARNINGS AHEAD IN RADIO-ELECTRONICS & TELEVISION

The offer I make you here is the opportunity of a lifetime. It's your big chance to get ready for a wonderful future in the swiftly expanding field of Radio-Electronics INCLUDING Radio, Television, Frequency Modulation and Industrial Electronics. Be wise! NOW'S the time to start. No previous experience is necessary. The Sprayberry Course starts right at the beginning of Radio. You can't get lost. It gets the various subjects across in such a clear, simple way that you understand and remember.

### I'll Show You a New, Fast Way to Test Radio Sets Without Mfg. Equipment

The very same Radio Parts I supply with your course for gaining pre-experience in Radio Repair work may be adapted through an exclusive Sprayberry wiring procedure to serve for complete, fast, accurate Radio Receiver trouble-shooting. Thus under Sprayberry methods you do not have one cent of outlay for manufactured Test Equipment which is not only expensive but scarce.

### Prepares You for a Business of Your Own or Good Radio Jobs . . . Civilian or Military

My training will give you the broad, fundamental principles so necessary as a background no matter which branch of Radio you wish to specialize in. I make it easy for you to learn Radio Set Repair and Installation Work. I teach you how to install and repair Electronic Equipment. If you enter the Army, Navy or Marines, my training will help you win higher rating and better pay.

### JUST OUT! FREE!

#### "How to Read Radio Diagrams and Symbols"

... a valuable new book which explains in simple, non-technical English how to read and understand any Radio Set Diagram. Provides the quick key to analyzing any Radio circuit. Includes translations of all Radio symbols. Send for this FREE book now while supply lasts and along with it I will send you another big FREE book describing my Radio-Electronic training.



### GET FREE BOOKS

■ SPRAYBERRY ACADEMY OF RADIO  
 ■ F. L. Sprayberry, Pres.  
 ■ Box 500WK  
 ■ Pueblo, Colorado  
 ■ Please rush my FREE copies of "HOW TO MAKE MONEY IN RADIO, ELECTRONICS and TELEVISION," and "HOW TO READ RADIO DIAGRAMS and SYMBOLS."  
 ■ Name ..... Age.....  
 ■ Address .....  
 ■ City ..... State.....  
 ■ Tear off this coupon, mail in envelope or paste on penny postcard.

"KNOW-HOW"  
IN A PACKAGE

# SYLVANIA SERVICEMAN SERVICE

by  
**FRANK FAX**



**JUST 70¢ BUYS:**

← No. 1  
Technical Manual  
**35¢**

No. 2 →  
Tube Complement Book  
**35¢**

No. 3 →  
Characteristics  
Sheet  
**FREE**

No. 4 →  
Correlation of  
Tube Types for  
Substitution Chart  
**FREE**

No. 5 →  
Sylvania Base  
Chart  
**FREE**

• If your jobber cannot supply you, mail your order to Frank Fax, Dept. RN-10 Sylvania Electric Products Inc., Emporium, Pa.

# SYLVANIA

**ELECTRIC PRODUCTS INC.**  
RADIO DIVISION

such relaxation may be forthcoming soon.

A study of postwar frequency allocation policies is now also under way by the FCC. Public hearings will be held to review the present allocations and also make recommendations to the State Department and to IRAC. The information obtained at these hearings will be utilized by the commission to determine the frequency requirements of the non-government services in this country. Information supplied by the RTPB covering the industry requirements will also be utilized in forming the FCC allocation plans.

The Department of State has set a deadline of December 1st for their postwar allocations and proposals. Incidentally, these proposals are intended to modify the international telecommunications convention (Madrid 1932) and the general radio regulations (Cairo 1938). It is believed that the FCC recommendations will be submitted on December 1st, too. It is hoped, too, that the RTPB will be able to submit their recommendations to the FCC prior to the deadline date so that the final proposal will be complete in industry, government and commercial requirements.

**A UNIQUE TELEVISION SYSTEM**

wherein but a single channel is used for both the video and audio, recently invented by James E. Robinson, is expected to be demonstrated before members of the FCC soon. This system, which would radically change present procedures, is an instantaneous recording method, according to the inventor. In a recent article, entitled "Sound on Video" which appeared in the September issue of RADIO-ELECTRONIC ENGINEERING, Mr. Robinson pointed out that the system is analogous to the practice standardized by the motion picture industry, insofar as the conversion of sound vibrations to light variations. He explained that the major difference was that his system was dependent upon increments for transmission and not wave forms. An increment, he said, is a sample or part of a whole retaining all of the characteristics of the original but in proportion. In this system we have a repetition rate of 15,750 increments per second, besides a phasing action rendered by a delay produced through a dissection process. This scanning rate is standardized today. However, a certain percentage of these active scanned lines are usually lost due to the lag of the blanking impulses. This condition, explained Mr. Robinson, is the only limiting factor in preventing a reproduction of a 15,750-cycle note, because the loss of the active scanned lines results in an equal reduction of available increments. The storage type of camera tube stores or records the introduced modulation during an interval when the electron screen is active over the adjacent area. In the non-storage type of tube, the storage effect is obtained by delaying the elec-

tron cloud. Therefore, said Mr. Robinson, since image dissection lacks intelligence to differentiate between the two introduced pictures, we have the television of one composite picture. This fact creates the working principle, for the Robinson principle, he said. That is, from this conversion point it only becomes necessary to consider the resultant signal as a singular type which can be handled like the present video signal used for transmission purposes without conflicting with existing standards as to ratio, bandwidth, wave form and synchronization. Mr. Robinson pointed out that his system is not only capable of meeting the requirements for high fidelity reproduction but also frees a portion of the frequency required for such reproduction, which is equal to about a quarter of a megacycle. Because of this additional frequency gained, it is possible to increase the guard zone between stations, add one additional station for every twenty-four employing existing standards, or introduce additional scanning lines, according to Mr. Robinson.

In the receiver the increments or impulses are caused to saturate a fluorescent material to produce visible light, explained Mr. Robinson. It is this fluorescent material that renders a delay or carry-over of the light because of its decay period. In the aural reception, these increments or impulses are passed through an audio amplifier, he said. And because of its resistance and capacity effects, we achieve a duplication of the original sound, he said. It is thus possible to eliminate the double intermediate frequency amplifiers in receivers, since we only have to pick up one single carrier, he explained. Mr. Robinson pointed out that his system is not the same as the single carrier system wherein sound is modulated during horizontal blanking. This latter system, he said, does not depend upon increments. It employs a wave form analysis for transmission and reproduction. Thus, the wave form is broken up and only segments or parts of the original wave form are received, according to Mr. Robinson.

Several months ago the RTPB requested a demonstration of the Robinson system. However, such a demonstration was not given, and accordingly the RTPB did not consider this method. Whether or not the proposed demonstration will effect the RTPB previous standing is not known at the present writing. According to reports, Mr. Robinson also plans to demonstrate his invention at the IRE-RMA meeting in Rochester in November.

**A SUBSTANTIAL TELEVISION INDUSTRY**

may soon rise in Mexico if the projected plans of Dr. Lee DeForest are completed. The famous inventor visited Mexico in the early part of the summer and discussed plans with officials of the government for a

*(Continued on page 132)*



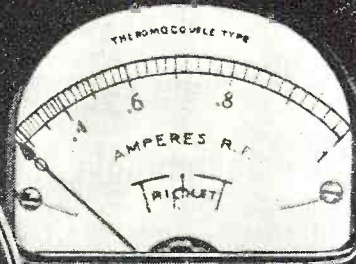
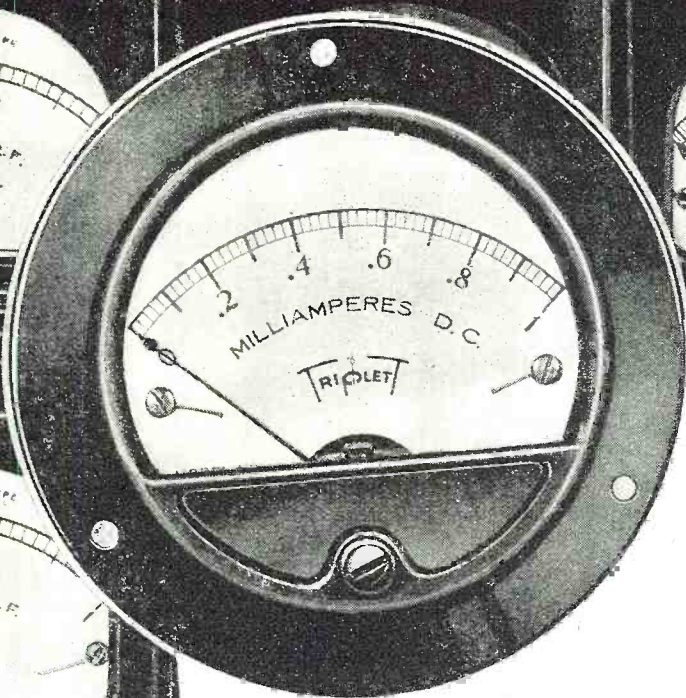

**AC OR DC**  
*Any Size*  
2" - 3" - 4" - 5" - 6" - 7"  
*Any Style*

**Shipment within 30 days**  
ON any AA Priority

The Triplet Line of Instruments—a complete line from one source and better than ever before—is now ready for the demands of "regular" business. Naturally, standard catalog numbers ready in the stock room can be shipped promptest, but all our instruments, through increased production facilities, are being delivered with gratifying speed. You can count on quick deliveries so place your orders now.

**Triplet**

**ELECTRICAL**  
BLUFFTON

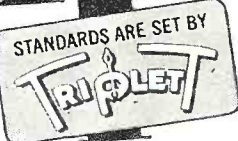

**INSTRUMENT CO.**  
OHIO \*\*\*

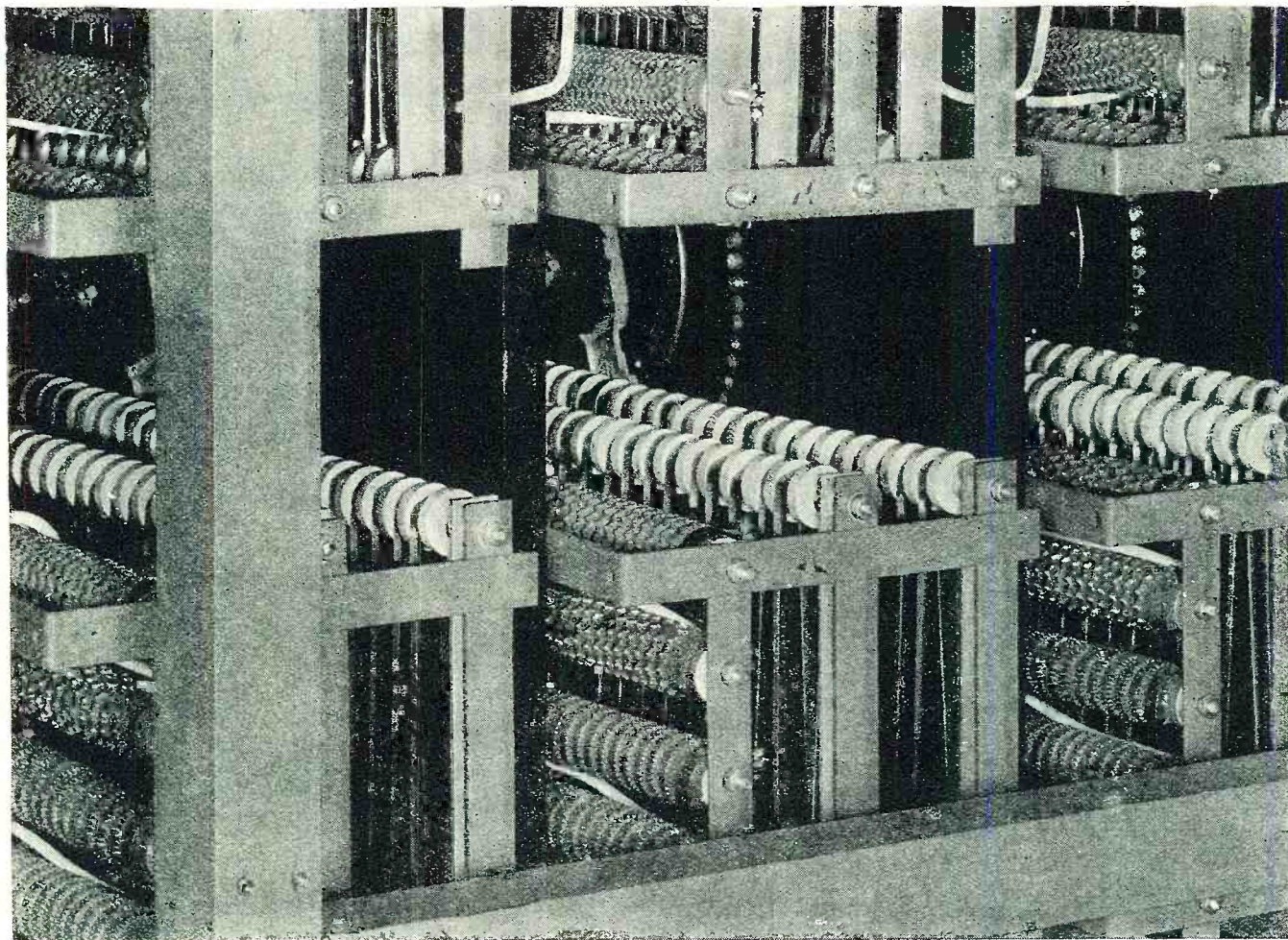

## ADAPTABLE and DEPENDABLE **RESISTORS**

**A**DAPTABILITY and dependability of resistors assume primary importance in the assembly of large rheostat control units. The wide range of resistance values and capacities that can be built up from the Ward Leonard line is limitless. The many types and mounting arrangements permit the meeting of load requirements in minimum space. In an assembly as shown above, the dependability of the individual resistor is an absolute essential.

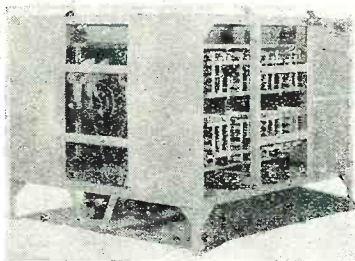

Motor operated Ward Leonard assembled rheostat built up from several types of Ward Leonard Resistors.

For over fifty years industry has looked to Ward Leonard for both resistors and resistor assemblies. This experience has given Ward Leonard Engineers the viewpoint of user and designer. It is reflected in the completeness of the Ward Leonard line of resistors.

Whatever your requirements you will find a Ward Leonard Resistor that exactly meets your conditions. Send for Bulletins.



# WARD LEONARD

## RELAYS • RESISTORS • RHEOSTATS

Electric control  devices since 1892.

**BUY MORE  
WAR BONDS**

WARD LEONARD ELECTRIC COMPANY, 47 SOUTH STREET, MOUNT VERNON, NEW YORK

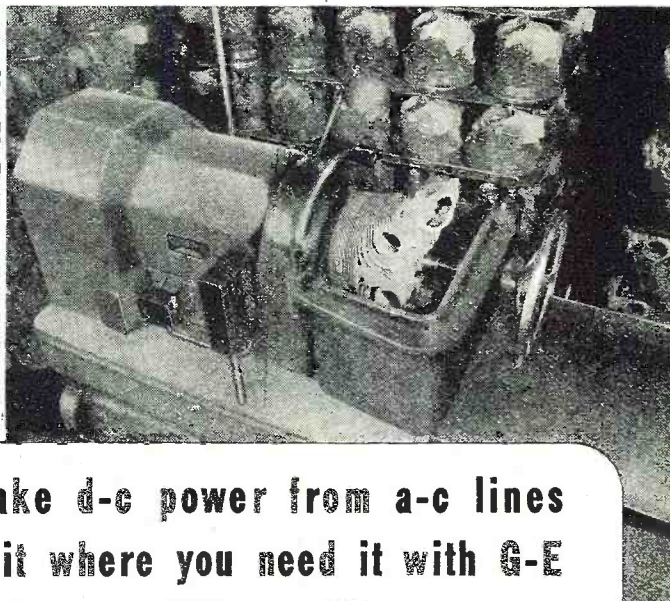
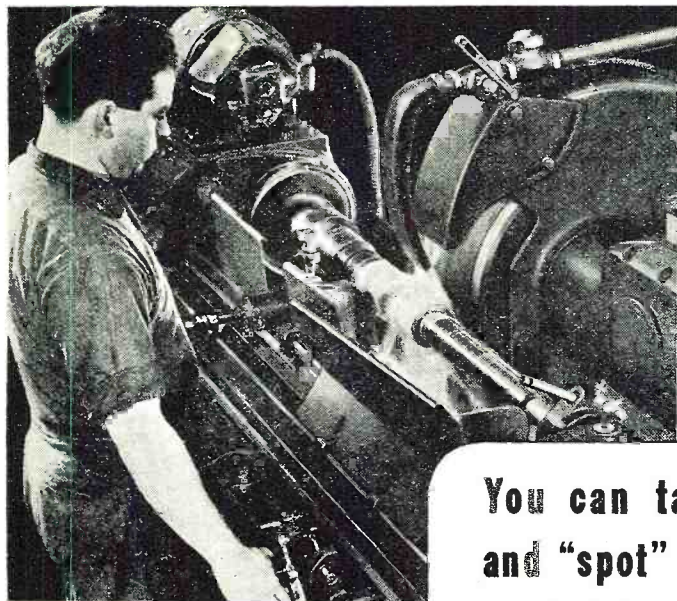

You can take d-c power from a-c lines and "spot" it where you need it with G-E sealed-ignitron rectifiers

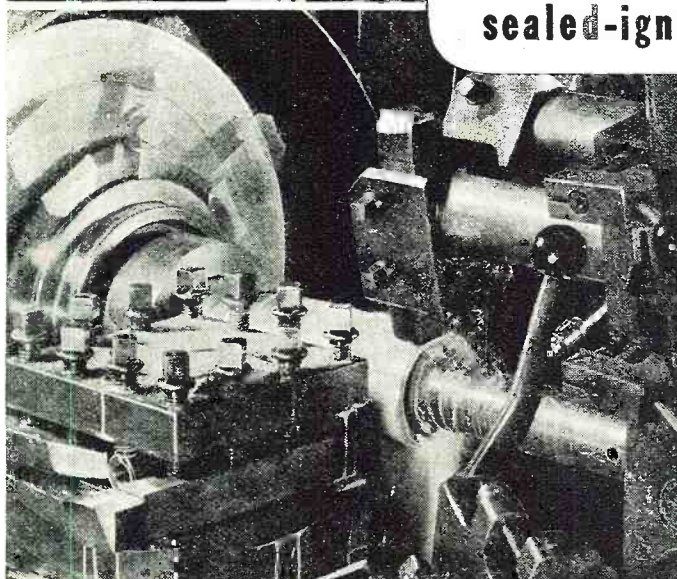

The thyatron (left) is the "timer" tube, which usually teams up with the ignitron (above)



The steel-jacketed G-E ignitron is an electronic tube of many uses, and nowhere is its versatility better demonstrated than in converting a-c to d-c economically and efficiently.

Many power-driven machines, such as machine tools, cranes, etc., require d-c power to drive them because of the necessity of the adjustable speed which the d-c motors can provide. The G-E steel igni-

tron takes a-c from the power lines, rectifies it, and supplies it to the specific locations where d-c motors require it.

Thus, without effect on any other equipment, or on the distribution system as a whole, d-c power can be fed to such diverse machines as drill press, milling machine, power lathe, grinder, and sander. Production is stepped up, and costs, in many cases, are reduced.

The G-E steel-jacketed ignitron tube has no moving parts; is quiet in operation; efficiency is high and practically constant over the entire load range. It can successfully carry severe peak loads.

The ignitron is only one of a complete line of G-E electronic tubes for innumerable industrial jobs. Through its nation-wide distributing system, General Electric is prepared to supply users of electronic devices with replacement tubes.

**"HOW ELECTRONIC TUBES WORK"**

This booklet will be mailed to you on request —without charge. Address *Electronics Department, General Electric, Schenectady, N. Y.*

• Tune in "The World Today" and hear the news direct from the men who see it happen, every evening except Sunday at 6:45 E.W.T. over CBS. On Sunday listen to the G-E "All Girl Orchestra" at 10 P.M. E.W.T. over NBC.

G.E. HAS MADE MORE BASIC ELECTRONIC-TUBE DEVELOPMENTS THAN ANY OTHER MANUFACTURER

**GENERAL  ELECTRIC**

162-C10-8850



... as in the laboratory

# PLANNING IS FOREMOST IN THE NATION

America today is analogous to the laboratory where work is scientifically planned on foundations of the past, present, and future. The mistakes that the world made after 1918, the current conflict, and our hopes for the years ahead serve as the foundation components for a postwar program of peace and security and abundance. Like the laboratory technician, our country's thinkers should plan our participation on a scientific basis.

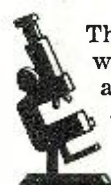

The effects of such a policy are closely allied to the welfare of the American people. An economy of abundance can be translated into an abundance of jobs . . . for present workers as well as men and women returning from the battlefields. Equally important, it gives our country the opportunity to make even greater strides in securing the well-being of the individuals . . . be they capital or labor. Through such an economy of abundance, the businessman can protect his production peaks without fear of drastic reductions in sales, and resulting tragedies—and the worker can be assured of a steady job, and all that it implies.

The objective of the nation is already established. You know that technical advancements, especially those in communications and transportation, have made isolationism and nationalism impossible.



America, therefore, *must* participate in world affairs. Friendly relations in the international community mean not only an interchange of ideas, but an interchange of goods. Out of the former comes a better understanding of each nation's problems . . . out of the latter will come wider markets for our greatly expanded production. In gaining such markets, we can still maintain our industrial set-up as it stands today, yet avoid any of the ills that might arise from overproduction.

We have the qualities for winning the war . . . that is certain. Whether or not we have the qualities for winning the peace remains to be determined. Should we recognize our nation as a huge laboratory, and ourselves as scientists, engineers and technicians working in the simplest, most direct method, we can achieve our goal of a just and lasting peace with opportunity and security for all.

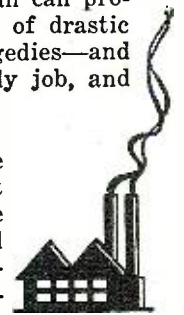

**READY SOON!** *A sound, workable and realistic plan for a postwar world of abundance and lasting peace, prepared by the Electronic Corporation of America. Write for your copy today.*



## ELECTRONIC CORP. OF AMERICA

45 WEST 18th STREET • NEW YORK II, N.Y. WATKINS 9-1870

The Electronic Corporation of America is "on the air," eight times a week, featuring two nationally-known commentators: Johannes Steel, over Station WMCA, New York, and William S. Gailmor, over Station WJLN, New York.



**The train of events** leading to Victory is speeding right into Tokyo and Berlin . . . and many of the deciding factors may be traced back to the service of skilled hands on the home front.

**Here at Cornell-Dubilier** skills handed down from mother to son have helped to bring Victory nearer. Some of our workers have been with C-D almost as long as modern capacitors have been in existence. Others are proud—as we are—of their five, ten and twenty years with C-D.

**C-D's expanded production** facilities and expert workmanship are at your service. Write us for further information. Cornell-Dubilier Electric Corp., South Plainfield, N. J.



**TYPE 6** Medium Power Mica Transmitter Capacitor. *Designed for a wide variety of r. f. applications where size and weight must be kept to a minimum. Patented series mica construction; vacuum impregnated—resulting in low loss, high insulation—no air voids; special low-loss filter reduces stray losses.*

**CORNELL - DUBILIER**  
**CAPACITORS** 1910  1944

MICA • DYKANOL • PAPER • WET AND DRY ELECTROLYTICS

ALSO AT NEW BEDFORD, BROOKLINE, WORCESTER, MASS.; PROVIDENCE, R. I.

HOGARTH DOESN'T MIND—HE'S USED TO HAVING  
A CROWD AROUND HIS **ECHOPHONE EC-1**

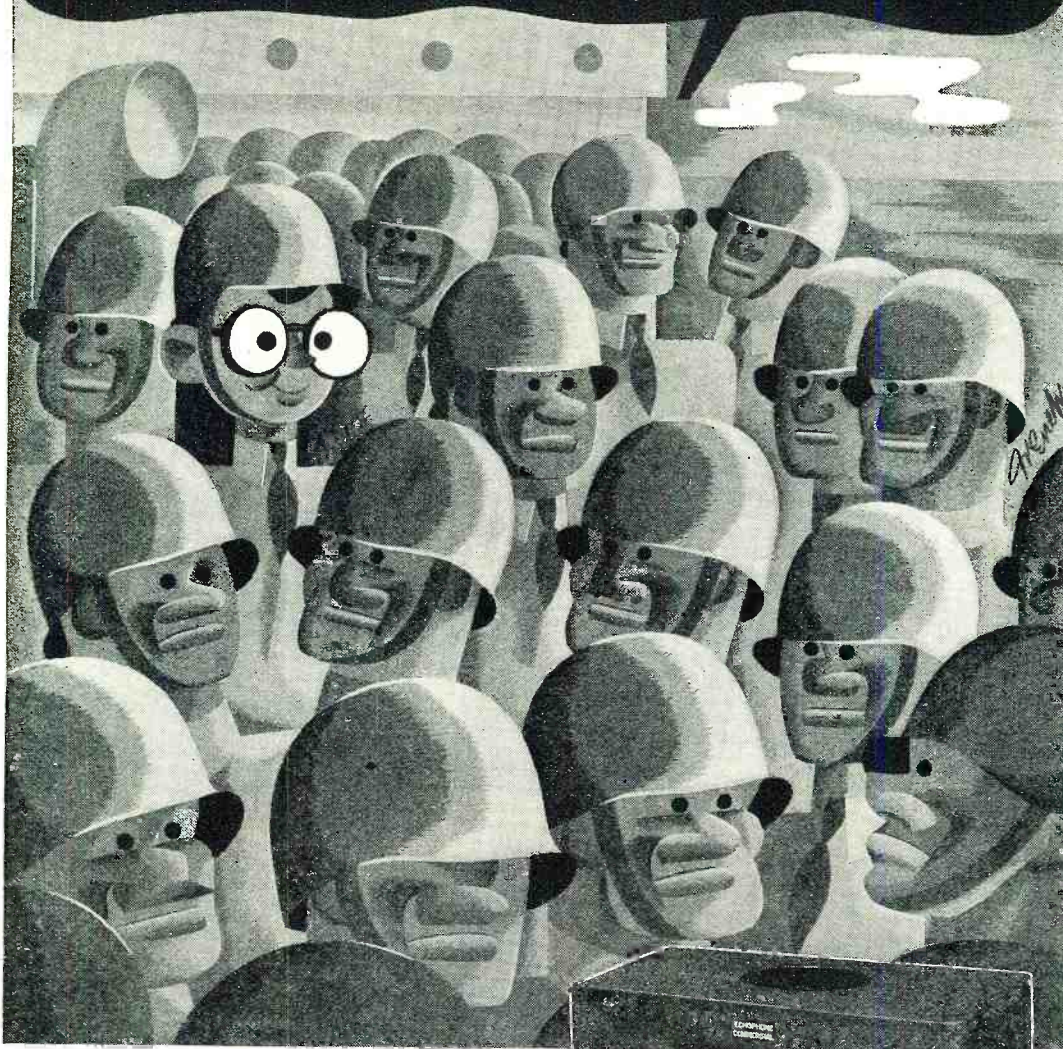

### **ECHOPHONE MODEL EC-1**

(Illustrated) a compact communications receiver with every necessary feature for good reception. Covers from 550 kc. to 30 mc. on 3 bands. Electrical bandspread on all bands. Six tubes. Self-contained speaker. 115-125 volts AC or DC.



**ECHOPHONE RADIO CO., 540 NORTH MICHIGAN AVE., CHICAGO 11, ILLINOIS**

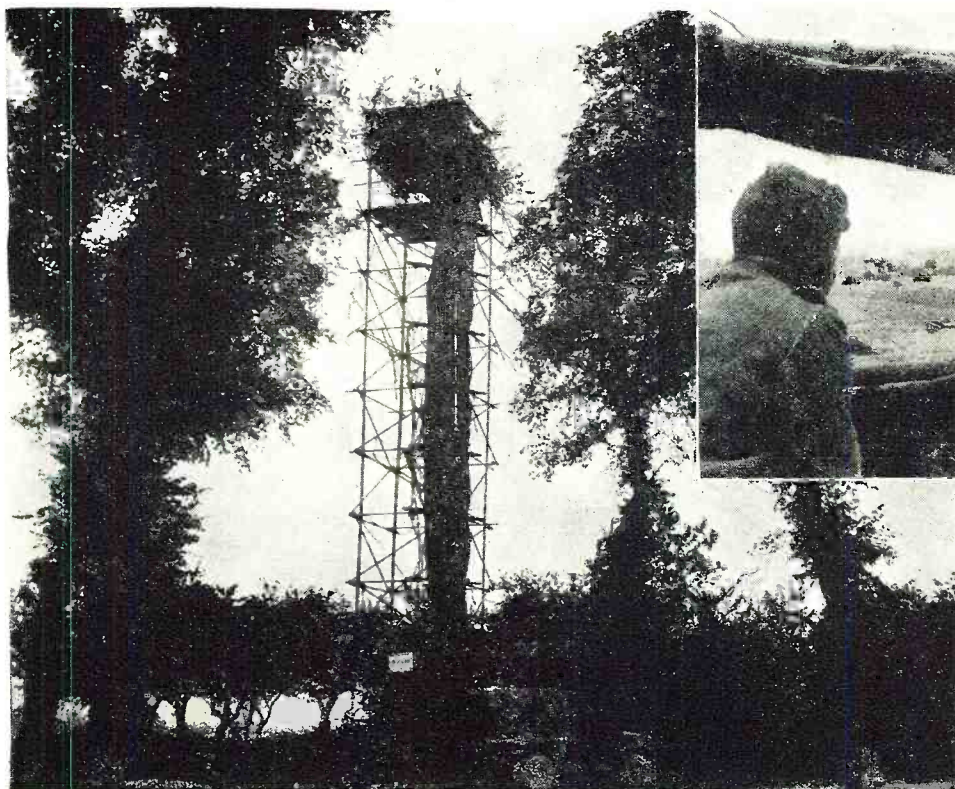

This 66 foot tower, built by British sappers in Normandy, commands an extensive view of enemy held territory south of Verson. Information about enemy gun flashes is reported to Corps Artillery by radio or telephone. Inset shows view from top of the tower.

# COMMUNICATIONS Score D-Day Triumph

By **KENNETH R. PORTER**  
RADIO NEWS War Correspondent

***The story of the greatest achievement in the history of military communications, effected by the Allied Forces in the initial invasion of Normandy.***



LOOKING over this grim battlefield, many weeks after D-Day, I realize as never before what a colossal part communications played in this history-making invasion. Never have signals played such a dramatic role, for every known (and secretly unknown) type of equipment was called upon to establish the vitally important contact between air, ground and sea forces.

It is only natural to expect that such a huge continental operation would require the tying together of vast armies under one control. Only through the combined use of radios, telephones, signal lamps, flags, pyrotechnics, public address systems, homing pigeons, and even smoke signals, was it possible for those tens of thousands of men to move as one into the murderous H-Hour assault that marked the opening of this struggle on the coast of France.

Even the lowly printed word (in French) played its part as a prelude to this greatest of all offensives. A half dozen U.S.A.A.F. Flying Fortresses flew over small towns and villages in this area during the early morning hours dropping leaflet messages warning the population that the Allied invasion was about to begin.

Under the withering shell fire of well-planned German fortifications overlooking the beach, our Signal troops

scored a communications triumph by tying together the swiftly moving armies. Valiant crews strung their lines on makeshift poles or plowed them into earth that was shaking with shell fire. Radio units moved forward as artillery blasts and the strafing of enemy planes hastened them in their work.

But the crippling of enemy communications is as important as the establishment of our own. At H-Hour more than 10,000 aircraft and 4,000 surface vessels had started a combined bombing and shelling operation that eventually severed all road, rail and wire connections between Rommel's troops and the northern sector from the Seine estuary to Dunkirk and those in the Le Havre-Cherbourg belt. Hundreds of telephone lines as well as some 34 bridges linking major highways to enemy fortifications in this vicinity were knocked out.

Many vital radio stations were demolished in the coastal area so effectively that even the high degree of technical skill possessed by the German engineers and signals officers were no match for the herculean repair task confronting them as the Allies forced their way inland. Many of these wrecked installations were quickly made service-

*(Continued on page 84)*

# CALIBRATED

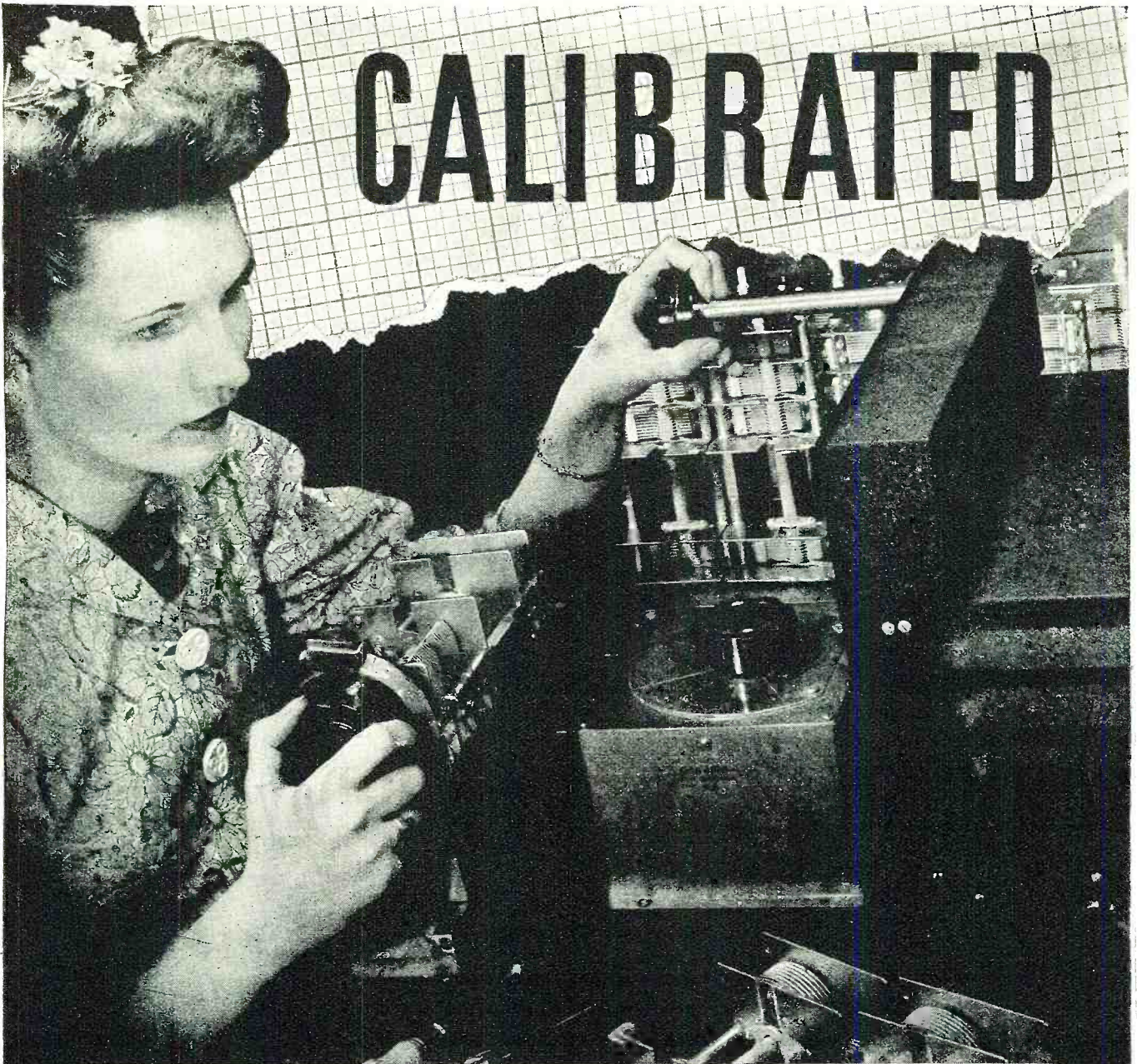

Through the development of our own highly specialized calibrating equipment Hammarlund engineers have made possible mass production of variable capacitors with accuracies comparable to laboratory standards.

## HAMMARLUND

THE HAMMARLUND MFG. CO., INC., 460 W. 34<sup>TH</sup> ST., N. Y. C.  
MANUFACTURERS OF PRECISION COMMUNICATIONS EQUIPMENT

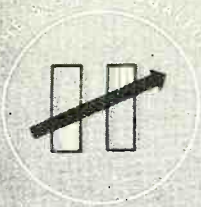

ESTABLISHED 1910



# RADIO INTELLIGENCE

By **OLIVER READ, W9ETI**

Managing Editor, RADIO NEWS

*An eye-witness report on the little known technical aspects of the RID.*



Adcock direction-finder—so critical in balance that a spiderweb across the transmission line will upset calibration. Operator is K. W. Miller, W5AOC, Asst. Supv.



**T**HE Radio Intelligence Division (RID) of the Federal Communications Commission is one of the government agencies least known to the American public. Up to the present time little information has been forthcoming showing the important functions of this non-military unit. Highly important in peace—the RID has been performing one of the most essential tasks in wartime—ridding this country of illegally-operated radio stations, most of them by spies of foreign powers. Furthermore, they have saved hundreds of lives by locating lost aircraft. Millions of dollars worth of vitally needed planes have also been saved from an untimely crack-up.

The RID was organized several years ago by George Sterling, W3DF, who still directs all activities as Chief. Assisting in this important work are Charles Ellert, W3LO and Stacy Norman, W7OK, all prominent radio amateurs.

Principal functions of the RID include: Maintaining a continuous policing of the entire radio spectrum to insure against unlicensed transmissions and taking appropriate action to suppress such operation; locating and eliminating interference to licensed stations; maintaining a continuous surveillance of licensed stations in cooperation with the Field Division of the Engineering Department, FCC; making intercepts of foreign non-military radiotelegraph traffic for the use of other civilian agencies of the Government, and recording foreign broadcasts for the Commission's Foreign Broadcast Intelligence Service.

Other important activities are performed by the members of the RID. Included are the rendering of emergency direction finding service to



Interior of RID mobile unit. Operator is adjusting the Hallicrafters SX-28 receiver while signal is being transcribed on Telecord wax cylinder machine. Wheel, upper right, is part of direction finder.

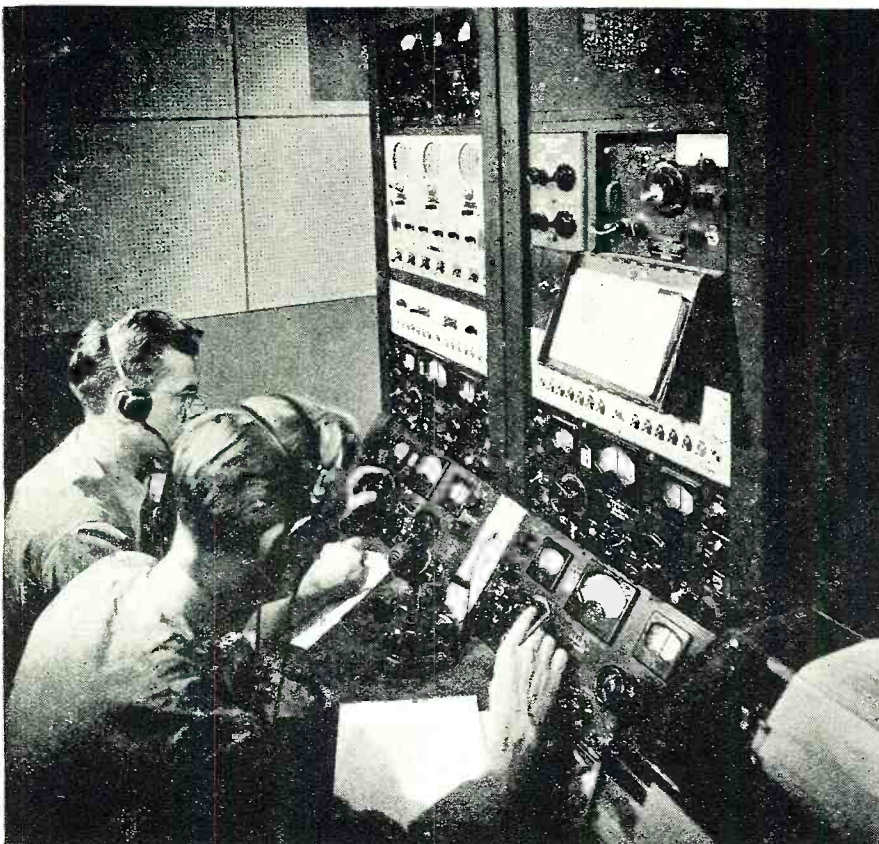

Operators of the "ether patrol" searching for a lost aircraft (LOP) from the Cruising Room at Allegan, Michigan. Receivers operate continuously day and night.

civilian and military aircraft, training personnel in radio intelligence work for other Government departments and foreign countries, and the furnishing of equipment to various Government departments, etc.

The RID is comprised of twelve primary monitoring stations and thirty-two secondary monitoring stations located throughout the United States, its territories and possessions. All of the primary stations and secondary stations within the United States and all the secondary stations in the territories are linked together for instantaneous communications, either by private tieline or by radio links. The activities of the monitoring stations is coordinated from three *Radio Intelligence Centers*. Work on the East Coast is coordinated from the Center in Washington, D.C., work on the West Coast from the Center at San Leandro, near San Francisco, and work in Hawaii from the Center in Honolulu.

Each of the primary monitoring stations is located on a large tract of land to permit erection of extensive receiving antennas. These stations are also located so as to be as far away as possible from electrical interference which would be experienced in or near cities.

A typical primary monitoring station, located near Allegan, Michigan, was visited by the editors of *RADIO NEWS* in order to get firsthand information on its activities and to meet the personnel of the RID. Supervis-

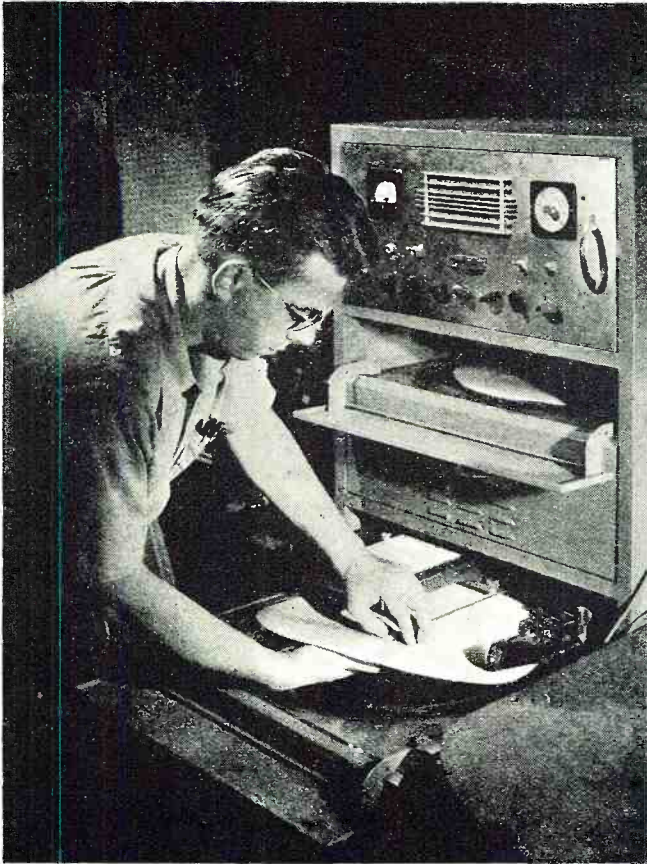

Changing a paper disc on one of the Memovox recorders in the Intercept Room. An hour's intelligence is recorded on each side.

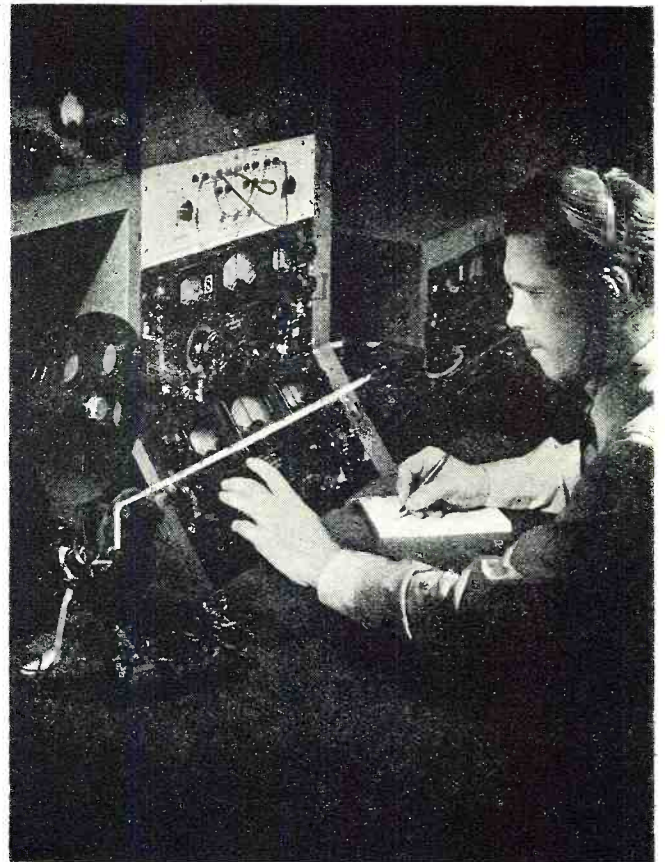

William J. Hoffert, W5HVB, RID supervisor at Allegan, recording high speed code on Boehme tape machine.

ing at Allegan is William J. Hoffert, W5HVB and his assistant, Kenneth W. Miller, W5AOC. We found that 90% of the personnel at Allegan were licensed amateurs. Their experience had given them a valuable background for this important work. The personnel in the RID Division of the FCC at this station includes four monitoring officers and twelve operators. Working in shifts, these men "patrol the ether" twenty-four hours a day.

Associated with each primary station are a number of satellite stations known as *secondary* stations. Location of these are chosen with regard to density of population and radio activity. They are situated on leased property at locations that permit good radio reception, the great majority of them being within the continental United States.

In addition, there are associated with each secondary station one or more special mobile units that are equipped with radio receivers, equipment for taking radio bearings at short range, and equipment for recording the radio signals which are intercepted. At times, two or more of these mobile units work together on a particular case. For the purpose of coordinating their work many of them are equipped with radio to communicate with each other.

It is interesting to note that practically all of the equipment at the RID stations is in continuous operation. Mr. Hoffert pointed out, for example,

that none of the receivers had required a major repair since they were installed in 1941. The equipment used at this station is typical of that used in all RID stations. In the "Cruising Room," for example, are one *Bendix* frequency standard; six *Hallicrafters* SX-28 and one S-27 receivers; one *Hallicrafters* HT-7 frequency standard; one *National* 1-10 receiver and one RCA 10kc. inverter with demodulator. In addition are the regular teletype-writers and emergency radio channels used for communications should the teletype fail. The operators in this cruising room tune the entire radio spectrum continuously in their search for unidentified signals. An Intercom connects to the two *Adcock* direction finders. This is used to "alert" the DF operator when a long-range bearing is required.

When it is necessary to report unidentified intelligence, operators in the "Intercept Room" record the transmissions on ink recorders, discs or cylinders. Equipment in this room includes a *Bohme* ink recorder, seven *Hallicrafters* SX-28 receivers, two *Memovox* recorders, *Telecord* wax cylinder machine and a *Telrad* frequency standard. A special receiver designated as SSR-202 (SX-28 with additional i.f. channel) is employed. This latter unit is capable of separating badly scrambled transmissions and by the use of special circuits (restricted at the moment) are able to bring in these signals clearly for recording.

There are six crystal-controlled standby frequencies always available. A Transmitter House far from the main building houses three RCA ET-8019 200 watt transmitters. These are operated by remote control from the Cruising Room. An *Onan* 5KW gasoline-driven generator supplies power to the transmitters in case of failure of the 60 cycle line supply.

We mentioned before that it is the job of the RID to police the entire radio spectrum. In order to detect subversive or other illegal use of radio it is necessary for the monitors at all of the stations to maintain continuous patrol of the ether. These monitors must be able readily to identify the hundreds of thousands of radio signals which they hear daily. There are a number of means by which radio signals can be identified. For example, checking call letters, checking frequencies, checking operating procedures, analyzing the traffic and analyzing technical characteristics of the signal, such as its strength, hum, echo, fading, and the particular style of the operator.

If it is still not possible to identify a signal by the application of these or similar criteria, it then becomes necessary to search and locate the transmitter by means of radio direction finding.

The RID stations make use of a highly perfected direction finder designed from the principles discovered by the Englishman, Adcock. It is



A "ham's paradise." Any type of signal may be recorded in the Intercept Room on tape, wax cylinders, or paper discs for observation and reference.



Transcribing copy from Boehme tape. Operator controls speed by foot.

known as a balanced H type and is shown on page 25.

A simple analogy to show how this direction finder operates would be the familiar battery operated portable radio set in a carrying case. These receivers use a built-in "loop" for picking up the signal. The loop consists of a number of turns of wire wound on a narrow rectangular framework usually fastened within the carrying case, and in some cases, mounted on the outside but always in a vertical position. Our readers are familiar with the fact that such a receiver has marked directional properties and that some stations are heard with much greater signal strength than others. These discriminations against a certain station may be altered by changing the position of the loop. This is basically the function of the direction finder.

If a pointer is attached to the loop and is made to traverse a circular scale graduated in degrees (marked from 0 to 360 degrees) it is possible to ascertain the true direction of a given radio station by noting the position of the pointer with reference to the scale when a null is obtained. This null is the point where the signal is no longer heard and occurs when the loop is "broadside" to the arrival of the signal.

In using a loop direction finder, the scale reading opposite the pointer is determined not only by the direction of the radio station with respect to the location of the loop but also by the position of the zero graduation on the circular scale. If the zero mark or graduation is placed so that it coincides with true north (which can be done either by revolving the scale or the object to which it is fastened) then the radio bearing obtained will be with reference to true north. It is advantageous to do this because the radio bearing can then be projected on a suitable chart or map in much the same manner as plotting a ship's course.

If only one direction finder is used, there is no way to ascertain the exact  
(Continued on page 124)

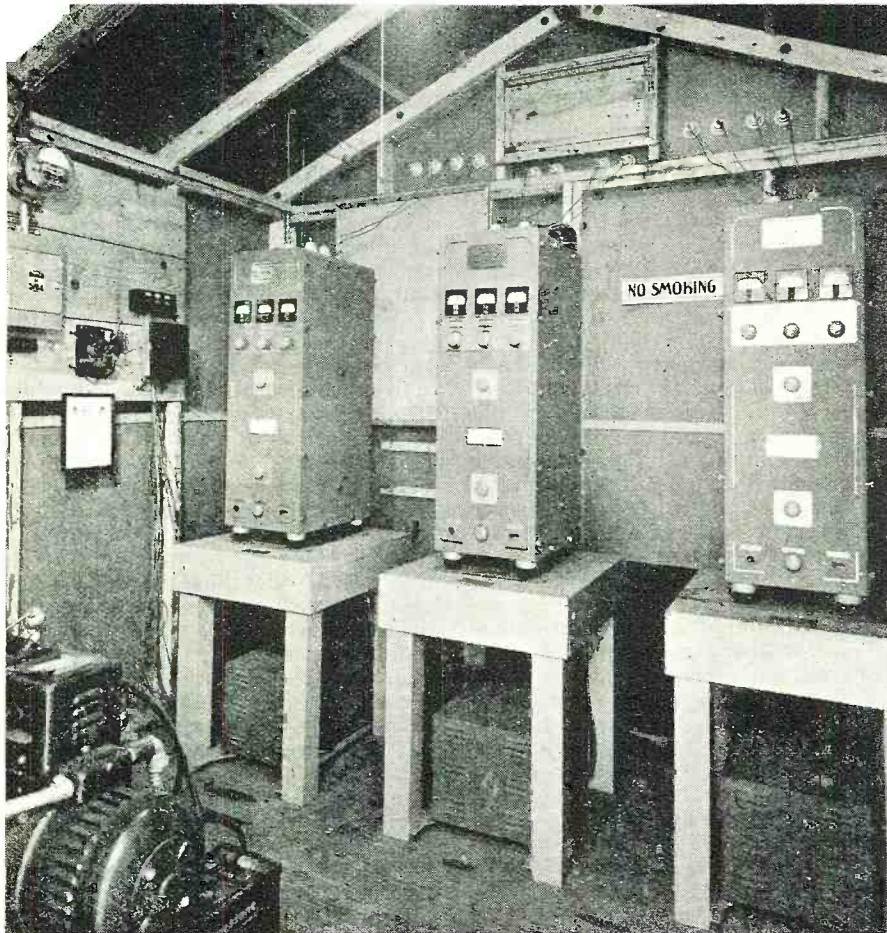

These three RCA transmitters are operated by remote control from the Cruising Room. They are used for emergency communications to other primary stations.

# End to End COMMUNICATIONS for TRAINS

By  
**ERNEST A. DAHL**

Electronic Eng., Rock Island Railroad

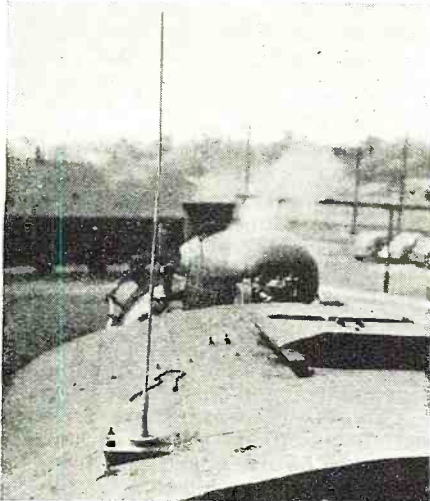

Quarter-wave whip antenna installed on top of locomotive used to handle freight.



Engineer of one of the Rock Island Lines' 5400 series freight diesels gets his "go ahead" or "hi-ball" orders by means of two-way FM radio.

## ***Operating procedures and results of the radio communications system installed by the Rock Island Railroad to facilitate handling of traffic.***

**I**N APRIL 1, 1944, the Rock Island Lines started a radio development program designed to develop and prepare material to be used as the basis for communication systems to be installed on the Rock Island Lines. In all, front-to-rear communications, yard operation, dispatcher to caboose operation, and the so-called "walkie-talkie" units were to be studied.

### **Power Supply Problem**

In all train communications, the first problem that presents itself is the standardization of equipment, and second, the problem of securing operating voltages from different types of primary power supplies. Diesel locomotives have a 64 volt battery which increases to 72 volts when the Diesel is running. Steam locomotives have a 32 volt d.c. power supply which is supplied by a steam driven turbine, while the caboose has no power source of any type.

Thus, it was decided to use all 110 volt, 60 cycle equipment, with the power supply, in all cases, built right on the transmitter or receiver combinations. Therefore, every transmitter and receiver would be interchangeable. Servicing would be easy since a.c. is available at all servicing points.

Hence, if trouble developed in the

converter itself or motor generator set, the power unit could be changed instantly, or if trouble should develop in the receiver or transmitter they could be interchanged with spare units available at all times.

For steam units a steam turbine connected directly to an a.c. alternator was designed. The a.c. alternator has a constant speed of 3600 revolutions per minute. Direct connection to an a.c. alternator provides 110 volts at 60 cycles at all times. This solved the power supply problem on the steam type of railroad locomotive.

The power supply on the Diesel locomotive, since 64 volts d.c. power was available, warranted the use of a converter unit designed to give 115 volts output with 70 volts on the primary. Therefore, while the Diesel is running, the battery voltage rises to 72 volts, the a.c. voltage rises to 118, and when the Diesel is standing still, the voltage drops to 64, and the a.c. voltage drops to 108. Any change in frequency due to the change in speed of the generator is not critical, as the power transformer will operate efficiently on as low as a 50 cycle power main.

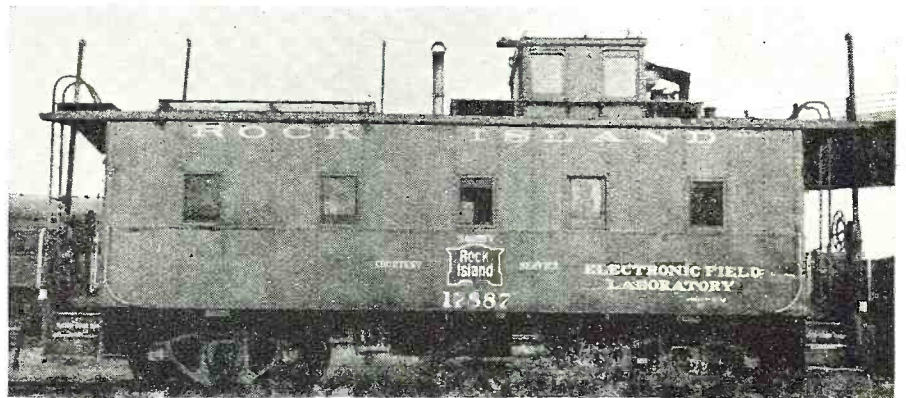

Fig. 1. Mobile electronics field laboratory built into an all-steel caboose. Tests and repairs can be made anywhere on the company lines.

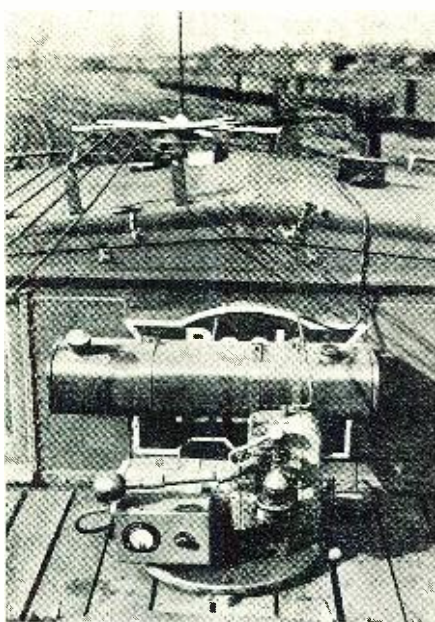
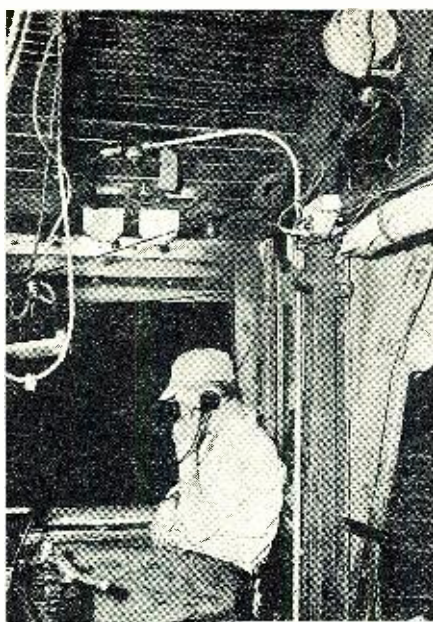

Fig. 2. Gasoline driven motor-generator unit installed on top of mobile laboratory.

The caboose power supply is designed around a 12 volt d.c. battery which is charged off a belt driven generator. The 12 volt batteries supply primary power for a 12 volt d.c. to 110 volt 60 cycle a.c. converter. Under normal operating conditions at a train speed of about 15 miles per hour, the wheel generator starts charging the batteries. On transmit, when the load is at maximum, the generator supplies enough power to float the battery, thus, under normal usage for train operation, the battery supply will stand up. With extended operation at a permanent location, the batteries must be replaced after every 15 hours of continuous use.

#### Laboratory Set-Up

In order to check various systems of operation, including microwave sets, 157 megacycle, 40 megacycle, and 80 kc., a field laboratory was set up. This laboratory is a new, all steel caboose.



Inside of locomotive cab, showing engineer in direct communications with dispatcher.

(See Fig. 1.) The caboose is equipped with a 1000 watt a.c. generator mounted on the roof directly behind the cupola. A five gallon gas tank is built-in to give 24-hour operation. The motor generator set and the gas tank are covered by a shield which gives a weatherproof covering from rain, but permits free air circulation for cooling. (Fig. 2.)

A work bench is built-in on one side of the caboose. The lower section of the work bench is equipped with storage batteries to provide 30 volts d.c. for the operation of airborne 157 megacycle equipment. The second half of the lower shelf is equipped with a 40 megacycle FM transmitter-receiver combination. This unit is used as a standard for office communication, securing materials, expediting materials, tuning antennas, and communication for comparing field strength measurements on other types of equipment.

Located on the top of the bench is a Hallicrafters FM-AM S-36 receiver, covering the frequency range from 27 to 143 megacycles, which is used for checking frequency, checking interference with other stations, and general communication work. A Hallicrafters communications receiver S-39 covering the frequency range from .55 to 30 megacycle, AM only, is installed here. (The receivers are shown on top of the bench in Fig. 6.)

In one clothes closet at the rear of the caboose, equipment shelves were built and an 80 kc. low frequency radiating system was installed, which, in turn, was connected to a loop which completely encircled the field laboratory. This loop is used in conjunction with producing a magnetic field which is induced in the telephone wires for dispatcher communications. A high frequency 157 megacycle transmitter-receiver combination as shown in Fig. 5 was also installed in the clothes closet. This unit contains both a receiver and a transmitter assembly and is connected by means of a coaxial cable to a quarter-wave ground-plane antenna mounted on the roof.

Two sets of controls are provided for all operation. All measurements are taken on the work bench itself by means of a vacuum tube voltmeter which provides a relative measure of signal strength by measuring the avc voltage in all receivers. Talking points for communications are set up in the cupola of the caboose itself, Fig. 7. The unit on the right hand side is connected to the 80 kc. low frequency radiating system. The telephone set and small loudspeaker in the center of the picture are connected jointly to both the 157 megacycle equipment and the 40 megacycle equipment.

This field laboratory was tied on a switching engine and pulled through the Burr Oak yards on the south side of Chicago in order to take measurements from a master control station operating from a control tower. The caboose is also used for line service to

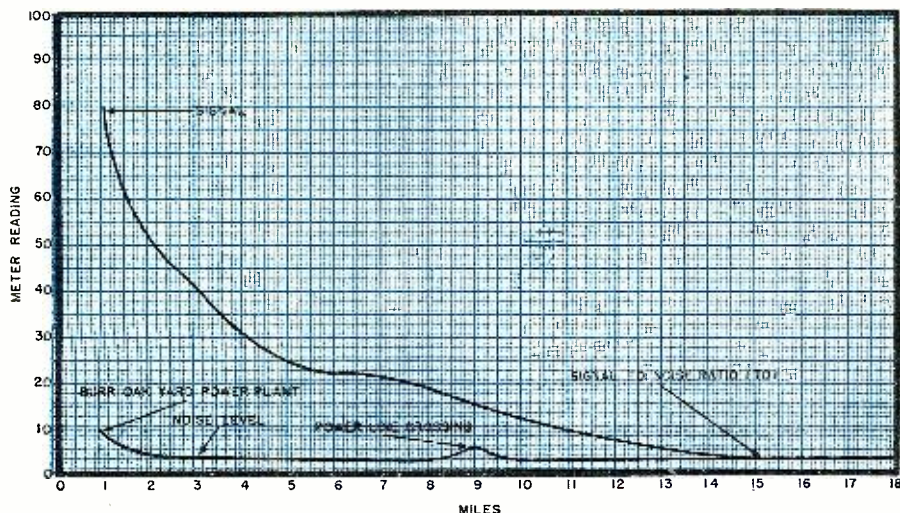

Fig. 4. Curves showing the radiation and field measurements made on equipment installed in locomotive at the Burr Oak Yard, Blue Island, Illinois.

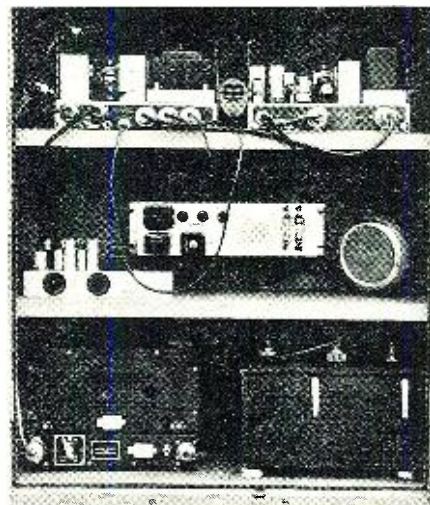

Fig. 3. Equipment of the master control station installed at the base of yard antenna.

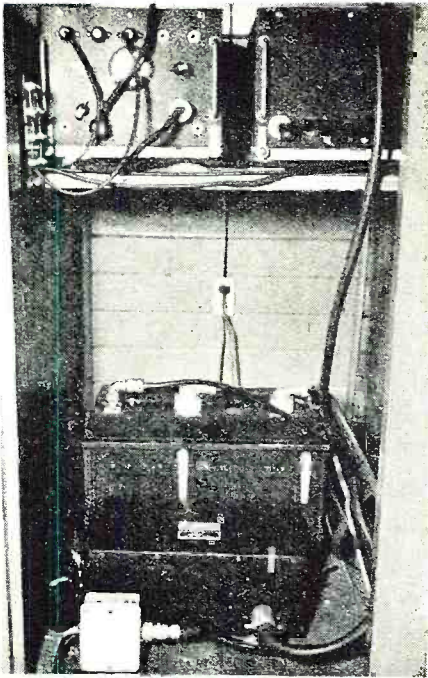

Fig. 5. High frequency, 157 megacycle transmitter-receiver installed in laboratory.

check the low frequency radiating system between Chicago and Rock Island, a distance of about 180 miles.

#### Master Control Station

The master control station itself is installed at the base of 100 foot lighting tower which is in the center of the Burr Oak yard. Two types of antennas were installed on top of the tower, a 40 megacycle co-axial antenna, and a "J"-type 157 megacycle antenna. Each antenna feeds directly down the tower into its respective transmitter-receiver combination.

Fig. 3 shows the case installed at the bottom of the tower which holds all equipment. The upper shelf contains a 40 megacycle FM transmitter combination. The maximum power output of the transmitter was 50 watts, but arrangements were made so that the power could be stepped down from 50 to 25 to 15 and to 10 watts so that an analysis could be made as to the maximum amount of power needed for dependable yard operations. The middle shelf contains a monitoring amplifier which bridges the telephone line which handles the signal for communication purposes. This provides a means of monitoring and servicing equipment while it is in yard operation. Also mounted above the middle shelf is a line-controlled relay circuit which provides, by means of d.c. voltage, a method for single telephone line operation for transmitting and receiving from remote control stations.

In normal operation the receiver output is fed through a relay into the telephone lines, over the telephone lines to a loudspeaker at a remote control point. When a signal comes in, the operator, if he is called, takes the telephone off the hook and pushes a button to answer. When the button is pushed it allows d.c. to flow in the tele-

*(Continued on page 112)*

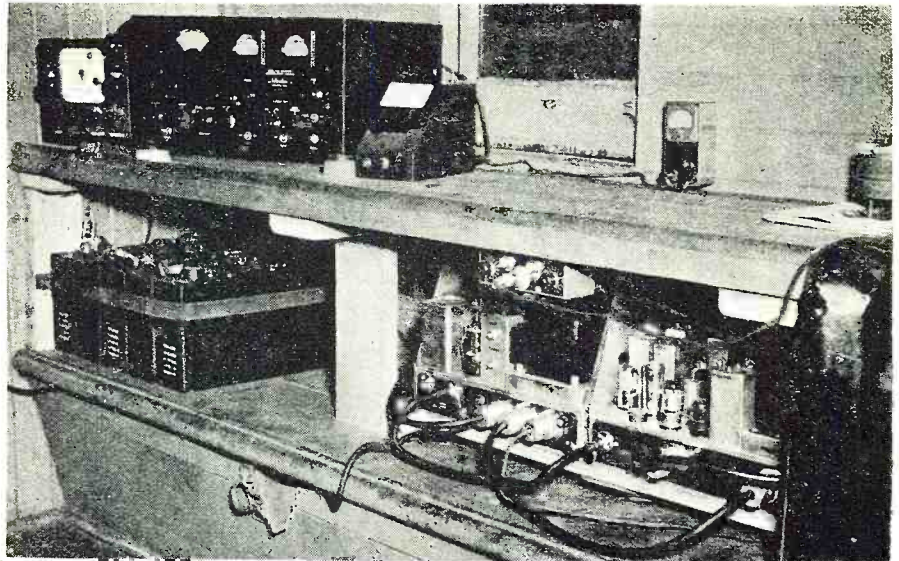

Fig. 6. Test bench installed in the mobile field laboratory, showing Hallicrafters S-36 and S-39 communications receivers. At the right is shown a 40 megacycle FM transmitter-receiver combination used as a standard for office communications.

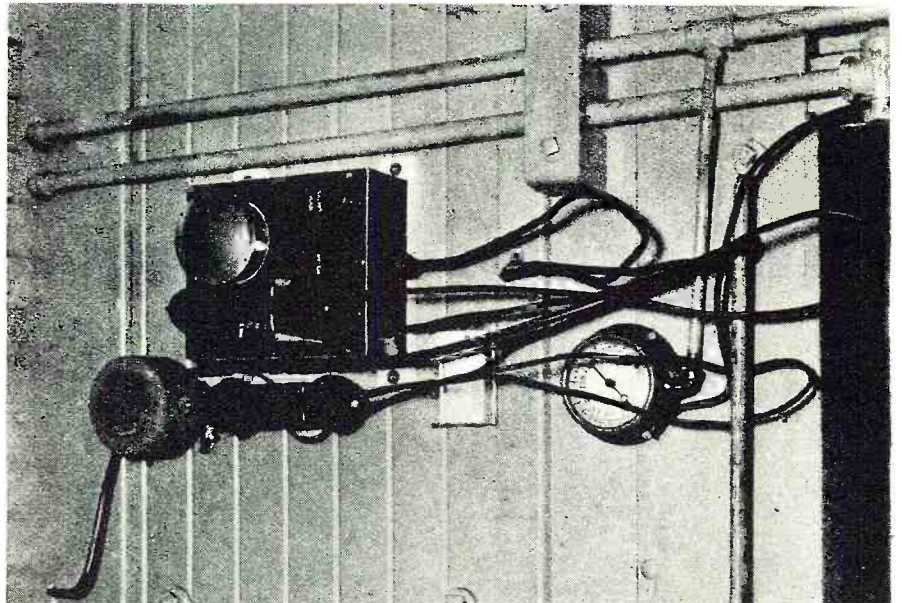
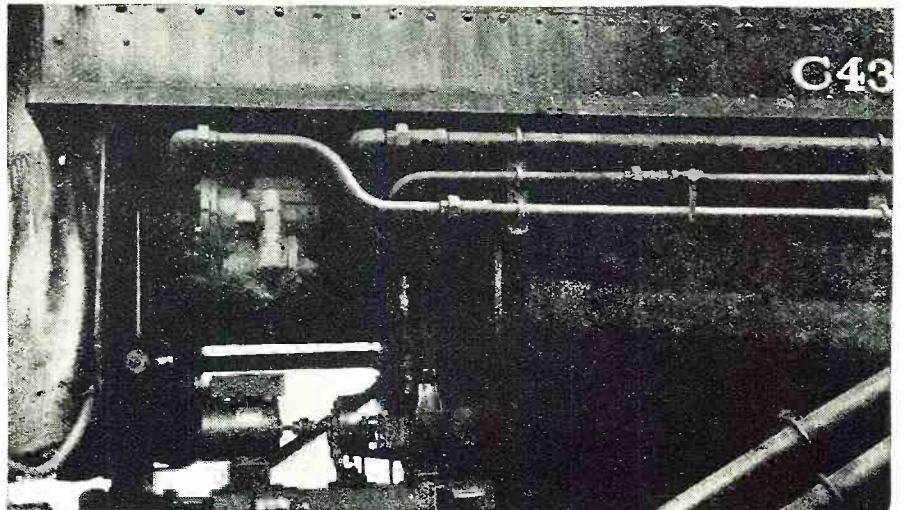

Fig. 7. Talking points for communications set up in the field laboratory. The upper unit is connected to the 80 kilocycle radiating system while telephone and small loud-speaker are connected jointly to the 157 and 40 megacycle equipment.



Power supply shown is used for radio equipment installed on steam locomotives. A constant speed, 3600 rpm alternator driven by a steam turbine supplies 110v. at 60 cycles.



Many servicemen must, of necessity, rewind small, defective radio transformers in view of present-day shortages.

## *Design tips for rewinding your own* **TRANSFORMERS**

By **JAMES E. DOLAN**

***Save those old transformer cores. Many of them  
can be used for self-designed units for special jobs.***

LACK of priority, special experimental work, urgency, a desire to design and construct your own transformer, any of these reasons may lead you to attempt the design and the construction of your own transformers. This article is intended to assist the prospective transformer builder who has been saving a stock of cores with the intention of making something out of them someday. To the constructor of transformers is opened the possibility of constructing transformers for his own special uses, to his own specifications, and in whatever electrical size he wishes.

As the experimenter generally plans to use cores which he has on hand, whether they be from some old discarded broadcast job, or something he overloaded once too often, or the parts of a pole transformer gained by a wise alliance with some local power company, this article will attempt to show how those cores can be put to good use.

The first consideration is the size of the cores on hand, both physical and electrical. Get a little notebook and then measure all of the cores on hand, putting this information into your notebook. Our first consideration of design will be the wattage of the transformer we are planning to make. Accordingly, it would be wise to list our transformer core stock in regards to the wattages which they will carry. Also listed, should be the thickness of

the core, the cross-sectional area of the center leg if the core is of the shell type, and the cross-sectional area of one leg if it is of the core type. The area and length and width dimensions of the window in the core into which the completed coils must fit should also be recorded. It is quite disconcerting to wind up a coil and then find that the window of the core is too small to receive the completed winding. It is well to allow 10% to 40% extra space allowance in making coil size computations unless you happen to have some sort of winding machine, such as a good lathe with proper change gears, on hand with which to wind your coils, as otherwise you are not going to attain the winding spaces shown in the common wire tables which give so many turns per square inch. Do not try to squeeze the wind-

ing into the least possible space; allow for your errors and the departure from perfection that you are sure to make.

The only tool required for the first part of our work is a good ruler; measure the outside dimensions of the cores, their length and width, the window area, and the thickness of the core. Compute the cross-sectional area from these figures. Remember to clamp the core up tightly when measuring the thickness, or an error will result in your computation.

The wattage that the core will handle is found by reference to the graph given for this purpose. This graph has the wattage ratings on the left-hand vertical column and the cross-sectional area is at the base of the graph. A curve on the graph is marked "Area to Watts." Find the cross-sectional area on the base scale and follow a



vertical line erected at the point representing the area up to the "Area to Watts" curve. Where this vertical line meets the curve draw a horizontal line to the left to the wattage column. This will indicate the wattage-handling capabilities of the core.

The next consideration is the use that is proposed for the cores on hand. If a requirement for a transformer comes up, have you a core that can be used for the purpose? That is the first question that must be answered; find the wattage. Wattage is equal to the product of voltage and amperage, or:

$$W = EI \dots\dots\dots (1)$$

Thus, we must multiply the voltage by the amperage of each secondary and add these together to find what wattage is required. Let us design and construct a transformer which will deliver 5 volts at 3 amperes with a center tap; 6.3 volts at 4 amperes with a center tap; and have a high-voltage winding of 450-0-450 volts and which will deliver 200 milliamperes of current. The transformer will operate on 115-volts, 60-cycle current. Applying our formula (1) we have,  $5 \times 3$  is 15;  $6.3 \times 4$  is 25.2; and  $450 \times 200$  milliamperes or .2 ampere, is 90. These products represent the wattages of the individual secondaries. Add them and the total secondary wattage is the result, in this case, 130 watts. The primary wattage is found by adding to this figure the losses in the core and windings. Usually these losses are about 10% of the rating of the transformer. Therefore, if we divide the secondary wattage by .9 we will find the primary wattage; thus:

$$W_p = \frac{W_s}{.9} \dots\dots\dots (2)$$

in which  $W_p$  represents primary wattage and  $W_s$  represents the secondary wattage.

If this is done, the primary wattage for the transformer is 144 watts. Let us call this 150 watts in order to secure an easy working value.

We can stop right here and consult our previously made chart in our notebook showing the cores on hand and the data on them. Have we a core on hand that will handle 150 watts? Perhaps a sheet of silicon steel must be purchased from a local steel dealer and cut up to make a core type transformer. Perhaps we have a 200-watt core on hand from which we can subtract a few laminations to use it for a 150-watt application.

Now, due to the power factor of the transformer we cannot divide this wattage value by 115 volts in order to find the current, but must take this power factor into account. As the power factor is generally about 90% we can find primary current by multiplying the primary voltage by .9 and dividing the primary wattage by this product.

$$I_p = \frac{W_p}{E_p \times .9} \dots\dots\dots (3)$$

If 115 volts is used for the primary voltage, this product ( $E_p \times .9$ ) becomes 103.5; if the primary voltage is

### NOMENCLATURE

W	Watts
E	Volts
I	Amperes
$W_p$	Primary wattage
$W_s$	Secondary Wattage
$I_p$	Primary current in amperes
$I_s$	Secondary current in amperes
$E_p$	Primary voltage
$E_s$	Secondary voltage
$N_p$	Primary turns
$N_s$	Secondary turns

110 volts, the product becomes 99. If we wish to secure an easy figuring value, we may call this product 100, which would represent a primary voltage of a little over 110 volts. If we use the factor of 100 in our proposed transformer design which has a primary wattage of 150 watts, we find that our primary current will be 1.50 amperes.

The next step in the design is the calculation of the turns in the windings. The graph indicates the primary turns for a 115-volt primary using a core flux density of 75,000 lines per square inch. As all types of steel will be in the cores that we shall use, it is necessary to pick out a value which is high enough for good operation and still not so high as to cause excessive core losses with the poorer grades of steel. This table is made by assuming the primary voltage as being 115 volts and the frequency 60 cycles per sec-

ond. It is easy to use the graph; having the core area (cross-sectional) on the base line, erect a vertical line from the base at the point representing the core cross-sectional area to the line marked "Area to Turns." At the point where this vertical intercepts the curve so marked, extend a horizontal line to the right-hand side of the graph where the turns in the primary circuit will be indicated.

Going back to the proposed transformer that we are building, it is noted again that the core has to carry 150 watts. Consulting our graph we find that the cross-sectional area required for this power of 150 watts is 2.2 square inches. The primary will have 270 turns of wire as shown by the "Area to Turns" curve.

As we have the primary turns from the graph, we can find the secondary turns for each winding by application of the formula stating that the ratio of primary voltage to primary turns is directly proportional to the ratio of secondary voltage to secondary turns. Mathematically this is:

$$\frac{E_p}{N_p} = \frac{E_s}{N_s} \dots\dots\dots (4)$$

This formula is made more usable by transposing it into a more workable form in which the factors are changed to indicate turns per volt rather than a proportional ratio problem. Thus, as turns per volt is the number of turns divided by the volt-

(Continued on page 138)

Fig. 1. Follow these curves carefully, when designing your own radio transformers, to obtain maximum efficiency and operating performance.

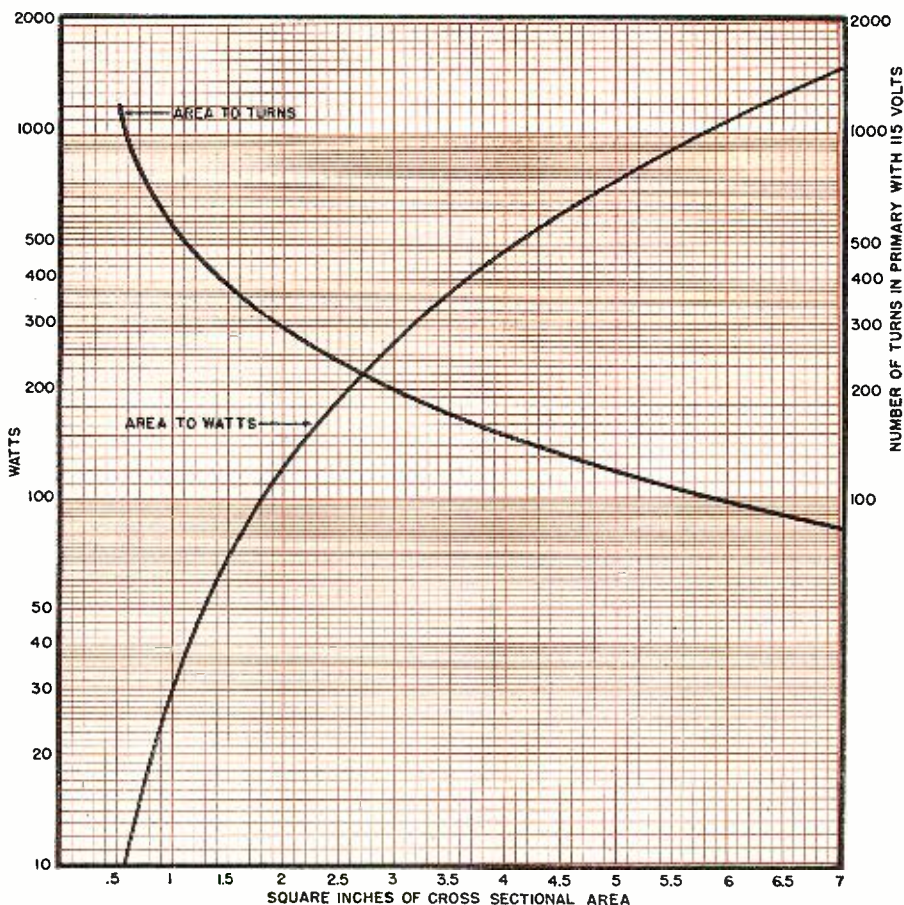

# Master Tube Tester

By **HARRY G. BURNETT**  
Hytron Corporation

**Deluxe test console for production testing miniature to medium-power transmitting type tubes.**

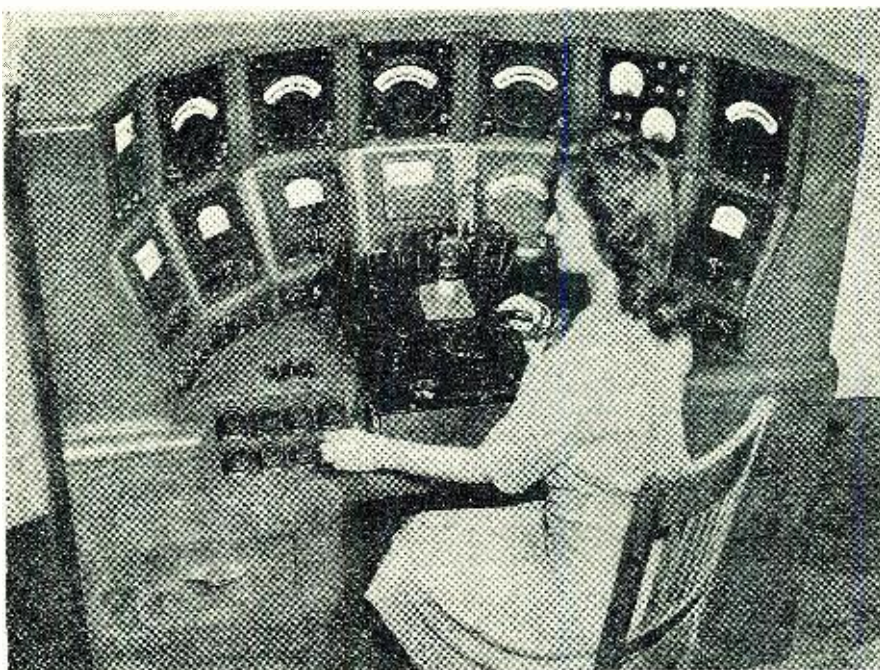

The versatility of this test unit permits highly accurate measurements of the major characteristics of many types of tubes.

DISSATISFACTION with the limitations of previous kits for production and quality testing of vacuum tubes, led Hytron engineers to design a master test kit which incorporates many features. Flexibility, simplicity of operation, automatic electronic fusing, automatic electronic switching of meter ranges, sufficient power supplies—all voltage-regulated, avoidance of parallax, standardized

components, and ease of serviceability were incorporated into the master test station illustrated.

The scope of possible measurements is highlighted in the accompanying table. For the sake of simplicity, only the over-all ranges are shown, but the choice of ranges for a given measurement is wide. For example, plate current ranges are as follows: 0-10-20-50-100-200-500-1000 ma. If necessary, ex-

ternal meters can be patched into the circuits for even greater diversity.

One of the most interesting features of this deluxe test console is the automatic range control for voltmeters. If the applied potential is increased beyond the range of a given meter scale, a thyatron and associated relay automatically switch in the multiplier for the next higher range. Simultaneously a pilot lamp on the instrument panel lights over the appropriate full scale value engraved on the panel.

Another novel electronic application is the fuse protection for all current meters except filament current meters (these are conventionally fused). This electronic fuse protection is automatically changed for different ranges. An ingenious circuit permits this same electronic protection even when the range of the measuring instrument is less than the current drawn by the voltmeter itself. A completely shorted tube may be inserted into the test socket without injuring a single instrument.

In designing this test station, the engineers incorporated voltage-regulated power packs throughout. The only exception is a 14-volt storage battery (equipped with automatic battery charger) for the lower d.c. filament potentials. The voltages of these regulated packs are essentially constant from zero to maximum, because a separate regulated pack supplies the control tubes. Once the test kit is adjusted for a given type of tube, no re-adjustments are necessary as different tubes of that type are plugged into the test socket. Two rheostats in the grid circuit of each control tube permit both coarse and fine adjustment of the supply voltage.

A glance at the photograph of the  
(Continued on page 64)

## Scope of Possible Measurements Hytron Master Test Station

CHARACTERISTIC	OVER-ALL RANGE	NO. OF RANGES	INSTRUMENT
Filament Voltage—d.c.	0-150 v.	3	Weston Model 430
Filament Voltage—a.c.	0-130 v.	Plug-in meters	Hickock Model 49X
Filament Current—d.c.	0-10 amp.	6	Weston Model 430
Filament Current—a.c.	0-10 amp.	Plug-in meters	Hickock Model 49
Heater-Cathode Voltage	0-300 v.	2	Weston Model 45
Heater-Cathode Current	0-1000 microamp.	3	Weston Model 741
Plate Voltage	0-750 v.*	3	Weston Model 45
Plate Current	0-1000 ma.	7	Weston Model 45
Control Grid Voltage	0-100 v. (pos.)	3	Weston Model 45
	0-100 v. (neg.)	3	Weston Model 45
Control Grid Current	0-50 microamp.	4	Weston Model 741
Screen Grid Voltage	0-750 v.*	3	Weston Model 45
Screen Grid Current	0-15 ma.	3	Weston Model 430
Suppressor Grid Voltage	0-100 v. (neg.)	3	Weston Model 45
	0-300 v. (pos.)	3	Weston Model 45
Suppressor Grid Current	Any required range	External meters	Weston Model 45
Emission Voltage	0-100 v.	1	Weston Model 45
Emission Current	0-1000 ma.	3	Weston Model 741

Transconductance  
Amplification Factor  
A.C. Plate Resistance } Full coverage of these characteristics with the electrode potentials and currents listed, is obtained by a built-in General Radio 561D vacuum tube bridge.

\*A supplementary power supply may be switched in to extend range to 1500 volts.

Each section of multi-section tubes may be measured separately. Dynamic measurements of rectifiers and converters are made on separate apparatus, because they present such different problems.

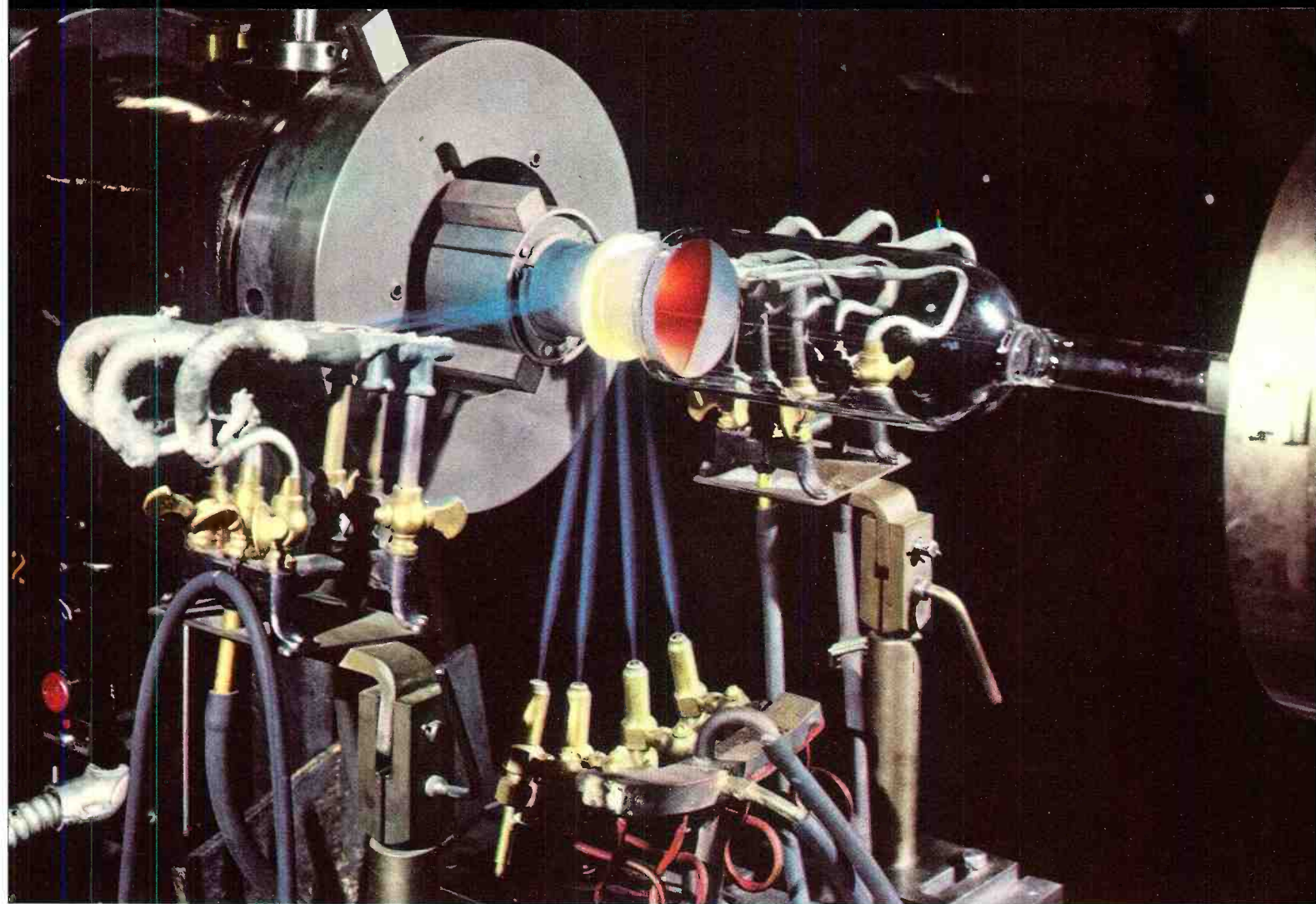

↑ Hydrogen-oxygen fed gas jets are used to seal base to envelope of electronic tube.

↓ Tube elements are brought to white-hot temperature during final stage of evacuation.

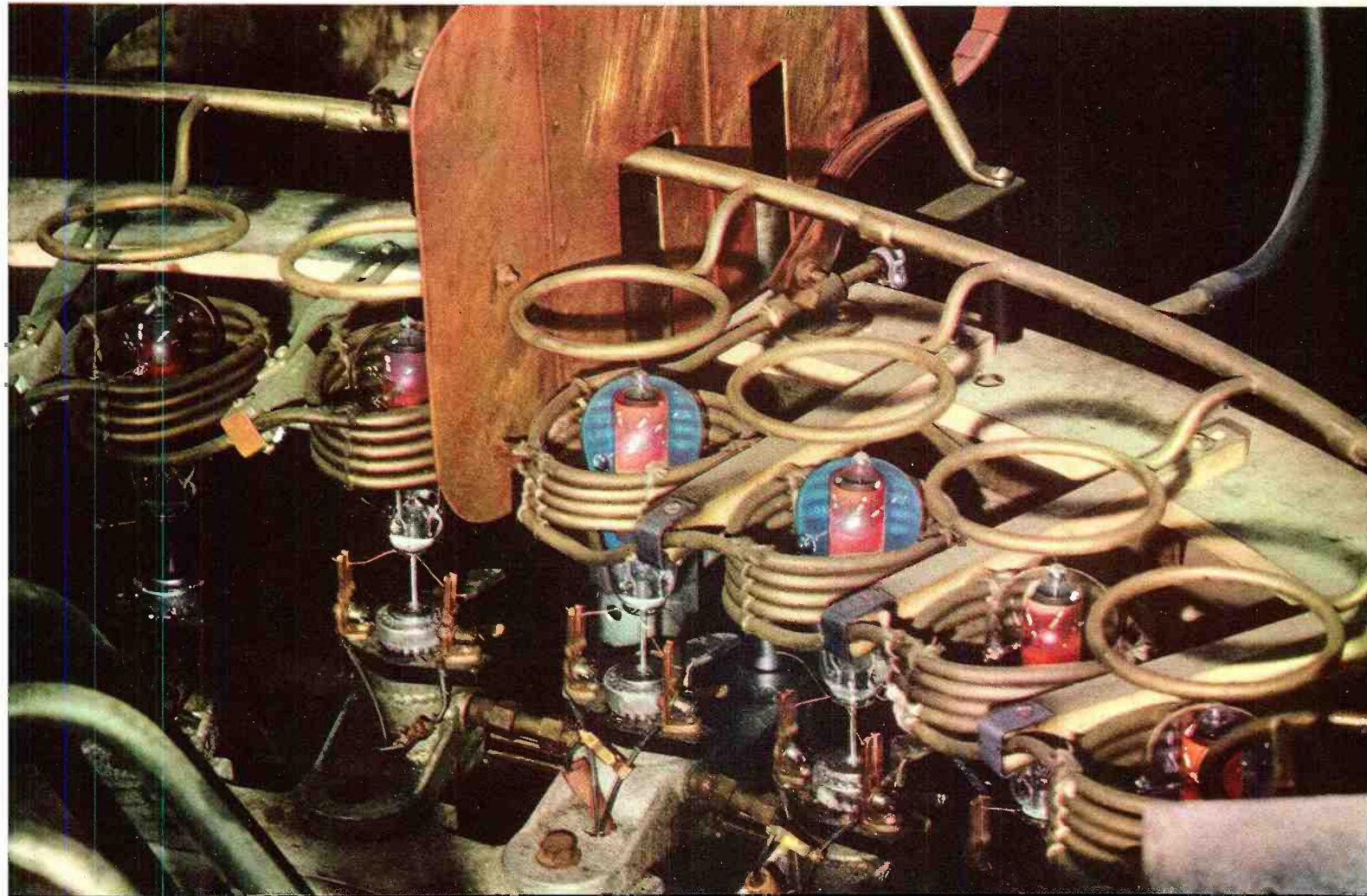



Operators wearing asbestos gloves feed dual UHF transmitting tubes into automatic assembly machine.



(Left) Action in control tower at Chanute Field. Weather conditions permitting, the signal light gun may project a powerful multi-colored beam of light for a distance of 11 miles in daytime; at night the gun may pierce to a distance of 15 miles. (Center) Officer at microphone is giving landing instructions to an approaching plane. The Chanute tower operator instructs the pilot to land on a specified runway and from the proper direction. The center weather instrument panel houses wind velocity and wind direction indicators, clock, and altimeter. (Right) One of AACS's busiest control towers at Mitchel Field, Long Island. The sergeant with binoculars is looking for a plane late in arrival, some seven miles distant.

# THE GREAT SPIDERWEB

*An intriguing story of war-born AACS, an outfit of rugged young Americans operating under Army Air Forces command, and officially known as the Army Airways Communications System.*

**By Pfc. H. D. COLSON**  
78th AAF Base Unit  
and  
**S/Sgt. R. C. Fleischman**  
Technical Advisor

**H**OW little is known about the AACS is indicated by a personal survey which I conducted some time ago in Chicago. I halted fifty officers and enlisted men one afternoon, asking each what he knew about AACS; forty-two of them had never heard of AACS; one of them was a Major in the Armored Command.

Although the AACS boys have often operated under Hirohito's nose in the South Pacific and in vainglorious Hitler's Mediterranean backyard, the obscure tale of AACS can best be told by narrating the adventures of a typical AACS expedition, the famed Baffin task force, for instance. This is a remarkable episode never before published, released now for the first time since Pearl Harbor only because Intelligence has relaxed certain restrictions. What was accomplished on this mission is herein revealed for the first time.

The youthful Americans who made up this neoteric pioneering force sailed from New York City unexpectedly one

cold October morning—destination unknown!

"We left with orders sealed, of course," Sergeant Leonard L. Barnes, former radio repairman of Elgin, Oregon, was reminiscing. "We didn't know where we were going but we had a hunch it was North because of the heavy clothing issued. On the first day out a peculiar notice was posted on the ship's bulletin board:

**"NO OFFICER OR ENLISTED MAN WILL BE PERMITTED TO TAKE A BATH UNTIL FURTHER NOTICE."**

"Twenty-three days passed; we still hadn't had a bath. But on the 23rd day we were too excited to worry about bathing for we had arrived at our destination—a God-forsaken strip of desolate bleak Arctic wasteland. It was 9:00 a.m. and the sun was beginning to rise; it was still pretty dark when we started unloading supplies. On the 24th day some of us decided to take a bath even though there was a

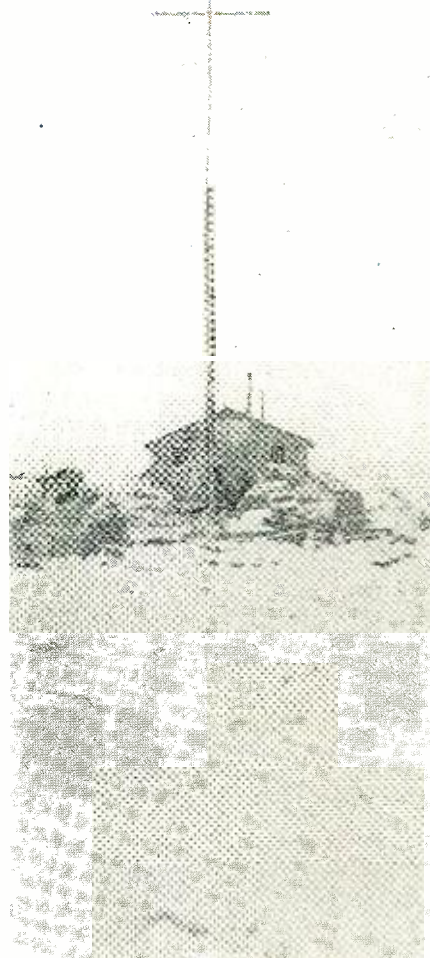

AACS station going up—the radio and weather equipment is the first to be put into operation. The transmitter building was assembled from prefabricated parts transported from the United States.

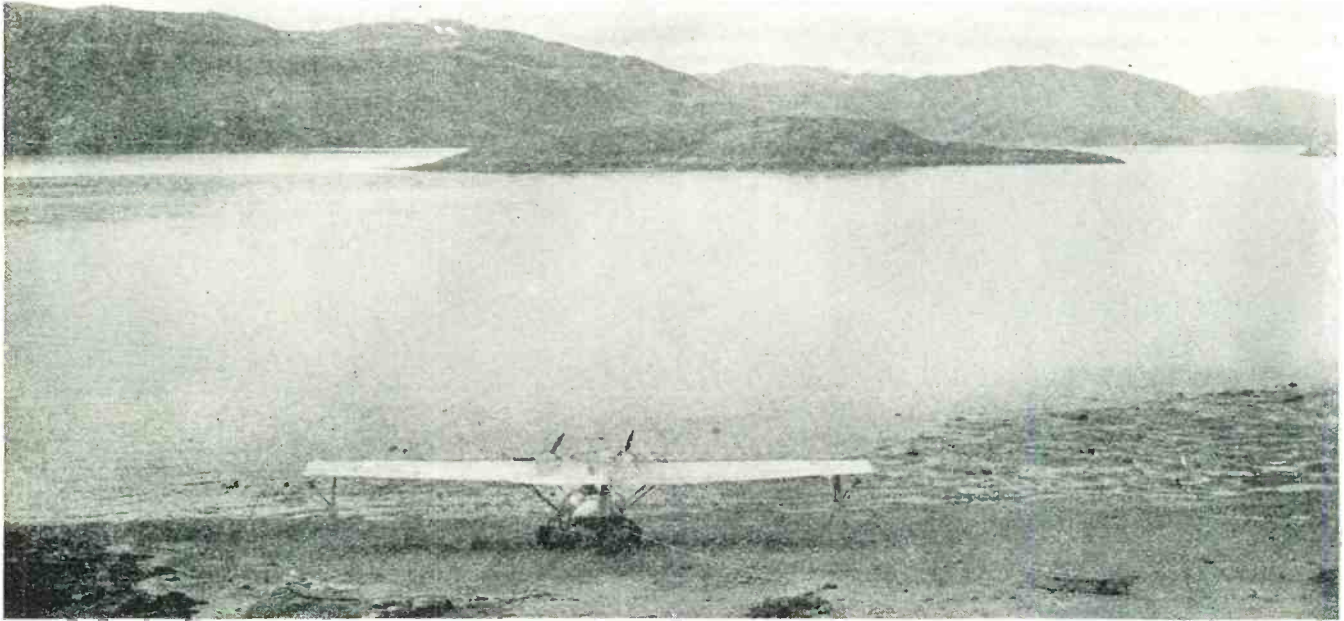

The most effective contact with civilization from Baffin Land was this Navy PBY Flying boat, shown on the Frobisher Bay Beach at low tide. An anchored steel cable is attached to its tail. Supplies, food, and personnel are transported to Baffin via this huge flying boat. Flights are infrequent, three being made to this AACCS outpost during a period of 14 months.

shortage of H<sub>2</sub>O and it would be another week before our machinery could be set up to melt snow. The water was used sparingly. We used only two gallons for a bath.

"Melted snow was soon to be used for practically everything—drinking, cooking, washing, bathing, and what have you. . . .

"Our dog team driver, pensive, easy-going Private Tony Colombo, was the only one in the outfit of two officers and six enlisted men who had ever been in the Arctic regions before. Tony had made two previous trips with Admiral Byrd. Tony commanded a lot of respect; he was the 'character' of our little group; he had a long

black beard, a pair of piercing black eyes, a furrowed brow, and was the silent type, always the thinker—"

A faraway look came into the sergeant's eyes. "We had the antenna masts up and the station on the air almost before we knew it. Prefabricated parts were used to set up our first building. Gruelling 15-hour work days followed. All track of time was forgotten in the rush; we seldom knew when Sunday came. The officers pitched in with us. Captain Crowell, our CO, and Captain Joachim, our medical officer, were gluttons for punishment . . . I mean the physical and mental punishment of back breaking toil. Both officers helped us dig

ditches, erect buildings, set up latrines, and raise the antenna masts like any buck private on a labor detail. They were there to do an incredible job. The passion with which they did it was an inspiration to us. The 'Doc' drilled the anchor holes in the rocks for the antenna rigging. His soft *medical* hands were soon calloused. His fingers were stiffened from the rough work and the exposure to sub-zero temperatures. Captain Crowell skinned up the icy vertical antenna pole to attach the guy wires; his feat was dangerous, the most dangerous of the whole damn job as a matter of fact for one slip might mean a broken limb, a permanent body injury. None of us relished the idea of climbing that icy antenna pole. Our CO insisted on doing it.

"Yes, we worked desperately. We had to," the sergeant exclaimed, "because every moment was precious. Thousands of lives could easily depend on the vital information our little remote radio station could convey, if conveyed to the proper place at the opportune moment.

"On one midsummer morning, at 3:00 a.m., Private Barrett awakened everybody in the barracks, excitedly hallooing at the top of his lungs. A load of coal had arrived on the supply schooner; it was imperative that we unload it before the tide went out. Sleepily we dragged ourselves out of our bunks to unload thirty thousand pounds of coal, by relays, in 200 pound burlap bags; each bag had to be carried half the length of a football field. That was a morning I'll never forget. We were dead on our feet before we started—we had had only about four hours sleep the night before—and those 200 pound bags got heavier by the minute. Three hours later we were finished, breakfast was ready, and we were ready to start our regular



The arrival of Col. Storie and Col. Wilmer Allison. They were the first white men to arrive by air to inspect AACCS facilities at "Crystal 2" (code name for location).



Hudson Bay Co. schooner "Nanook" transported supplies, technical equipment, and personnel to the north country.



Valuable radio parts and equipment were salvaged by the crew of this crashed plane and presented to AACS. Everyone aboard at the time of the forced landing survived and were cared for by the American task force at "Crystal 2".

day's work. Incidentally, Private Barrett ate 17 hotcakes that morning for breakfast.

"We had a narrow escape one night," Sergeant Barnes grimaced as he recalled the incident. "It was a howling blow, a snowstorm, the likes of which I had never seen. Even Tony was taken by surprise. The wind got up to over 75 m.p.h. and suddenly the building started trembling; it was like an earthquake. Tony casually informed us that one end of the building had probably been lifted off the ground by the wind. Yes, there was a possibility that the building would be blown away at any moment. Nonchalantly he told us, much in the same

dry matter-of-fact way that he would call a ten cent bet in a penny ante poker game. The wind let up a little along toward morning; we dashed outside with picks and shovels, dug into the ice and snow, piled great quantities of the stuff against the house, and cabled it down as best we could, thus preventing the blow from lifting the barracks off the ground.

"After we had been in Baffin about seven months we had our first mail call. A big Liberator flew over and dropped mail on the back doorstep of the kitchen. I'll always remember that day as one of the happiest of my life. The thrill of anticipation shot through us all; tremblingly we ripped

open envelopes, packages and home town newspapers; a spell of silence swept through the barrack and there were smiles and tears and we all understood. . . ."

Sergeant Barnes grinned broadly. "Another red letter day I'll never forget was the arrival of Colonel Storie and Captain Allison. They were our first visitors from civilization. We didn't attach a helluva lot of significance to the fact that they were the first two men ever to land an airplane here. Actually the only other planes we had seen were a Nazi reconnaissance, a PBY, and the B-24 that dropped mail. Anyhow, it was a gala

*(Continued on page 88)*



An Army B-24 drops mail—which was the first mail call in almost 7 months. It is impossible for a large plane to make a landing in this area of Baffin Land. Directly below the plane in flight may be seen the fuselage of a wrecked Canadian plane.

# "Limits Bridge" for Production Testing

By **McMURDO SILVER**

Vice President, Grenby Mfg. Co.

*The design and construction of a bridge unit used for rapid production testing of resistors, capacitors, or inductors.*



Fig. 1. Completed unit showing simplicity of panel layout, necessary when applied to production testing techniques.

IN THE large volume prewar manufacture of civilian radio broadcast receivers, tolerances of component parts were rather liberal. It seldom mattered in the design or production engineer's eyes if resistors and fixed capacitors differed from specified values by as much as 20%, either high or low, or whether such variation occurred within one receiver or between successive receivers. With mili-

tary radio equipment requirements, exceeding in stringency of specification anything heretofore considered feasible in quantity broadcast receiver manufacture, the problem of insuring a close and specified order of identicalness both between specified and actually used values, and between values of component parts in successive equipments, has become a "must."

In civilian production in prewar

days occasional "spot-checking" was deemed sufficient in most cases but was not regarded as necessary in many factories. Thus a few resistors or capacitors out of each lot received, might be tested for conformity with purchase specifications, but no attempt was made to test each and every such component going into equipment production. For such "spot-checking" the total amount of labor involved was not great, and inefficiency could be tolerated. The usual form of such inefficiency was to employ laboratory-type measuring equipment designed for independent and analytical investigation of all significant characteristics of the component under measurement. This method was inefficient because the test equipment was usually of so complex a character that it required considerable time and skill to manipulate, and because it was delicate, the equipment could easily be damaged by unskilled or careless operation.

Because of lack of prewar demand among radio manufacturers, there were no production test instruments available which were capable of either the required accuracy, speed and simplicity of operation, or of the required ruggedness and freedom from damage and derangement when manipulated by unskilled operators. The requirement of large volume production of precisely controlled military radio and radar equipment, coupled with the inescapable need of obtaining such production from "green" workers which frequently fell below the average of skill available before the war, has put a premium upon the design of simple

Fig. 2. Bottom view of chassis showing cabled wiring and an unusual lack of miscellaneous components. Chassis is assembled in a position vertical to the front panel.

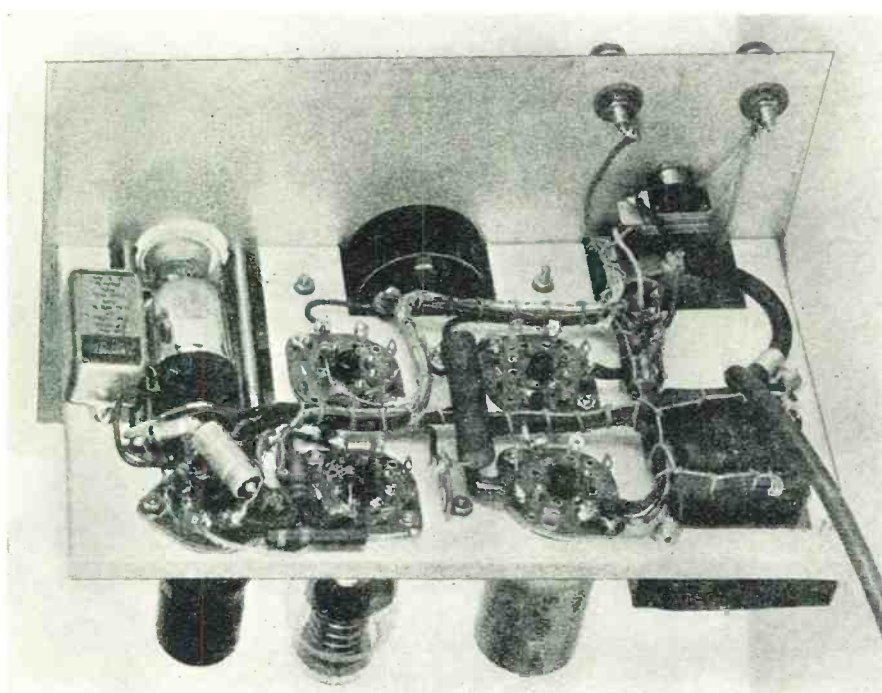



and rugged, yet withal accurate, production test equipment.

The instrument illustrated and described herewith is one answer to this demand. Nothing like it can be procured upon the open market, with or without priorities. The engineering department of The Grenby Manufacturing Company had to design and build it without precedent. The problem that it was designed to solve, and which it and its numerous counterparts throughout the factory have solved, is the maintenance of identicalness of resistors and capacitors used in large quantities during each operating shift. This, the "limits bridge" accomplishes in a most satisfactory manner, even when operated by workers who have had as little as five minutes instruction in its use. The combination of high accuracy in operation coupled with an extraordinary leniency in worker skill required, together with its ease of construction in the average factory test equipment shop (or its low purchase price) should make it of interest to all manufacturers who have faced the problem of supplying precision components.

Basically the limits bridge is an a.c.-operated Wheatstone bridge in its simplest form. The use of a.c. as a power source not only dispenses with the only too frequently run-down dry batteries of more complex laboratory-type instruments, but allows the single instrument to function most satisfactorily for comparison of unknown against known standards of mica, paper and electrolytic capacitors as well as fixed resistors—not to mention check on inductors. In order to provide maximum flexibility in operation no "standard" resistors, capacitors or inductors are built into the instrument. Instead two pairs of binding posts are provided. To one pair the "standard" for the value and type of component to be tested in a given run may be connected. The unknown component may then be connected to the "TEST" binding posts, or for rapid testing, by having its leads or lugs brought into contact with a pair of knife-edges which are, in turn, connected to the "TEST" terminals. Thus, the operator can hold the test specimen against the knife edges with one hand while manipulating the percentage difference knob on the instrument panel for maximum magic-eye closure.

With the shortage of meters and their susceptibility to damage in any bridge simple enough for production usage, and because no absolute indication of current or voltage is necessary in a bridge, a magic-eye has been used as a null, or balance, indicator. Since the degree of closure cannot be calibrated in a production-test instrument, the idealized concept of a limits bridge in which a meter indicates visually and directly plus or minus deviation of a test specimen from a standard may not be economically achieved. It is perfectly possible to build a bridge with a meter to indicate di-

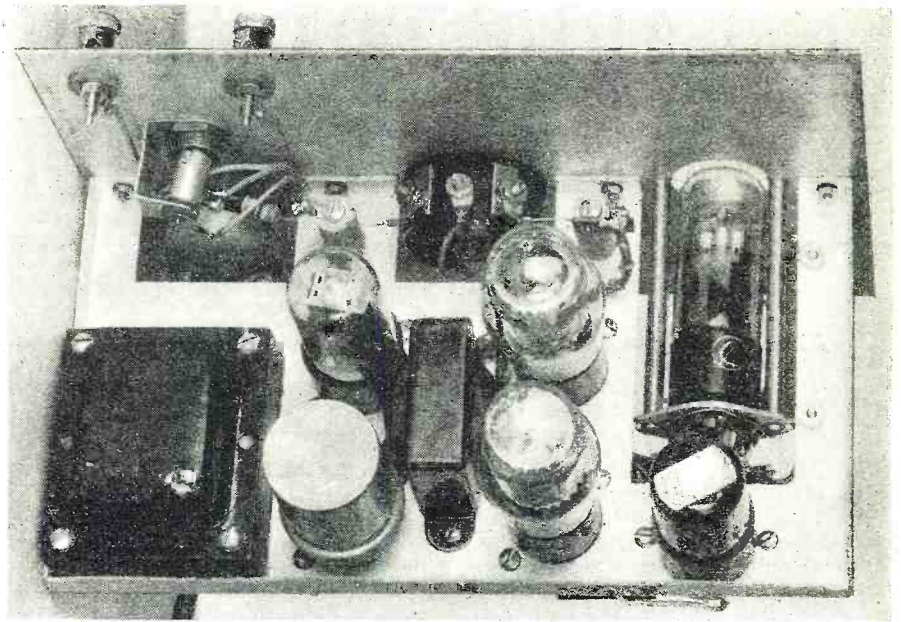

Fig. 3. Top view of chassis showing the placement of component parts.

rectly the deviation of a test from a standard specimen, but such an instrument will be delicate and liable to damage in unavoidably rough production operations and will be costly and complicated. It will require some protective switch to be operated when the test specimen is properly connected in order to protect the costly and difficult-to-obtain meter—a switch which can fail in its basic protective purpose

if the operator becomes careless and does not first make good connection of the test specimen to the bridge. Thus the magic-eye, which is not hurt by probable operating overloads, seems the logical choice for a null, or balance, indicator.

Such choice involves one manual control to effect balance, with the percentage of difference between stand-  
(Continued on page 100)

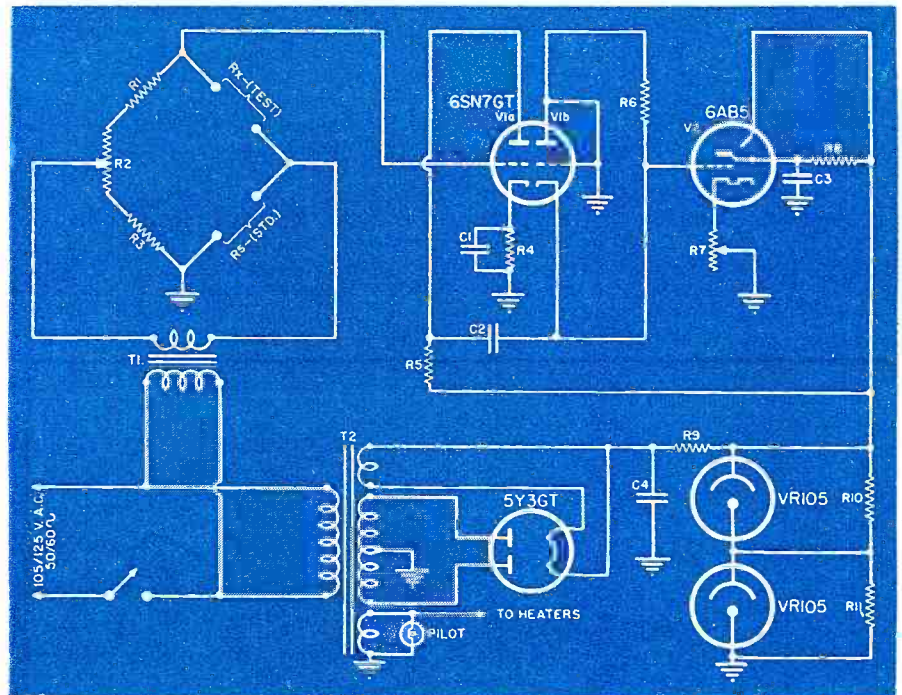

Fig. 4. Diagram of test unit. The heart of this unit is the Carey-Foster bridge circuit which permits comparison measurements to within 1% by a skilled operator.

- |                                                                  |                                        |
|------------------------------------------------------------------|----------------------------------------|
| $R_1, R_2$ —8,000 ohm, $\frac{1}{2}$ w. res. $\pm \frac{1}{2}\%$ | $C_2$ —.1 $\mu$ d, 400 v., tub. cond.  |
| $R_3$ —2,500 ohm, $\frac{1}{2}$ w. res.                          | $C_3$ —.25 $\mu$ d, 400 v., tub. cond. |
| $R_4$ —1,500 ohm, $\frac{1}{2}$ w. res.                          | $C_4$ —8 $\mu$ d, 400 v., elec. cond.  |
| $R_5, R_{10}, R_{11}$ —100,000 ohm, $\frac{1}{2}$ w. res.        | $T_1$ —Audio Freq. Trans. UTC-R34      |
| $R_6$ —1 megohm, $\frac{1}{2}$ w. res.                           | $T_2$ —Power Trans., UTC-R6            |
| $R_7$ —10,000 ohm, 1 w. res.                                     | Tubes—1-6SN7GT                         |
| $R_8$ —250,000 ohm, $\frac{1}{2}$ w. res.                        | —1-6AB5                                |
| $R_9$ —10,000 ohm, 10 w. res.                                    | —1-5Y3GT                               |
| $C_1$ —8 $\mu$ d, 200 v., elec. cond.                            | —2-VR105                               |

# RADIO COMMUNICATIONS IN THE FIELD\*

By Lt. Colonel STEVE GADLER

Signal Corps Instructor, Command and General Staff School

*The proper operation of radio communications when used as a reliable and flexible means of coordinating highly mechanized ground and air forces.*

**B**EFORE our entry into the present war military experts and observers were of the opinion that the success of modern fast-moving military "blitz" tactics was in direct proportion to the efficiency of the signal communications system employed.

The secret of German successes in Poland, Belgium, and France has been attributed to the very efficient and reliable system of signal communications employed to coordinate and control the operations of the highly mechanized, fast-moving panzer divisions with the Luftwaffe.

The old approved and tested signal agencies such as were provided by wire lines, visual aids, messengers, sound, and pigeons were adequate for the needs of the slower moving armies of World War I. The military tactics employed in the last war enabled the signal agencies, as then known, to furnish adequate signal communications for the slower military machines which moved only a few miles in any operation.

The tactics employed in the present war produce changing battle lines ranging over great distances best exemplified in the African campaign. In operations of this type, moving hun-

dreds of miles in a day required reliable signal communications between the commander and his widely separated ground divisions and between the commander and his air units. Obviously, the effectiveness and efficiency of his command depended on a highly reliable system of signal communications.

Quite naturally, wire lines, which require time for installation, messengers, or other slow methods could not be effectively employed. An agency was required that possessed the desirable military characteristics of reliability, speed, security and flexibility. Radio, the agency of signal communications possessing the characteristics of speed and flexibility, met the demands of modern military tactics. It is capable of transmitting voice infallibly over long distances, flexible to cover a wide range of frequencies, able to operate while in motion or at fixed locations under all types of weather conditions ranging from the heat and sand storms of the desert, the humidity of the jungles, to the extreme low temperature of the North. Radio is employed to provide the signal channels necessary for the control of the fast-moving tactics of modern war.

Since this important means of signal

communications of modern warfare is employed for tactical control of both ground and air units, for flight control of aircraft, for fire control of weapons, for administrative purposes, for liaison, and for aids to air and sea navigation, it is essential to understand the proper employment of radio for correct and efficient operation, and to understand some of the limitations placed upon it by nature and the handicaps imposed upon it by man.

## Radio Channels Are Crowded

Nature, in creating the frequency spectrum, made provision for the frequency bands upon which depend radio communication channels but disregarded man's requirements and demands for radio channels in time of war on the limited number of radio communication channels available, especially when it is understood that almost all radio channels employed as signal channels for war purposes operate in the h.f. and v.h.f. bands. Each radio channel requires a width of approximately one-tenth of one percent of the frequency value in kilocycles. For example, if the frequency employed is 10,000 kilocycles, the band width would be approximately ten kilocycles.

Radio frequencies are divided into groups or bands. For military purposes they are divided into the following bands:

VLF—Very low frequency.....	.....below 30 kc.
LF—Low Frequency .....	.....30 kc. to 300 kc.
MF—Medium frequency.....	.....300 kc to 3,000 kc.
VHF—Very high frequency.....	.....30 mc. to 300 mc.
UHF—Ultra high frequency.....	.....300 mc. to 3,000 mc.
SHF—Super high frequency.....	.....above 3,000 mc.

Frequencies above 30 mc. are limited in range and are classified as "line of sight" frequencies. United States commercial broadcasting stations operate with the medium frequency band varying from 550 kc. to 1600 kc.

A commercial broadcast station in the United States received a letter

\* Reprinted from the July, 1944 issue of MILITARY REVIEW.

Fig. 1. Skip distance effect of the sky wave, causing unpredictable radio communications.

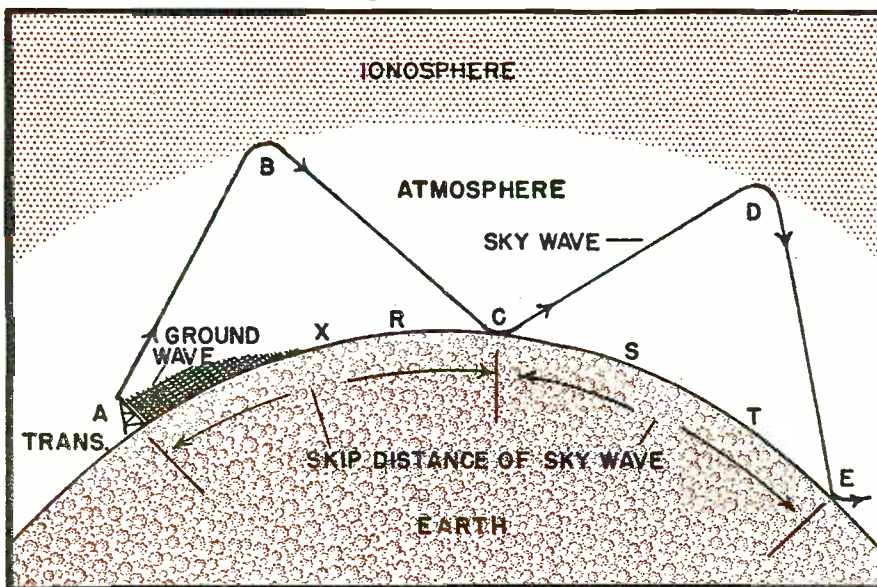

from a marine stationed somewhere in the Southwest Pacific informing the station of his enjoyment in being able to receive a high frequency broadcast transmitted by his home-town radio station. The power output of this station's high frequency transmitters precluded reception at such great distances and confirms the fact that radio is sometimes unpredictable. On the other hand two British units operating in the African desert early in 1940 found they could not carry on radio communication even though they were less than seventy miles apart. The power output of the transmitter was increased and new antennas employed, but still communications could not be carried on between the two units. Friendly stations located many hundreds of miles away heard the two units and in fact enjoyed very good reception. The problem of signal communication in this instance was easily solved by employing the receiving stations many hundreds of miles away as relay points for the traffic from these two closely adjoining units. The enemy unquestionably also enjoyed good reception. This phenomenon in radio is known as the "skip distance," or the area of "no signal" and has been known to scientists for a long time.

Possibly one of the best illustrations of the "skip distance" concerns the doughboy stationed on Guadalcanal who happened to tune his receiver to his favorite American short-wave broadcast station and to his amazement picked up the World Series broadcast. Series games are also broadcast after the event by short wave to our armed forces throughout the world. Naturally, knowing the outcome of the World Series before the regular short-wave broadcast enabled him to give vent to his gambling instinct and place bets with other soldiers at great odds without danger of loss to himself.

From a brief study of Fig. 1 the reasons for the apparent unpredictability of radio should be evident.

A radio wave leaving the antenna of the transmitter at *A* may be considered for our purposes to be composed of two parts. One part of the radiated energy, called the ground or surface wave, travels along the surface of the earth in all directions. The ground wave is depended upon for almost all military field radio communication. A radio receiver in the ground wave area, shaded on the graph, will receive a signal from the transmitter at *A*. The other part of the radiated energy, called the sky wave, travels upward into space, strikes the ionosphere, and a portion of the wave is reflected or refracted back to the earth as shown in the graph.

It is beyond the scope of this article to go into a technical discussion of this phenomenon. However, the following is quoted from a Technical News Bulletin of the Bureau of Standards:

"The ionosphere consists of several

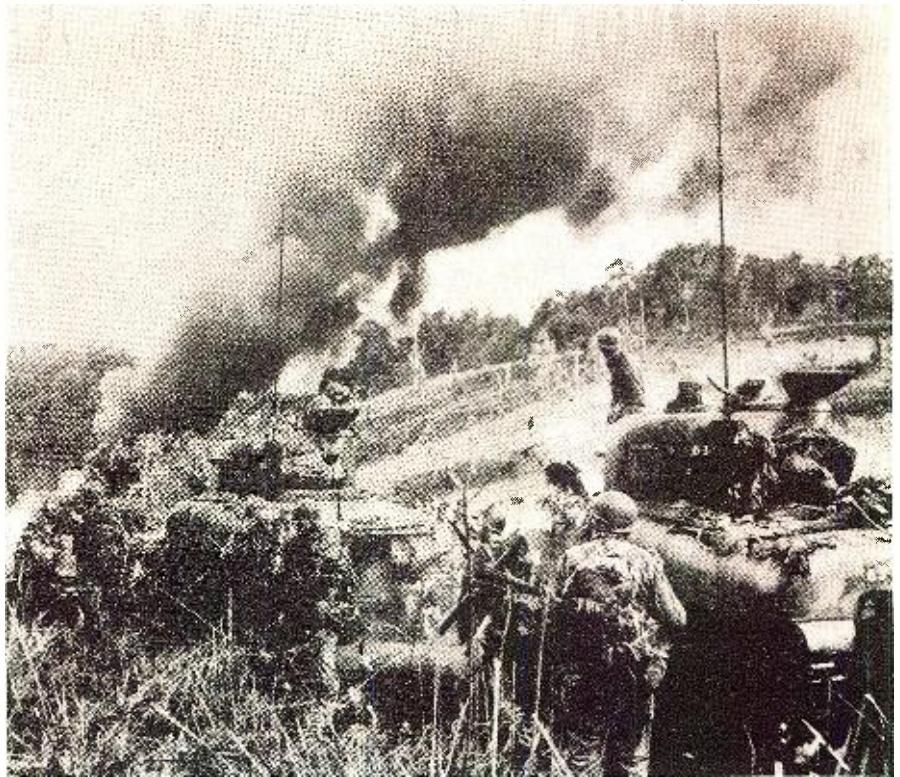

General Sherman tanks and troops are directed by radio as they continue conquest of enemy held territory. Note the massive whip type antennas used.

layers of ionized or electrically conducting air from 60 to 300 miles above the earth. These layers act as reflectors for radio waves and make possible radio transmission over long distances.

"Depending on the degree of ionization of a layer, there is an upper limit to the frequency which, when the waves are sent straight up, may be reflected from the layer. Radio waves of frequencies greater than this upper limit, or critical frequency, go completely through the layer and pass entirely out into space. The critical frequency for each layer varies with the hour of the day, season of the year, and also over a long period which seems to be associated with the eleven-year sunspot cycle.

"The air in these layers is ionized principally by ultra-violet light from the sun. Consequently the critical frequency would be expected to be greater during the day than during the night and greater during the summer than during the winter.

"In addition to the critical frequencies, the heights of the layers, and the amount of absorption of the radio waves play an important part in long-distance radio communication."

The sky wave leaving the transmitter at *A* strikes the ionosphere at *B* and is reflected to the earth at *C*. The earth in turn reflects a portion of remaining radiated energy upward into space where it is again returned to the earth at *E*, the process continuing until the energy is lost in space or completely absorbed. Transmitted radio waves (sky waves) from *A* will be received by a radio receiver at points

*C* and *E*, but will not be received at the points *R*, *S*, and *T* or any of the intervening spaces from *X*. These areas of no signal are known as the "skip distance" of the sky wave.

The examples cited above emphatically illustrate that low power radio transmissions may be received over great distances and remain inaudible to relatively nearby receiving stations. Signal security can be jeopardized because low power transmissions will not insure against the enemy's ability to listen to this traffic even though he is a thousand miles away, particularly in ranges between 1,000 and 30,000 kilocycles.

#### Mutual Interference

Consider any army division with the numerous radio sets it will have in operation, or better yet, an armored division which may have hundreds of radio sets of only a few different types and frequency ranges. Obviously, radio interference among the stations within the armored division will result unless proper control is exercised over the number of stations in operation at a given time or place. Consider, for instance, the final phases of the Tunisian campaign—a fast moving situation in which both friendly and enemy operations depended on radio. Mutual interference was one of the resulting problems undoubtedly kept to a minimum by proper allocation of frequencies and strict radio discipline.

The problem of mutual interference is multiplied many fold on a joint navy, air, and ground force operation. Radio will be the principal means of  
(Continued on page 96)

# Theory of WAVE ANALYZERS

By

**RUFUS P. TURNER**

Consulting Engineer, RADIO NEWS

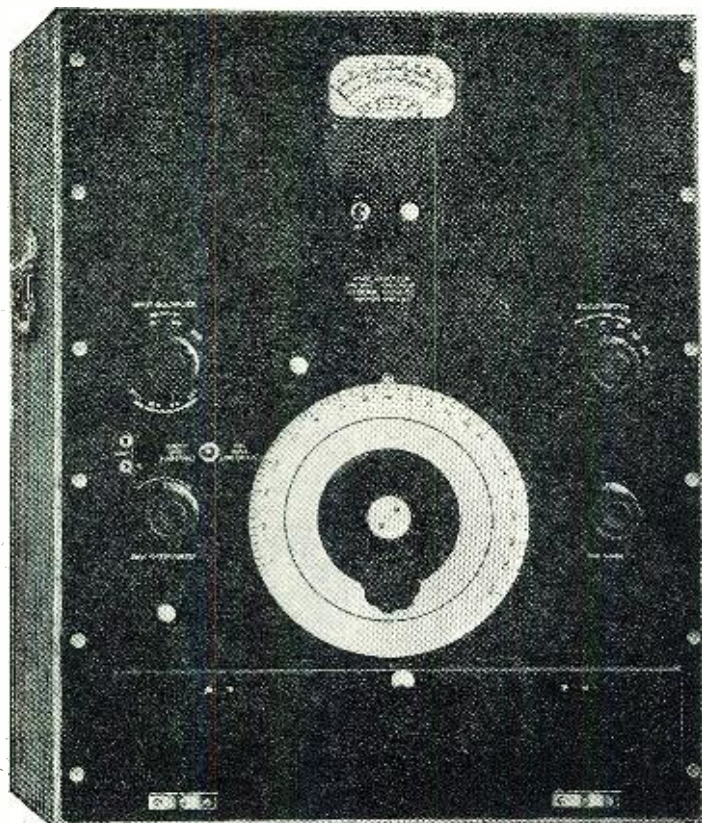

Fig. 1. Heterodyne type wave analyzer, having a tuning range of 20 to 16,500 cycles-per-second.



*Operating analysis of several types of wave analyzer circuits.*

*Used extensively in both research and laboratory testing.*



IN ELECTRICAL and electronic practice, simple sine waves are seldom encountered except in the output voltage of special oscillators designed for their generation. It is far more common to find *complex* waveforms in alternating currents and voltages, which is to say, mixtures of a fundamental frequency and several harmonics. Presence of such frequencies other than the fundamental is the condition well known as *distortion*.

Certain circuits, such as audio-frequency amplifiers and oscillators, generate harmonics as undesirable by-products of their normal functioning. A few other circuits, such as multi-vibrators and frequency multipliers, are designed specifically to set up har-

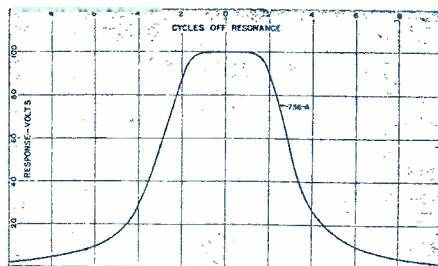

Fig. 3. Response characteristic of wave analyzer shown in Fig. 1.

monics of an input or control frequency. In either case, the complete measurement of harmonic generation (distortion) will establish an important characteristic of the circuit. It is

highly useful in such a measurement to determine the percentage of each harmonic voltage with respect to the fundamental voltage.

Simple distortion meters indicate the *total* harmonic content of a complex wave and are entirely adequate when individual harmonic magnitudes are of no interest. Wave analyzers, on the other hand, permit the complete exploration of a complex waveform—all low minute examination of the fundamental voltage and each harmonic voltage. For complex measurements, the wave analyzer is unsurpassed when speed of manipulation and direct indications are desired.

Wave analysis has an important place in many laboratory and field

Fig. 2. Block diagram of the analyzer shown in Fig. 1. The equipment employs a selective amplifier operating at a fixed frequency of 50 kc., embracing a filter with three quartz crystals specially designed to give the flat-top characteristic shown in Fig. 3.

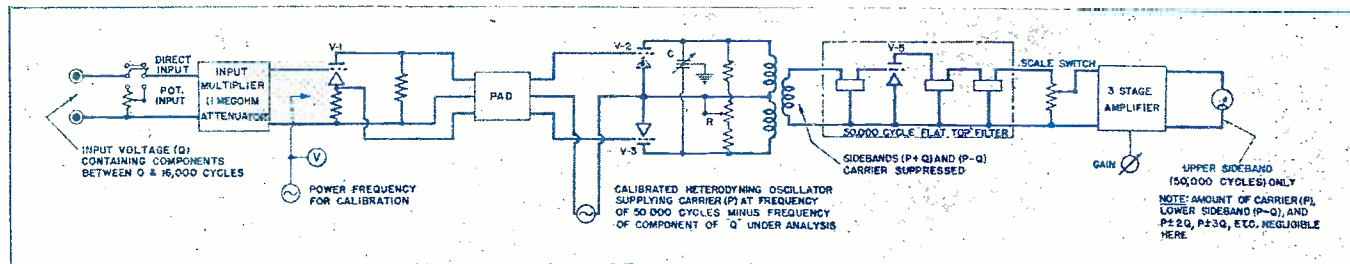

tests of alternating-current circuits and systems, and its usefulness extends beyond the communications field with which it is popularly associated. In the electric power field, for example, harmonics of the power-line frequency, as high as the 10th, 11th, and 12th, have been known to find resonant circuits in switching, power factor correction, and similar networks, and to interfere seriously with capacitors or other components. Such destructive harmonic voltages are readily discovered by means of wave analysis. Annoying overtones in equipment such as bells, horns, chimes, whistles, etc., likewise may be identified quickly and accurately by wave analysis and appropriate remedial measures may be applied. In certain blended-tone musical instruments (e. g., the electronic organ), overtones of controlled intensity and amount are desirable for pleasing timbre effects, and these may be introduced and regulated while the wave analyzer monitors harmonic intensity with respect to the fundamental and other overtones.

Wave analysis is generally restricted to the audio frequencies (i.e., 10-20,000 c.p.s.) where it commonly is most useful. Nevertheless, it has been applied less frequently to radio frequencies as well. The commercial wave analyzers are audio-frequency instruments.

#### Nature of the Instrument

In order to permit examination of a fundamental frequency and each of its harmonics, an instrument must be capable of (1) being tuned successively to these various frequencies, as a radio receiver might be tuned to various station carriers, and (2) indicating separately the voltage of each frequency component. These are the two jobs performed by the wave analyzer. Depending upon the point of view, this instrument accordingly may be regarded either as a highly-selective, tunable voltmeter or as a highly-selective, tunable audio-frequency receiver with output voltmeter.

Circuits and systems employed in practical wave analyzers vary somewhat without affecting the prime functions or nature of the instrument. Earliest attempts to achieve an instrument of this type took the form of tuned a.f. amplifiers with iron-core L-C circuits between plate and grid. Obviously, such circuits were more useful at single frequencies than otherwise, since they could not be tuned satisfactorily over a continuously variable range. Plug-in tuned circuits were attempted for the various frequency components, but a complete set of such accessories were necessarily bulky. In commercial instruments, the indicating meters generally read in percentage, as well as in volts and decibels.

This article will describe the established wave analyzer circuits and explain the use of the instrument.

#### Heterodyne Wave Analyzer

The heterodyne wave analyzer circuit is essentially that of a highly-selective audio-frequency superhetero-

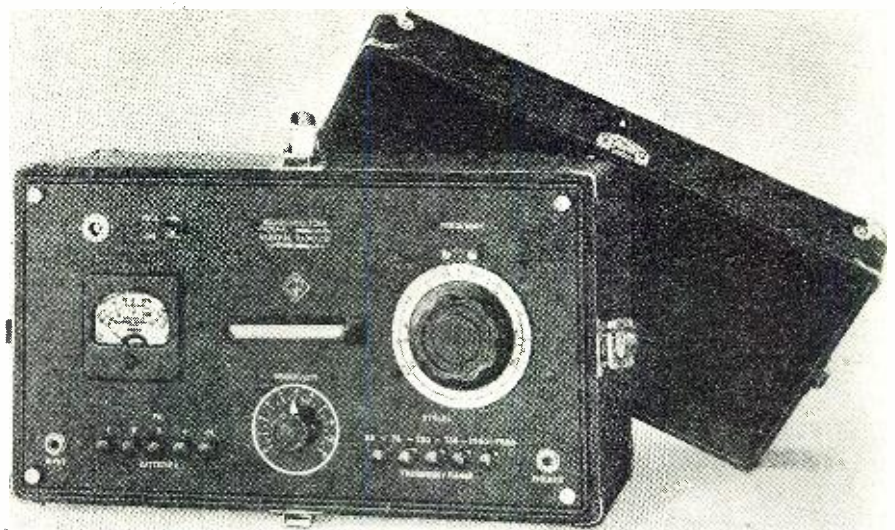

Fig. 4. Tuned-amplifier type analyzer manufactured by the General Radio Co.

dyme receiver with a tuning range extending throughout the a.f. spectrum and a narrow band width.

Heterodyne tuning action is obtained by beating the incoming complex audio signal voltage against r.f. voltage from a variable-frequency internal oscillator to obtain a low-frequency r.f. beat note. The latter is then amplified by a highly-selective i.f. amplifier terminated by a suitable amplifier-type vacuum-tube voltmeter. The dial controlling the internal oscillator is graduated directly in cycles-per-second and becomes the wave analyzer tuning control. A high degree of selectivity is secured in the intermediate amplifier either by crystal filter action or tuned degenerative feedback.

The instrument shown in photograph of Fig. 1 and depicted in functional block diagram in Fig. 2 is a heterodyne wave analyzer with a tuning range of 20 to 16,500 cycles-per-second and a 4-cycle band width. This

analyzer employs a selective amplifier, operated at a fixed frequency of 50 kc., embracing a filter with three quartz crystals specially designed to give the flat-top characteristic shown in Fig. 3. Self-contained standards are provided for both frequency and voltage calibration.

Operation of the instrument is explained, with the aid of Fig. 2, as follows: The complex signal voltage is applied to the input terminals and after modification by the input multiplier is presented by the degenerative phase inverter, V1, through the pad, to the grids of the balanced detector, V2-V3. It is the function of V1 to supply a balanced input voltage from the unbalanced input terminals of the instrument to the detector.

In the balanced detector stage, the signal is mixed with carrier voltage from the local tunable oscillator whose frequency is controlled by the large main dial seen in Fig. 1. Whenever the

Fig. 5. (A) Parallel-T network. (B) Arrangement of direct-coupled amplifier and parallel-T network in the tuned-amplifier type wave analyzer.

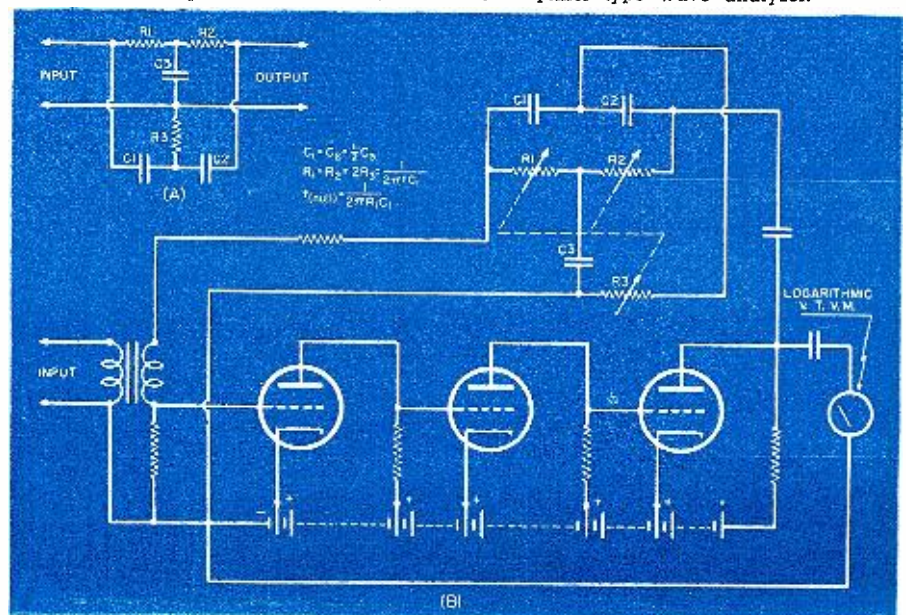

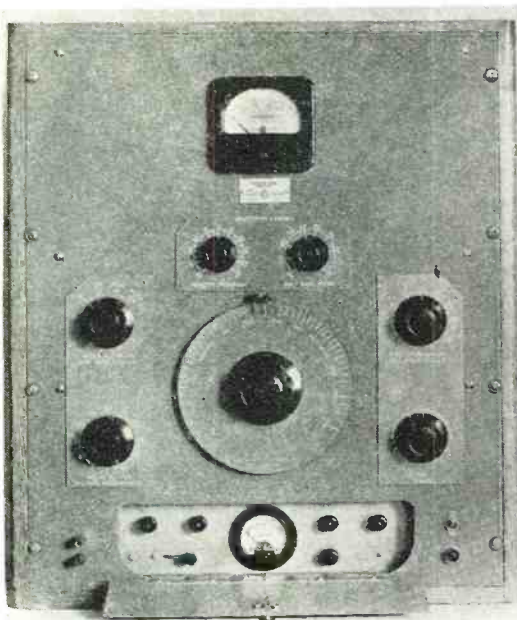

Fig. 6. Heterodyne type wave analyzer manufactured by the Hewlett Packard Co.

local oscillator frequency plus the component of signal voltage under observation equals 50 kc., the beat-note sum is transmitted by the highly-selective amplifier and the v.t. voltmeter indicates its amplitude. This amplitude is proportional to that of the signal component. Complete balancing of the local oscillator carrier out of the amplifier results from the carrier being applied to the two detector grids in phase. The detector output accordingly contains upper and lower side bands minus the carrier. The detector output voltage takes the form of modulated half-wave pulses (one for each signal half cycle).

The local oscillator frequency ( $f_1$ ) is set at 50 kc. minus the particular fre-

quency component ( $f_2$ ) of the complex signal voltage. The detector output therefore contains an upper side band equal to  $f_1 + f_2$  and a lower side band equal to  $f_1 - f_2$ . Since  $f_1 + f_2$  equals 50 kc., this side band is passed by the selective crystal amplifier, all other frequencies being highly attenuated. The local oscillator dial is graduated in  $f_2$  units so that it indicates directly the frequency of the signal component to which the wave analyzer is tuned.

The wave analyzer shown in the photograph, Fig. 6, is also of the heterodyne type. In this instrument, however, crystal filtration is not employed, the necessary high degree of amplifier selectivity (which, incidentally, is adjustable in this instrument by panel knob control) being secured uniquely by means of a special feedback arrangement. Like the analyzer just described, this instrument also contains a balanced detector, local oscillator (resistance-

tuned), and a direct-reading v.t. voltmeter.

Other points of difference are the 20-kc. fixed frequency employed in the selective amplifier of this instrument; use of the heterodyne *difference*, rather than the sum; and the tuning range of 0 to 16,000 cycles per second. The adjustable selectivity feature of the fixed-frequency amplifier enables the instrument response to be broadened to facilitate tuning-in tests, such as some forms of noise analysis, not requiring sharpest tuning.

A less sharply-tuned type of wave analyzer is an adaption of the resist-

<sup>1</sup> H. H. Scott, *Proc. I.R.E.*, Vol. 26, p. 226, 1938.

Fig. 7. Comparison of response characteristics of the analyzers shown in Figs. 1 and 4.

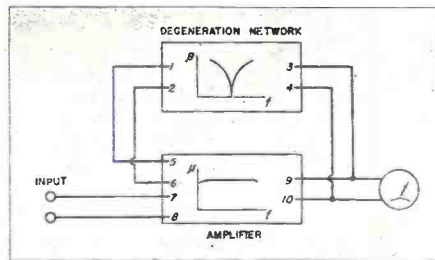
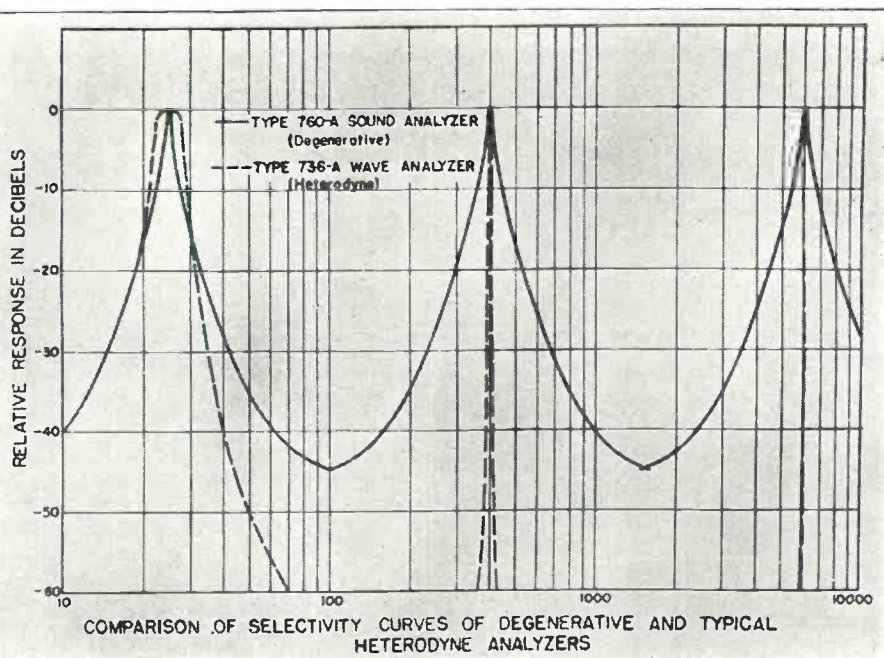

Fig. 8. Functional diagram of sound analyzer shown in Fig. 4. The circuit consists of an amplifier with a propagation constant  $\mu$  and a feedback network with a propagation constant  $\beta$ . The degeneration network is highly selective, and at its null point the normal gain of the amplifier is obtained. At lower and higher frequencies, degeneration occurs, and the gain of the amplifier is greatly reduced.

ance-capacitance-tuned audio amplifier described sometime ago by Scott.<sup>1</sup> While this type of instrument does not provide the extremely narrow bandwidth characteristic of the heterodyne type, it is entirely satisfactory for all measurements that do not require maximum sharpness of tuning. An example of such an analyzer is shown in the photograph of Fig. 4 and in the functional block diagram, Fig. 8.

An understanding of the arrangement of the tuned-amplifier type of analyzer may be had by reference to Fig. 5: The instrument comprises a flat-response, direct-coupled amplifier with a tunable parallel-T degenerative network connected between its output and input terminals. A logarithmic v.t. voltmeter is also connected to the output circuit.

The complex signal is applied to the input terminals and all of its components are transmitted with equal gain by the amplifier. Not all of these components are returned to the input circuit by the degeneration network. The parallel-T network (see Fig. 5) is a null circuit, which is to say, it may be set to reject one frequency from a current of complex waveform, while readily transmitting all other frequencies. Tuning to a desired null frequency is secured by simultaneous adjustment of all three capacitors or all three resistors. As a degenerative network, the parallel-T circuit will return (at any one adjustment) all components of the waveform except the one to which it is "resonant." The result is that amplifier gain is cancelled on all but the null frequency which is transmitted readily. The output voltmeter will accordingly indicate the strength of the one component to which the instrument is tuned. With such a tunable amplifier, a fundamental and each of its important harmonics may be measured successively by simply tuning to each of these frequencies and noting the corresponding voltage readings.

Commercial wave analyzers of the tuned-amplifier type do not ordinarily cover the entire audio spectrum in a single rotation of the tuning dial. This is because precise variable resistors

(Continued on page 148)

# NOISE SUPPRESSION on Small Boats



Radio technicians must be capable of suppressing noise interference invariably present on boats of this type.

By **HENRY E. DAVIS**

***As the end of the war draws nearer, technicians will be called upon for the construction, installation, and operation of radio equipment for all types of boats. This article covers ways and means of suppressing radio noise interference caused by engines and electrical equipment aboard boats.***

**T**HE problem of radio noise on small yachts and cabin cruisers has long been a source of grief to radio engineers and servicemen from one end of the coast line to the other. Offhand it would seem that this problem is the same as in an automobile radio. However, the solution for the car radio may make little or no improvement on the boat radio. There are several reasons for this which will be discussed later.

Although there is no panacea for all cases, it is possible by hard work, a little experimenting, and a systematic procedure, to eliminate or very greatly reduce the radio noise caused by the engines and electrical equipment on the boat. Each boat, however, must be considered as a special problem that requires special treatment. The remedy for one fault may give very little improvement on the next. Each manufacturer has his own manner of wiring and locating the equipment. As a result, boats that are identical in outward appearance may be entirely dif-

ferent electrically. These individual differences consequently call for a rather general treatment of the subject in an article of this kind.

A systematic approach and application of the usual methods of suppres-

*EDITOR'S NOTE: Although this article covers methods of suppressing radio noise interference on boats, the principles covered herein can well be adapted by servicemen to the suppression of local interference in all types of home and automobile receivers.*

sion will yield wonders in the improvement in radio reception, no matter what type of boat is considered.

As a general rule, the larger the boat the easier it is to eliminate the noise. The larger crafts are usually designed to accommodate radio equipment whether it is installed at once or later. As a result, the ignition system

and wiring are well shielded and bonded. Due to the size of the boat the radio equipment may be installed at a greater distance from the noise-generating machinery. In smaller crafts the ignition system may or may not be shielded and other wiring, if shielded, may not be bonded. In these smaller boats the radio, of necessity, is located close to the engine room where most of the noise originates. Consequently the noise level is at times so high that it becomes necessary to stop the engines before the radio may be used.

The noises with which the serviceman is mainly concerned on shipboard will be found under one of three general headings: ignition noise, electrical noise, and contact noise. Ignition noise on the smaller boats is usually confined to the main engine or engines; on the larger boats there may be one or more smaller gasoline engines for battery charging or other purposes. These will usually be found on boats equipped with 32 or 110 volt

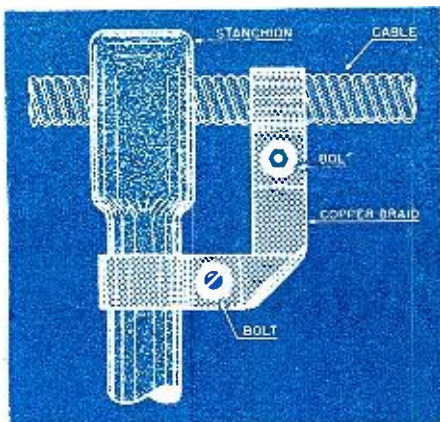

Fig. 1. Methods used in bonding metal cables to stanchions to ground noise signals.

lighting systems. The smaller boats using 6 or 12 volt lighting will, as a rule, charge the battery with a generator on the main engine. Often the ignition noise from the smaller engines is more troublesome than that from the main engine.

The electrical noise includes interference from all other electrical equipment including leakage noise if present. This consists mainly of noise caused by blowers, windshield wipers, autopulse units, air compressor, bilge pump, and fresh water system pump.

Contact noise, set up by intermittent contacts between metal surfaces at slightly different potentials is sometimes very difficult to locate since it may appear only when the boat rolls in a certain manner. Then again, it may appear only when the engine is in operation, or at all times. In one instance a troublesome noise was traced to the cable forming the rail of the boat. This cable was fed through stanchion eyes about every five feet. Any vibration caused an intermittent contact which made the radio all but useless. Conditions such as these, when once located, are usually very easily corrected by bonding as shown in Fig. 1. Other not uncommon forms of intermittent noise may arise from loose light bulbs, plugs, or fuses. Trouble is sometimes found in the fuses themselves. The fuse may be in the holder tightly and appear perfectly all right although the fuse element may not be making a good contact inside.

Radio noise may be typed as impulsive or random, depending on the character of the noise. The impulsive

Fig. 2. Condensers are used to reduce noise interference caused by small motors.

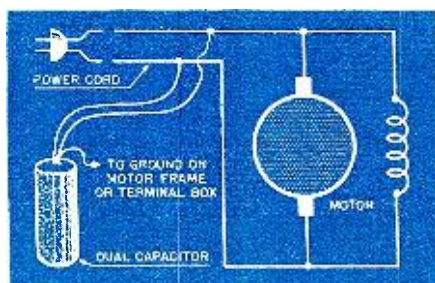

noises are those showing a definite pulse effect such as ignition noise, noise set up by vibrating contacts, and motor brush noise. Leakage noise is classed as random. There is no clear line of distinction between impulsive and random noise. If the transients causing an impulsive noise increase in frequency to the point where the pulses are not distinguishable, the noise will take on a random character.

A good conception of the electrical condition of the boat may be obtained by listening to the character of the noise. Random noise usually indicates a number of units contributing to the noise level, while if the noise is clearly impulsive, it may generally be traced to one or possibly two sources.

The noise detected on the receiver or noise meter is the result of electrical fields set up by transients in the electrical circuits. It may be shown that transients cannot be set up in a circuit when:

$$\frac{1}{LC} < \frac{R^2}{4L^2}$$

where  $R$  = resistance,  $C$  = capacitance, and  $L$  = inductance of the circuit. Thus, transients may be stopped by increasing the value of  $R$  making  $R^2/4L^2$  large with respect to  $1/LC$  or by increasing the circuit capacitance and making  $1/LC$  small with respect to  $R^2/4L^2$ .

In most applications,  $R$  cannot be increased without upsetting the circuit electrically. In ignition systems some resistance may be inserted but it is not always effective and may decrease the engine efficiency by suppressing the spark. It is, therefore, better to refrain from the use of spark-plug suppressors. The spark required for proper combustion is a prolific source of noise and cannot be eliminated. The noise can, however, be produced and then the noise fields restricted by shielding of the ignition system wiring.

For most electrical noises the proper use of capacitors is all that is required to silence the interference.

Noise voltages set up by the electrical machinery may be propagated by conduction, radiation, induction, or any combination of these. Consequently where possible, the noise should be eliminated at the source, or as near as possible to the source. A very short unshielded lead may act as a very efficient antenna, not, perhaps, as a true antenna but a nearby pipe or cable may conduct this noise all over the boat bringing the noise field close to the receiving antenna or lead-in. Noises not eliminated at the source may be conducted by means of the power wires, ungrounded wire shielding, speaking tubes, or other metal surfaces. Ungrounded ventilators sometimes conduct noise currents from the engine room to above deck where it is picked up by the antenna. Even with shielded light wires, noise is often brought above deck to a junction box from which an unshielded

cable leads to a search light, horn, or navigation light. Even a very short lead may show a very strong noise field if investigated with a noise meter.

The lead from the magneto primary to the switch used to stop the engine, by shorting the primary to ground, is a source of noise. If this lead is not shielded it should be replaced with shielded wire or run in conduit isolated from other wiring. At the switch end, the lead should be bypassed with a  $.25 \mu\text{fd.}$  capacitor.

Although it is good practice to ground the frame of the noise producers, it may lead to an increase in noise due to direct conduction to the receiver, induction or radiation from a long ground lead. A ground on the motor frames does not generally reduce the noise condition unless the ground lead is very short. If the noise increases with the ground connected it should, of course, be left off.

Since radio noise is transmitted by conduction, induction, and radiation, consequently there are several ways in which the noise voltages may get into the receiver. Up to a distance of  $\frac{\lambda}{2\pi}$  from the noise source, the induction field is predominant and may act directly on the circuits in the receiver if not well shielded. The noise sometimes enters through the power leads,

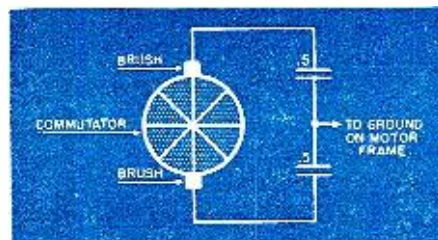

Fig. 3. Silencing engine room blowers by applying two  $.5 \mu\text{fd.}$  condensers.

however this is a rare case and filters added at the power entrance are usually of no value. The test for this condition is to short out, with a short piece of wire, the antenna and ground terminals of the receiver after the antenna and ground are disconnected. The set should then be silent. If the noise persists it may be entering by means of the power line and a filter should be tried. If a line filter does not help, the noise voltages are probably being induced directly into the set through faulty shielding. This condition is rarely encountered with modern receivers.

If practical, the lead-in may be disconnected from the antenna to determine whether the noise is being picked up by the lead-in or the antenna. If the lead-in is not shielded it will contribute a noticeable amount of noise since it lies close to other electrical circuits of the boat. The antenna may be in a relatively low noise field as it is away from other wires and machinery. Shielding the lead-in should be one of the first things done on noisy boats.



Variations in the character of the noise field will make a great deal of difference in the interfering effect of the noise in the receiver. The fact that two noise fields display equal strength, as determined on a noise meter, does not indicate that they will both cause the same amount of disturbance in the receiver. For this reason the best indication that the disturbance is caused by the equipment may be had by listening to the receiver. There are two general methods of investigation used for transient noises. The first is the practical method for determining the interference caused in the receiver. The second method is the noise meter which indicates intensity in a certain frequency range. These two methods should be used together. Although listening to the receiver will indicate a disturbance, it will not be of assistance in eliminating the noise, as the ear cannot detect a volume change of less than two decibels.

Often a filter may produce an obvious decrease in the average power of the noise field yet make no appreciable change in the apparent noise level in the receiver. For this reason the second or noise meter method should be used in studying the effect of any filter on the noise field. The use of a noise meter was justified on one certain occasion. In attempting to eliminate the noise caused by a pair of windshield wipers which were connected to one switch, a dual capacitor

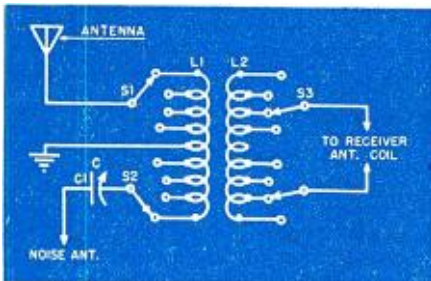

Fig. 4. Noise balancing circuit which occasionally may help in reducing interference.

$C_1$ —250  $\mu$ fd. variable cond.  
 $L_1$ —40 turns on 1" form, tapped every 5 turns  
 $L_2$ —40 turns on  $\frac{3}{4}$ " form, tapped every 5 turns  
 $S_1, S_2$ —SP4P rotary sw.  
 $S_3$ —2P4P rotary sw.

was connected from the motor brushes to the frame of one of the wipers. With both wipers in operation there was no noticeable decrease in the receiver noise level. The filter was moved to the other wiper motor with the same result. A noticeable decrease in the noise level was indicated on the noise meter with the filter installed on either motor. When capacitors were added to both motors at the same time every trace of the noise was eliminated.

Due to the pulse nature of the noise voltages, two equal noise fields of the same type do not add arithmetically to cause twice the noise in either the receiver or the noise meter. There may be little or no difference in the receiver but the noise meter will show

an increase in average noise power. For this reason the noise meter is an extremely valuable instrument for such work. If no commercial instrument is available, an output meter or a.c. voltmeter may be connected to the output of the receiver as a visual indicator.

Before attempting to eliminate noise, it is well to make a general survey of the boat to determine just what remedial action should be taken. For this investigation a table such as the one shown in Table I should be made. It will serve as a record of improvement and of work yet to be done.

Assume a typical case of boat noise. After the preliminary checks have been made to determine the overall noise level, the boat should be anchored off shore or tied to a dock where there is no interference from shore installations or other boats. With all motors and engines shut down, every possible source of noise should be started one at a time, and the individual noise levels as given by the meter recorded on the form. The apparent effect in the receiver may also be recorded. Next the noise meter should be taken on deck and several of the most noisy units, indicated on the form, turned on. By exploring with the noise meter among the wiring, cables, ventilators and other metal objects on deck several of these may be shown to be radiators of the noise. A note of these points should be made on the record for future reference.

Now that the cause of the noise is determined, remedial action may be taken. Before starting repairs on individual units, the boat should be put in drydock and a ground plate installed if the boat is not already so equipped. The plate should consist of about 20 square feet of copper sheet fastened on the hull by means of brass screws spaced every two inches around the edge of the sheet. The side of the plate next to the hull should be covered with a thick coating of red or white lead. Brass bolts should be installed in each end of the plate to act as terminals for the ground wires. These bolts must be soldered to the plate to insure a good contact. Al-

		DATE 7/8/44	
BOAT NO.	146	TYPE	Cruiser
OWNER	John Smith	BOAT MFGR.	Jones Mfg. Company
ADDRESS	New York City	DATE OF MFGR.	July, 1942
NOISE METER LOCATION	1 foot in front of receiver		
NOISE LEVEL, NORM. SPEED ALL EQPT. ON			160 db.
N.L. IDLING ALL EQPT. ON			125 db.
N.L. EVERYTHING OFF			0 db.
Unit	Noise before work done	Noise after work done	Work done
MAIN ENGINES	50 db.	5 db.	Cleaned shielding
AUTOPULSE UNITS	20 db.	2 db.	Bypassed with 1 $\mu$ fd. cond.
BAT. CHARGING GEN.	10 db.	0 db.	Replaced open filter
AIR COMPRESSOR	95 db.	0 db.	Filter on brushes, $\frac{1}{2}$ $\mu$ fd.
BLOWER (Galley)	0 db.	0 db.	
BLOWER (Forecastle)	0 db.	0 db.	
BLOWER (Eng. Room-Port)	10 db.	0 db.	$\frac{1}{2}$ $\mu$ fd. on brushes
BLOWER (Eng. Room Star.)	15 db.	0 db.	$\frac{1}{2}$ $\mu$ fd. on brushes
REFRIGERATOR	5 db.	0 db.	$\frac{1}{2}$ $\mu$ fd. on brushes
WINDSHIELD WIPERS	45 db.	0 db.	$\frac{1}{2}$ $\mu$ fd. on brushes
BILGE PUMP	0 db.	0 db.	
FRESH WATER PUMP	75 db.	10 db.	$\frac{1}{2}$ $\mu$ fd. on brushes
RADIATION POINTS			
Cable for junction box (power outlet) to horn			5 db.
Ventilator (Port) to Engine Room			7 db.
CHECKED BY			H. Brown

Table I. It is advisable to first make a general survey of various sources of interference, before attempting to eliminate noise. All such data should be recorded as shown.

though this plate may not in itself decrease the noise level it does provide a good ground for the radio receiver and transmitter and may result in increased signal pickup with a corresponding increase in the signal to noise ratio. The outside of the plate should not be painted.

The record form, Table I, indicates that most of the noise is due to the air compressor and fresh water system pump, therefore, corrective measures should be begun at these points. If an examination of the brushes and commutator of the air compressor shows them to be in good condition, yet there

(Continued on page 152)

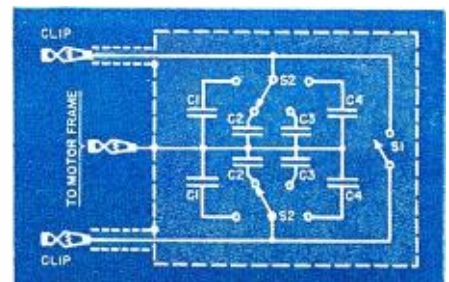

Fig. 5. Simple device used to determine quickly if a condenser is all that is needed.

$C_1$ —1  $\mu$ fd. @ 400 v., tub. cond.  
 $C_2$ —25  $\mu$ fd. @ 400 v., tub. cond.  
 $C_3$ —5  $\mu$ fd. @ 400 v., tub. cond.  
 $C_4$ —1  $\mu$ fd. @ 400 v., tub. cond.  
 $S_1$ —SPST sw.  
 $S_2$ —2P4P rotary sw.

# ADVANCED RADIO THEORY— For FCC Operator's Exams

By **CARL E. WINTER**

*Outline of advanced elements with which prospective licensees must be familiar before attempting to pass the FCC exams.*

**V**ITHOUT adequate preparation, some trained electronic engineers would encounter a few hard nuts to crack in the Federal Communications Commission examinations for a Commercial Radio Operator License.

A good percentage of the exam's questions apply to the basic principles of radio and offer little difficulty to ex-"hams" and ex-"servicemen," but the premise upon which the FCC examinations are based is a series of "elements," each of which requires progressively more advanced technical knowledge.

In addition to "Basic Radio Theory," which appeared in the September is-

ning a preparatory course of study.

## Mathematics

Ohm's Law problems involving application of the Law to circuit analysis occur frequently. These arithmetical problems are easily solved when a knowledge of when and where currents and voltages appear in any given circuit is obtained. You should know, for example, that a milliammeter connected between the center tap of a filament transformer and ground, will read the combined plate and grid currents of a simple triode stage. You should also be able to analyze other components of a circuit in similar fashion.

Ability to make mathematical computations pertaining to decibel gain or loss is required, particularly for applicants for Radiotelephone licenses. Ratios between average, effective and peak values of a sinusoidal wave should be memorized, as problems utilizing these values occur frequently.

Formulas for computing the angle of lead or lag of current with reference to voltage in an a.c. circuit should be learned and the meanings of "leading power factor" and "phase difference" understood. Study of phase angles will be simplified if you remember that in an a.c. circuit, a series condenser causes the current to lead the voltage and that when inductive reactance predominates in the circuit, current lags the voltage.

The importance of the formulas for reactance and impedance should not be underestimated. The formula for determining impedance at resonance

is essential and the values of reactance in series, parallel, and series-parallel circuits should be known.

The student should not become too

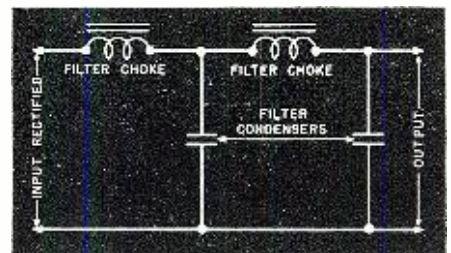

Fig. 2. Choke input filter.

perturbed at the vast array of mathematical problems which will confront him when he opens his examination sheet. All these problems are based on specific formulas and should present no difficulty provided these formulas have been learned well.

## Motor Generators

Questions pertaining to motor generators will be primarily mathematical and concern the "efficiency" and "regulation" of this equipment as well as for rectifier power supplies. "Efficiency" and "regulation" are not just terms but have definite mathematical formulas which are essential.

## Rectifier Tubes

Possessing basic knowledge of vacuum tube principles simplifies the specialized requirement for rectifier tubes. The various types, and their respective advantages and disadvantages should be understood; and "inverse peak voltage" mathematical problems, in which sinusoidal wave ratios are applied, occur frequently.

## Rectifiers

A knowledge of the principles of rectification is not sufficient for the examinations in the advanced elements. Formulas for the computation of ripple frequencies, the circuits for half-wave, full-wave, and bridge rectifiers should be learned. Mechanical rectifiers cannot be ignored for you may encounter a question or two pertaining to them.

## Filters

The function of the filter network in

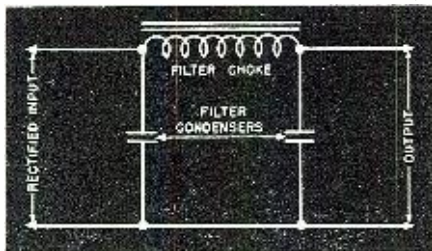

Fig. 1. Condenser input filter.

sue of RADIO NEWS, understanding the practical aspects of the commercial operator's work and the application of radio principles to actual equipment in use are required in these advanced elements. Therefore, the following classifications, including the scope of subjects covered, may be of assistance to prospective licensees who are plan-

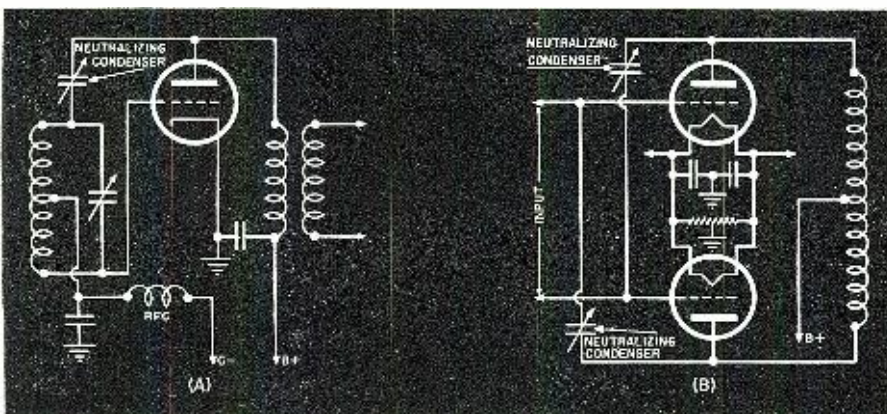

Fig. 3. Methods of neutralizing single and push-pull output stages.

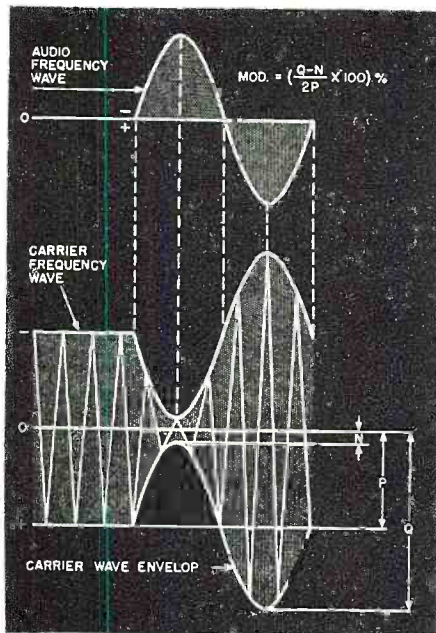

Fig. 4. Modulated carrier wave.

conjunction with a rectifier circuit is another *must* for prospective licensees. The effects of inductances and condensers in filters (see Figs. 1 and 2), the characteristics of "swinging chokes" and the applications of bleeder resistances should be mastered.

An analysis of the differences between low-pass and high-pass filters, as shown in Fig. 6, paves the way for the study of attenuators, line pads, line equalizers (Fig. 7), and mixers. The functions and principles of these various networks should be mastered, and their methods of connection to, and effects upon, circuits understood.

Impedance matching, Fig. 8, and the proper termination of transmission lines should be studied, particularly by those interested in Radiotelephone licenses.

### Crystals

As crystals play an important part in all radio equipment their function in stabilizing oscillators should be studied carefully. To assure adequate knowledge of crystal principles, the student should understand the meaning of, and terms used, in referring to

Fig. 5. Antenna directional characteristics.

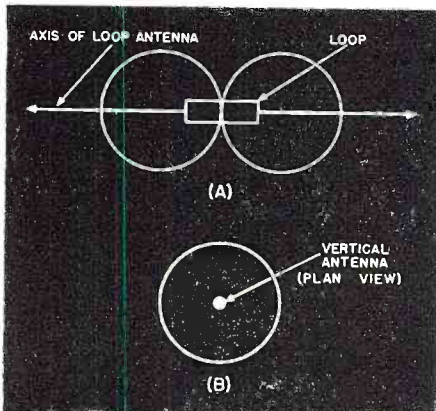

crystal temperature coefficients and learn to solve mathematical problems which involve the crystal temperature coefficient in determining a transmitter's output frequency.

### Oscillators

Comprehension of the basic oscillator circuits such as Colpitts, Hartley, MOPA and tuned-plate tuned-grid is vitally necessary. Surprisingly enough, the Commission demands a thorough understanding of ancient spark and arc oscillatory circuits.

The multivibrator, or relaxation oscillator, possesses peculiar characteristics of its own and should be studied as an individual type of circuit.

Electron-coupled, dynatron, and crystal oscillators should also be understood and the ability to draw any of the basic oscillator circuits from memory is an asset.

The student should know which oscillator circuits are particularly useful for generating harmonics and understand the several methods of keying a transmitter.

### Receivers

Inasmuch as many receivers utilize oscillators in regenerative circuits, the principle of regeneration should be understood. In regard to this, an understanding of the relationships of signal frequency, beat frequency and image frequency, as well as the ability to make simple computations pertaining to them, should be mastered.

Other types of receivers, such as, plate, grid leak, power, and diode detectors should not be neglected. Sufficient knowledge of receiver principles should be obtained to enable the student to answer trouble shooting questions. Learn what the super-heterodyne circuit is!

### Amplifiers

A thorough understanding of amplifiers and their classes of operation is perhaps the most crucial part of the requirements. All types of amplifier circuits should be studied, and here again the ability to trouble shoot, at least on the examination sheet, is essential. Special emphasis is placed on the principles of modulating amplifiers and the student should stress modulator circuits in his preparation for the examination.

### Neutralization

The purposes and methods of neutralizing a radio frequency amplifier; how to test for proper neutralization and the instruments used in such tests should be studied. Problems covering methods of neutralization (see Fig. 3) may occur.

### Modulation

The heart of all radio broadcasting systems is modulation. This is a major subject in itself, and, broadly speaking, one can't know too much about it. Particular attention should be paid to high and low level, grid and plate modulation.

Although frequency modulation is  
(Continued on page 62)

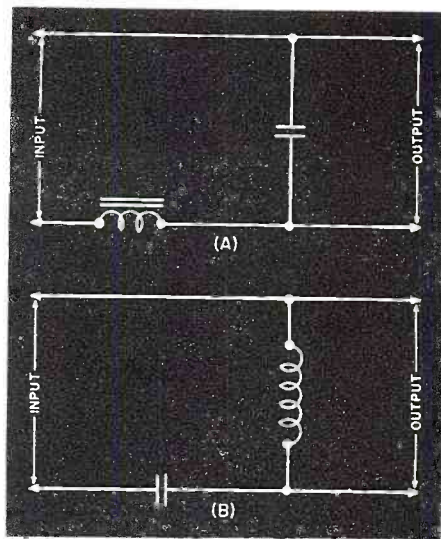

Fig. 6. (A) Low-pass filter. (B) High-pass filter. The condensers and inductors are designed to attenuate the higher frequencies (A) and the lower frequencies (B).

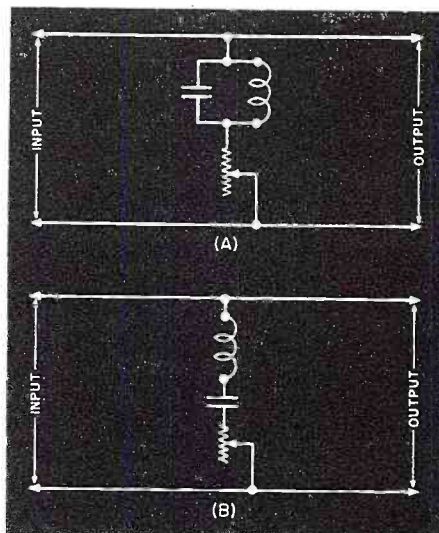

Fig. 7. Equalizers. Parallel resonance is depicted in (A) while (B) shows the equalizer as a series resonance type.

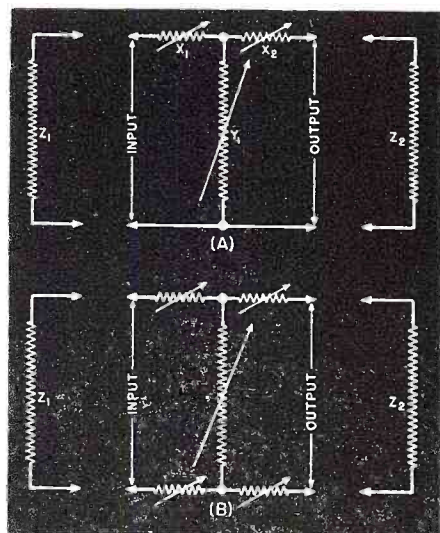

Fig. 8. (A) T-type pad. (B) H-type pad. Input terminals of the attenuation networks connect to microphone  $Z_1$ , while the output connects to amplifier shown as  $Z_2$ .



By CARL COLEMAN

ACCORDING to U. S. Maritime regulations chief radio officers or the sole radio officer aboard ship for at least five years on a first class license are entitled to a full lieutenant's commission in the Maritime Service. The second officer is entitled to Lieut. (jg) if he holds a first class license. Holders of second class licenses rate as an ensign and the "duration" temporary ticket holders may get a warrant officer billet or better. Age limits are 19 for warrant or ensign, 20 for Lieut. (jg) and 23 for Lieut. Previous sea service of a year or more, or current service for six months or more is a necessary requirement for application for any commission.

ROU's continual poundings about the jamming of two men in the small chief-radio-officer's room aboard the Liberty ships has begun to show results. The situation is clearing up as the cadet system is being eliminated or reduced on some ships. ROU has taken the FCOA of American Export Airlines under its wing. The airways division office is located at 37-46 82nd St., Jackson Heights, N. Y. There are still a goodly number of men shifting from the airways to marine work and vice versa and probably always will, so not much can be done about it.

THE U. S. Maritime Commission has indicated a gradual change from the Liberty ships to the newer "Victory" or "C" type ships but it will be some time before there will be any great number of the faster ships out of the yards, so don't spend all your time waiting for a faster ship, the old Liberty will still get you around. WSA announced plans for voting by merchant seamen who are away from the United States but the details are missing and no one seems to have much information on this.

ACA broadcast department, Philadelphia, sends along a few items; WPEN is to be sold to the Bulletin and only awaits FCC approval. WHAT is opening an all night program. Jim Tisdale is now Tech. Sup. at WIP during the absence of Cliff Harris who is overseas for WE. Sy Geller has left WPEN for WHOM up in the big city. F. Unterburger has completed installation of an RCA consolette. KYW has

five full-time licensed gal technicians on its staff. WHAT's stronger sigs are reportedly due to a new limiter amp. WFIL has acquired the use of the Little Playhouse with the thought of getting experience for television. Bulova is disposing of all its radio holdings except the WNEW.

SINCE the Selective Service order putting men over thirty and in essential work in a deferred class, there has been no turnover in local personnel on the technical staffs, and with the summer vacation schedules straightened out, it looks like smooth sailing in the future. The ACA broadcast department announced the addition of WWPG at West Palm Beach, Florida. In the broadcast field, it is reported that both television and FM construction permits are piling up at the FCC for action after "V-Day" and from the number of them, it looks as if there will be a shortage of competent and experienced men to install and operate this growing business.

All indications are that television is

definitely set to go shortly after the war is ended. FM has already established itself and only awaits the go-ahead on the equipment and an OK from FCC. WFIL, KYW and WCAU in Phila. have filed for television CP's. FM has plenty of room for expansion. A recent map shows that there are still about a dozen states which have had no FM CP's granted or applied for. In case you are interested, testimony before FCC shows that 1 kw, complete FM installation can be paid for with \$75,000. The "Log," ACA broadcast department publication, contains much of interest to those in the BC industry.

THE Radio Officers News, ROU's magazine issued from their new offices at 1440 Broadway, contains several items each issue about maintenance and operation which will provide the newcomer with a real helping hand. One recent issue carried articles on the TBY transceiver and care of storage batteries, (which many men are inclined to neglect). The dope on improving your Scott receiver and many other interesting things to a marine radio operator is included.

UNDER a recent War Shipping Administration order, all radio officers holding assignments as chief radio officer, on and after January 1, 1945 must have a Radio-Telegraph 1st class license. The order also stipulates that in making future chief's assignments, preference shall be given to those radio officers who hold a Radio-Telegraph 1st class license regardless of their position on the assignment lists. The answer is to get that 1st! Every radio officer now holding a "TLT" or a 2nd class license should exert every effort toward getting his 1st class license as soon as possible. There are any number of good books available at reasonable cost which you can get for brushing up.

ROU's DeForest O. Romain points out that WWV, the Bureau of Standards Washington station, can be used to advantage by marine radio operators as a source of time ticks since regular services are not on the air as often as they were in the past. WWV operates continuously on 5,000 kc. and 10,000 kc. During the daytime, it is also on 15,000 kc. which spot is replaced at night at 2,500 kc.

On one of these frequencies the station (Cont'd on page 107)

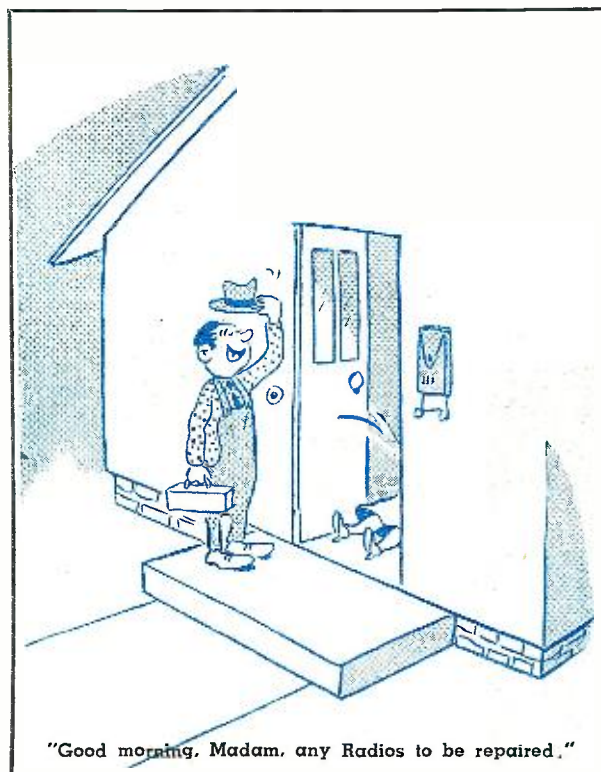

"Good morning, Madam, any Radios to be repaired."

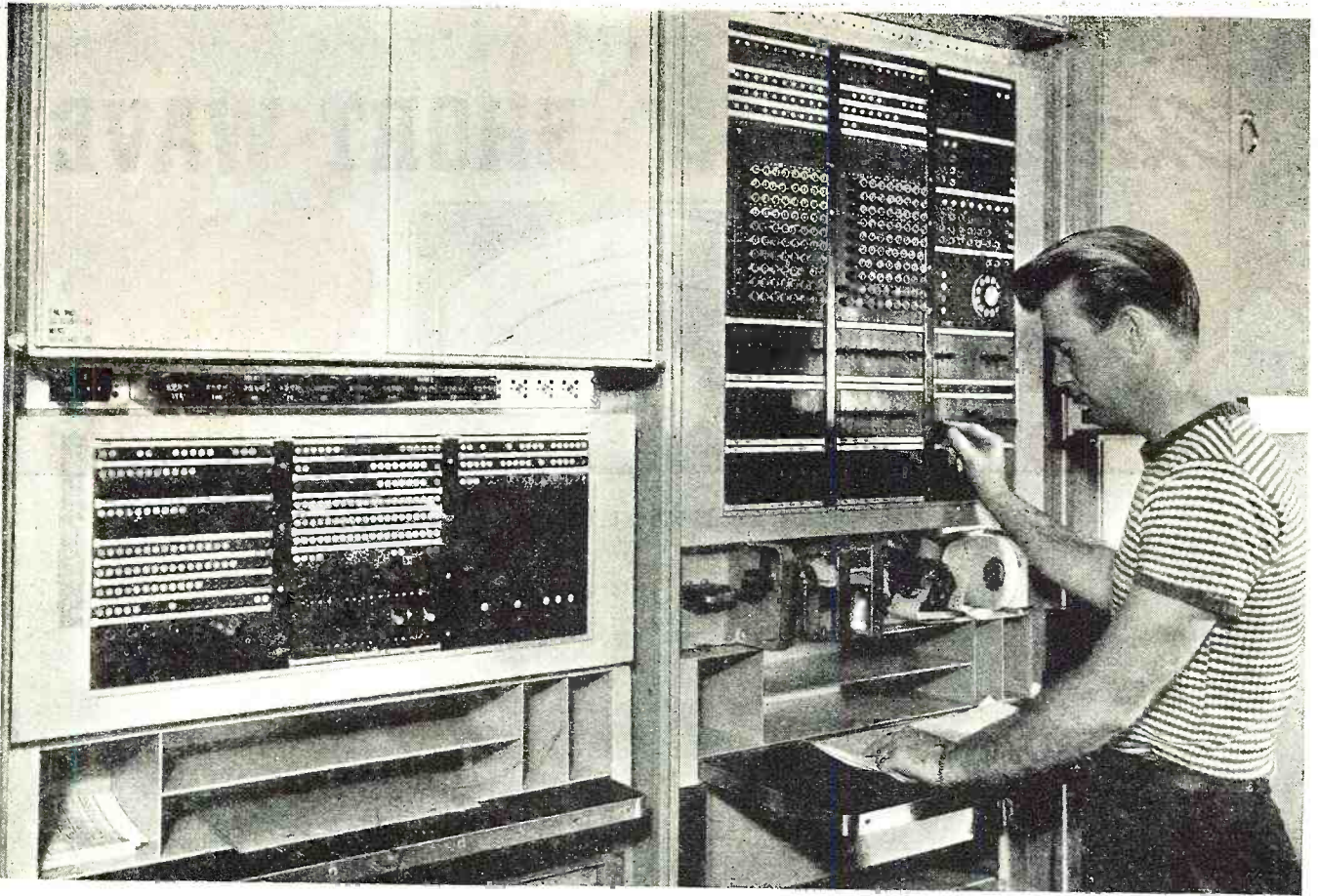

Test panel used to check operation of automatic ticketing equipment recently installed at Culver City, California.

By **P. GLANZER**

AMERICA'S first automatic toll call ticketing telephone equipment for regular use by subscribers is now in operation in Culver City, California, a suburb of Los Angeles.

By means of it, people can now dial 63 different prefixes in 15 telephone exchanges. In other words, neighboring towns in the metropolitan area are now at their fingertips literally, and they can dial Pasadena neighbors miles away just as readily as they can dial Los Angeles neighbors close by.

The telephone, apparently, is growing up, and growing fast. It can now talk (a robot voice tells callers the time and weather). It acts as if it could think too (when dialed on local calls), and recently in Philadelphia it was acting in that manner even more so. In Philadelphia a new Bell Telephone Laboratories mechanical brain which enables the instrument to put through long-distance calls without human assistance was in operation.

This is no mean achievement. A toll call, which must be relayed along a maze of loops and trunk lines, usually involves several skilled operators and a number of complex connections. In the new system, an operator in the town where the call originates calls the number by dialing or punching

*(Continued on page 82)*

# Latest in Telephone Toll Service

***Faster service begun by Bell as a result of automatic toll-call ticketing telephone equipment.***



Automatic ticketer prints along one edge of the ticket all the information required for billing purposes on calls made. As each call is completed, equipment slices off ticket and stacks it in a receptacle shown towards left.

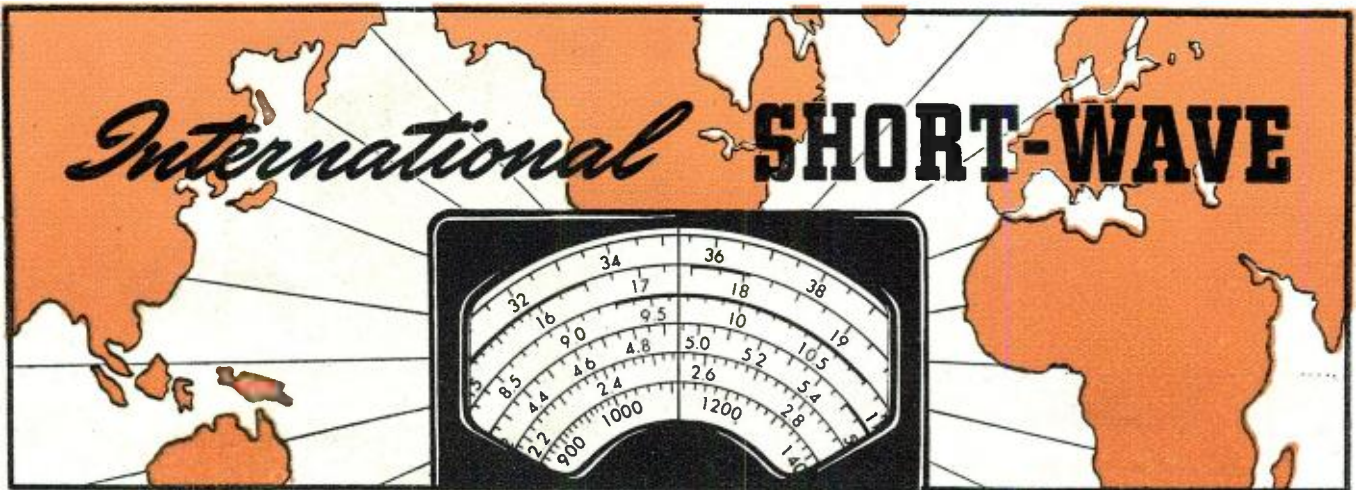

Compiled by **KENNETH R. BOORD**

URING the past few weeks a number of letters have been received from readers—chiefly old-time DX-ers—who deplore the fact that the short-wave bands are so overcrowded at the present time, particularly by high-powered stations in the United States. As many as four such stations have been heard in the 19-meter band at one time directing the same program to Europe and/or Africa.

A monitor in the East writes, in part:

"I've been in the radio game since 1916. At the present time I spend my spare time monitoring the Japs for the prisoner-of-war messages which I have relayed thus far to some 700 families. I have had some wonderful letters from the families of these boys. I 'phone for a radius of about 300 miles, which gives me a great thrill. It seems too bad, however, that the FCC doesn't do something about those high-powered transmitters that 'hog' the 19-meter band—there's WLWL on 15.20 and 15.23 and WLWK on 15.250. Why should three stations using 50 kw., within 250 kcs., broadcast the same program? I have been trying to get the FCC to correct this situation so as to get a clear channel for JLT3, Radio Tokyo, on 15.225, from 6:15 to 7:30 p.m. EWT. At times there is a terrible QRM; for almost three weeks it was too bad to copy JLTe's POW messages."

*(AUTHOR'S NOTE: I could add some other high-powered U. S. transmitters to the list given for the 19-meter band that certainly do QMR both JLTE and JZK (15.16) during Radio Tokyo's early evening transmission to Eastern North America (6:15-8:15 p.m. EWT). Sometimes either station will come in with an excellent signal, but more often Radio Tokyo is blanketed under by the powerful U. S. broadcasters.)*

Another correspondent poses the question: "Can't something be done to bring about announcements for identification of U. S. stations?" The reader goes on, "For years, I have thought

short-wave broadcasters were too unconcerned with local listeners, but now they very definitely let us know that, so far as they are concerned, we are non-existent. If we only had one short-wave station to which to turn for local programs during the summer season of static! I have to 'fish' and 'fish' to find a program, and usually have to listen to London for entertainment. Since before 8:30 a.m. (it is now 9:10) I have been hearing a station which sounds Oriental—news and announcements—but I'll be willing to wager that when—and if—they ever do announce, it will be San Francisco. If the program is intended for foreign listeners, why do they not announce in English, so we can tune out?

"The small band of DX-ers has always been neglected. Their contributions to radio are entirely forgotten now that radio has 'come of age,' so to speak. Are there enough of us left to petition either the FCC or the broadcasters themselves to come to the aid of the long-suffering listeners, of whom I believe there still is a goodly number interested in distant reception? Too, many of us like to hear the names of prisoners-of-war—nearly all of us know or have intimate friends in constant danger of being captured. This attitude might be termed selfish—I know there's a war going on!—but it is a condition that existed before there was a war."

**Note to Far North**

London is now adding the 2.88 mcs. transmitter, GRC, at 10:15 p.m. EWT, in the North American Service, for listeners in the Far North. Hitherto, this station has been used only in winter. Barring static, it is audible now on cool, moonless evenings.

**"Absie"**

ABSIE (The American Broadcasting Station in Europe) announces at 6 p.m. EWT that it may be heard on 307 and 367 meters, and on one station in the 49-meter band, two stations in the 41-meter band, and four stations in the 31-meter band. The "mid-

night" news is given at 6 p.m. EWT, and is followed at 6:15 p.m. EWT by "London Calling Europe" from the BBC's European Service.

"London Calling Europe," which is in English, is one of the finest programs we have listened to lately. We recommend it to you.

\* \* \*

**Heeding the Voice from "Radio Orange"**

When the invasion of Holland finally gets under way, allied forces will be welcomed and aided by an alert, well-disciplined populace as a result of the constant radio communication between the homeland and Hollanders in England, the Netherlands Information Bureau in New York City reports. Throughout the past four years the "RADIO ORANGE," Netherlands station in London, has been exchanging ideas with the Dutch underground. In the dark days of 1940-41-42 this manifested itself in morale-building programs to offset the depressive effects of defeat and occupation. During the latter part of 1942 and early part of 1943, resistance was the keynote, while the programs of the past twelve months have stressed invasion instructions and post-war planning.

Despite Nazi efforts to "blockade" these messages from the outside, Dutchmen contrive to receive them via clandestine radios. The latest evidence of this underground listening was supplied by the Nazis themselves. On May 21, a "RADIO ORANGE" commentator appealed to his compatriots to stock up on food sufficient to see them through the invasion period. "It is worthwhile to suffer hunger now so that food can be stored for future use," he declared. In a recent article discussing the effect on Holland of the allied invasion of Normandy, the German newspaper *Munich Nachrichten* reported that "foodshops were stormed and housewives bought all their monthly rations as had been recommended by the London radio ('RADIO ORANGE')." These recommendations, the paper added, also

*(Continued on page 116)*

## WORLDWIDE LOG OF SHORT-WAVE BROADCASTING STATIONS

(Numbers and letters at start of each item indicate frequency in megacycle and station call letters. To convert frequency to meters divide 300,000,000 by the frequency in cycles-per-second. Unless otherwise indicated, all times are EWT.)

- 2.880** LONDON, ENGLAND (BBC).  
**GRC** North American Service, 10:15 p.m.-12:45 a.m.
- 4.800** RADIO SAIGON, SAIGON, R.S. INDO-CHINA. 7:30-9:30 a.m.
- 4.920** CARACAS, VENEZUELA. 9-**YV5RN** 11:30 p.m.
- 5.940** KHABAROSVK, U.S.S.R. 4:10 a.m. (Relays RADIO MOSCOW.)
- 5.965** RADIO ANDORRA, ANDORRA. Heard 5-6 p.m. (daily).
- 5.985** CHUNGKING, CHINA. The **XGOA** Central Broadcasting Station. 10 a.m.-1:45 p.m.
- 6.005** MONTREAL, QUEBEC, CAN-**CFCX** ADA. Canadian Marconi Co., Ltd. Sunday, 7:45 a.m.-1:05 a.m.; Monday, 6:45 a.m.-1 a.m.; Tuesday, 6:45 a.m.-1:05 a.m.; Wednesday, 6:45 a.m.-1:04 a.m.; Thursday, 6:45 a.m.-1:10 a.m.; Friday, 6:45 a.m.-1:06 a.m.; Saturday, 6:45 a.m.-1:04 a.m. (75 w.) (Times listed are local.)
- 6.005** EDMONTON, ALBERTA, CAN-**VE9IA** ADA. Reported as heard, 12 a.m.-2 a.m. News on the hour.
- 6.010** SYDNEY, NOVA SCOTIA, CAN-**CJCX** ADA. Sunday, 8:55 a.m.-12 midnight; Monday through Thursday and on Saturday, 7:55 a.m.-12 midnight; Friday, 7:25 a.m.-12 midnight. (10 w.) (Times listed are local.)
- 6.010** LONDON, ENGLAND (BBC). To **GRB** North America, 8:15-10:15 p.m. To Scandinavia and Finland, 11:30 p.m.-12:10 a.m. To Norway, Sweden, Finland, and Denmark, 7-7:15 a.m. To Norway, 12:30-1 a.m. To Norway, Sweden, Finland, and Denmark, 1:10-1:30 a.m. To Western France, Spain, and Portugal, 2:10-2:45 a.m. To Spain, Portugal, and North Africa, 3:30-4 a.m. To Spain and Portugal, 4-4:30 a.m. To Norway, Sweden, Finland, and Denmark, 5:45-6 a.m. and 6-6:15 a.m. To Denmark, 6:15-6:30 a.m. To Norway and Finland, 6:30-7 a.m. To Spain and Portugal, 7:45-8:45 a.m. To Norway, 9-9:15 a.m. To Norway, Sweden, Finland, and Denmark, 10:30-11 a.m. and 11-11:15 a.m. To Scandinavia and Finland, 11:15 a.m.-12:10 p.m.; also 11:45 p.m.-12:10 a.m. and 1-1:10 a.m. To North Africa, 2:15-2:30 a.m. and 3:30-3:45 a.m. To Scandinavia, 1:45-2 p.m.; 2 p.m.-5:45 p.m. (all ABSIE). To Holland, Belgium, and Germany, 6:45-8 p.m. (ABSIE).
- 6.030** CALGARY, ALBERTA. The **CFVP** Voice of the Prairies, Ltd. Sunday, 8:15 a.m.-11:30 p.m.; Monday through Saturday, 6:30 a.m.-12 midnight. (100 w.) (Times listed are local.)
- 6.030** BERLIN, GERMANY. To North **DXP** America, 5:50 p.m.-1 a.m. News in English on the hour. Gives prisoner-of-war messages.
- 6.040** BOSTON, MASSACHUSETTS. **WRUW** Worldwide Broadcasting Corporation. Central American beam, 7:30 p.m.-2 a.m. (Spanish-Portuguese.)
- 6.050** LONDON, ENGLAND (BBC). To **GSA** Mexico, 10-11:45 p.m. (Radio Splendid). To Europe, 5-9:30 a.m., 12:30-1:30 p.m., 3:15-5:15 p.m., and 5:30-9:45 p.m. To France, 1:45-2 p.m.
- 6.060** BANGKOK, THAILAND. Heard — 6-9:30 a.m. (Home Service).
- 6.060** NEW YORK, N.Y. Columbia **WCBN** Broadcasting System. Mexican beam, 7:30 p.m.-2 a.m. (Spanish-Portuguese).
- 6.070** TORONTO, ONTARIO, CAN-**CFRX** ADA. Rogers Radio Broadcasting Co., Ltd. Sunday, 9 a.m.-12:05 a.m. Monday through Saturday, 7 a.m.-12:05 a.m. (1,000 w.) (Times listed are local.)
- 6.070** LONDON, ENGLAND (BBC). To **GRR** Central America and South America (North of Amazon), 7-11:45 p.m. To Southeastern Europe and Italy, 4-4:30 a.m. To Italy and Southeastern Europe, 12:30-12:45 a.m. To Austria, Italy, and Southeastern Europe, 12:45-1:30 a.m. To Italy and Southeastern Europe, 1:30-2 a.m. To Italy, Austria, and Southeastern Europe, 2-4 a.m. and 4:30-4:45 a.m. To Italy and Southeastern Europe, 5:15-5:30 a.m. (Radio Polska: For Polish Forces); also 5:30-5:45 a.m. To Austria and Southeastern Europe, 6:15-7 a.m. (Radio Polska). To Europe (including Southeastern Europe), 7-7:15 a.m. To Southeastern Europe, Italy, and Austria, 7:15-9:30 a.m. To Italy and Southeastern Europe, 10:30-11:30 a.m. and 11:30 a.m.-2:30 p.m., 2:30-2:45 p.m. To Southeastern Europe, 2:45-3:30 p.m. To Italy and Southeastern Europe, 3:30-3:45 p.m. To Austria and Southeastern Europe, 3:45-4:30 p.m. To Italy and Southeastern Europe, 4:30-5 p.m. To Southeastern Europe, 5-5:30 p.m. To Italy and Southeastern Europe, 5:30-5:45 p.m. To Europe (including Italy), 5:45-6 p.m. To Italy and Southeastern Europe, 6-6:15 a.m. To Holland, Belgium, and Germany, 6-6:45 p.m. (ABSIE).
- 6.080** VANCOUVER, BRITISH COLUM-**CKFX** BIA, CANADA. Western Broadcasting Co., Ltd. Sunday, 8 a.m.-11 p.m.; Monday through Saturday, 6:30 a.m.-11:30 p.m. (10 w.) (Times listed are local.)
- 6.080** CINCINNATI, OHIO. The Cross-**WLWK** ley Corporation. Latin American beam, 8:30 p.m.-12 midnight. European beam, 12:15-2:30 a.m. English news, 1, 2 a.m.
- 6.090** LONDON, ENGLAND (BBC). To **GWM** Northern Germany and Poland, 11:30 p.m.-4:15 a.m.; 1:45-7:30 p.m.; 8-9:45 p.m. To Holland, Belgium, and Germany, 7:45-8 p.m. (ABSIE).
- 6.100** ARMED FORCES RADIO, LOS **KROJ** ANGELES, CALIF. To American forces abroad, 12-3:45 a.m.
- 6.100** PEIPING, CHINA. Heard 5-9 **XGAP** a.m.
- 6.110** LONDON, ENGLAND (BBC). **GSL** North American Service, 8 p.m.-12:45 a.m. To Holland, Belgium, and Germany, 6:15-6:45 p.m.; 6:55-7 p.m.; 7-7:30 p.m.; 7:30-7:45 p.m. (all ABSIE). To Europe, 1-4 a.m.
- 6.120** HS IN KING, MANCHUKUO. **MTCY** 7:30-11 a.m. News, 10 a.m.
- 6.125** LONDON, ENGLAND (BBC). To **GWA** France, Spain, and North Africa, 11:30 p.m.-4:15 a.m. To France, Spain, and North Africa, 4:30-9:45 p.m. To North Africa, 12:30-12:45 a.m. and 1:30-1:45 a.m., 2:30-2:45 a.m., 4:30-5 a.m., and 6:30-6:45 p.m.
- 6.130** HALIFAX, NOVA SCOTIA, **CHNX** CANADA. The Maritime Broadcasting Co., Ltd. Sunday, 9 a.m.-11:25 p.m.; Monday through Friday, 7:45 a.m.-11:15 p.m.; Saturday, 7:45 a.m.-11:10 p.m. (500 w.) (Times listed are local.)
- 6.135** SUVA, FIJI ISLANDS. Heard **VPD2** 1:55 a.m.-6 a.m., Saturdays. Heard Sundays, 4:45 a.m., with semi-classical concert at 5 a.m. News at 5:15 a.m., followed by a program of hymns, and sign-off at 5:30 a.m. (with "God Save the King.")
- 6.150** WINNIPEG, MANITOBA, CAN-**CKRO** ADA. Transcanada Communications, Ltd. Sunday, 8 a.m.-11:30 p.m.; Monday through Friday, 6:30 a.m.-12 midnight; Saturday, 6:30 a.m.-1 a.m. (2,000 w.) (Times listed are local.)
- 6.150** LONDON, ENGLAND (BBC). To **GRW** Central America and West Indies, 10:15-11:30 p.m. (North American Service). To Iraq, Iran, Near and Middle East, East Africa, Italy, and Central Mediterranean, 12-1:15 a.m. To West Indies and Central America, 7-10:15 p.m.
- 6.160** VANCOUVER, BRITISH CO-**CBRX** LUMBIA, CANADA (CBC). Sunday, 8:15 a.m.-11:33 p.m.; Monday through Thursday, 7:30 a.m.-11:32 p.m.; Friday, 7:30 a.m.-11:33 p.m.; Saturday, 7:30 a.m.-11:34 p.m. (150 w.) (Times listed are local.)
- 6.165** LONDON, ENGLAND (BBC). To **GWK** Holland, Germany, and Czechoslovakia, 11:30 p.m.-2:45 a.m., 4:45-9:45 p.m.
- 6.180** LONDON, ENGLAND (BBC). To **GRO** Europe, 11:30 p.m.-12:30 a.m. To Europe, 8-9:45 p.m. To Norway, 12:30-1 a.m. and 6:20-6:35 p.m. To Holland, Belgium, and Germany, 7-7:30 p.m. (and including France), 7:30-8 p.m. (ABSIE).
- 6.195** LONDON, ENGLAND (BBC). To **GRN** France, 11:30 p.m.-7 a.m., 10:30-11 a.m., 11 a.m.-2 p.m., and 2:15-9:45 p.m. To France (in French), 7-7:15 a.m. and 2-2:15 p.m.
- 6.220** "DEUTSCHER KURZWELLEN-  
SENDER ATLANTIK" (RADIO ATLANTIC). This clandestine station is heard irregularly, evenings from "somewhere in Fortress Europa," usually after 8 p.m., in German.
- 6.275** "DEBUNK — VOICE OF ALL  
FREE AMERICA." Heard, Tuesday, Thursday, Saturday, Sunday, 8:30-8:50 p.m.
- 6.980** PAREETE, TAHITI. Wednesdays  
and Saturdays, 12-1 a.m. (Home Service).
- 6.990** KWEIYANG, CHINA. The **XPSA** Kweichow Broadcasting Station. 1:30-3:10 a.m. and 7 a.m.-12 noon.
- 7.000** SCHENECTADY, NEW YORK. **WGEA** Brazilian beam, 8:30-11:30 p.m.
- 7.035** VALÈNCIA, SPAIN. Heard sign-  
ing off at 6:03 p.m.

(Continued in November Issue)

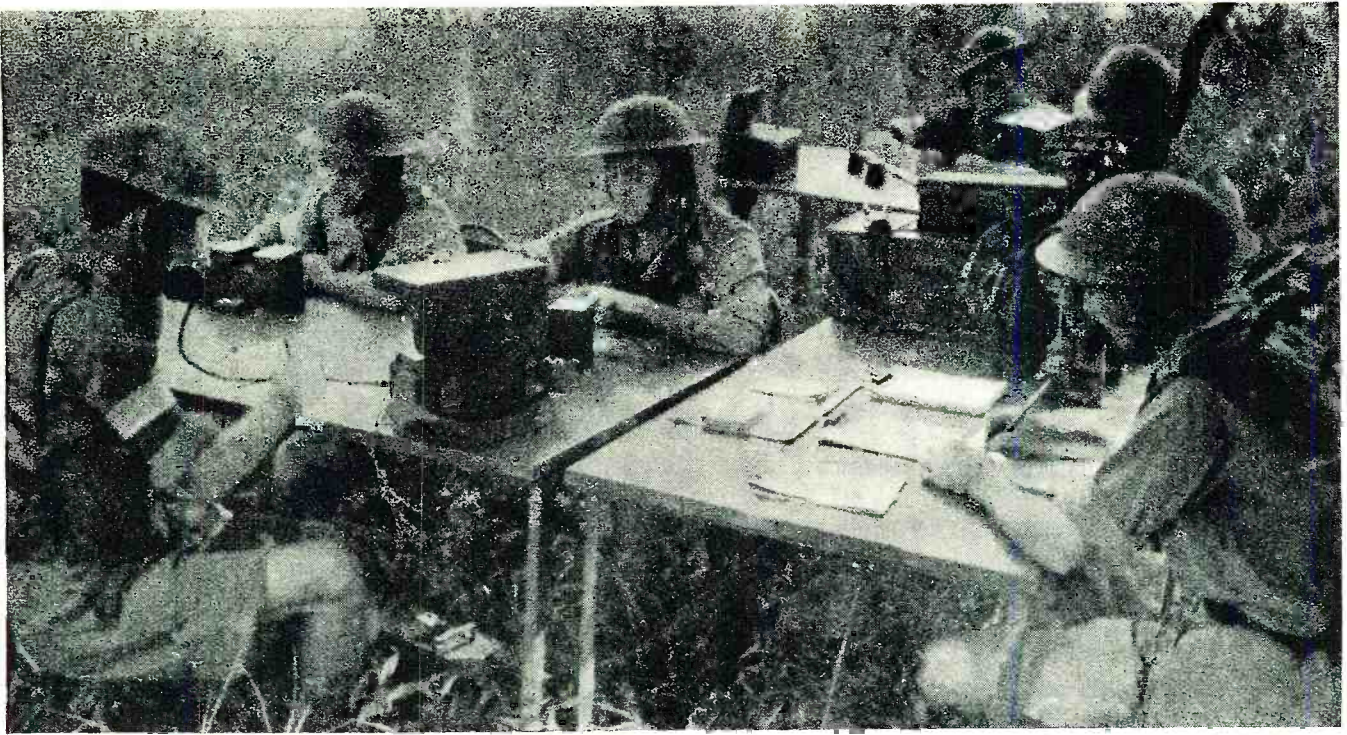

British Signals and Land-Line headquarters in the Malaya jungles, during the early phase of the war.

# SIGNALS in BRITAIN'S ARMY

By **CAPTAIN A. REID**

Signals Directorate, British War Office

*Problems that Britain's Army confronted in adapting radio communications to meet the mobility and speed required in modern warfare.*

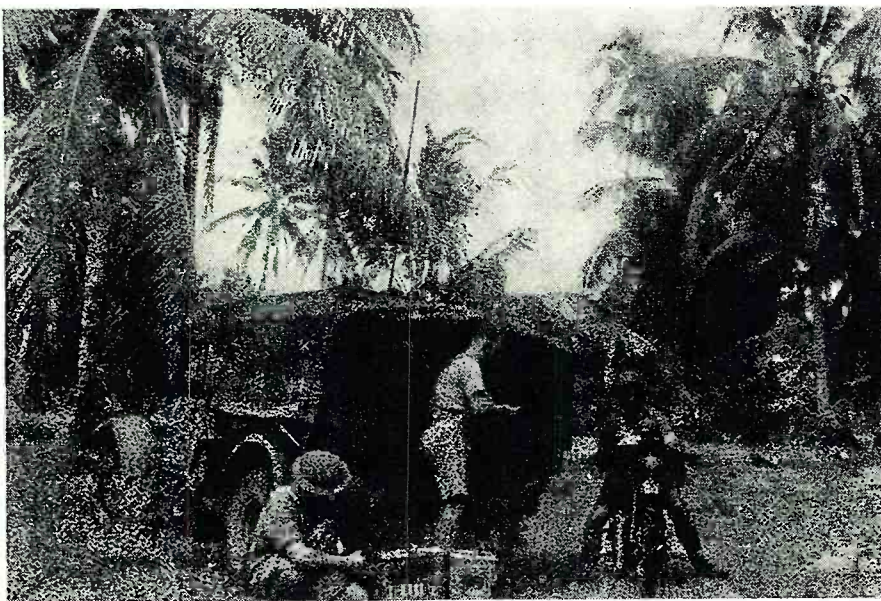

Radio van in the Malaya jungles, from which messages were sent via motorcycle carriers and pigeons. Radio has replaced many of these former methods of communications, particularly during the present phase of the war where speed is so essential.

**T**HE signal communications of Britain's Army have been very severely tested and extended to meet the mobility and speed of modern warfare and the vast distances over which the conflict is being waged. Radio, particularly, has been employed on a scale not hitherto contemplated.

In the field, for instance, radio communications have been provided not only for every headquarters and every fighting unit down to the infantry platoon, the tank and the armoured car; they also have been provided for the tank recovery units, the sappers and for the medical and supply services.

Special communications networks have been established for the control of air support for the Army, for initiating reconnaissance from the air and for disseminating reports of that reconnaissance. Elaborate networks have been established for the early stages of assault landings on hostile beaches. Every major development in the tactical handling of any arm of the Service has tended to increase the scale of signal communications.

Another problem has been that since 1940 the main theaters of the land war have never been less than 1,000 miles—and some several thousand from Britain.

Civil systems of communication either have not existed or have been unreliable or totally inadequate. The Army, therefore, has had to create, operate, and maintain its own worldwide radio chain as well as a network





Wireless operator at an R.A.F. bomber station where planes are sent off at two to five minute intervals.

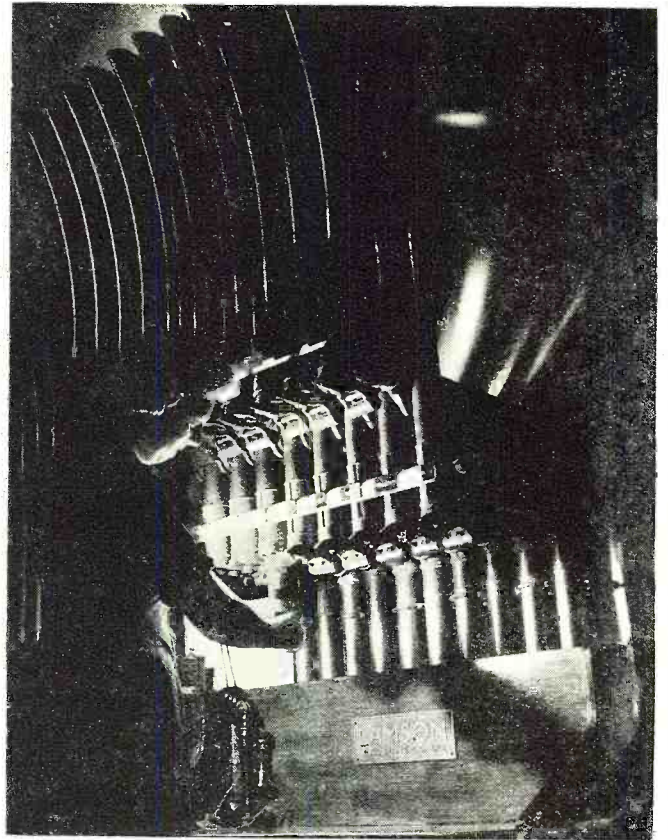

A W.A.A.F. orderly dispatches an urgent and secret message in its metal container through a Lamson tube.

of line telegraph and telephone communications.

Highly technical equipment not previously handled by the Army has had to be used for these purposes, and men who before the war were bank clerks, school teachers or shop assistants have had to be trained to use and tend it.

For communications with the Middle East and India, Britain formerly relied chiefly on the submarine cables through the Mediterranean. As soon as the Italians entered the war they cut the cables and laid minefields over the breaks. From that time until recently, when the Allies regained control of the Mediterranean, communications between the War Office in London and General Headquarters in the Middle East and India was almost entirely by means of the Army's radio system.

It was by radio, chiefly, that arrangements were made for building up the armies which were to protect the supply routes to India and the U.S.S.R. and eventually to drive westward across North Africa from El Alamein to Tunisia. The average daily traffic on the London-to-Cairo Army radio link alone amounted to 80,000 words.

The Allied landings in North Africa made it necessary to rely solely on radio communications also, for there was no adequate ready-made civil system and it was not long before the line communications between Allied headquarters and divisions in the field ex-

*(Continued on page 122)*

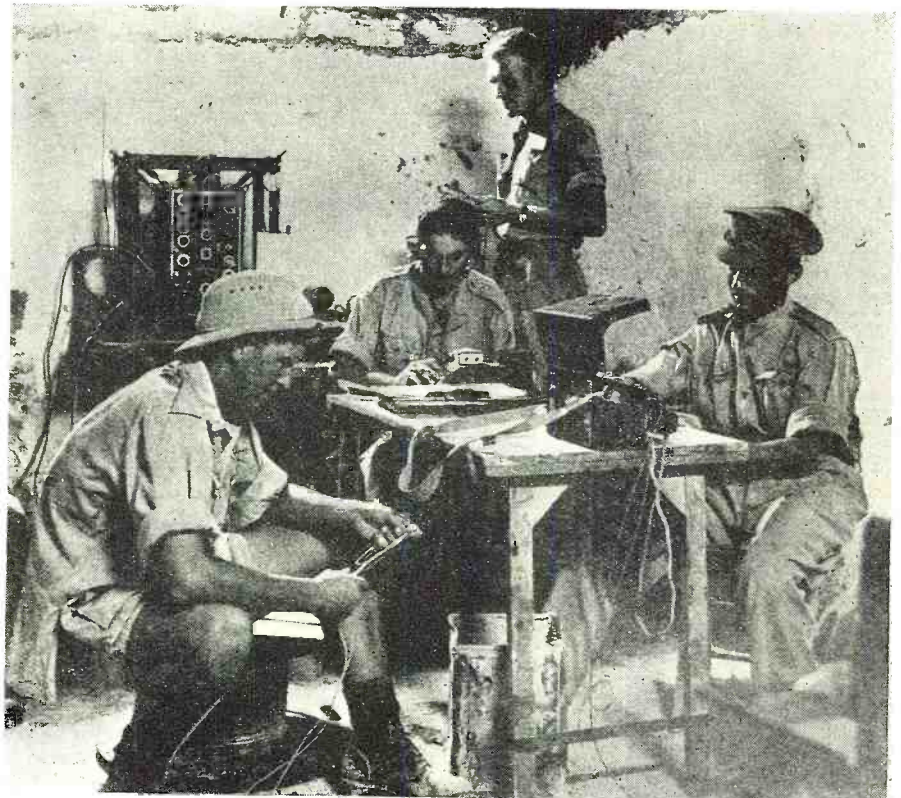

Signal section at work at a Brigade H.Q. near El Alamein, Africa. Radio operator Corp. B. MacAlister is shown receiving wireless message, while officer towards right is operating a British Fullerphone unit.

# THEORY AND APPLICATION OF U.H.F.

By MILTON S. KIVER

## Part 7. Additional properties of wave guides, used as a means of transmitting energy at the ultra-high frequencies.

IN the August issue of RADIO NEWS the fundamental ideas concerning wave guides and the electromagnetic waves that flow along these guides were presented. As stated, a wave guide merely confines the radio waves that ordinarily would flow uncontrolled in three-dimensional space. The method of starting these waves off is very much like our ordinary everyday processes with which all are so familiar. An antenna, in this case the inner conductor of a coaxial cable, is placed inside a guide and from this emanates the electromagnetic energy. By a series of reflections off the restricting walls of the guide, the energy is propagated down the guide to whatever use may be made of it. The end may be open, in which case the energy flows out into free space, or the receiving antenna may be placed here to pick up this energy.

The final property of a guide, mentioned in the last article, concerns the action of this wave guide in allowing waves of certain frequencies to be propagated down the guide, while others of a lower frequency are stopped, so to speak, at the very mouth of the guide. This selective effect, or filtering action, may be useful if only certain waves are desired to the exclusion of others of lower frequency. Note that this action is comparable to that of a high-pass filter in ordinary radio or electrical circuits. Keep in mind throughout this entire wave guide discussion that these guides are used for the very simple reason that they attenuate the high frequencies less than any coaxial cable devised so far. It is entirely permissible to think of these guides as transmission lines specifically designed for the ultra-highs, and, indeed many writers do.

Up to this time the types of waves

Fig. 2. Rectangular wave guide showing the three separate axes,  $x$ ,  $y$ , and  $z$ .

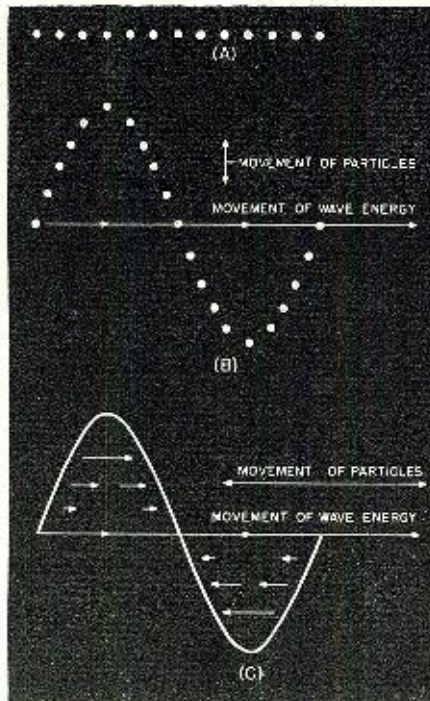
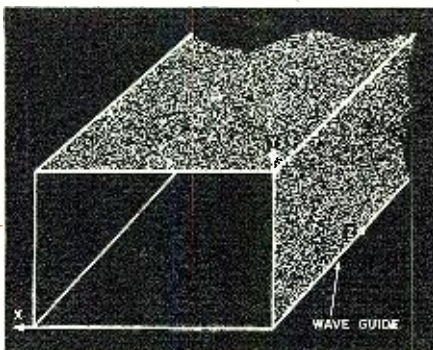

Fig. 1. Illustrating the variation between transverse and longitudinal waves. (A) No wave motion, particles are at rest. (B) Transverse wave, particles vibrate up and down while the wave energy moves forward. (C) Longitudinal wave, particles move back and forth while wave energy moves forward. Length of arrows in (C) indicates relative distance of particle movements.

merely have been mentioned without taking time out to explain the system used in arriving at these peculiar looking symbols. It might be best to start at the beginning and explain the difference between a transverse and a longitudinal wave which will lead more directly to the desired results. To demonstrate longitudinal wave motion take an ordinary tuning fork and hit it sharply, causing it to vibrate back and forth. This motion will force the molecules nearest the tuning fork to vibrate back and forth, and the resultant waves will travel outward in all directions. The vibration of the molecules, in this case, is in the same direction as the propagation of the sound waves thus causing their paths to be parallel. This is the defining characteristic of a longitudinal wave. It should, of course, be remembered that the molecules vibrate about a mean point while only the energy is expanding outward. It is somewhat

analogous to a situation where a straight row of billiard balls is tapped at one end. The energy is transmitted forward by the balls while the balls themselves remain fixed.

For the case of a transverse wave, consider the motion set up by water waves that is caused by a small pebble dropped into a pond. The waves travel outward while the small water molecules move up and down or at right angles to the direction of propagation of the wave. Another example of this type of wave motion is illustrated by the action of a rope, one end being secured and the other end moved up and down by hand. Fig. 1 emphasizes the difference between the two types of waves pictorially.

Changing from water waves and sound waves to electromagnetic vibrations, it can now be shown how the preceding information can be used to label the various types of waves in rectangular guides. As mentioned before, every electromagnetic wave may have electric and magnetic fields with components along any of the three conventional directions, namely,  $x$ ,  $y$  and  $z$  (see Fig. 2). Suppose a wave had a magnetic field along the  $z$  axis (Fig. 2) but no electric field in this direction. The electric components could be either in the  $x$  or the  $y$  direction or both. Since the direction of propagation of the wave is in the  $z$  direction, it can readily be seen that as far as the magnetic field is concerned, since it has a component in the  $z$  direction, this is a longitudinal wave. The necessary conditions as just defined at the beginning of this paragraph are satisfied. However, since the electric field has no components in the  $z$  direction, but only in the  $x$  or  $y$  directions, it can be called a transverse wave. This

Fig. 3. An electromagnetic wave in a plane propagated along axis  $X$ . Arrowed lines  $E$  signify electric lines of force, while those of  $H$  signify magnetic lines of force.

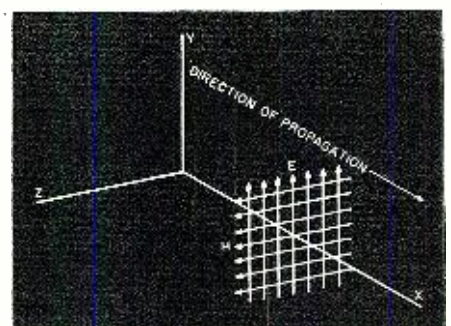

also follows from the definition of transverse waves. Thus, there is a choice. With regard to the magnetic field it is a longitudinal wave whereas with respect to the electric field it is a transverse wave. The custom has been to label the wave after the transverse component, so in this case the notation would be  $TE$ , standing, of course, for transverse electric. Another notation sometimes used is  $H$  waves.

To reverse the situation, let there be an electric field component along the direction of propagation, the  $z$  axis, but no component of the magnetic field. The latter will be confined to either the  $x$  direction, the  $y$  direction or both. (It has not been mentioned recently, but it will be recalled that the electric and magnetic fields must be at right angles to each other so that it is not possible to have a magnetic and an electric field along the same direction.) In this case there would be a longitudinal wave with respect to the electric field and a transverse vibration with respect to the magnetic field. Retaining the usual notation of labeling the wave after the transverse component, will give, for this wave, the name  $TM$  wave. The  $TM$  is an abbreviation for transverse magnetic. Another name that is sometimes used is  $E$  waves. Having taken care of the two main cases a third and final type of wave might be mentioned, which is in reality a plane wave (see Fig. 3). Here the electric and magnetic fields are at right angles to each other and at the same time are perpendicular to the direction of propagation. This can truly be called a transverse wave for here there are no longitudinal components. The name given this type of wave is a combination of the former two types and is  $TEM$ .

So far the nomenclature has been general, indicating only the class of waves in operation but we still lack a specific notation that would point out which particular wave in any group is being dealt with. In order to bring this out more clearly refer to Fig. 4 where three types of waves in the  $TE$  class are shown. The simplest wave in this group is shown in Fig. 4(A), where it can be seen that the dimension  $x$  is just wide enough to accommodate a half wave of the electric field. In Fig. 4(B) the frequency of the wave has been raised, so that now the same dimension  $x$  can accommodate a full wave. In Fig. 4(C) the frequency has again been increased and now we have three half waves. This process can be kept up as high as the frequencies can be generated and each wave is differentiated from the other by a small subscript  $n$ . Thus the lowest frequency waves, Fig. 4(A), would be represented by having  $n$  equal to 1, Fig. 4(B) would have an  $n$  of 2, Fig. 4(C) would have an  $n$  of 3, etc. The nomenclature is now more specific than it was before and is written as  $TE_n$ .

But there is no reason why the dimension in the  $y$  direction should be

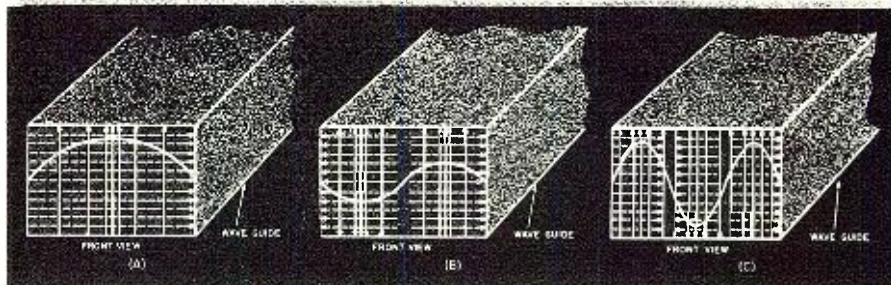

Fig. 4. Three wave guides, all of the same dimensions, showing the changes in electric and magnetic field strengths as a result of increasing frequency. Solid lines indicate electric field while dotted lines indicate magnetic field. (A)  $TE_{0,1}$  wave. (B)  $TE_{0,2}$  wave. (C)  $TE_{0,3}$  wave.

ignored since it is possible to have a variation in the electric field in that direction also. In this case, use the subscript  $m$  and call each half wave of variation in this direction 1. So finally the general notation is  $TE_{m,n}$  and specifically the wave in Fig. 4(A) is  $TE_{0,1}$  that in Fig. 4(B) is  $TE_{0,2}$  etc. Zero is used for  $m$  because there is no variation in the electric field in the  $y$  dimension, but let it not be forgotten that waves like  $TE_{1,1}$ ,  $TE_{2,1}$  etc. are perfectly possible. They are not frequently mentioned because of the extremely high frequencies involved, which for the present at least, are not easily generated. And whatever has been said about the subscripts  $m$  and  $n$  are equally applicable to the  $TM$  type of waves.

The discussion of wave guides has progressed far enough so that it is now possible to investigate the various methods used to excite these guides and get the different types of waves mentioned. Excitation was only vaguely referred to previously when it was merely stated that an antenna was placed in the guide and the electromagnetic waves radiated from it. Each general type of wave (both  $TE$  and

$TM$ ) and each specific wave requires a different setup to produce the desired field patterns. However, the similarity between the various waves of the  $TE$  group will be readily evident and the same holds for the  $TM$  group. The generator will be omitted in each case showing only the concentric cable placement in the wave guide but the obvious connection of the cable to the generator should be understood. The simplest wave of the  $TE$  group, namely  $TE_{0,1}$  can be generated by the arrangement shown in Fig. 5(A). The electric field pattern is shown underneath so that a mental connection between the two can be formed. The  $TE_{0,2}$  wave can be produced by the arrangement shown in Fig. 5(B). Since the exciting rods are  $180^\circ$  out of phase, the electric fields are shown as being in opposite directions. The closer the lines of force are, the stronger the electric field. As stated before, the intensity at the sides of the wave guide must be zero and this condition is adhered to here. The case of the  $TE_{0,3}$  wave is also shown and follows quite naturally, Fig. 5(C). Note that it is the inner conductor that is connected from the generator.

Fig. 5. Methods of exciting wave guides to obtain the wave patterns illustrated.

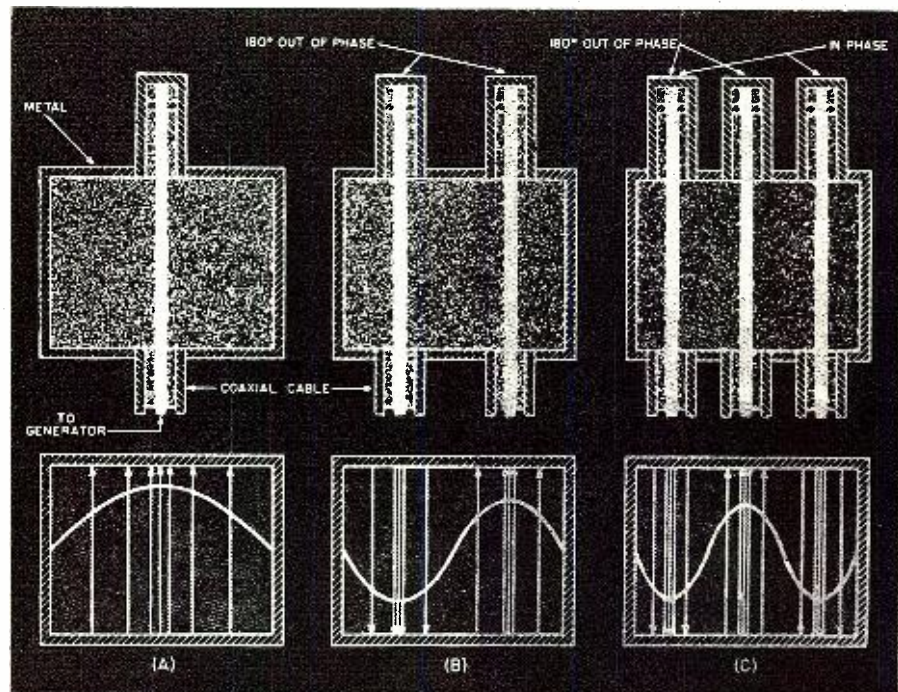

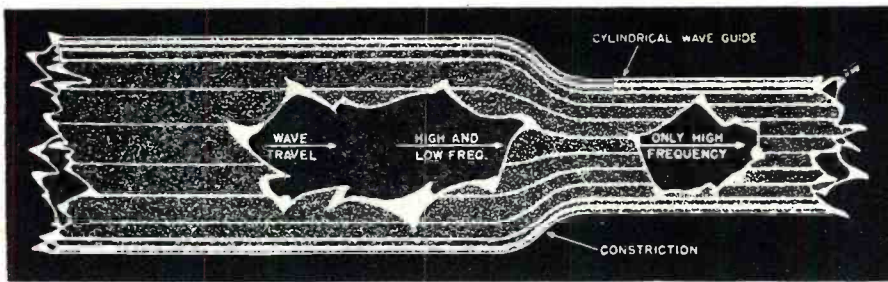
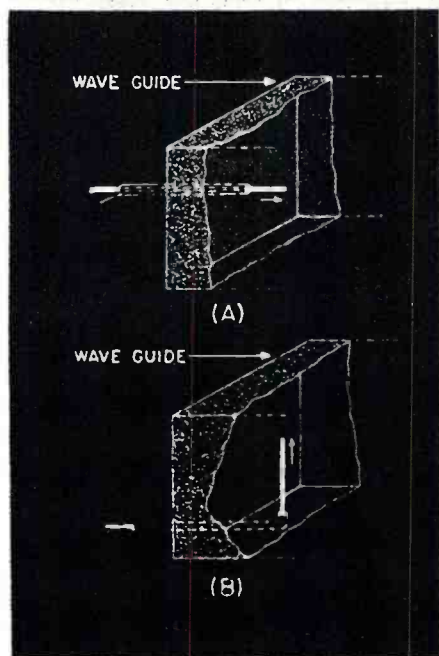

Fig. 6. Filtering action of a cylindrical (or rectangular) wave guide to separate two frequencies. The lower freq. is lost as the wave enters the smaller portion of the guide.

To produce the fields for the TM type of wave, a setup similar to that shown in Fig. 7(B) for the TE wave is used except for the position of the antenna in the wave guide. For comparison, methods of producing both the TE and TM fields are shown together in Fig. 7. In general, for the  $TE_{m,n}$  type of wave, the antenna will be at right angles to the direction of propagation while in the  $TM_{m,n}$  case, these antennas are parallel to the direction of propagation. This is logical since as previously pointed out, the TE wave has no electric field in the forward direction while the TM wave has. It is only natural, then, that the placement of the radiators should also differ by  $90^\circ$ . Provision is also usually made whereby the length of the antenna in the wave guide can be adjusted to give best results. This is an important adjustment since the measured intensity of the transmitted wave may vary quite a bit between the best condition and the worst. Another adjustment that is important is the distance between the antenna and the end of the wave guide nearest it which acts as a reflector or backboard. The correct alignment can greatly improve the transmitting efficiency. And while only the transmission has been discussed here, every radio man knows that a

Fig. 7. Two methods of exciting wave guides. (A) TM type wave. (B) TE type wave.



good transmitting antenna is also an excellent receiving antenna and so the results work both ways. In the case of reception, however, the coaxial cable from the antenna is connected to a crystal detector which rectifies the received current and thus makes it available for further use. Incidentally, these antennas when used for reception are pretty selective and will pick out one type of wave almost to the exclusion of all others. By having several types of transmitting antennas placed in various positions and at the other end of the guide receiving rods in similar positions, the guide can be used for multiple channel transmission. This is a point that will probably be of good use in days to come.

The reader may be a little confused by all the different types of waves that have been explained. A question might naturally arise in his mind as to the reason for having so many different modes of operation. The answer lies in the frequency that is to be transmitted down the guide. For low frequencies, where there is only one standing half wave across the mouth of the guide, a simple type of electromagnetic wave may be used, such as the  $TE_{0,1}$ . As the frequency is raised, the number of half waves likewise increase and so the wave becomes more and more complex. Each of these complex waves may be looked upon as combinations of simple types and they must observe the same general rules that apply to all electromagnetic radiations. Another reason for studying these different type waves lies in the fact that some have properties that may be of more use to us than those of other waves. Some may be easier to generate and send, while others may not suffer attenuation as they travel down the wave guides. Then, of course, there is the question of size. Higher frequency waves require smaller guides than those of the lower frequencies. However, the lower frequencies are easier to generate. Hence we arrive at a situation that is not unlike what we have today. Some people prefer one type of circuit over another and for each the reasons advanced are the best solution to the problem. As more and more uses of the ultra-high frequencies are found there probably will be greater simplicity and only a few types of waves will be used. But for a field that is just in its first stages, everything connected with it comes under the engi-

neer's microscope. It is only by this process of experimentation that better and easier working models are achieved.

The only wave guide discussed so far has been the rectangular wave guide, and this was used because it is easier to visualize the actions of the electromagnetic wave. However, there are other forms that these guides can assume, most of them being of little practical importance, except the cylindrical wave guides. As with the rectangular forms, it is possible to use the two notations ( $TE_{m,n}$  and  $TM_{m,n}$ ) to label the various types of waves that can be propagated down the length of the tube, provided the frequencies used are not too low for a particular diameter of the guide. The same conditions pertaining to electric and magnetic fields still hold true even if the shape of these fields has changed. In fact, the change is due to the difference in shape of the guide.

Usually, when dealing with these cylindrical wave guides, the geometrical notation is changed from that used with the rectangular guides. This is illustrated in Fig. 8 for a cylindrical guide. Note that the axis in the direction of propagation is left the same, the changes occurring where we previously used the  $x$  and  $y$  axis. Instead of these, we now deal with the radius

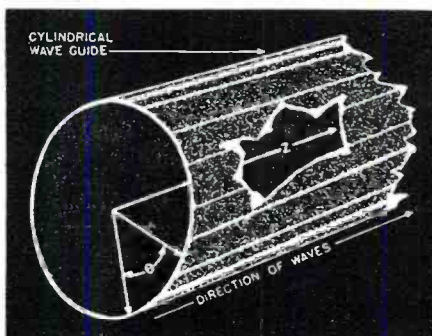

Fig. 8. Cylindrical wave guide showing direction of wave and various coordinates.

$r$  and the angle  $\theta$  which allows us to go any distance from the central axis and also to rotate through the complete  $360^\circ$  about this axis. Electric or magnetic fields having components along any of these directions are differentiated from each other by subscripts. Thus  $E_z$  means an electric field component in the  $z$  direction,  $E_r$  pertains to the radial direction and  $E_\theta$  tells of any field in the circular path. The same, of course, holds for the magnetic field components.

For excitation of perhaps the  $TM_{0,1}$  wave in cylindrical guides, it is possible to use a setup as pictured in Fig. 9(A). The resulting field pattern is shown in Fig. 9(B), the view being an end one. Having only transverse components of the electric field, the  $TE_{1,1}$  type depicted in Fig. 10 is obtained and its method of excitation is included for those who might be curious. The critical or cut-off frequency is higher for the  $TM_{0,1}$  wave than it is for the  $TE_{1,1}$

(Continued on page 80)

# For Consistently Accurate, Trouble-Free Service . . .



Many factors contribute to the permanent performance of Ohmite Units—factors of design and construction that enable them to meet every condition of service . . . to withstand shock, vibration, heat and humidity . . . and keep going. These characteristics make Ohmite Rheostats, Resistors, Chokes and Tap Switches especially well fit for today's critical wartime needs.

What's more . . . Ohmite leadership in developing an extensive range of types and sizes has made it possible to serve innumerable applications. All this, of course, makes them readily applicable for the new peacetime products of tomorrow. Ohmite Engineers are glad to assist on any problem for today . . . or tomorrow.

**Send for Handy Ohmite Ohm's Law Calculator.** *Thousands of these Ohmite Calculators are in practical use today. Figures ohms, watts, volts, amperes—quickly, easily. Solves any Ohm's Law problem with one setting of the slide. All values are direct reading. Send only 10c in coin to cover handling and mailing. (Also available in quantities.)*



**OHMITE MANUFACTURING COMPANY**  
4883 FLOURNOY STREET, CHICAGO 44, U. S. A.

# THE NATION'S CHOICE

... for Everything in RADIO and ELECTRONICS

From every corner of the Nation . . . come calls to ALLIED for rush delivery of vital radio and electronic supplies.

For it's well known that here are centralized today's largest and most complete stocks under one roof . . . tubes, parts, kits, test equipment, public address . . . over 10,000 items . . . for training, research, engineering, production and maintenance.

Here, too, are men of experience to give technical assistance or expedite procurement of "hard-to-get" items.

Wherever you are . . . whatever you need . . . call ALLIED first for fast, efficient, intelligent service.

Write, Wire, or Phone Haymarket 6800

**ALLIED RADIO CORP.**  
833 W. Jackson Blvd., Dept. 1-K-4, Chicago 7, U. S. A.



**FREE**  
Complete  
Up-to-date  
BUYING  
GUIDE

**REPAIR AND REPLACEMENT PARTS AVAILABLE WITHOUT PRIORITY**



### NEW Rapid R-F Resonance and Coil Winding Calculator

New, dual-purpose Calculator devised by Allied for fast and accurate determination of resonance factors and coil winding data. Simple, easy to use. Send for it now. No. 37-955.  
Price net, only . . . . . 25c

### 6 VALUABLE RADIO BOOKS FOR 75c

Specially prepared by technical experts for radio training and for helpful reference. Priced only to cover cost of preparation and mailing.

**RADIO BUILDERS' HANDBOOK.** Simplified theory and projects. No. 37-750 . . . 10c

**RADIO-FORMULAS & DATA BOOK.** Handy, pocket-size manual. No. 37-752 . . . 10c

**SIMPLIFIED RADIO SERVICING.** Short cuts in troubleshooting. No. 37-755 . . 10c

**DICTIONARY OF RADIO TERMS.** Easy-to-understand definitions. No. 37-751 . 10c

**RADIO CIRCUIT HANDBOOK.** Schematics and Pictures. No. 37-753 . . . 10c

**RADIO DATA HANDBOOK.** Formulas — Tables — Charts. No. 37-754 . . . . . 25c

**ALL SIX BOOKS No. 37-799 . . . . . 75c**  
Write for Quantity Quotations



ALLIED RADIO CORP., Dept. 1-K-4,  
833 W. Jackson Blvd., Chicago 7, Illinois

Please send the following items (\$ enclosed)

- 37-750       37-752       37-754
- 37-751       37-753       37-755
- All 6 Radio Books    Free Catalog    Calculator

Name \_\_\_\_\_

Address \_\_\_\_\_

City \_\_\_\_\_

State \_\_\_\_\_



## Advanced Radio Theory

(Continued from page 51)

with us, insofar as the FCC examinations are concerned, it remains something which the broadcast operator must prevent at all costs in his AM transmitter.

Investigate the causes of carrier and frequency shift and the results of over and under excitation! Learn exactly what overmodulation is and its effect upon transmitters! The ability to draw a carrier wave envelope and indicate on that drawing the dimensions from which the percentage of modulation is determined (Fig. 4) will be very helpful. Mathematical formulas for determining percentage modulation must be learned and trouble shooting in modulators is quite important.

The fluctuations and percentages of increase in antenna current and power during modulation should be understood. Possession of adequate knowledge of the principles of modulation will do much to clarify other principles of radio broadcast operation.

The foregoing outline might be considered the backbone of the knowledge required to pass the FCC examinations.

Getting back to mathematics, for a moment, formulas used in determining the resonant frequency of an antenna and the methods whereby these frequencies may be raised or lowered should also be learned. The directional characteristics of loop and vertical antennas must be known, as shown in Fig. 5. The formula for determining antenna resistance and current is simply an adaptation of basic Ohm's Law but should not be overlooked.

For the student who is interested in the Radiotelephone license, a knowledge of the respective advantages and disadvantages of lateral and vertical methods of transcription is required.

For those prospective licensees who are trying for a Radiotelegraph license a good deal of emphasis should be placed upon the operation and trouble shooting in auto alarms. This is a complex subject but the FCC is interested in knowing whether you can operate, adjust and maintain the two types of auto alarms in common use. The basic principles of radio, and you will certainly know them if you succeed in passing the FCC examinations, will carry you through the complexities of auto alarms.

The most important thing for the student to remember when preparing for the FCC Commercial Operator's examination is that without a solid background of radio fundamentals, the examination cannot be passed! The student must review radio fundamentals until this basic material becomes second nature to him when he sits down to take that important examination.

**ATTENTION TO DETAIL ADDS UP  
TO DEPENDABLE PERFORMANCE**



# POTENTIOMETERS

**TYPES 260, 275, 261, 276, 281, 291, 292, 296**

Twenty-five years of experience in the precision electrical instrument field assure quality and dependability in DeJur potentiometers. We have created a wide variety of standard models for practically all applications. Special attention is paid to individual specifications.

- Winding strip is wound on a linen bakelite card which has been carefully sanded before winding.
- Windings are made of either Nichrome or Advance wire, depending upon the resistance of the card to be wound.
- The card, wrapped around a moulded phenolic base, is held in position by heavily plated brass nuts and bolts.
- The wiper, incorporating five contacts, is made of plated bronze, carefully buffed where electrical contact is made with the winding.
- Types 261, 276, 281, 292 and 296 incorporate an "edge" type wiper for closer tolerances.
- The shaft may be either bakelite, cold rolled steel suitably plated, or solid brass, depending on whether the instrument is to have a live or dead shaft.
- The bushing which supports the shaft is made of precision machined brass.
- For ease of wiring installation, the selected terminal lugs are carefully tinned.
- In assembly, the cards are treated by dipping and baking to assure adhesion of the winding to the card; the entire unit is assembled to exacting specifications.

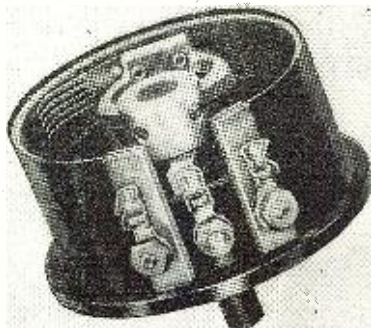
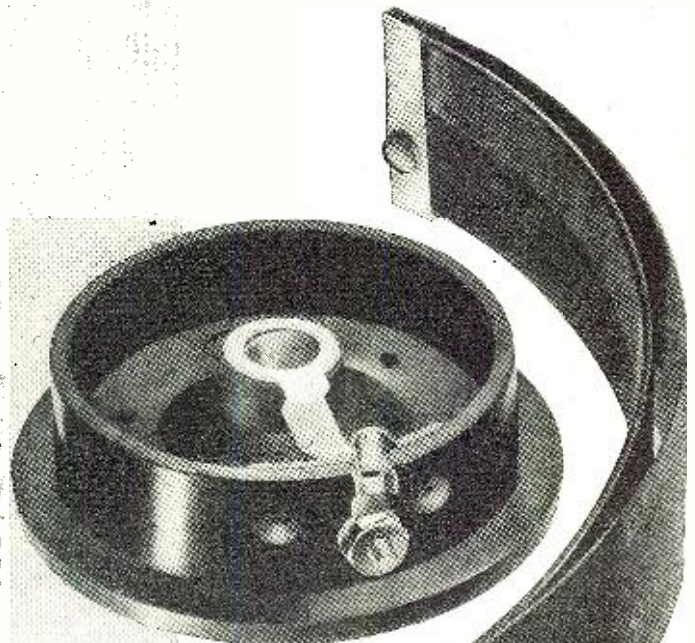
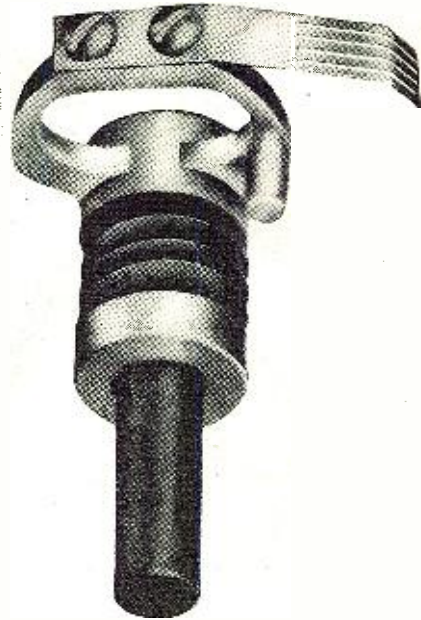

A DEJUR ENGINEER IS AVAILABLE FOR A DISCUSSION OF YOUR PRESENT OR POSTWAR APPLICATIONS

## DeJur-Amsco Corporation

MANUFACTURERS OF DEJUR METERS, PHOSTATS, POTENTIOMETERS AND OTHER PRECISION ELECTRONIC COMPONENTS

GENERAL OFFICE: NORTHERN BLVD. AT 45th ST., LONG ISLAND CITY 1, N. Y.

SHELTON FACTORY: Shelton, Conn. • CANADIAN SALES OFFICE: 560 King Street West, Toronto

BUY MORE  
THAN BEFORE...  
KEEP "HOARDING"  
WAR BONDS



## Master Tube Tester

(Continued from page 34)

test station, discloses the great care taken to avoid parallax in reading the instruments. By placing the meters in a carefully determined arc, and at the proper vertical heights, the eyes of an operator of average height are correctly positioned, assuring greater accuracy in final operation.

Painstaking planning provided all controls within easy reach. Accessible drawers are provided for adaptors, spare meters, headphones, and test records. A built-in cathode-ray tube may be used as a visual null indicator for the vacuum tube bridge, instead of headphones. Although not shown in the photograph, an adjustable fluorescent lamp mounted on top of the test station, floods the instrument panel with ample light.

The automatic electronic fusing protection for current meters and the automatic ranging of voltmeters make practicable the use of extremely accurate instruments. Use of vacuum tube voltmeters instead of microammeters eliminates meter burnouts. The v.t.v.m. is highly degenerated for stability, and adjusted for saturation above the range in use, to protect the measuring instruments from damaging overloads. The accompanying table indicates that meters have been chosen for  $\frac{1}{2}$  of 1% accuracy. The test station, therefore, may be used as a standard for all other production test equipment.

By means of patching cords, any meter or power supply may be connected into any desired tube circuit. Supplementary supplies having ranges of 0-100 volts negative and 0-1500 volts positive, can also be patched into chosen circuits. These features, plus the wide meter ranges, allow full coverage from miniatures to medium-power transmitting tubes.

A wealth of controls is furnished for: switching from a.c. to d.c. filament operation; adjusting of transformer primary voltages by transformer taps and by variacs; selecting of proper circuits for heater-cathode voltage measurements; zero adjustment of vacuum tube voltmeters; gain control of the bridge amplifier; switching on and off the voltages applied to the 561D General Radio vacuum tube bridge; switching positive or negative potentials to the grid; and varying the emission voltage between low and high values.

It can be readily understood that Hytron's electronic equipment design engineer, Ralph Thompson, and his engineering associates have lavished much thought on this piece of equipment. The assurance of accuracy when the test kit is in operation has repaid them many times for the midnight oil they burned in making their dreams of a really modern and versatile test kit come true.

-30-



STANCOR

*Transformers*

*... Battle-Tested!*



Before a Stancor Transformer is shipped, it is "certified for service" by engineers whose tests simulate actual conditions in the field... Because "Stancor" is battle-tested—right in our extensive laboratories—it has covered itself with glory on the battlefield. This is your assurance of the efficient performance of Stancor Products to which you may confidently look when the domestic market returns.

STANDARD TRANSFORMER CORPORATION  
1500 NORTH HALSTED STREET • CHICAGO 22, ILLINOIS



wherever a tube is used...

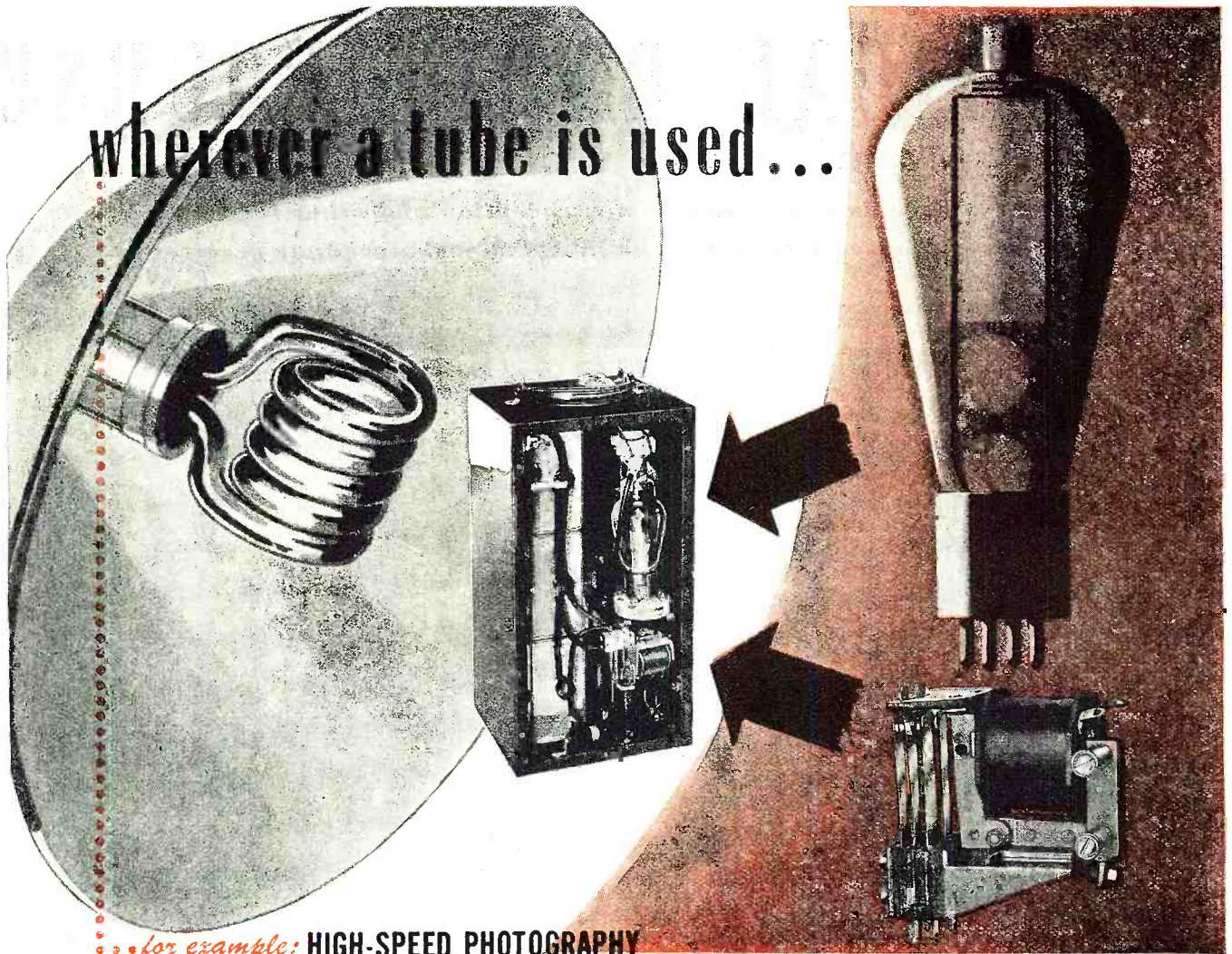

...for example: **HIGH-SPEED PHOTOGRAPHY**

The Lee Strobe-Speed lamp stops action of rapid movement with a flash of about one thirty-thousandth of a second. One flash exceeds in light intensity the illumination of 2,000 kilowatts of ordinary tungsten lamps. Operates on 115 volts, 60 cycles, A.C.

THERE'S A JOB FOR

*Relays* **BY GUARDIAN**

In the Lee Strobe-Speed lamp a rectifier tube is employed to build up a high charge on a bank of condensers. These are discharged through the flash lamps when the Guardian Series 15 relay is energized. This special application illustrates the flexibility of design incorporated into Guardian relays. The Guardian standard Series 15 was selected for the job and engineered to meet the high voltage requirements and other special conditions.

Another Lee Strobe-Speed unit with three flash tubes operating from three banks of condensers also employs the Series 15 relay. In this application the relay is equipped with additional switches to handle three circuits instead of one. Contact switches in both units are specially insulated to withstand the high voltages.

The Series 15 is a compact unit having a maximum switch capacity of 10 pole, single throw with 1½ amp. contacts; 6 pole single throw with 8 amp. contacts; 4 pole double throw with 12½ amp. contacts. Coils for standard voltages range up to 220 volts and may be equipped with copper slug time delay on release or attract.

For D. C.—write for Series 15 bulletin.

For A. C.—write for Series 30 bulletin.

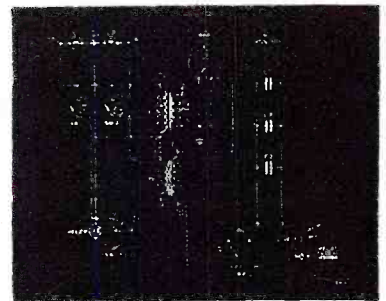

Single Flash Tube, Single Circuit Diagram.

Consult Guardian whenever a tube is used—however, Relays by Guardian are NOT limited to tube applications but are used wherever automatic control is desired for making, breaking, or changing the characteristics of electrical circuits.

**GUARDIAN**  **ELECTRIC**

1630-L W. WALNUT STREET

CHICAGO 12, ILLINOIS

A COMPLETE LINE OF RELAYS SERVING AMERICAN WAR INDUSTRY

# PRACTICAL RADIO COURSE

By ALFRED A. GHIRARDI

## Part 27. Covering image-frequency reception and other interfering spurious responses that can occur in AM superheterodyne receivers.

✓ **U**S far in our discussion of the superheterodyne receiver we have considered only: (a) the *desired* signal; and (b) the signals of *adjacent-channel* frequencies that are rejected mainly by the selectivity of the intermediate amplifier. Actually, a superheterodyne receiver, when tuned to a desired signal, is particularly sensitive to certain other frequencies (and combinations of frequencies) which, if allowed to, can produce *spurious* frequencies that will pass through the i.f. amplifier and cause annoying whistling or background-station interference with the desired signal. These are known as *spurious response* frequencies. Some of them are especially troublesome in receivers which must be operated in close proximity to transmitters whose carrier frequencies bear certain numerical relations to the frequencies existing in the receiver. In this, and several succeeding lessons we shall learn how the various types of spurious responses are caused, and what receiver designers have done to eliminate or minimize them in modern superhets.

### Types of Spurious Responses

Spurious responses may be of several types. Furthermore, some can occur only in superheterodyne receivers, others exist in any type of receiver. Those which may occur in amplitude-modulation (AM) superheterodyne receivers (unless proper design precautions are taken to prevent them) are:

1. Repeat points (double-spot tuning)
2. Image-response interference
3. Intermodulation interference
4. Direct intermediate-frequency interference (code, beacons, etc.)

Fig. 1. Illustrating how double-spot tuning (same station received at two different dial settings) can occur in a receiver having insufficient selectivity in the preselector circuits ahead of the mixer tube.

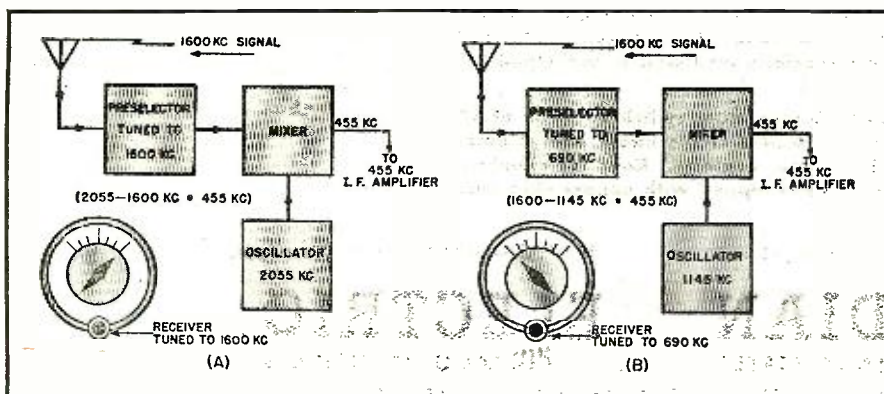

5. Signal-harmonic interference
6. Oscillator-harmonic interference
7. Signal-oscillator harmonic combination interference
8. Second-harmonic of i.f. interference
9. Local-oscillator radiation interference
10. Over-all i.f. feedback interference
11. Cross-modulation within re-

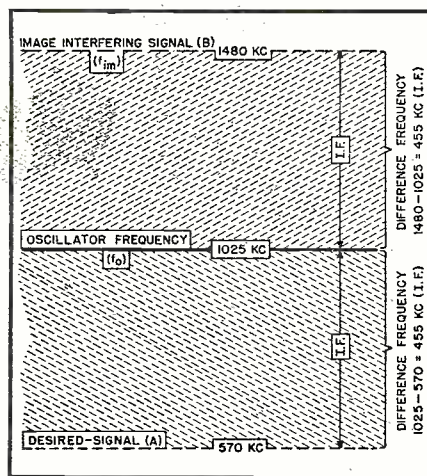

Fig. 2. For each oscillator frequency there are two signal frequencies; the desired signal and the image or interfering signal.

- ceiver (t.r.f. or superhet receivers)
12. Cross-modulation external to receiver (t.r.f. or superhet receivers)
13. Same-channel station beat interference
14. Adjacent-channel station beat interference
15. Monkey chatter

We shall now make a detailed study of the causes and most effective preventative measures for each of these spurious responses.

### Repeat Points (Double-Spot Tuning)

When superheterodyne receivers were built with separately-tuned oscillators (2-dial control receivers) it was possible to tune in a single station at two separate settings of the oscillator dial. This was called "double-spot" or "repeat point" reception. For example, assume that only one signal having a carrier frequency of 1,000 kc. was being received by the antenna and fed to the receiver and that the intermediate amplifier was designed for an i.f. value of 455 kc. Under these conditions, the required 455 kc. beat frequency would be produced when the oscillator was set to 1,455 kc. (since  $1,455 - 1,000 = 455$  kc.), and again when it was set to 545 kc. (since  $1,000 - 545 = 455$  kc.). Hence, there would be two oscillator tuning dial settings, one *above* the frequency of the incoming signal by an amount numerically equal to the i.f., and one *below* it by an equal amount, at which the incoming signal would be "converted" to the required 455 kc., passed on through the i.f. amplifier and heard—giving rise to *repeating* or *double-spot* tuning. These repeat points are present in any superheterodyne circuit when the oscillator can be separately tuned, *the repeat point for any one station always being separated from the correct oscillator dial setting by an amount equal to twice the i.f. value.*

Superheterodynes no longer are built with separately-tuned oscillators, but repeat-point response can also occur in a single-dial receiver if the selectivity of the preselector is insufficient due either to its design, circuit defects, or improper adjustment. For example, under such conditions, a 1600 kc. station will be heard at its correct dial setting of 1600 kc., as illustrated at (A) of Fig. 1. As illustrated at (B) of Fig. 1, it will be heard again at a "repeat point" dial setting (690 kc.) that will be below the correct dial setting by 910 kc., that is, by twice the i.f. value (assuming that the oscillator is designed to tune 455 kc. *above* the frequency of the incoming signal). In the latter case the 1600 kc. station signal is getting through the insufficiently selective preselector to the mixer, even though the preselector is tuned to only 690 kc., a frequency *lower* than 1600 kc. by twice the value

# SPRAGUE TRADING POST



## A FREE Buy-Exchange-Sell Service for Radio Men

**\* FLEXIBLE**

**\* MOISTURE PROOF**

**\* HEAT-PROOF TO 1000°C.**

**\* LARGER WIRE SIZES IN LESS SPACE**

**The ONLY Resistors wound with \* CERAMIC INSULATED WIRE!**

As a radio serviceman, no one has to tell you that a wire wound resistor is no better than its insulation—or that that is why Sprague Koolohm Resistors are "tops" by any test you care to name. Koolohm ceramic insulation is applied directly to the wire and the assembly is then DOUBLY protected by an outer ceramic tube. Koolohms operate so cool you can use them at full wattage ratings. They are highly resistant to both moisture and heat. They give you higher ratings in smaller sizes. KOOLOHMS will not let you down!

**FOR SALE**—Green flyer 2-speed phono motor in case, with Astatic pickup line coil and switch, complete \$35; RCA heavy duty, any speed motor with speed indicator, complete in case with astatic pickup, \$25; Philco station set (sig. gen.) \$15; Readirite #711 3-meter tester \$10. Need 1 and 12 volt tubes, L. R. Benorden, Box 52, Llano, Texas.

**FOR SALE OR TRADE**—Automatic code machine, 3-055 acorb tubes, vibrators, 7" Triplett foundation meter, photo electric cell with relay, chassis, etc. Want phono pickups and phono motors. What have you? Joe's Radio, 2224 W. Belden ave., Chicago 47, Ill.

**FOR SALE**—Precision #912 tube tester, \$35; Precision D-100, sig. generator \$36; Triplett Mod. Monitor #1696, \$15; Meissner 9-1001 sign, shifter with 3 sets coils, \$30. Pvt. Mayford C. Gale, Htry. Co., 85th AAA Gun Bn., Camp Pendleton, Va.

**URGENTLY NEEDED**—Polyphase Duplex Decit. slide-rule—preferably Cooke's radio slide-rule. Cash. Joseph Paulson, RP 3/C, Co. 37, Bar. 9, R.M.S., Treasure Island, San Francisco, Calif.

**WILL TRADE**—Brand new RCA 1" oscillograph #151, for RCA junior volt-ohmmyst #165. Radio Laboratory, Patchen Road, So. Burlington, Vt.

**FOR SALE**—Triplett set analyzer #1177, incl. multimeter, sig. generator, and free point set tester, in oak case; also Readirite-Ranger sig. generator #540, and Hickok tube tester Diamond Point, Jr., Lester P. Grove, 400 White Horse Pike, Egg Harbor, N. J.

**FOR SALE OR EXCHANGE**—1-5MP1, \$24.75; 1-5B14, \$27.50; 2-872-A, \$7.50. Robert Goetz, 321 Broadway, New York City.

**WANTED**—Rider's Manual No. 2. Leo Radio Service, Succasunna, N. J.

**WANTED**—Power transformer RCA #12463, for RCA record player R-99. George M. Gum, Major, T. C., Fort Slocum, N. Y.

**FOR SALE**—7" DeFrest Sanabria oscillograph, slightly used, \$170; V-O-M meter, \$50. Abe's Radio Shop, 907 Morris ave., Bronx, N. Y.

**FOR SALE**—4 Hammarlund midset condensers: 2-140 mid. and 2-200 mfd. \$1.50 each. Want Beede 3" square type O-1 M.A. meter. J. Goldstein, 151-09 34th ave., Flushing, L. I., N. Y.

**FOR SALE**—Supreme #501 set analyzer in perfect condition, Gernsback service manual, RCA service notes, \$50. R. S. Hope, Box 417, Darlington, S. C.

**URGENTLY NEEDED**—New or slightly used 45Z3 tube. Francis L. Munsch, Perry, Mich.

**WANTED**—Weston analyzer #772, late model tube tester (Hickok preferred), Rider manuals and sig. generator or equivalent, S. L. Malone, 2531 Sharon ave., Dallas 11, Texas.

**URGENTLY NEEDED**—Hickok tube tester (late model); also sig. generator. A. S. Wilde, 10708 Hulda ave., Cleveland 4, Ohio.

**FOR SALE**—Rebuilt National FBXA comm. receiver, including power supply, crystal, and coils. Excellent condition. \$55. R. L. Heaton, 231 Forest st., Reading, Mass.

**WANTED FOR CASH**—Sig. generator, tube tester, and V-O-M. A. Decker, P.O. Box 393, Utica 1, New York.

**WANTED FOR CASH**—National NC200, Hallcrafters SX 25 or 28, or Echophone EC3. G. H. Caballero, 327 E. 24th st., Los Angeles 11, Calif.

**TUBES FOR SALE OR TRADE**—30, 31, 32, 33, 40, 484, 250, 6B7, 38, 59 and 27. Want tube tester. Merrit Radio Electric Shop, 985 Hyperion ave., Los Angeles 27, Calif.

**SWAP OR SALE**—Hammarlund Comet pro. receiver complete with coils from 17 to 550 meters. Has crystal filter and B.F.O., 8" P.M. speaker in matching case. Electrical bandsread, Andrew Kissila, "K" Radio Company, 1611 West 11th ave., Gary, Ind.

**FOR SALE**—New G-44 sig. generator, all wave; R-55 multimeter, AC-DC, cap. ohm, A.A. inductance output. Also entire stock of preferred tube types. Write for list. All brand new. Shop closure; instruments and tubes together—\$375 to \$400, depending on tube inventory. Rowell Sales and Service, 1640 Steiner ave., Birmingham 7, Ala.

**FOR SALE**—Webster Chicago portable recorder W-1206, 110v. 60 cycle, 33 1/4 R.P.M., Astatic crystal mike J3, crystal pickup and cutting head. Tubes used: 1-5Z4, 1-6SF5, 2-8C7, 2-6V6GT. Extra set of tubes (except 5Z4) included. Good condition. P. A. Daley, 4255 Lennox Blvd., Inglewood, Calif.

**WANTED**—Rubber pulley for Presto recorder J-5. Eugene F. Caldwell, S 1/2 RT., 715 Lexington ave., Corpus Christi, Texas.

**WANTED**—Four 1 mfd. 2500 or 3000 v. condensers; also any number of 4, 8, 13 or 18 mfd. filter condensers with 200 to 600 volt ratings. Clair K. Fitzsimmons, East Duplex, Iowa State College Campus, Ames, Iowa.

**WANTED FOR CASH**—Tube tester for all tube types. Frank Hudson, 810 North 16th ave., Pensacola, Fla.

**FOR SALE**—Triumph #420 tube tester, \$27.50; 2 five-foot P.A. horns with 30-volt units, \$60. Want Rider manuals Nos. 8-9-10-11, and #7 official radio servicemen's manual. Bracken Radio Shop, P.O. Box 221, Portales, New Mexico.

**FOR SALE**—RCA station allocator #171, perfect condition, \$12. Electric Appliance, 324 W. 42nd st., New York 18, N. Y.

**FOR SALE**—Rider manuals 7 to 13 inc. \$56; 0-to-1 Jewell milliammeter Pat. #54, \$5; 0-to-200 Jewell Microampere meter Pat. #88, \$9; a few 35 mm sound films. Highland Field, 26 Weston st., Augusta, Maine.

**FOR SALE**—Supreme portable lab. #504; Supreme oscillator #571; Rider manuals 1, 2 and 3 (one volume) and 5 to 13 inc.; Philco year books 1928 to 1940 inc., and 1942; Emerson service notes volumes 1, 2, 3, 4; Chas. S. Alexander, 209 Howard st., New London, Conn.

**WANTED**—Set-tested sig. generator and tube tester; also set of Rider manuals. All modern. Isaac A. Smith, 16 Collins st., Waterville, Maine.

**ENEMY ACTION**—British engineer in important government work, having lost home and library through Huns, would appreciate gift of Ghirardi Modern Radio Service (any edition, 1936 onward) and any other radio publications. Cannot buy due to currency laws. E.W.J. Brydon, 8 Elgin rd., Seven Kings, Essex, England.

**URGENTLY NEEDED**—Good volt-ohmmyst, preferably 1000-ohm—per-volt. Stanley L. Brightwell, % Pearson Music Company, Indianapolis, Ind.

**WANTED**—Shop equipment and setch— or complete shop—by discharged veteran. G. T. Bechnell, 55 College ave., Elberton, Ga.

**FOR SALE**—7 new Rider manuals. John C. Neff, 1412 Clark st., Niles, Ohio.

**WANTED**—Test equipment, including multimeter, sig. generator, oscilloscope, etc. Will swap #3 Corona portable typewriter or pay cash. George R. Flake, 2002 E. Arthur st., Philadelphia, Pa.

**WANTED FOR CASH**—Hickok 4900 set tester or Triplett 1604, Triplett 1166C and 1600E or equivalent, Triplett 666H handy pocket V-O-M, and sig. tracer. A. V. Guthrie, P.O. Box 552, Butler, Pa.

**WANTED**—Two Sylvania stock box cabinets and P.A. eqpt. of all kinds, including amplifiers up to 100 watts output, phonograph motors, mike stands, etc. Fox Sound Equipment Co., 435 S. Fifth st., Richmond, Ind.

**FOR SALE**—4 new D.C. micro-ammeters: Simpson 0-50 square, \$20; Simpson 0-100 square, \$15; Triplett 0-200 square, \$15; Weston #600 0-50 round, \$20; 2 used D.C. Weston milliammeters 0-5 round, \$5; Weston 0-1 #301, \$12; A.C. ammeter #156620 "C" 45-65 cycles, 3.75 amp. in meter circuit, 90 amps. on dial, \$10; Starrett #14 amplifier, 15 watt, \$60; Triplett 2" scope and Cough-Brenco 3" scope, \$50 each. Want K-200 Precision sig. generator and volt-ohmmyst; also tubes. Munroe Radio Service, 111 Shelby st., Kinsport, Tenn.

**FOR SALE OR TRADE**—D.C. motor generator, input 6-12v D.C., output 250-700v, D.C. Just overhauled, S. Wiseman, 114 Elmwood ave., Buffalo, N. Y.

**URGENTLY NEEDED**—For use in army radio repair shop. #542 Supreme pocket multimeter, or similar; also parts, Dolmar Lewis, C.D. 94 Chem. Bn., Camp Rucker, Ala.

**FOR SALE**—Philco laboratory tester C.W. 41, including #040 audio sig. gen., #027 vacuum tube voltmeter, #077 sig. generator, #025 tube checker, vibrator tester and matching speaker arrangement, #22 oscilloscope, no tube; complete \$250 cash. J. W. Guertin, 5 Calif st., Saco, Me.

**WANTED**—Tubes, new and used, for cash. Send list and price. Keating's Radio Service, 928 7th st., Port Arthur, Texas.

### YOUR OWN AD RUN FREE!

This is Sprague's special wartime advertising service to help radio men get needed parts and equipment, or dispose of radio materials they do not need. Send your ad today. Write PLAINLY—hold it to 30 words or less. Due to the large number received, ads may be delayed a month or two, but will be published as rapidly as possible. Sprague reserves the right to reject ads which do not fit in with the spirit of this service.

HARRY KALKER, Sales Manager.

Dept. RN-104, SPRAGUE PRODUCTS CO., North Adams, Mass.

Jobbing distributing organization of products manufactured by SPRAGUE ELECTRIC COMPANY

# SPRAGUE CONDENSERS KOOLOHM RESISTORS

Obviously, Sprague cannot assume any responsibility, or guarantee goods, services, etc., which might be exchanged through the above advertisements

\* TRADEMARK REGISTERED U. S. PATENT OFFICE

LIKE THE  
RUGGED PARATROOPER

# MURDOCK RADIO PHONES

ARE  
"PICKED FOR THE JOB"

You can count on them!

Paratroopers are painstakingly selected to do a highly specialized job. Coordination, precision training, swiftness of action, courage and toughness are the qualities demanded of these hand-picked soldiers of the air.

So too, MURDOCK RADIO PHONES are "picked for the job" because of their precision construction, their dependability, the keenness of their reception, and their capacity to "take punishment."

For 40 years and through two wars, MURDOCK RADIO PHONES have been an important link in war and civilian communication. The high quality of MURDOCK RADIO PHONES will be maintained in peacetime as in war. For America's keenest "clear-as-a-bell" Radio Phones be sure to specify MURDOCK.

*Write for Catalog*

**SUB-CONTRACTS INVITED**

Need help on Radio Phones and related parts on a sub-contract basis? Our facilities are geared to exacting standards. We can handle your assignment with care and skill.

**WM. J. MURDOCK CO.**  
131 Carter St., Chelsea 50, Mass.

of the i.f. frequency. The remedy for this condition obviously is to provide an adequate degree of selectivity in the circuits which precede the mixer or frequency converter. Later, more will be said about such *preselector* circuits. Use of a moderately high i.f. in the receiver also is helpful, for, then only those stations whose carrier frequencies lie in the upper-frequency channels of the tuning band will have a double-spot tuning point that lies above the lower-frequency tuning limit of the band. The potential number of stations that can cause such interference is thereby reduced.

### Interference Caused by Image-Frequency Response

Image-response interference is related to double-spot tuning in that it also is caused by the fact that the fre-

Fig. 3. How the desired and image response signals can each combine with the local oscillator frequency to produce two signals, both equal to the i.f. frequency.

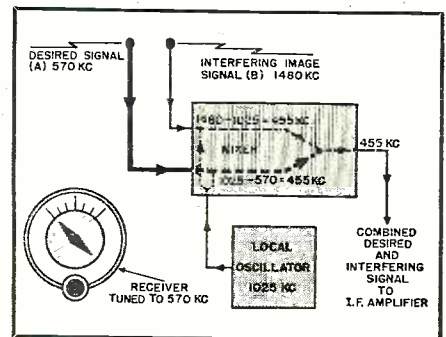

quency of the output signal of the mixer or frequency converter is equal numerically to the *difference* between the incoming signal frequency and the oscillator frequency. Consequently, for any given oscillator frequency there are two different signal frequencies (one *higher* by an amount equal to the i.f., and one *lower* by an amount equal to the i.f.) which can beat with this oscillator frequency to produce a similarly modulated signal of a frequency equal to that of the required i.f. This is illustrated in Fig. 2.

In the case shown, the receiver employs an i.f. of 455 kc. Assuming ordinary superheterodyne design practice in which the local oscillator always functions at a frequency *higher* than that of the desired signal by an amount numerically equal to the intermediate frequency, it will be seen that if a desired signal (A) of 570 kc. frequency is to be received, the oscillator will be set at 1025 kc. (since  $1025 - 570 = 455$  kc.). Now, assume that a sufficiently strong second incoming signal (B) also is present, whose frequency is *above* the frequency of the local oscillator by the amount of the i.f., i.e., its frequency is  $1025 + 455 = 1480$  kc. Should this signal get through to the mixer or frequency converter, it would likewise produce in the output circuit of the mixer or frequency converter a modulated signal of frequency equal to 455 kc., the i.f. (since

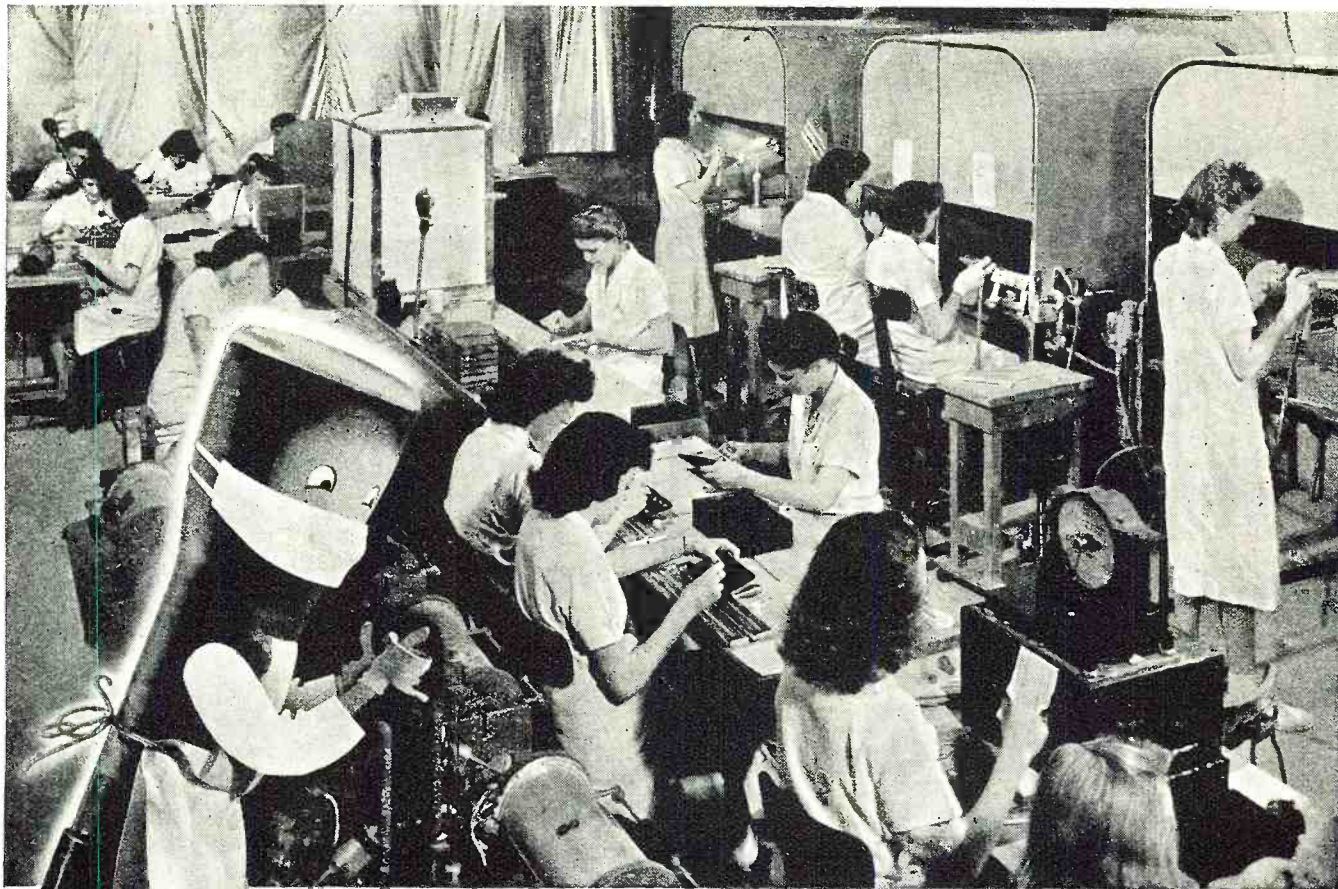

## NO SWEATER GIRLS, Please

Electronic tubes are as sensitive to lint, dust and minute particles of foreign matter, as a hay fever sufferer is to pollen. Unless the most stringent precautions are taken to keep tube parts free from impurities, trouble is sure to follow. Trouble—such as noisy receivers . . . discoloration or spots on the screen in cathode-ray tubes . . . power failure in transmitting tubes.

That is why National Union engineers go the limit to assure absolute cleanliness all along the production line. As an example, the model N. U. cathode spray room, pictured above, is not only clean—it's *hospital clean*. No fuzzy

sweaters or lint-shedding dresses are worn here. There is no dust, no dirt, because it's air-conditioned. Humidity and temperature are precisely controlled. The whole room is washed from ceiling to floor once a week. Then, to make sure, the individual parts are sterilized—some in boiling water—others in special solvents—still others by hydrogen firing.

Even should other factors be equal, the cleaner tube is the better tube. Remember this—and *count on* National Union.

**NATIONAL UNION RADIO CORPORATION, NEWARK, N. J.**  
 Factories: Newark and Maplewood, N. J.; Lansdale and Robesonia, Pa.



# NATIONAL UNION

## RADIO AND ELECTRONIC TUBES

*Transmitting, Cathode Ray, Receiving, Special Purpose Tubes • Condensers • Volume Controls • Photo Electric Cells • Panel Lamps • Flashlight Bulbs*



DESIGNED  
ENGINEERED  
**TURNER**  
MICROPHONES

*For Application  
Performance*

PIONEERS  
in the  
Communications  
field

One of a series showing Turner Applications  
in Electronic Developments

The G. E. *Magnetic Wire* RECORDER

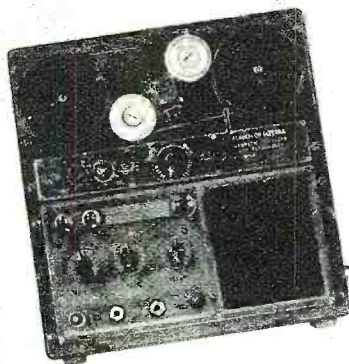

TURNER  
EQUIPPED

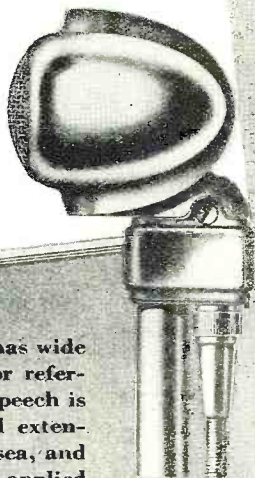

Model 50A G. E. Magnetic Wire Recorder has wide application wherever recording of sound for reference is important, or wherever analysis of speech is desirable. Today, these recorders are used extensively in military applications on land, on sea, and in the air. In the peace to come they may be applied in radio and entertainment, in business and industry, and in education and numerous specialized activities. Turner is proud to be associated with their performance.



*Free*  
TURNER Catalog.  
Write for your  
illustrated copy

It's Time to Turn to Turner for suggestions and applications in your Electronic Developments. Orders are being filled today for those whose needs meet priority requirements. But it isn't too early to start discussing your post-war plans.

Crystals licensed under patents of the Brush Development Company

**THE TURNER CO.**

CEDAR RAPIDS, IOWA, U.S.A.

1480 - 1025 = 455 kc.). This situation is illustrated in Fig. 2 and again in Fig. 3. Now only one of these, signal (A), is required, and the other, signal (B), causes interference if it is present simultaneously, and is of sufficient strength, since it will be superimposed upon the desired signal and both signals will be produced by the loudspeaker (or by the cathode-ray tube in the television receiver). The interference produced thereby is heard as a "whistle," or as a mixture of the modulations of both signals. It is termed the "image" frequency signal, and its frequency is known as the *image frequency*.

It is apparent from a study of Fig. 2 that if the receiver is designed so that the oscillator frequency is always *higher* than the desired signal frequency by an amount numerically equal to the i.f. employed (as is the case in most receivers), then the frequency that will cause image-response interference is *higher* than the desired signal frequency by an amount equal to double the i.f., or,

$$f_{im} = f_{sig} + 2f_{if} \text{ (kc.)}$$

On the other hand, in some receivers (particularly on short-wave bands), the oscillator functions at a frequency that is always *lower* than that of the desired frequency by an amount numerically equal to the i.f. In such receivers, the image-response frequency is *lower* than the desired signal frequency by this same amount, or,

$$f_{im} = f_{sig} - 2f_{if} \text{ (kc.)}$$

**Image-Rejection Ratio**

When a receiver is tuned to a desired signal of given frequency, the mathematical ratio of the image-frequency input signal voltage necessary to produce a given output, to the *desired frequency* input signal voltage required to give the same output is called the image-rejection ratio, or simply the *image ratio*. Thus:

The larger this ratio, the better will be the performance as regards image-frequency signal rejection.

**Preselection as Aid to Elimination of Image-Frequency Interference**

It is apparent that under suitable conditions of signal strength and carrier frequency, the superhet is inherently capable of responding *simultaneously* to the signals of *two* stations received via the antenna circuit, even though their frequency separation be many hundreds of kilocycles. Image-frequency reception is one example of this—others will be discussed in succeeding lessons of this series.

Once the "conversion" of the wanted signal and the unwanted interfering signal to a *common* intermediate frequency has been effected in the mixer or frequency converter stage, they are inseparable, and no subsequent degree of selectivity in the i.f. amplifier will attenuate one of the signals more than the other. The *interfering* image-fre-

**“They make  
everything  
in their line  
from the raw  
material to  
the finished  
product.”**

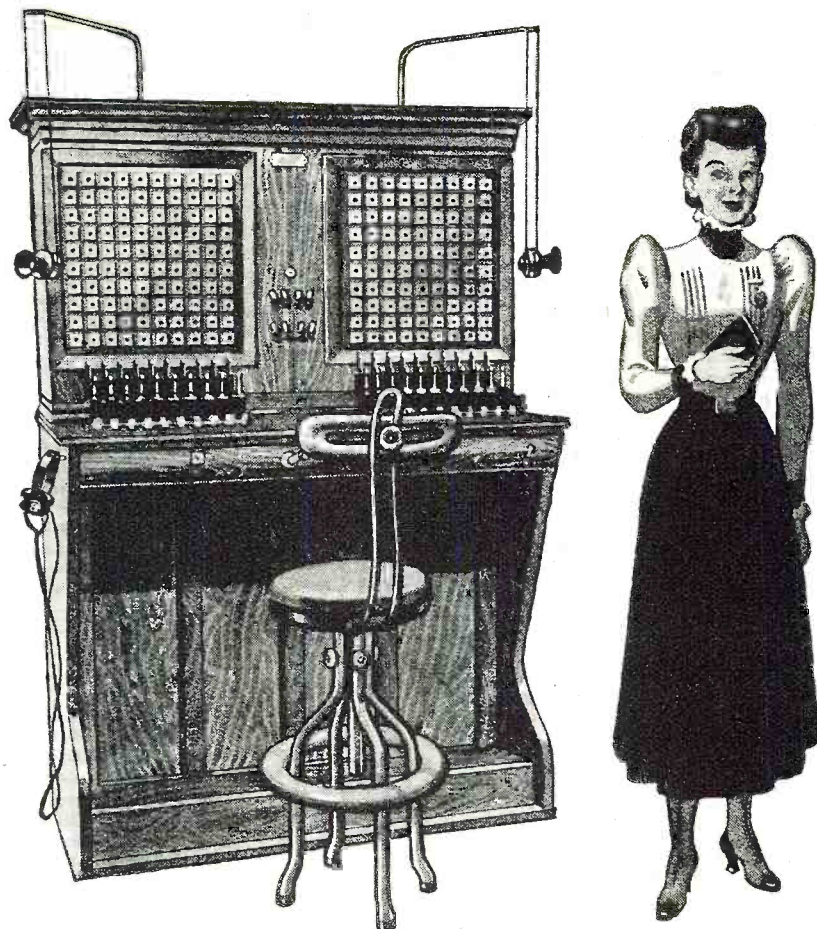
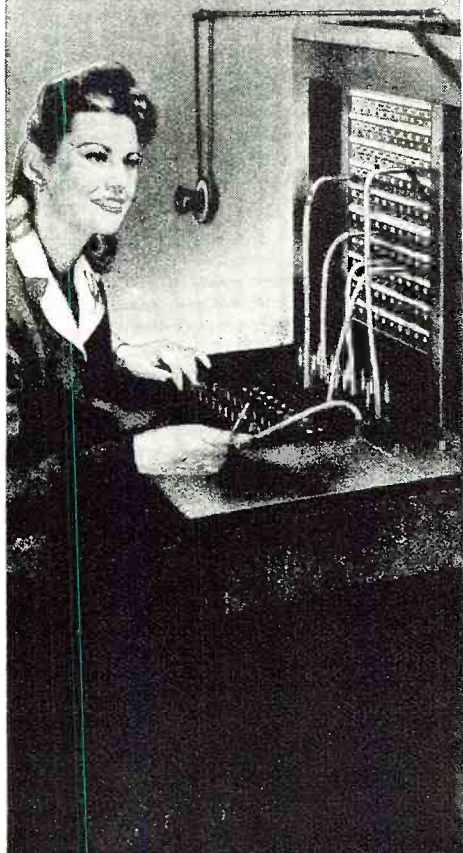

**T**his sentence was written about a news-worthy feature of Connecticut Telephone and Electric operations nearly forty years ago. It has been important ever since.

This Division's facilities for complete fabrication of electrical parts and devices within its own plants are unusual. Because of them, the production of vital communications equipment, aircraft ignition devices and other urgently needed war material is being speeded. It permits important manufacturing economies. It gives us better control of the equipment we make. These things are important in war and peace alike.

## **CONNECTICUT TELEPHONE & ELECTRIC DIVISION**

**GREAT AMERICAN INDUSTRIES, INC.**

**MERIDEN, CONNECTICUT**

TELEPHONIC SYSTEMS • SIGNALLING EQUIPMENT • ELECTRONIC DEVICES • ELECTRICAL EQUIPMENT • HOSPITAL AND SCHOOL COMMUNICATIONS AND SIGNALLING SYSTEMS • IGNITION SYSTEMS



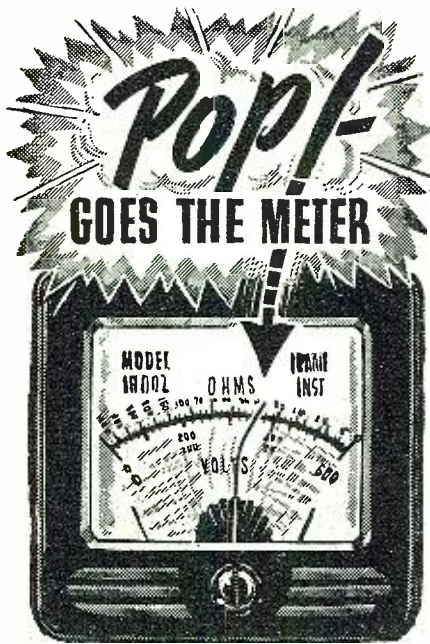

What happened to your meter when you made a miscue and slammed the pointer against the stops? Does the pointer above revive unpleasant memories?

Until Supreme started production of its own meters, the best general purpose meters available were secured for our test equipment. They were good... as good as any general purpose meter can possibly be. Today, however, Supreme built meters are designed for one specific field... the electronic service man.

Think back over the past years. How many days and dollars have you lost because of a slammed meter? No meter is indestructible, but these Supreme Meters can take it. Accurate? Yes! And double-rugged!

Investigate when considering post-war service equipment.

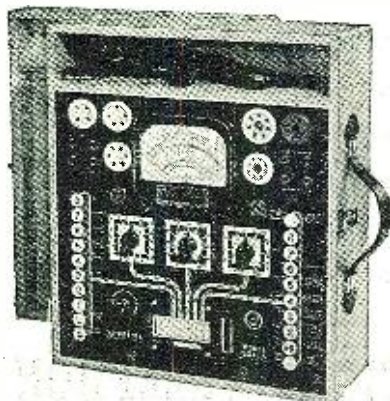

Supreme 504-A Tube and Set Tester. One of many test instruments incorporating a Supreme Meter.



quency signal, after its conversion to the intermediate frequency, is just as acceptable to the i.f. amplifier as is the desired signal after its conversion to the same intermediate frequency. The i.f. amplifier does not discriminate between the two in any way. It is quite obvious then, that the elimination of the undesired interfering signal must be effected prior to its reaching the frequency-conversion stage, and for this reason, *preselection* (pretuning) is employed. This is a self-explanatory term. An adequate degree of selectivity must be provided by specially designed tuned *preselector* circuits placed ahead of the mixer or frequency-converter, so as to eliminate signals of all outlying frequencies before they can reach the frequency converter. This leaves the task of providing the required *adjacent-channel* selectivity entirely to the i.f. amplifier.

#### Advantage of High I.F. for Reduction of Spurious-Response Interference

Since interference from the image-frequency signals is usually the outstanding undesired spurious response in superheterodynes it must be suppressed to the extent that it becomes negligible. Other types of spurious responses (to be studied later) are usually of smaller magnitude or less frequent occurrence, but there are cases where they also are of importance.

The extent to which interference is produced because of image-frequency response will depend upon: (a) the strength of the interfering signal; (b) the intermediate frequency employed in the receiver; and (c) the percentage difference in freq. between the image and the desired signal. The intermediate frequency chosen has a direct and important bearing on the inherent image-rejection ratio of the receiver.

To illustrate the advantage that is secured by using a high value of i.f., assume that reception of a station on 1,000 kc. is desired. Suppose the receiver uses a low i.f. value, say 175 kc. The oscillator frequency will then be  $1000 + 175 = 1,175$  kc., and image-frequency interference may occur from a station on  $1000 + (2 \times 175) = 1,350$  kc. This is illustrated at (A) of Fig. 4. Consequently, the signal-frequency circuits (tuned to the 1,000 kc. desired signal) will have to be sufficiently selective to attenuate strong signals of

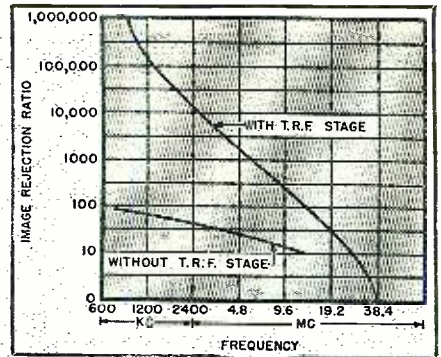

Fig. 5. Graphs showing how the image ratio decreases with an increase in signal frequency and the improvement in image ratio at various signal frequencies when a tuned r.f. stage precedes the mixer tube.

the latter frequency (1,350 kc.). Since this is only a 35 per cent frequency difference, a very selective preselector will be required. If, however, the intermediate frequency used were much higher, say 455 kc., the oscillator frequency would have to be  $1,000 + 455 = 1,455$  kc., and image-frequency interference could only occur from a station on  $1000 + (2 \times 455) = 1,910$  kc. This is illustrated at (B). This frequency is so much further removed ( $1,910 - 1000 = 910$  kc., or 91 per cent frequency difference) from the 1,000 kc. frequency to which the signal-frequency circuits are tuned that only a simple preselector tuned to the 1,000 kc. signal frequency is here needed to reject the undesired 1,910 kc. interfering signal.

Accordingly, in receivers employing the higher values of i.f. more simple and less costly preselectors suffice.

If this receiver were to be used to receive a short-wave signal of 18,000 kc. (18 mc.) under the same conditions, the image frequency ( $18,000 + (2 \times 455) = 18,910$  kc.) would differ but little (only 4.8 per cent) from that of the desired signal. It is apparent from this that image interference would be much worse on the short-wave bands than on the standard broadcast band. Hence the selectivity problem is much greater on the short waves than it is over the standard broadcast band.

For all-wave receivers designed to cover the standard broadcast band and also the short wave bands up to 18.0 mc., the standard i.f. of 455 kc. appears

Fig. 4. Image freq. signal interference is more likely to occur when a low value of i.f. is used (A) than if a higher value is employed (B). In the latter case the percentage difference between the desired and image signals is much greater.

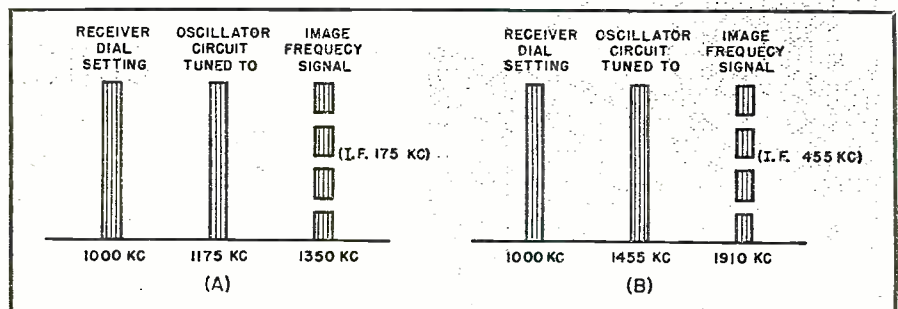



# 3 NEW RCA MINIATURES

(All on the Army/Navy Preferred List)

EACH of these 3 new tubes meets an important need in the miniature field:

**RCA-6J4 as a high-gain triode for frequencies up to 500 Mc**

**RCA-6AL5 as a high-perveance double-diode for efficient broad-band circuits**

**RCA-6AQ6 as a duplex-diode/triode to combine several functions in one miniature envelope**

All 3 combine sturdy construction with small size and high performance.

All 3 are on the Army/Navy Preferred Type List!

All 3 were completely engineered by RCA!

Additional technical data is available on request. Ask for it by tube type number. Radio Corporation of America, Tube & Equipment Dept., Harrison, N. J.

*The Magic Brain of all electronic equipment is a Tube . . . and the fountain-head of modern Tube development is RCA.*



**RCA-6AQ6** DUPLEX-DIODE TRIODE **\$1.50**

Actual Size

A multi-purpose miniature electrically similar to the metal 6SQ7, but with half the heater-power requirement. Primarily for use as a combined detector, amplifier, and AVC tube. Diode biasing of the triode unit is not suitable. Interelectrode capacitances are low. Heater: Volts, 6.3; Amp., 0.15. Max. overall length, 2 1/8 in.; seated, 1 7/8 in. Triode Characteristics (class A1 Amplifier): Plate volts, 250; Grid volts, -3; Amplification factor, 70; Plate resistance, 58,000 ohms; Transconductance, 1200 micromhos; Plate current, 1.0 ma.

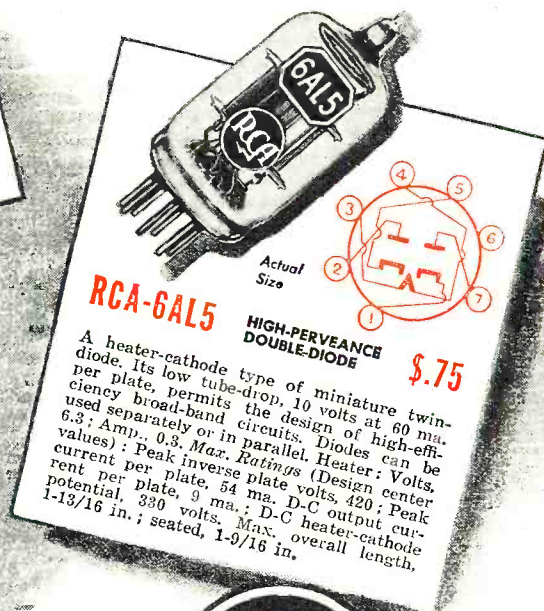

**RCA-6AL5** HIGH-PERVEANCE DOUBLE-DIODE **\$0.75**

Actual Size

A heater-cathode type of miniature twin-per plate, permits the design of high-efficiency broad-band circuits. Diodes can be used separately or in parallel. Heater: Volts, 6.3; Amp., 0.3. Max. Ratings (Design center values): Peak inverse plate volts, 420; Peak current per plate, 54 ma. D-C output potential, 330 volts. Max. overall length, 1-13/16 in.; seated, 1-9/16 in.

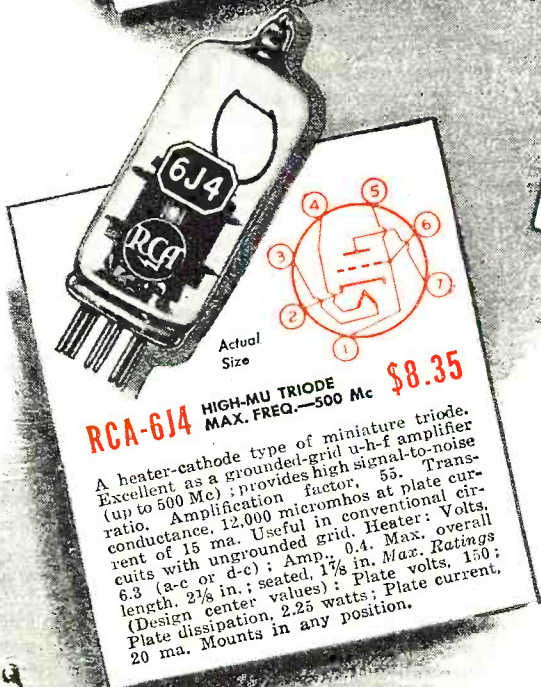

**RCA-6J4** HIGH-MU TRIODE **\$8.35**

Actual Size

MAX. FREQ.—500 Mc

A heater-cathode type of miniature triode. Excellent as a grounded-grid u-h-f amplifier (up to 500 Mc); provides high signal-to-noise ratio. Amplification factor, 55. Transconductance, 12,000 micromhos at plate current of 15 ma. Useful in conventional circuits with ungrounded grid. Heater: Volts, 6.3 (a-c or d-c); Amp., 0.4. Max. Ratings (Design center values): Plate volts, 150; Plate dissipation, 2.25 watts; Plate current, 20 ma. Mounts in any position.

BUY  
WAR  
BONDS



**RADIO CORPORATION OF AMERICA**

RCA VICTOR DIVISION • CAMDEN, N. J.

62-6431-9

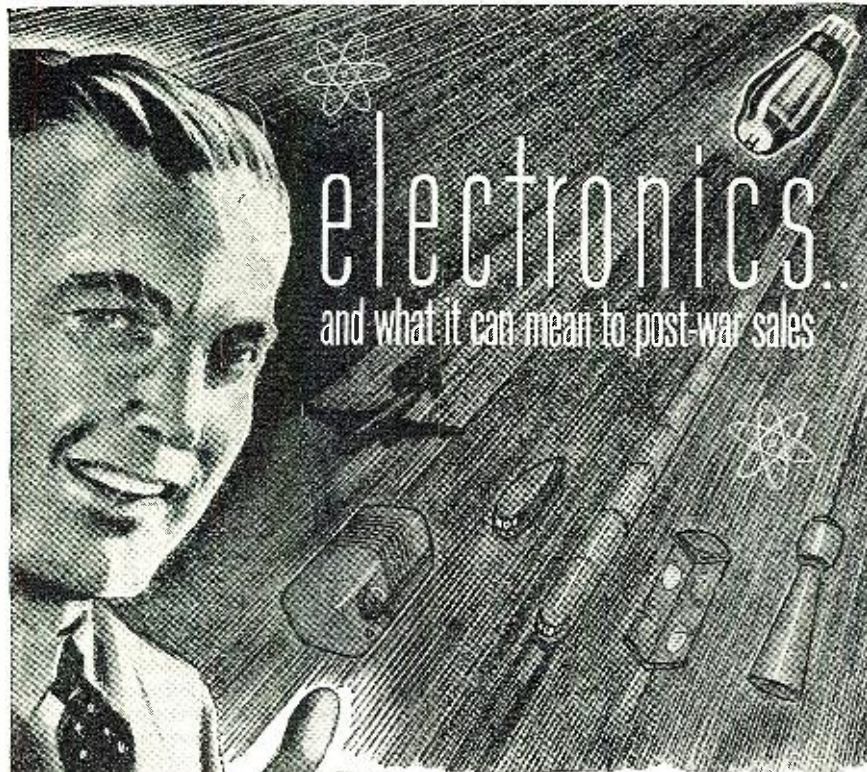

# electronics

and what it can mean to post-war sales

## Look ahead . . . Prepare your Salesmen For the Peacetime Electronic Era to Come!

● Where will you fit in the fiercely competitive markets that will come with the war's end? Your position can be determined now, by the methods you employ now, in the design and engineering of your post-war products. Right now, with the aid of seasoned electronic and mechanical engineers, your peacetime items can be started toward top-rank positions in their respective fields.

Alert manufacturers, with a view toward post-war sales and quick acceptance of their products, are urged to consult with National engineers now, on matters electronic, electrical or mechanical.

Write today—Your inquiry will receive prompt attention.

### -----QUARTZ CRYSTAL PROBLEMS-----

Our engineers and crystallographers are ready and willing to help you on the following items:

Radio Receivers	Crystal Oscillators	Supersonic Devices
Television Receivers	Filters	Control Devices
F-M Receivers	Stabilizers	Diathermic Devices
Transmitters	Timing Equipment	Induction Heating
H. F. Inter-Communications	Police Transmitters	Frequency Standards

Address your inquiry to—Crystal Division

Electrical and Mechanical Engineering

## NATIONAL SCIENTIFIC PRODUCTS COMPANY

Designers and Manufacturers of Electrical and Mechanical Devices

5015-25 NORTH KEDZIE AVE., CHICAGO 25, ILLINOIS

to be satisfactory in practice, since it is sufficiently high to give good image ratio and yet not high enough to produce other difficulties such as low gain, instability, and poor adjacent-channel selectivity. The large majority of AM receivers manufactured within the past few years employ an i.f. of 455 kc. In fact, with the exception of a few auto radio receivers that employ 175 kc., or 262 kc. i.f., the use of 455 kc. i.f. has been adopted almost universally in these receivers.

It has occasionally been found necessary to use two intermediate frequencies in the same receiver, a high i.f. (1500-5000 kc.) in the first i.f. to provide good image rejection, followed by a fixed-frequency oscillator converting this to a low-frequency (50-200 kc.) second i.f. section to provide sharp selectivity characteristics. Of course, such a receiver is more complicated than the ordinary superhet.

### Methods of Obtaining Image Rejection

A suitable degree of interfering image-frequency signal rejection may be obtained in several ways. For example, in the early days of superheterodyne development one extreme was adopted in some receivers. The value of the intermediate frequency employed was raised to such a high point that the second (interfering) signal a given oscillator frequency would heterodyne was sufficiently far removed in frequency from that of the wanted signal (to which the mixer input circuit was tuned) that the selectivity of this latter circuit was sufficient to suppress the unwanted signal. In the old Infradyne receivers, for example, the intermediate amplification was carried on at a frequency actually higher than the upper limit of the broadcast band so that the image frequency always would lie entirely outside of the broadcast band. Therefore, it was impossible for any image-frequency broadcasting station to come through to the intermediate amplifier for any oscillator setting. Of course, the use of such high intermediate frequencies resulted in lowered adjacent-channel selectivity and less gain per stage in the i.f. amplifier.

Later, superhets were built with a comparatively low i.f., in the neighborhood of 175 kc., in order to obtain good adjacent-channel selectivity. However, since with such a low value of i.f. the percentage difference between the frequency of the interfering image signal and that of the desired signal was relatively small, considerable selectivity had to be introduced in the r.f. circuits ahead of the mixer in order to suppress interfering signals of image frequency. This necessitated the use of one or more stages of tuned r.f. amplification using loosely-coupled transformers, or even the use of band-pass filters, with their attendant sacrifice in r.f. stage gain.

With the advent of lower-priced and more compact five-tube a.c. and a.c.-d.c. receivers, r.f. stages were elimi-

# In $\frac{1}{50}$ of a second it stops stock-still

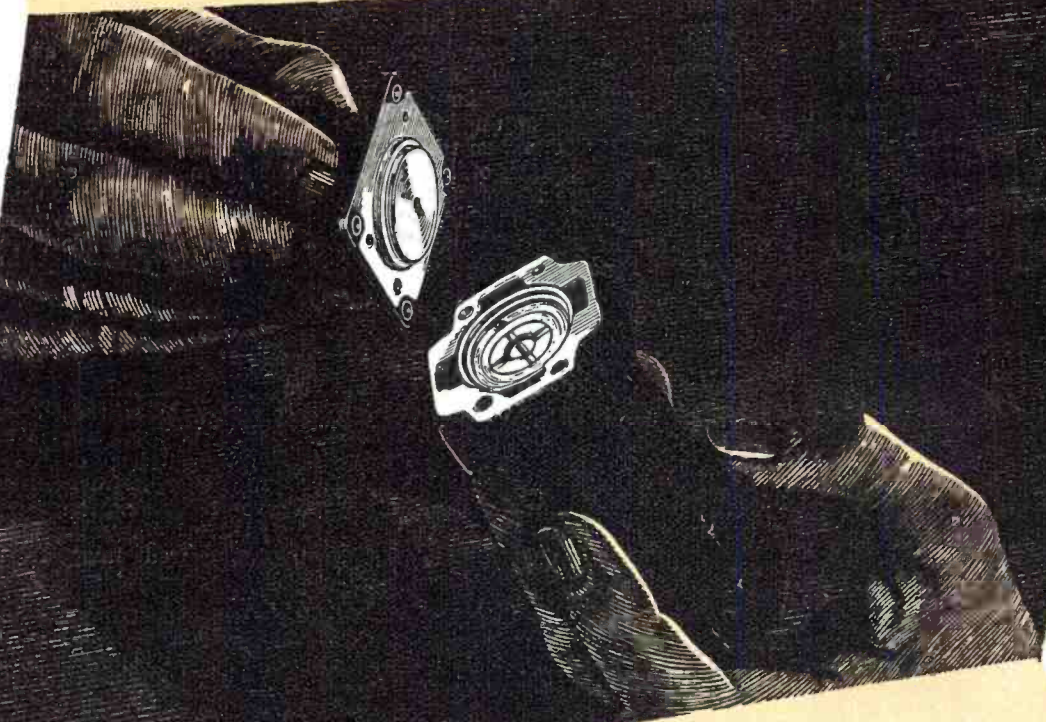

**W**HEN a plane pilot presses the button to adjust control flaps, he wants just so much motion and no more.

But electric motors take time to stop. They overrun.

So while electric controls were desirable because they were less vulnerable and didn't freeze up, they had the disadvantage of overcontrolling.

What you see in the picture is the Lear solution. It is the Fastop Clutch.

With this clutch, controls stop instantly. For it stops stock-still in about  $\frac{1}{50}$  of a second.

There is nothing else like this Fastop Clutch. It is built right into the Lear electric motor as a unit.

As with all aircraft equipment, this unit had to meet unusual and rigid requirements of space and weight. It had to have rare power

for its size. In fact the requirements were so severe, old-timers said it couldn't be done.

There will be many new conveniences and devices in the coming days of peace. Perhaps you are already planning one.

And perhaps you would welcome a motor like this and the Fastop Clutch — or some of the other 250 Lear products.

That is why we are telling you about them now. We want you to know that products like these are being made, and that there is available the kind of engineering that made them possible.

PLANTS: Piqua, O., and Grand Rapids, Mich. BRANCHES AT: New York, Los Angeles, Chicago, Detroit, Cleveland, Providence.



# HARVEY

can shoulder  
the responsibility  
of purchasing  
agents for Radio  
and Electronic  
Components

*Immediate deliveries*

on: Tubes • Meters  
Relays • Panels • Fuses  
Resistors • Sound Systems  
Batteries • Plugs  
Jacks • Capacitors  
Transformers • Test  
Equipment • Oscillators  
Attenuators • Terminal  
Strips, etc.

We can relieve you of the task of locating equipment ... give it to you in a hurry ... at competitive prices. Or, if you have difficulty in finding the part you need, we can use our resources and experience to find it for you. Making suggestions as to the effectiveness of substitutes is another part of our job. Moreover, our up-to-date knowledge of technical and priority problems is available to you.



TELEPHONE ORDERS TO LONGACRE 3-1800

# HARVEY RADIO COMPANY HARVEY

103 WEST 43rd ST., NEW YORK 18, N. Y.

nated so that a cheaper two-gang tuning condenser and a fewer number of associated parts could be used instead of the more costly and bulky three-gang condensers and extra tuning coils. In many such receivers no preselection other than that provided by tuning the input circuit to the frequency-converter tube was provided. In these receivers, solution of the image interference problem was attempted by increasing the i.f. to the neighborhood of 480 kc., on the theory that this higher value of i.f. would prevent image interference from stations on the broadcast band because then even a station at 550 kc. (lower end of the band) could be interfered with only by a signal on  $550 + (2 \times 480) = 1,510$  kc., which is above the upper frequency limit of the broadcast band. However, in many locations the performance of these receivers was spoiled by other types of spurious interferences brought about by omitting preselection. Reception was characterized by "tweets," internal, cross-modulation interferences, poor selectivity, interferences such as those from amateur police, airplane and marine beacon transmitters, etc. We will learn more about these later.

A suitable compromise between these extremes can usually be found. The desired image rejection may be attained by a combination of raising the intermediate frequency to the highest practical value (which is, in some measure, determined by another factor which will be considered later), and at the same time by placing a sufficient number of tuned circuits ahead of the mixer or frequency converter to insure that the image-frequency signal for a given oscillator setting will never be allowed to reach the mixer or frequency converter with sufficient magnitude to cause interference, even in the case of the most powerful local stations. This involves the use of a minimum of two tuned circuits preceding the mixer or frequency converter tube. A simple means of employing these circuits is in the form of a single-stage tuned radio frequency amplifier coupled to the mixer by a tuned r.f. transformer. The combined selectivity of the two tuned circuits, thereby introduced, suppresses the image frequency signal and does not allow it to reach the mixer in sufficient magnitude to cause serious image-frequency interference. Fig. 5 shows the typical improvement in image ratio which occurs at various signal frequencies when such a tuned r.f. stage precedes the mixer. The improvement is especially noticeable in the broadcast band.

The use of a tuned r.f. amplifier preceding the mixer is beneficial in the matter of crosstalk interference for, where the signal is fed directly from the antenna to the mixer through an untuned circuit or even a single tuned circuit, the possibility of crosstalk appears. Crosstalk is that form of interference so familiar to all who have used t.r.f. receivers having an untuned

input stage, and takes the form of the modulation of one or more powerful local stations riding in upon the carriers of other stations.

In broadcast-band receivers the use of a tuned r.f. stage ahead of the mixer is desirable from the standpoint of signal-to-noise ratio, as high r.f. gain assists in maintaining an optimum ratio. If a gain of 5 times or more is maintained in the r.f. circuit, the total receiver internal noise is comprised mainly of the first-grid-circuit noise, which is materially less than the noise generated in the mixer tube.

With the adoption by most manufacturers of the standard intermediate frequency in the neighborhood of 455 kc. (RMA standard) for broadcast band receivers, the image frequency (except for a few channels) falls outside of the broadcast band (on frequencies to which no existing services are assigned), so the image-frequency problem in these receivers has been simplified.

The effects of image interference in a given receiver often may be reduced by reducing the relative strengths of the undesired image-frequency signals by shortening the antenna. A very long antenna broadens the response characteristic of the first resonant circuit in the preselector, thus letting the undesired signals get through.

If only one or two particular stations are causing image interference in a specific receiver, this interference may be effectively reduced by installing suitable wave traps or absorption circuits (tuned to the frequency of the interfering signal) in the antenna circuit. This will be explained later. Wave traps, because of their simplicity and low cost, are the most common correction applied by service men to existing receivers in such cases.

#### **Image-Rejection Ratio Decreases on High Frequencies**

At a signal frequency of 1,000 kc., the image-rejection ratio of a superhet having a sharply-tuned r.f. stage ahead of the mixer will be of the order of 100,000 or better (assuming the use of an i.f. of the order of 455 kc. and the use of ordinary tubes and circuits at signal frequency). That is, the interfering image-frequency signal will have to be 100,000 or more times as strong as the desired signal to give the same output. As the frequency to which the receiver is tuned is increased, the image ratio decreases because as the frequency goes up, the *percentage difference* between the frequency of the desired signal and that of the interfering image signal becomes less and less—in other words, the selectivity decreases. For example, for the receiver considered above: at 2000 kc. the image ratio will be down to something like 10,000, and at 7 mc. to about 350. At 14 mc. a ratio of about 50 is usual and at 30 mc. a ratio of 2 or 3 is considered fair. (At these higher frequencies, some improvement in performance can be se-



**FOR SERVICES WELL RENDERED, I THANK  
THE MEN AND WOMEN WORKERS OF THE  
ELECTRO-VOICE MANUFACTURING COMPANY  
WHO HAVE BEEN AWARDED THE "E" BY THE  
ARMY AND NAVY OF THE UNITED STATES.**

*Albert Kahn*

**PRESIDENT, ELECTRO-VOICE MANUFACTURING CO., INC.**

*Electro-Voice* **MICROPHONES**

**ELECTRO-VOICE MANUFACTURING CO., INC. — 1239 SOUTH BEND AVENUE, SOUTH BEND 24, INDIANA**

**October, 1944**

**77**

# **BOTH are radio jobs!**

**EASY TO GET-  
FOR DURATION ONLY**

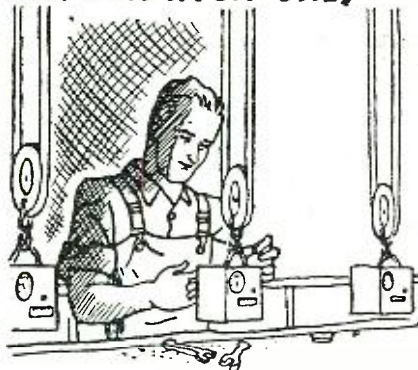

**ABILITY NEEDED-  
PERMANENT JOB**



## **CREI Spare-Time Technical Training Prepares You for the SECURE RADIO JOBS That Pay Good Money for Ability!**

Radio jobs are easy to get—the demand runs from technicians to engineers in every branch of the industry. But these jobs which come so easy today, won't be so easy to hold tomorrow . . . when more qualified men are ready to take over . . . and when the war is ended and the radio industry returns to peacetime production.

The ambitious radioman who is sincere and ambitious in his desire to enjoy a secure future in radio, will be the first to recognize that today's better-paying jobs and tomorrow's careers will go to those who have modern technical training in practical radio engineering.

The opportunity to make sure of your future security was never as great as it is right this minute. There are good-paying, responsible positions awaiting you in broadcasting, manufacturing, government, aviation . . . jobs that you can get AND HOLD by combining your own radio experience with the CREI planned program of advanced technical training. The complete facts are in our 36-page booklet. Send for it today.



**WRITE FOR  
FREE 36-PAGE  
BOOKLET**

**"Your Opportunity in the New  
World of  
Electronics"**

If you have had professional or amateur radio experience and want to make more money — let us prove to you we have something you need to qualify for a better radio job. To help us intelligently answer your inquiry — PLEASE STATE BRIEFLY YOUR BACKGROUND OF EXPERIENCE, EDUCATION AND PRESENT POSITION.

## **CAPITOL RADIO ENGINEERING INSTITUTE**

HOME STUDY COURSES IN PRACTICAL RADIO-ELECTRONICS  
ENGINEERING FOR PROFESSIONAL SELF-IMPROVEMENT

**Dept. RN-10, 3224—16th Street, N. W., Washington 10, D. C.**

Contractors to U. S. Navy—U. S. Coast Guard—Canadian Broadcasting Corp.  
Producers of Well-trained Technical Radiomen for Industry.

cured by using acorn tubes because of their lessened "loading" effect on the tuned circuits.

As indicated by the graphs of Fig. 5, the image-ratio improvement resulting from the use of an r.f. stage is much greater at frequencies in the broadcast band than at higher frequencies. The improvement decreases rapidly above about 12 mc. If we attempt to eradicate the interfering image-frequency signals by means of the ordinary forms of purely selective devices at frequencies in the neighborhood of 30 mc. and higher, we find that stages cannot be added indefinitely as improved performance cannot be achieved in this manner. In receivers designed for television signal frequencies, for example, an r.f. stage of one tuned circuit preceded by a single tuned antenna circuit has the disadvantage of possessing less selectivity than that of two coupled antenna circuits, but an r.f. stage provides amplification for both picture and sound frequencies simultaneously, thus offering possibilities of economy. An r.f. stage may also be used to reduce the necessary i.f. stage gain, which may permit more complete stabilization of the receiver. The use of an r.f. stage should be the subject of very careful study and test in the design of any ultra-high frequency receiver. A choice should be made only after considering various practical factors, as well as the fundamental theoretical ones. Present detailed construction technique is such that these practical considerations often tend to nullify the normal advantages of an r.f. stage from the over-all standpoint. In many cases the use of a higher i.f. instead of an r.f. stage (for u.h.f. applications this may range from 10 to 100 megacycles) is more desirable. Then, too, the question of whether to use one or more stages of r.f. amplification or whether to convert immediately in the first stage of such receivers depends upon other considerations which will be discussed later.

Special r.f. rejector circuits have been designed to provide comparatively good attenuation to image frequencies at the high frequencies. These are applied in some communication type receivers.

*(To be Continued)*

### **HOSPITAL GIFT**

**T**he management and employees of the Hallcrafters Company of Chicago, makers of the SCR-299, have presented a check for \$5,000 to the Army's new Vaughan General Hospital at Hines, Illinois.

Half of the gift represents wages that had been earned by the employees who worked an extra two hours overtime on European D-day and the other half represents the amount which would have been spent by the company on the workers' annual picnic. The employees voted to dispense with the picnic this year in favor of working full time on vitally needed war materials.

-30-

# THANKS FOR THE PLUG, ROMMEL

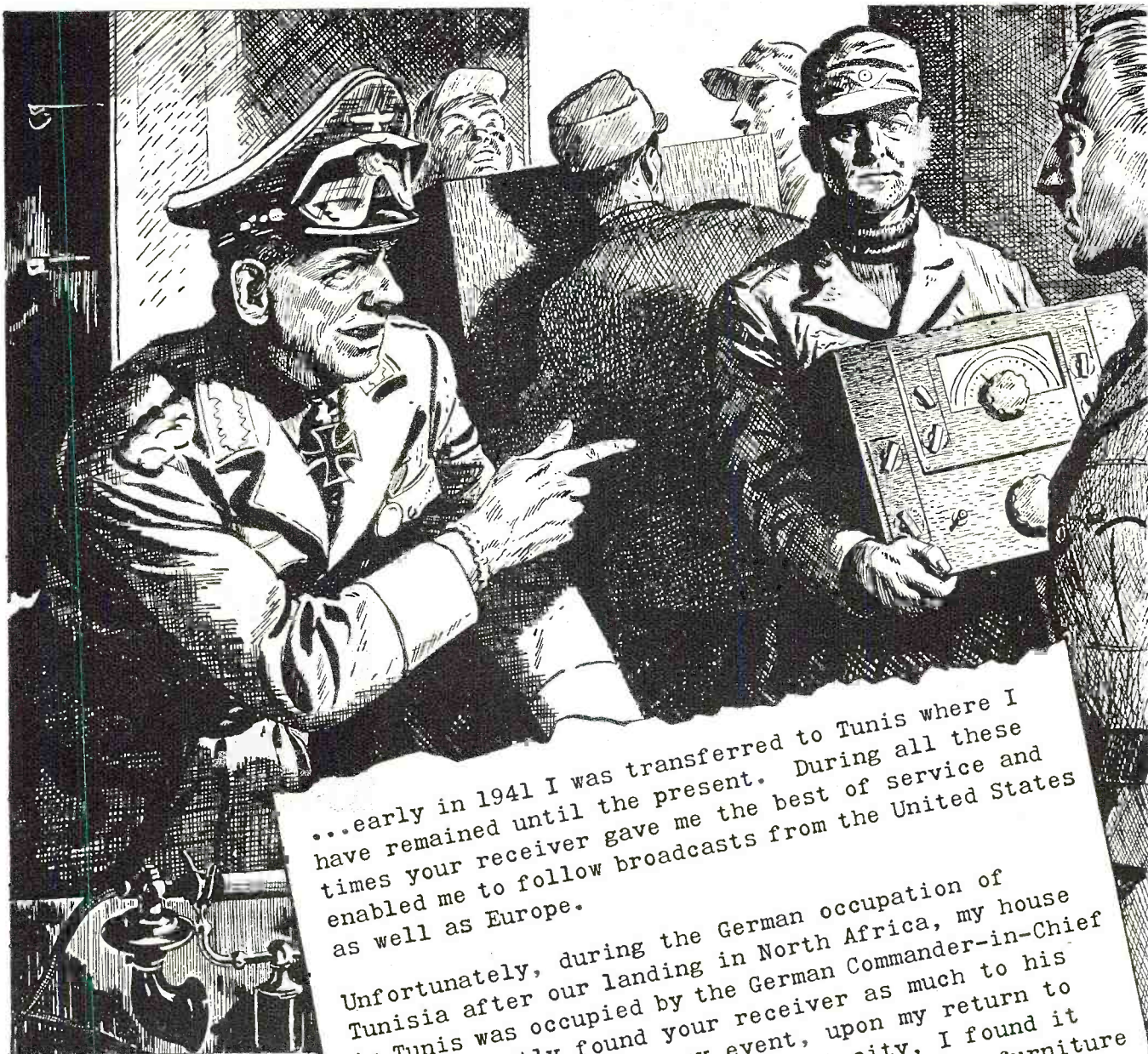

...early in 1941 I was transferred to Tunis where I have remained until the present. During all these times your receiver gave me the best of service and enabled me to follow broadcasts from the United States as well as Europe.

Unfortunately, during the German occupation of Tunisia after our landing in North Africa, my house who apparently found your receiver as much to his liking as I had. In any event, upon my return to Tunis after the recapture of that city, I found it missing together with the greater part of my furniture and household effects.

It would be appreciated if you would again provide me with the present equivalent of the set which I possessed.

(Excerpt from a letter we received from a member of the State Department)

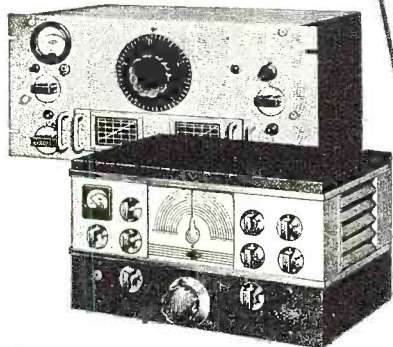

## NATIONAL COMPANY, INC.

MALDEN MASS., U. S. A.

NATIONAL RECEIVERS ARE IN SERVICE THROUGHOUT THE WORLD

**U.H.F. Course**  
(Continued from page 60)

wave, identical diameters being used in each case. This can be easily seen when the formulas are given:

$$f \text{ cut-off} = \frac{1.15 \times 10^{10}}{r(\text{cm})} \text{ cycles/sec.}$$

for the  $TM_{0,1}$  wave and

$$f \text{ cut-off} = \frac{8.79 \times 10^9}{r(\text{cm})} \text{ cycles/sec.}$$

for the  $TE_{1,1}$  wave. Note that due to the inverse relationship of the frequency to the radius, a higher cut-off frequency requires a smaller opening of the cylinder. Remember again that this frequency represents the lowest frequency (or longest wavelength) that will be propagated down the tube without too much attenuation. Practically, it is possible to transmit below this frequency but the range is rather limited. Theoretically, all higher wavelengths can be easily transmitted without much attenuation (using actual conductors), but in practice the upper frequencies begin to show excessive attenuation because of increased skin effect. In between these two extremes can usually be found a frequency that will have least attenuation. Whether or not it is used will be determined by other factors that may assume greater importance than attenuation.

It is now possible, since the action of a wave guide has been described in some detail, to study some of the uses that have been evolved for wave guides. First and foremost is its most important use, that of carrying ultra-high frequency power from one circuit to another. The wave guide is essentially a transmission line which has been modified for the very high frequencies and its extensive use is due to the low loss or small attenuation introduced. What attenuation there is results from the fact that the walls of the guide are not perfect conductors.

Fig. 10. Method of exciting a cylindrical wave guide to obtain a  $TE_{1,1}$  type of wave. Compare this with Fig. 9 and note the 90° change in antenna position.

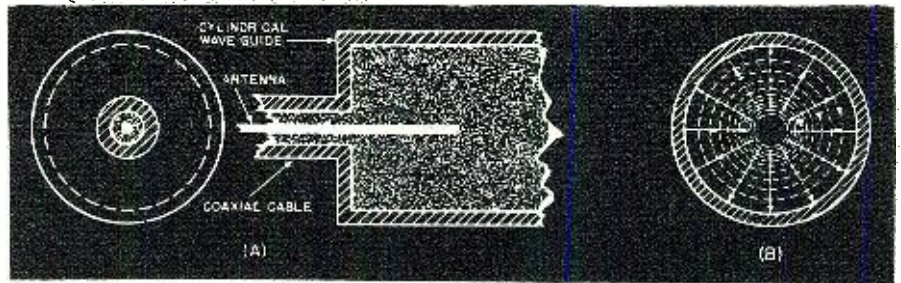
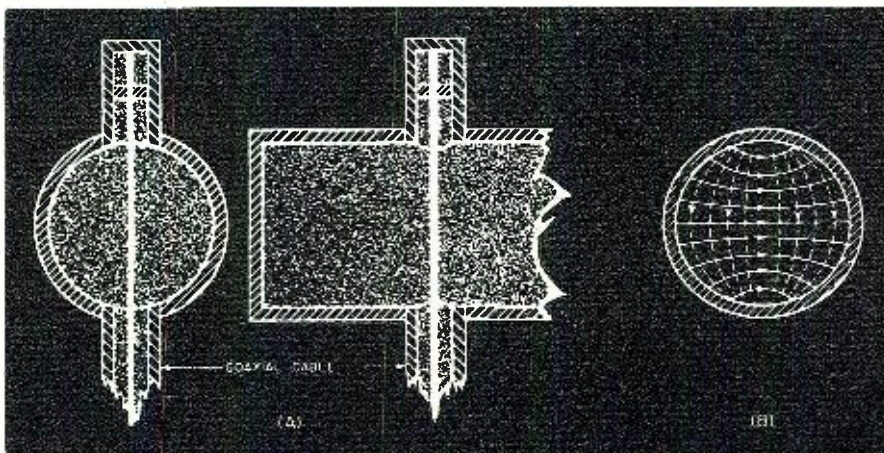

Fig. 9. (A) Method of exciting a cylindrical wave guide to obtain a  $TM_{0,1}$  type of wave. (B) Electric and magnetic lines of force set up for this type of wave.

Some readers may resent the fact that it has been mentioned several times that imperfect conducting walls will result in power losses and yet, no explanation has been advanced which would prove or explain this. The explanation can be found quite easily, but only if the investigator is equipped with a good knowledge of electric and magnetic fields and also the differential equations developed by Maxwell. Since only an elementary knowledge of mathematics has been assumed throughout this series, all complicated expressions have been omitted.

Continuing on, another use for the wave guide is possible, that of a high pass filter. This property is connected with the action of a guide in allowing only frequencies that are above a certain minimum value, which is known as the cut-off frequency, to pass and all lower values to be rejected. This effect does not necessarily have to take place at the opening of the guide; it may occur anywhere along its length. Fig. 6 illustrates what is meant. The first section of the pipe has a certain diameter which becomes less after the constriction. Waves that could be propagated in the first half might not continue on after the diameter has been decreased and would thus be attenuated or reflected, probably both. The point, however, is that they would not continue on in the latter portion of the pipe. In this way frequencies may be separated, an action that can only be brought about at lower frequencies by coils and condensers. In fact, the analogy to filter

circuits can be extended even further by combining sections of wave guides that have different filtering characteristics.

Another use that will be mentioned briefly here (but to be described later in greater detail) is the cavity resonator which can be considered as a section of a wave guide. Just as it was possible to take a small portion of an ordinary transmission line and convert it into a resonant circuit, so is it possible to close one end of a small sec-

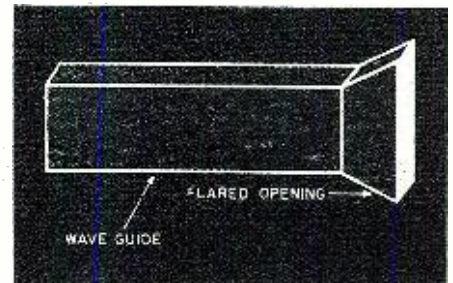

Fig. 11. An electromagnetic horn.

tion of a wave guide and get the same results, only at much higher frequencies. The transition of the tuned circuit can be pictured as starting out at the low frequencies with a coil and condenser, becoming a section of a transmission line at the hyper frequencies and then finally ending as a cavity resonator at the ultra-high frequencies. The function still remains the same, the means for accomplishing this end being varied.

The final use to be considered will also be gone into in greater detail in another chapter and concerns itself with the action of a wave guide as an antenna. The wave will travel down a wave guide without reflection of any of its energy just as long as no changes occur in the guide itself. This is equally true in any transmission line. However, should any change occur, such as a solid wall or constriction in the guide, it immediately results in a reflection of energy back along the guide. For transmitting purposes, the open end is of most importance. Some of the energy hitting this open end will continue out into free space while some of it will be sent back. However, if the change is not made very abruptly, but rather is introduced gradually, then the amount of energy sent back (or reflected) will be less and the forward transmitting efficiency of the wave guide will increase appreciably.





*Yes—*

**MR. RADIO DEALER**

it will certainly pay  
you, at war's end, to

**"TEAM UP!"**

with



**TEMPLETONE RADIO COMPANY, Mystic, Conn.**

*FM ... Television ... Radio-Phono' Combinations*

**WHERE FM WILL ALSO MEAN FINEST MADE!**

Licensed under Armstrong and RCA Patents

# Full Speed Ahead!

... and Going Places with  
Permoflux Acoustical Devices

● Performance is the priceless, indispensable factor that distinguishes all Permoflux Products. With a vision fixed upon the requirements of tomorrow, Permoflux is perfecting devices and processes that will widen the opportunities for all electronic development.

**BUY MORE WAR BONDS FOR VICTORY!**

TRADE MARK  
**PERM-FLUX**  
PERMOFLUX CORPORATION  
4916-22 W. Grand Ave., Chicago 39, Ill.  
PIONEER MANUFACTURERS OF PERMANENT MAGNET DYNAMIC TRANSDUCERS

This flared type of guide (Fig. 11) is known as an electromagnetic horn and has very definite directional properties. It will be considered in greater detail along with other types of ultrahigh frequency antennas to be taken up presently. Here the flare is a gradual change in the wave guide which allows more of the wave to be sent forward and less reflected back. (To be continued in December issue)

**Toll Service**  
(Continued from page 53)

keys on a new kind of switchboard. Instead of plugs, this board has a numbered keyboard like an adding machine. The message goes to the mechanical brain, called a "marker," which hunts out an available trunk line, tests a path to the destination and electrically sets up all connections—all within one second. If all lines are busy, overflow and calls are stacked up in a special circuit and put through in order of priority as soon as lines are free. The marker has a trouble indicator which, on bungled calls, reports where and what the trouble is.

In the Philadelphia tests, this amazing instrument (known as the "crossbar toll switching system") has greatly speeded up long-distance telephoning and relieved wartime overcrowding of toll lines. Telephone officials expect to install the system throughout the nation as soon as equipment is available after the war. Eventually, they believe, it will be possible for a customer to dial an out-of-town call on his home or office phone. Already, as in Culver City, Calif., engineers tested the instrument which not only permitted direct dialing of toll calls (within a limited area) but automatically recorded on a printed ticket the length of the call and the charges.

Telephone engineers do not believe that the new system will end the need for operators; despite wide installation of local dialing systems, the telephone companies today employ more operators than ever before (because telephone use has increased). But the new device seems to foreshadow a day when men will seldom hear an operator's voice.

As in Culver City, the telephones

Complete records of toll calls are recorded by these automatic ticketers.

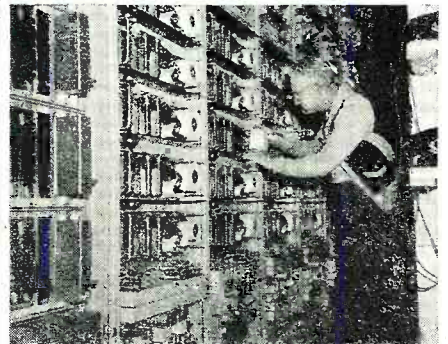

## BREEZE AIRCRAFT ARMOR PLATE

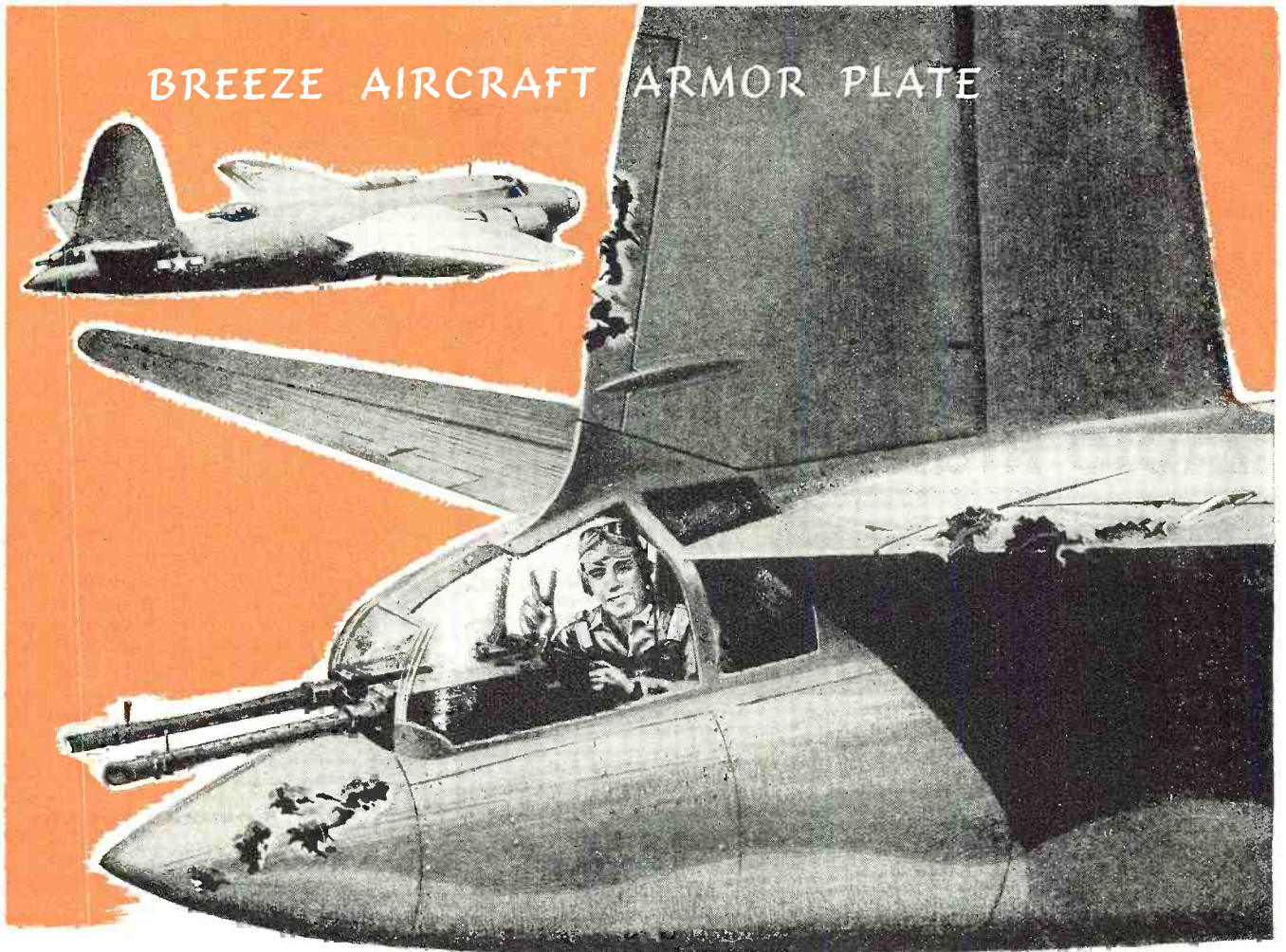

# Homeward Bound

**Breeze Aircraft Armor Plate Brings 'Em Back Alive  
In World-Wide Theatres of Warfare**

Breeze Aircraft Armor Plate is in action today on Allied invasion fronts, providing dependable protection for pilots and gunners of America's hard-hitting bombers and fighters. Produced in quantity by the Breeze Electric Heat Treating Process, the fastest known for the purpose, this Armor Plate helps to bring home not only trained personnel but valuable equipment as well.

Breeze Armor is manufactured in two types: homogeneous and face-hardened. Although light in weight, it possesses the highest ballistic qualities and resistance to shatter. Complete assemblies to designers' special requirements are a specialty. Aircraft Armor Plate supplements the well-known Breeze line of equipment which is now in service on land, on the sea, and in the air.

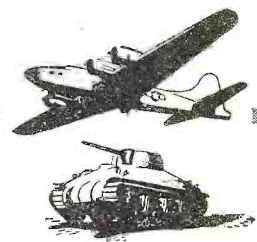

**A Few of the Many Breeze  
Products in the Nation's  
Service**

Radio Ignition and Auxiliary Shielding • Multiple Circuit Electrical Connectors • Flexible Shielding Conduit and Fittings • Cartridge Engine Starters • Internal Tie Rods • Elevator and Rudder Tab Controls • Flexible Shaft and Case Assemblies • Aircraft Armor Plate

**Breeze** 

**CORPORATIONS, INC.** NEWARK, N. J.

PRODUCTION FOR VICTORY • PRODUCTS FOR PEACE

October, 1944

83

**9 out of 10**  
**BUSY RADIO**  
**TECHNICIANS SAID**

**"HERE'S THE WAY  
 TO LEARN  
 RADIO RIGHT!"**

**GHIRARDI**  
**TEACHES IT TO YOU**  
**EASIER • BETTER • FASTER**

**724 OUT OF 817!**

When you want the facts about something—go to the men who know! When you want to find out what is the best Radio-Electronic Training for YOU—ask Radio-Electronic men! That was exactly our idea when we went to a mixed group of 817 radio-electronic men—a group made up of instructors, students, repair men, radio-electronic experts in the armed forces and in big manufacturing plants. We asked them to tell us exactly what they think of various books and courses now being offered for the study of Radio-Electronic fundamentals. NINE OUT OF TEN of these men wrote back that Alfred A. Ghirardi's RADIO PHYSICS COURSE book is their choice, as the best buy on the market—far better than any other book or course they have ever seen. And, as they explained—

**HERE ARE THEIR REASONS WHY:**

- 1 "It's simple, clear way of thoroughly explaining every detail makes it the most easily understood of all Radio-Electronic books and courses.
- 2 "It teaches Radio-Electronic fundamentals more quickly and more interestingly than any other.
- 3 "It gives the most complete coverage of Radio and Electronic subjects—all in one handy volume.
- 4 "It is the most inexpensive, complete basic training available—easily worth from \$50 to \$100 if you bought it as a course."

**TRAIN AT HOME—In Spare Time**

Ghirardi's RADIO PHYSICS COURSE is tried and tested. It gives MAXIMUM training in MINIMUM time and at an absolute MINIMUM cost. You learn at home in spare time. You progress as fast as you want to. Actually Ghirardi's RADIO PHYSICS COURSE gives you the scope of 36 different courses in one—all packed into an easy-to-follow 972-page book with 508 clear illustrations, and 856 self-testing review questions. You can understand every word of it without previous training—and you'll be pleasantly surprised how easily you'll master the subjects that other books, and courses make seem very complicated. Our 5-day Money Back Guarantee enables you to examine this great book for five full days—and get every cent of your money back if you're not more than satisfied.



Let A. A. Ghirardi—Radio's most widely read technical author—help you start your training for a fascinating, profitable, wartime or peacetime job in the vast new Radio-Electronics field.

**MAIL THIS COUPON NOW!**

**RADIO & TECHNICAL DIVISION**  
**Murray Hill Books, Inc.**

Dept. RN-104, 232 Madison Ave., New York 16, N. Y.

- Rush me a copy of your big, 972-page RADIO PHYSICS COURSE BOOK. I am enclosing \$5. ( \$5.50 foreign.)
- Send C.O.D. (in U.S.A. only) for \$5 plus postage.

In either case, I may return the book within 5 days for refund if I am not completely satisfied with it.

Name .....

Address .....

(to and Dist. No.) ..... State .....

**COMPLETE BASIC RADIO-ELECTRONIC TRAINING** IN ONE BIG VOLUME



**ONLY \$5**  
**Complete**  
 (Postpaid in the U.S.A.)

Easily worth \$50 if you bought it as a course

**NO OTHER COURSE LIKE IT**

There is no substitute for Ghirardi's RADIO PHYSICS COURSE—simply because there isn't any other book or course like it at any price. That's FACT—not fiction—and backed up by PROOF, not mere claims!

M. J. Turin of Brooklyn, N. Y., says: "I've read many Radio books but have failed to find a more detailed, thorough, and easy-to-understand book than Ghirardi's Radio Physics Course. It's the best course on the subject available today—ABSOLUTELY UNBEATABLE."

J. R. Robertson, Jr., of Bessmer, Ala., says: "As simplified, complete and understandable a Radio-Electronic Training course as I have ever seen AT ANY PRICE."

**ELECTRONICS, TOO!**

And don't forget, RADIO PHYSICS COURSE does not end at teaching you only Radio! The basic instruction you get from this big book is your introduction to the vast, rapidly growing field of Electronics, too. It is your "Open Sesame!" to more money and a better job in this amazing new industry you've been reading so much about.

Order your copy today. SEE it. EXAMINE it for yourself. Here is our GUARANTEE.

**YOUR MONEY BACK IN 5 DAYS**  
 If Ghirardi's Big 972-page RADIO PHYSICS COURSE doesn't teach you RADIO-ELECTRONIC fundamentals EASIER, FASTER, and at LESS COST than any other book or course.  
**YOU BE THE JUDGE!**

look just the same as they used to, it is the exchange equipment that represents a radical innovation in telephone facilities. Described conservatively as remarkable, the new equipment makes a complete record of the call in all its details, thus saving the operator the time and effort of writing out the usual toll ticket in pencil.

The automatic device at the central exchange prints a ticket showing the prefix of the dial office where the call was placed, the calling subscriber's number, the month, day, and hour to the nearest tenth of an hour, the called subscriber's office prefix, and number, the initial period rate, and the length of the conversation.

The machinery in the exchange is somewhat like the familiar teletype. On a continuous strip of paper, fed from a small roll, it prints, cuts, and deposits tickets as calls are completed.

When wider production is permissible after the war, it is expected that this device will result in much faster toll service throughout adjacent areas. In the meantime, telephone factories have to stick to vital war jobs, and for a considerable period at least, Culver City, for one, will have a unique toll system.

-30-

**D-Day Communications**

(Continued from page 23)

able by our own men and used against the retreating enemy.

Such feats reflect clearly the tremendously important lessons learned during those precious months before D-Day. Those months of training that can now be measured in the results of our first big campaign. While in Britain the lads who are today manning single phone or radio outposts on the front were assisting in the operation of a telephone system that would service a town the size of Duluth, Minnesota, so that air, ground, and naval personnel might be in constant communication. This vast network alone consisted of 900 switchboards on which 1,200 operators handled close to 9,000,000 calls a month. Today, field telephone service in France is equally as good as that which is the daily fare of Londoners.

An additional 18 teletype switchboards connected some 300 teletype machines. More than 900,000 messages, handled by a GHS message service, were carried a total of 375,000 miles a month by train, plane and automobile. The maintenance as well as the installation of the American Forces Network, the G.I. Radio station in London, and the two-way radio system for MP patrol cars, also fell to the lot of the Signal Corps while it was rehearsing for the "big show."

Of the millions of still pictures being made for publications, many are broadcast to the United States on the RC-120 facsimile transmitter which is adaptable both to wire lines or radio transmission and reception. A stand-

ard photo can be sent by this process to any part of the world in approximately 6½ minutes. Many pictures are sent directly from the battle-front.

Complete public address systems with directional sound projectors, the standard six speaker 100 watt units, were employed advantageously as our troops moved in during the early morning landings. In countless instances hundreds of prisoners have been taken by a mere handful of Allied troops through the skillful application of this equipment.

Many new adaptations of radio to the air-ground offensive, now so successfully practiced by the Allies, were initiated in the Normandy campaign. Doubtlessly many of them, some of which are still on the secret list, will play vitally important parts in forthcoming battles, particularly as control of the forward movement of troops passes from British mainland bases across the channel.

One of the most recent uses of a specially designed radio transmitter is the extension of visual control and observation posts by exceptionally heavily armored vehicles up on the front lines. These sets are also carried by the infantry troops; but armored cars, jeeps, and even tanks play the biggest role in this novel air-ground radio system.

These advance units, which are constantly up front probing for stiff enemy resistance, by using this special transmitter, can quickly radio back to their regimental headquarters giving practically the exact target range and a specific map reference in relation to our forward positions. Only obstacles or targets which seem to call for air attack come into the operational scope of these "radio scouts," however, as they act as the "eyes" for this special air-ground service.

As soon as vital information reaches headquarters it is relayed through recording offices to an air-ground "Taxi" base, which is actually a corral of aircraft aloft with their radio receivers constantly on the alert. Instantly upon call, one by one, these patrolling Typhoons swoop down on their designated targets with bombs, rockets and blazing automatic guns, to eliminate the cause of any Allied holdup. While these Typhoons refuel and rearm, squadrons of bomb-laden Spitfires maintain a constant vigil against enemy retaliation.

At present, this novel system is being used primarily by the British whose army leaders say that never has air-ground support been so close, quick and devastating. These high-speed spotters form the advance echelon of the second tactical air force and as they poke their way into positions affording good views of enemy installations they keep in direct radio contact with their fighter-bombers cruising overhead. These aircraft dive to the attack within seconds after the ground observer has spoken into his microphone.

This front-line "Merry-Go-Round"

# These 2 GHIRARDI BOOKS

## Will help you to Diagnose, Locate and Repair Receiver Troubles

### EASIER • BETTER and FASTER



**ALFRED A. GHIRARDI**  
—the man who makes Radio easy to learn

Ghirardi's Famous

#### MODERN RADIO SERVICING

The book that trains you quickly to **MAKE MORE MONEY** and get a bigger job as a Radio-Electronic repair technician **BECAUSE** it is by far the largest, finest, most easily understood how-to-do-it training course on the subject!

"Modern Radio Servicing" is the **only** single, inexpensive book that gives you a thorough training in the construction and working of all types of test instruments; receiver trouble-shooting procedure; circuit analysis; testing, repair, and replacement of individual receiver parts; installation; adjustments, maintenance; service shop management, etc.

No other book can compare with this one for complete, easily understandable instruction on every phase of service work. "I recently finished a course in Radio Repair at one of the N. Y. radio schools and all my learning at this school did not help me to understand and repair radios as quickly as did this one book. I made my money back on one job alone!" writes Henry Miller of Brooklyn, N. Y.

#### TEST INSTRUMENTS—TROUBLESHOOTING—REPAIR

You, too, can get a thorough and practical working training in Radio-Electronic servicing from this famous Ghirardi book—by yourself, in spare time at home—just as Mr. Miller and thousands of others have done. Its 1300 pages and 700 illustrations help you visualize every action. The 720 self-testing review questions help you check your progress. Progress as fast as you want to. It's the biggest servicing training bargain you can buy anywhere. You are protected completely by our 5-day money-back guarantee.

### SPECIAL MONEY-SAVING COMBINATION OFFER!

Both books for only **\$9.50** (\$10.50 foreign)

A total of **OVER 2,000 PAGES** of the world's most helpful and profitable servicing information!

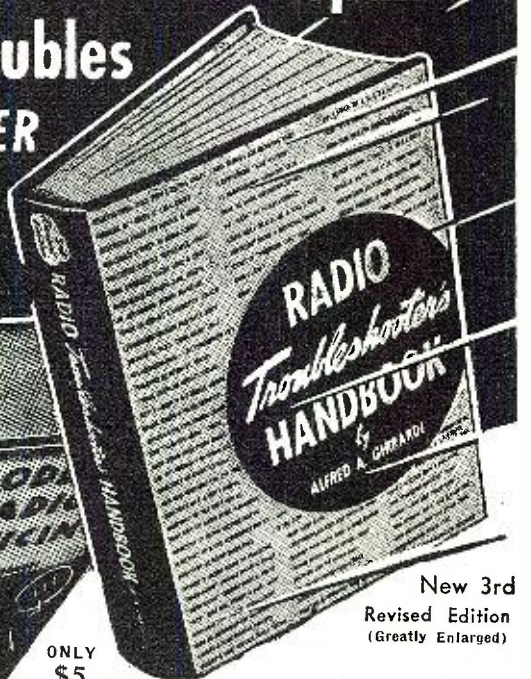

New 3rd Revised Edition (Greatly Enlarged)

ONLY \$5 EACH!

#### RADIO TROUBLESHOOTER'S HANDBOOK

744 big pages, chock-full of just the kind of time-saving, money-making, tabulated and charted servicing data that servicemen are finding invaluable.

#### HERE'S HOW TO TEST A RADIO IN 2 MINUTES or less!

Ghirardi's **RADIO TROUBLESHOOTER'S HANDBOOK** isn't a "study" book. It's an on-the-job data book to be referred to in your everyday work. For example, don't waste your time on complicated troubleshooting for every ailing receiver you are called upon to repair! First, look up its model number in the big Trouble Case History Section of the Handbook which lists common troubles and their remedies for over 4,800 models of receivers and record changers.

#### MAKE MORE MONEY!

Nine times out of ten the Handbook will give you the exact clue you need to repair a receiver at once—often **without any testing at all!** Similarly, on tubes, parts, replacements, substitutions, color codes, circuit alignment, auto radio, batteries, vibrators, ballasts, grid bias resistors, condensers, transformers, tone controls, filters, etc., etc., you get pages of quick-find tabulated data to help do every repair job better—**AND A LOT FASTER!** This big new Handbook that weighs over 4 pounds is yours to use every day to make more money for only \$5 complete (\$5.50 foreign) and our Money Back Guarantee protects you. Order today!

#### 5-DAY MONEY-BACK GUARANTEE

### MAIL THIS COUPON NOW!

RADIO & TECHNICAL DIV. of Murray Hill Books, Inc., Dept. RN-104, 232 Madison Ave., New York 16, N. Y.

Enclosed find \$..... for books checked or  send C.O.D. for this amount plus postage (sent C.O.D. in U.S.A. only). If not fully satisfactory, I may return books within 5 days and receive my money back.

- Special **MONEY-SAVING COMBINATION** — Both books \$9.50 (\$10.50 foreign).
- RADIO TROUBLESHOOTER'S HANDBOOK**, \$5. (\$5.50 foreign.)
- MODERN RADIO SERVICING**, \$5. (\$5.50 foreign.)

Name .....

Address .....

City (and Dist. No.) ..... State .....

**REPAIR ANY KIND OF RADIO EQUIPMENT**  
PREPARE FOR A BETTER JOB AS A RADIO-ELECTRONIC TECHNICIAN

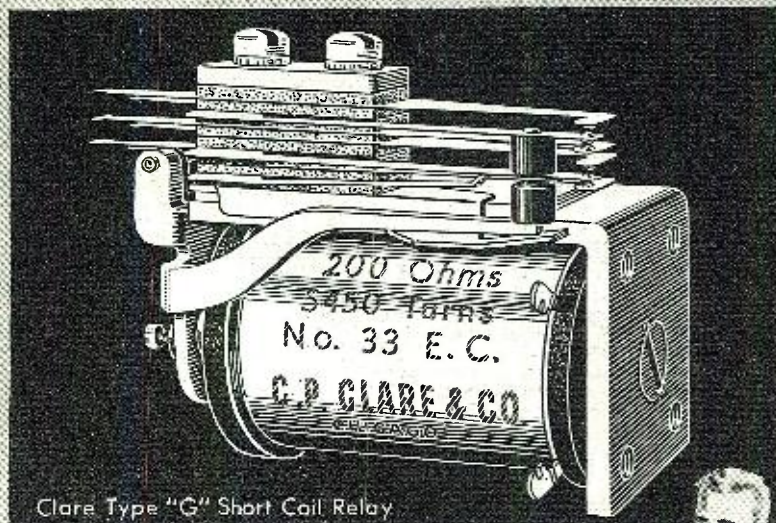

## WE DON'T PULL CLARE RELAYS OUT OF A HAT



There is no magic in the way Clare "Custom-Built" Relays perform. They are manufactured to operate perfectly in the job for which they are designed. This is the basic principle of "custom-building." Years of "know how" have given Clare engineers an exact understanding of *what* you must have in your relay and *how* to build it for you.

Precise design and manufacture, the use of the finest materials available, and fine adjustment are vitally important in "custom-building" Clare Relays. Our engineers are never satisfied until every part of every relay is as carefully selected and precisely fitted as the parts of a fine watch.

Added to these factors is the flexibility of application made possible by "custom-building." Clare Relays can be supplied with various types of mountings; with contacts of rare metals or special alloys in a wide range of sizes, ratings and forms; with coil windings to match the circuit and application; with contact closure sequence and desired contact pressures to meet the requirements of your specifications.

If you have a design problem which the ordinary relay will not solve, send us a print showing your requirements and let our engineers "custom-build" the relay you need. Ask for the Clare catalog and data book. C. P. Clare & Co., 4719 Sunnyside Avenue, Chicago (30), Illinois. Sales engineers in all principal cities. Cable address: CLARELAY.

# CLARE RELAYS

"CUSTOM-BUILT" Multiple Contact Relays for Electrical, Electronic and Industrial Use

technique, as it is termed, depends solely on the radio-telephone equipped vehicles to watch every enemy move. It has been used successfully in advanced areas against enemy tank parks, convoys, troop concentrations, gun positions, fuel and ammunition dumps and other vital targets.

If requests for this particular type of aerial bombardment are few during any given period of an assault they are accepted in the order received and disposed of immediately. If, however, a great number of requests pour in at once they are sorted out and appraised according to their apparent urgency as determined by the assessment officers.

Now, as troops are rapidly pushing farther into France, countless squadrons of Allied fighter-bombers are ready to take off with the minimum of delay from auxiliary fields as quickly as decisions on the targets are made. They park in dispersal areas fully "bombed-up" and fueled, armed, and with engines already warmed, awaiting radioed orders to join their "Taxi" base comrades or the sky corral.

When these particular air units were based in England there was inevitable delay in getting the ground information back and assessment of the targets made so that correct disposition could be made of these orders. There was also the further delay in flying time between Britain and the continent which is now eliminated.

Among standard radio sets that I have frequently seen in use and are well known to practically every G.I., are the "handy-talkie" and "walkie-talkie." These instruments have proven themselves to be of inestimable value to the slogging foot soldiers as they move forward under the terrific hazards of bad weather, shell fire and the added dangers of secluded and often camouflaged sniper's nests.

Another of the favorites with the Signal troops is the SCR-399 which is piling up a record of accomplishments similar to that of the famous battle of Kasserine Pass. Although operating under tremendous handicaps, both from the standpoint of weather and locale, it is performing brilliantly. In some instances the SCR-399 has surprised even its operators by doing jobs for which it was never designed. The Propaganda & Psychological Warfare Department is employing a modified version of the SCR-299 in their "word battles" carried on against the Nazi.

For special communications the almost all-purpose FM satchel set, SCR-610, is used in everything from jeeps to naval landing craft. In fact special and standard radio equipment of every size and style was employed in linking together the huge armada of LST and LCT amphibious troop carrying craft which on D-Day weathered one of the roughest crossings ever recorded on the English Channel.

Since the first time I laid eyes on the guidon radio transmitter, being used by infantry troops in training at Fort Monmouth, N.J., some two years ago, I saw it being employed correctly as



INSPECTION ON THE LINE

## MAKING HISTORY IN COMMUNICATIONS



Inspection before assembly, quality control . . . more than that . . . team work from material dispatcher, assembler, inspector, to the girl on the packing line . . . have made possible the fine achievement represented by the Army and Navy "E" Award presented to the men and women of the Universal Microphone Company.

In production of military microphones before Pearl Harbor, Universal had the necessary "know how" for immediate war production. The engineering experience and production efficiency of war production will be reflected in the electronic voice communication components offered by Universal to consumers in the future. Until then — BUY WAR BONDS.

**UNIVERSAL MICROPHONE COMPANY**  
INGLEWOOD, CALIFORNIA



FOREIGN DIVISION: 301 CLAY STREET, SAN FRANCISCO 11, CALIFORNIA .. CANADIAN DIVISION: 560 KING STREET WEST, TORONTO 1, ONTARIO, CANADA

October, 1944

87

a cavalry set. We were within sniper range of the lines between Carentan and Isigny where two of our Signal observers, astride captured German horses (good looking ones, by the way) were reporting back to their field headquarters by means of these queer shaped sets.

The instruments looked, as they should, as though they were part of the Signal horsemen's gear and according to the men they "worked swell." Using these sets in this way, the users have the advantage of being able to report "on the fly" as they search out enemy defenses for our ground fire.

Stacks of miscellaneous captured Nazi radio and field telephone equipment was piled amidst the ruins of a small French village that we passed enroute to the Caën sector. I stopped momentarily to inspect it and for the most part it was obsolete equipment compared to our own, having none of those qualities of design, range, or operation so apparent in Allied radio sets.

Going back to the telephonic side of our communication network on the continent, it is impossible to pay sufficient homage to the Signal Corps men who clamber up poles, trees, statues, and hedgerows, to string wire, under enemy fire. It takes a special brand of courage to move out of a foxhole as the infantry moves forward and string the vital lines that connect the division commander with his regiment, and the regiment with the company, and the company with the platoon.

At the very front, the mortar crew observer carries a reel of telephone wire as he moves to his vantage point, and by telephone he corrects mortar fire to bring it onto the target.

A story from the current offensive tells how enemy artillery fire, through a lucky hit, managed to strike an ammunition truck near a vital communications link. The artillery commander was out of touch with his guns when exploding shells knocked out the wire. The truck was still burning, and ammunition still was exploding when three signal corps men stepped in. They made temporary repairs within five minutes. In twenty-five minutes normal communications were resumed. The offensive went on and there is no telling how many doughboy's lives were saved by those three cool signalmen.

There are many stories like this one, and many that haven't been told because the men involved didn't survive their perilous missions. It is not only the wire stringers who are exposed to danger, the radiomen too must move up under heavy fire so they can report back as to what fire is needed, and where, and whether it should be by infantry, artillery, or aircraft.

The equipment these men carry is good—it's the best. But the men must be as good as their equipment. They must be better. And, thank God, they are!

## The Great Spiderweb

(Continued from page 39)

occasion for us. The cook put up the swellest meal of his career and we started a real bull session after chow; everybody was firing questions and interrupting each other in a vain attempt to get in on every bit of the conversation. Excitedly we sputtered and pleaded for news from the good old U. S. A.

"In the midst of all the confusion Captain Crowell quieted us with the reminder that there was work to be done. Rubbing his chin thoughtfully, he smiled obliquely and pinned the Colonel with his narrowing gaze: 'Well, Colonel . . . Are you ready to wash the dishes?'

"There was a moment of silence. Captain Crowell's face broke into a slow dubious smile as he informed the Colonel that it was officers' night to do KP. The Colonel's mouth fell open in mild amazement, his face reddened with the realization that Captain Crowell was serious; he eyed the dirty dishes hesitantly and exploded in a roar of laughter. Everyone in the room broke into hysterical laughter as Colonel Storie flipped a coin with Captain Allison to see who would wash and who would dry. Private Evans, the cook, and the rest of us leaned our chairs back, lit up cigarettes and watched the Colonel and the two Captains clean up the dishes." I'd go through hell for those officers. . . .

Red tape is notably absent in overseas AACS stations. Obviously, rank is highly respected but the man is more respected for the job that he does. Every man, regardless of rank, pitches in to do the job at hand. Great responsibility may be carried with the lowest rank. With the responsibility

goes the authority, regardless of rank. This may be best illustrated to the civilian by relating a recent odd happening; it occurred at X airport. A Brigadier-General circled the field for a landing. On duty in the control tower was an enlisted man. The General requested permission by radio to land his plane by a right hand approach.

The enlisted man in the control tower replied: "Army 1234 . . . this is X tower. . . . No! You cannot make a right hand approach . . . traffic pattern is to the left . . . we have two AT-6's approaching the field from the south. Make left hand approach—"

"Roger!" exclaimed the General, acknowledging the control tower operator's instructions. In such a case, the control tower operator's order—though the operator be a Private—is mandatory.

AACS men are endowed with a deep sense of self reliance; they must be "on the beam," act quickly in an emergency, and not pass the buck to the other guy.

The AACS man's way of life is usually a far cry from the usual Army routine experienced by most GIs; often there are no formations—no calisthenics, no chow lines, no reveille or retreat—for the AACS soldier may be on duty or call 24 hours a day—week in, week out and month in, month out. He may reside in remote places, alone, from one year to the next, realizing few or no conveniences. He may prepare meals, keep house for himself, do his own laundry and, in general, shift for himself in addition to carrying on a multitude of official duties. Little recognition goes with these nerve wracking jobs. Officers, of necessity, are extremely tolerant with these men for there are many human problems to be considered—loneliness, conflicting emotions, temperament, and

Sealing-in metallic buttons on large numbers of cathode-ray tubes at the Dobbs Ferry plant of North American Philips Company, Inc. With her mouth, the operator controls air pressure in the tube while the gas burner is rotated around the button. These tubes literally "shoot" electrons at the fluorescent screen and are indispensable to our Armed Forces.

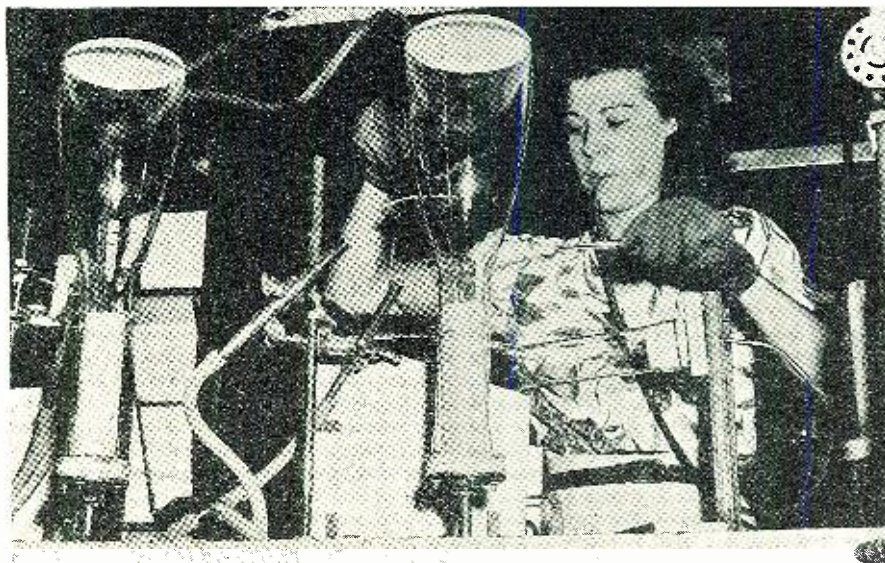



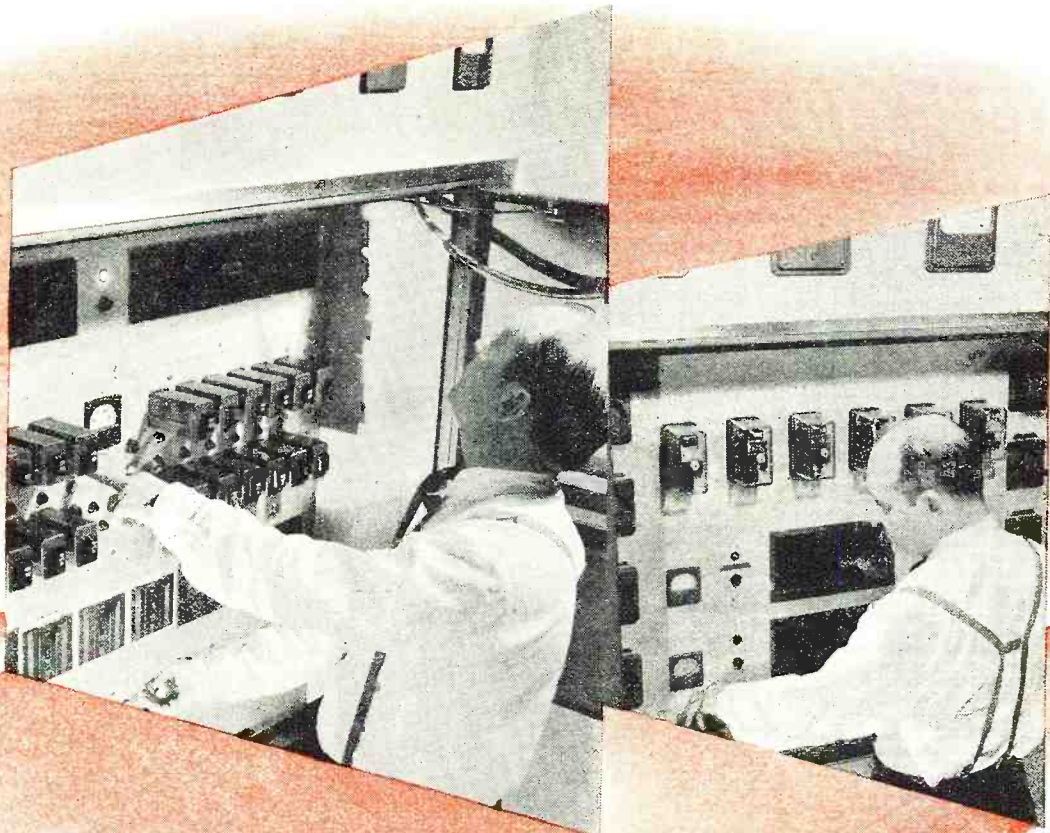

**CONSIDER** *Simplicity of Control*  
**WHEN YOU SELECT A NEW TRANSMITTER**

Easy to put on the air, easy to keep on the air . . . that's what you want in a transmitter, and that's what Westinghouse equipment assures.

Specifically, here are some of the features that make for operating simplicity in Westinghouse Transmitters:

1. One Master Control puts the transmitter on the air and cuts the power off at the end of the broadcast period. It is impossible for power to be applied in the wrong sequence.
2. Individual Tuning and Adjustment Controls are mounted on the front panel, easily accessible.
3. Indicator Lights Flash Circuit Conditions to Operator, indicating instantly which circuit requires attention.
4. Simplified Circuits—require a minimum of tubes . . . no tricky wiring.

5. "De-ion" Breakers Show Outage Location, providing fuseless protection for the low-voltage power circuits.

Simplicity of Control is only one feature of Westinghouse Transmitters. Others equally important are: *Low Operating Cost, Continuity of Operation, High Fidelity Signals, Ease of Maintenance.*

**PLACE YOUR ORDER NOW  
 FOR YOUR POSTWAR TRANSMITTER**

By placing your order today for a Westinghouse transmitter, you assure yourself of the fastest possible delivery following the lifting of wartime manufacturing restrictions. We are scheduling deliveries in the sequence in which orders are received. For details, write Westinghouse Electric & Mfg. Company, Dept. 1NB, P. O. Box 868, Pittsburgh 30, Pa.

**Westinghouse** RADIO DIVISION  
 PLANTS IN 25 CITIES . . . OFFICES EVERYWHERE



J-08080

**A M • E L E C T R O N I C S • F M**

**October, 1944**

**89**

## Wherever Precision Counts Most...



### Products of "MERIT" are passing the test

Complying with the most exacting requirements for precision workmanship and durable construction, MERIT has established its ability to produce in quantity and deliver promptly—

Transformers • Coils • Reactors • Electrical Windings of All Types for Radio, Radar and Electronic Applications.

Today these dependable MERIT precision parts are secret weapons; tomorrow when they can be shown in detail as MERIT standard products you will want them in solving the problems of a new electronic era.

Illustrated: High Voltage Transformers A-2123 (small) and A-2124. Designed for high altitudes. Oil-filled and Hermetic sealed.

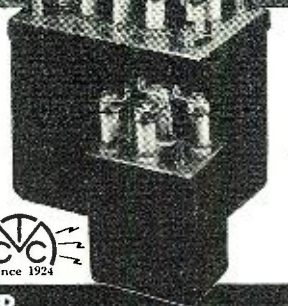

**MERIT COIL & TRANSFORMER CORP.**  
311 North Desplaines St. CHICAGO 6, ILL.

## A New TWIST TO CRYSTAL CLEANING

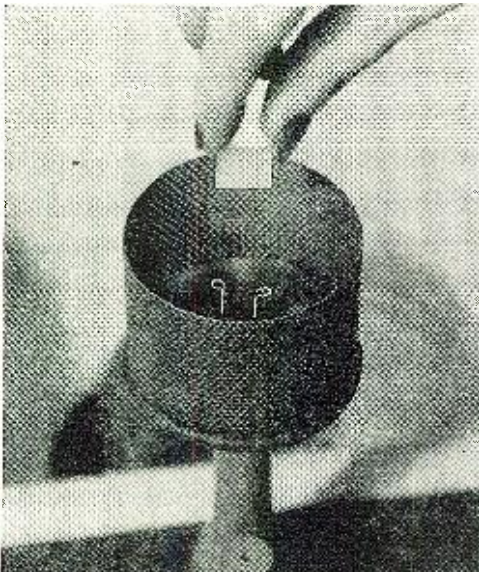

THIS is an actual photograph of the centrifugal air drier, or "spinner," used in Bliley production to facilitate clean handling of crystals during finishing and testing operations. Quartz blanks are dried in 5 seconds in this device which is powered with an air motor and spins at 15,000 r.p.m.

Little things like lint or microscopic amounts of foreign material can have a serious effect on crystal performance. The "spinner" eliminates the hazards encountered when crystals are dried with towels and makes certain that the finished product has the long range reliability required and expected in Bliley crystals.

This technique is only one small example of the methods and tests devised by Bliley Engineers over a long period of years. Our experience in every phase of quartz piezoelectric application is your assurance of dependable and accurate crystals that meet the test of time.

BLILEY ELECTRIC COMPANY - - - ERIE, PA.



ragged nerves. Long confinement often brings the AACS man to tantrums.

"You start talking to the seals after you're in the Arctic for a few months," reports Staff Sergeant Joseph E. Diehl, of Detroit. "What really makes you mad is—well—the damned seals don't answer!"

Occasionally an operator will rip loose a transmitting key or toss a typewriter through a window. Such actions are not out of the ordinary; AACS veterans indicate this in advising: "Don't fret about the guy that throws a typewriter through a window. He's probably all right. Keep your eye on the man that hasn't lost his temper yet!"

A story is told about one operator in the Arctic who waited some 25 weeks for a new transmitter; when the valuable set arrived it was opened with trembling fingers. The operator fondled the precious radio assembly with loving fingers, leaned over and kissed the tubes one by one; then his eyes fell upon an envelope. Upon opening the envelope he found a printed form which stated: "The bolts used in the assembly of this equipment are of standard variety and may be purchased at any hardware store." The nearest hardware store was more than a thousand miles away.

Scores of AACS stations similar to the Baffin Land establishment now dot the Arctic regions; the AACS boys are literally "talking" thousands of planes over the skyways that were once considered *suicide* lanes. Less than two percent of the ships which have flown these erstwhile North Atlantic *suicide* lanes—guided by AACS—have failed to reach scheduled destinations. An enviable record for safety in the sky has been established by Uncle Sam's communication operators. Today, there is a shuttle service of thirty giant transports flying on regular schedule over this Great Circle route.

Another most remarkable adventure, herewith revealed by the boys of the great North for the first time, was the one in which four Flying Fortresses were involved. The big ships were ordered for a special flight. No ammunition was carried. Several important Washington diplomatic officials were aboard; army personnel and much secret matériel made up the vital cargo. It was a big assignment for the flight officer; he utilized every inch of space on the four B-17s.

The bombers cruised along over the Great Circle route without mishap until the Scottish coast was virtually within sight. Suddenly one of the Fortress pilots sighted a formation of some twenty Luftwaffe pursuits—Messerschmitt 109s. These Nazi interceptors—ostensibly ignorant of the fact that the American ships, though armed, were without ammunition—did not seem overanxious to engage the Fortresses. In desperation the Yankee flight officer made a quick decision; he reversed the course. The Nazis must have caught on for they instantly



**MONITOR with**  
**PANORAMIC**  
**See a wide band- all at once**

In the typical monitoring station—up to the present time—each received signal has required the active attendance of an operator and a receiver—the operator turning the dials ceaselessly and recording the signals on the air. With the aid of PANORAMIC RECEPTION, however, just one piece of equipment can do the work of many. Because PANORAMIC RECEPTION SHOWS ALL SIGNALS ON A GIVEN BAND OF THE RADIO FREQUENCY SPECTRUM SIMULTANEOUSLY, one operator can cover wider bands of the spectrum with more accuracy and less operator fatigue. Without dial manipulation, he can see immediately open channels and intermittent signals. Moreover, the patterns on the screen tell him the frequencies of the stations; their stability; their signal strength as they reach him; whether the station is AM, FM, or CW; and the type and extent of interference.

In monitoring, as in direction finding, navigation, production, and laboratory procedure, PANORAMIC RECEPTION is becoming an indispensable timesaver. Its unique capabilities will offer new solutions to your industrial and laboratory problems. Allow one of our engineers to explain how PANORAMIC RECEPTION may be used to your best advantage.

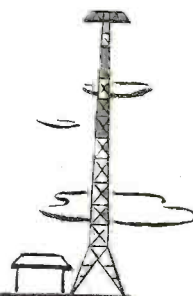

**PANORAMIC**  **RADIO CORPORATION**  
 242-250 WEST 55<sup>TH</sup> ST. *New York 19, N.Y.*

picked up in hot pursuit. A grim game of hide and seek in the clouds continued for hundreds of miles, with the ME-109s circling, diving, and spitting lead into the Fortress formation. But the enemy efforts were all in vain for the American ships carried a surplus fuel supply—sufficient to carry them far beyond the reach of the ME-109s; eventually the German pilots were forced to turn back for distant home bases without the satisfaction of downing a single one of the American ships.

Nevertheless, the B-17s were forced far off the course; crash landings were made on the Ice Cap in the frigid North Atlantic; much equipment was smashed in the forced landings. Fortunately, no passengers were killed.

Emergency transmitting facilities were salvaged and assembled and a frantic SOS went out. It was picked up by a remote station in the Arctic. The AACCS man on duty ordered a dog team expedition and called for volunteers. Three days of intense and feverish preparation were required before the rescuers could set out on the search. The rescuers struggled over a wild trail of dangerous ice-land never before seen by man. Three weeks later all the survivors—the diplomatic officials, army personnel and crew members—were picked up and brought back alive. Those four B-17s are still perched on the Ice Cap.

The story of AACCS teems with impossibilities, or seeming impossibili-

ties. Its achievements are based on the old adage: If at first you don't succeed, try, try again! When war clouds were darkening in 1939, Air Corps communications were in a poor state. Funds for operations were limited. Few were interested in Army radio. Civilian operators were handling most of the Army traffic; and many "old school" pilots were content to rely primarily on instinct and intuition in the air. Thousands of new planes were rolling off the assembly lines; new and inexperienced pilots were being trained. Ground facilities were sorely lacking. If war came suddenly there was a great possibility of confusion and tragedy in the skies. A dangerous situation existed—we had a rapidly expanding Air Force handicapped by poor and insufficient communications.

In 1939 AACCS personnel numbered four officers and less than four hundred enlisted men; 33 stations were doing a job which was soon to require hundreds. It was difficult to procure funds.

A few far sighted Army officers realized that the situation was a desperate one; few others saw the handwriting on the wall. Brigadier-General H. M. MacClelland, Brigadier-General A. W. Marriner and Colonel Lloyd Watnee—men of action—determined to carry on a fight for the expansion of AACCS during the days when many were convinced that war could not come to America. Washington set the wheels in motion when war became a growing possibility but progress was very slow. During the first twelve months only 74 radio men were recruited into the AACCS from civilian ranks. Hundreds were needed to operate a growing nucleus of domestic stations.

America was indeed fortunate to have a tremendous reserve of radio *hobbyists* or *hams*—men with radio *know how* requiring no extended technical training—for without these men, those "kids around the corner," and the innumerable radio repairmen, this gigantic enterprise probably would have failed at the outset. So pressing was the demand for *hams* during those days that Uncle Sam waived basic training for many of these men. Hams were hurried overseas to all parts of the world in a ceaseless stream of task forces; there was a desperate rush to get stations on the air. How they got the stations on the air is a story of monumental courage, patience and intestinal fortitude; during that period equipment was scarce, second-hand, make-shift and difficult to transport. The manpower shortage was discouragingly acute.

It was at this opportune time that Wilmer L. Allison, renowned sportsman and enthusiastic radio *ham*, entered the picture. Allison was a reserve officer; he was called to active duty, commissioned as a captain and assigned to Colonel Watnee's staff as the key man to expedite ham recruiting. Allison was given a free hand. He started an effective grapevine campaign by word-of-mouth; direct

**HE HAS YOUR BATTERY**



Today flasher signal lights and invasion-barge searchlights are more important than battery-powered lights at home. Burgess Batteries go *first* to the men who need them most, so we'll all have to take better care of what batteries we may have. Keep them cool and dry... use them as little as possible and rest them as *often* as possible.

Paper Packs a War Punch—Save It!

**BURGESS BATTERIES**

IN THE NATION'S SERVICE

Free Battery Hints—Write Burgess Battery Co., Dept. N-2 Freeport, Ill.





## ... *in Low and High Temperatures*

There is a range of 210 degrees between the prevailing temperatures at the Equator and the Arctic Circle. Yet microphones must operate unflinching, whether used at New Guinea or Murmansk. Shure Research, in heated chambers and dry ice temperatures, assures our armed forces Microphones that will bring the message through under any temperature condition. It's the same Shure Research that assures you a better postwar product.

**SHURE BROTHERS, 225 West Huron Street, Chicago**  
*Designers and Manufacturers of Microphones and Acoustic Devices*



# MULTI CHANNEL FILTERS BY...

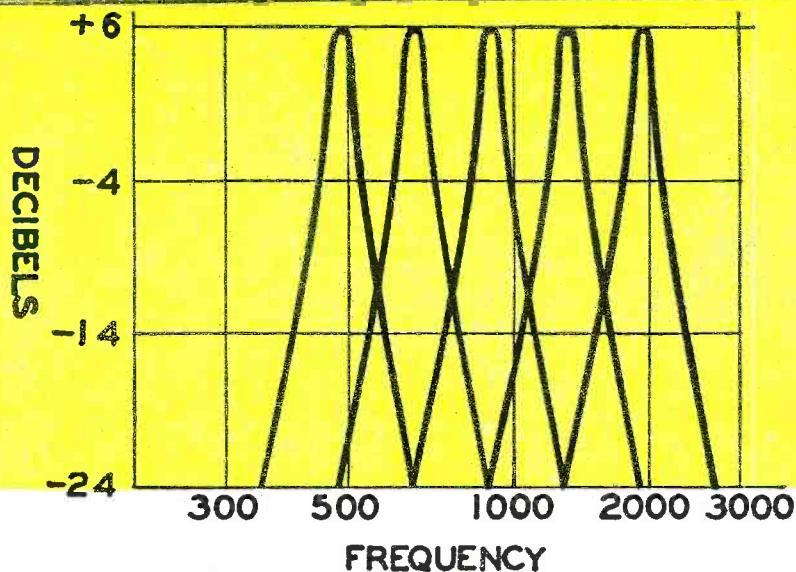
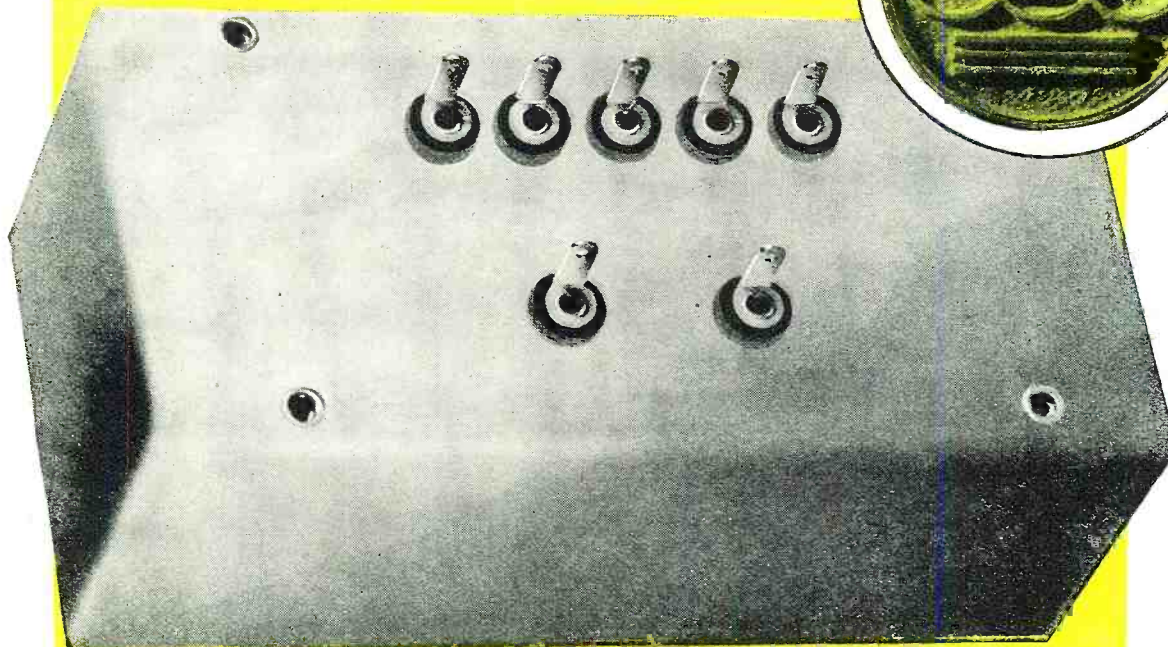

Multi-Channel Filters lend themselves to remote control apparatus employing frequency selection. The unit illustrated is a five channel band pass filter of the interstage type with the inputs in parallel and 5 separate output channels designed to feed into open grids. This circuit arrangement provides a 2:1 stepup ratio, with a band pass attenuation of approximately 30 DB per half octave. The dimensions of this unit in its hermetically sealed case are 2½" x 3" x 6". Filters of this type can be supplied for any group of band pass frequencies from 200 to 7000 cycles.

*May we cooperate with you on design savings for your application . . . war or postwar?*

*United Transformer Co.*

150 VARICK STREET

NEW YORK 13, N. Y.

EXPORT DIVISION: 13 EAST 40th STREET, NEW YORK 16, N. Y.. CABLES: "ARLAB"

# CODE PRACTICE OSCILLATOR

By **CLAYTON COOL, Jr.**

mail and national advertising media were subsequently used. Hundreds heeded the call—selling home assembled transmitters and miscellaneous radio parts to the Government—and “joined up.” The success of Allison’s big ham crusade was a definite turning point in AACS history. Erstwhile hams now largely command AACS, comprising about nine-tenths of the technical officers’ staff at Wing Headquarters in Asheville, North Carolina.

The indomitable spirit which has keynoted AACS activities is best exemplified by some of the assignments it has completed against overwhelming odds. One AACS force was ordered to establish a station at a strategic spot somewhere in India. It was on an Air Transport Command. ATC was commuting over “the hump” between India and China; it was a vital supply line for Chiang Kaishek and General Chennault’s “Flying Tigers.” Unarmed C-46s, C-47s, C-53s and C-87s needed AACS help in the worst way over the Himalayas, the world’s highest mountain range. Sporadic interception by Jap Zeros and howling 100 mile-an-hour winds were taking a toll. An AACS task force was rushed from the States and worked feverishly for weeks to get the station on the air. Equipment came through in dribbles, irregularly and slowly, but after ninety-one days the station was ready to take the air. On the night before the transmitter was to officially begin operation the entire installation was swallowed up in flames. An Indian boy, a careless native, had absentmindedly tossed a flaming match on the ground near a fuel tank: Three months of painstaking accomplishment was destroyed in thirty minutes, yet there was a broadcasting station on the air in the midst of these ruins a week later—thanks to the ingenuity of the ham on duty.

All AACS jobs are not so secure and distant from enemy action, as Captain J. E. Roberts and Staff Sergeant John R. Dunn will verify. They were stationed at famed Henderson Field during the early fighting on Guadalcanal. Roberts and Dunn reported that the original AACS tower was hit so often by bombs and shrapnel that it “looked like a second-hand rocking chair.”

AACS stations have since mushroomed into existence throughout the great expanse of the Arctic regions, in the tropics, the Far East, in Africa and Europe. Hundreds of stations and thousands of operators and dit-dah men are maintaining contact with tens of thousands of planes and bombers—be they in enemy territory on a bombing mission, taking off from a Kentucky pasture or making a crash landing in the South Pacific. These are the boys who literally “talk” the fighter and cargo ships across the treacherous reaches of the northern oceans and the vast stretches of southern seas—in 48 states and 52 foreign countries—through storm and fair weather, by bombers’ moon and ceiling zero!

**T**HIS simple code practice or audio oscillator operates solely on 6-volts direct current and uses three components from the junkbox—a 1A or similar tube; an audio transformer (3:1 was used); and a rheostat, which can be from 10 to 30 ohms.

These can usually be found in sets of early design, which also may provide the hookup wire, tube socket, and binding posts required. The radio experimenter probably has on hand the accessories, which consist of a 6-volt battery, earphones, and key.

The author was told that this unit would not work because no grid leak was used. However, he decided to make the experiment, and succeeded in getting it to operate.

Although it seems almost impossible, the unit also works without a plate voltage supply. The phenomenon of current flowing in an external circuit between the plate and positive filament terminals of an electron tube is known as the Edison effect. This, with the aid of a low voltage across the rheostat, gives sufficient current in the plate circuit to cause oscillation, with loud volume in the two sets of phones used, as well as excellent tonal purity, and clean keying.

The rheostat also acts as an on-off switch, volume control, tone control, and voltage-dropping resistor if the tube used operates on less than the voltage of the battery. A higher rheostat setting gives a higher note. Set the control for the best volume and tone; at this power the tube is not damaged by operating below its rated filament voltage.

Flashlight or other dry batteries may be added in the plate circuit for more volume, as shown in the diagram. If a high voltage is used, a grid leak and condenser will be needed in the grid circuit. In this way a conventional oscillator is obtained and loudspeaker volume should be secured.

The accessories in the plate circuit are usually in series but their order is not important. Binding posts allow for easily arranging, adding, or removing phones, batteries, and keys. To allow two persons to practice, two keys may be hooked in parallel. The schematic of Fig. 1B is suggested to give two different tones, simulating two different radio stations. Better results may be obtained with the flashlight battery and the resistor both in series with the same key. Fig. 1C

shows a realistic two-way setup, where each operator cannot hear his own sending. These are but suggestions for circuits which may be used.

Several tubes and transformers may have to be tried before good tone or oscillations are obtained in this simple circuit. A condenser across a winding of the transformer will change the characteristics of the transformer. The filament polarity and the transformer connections must be correct.

The neon-tube resistance-capacitance relaxation oscillators are also as simple, but operate on a direct current of 100 to 300 volts. The circuit is a resistor in series with a parallel combination of a condenser and the neon tube. Increasing the resistance or capacitance lowers the frequency. Oscillations of a sawtooth nature may be obtained up to 50,000 cycles.

—30—

Fig. 1. Diagrams of various applications of the code oscillator. (A) Basic diagram. (B) Suggested hookup to obtain two different tones, simulating two separate radio stations. (C) Two-way hookup where each operator cannot hear his own sending.

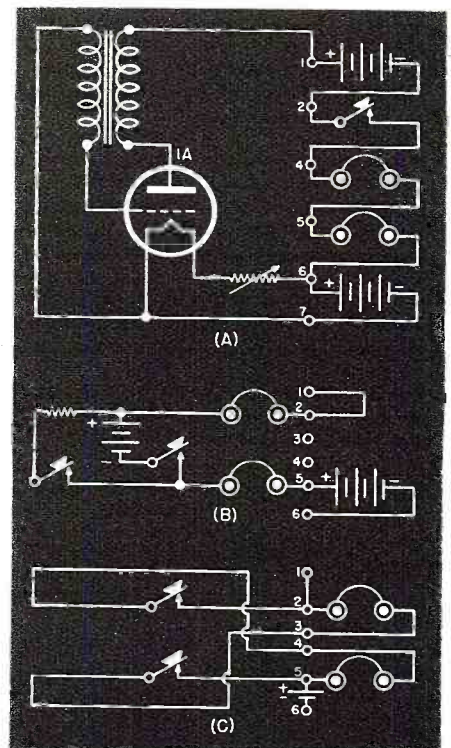

## Radio Communications

(Continued from page 43)

signal communications employed by all forces until land lines can be installed. Cooperation, coordination, and planning must of necessity insure successful operations, be foremost in the allocation of frequencies in a joint maneuver for the prevention of mutual interference to signal radio channels.

Among some of the methods employed to control mutual interference are the following: limitation of the power output of transmitters, employment of a system of time priorities for

suppression of stations which could probably interfere with important transmitters, strict radio discipline, proper preplanning, and coordination. Frequency allocation must be thoroughly coordinated and correctly planned, and must be flexible to meet "all" conditions of interference.

### Radio Discipline

It is not overemphasizing to say the course of recent history has hinged on radio discipline. General Ronge of the Austrian Army, talking of conditions prevailing in 1914 before the famous battle of Tannenberg, said concerning radio transmission: "An effective, unsurpassed source of information was, however, opened to us by the Russian

radio messages, which were transmitted with a carelessness similar to that of which the Germany were guilty when opposite the French troops at the beginning of the war," and Lieutenant Colonel Philip Neame in his book, "German Strategy in the Great War," also mentions the Russian radio indiscretions before the Battle of Tannenberg.

It never happened before and probably will never happen again in the history of signal communication as it happened in the Battle of Tannenberg, that so much important information concerning the dispositions and grouping of entire armies of one side would be betrayed to the enemy because of the failure to take proper measures to insure radio discipline.

General von Falkenhayn of the German Army states in his memoirs of World War I: "Intercepted radio messages enabled us from the start of the war until the end of 1915 to follow all movements of the enemy on the Eastern Front, and our daily orders were issued accordingly."

In 1939 a very important ammunition dump was left undestroyed by the Poles because a telephone call via radio channels had informed the commanding officer of a demolition party to hold up destruction of the dump until a retreating Polish unit obtained some special powder. Shortly thereafter the demolition party was surprised by a German unit. In this instance it was later determined that the call had not been verified by authenticators. Here also radio discipline failed.

Because of the limited number of radio channels available, there is a great urge to search the spectrum for an open radio frequency. This practice is dangerous and can be avoided by application of radio discipline. Obviously a frequency found by "hunting" on the spectrum may be a frequency that has been allocated for other purposes. The use of unauthorized and stolen frequency can prevent necessary signal communication for either ground or air operations and jeopardize any operation or an entire command. Imagine the confusion and chaos that would result if all commanders in any theater permitted the practice of searching for and employing stolen channels. The enemy would dance with glee.

An effective means of enforcing radio discipline is by use of monitoring or listening stations. All monitor stations should be operated by trained radio personnel who should know all the tricks of radio operating. The many channels to be guarded or monitored may be chosen at random at any hour of the day or night. All pertinent data on infringements or discrepancies are recorded, pertaining to unauthorized and off-frequency transmissions, radio procedure not in accordance with Field Manuals, and malfunctioning of equipment.

There is no such thing as an unimportant radio transmission, for the

**"THE HELP SITUATION" by Larlar**



**HERE'S HELP THAT WORKS 'ROUND THE CLOCK**

**RIDER MANUALS (13 VOLUMES)**  
 Volumes XIII to VIII ..... \$11.00 each volume  
 Volumes VI to III ..... 8.25 each volume  
 Abridged Manuals I to V [1 volume]... \$12.50  
 Automatic Record Changers and Recorders 6.00

**OTHER RIDER BOOKS YOU NEED**

The Cathode Ray Tube at Work Accepted authority on subject .....	\$3.00
Frequency Modulation Gives principles of FM radio .....	1.50
Servicing by Signal Tracing Basic Method of radio servicing .....	3.00
The Meter at Work An elementary text on meters .....	1.50
The Oscillator at Work How to use, test and repair .....	2.00
Vacuum Tube Voltmeters Both theory and practice .....	2.00
Automatic Frequency Control Systems —also automatic tuning systems .....	1.25
A-C Calculation Charts Two to five times as fast as slide rule .....	7.50
Hour-A-Day-with-Rider Series—	
On "Alternating Currents in Radio Receivers"—	
On "Resonance & Alignment"—	
On "Automatic Volume Control"—	
On "D-C Voltage Distribution"—	90c each

**JOHN F. RIDER PUBLISHER, INC.**  
 404 Fourth Avenue, New York 16, N. Y.  
 Export Division: Rocke-International Corporation  
 13 E. 40th Street, New York City Cable: ARLAB

PLACE YOUR ORDER TODAY!

**RIDER MANUALS**  
 GIVE YOU THE HELP YOU NEED!





# RADIO NEWS

RADIO ELECTRONIC  
*Engineering*  
EDITION OF RADIO NEWS

**FOLLOW  
WARTIME RADIO  
*Into Peace!***

**Receive Radio News Regularly  
1 Magazine in 2 Editions**

The curtain of military secrecy surrounding many wartime developments in radio is gradually being lifted. Experts in radio, those who want to become expert, find it helpful, interesting and profitable to receive *every* issue of fact-packed *Radio News*. Only through the pages of this magazine or the Radio Electronic Engineering Edition can they follow the developments of wartime radio into peace.

**Radio News**—\$3.00 a year—covers all the developments in the field for the reader who builds, services, or sells radio.

**The Radio Electronic Engineering Edition**—\$3.50 a year—offers a special section of full magazine dimensions bound into the regular issue of *Radio News*. This edition carries technical articles of special interest to management, production men, and to specialists in electronics: engineers, designers, technical men and purchasing agents... is edited for and limited to this group.

**Your subscription to the regular edition of *Radio News*** will bring timely articles and news stories of interest to everyone whose business future depends on radio. The Radio Electronic Engineering Edition contains the same editorial matter plus the special section of highly technical matter of interest only to those in specialized fields. Subscribe to your edition today—don't miss a single issue.

RECEIVE  
RADIO NEWS  
*Regularly*  
1 MAGAZINE  
IN 2 EDITIONS

Ziff-Davis Publishing Company  
540 N. Michigan Ave., Chicago 11, Illinois

Enter my subscription to Radio News. Enclosed find check for

.....1 year, \$3.00 .....2 years, \$5.00.  
Radio Electronic Engineering Edition  
.....1 year, \$3.50 .....2 years, \$5.50

Name.....  
Address.....  
Title.....  
City.....State.....

**ZIFF-DAVIS PUBLISHING COMPANY**

540 North Michigan Ave., Chicago 11, Illinois

New York • Washington • Los Angeles • London, Ontario

most trivial message may give away information that can change the course of events. For instance, in 1914 the French monitor or listening station located in the Eiffel Tower heard the Second German Army passing on information to the German cavalry who were advancing into the gap between the British and the French Fifth Army. Brigadier General E. L. Spears, in his book, "Liaison 1914," comments as follows on this operation:

"The first information of this new and terrifying development reached us at Laon at 9:15 a.m., when the General Headquarters telephoned that an enemy wireless message had been intercepted ordering a German cavalry

corps to cross the Oise at Bailly and march on Vauxaillon, which lay some fifteen miles southwest of Laon where we were sitting at that moment. . . . Information that came in during the afternoon did nothing to allay our anxiety. Intercepted enemy wireless showed that three German cavalry divisions had grouped their first line transport about Compiègne. If the enemy cavalry moved at any speed they would reach Vauxaillon hours before the retiring French infantry, completely outflanking our left. They would cut the Laon-Soisson Railway and be only a very short distance from the Aisne, from which the main body of the Fifth Army was separated by

many miles of difficult hilly country. If the Germans occupied the passages of the river before the Fifth Army, they would cut off its retreat to the South."

The monitor station in the Eiffel Tower continued intercepting German wireless messages, one from the German cavalry which stated that it needed nails for shoeing horses immediately.

General Spears states that the Fifth Army owed its extraordinary escape to a lucky accident. The inference drawn from the statement suggests the importance of radio silence, for even an isolated scrap of information, such as the need of nails for shoeing, can be the turning point of a war. Perhaps a scrap of information obtained there may be meaningless, but the scraps of information so obtained may fit into a pattern to form a complete picture enabling the enemy to obtain the detailed and comprehensive plans of an operation.

The British in the early days of 1941 had been in the habit of transmitting names of war casualties to higher headquarters. The Italians listening to these reports, meaningless in themselves, were able to determine that important British units had been withdrawn from Africa, thereby enabling them to defeat the British.

Unauthorized transmissions and "jabbering" over the radio is a valuable source of information to the enemy. Two sergeant radio operators of British units stationed near Cairo had formed the bad habit of jabbering over the radio. Main topics of discussion concerned two beautiful American girls they had met in Cairo and the plans they both had made with the two girls for a future weekend. In the course of events one of the British units received secret orders to surprise the Italians with a dawn attack on a Sunday morning. The radio sergeant of the attacking British unit, by the easy expedient of continuing to employ the radio for unauthorized transmission to the other radio operator, requested him to express the necessary regrets to the waiting American girl in Cairo. Alert Italian radio monitors having previously heard all the romantic details via the radio waves, reasoned, and rightly so, that the sergeant's change in plans had been interrupted by decision of higher authorities to move the unit. "Move" in this case meant only one thing—attack. Thus, the element of surprise, so necessary in the attack on that Sunday morning, was lost, and this was a contributing factor in saving the Italian units from complete annihilation.

Valuable military information was disclosed to the British desert units by Italian radio operators who announced the arrival and departure of a visiting chaplain. It was a simple matter for the British to find out the number and location of all Italian units in the area.

Another source of enemy information is phrases coined on the spur of

# WANTED

## "HOME ENTRY" AND "CONFIDENCE" WORKERS

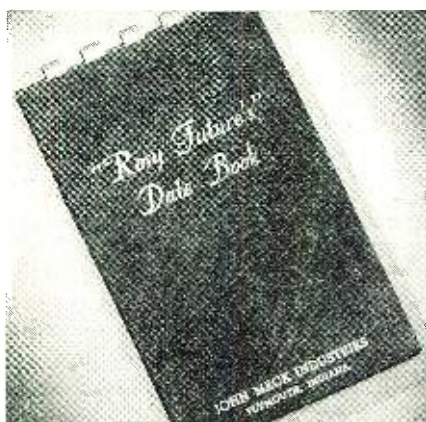

## BIG OPPORTUNITY FACING YOU

As a result of your knowledge and skill in radio, you are welcome in the homes of your community. Your statements carry weight because your customers have confidence in you. Have you thought what this sales advantage means to your future? To meet that future, when there may be less service work, MECK has planned a line of Radios and Phonographs that are Built to Perform and Priced to Sell. MECK is offering you "Rosy Future's" Date Book—Free—to record the future needs of your present service customers. Send for your copy today. Then — when "Delivery Day" comes, meet those customers' needs with MECK Radios and Phonographs.

*Built to Perform — Priced to Sell!*

Distributed Nationally Thru Radio Equipment Jobbers

WRITE FOR *Free*  
"DATE BOOK" NOW

*Pocket size, durable — get started on YOUR post-war plans now. Just write — it's free!*



**MECK** RADIOS • PHONOGRAPHS  
\* \* \*  
INDUSTRIAL SOUND

BUY MORE BONDS—AND KEEP THEM!

JOHN MECK INDUSTRIES, PLYMOUTH, INDIANA, U. S. A.



**AMPHENOL**

Electronic Connectors and Parts

**FLY WITH THE B-29's**

• Even counting all the days—and nights—put into planning and preparation by designers, builders and suppliers, B-29 still represents a miracle in achievement—the number of days still seem far too few for the undertaking.

Built to carry loads beyond former limits, at speeds never before considered, and safeguarded as no fighting plane before it, the Superfortress history-maker represents a new high in co-ordination between those who plan and those who build.

Leaders among manufacturers—known for quality of products and ability to deliver on schedule the various types of equipment needed, were asked to pledge their co-operation in this twenty-four hour a day job. Amphenol is proud to have been chosen to furnish the electronic connectors and parts for this great weapon.

Engineers in these plants from coast to coast worked simultaneously in designing parts that would meet the requirements set. Each production department set up a time table of the dates on which it would make first and subsequent deliveries. And B-29 progressed by the clock.

The first take off was on schedule. Japan was bombed on schedule. And today, American flyers have a marvelous weapon which gives their talents full play.



• SEND FOR THIS BOOK. Twenty-four illustrated pages of suggestions on dependable wiring—directly from the benches. These are things that other practical men have worked out and by which you or your wiring department can benefit. Send for a copy—you will enjoy reading it.



Depend upon  
**AMPHENOL**  
Quality  
AMERICAN PHENOLIC CORPORATION  
1830 S. 54th Avenue, Chicago 50, Illinois  
IN CANADA • AMPHENOL LIMITED • TORONTO

Makers of Connectors (AN, British, UHF), Fittings, Conduit (Flexible Metal and Plastic), Cable Assemblies, UHF (RG) Cable, Radio Parts, Plastics for Industry.



**NO TIME FOR FAILURE**

Split-second decisions on the invasion fronts are possible only because of constant and immediate communications between fighting units and their headquarters—and we are proud that Halldorson Transformers are helping to maintain these communication lines—giving dependable performance even when the going is "rugged".

Homefront communications must also be maintained, so we now make—in limited quantities, of course—a complete line of Victory Type transformers. Built to meet Halldorson standards, these replacement transformers will assure continued operation of civilian radios.

**THE HALLDORSON COMPANY, 4500  
Ravenswood Avenue, Chicago 40, Illinois**

**JOBBER:** We'll be glad to send you complete information regarding Halldorson Victory Type Transformers upon request.



**HALLDORSON**  
*Vacuum Sealed*  
**TRANSFORMERS**

the moment; "four horses out of commission," "three horses have broken legs," or "feed needed for the horses" fool no one, least of all the enemy.

Proper training and radio discipline will prevent the enemy from securing information from our radio transmissions. It is well to remember that the enemy listens to or monitors all of our radio transmissions regardless of their importance.

Preventing the enemy from obtaining information from our radio transmitters operating in the field is the responsibility and duty of all radio personnel.

On the transmitter of a field radio station in New Guinea is a large sign reading, "Remember the enemy is listening." That phrase is applicable to all personnel in every theater.

In conclusion it may be said that in spite of the limitations placed upon it by nature and handicaps imposed upon it by man, radio, if correctly employed and effectively utilized, is a reliable and flexible means of signal communication providing the necessary channels to control the fast moving highly mechanized tactics of modern warfare, either on the ground or in the air.

-30-

**"Limits Bridge"**

*(Continued from page 41)*

ard and test components read directly from the dial thereof. Far from being a disadvantage, or a waste of time in operation, this manual control has been found to serve a most useful psychological purpose. It eliminates the tendency of an operator engaged for hours on end in a simple repetitive operation to "go through the motions" while losing consciousness of their significance for minutes at a time. The very fact that the operator must manipulate a knob to operate the instrument seems to cause a concentration of attention upon its operation which in turn prevents laxity and the passing of out-of-limit specimens. Speed of operation is entirely satisfactory; it is possible for an average operator to test 1000 to 1500 resistors or capacitors per hour. All this, coupled with a simplicity and dependability which has resulted in no single failure or case of trouble during months of operation of a number of these limits bridges, tells a most satisfying story, as does the fact that rarely has an out-of-bounds component passed through the bridge test positions.

Fig. 1 illustrates the operational simplicity of the limits bridge, for its 7" by 10" metal panel carries but one operating control in the form of a long bar-knob easily manipulated by one finger of the operator's left (usual) hand, plus the magic eye balance indicator. In operation the user's right hand picks a test specimen out of a convenient box, touches its leads or lugs directly to the "TEST" terminals at the lower right (or to a knife-edge

**JAMES KNIGHTS**

# Crystals



*A Habit With Us--*  
**HERMETICALLY SEALED**  
**ETCHED Crystals**

The engineers of the James Knights Company pioneered in the development and manufacture of Etched quartz crystals. For some time now, we have been supplying quantities of these definitely better type crystals in hermetically sealed holders. James Knights Etched Crystals are available to improve the performance of your equipment. Catalog on request.

**BUY WAR BONDS FOR VICTORY!**

**The JAMES KNIGHTS Co.**  
SANDWICH, ILLINOIS



**CRYSTALS FOR THE CRITICAL**

**READY FOR SHIPMENT from Lafayette Radio Corp. Chicago or Atlanta**

**Fractional H.P. Motor**

For use in model work or in any usage where a small, powerful, slow speed motor is required. Compact, 1/20th horsepower induction type. Operates from 25 to 30 volts AC, 60 cycles. Motor speed 2400 RPM, with gear train driving 1/4" shaft at 24 RPM. 2"x1 3/4"x3" overall, excluding shaft. M14699. Specially priced, \$2.50

**RCA Facsimile Broadcast Receiver**  
RCA MODEL FAX-2A

Fully automatic pre-tuned high fidelity radio receiver, facsimile printer amplifier, facsimile printing unit, and Telechron time switch clock. This instrument has many uses in the laboratory. The printing unit utilizes carbon paper in contact with white paper as a recording medium. Complete with tubes and operating and service instructions, but less recording paper. M25749 \$99.50



**IRC 20-Ohm, 25-Watt Power Rheostat**

All metal, die cast aluminum case. Heat uniformly dissipated throughout element. 1/4" shaft screw driver adjustment. M8167. 1 1/2" diameter \$1.39

**Meissner 9" Slide Rule Dial**

Single speed vernier dial mechanism. Fits 3/8" shaft. 5-band scale calibrated 5.85-18.2mc, 17.6-42mc and 133-406kc. Includes escutcheon and bayonet type dial light sockets. Ratio 17:1. M9978-Type. 23-8230 \$4.70

NOTE: All items subject to prior sale

**FREE!** The country's most valuable catalog of Radio and Electronic Components and Equipment. 104 pages packed with items and values of high interest to industry, governmental agencies, dealers, service men, radio schools, etc. The only 1944 volume of its kind. Copies are going fast... MAIL COUPON IMMEDIATELY.

LAFAYETTE RADIO CORP.  
901 W. Jackson Blvd., Chicago 7, Ill.  
Dept. E-10  
Please rush my FREE copy of the Lafayette Radio Corporation Catalog No. 94.

NAME \_\_\_\_\_  
ADDRESS \_\_\_\_\_  
CITY \_\_\_\_\_ STATE \_\_\_\_\_

**Lafayette Radio Corp.**

901 W. Jackson Blvd. 265 Peachtree Street  
CHICAGO 7, ILLINOIS ATLANTA 3, GEORGIA

jig connected thereto), holds the test specimen in place, rotates the bar knob for magic-eye closure, notes the dial reading, and then drops the test specimen in a "go" or "no-go" box as the reading justifies. At the lower left are the "STANDARD" binding posts to which a standard component of previously determined correct value is attached, the test specimen always being compared to this standard component directly. Between the two pairs of terminals is the on-off switch, power-on pilot lamp bezel, and a sunken screw-driver adjustment for setting the magic-eye initially to exact closure.

The interior construction illustrated in Figs. 2 and 3 is believed to be somewhat novel in that maximum simplicity and ease of servicing is obtained; while maximum utilization of interior cabinet space is secured by the use of a vertical rather than the conventional horizontal chassis. The folded rear flange of this chassis carries tapped holes to accept machine screws inserted through matching holes in the cabinet back to hold the panel and chassis in place. This rear fastening of the chassis to cabinet, coupled with suitable positioning nubs on the rear of the panel insures permanent alignment of the panel-chassis within the cabinet and at the same time takes unsightly screws off the front panel. The net result is simplicity, economy and ruggedness not usually attained in conventional structures.

The placement of parts upon the chassis, the two sides of which are illustrated in Figs. 2 and 3, is so simple and straightforward as to require little description. The power transformer is at the bottom of the 5 1/2" deep chassis, with plug-in electrolytic filter capacitor and 5Y3GT rectifier tube immediately above; next, the bridge voltage regulator, the two VR105 plate voltage regulator tubes and above them the 6SN7GT dual triode used as null-indicator amplifier and rectifier to raise bridge sensitivity and finally 6AB5 magic-eye tube.

Fig. 4 is the schematic circuit diagram, with the bridge itself at the left, amplifier and rectifier triodes (the second, diode-connected) of the single 6SN7GT to the right. At the extreme right is the 6AB5 magic-eye tube, closure of which is effected by the absence of positive rectifier-developed grid voltage (to offset the initial negative automatic bias on V2) from V1b when the bridge is in balance. At the bottom of Fig. 4 is the power supply consisting of transformer T2, 5Y3GT rectifier tube, filter capacitor C4, filter resistor R9 (to drop voltage to a safe value for V1, V2, and to eliminate an additional filter reactor) and the two VR105 gaseous voltage regulator tubes. These regulator tubes, seemingly unnecessary at first glance, are very necessary to prevent usual and irregular but sharp fluctuations in line voltage from masking true balance as indicated by V2 in rapid opera-

tion. Adjustment of R7 when the instrument is initially put into operation, or as V2 deteriorates with age, serves to establish the shadows of V2 at exact closure for correct bridge balance, and to so avoid difficulty in rapid reading due to uncertainty as to overclosure or under-closure of the magic-eye.

Transformer T1 supplies about 50 volts of 60-cycle a.c. to the horizontal bridge terminals, the amplifier-rectifier-indicator connecting across the vertical bridge terminals. This voltage, rather high for usual laboratory bridges but sufficiently low to avoid damage to any components to be tested, makes for good sensitivity and a clean, clear balance indication, as does the amplifier and rectifier. The rectifier, V1b, could have been dispensed with in favor of causing the triode section of V2 to function as a grid-leak rectifier. This course was avoided, since the savings resulting were far less significant than the increased sensitivity and generally more satisfactory performance.

Possibly the most interesting part of the limits bridge is the actual Carey-Foster bridge circuit itself. This is basically a simple Wheatstone bridge with which it is possible to compare values of resistors, capacitors or inductors within the percentage limits established for the bridge by the size of R1, R2, R3, and by the voltage applied to the bridge, not to mention the sensitivity of the null-indicator. Assuming R1 = R3, and that R2 is about 30% of the value of R1 or R3, it is apparent that as the contact arm of R2 is varied from one end to the other, the R1 arm of the bridge will vary from R1 to R1 + R2 while the R3 bridge arm will simultaneously vary from R3 + R2 down to R3. Recognizing this fact, it is not difficult to calculate the indicated percentage difference between STD. and TEST component connected to the circuit as R2 is rotated—it is quite easy to calculate the exact calibration for R2 in advance if all values are known and if R2 is a high-quality wire-wound laboratory instrument—but not if it is a cheap receiver volume control.

The percentage difference which can be read for a given set of values for R1, R2, R3 will not be the same for plus and minus deviations from standard, as consideration of the bridge will reveal. Assuming identical values of the components connected to STD. and TEST terminals, balance will occur when  $R1 + \frac{1}{2}R2 = \frac{1}{2}R2 + R3$ . The extremes of difference for which R2 may have its scale calibrated are:

$\frac{R1}{R2 + R3}$  for minus deviations,  
and  
 $\frac{R1 + R2}{R3}$  for plus deviations for TEST  
from STD. value.

# Quality in Quantity

Building a quality product calls for skilled engineering, superior materials and extra-fine craftsmanship. Building a quality product *in quantity* calls for all these things, plus a plant laid out and organized for maximum production efficiency. The streamlined and efficient assembly lines which have poured forth unrevealable numbers of the SCR 299 and 399 Mobile Radio Stations, Mine Detectors, Aircraft Radio Receivers and transmitters and other equipment are International Detrola's promise of great quantities of the best in radio, television and electronics for a world at peace.

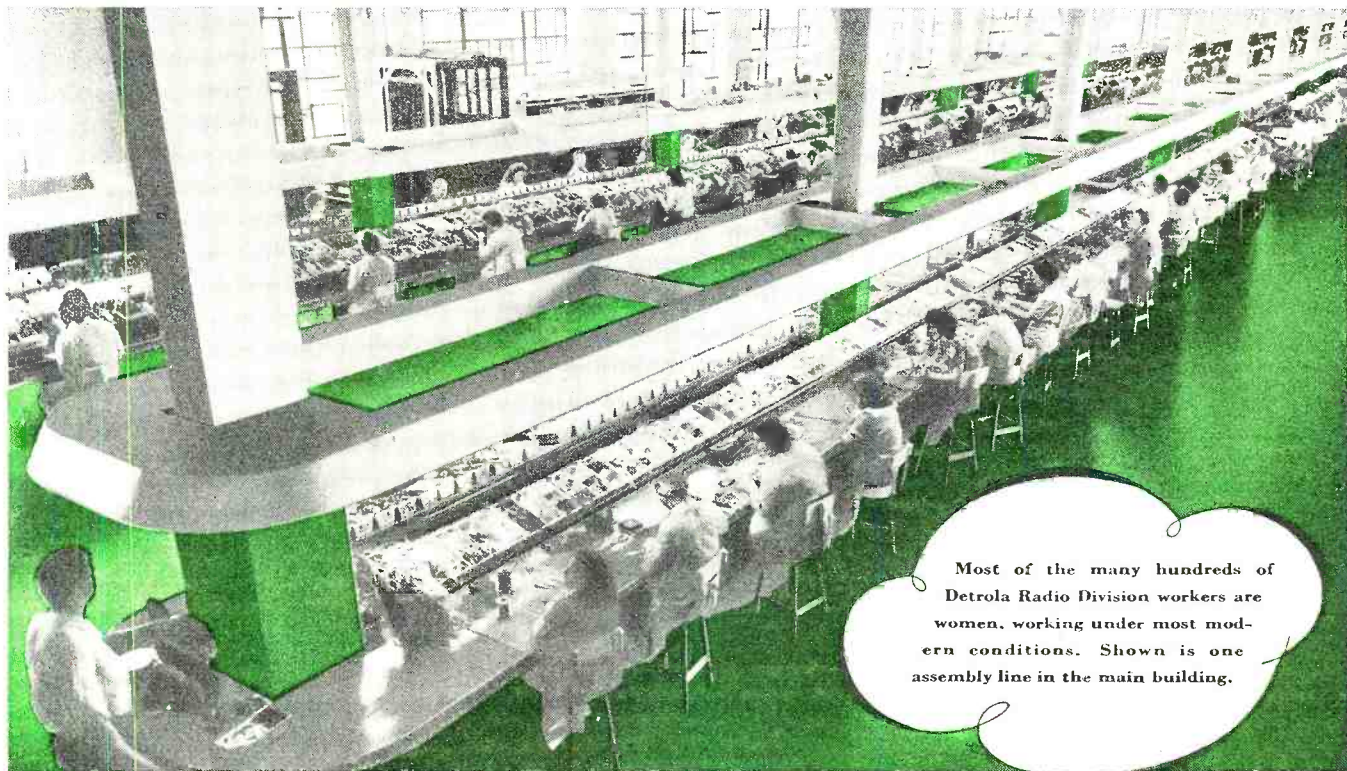

Most of the many hundreds of Detrola Radio Division workers are women, working under most modern conditions. Shown is one assembly line in the main building.

Buy War Bonds—and Keep Them

## DETROLA RADIO

DIVISION OF INTERNATIONAL DETROLA CORPORATION • BEARD AT CHATFIELD, DETROIT 9, MICH.

C. RUSSELL FELDMANN  PRESIDENT



**\*Old Man Centralab**  
 "Old Man" is right  
 ... for he is a real  
 "old timer". There  
 is no substitute for  
 experience, and  
 the "Old Man"  
 now, as in the past  
 twenty-two years,  
 is still your best bet.

**Still your  
 best bet for  
 replacements**

**Centralab**  
CRL  
**VOLUME CONTROLS**



**Centralab**  
CRL  
 Division of GLOBE-UNION INC., Milwaukee

*If* you want

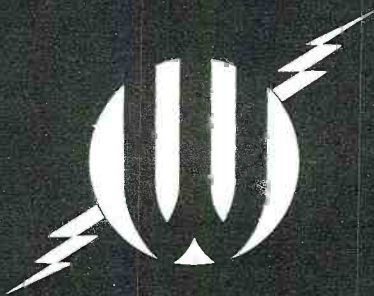

- CRYSTALS
- CABLES
- HARNESES
- ELECTRONIC ASSEMBLIES
- CABINETS

Telephone Peru, Indiana  
**151**

*Serving the Radio and Electronic Industries with precision engineered products.*

**Wm. T. WALLACE MFG. Co.**  
 General Offices: PERU, INDIANA  
 Cable Assembly Division: ROCHESTER, INDIANA

From the above simple relationships it is possible to arrive at values which will yield a "% DIFFERENCE" scale of any reasonable range which may be desired. Since 20% tolerance is about the loosest limit ordinarily allowed, then with  $R1 = R3$ ,  $R2$  should be about 30% of the value of  $R1$  or  $R3$ . This will yield a plus percentage deviation of approximately 30%, and a minus deviation of about 23%. If the scale of  $R2$  be spread over  $270^\circ$  or more, the resultant scale calibration can be read to 1% or less by a skilled operator.

Since the variation, possible in this type of limits bridge, in the ratio arm is necessarily small, the bridge containing a given set of resistance values for  $R1, R2, R3$  will not be capable of comparing an unlimited range of component values, and several bridges may have to be built, each containing different values of resistance for  $R1, R2, R3$  to cover the range of a few ohms to ten or more megohms. It has been determined that if  $R1$  and  $R3$  are each 8000 ohms,  $R2, 2500$  ohms, then the bridge illustrated and diagrammed will give good readable balance indications from well over +25% to -22½% for resistors ranging from 100 ohms up to 1 megohm. Obviously capacitors having  $X_c$  at 60 cycles within this range can likewise be measured, as can inductors having  $X_L$  within the same range at 60 cycles. In each case bridge balance will occur when the percentage difference between the standard and test specimens has been established exactly with the "% DIFFERENCE" dial.

It has heretofore been considered almost sacrilegious to even think of measuring the d.c. resistance of resistors on any source but direct current. Actually this is relatively unimportant, even in precise laboratory work, if the test voltage be of low enough frequency, so that inductive effects do not become serious. It takes a large inductive resistor indeed to exhibit enough inductance at 60 cycles to invalidate even supposedly quite accurate resistance measurements in any significant degree. In practice the resistance of any ordinary inductive resistor able to exhibit appreciable inductance will invariably be so high as to render the reactive component quite insignificant.

In the comparison of capacitors the limits bridge actually compares capacitive reactance at 60 cycles. Here the resistive component is usually so low as to be insignificant, and in any case the bridge performs the desirable production-test combination function of comparing the over-all merit of the standard and test capacitors or resistors in a single operation. Much the same thing occurs in comparison of inductors.

Further applications of this principle may be developed to permit even greater flexibility in rapid production testing of other types of electronic components.



*You can become a practical*

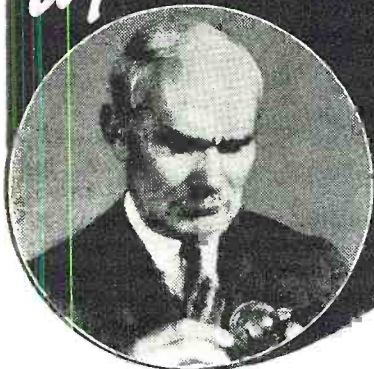

Radio-Electronics authority, Dr. Lee DeForest, under whose supervision DeForest's Training was prepared.

# RADIO ELECTRONICS MAN

DEFOREST'S MODERN A·B·C WAY

*.. at Home*

DEFOREST'S TRAINING INCLUDES INSTRUCTION IN MOTION PICTURE SOUND EQUIPMENT, FM RADIO, AND TELEVISION.

See how you may readily—in spare time at home—start toward a bright career in one of America's most interesting, fast-growing fields—RADIO and ELECTRONICS. We don't mean "Radio Servicing" only—but also a wide variety of other good-pay, NEWER opportunities in this BILLION-DOLLAR FIELD that seeks many trained men NOW, and promises such a bright POSTWAR future. Investigate these many profitable opportunities. See how you can prepare and GET STARTED with DeFOREST'S. Mail coupon below for big, free book, "VICTORY FOR YOU!" No obligation. You be the judge.

## TRAINED RADIO-ELECTRONICS MEN Needed NOW and in the FUTURE

Only from DeFOREST'S do you get this modern combination of movies, radio parts and helpfully illustrated text-lessons to speed you to a practical working knowledge of Radio-Electronics—in your spare time—at home.



You get 90 up-to-date, well-illustrated, loose-leaf lessons—presented so you can readily understand them—prepared under the supervision of Dr. Lee DeForest, inventor of the Audion tube—a man recognized as one of the world's foremost Radio-Electronics authorities.



You work out 133 interesting, practical Radio-Electronics experiments, with 8 big kits of Radio Parts and Assemblies. You build and operate six different radio receiving circuits—a public address system—"Electric-Eye" control devices—light beam transmitter, etc. You put your training to work in your home . . . speed your preparation for a start in the Radio-Electronics field . . . in your spare time.



You get the use of a 16mm. DeVERY Movie Projector and special training films which show and explain *visually* the action that takes place in various Radio circuits and parts—help you understand the principles and the "reason-why" of Radio—make it easier to grasp the fundamentals of Radio-Electronics.

**YOU GET VALUABLE EMPLOYMENT SERVICE.** DeFOREST'S actually helps you get started in the Radio-Electronics field—or in a Radio Business of Your Own. We have long-established contacts with many employers using large numbers of Radio-Electronics men.

Why not get more complete facts about DeFOREST'S Training at once—and about the interesting, good-pay jobs—opportunities now ahead in Radio and Electronics. Send for your free copy of "VICTORY FOR YOU" and the "KIT FOLDER."

**DEFOREST'S TRAINING, INC.**  
CHICAGO 14, ILLINOIS

## YOU "LEARN-BY-DOING"

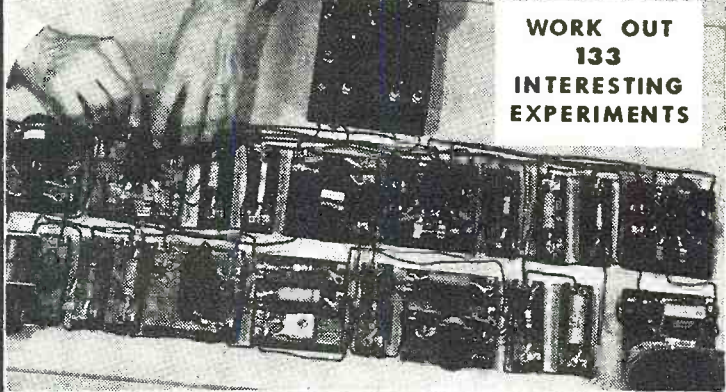

WORK OUT 133 INTERESTING EXPERIMENTS

## YOU "LEARN-BY-SEEING"

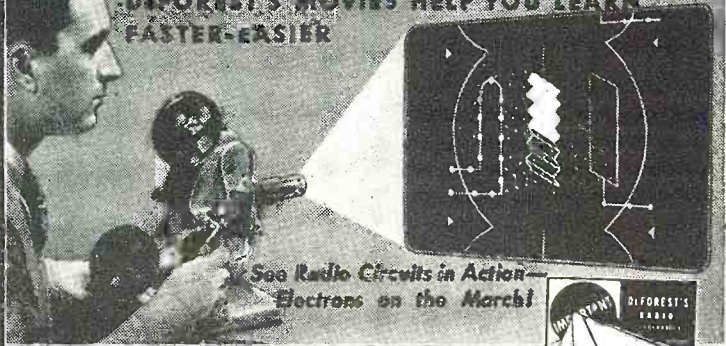

DEFOREST'S MOVIES HELP YOU LEARN FASTER-EASIER

See Radio Circuits in Action—Electrons on the March!

**Mail the Coupon TODAY!**

DEFOREST'S TRAINING, INC.  
2533 North Ashland Ave., Dept. R-11  
Chicago 14, Illinois

Please send me "VICTORY FOR YOU" book and "KIT FOLDER," FREE and without obligation.

NAME \_\_\_\_\_ AGE \_\_\_\_\_

ADDRESS \_\_\_\_\_

CITY \_\_\_\_\_ STATE \_\_\_\_\_

Check here, if under 16, for Special Information.



HOW BUSINESSES ARE RUINED --



**Lets Be Reasonable**  
by don herold

The wisest thing Abraham Lincoln ever said was: "This, too, will pass." I forget what he said it about. But it was some kind of trouble.

The smartest thing any of us can say about this war is: "This, too, will pass."

If we're wise, we'll figure on still being in business at the same old stand with the same old customers, and some new ones that the satisfied old ones have sent in.

So let's be reasonable. Reasonable (to ourselves and to our customers) in prices. Reasonable in our attitudes. Reasonable in our conduct toward our public.



If possible, we should make some money. There is no point to pleasing customers if we aren't going to be here when they come back for more. We're all entitled to fair mark-up on our merchandise.

I like to see even my competitor make money. It's better for two

of us guys to be making honest money in a community than for both of us to go broke in a big way.



On the other hand, nobody ever got rich selling the Brooklyn Bridge. There's no future in it. If we overcharge anybody during the war, we'll never see him after that armistice.

"This, too, will pass." Let's be here with a lot of old and new friends, when it does.

No. 8 in a series of special messages prepared by America's famous business writer, humorist and cartoonist, Don Herold... in sponsoring these Don Herold "broadcasts," IRC pays tribute to the thousands of Radio Service Men who, whenever possible, specify and use IRC resistance units in their work.



**INTERNATIONAL RESISTANCE CO.**

401 N. Broad St. • Philadelphia 8, Pa.

IRC makes more types of resistance units, in more shapes, for more applications than any other manufacturer in the world.



may be heard day or night in almost any part of the world. A 4,000 cycle note modulates the carrier for four minutes and is off for one minute, going off on the five minute period. That is to say, the modulation is cut off at exactly 0000, 0005, 0010, etc. The signal comes on at exactly 0001, 0006, 0011, etc. A ticking sound is heard every second except the fifty-ninth. Call letters are announced on the hour and on the half hour. This station is precise as to both frequency and time. Mr. Romain also pointed out some helpful kinks on vibrators.

**U. S. MARITIME COMMISSION** has announced that the first Victory ship to be built on the East Coast was launched in August. These Victories are all-weld jobs, but will not be put out as fast as the Libertys were.

**WSA** also reports additions to their stock of Scott receivers so those of you who have been unable to get this equipment will find them coming aboard soon, if they are not already there. The later sets seem to be somewhat better built than some of the earlier models and it is believed that they will stand up better. Many of the boys have had considerable trouble with their Scotts in the past, due in great part to the vibrator power supplies. The majority of the units furnished this year, however, in the HF model have been equipped with a rotary converter. As soon as the same is done with the broadcast models, everyone will be happy, even the Scott servicemen. There is no doubt that they are a very good receiver and will really bring in the signals when properly operated and hung on the end of a decently constructed antenna. The long awaited HF transmitter for the Libertys is also making its appearance and they are being installed as fast as production will permit.

**THE** mail box, this month, has brought us word from the following men: Geo. McKay has shipped out on a tanker. M. O. Johnson took one of the new concrete ships out of the Gulf. The ships of this type are being constructed at Tampa . . . we hope they prove to be better than the concrete craft constructed during the last war. Bob Brown ex-of Submarine Signal Company is out on a C-2, as is D. E. McEwen. K. S. Sinclair has a new tanker assignment from the East Coast. New Liberty assignments include C. Munnerlyn, R. Hurley, W. Lesslie, E. Ellis, J. Breaux and F. Jenne out of the Gulf. P. F. Brown is out on a C-2 again after the first one was lost. J. Coney ex-FCC is now out on a new C-1. G. Hicks, C. Williams, A. Gilbert, and C. Curet have all left FCC for the "back to sea" movement. . . .73

# Within the INDUSTRY

**THOMPSON H. MITCHELL**, who has been serving as Chief of the Traffic Operational Engineering section of the U. S. Army Communications Service with the rank of Lt. Col., has been appointed General Manager of *RCA Communications, Inc.* Col. Mitchell is a graduate of Annapolis but resigned from the Navy in 1927 to enter the communications field. Early in 1942 he accepted a commission as Major in the Office of the Chief Signal Officer. In March of 1943 he was promoted to Lt. Col. He was in the European theater of operations for two months last winter.



\* \* \*

**ADMIRAL CORPORATION** has announced several changes in executive positions, through its president Ross D. Siragusa.

J. B. Huarisa was elected to the post of executive vice-president in charge of production and engineering for all divisions of the company, while Irwin Mendels, former president of Radio Products Corporation which was absorbed by Admiral, was elected chairman of the Executive Committee.

Richard A. Graver was made vice-president of the Radio Division. Graver was formerly Midwest Regional Manager of Admiral.

\* \* \*

**LESTER L. KELSEY** has been appointed to the *Belmont Radio Corporation's* executive staff. In his new connection, he will handle war contract negotiation and assist in postwar planning activities for the company. Mr. Kelsey has 21 years of radio experience behind him with Stewart Warner, and Grunow. He has also served as a director of the RMA for many years.



\* \* \*

**GENERAL ELECTRIC** has appointed the G. E. Supply Corporation of New York City and the G. E. Supply Company of Newark, New Jersey, as wholesale distributors for radio receivers. The New York firm assumes the responsibility for the sale and service of these products in the metropolitan New York area, except for Staten Island. This latter territory plus the northern New Jersey area will be sold by the Newark house.

The company has also announced the appointment of Roy N. Fowler as Southwestern District Manager for the Electronics Division. Mr. Fowler's headquarters will be at the G. E. district office at Dallas, Texas. In his new capacity, Mr. Fowler will be responsible for the sale of all products of the department in his district.

A. A. Brandt, General Sales Manager of the Electronics Department, announced another appointment when he advised that Howard L. Perdiue will fill the post of district representative for Districts 1, 2 and 3 of the Electronics Department. Mr. Perdiue will be responsible for the sale of products of the Transmitter Division in these districts and will have his headquarters in the New York Office of the company. Mr. Perdiue was graduated from Purdue University with a degree of B.S. in electrical engineering in 1922. He joined the company in that year and has held positions in various departments of General Electric.

\* \* \*

**REX L. MUNGER** has returned to *Taylor Tubes, Inc.* in the capacity of Sales and Advertising manager after a two years' leave of absence with Douglas Aircraft. He served in Africa and the Middle East as Technical Advisor and representative. Mr. Munger's experience in overseas conditions will be of value to the company in making plans for postwar conversion to the civilian manufacture of various types of transmitting tubes.



\* \* \*

**WEST COAST ELECTRONIC MANUFACTURERS ASSOCIATION** has accepted six new members into its organization. Brittain Sound Equipment Company, Merle F. Faber, Harvey Machine Company, Inc., Howard Pacific Corporation, The Lake Mfg. Co., and Special Electric Laboratories.

The addition of these new members brings to more than fifty the number of firms represented in this organization of electronic manufacturers on the West Coast.

The association is acting as a clearing house for information and opinion as well as action for the advancement of electronics in that area.

\* \* \*

**SOLAR MFG. CORPORATION** has acquired the services of Mr. Leslie G. Thomas as Works Manager.

Mr. Thomas was formerly vice-president and works manager of Interna-

# RADIO PARTS FOR IMMEDIATE DELIVERY

We carry a complete supply of all types of radio parts and electronic equipment.

**TRF HIGH GAIN COILS** 69¢ per set  
Ant. and RF Matched Coils

**MATCHING VARIABLE CONDENSERS**  
Two Gang TRF Condensers 59¢ ea.

**MICROPHONES** 10 for \$5.50

## TURNER . . . CRYSTALS

Model	Last	Your Cost
BX	\$ 9.95	\$ 5.85
CX	15.00	8.82
22X	18.50	10.88
33X	21.00	12.35
34X	25.50	14.99



## TURNER . . . DYNAMIC . . .

HI IMPEDANCE		
22D	\$23.50	\$13.82
33D	23.50	13.82
99	30.50	17.93
999	33.00	19.41
211	45.00	26.46

Available with proper certification.

## ASTATIC

JT30 . . . . . \$15.50 \$9.11

(Complete with table stand)



## SPEAKERS

3" P. M. less transf.  
\$1.25 each

	Each	10	20	30
3 3/4" P.M. less transf.	\$1.35	\$12.50		\$36.00
4" P.M. less transf.	1.40	13.00		36.00
5" P.M. less transf.	1.55		29.00	
6" P.M. less transf.	1.95		35.00	
8" P.M. less transf. heavy.	3.53			
8" P.M. less transf. light.	2.94			
12" P.M. less transf.	8.40			
4" 450 ohm.	1.45			40.50
5" 450 ohm.	1.65		30.00	
6" 450 ohm.	2.19		39.50	
12" 1000 ohm.	6.95			Universal Output

## NATIONALLY KNOWN VOLUME CONTROLS WITH SWITCH

5,000 ohm	100,000 ohm	} 59¢ EACH
10,000 ohm	250,000 ohm	
15,000 ohm	500,000 ohm	
25,000 ohm	1 meg. ohm	
50,000 ohm	2 meg. ohm	
10 for . . . . .	\$5.00	
100 for . . . . .	\$45.00	
1000 for . . . . .	\$375.00	



## SPECIAL on MAZDA BULBS

#40	# 51	} Per 10 45¢
#41	# 55	
#43	# 13	
#44	# 14	
#46	#222	
#47	#233	
	#365	
		Per 1000 \$37.50

**FREE!**

Write for CATALOG and  
Free Stroboscopes



## RADIO PARTS COMPANY

612 W. RANDOLPH ST.  
CHICAGO 6, ILLINOIS

tional Resistance Corporation. Solar manufactures a complete line of capacitors at their Bayonne, New Jersey, plant.

\* \* \*

**WILLIAM C. SPEED**, one of the founders of *Audio Devices, Inc.*, and *Audio Manufacturing Corporation* has been elected president of both companies following the resignation of Hazard E. Reeves, former president. The companies, organized in 1937, manufacture and distribute Audiodiscs, professional recording discs. Mr. Speed has been active in sound recording both of the film and disc type since 1926. He has held positions in leading studios in France, England, and South America, as well as in this country.



\* \* \*

**CROSLEY CORPORATION** has appointed five new distributors for their products according to the announcement made by B. T. Roe, Crosley manager of distribution.

The Richardson-Wayland Electrical Corporation will act as distributor for the company products in the Roanoke, Virginia area. Mr. J. M. Richardson is president and general manager of this distributing company.

The E. Keeler Company will be the Crosley outlet in the central part of Pennsylvania and will handle a full line of Crosley radios and refrigerators, as well as service and repair equipment in this area.

The Lehigh Valley Distributors of Hazleton, Pennsylvania, will assist customers in the northeastern part of Pennsylvania. This is a newly formed company which will handle the complete company line when available but until new products are off of the line,

they will carry a complete stock of repair parts for existing equipment.

Dorrance Supply Company of Youngstown, Ohio, will act as distributor for the northeastern part of Ohio and the central western part of Pennsylvania. Mr. R. G. Dorrance, formerly president of the Brown-Dorrance Electrical Company of Pittsburgh, will be in charge of sales and service.

The Southwestern Electrical Appliance Company of Amarillo, Texas, will handle the company line in northwestern Texas. Harvey Southworth is the owner of the company and he and his partners, Glenn Frazier and Robert Lewis will handle the Crosley business in this area.

\* \* \*

**E. BRUCE McEVROY, JR.** has been appointed assistant to L. S. Raynor, radio tube equipment sales manager for the eastern division of *Sylvania Electric Products, Inc.* Mr. McEvoy has recently received his medical discharge after serving overseas as a 1st Lt. He is a graduate of Niagara University.



He was formerly associated with Ken-Rad and the North American Lamp Company. His headquarters will be at the executive offices of Sylvania, 500 Fifth Avenue, New York City.

\* \* \*

**MERIT COIL AND TRANSFORMER CORP.** has appointed John I. Crockett, Jr., as sales manager. Previously with Thordarson Electric Mfg. Co., where he was chief expediter, Mr. Crockett brings to Merit an extensive background of sales and distribution experience. In addition to sales development and the creation of a distributing organization, he will



## HONOR ROLL OF RECENT ARMY-NAVY "E" AWARDS

COMPANY	AWARD
Aerovox Corporation, New Bedford and Taunton Plants	"E" Flag
Burgess Battery Company, Freeport, Illinois	"E" Flag
The Electro-Voice Manufacturing Company, Inc., South Bend, Indiana	"E" Flag
Erco Radio Laboratories, Hempstead, Long Island	White Star
National Union Radio Corporation, Lansdale, Pa., Plant	"E" Flag
Philco Radio Corporation, Philadelphia Plants	3rd White Star
Zenith Radio Corporation, Chicago, Illinois	3rd White Star

**MAKE MORE MONEY**

**IN**

# RADIO TELEVISION & ELECTRONICS

**Now!**

**GET THESE 3 BOOKS**

**FREE!**

You men already in radio know how great the demand is for trained, experienced service men, operators and technicians. You know how fast the field is growing and how important it is to keep up with developments—FM receivers, television, electronics.

Or even if you are merely INTERESTED in radio as an amateur, you must recognize the WONDERFUL OPPORTUNITY right within your grasp to cash in on your natural talent. Make it pay dividends. Get into the EXPERT RADIO SERVICE Line. Be a TELEVISION specialist—OWN A BUSINESS OF YOUR OWN. Fill out and mail the coupon below for all the details.

**Get the Latest Inside Information—  
Trade Secrets by**

## SHOP-METHOD HOME TRAINING

**Learn  
by  
Doing**



**Use Actual Radio Equipment  
Furnished With Your Course**

Experience is the best teacher. You learn by experience with the exclusive National Shop-Method of Home Training—actually build many circuits and do experiments with the big kits of standard radio parts included in your training equipment at no extra cost to you.

In the course of your study you actually build various types of receivers—a powerful superheterodyne, a signal generator, an audio oscillator and others. You make tests and conduct experiments that show you the why and how of things. You understand what makes the various elements of electronics operate because you actually see them work for you. Not only do you gain marvelous actual experience in valuable equipment you will use on the job in the practice of your profession as an electronics expert. Mail the coupon and learn what this means to you.



Now the famous National Schools brings its exclusive Shop-Method of training right in your own home. You can learn the most up-to-date, approved projects, systems and hook-ups step by step in your spare time. This is the sound, practical training you want and need—the development of experienced instructors working with thousands of students right in the shops and experimental laboratories of National Schools—one of the most advanced trade educational centers of the world.

This is the MODERN SYSTEM OF TRAINING. It matches the rapid progress constantly being made in radio, television and electronics. It is TIME TESTED, too. National Schools has been training men for more than a third of a century. In essence this is the very same training that has helped thousands to more pay and greater opportunity.

You owe it to yourself—your future—to read the book "Radionics"—FREE to you when you send in the coupon.

### National Trained Men Now

#### Making the Best Money in History

The real value of National training shows up in the quick progress our men make on the job. Joe Grumich of Lake Hiawatha, N. J., turned down a job most men would welcome. He writes: "My latest offer was \$5,800.00 as radio photo engineer, but I am doing well where I am now engaged. I am deeply indebted to National."

Ely Bergman, now on Station WOR, told us: "My salary has been boosted considerably and at the present time I am making over \$3,000.00 per year, thanks to National Training." And from the far-off Hawaiian Islands, Wallace Choi sends this: "I am averaging \$325.00 a

month. I will say that I honestly owe all this to the excellent training I had at National."

National is proud of the progress graduates are making all over the world. Read about their records yourself in the books we send you FREE.

#### Make Extra Money Right From The Start

You get ahead fast with National Training. Many beginners make good money on the side fixing radios and doing service work. You can turn your knowledge into cash after the first few lessons. Progress is rapid. You can actually SEE YOURSELF GET AHEAD, because the National Shop Method is so sound and practical.

Now, right now, is the time to grasp the opportunity of today—a successful career for tomorrow. Get into the big money, rapid advancement, a position of importance. A BUSINESS OF YOUR OWN. Radio, television and the whole field of electronics invites you. The industry is crying for trained men everywhere. A rapidly expanding industry—probably the greatest in history—holds out the promise of a rich future—prosperous security.

#### Train While You Are In Service

Prepare, right now, while you are in uniform, for a glorious secure future in the field of radio and televi-



1. A complete catalog describing the industry and the extensive training facilities of National Schools.

2. You receive a sample lesson illustrating the modern "Shop Method" instruction technique.

3. The vast opportunity field of Electronics, "The Dawn of a New World," is revealed in this fully illustrated book recently published.



When the war is over, Make good use of your spare time by taking your National Training now. Men in our armed service, or about to enter, get better ratings and more pay almost right from the start if they are trained in radio, television and electronics. The government needs experienced men in nearly all branches of the service. Prepare for present advancement and a sound future. Learn how easy it is the National way. We are so enthusiastic because we have seen the marvelous results of National Shop Method Home Training. Send in your coupon today and see for yourself.

## NATIONAL SCHOOLS

LOS ANGELES 37, CALIFORNIA EST. 1905

### MAIL OPPORTUNITY COUPON FOR QUICK ACTION

National Schools, Dept. 10-RNR  
4000 South Figueroa Street, Los Angeles 37, California

(Mail in envelope or paste on penny post card)

Mail me FREE the three books mentioned in your ad including a sample lesson of your course. I understand no salesman will call on me.

NAME..... AGE.....

ADDRESS.....

CITY..... STATE.....

Include your zone number

## FREE LESSON INCLUDED

Examine the exclusive National Shop Method of Home Training. See for yourself how sound and practical it is. Be convinced that you can learn radio—electronics, television—quickly and easily in your spare time. You can't tell until you try. This trial is ABSOLUTELY FREE. And you may keep all the valuable material we send you with out any obligation of any sort. Fill out the coupon immediately while you are thinking about it and drop it in the mail at once.

Thousands of men in the Army, Navy and Coast Guard have trained at National under U. S. Government sponsorship.

You are the man who must be satisfied.

Mail the coupon here for the three books that tell you the complete story of the marvelous new system of training in radio, electronics and television. Learn the facts of this exclusive shop-method of home training. See for yourself! DECIDE FOR YOURSELF!

# NEED PARTS?

National can supply you quickly with most of those hard-to-get parts at exceptional prices. Take a look at these bargains—

**CONTINENTAL CARBON RESISTOR KIT No. C6 Assortment. 100 RMA coated ½ and 1 Watt resistors (2/3's are one watt). Unusual bargain at...\$3.35**

**AERIAL KIT** containing aerial wire, rubber coated lead-in, insulators, ground clamp, window strip, etc. ....Each, **89c**

**20 MFD 150 WV Tubular Pigtail Electrolytic, One Year Guar.**  
Each, **35c; 10 for \$3.30**

**10 MFD 450 WV Tubular Pigtail Electrolytic, One Year Guar.**  
Each, **43c; 10 for \$3.95**

**Deluxe assortment of 50 Bakelite Set Screw Knobs for ¼" Shaft.....Kit, \$4.19**

**100 Ohm (Tapped at 30) WIRE WOUND CEMENT COATED RESISTORS 30 Watt.**  
Each, **45c; 10 for \$3.90**

**50 MFD 150 WV Tubular Pigtail Electrolytic, One Year Guar.**  
Each, **49c; 10 for \$4.45**

**ASSORTMENT OF 147 FIRST LINE 600WV TUBULAR BY-PASS CONDENSERS CONSISTING OF 64 .01-600WV, 32 .02-600WV, 24 .05-600WV, 27 1-600WV. One Year Guarantee. List Price, \$33.30. Your cost only.....**

**\$11.95**

**Assortment of 200 pcs. Special Radio Hardware including Tube Sockets, Terminal Strips, Grid Caps and Plugs.....Kit, \$4.19**

**20x20/150WV Tubular Electrolytic. First Line Condenser. One Year Guarantee.**  
Each, **61c; 10 for \$5.60**

**Assortment of 100 ¼ and ½ Watt RMA Color Coded Carbon Resistors, including 5, 10 and 20% Tol. ....Your Cost Only \$1.89**

**BALLAST TUBES — K42B, K42C, K49B, K49C, K55B, K55C, L49B, L49C, L55B, L55C.....Each, 45c; 10 for \$3.99**

**100-37, 100-70, 100-77 and 100-79.**  
Each, **59c; 10 for \$5.45**

**Continental Bakelite Suppressors — S19A (Straight type with Rajah spring snap-on connector, fits all makes of spark plugs Terminal nut cable connector)**  
Each, **18c; 10 for \$1.65**

**GENERATOR CONDENSER—Universal type with six inch lead. .5MFD 200WV.**  
Each, **18c; 10 for \$1.65**

**HI-TEMP RUBBER PUSH BACK WIRE—Solid and Stranded (#20).**  
**100 Ft. Roll, 71c; 10 for \$6.50**

**Assortment of 46 First Line Tubular Electrolytic Condensers most frequently used, consisting of 1 100MFD 25WV, 2 10MFD 50WV, 15 20MFD 150WV, 8 20-20MFD 150WV, 6 50MFD 150WV, 10 10MFD 450WV and 4 10-10MFD 450WV. One Year Guar. Your Cost Only..**

**\$18.95**

**Rola 8" Auto Spkr. 6 Ohm Field, Copper Hash Buckler plate. A Beautiful Job. Delco Part No. 7242532.**  
Each, **\$1.15; Lots of 16, 99c each**

**LOCTAL SOCKETS — (Metal Supporting Ring).....10 for \$1.10; 100 for \$9.99**

**10 MFD 50WV Tubular Pigtail Electrolytic Condenser. One Year Guar.**  
Each, **28c; 10 for \$2.45**

**10x10/450WV Tubular Electrolytic. First Line Condenser. One Year Guarantee.**  
Each, **74c; 10 for \$6.90**

**Assortment of 25 Muter Candohm Wire Wound Resistors (All are 7 to 15 W, 15 or more are between 100 and 500 Ohms).**  
Assortment, **\$4.99**

**20% Deposit required on all C.O.D. orders. Don't forget L-265 or AA-3 Certificates. Orders of \$25.00 or more, accompanied by payment in full, will be shipped prepaid.**

**Free Bulletin No. 106 lists hundreds of other radio parts and supplies. Write for it today!**

**NATIONAL ELECTRONIC SUPPLY**

**77 W. Washington Blvd. Chicago 2, Ill.**

handle all expediting in connection with current production.

The company has recently completed a new plant at 4427 North Clark Street, Chicago 40, Illinois. Under the direction of Harold Jones, Chief Engineer, the new plant has been designed to incorporate all of the latest devices for precision radio part manufacturing, and specially built equipment for impregnating, heat treating and other processing operations is now being installed.

\* \* \*

**RAY R. HUTMACHER** is the new district manager of the *Meissner Manufacturing Company* of Mt. Carmel and Chicago, Illinois. His appointment is the first of several executive appointments to be made by the company in the creation of a national sales organization to distribute the company's radio-phonograph after the war. Mr. Hutmacher formerly was associated with Utah Radio Products Co. as manager of the Midwestern Division. Mr. Hutmacher's headquarters will be at the Chicago office of the company in the Palmolive Building.



\* \* \*

**STEWART-WARNER CORPORATION** has appointed Floyd Masters as manager of the Radio Division for the corporation's postwar program covering the production of radio products.

Masters, who has been the Midwest district manager for Stewart-Warner appliances since 1939, was formerly general sales manager for General Refrigeration Corporation, Beloit, Wisconsin. His experience in radio dates back to 1928 when he was sales manager of the radio division of Grigsby-Grunow Majestic Company. He is replacing L. L. Kelsey who resigned to join Belmont Radio Corporation.

According to Mr. F. A. Hiter, senior vice-president of Stewart-Warner, the company will devote most of its facilities to the manufacture of radio receivers. This work will be confined to the Chicago plant.

\* \* \*

**WILLIAM B. KELLEY** has been appointed to the post of General Sales Manager for the *Galvin Manufacturing Corporation* according to the announcement of Mr. Paul Galvin, president. Mr. Kelley comes to Galvin after 20 years with RCA in sales positions. Galvin will manufacture a complete line of AM and FM home receivers, automatic phonographs, portable and personal radios, as well as two-way radio-telephone systems and automobile radios. The company is in an excellent position for quick conversion to peacetime manufacture in-



asmuch as their entire war output was in the radio field.

\* \* \*

**WESTERN ELECTRIC COMPANY** has recently leased the Lane Bryant Building, 529 West 42nd Street, New York, New York, for the manufacture of electronic equipment for the Armed Forces. It is estimated that approximately 2,000 persons will be employed there when full production is reached in the late fall or early part of 1945.

This location becomes the fourth manufacturing plant of the company in the metropolitan New York area. The lease will run for five years. The new plant is a six story building. Henry F. Snyder has been appointed superintendent of the plant, transferring from a similar position at the company's Bayonne and City Line plants.

\* \* \*

**R. G. AKIN** is the new Midwestern Sales Manager of the *Littelfuse Company* of Chicago and El Monte, California, manufacturers of electrical fuses and accessories for aircraft instruments. Mr. Akin has held market research positions with Swift



and Company, and John Morrell and Company, as well as sales posts with Sylvania Industrial Corp. of New York. Mr. Akin is a graduate of the University of Missouri and is a member of the Sales Executives Club, and the Chemists Club of New York.

\* \* \*

**ROBERT C. HILL** has been appointed to the post of Director of the *National Electrical Wholesalers Association* according to an announcement made by Mr. Charles G. Pyle, managing director. Mr. Hill has over twenty years' experience in the electrical appliance field. The NEWA is making elaborate and extensive postwar plans for the merchandising of electrical appliances and will cooperate closely with the manufacturers, dealers, retailers and utilities on a national basis in order to meet the public's postwar requirements for new electrical appliances.



According to Mr. F. A. Hiter, senior vice-president of Stewart-Warner, the company will devote most of its facilities to the manufacture of radio receivers. This work will be confined to the Chicago plant.

\* \* \*

**PRESS WIRELESS, INC.** has elected A. Warren Norton, former manager of the Christian Science Publishing Society and the Christian Science Monitor of Boston, Massachusetts, as president and general manager of the company.

Press Wireless is the world's largest carrier of radio news dispatches and a manufacturer of special types of radio equipment for the Armed Forces.

Mr. Norton succeeds Joseph Pierson, founder and president of the company.

-30-

*The Clarion Curtain  
begins to rise*



SOMETHING definite about Clarion radios for post-war can now be revealed.

Here are seven of many important reasons why you as a Dealer will soon say:

*"Yes, Clarion is the radio for me."*

- 1 Startling new developments in FM receivers with exclusive Clarion features.
- 2 Engineered to assure trouble-free performance and long life.
- 3 A radio built to defeat destruction caused by DAMPNESS... FUNGUS and all adverse weather conditions.
- 4 A new high degree of selectivity.
- 5 Super-sensitivity to capture the weakest signals.
- 6 Precision engineering. New close tolerances.
- 7 Smartly designed cabinets of enduring beauty.

These are a few of the features that will give the Clarion line the turnover and profit you are looking for.

Write for the name of the Clarion distributor in your territory. Don't miss the complete Clarion profit story.



*Clarion Radio*

**WARWICK MANUFACTURING CORPORATION**  
4640 West Harrison Street, Chicago 44, Illinois

# New Process restores "dead" radio tubes

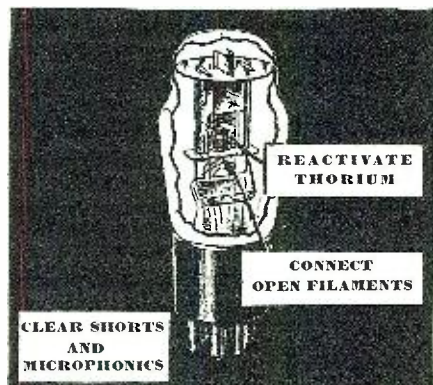

The R T S Tube Restoration Process is an improved, thoroughly dependable technique, recently perfected for restoring the life of old radio tubes. This process is *not* to be confused with the old makeshift methods such as "flashing" or similar high voltage treatment.

The R T S PROCESS will

1. **REACTIVATE THORIUM** where emissions are low.
2. **CONNECT OPEN FILAMENTS**
3. **CLEAR SHORTS AND MICROPHONICS**

Practically every type of tube can be restored by this process . . . so long as its glass envelope, base and prongs are intact. (Flashed, Exploded or Open Cathodes are *not* acceptable for Re-processing).

After Reprocessing all tubes are individually and thoroughly checked not only in tube checkers but also in set for actual playing. Tubes are returned in approximately 48 hours with R T S **GUARANTEE for 30 DAYS** efficient performance. Records show that most tubes reprocessed by this R T S technique have lasted six months or more. Prompt service is available on all tubes including

50-L-6 12-S-A-7 12-S-K-7  
12-S-Q-7 35-L-6 35-Z-5, etc.

Charges for this service are: **50c for most tubes . . . \$1.00 on Iv. tubes including 3Q-5 . . .** Television tubes can also be Reprocessed.

The R T S Process for Tube Restoration is in use by many firms of national prominence and has the approval of the O. P. A.

*In sending "Dead" tubes to this laboratory for Re-processing, a packing slip must accompany each shipment.*

**Radio Tube Service Co. Inc.**  
6811 20th Avenue, Brooklyn 4, N. Y.

## Communications for Trains

(Continued from page 31)

phone line which pulls in a relay at this control panel and turns the transmitter on. The operator at the remote control point thus disconnects the receiver, connects the telephone line to the transmitter, and turns the transmitter on. After sending his message he releases the button, and the receiver is again connected to the telephone line so he can hear the incoming message.

In addition, a polarized relay was inserted which under normal conditions, when positive voltages were used, was connected to the 40 megacycle equipment, and when negative pulses were used was connected to the 150 megacycle equipment.

It was possible, therefore, to operate two different sets of equipment in direct comparison without going out to the signal box to change units, and a direct comparison of frequencies may be obtained, using the same amount of power.

### Yard Operation

For yard operation, each one of the switching Diesels is equipped with 40 megacycle equipment. This equipment is installed directly behind the engineer's operating position. The original operating power was a gasoline driven generator which was mounted on the rear of the engine. This was later replaced by a permanent converter set which runs off the 64 volt Diesel battery power. A quarter-wave whip antenna is mounted on the hood of the Diesel locomotive and fed by means of co-axial cable run under the floor and through the cab of the engine. This locomotive on field tests showed that communications could be maintained for 15 miles between this locomotive, No. 700, and the central control point.

Fig. 4 shows a graph of the signal to noise ratio measured in the locomotive during this test.

In addition to the various means of communications discussed thus far, it was thought necessary to have continuous communication between the engineer and conductor in order to expedite the handling of trains.

Two types of front-to-rear communications have been tested: one type consisting of 1 watt, FM 40 megacycle pack sets. These sets gave perfect transmission from engine to caboose and were used by a brakeman who got off a train to inspect a hotbox and to give the engineer orders as to the handling of the removal of the car with the hotbox. The other units were 40 megacycle permanently installed transmitter-receivers mounted in the engine and caboose. These units were installed in the Silvis Yards, Moline, Illinois, and operated on a 160-car freight running from Chicago to Silvis to Kansas City. *In three test runs, a very material saving of time was made*

*in breaking up and handling the trains during these runs.*

The 157 megacycle equipment was also installed and checked on this same run. Operation under viaducts, through bridges, and around curves with the FM unit seemed less noisy in extremely noisy yards than the AM unit, which was expected. The comparisons, of course, were made between FM and AM on 40 megacycles. The AM on 157 megacycles was considerably less noisy than the AM on 40 megacycles.

### Long Distance Service

An installation of low frequency long distance service was tried and proved very satisfactory. A 76 kc. transmitter-receiver combination was installed in the caboose and connected to the wire loop which extends completely around the caboose. Two similar units were installed in both the Blue Island station and the Bureau, Illinois, station of the Rock Island Lines. These units were approximately 100 miles apart. One of the dispatching units was connected directly to the telephone lines through a condenser, and superimposed the carrier on the telephone lines to the ground. The loop on the caboose picks up the field from the telephone lines and brings it in to the receiver, a reverse operation is used for caboose-to-dispatcher transmission.

This system operates extremely well and provides communication at all times over this distance. During an intense electrical storm in the middle of July, a slight amount of noise was encountered but it was not great enough to interfere with operational characteristics of the system. General operation of this system is considered satisfactory. Generally speaking, a satisfactory system of train communication is maintained by means of radio waves, both 40 megacycles and 157 megacycles, from caboose to engine, which gives the conductor complete control of the train at all times and allows the conductor to advise the engineer of any changes to be made. Then, by using the 80 kc. induction system it is possible to communicate with wayside stations or division points. This system fills all the basic requirements of a general communications system for railroads.

### Facsimile

Investigation has been made by the Rock Island into the possibilities of the use of facsimile in conjunction with both radio and carrier type of communication. A facsimile printer and transmitter unit was secured from the Faximile Company, Inc. This unit is used in conjunction with both the Aircraft Accessories' 80 kilocycle induction system and the Motorola 40 megacycle F.M. system. The original installation consists of the Faximile recorder installed in the Blue Island Station, Blue Island, Illinois. The printer, or receiver, is installed in the caboose of a high speed freight train. Provisions are made for switching both the



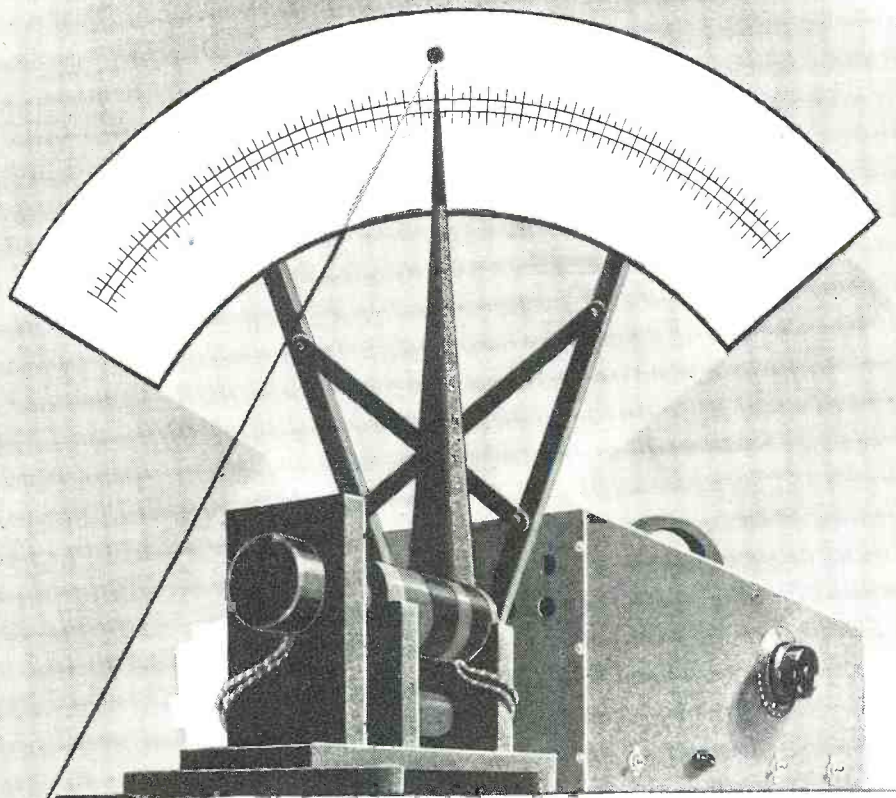

## *measuring mighty muscles of midget motors*

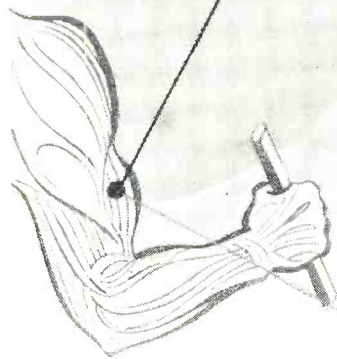

• The might of this midget motor is no secret to this special dynamometer used in the Utah laboratory. It accurately measures the horsepower; actually pre-determines the successful performance of this Utah motor in its many vital functions in actual use.

Utah's complete testing service is

playing an important part in the war effort today, and is scheduled for an equally important role tomorrow . . . in adapting war-born electronic and radio developments to commercial and consumer needs. \* \* \*

**Every Product Made for the Trade, by Utah, Is Thoroughly Tested and Approved**

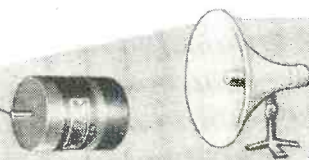

*Keyed to "tomorrow's" demands: Utah transformers, speakers, vibrators, vitreous enamel resistors, wirewound controls, plugs, jacks, switches and small electric motors.*

**utah**



**Utah Radio Products Company, 824 Orleans Street, Chicago 10, Ill.**

# HARCO

## RADIO MASTS and TOWERS

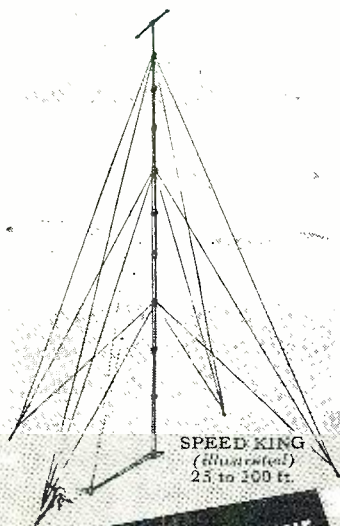

are the solution to your  
**PROBLEMS** (present or  
post-war)

*because—*

**1. LOW TRANSPORTATION COST.**  
Shipping expense reduced to a minimum because total weight and shipping space is extremely small. Also low storage and handling costs.

**2. MINIMUM ERECTION COST.**  
Speedy erection insured—due to elimination of Bolts and because customary erection labor expense has been reduced by shop fabrication. All connections reduced to simplest form.

**3. CAN BE ERECTED WITH INEXPERIENCED LABOR.**  
HARCO MASTS AND TOWERS are easy to put up. Emphasis placed on portability—no sections are too heavy for one man. No skill required for making connections. None of the usual hazards exist. Ground assembly optional.

**4. CAN BE ERECTED UNDER ADVERSE CONDITIONS.**  
Erection accomplished under all weather conditions and extreme temperatures by men wearing gloves. Rigid construction is the result of all sections having a high strength-weight ratio, and the type of connections and bracing used. Every safety precaution possible has been taken.

Whatever your problems may be, HARCO can solve them from every Engineering angle. If none of our 16 Standard Designs meet your requirements, we can give you a "Custom Built" job.

Please send complete design specifications when inquiring for detailed information.

# HARCO

STEEL CONSTRUCTION CO., Inc.  
Elizabeth 4, New Jersey

printer and transmitter to either carrier or 40 megacycle F.M. The 40 megacycle F.M. has a usable range of about 15 miles, while the carrier system has a usable range of approximately 50 miles.

The present method of transmitting information to a conductor on a train in motion, is by means of a message tied to a wax string which is held on a bamboo pole. As the train passes the wayside station the conductor reaches out and hooks this "train order." The apparent use for a facsimile system is only in replacing the bamboo rod. The wayside station operator takes the message off the telegraph or telephone, types it, and places it in the transmitter. When the transmitter is turned on, the carrier automatically opens the squelch circuit in the receiver and starts the printer in operation and the train receives the order. When the carrier is turned off at the completion of the message, the squelch circuit, in closing, triggers an alarm circuit which rings until the message is taken from the facsimile receiver. If at that time there are any questions about the received message, the operator can contact the wayside station by means of his radio or carrier telephone circuits. The distinct advantages of this system are:

1. The conductor does not have to stop the work he is doing to accept the message.
2. A written form of message is handed him which may be kept as a record.
3. He is automatically notified when a message is on the machine.
4. He can confirm this message by reading it back over the radio or carrier telephone circuit.

The actual system which is being used was designed by Mr. J. V. L. Hogan. The transmitter unit has only

one moving part, which is driven by a synchronization motor which drives a lead screw and rotates the message. Drum scanning is accomplished by means of a photo-electric cell. The receiver unit is very similar in mechanical construction. The actual printing is done by means of a low voltage applied across an electrolytic paper. This then discolors the paper which gives the printed matter. The actual synchronization between the transmitter and the receiver is done by means of tuning forks. The station transmitter is synchronized by the 60 cycle power line. The receiver unit has an 1800 cycle tuning fork which triggers a multi-vibrator, whose frequency is 60 cycles per second, therefore a rephasing of the tuning fork circuit would affect 60 cycle synchronization. Once this synchronization is locked, the phasing of the signals held constant and the equipment works satisfactorily.

All of the forms of communication mentioned in this article have been used in experimental installations for trial handling of freight over sections of the company lines. Much work has already been done toward adapting available communications equipment to the needs of the railroads, but more work remains to be done in the laboratories and engineering departments of the nation's electronic manufacturers. The experiment has proven conclusively that railroad radio communications is possible and practical.

At the present time the Federal Communications Commission has the railroad operating companies' petitions for frequency allocations under advisement. From their decisions will arise a new and expanded industry in the field of such communications, should their decision favor the petitions.

-30-

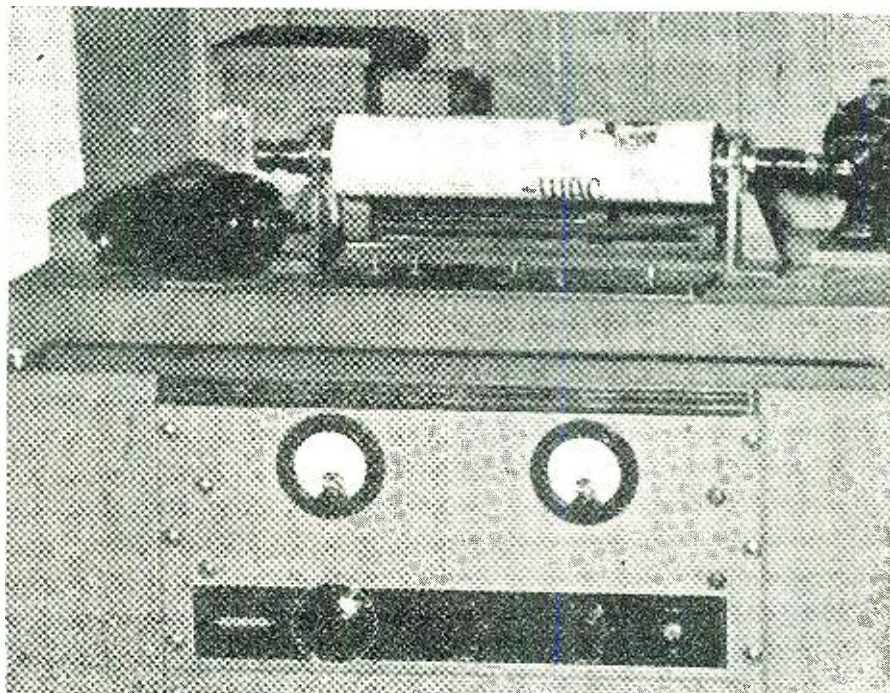

Facsimile equipment located in the dispatching office of the Rock Island Railroad.

FOR *Dependability*  
 IN ANY EMERGENCY  
 THEY RELY ON  
**RAYTHEON**  
 TUBES

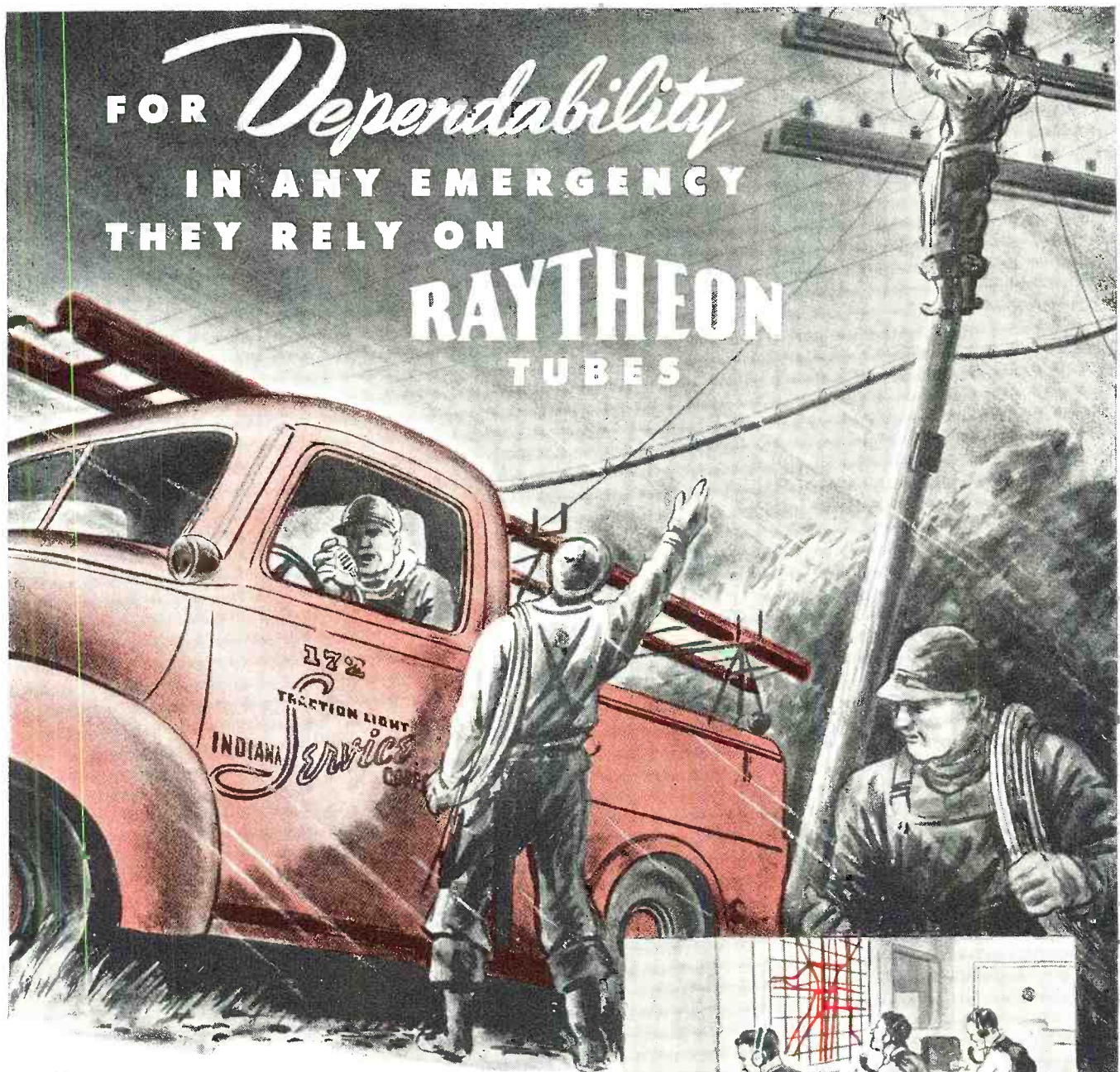

In a busy industrial city like Fort Wayne, Indiana, it is necessary that any interruption in electric service be remedied immediately. INDIANA SERVICE CORPORATION which supplies electric light and power to Fort Wayne's war plants, has found that two-way radio between the dispatcher's office and service, patrol and repair trucks assures the quickest and most reliable means of communication in any emergency. To assure even greater reliability, this electronic communication system is equipped with RAYTHEON high fidelity tubes.

That "Plus-Extra" quality that proved RAYTHEON the best tube in the past, will be enhanced with all the knowledge that is being gained from manufacturing advanced electronic equipment for the war effort. This wartime



experience will doubly guarantee that you will be able to offer your customers the best engineered and precision-made electronic tubes for all applications. In the meantime, RAYTHEON will continue to supply you with all the MR tubes that WPB allows, for you to pass on to those who need them most.

*Raytheon Manufacturing Company*

RADIO RECEIVING TUBE DIVISION

Newton, Massachusetts • Los Angeles • New York • Chicago • Atlanta



All Four Raytheon Divisions Have Been Awarded Army-Navy "E" Plus Stars

**RAYTHEON**

*High Fidelity*

RADIO AND ELECTRONIC TUBES



DEVOTED TO RESEARCH AND MANUFACTURE OF TUBES FOR THE NEW ERA OF ELECTRONICS

October, 1944

115

## International Short-Wave

(Continued from page 54)

urged the people to buy in the black market because such purchases would be detrimental to the Nazi occupation forces.

In recent weeks "RADIO ORANGE" (carried by several of the powerful BBC short-wave transmitters and quite audible in the United States) has broadcast messages from high Dutch and allied officials warning the Netherlands against pre-mature nationwide acts of resistance; also to keep all fishing vessels in port, thereby maintaining a clear field for naval invasion operations. Hollanders have, in addition, been asked to familiarize themselves with every detail of the local terrain in order to act as guides for the invading forces. Based on past response to these broadcasts from "RADIO ORANGE," the liberators will find themselves in the company of alert, well-informed allies.

### Report from the West Coast (E.W.T.)

August Balbi, monitor on the West Coast, reports this month as follows:

Radio Tokyo will no doubt drop the 15-megacycle transmissions and use the 11- and 9-megacycle bands by the middle of October. (Watch for the change-over.) Leopoldville, Belgian

Congo, will likely move to 9.785 megacycles from 11.645 megacycles, and Brazzaville, French Equatorial Africa, will also use 9.440 megacycles. (This is in use now, but is weak on the West Coast; it should be good by early October.)

Shonan (Singapore), on 9.555 mcs., can be heard signing off irregularly from 7 to 7:35 a.m. Has been heard signing off sometimes at 10:25 a.m., and back on at 10:30 a.m. A recent Sunday, Shonan signed off finally at 2:20 p.m.

Moscow is weak on 15.11 from 6:48-7:15 p.m., with English news to the United States. The only other Moscow transmitter heard on the West Coast is on 9.565 mcs., from 7:40 to 8:20 a.m.

XEQQ, Mexico City, is back in operation from 9 a.m. to 1 a.m. next day, on 9.68 mcs. HP5G, 11.78 mcs., Panama City, is weak on the West Coast to 11 p.m. HP5A, 11.705 mcs., also in Panama City, is badly QRM'd by CXA19, Montevideo, Uruguay, to 11:30 p.m. LRR, Rosario, Argentina, on 11.88 mcs., is fair, 7-10 p.m. The same is true of CXA10, 11.900 mcs., in Montevideo, 7-10 p.m.

For the benefit of Eastern listeners who'd like to "fish" for some "hard-to-get" stations, Mr. Balbi this month lists the following:

Peiping, China—XGAP, 6.10 mcs., 5-9 a.m. Also on 10.28 mcs., 9-11:50 a.m. (Home Service).

Taihuko, Taiwan—JIE2—9.69 mcs.,

9:30-11 a.m. English news, 9:30 a.m.

Tokyo, Japan—JVW3, 11.725 mcs., at intervals, 7 p.m.-8 a.m. Also heard on 11.74 mcs. and 11.825 mcs. (This one is heard well in the Eastern U. S. from 9 to 10:40 a.m. with news in English on the hour.)

Johannesburg, South Africa—ZRL, 9.606 mcs., 10-11:45 a.m. (Home Service).

Shanghai, China—XGOI, 9.66 mcs., 5-10 a.m. (Home Service).

Canton, China—XGOK, 11.65 mcs., 5:30-9:30 a.m. (Home Service).

Papeete, Tahiti—FO8AA, 6.98 mcs., Wednesdays and Saturdays, 12-1 a.m. (Home Service).

If anyone in the East receives these stations, a report of such reception would be appreciated.

\* \* \*

### Leopoldville Relays BBC Program

Since about the first of August, RADIO NATIONAL BELGE, Leopoldville, Belgian Congo, 9.783 mcs., has been relaying the North American Service of the BBC from London, 9:30 p.m.-12:45 a.m.

Direct beams from London have been a bit louder than Leopoldville, but in a short time listeners will probably hear the Belgian station carrying London programs with a fine and steady signal.

\* \* \*

### Brazzaville Has New Outlet

FZI, Radio Brazzaville, in the French Congo (French Equatorial Africa), is now using a new outlet, 9.440 mcs., evenings, along with the 11.970 mcs. beam.

It is reported by monitors that the 9.440 mcs. frequency may be located at Tananarive, Madagascar, which spot has also been relaying Brazzaville from 7 to 8 a.m. on approximately 12.12 mcs.

From Radio Brazzaville, the Free French English bulletins begin now at 7:25 p.m. EWT, over the 9.440 mcs. and 11.970 mcs. frequencies. Early in August, the announcer promised that the Brazzaville broadcasters "would be speaking from Paris" before many months have passed.

\* \* \*

### San Francisco Adds Frequency

San Francisco, which short-waves many of America's finest radio programs to Central and South America from 11 a.m. to 12 midnight daily, has added the 17.76 mcs. outlet, KWID, to its summer schedule.

This station in the 16-meter band is heard from 4 to 7:45 p.m. daily. This is the first time the West Coast has used the 16-meter range for regular broadcasts beamed southward.

\* \* \*

### Australian Change

The first daily transmission from Australia to North America, beamed to the East Coast from 8 to 8:45 a.m., is now being radiated over VLC6, 9.615 megacycles, which replaces VLC5, 9.54 mcs., and VLG3, 11.71 mcs., for this transmission.

VLC6's transmitter is located at

**Attention: RADIO SERVICEMEN**

Here is the new, Jensen Phonograph Needle Saleskit designed especially for the Radio Serviceman. It's colorful, compact and convenient—just the thing for slipping into the pocket and taking on service calls...a definite aid in demonstrating fine phonograph needles...the first real saleshelp ever offered exclusively to servicemen.



Now available at your jobber. WRITE TO-DAY for complete details and our better than usual discount to servicemen.

Contains 3 Jensen Concert Needles retailing at \$1 each and 3 Jensen Genuine Sapphire Needles at \$2.50 each. Install the needle that augments your work, assures full clear tone of the instruments you repair.

**JENSEN INDUSTRIES, INC., 737 N. MICHIGAN AVE., CHICAGO 11, ILL.**

The Model 710

# VOLT-OHM-MILLIAMMETER

Now available for prompt delivery on  
priority of AA3 or better!!

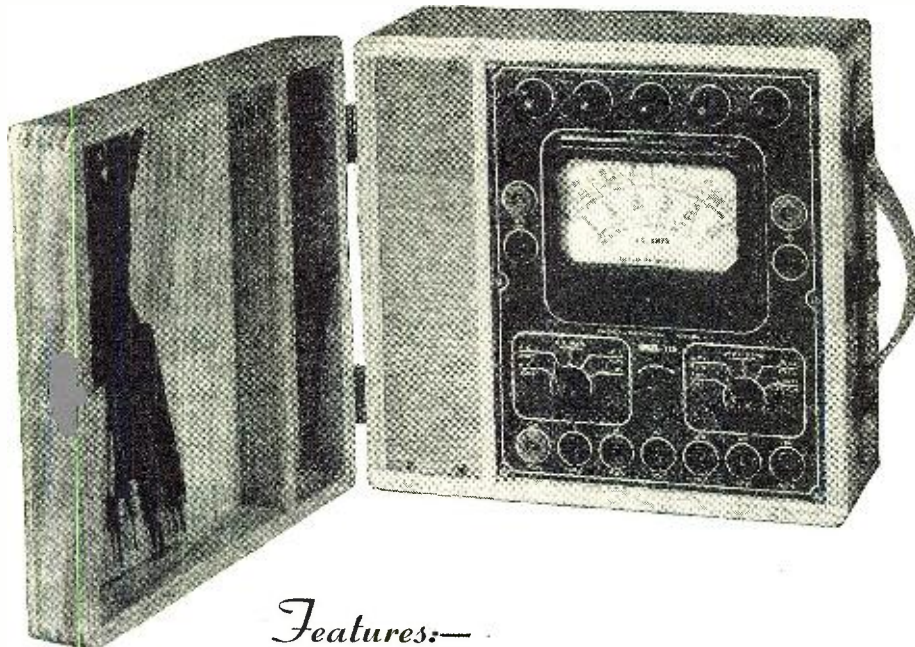

## Sensitivity:—

**1,000 OHMS PER VOLT**  
ON BOTH A.C. AND D.C.!!

## Measures:—

A.C. AND D.C. VOLTAGES  
UP TO —

**1500 VOLTS**

A.C. CURRENT UP TO —

**3 AMPERES**

D.C. CURRENT UP TO —

**30 AMPERES**

RESISTANCE UP TO —

**10 MEGOHMS**

## Features:—

- \*Uses New 4 1/2" Square Rugged 0-400 Microampere Meter.
- \*Direct Reading—All Calibrations Printed Directly on Meter Scale in Large Easy-to-Read Type.
- \*Housed in Rugged Heavy Duty Portable Oak Cabinet.
- \*Completely self-contained—No External Source of Current Required.

A 400 Microampere meter movement is shunted to provide a sensitivity of 1,000 Ohms Per Volt on both A.C. and D.C. This method—using a 400 Microampere meter instead of a 1 Milliampere meter—affords improved damping because the meter is at all times shunted by a resistance. An Ayrton universal shunt is used for all current and resistance ranges. Paired multipliers insure accuracy of all voltage ranges and in addition two indi-

vidual master calibrating adjusters enable precise calibration of all A.C. and D.C. Voltage Ranges. An almost perfectly linear A.C. scale is provided by using a special copper oxide rectifier unit which has an inverse to forward resistance ratio of better than 400 to 1. Although the current carrying capacity of this rectifier is 15 ma. a maximum of 1 Milliampere is permitted to pass through the unit. This insures minimum heating in the rectifier unit guaranteeing high stability of all A.C. calibrations.

## Specifications:—

**6 D.C. VOLTAGE RANGES (1000 OHMS PER VOLT)**

0 to 15/60/150/300/600/1500 Volts.

**6 A.C. VOLTAGE RANGES (1000 OHMS PER VOLT)**

0 to 15/60/150/300/600/1500 Volts.

**7 D.C. CURRENT RANGES:**

0 to 3/15/60/150 Milliampere,                      0 to 3/15/30 Amperes.

**A.C. CURRENT RANGE:**

0 to 3 Amperes.

**5 RESISTANCE RANGES:**

0 to 1,000/10,000/100,000 Ohms.                      0 to 1 Megohm.                      0 to 10 Megohms.

The MODEL 710 comes complete with cover, self-contained batteries, test leads and instructions. Size 6" x 10" x 10". Net weight 11 pounds. Price.....

**\$34<sup>50</sup>**

**SUPERIOR INSTRUMENTS CO.,**  
**227 FULTON STREET**

**Dept. R. N.**  
**NEW YORK 7, N. Y.**

**SUBSTITUTE  
AVAILABLE TUBES  
QUICKLY!**



**WITH THIS HANDY  
TUBE-BASE  
CALCULATOR**

**Special Get-acquainted Offer!**

Send Only 25¢

Thousands of service men, experimenters and amateurs have already taken advantage of this offer. Easy to use, this calculator tells you tube characteristics that enable you to substitute available tubes for those hard to get. Send for yours today. Postpaid, only 25c.

**FREE! Giant Radio Reference Map**

Here's a gift from Leo-W9GFQ that you'll want. Size 3½ by 4½ ft. Map has time charts, station list, amateur zones, networks, world shortwave, etc. Yours free. Send 15c to help with mailing and packing.

**TRY LEO  
FOR HARD-TO-GET  
RADIO PARTS**

You'll be surprised at the many hard to get parts I have been able to obtain for you fellows. They're yours as long as they last. Send today for my latest flyer. It's full of merchandise you've been trying to get. Stocks won't last long, so send today.

**I WANT HALLICRAFTERS!**

I'll pay the highest cash price for that equipment you're not using. I'm especially interested in any Hallicrafter sets you have but I'll buy other makes of equipment, too. Tell me what you have—I'll quote top price.

**WHOLESALE  
RADIO LABORATORIES  
744 W. Broadway, Council Bluffs, Ia.**

--- Mail Coupon Today ---

Leo, W9GFQ—Dept. RN10.  
Wholesale Radio Laboratories  
744 W. Bdwy., Council Bluffs, Iowa

You bet I want one of the tube base calculators. Here's my 25c.

While you're at it, send your free radio map. 15c is enclosed for mailing and packing.

Name.....

Address.....

Town.....State.....

I am a  service man;  experimenter;  
 amateur.

Shepparton, Victoria, north of Melbourne.

\* \* \*

**Code Stations**

Joe Angsten, of Chicago, writes that he believes there are many DX-ers in the country who like to listen to code or press transmissions in code from the many press stations in this country and abroad that give the latest news flashes—and he would like a list of code stations, with frequencies, and time schedules.

"I have found real enjoyment in copying press stations with a typewriter to increase my code speed," he writes. "I have only a small antenna at present and my receiver is a S20-R Hallicrafters communication receiver. With this receiver, I am able to listen to JAU, Tokyo, at six a.m. (CST) sending press news in English. Then, I often copy Moscow in the evening; some of the press wireless stations in New York; the Government press for foreign service; as well as Reuter's News Agency in London. It is thrilling to be listening to Reuter's sending out an item, and then hear their break in with the word, 'Flash,' when there is something of the latest importance about the war coming over the ether waves. Being a radio operator, and employed in a radio war plant, most of my time is spent in copying the war news. I believe I have the only Radio Listening Post for code reception in Chicago. If one is a code operator, it's really great fun copying the latest war news."

From Allston, Massachusetts, Charles T. Florentine writes that he has been extremely interested in radio code and DX work for the past six years—using a Hallicrafters Sky Buddy S19-R. He reports that he has copied many Navy radio stations, including NSS, NPG, and others. "I have many DX (QSL) cards from 'harr' stations copied on 40 and 20 meters CW before the war," he writes, "including OQ5AB, G16TK, NY1AE, K5AT, K4HVQ, K4EJG, XE1AD, K6BNR, YV4AE, CO7VP, CM7AI, K6LKN, CX1FB and NY1AD."

For the benefit of Mr. Angsten and others interested in code stations, Mr. Florentine has offered to compile a list of code stations which will appear in an early issue of INTERNATIONAL SHORT-WAVE. If anyone else interested in radio code stations has an up-to-date list, we would be glad to see it.

\* \* \*

**"The World Speaks"**

By referring to the worldwide log presented to readers of RADIO NEWS last month, you will see that it is convincing truism that "The World Speaks" on short-wave. This list is not complete, but it does include most of the stations that can be heard in the United States. The information therein is as nearly accurate as your short-wave editor could make it. It must be borne in mind that schedules, frequencies, and even call letters are subject to change.

With the exception of data fur-

nished by the short-wave broadcasters themselves (and the editor's own Listening Post), this log was compiled from the reports of readers of the INTERNATIONAL SHORT-WAVE DEPARTMENT. The list was made up, insofar as possible, with stations that can *ACTUALLY BE HEARD* in this country. Of course, certain stations will be heard in specific areas while they can not be picked up in another section of the country.

The author is grateful to the monitors in all sections of the United States for their fine cooperation in contributing to this worldwide log, and will be glad to receive reports of any stations not included in it.

\* \* \*

**Acknowledgments**

The author wishes to acknowledge reports and/or correspondence this month from the following:

The Australian News and Information Bureau, the Netherlands Information Bureau, and the British Broadcasting Corporation, all of New York City; August Balbi, Los Angeles, California; Charles T. Florentine, Allston, Massachusetts; Joe Angsten, Chicago, Illinois; members of the National Radio Club; Mrs. John M. Hart, Anderson, Indiana; Gilbert Harris, North Adams, Massachusetts; Mrs. L. R. Ledbetter, Vicksburg, Mississippi; Joe Stauhs, Bloomfield, New Jersey; Peter J. McKenna, secretary, Newark News Radio Club, Newark, N. J.; Larry Gutter, Hallicrafters Short Wave Monitor, Chicago; the United Network, San Francisco, California; James J. "Jimmy" Hart, Short-Wave Editor, Newark News Radio Club, Irvington, New Jersey; Allan H. Fry, Content and Planning Division, Coordinator of Inter-American Affairs, Washington, D. C.; Adrian Richards, Snyder, New York; John J. Kernan, Boston, Massachusetts; Kay Bailey, Radio Division, Coordinator of Inter-American Affairs, Washington, D. C.; the Crosley Corporation, Cincinnati, Ohio; and Charles A. Mangano, NBC International Division, New York City.

**Last Minute Tips**

FLASH! VLC4, 15.315, Melbourne (with transmitter located at Shepparton, Victoria, north of Melbourne), which has been beaming the "third daily transmission" to Eastern North America, between 10:30 and 11:30 p.m. EWT, is now heard from 9:45 to 10:45 p.m. EWT. The news continues to be given at 10:30 p.m., however.

From Berlin, Germany, over DZD, 10.543 mcs., and DXP, 6.030 mcs., prisoner-of-war messages are given several times during the evening transmission to North America. Among the times they are heard is between 10:20 and 10:37 p.m. EWT, daily, with a woman announcing. At approximately 11:05 p.m. EWT, a man gives medical reports about wounded American flyers "shot down over the Reich and occupied territories." At 11:10 p.m., more messages are given by a woman announcer, "Mary Ellen." Another interesting broadcast from Berlin is the

### Original Circuit

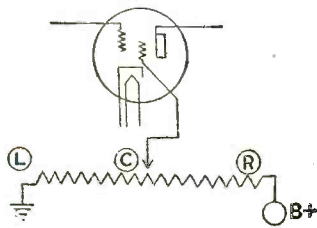

**Suggestion No. 1** for 10,000 ohm wire-wound original control.  
No change necessary.

**Suggestion No. 2** where original control is under 10,000 ohms.

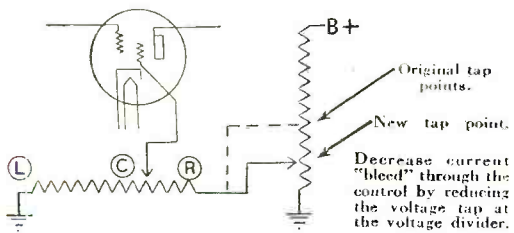

**Suggestion No. 3** where original control is over 10,000 ohms.

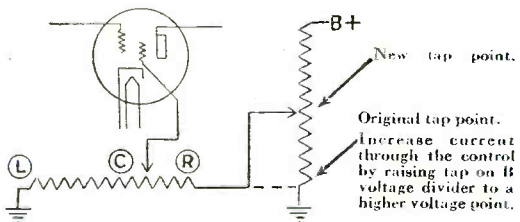

**Suggestion No. 4** Change circuit to Antenna Bias. Wire in screen circuit permanently at correct voltage.

# To Help You Replace Volume Controls in Screen Circuits with the 10,000 Ohm Linear Units

In screen voltage control circuits, the action of the control is similar in most respects to the action obtained by controlling the bias of the tube. The mutual conductance (plate current to grid voltage trans-conductance) of the tube varies with the screen voltage.

When you must make a replacement and are unable to match the value and taper of the original control, try whichever of the four suggestions listed here fits your particular job. The suggestions are purposely general—to show the possibilities of wartime radio servicing. In cases where you feel you require additional assistance, send your problems to Mallory Technical Information Service. We'll be glad to help you find solutions.

P. R. MALLORY & CO., Inc.  
INDIANAPOLIS 6 INDIANA



Buy More War Bonds

### Mallory Helps for the Radio Service Engineer

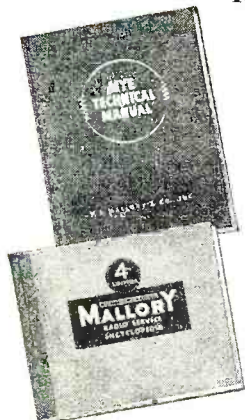

**MYE TECHNICAL MANUAL**  
—408 pages of complete data on capacitors, noise suppression, receiving tubes, loud speakers, vibrators, phono-radios, automatic tuning and other valuable information. Available from your Mallory distributor...Price, \$2.00.

**4TH EDITION RADIO SERVICE ENCYCLOPEDIA**  
Complete information on repairing any make or model of receiver. Circuit references, original part numbers and recommended replacements. Available from your Mallory distributor... Price, 95 cents.

## P. R. MALLORY & CO. Inc. MALLORY Approved Precision Products



# THE RIGHT BULB TO USE NO LONGER A MYSTERY

## THE NEW GOTHARD CATALOG

is actually an Engineering Handbook that gives you this and complete engineering data on each of a wide range of models for varied applications. Here is an example of the data given:

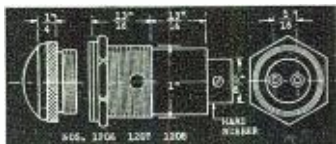

### Voltages:

Mazda No. 63 6-8 Volt  
Mazda No. 68 12-16 Volt  
Mazda No. 72 18-24 Volt  
Mazda No. 1252 24-28 Volt



### Listings of

- \* 1206 Faceted Jewel
- \* 1207 Plain Jewel
- \* 1208 Frosted Jewel, Colored Disc.

### Prices Do Not Include Lamp Bulbs

Mazda No. and Voltage of lamp received by each specific Pilot Light is given opposite each photograph.

Pilot Light Dimensions are presented in blue print diagram.

Specifications include essential data on panel thickness, mounting dimensions, metal substance, jewel colors, etc.

Request your copy immediately.

# Gothard

MANUFACTURING COMPANY

1350 North Ninth Street, Springfield, Illinois

EXPORT DIVISION—25 Warren Street  
New York 7, N. Y.

CABLES—Simonrice New York

**FADA'S S.M. 81 SERVICE MANUAL**

**AN INDISPENSABLE AID TO THE SERVICE MAN**

Here's the Book You've Been Waiting for!  
Contains all available Service Data on all FADA Receivers

**\$1.00** Plus Postage  
Send for it Now!

**FADA OF NEW YORK**  
92B BROADWAY NEW YORK, N.Y.  
Large Stock of Replacement Parts & Cabinets

Japanese Quarter Hour at 10 p.m. EWT, with news from Asia and messages from prisoners-of-war in Japan. News from DKM, 7.270, is reported as heard at midnight EWT.

PJY has been heard calling WRS, Saturday, 3:15 p.m. EWT.

JLP2, Radio Tokyo, 15.325 mcs., has been heard, 12:45-1:00 a.m. News in English is given at 1 a.m., followed by prisoner-of-war messages at 1:05 a.m. EWT.

Stations on 10.40 mcs. and 11.47 mcs. are reported heard at 10:30 a.m. EWT (steady signal, sounds Russian).

AFHQ, on approximately 8.92 mcs., has been heard calling WPO and others with news in English from North Africa.

Through the courtesy of the Newark News Radio Club, we list the following last minute tips:

KHE, 17.980 mcs., Kahuku, Hawaii, is on for the Army Hour, WEAF network feature heard each Sunday, 3:30-4:30 p.m. EWT; relays all islands in the South Pacific (but not the continent of Australia). Other stations utilized to relay programs to the Army Hour include AFHQ, 16.025 mcs., which handles Rome broadcasts, and station GCU, 9.950 mcs., which pipes programs from London and the Normandy section of France.

WLWL, Cincinnati, Ohio, is on 15.200 mcs. for evening programs. While only 15.200 mcs. has been announced, this station is also heard on 15.300 (according to the admission of the station when queried). WLWL, with its super-power (being on these close frequencies), is now blanketing JLT3, Radio Tokyo, 15.225 mcs., most of the time during the evening transmission to North America, 6:15-8:15 p.m. EWT.

XGOX, Chungking, China, 15.190 mcs., is used for NBC relays at 7:15 p.m. EWT. XGOX has not been heard in the East lately (because KROJ covers that band). The Chinese station should soon be using 11.915 mcs. and as the nights grow longer, it is quite likely it will be picked up again in the East. (EDITOR'S NOTE: We have a report that 11.915 mcs., is now being used.)

EDS, Madrid, Spain, is utilized to relay programs to CBS at 6:45 p.m. EWT, on 14.985 mcs. Station EAY, 10.070 mcs., is also on the air at that time to be used in the event there is severe fading via EDS.

Athens, Greece, on 13.650 mcs., has changed schedule, and is now on the air Wednesday, Saturday, and Sunday at 8 p.m. EWT. The opening and closing announcements are in English—but all others are Greek. Sign-off usually comes at 8:50 p.m.

While Radio Brazzaville, French Equatorial Africa, is broadcasting the English news on 9.440 mcs. as well as on 11.970 mcs. at 7:30 p.m. EWT, there is much interference with the signals on the lower frequency. It should improve during the autumn months.

JVU3, Radio Tokyo, on 11.897 mcs., is putting out a good signal to Eastern

North America, between 6:15 and 7 p.m. EWT daily. At 7 p.m., EWT, however, KWIX on 11.900 mcs., comes on the air and just about blankets the Nipponese.

WGEX, Schenectady, New York, uses the frequency of 11.847 mcs. for morning transmissions now. This is reported to be a new call for WGEA.

VLG4, Melbourne, Australia, 11.840 mcs., has a newscast at 6 a.m. EWT and usually signs off at 6:10 a.m. EWT, requesting its listeners to tune to VLI3 on 15.320 mcs. VLG3, Perth, Western Australia, 11.830 mcs., presents the news at 4:45 a.m. EWT and follows with a musical program at 6 a.m. EWT. Sign-off usually occurs at 6:55 a.m. and at 7 a.m., VLW6, 9.680 mcs., carries on.

TAP, Ankara, Turkey, on 9.465, has a program for NBC at 7:15 p.m. daily. The commentator stated recently that Radio Metropole plays politics with both the Allies and the Axis.

ZLT7, Wellington, New Zealand, on 6.715, is still coming through nicely at 5:30 a.m. EWT daily. This station broadcasts sports news at 5:45 a.m. EWT, Sundays.

VPD2, Suva, Fiji Islands, on 6.130, mcs., broadcasts a program of hymns at 5:15 a.m. EWT each Sunday. Sign-off comes at 5:30 a.m. EWT, accompanied by rendition of the British national anthem, "God Save the King."

Radio Andorra, Andorra, has found a clear channel on 5.985 mcs., and is coming through with excellent signal strength from 5:30 to 6:30 p.m. EWT, when it leaves the air. Announcements in French are made by a male announcer and those in Spanish by a woman. This station identifies itself as "Emissora Andorra."

The Allied short-wave station, ICD, located "somewhere in Italy" and transmitting on a frequency of 13.250 mcs., is on the air daily at 8 a.m., 6:45 p.m., and 7:15 p.m., all EWT, when it relays Allied Press Headquarters in Rome to the networks in this country. ICD is also on the air at various other times of the day sending press releases to the United States. AFHQ, Allied Force Headquarters station in Algiers, can be heard at the same times ICD transmits. AFHQ is currently broadcasting on a frequency of 8.960 mcs.

Joe Stauhs, of Bloomfield, New Jersey, is the first NNRC member (and insofar as we know, the first SW listener) to receive an official verification from ABSIE (the American Broadcasting Station in Europe). His confirmation covers reception of one of ABSIE's earlier transmissions on the 9.625 mcs. frequency. This prized verification was received through the Office of War Information.

The Australian short-wave station, VLC6, 9.615 mcs., is coming through exceptionally well at present on this frequency, between 8 and 8:45 a.m. EWT when it carries the "first daily transmission for North America" (Eastern United States).

FLASH! Political events in Guatemala, Central America, have once



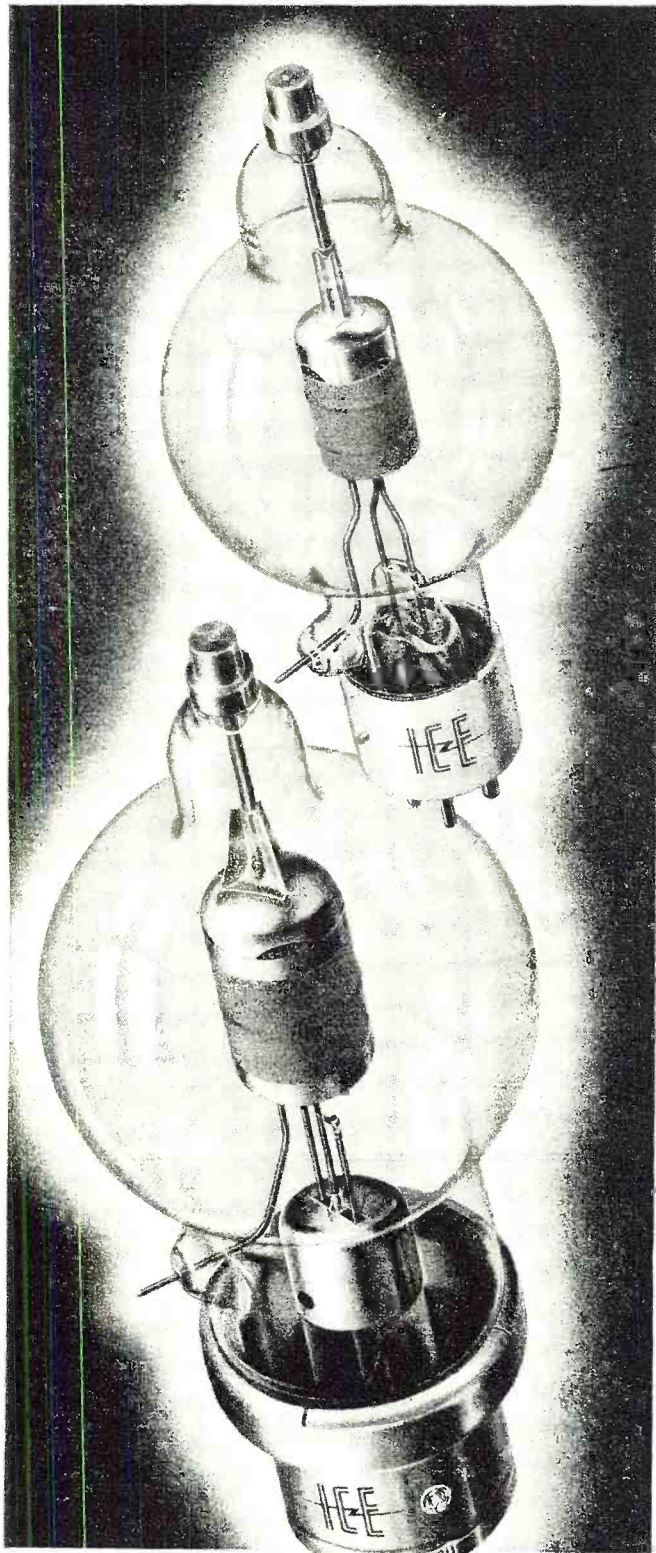

I. C. E. 250th • I. C. E. 100th

**I.C.E.**  
...the Symbol of  
**PRECISION** manufacturing

#### **MORE DEPENDABLE TUBE PERFORMANCE**

"Precision" is something more than a motto at I. C. E. "Precision" I. C. E. tubes must be *right*... consistently *right*... long-lived and dependable. I. C. E. engineers don't believe in "good enough"... they're constantly searching... experimenting... striving for even better tube performance.

Right now the war effort is claiming most of our production facilities... but we do have a limited number of precision-engineered electronic tubes, ready for delivery. Whether your problem be radio transmitting or industrial application... we invite your inquiries.

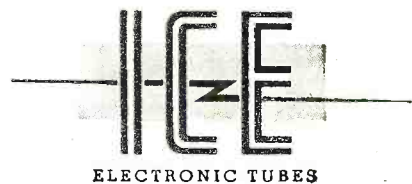

**ELECTRONIC TUBES**

**INDUSTRIAL & COMMERCIAL ELECTRONICS**  
BELMONT, CALIFORNIA

# LAKE RADIO CABINETS

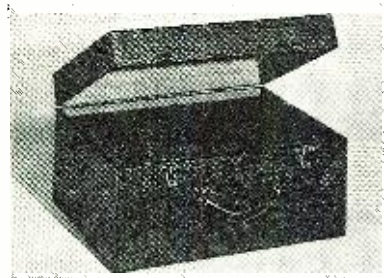

Portable Phonograph case, of sturdy durable plywood, in handsome brown leatherette finish. Inside dimensions 16½" long, 13" wide, 9½" high. Has blank motor board. As illustrated above, specially priced at..... **\$6.95**

Replacement cabinet in dark walnut finish plastic. Inside dimensions 10W x 6½H x 6D. Price..... **\$1.95**



Dark walnut finish plastic cabinet to accommodate practically any Tiny Tim radio. Size 7½W x 4½H x 4D. Price..... **\$1.50**

Also blank table cabinets of walnut veneer in the following sizes:

8¼W x 5½H x 4D	<b>\$1.95</b>
10¼W x 6¾H x 5D	<b>\$2.75</b>
13½W x 7¾H x 6¼D	<b>\$3.25</b>

Cabinets available in ivory color and Swedish Modern. Write for prices.

## 14" SPEAKERS

14" electro-dynamic speakers, 900 ohm field, 6—8 ohm voice coil. 6V6 push-pull transformer. Special, only..... **\$450**

All types of radio parts available in today's market can be obtained at Lake's money-saving prices. Large stock listed in our new Bargain Bulletin. Write us for your copy. It's free.

**LAKE RADIO SALES CO.**  
615 W. Randolph Street Chicago 6, Ill.

## Short-Cut Mathematics

COMBINED WITH  
*Practical Mechanics Simplified*

NEW 2-in-1 reading course! Now you can learn the speedy, simplified system of calculation used by draftsmen, engineers, accountants, "master minds" on the stage. Learn easy way to multiply 4 figures by 4 figures without using old-fashioned multiplication; add long columns of figures this lightning short-cut method. Learn horsepower, slide rule, micrometer, logarithms, wood measure, puzzles, etc. etc. Large illustrated volume complete with answers, only \$1 postpaid. Satisfaction or refund. Amaze friends with your magic-like mental powers.

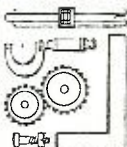

**FREE** Complete details... mail coupon TODAY!

NELSON CO., 321 S. Wabash, Dept. 3M59, Chicago 4, Ill. Please send free details about "Short-Cut Mathematics and Practical Mechanics Simplified." No obligation.

Name .....  
Address .....

again focused attention on its short-wave stations, which have long been noted for their excellent marimba band concerts. TGWA is now beamed to the United States on 9.685 megacycles from 10 to 11:45 p.m., Monday, Tuesday, Thursday, and Saturdays. Concerts for European listeners are carried from 3:30 to 5:15 p.m., Sundays, on 15.17 megacycles. Announcements are in English, as well as Spanish.

-30-

## Britain's Signals

(Continued from page 57)

tended to over 500 miles. It can be imagined that this presented considerable difficulties to a force which had been landed with the minimum amount of equipment.

The whole of the British Army's signal communications, as well as the line communications of the Navy and the Royal Air Force when away from Britain, are the responsibility of the Royal Corps of Signals, a fully combatant corps which was formed in 1920 to take over communications work previously performed by the Royal Engineers.

All men in the Royal Corps of Signals, although armed and trained to fight, are also trained to an Army "trade," the chief trades being those of operator, electrician, instrument mechanic, lineman, dispatch rider and driver. For every headquarters in Britain's Army, from the War Office down to divisions in the field, there is a signal unit, commanded by a lieutenant colonel, with enough men of appropriate trades and enough equipment to provide the radio, telegraph, telephone and messenger services from that headquarters to the formations or units under its command or cooperating with it. (Messenger services include air courier, dispatch-rider and pigeon).

A unit known as War Office Signals operates communications from London to the headquarters of commands at home and abroad. Each General Headquarters, such as that in Cairo, has a unit to provide communications with the armies in the field, to the Royal Navy in its various ports, to the Royal Air Force and to civil authorities. Similarly, there are appropriate units at each Army and Corps Headquarters, the communications becoming less static and the equipment more mobile with each step down the chain of command.

The divisional signals unit, whether serving an infantry or an armoured division is highly mobile. It consists of over 700 men—almost three times the size of the corresponding unit at the end of World War I—and the number of its vehicles approaches 200. It is organized into companies and sections (or squadrons and troops in an armoured division) each with a particular role. There is an administrative section; a maintenance section

for maintenance and first-line repairs of all signal equipment in the division; radio sections; dispatch-rider section; and cable section for laying the lines which are still used whenever possible because they can carry more traffic than radio with less risk of interception.

A separate self-contained section, consisting of operators, linemen, maintenance personnel, dispatch-riders and drivers, is also detached and sent under the command of an officer to the headquarters of each brigade and artillery regiment in the division, the role of each such section being to provide communications from the headquarters to which it is attached forward to the battalions or batteries or squadrons, as the case may be. Within those battalions and other units the signal communications are operated by the regimental signallers belonging to the unit and not by the Royal Signals.

On the Headquarters Staff of every Army and Corps there is also a Chief Signal Officer, usually a brigadier. He has a small staff of officers who are specialists in the various forms of communication and have supervisory duties throughout the Army or Corps concerned, and he himself is the adviser of the Army or Corps commander on everything to do with communications.

In a theater of war, as in the Middle East, there may be a Signal Officer-in-Chief with the rank of major-general, the highest rank in the organization of Signals in the British Army.

Signal equipment ranges from the lineman's portable telephone and the infantryman's pack radio set to the 200-line telephone switchboard at Army Headquarters and the high-power mobile radio station capable of communication of over 100 words a minute half way round the world.

Between these extremes is a wide variety of equipment such as the Fullerphone, a small line-telegraph instrument for safe use in forward areas, teleprinter sometimes carried in a vehicle ready for instant connection to a line as soon as a halt is made; multi-channel equipment, which enables several telephone conversations and telegraph messages to be passed simultaneously over the same pair of wires; the 750 cwt. radio truck, the standard radio vehicle in forward areas; the 13-ton armoured command vehicle in which a divisional commander can conduct a battle while on the move, keeping in constant touch by radio with his troops and with his staff officers traveling in other similar vehicles.

There are also vehicles equipped as signal offices, cipher offices, workshops and pigeon-lofts and there are specially designed radio hand-carts for airborne signal units and beach signallers who wade ashore with the first assault landings to keep communications going until the ordinary signal units get firmly established on land.

-30-

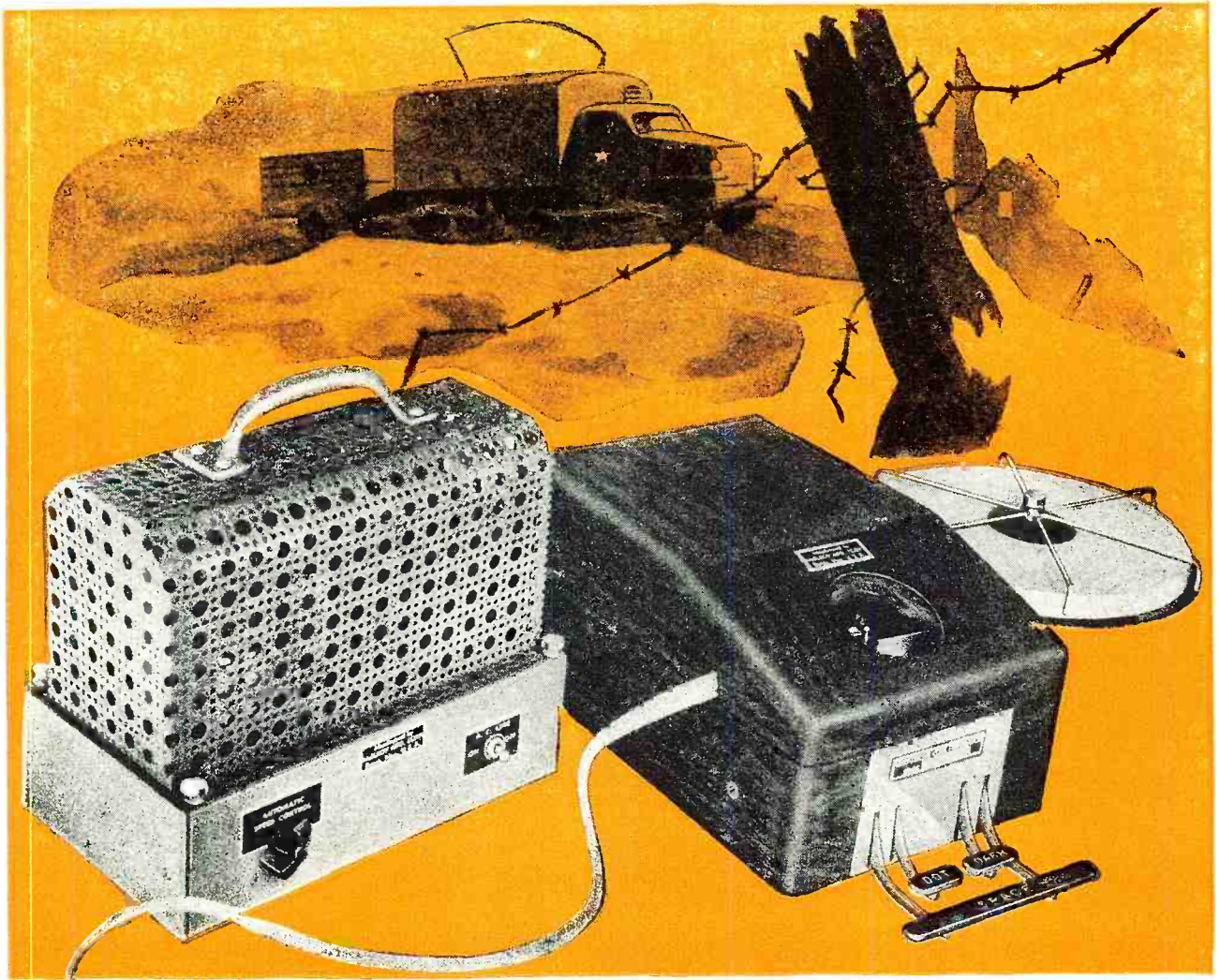

**STANDING STILL, OR BOUNCING ALONG SHELL-TORN COUNTRY, THE NEW AND IMPROVED**

**McELROY WHEATSTONE CODE TAPE PERFORATOR**

**FACILITATES HIGH SPEED RADIOTELEGRAPH TRANSMISSION**

Shorn of bulk and complicated construction, the McElroy Model PFR-443-A prepares clean and accurate tapes for transmission at speeds up to 300 words per minute. Extremely simple to operate and requiring no more than ordinary typewriter attention, this unit is solidly constructed to give dependable performance—on land and sea—stationary or rolling.

Two easily carried units comprise the PFR-443-A—the keying device and the electronic drive. Both are compact and self-protected against jolts and jars. In the hands of experienced operators, speeds of between 30 and 40

words a minute can be maintained in all Morse combinations assigned to the Russian, Turkish, Greek, Arabic and Japanese alphabets and languages. We cannot say for sure, but it is almost a certainty that this McElroy development landed with the Armies of Liberation and will continue to help provide high speed transmissions until V-Day. We will be glad to supply additional technical information.

*McElroy engineers never copy and never imitate. We create . . . design . . . build. We are never satisfied with mediocrity.*



**BACK THE INVASION WITH YOUR BLOOD . . . DONATE A PINT TO THE RED CROSS**

**McElroy** MANUFACTURING CORP.  
82 BROOKLINE AVE., BOSTON, MASS.

## Radio Intelligence

(Continued from page 28)

point on the projected bearing line which would correspond with the location of the radio transmitter. However, if an additional direction finder is used so as to provide a bearing from a different location, and this bearing was drawn on the map, then the intersection between the first and second bearing lines will correspond to the radio transmitter location. This is so because there can be only one common point between two straight lines, namely, at the intersection. The point of intersection between two such projected radio bearings is called a radio "fix." One direction finder *could* be moved about to provide two or more bearings; however, this process is too slow for obtaining a fix when time is important.

Even with the very best direction finders, the precision with which a radio bearing can be obtained is seldom better than 1 degree. In other words, the observed radio bearing may differ from the true or correct bearing by the amount mentioned. Among radio direction finder technicians this degree of precision in equipment performance is often referred to as an accuracy of plus or minus 1 degree. Precision is an important factor in selecting direction finder locations because it directly affects the accuracy of a radio fix which is one of the basic considerations in the evaluation of radio bearings.

When dealing with *three* radio bearings, the inaccuracy in the individual bearing causes the radio fix not to appear as a one point intersection of three lines but as a triangular area often referred to as a "cocked hat." If the direction finders are poorly placed, the area encompassed by this "cocked hat" may be large and the

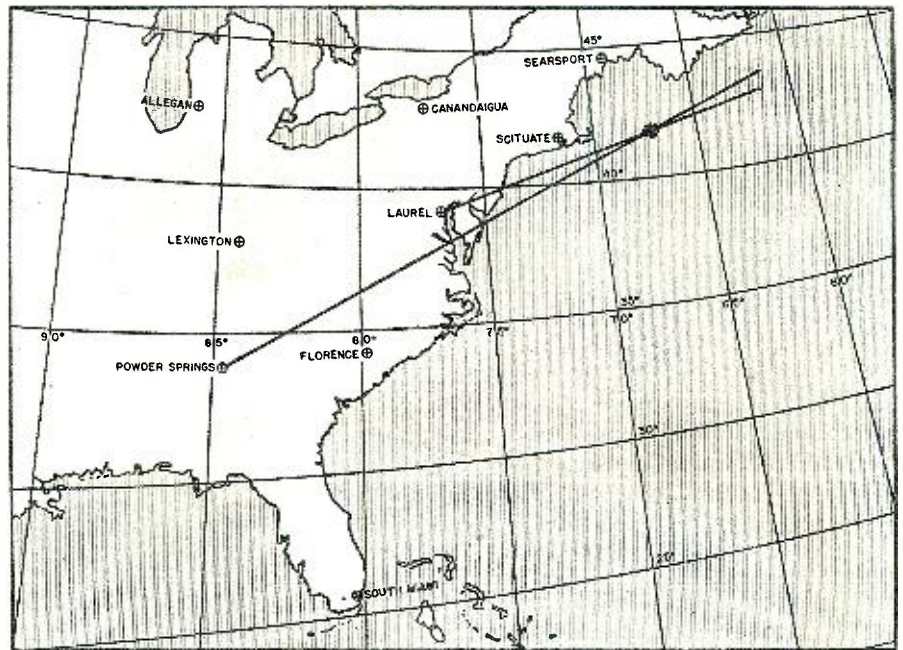

A two-bearing fix can never be considered as being satisfactory.

ability to estimate the position of the radio fix becomes most difficult. Reference to the charts will show that in the case of a two bearing fix and that if either has even 1 degree error, the point of intersection of the projected bearing would shift greatly due to the small angle formed by the bearing lines. It can be shown mathematically and, in fact, it is fairly obvious, that for a given bearing inaccuracy the determination of the radio fix is subject to the least error if the radio bearing lines intersect at an approximate right angle of 90 degrees. The size or the extent of the area enclosed by the "cocked hat," formed by the projection of three radio bearings, is no indication as to the probable accuracy of the radio fix. If two or all three of the bearings are subject to observational

errors, it is entirely possible to have all three bearing lines intersect at a single point, but the radio fix may not at all correspond to the actual position of the radio transmitter. For this reason, a three bearing radio fix can never be classed as being reliable and even when the angle between the outside bearing lines approaches the favorable 90 degree cut such a radio fix can never be rated better than fair.

In order to obtain a good radio fix, it is practically necessary that at least *four* radio bearings be taken. It has been found that by taking a fourth bearing, or even more, that these will give confirmatory information which enables experienced personnel to judge whether the quality of the radio fix is good. By taking into account the angles between radio bearings, the distribution of the radio direction finders with respect to the probable radio fix, and the effect of propagation conditions on the accuracy of the radio bearings, remarkably good radio fixes are possible. The process of taking into account these factors is called "evaluation of bearings." However, for long range work more elaborate equipment is required due to the nature of radio propagation.

When a signal is emitted from a radio transmitting antenna, a portion of the total signal power leaves the antenna in all directions and travels parallel to the surface of the earth. In accordance with well-known physical laws the signal strength decreases as the distance between the transmitter and radio receiver and continues until the signal strength or intensity is too low to actuate the receiver. This is commonly known as the ground wave—the distance range of which does not generally exceed 100 miles except under certain favorable circumstances. Within the ground wave distance range the loop direction finder

Operators on duty at Laurel, Md., recording foreign propaganda. The receivers shown are Hallicrafter SX-28's while the recorders are Memovox.

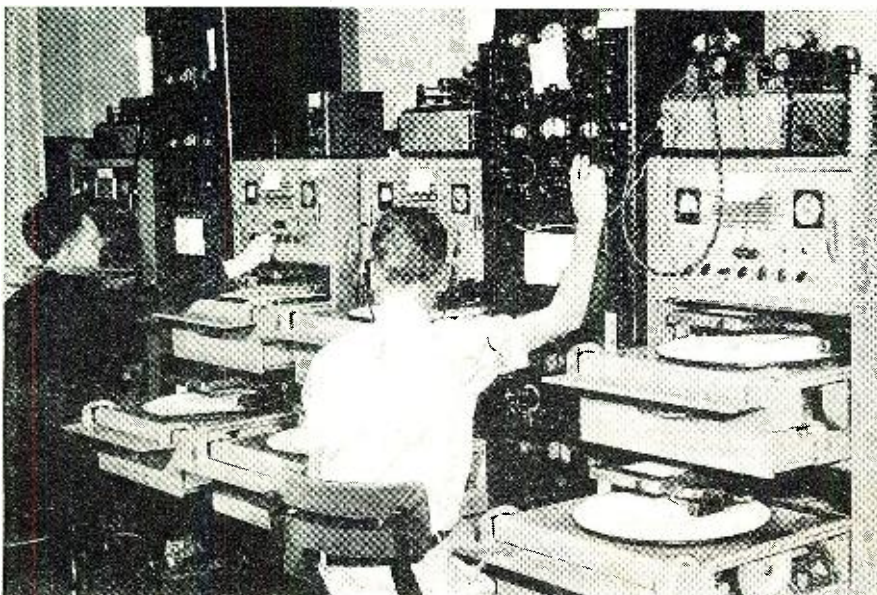

# Another **Du MONT** Contribution...

## TYPE 247 CATHODE-RAY OSCILLOGRAPH



This latest oscillograph facilitates the investigation of transient as well as recurrent phenomena over a wide frequency range. And since a permanent record of transient phenomena is usually desirable, this instrument provides for such photographic recording by applying comparatively high accelerating potentials to its cathode-ray tube. Furthermore, a new type of beam-control circuit is incorporated.

The sweep frequency range has been extended. The instrument may be used for observations on low-speed machinery and for other low-frequency signal functions—even down to  $\frac{1}{2}$  cycle per second. At the other extreme, the instrument handles radio-frequency signals as high as 500 kilocycles. The time-base has the necessary range to display such signals properly. Also, the vertical amplifier can satisfactorily accommodate them.

Uses new Army-Navy preferred Type 5CP1 cathode-ray tube with intensifier electrode operated at overall accelerating potential of 3000 v. High-intensity patterns. 5" dia. screen.

Medium-persistence green screen, standard. Also available with short-persistence blue screen Type 5CP5 tube for high-speed photographic recording. Or Type 5CP2 long-persistence green screen for visual observation of low-speed phenomena.

Vertical or Y-axis amplifier response does not fall more than 10% below the uniform value from 2 to 200,000 C.P.S. Sufficient gain for maximum deflection factor of 0.05 r.m.s. volt input signal for 1" deflection of beam.

Distortionless, continuously-variable low-impedance attenuator or gain control. Stepped attenuator with ratios of 1:1, 10:1 and 100:1.

X-axis or horizontal amplifier accommodates signal produced by linear time-base generator. Reasonably uniform response from d-c to 100,000 sinusoidal C.P.S. Signal amplitude of 0.5 v. r.m.s. sufficient for deflection of 1" through amplifier.

Recurrent, repetitive and single-sweep operation of linear time-base generator. Continuously variable from 0.5 to 50,000 sawtooth cycles per second. Single sweep of writing rates corresponding to 0.5 to 10,000 cycles per second.

Z amplifier channel for applying external signal to grid or modulating electrode of cathode-ray tube.

Steel case. Black wrinkled finish. Copper-finished steel chassis. Two carrying handles. 14" w.; 19" h.; 26" d. 130 lbs.

► Literature on request...

**DUMONT** Precision Electronics & Television  
ALLEN B. DUMONT LABORATORIES, INC., PASSAIC, NEW JERSEY • CABLE ADDRESS: WESPEXLIN, NEW YORK

will function satisfactorily. The mobile units of the RID operate within this range when taking their short-range bearings.

Part of the total signal power is emitted from a radio transmitting antenna at various angles above the ground. This portion of the signal travels skyward until it reaches a region known as the Kennelly-Heaviside layer. This region consists of electrified particles created as a result of solar radiations striking the outer limits of the earth's atmosphere. In accordance with well-known physical laws, some signals are reflected and returned to earth where they are capable of actuating a radio receiver which may be thousands of miles from a radio transmitter. A signal arriving by this means is known as the skywave signal. In the process of signal reflection, an electrical change in signal occurs resulting in the production of two signal components one of which is said to be horizontally polarized and the other vertically polarized. The combination or resultant of these two components forms the skywave signal. Inexperienced personnel, unable to distinguish between ground wave and skywave signals, frequently attempt to take radio bearings on skywave signals with loop-operated equipment with the result that the radio fix obtained by projecting such bearings is invariably in error.

Using an aerial of special design, it is possible to obtain the same directional characteristics as that possessed by a loop and the horizontally polarized error inherent in the loop is reduced to a negligible value. This type of signal collector, together with its associated receiver (*Hallcrafters SX-28*) is commonly called the *Adcock* direction finder. The dipoles, or collecting portions of the equipment consist

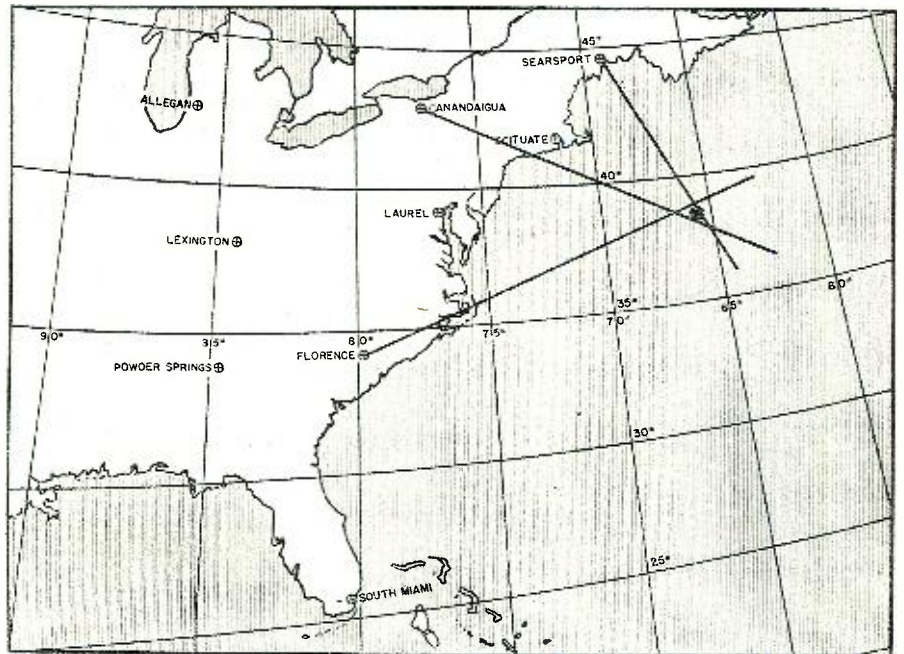

A three-bearing fix gives a "cocked hat" triangulation.

of a rotating beam and balanced H antenna. Each of the vertical dipoles are approximately 20 feet long. The spacing between these vertical elements is also approximately 20 feet. These elements, resembling the letter H, are supported at their centers and interconnected by a horizontal transmission line from the midpoint of which signal energy is taken and delivered to the radio receiver. The beam is supported at its center on a small hut on top of a tower approximately 20 feet above the ground.

Unlike the ordinary radio receiver used for broadcast station reception, both the loop and Adcock type of direction finders must be located at sites

carefully selected to minimize those effects which are capable of introducing errors in radio bearings. In general, such locations must be out in open flat country, free from electrical noise-producing industrial areas, free from overhead wiring, such as aerials, power, telephone and telegraph lines, free from barbed wire and other metallic fences, and free from wooded areas. In order to keep the site error low, separation from the direction finder to the obstructions mentioned must be not less than about 350 feet.

The basic reasons for providing good base lines for radio direction finders has already been discussed. From experience gained prior to Pearl Harbor, and that obtained in dealing with the many and varied problems since that date, the RID has evolved a direction finding network which has proven to be adequate in quickly locating the source of any radio signal. A network capable of rendering satisfactory service over the entire continental United States, its territories and possessions, is necessarily extensive because of the physical laws that govern radio propagation. For example, a radio transmitter located in New York City and operating on frequencies below 5 megacycles would have a distance range of only a few hundred miles during daytime hours. In order to obtain a sufficient number of radio bearings to obtain a good radio fix, it is obvious that a substantial number of direction finders would be necessary east of the Mississippi River. It is also obvious that direction finders west of the Mississippi would be worthless in the problem cited because of the inability to hear the signal of the station on which bearings are desired. For such reasons, the RID direction finder system is composed of several networks, each reporting to its re-

## ELECTRICITY for RADIO WORK ANYWHERE

Plant shown is W3S.  
3000-watt, 115-volt, 60-  
cycle; engine is 2-cyl.  
water-cooled.

For a dependable source of electricity on all radio projects remote from commercial power, Onan Electric Plants are proven leaders in the field. More than half of the armed Forces' total requirements for power plants are built by Onan.

Gasoline driven . . . Single-unit, compact design . . . Sturdy construction . . . Suitable for mobile, stationary or emergency service.

Over 65 models, ranging in sizes from 350 to 35,000 watts. 50 to 800 cycles, 115 to 660 volts, A.C.—6 to 4000 volts, D.C.—Also dual A.C.-D.C. output types.

Descriptive literature sent promptly on request.

D. W. Onan & Sons, 2153 Royalston Ave., Minneapolis 5, Minn.

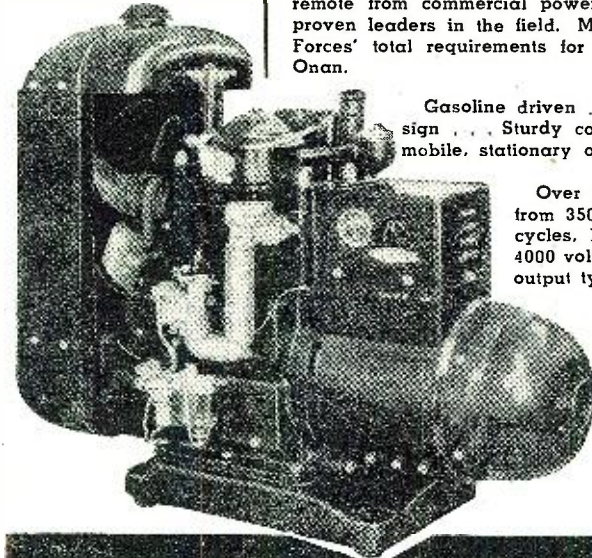

**ONAN**  
ELECTRIC PLANTS

# TRANSFORMERS

*Small and  
Medium*

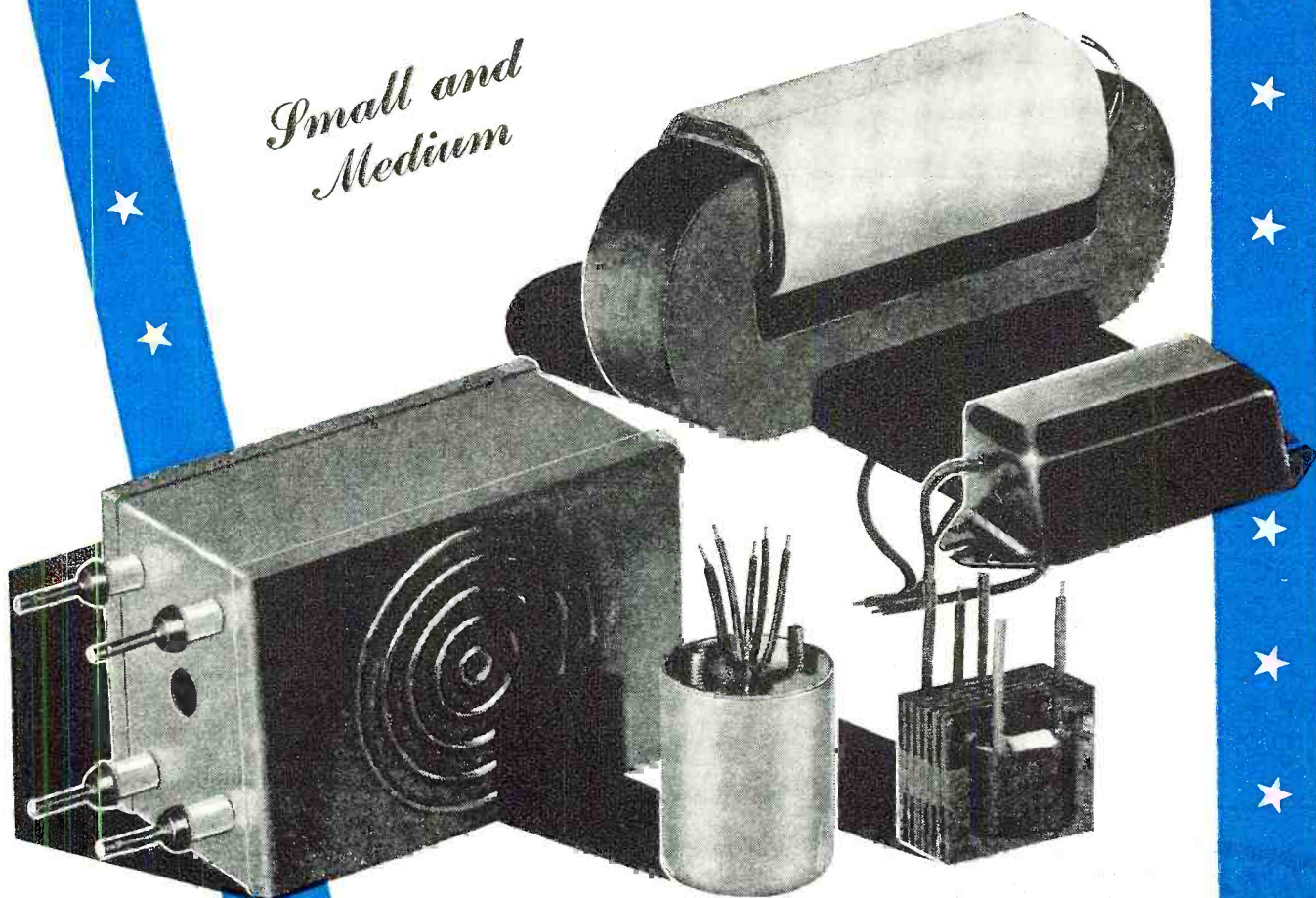

Control of all stages of production is the watchword at Consolidated Radio Products Company. That is why Consolidated's products can be depended on for quality, high efficiency, consistent performance and long life. International acceptance is the result of such high standards of production.



*Electronic and Magnetic Devices*  
**CONSOLIDATED RADIO**

*Products Company*  
350 W. ERIE ST. CHICAGO 10, ILL.

# NOW—A REALLY HIGH-POWERED— Radio Engineering Library

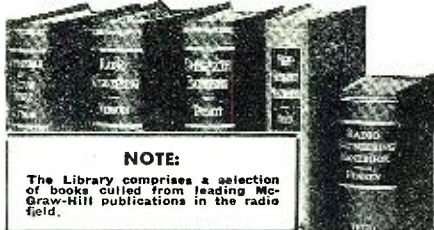

**NOTE:**

The Library comprises a selection of books culled from leading McGraw-Hill publications in the radio field.

- especially selected by radio specialists of McGraw-Hill publications
- to give most complete, dependable coverage of facts needed by all whose fields are grounded on radio fundamentals.
- available at a special price and terms

THESE books cover circuit phenomena, tube theory, networks, measurements, and other subjects—give specialized treatments of all fields of practical design and application. They are books of recognized position in the literature—books you will refer to and be referred to often. If you are a practical designer, researcher or engineer in any field based on radio, you want these books for the help they give in hundreds of problems throughout the whole field of radio engineering.

**5 VOLUMES, 3559 PAGES, 2558 ILLUSTRATIONS**

1. Eastman's FUNDAMENTALS OF VACUUM TUBES
2. Terman's RADIO ENGINEERING
3. Everitt's COMMUNICATION ENGINEERING
4. Hund's HIGH FREQUENCY MEASUREMENTS
5. Henny's RADIO ENGINEERING HANDBOOK

10 days' examination. Easy terms. Special price under this offer less than books bought separately. Add these standard works to your library now; pay small monthly installments, while you use the books.

**10 DAYS' FREE EXAMINATION—SEND COUPON**

**McGraw-Hill Book Co.,**  
330 W. 42nd Street, New York 18, N. Y.

Send me Radio Engineering Library, 5 vols., for 10 days' examination on approval. In 10 days I will send \$3.00 plus few cents postage, and \$3.00 monthly till \$24.00 is paid, or return books postpaid. (We pay postage on orders accompanied by remittance of first installment.)

Name .....

Address .....

City and State .....

Position .....

Company ..... RN-10-44

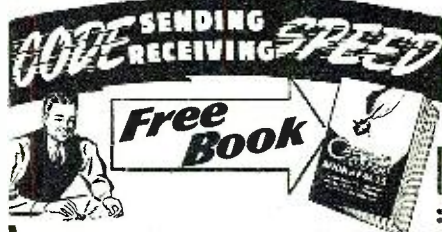

**Get High Speed Without Nervous Tension**

Amazing Book Shows How "Crack" operators rely on something besides practice to develop their high speeds and proficiency; it explains the "knack" of sound-send and sound-consciousness—the secret of speedy sending and receiving. Once you acquire these mental processes, reading code becomes almost second nature to you: just as the swing rhythm of a dance band becomes automatic to musician and dancer.

**Champions Endorse the Candler System**

Used in training commercial operators, Amateurs, and Radiotelegraph Specialists in Signal Corps, Navy, Marine Corps, Coast Guard, Naval Reserve, Airlines. Wherever the fastest and most efficient operators are found, there you will find Candler trained men.

If you want s-p-e-e-d, if you have any difficulties in operating technique, if 40-50 and more w.p.m. seem fantastic speeds to you—send for this revealing book now. It's yours without cost or obligation. Simply send your name and address.

**CANDLER SYSTEM CO.**

P. O. Box 928 Dept. 2-L  
Denver 1, Colorado, U.S.A.  
and at 121, Kingsway, London, W.C. 2, Eng.

gional clearing house of information called an Intelligence Center. Here the efforts of each direction finder are directed, coordinated and evaluated.

A major factor in the successful coordination of a direction finder network is communications. Of the hundreds of radio signals appearing in a small section of the radio frequency spectrum, the problem of directing the efforts of several direction finders to a specific signal to make certain that all bearings are taken simultaneously on the desired signal requires a thoroughly reliable communications circuit from each direction finder to its intelligence center. In the RID this is accomplished by using both radio and wire teletypewriter service, the former being used in the outlying territorial and secondary direction finders and the latter in the important primary stations.

In performing operations leading to the location of an illegal or clandestine transmitter, the direction finding nets are operated as one net and controlled from the Division's Headquarters in Washington. Intelligence Centers control regional nets for the purpose of rendering emergency direction finding service to aircraft, locating the sources of interference to radio services and for certain other operations.

It has been found that the accuracy of a bearing will vary with the time of day, atmospheric conditions along the route of propagation from the transmitter to the direction finder, and a variety of other factors. The accuracy of the fix, in turn, will depend on how well the bearings are evaluated. To cope with this problem, the RID has made extensive studies of the variation of bearings taken through the so-called "twilight zone" and other atmospheric peculiarities, and has charted the corrections to be applied to observed bearings to compensate for

such conditions as twilight and distance. The RID furthermore has made a study of radio propagation factors, the effect of the sun spot cycle, etc., on long range direction finding.

It is a routine procedure for the RID personnel to take periodic "check bearings" on various known stations to determine any deviation in the accuracy of the bearings supplied by each direction finder. As a result, RID has developed a whole series of check-bearing procedures by which it can determine from day to day what deviations may be expected from particular direction finders on particular frequencies and at particular times.

There is an inevitable tendency for radio operators taking bearings on known stations to approximate these bearing readings to the bearings which they know in advance to be correct. The RID has developed its check-bearing procedures to such an extent that where an operator turns in a bearing on a known station which is more accurate than conditions warrant, his bearing can be questioned.

While direction finding is absolutely essential in the location of subversive or illegal transmitters, it has many other uses. For example, the same techniques are employed in tracking down the source of interference to licensed broadcast stations. Such interference may come from another station which is operating improperly or from some medical or industrial device using equipment which generates radio interference. One of the most important uses for radio direction finding techniques is fixing the position of lost aircraft. Bearings can be taken on a plane which does not know its position and the pilot can then be advised by radio of his position and the proper course to fly to bring him to his desired destination or to a safe landing.

A fourth bearing gives confirmatory information for fix.

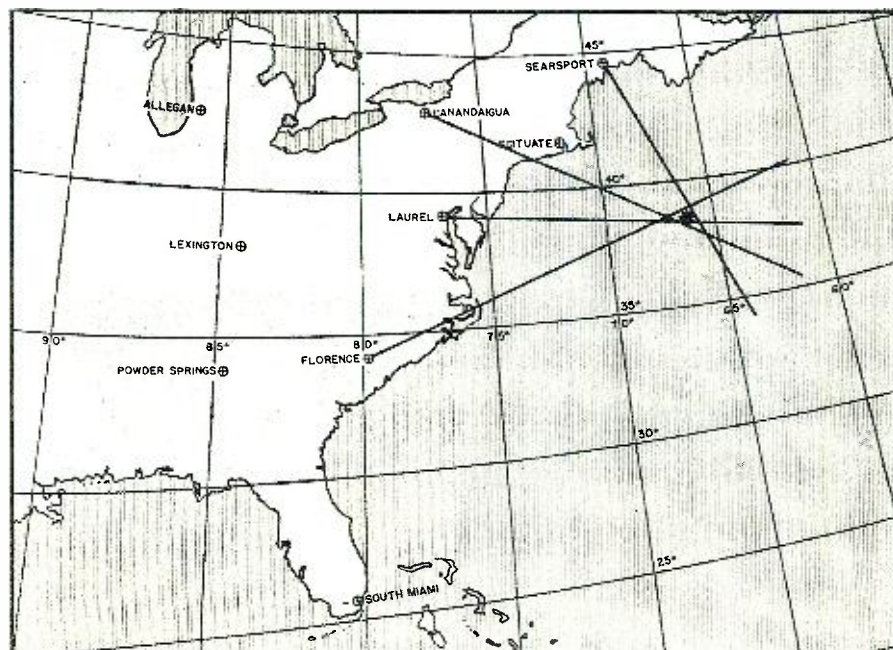



# THIS PIVOT PROVES A POINT

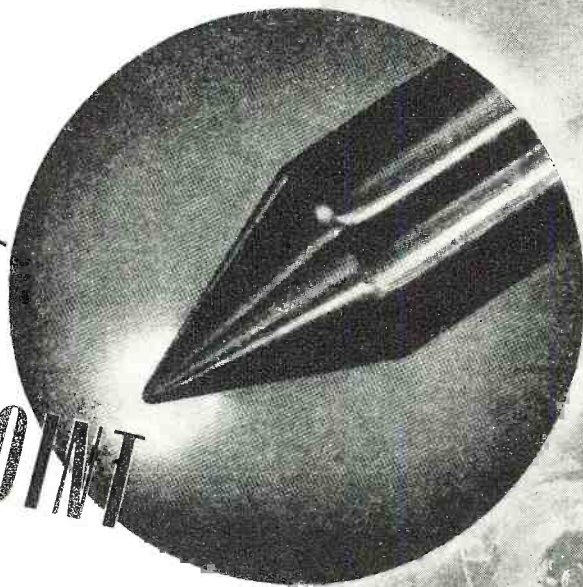

**T**HIS unretouched photomicrograph, approximately 50 times actual size, shows pretty clearly what we mean by the value of experience, when it comes to the making of electrical instruments and testing equipment.

Pivots play an important part in determining an instrument's life and accuracy. In the Simpson-made pivot above, you have what is truly a masterpiece of its kind . . . perfect in contour . . . all surfaces brilliantly polished to prevent rusting . . . rounded end properly correlated with radius of jewel to minimize friction and withstand vibration and shock . . . heat-treated for an unusual combination of strength and hardness.

The obvious explanation for this excellence rests in the fact that Simpson employs some processes others do not, and safeguards every step of manufacture by the finest and most complete control modern science can provide. But in the final analysis, it is only Simpson's long experience which makes such a pivot possible.

That experience reaches back more than 30 years. From it has come new shortcuts in manufacture, new refinements in design, which today permit Simpson to make "instruments that stay accurate" in greater volume than ever before. From this long specialization has come too a sound basis for further advance; in your postwar Simpson Instruments you will see still more forcefully the value of this experience.

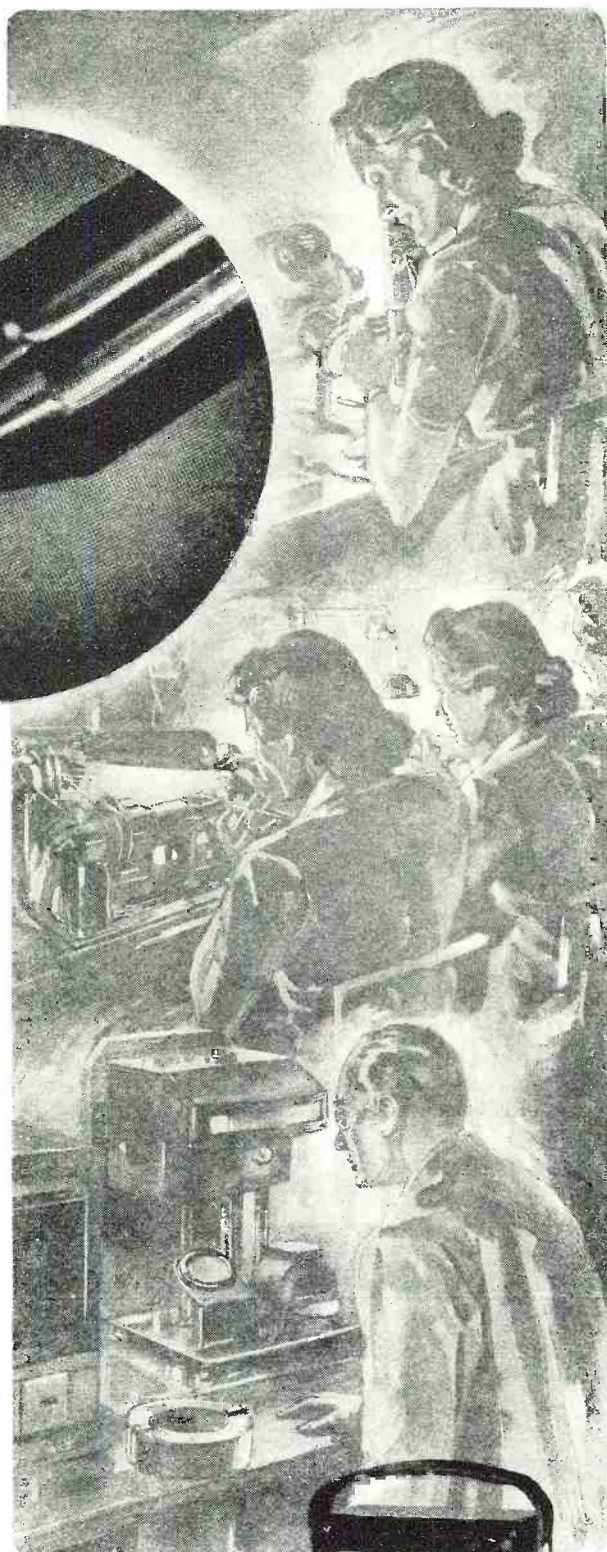

**SIMPSON ELECTRIC CO.**  
5200-5218 Kinzie St., Chicago 44, Ill.

# Simpson

INSTRUMENTS THAT STAY ACCURATE

Buy War Bonds and Stamps for Victory

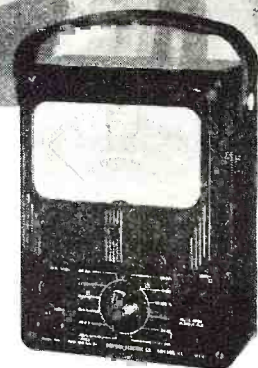
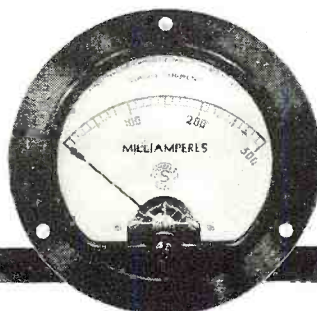

# RADIO-ELECTRONICS HOME-STUDY COURSE

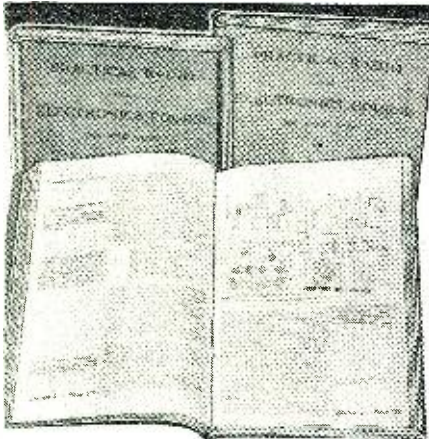

New home-study course in 3 volumes. Covers every topic of radio and electronics. Brush-up on useful radio fundamentals, use the practical service hints, prepare for a future in Electronics and Radio.

□ **Volume 1. Fundamentals of Radio and Electronics** Use the 13 lessons of this volume to really understand radio and electronics. Parts, tubes, circuits, tests. 172 large pages, all lessons size 8 1/2 x 11", with instructor's tips, 201 charts and pictures, index. . . . **\$1.50**

□ **Volume 2. Receivers, Transmitters, & Test Equipment** Superhets, communication receivers, oscillators, transmitters, repair, adjustment, antennas, meters, electronic test equipment, signal tracers, AFC, television, and other topics. In 9 large lessons and index. 103 helpful illustrations. Large size: 8 1/2 x 11 inches. . . . **\$1.50**

□ **Volume 3. Applied Electronics and Radio Servicing** Lessons on photo-cell equipment, special radio receivers, radio compass, frequency meters, life-boat transmitter, U.H.F. heating, electronic shaping circuits, aircraft direction finders, absolute altimeter, radar, metal locators, special tubes, welding controls, voltage regulators, X-rays, magnetron, electronic gages, facsimile, recording, inter-comms. Also lessons on radio servicing, case histories, diagrams. Manual contains 31 large lessons. Size: 8 1/2 x 11 in., 102 illustrations, index. . . . **\$1.50**

□ **All 3 Volumes, 53 Lessons, only. . . . . \$3.95**

Clip this ad. Check manuals wanted. Enclose your remittance. Books sent postpaid. Money back guaranteed.

**SUPREME PUBLICATIONS**

328 S. Jefferson St.

Chicago 6, ILL.



# WIRES

MADE BY

Engineers FOR  
Engineers

## VICTORY

concentrating upon  
for the duration . . . .

**cornish**

WIRE COMPANY, INC.

15 Park Bow, New York City, New York



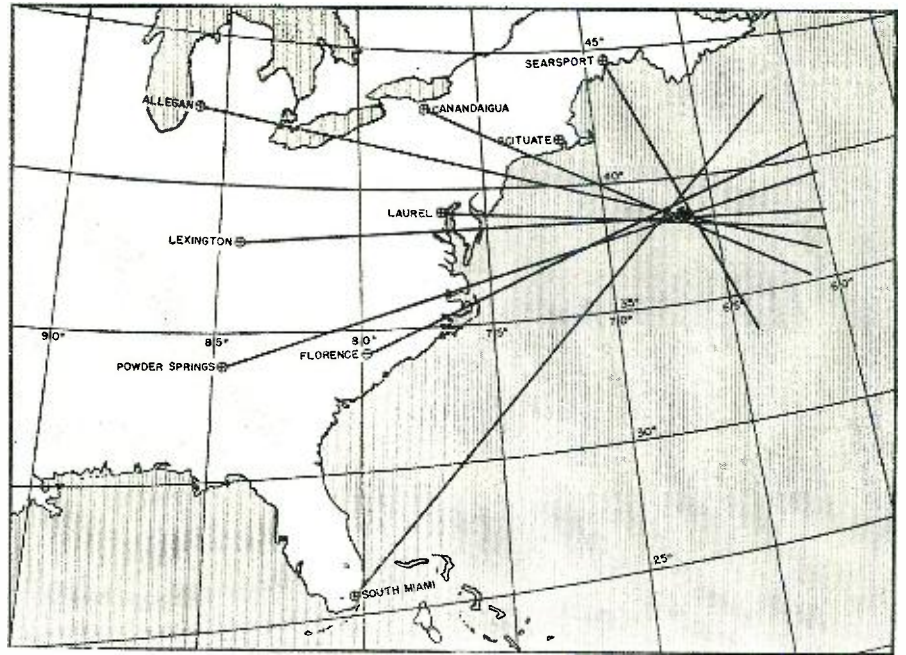

Highly reliable eight-bearing fix is known to be accurate.

The RID has standing requests from a number of government agencies which require it to intercept the traffic of thousands of foreign non-military stations. The simplest form for making an intercept is for the operator to listen to the transmission through headphones and simultaneously type the message. The maximum speed for this type of operation rarely exceeds 40 words per minute. Sometimes it is not feasible to transcribe the message simultaneously with its transmission and it is then necessary to make a dictaphone cylinder or a flat disc recording.

Frequently, radio intelligence transmissions instead of being sent by manual keying are sent by mechanical devices at speeds up to 500 words per minute. These high speed transmissions cannot be transcribed manually. Accordingly, for this type of transmission a high speed tape recorder is employed. It is possible for operators without any skill in aural reception of radio signals to learn to accurately read such tape and transcribe it on a typewriter.

Another type of tape recording device is the *Hellesreiber* which, instead of printing dots and dashes, actually prints letters and words on the tape.

It should be pointed out that frequently single monitoring stations, because of the physical laws which govern long distance radio transmission, cannot obtain a full and complete copy or recording of the radio signal being intercepted. To remedy this it is necessary to have two or more monitoring stations intercept the same transmission. When, because of fading, the signal cannot be received intelligibly at one point, it is possible at that very same moment to receive it clearly at another point. By putting together the incomplete or "broken" copy re-

ceived by several monitoring stations, it is possible for the RID to furnish the interested government agency with a "solid" copy of the foreign transmission.

The RID also records voice broadcasts and radiotelegraph press dispatches from foreign stations throughout the world for the *Commission's Foreign Broadcast Intelligence Service*. For this work, RID maintains five units which are known as *Broadcast Recording Units*. These units are in addition to the physical set-up previously described and they are located at Silver Hill, Maryland; Hato Rey, Puerto Rico; Kingsville, Texas; Hayward, California, and Portland, Oregon.

After V-day we expect to see an ever-increasing demand on the RID for the taking of bearings on lost aircraft piloted by private fliers. The *Civil Aeronautics Administration* expects a tremendous increase in air traffic. Even with new electronic devices, many of them automatic, there will still be many planes lost and it will be the job of the RID to find them and to direct them to a safe landing. The finding of boats of many varieties will also make it necessary for the RID to expand its activities.

We point with pride to the fact that 70% of the total personnel of the RID are licensed radio amateurs—just another "case history" which should point out to the public that without these hobbyists America might still be faced with the problem of ridding the country of foreign spies—operating illegal transmitters and transmitting vital information to the enemy. Thanks to Radio Intelligence—such clandestine stations are now almost non-existent.

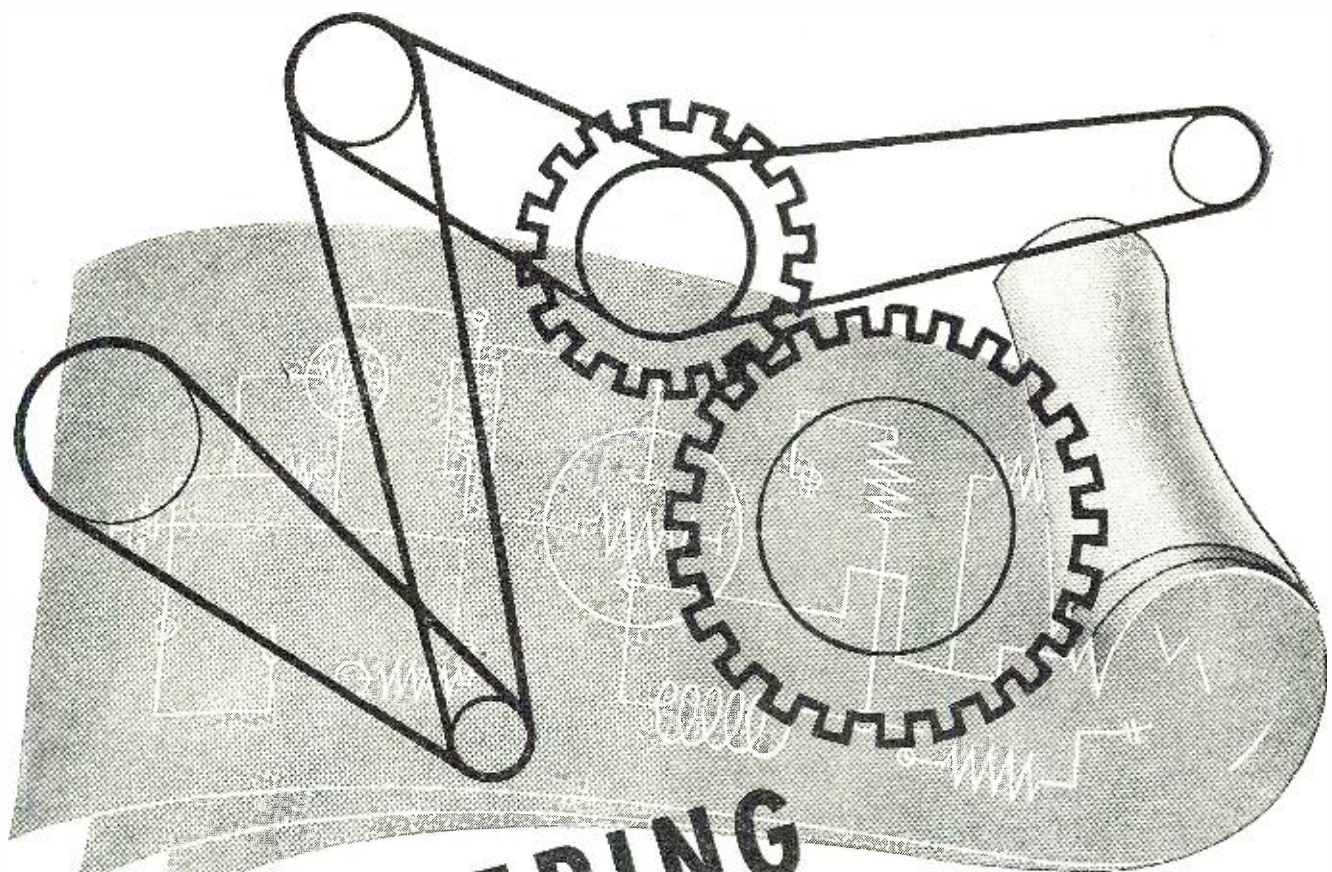

# ENGINEERING AND PRODUCTION

Doolittle Engineers are still designing and producing radio equipment for the *Naval Aircraft Factory* and the *Bureau of Aeronautics*. . . . Before the war began, "Specialized Communications Equipment" by DOOLITTLE was a consistent aid to aviation, broadcast and police radio engineers . . . Come tomorrow, our pre-war and war-born experience will be translated into many new benefits for a world of peacetime communications . . . *Look Ahead with DOOLITTLE!*



*Doolittle* **RADIO, INC.**

*Builders of Precision Radio Communications Equipment*  
7421 South Loomis Boulevard, Chicago 36, Illinois

# CUT HOLES

3/4" TO 3 1/2"



## in radio chassis

Punch cuts through chassis, die supports metal to prevent distortion, cap screw is turned with wrench to cut clean, accurate holes for sockets, plugs, and other receptacles. Saves hours of work — no reaming, filing or drilling! 3/4" to 3 1/2" sizes. Get complete data now from Greenlee Tool Co., 1890 Columbia Ave., Rockford, Illinois.

WRITE FOR FREE FOLDER S-119 ♦

Get Ready with Greenlee!



## Katolight A. C. Generators

Furnish Same Current as  
City Power Lines

Kato Engineering products are carrying  
out an important job in the War Effort.

A maneuvering fighting force cannot arrange for a power line hook-up. KATOLIGHT GENERATORS furnish electricity on the field of battle which permits equipping our fighting forces with the most modern electrical appliances

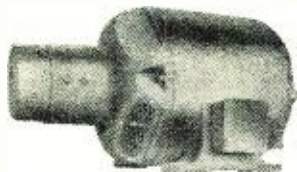

"10 K.W. Revolving Field Generator"

Fighting forces need guns, planes, tanks, trucks, kitchens, emergency hospitals, lights, etc. To keep this equipment going, complete repair equipment such as drills, grinders, saws, air-compressors, etc., are needed. Standard A.C. electricity, the same as you get from the power line, must be had for operating these devices. Portable Katolight generators supply this electricity. They also supply current for radio transmitters, beacons, landing field controls, etc.

Available in all standard voltages and sizes up through 25,000 watts. Also manufacturers of rotary converters, frequency changers, motor-generator sets, gas engine driven battery chargers, high frequency motor-generators and converters.

**KATO ENGINEERING CO.**

118 Rock St.

Mankato, Minn., U. S. A.

## Spot News

(Continued from page 16)

proposed high power television station and television receiver manufacturing facilities. At a banquet given in his honor, members of the National Cinematographic Chamber pledged half a million dollars for the construction of television installations.

Dr. DeForest also discussed an electronic research and study center that would serve as a laboratory for some five thousand students from all the American republics. He discussed his plan with Dr. Jaime Torres Bodet, the Secretary of Public Education. As a result, a technical mission is being formed to study the plans for this center, with Dr. DeForest as director. The research laboratory is expected to cost around a million dollars. The center will also house translators who will translate all electronic literature into Spanish and Portuguese for publication and distribution in Latin American countries.

Dr. DeForest was most enthusiastic about the prospects of color television too. He expects to return in the early fall to begin work on the television and electronic projects.

**THE DEPARTMENT STORES'** interest in television has spurred during the past months. Dozens of stores, large and small, have not only made application for television stations, but intra-store television systems. Several manufacturers have found this move so significant that they have detailed engineers and economic experts to survey the field and prepare cost charts. One large cathode-ray and television equipment manufacturer has completed one such survey which provides an interesting breakdown of the costs of a television station for a department store. This report shows that about \$95,000 a year would have to be spent to operate a complete service which would include the mobile unit, operation of the transmitter during five daytime hours, and intra-store operation as well. The report cites that the system could operate profitably from 10 a.m. to 5 p.m., or seven hours daily. In breaking down the costs, the report shows that seven studio technicians would be required and their salaries would total about \$24,000. Other personnel and costs include: one studio manager, \$5,200; one station manager, \$10,000; one chief engineer, \$8,000; three operating engineers, \$13,500; one audio control operator, \$3,500; three maintenance men, \$5,400; replacement parts, etc., \$5,000; rental of about five thousand square feet, \$12,500; and power, \$7,400. The initial cost of such a station would be around \$100,000 although higher power stations up to \$350,00 will be available, according to this report.

The intra-store feature of the television system seems to have gained many friends. This feature has many possibilities, merchandise experts in-

dicating that such a television system will be a material factor in building sales.

**THEATER TELEVISION** is still very much in the limelight. During a recent discussion of this subject at a Television Seminar, conducted in Radio City, New York, Paul Raibourn, economist of Paramount Pictures, said that the theatre business is largely a fixed-cost business. That is, the cost of operation of the theatre is within certain limits independent of the theatre attendance. Accordingly, he said, a large drop in attendance during some periods could turn a profitable week into a losing one. Television might be an instrument which could accent such a tendency, he said. In view of this possibility, Paramount is studying television and feels that television might be used in an effective form in theatres. He said that the 525-line picture is quite satisfactory at the present time. However, if we do increase the brilliance we might find it necessary to extend this lineage, he pointed out. In describing the word *brilliance*, he said he was not referring to the ordinary meaning of the term, namely absolute maximum light value. Instead, he said, he was referring to the contrast ratio of a perfect white to a perfect black in the picture, as compared with the contrast ratios and absolute light values reflected from similar associated and nearby visual objects. He said that a new cathode-ray tube, known as a black tube, recently developed by an eastern manufacturer, provides more of this contrast than any other development. This tube will certainly help to improve viewing, he emphasized.

A New York newspaper reporter, interviewing executives and artists on the possibilities of theatre television, was told that theatre television will supplement all present forms of entertainment and supply another new and interesting medium. Such a medium of entertainment, however, will in no way replace or destroy the motion picture presentation, he was told.

**APPLICANTS FOR TELEVISION STATIONS** have found that the FCC is quite inquisitive. The familiar form, 330, is quite a lengthy one and serves to provide FCC with an excellent guide as to whether or not the applicant should have a television station. In this form the FCC asks among other questions what types of programs will be offered to the public, the number of hours per week such programs will be transmitted, what transmitting channel is required, and where the studio and transmitting facilities will be located. In the latter instance the applicant must state whether the antenna will be on a tall building, a hill or a mountain. It is thus necessary to determine the accessibility to power lines, roads, telephone lines. It is also necessary to determine whether the link between studio and transmitter will be by coaxial cable or via a relay station. Applicants are also re-



*Yesterday and* **TODAY**

The Army-Navy Production Award for outstanding achievement in producing vitally important materials essential to the war effort will be an added incentive to the management and employees of

WARD PRODUCTS CORPORATION to keep producing more and better equipment for the men who are doing the fighting. While yesterday WARD Antennas were accessories for pleasure, today they are implements of War.



**WARD** *Antennas*

THE WARD PRODUCTS CORPORATION, 1523 EAST 45TH STREET, CLEVELAND, OHIO



types of Screw Drivers  
and Small Tools

MEANS

**VACO AMBERYL**

HAS THE TOOL YOU NEED

... TO SUIT THE JOB

IT'S NEEDED FOR



Write for catalog

**VACO PRODUCTS CO.**

319 E. ONTARIO STREET CHICAGO 11, ILL.

Canadian Branch Warehouse: 560 King St., W.,  
Toronto 2, Ont.

**7 Days**

**Free Examination**

**PRACTICAL  
RADIO  
INFORMATION**

Including Frequency Modulation—Television, etc.

Inside Radio Information for all Servicemen—Aircraft Pilots, Students. AUDELS RADIO-MANS GUIDE contains 772 Pages, 400 Diagrams & Photos is complete—gives Authentic Principles & Practices in Construction, Operation, Service & Repairs. Covers clearly and concisely Radio fundamentals—Ohm's Law—Physics of sound as related to radio science—Measuring Instruments—Power supply—Resistors—Inductors—Condensers—Transformers and examples—Broadcasting stations—Radio Telephony—Receivers—Diagrams—Construction—Control systems—Loud speakers—Antenna systems—Auto Radio—Phonograph pickups—Public Address Systems—Aircraft & Marine Radio—Radio Compass—Beacons—Automatic Radio Alarms—Short Wave—Coil Calculations—Testing—Cathode ray oscillographs—Static Elimination—Trouble Pointers—Underwriters' standards—Units and tables—Frequency Modulation—REVIEW QUESTIONS & ANSWERS. Ready Reference Index.

**\$4 COMPLETE • PAY ONLY \$1 A MO.**  
Get this practical information in handy form for yourself—Fill in and MAIL COUPON TODAY

AUDELS Publishers, 49 W. 23rd St., N.Y.  
Mail AUDELS NEW RADIO-MANS GUIDE for free examination. If O. K., I will send you \$1 in 7 days; then remit \$1 monthly until \$4 is paid. Otherwise I will return it.

Name \_\_\_\_\_  
Address \_\_\_\_\_  
Occupation \_\_\_\_\_  
Reference \_\_\_\_\_ R.N.

quired to study their service area so that they might intelligently present the power of the proposed transmitter and the location of the transmitting antenna.

Discussing antennas and ranges, Leonard F. Cramer of Allen B. DuMont pointed out during a recent talk in New York City that the primary effective range of the television signal is slightly more than the area visible from the transmitting antenna, or about from ten to twenty per cent in excess of the line of vision. If the transmitting antenna were located on Mt. Wilson, in southern California, he said, receivers two hundred miles distant might be served. However, for such coverage it would be necessary to have a 40-kilowatt sight and 20-kilowatt audio transmitter. If the transmitting antenna were located on a 500-foot skyscraper, he said, the primary service area would be a radius of from fifty to seventy-five miles. Such coverage would require a 25-kilowatt sight and 12½-kilowatt audio transmitter.

Mr. Cramer also discussed the possible cost of the television station, pointing out that studio equipment costs around \$123,000, pickup equipment around \$40,000, and installation, sound and lighting expenses involve some \$64,000, approximating a total cost of about \$258,000. The transmitter covered in this cost analysis was the 25-kilowatt sight and 12½-kilowatt audio unit.

Many of the reports submitted to the FCC indicate that television towers will be located atop mountains. In fact mountain tops have become valuable pieces of property. Recently Mt. Tom, a 1200-foot mountain in the New Hampshire area, was sold by the streetcar company to radio station WHYN. The cost of the mountain top ran well into five figures. The purchasers plan to install an FM station as well as a television transmitter. Many popular FM transmitters are located on mountain tops that can be reached only by scaling or cable cars. Engineers and operators of these stations usually have permanent quarters at the station, with complete emergency facilities at their command in case of storms. Several companies are planning to construct portable housing facilities to accommodate the expected increased requirements for mountain top operator residences.

**THE CONTROVERSIAL SUBJECT OF F.M. AND A.M.** served as the basis of a recent New York City talk by James D. Shouse, general manager of WLW. He said that during the past two or three years frequency modulation appeared to be attracting much more attention than, for instance, television.

"This I could never fully understand," he said. "We have an experimental FM station but I cannot help but feel that a great deal of the impetus and preferential consideration which has been given to FM arises out of the general problem of allocation

as distinguished from any need for FM on the part of the public. I have never been able to understand why the mere fact of being able to do approximately the same thing but in a different way represented an impelling reason to induce a replacement of one form of broadcasting for another. I think that very influential and very sincere forces in the industry who are concerned primarily with an equalization of facilities, see in FM a means whereby all broadcasters can be put on a common denominator. If the things claimed for FM are as definite and positive in fact as the claims are in theory, I still think it would be well to assume that the people today who are big in AM broadcasting will continue to be big in FM broadcasting.

Newspaper owners are flocking to FM, however, feeling that they have in this medium a formidable power of expression. Ernest L. Owen, publisher of a newspaper in Syracuse, pointed out that newspapers of the future will either own or be closely allied with FM radio. He said that newspapers have the organization, the capital and the public relations to proceed in an intelligent manner to conduct a radio station. Since FM stations are so nominal in cost (from \$12,000 for 250- to 500-watt station with 27- to 30-mile range, to \$100,000 for a 50,000-watt station with a 60-mile range) and so economical to operate (from \$5,500 a year for a 250-watt station, to \$45,000 a year for a 50,000-watt station), newspapers should find this plan of broadcasting a profitable one, said Mr. Owen.

**A NEW PROPOSAL ON F.M. CHANNEL WIDTHS** was recently prepared by Committee One of Panel One of the RTPB. This report recommends a channel width of 120 kilocycles and an audio frequency range of 10 kilocycles. The proposal also carries a number of other recommendations. It suggests, for instance, for the provision of sixty-five commercial and ten educational broadcast channels in the 41 to 50 megacycle spectrum. The proposal also calls for a deviation ratio of four instead of the previously recommended five.

In this report the committee also indicated that various members are continuing their study of impulse noise and interference. When these studies have been completed, the recommendations contained in the proposal may be altered. Data available thus far indicates that the recommendations will probably be retained. The proposals will not become final until the entire panel has approved them. Data of this nature will, in its final form, be submitted to the FCC who in turn will study and modify or adopt the proposals in their postwar allocation plan.

**THERE'S NO WASTE IN THE SIGNAL CORPS.** Old type walkie-talkies being replaced by new models are being taken apart for salvage purposes. And every part is being used.

NOW! A WORKING MODEL OF GATES  
POST-WAR TRANSMITTER DESIGNING

Orders Accepted Now  
for Post-War Delivery\*

*Gates*

MODEL 1D  
ONE KILOWATT

## BROADCAST TRANSMITTER

An Example of How Gates Wartime Developments Create Higher Efficiency at Lower Cost

Here is "tomorrow's transmitter—completely engineered today!" Combining these important features:

- Low initial tube cost
- Low operating cost
- High fidelity performance
- Extreme accessibility of all components
- Modern, streamlined design
- Extremely easy to install
- "Easy-view" meter panel

Yes! Gates is ready for your post-war equipment needs. This new, 1000 watt transmitter is completely designed and operating under rigorous conditions . . . ready for post-war delivery. The Model 1D is designed as a commercial broadcast transmitter, but is also available, on special order, for high frequency operation up to 20 megacycles. You can order now with confidence, knowing that Gates has taken advantage of every wartime engineering advancement in designing this efficient and economical transmitter.

\*May we send you details regarding the Gates Priority System for prompt postwar delivery?

WRITE TODAY FOR COMPLETE,  
ILLUSTRATED TECHNICAL BULLETIN

*Gates*

# RADIO and Supply Co.

QUINCY, ILLINOIS, U. S. A.

Manufacturers of Radio Broadcast Transmitters, Speech Equipment, Recording Apparatus and Allied Equipment in the Electronics Field.

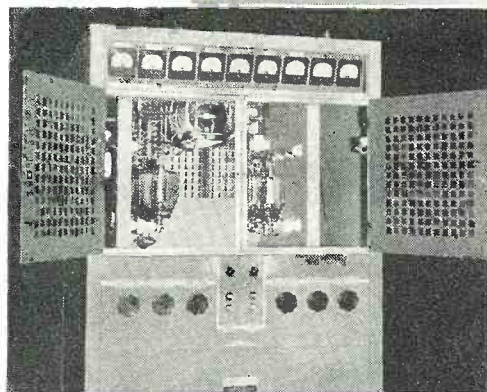
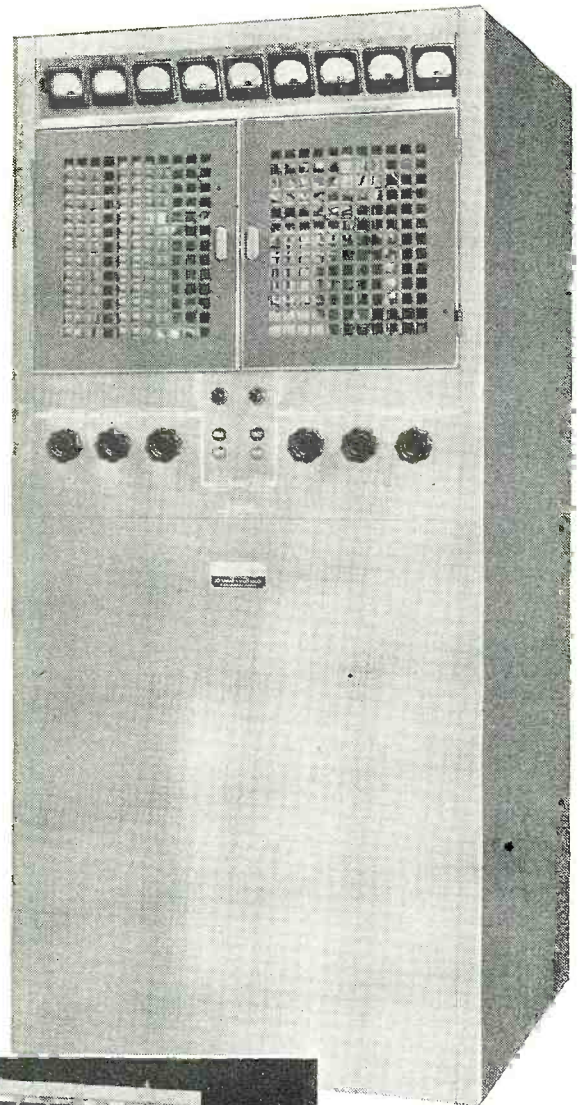

Model 1D—1000 watt Transmitter. Full front view and close-up of front top with doors open.

Wartime restrictions do not allow the sale of new broadcasting equipment without priority. This equipment is presented merely to acquaint you with Gates developments.

Capacitors, resistors, switches and sockets, and such individual articles as transformers, hand sets, voltmeters, and even antennas are being used as replacements or substitutes in other transmitting and receiving units used by the Army. Even the two quartz crystals found in the old walkie-talkies are being reground and repolished for further use. Screws, washers and nuts are not being thrown away either. They are being neatly sorted and kept for general hardware stock. This conservation program is receiving such meticulous attention from the War Department that notes on how to take care of such details as pigtail leads are being issued. This recommendation reads: "In removing items such as resistors and capacitors, care should be taken to keep any attached pigtail leads as long as possible. In the event that the pigtail leads are less than one inch in length, the item should be salvaged."

There are some eighty-five parts that have salvage possibilities in the old models, known as the SCR-194 and 195. The new walkie-talkie is known as the SCR-300. It has a number of improvements, including an extra gooseneck antenna which enables the user to remain inconspicuous while lying on the ground or in a foxhole, triple transmitting range, thorough water-resisting and fungus-resisting treatment, FM, and *no squeal*. The early models suffered from a squeal defect. This re-radiation proved quite embarrassing in combat since it afforded direction information. Fortunately the design was improved quickly, and the offending squeal is now "out."

The postwar applications of the walkie-talkie were demonstrated recently in Chicago during a victory golf match. The walkie-talkie was used to

report progress of the golf players to those who could not get too close to the actual playing. The walkie-talkies were also used to feed signals to the field pickup units of local broadcast stations.

The postwar era will see countless other applications of this effective lightweight, compact portable means of transmission.

**STANDARDIZATION OF COMPONENTS BY THE ARMY AND NAVY** has been progressing at a healthy pace. Thus far over fifteen hundred qualification approvals have been coordinated between the Signal Corps and the Bureau of Ships. There are two new agencies who are handling this effective format of standardization. There is first, the Signal Corps Standards Agency. This was organized in accordance with a joint agreement between Lieut. Gen. Brehon Somervell, Commanding General ASF, USA, and Vice Admiral Robinson, OP & M, USN, permanent representative for the Bureau of Ships. There is a second organization known as the Army-Navy Electronics Standards Agency, which supplements the Signal Corps Agency work.

In operation, one agency makes a qualification test and forwards data to other interested agencies as a basis for approvals. Plastics, for instance, become the project of study of the Bureau of Ships, while dry batteries are studied by the Signal Corps. Specifications on these and other materials are processed as joint Army-Navy standards and then used by all of the services of the Army and all of the bureaus of the Navy. There are also special groups or subcommittees that study very technical problems which might occur in the standardization of vacuum tubes or coaxial cables. But even here simplification is the first aim and all

elaborate details are being modified.

Both agencies are at Red Bank, New Jersey. The industry has followed the work of these agencies with interest, believing that their approach may serve as an effective basis for postwar planning.

**THE ANNUAL REPORT OF THE SOUTH AFRICAN** Broadcasting Corporation reveals that FM, "wired wireless" and television will be the major topics of study in the postwar era. The report cites that frequency modulation experiments were carried out this past year with what is believed to be the only FM transmitter now in operation in the British Commonwealth. The reports were very satisfactory, particularly from rural listeners.

The "wired-wireless" program will probably be extended, too, by supplying more programs directly to specific locations.

According to the report, every effort will be made to establish a television service after the war. The report cites that wartime research will prove most useful in providing such a service. Two new studios are planned in Durban and Capetown. These studios are expected to be of advanced design and replete with every modern development.

Mobile recording unit services which have proved so useful will not only continue to be used, but expanded, according to the report.

**SEVERAL NEW CHANGES** have been made in the WPB radio and radar division. At the present writing the following are the executives in charge of various sections: John Creutz (civilian radios and sound systems); H. P. Rockwell, Jr. (electronic components); Dr. P. M. Deeley (capacitors); Lieut. L. J. Stevens, USNR (rotating antenna and coaxial cable); F. S. Adkins (electric panel indicating instruments); H. Kitchen (vibrators, vibrapacks, microphones, speakers, radio hardware, switches and relays); Kenneth Hathaway (resistors); H. B. Esterly (distribution of test equipment); R. G. McCurdy (test instruments and test equipment production); J. E. Hart (temperature instruments); F. C. Bash (electron tubes); M. J. McNicholas (electronic equipment); S. C. Stimmel (tungsten and molybdenum products); W. E. Wilson (transformers); Edward McWilliam (commercial instruments); W. H. Magee (pressure instruments); Alan Foster (fluid instruments and counters).

**THEY SOON MAY BE BROADCASTING SESSIONS** of both the House and Senate, for Senator Claude Pepper has introduced a resolution calling for such authorization. In this proposal Senator Pepper asks for the necessary changes in the architecture of the Capitol to permit both direct broadcasts and recordings of all proceedings. The service would be of-

## STEEL CABINETS

Now Available with Popular  
**G-C Dial Belt Kits**

G-C Woven Fabric Belts are the finest replacements for all sets. Easy to install — no slipping — no stretching — no adjustments. A perfect fit every time.

Kits Available  
with 25, 50,  
100, 200 or  
300 Belts.

Order From Your  
Radio Parts Jobber



**STEEL  
CABINET AND  
MEASURING DEVICE**

**FREE!** You Pay  
For Belts Only

**GENERAL CEMENT MFG. CO.**  
ROCKFORD, ILLINOIS





# "Wire Conscious"

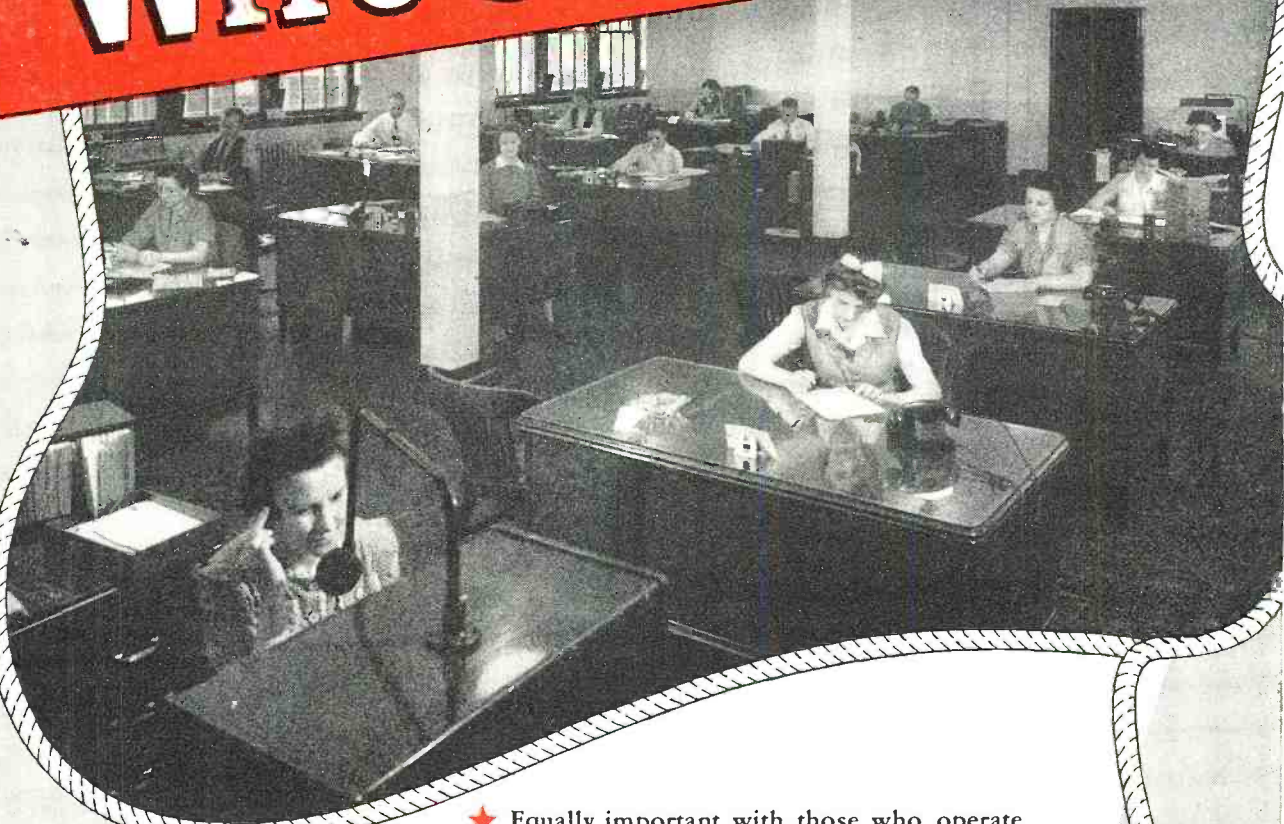

★ Equally important with those who operate the machines in our factory are the folks who sit at the desks in our general offices. . . . It is their interest in wire-making, their enthusiasm for selling a good product and rendering a high type of service which has enabled us to enjoy the confidence of all types of firms having a need for cords, wires and cables.

*Runzel*  
CORDS · WIRES / CABLES

FOR RADIO,  
TELEPHONY AND  
ELECTRONICS . . .  
WORLD-FAMOUS  
AND WORLD-USED

**RUNZEL CORD & WIRE CO.**  
4723-31 MONTROSE AVENUE • CHICAGO 41



JARO FABRY

"Since it's so tough to get waiters nowadays, the management furnishes a copy of TRUE while you wait." (One of the great family of Fawcett Publications.)

**Time Tested Quality**



**PAPER and ELECTROLYTIC Capacitors!**

Each paper and electrolytic capacitor of ILLINOIS CONDENSER COMPANY is known for its "TIME TESTED QUALITY." Countless satisfied users choose Illinois Condensers which operate under the severest conditions. Select the capacitors of "TIME TESTED QUALITY" — manufactured by ILLINOIS CONDENSER COMPANY, the Condenser Specialists.

**ILLINOIS CONDENSER COMPANY**  
1160 NORTH HOWE STREET  
CHICAGO 10, ILLINOIS

ferred to local stations and networks, although either the Senate or House of Representatives would be authorized to withhold privileges for any particular broadcast for security reasons. The stations would not be compelled to transmit these sessions, according to Senator Pepper. It would be purely a matter of choice, he said.

The Senate and House Rules committees are studying the proposal. It will be necessary for them to approve this resolution before it is presented on the floor of the House and Senate.

The move has gained many friends and has an even chance of becoming a law, according to government technical and political specialists.

(Continued on page 146)

**Transformer Design**  
(Continued from page 33)

age, one term of our new formula should be in this form:

$$N_s = \frac{N_p}{E_p} \times E_s \dots\dots\dots (5)$$

The new formula now states that the secondary turns is equal to the primary voltage divided by the primary turns and this result is to be multiplied by the secondary voltage. In our proposed transformer we have found our primary turns to be 270; substituting this value and inserting the primary voltage into our equation (5) we have:

$$N_s = \frac{270}{115} \times E_s = E_s \times 2.35.$$

Now, by substituting the various secondary voltages in place of  $E_s$  in our formula we can easily find our secondary turns. Our proposed transformer has three secondaries, 5 volts, 6.3 volts, and 900 volts, all center-tapped. Using the above formula we find that the 5-volt winding requires 12 turns; the 6.3-volt winding requires 14.8 or 15 turns; and the 900-volt winding requires 2115 turns. Center taps will be on each winding at 6, 7½, and 1058 turns respectively.

A small chart showing the design considerations of the various windings should now be constructed. This chart should show primary voltage, current, turns, wire size, and the cross-sectional area of the winding. The same data for each secondary also will be shown. The wire insulation also should be indicated for each winding.

Returning to our proposed transformer, we found that the core had to have 2.2 square inches of cross-sectional area. We have on hand a core of the shell type, the center leg of which is 1½-inches wide and 1½-inches thick. By removing a few laminations we can bring this core down to 2.2 in cross-sectional area to suit our purpose. The window of this core is 2¼-inches long and ¾-inches wide. It is now our concern to find out if our coil will fit into this window. The window area is 1.688 square inches.

It is now necessary to decide the size

of wire to be used for the various windings. In general, the wire should have a cross-sectional area of between 750 and 1500 circular mils per ampere of current to avoid excessive copper losses and to prevent the coil from becoming overheated. By examining a wire table, we find that No. 14 wire has a cross-sectional area of 4107 circular mils, which is acceptable for the 3- and 4-ampere windings. The 1½ ampere winding requires a smaller wire size, so we choose No. 19 wire with a cross-sectional area of 1288 circular mils. The high-voltage winding which carries a current of 0.2 ampere should have an area of about 150 circular mils. We find that No. 28 wire has an area of 151 circular mils, which is satisfactory for our purpose.

Our chart of wire and turns information should now be constructed and for the transformer which we propose to construct, it is shown in Chart I. When we add the last column of our chart we will find the cross-sectional area required for the wire in the coil, in this instance, .922 square inches.

An allowance must be made for insulation which should be placed around the core and between the windings. We shall allow .050 inch of thickness of insulation for the insulation around the core; as the winding space is 2¼-inches long, this means 2¼ × .050 or .11 square inch of insulation at this point. There are four coils to take into consideration, the primary and three secondaries, and between each of these will be inserted .025 inch thickness of insulation.

As these coils are again 2¼-inches long, this means that this insulation will occupy .056 between each pair of coils. As there are four coils with three spaces between them, it means that the insulation between the coils will amount to .170 square inch. In addition to this insulation, a cover insulation will be needed to cover the outside of the coil. Let this insulation be 2¼-inches long and .025 thick; this will occupy .06 square inch. Each end of the coil must be insulated. This insulation will be .050 thick and ¾ wide or .08 square inch for both ends. The area of the insulation of the coil is the total of all of these individual insulations, or .42 square inch for insulation.

Adding this insulation area to the area required by the wire will give the total core window area needed to accommodate the coils. In our proposed design our windings require .922 square inches and our insulation requires .42 square inch. The finished coil will then require 1.342 square inches. We have not made any allowances for the unevenness and other discrepancies of hand winding or hand construction of the coil. It is necessary to make from 10% to as much as 40% allowance for winding and insulating. If you are careful, the lower percentages will apply, otherwise, the coils should be considered as requiring 30% or 40% of the calculated space requirements. In our present case, we will count on being quite careful and

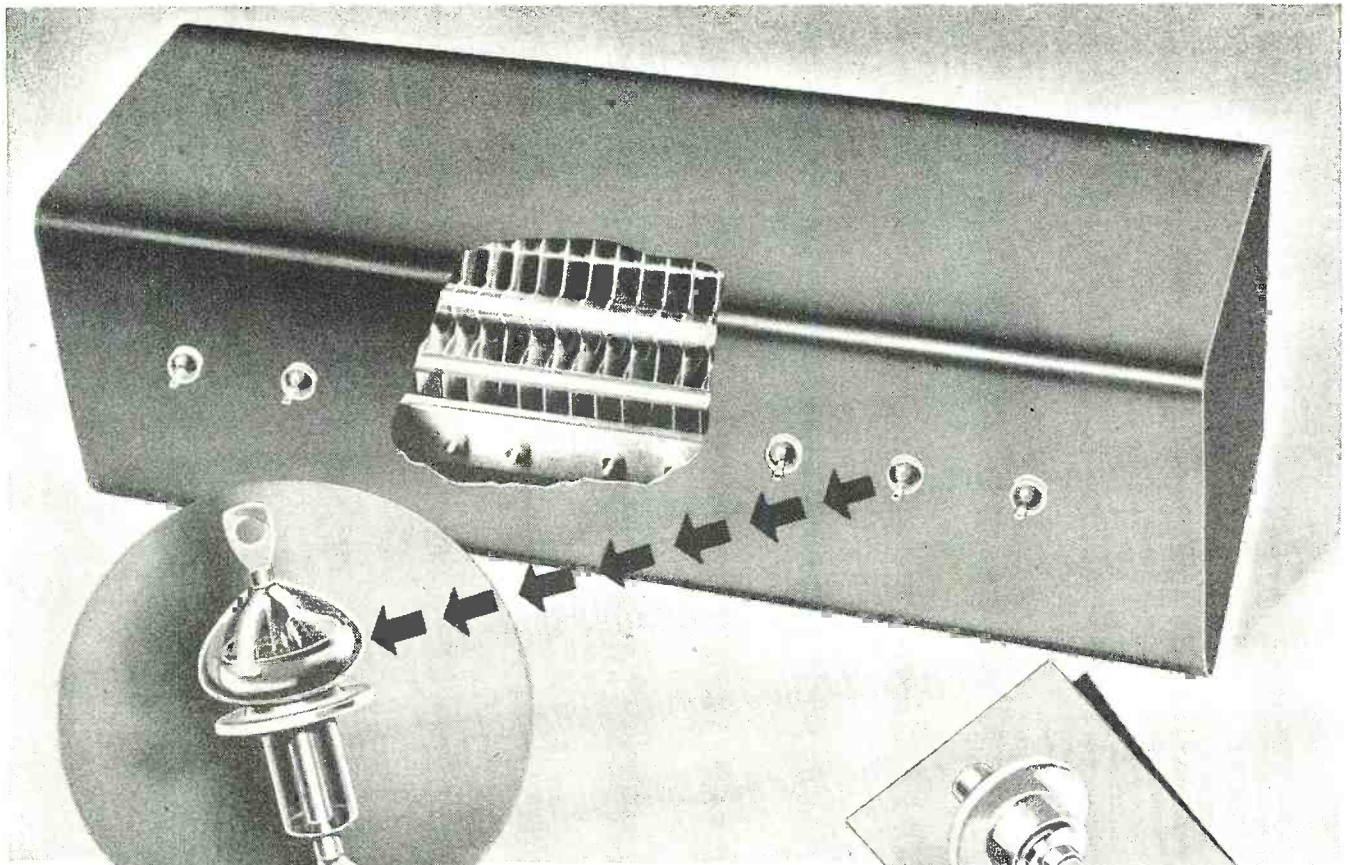

GIVE SENSITIVE EQUIPMENT  
AN IMPENETRABLE DEFENSE WITH

# Sperti Hermetic Seals

*Volume production! Prompt deliveries!*

Block the only points of entry for dust, fungus, moisture and other external elements that threaten the efficiency of equipment under tough military conditions. Adopt Sperti Hermetic Seals for capacitors, condensers, inductances, relays, vibrators, transformers and other component parts.

**ONE PIECE.** Glass and metal are fused into one piece to form a vacuum-tight hermetic bond. Resist corrosion. Have a thermal operating range of  $-70^{\circ}$  C. to  $200^{\circ}$  C. Insulation leakage resistance, 30,000 megohms, minimum, after Navy immersion test.

**SOLDERING TEMPERATURE NOT CRITICAL.** Simple, easy to attach by means of high frequency, oven-soldering or standard soldering iron.

**WIRE, WRITE OR PHONE TODAY** for information. Full details of planned use of Sperti Hermetic Seals will bring proper recommendations and desired samples, promptly.

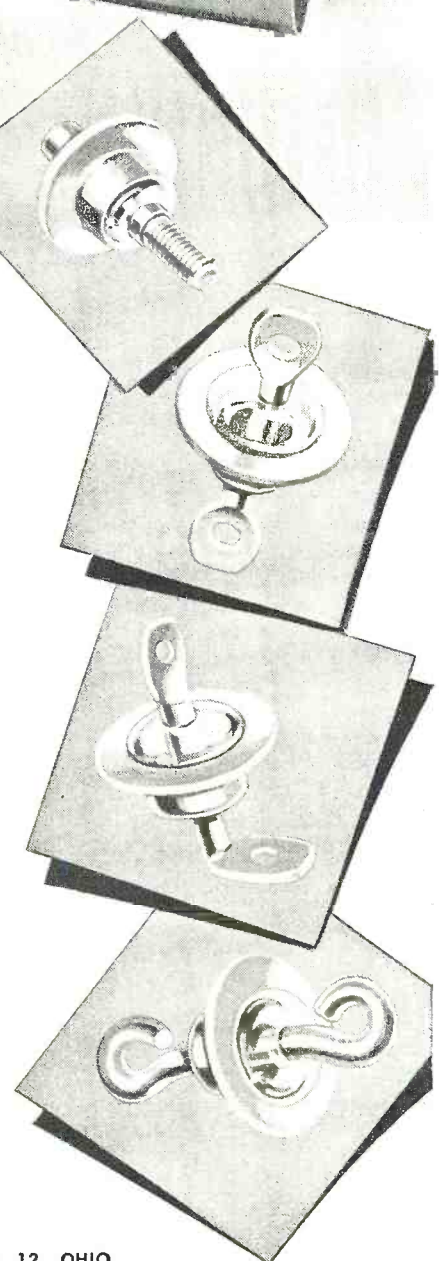

**Sperti** INCORPORATED



Electronic Division, Dept. RN-4

RESEARCH • DEVELOPMENT • MANUFACTURING • CINCINNATI 12, OHIO

# NEWCOMB

## Portable SOUND SYSTEM



Signal Corps Photo

**R**EADY for immediate action anywhere... only 39½ pounds... a complete, powerful sound system. Remarkable volume! Users report: practical on land up to ½ mile; at sea, up to 2 miles.

Ideal for use in amphibious operations, ship-to-ship communications where radio might be dangerous, life saving operations, civilian or prisoner control, cadet training, field instruction, any similar activity.

Unit includes: microphone, amplifier, power supply, loudspeaker. Write today for complete specifications.

**NEWCOMB**  
AUDIO PRODUCTS CO.  
COMPLETE SOUND SYSTEMS  
Dept. M, 2815 S. Hill St., Los Angeles 7, Calif.

Come to the famous  
**COYNE**  
TRAINING SHOPS  
where you learn by doing

TRAIN FOR **RADIO ELECTRONICS**  
IN 12 WEEKS

**Prepare For A War Time Job Now With A Peace Time Future!**

Trained Radio-Electronics men needed now. They will be needed too when the war is over. Don't be caught napping. Get a Radio training now and be ready when the war is over. Learn by Doing. Free employment services for life after graduation. Many earn while learning. If you are short of money, I'll finance your training. I will include extra training in Industrial Electronics at no extra charge. We also have facilities for men with physical disabilities. Write for details. I'll send you all details of my training and my offers. Fill in and mail coupon.

**SEND COUPON FOR FULL DETAILS**

H. C. LEWIS, President,  
COYNE ELECTRICAL & RADIO SCHOOL,  
500 S. Paulina St., Dept. 74-18, Chicago 12, Ill.  
Send Big Free Book about Coyne Spare Time Employment, "Pay After Graduation Plan, and Extra Industrial Electronics training.

NAME.....AGE.....  
ADDRESS.....  
CITY.....ZONE.....STATE.....

**RADIO RADAR ELECTRONICS SERVICE MEN**  
Repair Your Equipment in a Minimum of Time with the  
**ELECTRONICS TROUBLESHOOTING CHART**  
Indicates Common Causes for Set Failure and their Remedies. Uses Radio Keywords to Indicate Methods of the Oldtimers. Sent on Approval, \$1.00. Write Immediately.  
ALLIED RADIONICS AGENCY  
P. O. Box 365, DAVIS, CAL.

allow 20% for extra space. This 20% of 1.342 square inches is .268 square inch and adding this to our computed area we find our complete area, with allowances, is 1.610 square inches. As the window in the core that we have picked for this job is of ample size to accommodate this size of winding we may proceed with our design. (Our window area is 1.688 square inch.)

Now find the mean length of turn of each secondary and multiply this mean turn length by the number of turns in each secondary to find the length of wire required for each secondary. This also applies to the primary. Record this length, as it is our purchasing guide for our wire requirements. From a wire table find the resistance per 1000 feet of each size of wire to be used in the various secondaries. Calculate the resistance of the secondary windings. Multiplying the resistance of each winding by the current passing through the winding will give us the voltage drop in each winding. If the voltage drop is objectionable by being too high to give us our desired characteristics of voltage and current then add a few turns to the deficient windings to compensate for this voltage drop. Now square the current of each winding and multiply this by the resistance of each respective winding. This will give a product which represents the I<sup>2</sup>R or copper loss caused by heat in the windings generated by the passage of current. Note these copper losses and their sum as this factor will be used shortly in computing transformer efficiency. Finding the losses present in the core of the transformer is easily done by calculating the cubical contents of the core, and, knowing that silicon steel weighs .27 lb. per cubic inch, we can compute the weight of the core. Of course, it is also an easy matter to put the core on a scale and read the weight if a scale is handy. Our core losses will be about 1.7 watt per pound of core material. Multiply the weight of the core by 1.7 and the result will be the losses in the core in terms of watts. Add these loss figures together with the copper loss and the core loss figures, and their sum will give us the total losses of our transformer.

Take the wattage of the secondaries and multiply it by 100. Divide this product by the same wattage plus the total losses, including both copper losses and iron losses. This will result in a percentage factor which will be the efficiency of the transformer. Stated mathematically:

$$\text{Eff.} = \frac{W_s \times 100}{W_s + \text{losses}}$$

Chart I showing the design considerations of the various windings.

Winding	Volts	Current amps.	Wire size and insulation	Turns Req'd	Turns /in. <sup>2</sup>	Area Req'd in. <sup>2</sup>
Primary	115	1.5	19 Enam.	270	681	.397
Sec. #1	5	3.0	14 Enam.	12	221	.054
Sec. #2	6.3	4.0	14 Enam.	15	221	.068
Sec. #3	900	.2	28 Enam.	2115	5250	.403

The efficiency should be about 90% or better. If you have used a smaller wire size somewhere because you had it on hand, you may have increased the copper loss; if the core loss seems high do not reduce the core size, rather use a larger size wire on one or more of the windings to reduce the copper losses.

Lumping all the calculations of our last paragraph for our proposed transformer we find, first, that our mean turn length is approximately 7 inches. There are 270 primary turns, requiring 157 feet of No. 19 enamel wire. As secondary #1 and #2 use the same size wire, we can consider both at one time, and our wire requirement here is 16 feet of No. 14 enamel wire. Secondary #3 will require 1232 feet of No. 28 enamel wire. The resistance per foot of these wire sizes is: .002525 ohm per foot for No. 14; .008051 ohm per foot for No. 19 enamel; and .065 ohm per foot for No. 25 wire. The resistance of the various windings are:

Primary 1.26 ohms; secondary #1, .018 ohm; secondary #2, .022 ohm; secondary #3, 80 ohms.

The voltage drop per winding is: Secondary #1, .054 volt; secondary #2, .088 volt; secondary #3, 16 volts.

The voltage drop in secondary #3 is not objectionable. In order to compensate for our voltage drops in secondaries Nos. 1 and 2, and to overcome the resistance in the leads from the transformer to the sockets, we shall add one turn to each of these windings. Thus, we give them a new value of 13 and 16 turns respectively with the center taps now at 6½ and 8 turns. Change the previously made chart to these new values.

The current squared times the resistance of each winding is:

Primary, 2.8 watts; secondary #1, .16 watt; secondary #2, .35 watt; secondary #3, 3.2 watts. The total copper loss is 6.51 watts.

As the core has outside dimensions of 4½ by 3¼ inches and weighs 4.6 lbs., the core losses are 7.8 watts. The total losses are the sum of the copper and core losses or 14.3 watts. The efficiency of the transformer is:

$$\frac{W_s \times 100}{W_s + \text{losses}} \quad \text{or} \quad \frac{130 \times 100}{130 + 14.3}$$

Doing the mathematical operations indicated, we find that our efficiency is nearly 91%. As our efficiency figure is our check on the usefulness of our design and our efficiency is over 90% in this case, the design is fully satisfactory and we may go ahead and construct our transformer.

-30-

# Win WAR BONDS

A GRAND TOTAL OF

# \$1,000.00

IN PRIZES *for Your Ideas*

Midwest Radio Corporation—since 1920, famous for fine radios, and their factory-to-you selling plan with savings up to 50%—looks to the post-war future. To build the kind of radio you want, they ask you now to submit a letter on the subject: "What I Want In My Post-War Radio." For the 11 best letters, Midwest will give \$1,000.00 in War Bonds. Letters must not exceed 200 words and you may send as many entries as you wish. Letters will be judged on the practical value of the ideas contained, therein and the decision of the judges will be final. In case of ties, duplicate prizes will be awarded. All entries must be postmarked not later than midnight Dec. 31, 1944. Contest open to all except employees of Midwest Radio Corporation, their advertising agency, and members of their families. Winners will be notified on Jan. 31, 1945. Prizes will be awarded as follows:

**First Prize . . . . \$500 in War Bonds**

**Second Prize . . \$200 in War Bonds**

**Third Prize . . . \$100 in War Bonds**

**and eight prizes of a \$25 War Bond each.**

Send your entry to Contest Editor at  
**MIDWEST RADIO CORP., Dept. 11-H, Cincinnati 2, O.**



# MIDWEST RADIO

*Casting the International Meter Rods in Paris 1874. The degree of accuracy attained 1/10,000,000 of a quadrant of a terrestrial meridian.*

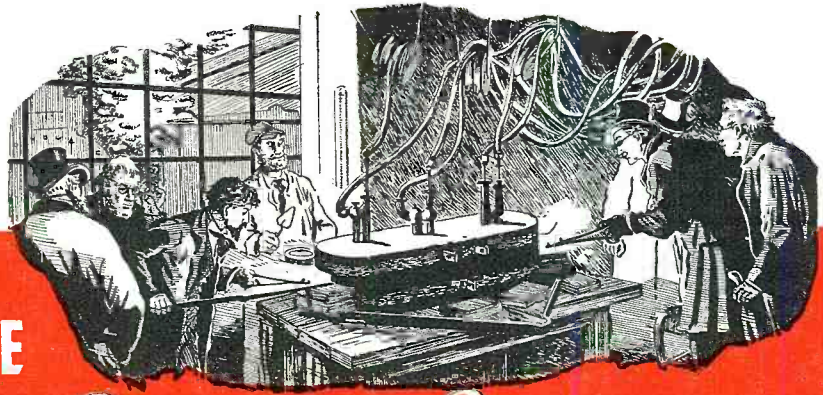

**WHO SETS THE**

*Quality Standard*  
**FOR TRANSMITTING TUBES**

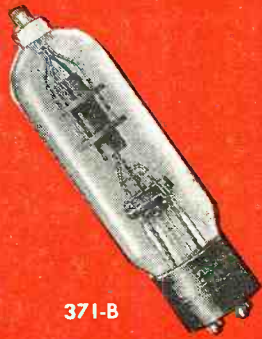

371-B



BW-II

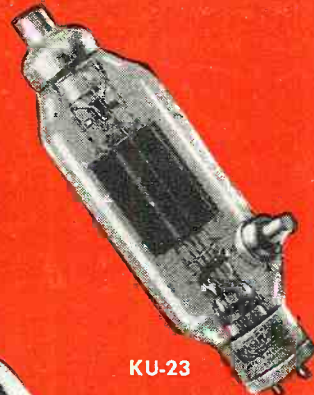

KU-23



813

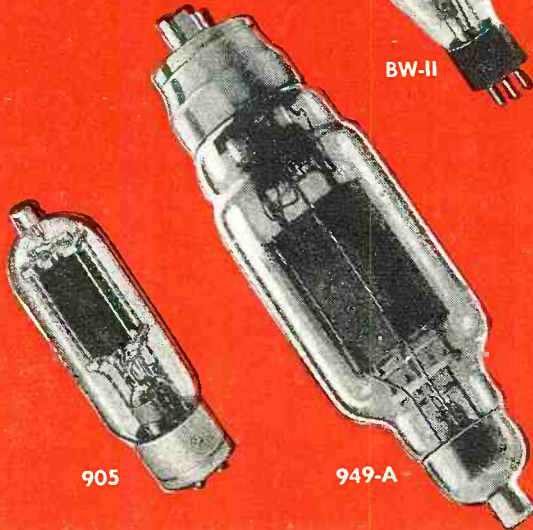

949-A

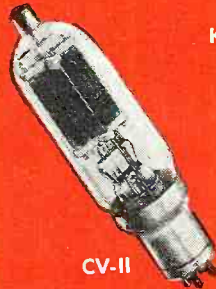

CV-II



967



972-A

**UNITED**



**TRANSMITTING  
TUBES**



**I**N every art or craft, the work of some acknowledged master sets the standard.

Since 1934 UNITED has won recognition by specializing exclusively in the engineering, design and building of transmitting tubes which are unchallenged for excellence. UNITED tubes excel in every electronic application . . . including radio communication, physiotherapy, industrial control and electronic heating. In these and other applications, tubes by UNITED continue to win top honors for uniformly dependable performance.

In communication equipment for airlines, commercial broadcasting, police radio stations and other vital civilian services, UNITED transmitting tubes set the standard. Accept nothing less than UNITED quality tubes for your requirements.

*Order direct or from your electronic parts jobber.*

**UNITED ELECTRONICS COMPANY**

NEWARK, 2

New Jersey

Transmitting Tubes EXCLUSIVELY Since 1934

# WHAT'S NEW IN RADIO

## New products for military and civilian use.

### COMPARISON BRIDGE

A production test instrument which is capable of testing resistors, capacitors and inductors rapidly, is being offered by *Industrial Instruments, Inc.*

This unit is an a.c. slidewire bridge with a vacuum tube null indicator arranged so that resistors, capacitors, or

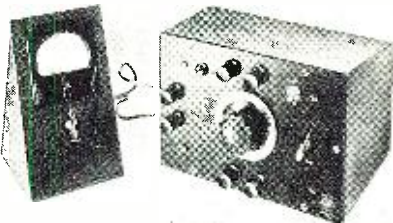

inductors can be compared with a similar standard. The capacitance range is from .0001 to 1.0  $\mu$ fd; the resistances which can be measured are between 2000 ohms and 20 megohms; while inductances between 5 and 50,000 henries may be recorded. The slidewire is uncalibrated as external standards must be used.

In use, the units to be tested are connected one by one to the "X" terminals and are passed or rejected as the result of readings obtained on the direct-reading indicating meter. Operation is simple and rapid as the operator reads the meter directly, without having to rotate dials or press buttons. Limits may be set up with any combination of high or low values; such as minus 6%, plus 14%.

The instrument includes the main unit with a separate meter on a stand. The net weight is 6 pounds.

Complete details of this bridge may be obtained by writing direct to *Industrial Instruments, Inc.*, 17 Pollock Avenue, Jersey City, New Jersey.

### NEW RHEOSTAT

Years of development and engineering have been incorporated in the new Type 58 wire-wound potentiometer or rheostat recently released by *Clarostat Mfg. Co., Inc.* of Brooklyn.

This control is fully capable of withstanding extreme vibration and mechanical abuse, such as might be encountered in wartime service.

The new design differs somewhat from the previous Type 58. A metal strap on the shaft face provides for the two-position locating pin which cannot break or tear off. The metal strap also grounds the metal cover which is clinched to it. The cover is keyed in place on the casing and will not loosen or turn.

The bushing is keyed into the bakelite case and will not slip or turn when the locking nut is drawn up tightly. High-grade molded bakelite cans eliminate corrosion and electrolytic action especially when the control is used on d.c.

The center rail and terminal are in one piece and there is a direct connection between the winding and the "L" and "R" terminal lugs. The terminals are so constructed that melted solder cannot get inside of the case.

Engineering data and ratings on various units may be obtained by writing direct to *Clarostat Mfg. Co., Inc.*, 285 North 6th Street, Brooklyn, New York.

### PANEL CUTTER

A new adjustable hole-cutting tool has been announced by *Bruno Tools* of Beverly Hills, California.

This tool, which is suitable for cutting wood, steel, brass, hard rubber and plastics, is available in two sizes each equipped with easily resharpened high speed steel blades. One model cuts holes to any diameter from  $\frac{5}{8}$  inch to  $1\frac{1}{4}$  inch through  $\frac{1}{8}$  inch thickness. The other model covers all expansions from 1 to  $2\frac{1}{2}$  inches through thicknesses up to  $\frac{3}{4}$  inch. These tools are designed to operate in light drill presses, portable drills or breast drills. They are also available with square shanks for use in hand braces.

Accuracy of the tool is assured by means of a drill which starts the hole and also serves as a pilot for the tool. Adjustment is obtained by loosening the hex bolt which holds a firm locking clip, and sliding the blade to the correct distance from the pilot.

The manufacturer recommends this tool particularly to radio men and those who have home workshops, for the drilling of panels and chasses. The

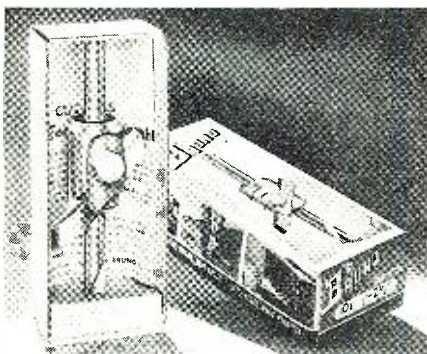

tool is available in most hardware stores, and electrical and radio shops. Further information may be obtained

from the manufacturer by writing *Bruno Tools*, 9330 Santa Monica Boulevard, Beverly Hills, California.

### HAND GENERATOR

A new type hand generator, with a maximum output of 100 watts, has been developed by the Carter Motor Company of Chicago.

This unit which is the largest permanent magnet hand generator manufactured requires no outside electricity of any kind to operate. Two men turning cranks which are designed to prevent breakage due to operational leverage, can, by watching the shatter-proof enclosed meter, keep the output



at the correct value. The unit contains a ripple meter for improved performance.

Output is to a four-pin connector but other types of output connections can be furnished.

The stand comes complete with seats and is totally collapsible, while a chain keeps the legs from spreading beyond holding position when the unit is set up.

Drive is by means of direct gears, and one of the gears is bakelite constructed, helical cut, to reduce operation noise to a minimum. The unit has waterproof seals on the shafts, and the metal needle is tipped with phosphorescent material, as is the "correct operations line" on the meter scale for nighttime operation.

The unit is made of cast aluminum to reduce weight and corrosion. The output supplies filament voltage and a d.c. voltage up to 500 volts. An a.c. output of 117 volts is also available. The weight of the unit is 37 pounds.

### PORTABLE STEEL MASTS

A new portable steel antenna mast 90 feet in height but weighing only 750 pounds has been developed by the *Harco Steel Construction Company*.

*We wish to  
acquaint you with*

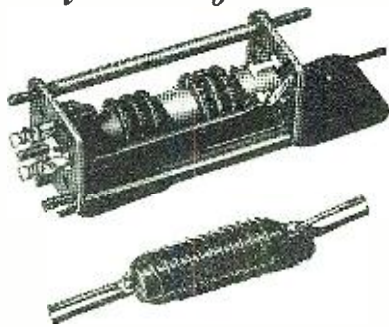

**STANWYCK**  
**R. F. COILS**  
and  
*Associated Assemblies*

There is a Stanwyck coil for every application in the Radio Frequency Spectrum — coils that have met the requirements of war and which will meet your requirements when the war is won . . . Send for folder describing our line and facilities.

**STANWYCK**  
*Winding Company*  
NEWBURGH. NEW YORK



*Manufacturer*  
**WANTS IDEAS  
OR PATENTS**

We are interested in the following:

1. Purchasing outright patents on products applicable for the Radio or Electronics field for post war.
2. We are interested in making an arrangement with an individual or firm whereby we would manufacture a patented product and pay a royalty on each one manufactured by us.
3. We are interested in communicating with an individual who has a workable idea or ideas with regard to developing and manufacturing new products or devices for the Radio and Electronics field.

Ours is a reputable, well rated organization that has made products for the radio industry for over 15 years. Now we are making parts and sub-assemblies for the Signal Corps.

If you have a patent or patented product for the above industries that you wish to sell or deal on a royalty basis, send us complete information. Negotiations will be handled by a principal of our firm. We prefer dealing with principals only.

BOX 369

**RADIO NEWS**

Empire State Bldg. New York 1, N. Y.

This unit can be erected by five men in approximately one hour, including every operation from the setting of the ground anchors to the attachment of the auxiliary crossarm at the top.

This mast is capable of withstanding a wind velocity of 125 miles per hour without ice, or 100 miles per hour with ¼ inch ice. The mast may be used as a single unit or two or more masts may be set up as a multiple unit for various types of antennas.

Built of light weight steel tubing, a relatively high strength-weight ratio is obtained. Each of the sections slides over or under the adjoining member for a length of 24 inches and both members are rigidly joined through an ingenious use of tapered bars and wedges.

These units have been built in various sizes and are available in heights from 25 to 300 feet.

Complete engineering data and specifications may be obtained from the manufacturer, *Harco Construction Company*, 1180 Broad Street, Elizabeth, New Jersey.

**LIGHTWEIGHT MAGNETO**

The latest product of the *Edison-Splitdorf Division of Thomas A. Edison, Inc.*, is the new Edison SF9LD-1 aircraft magneto that is more than six pounds lighter than any other magneto of the same capacity.

The instrument is installed as standard equipment on "Wildcats," Douglas "Dauntless" bombers, Curtis Scout and Grumman and Columbia amphibious planes. Although this magneto has been in service for some time, the Army Ordnance has only recently permitted information on this component to be released.

The unit is limited to nine pounds in weight through improved design rather than substitution of heavy metals with light weight alloys. The

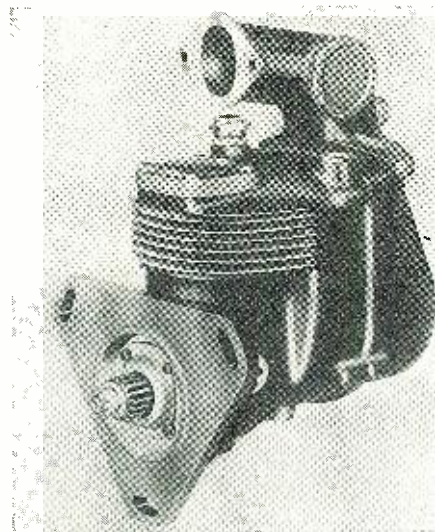

magneto is of the rotating magnet type. The rotor carries two laminated segments of soft iron placed over semi-circular cast Alnico magnets which are permanently magnetized. The rotation of the two pole rotor serves to direct the flux through the wide sec-

tions of the laminated pole pieces extending into the rotor tunnel, while the opposite ends form the extensions for the stationary coil which is mounted at right angles to the axis of the rotor.

This unit is not available at the present time for other than military applications, but postwar inclusion in commercial or private aircraft may be expected, according to the manufacturer.

**LIGHTED WALL SWITCH**

An electrically lighted wall switch that operates for less than two cents a year has been introduced by the *Associated Products Company* of Columbus, Ohio.

Known as the LumiNite Wall Switch



Plate, it features a tiny shielded light that comes on automatically when room lights are turned out, and remains off whenever room lights are burning. Besides making the switch easy to locate in the dark, it also serves as a safety or pilot light at night. Used as an indicator for lights removed at a distance from the control switch, such as attics and basements, this unit will help to conserve electricity by indicating which lights are on.

The plate is made from a single piece of ivory plastic, at the top of which is the housing for the fractional-watt glow lamp and mechanism. The unit fits any standard switch and can be installed quickly by connecting two wires to the terminals found on the switch.

The switch is available in some stores or can be ordered direct from the manufacturer, *Associated Products Company*, 74 East Long Street, Columbus, 15, Ohio.

**ADJUSTABLE TOOL HOLDER**

A new adjustable tool holder with a vise grip for use in lathes, shapers and planers has been announced by the *Robert H. Clark Company* of Beverly Hills, California.

This tool holder, by means of an exclusive principle of adjustability, makes possible the use of any of four or more sizes of tool bits in the same holder instead of requiring a separate holder for each size. Models are available in the 15 degree sloping cutter channel type and the horizontal or parallel channel type in both right and left hand offset. Each type is available in several shank sizes.

In addition, a special vise grip jaw



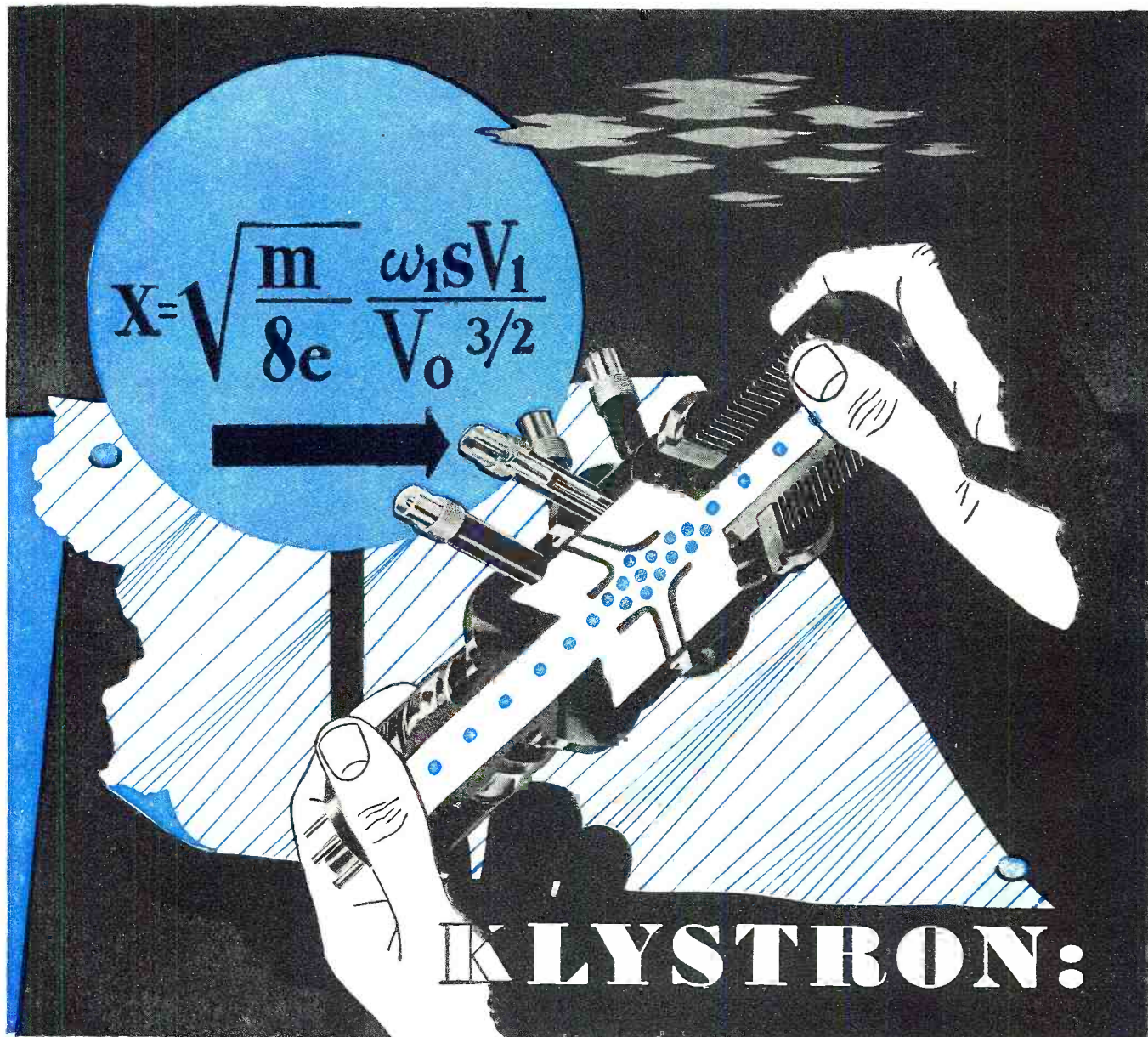

# KLYSTRON:

## Mathematically, here's the inside story

**T**HE FORMULA in the picture above is an expression of *bunching* as it takes place in the Klystron tube.

This Sperry tube converts DC energy into radio frequency energy by allowing an electron beam to become bunched, or pulsating, between spaced grids.

► The ultra-high-frequency micro-

waves thus generated can be concentrated into a narrow beam and directed with great accuracy.

Various other forms of the Klystron have been developed by Sperry to aid in the amplification and reception of ultra-high-frequency waves. Today they are vital parts of many a device used by our Armed Forces.

The name "KLYSTRON" is a registered trade-mark of the Sperry Gyroscope Company, Inc. Like other Sperry devices, Klystrons are also being made during the emergency by other companies.

► Klystrons are now being produced in quantities, and certain types are available. Write us for information.

### Sperry Gyroscope Company

GREAT NECK, N. Y. • DIVISION OF THE SPERRY CORPORATION

GYROSCOPICS • ELECTRONICS • AUTOMATIC COMPUTATION • SERVO-MECHANISMS

October, 1944

145

# Order From RADOLEK

## RADIO PARTS ELECTRONIC APPARATUS SOUND SYSTEMS

Make Radolek your dependable buying source for everything in radio, sound and electronics. We can supply essential merchandise to repair any radio—tubes, condensers, resistors, controls, transformers, etc.—all at lowest prices.

**Large Stocks:** Radolek's large stocks assure the finest and most complete selections of all available items. Thousands of servicemen rely on Radolek for their entire requirements.

**Fast Service:** Streamlined handling of every order simplifies procurement problems and gives you fastest possible delivery. Whatever your need—for industry, the Armed Forces or civilian replacement—ordering from Radolek saves time, effort and expense.

Get This Free  
Buying Guide



**SEND TODAY!**

RADOLEK CO., Dept. B-104  
601 W. Randolph St., Chicago, Ill.  
Please send your FREE Buying Guide.

Name .....

Address .....

DEALER

SERVICEMAN

SOUND ENG.

**SAVE AT RADOLEK**

**Do Not Burn Waste Paper  
It Is a Vital War Material**

## BARGAIN BULLETIN Radio and Electrical Parts

SAVE Time—Money—Worry!  
10,000 Items—Ready for Shipment.  
EXTRA SPECIAL—Sensational Vibrator  
Supply for Farm Radios. Complete and  
ready to install. Priced right.  
FACTORY OUTLET for Job Lots and dis-  
tress items. First come—first served.  
**BIG BARGAIN LIST—just off the press.**  
Write for YOUR copy TODAY.  
McGEE RADIO & ELECTRIC CO.  
R-944, 1225 McGee Street  
Kansas City—Missouri

## ELECTRICITY

Prepare for a Peace  
Time Future  
Electricity offers you opportunities  
for the best jobs today—with a real  
peace time future. Learn by  
Doing! on real machinery. Earn while  
learning. Right now I'm offering extra  
training in Industrial Electronics at no  
extra cost. Lifetime employment ser-  
vice after graduation. Get all-around  
practical training at Coyne in 12 weeks.  
If you are short of money, I'll finance  
your training. Mail coupon now for  
Free Book and all details. No obliga-  
tion and no salesman will call. I want  
to send you the facts and you decide.

H. C. LEWIS, President, COYNE ELECTRICAL SCHOOL  
500 S. Paulina St., Dept. 74-81, Chicago 12, Ill.  
Send free book and all details.

NAME \_\_\_\_\_  
ADDRESS \_\_\_\_\_  
CITY \_\_\_\_\_ ZONE \_\_\_\_\_ STATE \_\_\_\_\_

with a unique clamping action holds the bit vertically and horizontally with pressure evenly distributed over the entire holder, rather than with the more conventional manner of screw contact at a single point.

Short tool bits which might other-

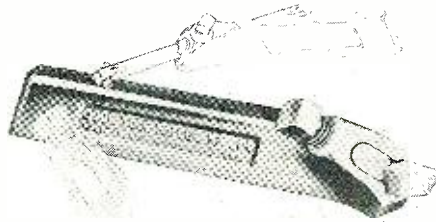

wise have to be scrapped, may be used in this holder.

The holders are made of drop forged tool steel and are heat treated and hardened for maximum resistance to wear. For sizes, prices and additional information, write the manufacturer direct at 9330 Santa Monica Boulevard, Beverly Hills, California.

### FILMGRAPH

A simplified method for making sound films without processing has been developed by Miles Reproducer Company, Inc.

The instrument consists of an electro-magnetic dual purpose head (the same head being used for recording and play-back), a sapphire stylus, a motor and necessary controls and connections. The unit is available in a cabinet complete with amplifier, speaker and microphone which weighs 16 pounds, or may be had without this equipment for those who have good amplifiers, speakers and microphones. The hookup between the Filmgraph and a separate amplifier is simple and easily made.

Recordings can be made on Filmgraph M-5 special film on which a number of sound tracks, up to 40, may be recorded or a recording may be made directly on 16 mm. film close to the sprocket holes so the sound track will not show on the screen. When the recording is made directly on 16 mm. motion picture film, the Filmgraph is placed alongside of or in front of the projector in such a position that it will not obstruct the showing of the picture.

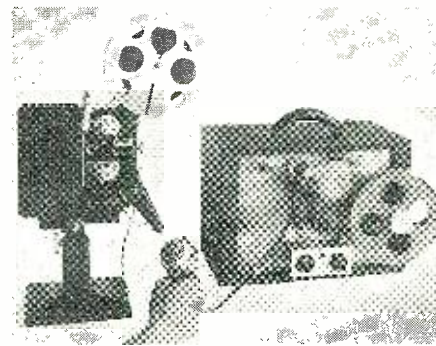

Recordings cannot be made directly on 8 mm. film because the speed of the 8 mm. projector is too slow for good

results. Owners of 8 mm. cameras, can record on M-5 special film and this film then used as an auxiliary. The auxiliary film is run at a ratio of two to one, the picture at 12 feet per minute and the recorded film at 24 feet per minute.

The sound is recorded after the picture is processed. Best results are obtained when a rehearsed script is synchronized while the picture being shown on the screen and then recorded by microphone directly onto the film.

Complete details of this unit are available from Miles Reproducer Company, Inc., 812 Broadway, New York, 3, N.Y.

### PLASTIC LACING CORD

A new plastic lacing cord, which is being marketed under the trade name "Bind-Tite," is being announced by The Art Chrome Company of America.

This cord is used to lace or tie electric wires or cables in electronic or switchboard work in place of the waxed twine normally used for such operations. The points of superiority, according to the manufacturer, include, fungus and insect proof for tropical applications, elasticity which is retained permanently, non-slip knots and permanent adherence to the wires.

Eligible persons may secure samples and further details of this cord by writing direct to The Art Chrome Company of America, 141 Malden Street, Boston, 18, Massachusetts.

-30-

### Spot News (Continued from page 138)

**POLICE RADIO STATIONS AGAIN DEMONSTRATED** their emergency value during a recent storm in West Virginia. Many thousands were saved when these stations were used to summon doctors, nurses and ambulances during the tornado that battered hundreds of homes. The State Police network, including aircraft and mobile units, served to coordinate communications between State agencies and municipal radio stations. So effective was this service that the West Virginia Department of Public Safety is now considering the installation of additional equipment, as well as auxiliary power plants for all emergency radio stations.

**THE REPORT THAT FCC COMMISSIONER JAMES LAWRENCE FLY** would resign was denied by the commissioner during recent interviews. He said, "In view of the unreliable rumors as to my resignation from the Federal Communications Commission, I should like to set this matter at rest. I have been in the government service for a continuous period of fifteen years. For some time I have been conscious of personal considerations which indicate the wisdom of my returning to the private practice of the law. However, there are a

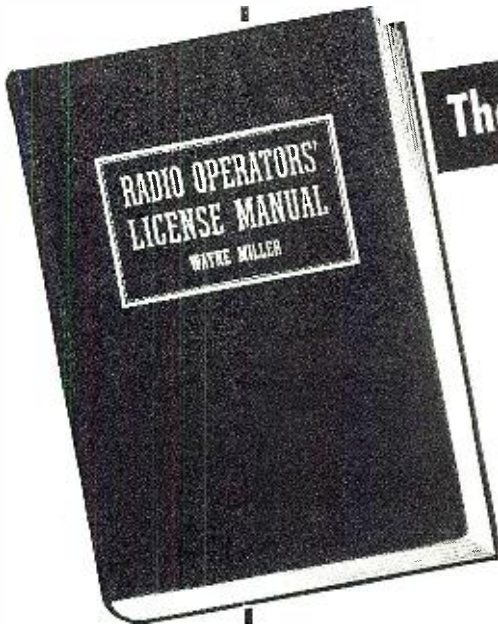

# The "Q" & "A" Radio Men Have Been Waiting For!

Covers the Federal Communications Commission examinations for all classes of licenses together with the proper answers, representing the scope of material from which examination questions will be prepared.

Written and compiled by Wayne Miller, consulting communications engineer, formerly with the Engineering Department, Federal Communications Commission.

- For all types of commercial radio licenses*
- Aviation . . . broadcasting*
- Facsimile . . . police*
- The questions that will be asked*
- The answers that should be given*
- Basic law*
- Basic theory and practice*
- Basic radiotelephony*
- Advanced radiotelephony*
- FCC rules and regulations*
- Field offices of the FCC*
- The "Q" code*

**\$3.00**



# Conquer The Code With Rhythm

An easy method for learning the code and touch typing in **one** process. Use the **same** book for home study which has been adopted by numerous radio schools.

- Concise and easily understood text*
- Starts with elementary principles*
- Supplies concrete advice for efficient operating*
- Touch-typing charts*
- Pen-lettering charts*
- How to construct a hand key!*
- How to construct a battery-powered, low power output vacuum tube oscillator!*

**\$2.00**

Excellently written practice material, organized in logical sequence.  
**DON'T WASTE TIME STUDYING OBSOLETE TEXTS!**

**Use this coupon TODAY**

**ZIFF-DAVIS PUBLISHING COMPANY**  
540 NORTH MICHIGAN AVE., CHICAGO 11, ILLINOIS

Ziff-Davis Publishing Company  
540 N. Michigan Avenue—Chicago 11, Illinois

Please Send:

.. copy(ies) Radio Operators' License Manual—Price \$3.00  
.. copy(ies) Radio Operators' Code Manual—Price \$2.00

Name.....

Address.....

City.....State.....

Amount enclosed (Postage prepaid for cash orders).  
 C.O.D

few jobs to finish around here, and I propose to see them finished. At the moment I have no definite plan except to remain here for some substantial period of time."

There are many projects to be completed, such as the Select Committee Investigation and possibly the White-Wheeler bill. Either of these major problems might be in the "few jobs to finish" class. However, there was no definite statement on this phase or other projects.

**THERE ARE NEARLY** three million receivers in Brazil, according to recent reports. This is quite an increase, for in 1928 there were only about two hundred thousand or so.

In Venezuela the Department of Commerce reports that there are about one hundred and fifty thousand receivers, and some five thousand radio phonograph combinations. The report also states that the majority of these receivers are equipped to receive shortwave broadcasts.

In Sweden there are about two hun-

dred and sixty-three receivers to every thousand persons. And at the last recording there were over a million and a half radio licenses issued for receivers.

**NATIONAL RADIO INSTITUTE** employees will hold a celebration luncheon at the Statler Hotel in Washington, October 18 in celebration of the Institute's 30th anniversary. Congratulations!

**A RECENT SURVEY OF FIVE THOUSAND** New York Central passengers revealed that radio was a *must* on trains. However, the radio equipment desired was the privately-operated type, which might be located on the backs of seats. Most objected to the public type of receiver which was called quite annoying. Passengers claimed that the individual receiver would supply the program best suited to the individual, and at a volume that could accommodate the personal requirements.

#### Personals . . .

**Beardsley Ruml**, treasurer of the Macy department store, is now a director of the Muzak Corporation, the wired radio outfit. . . . **Bernard F. McNamara** has become head of electronic research at Littelfuse, Inc. . . . **Homer R. Denius**, formerly with Crosley, is now the plant manager of the electronic division of John Meck. . . . **Charles R. Wexler** has also joined the John Meck staff as chief engineer. He was formerly with Magnavox Corp. . . . **Philip F. Siling**, assistant chief engineer in charge of broadcasting of the FCC, will become engineer in charge of the frequency bureau of RCA. . . . **A. Senauke** has been elected president of Amperex Electronic Corp., which incidentally becomes affiliated with the North American Philips Co. Inc. . . . **Nat Goldman**, senior partner, has retired because of illness. **Samuel Morris** becomes vice president in charge of sales and **Nicholas Anton** will serve as vice president in charge of manufacturing. . . . **O. B. Hanson**, vice president and chief engineer of NBC, will serve as chairman of the first annual conference of the Television Broadcasting Association which will take place on December 7th and 8th in New York City. **Jack R. Poppele**, chief engineer of WOR, will be conference coordinator. . . . **Edmund A. Laport** is now staff engineer for the international communications system of RCA, Camden, New Jersey. **James B. Knox** succeeds Mr. Laport as chief engineer for engineering products at RCA Victor Ltd. in Canada. . . . **J. H. Clippinger** has resigned from Admiral Corp. **John B. Huarisa** has been named executive vice president in charge of production and engineering. . . . **Charles H. McGee, Sr.**, chief of the orders and appeals section of the domestic and foreign branch, radio and radar division, WPB, has resigned to return to private practice.

## Wave Analyzers

(Continued from page 46)

and variable capacitors of the size required at these low frequencies do not ordinarily provide the wide tuning range required. It thus is more common to find in this type of instrument a relatively narrow basic dial range (e. g., 20 to 200 cycles per second) and a suitable decade multiplier. In this way, it becomes possible to cover the range 20-20,000 cycles per second in three steps with standard variable components—20-200, 200-2000, and 2000-20,000 cycles per second.

#### Special Design Considerations

In order for the wave analyzer, of whatever type, to function most efficiently, particular rules of effective instrument design must be observed in its development. *Input Impedance*, for example, is kept as high as practicable, in order to minimize loading effects upon the signal voltage source. *Oscillator Stability*, in the case of the internal variable-frequency stage, must be assured. *Stray Signal Pickup* at the frequency of operation is made negligible by appropriate overall and interstage shielding, decoupling, etc. Pickup of voltages at frequencies other than the one to which the instrument is tuned is prevented by the high selectivity of the analyzer. The effect of *Insertion Loss* of the overall instrument circuit and of its component stages is taken into consideration in the initial calibration. *Drift* in the fixed-frequency amplifier in terms either of resonant frequency or band width, is controlled by the use of stable circuits and thermal shielding where necessary. Where crystal filters are employed in this amplifier, they are arranged mechanically so that thermal changes will have the minimum effect upon the quartz plates. *Freedom from the Effects of Local Vibration* is achieved by efficient cushioning of susceptible parts and use of rigid wiring in critical circuits. Careful consideration of each of these expedients in development and manufacture provides an instrument of exceptional ruggedness and dependability with high retrace efficiency, and one which may be attached to signal voltage sources and operated by personnel with limited electronic training.

#### Measurement Range

Operational characteristics, though closely similar, vary somewhat with the type and manufacture of individual wave analyzers. An idea of the range of response and adjustments of such instruments may be had from an examination of the electrical scope of the analyzers illustrated in this article.

The instrument shown in Fig. 1, for example, will permit measurements in the range 300 microvolts to 300 volts full scale on the indicating meter—a range of 10<sup>6</sup>, or 120 db. With the 4-

**COMMERCIAL RADIO INSTITUTE**  
A radio Training center for over twenty-four years.  
**RESIDENT COURSES ONLY.**  
ACREDITED FOR VETERAN TRAINING  
Pre-induction. Broadcast. Marine. Telegraphy  
Aeronautical. Television. Service.  
Classes now forming for Fall term. Oct. 9th. Literature upon request.  
Dept. D., 38 W. Biddle St.  
Baltimore 1, Md.

**WOMEN IN RADIO?**  
Certainly. Making good, too—as radio technicians in broadcast stations, with airline companies, police radio networks, radio laboratories and radio mfg. plants. Our thorough course prepares for all these fascinating fields. Write for details, stating age and education. No salesman will call.  
**VALPARAISO TECHNICAL INSTITUTE**  
Dept. W Valparaiso, Ind.

**Guaranteed Rebuilt**  
**VIBRATORS—\$1.00 ea.**  
Send old vibrator. For very prompt delivery, enclose remittance and return postage. We rebuild any make or kind of vibrator or relay. Send your old vibrator to  
**BEST VIBRATOR CO., Box 5802**  
Cleveland 1, Ohio

**RADIO TECHNOLOGY**  
 RCA Institute offers an intensive two-year course of high standard embracing all phases of Radio and Television. Practical training with modern equipment. Also shorter specialized courses in Commercial Radio Operating, Radio and Television Servicing, and Aviation Communications. For Free Catalog write Dept. RN-44.  
**RCA INSTITUTES, Inc.**  
A Radio Corporation of America Service  
75 Varick St., New York 13, N. Y.

- AT HOME
- AT THE STORE
- AT THE OFFICE

**SAVE PAPER!**  
**Our Army Needs It!**

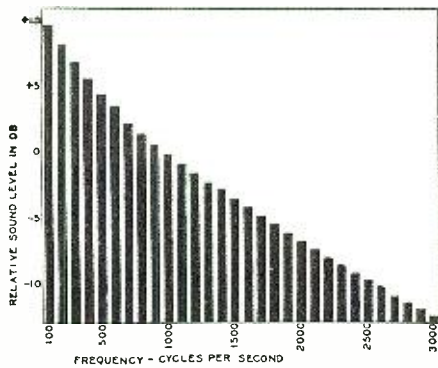

A wave analysis response showing relative contribution made by 100-cycle bands over the frequency spectrum, as obtained from analysis of noises of a general character.

cycle flat-top band width provided by the crystal filter, response of the instrument is 15 db. down at 5 cycles from the peak, 30 db. down at 10 cycles, and 60 db. down 30 cycles from the peak. The selectivity remains constant throughout the tuning range of the instrument. Voltage byproducts of the detector, in the form of high-order modulation components, are suppressed by 70 db., and hum by at least 75 db.

The analyzer shown in Fig. 6 permits measurements in the signal voltage range 50 microvolts to 500 volts. Full-scale values on the output meter cover 2.5 millivolts to 5 volts. Input and range multipliers permit full-scale meter deflections from 1 millivolt to 500 volts. Residual modulation products, due to detector action, are 65 db. below the maximum input signal voltage, and hum components are at least 75 db. below the maximum allowable signal voltage on any setting of the input multiplier. The fixed-frequency amplifier has a variable-selectivity characteristic, band width being varied by means of front-panel controls. The selectivity dial is graduated in the number of cycles off peak at which the response is 40 db. down (this is half band width).

The amplifier comprising the basic portion of the analyzer shown in Fig. 5 has a flat frequency response (plus or minus 2 db. between 25 and 7500 cycles per second), and its input impedance is between 20,000 and 30,000 ohms. The instrument covers the tuning range 25-7500 c.p.s. in five steps, and its average selectivity results in a 3 db. attenuation at settings 1% off the resonant peak to which the instrument is tuned. The instrument will handle signal voltages between 1 millivolt and 10 volts. The output voltmeter is logarithmic in response and permits a 100-1 voltage ratio to be observed without range switching.

Use of the wave analyzer is remarkably straightforward for an instrument of such great internal complexity. There are three general types of applications which cover most uses of this instrument—(1) direct measurement of component voltages in a complex waveform, (2) measurement of actual sound components, and (3) use

of the instrument as a highly-selective detector. Obviously, numerous other applications are subordinate to these general classifications. For example, use of the wave analyzer as a frequency meter for the identification of a single frequency might be listed under (3).

**Direct Measurement of Voltage.** This is the application included in distortion and similar measurements in the communications field with which the analyzer is usually associated. In this case, the analyzer input terminals are connected directly to the output circuit of the signal voltage source with its tuning dial set at zero or at the lowest frequency reading. Tuning upward, the fundamental frequency is first located, careful adjustment being made for maximum meter swing. The input attenuator is adjusted to give full-scale meter deflection. The various harmonics are then located by continuing the tuning upward in frequency, noting the voltage of each.

**Sound Measurements.** A microphone must be provided in this case to convert the sound energy into electric currents. With the heterodyne type of analyzer an audio amplifier will also be required, in order that the relatively low microphone voltage may be stepped up to a practical value. The gain of this amplifier will depend, of course, upon the amplification which will be required for raising the microphone output. The amplifier response must be flat and its own inherent distortion extremely low, otherwise calculations will be necessary for accurate determination of harmonic ratios. With the amplifier-type of analyzer (see Fig. 4), a crystal microphone may be used directly without additional amplification, since this instrument is fundamentally a sound analyzer and is provided with a microphone input jack.

In either of the two applications just described, the input gain may be set such that on the fundamental frequency the output voltmeter will give full-scale deflection. This point corresponding to 100% deflection is usually so marked on a meter scale with arbitrary graduations. Deflections for the various harmonics will then be direct indications of the percentage of those voltage components with respect to the fundamental voltage.

**Selective Detector.** In all applications, such as bridge null indication, wave filter adjustment, communications line adjustments and measurements and the like, where the indicating instrument must transmit only the test frequency, the wave analyzer finds wide acceptance as a highly selective detector. The instrument may be tuned precisely to the frequency of the test signal, with the test circuit disconnected. Ordinarily, its high input impedance renders the analyzer extremely useful in such tests because of the combination of minimum loading effects and high selectivity.

# LEARN CODE

the way you'll be using it

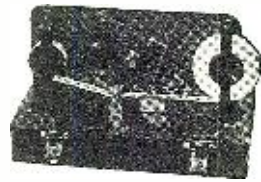

by SOUND

The best way to learn to read code is by listening to code. The best way to learn to send code is by hearing your own

sending repeated back to you. With the new All-Electric Master Teleplex Code Teaching Machine, you learn code the natural, easy, fascinating way. Only instrument ever produced which records your sending in visible dots and dashes—then SENDS BACK your own key work at any speed you desire. There are NO PERFORATIONS—NO INK. Far superior to anything ever developed... a marvel of simplicity. That's why practically every school teaching code uses MASTER TELEPLEX. We furnish complete course, including the All-Electric Master Teleplex, give you personal instruction with a MONEY-BACK GUARANTEE—all at a surprisingly low cost. Write today for FREE catalog RN-6. No obligation.

TELEPLEX CO., 107 HUDSON ST. JERSEY CITY, N. J.

**Radio AND ELECTRONIC DEVICES**

**BURSTEIN-APPLEBEE CO.**  
1012-1014 McGee St. • Kansas City 6, Missouri

**Free! TO PIPE SMOKERS SAVES YOU MONEY**

FREE! Six Months' subscription to PIPE LORE... crammed full of illustrations, helpful hints ('How To Keep Your Pipe Sweet', 'How To Blend Tobaccos'); pipe-news about new styles, inventions, and collections; pipe and tobacco bargains, pouches, racks, humidors, and pipe gadgets. We cater to pipe-smokers EXCLUSIVELY. Get the next six issues of Pipe Lore FREE, no obligation, of course. Act Now! Send this ad and your name and address to:

**WALLY FRANK, Ltd.,**  
10 E. 45th ST., NEW YORK 17, N. Y., DEPT. 110

**LEARN TO SEND** Correspondence Courses in **RADIO AND ELECTRICAL ENGINEERING**

**ELECTRICAL ENGINEERING** Get good electrical field. Prepare yourself at Low Cost, for secure future. Modern course. So simplified anyone can understand quickly.

**RADIO ENGINEERING** Extra fine course in radio, public address, photo-electric work. Train you to be super-service man, real vacuum-tube technician. Service men needed badly. Diploma on completion.

**WRITE** Send postcard or letter for Free LOW \$25 Either AS Course

**LINCOLN ENGINEERING SCHOOL, Box 618-70 Lincoln, Neb.** (Formerly of Washington, D. C.)

**PEN-OSC-LITE**

Extremely convenient test oscillator for all radio servicing: alignment • Small as a pen • Self powered • Range from 700 cycles audio to over 600 megacycles u.h.f. • Output from zero to 125 v. • In use by Signal Corps.

**GENERAL TEST EQUIPMENT CO.**  
38 Argyle Buffalo 9, N. Y.

**Specify SAUERISEN**  
**ACIDPROOF CEMENTS—COMPOUNDS**  
FOR  
Tanks, Sewers, Stacks, Floors  
Technical cements for all purposes.  
Send sketches or samples  
Sauerisen Cements Company • Pittsburgh 15, Penna.

# Wanted ENGINEERS

- Radio
- Chemical
- Electrical
- Electronic
- Mechanical
- Metallurgical
- Factory Planning
- Materials Handling
- Manufacturing Planning

Work in connection with the manufacture of a wide variety of new and advanced types of communications equipment and special electronic products.

Apply (or write), giving full qualifications, to:

C. R. L.

EMPLOYMENT DEPARTMENT

**Western Electric Co.**

100 CENTRAL AV., KEARNY, N. J.

Applicants must comply with WMC regulations

## Your Future

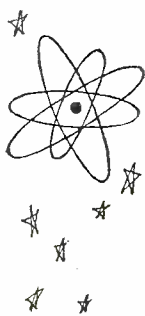

AS A  
Radio Engineer  
Assistant Engineer  
Layout Draftsman  
Laboratory Assistant  
Quality Tester  
Analyser  
Phaser

**depends on what you do now!**

Why not find out what Motorola offers you in future security, rapid advancement, recognition, and salary increases. The positions open are in Development, Specifications, Production, Engineering and Test Equipment. List your qualifications on one side of a sheet of paper. Name the position you want. We'll send you the details. Get your letter in the mail today.

**Motorola Radio**  
**GALVIN** MFG. CORPORATION, 4545  
AUGUSTA BLVD., CHICAGO 51, ILL.

## ★ INDUSTRIAL ★ MAN-POWER BUREAU

### An Exceptional Opportunity for Research Scientists

One of America's largest organizations engaged in conducting research for industrial corporations and governmental agencies is expanding its present staff of 300 people.

Research-minded engineers and scientists, who can measure up to this organization's high standard, are invited to investigate the wartime and postwar opportunities of the Armour Research Foundation.

Important work of challenging interest is open to scientists in the following fields:

<i>Physics</i>	<i>Automotive Engineering</i>
<i>Chemistry</i>	<i>Chemical Engineering</i>
<i>Metallurgy</i>	<i>Electrical Engineering</i>
<i>Ceramics</i>	<i>Mechanical Engineering</i>
<i>Electronics</i>	<i>Civil Engineering</i>

Men and women who can be released from present duties and meet the above qualifications are assured salary and opportunity commensurate with ability. And, future research commitments promise postwar permanence. If you are interested, please write immediately.

Applications are also invited from scientists who are on leave of absence from educational institutions for the duration.

ARMOUR RESEARCH FOUNDATION

37-A West 33rd Street, Chicago 16, Illinois

*Transmitting or Receiving*

### RADIO STATION TECHNICIANS

MEN AND WOMEN

for Point-to-Point International Radio-communications Stations in the United States and abroad

Applicants, possessing at least an F. C. C. Radiotelegraph Commercial License, are preferred.

Essential workers need release statement.

Apply weekdays except Saturdays between 10 am and 3 pm or write

PERSONNEL DEPARTMENT

**R.C.A. COMMUNICATIONS, Inc.**

64 Broad Street  
NEW YORK 4, N. Y.

### Engineers Wanted as APPLICATION ENGINEERS

Exceptional opportunity for several bright men, graduate engineers or equivalent, with imagination and ability to prove equipment and application. Radio, ultra high frequency or communication experience an asset. These positions provide excellent post war possibilities with one of the largest communication manufacturers in the world.

Write in full details, age, experience, education to Personnel Manager.

### FEDERAL TELEPHONE & RADIO CORP.

The Mfg. Unit of the I. T. & T.  
39 Central Ave., East Newark, N. J.

### RADIO ENGINEERS

At least two years' design and development experience with Radio Communications Equipment manufacturer on items subsequently satisfactorily produced in quantity. Knowledge and experience in two-way mobile equipment, low power transmitters, receivers, and control equipment essential. Permanent position. West Coast Manufacturer. Will pay expenses to coast for interview if qualifications satisfactory. Write giving complete past experience, employment record, salary received, and technical references.  
**BOX NO. 371** c/o RADIO NEWS

"This section is designed to help the radio industry obtain trained, experienced, technical men to facilitate vital war production. Before applying for any of these positions consult your local United States Employment Service office to determine War Manpower Commission regulations concerning the changing of jobs. If you are already employed in your work at your highest skill, stick to your present job."

## IS *Your* OPPORTUNITY HERE?

Think this over carefully. Where do you go from the spot you're in now? Are your surroundings friendly and full of promise for the future? Consider now the place you might fill in the electronic industry leadership assured to the fine staff of engineers, scientists, technicians at NATIONAL UNION RADIO CORPORATION. We're all young in years and ideas though most of us are old in electronic experience. We enjoy working together. We know we're going places! We're inviting you to join us if you have the qualifications. If you're looking for a success pattern for your future, it may be here with us at National Union. Find out! Come in and talk it over or write us!

### NATIONAL UNION WANTS:

- \* **QUALITY CONTROL ENGINEER AND SENIOR TUBE ENGINEERS**—These men **MUST** have executive ability and extensive experience with radio tube manufacture. The pay and opportunities are commensurate with your ability.
- \* **COMMERCIAL ENGINEERS**—Men with pleasing personalities, initiative and a knowledge of vacuum tube applications.
- \* **QUALITY CONTROL MEN**—Statistical Training is chief requirement though a knowledge of vacuum tubes will help.
- \* **JUNIOR ENGINEERS—MEN or WOMEN**—If you have a college degree in Physics, Electrical Engineering, Mathematics or Chemistry and are the type of young person who is able to 'go places,' you'll be starting with your best foot forward if you are accepted at National Union Radio Corporation.
- \* **FOREMEN and ASSISTANT FOREMEN**—Men with foremanship experience in exhaust, stem or grid operations in radio tube manufacture.
- \* **TECHNICIANS**—Maybe you've been repairing radios, maybe you've gained a knowledge of circuits by working on test equipment. It makes no difference either way if you have the 'know how' of circuits write us about the opportunities we have to offer!

### WOMEN!

We have a number of fine young women engineers with us now. We need more. If you have a degree in Electrical Engineering, Physics, Chemistry or Mathematics and are seeking career opportunities, investigate.

*Phone or Write*

**DR. L. GRANT HECTOR**

*Director of Engineering*

## NATIONAL UNION RADIO CORPORATION

### RESEARCH LABORATORIES

Plane St. at Raymond Blvd.

Newark 2, New Jersey

WMC RULES OBSERVED

### SERVICEMEN!

Can you write articles on construction, substitutions, repairing shortcuts, or other subjects of particular interest to radio servicemen for publication in a radio magazine? If you can, write and give us a list of the subjects on which you can prepare a 2000 or 3000 word article.

Reply, Box 370, RADIO NEWS, 540 N. Michigan Ave., Chicago 11, Ill.

### Openings for

**RADIO  
ENGINEERS**

•  
**ELECTRICAL  
ENGINEERS**

•  
**MECHANICAL  
ENGINEERS**

In the development and production of all types of radio receiving and low-power transmitting tubes. Excellent post-war opportunities with an established company in a field having unlimited post-war possibilities.

*Apply in person or in writing to:*

**PERSONNEL MANAGER**

**RAYTHEON**  
**MANUFACTURING COMPANY**

Radio Receiving Tube Division

55 Chapel St.

Newton, Mass.

### STATISTICIAN WANTED

preferably a B.S. or B.A.  
in **ECONOMICS**

must have some background in  
market research and writing reports

An excellent post war future for a  
capable man in the radio division of  
this internationally known company.

Essential workers need release

**FEDERAL**  
**TELEPHONE & RADIO CORP.**

The mfg. unit of the I. T. & T.  
39 Central Ave., East Newark, N. J.

### Technical Writers Wanted!

Engineers and physicists who have had experience in (spare time) writing technical manuscripts on electronic design or applications including radio, television, facsimile, etc. Highest rates.

Reply Box 310, c/o RADIO NEWS  
540 N. Michigan Ave., Chicago 11, Ill.

# ENGINEERS....

## Are You Concerned With YOUR POST WAR FUTURE?

The Federal Telephone & Radio Corporation, the manufacturing unit of the International Telephone & Telegraph Corporation with its multiple business activities extending to all parts of the civilized world, will accept applications from experienced men for immediate employment with almost limitless post war possibilities. These positions should interest those with an eye to the future and whose interest lies in forging ahead with this internationally known organization whose expansion plans for post war are of great magnitude covering all types of radio & telephone communications. Advancement as rapid as ability warrants. Majority of positions are located in the New York area! Essential workers need release statement.

We need the following personnel! Men with long experience or recent graduates considered.

- ENGINEERS
  - ELECTRONICS
  - ELECTRICAL
  - RADIO
  - MECHANICAL
  - CHEMICAL
  - TRANSFORMER DESIGN
- SALES AND APPLICATION ENGINEERS
- PHYSICISTS
- DESIGNERS
- DRAFTSMEN
- TOOL DESIGNERS
- TECHNICAL WRITERS

### *Look Ahead With Federal!*

If inconvenient to apply in person, write letter in full, detailing about yourself, education, experience, age, etc., to Personnel Manager.

**FEDERAL TELEPHONE & RADIO CORP.**

39 Central Avenue

EAST NEWARK

NEW JERSEY

## A WAR JOB FOR YOU

Men and Women Wanted

for

**RADIO WORK**

at

**WESTINGHOUSE**

Radio Amateurs, Radio Service Men,  
Ex-Service Men with Radio Training,  
Girl and Women Graduates of  
Radio Training Courses

are

needed to test

**Radio and Electrical Equipment**

All grades of positions open to fit  
individual electrical background.

Apply by letter or in person

to

Westinghouse Electric and Mfg. Co.  
2519 Wilkens Ave.—Baltimore 3, Md.

or

Susquehanna and Front Streets  
Sunbury, Pennsylvania

Those now employed at highest skill  
in essential industry need not apply

## FIELD SERVICE ENGINEERS

**For Domestic and  
Foreign Service**



Must possess good knowledge  
of Radio.

Essential workers need  
release.

**HAZELTINE  
ELECTRONICS CORP.**

58-25 Little Neck Parkway  
Little Neck, L. I.

## Noise Suppression

(Continued from page 49)

is bad sparking in operation, a closer examination should be made. In this instance, one of the brushes was not properly seated due to improper spring tension. The spring tension was increased and the commutator cleaned with carbon tetrachloride. A definite improvement was noted. By installing two  $\frac{1}{2}$   $\mu$ fd. capacitors as shown in Fig. 2 the air compressor noise was completely eliminated.

The fresh water pump motor was considered next. The commutator in this case was dirty and somewhat pitted. Cleaning and sanding improved its operation considerably. Installation of the capacitors as shown in Fig. 2 brought the noise level down to 10 db. However, increased capacity was ineffective in reducing the noise below this point. The necessity of removing the motor armature and turning down the commutator to remove the pits, was avoided when the receiver showed that this was causing very little actual noise as the noise field was not being picked up by the antenna to any great extent.

The main engines are considered next. These engines are apparently well shielded but due to the fact that the noise has gradually been increasing over a period of months it is probable that the shielding couplings are corroded. This trouble is very difficult to isolate because in all probability there are many points contributing to the noise. Time may be saved by giving all shielding a complete checking. At each end of every ignition lead the coupling should be opened for examination, and cleaned with steel wool or sandpaper. Steel wool should be avoided unless it is used away from the wiring and electrical circuits because of the possibility of metal threads that may cause considerable trouble if they get in the shields. To be effective the shielding must make good contact at all points with the coupling nut. If the shielding is broken it must be replaced. The shielding should be carefully and completely examined, not only for the purpose of eliminating existing noise but to prevent future trouble. Wires that are oil soaked and rubber which is rotted, or insulation broken on the high voltage leads, should be replaced with new wire. If the trouble persists, bypassing at the magneto or coil terminals and also at the switch on the dashboard should be tried.

The windshield wipers, although sometimes neglected since they are used only occasionally, are one of the serious sources of trouble. The noise level from these units is usually very high and since they are used in bad weather where the proper operation of the radio may be of utmost importance they should be considered carefully. Fortunately the trouble re-



sponds very nicely to a filter installed as shown in Fig. 2.

Due to the size of the wiper motor the capacitors must be mounted externally. For this purpose one of the many dual capacitors now on the market serves excellently. The capacitor should be mounted on the frame and a hole drilled in the case for the leads to enter. The leads may then be soldered to the brush holders and the hole in the case sealed with rubber tape. With these wipers a ground is usually so long that grounding only increases the noise level. In one instance the wiper noise could not be greatly reduced until the motor frame was insulated from the metal window frame. The noise then disappeared completely.

The starboard engine room blower may be silenced by two  $\frac{1}{2}\mu\text{fd.}$  capacitors connected as shown in Fig. 3. With these units it is often impractical, if not impossible, to mount the capacitors inside the motor housing, however they may be mounted on the motor frame and leads run into the terminal box through the power cord entrance.

The port engine room blower is so mounted as to require the complete removal of the blower to get into the motor terminal box. This is often a major operation. To avoid this, the power cord may be cut as close as possible to the motor and the filters connected at this point. This will usually give good suppression but their use should be avoided if at all possible.

Although the galley and forecabin blowers show no sound on the noise meter it is possible they may cause some noise in the receiver. However, it is well to install filter units on these blowers also. Although not troublesome at the present it is probable that as the motors age the noise will increase hence, installation of capacitors now may avoid trouble in the future.

The autopulse units are used as automatic primers on the engines and are used mainly on starting the engines. These units are very noisy because of vibrating contacts. They may be quieted by bypassing the battery lead to ground with a R.C. filter designed for vibrating contacts.

The battery charging generator which is driven by a gasoline engine may be silenced in the manner prescribed for the main boat engines. When the generator is thrown on, the noise comes to a maximum. These generators are usually equipped with filters on the brushes, mounted inside the generator. By taking off the cover plates these capacitors may be inspected for open circuits or poor connections. If necessary capacitors may be installed in the junction box to reduce the feedback of noise to the control panel.

The refrigerator will respond in the same manner as the blowers and other motors to corrective measures. It should be remembered that the common connection of the two capacitors

## PHOTO CREDITS

PAGES	
23	British Official Photos
25, 26, 27, 28, 124	Black Box Studios
32	F. Ross (Staff Photographer)
34, 36	Hytron
35	General Electric
37 (top)	AAF
37 (bottom), 38, 39	AACS
43	Acme
44 (Fig. 1, 2, & 3), 46 (Fig. 7 & 8), 149	General Radio Co.
47	P. and A. Photo
56, 57	British Press Service

should return to the frame of the motor and not direct to ground.

The boat may now be checked for over-all improvement by returning the noise meter to original positions and again turning on all the equipment. A considerable improvement should now be noted.

Although the foregoing sounds easy, it will be found in practice that many of the units are in inaccessible positions and considerable ingenuity will be required to silence completely all the units. Continued experimenting will usually bring the desired results.

Although it is always best where possible to reduce the noise to a minimum at the source, the hookup in Fig. 4 may sometimes be used to advantage. This device is familiar as a noise balancing circuit and it may sometimes be the solution to all of the problems. There are several disadvantages in this circuit, however; it is balanced for only one small frequency

range and must be rebalanced if the receiver is tuned to a different frequency; it will not give complete balancing when the noise is originating from several different sources since the noise antenna and receiving antenna will not pick up the same ratio of noise voltage from each source. There will be a small loss in the signal strength but this is usually negligible compared to the great improvement in signal to noise ratio. In one boat a similar unit completely eliminated a high noise level by utilizing the speaking tube to the engine room as a noise antenna. At any rate it may be well worth a try. The dimensions and data are given in Fig. 4. S3 is a double pole 4 position switch so connected as to maintain the pickup coil L2 balanced with respect to the center of L1.

In Fig. 5 is shown the diagram of a simple device which will pay for itself many times over in time and material saved. By connecting the test leads to the unit to be filtered, a flip of the switch will show quickly whether or not capacity is all that is needed to silence the noise and if so the minimum size capacitor that can be used satisfactorily. In case only a single capacitor is desired, a switch may be used to parallel the capacitors thus giving double the maximum capacity of the split connection.

-50-



# MOISTURE

## "Sealed Out"

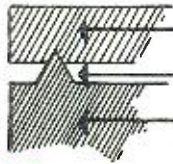

- GASKET
- SEALING RING
- BASE

### Moisture Proof

## OCTAL-TYPE BASE

HOWARD'S Octal-type base keeps out all moisture and dirt, in spite of contraction and expansion caused by heat and cold, by means of a gasket seated on a sealing ring. Designed for radio tubes, crystal holders, transformers, electrolytic condensers, and practically all types of plug-in equipment, this base is made in natural or black Bakelite and has *molded-in pins*. Write today to HOWARD for prices!

★ BUY WAR BONDS ★

# HOWARD MANUFACTURING CORP.

COUNCIL BLUFFS, IOWA

# INDEX OF Advertisers

Oct.  
1944

COMPANY	AGENCY	PAGE No.	COMPANY	AGENCY	PAGE No.
Aerovox Corporation	Austin C. Lescarboura & Staff	155	Mallory, P. R. & Co., Inc.	Aitkin-Kynett Co., Advertising	119
Allied Radio Corporation	Henry H. Teplitz Advertising Agency	62	Meck, John Industries	Western Advertising Agency	98
Allied Radionic Agency		140	Merit Coil & Transformer Corp.	Ross Llewellyn, Inc.	90
American Phenolic Corporation	Evans Associates, Inc.	99	Midwest Radio Corporation	Key Advertising Company	141
Armour Research Foundation	The Fensholt Company	150	Millen, James Mfg. Co., Inc.	James Millen, Inc.	12
Audak Company	Hart Lehman Advertising	8	Murdock, Wm. J. Co.	John A. Smith & Staff	68
Audel, Theodore & Co.	Grant & Wadsworth, Inc.	134	McElroy, T. R. Mfg. Co.	Shappe-Wilkes, Inc.	123
Fest Vibrator Company		148	McGee Radio Co.	Clyde H. Smith Advertising Co.	146
Eliley Electric Company	W. S. Hill Company	90	McGraw-Hill Book Co.		128
Breeze Corporation	Burke Dowling Adams & Co.	83	National Company, Inc.	Graydon Smith, Advertising	79
Burgess Battery Co.	Howard H. Monk and Associates	92	National Electronic Supply		110
Burstein-Applebee Company	Frank C. Whalen Advertising Co.	149	National Radio Institute	Vansant, Dugdale & Co.	3
Candler System	Van de Mark Advertising, Inc.	128	National Schools	The Mayers Company	109
Capitol Radio Engineering Institute	Henry J. Kaufman Adv.	78	National Scientific Products Co.	Kennedy & Co.	74
Centralab	Gustav Marx Advertising Agency	104	National Union Radio Corporation	Hutchins Adv. Agency	69, 151
Clare, C. P. & Company	J. R. Hamilton Advertising Agency, Inc.	86	Nelson Co.	A. N. Baker Advertising Agency	122
Commercial Radio Institute		148	Newcomb Audio Products	Dozier Graham Eastman Adv.	140
Connecticut Telephone & Elec. Div.	Wilson & Haight, Inc., Advertising	71	Ohmrite Manufacturing Co.	Henry H. Teplitz Advertising Agency	61
Consolidated Radio Products Co.	Burton Browne Advertising	127	Onan, D. W. & Sons	Pioneer Advertising Company	126
Cornell Dubilier	Reiss Advertising	21	Panoramic Radio Corporation	Shappe-Wilkes, Inc.	91
Cornish Wire Company, Inc.	Hart Lehman Advertising	130	Permoflux Corporation	Turner Advertising Agency	82
Coyne Electrical School	McJunkin Advertising Co.	140, 146	Radio & Technical Division of Murray Hill Books, Inc.	Harry P. Bridge Co., Advertising	84, 85
DeForest's Training, Inc.	MacDonald-Cook Co.	105	R.C.A. Communications	Albert Frank-Guenther Law, Inc.	150
DeJur-Amsco Corporation	Shappe-Wilkes, Inc.	63	R.C.A. Institutes, Inc.		148
Doolittle Radio	Henry H. Teplitz Advertising Agency	131	R.C.A. Victor Division	Kenyon & Eckhardt, Inc.	73
DuMont, Allen B. Labs.	Austin C. Lescarboura & Staff	125	Radio Parts Co.	Sidney S. Lovitt	108
Echophone Radio Company	Burton Browne Advertising	22	Radio Tube Service	Daniel DeKoven	112
Electro-Voice Mfg. Co.	Shappe-Wilkes, Inc.	77	Radolek Company	Turner Advertising Agency	146
Electronic Corp. of America	Shappe-Wilkes, Inc.	20	Raytheon Manufacturing Co.	Burton Browne Advertising	115, 151
Fada Radio & Electric Co.	Sternfield-Godley, Inc.	7, 120	Rider, John F. Publisher, Inc.	Lansford F. King	96
Fawcett Publications	Hill Advertising, Inc.	138	Runzel Cord & Wire Company	Duane Wanamaker Advertising	137
Federal Telephone & Radio Corp.	Commerce Adv. Agency	150, 151, 152	Sauereisen Cements Co.		149
Federal Telephone & Radio Corp.	Marshalk & Pratt	10, 11	Shure Brothers	Henry H. Teplitz Advertising Agency	93
Galvin Mfg. Corporation (Motorola)	Gourfain-Cobb Advertising Agency	150	Simpson Electric Company	Kreicker & Meloan	129
Gates Radio & Supply Co.	Henry J. Kaufman Advertising	135	Snyder Mfg. Co.	Philip Klein Adv. Agency	100
General Cement Manufacturing Co.	Turner Advertising Agency	136	Solar Manufacturing Corp.	O. S. Tyson & Company, Inc.	13
General Electric Company	N. W. Ayer & Son, Inc.	19	Sperry Gyroscope Co.	Young & Rubicam, Inc.	145
General Motors, Delco Division	Campbell-Ewald Company	9	Sperli, Inc.	Stockton-West-Burkhart, Inc.	139
General Test Equipment	Suzanne Hayman, Advertising	149	Sprague Products Co.	Harry P. Bridge Co. Adv.	67
Gothard Manufacturing Co.	Merchandising Advertisers	120	Sprayberry Academy of Radio	Harry P. Bridge Co., Adv.	15
Gothard Manufacturing Co.	Howard H. Monk and Associates	132	Standard Transformer Corp.	Burnet-Kuhn Advertising Co.	64
Greenlee Tool Company	Kennedy & Company	65	Stanwyck Winding Co.	Franklin Advertising Service	144
Guardian Electric Mfg. Co.		100	Stevens-Walden, Inc.	Howard-Wesson Co.	14
Haldorson Company	Burton Browne Adv.	5, Back Cover	Superior Instrument Corp.	Loewy Advertising Agency	117
Halicrafters	Roeding & Arnold, Inc.	24	Supreme Instruments Corp.	O'Callaghan Adv. Agency, Inc.	72
Hammarlund Mfg. Co., Inc.	Lewis Advertising Agency	114	Supreme Publications	Henry H. Teplitz Advertising Agency	130
Harco Steel Construction Co.	Shappe-Wilkes, Inc.	76	Sylvania Electric Products, Inc.	Arthur Kudner, Inc.	16
Harvey Radio Co.	Equity Advertising Agency	152	Teleplex Company	Cerrill Belknap Marsch Associates	149
Hazeltine Electronics Corp.	Bozell and Jacobs	153	Templetone Radio Co.	Peck Advertising Agency	81
Howard Manufacturing Corp.	Henry A. Loudon Advertising	2nd Cover	Tobe Deutschmann Corp.	Franklin Bruck Adv. Corp.	156
Hytron Corporation		138	Triplett Electrical Instrument Co.	Western Advertising Agency	17
Illinois Condenser Co.	Sander-Rodkin Advertising Agency	138	The Turner Company	W. D. Lyon Co.	70
Industrial & Commercial Electronics	Garfield & Guild Advertising	121	United Electronics Co.	H. W. Lewin Co.	142
International Detrola Corp.	Zimmer-Keller, Inc.	103	United Transformer Co.	Shappe-Wilkes, Inc.	94
International Resistance Co.	Lavenson Bureau	106	Universal Microphone Co., Ltd.	Ralph L. Power, Ph.D.	87
Jensen Industries, Inc.	Allen D. Parsons, Advertising	116	Utah Radio Products Co.	The Buchen Company	113
Jensen Radio Mfg. Company	Burton Browne Advertising	6	Vaco Products Co.	Duane Wanamaker, Advertising	134
Johnson, E. F. Co.	David, Inc.	3rd Cover	Valparaiso Technical Institute	Smith, Benson & McClure, Inc.	148
Kato Engineering Co.		132	Wallace, William T. Mfg. Co.	Michael F. Mayger, Adv.	104
Knights, James Company	Turner Advertising Agency	101	Wally Frank, Ltd.	Dundes & Frank, Incorporated	149
Lafayette Radio Corporation	Shappe-Wilkes, Inc.	102	Ward Leonard Electric Co.	E. M. Freystadt Associates, Inc.	13
Lake Radio Sales	Sander-Rodkin Advertising Agency	122	Ward Products	Burton Browne Advertising	133
Lear Avia, Inc.	Arthur Kudner, Inc.	75	Warwick Manufacturing Company	Agency Service Corporation	111
Lincoln Engineering School	Buchanan, Thomas Adv. Co.	149	Western Electric Co.	Deutsch & Shea	150
			Westinghouse Electric & Mfg. Co.	Fuller & Smith & Ross, Inc.	89, 152
			Wholesale Radio Laboratories	Allen & Reynolds	118

**Classified**  
Rate 20c per word, Minimum, 10 words

**CORRESPONDENCE COURSES**

PREPARE now for tremendous opportunities in new fields of Radio after the war. Training for Federal licenses. Write for particulars. American Radio Institute, 44 East 23rd St., New York 10, N. Y.

USED Correspondence Courses and Educational Books sold or rented. Inexpensive. Money-back guarantee. Write for Free Catalog listing 4000 bargains.—(Courses Bought.)—Lee Mountain, Pisgah, Ala.

CORRESPONDENCE Courses and self-instruction books, slightly used. Sold. Rented. Exchanged. All subjects. Satisfaction guaranteed. Cash paid for used courses. Complete information and 92-page illustrated bargain catalog FREE. Write Nelson Company, Dept. 2-59, Chicago 4.

**RADIO ENGINEERING**

RADIO Engineering, Broadcasting, Aviation and Police Radio, Servicing, Marine Operating and Electronics taught thoroughly. Expenses low. Write for catalog, Valparaiso Technical Institute, Dept. N, Valparaiso, Ind.

**PATENT ATTORNEYS**

INVENTORS—Before disclosing your invention to anyone, send for Form "Evidence of Conception"; "Schedule of Government and Attorneys' Fees"; and instructions. Sent free. Lancaster, Allwine & Rommel, 414 Bowen Building, Washington 5, D. C.

INVENTORS sell your ideas! Selected list 65 manufacturers anxious to buy inventions for post-war products, including special sales instructions. \$1.00 postpaid. Science and Mechanics Magazine, 823 St. Clair Bldg., Chicago, Ill.

**RADIO EQUIPMENT**

RADIO Service men and experimenters send for our giant radio catalogue. Save dollars. United Radio Co., (1000M) Newark, N. J.

**WANTED**

WANT to buy Automobile Radios. State type, quantity, and price. L. S. Jullien, Inc., 1443 P Street, N.W., Washington 5, D. C.

WANTED: back issues, Wireless Engineer, Electrical Communications, Phillips Technical Review, Electrical Engineering, Journal I.E.E., G.E. Review. Grote Reber, Wheaton, Ill.

WANTED: GRADUATE JUNIOR AND SENIOR Mechanical and Civil Engineers. Excellent immediate and post-war opportunity for qualified engineers who have specialized on Stress Analysis. Apply by letter only to: Lear Avia, Inc., Piqua, Ohio. R. J. Biggs, Special Representative. Must comply with W.M.C. regulations.

**FOR SALE**

CLOSING out stock of 2,000 new Radio and Amplifier Tubes. Send for list. Roxy Radio Repair, Mitchell, S. D.

BUILD a radio, complete kit with tubes, \$9.95. Details Radio, 911 New York Ave., Brooklyn, N. Y.



**A liberal choice  
of types to meet most electrical  
and mechanical requirements...**

**AEROVOX**

*Electrolytics*

● Along with pioneering the dry electrolytic capacitor for radio, electronic and motor-starting functions, Aerovox has always maintained an outstanding choice of types.

The new Aerovox Capacitor Catalog now off the press lists 17 types of electrolytics—round-can, square-can, cardboard-case, tubulars, plug-ins, twist-prong base, etc. You will usually find a type listed that precisely meets your capacitance, voltage, mounting, terminal and container requirements. But if your requirements happen to be very unusual, this wide variety of designs enables Aerovox to work out a special type to meet those high-priority needs quickly, satisfactorily, economically.

● **Write for Literature...**

Write on your business stationery for latest catalog on electrolytics. Submit that capacitance problem for our engineering collaboration, specifications, quotations.



*Capacitors*

**INDIVIDUALLY TESTED**

**AEROVOX CORPORATION, NEW BEDFORD, MASS., U. S. A.**

**SALES OFFICES IN ALL PRINCIPAL CITIES**

**Export: 13 E. 40 ST. NEW YORK 16, N. Y. • Cable: 'ARLAB' • In Canada: AEROVOX CANADA LTD., HAMILTON, ONT.**

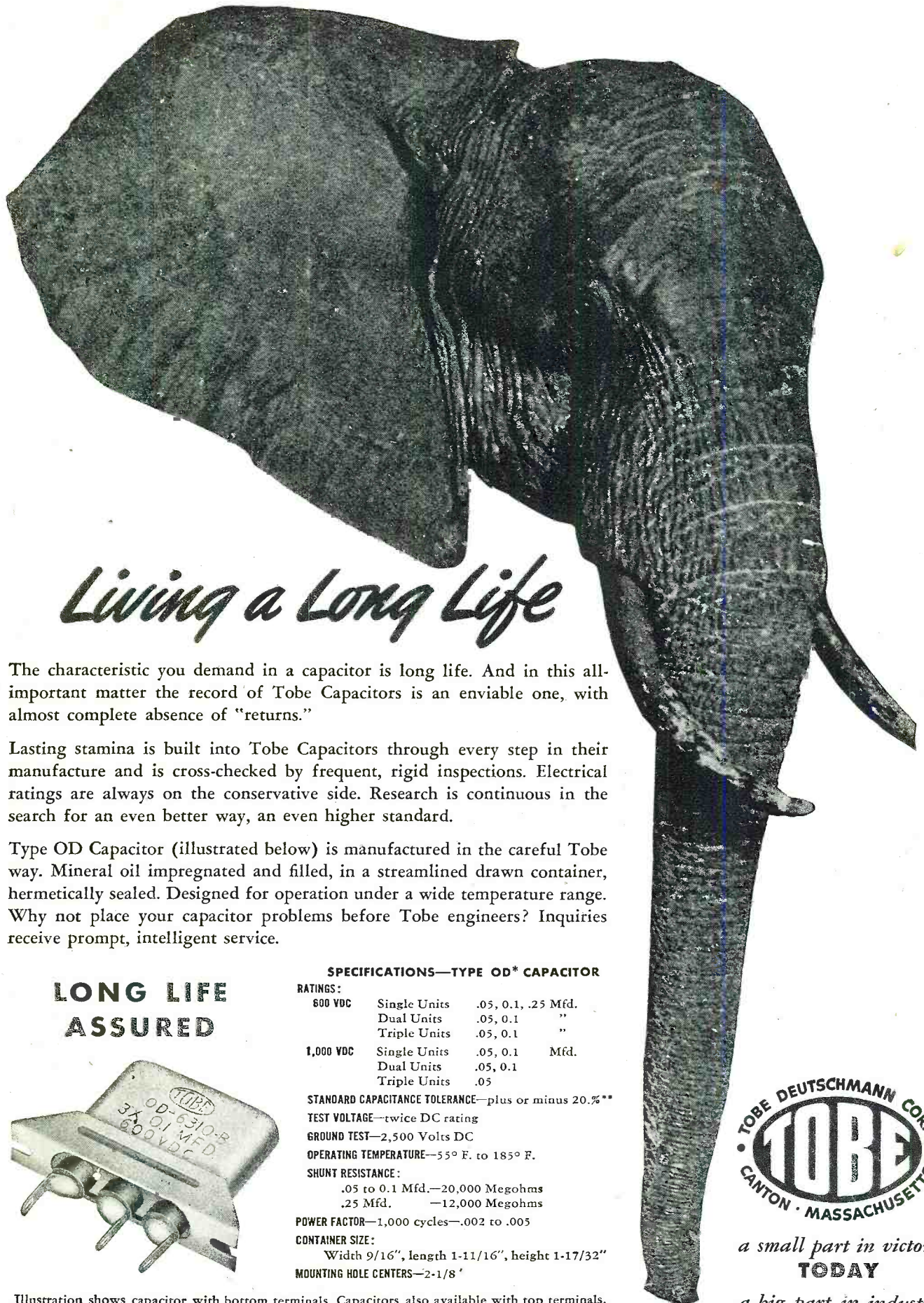

## Living a Long Life

The characteristic you demand in a capacitor is long life. And in this all-important matter the record of Tobe Capacitors is an enviable one, with almost complete absence of "returns."

Lasting stamina is built into Tobe Capacitors through every step in their manufacture and is cross-checked by frequent, rigid inspections. Electrical ratings are always on the conservative side. Research is continuous in the search for an even better way, an even higher standard.

Type OD Capacitor (illustrated below) is manufactured in the careful Tobe way. Mineral oil impregnated and filled, in a streamlined drawn container, hermetically sealed. Designed for operation under a wide temperature range. Why not place your capacitor problems before Tobe engineers? Inquiries receive prompt, intelligent service.

### LONG LIFE ASSURED

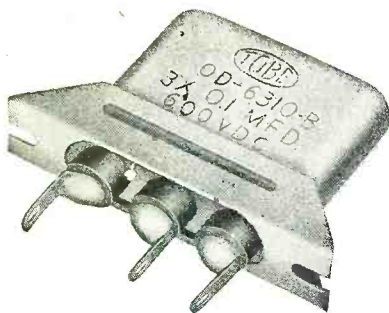

#### SPECIFICATIONS—TYPE OD\* CAPACITOR

##### RATINGS:

600 VDC	Single Units	.05, 0.1, .25 Mfd.
	Dual Units	.05, 0.1 "
	Triple Units	.05, 0.1 "
1,000 VDC	Single Units	.05, 0.1 Mfd.
	Dual Units	.05, 0.1 "
	Triple Units	.05

STANDARD CAPACITANCE TOLERANCE—plus or minus 20.%\*\*

TEST VOLTAGE—twice DC rating

GROUND TEST—2,500 Volts DC

OPERATING TEMPERATURE—55° F. to 185° F.

##### SHUNT RESISTANCE:

.05 to 0.1 Mfd.	—20,000 Megohms
.25 Mfd.	—12,000 Megohms

POWER FACTOR—1,000 cycles—.002 to .005

##### CONTAINER SIZE:

Width 9/16", length 1-11/16", height 1-17/32"

MOUNTING HOLE CENTERS—2-1/8"

Illustration shows capacitor with bottom terminals. Capacitors also available with top terminals.

\*Data sheets showing complete code number for units having a specific capacitance value and voltage ratings available on request. \*\*Other tolerances available.



a small part in victory  
**TODAY**

a big part in industry  
**TOMORROW**

**RADIO NEWS**

# New Development

Decreased Spacing  
Shorter Length  
Lower Minimum  
Less Inductance

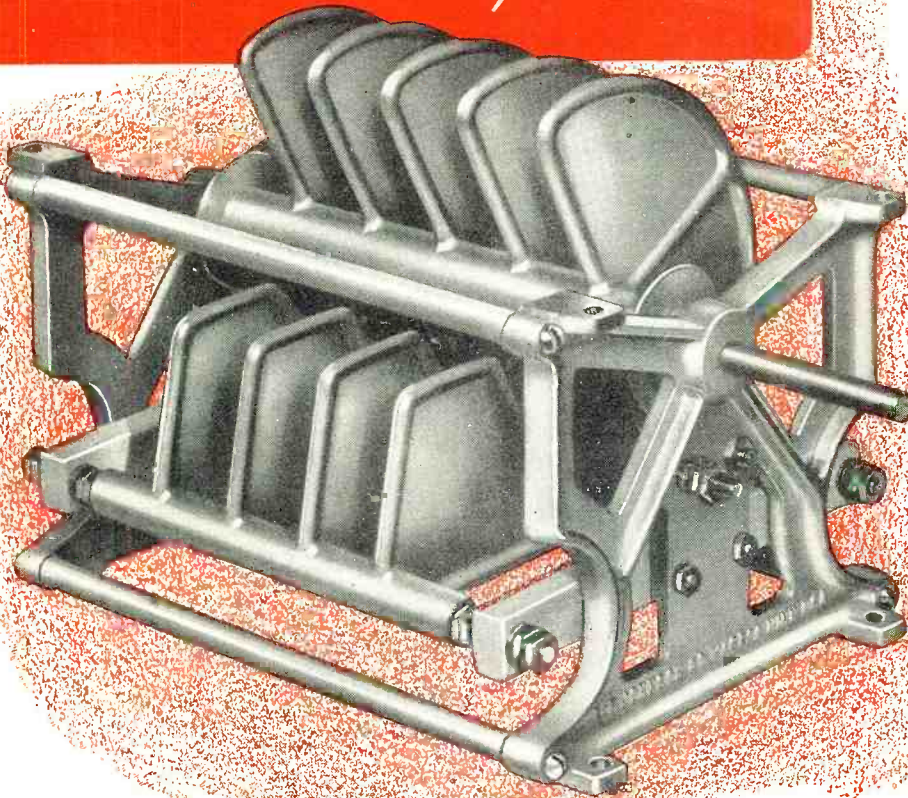

Again Johnson scores a first with newly designed thick plates which allow much higher voltages, particularly at high frequencies.

It has long been known that plates with rounded edges have higher breakdown voltages in variable condensers, but it remained for Johnson Engineers to work out ratios of plate thickness, design, voltage, and spacing for maximum advantage.

Greatly decreased length (as much as one-third in some cases) results in lower minimum capacity and lower inductance due to shorter frame rods and other metal parts, which is extremely important at high frequencies.

Corona is noticeably less with the new type plates and corona shields have been added where stator bars enter insulators, resulting in still further improved performance.

Despite these many improvements, in most cases prices are lower because of the saving in material.

Now available in Types A and B, both fixed and variable, this new plate shape and construction will be incorporated in other types as quickly as possible. Write Johnson today for more information and for recommendations on YOUR variable condenser application.

New Catalog 968-Z now ready.

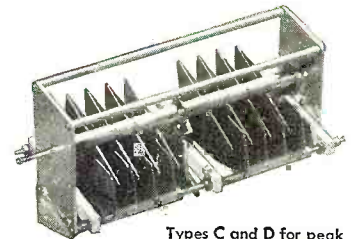

Types C and D for peak voltages of 3500 to 13,000

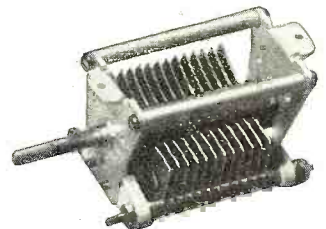

Types E and F for peak voltages of 2000 to 4500

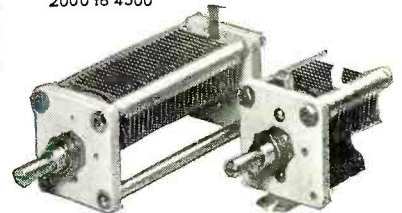

Type H for peak voltages of 1500 to 3000



Type N neutralizing condensers in 5 sizes

# JOHNSON

*a famous name in Radio*



E. F. JOHNSON COMPANY • WASECA • MINNESOTA

# THERE'S GOLD HERE!

*another new letter contest*



**\$200<sup>00</sup> in prizes every month**

**\$100.00 first prize, \$50.00 second prize, \$25.00 third prize, \$15.00 fourth prize, \$10.00 fifth prize, plus \$1.00 for every letter received.**

Here we go again. Another great Hallicrafters letter contest for service men. Wherever you are, whenever you see this announcement, drop us a line. Write and tell us your first hand experience with *all* types of radio communications built by Hallicrafters, including the famous SCR-299.

*There is gold here!* Write today to get your share. Tell us your story in your own way. You can't lose and you *can* win as high as \$100.00.

## Rules for the Contest

Hallicrafters will give \$200.00 for the best letters received during each of the six months of September, October, November, December, 1944, January, and February, 1945. (Deadline: Your letter must be received by midnight, the last day of each month.)

For every serious letter received, Hallicrafters will send \$1.00 so even if you do not win a big prize your time will not be in vain. Your letter will become the property of Hallicrafters and they will have the right to reproduce it in a Hallicrafters advertisement. Write as many letters as you wish. V-mail letters will do.

Open to servicemen around the world. Wherever you are, whenever you see this ad, drop us a line. Monthly winners will be notified immediately upon judging.

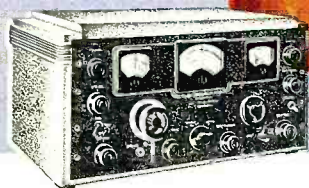

There's gold here at the end of the rainbow in Hallicrafters great letter contest—and there's a great and exciting future ahead for short wave enthusiasts. In peace time Hallicrafters will continue to build "the radio man's radio" and that means the best that can be made. There will be a set for you in our postwar line.



BUY A WAR BOND TODAY!

# hallicrafters RADIO

THE HALLCRAFTERS COMPANY, MANUFACTURERS OF RADIO AND ELECTRONIC EQUIPMENT. CHICAGO 16, U. S. A.