

# RADIO NEWS

TOP VIEW

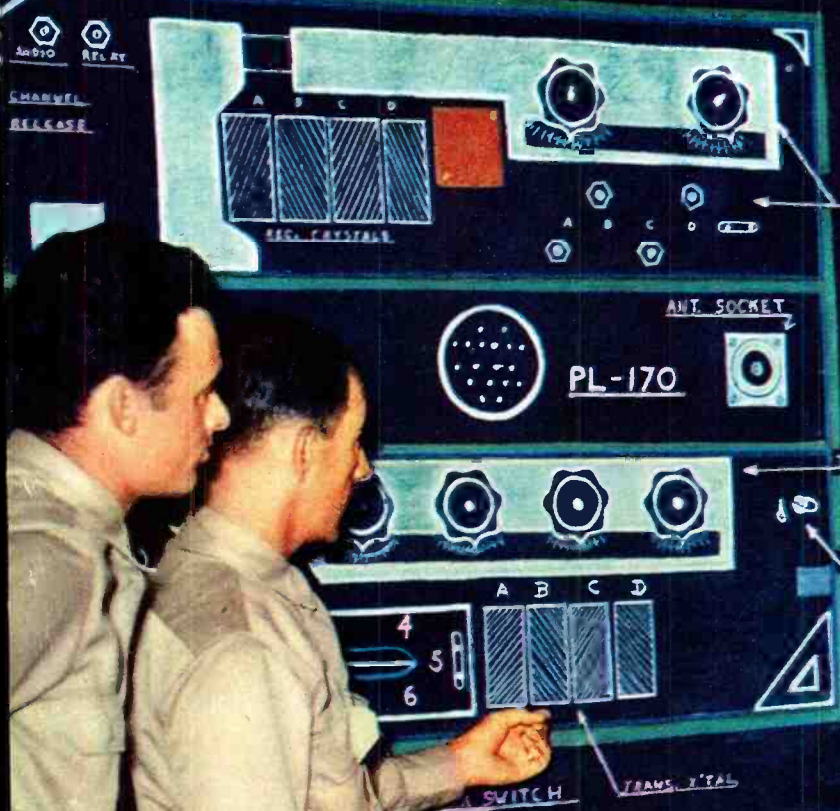

CONTROL BOX

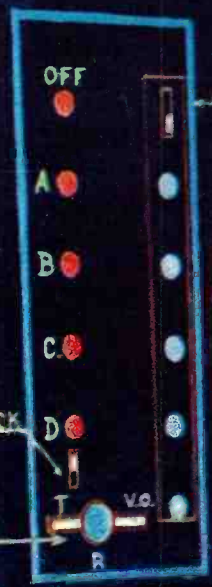

SEPTEMBER  
1944  
25c  
In Canada 30c

# NOW A Miniature Thyatron with a Man-Size Rating

## RCA-2D21—For Control Jobs Where Lightness and Small Size Count

**S**TURDY construction—stable operation—high control ratio—yet this new RCA thyatron, the 2D21—is a true miniature. It weighs but ½ ounce; stands just 2 7/8 inches high. And it will handle 100 milliamperes average; 500 milliamperes peak. The 2D21 is a gas-type tetrode electrically similar to the well-known RCA-2050.

In addition to its small size, RCA-2D21 has many application advantages—for example:

**Low Internal Drop:** Only 8 volts!

**Any-position Mounting:** The 2D21 is xenon-filled; no mercury to limit mounting position, or to restrict motion while in operation.

**Wide Temperature Range:** —55 to +90°C, with little change in operating characteristics over the entire range.

**Quick Heating:** Anode voltage may be applied not less than 10 seconds after application of heater voltage.

**Stable Operation:** The inherent stability of this type of gas-filled thyatron makes greater control-circuit sensitivity possible. Low grid-anode capacitance makes the 2D21 insensitive to line-voltage surges.

**Versatility of Control:** You can control the operation of the 2D21 by means of both the shield grid and the control grid. This makes for flexibility of control where needed.

**Low Preconduction Current:** Electrode structure provides low preconduction current up to start of conduction.

**High Sensitivity:** Grid current is very low; hence, a high resistance can be used in the grid circuit, providing high sensitivity. A high-vacuum phototube can be coupled to a 2D21 without intervening amplifier.

**Need further information?** Write to Commercial Engineering Section, Radio Corporation of America, Harrison, N. J.

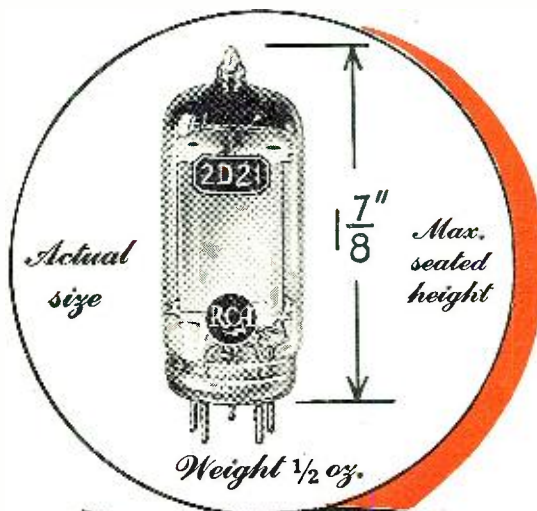

### TECHNICAL DATA

**RCA - 2D21** **\$3.75**

Heater Volts (A. C. or D. C.)	6.3
Heater Amperes	0.6
Tube Drop (Approx.)	8 volts
Max. Overall Length	2 7/8 in.
Max. Seated Height	1 7/8 in.
Bulb	T-5 1/2
Base	Miniature Button 7-pin
Ambient Temp. Range	-55° to +90° C.

#### MAXIMUM RATINGS

Peak Forward Anode Volts	650
Peak Inverse Anode Volts	1300
Shield-grid Volts	-100
Control-grid Volts	-100
Peak Cathode Milliamperes	500
Average Cathode Milliamperes	100
Max. Control-grid Circuit Resistance	10 Megohms

Typical A-C operation: RMS Anode Volts, 400; Shield-grid Volts, 0; RMS Control-grid Bias Volts, 5; Control-grid Signal Volts (Peak), 5; Control-grid Circuit Resistance, 1 megohm; Anode Circuit Resistance, 2000 ohms.

★ The Magic Brain of all electronic equipment is a Tube . . . and the fountain-head of modern Tube development is RCA

## RADIO CORPORATION OF AMERICA

RCA VICTOR DIVISION • CAMDEN, N. J.

BUY  
MORE  
WAR BONDS



62-6431-8

# Do You Want Success Like This in RADIO



BEFORE COMPLETING YOUR COURSE I OBTAINED MY RADIO BROADCAST OPERATOR'S LICENSE AND IMMEDIATELY JOINED STATION WMPC WHERE I AM NOW CHIEF OPERATOR.

**HOLLIS F. HAYES**

I WAS WORKING IN A GARAGE WHEN I ENROLLED WITH N.R.I. I AM NOW RADIO SERVICE MANAGER FOR M----- FURNITURE CO. FOR THEIR 4 STORES.



**JAMES E. RYAN**

CLIPPING YOUR COUPON GOT ME STARTED IN RADIO. HERE AT AMERICAN AIRLINES I AM INSTRUCTING FLIGHT PERSONNEL IN AIRCRAFT RADIO EQUIPMENT.



**WALTER B. MURRAY**

I MADE \$800 WHILE TAKING THE N.R.I. COURSE. NOW I AM MAKING \$50 AND MORE A WEEK AND HAVE ALL THE WORK I CAN DO.

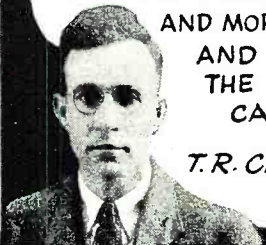

**T.R. CHAFFEE**

I REPAIRED SOME RADIO SETS WHEN I WAS ON MY TENTH LESSON. I HAVE MADE AN AVERAGE OF \$10 A WEEK--JUST SPARE TIME.



**JOHN JERRY**

I AM NOW SENIOR SERVICE MAN FOR A RADIO SUPPLY COMPANY. I HAVE BEEN PROMOTED FOUR TIMES WITHIN A YEAR. I AM LOOKING TO THE FUTURE FOR BIGGER AND BETTER THINGS.



**J. K. DUCKWORTH**

Here's the formula that has worked for hundreds. They mailed the Coupon like the one below. Let me send you FREE, my 64-page illustrated book, "Win Rich Rewards in Radio." You'll see how my practical methods offer a tested way to good pay and a chance to get a good job in a busy field with a bright peacetime future. It's not a "miracle cure," but the same formula that worked for the men above, and hundreds of others too.

### Big Demand Now for Well Trained Radio Technicians, Operators

Keeping old Radios working is booming the Radio Repair business. Profits are large. After-the-war prospects are bright. Think of the new boom in Radio Sales and Servicing that's coming when new Radios are again available--when Frequency Modulation and Electronics can be promoted--when Television starts its postwar expansion!

Broadcasting Stations, Aviation Radio, Police Radio, Loudspeaker Systems, Radio Manufacturing all offer good jobs now to Radio men--and most of these fields have a big backlog of business that is building up during the war, plus opportunities to expand into new fields opened by wartime developments. You may never again see a time when it is so easy to get a start in Radio!

**Many Beginners Soon Make \$5, \$10 a Week EXTRA in Spare Time**

The day you enroll for my Course I start sending you EXTRA MONEY JOB SHEETS that help show how to make EXTRA money fixing Radios in spare time while still learning.

**My Radio Course Includes TELEVISION • ELECTRONICS FREQUENCY MODULATION**

### I Send You Six Kits of Radio Parts

My "50-50 Method"--half building and testing real Radio Circuits, half-learning from illustrated lessons--is a tested, proven way to learn Radio at home. Think how much PRACTICAL experience you'll get by building a Superheterodyne Circuit, and A. M. Signal Generator -- by conducting 60 sets of experiments on these and other Circuits you build with Radio parts I supply!

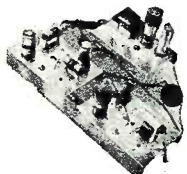

### Find Out What N.R.I. Can Do for You

MAIL COUPON to get my 64-page book FREE. It's packed with facts--things you never knew about opportunities in Broadcasting, Radio Servicing, Aviation Radio, other Radio fields. Read the details about my Course--"50-50 Training Method"--6 Experimental Kits--EXTRA MONEY JOB SHEETS. See the fascinating jobs Radio offers and how you can train at home. Read many letters from men I trained, telling what they are doing, earning. No obligation. Just MAIL COUPON in an envelope or pasted on a penny postal! J. E. SMITH, President, Dept. 4JR, National Radio Institute, Washington 9, D. C.

**Our 30th Year of Training Men for Success in Radio.**

**I Trained These Men at Home / Will Train You Too**



**THIS FREE BOOK HAS SHOWN HUNDREDS HOW TO MAKE GOOD MONEY**

J. E. SMITH, President, Dept. 4JR, National Radio Institute, Washington 9, D. C.

Mail me FREE, without obligation, your 64-page book: "Win Rich Rewards in Radio." (No salesman will call. Please write plainly.)

Name..... Age.....

Address .....

City..... State.....

# CONTENTS

## FEATURES

Women Radio Commandos.....	<i>Kenneth R. Porter</i>	25
The Oscilloscope Applied to Radio Servicing.....	<i>A. Howard and M. Eddy</i>	28
Transport Communications for Railways.....	<i>John A. Curtis</i>	32
Transport Communications for Highways.....	<i>John A. Curtis</i>	37
The SCR-284 .....	<i>H. V. Noble</i>	38
Direct-Reading Capacity Meter.....	<i>Rufus P. Turner</i>	40
The SoundScriber .....	<i>Stanley Kempner</i>	43
Modernize Those Police Receivers.....	<i>Herbert L. Lipson</i>	44
The Saga of the Vacuum Tube.....	<i>Gerald F. J. Tyne</i>	46
Radio Theory Review—for FCC Operator Exams..	<i>Carl E. Winter</i>	48
Clearing That Intermittent.....	<i>Y. Gabin</i>	50
Marine Battle Broadcasting System.....		56
Transients and Time Constants.....	<i>Abraham Tatz</i>	58
Wartime Production of Radio Equipment.....	<i>Phil Glanzer</i>	66
Practical Radio Course.....	<i>Alfred A. Ghirardi</i>	72

## DEPARTMENTS

For the Record.....		8
Spot Radio News.....		12
QTC.....	<i>Carl Coleman</i>	53
International Short-Wave.....	<i>Kenneth R. Boord</i>	54
Technical Book and Bulletin Review.....		64
What's New in Radio.....		82
Manufacturers' Literature .....		124

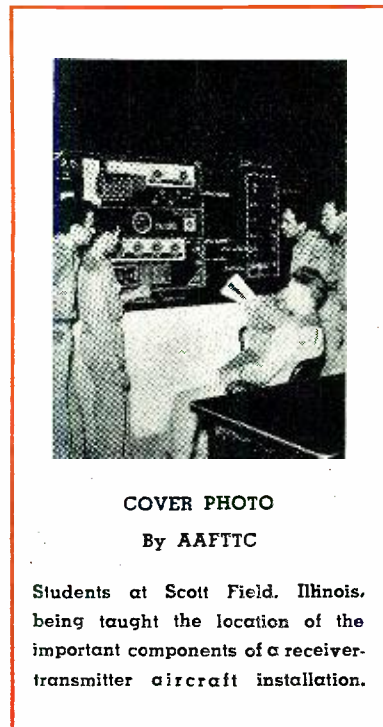

**COVER PHOTO**  
By AAFTC

Students at Scott Field, Illinois, being taught the location of the important components of a receiver-transmitter aircraft installation.

**WILLIAM B. ZIFF**  
*Publisher*

**B. G. DAVIS** *Editor*      **C. R. TIGHE** *Ass't to Publisher*

**OLIVER READ, W9ETI**  
*Managing Editor*

**WM. A. STOCKLIN** *Associate Editor*      **HAROLD S. RENNE** *Technical Editor*

**JOE MARTY, JR.** *Field Editor*      **FRED HAMLIN** *Washington Editor*

**E. H. SEHNERT** *Chief Draftsman*      **HERMAN R. BOLLIN** *Art Director*

**K. R. PORTER** *War Correspondent*      **FRANK ROSS** *Staff Photographer*

**GEORGE BERNER** *Advertising Director*      **S. L. CAHN** *Advertising Mgr.*

**R. B. FRANK, W9JU** *(on leave)*      **J. M. ECKERT** *Midwest Adv. Mgr.*

**H. G. STRONG** *Circulation Director*      **H. J. MORGANROTH** *Production Director*

Copyright, 1944  
ZIFF-DAVIS PUBLISHING COMPANY  
Editorial Offices: 540 N. Michigan Ave., Chicago 11, Ill.  
Member of the Audit Bureau of Circulation

RADIO NEWS is published monthly by the Ziff-Davis Publishing Company at 540 N. Michigan Ave., Chicago 11, Ill. New York Office, Empire State Building, New York 1, N.Y. Washington, D. C., Office, Earle Bldg. Los Angeles Office, William L. Pinney, Manager, 815 S. Hill St., Los Angeles 14, Calif. Subscription Rates: In U. S. \$3.00 (12 issues), single copies, 25 cents; in Mexico, South and Central America, and U. S. Possessions, \$3.00 (12 issues); in Canada \$3.50 (12 issues), single copies 30 cents; in British Empire, \$4.00 (12 issues); all other foreign countries \$6.00 (12 issues). Subscribers should allow at least 2 weeks for change of address. All communications about subscriptions should be addressed to: Director of Circulation, 540 N. Michigan Ave., Chicago 11, Ill. Entered as second class matter March 9, 1938, at the Post Office, Chicago, Illinois, under the Act of March 3, 1879. Entered as second class matter at the Post Office Department, Ottawa, Canada. Contributors should retain a copy of contributions. All submitted material must contain return postage. Contributions will be handled with reasonable care, but this magazine assumes no responsibility for their safety. Accepted material is subject to whatever adaptations, and revisions, including "by-line" changes necessary to meet requirements. Payment covers all authors, contributors or contestants rights, title, and interest in and to the material accepted and will be made at our current rates upon acceptance. All photos and drawings will be considered as part of material purchased.



# THERE'S GOLD HERE!

*another new letter contest*



**\$200<sup>00</sup> in prizes every month**  
**\$100.00 first prize, \$50.00 second prize, \$25.00**  
**third prize, \$15.00 fourth prize, \$10.00 fifth prize,**  
**plus \$1.00 for every letter received.**

Here we go again. Another great Hallicrafters letter contest for service men. Wherever you are, whenever you see this announcement, drop us a line. Write and tell us your first hand experience with *all* types of radio communications built by Hallicrafters, including the famous SCR-299.

*There is gold here!* Write today to get your share. Tell us your story in your own way. You can't lose and you *can* win as high as \$100.00.

## Rules for the Contest

Hallicrafters will give \$200.00 for the best letters received during each of the six months of September, October, November, December, 1944, January, and February, 1945. (Deadline: Your letter must be received by midnight, the last day of each month.)

For every serious letter received, Hallicrafters will send \$1.00 so even if you do not win a big prize your time will not be in vain. Your letter will become the property of Hallicrafters and they will have the right to reproduce it in a Hallicrafters advertisement. Write as many letters as you wish. V-mail letters will do.

Open to servicemen around the world. Wherever you are, whenever you see this ad, drop us a line. Monthly winners will be notified immediately upon judging.

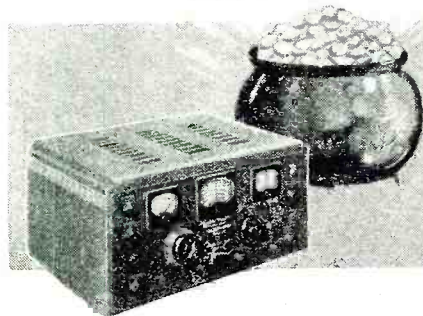

There's gold here at the end of the rainbow in Hallicrafters great letter contest—and there's a great and exciting future ahead for short wave enthusiasts. In peace time Hallicrafters will continue to build "the radio man's radio" and that means the best that can be made. There will be a set for you in our postwar line.

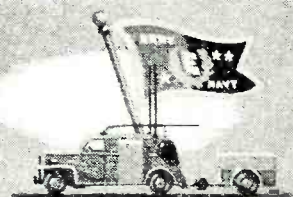

BUY A WAR BOND TODAY!

# hallicrafters RADIO

THE HALLICRAFTERS COMPANY, MANUFACTURERS OF RADIO AND ELECTRONIC EQUIPMENT, CHICAGO 16, U.S.A.

September, 1944

*Daddy's*

**GONE  
A'HUNTING**



But not "to get a little rabbit skin." He's gone to prove your right to grow up in a world all clean and bright and freed of threat and terror. And in that wonderful, carefree world of your boyhood, radio — Fada radio — will play an exciting role. For all of the genius and ingenuity that Fada has expended in the development of war-vital communications will have an immediate application to the perfection of radios, table models, television sets and other electronic marvels of the peacetime future.

PLACE YOUR FAITH IN THE

**FADA**  
*Radio*

OF THE FUTURE

*Famous Since Broadcasting Began!*

**FADA RADIO AND ELECTRIC COMPANY, INC., LONG ISLAND CITY, N. Y.**

# How to Match Impedance and Distribute Power in Loud Speaker Systems

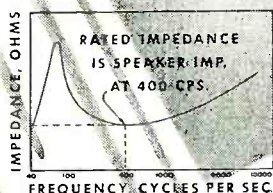

Here is Number 2 in the series of practical, instructive Monographs prepared by the Jensen Technical Service Department. The title, "Impedance Matching and Power Distribution in Loud Speaker Systems," suggests the scope and treatment of a subject in which everyone concerned with loud speakers and the reproduction of sound, is vitally interested. ¶ The reading material is supported by twenty-eight drawings and tables. More than a score of questions are described, illustrated and solved. One of the problems is that of a comprehensive sound system for a military installation. ¶ Like Monograph Number 1—"Loud Speaker Frequency-Response Measurements"—Number 2 is offered by JENSEN in the interest of improved sound reproduction. Get either copy, or both, from your jobber or dealer, or fill out the coupon and mail it with 25c for each book, to:

IMPEDANCE MATCHING and POWER DISTRIBUTION in LOUD SPEAKER SYSTEMS. The second of a valuable and important series of treatises on the selection, installation and operation of loud speakers.

FREE to men in the Armed Services and to Libraries and Technical Schools.

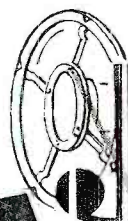

## Jensen

RADIO MANUFACTURING COMPANY

6617 SOUTH LARAMIE AVENUE

CHICAGO 38, ILLINOIS

JENSEN RADIO MANUFACTURING COMPANY  
6617 South Laramie Avenue  
Chicago 38, Illinois

Send me at once:  
 Impedance Matching and Power Distribution in Loud Speaker Systems.  
 Loud Speaker Frequency-Response Measurements.  
 (Check one or both. Send 25c for each book ordered.)

NAME \_\_\_\_\_  
 ADDRESS \_\_\_\_\_  
 CITY \_\_\_\_\_ ZONE \_\_\_\_\_ STATE \_\_\_\_\_

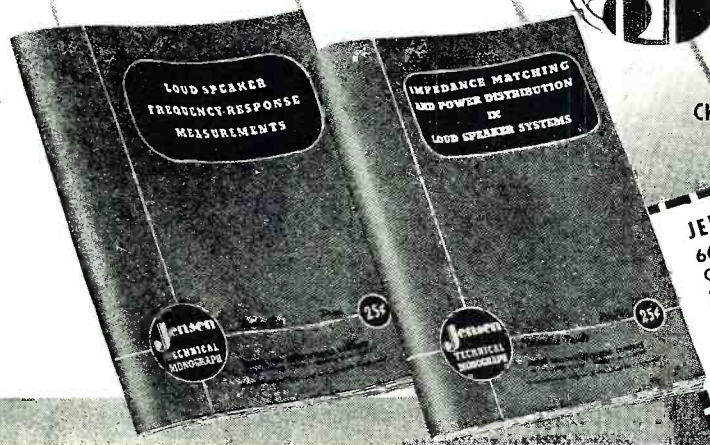

# AUDAX

RELAYED-FLUX  
Microdyne

Long before this war began  
AUDAX PICKUPS were in . . .

## SELECTIVE SERVICE

Since pickups first became important commercially, the distinguished products of AUDAX have been SELECTED wherever and whenever the requirements were exacting.

Today AUDAX magnetically powered pickups are SELECTED for War contracts that demand the highest standards of performance, regardless of climatic variations or severe handling.

Our stern peacetime standards, maintained for so many years, have proven comfortably adequate to meet government specifications.

The sharp, clean-cut facsimile reproduction of MICRODYNE is a marvel to all who have put it to the only test that really matters . . . the EAR TEST.

**AUDAX COMPANY**  
500-N Fifth Ave., New York 18, N. Y.

Creators of High Grade Electrical  
and Acoustical Apparatus Since 1915

Send for your copy of our informative  
"PICK-UP FACTS"

★ BUY  
WAR BONDS

"The Standard by Which Others  
Are Judged and Valued"



# FOR THE RECORD

by the editor

ON the morning of August 4, 1944 the crack "20th Century Limited" streaks over shiny rails at 65 miles per hour. The train is now fifteen minutes late as it approaches South Bend, Indiana. Dining cars are full of passengers as the train glides swiftly along.

Suddenly there is a screeching of brakes, followed by a dull thud a split second later, and the streamliner literally slides to a stop. There is no confusion—most of the riders are apparently not aware that they had just narrowly missed possible death as the thundering monster hastened to make up precious time on its way to Chicago from New York. One passenger, being curious, made his way to the exit of the car in which he was riding at the time. His morning shave had been suddenly interrupted. The porter had already opened the top half of the entrance way and was peering out. This passenger, also being inquisitive, peered out. He was in the third car back of the locomotive. What appeared to be a reasonable small object painted yellow was seen jutting from the nose of the engine. This object later turned out to be a gasoline-powered track truck—the kind used by repair crews and weighing more than a heavy automobile.

The huge "iron horse," now building up a terrific steam pressure, seemed to snort like an angry bull who had been wounded. Jet black smoke belched from the funnel as the train awaited the "all clear" in order not to be late in its arrival at the Chicago terminal. Long possessor of one of the most enviable safety records in railroad history, this deluxe train, affectionately known to America as one of her "pride and joys," remained at a standstill while the wreckage was pried loose from the cowcatcher of the locomotive.

The passenger was told later that there were approximately 250 persons on board at the time and that a train such as this cost hundreds of thousands of dollars.

Further questioning revealed that the foreman of the track crew had ap-

parently *taken it for granted* that the train had already passed.

Block signals were found to be in perfect operating condition and it seemed fantastic that in broad daylight and on a clear track that such an accident could occur. But it did happen!

The delayed train limped into Chicago with an ominous clunk-clunk as the flattened wheels beat out their rhythmic sound on the rails. As they neared the station, the passenger was told that many of the cars would require wheel replacements before they could again proceed on their daily trips to and from New York. The locomotive would be laid up in a repair shop at a time when railroad equipment is vitally needed during wartime and when there are no ready "spares."

A heavy steel plate on the nose of No. 5452 was bashed in. Oil and other bits of the wreckage were clearly visible as the passenger took a final look before leaving the terminal.

Could radio communications have prevented such an accident? We think it could! Several varieties of equipment which would be highly suited for installation on crew repair trucks have been available for many months. A simple receiver and loud speaker, if installed on that truck, could have warned the repair crew in ample time and the object could have been removed from the right-of-way.

In this issue of RADIO NEWS are two feature articles on "Transport Communications." They point out in no uncertain terms that radio communications are a vital necessity for the protection of lives and property on railways—regardless of what other safety measures have been taken.

We have made pleas on several occasions that railroads be given a high priority for the purchase of such radio equipment. The cost of a simple installation, which could prevent such accidents as these, is a minute fraction of the cost of a train such as the famous 20th Century.

To some the above may seem a bit fantastic. I can assure you however, that it was a "reality." You see—I was the inquisitive passenger. . . . O.R.



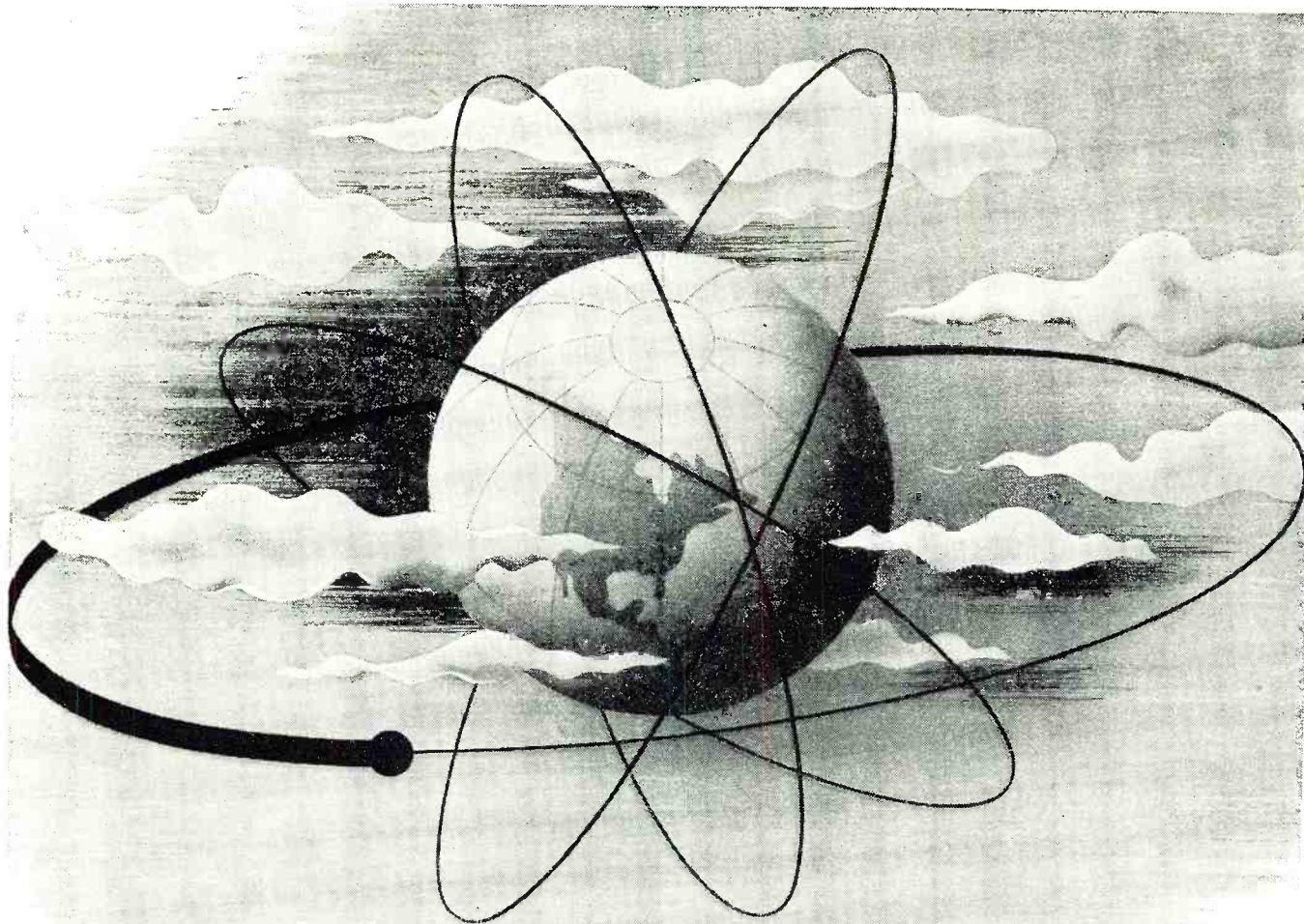

## **D**elco Radio Products Mean Uniform Quality

**Delco Radio products—wherever in use—are of uniformly fine quality.**

**For two reasons . . . First, capable engineering by Delco Radio's laboratories . . . Second, advanced techniques in mass production. It is through this combination of engineering vision and manufacturing precision that Delco Radio meets the demands of war, the needs of peace.**

**Put Your Dollars In Action  
BUY MORE WAR BONDS**

**Delco Radio**  
DIVISION OF  
**GENERAL MOTORS**

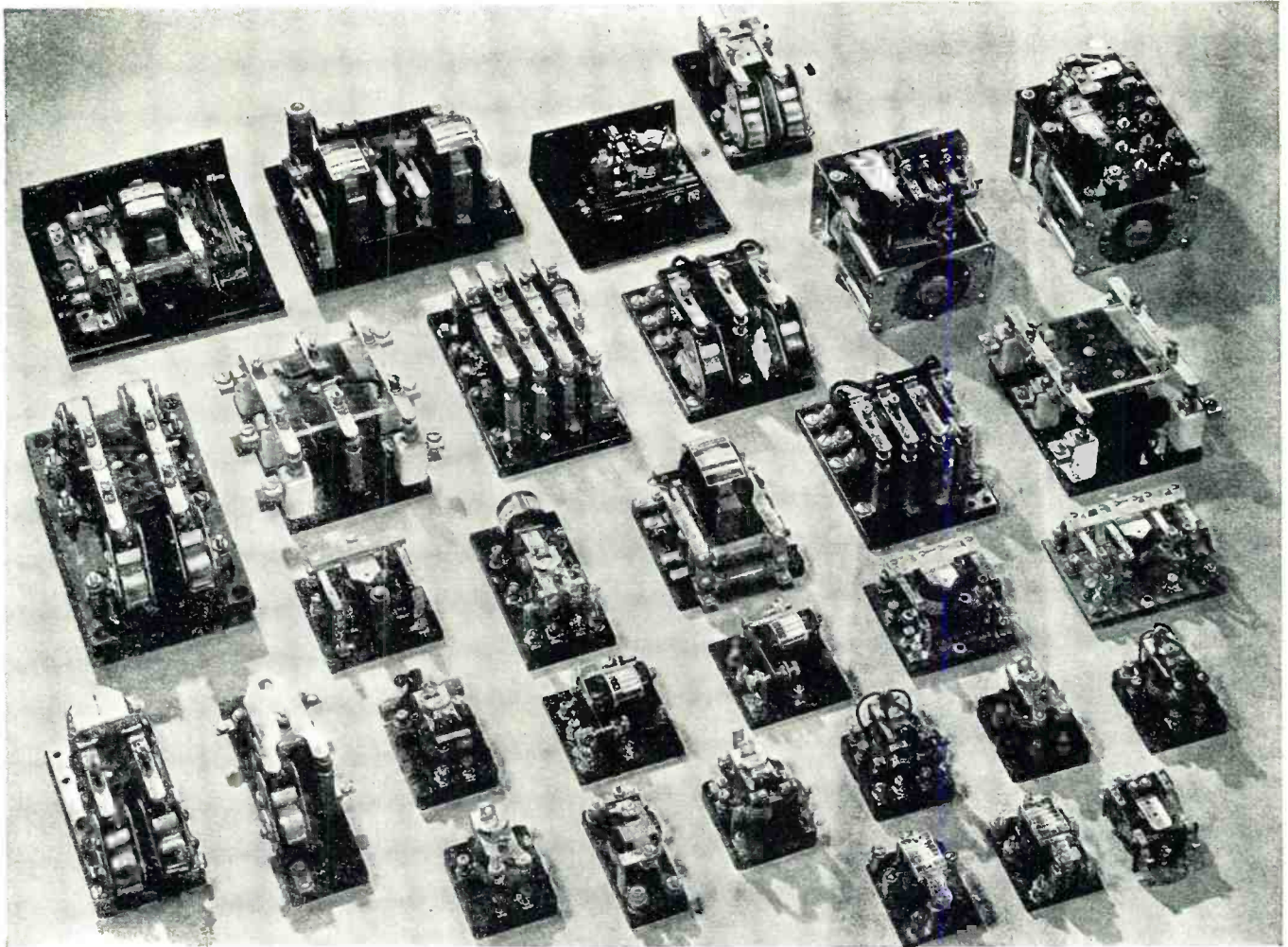

## **WL BULLETINS TELL THE WHOLE RELAY STORY**

When you can select the relay that exactly meets your requirements from a regular line, you have saved man power, time and money. WARD LEONARD RELAYS include types and sizes for every

application. They all have crisp action, are dependable and durable yet consume but little current. Send for the data bulletins of interest to you.

### RELAY BULLETINS

#### Bulletin 105

"Little Giant Relay" single pole, single and double throw. Controls  $\frac{3}{4}$  HP on 115-230V.

#### Bulletin 106

Midget Relays for light duty available in single and double pole, single and double throw.

#### Bulletin 81

Intermediate Duty Relays in single and multiple arrangements, single and double throw.

#### Bulletin 362

Motor Driven Time Delay Relays for operation on alternating current.

#### Bulletin 104

Midget Relay for tight places—Vibration resistant—Double Pole, Double Throw—Available for 6 to 115 volts A.C. or D.C.

#### Bulletin 131 and 132

Heavy Duty Relays single and multiple, single and double, contracts rated up to 25 amp. on 125-250V.

#### Bulletin 251

Sensitive Type Relays for direct and alternating current operating on .014 watts.

#### Bulletin 351

Thermal Time Delay Relays with thermostat built into relay assembly.

#### Bulletin 103

Aircraft Power Relay. Single Pole, Single Throw for 24 volts at 25 amps. D.C. Withstands high values of acceleration of gravity, shock, and vibration.



# WARD LEONARD

## RELAYS • RESISTORS • RHEOSTATS

Electric control **WL** devices since 1892.

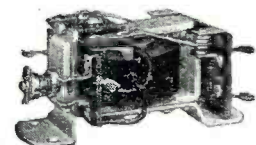

Midget Metal Base Relay measures  $1\frac{1}{4}$  inches high for tight places in aircraft radio and control circuits where space is limited.

WARD LEONARD ELECTRIC COMPANY, 47 SOUTH STREET, MOUNT VERNON, NEW YORK

**NO OXIDATION  
NO CONTAMINATION  
NO MOISTURE . . .**

**3 MORE REASONS WHY  
FEDERAL MAKES  
BETTER TUBES**

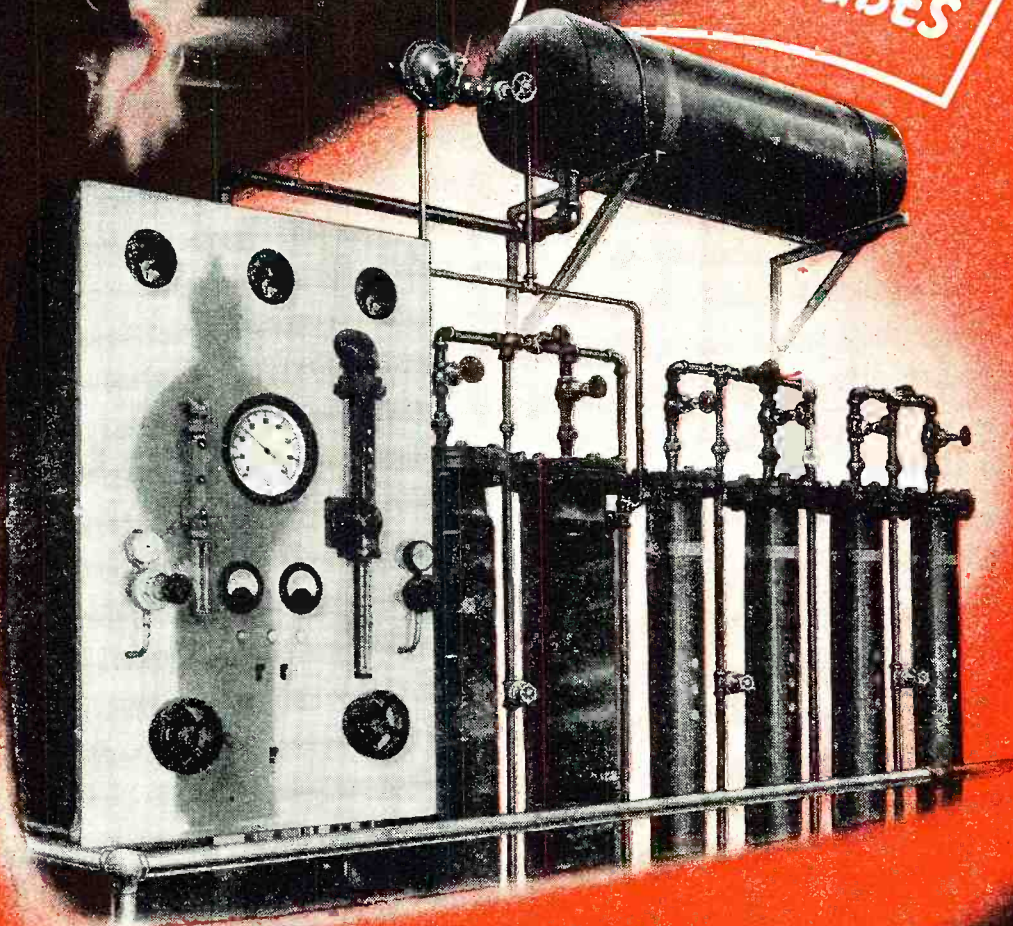

**FEDERAL HAS DEVELOPED  
THE FIRST NITROGEN PURIFIER**



*Intelin Ultra High Frequency Coaxial Cable, developed and manufactured by Federal, has extreme ruggedness and meets all specifications with precision, accuracy, uniformity and dependability.*

No oxidation, no contamination, no moisture!

Another Federal First adds extra performance guarantees to FTR vacuum tubes.

In a corner of the new FTR tube plant is this automatic nitrogen purifier. During the process of sealing the anode to the stem, the elements of every FTR tube are now protected from oxidation, contamination and moisture in a

scientifically controlled atmosphere of automatically mixed nitrogen and hydrogen.

Here is another reason why you get higher operating efficiency and still longer life when you use FTR tubes. Another evidence of the ability, brains and technical understanding which have earned the reputation that "Federal always has made better tubes."

Now is the time to know Federal.

**Federal Telephone and Radio Corporation**



Newark 1, N. J.

INVEST IN THE FUTURE — BUY WAR BONDS

Designed for



Application

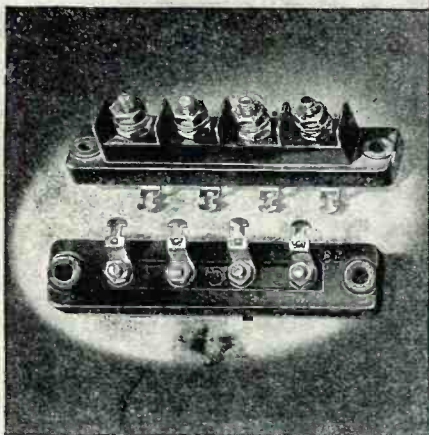

**The No. 37104  
Terminal Strip**

is a sturdy four-terminal strip of molded black General Electric Textolite much used on present production Army and Navy equipment. Barriers between contacts. "Non turning" studs, threaded 8/32 each end.

**JAMES MILLEN  
MFG. CO., INC.**

MAIN OFFICE AND FACTORY  
**MALDEN  
MASSACHUSETTS**



*Presenting latest information on the Radio Industry.*

**RADIO ENTERED THE PRESIDENTIAL CAMPAIGN** with a mighty flourish, providing spectacular coverage at the recent Republican and Democratic national conventions in Chicago. Over seven-hundred stations in this country and Canada carried a minute-by-minute description of this important event. In this group were the two-hundred stations of WOR, Mutual; one-hundred and ninety-three stations of WJZ, Blue Network; one-hundred and thirty-six stations of CBS; and about one-hundred and fifty stations of NBC.

Nearly ten-thousand engineers, technicians and commentators participated in operating this gigantic radio network. NBC reported that over two-thousand men were used to control the circuit lines only. Microphones were everywhere. There was a microphone for practically every state and territorial delegation. Interview microphones were at strategic points in the lobby and on the floor. To intercept crowd noises and cheers, and pick up organ and band concerts, parabolic microphones were used. Broadcast type handy-talkies and pack control sets were used to permit transmission of "on the floor" interviews. Most of these transmitters used frequencies of 30 to 40 megacycles. Some of the transmitters operated on as high as 165 megacycles.

The proceedings were also televised, using film-pickup procedure. Express airplanes picked up the films as soon as available, and flew them to New York. WNBT, the NBC station in New York, "piped" the film telecast to the G.E. station in Schenectady, WRGB, and the Philco station in Philadelphia, WPTZ. Other television stations in New York, WABD and WCBW, and in Los Angeles, W6XYZ, also participated in transmitting convention activities by television.

In the months to come, radio will be called upon to transmit millions of political words . . . words that will produce the "yes" or "no" on the ballots next November.

**FABRICATING FACILITIES NOW APPEAR** to be the principle bottleneck in the production of radio and radar equipment, John Creutz, chief of the Domestic and Foreign Branch of the Radio and Radar Division, WPB, disclosed at a recent special meeting of the Electronics Distributors Industry Advisory Committee. The trend of war will indicate when this condition may or may not improve, he cited.

In discussing L-293 restrictions, Mr. Creutz provided some pleasant news,

He said that condenser manufacturers have been permitted to use aluminum cans. A similar step of casing L-293, is planned for transformers, he pointed out. These transformers will be made for replacement purposes. Although at the present time much production is not being authorized, by the end of the year the transformer situation should be more favorable.

Discussing standardized lines of replacement parts, Mr. Creutz pointed out that the proposed standard for volume controls probably will not be adopted since standardization is no longer as necessary as it was two years ago.

The victory line of transformers was discussed by several members of the committee. They reported that deliveries had been very poor, particularly on power transformers. It was their opinion that the victory line might as well be eliminated, since transformers were fairly well standardized before the victory line was instituted. In addition, they pointed out, further standardization had been effected during the war, and the production of the victory line meant only an additional burden on plant facilities. Objection was also raised to the lack of a small six-volt transformer. The victory line transformer's physical dimensions were too large for chasses of table models, because these victory transformers were made to comply with strict specifications which involved larger cores and more wire. Mr. Creutz said these matters will be taken under advisement.

The tube situation also came in for a bit of analysis. Good and bad news was provided. On the negative side appeared the fact that the industry, during the last half of the year, must produce at a rate 25 per cent greater than ever before. Switching over to the positive side of the ledger, Mr. Creutz said that all military requirements for metal, glass and loctal tubes should be met during the third quarter. On the basis of a yearly requirement of eighteen million tubes, virtually all civilian requirements should be produced during the third quarter. It was pointed out, however, that even the year's requirements of eighteen million tubes will not really satisfy the demand, since 1941 shipments of carton packed tubes were thirty-three million. One of the committee members stated that the known demand for the last few years has been as much as sixty-five million to seventy million. Yet, he said, according to the information supplied by the RCA License Bureau for 1941, only thirty-six million tubes were bought. It was his belief that

**RADIO NEWS**

# SPRAYBERRY RADIO TRAINING

*Gives you Both*



**FULL RADIO SET SUPPLIED FOR SHOP PRACTICE!**

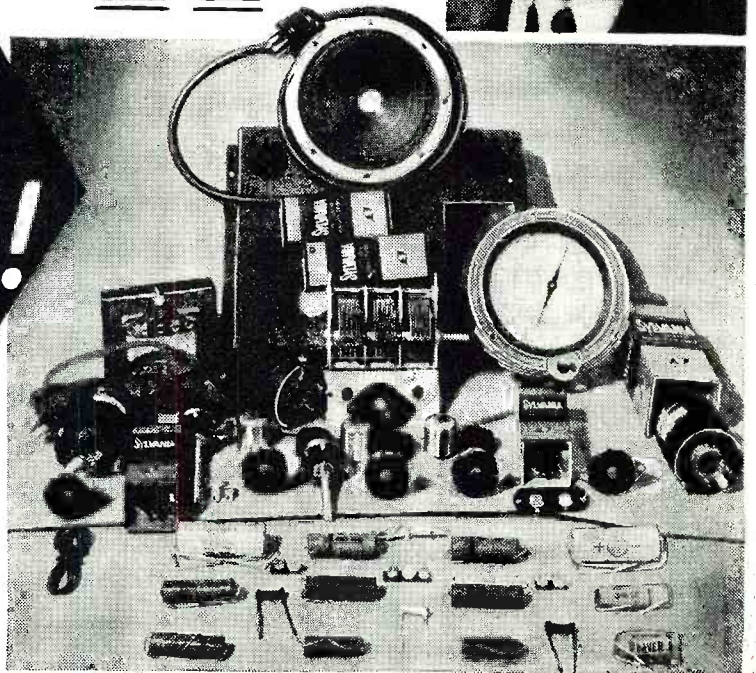

## HERE'S THE ONE PRACTICAL WAY TO TRAIN FOR BIG EARNINGS AHEAD IN RADIO-ELECTRONICS & TELEVISION

The offer I make you here is the opportunity of a lifetime. It's your big chance to get ready for a wonderful future in the swiftly expanding field of Radio-Electronics INCLUDING Radio, Television, Frequency Modulation and Industrial Electronics. Be wise! NOW'S the time to start. No previous experience is necessary. The Sprayberry Course starts right at the beginning of Radio. You can't get lost. It gets the various subjects across in such a clear, simple way that you understand and remember.

### I'll Show You a New, Fast Way to Test Radio Sets Without Mfg. Equipment

The very same Radio Parts I supply with your course for gaining pre-experience in Radio Repair work may be adapted through an exclusive Sprayberry wiring procedure to serve for complete, fast, accurate Radio Receiver trouble-shooting. Thus under Sprayberry methods you do not have one cent of outlay for manufactured Test Equipment which is not only expensive but scarce.

### Prepares You for a Business of Your Own or Good Radio Jobs . . . Civilian or Military

My training will give you the broad, fundamental principles so necessary as a background no matter which branch of Radio you wish to specialize in. I make it easy for you to learn Radio Set Repair and Installation Work. I teach you how to install and repair Electronic Equipment. If you enter the Army, Navy or Marines, my training will help you win higher rating and better pay.

### JUST OUT! FREE!

"How to Read Radio Diagrams and Symbols"

. . . a valuable new book which explains in simple, non-technical English how to read and understand any Radio Set Diagram. Provides the quick key to analyzing any Radio circuit. Includes translations of all Radio symbols. Send for this FREE book now while supply lasts and along with it I will send you another big FREE book describing my Radio-Electronic training.



### GET FREE BOOKS

SPRAYBERRY ACADEMY OF RADIO  
F. L. Sprayberry, Pres.

Box 500WJ,  
Pueblo, Colorado

Please rush my FREE copies of "HOW TO MAKE MONEY IN RADIO, ELECTRONICS and TELEVISION," and "HOW TO READ RADIO DIAGRAMS and SYMBOLS."

Name . . . . . Age . . . . .

Address . . . . .

City . . . . . State . . . . .

Tear off this coupon, mail in envelope or paste on penny postcard.

NEED A SUPPLY OF MATCHES?

# SYLVANIA SERVICEMAN SERVICE

by  
FRANK FAX



Book matches, imprinted with your name, are one of the best and most economical ways to advertise your business.

Sylvania has prepared a new style of book match for your use.

Supplied to you for cost, with your name handsomely imprinted:

1,000 .. \$3.25	5,000 .. \$14.90
2,500 .. 7.50	7,500 .. 22.40

Plus 40 cents per thousand Federal Tax. Orders under 7,500 are shipped FOB Shipping Point; over 7,500, FOB your address.

Order from your local Sylvania distributor, or send your order to Frank Fax, Sylvania, Emporium, Pa.



# SYLVANIA

ELECTRIC PRODUCTS INC.  
RADIO DIVISION

many of the tubes purchased in bulk have been used for replacements rather than for original equipment.

The new program calling for the production of "MR" tubes and the interchanging of a specified number between manufacturers on a basis comparable to 1941 distribution, appears to be working out quite well, stated Mr. Creutz, considering that the program started only at the beginning of this year. Mr. Creutz said that each of the tube producers has presented a definite distribution plan which has been approved by WPB. Some of the committee members pointed out that consumers in metropolitan areas were not receiving fair treatment on tube purchases. Many dealers were holding tubes to use in repair work, rather than selling them separately for replacement purposes, these committee members said.

Mr. Creutz also revealed at this meeting that repairmen who are being discharged from the services will be able to buy representative stocks of equipment and supplies to start all over again. Mr. Creutz pointed out that enough equipment to run a service shop is available on a short procurement cycle on the AA5 rating, which radio repairmen may extend or "MRO" (maintenance repair order). All regional offices have been advised to assist veterans, who wish to return or enter radio repair business, in securing the necessary equipment and parts.

The surplus material project, now under way, was discussed at this meeting by Wesley Smith, who is chief of the Components Recovery Section. This section was established for the primary purpose of redistributing the components available from sources other than the normal production of the industry, so that the heavy production schedules could be met. This section also screens material to see whether any items can be used to fill military requirements before these items are declared surplus. The section operates in conjunction with the WPB Redistribution Division. This division was originally established to facilitate sales in such cases where WPB regulations made the sale through the usual trade channels difficult. In explaining the operation of his section, Mr. Smith said that it is particularly important for the prospective purchaser to relate just what he intends to use the material for, and explain that any of this material will be made available to the Armed Services, if so necessary. The form used to supply this information on is known as WPB-1161.

Committees of the Radio Manufacturers Association are also studying the surplus problem. The Defense Supplies Corporation is handling surplus tubes and parts which have been officially declared as "war surplus." Surplus receivers will be handled by the Treasury Department. Immediate surpluses resulting from contract termination, until officially declared as a "war surplus," are being handled by

the Army and Navy, assisted by the WPB Radio and Radar Division.

**THERE IS EVERY INDICATION THAT THE BATTERY** situation will ease up during the next few months. At a recent conference with dry cell battery and zinc battery shell industry executives, plans for expansion of dry cell battery production were discussed. To permit increased manufacture, restrictions on the use of iron, steel, copper and copper base alloys have been removed by WPB.

Stanley B. Adams, director, Consumers Durable Goods Division, said that WPB is fully aware that the present production of farm radio batteries is not sufficient to meet the minimum essential needs of civilians. Accordingly, he said, WPB is taking steps to expand the production of farm radio batteries where it will not affect military production. In this respect new facilities for the manufacture of battery electrodes are being studied. Permission for the construction of a plant capable of producing sixty-million electrodes each month has already been granted. It is expected that the new plant, which is being financed by the Defense Plant Corporation, will be in operation by October 1st, 1944.

**THE EXPERIMENTAL MODEL ORDER**, which was to be effective on July 1st, was not put into effect until July 22nd. This revised order permits the production of an experimental model costing no more than \$5,000. Models costing in excess of \$5,000 require the specific approval of WPB and the War Manpower Commission. An AA3 rating has been granted for material required in these experimental models. Before proceeding with the work on experimental models, a formal pledge, citing that activity of this nature will not interfere with war production or essential civilian production, must be filed with WPB.

Inquiry among several manufacturers revealed that while experimental plans were in mind, actual development work was not being contemplated as yet. A few of the manufacturers stated that they did not believe it would be possible to engage in such work in view of their enormous war activities. These manufacturers were in agreement with the automobile manufacturers, who felt that they could not devote any effort at the present time to such experimental work. Of course, the models required by the radio industry are of a much smaller nature than those required by the automotive industry, and thus it appears as if some of the manufacturers may be in a position to proceed with such experimental work in the not-too-distant future.

**UNPRECEDENTED COMPETITION** appears to be in view for the broadcast industry, according to Harold Fair, program director, WHO. In an analysis of program management prepared for the NAB, Mr. Fair points out that the struggle for the ear of the



# Temple TELEVISION

*will be a BUY-line*  
**—NOT A SIDE LINE**

If you, as a radio retailer, are interested in the profit aspects of Television, as well as the scientific, read the enlightening paragraphs below.

**TEMPLE TELEVISION** will reflect not only the skill and forward thinking of Temple engineers, but also practical, down-to-earth planning—of both merchandise and merchandising—that has you, the dealer, and your customers in mind.

**TEMPLE TELEVISION** will be engineered by top-flight electronic engineers who will combine Television and radio into a *complete line* of instruments that the radio dealer can sell with confidence and profit—instruments not merely designed for studio or exhibition purposes, but produced to deliver full value and performance to his customers.

**TEMPLE TELEVISION** will be built of highest quality materials by quality-minded craftsmen keenly alive to insure complete and lasting customer-satisfaction, as well as to minimize dealer service problems.

**TEMPLE TELEVISION** will enjoy the advantage of being housed in Temple-designed, Temple-built cabinets—furniture that is bench-made, not “bunch” made—providing not only extra outer beauty and extra variety, but extra VALUE, as well.

**YES, IN TELEVISION, TOO, IT WILL PAY YOU TO “TEAM UP WITH TEMPLE”**

FM . . . . TELEVISION . . . .  
RADIO-PHONO' COMBINATIONS



WHERE **FM** WILL ALSO  
MEAN **FINEST MADE**

**TEMPLE TONE RADIO COMPANY, Mystic, Conn.**

**SUPREME**  
BY COMPARISON  
\* Current Supreme Models

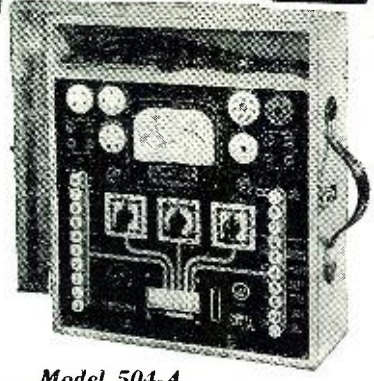

Model 504-A  
Tube and Set Tester



Model 542  
Pocket Multimeter

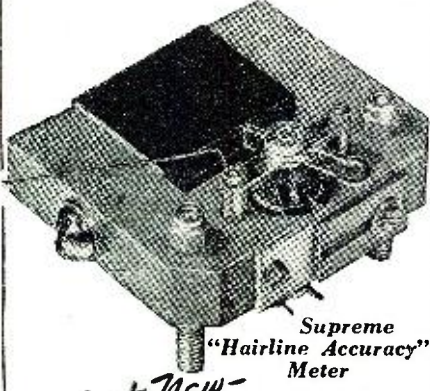

Supreme  
"Hairline Accuracy"  
Meter

*Whats New-*

**IN TEST EQUIPMENT?**

Military secrecy precludes our answering that now. But radical new developments in testing techniques have been and are being perfected. Because of these important advances, when Victory comes your NEW Supreme Test Equipment will be, more than ever, "Supreme By Comparison."

**SUPREME INSTRUMENTS CORP.**  
Greenwood, Miss., U. S. A.

listening audience will become keener than ever before in the history of the industry, particularly because of the advent of television and FM.

He said, "The day is coming when the successful station operator will be pulling out all the stops to stay in the orchestra. A logical analysis of this situation indicates clearly that more and more emphasis on good programming is the answer.

"Programs are the show windows through which the radio industry displays its wares. They are beyond question the most potent factor in promotion and public relations. And most important, they are the one medium through which a radio station can grasp, maintain and expand a large and consistent audience. And that audience is the insurance against dwindling prestige and mounting competition."

Analyzing the obligation of the program manager in this NAB report, Irvin G. Abeloff, program service manager, WRVA, points out that the program manager must be a jack-of-all-trades and "master of most!"

Mr. Abeloff says, "The program manager must be a musician, copywriter, copyright authority, announcer, traffic authority, production man, public relations expert, salesman, and shrewd diplomat."

**A PRODUCTION SCHEDULE FOR CIVILIAN RECEIVERS**

in England has been officially approved by the British government. A statement from the Radio Manufacturers Association in England reveals that 175,000 a.c. and 75,000 battery receivers will be made during the next twelve months. The a.c. models will cost around fifty dollars, and the battery models will cost around forty-five dollars. No d.c. models are scheduled.

In the a.c. model, four tubes will be used. The receiver will be designed for 195-250 volts, 50 cycles only. A pentode output and delayed a.v.c is planned for this receiver. In the battery model, 2-volt tubes probably will be used. The output here will use a double diode-triode which also will afford a.v.c. action. B-battery voltage will be around 100 to 120.

According to the Board of Trade in London, the prewar practice of distribution will be followed in distributing the new receivers. The receivers will be known as "wartime civilian receivers," and will be identified as such with a special label. The tuning ranges will be from 200 to 560 meters for local pickups. Speakers will be of the 6½ permanent magnet type, and cabinets will be wood. Materials and parts required for the production of the receivers were released in April. No definite information as to actual receiver production has as yet been received. It appears, though, that the bulk of receivers will be available during the latter part of the twelve-month period.

Incidentally, the American receivers sent over to England many months ago, recently have been placed into

four price groups, ranging from \$47.00 to \$68.00. Approximately 140 different models are included in this price classification. Many popular name receivers appear. Types include simple broadcast band for a.c. and d.c., two-band a.c.-d.c., and push-button tuning. Receivers are in wooden and molded cabinets, and with five and six tubes.

As stated in these columns earlier, most of the receivers had to be converted for use on the higher voltage lines of England.

The receivers are being distributed through carefully controlled channels, and in small groups. Distribution began a few months ago. No figures are available yet as to the quantities distributed.

**FROM MEXICO COMES A REPORT**

that a purchase of one-million low-priced American-made receivers is planned for the lower-income bracket civilians. The receivers would cost around five dollars, and would be sold on installments. Inquiry among American manufacturers indicated that such a unit was practical only if a number of powerful stations with wide coverage were available.

At the present time there aren't too many of these high powered stations in Mexico. It was felt, however, that it is entirely possible that such stations may be built.

At the present time, receiver production in Mexico is negligible. There are four or five factories operating now, which produce around two thousand sets a year.

**SALE OF DRY BATTERIES REJECTED BY THE ARMY**

is now covered by an OPA ruling which provides for maximum price labelling and battery property specifications. According to this new ruling, the maximum price for sales of these salvaged batteries is being fixed by each OPA district office at 80 per cent of the prevailing maximum price for the most closely comparable new civilian battery. A manufacturer's published price list in effect during March, 1942, is being used as a guide in determining the prices.

The ruling also describes what constitutes a military salvaged battery. Such a battery, according to this ruling, is one which was originally manufactured and sold for eventual use by the Military Forces, but subsequently was sold or offered for sale by any person other than an agency of the U. S. government. If the battery is reassembled, it must meet the following specifications, according to this OPA ruling: (1)—Single No. 6 dry cells and flashlight unit cells must be enclosed in close fitting jackets. (2)—The voltage must be at least equal to a specified minimum voltage. For instance, B and C batteries tested on a calibrated ohm voltmeter (thousand ohms per volt), must have 1.47 volts per cell or per groups of cells in parallel. A flashlight and other A batteries of C size cells must have the same voltage per cell when tested on a 100-ohm per



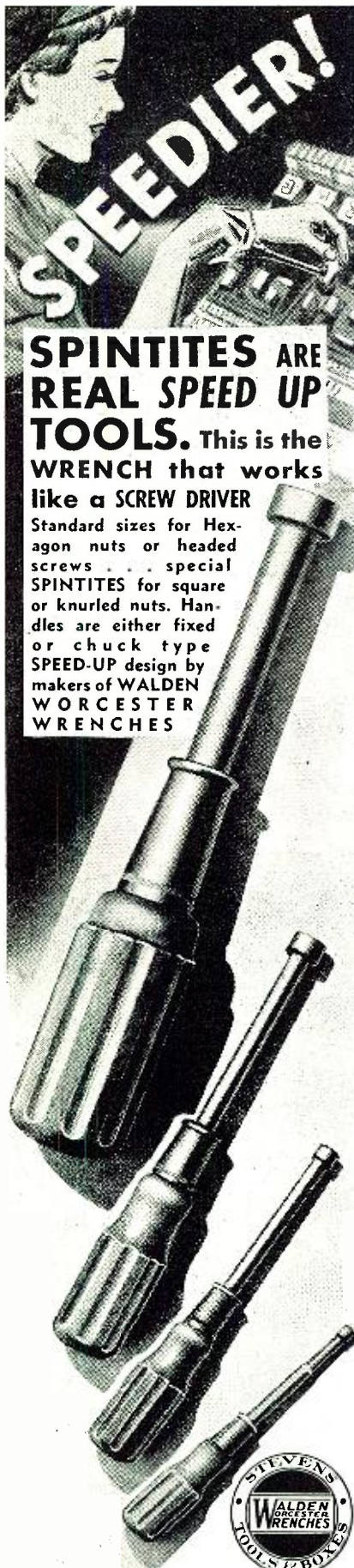

**SPEEDIER!**

**SPINTITES ARE REAL SPEED UP TOOLS.** This is the **WRENCH** that works like a **SCREW DRIVER**

Standard sizes for Hexagon nuts or headed screws . . . special SPINTITES for square or knurled nuts. Handles are either fixed or chuck type **SPEED-UP** design by makers of **WALDEN WORCESTER WRENCHES**

**STEVENS WALDEN, INC.**  
465 SHREWSBURY STREET  
WORCESTER, MASSACHUSETTS

volt meter. (3)—Individual cells and batteries must be free from loose terminals, corrosion, loose or cracked seals, and leaking or distorted zinc containers.

**"YES, WE HAVE RADIOS,"** headlined an advertisement of a Pittsburgh department store recently . . . believe it or not. Receivers offered included consoles, table models, and phono combinations, with prices ranging from \$79.00 to \$239.00. No receiver identity appeared, nor did any details on the technical features appear. Where the receivers came from, no one would say. In any event, Pittsburgh was once again buying receivers.

**ONE OF THE MOST IMPORTANT FCC HEARINGS** of the year will begin on September 13, when the investigation of railroad radio communication systems gets under way. A committee of three, composed of Commissioners Walker, Case and Jett, will preside. Commissioner Walker will be chairman. These hearings, which will be of a preliminary nature, will serve to provide information which should be of assistance and guidance to the many who are interested in carrying out railroad-radio programs. Among those organizations who are expected to be represented are the Association of American Railroads, Aeronautical Radio, Inc., CAA, RTPB, and War Department.

Sharp debates undoubtedly will prevail, for there appear to be several schools of thought on the systems that should be used. The carrier-current group, for instance, has already begun its campaign to prove that this method is best. They are quite specific in their criticism of radio, pointing out that "every available principle of communication has been studied, and all have been rejected in favor of induction (a carrier-current transmitted through the rails, the ground and adjacent conductors, is received by induction . . . the frequency of a carrier is between 5 and 250,000 cycles, with voice current imposed upon the carrier by means of AM or FM)." Radio enthusiasts say that space-radio systems are the best, as evidenced by recent successful tests over long runs. The latter interest is further emphasized by the number of applications that the FCC has already received for construction permits. Since May 1st, thirty applications have already been received. Many grants have been made already, and installations have been successfully completed in many instances. We'll watch train radio closely.

**FINAL APPROVAL OF FM** as the sound channel in television appears to be certain at this writing. Recommendations are that frequency modulation with a maximum frequency swing of 25 kilocycles be used for the sound channel. This decision was reached after a series of discussions among Committee Three members of Panel Six of the RTPB. In presenting the

case for frequency modulation, one member pointed out five points that were in favor of FM. These were: established practicability, better signal-to-noise ratio, lower sound-transmitter power, correlation with v.h.f. broadcasting (since television is on v.h.f. it certainly would be wise to use FM which is also on v.h.f.), and adaptability to oscillator stabilization. In the latter instance, the problem of oscillator stability in the higher frequencies was explained by comparing stability requirements. It was pointed out that the difference in stability requirements is of the order of four-to-one in favor of AM. Such stability, however, requires automatic frequency control. This feature can be included in an FM receiver more economically in view of the presence of the discriminator circuit. With the addition of this a.f.c. system, it is therefore possible to maintain accurate oscillator tuning in FM receivers.

Nine points in favor of AM were offered by another member of the committee. These were: stability, superiority in presence of multipath, low expense, adequate signal-to-noise ratio, favorable i.f. band, transmitter economy, spectrum economy, ease of receiver servicing, and ease of tuning. Notwithstanding these apparent virtues, the committee members found that FM offered equitable properties that justified its use in the sound channel.

The discussion of the sound channel also prompted some interesting statements on high fidelity. These statements stress the fact that it wasn't prudent to publicize and create a demand for 15,000-cycle type receivers or systems when a suitable 10,000-cycle receiver is not as yet available.

These experts went on to say that the range of 60 to 8,000 cycles or possibly 50 to 10,000 cycles should be considered for all types of broadcasting, including frequency modulation, so that owners of FM or AM receivers may profit by the use of such wideband design. Such a balanced system of reproduction, they pointed out, was more practical than the extension beyond 10,000 cycles. It was also brought out that reproduction of the lower frequencies should be investigated and improved, since in this direction we have a system of balance that most people want.

The question of whether AM or FM was suitable for the video channel received extensive consideration by the committee members. The decisions favored AM. In pointing out the problems of FM video transmission, members said that the multipath troubles were quite serious. This appeared to be the consensus of most of the members who had experience with FM for video.

In commenting on television receiver design, during a meeting, a member of Committee Four said that a receiver with a sensitivity of 200-microvolts

(Continued on page 120)

**QUALITY**

**WIRES AND CABLES**

***Thermoplastic Specialists***

**THE  
PLASTIC WIRE & CABLE  
CORPORATION**

**NORWICH + CONNECTICUT**

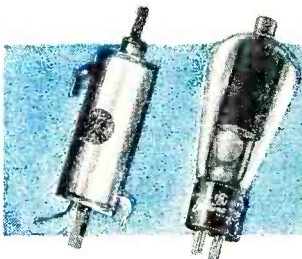
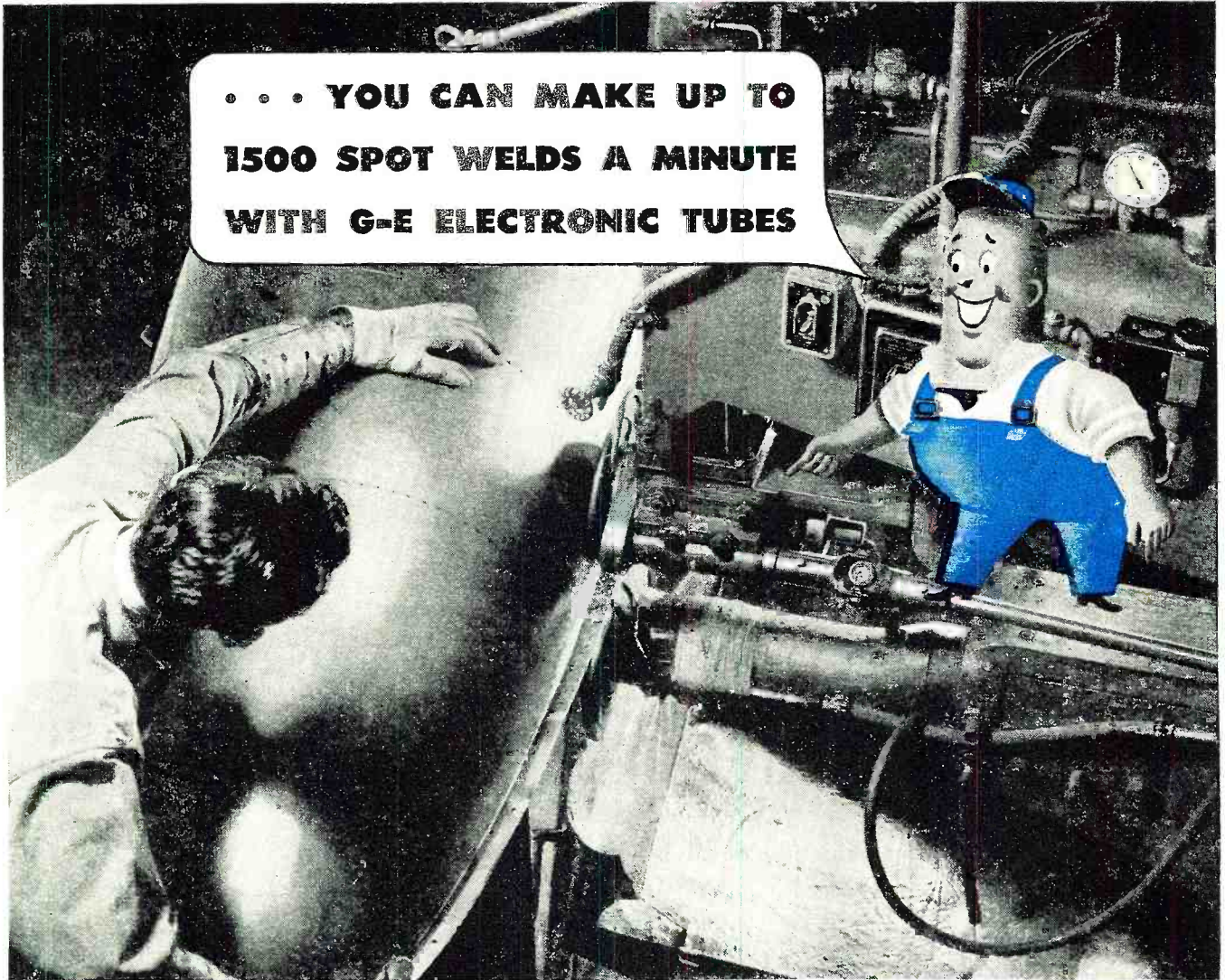

**HIGH-SPEED PRECISION WELDING IS MADE POSSIBLE BY THE G-E IGNITRON AND THE G-E THYRATRON**

IN THE photograph above, a droppable fuel tank for aircraft is being seam-welded with the aid of G-E electronic tubes, at a production rate far in excess of what was considered possible only a short while ago.

The heart of the welding control equipment is the G-E electronic tube — the steel-clad ignitron, which provides the high current demanded; and the thyatron, a precision timer, which controls the passage of current as seam

welds are spotted at any desired distance, overlapped, or brought into a solid line. Seam welds can be made at speeds up to 1500 or more welds a minute.

Thyatron control is especially valuable for spot or seam welders because it automatically opens and closes the circuit at precisely the same point each time on the a-c supply voltage wave. This minimizes transient currents, the cause of non-uniform welds.

Advantages of the electronic-tube method over mechanical methods are: Improved quality of welds; reduced voltage regulation; low maintenance cost; smooth heat adjustment over a wide range.

There is a complete line of G-E electronic tubes for innumerable industrial jobs; and near you is a G-E electronic-tube distributor who is prepared to fulfil your requirements.

**"HOW ELECTRONIC TUBES WORK"**

This booklet will be mailed to you on request—without charge. Address Electronics Department, General Electric, Schenectady, New York.

• Tune in "The World Today" and hear the news direct from the men who see it happen, every evening except Sunday at 6:45 E.W.T. over CBS. On Sunday listen to the G-E "All Girl Orchestra" at 10 P. M. E.W.T. over NBC.

G. E. HAS MADE MORE BASIC ELECTRONIC-TUBE DEVELOPMENTS THAN ANY OTHER MANUFACTURER

**GENERAL  ELECTRIC**  
162-C9-9830

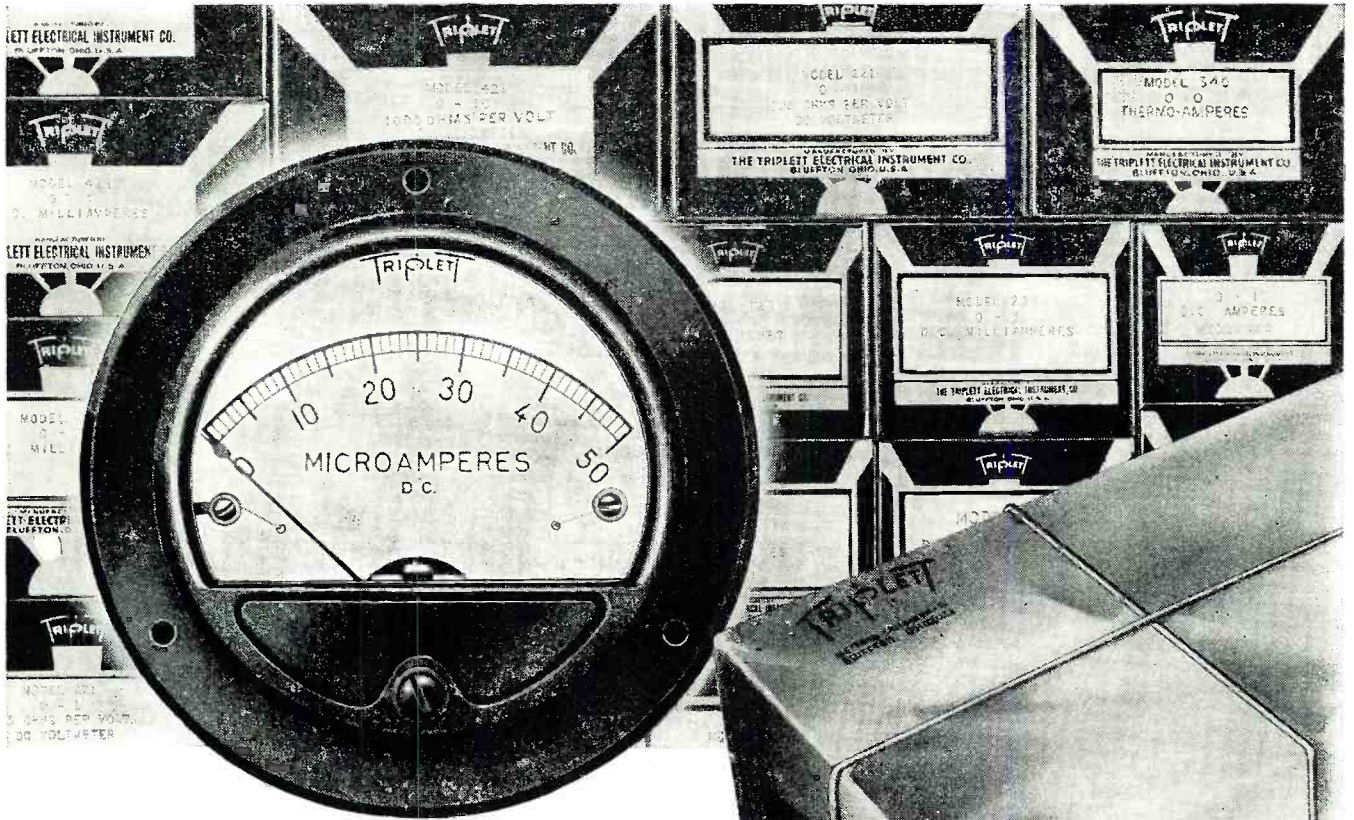

## INSTRUMENT DELIVERIES!

American Instrument production is catching up with the needs of our armed forces—closing the gap between too little and enough. Caring for those needs has expanded Triplet production lines unbelievably far beyond previous capacities. And the experiences of war, added to more than forty years of instrument manufacturing, have bettered the products coming off those lines.

Now—instruments—better than ever before—are ready for general use. Better place your orders, at once, with Triplet—headquarters for a complete line of instruments made to one fine standard of engineering.

D'Arsonval Moving Coil D.C. Instruments    Electrodynamicometer A.C.-D.C.  
 Double Iron Repulsion A.C. Instruments    R.F. and Rectifier Types; Sizes 2" through 7"

**Triplet**  
 ELECTRICAL INSTRUMENT CO.  
 BLUFFTON OHIO \*\*\*

STANDARDS ARE SET BY  

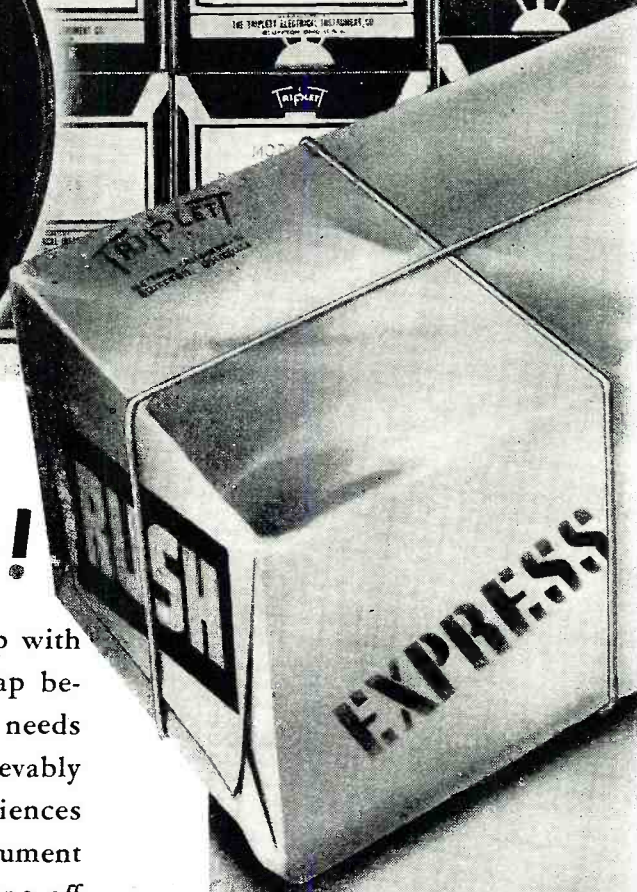
- ★ Greater Production Capacity
- ★ Better Instrument Quality
- ★ Complete Line of Instruments
- ★ One Source of Supply
- ★ Prompt Deliveries
- ★ SEND YOUR ORDERS TO TRIPLET NOW

Photo Courtesy Pan American Airways



*NEW!*  
**Electro-Voice**  
**Model 600-D** HAND-HELD  
MOVING COIL  
**COMMUNICATION**  
**MICROPHONE**  
 (REPLACING MODEL 600-C)

**FOR MOBILE RADIO TRANSMITTERS AND SOUND EQUIPMENT.**

- Resistant to high humidity, wide temperature ranges, mechanical shock and vibration
- Frequency curve scientifically designed for highest articulation through interference and background noise
- The new Electro-Voice Model 600-D is available in high or low impedance output
- Lightweight, can be held for long periods without fatigue
- Shock-proof, high impact molded phenolic case
- Press-to-talk switch (switch-lock optional) for relay operation, with choice of switching circuits

To the growing list of Electro-Voice developments, we now add the Model 600-D which may be adapted to a number of essential civilian applications. Built to rigid wartime specifications, it reflects the painstaking care of the Electro-Voice design laboratory. Electro-Voice Microphones serve you better . . . for longer periods of time.

If your present limited quantity needs can be filled by any of our Standard Model Microphones, with or without minor modifications, please contact your nearest radio parts distributor.

**PAPER PACKS A WAR PUNCH . . .  
. . . . . SAVE EVERY SCRAP**

**ELECTRO-VOICE MANUFACTURING CO., INC. • 1239 SOUTH BEND AVENUE • SOUTH BEND, INDIANA**  
Export Division: 13 East 40th Street, New York 16, N. Y. — U. S. A. Cables: ARLAB

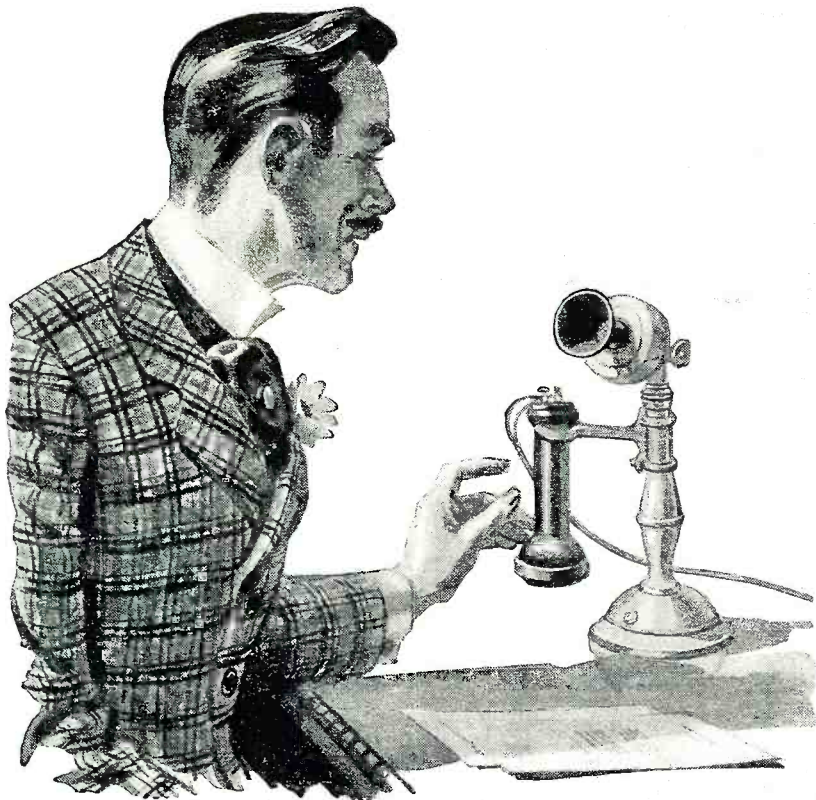

If "skill to do comes of doing," this thirty-eight year old commentary explains the record of Connecticut Telephone and Electric in manufacturing telephones, switchboards, and electrical supplies for the military needs of this war.

We look forward to the next thirty-eight years, confident that this is the dawn of the most important era yet, in the development of communications, and every other branch of electrical science.

If our seasoned, but progressive, experience can be of help to you in connection with your communications requirements or the development and manufacture of electrical or electronic devices, we shall be glad indeed to talk with you.

## CONNECTICUT TELEPHONE & ELECTRIC DIVISION

GREAT AMERICAN INDUSTRIES, INC.

MERIDEN, CONNECTICUT

TELEPHONIC SYSTEMS • SIGNALLING EQUIPMENT • ELECTRONIC DEVICES • ELECTRICAL EQUIPMENT • HOSPITAL AND SCHOOL COMMUNICATIONS AND SIGNALLING SYSTEMS • IGNITION SYSTEMS



"The high quality of their product, which comprises telephones, switchboards and electrical supplies, has placed them in the position of the largest manufacturer of their goods in this section of the country."

... from

A CENTURY OF MERIDEN

published in 1906

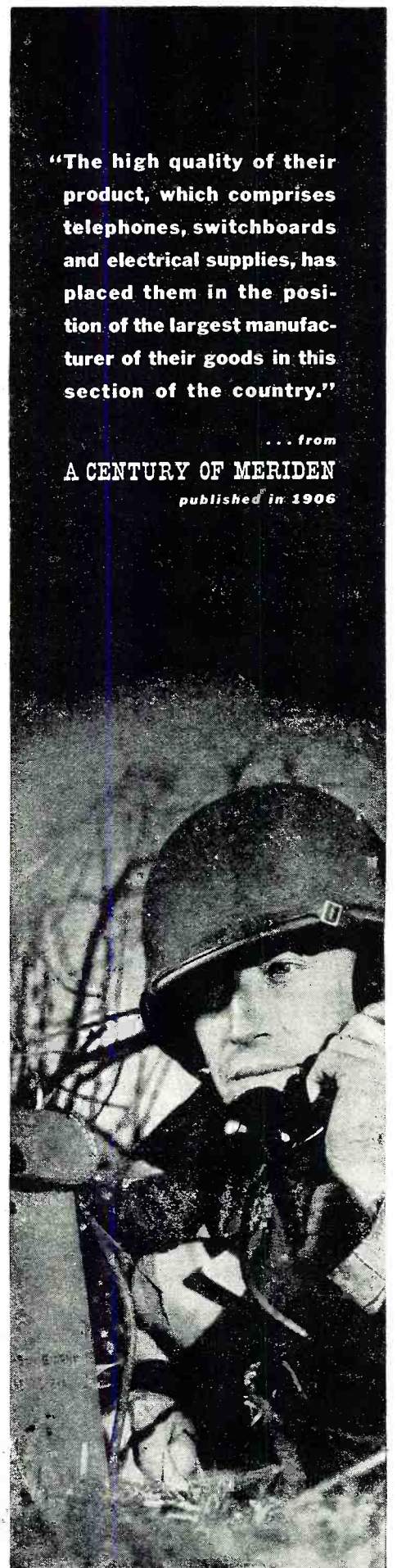

# NO SUBSTITUTE NEEDED!

## USE HYTRON 6AL5

## VERY-HIGH-FREQUENCY TWIN DIODE

**TYPE 6AL5**  
(Developmental  
Hytron D27)

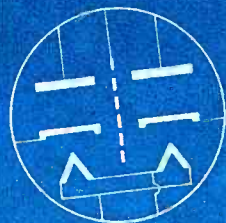

**BASING**  
Pin 1 — Cathode 1  
Pin 2 — Plate 2  
Pin 3 — Heater  
Pin 4 — Heater  
Pin 5 — Cathode 2  
Pin 6 — Shield  
Pin 7 — Plate 1

### CONSTRUCTIONAL FEATURES

- 1 Rugged mount is supported by short, heavy stem leads as well as by top mica.
- 2 Close cathode-to-plate spacing gives high perveance. (Note plate cooling fins.)
- 3 Electrostatic shield connects to pin 6.
- 4 Baffle mica shields the elements from getter spray.
- 5 Miniature stem permits negligible lead inductance and minimum interelectrode capacitances.

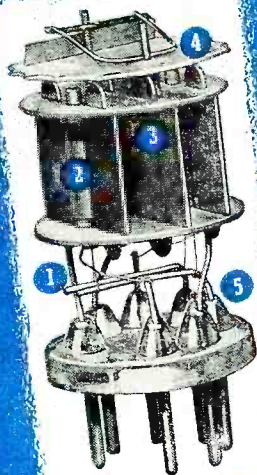

The 6AL5 fills the need for a high perveance twin diode with the low voltage drop required for many special r.f. circuit applications. WPB and the Services consider diode connection of the 6J6 twin triode (and other triodes) to be a wasteful misuse. With minor changes of socket wiring, the 6AL5 easily replaces the diode-connected 6J6.

Specifically manufactured and rated as a diode, the 6AL5 is tested as a diode. Close production control keeps within a narrow range the cutoff characteristic in the contact potential region. Designed throughout for efficiency on high and very-high radio frequencies, the 6AL5 has a separately connected shield which may be grounded to isolate the two diodes and their associated circuits. A midget miniature bulb permits extra space savings.

Possible uses include: Detector and AVC, clipper, limiter, FM frequency discriminator, special high-frequency diode, power rectifier.

### HYTRON TYPE 6AL5

Very-High-Frequency Twin Diode

ELECTRICAL CHARACTERISTICS	
Heater potential (AC or DC)	6.3 volts
Heater current	0.3 amperes
Peak inverse potential†	460 max. volts
Heater-cathode potential†	350 max. volts
Peak plate current per plate†	60 max. ma.
Average plate current per plate†	10 max. DC ma.

INTERELECTRODE CAPACITANCES	
Plate 1 to plate 2	0.015 mmf.
Plate to cathode*	2.8 mmf.
Cathode to all*	3.8 mmf.

Capacitances are averages with close-fitting shield.

PHYSICAL CHARACTERISTICS	
Bulb	T-5½ midget
Base	Miniature button 7-pin
Height overall	1.82 inches max.
Diameter	0.75 inch max.

† Maximum ratings shown are absolute design maximums should be approximately 10% lower to allow for line voltage variations.  
\* Value is for one of the two twin diode sections.

OLDEST EXCLUSIVE MANUFACTURER OF RADIO RECEIVING TUBES

# HYTRON CORPORATION

ELECTRONIC AND RADIO TUBES



SALEM AND NEWBURYPORT, MASS.

BUY ANOTHER WAR BOND

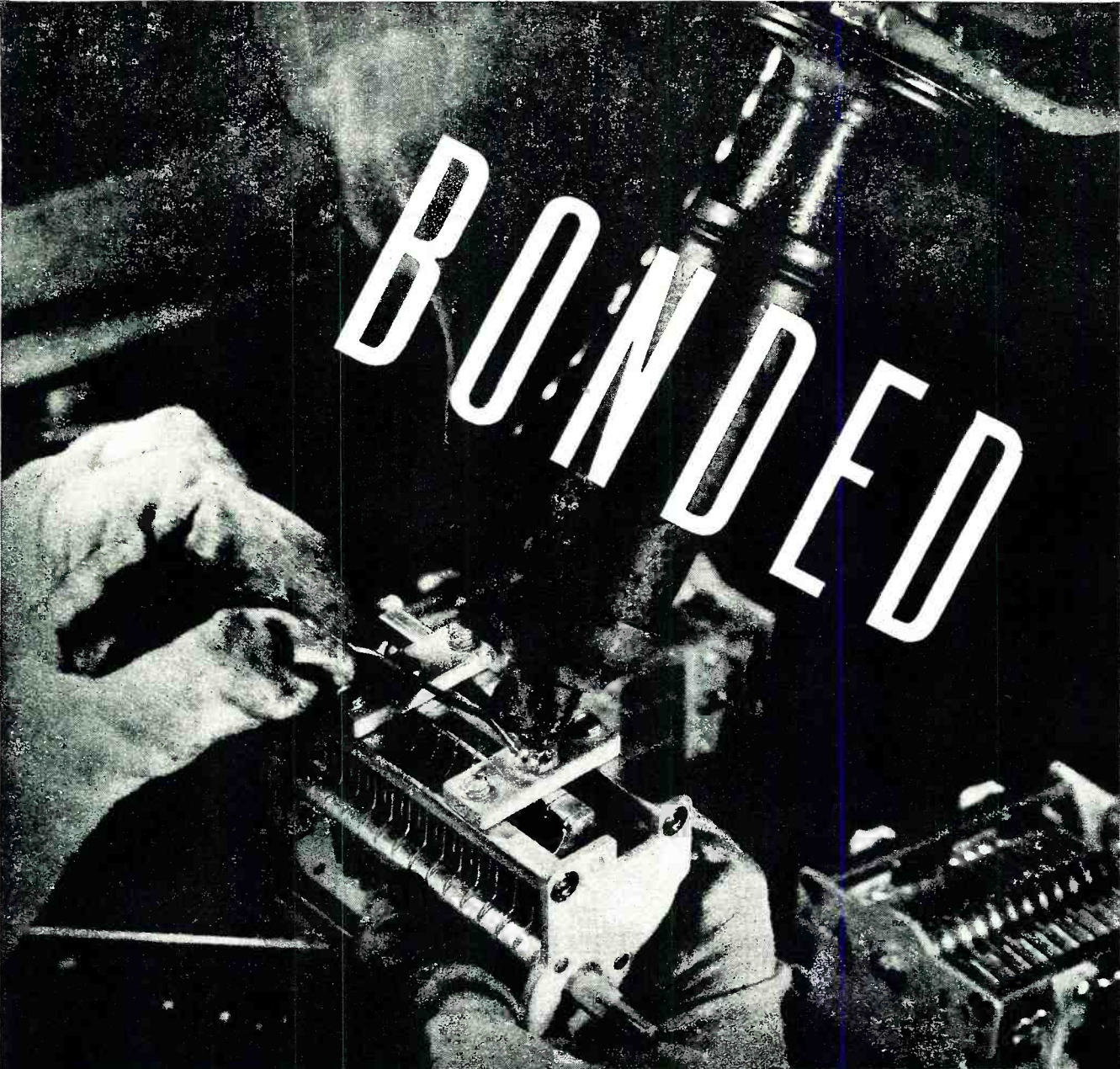

# BONDED

Hammarlund engineers developed the technique of soldering variable capacitors as a means of preserving their original characteristics. Where specifications call for vibration-proof components, always specify Hammarlund solder-bonded variables.

## HAMMARLUND

THE HAMMARLUND MFG. CO., INC., 460 W. 34<sup>TH</sup> ST., N. Y. C.  
MANUFACTURERS OF PRECISION COMMUNICATIONS EQUIPMENT



ESTABLISHED 1917



# WOMEN RADIO COMMANDOS

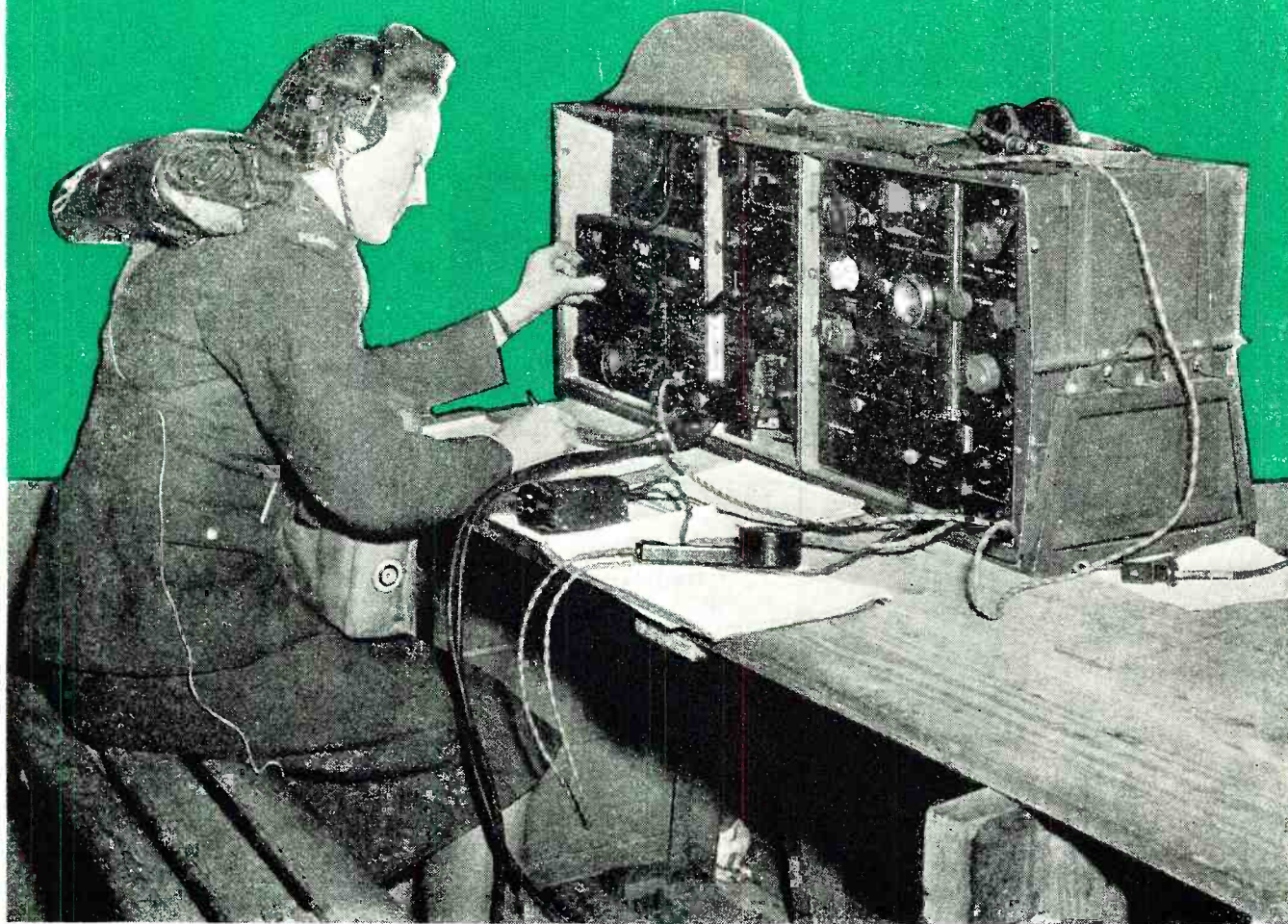

Radio transmitter used at a Polish woman commando camp in Britain. Many of these women were skilled technicians before the war.

By **KENNETH R. PORTER**

RADIO NEWS War Correspondent

**Fighting with the Allies for Poland's liberation, the women of the P.S.K. are receiving training in all methods of warfare, including most types of communications**

**B**LEAK and dismal, the Scottish cliffs overlooking the North Sea provide a perfect setting for one of the most stirring sights to be seen on all of the British Isles.

Far above the roar of waves dashing against rock comes the sound of gunfire. And through the perpetual mist that eerily silhouettes all it touches, figures throw themselves flat, aim rifles, and then leap forward to another firing position.

The figures are women, Polish women in whom wild, unreasoning hate is being molded into a sound, effective striking force. They are undergoing commando type training. To them it is mild compared with what they have been through in actual warfare.

The way they run, the purposeful

manner with which they aim and fire, the harsh battle cries that issue almost unconsciously from their throats, bode no good for any hapless Nazis who might be caught before a charge of these petticoat commandos.

These women would like to fight shoulder to shoulder with their countrymen in Great Britain and Russia who are poised to help their allies crack Hitler's "Fortress of Europe." They would like to kill Germans—lots of Germans. They may—in extreme emergencies—but primarily they are technicians whose chief work is close to the front lines, but not *on* the front lines.

Hundreds of them, beside their battle training, are attending highly-specialized schools where the curriculum includes advanced instruction in tele-



Women commandos obtaining experience in the operation of mobile radio equipment.

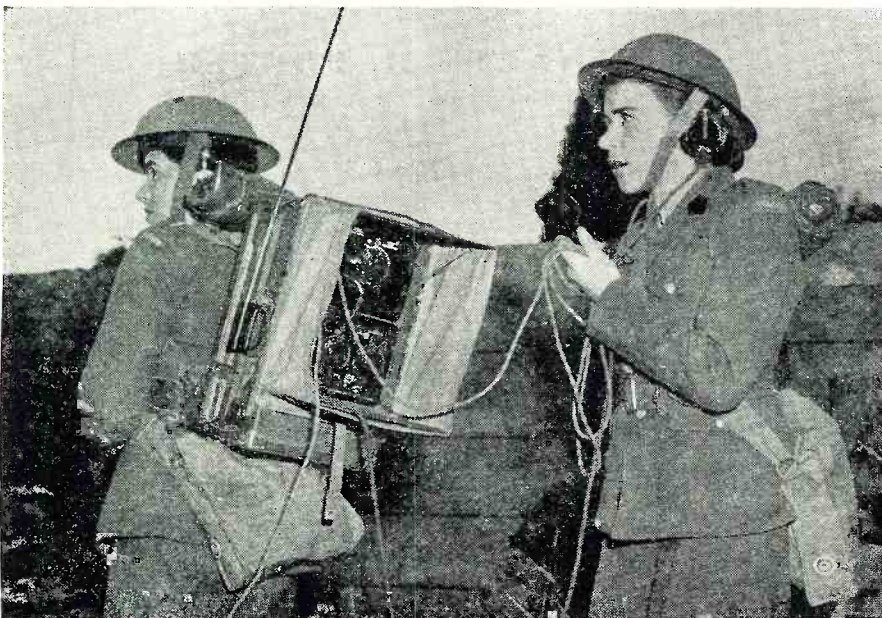

Airplane spotter team reporting the location of enemy planes to headquarters.

phone, telegraph, teletypewriter, television, and other types of radio communication.

Many of the petticoat warriors were skilled electrical or radio technicians before the outbreak of war. Some hold degrees in radio engineering and allied sciences. All know the desolation and hardship of flight before the Nazi Invaders and the bitterness of life in a strange land where their hate was fed daily with new stories of what the Germans were doing to their homeland, and their less fortunate brothers and husbands.

Now, as members of the reorganized P.S.K. (Pomocnicza Sluzba Kobiet), the Polish equivalent to the British Auxiliary Territorial Service and the American Women's Army Corps, they are prepared to add further to the history of the P.S.K.

The organization is not new. It existed in Poland before the war. It has been through fire and pillage, occupation and exile. Its full part in Poland's struggle against tyranny will not be known until the war is ended.

How the P.S.K. came into being again is a story in itself. It starts with the Nazi invasion.

When Hitler struck, the old P.S.K. was, as it is now, primarily a communications outfit. Many of the veteran officers and instructors of the present signal section recall vividly the trying days of September, 1939, when through their untiring efforts communications were kept open without a break for 22 days—the last phase of the fight for Poland. Their gallant stand made it possible for thousand of troops to escape over the Hungarian frontier without the loss of materials and with a minimum loss of men.

Some of the women were attached to the Tank Division, commanded by General Stanislaw Maczek, which covered this orderly retreat in the face of overpowering Nazi forces. Their job was at the mobile field radio stations and message centers.

But while they helped their men escape, few of the women were so fortunate. Instead they were captured, and many became part of the millions of Poles taken from their homes and sent to Nazi prison camps and slave factories.

A considerable group fled east, where Russians, then biding their time so that they would be prepared for the inevitable Nazi blow at Russia, took the girls prisoner. They were sent to isolated rural areas. Those with professional or scientific knowledge, especially in communications, dared not reveal their background.

Unaccustomed to any sort of manual labor, these experts were put to work on farms and kilns. They were luckier than those captured by the Nazis, for those unfortunates were cutting timber and working in mines where, if they died, were left in natural graves far below the earth's surface.

Although those in Russia were under strict surveillance, too, they soon built up an underground communications system with their German-held

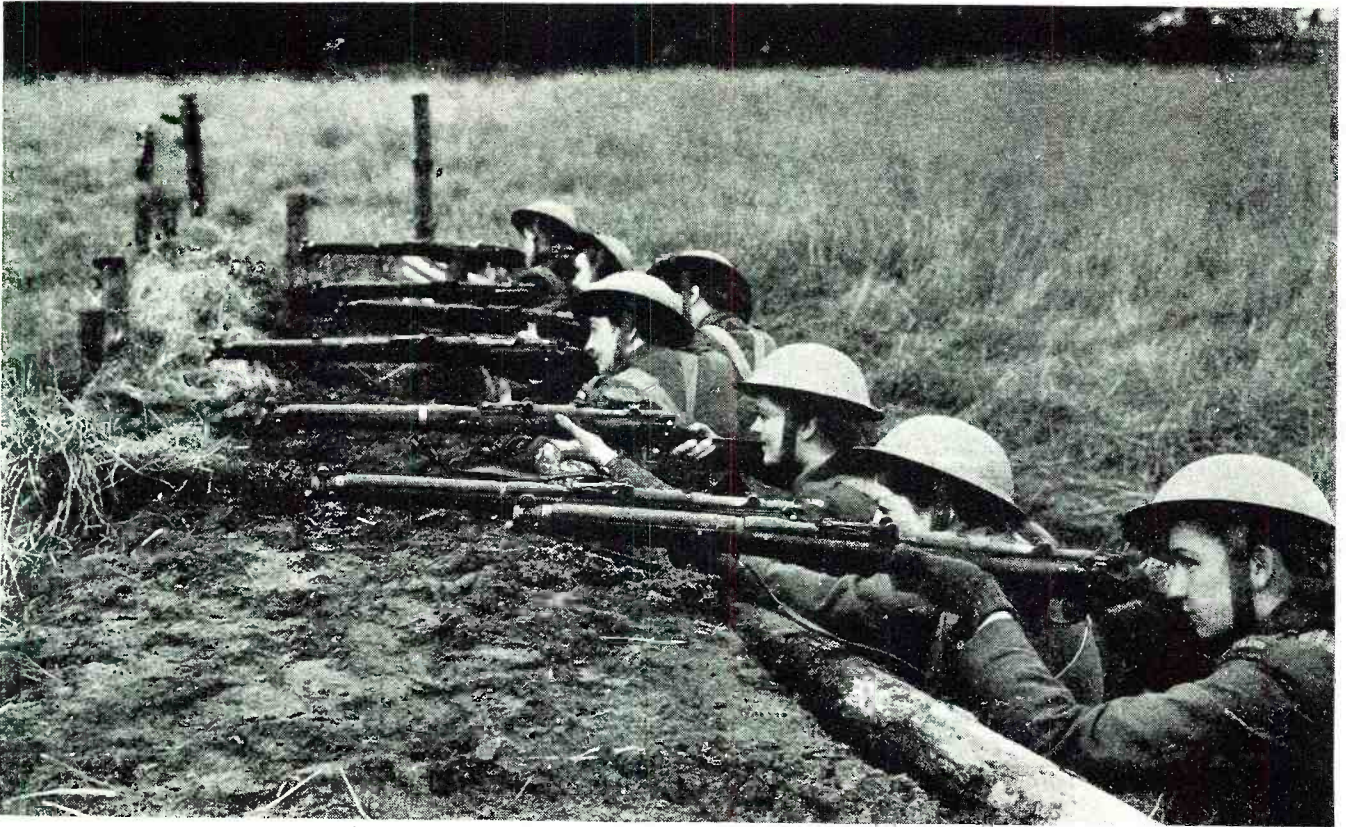

sisters. This system flourishes today, working relentlessly for the Allies.

The Russian-Polish agreement signed by Stalin and the late Wladyslaw Sikorski in Moscow in July, 1941, freed thousands of girls to fight again for their country. They began a great trek southward to Buzuluk, a hundred miles east of the Volga.

They went by foot, sometimes with luck by boat or in slow-moving trains. At Buzuluk, an oasis for Poles, these stragglers were greeted by their own people. The P.S.K.'s reorganized and began work again with Polish troops. Reverses of the war, however, forced them to evacuate and finally, by a circuitous route through Iran, Iraq, Persia and Palestine, the first small group of P.S.K.'s eventually reached the rugged and friendly shores of Scotland.

They had circled half the globe by this time; but during their travels they trained, learning to drive, to code and decode signals, to operate the newer type radio transmitters and receivers, to handle arms, to perfect themselves in nursing and, of course, to master the English language.

Now, under the direction of Lt. Col. Maria Lesniak, Commandant of the Polish A.T.S. (P.S.K.), these women receive specialist training in all of warfare's grim departments. Because of their natural aggressiveness and attention to duty they have quickly become superior to their brother signalmen in communications work.

"They have learned to withstand the physical hardships of their work as readily as men and they must be able to use all of the weapons of war for  
(Continued on page 100)

Firing at moving targets from a muddy rifle range, these women undergo commando type training. Their wild hate is being molded into a sound and effective striking force.

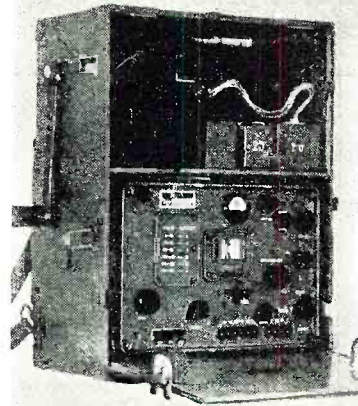

Prewar Polish-made model, type "N2-WZ37", made in 1937. (Left) Transmitter from mobile field radio set. (Bottom) Mobile unit complete with radio equipment. Like all Polish mobile units, this has special facilities for communications with aircraft.

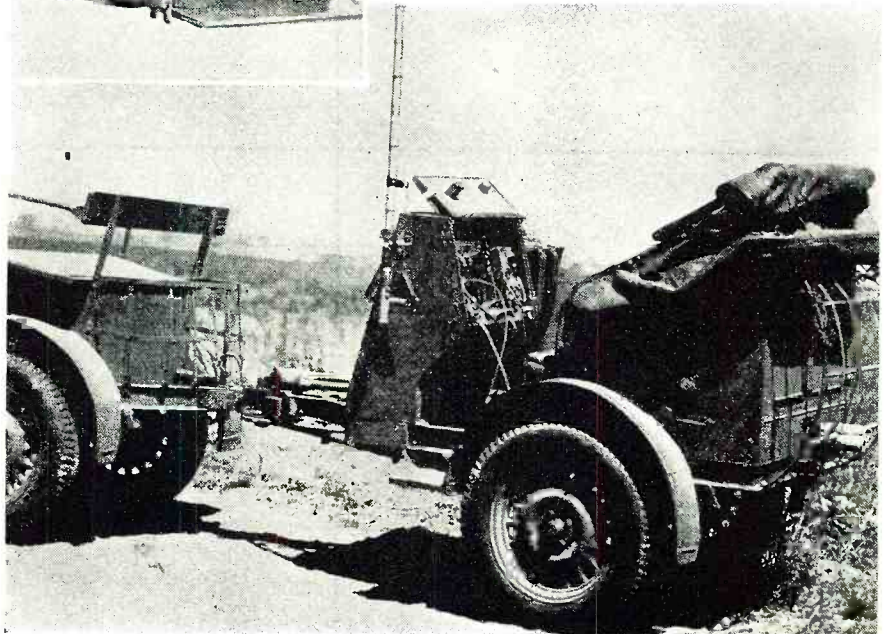

# THE OSCILLOSCOPE APPLIED TO RADIO SERVICING

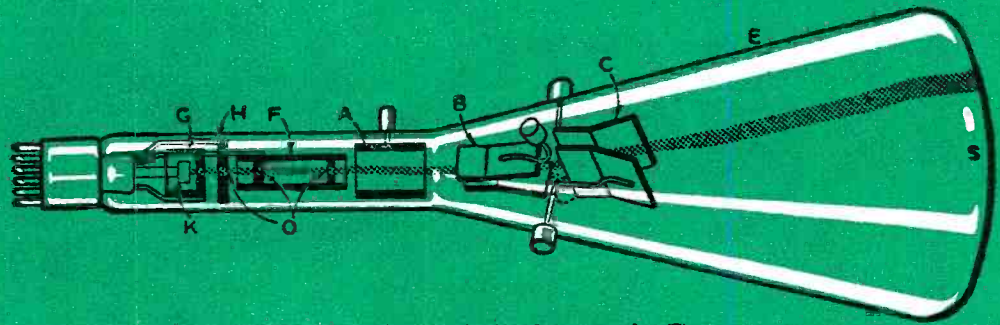

Fig. 1. The cathode-ray tube; (A) high-voltage anode, (B) vertical deflecting plates, (C) horizontal deflecting plates, (E) tube, (F) low-voltage anode, (G) cathode, (H) control grid, (K) filament, (O) electron stream, and (S) fluorescent screen.

By **A. HOWARD** and **M. EDDY**

*The application of the oscilloscope to the problems of radio servicing will save the serviceman considerable time and labor.*

THE oscilloscope is no longer confined to the research laboratory, but recently has become standard equipment for the entire radio industry. Its extreme versatility renders it capable of almost every type of measurement. Nowadays, because of the relatively low cost of the instrument, every serviceman can afford and should own one. The advantages derived from the use of the oscilloscope result in saving of time and permit a great many measurements with accuracy hitherto considered impossible.

The purpose of this article is to relate to the serviceman some of the many possible applications the instrument affords. Therefore, remarks will be along the practical channels. However, for the benefit of those who may have forgotten their theory, a brief outline of the operation of the oscilloscope will be given.

#### Internal Structure and Operation

The cathode-ray tube, which is the heart of the oscilloscope, consists of a cathode which emits electrons that

strike a fluorescent screen, causing it to light up momentarily. A grid controls the amount of electrons emitted. Two high-voltage anodes focus the beam so that it forms only a small spot of light on the viewing screen. The potential of these anodes are usually in the ratio of 5:1. The aforementioned components comprise the "electron-gun."

A pair of deflecting plates mounted horizontally cause the beam to move vertically when a voltage is placed upon them. The amount of movement

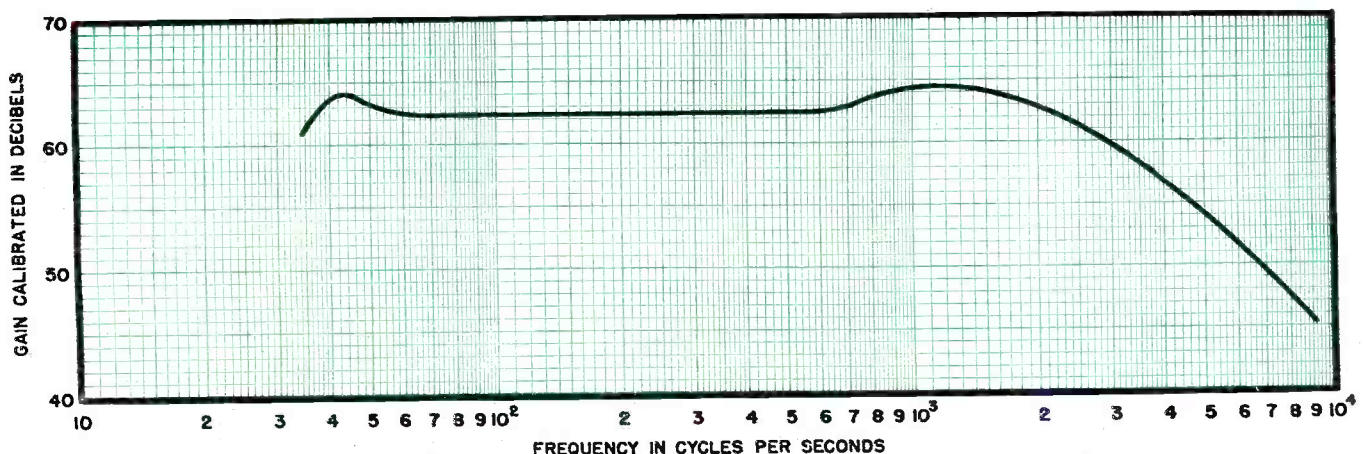

Fig. 2. Typical response curve of an amplifier designed for a relatively good low-frequency response.

is proportional to the voltage. This phenomenon is analogous to the action of the vacuum tube, in that electrons emanating from the cathode are attracted to the plate. Similarly, a pair of vertical plates excite the beam horizontally. Horizontal and vertical amplifiers are included to amplify weak voltages. The amplifiers are more or less of the orthodox class-A design with which the serviceman is already so familiar. They should possess as little distortion as possible and have flat frequency characteristics. By varying the gain of the vertical amplifier, it causes the amplitude of the wave being viewed to change accordingly. Likewise, when varying the gain of the horizontal amplifier, the width (time base) of the wave varies too. (Fig. 6).

In order to spread the voltage being viewed across the screen, a device known as a sweep circuit is used. It contains a saw-tooth oscillator. The waveform emanating therefrom, rises at a linear rate until it reaches a certain point. At this point, it immediately drops to zero. The waveform resembles the saw-tooth on a rip saw. This saw-tooth waveform repeats continuously, being fed into the horizontal deflecting plates of the cathode-ray tube (when desired). Refer to Fig. 4.

To make the desired image stand still on the screen, thus facilitating viewing, a synchronizer is used. Some of the voltage applied to the vertical axis is fed to the input of the saw-tooth oscillator. This results in a "locking-in" effect, making the image appear motionless. For convenience to the serviceman, external synchronization also can be utilized. Jacks are mounted on the instrument for this purpose.

Generally, a single power supply system supplies the necessary voltages to all the components of the oscilloscope. Caution should be exercised when using the instrument. The chassis should never be taken out from the cabinet when the current is on as the high voltages may prove to be fatal.

### Applications to Servicing

#### Measuring Voltages and Currents

Since the deflection of the spot is proportional to the voltage impressed on the deflector plates, the screen may be calibrated and used as an instrument for measuring directly low-frequency and high-frequency voltages. The instrument used in this manner acts as a high-resistance voltmeter. It is very important to determine the gain of the amplifier of the oscilloscope and the sensitivity of the cathode-ray tube. Once these factors have been established, the screen should be calibrated. Obviously, the accuracy of the reading will vary directly with the accuracy of the calibrations.

To measure a.c. voltages, simply apply the voltage to the vertical deflector plates. If desired, it can be amplified, as will be explained later. The sweep circuit should not be used. The length of the line formed on the screen, indicates the "peak-to-peak" value of the voltage observed. To find its effective

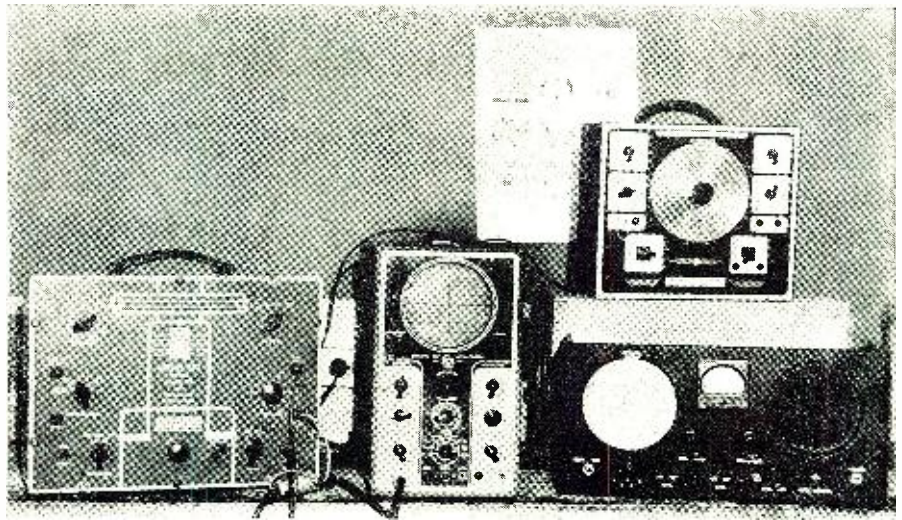

General layout of equipment used in conjunction with oscilloscope servicing.

value, multiply the "peak-to-peak" value by 0.353. There will be a deviation of reading when measuring high-frequency voltages due to losses in the connecting wires.

When measuring d.c. voltages, obviously the amplifier contained in the oscilloscope cannot be utilized. Also, the sweep circuit is not used.

Apply the d.c. voltage to be measured to the vertical deflector plates. In this instance, the voltage is equal to the distance the spot moves across the screen from the "no-voltage-position" to "voltage-position." As mentioned before, the accuracy of the reading depends on how accurately you calibrated the tube.

When measuring very low voltages, the vertical amplifier can be put into

use. For example, a low a.c. voltage is applied to the vertical input of the oscilloscope, the amplifier contained therein being used. If the r.m.s. value, as read on the screen, is 50 and the gain of the amplifier, at that particular instance (the gain of the amplifier can be varied), is 100—then the r.m.s. value of the voltage being fed into the vertical input of the oscilloscope is equal to 50/100, or 0.5 volt.

To measure current, a resistor of known value is placed across the scope in series with the circuit whose current is unknown. Actually, this forms a series-parallel circuit. The voltage is then determined as was outlined above, and the current may be readily calculated by Ohm's law;  $I = E/R$ .

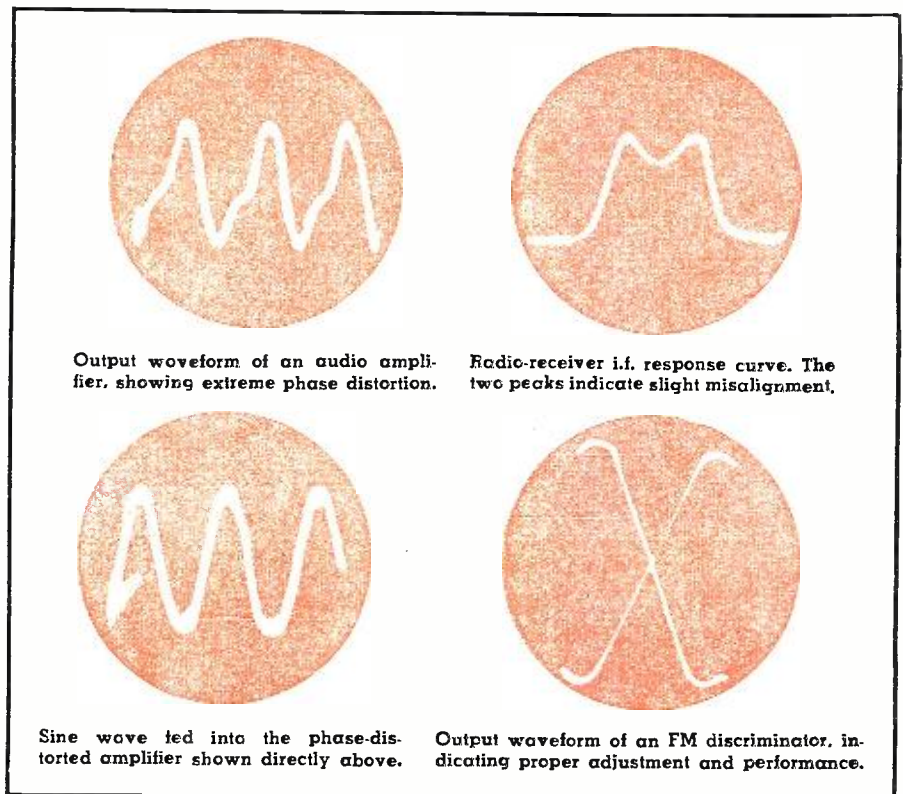

## TYPICAL RESONANCE CURVES AND THEIR INTERPRETATIONS

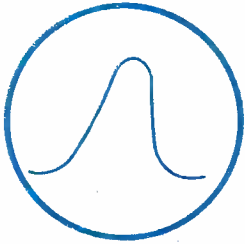

Sharp response curve, unsuitable for high fidelity (six-kc. band width).



Pattern for a good home receiver. Steep-sided curve gives good selectivity.

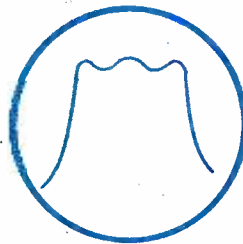

High fidelity receiver response curve with a band width of 16 kilocycles.



Improperly aligned tuned circuit, giving adjacent channel interference.



Good response curve of superheterodyne, having flat-top i.f.'s.



Circuit requires slight adjustment of the trimmers to bring it to symmetry.

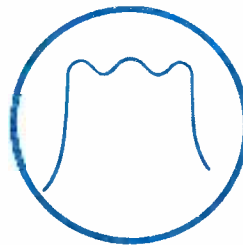

Wide-band high-fidelity amplification obtained by staggering the three i.f.'s.



Rippling trace indicates that oscillation is present in the circuit.

## FM DISCRIMINATOR TRACES



Nonlinearity of the discriminator caused by detuning the primary.



Crossover point not at center, showing that detuning of secondary exists.

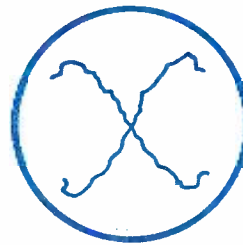

Rippling curve indicates that regeneration occurs in the i.f. circuit.

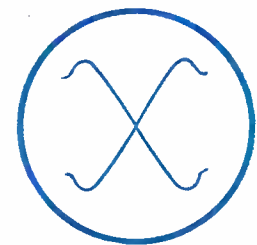

A good curve, correctly centered and adjusted, showing high quality design.

## DISTORTION IN AUDIO-FREQUENCY AMPLIFIERS



Overload distortion with cut-off flat peaks. Gain control turned too far up or improper grid bias.

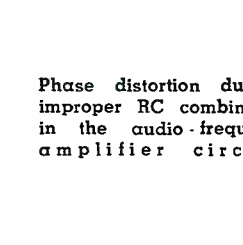

Phase distortion due to improper RC combination in the audio-frequency amplifier circuit.

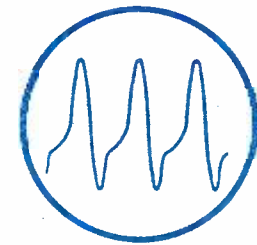

### Testing Over-all Audio Fidelity of a Receiver

The criterion of any audio amplifier is how faithfully the amplifier reproduces in its output the waveform that was impressed in its input. To determine this fidelity and, hence, how good the amplifier is, the oscilloscope can be utilized to good advantage, as illustrated in the following discussion.

To test for the over-all audio fidelity, a modulated test oscillator is re-

quired. First, apply some of the a.f. modulated voltage to the vertical axis of the scope. Then the saw-tooth oscillator is made to synchronize with it (by adjusting the synchronizing control on the instrument) and the resultant wave is carefully observed. After this is done, feed the modulated oscillations to the antenna posts, and connect the scope to the voice coil of the speaker. There should be practically no difference between this and

the previous waveform observed. If there exists a marked difference between the two, then distortion is prevalent.

Another test for quality is the frequency distortion test. Frequency distortion is the condition whereby certain frequencies passing through the amplifier are either accentuated or attenuated. To test for this, apply a continuously variable frequency of constant amplitude (this is impor-

tant), from about 100 cycles to 15,000 cycles, in steps of 1,000 cycles. Connect the oscilloscope to the output and adjust the sweep circuit. Observe carefully! If frequency distortion exists, the amplitude at certain frequencies will either increase or decrease from the mean voltage.

If desired, a graph can be made, thus enabling the serviceman to make a more accurate determination of frequency distortion. Take a piece of semi-log paper and plot the points as shown in Fig. 2. If the resulting curve shows a fairly flat-topped characteristic, the amplifier lacks frequency distortion.

Phase distortion is the condition whereby the phase relationship between two or more frequencies passing through an amplifier is changed. The oscilloscope lends itself admirably for establishing this unwanted condition.

Apply a saw-tooth waveform (known to be fairly linear) to the amplifier. As in the previous procedures, connect the scope to the output of the amplifier. If the resultant waveform does not conform to a linear saw-tooth shape, phase distortion is present.

It should be borne in mind by the serviceman that the above procedures just relate some of the many possible tests that can be made in order to determine the fidelity of an amplifier system. As the serviceman will appreciate, after using the oscilloscope for a while, many faults can be determined that were undetectable by the human ear.

#### Localizing a.f. Distortion in a Receiver

If, in the above tests any distortion is found to exist, this can be localized to the source of trouble.

To localize the source of trouble when distortion is found to occur in the over-all test, connect the modulated oscillator to the input terminals of the receiver. Then, the scope terminals are successfully connected to the detector stage, amplifier and output stages. The stage causing the trouble may then be determined and rectified.

Likewise, it is possible to localize the other types of distortion in any a.f. amplifier or p.a. system by the method outlined above. However, instead of a modulated test oscillator, a source of a.f. voltage is used.

#### Visual Alignment of Tuned Circuits

With the aid of an oscilloscope and auxiliary equipment, the serviceman can actually observe the resonance curve of a tuned circuit. He can see the changes produced while adjusting the circuit constants. This is very desirable when certain types of circuits are to be studied. These include, triple-peaked, wide-band, steep-sided, and flat-topped curves. The visual method insures accurate alignment and speeds up the process considerably.

To observe resonance curves, a frequency wobbler is necessary. One type of wobbler consists of a synchronous motor rotating a condenser connected in parallel with a test oscillator. (Fig.

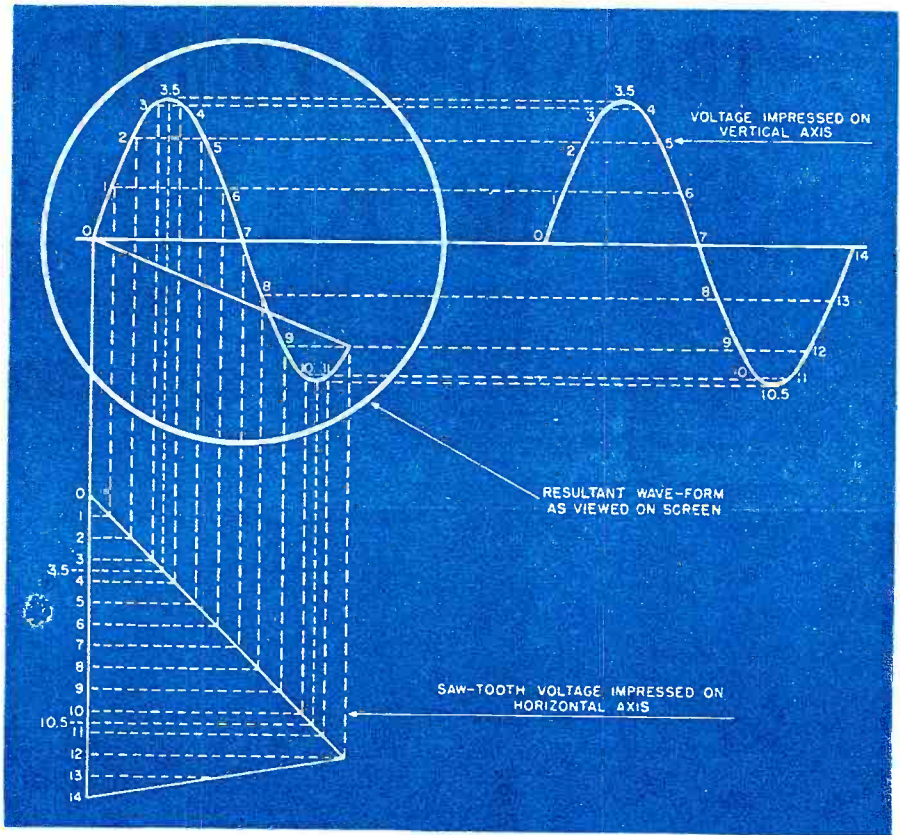

Fig. 4. How the sweep circuit of an oscilloscope spreads the image across the screen.

5 makes this clear.) It moves the oscillator's frequency back and forth across the resonant frequency of the tuned circuit and the output varies according to the response curve.

Instead of using a mechanical frequency wobbler, a frequency-modulated signal generator with little or no traces of amplitude modulation can be utilized. This kind is the electronic type. It functions just as an FM station—sending out a frequency-modulated signal. A control is provided to determine the frequency of the modulated signal, which may be 10, 20 or 30 kc., depending upon the tuned circuit to be examined.

Now, to put the visual method in practice, apply a signal from a test oscillator (either frequency-wobulated or frequency-modulated type) to the

grid of the tube preceding the stage to be aligned. The scope (vertical axis thereof) is connected to the output of the detector. A saw-tooth voltage is impressed upon the horizontal axis, and the wobbler-frequency voltage (or the FM voltage) is fed to the synchronization jack of the instrument. This is done in order to synchronize the saw-tooth voltage with the wobbler frequency. Also, these frequencies, i.e., the saw-tooth voltage and wobbler-frequency voltage should be the same. This makes the image stand still. The frequency could be from 10 to 30 kc.

In a superhet, the oscilloscope is hooked-up to the second detector. In all cases, it is essential that the central frequency of the test oscillator be

(Continued on page 128)

Fig. 5. Test setup arrangement for observing visual resonance curves.

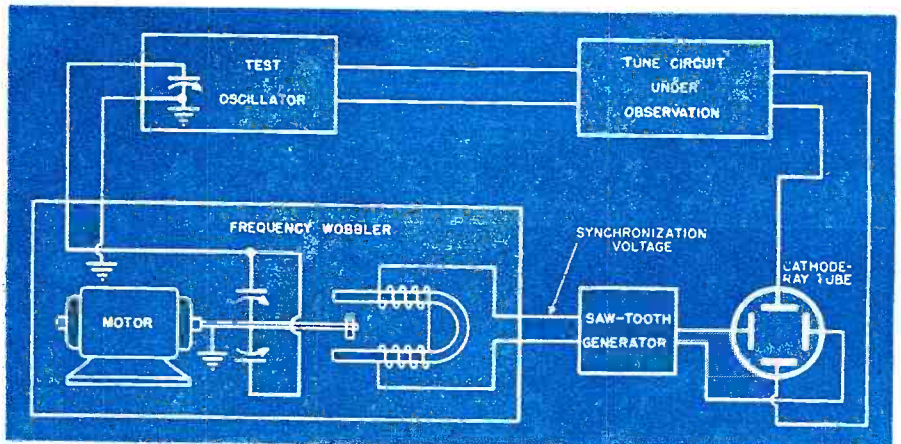

# TRANSPORT COMMUNICATIONS FOR RAILWAYS

By **JOHN A. CURTIS**

Vice Pres., Halstead Traffic Comm. Corp.

***The application of radiotelephony to railway transportation facilities opens important new markets and communications services.***

**I**T HAS been said that World War II is primarily a war of movement. The complete mechanization of our Armed Forces, the importance of air superiority, and the worldwide scope of military and naval operations support this belief. Behind this war of movement, and the life blood of it, are the radio services operated by our military and naval branches. Whether employed as a means for detection and location of unseen mobile units or for the transmission and reception of vital military intelligence, radio, with its many indispensable uses, is the prerequisite of modern warfare.

To meet this war's urgent demands for radio equipment, the United States Government has invested over sixty-nine million dollars in new radio facilities. Private radio interests have made further substantial investments in new plants. Additional millions have been spent to train men and women to design, fabricate and assemble radio equipment; to operate this equipment in the field; and to service it at many points throughout the world.

The facts are that, whereas in 1940 the total investment in American radio manufacturing plants approximated \$50,000,000, employed about 75,-

**EDITOR'S NOTE:** *Owing to the fact that the problems of radio communications applied to railway and highway transportation are entirely segregated and distinct from one another, in regards to the installation of the equipment and final operation, it was necessary to present the story of transport communications in two companion articles, the article covering transport communications for railways starting on this page, and its companion article on highway communications on page 37.*

000 people, and did an annual gross business of approximately \$300,000,000, today the American investment in radio manufacturing facilities is approximately \$350,000,000, employs over 400,000 men and women, and has reached an annual production rate of some \$3,500,000,000.

When peace comes, what is to happen to this massive investment in radio production facilities and especially trained personnel? Will these facilities and reservoirs of skilled manpower continue to be a national asset? Or will they be allowed to dissipate, with a resulting effect of unnecessary waste and unemployment?

Perhaps the most important single factor to be considered in determining whether or not the nation's greatly expanded war-established radio production facilities will become a source of new, peacetime wealth and employment or a war-necessitated waste, lies in the answer to one question: Into what new, economically-important fields can radio techniques be quickly extended after the war?

In analyzing undeveloped radio markets of important magnitude, two broad fields, in which extensive applications of radio techniques may be made, stand out with particular clarity. These are the fields of railway and highway radio.

As an indication of the tremendous scope of the railroad industry, we need examine only a few significant figures. American Class I railroads, for instance, operate almost 400,000 miles of trackage, employ approximately 1,500,000 men and women, own almost 2,000,000 freight cars, 46,000 passenger cars, over 42,000 locomotives, and 23,000 cabooses. In 1940, a normal year, the railroads transported almost 2,000,000,000 tons of freight and almost 450,000,000 passengers.

In brief, it can be stated that the bulk of America's food, clothing, and materials for shelter, as well as other

**Completely radio-equipped railroad service and repair truck. Police escort is used when extreme emergencies arise.**





commodities, are carried by our rail systems. Without the railroads, America's present type of economy would cease to function and the nation's high standard of living would probably bog down to an all-time low.

Despite the magnitude and importance of the railway industry, radiotelephony, the most flexible and efficient of all communicating media, has yet to be applied on a coordinated basis to bring about increased efficiency and safety. Fortunately, however, at this writing railway operators, radio engineers and manufacturers, and the government agencies concerned, are conducting comprehensive and cooperative studies of the potentials of railroad radio.

Just how might radio techniques, as they are now known, be applied on a comprehensive scale to railway operations?

There appear to be at least two major operational applications for radio in the railway fields. One of these is in yard and terminal areas; the other is along mainline trackage. As an example of the extent to which radio can be useful in yard areas, it should be pointed out that, under the communicating systems at present employed in the majority of yards, the yardmaster delivers his instructions to locomotive engineers and conductors via written orders, telephone, or, in some yards, loudspeakers. In the first two instances, the conductor or engineer must go to a fixed control point, such as a yard office or telephone station, to get his orders. In the latter case, although he may be able to receive his orders in any part of the yard, to talk back, he must, likewise, go to a fixed point where a wire communicating facility is available.

With radio, on the other hand, the yardmaster is able at all times to establish instantaneous two-way communications with his engineers, conductors, and supervisory yard personnel, whether they are in engines, on freight cars or other mobile units, or walking on foot. What is more, the position of all equipment and personnel, and the progress and the completion of their assignments can be ascertained instantaneously by the yardmaster. Instead of returning to the yardmaster's office, or other fixed control point to clarify orders, to deliver reports, or to receive new instructions, personnel at any point in a yard area can send, as well as receive, required information.

Before the war, sufficient opportunity had not been provided to demonstrate to railroad operators and government agencies the full extent to which radio could provide coordinated managerial control of large yard areas. During the war, however, case histories have been secured on the railway systems of government-operated ordnance plants to prove the unquestionable value of radio in bringing increased efficiency and safety to yard and terminal operations.

At the suggestion of the *Halstead* engineering group, the operators of the *Kingsbury Ordnance Plant* gave con-

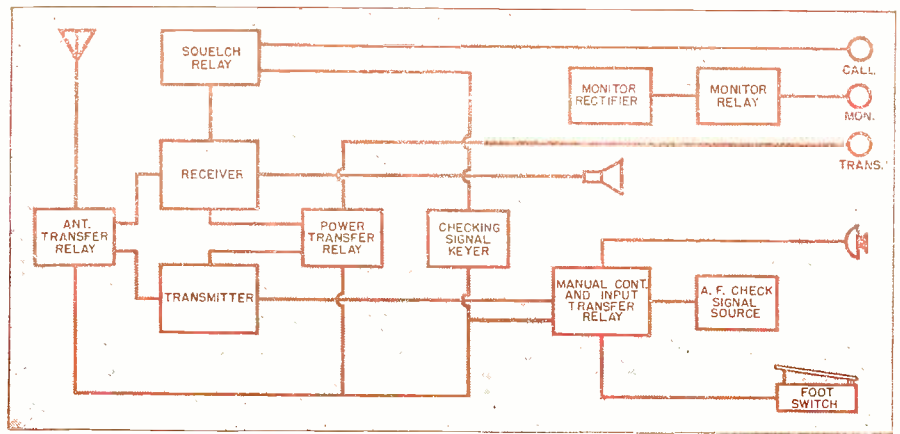

Block diagram of central-station radiotelephone equipment, showing voice and checking signal circuits employed in the *Halstead* system. Visual indicators provide a check on emission of signals from the central-station transmitter, and reception of carrier signals from mobile units. A carrier-operated relay automatically suspends transmission of the periodic checking signal during reception of a carrier from a cooperating mobile unit.

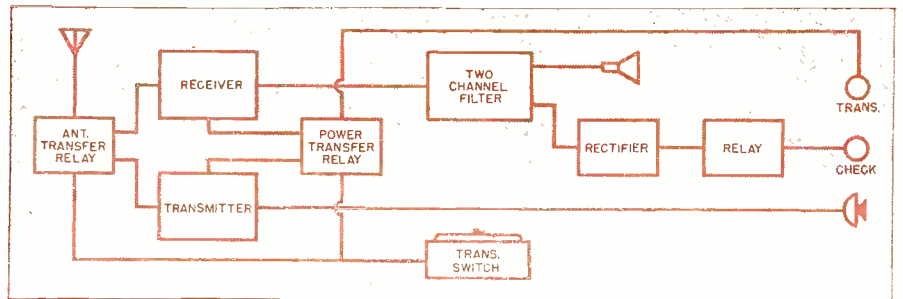

Block diagram of locomotive radiotelephone equipment, including units employed in one form of the *Halstead* audio-visual checking system.

sideration, in the early part of 1941, to the use of radiotelephone equipment on their extensive rail system. Subsequently, after tests in May, 1941, radiotelephony was employed on their railway system, as well as on those of many of the other larger shell-loading plants. These installations have provided excellent opportunities to determine the extent to which radio can increase the efficiency and safety of rail

operations in large yard areas. It has been stated, for instance, by the operator of the *Kingsbury Ordnance Plant* railway system, that radio has increased the efficiency of his rail operations by 25%. In fact, according to Mr. L. E. Hewitt, Superintendent of Railways, the continuous movement of freight cars over a wide area, required in the operation of a large, modern shell-loading plant, could not be ac-

Typical layout of one form of railroad radiotelephone equipment (30-40 mc.) for Diesel-electric locomotives, incorporating the audio-visual checking system.

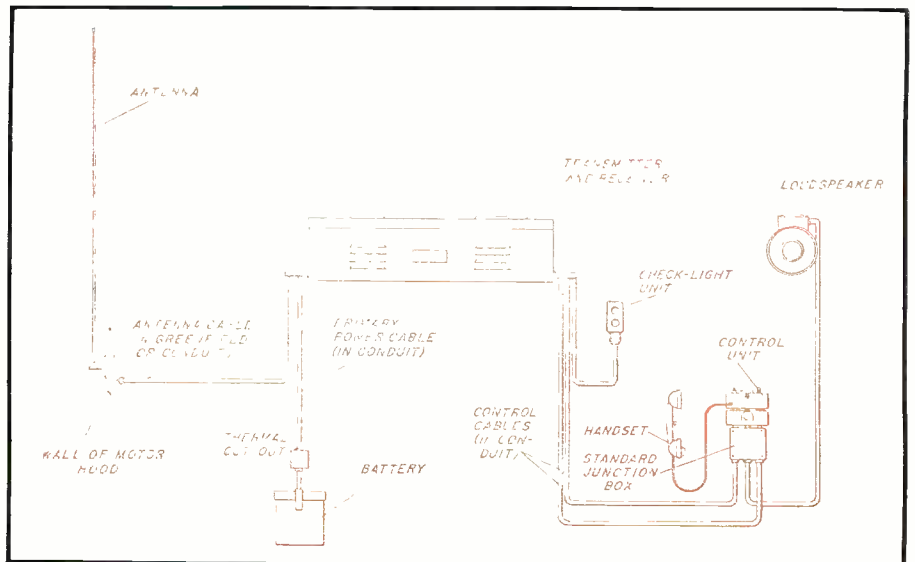



Yardmaster at Kingsbury Radio Central, whose desk is located alongside that of the radio dispatcher. The locations of all cars are shown by the extensive card file.

complished on any efficient basis without the use of radio.

In addition to increased efficiency, radio has proved itself a safety factor in these operations. In the case of emergencies, aid can be immediately dispatched to any part of the yard. In the event that locomotives or cars are switched to the wrong tracks, the error can be instantaneously corrected. The fact is that radio has proved itself so safe and efficient in providing comprehensive control of dispatching of locomotives in the larger ordnance plant areas that most operators depend solely upon it for the direction of movement of cars bearing high explosives.

It is to be expected, therefore, that the same benefits, on a greatly augmented scale, can be obtained by our national railway systems in applying railway radiotelephony to their yard and terminal operations. In some cases, normal space radiating systems, blanketing an entire area with radio-wave energy, as in conventional police

radio communications services, will probably be utilized; in other instances, radio-frequency signals, inductively impressed on wayside conductors, may be more practicable. *(In addition to these two methods, there is a third, generally designated as a carrier telephone system, which utilizes the rails as its primary conductors. However, since this is not considered as a radio system, it is not included in the subject matter of this article.—Ed.)* In the latter case, the signals are confined within a short distance of the track area and do not spread out into space as do normal radio signals.

In the opinion of some engineers, normal space radio systems have an advantage in that coverage of an entire area can be secured regardless of the presence of wayside conductors. On the other hand, the induction radio systems have, in the opinion of many engineers, an advantage in that signals are confined substantially to railroad property and can be operated in such a manner that they do not re-

quire Federal licensing under the existing rules and regulations of the Federal Communications Commission. It is anticipated, therefore, that both types of systems will find extensive application to America's railway systems, with space radiating equipment possibly being favored in the larger yard and terminal areas; and induction radio systems in the smaller yard areas, such as those associated with industrial plants, in terminals where wayside wires already exist, or where numerous obstructions to space propagation, such as steel frame buildings and tunnels, might require relatively costly installations of repeater equipment to obtain complete coverage by space-radiating systems of the high-frequency type.

Both types of systems incorporate transmitting and receiving units of approximately the same size and weight, and have approximately the same power output ratings, usually ranging from 10 to 50 watts. The cost of either type of equipment appears to be, at this writing, approximately the same—another reason why it may be anticipated that both types of systems will find extensive application to America's railway systems.

As in yard and terminal applications, it is believed that both space-radiating and induction-radio techniques will be applied to main-line operations. Many factors, including those of terrain, the existence of already erected wayside wire conductors and the operating setup of the individual railroad involved, will determine to a considerable extent whether space or induction radio techniques are best for a particular railroad's communications problems.

It should be noted, however, that one school of engineering thought believes that only space-radiating techniques can be of practical value; that another favors the utilization of induction-radio techniques. The former points out that the telephone and telegraph lines which follow most all of American railway rights-of-way are sometimes a considerable distance from the railway tracks, are occasionally lead-sheathed, and sometimes are installed under the ground; that these wires are occasionally destroyed by storms, floods or wrecks, when radio communications are most urgently needed. The proponents of induction radio challenge this viewpoint by stating that, even when wires are several hundred feet away from the track, satisfactory communications can be established; that if, at certain locations, existing conductors are so located as to prevent adequate communications, supplementary wires can be installed at these locations at low cost to bridge the comparatively short distances usually involved in such instances. The proponents of induction radio further point out that, in the event of damage to the normal wire lines, involving broken wire lines in all circuits, the signals will bridge a considerable distance before the system is

*(Continued on page 114)*

Shock-mounted frequency-modulation transmitter and receiver installed in locomotive cab.

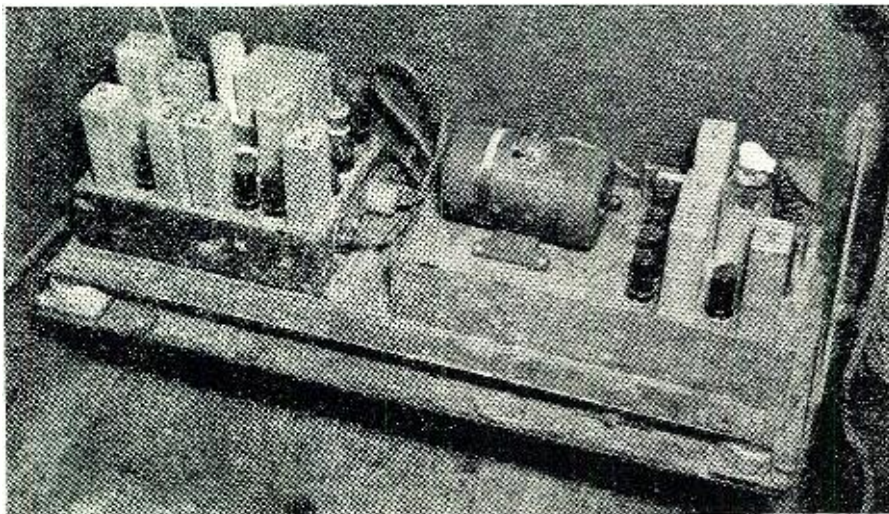

(Right) Radio-control equipment mounted in locomotive cab. Simplicity of operation is comparable to our present-day telephone. (Below) Diesel-powered locomotives standing by for orders. U.h.f. antenna, shown mounted on top of cab, radiates a vertically polarized signal to cover a large area.

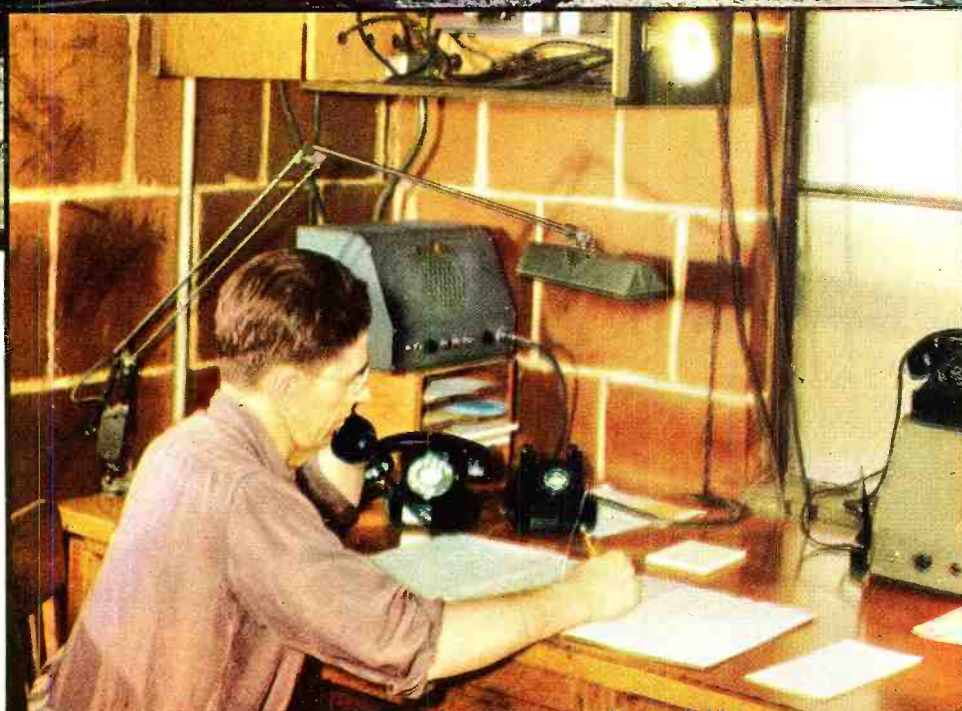

The "nerve center" of the railroad communications system, showing operator routing traffic by means of radio communications.



Control office of Queens Midtown Tunnel experimental installation may be used to transmit programs, emergency warnings, and traffic instructions to tunnel users instantly. All repeated instructions are sent by magnetic-tape recorders.

Remote-control installation, designed particularly for the Queens Midtown Tunnel, permits supervision of all radio-transmitted messages.

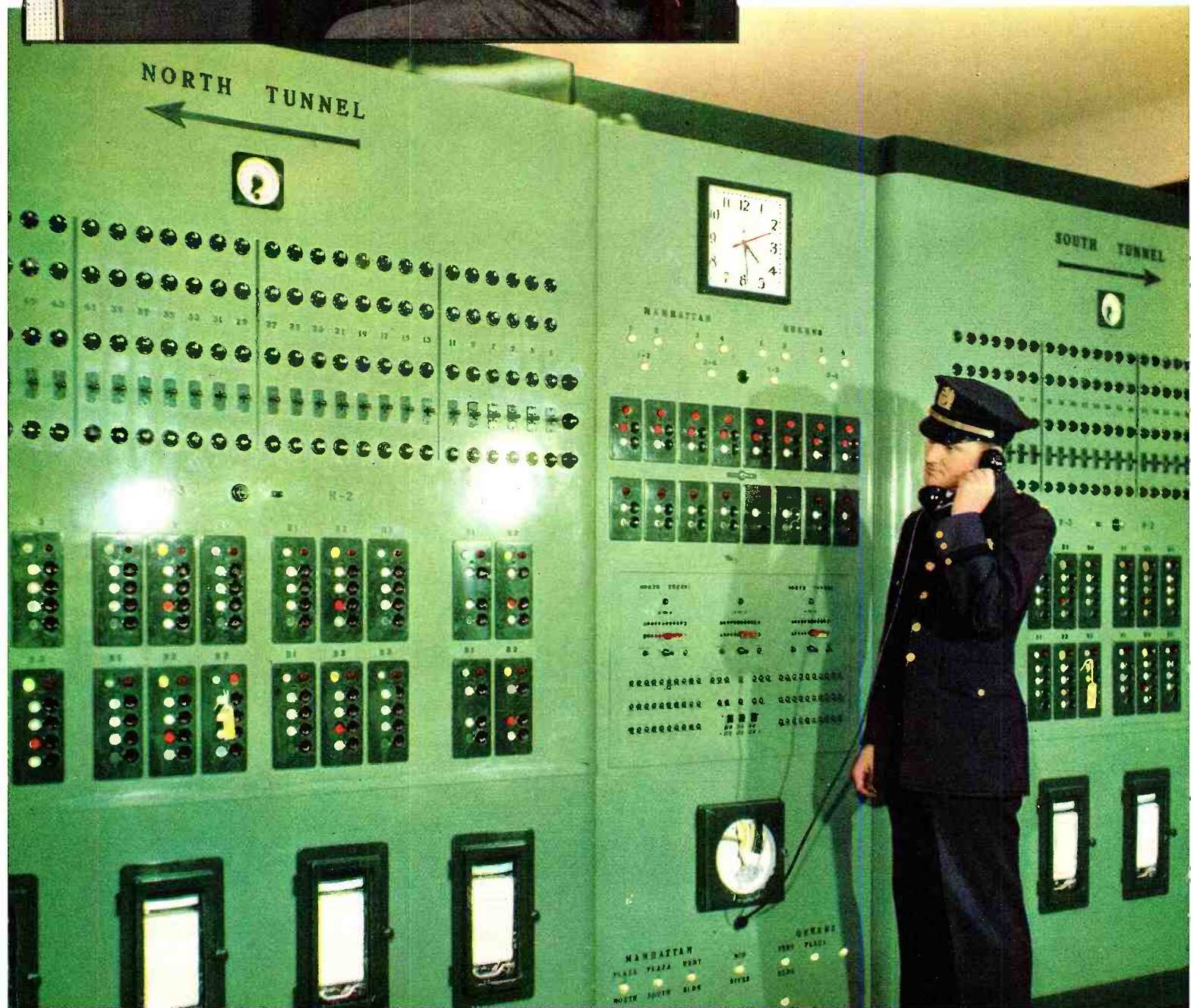

# TRANSPORT COMMUNICATIONS FOR HIGHWAYS

***The application of a radio communications system to America's highway network will produce a safer and more efficient means of mass transportation.***

JUST as the application of radio techniques in the field of railway transportation can bring about greater efficiency, speed and safety, so a comprehensive highway radio communications system can make America's highway system a safer and more efficient means of mass transportation. As an indication of the magnitude of the highway transportation field, the following salient statistics are given: In the year of 1941, there were in the United States over 1,500,000 miles of surfaced roads; America owned in excess of 29,500,000 passenger cars; 4,800,000 trucks; and over 146,000 buses.

Not only does America's highway transportation system represent a huge public investment, and a vital and necessary part of American economy, but the loss of life, maimed bodies and property damage, caused by highway accidents, especially during normal times, represent one of this nation's greatest peacetime problems. The extent to which this waste of life and property exists is shown by the following figures, based on the year 1941: Approximately 40,000 people were killed on American highways; almost 1,400,000 were injured, many of them permanently maimed; the property damage caused by highway accidents had reached such alarming proportions that, just before the war, the President is reported to have referred to it as America's Number One peacetime problem. According to statistics compiled by one of the leading insurance companies, the number of deaths in the last fifteen years that were a direct result of automobile accidents is nearly double the loss of lives of our citizens as a result of all wars in which the United States has been engaged, not including the present world war. Any means, therefore, which promises to contribute to greater safety and more efficient use of America's highways is of utmost national importance.

In the past, drivers have depended primarily upon visual means, such as provided by roadside signs, markers, red and green lights, and hand signaling, for traffic instructions. Such means place an additional burden on the already over-taxed eye of the driver, and have a further disadvantage in that they often take the at-

tention of the driver off the road at a crucial moment, especially at intersections. Visual communicating means have an additional disadvantage in that their efficiency is impaired by darkness, storms, fog, or when normal view is obstructed by other obstacles.

Through the specialized application of radio techniques, already developed and tested in public installations, it has been proven that radio techniques will bring entirely new concepts of highway traffic control, as well as highway communications. Since radio employs the comparatively-unused sensory organ of the ear, rather than the over-taxed eye, not only does the application of radio make for safer and more efficient highway driving, but it accomplishes its results, regardless of conditions of visibility.

In using radio as an operational and safety aid on highways, directional, limited-range radio techniques can be employed in roadway signaling zones to direct traffic from primary routes to secondary traffic arteries when peak traffic loads or temporary obstructions cause congestion on main highways. Automatic roadside radio equipment, remotely controlled from a central point, can advise motorists of danger zones, such as blind intersections, curves, ice formations, and approach of railroad trains. Similar equipment can provide detailed instructions with regard to routing and destination, now ineffectively given by roadside signs. Radio can automatically warn drivers of approaching cars at dangerous intersections, speed limits, and may readily be coordinated with existing

traffic control systems to provide audible and visual traffic control signals within vehicles. Further, a coordinated highway radio system can provide paging and radiotelephone communicating services, limited substantially to highway areas, for private cars, bus and trucking companies, doctors and others who normally utilize motor vehicles in their business and professional activities. Thus, radio can help make more efficient use of America's already-existing highway system, and bring greater safety and efficiency to the projected superhighways of the future.

Realizing the potential services which highway radio might bring the American public, engineers of the Halstead group began, in 1937, an extensive, long-range development program in the highway radio field. As a result of this program, the first practical public installation of a highway radio system, operating as a public service, was made on the George Washington Bridge in 1940, during the second year of the World's Fair. Since it was difficult for out-of-town motorists to know which of the several exits to use at the New York end of the Bridge, a traffic hazard existed at this point when drivers slowed down or stopped on the Bridge to read signs. The George Washington Bridge installation was such that motorists, using standard car radio broadcast receivers, could receive detailed routing information as they crossed the Bridge for a distance of approximately 3000 feet.

As a result of the operating success  
(Continued on page 126)

Illustration of vehicle rerouting by means of radio traffic control methods.

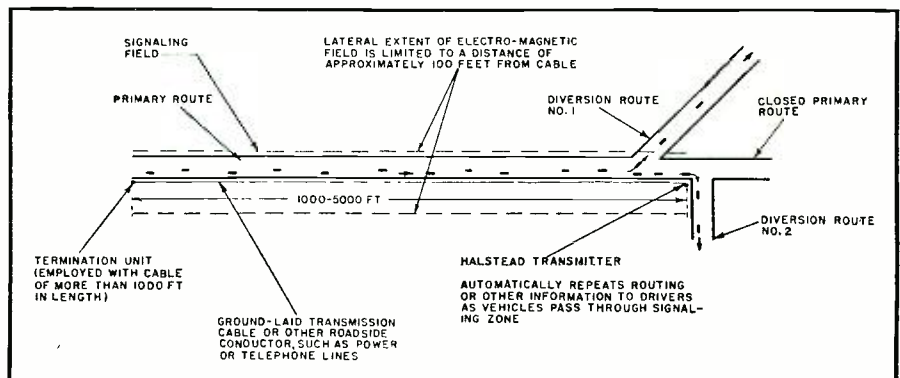

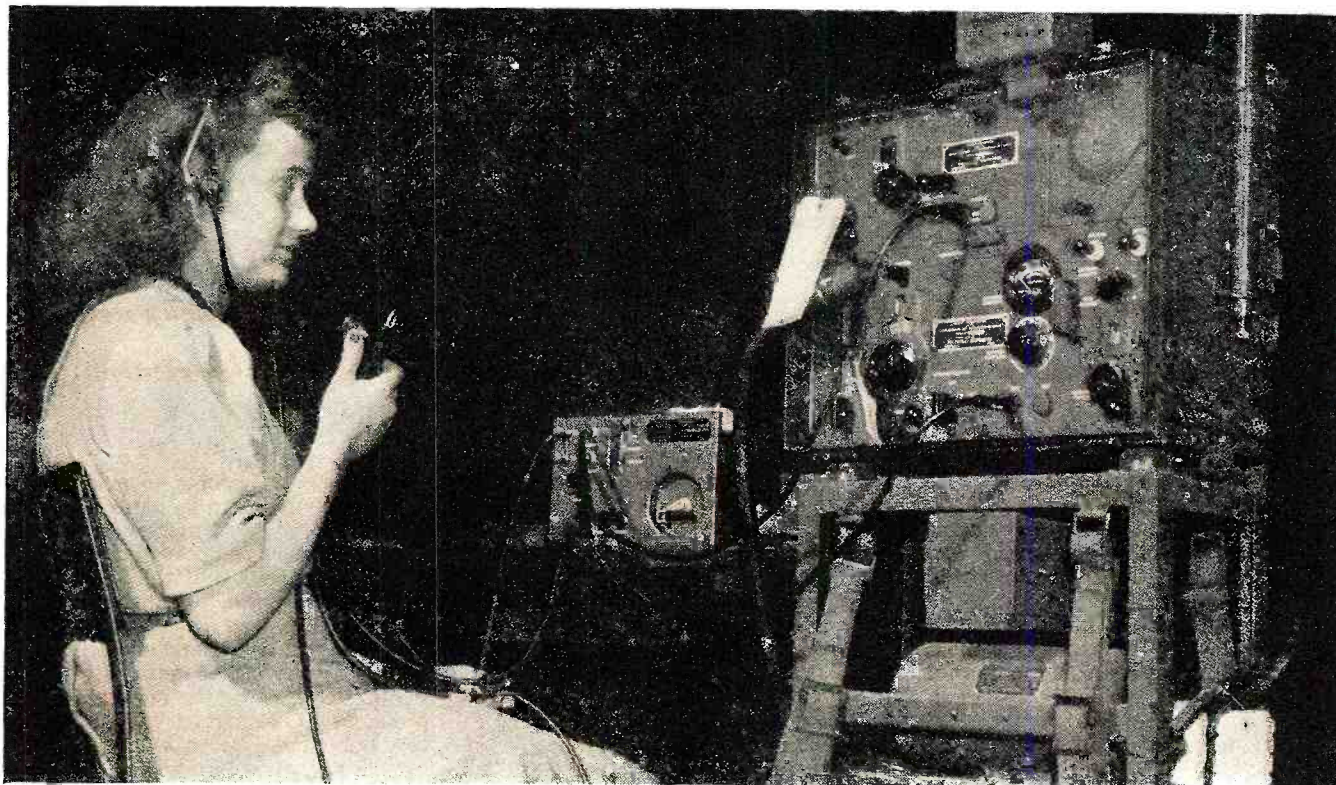

Signal Corps test of SCR-284-A, using PE-103-A dynamotor to supply power to the transmitter.

# THE SCR-284

By **H. V. NOBLE**

Chief Trans. Eng., Crosley Corp.

**A description of the SCR-284 together with a picture story of techniques used in manufacturing and testing this set.**

**I**N THE all out effort to defeat the Axis it was necessary for many manufacturers to build radio equipment to exacting Signal Corps specifications, which was a far cry from the standard broadcast receivers they had been used to making. Factory layouts had to be changed and personnel retrained to make and handle precision radios. The award of a production contract for the SCR-284-A Field Radio equipment to the Crosley Corporation meant that it had to train its people to make and test receivers

and transmitters, dynamotors, hand generators, and all antenna equipment and accessory parts. The SCR-284-A is a complete portable and mobile radio station.

The electrical specifications for the SCR-284 are as follows:

1. *Use:* As a portable or vehicular set
2. *Transportation:* By vehicle or carried by foot soldiers
3. *Range:* (Transferred into electrical characteristics.)

*Receiver*

Sensitivity 3  $\mu\text{v.}$  for c.w. and 5  $\mu\text{v.}$  for

voice with a 10/1 signal-to-noise ratio.

*Transmitter*

Power output 20 watts for c.w. and 5 watts for voice.

*Frequency Range:* To be continuously variable from 3800 kc. to 5800 kc. Receiver dial to be calibrated directly in frequency and the transmitter to be calibrated accurately every 10 kc.

4. *Power Supply:* For vehicular use, from a 6- or 12-volt vehicular storage battery with either the positive or negative side grounded.

For field use, from a hand-operated generator for transmitter with the generator output not to exceed 50 watts. The receiver to obtain its power from a dry battery pack.

Quick-heating filament type tubes to be used throughout.

5. *Miscellaneous:* The number of controls to be as few as possible. A 200 kc. calibration crystal to be used for calibrating the transmitter. The set must be capable of "netting" without radiation of power. A list of applicable specifications included for guidance of designs.

(Continued on page 108)

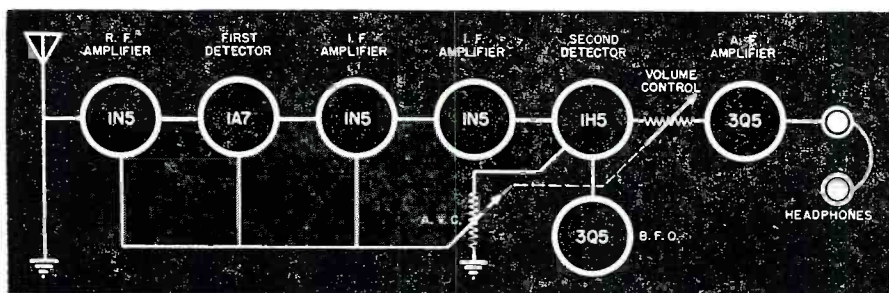
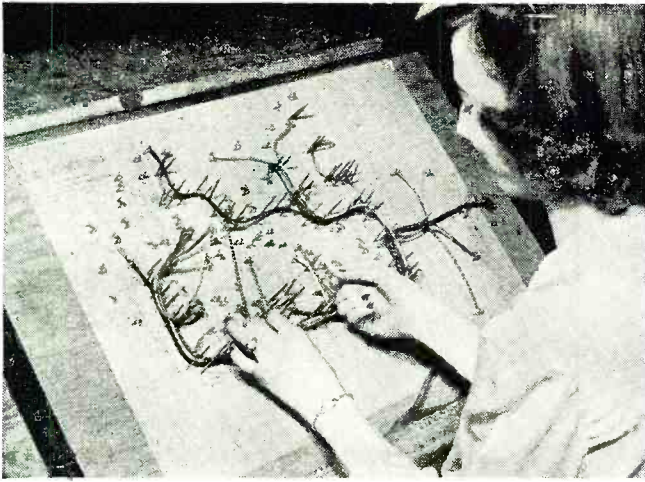

Fig. 1. Block diagram of the conventional receiver circuit.



Making receiver and transmitter harness on cable board, according to blueprint specifications.



Keying relay and capacitors being placed on antenna-tuning coil, making a complete sub-assembly.



Mounting trimmer condenser on transmitter chassis. Junction blocks are on rack.

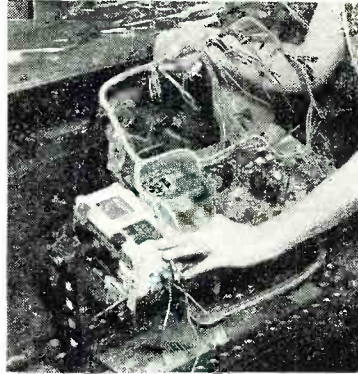

A laced cable harness is placed in the transmitter chassis.

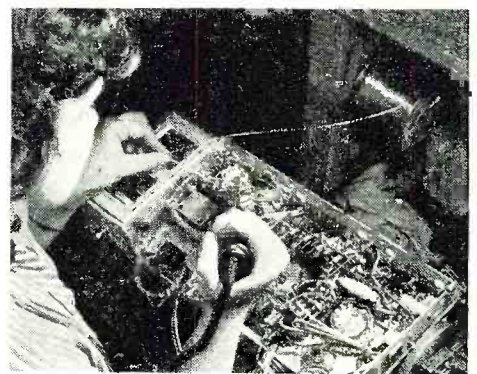

Cable harness and components being soldered to terminals on bottom of transmitter.

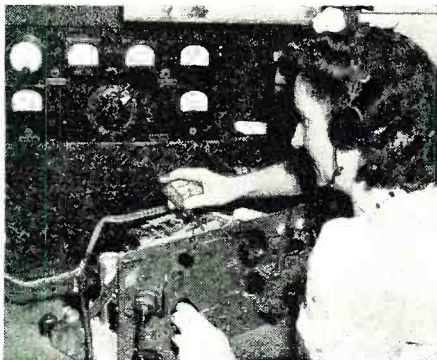

Aligning transmitter for proper performance in specially-equipped and shielded booth.

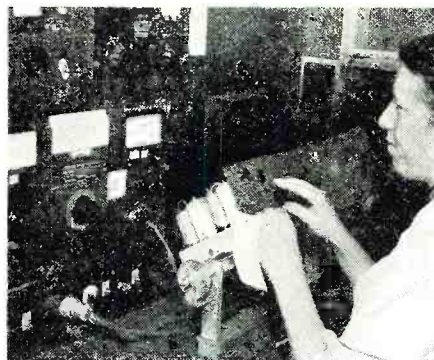

Receiver being aligned in another shielded booth.

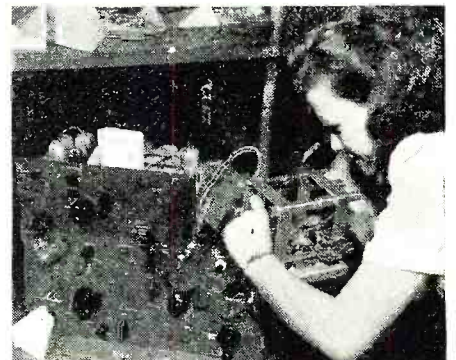

Receiver and transmitter being joined together on the "marriage line."

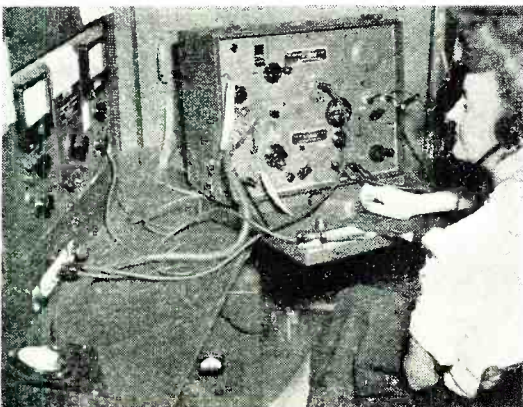

Final inspection of a BC-654-A by a U. S. Signal Corps inspector.

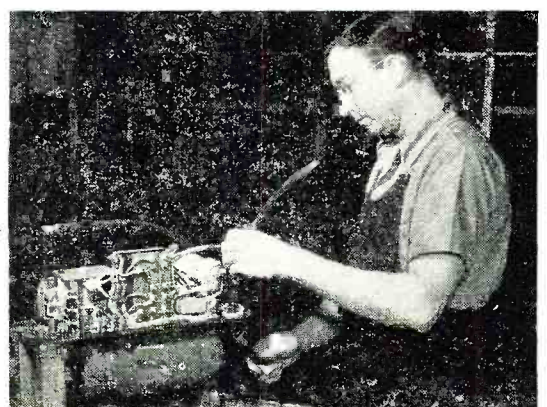

Final assembly of the PE-103-A dynamotor power unit which supplies power for the transmitter for vehicular operation.

# Direct-Reading CAPACITY METER

By

**RUFUS P. TURNER**

Consulting Engineer, RADIO NEWS

*Constructional details of an easily built substitution-type capacity meter for the measurement of small capacitances.*

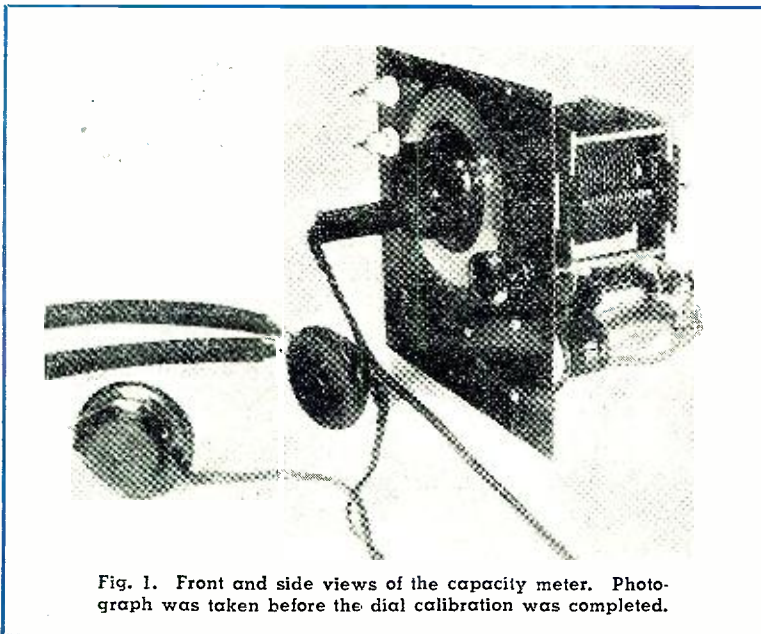

Fig. 1. Front and side views of the capacity meter. Photograph was taken before the dial calibration was completed.

THE substitution method is widely accepted as an accurate means of measuring small capacitances and capacitance increments. This method affords close measurement of capacitance over a continuously variable range from 0.1 to 0.0011  $\mu\text{fd.}$ ; and its scope of application includes such extremes as stray-circuit and electron-tube interelectrode capacitances and bypass and coupling capacitances.

Maximum measurable capacitance is limited in the substitution process by the capacitance range of the variable capacitor employed in the substitution instrument. Larger values than about 0.0001  $\mu\text{fd.}$  are adequately handled, however, by direct-measurement bridges.

## Theory

The substitution method may be adapted to both a.f. and r.f. measurements. The former are the most common. Fig. 2 illustrates the basic circuits employed for a.f. testing, and it will be seen that these are simple four-arm alternating-current bridges.

In Fig. 2A,  $R_1$  and  $R_2$  are equal ratio arms which establish a 1 to 1 ratio for the bridge; STD is the standard capacitor having good capacitance and power factor stability at the bridge test frequency; and C is a variable air capacitor, the maximum capacitance of which coincides with the value of STD.

$R_1$  and  $R_2$  are made reasonably high in resistance to minimize loading of the bridge voltage source. These components seldom are less than 5000 ohms each. STD is of the silvered mica variety, and the variable unit (C)

is chosen to have the heaviest plates, widest spacing, and most rugged construction obtainable. The dial attached to capacitor C is graduated in micromicrofarads so that the capacitance of this component may be known at all

Fig. 2. Basic circuits used for measuring capacitance at audio frequencies, employing the substitution method.

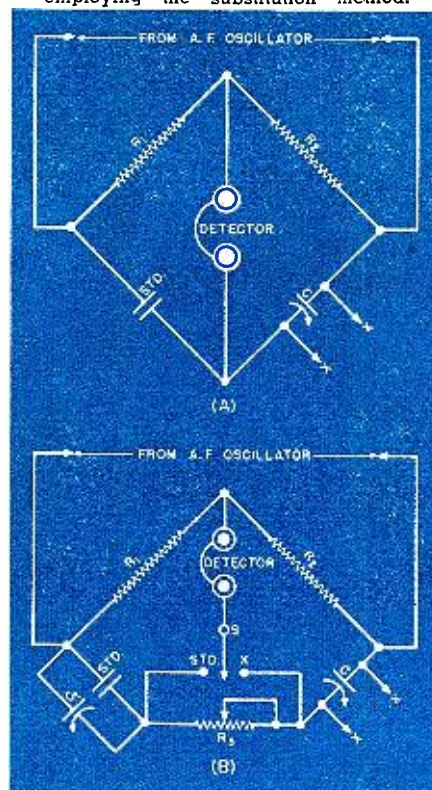

settings. For accuracy and ease of calibration and reading, C must be of straight-line capacitance design. The bridge test voltage is supplied by an oscillator capable of delivering up to 50-volts r.m.s. at the desired frequency, or (when 60-cycle operation is satisfactory) by the secondary of a transformer actuated by the power line and delivering up to 50-volts r.m.s. Test frequencies normally employed in capacitance measurements by the substitution process are 400 and 1000 cycles per second. The null detector may be, as indicated in Fig. 2, simply a pair of high-resistance headphones; or, for sharp visual indication, a magic-eye tube, cathode-ray oscilloscope, or v.t. voltmeter. Terminals X-X, in parallel with the variable capacitor, are provided for connection of the unknown capacitor into the circuit.

In operation, the bridge is initially balanced with no external capacitor connected to terminals X-X. If the standard capacitance (STD) and the maximum capacitance of C are the same, balance is obtained at the highest setting of the variable capacitor dial, and this initial null setting is the bridge zero. The capacitance of unknown value is then introduced into the circuit by connection of the test capacitor to the X-X terminals and the variable capacitor readjusted to restore null. Presence of the unknown capacitance in the circuit increases the capacitance of the lower right-hand arm of the bridge by the value of the unknown. The setting of C accordingly must be reduced in order to restore balance. The difference in micromicrofarads between the settings of C with



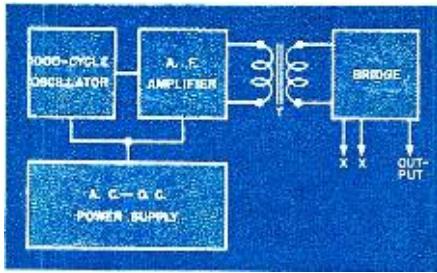

Fig. 3. Functional block diagram of the capacity-measuring instrument.

and without the unknown capacitor in the circuit equals the unknown capacitance. This circuit in this manner indicates an unknown capacitance value in terms of a capacitance change in the variable unit, C. The initial balance takes into account automatically all stray circuit capacitances within the bridge and thereby eliminates errors which ordinarily would arise from that source.

For convenience, the maximum capacitance setting of the variable capacitor may be marked O on its dial, since this position corresponds to zero capacitance change. Between this point and the minimum capacitance setting of C (maximum capacitance change), graduations may be made directly in micromicrofarads. In this manner, a direct-reading substitution-type capacitance bridge is obtained. Since the only variable element is the capacitor C, closeness and accuracy of capacitance readings will depend upon the length of the dial circumference and the accuracy with which the variable capacitor is calibrated.

In actual practice, the resistance (power factor) components of the unknown (X) and the standard (STD) capacitors, as well as their capacitances, must be balanced, otherwise the null indication will not be sharp. The resistive and reactive balances are made separately with this type of bridge. In order to obtain the absolute zero null indication which is necessary for most sensitive bridge action, a variable resistor,  $R_x$ , (See Fig. 2B) is provided for the resistive balance. This resistor may be switched in series with either the standard or unknown capacitance arm by means of the switch, S. When measurements are being made upon capacitors having a power factor equal to or lower than that of the standard, S is thrown to the X position, placing  $R_x$  in series with the standard capacitor. When the power factor of the unknown is higher than that of the standard (e. g., the case of an air capacitor), S is thrown to the STD position, placing  $R_x$  in the arm containing the unknown and tuning capacitors. Complete adjustment of the bridge consists alternately of adjusting the variable capacitor, C, and the variable resistor,  $R_x$ , until a full zero null indicates that both resistive and reactive components have been balanced.

A further circuit improvement is the addition of the air-type trimmer capacitor ( $C_t$ ) in parallel with the stand-

ard. (See Fig. 2B.) This trimmer permits the capacitance effect of long leads between the terminals X-X and the unknown capacitor to be balanced out during the initial zero adjustment of the bridge.

### Substitution-Type Capacity Meter

The capacity meter described in this article utilizes a bridge circuit similar to the ones just discussed. The bridge is adjusted by means of a large dial reading direct in micromicrofarads and a small potentiometer for the power factor balance.

A 1000-cycle oscillator is built into the instrument, making it unnecessary to provide an external source of signal voltage, and the entire unit is powered by the 110- to 115-volt line. Operation is practical on both a.c. and d.c. From the complete circuit diagram (Fig. 4), it will be seen that although the instrument is powered by a line-type rectifier, neither the chassis nor any of the terminals is at line potential. This safety arrangement is achieved by use of the signal-coupling transformer, T<sub>1</sub>, which isolates the measuring circuit entirely from the a.c.-d.c.-powered oscillator.

Since a pair of high-resistance head-

phones will suffice as a null detector in most cases, a phone jack, J, is included in the bridge output circuit. However, connections from any other type of null detector may be plugged into this jack in lieu of headphones.

The basis of the capacity meter is a 500- $\mu\text{mf}$ . variable capacitor with straight-line capacitance curve. This part, which was culled from an ancient broadcast receiver, has heavy plates, good separation, and reasonably sturdy mountings. The range of the instrument might be increased to twice that of the capacity meter shown in this article by using a 1000- $\mu\text{mf}$ . variable.

The capacity meter is shown in the photographs. Fig. 3 shows its functional block diagram. The 1000-cycle oscillator and the audio amplifier following it are energized by an a.c.-d.c. half-wave power supply. The amplifier is coupled through a midget audio transformer to the bridge circuit, and the latter is connected in turn to the output jack. The only external connections necessary are the line cord and the terminals for the unknown capacitor.

### Electrical Features

The complete circuit schematic for

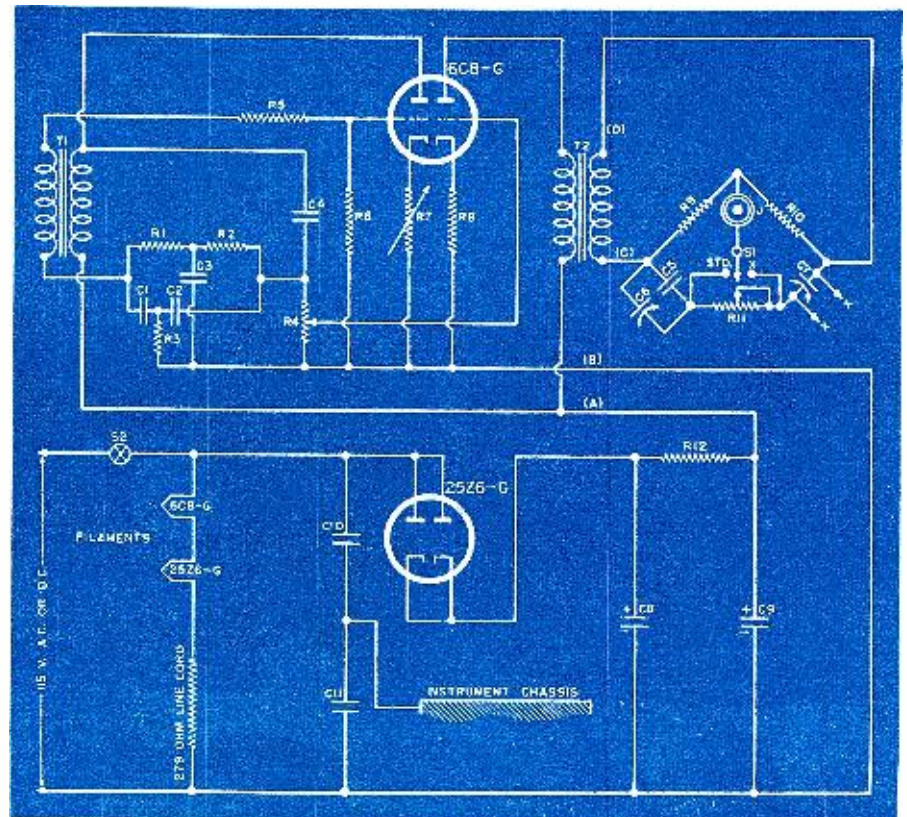

Fig. 4. Complete circuit diagram of the capacity meter, incorporating a simple four-arm bridge and a 1000-cycle oscillator.

$C_1, C_2$ —0.004  $\mu\text{fd}$ . mica cond.—Aerovox 1467  
 $C_3$ —0.008  $\mu\text{fd}$ . mica cond.—Aerovox 1467  
 $C_4$ —0.1  $\mu\text{fd}$ . 400-v. tub. cond.—Aerovox 484  
 $C_5$ —400  $\mu\text{fd}$ . silvered mica cond.—Aerovox 1464  
 $C_6$ —150  $\mu\text{fd}$ . midget trimmer cond.—National  
 Se150  
 $C_7$ —500  $\mu\text{fd}$ . variable cond. (See text)  
 $C_8, C_9$ —40  $\mu\text{fd}$ . 200-v. elec. cond.—Aerovox PRS  
 $C_{10}, C_{11}$ —0.1  $\mu\text{fd}$ . 200-v. tubular cond.—Aerovox 284  
 $R_1, R_2$ —40,000-ohm, 1-w. res.—Aerovox 1098  
 $R_3$ —20,000-ohm, 1-w. res.—Aerovox 1098  
 $R_4$ —0.5-megohm pot.—I.R.C. Type CS

$R_5$ —500-ohm, 1-w. res.—Aerovox 1098  
 $R_6$ —0.25-megohm, 1-w. res.—Aerovox 1098  
 $R_7$ —5,000-ohm w.w. pot.—I.R.C. Type W-5000  
 $R_8$ —5,000-ohm, 1-w. res.—Aerovox 1098  
 $R_9, R_{10}$ —5,000-ohm precision, 1-w. w.w. res.—I.R.C. Type WW4  
 $R_{11}$ —10,000-ohm w.w. pot.—I.R.C.  
 $R_{12}$ —2,500-ohm, 5-w. res.—I.R.C.  
 $S_1$ —3-p.s.t. changeover switch—Utah Type 602  
 $S_2$ —3-p.s.t. toggle switch—Arrow  
 $T_1, T_2$ —5:1 ratio interstage audio trans.—(See text)  
 Tubes—6C8G, 25Z6G

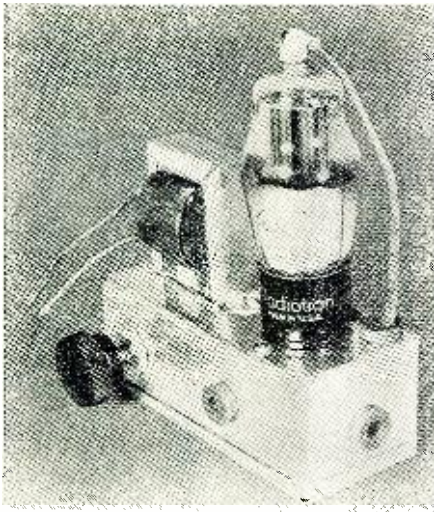

Fig. 5. The oscillator-amplifier unit before mounting to rear of front panel. The single 6C8-G acts as both oscillator and amplifier.

the capacity meter is given in Fig. 4. The electrical features of each section of this circuit will be discussed separately in the following paragraphs.

**Power Supply.** The power supply section comprises a 25Z6-G line rectifier, 2500-ohm filter resistor ( $R_{12}$ ) which is used in place of a choke, and two 40- $\mu$ fd. electrolytic filter capacitors,  $C_8$  and  $C_9$ . Heaters of the 25Z6-G and 6C8-G tubes are wired in series, as shown, and powered through a 279-ohm line cord resistor. The line bypass capacitors ( $C_{10}$  and  $C_{11}$ ) are necessary to prevent line hum modulation of the bridge signal when the capacity meter is used on a.c. The power supply section will operate on either a.c. or d.c. at common voltages in the 110- to 115-volt region.

**Oscillator-Amplifier.** The 1000-cycle oscillator and amplifier sections are combined in one stage. The circuit is built around the 6C8-G dual triode tube, one triode serving as the low-distortion oscillator and the other as the output amplifier. The oscillator-amplifier section is built upon a single subchassis, 2" x 2" x 4" in size, which is held to the front panel of the instrument by two 6-32 screws. The oscillator-amplifier unit is shown separately before mounting in the photograph of Fig. 5, and may be seen directly below the variable capacitor in Fig. 1.

The oscillator employs a special version of the degenerative parallel-T feedback circuit, as described some time ago by Caywood<sup>1</sup>. In this circuit, the frequency is set by the parallel-T degenerative network,  $C_1$ - $C_3$ - $C_4$ - $R_1$ - $R_2$ - $R_3$ , the constants given in Fig. 4 being for 1000 cycles per second. Transformer  $T_1$  is an inexpensive 3:1 audio transformer connected so that the low-impedance winding is in the grid circuit. Any available transformer having the required turns ratio may be used in this position, since quality is not a factor. Rheostat  $R_4$  is a regener-

ation control, which generally needs to be set only during initial calibration and adjustment of the oscillator. It accordingly is provided with a screw-driver slot and is mounted anywhere on the oscillator subchassis.  $R_4$  is set to the point at which strong oscillation starts readily when the instrument is switched on and the tubes attain normal operating temperature. The waveform of output voltage from this oscillator-amplifier is unusually pure, and if the resistance-capacitance network constants are carefully chosen, will operate so close to 1000 cycles that for all ordinary purposes no frequency calibration will be required.

The oscillator feeds through gain control  $R_5$  into the grid circuit of the amplifier section of the 6C8-G. The finger knob controlling  $R_5$  may be seen in Fig. 5. This control is mounted within the case inasmuch as it is used only during initial adjustment. The cathode resistor in the amplifier stage has purposely been left unbypassed in order to introduce enough degeneration to smooth out distortion which normally might arise in this stage. The bridge input transformer,  $T_2$ , is another small-sized 3:1-ratio inter-stage audio transformer with its high-impedance winding connected to the bridge circuit. Although a shield between windings is of unquestionable value in bridge circuits, this luxury may be dispensed with without materially affecting the usefulness of the capacity meter.

For convenience and neatness of layout, filter capacitors  $C_8$  and  $C_9$  are mounted inside the subchassis box which holds the oscillator-amplifier section. Leads pass through the grommet-lined holes visible in Fig. 5.

**Bridge Section.** The bridge section comprises the 5000-ohm ratio arms ( $R_6$  and  $R_{10}$ ), the .0004- $\mu$ fd. silvered mica standard capacitor ( $C_5$ ), the 150- $\mu$ fd. air trimmer ( $C_6$ ), the resistance-balance potentiometer ( $R_{11}$ ), the resistance position switch ( $S_1$ ), and the 500- $\mu$ fd. variable air capacitor ( $C_7$ ). The latter is a straight-line-capacitance unit and may have higher maximum capacitance if the builder desires. It has thick plates and is built with wide

spacing and sturdy bracing. The capacitor shown in the photographs is an ancient National Type DX, a relic of the "low-loss craze" of the early days of broadcast reception, and has had its old bakelite insulation replaced with new bars of polystyrene.

It is recommended that  $R_9$  and  $R_{10}$  be precision noninductive wirewound resistors having an accuracy of 1% or better. However, the common 1-watt carbon variety may be employed, provided they are carefully chosen with respect to ohmic value. If carbon resistors are used, they need not be exactly 5000 ohms as long as each is of the same value. They serve merely to establish a 1:1 ratio.

For best results, potentiometer  $R_{11}$  should be wirewound and should possess a linear taper. Carbon variables do not give satisfaction in these bridge circuits and should be used only in an emergency. The shaft of the potentiometer must be "cold," that is, must not be a part of the circuit, otherwise the slider will be grounded to the instrument panel.

The studs supporting variable capacitors,  $C_6$  and  $C_7$ , are insulated from the chassis and instrument case by means of polystyrene or good-grade bakelite washers. In the author's instrument,  $C_6$  and  $S_1$  are mounted inside the capacity meter but to one side of its case, while  $C_7$  is mounted directly to the front panel.

As much of the bridge circuit wiring as possible must be done in heavy rigid bus wire (at least No. 12 tinned copper). It is entirely satisfactory to wire the remainder of the instrument with heavy flexible hookup wire, but it is advisable to keep all leads short and to run them close to the metal foundation.

### Mechanical Features

The capacity meter is mounted entirely upon a 7" x 7" metal panel, with the exception of the trimmer  $C_6$  and switch  $S_1$  which are mounted on one side of the case housing the instrument. The panel may be made of aluminum, steel, tin-steel, or galvanized sheet stock at the builder's convenience. While in the interest of shielding from stray fields, it is desirable that the capacity meter be housed in a metal box-container, it is entirely permissible to employ a wood cabinet, with or without an internal shield.

The dial controlling  $C_7$  is a 4-inch-diameter finger-grip type. A plain face is cemented to its regular plate by means of a good adhesive and may be cut from a stiff Bristol board. After the  $\mu$ fd. graduations are made upon this white face with India ink, the entire scale is covered with a protective plate of heavy transparent celluloid.

The "unknown" terminals (X-X in the schematic) are two small-sized feed-through stand-off ceramic insulators mounted in the upper left-hand corner of the front panel. These are connected by means of heavy bus-bars to the tuning capacitor.

The 25Z6-G rectifier-tube socket is  
(Continued on page 87)

Fig. 6. Rear view of the capacity meter. Note the compact arrangement.

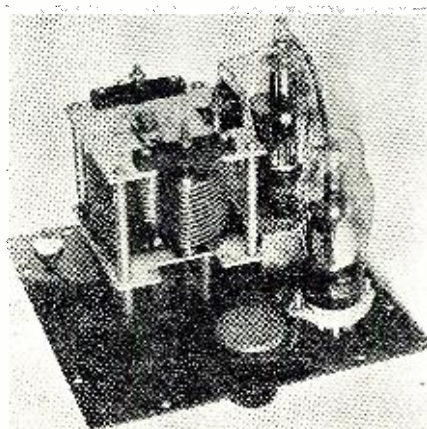

<sup>1</sup>An Amateur Application of the Wien Bridge. R. W. Caywood. QST. January 1941, p. 22.

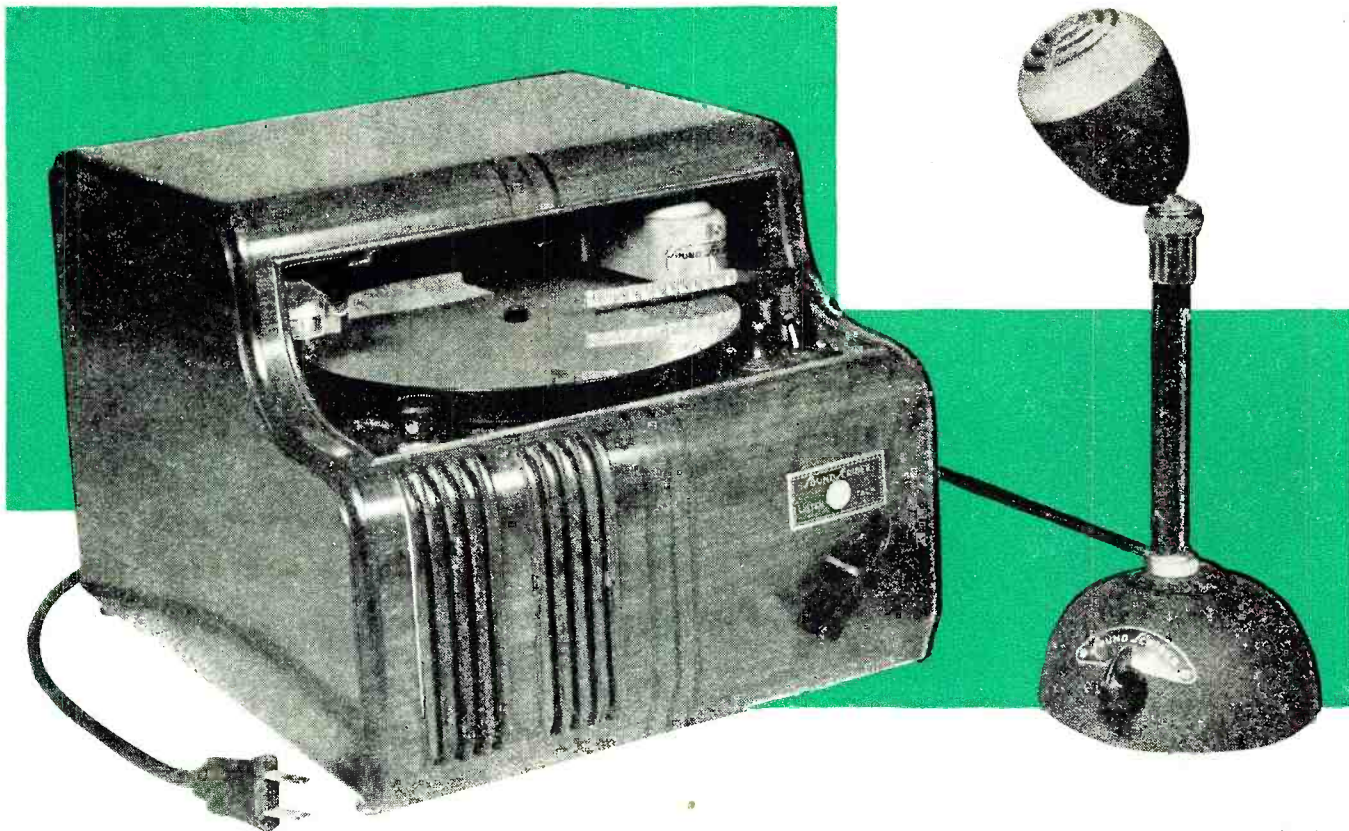

SoundScriber recorder with lip-high microphone and power cord.

# The SOUNDSCRIBER

By STANLEY KEMPNER

*A new, compact dictating machine is one of the outstanding developments in the field of sound recording.*

NE of the most outstanding developments in the field of sound recording was the introduction of a commercially-made device, known as the SoundScriber. Unlike its predecessor, the conventional dictating machine, this new instrument utilizes a thin, round, wafer-like disc in place of the old-fashioned hard rubber cylinder.

Of more compact design, the SoundScriber occupies but little space in crowded offices and the new type of recording permits a more conventional filing system. Instantaneous recordings are made on these new vinylite discs and provide a permanent record of correspondence, etc. The new plastic vinylite belongs to the so-called "thermoplastic" group. The material is molded into rigid sheets and the finished product displays characteristics

having dimensional stability, which will neither shrink nor warp, and in addition possesses extreme rigidity, strength and toughness. This material should not be compared to the commonly-used paper-based discs used for home recording. The latter are not suited to this application, having been tried with no degree of success.

It was necessary to design special disc materials in order to take full ad-

vantage of the particular recording technique used with the SoundScriber. The plastic discs have a high softening point (140 to 150° F.), are resistant to aging, and possess highly satisfactory tensile strength, in addition to their noninflammable characteristics.

The recording procedure is similar to the so-called home recorders that became so popular just before the present war. Home recorders employ conventional cutting of a groove in a disc laterally and by means of a cutting stylus. This stylus cuts in a manner similar to that of a chisel. Not only does the stylus actually remove material from the disc, but it also engraves the sound directly into the groove that it is cutting.

The SoundScriber, on the other hand, utilizes a *vertical* embossing technique, whereby sound is impressed in the up and down direction and no material is actually cut from the disc. It is similar to the Western Electric "hill and dale" technique used for high-fidelity transcriptions but does no cutting.

A special diamond-pointed stylus is  
(Continued on page 103)

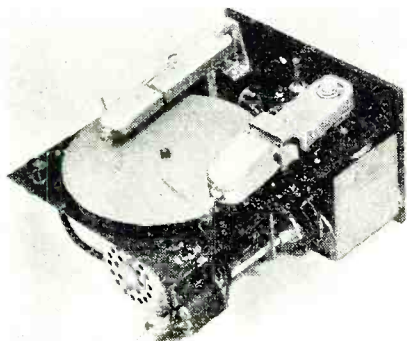

Office type recording machine showing magnetic recording and reproducing heads.

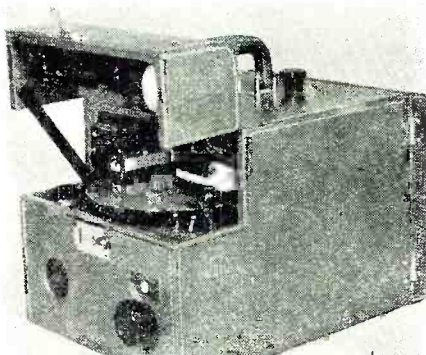

Portable recorder in leather-covered case with built in microphone and power cord.



Police officers using modern G.E. frequency-modulation equipment.

# MODERNIZE THOSE POLICE RECEIVERS

By **HERBERT L. LIPSON**

*The rejuvenation of obsolete police equipment to meet present-day standards.*

**M**ANY a police department, faced with a shortage of mobile receivers, is surveying the stock room and wondering if it is possible to rejuvenate some of the obsolete units and put them back into service. Then, again, many police departments still using older model receivers are wondering if they can be modernized more readily than new units can be procured. Faced with a similar problem, we gave the matter a little thought, and after a few false starts finally arrived at a system for bringing these receivers up to date at a small cost.

The receivers upon which we worked were the American Bosch model 139, 149, and 159 series. These were used by most police departments in the middle and late thirties. However, the circuits and modernizing procedure outlined here will hold true for any police mobile receiver normally used for reception of frequencies between 1500 and 3000 kilocycles.

This article is divided into four parts. First, there are a few pointers on how to overhaul the units and restore them to their original operating efficiency. Second, we show how to add a simple noise limiter, which, incidentally, no mobile receiver should be without. Third, a squelch circuit is described. A squelch circuit is indispensable in many locations. And fourth, the noise limiter and squelch circuit combined will give you a super-deluxe job.

## Overhauling and Cleaning

If your receivers have been in storage for a year or so, or have been in service for several years, here is the procedure for putting them back into brand-new condition:

1. Get all the dirt and corrosion out of the receiver. This means take the tubes out, take the chassis out of the metal case, and clean everything with an air hose, if available. Use a dry

paint brush to get into those corners. Touch up rusty spots with shellac or lacquer. Coil dope makes a good substitute if the former is unavailable.

2. Put a coat or two of good black paint on the metal case first, so that it will be dry when you are ready to reassemble the receiver.

3. If the units haven't been used for several years, put in *all* new electrolytic condensers. It is a good idea to do this to all receivers after a few years of service.

4. Put in a new audio coupling condenser and audio grid resistor. These will cause troublesome noise if they are several years old.

5. Change all worn and frayed

leads. Check all soldered connections on shielded wires, reheating all doubtful ones.

6. Check all tubes, replacing the doubtful ones.

7. Repair or replace anything else that needs it. Especially watch for worn volume controls and switches.

8. When the paint is dry on the case, reassemble the receiver and put it on the test bench. Realign the whole circuit. Watch especially for lack of gain in the r.f. and i.f. stages. If you are located along the coast, or in a moist climate, very likely you will find the over-all gain very low, with apparently nothing wrong in the individual stages. This is caused by the coils losing their Q due to the gradual creeping in of moisture over a period of time. The best remedy for this is to boil the i.f. and r.f. coils in paraffin for fifteen or twenty minutes. This will drive out the moisture and reseal the pores of the coil forms. Now test the receiver and notice the difference!

The power packs, too, should be gone over. It is best to replace the vibrator, buffer condensers, and the electrolytic condensers. If the rectifier tube is weak, it should also be replaced.

## Adding a Noise Limiter

There is usually some confusion regarding the difference in functions of the noise limiter and the squelch circuit. Before we proceed, it might be a good idea to differentiate briefly between the two.

A noise limiter is primarily a circuit for cutting out the noise peaks which are of greater intensity than the carrier. The usual noise limiter is a diode which momentarily short-circuits the audio system when a strong noise peak reaches the second detector.

The squelch circuit, on the other hand, is a device to eliminate objectionable background hash when no signal is being received. It usually consists of a triode circuit which blocks

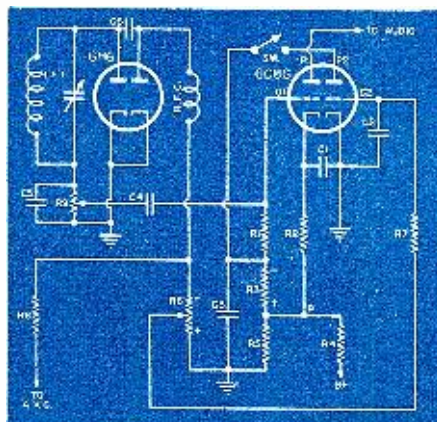

Fig. 1. An effective squelch circuit that can be added to existing receivers.

$R_1, R_7$ —1 megohm,  $\frac{1}{2}$  w. res.  
 $R_2$ —5000 ohm,  $\frac{1}{2}$  w. res.  
 $R_3$ —250,000 ohm,  $\frac{1}{2}$  w. res.  
 $R_4$ —50,000 ohm,  $\frac{1}{2}$  w. res.  
 $R_5$ —7500 ohm,  $\frac{1}{2}$  w. res.  
 $R_6$ —1 megohm pot. (squelch control)  
 $R_8$ —500,000 ohm,  $\frac{1}{2}$  w. res.  
 $R_9$ —500,000 ohm pot. (volume control)  
 $C_1$ —5  $\mu$ fd., 25 v. elec. cond.  
 $C_2$ —.25  $\mu$ fd., 200 v. tub. cond.  
 $C_3$ —.05  $\mu$ fd., 400 v. tub. cond.  
 $C_4$ —.005  $\mu$ fd., 600 v. tub. cond.  
 $C_5, C_6$ —100  $\mu$ fd. mica cond.  
 RFC—16 millihenry choke  
 Sw—S.p.s.t. toggle switch

the audio circuit when there is no signal at the antenna. As soon as a signal of predetermined strength is received, the receiver is restored to full sensitivity.

It can be seen, then, that the squelch circuit is in operation only when the carrier falls below a certain level, while the noise limiter is in operation at all times, limiting the receiver output to the average intensity of the signal being received.

Fig. 3 shows a simple but efficient noise limiter that may be added to most police mobile receivers. Fig. 3A shows a typical second detector circuit without a limiter, and Fig. 3B shows the circuit with the limiter added.

The limiter is a modified Dickert circuit. The 6H6 tube is mounted under the chassis near the second detector to facilitate short leads. It is necessary to change the a.v.c. circuit to combine the diode load resistor and the a.v.c. voltage divider. The switch is optional and may be omitted.

Briefly, the operation of the limiter is as follows: When a steady carrier is being received, the voltage divider assumes a polarity, as shown in Fig. 3B. The cathode of the 6H6 is at positive potential in respect to the plate. In this condition the tube offers infinite impedance—practically an open circuit. Condenser  $C_1$  is charged through  $R_4$  to give it a negative charge equal to the a.v.c. voltage. This charge varies slowly with the a.v.c. voltage, depending upon the carrier level. When a sudden noise peak occurs, the a.v.c. voltage rises to a high negative value, but the time constant of  $R_4$ - $C_1$  prevents it from following. Therefore, the cathode becomes momentarily more negative than the plate, and the diode becomes a conductor and short-circuits the audio circuit. As soon as the noise peak has passed, the negative bias is returned to the plate of the 6H6, and the limiter becomes inoperative, allowing the signal to come through again.

The point at which the limiter begins functioning is determined partially by  $R_2$ . To make the limiter function instantly at zero signal level, this resistor should be removed. If the resistance is increased the noise peaks must be of greater intensity for the limiter to operate. Optimum results were obtained with the 40,000 ohm resistor shown; more resistance reduced the limiting action too much while less resistance caused too much distortion on voice peaks. A bit of experimentation will give the exact value needed in your individual case.

#### Adding a Squelch Circuit

If your location is such that during times when the carrier is off you are troubled with a snapping and popping background noise, but the carrier itself is strong enough to overcome any ignition interference, then the squelch circuit is the answer.

Fig. 1 shows a very effective circuit that can be added to existing receivers. In the case of the Bosch receivers the 75-tube socket is removed and

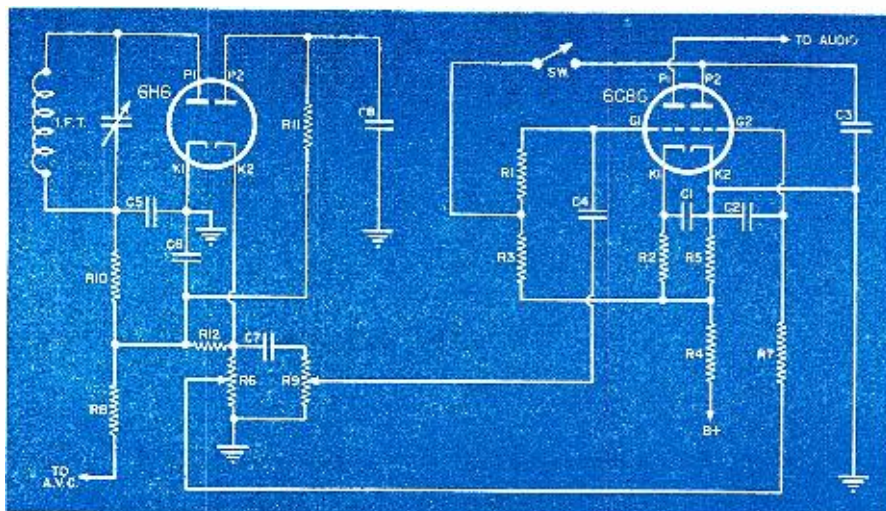

Fig. 2. Combination squelch circuit and noise limiter.

- |   |   |
|---|---|
| $R_1, R_7$ —11,111—1 megohm, $\frac{1}{2}$ w. res.  | $C_1$ —5 $\mu$ f., 25 v. elec. cond.    |
| $R_2$ —5000 ohm, $\frac{1}{2}$ w. res.              | $C_2$ —.25 $\mu$ f., 200 v. tub. cond.  |
| $R_3$ —250,000 ohm, $\frac{1}{2}$ w. res.           | $C_3$ —.05 $\mu$ f., 400 v. tub. cond.  |
| $R_4$ — $R_{10}$ —50,000 ohm, $\frac{1}{2}$ w. res. | $C_4$ —.005 $\mu$ f., 600 v. tub. cond. |
| $R_5$ —7500 ohm, $\frac{1}{2}$ w. res.              | $C_5$ —100 $\mu$ f. mica cond.          |
| $R_6$ —500,000 ohm pot. (squelch control)           | $C_6$ —50 $\mu$ f. mica cond.           |
| $R_8$ —500,000 ohm, $\frac{1}{2}$ w. res.           | $C_7$ —.005 $\mu$ f., 400 v. tub. cond. |
| $R_9$ —500,000 ohm pot. (volume control)            | $Sw$ —S.p.s.t. toggle switch            |
| $R_{10}$ —40,000 ohm, $\frac{1}{2}$ w. res.         |   |

the 6C8G socket substituted in its place. The 6H6 is mounted underneath, near the base of the 6C8G. It may be necessary to remove the can-type electrolytic condenser and replace it with a smaller tubular condenser mounted elsewhere.

In this circuit the 6H6 is used as the second detector while  $P_1$  of the 6C8G is the audio plate and  $P_2$  the squelch plate. With no signal being received, grid  $G_2$  is at ground potential. Since there is no bias on the grid, plate  $P_2$  draws current through  $R_2$ , causing a voltage drop across  $R_2$ . This blocks grid  $G_1$  of the audio tube, and the receiver is dead.

When a signal is received, the a.v.c. voltage developed across  $R_6$  puts enough negative bias on grid  $G_2$

(through filter  $R_7$  and  $C_2$ ) to cut off the tube. Since there is now no current flowing through  $R_2$ , grid  $G_1$  and plate  $P_2$  are at the same potential as point P. This puts the correct bias (developed across  $R_2$ ) on the grid  $G_1$ , and restores normal operation to the tube.

The signal strength necessary to cut off the squelch action is regulated by  $R_6$ , which changes the amount of negative bias on grid  $G_2$  in proportion to the signal.

To set the control  $R_6$  properly, first take the receiver to the spot where the most troublesome noise occurs. Then adjust  $R_6$  until the noise just cuts in. A fraction of a turn before this point is reached should be the proper setting. Now test the receiver by having

(Continued on page 80)

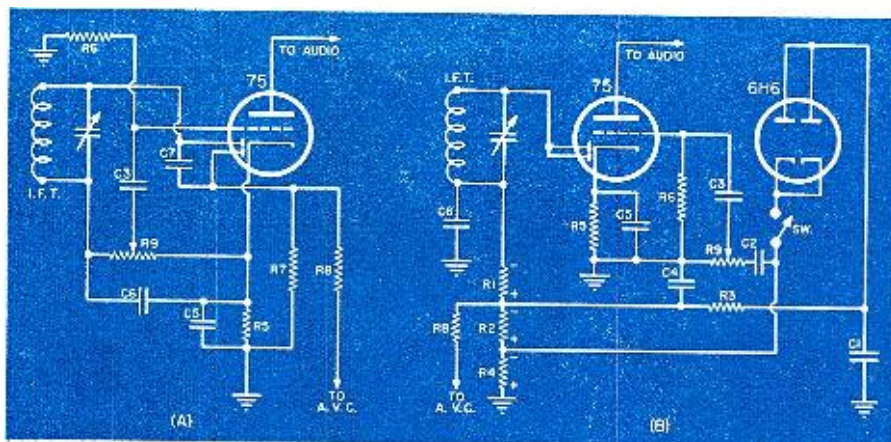

Fig. 3. An effective noise limiter; (A) typical second detector circuit without the limiter, and (B) with the addition of the limiter to the circuit.

- |   |   |
|---|---|
| $R_1$ —50,000 ohm, $\frac{1}{2}$ w. res.    | $C_1$ —.05 $\mu$ f., 400 v. tub. cond.  |
| $R_2$ —40,000 ohm, $\frac{1}{2}$ w. res.    | $C_2$ —.005 $\mu$ f., 400 v. tub. cond. |
| $R_3, R_6$ —1 megohm, $\frac{1}{2}$ w. res. | $C_3$ —.005 $\mu$ f., 600 tub. cond.    |
| $R_4$ —150,000 ohm, $\frac{1}{2}$ w. res.   | $C_4$ —50 $\mu$ f. mica cond.           |
| $R_5$ —5000 ohm, $\frac{1}{2}$ w. res.      | $C_5$ —5 $\mu$ f., 25 v. elec. cond.    |
| $R_7$ —2 megohm, $\frac{1}{2}$ w. res.      | $C_6, C_7$ —100 $\mu$ f. mica cond.     |
| $R_8$ —500,000 ohm, $\frac{1}{2}$ w. res.   | $Sw$ —S.p.s.t. switch                   |
| $R_9$ —500,000 ohm pot. (volume control)    |   |

# THE SAGA OF THE VACUUM TUBE

By **GERALD F. J. TYNE**

Research Engineer, N. Y.

## **Part 13. Covering the developments by the General Electric Co. of higher power-output alternators for use in the fields of telegraphy and telephony.**

THE development of the comparatively crude Audion into a satisfactory high-vacuum telephone repeater element was undertaken and carried through by the engineers of the Western Electric Company because of an urgent need. The problems of wire telephony in general do not involve the use and control of large powers, and the Audion, as submitted for their consideration by de Forest, was limited to low power applications. The General Electric Company, on the other hand, dealt essentially in comparatively high-power devices. Why then did they become interested in the low-power Audion? Paradoxically enough it was because they had need of a high-power device—but one with the type of characteristics exhibited by the Audion at low power levels.

Although in the popular mind the name of the General Electric Company is associated with power equipment in the early 1900's, the engineers of this Company had for some years been engaged in an attempt to develop a radio-

frequency alternator for long-distance communication. The work was begun about 1904 at the request of Mr. Reginald A. Fessenden of the National Electric Signalling Company. At that time Fessenden was working at Brant Rock, Massachusetts, trying to develop a method of obtaining a continuous flow of high-frequency energy, and had requested the General Electric Company to undertake the development of an alternator to operate at 100,000 cycles. He was familiar with the work done previously at the General Electric laboratory by Thompson and Steinmetz along this line. Fessenden was using an arc transmitter, the only satisfactory generator of continuous waves of that day. He experienced many difficulties in this work because the arc was tricky to handle and not entirely free from self-modulation. When Fessenden appealed to the General Electric Company to undertake this work, E. F. W. Alexanderson was assigned the job of developing such an alternator. The result of the next few

years' work on his part was what became known as the Alexanderson Alternator. The real significance of this development was realized in 1919, when the General Electric Company, after having spent millions of dollars to make such a device practicable, refused to sell to its only customer, the British-controlled Marconi Company, and in so doing helped return the control of transatlantic radiotelegraph stations to the United States.<sup>186</sup> By this act also, the General Electric Company paved the way for the founding of the Radio Corporation of America.

Therefore, it might be said that in the early 1900's the General Electric Company was trying to build a machine—a mechanical device—to do the job of the vacuum-tube transmitter of the present day.

By 1913 Alexanderson had been able to construct satisfactory alternators of several kilowatts output at frequencies up to 200,000 cycles.<sup>187, 188</sup> They were satisfactory, that is, for use



Fig. 149.

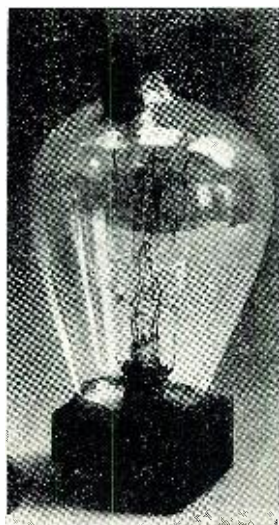

Fig. 150.

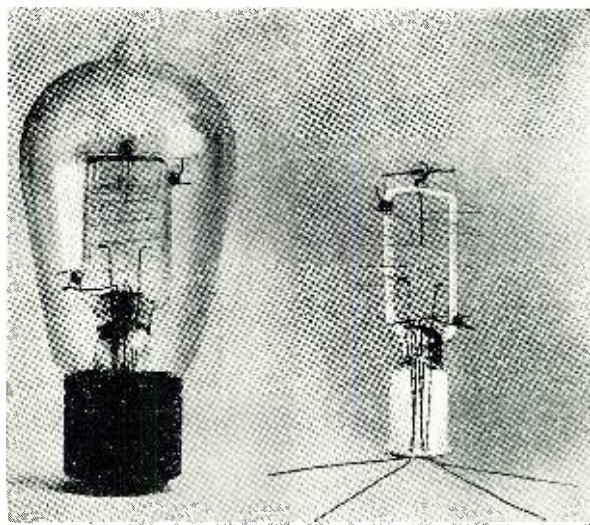

Fig. 151.

in continuous-wave telegraphy, but could not be used for satisfactory radiotelephonic communication since no method of adequate modulation of their output was available. Alexanderson had tried various methods of modulation with varying degrees of success. One method utilized a generator with its field excited by the telephone current. Another involved the use of the so-called "magnetic amplifier" or magnetic modulator.<sup>189</sup> A third was the use of a three-electrode mercury arc tube, in which an attempt was made to control the arc current by the use of the third electrode. None of these methods was completely satisfactory, and Alexanderson continued his search for a better modulator.

In 1912 the General Electric Company sold to John Hays Hammond, Jr., two high-frequency alternators for use in his experimental work on radio-controlled devices. In October of that year Alexanderson discussed with Hammond, at the latter's laboratory in Gloucester, Mass., the problem of obtaining the necessary modulation. While there, Alexanderson was told of some receiving apparatus, designed and constructed by Benjamin F. Miessner, one of Hammond's assistants, in which Audions were used. Alexanderson, who had never seen an Audion and its characteristics that it might be promising as a high-frequency relay. He thought that it was in many ways defective but considered that the defects might be overcome. He therefore arranged to obtain a sample of the Audion from Hammond, to see if it might be made into a suitable device for the application he had in mind.

At Schenectady he showed the Audion to Drs. W. D. Coolidge and Irving Langmuir, with whom he often discussed problems. The discussion with Langmuir was fruitful. Langmuir said that he could develop a high-vacuum device of the three-electrode type which would function satisfactorily as a high-frequency relay. Alexanderson felt that such a device as Langmuir described could be used not only for modulation of the transmitted wave from his alternator, but also could be used in a new system of reception on which he was working. Accordingly, Langmuir set about the development.

Irving Langmuir had been in the employ of the General Electric Company since 1909. He was graduated from Columbia University in 1903, and had done postgraduate work at the University of Göttingen under Nernst, receiving his Ph.D. in 1906. When he entered the employ of the General Electric Company he attacked some of the problems still to be solved in connection with the tungsten filament incandescent lamp. The Coolidge process of making drawn tungsten wire had recently been introduced into commercial manufacture and had given rise to a number of problems, as does any new process.

One of the problems which Lang-

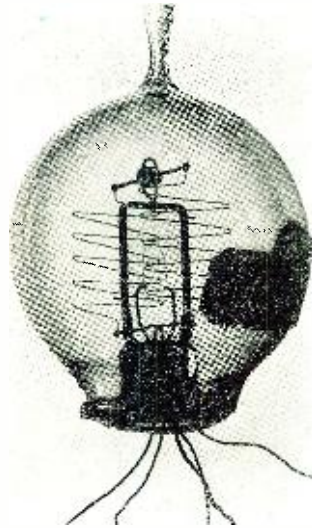

Fig. 152.

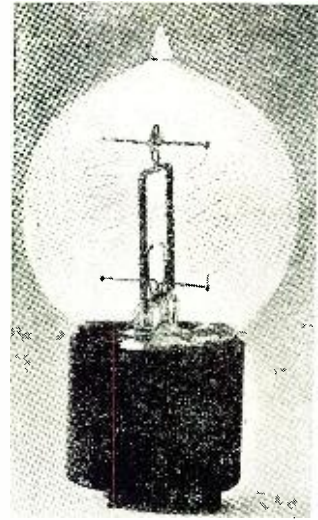

Fig. 153.

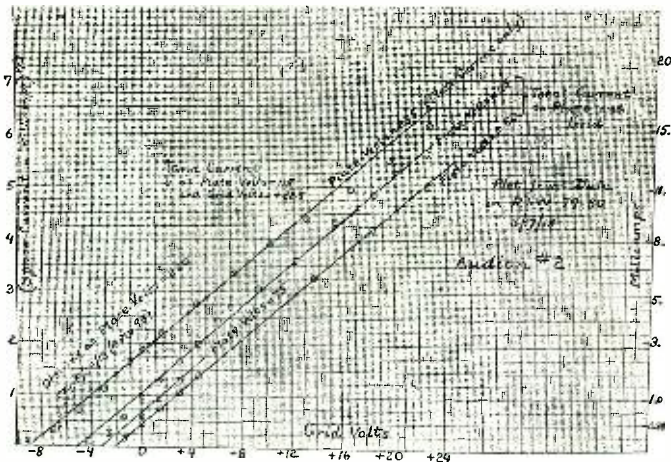

Fig. 154.

muir studied in connection with tungsten filament lamps was the blackening of the bulbs in service. This same problem in connection with carbon filament lamps, it will be remembered, led to the discovery by Edison of the "Edison Effect." It was the common idea in the General Electric laboratory that this blackening, in the case of the tungsten filament lamp, was due to secondary causes, among them electric discharges. It had been observed that the "blue glow," characteristic of insufficiently exhausted lamps, caused very rapid blackening. Also the presence of water vapor in the lamp bulb accelerated the blackening. From this it would seem that better vacuums were desirable.

Others had attempted to solve the problem by increasing the vacuum. Langmuir adopted a different approach. He attempted to determine the cause of the blackening by increasing the amount of the impurities introduced into the bulb. Particularly he studied the effect on the filament of gases introduced. Some of these, such

as hydrogen, would disappear if introduced in limited amounts. Others, such as nitrogen, would react with the tungsten vapor given off by the hot filament.

In this work Langmuir had to differentiate between the effects due to evaporation of the filament—because of its high operating temperature—and the effects due to electric discharges within the bulb. To accomplish this he used low-voltage filaments to study the evaporation phenomena, and high-voltage (50-250 volt) filaments to study the effect of discharges. From all this he began to get a picture of what would happen in a perfect vacuum. He concluded that the blackening of the bulb was due to normal evaporation of the filament, not to electric discharges. He found the reason why the presence of water vapor accelerated the blackening. He found that even if the vacuum were perfect the blackening still would occur.

From his studies he concluded that  
(Continued on page 94)

# RADIO THEORY REVIEW

## - for FCC Operator Exams

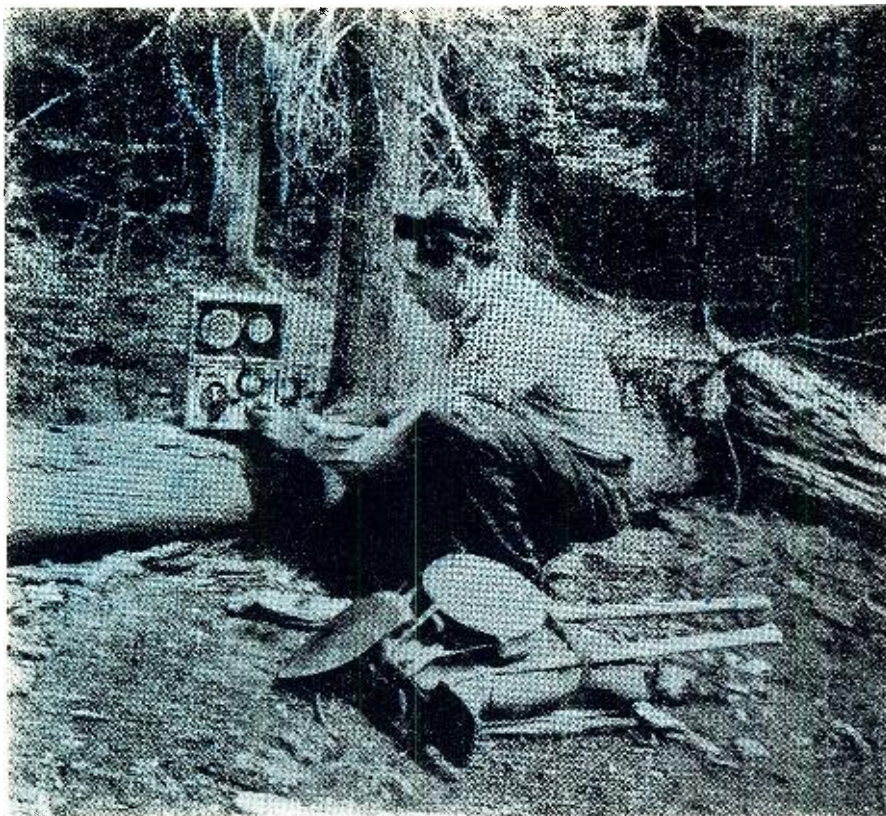

By

**CARL E. WINTER**

*Summary of what a potential commercial radio operator should know or study, before attempting to pass the FCC examination.*

←  
Licensed radio operator using short-wave equipment to combat forest fires.

“IT’S not so tough if you know your stuff,” gloats many a proud possessor of a new “ticket” as he walks out of the Federal Communications Commission examination room after successfully completing the tests for a commercial radio operator license.

It’s true. The 1300 questions outlined in the official Study Guide for Commercial Operator Examinations present difficulties only if a student attempts to study each question individually. The most vital and difficult point to determine is exactly what, and how much, of each pertinent radio subject must be covered to provide sufficient knowledge to assure a good chance of passing the examinations.

It is quite a chore for the student to figure this out. It can be done, but the FCC Study Guide offers no continuity. Therefore, this analysis of what, and how much, of each subject is required, was prepared to indicate a definite line of study and not to supply answers to individual questions.

To begin with, you probably would not be reading this article if you did not already possess at least a nodding acquaintance with radio terminology. If you already know that EMF (electromotive force) is just another name for voltage and that amperage is

merely another term for current, you are well on the way.

It is quite necessary to have a sound knowledge of the names of the various electrical factors. As an example, the student should know that “gilbert” is the name for a unit of magnetomotive force. He should also know that ampere turns can be changed to gilberts by multiplying by 1.26.

The mathematical meanings of micro and micromicro, kilo and meg, should also be learned.

Remember that these are preliminary steps. Without this fundamental knowledge of terminology the task of studying radio becomes much more difficult.

The meanings of other terms such

as permeability, residual magnetism, inductance, and conductance are easily absorbed but some phrases, such as power factor, decibels and ampere turns may require a little more study and concentration.

During this period of familiarization with radio terminology the student will doubtlessly assimilate a good deal of basic knowledge pertaining to methods of generating electricity and the nature of conductors and insulators. This will simplify the study of factors determining the resistance of a conductor and, in turn, serves as preparation for learning the principal mathematical premise of radio—Ohm’s Law.

Ohm’s Law is the basic formula for all mathematical problems in radio. The importance of a sound understanding of its principles and usage cannot be overemphasized. The student should learn it well and know how to apply the law to both a.c. and d.c. problems. It will then be a simple step to learn the very necessary power formulas as well.

A logical time to learn the principles of series and parallel connections is while Ohm’s Law is still fresh in one’s mind. There is nothing too difficult about the application of these connections and the formulas for them. For-

Fig. 1. Battery-charging arrangement.

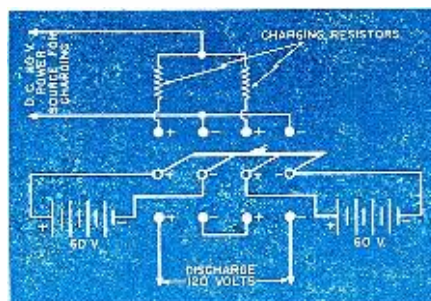



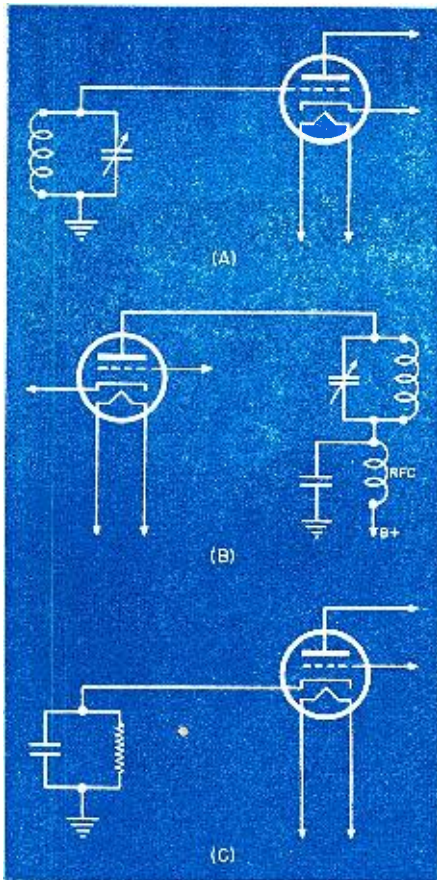

Fig. 2. Conventional radio circuits: (A) grid, (B) plate, and (C) cathode.

mulas are among the few things in radio that should be memorized.

The foregoing preliminary work, if well learned, will enable the student to delve more deeply into radio lore. The following classifications and scope of subjects may be of value in directing studies along the most economic lines in preparation for the Commission's Examinations.

### Condensers

A knowledge is required of the construction and electrical characteristics of condensers insofar as the effect of changes in condenser plates and dielectrics is concerned. The formulas for determining the amount of electricity a condenser will hold, and for determining the energy stored in a condenser, should be learned, as well as the formula for capacitive reactance.

### Induction and Inductances

Understanding of the principles of induction is essential. There is no limit to the amount of knowledge the student can use on this subject. Briefly, however, if the factors that determine the figure of merit or  $Q$  of an inductance are known and understood, this will suffice for basic radio theory.

The electrical effects of the mechanical construction of the inductance should be learned. The factors which determine the impedance of a coil and the formula for inductive reactance can be memorized.

It is necessary to know the formula for determining the resonant fre-

quency of a circuit and the manner in which the resonant frequency of an antenna can be raised or lowered. While on the subject, the factors which decide the resonant frequency of any given antenna should be learned, as well as the formula for transposing meters to kilocycles.

### Fuses and Relays

Learn the differences between fuses and relays and their various applications.

### Microphones and Telephones

It is necessary to know what high and low reactance head telephones are and what means are used to connect low impedance phones to vacuum-tube amplifier outputs.

An understanding of the operation, construction, and characteristics of the most commonly used types of microphones, such as the carbon button microphone, is also a requisite.

### Meters

Meters play an important part in the FCC examinations. It is not sufficient to know the particular type of meter used to measure a given condition. A thorough knowledge of the construction and principles of operation of all types is required. Thermocouple, electro-dynamometer, repulsion, and hot-wire meters should be studied, as well as the D'Arsonval type. Learn the application of ampere hour meters and pay particular attention to the use of shunts and multipliers with the various meters specified above.

Some practice in applying the Ohm's Law to meter readings is necessary. Frequency meters, while not of the type discussed, must also be understood and some knowledge of their construction, usage, and principle of operation is necessary. While the student may lack the radio knowledge necessary to understand the proper functioning of frequency meters at this point, it should not be neglected, as the subject will clarify itself as progress is made in the study of radio theory.

### Batteries

The Commission desires that every applicant possess an adequate knowledge of all points pertaining to batteries. Many of us wonder why, but there it is, so it would pay for you to spend a little time in learning the construction details and operating characteristics of both lead-acid and Edison type cells. The student should know how to take care of batteries and be familiar with the various troubles which may result from improper maintenance procedure.

Learn to draw a schematic which will illustrate how to hook up two battery banks so that one bank will discharge while the other charges, and don't forget to learn the difference between primary and secondary cells.

### Motors and Generators

Motors and generators must also be covered preparatory to taking the ex-

aminations. Familiarize yourself with the terminology and standard construction of various types of motor-generator units. As there are many types of d.c. and a.c. units in use, it is advisable to understand the operation and maintenance procedures for all kinds. Some mathematical problems relating to the speed in revolutions of alternators and also to output frequencies appear in the examinations. These are simple but a knowledge of the formula applied is essential.

### Vacuum Tubes

Vacuum tubes are perhaps the most important part of all the radio knowledge required to pass the Commission's examinations. Here again, terminology is very important. Study all the information you can get regarding pentodes, tetrodes and triodes. Learn what a thyratron is and how it

(Continued on page 132)

Fig. 3. Various conventional forms of coupling: (A) antenna, (B) speaker, (C) link, (D) resistance, and (E) transformer.

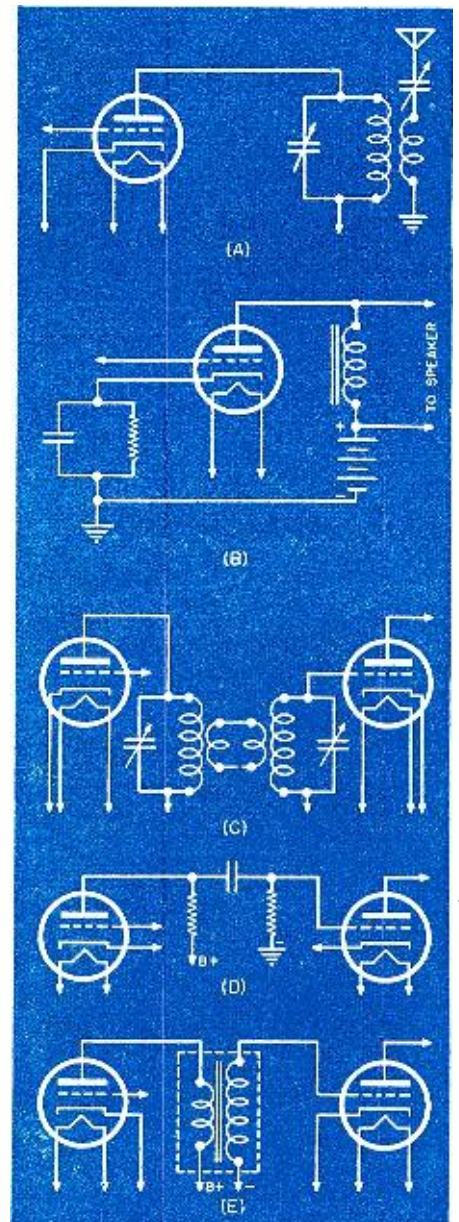

# Clearing that INTERMITTENT

By  
**Y. GABIN**

*Repairing those intermittent radio receivers can be simplified by following the proper techniques described herein.*

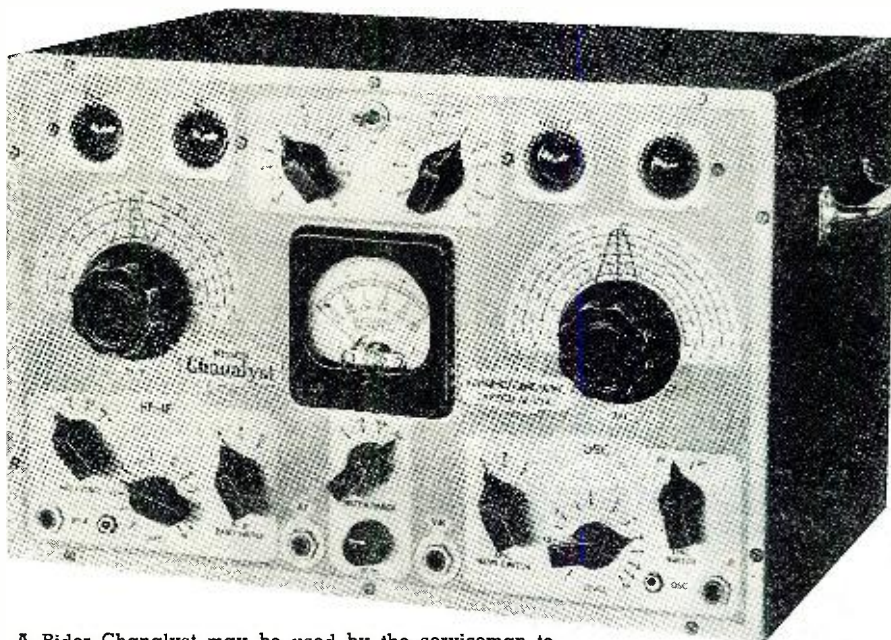

A Rider Chanalyst may be used by the serviceman to simplify his problem of repairing intermittent receivers.

INTERMITTENTS, it has been truly said, are the serviceman's Nemesis. In spite of the advances made in servicing techniques, especially the introduction of cathode-ray tubes and "signal chasers," this type of trouble still wastes more of his time than all others put together. War-time lack of signal-tracing instruments has aggravated the serviceman's difficulties. So has the scarcity of tubes, which often bars the old technique of inserting a whole new set while checking over a receiver.

An "intermittent" is that type of defect that causes a set, otherwise normal, to stop playing suddenly, or to drop greatly in volume. Turning it off and on again, jarring or tapping it, or occasionally simply switching a light on or off in the room, is often sufficient to start it playing again. Here is the main problem posed by the intermittent: When the serviceman attempts to localize the trouble, the set springs back to normal as soon as he places the test prods across a suspected circuit. He cannot find the trouble in a set which has nothing wrong with it!

The cause of intermittent cut-off or volume drop is almost invariably a poor contact which becomes an absolute open because of a sudden surge or change in the amount of current flowing through it. There are slight variations; a tube-shield which makes intermittent contact with the chassis may send the receiver into oscillation and thus cut off reception, but the underlying principle is the same even in this case. Such poor contacts may appear anywhere in the set, and in any component. The trouble-making spot may be in the antenna-coil or voice-coil, or anywhere between.

Circuits carrying only r.f. currents are the playgrounds of the intermittent. Poor contacts in the path of di-

rect currents often show up through creating high resistance, burn out, or tend to weld themselves (though certain low-wattage resistors give rise to beautiful intermittents). They also are detected more readily by test instruments in such circuits. In the r.f. leads, the very minuteness of the currents prevents any breakdown or self-healing effects.

The r.f. bypass condenser is the most common hideout of the intermittent, though poorly soldered connections and poor friction contacts run it a close second. Such contacts often are found in variable condensers and tube prongs. Intermittent opens or poor contacts in the r.f. transformer secondaries and variations in the high-frequency resistance of filter condensers, all have been found guilty of "killing the signal." The rule is that no part of the set can be free from suspicion, from power pack to cathode resistor, and from antenna to loud speaker.

Another intermittent—or semi-intermittent—is worth noting. This shows up after the set has been playing for some time and does not respond to the usual switching or shaking, but disappears after the set has been turned off for a while. It is obviously caused by heat, and is easier to find, as the set will remain out of commission while tests are made on it in the "live" condition. It is mentioned only to point out that many true intermittents are also "thermals," but such small ones that they may cool immediately when the set goes out of action, and be ready for the slightest surge to put them

back to work again. Indeed, the action is sometimes automatic, and the set goes on and off periodically. The author remembers one old '27 tube whose filament used to open after it had been playing a few minutes. After the first cut-off, it would open and close at regular 30-second intervals, with wierd effects on the program. The trouble, of course, made itself known at once, and the tube was long kept in the shop as a curiosity.

Servicemen have three standard methods of attacking intermittents. The oldest and crudest is to go through the set, checking all suspicious parts by removing or replacing, and playing the receiver for long periods to make sure a cure is effected. This is a time-wasting and unsure procedure, but has a few very good features. In certain models, bypass condensers are notorious as the cause of intermittent fading, and it has been common practice in some such cases to replace *all* the fixed condensers before even starting to search for the trouble. Nowadays it may not be practical to replace condensers in such a wholesale manner, but it is often worth-while to disconnect bypasses till one is found which produces the intermittent when removed from the circuit. Replacement with a new condenser and playing the set for several hours may prove the trouble to have been cured.

The second good point to pick up from the old hit-or-miss method is that of "sweating" all the soldered joints in a receiver, especially those which carry r.f. only. This, and cleaning all socket contacts (note that occasionally

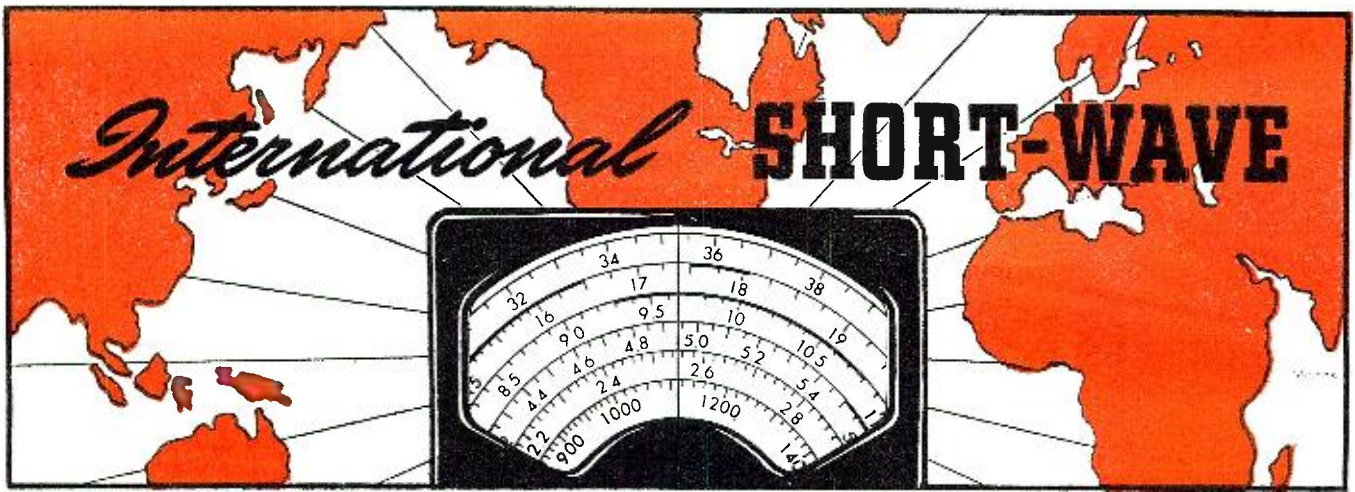

**Compiled by KENNETH R. BOORD**

“RECEIVER is no better than its antenna”—that is radio’s time-honored truism.

From the advent of the “wireless” height of the receiving wire has been widely regarded as a general measure of its worth for clear, consistent reception. This is true on all bands, I believe. Given a “good” wire, it becomes possible to turn up the radio’s volume control without scooping up too much of the disturbing dregs in the ether waves.

Saying it another way, the higher the antenna wire, the more it is isolated from manmade noise sources—such as street cars, electric signs, refrigerators, and automobile ignition systems. When this happens, a more favorable signal-to-noise ratio has been established. The strength of the signal in the wire far overbalances the manmade noise. This is the first requirement of good reception.

By now you’re probably asking in your mind, “Just what kind and how much antenna should I have?” After having experimented with various types of antenna systems for more than ten years, I’m afraid I can’t give you a cut-and-dried answer.

It has been my experience, however, that satisfactory results throughout the tuning range of the average all-wave home receiver will be obtained with a conventional inverted “L” Marconi type of antenna, 75 to 100 feet long, including leadin. As has been indicated, for best results, erect the antenna as high as possible and see that it is removed from surrounding ob-

jects. *Have it in the open*, if at all possible. Be sure the antenna is insulated from the ground at all points.

If your set has two antenna terminals—usually designated by the manufacturer as A-1 and A-2—you may wish to employ a doublet antenna system. On such receivers, you may find a “jumper” between A-2 and G (ground). If you use the conventional inverted “L” Marconi type of antenna, it will not be necessary to remove this “jumper.” When this type of antenna is used, it is connected to terminal A-1.

In the event a doublet antenna is to be installed, the two wires of the doublet leadin should be connected to terminals A-1 and A-2. The “jumper” between A-2 and G can remain connected, or you can remove it—depending upon its effect on favorable reception.

With most receivers, a ground can be used, if desired, and should be connected to the G terminal. Connecting the receiver to a good ground—a cold-water pipe or 6-foot rod driven in moist soil—may improve reception and reduce noise. With many sets, however, and under normal conditions, no noticeable difference will exist—so a ground is suggested only if it aids reception. A little experimentation on your part will be your best criterion.

Should you wish to have a separate antenna for some one short-wave frequency or band, a half-wave antenna cut to the proper length for the desired frequency will prove effective, I’ve found. The following formula will give the length of the one-half wave-

length antenna, depending on the desired frequency:

$$\text{Length in feet} = \frac{480}{\text{Frequency in megacycles}}$$

or, for example, a half-wave 40-meter antenna would be:

$$\frac{480}{7.5} = 64 \text{ feet long.}$$

The antenna should preferably be of solid, soft drawn enameled copper wire for ease in handling. The center of the wire should be cut and an insulator inserted at that point. The twisted pair, or open wire transmission line, should then be soldered to each 32-foot length, after the enamel has been carefully scraped off, directly on either side of this center insulator. The other end of the transmission line should be connected to A-1 and A-2 on your receiver.

It should be remembered that such an antenna has directional properties broadside to its length and should be so oriented if maximum pickup from a certain direction is to be expected.

All in all, it has been my experience, as well as that of many others, that a conventional “L” Marconi type antenna of 75 to 100 feet in length—including leadin—erected as high as possible, and kept away from surrounding objects, the use of as short a leadin and ground line as possible, together with carefully soldered connections, will give exceptionally good service on all wavelengths throughout the tuning range of the average home receiver.

\* \* \*

**RADIO MOSCOW BROADCASTS**

Through the courtesy of the Embassy of the U. S. S. R. in Washington, we are listing below the current schedule of Soviet transmissions from Radio Moscow:

7:40 a.m. EWT—11.88, 11.94, and 9.56 mcs.

8:20 a.m. EWT—11.94 mcs.

12:00 noon EWT—15.74 mcs.

(Continued on page 134)

Table 1. A report from Don Brewer of Tulsa, Oklahoma, on the quality of foreign station reception using his four-band all-wave receiver.

CALL	LOCATION	MEGS.	TIME HEARD (C.W.T.)	RATING
GSC	London	9.58	6:30- 9:00 p.m.	Good
GVX	London	11.93	6:30- 7:00 p.m.	Excellent
GRH	London	9.825	6:30-11:45 p.m.	Excellent
GSU	London	7.26	7:15-11:45 p.m.	Excellent
GRX	London	9.69	6:30- 7:30 p.m.	Excellent
VLG	Melbourne	9.58	10:00-10:45 a.m.	Poor
VLG4	Melbourne	11.84	12:15-12:45 a.m.	Good
DJD	Berlin, Germany	11.77	4:00- 8:00 p.m.	Fair

**T**HERE has been a rather full-scale "speedup" and a lot of renewed activity at the War Shipping Administration's radio training station at Gallops Island up in Boston harbor. The school is, we understand, filled to its capacity at present. The general trend of thought seems to be that when the present group of trainees graduates in October, and shortly thereafter, the present shortage of radio officers to man the ships under the new three men to a ship regulations of the WSA will be greatly relieved. In the meantime, however, the U. S. Maritime Service is still asking for marine radiomen for the merchant fleet. The Maritime Service also has had a few positions open for radio instructors, such jobs being open to those in the 4F draft classification, those recently discharged from the Armed Forces and men in the thirty-eight to fifty age bracket. Communicate with WSA, Room 300 at 39 Broadway, New York City.

**B**ILL McEWAN and E. D. Baker, who called in at the East Coast recently, are both sticking well to their respective tankers lately. We hear that Walter Glazar has taken to the briny deep. "WG" was formerly with the MRT service depot in New York. A. Richardson was around the big city recently and left aboard a cargo assignment. K. Johnson has taken a Liberty berth. D. R. Duncan is out on a tanker for a change, after experimenting with a few cargo ships. K. Whooley picked up a rather nice tanker assignment after a few weeks ashore and K. Romsas went out on a freighter as his latest assignment. Harry Morgan of ACA is back, at this writing, after an illness of several weeks. B. Peterson has taken out a tankship.

**T**HERE are hundreds of marine radio officers who have had many years experience at sea and in many cases have supplemented their sea duty with experience in the various radio fields ashore. Do you men with long years of experience realize that there is an organization of oldtime, experienced radiomen? The Veteran Wireless Operators Association, Inc., with headquarters in New York, is such an organization for men with long and varied experience in marine radio. Any professional wireless operator who has served in such capacity afloat or ashore ten years prior to date of application is eligible to join the Association as a Veteran Member. Such services may be commercial, industrial or with any branch of the Government service. One with less than the above ten (10) years service shall be eligible to join as an Associate Member and can be advanced to Veteran Membership after the date of commencement of service. Annual dues are only three dollars and include a magazine subscription. The VWOA officers and directors include many of the most well-known names



**By CARL COLEMAN**

in radio—such as Dr. Lee De Forest, Bill McGonigle, A. J. Costigan, George Clark, Fred Muller, J. R. Poppele, C. D. Guthrie, David Sarnoff, and a host of others who are just as well known. The association holds regular meetings and has representatives in many cities. An annual dinner is held in New York, usually during the winter months, which brings together the men in radio you have always wanted to meet. Here is your chance to get together with all of the other men in your profession. For further details write to the Treasurer, Mr. William C. Simon, 149 President St., Lynbrook, N. Y.

**N**AVY Secretary James Forrestal, in a recent statement, warned that the United States must keep the Navy and naval air arm in fighting shape after the present war if there is to be any real security from wars in the future. The Navy Department head

stated that the United States started out on an era of self-destruction after the last war by the scrapping or sinking under treaty obligations of 30 battleships, 15 cruisers, 139 destroyers and 52 submarines, and pointed out that a fair-sized U. S. Navy was destroyed by scrapping or sinking. We hope in view of the above that the powers that be will keep Secretary Forrestal's words in mind, not only in the Navy but in the U. S. Merchant Marine as well. The merchant marine is to a great extent the mainstay of the Navy, as supplies for operating far from home bases must be carried by this service. We sincerely hope that the disgraceful rotting-away of the U. S. Merchant Marine will not be repeated at the conclusion of the present war, to the extent it was allowed to go in World War I. While we are on the subject of the Navy, congratulations to Raymond A. Spruance, 57, the youngest

*(Continued on page 62)*



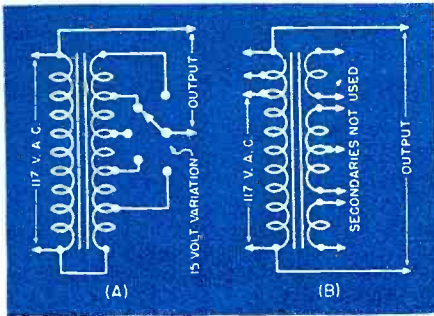

Fig. 2. Many intermittents may be located easily by operating the receiver at a line voltage higher than specified. A higher line voltage can be obtained by connecting two transformers, as shown.

the quick cure is to replace all condensers and resistors which might cause the trouble, sweat all joints and brighten all contacts.

Even when using signal tracing, much time may be wasted and equipment tied up in some obstinate cases. Sets have been known to play eight hours per day for two or three days without giving any evidence of fading, and to continue for a day or two in the owner's home before starting to fade again. In some cases this is due to different conditions in the home and shop. For this reason it is always well to check on the voltage at the home location, and to ask if the fading occurs more often at a given time of day—often a valuable clue to voltage conditions. If a set refuses to "intermit" it is often a good idea to put a box over it and let it get a few degrees warmer than the surrounding air. Perhaps taking it out of the cabinet will improve conditions.

The third method of attacking in-

termittents—little used in the past—is to increase the line voltage to a point where faulty components are likely to break down under d.c. overloads or heavier r.f. surges. One of the weaknesses of this system is that it is quite useless against such defects as a poor antenna-coil connection, and little better for *pure* r.f. circuits in other parts of the set. Where r.f. is superimposed on d.c., it may work well.

The serious fault of this method is that it makes a complete breakdown out of an intermittent. In many cases there have been disagreements between servicemen and owners over estimates, the owner preferring to take his set back rather than have it repaired. Naturally, he insisted on getting it in the same condition as it was when he let it go to the shop. One bad experience with this technically excellent, but commercially embarrassing servicing method was too much for the serviceman.

Now that the market is more in his favor, he can be a little bolder and explain the situation to his customer. In most cases, if he stresses the saving of time and money the method involves he will get a go-ahead signal. Neither is there now any necessity for the check-and-estimate method in the case of intermittents. The serviceman can make an estimate sufficient to cover the case before running any tests.

The apparatus used in the over-voltage test is simple. An old toy transformer, with taps up to 15 volts, is sufficient; circuit is shown in Fig. 2. Often a variable-primary transformer may be found in an old receiver. The 117-volt line may then be connected across the 100-volt tap and the set

across the 120-volt tap, giving a 20% increase in voltage. Just to make the test more gruesome, a sign flasher may be inserted in series with the primary. A fuse just big enough to carry the current used by the set should in all cases be used. There is no reason why breakdown of a bypass condenser should be followed by burn-out of a filter choke or rectifier tube.

To repair an intermittent receiver in the shortest possible time, a judicious combination of all three methods is advisable. First, put in a set of new tubes, if possible. Then turn the chassis over and sweat any suspicious joints—or all joints carrying r.f. only. If the set is one in which fading is often traced to certain bypass condensers, these also should be replaced. Many servicemen replace the a.v.c. condensers in practically all old sets at this point, just as a matter of principle. This is often worth doing, for very often "fading" is a fade in reverse—a leaky a.v.c. condenser takes the bias off the controlled tubes, and the volume is turned down accordingly. As soon as the intermittent condenser functions properly, the a.v.c. goes on with a bang, and the volume drops, often below the audibility level.

The receiver may then be played on the bench, while the serviceman goes about his regular work. If it still fades, it may be given an hour's run at a voltage of 130 or higher. Then if nothing happens, the signal tracer should be called into play. The proper combination of all available methods will conquer the intermittent with no serious loss of that now more-than-ever valuable commodity, time.

-50-

Fig. 3. Wiring diagram of a simplified channel analyzer, which may be used if a professional type Chanalyst is not available. This unit may be constructed from one of those old receivers on hand by adding the closed circuit jacks shown to accommodate the test lead. Special test prods are suggested in the diagram for use with this instrument.

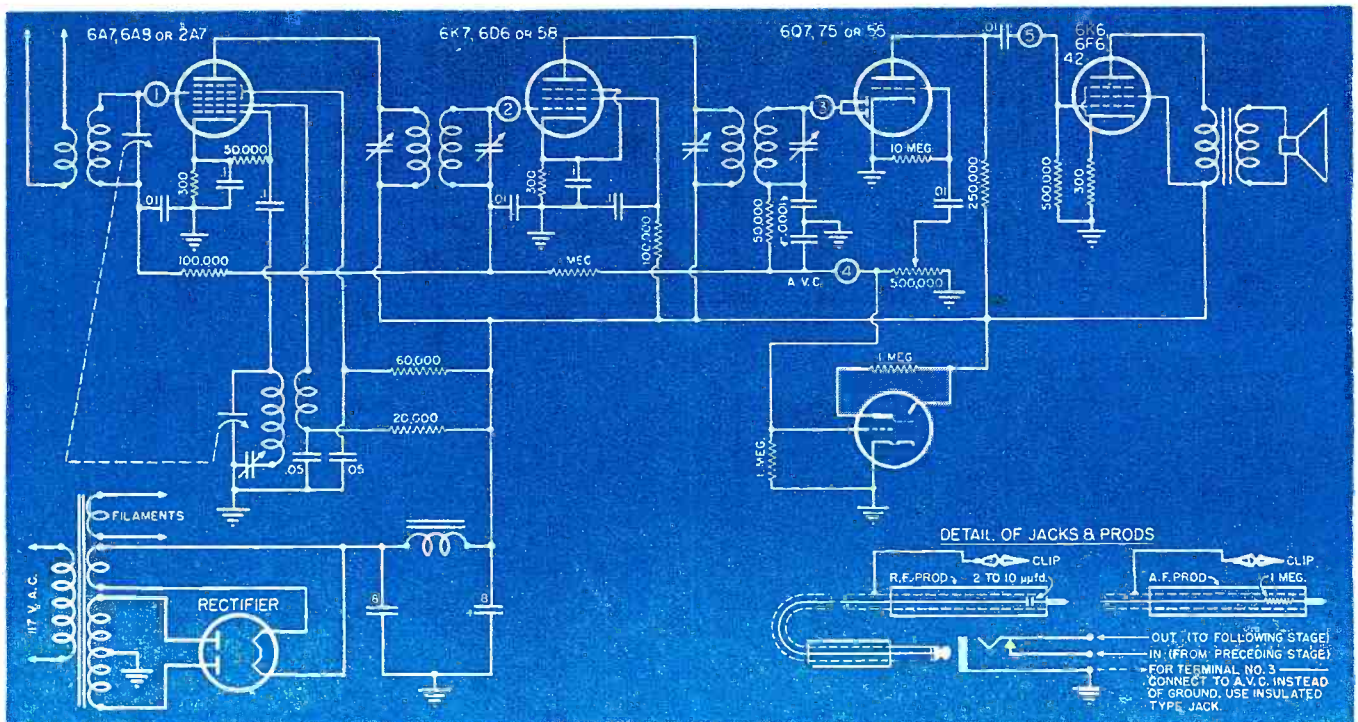

the trouble is *inside* the tube prong itself), will put a surprising number of intermittent receivers back into operation again.

Method No. 2 is signal-chasing. This is the only really efficient system, especially if used in conjunction with one of those multichannel analyzers with a flock of self-locking electron-ray indicators. Such instruments are rare indeed today, and the serviceman may be compelled to build his own tracer. Almost any old superheterodyne may be used for this purpose, though one with an "eye-tube" may be used as a two-channel indicator.

The old set is broken into as indicated in Fig. 3, either with switches or closed-circuit jacks, to accommodate the "hot" test lead. The "cold" one is attached to the chassis. The set should be one with a 455-kc. i.f. and should be of the a.c. type. Sets connected directly to the line are not adapted to signal-tracing, as there is a possibility of grounding them through the test prods unless special precaution is taken. The test prods should be specially built, at least for the r.f. circuit, as is shown in Fig. 3. The small condenser may be made simply by twisting two lengths of enamel-insulated wire together for a short distance. The a.f. prod may be an ordinary test prod, though the one shown will not load the circuit to which it is applied, sometimes an important point

to remember in tracing intermittents.

It may be necessary to connect a 1-megohm, or smaller, resistor between grid and ground of the i.f. stage, if the tracer shows any tendency to oscillate. Slight retrimming of this stage is also often necessary to compensate for the leads, and, of course, to adapt the tracer to various i.f.'s from 445 to 470. Values of parts are given, in case the serviceman wishes to modify slightly the set used as a tracer, but he is warned that building such a tracer from the ground up is a waste of time. Use a junked set from the shop!

It is hardly necessary to outline the methods of signal tracing; plenty has been written on that subject. Suffice it to say that an input to lead 1 can be used to check the performance of any r.f. circuit (point A in Fig. 1); lead 2, the convertor output and i.f. input or output (points B, C, D, and E); lead 3, the i.f. output (point F or any strong r.f. signal, no tuning required); lead 4, weak audio signals (point G); and lead 5, strong a.f. signals (points H, I, J, and K).

A simpler type of signal tracer is one that has only the detector and audio stages (sometimes with a resistance-coupled r.f. stage as well). Such tracers usually are not oversensitive, but are rigged up very easily from any type of old receiver, and require no tuning. The prod is simply applied to

r.f. leads of any frequency, the signal being rectified and amplified in the tracer. A second prod is required for audio signals.

Used to detect intermittents, the signal tracer is hooked up across that part of the receiver under test. If a tracer with an eye-tube is available, lead 4 may be hooked in at point G of Fig. 1. The eye will remain closed and signals will come from speakers of both the set under test and the signal tracer. A failure of the signal appearing in the output of the set under test, accompanied by an opening of the eye, indicates trouble before the detector. Cessation of sound from the speaker with the eye remaining closed shows that the intermittent is in the a.f. circuits. Should this be the case, the hot prod is attached to the grid of the output tube (point I), and the set played till it again fails. Should the speaker of the tracer continue to play, the trouble is obviously in the output circuits of the receiver, and points J and K should be tried next. If both speakers stop, the signal-tracer lead may be moved back to the grid circuit of the preceding tube, point G, and the process repeated.

The same method is used in the i.f. and r.f. circuits, should the trouble be located before the detector. Using leads 3, 2, or 1, the faulty stage is located. Once the trouble is localized within the narrowest possible limits,

Fig. 1. Diagram of a Wells Gardner Model 7A66-2 radio receiver, used to illustrate the various test-prod connections to be made on any similar receiver in order to simplify the serviceman's problem of locating the source of intermittent.

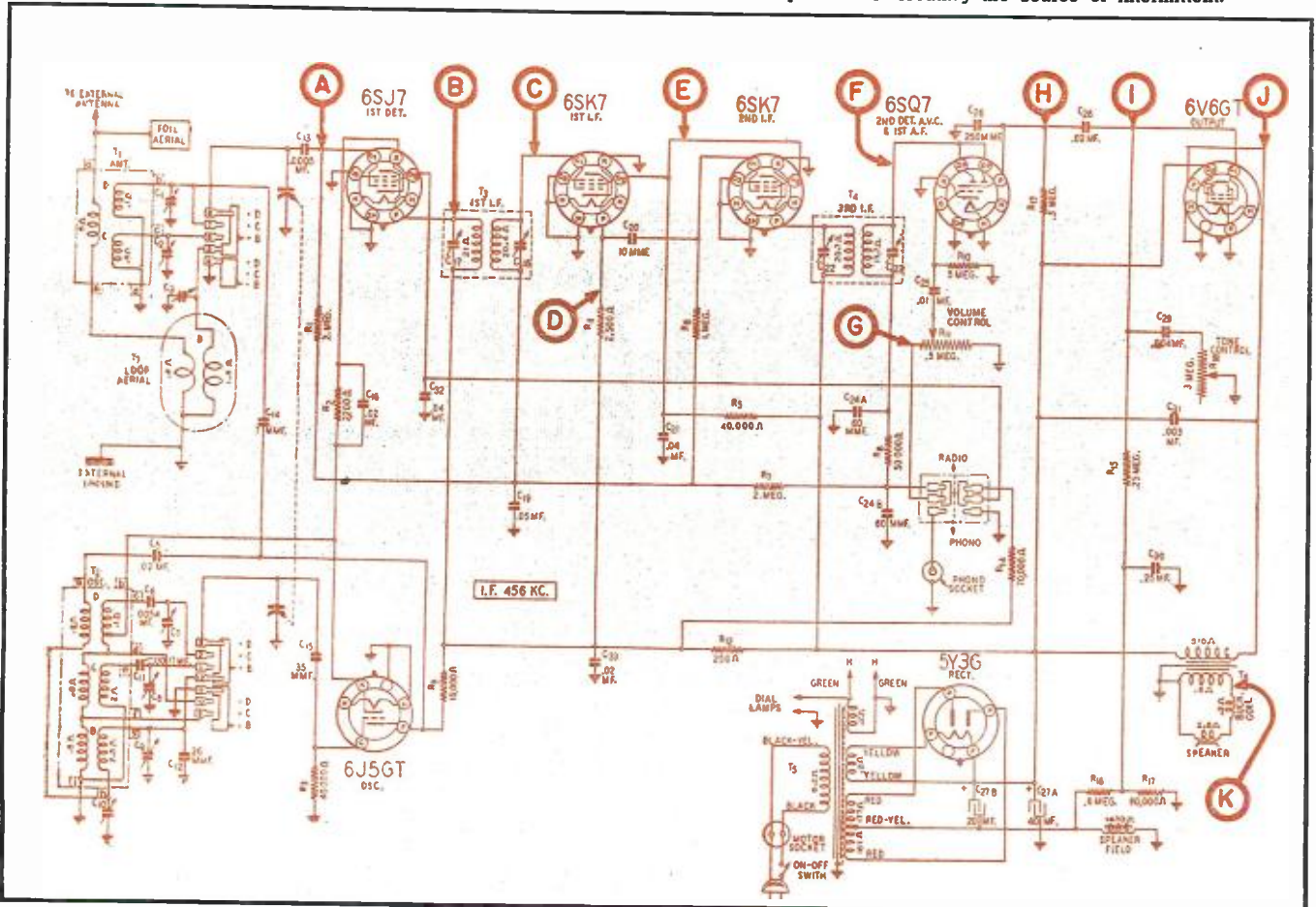

## AROUND THE CLOCK WITH THE WAR NEWSCASTS IN ENGLISH

### MORNING

EWT	LOCATION	CALL	FREQ.*
7:00 a.m.	London	GSB	9.51
		GWC	15.07
		GWE	15.43
		GSV	17.81
		GSP	15.14
		GRG	11.68
		GSH	21.47
		GRF	12.09
		GSD	11.75
		VLW3	11.83
7:15 a.m.	Perth	VLW6	9.68
7:30 a.m.	Berlin	DJB	15.20
7:40 a.m.	Moscow		11.88
			11.94
			9.56
7:50 a.m.	Tokyo	JLG2	9.505
8:00 a.m.	Melbourne	VLC5	9.54
		VLG3	11.71
			11.94
8:20 a.m.	Moscow	PIRM	6.14
8:30 a.m.	Manila		9.64
9:00 a.m.	Tokyo	JVW3	11.725
9:00 a.m.	London	JZK	15.16
		GSP	15.31
		GSV	17.81
		GWC	15.07
		GWE	15.43
		GSP	15.14
		GSH	21.47
		JZHA	9.47
		DJB	15.20
		R.S.	11.775
9:00 a.m.	Hongkong		9.47
9:30 a.m.	Berlin	DJB	15.20
10:00 a.m.	Saigon	R.S.	11.775
10:00 a.m.	Tokyo	JVW3	11.725
		JZK	15.16
10:00 a.m.	Chungking	XGOY	9.646
			7.17
		XGOA	9.73
10:00 a.m.	Hsinking	MTCY	5.51
			6.125
10:15 a.m.	Melbourne	VLG	9.58
		VL19	7.28
11:00 a.m.	Tokyo	JVW3	11.725
		JZK	15.16
11:00 a.m.	Chungking	XGOY	9.646
			7.17
11:00 a.m.	Ceylon		4.90
11:00 a.m.	Stockholm	SBT	15.155
11:00 a.m.	Melbourne	VLC6	9.615
		VLG3	11.71
11:00 a.m.	London	GSP	15.31
		GWC	15.07
		GVU	11.78
		GRG	11.68
		GSV	17.81
		GSH	21.47
		GRF	12.09
		GSD	11.75
11:00 a.m.	New Delhi	VUD2	6.19

\*\*\*\*\*

### AFTERNOON

EWT	LOCATION	CALL	FREQ.*
12:00 noon	London	GSP	15.31
		GRW	11.70
		GRU	9.445
12:00 noon	Chungking	XGOY	9.646
			7.171
12:00 noon	Moscow		15.74
12:00 noon	Tokyo	JVW3	11.725
		JZK	15.16
12:50 p.m.	Vichy	TPC5	15.24
1:00 p.m.	Tokyo	JVW3	11.725
		JZK	15.16
1:00 p.m.	London	GVU	11.78
		GRG	11.68
		GSB	9.51
		GRD	15.45
		GSD	11.75
		GSP	15.14
		GRS	7.06
		GWC	15.07
2:00 p.m.	Tokyo	JVW3	11.725
		JZK	15.16
2:30 p.m.	Moscow		11.94
2:45 p.m.	Brazzaville	FZI	11.97
2:45 p.m.	London	GRG	11.68
3:45 p.m.	London	GRG	11.68
5:45 p.m.	London	GVX	11.93
		GSC	9.58
		GRH	9.825

\*\*\*\*\*

\*Frequencies shown are in megacycles. To convert to meters divide 300,000,000 by the frequency in cycles-per-second.

### EVENING

EWT	LOCATION	CALL	FREQ.*
6:15 p.m.	Tokyo	JZJ	11.80
		JLG2	9.505
		JLG4	15.105
6:45 p.m.	London	GVX	11.93
		GSC	9.58
		GRX	9.69
		GRG	11.68
		GRC	2.88
6:45 p.m.	Moscow		11.94
			15.10
			15.2
7:00 p.m.	Berlin	DJD	11.77
		DXJ	7.24
		DXP	6.03
7:30 p.m.	Tokyo	JLG4	15.105
7:45 p.m.	Brazzaville	FZI	11.97
8:00 p.m.	Berlin	DXL25	7.28
		DXJ	7.24
		DXP	6.03
8:15 p.m.	Chungking	XGOY	11.90
8:15 p.m.	Leopoldville	OPL	9.785
8:30 p.m.	Leopoldville	OPL	11.64
9:00 p.m.	Berlin	DXL25	7.28
		DXJ	7.24
		DXP	6.03
9:00 p.m.	London	GSC	9.58
		GSL	6.11
		GSU	7.26
		GRX	9.69
		GRC	2.88
		GRB	6.01
9:30 p.m.	Bern		7.38
			9.185
			9.539
10:00 p.m.	Berlin	DXL25	7.28
		DXJ	7.24
		DXP	6.03
		PRL8	11.72
10:00 p.m.	Rio de Janeiro		18.13
10:15 p.m.	Djarkarta		15.315
10:30 p.m.	Melbourne	VLC4	15.315
10:45 p.m.	London	GSC	9.58
		GSL	6.11
		GSU	7.26
		GRM	7.12
		GRC	2.88
		GSB	9.51
		GRW	6.15
11:00 p.m.	Berlin	DXJ	7.24
		DXP	6.03
11:40 p.m.	Berlin	JLG4	15.105
		JZJ	11.80
		JLG2	9.505
12:00 midnight	Berlin	DXJ	7.24
12:00 midnight	Durban (So. Africa)	DXP	6.03
		ZRD	5.945

\*\*\*\*\*

### AFTER MIDNIGHT

EWT	LOCATION	CALL	FREQ.*
12:30 a.m.	Durban (So. Africa)	ZRD	5.945
12:30 a.m.	Johannesburg	ZRH	6.007
12:30 a.m.	Capetown		5.882
12:30 a.m.	London	GSC	9.58
		GSL	6.11
		GSU	7.26
1:00 a.m.	Tokyo	JZJ	11.80
		JLG2	9.505
1:00 a.m.	London	GRC	2.88
1:00 a.m.	Berlin	DXJ	7.24
		DXP	6.03
1:15 a.m.	Melbourne	VLC4	15.315
		VLG3	11.71
1:30 a.m.	Hsinking	MTCY	11.775
2:00 a.m.	Suva (Fiji Island)	VPD2	6.135
2:00 a.m.	London	GSD	11.75
		GSB	9.51
		GWC	15.07
		GVU	11.78
		GSP	15.31
2:30 a.m.	Hsinking	MTCY	11.775
3:00 a.m.	Tokyo	JZJ	11.80
		JLG2	9.505
3:00 a.m.	Shonan (Singapore)		9.555
3:00 a.m.	London	GSB	9.51
		GSD	11.75
		GSW	7.23
		GRG	11.68
		GSP	15.31
		GRD	15.45
4:00 a.m.	Suva (Fiji Island)	VPD2	6.135
4:00 a.m.	Melbourne	VLC4	15.315
		VLR	9.58
		VL14	7.22
4:00 a.m.	Perth	VLW3	11.83
5:00 a.m.	American Broadcaster Somewhere in Australia	VLC2	9.68
5:00 a.m.	London	GSV	17.81
		GSB	9.51
		GSE	15.14
6:30 a.m.	Shonan (Singapore)		9.555

\*\*\*\*\*

# MARINE BATTLE BROADCASTING SYSTEM

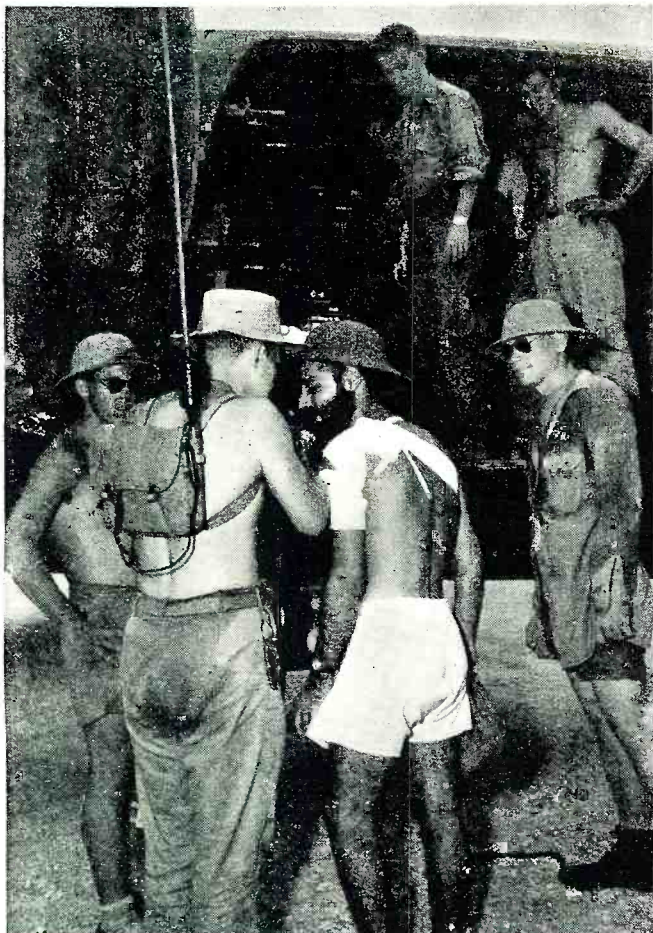

Interviewing a wounded Marine Platoon Sergeant over a pack transmitter, as he boards transport plane for evacuation.

*Bringing important events into homes thousands of miles away by instantaneous electrical transcriptions.*

**W**HEN the special events programs disappeared from the commercial networks with the advent of war, they were not a casualty of war since they had gone to war with the Marines and become known as Battle Broadcasting. They are bringing the biggest event in history right into homes thousands of miles from the scene of the conflict.

A small group of Marines assigned to the work had to discard most of the expensive and delicate equipment used by commercial networks because the intense heat, heavy rainfalls and high humidity affected it with rust, mold and corrosion. Direct short-wave broadcasts were ruled out since the international broadcasting stations were far behind the lines and would defeat the principal purpose—which was on-the-scene accounts of battle action as described by the participants. Instantaneous electrical transcriptions were the answer, with the transcriptions being flown to the United States by air transport.

The ingenuity of the directors has enabled listeners to get the "feel of battle" right in their own homes. Interviews with fliers just back from important missions and the stories of wounded men help to impress the seriousness of the present conflict. A lighter touch is given by programs presented by the natives of the islands on which our Marines are stationed, and by messages to the folks at home from the boys. Due to the speed with which the transcriptions are shipped, listeners can keep right up-to-the-minute with current events, thanks to Battle Broadcasting.

-30-

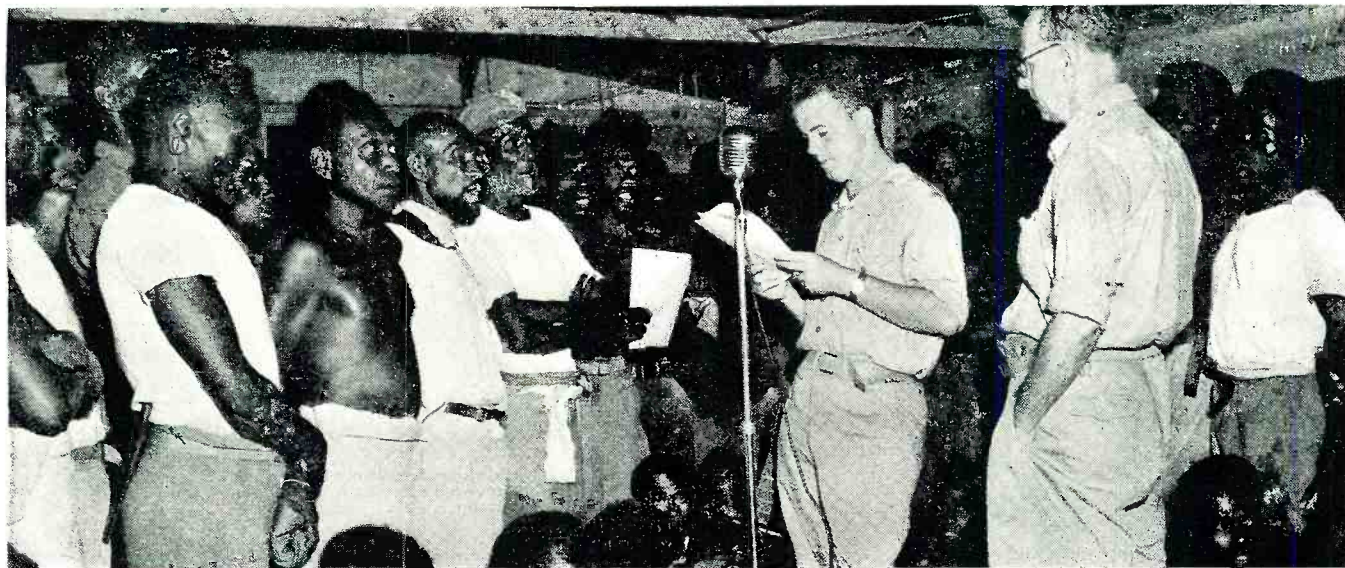

Natives of a South Pacific island serenade United States listeners via Battle Broadcasting. A Marine Corps radio correspondent was master of ceremonies for this unusual feature and U. S. liaison office assisted with arrangements.



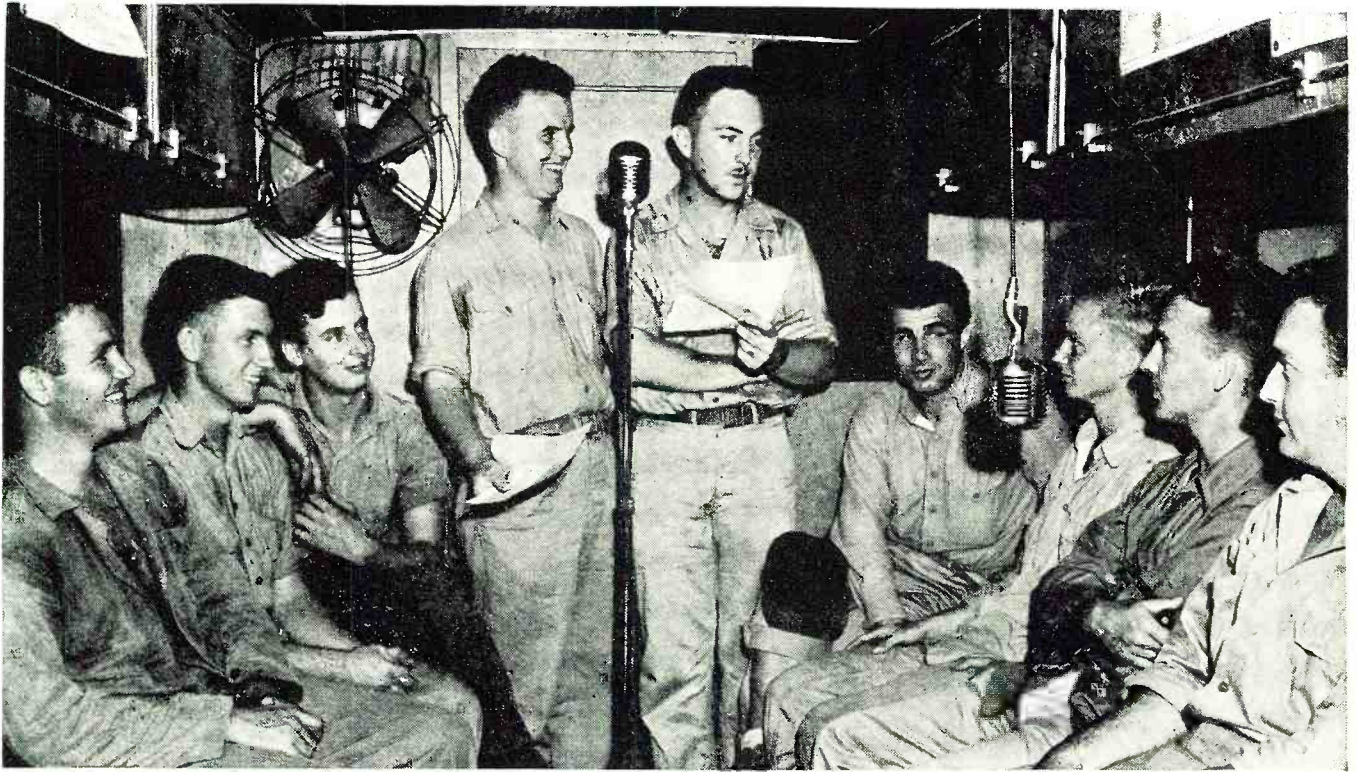

Navy and Marine fighters, all from Georgia, send messages from the South Pacific via Battle Broadcasting. All broadcasts are electrically transcribed instantly and the transcriptions flown to the United States by air transport,



A Marine Lieutenant is interviewed before he can leave his plane after a fighter sweep over an important key Japanese base in the South Pacific.



Marine Corps correspondents record their impressions of a recent invasion, for the Battle Broadcasting unit on the island, after completing original assignments during the early days of the offensive.

# TRANSIENTS AND TIME CONSTANTS

By ABRAHAM TATZ

*An analysis of the effect of inductive and capacitive circuits having various time constants upon sinusoidal and non-sinusoidal waveforms.*

IN testing the frequency response of amplifiers and transformers, square waves have found great application because of their high harmonic content. The distortion of the square wave in the output of the circuit tested yields a picture of the lack of uniform response for the various frequencies involved among the harmonics. This process of distortion to a new wave shape has now become a tool in the hands of the research engineer in the new fields of electronics and television. The new wave shapes needed for this work include narrow trigger pulses for synchronization, and linear saw-tooth waves for sweep circuits. This desirable distortion of square waves can be accomplished by a simple coupling unit of resistance and capacitance, or resistance and inductance, in either case utilizing the frequency discriminating quality of the reactance to change the shape of an applied voltage wave.

The original generation of a square, or rectangular waveform usually requires a vacuum-tube circuit for the production of the original distortion and hence the creation of the harmonics. A circuit that can be used to generate a symmetrical square wave or an asymmetrical rectangular wave is shown in Fig. 1. The input is a sine wave of sufficient amplitude (25 volts peak) to overdrive the first triode, yielding a square wave on the plate when the cathode resistor  $R_1$  is set at minimum. The second triode is an amplifier, also overdriven, which squares the output of the first tube.

$R_1$  can be adjusted for symmetry of the output square wave. When  $R_1$  is set at maximum the surge of tube current through it on the positive signal swing accumulates a heavy charge on  $C_1$  sufficient to bias the tube for Class C operation. The output pulse is then amplified by the second triode to yield a rectangular wave at this bias setting.

### Transients in RC circuits

To examine the effect of a resistance-capacitance circuit upon a square wave it is helpful to regard the square wave as a sudden application of d.c. voltage lasting for the duration limited by the positive alternation, and then a sudden removal of the applied voltage. In Fig. 2, upon throwing the switch to position 1, the battery will force current through the circuit until the condenser is fully charged to 100 volts. The charging of the condenser is not instantaneous, but takes place in a measurable time, which is lengthened by an increase in the size of either R or C. The formula for the charging curve of condenser voltage is

$$E_c = E_a \left(1 - \frac{1}{e^{t/RC}}\right)$$

where  $E_a$  is the applied d.c., t is in seconds, R in ohms, C in farads, and e is a mathematical constant, 2.718. The formula yields the following information:

- 1) At initial time  $t = 0$ ,  $E_c$  equals zero.
  - 2) At time  $t = RC$  seconds,  $E_c = 63\%$  of  $E_a$ .
- This time (RC seconds) is called the

time constant of the circuit, the product of R and C, and is defined as the time required for the condenser to acquire 63% of the applied d.c. voltage.

- 3) At time  $t = 5 RC$  the condenser voltage practically reaches the applied voltage.
- 4) The charging curve is linear up to the time  $t = .3 RC$ , or 30% of the first time constant.
- 5) The initial slope is such that the condenser would be fully charged in one RC if the initial charging rate had been maintained.

During this charging time the resistor voltage, initially 100 volts because of the heavy charging current, drops to zero in 5 RC time constants, when current flow ceases because the condenser is fully charged.  $E_r$  drops 63% in the first time constant.

Upon throwing the switch to position 2 the condenser will discharge, taking five time constants to do so. The discharge curve follows the formula

$$E_c = \frac{E_a}{e^{t/RC}}$$

During the discharge the resistor voltage is in the opposite direction because of reversed current flow. Here  $E_r$  is initially negative 100 volts and falls back to zero in 5 RC's, the end of the discharge.

### Distortion by Time Constants

Now consider the square wave of Fig. 3a. It shoots from zero to 100 volts and back, much as the plate voltage wave of a triode driven to cut-off and saturation. Its frequency is 50 cycles per second, and the time between points A and B, the duration of a half-cycle of positive d.c. voltage, is 0.01 second or 10,000 microseconds. The circuit to which the square wave is applied has a time constant of 1,000 microseconds (100,000 ohms times .01  $\mu$ fd.). The condenser becomes fully charged in 5 RC's, halfway between A and B, and fully discharged halfway between B and C. Note that the condenser wave follows the applied square wave but lags behind it. The resistor voltage, always the difference between the applied voltage and the condenser voltage, is a positive peaked wave between A and B (condenser charging) and a negative peaked wave between B and C (condenser discharging). At all times  $E_a = E_r + E_c$ , whether  $E_a$  is 100 volts or zero. The resistor voltage is pure a.c., equal areas each side of

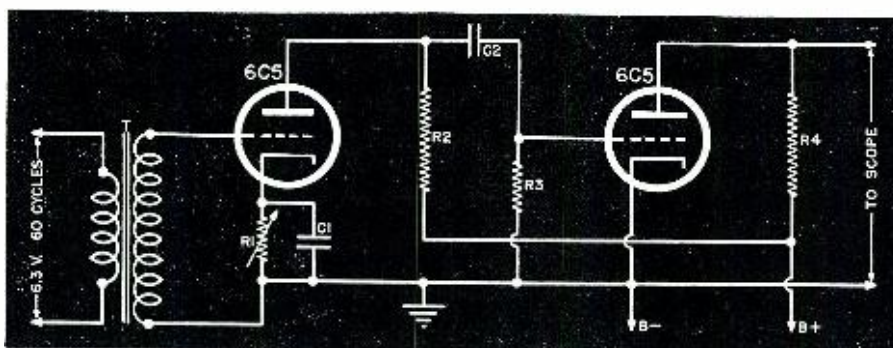

Fig. 1. Circuit for generating either square or rectangular waves.

$C_1$ —1- $\mu$ fd., 400-v. tub. cond.  
 $C_2$ —1- $\mu$ fd., 400-v. tub. cond.  
 $R_1$ —1-megohm carbon pot.  
 $R_2$ —5-megohm, 1/2-w. res.

$R_3$ —1-megohm, 1/2-w. res.  
 $R_4$ —50,000-ohm, 1/2-w. res.  
 T—Audio trans., 1:3 stepup

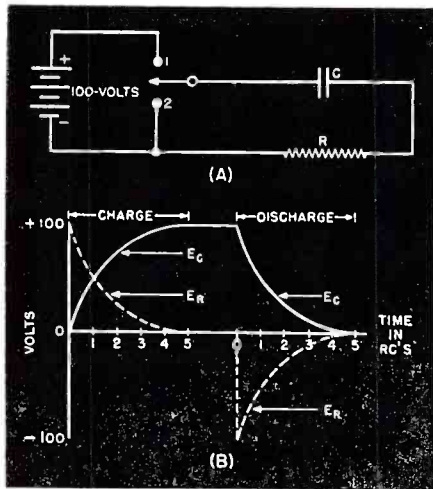

Fig. 2. Charge and discharge effect of a condenser through a resistance.

the zero axis, whereas the condenser voltage is all above the zero axis.

The time constant of Fig. 3a is termed "short," allowing the condenser a full charge or discharge within the time of an alternation. The resistor wave is the useful output, finding its application as a trigger pulse. Note that the peaks can be made more narrow by using a shorter time constant. A time constant is short only in relation to the frequency of the applied wave. When the resistor voltage is obtained as output from an RC circuit of short time constant the process is called "differentiation," and in this case distorts a square wave into a peaked wave.

The distortion in the output is due to poor low frequency response. The square wave has an infinite number of odd harmonics, sine waves whose frequencies are odd multiples of the fundamental fifty cycles per second. The highest frequency harmonics cause the wave shape to be further removed from the appearance of the fundamental sine wave. The reactance of the condenser in the differentiating circuit of Fig. 3a is greatest for the low frequency harmonics, causing the output across the resistor to have an exaggerated component of high frequency harmonics. Thus, the peaked wave is further removed from the sinusoidal appearance than the square wave.

The rectangular wave of Fig. 3b can be differentiated by the same time constant, resulting in the peaked wave shown. Here the time constant must be short enough to allow the condenser to become fully charged within the narrow portion of the applied wave. For example, if the time between A and B is less than 5,000 microseconds the time constant must be shorter than the one used in Fig. 3b to obtain a peaked wave output.

When the square wave is applied to a circuit whose time constant is relatively long, never allowing the condenser to become fully charged or discharged, distortion can result in a useful voltage across the condenser. This

process is called "integration" and is illustrated in Fig. 3c. Here the fifty cycles per second square wave is applied to a time constant of 50,000 microseconds. The time between A and B is merely two tenths of one time constant, so the condenser voltage rises and falls only slightly, and always within the linear portion of its charging or discharging curve. The condenser output is called a triangular wave, whose operating axis is the same as the axis of the input square wave, namely fifty volts. Several cycles after it starts, the triangle settles to a fluctuation between 45 volts and 55 volts. This amplitude could be increased by making the time constant smaller, but the wave might then become nonlinear, especially since the discharge path is usually through a heavily conducting tube of low resistance.

Examining the output triangle in the light of harmonic content of the input square wave, it is seen that the condenser voltage is greatest for the lowest harmonic frequencies. Hence the output contains a smaller proportion of high frequency harmonics, resulting in a wave more nearly approximating the sinusoidal appearance.

The rectangular wave may be similarly integrated by the same time constant circuit (Fig. 3d), resulting in a sawtooth wave of condenser voltage. This is the most useful process of integration, yielding a voltage wave form used as a linear sweep for deflection of the beam in a cathode-ray tube.

Note that neither portion of the sawtooth is an instantaneous "fly-back," necessitating a blanking circuit to light up the tube during only the sweep time. The great advantage of this sweep circuit is that its frequency is rigidly controlled by the input wave being integrated.

### Further Applications of RC Circuits

When the triangular wave is obtained in Fig. 3c, the resistor voltage wave is a somewhat distorted square wave. The sides are steep, but the positive portion falls off as the condenser charges up, and the negative portion falls off to the extent that the condenser discharges within the time of one alternation. If the time constant is made very long the triangle will become of negligible amplitude, and the resistor voltage will be substantially square. This long time constant circuit has application as the coupling circuit of Fig. 4a. Here the time constant of one million microseconds yields an output resistor wave which is a replica of the input. This coupling circuit is used to pass any harmonic wave with a minimum of distortion. The reactance of the condenser is small for practically all harmonics, avoiding distortion as the wave shape is coupled to a succeeding stage of amplification.

The triangular wave can be differentiated by using the short time constant circuit of 100 microseconds in Fig. 4b. Here the voltage across the .001  $\mu$ fd.

Fig. 3. Wave shaping by means of RC distortion.

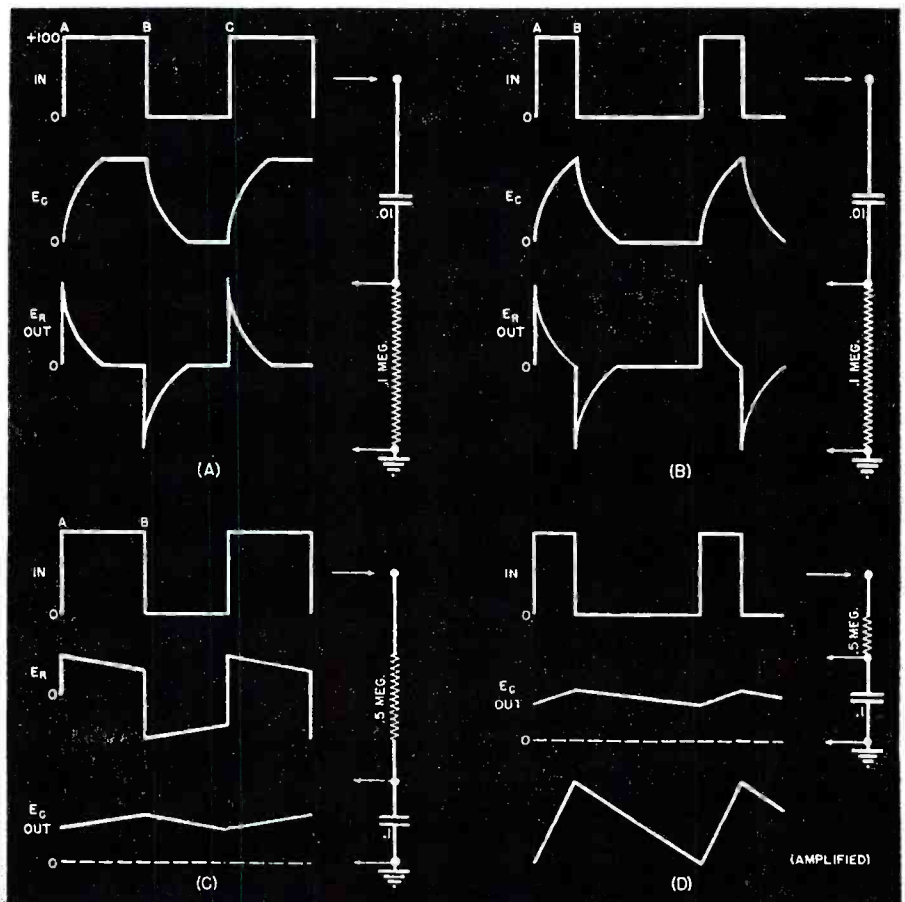

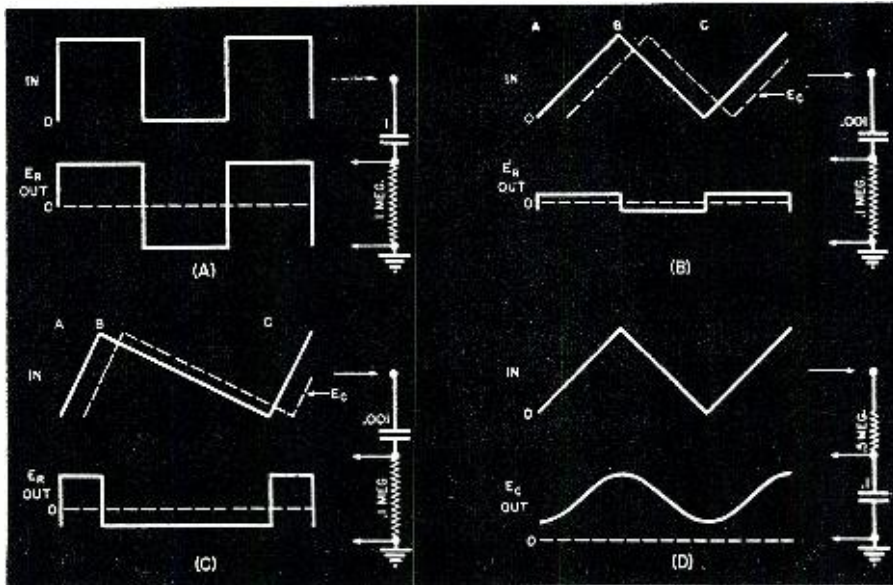

Fig. 4. Additional applications of time constant circuits to wave shapes.

condenser is another triangle, following the applied voltage very closely and always lagging it. Between times A and B the resistor voltage ( $E_r = E_a - E_c$ ) is a constant positive value; between times B and C the resistor voltage is a constant negative value. Hence the output  $E_r$  is an a.c. square wave. The constant rate of change of applied voltage causes a steady current to flow through the resistor during charging, and a steady current flow in the opposite direction during the discharging time.

The same time constant may be used to differentiate the sawtooth wave (Fig. 4c). The resistor output is a rectangular wave whose positive portion is of greater amplitude because the slope of the sawtooth portion which produced it, A to B, is steeper than the slope from B to C.

The processes of differentiating and integrating will change the shape of any input wave containing harmonics. For example, the triangular wave will be integrated by the circuit of Fig. 4d. The condenser output is smoothed out as compared to the input and because of the further removal of high frequency harmonics, has very nearly the appearance of a sine wave. However, it still contains harmonics, and is called a parabolic wave. Upon being differentiated this wave would yield a triangle, whereas a pure sine wave, containing no harmonics against which the reactance may discriminate, would yield another sine wave of diminished amplitude. The integration of a sawtooth wave, just as in Fig. 4d, would result in a parabolic wave which is as symmetrical. Mathematically, it is said that an infinite number of integrations of a harmonic wave will yield a sine wave. Practically, further integrations approach a sine wave.

As a summary of these processes of distortion the chart of Fig. 5 shows the interrelation of differentiation and integration. Note that two successive opposite operations result in cancella-

tion of the distortion. For example, the square wave differentiated yields a peaked wave; the peaked wave integrated yields a square wave of the same frequency. Actually, the new square waves usually will not be as perfectly formed as the original unless the peaks are very narrow, but it does work. It must be pointed out that each operation of wave shaping by distortion involves a loss of amplitude in the output. Therefore, a string of successive differentiations or integrations will require intermediate amplification, using a Class A amplifier.

#### Inductive Reactance for Wave Shaping

Just as the reactance of the condenser in a resistance-capacitance circuit can produce desirable distortion effects upon a wave of high harmonic content, so can the reactance of a coil in a circuit of inductance and resist-

Fig. 5. Wave shapes shown according to their harmonic content.

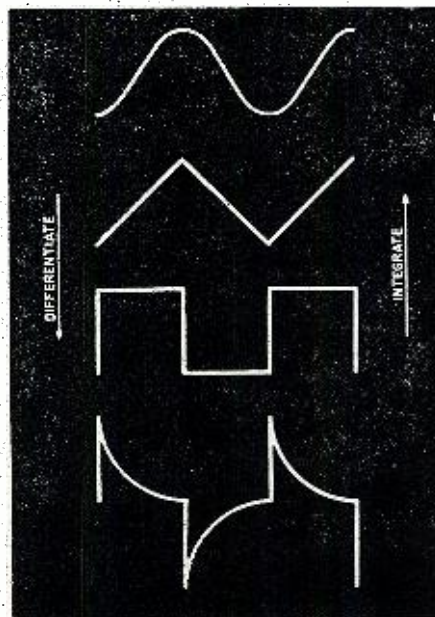

ance yield analogous results for wave shaping. The previous discussion of differentiating and integrating can be applied to this inductive circuit by deriving the definition of a time constant with the same introductory example of a sudden application of a battery and a sudden removal of the d.c. voltage. In Fig. 6 the closing of switch number 1 will allow current to flow in the circuit. The back voltage induced in the coil by the sudden current change prevents the current from rising instantaneously. Instead it rises to its full value, 2 ma. (assuming no coil resistance) along the curve shown. The curve is therefore a picture of the resistor voltage in the circuit. The formula for this rise of resistor voltage is:

$$E_r = E_a \left( 1 - \frac{1}{e^{\frac{Rt}{L}}} \right)$$

where  $E_a$  is the battery voltage applied,  $R$  is in ohms,  $L$  in henries,  $t$  in seconds, and  $e$  is a mathematical constant, 2.718.

Analysis of this formula yields the following information:

- 1) At time  $t = 0$ ,  $E_r = 0$
- 2) At time  $t = \frac{L}{R}$ ,  $E_r = 63\%$  of  $E_a$ .
- 3) At time  $t = 5 \frac{L}{R}$ ,  $E_r$  practically equals  $E_a$ .

The term  $L/R$  is the time constant of the circuit, defined as the time in seconds for the current to reach 63% of its total possible rise toward a steady state. Here again five time constants are required for a steady state to be reached.

The coil voltage  $E_L$  is always the difference between the applied voltage and the resistor voltage. It is initially 100 volts, and becomes zero after five time constants. Remember that a coil voltage depends only upon changes in current. Initially the current change is greatest; therefore  $E_L$  is greatest. After five time constants the circuit has become steady and  $E_L$  becomes zero.

Closing switch 2 will cause the current in the circuit to die out. Again the decay is not instantaneous, but requires five time constants for  $E_r$  to become zero. The sudden change to a decreasing current puts a voltage across the coil of opposite polarity because the change is in the opposite direction.  $E_L$  becomes zero when the current finally becomes a steady zero value. The formula for this decay is

$$E_r = E_a \frac{1}{e^{\frac{Rt}{L}}}$$

The time constant for this circuit is  $L$  in henries divided by  $R$  in ohms, with the answer in seconds. Increasing the size of the inductance in the circuit of Fig. 6 will increase the time for the current to become a steady 2 ma. Keeping  $L$  constant, decreasing  $R$  to 25,000 ohms will cause more time to be taken for the current to reach its higher final

(Continued on page 90)

# OHMITE

## Rheostats and Resistors

*for Dependable Control in Communications*

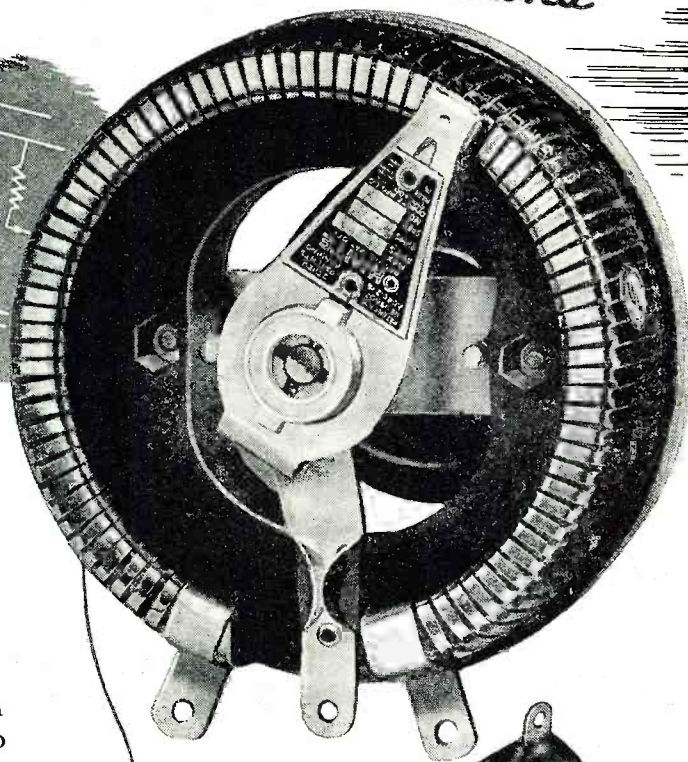
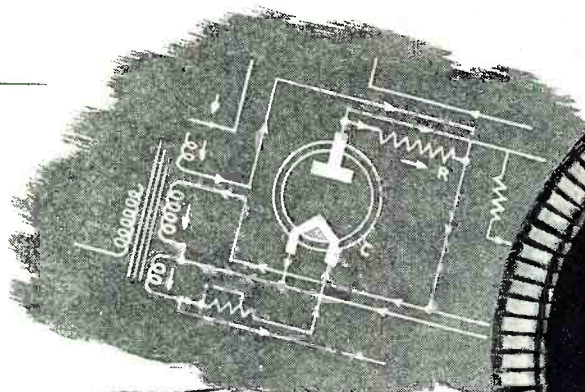

From experience . . . engineers, scientists and manufacturers have come to know and rely on Ohmite Resistors and Rheostats for fixed or variable resistance-control.

As electronic development advances, this assurance of reliability becomes increasingly important. As a result, you find Ohmite Units widely used in vital communications equipment to help defeat the enemy . . . and figuring prominently in the planning of new products for the postwar era.

*In resistance-control, Ohmite experience makes a difference.*

**OHMITE MANUFACTURING CO.**  
4885 FLOURNOY STREET • CHICAGO 44, ILLINOIS



Send for Catalog 18

Gives helpful information on Ohmite stock resistors, rheostats, chokes, and tap switches . . . for all types of applications.



Send for Handy Ohm's Law Calculator

Helps you figure, ohms, watts, volts, amperes — quickly. Solves any Ohm's Law Problem with one setting of the slide. Send only 10c in coin to cover cost of handling and mailing.

**Be Right with OHMITE**  
RHEOSTATS • RESISTORS • TAP SWITCHES

# THE NATION'S CHOICE

## ...for Everything in RADIO and ELECTRONICS

From every corner of the Nation . . . come calls to ALLIED for rush delivery of vital radio and electronic supplies.

For it's well known that here are centralized today's largest and most complete stocks under one roof . . . tubes, parts, kits, test equipment, public address . . . over 10,000 items . . . for training, research, engineering, production and maintenance.

Here, too, are men of experience to give technical assistance or expedite procurement of "hard-to-get" items.

Wherever you are . . . whatever you need . . . call ALLIED first for fast, efficient, intelligent service.

Write, Wire, or Phone Haymarket 6800

### ALLIED RADIO CORP.

833 W. Jackson Blvd., Dept. 1-J-4, Chicago 7, U. S. A.



**FREE**  
Complete  
Up-to-date  
BUYING  
GUIDE

**REPAIR AND REPLACEMENT PARTS AVAILABLE WITHOUT PRIORITY**



#### NEW Rapid R-F Resonance and Coil Winding Calculator

New, dual-purpose Calculator devised by Allied for fast and accurate determination of resonance factors and coil winding data. Simple, easy to use. Send for it now. No. 37-955. Price net, only . . . . . 25c

#### 6 VALUABLE RADIO BOOKS FOR 75c

Specially prepared by technical experts for radio training and for helpful reference. Priced only to cover cost of preparation and mailing.



- |   |  |  |
|---|--|--|
| <b>RADIO BUILDERS' HANDBOOK.</b> Simplified theory and projects. No. 37-750 . . . 10c | <b>RADIO-FORMULAS &amp; DATA BOOK.</b> Handy, pocket-size manual. No. 37-752 . . . 10c | <b>SIMPLIFIED RADIO SERVICING.</b> Short cuts in troubleshooting. No. 37-755 . . . 10c |
| <b>DICTIONARY OF RADIO TERMS.</b> Easy-to-understand definitions. No. 37-751 . 10c    | <b>RADIO CIRCUIT HANDBOOK.</b> Schematics and Pictures. No. 37-753 . . . 10c           | <b>RADIO DATA HANDBOOK</b> Formulas — Tables — Charts No. 37-754 . . . . . 25c         |

ALL SIX BOOKS No. 37-799 . . . . . 75c  
Write for Quantity Quotations

ALLIED RADIO CORP., Dept. -J-4  
833 W. Jackson Blvd., Chicago 7, Illinois

Please send the following items (\$\_\_\_\_\_ enclosed)

37-750       37-752       37-754  
 37-751       37-753       37-755  
 All 6 Radio Books    Free Catalog    Calculator

Name \_\_\_\_\_  
 Address \_\_\_\_\_  
 City \_\_\_\_\_ State \_\_\_\_\_



**QTC**  
(Continued from page 53)

full admiral in the U. S. Navy. Admiral Spruance on several occasions has caught the Japs flat-footed and beaten them to the punch each time. A few more like him and this war won't take so long to finish.

**H**AVING a rather large number of requests from men in the various branches of the Armed Forces for information on how to get started in the merchant marine after the war, we would like to make a few observations and call attention to a few points which may have been overlooked by many of the men interested in going into marine radio. First, to become a commercial radio operator aboard ship it is necessary that you obtain either a Radiotelegraph First or Second Class license (the present Temporary Limited Licenses are issued only in wartime) from the Federal Communications Commission. To obtain this license, the applicant must be a U. S. citizen, pass a code test in plain English at 20 w.p.m. and 16 w.p.m. in code groups. The remainder of the examination consists of questions about the various types of equipment which you will be called upon to operate, such as receivers, transmitters, motors, generators, batteries, automatic alarms, etc. You also will be expected to draw diagrams of the various circuits encountered in the equipment. The exam usually takes a day or two for the average applicant. At the present time regulations are no doubt somewhat easier than they will be after the war. as right now the merchant marine needs radio officers. After the war there is bound to be a certain amount of slacking off, at least for a period, in shipping and there probably will be once again the problem of more men than ships.

If you have any training in radio, which you may have been fortunate enough to get while in the Armed Forces, why not try to get into that branch of radio which you have been studying or for which you might be better fitted. There is no doubt a large number of men sailing today who do not intend to continue after the war, which, of course, will help to relieve the possible surplus; however, it is generally believed that there will be an oversupply of men. The license is the necessary evil for those who have never been in the commercial end of radio, however, and is something that you must have to get a job. Incidentally it will help you to get positions other than in operating so it would do no harm to try for one. Men with over a year's experience at stations open to public correspondence may try for the first class ticket; lacking the year's experience you will be permitted to take the second class exam only and the second class license will, of course, permit you to operate aboard ship. . . . 73.

# MOVING COIL ASSEMBLY

## OF THE DE JUR METER

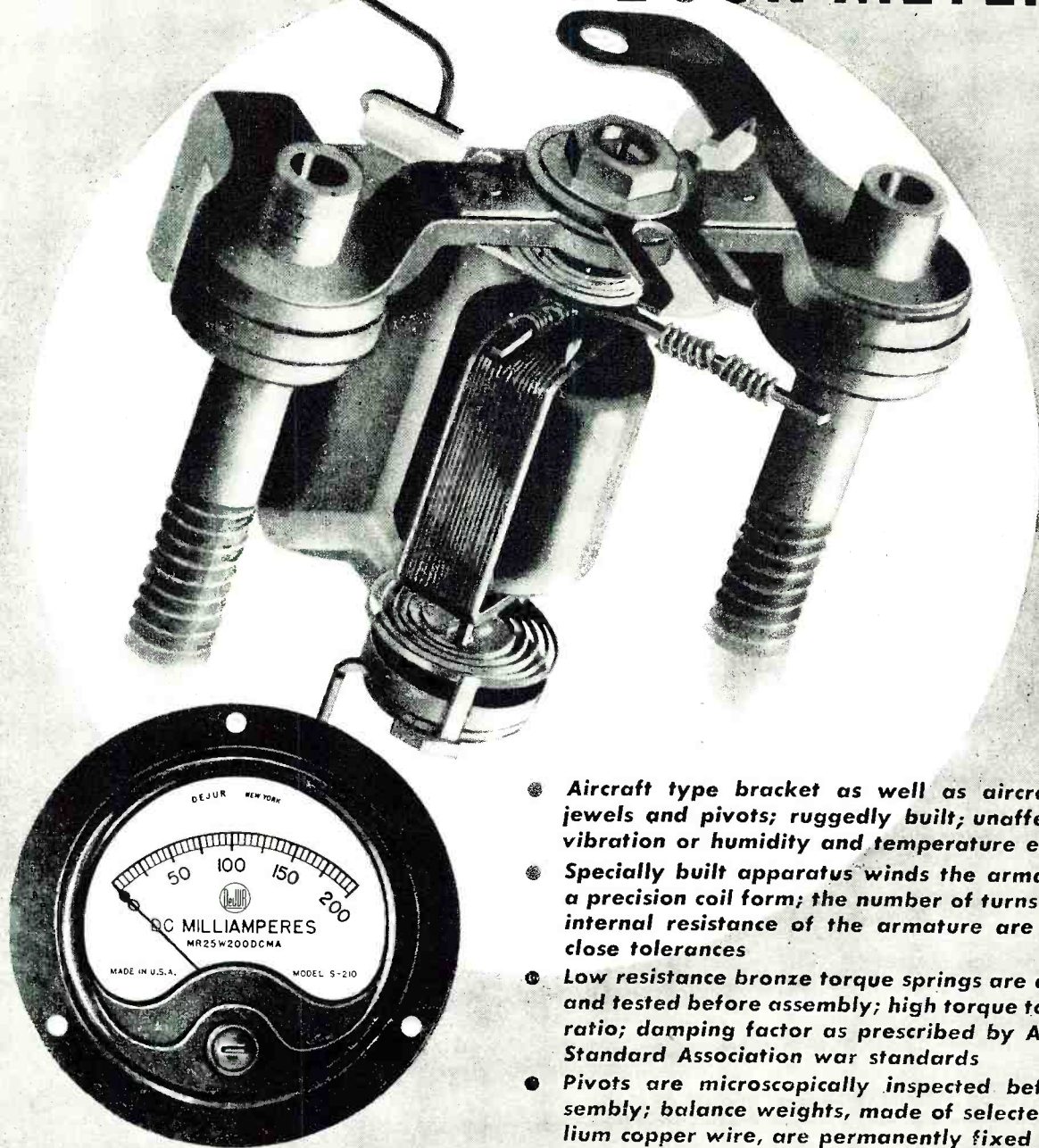

- Aircraft type bracket as well as aircraft type jewels and pivots; ruggedly built; unaffected by vibration or humidity and temperature extremes
- Specially built apparatus winds the armature on a precision coil form; the number of turns and the internal resistance of the armature are held to close tolerances
- Low resistance bronze torque springs are adjusted and tested before assembly; high torque to weight ratio; damping factor as prescribed by American Standard Association war standards
- Pivots are microscopically inspected before assembly; balance weights, made of selected beryllium copper wire, are permanently fixed in place
- DeJur Meters are characterized by their ruggedness, close tolerances, and highest quality materials

YOUR BLOOD IS URGENTLY NEEDED ON THE ROAD TO BERLIN . . . DONATE A PINT TO THE RED CROSS TODAY



### De Jur-Amsco Corporation

MANUFACTURERS OF De JUR METERS, RHEOSTATS, POTENTIOMETERS AND OTHER PRECISION ELECTRONIC COMPONENTS

SHELTON,

CONNECTICUT



NEW YORK PLANT: 99 Hudson Street, New York 13, N.Y. • CANADIAN SALES OFFICE: 560 King Street West, Toronto

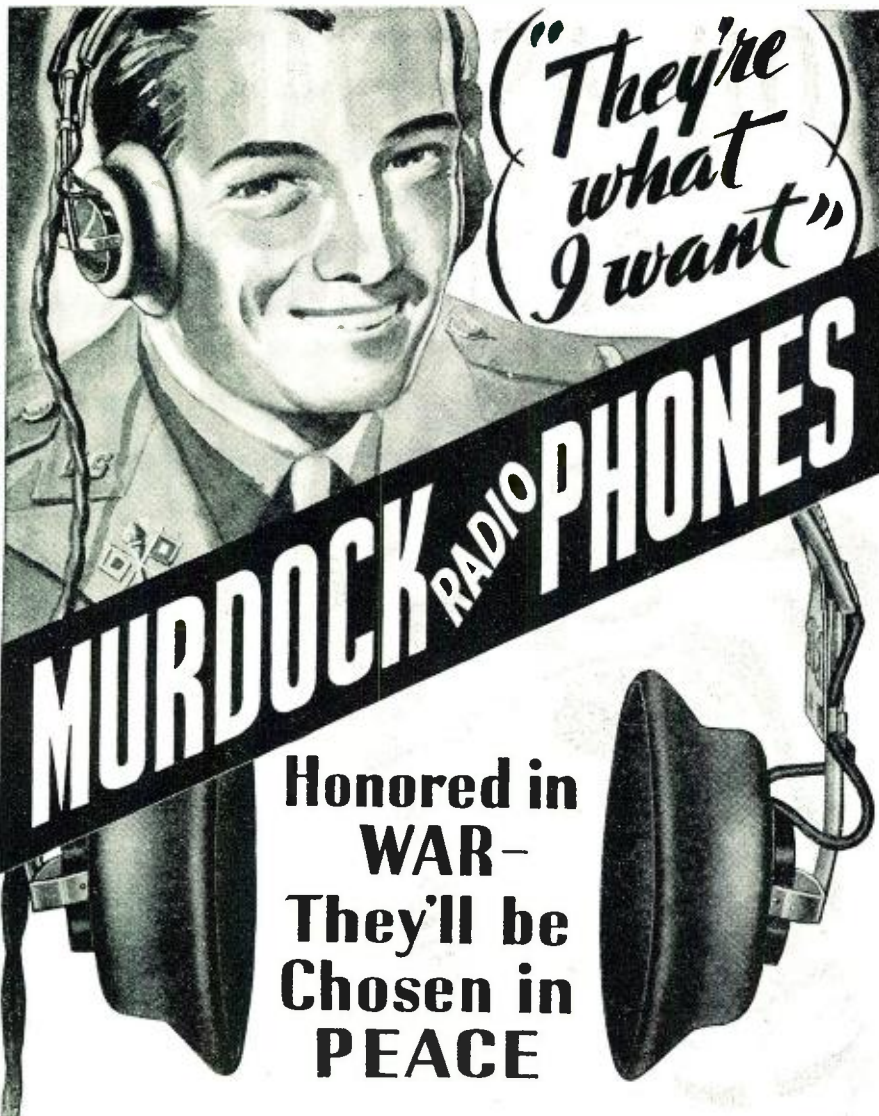

Solidly built, MURDOCK RADIO PHONES are Radio's Keenest Ears. Precision Methods with close tolerances eliminate any chance of loose parts or weak connections — this is due to Murdock's molded construction.

Your MURDOCK HEADSET is always comfortable and dependable, with adjustments that "stay put."

Every part is scientifically right, to give you that confidence which only comes from precision manufacturing. Coming through battle after battle with flying colors, MURDOCK RADIO PHONES will march ahead when peace bells ring. It's your duty to learn more about this "Service-Wanted" Headset. Send for our Catalogue now to see these "solidly built" Radio Phones!

#### SUB-CONTRACT WORK WELCOMED

Our busy plant has facilities for making more Radio Phones and related parts — on a sub-contract basis. Can we help you? Write us!

**WM. J. MURDOCK CO.**  
130 Carter St., Chelsea 50, Mass.

#### TECHNICAL BOOK & BULLETIN REVIEW

"**MUSIC IN INDUSTRY**", published by the *Industrial Recreation Association* Chicago, Illinois. 63 pages. Price \$1.00.

One of the most interesting of all industrial discussions has revolved around the use of music in factories. The proponents of its use are loud in their praises of the system, while its opponents are equally vocal.

In this book, presented by the Industrial Recreation Association, the problem has been presented scientifically with emphasis on programming and timing.

The timing of the program should be made so that definite needs of the worker can be taken into consideration. As the workers assemble in the morning, the march sets a brisk and cheerful pace for the day. Later during the pre-fatigue and fatigue periods (the mid-morning and mid-afternoon slumps) gay and familiar music which can be whistled or hummed is the most popular. The total length of the program, in periods ranging from 10 minutes to 30 minutes, should not exceed 2-3 hours maximum. Too frequent musical periods tend to annoy rather than please the worker.

Much valuable data has been included in this book, in addition to the information given above. The organization and management of employee musical groups, live talent programming, and the use of special features is given to guide the industrial relations department. The booklet should be in the hands of every executive of plants which now have, or plan to have "Music While You Work."

"**RADIO SERVICING MADE EASY**", edited by M. N. Beitman. Published by *Supreme Publications*, Chicago, Illinois. 44 pages. Price 25 cents.

This is a condensed manual which contains much of the information included in several lessons of the three-volume, 53-lesson "Practical Radio and Electronics" course published by the same company.

The course covered in this book, is practical in that every component part of the radio receiver is described and discussed in some detail. From this book it is possible to get an over-all picture of the functioning of the superheterodyne, told in simple and easy-to-understand language.

The subject matter covered on each page is summarized in the border of the page to enable the user to find the topic he is seeking rapidly. It must not be inferred from this review that by reading and studying this book, the user will become a finished radio repairman or technician, but the book serves its purpose as an all around introduction to the superheterodyne.





*The Symbol of  
Capacitor Experience*

Pride is something that comes from the heart. It cannot be seen — except as a symbol. Such as these service pins worn by our skilled craftsmen.

C-D's men and women are outstanding technicians in their special field — capacitors. Many of our men have been working on C-D capacitors almost as long as modern capacitors have been in existence . . . for C-D pioneered in capacitors and has manufactured them exclusively for 34 years.

Some of our men designed and made capacitors for wireless equipment used in World War I. They proudly wear their symbols of long service. Others wear their 5-year pins, their 10-year pins, their 20-year pins as a mark of their skill, accumulated knowledge and experience in capacitors.

Our men and women are constantly striving for improvements . . . and out of their inquiring minds come new developments to meet the changing needs of capacitor users. These are the people who build dependability into C-D capacitors — that make them top quality always. Cornell-Dubilier Electric Corporation, South Plainfield, N. J.

**CORNELL-DUBILIER**  
**CAPACITORS** WORLD'S  
LARGEST MANUFACTURER OF CAPACITORS

MICA • DYKANOL • PAPER • WET AND DRY ELECTROLYTICS



1910-1944



Gerard Swope, president of G.E., inspects crystal manufacturing operations.

# Wartime Production of Radio Equipment

By PHIL GLANZER

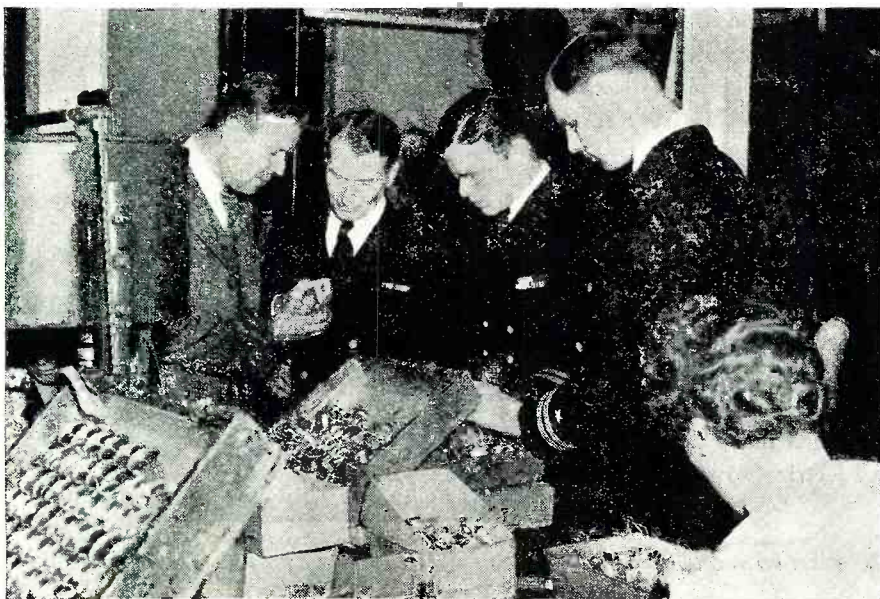

R. C. Sprague, of Sprague Electric Co., explains processing operations to USN officers.

**Radio manufacturers step up tempo of military electronic equipment production—keynote for ultimate victory.**

**T**HE volume of radio communications equipment produced in the United States and Canada in 1943 was greater than any previous year in the history of the industry. As many of the increased plant facilities only reached completion during the year, the industry did not have the benefit of a full year's production out of the expanded facilities. Consequently, providing there are no cancellations, the production of war equipment in 1944 should reach even higher figures.

Few government contracts were placed with the industry in the early part of the war. It was not until well along in 1941 that the full productive capacity was called upon for communications equipment. As a result, the industry has not yet experienced any lessening in demand.

Another factor contributing to the continuing demand for radio equipment is that developments in the radio art are probably taking place faster, and are more startling, than in any other type of product. There is a constant demand, however, for new and better equipment to replace what was, only a few months before, the most modern then available.

The contribution made by the Canadian radio communications industry, as well as the United States, has not been in the field of production only. In the field of design and engineering, the radio industry has made notable contributions. Various types of equipment which have been conceived, designed and produced are in use throughout all the theaters of war and are being used by all of the United Nations.

## Depends on Communications

Successful smashing of the roof of Hitler's vaunted "Festung Europa"—the destruction of Hamburg and the Ruhr; the harrying of Berlin, Nuremberg, Kiel; the day and night pounding of Germany's war plants, oil storage facilities, supply dumps and communications—owes much to the radio communications equipment recently produced.

Successes of the invasion of Europe, on the Mediterranean fronts, in Russia, and the far-off battles in the sky over the South Pacific have depended upon radio transmitting and receiving equipment without which the co-ordinated air operations would be impossible.

The brilliant and successful welding of land, sea and air operations that culminated in the successful landings on the coast of Normandy, the complete subjugation of Sicily and the heartening progress up the Italian "boot" and other triumphs, hinged largely on radio.

# SPRAGUE TRADING POST



## A FREE Buy-Exchange-Sell Service for Radio Men

**ASK FOR THEM BY NAME**

If you appreciate the Trading Post Advertising Service—and hundreds of servicemen have told us that they do—we know we can count on you to ask for Sprague Atom midget dry electrolytic capacitors by name, and to insist on getting them whenever they are available. Atoms are smaller, less costly, and are fully as reliable as the big, old-fashioned condensers they replace. Use them universally on all of your jobs. They're more dependable—they speed up your work!

**IMPORTANT NOTICE!**

We discourage offers to buy or sell anything beyond the O.P.A. ceiling prices, and will not knowingly accept such ads for the Sprague Trading Post.

**FOR SALE**—Latest National 81X communication receiver, complete. R. H. Werner, ART 2/c, UR 3 Det., Floyd Bennett Field, Brooklyn, N. Y.

**FOR SALE**—Lafayette rotary converter, complete with radio filter. Delivers 110v. A.C. at 225 watts from 32v. D.C.; also National D.C. SW-3 receiver with tubes and set of coils. Send for list of other items. Wm. H. Lorimer, 432 Sheridan St., Williamsport, Pa.

**WILL TRADE**—Ten 6S17GT, ten 6S17GT, three 80, four 6L6, eight 3-1/2A4, eight 37, two 6B8G, 5-174, and 3-635. Want good sig. generator. Robey's Radio Service, Waldorf, Md.

**WANTED**—Tube tester, or tube and set tester combined, late model. What do you have? Rushing Electrical Shop, Hazlehurst, Miss.

**FOR SALE**—One Philco sig. generator #070. Like new. Rushing Electrical Shop, Hazlehurst, Miss.

**FOR SALE**—Tubes, tube tester, condensers, resistors, wire, coils, switches, sockets (all new or slightly used). Write for list. Prefer selling entire lot to one purchaser. R. A. Dechene, Room 1511, 90 State St., Albany 7, N. Y.

**SWAP OR SELL**—Home made record player, hi-impedance type, tone and volume controls incorporated, \$11; 12" turntable, code practice oscillator, 115v. A.C., complete with 117L7 tube, 2" speaker and key \$8. Want small short wave receiver or tester. Bill's Radio Shop, 1636 W. Va. Ave., Clarksburg, West Virginia.

**WANTED**—Recording motor with table top—either with or without pickup or cutter. George Sikora, 627 Buchanan St., Bethlehem, Pa.

**FOR SALE OR TRADE**—500-watt, 110v. 60 cy. Timkin roller bearing Cushman light plant with new 3" meters (volt and amp.) in panel, voltage control, good condition; Philco 888 all-wave signal generator; four small, two medium Racoon

units (all 6v. field), and four Racoon 6-foot outdoor trumpets. Want Sprague or Solar "CB" or "CE" capacity analyzer or equal; Unidyne #53 or equal; University P.M. units (SAH or HAP) with or without projectors (Type LII). Harbert's Radio Electric, 610 Grant Ave., York, Nebr.

**WILL SWAP**—Following used tubes in good condition: 24-25; 20-26; 40-27; 10-35; 5-41; 10-45; 5-46; 5-47; 20-80; 5-6A7; 5-6F6; 10-485; and many others; two Weston #506 D.C. meters; Weston #476 A.C. meter; Jewell #54 D.C. meter; Radio and Television Institute and I.C.S. radio courses; Modern Radio Servicing and supplement. Want V-O-M: tube tester; meters; or any other radio equipment. Peter Kay, 4 Plymouth Ave., Toronto 3, Ont., Canada.

**FOR SALE**—Slightly used transmitting and receiving tubes, 3/2 to 3/2 off, as follows: 832, 1625, 814, 837, 841, 1K34, 956, 957, 205L, 7193, 9003; VRI150, 1201, 1205A, 11X114B, HY615, 307A, 1626, and 866. Lanam Radio Co., 2320 Shattuck Ave., Berkeley 4, Calif.

**WANTED**—Standard tube tester and ohmmeter, used, but in good condition, for student. Norman Gurath, 17 W. Cotton St., Fond du Lac, Wis.

**WANTED**—Rider voltohmmst, junior or senior in A-1 condition. Cash. Southern Radio Service, 124 E. Jackson St., Thomasville, Ga.

**FOR SALE**—Triplet 1166A combination analyzer and sig. generator in light wood case, like new. Cost \$70. Will sell for \$60. Also Jewell 199 analyzer, in excellent condition, complete with adapters and instructions, \$30; Philco battery operated sig. generator, \$20; and Readrite 550 battery-operated sig. generator, \$20. Franklin C. J. Slav, 243 West 107th St., New York 25, N. Y.

**WANTED FOR CASH**—Modern tube tester in good condition; also Rider manuals. Bernard R. Nelson, 409 Ferry St., Malden 48, Mass.

**FOR SALE**—Hallierafter SX-16 in good condition. J. M. Schaufler, 313 S. 3rd St., Effingham, Ill.

**SELL OR TRADE**—Radio City tube tester #309 (unassembled) with instruction sheet and diagram. L. O. Dupps, Jasper, Ind.

**TO SWAP**—One complete N.R.I. code course in A-1 condition for 110v. A.C. sig. generator in good condition. 12" 110v. A.C. fan, or what have you? Give details. Edison Radio Service, Centertown, Ky.

**URGENTLY NEEDED**—500-watt universal modulation transformer, 20-watt Class B universal driver transformer, 2.5 volt @ 5a hl. transformer—insulated for 7500 or 10,000 volts. Station WSKY, Room 401 Engineering Hall, Carnegie Institute of Technology, Pittsburgh, Pa.

**FOR SALE**—Radio repair parts, supplies, etc. in limited quantities. J. C. Thimlin, Jan, 715 N. 7th St., Lake City, Minn.

**WANTED**—Triplet vibrator tester, appliance tester, adding machine, and new receiving tubes. State condition, model and price. L. M. Mick, 424 Second Ave., Dixon, Ill.

**WANTED**—A condenser checker in good condition. Byron Radio Service, 151-40th St., N.E., Cedar Rapids, Ia.

**FOR SALE**—Four #58 tubes, one #42 tube; all new. Want 6v. vibrator, all-wave 3-band radios, and all wave oscillator, in any condition. C. M. Rebellin, Kiester, Minn.

**WANTED**—Superior X-Raymeter, Superior tube tester #1240 and chart for Radio City tube tester #307. R. H. Safford, 3104 Flesher St., Greenmont Village, Dayton 10, Ohio.

**FOR SALE**—Instruments, tubes, etc. Also need some. What have you? John Trobridge, 7936 Parnell St., Chicago 20, Ill.

**WANTED FOR RESEARCH**—Receiving, transmitting or power tubes, for research purposes. Condition immaterial (price good). Jesse Martinez, 332 S. 13th St., Philadelphia, Pa.

**FOR SALE**—Supreme tube checker #85; Remington office typewriter, \$55; Kodak 616 (excellent condition), \$30. Wanted—electric light time switch, crystal set with speaker, new Motorola car radio, camera. Stanley J. Krzak, 102 Cameron St., Pawtucket, R. I.

**WANT TUBES**—35L6, 50L6, 12SK7, 12SQ7, or what have you? Sunnyside Radio Shack, Burlington, N. J.

**WANTED**—Two midget condensers, 15 mfd. and 100 mfd. Norman Weston, N. 1004 Crestline, Spokane, Wash.

**WILL TRADE**—One pair homing pigeons for one 1150T and 1A70T. You pay special low express. Charles L. Culley, Melville, Louisiana.

**FOR SALE**—Supreme audolyzer, complete with probes, etc. Like new. Chase Radio Shops, Jeffersonville, Vt.

**WANTED**—Sailor leaving states urgently needs 12SA7, 12SK7, 12SQ7, 70L7GT for radio. E. L. Shuey A.R.T. 3/c, Co. B, 70th, 2, NATTC, Ward Island, Corpus Christi, Texas.

**WANTED**—Supreme 582A or 56L, Jackson 420, RCA 150, Hickok 188x signal generator. John Pokrifcak, 4122 Todd Ave., East Chicago, Ind.

**WANTED**—Phono & recorder with amplifier & speaker. Joseph LaDolce, 451 E. 102 St., New York 29, N. Y.

**FOR SALE**—Billey crystal 465 freq. Type C.F.1., also Davard tube tester, test to 50v. Tauber's Radio Shop, 516 So. Cicero Ave., Chicago 44, Ill.

**WANTED**—Philco sig. tracer and auto radio power pack 115v. A.C. input, 6v. D.C. output, Stancor preferred. C. Casse, 1119 Walnut St., McKeesport, Pa.

**WANTED FOR CASH**—Mod. AAA-1, S.H.31 Supreme diammeter, #89-D Supreme, #347 Supreme; #549 Supreme;

#504A Supreme; #E.V.10 Precision; #802 R.C.P.; Sprague De Luxe Tolomike. Must be in good working condition. Radio Service & Sales, 236 N. Water St., Kent, Ohio.

**WANTED**—35L6GT, 12SA7, 12SQ7, 12SK7, 35Z5. One of each. Stanley M. Watts, Room 542, Y.M.C.A., St. Paul 2, Minn.

**WANTED**—Rider's manuals 5 to 13, voltohmmst, radio phono combination, Cash, no trades. Wm. E. Oliver, 71 Lipitt St., Providence 6, R. I.

**WANTED**—.01 ma. universal meter, 3" or larger, or all-purpose multimeter, also wiring diagram of Majestic "300" radio showing fl. connection. Have 6v. and 2v. tubes, also some magnetic & dynamic speakers to trade. J. R. Reed, 2178 W. 3rd St., Durango, Colo.

**WANTED**—Good signal generator, set analyzer with large scale, and set of Rider's manuals. Sam Berenblum, Greenwich, Conn.

**WILL EXCHANGE** following tubes for other desirable types: 42G; 6A8G; 6A8GT; 6K7GT; and 12Q7G. Also need test cap. What have you? R. E. Thompson, 1526 W. Santa Barbara Blvd., Los Angeles 37, Calif.

**FOR SALE**—RCA police transmitter 30 to 36 meg. range; easily adaptable to 10 meter phox. Priced cheap for quick sale. Paul P. Lesser, St. Marys, Pa.

**SALE OR SWAP**—Ten types new RCA vol. controls, short shafts; Weston #571 output meter a.c. volts to 150; RCA frequency modulator #FMV-125A; RCA Piezo electric calibrator #TMV-133A; RCA output indicator TMV-121A; Jackson test oscillator #640; G.T.C. portable power pack 1 1/2A-90VB; radiophone-preceptor dynamic tube checker for all tubes up to 2520. Want V-O-M, or RCA voltohmmst, Jr. Kelly W. Alderman, Box 14, Thorpe, W. Va.

**FOR SALE**—FM-AM receiver covering international short wave bands; plug-in coils; IFO; noise limiter; headphone or speaker output; FM 40 to 50 MC; inverse feedback. Price \$75 plus shipping. Peter Rice, 856 Montrose Ave., Chicago 13, Ill.

**WANTED**—FOR CASH—Hallierafter "Sky Buddy" or "Sky Champion" or Echo-Phone EC-1 receivers. Condition is unimportant. Cpl. J. P. Hummel, Hq. & Hq. Co., (Prov) Vint Hill Farms Station, Warrenton, Va.

**WANTED**—Radio sig. generator. In A-1 condition. Advise make, model number and price. Paul H. Funk, St. Croix Falls, Wis.

**FOR SALE**—Beclco milliamperes 0-75 D.C. Want kit of three wired or unwired adapters to test RCA miniatures 184, 1T1, 1R5, and 185 tubes. Must be RCA miniature to octal. Bou Radio Service, 3151 North Percy St., Philadelphia 33, Pa.

**YOUR OWN AD RUN FREE!**

This is Sprague's special wartime advertising service to help radio men get needed parts and equipment, or dispose of radio materials they do not need. Send your ad today. Write PLAINLY—hold it to 40 words or less. Due to the large number received, ads may be delayed a month or two, but will be published as rapidly as possible.

Different Trading Post ads appear monthly in Radio Retailing-Today, Radio Service-Dealer, Service, Radio News, and Radio-Craft. Sprague reserves the right to reject ads which do not fit in with the spirit of this service.

HARRY KALKER, Sales Manager.



Dept. RN-94, SPRAGUE PRODUCTS CO., North Adams, Mass.

# SPRAGUE CONDENSERS KOOLOHM RESISTORS

Obviously, Sprague cannot assume any responsibility, or guarantee goods, services, etc., which might be exchanged through the above advertisements

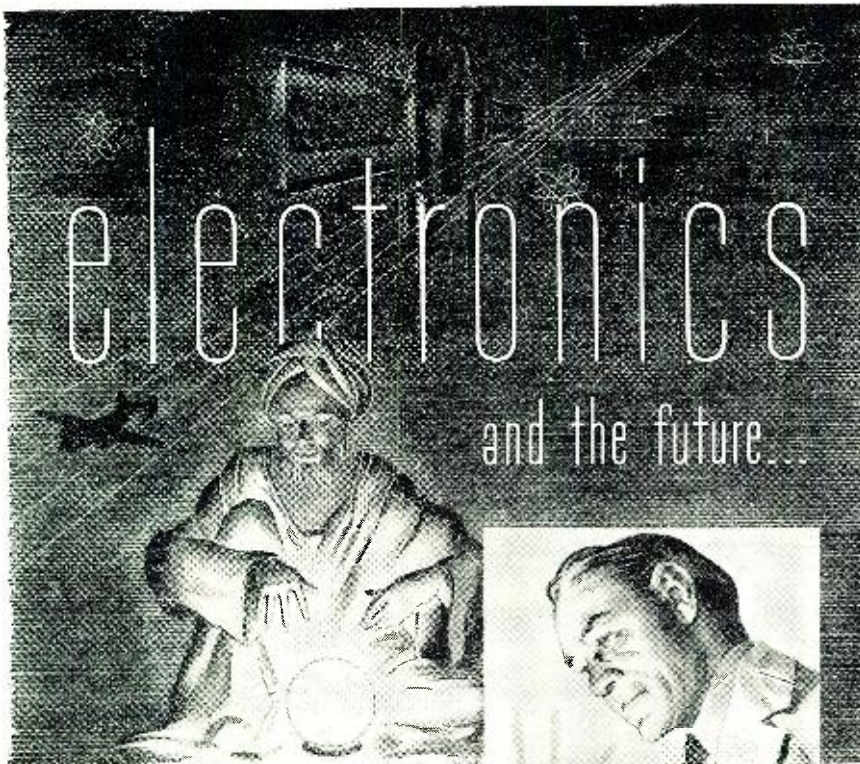

★ No need to crystal gaze into the future of electronics. For, as we at National Scientific Products Company engage in secret wartime electronic developments, many peacetime applications of these very same electronic principles are revealed daily.

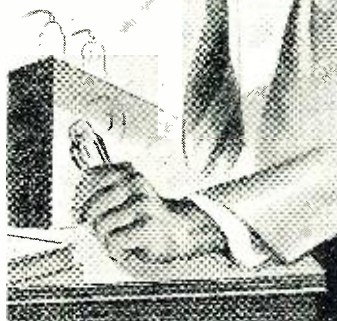

New, cost-saving electronic designs which are applicable to post-war products ranging from radios, lighting units, thermal devices, timing and measuring instruments, electrical-therapy machines and door openers, to a host of other peacetime items, are everyday occurrences in National laboratories.

If your post-war product incorporates a tube, singly or in combination with an electrical control, or other electronic or electrical unit, we are prepared to make specific recommendations to bring it to maximum efficiency.

Write today. Your inquiry will receive prompt attention.

*Electrical and Mechanical Engineering*

## NATIONAL SCIENTIFIC PRODUCTS COMPANY

*Designers and Manufacturers of Electrical and Mechanical Devices*

5015-25 NORTH KEDZIE AVE., CHICAGO 25, ILLINOIS

Much of the equipment for the tanks, armored vehicles, field communications and other portable sets come from Canadian and American factories.

Demands made upon the industry have been many and varied. In meeting them manufacturers have called upon all their skill, technical knowledge and plant facilities. With some the contribution has been bigger than with others, but all have shared in this vitally important work to the limit of their resources. Well to the fore have been RCA, RCA-Victor, Northern Electric, Canadian Marconi Company, Philco, Westinghouse, General Electric, Stewart-Warner, Sperton, and other manufacturers, whose names are household words throughout the length and breadth of the United States and Canada.

If any one job which the radio communications industry has done in this war could be picked out for special mention, perhaps the quartz crystal stands in a class by itself.

Prior to the war, all radio crystal oscillator units used were manufactured solely in the United States. Even before Pearl Harbor, radio-equipped planes, tanks and ships were being turned out by the thousands each month in the United States, and Uncle Sam could not keep up with domestic demands, much less export to her Allies.

Stepping into the breach, from our neighbor, Canada, was the Canadian Marconi Company which opened the Dominion's first production center for the processing of crystal quartz from Brazil into oscillator units. Small as it is, the quartz crystal might be said to be the brain of radio communications, for it keeps the transmitter and receiver correctly tuned in spite of all outside influences, thus enabling contact at all times without attention.

### **Design General Set**

Before the war, the radio industry was working with the United States Army Air Forces on the design of a radio communications system which would serve for use in several types of aircraft. The result was the GP (General Purpose) set, consisting of transmitter and receiver, direction finder, intercommunicating system and local and remote controls. These sets must and do operate under exacting conditions of vibration, humidity, temperature and altitude or air pressure.

Designed primarily for training planes, this set was found to be equally useful in other types of aircraft and for use at ground stations as well.

Another development was in the ear-phone amplifier now used exclusively in Harvard trainers, for intercommunication between pilot and crew or instructor and student.

### **Build Special "Mikes"**

An interesting item of production is the tiny microphone in use by pilots. This was originally developed as the receiver of the audiphone, a device to aid the hard of hearing, but its charac-

# Need a Motor that can lift 500 times its own weight?

**T**HIS electric motor weighs only a pound. But more power is packed in that one pound of motor than has ever been before.

With Lear gearing it can handle a quarter-ton load.

And it has to be ready to do that in an instant. Because this motor moves control flaps, and heater shutters on warplanes. And air pressures mount high at the speed these ships fly.

On aircraft, even the weight of a coat of paint has to be considered. So this motor had to be light.

There's little room in an airplane. So it had to be small.

Designing it meant starting from scratch. There was no precedent for this kind of engineering.

You may never need a motor like this. It may cost more than you might want to pay.

But if you are looking ahead toward manufacturing some peacetime product, we want you to know that such a motor has been developed along with 250 other Lear products.

And equally important, we want you to know that there is available the kind of engineering thinking that could conceive and produce it.

PLANTS: Piqua, O., and Grand Rapids, Mich. BRANCHES AT:  
New York, Los Angeles, Chicago, Detroit, Cleveland, Providence.

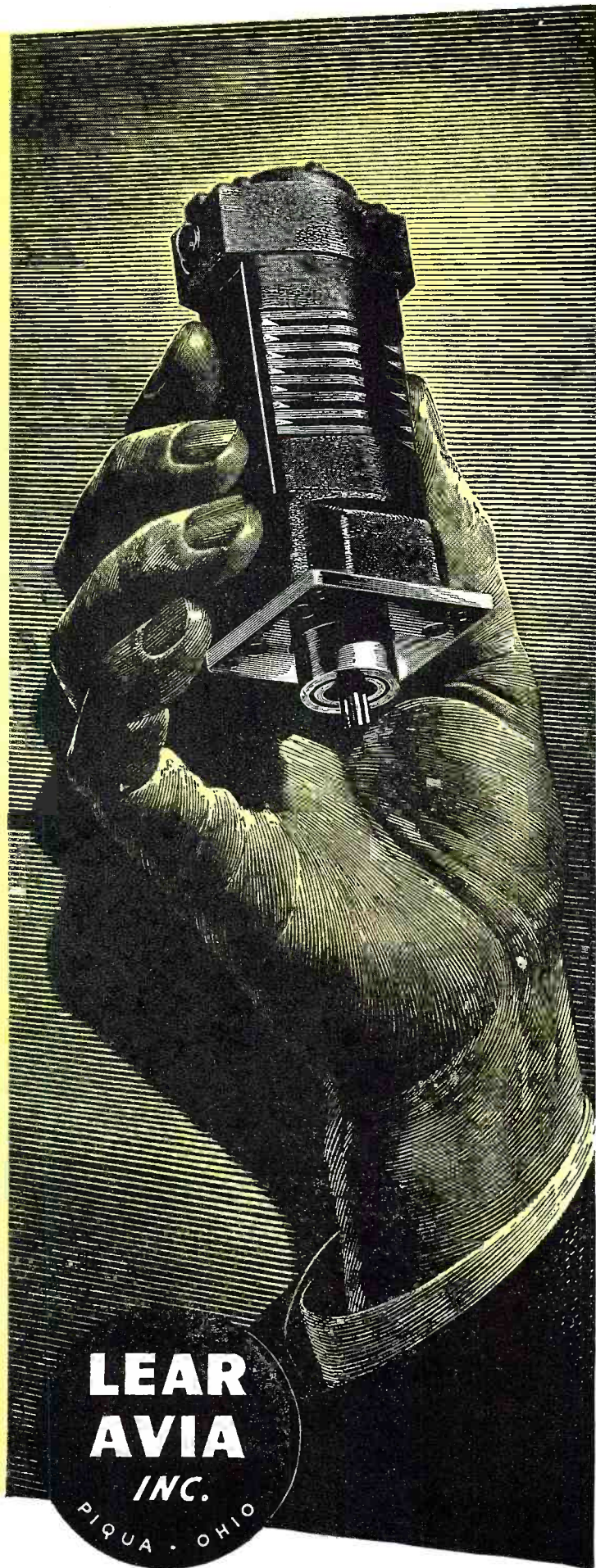

# SLIDE RULE or SCREWDRIVER

... which will YOU be using 2 years from now!

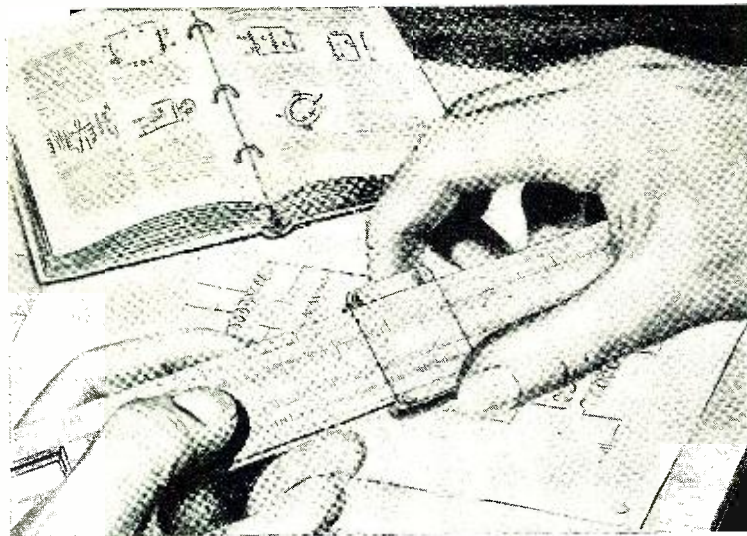

**Add CREI technical training to your present experience—then get that better radio job you want—make more money—enjoy security**

Thousands of new men have joined the ranks of the radio industry for the duration. But after the war, even more thousands will return from the armed forces. War production will settle down to supplying civilian needs. Where will you fit into this picture?

If you are wise, you will look ahead and prepare for the good-paying jobs in radio-electronics and industrial electronics. Every man in radio today has the opportunity to see the amazing developments that are taking place, as well as the unlimited opportunities available to men with modern technical training.

It is up to you to decide if you will be a "screwdriver" mechanic or a real technician in a responsible engineering position.

CREI can help you prepare by providing you with a proven program of home study training that will increase your technical ability and equip you to advance to the better-paying radio jobs that offer security and opportunity. The facts about CREI and what it can do for you are printed in a 32-page booklet. It is well worth your reading. Send for it today.



**WRITE FOR  
FREE 32-PAGE  
BOOKLET**

**"Your Opportunity  
in the New  
World of  
Electronics"**

If you have had professional or amateur radio experience and want to make more money—let us prove to you we have something you need to qualify for a better radio job. To help us intelligently answer your inquiry—PLEASE STATE BRIEFLY YOUR BACKGROUND OF EXPERIENCE, EDUCATION AND PRESENT POSITION.

## CAPITOL RADIO ENGINEERING INSTITUTE

HOME STUDY COURSES IN PRACTICAL RADIO-ELECTRONICS  
ENGINEERING FOR PROFESSIONAL SELF-IMPROVEMENT

Dept. RN-9, 3224—16th Street, N. W., Washington 10, D. C.

Contractors to U. S. Navy—U. S. Coast Guard—Canadian Broadcasting Corp.  
Producers of Well-trained Technical Radiomen for Industry.

teristics rendered it unusually adaptable in reverse as a supersensitive microphone, or transmitter.

Then, of course, there is another type of microphone specially designed for use in oxygen masks.

The beacon transmitter equipment, a highly-developed form of radio transmission for guiding pilots, was in use prior to the war, and has found a wider use today under war conditions.

Special airport transmitters and receivers also were designed and in use at airports across the United States and Canada before the war, for reception of c.w. (continuous wave) or m.c.w. (modulated continuous wave), connecting airport to airport and plane to airport.

Then there is the radio compass which is now entirely manufactured and used in the Mosquito and Lancaster bombers. Previously they were imported. In radio, too, there is the set which is used by the Allied Nations in tanks and trucks of various types.

As for wires and cables, some hundreds of types and designs for specialized use by Army, Navy, and the auxiliary Air Forces, form a large part of wire and cable production of Western Electric in the United States and Northern Electric in Canada, as well as other producers similarly engaged in this branch of work.

There are numerous other radio developments born in the modern engineering laboratories. But the most spectacular of all, to date, is the 100 kw. low-frequency telegraph transmitter designed for long-distance, point-to-point transmission. This is an RCA development; it is sensational in operation. Its postwar possibilities are unlimited. Its details are, for the present at least, strictly secret.

Present radio equipment is designed, developed and manufactured by the radio communications industry for world-wide employment by the United States and other Allied Forces. Much of the work done by the industry, however, is still on the secret list—some of it only partially so. At this time, it is permissible to say that many of the developments arising out of the war will find wide and highly important application in the postwar era.

There has been widespread anticipation that immediately after the war is over, fundamental new products will be available to the public. This, definitely, does not pertain to radio. Manufacturers say it is likely that receivers available to the public in the early months following the lifting of restrictions on the production of radio for domestic uses, will be similar to those sets on the market at the time the industry stopped producing civilian radios. There will be some improvements, of course, but these will not be of a fundamental or spectacular character. It will take many months, possibly years, they agree, before all the advances by the radio art during the war will be adapted and produced for the general public.

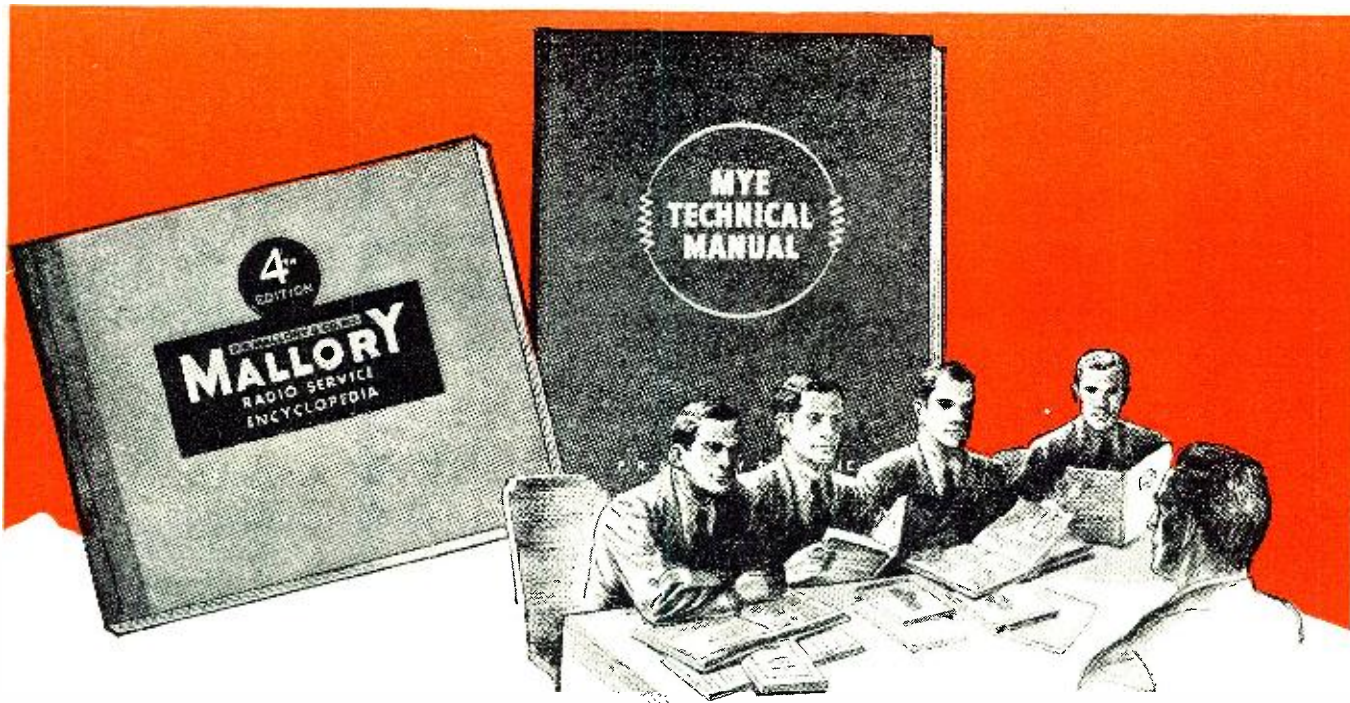

## Service Information Please...

It's true some radio parts are hard to get—but there's no shortage of helpful service information. With these valuable Mallory handbooks, you're assured of a speedy answer to 'most every problem that pops up.

Servicemen everywhere are depending on these comprehensive reference works to speed up work and to save valuable man hours. Here are some of the subjects covered:

**M. Y. E. Technical Manual**—408 pages packed with information on radio practice and theory. Covers Loud Speakers and Their Use . . . Superheterodyne First Detectors and Oscillators . . . Half-Wave and Voltage Doubler Power Supplies . . . Vibrators and Vibrator Power Supplies . . . Automatic Tuning . . . Frequency Modulation . . . Television . . . Capacitors . . . Phono-radio Service Data . . . Practical Radio Noise Suppression . . . Vacuum Tube Voltmeters . . .

Useful Servicing Information . . . Receiving Tube Characteristics. Available from your Mallory distributor. Price \$2.00.

**4th Edition Radio Service Encyclopedia**—Complete information on servicing all types of controls, condensers and vibrators. Circuit references, original part numbers and recommended replacements. A book that will pull you out of many a tight servicing spot. Available from your Mallory distributor. Price 95 cents.

**P. R. MALLORY & CO., Inc., INDIANAPOLIS 6, INDIANA**



*Finish the Job—Buy War Bonds*



# PRACTICAL RADIO COURSE

By ALFRED A. GHIRARDI

## Part 26. Covering signal-frequency conversion in the AM superheterodyne receiver, choice of local oscillator frequency, and adjacent channel selectivity.

**B**ECAUSE of the reasons discussed in detail in last month's lesson, the better modern radio receivers that combine a high degree of sensitivity and selectivity with high quality of reproduction now are almost universally designed to employ the superheterodyne circuit. In such a circuit, the incoming wanted signal with its sound (audio), or picture (video), modulation<sup>1</sup> is first selected from all adjacent-channel signals by a tuned preselector. It is then heterodyned with the unmodulated carrier of a local oscillator to produce a *similarly modulated* signal of specially chosen new carrier frequency known as the *intermediate frequency* (or simply *i.f.*). This *i.f.* signal is amplified by the highly-efficient, selective, fixed-tuned *intermediate-frequency amplifier*, after which it is detected or demodulated by the second detector. The resulting audio (modulation) signal is amplified by a conventional form of audio amplifier and fed, finally, to a conventional loudspeaker.

The functional block diagram of a superheterodyne amplifier (repeated here as Fig. 1) was presented in last month's lesson, and the purpose of each part was explained there. This important material should be reviewed by the reader at this point. The signal current existing in each section of the receiver is illustrated again here in Fig. 1. Referring to this, we find that the typical superheterodyne contains the following six main sections:

1. Preselector
2. Frequency Converter<sup>2</sup>
  - (a) local oscillator
  - (b) modulator or mixer (also sometimes called a "first-detector")
3. I.f. amplifier
4. Second Detector or Demodulator

5. Audio Amplifier
6. Loudspeaker

We will study each of these in detail in the order in which they appear above.

### The Signal-Frequency Conversion

The process of combining the modulated incoming signal carrier with the unmodulated local oscillator carrier to produce a *similarly modulated* signal of new carrier frequency is really a process of modulation. Although this process was originally called *heterodyne detection* and later, *first detection*, it is now more generally called frequency changing, or *frequency conversion*. The complete portion of the superhet receiver which produces the conversion may, therefore, properly be identified as the *frequency converter* or, simply, the *converter*. The operation of the various systems for accomplishing the frequency conversion, and the types of tubes employed, will be discussed later, in detail. For the purposes of our present discussion it is sufficient to know that when the modulated received signal (of carrier frequency  $f_s$ ) and the unmodulated local-oscillator signal (of carrier frequency  $f_o$ ) are acted upon by the mixer or converter tube, its plate current is complex and contains several components. These are:

1. A steady or d.c. component
2. A component of original signal frequency  $f_s$

3. A component of fundamental oscillator frequency  $f_o$
4. A component whose frequency is equal to the *difference* between the two original frequencies, i.e.,  $f_o - f_s$  or  $f_s - f_o$  (depending upon whether  $f_s$  or  $f_o$  is the higher frequency)
5. A component whose frequency is equal to the *sum* of the original frequencies, i.e.,  $f_o + f_s$
6. Components whose frequencies are equal to the *difference* between the original signal frequency  $f_s$  and harmonics (second, third, etc.) of the local-oscillator fundamental frequency, i.e.,  $f_s - n f_o$
7. Components whose frequencies are equal to the *sum* of the original signal frequency  $f_s$  and harmonics (second, third, etc.) of the local-oscillator fundamental frequency, i.e.,  $f_s + n f_o$

It is important to remember always that each one of these components carries the modulation of the original signal frequency. The two predominating components are those of frequency equal to the *sum* and the *difference* of the signal and fundamental oscillator frequencies.

Since the components listed above are all of different frequency, by inserting a resonant or tank circuit in the plate circuit of the frequency converter tube, as shown in Fig. 2, we can easily tune to any one of these signal components and thus separate it from the others. Since each of these components carries the modulations of the original signal frequency we could, theoretically, choose any one of them to be amplified by a suitable fixed-frequency amplifier and demodulated by a second detector in order to reproduce an amplified version of the original signal audio or video modulation. Since the lower is the carrier fre-

<sup>1</sup> Reception of continuous wave (c.w.) signals requires the addition of a "beat" oscillator to the system described here. Superheterodyne receivers for this type of service will be described later.

<sup>2</sup> When separate tubes are used for the oscillator and "modulator" or "mixer" portions of the frequency converter, respectively, the tube for the latter purpose is conveniently called the modulator or mixer tube. If conversion is accomplished in a single suitably-designed vacuum tube which combines the functions of both oscillator and modulator or mixer, this tube is logically termed a frequency converter, or simply, converter.

Fig. 1. Functional block diagram of a typical superheterodyne receiver, showing the various changes the modulated signal undergoes as it progresses successively through the various stages of the receiver.

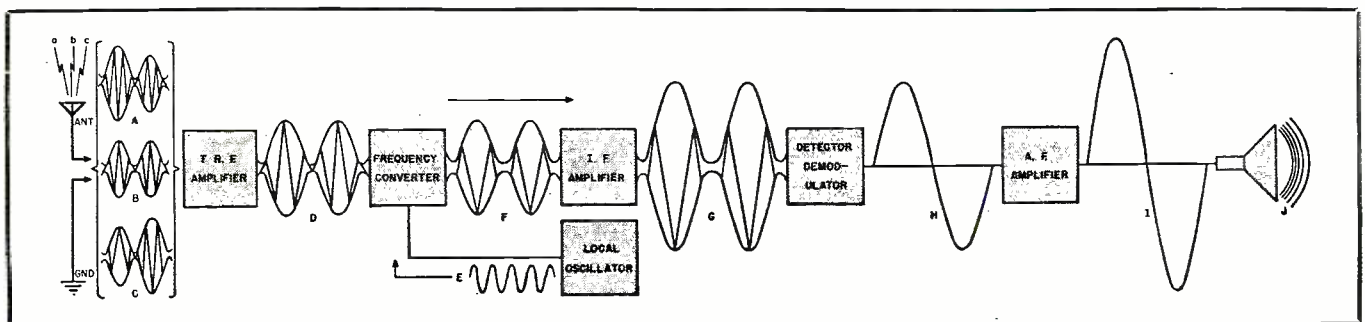



# THE MOST RADIO-ELECTRONIC TRAINING

★ in the shortest time  
★ at the lowest cost

**FOR BEGINNERS . . . no previous training necessary**

You can pay a big price for basic Radio-Electronic Training—but the amazing fact remains that Ghirardi's famous 972-page RADIO PHYSICS COURSE book will give you just the training you need, all you need—and easier, better, and faster—at a total cost of only \$5 complete!

## LEARN EASIER—BETTER—FASTER

With other types of training selling for as much as \$150 that's a big statement to make—BUT HERE ARE THE FACTS: Ghirardi's big RADIO PHYSICS COURSE book has given more people their start in Radio than any other book or course. It is more universally employed in U. S. Army Signal Corps and Navy Schools than any other book of its kind.

It is more widely used for home study—and by civilian schools and colleges. Most important of all, it is more widely endorsed by thousands of radio men themselves as the finest, most complete, easiest-to-understand Radio-Electronic course on the market.

No previous knowledge of Radio-Electronics is necessary. Ghirardi's Radio Physics Course carries you rapidly along

from the very basic fundamentals of Electricity to the latest, most modern Radio-Electronic developments. Nothing is omitted—nothing condensed. Every step is made crystal clear and understandable by thorough, simplified explanations, and by more than 500 special illustrations.

Each section is followed by self-testing review questions so that you can check your progress every step of the way. There are no monthly lessons to wait for. You go ahead as fast as you want to. All you need is a little spare reading time plus a desire to get started RIGHT for a worthwhile future in broadcasting, aviation radio, servicing, electronic manufacturing television—or any other of Radio-Electronics' fast growing branches.

## 36 COURSES IN ONE!

Actually, RADIO PHYSICS COURSE gives you the scope of 36 complete courses in one big book. If it were broken into sections and sold as a course, you'd regard it as a bargain at \$50 or more. It's yours, however, for only \$5 complete (\$5.50 foreign)—and you don't even take the slightest chance on that! Our 5-Day Money-Back Guarantee is your absolute protection. Send the coupon today!



Let Alfred A. Ghirardi—Radio's best known technical author—start you on a fascinating, profitable RADIO-ELECTRONIC career!



**SEE IT • STUDY IT • BEFORE YOU BUY IT**

Here's how sure we are that you will like it:

Judge Ghirardi's RADIO PHYSICS COURSE for yourself. Compare it with any other Radio book or course at any price. Use it for 5 full days. Then, if you are not convinced that it will teach you basic Radio-Electronics EASIER, FASTER, and at LESS COST, return it and we will send you MONEY BACK!

## HERE'S HOW TO "TEST" A RADIO IN TWO MINUTES . . . or less!

Then fix it in half the time you'd normally expect to take

If you repair Radios for a living—or, even if you only tinker with sets occasionally, this big, new, completely revised edition of Ghirardi's famous RADIO TROUBLESHOOTER'S HANDBOOK is a book you cannot afford to miss! This big, 744-page, manual-size book is a complete guide to trouble diagnosing, locating, and fast repairing for practically EVERY type of Radio Receiver now in use. It eliminates extensive testing; helps you do two jobs in the time normally required for one; repair cheap sets at a profit; substitute available tubes and parts properly; train new helpers, etc.

## TELLS WHAT TO DO—EXACTLY HOW TO DO IT!

New, fully revised, the RADIO TROUBLESHOOTER'S HANDBOOK now contains 404-page Case-History compilations covering over 4,800 models of receivers and record changers—I.F. alignment peaks for over 20,000 superhets; big section on I.F. trans. troubles, and hundreds of tables, graphs, charts, and data sections, including a big new tube chart ESPECIALLY DESIGNED FOR WARTIME SERVICE NEEDS. It is yours complete for only \$5 (\$5.50 foreign) on an absolute 5-DAY MONEY-BACK GUARANTEE BASIS.



### WORK TWICE AS FAST!

"It has helped me fix twice as many radios in a day as I could fix before owning this book," writes Vernon Taylor of Elgin, Texas.

## THIS GHIRARDI WINNER WILL TEACH YOU RADIO SERVICING!

How would you like to have Radio's most widely acclaimed servicing expert at your side to teach you everything you need to know to help make you an accomplished radio service man? Actually, ownership of Ghirardi's MODERN RADIO SERVICING means just about that! It is the only single, inexpensive book that gives a thorough and easily understandable explanation of test instruments; receiver troubleshooting procedure; circuit analysis; parts testing and repair; maintenance, etc. 1300 pages with 706 illustrations, 720 self-testing review questions; 766 different topics! Only \$5 complete (\$5.50 foreign).

See MONEY-SAVING COMBINATION in Coupon



RADIO & TECHNICAL DIVISION OF MURRAY HILL BOOKS, INC.  
Dept. RN-94, 232 Madison Ave., New York 16, N. Y.

Enclosed find \$..... for books checked (send postpaid); or  send C.O.D. (in U.S.A. only) for this amount plus postage. If I am not fully satisfied, I may return the books within 5 days and receive my money back.

RADIO PHYSICS COURSE

MODERN RADIO SERVICING

3rd Revised Ed. RADIO TROUBLESHOOTER'S HANDBOOK

Special MONEY-SAVING COMBINATION: MODERN RADIO-SERVICING with the TROUBLESHOOTER'S HANDBOOK \$9.50 for the two (\$10.50 foreign)

Name .....

Address .....

City and Dist. No. .... State .....

**REPAIR ANY KIND OF RADIO EQUIPMENT**  
PREPARE YOURSELF FOR A BETTER JOB AT HIGHER PAY IN THE RADIO-ELECTRONIC FIELD

WHAT'S YOUR IDEA OF THE  
IDEAL POST-WAR RADIO &  
TELEVISION **SERVICE BENCH**

Every Month!  
**\$100 in WAR BONDS**  
Given For **BEST LETTERS!**

★ Each Month's 1st Prize,  
a \$50 Bond. 2nd and 3rd  
Prizes each a \$25 Bond.

Contest Now in Progress.  
Ends December 31, 1944.

★ **THINK OF IT—**

You can win a War Bond just by putting down your ideas as to what the ideal post-war Radio Service Bench should be. How many and what type of testing instruments for use on Radio, F-M, Television and so forth. How it must be arranged to render most efficient service—confidence. Your Ideal Service Bench.

★ **ANYONE CAN WIN—**

You can win. We want opinions from everyone interested in Radio and Television Service—Old Timers—Beginners. Experience will help—new-comers with good ideas can win.

★ **ENTER EACH MONTH—**

If you don't win this month, write again next month—and next—until the contest closes. Remember, it is your opinion that wins, not literary ability.

It's Easy to Enter and the Rules Are Simple! Get That Letter Off to Us Today!

**RULES OF THE CONTEST**

1. Simply write a letter (500 words or less) on the subject: "My Idea of the Ideal Post-War Radio and Television Service Bench."
2. Contest is open to all readers of Radio News (excepting employees of Burlingame Associates, their relatives, or their Advertising Agency).
3. You need not own a Radio Shop or possess testing apparatus.
4. No detailed technical description of the apparatus is required or desired, nor the names of the manufacturers.
5. Mention of elaborate testing equipment suitable only for exhibition use will detract from the value of the letter. The inclusion of useful, confidence-inspiring apparatus, however, is recommended.
6. Literary ability is not required. Anyone writing in understandable English, giving a good word description, has an equal opportunity of winning one of the prizes.
7. Write only on one side; sign your name and address CLEARLY in the upper-right-hand corner; number each sheet.
8. Contest runs 6 months, July 1, 1944, through December 31st, 1944. Each month's contest begins first of that month, with deadline for entries the last day of that month. Enter as often as you like.
9. No letters will be returned. Letters, contents and the ideas contained therein become the property of Burlingame Associates.
10. Judges' decisions will be final and duplicate prizes awarded in case of ties.

SEND ALL ENTRIES TO  
**BURLINGAME ASSOCIATES**

10 MURRAY STREET—NEW YORK 7, N. Y.

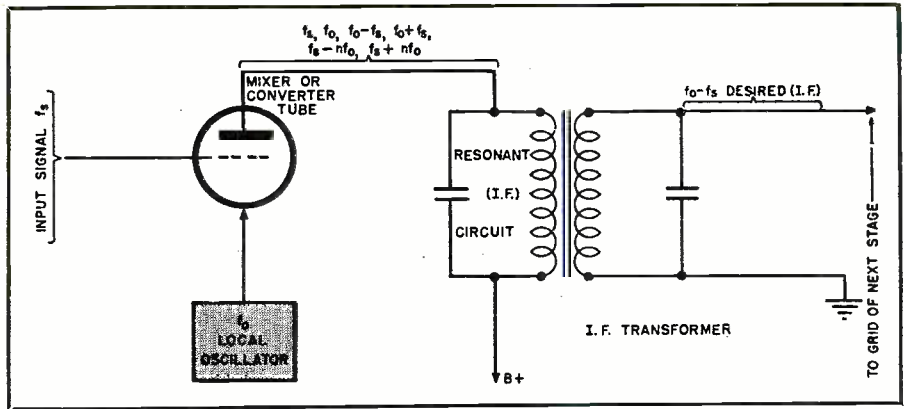

Fig. 2. The i.f. transformer in the plate lead of the mixer or converter tube is used to reject all undesired frequencies developed by the frequency-conversion process.

quency to be amplified the easier it is to construct selective high-gain fixed-tuned amplifiers for amplifying it, the signal of the *difference*<sup>3</sup> frequency, is usually selected for this purpose in standard broadcast band receivers, because by reason of the "arithmetic" of the situation this is the lowest-frequency signal of the group. It is customary to insert a tuned circuit in the output plate lead of the mixer or converter tube, as shown in Fig. 2, this circuit being tuned to the frequency  $fo - fs$  or  $fs - fo$  (depending upon whether  $fo$  or  $fs$  is the higher frequency). The signal voltage developed across this tuned circuit is then fed into the intermediate amplifier which is sharply fixed-tuned to this frequency. The resonant load presented by this tuned circuit must be highly selective, so it will tune to the desired difference frequency or i.f. value (and its modulation side-band frequencies) while effectively rejecting all the other unwanted frequencies present in the plate circuit.

**Why Local-Oscillator Frequency Is Usually Made Higher Than Signal Frequency**

It is possible to operate the local oscillator so that the frequency of its output is always *higher* by a fixed amount (numerically equal to the i.f. of the receiver) than the signal frequency. It is also possible to operate it so that its frequency is *lower* than that of the signal by this same amount. For example, for a 540 kc. incoming signal and a 455 kc. i.f. we may have:

$$\text{Oscillator (995) - Signal (540) = Output (i.f.) (455 kc.)}$$

or, we may have:

$$\text{Signal (540) - Oscillator (85) = Output (i.f.) (455 kc.)}$$

In either case (see Fig. 3), the frequency *difference* between the two, which is the i.f., will be exactly the same. It becomes necessary, therefore, to decide which of the two shall be used, since the electrical design of the oscillator tuning circuits depends upon this.

Let us consider this problem for a

<sup>3</sup> While this mode of i.f. operation (commonly referred to as *fundamental* operation, since the i.f. is equal in absolute value to the difference between the signal frequency,  $fs$ , and the *fundamental* local-oscillator frequency,  $fo$ ), is generally the preferred one, in certain cases it is convenient to operate at one of the other possible intermediate frequencies listed under item 6, that is, at an i.f. equal to the signal frequency minus one of the oscillator harmonic frequencies. This is referred to as *harmonic* operation. In these cases, the tuned output circuit is tuned to a frequency equal to the signal frequency minus the frequency of the oscillator harmonic that is to be employed. Harmonic operation may be used when the local-oscillator signal frequency required for the frequency conversion is so high that generation of such a signal of sufficient power at fundamental frequency is difficult. This is often the case in superheterodynes designed for ultra-high-frequency reception. However, in general, harmonic operation yields a lower signal-to-noise ratio than does fundamental operation, and is thus avoided, if possible, where signal-to-noise ratio is of fundamental importance (as is the case in many ultra-high-frequency applications). Then, too, when grid-controlled tubes are used, the maximum possible conversion transconductance at fundamental frequency is equal approximately to 28 per cent of the maximum signal-grid-to-plate transconductance. The maximum attainable second harmonic conversion transconductance is roughly half as great, and for third-harmonic conversion the transconductance is only about one-third as great. Then too, harmonic operation requires greater excitation, as a rule, than fundamental operation, and the optimum operating point is differently located.

Table 1. Local oscillator frequencies, in relation to the incoming signals, necessary to obtain the proper intermediate-frequency signal of 455 kc.

Frequency of Incoming Signal (fs)	Local Oscillator Frequency Required		Freq. of i.f. Signal Resulting (fi)
	(a) Oscill. freq. Lower than Signal freq. (fi = fs - fo)	(b) Oscill. freq. Higher than Signal freq. (fi = fo - fs)	
540 kc	85 kc	995 kc	455 kc
600 kc	145 kc	1,055 kc	455 kc
800 kc	345 kc	1,255 kc	455 kc
1,000 kc	545 kc	1,455 kc	455 kc
1,200 kc	745 kc	1,655 kc	455 kc
1,400 kc	945 kc	1,855 kc	455 kc
1,600 kc	1,145 kc	2,055 kc	455 kc

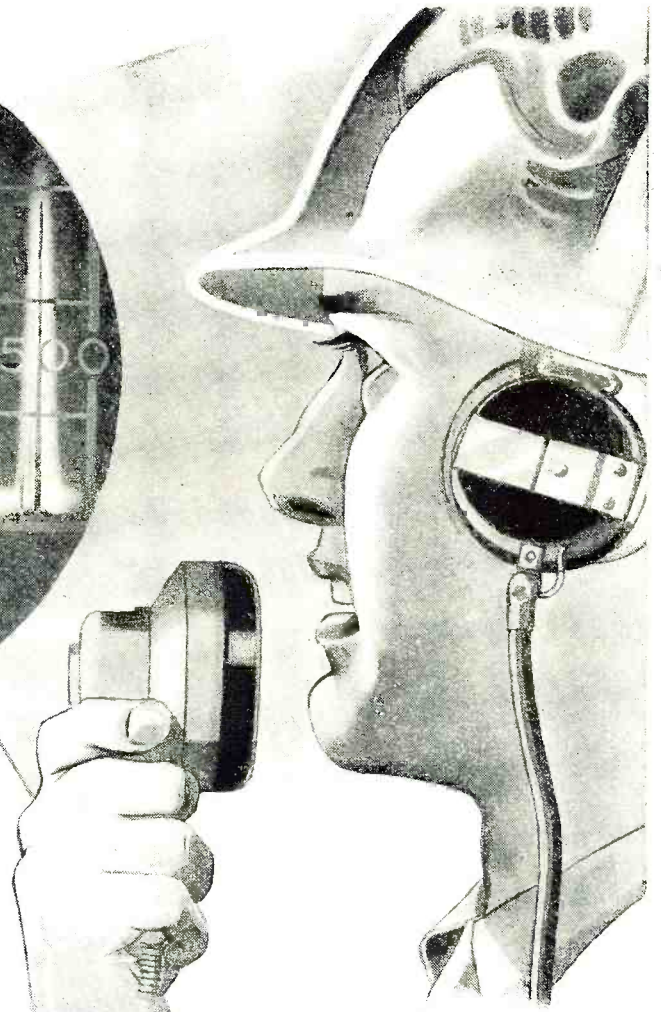
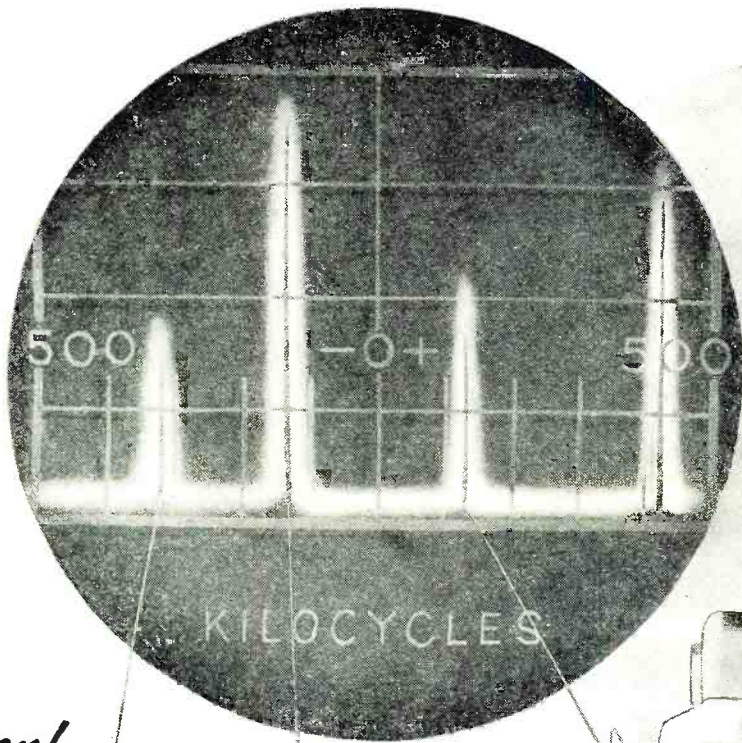

Soon!

# PANORAMIC RECEPTION

WILL BE USED BY GI JOE WITH HIS "HAM" RIG

When GI Joe takes off his helmet, he will still remember many of the things he is learning in the Army. As a radio operator, he uses **Panoramic** reception for effective monitoring and for catching tricks in enemy field communications. He recognizes its value for peacetime as well as for wartime. On the basis of military experience, he will want to make use of **Panoramic** reception for many more pleasant hours at his own rig. Because it **SHOWS ALL SIGNALS ON A GIVEN BAND OF THE RADIO FREQUENCY SPECTRUM SIMULTANEOUSLY**, GI Joe knows that **Panoramic** reception will tell him what stations are on the air, whether they are phone or CW, and what their signal strengths are when

they reach him. Most important, he can be sure that he will miss very few calls in response to his CQ's.

Currently, **Panoramic** reception also is doing good work in laboratory development and industrial applications. Its ability to measure, interpret and compare variations in inductance, capacitance and resistance has created possibilities that are being utilized by far-sighted manufacturers. If

**Panoramic** technique can be adapted to your present or future needs, ask our engineers for more detailed information.



COMMENT  
CAVA?



¿COMO ESTÁS?



## PANORAMIC



## RADIO CORPORATION

242-250 WEST 55TH ST., New York 19, N.Y.

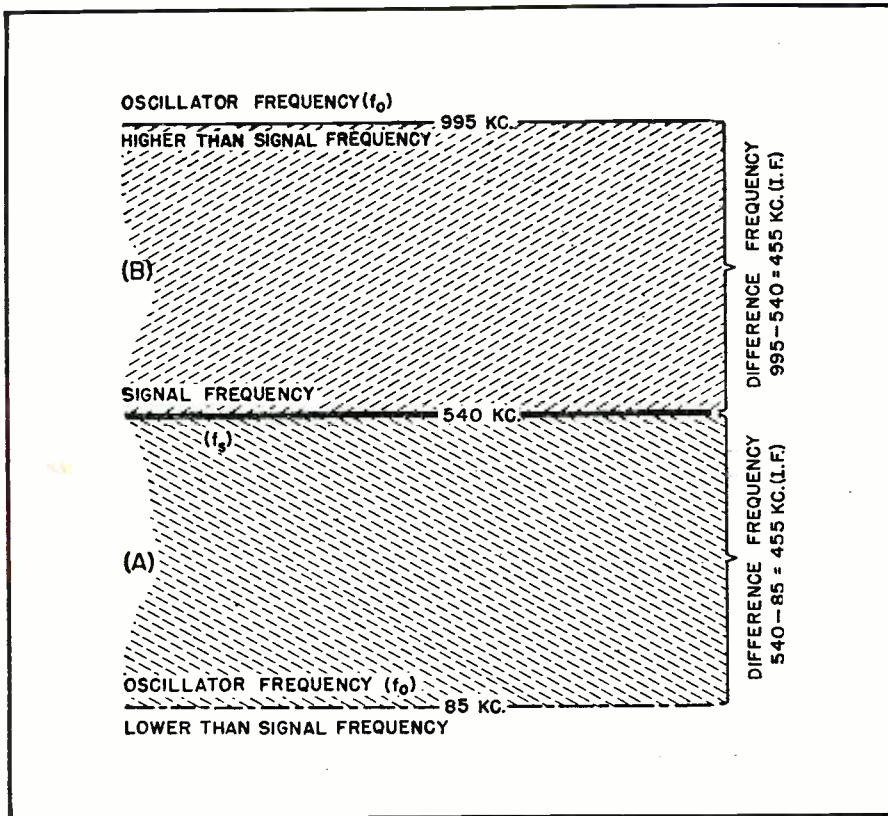

Fig. 3. Illustrating theoretically why the oscillator frequency can be made either lower or higher than the frequency of the incoming signal by an amount equal to the desired intermediate frequency.

typical superhet receiver that is to tune over the standard broadcast band of 540 to 1600 kc., and which is designed to employ an i.f. of 455 kc. (this i.f. has been standardized by the RMA for Standard Broadcast Band receivers). The tabulation in Table 1 shows what the local-oscillator frequency would have to be in each case, in order that the incoming signals from different stations within the tuning range would all be correctly converted to a 455-kc. signal for the i.f. amplifier. The oscillator frequencies required are tabulated for the following arrangements: (a) oscillator frequency *lower* than the signal frequency; (b) oscillator frequency *higher* than the signal frequency. It is as-

sumed, of course, that in each case the "difference" frequency is the one selected for the i.f.

Examination of Table I (and also of Fig. 3) reveals that for every signal tuned in, there are two local-oscillator frequencies that will produce the required "difference" frequency (i.f.) of 455 kc. The tabulation shows that if the i.f. is fixed at 455 kc. and the *lower* oscillator frequency is used during the reception of each signal, the oscillator will be required to operate over the frequency range from 85 kc. to 1145 kc. if the receiver is to cover the 540 kc. to 1600 kc. standard broadcast band. If the *higher* oscillator frequency is used for each signal instead, the oscillator will be required to oper-

ate over the frequency range from 995 kc. to 2055 kc. In the first case (85 to 1145 kc.) there is a 13.5 to 1 change from the highest to the lowest frequency; in the second case (995 to 2055 kc.) it is only a 2.1 to 1 change. From a practical standpoint, it is difficult to design a coil, and tuning condenser combination (especially for short-wave bands) to tune over a frequency range where the ratio of the highest to the lowest frequency is greater than about 3 to 1, unless band switching is resorted to. This is one of the reasons why the local oscillator in a superheterodyne is generally designed to produce an output of frequency *higher than that of the incoming signal* by an amount equal to the required i.f. The frequency range that the oscillator tuning circuit is required to cover is thereby reduced to a desirable minimum. In fact the oscillator tuning range then required is *less* than that required for the r.f. amplifier circuits. In the receiver discussed in the foregoing example, for example, the oscillator will be required to vary in frequency from 995 kc. to 2055 kc. (ratio of 2.1 to 1) as the receiver is tuned from 540 kc. to 1600 kc. (ratio of 3 to 1).

As we shall see presently, other important considerations, for example that of image-frequency interference, also enter into the question of whether the higher or the lower possible oscillator frequency should be used. As a result, in some superhets, especially those for use at the ultra-high carrier frequencies employed in FM and television broadcasting, the oscillator frequency is designed to be *lower* than the incoming signal frequency—at least on some of the bands.

#### Adjacent-Channel (Arithmetical) Selectivity of the Superhet

In a superheterodyne receiver the incoming signal is "converted" to the frequency of the intermediate amplifier. Most of the amplification, and the adjacent-channel selectivity (for amplitude-modulation receivers this is the ability to discriminate against interfering signals on an adjacent broadcasting channel 10 or 15 kc. removed from the desired signal frequency), are

Fig. 4. Showing why a superheterodyne receiver (B) possesses greater adjacent-channel selectivity than does a t.r.f. receiver (A).

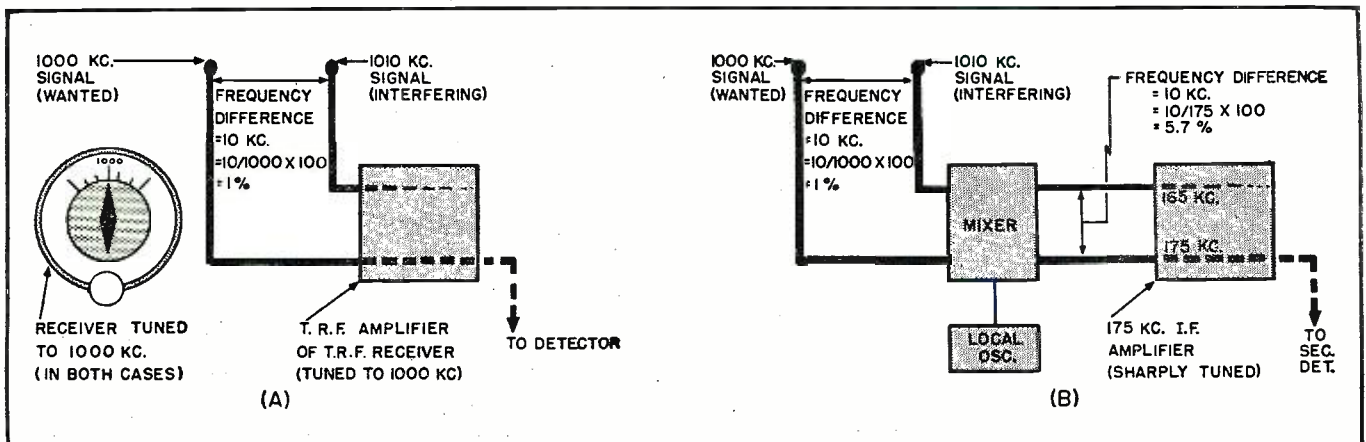

**"NO! HOGARTH ISN'T GOING NATIVE—HE'S JUST  
SHOWING OFF HIS ECHOPHONE EC-1"**



### **ECHOPHONE MODEL EC-1**

(Illustrated) a compact communications receiver with every necessary feature for good reception. Covers from 550 kc. to 30 mc. on 3 bands. Electrical bandspread on all bands. Six tubes. Self-contained speaker. 115-125 volts AC or DC.



**ECHOPHONE RADIO CO., 540 N. MICHIGAN AVE., CHICAGO 11, ILLINOIS**

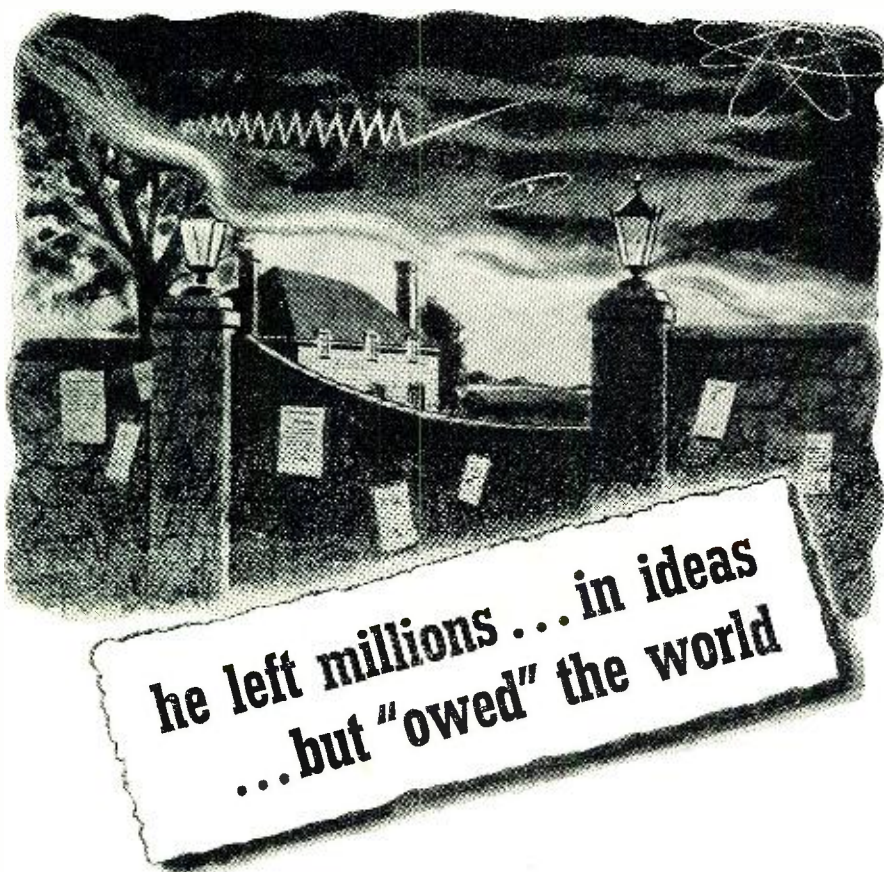

He left millions... in ideas... but "owed" the world

**HE** called himself a "philanthropist", and yet the door of his villa at Torquay in France was nailed with notices for unpaid debts. He gave away discoveries worth millions of dollars to the communications industries. He founded the modern science of telephonic communication. His name? Oliver Heaviside.

Advance theories of communication have been forced into practice by urgent war needs. Fundamental to all new developments, in this and other fields of electricity, is the transformer. Stancor engineers are fully conscious of their responsibility to keep pace with and to set pace in their transformer designs for tomorrow's peacetime industry.

SEND FOR NEW COMPLETE CATALOG

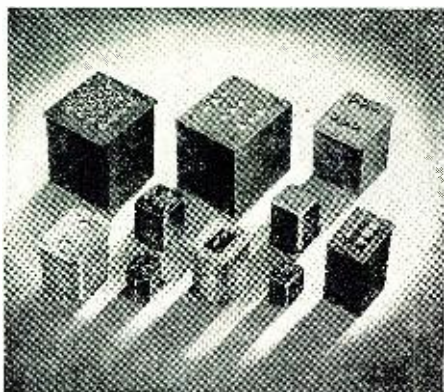

# STANCOR

## Transformers

STANDARD TRANSFORMER CORPORATION  
1500 NORTH HALSTED ST. • CHICAGO 22



Manufacturers of quality transformers, reactors, power packs and allied products for the electronic industries.

obtained in this sharply tuned fixed-frequency amplifier. When the receiver uses an i.f. lower than the frequency of the desired signal, this frequency conversion gives it an important *arithmetical* or *adjacent-channel selectivity* advantage over the straight t.r.f. receiver. It is highly desirable for a radio receiver to discriminate against interference from signals on an adjacent channel.

The percentage of difference between the frequency of the desired frequency and the signal on an adjacent channel (10 kc. difference) varies with the frequency, thus, at 540 kc. the adjacent channels are off-resonance by 1.85%. At 1000 kc. the difference is 1%, while at 1600 kc. the difference is only 0.63%. At the high and ultra-high frequencies it is very much less, as we shall see later. A clear understanding of the arithmetical selectivity factor may be had by considering the problem of separating the signals received from two stations lying at about the middle of the standard broadcast band and assigned to adjacent carrier frequency channels 10 kc. apart. Suppose the carrier frequency of the "wanted" signal (to which the receiver is tuned) is 1000 kc., and that of the unwanted "interfering" signal is 1010 kc.

If a t.r.f. receiver were used for the reception, see (A) of Fig. 4, since effective elimination of the undesired 1010 kc. signal would have to take place in the tuned circuits of the r.f. amplifier (which operate at the received carrier frequency) the frequency discrimination required would be  $1010 - 1000 = 10$  kc. The percentage frequency discrimination would therefore have to be  $10/1000 \times 100 = 1\%$ . Now such a high degree of frequency discrimination presents problems that no t.r.f. receiver (even one employing five or six tuned circuits) can successfully solve.

In a superheterodyne receiver practically all of the adjacent-channel selectivity is provided by the sharply tuned circuits of the i.f. amplifier. Therefore, if a receiver of this type were used instead, the frequency discrimination effected at the frequency of the i.f. amplifier would be the one to consider. Assuming the receiver to be designed for an i.f. of 175 kc., both signals would have their frequency "converted," as illustrated at (B) of Fig. 4, the "desired" one to  $1175 - 1000 = 175$  kc., and the "undesired" one to  $1175 - 1010 = 165$  kc. (1175 kc. being the frequency of the local oscillator when the receiver tuning dial is set for reception of the 1000 kc. station). It is evident that the two frequencies which appear in the i.f. amplifier are only  $175 - 165 = 10$  kc. apart. However, because of the lower *total* frequency, the percentage discrimination required of the i.f. amplifier in order to eliminate the undesired 165-kc. signal is, in this case,  $10/175 \times 100 = 5.7\%$ . In simple terms, this means that the selectivity problem for this particular i.f. amplifier is over 5.7

# JOHNSON MINIATURE SOCKETS

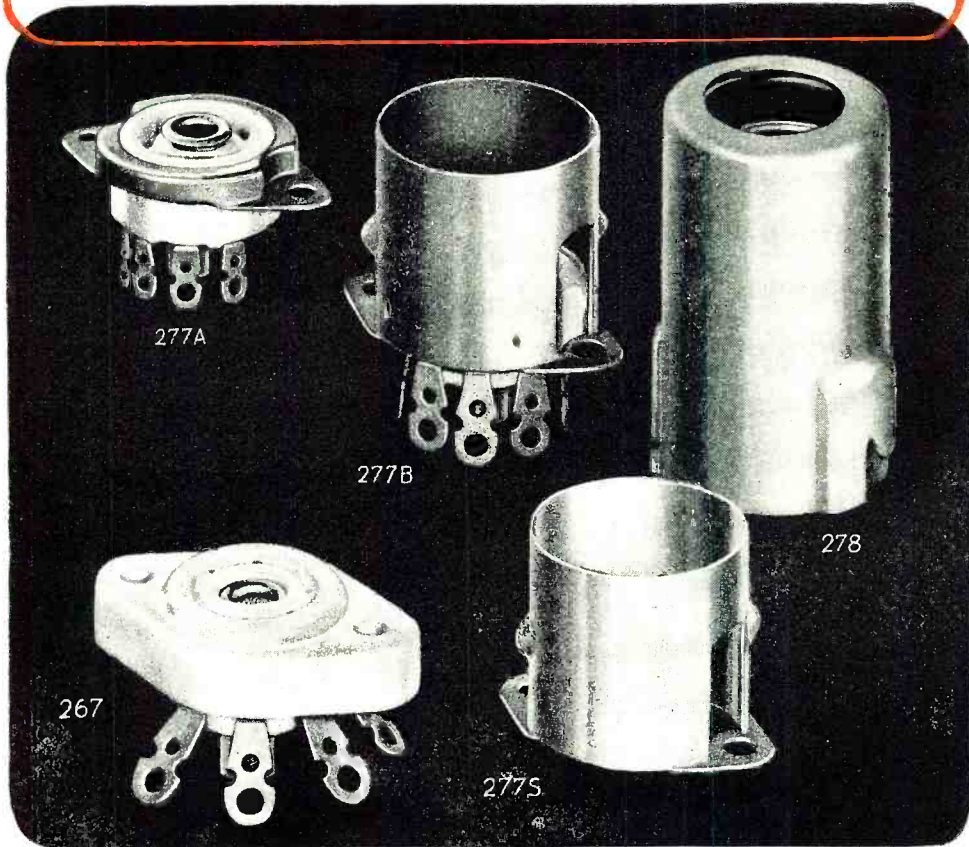

Pre-eminent in the ceramic socket field, it was to be expected that Johnson was asked in 1941 to develop the first miniature ceramic socket (No. 267), or that it was quickly approved and widely adopted a year or more ahead of the field, and today is going into critical equipments by the hundreds of thousands.

The same Johnson skill in engineering both ceramics and metal has gone into the No. 277, and the associated shields and shield base (usable with other sockets as well). These Johnson sockets not only meet standards (developed jointly by us, the W. P. B. Socket Sub-committee, Signal Corps, Navy and private laboratories); in each of them you may count on that EXTRA value that's typical of products bearing the Viking mark. High grade steatite insulation with long creepage and arcing paths and low inter-contact capacity; accurately formed and processed contacts of silver plated beryllium copper or phosphor bronze, freely floating and with just the right tension, feature this series of sockets.

If you have a socket problem, whether it's engineering, design, substitution, or delivery, first try Johnson.

Ask for NEW catalog 968Z

# JOHNSON

*a famous name in Radio*



## JOHNSON

*Made*

PLUGS and JACKS  
INSULATORS  
SOCKETS  
CONDENSERS  
INDUCTORS  
BROADCAST  
CABINETS

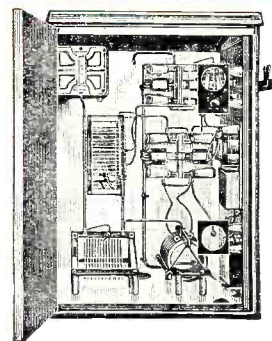
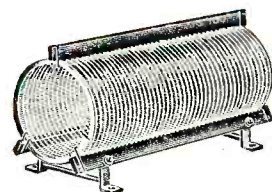
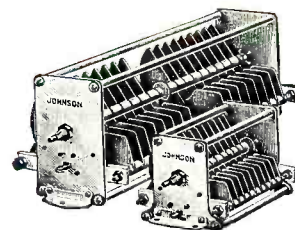
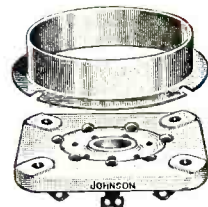

E. F. JOHNSON COMPANY • WASECA • MINNESOTA

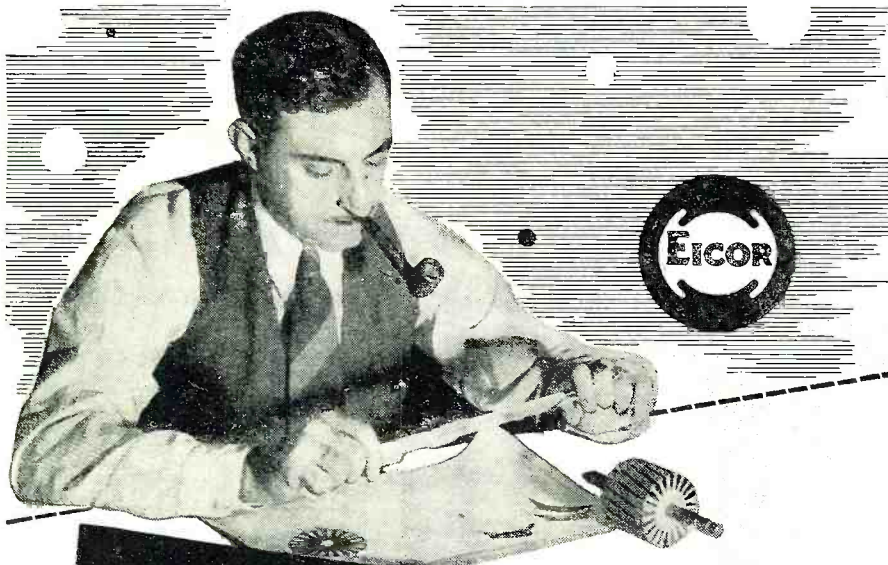

## SPADEWORK

**Far in advance** of today's production schedules and in anticipation of tomorrow's needs, EICOR engineers are preparing to meet the inevitable demand for rotary electrical equipment designed for new applications. During recent years their store of knowledge has been used to direct our activities and those of others in the manufacture of more and better motors and dynamotors for war service. The breadth of experience gained in this effort fits them, and our entire organization, for an important future in this field.

**An exceptional range** of designs and frame sizes facilitates the development of equipment to meet your exact specifications—from tiny direct current motors to dynamotors and generators for every conceivable output or purpose. Our facilities are equally adaptable to the engineering of a single experimental unit or to production runs.

**Years** of patient research, the "spadework" that improves existing products or creates new designs, are represented in every EICOR part. If you use—or expect to use—motors, dynamotors, or generators, submit your requirements to us; our engineers may have something smaller or lighter or better to recommend.

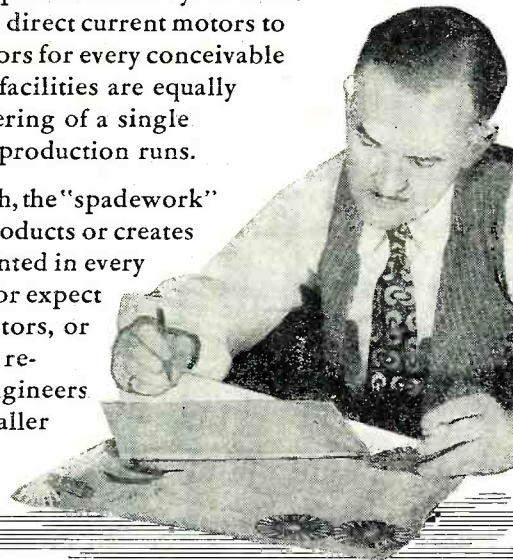

**EICOR INC.** 1501 W. Congress St., Chicago, U. S. A.  
 DYNAMOTORS • D. C. MOTORS • POWER PLANTS • CONVERTERS  
 Export: Ad Auriema, 89 Broad St., New York, U. S. A. Cable: Auriema; New York

times as simple as it would be for the t.r.f. receiver.

Obviously, the *lower* the intermediate amplification frequency employed in the receiver, the smaller will be the denominator in the foregoing fraction and, consequently, the larger will be the numerical value of the percentage frequency discrimination accomplished. Hence, the lower the i.f. used, the greater is the arithmetical, or adjacent-channel, selectivity advantage, or the percentage frequency separation of wanted and unwanted adjacent-channel signals. However, the important problems of image-frequency interference and other spurious responses (which will be considered next) enter into the picture and set a practical lower limit on the value of i.f. that may be employed, since the higher the i.f., the *less* is the trouble from these sources. Because of this, the industry now has considered it advisable to standardize on i.f. values in the neighborhood of 455 kc. in standard broadcast band receivers. Even with this higher value of i.f., the adjacent channel selectivity situation is about 2.2 better at the middle of the broadcast band than it is for a t.r.f. receiver. For ultra-high-frequency reception, even higher i.f. than this must be employed, as we shall see presently.

(To be Continued)

### Police Receivers

(Continued from page 45)

someone switch on the carrier to be received. If the setting is correct, the receiver will jump into operation immediately each time. If the squelch does not release every time, then the control will have to be set back a little to admit a slight amount of noise. This is seldom necessary, however, unless the receiver is used in an unusually noisy location. After the unit is once set, an occasional strong noise peak or crash of static may break through for a fraction of a second.

The circuit is very effective, and once properly set will give little trouble.

Since it will be necessary to mount both the 6C8G and the 6H6 in the receiver to install the circuit shown in Fig. 1, it might be well to consider the combined squelch circuit and noise limiter shown in Fig. 2. This is a combination of Figs. 1 and 3.

In this circuit, one half of the 6H6 is used for the diode detector and the other for the limiter. Otherwise the circuits and methods of operation and adjustment are the same as explained previously.

The writer makes no claim for the originality of the circuits shown. They have been gleaned from various sources, being standard circuits in use for a number of years in modern communications equipment. This article merely shows how older receivers may be modernized by the inclusion of these noise limiter and squelch circuits.



# GOLD makes Electrons Behave

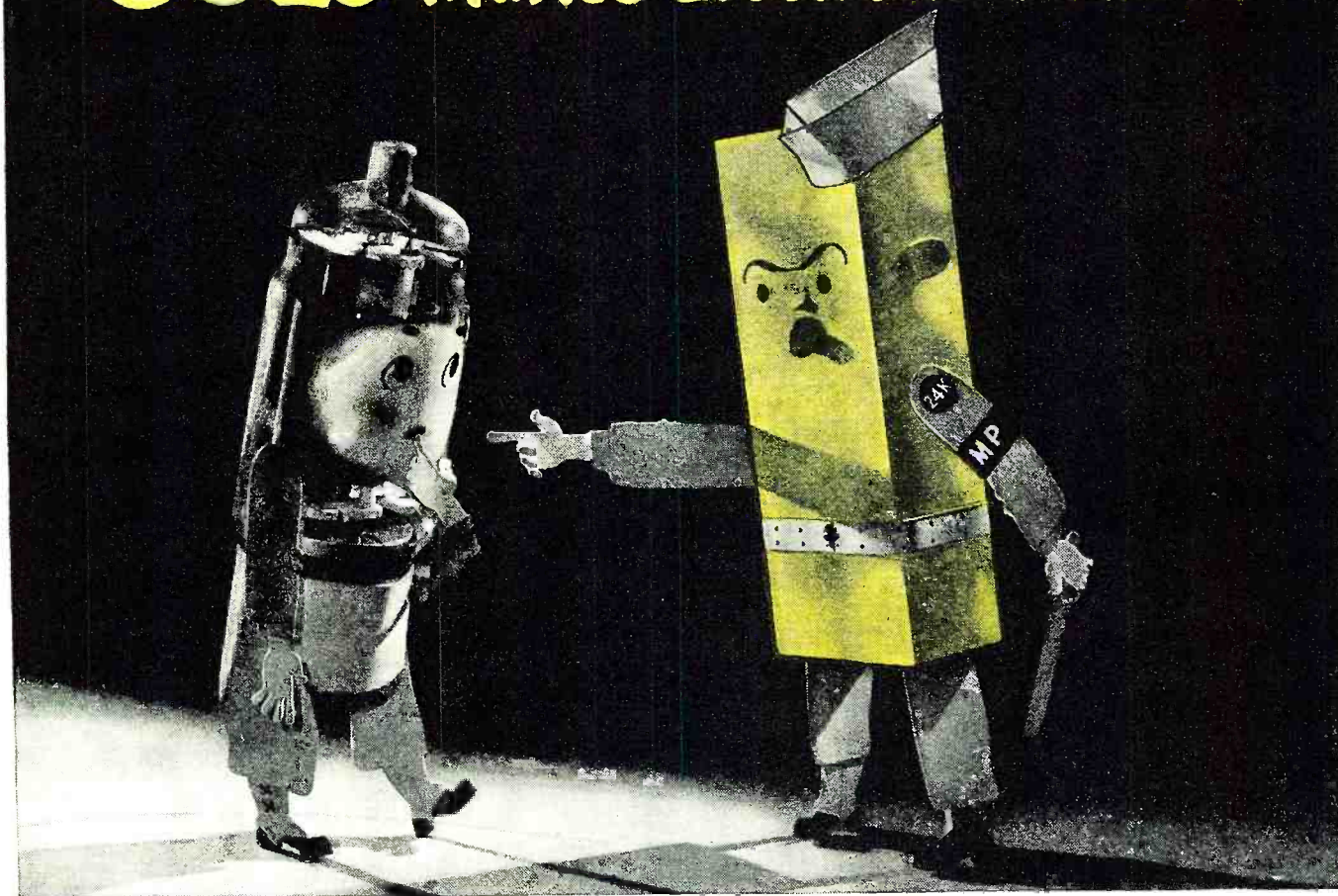

It was a great day for radio communication when National Union engineers developed the technique of gold plating certain tube parts. For by this ingenious means they measurably extended the life of power tubes.

The object, here, was not to make power tubes structurally stronger—or even more durable. Already these tubes were sound enough mechanically to do a bang-up job. What the N. U. process of gold plating did, was to make the electrons behave. N. U. engineers demonstrated that by gold-plating the grid wire, they automatically eliminated a very disturbing factor in power tube performance, known as

grid emission. The source of this undesirable primary emission was imprisoned within the gold. No longer could it interfere with the planned and controlled electron flow within the tube. Result—power tubes of a higher performance level and longer life.

Thanks to the greatly expanded electronic research program at National Union Laboratories, many such improved tubes with wide application in America's homes and industries will be available at the war's end. *Count on National Union.*

**NATIONAL UNION RADIO CORPORATION, NEWARK, N. J.**  
*Factories: Newark and Maplewood, N. J.; Lansdale and Robesonia, Pa.*



## NATIONAL UNION RADIO AND ELECTRONIC TUBES

*Transmitting, Cathode Ray, Receiving, Special Purpose Tubes • Condensers • Volume Controls • Photo Electric Cells • Panel Lamps • Flashlight Bulbs*

# WHAT'S NEW IN RADIO

New products for military and civilian use.

## TUBE TESTER

A new and exceptionally flexible tube tester is now being made by the *Radio City Products Company* of New York. This tester, known as the Model 314, provides simple operation and speed in the testing of octal, loktal, Bantam, Jr., miniature, midget and all acorn tubes. The filament voltage switch is designed to test all present filament

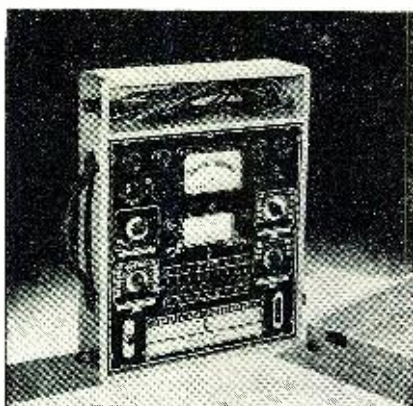

voltages from 1.1 to 117 volts, a range which anticipates the voltages of the future.

The tester has individual connections for each element. A lever type switch individually controls each tube prong, checks roaming filaments, dual cathode structures and multi-purpose tubes. Separate plate tests may be run on diodes and rectifiers. A neon short test indicates the slightest leaking between any two elements while the tube is hot.

The unit weighs 12 and one-fourth pounds and is available in 50 to 60 cycle, 110 volt and 50-60 cycle, 220 volt models.

Details are available from the *Radio City Products Company*, 127 West 26th Street, New York 1, New York.

## TERMINAL STRIPS

A Barrier type terminal strip, with facilities for connecting both above and below the mounting surface is be-



ing manufactured by the *Howard B. Jones Company*.

This "Y" type terminal permits a screw connection above the panel and a solder connection below. The terminal mounts securely in the block and

is also held in place by a screw so that the connecting wire comes in direct contact with the terminal.

This terminal is made for the No. 140, No. 141 and the No. 142 series Barrier Strips.

The bakelite body is of BM 120 compound according to Navy Specifications and the "Y" terminal is made of tin-plated brass. The barriers separating the terminals are of sufficient height to give the desired creepage distance and prevents shorts from frayed wires.

Further information and prices may be obtained by writing the *Howard B. Jones Company*, 2460 W. George Street, Chicago 18, Illinois.

## HICKOK TESTER

An improved electrical appliance tester is now being offered by the *Hickok Electrical Instrument Company*. This tester operates at an extremely low range of from 0-20 watts as well as a high range up to 2000 watts.

This unit tests all electrical appliances from bell transformers and

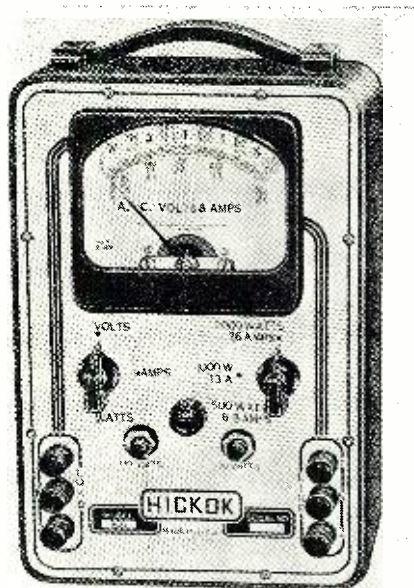

clocks to electric ironers and ranges operating on 220-volt, three-wire systems. The tester measures actual load values of volts, amperes and watts. By means of this tester, trouble may be located in a.c. appliances while the equipment is in operation. The unit is protected from accidental overload by means of a fuse.

Over-all dimensions are 9½" high, 6¾" wide and 3" deep and it weighs 8½ lbs. The meter is 4" square.

Additional information on this Model

900 tester may be obtained from the *Hickok Electrical Instrument Company*, 10524 Dupont Avenue, Cleveland, 8, Ohio.

## SAFETY FLOORING

A new improved safety mat is being manufactured by the *William F. Klemp Company*, specialists in steel floorings.

Of particular value where it is necessary for the operator of equipment

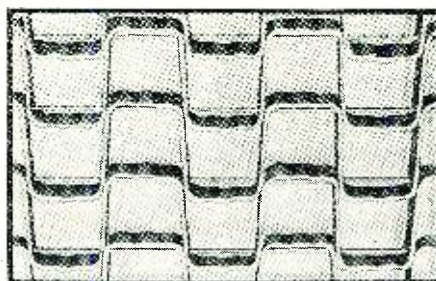

to be protected against slipping, wet feet, and falls, this matting may be placed anywhere and transported easily, rolled up like a rug. This flooring is made of steel, is non-absorbent and is easily cleaned with hot water or cleaning solution. The mat comes in any length up to 25 feet and in any width to 6 feet.

Plant executives who are interested in this product are asked to write directly to *William F. Klemp Company*, 6641 S. Melvina Avenue, Chicago, 38, Illinois.

## UHF DISPLAY CABINET

Increased interest in u.h.f. has prompted the *Andrew Company* of Chicago, Illinois, to design a display cabinet in which various coaxial transmission lines of different diameters, commonly used connectors, junction

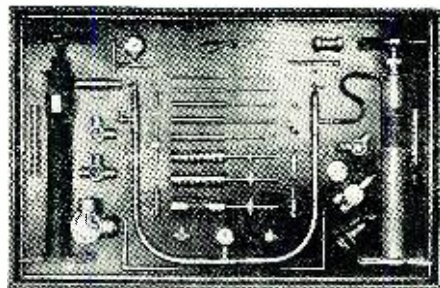

boxes and terminals may be demonstrated.

This cabinet has already been used with success to illustrate classroom lectures and public addresses. The unit is available in two models, the All-Purpose model and the Military model.

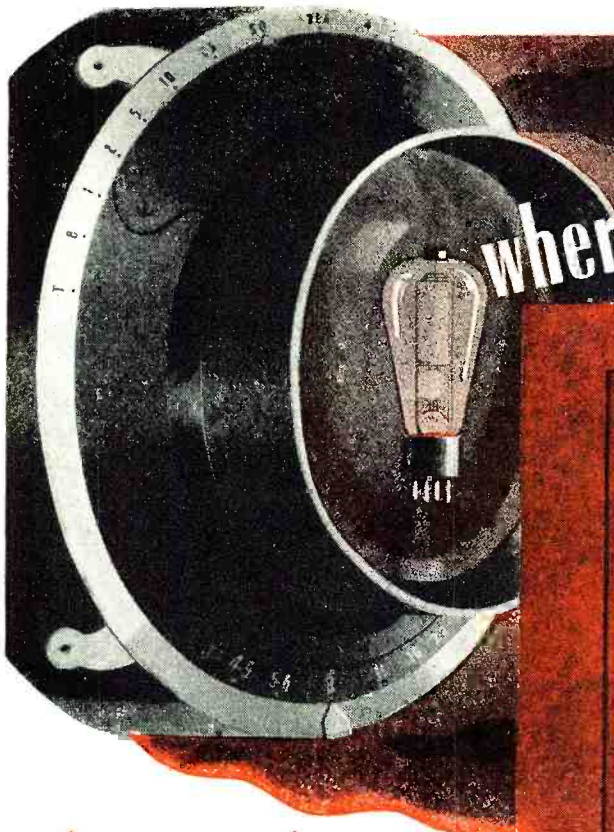

wherever a tube is used...

for example:

### ELECTRONIC TIMING

Industry is making increasing use of electronic timers in timing or controlling intervals that are beyond the accuracy and scope of mechanical measurement. Such applications as measurement of the speed of a camera's shutter, welding control, plastic molding, photographic exposure and measurement of turbine speeds are typical.

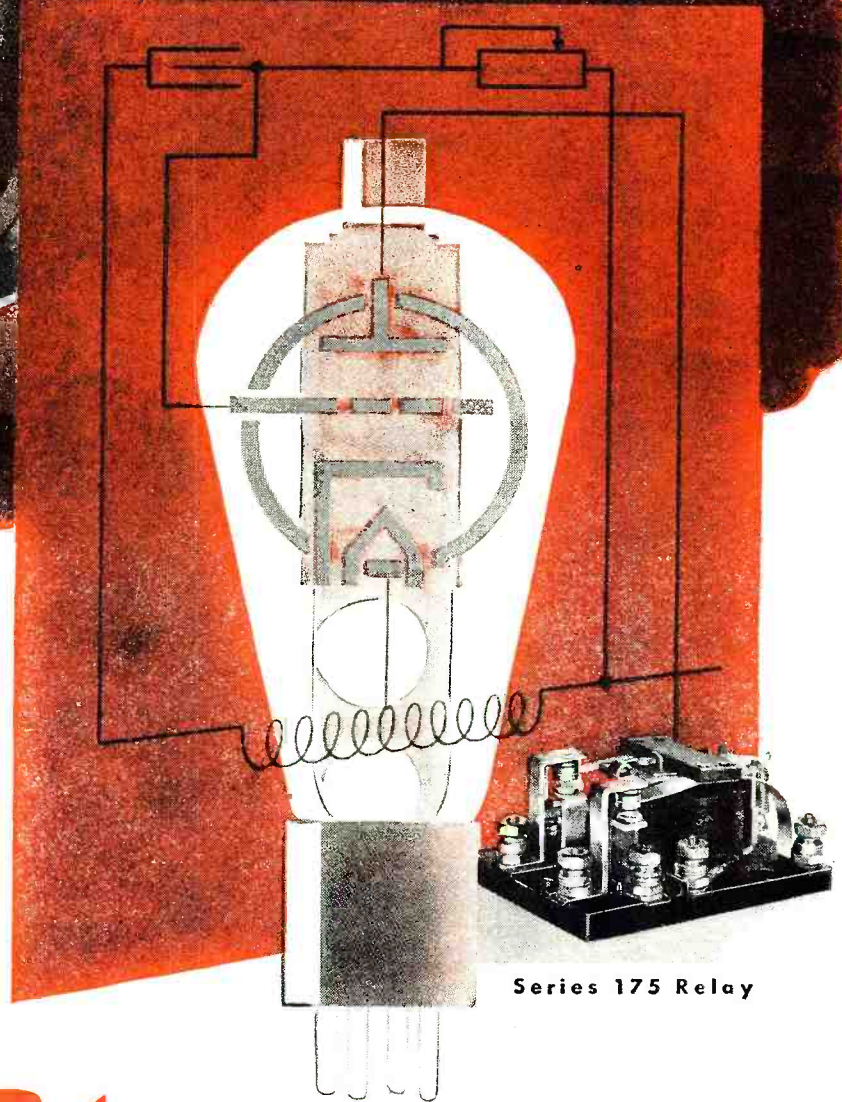

Series 175 Relay

## THERE'S A JOB FOR *Relays* BY GUARDIAN

The above diagram of an electronic timing circuit shows a capacitor and an adjustable resistor connected to the grid of a thyatron or "trigger" type of tube. As the capacitor discharges, the grid potential reaches a point where the tube becomes conductive and energizes a relay.

The relay is generally a fast-acting type such as the Guardian Series 175 operating at a speed which minimizes interference with the timing interval. Coil operating voltages range from 6 to 110 volts D.C. (Also

available for A.C. in Series 170). Contacts are rated at 12½ amps. at 110 volts, 60 cycles, non-inductive in combinations up to D.P., D.T. Bakelite base is molded to reduce surface leakage. Has binding post terminals in place of solder lugs. Write for Bulletin 175.

Consult Guardian whenever a tube is used—however—Relays by Guardian are NOT limited to tube applications but are used wherever automatic control is desired for making, breaking, or changing the characteristics of electrical circuits.

**GUARDIAN**  **ELECTRIC**  
 1630-K W. WALNUT STREET CHICAGO 12, ILLINOIS  
 A COMPLETE LINE OF RELAYS SERVING AMERICAN WAR INDUSTRY

# THE LATEST UP-TO-THE-MINUTE RADIO AND ELECTRONIC CATALOG IN THE COUNTRY TODAY!



## Available

Newest listings of amplifiers, communications equipment, radio tubes, testers, etc. • The latest developments in intercommunications equipment. • Greatly expanded listing of needed tools, especially for assembly and factory use. • Advance listings of 1944 radio and electronic books; repair and replacement parts; bargain section of values. • A brand new, up-to-the-minute catalog that should be in the hands of industrial plants, laboratories, government and military services, schools, radio servicemen and dealers (on L265), everybody engaged in vital war and civilian work.

**FREE!** The Lafayette Radio Catalog No. 94 will be rushed to you upon request. Fill out this coupon NOW!

**LAFAYETTE RADIO CORP.**  
901 W. Jackson Blvd., Chicago 7, Ill.  
Dept. E-9

Please rush my FREE copy of the Lafayette Radio Catalog No. 94.

NAME .....

ADDRESS .....

CITY..... STATE.....

Back the Attack Buy More War Bonds

**Lafayette  
Radio Corp.**

901 W. Jackson Blvd. 265 Peachtree Street  
CHICAGO 7, ILLINOIS ATLANTA 3, GEORGIA

This display cabinet is available for exhibition at conventions, meetings and other gatherings where radio men may be present. Further information may be obtained by writing *Andrew Company*, 363 East 75th Street, Chicago, 19, Illinois.

### KNIFE DISCONNECT

A solderless knife-disconnect terminal to provide quick connection and disconnection to contacts of small switches is the newest product of the *Aircraft-Marine Products, Inc.*

Switches which have tabs extending from the contacts to which external connections are soldered may be converted readily to quick disconnection switches by simply replacing the contact members with members embodying a knife-disconnect end instead of a soldering tab. In this way, the change may be made without affecting the housing or any switch parts other than the contact members.

Switches which have screws or binding posts may be similarly adapted for certain applications.

New switches now being engineered

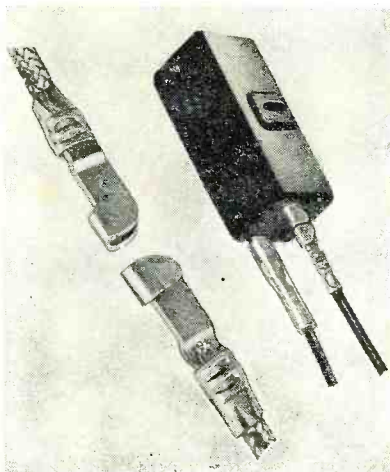

may be designed to incorporate the knife-disconnect principle as an integral part of the design since it is of similar construction to most of the switch parts, being a simple stamping of high-conductivity copper, hot-electro tinned for maximum corrosion resistance.

Complete information and literature is available upon request to the *Aircraft-Marine Products, Inc.*, 1591 North Fourth Street, Harrisburg, Pennsylvania.

### MULTI-CELLULAR SPEAKER

A new speaker which combines both high and low frequency units in a compact two-way multi-cellular loud-speaker has been announced by *Altec Lansing Corporation*.

This speaker provides high-quality sound for monitoring, radio, public address and recording. In actual performance, the new speaker delivers up to 500% greater efficiency in these operations. The speaker occupies less than one and one-half cubic feet of space.

This unit provides up to 1200% increased area of distribution. In the horizontal plane, it delivers 12 times the area distribution at high frequencies compared to the usual single-unit speakers of comparable size. Its horizontal area of distribution is 60 degrees and in the vertical plane, the area of distribution is a full 40 degrees.

One of the important features of this speaker is the high-frequency horn construction. The voice coil is wound with rectangular aluminum wire and operates in a magnetic field of very high flux density, which is supplied by a recently perfected type of permanent magnet. The aluminum alloy metal diaphragm provides mass stiffness and high velocity of transmission speed, at least five times greater than through paper cone material. This high frequency unit is designed to operate as a piston up to frequencies above the limit of audibility. The high frequency horn is a multi-cellular unit having six cells in a 2 x 3 configuration. This horn is covered with a sound-deadening material and mounted in the face of the low frequency unit. Power from the high frequency unit is supplied through the pole piece of the low frequency unit.

The unit is also capable of delivering high-quality phonograph, radio, and FM reproductions.

Complete engineering details of this speaker may be obtained by writing directly to *Altec Lansing Corporation*, 1210 Taft Building, Hollywood, 28, California.

-50-

### ELECTRONICS IN MINING

**A** PROBLEM which confronts many mining engineers may be solved by electronics if Hans Lundberg, one of the world's foremost geophysicists, is correct in his conclusions. For some months Donald mines has carried on an intensive diamond drilling campaign in an effort to intersect a rich zone of 120 feet which has been cut by drill-hole.

Although ten holes of various footages have been completed, this ore-body has not yet been accurately located. Mr. Lundberg has been asked to apply his methods of locating drill-holes through the use of electronics. His method consists of inserting ordinary diamond-drill rods in the hole, relying on the electric fields produced from a portable generator, which are kept under observation on the surface. Electrodes are used and grounded with pegs across the area above which the hole was drilled. Earphones, connected to amplifiers and other electronic devices utilized by Mr. Lundberg, enable him to make readings that will reveal the location of the hole.

Should this survey locate the deflection and diversion of the No. 3 hole, it will establish a new and important technique of far-reaching value to the mining industry as a whole.

-30-

**W. J. HALLIGAN, President,**  
**Hallicrafters Radio . . .**

*Mr. Halligan says, "Those of us who are building radio communications equipment in this war anticipate a tremendous demand in the future for radios and radio telephones for plane to ground, ship to shore use, and many other applications."*



**"COMMUNICATIONS EQUIPMENT IS ONLY AS GOOD  
 AS ITS POWER SUPPLY"**

*"Radio equipment needs an efficient, reliable power supply," continues Mr. Halligan, "And for that reason, the radio industry is constantly on the alert for new and better power supplies and devices for adapting current for radio use. Such power supplies and such devices are of inestimable value to the communications equipment manufacturer."*

Electronic Laboratories has vibrator power supplies for use wherever current must be changed in voltage, frequency or type, or will engineer one to fit specific space, weight and voltage requirements. E•L Vibrator Power Supplies offer many advantages for all current conversion requirements up to 1500 watts as a result of development in circuits and design pioneered and perfected by Electronic Laboratories. E•L Power Supplies are definitely more efficient, and give substantially longer service life. In addition, they are highly versatile, permitting multiple inputs and outputs, any needed wave-form, great flexibility in shape and size, and a high degree of voltage regulation when needed. They are economical in price and require almost no attention or maintenance. Their dependability is being demonstrated everyday on the fighting fronts. E•L engineers offer consultation on power supply problems.

**E-L STANDARD POWER SUPPLY  
 MODEL 307**

For the operation of standard 110 volt AC equipment, such as radios and small motors, from a 6 volt battery. Characteristics: Input voltage, 6 v. DC; Output voltage, 115 v. AC; Output power, 100 watts; Output frequency, 60 cycles.

*Dimensions: 7½x8¼x10¼ in. Weight: 23½ pounds.*



*Write for further information of this and other models of the extensive E-L line.*

**Electronic**



**LABORATORIES INC.**



INDIANAPOLIS

VIBRATOR POWER SUPPLIES FOR LIGHTING, COMMUNICATIONS, AND ELECTRIC MOTOR OPERATION • ELECTRIC, ELECTRONIC AND OTHER EQUIPMENT

# TRANSMITTING TUBES AND VACUUM CONDENSERS



# Jennings RADIO

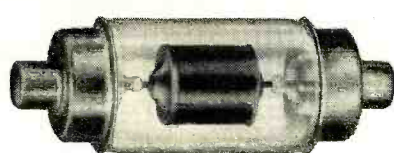

## TRANSMITTING TUBES and VACUUM CONDENSERS

*Serving the Radio-Electronic  
Field with the Armed Forces*

OVER a period of years, the name JENNINGS has been associated with many of the outstanding developments in the Radio Industrial field.

Today, JENNINGS RADIO enjoys a well-earned niche in the top flight ranks of Radio manufacturers now serving the armed forces.

Tomorrow, the post-war period, will find JENNINGS RADIO far

out in front with a new and improved line of Radio Tubes and Vacuum Condensers meeting the exacting needs of the new industrial-electronic world.

While today, we are devoting our entire engineering thought and output to the business of winning the war, we can, however, invite a discussion of your commercial peacetime products.

*Our new catalog will be sent on request*

**JENNINGS RADIO MANUFACTURING CO.**

MEMBER WEST COAST ELECTRONIC INDUSTRIES

San Jose, California

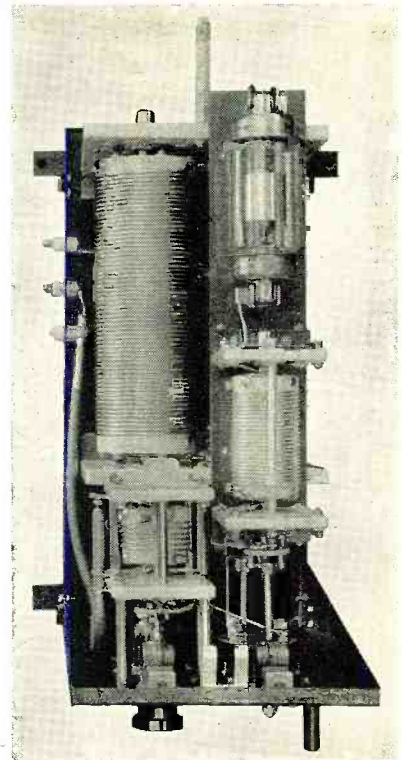

**hallicrafters**  
SCR-299

is being powered by  
**JENNINGS**  
Transmitting Tubes  
and Vacuum Condensers

## Capacity Meter

(Continued from page 42)

mounted directly to the front panel, being supported by long screws passing through  $\frac{1}{2}$ -inch studs at the lower right-hand corner. The oscillator-amplifier subchassis is mounted to the front panel directly below the tuning capacitor, as may be seen from the photographs, and the null-detector jack passes through the front panel just above the subchassis and below the X-X terminals. Bakelite shoulder-type washers insulate this jack from the panel.

Considerable latitude is possible in the layout and general mechanical arrangement of individually built capacity meters, since this type of instrument is not nearly as critical as regards layout as are certain radio-frequency instruments. The builder may make his own instrument more compact or more roomy, as the spirit moves, and may even enlist a totally different panel arrangement without impairing the usefulness or accuracy of the instrument. The author's arrangement is only suggestive of the numerous possibilities in the way of mechanical arrangement.

### Testing and Calibration

After the circuit wiring has been inspected for correctness, the capacity meter sections may be checked in this suggested order—(1) power supply, (2) oscillator-amplifier, and (3) bridge. The following directions will be of aid in carrying out the tests.

**Power Supply.** (1) Plug the instrument into the power line and throw switch  $S_2$  to the On position. Allow from 2 to 3 minutes for the tubes to come up to steady heater and plate current conditions.

(2) With a d.c. voltmeter having a sensitivity of 1000 ohms per volt or better, test the voltage between points A and B in the circuit. This potential should be between 90 and 112 volts, depending upon the power line voltage, and the polarity should be: A positive, B negative.

**Oscillator-Amplifier.** (1) Disconnect the secondary of  $T_2$  from the bridge circuit and connect a pair of headphones between points C and D.

(2) Switch on the instrument and advance gain control  $R_1$  to maximum volume. After tubes have heated, a clear strong 1000-cycle tone should be heard in the headphones and it should become necessary to reduce the setting of  $R_1$  to cut down the volume.

(3) If no oscillation is heard, even when  $R_1$  is adjusted, it is likely that the secondary connections of  $T_1$  are reversed or that the parallel-T network wiring is incorrect.

(4) Oscillation control  $R_2$  must be set to the position which permits the oscillator to start promptly when the 6C8-G cathode has come up to operating temperature.

(5) If it is desired to check the os-

## Pioneers in the Communication Field

### TURNER 22 D Dynamic

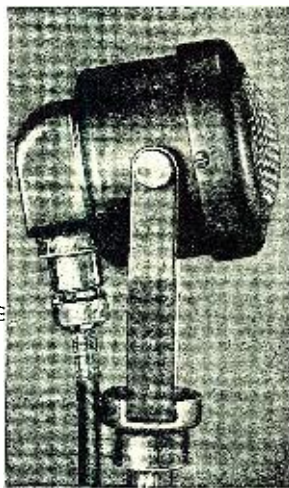
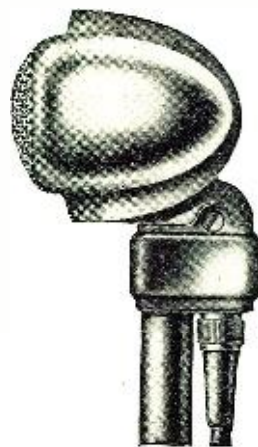

### TURNER 999 Balanced Line Dynamic

for Crystal-Clear Reproduction  
in ANY Climate—Indoors or Out

## T U R N E R Microphones

For crisp, clear reproduction of ANY sound without distortion—Turn to a TURNER. These microphones are scientifically engineered to faithfully reproduce all gradations of volume, to amplify ONLY those vibrations received by the diaphragm without adding any of the harmonics. On land, on sea, and in the air—from the arctic to the tropics, TURNER stands up and delivers intelligibility under varying acoustic conditions.

**22 D Dynamic** A top-performing general utility microphone with high level dynamic cartridge. Reproduces smoothly at all frequencies. Has a range of 40-8,000 cycles with output of -54DB. Available in 200 or 500 ohms or high impedance.

Write for FREE  
TURNER Catalog

### 999 Balance Line Dynamic

Especially engineered for those who insist on professional results under all conditions. Voice coil and transformer leads insulated from microphone case. Line is balanced to the ground. Range 40-9,000 cycles with output of -52 DB. Available in 200 or 500 ohms or hi-impedance.

*Crystal Microphones Licensed Under Patents of the Brush Development Company*

**THE TURNER CO.**  
CEDAR RAPIDS, IOWA

# INDUCTORS

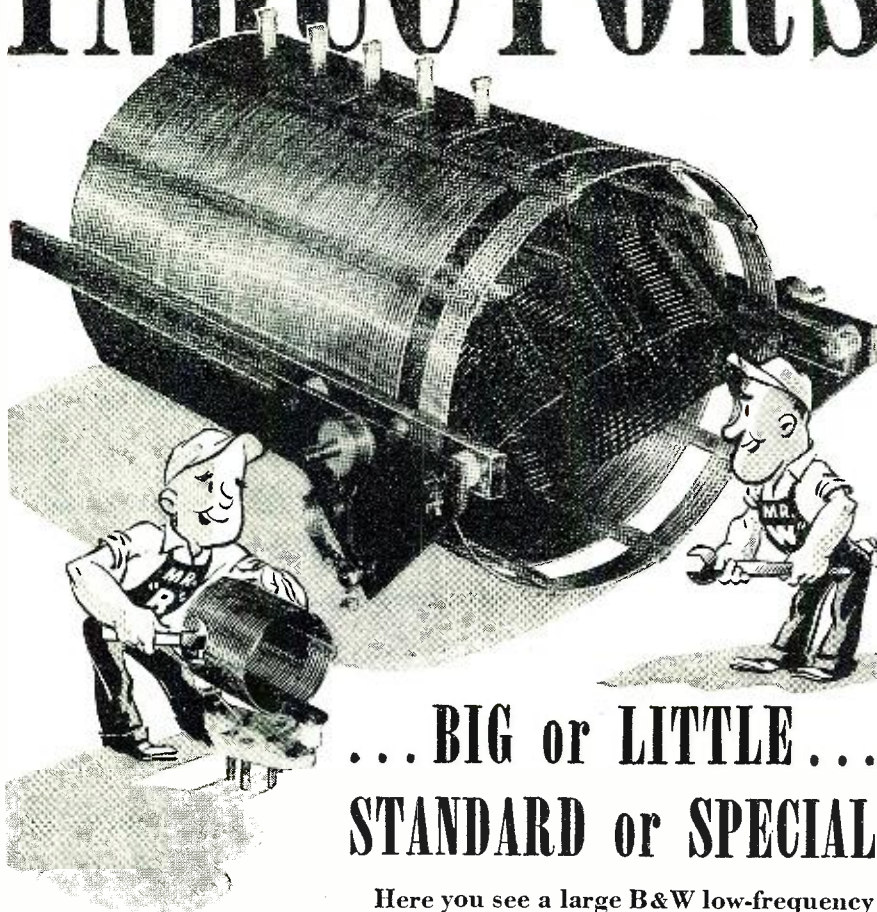

## ... BIG or LITTLE ... STANDARD or SPECIAL

Here you see a large B&W low-frequency variometer-type inductor, tailor-made for a war equipment application, compared in size to the B&W 75-watt "Junior" of amateur radio fame. If a 25-watt "Baby" were put in the picture you'd hardly see it—and some of the new coils just coming off B&W production lines are many times smaller than that!

The point is that B&W offers inductors in the broadest assortment of shapes, sizes, and types on the market today. Whatever your requirement, write for recommendations and suggestions.



**BARKER & WILLIAMSON**  
235 FAIRFIELD AVENUE      UPPER DARBY, PA.

Export: LINDETEVES, INC., 10 Rockefeller Plaza, New York, N. Y., U. S. A.

cillator frequency, connect the amplified vertical-input terminals of a cathode-ray oscilloscope to the secondary terminals of  $T_2$  (the latter winding being disconnected from the bridge circuit). Connect a variable-frequency audio oscillator to the amplified horizontal input terminals of the oscilloscope, and switch off the internal sweep oscillator of the 'scope. To locate the frequency of the bridge oscillator, tune the audio oscillator slowly until a *stationary* circle or ellipse appears on the oscilloscope screen. At this point, the frequency of the two oscillators are the same and this value may be read on the dial of the variable-frequency audio oscillator. Frequency corrections may be made by altering the values of the parallel-T network components,  $C_1$ ,  $C_2$ , and  $C_3$ —or  $R_1$ ,  $R_2$  and  $R_3$  being raised or lowered together.

**Bridge Circuit.** Reconnect the secondary of  $T_2$  to the bridge, and switch on the instrument.

(1) With no external capacitor connected to terminals X-X, and with  $C_6$  set at half-scale and  $C_7$  at minimum, plug a pair of high-resistance headphones into jack J. ( $S_1$  may be in either position.) A strong 1000-cycle tone signal will be heard.

(2) Now, advance  $C_7$  to maximum capacitance and vary  $C_6$  slowly. A null point will be found near the maximum capacitance setting of  $C_6$ . This null may be made quite sharp by switching  $S_1$  to the STD position and adjusting  $R_1$  for a resistive balance. After balancing the bridge as sharply as possible in this manner, mark this as the zero setting on the  $C_7$  dial.

(3) Connect an external capacitor of not more than 400- $\mu$ fd. value to terminals X-X and note that the bridge immediately is unbalanced (null being lost). Reduce the setting of  $C_7$  until another null point is located, and proceed as before with adjustments of  $S_1$  and  $R_1$  to achieve a resistive balance.

The dial may be calibrated in several ways. (1) By successively connecting to the X-X terminals numerous capacitors of known value, resetting the  $C_7$  dial to null for each, and marking the known capacitor values on the dial. (2) If it is known that the variable unit  $C_7$  is of good straight-line capacitance design and that its maximum capacitance is 500, the initial null point, obtained in the manner described under (3), may be marked zero. A capacitor of exactly 450  $\mu$ fd. is then connected to X-X and the bridge rebalanced, this new null point being marked 450 (corresponding to a capacitance change of 500 - 50 or 450), and the dial circumference then marked off into a number of equal subdivisions to cover the 0-450- $\mu$ fd. range. Beyond this 450 point (or beyond a 900 point if  $C_7$  is 1000  $\mu$ fd. or higher maximum capacitance), the capacitance curve for  $C_7$  will depart from linearity and will require special dial markings which may not be obtained simply by subdividing the space be-

### NOTE THESE ADVANTAGES OF B&W "AIR WOUND" CONSTRUCTION

- Weigh less
- Mount easier
- Less susceptible to damage
- Offer greater design adaptability
- Wound to uniform pitch
- Exceptionally low dielectric loss



**MAKE MORE MONEY**

**IN Radio TELEVISION & ELECTRONICS**

**Now!**

**GET THESE 3 BOOKS**

**FREE!**

You men already in radio know how great the demand is for trained, experienced service men, operators and technicians. You know how fast the field is growing and how important it is to keep up with developments—FM receivers, television, electronics.

Or even if you are merely INTERESTED in radio as an amateur, you must recognize the WONDERFUL OPPORTUNITY right within your grasp to cash in on your natural talent. Make it pay dividends. Get into the EXPERT RADIO SERVICE Line. Be a TELEVISION specialist—OWN A BUSINESS OF YOUR OWN. Fill out and mail the coupon below for all the details.

**Get the Latest Inside Information—  
Trade Secrets by**

**SHOP-METHOD HOME TRAINING**

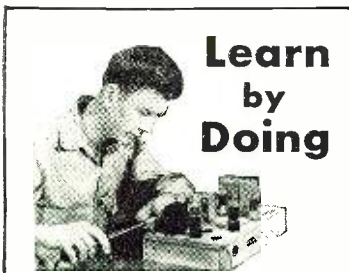

**Learn by Doing**

Use Actual Radio Equipment Furnished With Your Course

Experience is the best teacher. You learn by experience with the exclusive National Shop-Method of Home Training—actually build many circuits and do experiments with the big kits of standard radio parts included in your training equipment at no extra cost to you.

In the course of your study you actually build various types of receivers—a powerful superheterodyne, a signal generator, an audio oscillator and others. You make tests and conduct experiments that show you the why and how of things. You understand what makes the various elements of electronics operate because you actually see them work for you. Not only do you gain marvelous actual experience by this method of learning but you have valuable equipment you will use on the job in the practice of your profession. Fill out the coupon immediately while you are thinking about it and drop it in the mail at once.

Now the famous National Schools brings its exclusive Shop-Method of training right in your own home. You can learn the most up-to-date, approved projects, systems and hook-ups step by step in your spare time. This is the sound, practical training you want and need—the development of experienced instructors working with thousands of students right in the shops and experimental laboratories of National Schools—one of the most advanced trade educational centers of the world.

This is the MODERN SYSTEM OF TRAINING. It matches the rapid progress constantly being made in radio, television and electronics. It is TIME TESTED too. National Schools has been training men for more than a third of a century. In essence this is the very same training that has helped thousands to more pay and greater opportunity. You owe it to yourself—your future—to read the book 'Radionics'—FREE to you when you send in the coupon.

**National Trained Men Now Making the Best Money in History**

The real value of National training shows up in the quick progress our men make on the job. Joe Grumich of Lake Hiawatha, N. J., turned down a job most men would welcome. He writes: "My latest offer was \$5,800.00 as radio photo engineer, but I am doing well where I am now engaged. I am deeply indebted to National."

Ely Bergman, now on Station WOR, told us: "My salary has been boosted considerably and at the present time I am making over \$3,000.00 per year, thanks to National Training." And from the far-off Hawaiian Islands, Wallace Choi sends this: "I am averaging \$325.00 a

month. I will say that I honestly owe all this to the excellent training I had at National."

National is proud of the progress graduates are making all over the world. Read about their records yourself in the books we send you FREE.

**Make Extra Money Right From The Start**

You get ahead fast with National Training. Many beginners make good money on the side fixing radios and doing service work. You can turn your knowledge into cash after the first few lessons. Progress is rapid. You can actually SEE YOURSELF GET AHEAD, because the National Shop Method is so sound and practical.

Now, right now, is the time to grasp the opportunity of today—a successful career for tomorrow. Get into the big money, rapid advancement, a position of importance. A BUSINESS OF YOUR OWN. Radio, television and the whole field of electronics invites you. The industry is crying for trained men everywhere. A rapidly expanding industry—probably the greatest in history—holds out the promise of a rich future—prosperous security.

**Train While You Are In Service**

Prepare, right now, while you are in uniform, for a glorious secure future in the field of radio and televi-

1. A complete catalog describing the industry and the extensive training facilities of National Schools.
2. You receive a sample lesson illustrating the modern "Shop Method" instruction technique.
3. The vast opportunity field of Electronics, "The Dawn of a New World," is revealed in this fully illustrated book recently published.

...sion when the war is over. Make good use of your spare time by taking your National Training now. Men in our armed service, or about to enter, get better ratings and more pay almost right from the start if they are trained in radio, television and electronics. The government needs experienced men in nearly all branches of the service. Prepare for present advancement and a sound future. Learn how easy it is the National way. We are so enthusiastic because we have seen the marvelous results of National Shop Method Home Training. Send in your coupon today and see for yourself.

**NATIONAL SCHOOLS**

LOS ANGELES 37, CALIFORNIA EST. 1905

**MAIL OPPORTUNITY COUPON FOR QUICK ACTION**

National Schools, Dept. 9-RNR

4000 South Figueroa Street, Los Angeles 37, California

(Mail in envelope or paste on penny post card)

Mail me FREE the three books mentioned in your ad including a sample lesson of your course. I understand no salesman will call on me.

NAME..... AGE.....

ADDRESS .....

CITY..... STATE.....

Include your zone number

**FREE LESSON INCLUDED**

Examine the exclusive National Shop Method of Home Training see for yourself how sound and practical it is. Be convinced that you can learn radio—electronics, television—quickly and easily in your spare time. You can't tell until you try. This trial is ABSOLUTELY FREE. And you may keep all the valuable material we send you without any obligation of any sort. Fill out the coupon immediately while you are thinking about it and drop it in the mail at once.

Thousands of men in the Army Navy and Coast Guard have trained at National under U. S. Government sponsorship.

You are the man who must be satisfied.

Mail the coupon here for the three books that tell you the complete story of the marvelous new system of training in radio electronics and television. Learn the facts of this exclusive shop-method of home training. See for yourself! DECIDE FOR YOURSELF!

# NEED PARTS?

National can supply you quickly with most of those hard-to-get parts at exceptional prices. Take a look at these bargains—

STANCOR MIDGET OUTPUT TRANSFORMERS, L6 to 3-6 Ohms. Mounting strap center 1 1/2" ..... Each, 55c; 10 for \$4.95

10 WATT PIGTAIL WIREWOUND RESISTORS—500, 1000, 1250, 1500, 1750, 2000, 2500, 3000, 4000, and 5000 ohm sizes in stock ..... Each, 24c; 10 for \$2.19

AERIAL KIT containing aerial wire, rubber coated lead-in, insulators, ground clamp, window strip, etc ..... Each, 89c

20 MFD 150 WV Tubular Pigtail Electrolytic, One Year Guar. .... Each, 35c; 10 for \$3.30

10 MFD 450 WV Tubular Pigtail Electrolytic, One Year Guar. .... Each, 43c; 10 for \$3.95

Deluxe assortment of 50 Bakelite Set Screw Knobs for 1/4" Shaft ..... Kit, \$4.19

100 Ohm (Tapped at 30) WIRE WOUND CEMENT COATED RESISTORS 30 Watt. .... Each, 45c; 10 for \$3.90

50 MFD 150 WV Tubular Pigtail Electrolytic, One Year Guar. .... Each, 49c; 10 for \$4.45

ASSORTMENT OF 147 FIRST LINE 600WV TUBULAR BY-PASS CONDENSERS CONSISTING OF 64 .01-600WV, 32 .02-600WV, 24 .05-600WV, 27 .1-600WV. One Year Guarantee. List Price, \$33.30. **\$11.95**  
Your cost only.....

Assortment of 200 pcs. Special Radio Hardware including Tube Sockets, Terminal Strips, Grid Caps and Plugs ..... Kit, \$1.49

20x20/150WV Tubular Electrolytic. First Line Condenser. One Year Guarantee. .... Each, 61c; 10 for \$5.60

Assortment of 100 1/4 and 1/2 Watt RMA Color Coded Carbon Resistors, including 5, 10 and 20% Tol. .... Your Cost Only \$1.89

BALLAST TUBES — K42B, K42C, K49B, K49C, K55B, K55C, L49B, L49C, L55B, L55C ..... Each, 45c; 10 for \$3.99

100-37, 100-70, 100-77 and 100-79. .... Each, 59c; 10 for \$5.45

Continental Bakelite Suppressors — S19A (Straight type with Rajah spring snap-on connector, fits all makes of spark plugs. Terminal nut cable connector). .... Each, 18c; 10 for \$1.65

GENERATOR CONDENSER—Universal type with six inch lead. 5MFD 200WV. .... Each, 18c; 10 for \$1.65

HI-TEMP RUBBER PUSH BACK WIRE—Solid and Stranded (#20). 100 Ft. Roll, 71c; 10 for \$6.50

Assortment of 46 First Line Tubular Electrolytic Condensers most frequently used, consisting of 1 100MFD 25WV, 2 10MFD 50WV, 15 20MFD 150WV, 8 20-20MFD 150WV, 6 50MFD 150WV, 10 10MFD 450WV and 4 10-10MFD 450WV. One Year Guar. Your Cost Only.. **\$18.95**

Kela 8" Auto Spkr. 6 Ohm Field, Copper Hash Buckler plate. A Beautiful Job. Delco Part No. 7242532. .... Each, \$1.15; Lots of 16, 99c each

LOCTAL SOCKETS — (Metal Supporting Ring) ..... 10 for \$1.10; 100 for \$9.99

10 MFD 50WV Tubular Pigtail Electrolytic Condenser. One Year Guar. .... Each, 28c; 10 for \$2.45

10x10/450WV Tubular Electrolytic. First Line Condenser. One Year Guarantee. .... Each, 74c; 10 for \$6.90

Assortment of 25 Muter Candohm Wire Wound Resistors (All are 7 to 15 W, 15 or more are between 100 and 500 Ohms). .... Assortment, \$4.99

20% Deposit required on all C.O.D. orders. Don't forget L-265 or AA-3 Certificates. Orders of \$25.00 or more, accompanied by payment in full, will be shipped prepaid.

Free Bulletin No. 106 lists hundreds of other radio parts and supplies. Write for it today!

**NATIONAL ELECTRONIC SUPPLY**

77 W. Washington Blvd. Chicago 2, Ill.

tween two known points. If a 1000- $\mu$ fd. variable is employed at  $C_1$ , the test capacitor should be 900  $\mu$ fd. and its corresponding null point on the dial will be marked 900  $\mu$ fd. (3) If the builder has access to a capacitance bridge or similar instrument, he may calibrate  $C_1$  throughout its entire range by connecting this instrument to terminals X-X and setting the  $C_1$  dial to various spot capacitance values as determined by settings of the capacitance bridge. If this method of calibration is employed,  $R_{10}$  must be disconnected temporarily from  $C_1$ . Direct capacitance points will be obtained by this method, and each such reading must be subtracted from the maximum capacitance of  $C_1$  in order to obtain the proper figures for the  $C_1$  dial. A last method which will suffice in a few cases is to obtain from the manufacturer of  $C_1$  an average capacitance-vs.-degrees rotation curve for this type of capacitor, and to derive from the direct capacitance values along this curve the  $C_1$  dial values (in the same manner as just described under method 3).

## Operation

Once the main dial ( $C_1$ ) has been calibrated, operation of the capacity meter is reduced to the following simple steps: (1) Setting the bridge initially to zero by adjusting trimmer  $C_2$  for null, with the main control  $C_1$  at zero on its dial; (2) connecting the test capacitor (10 to about 475  $\mu$ fd. for a  $C_1$  value of 500  $\mu$ fd.) to the terminals X-X; (3) readjusting the  $C_1$  dial to null and reading the unknown capacitance value directly from this dial; and (4) making the necessary resistive balance. When making the initial null adjustment, throw switch  $S_1$  to position X and adjust  $R_{11}$  for zero null; however, when balancing with the test capacitor in place, throw  $S_1$  to the STD position and readjust  $R_{11}$  for zero null.

Most test capacitors will be held to the X-X terminals by their own pigtail leads. Occasionally, however, measurements will be performed upon capacitors, tubes, terminal blocks, etc., requiring the connection of wire leads between the terminals and the sample. In these cases, capacitance between the connecting leads must be taken into account, since it will be effectively in parallel with that of the test sample. But this stray capacitance may be compensated automatically in the initial zero adjustment by connecting the leads to be used (minus the sample capacitor) bent in the same approximate position they will occupy when the capacitor is connected to their far ends. The initial zero balance will then be in terms of the total tuning, stray, and terminal capacitances.

The capacity meter circuit may be employed with slight alterations for measurement of larger or smaller capacitance values than those accommodated by the author's model. By increasing  $C_1$  to 1000 or 5000  $\mu$ fd., the range will be increased proportionately. Similarly, by reducing the

maximum value of  $C_1$  (say to 100, 50, or even 10  $\mu$ fd.), the instrument will accommodate smaller capacitances.

For most purposes, the 1000-cycle measurement will be entirely satisfactory, since the capacitance values at this frequency and at r.f. are not sufficiently different to warrant special radio-frequency measurements except in the most exacting applications. For 60-cycle tests, the oscillator-amplifier section may be replaced by a 50-volt transformer secondary; for 120-cycle operation, a signal of this frequency may be obtained (in lieu of the oscillator-amplifier) through coupling capacitors from the unfiltered section of a power supply delivering at least 50-volts r.m.s.; and for higher frequencies, the parallel-T network resistance and capacitance values may be altered. The formula for this operation is  $f = 1/(6.28 C_1 R_1)$ ; where  $f$  is in cycles per second,  $R$  in ohms, and  $C$  in farads.

-30-

## Transients and Time Constants

(Continued from page 60)

value, 4 ma. Hence a time constant is made long by a large L and a small R.

### Wave Shaping Application of L/R Circuits

The fifty cycles per second square wave may now be applied to the circuit of Fig. 7a. Here the time constant of 1,000 microseconds is short, for it allows the resistor voltage to reach a final steady value within the time of one-half cycle. The coil voltage is a peaked wave, a.c. This circuit is differentiating, yielding the same output wave shape as the differentiating RC circuit. Distortion of the square wave into the peaked wave is due to the loss of low frequency harmonics, for these low frequencies will meet less coil reactance and will yield a smaller coil voltage as compared to the high frequency output response. The rectangular wave used in Fig. 3b can be ap-

Fig. 6. The rise and fall of a current through an inductor as the potential is momentarily turned on or off.

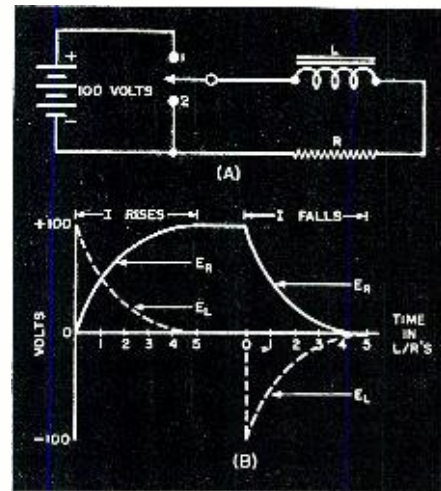

**MORE** small and medium  
**TRANSFORMERS**  
**AVAILABLE**

**because production facilities have been  
expanded AGAIN**

More rapid delivery is now possible because an additional expansion of production facilities has made possible the increased manufacture of Consolidated's well-known small and medium transformers. These transformer types include Pulse Transformers, Power Transformers, Solenoid Coils and Search Coils. Other products include Range Filters and Headsets.

Consolidated engineers will also design transformers for special applications or will build to your specifications.



*Electronic and Magnetic Devices*  
**CONSOLIDATED RADIO**

*Products Company*  
350 W. ERIE ST., CHICAGO 10, ILL.

plied to the same L/R circuit used above, yielding peaked waves across the coil.

Since the circuit differentiates, it might be expected that a triangular wave applied to it would yield a square wave across the coil. This is true, and is shown in Fig. 7b. Note that the current wave,  $E_r$ , follows the applied triangle closely but always lags it. A current lag is natural to an inductive circuit. Similarly, the sawtooth wave of Fig. 4c, differentiated by the L/R circuit above, will result in a rectangular voltage across the coil.

It will be remembered that integration, passing from a square wave to a triangle, involves the use of a long time constant. A long L/R time constant needs a large inductance and small resistance. The time constant must be sufficiently long to allow only the linear portion of the rise and fall of resistor voltage to take effect. When the square wave is applied to the circuit of Fig. 7c, whose time constant is 50,000 microseconds, the output across the resistor is a triangular wave. Here the high frequency harmonics are blocked from the output, leaving the low harmonics to make up the triangle, the next step toward a sine wave. The rectangular wave of Fig. 7d results in a sawtooth resistor wave, after integration by the same long time constant.

### Conclusions

Although wave shaping can be produced by either an RC or L/R circuit,

several important differences exist. The principal advantages of the RC circuit are:

- 1) It is simpler, lighter and cheaper, therefore more prevalent.
- 2) The differentiating circuit can be used as coupling between two vacuum tube stages, because the input condenser effectively blocks the d.c. voltage of a previous tube from the succeeding grid circuit.
- 3) The differentiating RC circuit automatically insures a low impedance output across the resistor, which can be made small for a shorter time constant.
- 4) The integrating circuit insures a high impedance output because the output contains mostly the low harmonic frequencies across the condenser.

The L/R circuit enjoys the following advantages:

- 1) The differentiating circuit yields a high impedance output, only the higher frequencies predominating across the coil output.
- 2) The integrating circuit results in a low impedance output, for this output is taken across a resistor whose value is relatively small.
- 3) The principal advantage of the L/R circuit is that the triangular or sawtooth wave obtained in the output of the integrating circuit is a resistor voltage, hence a linear change in current. This linear rise or fall of current finds its greatest application in magnetic sweep circuits using coils

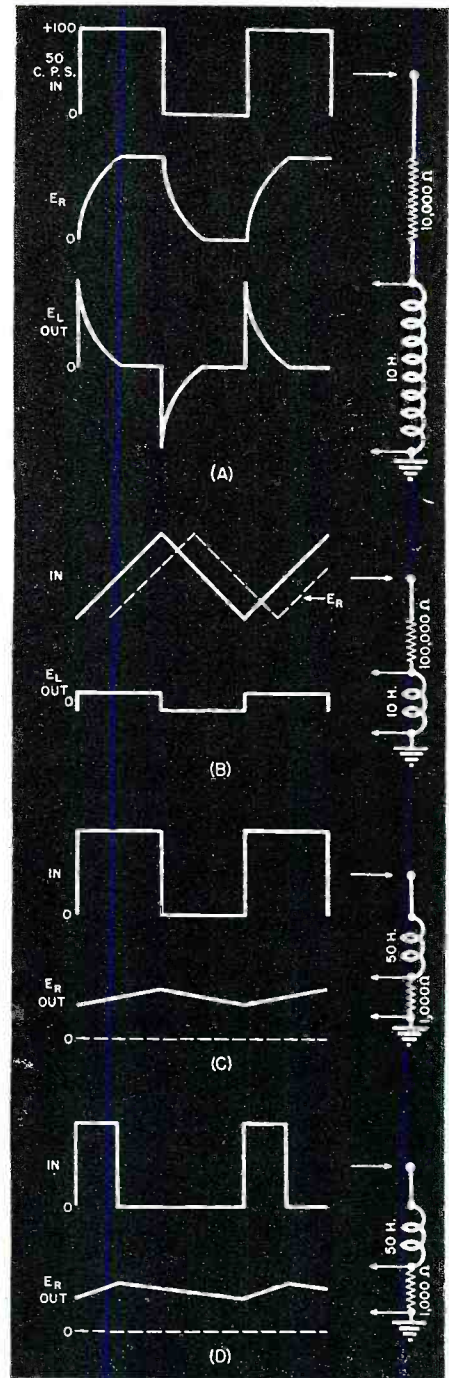

Fig. 7. Wave shaping by means of L/R circuits. (A) By applying a 50 cycles per second square wave, the time constant is short for it allows the current to reach a final steady value within the time of  $\frac{1}{2}$  cycle. Distortion of the square wave into the peaked wave is due to the loss of low-frequency harmonics. (B) By applying a triangular wave to the L/R circuit, the output will be a square wave. (C) By applying a square wave to the circuit whose time constant is 50,000 microseconds, the output across the resistor is a triangular wave. (D) Saw-tooth wave is obtained from the application of a rectangular wave.

as the mechanism to deflect the electron beam of a cathode-ray tube. This linear change in current guarantees a linear change in the magnetic field deflecting the electron beam.

# If you want

- CRYSTALS
- CABLES
- HARNESSES
- ELECTRONIC ASSEMBLIES
- CABINETS

Telephone Peru, Indiana

## 151

*Serving the Radio and Electronic Industries with precision engineered products.*

# Wm. T. WALLACE MFG. CO.

General Offices: PERU, INDIANA  
Cable Assembly Division: ROCHESTER, INDIANA

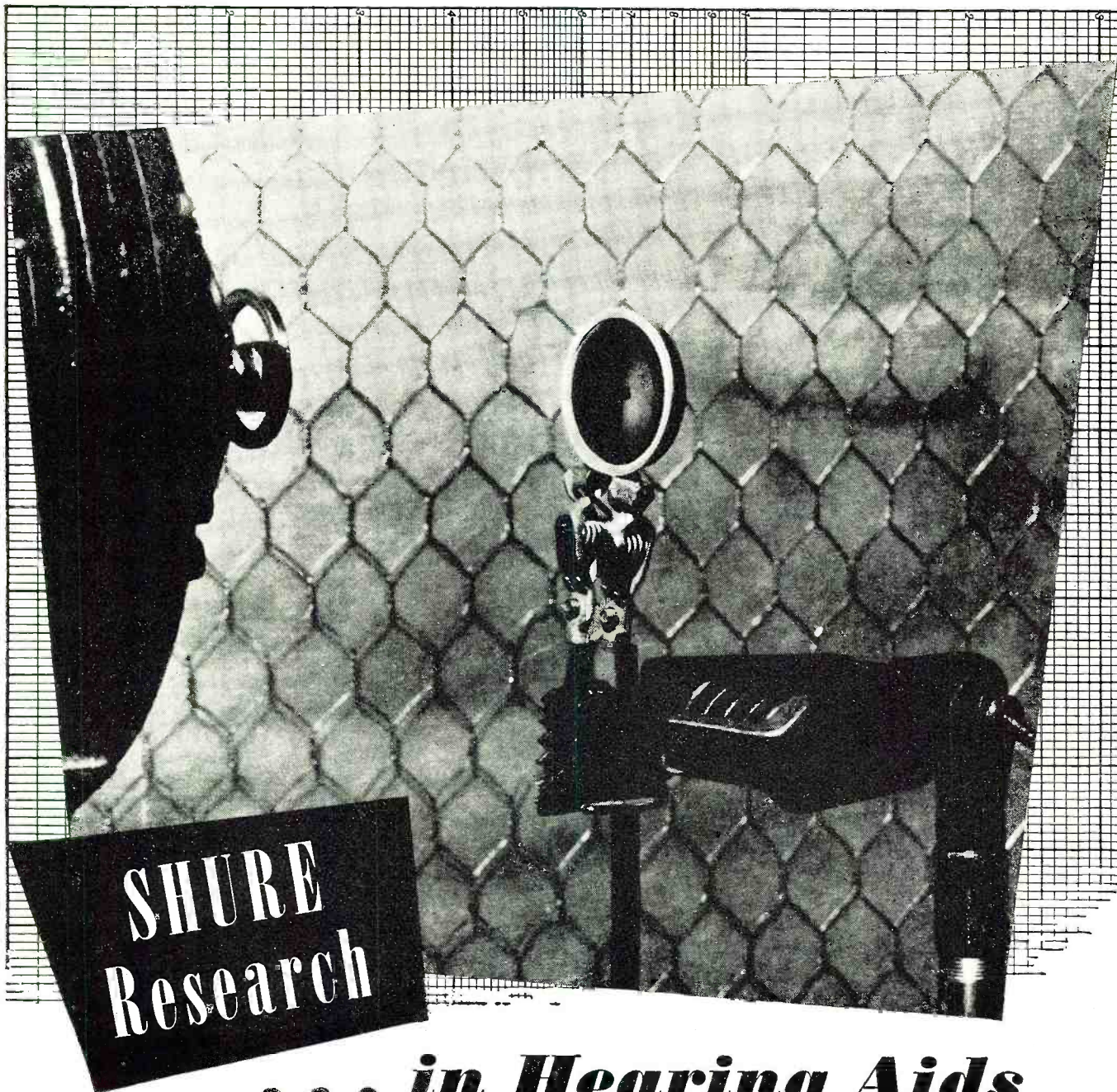

**SHURE**  
**Research**

## ... *in Hearing Aids*

A vital component of the Hearing Aid is the Microphone which must be small, light, moisture-proof and possess the frequency response adapted to the Hearing Aid Device. Often the Microphone must be chosen to fit the threshold of hearing of the patient. Shure Research has succeeded so well in controlling the frequency response and output level of small size Hearing Aid Microphones that, today, Shure Brothers produces microphones for practically every major manufacturer of Hearing Aids.

**SHURE BROTHERS, 225 West Huron Street, Chicago**  
*Designers and Manufacturers of Microphones and Acoustic Devices.*



## Saga of the Vacuum Tube

(Continued from page 47)

the presence of pure gases was not harmful, and from this work came the high-efficiency, gas-filled incandescent lamp.

During the period just before Alexander brought the Audion to his attention, Langmuir had been studying the properties of filaments as a function of their length. It was thought at the time that with long filaments, requiring a comparatively high voltage for their operation, there might be a considerable amount of

current flowing through the vacuum space and hence, for the same total current into the lamp, the actual filament current might be less and the lamp less efficient. Langmuir looked for this effect but could not find it. That is, in well-exhausted lamps there was a negligible space current, regardless of the length of the filament. Others had worked along this same line and were of the opinion that in a perfect vacuum there would be no space current.

One of these others was Dr. Coolidge, who was working on X-ray tubes. In the old-fashioned X-ray tube of high power most of the electrical energy supplied to the tube appeared

at the anode, which would operate sometimes at white heat. Coolidge used tungsten for the anode and in some cases tried tubes with tungsten cathodes as well. In the case of the tungsten cathodes he found that after the tube had been in operation for some time the cathode also became white hot, and shortly thereafter the tube ceased to pass current and became inoperative. Coolidge was aware of the "clean-up" effect of white-hot tungsten and believed that the stoppage of the tube was caused by its becoming too "hard," that is, the vacuum had become too high to permit the passage of current. Langmuir's own experimental work indicated that these currents would become very small when the highest vacuums, obtained by thoroughly baking the lamps to free them from occluded gases, were attained.

On the other hand, Langmuir was familiar with the work of O. W. Richardson on thermionic emission, which showed that thermionic emission increased with temperature.<sup>190</sup> Calculations based on Richardson's equations indicated that at the temperature at which Langmuir was operating his tungsten filaments the thermionic currents should have been hundreds of amperes per square centimeter of filament surface. He checked the discharge from a hot filament to a cold anode in the presence of mercury vapor and found that the space current followed Richardson's law up to very high filament temperatures. Hence, he concluded that there was nothing abnormal about tungsten and that the filaments actually were emitting electrons in accordance with Richardson's law.

The ordinary tungsten lamp of that time had a long zigzag filament of six loops, with two leads brought out and connected to a base for use in a standard screw type socket. Langmuir had made some experimental lamps in which two additional leads, connected to intermediate points on the filament, were brought out. These leads were placed so that between any two consecutive leads there were two loops of filament. These lamps were exhausted by the ordinary procedure, but Langmuir then proceeded to raise the middle two loops of the filament to a very high temperature and vaporize the tungsten, so as to "clean-up" the vacuum. The act of vaporizing the tungsten assists in the removal of some of the residual gases. The tungsten vapors will combine with nitrogen, oxygen, carbon monoxide, and carbon dioxide, and these are the gases which are likely to be present in the bulbs. When this was done, and the middle portion of the filament burnt out, there were left two sections of filament electrically separated from each other, between which a voltage could be applied.

Langmuir then heated one filament by passing a current through it, and applied a voltage between that filament and the other which was cold. He measured the space current as a

## Keep that date with "ROSY FUTURE"



### Mr. Dealer—Sell Now for Post War!

*Nothing to sell? Don't kid yourself!*

True—your business today is mostly service, your servicemen are busy calling on customers—folks are bringing defective appliances into your store for repair. That's good business.

It's also good business to ask your service customers what type radios, phonographs or appliances they will buy when the war ends. Jot it down in your notebook. Then—when "Delivery Day" comes, you'll have your own list of ready made customers.

We'll be glad to supply a "Rosy Future's Date Book" for each of your servicemen—free. Simply request them. Then—start post war selling—make every service call a sales call.

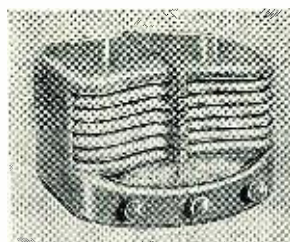
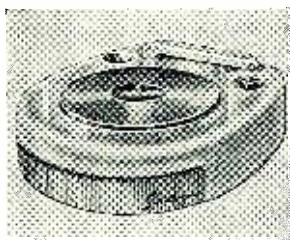

**Will you be ready?**  
28% of all radios need repair, 15% won't work at all according to recent W'PB report. Meck Radios and Phonographs will be beamed straight at this post-war market and they'll be "Built to Perform—Priced to Sell!"

DISTRIBUTED NATIONALLY THROUGH RADIO EQUIPMENT JOBBERS

**MECK** RADIOS AND PHONOGRAPHS  
★ ★ ★  
INDUSTRIAL SOUND EQUIPMENT

**JOHN MECK INDUSTRIES, PLYMOUTH, INDIANA, U. S. A.**

New York 18: 500 Fifth Ave., Chickerling 4-3545 • Chicago 11: 540 N. Michigan Ave., Delaware 1561

# Obvious Quality

## VISUAL

Clean cut mechanical nicety literally radiates from these UNITED mercury rectifiers. It is only natural that their eye appeal impresses the exacting minds of so many government and commercial engineers.

## TEST

The physical ruggedness and sterling workmanship in these tubes reveal the kind of care and precision that has entered into the electrical phases of their design. They are criterions, rather than ordinary conformers to the constantly stiffening Army and Navy test specifications—both mechanical and electrical.

## SERVICE RECORDS

Representative service records maintained over a period of 10 years by large users prove an average of many thousands of hours satisfactory operating life.

THERE IS NO SPECULATION IN CHOOSING UNITED  
MERCURY RECTIFIERS

# UNITED

## MERCURY RECTIFIERS



UNITED ELECTRONICS COMPANY • NEWARK 2, N. J.

Transmitting tubes exclusively since 1934

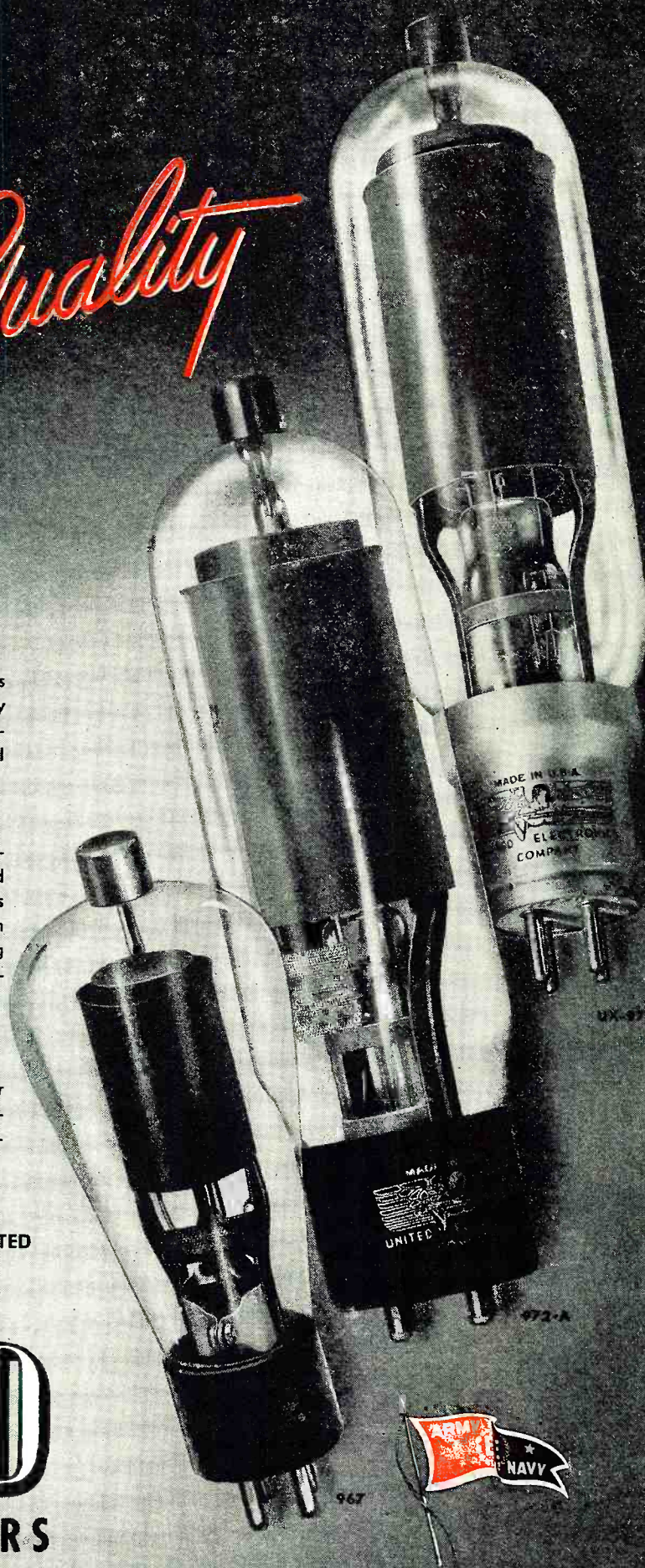

The UNITED types illustrated will interchange with and replace other type tubes as follows:

USE UNITED TYPE 967	to replace PG-17
" " " 972-A	" " 872-A
" " " UX-973	" " 873-A
" " " 973 (Not illustrated)	873



# War Gem Today

WHAT WILL THE QUARTZ CRYSTAL DO TOMORROW?

The fabled princes of Hindustan or the wealthy Nizam of Hyderabad never owned a gem more valuable.

The quartz crystal is doing more than rubies or emeralds to protect our way of life against the aggressor.

Cut into tiny wafers the quartz crystal is performing with merit wherever fixed radio frequencies are a "must".

Federal is mass producing frequency control crystals for military use. How many difficult jobs they are doing is a war secret. But their versatility is unlimited.

Even now — in the great FTR research laboratories — men are finding new uses for

quartz crystals — pointing the way to widespread industrial and civilian use after the war is won.

Not alone in communications — but in such widespread applications as precision timing and measuring devices, television, supersonics, pressure gauges, filters, generators, induction heating devices and automatic control equipment, crystals will find new uses . . . a war gem will become a peacetime servant.



*Megatherm, Federal's pioneering induction and dielectric heating equipment, is giving outstanding production line performance in the metals, plastics, food, textile and other industries.*

To achieve mass production Federal has installed new machinery and new methods to speed crystals on their way to war—and will continue to be a leader in crystal production. Now is the time to get to know Federal.

*Federal Telephone and Radio Corporation*



Newark 1, N. J.



function of temperature for various filament temperatures and compared the results obtained with values calculated according to Richardson's law. He found that at first the space current followed the law, but as the temperature increased the space current tended toward a constant value. This always occurred, although the limiting value was different for different voltages between the hot and cold electrodes. He found that this limiting current was approximately proportional to the voltage difference between the hot and cold electrodes, and to the area of the anode.

He discovered also that a potential applied to the bulb externally affected the space current. If, for example, he placed one hand on the bulb and with the other hand touched the terminals of the d.c. power circuit in the laboratory, the space current increased or decreased.

By November 22, 1912, Langmuir had accumulated enough data to enable him to formulate a qualitative theory concerning the space current. This theory, as entered in one of his notebooks under that date, was as follows:

*"New Theory of Edison Current. The velocity of electrons in a conductor corresponds to that produced by a fall through a potential diff. (sic) of only a few tenths of a volt. Electrons leaving a filament will leave irrespective of the presence of a field, but they will only travel a very short distance if there is an electric field of only 0.1 volt per centimeter against them. Hence, around filament there is an atmosphere of electrons in equilibrium with the filament. Below a certain temperature the potential is determined by wires (i.e. electrodes) only.*

*"Above a certain temperature the concentration of electrons becomes so great that they determine the field. Hence, two laws: Richardson's at low and some other at high temperature.*

*"Cooling bulb has no effect when no gas molecules present, but if gas is there the molecules collide with electrons (which have the same velocities as those of the filament) and slow them up and make them move readily absorbed by the anode wires."*

This last paragraph was an attempt to explain the fact that the presence of gas caused an increase in the space current. This, we know now, was not the correct theory. The increase in current when the gas is present at high voltage is due to the fact that the positive ions formed, neutralize the space charge and allow the space current to rise toward the temperature saturation value.

These experiments threw an entirely new light on the theory of discharges from hot electrodes in very-high vacuums. It showed why, in the past, such small space currents were found under conditions where large currents were indicated by Richardson's equation.

Langmuir attached great importance to this explanation and theory, and proceeded to make a detailed

study of the laws governing the phenomenon under high-vacuum conditions. His first step was to have constructed another lamp in which were placed two independent filaments, both of which could be heated during the process of exhausting the bulb. The bulb of this lamp was baked at high temperature during exhaust and a liquid air trap was used to remove traces of water vapor and carbon dioxide. Thus Langmuir removed as much of the occluded gases as possible, and pushed the vacuum to the limit attainable with the available equipment.

Tests run on this new bulb were made using anode voltages up to 250 volts d.c. and about 500 volts a.c. When

the test data was plotted in a curve, the shape of the curve indicated that the space current varied as the 1.5 power of the voltage.

This, then, was the background of knowledge born of experience that enabled Langmuir to tell Alexanderson, in January of 1913, that he could improve the gadget which Alexanderson had obtained from Hammond, and make of it a device which would enable Alexanderson to do what he wanted. In order to do so Langmuir needed another assistant, and William C. White was assigned to this work. White studied the characteristics of the Audion and discussed the results of his tests with Langmuir.

While White was studying the



**For Good Jobs TODAY... TOMORROW... LEARN**

# RADIO ELECTRONICS

**DeFOREST'S A-B-C WAY**

DeFOREST'S prepares you for a wide range of interesting, good pay jobs in the fascinating Radio-Electronics industry.

**THE** fast-moving Opportunity Field of Radio-Electronics needs many trained men! Let us show you how to get ready to take advantage of the breaks—the good jobs—the satisfying pay checks of today, and the bright postwar opportunities of tomorrow. Write for DeFOREST'S big, free book—"VICTORY FOR YOU!"

You see how you may cash-in on a field that includes F. M. Radio, Communication Radio, Electronics, Broadcast Radio, Motion Picture Sound, Radio Sales and Service, or a Radio business of your own.

You see how DeFOREST'S has helped many get their start in Radio-Electronics—helped them to good pay jobs in essential industries—helped others to preferred military classifications with higher ratings and better pay. Helped others to full and part time sales and service businesses of their own. Mail the coupon NOW—TODAY! See how DeFOREST'S can help YOU get started toward this fascinating work by means of its effective "A-B-C" Training Method—in your spare time, at home.

### **A YOU GET INTERESTING, PRACTICAL LOOSE-LEAF LESSONS**

DeFOREST'S TRAINING includes 90 modern, well illustrated loose-leaf lessons, prepared under the supervision of one of the world's foremost Radio authorities, Dr. Lee DeForest—inventor of the Audion tube which helped make modern Radio possible.

### **B YOU WORK AT HOME WITH THIS PRACTICAL EQUIPMENT**

You "learn-by-doing" with eight big kits of standard Radio parts and assemblies—working out 133 interesting experiments to gain valuable experience at home. You experiment with Light Beam Transmission. You build and operate an Aviation Band Radio Receiver, Wireless Microphone, 5-tube Superheterodyne Receiver, an intriguing "Electric-Eye" device—and many other projects.

### **C YOU SHOW MOVIES AT HOME**

You use a genuine DeVRY 16mm Motion Picture Projector and Films to help you learn Radio faster, easier. Hidden Radio-Electronic action comes to life! You see Electricity in motion—*Electrons on the march!* DeFOREST'S also provides an effective EMPLOYMENT SERVICE which has long-established contacts with employers with whom we have placed many trained radio men. Act now! Mail the coupon! See how you may get ready to cash-in on both today's and postwar's promising future in the broad and exciting field of Radio-Electronics.

**Mail the Coupon TODAY!**

### **READ WHAT THESE DeFOREST MEN SAY!**

"Let me say that since being on this job I have many times expressed the fact that I wouldn't take a lot of money for the training I had from your organization. It has helped me immensely."  
—Richard Siroshak, Oklahoma.  
"Your course was the only important training I received in order to make the transition from a Radio-telegrapher to Radio Engineer with a fine salary."  
—Samuel Freedman, Connecticut.

"I have obtained employment with the ... Mfg. Company. You may be interested to know they speak very highly of DeForest's students, and state they have had excellent results with your men whom they have employed."  
—Clifford Taylor, Mass.  
"As a result of DeForest's Training, I am doing very well. If my income doesn't range between \$50.00 and \$75.00 per week, I figure something is wrong."  
—Lyle Kieley, Wis.

**DeFOREST'S TRAINING INCLUDES INSTRUCTION IN MOTION PICTURE SOUND EQUIPMENT F-M RADIO AND TELEVISION**



## **DeFOREST'S TRAINING INC., Chicago, Ill**

DeFOREST'S TRAINING, INC.  
233-41 N. Ashland Ave., Dept. R-10  
Chicago 14, Illinois

Please send me your "VICTORY FOR YOU" book and KIT FOLDER, FREE and without obligation.

Name ..... Age .....

Address .....

City ..... State .....

Check here, if under 16, for Special Information.



### Broadcasting Material Copied Accurately at Low Cost

A-PE-CO photo-copies of music, script and schedules or of wiring diagrams, and other engineering details give exactly the same correct and complete information quickly to all. The low cost of A-PE-CO photo-copy equipment justifies its installation in your office. That it is so easy to make A-PE-CO photo-copies is another practical advantage. A-PE-CO pays for itself in an amazingly short time.



ACCURATE AS A MIRROR  
PHOTO-COPIES  
MADE FAST BY  
ANYONE — ANYTIME

**A-PE-CO** "Photo exact"  
PHOTO-COPYER  
**\$55.00**

Legally Accepted Copies of

- Letters • Documents
- Records • Blueprints
- Pictures • Drawings

A-PE-CO photo-copies direct from anything written, printed, drawn or photographed—letters, legal documents, blueprints, receipts, graphs, tracings, telegrams, shop orders—up to 18"x22". A-PE-CO photo-copies are permanent and error proof. Thousands in use by industry, Government and engineers. Eliminate steno-copying, tracing, proof-reading.

No Camera—No Film—Easy to Use  
Employees learn quickly. Use A-PE CO on any table. Low cost per copy. Lowest investment. Immediate delivery. Write for A-PE-CO folder.

AMERICAN PHOTOCOPY EQUIPMENT CO.  
2849 N. Clark St., Dept. HK-94,  
Chicago 14, Ill.

Representatives in principal cities. In Canada: Railway and Power Eng. Corp., Ltd.

Audion, Langmuir had made up a tube similar to the Audion but with leads widely separated in order to enable him to apply high voltages during the exhausting process, and thus heat the electrodes by bombardment and free them from occluded gases. The results obtained were unsatisfactory and Langmuir decided to alter the construction of the tube in such a way as to facilitate the evacuation.

In order to accomplish this he abandoned the conventional Audion construction and made a three-electrode tube in which all three of the electrodes (filament, grid, and anode) were made of wire. The filament was made of 2.7 mil tungsten wire and was about 5½ inches in length. The grid was of 1.5 mil wire, hand wound on a glass frame. The anode was a zigzag wire 5 mils in diameter. The filament operated at about 2.5 amperes. This tube was known as "Tungsten Wire Audion No. 2" and is shown in Fig. 149.

This type of construction was adopted so that the electrodes could be heated by current from an external source during exhaust, in order to expel the occluded gases. This form of construction was used from March, 1913 until well into 1914 for all small tubes for operation at or below 250 volts, and somewhat longer for special tubes. Samples of tubes using this construction are shown in Figs. 150, 151, 152, and 153.

After this tube had been exhausted and sealed off the pump at a pressure of 0.05 micron it was subjected to numerous tests. In one case the anode voltage was held constant at 250 volts and the anode current measured as a function of grid voltage. Curves plotted of total space current showed that the space current obeyed the 3/2 power law. These curves are reproduced in Fig. 154.

This tube was also tested and functioned satisfactorily as a detector of wireless signals. Others made up shortly thereafter were also operated successfully when tested, in May of 1913, by Alexanderson for use as radio-frequency amplifiers.

While these experiments were under way, Coolidge was continuing his work on X-ray tubes. In December, 1912, Langmuir had discussed with Coolidge the results of his experiments and suggested that Coolidge try a tungsten cathode which could be heated by electric current from an external source, for the purpose of getting electrons in his X-ray tube. He told Coolidge that electrons were emitted from such filaments even in the highest vacuum, and that controlling the heating current would control the electron emission and the space current, independently of the applied voltage. Coolidge immediately proceeded to build an X-ray tube using an independently heated tungsten cathode of the type suggested. He used a tungsten anode, which he degassed by electron bombardment while the tube was still on the pump. He found it necessary to add a focussing shield around the

cathode, and with this addition obtained a tube which was steady in operation, with none of the crankiness of the old type of cold-cathode tube, and one with which he could obtain reproducible results. By December, 1913, Coolidge had developed this tube to the point of commercial use, and described it in a paper before the American Physical Society.<sup>191</sup>

### References

186. Report of the Federal Trade Commission on the Radio Industry. Government Printing Office—1924, pp. 14-16.
187. Alexanderson, E. F. W.—"Alternator for 100,000 Cycles." Trans. A.I.E.E., Vol. 28, Part 2, 1909, pp. 399-415.
188. Alexanderson, E. F. W.—"Magnetic Properties of Iron at Frequencies Up to 200,000 Cycles." Trans. A.I.E.E., Vol. 30, Part 3, 1911, pp. 2433-2454.
189. Alexanderson, E. F. W. and Nizhoff, S. P.—"A Magnetic Amplifier for Radio Telephone." Proc. I.R.E., Vol. 4, 1916, pp. 101-129.
190. Richardson, Owen Willans—See Proceedings of Cambridge Philosophical Society, Vol. 11, page 296 for preliminary note on this work.
- Richardson, Owen Willans—"The Electrical Conductivity Imparted to a Vacuum by Hot Conductors." Philosophical Transactions of Royal Society of London, A, Vol. 201, 1903, pp. 497-549. An abstract of this paper will be found in Proc. Roy. Soc. London, Vol. 71, 1903, pp. 415-418.
- Richardson, O. W. and Brown, F. C.—"The Kinetic Energy of the Negative Electrons Emitted by Hot Bodies." Philosophical Magazine, 6th Series, Vol. 16, No. 93, September 1908, pp. 353-376.
- Richardson, Owen Willans—"Thermionics Phil. Mag., 6th Series, Vol. 17, No. 102, 1909, pp. 813-833.
191. Coolidge, W. D.—"A Powerful Roentgen Ray Tube with a Pure Electron Discharge." Physical Review, 2nd Series, Vol. 2, No. 6, December 1913, pp. 409-430.

### CAPTIONS FOR ILLUSTRATIONS

Fig. 149. Langmuir's "Tungsten Wire Audion No. 2". Reproduced from Interference Record, Interference No. 40,380.

Fig. 150. Early type of wire element Pliotron, now in Science Museum, South Kensington, England. Photograph copyright by H. M. Stationery Office.

Fig. 151. Left—early Langmuir Pliotron complete. Right—element assembly on stem. Photograph courtesy General Electric Company.

Fig. 152. Early Langmuir Pliotron, before exhaust. This Pliotron has a grid of tungsten wire 0.4 mil in diameter, wound on a metal frame, with a pitch of 120 turns per inch. The anode is of 7 mil tungsten wire. Note the 5 leads, two filament, one grid, and both ends of wire anode. Exact date uncertain, but prior to 1917.

Fig. 153. Completed, based Pliotron, Type CA. Vintage of 1917. This is a high- $\mu$  triode. The filament takes 1.0 ampere at 3.5 volts. The usual plate voltage was 180 volts. Photograph courtesy General Electric Company.

Fig. 154. Characteristic curve of Langmuir "Tungsten Wire Audion No. 2". Reproduced from Transcript of Record, General Electric Company vs. De Forest Radio Company, U.S.C.C. of A., Nos. 3799, 3800, 3801, March Term, 1928.

(To be continued)

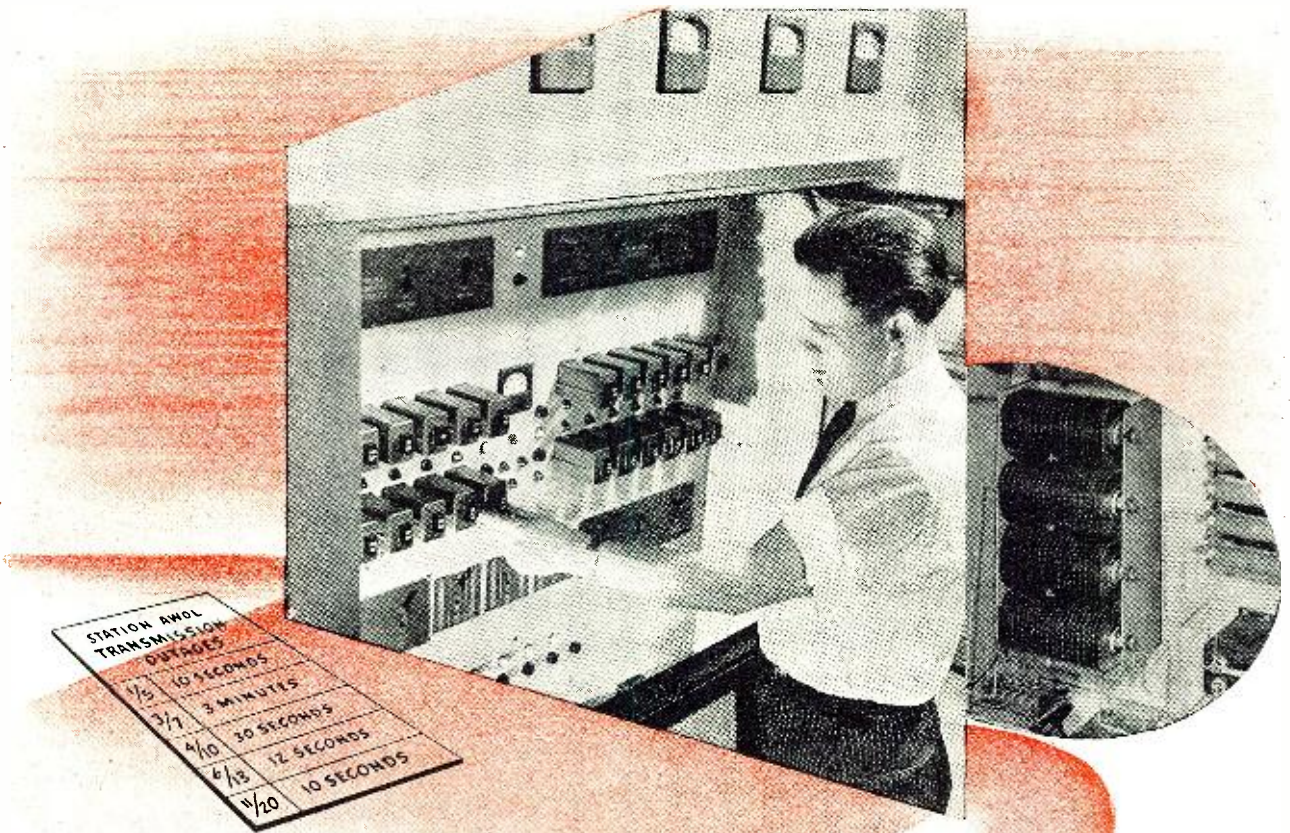

**CONSIDER** *Continuity of Operation*  
**WHEN YOU SELECT A NEW TRANSMITTER**

Off the air, right in the middle of a program—that's the nightmare of operating a radio station. That's when seconds seem like hours, and minutes like eternities. As though you didn't know!

Westinghouse Transmitters have been designed to cut program outage down to an almost unbelievable point. For example:

1. *Indicator Lights* show at a glance which circuit suffered an overload—even though the transmitter has returned to the air . . . making circuit checkup easy.
2. *Conservative Operation of All Tubes*—greatly increases reliability . . . lengthens tube life.
3. *Air-Cooled Tubes*—eliminate complicated and unreliable water cooling equipment.
4. *Surgeproof Metal Rectifiers* eliminate low voltage rectifier failures.
5. *Tube Life Meter* indicates the end of reliable tube life.

6. *Circuit Breakers* supply full overload and undervoltage protection automatically reducing length of outage.

We'll gladly give you complete information on these features, as well as other important advantages of Westinghouse Transmitters, such as: **Low Operating Cost, Simplicity of Control, High Fidelity Signals, Ease of Maintenance.**

**PLACE YOUR ORDER NOW  
 FOR YOUR POSTWAR TRANSMITTER.**

By placing your order today for a Westinghouse Transmitter, you assure yourself of the fastest possible delivery following the lifting of wartime manufacturing restrictions. We are scheduling deliveries in the sequence in which orders are received. For details, write Westinghouse Electric & Mfg. Company, Dept. 1NB, P. O. Box 868, Pittsburgh 30, Pa.

J-08079

**Westinghouse** RADIO DIVISION  
 PLANTS IN 25 CITIES . . . OFFICES EVERYWHERE



**A M • E L E C T R O N I C S • F M**

September, 1944

99

## Women Commandos

(Continued from page 27)

their own defense, when the time comes," said Colonel Lesniak. "They are naturally qualified for radio and communications work and are without question more adept in its operation than men."

Such a statement might be challenged if made by any other than a good-looking commandant—but who wants to disagree with a lady, especially a lady commando!

One of the P.S.K.'s favorite types of equipment is the same mobile field radio station they used under General

Maczek. It is the "Number 1-3." This set designed for Cavalry and Mechanized Service, resembles in its simplicity some of the characteristics of the famous U. S. Army mobile set known as the SCR-299. So compact, flexible and serviceable were the "Number 1-3" sets that even today they are being used as a part of the basic training course of the women commandos.

The most outstanding feature of this mobile field equipment, which at the time of its use in combat differed from that employed by armies of other nations, is the exceptionally easy calibration of the radio receiver and the stabilization of the transmitting device, without the necessity for using crystals. Another feature is that it can be

operated in motion without an antenna and yet cover a range of more than 30 miles.

Instruction pamphlets on the use of the set specifically state that the call letter should never be used more than three times when signalling a station. A single movement of the key by the operator giving the correct call letter should be quite sufficient for contacting another station.

Interception by the enemy is virtually impossible due to the high perfection of calibration which permits the use of the set for special liaison work. Each station has its own frequency and each station frequency differs from the other. It is possible to change frequency in a split second, however, and thus attain the variable frequency so the transmitter can reach the receiver of any of the other stations almost instantly. The enemy is therefore unable to tune in or intercept the messages being sent, which is a desirable condition.

The station was originally built to make possible its operation under the worst imaginable field conditions and is mounted on a two-wheeled trailer chassis. Power for its operation can be generated manually, either by hand or foot or by a small engine which normally is carried in another vehicle. It contains two separate radio compartments, one forward and one to the rear of the center control panel. During its combat use in the early stages of the war, it was the principal radio apparatus of Polish division and brigade headquarters.

Smaller troop units such as battalions and regiments used a similar type station, designed in 1937 and known as the "N2-WZ37" which was employed very successfully against the enemy. It was more compact than the "Number 1-3" although it had the same qualities in transmission and reception and like all Polish mobile units it had special facilities for communication with aircraft.

The carriage appeared outwardly very similar to its larger counterpart but the operator sat in the seat in the rear with the instruments in a boxed-in panel in the front. The entire unit could be trailed behind any motorized or horse-drawn vehicle.

It contained a transmitter capable of sending messages a distance of from six to eight miles by telephone and about fifteen miles by telegraphic code on an aerial 20 feet in length. With a shorter aerial, 2½ feet long, it had a range of three miles with the telephone, and from six to eight miles by telegraphic code. It operated on a frequency of from 2250 kilocycles to 6750 kilocycles. Power was produced by a hand-cranked generator supplied with the unit, which obviated the necessity for batteries.

Both the transmitter and receiving apparatus could be readily removed from the trailer carriage and used as fixed equipment by foot soldiers. Due to its weight it was designed to be operated by three persons when employed as a temporary ground station.

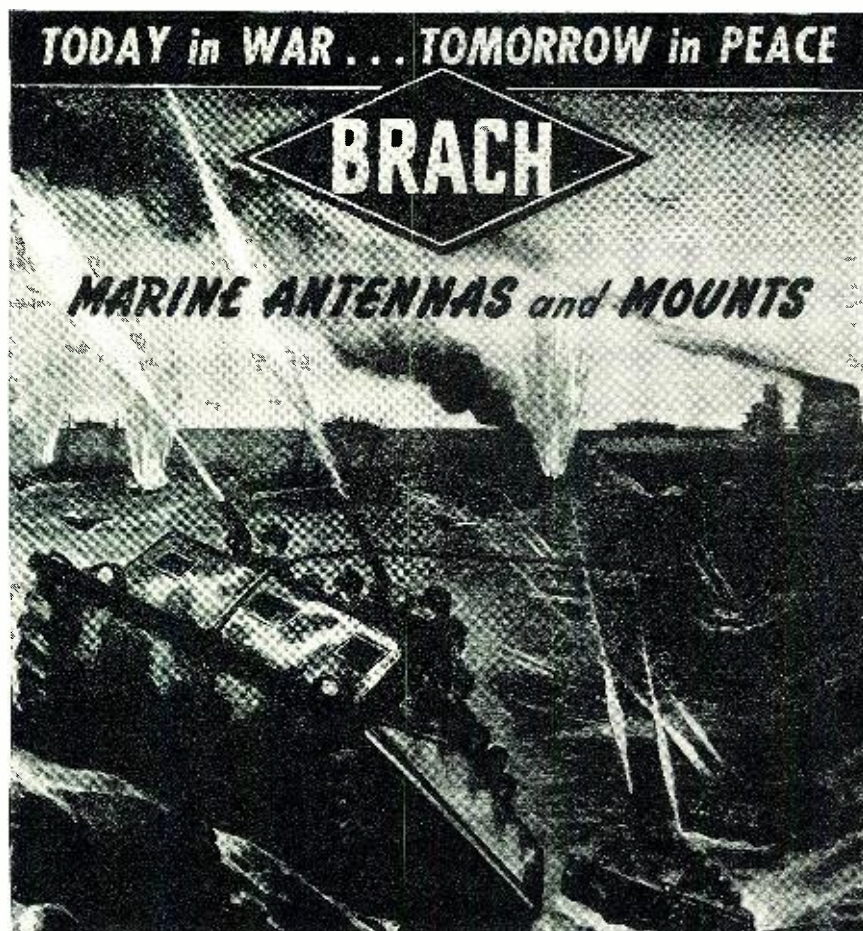

Brach Marine Antennas and Mounts are now manufactured 100% for the service of Uncle Sam's amphibian tanks, PT boats, etc. But with the dawn of Victory we shall be ready and able to utilize our enhanced experience and wartime "know how" in supplying the civilian requirements for antenna equipment for ship-to-shore communication.

# L. S. BRACH MFG. CORP.

World's Oldest and Largest Manufacturers of Radio Antennas and Accessories  
55-65 DICKERSON STREET • NEWARK N. J.

**PROFESSORS PREFER...**

**JAMES KNIGHTS**

**Crystals**

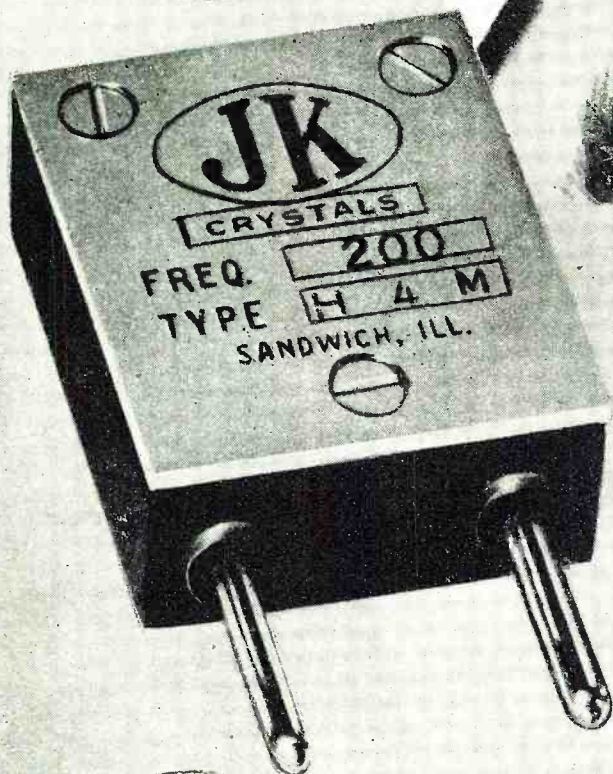

**..... for Efficiency,  
Dependability and Accuracy**

In instance after instance, James Knights is called upon to supply precision quartz crystals to meet the intricate specifications of university experimental work. In many of these cases, research done in university laboratories with James Knights Crystals is contributing directly to war communication development. That James Knights Crystals are so often considered "first choice" with university scientists is proof of their superior qualifications under the most exacting conditions. Why not let the men of The James Knights Company help with your crystal problems!

**BUY WAR BONDS FOR VICTORY!**

The **JAMES KNIGHTS Co.**  
SANDWICH, ILLINOIS



**CRYSTALS FOR THE CRITICAL**

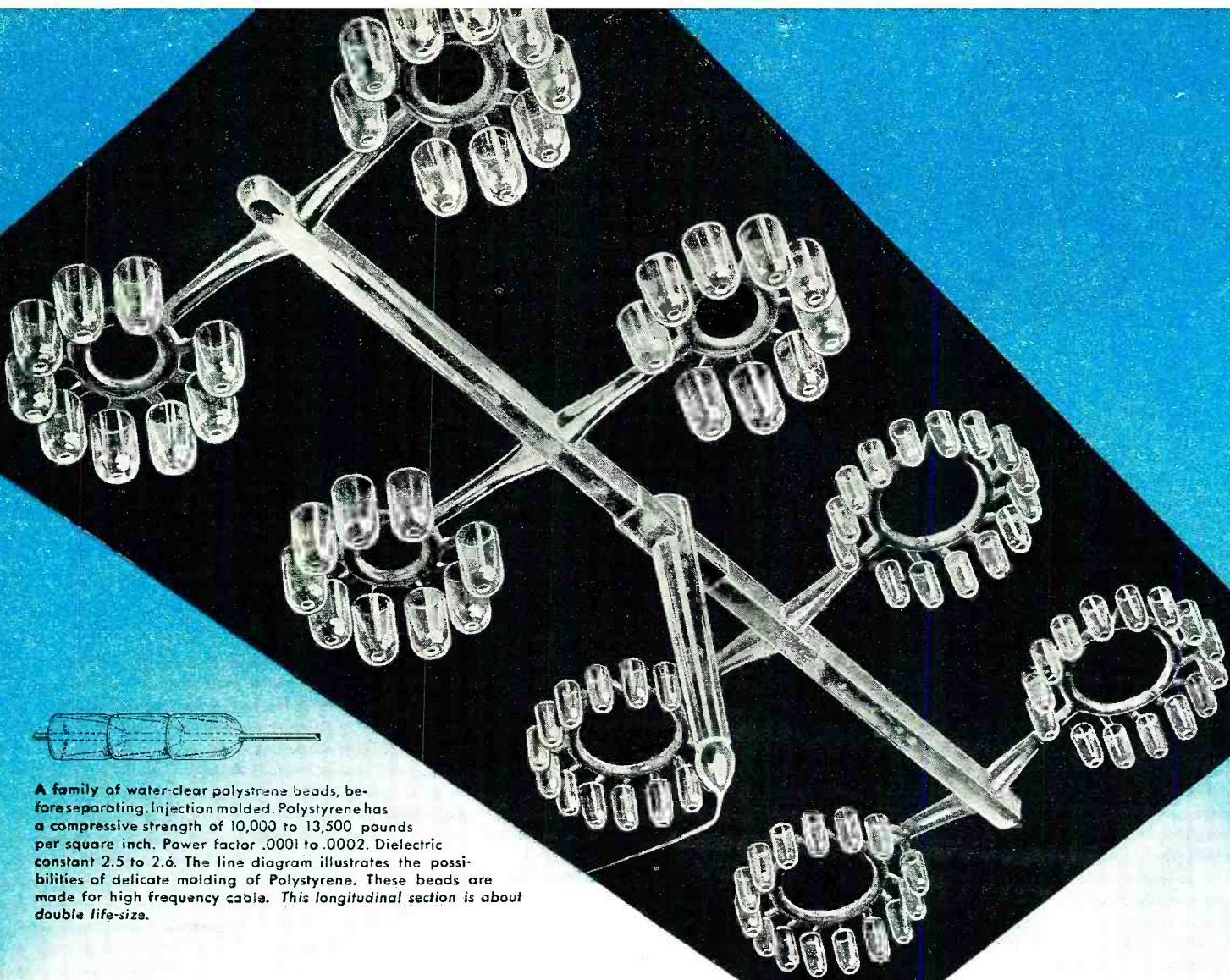

A family of water-clear polystyrene beads, before separating. Injection molded. Polystyrene has a compressive strength of 10,000 to 13,500 pounds per square inch. Power factor .0001 to .0002. Dielectric constant 2.5 to 2.6. The line diagram illustrates the possibilities of delicate molding of Polystyrene. These beads are made for high frequency cable. This longitudinal section is about double life-size.

## Synthetics for Industry

In the handling of plastics a complete knowledge of the characteristics of the various synthetics, their possibilities and the technique of working with each is fundamental. That is equally true of *experience* and *skill* and up-to-date equipment. With all of these, Amphenol, has consistently been a leader in this rising industry.

Practical experience in molding synthetics for industrial use dates back, at Amphenol, to the days, many years ago, when "plastics" meant Bakelite. Today Amphenol has batteries of up-to-date injection molding, compression molding, and extruding machines — many specially designed and custom built.

The help of Amphenol's engineers in the choice of materials, planning and designing of products is available to those interested in keeping step with the times in the use of plastics.

Ultra high frequency R. G. cables. Dielectric, polyethylene, extruded with inner conductor centered to within 10%. Diameter tolerance permitted .010". Vinylite outer covering extruded over wire, dielectric and braided copper shield.

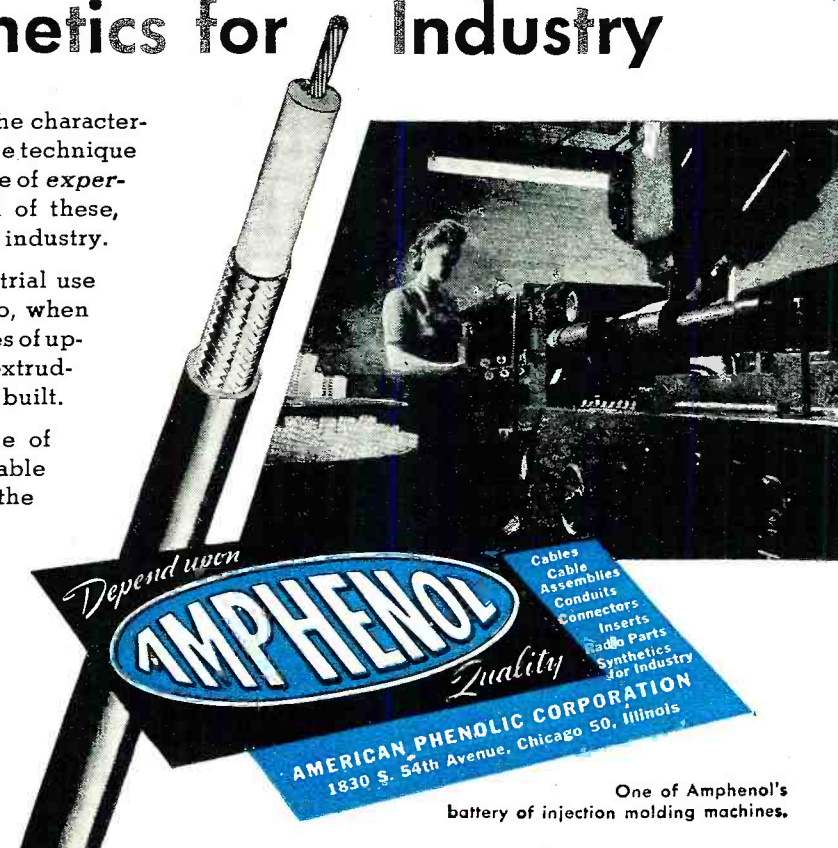

Depend upon  
**AMPHENOL**  
 Quality  
 AMERICAN PHENOLIC CORPORATION  
 1830 S. 54th Avenue, Chicago 50, Illinois

- Cables
- Cable Assemblies
- Conduits
- Connectors
- Inserts
- Radio Parts
- Synthetics for Industry

One of Amphenol's battery of injection molding machines.

## The SoundScriber

(Continued from page 43)

A still smaller station type, known as the "S," was utilized for front line troops. A superheterodyne receiver was employed even though most equipment being used by other troops at this time was of the basic detector and audio amplifier type.

Many of the features of Polish radio equipment were of German origin since the Poles had relied for many years on German-made sets. It was only after the Soviet-Polish War in 1920 that military radio equipment was developed to any extent by the Poles. During the intervening years, however, up to the outbreak of hostilities in 1939, they had built up reserves sufficient to equip at least four armies of from 40 to 50 divisions. This included, besides mobile equipment, sets similar in design and purpose to the walkie-talkie and handie-talkie now in use by Allied troops. They were serviceable, rugged and measured up favorably to other apparatus being used at that time.

At the height of the Nazi invasion most of this equipment was destroyed and the huge factories, including the Electrit in Vilno, Ica in Lody and the Telefunken (German branch) and Phillips in Warsaw, were put on a mass production basis under forced women labor, producing radios for Germany. Most of the male Morse operators and radio experts were either evacuated or shot by the invasion forces. It was in these factories that many members of the present Polish P.S.K., who were fortunate enough to escape, received their elementary training in radio maintenance, repair and operation.

Although various American and British exchange and financial agencies have made available modern equipment, most of the military and commercial maritime radio sets in use on Polish ships are of their own pre-war design and manufacture. The Polish Technical Division now attached to British research laboratories, with engineers working in British war production, have developed and carried on exhaustive research on many radio devices used both by the Polish air and ground forces.

Allied experts have recognized many Polish radio inventions as being products of the highest skill and although it is impossible to make public what all of them are, they are considered a real contribution to the war effort. One is a miniature hand radio set for use with paratroops and a series of small ground sets perfected in the past year which already have found favor among the various services.

With the introduction of American and British radio equipment, a complete new system of training became necessary for the Polish P.S.K. girls. They quickly mastered the technique of the more modern apparatus, however, as in most instances they had been trained on similar equipment that has become obsolete through capture by the enemy or further development by engineers.

Fundamentally their course is prac-

tically identical to that of the male signalmen. Candidates are selected from the ranks of the battalions and they need only to pass a rather elementary aptitude test to become eligible for signal training. If any of the women prefer aviation communications, a special course is provided.

After watching these hardy daughters of Poland go through combat maneuvers in full battle dress of British khaki and steel helmets one realizes they are not carrying rifles, throwing grenades or operating radios for the sheer love of duty alone.

They're fighting their way back home!

-50-

used in the recording head. Of special design, the recording head relies upon its own weight to maintain a proper pressure for the stylus on the disc.

A specially-designed audio amplifier, having sufficient gain to operate a microphone, is self-contained in the recording unit. Special mountings for the microphone permit both hands to remain free in order that the operator may proceed with typing or other office duties while the machine is actually in use. The design of the microphone



**HE HAS YOUR BATTERY**



His message must get through! Lack of a "Walkie-Talkie" battery might mean death... not for one man but for thousands! The very dry cells that normally go into your batteries now supply the vital voltage for "Walkie-Talkies." That means limited supplies "over here," so use your available Burgess Batteries sparingly... and handle them carefully as eggs.

**BURGESS BATTERIES**

IN THE NATION'S SERVICE

On the Fighting Front—On the Home Front

From Battery Hints—Write Burgess Battery Co., Dept. N-1, Freeport, Ill.





**Still your best bet for replacements**

**\*Old Man Centralab**  
 "Old Man" is right ... for he is a real "old timer". There is no substitute for experience, and the "Old Man" now, as in the past twenty-two years, is still your best bet.

# Centralab CR VOLUME CONTROLS



# Centralab

Division of GLOBE-UNION INC., Milwaukee

permits accurate reproduction to be had from distances of from a few inches to over five feet. It is of the dynamic type and has-semidirectional characteristics. A special built-in attenuator located in the base of the microphone permits a wide selection of output by the operator.

The tube lineup of the amplifier is as follows: Two 12SC7's, two 35L6GT's, and one 35A4GT. The over-all gain is 110 db. with an output of three watts.

In order to obtain the best possible results for voice frequencies, special filters are included to limit the response of the system to include from 200 to 4000 cycles. Resistance coupling is employed together with a conventional phase-inverter and inverse feedback is utilized from the 4-ohm amplifier output back through the last two stages. The response is held essentially flat up to about 4000 cycles by means of inverse feedback.

A patented feed mechanism is used which is capable of guiding the recording head at 200 grooves an inch. It employs two worm gear boxes in series as well as positive differential friction take-up to eliminate backlash. The feed arm is movable when the unit is in the "talk" position by means of the friction drive, but is locked when recordings are being played back and the switch is in the "listen" position. The gear boxes are sealed and permanently greased for minimum service difficulty. Continuous recording of 15 minutes on each side of a 7" disc is had at a cost of less than 5 cents per side.

The motor is a 33 r.p.m. induction type which eliminates brushes, commutators, slip rings and all moving electrical contacts or friction surfaces. The bearings are sealed in oil for permanent lubrication. The motor itself is hung from the chassis with special springs which are coupled to the turntable with patented fabric membrane coupling.

The turntable drive is by means of a motor supported on curved flat springs coupled by the special fabric membranes mentioned above. The spindle is splined and force-fitted to a three pound die-cast turntable of high inertia and equipped with a cork clutch ring on the upper surface. The bakelite turntable shell rests on the cork ring and the turntable is driven by the friction between these parts. This coupling, the heavy turntable, the cork ring, and the bakelite shell make up the mechanical filter system of the unit. The turntable shell is driven through a cork ring friction clutch on the heavy die cast table connected to the motor drive. A magnetically actuated brake shoe stops the turntable shell as necessary during transcribing without stopping the motor. The motor and turntable run continuously.

Upon completion of a recording or series of recordings, the disc may be played back instantaneously. The pickup is of the oil damped, moving coil type. This pick-up head is equipped with a sapphire reproducing stylus. The coil frame is of molded lucite with an Alnico magnet about the coil. The

## Wherever Precision Counts Most ...

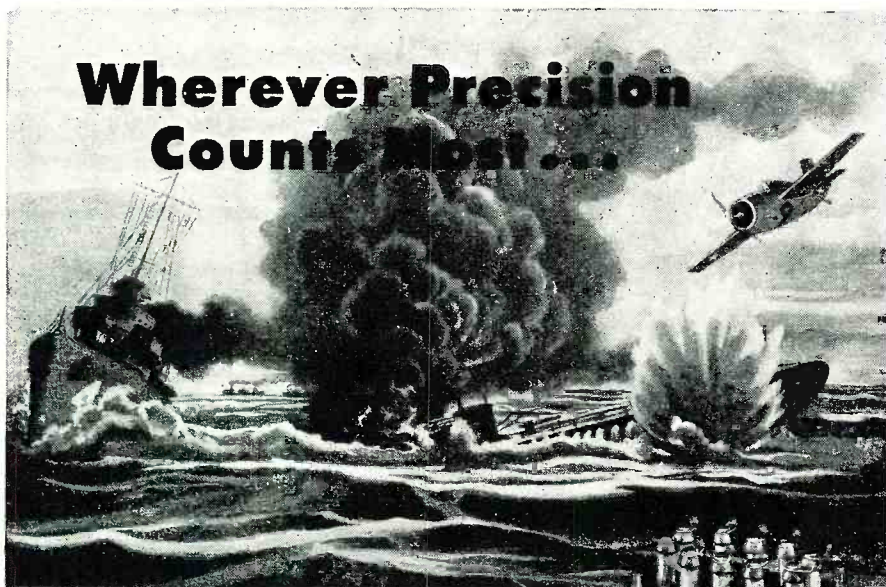

### Products of "MERIT" are passing the test

Complying with the most exacting requirements for precision workmanship and durable construction, MERIT has established its ability to produce in quantity and deliver promptly—

Transformers • Coils • Reactors • Electrical Windings of All Types for Radio, Radar and Electronic Applications.

Today these dependable MERIT precision parts are secret weapons; tomorrow when they can be shown in detail as MERIT standard products you will want them in solving the problems of a new electronic era.

Illustrated: High Voltage Transformers A-2123 (small) and A-2124. Designed for high altitudes. Oil-filled and Hermetic sealed.

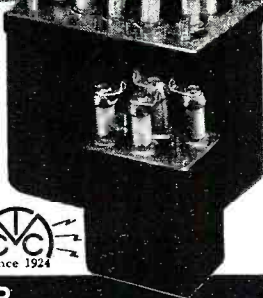

**MERIT COIL & TRANSFORMER CORP.**  
 311 North Desplaines St. CHICAGO 6, ILL.





# The **ECA** STORY

The story of the Electronic Corporation of America is one which has great significance at this time . . . one which gives life to the American principles of equality and opportunity for all.

During the course of 25 years work in radio and electronics, we have maintained close collaboration between management and labor. Responsible union representatives working with equally responsible executives have established a hub of friendly relations around which revolve various phases of our production and internal structure.

One pertinent result of our smoothly operating labor-management committee is that we are free from friction . . . production schedules are, therefore, adhered to. Another is that the quality of our products remains at a consistently high level. And the most important immediate result is that our cooperative efficiency has enabled us to increase our output more than six-fold in a single year.

Our engineering, too, is a reflection of the-ECA story. Experiences and knowledge have been tested under the rigid requirements of military specifications. We give due credit to our engineers for the accuracy and dependability of the delicate equipment we are now producing for the Armies of Liberation.

This, in brief, is the ECA story. Currently, we are engaged 100% in war work . . . and each of us is giving his best to help speed the defeat of our enemies. In the coming electronic era the same teamwork, the same skill, and the same efficiency will be devoted to the design and manufacture of products for home and industry.

THESE ARE  
THE WAR BONDS  
THAT COUNT...  
KEEP  
BUYING  
THEM

**ELECTRONIC CORP. OF AMERICA**

45 WEST 18th STREET • NEW YORK 11, N.Y. WATKINS 9-1870



**FATIGUE TESTS**  
dependent on  
**THORDARSON**  
AMPLIFIERS

Four of the Thordarson 2500 Watt Amplifiers are used in the laboratories of the Curtis Wright Corporation-Propeller Division. Fatigue analysis of Aircraft components demands continuous 24-hour a day operation. Thordarson amplifiers serve continuously in these unusual tests, demonstrating their ability to "stand the gauff" under the most exacting conditions.



**THORDARSON**

TRANSFORMER DIVISION  
**THORDARSON ELECTRIC MFG. CO.**  
500 WEST HURON STREET, CHICAGO, ILL.

*Transformer Specialists Since 1895*  
... ORIGINATORS OF TRU-FIDELITY AMPLIFIERS

**FATIGUE AMPLIFIER**  
POWER OUTPUT—2500 watts, less than 5% distortion, continuous duty.  
FREQUENCY RESPONSE—Within — 20 to 35 to 1500 C.P.S. (Other frequency response available on special order).  
GAIN—80 db.  
OUTPUT IMPEDANCES—5, 7.5, 10, 15, 20, 30, 50, 75, 100, 125, 250 and 500 ohms (Rotary switch selection).

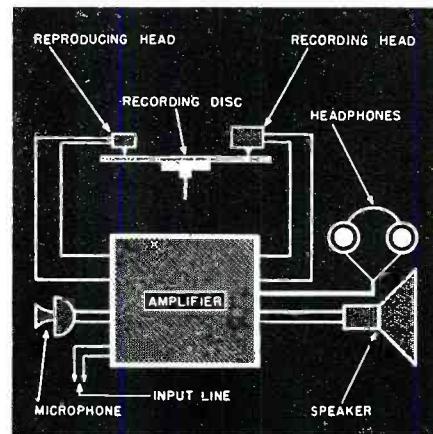

Fig. 1. Wiring arrangement of SoundScriber.

needle pressure is from  $\frac{7}{10}$  to  $\frac{9}{10}$  of an ounce. The transcriber is equipped with an instantaneous stop and start switch, controlling the turntable, as well as a stepback arrangement for backspacing the pickup for transcribing by remote control. The tone control permits the listener to adjust the quality of the sound to be transcribed. A foot-operated back spacing switch, mounted alongside the start-stop switch, moves the playback head back across the disc for repeating words, phrases or sentences.

The back spacing mechanism consists of an arcuate plate whose edge is engaged by a clapper actuated magnetically in timed sequence to give back-step space movement, by first contacting and then moving the plate for backspacing operation.

This machine plays back recorded material through a flexible soft speaker mounted near the typist. The embossed impressions in the grooves vibrate the sapphire-tipped stylus in the playback head and the resulting impulses are amplified by the amplifier. The tone quality, as well as the sound volume, can be adjusted by turning radio-type knobs. A miniature neon light indicator in front of the playback head enables the typist to find any desired portion of the dictated material on the disc.

The soft speaker is a 3" permanent magnet speaker mounted in a diecast acoustical housing which is mounted on an adjustable gooseneck. The speaker plugs into a two-prong receptacle. The volume may be reduced to a level where the recording is audible within a very limited area. The unit is also equipped with earphones which may be used instead of the speaker. The earphones are of the lightweight crystal type with the attenuator built into the phone jack.

The transcribing controls consist of the instantaneous start-stop switch and the step-back switch which is plugged into the Jones 3-prong socket in the rear of the machine. Both of the micro-switches are mounted in a special housing for foot control.

The entire unit operates on 110 volts a.c. with a power consumption of less than 50 watts, the average consumption running around 21 watts. The

## A New TWIST TO CRYSTAL CLEANING

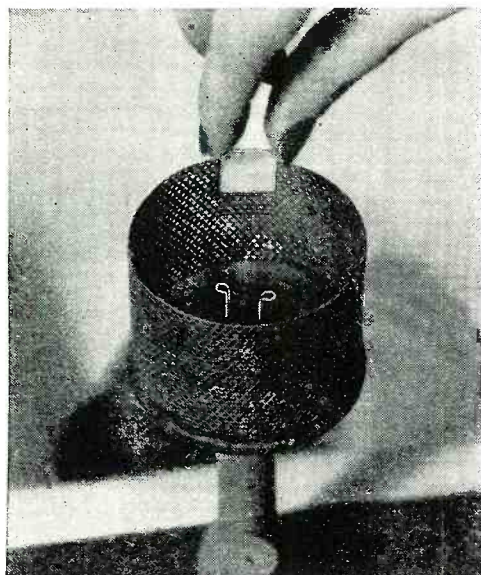

THIS is an actual photograph of the centrifugal air drier, or "spinner," used in Bliley production to facilitate clean handling of crystals during finishing and testing operations. Quartz blanks are dried in 5 seconds in this device which is powered with an air motor and spins at 15,000 r.p.m.

Little things like lint or microscopic amounts of foreign material can have a serious effect on crystal performance. The "spinner" eliminates the hazards encountered when crystals are dried with towels and makes certain that the finished product has the long range reliability required and expected in Bliley crystals.

This technique is only one small example of the methods and tests devised by Bliley Engineers over a long period of years. Our experience in every phase of quartz piezoelectric application is your assurance of dependable and accurate crystals that meet the test of time.

BLILEY ELECTRIC COMPANY . . . ERIE, PA.



# Yesterday and TODAY



Yesterday, WARD antennas were found on most of the peacetime automobiles, radios and portable radios.

All of the manufacture of antennas and radar equipment of THE WARD PRODUCTS CORPORATION is, today, going entirely to the war effort and being used on all fighting fronts.

The knowledge that is being gained from this wartime effort will mean new and improved products in peacetime. If your postwar planning includes the use or specifying of antennas, look to WARD.



# WARD

*Antennas*

THE WARD PRODUCTS CORPORATION



1523 E. 45TH STREET, CLEVELAND, OHIO

September, 1944

107

# HARVEY

**can tell you  
what you can get  
and what you can  
anticipate**

**ASK US FOR THE RADIO  
AND ELECTRONIC COM-  
PONENTS YOU REQUIRE:**

**Tubes!  
Relays!  
Resistors!  
Capacitors!  
Transformers!  
Test Equipment!**  
*or 1001 other items!*



Chances are that we've got them right on our shelves ready to be shipped to you the same day. But, on rare occasions, should we not have what you want, our advisory board can tell you what will be the most effective substitute. Or, if you question the availability of a component, HARVEY can tell you the ease or difficulty you may anticipate in getting it. And we'll do everything possible to trace and procure hard-to-find radio and electronic parts and equipment for you anywhere in this country.

**And, WE DELIVER  
Telephone orders to:  
LONGACRE 3-1800**

**HARVEY  
RADIO COMPANY  
HARVEY  
103 WEST 43rd ST., NEW YORK 18, N. Y.**

motor is 110 volts a.c. and uses 25 watts. For 110 volt d.c. operation or 6 volt storage battery operation, special inverters are available.

Although in most applications the discs are played back at once and transcribed on the spot, the discs may be stored for long periods of time, under varying climatic conditions without impairing the clarity of recording.

The ease with which these discs can be handled, filed and mailed makes them valuable where space is at a premium. War plants, hospitals, courts, research organizations, many branches of the Armed Forces and the government have utilized this type of recording to speed their activities. The records may be transcribed into written form, in much the same way as a dictaphone dictated letter, or the disc itself may be forwarded to the recipient of the message, to be played back in the addressee's office.

Some of the suggested uses for this equipment include the recording of lawyer's and doctor's consultations with their clients or patients which gives a complete and permanent record of questions and answers. One hundred hours of spoken material may be, upon being recorded on these discs, filed in a space seven inches wide and three inches deep, a substantial saving in filing cabinet space.

-50-

### The SCR-284

(Continued from page 38)

The block diagram of the receiver circuit shows that it is more or less of conventional design. An r.f. stage is used to amplify the received signals before they reach the first detector which is a combination detector and oscillator stage. The resultant intermediate frequency is amplified by two stages of intermediate-frequency amplification. The signals are then rectified by a second detector which provides a.v.c. voltage. This controls the sensitivity of the radio-frequency and intermediate-frequency amplifiers.

The audio signals are amplified by an audio-frequency stage which in turn delivers power to a pair of headsets or loudspeaker. For c.w. operation a beat frequency oscillator, oscillating at the i.f. frequency, mixes with the incoming signals at the second detector, thus providing a beat note for keyed signals.

The a.v.c. circuit is disconnected by means of a switch for c.w. reception so that the r.f. and i.f. amplifiers operate at maximum sensitivity, the final volume level being determined by a volume control which varies the amount of signal sent into the a.f. amplifier.

When this set is to be used in the field, the specifications require that all of the receiver power be obtained from a dry battery. Hence, it is mandatory that 1.4-volt filament type tubes be used throughout with as low a screen and plate voltage as is necessary to produce the over-all characteristics.

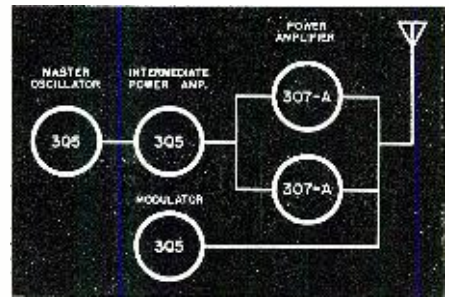

Fig. 2. Block diagram of the transmitter.

The SCR-284 receiver uses a 90-volt supply for the plate power with appropriate dropping resistors for the screen voltage. The over-all sensitivity requirements for a 10/1 signal-to-noise ratio was 3 microvolts for c.w. and 5 microvolts for voice operation, but present actual production is now running with a c.w. sensitivity of less than 1 microvolt and a corresponding decrease for voice operation. An output of approximately 150 milliwatts is available from the a.f. amplifier which makes it possible to operate a small loud speaker. This gives sufficient volume to be heard at a considerable distance from the radio set and makes it unnecessary for the operator to wear headphones and be constantly at the radio set during long standby periods.

The receiver has only two controls, a tuning knob and a volume control. All switching is done by switches on the transmitter.

### Transmitter

The block diagram of the transmitter indicates a conventional transmitter as far as the tube lineup is concerned. In the interest of standardization an effort was made to limit the number of types of tubes to a minimum in both the transmitter and receiver and since a 3Q5 tube was used in the receiver audio-frequency power-output amplifier, this tube was used in the transmitter in all socket positions

**Final moistureproof packing of one complete SCR-284-A unit, containing all equipment for both vehicular and field equipment.**



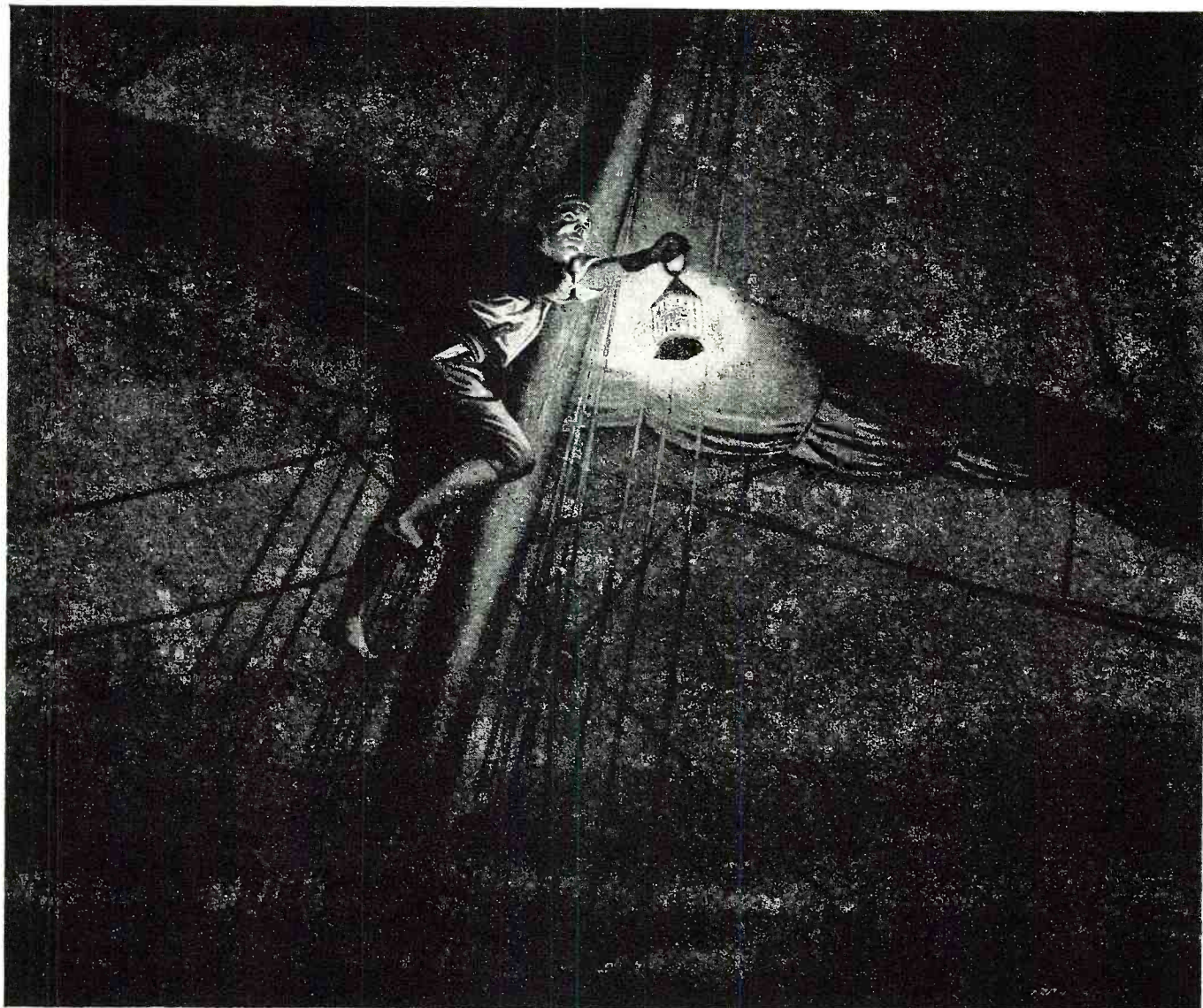

*History of Communications Number Five of a Series*

## NIGHT COMMUNICATIONS ON THE HIGH SEAS

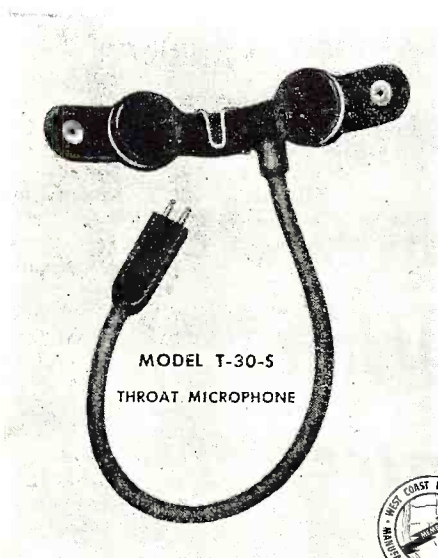

MODEL T-30-S  
THROAT MICROPHONE



In those early days when our Navy was first organized night communication was made by lantern from the masthead. This was the only communication between ships at sea during through which many times news from home was transmitted.

Today, through the use of Universal Microphones and voice communication components, vital communications of War are speedily transmitted equally as well from small sea-craft and battle cruiser to home port.

Many new types of Universal microphones shall be developed from the experience obtained from the production of military units, for the private citizens in the marine pleasure-craft in the days after Victory is ours.

< Model T-30-S, illustrated at left, is but one of several military type microphones now available to priority users through local radio jobbers.

**UNIVERSAL MICROPHONE COMPANY**  
INGLEWOOD, CALIFORNIA



FOREIGN DIVISION: 301 CLAY STREET, SAN FRANCISCO 11, CALIFORNIA -- CANADIAN DIVISION: 560 KING STREET WEST, TORONTO 1, ONTARIO, CANADA

September, 1944

109

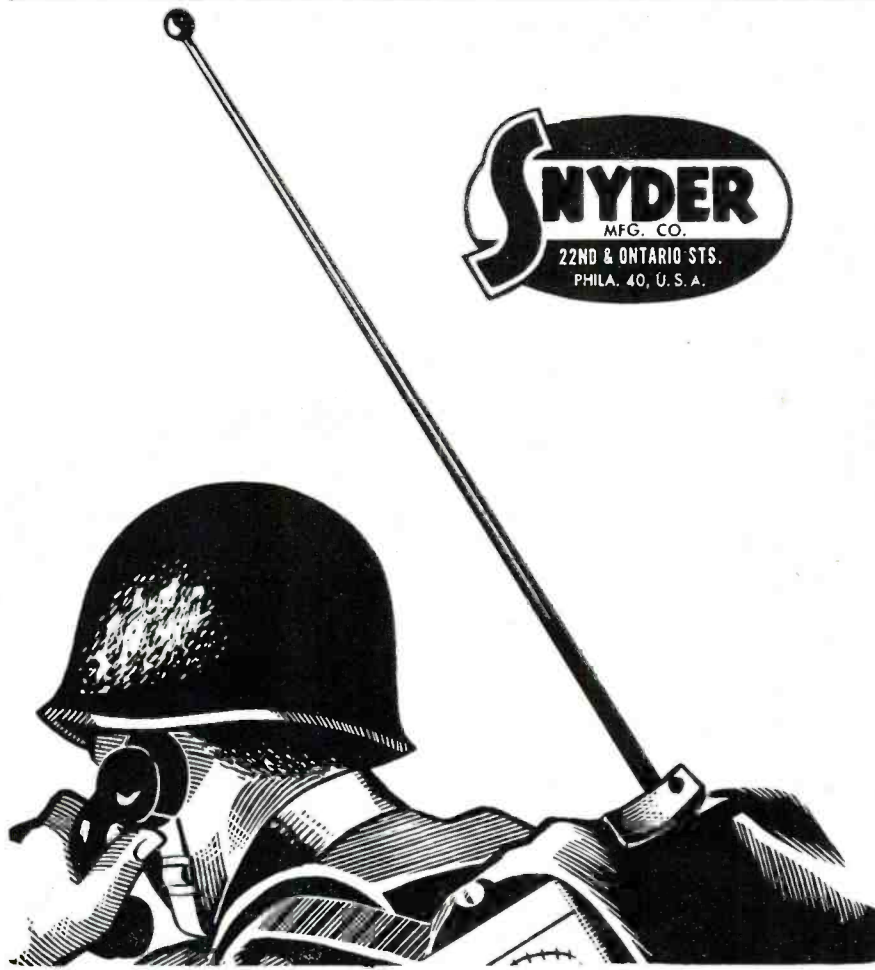

except for the power amplifier. This circuit consisted of a master oscillator, an intermediate-frequency power amplifier, a power amplifier and a modulator for voice operation.

The power amplifier used two Western Electric 307-A tubes in parallel which required a 500-volt plate supply and approximately 250-volt screen supply. At first thought it seems that this power amplifier is overly large for this set since each of the 307-A tubes is capable of delivering approximately 20 watts of c.w. power output, but since the specifications require an output of 20 watts into a vehicular antenna (which is actually the equivalent of 8 ohms in series with 110  $\mu$ fds. of capacity) it becomes evident that the antenna-tuning network for this type of antenna must consume considerable power.

A further requirement for this set was that it work into practically any kind of antenna including a conventional single-wire voltage-fed half-wave antenna, vertical, L or T antennas and finally into merely a piece of wire lying on the ground. This required a special antenna network. The resulting power loss in such a network is approximately equal to the power output delivered to the antenna which thus made it necessary to develop 40 watts of tube power. This meant putting two of the WE-307-A tubes in the final amplifier stage, but caused no particular hardship since one 3Q5 intermediate amplifier was quite adequate to drive two 307-A tubes.

In the interests of simplicity, and to make the operation as simple as possible, all frequency-determining elements of the transmitter are controlled by one four-section gang condenser which makes this transmitter a single-control tuning set. Three other controls are necessary for proper loading of the transmitter into various antennas, one of which consists of the antenna selector switch (which determines the type of network that will be used), a series antenna-tuning coil, and a voltage-coupling coil (which determines the amount of coupling power for zero to maximum that will be delivered to the antenna circuit). Two additional controls are required for the whole set. One is a switch for operating the set on either voice or c.w. which has interconnecting leads to the receiver to simultaneously connect the receiver so that it correspondingly receives the same type of signal that the transmitter radiates. The other control is required for the transmitter to reduce the power input requirements to 50 watts for hand generator use or connect the transmitter to "Standby" for minimum power consumption. The 50-watt input requirement is accomplished by merely turning off the filament of one of the power amplifier tubes. This lowered input permits the foot soldier to crank the hand generator without becoming excessively tired.

#### Power Supplies

In general, two types of power supplies were designed to operate the

## Send Only 25c for this Handy TUBE-BASE CALCULATOR

### SPECIAL GET-ACQUAINTED OFFER

Here's just the calculator you've wished you had time and again. Designed especially for you by Wholesale Radio Laboratories engineers, this lightning-fast, slide-rule type indicator tells you in a jiffy tube characteristics that enable you to substitute available tubes for those hard to get. Leo, W9GFQ, wants to send it to you at a fraction of its value — just to get acquainted.

Durable in construction, simple to operate, this calculator is a handy, time-saving device you can't afford to be without. Send for yours today. We pay the shipping expense. Mail 25c to Leo, W9GFQ.

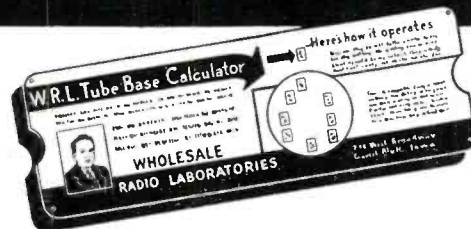

### FOR HARD-TO-GET PARTS WRITE LEO

I've got thousands of hard-to-get items including speakers, meters, test meters, transformers, tubes, telegraph operator keys and equipment. All types of radio hardware at unusually low prices. Send today for free flyer.

#### HALLICRAFTERS

I have always been a big distributor of Hallicrafter equipment. I'll buy used Hallicrafter rigs, highest prices. Other sets, parts too. Write. I'll quote top prices for your used equipment.

Leo, W9GFQ  
Wholesale Radio Laboratories  
744 West Broadway, Dept. RN-9  
Council Bluffs, Iowa.

You bet I want one of the tube base calculators. Here's my 25c.

While you're at it, send your free flyer of hard-to-get items.

Name.....

Address.....

Town..... State.....

I am  service man;  experimenter;  amateur.

MAIL COUPON TODAY

**WHOLESALE RADIO LABORATORIES**

744 W. BROADWAY  
COUNCIL BLUFFS, IOWA

# Florida's SENTINELS OF SAFETY



**POWERFUL STATEWIDE PROTECTION**

WITH **Motorola**

**F-M 3-Way**

*Radiotelephone System*

Florida's long shoreline presents unusual police protection problems. Instant, efficient and economical protection is vital. Now with 17 Central Headquarter Stations equipped with Motorola F-M 3-way radio and 93 patrol cars with two way radiotelephone service, Florida has all the protection it needs.

Instant communication with any patrol

car in any part of the State is obtained with needless cruising cut to a minimum, conserving personnel, tires, gas and automotive parts and repairs. Let us show you how your State, County or City can also obtain a complete Motorola police radiotelephone system designed precisely to solve *your* problem. Our installations are standard in many states.

Write or phone for full information today

**GALVIN MFG. CORPORATION · CHICAGO 51**

**Practical RADIO help  
in these 4  
McGRAW-HILL  
BOOKS**

See  
them  
10  
days  
on  
approval

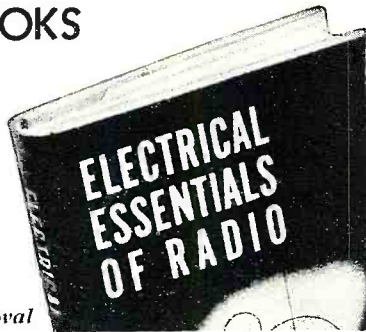

**ELECTRICAL ESSENTIALS OF RADIO**

By Morris Sturzberg and William Osterheld, Instructors of Electricity and Radio, William L. Dickinson High School, and Evening Technical and Industrial High School, Jersey City, N. J. Here is a simple introduction to electrical theory and its applications to practical work with any type of radio set, test equipment, or electronic device. The book offers the background of electrical theory required to make an efficient, thoroughly qualified radioman, equipped to carry out repair and manufacturing jobs quickly and successfully and to keep in step with the rapidly advancing science of electronics. 529 pages, \$4.00.

**RADIO DIRECTION FINDERS**

By Donald S. Bond, Radio Corporation of America. For all concerned with the design, procurement, or operation of radio direction finders for aircraft, shipboard, or fixed station use, this book will fill a long-existing need. A text and reference on recent developments, practical systems now in use, and present and future trends in this specialized field, the book covers wave propagation, directive antenna systems, aural null direction finders, performance characteristics of loop input circuits, visual direction finders and radio navigation aids. 287 pages, \$3.00.

**BASIC RADIO PRINCIPLES**

By Capt. Maurice G. Sufferin, Signal Corps, U. S. Army. Here are full explanations of the major radio theories and actual radio equipment showing the construction and function of the composite parts of radio equipment for practical radio work as repairman, technician or operator. The manual begins with the most fundamental radio theory, goes on to more particularized discussions of radio theory and equipment, and shows how to recognize and interpret radio symbols and understand the way the individual symbols are joined together to form a circuit. 271 pages, \$3.00.

**GRAPHICAL CONSTRUCTIONS FOR VACUUM TUBE CIRCUITS**

By Albert Preisman, Director of Engineering Tests and Consulting Engineer, Capital Radio Engineering Institute. This book presents vacuum tube circuits and problems mainly from the graphical point of view. This approach helps in the solution of actual problems and also presents visually the mode of operation of the tube. In particular, the nonlinear nature of vacuum tube problems is stressed. Recent advances are taken into account in the treatment of many topics such as balanced amplifiers, detectors, and inverse feedback. 237 pages, \$2.75.

Send This McGRAW-HILL Coupon

McGRAW-HILL BOOK CO., INC.,  
330 W. 42nd St., New York 18, N. Y.

Send me the books checked below for 10 days' examination on approval. In 10 days I will pay for the books, plus few cents postage, or return them postpaid. (Postage paid on cash orders.)

- Sturzberg and Osterheld—Electrical Essentials of Radio, \$4.00
- Bond—Radio Direction Finders, \$3.00
- Sufferin—Basic Radio Principles, \$3.00
- Preisman—Graphical Constructions for Vacuum Tube Circuits, \$2.75

Name .....

Address .....

City and State .....

Position .....

Company ..... RN 9-44  
(Books sent on approval in U. S. and Canada only.)

SCR-284. One was for field operation and the other was for vehicular operation with either 6 or 12 volts, whichever was available from the vehicular storage battery and with either the positive or negative side grounded.

**Field Power Supply**

As previously mentioned, the receiver obtains its power from a dry battery. This dry battery pack consists of 3 voltage sources:

1. 1.4 v. at 0.4 a. (For receiver filaments)

2. 90 v. at 9 ma. (For receiver plate and screens)

3. -45 v. bias at 1 ma. (For grid and suppressor bias on the transmitter power output tubes.)

A hand operated generator is used to supply the transmitter power. It delivers a filament voltage of 6 volts at 1½ a. and plate voltage of 500 v. at 80 ma., which makes a total power input of approximately 50 watts.

**Vehicular Power Supply**

When used in a vehicle it is desirable to save the dry battery for possible field use, consequently a vibrator power pack known as PE-104-A was designed to operate from either 6-

12-volt vehicular battery and deliver 1.4, 90 and 45 volts, the same as delivered by the dry battery pack. This power pack is physically the same size as the battery pack so that it fits into the same space in the radio set proper.

A dynamotor power supply was designed to supply power to the transmitter. This unit is known as the PE-103-A and takes power from either a 6- or 12-volt vehicular battery with either the positive or negative side of the battery being grounded. It delivers 6 volts to the transmitter filaments and 500 volts to the plate and the screen circuits. The requirements



The SCR-284-A in actual field service in an active combat area.

The receiver and transmitter unit (SCR-284-A) shown completely mounted in half-trac.

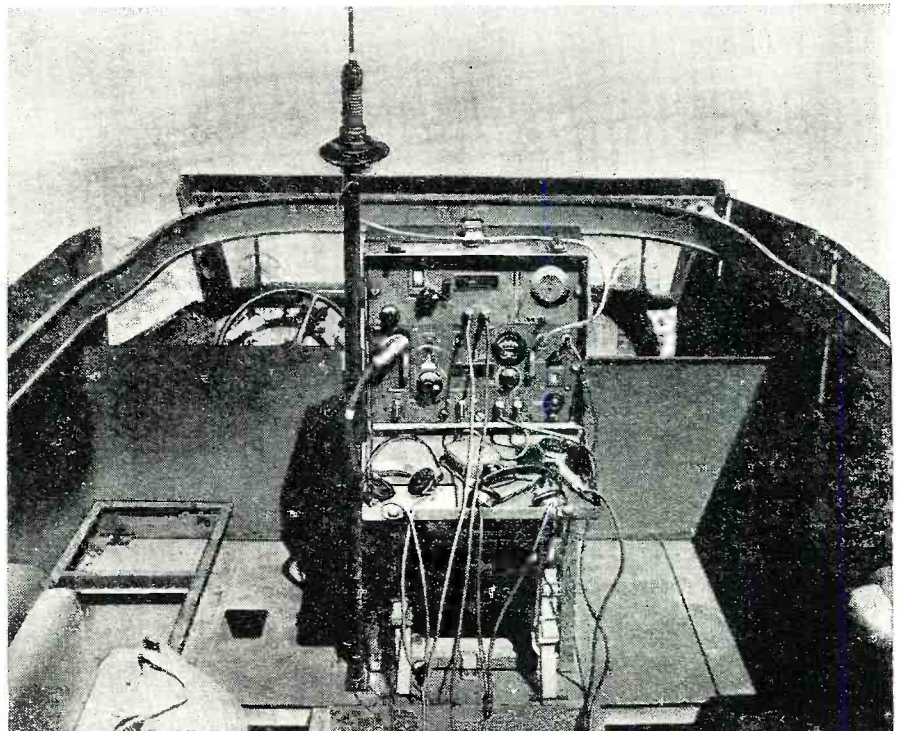



**\*6 HOURS, 57 MINUTES, 56 SECONDS**



**"NATIONAL" HELPED MAKE HISTORY IN  
"THE FLIGHT OF THE FUTURE"**

It was "National" all the way in the Constellation's air-ground communications in her record breaking\* flight from Los Angeles to Washington! National RCK-1 receivers were used at both take-off and landing. And from coast to coast, TWA checkpoints monitored her flight on their NC-100 equipment.

TWA's mighty Queen of the Air has gone to war. But the lessons learned in her prophetic flight promise even greater feats for postwar passenger transport. New Constellations will flash through the skylanes, checked and guided, then as now, by National air-ground equipment.

**NATIONAL COMPANY, INC.**  
MASS., U. S. A.  
**MALDEN**

\*6 hours, 57 minutes and 56 seconds

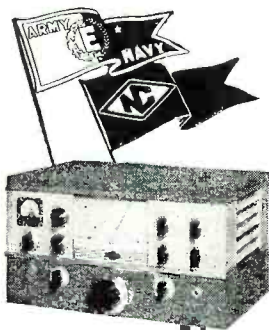

**NATIONAL RECEIVERS ARE IN SERVICE THROUGHOUT THE WORLD**  
September, 1944

# RADIO PARTS FOR IMMEDIATE DELIVERY

We carry a complete supply of all types of radio parts and electronic equipment.

## CABINETS

11 x 8 x 5 1/2  
Available in bleached or natural wood.

**\$2.75 each**  
10 for \$25.00



**\$3.50 each**

14 3/4 x  
8 1/2 x 6 1/2

10 for \$32.50



## SPEAKERS

CASE PACKED

	Each	10	20	30
3" P.M. less transf.	\$1.25			
3 1/2" P.M. less transf.	1.35	12.50		\$36.00
4" P.M. less transf.	1.40	13.00		36.00
5" P.M. less transf.	1.55		29.00	
6" P.M. less transf.	1.95		35.00	
8" P.M. less transf. heavy	3.53			
8" P.M. less transf. light	2.94			
12" P.M. less transf.	8.40			
4" 450 ohm	1.45			40.50
5" 450 ohm	1.65		30.00	
6" 450 ohm	2.19		39.50	
12" 1000 ohm	6.95			Universal Output

NATIONALLY KNOWN

## VOLUME CONTROLS

WITH SWITCH

5,000 ohm	100,000 ohm	} 59c Each 10 for \$5.00 100 for \$45.00 1000 for \$375.00
10,000 ohm	250,000 ohm	
15,000 ohm	500,000 ohm	
25,000 ohm	1 meg. ohm	
50,000 ohm	2 meg. ohm	



## SPECIAL on MAZDA BULBS

#40	# 51	} Per 10 45c Per 100 \$4.00 Per 1000 \$37.50
#41	# 55	
#43	# 13	
#44	# 14	
#46	#222	
#47	#233	

**FREE!**

Write for CATALOG and  
Free Stroboscope



# RADIO PARTS COMPANY

612 W. RANDOLPH ST.  
CHICAGO 3, ILLINOIS

that the set operate with either a positive or negative grounded circuit meant complete isolation from ground of all filament, screen and plate circuits in both the transmitter and receiver. The PE-193-A dynamotor power supply is provided with two circuit breakers for protecting the equipment from overloads in both the plate and filament circuits. Another breaker is provided which automatically opens the primary circuit when the equipment is connected to a 12-volt source when the set circuit is connected for 6-volt operation. This protective circuit acts so fast that the filaments of the 6-volt, 1.4-volt tubes are not damaged when accidentally connected to a 12-volt source.

Additional items such as antenna, counterpoise, bags for carrying equipment of the various items, etc., had to be designed so that the over-all equipment could be used either for vehicular or field use.

-50-

## Railway Communications

(Continued from page 34)

put out of operation, especially if automatic repeaters are utilized along the right of way.

In any event, it is of importance to note that distances in excess of 100 miles along railway rights-of-way have been covered with a single low-power induction radio transmitter and cooperative receiving equipment; that the induction technique is more readily adaptable to the problem of maintaining communications through tunnels and in other locations where normal space radio systems would require more complicated and more expensive equipment. There is also the consideration that, though induction radio techniques are capable of developing

intense signalling fields along the right of way, these induction radio fields, at relatively short lateral distances, quickly drop below ambient electrical noise levels and therefore cannot cause interference with similar services on the same frequency in adjoining areas not served by the same wire system.

Engineers who have had considerable practical experience with both space-radio and induction-radio communications, believe that both high-frequency space-radiating and induction-radio techniques will be applied to meet the different specific problems and varying operating conditions involved in main-line railway operations. It would seem, therefore, that, until further factual test data is made available to the railroad industry, railroad operators will keep an open mind on the subject of what type of radio equipment is best suited for their mainline operations.

In designing railway radio equipment, several important technical factors should be considered. Because of the relatively high electric noise levels experienced on the majority of railway systems, particularly where electromotive equipment is employed, it appears desirable, in applying radio techniques to railway operations, that equipment of the frequency-modulation type be used. Radio engineers and manufacturers, who may not be well acquainted with railway operations, may find it difficult to realize the intensity of multidirectional shock and vibration which all railroad equipment must be capable of withstanding—especially equipment on the older steam locomotives employed in yard areas. It is also a necessity that proper housing be supplied to prevent corrosion and oxidation of vital components by gases emanating from steam locomotives.

One of the major technical features that appears to be a fundamental re-

Communications equipment assembled in maintenance and repair truck. This equipment is quite similar to that used in railway locomotives, including the automatic visual signal lights which indicate any signal failures.

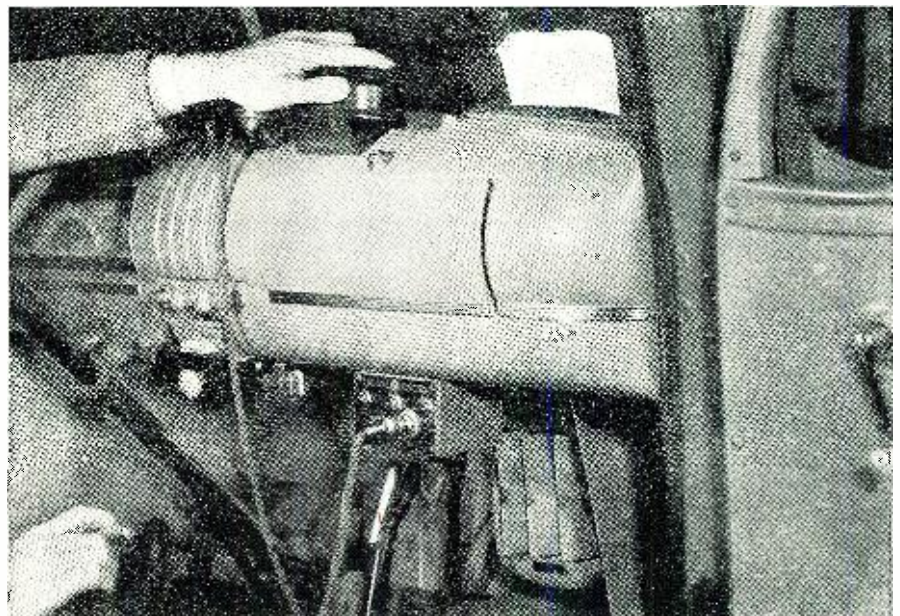



*When the Blackout  
of Radio Sales  
is over  
The Spotlight  
will be on  
CLARION*

One of these days war work will give way to peacetime production—business will resume its flow in normal channels—and radios will be released for sale to civilians.

Radio dealers will then find CLARION in the spotlight, because we have been developing good consumer markets for you during the long months of preparation—invasion—and today's march to victory.

We'll be glad to give you facts that will help you get your full share of the CLARION harvest that is coming after the war.

**WARWICK MANUFACTURING CORPORATION**

4640 West Harrison Street • • • Chicago 44, Illinois



quirement for radio equipment intended for extensive railway use, especially in main-line operations, is a radio counterpart to the "closed-circuit principle" employed in all railway signaling systems.

Railroad operations differ from those in other forms of transportation in that locomotive movements in a specific area are under the complete direction of a supervisory authority located at a fixed point. Once an order has been given to an engineer, he proceeds to carry out that order in every detail until it is countermanded or completed. Unlike aircraft, automobiles, or other mobile units employed in our transportation systems, a locomotive cannot pass to the right or left

of another vehicle at will, and the locomotive engineer therefore does not have the freedom of decision available to the pilots of aircraft or the operators of motor vehicles.

It has become a fundamental requirement in railway signaling systems, therefore, that all devices employed in conveying information to engineers, such as visual wayside signals, or cab signals, be operated on the normally closed-circuit principle. The principle requires that, in the event of failure of any part of the signaling system, means must be provided to give a positive "danger" indication to warn the engineer. A simple illustration of this point may be seen in observing a conventional railway sem-

aphore. The arm of the semaphore is so designed that, in the event of the failure of power or any other portion of the signaling circuits, the arm drops by gravity to the "danger" position. Thereafter, an engineer, observing the signal, will follow predetermined precautionary procedures.

If full benefits are to be derived from the coordinated applications of radio techniques on railway systems, any radio system applied to railway operation must incorporate an automatic means by which locomotive engineers may be certain that radio equipment is in operating condition, so that, in the event of failure of any component of the radio system, definite foolproof indication will be given.

The future importance of this type of safety feature is indicated by the operators of the railway system at the *Kingsbury Ordnance Plant*, where a checking system has been in use for over two years, who report that their entire railroad system depends on the device, and that, without this safety feature, they would insist upon telephone service.

One checking system of this type, which has been utilized in certain of the Government-operated ordnance plants over a period of the past two years, was developed by engineers of the *Halstead Traffic Communications Corporation*, and provides both audio and visual indications in locomotive cabs. (See Figs. on page 33.) In this audio-visual checking method, power is applied to the central station transmitter at periodic, five-second intervals. Concurrently, a tone signal is impressed on the modulating circuit of the transmitter. In locomotive cabs, a visual signal light within the cab is energized by the received signal, while the tone signal is reproduced from the cab loudspeaker.

In the event of failure of any portion of the central station transmitter or any portion of the locomotive receiving equipment, the check light will not be actuated in the cab nor will the tone signal be heard. The engineer, therefore, knows that he should not depend upon the radio system but should observe precautionary regulations, as he would do in the event of failure of any railway signaling system.

The system also provides means for checking on emission of signals at the dispatching point and incorporates automatic "lock-out" circuits, by means of which the automatic pulse transmission is suspended during periods in which voice signals are being received from mobile units. This portion of the checking system is important because it prevents interference between signals from mobile units and automatic checking signals.

The same principles employed in the audio-visual checking equipment have been incorporated in other radio traffic control equipment, in which miniature signal lights, installed directly in the operator's line of vision, are selectively actuated. In other words, if a "proceed" indication is to be pro-



**ON SWITCHBOARDS...  
PANEL EQUIPMENT**

**Show 'em How**

**XCELITE Hollow Shaft Nut Drivers  
get into tight places**

Seeing is believing! Display — explain the advantages of these Xcelite tools. You find scores of quick-to-buy customers. On all types of radio panels, telephone and switchboards, Xcelite Hollow Shaft Nut Drivers (shaft insulated if desired) speed up nut handling, even in awkward installations. The hollow shaft slips

over protruding studs; the accurately machined socket accommodates two nuts. Genuine shockproof Xcelite handle. Seven sizes, from 5/16" to 3/8" (nut sizes). Priorities required — delivery necessarily delayed by war conditions. Details and prices on request. Write Dept. L.

**PARK METALWARE CO., Inc., Orchard Park, New York**

**XCELITE**

**Back the Attack—Keep the War Bonds You Buy**

## ELECTRICITY for RADIO WORK ANYWHERE

Plant shown is W3S, 3000-watt, 115-volt, 60-cycle; engine is 2-cyl water-cooled.

For a dependable source of electricity on all radio projects remote from commercial power. Onan Electric Plants are proven leaders in the field. More than half of the armed Forces' total requirements for power plants are built by Onan.

Gasoline driven . . . Single-unit, compact design . . . Sturdy construction . . . Suitable for mobile, stationary or emergency service.

Over 65 models, ranging in sizes from 350 to 35,000 watts. 50 to 800 cycles. 115 to 660 volts, A.C.—5 to 4000 volts, D.C.—Also dual A.C.-D.C. output types.

Descriptive literature sent promptly on request.

D. W. Onan & Sons, 2152 Royalston Ave., Minneapolis 5, Minn.

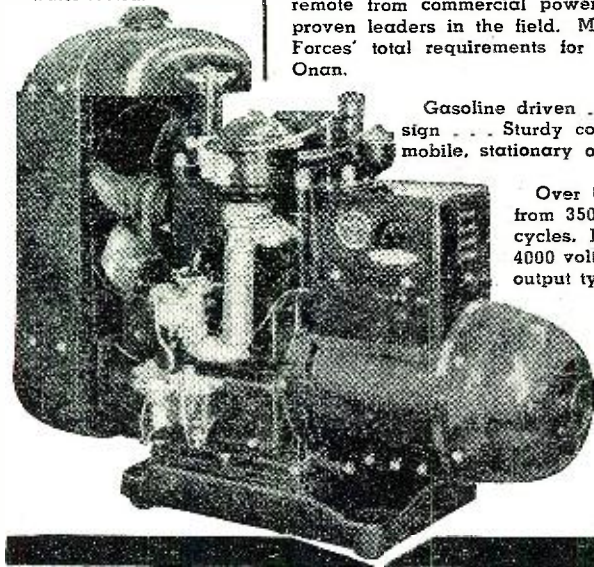

# DESIGNED "TO ORDER"

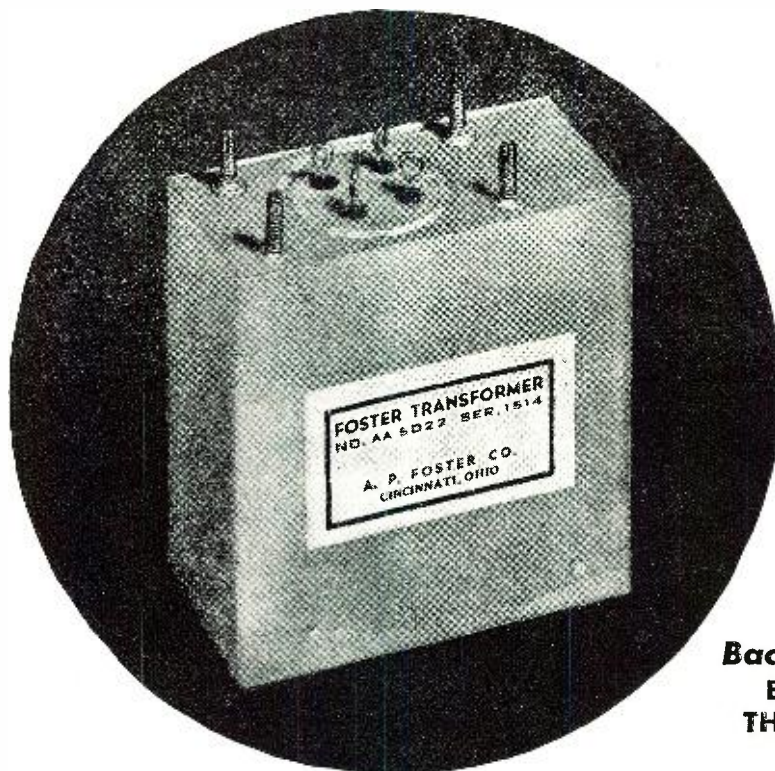

**Back the Attack  
BUY MORE  
THAN BEFORE**

**TYPICAL OF**

## **FOSTER TRANSFORMERS**

IS THIS AUDIO OSCILLATOR TRANSFORMER PACK BUILT TO A RIGID NAVY SPECIFICATION. IT IS TUNED TO A FREQUENCY TOLERANCE OF PLUS OR MINUS .4 OF 1%. PERFECT HERMETIC SEALING IS ASSURED BY THE USE OF OUR NEW VITROSEAL TERMINAL CONSTRUCTION FOR THE ENTRY OF THE CONNECTIONS INTO THE CASE.

Yes, we are designing and building transformers for the armed forces to meet specific requirements. This skill of being able to create exactly the right transformer for the individual need will be of great value after the war in the new world of electronic equipment. Our experience covers close tolerance vibrator transformers, output transformers, microphone transformers, saturable reactors, power transformers, audio filters and reactors . . . designed and custom-built to fit the most exacting individual requirements.

SPECIALISTS IN BUILDING TRANSFORMERS SINCE 1938

# **A. P. FOSTER COMPANY**

TRANSFORMER ENGINEERS & MANUFACTURERS  
719 WYOMING AVENUE, LOCKLAND 15, OHIO

# NEW

## Gothard

NAVY SPEC.—BAKELITE BASE

### PILOT LIGHT

for 110 volt operation

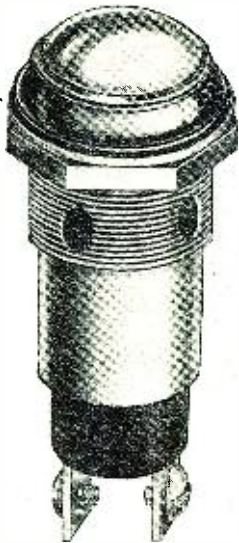

This new light, with 1" jewel, is available in three models; No. 1032 faceted jewel; No. 1033 plain jewel and No. 1034 frosted jewel, colored disc. Sockets are molded of bakelite to meet Navy specifications, 17P4-CFG. Removable jewel holder, of snap-in type, permits change of lamp from front of panel.  $\frac{3}{8}$ " between terminals. Designed for Mazda 6S6 lamps. Selection of jewel colors; red, green, amber, blue, opal and clear—specify choice when ordering.

Ask for the new Gothard Catalog of other models.

## Gothard

MANUFACTURING COMPANY  
1350 North Ninth Street  
SPRINGFIELD, ILLINOIS

**FADA'S**  
S.M. 81  
**SERVICE**  
**MANUAL**

**AN**  
**INDISPENSABLE**  
**AID TO THE**  
**SERVICE MAN**

Here's the  
Book You've  
Been Waiting for!  
Contains all  
available Service  
Data on all  
FADA Receivers  
\$1.00 plus  
Postage  
Send for it Now!

**FADA OF NEW YORK**  
928 BROADWAY NEW YORK, N. Y.  
Large Stock of Replacement Parts & Cabinets

vided in the cab, a green light is energized within the cab by means of radio signals. Likewise, an amber or red light can be selectively controlled within the cab. These radio signals are "harnessed" to a particular signaling zone for a desired length by means of a radio-frequency transmission line extending along the track for the desired distance.

Radio's potential railway services are not, however, limited to operational uses. Farsighted railroad executives are planning for wide use of radio to provide entertainment and other services, such as telephone and telegraph, for the comfort and convenience of passengers. Individual radio receiving sets, facsimile recording and transmitting devices, and television receivers will also serve the railway passengers of the future. Rail passengers will then have available on trains the various communications services to which they are accustomed in their offices and in their homes. Such services as these should not only attract more passenger traffic, especially of long-distance type, but should, if properly employed, provide additional railroad income and employment.

In providing the various projected railroad radio services, the problem of frequency allocation is of major importance. In this regard, the use of induction radio techniques will be of particular value by reason of the fact that signals are "harnessed" substantially to the vicinity of railway trackage. The projected use of directional microwave radio circuits will further alleviate the difficulties in providing channels for a number of railroad services.

The comprehensive application of

radio to railway operations throughout the nation, as discussed in this article, obviously will, however, require the assignment of a large number of frequencies for railway use. Since the railroads are of such primary importance to the national economy, and especially since the exhaustive research required by the war has developed practical radio equipment utilizing the higher frequencies of the spectrum where frequency allocations have not yet been made, it would seem that the Federal Communications Commission is likely to approve the assignment of a substantial number of channels for railway use. The Commission has already announced its intention to begin hearings shortly on this subject. If the present enthusiastic, cooperative efforts of the railroads, radio engineering groups and the concerned government agencies, continues, ample technical data should be available for these hearings so that intelligent decisions as to the permanent assignment of frequencies for the proposed railway services can be made.

It is to be hoped that the decisions on frequency allocations will be made as promptly as sound engineering procedures permit so that this new, important radio market can be ready to employ the vast war-necessitated radio facilities and personnel as soon as these are available.

Since radio techniques, capable of increasing railway efficiency, safety and revenues are already available, and since the railroads will have substantial funds for sizeable capital investment, railway radiotelephony should develop quickly on a substantial scale, once railroad operators, radio engineering groups and manufacturers are certain of the exact parts

Ammunition being loaded at railway loading platform. All trains at this particular loading depot, one of the largest in this country, are completely equipped with radio communications.

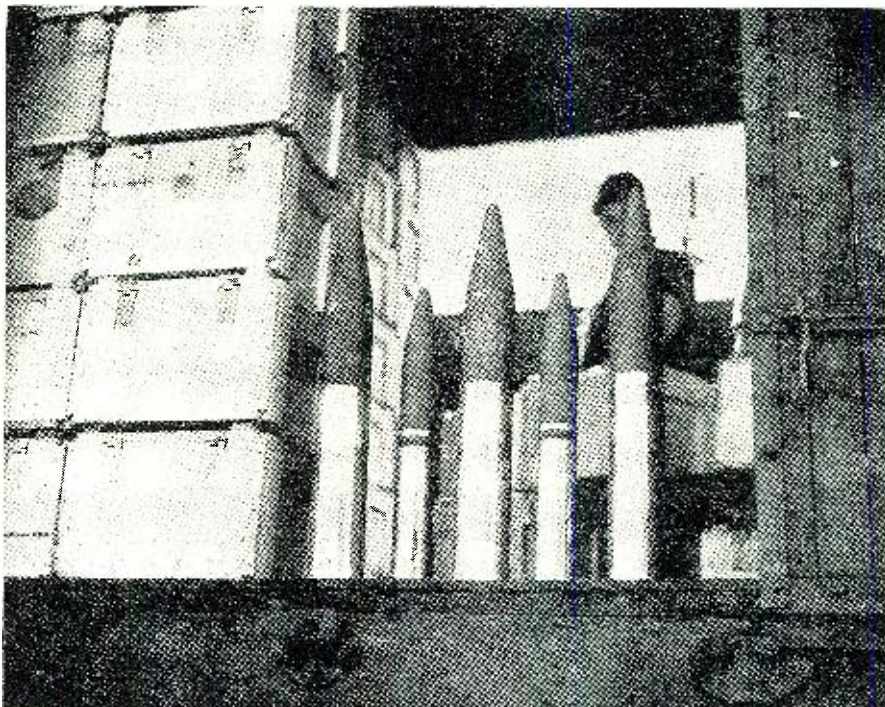



# LISTENING

on every battle front . . . and on  
all home fronts — is keener —  
clearer — swifter BECAUSE OF

*Runzel*  
CORDS · WIRES CABLES

for  
RADIO-TELEPHONY  
ELECTRONICS

**RUNZEL CORD & WIRE CO.**

4723-31 MONTROSE AVENUE · CHICAGO 41

# LAKE RADIO CABINETS



Beautiful Hand-rubbed walnut cabinet for table model phonograph combination. Inside size 16" wide, 11" high, 12½" deep. As illustrated above. **\$7.95**  
Specially priced at.....

Replacement cabinet in dark walnut finish plastic. Inside dimensions 10W x 6½H x 6D. Price..... **\$1.95**

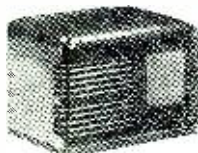

Dark walnut finish elastic cabinet to accommodate practically any Tiny Tim radio. Size 7¾W x 4¾H x 4D. Price..... **\$1.50**



Also blank table cabinets of walnut veneer in the following sizes:

8¼W x 5½H x 4D	<b>\$1.95</b>
10¼W x 6¾H x 5D	<b>\$2.75</b>
13½W x 7¾H x 6¼D	<b>\$3.25</b>

Cabinets available in ivory color and Swedish Modern. Write for prices.

**14" SPEAKERS**  
14" electro-dynamic speakers, 900 ohm field-6—8 ohm voice coil. 6V6 push-pull transformer. Special, only..... **\$4.50**

All types of radio parts available in today's market can be obtained at Lake's money-saving prices. Large stock listed in our new Bargain Bulletin. Write us for your copy. It's free.

**LAKE RADIO SALES CO.**  
615 W. Randolph Street Chicago 6, Ill.

**Short-Cut Mathematics**  
COMBINED WITH  
**Practical Mechanics Simplified**

NEW 2-in-1 reading course! Now you can learn the speedy, simplified system of calculation used by draftsmen, engineers, accountants, "master minds" on the stage. Learn easy way to multiply 4 figures by 4 figures without using old-fashioned multiplication; add long columns of figures this lightning short-cut method. Learn horsepower, slide rule, micrometer, logarithms, wood measure, puzzles, etc., etc. Large illustrated volume complete with answers, only \$1 postpaid. Satisfaction or refund. Amaze friends with your magic-like mental powers.

**FREE** Complete details... mail coupon TODAY!

NELSON CO., 321 S. Wabash, Dept. 3J59, Chicago 4, Ill. Please send free details about "Short-Cut Mathematics and Practical Mechanics Simplified." No obligation.

Name.....  
Address.....

of the spectrum and the number of frequencies which will be available for railroad communications services.

Coordinated application of radiotelephone systems on American railroads will also be an important factor in stimulating a large foreign market for railroad radio equipment. The extensive rail systems of Europe and Asia, destroyed or seriously damaged by air bombardment, will inevitably be rebuilt during the postwar period of reconstruction and modernization. It is logical to believe that new technological developments, such as railroad radio, will be incorporated in the plans of the various transportation groups abroad as American railroads demonstrate that through the use of radio techniques appreciable gains in efficiency and safety may be obtained.

-50-

**Spot News**  
(Continued from page 18)

operating between 40 and 224 megacycles could be developed. He pointed out that such a receiver might be a little expensive, but continued development would overcome this objection. For best operation at present, assignments from 50 to 108 megacycles in a continuous spread were cited as being most suitable.

Antenna design problems were also analyzed at one of the television panel sessions. An interesting point regarding urban installations was brought up. In areas of high field intensity it will probably become necessary to resort to the indoor or loop type antenna. Separate antennas or separately-tuned elements also will have to be provided. It may even be necessary, according to these experts, to provide for preset loops which will be switched in to the r.f. section by push buttons.

The region above 40 megacycles was cited as being most suitable for operation of a television system by members of Committee One. Frequencies in the lower half of the 45-megacycle range appear to have given better service with a minimum of multipath signal trouble. In view of these reports, it was the general consensus that the lower end of the television spectrum should be in the vicinity of 40 megacycles.

Frequencies lying in the bands between 300 and 1,000 mc. were recommended for relay allocation use in television systems by Committee Six. In this band, a continuous band of 200 mc. was suggested. This would provide for twenty 10-megacycle channels. An additional recommendation called for a continuous band of 400 mc., providing for twenty 20-megacycle channels. The selection of 10 megacycles, as the minimum channel width for relaying commercial television programs in the 200-megacycle band, was recommended, along with the 20-megacycle bandwidth for the

respective 400-megacycle channel.

According to Committees Two and Three who reported on standards, the width of the standard television channel should be 6 megacycles. And the standard number of scanning lines per frame period should be 525, interlaced two-to-one.

During a general meeting of the various committees of the television panel, an interesting letter concerning the establishment of a high-power transmitter offering standard frequency test transmission to not only stations in this country but Canada as well, was read. The letter came from the engineering division of a large Canadian manufacturer, and cited that such a transmitter, installed by perhaps the Bureau of Standards, would serve as a primary signal source for direct utilization of the base frequency for all types of time-actuated devices such as radio station frequencies, power frequencies, and time devices requiring high accuracy. All the radio stations could be directly controlled from such a source, said this letter, and thus maintain automatic synchronism on any channel. The establishment of such a standard would open the way for the use of stations requiring synchronization. That is, stations who might use suppressed carrier single-sideband broadcasting would find this service invaluable. Synchronizing and timing circuits of facsimile and television systems could also be kept accurate by such a constancy of transmission. The present frequency transmissions of the Bureau of Standards do not permit this proposed application, according to the writers of the letter.

The letter also went on to say that a continental radio base frequency would permit more intense spectrum utilization by the elimination of individual variations from thousands of independent secondary standards of frequency now generated by transmitters in service. This base frequency would also reduce the guard bands designed to allow for the inevitable variation in these independent standards, and thus open the way for advanced types of emission requiring synchronizing at the receiver. The letter also stressed the fact that this proposal would be justified if it did no more than permit the application of the single side-band suppressed carrier to standard broadcasting. The Canadian engineers cited that this system applied to broadcasting would eliminate most of the detrimental effects of selective fading caused by random interference between the carrier and sidebands in the present broadcasting technique, where ground and sky waves mix at substantially equal amplitudes. This would increase the effectiveness of present high power transmission. Improved fidelity would also result if this quiescent-carrier broadcasting system structure were adopted. In spite of television and FM, according to these experts, the



# THE TROJAN HORSE IS NOT A MYTH!

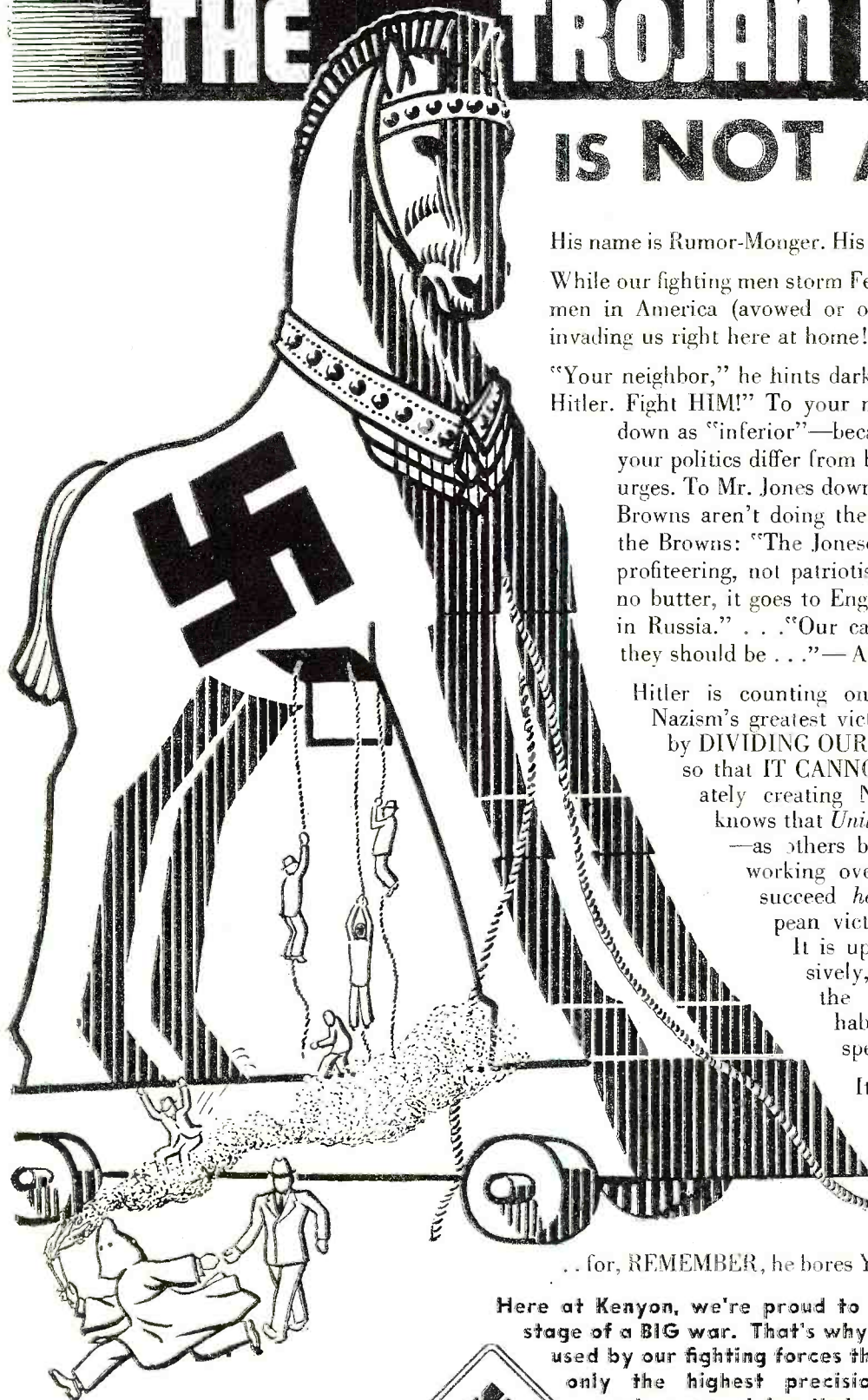

His name is Rumor-Monger. His job is to divide us *from within*.

While our fighting men storm Festung Europa, Hitler's henchmen in America (avowed or otherwise) bore from within, invading us right here at home!

"Your neighbor," he hints darkly, "is your real enemy—not Hitler. Fight HIM!" To your neighbor, he slyly builds you down as "inferior"—because your faith, your color or your politics differ from his. "Put him in his place" he urges. To Mr. Jones down the street he whispers, "The Browns aren't doing their share to win the war!" To the Browns: "The Joneses' war efforts are spurred by profiteering, not patriotism . . ." "No wonder there's no butter, it goes to England." . . . "OUR beefsteak is in Russia." . . . "Our casualties are way higher than they should be . . ."—And so on and on, ad nauseum.

Hitler is counting on his Trojan Horse to win Nazism's greatest victory over America, *internally*, by DIVIDING OUR NATION AGAINST ITSELF, so that IT CANNOT STAND—through deliberately creating Nazi-like racial disunion. He knows that *United We Stand, Divided We Fall*—as others before us fell! Therefore, he's working overtime to divide us! Will he succeed *here*, cancelling-out our European victories into American defeats?

It is up to YOU to defeat him decisively, every time he crawls out of the slime which is his natural habitat to rear his ugly head and spew forth his loathesome bilge.

It is up to YOU to throw out his literature, cast out his words, give no credence to the noxious thoughts he seeks to plant in your mind. You can't simply dismiss him as a crackpot or a bore

.. for, REMEMBER, he bores YOUR COUNTRY from *within*!

Here at Kenyon, we're proud to play our small role on the stage of a BIG war. That's why EVERY Kenyon transformer used by our fighting forces throughout the world reflects only the highest precision craftsmanship. Kenyon workers are doing their full share to bring Victory nearer—by turning out top quality transformers *uninterruptedly*—and as fast as possible!



THE MARK OF

EXCELLENCE

**KENYON TRANSFORMER CO., Inc.** 840 BARRY STREET  
NEW YORK, U. S. A.

standard broadcast band seems destined to a very important future.

**A POSTWAR DEVELOPMENT REPORT**, just issued by the British Institute of Radio Engineers, reveals that while television will probably be the most important commercial post-war project as judged by the immediate volume of business, the scope of electronics is much wider. The report goes on to say that although electronics is a comparatively new science, the tremendous possibilities of the industry have been amply demonstrated during the war. However, says the report, electronics will never be a solution to all the mechanical and electrical problems. In several industries, radio principles have provided improved performances. In such cases electronics will serve very effectively.

The report also covers television. The band width of 4 megacycles, which was used before the war, was recommended for continued application. The 525-line interlaced picture was also recommended in this report for post-war use.

It appears as if Britain may allow commercial broadcasting in the post-war era. For in this report, the question is raised as to whether or not it is wise to have a government monopoly of radio entertainment.

The report says, "Especially is this the case when the limitation of available transmission channels, the historical basis for a natural monopoly,

is overcome by the use of the ultra-high-frequency band, or 30 to 100 megacycles."

**OUR THROAT MIKES** have not fared so well with the English. It appears that most Englishmen form their tones in the roofs of their mouths and thus their words are unintelligible over the throat mike. This unusual disclosure was made by the Army Signal Corps recently. The words of Welshmen, Hollanders, Scotsmen can be heard clearly for they, like we, produce sounds through the throat. Thus comes the answer to a problem that has puzzled many.

**DIATHERMY AND INDUSTRIAL HEATING** may be given a special frequency, if the recommendations of Panel Thirteen of the RTPB are accepted. Their suggestion calls for the use of the 27-megacycle band, and perhaps an emergency band around 25 megacycles for these two services. Such a special allocation would eliminate the interference bugaboo now so prevalent on the bands that are used by the emergency services. Dual-frequency operation would allow for more occupants than single-frequency systems, a member of the committee pointed out. Everyone trusts that this recommendation will be accepted.

**Personals . . .**

The **Associated Police Communication Officers** will hold their eleventh annual national conference at the Commodore Perry Hotel, Toledo, Ohio, September 18, 19 and 20. . . . On November 13 and 14 the annual Rochester Fall Meeting of the **RMA Engineering Department** and the **IRE** will be held at the Sagamore Hotel, Rochester, N. Y. . . . Sound-effects expert, **Count Gaetano Cutelli**, died recently. It was he who created many of the unusual sound effects used in radio and motion pictures. One of the most famous of his sound effects was the high pitched s t a m m e r o f "Porky," the cheerful bustling pig in "Loony Tunes." . . . Certificates of Appreciation have been awarded by the Signal Corps to **Dr. Harold H. Beverage** of RCA Laboratories and **Chester W. Latimer**, vice presi-

dent and chief engineer of RCA Communications. . . . **Charles A. Stanton**, CAA Administrator, was recently awarded the honorary degree of Doctor of Sciences by Tufts College, Medford, Mass. . . . **Dan Fairbanks** is now jobbing division sales manager for Cornell-Dubilier. He was formerly with IRC in a similar post. . . . **E. H. Rehfeldt**, former advertising and sales promotion manager of Thordarson, is now in charge of planning and production of Electronic Engineering Co. Associated with Mr. Rehfeldt is **Harry Holubow**, as chief engineer. He was formerly design and research engineer at Thordarson. . . . **Frank A. Bailey** is now on the sales engineering staff of Operadio Manufacturing Co., St. Charles, Ill. . . . **S. I. Cole**, Aerovox Corporation president, has been elected an RMA director for the parts division. . . . **Ralph M. Hill** and **Gordon E. Gray** have formed a manufacturing company known as Grayhill, at 1 North Pulaski Road, Chicago 24. They will manufacture switches. **W. S. Lewis** is general manager and chief mechanical engineer. . . . **F. A. O'Leary**, formerly with Raytheon, has been named chief of the radio and radar section of WPB in New England. . . . **Harry T. Byrne** is now acting as advertising and sales promotion manager for John Meck Industries, Plymouth, Ind. He was formerly with Majestic Radio. . . . **Alfred A. Ghirardi** was married recently to Miss Evelyn Reilly in Arizona. . . . **A. James Ebel** has opened a consulting engineering office in Champaign, Illinois. He retains his post as chief engineer of WILL, University of Illinois. . . . **W. J. Stevenson** is now secretary of Utah Radio Products, for whom he has been general counsel. . . . **Floyd Masters** was recently appointed sales manager of the radio division of Stewart-Warner Corp. He replaces **L. L. Kelsey**, who is now with Belmont Radio. . . . **Dr. Ralph L. Power** has returned to civil life as a consultant. He had been, for the past two years, with the San Francisco Signal Corps Inspection Zone. . . . **Ted Collins**, manager of Kate Smith, has been appointed program consultant for the Dumont television station, WABD. . . . **Dee Breen** is now western division sales manager of Littelfuse, Inc. in El Monte, California. **Curtis A. Haines**, formerly manager of the Mill Hall and Altoona, Pa., plants of Sylvania Electric Products, Inc., has been promoted to the position of general manufacturing manager of these plants and new plants at Huntington, W. Va., and Lexington, Ky. . . . **William A. Winterbottom**, Vice President and General Manager of RCA Communications, Inc., died of a heart attack recently. . . . Completely recuperated from a recent operation, **W. S. Hartford**, Sales Manager is back at work at Webster Products, Chicago, Ill.

**FAST, PROPER AND EASY**

**FERRULING**  
with  
**AMPHENOL**  
FERRULE CRIMPING  
MACHINE



Here is a machine that really puts ferrules on flexible conduit SQUARELY and SECURELY. It rolls two smooth beads into ferrule and conduit—makes a secure and thoroughly workmanlike job. Connections made by this machine stand strains greater than called for by AN Specifications. The machine is furnished with mandrels and collects for 8 sizes of ferrules.

Anyone can learn in a few minutes to apply ferrules fast and properly with this machine.

Write for detailed information.

**AMERICAN PHENOLIC CORPORATION**  
1830 So. 54th Ave. - Chicago 50, Illinois  
Makers of Cable Assemblies, Conduit, Connectors,  
U.H.F. Cable, Radio Parts and Molders of all Types of Plastics.



I'm sorry, Mrs. Ooglewoop, but on account of shortage of help and materials, it will take me about four weeks to repair your radio



Well, I guess that is not too much of a wartime sock for me to stand

## Your customers can "take" it

by don herold

Americans are not sissies. When they know the truth, they can take it—especially when it relates to the war.

It's only when somebody tries to fool them, that they rear up on their hind legs and yowl. So, you can afford to be frank and honest with your customers about probable slowness of delivery, inferiority in details of repairs and your other possible wartime shortcomings.

THIS IS JUST A TEMPORARY REPAIR—NOT THE WAY I'D LIKE TO DO IT. THE WAR, YOU KNOW



THANKS FOR BEING SO FRANK

You don't have to be ashamed of them or to fib about them. Everybody knows there's a war and that Hitler started it—not you. The only mistake you can make is to give promises you can't keep, or do an inferior job that you don't explain to the customer. Your customers will even like you better for putting all your

cards on the table, and remember, customers will count again, buy and buy. Keep them friendly for those selling days to come.



AFTER ALL, EACH OF US IS SOMEBODY'S CUSTOMER

Even your distributor may have to turn you down occasionally on International Resistance Units. But he's pretty sure to do it pleasantly, with the result that you'll understand his position based on the continued need for I R C resistors in vital war equipment.

No. 7 in a series of special messages prepared by America's famous business writer, humorist and cartoonist, Don Herold. . . In sponsoring these Don Herold "broadcasts," IRC pays tribute to the thousands of Radio Service Men who, whenever possible, specify and use IRC resistance units in their work.



# INTERNATIONAL RESISTANCE CO.

401 N. Broad St. • Philadelphia 8, Pa.

IRC makes more types of resistance units, in more shapes, for more applications than any other manufacturer in the world.



# Manufacturers' Literature

Readers are asked to write directly to the manufacturer for the literature. By mentioning RADIO NEWS, the issue and page, and enclosing the proper amount, when indicated, delay will be prevented.

WHAT DOES THE  
"BL BUTTON"  
MEAN?



In the case of the Frequency Meter shown above, the "BL button" (shown below) means that by using it, transmitters can be kept "right on the button." On any piece of equipment it means sound design, rugged construction, fair price. Watch for the "BL button" after the war.



## BROWNING

LABORATORIES, INC., WINCHESTER, MASS.

CORWICO

# WIRES

MADE BY

Engineers FOR  
Engineers

## VICTORY

concentrating upon

for the duration . . . .

## cornish

WIRE COMPANY, INC.

15 Park Row, New York City, New York

CORWICO

### TELEVISION BOOKLET

The *General Electric Company* has issued a booklet entitled "Television at WRGB" which describes the development of television from 1928, when station WGY in Schenectady first began regular telecasts, until the present day.

Actual studio photographs are included in this booklet to illustrate the programming of television features as well as pictures of the "behind the scene" work involved in providing television programs.

This booklet is available at no charge from the *General Electric Company*, Schenectady, New York. Please specify Publication Number GEB-146.

### CAPACITOR CATALOGUE

The *Electro-Motive Mfg. Co.* has issued four new data sheets for inclusion in their standard catalogue. These sheets cover new additions to the Elmenco capacitor line.

The CM-20 and the CM-40, with ranges from 5 to 75  $\mu\text{f}$ . and tolerances from  $\pm 2\%$  to  $\pm 10\%$ , are described in detail with engineering data included.

Persons holding the "Elmenco" catalogues are urged to write in for these additional sheets. Address inquiries to the *Electro-Motive Mfg. Co.*, Willimantic, Conn.

### SEARCHRAY BULLETIN

A complete, self-contained industrial X-ray unit, known as the Norelco Searchray No. 150 is described in a bulletin offered by *Walker-Jimieson* who are the distributors for this product in the Chicago area.

This unit, which is manufactured by the North American Philips Co., provides a nondestructive means of examining specimens for internal flaws, cracks or foreign matter.

This bulletin includes a description of the operation of the unit as well as a list of applications and advantages. A demonstration unit is on display at the *Walker-Jimieson* showrooms at 311 S. Western Avenue, Chicago, 12, Illinois. Copies of the bulletin, \$150, may be obtained at the same address.

### TRANSMISSION LINES

A  $\frac{3}{8}$ " diameter coaxial transmission line is covered in Bulletin No. 29 recently published by the *Victor J. Andrew Company* of Chicago.

Known as No. 83, this line is a low loss type which is widely used in high and ultra-high frequency work, as a connecting link between transmitter and the antenna in any low power in-

stallation; for interconnecting r.f. circuits in transmitter and television apparatus; for transmitting standard frequencies from generator to test positions; and for phase sampling purposes in broadcast directional systems.

The transmission line is air insulated and the low power loss is assured by using a minimum of insulating spacers for mechanical support. The spacers are made of Navy grade "G" steatite. The outer conductor material is soft temper copper tubing which may be bent by hand, but is resistant to crushing.

Suitable fittings and accessories for this line are also described in the same bulletin, copies of which may be obtained by writing to *Victor J. Andrew Company*, 363 East 75th St., Chicago, 19, Illinois.

### COMMERCIAL INSTITUTE

A new catalogue covering the fall term has been issued by *Commercial Radio Institute* of Baltimore, Maryland.

Several types of courses are available to students interested in broadcast, ship's operator, television and commercial applications of radio. These courses are outlined along with prerequisites, fees, tuition, books and supplies needed in the courses.

Pictures of the school equipment and facilities are included along with the records of some of the school's graduates. The fall session opens on October 9th. School sessions are open to women as well as men.

Persons interested in enrolling or securing information about the school should write directly to *Commercial Radio Institute*, 38 West Biddle Street, Baltimore, 1, Maryland.

### "ELECTRONIC TELESIS"

The *Eitel-McCullough Company* has issued an interesting booklet entitled "Electronic Telesis" which shows the many applications of electronic tubes, in medicine, industry, broadcasting, television and facsimile.

The development of the electronic tube is traced and the steps in its manufacture are explained so that the story is of interest to the layman as well as the engineer or radioman.

Throughout the booklet, photographs and pencil drawings are used to illustrate some of the many uses to which tubes may be adapted.

Persons interested in securing this booklet may do so by writing to *Eitel-McCullough, Inc.*, San Bruno, California, and requesting "Electronic Telesis."

-30-

# Dials by **CROWNAME**

GLASS METAL  
PLASTICS



CERAMIC  
ETCHED  
LITHOGRAPHED  
ENGRAVED  
EMBOSSED

**CROWE NAME PLATE AND MANUFACTURING CO.**  
3701 RAVENSWOOD AVENUE CHICAGO 13 ILLINOIS  
40 YEARS EXPERIENCE IN FINE METALCRAFT

## Highway Communications (Continued from page 37)

of the George Washington Bridge experimental installation, a program was initiated, just before the war, to install the *Halstead Highway Radio System* at strategic points along some 250 miles of one of America's principal highways. Although this program was interrupted by the war, the engineers continued the development of highway radio techniques and have kept test equipment in place. One installation of this general type is located in the Queens Midtown Tunnel, New York City, one of the major traffic arteries connecting midtown Manhattan and Long Island City. The system was installed shortly before Pearl Harbor in cooperation with the New York City Tunnel Authority, and under the supervision of E. Hajos, Engineer of the tunnel authority, for the purpose of conducting tests of a projected radio service for motorists proceeding within the tunnel.

Since highway radio communications and radio traffic control equipment incorporate many recent advances in the radio art, a short description of one form of the *Halstead* highway radio system installed on an experimental basis in the Queens Midtown Tunnel may be of interest. In this installation, a low-power induction radiotelephone transmitter, located in the tunnel, is connected to a radio-frequency transmission line extending throughout the length of the tunnel, thereby establishing an intense induction radio

field confined substantially within the tunnel structure. Through the use of a new signaling technique, the information or programs transmitted by the system can be heard, during test periods, in all cars equipped with modern radio broadcast receivers without need for drivers to tune their receivers to a given highway radio frequency. As signals from conventional broadcasting stations cannot be received in the tunnel, this method provides a means by which an automobile receiver, tuned to a local broadcasting station, accepts the tunnel broadcast at the moment when the automobile enters the tunnel and signals from the outside station disappear.

A second transmitter, tuned to a specified highway radio frequency, in a locally-unutilized portion of the broadcast band, has also been used successfully in the tests. The latter technique is employed on open highways where frequency blanketing techniques cannot be used for program transmissions. In such instances, the drivers must tune to the specific highway frequency as directed by a distinctive visual or audible marker, or utilize a small pre-tuned receiver made specifically for highway radio traffic control and communications purposes.

All tunnel radio equipment is operated from a remote-control room where connections with telephone or power lines may be made. A remote-control unit, as well as a record reproducing device, are also installed at this point. By means of a radio-frequency monitoring circuit, an operator at the remote-control point can check

on the signals as actually transmitted within the tunnel proper, while the information or program transmission may be changed at any time from the control point.

In order to provide continuous repetition of information of particular value to motorists a magnetic tape recorder-reproducer of continuous, repetitive type is employed in conjunction with the tunnel transmitters. This device makes it possible to acquaint motorists with exit routes or convey such other information as may be useful in emergencies. When not carrying traffic instructions, late news flashes or musical programs may be transmitted to the driver as the car proceeds through the tunnel.

The Queens Midtown Tunnel experimental installation is representative of one type of system which may be employed after the war at strategic points along the nation's traffic arteries. In such instances where power or telephone lines exist, no special transmission line, or induction cable, is required. *Halstead* engineers have developed means by which the lateral extent of the signaling zone may be substantially limited to the width of the highway and its length can be established at any distance desired, ranging from 25 feet to 25 miles or more. These techniques accomplish two purposes. First, by limiting the effective signaling field to the highway, the system can be operated without Federal licensing under existing Federal Communications Commission

Diagram of Halstead traffic communications system at the Queens Midtown Tunnel experimental installation.

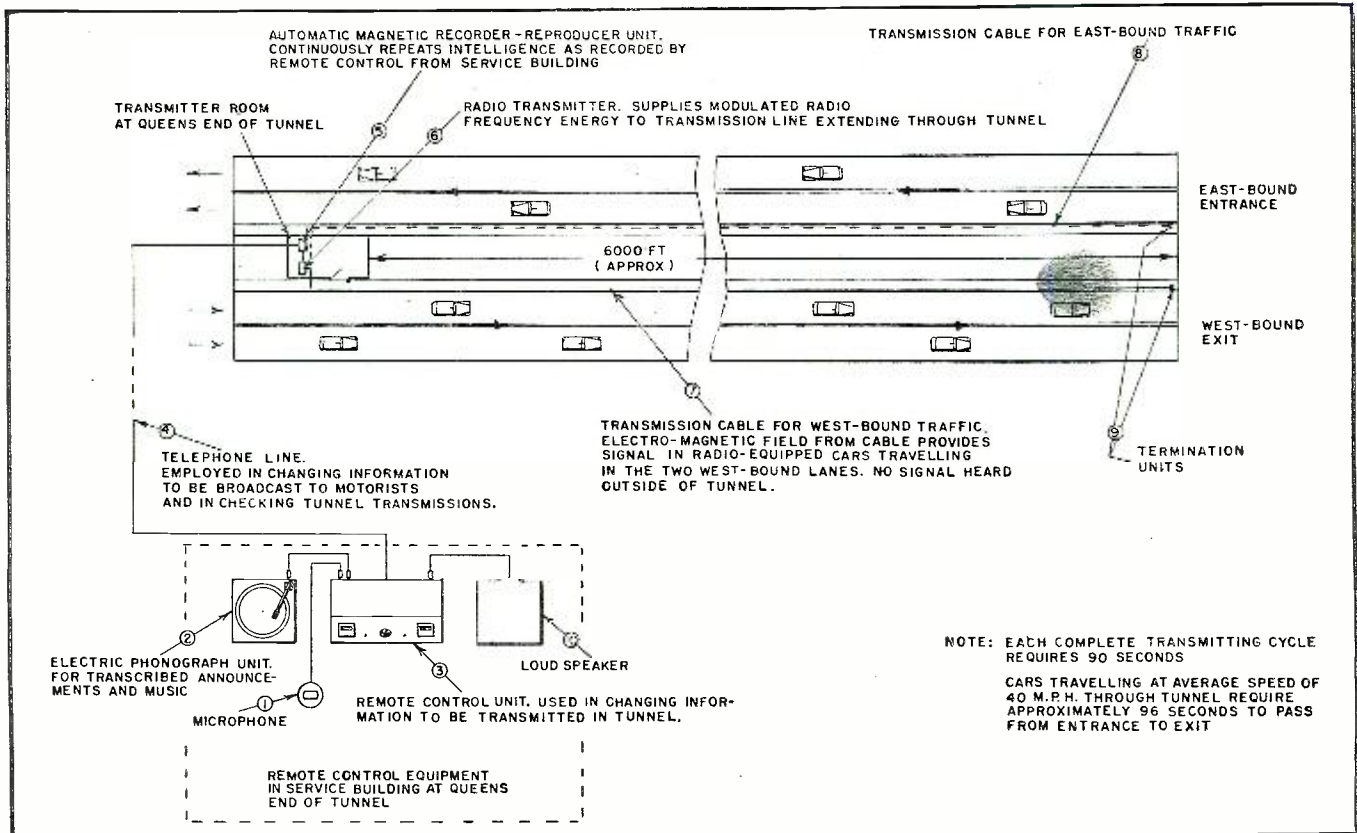

# Straight Furrows

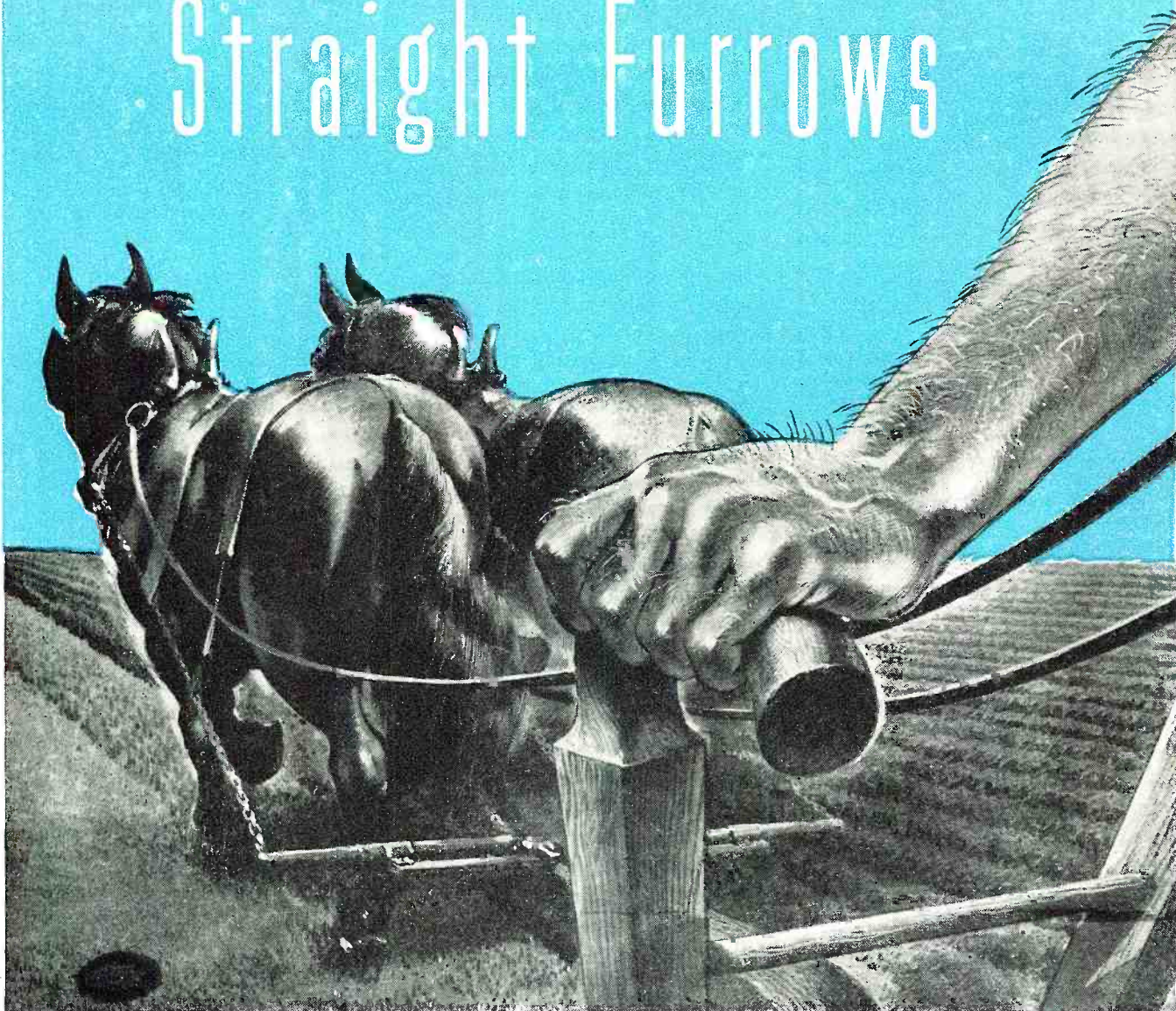

It takes a steady, knowing hand to plow a straight furrow. And a good plowman is never satisfied with anything short of perfection. It takes men of experience and judgment—men imbued with quality ideals—to build quality products. The skilled direction the NEW DETROLA management now applies to the manufacture of precision war equipment will one day guide the making of fine electronic products for home and industry. *Hasten The Day Of Victory By Buying More And MORE War Bonds.*

## DETROLA RADIO

DIVISION OF INTERNATIONAL DETROLA CORPORATION • BEARD AT CHATFIELD, DETROIT 9, MICH.

C. RUSSELL FELDMANN



PRESIDENT



### PLUG-IN CONDENSER

Plug-in capacitors with a wide range of voltages and capacities are one of the many different paper and electrolytic capacitors manufactured by the Illinois Condenser Company. This unit is hermetically sealed and built to operate under the severest conditions. We also manufacture condensers for special applications with a wide temperature range of from  $-50^{\circ}\text{C}$  to  $+85^{\circ}\text{C}$  and from one volt to 500 volts D.C. working on the electrolytic types.

## ILLINOIS CONDENSER COMPANY

1160 NORTH HOWE STREET  
CHICAGO 10, ILLINOIS

# 7 Days

## Free Examination

# PRACTICAL RADIO I FORMATION

Including Frequency Modulation—Television, etc.

Inside Radio Information for all Servicemen—Aircraft Pilots, Students. AUDEL'S RADIO-MANS GUIDE contains 772 Pages, 400 Diagrams & Photos is complete—gives Authentic Principles & Practices in Construction, Operation, Service & Repairs. Covers clearly and concisely Radio fundamentals—Ohm's Law—Physics of sound as related to radio science—Measuring instruments—Power supply—Resistors—Inductors—Condensers—Transformers and examples—Broadcasting stations—Radio Telephony—Receivers—Diagrams—Construction—Control systems—Loud speakers—Antenna systems—Auto Radio—Phonograph pickups—Public Address Systems—Aircraft & Marine Radio—Radio Compass—Beacons—Automatic Radio Alarms—Short Wave—Coil Calculations—Testing—Cathode ray oscillographs—Static Elimination—Trouble Pointers—Underwriter's standards—Units and tables—Frequency Modulation—REVIEW QUESTIONS & ANSWERS, Ready Reference Index.

**\$4 COMPLETE • PAY ONLY \$1 A MO.**  
Get this practical information in handy form for yourself—Fill in and MAIL COUPON TODAY

AUDEL, Publishers, 49 W. 23rd St., N.Y.  
Mail AUDEL'S NEW RADIO-MANS GUIDE for free examination. If O. K., I will send you \$1 in 7 days; then remit \$1 monthly until \$4 is paid. Otherwise I will return it.

Name \_\_\_\_\_  
Address \_\_\_\_\_  
Occupation \_\_\_\_\_  
Reference \_\_\_\_\_ R.N.

rulings. By control of the longitudinal extent of the signaling zone, information applicable to a specific point or section along the highway can be given to the motorist at the desired point, or a continuous program extending over an appreciable period of time can be transmitted to the driver while he is proceeding along the highway.

As a part of the *Halstead* highway radio system is the projected use of the system in cooperative connection with existing traffic control equipment so that traffic control signals may be reproduced audibly and visually, if desired, within motor vehicles. In the latter case, miniature red, green and amber lights are installed on the instrument panel of a motor car. A characteristic tone signal, indicating whether the light is red, green or amber, is reproduced by the loudspeaker of the car receiver. In many operational tests of the system, it has been observed that the nerve strain placed on drivers because of the need to divide attention between tiny spots of light along the road side and traffic on the road is obviated, and greater convenience, as well as safety, is thereby accomplished.

Induction-radiotelephone systems are also well adapted for use in other forms of transport communications, and provide a practicable means in many communities for establishment of various highway radio services, including centralized control of direction of movements of trucks, buses and taxicabs. The systems already developed are expected to meet a need for paging of doctors and other individuals while traveling in their cars between various sections of a community.

Such induction radio services have an advantage over normal space-radio systems in that signaling zones are confined to the immediate vicinity of roadside conductors, thereby enabling the use of the same frequency in other communities without causing mutual interference. FM techniques are of particular advantage in this respect for the reason that the local signal will completely over-ride carrier signals from an adjoining municipality with no heterodyne effect being noticed. Inasmuch as induction-radio systems may also be operated in compliance with existing rules of the Federal Communications Commission covering use of low-power radio frequency devices without Federal licensing, it is anticipated that many desirable community services will be provided through coordinated use of such limited-range induction-radio communicating techniques. Later, as directional microwave equipment becomes commercially available, the initial systems may be expanded to include proposed subscriber services involving two-way communications in which mobile units are involved.

Obviously, the comprehensive application of radio systems on highways and the development of a coordinated highway system will involve substantial sums of money. Some traffic engineers believe that highway radio

traffic control and communications systems will be installed and operated after the war by various governmental or municipal authorities in areas where traffic congestion and road hazards present serious problems, and where radio might be used successfully to alleviate them.

In summary, it may be said that through aggressive, imaginative application of new radio techniques on railroad and highway transportation systems, we may anticipate the opening of important new industrial frontiers. With continued faith in the American pioneering spirit, in which the creative efforts of individual engineers and the smaller engineering groups are a basic factor, as in the development of frequency-modulation by Major Armstrong, we may expect to see full use of our expanded wartime radio manufacturing facilities. New public services, hitherto nonexistent, will be developed, while our basic mass transportation systems will attain a degree of safety and efficiency far beyond that now realized.

—30—

## The Oscilloscope

(Continued from page 31)

the same as the desired resonance frequency of the tuned circuit. The alignment trimmers should then be adjusted to secure the desired curve.

Various troubles may develop in the tuning section of a receiver. Lopsided curves, wide-band interference, off-frequency resonance, oscillation, etc., are all indicated by the oscilloscope. The cause can be located easily and quickly corrected by the usual service technique as employed by the serviceman. A few typical patterns and their interpretations are given herein.

In order to align the r.f. stages of either a superhet or a t.r.f., the identical equipment is used as when align-

The omnidirectional radio range beacon, consisting of five rods, 24 inches long, and supplanting the 125-foot poles formerly used for this service. The system was developed by David H. G. Luck of RCA.





# 3 REASONS WHY...

SPERTI HERMETIC SEALS ARE SPECIFIED ON EQUIPMENT DESIGNED FOR TOUGH MILITARY CONDITIONS

1

FUSED INTO ONE PIECE. Glass-to-metal vacuum tight hermetic bond, resistant to shock and corrosion.

2

EFFECTIVELY SEALS out dust, humidity, and fungus from transformers, relays, vibrators and other sensitive component parts.

3

WIDE THERMAL OPERATING RANGE AND HIGH INSULATION LEAKAGE RESISTANCE. Thermal operating range,  $-70^{\circ}\text{C.}$  to  $200^{\circ}\text{C.}$  Insulation leakage resistance, 30,000 megohms, minimum, after Navy immersion test.

SOLDERING TEMPERATURE NOT CRITICAL. Simple, easy to attach by means of high frequency, oven-soldering or standard soldering iron.

*Now in Volume production*

WRITE, WIRE OR PHONE TODAY FOR INFORMATION!

Sperti



INCORPORATED

ELECTRONIC DIVISION, DEPT. - (RN-3)  
RESEARCH · DEVELOPMENT · MANUFACTURING · CINCINNATI 12, OHIO

17 118  
20 121 122 123 124  
125 126 127 128 129 130 131  
133 134 135 136  
143 144 145 146  
153 154 155 156  
163 164 165 166

# 173

types of Screw Drivers  
and Small Tools  
MEANS

## VACO AMBERYL

HAS THE TOOL YOU NEED  
... TO SUIT THE JOB  
IT'S NEEDED FOR

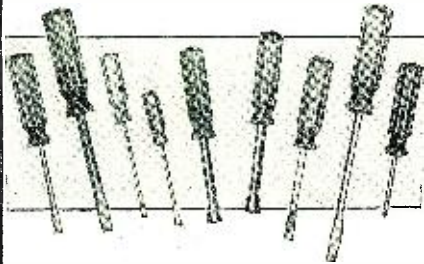

Write for catalog

### VACO PRODUCTS CO.

319 E. ONTARIO STREET CHICAGO 11, ILL.

Canadian Branch Warehouse: 560 King St., W.,  
Toronto 2, Ont.

## AT 100 MC

POWER FACTOR 0.0033  
DIELECTRIC CONSTANT 3.57

## DILECTENE

A CONTINENTAL-DIAMOND  
ENGINEERED U-H-F  
INSULATING PLASTIC

◆  
**STABLE UNDER**

- ◆ High Humidity
- ◆ Temperature Extremes
- ◆ Mechanical Stress
- ◆ Chemical Conditions

◆  
READILY MACHINED  
for complete technical  
data, send for Bulletin DN

### CONTINENTAL-DIAMOND FIBRE COMPANY

NEWARK 49

DELAWARE

ing i.f.'s. However, the test oscillator must be connected across the antenna posts of the receiver, and the central frequency thereof must be the same as that to which the receiver is tuned.

#### Visual Alignment of FM Discriminator Circuits

FM discriminator circuits can be easily aligned by the serviceman with great accuracy when the visual method is employed. The procedure is very similar to the one used when aligning the tuned circuits (i.f. and r.f.), of an AM receiver.

A frequency-modulated generator is required. Tune this to the particular i.f. frequency and adjust it to vary from about 250 to 300 kc. Then, connect this FM generator to one of the i.f. grids. The vertical axis of the scope is hooked up to the output of the discriminator. Impress a saw-tooth voltage on the horizontal axis of the scope. Synchronizing impulses obtained from the FM generator are fed to the synchronizing jack of the scope (as when aligning i.f.'s) so that the pattern will remain stationary.

As in the alignment of tuned circuits in an AM receiver, a response curve is obtained. But, obviously, in this case we have the response curve of the discriminator circuit. In a well-adjusted

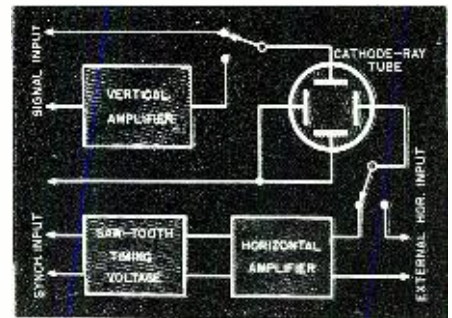

Fig. 6. Simplified block diagram of an oscilloscope.

FM receiver, two curves are obtainable. These are the overlapping resonance curves of two tuned circuits showing the forward trace of one and the backward trace of the other. If the frequency modulation or deviation is wide enough, the entire curves may be viewed.

The crossover point should be at the i.f. frequency and the sides should be linear. As in the case of ordinary tuned circuits, troubles in AM receivers, such as nonlinearity, off-frequency resonance, etc., may likewise occur in FM sets. These can be easily observed and adjusted when once seen.

On the screen, the horizontal axis



## HONOR ROLL OF RECENT ARMY-NAVY "E" AWARDS

COMPANY	AWARD
The Insuline Corp. of America, Long Island City, N. Y.	"E" Flag
Bell Sound Systems, Inc., Columbus, Ohio	White Star
Crowe Name Plate & Mfg. Co., Chicago, Illinois	"E" Flag
Fansteel Metallurgical Corp., North Chicago, Illinois	White Star
Meissner Manufacturing Co., Mt. Carmel, Illinois	2nd White Star
Emerson Radio and Phonograph Corp., New York, N. Y.	"E" Flag
Utah Radio Products Company, Chicago, Illinois	White Star
The Sheffield Corporation, Dayton, Ohio	3rd White Star
Federal Manufacturing and Engineering Corp., Brooklyn, New York	3rd White Star
Raytheon Manufacturing Co. (4 Divisions), Newton and Waltham, Mass.	2nd White Star
Universal Microphone Company, Inglewood, Calif.	"E" Flag
Electronic Enterprises, Inc., Newark, N. J.	White Star
Bell Telephone Laboratories, New York, New York	3rd White Star

# At WESTON . . . RELAY SENSITIVITY has been advancing with seven-league boots!



1935 . . . Sensitivity 1 milliamperes

1938 . . . Sensitivity 10 microamperes

1940 . . . Sensitivity 5 microamperes

1944 . . . Sensitivity \* \*

**\*\* Sensitivity many times greater than in 1940; with amplification factor 2,000,000,000 to 1, or better!**

With today's emphasis on electronics, WESTON developments in the field of Sensitive Relays assume utmost interest to design engineers. Even prior to the war, these relays provided positive control at input values low as 2 microamperes or 1 millivolt. Employing WESTON'S exclusive *magnetic contact* principle, they handled 5 watts at 110 volts, with complete freedom from contact troubles.

But relay development at WESTON has kept pace with the more exacting *control* needs of this war. Relays with sensitivity *for exceeding* that of pre-war days already have proved their reliability on critical equipment, and under the most rigorous conditions!

More than likely, these relays provide the answer for many of tomorrow's products; for they provide the simplest, most compact means of controlling at minute energy levels.

Have the full story on "what's ahead" in sensitive relays and instruments at your fingertips. Check WESTON, too, on all *war instrument* needs!



Laboratory Standards . . . Precision DC and AC Portables . . . Instrument Transformers . . . Sensitive Relays . . . DC, AC, and Thermo Switchboard and Panel Instruments.

# WESTON

Specialized Test Equipment . . . Light Measurement and Control Devices . . . Exposure Meters . . . Aircraft Instruments . . . Electric Tachometers . . . Dial Thermometers.

**FOR OVER 56 YEARS LEADERS IN ELECTRICAL MEASURING INSTRUMENTS**

# UNDER 4 FLAGS

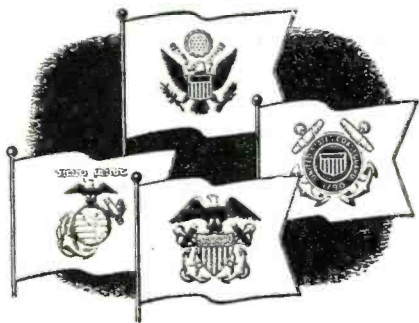

## RIDER BOOKS

*are training Radio men*

In addition to use as texts in all the armed services, Rider Radio Books are also found in leading libraries and famous technical schools; to mention a few: Georgia Tech., Univ. of Pennsylvania, Northwestern Univ., Virginia Polytech., Manhattan College, M I T, Univ. of Delaware, Carnegie, Duke, Harvard, Syracuse and Univ. of Alabama.

Send Today for New Catalog

**JOHN F. RIDER, Publisher, Inc.**

404 FOURTH AVENUE • NEW YORK CITY  
EXPORT DIV.: ROCKE-INTERNATIONAL ELEC. CORP.  
100 VARICK STREET, NEW YORK CITY. CABLE: ARLAB

# Electronics RADIO ENGINEERING

### NEW COURSES FOR MODERN NEEDS

**RADIONICS**, the science of electronic applications, is widening its horizon hour by hour. There's a secure future in this field for YOU—provided you put **OUR TRAINING ON YOUR** must list NOW.

Needed at once are specialists in Marine Radio, Police Radio, Aviation Radio, Broadcasting, Television, Frequency Modulation, High Frequency Broadcasting, and Commercial Radio Telegraph. That need will continue.

Our school is co-educational. It offers to women as well as men streamlined elementary and advanced courses for Radio Servicemen, Radio Engineering Assistants, Radio Test and Maintenance men. The work is thorough, practical, void of frills. The courses are approved by State Vocational Departments, Major Airlines, State Police Systems, Radio manufacturers, and hundreds of Broadcasting Stations.

Credit is given for Army radio courses and experience toward any of our courses. High school graduation or its equivalent necessary for advanced courses. Tuition at pre-war levels. Send for catalog today.

**MAIL THIS COUPON NOW!**

VALPARAISO TECHNICAL INSTITUTE,  
Dept. R., VALPARAISO, Ind.

NAME.....

P. O. ADDRESS..... AGE.....

CITY and STATE.....

CATALOG REQUEST—RADIO NEWS

represents frequency and the vertical axis, output. It is very useful to know the location of certain frequencies on the screen, such as the central i.f. frequency. Thus, if we know this point, we can readily shift the crossover point of the discriminator curve to this spot. To locate the point, tune an unmodulated oscillator to the desired frequency. The trace is slightly blurred at this point. Similarly, several frequencies may be indicated on the screen so that frequency deviation points may be determined.

In closing, we hope that the above discussion, touching on some of the many possible applications of the oscilloscope in radio servicing, will benefit the reader. For those wishing a more comprehensive treatment of this subject, we recommend to him any one of the available standard texts.

—30—

### Radio Theory Review

(Continued from page 49)

differs from other types of tubes.

It is necessary to understand the function of every component in a vacuum tube so that the meanings of terms such as electron emission, secondary emission, and plate dissipation are clear to you. Plate impedance and plate dissipation should be clarified, as should amplification factor and mutual transconductance.

The application of filament power

to a tube is simple and the student should know what types of tube filaments can be reactivated.

Specific types of tubes, such as rectifier tubes, must be properly classified and the relative merits of high-vacuum and hot-cathode mercury-vapor tubes understood. The operating characteristics of both of these types of tubes should be studied.

### Rectifiers

At this point the student should delve quite deeply into rectifier principles. Learn what a rectifier circuit is and why it is necessary. Learn how it operates and the relative advantages of half-wave and full-wave rectification. It is essential to know how to compute the ripple frequency of a given rectifier and it would be helpful to memorize the ratios between the average, effective and peak values of a sinusoidal wave, as no doubt a question or two requiring this knowledge will appear on your examination sheet.

Simplified schematics of half-wave, full-wave and bridge type rectifiers, single- and three-phase, should be learned. Let me emphasize that in learning schematics, do not memorize them. Learn the basic principles, as very often all that will be required of you in the examination, will be to fill in a missing line which is required to complete a circuit laid out quite differently from any you've seen before.

Before finishing with rectifiers, make certain that you understand

Fig. 4. Simple rectifier circuits, showing half-wave rectifier (A), and full-wave, single-phase rectifier (B).

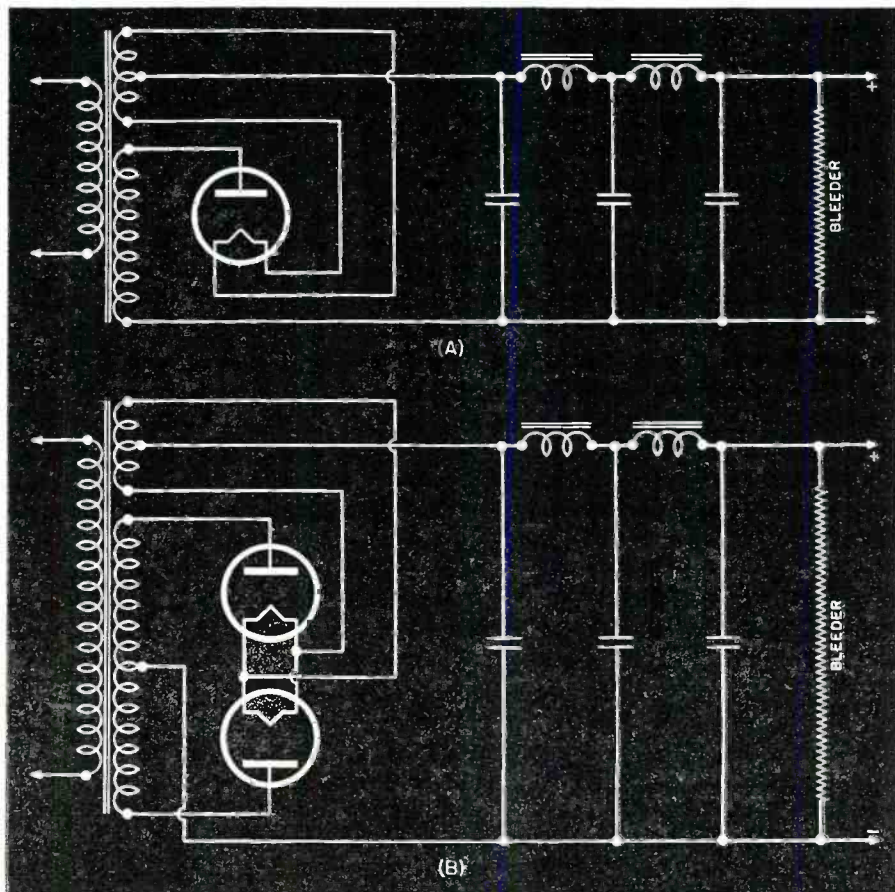

# A PRECISION LABORATORY INSTRUMENT

## FEDERAL

### U. H. F.

## SIGNAL GENERATOR MODELS 804-C51

also 804-C52

FOR MORE DETAILED INFORMATION WRITE TO DEPT. RN-9

PRICE \$350.00  
F.O.B. FACTORY

Carefully and difficultly acquired experience enabled **Federal** to produce more Ultra High Frequency Test Signal Generators than were ever thought possible—and quickly, too.

Breaking the tightness of demand by the Army and Navy, these high quality laboratory precision instruments are available to research laboratories and industrial manufacturers engaged in the production of electronic equipment.

Your inquiries are invited.

**CARRIER FREQUENCY RANGE:** 7.6 to 330 megacycles plus or minus 2%, direct-reading in 5 bands, 6th band available for use with blank coil form supplied.

**OUTPUT VOLTAGE RANGE:** Calibrated Attenuator continuously variable from 1 to 20,000 microvolts, accuracy plus or minus 10%.

**MODULATION:** Internal Modulation 1,000 cycles; external modulation up to 20,000 cycles; 0 to 60% direct-reading modulation meter.

**STRAY FIELD LEAKAGE:** Held to a minimum by improved shielding and R.F. Filters.

**VIDEO OR PULSE MODULATION:** Can be pulse modulated externally with signals having very steep wave fronts.

**VOLTAGE REGULATED POWER SUPPLY:** 115 or 230 volts, 40 to 60 cycles, single-phase.

Manufactured by arrangement with the General Radio Company of Cambridge, Massachusetts, and in accordance with their designs.



FOR THE FOURTH TIME

BACK THE  
INVASION ...  
KEEP BUYING  
MORE WAR BONDS

**Federal Manufacturing and Engineering Corp.**  
Manufacturers of Federal Photographic Equipment and Federal Electronic Devices  
**BROOKLYN 5 NEW YORK**

# NEWCOMB

## Portable SOUND SYSTEM



**R**EADY for immediate action anywhere... only 39½ pounds... a complete, powerful sound system. Remarkable volume! Users report: practical on land up to ½ mile; at sea, up to 2 miles.

Ideal for use in amphibious operations, ship-to-ship communications where radio might be dangerous, life saving operations, civilian or prisoner control, cadet training, field instruction, any similar activity.

Unit includes: microphone, amplifier, power supply, loudspeaker. Write today for complete specifications.

**NEWCOMB**  
AUDIO PRODUCTS CO.  
COMPLETE SOUND SYSTEMS  
Dept. M, 2815 S. Hill St., Los Angeles 7, Calif.

## RADIO-ELECTRONICS HOME-STUDY COURSE

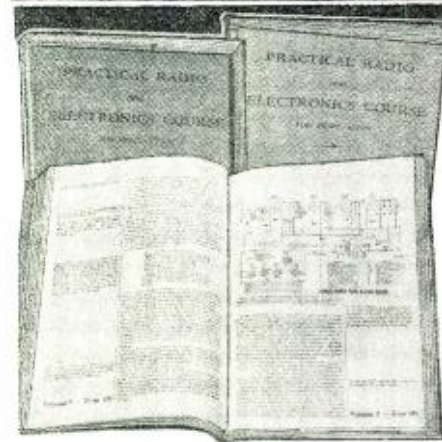

New home-study course in 3 volumes. Covers every topic of radio and electronics. Brush-up on useful radio fundamentals, use the practical service hints, prepare for a future in Electronics and Radio.

□ Volume 1. Fundamentals of Radio and Electronics. Use the 13 lessons of this volume to really understand radio and electronics. Facts, tubes, circuits, tests. 172 large pages, all lessons size 8½ x 11½, with instructor's tips, 201 charts and pictures, index... **\$1.50**

□ Volume 2. Receivers, Transmitters, & Test Equipment. Superhets, communication receivers, oscillators, transmitters, repair, adjustment, antennas, meters, electronic test equipment, signal tracers, AFC, television, and other topics. In 9 large lessons and index. 105 helpful illustrations. Large size: 8½ x 11 inches... **\$1.50**

□ Volume 3. Applied Electronics and Radio Servicing. Lessons on photo-cell equipment, special radio receivers, radio compass, frequency meters, life-boat transmitter, D.R.F. hearing, electronic sniping circuits, aircraft direction finders, absolute altimeter, radar, metal locators, special tubes, welding controls, voltage regulators, X-rays, magnetron, electronic gauges, facsimile, recording, intercoms. Also lessons on radio servicing, case histories, diagrams. Manual contains 31 large lessons... **\$1.50**

□ All 3 Volumes. 53 Lessons, only... **\$3.95**

Clip this ad. Check manuals wanted. Enclose your remittance. Books sent postpaid. Money back guaranteed.

**SUPREME PUBLICATIONS**

323 S. Jefferson St., Chicago 9, ILL.

what a copper-oxide rectifier is and how it operates.

### Filters

Check back on the studying you did on inductances and see what particular points apply to filter chokes. An adequate knowledge of filter construction and its application is required. Learn the differences between condenser input filters and choke input filters.

### Radio Circuit and Tube Operation

The basic factors which determine operating voltages for all classes of vacuum tubes should be understood. As these factors depend upon the class of operation in which the vacuum tube will be employed, it is also necessary for the student to know the principles and purposes of the various classes of operation which may be applied to vacuum-tube circuits.

The circuit and electron tube factors which influence the voltage gain of a given tube must also be known as should the details of load impedance matching.

Push-pull and single-stage operations, detector circuits, and frequency-doubler amplifier characteristics should also be comprehensively studied.

### Improper Circuit Operation

As the Commission considers it essential for the prospective license holder to be able to quickly locate various types of trouble and operating faults in all types of equipment, the student may be required to answer many trouble-shooter's questions in the examinations. Therefore, it is recommended that a good deal of time be spent on circuit analysis.

Determine the factors which may lead to improper operation of any circuit component or the circuit itself and study them well. Make certain that your knowledge of this point is more than rudimentary as trouble-shooting plays an important part in all radio work.

### Coupling Systems

The student should familiarize himself with the many types of coupling systems in use. These systems are usually used to couple the plate of one tube to the grid of another tube and, consequently, it is only necessary to draw the basic symbols for each type of coupling in its proper place on a schematic. The advantages of one type of system over another should be clearly understood.

Several types of coupling systems are shown in Fig. 3.

### Circuit Schematics

A student may be required during the examination to draw from memory any one of several types of oscillator or detector circuits. A simple method whereby the plate, grid, and cathode circuits may be easily learned is given.

It is hoped that the foregoing outline will assist the student in accumu-

lating the necessary knowledge and background in radio theory required to pass Element 2 of the Commercial Radio Operator Examinations. This element, while far from being the most difficult technically, is nevertheless difficult for the beginning student to pass. By the time the student has covered the comprehensive outline given above he should be sufficiently well versed in radio lore to have a comparatively easier time with the more advanced elements required for a Commercial Operator's License.

It is quite important to remember that there is no "short cut" to radio knowledge. Study every subject fully and delve deeply into all subjects which appear even remotely connected with those in which you are interested.

-30-

## International Short-Wave

(Continued from page 54)

2:30 p.m. EWT—11.94 mcs.

6:47 p.m. EWT—11.94, 15.1, and 15.2 mcs.

8:00 p.m. EWT—11.94, and 9.48 mcs.

News in English is generally given by Radio Moscow at the beginning of each transmission.

\* \* \*

### BASIC ENGLISH LESSONS

At 8:45 p.m. EWT one may now eavesdrop on the European service of the British Broadcasting Corporation and hear the nightly lesson in basic English directed to the peoples of the Continent.

Frequencies used include 261.1, 307, 49.59, 48.98, 48.54, 49.26, 48.66, 41.64, 41.49, 41.38 meters. This program is broadcast at 1:10 a.m. EWT on 1,500, 49.42, 41.21, 31.50, 49.92, 41.96, and 31.41 meters; at 2:10 a.m. EWT on 49.92, 41.96, 31.61, and 31.41 meters; at 2:30 a.m. EWT on 49.92, 41.96, 31.61, and 31.41 meters; at 6:00 a.m. EWT on 49.92, 49.42, 41.96, 31.50, 31.41, and 25.42; and at 10:45 a.m. EWT on 49.92, 41.96, 31.61, 31.41, 25.42, and 19.76 meters.

\* \* \*

### U.S.A. STATIONS

Though short-wave listening is associated chiefly with broadcasts from overseas, the stations here at home are by no means without interest. Practically around the clock, the overseas

## ELECTRONIC LISTENER

**A** NEW twist has been added to the time-honored method of testing castings or forgings by hitting them with a hammer. When the piece to be tested is struck, the sound is picked up by a microphone and amplified. A filter then suppresses the harmonic frequencies. The remaining base frequency determines whether or not the casting or forging is defective as there is a variation in base frequency between a defective and a perfect specimen.

-30-

# Recognition

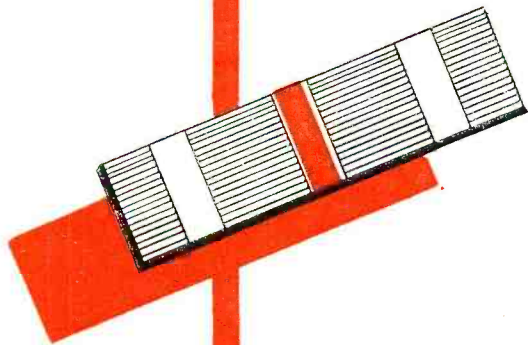

Proud is the wearer of this breast ribbon, for it is a testimonial to his conspicuous bravery on the field of battle.

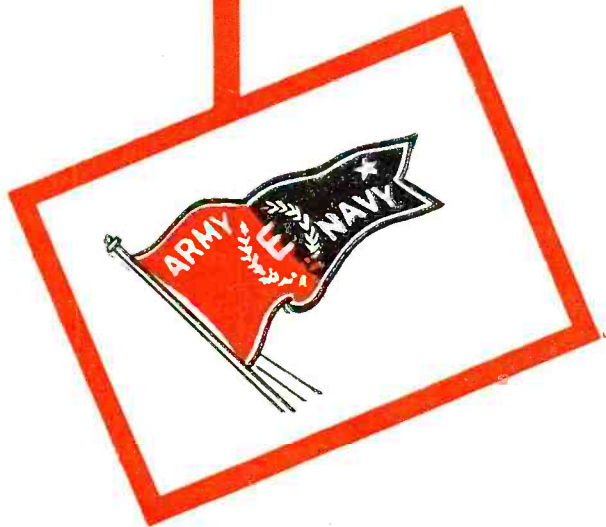

Equally proud are we of the pennant that flies over our Willimantic plant — The Army and Navy "E", awarded "For High Achievement" in war need production.



At countless vital points in communications equipment, El Menco Molded Mica Capacitors serve unobtrusively, but with efficiency that has become a recognized standard.

Our New Capacitor Catalog for manufacturers of electronic equipment is now ready for distribution. Send for it today—on your firm letterhead.

## El-Menco

### MOLDED MICA CAPACITORS

THE ELECTRO MOTIVE MFG. CO.  
Willimantic, Connecticut

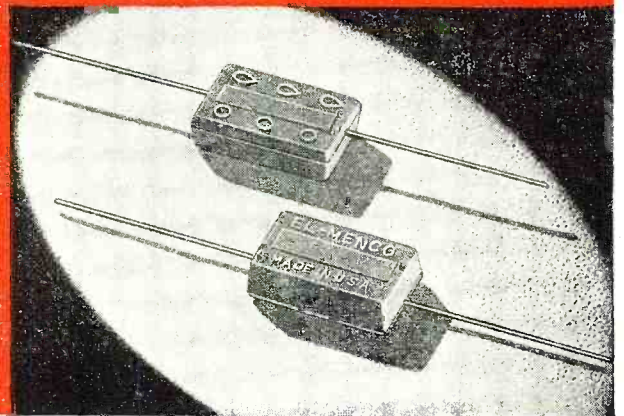

# CLEAN ACCURATE HOLES



**cut in radio chassis**

Greenlee Punches make this tough job easy. No reaming, filing or tedious drilling. Tool has three parts: *punch* cuts through chassis, *die* supports metal to prevent distortion, *cap screw* is turned with wrench to cut holes. Sizes for holes 3/4" to 3 1/2". Ask your radio supply or electrical jobber or write for folder and prices. Greenlee Tool Co., 1889 Columbia Ave., Rockford, Illinois.

WRITE FOR FREE FOLDER S-119

Get Ready with Greenlee!

REGISTERED TOOLS

**GREENLEE**

FOR THE CRAFTSMAN



**Special INDUSTRIAL ELECTRONICS TRAINING**  
No Extra Charge

**TRAIN FOR A GOOD WAR-TIME JOB IN ELECTRICITY**  
WITH A REAL PEACE-TIME FUTURE!

*Pay Tuition After Graduation*

Practical training on real electrical equipment. "Learn-by-Doing" at Coyne—12 weeks' shop training. No previous experience or advanced education needed. Serve your country in vital war work—protect your future after the war in this great field. **NEW INDUSTRIAL-ELECTRONICS TRAINING—NO EXTRA CHARGE!**

Learn about the "Pay Tuition After Graduation Plan", "Part-Time Employment Plan", "Job After Graduation Service". Whether you're 16 or up to 50, send coupon now for my Big Free Book. We also have facilities for men with physical disabilities.

**H. C. LEWIS, Pres., COYNE ELECTRICAL SCHOOL**  
500 S. Paulina St. Dept. 64-81 Chicago 12, Illinois

**MAIL THIS COUPON TODAY**

H. C. LEWIS, Pres., Coyne Electrical School  
500 S. Paulina St., Dept. 64-81 Chicago, Ill.

Please send me your Big Free Book and details of special Industrial-Electronics training offer, "Pay Tuition After Graduation Plan" and Lifetime job service.

Name.....  
Street.....  
City..... State.....

division of the Office of War Information is beaming news programs and special shows which frequently are singularly informative in that they represent the government's position on the war's manifold problems.

News in English is broadcast hourly on the hour over a battery of transmitters on all the popular bands, and usually it is only a matter of a little dialing to pick the loudest. They are heard consistently with clarity and volume throughout the Western Hemisphere, as well as abroad.

A writer on the *New York Times* recently observed, in this connection:

"After ups and downs earlier in its career, the OWI seems to be doing a first-rate job at the moment. It does not hesitate to break in with last-minute bulletins and since the invasion has been on its toes. So far as a reasonable amount of monitoring can tell, the OWI also has been scrupulously fair to Gov. Thomas E. Dewey on political topics. By way of summarizing how Americans feel on international matters, the OWI offers at 9:00 a.m. EWT a show called 'Cross-Section,' consisting of excerpts from editorials appearing in newspapers throughout the country."

I have been monitoring "Cross-Section" lately, and can recommend it to listeners as being highly informative.

Below are listed the more important U. S. A. short-wave stations which carry OWI and other releases daily:

- WRCA, 11.893, 17.78, 15.15, and 9.67; WNBI, 9.67, 15.15, 17.78, 11.87;
- WGEO, 15.33; WGEX, 11.790; WGEA, 11.847; WBOS, 11.87; WOOC, 15.290; WOOW, 11.87; WLWO, 17.80; WLWK, 15.25; WRUS, 15.130; WKLJ, 19.75; WKRD, 12.967; WRUA, 11.79; WRUW, 17.75; WCBX, 9.49; WCDA, 6.06; WCRC, 11.83; WRUL, 11.73; WRUA, 6.14; WKRD, 6.10; WKTU, 6.37; WKLJ, 7.565; WGEA, 7.00; WCBX, 6.17; WLWK, 6.08; WLWO,

- 7.575; WRUA, 6.14; WOOC, 6.12; WOOW, 7.82; WGEO, 6.19; WRUL, 7.805; WRUW, 6.04; WKRD, 9.897; and others.

The *United Network*, San Francisco, lists its current schedule as follows:

KWIX, 15.29, 11.00 a.m. to 1:00 p.m. EWT; KWID, 15.29, 1:00 p.m. to 9:00 p.m. EWT; KGEI, 11.79, 5:00 p.m. to 12:45 a.m. EWT; and KWIX, 9.57, 8:00 p.m. to 12:00 midnight EWT. These stations are sometimes heard on other frequencies as well. San Francisco's signal is especially good to the East Coast at any time during its broadcasts.

\* \* \*

## REPORT FROM OKLAHOMA

Don Brewer, of Tulsa, Oklahoma, writes: "I receive my short-wave programs on an all-wave Philco, the model that has four bands—three short-wave and one standard. The stations that come in good in northeast Oklahoma are listed in Table I.

"A few Tokyo stations are heard irregularly, 'fair,' as is HER4, Bern, Switzerland, on 9.54 mcs."

NOTE: Your short-wave editor would appreciate more good reports similar to this one from Mr. Brewer.

\* \* \*

## RADIO TOKYO REACHES EAST

During the summer months, *Radio Tokyo* has been sending an unusually good signal to the East Coast. At 7:15 p.m. EWT, what is believed to be JLG4 on 15.105 mcs. continues to send out recorded messages from prisoners-of-war interned in Japan. The middle of June these messages were confined to prisoners "formerly of Wake Island," *Radio Tokyo* announced. At 7:30 the news is presented each evening.

I have been picking up the same station (approximately 15.105 mcs.) around 11:20 p.m. EWT, when more messages from Americans interned in Japan have been presented. The announcer is generally a woman.

## NATIONAL ELECTRONICS CONFERENCE

THE Medinah Club, 505 North Michigan Avenue in Chicago, will be the scene of the first National Electronics Conference to be held October 5th through 7th. This conference, which is jointly sponsored by Illinois Institute of Technology, Northwestern University, the A.I.E.E. and I.R.E., will feature papers by leading electronic engineers and scientists on all phases of electronic application.

Television, u.h.f., radio, industrial measurements, industrial electronic controls, induction heating, and medical applications of electronics will be covered in the three day conference.

Keynoting the objectives of the conference will be an opening address by Mr. Ralph Beal, Research Director of Radio Corporation of America. He will speak on "Electronic Research Opens New Frontiers." Mr. W. C. White, Director of Research of the General Electric Company will speak on "Electronics in Industry" at one of the conference luncheons.

Forty papers, representing the best thought in the country on electronic themes, will be given by men in various industries and laboratories.

Dr. J. E. Hobson, Director of the School of Engineering, Illinois Institute of Technology, is the chairman of the convention. Prof. A. B. Bronwell of Northwestern University, Evanston, Illinois, is the program chairman. Arrangements for the conference are in charge of Prof. P. G. Andres of Illinois Institute. Publicity is being handled by Mr. B. Dudley who is also serving as secretary of the conference.

Housing facilities for the convention are available at either the Medinah Club or at other specified Near North Side hotels within easy walking distance of the conference headquarters.

Reservations for the conference must be made with Prof. P. G. Andres, Illinois Institute of Technology, 3300 Federal Street, Chicago 16, Illinois, in order that adequate facilities may be arranged.



I believe the best reception from Japan for the Eastern part of the United States is at 10:00 a.m. EWT, when the news is relayed by JWV3, 15.79 mcs., and JYW3, 11.71 mcs.

**REPORT FROM THE WEST COAST**

From Los Angeles, August Balbi, veteran short-wave monitor, reports that he keeps a daily record of what is heard—with time, frequency, and signal strength; new stations underlined in red, changes in blue. The records go back to 1933. "It means work, but it is well worthwhile," says Mr. Balbi, "since no one can remember those things from day to day. That's the only way to 'keep tab,' I believe."

This month, Mr. Balbi reports the following items:

PRL7, 9.72 mcs., in Rio de Janeiro, is fair now; PRL8, 11.72 mcs., 7:00-8:00 p.m. PWT, is seldom good, often inaudible. Last year when they first started operations they were "tops," but dropped down more and more as time went by. Evidently the beam is missing the West Coast, the full power hits the Eastern part of the country no doubt.

(Editor's Note: *This is true; they put in an excellent signal in the East.*) I understand they do not verify reception, although they do send out some pamphlets instead.

London and Berlin show little strength in their transmissions to the Pacific Coast. The average is just "fair," often "poor." That includes all frequencies from 11 mcs. to 6 mcs. GVX, 11.93 mcs., is best—to 5:00 p.m. PWT, but it is bothered by code whistles.

Bern and all other Europeans are not heard at present.

The Philippine Islands are seldom heard here; best on 6.14 mcs. in early morning; the 9.64 mcs. frequency is mostly GRM'd; and 9:00-10:00 p.m. PWT transmission on 15.32 mcs. is barely audible.

Shonan (Singapore) is heard only on 9.55 mcs., 6:00 a.m. to 12:00 noon EWT, at intervals; English news, 3:00 a.m. EWT.

VLC6, 9.615 mcs., and VLC4, 15.315, Australia, put in the best SW signals ever heard from foreign countries; so is VLC5, 9.54 mcs., to East Coast, 8:00-8:50 a.m. EWT.

Radio Tokyo is heard as follows:

JVW3, 11.725 mcs., JZK, 15.16 mcs., 9:00-10:40 a.m. EWT to Eastern United States; and the same transmitters are beamed to the Western United States from 11:00 a.m. to 2:40 p.m. EWT.

Chungking is being heard on the Pacific Coast as follows:

XGOY, 9.646 mcs., 7:35 to 11:30 a.m. EWT; English news at 10:00 a.m. EWT; Mailbag Saturday, 10:15 a.m. EWT. They are also received on 7.17 mcs. XGOA, 9.73 mcs., 7:00 to 11:00 a.m. EWT; English news at 10:00 a.m. EWT.

Australia's VLC2, 9.68 mcs., is heard between 5:00 and 6:00 a.m. EWT, beamed to the Philippines; English

(Continued on page 139)

**Now! THE UNGAR ELECTRIC SOLDERING PENCIL WITH 5 DIFFERENT TIPS To Solve EVERY Soldering Problem**

No. 536 Standard Tip, made from Hard Drawn Copper

No. 539 Extra Hot Made from Elkaloy A

No. 538 Chisel Tip, made from Elkaloy A, Tip 1/8" dia.

No. 277 Brass — for Plastics or Marking

No. 537 Pencil Tip, made from Elkaloy A, Tip 1/8" dia.

### The "Quin-TIP-lets" make their debut

The Electrical industry's newest, trimmest, slimmest soldering tool—the Ungar light-as-a-feather Soldering Pencil — now available in your choice of FIVE INTERCHANGEABLE TIPS — each an entirely different design to solve *your* particular soldering problems.

Originally designed for speedy, precision production on intricate, hard-to-reach soldering jobs, the Ungar Soldering Pencil is now *five times more versatile* — 100% *more efficient* — can be used for everything from the most delicate operations to some of the larger, heavier soldering tasks.

The Ungar Soldering Pencil is ruggedly constructed, built to take plenty of punishment. Yet it's lightweight . . . weighs only 3.6 ounces . . . is perfectly balanced . . . handles with the ease of a fountain pen . . . heats in 90 seconds, draws only 17 watts. Overall length, 7 inches.

The soldering unit complete with handle and cord set, No. 776 and any one of the tips pictured above sells for considerably less than \$2.00 each. Priority required on all orders. Immediate delivery.

Please send your order to your nearest Electronics Distributor or Mill Supply House.

**HARRY A. UNGAR, Inc.**  
615 DUCOMMUN STREET, DEPT. 500, LOS ANGELES 12, CALIFORNIA

**Harry A. Ungar, Inc.**  
MANUFACTURERS OF ELECTRICAL WAR PRODUCTS

# LETTERS

## FROM OUR READERS



Jaro Fabry

"No — Nothing can distract Herbert when he's reading TRUE." (One of the great family of Fawcett Publications.)

### A SUGGESTION

"AT this time, I wish to express my thanks for your attention to your subscribers. I have sent in my renewal, via the local news agency, with the extra amount included for RADIO-ELECTRONIC ENGINEERING. I trust that it reaches you in time.

"I also wish to state that all articles by Guy Dexter and Rufus Turner are really tops with me. This is the material that we really need.

"How about an article on a Signal Generator, including all coil winding data, separate modulating tube, and sufficient band spread so that calibration will not be congested."

Yours sincerely,  
E. H. POGEL,  
Fitzroy Harbour, Ontario.

*Sounds like a good idea. Perhaps we can make Reader Pogel doubly happy by having either Mr. Turner or Mr. Dexter write such an article.*

### GRAVITY DEFIER

"IN reference to your June, 1944 issue of RADIO NEWS, I would like to draw your attention to the picture in the upper right hand corner of page 23. To me it appears to be upside down because if you turn the magazine around you can see a man's face behind the grill.

"I have been a constant reader of your magazine and find it very interesting and I just thought this little letter might interest you even though it has no actual importance as I thought it was a very rare happening, especially in your magazine.

"I am employed by a large communications firm in Toronto and I get some very useful information from RADIO NEWS."

Yours truly,  
A. H. HARRINGTON,  
Toronto, Ontario.

*Right you are. Sorry.*

### MORE JAP TREACHERY

"AT the outbreak of the 'Warm Up War I,' I was a Marconi operator on the *SS Congress* plying Pacific waters, and I have vivid recollections of the events described in Mr. A. Kiralfy's fine article on 'Japan's Wireless War,' appearing in RADIO NEWS for April, 1944.

"I recall clearly the appearance of two Japanese cruisers, the *Idzumo* and *Assamu*, along our coast. For a long time, the former sat placidly anchored in the calm waters of San Pedro harbor, politely refusing visitors generally. Those who did get aboard were politely hissed away from the radio offices beneath her awkward appearing aerials. To hear her peculiar sounding wireless working overtime and inefficiently, with San Diego only

96 miles away, gave us a rather disparaging impression of her, which we learned later was wrong. Her transmitter appeared to be of low power, and had a most peculiar metallic spluttering sound, evidently an auxiliary using a mercury interrupter, which rarely could be heard more than a hundred miles or so. We assumed she had no better.

"A few days after war broke out, observers were surprised to note neat, slender, hundred-foot extension spars run up and stayed with insulator studded guys, atop her main masts. As soon as these cruisers sailed on declarations of war, the *Idzumo*, to our surprise, broke out with the strongest and most raucous Shensho transmitter I have ever heard. Operating on a very broad band, and very powerful, it could be heard all over the Pacific. It was very difficult to estimate her distance away under these circumstances. It could be 100 or 1,000 miles, or even more. Later on, after the United States entered the war, I could still hear her while I was on the Atlantic, as powerful as ever and jamming away continuously. We could never figure out where the Japanese could obtain so much information to transmit. All of their better ships would transmit almost continuously, day in and day out. This was the case for the large lines, also Navy ships as well as merchantmen of all sizes. They ignored absolutely all international rules and regulations and nothing we could do from polite requests to plain and fancy cussing could dissuade them from their continuous chatter, if it so pleased them to carry on at length with a ten-hour bedtime story, and jam heavy long-distance traffic as a consequence.

"It was supposed to be the *Idzumo* that stood off a half mile or so from a sinking American passenger ship in distress off upper California, looking on casually without sending over a single buoy or boat to pick up the few survivors, and then, apparently with great reluctance, sending the news leisurely to Victoria in closed code. Of course, aid came too late to rescue anyone. Peculiar psychology!

"We knew that the German *Leipzig* and *Dresden*, both of which had been on the coast at the outbreak of the war, were by then far away. Their signals had faded out as they went south to a rendezvous to defeat the British off Chile and then to be destroyed themselves finally off the Falklands. So it was felt these Japs had no logic whatever in being so over-cautious. Certainly, they were never refused a lifeline when they were in trouble, so far as I can recall.

"I had returned to college in 1916, but left school to rejoin Marconi within ten days after the United States

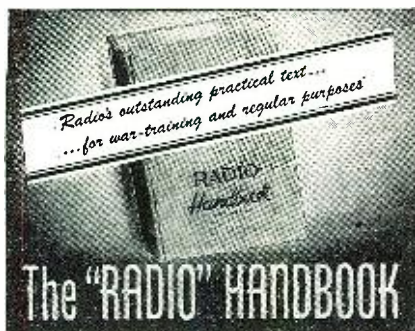

Basic electrical and radio theory in the simplest possible language, written especially for those without mathematical or technical training.

Dozens of complete how-to-build-it descriptions of many types of receiving, transmitting, and test equipment show practical applications. Hundreds of diagrams and large photographs.

Enlarged war-training chapters include: expanded basic principles, more test equipment which can be field-built, and mathematics for solving simple radio problems.

Over 600 pages, durably clothbound, gold-stamped. From your favorite dealer, or from us, postpaid; please add any applicable taxes.

\$2.00 in Continental U.S.A. Elsewhere, \$2.25

EDITORS AND ENGINEERS  
1420 North Highland Avenue, Los Angeles

## Any difficulty obtaining PARTS?

Write for our latest catalog listing Condensers, Speakers, Volume Controls, Vibrators, Resistors, Transformers and hundreds of hard-to-get replacement parts at unbelievably low prices!

IMMEDIATE DELIVERY



**Radio Warehouse**  
73-b EAST MILL ST., AKRON 8, OHIO

entered the war. I had asked Marconi for a tough job in the war zone and believe me, I got it. My assignment was a converted French cable ship, armed by the Navy and manned by nearly all oldtime Navy men. I never realized so much could happen to a crew as actually did happen to this ship and her complement. As yet there were no American troops or Navy units stationed overseas and the submarines were just then at peak performance. I kept a daily account of all that went on aboard the ship and find that many of the things which happened then are closely paralleled in today's headlines. Lowell Thomas' famous chronicle of German subs, 'Raiders of the Deep' mentions some of the incidents I set down in my daily account.

Thank you very much for the many fine things RADIO NEWS has done for me through the years.

Sincerely yours,

DALE R. CLEMONS,  
Riverside, Illinois.

*The letter speaks for itself. Many thanks to Mr. Clemons for sending along this first-hand story.*

### International Short-Wave

(Continued from page 137)

news is given at 5:00 a.m. EWT; announces as "the American Broadcaster somewhere in Australia."

U.S.S.R., Moscow, 15.11 mcs., and 15.23 mcs., is heard only in English between 6:47 and 7:15 p.m. EWT now. A native program is transmitted (and is received on the Pacific Coast) on 15.37 mcs. and 12.26 mcs. between 11:00 p.m. and 2:00 a.m. EWT; and on 13.13 mcs. from 1:00 a.m. to 2:40 a.m. EWT.

Belgian Congo, Leopoldville, is heard on 11.64 mcs., 12:00 noon-9:15 p.m. EWT; English news at 8:30 and 9:10 p.m. EWT. Also heard from 12:45 to 1:45 a.m. EWT (no English).

Manchukuo, Hsinking, 5.51 mcs. and 6.125 mcs., 9:30-11.00 a.m. EWT; English news, 10:00 a.m. EWT.

China, Shanghai, XMHA, 11.86 mcs., is heard at intervals from 1:00 to 10:00 a.m. EWT.

Canada, Edmonton, Alberta, VE9AI, 9.54 mcs., is heard from 5:30 a.m. to 12:00 midnight EWT; and on 6.005 mcs. from 12:00 midnight to 2:00 a.m. EWT.

French Equatorial Africa, Radio Brazzaville, 11.97 mcs., is heard 1:00-2:30 a.m. EWT (in French only).

Mr. Balbi reports that "friend wife helps to check Australia daily at 8:00 a.m. EWT, as I am at work then."

### AUSTRALIAN SCHEDULE

While monitoring the 19-meter band at 11:00 p.m. EWT on June 14 and 15, I picked up two of three test transmissions directed to the East Coast of North America by VLC4, Melbourne. On the latter transmission it was announced that reception reports of the

# Individually Designed



## TO YOUR Specifications

Harnesses or other wiring assembly in your plans, now, or for the future, individually designed by HOWARD! Send your specifications to HOWARD, specialists in the design and manufacture of radio equipment.

# HOWARD MANUFACTURING CORP.

★ BUY WAR BONDS ★

COUNCIL BLUFFS, IOWA

*They Are Tough!*

American Capacitors are giving peak performance in front line battle areas . . . they have to be tough! They are precision engineered to meet the most exacting demands. American Electrolytic and Paper Capacitors, incorporating new plastic designs, cover all standard capacitance values and working voltages.

**AMERICAN CONDENSER CO.**

4470 RAYNSWOOD AVENUE, CHICAGO 40, ILLINOIS  
THERE IS AN AMERICAN CAPACITOR FOR EVERY SIZE AND PURPOSE



### RCP ULTRA-SENSITIVE MULTITESTER MODEL 488

This instrument, widely used by the Signal Corps, has many features, among them: dual DC sensitivity of 20,000 and 1,000 ohms per volt; AC sensitivity, 1,000 ohms per volt; wide dial with movement of 50 microamperes and readings as low as 1 microampere; center of ohmmeter scale 37 with readings as low as 0.25; accessible batteries held by spring clip; quick change, plug-in copper oxide rectifier; high voltage leads. Ranges arc: DC, AC and output to 6,000 volts; DC readings to 300 microamperes and 600 milliamperes; DC and AC to 12 amperes; and ohmmeter from zero to 30 million ohms. This is Model 488 which complete and ready to operate costs \$59.50.

*Only one, out of the complete RCP line that built a reputation for quality and value before the war—today, packed with still greater technical advancements, better engineering, smarter design. Write for catalog No. 128 of standard commercial models.*

**RADIO CITY PRODUCTS CO., INC.**  
127 West 26th Street, New York 1, N. Y.



#### Get High Speed Without Nervous Tension

Amazing Book Shows How "Crack" operators rely on something besides practice to develop their high speeds and proficiency; it explains the "knack" of sound-send and sound-consciousness—the secret of speedy sending and receiving. Once you acquire these mental processes, reading code becomes almost second nature to you; just as the swing rhythm of a dance band becomes automatic to musician and dancer.

#### Champions Endorse the Candler System

Used in training commercial operators, Amateurs, and Radiotelegraph Specialists in Signal Corps, Navy, Marine Corps, Coast Guard, Naval Reserve, Airlines. Wherever the fastest and most efficient operators are found, there you will find Candler trained men.

If you want s-p-e-e-d, if you have any difficulties in operating technique, if 40-50 and more w.p.m. seem fantastic speeds to you—send for this revealing book now. It's yours without cost or obligation. Simply send your name and address.

#### CANDLER SYSTEM CO.

P. O. Box 928 Dept. 2-K  
Denver 1, Colorado, U.S.A.  
and at 121, Kingsway, London, W.C. 2, Eng.

### RADIO TECHNOLOGY

**RCA** Institute offers an intensive two-year course of high standard embracing all phases of Radio and Television. Practical training with modern equipment. Also shorter specialized courses in Commercial Radio Operating, Radio and Television Servicing, and Aviation Communications. For Free Catalog write Dept. RN-41.

**RCA INSTITUTES, Inc.**  
A Radio Corporation of America Service  
75 Varick St., New York 13, N. Y.

tests conducted were so favorable that this would become a nightly feature of the Australian Broadcasting Corporation's Overseas Service.

On these broadcasts, which were inaugurated Monday evening, June 17, VLC4, 15.315 mcs., has been putting in an excellent signal to the East Coast, on its "3rd transmission of the day" to North America. For identification purposes, VLC4 signs on at 10:30 p.m. EWT with the call of the kookaburra bird (or "laughing jackass"), and closes down at 11:30 p.m. EWT after playing "The Star-Spangled Banner" and "God Save the King."

Other Australian broadcasts daily that are heard well in this country include the following:

VLC4, 15.315 mcs., and VLG5, 11.71 mcs., 12:45 to 1:45 a.m. EWT, to West Coast; news at 1:15 a.m. EWT.

VLC6, 9.615 mcs., and VLG5, 11.71 mcs., 11:00-11:45 a.m. EWT, to West Coast; news at 11:00 a.m. EWT.

VLC5, 9.54 mcs., and VLG3, 11.79 mcs., 8:00-8:50 a.m. EWT, to East Coast; news, 8:00 a.m. EWT, and irregularly at 8:40 a.m. EWT.

VLG, 9.58 mcs., and VL19, 7.28 mcs., 10:15-10:55 a.m. EWT, to Asia; news in English at 10:15 a.m. EWT.

VLC2, 9.68 mcs., 5:00-6:00 a.m. EWT, to the Philippines; announces as "the American Broadcaster somewhere in Australia," and gives the news in English at 5:00 a.m. EWT.

The Australian Broadcasting Corporation has been carrying on many tests during recent weeks, and I am informed that their schedules are subject to change from time to time—in order to provide the maximum service from "down under" to a worldwide audience. They are always glad to receive reception reports from listeners,

and have been heard receive reports from the East Coast reception of VLC4, 15.315 mcs., 10:30-11:30 p.m. EWT transmiss. Such reports should be addressed to the Australian News and Information Bureau, 610 Fifth Avenue, New York 20, New York.

#### \* \* \*

#### PHILIPPINE BROADCASTS

Although PIRM, the Japanese-controlled short-wave transmitter in Manila, P. I., is not heard well in the United States, its schedule is given as 4:00 to 9:30 a.m. EWT on 6.14 mcs., and 9.64 mcs., with the news in English at 8:30 a.m. EWT.

We would appreciate reception reports on PIRM from various parts of the nation. \* \* \*

#### "SWITZERLAND CALLING"

The facilities of the Swiss Broadcasting Corporation are now directing a nightly hour and one-half program to North America—on frequencies of 7.38 mcs., 9.185 mcs., and 9.539 mcs., respectively, between 9:30 and 11:00 p. m. EWT.

The program consists of the news, talks which embody neutral phases of the war in Europe, and fine classical music. The stations shut down at 11:00 p.m. EWT with the playing (singing) of the Swiss National Anthem. While reports indicate these transmissions are seldom heard on the West Coast, the Swiss transmitters put in a good signal in the East.

\* \* \*

#### CHINESE SCHEDULES

Through the courtesy of Ke-chin Wang, attache of the Chinese Embassy in Washington, and Ying Ong, of Phoenix, Arizona, we are able to present the schedules of short-wave stations of

Radio transmitter and receiving equipment set up and used by Heinz August Luning, alias Enrique Augusto Luni, in sending news of shipping to Nazi submarines in the Caribbean Sea, according to the Cuban police.



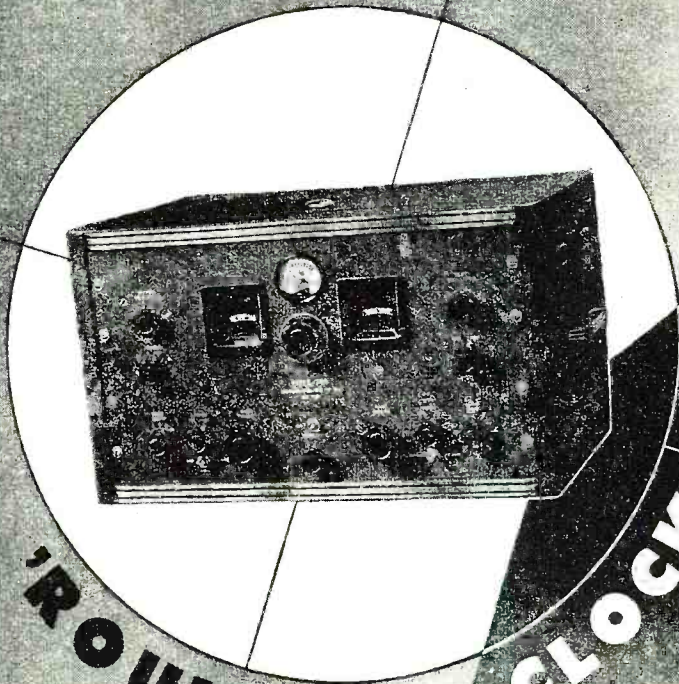

**'ROUND THE**

**CLOCK**

**WITH SUPER-PRO**

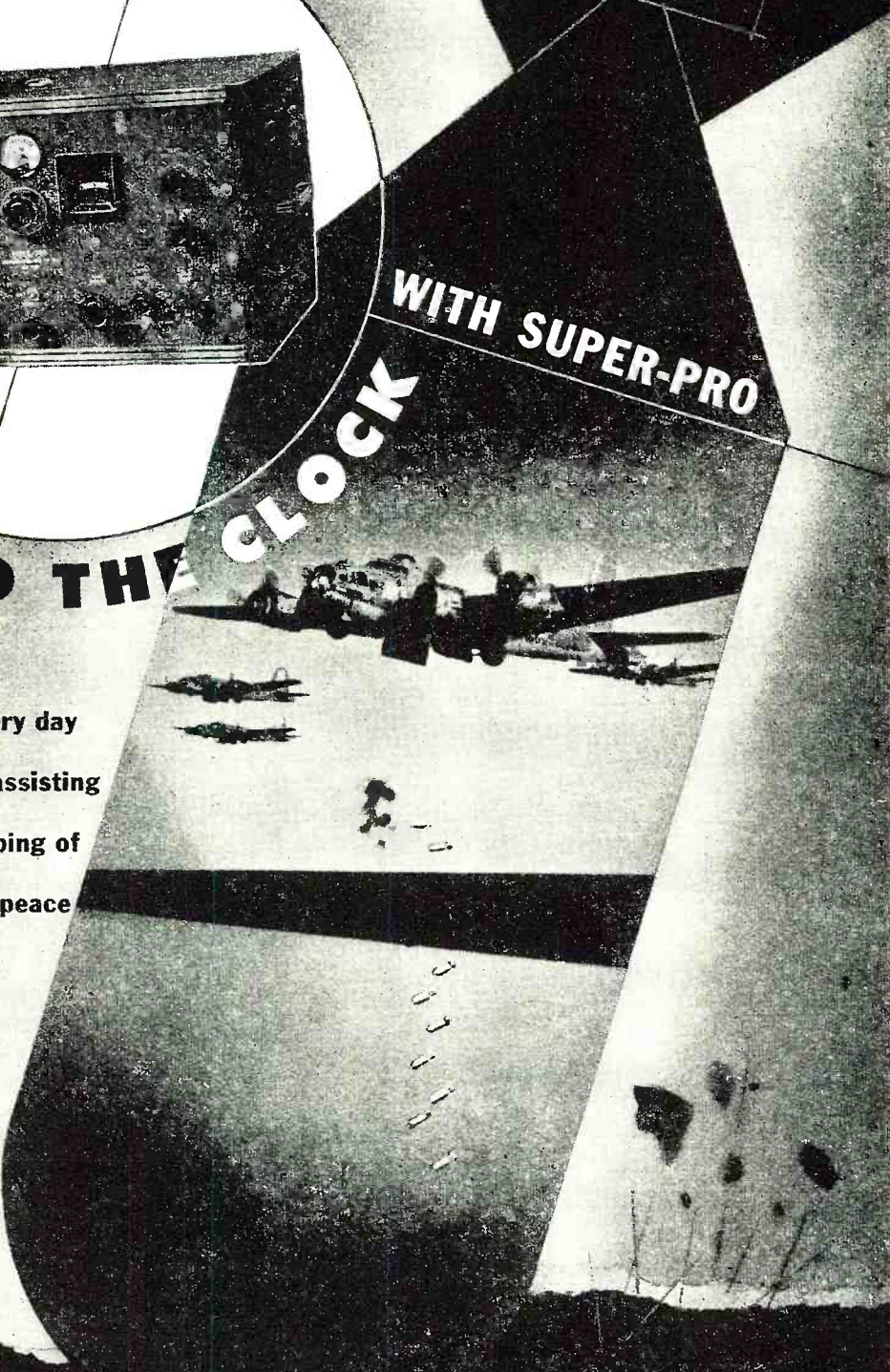

For twenty-four hours of every day  
"Super-Pro" receivers are assisting  
the "Round the Clock" bombing of  
the enemy.... In war and in peace  
"Super-Pro" leads the field.



**THE HAMMARLUND MFG. CO., INC., 460 W. 34<sup>TH</sup> ST., N.Y.C.**  
**MANUFACTURERS OF PRECISION COMMUNICATIONS EQUIPMENT**

## EXPORT ATTENTION MANUFACTURERS

We wish to represent several progressive manufacturers of Radio, Electronic and allied products in the foreign markets of the world.

Ours, is an organization that was devoted exclusively to the export of the above products prior to the advent of this war. We are well grounded in exporting and all its ramifications.

It is our aim to take over all export problems from you, remove all credit risk by paying you cash for all orders; yet you do not lose your identity with your product nor do you pay a service fee of any kind as we operate on a commission basis and identify ourselves as your export department.

Before planning your export department for post-war we suggest that you communicate with us first. Send your literature or write us regarding the products you manufacture or expect to manufacture. Your letter will bring our prompt response; all inquiries will be kept strictly confidential. Reference exchanged.

### INTEX COMPANY

303 West 42nd St.  
New York 18, New York

## RADIO ENGINEERING!

DEGREE IN  
27 MONTHS

Radio offers great POSTWAR FUTURE. Courses also in Civil, Electrical, Mechanical, Chemical, Aeronautical Engineering; Business Administration, Accounting, Secretarial Science. TRI-STATE, long distinguished for its 24 yr. courses, offers a great advantage to EX-SERVICE MEN who can COMPLETE THEIR WORK here in the SHORTEST POSSIBLE TIME. Special Preparatory Dept. for those who lack high school or graduates who desire REFRESHER COURSES. Tuition, living costs low. 61st year. Cosmopolitan student body. Men and women. Enter Sept., Jan., March, June. Catalog.

**TRI-STATE COLLEGE** 1694 College Ave.  
Angola, Ind.

## Guaranteed Rebuilt VIBRATORS—\$1.00 ea.

Send old vibrator. For very prompt delivery, enclose remittance and return postage. We rebuild any make or kind of vibrator or relay. Send your old vibrator to

**BEST VIBRATOR CO., Box 5802**  
Cleveland 1, Ohio

## WANTED— ELECTRONIC BOOK BUSINESS or MANUSCRIPTS

Small but established electronic book publisher will buy one or several going electronic books or an electronic book business. Might also consider manuscripts of unusual promise.

Box 361, care RADIO NEWS, Chicago 11

## COMMERCIAL RADIO INSTITUTE

A radio Training center for over twenty-four years.

**RESIDENT COURSES ONLY.**  
ACCREDITED FOR VETERAN TRAINING  
Pre-induction, Broadcast, Marine Telegraphy, Aeronautical, Television, Service.  
Classes now forming for Fall term, Oct. 9th. Literature upon request.  
Dept. D., 38 W. Biddle St.  
Baltimore 1, Md.

the Central Broadcasting Administration, Central Executive Committee of The Kuomintang, Chungking, China. Mr. Ying Ong monitors the government stations of China regularly.

XGOY (the Chinese International Broadcasting Station) Chungking, now uses the frequencies of 7.171 mcs. and 9.646 mcs., respectively, in its broadcasts beamed to East Asia, South Seas, North America, and Europe daily. During the day the news is given in Spanish, Annamese, Cantonese, French, Japanese, Burmese, Dutch, Siamese, Chinese, Malay, and Russian. On Saturdays the American Hour may be heard at 9:00 a.m. EWT.

World news in English is given daily at 10:00 a.m. EWT; this is followed at 10:15 a.m. EWT with music, and then at 10:20 a.m. EWT there is a talk in English (on Saturdays this is the Mailbag Program); press news in English is given daily at 11:00 a.m. EWT; there is more news at 12:00 noon EWT, and following a talk at 12:15 p.m. EWT, in English, the station closes down at 12:30 p.m. EWT.

The complete schedule of XGOY is as follows:

8:00-9:00 p.m. 11.90 mcs., to Allied Forces in the Far East; 6:00-6:30 a.m., 11.90 mcs., to Asia, Australia, and New Zealand; 6:30-7:00 a.m., 11.90 mcs., to East Russia; 7:00-7:30 a.m., 11.9 mcs., to Japan; 7:35-9:40 a.m., 9.646 mcs. and 7.171 mcs., to East Asia and South Seas; 9:45-11:40 a.m., 9.646 mcs. and 7.171 mcs., to North America; 11:45 a.m.-12:30 p.m., 9.646 mcs. and 7.171 mcs., to Europe; and 12:30-1:45 p.m., 9.646 mcs. and 7.171 mcs., to East Asia and South Seas (Eastern War Time).

On the 11.90 mcs. frequency, XGOY presents the news in English nightly at 8:15 p.m. EWT.

XGOA, transmitter of the Central Broadcasting Station, also in Chungking, is heard on 9.730 mcs. between 1:30 and 2:40 a.m. EWT, and from 6:30 to 10:00 a.m. EWT, as well as on 5.985 mcs. between 10:00 a.m. and 1:45 p.m. EWT, daily.

The Kweichow broadcasting station, XPSA, is heard from 1:30 a.m. to 3:10 a.m. EWT on 6.99 mcs., and from 7:00 a.m. to 12:00 noon, on the same frequency.

\* \* \*

### BBC ACTUALITY BROADCASTS

Reports indicate much interest in the actualities and eyewitness accounts which have been radiated frequently during the mornings, afternoons, and evenings by the BBC in their General Overseas, General Forces, and North American Services from London, since the invasion began.

The BBC has generously permitted local—usually small, independent stations—in the United States to relay many of these broadcasts, in addition to regular newscasts. My own local station has been offering many BBC programs lately and such features are well received by the local public.

If you are interested in tuning in these actuality broadcasts direct from London, here are the times and frequencies used:

# Class

Rate 20c per word, Minimum.

### CORRESPONDENCE COURSES

PREFARE now for tremendous opportunity, new fields of radio after the war. Training Federal licenses. Write for particulars. American Radio Institute, 44 East 23rd St., New York 10, N. Y.

USED Correspondence Courses and Educational Books sold or rented. Inexpensive. Money-back guarantee. Write for Free Catalog listing 4000 bargains.—(Courses Bought.)—Lee Mountain, Pisgah, Ala.

CORRESPONDENCE Courses and self-instruction books, slightly used. Sold. Rented. Exchanged. All subjects. Satisfaction guaranteed. Cash paid for used courses. Complete information and 92-page illustrated bargain catalog FREE. Write Nelson Company, Dept. 2-59, Chicago 4.

### RADIO ENGINEERING

RADIO Engineering, Broadcasting, Aviation and Police Radio, Servicing, Marine Operating and Electronics taught thoroughly. Expenses low. Write for catalog. Valparaiso Technical Institute, Dept. N, Valparaiso, Ind.

### FOR SALE

BRAND new, five-tube, AC-DC superhet kits! Crystal kits, and other radio parts. No priority needed! Complete price list, 10c. Melvin Okin, 915 Bryant Ave., Bronx, New York, N. Y.

BUZZER code practice set complete with key, battery and instructions. Sends real wireless signals. Only \$1.65. Two sets \$3.00. Guaranteed. Rathert Electric, Cresco, Iowa.

MISCELLANEOUS radio equipment: Slightly used in Signal Corps training program. All sales F. O. B. Newark, N. J. McElroy keyers and tape pullers, \$65.00. Tapes, per reel, \$1.00. Code keys, \$1.25 and \$2.50. Riders Manuals, 13 volumes, \$125.00. Utah, Collins, Stancor, and National transmitters, never used (write for prices). Radio compass, \$175.00. RCA, TT-5 television receiver, \$100.00. National FB-7 receiver, speaker, five sets coils, 20, 40, 80, 160 meters, \$75.00. D.C. to A.C. Panatrop Converter, \$35.00. Send money order to R. G. Dougherty, 158 Market Street, Newark, N. J.

MICROPHONE Cable—Best Quality. Single conductor, shielded, rubber-covered. 20c per foot. Cash with order. 25 to 200 foot lengths. Oahu Publishing Company, 805 Film Building, Cleveland 14, Ohio.

### PATENT ATTORNEYS

INVENTORS—Before disclosing your invention to anyone, send for Form "Evidence of Conception"; "Schedule of Government and Attorneys' Fees"; and instructions. Sent free. Lancaster, Allwine & Rommel, 414 Bowen Building, Washington 5, D. C.

### RADIO EQUIPMENT

RADIO Service men and experimenters send for our giant radio catalogue. Save dollars. United Radio Co., (1000M) Newark, N. J.

RADIO Service Men—Display our Scientific Service System Card. Builds goodwill, prestige, confidence and better profits, by indicating the number of common causes for various radio troubles. Details free. Scientific Radio Service System, Box 1332-B, Des Moines, Iowa.

### WANTED

WANT to buy Automobile Radios. State type, quantity, and price. L. S. Jullien, Inc., 1443 P Street, N.W., Washington 5, D. C.

WANTED—Rider Manuals. Highest prices paid. Box 360, % Radio News.

RADIO Advertisers, sample 10c; pays 60%. Amogen Co., San Antonio, Texas.

EXPERIENCED Radio Serviceman, by old established firm. Write stating salary expected. Gregg Radio & Appliance Co., 503 East State St., Fremont, Ohio.

### SITUATIONS WANTED

WANTED: Situation Southeastern Sales Engineer-representative; Radio-Electronics. Several years' experience large corporation and U. S. Signal Corps. M. S. Gathright, No. 993 Mt. Airy Dr., S.W., Atlanta, Ga.

PHOTO CREDITS	
Page	Credit
32, 34, 114,	Halstead Traffic Comm.
118	Corp.
38, 39, 108, 112	Crosley Corp.
44	G.E.
48	U. S. Forest Service
56, 57	U. S. Marine Corps
140	Acme



**BURSTEIN-APPLEBEE CO.**  
1012-1014 McGee St. • Kansas City 6, Missouri

**RADIO AND ELECTRONICS BOOKS**  
Immediate Shipment on Mail Orders Anywhere

We stock nearly all radio and electronics books, and can furnish any other currently published one on short notice. Send stamp for catalog. Currently popular books include:

- "Practical Radio Communication," Nilson, \$6.00\*
- "Principles of Radio," Henney, 3.50\*
- "Mathematics for Radionomen," Cooke, 4.00\*
- "Radio Physics Course," Ghirard, 5.00\*
- "Radio Engineering Handbook," Henney, 5.00\*
- "Radio Engineers' Handbook," Terman, 6.00\*
- "Theory and Appl. of Vacuum Tubes," Reich, 5.00\*
- "Electronics," Millman and Seely, 5.00\*
- "Radio Engineering," Terman, 5.50\*
- "Microwave Transmission," Slater, 3.50\*
- "Cathode-Ray Tube at Work," Rider, 3.00\*
- "Frequency Modulation," Rider, 1.50\*
- "Radio Manual," Sterling, 6.00\*
- "Measurements in Radio Engineering," Terman, 4.00\*
- "U. S. F. Techniques," 4 authors, 4.50\*

\* Add 4% for domestic postage (including A.P.C.'s); foreign, 10%; in Calif. add 2 1/2% sales tax.

**EDITORS AND ENGINEERS**  
1420 North Highland Ave., Los Angeles 28, Calif.

**LES** Correspondence Courses in  
**RADIO and ELECTRICAL ENGINEERING**

**ELECTRICAL ENGINEERING** Get good grasp of wide electrical field. Prepare yourself at Low Cost, for secure future. Modern course. Be simplified anyone can understand quickly.

**RADIO ENGINEERING** Extra fine course in radio, public address, photo-electric work, training you to be super-service man, rest vacuum-tube technician. Service men needed badly. Diploma on completion.

Send postcard or letter for Free LOW \$25 Either Course  
Copies of school catalogs, full details, all about deferred payment plan, etc. SEND NOW!  
**WRITE** LINCOLN ENGINEERING SCHOOL, Box 61R-68 Lincoln, Nebr., (Formerly of Washington, D. C.)

**PEN-OSCIL-LITE**

Extremely convenient test oscillator for all radio servicing; alignment • Small as a pen • Self powered • Range from 700 cycles audio to over 600 megacycles u.h.f. • Output from zero to 125 V. • In use by Signal Corps.

**GENERAL TEST EQUIPMENT CO.**  
38 Argyle Buffalo 9, N. Y.

**RADIO MADE EASY**

Learn quickly to repair any radio. New simplified manual tells how. Hints, pictures, tube data, diagrams to help you. Large size: 8 1/2 x 11 in., 48 pages.

**25¢**

**SUPREME PUBLICATIONS**  
328 S. Jefferson Street Chicago 6, Ill.

**Radio Servicemen:**  
**RADIO PARTS—TUBES**  
**BARGAIN PRICES—NO PRIORITIES**

20-20 Mfd. 150 v. Condensers..... \$0.49  
Dial Cable (Light), 75 Ft..... .69  
P.M. Speakers, 4 or 5 Inch..... 1.29

Write Today for Bargain Bulletin  
**RADIO DISTRIBUTION COMPANY**  
P.O. Box 497—PASADENA 18, California

7:10 a.m., 11.68 mcs. (GRG); 8:00 a.m., 15.31 mcs. (GSP); 8:20 a.m., GSP; 10:30 a.m., GSP; 4:00 p.m., GSP; 6:55 p.m., 11.93 mcs. (GVX), 9.58 mcs. (GSC), 9.69 mcs. (GRX), 11.68 mcs. (GRG), 2.88 mcs. (GRC); 7:30 p.m., same frequencies as at 6:55 p.m.; 7:45 p.m., 11.93 mcs. (GVX), 9.58 mcs. (GSC); 11:00 p.m., 9.58 mcs. (GSC), 6.11 mcs. (GSL) (EWT).

\* \* \*

**RECEPTION REPORTS**

We would appreciate reception reports from listeners in all parts of the country, or abroad, under the headings: (1) Call, (2) location, (3) frequency, (4) time heard—schedules, where possible (EWT), (5) rating, (6) kind of receiver and antenna system used, and especially (7) newscasts in the English language. Address your reports to Kenneth R. Boord, Short-Wave Editor, RADIO NEWS, 540 N. Michigan Avenue, Chicago 11, Illinois.

This month we wish to acknowledge correspondence from the British Broadcasting Corporation; the Australian Broadcasting Corporation; Ying Ong, Phoenix, Arizona; August Balbi, Los Angeles, Calif.; Don Brewer, Tulsa, Oklahoma; the United Network, San Francisco, Calif.; WLWO and WLWK of the Crosley Radio Corporation, Cincinnati, Ohio; F. P. Nelson, Short-Wave and Television Manager, Westinghouse Radio Stations, Inc., Philadelphia, Pa.; and the Embassies in Washington of the following governments: U.S.S.R.; Guatemala; Bolivia; Venezuela; Norway; The Netherlands; Ecuador; Panama; Sweden; and others. Many thanks!

-50-

**POSTWAR APPLIANCES**

**A** PREVIEW of postwar home equipment was given by Mr. J. H. Rasmussen of the Crosley Corporation when he addressed a sales executive club recently.

Mr. Rasmussen summarized his views of what the future holds for various electrical products and appliances in the following manner. In 1941, 3,700,000 electric refrigerators were produced. More would have been manufactured and sold had the limitation order not curtailed the production program.

The radio industry produced 13,000,000 receivers in its peak year of 1941. This year the industry will produce about \$3,000,000 worth of signal and communications equipment for the armed services. An estimated postwar demand for 20,000,000 sets now exists; this will expand as television and FM becomes generally available.

Forty-three commercial FM stations and six experimental FM stations are now in operation. The FCC is reported to hold applications for 77 additional licenses. More than 500,000 FM receivers have been sold. It will be possible for 3,000 FM stations to occupy the frequency band allotted by the FCC for this purpose. Since there are less than 1,000 AM stations in operation, FM will permit a fine broadcasting service for many communities that do not have adequate service today.

-50-

**Katolight A. C. Generators**

Furnish Same Current as City Power Lines

Kato Engineering products are carrying out an important job in the War Effort.

A maneuvering fighting force cannot arrange for a power line hook-up. KATOLIGHT GENERATORS furnish electricity on the field of battle which permits equipping our fighting forces with the most modern electrical appliances.

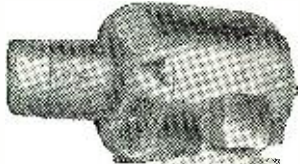

"10 K.W. Revolving Field Generator"

Fighting forces need guns, planes, tanks, trucks, kitchens, emergency hospitals, lights, etc. To keep this equipment going, complete repair equipment such as drills, grinders, saws, air-compressors, etc., are needed. Standard A.C. electricity, the same as you get from the power line, must be had for operating these devices. Portable Katolight generators supply this electricity. They also supply current for radio transmitters, beacons, landing field controls, etc.

Available in all standard voltages and sizes up through 25,000 watts. Also manufacturers of rotary converters, frequency changers, motor-generator sets, gas engine driven battery chargers, high frequency motor-generators and converters.

**KATO ENGINEERING CO.**  
117 Rock St. Mankato, Minn., U. S. A.

**Do Not Burn Waste Paper**  
**It Is a Vital War Material**

**Learn RADIO-ELECTRONICS**

**12 WEEKS TRAINING IN COYNE SHOPS ON REAL RADIO—ELECTRONICS EQUIPMENT!** FOR MEN 16 UP TO 50

Prepare for a great Peace time future and a good job in Radio—Electronics now. Coyne "LEARN BY DOING" training covers latest developments in this field. Prepare quickly, easily. Fascinating well paid work in maintenance, installation and servicing Radio—Electronic equipment.

**ELECTRONICS AND TELEVISION**  
Tremendous expansion in Radio, Electronics, Frequency Modulation and Television predicted after the war—a world of new opportunities. Get ready for a Peace time future and a good job NOW with practical Coyne Radio Training.

**I'LL FINANCE YOUR TRAINING!**  
Get training first—then pay for it in easy monthly payments starting 60 days after your training period is over. I assist you in getting part-time work while at COYNE to help pay living expenses. Job Service when trained. ALSO HAVE FACILITIES FOR MEN WITH PHYSICAL DISABILITIES. WRITE!

**FREE BOOK!** Whether you're 16 or up to 50 Electronics training included at no extra cost now. Mail coupon today.

H. C. LEWIS, Pres., RADIO DIV., COYNE ELEC. SCHOOL  
500 S. Paulina St., Dept. 64-1K Chicago 12, Illinois



H. C. LEWIS, Pres., RADIO DIV., COYNE ELEC. SCHOOL  
500 S. Paulina St., Dept. 64-1K Chicago 12, Illinois

Send me FREE BOOK, "Your Future in Radio-Electronics", and details of Industrial Electronics training included at no extra charge and easy "Pay-After-Graduation" plan.

NAME.....AGE.....  
ADDRESS.....  
CITY.....STATE.....

# CAREERS

for  
**ENGINEERS**  
at  
**NATIONAL UNION RADIO CORPORATION**

You who join our research and engineering staff now to help us with the important war work we are doing will be embarking on a career. Our plans for the future offer unusual opportunities for able men. Our staff today forms a friendly capable team of scientists and engineers whose accomplishments have brought national recognition. You'll enjoy working with them, growing with them.

THESE ARE OPPORTUNITIES. We are adding to our staff engineers who specialize in

- ELECTRONIC TUBES
- PRODUCTION
- DEVELOPMENT
- MEASUREMENTS
- PHYSICS
- ELECTRICITY
- TRANSMITTING TUBES

Our laboratories in Newark, N. J., offer ideal working conditions. We prefer that you have a degree in electrical engineering, physics, chemistry or mathematics—your experience, however, may be sufficient.

Why don't you find out whether there's a place for you with our fine staff of specialists. Write and tell us about yourself or Phone HUmboldt 2-5252, Ext. 72, for appointment.

**NATIONAL UNION RADIO CORPORATION**  
50 Spring Street, Newark 2, N. J.

★ **INDUSTRIAL** ★  
**MAN-POWER BUREAU**

## Wanted ENGINEERS

- Radio
- Chemical
- Electrical
- Electronic
- Mechanical
- Metallurgical
- Factory Planning
- Materials Handling
- Manufacturing Planning

Work in connection with the manufacture of a wide variety of new and advanced types of communications equipment and special electronic products.

Apply (or write), giving full qualifications, to:

C. R. L.  
EMPLOYMENT DEPARTMENT  
**Western Electric Co.**  
100 CENTRAL AV., KEARNY, N. J.  
Applicants must comply with WMC regulation.

## PUBLICITY MAN

Capable handling magazine advertising, catalog preparation, news items for magazines, assist with house organ, etc., for radio transmitter equipment manufacturer. Experience with radio and in sales helpful. Salary commensurate with experience and qualifications. Write details of experience and salary desired. Town of 4,000, 20-year-old manufacturer, organization of 500, living costs moderate, good hunting and fishing.

**E. F. JOHNSON COMPANY**  
Waseca, Minnesota

## RADIO ENGINEERS

At least two years' design and development experience with Radio Communications Equipment manufacturer on items subsequently satisfactorily produced in quantity. Knowledge and experience in two-way mobile equipment, low power transmitters, receivers, and control equipment essential. Permanent position. West Coast Manufacturer. Will pay expenses to coast for interview if qualifications satisfactory. Write giving complete past experience, employment record, salary received, and technical references.  
**BOX NO. 367 c/o RADIO NEWS**

**SALESMAN** for New York City and Metropolitan Area, one who is well acquainted with electronic, radio and electrical manufacturing companies to sell fabricated sheet metal products. Box 364.

## ELECTRONIC

- ENGINEERS
- TECHNICIANS
- DESIGNERS
- DRAFTSMEN
- TUBE TECHNICIANS

EXCELLENT OPPORTUNITIES  
IN A MAJOR POST-WAR FIELD!

Openings available at our Research Laboratories and Electronics Manufacturing Unit. Leaders in the design and development of vital electronic equipment for the Armed Forces.

Essential workers need release. Write, stating Experience, Education, Draft Status, Salary. Include snapshot if available. Or apply to

## SPERRY

GYROSCOPE COMPANY, INC.  
RESEARCH LABORATORIES  
STEWART AVE. & CLINTON RD.  
GARDEN CITY, NEW YORK

- TECHNICAL MANUSCRIPTS
- INSTRUCTION MANUALS
- CONSULTATION SERVICE

In all phases of Electronics  
**INDUSTRIAL ELECTRONICS, INC.**  
21 Henry St., Detroit 1, Mich.

## Wanted Graduate Mechanical-Electrical Engineers AND STRESS ANALYSTS

Excellent immediate and post-war opportunity for qualified engineers having experience on small electro-mechanical devices. Apply by letter only, giving experience and training resume and draft status. Must comply with W.M.C. Regulations.

**LEAR AVIA, INC.**  
Piqua, Ohio  
R. J. Biggs, Special Representative

## WANTED PLASTIC DESIGNER

Man fully capable of designing plastic parts and tools. Interested eventually in moving ahead with a post-war program. Opportunity excellent with well established molder. Reply Box 362, Radio News.

## WANTED RADIO LICENSED AMATEURS

thoroughly familiar with all types of parts, tubes, meters, test equipment, receivers, transmitters, etc., capable of dealing with our industrial accounts. Permanent position; exceptional salary to the right man.

**SUN RADIO & ELECTRONICS CO.**  
212 Fulton St. New York 7, N. Y.



"This section is designed to help the radio industry obtain trained, experienced, technical men to facilitate vital war production. Before applying for any of these positions consult your local United States Employment Service office to determine War Manpower Commission regulations concerning the changing of jobs. If you are already employed in war work at your highest skill, stick to your present job."

## SYLVANIA ELECTRIC PRODUCTS INC.

has openings for

**ELECTRICAL ENGINEERS  
MECHANICAL ENGINEERS  
MACHINE DESIGNERS  
RADIO TECHNICIANS**

to work on the design, development and production of radio tubes, fluorescent lamps, electronic equipment and devices.

We want men who have the "know how" of getting things done under pressure, and who would like to become associated with a company whose post-war future is indeed encouraging.

Reply giving age, education, and experience to our

**INDUSTRIAL RELATIONS  
DEPARTMENT**

500 Fifth Avenue New York (18), New York

## ENGINEERS DRAFTSMEN POST WAR OPPORTUNITY

Progressive New York Electronic Manufacturing Company is now seeking additional personnel. Require two (2) transmitter, five (5) receiver and two (2) special equipment engineers, as well as four (4) draftsmen and two (2) laboratory technicians. This is not a "Duration" program. Personnel of proven capabilities assured a post war position, comparable current status. Transportation will be paid to New York. Salaries commensurate with experience and ability and current earnings. All negotiations confidential. Address replies to

**ELECTRONICS**

Room 411 280 Broadway, N. Y.

## RADIO ENGINEERS

Men wanted with laboratory research and complete electrical or mechanical chassis design experience.

Trav-Ler Karenola Radio & Television Corporation  
1028-36 West Van Buren St.  
CHICAGO 7, ILLINOIS

## ELECTRONIC (COMMUNICATIONS) ENGINEERS WANTED

Openings in our permanent organization for several capable engineers with experience and initiative, trained in both designing and production problems in our or closely allied field.

Our line includes the designing and manufacturing of attenuators, switches, and audio test equipment.

We anticipate no readjustment in our engineering staff as a result of peacetime production requirements. In applying, kindly state qualifications and earliest availability. All inquiries will be held in strict confidence.

**THE DAVEN CO.**  
191 CENTRAL AVE.  
NEWARK 4, N. J.

*Transmitting or Receiving*

## RADIO STATION TECHNICIANS

**MEN AND WOMEN**

for Point-to-Point International Radio-communications Stations in the United States and abroad

Applicants, possessing at least an F. C. C. Radiotelegraph Commercial License, are preferred.

Essential workers need release statement.

Apply weekdays except Saturdays between 10 am and 3 pm  
or write

PERSONNEL DEPARTMENT

**R.C.A. COMMUNICATIONS, Inc.**  
64 Broad Street  
NEW YORK 4, N. Y.

## WORK NOW IN THE INDUSTRY OF THE FUTURE

★ ★ ★

**RADIO ENGINEERS  
ASSISTANT ENGINEERS  
LAYOUT DRAFTSMEN**

Immediate Openings in Development, Specifications, Production Engineering and Test Equipment.

### 100% WAR PRODUCTION

Post War Future  
Good Wages  
Semi-Annual Bonus  
Free Life Insurance  
Weekly Sick Benefits  
Surgical and Hospital Care  
Paid Vacations

We also need Lab Assistants, Quality Testers, Analyzers, Phasers.

**MOTOROLA**  
GALVIN MFG. CORPORATION  
4545 Augusta Blvd. • Chicago

*Engineers...*

## FOR DESIGN, DEVELOPMENT AND PRODUCTION OF

**Electrical Measuring Instruments  
or Radio Test Equipments or Both**  
IF YOU ARE THINKING ABOUT YOUR  
POST-WAR FUTURE—IF YOU WANT A POSITION OF PERMANENCE

Here is your chance to become associated with a long-established and progressive manufacturing concern, well known in the industry for the quality of its products.

This company has been successful in manufacturing pre-war equipment identical with that now provided in the war effort. We will have a continuing program of post-war engineering development assuring peace-time security and permanence of employment in a major field.

We need men well grounded in the fundamentals of electronic engineering and who have substantial experience in electrical measuring instrument or test equipment design. Practical production experience also is desired. Salary commensurate with previous experience and ability.

Our engineering staff is a congenial, capable team of technicians with whom you will enjoy working. Modern plant buildings provide pleasant working conditions, and this small northwestern Ohio college town is an ideal place to live and enjoy life.

Write to—

**THE TRIPLETT  
ELECTRICAL INSTRUMENT CO.**  
333 Harmon Road, Bluffton, Ohio

**INDUSTRIAL  
MAN-POWER BUREAU**

*Continued*

**A WAR JOB FOR YOU**

Men and Women Wanted

for

**RADIO WORK**

at

**WESTINGHOUSE**

Radio Amateurs, Radio Service Men,  
Ex-Service Men with Radio Training,  
Girl and Women Graduates of  
Radio Training Courses

are

needed to test

Radio and Electrical Equipment

All grades of positions open to fit  
individual electrical background.

Apply by letter or in person

to

Westinghouse Electric and Mfg. Co.  
2519 Wilkens Ave.—Baltimore 3, Md.

or

Susquehanna and Front Streets  
Sunbury, Pennsylvania

Those now employed at highest skill  
in essential industry need not apply

**HELP WANTED**

**ENGINEER**

CAPACITOR LABORATORY

ELECTROLYTIC OR PAPER DESIGN

**DRAFTSMEN**

DESIGN AND LAYOUT RADIO PARTS

**MECHANICAL  
ENGINEER**

DESIGN AND DETAIL AUTOMATIC  
MACHINES

WMC RULES

**MICAMOLD RADIO**

CORPORATION

1087 FLUSHING AVE., BROOKLYN, N. Y.

**WANTED:**

**MECHANICAL  
DRAFTSMEN**

AND

**DESIGNERS**

**WANTED:** Mechanical draftsmen and designers. If you want to get into a top rated field of war work. If you want to win a spot in an organization which plans to lead its field in post-war activity. If you want bright and new surroundings. If you want to work with new equipment. If you want to live in a nice Northern Illinois community—not small and not large—close to America's vacation land. If drafting and designing is your highest skill and you can legitimately change jobs. If you know that you can do a good job in designing small electrical devices. If you know precision manufacturing requirements—split thousandths—small stampings, plastic molding, die castings, etc. If you are good enough to turn out neat and sensible drawings and selfish enough to expect pay commensurate with high class work. There is a place in our division for you.

Box 368

c/o RADIO NEWS  
540 N. Michigan Ave.  
Chicago 11, Ill.

**ENGINEERS**

• with experience  
in the  
**DESIGN  
DEVELOPMENT  
PRODUCTION  
of AM and FM  
RECEIVERS**

• Also Mechanical Engineers and Engineers familiar with Electro-Physical Apparatus & Design.

We are a well-established concern located in New York City. To men who are qualified, we offer a most interesting proposition. You will, of course, be paid a good salary. You will have wide range of expression due to our progressive thinking and planning. You will work with engineers who have contributed much to radio and electronics. You will have the opportunity to carve out for yourself a real and secure future. And you will not be hamstrung by "inside" politics. Tell us all about yourself in your first letter. It will be held in confidence.

Box No. 366, RADIO NEWS  
540 No. Michigan, Chicago 11, Ill.

**SERVICEMEN!**

Can you write articles on construction, substitutions, repairing shortcuts, or other subjects of particular interest to radio servicemen for publication in a radio magazine? If you can, write and give us a list of the subjects on which you can prepare a 2000 or 3000 word article.

Reply, Box 370, RADIO NEWS  
540 N. Michigan Ave., Chicago 11, Illinois

**POST-WAR**

Well financed—growing organization has openings for men with electrical engineering background and training in sales field. Degree not necessary but desirable.

Box # 363, % Radio News

**ELECTRICAL ENGINEERS  
RADIO TECHNICIANS**

FOR DESIGN, DEVELOPMENT  
AND PRODUCTION WORK  
POST WAR OPPORTUNITY

ALLEN D. CARDWELL MFG. CORP.  
81 Prospect St. Brooklyn

**Assistant to PRESIDENT**

company manufacturing fabricated sheet metal products for electronic industry, one who is experienced and familiar with Production Control, Sales and Advertising. Splendid opportunity. Give full resume of past. Box 365.

**Technical Writers  
Wanted!**

Engineers and physicists who have had experience in (spare time) writing technical manuscripts on electronic design or applications including radio, television, facsimile, etc. Highest rates.

Reply Box 310, c/o RADIO NEWS  
540 N. Michigan Ave. Chicago 11, Ill.

# RESEARCH IN THE FIELDS OF PHOSPHORS

**D**EVELOPMENT of new and highly efficient luminescent materials by scientists in RCA Laboratories holds great promise of opening new fields and activity in the postwar era.

The war has tremendously accelerated research in the field of phosphors, which are tiny crystals that convert invisible radiations to visible light. Thou-

sands of phosphors synthesized prior to the war had unusual properties, but low efficiencies. Today many uses have been found for these phosphors although they were previously ignored in the search for greater brilliancies.

When blackout conditions were imposed, the despised phosphors received careful reconsideration by research men because the dark-adapted eye is some 200,000 times as sensitive as it is in daylight vision.

The electrical energy applied to phosphor crystals creates light by changing the atomic structure of the crystals. When a swift cathode ray or quantum of ultraviolet strikes a phosphor

crystal, one of the "bombed" atoms in the crystal is stripped of its least tenacious electron. This electron wanders through the crystal until it is trapped in one of the few imperfections. Some time later, latent heat energy again liberates the electron so that it can once more wander about until it chances to near its own "home" or another vacant site. On close approach, the electron dives into the parent haven, which acknowledges its arrival by a momentary scintillation of light. This simple act multiplied by "skintillions" emits light useful for commercial and scientific purposes.

When this war ends and our fighting men return, they will have an opportunity to help achieve a resplendent new electronic era. Phosphor crystals in fluorescent lamps will inexpensively illuminate workplaces and homes or gaily brighten the streets of our cities with vari-colored sign-tubing. Other

phosphor crystals will display news and entertainment on the screens of our television sets which may be tuned by the light from phosphors in "Magic Eye" tuning indicators. Kindred phosphors in the screens of microscopes will aid in fathoming the mysteries of bacteria and molecules in order to insure a healthier and happier life for all.

Other possible uses for phosphor include intense light sources for sound recording and theater projection; in direct illumination wherein the very walls, ceilings, and murals luminesce to illuminate as well as decorate the room; luminescent plastics in thousands of forms to make night-time safer and more colorful; and phosphors emitting specific radiations for controlled treatments of living tissues and organisms.

Although phosphorescent materials were discovered as early as 1603 by De Vicenzio Casciarolo, a Bolognese alchemist, it has been pointed out that the development of phosphors

languished for more than three centuries until electronic television research devised highly efficient luminescent materials capable of glowing in practically any conceivable color.

Phosphors are synthesized as clear tiny crystals measuring about one ten thousandth of an inch in size. These crystals gleam like miniature diamonds when viewed under a microscope. Phosphors are unique in being able to do the following:

Instantaneously transform invisible radiations, such as cathode rays (swiftly-moving electrons) or ultraviolet, into visible light.

Store light, or "remember" information, for controllable time intervals lasting from less than a hundred-thousandth of a second to considerably more than a day.

Convert electric power into white or colored light more efficiently than any other known practical means. —50—

## RADIOODDITIES

Of the various receiving tubes offered by one representative manufacturer, 46 are combinations, 38 are triodes, 36 are diodes, 25 are tetrodes, 19 are converters, and 4 are eye-type indicators.

One popular transmitting tube manufacturer makes only triodes.

After acceleration by 1 volt, a single electron acquires a speed of 368 miles per second.

Have you experimenters ever heard of a jar? This is a little-known electrical unit. 1 jar is equal to 1.11  $\mu$ fd. capacitance.

Tubes are used in building tubes! The precision spot welder used in tube manufacture is electronic.

Barbara Fones writes radio script.

Although New York State boasts the largest U. S. population, Mississippi has the most radios per home—almost 2½ times the figure of New York. South Carolina is second highest.

You can insulate with *insulate*. Insulate is the name of a special dielectric material.

On New Year's Day in 1933, a prominent manufacturer of cathode-ray tubes and television equipment greeted his friends with "electronic holiday cards," which when "played back" in cathode-ray oscilloscopes reproduced a written greeting on the screen.

**Order From**  
**RADOLEK**

**RADIO PARTS  
ELECTRONIC  
APPARATUS  
SOUND SYSTEMS**



Make Radolek your dependable buying source for everything in radio, sound and electronics. We can supply essential merchandise to repair any radio—tubes, condensers, resistors, controls, transformers, etc. — all at lowest prices.

Large Stocks: Radolek's large stocks assure the finest and most complete selections of all available items. Thousands of servicemen rely on Radolek for their entire requirements.

Fast Service: Streamlined handling of every order simplifies procurement problems and gives you fastest possible delivery. Whatever your need—for Industry, the Armed Forces or Civilian replacement—ordering from Radolek saves time, effort and expense.

Get This Free  
Buying Guide



**SEND TODAY!**

RADOLEK CO., Dept. B-94,  
601 W. Randolph St., Chicago, Ill.  
Please send your FREE Buying Guide.

Name .....

Address .....

DEALER     SERVICEMAN     SOUND ENG.

## SAVE AT RADOLEK LEARN CODE the way you'll be using it



**by SOUND**

The best way to learn to read code is by listening to code. The best way to learn to send code is by hearing your own

sending repeated back to you. With the new All-Electric Master Telex Code Teaching Machine, you learn code the natural, easy, fascinating way. Only instrument ever produced which records your sending in visible dots and dashes—then SENDS BACK your own key work at any speed you desire. There are NO PERFORATIONS—NO INK. Far superior to anything ever developed... a marvel of simplicity that's why practically every school teaching code uses MASTER TELEPLEX. We furnish complete course, including the All-Electric Master Telex, give you personal instruction with a MONEY-BACK GUARANTEED—All at a surprisingly low cost. Write today for FREE catalog RN-6. No obligation.

**TELEPLEX CO., 107 HUDSON ST., JERSEY CITY, N. J.**

## WOMEN IN RADIO?

Certainly. Making good, too—as radio technicians in broadcast stations, with airline companies, police radio networks, radio laboratories and radio mfg. plants. Our thorough course prepares for all these fascinating fields. Write for details, stating age and education. No salesman will call.

**VALPARAISO TECHNICAL INSTITUTE**  
Dept. W    Valparaiso, Ind.

**Specify SAUERISEN**  
**ACIDPROOF CEMENTS—COMPOUNDS**  
**FOR**  
Tanks, Sewers, Stacks, Floors  
Technical cements for all purposes.  
Send sketches or samples  
Sauerisen Cements Company · Pittsburgh 15, Penna.

COMPANY	AGENCY	PAGE No.
Aerovox Corporation	Austin C. Lescarboursa & Staff	149
Allied Radio Corporation	Henry H. Teplitz Advertising Agency	62
American Condenser Co.	Michael F. Mayger, Advertising	139
American Phenolic Corporation	Evans Associates, Inc.	102, 122
American Photocopy Equipment Co.	Klau-Van Pietersom-Dunlap Associates	98
Audak Company	Hart Lehman Advertising	8
Audel, Theodore & Co.	Grant & Wadsworth, Inc.	128
Barker & Williamson	Harry P. Bridge Co., Advertising	88
Best Vibrator Company		142
Bliley Electric Company	W. S. Hill Company	106
Brach, L. S. Company	United Advertising Agency	100
Browning Labs., Inc.	Charles Brunelle	124
Burgess Battery Co.	Howard H. Monk and Associates	103
Burlingame Associates	O'Callaghan Advertising Agency, Inc.	74
Burstein-Applebee Company	Frank C. Whalen Adv. Co.	143
Candler System	Van de Mark Advertising, Inc.	140
Capitol Radio Engineering Institute	Henry J. Kaufman	70
Cardwell, Allen D. Mfg. Co.		146
Centralab	Gustav Marx Advertising Agency	104
Commercial Radio Institute		142
Connecticut Telephone & Elec. Div.	Wilson & Haight, Inc., Advertising	22
Consolidated Radio Products Co.	Burton Browne Advertising	91
Continental Diamond Fibre Co.	Harry P. Bridge Co., Advertising	130
Cornell Dubilier	Reiss Advertising	65
Cornish Wire Company, Inc.	Hart Lehman Advertising	124
Coyne Electrical School	McJunkin Advertising Co.	136, 143
Crowe Name Plate & Mfg. Co.		125
Daven Co.	Shappe-Wilkwa, Inc.	145
DeForest's Training, Inc.	MacDonald-Cook Co.	97
DeJur-Amsco Corporation	Shappe-Wilkes, Inc.	63
Echophone Radio Co.	Burton Browne Advertising	77
Editors and Engineers		138, 143
Eicor, Incorporated	Henry H. Teplitz Advertising Agency	80
Electro Motive Mfg. Co.	Cory Snow, Inc.	135
Electro-Voice Mfg. Co.	Shappe-Wilkes, Inc.	21
Electronic Corp. of America	Shappe-Wilkes, Inc.	105, 146
Electronic Laboratories, Inc.	Burton Browne Advertising	85
Fada Radio & Electric Co.	Sternfield-Godley, Inc.	6, 118
Fawcett Publications	Hill Advertising, Inc.	138
Federal Manufacturing & Engineering Corp.	Shappe-Wilkes, Inc.	133
Federal Telephone and Radio Corp.	Marschalk & Pratt	11, 96
Foster, Arnot P., Incorporated	Gotham Advertising Company, Incorporated	117
Galvin Mfg. Corporation (Motorola)	Gourfain-Cobb Advertising Agency	111, 145
General Electric Co.	N. W. Ayer & Son, Inc.	19
General Motors, Delco Division	Campbell-Ewald Company	9
General Test Equipment	Suzanne Hayman, Advertising	143
Gerhard Manufacturing Co.	Merchandising Advertisers	118
Greenlee Tool Company	Howard H. Monk and Associates	136
Guardian Electric Mfg. Co.	Kennedy & Company	83
Hallicrafters	Burton Browne Advertising	5, Back Cover
Hammarlund Mfg. Co., Inc.	Roeding & Arnold, Inc.	24, 141
Harvey Radio Co.	Shappe-Wilkes, Inc.	108
Howard Manufacturing Co.	Bozell and Jacobs	139
Hytron Corporation	Henry A. Loudon Advertising	23
Illinois Condenser Co.	Sander Rodkin Advertising Agency	123
Industrial Electronics, Inc.		144
International Detrola Corp.	Zimmer-Keller, Inc.	127
International Resistance Co.	Lavenson Bureau	123
Intex Company		142
Jennings Radio Mfg. Co.	L. H. Waldron Adv. Agency	86
Jensen Radio Mfg. Company	Burton Browne Advertising	7
Johnson, E. F. Co.	David, Inc.	73, 144
Kato Engineering Co.		143
Kenyon Transformer Co.	Jasper, Lynch & Fishel, Inc.	121
Knights, James Company	Turner Advertising Agency	101

COMPANY	AGENCY	PAGE No.
Lafayette Radio Corporation	Shappe-Wilkes, Inc.	84
Lake Radio Sales	Sander Rodkin Adv. Agency	120
Lear Avia, Inc.	Arthur Kudner, Inc.	69, 144
Lincoln Engineering School	Buchanan, Thomas Adv. Co.	143
Mallory, P. R. & Co., Inc.	Aitkin-Kynett Co., Advertising	71
Meck, John Industries	Western Advertising Agency	94
Merit Coil & Transformer Corp.	Ross Llewellyn, Inc.	104
Micamold Radio Corp.	Shappe-Wilkes, Inc.	146
Millen, James Mfg. Co.	James Millen, Inc.	12
Murdock, Wm. J. Co.	John A. Smith & Staff	64
McGraw-Hill Book Co.		112
National Company, Inc.	Graydon Smith, Advertising	113
National Electronic Supply		90
National Radio Institute	Van Sant, Dugdale & Co.	3
National Schools	The Mayers Company	89
National Scientific Products Co.	Kennedy & Co.	68
National Union Radio Corporation	Hutchins Adv. Agency	81, 144
Nelson Company	A. N. Baker Advertising Agency	120
Newcomb Audio Products	Dozier Graham Eastman Adv.	134
Ohmite Mfg. Company	Henry H. Teplitz	61
Olson Radio Warehouse	Jessop Advertising Agency	138
Onan, D. W. & Sons	Pioneer Advertising Company	116
Panoramic Radio Corporation	Shappe-Wilkes, Inc.	75
Park Metalware Company	Melvin F. Hall Adv. Agy., Inc.	116
Plastic Wire & Cable Corp., The		17
Radio & Technical Division of Murray Hill Books, Inc.	Harry P. Bridge Co., Adv.	73
Radio City Products Co., Inc.	Reiss Advertising	140
RCA Communications		145
RCA Institute, Inc.		140
RCA Victor Division	Kenyon & Eckhardt, Inc.	2nd Cover
Radio Distributing Co.		143
Radolek Company	Turner Advertising Agency	147
Radio Parts Co.		114
Rider, John F. Publisher, Inc.	Lansford F. King	132
Runzel Cord & Wire Company	Duane Wanamaker Advertising	119
Sauereisen Cements Co.		147
Shure Brothers	Henry H. Teplitz, Advertising	93
Snyder Mfg. Co.	Philip Klein Adv. Agency	110
Sperry Gyroscope Co.	Equity Advertising Agency	144
Sperti, Inc.	Stockton-West-Burkhart, Inc.	129
Sprague Products Co.	Harry P. Bridge Co., Adv.	67
Sprayberry Academy of Radio	Harry P. Bridge Co., Adv.	13
Standard Transformer Corp.	Burnet-Kuhn Advertising Co.	78
Stevens-Walden, Inc.	Howard-Wesson Co.	18
Sun Radio & Electronics		144
Supreme Instruments Corp.	O'Callaghan Adv. Agency, Inc.	16
Supreme Publications	Henry H. Teplitz, Adv.	134, 143
Sylvania Electric Products, Inc.	Arthur Kudner, Inc.	14, 145
Teleplex Company	Terrill Belknap Marsch Asso	147
Templetone Radio Co.	Peck Advertising Agency	15
Thordarson Electric Mfg. Co.	Duane Wanamaker, Adv.	106
Tobe Deutschmann Corp.	Franklin Bruck Adv. Corp.	150
Trav-Ler Karenola Radio Co.		145
Triplett Electrical Instrument Co.	Western Adv. Agency	20, 145
Tri State College	Clem J. Steigmeyer	142
The Turner Company	W. D. Lyon Co.	87
Unger, Harry A.		137
United Electronics Co.	H. W. Lewin Co.	95
United Transformer Co.	Shappe-Wilkes, Inc.	3rd Cover
Universal Microphone	Ralph L. Power, Ph. D.	109
Vaco Products Co.	Duane Wanamaker, Adv.	130
Valparaiso Technical Institute	Smith, Benson & McClure, Inc.	132, 147
Wallace, William T. Mfg. Co.	Michael F. Mayger Adv.	92
Ward Leonard Electric Co.	E. M. Freystadt Asso., Inc.	10
Ward Products	Burton Browne Advertising	107
Warwick Manufacturing Company	Agency Service Corporation	115
Western Electric Co.	Deutsch & Shea	144
Weston Electrical Instrument Corp.	G. M. Basford Company	131
Westinghouse Electric & Mfg. Co.	Fuller & Smith & Ross, Inc.	99, 146
Wholesale Radio Laboratories	Allen & Reynolds	110

A TYPE FOR *Every* APPLICATION  
**OIL-FILLED  
 CAPACITORS**

• Functionally fitted to given application—that's the keynote of the extensive Aerovox oil-filled capacitor line. A plentiful selection of containers, mountings, terminals, sizes and impregnants, assures virtually custom-built capacitors with guaranteed performance.

Aerovox offers both Hyvol and Hyvol-M (mineral oil) liquid impregnants. For applications subjected to wide temperature variations, and where weight and size are important, Hyvol is recommended. Hyvol capacitors are considerably more constant with temperature variations than are those with other impregnating materials of the same specific inductive capacity, showing no capacitance drop until temperatures of  $-20^{\circ}$  F. ( $-29^{\circ}$  C.) are reached. At  $-40^{\circ}$  F. ( $-40^{\circ}$  C.) the maximum capacitance drop that may be expected is of the order of 5 to 10%.

Hyvol-M (mineral oil) capacitors have an exceptionally flat temperature coefficient of capacitance curve but approximately 35% greater bulk and corresponding weight which usually rules them out in favor of Hyvol.

At any rate, Aerovox offers both Hyvol and mineral oil capacitors, as well as wax-impregnated units for limited service—along with that wide choice of containers, mountings, terminals—to meet your exact needs.

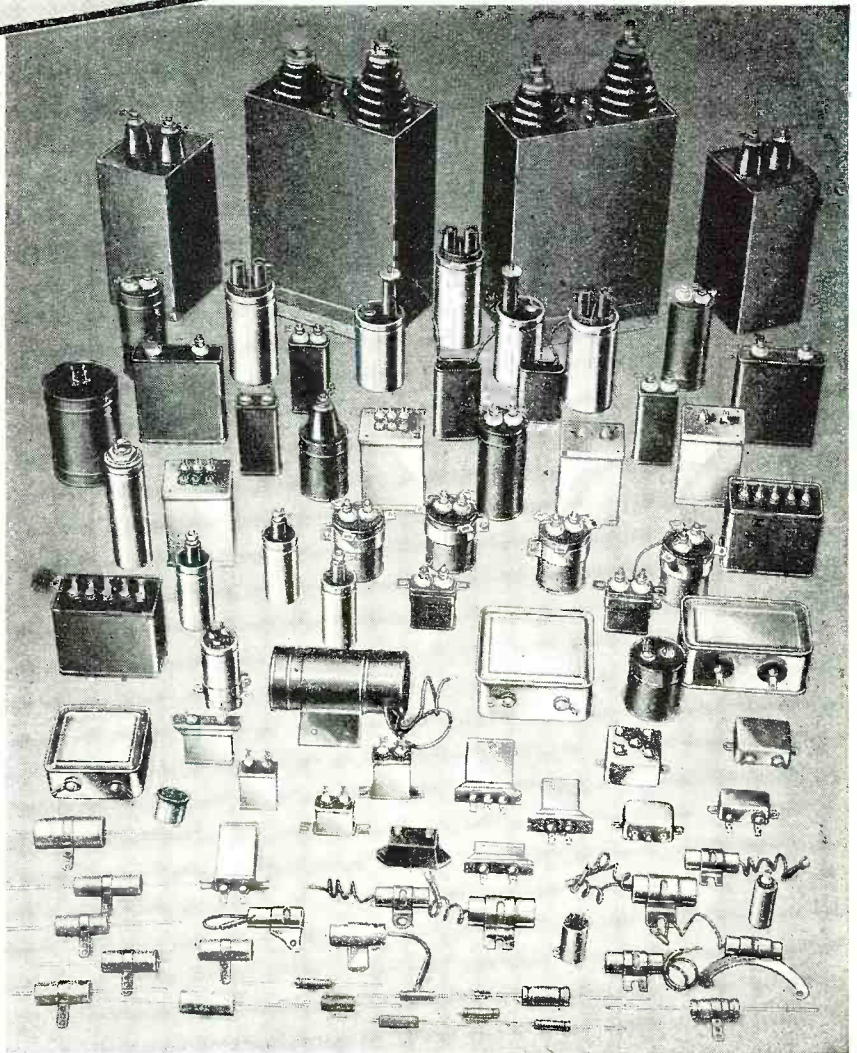

• **NEW CATALOG** lists the exceptionally wide selection of Aerovox oil capacitors, as well as other types. Write on business letterhead for registered copy available only to engineers, designers, electronic maintenance men, manufacturers of equipment, and executives.



*Capacitors*

**INDIVIDUALLY TESTED**

AEROVOX CORPORATION, NEW BEDFORD, MASS., U. S. A.

SALES OFFICES IN ALL PRINCIPAL CITIES

Export: 13 E. 40 ST., NEW YORK 16, N. Y. • Cable: 'ARLAB' • In Canada: AEROVOX CANADA LTD., HAMILTON, ONT.

Old Mining Shaft at Newgate Prison in Granby, Conn. The Granby Mines, perhaps the most historic in America, are over 225 years old.

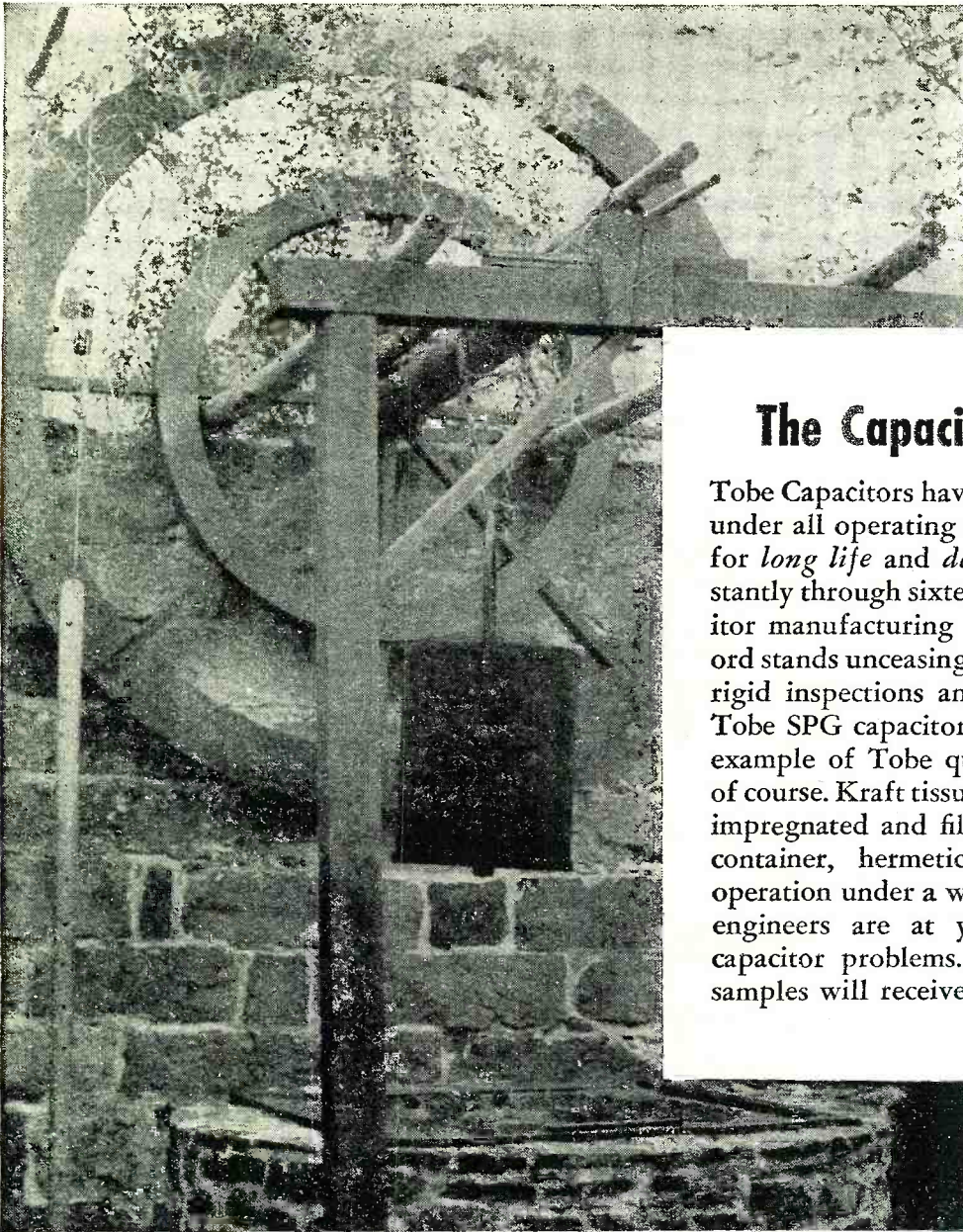

## The Capacity to "TAKE IT!"

Tobe Capacitors have proved they can "take it"—under all operating conditions. Their reputation for *long life* and *dependability* has grown constantly through sixteen years of specialized capacitor manufacturing experience. Behind this record stands unceasing Tobe research, frequent and rigid inspections and *conservative ratings*. The Tobe SPG capacitor illustrated below is a good example of Tobe quality. Top grade materials, of course. Kraft tissue, aluminum foil. Mineral oil impregnated and filled, in a streamlined drawn container, hermetically sealed. Designed for operation under a wide temperature range. Tobe engineers are at your ready disposal in all capacitor problems. Inquiries and requests for samples will receive prompt attention.

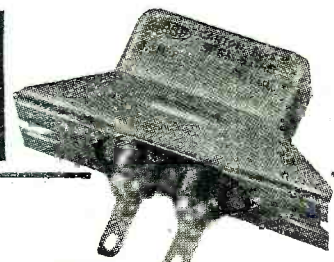

MIDGET SPG CAPACITOR



SPG CAPACITOR

### SPECIFICATIONS

#### SPG-CAPACITORS

TYPE	SPG*
RATINGS . . .	.05 to 2.0 mfd. 600 V. D. C.
	.05 mfd. to 1.0 mfd. 1,000 V. D. C.
STANDARD CAPACITANCE TOLERANCE . . .	20%**
TEST VOLTAGE . . . . .	Twice D. C. rating
GROUND TEST . . . . .	2,500 Volts D. C.
OPERATING TEMPERATURE . . .	-55° F to 185° F
SHUNT RESISTANCE	
	.05 to 0.1 mfd. 20,000 megohms
	.25 to 0.5 mfd. 12,000 megohms
	1.0 mfd. 10,000 megohms
	2.0 mfd. 5,000 megohms
POWER FACTOR 1,000 cycles—	.002 to .005
CONTAINER SIZE	
	Width 3/8", length 1 5/16", height 2 1/4"
MOUNTING HOLE CENTERS . . . . .	1 1/2"

#### MIDGET SPG-CAPACITORS

TYPE	SPGM*
RATINGS . . . . .	.05, .1 and
	2 x .05 600 V. D. C.
	.05 and .1 1,000 V. D. C.
STANDARD CAPACITANCE TOLERANCE . . .	20%**
GROUND TEST . . . . .	2,500 V. D. C.
OPERATING TEMPERATURES . . .	-55° F to 185° F
SHUNT RESISTANCE . . . . .	20,000 megohms
POWER FACTOR . . .	At 1,000 cycles—.0075
CONTAINER SIZE	
	Width 3/8", length 1 5/16", height 1 11/64"
MOUNTING HOLE CENTERS . . . . .	1 1/2"

\*Data sheets showing complete code number for units having a specific capacitance value and voltage rating available on request. \*\*Other tolerances available.

Illustrations show capacitors with terminals on bottom. Capacitors also available with terminals on top.



A small part in victory today... A BIG PART IN INDUSTRY TOMORROW

**POWER SUPPLY  
COMPONENTS  
FOR WAR**

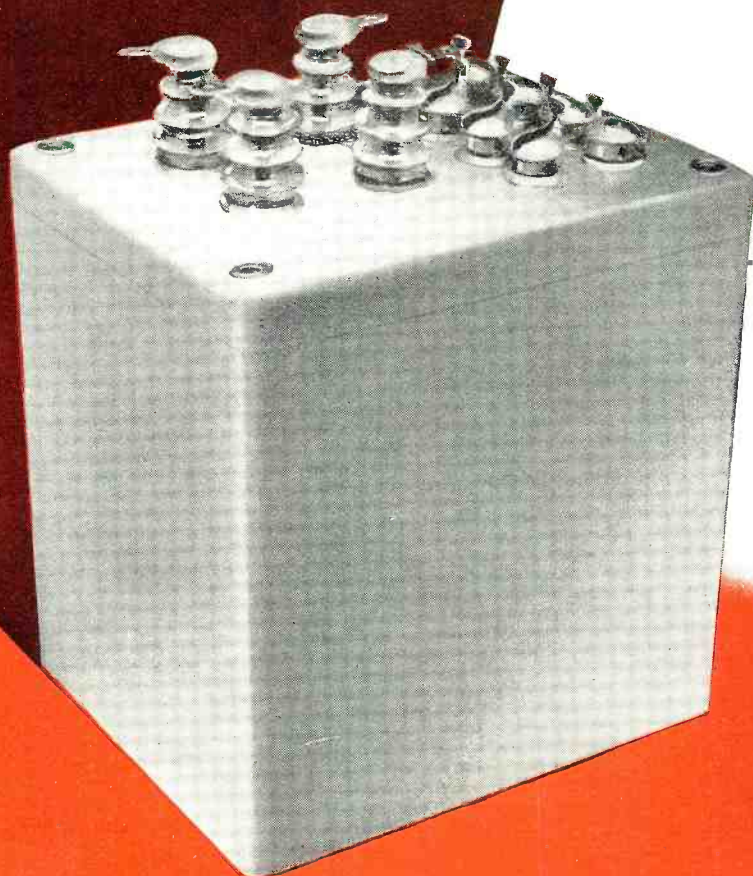

The complex power supplies of war apparatus require components of maximum dependability. The unit illustrated is a typical power transformer for cathode ray application. In addition to the tapped primary, this unit provides a low voltage filament winding . . . a 5,000 volt anode supply winding . . . and a filament winding insulated for 15,000 volts peak inverse.

For hermetic sealing this unit employs an all metal enclosure . . . glass seal terminals . . . sealing compound which neither cracks nor flows from  $-55^{\circ}\text{C}$  to  $+130^{\circ}\text{C}$ .

*May we cooperate with you on design savings for your applications...war or postwar?*

*United Transformer Co.*

**150 VARICK STREET**

**NEW YORK 13, N. Y.**

**EXPORT DIVISION: 13 EAST 40th STREET, NEW YORK 16, N. Y., CABLES: "ARLAB"**



## MEET YOUR NEW NEIGHBOR . . .

"The radio man's radio." That's the reputation Hallicrafters equipment has earned and held through the terrible days of war. After the war Hallicrafters will help introduce thousands of new radio enthusiasts to their new neighbors in Greenland and around the world. Meanwhile thousands of men in the armed services have come to realize the dependability of Hallicrafters short wave equipment. They have learned first hand that Hallicrafters-built sets can take it under withering fire and brutal travel conditions—can take it, stand up, and continue to send the messages through. . . . To men who make radio communications a life work, Hallicrafters has one post-war promise towards the top of the list: to keep on making "the radio man's radio" and that means, according to Hallicrafters standards, the best that can be made.



It will be sets like this that will help you to meet your new neighbor, in Greenland and around the world, when peace time production permits. Hallicrafters is projecting a line that most certainly will include the rig you need. **THE HALLCRAFTERS COMPANY, Manufacturers of Radio and Electronic Equipment, Chicago 16, U. S. A.**

**BUY A WAR BOND TODAY!**

# hallicrafters RADIO

