

RADIO NEWS

NN-84
E WILLARD WOLFOLK
4484 O SPREY ST
OCEAN BEACH CALIF



AUGUST
1944
25c
In Canada 30c



Microscopic enlargement
approximately 10 power

Science on the Production Line

Commonly you think of the microscope as a scientific laboratory instrument. But at National Union, these days, you will find it even more extensively used, as a *production* machine, insuring microscopic precision step by step through many processes of manufacture.

With the aid of microscopes, National Union workers accurately check almost invisibly small parts. They *see* to it that welds are sound, clearances are exact and the structure is mechanically perfect. In the photograph above for example, a N. U. 6AG5 miniature tube mount, no higher than your thumb nail is enlarged approximately 10 times, to permit minute examination of important structural factors. Enlargements up to

500 times—making a hair on your head look as tall as a tree—are just as readily obtained, when needed. Moreover, this tube, assembled from 31 individual parts, must pass 40 individual inspections, in addition to thorough examination under the microscope.

Here, again, is one of those unusual techniques developed by National Union engineers to make tube manufacture a more exact science. Such infinite care makes certain that every electronic tube which carries the National Union name will deliver a uniformly high level of performance with long service life. *Count on National Union.*

NATIONAL UNION RADIO CORPORATION, NEWARK, N. J.
Factories: Newark and Maplewood, N. J.; Lansdale and Robeson, Pa.



NATIONAL UNION

RADIO AND ELECTRONIC TUBES

Transmitting, Cathode Ray, Receiving, Special Purpose Tubes • Condensers • Volume Controls • Photo Electric Cells • Panel Lamps • Flashlight Bulbs

This FREE Lesson in Radio

gives you a real start toward understanding these subjects

With 31 Photos, Sketches, Radio Drawings

How superheterodyne circuits work
How to remove tubes, tube shields
Three reasons why Radio tubes fail
Electrodynamic loudspeaker:
How it works
Replacing damaged cone
Recentering voice coil
Remedies for open field coil
Output transformer construction, repair
Gang Tuning condenser:
Construction of rotor, stator
How capacity varies

Restringing dial cord
Straightening bent rotor plates
I.F. transformers:
What they do, repair hints
How to locate defective soldered joints
Inside story of carbon resistors
Paper, electrolytic, mica, trimmer condensers
How condensers become shorted, leaky
Antenna, oscillator coil facts
Power transformer:
Construction, possible troubles

Installing power cord
Troubles of combination volume control, on-off switch
Tone controls
Dial lamp connections
Receiver servicing technique:
Checking performance
Testing tubes
Circuit disturbance test
Isolating defective stage
Locating defective part

GETTING ACQUAINTED WITH RECEIVER SERVICING

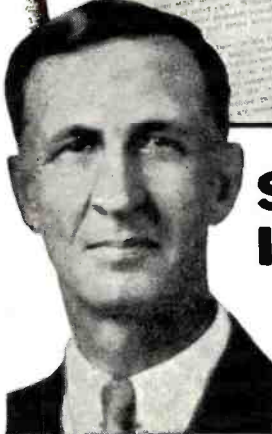

See For Yourself How I Train You at Home to BE A RADIO TECHNICIAN

I want to give every man who's interested in Radio, either professionally or as a hobby, a copy of my Lesson, "Getting Acquainted With Receiver Servicing"—absolutely FREE! It's a valuable lesson. Study it—keep it—use it—without obligation! And with it I'll send my 64-page, illustrated book, "Win Rich Rewards in Radio," FREE. It describes many fascinating jobs in Radio, tells how N.R.I. trains you at home in spare time, how you get practical experience with SIX KITS OF RADIO PARTS I send.

This "sample" Lesson will show you why the easy-to-grasp lessons of the N.R.I. Course have paved the way to good pay for hundreds of other men. I will send it to you without obligation. MAIL THE COUPON!

Big Demand Now For Well-Trained Radio Technicians, Operators

Today there's a shortage of capable Radio Technicians and Operators. Fixing Radios pays

I TRAINED THESE MEN

\$200 Month in Own Business
"I am in business for myself making around \$200 a month." — writes Arlie J. Froehner, 300 W. Texas Avenue, Goose Creek, Texas.



\$5 to \$10 Week in Spare Time
"I am engaged in spare time Radio work. I average from \$5 to \$10 a week extra from this work." — T. K. Dubree, Horsham, Pa.



Communication Station Operator "Am with Civil Aeronautics Administration at Shreveport Airways Communication station. Have a lifetime position with pension after retirement." — Jesse Roberts, Box 1076, Shreveport, La.



Chief Operator Broadcasting Station "Before I completed your lessons, I obtained my Radio Operator's license and joined Station WMPG where I am now Chief Operator." — Hollis F. Hayes, 327 Madison St., Lapeer, Michigan.



My Radio Course Includes TELEVISION • ELECTRONICS FREQUENCY MODULATION

better now than for years. With new Radios out of production, fixing old sets, which were formerly traded in, adds greatly to the number of servicing jobs.

Broadcasting Stations. Aviation and Police Radio, and other Radio branches are searching for Operators and Technicians. Radio Manufacturers employ many trained men. And think of the NEW jobs that Television, Electronics, and Frequency Modulation will open up after the war!

Many Beginners Soon Make \$5, \$10 a Week EXTRA in Spare Time

As soon as you enroll for my Course I start sending you EXTRA MONEY JOB SHEETS that help show you how to earn \$5 to \$10 a week EXTRA in spare time while still learning.

Mail Coupon for Free Lesson and Book

The opportunity the war has given beginners to get started in Radio may never be repeated. So take the first step at once. Get my FREE Lesson and 64-page, illustrated book. No obligation. Just mail coupon in an envelope or paste it on a penny postal.—J. E. SMITH, President, Dept. 4HR, National Radio Institute, Washington 9, D. C.

Our 30th Year of Training Men for Success in RADIO

You Build These and Many Other Radio Circuits with 6 Kits of Parts I Supply

By the time you've conducted 60 sets of Experiments, made hundreds of measurements and adjustments, you'll have valuable PRACTICAL Radio experience.

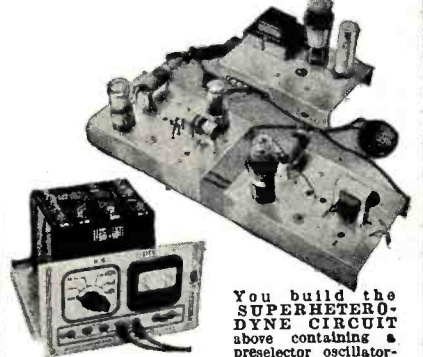

You build MEASURING INSTRUMENT above early in Course, useful for Radio work to pick up EXTRA spare time money. It is a vacuum tube multimeter, measures A.C., D.C., R.F. volts, D.C. currents, resistance, receiver output.

You build the SUPERHETERODYNE CIRCUIT above containing a preselector oscillator-mixer-first detector, i.f. stage, diode-detector-a.v.c. stage and audio stages. It will bring in local and distant stations. Get the thrill of learning at home evenings in spare time while you put the set through fascinating tests!

Building the A. M. SIGNAL GENERATOR at right will give you valuable experience. Provides amplitude-modulated signals for test and experimental purposes.



GOOD FOR BOTH 64 PAGE BOOK SAMPLE LESSON FREE

Mr. J. E. SMITH, President, Dept. 4HR, NATIONAL RADIO INSTITUTE, Washington 9, D. C.

Mail me FREE, without obligation, Sample Lesson and 64-page book, "Win Rich Rewards in Radio." (No salesman will call. Please write plainly.)

Age.....
Name.....
Address.....
City..... State..... 4HR



"Reg. U. S. Pat. Off."

AUGUST • 1944

VOLUME 32, NUMBER 8

CONTENTS

FEATURES

What is Electronics? J. D. Ryder 23
Crystal Processing. Kenton K. Garrison 25
Theater Acoustics. Willard Moody 29
Weather Testing Walkie-Talkies. 32
Large Transmitter Construction. 34
Electrons at Work. 37
Preconstruction Requirements for Local Broadcast Stations. Roger W. Hodgkins 38
Tube Substitutions for Radio Receivers. M. S. Kay 40
Recording Laboratory—Library of Congress. Oliver Read, W9ETI 43
Problems of a Radio Serviceman. Art Becker 47
6-8 mc. Portable Transmitter. William Maron 48
R.F. Impedance Matching. M. Dean Post 51
Theory and Application of U.H.F. Milton S. Kiver 53
Sound on Cellophane. Stanley Kempner 56
Radio and the Blitz. Leslie W. Orton 62
Practical Radio Course. Alfred A. Ghirardi 72
Government Acceptance Tests of Airborne Electronic Equipment James C. Coe 83

DEPARTMENTS

For the Record. 8
Spot Radio News. 12
QTC. Carl Coleman 52
Technical Book and Bulletin Review. 60
International Short-Wave. Kenneth R. Boord 92
What's New in Radio. 112
Manufacturers' Literature 134

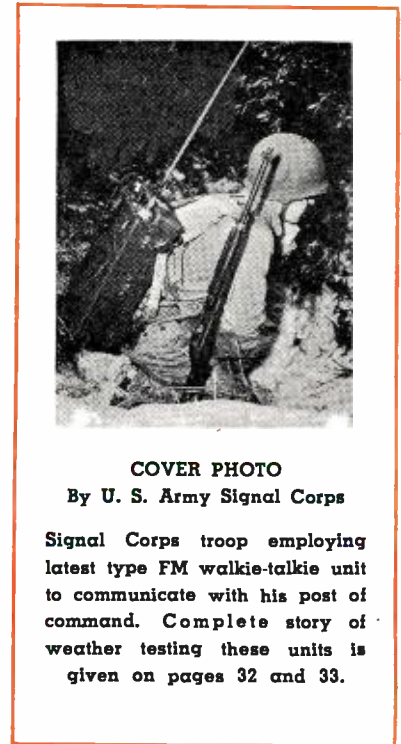

COVER PHOTO
By U. S. Army Signal Corps
Signal Corps troop employing latest type FM walkie-talkie unit to communicate with his post of command. Complete story of weather testing these units is given on pages 32 and 33.

WILLIAM B. ZIFF
Publisher

B. G. DAVIS
Editor

C. R. TIGHE
Ass't to Publisher

OLIVER READ, W9ETI
Managing Editor

WM. A. STOCKLIN
Associate Editor

HAROLD S. RENNE
Technical Editor

JOE MARTY, JR.
Field Editor

FRED HAMLIN
Washington Editor

E. H. SEHNERT
Chief Draftsman

HERMAN R. BOLLIN
Art Director

K. R. PORTER
War Correspondent

FRANK ROSS
Staff Photographer

GEORGE BEKNER
Advertising Director

S. L. CAHN
Advertising Mgr.

R. B. FRANK, W9JU
(on leave)

J. M. ECKERT
Midwest Adv. Mgr.

H. G. STRONG
Circulation Director

H. J. MORGANROTH
Production Director

Copyright, 1944
ZIFF-DAVIS PUBLISHING COMPANY
Editorial Offices: 540 N. Michigan Ave., Chicago 11, Ill.
Member of the Audit Bureau of Circulations

RADIO NEWS is published monthly by the Ziff-Davis Publishing Company at 540 N. Michigan Ave., Chicago 11, Ill. New York Office, 270 Madison Ave., New York 16, N. Y. Washington, D. C., Office, Earle Bldg. Los Angeles Office, William L. Pinney, Manager, 815 S. Hill St., Los Angeles 14, Calif. London Editorial Representative, A. Spenser Allberry. Subscription Rates: In U. S. \$3.00 (12 issues), single copies, 25 cents; in Mexico, South and Central America, and U. S. Possessions, \$3.00 (12 issues); in Canada \$3.50 (12 issues), single copies 30 cents; in British Empire, \$4.00 (12 issues); all other foreign countries \$6.00 (12 issues). Subscribers should allow at least 2 weeks for change of address. All communications about subscriptions should be addressed to: Director of Circulation, 540 N. Michigan Ave., Chicago, 11, Ill. Entered as second class matter March 9, 1938, at the Post Office, Chicago, Illinois, under the Act of March 3, 1879. Entered as second class matter at the Post Office Department, Ottawa, Canada. Contributors should retain a copy of contributions. All submitted material must contain return postage. Contributions will be handled with reasonable care, but this magazine assumes no responsibility for their safety. Accepted material is subject to whatever adaptations, and revisions, including "by-line" changes necessary to meet requirements. Payment covers all authors, contributors or contestants rights, title, and interest in and to the material accepted and will be made at our current rates upon acceptance. All photos and drawings will be considered as part of material purchased.



NEW LETTER CONTEST for SERVICEMEN!



**ELEVEN 1st PRIZE WINNERS
IN 5 MONTHS IN CONTEST #1!**

Yes sir, guys, the hundreds of letters received were so swell that double first prize winners had to be awarded each of the first four months and there were triple first prize winners the fifth and last month . . .

SO — HERE WE GO AGAIN!

Get in on this NEW letter contest — write and tell us your *first hand* experiences with *all* types of Radio Communications equipment built by Hallicrafters including the famous SCR-299!

RULES FOR THE CONTEST

Hallicrafters will give \$100.00 for the best letter received during each of the five months of April, May, June, July and August. (Deadline: Received by midnight, the last day of each month.) . . . For every serious letter received Hallicrafters will send \$1.00 so even if you do not win a big prize your time will not be in vain. . . . Your letter will become the property of Hallicrafters and they will have the right to reproduce it in a Hallicrafters advertisement. Write as many letters as you wish. V-mail letters will do. . . . Military regulations prohibit the publication of winners' names and photos at present . . . monthly winners will be notified immediately upon judging.



hallicrafters RADIO

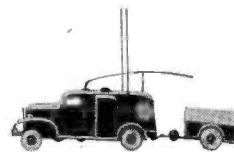

BUY A WAR BOND TODAY!

THE HALLICRAFTERS CO., MANUFACTURERS OF RADIO AND ELECTRONIC EQUIPMENT, CHICAGO 16, U. S. A.



Johnny

**GOT HIS
GUN**

... and more! He got what it takes to make that gun talk the only language the enemy understands... to make that gun spit death and destruction with uncanny, devastating effectiveness. For with this gun, Johnny got a thorough education in *radio*... the war-time radio that makes communications one of the forces most vital to the armed services. Fada is helping to provide the radio and electronic materiel that is hastening victory. And then Fada will resume its leadership in the design and manufacture of whatever radio, television and electronic marvels the Peace may bring.

PLACE YOUR FAITH IN THE

FADA
Radio

OF THE FUTURE

Famous Since Broadcasting Began!

FADA RADIO AND ELECTRIC COMPANY, INC., LONG ISLAND CITY, N. Y.

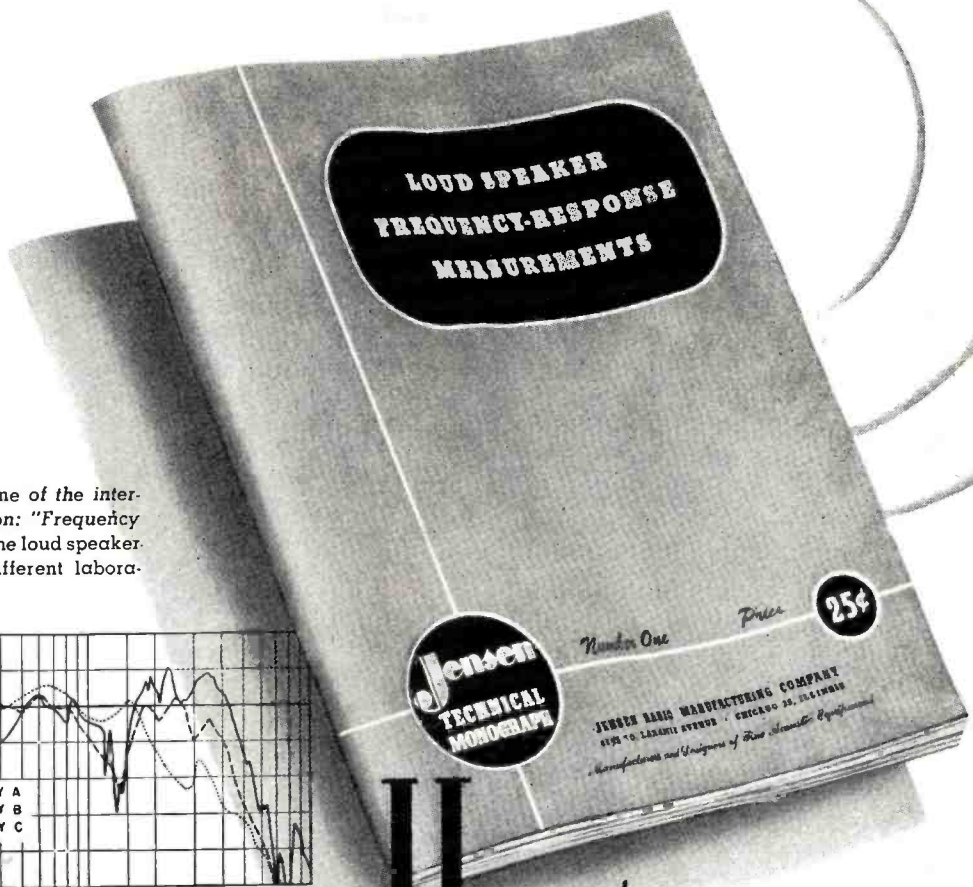

The graph shows only one of the interesting points of discussion: "Frequency response curves of the same loud speaker as measured in three different laboratories."

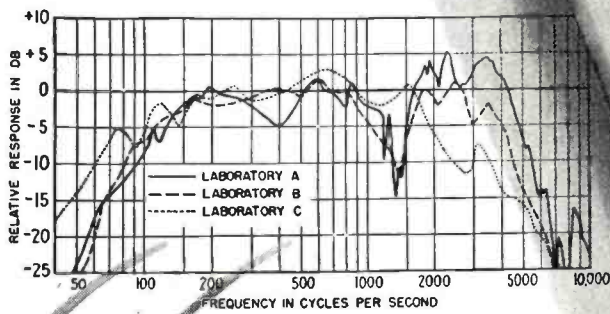

How to judge Loud Speakers from Frequency Response Curves

Here is an informative and educational monograph full of pertinent data on one of the most controversial subjects in the reproduction of sound. "Loud Speaker Frequency Response Measurement" deals with the practical significance of frequency response curves—a subject of interest to everybody who uses speakers. ¶ Jensen engineers have prepared an authoritative and technical series of monographs to help the radio service man, engineer, student, amateur and hobbyist properly select, install, use and operate a loud speaker. "Loud Speaker Frequency Response Measurement" is the first of this series. It is ready NOW. Get your copy from your jobber or dealer, or fill out the coupon and send \$.25 to

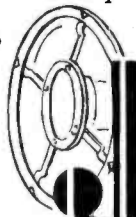

Jensen

JENSEN RADIO MANUFACTURING COMPANY
 6601 SO. LARAMIE AVENUE, CHICAGO 38, ILLINOIS

Gentlemen:
 I am interested in the monograph, "Loud Speaker Frequency Response Measurement." Enclosed is 25¢ for my copy.

NAME _____ STATE _____
 ADDRESS _____
 CITY _____

Watch for the rest of this series! Each will deal with an equally important and interesting aspect of loud speaker selection and operation.

Free to men in the armed services and to the libraries of technical colleges and universities.

KITS

SYLVANIA SERVICEMAN SERVICE



by
FRANK FAX

If you need a good service kit, take a look at these. They are available at low cost because Sylvania orders them in quantity. Send for yours now while it is still in stock.



SERVICE KIT NO. 1 is sturdy in construction, has black leatherette covering, metal fittings, handy tool tray and neat professional appearance. Measures 10 x 17 x 7 inches. Makes service calls easier to handle. Price: \$3. Also Service Kit No. 1A. Same as Kit No. 1 except covered in black and white airplane cloth instead of black leatherette. Price: \$3.



SERVICE KIT NO. 2 has the same quality construction but is roomier. Measures 14 x 22 x 8 inches. Many servicemen put both kits to good use. While they last: \$5.

If your Sylvania distributor does not have service kits in stock, send your order to Frank Fax, Sylvania, Emporium, Pa.

SYLVANIA

ELECTRIC PRODUCTS INC.
RADIO DIVISION

FOR THE RECORD

by the editor

WE have heard very little of late regarding the status of facsimile. This does not mean that development hasn't gone on at a fast pace in the design of new equipment which is greatly simplified as compared to pre-war models and new designs for units which eventually may sell for around \$25.00 or \$30.00. These units according to present plans will be in the form of a device which may be attached to any conventional radio and which, by careful planning, may be manufactured by mass production methods in order to arrive at a price which will have nationwide appeal from the purchaser's viewpoint.

Of particular interest will be its use by American farmers who, being out in their fields from sunrise to sunset, have little time to digest thoroughly the contents of local newspapers. By turning on their facsimile device, which we assume will be automatic in operation, Farmer Jones may return from the fields to find a complete summary of news and other information awaiting him at his dinner table. Furthermore, if present plans come true, these new facsimile units may be operated either with or without sound.

A tremendous market appears to be over the horizon. Like television, it will provide a new service. It will be possible to listen to a war commentator as he explains the news of the day and his reports illustrated with maps or photographs which point out visually the location of the scene being discussed. Farmers alone will not benefit from facsimile. There is a tremendous market in police radio. By combining facsimile with sound in police cars officers will be able to eliminate many errors which arise when for some unexpected reason interference or other disturbances distract from the reception of a license number or other pertinent information. For example, a bank may be held up and the gunman make his escape in a stolen automobile. Passers-by note the license number of the car and the usual procedure in police communications follows. That is, license number is given over the microphone to the squad cars. With the use of facsimile the same license number could be chalked on a board and sent by facsimile transmission to the police car with little delay.

Military engineers employed by the United States Army Signal Corps have done considerable experimental work

with facsimile units. Systems have been improved upon and at present we find the status of facsimile comparable to present standards of television.

WHEN new cars are available after V-Day, there will be a tremendous demand for automobile radios. Engineers are now thinking in terms of FM versus AM. In addition, many manufacturers feel that if automobile radios can be produced at lower cost than prewar models, it may be to their advantage to include radio as part and parcel of the automobile equipment as it leaves the factory. We see a tremendous advantage in such a plan. In the first place, it would eliminate many shapes and sizes of various models and would cut down tremendously on the amount of special plates and mountings which heretofore were required in order to fit sets of many manufacturers to the same automobile. More attention could be paid to the acoustics found in various cars and the net result would be improved reception. Too often, in present car radio reception, persons riding in the back seat are unable to hear programs clearly unless the volume control is set at maximum, which condition proves to be annoying and unpleasant to the persons in the front seat. Standardizing radios as car equipment would force the designers to take this problem into account.

If combination FM-AM sets were employed, then the owner would be able to enjoy improved reception due to the elimination of ignition noise and other interference. In talking to several manufacturers of automobile radios, it seems that the greatest preference at the present time is to install standard broadcast receivers and to give the customer an option for a set which includes FM at slightly higher prices. As far as the radio serviceman is concerned, we find that his primary interest is in simplified mechanical designs which will allow him to expedite the needed repairs on various car radios and to cut down on the maze of special attachments he has had to combat in getting a set out of a car. Simplification has been the keynote in the design of much of our most successful military communications equipment. The lessons learned in the manufacture of these units will well be applied to future car radios. The serviceman certainly would welcome such a move.....O.R.

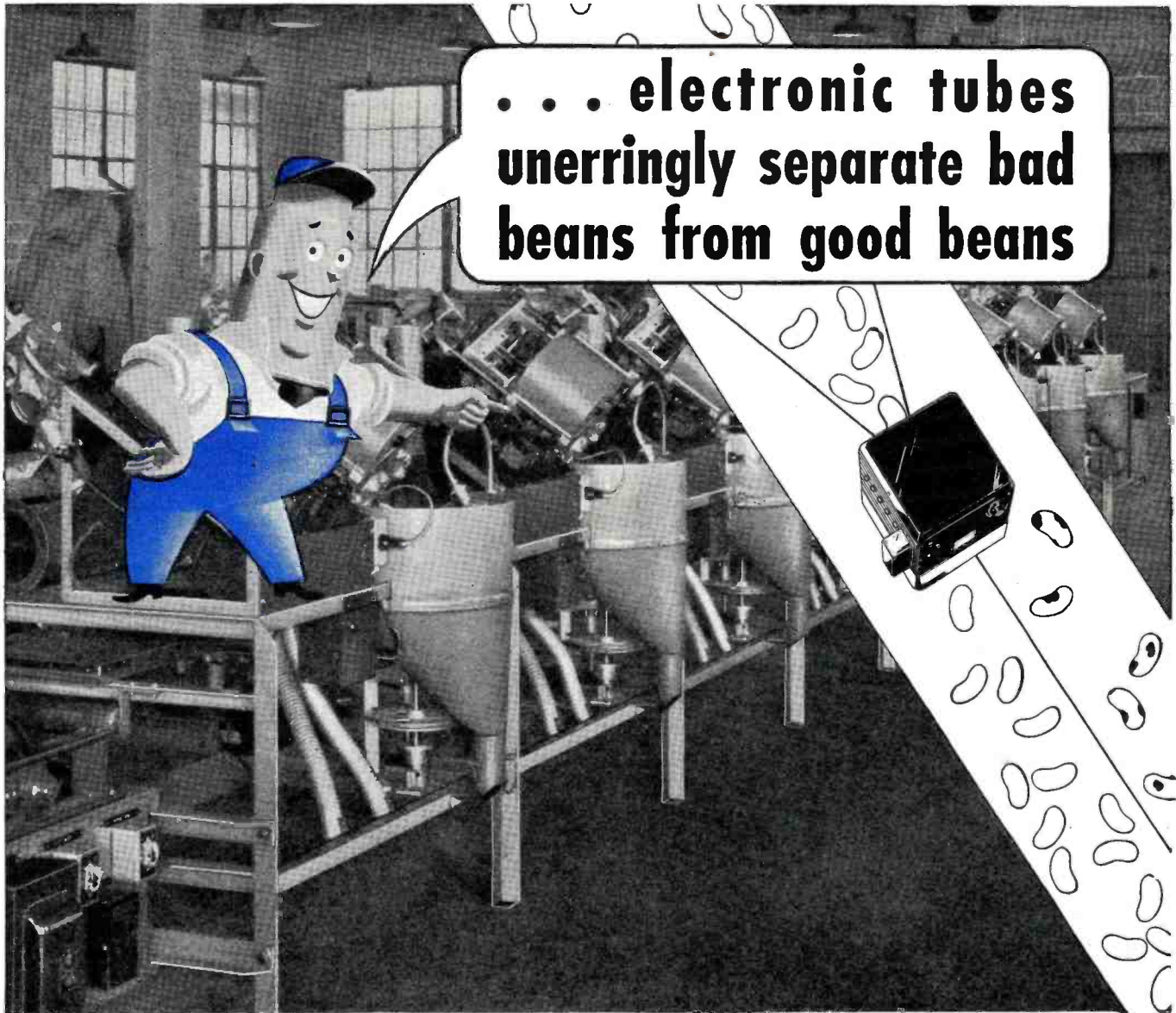

G-E thyratrons pull the trigger when phototubes spot a bad bean in Electric Sorting Machine Co. units

DAILY, in four Michigan plants, 510,000 pounds of beans are sorted with the aid of G-E electronic tubes that never fail to do their part in preventing bad beans from passing on to the packing stage.

Beans to be sorted are fed onto a drum and held over tiny apertures around its circumference. A mechanical patten positions the beans for inspection by the sorting eye—the phototube. The marketable white beans get the high sign.

With the discolored ones it's thumbs down . . . for when their dark skin fails to reflect the light beam, the phototube tells the G-E thyratron tube which picks up the signal, sets a tripper, and a mechanical finger flips the rejects into the discard.

Thus, in another industrial process, speed and accuracy replace tedium and error—through “the inspector that never tires”: the electronic tube.

G-E electronic tubes also work at counting, grading, maintaining register in printing and papermaking, detecting pinholes in sheet metal, opening doors, setting off burglar alarms, actuating safety devices.

There is a complete line of G-E electronic tubes for innumerable industrial jobs; and near you is a G-E electronic tube distributor who is prepared to fulfill your requirements.

“HOW ELECTRONIC TUBES WORK”

This booklet will be mailed to you on request—without charge. Address *Electronics Department, General Electric, Schenectady, N. Y.*

• Tune in “The World Today” and hear the news direct from the men who see it happen, every evening except Sunday at 6:45 E.W.T. over CBS. On Sunday listen to the G-E “All Girl Orchestra” at 10 P. M. E.W.T. over NBC.

G. E. HAS MADE MORE BASIC ELECTRONIC-TUBE DEVELOPMENTS THAN ANY OTHER MANUFACTURER

GENERAL  ELECTRIC

162-C7-8850

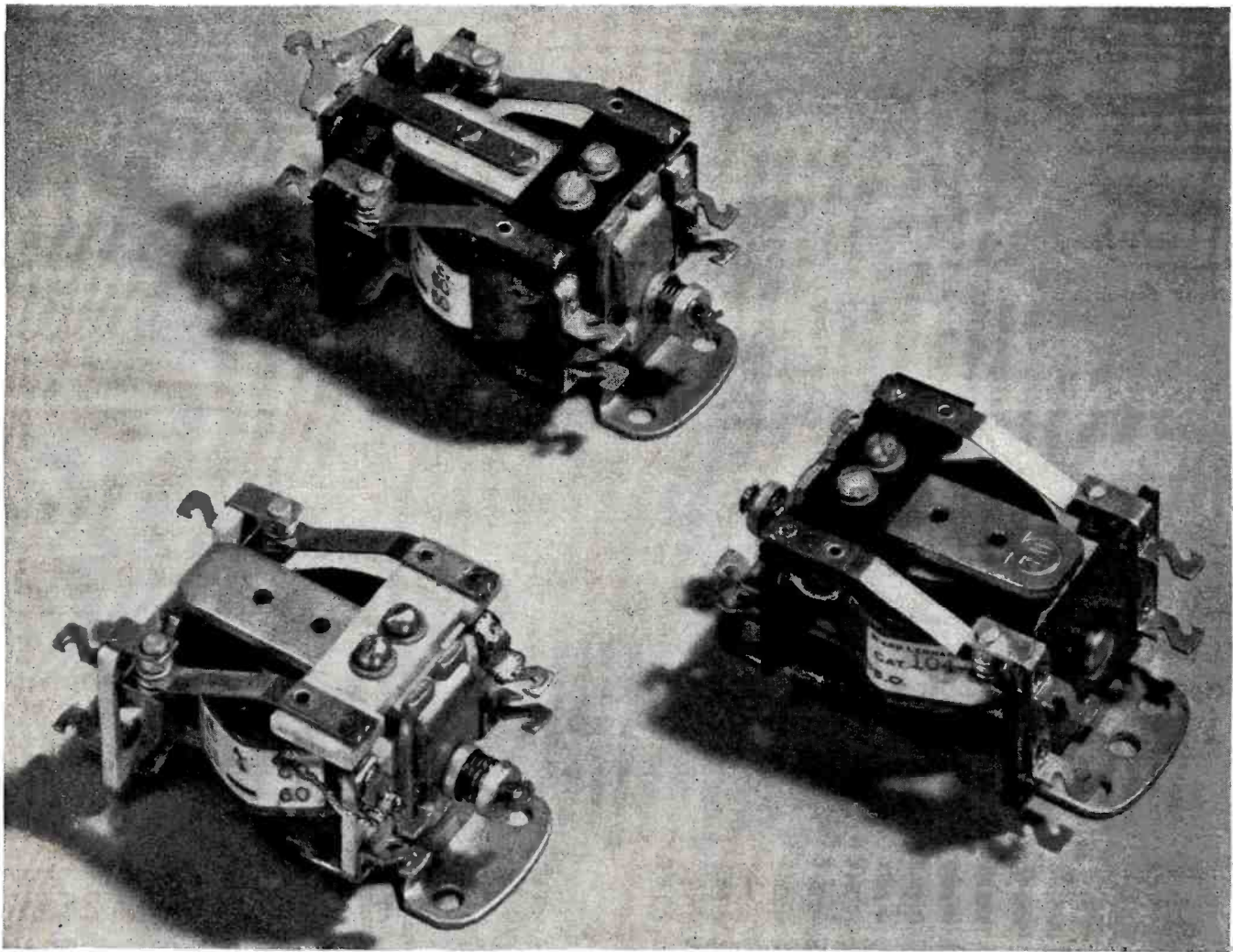

ADAPTABLE... FOR MANY PURPOSES

The Ward Leonard Midget Metal Base Relay has proven so satisfactory and dependable that several adaptations have been made in it to give it even wider application. The relays shown above are the original relay, one with auxiliary contact and one with porcelain insulation. Any of these may also be used with studs and without the metal base to enable even closer mounting.

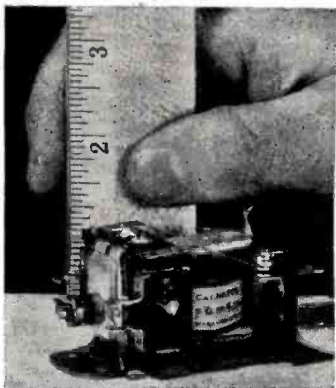

Only 1¼ inches in height. For continuous operation on AC and DC voltages up to 110-115. Double pole, double throw. This Relay described in data Bulletin 104. Send for a copy.



WARD LEONARD

RELAYS • RESISTORS • RHEOSTATS

Electric control  devices since 1892.

WARD LEONARD ELECTRIC COMPANY, 47 SOUTH STREET, MOUNT VERNON, NEW YORK

**NO OXIDATION
NO CONTAMINATION
NO MOISTURE . . .**

**3 MORE REASONS WHY
FEDERAL MAKES
BETTER TUBES**

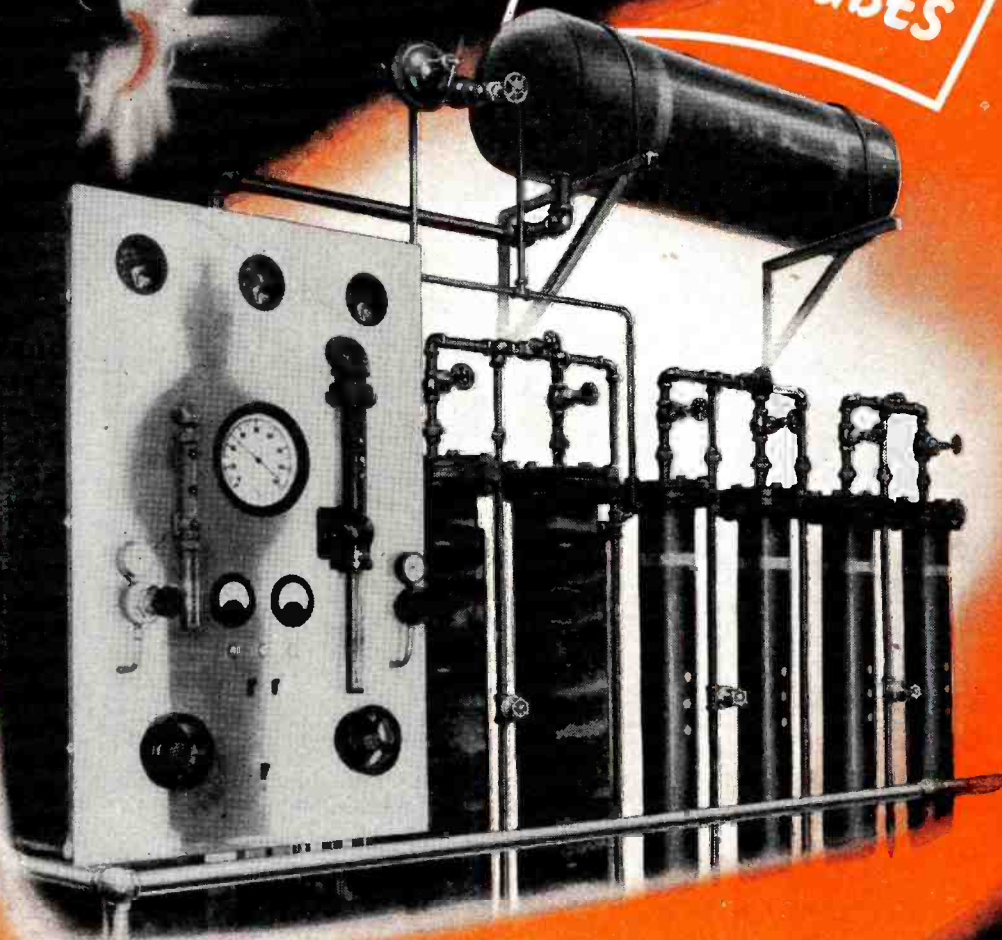

**FEDERAL HAS DEVELOPED
THE FIRST NITROGEN PURIFIER**



Intelin Ultra High Frequency Coaxial Cable, developed and manufactured by Federal, has extreme ruggedness and meets all specifications with precision, accuracy, uniformity and dependability.

No oxidation, no contamination, no moisture!

Another Federal First adds extra performance guarantees to FTR vacuum tubes.

In a corner of the new FTR tube plant is this automatic nitrogen purifier. During the process of sealing the anode to the stem, the elements of every FTR tube are now protected from oxidation, contamination and moisture in a

scientifically controlled atmosphere of automatically mixed nitrogen and hydrogen.

Here is another reason why you get higher operating efficiency and still longer life when you use FTR tubes. Another evidence of the ability, brains and technical understanding which have earned the reputation that "Federal always has made better tubes."

Now is the time to know Federal.

Federal Telephone and Radio Corporation

Designed for



Application

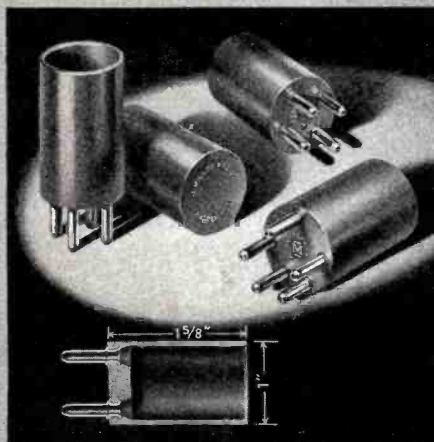

THE 45000 SERIES MIDGET COIL FORMS

are a good illustration of our slogan, "Designed for Application." Coil forms of this general type (evolved from use of discarded tube bases) have long been used by electronic research workers and radio amateurs. The shortcomings of previous types were overcome four years ago when we designed and put into production the first of the No. 45000 Series.

The "Designed for Application" features include:

1. The guide "funnel" (easier to thread leads into pins)
2. The longer-than-normal length
3. Made in 5-pin as well as 4-pin and blank bases.

The material, of course, is low loss mica-filled bakelite.

**JAMES MILLEN
MFG. CO., INC.**

MAIN OFFICE AND FACTORY
**MALDEN
MASSACHUSETTS**



Presenting latest information on the Radio Industry.

D-DAY FOUND RADIO SERVING BRILLIANTLY in one of the most important roles of its history. In Washington, officialdom crowded around receivers to hear the all-important news of the year. The Senate Radio Gallery had an SRO sign up all day. At homes and offices, here and over there, and even in the occupied countries, everyone's ear was glued to the loudspeaker. The audience ran into the hundreds of millions. According to a report by the British Broadcasting Company, over thirty-million receivers were probably used in Europe, Asia, Africa, and Australia to listen to the news. This approximation was based on the twenty-eight odd million licensed receivers, and over seven million unlicensed radios in Germany and occupied countries. In France, the estimated listening audience ran around one million. Holland, Norway, Poland, and other occupied countries contributed thousands and thousands of listeners.

Civilian and military specialists participated in culling the news and feeding it to the airplanes at a truly breathtaking speed. Into the complicated D-Day schedules went months and months of organization and arduous training. The Signal Corps System, linking many corners of the world, established communications history on D-Day. Connected by remote control with powerful stations, Signal Center beamed messages to London, Algiers, Teheran, Naples, Brisbane, Chungking, New Delhi, Asmara, Accra, Recife, and other points in the theaters of operation. Transmitters used ranged from one to forty kilowatts in power. Methods of transmission were varied. They included the standard International Morse Code, the Boehme Siphon System in which a stylus converts the dots and dashes into a staggered line on a tape, the radio type system handling a hundred words per minute, and radio teletype operating at sixty words a minute. For the first time in the history of warfare, according to the Signal Corps, officials in Washington were able to direct, instantly, the operations of our military forces throughout the world without the loss of a second.

Radio not only served to flash a word picture of the invasion, but actual photographs of the operations, too. Less than four hours after General Eisenhower's announcement that the invasion of Europe had begun, the first photographs of the operations were given to news picture agencies in Washington. The first picture was

received at 5:22 a.m. on June 6th. It showed infantrymen leaving England in a landing craft, and was received over the radiotelephoto equipment on the fifth floor of the Pentagon Building, the headquarters of the Signal Corps' Army Communications Service. During the next eighteen hours, approximately forty-seven radiotelephotos were received, processed and released. The picture of the Allied Forces landing on French soil was printed here at 11:30 p.m., eighteen hours after the first picture was flashed from England.

This unique radiotelephoto service went through an extensive series of experiments months before the actual invasion. The service, which is under the general jurisdiction of Brig. Gen. Frank E. Stoner, is organized into a photographic pool. Thus, they receive photos taken by the Army Air Corps, Signal Corps, official British and Canadian sources, U. S. Navy and Coast Guard, in addition to any other special services that are members of this photographic system.

The story of the invasion was given to the world in twenty-eight languages by the OWI. Short-wave transmitters in New York sent out the first flash in French. This was followed by a series of flashes to Chungking, Algiers and Naples. These flashes were followed by others that were directed to Bombay, Stockholm, Istanbul and Cairo.

The famous communique of General Eisenhower was translated into twenty-six languages and beamed to all parts of the world. President Roosevelt's historic D-Day night prayer was also translated and flashed to all parts of the globe.

In preparing receiver owners in occupied countries for D-Day news, OWI transmitted specific instructions on how to repair and maintain receivers. In a broadcast in French, OWI told listeners to form a spare part stock pile of tubes and old parts; make use of earphones; insert old tubes in receivers if compelled to turn them over to the enemy; have receivers repaired by a trustworthy person; and organize listening groups where there might be at least one radioman present to make repairs, if necessary.

THE PASSAGE OF NEW RADIO LEGISLATION at this session of Congress seems quite remote at the present moment. The strongest evidence of this unfortunate condition stems from the remarks of Senator Burton K. Wheeler of the Senate Interstate Commerce Committee, and co-author

These Solar Capacitors

SERVE THE SERVICES

So you can see what they look like, they stopped to have their pictures taken, before going to war. They will serve with the Signal Corps, the Navy, with Ordnance vehicles and tanks; they will enable the Marines to tell it to each other; they will drop with paratroopers; they will visit every climate on the earth and will climb with the Air Force, above climate; they will win many merits even though they never wear them. Principally, they want you to remember, they will render an assist in the saving of many lives,—through reliable communications. *Their story is told in pictures—including many official color photographs of troops in action . . . in a 40-page book "Solar Capacitors . . . in the War . . . in the Peace." Just fill out and mail the coupon.*



SOLAR MANUFACTURING CORP.
285 Madison Avenue, New York 17, N. Y.

Please send me your 40-page booklet
"Solar Capacitors . . . in the War . . . in the Peace"

Name _____

Street _____

City _____ State _____

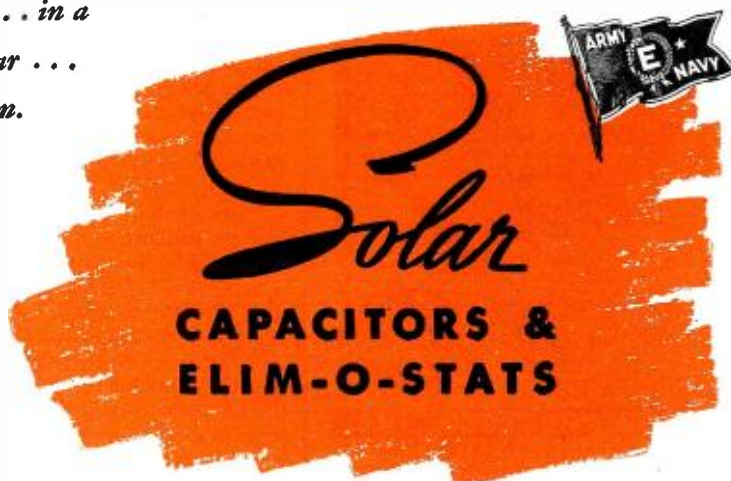

SPEEDIER!

SPINTITES ARE REAL SPEED UP TOOLS. This is the **WRENCH** that works like a **SCREW DRIVER**

Standard sizes for Hexagon nuts or headed screws . . . special SPINTITES for square or knurled nuts. Handles are either fixed or chuck type **SPEED-UP** design by makers of **WALDEN WORCESTER WRENCHES**

STEVENS WALDEN, INC.
465 SHREWSBURY STREET
WORCESTER, MASSACHUSETTS

WALDEN WORCESTER WRENCHES

of the White-Wheeler Bill (S.814). He said they had given up all hope of Congressional action this year on legislative regulation of the radio industry. He implied that he had tried to work out a compromise bill which would curb some of the FCC powers, but at the same time impose some regulation upon the industry. Apparently, however, he said, the radio industry wants no regulation.

Soon after Senator Wheeler's statement, the National Association of Broadcasters issued a statement citing disappointment over Senator Wheeler's conclusions. NAB said that they had pointed out time and time again the vital need for definite legislation. They admitted that they were obliged to point out certain operating difficulties which might arise from the adoption of some of the proposals, but they did so in the hopes that a more effective format of legislation would be enacted.

The Wheeler statement followed the presentation of a revised White-Wheeler bill by Senator Wheeler. This redraft, which was submitted to the Senate Interstate Commerce Committee, called for the abolishment of the present FCC board of seven. A commission of five, with a rotating chairmanship, was proposed instead. This chairman would serve for one year and would be elected by the fellow commissioners. The commissioners would serve for a two-year period on two separate divisions, one covering broadcast problems and the other common carrier systems. All members of the present Commission would serve until three members of the new commission were named by the President. The bill suggested the limitation of power of standard broadcast stations on clear channels to fifty kilowatts. However, clear channels were to be available every 750 miles. Multiple ownership of stations in the same area, two years after the date of enactment, would also be banned. The bill also proposed that no news analyses or commentaries were to be included in any commercially sponsored broadcast. It also limited network ownership to one network in a single broadcast channel. Thus, one network could operate standard, television, and FM systems.

Commenting on the proposal that no station could operate with power in excess of 50,000 watts, and restricting the service areas of clear channel stations, NAB said that the proposed restrictions would in many cases deprive listeners in remote rural areas of their only broadcasting services, and would in many more areas deprive listeners of any choice of programs.

An amendment to the original White-Wheeler bill and another bill were also offered prior to Senator Wheeler's "no-action" statement. Senator Johnson of Colorado submitted an amendment licensing commentators, and prohibiting the broadcast into a state where the advertised message was in violation of the state law. This amendment cited that a code of ethics was to be followed by a licensed com-

mentator. The second piece of legislation was offered by Senator Vandenberg of Michigan. His bill, S.1957, would make it unlawful "for any person as a part of a group or organization to threaten or intimidate any other person for the purpose of preventing by group action the operation of any broadcasting station while preparing for or in the operation of broadcasting such noncommercial educational or cultural programs, unless such interference is part of a general action for other purposes and is of general and broader nature than to prevent or interfere with the broadcasting of such noncommercial and cultural programs." This bill, therefore, would prohibit interference with noncommercial cultural or educational programs. Such interference prevailed last summer when amateur school orchestras were prevented from broadcasting.

Broadcast industry officials are bending every effort to reactivate radio legislation activities. They feel that, notwithstanding Senator Wheeler's decision, there is still a possibility that effective legislation may be enacted before this session of Congress ends.

THE OFFICIAL STATUS OF TELEVISION has not been decided upon as yet, according to David Smith, chairman of RTPB Television Panel Six. Speaking at one of the sessions of the television seminar, recently introduced by the Radio Executives Club of New York, Mr. Smith said that at the present moment the panel is still collecting information. The panel is about half way through with the job, and trying to arrive at some recommendations which would then be considered by various sponsors. After these sponsors have studied the proposals, they will be reviewed further and then finally released.

Discussing the representation on Panel Six, Mr. Smith said that the panel consists of sixty-odd people, of whom thirty are voting members. J. K. Kaar of G.E. is industry chairman, and George Town of Stromberg-Carlson is secretary. Members of the panel include George Beers, RCA; Frank Bingley, chief television engineer for Philco; B. Ray Cummings, Farnsworth; Allen B. Du Mont; O. B. Hanson, NBC; John Reid, Crosley; Peter Goldmark, CBS; M. L. Levy, Emerson Radio; C. A. Priest, G.E.; Ray Manson, Stromberg-Carlson; Joe E. Brown, Zenith; Harry Lubcke, Don Lee Broadcasting; Dan Harnett, Hazeltine; C. E. Nobles, Westinghouse; Howard Frazier, NAB; H. G. Boyle, North American Philips.

During a question and answer period, Mr. Smith was asked if frequency modulation will be used for picture and sound transmission. Mr. Smith replied that amplitude modulation will be used for picture transmission. FM transmission was tried by several people, he said, but was found quite unsatisfactory. The matter of sound transmission, however, he pointed out, has not yet been determined.

SPRAYBERRY RADIO TRAINING

Gives you Both



FULL RADIO SET SUPPLIED FOR SHOP PRACTICE!

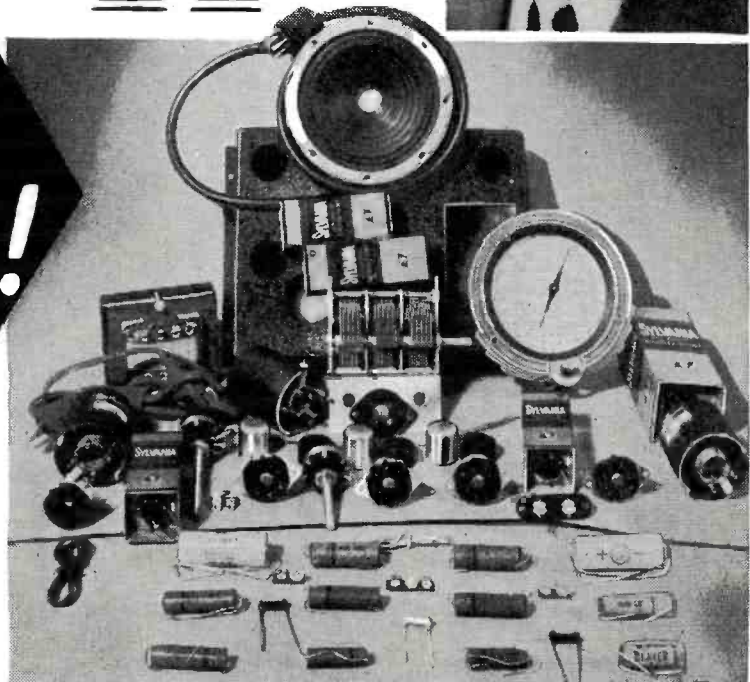

HERE'S THE ONE PRACTICAL WAY TO TRAIN FOR BIG EARNINGS AHEAD IN RADIO-ELECTRONICS & TELEVISION

The offer I make you here is the opportunity of a lifetime. It's your big chance to get ready for a wonderful future in the swiftly expanding field of Radio-Electronics INCLUDING Radio, Television, Frequency Modulation and Industrial Electronics. Be wise! NOW'S the time to start. No previous experience is necessary. The Sprayberry Course starts right at the beginning of Radio. You can't get lost. It gets the various subjects across in such a clear, simple way that you understand and remember.

I'll Show You a New, Fast Way to Test Radio Sets Without Mfg. Equipment

The very same Radio Parts I supply with your course for gaining pre-experience in Radio Repair work may be adapted through an exclusive Sprayberry wiring procedure to serve for complete, fast, accurate Radio Receiver trouble-shooting. Thus under Sprayberry methods you do not have one cent of outlay for manufactured Test Equipment which is not only expensive but scarce.

Prepares You for a Business of Your Own or Good Radio Jobs . . . Civilian or Military

My training will give you the broad, fundamental principles so necessary as a background no matter which branch of Radio you wish to specialize in. I make it easy for you to learn Radio Set Repair and Installation Work. I teach you how to install and repair Electronic Equipment. If you enter the Army, Navy or Marines, my training will help you win higher rating and better pay.

EASY TO START

You can master the Sprayberry course in your spare time. It will not interfere in any way with your present duties. Get the facts about my training now. Take the first important step toward the money-making future of your dreams. All features are fully explained in my big, illustrated Free Book. Write for it at once!

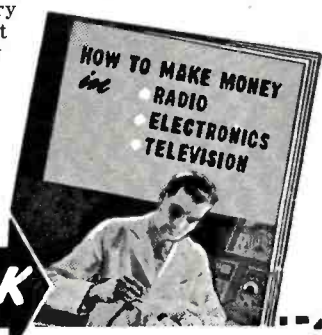

GET FREE BOOK

SPRAYBERRY ACADEMY OF RADIO
 F. L. Sprayberry, Pres.
 Box 500 WH,
 Pueblo, Colorado

Please rush my FREE copy of "HOW TO MAKE MONEY IN RADIO, ELECTRONICS and TELEVISION."

Name Age.....
 Address
 City State.....
 Tear off this coupon, mail in envelope or paste on penny postcard.



- ★ Design proven by over 5 years production
- ★ Dual D.C. Sensitivity—25,000 ohms per volt and 1000 ohms per volt.
- ★ Matched resistors of 1% accuracy
- ★ Push button operated—no roaming test leads
- ★ Open face—wide scale 4 1/4" meter. 40 microamperes sensitivity.
- ★ 1 Microampere first scale division.

SPECIFICATIONS

D.C. MICROAMPERES:
0-70-700 microamperes

D.C. MILLIAMMETER:
0-7-35-140-350 milliamperes

D.C. AMMETER:
0-1.4-14 amperes

D.C. VOLTS, 25,000 OHMS PER VOLT:
0-3.5-7-35-140-350-700-1400 volts

D.C. VOLTS, 1000 OHMS PER VOLT:
0-3.5-7-35-140-350-700-1400 volts

A.C. VOLTS, 1000 OHMS PER VOLT:
0-7-35-140-350-700-1400 volts

OUTPUT VOLTMETER:
0-7-35-140-350-700-1400 volts

DECIBEL METER:
0 db to plus 46 db

OHMMETER:
0-500-5000-50,000-500,000 OHMS
0-5-50 MEGOHMS

POWER SUPPLY
Battery Operated

With the above specifications the Supreme Model 592 Speed Tester meets today's requirements for general laboratory use, assembly line tests and inspection, radio and other electronic repair and maintenance.



SUPREME INSTRUMENTS CORP.
Greenwood, Miss., U. S. A.

Mr. Smith also was asked if it were possible to transmit video and sound signals on the same wavelength. He replied: "There are two sources of information from which you get the intelligence you are transmitting, and fundamentally, you use exactly the same mechanism to send out the picture as you use to send out sound. Once it gets into the transmitter, the fact that one or the other is a sound and the other is a picture source makes no difference. The thing you are sending out is fundamentally the same for sound or picture or anything else you might want to put on that carrier. Therefore, you cannot unscramble it any more than you can unscramble two glasses of water, even though the sources for the water were different."

Dr. Charles B. Jolliffe, chairman of Panel Two of the RTPB, covering frequencies and allocations, also appeared at this meeting and supplied some interesting data. Discussing channels, Dr. Jolliffe pointed out that the number of people in an area, possible interference, and number of channels that might be used in the vicinity of each of the large metropolitan areas, served as a basis of consideration of channel allocation. In an area from Boston to Washington, for instance, about twenty per cent of the United States population could be covered. Accordingly, in New York, twelve channels might be available; in Philadelphia it might be nine. This trade-area method of channel selection is thus serving as the basis of channel proposals. Important considerations, according to Dr. Jolliffe, are also ability of the area to support the stations and provide a competitive service.

Appearing at another television seminar session, Allen B. Du Mont analyzed lineage brilliance and television tubes of the future. Discussing the picture frequencies, which at the present time are sixty, Mr. Du Mont pointed out that this compares favorably with twenty-four pictures a second transmitted over an ordinary movie camera.

"Thus, actually," he said, "we are better off than motion pictures, for there is practically no flicker."

Continuing this comparison, Mr. Du Mont said that the ordinary sixteen-millimeter motion picture is equivalent approximately to a 375-line television picture. "The thirty-five millimeter film, which is the standard commercial type of film, is equal to about seven-hundred lines. In the sixteen-millimeter picture there are about one-hundred and twenty-five thousand individual sections to the picture," said Mr. Du Mont.

The television picture has twice as many sections, while the thirty-five millimeter film has twice as many as the television picture, or five-hundred-thousand individual elements.

Describing brilliance, Mr. Du Mont said that the ordinary motion picture has an average figure of twelve-foot lamberts. "About twenty-foot lamberts are possible with the television system of today," he said. "We are at-

tempting to secure increased illumination in television," cited Mr. Du Mont, "because the living room which has a moderate amount of illumination will require this."

Mr. Du Mont was asked if there was any difference between a 525-line picture and a 735-line picture, when seated at an average viewing distance of from four to six feet from the television receiver. Mr. Du Mont replied that the average viewing distance generally is considered to be from five to ten times the picture height. He therefore doubted whether anyone could detect the difference between the two pictures at the four to six feet distance. If, however, the viewer was about two to three feet from the picture it would be possible to tell the difference. Mr. Du Mont was also asked if there is a point at which it is not worth while to increase number of lines in pictures. Replying, he said, that there certainly is a definite point.

"The 525-line format was chosen because it was found to provide the best type of picture, even for a projected picture of from two to three feet in size. The 735-line system was tried several years ago," explained Mr. Du Mont, "and not found to offer any improvement over the 525-line picture. If a very large picture, such as the twenty-foot scene used in large theaters, is used, then, of course, increased lineage would be advisable," said Mr. Du Mont.

Tube sizes were also discussed by Mr. Du Mont. He said that the twenty-inch tube is about the maximum size that we are likely to get in post-war receivers. He explained that a twenty-inch tube had been in use at the laboratories for quite a period, but they had found that a fifteen- or sixteen-inch tube offered the same practical results. It was possible to get the same size picture on the sixteen-inch tube as on the twenty by using a flatter screen.

Describing the tube size problem, Mr. Du Mont said, "You can go to any size you want, but you have to remember that with fifteen pounds per square inch on glass—when you get it too big—there is quite a pressure. If it gets too big and the glass is too thick, it is hard to handle; thus, it is not practical. It is possible, however, to manufacture them."

Interesting television tube facts were also revealed at the seminar by Ralph R. Beal, assistant to the vice president in charge of RCA laboratories. He said that new kinds of television reproducing devices may be developed in the future. Some of these will probably be of the cathode-ray controlled light valve type.

"This new type of tube uses an external light valve. That is, in the kinescope the light for the picture is produced inside the tube," explained Mr. Beal. "However, with light valves the picture is formed by controlling the capacity of the valve over the picture area in accordance with the lights and shadows of the scene to be repro-

(Continued on page 116)

*"When we think of the
OD3/VR-150,
we think of HYTRON"*

This enthusiastic comment by an expeditor for one of the largest electronic equipment manufacturers, is typical. Engineers and purchasing agents everywhere are automatically associating Hytron with the OD3/VR-150. Since the tube was not originated by Hytron (Hytron was called upon to manufacture the tube to help satisfy a mushrooming demand), the reason must lie in Hytron's ability to do a better job.



WHY THE HYTRON OD3/VR-150 IS PREFERRED

1

**CAREFUL
ENGINEERING DESIGN**

Hytron re-design, among other improvements, resulted in the addition of a new starting electrode which permits a uniformly lower starting voltage.

2

**RIGID
PRODUCTION CONTROL**

Handling and dimensioning of internal parts during pre-processing and assembly are extremely painstaking.

3

**TIGHTER FACTORY
SPECIFICATIONS**

For example, the minimum required starting voltage is 180 volts. Average starting voltage of the Hytron OD3/VR-150 is less than 160 volts.

4

**CONTINUOUS ENGI-
NEERING CONTROL OF
QUALITY**

In over 15 months, there have been no Government rejections of lots submitted for inspection.

5

**MASS
PRODUCTION**

This apparently simple tube is in fact difficult to produce. Yet Hytron is manufacturing it at a rate sufficient to meet on schedule the growing demands of both new and old customers.

MORAL: You too should specify the Hytron OD3/VR-150 (and OC3/VR-105).

OD3/VR-150 AND VR-150-30 COMPARED

Frequently engineers ask how the OD3 and VR-150-30 differ. The maximum regulation limit for the VR-150-30 was 5.5 volts from 5 ma. to 30 ma. The OD3 has a maximum regulation limit of 4 volts from 5 ma. to 30 ma. Viewed another way, the current range is expanded to 40 ma., with the original maximum voltage regulation limit of 5.5 volts. The OD3/VR-150 is in short an improved replacement which supersedes the VR-150-30; it has the advantages of the increased 40 ma. max. rating.*

* The OC3/VR-105 also has ratings up to 40 ma. max.; it supersedes and is a replacement for the VR-105-30.

OD3/VR-150 CHARACTERISTICS

Type	Glow Discharge Voltage Regulator
Maximum Overall Length	4-1/8"
Maximum Diameter	1-9/16"
Bulb	ST-12
Base	Small Shell Octal 6-Pin

Average Operating Conditions

Starting Supply Voltage	180 min. d.c. v.
Operating Voltage (approx.)	150 d.c. v.
Operating Current	{ 5 min. d.c. ma. 40 max. d.c. ma.
Regulation = (E ₄₀ - E ₅)	3.5 d.c. v.

OLDEST EXCLUSIVE MANUFACTURER OF RADIO RECEIVING TUBES

HYTRON
CORPORATION
ELECTRONIC AND
RADIO TUBES
SALEM AND NEWBURYPORT, MASS.



BUY ANOTHER WAR BOND

HERMETIC SEALING

a type for every requirement

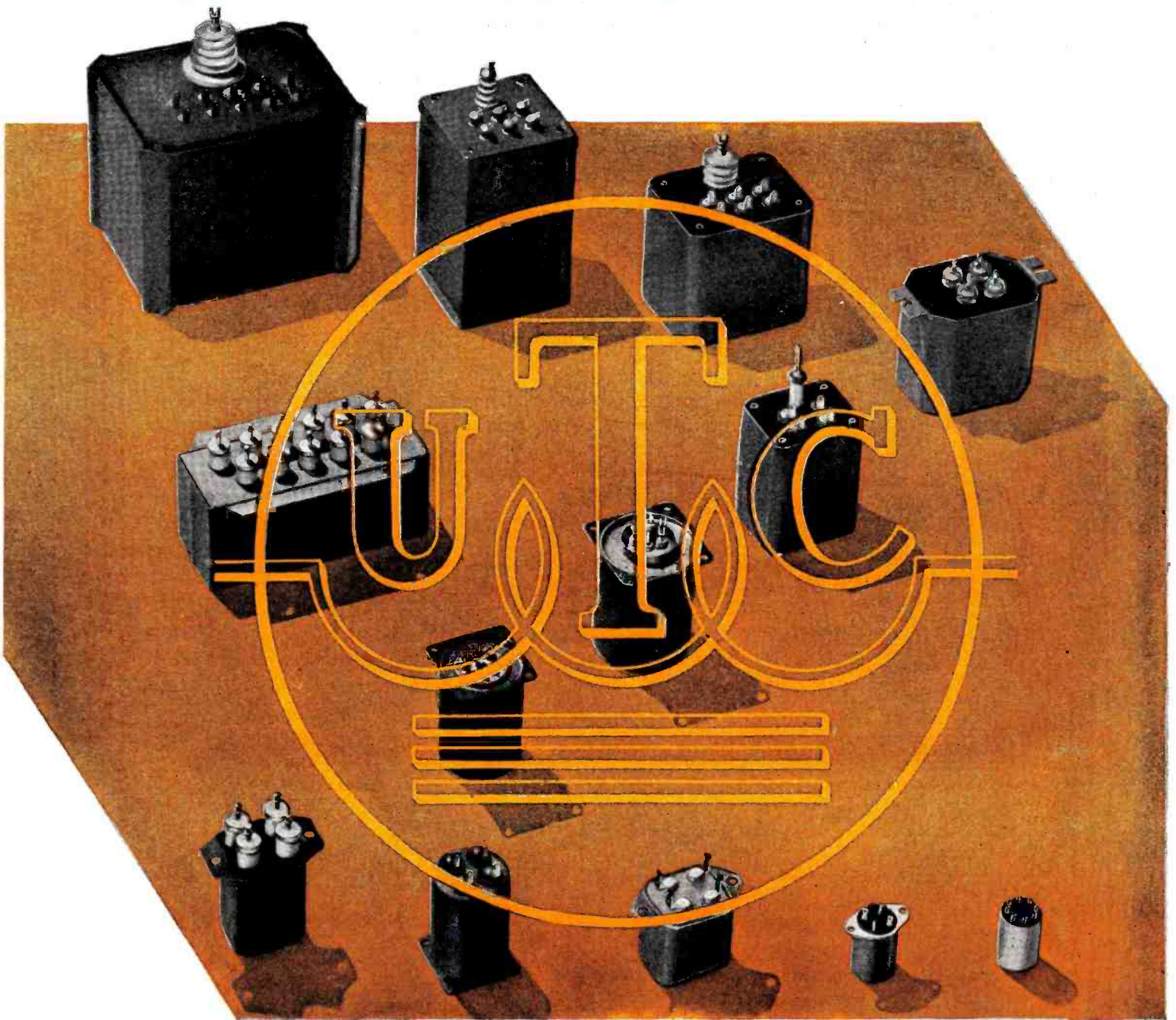

May we cooperate with you on design savings for your application . . . war or postwar?

United Transformer Co.

150 VARICK STREET

NEW YORK 13, N. Y.

"NO! HOGARTH ISN'T GOING NATIVE—HE'S JUST SHOWING OFF HIS ECHOPHONE EC-1"



ECHOPHONE MODEL EC-1

(Illustrated) a compact communications receiver with every necessary feature for good reception. Covers from 550 kc. to 30 mc. on 3 bands. Electrical bandspread on all bands. Six tubes. Self-contained speaker. 115-125 volts AC or DC.



ECHOPHONE RADIO CO., 540 N. MICHIGAN AVE., CHICAGO 11, ILLINOIS

Paving the Way for

Home of the Brave

When she said goodbye to her son brave
 with a smile that never faded
 ... a smile that said "I'm not at all
 worried about her... she would be all right. And
 she will continue to care in the spirit of the
 child... in willing acceptance of our lady
 chivalry, in uncomplaining sacrifice, in always
 cheerful, uncomplaining letters.
 With courage that has inspired mothers
 since time began, she is helping her sons do

their parts at war. And she is being into as
 mothers always have. And...
 It is she who sets the pace in Red Cross
 work... who fulfills the duties of War Bond
 drives... who is always the first to volunteer
 for every war-time activity. It is she who
 keeps America's home front shining. With
 her hands and her heart, she is the heart of
 the land! *Let's Buy War Bonds!* Call
 1008, 9225 W. Dearborn Ave., Chicago 19, Ill.



When she said goodbye to her son brave
 with a smile that never faded
 ... a smile that said "I'm not at all
 worried about her... she would be all right. And
 she will continue to care in the spirit of the
 child... in willing acceptance of our lady
 chivalry, in uncomplaining sacrifice, in always
 cheerful, uncomplaining letters.
 With courage that has inspired mothers
 since time began, she is helping her sons do

Belmont Radio
 SONGS



PUT YOURSELF IN HIS SHOES

But would YOU expect of the folks back home?

It's a long time since we've had the call of "Home Front". It's a long time since we've had the call of "Home Front". It's a long time since we've had the call of "Home Front".

We cannot do it alone. But we can look to you for the "Home Front" spirit. We can look to you for the "Home Front" spirit. We can look to you for the "Home Front" spirit.

That's no more than our plain, clear duty to our fight. We can look to you for the "Home Front" spirit. We can look to you for the "Home Front" spirit.

Belmont Radio
 SONGS

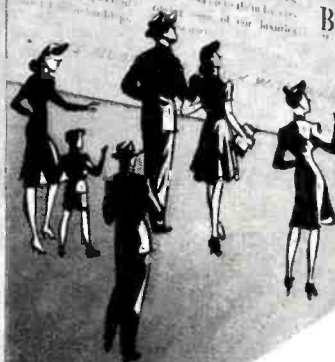

BETTER RECEPTION



Finest possible *broadcast reception* . . . That is the standard to which the millions of Belmont-made prewar radio receivers were built.

And now, to insure the finest possible *public reception* of postwar products made by Belmont, extensive national advertising is winning increasing attention for Belmont throughout America.

Belmont advertisements are keyed to public thought and interest—just as Belmont-made radio and electronic products in peacetime will be keyed to the latest in public desire and need.

Today, in turning out radar and electronic weapons for the armed forces, Belmont is producing much equipment that is foreign to normal peacetime production. Yet, even so, Belmont is on familiar ground. For the job still is one of combining excellence with volume. And this is a job which Belmont does well.

When the war is won, Belmont will have an unusually interesting story to tell. Keep your eyes on Belmont! Belmont Radio Corporation, 5929 Dickens Avenue, Chicago 39, Illinois.

Belmont Radio



RADAR * TELEVISION * FM * ELECTRONICS

A highly RELIABLE, FAST and, when necessary, MOBILE adjunct to radiotelegraph communications!



The new
McELROY WHEATSTONE CODE TAPE PERFORATOR, PFR 443-A

Not only can the PFR-443-A, a proud McElroy achievement, be set up to operate immediately as a stationary unit, but it can be used with equal efficiency in moving vehicles. Requiring little or no maintenance, the PFR-443-A now provides high speed transmission where once it was impossible because of the bulky and complicated equipment required to perforate tape. With this unit, accurate tapes can be prepared for transmission at speeds up to 300 words per minute.

The McElroy PFR-443-A consists of two units. The **Keying Unit**, which is silent in operation, comprises two keys, space bar and punching mechanism. The **Electronic Unit**, which relieves the keying contacts of high current and voltage, is designed so that the tube and relay are separated from the mechanical section. Thus, the delicate electronic components are not subjected to jolts and jars.

Although the transmission of dots and dashes is automatic, the operation is similar to a semi-automatic (bug) key. A light touch actuates the punching mechanism for as long as either the key or space bar is depressed. Experienced operators can maintain, with ease, speeds of between 30 and 40 words per minute in all Morse combinations assigned to the Russian, Turkish, Greek, Arabic and Japanese alphabets and languages. This is a McElroy advantage not found on the keyboards of standard perforators manufactured in the U. S. or Great Britain.

McELROY
 ENGINEERS
 CREATE ...
 DESIGN ...
 BUILD.
 WE
 ARE
 NEVER
 SATISFIED
 WITH
 MEOCRITY



SUPPORT THE FIFTH WAR LOAN DRIVE

McElroy **MANUFACTURING CORP.**
 82 BROOKLINE AVE., BOSTON, MASS.

What is

ELECTRONICS?

By **J. D. RYDER**

Asst. Prof., E.E., Iowa State Col.

Graduated with M.S. degree in E.E. from Ohio State U., 1929. Next 2 years employed by General Electric, first in work in acoustics, then in development of Thyatron tubes. 1931 joined Bailey Meter Co. of Cleveland, in charge of developing electrical and electronic apparatus, including telemetering systems, photoelectric smoke recorders, high-speed temperature recorder, and instruments for calculating and recording operating efficiency of cracking furnace in oil refinery. Became member staff of E. E. Dept., Iowa State College at Ames, 1941, teaching electrical engineering subjects, specializing in electronics.



The Author

EVEN the Greeks had a word for it. When Thales in 600 B.C. rubbed a piece of amber with rabbit fur and found that the amber would then attract small particles he associated this remarkable property with the amber. The Greek word for amber was "elektron."

In 1752 Benjamin Franklin performed his famous kite experiment, and incidentally nearly committed suicide, showing that lightning was the same as the "fluid" then known as "electricity", and that it could be stored in a Leyden jar condenser in the same manner as the output of his static generator. With the knowledge gained from his experiments Franklin invented the lightning rod, which has saved millions of dollars in property values from destruction by lightning.

In modern language the experiments of Thales and Franklin would be called "electronic" since we have taken over for our use in this new field the Greek word for the material, amber, in which "electricity" first made itself known.

Modern electronics is usually considered as having been born in 1883 with the discovery of the "Edison Effect". Edison, in his search for improvements in incandescent lamps, had sealed into one of his lamps a small metal plate in addition to the usual filament. During experiments with this lamp he discovered that, when the plate was made positive with respect to the heated filament, an electric current would flow in the wire leading to the plate, as indicated by the deflection of a galvanometer in the circuit. When he reversed the potential, the flow of current through the space inside the lamp ceased. Edison, interested only in improving his lamp, noted and reported on this phenomena and then passed on to other things which seemed more important to him.

About 1885 the infant street railway industry was handicapped by difficulties due to burning of the contact tips on their starting contactors. Due to this need, Elihu Thomson invented the "magnetic blowout", a device which makes an electric arc commit suicide. The arc set up between the contact tips by the opening of the contactor, is passed through a magnetic field which is created by the very current flowing in the arc. The arc, though actually passing through air, is a conductor carrying current in a magnetic field, and is forced out of the magnetic field, just as a current carrying wire is forced out of the magnetic field in a motor. As a result the arc is stretched to the point where it can no longer sustain itself and is broken. Without the stretching action of the magnetic field the

arc would continue and would burn the contact tips severely. The arc literally "blows itself out."

We have then the demonstration of electronic phenomena in 600 B.C., the application of electronics in the lightning rod in the 1750's, the "birth" of electronics in 1883, and an application in the magnetic blowout in 1885. How can our press agents of today proclaim electronics as a new science, a newly discovered field? Could it be because the press agents themselves have only just discovered it?

Actually electronics is not quite as old as the data above might make it appear. A science is not born until it ceases to be an art, and it remains an art until the underlying fundamentals are explored and understood. Until 1900 we had no understanding of the basic principles or reasons, why our electronic devices of that day, the lightning rod, the magnetic blowout, the arc lamp, the early radio diode or Fleming valve, operated as they did. In that year Sir J. J. Thomson proposed the electron theory of matter. This theory assumed that all matter was made up of small bodies called atoms, and each of these atoms consisted of a central nucleus with a positive electrical charge, surrounded by one or more negatively charged small particles for which he proposed the name of "electrons."

As a result of this theory and because it was already established that an electric current was a flow or movement of electric charge, it became possible to explain the conduction of electricity as a flow of the negatively charged particles or electrons, through a wire, and likewise in the Edison Effect as a flow of these negative charges through the evacuated space.

This theory has been developed further by Bohr and others into our modern theory of atomic structure, and has given us a firm foundation with which to explain the older electronic devices and to predict and develop new forms of electronic applications.

To understand electronics we must first learn as much as possible about this tiny charged particle called the electron. We know that it is exceedingly small, although we know nothing of its shape, and that it takes 5×10^{29} of these electrons to weigh a pound. This is an inconceivably large number. We also know that the electric charge carried by an electron is our smallest indivisible unit of electricity. This unit charge is so small, however, that if a pound of electrons could be gathered and passed

(Continued on page 106)

TORQUE

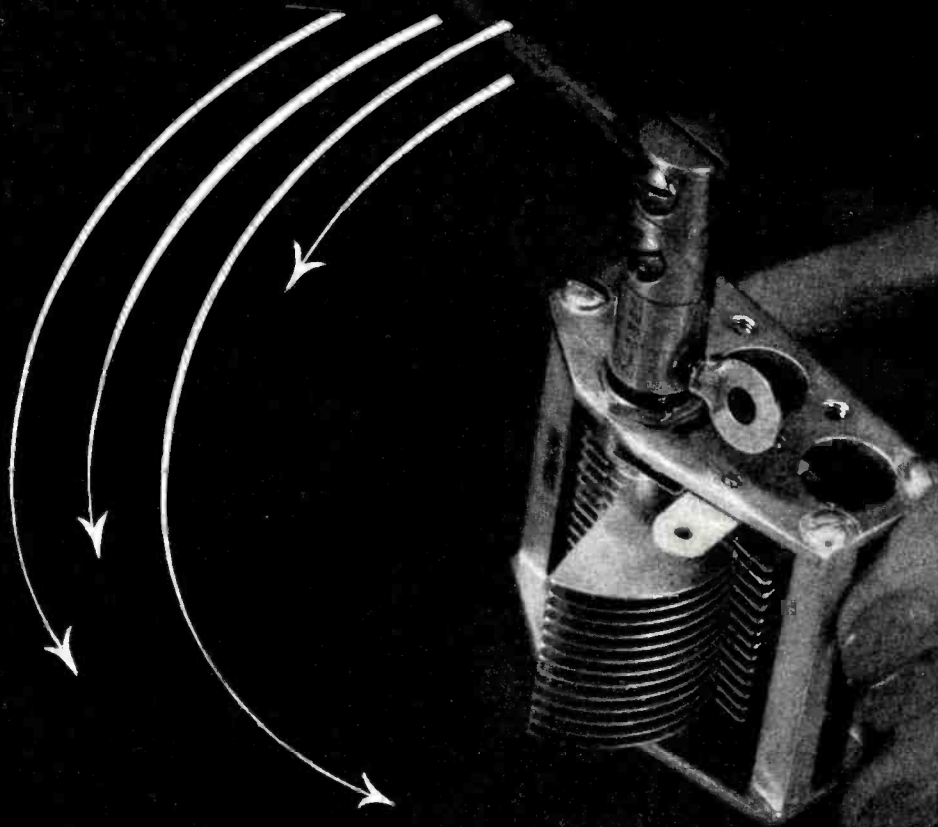

Hammarlund precision variable capacitors have just the right amount of **TORQUE**, to permit smooth and accurate adjustment. You don't have to fight rough and jumpy action when you tune with Hammarlund variables.



HAMMARLUND

THE HAMMARLUND MFG. CO., INC., 460 W. 34TH ST., N. Y. C.
MANUFACTURERS OF PRECISION COMMUNICATIONS EQUIPMENT



Brazilian open-pit mine where quartz is obtained entirely by hand labor.



Inspecting mother quartz for mechanical flaws.

CRYSTAL PROCESSING

By **KENTON K. GARRISON**

Eng., Federal Telephone & Radio Corp.

Mass production processes of the piezo quartz crystal, from its origin as raw quartz to its use in present-day military equipment.

THE quartz crystal, that precision-made frequency control which has come into its own as the heart of wartime communications, is an electric device with a future.

With the curtain rising on what has been called the Electronic Age, innumerable new uses, some of them already here, others indicated, and still others yet to evolve, are seen. These will take the unimpressive-looking, but indispensable crystal into many domestic and industrial applications, in addition to widening use in the fields of its first broad service, that of radio and telephone communications.

When the first World War was waged, oscillating crystals had but a single application. Then they were employed as supersonic resonators for the detection of submarines. As radio developed, transmitters and receivers controlled by crystals were introduced, and, of course, for some time these quartz oscillators have been the medium for stabilizing broadcast fre-

quencies. Crystals hold the stations to their assigned frequencies, preventing drift and program interference.

These oscillators also perform a highly useful purpose in the field of telephony, where they control the frequencies of carrier telephone systems. Not only do they make possible the simultaneous transmission of a number of telephone conversations over a single long-distance circuit, but installed in filters they help unscramble these conversations at the receiving end of the circuit. Thus it is that each telephone user hears only the words intended for his ears.

But it is in the present world con-

flict that the quartz crystal has proved its tremendous value. An essential item in all forms of communications—airborne, ground, marine—it has a part in military operations that ranks with the most vital equipment. Because the crystal fixes the frequencies at which communication between armed units, or even isolated soldiers, tanks or planes, is established and maintained, instant and continued contact is possible without confusion or monitoring by the enemy. In a war where communications are of the greatest urgency, the quartz crystal is contributing in a major way to victory.

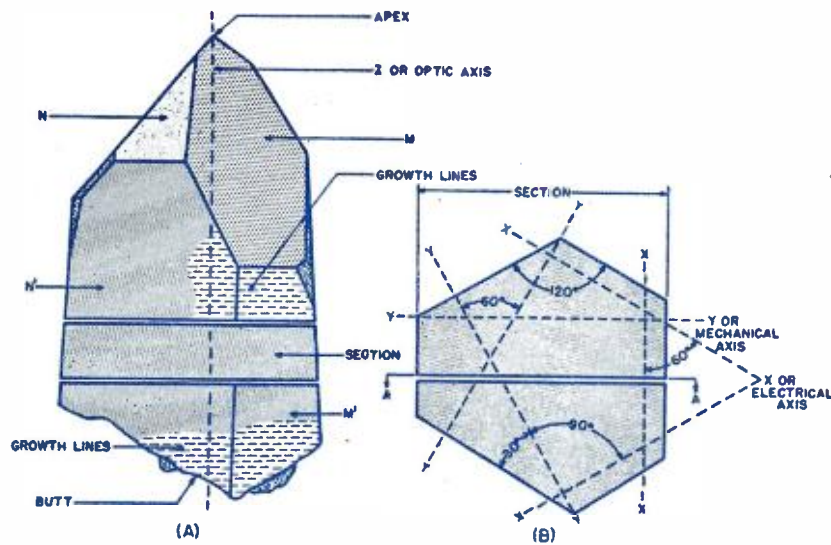

Quartz crystal axes. In their natural formative state, quartz crystals have regular surface planes bearing fixed relation to their main crystallographic axes, which are axes of symmetry in the atomic structure. These are the Z, or optical axis; the X, or electrical; and the Y, or mechanical.

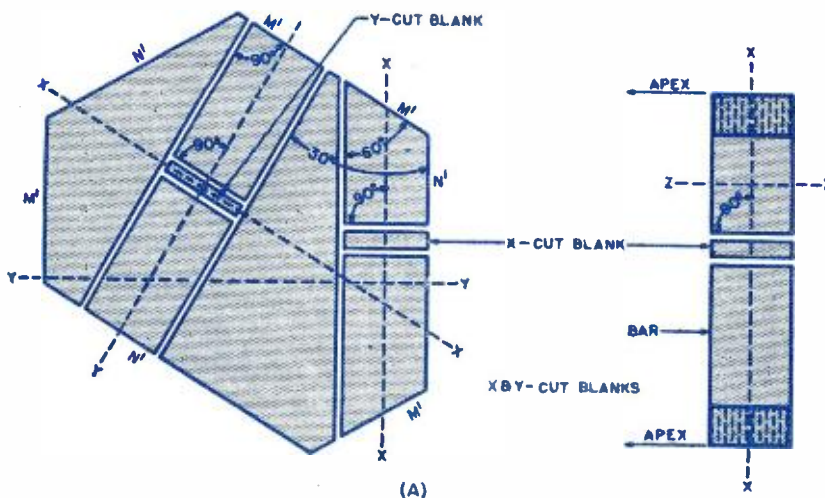

Preferred crystal cuts. Irregular material first requires finding the approximate optical axes by means of color interference or color fringes in polarized light when immersed in oil.

The needs of war and the emphasis placed on electronics in wartime developments, have given crystals an importance never before attained. With many types of combat equipment each requiring a number of quartz oscillators, the total demand for war reaches astronomical figures. This has put production on a mass basis, resulting in lowered production costs and increasing enormously the knowledge and use of crystals. Consequently, they will not revert to their prewar position, because in any device requiring fixed frequencies, the quartz crystal is the most inexpensive, the most practical, and the most accurate means of controlling frequencies.

The real extent to which the crystal will be used in the future cannot now be seen. That there will be wide and varied applications is certain. The continued development of new and amazing electronic appliances and equipment is bringing the crystal into immediate uses heretofore unknown. The prospect of even greater employment is limited only by the inventive genius of radio engineers in evolving more conveniences for the American people and their homes, and in developing new production facilities for the country's industrial system.

Numerous predictions have been made for the Electronic Age, many of them almost fabulous in their conception of the fundamental changes in the present mode of living. How homes and buildings will be heated and lighted by radio; how it will cook food in nearly the winking of an eye; how tiny radio sets that can be carried in the vest pocket or hand bag will make instant communication possible, are but hints of what has been forecast. These things, in all probability will come to pass, although not soon to be realized, but when and as they do, the crystal will be the controlling factor of the equipment or device.

In the meantime, many practical applications of the quartz oscillators are being made, in addition to the innumerable wartime uses about which nothing now can be written. The place they have in broadcasting and in radio and telephone communications, of course, is well known, and crystals will be in greater demand as the use of fixed, mobile, portable and airborne communications equipment increases. It is agreed, that in spite of the progress in civilian communications facilities, the possibilities have barely been visioned. In this field alone, the application of the crystal is just beginning.

Aside from radio and telephone, the worth of crystals is shown everyday to those for whom diathermy treatments are prescribed, and will be shown increasingly as electronic developments applied to medicine come into use. It may be, too, that homogenized milk, now so popular, will be produced better and more efficiently by the use of the quartz oscillator. Another general benefit to be derived from the crystal will be in its employment as a killer of bacteria in solutions.

In these two latter applications, and any other where a mechanical action is required, the secret of the crystal's efficiency is in its piezoelectric effect. Piezo is from a Greek word meaning "to press." When electric pressure is applied to the quartz crystal, it results in mechanical action, or oscillations. Therefore, the oscillations of a crystal in a container of milk will break up the fat, or cream, globules of the liquid into minute suspended particles, producing what is known as "homogenized" milk. The same type of application can be used for the killing of bacteria.

In industry there are already a growing number of applications for crystals, such as precision timing and measuring devices, pressure gauges, filters, generators, induction-heating apparatus, and other electronic and automatic control equipment. As high-frequency equipment becomes more and more a part of production processes, as it will, the crystal will assume, of necessity, a proportionately important industrial role. The limit of use is almost anybody's guess.

Because crystals are precision-made, produced with all the care given precious stones, their prewar cost obviously was high. Mass production methods developed to meet war needs have reduced that cost to fractional figures. This economy makes the use of crystals a more practical matter from the standpoint of pricing the equipment in which they are used.

As an instance, crystal filters to control the image frequency of receivers have been limited heretofore to the higher priced home radios and other expensive receiving equipment. With the cost of crystals reduced to a minimum, these filters, as well as crystals for push button tuning, could well be included in the average home radio set without an increase in price.

Due to the war, the production of crystals has expanded in the United States to about 200 times its former output. This has resulted in heavy imports of the raw quartz from which they are made. The supply of this quartz for piezoelectric purposes comes principally from Brazil, where it is mined in open pits entirely by hand labor. The quartz itself is a compound of silicon and oxygen, with a hardness scale rating of 7 as compared with a hardness rating of 10 for the diamond, and is found in varying shapes and sizes, some of it in beautiful apex formations.

A trip through a crystal laboratory, such as that of the *Federal Telephone and Radio Corporation*, Newark, N. J., manufacturing associate of the International Telephone and Telegraph Corporation, where one day's crystal production equals an entire two weeks' output in the United States prior to the war, would show production methods that are marvels of care and precision. And at every step there is inspection—and reinspection—to insure that the tiny quartz plates, no larger than a thumb nail and cut into neat rectangles, will oscillate or vi-

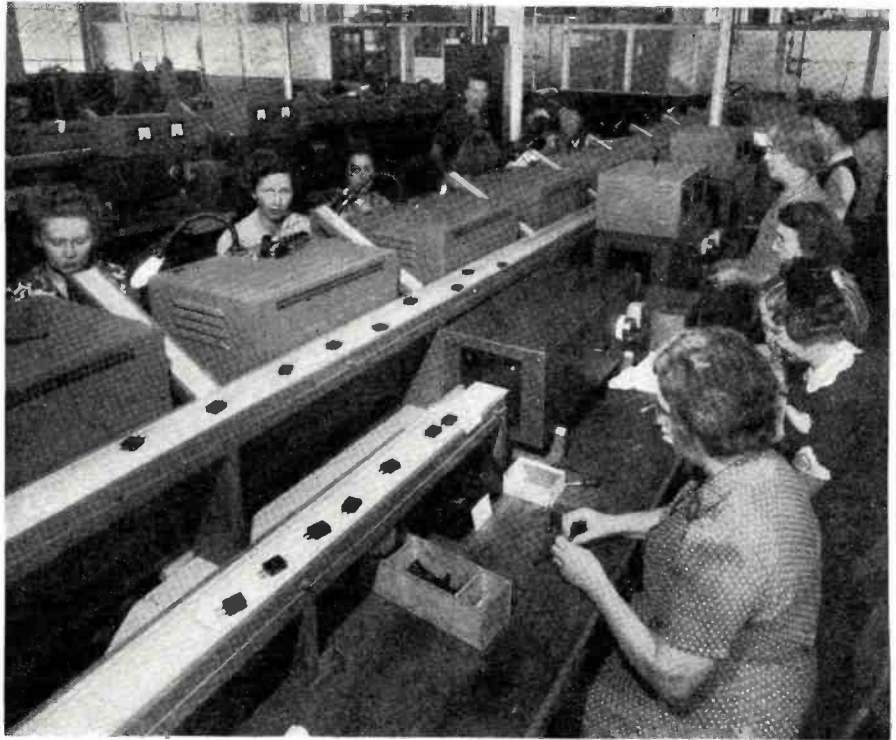

Conveyor belt system is used in the final assembly of holders and the pretesting of completed crystal units in a modern crystal laboratory.

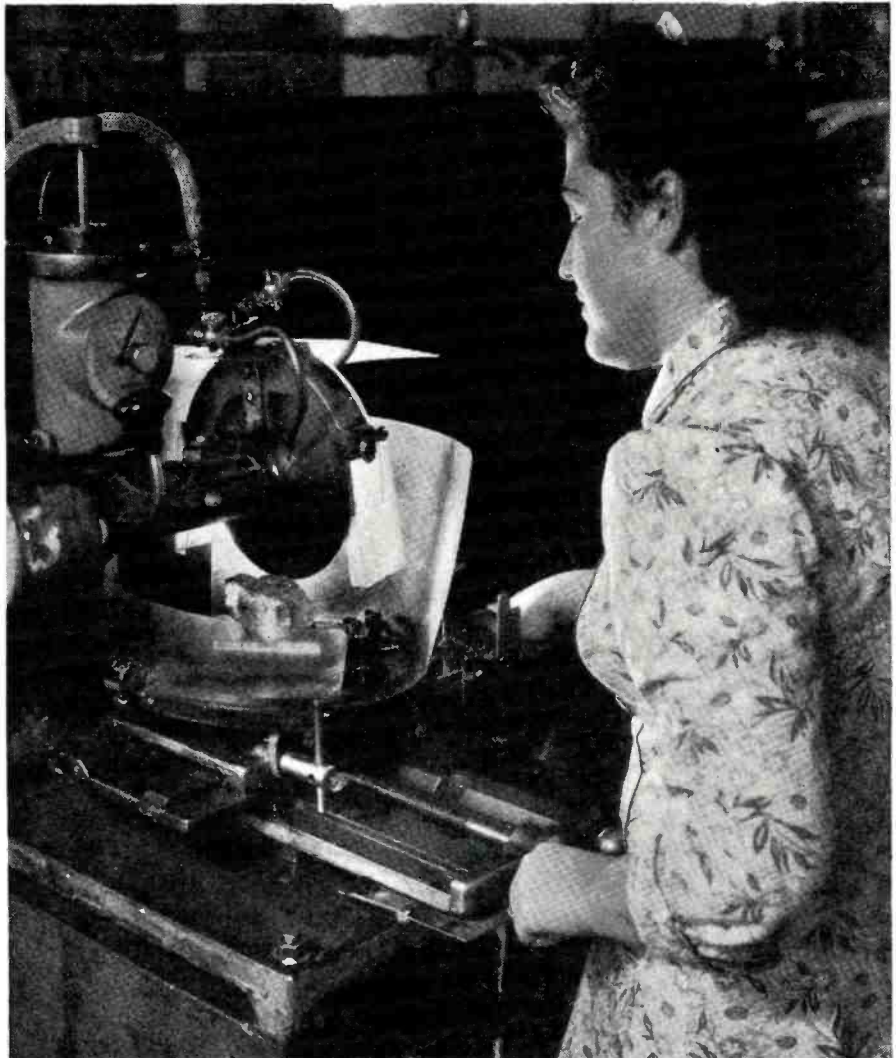

Sawing the mother quartz into thin wafers. The quartz piece is mounted on a glass base by means of a thermoplastic cement so that it can be held rigid.



Automatically lapping, or grinding, crystals to approximate thickness.



Crystals being etched to exact frequency prior to final assembly.

brate at the specific frequencies set for vital wartime radio communications—because their job is victory.

The stockroom is where the quartz is received and sorted for processing—first according to size, the classifications being 100 to 200 grams, 200 to 300, 300 to 400—100 gram steps, for easier handling and mounting and for efficient cutting in the saw room. The quartz then is assorted according to shape—regular or faced, and fully irregular with no indication of the crystallographic axes. The reason for this is that regular quartz, which has hexagonal prism faces with pyramidal tips at each end—each pyramid formed of 6 apex faces—can be mounted easier and more inexpensively than the irregular. The latter requires special treatment or processing.

Quartz is a true crystal and all crystals have definite atomic structures. In the natural formative state, they have regular surface planes bearing fixed relation to their main crystallographic axes, which are axes of symmetry in the atomic structure. These are the Z, or optical axis; the X, or electrical; and the Y, or mechanical.

In the mounting room the quartz is placed on sawing mounts—slabs of thick glass—in such position with respect to its axes that when sent to the saw room, cuts can be made in the proper direction and at the proper angle. The combination of hand and polarity determines the direction of cutting to obtain proper thickness and constant frequency and temperature characteristics. Right-hand quartz rotates polarized light to the right; left hand to the left. The electrical polarity is determined by compressing the quartz on an electrometer to find which end of the electrical axis is positive and which is negative.

In cases of quartz having natural faces, the optical, electrical, and mechanical axes are determined by these faces within two or three degrees; then closer adjustments are made by the use of polarized light equipment. The quartz is mounted on glass by means of a thermoplastic cement. Irregular material first requires finding the approximate optical axis by means of color interference or color fringes when immersed in oil in polarized light.

In faced quartz the position of the three axes is known. The Z axis is, in most cases, in the direction of length of a natural crystal. The X axis is parallel to any natural face and perpendicular to the Z axis. The Y axis is perpendicular to any prism face and to the Z axis, 30° to the nearest X axis.

The Z axis (optical) is the only one which can be determined by the use of plane polarized light. The light when passing through quartz along the optic axis rotates and produces an interference pattern. If monochromatic light (such as sodium or mercury arc light) is passed through two crossed polaroids a pattern of alternate rings or

(Continued on page 100)

THE acoustics of a theater which is about to be built may be determined to a certain extent by the engineering design. The sound absorption coefficients of many materials are given in standard engineering texts although empirical formulas have been developed which permit valid predictions of performance. Theaters produced or built in recent years are usually superior not only from an architectural viewpoint but equally from the viewpoint of excellent acoustic conditions. However, there are many theaters which are old, and which sadly lack ideal acoustic conditions, particularly if an attempt is made to use sound reproduction apparatus. The practical treatment is important for improved results in the operation of sound equipment of such theaters. Very often existing installations can be improved materially and something better added to secure more lifelike reproduction of speech and better quality of music.

Theater acoustics is not a thing apart from the sound reinforcement equipment, itself; both are tied together. For example, no matter how good the acoustics may be, the voice of the performer is not going to sound well unless that performer has mastered the mike technique; if you watch closely, as an illustration, you will see that many skilled entertainers when the song is at a low level keep their lips fairly close to the mike, and when the voice must be raised they may back away as much as three feet and let go with full power. If they had kept a constant distance, the mike would have been blasted with the high-intensity of sound and the intelligibility would have been ruined. This technique might not be required if it were possible to continuously monitor the pickup, as in a broadcast studio or in a recording studio, but even then the volume range would be limited. In movie work, the mike boom could be moved away or nearer to give artistic effects. To give still another illustration, many mikes have an adjustment for tilting, the mike diaphragm forming an angle with a straight line drawn out from the speaker's mouth, so that direct high-intensity sound does not blast the mike. The angle the mike makes with a vertical or perpendicular line may, in a typical case, be about 70 degrees.

The operation of the sound equipment involves a great many other factors as well. The feedback of the sound of the loudspeakers to the mike may result in a howling that is unpleasant and, in less extreme cases, may simply cause a certain amount of distortion without sending the amplifier into actual oscillation. The use of a cardioid mike at the stage has the important advantage of discriminating against audience sounds and also limiting to a great extent the pickup of acoustic feedback. The heart-shaped directional characteristic of the cardioid mike is therefore quite valuable. The apex of the heart is directed, usually, at a right angle to the stage line or

THEATER ACOUSTICS

By **WILLARD MOODY**

Important factors in determining the acoustical response of a theater, including installation of suitable sound equipment.

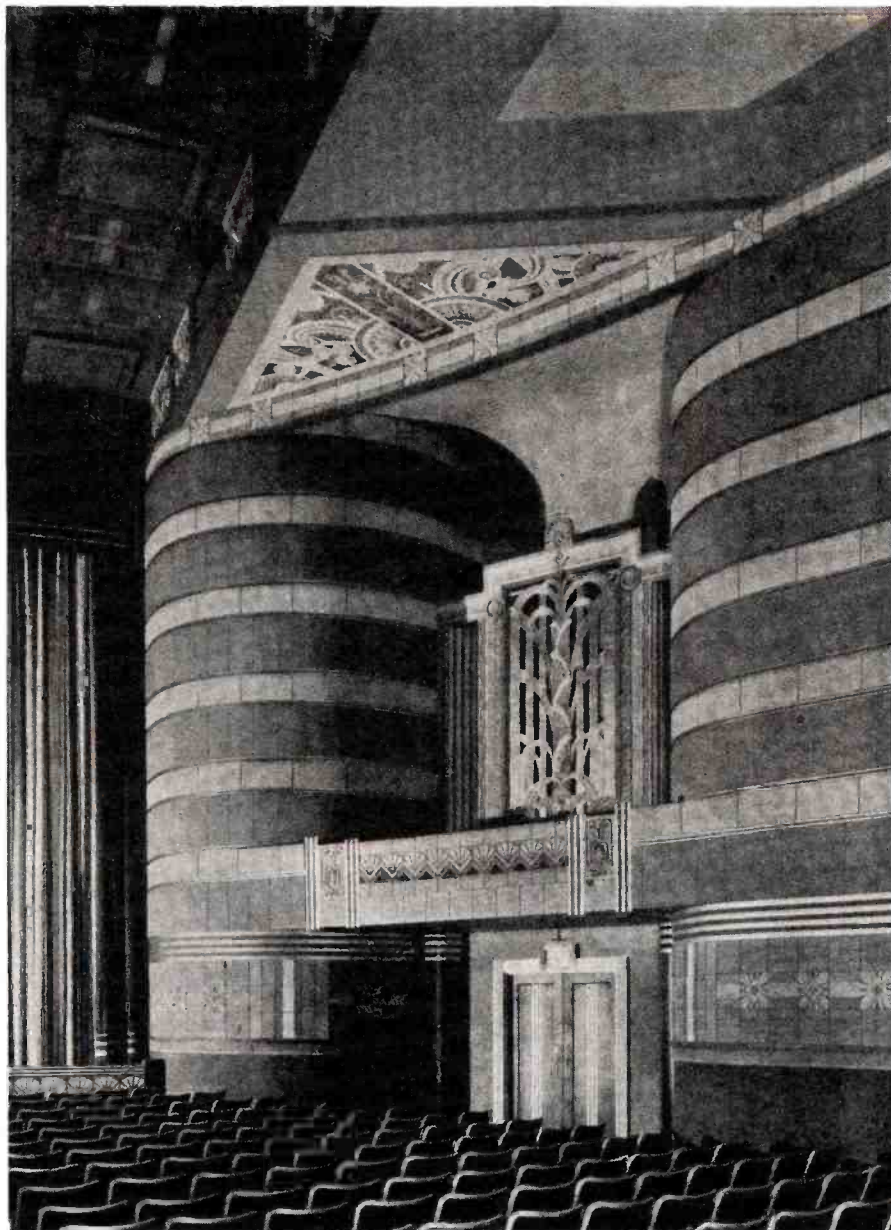

Acousti-Celctex used on the walls of the Ambassador Theater, Baltimore, Md., to eliminate echoes, flutters, dead spots, etc. This material is an ideal sound conditioner and may be applied directly to existing walls and ceilings.

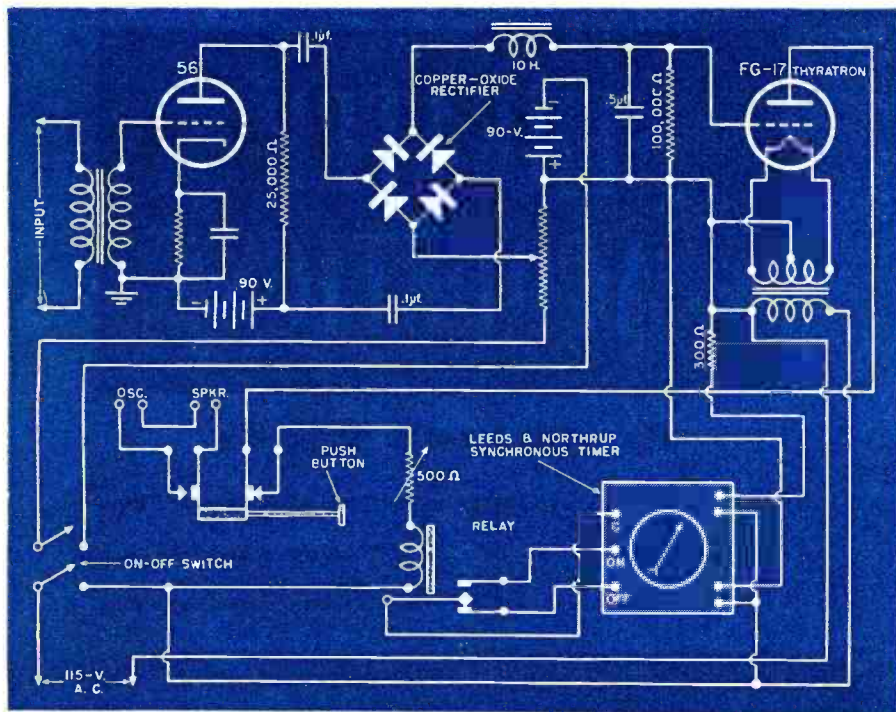

Fig. 1. Wiring diagram of the portable reverberation meter shown in Fig. 2.

footlights, in such a way that minimum pickup from the audience will result. This means that sounds reflected off walls or other surfaces and coming back to the stage will not strike the mike directly, or if they do will not be picked up efficiently because the pickup is low towards the audience. The sounds coming back, however, which pass the mike and are re-reflected from the stage scenery, may enter the mike. Fortunately, for every reflection a certain amount of sound energy is used up, so that the intensity goes down, and also there is a certain amount of loss in passing through the air which has a definite amount of acoustic resistance.

In the practical operation of the sound amplifier it may be found that reducing the high-frequency response cuts the tendency to oscillation. Musical instruments such as the violin or mandolin may, however, sound dull and uninteresting. By carefully controlling feedback, the necessity of limiting the frequency response is re-

duced. The use of tweeters in banks of three or four, fed through a frequency dividing network, may be permissible to really convey the ultimate in musical and speech fidelity.

Because the higher pitched sounds have short wavelengths they may usually be reflected repeatedly with more ease than the lower frequency waves. An accurate figure of the velocity of sound is 1086.7 ft. per second at 0 degrees C., with an increase in the velocity of about 2 ft. per degree C. At 70 degrees F., the velocity is 1128 ft. per sec. Repeated reflections may result in a sound reverberation. That is, a sound may be produced and not die out immediately, but it may require instead a certain period to do so. When the original sound intensity has dropped to one millionth of the original value, or 60 db., it is assumed dead. The time required to obtain that condition is the so-called reverberation time and is rated in seconds. The optimum reverberation time varies according to whether the sound is speech

or music, and also varies according to the size of the theater and its acoustic treatment. If the use of sound-absorbing material is very liberal, the sound striking the walls or other surfaces will be readily absorbed and there will be little or no reverberation. Such a theater may be acoustically "dead." On the other hand, you can have the opposite extreme, with a great many hard, reflecting surfaces causing sound to bounce repeatedly off the walls and ceiling. Somewhere between these two extremes is the ideal condition, generally best determined by experimentation. Incidentally, it should be remembered that each member of the audience represents a definite amount of sound absorption. A perfect sound absorber would be an open window, with all of the sound going away and not being reflected at all. The coefficient of sound absorption for the window would be unity or one.

To a certain extent, sound waves are like electrical waves. That is, when you have feedback in phase the intensities add up, and when out of phase, cancel. Thus, it is possible, due to reflection, to have sound focussed at some particular point in the theater, making it much louder at that point than it should be and, conversely, to have sound much weaker at some other point because of phase cancellation. The breaking up of the sound patterns may be secured by using irregular surfaces. Columns or angular walls will accomplish this purpose. A chandelier hung from the ceiling will break up sound. The rear wall of the theater may be of hard concrete or other material such as plaster, having the ability to reflect sound efficiently. Drapes or curtains properly situated absorb the sound and prevent troublesome reflections. But they may serve another purpose as well, and that is to exclude sounds from the outside. For example, certain exits may face the street and even though heavy steel doors are used, street vibrations may come through and attempt to mask sounds within the theater. Often the use of curtains of heavy cloth will help materially to deaden the sound.

As has been mentioned previously, it requires no stretch of the imagination to see that as the temperature affects sound velocity, the acoustics of the theater will be tied in with temperature. By equalizing the temperature so that it is the same in winter as in summer, the theoretically perfect job, no change in velocity should be experienced. The actual effect may be slight, but it is noticeable. The tone controls of the amplifier may be set to compensate for the change. If some provision for remote control of tone is incorporated, for example, by using a concealed mike in the vicinity of the main audience, this mike being connected by a transmission line to a small amplifier and monitor speaker, adjustments as required may be made. The capacity of the house, or number of people present, will affect the acoustics. The power output of the

Fig. 2. Block diagram of the equipment necessary for measuring the reverberation time, an important factor of the acoustical response of a theater.

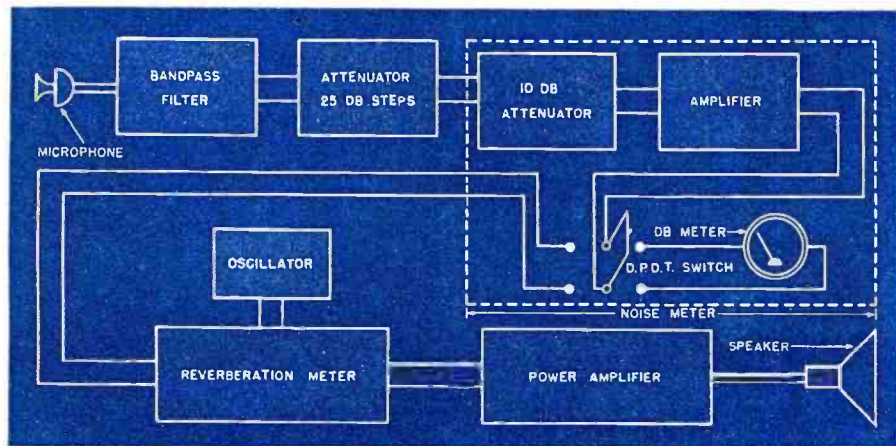

MATERIAL	FREQUENCY		
	128	512	2048
Brick wall, painted.....	.012	.017	.023
Same, unpainted.....	.024	.03	.049
Carpet, unlined.....	.09	.20	.27
Same, felt lined.....	.11	.37	.27
Fabrics, hung straight			
Light, 10 ozs. per sq. yd.....	.04	.11	.30
Medium, 14 ozs. per sq. yd....	.06	.13	.40
Heavy, draped, 18 ozs. per sq. yd.10	.50	.82
Floors			
Concrete or terrazzo.....	.01	.015	.02
Wood.....	.05	.03	.03
Linoleum, asphalt, rubber or cork tile on concrete.....		.03-.08	
Glass.....	.035	.027	.02
Marble or Glazed Tile.....	.01	.01	.015
Openings			
Stage, depending on furnishings.....		.25-.75	
Deep balcony, upholstered seats.....		.50-1.00	
Grills, ventilating.....		.15-.50	
Plaster, gypsum or lime, smooth finish on tile or brick.....	.013	.025	.04
Same, on lath.....	.02	.03	.04
Plaster, gypsum or lime, rough finish on lath.....	.039	.06	.054
Wood Panelling.....	.08	.06	.06
Absorption of Seats and Audience			
Audience, seated, units per person, depending on character of seats, etc.....	1.0-2.0	3.0-4.3	3.5-6.0
Chairs, metal or wood.....	.15	.17	.20
Pew Cushions.....	.75-1.1	1.45-1.90	1.4-1.7

Fig. 3. Tabulation of the sound coefficients for some of the more common materials.

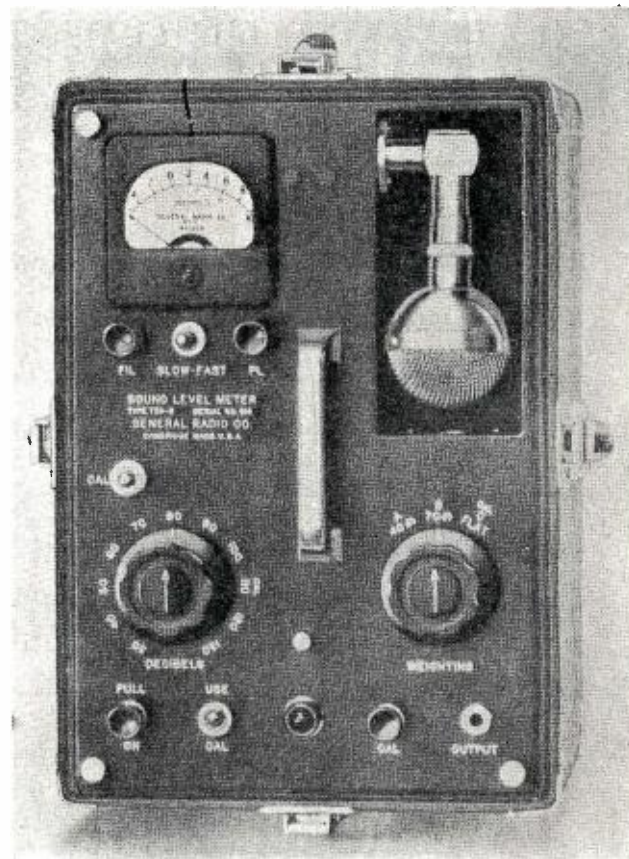

A professionally-constructed sound level meter, manufactured by the General Radio Co.

audio system must be greater when there is a large audience than when there is a small audience. The absorption of the larger audience accounts for this and also the fact that more people make more noise than fewer people is perfectly clear. Even the seats themselves tell a story. If they creak and squeak, distressing high-intensity noises may be produced. The use of upholstering and leather in modern seats means much in keeping down the noise level.

From the acoustical viewpoint, the less noise that is present the better. With low noise level, low sound intensities can be employed to greater advantage and a greater range of sound, from a whisper to a rising, thunderous crescendo is possible, giving thrilling realism and power to music and enhancing speech. This also makes listening easier and less fatiguing, since the human auditor has less work to do in discriminating against unwanted sounds, and can concentrate solely on the speech or music. Sound above a certain level becomes tiresome. The reference level of sound may be taken as 1 microwatt per square centimeter, which is the average sound power when an ordinary individual speaks ½ inch away from your ear. The sound level that you hear may be expressed with reference to some arbitrarily chosen level, as so many decibels above that level. If the lowest intensity sound of a frequency of 3000 to 4000 cycles is heard just faintly and is distinguishable, that

value of sound intensity can be taken as the threshold of hearing and can be made the reference level. Ordinary conversational speech is carried on at a level of about 55 db. above the threshold of hearing or above 0 db. It is important, in discussing sound intensities, to specify the reference level.

It would be possible to make elaborate tests to determine the acoustic conditions. However, the practical man often finds a practical approach more efficient without the use of a great deal of physics and calculation. An automatic record player may be hooked up to an amplifier and a suitable series of records used to determine the musical quality. With the record player operating an observer could move to various points within the theater, checking the quality and

intensity of sound by ear—which after all is exactly what the audience will do.

In order to check speech a radio may be tuned in to one of those priceless human comedies which are supposed to represent drama on the air, or to one of the commercial announcements which seem never to end and for testing purposes are ideal, whatever else they may be. The radio output may be fed to the amplifier input. If the amplifier input is of a high impedance, a blocking condenser in series with the line may be used, and then connected to the plate and chassis of the output stage of the radio, as shown in Fig. 4. If instead of a high impedance the amplifier has an input circuit for a 200-ohm or 500-ohm line, or some value

(Continued on page 126)

Volume levels in decibels for various sources of sound.

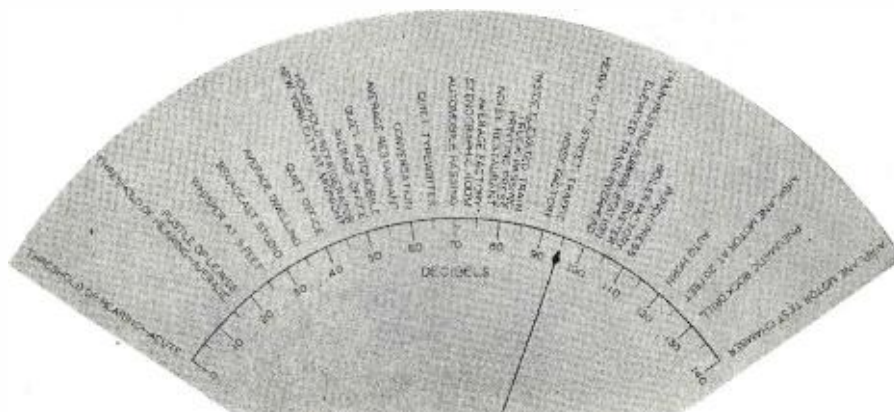

WEATHER TESTING WALKIE-TALKIES

To assure rated performance under battle conditions, walkie-talkie units are weather-tested. Tests range from -35° to 149° F. and include a simulated rainstorm. Photographs show actual tests being made during production at the Galvin Mfg. Corp. plant.

Walkie-talkie shown in operation. When operating in the prone position, the special goose-neck allows the antenna to be bent and maintain its vertical polarity, essential for good transmission and reception.

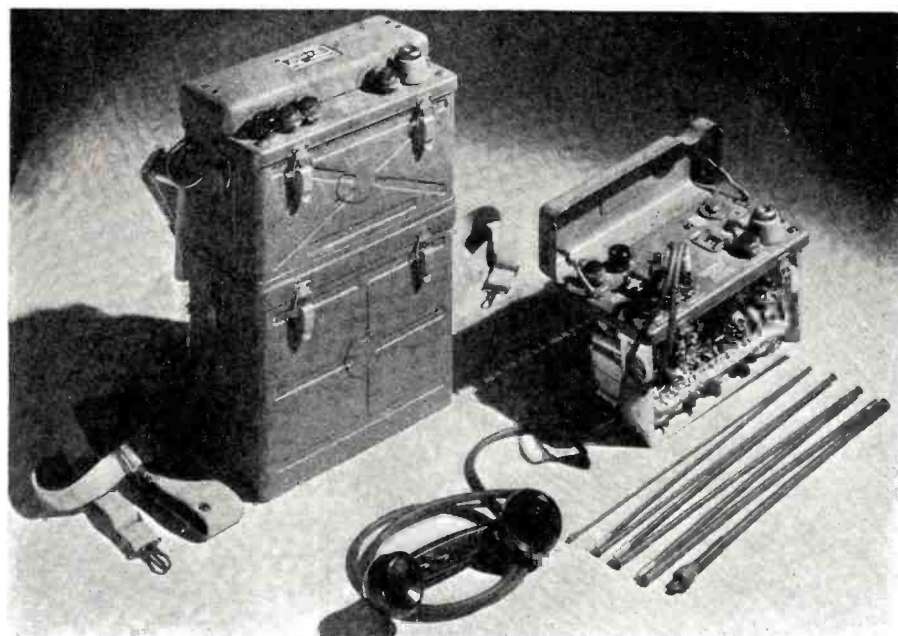

The walkie-talkie is a portable two-way FM radiotelephone set, used by our fighting forces on almost every battle front. The unit weighs about 40 pounds, supplies its own power, and has a special type of antenna, one set of headphones, and one auxiliary listening set. Sending or receiving is accomplished with a flip of the finger and communications are maintained while the soldier is either stationary or moving. The walkie-talkie is used principally for maintaining short-distance communications between soldiers on the front lines and their various posts of command.

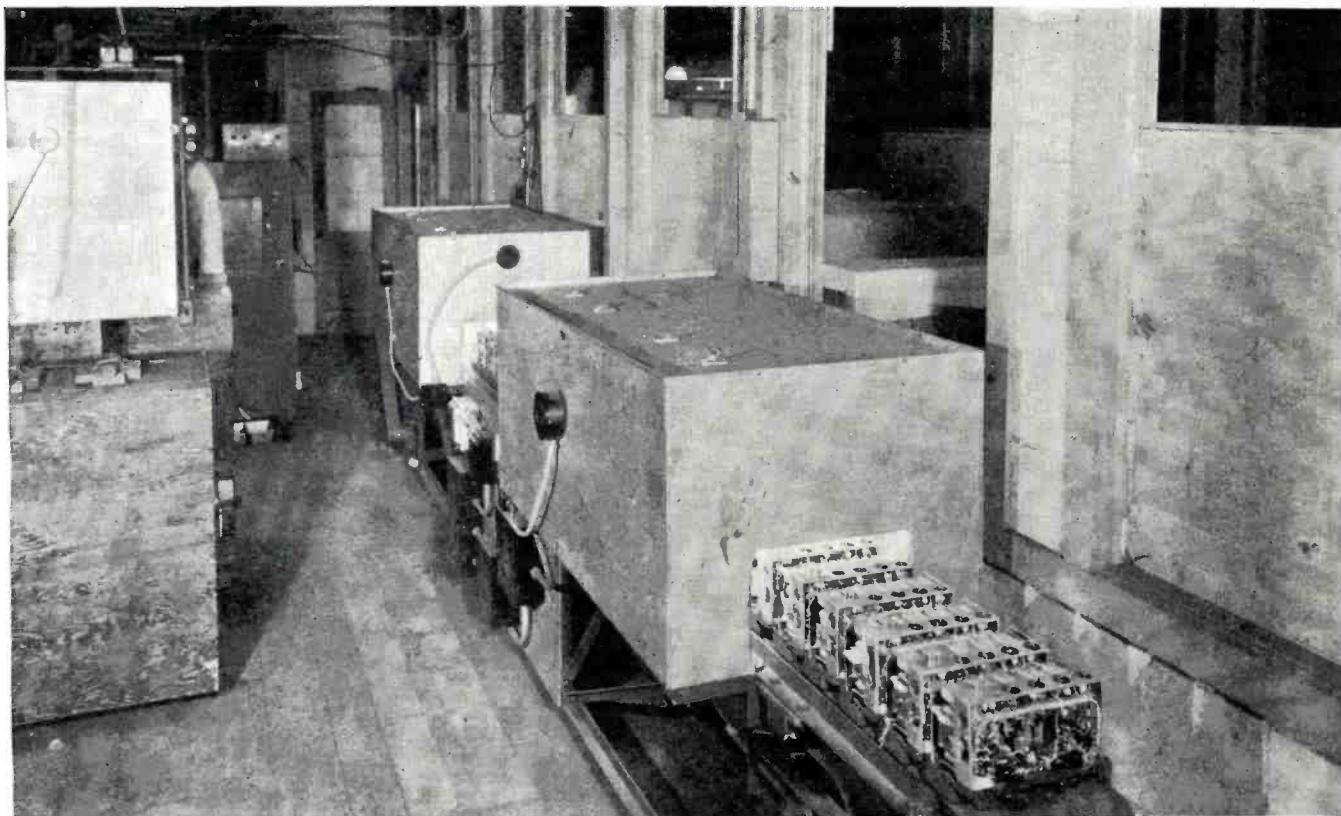

Walkie-talkie sets, stripped to bare essentials, resting on conveyor belt and moving at the rate of one inch per minute. Sets move from room temperature into heat chamber of 145° F., back into room temperature, then into second heat chamber before moving again into room temperature. All sets are then rephased and checked electrically and operationally. The purpose of the heat tests at this phase is to dry out any moisture accumulated during the assembly operations. Both heat chambers and the space in-between are 60 inches in length so that each set spends exactly one hour in each heat chamber.

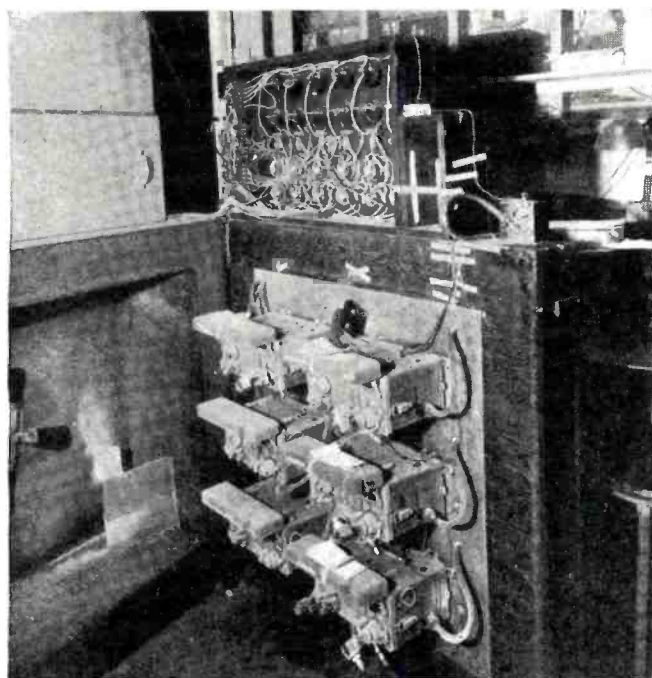

Six chassis are shown fastened to the swinging door of the cabinet in which they are subjected to a temperature of 35° below zero, and then to 149° above F. Photo was taken directly after exposure to 35° below zero and heavy frost deposits may be seen. Exposure cycle follows, each one lasting one-half hour: first, room temperature, then 35° below zero, room temperature again, then 149° above zero, and finally back to room temperature. After each exposure, each set is checked for frequency variation. All sets are kept in operation while exposed so that operational and electrical checks may be made.



The tops of the walkie-talkie units are visible while undergoing the rain test. Overhead may be seen the jets from which water is sprayed during the required two-hour period. A certain percentage also receives a 24-hour rain test. This test is given in addition to a simple immersion test, which is made to reveal any imperfections or pinholes that may have resulted during assembly. After the test is made, the presence of four or five drops of water inside the case is considered sufficient for rejection. This is the final test and after its completion the walkie-talkie units are prepared for shipment to our Armed Forces.



Mechanical assembly line of 2½-kw. transmitters at a Press Wireless plant. Note wooden skids.

Large Transmitter Construction

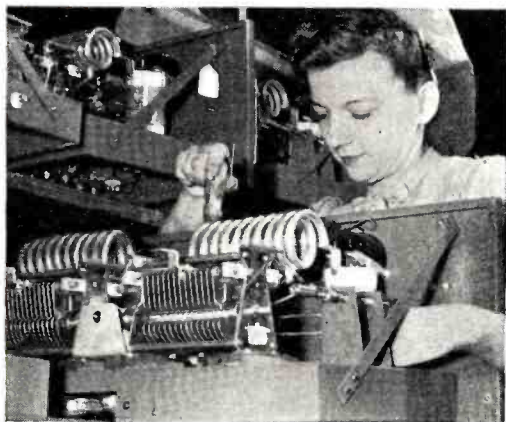

Working on driver chassis for 2½-kw. transmitter.

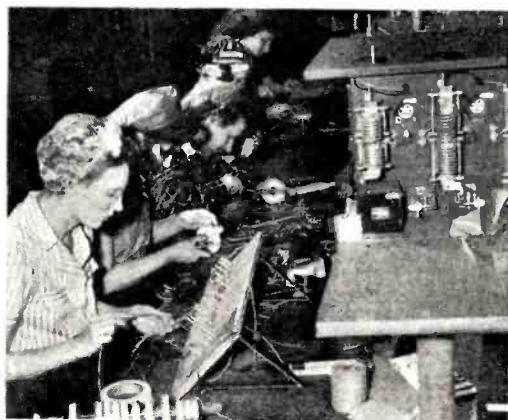

Assembling double chassis of 2½-kw. transmitter.

SHOWN on these pages are various operations in constructing a high-powered transmitter for the United States Army Signal Corps. Unlike smaller units, these must be custom-built and many sections must be fabricated individually to fit. Such units cannot be efficiently mass produced. They must be built as individual projects. For example, a typical chassis which may contain only the exciter portion of the transmitter may be even larger than a complete low-powered radio transmitter together with its power supply. Ruggedness is of paramount importance. Everything must be securely bolted together and parts welded in order that the completed transmitter may be shipped to distant lands without risk of mechanical distortion upsetting the very functions of the transmitter.

These photographs, which were taken at the *Press Wireless plant* in New Jersey, typify the high quality craftsmanship that is going into our military communications equipment. Our photographer, Frank Ross, spotted these subjects as typical examples of "women at work." Their daily routine includes highly skilled operations which, in many cases, require very delicate maneuvering in assembling intricate parts.

Transmitters of this size have their basic units preassembled and tested before they are placed in the transmitter cabinet. Bulky parts, controls, relays, transmitting tubes, etc., follow in the assembly. Then comes the task of making the various circuits complete by means of harnesses and especially prepared cables. Complete safety protection is afforded these units so that all high voltage is removed whenever one of the metal doors are open. Rigid specifications as set forth by the Signal Corps are carefully adhered to. There can be no failures where lives depend on communications.

Before shipment, each transmitter must undergo a series of final tests. These include overload of vacuum tubes, frequency stability tests, and a general performance test to indicate whether or not the transmitter has met all of its requirements. Instructions for the operation and

(Continued on page 80)

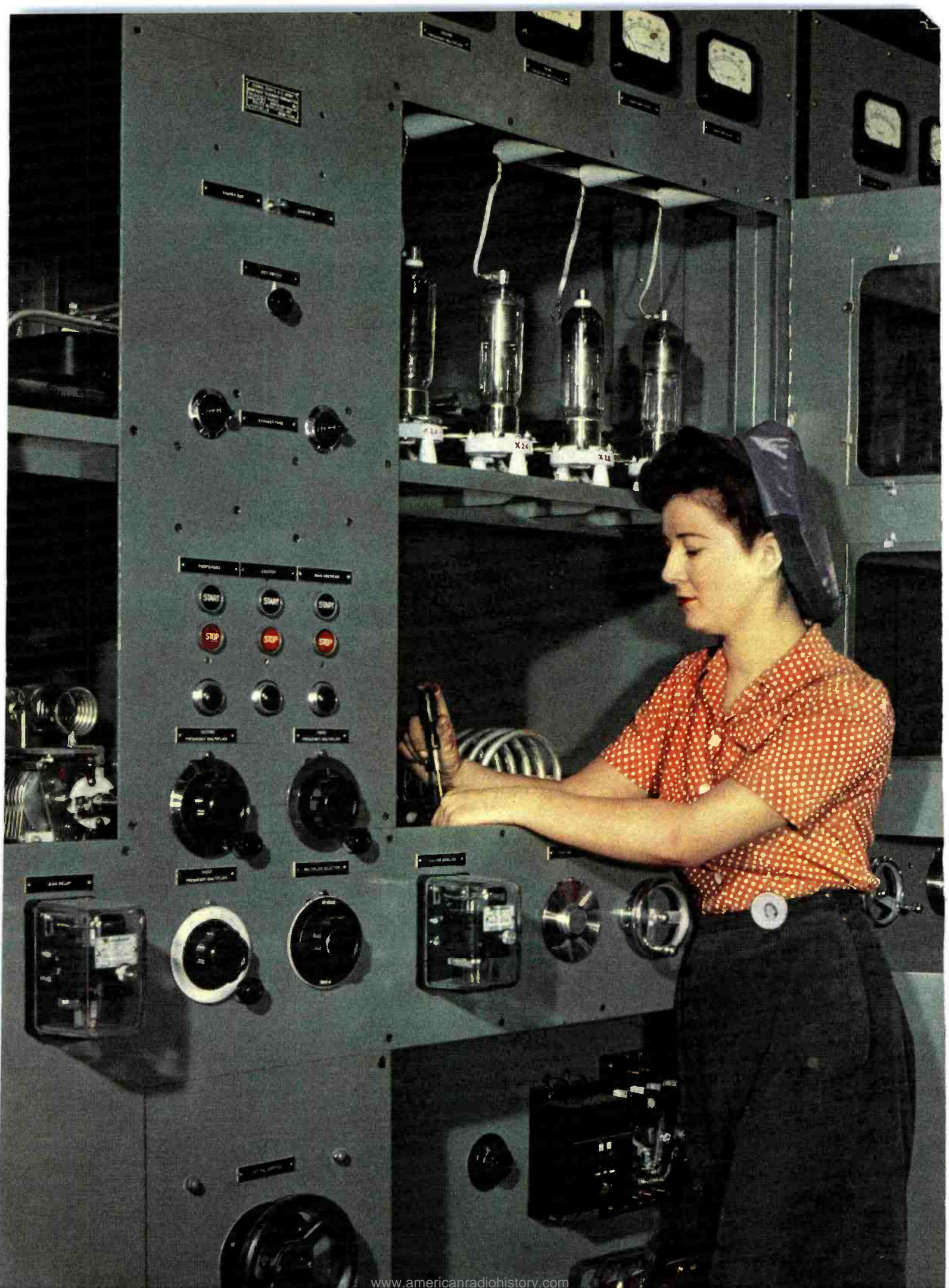



ELECTRONS AT WORK

IT WOULD indeed be hard to find any industry requiring the utilization of greater skill or engineering perfection than that of the electronics manufacturer. The making of huge transmitting tubes, such as those depicted on the opposite page, requires a vast amount of research and delicate operating technique for their evolution and fabrication. The present war with its inordinate demands of the military has given impetus to the designing of these vital implements of modern warfare. New designs have resulted in greater economies; greater efficiency, both in the tube operation and cooling systems required; and an important saving of critically needed space.

Of many shapes and sizes, these electronic tubes are now finding application in thousands of pieces of equipment, not only for the broadcasting of entertainment for the public, but for the even more important task of keeping a world-at-war informed of every major development almost as soon as it takes place.

Typical of the transmitting tubes which are performing yeoman service in World War II are the air-cooled tubes illustrated on the opposite page. All transmitting tubes over 2 kw. rating must be cooled by some external means to assure safe anode operating temperatures. The two most common ways of achieving this temperature control are water-cooling and air-cooling. The water-cooled tube is the older tube type and is widely used in permanent installations in fixed transmitters.

The newer air-cooled transmitting tube is rapidly gaining favor because of several improved design factors, namely, elimination of water piping and water source, greater cooling area and the ability to operate in extremely cold climates without danger of freezing.

The cooling of this tube is accomplished by means of vertical radiating fins which are silver-soldered to the cooling core in which the tube rests. An external blower aids in dissipating the heat given off by the tube.

Replacement of this tube is usually made by removing the entire unit from the transmitter and replacing it with another cooling core and tube. Great precision is required to change the glass envelope within the cooler as the core must be carefully soldered to the envelope. This operation is rarely performed at the transmitter by the station engineer and the entire unit is handled and transported together.

The control circuits for the air-cooled type of transmitting tube are much simpler than those necessary for the water-cooled tube. A simple interlock and a keep-alive relay provide tube protection by starting the air-cooling operation before the plate and filament voltages are applied and continuing that operation for a period of from 4 to 7 minutes after the filament voltage has been removed.

The operation of the water-cooled tube depends on maintaining a continuous flow of pure water which is kept circulating by means of main-pressure, when available or forced pressure when the city water supply is unavailable or tests at more than 10 grains hardness per gallon. Distilled water is used when possible to prevent scaling on the anode and deterioration of the rubber connecting hose and associated tubing.

Each of the tubes illustrated represent a custom-built, hand-made unit whose construction is carefully controlled at every stage of its manufacture. Highly developed skills are utilized to the fullest extent in producing precision electronic equipment of which the transmitter tube is one of the most outstanding examples.

-30-



The key part of the mass spectrometer, a newly-designed electronic tube to be used in the gasoline and synthetic rubber industry. A magnet draws electrified molecules towards a target, where they are collected and their electrical charges counted by meters, enabling an accurate check of the composition of the mixture being tested.

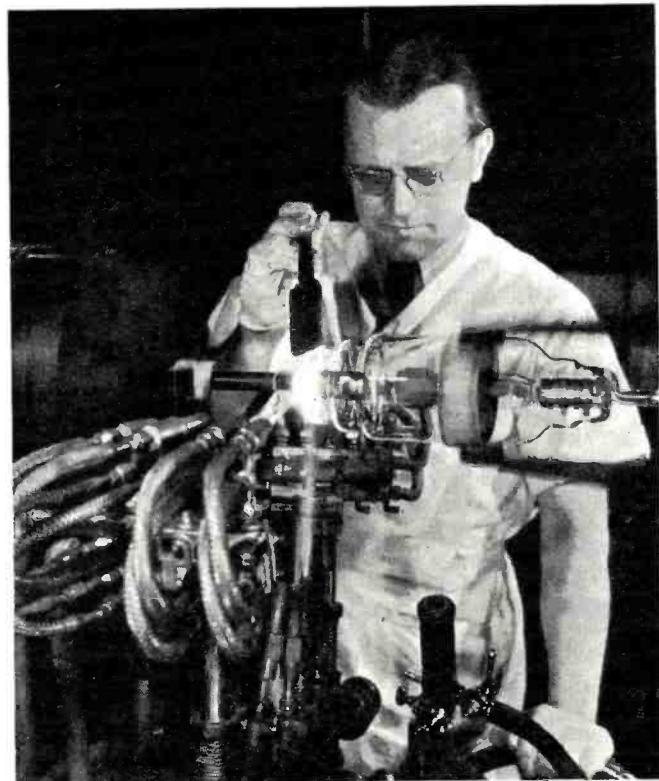

Hot tongues of flame from a dozen gas jets are played on the rim of a 400-watt radio broadcasting tube as the filament mount (cathode) is being sealed to the tube proper. For this purpose the tube is placed in the jaws of a glass lathe and rotated rapidly while the operator, using a small metal paddle, shapes the hot glass as desired.

Preconstruction Requirements for LOCAL BROADCAST STATIONS

By **ROGER W. HODGKINS**

Chief Engineer, Station WGAN

The legal, financial, and technical problems involved in preparing FCC applications for the construction of broadcast stations.

BEFORE a standard broadcast station may be constructed, an application must be filed with the Federal Communications Commission. If the application is approved a construction permit will be issued and actual work may be commenced. The legal, financial, and technical problems involved in the preparation of such an application are closely related. It is the purpose of this discussion to outline the necessary requirements for an application and to suggest an orderly manner of dealing with them.

Grants for station construction are predicated on the basic consideration of public interest, convenience, and necessity. Primarily, the proposed application must meet this test. In addition, consideration must be given to interference which may be caused to existing stations. Such a condition will be the rule rather than the exception, especially in the eastern area of the United States, and the service to be rendered must be of enough importance to offset the loss to other stations. The applicant must show actual evidence of liquid assets to the extent required for construction and operation of the facilities requested. It is intended that assignments of frequencies create an equitable distribution of stations with respect to state and nationwide population. Also the applicant must be legally qualified, possess good character, and give evidence that satisfactory public service will be rendered. Lastly, the technical phases of the application must meet rigid engineering requirements as pro-

mulgated by the Federal Communications Commission and be subject to assignment under international agreement. This last is sometimes a factor near the border of Mexico or Canada.

Broadcast stations are grouped according to certain classifications, powers, and frequencies in accordance with the type of service to be rendered. Hours of operation are determined in each case and may be unlimited, limited, daytime, shared time, or specified hours. For a complete definition of these classifications, powers, and operating hours, reference may be made to Part 3 of the Federal Communications Commission Rules and Regulations. In the case of a new station it is usual to consider a 250-watt station, with operating hours to be determined, transmitting on either 1200, 1210, 1310, 1370, 1420, or 1500 kilocycles. However, under certain conditions, local stations may also be assigned to regional channels.

Once the need for a proposed station is shown to exist, an important problem is the selection of a frequency that will serve the most people in the area under consideration, with the least amount of interference. To determine such interference the separation in miles between the proposed station and other nearby existing stations should be ascertained. This may be conveniently accomplished by reference to a U. S. Albers Equal Area Projection Map. By plotting on the map locations of existing stations operating on the same, or adjacent frequencies, Table I can be used. This table sets forth the

minimum allowable separation in miles between a 250-watt local station and stations of other powers operating on the same, or adjacent channels, and can be used to disclose potential interference.

A careful consideration of the requirements which have been presented up to this point should enable a prospective applicant to decide whether or not to proceed with the filling out of the proper application blanks to place on file with the Federal Communications Commission. The chance of approval, coupled with the financial risk involved, determines what course of action is more prudent. Enough application blanks should be obtained so that file copies may be kept for future reference. The legal and financial questions contained in the application form are not within the province of this discussion. However, all questions must be answered, whether relevant or not, and it is wise to employ competent legal advice when dealing with this part of the form.

The technical aspects of the application will require the attention of someone with adequate radio experience. A person undertaking such responsibility should possess a knowledge of radio telephone transmitters, antennas, ground systems, transmission lines, measurements, amplifiers, telephone lines, and general studio equipment. A radiotelephone first class license is desirable and usually indicative of competence. Progressive amateurs, who have held unrestricted licenses, and have demonstrated their ability by sound theoretical study and practical construction experience make highly desirable candidates for this work. An adequate knowledge of the FCC Rules and Regulations and Standards of Good Engineering Practice is imperative and should not be overlooked. It is also important to recognize the value of the services offered by a consulting radio engineer. Normally, a local outlet can profitably engage a professional engineer for preparation of maps, predicted signal contours, blueprints, site location, and choice of frequency. This does not imply that others can not accomplish the same results. The crux of the situation is the

Table I. The minimum allowable separation in miles between a 250-watt local station and stations of other powers operating on the same or adjacent channels.

CLASS IV		CLASS II AND III								CLASS I		
Channel	0.1 kw	0.25 kw	0.25 kw	0.5 kw	1 kw	5 kw	10 kw	25 kw	50 kw	10 kw	25 kw	50 kw
Same	165	173	180	200	221	273	293	318	343	415	442	462
10 kc adj	82	90	94	102	113	141	157	180	198	170	191	211
20 kc adj	45	48	50	58	66	87	101	118	134	110	129	147
30 kc adj	40	41	43	51	59	80	94	111	127	103	122	140

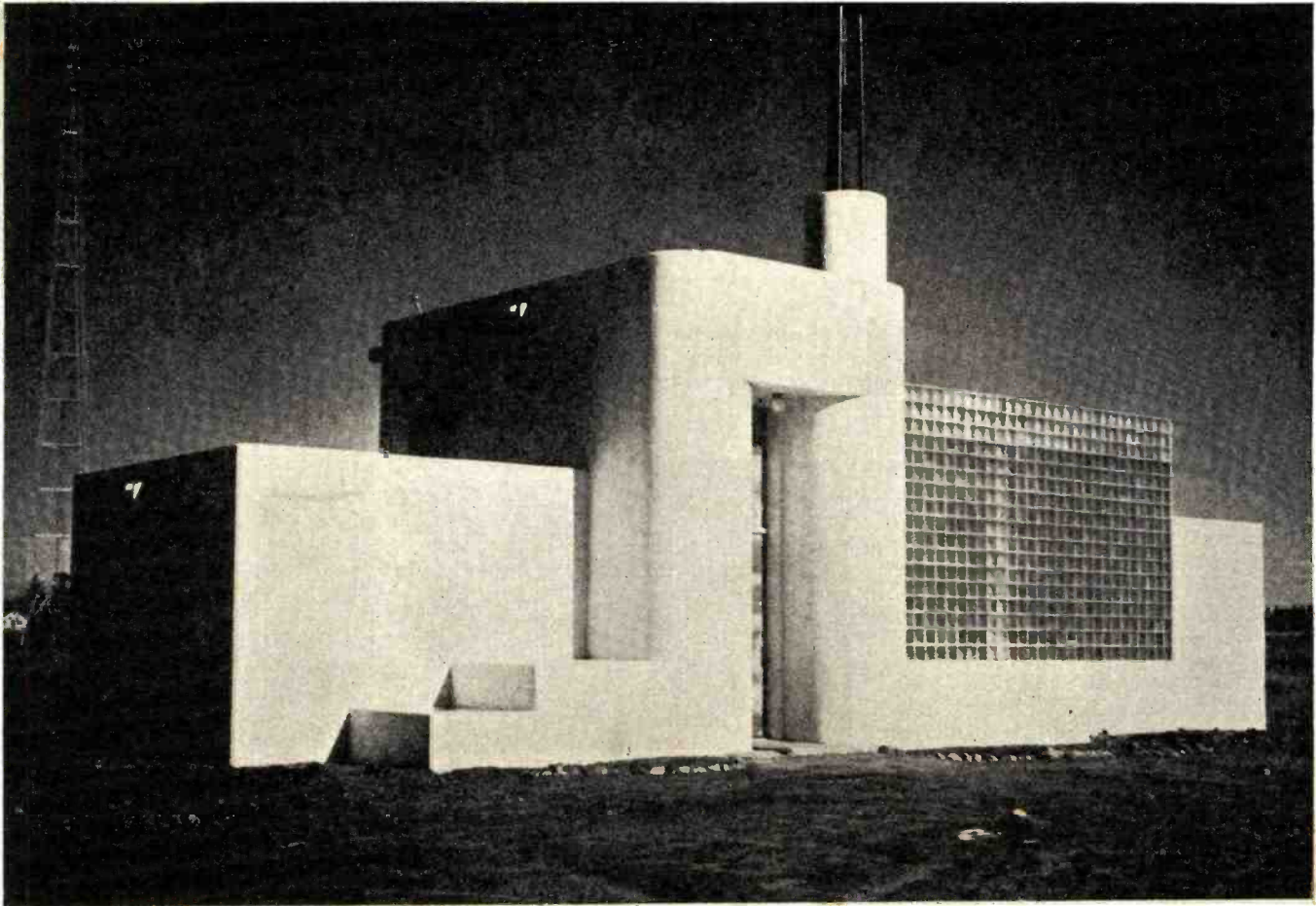

The new transmitter building of station KFPY, Spokane, Washington, symbolic of modern art and architecture. The hollow glass blocks, being partially evacuated, reduce heat flow, thereby greatly assisting in temperature control and reducing transmission of exterior noises.

fact that the work requires specialized knowledge, facilities for doing drafting or photostat work, and ownership of expensive measuring instruments, all of which are difficult to attain for a new organization.

A knowledge of the equipment requirements for a standard broadcast station should be clearly comprehended. The most important part of the apparatus is the transmitter with its associated antenna, transmission line, ground system, monitoring devices, and amplifiers. The efficiency of a transmitter installation depends, to a great extent, on the antenna and ground system, as well as the character of the soil on which it is constructed. Salt water, marshy ground, and clay are preferable to sand, gravel, or rocky terrain. In smaller cities or towns the site should be outside the central, or business area, a distance of from one to three miles. However the closer the transmitter can be kept to the center of population the better will be the service rendered. In the case of large cities a 250-watt station should be located in the business area as far removed from the residential district as possible. This will yield high signal intensities where they are of most value. For more complete consideration of this topic, reference is made to Standards of Good Engineering Practice, Part 4.

Inevitably the question will arise concerning the choice of buying or building the equipment. It seems advisable to devote some consideration to each method. If the apparatus is composite, or in other words made up of miscellaneous assembled parts, it will be found that there are a number of items which can be more advantageously purchased from a manufacturer. These are the frequency monitor, modulation monitor, and crystal oscillator. They are delicate units and in addition to requiring FCC approval, need laboratory adjustment. The transmitter then resolves itself into a suitable mechanical and electrical design which will meet the approval of the FCC. The ability to produce good equipment in this manner varies with individuals. In some cases composite equipment is equal to, or better than, commercial counterparts. And in other cases such apparatus defies description. The circuit details of low power

Table 2. The FCC estimate of minimum cost to properly construct broadcast stations, including transmitter and studios.

POWER STATION	MONEY REQUIRED
100 watts	\$6,500
250 watts	\$8,500-\$10,000

transmitters for broadcast use are about equivalent to those of advanced amateur telephone practice. The main difference is in the size and quality of components employed in construction, plus adherence to rigid safety and wiring rules. Parts operating at full capacity, with no margin for safety, are prone to break down during commercial time on the air with a resultant monetary loss often in excess of that expended for the device in question. For the conscientious builder of composite equipment, this possibility raises the cost of construction and explains in part the usual higher cost of manufactured transmitters. Most firms are reluctant to release a dubious product for sale. In general, reference to Part 12 and Part 13 of the Standards of Good Engineering Practice will give the person who decides to build adequate data for producing approved equipment. With careful planning, and elimination of unnecessary items, composite construction is capable of saving money, but it is amazingly easy to approach the cost of ready-made apparatus without realizing it until the final bill is computed.

Complete transmitters are usually associated with a well-known manufacturer and as such enjoy a reputation of being proven and reliable. Use of such equipment exerts a favorable
(Continued on page 123)

TUBE SUBSTITUTIONS for Radio Receivers

By M. S. KAY

Servicemen's hints, including necessary circuit changes for substituting hard-to-get diode-detector and audio tubes.

IN most sets, whether of the midget variety or console type, the diode detector also incorporates, within the same envelope, the first audio amplifier. This amplifier may be either a triode or a pentode, and is usually resistance-coupled to the output tube. Voltage amplifiers of the resistance type present very few problems since the general principle required for their design calls for as high a plate resistance as possible. This rule is limited only by the amount of voltage that can be put on the plate of the tube. Distortion will result if a large portion of the d.c. supply voltage is dropped across the load resistor so that very little reaches the anode of the tube itself. In this case it is necessary to drop the value of the resistor used until an undistorted signal results. However, this process also results in less amplification being realized, since the over-all voltage output increases as the load resistance increases.

For the serviceman who is trying to replace one of these tubes with another, the most important considera-

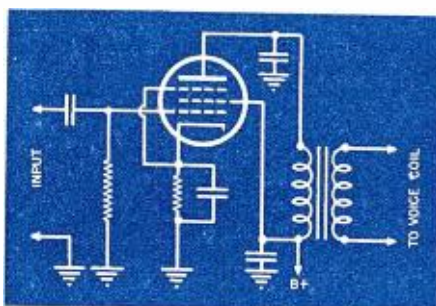

Fig. 1. Typical power-output amplifier. Characteristic curves shown in Fig. 7.

tion is replacement with a minimum of extra work. He will not be bothered with experimentation of load values to see whether good results are obtained. This information should be on hand. Fortunately such a chart is available and is found in the RCA tube manual, pages 198 to 203. Here, for different values of supply voltages, the appropriate values of load resistances are given. Included also is the proper cathode bias resistor.

If a triode is to be replaced by a pentode, the value of the screen dropping resistor also will be found. In general, the serviceman can use any of the duo-diode pentodes or triodes in each other's places as far as output performance is concerned, as long as the correct values of voltages and resistances are inserted.

Power Output Tubes

While all of the preceding tubes may be considered as important, the greatest headache that besets the radio serviceman is concerned with power tubes. For it is here that a bad mismatch shows up quite readily in the loud speaker. And if this weren't enough, one of the most popular tubes used in sets, the 50L6, goes out most easily and is one of the rarest tubes on the market. So perhaps it would be instructive if the power output tubes were thoroughly covered to see what limits are permissible.

Aside from push-pull circuits, which will be considered later, there are basically two types of power amplifiers on the market, triodes and pentodes. Beam power tubes are usually designed for circuits in quite the same manner as pentodes and so will be considered first. The last few years has seen the power pentode take over the output stage since it is capable of greater output with less voltage input. This increase in power, however, has not been all to our good. With the pentode came a large increase in distortion, far greater than what was obtained from a power triode tube, driven class A. Now, there are two reasons why a good knowledge of the triode power output tube may be of use to us. First, because many midget sets have more than sufficient power and, as will be presently shown, operating a pentode as a triode may allow this tube to be used in places where it could not fit before. In normal times this procedure was not necessary. However, with the present war condition, triodes or pentodes used this way may be of service to us, at least until such time as the pentodes may again become easily available. And secondly, by being familiar with the properties of triodes, a greater variety of replacement tubes becomes avail-

Fig. 2. Curves showing the changes in power output and second harmonic distortion for a typical triode tube with various load impedance values.

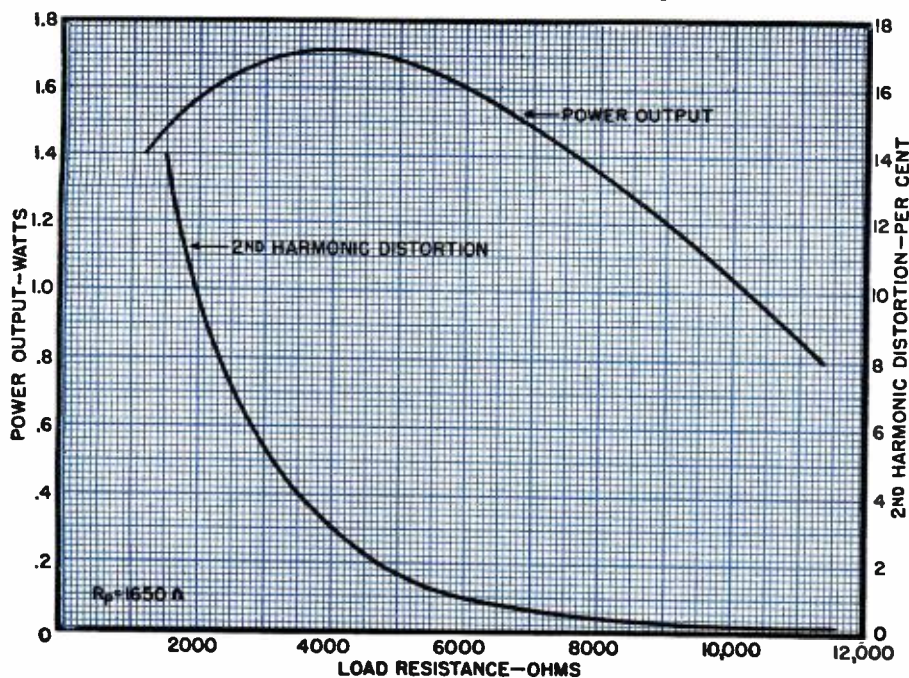

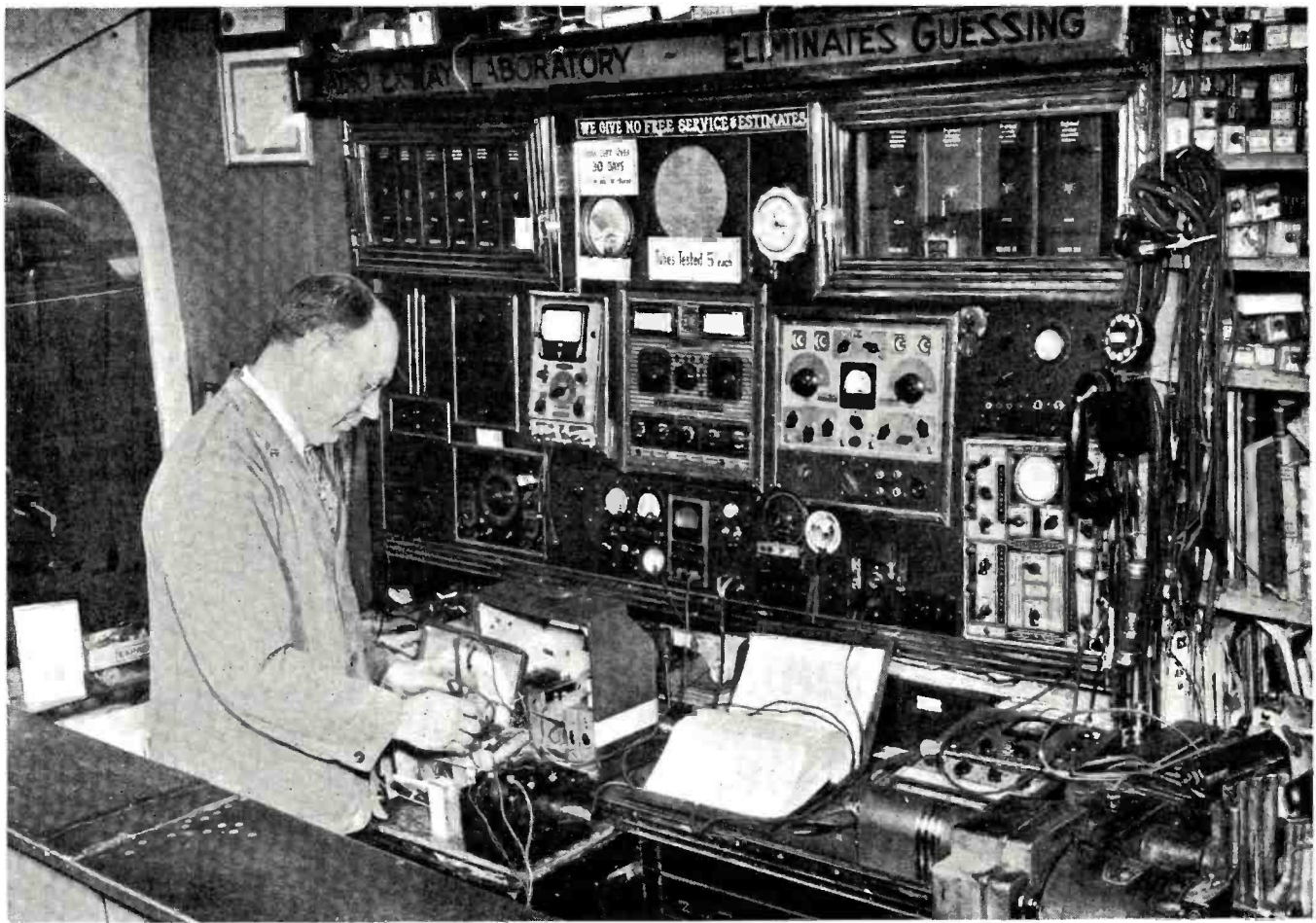

Test bench of Hyman Leve, Boston, Mass., shows careful planning.

able to us, a situation that may be of great use. Following the discussion of the triode, the pentode will then be attacked to see just how much leeway may be had.

For a triode power amplifier, or, for that matter any power amplifier, the main consideration is current, since speakers are current-operated devices. Essentially, the circuit in which the current flows is shown in Fig. 3. Here it can be seen that there are two resistances in series, one being the plate resistance of the tube, the other the load impedance. Now, it can be shown that for maximum power to develop across this load its value should be equal to that of the tube's plate resistance. This condition, however, while giving maximum power, also gives a high percentage of distortion. Consequently, radio engineers prefer a quantity which they call maximum undistorted power and represents a compromise between power and distortion. This condition calls for having the load resistance equal to twice the internal plate resistance of the tube. Distortion, usually allowed at 5 per cent, is mainly due to the second harmonic, there being very little of the higher harmonics present in triodes.

Of interest to the serviceman would be the following considerations.

1. How much leeway is there in load resistance in triodes?
2. How would the power output vary with change in load resistance?

3. And finally, how would the second harmonic distortion vary with the above changes?

Perhaps the best way to cover all three questions at the same time would be by means of a graph showing the variation in load resistance and the related changes in power output and second harmonic distortion. Such a graph has been drawn in Fig. 2 for a typical triode amplifier. As predicted above, the maximum power output with 5 per cent distortion occurs when the load resistance is equal to twice the plate resistance. Increasing the load beyond this value will slowly de-

crease the power output while the second harmonic distortion decreases, at first quite sharply, then very slowly. Hence, increasing the load to 10,000 ohms would only decrease the power output from 1.7 to 1.1 watts. At this load value the second harmonic distortion would be almost zero. With the above chart in mind, it appears that the following conclusions regarding triode power tubes may be drawn.

1. A large increase in load over the optimum value decreases the power output and second harmonic distortion.

2. Decreasing the load from the best value has slight effect on the power output at first, the rate of decrease, however, increasing sharply as the load gets smaller and smaller. The second harmonic distortion, on the other hand, increases quite sharply, a very undesirable condition. As a general rule, then, it is possible to operate a triode power tube with load resistances that vary from $1\frac{1}{2}$ times the internal plate resistance on up. This is a very flexible arrangement, something highly desirable in these days of tube substitutions.

While all of the foregoing applies to the triode, almost the exact considerations apply to pentodes used as triodes. Thus, any beam power or pentode output tube operated with the screen grid connected to the plate can be considered as in the same class as a true triode tube and will have much more flexibility with regards to load resist-

Fig. 3. Triode power amplifier diagram and its equivalent circuit.

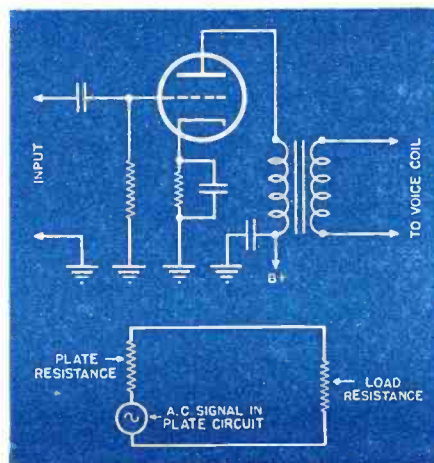

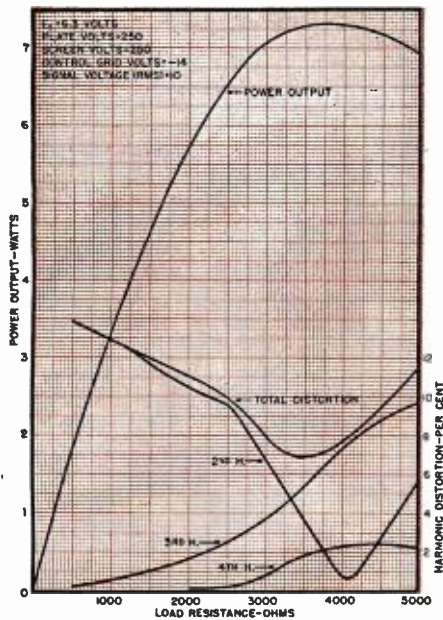

Fig. 4. Variations in power output and harmonic distortion of a 6L6 with various load impedances (recommended load—4200 ohms).

ance than operating the same tube with all the elements separate. Likewise, the distortion would be reduced since triodes have, on the average, less distortion than power pentodes. The one great fault arising from the use of a pentode as a triode, however, is the decrease in power that takes place. As an example, consider the published figures in Table I for a 6L6 taken from a tube manual.

Note the following facts:

1. The triode needs a larger input signal.
2. The output power has decreased from 6.5 to 1.4 watts.
3. The total harmonic distortion has been cut in half as compared to the pentode.
4. The triode load resistance is about three times larger than the plate resistance, which is now only 1700 ohms. For the pentode connection, the load is about 1/10 the plate resistance, a value which is average for such tubes. This is the point that gives the greatest undistorted output in a pentode.

Fig. 6. A 6V6 power-output and harmonic-distortion curve (recommended load—5000 ohms).

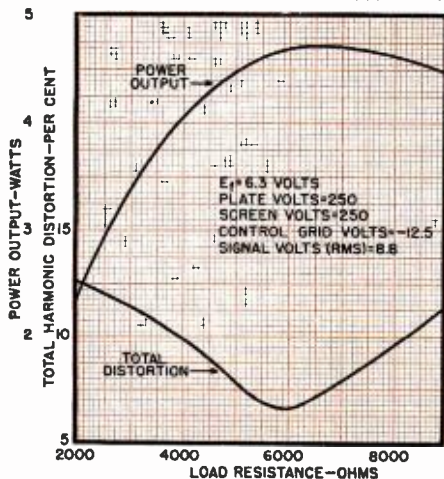

So much for the triode or tubes capable of being operated as such. It has some very desirable properties and one undesirable, that of decreased power. Application of these properties will be delayed while the pentode is being considered. Then, with both in mind, examples will be given to illustrate their use. The above discussion was perfectly general and so may be applied to any related tube. Now the pentode will be analyzed to see between what limits it may be used and still remain of service to us.

To begin, refer to Fig. 1 where a typical pentode output circuit has been drawn together with a chart of its characteristics (Fig. 7) at different load values. The tube is being used as a class A₁ amplifier, at which point is obtained the least amount of distortion. It is seen that with a load of 7,000 ohms, the second harmonic distortion has decreased to zero and only third harmonic distortion is present. With a tube operated at this point, the least percentage distortion is obtained and this might be termed the optimum operating value. On each side of this point the distortion increases. One item of practical interest to servicemen is in regard to the distinction between second and third harmonic distortion. The human ear can stand less third harmonic distortion than second, so a favorite practice among set designers is to operate a tube with a little second harmonic distortion but at the same time decreasing the third harmonic frequencies. Hence, in the above figure, operating the load at 6,000 ohms would increase the second harmonic distortion but at the same time tend to lessen the more unbearable third harmonics. A push-pull arrangement eliminates the second harmonics very nicely, but has no effect on the odd harmonic frequencies.

With the basic ideas just given, let us translate that into everyday tube substitutions. First, it was seen that the load values are more critical in a pentode, quite unlike the previously discussed triodes. Hence, mismatching of impedances may quickly lead to bad results. The question, then, confronting the serviceman who is trying to replace one pentode with another, is, how much leeway is allowed with these tubes? To determine that, it is first necessary to arrive at a definite limit within which each pentode may have its load resistance changed without having the resultant distortion become too noticeable. Results of various tests carried out by engineers indicate that for an average, 12 per cent distortion may be considered as the top value for enjoyable listening. Remember this is an average value, while personal tastes differ widely. As long as we remain below this figure then the chances are very good that the substitution will work to everyone's satisfaction. Inspection of the load resistance versus total distortion graphs of many power pentodes indicate that the load resistance may vary by as much as about 1/3 the

mean value and still keep within our preassigned distortion value of 12 per cent. This mean value is the recommended figure for the load resistance as given in any tube manual.

To cite several examples, refer to Figs. 4, 5, and 6 where the load resistance versus total distortion and power output curves are given for the 6L6, 35L6, and 6V6, respectively. Inspection will reveal that using the above rule will give results that are less than the 12 per cent figure we set. In many cases this may be too conservative a value, while a few cases will be found where more than 12 per cent distortion will occur; on the average, though, it works to our advantage. It is best to point out again that the figure is 1/3 on either side of the optimum value, above and below. With this variation likewise will come a change in power output, but as seen from the above curves, this does not amount to very much. Many a set has far more volume on hand than is necessary for comfortable listening.

It should be noticed, with this meth-

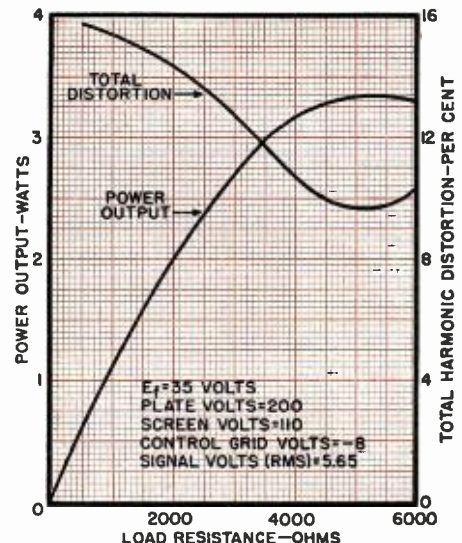
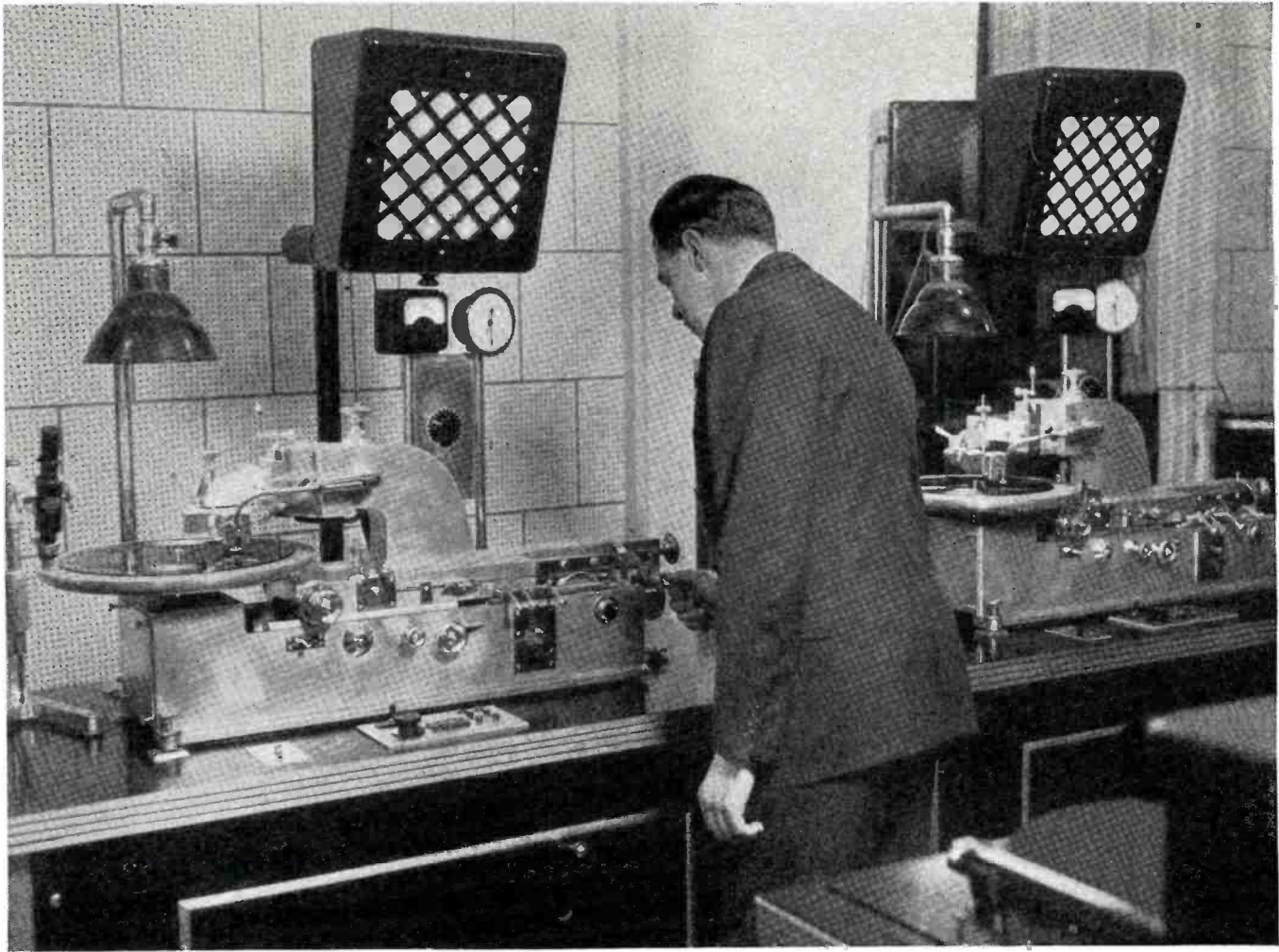

Fig. 5. Power-output and harmonic-distortion characteristic curve of a 35L6 output tube (recommended load impedance—4500 ohms).

od, that in replacing one tube with another, the serviceman need not measure the impedance of the output transformer. For example, suppose a set needs a 35L6 replaced, and, as can easily be the case, none is available. By inspection of any tube manual the recommended load impedance value is 2,500 ohms for 110 volts on the plate. Then any pentode whose recommended load is within reach of this value, by the above rule, may be used successfully. Of course, in addition, there may be some socket changes or a new bias resistor needed, but this is a matter which probably will influence the radio man to pick one tube over another. We are assuming above that the manufacturer did right by the old 35L6 and matched it properly. However, there may be bad cases of mismatching on the part of the designer, in which case the serviceman had best
(Continued on page 130)



Adjusting the feed mechanism on one of the Scully recorders. Controls in foreground are for the automatic relay system, head controls and a variable control for adjusting the program monitor output.

RECORDING LABORATORY- LIBRARY OF CONGRESS

By **OLIVER READ (W9ETI)**
Managing Editor, RADIO NEWS

ONE of the most elaborate and completely equipped recording laboratories in the U. S. A. is installed in the Library of Congress, Division of Music, under the direction of Archibald MacLeish; Dr. Harold Speeback, Director of Music; Dr. B. A. Bobtin, Archivist of American Folk Music; John Langenegger, Chief Engineer; and Arthur D. Semmig, Assistant. It compares with the most modern installations presently found operating with our major broadcast networks.

The purpose of the Laboratory is to record by transcription the history of America on discs for permanent reference for future generations. Every conceivable type of early mechanical transcribers are kept on hand so that from them may be taken history-making addresses, music, etc., from the

early days of the original wax disc, the early Edison cylinder, early commercial records made by acoustical process, and then finally from modern records and transcriptions. Eventually all of these are cut or dubbed on standard 16" transcriptions.

Special sound trucks are sent out into the field to pick up first-hand American folk music from all parts of the United States. Interviews are made with representative folk and they are allowed to talk about whatever may be on their minds, whether it be politics, about the war, or baseball.

As far as technical equipment is concerned, engineers of the Library of Congress have installed units which will give trouble-free service for many years to come.

An elaborate studio is available

where direct pickup may be made under expert direction. Completely sound-proofed and acoustically treated, the main studio includes high-grade microphone equipment and special signal devices which are extremely rapid in their operation. Microphones used include RCA 88A and M1 3044 and a talk-back mike M1 4017 with its associated 78-B1 studio equipment.

In the main recording room is a four channel steel cabinet containing the following: *Hallicrafters* SX-28 communications receiver, *Hallicrafters* S-31 FM-AM high-fidelity tuner, RCA 85B preamplifiers, RCA 94-D monitor amplifiers, RCA 40-D general purpose amplifiers, *Presto* 88-A recording amplifiers, *Scully* recording lathes equipped with RCA MI 4887 recording heads, monitor loud speakers and RCA 64-B.

Block diagram of the entire recording network at the Library of Congress Recording Laboratory

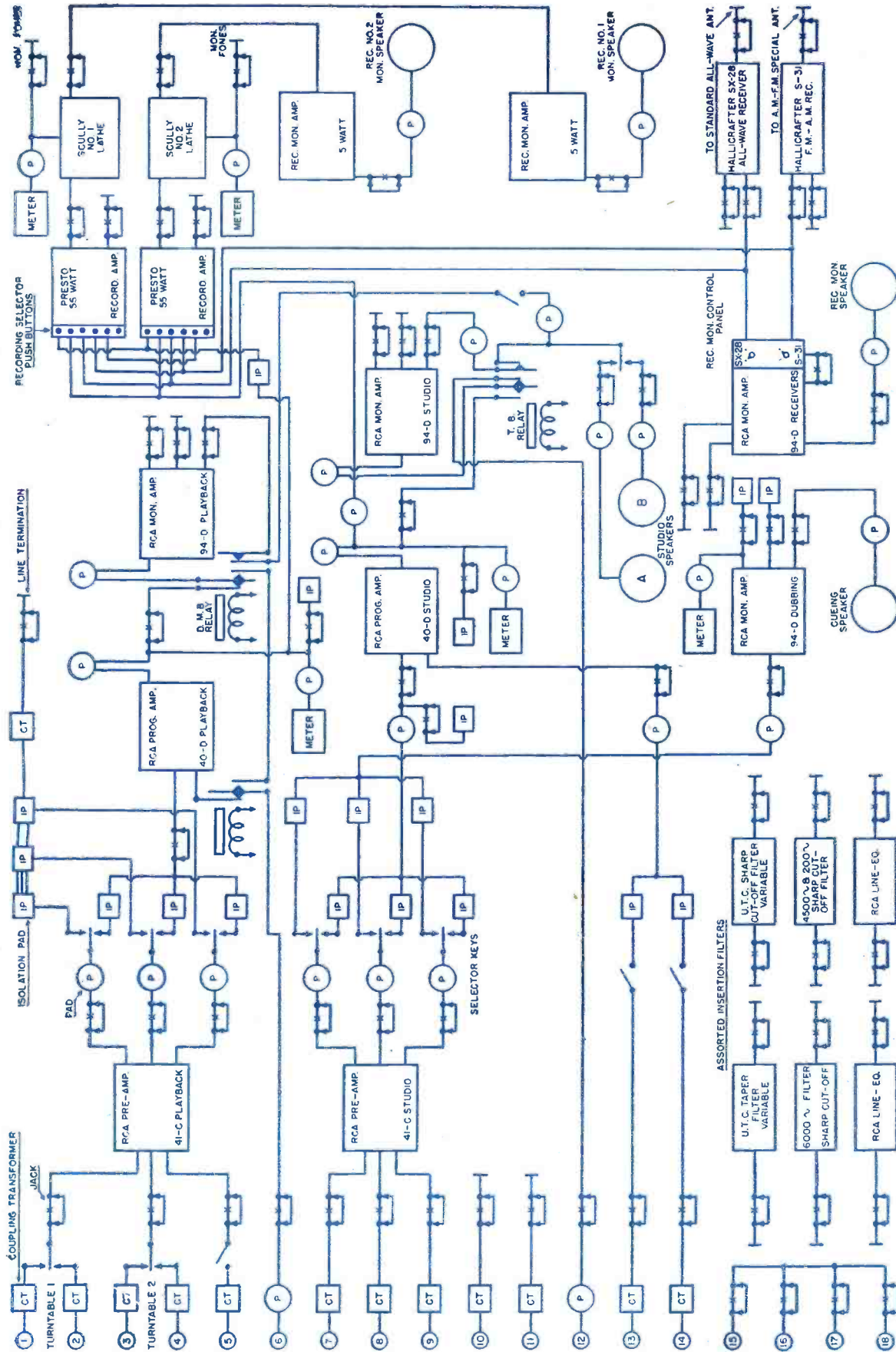

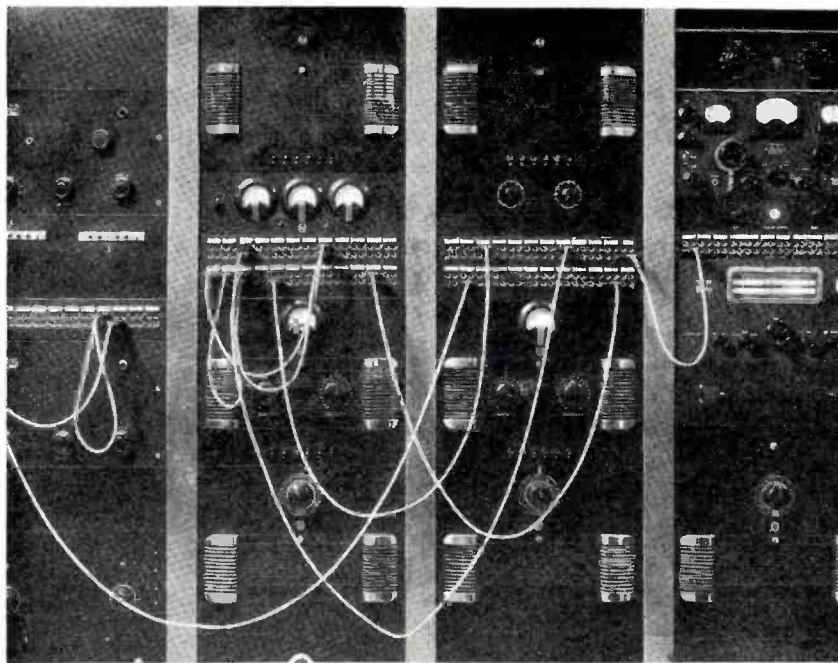

Control panels (left to right): (1) Presto 50-watt recording amplifier and cutting head bridging monitor amplifier; (2) 3 channel preamplifier meter panel, patch panel, RCA 40-D program amplifier and 94-D monitor; (3) 3-channel RCA preamplifier, dual channel line equalizer, patch panel, 40-D program amplifier and 94-D monitor; (4) Hallicrafters SX-28 receiver, and S-31 tuner, and RCA 94-D monitor.

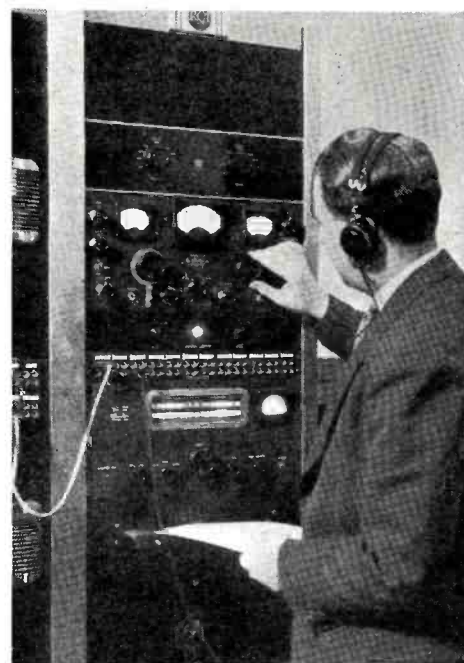

John Langenegger, Chief Engineer of the Library of Congress Recording Laboratory, shown tuning in on the Hallicrafters SX-28 receiver. The high-fidelity AM-FM tuner is shown mounted below the SX-28.

Other equipment includes a pair of *Presto* 6N recorders, a pair of *Fairchild* playback tables, and RCA Type 70-C turntables.

Occasionally programs are recorded which originate outside of the studio. Many receivers and tuners were installed and tried in order to find a combination that would give the highest fidelity possible with an unusually low background level. The final selection included the *Hallicrafters* SX-28 and the S-31. These have been installed permanently as a part of the recording setup.

A group of patch panels permits a wide assortment of possible connections to be made so that the entire system becomes most flexible and so that monitoring may be made at practically any point of any signal circuit.

The two *Scully* recorders are precision instruments and are equipped with automatic spiraling and include other features which make them most flexible in their operation. A special relay operated change-over circuit was devised by the engineers to transfer the modulation from one cutter to the other instantaneously, using push-but-

ton control. High-power microscopes are used for groove examination and allow continuous visual inspection of the cutting as it takes place. Approximately twelve grooves may be seen at one time through these microscopes and a tiny light directly over the record surface gives proper illumination at all times.

If at any time the main recording equipment should fail, the two *Presto* 6N tables may be put into service with little delay. All recording tables are adjusted carefully for proper level and are mounted substantially, then shock-



Portable phonograph equipment, including Presto Model L playback unit, used by secretarial staff when filing historical recordings.



Closeup of dubbing table. Controls include automatic studio control board, filters, and equalizers.



Dr. Arthur D. Semmig operating oldtime cylinder transcribing machine. Crystal pickup output is fed to Scully recorder for dubbing.

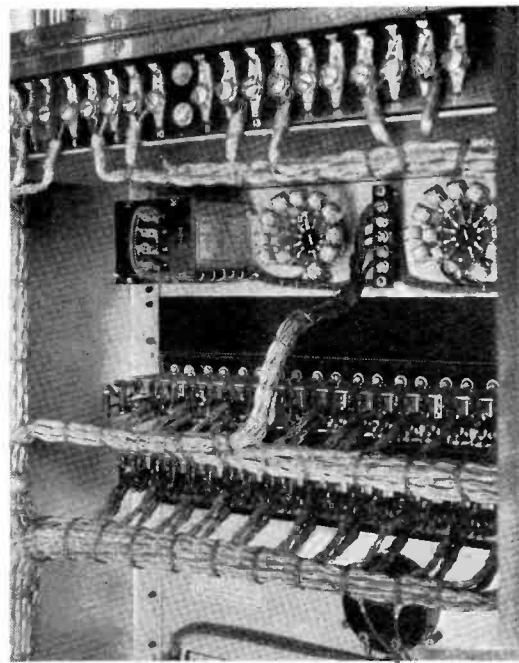

Back view of patching panel and line equalizer. All wiring is neatly cabled and well shielded.

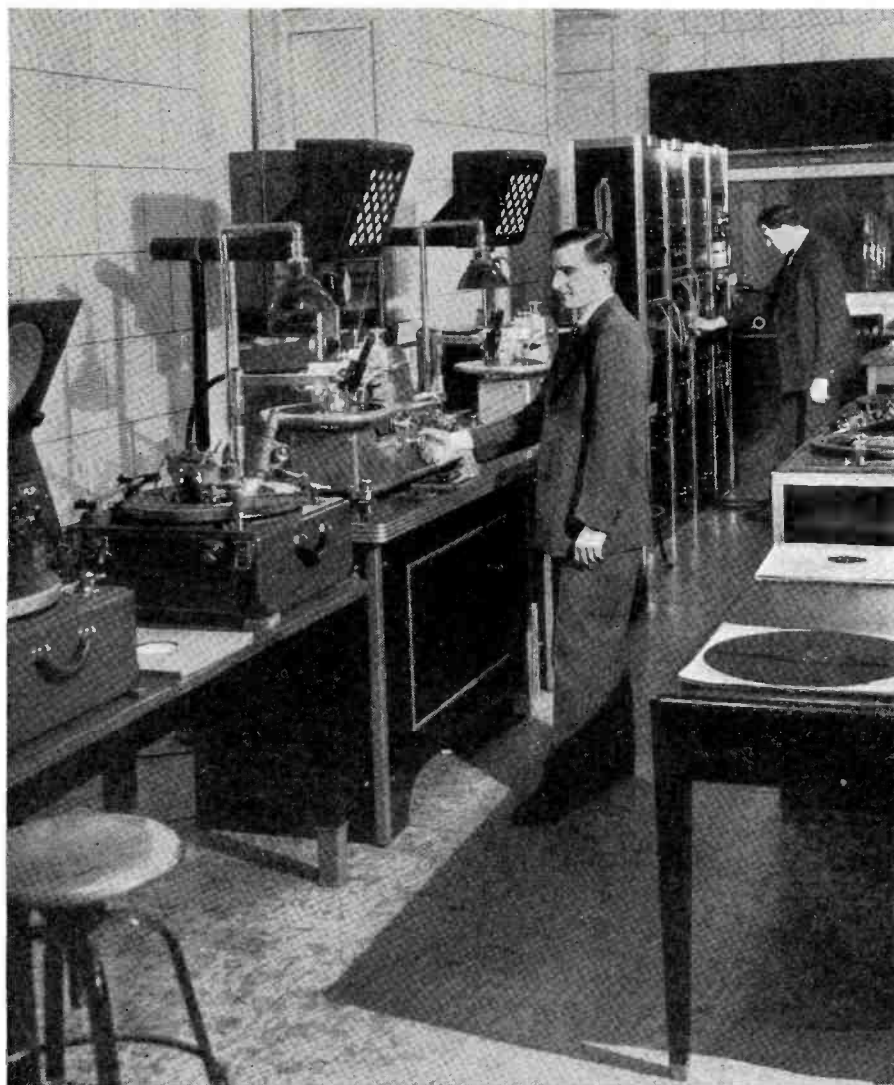

Complete recording setup includes two Scully recording machines, two Presto 6N recording machines, RCA high-fidelity amplifiers, Presto recording amplifiers, Fairchild playback tables, and Hallicrafters S-31 and SX-28 receivers.

proofed to guard against external vibrations.

Inasmuch as a wide combination of dubbings is used, special mixing panels have been assembled to give the widest possible flexibility to the particular dubbing technique employed for any given type of transcription. The dubbing panel includes *Brush* PL-20 and RCA pickups. Other controls include an automatic studio control board with talkback mike, on-the-air switches, cue lights and various filter and equalizer switches, attenuator controls and three faders.

A Customers' Room next to the Recording Laboratory was installed so that clients visiting the Library could have an opportunity to hear copies of discs which they required for historical reference. The equipment includes *Presto* Model L playback and a *Hallcrafters* high-fidelity speaker system. This room is also soundproofed.

One of the most interesting pieces of equipment found in the Laboratory is an oldtime cylinder transcribing machine. A crystal pickup has been installed in place of the original mechanical pickup so that the sound from the cylinders may be sent directly to the main recording equipment for dubbing. By the careful and intelligent use of equalizers, much of the original noise can be removed and the over-all cutting improved. One of the photographs shows Dr. Arthur D. Semmig operating this interesting and historical unit.

Completed transcriptions are carefully stored in metal containers and are placed in air-conditioned vaults where they will be kept clean and orderly for years to come. Careful indexing and tabulations make the finding of any one particular disc but a simple matter. Yes, America's voice is being preserved.

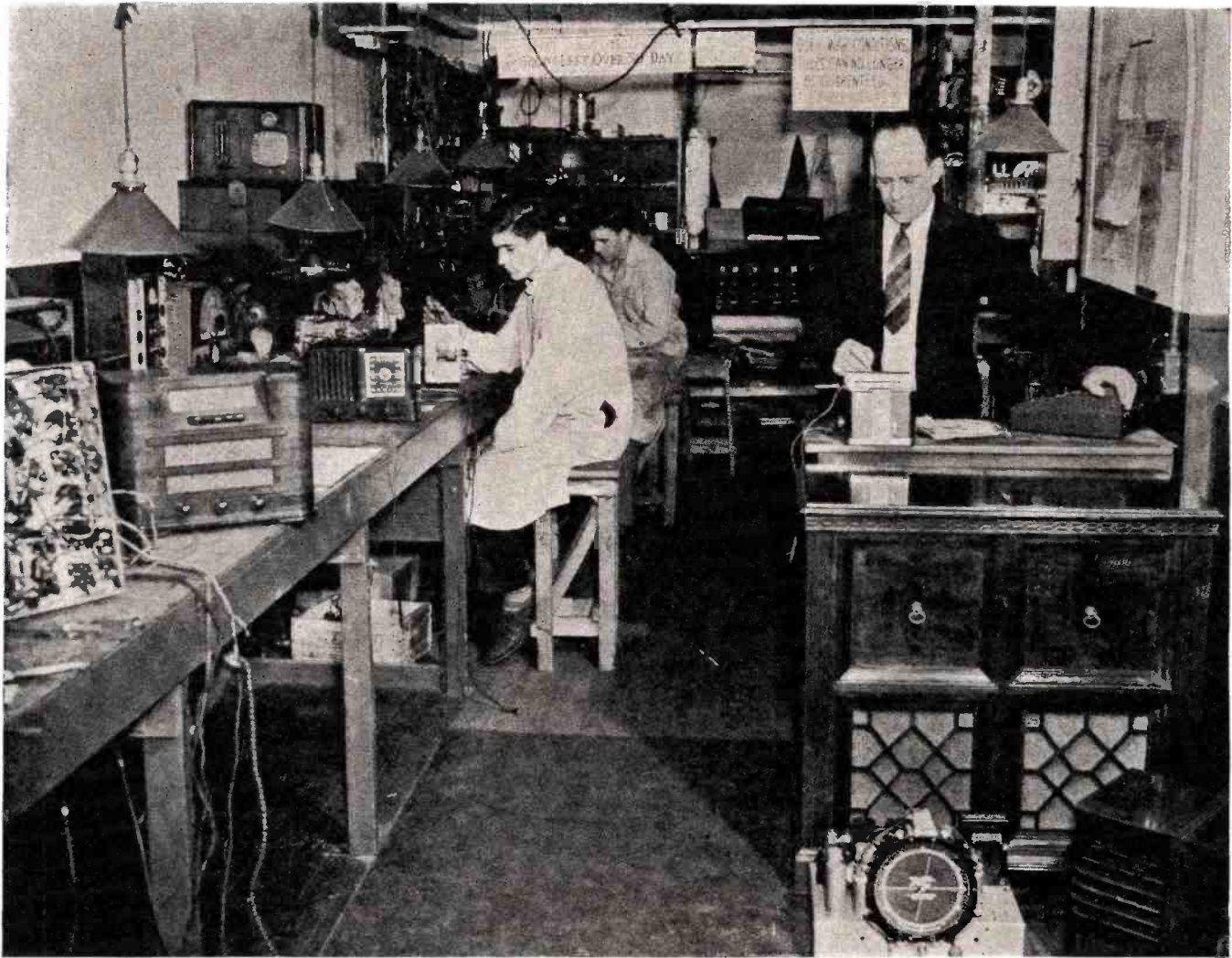

Present-day parts shortages create an additional burden on the serviceman, demanding an efficient substitution procedure.

THE business discussed in this article is operated by my father and myself and was founded by my father in 1904. This is the second war the shop has managed to survive, so perhaps I do not "view with alarm" in the proper manner. The problems of the radio serviceman, as I see them, boil down to two factors: manpower and the unavailability of mechanical parts.

So much has been said by the press about the shortage of tubes that perhaps the reader will wonder why that isn't my number one complaint. The fact is, I have experienced some difficulty in the matter of securing tubes for replacements, and I have none to sell over the counter. A careful substitution of similar tubes with the same heater voltages and characteristics has made it possible to put sets in working order without resorting to adapters or circuit changes. Some servicemen have been making such extreme changes and tube substitutions by rewiring the set that the owner often wonders what has happened to his radio. The owner may seem satisfied with the set because it is playing, but he will avoid such a serviceman in normal times because of his lack of confidence in a serviceman who pro-

duces that caliber of work. It is better to turn a radio back to the owner not operating than it is to make some changes on his radio that will make it play in a poor manner.

The lack of mechanical parts, such as springs, dials and speaker cones, is keeping many sets on the workroom shelves. The unavailability of these parts is due almost entirely to the fact that the wholesalers are unable to fill the orders because of the press of priority business and their own lack of manpower, not due to the lack of parts in stock. If this condition could be eased, we could release many radios we are now holding.

The manpower situation is not so easily cleared. Before the war, eight fulltime repairmen and one general apprentice were handling the repair

end of the business and I worked in the store. Today, I have two repairmen, one of whom is in 1-A, and myself. Since I can no longer take care of the store, answer the phone, and take in sets, I have enlisted the aid of the distaff side of the Becker family. All servicemen are not as fortunate as I in being able to solve part of their manpower shortage in this manner, but nevertheless I am faced with the problem of finding repairmen. At the start of the war, I began training high school boys to do service work and had some fair amount of success, but it was only a matter of months before they were seventeen and eligible for service in the Armed Forces, so I had to give that up.

Former employees who return home
(Continued on page 98)

Problems of a **RADIO SERVICEMAN**

By **ART BECKER**

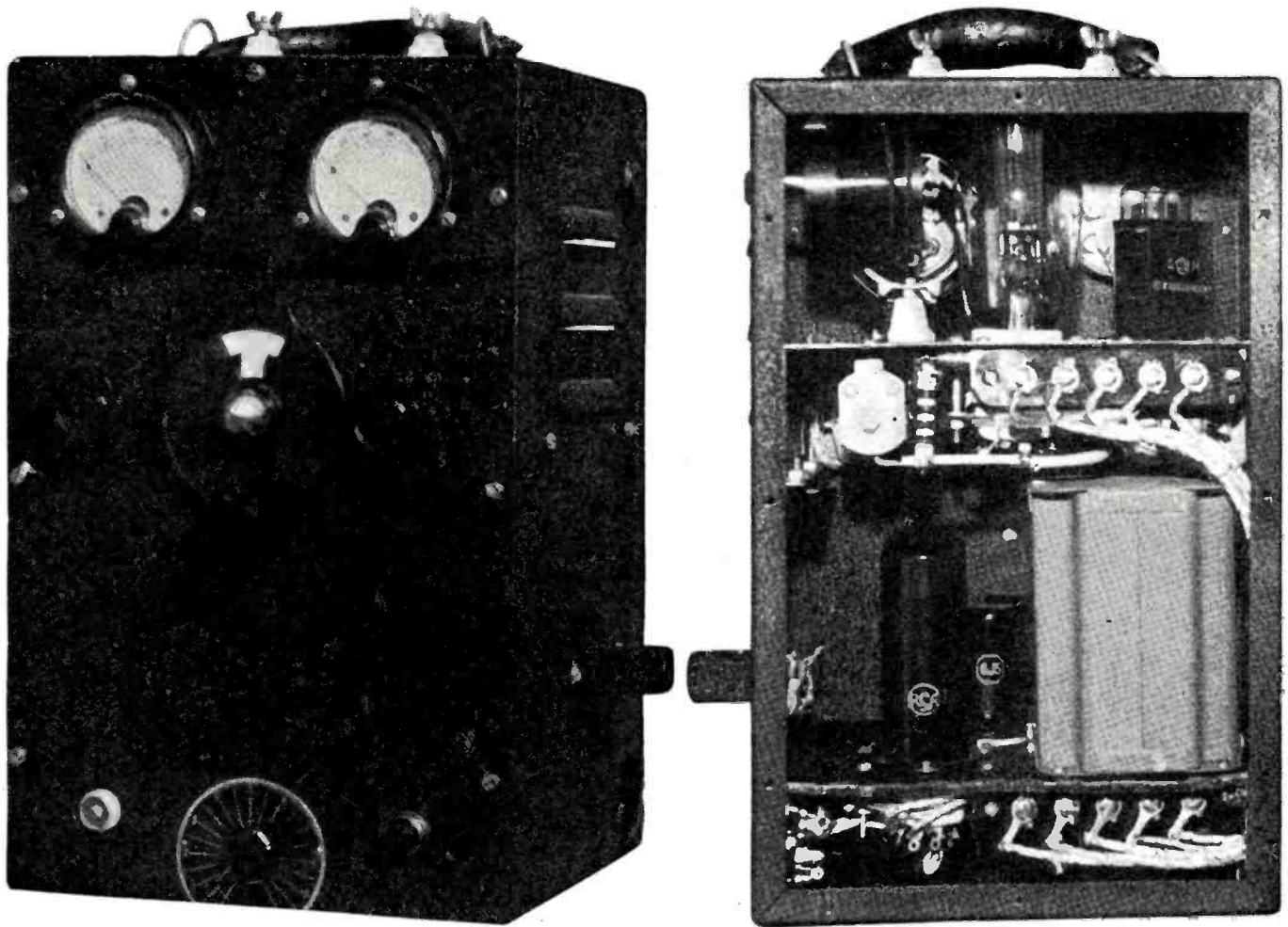

Modulator and r.f. portion of the portable transmitter. Power supply is mounted in separate cabinet.

6-8mc. PORTABLE TRANSMITTER

By **WILLIAM MARON**

Radio Engineer

Constructional details of a versatile four-channel crystal-controlled two-unit portable transmitter, power output being approximately 30-35 watts.

IN DESIGNING a portable transmitter, two diametric forces are at work, one being to obtain as much power output as possible and the other to keep the physical size down to a minimum.

Of course, there are many other factors that must be considered: versatility, reliability, quality of emitted signal, simplicity of operation, ease of servicing, use of standard tubes, and the like, but these factors merit consideration in any transmitter.

Power output versus physical size has been the buoy marking the channel in this design—the other necessary objectives were not neglected, either.

The transmitter is built in two units—it is more correct to say that the power supply is separate from the

audio- and radio-frequency chassis—for several good reasons.

It enables each unit to be smaller, making carrying, packing, storing and even operating easier. The power supply is separate and better shielded, therefore decreasing chances of hum disturbances in the audio and of r.f. getting back into the power supply.

Operation is very convenient as the power supply can be set on the floor, while the transmitter is placed on a table, or some other similar arrangement where space is limited.

The following describes the transmitter, together with construction data. Power is 30-35 watts, four-channel crystal control. It is designed for operation between six and eight megacycles. The operating frequencies may

be changed by any constructor to meet individual requirements by simple alterations in the tuned circuits and selecting different crystal frequencies. The antenna coupler may also readily be changed to match various antenna types and feeders.

The housing cabinets are seven-inches deep, eight-inches wide and twelve-inches high. In one cabinet is the power supply; space in the lower half is utilized for storing interconnecting cables, antenna, microphone and accessories. The other cabinet contains the audio- and radio-frequency units, complete with antenna coupler.

Fig. 1 shows the complete circuit schematic. The tubes used are as follows: 6J5G as a Pierce oscillator, a

6L6GX as a neutralized r.f. power amplifier, while a 6SJ7, 6C5 and push-pull 6L6's comprise the audio-frequency-modulator unit. An 83 followed by a choke-input two-section filter is used for the power supply.

Adequate filtering and bypassing are incorporated in the audio-frequency section so that a pair of headphones put across the output of the *modulator* gives only a barely audible hum with the phones tightly pressed against the ears.

For mobile operation or in places where mains power is not available, a six-volt storage battery and dynamotor or vibrapack may effectively be used.

The Pierce oscillator was selected to eliminate a tuned oscillator tank circuit. Sufficient output is obtained

from the oscillator to excite the power amplifier. Rapid change of output frequency is accomplished by turning the crystal selector switch to any one of four crystal channels and retuning the power amplifier to resonance.

Where the crystal frequencies are fairly close together it is not necessary to retune the amplifier and so frequency changing means merely turning the selector switch to the proper crystal in which channel operation is desired.

Two switches are on the power supply panel. One is in the a.c. mains. Snapping this one "on" energizes the power transformer lighting the filaments in all tubes . . . the other switch is in the centertap of the high-voltage winding and is used for turning the carrier "on" and "off"

An interesting feature is incorporated in the transmitter. A small six-pin Jones female plug on the side of the a.f.-r.f. unit is connected as shown in Fig. 1 and appears in several of the illustrations.

Here is the purpose of this plug: When the transmitter is used with a receiver having its own power supply or for transmitting messages one way, or other similar purposes when reception is not required, a dummy male plug is inserted to complete the circuit and the regular switch in the high-voltage winding centertap is used for controlling the transmitter.

However, should it be desired to use a small receiver, not having its own power supply, then another male plug (MP1), wired as shown in Fig. 1, is used to conduct power to the receiver.

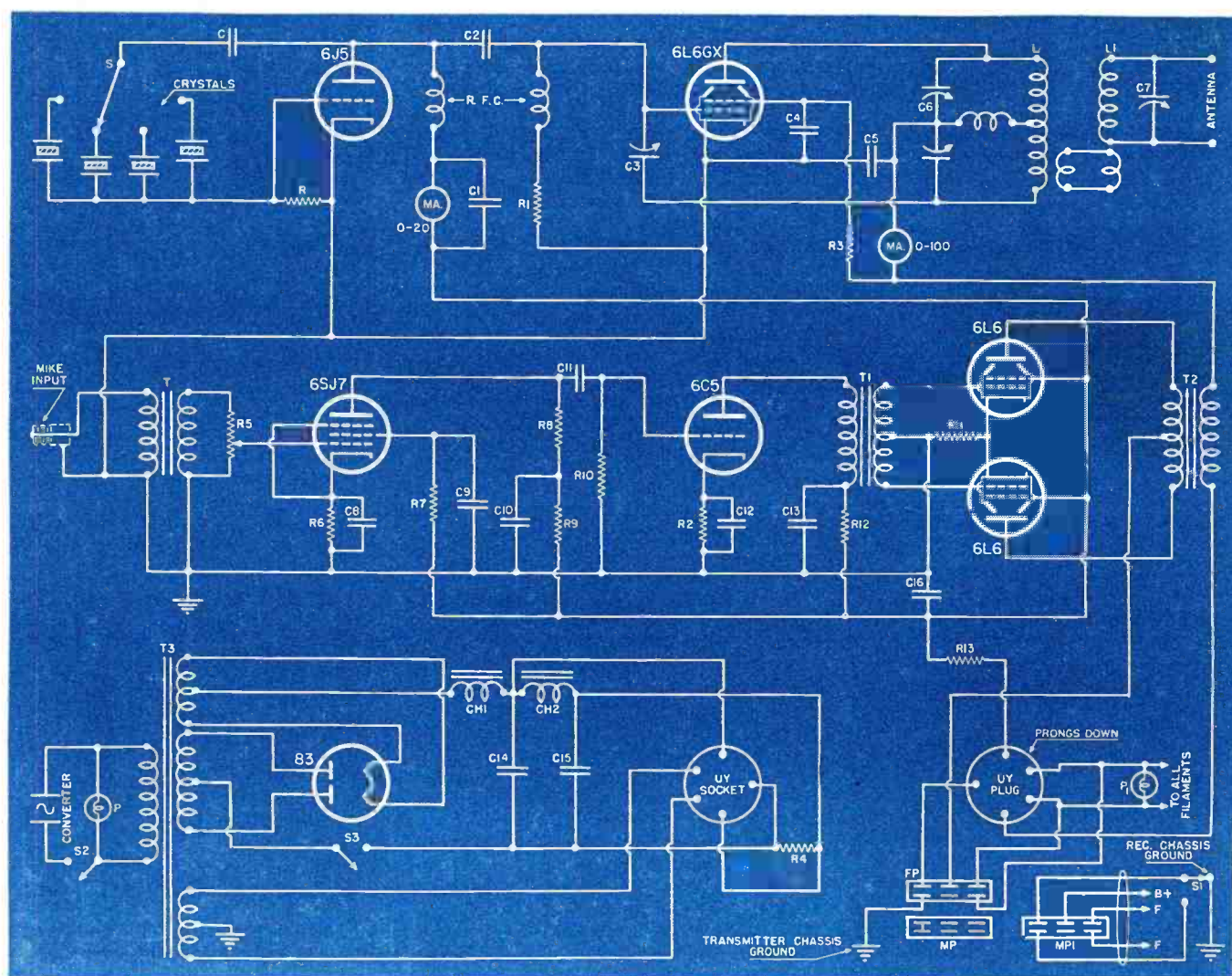
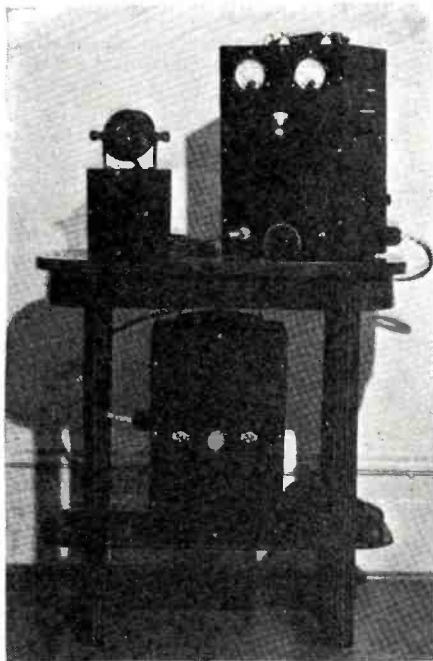

Fig. 1. Diagram of transmitter, encompassing a standard Pierce oscillator, neutralized r.f. power amplifier and push-pull 6L6 modulators.

C— $.006 \mu\text{fd.}$ mica cond.
 C₁— $.001 \mu\text{fd.}$ mica cond.
 C₂— $.0001 \mu\text{fd.}$ mica cond.
 C₃—8-plate double-spaced midget (Bud) cond.
 C₄— $.01 \mu\text{fd.}$, 600-v. paper cond.
 C₅— $.002 \mu\text{fd.}$ mica cond., 2500 v.
 C₆—dual variable cond., 60 $\mu\text{fd.}$ per section (see text)
 C₇—100 $\mu\text{fd.}$ midget variable cond.
 C₈, C₉, C₁₀, C₁₂, C₁₃, C₁₅—8 $\mu\text{fd.}$ elec. cond.
 C₁₁—1 $\mu\text{fd.}$, 400-v. paper cond.
 C₁₄, C₁₅—8 $\mu\text{fd.}$, 525-v. elec. cond.
 R—50,000-ohm, 1-w. res.

R₁—20,000-ohm, 1-w. res.
 R₂—2000-ohm, 1-w. res.
 R₃—35,000-ohm, 5-w. res.
 R₄—200,000-ohm, 20-w. bleeder
 R₅—1-megohm pot.
 R₆—1500-ohm, 1-w. res.
 R₇, R₁₀—1-megohm, 1-w. res.
 R₈—500,000-ohm, 1-w. res.
 R₉, R₁₂—10,000-ohm, 1-w. res.
 R₁₁—200-ohm, 20-w. res.
 R₁₃—5000-ohm, 5-w. res.
 RFC—R.f. chokes, National # 100
 S—S.p. rotary switch
 S₁—S.p.d.t. switch

S₂, S₃—S.p.s.t. switches
 T—Microphone trans., Stancor
 T₁—Single plate to p-p. grids (Thordarson)
 T₂—Mod. trans., UTC Vari-Match
 T₃—375-0-375 volts a.c., 200-mill. 5-v. 3-amp., 6.3-v. 6 amp., Stancor
 Ch₁—10-henry, 200-mill. filter choke
 Ch₂—20-henry, 200-mill. filter choke
 P—110-v. pilot light
 P₁—6.3-v. pilot light
 FP—6-connector chassis socket, Jones
 MP, MP₁—6-connector male plug, Jones
 UY—5-prong socket and plug



Complete transmitter, constructed in two units, set up in operating position.

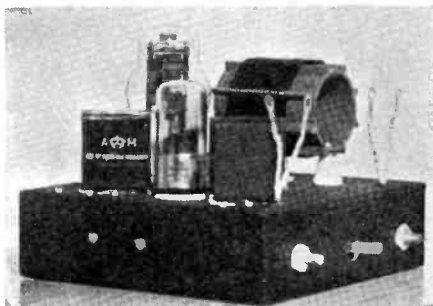

Three-quarter view of the r.f. chassis, showing proper placement of component parts.

Rear view of power supply cabinet, showing storage space for accessories.



A single-pole, double-throw switch on the receiver becomes the control switch by leaving the previously mentioned switch in the "on" position.

Throwing the switch on the receiver to "send" will remove the "B—" return from the receiver and connect it to the transmitter (carrier on the air). Reverse operation occurs when the switch is turned to "receive."

Construction is relatively simple, although attention should be given to layout and soldered joints. Too much stress cannot be put on the last mentioned point, as any portable equipment receives plenty of hard knocks and jolts in the course of a day.

Many of the components shown cannot be obtained and equivalent substitutes may be successfully used.

The power amplifier tank condenser (C_6) was originally a National 150- μ fd. receiver type. It was converted to a splitstator (about 60- μ fd. per section) in about an hour's time. The tank coil (L) is wound on a large Bud receiver type form, 2 $\frac{1}{4}$ " in diameter and pregrooved. The flange and pins were sawed off so that the final length is three inches, the coil being twenty turns. The antenna coil (L_1) is wound on an ordinary black bakelite form, 1 $\frac{1}{2}$ " in diameter.

Metal 6L6 tubes are quite scarce, but glass tubes operate equally well, the 6L6GX being used because it was on hand.

The photographs clearly show the placement of parts on the a.f. and r.f. chassis. Underneath views should prove extremely helpful to anyone duplicating the transmitter.

The front panel of the a.f.-r.f. unit encompasses two meters, one a 0-20 ma. to read the 6J5 oscillator plate current. The other meter, being a 0-100 ma., is wired directly into the power amplifier d.c. plate circuit, thereby showing the plate current of the 6L6 power amplifier tube. Standard two-inch meters are used.

The lower left of the panel has an Amphenol chassis connector for the microphone input, an a.f. gain control and a red pilot light.

The antenna loading is tuned by inserting a small screwdriver through a hole (insulated with a rubber grommet) in the right side, near the top, and toward the rear.

The antenna coil has its tuning condenser mounted inside the form, with a slotted shaft to engage the screwdriver. The antenna feeders are coupled to two ceramic feed-through insulators on top of the cabinet. Wing nuts are used for ease in attaching the feeders, the ends of the bolts in the feed-through insulators are burred to prevent loss of the wing nuts.

No internal photograph of the power supply chassis is shown as the placement of components is not critical as long as all parts fit into the available space.

Putting the transmitter into operation is rather simple. After construction is completed a careful check of the wiring should be made. Making sure both switches on the power sup-

ply panel are in "off" position, insert all tubes in their respective sockets, also the dummy plug should be in place and one or more crystals. The power cable between the two units is connected, as is the power cord to the a.c. inlet of the power supply, it then being plugged into a mains outlet.

The mains switch is turned "on" and the filaments are allowed to warm up at least fifteen minutes. This rather lengthy warmup period is required the first time so that any mercury splattered on the filament of a new 83 will vaporize off and prevent damage to the tube when the high voltage is applied.

Snap "on" the other switch and note the oscillator plate current. If it is

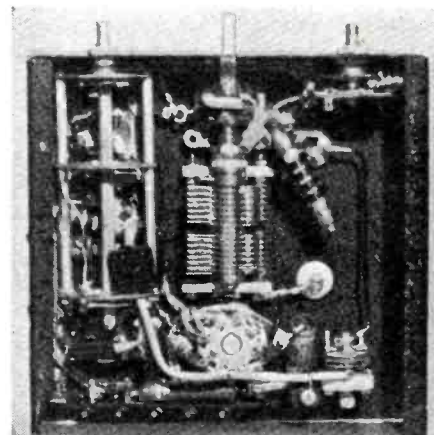

Bottom view of r.f. chassis.

much above 10 ma. then the crystal selector switch happens to be in a position where there is no crystal, if the full complement of crystals is not being used. Merely rotate this switch to a crystal position. With a good crystal and correct wiring the oscilla-

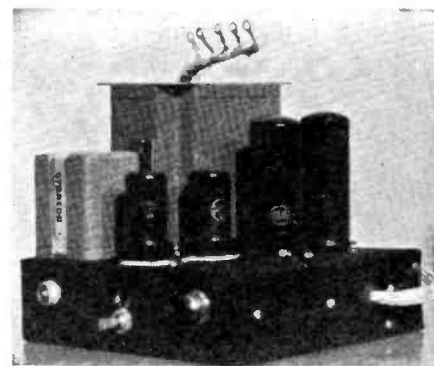

Three-quarter front view of the a.f. chassis. Note the high quality transformers used.

tor will function without any further ado.

The amplifier tube should next be neutralized by conventional methods. The 6L6 tube can be perfectly neutralized despite many opinions that it cannot be.

The amplifier is then tuned to resonance—no load current is about 15 ma.

If the antenna has not been connected up to this point, it should now be done, and tuned so that the ampli-

(Continued on page 126)

HOW many turns should the antenna pickup coil have? is a question frequently asked by the average constructor of transmitters. The general practice is to use a random number of turns and hope for the best, but relatively few amateurs are aware of the exact requirements of coupling devices, or of how to determine them. At first thought, it might seem that the turns ratio would be important. Audio transformers, for example, reflect an impedance from secondary to primary which is a function of the square of the turns ratio. Thus, if a transformer having a 5 to 1 ratio and unity coupling, primary to secondary, were loaded with a 100-ohm resistor, a resistance of 2500 ohms would appear across the primary. In order to match this 100-ohm load with this transformer, therefore, a 2500-ohm source of energy must be connected to the primary. A maximum of power will now be transferred.

The coupling of energy from a class C amplifier tank circuit to a transmission line is a somewhat different matter, however. For an analysis of the situation, let us refer to Fig. 1.

The turns ratio of L_1 and L_2 has little bearing on the system other than to provide the required amount of mutual reactance. The only other factor is that the loss in the two coils will be a minimum if they are so proportioned that the I^2R (copper) loss in L_1 will equal the I^2R loss in L_2 . Therefore if the current in L_1 is less than the current in L_2 , a somewhat greater efficiency will be obtained if L_2 has more turns than L_1 . However, it is possible to effect a satisfactory match with a wide variety of values for X_1 and X_2 .

When matching the plate of a class C amplifier to some external system, it should be remembered that the problem is to present to the plate circuit, at the output frequency, a resistance which will make the tube load up to the point where the desired output power is obtained. This is quite a different proposition from making the external impedance equal to the internal impedance. (If the internal impedance of a source of energy is made equal to the impedance of the load being supplied, a maximum of power will be transferred, but the efficiency will be only 50%.) If the coils L_1 and L_2 had no resistance (hence no dissipation) the resultant efficiency of the matching system could be made 100%. Unfortunately, these coils will have some resistance, so that such a high conversion efficiency would be impossible to realize. We can, however, reduce these losses to a minimum by properly designing the coils (correct form factor, and wire of adequate diameter, wound on forms of low loss or preferably self-supporting). Such well-constructed coils will have a high Q (ratio of inductive reactance to effective resistance) and an efficiency of some 90% can be realized for the matching system. The efficiency of the

R.F. Impedance Matching

By **M. DEAN POST**

Senior Instructor, AAFTTC

Design hints for amateurs on r.f. impedance matching, to obtain maximum transfer of power.

class C amplifier in converting d.c. power to a.c. power is another matter, and is dependent upon the characteristics of the tubes, the amplitude of the impressed driving voltage, the grid bias, and the plate voltage. A conversion efficiency in the order of 70% can be secured in most cases, except for the very-high frequencies and above.

Let us investigate a hypothetical case in order to clarify the situation. Suppose in the particular tube of Fig. 1, the desired output power will be obtained if the load impedance is equal to 4000-ohms resistance at the output frequency, and further that with this load and appropriate B and C voltages and grid driving voltage, the efficiency might be 70%. Then the problem of the matching network is to present this 4000-ohm load to the tube. The coil L_1 and its tuning condenser compose the tank circuit, but in addition, a resistance R_1 is reflected by the coupling system so that it is effectively in series with L_1 . Assume the coil L_1 to have a reactance of 400 ohms. For all practical purposes, the approximate expression for reflected resistance is X_1^2/R , where R is the load resistance mentioned above. Then the resistance R_1 , which is reflected by the coupling circuit must be, for maximum secondary current,

$$R_1 = \frac{(400)^2}{4000} = 40 \text{ ohms.}$$

Since we are attempting to feed a transmission line which has, say, a characteristic impedance of 72 ohms, the 40 ohms must be secured by ob-

taining the proper mutual reactance (X_m). The condition for maximum secondary current I_2 is obtained when $X_m = \sqrt{R_1 R_2}$. For our case, therefore, $X_m = \sqrt{40 \times 72} = 54$ ohms. In other words, the inductance L_2 must be made of such a magnitude that 54 ohms of mutual inductive reactance can be secured. If only 54-ohms mutual reactance is used, then the secondary should have a series condenser so that the effective reactance in the secondary is zero. However, in many cases it is possible to secure the proper adjustment without tuning the secondary by considering the fact that in addition to resistance, some reactance may be reflected by the coupling due to the nature of the load, which in some cases may not be purely resistive. If desirable, this additional reactance could be tuned out, if not too large, by a slight readjustment of the tuning condenser. Extreme caution must be observed if this practice is followed, however, because too much adjustment of the tuning condenser will throw the tank circuit seriously out of resonance. If the load is an antenna, coupled to the tank circuit by means of a 72-ohm line, the antenna should be properly trimmed to the operating frequency so that it offers a pure resistive load. This condition can be indicated by observing the d.c. plate current meter, and the dial setting of the tuning condenser. When the antenna is properly cut, no change in the condenser setting will be necessary to obtain resonance when going from no load to full load.

(Continued on page 110)

Fig. 1. Diagram used to analyze the electrical characteristics of a Class C amplifier tank circuit coupled to a transmission line.

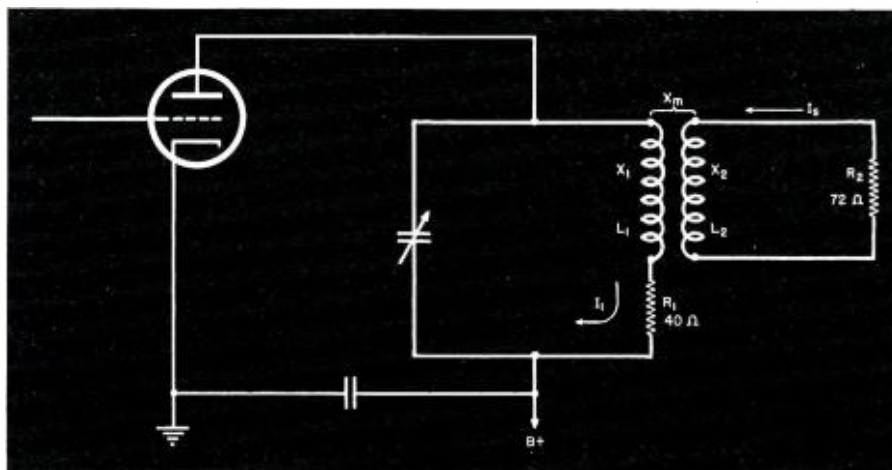



By **CARL COLEMAN**

JIMMY YOUNG has taken a tanker out of the East Coast. Al Fuller has been assigned to a new cargo job. James Minn was out on a former small passenger vessel for a few trips. P. Karamt is on a Liberty assignment and S. A. McGowan was assigned to a fine berth aboard a cargo-passenger job recently. L. Naughton was in the big town for a brief vacation a short while ago. E. Crabtree is still on his cargo craft which he likes so well. W. Panza is still with the Agwi Lines and O. Oland left the Atlantic Coast recently aboard a tanker assignment.

THE War Shipping Administration has reported a continued shortage of marine radio operators to man the merchant marine vessels. The three men to a ship regulation which went into effect some months ago has caused a shortage of men that appears difficult to overcome. There even have been several reports of men having obtained a release from the Armed Forces in order to join the merchant marine; these cases however, appear to be few and far between. Ex-merchant marine men now working ashore have been urged by the WSA to return to sea as operators if at all possible to do so. Contact U. S. Maritime Service at 45 Broadway, New York City, or your local marine radio operators' union. Any local WSA office will also be able to give you the necessary information on getting started back to sea.

FRED HOWE of The Radio Officers' Union reports a new location at 1440 Broadway, room 1568. The new location is near 40th Street in the Times Square district. The new office of ACA is at 5 Beekman Street, New York City.

R. T. LEMON, director of War Shipping Administration's maintenance and repair division in New York, reported that overmanning by the various ship repair yards in the district had caused them to overcharge the U. S. Government for repairs to government operated ships of the merchant fleet. The ship operators, acting as WSA agents, make the only check on repair costs. Merchant ship repair costs in 1943 totaled about \$600,000,000 throughout the country. WSA, by the way, has now started taking them young; lads of 16 to 17½

years of age may enlist in the U. S. Maritime Service provided their parents give consent. Previous minimum age was 18, which was for deck and engine training service. Radio training requirements are still the same.

E. K. CHRISTIAN sailed after a few weeks ashore, taking out a cargo assignment. K. Skaaren is looking for a new berth ashore. Joe Maloney is with U. S. Maritime as inspector now. Dave Carruthers reports having invested in a "country estate"—we hear it is out in the sticks—over in Jersey. R. Lacey was in recently aboard a Liberty. W. C. Simon of TRT went down to NOLA on business recently, getting his new service organization going.

HEARST newspapers carried a short but interesting story by Ernie Pyle from the Anzio area concerning the loading and discharging of cargo aboard merchant vessels. It's something to think about when you are in a location like that and probably loaded with munitions. The Japs have boasted that their ship construction in 1944 would be double the output of 1943—they will need it. Rear Admiral E. L. Cochrane, chief of the

bureau of ships, announced an increase from 380 fighting units in the U. S. Fleet four years ago to over 1200 at the present time.

CHARLIE REBERGER and C. Tjevenet, last heard from down in the Gulf, will be interested to know that Charles Leipert recently passed his exam for a position as Radio Inspector with FCC; he will stay, however, in the RID as Monitoring Officer out on the West Coast. K. Sullivan has taken out a tanker assignment from the East Coast. N. Heeley and T. Molerg are both on new cargo berths. Shandy of RMCA in New York has been transferred to the Great Lakes Division. Not having heard from L. Hvidsten, who is in the Armed Forces for some time, we suspect he has been shipped overseas. T. Haulker has been assigned to a tanker out of the East Coast. H. Fuller is now aboard a cargo vessel. F. Rasees has been assigned a new freighter berth after a short stay in New York. Harry Morgan of ACA is on leave, Murray Winocur taking over in New York. B. Edwards is now free after a release from the Army, and located in Texas trying to get organized again; he is interested in information from the West Coast around Frisco.

A VERY interesting letter from one of the boys in radiotelephone work brought out a request for information which ex-marine men in other lines of work ashore may have had in mind . . . "One or two of us have been nursing the ambition to do a little coastwise brass pounding, or what goes for it nowadays, on our vacations." These men have a three-week vacation period during the summer and figured that they might get in a trip as a relief operator while the regular man was ashore for his vacation. "A bit of monitoring on 500 kc. seems to show that there isn't much work going on up there, and it seems likely that the transmitter would not be opened up from start to finish. This takes a little of the joy out of the prospect.

We contacted the folks who could give us the information and they held the same opinion that we had, namely that to start with the average ship's voyage in wartime is much longer than three weeks and even the shortest runs would be over that time. Also that as the movement of ships during wartime is a military secret it is
(Cont. on page 94)



THEORY AND APPLICATION OF U.H.F.

By MILTON S. KIVER

Part 6. An introduction to the more recent method of transporting energy at the ultra high frequencies from one place to another by means of hollow rectangular pipes.

IF A radioman were asked just how he would send power from a transmitter to an antenna, the answer would invariably be by transmission lines. This would be correct for most frequencies—at least until the ultra-highs were reached. Even at these frequencies transmission lines could be used—except that a better way has recently been devised, a method that introduces far less losses than even well-constructed concentric cables. So, it is only natural that this system would replace transmission lines at frequencies from 1500 megacycles up. Below this, transmission lines will regain preference because at these lower frequencies the size of the conductors needed in this new system becomes too large. The name given to these new conductors is *wave guides*, and it is the purpose of this chapter to illustrate their mechanisms and resulting properties, and how they can be used to guide power from the oscillator to its antenna. The important point to remember is that these wave guides take the place of transmission lines at the ultra-high frequencies and it is just another example of how low-frequency apparatus had to be modified to deal with these extremely short wavelengths.

Returning to the usual method, one end of the transmission line is coupled to the output of the transmitter (or oscillator) and the other end connects to the antenna itself. As the frequency increases, the size of the antenna decreases until at 1500 megacycles the length of a half-wave dipole needed amounts to one half of the wavelength in centimeters or 10 cms. (A 1500 megacycle wave has a wavelength of 20 cm.) This is close to 4 inches and is certainly not very large. Now suppose that instead of using a long transmission line with which to conduct the energy from the oscillator to the antenna, a very short length of line is used and the antenna is placed close to the set itself. Immediately someone would object, stating that for best transmission it is more desirable to place the radiator well in the clear and not close to any other objects. To get around this objection, suppose this small dipole antenna is left near the set, but now it's enclosed in a rectangular pipe and the other end of this pipe is placed well in the clear in order that the waves coming out will not be close to any other objects. Fig. 2 depicts the above situation. In this case

the rectangular-shaped pipe acts as a guide for the radio waves given off by the small 4-inch dipole antenna. The waves travel down the guide and finally out into space when the end of the guide is reached.

The questions that might appear in

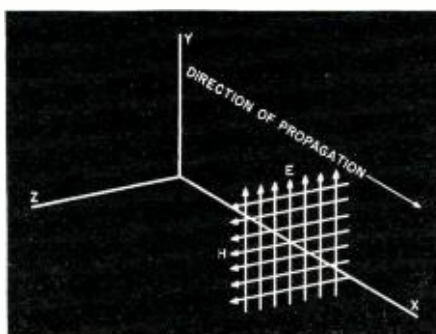

Fig. 1. An electromagnetic wave in a plane propagated along axis X. Arrowed lines E signify electric lines of force, while those of H signify magnetic lines of force.

a reader's mind would be—one, wouldn't the wave guide absorb a great deal of this energy and two, if this system is so good, why isn't it used for lower frequencies. To answer the first, it will be shown that when the radio waves are sent down the guide under certain conditions, much less absorption of energy takes place than would occur in an equivalent length of transmission line. And for the second question, it will likewise be shown that the frequency of the waves that can be sent down a guide without too much attenuation or loss depends on the size of the guide itself. Wave guides could be used for the lower frequencies, but they would be much too large and not very easily moved. They could be used, however they would not be practical. To summarize this new method then, a transmission line or coaxial cable is used for only an extremely short length, just enough to bring energy from the transmitter to the small an-

tenna placed in a wave guide close by. Once the energy reaches the small dipole antenna, it is conducted by the wave guide out into the clear where it is transmitted through to some distant point to be received by an appropriate receiver.

Now, in order to discuss the properties of a wave guide and its relationship to the waves that are propagated down these guides, it would perhaps be best to begin with the characteristics of the waves themselves and then tie these in with the necessary conditions for transmission of waves down wave guides.

To start with, the electromagnetic energy that is radiated by an antenna differs in no way whether the antenna is confined in a wave guide or unconfined as an antenna placed out in the clear. The only difference between the two concerns the direction that this energy will travel. In the open antenna, energy is propagated in all directions while in a wave guide it is forced to remain within certain limits determined by the guide walls. Thus, anything that is said regarding the general nature of these waves will apply equally to both cases.

The waves, as they leave the antenna, are referred to as electromagnetic waves. These waves, of course, have been set up by the oscillating or varying currents in the antenna itself. The set of rules or laws that these electromagnetic waves follow are referred to as Maxwell's equations and a good idea of what these equations mean will be given in a later chapter. For the time being it will be sufficient to use the general conclusions that are derived from Maxwell's equations while the complete story will, as just mentioned, be detailed later on. These electromagnetic waves or fields that are set up by the antenna are of the same general character as those sent out at the broadcast frequencies. Thus, any knowledge that may be had about

Fig. 2. Illustrating how wave guides may be used at u.h.f. in place of transmission lines.

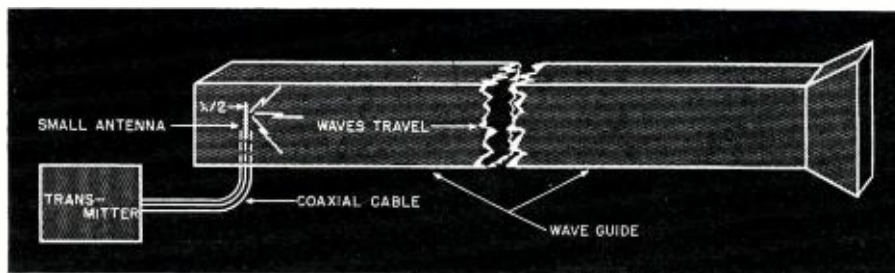

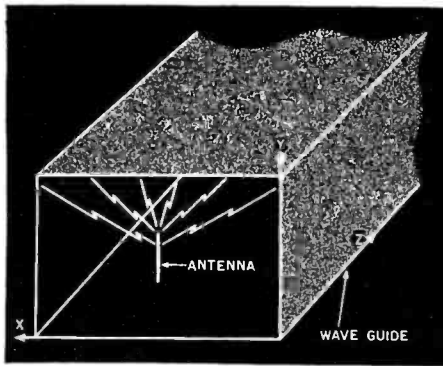

Fig. 3. Rectangular wave guide with small antenna mounted internally, used to transmit signals.

wave propagation over the surface of the earth applies equally well here with the two exceptions that a wave guide confines these waves and the frequency is very high.

When dealing with an electromagnetic field there are several fundamental ideas that should be kept in mind and it might be well to briefly consider the basic concepts. Whenever energy is sent out by an antenna, it will be found that this energy consists of two forms. One is the electric field and the other is the magnetic field and each one is dependent on the other. It is impossible to have one without the other, a relationship that is brought out clearly by Maxwell's equations. Besides their dependency on each other, it will generally be found that these two fields are at right angles to each other. Everyone is probably familiar with the fact that when current flows through a wire, it sets up a magnetic field around this wire. If the current is alternating or periodically changing in value, so is the magnetic field varying. And another well known fact is that varying magnetic fields, when they cut across a wire, will likewise induce an e.m.f. in this wire. Generalizing this latter statement, it is possible to state that a

changing magnetic field gives rise to a varying e.m.f. or, what is the same thing, a varying electric force or field. Thus, if we have a varying electric field, we will have a changing magnetic field and both will exist together. Every electromagnetic wave may have electric and magnetic fields with components in either the x, y, or z directions. (The conventional rectangular coordinate system is being used.) The fields referred to throughout this chapter are, as mentioned above, always changing in magnitude since it is only a varying magnetic field that will produce an electric field and only a changing electric field that will give rise to a magnetic field.

It is from these variations that an insight into the wave propagation can be obtained. It would be best to start at the antenna where the high-frequency currents are rapidly oscillating back and forth along the transmitting wires. These moving currents set up rapidly changing fields that travel outward away from the antenna with the velocity of light (approximately 3×10^{10} cms. per second). Focusing attention on the magnetic wave for an instant, as this wave travels outward, it will, because it is changing in magnitude, induce an electric field in the surrounding space. But this electric field will not appear in the same place that the magnetic field was, rather it will appear a little beyond. And this electric field just produced, as it travels outward, will produce a magnetic field—again slightly removed from the agent that produced it. By having these fields sustain each other, and at the same time move outward, the mechanism of wave propagation may, in a general way, be pictured.

In space the energy of the wave is divided equally between the electric and magnetic components. This balance of energy is disrupted only when the wave enters some new medium such as some of the Kennelly-Heaviside layers found about 90 to 250 miles

above the earth. Since no new energy is usually added to the wave, the only way that the readjustment can be brought about is for some of the energy already in the wave to be reflected. Thus, this process can be compared to light being reflected from a mirror or sound waves producing an echo. In each case a new medium was in the path of the energy and in each case a readjustment was necessary.

In dealing with electromagnetic waves, it is easier, many times, to consider the electric field as being in only one direction, say the y axis, and the magnetic field as being in some other direction. By confining these fields to special directions and not allowing them to be in every direction, a process

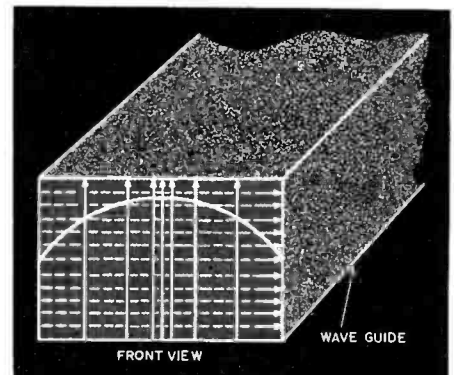
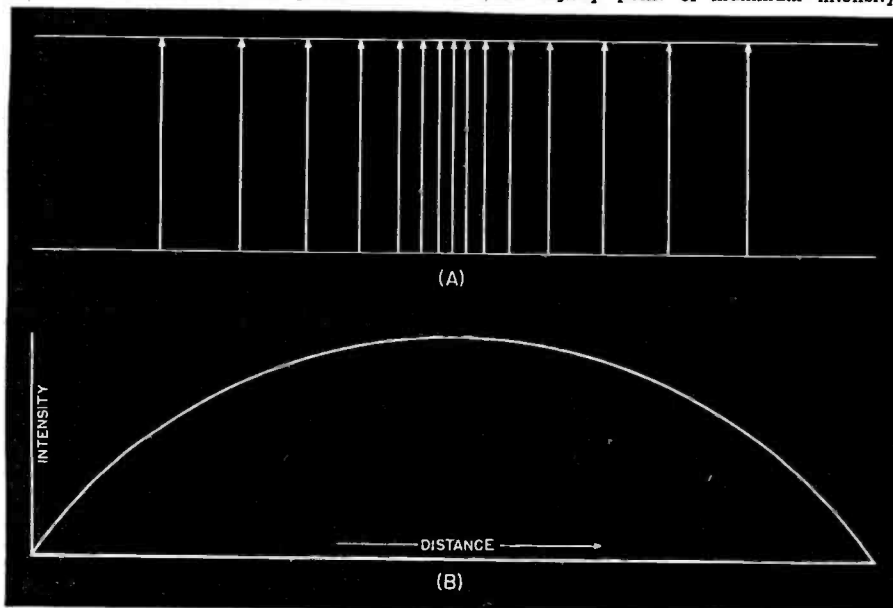

Fig. 5. Arrangement of the electric and magnetic lines of force of the $TE_{0,1}$ type of wave. The half wave shows that the electric intensity at the sides is zero, while maximum intensity is obtained at center. Solid lines denote electric fields, while dotted lines signify magnetic fields.

Fig. 4. Illustrating how arrowed lines and a sine wave may be used to similarly signify electric field strength. The grouped arrowed lines signify point of maximum intensity.



known as polarization takes place. In general, any field that is restricted to certain directions is said to be polarized. The reason this is mentioned at this time is due to the fact that in radio, almost every radio wave suffers some sort of polarizing action as it travels through space. In the consideration of waves which travel down wave guides, the direction of the electric and magnetic fields or, in other words, the polarization of the wave, is very important.

The plane wave shown in Fig. 1 is an example of a polarized wave, since the electric field is only in the vertical direction, everywhere else being zero. In radio, the direction of polarization is always taken to be the same as that of the electric vector, although this is arbitrary and is only by definition. Vertical antennas send out vertically polarized waves and if these waves do not change their sense of polarization as they travel, they may best be received or picked up by a vertical antenna. At the broadcast and short-wave frequencies the sense of polarization of the electromagnetic wave is not very important since the atmosphere is used for transmission of signals. At the very-high frequencies, however, we shall soon see that when using wave guides, the type of polarization has an important bearing on the behavior of the wave as it travels down the guide.

All this has been by way of an introduction to the behavior of electromagnetic waves and has been presented here for two reasons: firstly, because most elementary radio courses deal only hazily with the fundamental concepts of radio waves in general; and secondly, because a basic knowledge of their properties must be on hand before any discussion of wave guides can intelligently be undertaken. And there are still more fundamental ideas coming which will be combined with those facts just given, to form as complete a picture as can be obtained without the extensive use of higher mathematics.

The case of an antenna sending out waves in free space unhampered by any manmade obstructions and free to move in any direction has just been mentioned. Let the antenna now be confined to an enclosure constructed, for example, of copper and let this enclosure be rectangular in shape. Fig. 3 shows such a device and also orients it in space with regard to the ordinary three dimensional coordinate axis. The waves now leaving the antenna will not be free to move wherever they desire, but will be confined or directed by the walls of the device which is the previously mentioned wave guide. It should be particularly noted that the electromagnetic wave does not travel through the conducting walls of the wave guide, but rather through the dielectric material contained within the walls. In most cases encountered, the dielectric is air but it does not necessarily have to be so. It may be any nonconducting material but is usually air for a very simple reason. The losses are lower than for most other materials.

Now, for the wave to be propagated down the wave guide several precautions must be observed. First, the electric lines of force that comprise part of the electromagnetic wave must intersect the walls of the guide only at right angles, for if these lines of force cut across the confining walls at any other angle a current will be caused to flow and the original field will be distorted. That this is so can be seen from the following line of reasoning. An electric field will exert a force on any electrons that happen to be in its vicinity. Should this force cut across a conductor at any angle except right angles, the electrons in the conductor will move under this force. Moving electrons constitute a current and this will give rise to a magnetic field. But if the lines of force hit the conductor at right angles, the electrons in this conductor will move only a very small distance equal to the thickness of the walls (which should be very small) and soon come to rest, being unable to leave the confines of the enclosure and continue into space. In this latter case the electric field will not be distorted to any noticeable degree. The second condition that must be obtained is to have the magnetic lines of force at right angles to the electric lines of force. This was previously mentioned when discussing Maxwell's equations.

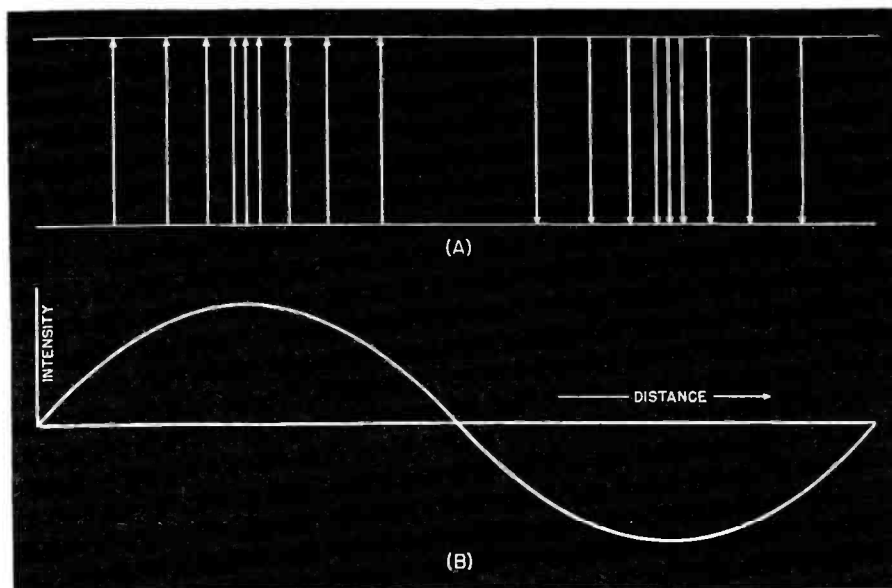

Fig. 6. Variations in electric field strength of a full-wave signal; (A) showing field strength and direction by means of arrowed lines, and (B) by means of sine curve.

Correlating all these facts will give Fig. 5 where the simplest type of electromagnetic wave, $TE_{0,1}$ is pictured. The method of labeling the waves will be considered presently. The end view shown is what would be seen if one were to stand squarely in front of the wave guide and look down its length. For the next higher order type of wave, refer to Fig. 9 where the distribution of the various fields are shown. The wave is referred to as the $TE_{0,2}$ type.

Electromagnetic waves traveling in wave guides, for example Fig. 3, may be represented by the symbol $TE_{m,n}$ or $TM_{m,n}$, depending on the mode of propagation. The $TE_{m,n}$ wave is called the transverse *electric* wave, which means that the electric field may have components in the x and y directions, but not in the direction of propagation, z. Similarly, the $TM_{m,n}$ or transverse *magnetic* wave may have components of the magnetic field in the x and y

directions, but not in the direction of propagation, z. The subscript m indicates the number of half wavelengths of variation of the field in the y direction, and n indicates the number of half wavelengths of variation of the field in the x direction. Thus, the $TE_{0,2}$ wave illustrated in Fig. 6 would be a transverse electric wave with no variation of the field in the y direction, and two complete half wavelengths, or one full wavelength, of variation in the x direction.

It is necessary for the reader to become familiar with the method of showing an electromagnetic wave by means of its electric and magnetic field components. The reason for this will become increasingly obvious when, as this chapter progresses, it will be shown that the differences between various waves depend only on the differences between the electric and magnetic field arrangements. It has been

(Continued on page 135)

Fig. 7. Electric field strength variations of a signal $1\frac{1}{2}$ wavelengths; (A) illustrating by means of electric lines of force; and (B) by means of a sine curve.

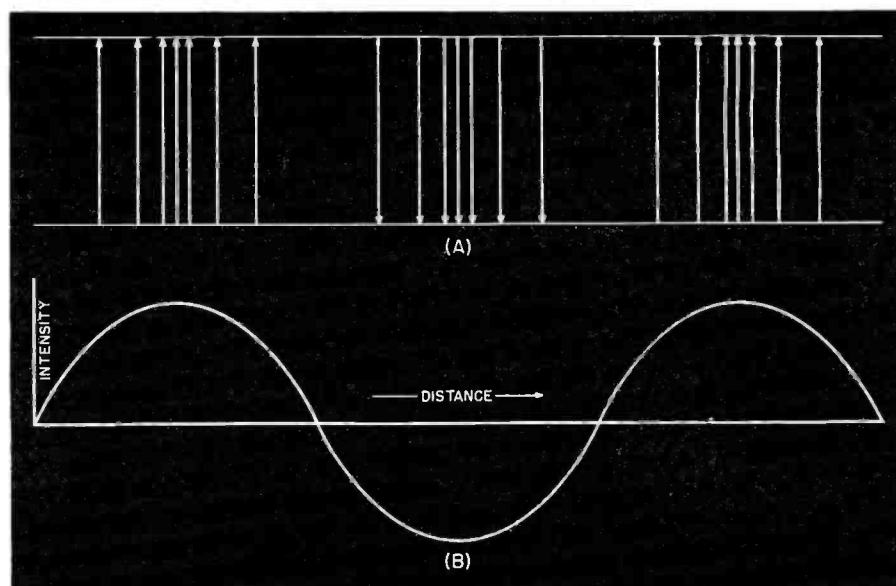

THE recording of sound on cellophane tape with a revolutionary and economical new sound-recorder and playback machine, capable of up to eight hours of recording and automatic playback, was recently introduced at a special demonstration held at the Waldorf-Astoria Hotel in New York.

This new sound recorder which may find prominence in the recording industry is a compact unit, not much larger than the average portable radio and makes records on cellophane tape. It is a precision instrument which records and plays back on cellophane with high fidelity and low cost of operation.

The machine is a record devotee's dream which can be operated from a microphone, radio, or telephone for recording; then a flip of a switch sets the machine to playback. Its cellophane tape permits eight continuous hours of recording or playing without changing. Its sapphire needle does not have to be changed, never scratches the tape and cannot be broken unless taken out from the machine and tampered with. The high-fidelity cello-

phane record emits almost no surface noise and may be played many thousands of times.

The tape, a little more than an inch in width, is an endless loop 350 feet long on which recording can be made at a cost of only fifty cents per hour to the consumer. This cost will be even further substantially reduced in the future.

The principle of sound on cellophane was taken from that of the film sound track, the main difference being that a needle is applied to do the work done on film by an intensified light. The cellophane is embossed through the use of the needle. Outstanding problem, of course, was to overcome pressing the soundtrack on the tape with a needle without cutting. This was finally solved through the adoption of a yieldable bed of felt directly under the recording needle, on the basis of which patents were subsequently granted.

Twice the thickness of ordinary cellophane is necessary, as the tape is run under the needle at the rate of about 40 feet a minute and is capable of carrying 60 parallel grooves. Move-

SOUND ON

By

STANLEY KEMPNER

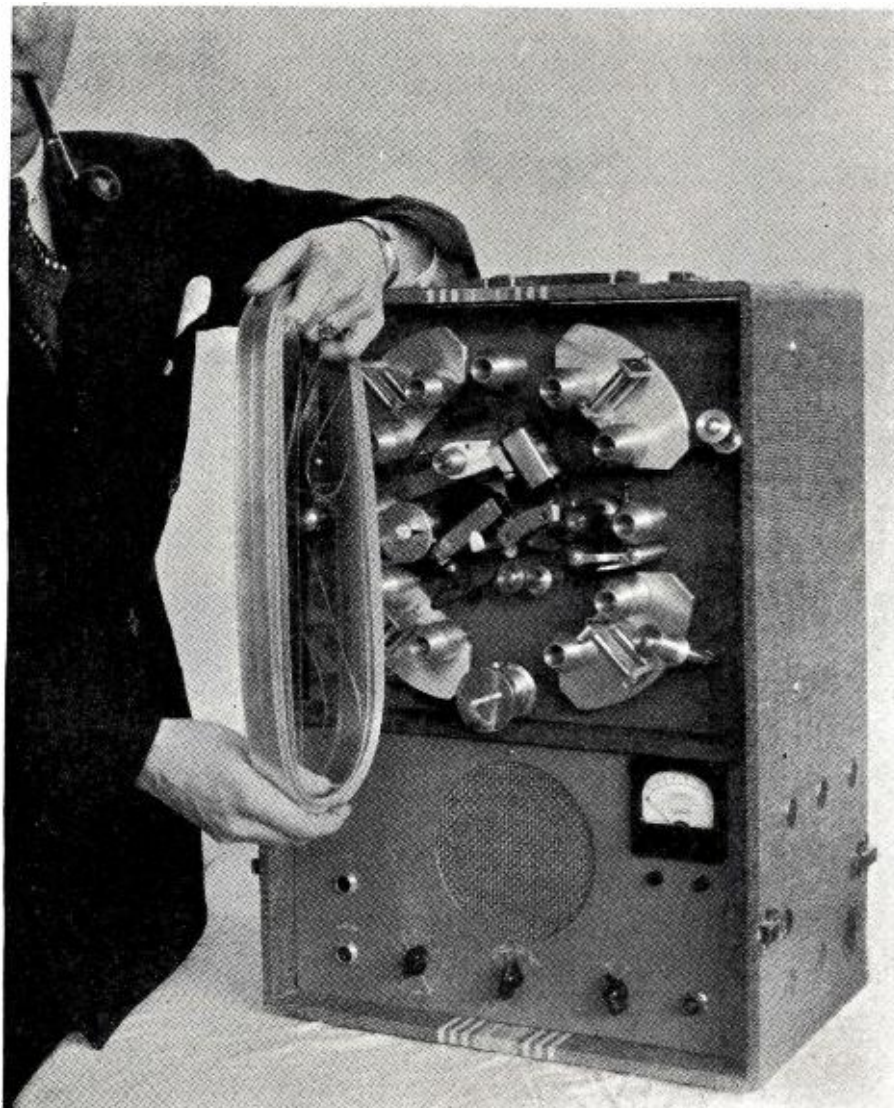

The loop of cellophane, 350 feet long and more than an inch in width, prior to its assembly in the automatic cellophane recorder.

ment is by friction, pull or force. Each of the 60 grooves plays eight minutes. Knowledge of the approximate time of a program requires only a minute or two to spot any portion of a recording whether or not the tape has been scored during the recording.

Quality of reproduction obtained from the recorder depends upon the rate of speed with which the tape travels past the recording needle. For medium quality reference recording, a speed of 40 feet a minute is used. To obtain higher quality reproduction a tape speed of 60 feet per minute is used, increasing the recording cost from 50 to 75 cents an hour. The cost of recording is thus made proportionate to the quality of the reproduction required.

Tape recordings are surprisingly free of surface noises; will remain quiet and give natural distinct reproduction of voice or music for many years. Cellophane used is durable and has a life expectancy of 21 years, according to the tests made by the E. I. du Pont de Nemours Co. It can be kinked up and tied into knots almost at any but right angles. If broken, the tape can be spliced without damaging the recording to any appreciable extent. It has been tested and found nonflammable. Under laboratory test conditions, the cellophane has worked from minus 26 degrees centigrade to plus 61 degrees centigrade with 95% humidity. The cellophane has been processed to overcome effects of changes in climatic conditions.

Because of its relatively simple construction, the recorder, it is stated by the makers, is now the lowest priced continuous recorder on the market. It is economical to operate because it requires attention only three times in 24 hours. Exceptional reproduction of voice and music is said to result be-

CELLOPHANE

An economical, portable cellophane tape sound recorder and playback unit, capable of eight hours of automatic recording.

cause of the designation of cellophane which is declared to be an ideal recording medium.

The cellophane tape recorder is acclaimed by its inventor and manufacturers as a completely new type of sound recording instrument that combines all the features wanted in a reference recorder.

A complete fifteen minute radio program can be recorded for as little as 12½¢. The recordings made on the inexpensive cellophane tape are permanent, can be played hundreds of times, and are easy to file for future reference.

The recorder is simple to install. The complete recording mechanism and amplifier are mounted in a small lightweight carrying case and can be quickly connected to any radio set or to a program line from a studio. It can also be used with a microphone for recording conferences.

No technical knowledge or experience is needed to operate the recorder. A switch is simply turned when the program starts and another when it is completed. That is all there is to recording on this new machine. No supervision is required while recording any monitored programs.

The tape magazine comes preformed, ready to slip into the machine and is simpler than threading a home movie projector. When the recording head is lowered on the tape, it is ready to record continuously or intermittently for eight hours.

To play the recording, the reproducer is simply placed on the tape. Each groove contains eight minutes of recording, making it simple to select the desired program.

Both the recording and reproducing needles have permanent gem points. The needles do not require changing and shavings are eliminated.



Front view showing amplifier panel arrangement and recording mechanism.

The model "AV" tape recorder consists of a motor drive system which passes through an endless loop of cellophane tape over a ring of idler wheels. One loop of tape passes over a bed of woven felt (billiard cloth) where the recording stylus embosses a groove of constant depth. A worm and gear system moves the recording head across the width of the tape, making a continuous groove at a pitch of 60 grooves to the inch.

No sprocket drive is on film—it is friction driven. Therefore, there is no wear or tear on the cellophane.

The sound modulation is applied laterally in the groove. The reproducing head moves freely and is guided by the groove. The amplifier combined with the recorder has a gain of 110 decibels and power output of five watts. The frequency response is uniform within two decibels from 50 to 8000 cycles. Inputs are provided for a high-impedance microphone or a radio tuner.

Over all frequency response is determined by the tape speed. At forty *fpm*, the useful frequency response extends to 3000 *cps*; at 60 *fpm*, the range is extended to 6000 *cps*. The low-freq. response extends to 80 *cps*.

Background noise due to combined mechanical vibration and needle friction is 25 db. below maximum signal level at 40 *fpm* and down 30 db. at 60 *fpm*.

Speed regulation is sufficiently accurate to prevent any noticeable "wows"

when reproducing sustained notes.

The recording head is magnetic, using a diamond stylus with an impedance of 500 ohms. The crystal pickup with sapphire stylus is used for reproduction.

The audio power level at the normal input to the cutting head is plus 20 db. The gain required to raise the reproducer output to zero level (.006 w.) is 15 db. The amplifier input is as noted above, high impedance output 500-15-8 and 4 ohms.

The control panel contains receptacles for microphone and radio or wire line input, volume control, selector switch for recording and playback, power switch, volume indicator, meter and pinjacks for monitoring headphones. The loudspeaker is dynamic, eight-inch size, mounted in an amplifier panel.

Power requirements for standard operation are 110 volts 60 cycle a.c. and the unit draws 150 watts.

The recorder and amplifier are mounted in a carrying case which measures, when closed, 17"x23"x13" and weighs 53 pounds.

The machine is equipped with an automatic stop. A red light will flash on eight minutes before the end of the eight hours recording. It will automatically stop when a full eight hours of recording is completed if set for that period of time.

Carbon tetrachloride and denatured alcohol are supplied to keep machine clean. The recording track is cleaned

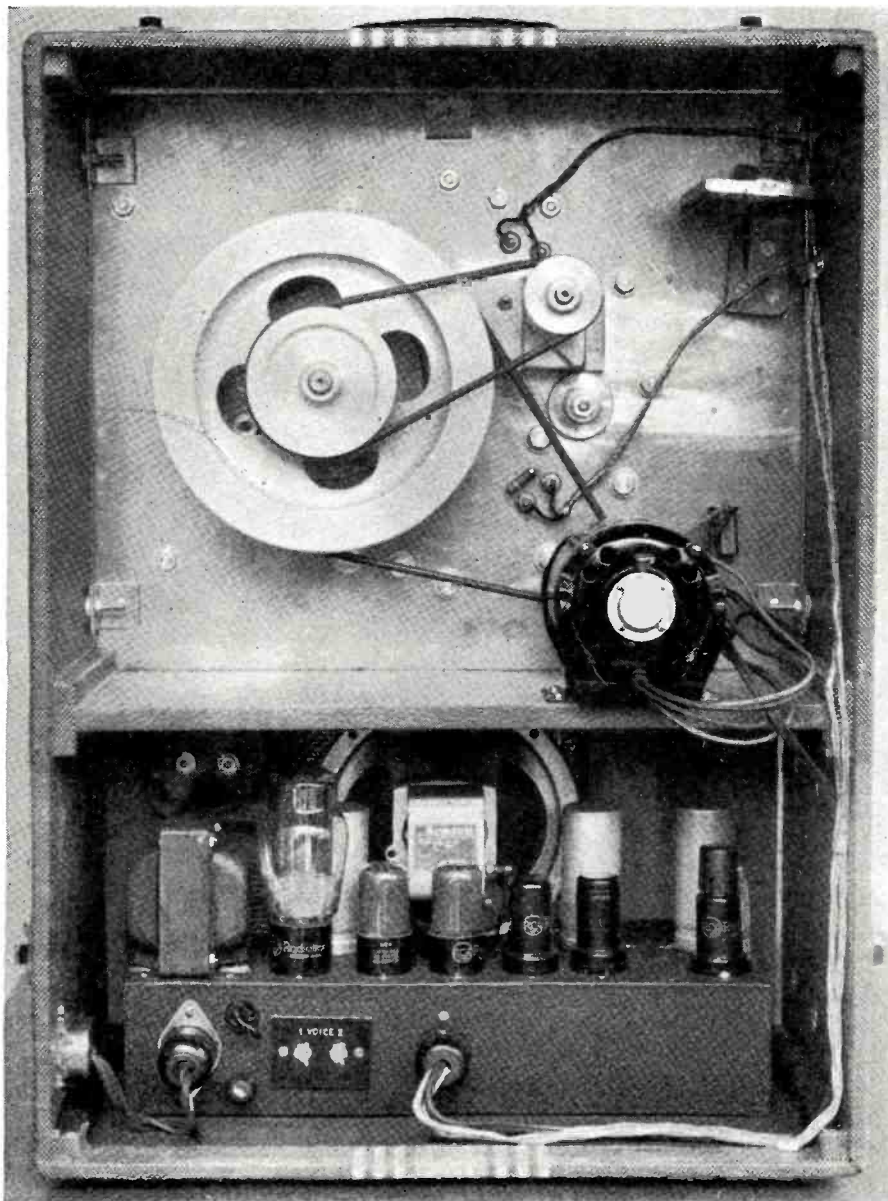

Rear view showing the simplicity of assembly. All units are neatly wired and well shielded to prevent any hum pickup from magnetic or electrical fields.

whenever necessary with a piece of felt pad saturated with the carbon tetrachloride. The drive roller must be cleaned frequently with a felt pad saturated with alcohol.

Recently, a recording was used as an indestructible record at a government hearing in Pennsylvania and the cellophane retained as an official transcription file which could be referred to for future use.

Advantage in the use of cellophane as a means of retaining valuable information for more than two decades lies in the fact that the tape cannot be altered or tampered with unless a specific portion of the cellophane is completely cut away. In wire recording, the erasing of a definite portion of the tape is possible and re-recording probable.

Cellophane tape is advantageous when compared to disc records in that there is compactness of storage space, lightness in weight, smallness in size and the fact that 60 different pro-

grams can be cut on the physical part of the tape without altering or losing any of its advantageous properties.

Recording on cellophane, moreover, is more effective, as it remains constant, whereas on the disc it will leave different characteristics.

On cellophane, the same type of recording is made from one roll of tape to another providing the thickness of the tape is the same. The cellophane is not subject to normal or abnormal temperature changes, whereas wire used along similar lines is subject to the variables of temperature changes.

Cellophane is made on the basis of woodpulp. Film acetate comes from cotton.

Of course, cellophane has its limitations. First, surface noises are higher than on acetate. Second, there is no way to tell about the physical properties, that is, how it goes into high-frequency recordings. In acetate, it is known how to be used for high-fidelity work.

Cellophane is cheaper than any other material used in recordings when compared to wire or film. The price of cellophane now is fifty cents an hour which represents the maximum that cellophane will probably ever sell at. In fact, the anticipated cost is figured as low as fifteen to twenty cents when demand and supply tend to meet sometime after the war.

Sound on film costs have been estimated at roughly around six and one-half mills per foot (\$.0065 [positive cost]). Developing on the sound track is figured roughly at one cent a foot, bringing the total to about \$.0165. Estimating the cost of 350 feet brings the cost of film to \$5.77 as against \$4.00 for cellophane, a difference of around \$1.77. Then, one could not get the same amount of recording on film, since only one track is possible playing eight minutes. On cellophane 60 tracks are available.

The recorder is the development of Jay C. Fonda, chief engineer of the Fonda Corporation, New York, who learned the advantages of this type of recording while working as a film man for several of the leading motion picture companies, including Fox, Pathe, Paramount and the old Cosmopolitan studios. He developed his machine in a home laboratory.

He spent two years just attacking the film, starting in 1929 when the art of recording was a closed field. With the advent of home recording, records became the property of the general public.

In 1940 he got the idea of recording on cellophane. He first recorded sound on the ordinary cellophane wrapper such as used previously around cigarette packs and around hams. The size of ordinary cellophane is 1½ thousandth of an inch thick and cannot be cast much thicker because of the high cost and for technical reasons. By laminating two sheets together, a little over 3/1000 inches in thickness was obtained and found to be practical for sound recording.

Mr. Fonda experimented with heated needles and chemical formulas, but discovered that when the material cooled, the waveform of the recorded sound was distorted and produced extremely high surface noise.

Accidentally, he stumbled on the idea of putting woven felt under the tape. Immediately, he discovered that first, tests proved reduced surface noise; second, it allowed use of sharply pointed stylus which allowed higher frequencies; and third, designs of recording and reproducing styli changed and eliminated the danger of wearing out the materials. Success of the yieldable bed is in its resiliency. The yieldable bed allowed the pushing downwardly of the material by the use of pressure and not the cutting process. Felt allows the material to press down, giving an added depth due to the thickness of the material used.

Cellophane is strictly used at present for speech ranging from 100 to
(Continued on page 96)

OHMITE

RHEOSTATS and RESISTORS

Veterans in Bombing Missions Over OCCUPIED EUROPE

Acme Photo

Wherever Allied bombers and fighters go, you are certain to find Ohmite Rheostats and Resistors faithfully doing their specific job. They serve in vital communications equipment as well as in instrument controls . . . "earning their wings" under all types of operating conditions. As the tempo of the Battle of Europe increases, the more important becomes their dependability. *In Resistance-Control, Ohmite Experience makes a Difference.*

Send for Ohm's Law Calculator. Helps you figure ohms, watts, volts, amperes—quickly. Solves any Ohm's Law problem. Only 10c in coin.

OHMITE MANUFACTURING COMPANY
4884 FLOURNOY STREET • CHICAGO 44, ILLINOIS

Be Right with **OHMITE**
RHEOSTATS • RESISTORS • TAP SWITCHES

Back the Attack
Buy More War Bonds

"A NICE little SET-UP IN A CAVE"*

at present we have a nice little set-up in a cave. It's really nice & I'll tell you - it's just 4 AM in the morning and I'm writing this by light of a lantern -

POWERFULLY INTERESTING are these letters from our boys at the front. So often we read how the vital communications wire that CORWICO makes is helping toward final Victory. For the duration—we are pledged 100% to this big job.

**Another excerpt from a letter to William Ogert of Cornish Wire Co., from his son overseas, telling how CORWICO wire is in daily use in his fighting outfit.*

cornish



WIRE COMPANY, INC.
15 Park Row, New York City,
New York

"Made by Engineers for Engineers"

TECHNICAL BOOK & BULLETIN REVIEW

"SHOP JOB SHEETS IN RADIO"
Book II Service Problems, by Robert Neil Auble. Published by Macmillan Company, New York. 128 pages. Price \$1.50.

This is the second book by Mr. Auble on the practical side of radio, the first book, reviewed in the July issue of this magazine, covered the fundamentals of radio shop techniques, while this second book covers radio components, testing, the superheterodyne receiver and a study of the fundamental parts of the transmitter.

As was pointed out in the first review, these manuals are intended to supplement classroom work and reference texts on the subject, and when used in conjunction with this material, they will provide the student with a practical working knowledge of radio fundamentals.

The proper methods of testing the various radio components are covered along with a study of the test equipment with which the operations are performed. The construction of various pieces of receiver equipment is included in order that the student may encounter the various aspects of power supply design and audio amplifier design, as well as phase inverter drivers, and amplifier stages.

The study of the transmitter includes the Hartley oscillator, the electron-coupled oscillator, the quartz-crystal oscillator, r.f. amplifiers, frequency doubler circuits, power supplies and modulation.

For instructors in laboratory courses of elementary radio these job sheets should prove to be a valuable aid.

"RADIO AUDIENCE MEASUREMENT," by Matthew N. Chappell and C. E. Hooper. Published by Stephen Daye, Inc., New York. 239 pages. Price \$3.50.

If you have ever been awakened from a nice post-dinner snooze by the ring of the telephone and have been asked what radio program you are listening to, this book will explain, but may not mollify you, the reason for the call.

Since radio programs in America are for the most part sponsored, it becomes necessary to test the audience reaction from time to time to determine whether any changes should be made in the type of program being offered by the sponsor.

Some indication of public listening can, of course, be determined by the public's acceptance of the sponsor's products by means of dollar and cents over-the-counter-sales. This method, while music to the sponsor's ears, does not present a true picture of the complete listening public to any one program at any given hour.

Thus, the Hooper rating, which de-
(Continued on page 141)

For important assignments

The accuracy of DeJur precision meters on the "Testing Grounds" of many important manufacturers has resulted in their preference for standard or special projects.

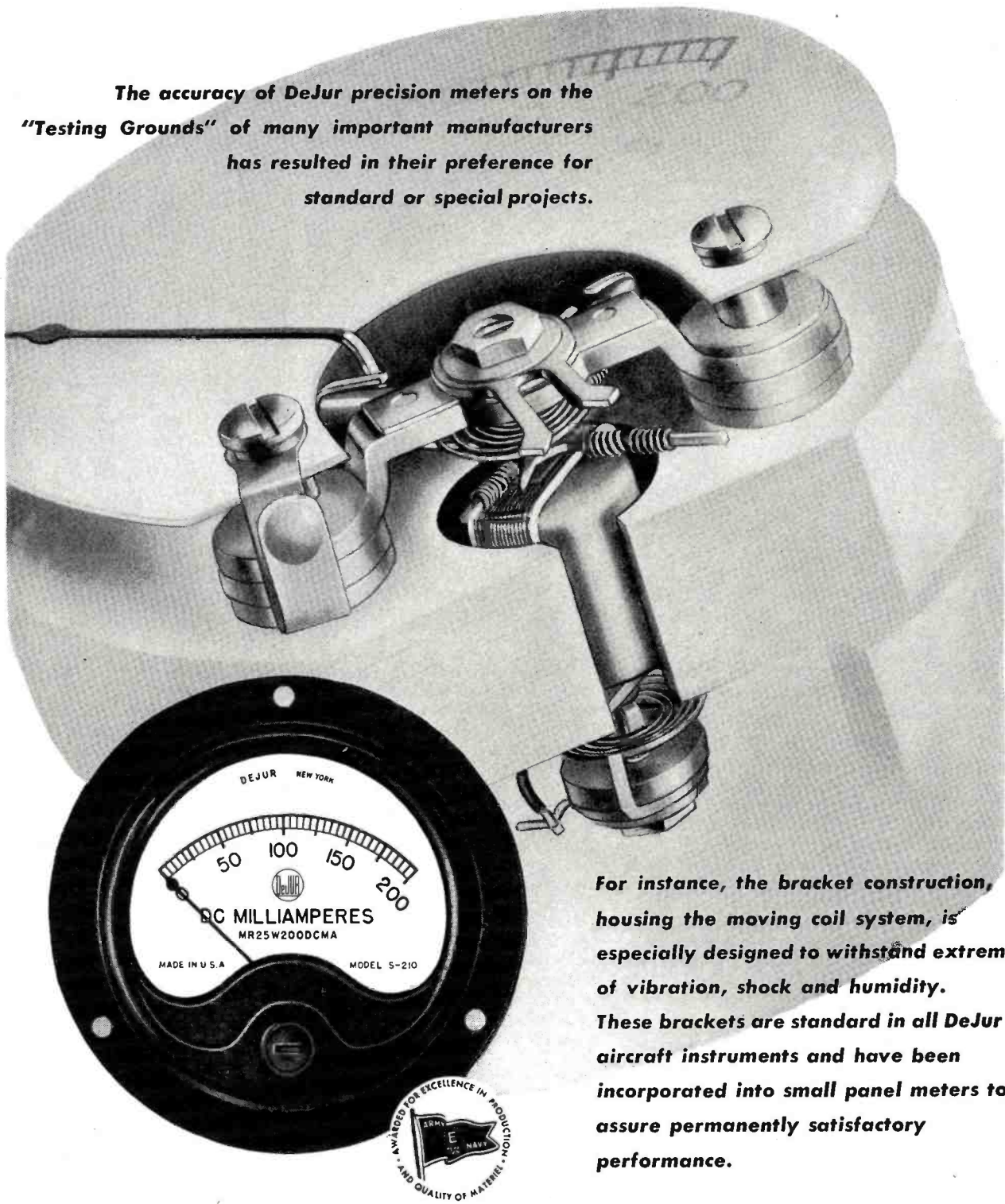

For instance, the bracket construction, housing the moving coil system, is especially designed to withstand extremes of vibration, shock and humidity. These brackets are standard in all DeJur aircraft instruments and have been incorporated into small panel meters to assure permanently satisfactory performance.

WASTEPAPER IS ESSENTIAL
... TURN IT IN REGULARLY

De Jur-Amsco Corporation

MANUFACTURERS OF DE JUR METERS, RHEOSTATS, POTENTIOMETERS AND OTHER PRECISION ELECTRONIC COMPONENTS
SHELTON, CONNECTICUT

NEW YORK PLANT: 99 Hudson Street, New York 13, N. Y. CANADIAN SALES OFFICE: 560 King Street West, Toronto

RADIO AND THE BLITZ

By **LESLIE W. ORTON**

London, England

Many of the electronic devices that have been used in the E.T.O. are used not only as weapons of aggression, but also as means of defense.

AT 4:56 p.m. on the 7th of September, 1940, the warble of the air raid sirens sounded in the London area. Scores upon scores of black specks had been seen heading towards the capital—they were Nazi bombers and fighters, 375 of them, and they heralded the opening of an air "blitz" that was to last months and result in many new scientific wonders being devised to combat the raiders and to rescue the injured buried under piles of debris.

Terror

Some idea of what terror Londoners had to put up with can be gauged by the fact that fifty-thousand high-explosive bombs and millions of incendiary bombs were dropped on the capital in just over six months. Under such conditions scientists worked day and night upon schemes and ideas to combat the raider and minimize the damage and suffering caused by bombing.

Night bombing was the most difficult to tackle, for the Royal Air Force effectively tackled the day raider and forced the Nazis to rely upon darkness to conceal their machines. How was a fighter on the watch for enemy aircraft to locate his target under such conditions?

Science supplied the answer. It also provided means of aiding anti-aircraft gunners. Special sound locators were constructed. These were various in types, employing, in some cases, directional microphones and amplifiers. Thanks to these locators we were given warning when aircraft neared our coast.

Nazi Locators

It would be hardly reasonable to think that we alone evolved apparatus to locate hostile aircraft. The Nazis had a form of radiolocation. Readers may remember that one of our most

London flats badly damaged by the force of German bomb explosions.



daring Commando raids was carried out in order to put out of commission one of the German's radiolocation stations near Dieppe. Doubtlessly, when the raid was carried out our men learned much about the methods employed by the enemy and perhaps such knowledge resulted in their employing special metallized black ribbons to throw out radiolocation sets.

These tapes comprised strips of black metallic paper. Dropped from aircraft they are reported to make a rustling noise which confuses the locating apparatus and thereby impairs the use of the apparatus. At the same time these paper strips would tend to act as a screen between the aircraft and ground, absorbing waves and, once again, tend to render radiolocation apparatus useless.

The Germans have tried to use similar tactics over Britain but judging by the number of aircraft shot down during recent raids one is led to think that the idea is of little value. Nevertheless, after raids it is by no means an uncommon sight to see strips of this black metallized paper lying in gardens, on roads, etc. In appearance it is rather like adhesive tape silvered on one side.

In one area metallized cardboard disks were dropped, presumably with the same idea in mind as when the black strips were used.

But though locating apparatus was used to a great extent during the "blitz" and is used to a far greater ex-

tent now, many aircraft escape through the "flak" shot up by our guns, and when one considers the speed at which a modern plane travels, and realizes that a slight twist, a gust of wind, or one or other of many other phenomena can result in a "miss," this is not surprising.

Searchlights for Aircraft

Consequently, many scientists concentrated upon equipping night fighters with means of locating enemy aircraft in the dark. One of the most straightforward systems employed was the use of a searchlight. This apparatus comprised a powerful lamp which was affixed to night fighting aircraft and could project a bright light which effectively revealed aircraft coming within its sphere. This apparatus has been used with good effect within recent months in helping to combat the U-boat menace. When these undersea vessels rose to the surface in order to let gasses escape while charging their batteries, or to radio their base, aircraft equipped with these searchlights would swoop down upon them and, in many cases, sink them before they could dive.

For obvious reasons the other systems employed by the Allies to combat night fighting cannot be described.

Germany Tries "Black Light"

In the *Daily Herald* for the 9th of February a scheme was described which it was claimed was used by Ger-

SPRAGUE TRADING POST



A FREE Buy-Exchange-Sell Service for Radio Men

"NOT A FAILURE IN A MILLION"



SPRAGUE "TC" TUBULARS

When there's a by-pass capacitor job to do, do it with famous Sprague TC Tubulars — and forget it. They will not let you down!

We'll appreciate it if you ask for them by name.

FOR SALE—Practically new Supreme 546 oscilloscope, used only once. Perfect. \$80. Albert, 441 Madison Ave., New York 22, N. Y.

WANTED—Hickok 155 Tracometer; Hickok tube & set tester \$510X. Cash. L. W. Bakewell, 434 W. Locust St., Springfield, Mo.

FOR SALE—My complete stock of tubes, around 200 in orig. cartons, 20% off list. Also one Superior 1250 multimeter. Al's Radio & Electrical Service, Saunemin, Ill.

FOR SALE—Supreme sig. generator #581 in good condition. Address inquiries to Mrs. Elsie Leuty, 401 E. Church St., Salem, Ill.

URGENTLY NEEDED—Tube tester, sig. generator, latest models for vital war work. Cash. A. F. Rockholt, 872 McAlister St., San Francisco 2, Calif.

WANTED—We need an 884 or an 885 for our oscilloscope. Advise immediately. Also need an 0-1 ma. meter, White's Radio Service, Box 146, Mansfield, La.

FOR SALE—#702A Shure ultra-wide-range crystal mike, sound cell type, with 15' shielded cord. Also a 3-tube pre-amplifier AC built-in power supply with tubes on metal-covered chassis, amphenol connections. Both for \$50. Mike @ \$20. Amplifier @ \$20. Mahoney Furniture & Hardware Co., Montpelier, Ind.

FOR SALE OR TRADE—Heavy duty 2-speed phono motor & Astatic crystal pickup. New G.I. 2-speed home recorder, National NC-200 receiver. FM converter or receiver, V.I. recording meter. A. C. Deldricksen, 14 Vine St., New Britain, Conn.

URGENTLY NEEDED—1—HY615 tube, Will trade 12SA7 and others for it or buy outright. Hobt. Westfall, The Pines, Woolwich, Maine.

WANTED—Hickok 188X sig. generator, also 5Y3, 6A8, 35L6, 35Z5, 12SQ7 tubes. All inq. answered. Lowell L. Young, 811 McKenzie, Bremerton, Wash.

FOR SALE—Shure 3-B d.b. mike mtd. in spring susp. ring, brand new boxed. \$4; Jefferson elec. train trans. 50-watt, ad. 5 1/2 to 13v. \$2.50; RCA 30 & 31 tubes, 40c ea.; 6C5 & 6J5 @ 65c ea.; 8S5 @ 90c ea. M. S. Schaefer, 280 Wadsworth Ave., New York 33, N. Y.

FOR SALE—Asst. of UTC-LS xformers & chokes, except outputs. Same make VT-1, VT-2, VM-O; PA-15 & PA-59AX. Also Jefferson and G.E. cased neon sign lighting transformers. Radiart var. voltage Type 4200 vibrapack. Lots of television parts & tubes. Philip Rosenblatt P. O. Box 905, Hoboken, N. J.

WANTED—ATR radio inverter, input 6v D.C., output 110v A.C. All inq. answered. J. Korzek, Box 63, Putnam, Conn.

NEW TUBES FOR SALE in orig. cartons four each 6F8G; 6C8G; 6B8G; 6L6G; also two 6L6 metal. 80% of list. Jim's Radio Shop, Mankato, Kans.

TUBES FOR SALE—at 40% off: 12 Raytheon 1C5G; 9 Sylvania 1C5G; 10 RCA 1LA4; 10 Raytheon 1L14; 8 Sylvania 1Q5GT; 10 Raytheon 1Q5G. Ritter Bros. Jac. Frank Bldg., Hartford, Wisc.

WANTED—2-scale AC voltmeter (0-4 & 0-8); 0-100 milliammeter (D.C.); a filament heating transformer (D.C.); a filament heating transformer 7.5v secondary; 500 ohm power rheostat. 75 watts; and a 15-watt tungsten filament lamp. Robt. Funk, 2517 Woodbridge, Cleveland, Ohio.

FOR SALE—12 6v auto vibrator transformers, 50c ea.; 12 audio trans. 3.1, 6.1, etc., 50c ea.; 3-tube microtube hearing aid kit with crystal mike, \$15; good microtubes M74, M54 @ \$3; midset output trans. \$1; midset 1 meg. vol. controls 75c ea. Edwin T. Larason, Box 46, Martinsburg, O.

FOR SALE—Fansteel Balkite A current supply 115v 60 cpl. \$10; Westinghouse Recticon charger \$10; 4-wire speaker cord, iron cord, tubes, one 6v tuntable in case. Write for list. Want 5Y3; 5Z4; 0Z4; 12SA7; 12SK7; 12SQ7; 35L6; 35Z5; 7E8; 25A7 tubes. A. L. Heintz, Minster, Ohio.

WANTED—Television receiver, prefer large screen. Describe fully. Jack's Radio Service, 296 Wainwright St., Newark, N. J.

FOR SALE—Cornell-Dublier BF-50 capacitor analyzer. Will ship COD express with inspection privilege. L. P. Work, 10441 Threman, Dearborn, Mich.

BUY, SELL, OR TRADE—Want an a-c ampmeter 0-10. Have Readrite d-c milliammeter; and Readrite voltmeter 0-100. Louis E. Pollard, 2226-3rd Ave., Moline, Ill.

URGENTLY NEEDED—New or used household 110v elec. iron. W. H. Thomas, ART 3/C; U.S.N.A.T.T.C.; Bks. 13, Co. M, Sec. 4-B; Ward Island, Corpus Christi, Texas.

FOR SALE—One new table type Silver-tone 32v d-c 2-band receiver, designed for Delco farm use. 5 tubes. \$25. Frank A. Butler, 918 N. Taylor Ave., Oak Park, Ill.

WANTED—1—1R5; 2—1T4; 1—1S5 tubes; also a 30v hearing aid battery. Don Anderson, 917 E. Kemp, Watertown, S. D.

WANTED—RCA Jr. Voltohmyst in perfect condition. Cash. Chas. L. Kramer, 112 Government Ave., Norfolk 3, Va.

WANTED—Late model tube checker; sig. generator; also good V-O-M. Howard H. Vroom, 2923 Brook Way, Richmond, Calif.

FOR SALE—5—807 tubes (new); 1—811, new; 2—35T new; 4 new phono motors (\$5 ea.); 1 receiver 2 1/2 meters, complete; 5 crystals & holders; 1—HY-75 xmitter complete with power supply. Pauline Twilley, 505 Riverside Drive, Essex 21, Md.

WANTED FOR CASH—Superior Channel analyzer. Glen Peterson, Glen Miller, Ont., Canada.

WILL SWAP a Burton oscillator model 111 for anything useful to a radio serviceman. Stanley Garner, 20 W. Chestnut St., Norristown, Pa.

FOR SALE—A small quantity of 35Z5, 35Z4, 35Z3, 117N7, and 117L7 tubes. Will sell or trade for other eqpt, preferably meters, mikes, crystals. R. W. Wood, 10950 Longview Ave., Detroit 5, Mich.

WANTED—Tubes, meters tube tester, and parts for service business. Cash. A. E. Sickler, 6417 E. 14th St., Kansas City, Mo.

IMPORTANT NOTICE!

We discourage offers to buy or sell anything beyond the O.P.A. ceiling prices, and will not knowingly accept such ads for the Sprague Trading Post.

FOR SALE—Weston thermo-galvanometer #425, panel mtg. Open thermo-couple, otherwise 1st class; two radio B battery voltmeters, Shur-Test and Yankee; Weston #254 center reading ammeter 0-30; Westinghouse O-3 a-c ammeter, type CK, style 312000. General Radio Service, 1203 Eckart St., Fort Wayne 5, Ind.

WANTED—Radio City model 411-12-13 or 504 tester, cash or trade 1-35Z5, 2-1299, 1-T4, 1-6L6, 1-5U4, 2-205D, 1 Weston amp. meter 0-5; 1-6 amp. Tun-gar bulb; 1 Hickok d-c meter 120v. 80 amp.; 1 type A Trumbull switch D1'DT 60 amp. 250v d.c. Gus A. Dulumbuck, West Frankfort, Ill.

WANTED—Dynamic tube checker (late model); condenser tester; 1A7, 1B7; 50Y6; 50Z7; 117L7; 50L6; 117P7; 117Z6; 35Z5; 3Q5; 7A8; 14Q7; 1Q5; 1LA6; 1LC6; 14E6; 25Z6; 12SA7; 12SK7; 12SQ7; 35L6 tubes; test eqpt. of all kinds especially 20m per volt meter. Pauline Gibbs, 336 W. Monroe St., Jacksonville 1, Fla.

FOR SALE—Clough-Brenke scope, model CPA, serial 440, \$50; Solar condenser checker, type CC-1-60, \$25; Superior channel analyzer, \$14; Supreme 503 tube tester, \$37.50; Jackson tube tester to handle latest tubes, \$30; Triplet 2" scope, \$50; 14-w P. A. model 414 Stancor;

60-w P. A. 4 mike inputs, phono input, small rack & panel job, 1-12" bell incl.; 90 watt P. A. 4-mike inputs, 1 phono rack & cabinet and 2-12" P.M. in bells. All P.A. outfits are A-1. Need 1A7; 1H5; 1A3; all 12, 25, 35, 50, 70, 117 series tubes, phono motors, or what have you? Munroe Radio Service, 111 Shelby St., Kingsport, Tenn.

EQUIPMENT FOR SALE—Hickok test panel complete, incl. 170X sig. generator; 510X tube tester; TS-50 universal speaker. Also Hickok 155 Tracometer; Solar CB160 capacitor analyzer; Stanco 132 power pack; Standard register; #7, #8 Rider's; resistor kit, 50 asstd. tubes, speakers, coils, condensers, vibrators, etc. Write for list. Would like to sell as one lot if possible. Robert M. Patton, 163 Blackburn Ave., Lansdowne Pa.

WANTED IN CANADA—Late V-O-M and sig. generator for 25 cycle operation. John H. Scott, 38 Hogarth Ave., Toronto 6, Ont., Canada.

WANTED—Good receiver such as 11Q-120X, Super-pro or what have you? Cash. Robt. M. Stillmaker, ARM 1/C, U.S.S. Tripoli, CVE-64 Div. V-2, % F.P.O., New York N. Y.

WANTED—Urgently in need of new or used 16" crystal pickup for 3 1/2 v.m.m. U.S. govt. baud transcriptions. David A. Bensman, North High School, Shebovau Wisc.

WANTED—Sky Buddy or Echophone EC-1 in good condition or late model tube checker. Have 20-shot 22 cal. auto. rifle to trade. Roland Jarrard, 616 W. W. Ocala, Florida.

WANTED—SX-24 or SX-99 Hallicrafter in good condition, also 35Z5; 50L6; 12SA7; 1A7; and 1H5 tubes; also RCA Jr. volt-ohmyst or any good V.T.V.M. and crystal pickup cartridge. W. O. Fred W. Bearinger, W-212138 Hdq. 491st A.F.A. Bn., A.P.O. 261, Camp Cook, Calif.

WANTED—Model 162-C RCA-Rider channel; Supreme portable lab. #504-A; Rider's manuals 1 to 12. Cash. All letters answered. Joseph Nieradka, 9 Monroe St. Garfield, N. J.

WILL SELL OR TRADE my 8x10 professional plate camera, an American dynamic mike D8T, and port. recording unit with built-in amplifier and playback head for good test eqpt. or good small 35 mm camera of equal value. D. Pommers, P.O. Box 97, N. Y. Airport Sta., Jackson Heights, N. Y.

WILL TRADE—Readrite 430 tube tester and Weston counter model 676R with case, both in excellent condition. Want Rider's manuals or what have you? E. James Hilton, Waymart, Pa.

WANTED—New radio tubes 26, 27, 24A, 45, 47, 71A, etc. Want four or six of each. Send list. W. F. Onder, Rt. 1, Box 380, Kimmswick, Mo.

YOUR OWN AD RUN FREE!

This is Sprague's special wartime advertising service to help radio men get needed parts and equipment, or dispose of radio materials they do not need. Send your ad today. Write PLAINLY—hold it to 40 words or less. Due to the large number received, ads may be delayed a month or two, but will be published as rapidly as possible.

Different Trading Post ads appear monthly in Radio Retailing-Today, Radio Service-Dealer, Service, Radio News, and Radio-Craft. Sprague reserves the right to reject ads which do not fit in with the spirit of this service.

HARRY KALKER, Sales Manager.

SPRAGUE PRODUCTS CO., DEPT. RN-84 North Adams, Mass.



SPRAGUE CONDENSERS KOOLOHM RESISTORS

Obviously, Sprague cannot assume any responsibility, or guarantee goods, services, etc., which might be exchanged through the above advertisements

Your best bet!

...for Everything in
RADIO and ELECTRONICS

You can get *all* your needs *faster* from this *one* central source. Here's why:

- (1) Largest and most complete stocks under one roof
- (2) Over 10,000 radio and electronic items on hand for rush delivery ... tubes, parts, kits, test equipment, public address ... for training, research, engineering, production and maintenance
- (3) Close contact with all the leading manufacturers
- (4) Centralized procurement and expediting
- (5) Technical assistance.

Whether you need one item, or a hundred ... **Call Allied First!**

Write, Wire or Phone Haymarket 6800

ALLIED RADIO CORP.
833 W. Jackson Blvd., Dept. 1-H-4 Chicago 7, U.S.A.



REPAIR AND REPLACEMENT PARTS AVAILABLE WITHOUT PRIORITY



NEW Rapid R-F Resonance and Coil Winding Calculator
New, dual-purpose Calculator devised by Allied for fast and accurate determination of resonance factors and coil winding data. Simple, easy to use. Send for it now. No. 37-955.
Price net, only.....25c

6 VALUABLE RADIO BOOKS FOR 75c

Specially prepared by technical experts for radio training and for helpful reference. Priced only to cover cost of preparation and mailing.



RADIO BUILDERS' HANDBOOK. Simplified theory and projects. No. 37-750 .. 10c

RADIO-FORMULAS & DATA BOOK. Handy, pocket-size manual. No. 37-752 ... 10c

SIMPLIFIED RADIO SERVICING. Short cuts in troubleshooting. No. 37-755 .. 10c

DICTIONARY OF RADIO TERMS. Easy-to-understand definitions. No. 37-751 .. 10c

RADIO CIRCUIT HANDBOOK. Schematics and Pictures. No. 37-753 10c

RADIO DATA HANDBOOK Formulas — Tables — Charts No. 37-754 25c

ALL SIX BOOKS No. 37-799 75c
Write for Quantity Quotations

ALLIED RADIO CORP., Dept. 1-H-4
833 W. Jackson Blvd., Chicago 7, Illinois

Please send the following items (\$ enclosed)

- | | | |
|--|---------------------------------|---------------------------------|
| <input type="checkbox"/> 37-750 | <input type="checkbox"/> 37-752 | <input type="checkbox"/> 37-754 |
| <input type="checkbox"/> 37-751 | <input type="checkbox"/> 37-753 | <input type="checkbox"/> 37-755 |
| <input type="checkbox"/> All 6 Radio Books <input type="checkbox"/> Free Catalog <input type="checkbox"/> Calculator | | |

Name _____

Address _____

City _____ State _____



mans in an attempt to combat our bombing.

As most of us know light rays can be split up into colors. If we look at the sun through a prism we find that there are seven distinct colors visible. The order of these colors never varies and is as follows: violet, indigo, blue, green, yellow, orange, and red.

Although the order of the colors remains the same, a variation in the spectrum (the band of colors) may be obtained by burning different substances in a flame. Thus a scientist could tell by the spectrum if a piece of copper wire was actually copper by holding it in a flame and viewing it through a spectroscope or prism.

Needless to say this property of a prism to split up light has had great use made of it. Scientists have been able to ascertain the composition of the sun and stars.

Photographers have found that the placing of special screens before a light will allow only parts of the spectrum to pass. Thus we might project a spectrum upon a screen through a spectroscope and wipe out all but the violet light by placing a suitable screen in front of the light. We could likewise cut out all but, shall we say, the red from the light.

Thus it is possible to place a screen before a light and, even though there appears to be no light to the naked eye, use a certain part of the spectrum to light objects, these objects being shown upon special screens.

According to the *Daily Herald*, German "back room" boys took these facts into account when trying to devise systems to combat our raids. It is claimed that they used certain parts of the spectrum, which are invisible to the human eye, to illuminate our aircraft. These rays, the claim goes, could penetrate fog and cloud and aircraft coming within their sphere could be seen on a special screen although the pilot in the aircraft sighted would be unaware that he had been seen.

Disadvantages

The disadvantages of such invisible (or "black") searchlights are similar to those which affect the more usual visible searchlight. Aircraft may be out of range of the beam, or even if visible, opening fire will result in evasive action which will most likely result in the aircraft being lost from sight.

Of course the greatest danger would be if such equipment were used on night fighters, as the *Daily Herald* claimed that it was. It would be possible for a night fighter to slip up close to one of our aircraft unobserved unless we had some counter measure in use. The tremendous number of fighter aircraft shot down by our bombers over Germany seems to conclusively prove that we have such a counter measure.

Flare Paths

You have probably read of another Nazi scheme employed against our planes. Night fighters patrol at a

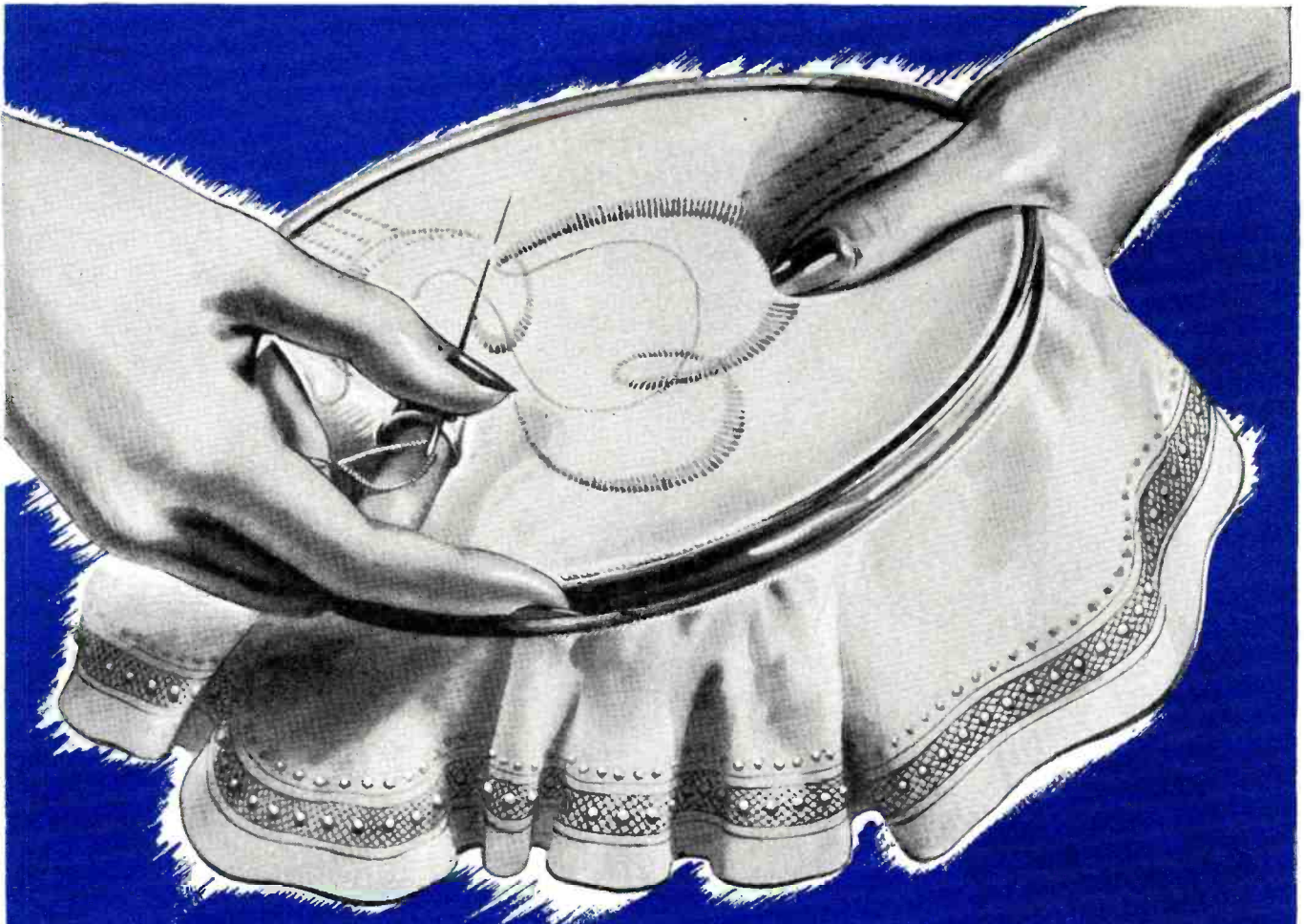

*What's EMBROIDERY got to do
with making RADIOS?*

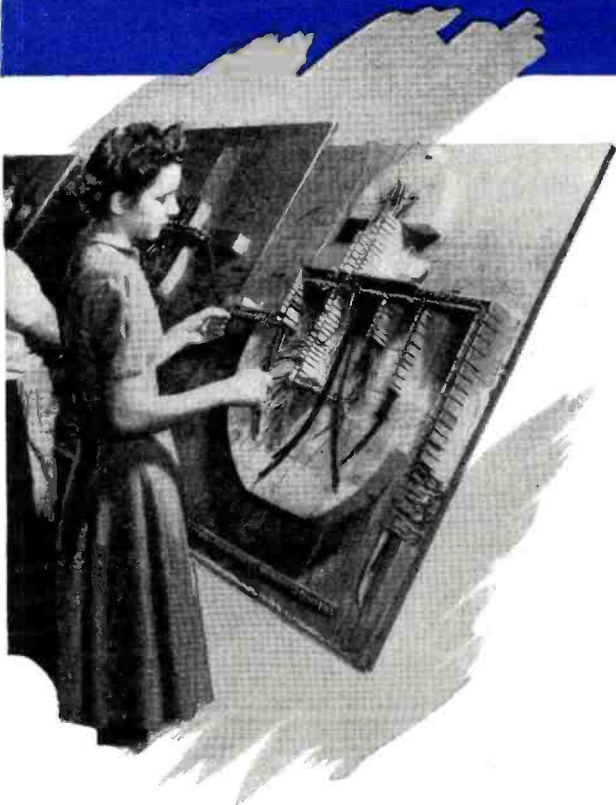

Both fine needlework and the delicate tasks of assembling quality electronic fighting equipment are natural for the supple hands of women, who compose 75 per cent of Detrola Radio workers. After Victory their skill and trained fingers will build highest quality radio and television for the American home. *Speed Victory—Buy War Bonds.*

DETROLA RADIO

DIVISION OF INTERNATIONAL DETROLA CORPORATION • BEARD AT CHATFIELD, DETROIT 9, MICH.

C. RUSSELL FELDMANN  PRESIDENT

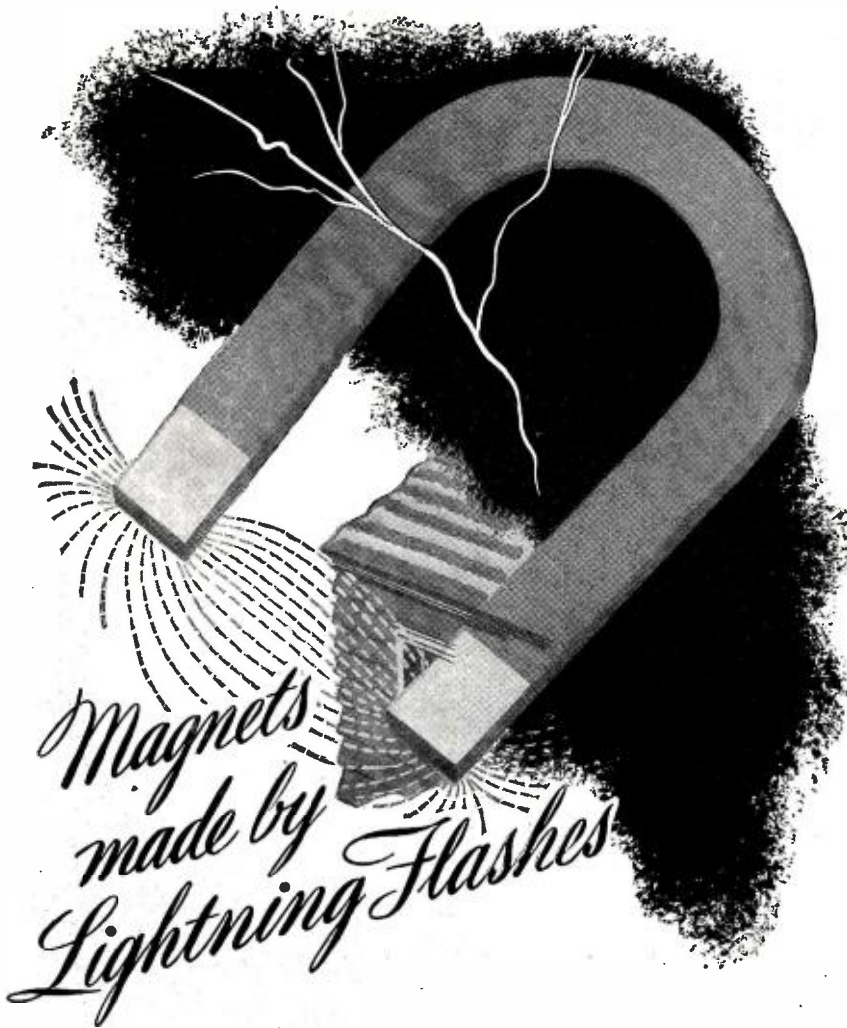

*Magnets
made by
Lightning Flashes*

Distant flashes of lightning were used to magnetize needles by Joseph Henry during his experiments at Princeton in the 1840's. The needles were placed in coils attached to a metal roof and grounded. This little-known incident demonstrated to Henry that electromagnetic force was propagated—"wave-fashion."

Electronic research is an ever-unfolding drama that often magically turns into real-life factors—as Stancor engineers discover almost daily—and the values of which they build into the devices now being perfected for better coordination and control of communication.

SEND FOR NEW COMPLETE CATALOG

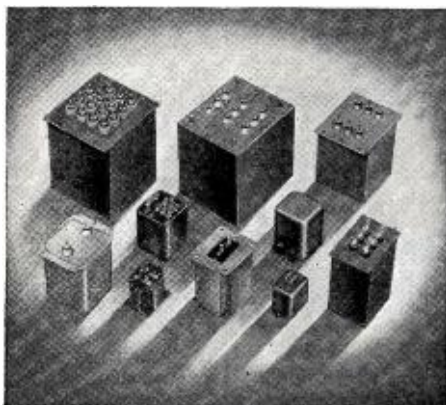

STANCOR

Transformers

STANDARD TRANSFORMER CORPORATION
1500 NORTH HALSTED ST. • CHICAGO 22



*Manufacturers of quality transformers,
reactors, power packs and allied products
for the electronic industries.*

great height—higher than our bombers—and when the attackers arrive other planes drop flares below them, or, alternatively flares are shot into the air by guns. The idea is to throw our machines into relief so that the night fighters can see and attack them.

This scheme has a very decided disadvantage. Besides showing up our planes it also enables our planes to see the fighters when they come in to attack; consequently, the "flare path" idea has proved to be somewhat costly to the Nazis who have lost many fighter planes as a result of it.

The New "Blitz"

For a short time in 1944 it appeared that the Nazis were determined to give London a "blitz." Upon several nights' running aircraft came over and dropped bombs and incendiaries upon the capital and in the suburbs. They did not keep the attack up for long and this was probably due to their having to retain their aircraft for the second front and also thanks to the surprises given them through the work of scientists.

One of the new devices employed was a rocket gun. This weapon could be heard above the roar of the ordinary guns and its firing was marked by a group of bursts in the sky—similar in appearance to a bunch of grapes—sour grapes to the Nazis who happened to be in the vicinity.

The Nazis have also introduced some so-called secret weapons. One of these, heralded with a blare of trumpets and much propaganda as "a new rocket bomb" incorporates radio control.

The idea of a rocket bomb is not new. One thousand years ago a manuscript called "Liber ignium" ("The book of fireworks") was written. In it various methods were described whereby fireworks could be used in warfare.

Over 2000 years ago the Chinese and Hindus used fireworks and rockets but they were generally employed in celebrating.

Greek fire was another type of fireworks used with great success many centuries ago. It would burn through any armor and set fire to practically anything upon which it was thrown.

Coming back to modern times we find that Sir William Congreve invented two rockets for war purposes. One of these had a small parachute incorporated in it. When the rocket exploded this fell out and floated in the air, a brilliant light flaring under it, being attached with cord, and lighting up the ground below. The other released a mass of blazing material upon exploding. This material was intended to set fire to enemy buildings upon which it fell.

The Rocket Radio Bomb

Referred to above was the fact that one of the new bombs used by the Nazis was radio controlled. In appearance this bomb looks like a small monoplane. It is controlled by radio, being directed to its target by an op-

\$23,000. WORTH OF HELP FOR YOU!

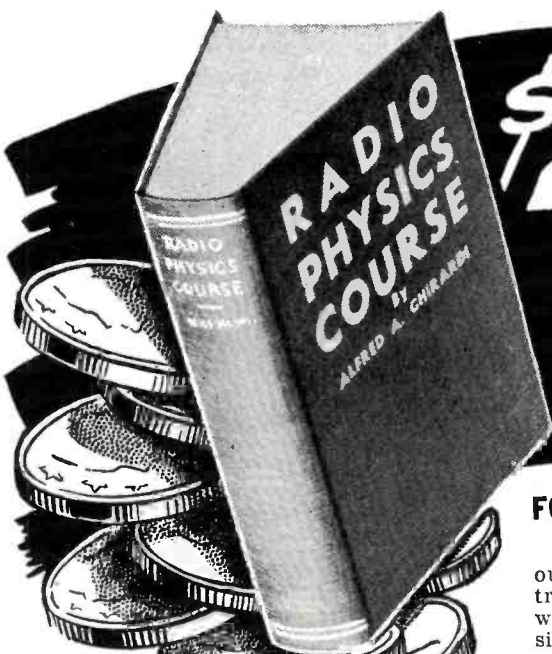

Meet **A. A. GHIRARDI**—the man who has started thousands of students on successful Radio-Electronic careers by making their training easy.

HERE'S HOW TO TEST A RADIO in 2 Minutes or less!

If you repair Radios for a living—or even if you only “tinker” with them occasionally—this big special wartime edition of Ghirardi's **RADIO TROUBLESHOOTER'S HANDBOOK** is the book for you! 744 manual-size pages contain a complete guide to diagnosing, locating, and quickly repairing practically every type of Radio receiver now in use. Simply look up the Trouble Case History data on the particular set you want to repair. Nine times out of ten, the Handbook will tell you just what is wrong and how to fix it in a jiffy! No extensive testing—no guesswork—no lost motion—more sets fixed per day!

Now contains 404 pages of case histories giving the common trouble symptoms, their causes and remedies for over 4000 receiver models. Also



Work Twice as Fast!

hundreds of additional pages on i-f alignment peaks for over 20,000 superhets—parts substitution data—tube replacement charts—and dozens of data sections, charts, etc., invaluable in service work. Only \$5 complete (\$5.50 foreign) on a 5-Day Money Back Guarantee.

FOR BEGINNERS! No Previous Training Necessary

Here, in one big, 972-page volume that cost over \$23,000 in actual cash outlay before a single book was sold, you get complete basic Radio-Electronic Training *at a cost to you of only \$5 complete*. Think of it! \$23,000 worth of the finest, learn-at-home instruction—at a price so low you simply cannot afford to miss it! And remember: Literally hundreds of successful Radio men themselves state without reservation that you cannot get better, more complete basic instruction **AT ANY PRICE**. Actually, Ghirardi's famous **RADIO PHYSICS COURSE** book covers the scope of 36 courses. If it were broken into sections and sold in course form, you'd consider it cheap at \$50 or more!

LEARN RADIO EASIER ... LEARN IT FASTER

... at a price you can afford to pay!

Ghirardi's **RADIO PHYSICS COURSE** book is acclaimed throughout Radio as the “biggest bargain” in easy-to-understand, complete, and fully modern Radio-Electronic Training. This same inexpensive book has given more people their start in Radio than any other ever published. It is more widely endorsed, more universally recommended by men who know Radio, who are in Radio themselves. Because of its sheer merit, it is more universally employed in U. S. Army Signal Corps, Navy, and civilian schools than any other book on the subject. Because it explains everything so clearly, it is more widely used for home study. Facts like these speak for themselves. They prove that you don't have to spend a lot of money to learn Radio-Electronics easily—and to learn it **RIGHT!**

No previous study is necessary. Ghirardi's **RADIO PHYSICS COURSE** painstakingly explains everything in detail.

Nothing is left out. Nothing is condensed. Over 500 specially prepared illustrations help you visualize every step. You don't need to wait for monthly lessons. All you need is a little spare reading time and a desire to get started right in any of Radio-Electronics' many branches—service work, aviation, military, broadcasting, manufacturing, television, and many others.

YOU DON'T RISK A CENT!

BEST OF ALL, you don't risk a cent. We'll gladly give your money back if, in 5 days, you are not absolutely convinced that this big book will teach you the fundamentals of Radio-Electronics **EASIER, FASTER**, and at **LESS COST** than any other book or course. That's how sure we are that it is the best in the field! You be the judge!

HERE'S PROOF!

“Ghirardi's **RADIO PHYSICS COURSE** is the handiest and easiest to understand of any Radio book we used in the Navy,” writes C. A. Randall, Radio Technician 2nd Class, U.S.N.R.

“This book has really been my instructor. With its aid, I passed the Army Communications Cadet exam. It is virtually a radio encyclopedia.” Pfc. Bernard Bragin, Scott Field, Ill.

“I cannot understand how you could possibly publish a book that completely covers Radio and Electricity at such a low price. I only regret that I did not get my copy sooner.” A. DeRossi, Serviceman.

“I have searched all over for a book on Radio which would completely cover the subject and still be easily understandable to a beginner. This is it!” Robert Becker, student.

WARNING! Paper shortages may make it impossible for us to continue meeting the tremendous demand for Ghirardi Radio Books. Order yours today while they are still available!

THE ONLY COMPLETE BOOK ON MODERN RADIO SERVICING

Ghirardi's 1300-page **MODERN RADIO SERVICING** is a hard-hitting, intensely practical volume worth its weight in gold to the busy serviceman. It is the only single, inexpensive course giving a thorough explanation of the workings of all Test Instruments; Receiver Troubleshooting Procedure; Circuit Analysis; Testing and Repair of Component Parts; Installation; Adjustment; Maintenance, etc. 706 illustrations, 720 self-testing review questions, 766 different topics. Only \$5 complete (\$5.50 foreign) on 5-Day Money-Back Guarantee Basis.

SEE SPECIAL OFFER IN COUPON



THE 3 GREATEST VALUES IN MODERN RADIO TRAINING

RADIO & TECHNICAL DIVISION,
Murray Hill Books, Inc., Dept. RN-84
232 Madison Ave., New York 16, N. Y.

Enclosed find \$..... for books checked; or I send C.O.D. (in U.S.A. only) for this amount plus postage. If I am not fully satisfied, it is understood that I may return the books within 5 days and receive my money back.

RADIO PHYSICS COURSE

\$5 (\$5.50 foreign)

RADIO TROUBLESHOOTER'S HANDBOOK \$5 (\$5.50 foreign)

Send **FREE** literature

MODERN RADIO SERVICING

\$5 (\$5.50 foreign)

SPECIAL MONEY-SAVING OFFER

"Modern Radio Servicing" with "Troubleshooter's Handbook" \$9.50 (\$10.50 foreign)

NAME

ADDRESS

CITY & DIST. NO.

STATE

5-DAY MONEY BACK GUARANTEE

MAIL THIS NOW!



PERFECT reception and trouble-free performance of MURDOCK RADIO PHONES among our armed forces NOW, is insuring a tremendous postwar demand.

Remember, sensitive radio phones can be built in only one way — by precision methods — close tolerances and close inspection. That's the secret of MURDOCK performance. Close limits eliminate any chance of loose parts or weak connections — this is due to Murdock's molded construction. You are always sure of clear reception and permanently fine adjustment when you wear Murdock Headphones.

See these "Master Radio Phones!" Send for Catalogue of Murdock Radio Phones and accessories *TODAY!*

SUB-CONTRACTS

Though very busy, our efficient production methods open opportunities for making more Radio Phones and parts for others through sub-contracts. WRITE US.

WM. J. MURDOCK CO.
129 Carter St., Chelsea 50, Mass.

erator in a plane following it. The disadvantages of this bomb are obvious. Firstly, the plane guiding it is very vulnerable to attack as it cannot do a lot of evading without losing control of the radio bomb.

Secondly, it is possible to jam the transmissions sent out to control the bomb and so precipitate it on the spot.

(Ed. Note: This bomb is not to be confused with the more recent one which was propelled solely by rockets on a predetermined set course, which has appeared in recent headlines. The Germans, several months ago, had experimented with a radio-controlled bomb, as described herein.)

A radio-controlled tank was used at the Anzio beachhead. The same defects applied to this. The tank was intended to be guided to our lines and when it arrived, to be exploded by radio. In reality our guns exploded many of these tanks, described as "beetles," among the enemy by firing at them.

Radio Locates the Enemy

The author has described various systems employed by ourselves and the enemy in an endeavor to destroy each other. In most of the systems described, radio has played a minor part. Now it is proposed to mention a way in which an ordinary radio set could be used to locate enemy aircraft. The noises caused by the electrical system of the intruder could be picked up by a sensitive radio set incorporated in a night fighter. A directional aerial of the revolving type would enable an operator in the night fighter to ascertain the direction of the aircraft whose ignition noises were being picked up. It would then be merely a matter of guiding the plane towards the intruder, using the aerial as a pointer.

So far we have been dealing with the aggressive side. Just as important, work has been done on the humane side. Special apparatus described as a "life detector" first received prominence when an unexploded bomb went off under a tenement building in the Elephant and Castle area of London causing great loss of life.

The bomb laid dormant for the greater part of a year, its presence not even being suspected, for it should be remembered that an unexploded bomb leaves only a small hole when it enters the soil and this may fall in giving the impression that the ground has been turned over. In this particular case the bomb exploded one Sunday evening. Buildings folded up like packs of cards and many people were buried amidst the debris.

Then special apparatus was brought into action. It comprised huge admirably loud speakers capable of being heard over a distance of five miles, their amplifiers, and a series of microphones which looked like round tins.

The microphones were numbered, each number corresponding to a number on a dial. When the apparatus was used the microphones were placed to surround the debris. Then the am-

JAMES

Crystals

KNIGHTS

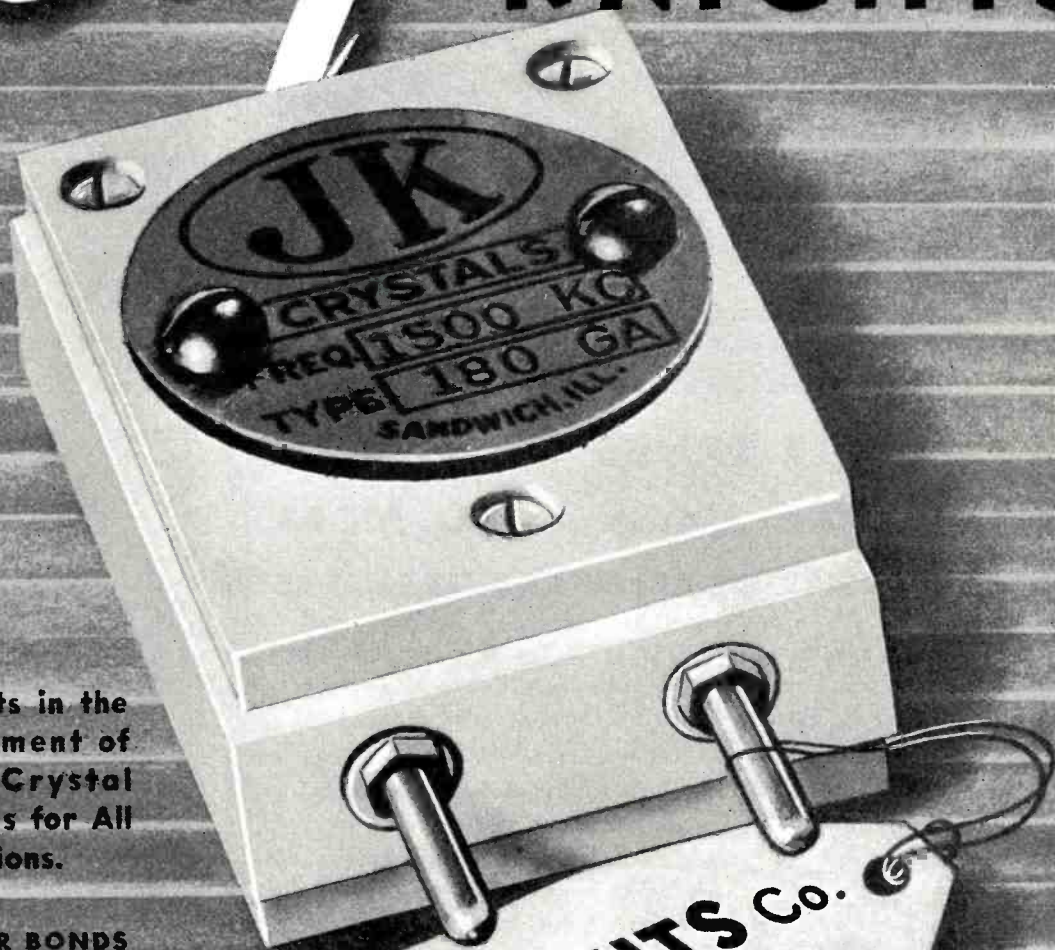

Specialists in the
Development of
Quartz Crystal
Products for All
Applications.

BUY WAR BONDS
FOR VICTORY!

The **JAMES KNIGHTS** Co.
SANDWICH, ILLINOIS

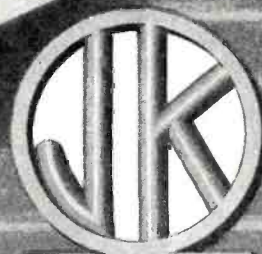

CRYSTALS

CRYSTALS FOR THE CRITICAL



IT TAKES

CLARE "Custom-Building" TO MEET TODAY'S DIVERSITY OF RELAY REQUIREMENTS

Clare Relays are being specified by radio engineers with increasing frequency because Clare "Custom-Building" gives them the flexibility of design that meets almost every relay problem.

Illustrated here is the Clare Type "C" d.c. relay with plug-in mounting which is especially designed for requirements that call for rapid opening and closing of circuits. The Type "C" may be used for control of up to 12 circuits.

Clare "Custom-Building" makes possible the use of the widest range of contact ratings; a choice of five different contact forms or any combination of them; either flat or hemispherical contacts of rare metals or

special alloys. It gives coil windings to match the circuit and application, the contact closure sequence and desired contact pressures.

Clare Relays are well known for their careful design and precise manufacture from the finest materials. They come to you accurately adjusted and with an adjustment that stands up under severe usage. Clare engineers are ready to "custom-build" a relay to your exact requirements. Let us know your problem and receive our suggestions. Send for the Clare catalog and data book. Write C. P. Clare and Co., 4719 West Sunnyside Avenue, Chicago (30), Illinois. Sales engineers in all principal cities. Cable address: CLARELAY.

"Custom-Built" Multiple Contact Relays for Electrical, Electronic and Industrial Use

CLARE RELAYS

plifiers were switched on. When this is done the slightest noise is almost deafening to the operator who sits before the dial with the microphone numbers upon it.

Silence is called for and the operator then gradually turns the dial. As a pointer comes to rest against a number the microphone corresponding to that number is brought into action. There are usually about nine microphones and if a sound is heard upon one of them some idea of the locality of a victim can be ascertained.

The apparatus has not been tested thoroughly as yet because there are only about five such detectors in Britain. They are kept in readiness at central places in order that they may be rushed to the scene of a disaster should other methods of locating victims fail.

Prior to the introduction of the "life detector" at the Elephant and Castle disaster the author described special apparatus which he had evolved. In this arrangement he also made use of powerful amplifiers and microphones, but in a different way. A sound would be located on one microphone and then on a second one. By doing this it was possible to ascertain the exact spot under which a victim was buried by drawing a line towards the sound from each microphone.

The author also designed a special piece of apparatus which he named a "Locator." It comprised a magnetic arrangement similar to a pickup. When rested against beams going down into debris it would record the vibrations caused by knocking or speaking close to the beam, in headphones. The advantage of this system was that it was not necessary for silence to operate it—thus the apparatus could be used when a raid was in progress.

—30—

Testing the accuracy of radio-frequency bands is an important part of the general checkup which military aircraft must receive periodically. The photograph shows Technical Sergeant William A. Stott, Jr., of Jasper, Texas as he heads back to his lair, "Ye Gremlin Inn," after making a band check on a P51 Mustang fighter. The unit which he is carrying is the field strength meter used in this test.



THE SCIENCE OF ELECTRONICS ALSO PROVIDES A NEW TRIUMPH IN
ELECTRO-MEDICAL ANALYSIS AND LABORATORY RESEARCH . . .

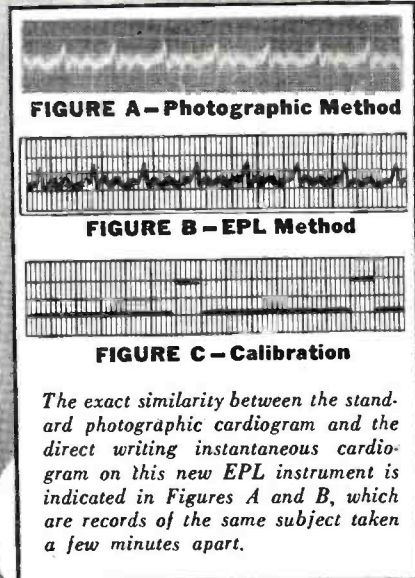

The exact similarity between the standard photographic cardiogram and the direct writing instantaneous cardiogram on this new EPL instrument is indicated in Figures A and B, which are records of the same subject taken a few minutes apart.

New

EPL Direct-recording Electrocardiograph* ...giving instantaneous *standard* readings

- Built to exacting laboratory standards after years of research
- Completely eliminates all photographic procedures
- Useful in the laboratory as well as a benefit to mankind
- Compact, lightweight, portable; simple and efficient in operation
- Cardiograph record appears instantaneously
- Built-in interference filter makes possible perfectly usable cardiograms in strong interfering electrical field
- Operates from any 110-120 volt, 60 cycle, AC service
- Uses no ink or other fluids
- High operating economy

*PATENT PENDING

Note to
MEDICAL DIVISION
of the
ARMED SERVICES

We will gladly demonstrate this new Direct-recording Electrocardiograph before you at your convenience. We sincerely believe that this instrument can lend material assistance to the work that the Armed Services are now doing in the rehabilitation of wounded veterans.

For Laboratory Procedure

The recorder of this new Electrocardiograph may be used in conjunction with other equipment for laboratory research. It provides an amplifier and recorder which will give a graphic record between .1 cycle and 80 cycles per second at a sensitivity of 1 millivolt for 2 cms total deflection; or a range from zero to 80 cycles for 60 millivolts for 2 cms deflection. A high speed writer can be supplied which will extend the operating frequency to about 200 cycles. Because of the special damping circuit employed, excellent transient response is secured.

Although in the high sensitivity connection, the amplifier is not a true D-C amplifier, the phase correction is such that perfect square wave response from .25 cycles to 80 cycles is realized with the one millivolt sensitivity connection.

*At present, deliveries will be made on priority only.
Write for descriptive booklet.*

ELECTRO-PHYSICAL LABORATORIES, INC.
45 W. 18th STREET • NEW YORK 11, N. Y. • WAtkins 9-1870

Manufacturers of Electro-Encephalographs and Electric Shock-proof Machines

A Division of the ELECTRONIC CORPORATION OF AMERICA



PRACTICAL RADIO COURSE

By ALFRED A. GHIRARDI

Part 25. The operation and shortcomings of the tuned-radio-frequency receiver and an analysis of the superheterodyne system of reception.

THE preceding articles of this series were intended to acquaint the reader with the theory of operation of detectors, oscillators, radio-frequency amplifiers and audio-frequency amplifiers. We are now ready to proceed to a study of practical tuned-radio-frequency and superheterodyne receivers which employ them.

How the Tuned-radio-frequency Receiver Functions

The tuned-radio-frequency receiver, commonly abbreviated t.r.f., usually consists of a multistage radio-frequency amplifier, a detector and an audio-frequency amplifier arranged in the sequence illustrated in Fig. 3. The schematic circuit diagram for the t.r.f. amplifier and detector portion of such a receiver is illustrated in Fig. 2. It is important that all three tuned stages L_1C_1 , L_2C_2 , and L_3C_3 , be made sufficiently alike electrically so that they will be in tune with each other at every position of the 3-gang tuning condenser, in order that all stages may be tuned simultaneously by a single control knob on the gang condenser.

Referring to Fig. 3, electromagnetic radiations (radio waves) A , B , C , etc., (of differing carrier frequencies) from three different broadcasting stations are shown cutting across the aerial and inducing modulated signal voltages A , B and C of corresponding frequencies therein. In each case, the fine lines represent the carrier frequency, and the wave envelope indicates the modulation component. These voltages result in the flow of minute signal currents of these respective frequencies through the primary winding of the antenna transformer L_1 (Fig. 2). The currents induce corresponding signal voltages in the secondary of the transformer. That signal voltage whose carrier frequency is the same as that to which the resonant circuit L_1C_1 is tuned (let us assume it is signal voltage B) will be of maxi-

imum strength; the others will be very much weaker. Since they all act on the grid of the first r.f. amplifier tube, they will appear as much stronger (amplified) signals in the plate circuit of this tube. The rapid changes in plate current due to these r.f. signals will set up a flux about the secondary winding of the second r.f. coil L_2 , so that corresponding signal voltages will be induced in it. Here again, the tuned circuit (L_2C_2) causes that signal voltage whose frequency is the same as that to which the circuit is tuned to be of maximum strength, thus increasing further the ratio and discrimination between the strength of the *wanted* and *unwanted* signals. The same process of amplification and selection is repeated by the second r.f. amplifier tube and tuned circuit L_3C_3 , resulting in the amplified output, D , of the original waveform. Notice that the frequency of the modulated wave has not changed.

The signal is then detected or demodulated. Waveform E represents the extracted a.f. modulation component of the carrier. Notice that the waveform of this detector output is similar to the modulation envelope of the original carrier wave B . This is now amplified to the desired strength by one or more stages of conventional audio-frequency (a.f.) amplification, resulting in amplified version, F , of the detector output waveform. This is fed into the loudspeaker, producing sound waves G . One important thing to remember about the operation of a t.r.f. receiver is that up to the point where it is demodulated, the signal voltage is amplified *at its own carrier frequency*. This means that the tuned circuits L_1C_1 , L_2C_2 , L_3C_3 , must be made variable in order to be able to tune to the carrier frequencies of the various stations it is desired to receive. Tuning to the various carrier frequencies is usually accomplished by varying the condenser capacity in each tuned cir-

cuit, although it is possible to achieve the same result electrically by varying the inductance of the coil instead.

Limitations of the t.r.f. Receiver

First of all, in order to provide adequate selectivity under modern broadcasting conditions, at least *three* (and usually *four*) tuned stages are required. Since all the stages are to be tuned by a gang condenser controlled by a single knob, it means that they must be made sufficiently alike electrically so that they will be in tune with the wanted signal and with each other *at every position of the dial*. This involves precision of manufacture in the various parts, since it requires that the tuning condensers, coils, and capacities between the wires and circuit elements be exactly alike in each stage. Although small, adjustable trimmer condensers are employed across each section of the gang tuning condenser (or across the coils themselves) in an attempt to compensate for such differences, it usually is not possible to maintain each stage of such an r.f. amplifier *exactly* in tune at all frequencies throughout its tuning range with components of allowable cost. Therefore, at frequencies for which the circuits are not all exactly in tune, the *selectivity*, *sensitivity*, and *fidelity* will suffer.

Furthermore, when a tuned circuit is made *variable* (as it must be in a t.r.f. amplifier), since the condenser capacity employed in each tuned circuit is being varied, the L/C ratio changes over the frequency range of the receiver. For this reason, and because the tuning circuit losses also are different at each frequency, uniform amplification over the entire tuning range is not readily obtained. Thus the sensitivity, selectivity, and fidelity of such receivers tend to be different at each setting of the tuning dial. Compensating methods are usually employed for partially offsetting these

Fig. 1. Functional block diagram of a typical superheterodyne receiver, showing the various changes the modulated signal undergoes as it progresses successively through the various stages of the receiver.

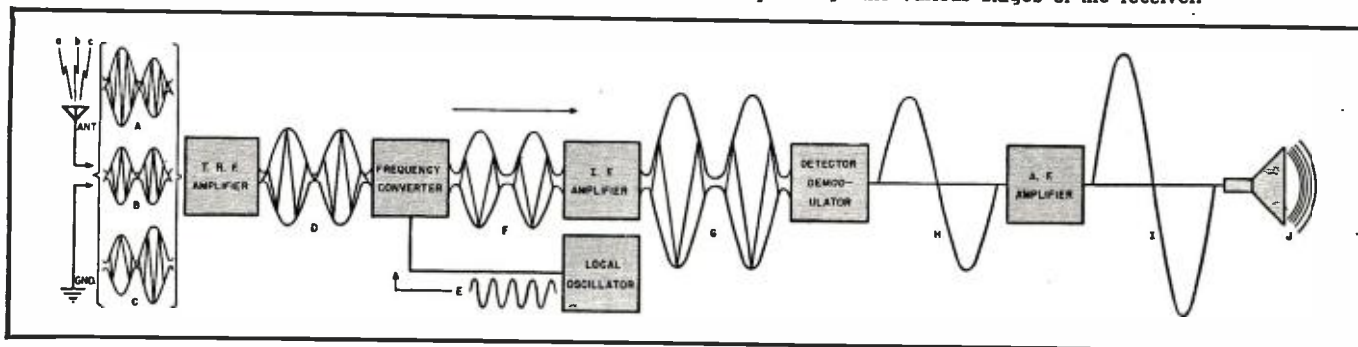

RIGHT, MAJOR, IT WON'T TRANSLATE JAPANESE

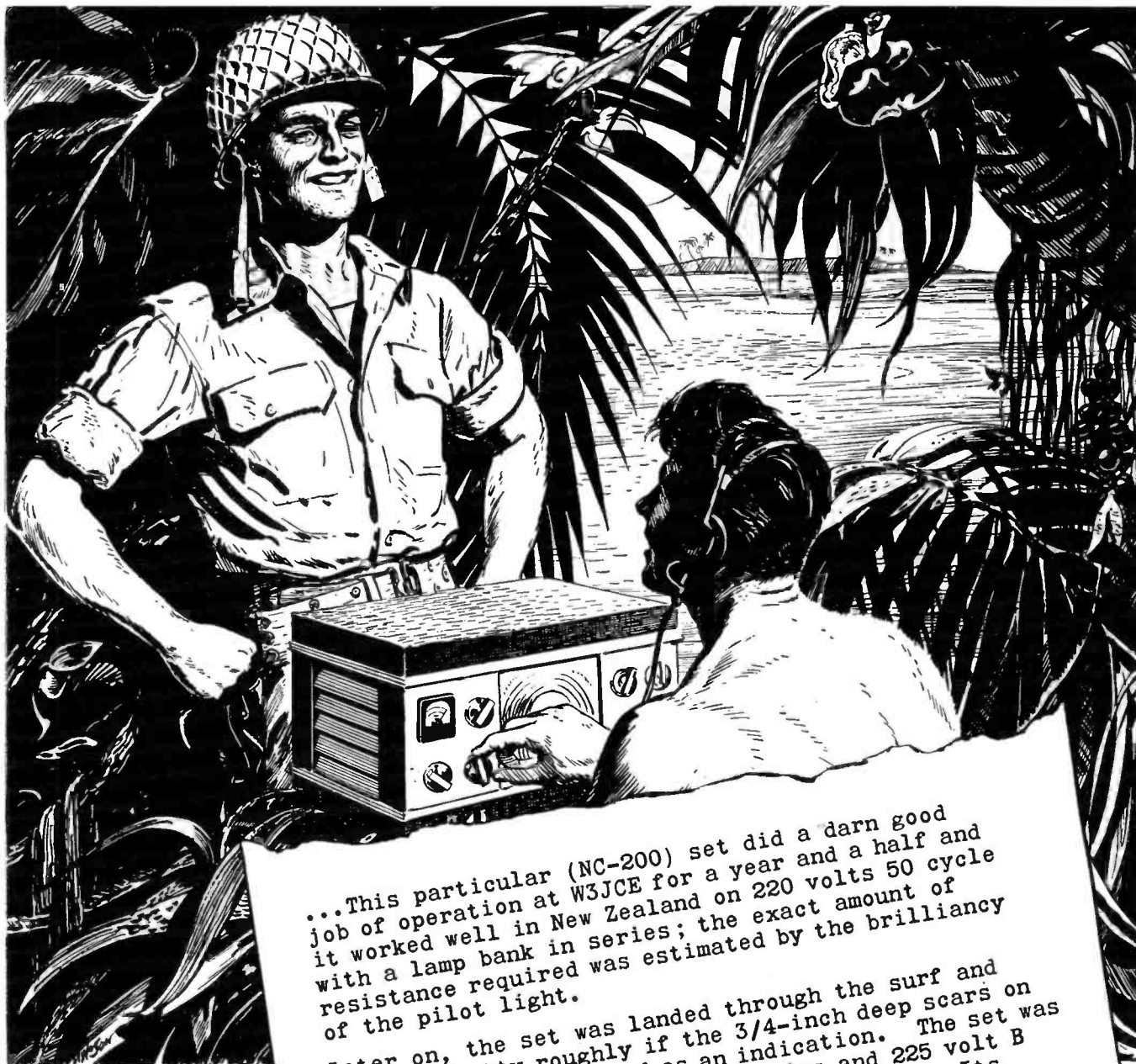

...This particular (NC-200) set did a darn good job of operation at W3JCE for a year and a half and it worked well in New Zealand on 220 volts 50 cycle with a lamp bank in series; the exact amount of resistance required was estimated by the brilliancy of the pilot light.

Later on, the set was landed through the surf and handled pretty roughly if the 3/4-inch deep scars on the packing box are used as an indication. The set was operated on 6 volt storage batteries and 225 volt B for several weeks until AC became available. Its reception of broadcast programs from the States 7000 miles away was excellent. In fact, the only thing it wouldn't do was translate Japanese. The NC-200 was by far the best radio on the island except for one 'RAS' and I guess you know who built that.

When I received my orders to come back to this country, it almost broke my heart to part with 'Baby', but I sold it because a good radio means a lot out there.

(Excerpt from a letter from a Major of Marines in the Pacific)



NATIONAL COMPANY

MALDEN



MASS., U. S. A.

NATIONAL RECEIVERS ARE IN SERVICE THROUGHOUT THE WORLD

A CUSTOM DIVISION FOR SPECIAL "SOUND" JOBS

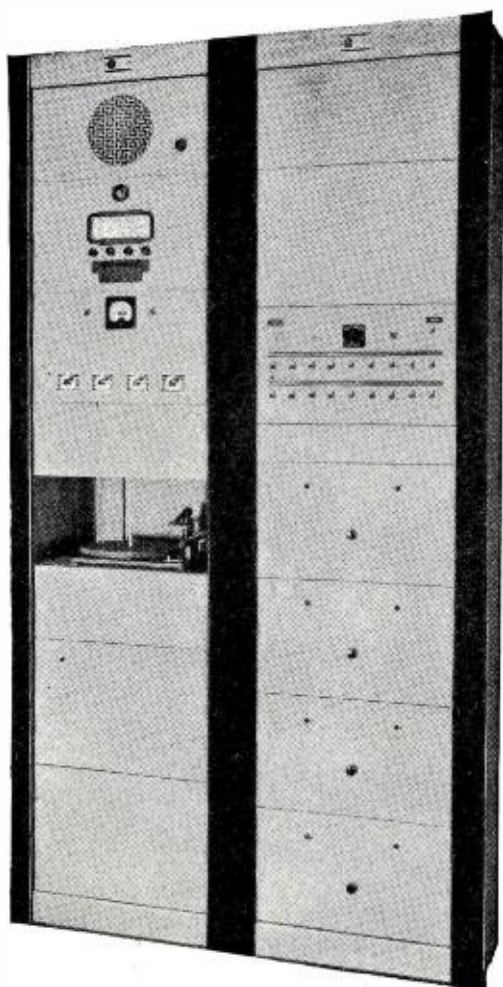

The Custom Division of the David Bogen Company is devoted exclusively to the design and manufacture of special sound systems. Whatever the assignment—an industrial plant, air field, hospital or shipyard—each differs in conditions of noise level, areas to be covered, functions and features required. The Bogen custom sound system is individually designed and built to fulfill the requirements of the individual job.

To do the job in the right way, the David Bogen Company maintains an engineering staff and separate construction Department. The services of a field engineer are available to Bogen distributors for making the sound survey and "laying out" the system.

The War Production Board has relaxed the restrictions on granting priorities for industrial sound systems. The David Bogen Company is one of the limited number of manufacturers permitted to expand the production of this vital equipment.

Help Crack the Axis More Quickly . . . Buy More War Bonds



David Bogen Co. Inc.

THE STANDARD OF PERFORMANCE

663 BROADWAY NEW YORK 12, N. Y.

Bogen Sound Systems • Communo-Phones • Amplifiers • Electronic Equipment

variations, but since they complicate the receiver it is costly to try to obtain uniform selectivity and sensitivity through their use.

Then, too, it is extremely difficult to keep the Q of a tuned circuit high if the resonant frequency of the circuit runs into the higher frequencies. In a t.r.f. receiver, the r.f. amplifier stages are required to amplify the incoming signal directly at its original carrier frequency; even in the low-frequency broadcast band, between 550 and 1600 kc., the frequency range is too high to expect to obtain uniformly high Q all over the band. The sensitivity and amplification suffer at the higher frequencies. Here again, compensating circuit arrangements can be employed to partially offset this, but they add to the cost and complexity of the receiver. In addition, since the sensitivity of a t.r.f. receiver depends so greatly on the signal carrier frequency being received, it generally becomes impractical to employ the t.r.f. type as an all-wave receiver since the sensitivity would be extremely low on the short-wave bands. This is a serious limitation, considering the increasing popularity of short-wave transmission for FM, television, etc.

It is apparent that if it were possible to design a receiver in which the selective tuning circuits were *fixed tuned*, these circuits could very easily be designed for high Q for the particular frequency at which they are to operate. As we shall see later, this desirable arrangement is accomplished in the superheterodyne receiver.

Another difficulty in the design of t.r.f. receivers lies in the fact that even if pentode tubes are used, the amplification at the higher carrier frequencies employed in broadcasting drops off due to the tendency of the tube-element capacitances and stray circuit capacitances to shunt or bypass the signal to ground because of their comparatively low impedances to the high frequencies. Furthermore, the stray couplings between parts comprising the grid and plate circuits of the r.f. amplifier tubes, and even between circuit parts which are remote from each other in the amplification circuit, are closely spaced together physically by the construction requirements of present-day compact receivers. Such couplings cause feedback or regeneration, and naturally this becomes worse at the high carrier frequencies, with the danger of oscillation resulting. Consequently, unless unusual pains are taken in the design and construction (with a proportionate increase in design and production costs), the t.r.f. receiver is limited to relatively low sensitivity.

Because of these difficulties, it has not been possible to produce t.r.f. receivers commercially that will provide, at equal or lower design and manufacturing cost, the desirable combination of high sensitivity, selectivity, and fidelity that is obtainable in our modern well-designed superheterodyne receivers. Consequently, the t.r.f. receiver has been almost supplanted by

Small and Medium
TRANSFORMERS
*to meet airborne communications
equipment specifications*

Consolidated Radio Products Company specializes in 400 cycle transformers to meet Army and Navy specifications on airborne communications equipment, and also, supplies prime contractors of the Signal Corps and Maritime Commission.

Greatly expanded production facilities on a wide range of small and medium transformers include Pulse Transformers, Solenoid Coils, Search Coils. Other products include Range Filters and Headsets.

Consolidated Engineers will also design transformers for special applications or will build to your specifications.



Electronic and Magnetic Devices
CONSOLIDATED RADIO
Products Company
350 W. ERIE ST., CHICAGO, ILL.

**WHAT'S YOUR IDEA OF THE
IDEAL POST-WAR RADIO &
TELEVISION SERVICE
BENCH**

**Every Month!
\$100 in WAR BONDS
Given For BEST LETTERS!**

★ Each Month's 1st Prize,
a \$50 Bond. 2nd and 3rd
Prizes each a \$25 Bond.

Contest Now in Progress.
Ends December 31, 1944.

★ **THINK OF IT—**

You can win a War Bond just by putting down your ideas as to what the ideal post-war Radio Service Bench should be. How many and what type of testing instruments for use on Radio, F-M, Television and so forth. How it must be arranged to render most efficient service—confidence. Your Ideal Service Bench.

★ **ANYONE CAN WIN—**

You can win. We want opinions from everyone interested in Radio and Television Service—Old Timers—Beginners. Experience will help—new-comers with good ideas can win.

★ **ENTER EACH MONTH—**

If you don't win this month, write again next month—and next—until the contest closes. Remember, it is your opinion that wins, not literary ability.

It's Easy to Enter and the Rules Are Simple! Get That Letter Off to Us Today!

RULES OF THE CONTEST

1. Simply write a letter (500 words or less) on the subject: "My Idea of the Ideal Post-War Radio and Television Service Bench."
2. Contest is open to all readers of Radio News (excepting employees of Burlingame Associates, their relatives, or their Advertising Agency).
3. You need not own a Radio Shop or possess any of the equipment you describe.
4. No detailed technical description of the apparatus is required or desired, nor the names of the manufacturers.
5. Mention of elaborate testing equipment suitable only for exhibition use will detract from the value of the letter. The inclusion of useful, confidence-creating apparatus, however, is recommended.
6. Literary ability is not required. Anyone writing in understandable English, giving a good word description, has an equal opportunity of winning one of the prizes.
7. Write only on one side; sign your name and address CLEARLY in the upper-right-hand corner, number each sheet.
8. Contest runs 6 months, July 1, 1944, through December 31st, 1944. Each month's contest begins first of that month with deadline for entries the last day of that month. Enter as often as you like.
9. No letters will be returned. Letters, contents and the ideas contained therein become the property of Burlingame Associates.
10. Judges' decision will be final and duplicate prizes awarded in case of ties.

SEND ALL ENTRIES TO

**BURLINGAME
ASSOCIATES**

10 MURRAY STREET—NEW YORK 7, N. Y.

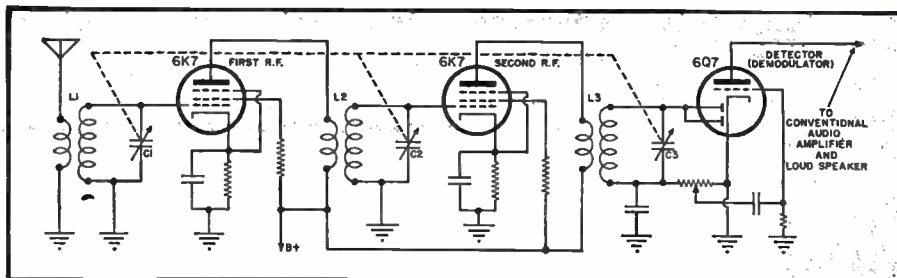

Fig. 2. Diagram of r.f. amplifier and detector stages of a typical t.r.f. receiver.

the superheterodyne type of receiver—excepting in those special applications where high-fidelity reproduction of the programs of powerful local stations only is desired. For such applications, the limited sensitivity and selectivity are not objectionable. In fact, the comparatively broad tuning is an advantage, because extreme sharpness of tuning is a natural enemy of good quality reception. Therefore, the t.r.f. receiver has certain advantages as an economical high-fidelity local-station receiver. However, even in such applications, the problem of providing adequate selectivity to prevent inter-station interference, while still retaining the desirable good high-fidelity characteristics is usually a very troublesome one.

Development of the Superheterodyne Receiver

It was because of the limitations of the t.r.f. receivers then available, especially that imposed by the difficulty of obtaining high amplification at high frequencies with the crude tubes then in use, that Major E. H. Armstrong (of recent FM fame) worked out an entirely new radio receiver principle in 1917-18 when he developed the *superheterodyne* for use in the Army listening posts behind the lines during World War I. During this crisis a great deal depended upon having super-sensitive receivers available for the successful interception of secret code messages passing between various units of the opposing army.

At that time it was difficult to build sensitive and perfectly controlled amplifiers to amplify a wide band of *high* radio frequencies (above about 500 kc.). But it was possible to build sensitive and stable fixed-tuned amplifiers to cover a narrow band of *low* radio frequencies (below about 200 kc.).

With such amplifiers available, it was a logical step to decide to receive the modulated high radio-frequency carrier on a suitable tuner, convert it (at the receiver) to a low radio-frequency carrier containing exactly the same modulation characteristics, then amplify this modulated low radio-frequency carrier efficiently in a fixed-frequency amplifier designed especially for the purpose, then demodulate or detect it, and finally amplify the resulting audio-frequency wave and feed it to a loudspeaker. This system, now known as the superheterodyne, has proved extremely successful, and the same underlying principle is used today in modern superheterodyne receivers. The functional block diagram of such a receiver is illustrated in Fig. 1. Since the low radio frequency which exists in the fixed-frequency amplifier is intermediate in value between the radio and audio, it is termed the *intermediate frequency* (commonly abbreviated i.f.). The fixed-frequency amplifier is called the *i.f. amplifier*.

It is evident that the superheterodyne receiver fundamentally consists of six main parts (see Fig. 1):

1. A radio-frequency tuner and amplifier system.
2. A frequency-converting system comprising a local oscillator and converter unit.
3. An intermediate-frequency amplifying system.
4. A demodulator-detector.
5. An audio-frequency amplifying system.
6. A loudspeaker.

Parts 1, 4, 5 and 6 are practically the same as found in any ordinary t.r.f. receiver.

It was not until the perfection of the screen-grid tube and its successful ap-

Fig. 3. Block diagram of a t.r.f. receiver, showing the various changes the modulated signal undergoes as it progresses through the separate stages.

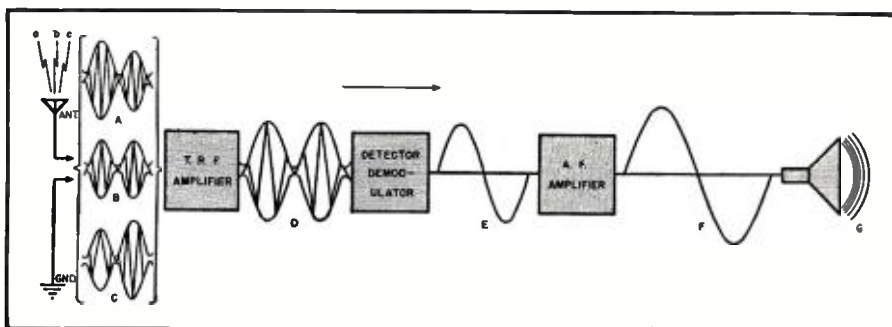

HOW CAN THE RCA ELECTRON MICROSCOPE HELP YOU?

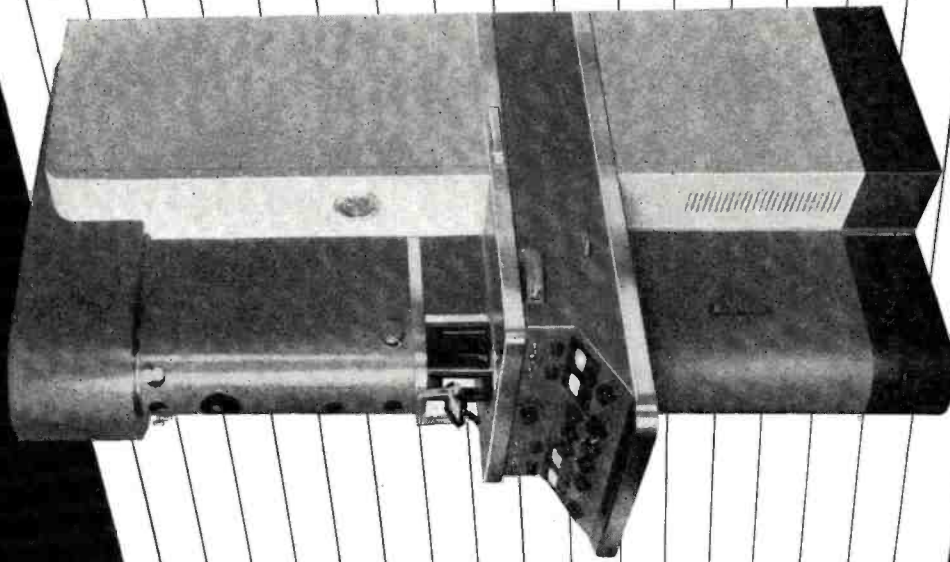
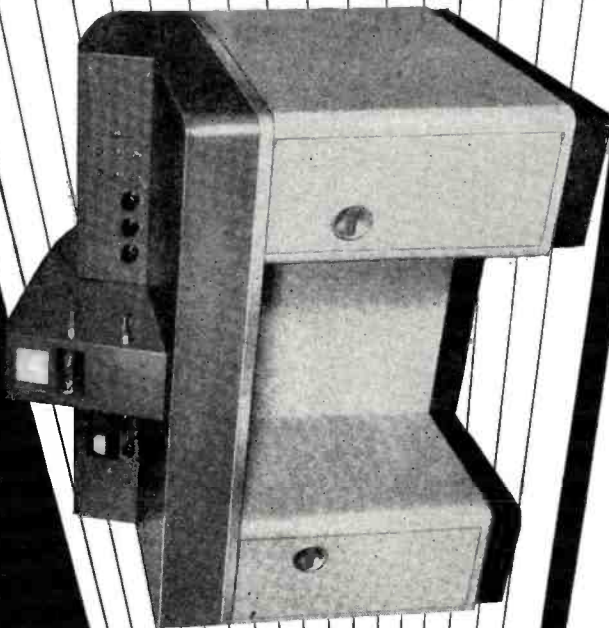

The RCA Electron Microscope, an instrument which magnifies up to 22,000 times (and makes micrographs which, enlarged photographically, make possible useful magnifications up to 200,000 times), has enabled scientists to achieve impor-

tant advances in industry and research. Its tremendous magnifying power is of great value to the chemical, metallurgical, ceramic, plastic, aviation, textile, rubber and petroleum industries—or to any field where particle size, shape, structure or distribution are of interest, or where minute surface details of metals or other materials must be studied.

Two new models of the RCA Electron Microscope are now available. One is a compact desk model—the other, a new Universal type containing an electron diffraction camera. Information on these instruments, their use and applications, is offered in a new 16-page booklet "The RCA Electron Microscope." The coupon at the left will bring you this booklet by return mail.

Please Use This Coupon

Electron Microscope Section, Dept. I29
Radio Corporation of America, Camden, N. J.
Please send me the new bulletin entitled "The RCA Electron Microscope."

Name.....
Position.....
Company.....
Street..... City.....



BUY MORE WAR BONDS

RADIO CORPORATION OF AMERICA

RCA VICTOR DIVISION • CAMDEN, N. J.

LEADS THE WAY... In Radio... Television... Tubes...
Phonographs... Records... Electronics

WILL YOU BE READY...

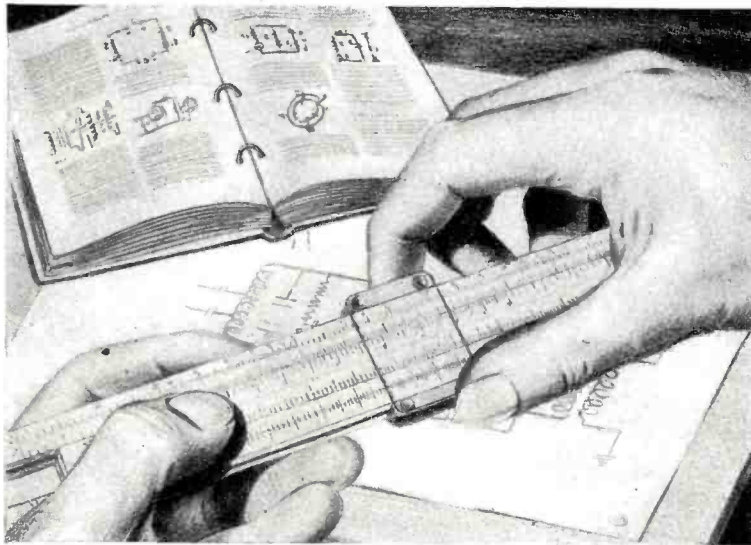

For A Better Job and Secure Career In **RADIO-ELECTRONICS**

*CREI technical home-study training prepares you now for
the secure radio jobs that pay good money for ability!*

Mr. Radioman: you can be ready to enjoy the security of an important engineering position and take advantage of new career opportunities . . . if you prepare yourself *now*.

Join the ambitious radiomen who are assuring themselves of secure good-paying jobs with a planned program of advancement made possible by CREI home study training in Practical Radio-Electronics Engineering.

You can study at home—in your spare time—develop your technical ability—increase your knowledge to keep pace with important developments now taking place in the industry.

The opportunity for advancement was never as great as it is right this minute. There are good-paying, responsible positions awaiting you in broadcasting, manufacturing, government, aviation . . . jobs that you can get AND HOLD by combining your own radio experience with the CREI planned program of advanced technical training.

When the war is over, the good jobs will go to the "survival of the fittest," so make sure that you will not be left behind. Get ready now, for a secure job in the coming new world of Electronics.

CAPITOL RADIO ENGINEERING INSTITUTE

HOME STUDY COURSES IN PRACTICAL RADIO-ELECTRONICS
ENGINEERING FOR PROFESSIONAL SELF-IMPROVEMENT

Dept. RN-8, 3224—16th Street, N. W., Washington 10, D. C.

Contractors to U. S. Navy—U. S. Coast Guard—Canadian Broadcasting Corp.
Producers of Well-trained Technical Radiomen for Industry.



**WRITE FOR
FREE 32-PAGE
BOOKLET**

"Your Opportunity in the
New World of
Electronics"

If you have had professional or amateur radio experience and want to make more money—let us prove to you we have something you need to qualify for a better radio job. To help us intelligently answer your inquiry—PLEASE STATE BRIEFLY YOUR BACKGROUND OF EXPERIENCE, EDUCATION AND PRESENT POSITION.

plication to the superheterodyne circuit, together with the accomplishment of successfully building the superheterodyne as a single-dial tuning control receiver that it was able to compete commercially with modern t.r.f. receivers which had outdistanced the superheterodyne in practical development up to that time. Now, because of its practical advantages which make compact, extremely sensitive and selective, and relatively inexpensive receivers possible, the superheterodyne has practically supplanted the t.r.f. receiver.

Reference to Fig. 1 shows that in the superheterodyne receiver, the received signals *A, B, C* are passed through one or two *preselector* t.r.f. stages as in the t.r.f. receiver (for reasons which we shall learn later), but after having passed through these stages the desired signal, *D*, is *mixed* with or acted upon by another locally-generated unmodulated r.f. signal, *E*, so as to produce a third signal, *F*, which contains all the modulation characteristics of the original signal, but differs from the original signal in carrier frequency (is usually *lower* in frequency). This is greatly amplified by the efficient fixed-tuned i.f. amplifier, and the resulting amplified signal, *G*, is then demodulated or detected to produce audio wave *H*. This is further amplified by the audio amplifier to produce amplified audio wave *I*, which is fed into a loudspeaker to produce the sound waves, *J*.

Thus, it is seen that the t.r.f. and superheterodyne receivers have several things in common: In both of them the received signals are first fed into a t.r.f. amplifier stage (although for a different reason, as we shall see later); both use a conventional detector or demodulator for extracting the a.f. modulation component of the amplified carrier; both use a conventional audio amplifier; and both employ a conventional loudspeaker.

They differ mainly in that in the t.r.f. receiver all of the radio-frequency signal discrimination and amplification takes place upon the originally-received carriers (and at their *high* frequency), whereas in the superheterodyne, instead of doing all the selecting and amplifying of the signals at their own particular carrier frequencies (which are high radio frequencies) by means of circuits which must necessarily be adjusted to the particular carrier frequency of whatever station it is desired to receive at the time, most of the amplification and selection are done much more efficiently at a *fixed* (intermediate) frequency to which the received carriers are converted, and which is purposely made considerably *lower* (in most receivers) than that of the received carrier. Also, in the t.r.f. receiver the detection or demodulation takes place upon the amplified originally-received carrier, whereas in the superheterodyne it takes place upon the similarly-modulated locally-created i.f. carrier (which is usually of lower frequency).

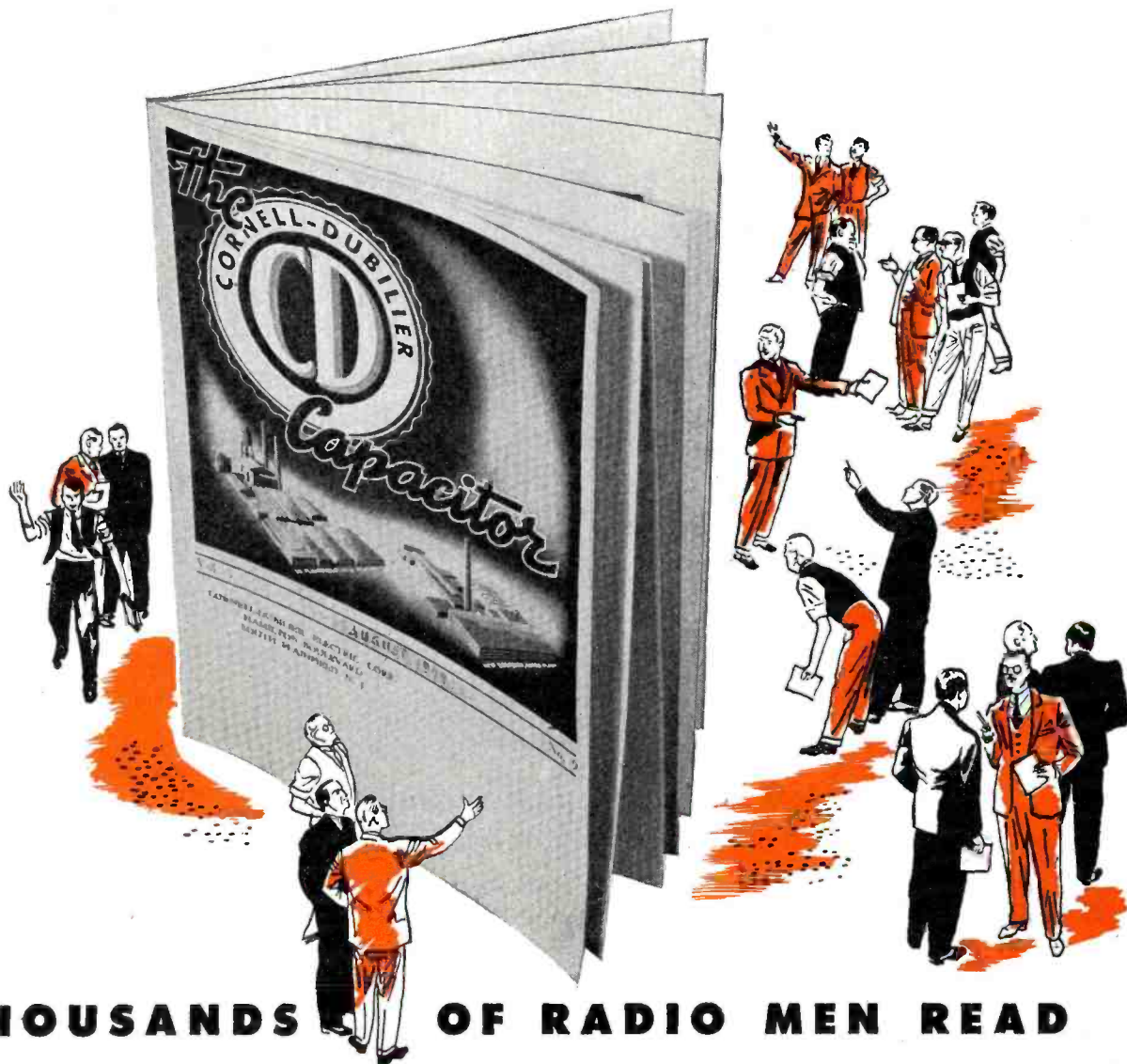

THOUSANDS OF RADIO MEN READ THE C-D CAPACITOR MONTHLY...

*get on the mailing list
get this helpful magazine* **free**

Radio men like this pocket-size magazine because it gives them information they can use in their work. Timely, factual, authentic articles and data on capacitors, instruments, equipment, culled from the radio trade press, condensed for quick reading.

A popular feature is the Radio Trading Post, in which the C-D Capacitor's readers may insert free ads

— offers to swap, buy or sell, or even obtain a position.

You won't want to miss the next issue, so write immediately—there is no charge and you will receive the magazine every month. Make your request to Cornell-Dubilier Electric Corporation, South Plainfield, N. J.



**CORNELL-DUBILIER
ELECTRIC CORP.**

SOUTH PLAINFIELD, N. J. • PROVIDENCE, R. I. • WORCESTER, BROOKLINE, NEW BEDFORD, MASS.

**you get the best
in capacitors from the leader**

RESEARCH — To develop new and better ingredients and production methods... to anticipate design... to give you help in all capacitor problems.

QUALITY — Engineered and built-in through 34 years of specialization. The choice of 4 out of 5 engineers for their outstanding performance and characteristics.

LINE — whether you want a single standard replacement unit or thousands of specially designed capacitors, CD has the facilities and the ability to offer the most complete line in Radio. Catalogs available.

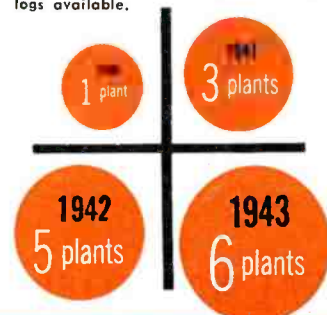



electronics..

and what it can mean to post-war sales

Look ahead . . . Prepare your Salesmen For the Peacetime Electronic Era to Come!

● Where will you fit in the fiercely competitive markets that will come with the war's end? Your position can be determined now, by the methods you employ now, in the design and engineering of your post-war products. Right now, with the aid of seasoned electronic and mechanical engineers, your peacetime items can be started toward top-rank positions in their respective fields.

Alert manufacturers, with a view toward post-war sales and quick acceptance of their products, are urged to consult with National engineers now, on matters electronic, electrical or mechanical. Write today—Your inquiry will receive prompt attention.

-----QUARTZ CRYSTAL PROBLEMS-----

Our engineers and crystallographers are ready and willing to help you on the following items:

- | | | |
|----------------------------|---------------------|---------------------|
| Radio Receivers | Crystal Oscillators | Supersonic Devices |
| Television Receivers | Filters | Control Devices |
| F-M Receivers | Stabilizers | Diathermic Devices |
| Transmitters | Timing Equipment | Induction Heating |
| H. F. Inter-Communications | Police Transmitters | Frequency Standards |

Address your inquiry to—Crystal Division

Electrical and Mechanical Engineering

NATIONAL SCIENTIFIC PRODUCTS COMPANY
Designers and Manufacturers of Electrical and Mechanical Devices
 5015-25 NORTH KEDZIE AVE., CHICAGO 25, ILLINOIS

Because of the different signal tuning and amplification systems employed, the superheterodyne possesses the following general advantages over the straight t.r.f. receiver:

1. Since a major part of the receiver amplification always takes place at the same fixed frequency (the i.f. frequency) regardless of the band of carrier frequencies the receiver is designed to receive, higher and more uniform amplification and selectivity over the entire tuning range of the receiver can be obtained.
2. Since the intermediate frequency is generally made much lower than the carrier frequency of the received signal, the inherent selectivity is greater and it is possible to obtain more amplification without running into oscillation difficulties.
3. Since the major part of the amplification takes place in the i.f. amplifier where a fixed frequency exists, it is possible to employ inexpensive but effective i.f. amplifier design arrangements that result in the type of straight-sided flat-topped tuning characteristic so desirable for a high degree of selectivity combined with good fidelity and tone quality characteristics.
4. Greater over-all selectivity is obtained because so-called "arithmetical" selectivity is obtained due to the mixing or *frequency conversion*, since the conversion causes a greater percentage of frequency separation between operating channels.
5. The receiver sensitivity does not depend wholly upon the strength of the received signal since a definite gain is generally obtained during the frequency conversion process.

While these are probably the most important advantages of the superheterodyne, others will be pointed out as we proceed with our detailed study of the operation of the various parts of the superheterodyne receiver in succeeding lessons.

(To be continued)

Transmitter Construction *(Continued from page 34)*

maintenance of each transmitter must be included as an important part of each shipment. They must be clearly written and give complete and specific information for the proper procedure to follow in keeping the unit in top operating condition. The old proverb "cleanliness is next to godliness" certainly applies to equipment of this type. For that reason the manufacturer takes every possible precaution in the design of the units to keep them free from external dust and other foreign particles which would seriously hamper the effectiveness of the transmitter. These are excellent examples of what American ingenuity is doing to hasten the day of victory. Without such facilities America could not have gained its reputation of producing the finest radio equipment in all the world.

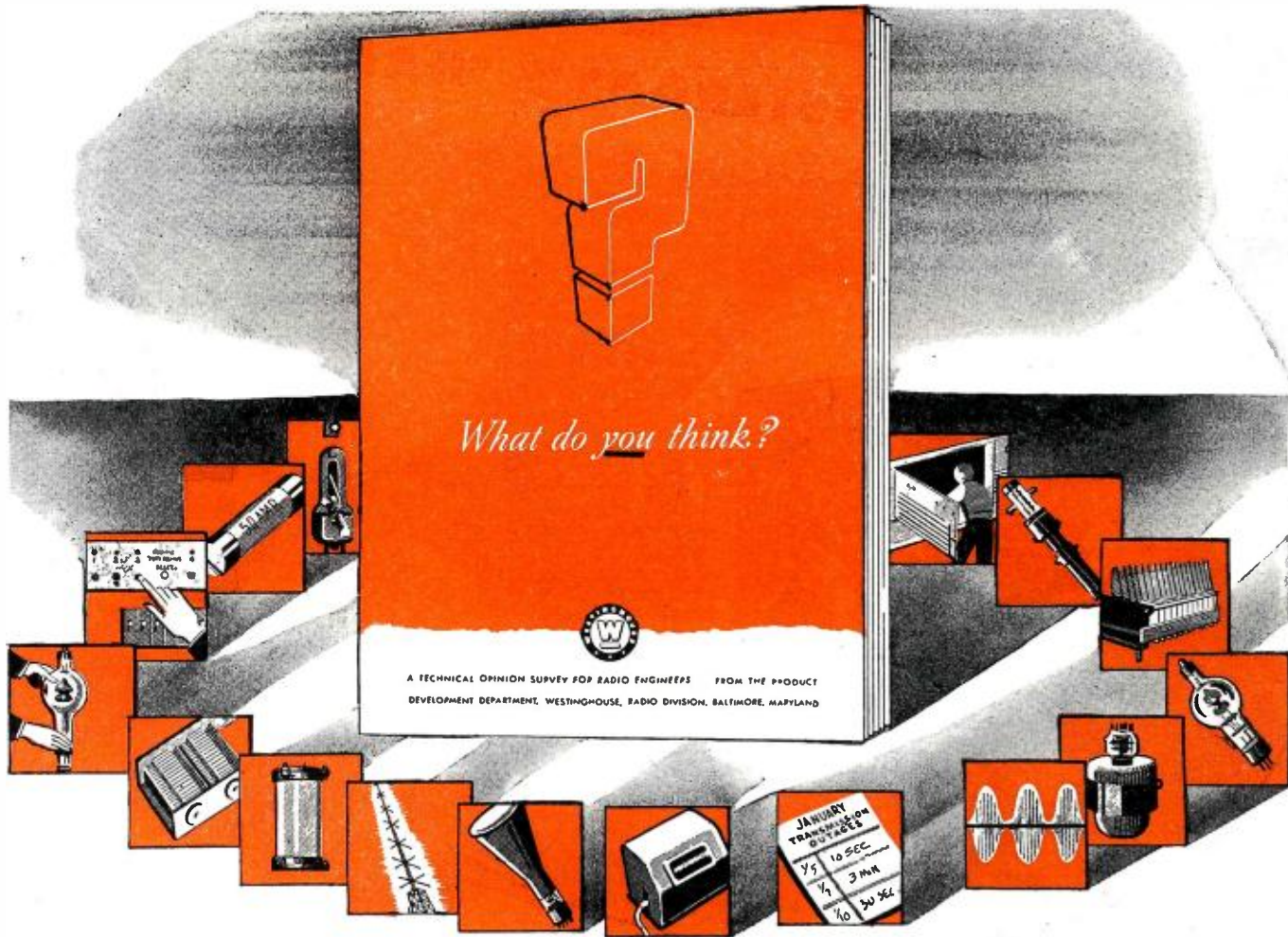

CALLING ALL RADIO ENGINEERS!



In the interest of better broadcasting... and as a check on the features we are incorporating in our new transmitter designs... Westinghouse would like to know what radio engineers think about transmission equipment, feature by feature.

There's more than one way to "skin a cat", but there's one *best* way. You men who are responsible for operating the equipment are interested, we believe, in these factors:

HIGH FIDELITY SIGNALS . . . CONTINUITY OF SERVICE
SIMPLICITY OF CONTROL . . . LOW OPERATING COST
EASE OF MAINTENANCE

We will appreciate knowing what you consider the best way to incorporate these advantages in postwar transmitters. To facilitate this, the questionnaire booklet pictured above will be distributed to all stations in the near future. If you do not receive your copy . . . write Westinghouse Electric & Manufacturing Company, Dept. 7-N, East Pittsburgh, Pennsylvania. J-08075

Westinghouse RADIO DIVISION
 PLANTS IN 25 CITIES . . . OFFICES EVERYWHERE



A M • E L E C T R O N I C S • F M

AMPHENOL—

FRIEND OF YESTERDAY'S "HAMS"...

*... Now
Radar
Radio
Experts*



Back in the days when thousands of home basements sheltered embryo radio research laboratories, "Amphenol," stamped on a plug, socket or knob, meant a "good job." The "hams" learned the value of quality the *hard* way, and after the first disappointments saved their dimes and quarters to buy the better job identified by "Amphenol."

Now those "hams" are grown-up sergeants, ensigns, lieutenants, captains. They are communications officers, radio technicians, members of the secret radar fraternity, or concerned in some of the other war-time uses of electronics. Many of them are getting to foreign countries in person instead of by airwave. But wherever they are, "Amphenol" is with them—on cables, on wiring assemblies, connectors, sockets. To them Amphenol quality today has a new meaning, a more important personal dependability, in the electrical and electronics equipment they use in battle.

They will bring home their battle experience to the new radio sets, television, frequency modulation, the electronic and electrical developments to follow V-Day. Quality parts will be made by an equally war-seasoned and broadened Amphenol—a leader wherever electronic and electrical equipment are used.

Depend upon

AMPHENOL

Quality

AMERICAN PHENOLIC CORPORATION
1830 S. 54th Avenue, Chicago 50, Illinois

Connectors
Fittings
Conduit
Cable
Radio
Parts
Synthetics

HERE we have several types of similar equipment, yet each requires a different test procedure." This is a common complaint of manufacturers of airborne electronic equipment. A very considerable portion of the total cost in dollars, time, space, test gear and trained personnel, is directly chargeable to government test procedure, and it constitutes a major problem in the production of electronics equipment for war. An airplane without radio equipment is as unfit for combat as one without machine guns. Production of radio equipment must keep abreast of plane production, or planes will be grounded. Just as the airplane industry is manufacturing planes at an unprecedented rate, so the electronic manufacturing industry is producing at an unheard of rate. Anything which speeds up test procedure, speeds up production. Any improvements in test procedure may result in a better product.

Of the many different ways of performing a single test, one is the best, and the best one may require less time, equipment, and personnel than some of the other methods employed. The purpose of the tests is obvious, namely to make certain that the equipment

Government Acceptance Tests of Airborne Electronic Equipment

By **JAMES C. COE**

General operating conditions and production test procedures of electronic military equipment.

meets prescribed standards of performance based on actual operating conditions. It can be said to the credit of the electronics industry that the manufacturers themselves realize their responsibility and impose tests not required by specifications. It is likewise to the credit of government inspectors that they have taken a reasonable attitude in interpreting test procedure within the limits of their authority. The difficulty goes back to the specifications and their preparation. There is too much variation in test procedure due to a number of

causes. There are some differences in test equipment; however there are more differences of opinion. There are differences in the interpretation of specifications, and more fundamentally there are different viewpoints as to the scope, extent, and purposes of the test themselves. The object of this paper is to briefly discuss some of these.

In January, 1941, the Radio Technical Committee for Aeronautics Test Procedures for the Aircraft Radio Equipment was issued. The following is quoted from the foreword. "The ma-

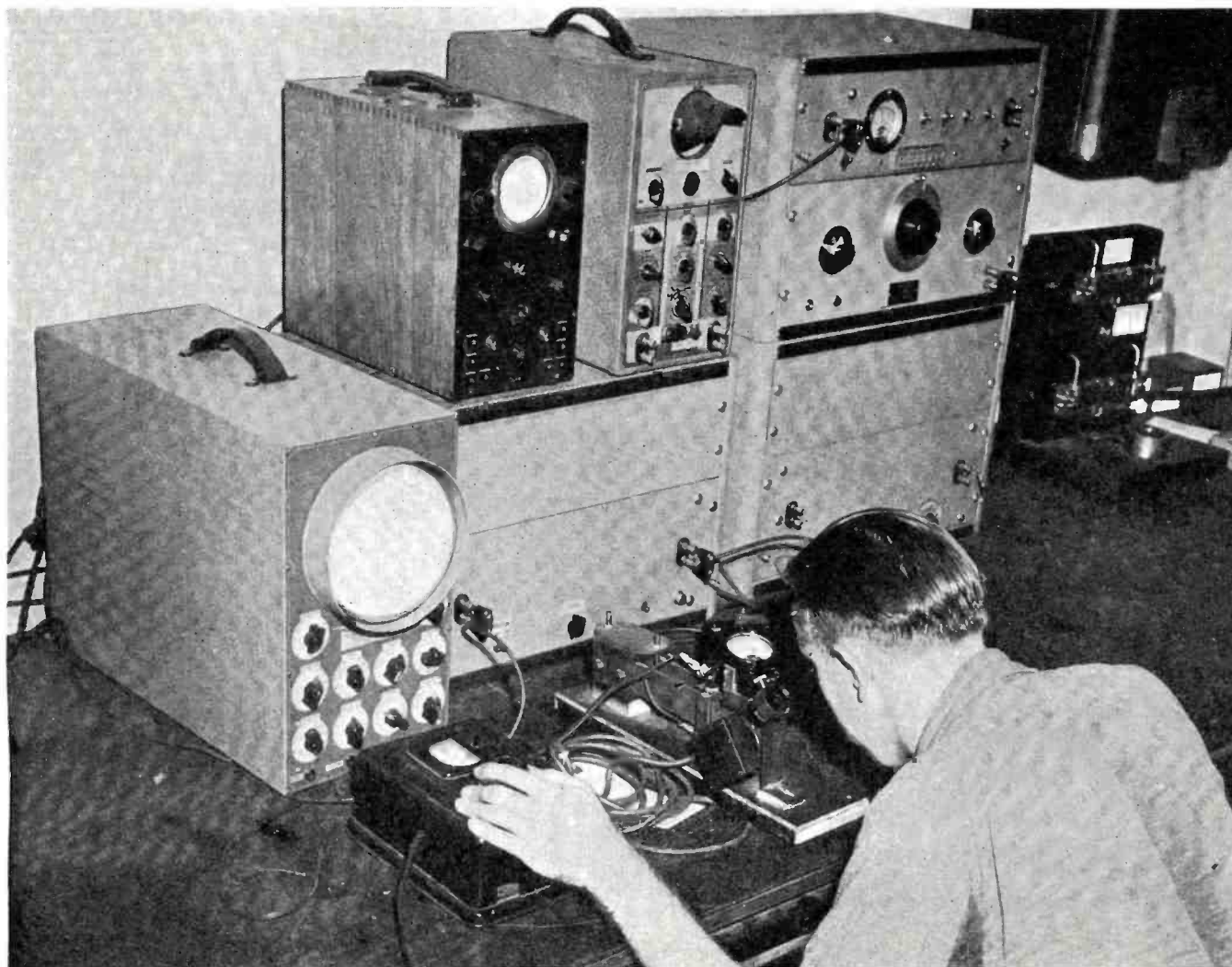

Design engineer determining production test limits on a microphone in order to meet military requirements.



Where Commands are Vital . . .

At high altitudes and under all temperature and humidity variations, PermoFlux Dynamic Headphones meet pounding battle requirements with rugged mechanical strength and the utmost in communication intelligibility. The same engineering principles that set the pace for improved headphone performance under adverse noise conditions are making their contribution to the superior line of PermoFlux Speakers, Microphones, Transformers and other electronic apparatus.

BUY WAR BONDS FOR VICTORY!

TRADE MARK
PERMO-FLUX

PERMOFLUX CORPORATION
 4916-22 W. Grand Ave., Chicago 39, Ill.

PIONEER MANUFACTURERS OF PERMANENT MAGNET DYNAMIC TRANSDUCERS

terial contained in this booklet represents the 'Standards' developed by the Radio Technical Committee for Aeronautics to provide standardized methods for conducting measurements and certain tests on aircraft radio equipment. A study of the standards contained herein will show that many methods of measurements are new and were developed especially for aeronautical radio equipment." A standardized test procedure is desirable, both to the government and the contractor. Test personnel of the government and the contractor need familiarize themselves with fewer test procedures. Different equipment could be tested simultaneously. With a definite routine established, more labor-saving devices could be introduced, and less skilled personnel required. The vacuum-tube industry furnishes an outstanding example of this. With identical test procedures for similar equipment, each detail of performance is reduced to a common denominator, and improvements in design are inevitable because like quantities permit comparison. An apparently slight variation in procedure may cause a variation of several hundred percent in results.

A wide diversity of opinion exists between contractors who advance many convincing reasons for their particular course of procedure. For example, some desire electrical tests to be run ahead of mechanical inspection, and vice versa. Incidentally, there is also a wide diversity of practice in manufacturing drawings. This has made it difficult for one contractor to use the drawings of another, with resulting delays and confusion. If the industry could standardize in this regard, both industry and government would benefit. Government personnel have the same aversion to the different drawing practices of contractors, as the contractors have to different government test procedures.

At this point a brief discussion of operating conditions might be appropriate because they form the basis upon which all tests are predicated. Temperatures of 134° F in the shade have been recorded in arid locations. In humid climates the relative humidity is over 99% for weeks but the temperature is far from 134°. A plane in the sun may have water inside, and without ventilation a condition of high temperature and high relative humidity results. In the course of hours the interior of the electronic equipment tends to stabilize. These conditions are encountered with the plane on the ground. Upon turning on the equipment it should operate satisfactorily without failure or other malfunctioning such as excessive deviation in frequency, etc. There may be a rapid increase in altitude and the air surrounding the equipment cooled. Transmitting equipment may be inoperative during periods of radio silence, while receiving equipment may operate continuously in rarified atmosphere. Upon descending to warm levels where a high absolute humidity prevails, condensation may take place, especially if



SYMBOL OF QUALITY

In the peacetime era to come, the Temple trademark will identify the finest line of radios the minds and hands of Man have ever produced—radios engineered and constructed to attain new performance standards—radios styled and cabined to new measures of beauty—radios valued and priced to make money for you. In brief, radios your customers will want to buy, radios you will want to sell. It will pay you to "team up with Temple".

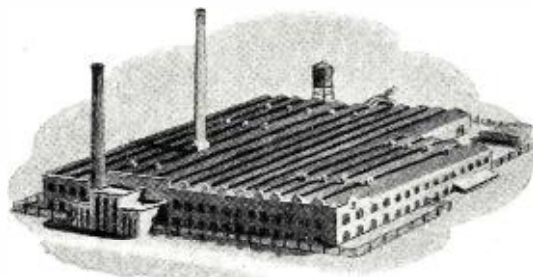

WHERE **FM** WILL ALSO MEAN **F**INEST **M**ADE

TEMPLE TONE RADIO COMPANY, MYSTIC, CONN.

FM... TELEVISION... RADIO-PHONO' COMBINATIONS

Licensed under Armstrong and RCA patents

A New Miniature Diffusion Vacuum Pump

Compact.. All-Metal

THE DPI miniature all-metal pump, Type VMF-10, marks an entirely new application of the fractionating, self-conditioning principle for the production of high vacua. The VMF-10 meets the demand of industry for a rugged yet compact pump capable of reaching pressures of 10^{-6} mm. and lower.

This unit was primarily designed for use on electron microscopes, automatic exhaust machines, continuously evacuated tubes, and other industrial applications where an inexpensive miniature metal pump is required. It will be found useful on any system of moderate size. Choice of water or air cooling.

CHARACTERISTICS

SPEED	10 L/sec. at 10^{-4} mm. Hg.
ULTIMATE VACUUM	1×10^{-6} mm. Hg. with Octoil-S
REQUIRED FOREPRESSURE	0.125 mm. Hg.
HEIGHT	7 $\frac{3}{4}$ in.
WIDTH	3 $\frac{3}{8}$ in.
WEIGHT	2.5 lb.



WRITE for details about this new-style diffusion pump—or similar models with different capacities—as well as 20 other types of diffusion pumps, low-vapor-pressure fluids, greases, vacuum gauges, control circuits, and other items for high-vacuum technology. Address Vacuum Equipment Division.

METAL FRACTIONATING PUMP, TYPE VMF-10 (Water-Cooled)



DISTILLATION PRODUCTS, INC.
Jointly owned by EASTMAN KODAK COMPANY and GENERAL MILLS, INC.
ROCHESTER 13, N. Y.

the equipment has been inoperative. Condensation is also noticed after periods of inactivity, and turning on plate power without adequate filament warmup has resulted in flash-overs and failures. Catapultings and rough landings, recoil from ordnance, and erratic engine behavior should not cause damage or excessive permanent change in performance. These illustrate some of the conditions of operation, and some variables effecting performance are temperature, humidity, altitude, voltage input, vibration, shock, and various combinations of these. It is up to the services to prescribe ground tests which simulate such conditions, taking into account time of operation. The specifications should not only establish limiting conditions but be specific as to test procedure.

Tests might be placed in the following categories: accelerated life tests, type tests on design details, and production tests. Accelerated life tests might be of the nature of overload tests or endurance runs, and should insure an adequate factor of safety in design. Equipment, or parts thereof, is tested under rigorous conditions beyond those usually encountered in actual service, either to destruction or to a point where failure is imminent due to overload, fatigue, etc. To issue equipment which has been tested to such extremes defeats the purpose, namely the supply of good equipment. To deliberately damage or destroy an appreciable percentage of components or completed equipment is wasteful. It should not be necessary to subject any appreciable percentage of the equipment to such tests. To have a 300% safety factor or overload capacity in one detail and 2000% in a similar detail without justification is wasteful of material and needlessly heavy.

A well-balanced design strives toward economical and efficient use of material and components. Some components naturally should have a higher overload capacity than others. Such tests belong in the design stage and early production rather than after production is well underway. Once an adequate design is determined upon, the parts and assembly methods should be sufficiently uniform so that it would be reasonable to assume that all usual operating conditions are more than safeguarded. These tests include bench tests and flight tests, and their value is obvious. These tests should be thorough and painstaking. For years the Signal Corps has sent models to various combat organizations for flight testing in order that the viewpoints of operating personnel might be obtained. Specially trained test personnel who do nothing but test equipment perform useful functions but are too likely to take the viewpoint of engineers and physicists, rather than the viewpoint of the pilot or machine gunner who has incidental radio duties thrust upon him.

Production tests on each piece of equipment insure proper adjustment, operation, and include mechanical in-

INVASION BY.. TELEPHONE



According to War Department records, rehabilitation of 49,176 wire miles of communications was accomplished by the Signal Corps in Sicily alone.

The magazine, "Steel", comments on the fact that wire communication remains basic in this zone. It enjoys the advantage of a degree of security not enjoyed by other mediums. The editor of "Steel" points out that the demand for wire field communications will continue to be heavy until the wars in both major zones are won.

Imagine the demand for field telephone equipment with the whole continent of Europe under invasion, and Pacific operations constantly expanding!

The men and women of Connecticut Telephone & Electric Division, commended personally by War Manpower Commissioner McNutt for their splendid record in turning out field telephones and other basic communications equipment, realize their ever-increasing responsibilities. They are determined to fulfill this obligation to our armed forces and those of our allies.

**CONNECTICUT
TELEPHONE & ELECTRIC
★ DIVISION ★**

GREAT AMERICAN INDUSTRIES, INC.

MERIDEN



CONN.

G. A. I. divisions are producing for the war effort: Military Trucks, Fire Apparatus, Communications and Electronic Equipment, Aircraft Ignition Components, Cellular Rubber Products.



W K B N
Youngstown, Ohio



E. F. JOHNSON CO.

Waseca, Minnesota

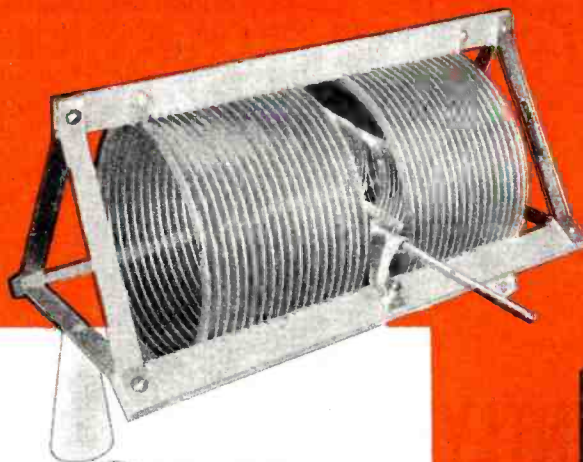

JOHNSON *Broadcast Components*

Widely used by discriminating broadcast engineers. Typical is the Phasing Equipment installation by WKBN, Youngstown, Ohio. Variable air condensers, fixed air condensers, gas pressure condensers (for higher voltages), inductors (all kinds), chokes, remote motor driven tuning controls and other components.

Send your specifications or problems for Johnson suggestions and prices -- no obligation.

Ask for Catalog 968Z.

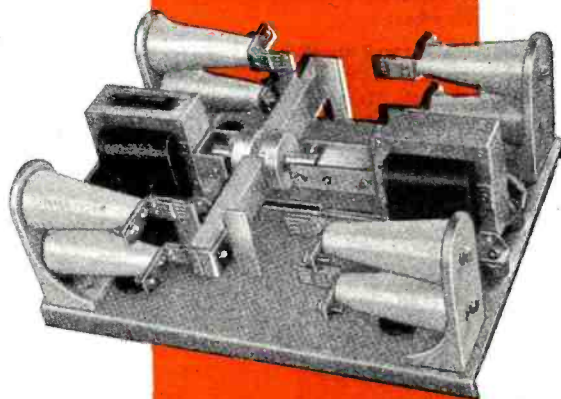

JOHNSON

a famous name in Radio

E. F. JOHNSON COMPANY • WASECA • MINNESOTA

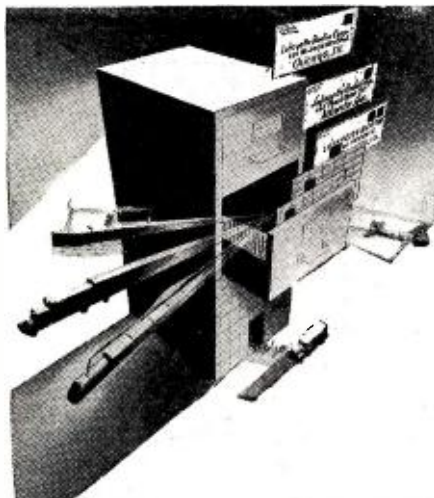

INTELLIGENTLY SPEEDILY...

The Lafayette Radio Corp. organization, built soundly over a period of 25 years, functions in two "key" shipping centers — Atlanta and Chicago. Yes, we maintain tremendous stocks of radio and electronic components and equipment. But, equally important, there are "brains" to go with them. Our men are truly appreciative of what you are up against these days...whether you're a giant of industry, the little service man around the corner, or represent a military agency or training school.

Because we are well versed in all fields utilizing electronics, your orders are handled intelligently. At our fingertips is complete data on shipping routes, priorities, effective substitutes...all things a purchasing agent wants to know. Write, wire, telephone or teletype — get to know the superior service of Lafayette Radio Corp.



NEW — 8-Page CIRCULAR, listing merchandise available for immediate delivery, will be rushed to you on request. All items are subject to prior sale. Write or wire Dept. E8

P. S. We specialize in equipment for laboratory and experimental use. Such equipment built to your specifications if you desire.

Lafayette Radio Corp.

901 W. Jackson Blvd. 265 Peachtree Street
CHICAGO 7, ILLINOIS ATLANTA 3, GEORGIA

spection. The tests are often more of a qualitative than a quantitative nature. Measurements of power output, etc., are generally at room temperature. Navy specifications, covering tests for 100% of the equipment, have usually been of a general character and permitted the contractor and Resident Inspector of Naval Material wide latitude in sandwiching these tests in with production.

The term "type tests" has also been applied to special checks on selected production equipment in order to insure uniformity of production. Perhaps a better name would be "percentage production tests." These include accurate measurements such as audio fidelity, output and frequency stability, taken under various conditions of temperature and humidity, etc., as distinguished from tests performed on each unit. They should consist of detailed measurements of performance conducted so as to simulate usual conditions of operation.

One manner of conducting these tests, used for years by the Bureau of Ships, was that of two variables. For example, frequency stability was measured as a function of temperature with voltage input, warming-up time, etc. constant. The theory was that by isolating the causes of frequency drift each one could be reduced to a minimum. In flight more than two variables change at the same time, sometimes their effects are additive, and the addition of the simulated bench tests gives a true picture. If in actual use the effects should cancel, then the bench tests gave a pessimistic picture. Combining several variables is dangerous if they cancel each other, while in flight they may be additive. The specifications should specify the maximum variations which may be tolerated. It is seldom that all the contributing causes of frequency drift are just within the specifications.

Even if facilities and personnel were available the added expense of running all equipment through these lengthy percentage tests would not be justified. The time might better be spent in more thoroughly checking components and on the "100% production" tests. A common cause of shipping equipment in a defective or inoperative condition is due to replacing or readjusting one part, and inadvertently damaging or leaving off something else. As it is, the using services insist that the equipment was not properly inspected and was shipped in an inoperative manner. Inspection personnel produce records to prove that it was tested and operated. These are common occurrences and corrective measures should be taken. Each unit of equipment should be placed in an operative installation and a regular schedule of operation supplemented by the necessary measurements before shipping.

The problem at hand is to furnish a sufficient supply of serviceable equipment on time. An equipment failure may result in failure of the mission to accomplish its purpose and loss of life. Only by adequate test procedure can serviceable equipment be produced. The design must be adequate electrically and mechanically to meet service conditions. Actual flight tests and rigorous, exhaustive bench tests should establish adequacy of design. Detailed performance tests on selected equipment should be made as a check to insure uniformity of production. These tests should be detailed and standardized, both as to sequence and other details of procedure. Tests performed on all equipment should be fitted to production procedure for the particular equipment and, hence, less standardization as to sequence, etc., is possible. In general, test procedure should be thorough but without needless repetition or deviation.

-50-

Photograph, submitted by Alvin L. Campbell of the Radio Test Service Shop, illustrates how a well laid-out test bench should appear. Most of the equipment is quite discernible. The small panel below the tube tester contains, on the left, the switch and selector for the preheater sockets, mounted at the left of the tube tester. Towards the right of this same panel are switches for the variable voltage transformer which gives voltages in steps of 3 volts from 105 to 135 volts at the outlet of the panel. The meter mounted directly above the tube tester is a 0-150 volts a.c. meter, which indicates accurately the line voltage at all times. The variable voltage transformer also acts as an isolating transformer when aligning a.c.-d.c. sets. The panels and bench tops are constructed of tempered masonite, varnished, and waxed.

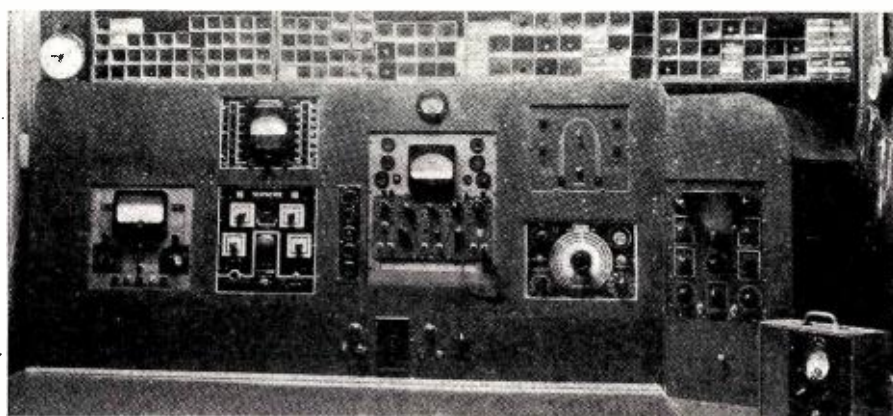

The Model 710

VOLT-OHM-MILLIAMMETER

Now available for prompt delivery on
priority of AA3 or better!!

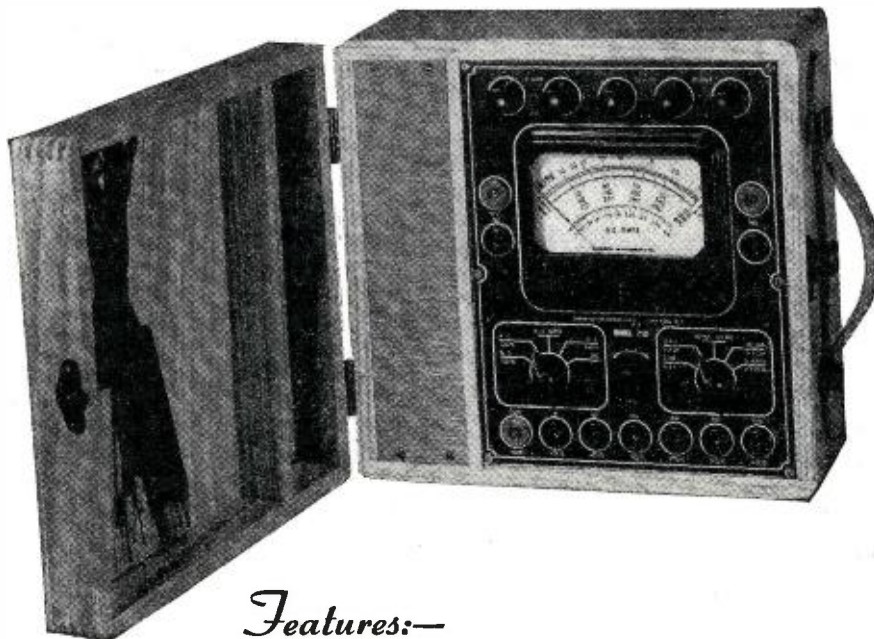

Sensitivity:—

1,000 OHMS PER VOLT
ON BOTH A.C. AND D.C.!!

Measures:—

A.C. AND D.C. VOLTAGES
UP TO —

1500 VOLTS

A.C. CURRENT UP TO —

3 AMPERES

D.C. CURRENT UP TO —

30 AMPERES

RESISTANCE UP TO —

10 MEGOHMS

Features:—

- *Uses New 4 1/2" Square Rugged 0-400 Microampere Meter.
- *Direct Reading—All Calibrations Printed Directly on Meter Scale in Large Easy-to-Read Type.
- *Housed in Rugged Heavy Duty Portable Oak Cabinet.
- *Completely self-contained—No External Source of Current Required.

A 400 Microampere meter movement is shunted to provide a sensitivity of 1,000 Ohms Per Volt on both A.C. and D.C. This method—using a 400 Microampere meter instead of a 1 Milliampere meter—affords improved damping because the meter is at all times shunted by a resistance. An Ayrton universal shunt is used for all current and resistance ranges. Paired multipliers insure accuracy of all voltage ranges and in addition two indi-

vidual master calibrating adjusters enable precise calibration of all A.C. and D.C. Voltage Ranges. An almost perfectly linear A.C. scale is provided by using a special copper oxide rectifier unit which has an inverse to forward resistance ratio of better than 400 to 1. Although the current carrying capacity of this rectifier is 15 ma. a maximum of 1 Milliampere is permitted to pass through the unit. This insures minimum heating in the rectifier unit guaranteeing high stability of all A.C. calibrations.

Specifications:—

6 D.C. VOLTAGE RANGES (1000 OHMS PER VOLT)

0 to 15/60/150/300/600/1500 Volts.

6 A.C. VOLTAGE RANGES (1000 OHMS PER VOLT)

0 to 15/60/150/300/600/1500 Volts.

7 D.C. CURRENT RANGES:

0 to 3/15/60/150 Milliampere

0 to 3/15/30 Amperes.

A.C. CURRENT RANGE:

0 to 3 Amperes.

5 RESISTANCE RANGES:

0 to 1,000/10,000/100,000 Ohms.

0 to 1 Megohm

0 to 10 Megohms.

The MODEL 710 comes complete with cover, self-contained batteries, test leads and instructions. Size 6" x 10" x 10". Net weight 11 pounds. Price.....

\$34⁵⁰

SUPERIOR INSTRUMENTS CO., Dept. R. N.

227 FULTON STREET

NEW YORK 7, N. Y.

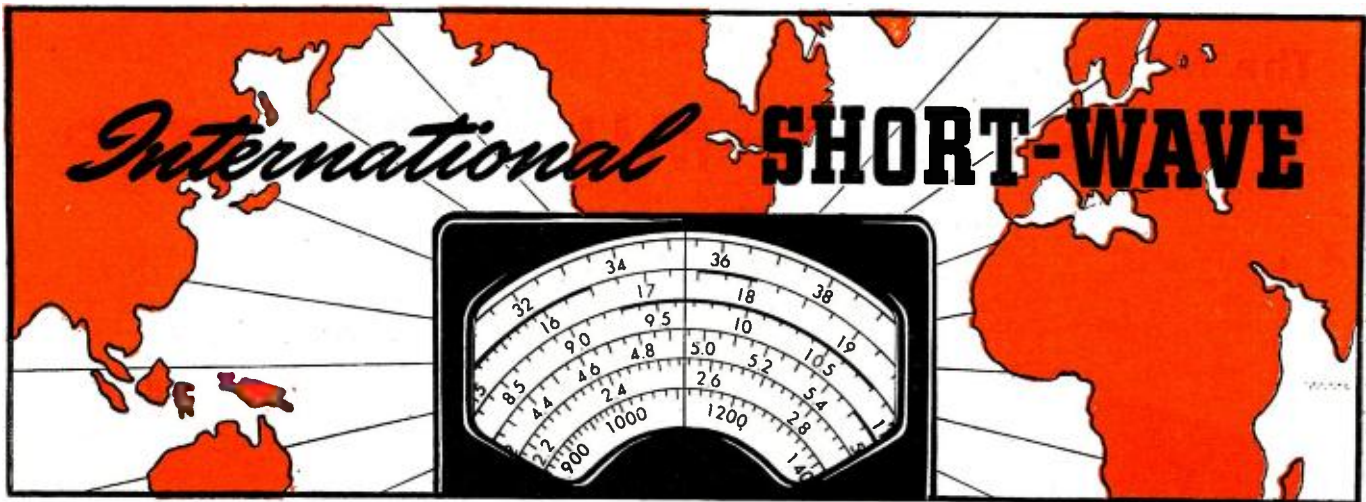

Compiled by KENNETH R. BOORD

FOR the benefit of those who wish to keep close contact with the progress of the war in the European theater of operations, following are the principal "regular" features of the British Broadcasting Corporation's North American Service which is directed to this hemisphere between the hours of 5:15 p.m. and 12:45 a.m. daily (EWT):

- 5:15 p.m. (Daily)—Program Preview.
- 5:30 p.m. (Sunday)—Feeding the World; (Monday through Friday)—Front Line Family (drama); (Saturday)—British Tommy.
- 5:45 p.m. (Daily)—News.
- 6:00 p.m. (Sunday)—Transatlantic Call; (Monday)—Shipmates Ashore;

(Tuesday)—Famous Names; (Wed., Thur., Fri.)—Announced on Program Preview at 5:15 p.m.; (Saturday)—Canadian Actuality Feature: Eyes Front.

- 6:15 p.m. (Tuesday only)—Music.
- 6:30 p.m. (Sunday)—Music; (Monday through Friday)—News in French for Canada; (Saturday)—Topical Survey.
- 6:45 p.m. (Daily)—News.
- 7:00 p.m. (Sunday)—Feature: Daniel Defoe; (Monday)—Calling Newfoundland; (Tuesday)—Old Time Music Hall; (Wednesday)—William Holt Reports; (Thursday)—London Calling Europe; (Friday)—Orchestral Music; (Saturday)—The Old Town Hall.
- 7:30 (Daily)—Radio Newsreel (Ac-

tuality). (This is one of the world's most popular programs.)

- 7:45 (Daily)—Music.
- 8:00 p.m. (Sunday)—North American Guest Night; (Monday)—Current Events; (Tuesday)—Stanley Maxted; (Wednesday)—Bridgebuilders; (Thursday)—London Letter; (Friday)—William Holt Reports; (Saturday)—American Eagle in Britain.
- 8:15 p.m. (Sun., Wed., Fri.)—Program Preview; (Mon., Tue., Thur.)—Listening Post.
- 8:30 p.m. (Sun., Mon.)—Topical Survey; (Tuesday)—What War Means to Me; (Wednesday)—George Blake; (Thursday)—World Perspective; (Friday)—World Affairs; (Saturday)—Music.

8:45 p.m. (Sunday)—Britain Sings; (Monday)—Music; (Tuesday)—Cross Section; (Wednesday)—Spotlight; (Thursday)—Bridgebuilders (repeat); (Friday)—Junior Bridgebuilders.

9:00 p.m. (Daily)—News.
9:10 p.m. (Daily)—Tomorrow's London Papers (what Londoners will read in their tomorrow's newspaper).

9:15 p.m. (Sunday)—Sunday Religious Service; (Monday through Friday)—Front Line Family (repeat); (Saturday)—Experiment in Freedom.

9:30 p.m. (Monday)—Feature: Welfare Officer; (Tuesday)—Promenade Concert; (Wednesday)—Radio Theater; (Thursday)—Songs from the Shows; (Friday)—Dance Music; (Saturday)—Program Preview.

9:45 p.m. (Sunday and Tuesday)—Music; (Saturday)—Transatlantic Quiz.

10:00 p.m. (Daily)—Program Preview (given in EWT and PWT).

10:10 p.m. (Monday through Saturday)—Daily Service.

10:15 p.m. (Sunday)—Orchestral Music; (Monday)—J. Canuck's Revue; (Tuesday)—Brain Trust; (Wednesday)—Orchestral Music; (Thursday)—London Calling Europe (repeat); (Friday)—To be announced; (Saturday)—Feature: Country Magazine.

10:30 p.m. (Thursday)—Music.
10:45 p.m. (Daily)—News.

CANADIAN SHORT-WAVE STATION LIST

CALL	CITY	POWER	FREQ.	LOCAL CANADIAN TIME
CBFW	Montreal	7500 W.	6090 Kcs.	Sun. 9:00 a.m. to 11:30 p.m. Mon. to Sat. inclusive 7:30 a.m. to 11:30 p.m. Same as CBFW
CBFX	Montreal	7500	9360	Sun. 8:15 a.m. to 11:33 p.m. Mon. to Thur. inclusive 7:30 a.m. to 11:32 p.m.
CBRX	Vancouver	150	6160	Fri. 7:30 a.m. to 11:33 p.m. Sat. 7:30 a.m. to 11:34 p.m.
CFCX	Montreal	75	6005	Sun. 7:45 a.m. to 1:05 a.m. Mon. 6:45 a.m. to 1:00 a.m. Tues. 6:45 a.m. to 1:05 a.m. Wed. 6:45 a.m. to 1:04 a.m. Thur. 6:45 a.m. to 1:10 a.m. Fri. 6:45 a.m. to 1:06 a.m. Sat. 6:45 a.m. to 1:04 a.m.
CKFX	Vancouver	10	6080	Sun. 8:00 a.m. to 11:00 p.m. Mon. to Sat. inclusive 6:30 a.m. to 11:30 p.m.
CJCX	Sydney	1000	6010	Sun. 8:55 a.m. to 12:00 Mid. Mon. to Thur. inclusive 7:55 a.m. to 12:00 Mid. Fri. 7:25 a.m. to 12:00 Mid. Sat. 7:55 a.m. to 12:00 Mid.
CKRO	Winnipeg	2000	6150	Sun. 8:00 a.m. to 11:30 p.m. Mon. to Fri. inclusive 6:30 a.m. to 12:00 Mid. Sat. 6:30 a.m. to 1:00 a.m.
CKRX	Winnipeg	2000	11720	Sun. 8:00 a.m. to 11:30 p.m. Mon. to Fri. inclusive 6:30 a.m. to 12:00 Mid. Sat. 6:30 a.m. to 1:00 a.m.
CFRX	Toronto	1000	6070	Sun. 9:00 a.m. to 12:05 a.m. Mon. to Sat. inclusive 7:00 a.m. to 12:05 a.m.
CFVP	Calgary	100	6030	Sun. 8:15 a.m. to 11:30 p.m. Mon. to Sat. inclusive 6:30 a.m. to 12:00 Mid.
CHNX	Halifax	500	6130	Sun. 9:00 a.m. to 11:25 p.m. Mon. to Fri. inclusive 7:45 a.m. to 11:15 p.m. Sat. 7:45 a.m. to 11:10 p.m.

Are you acquainted with these RCA HIGH-VALUE RECTIFIERS?

FOR power supplies for low- and medium-power stages of transmitters, and for other electronic apparatus, these two RCA rectifiers fill a real need. Both are sturdily built to give dependable, low-cost service.

RCA-5R4-GY

FULL-WAVE
HIGH-VACUUM
RECTIFIER
250 Ma @ 700
volts RMS input
per plate

\$1⁰⁰



RCA-816

HALF-WAVE
MERCURY-VAPOR
RECTIFIER
125 Ma @ 1750
volts RMS input

\$1⁰⁰

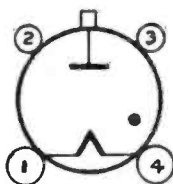

TECHNICAL DATA

	5R4-GY	816
Fil. Volts (A. C.)	5.0	2.5
Fil. Amp.	2.0	2.0
Max. Overall Length, inches	5-5/16	4-11/16
Base	Micanol; Med. Shell Octal, 5-pin	Small 4-pin
Cap	—	Small
Mounting: Vertical	Yes	Yes—base down only
Horizontal	With pins 1 and 4 in vertical plane	No

MAXIMUM RATINGS (Design Center Values)

	5R4-GY	816
Peak Inverse Volts	2800	5000
Peak Plate Milliamperes	650 per plate	500
Average Plate Milliamperes		125
For Condenser-input Filter	250 max. @ 1400 volts* 150 " @ 1800 " *	
For Choke-input Filter	250 " @ 1500 " * 175 " @ 1900 " *	
Warm-up Time, Seconds	10	10

*RMS plate-to-plate input value

The Magic Brain of all electronic equipment is a Tube . . . and the fountain-head of modern Tube development is RCA.



**RADIO CORPORATION
OF AMERICA**

RCA VICTOR DIVISION • CAMDEN, N. J.

BUY MORE WAR BONDS

62-6431-7

NEED PARTS?

National can supply you quickly with most of those hard-to-get parts at exceptional prices. Take a look at these bargains—

STANCOR MIDGET OUTPUT TRANSFORMERS, L6 to 3-6 Ohms. Mounting strap center 1 1/2" Each, 55c; 10 for \$4.95

10 WATT PIGTAIL WIREWOUND RESISTORS—500, 1000, 1250, 1500, 1750, 2000, 2500, 3000, 4000, and 5000 ohm sizes in stock..... Each, 24c; 10 for \$2.19

AERIAL KIT containing aerial wire, rubber coated lead-in, insulators, ground clamp, window strip, etc. Each, 89c

20 MFD 150 WV Tubular Pigtail Electrolytic, One Year Guar. Each, 35c; 10 for \$3.30

10 MFD 450 WV Tubular Pigtail Electrolytic, One Year Guar. Each, 43c; 10 for \$3.95

CLAROSTAT 1 MEG. (#6 Curve) VOLUME CONTROL WITH SWITCH. Shaft 1/4"x1" Each, 44c; 10 for \$3.90

100 Ohm (Tapped at 30) WIRE WOUND CEMENT COATED RESISTORS 30 Watt. Each, 45c; 10 for \$3.90

50 MFD 150 WV Tubular Pigtail Electrolytic, One Year Guar. Each, 49c; 10 for \$4.45

ASSORTMENT OF 147 FIRST LINE 600WV TUBULAR BY-PASS CONDENSERS CONSISTING OF 64 .01-600WV. 32 .02-600WV. 24 .05-600WV. 27 1-600WV. One Year Guarantee. List Price, \$33.30. Your cost only. **\$11.95**

4.5 KC Meissner IF Transformer, 1 1/2"x1 1/2"x 2". Universal Replacement Type, Spade Bolt Mounting Each, 61c; 10 for \$5.55

20x20/150WV Tubular Electrolytic. First Line Condenser. One Year Guarantee. Each, 61c; 10 for \$5.60

Assortment of 100 1/4 and 1/2 Watt RMA Color Coded Carbon Resistors, including 5, 10 and 20% Tol. Your Cost Only \$1.89

BALLAST TUBES — K42B, K42C, K49B, K49C, K55B, K55C, L49B, L49C, L55B, L55C..... Each, 45c; 10 for \$3.99

100-37, 100-70, 100-77 and 100-79. Each, 59c; 10 for \$5.45

Continental Bakelite Suppressors — S19A (Straight type with Rajah spring snap-on connector, fits all makes of spark plugs. Terminal nut cable connector). Each, 18c; 10 for \$1.65

GENERATOR CONDENSER—Universal type with six inch lead. .5MFD 200WV. Each, 18c; 10 for \$1.65

HI-TEMP RUBBER PUSH BACK WIRE—Solid and Stranded (#20) 100 Ft. Roll, 71c; 10 for \$6.50

Assortment of 46 First Line Tubular Electrolytic Condensers most frequently used, consisting of 1 100MFD 25WV, 2 10MFD 50WV, 15 20MFD 150WV, 8 20-20MFD 150WV, 6 50MFD 150WV, 10 10MFD 450WV and 4 10-10MFD 450WV. One Year Guar. Your Cost Only.. **\$18.95**

Rola 8" Auto Spkr. 6 Ohm Field, Copper Hash Bucker plate. A Beautiful Job. Delco Part No. 7242532.

Each, \$1.15; Lots of 16, 99c each 50x60/150WV Tubular Electrolytic. One Year Guarantee (Solar or CD). Each, 85c; 10 for \$7.95

LOCTAL SOCKETS — (Metal Supporting Ring) 10 for \$1.10; 100 for \$9.99

10 MFD 50WV Tubular Pigtail Electrolytic Condenser. One Year Guar. Each, 28c; 10 for \$2.45

10x10/450WV Tubular Electrolytic. First Line Condenser. One Year Guarantee. Each, 74c; 10 for \$6.90

Assortment of 25 Muter Candohm Wire Wound Resistors (All are 7 to 15 W, 15 or more are between 100 and 500 Ohms). Assortment, \$4.99

20% Deposit required on all C.O.D. orders. Don't forget L-265 or AA-3 Certificates. Orders of \$25.00 or more, accompanied by payment in full, will be shipped prepaid.

Free Bulletin No. 106 lists hundreds of other radio parts and supplies. Write for it today!

NATIONAL ELECTRONIC SUPPLY

77 W. Washington Blvd. Chicago 2, Ill.

FREQ. (MCS.)	METERS	CALL LETTERS	OPERATING HOURS (EWT)
11.93	25.15	GVX	5:15 p.m.—8:00 p.m.
9.58	31.32	GSC	5:15 p.m.—12:45 a.m.
6.11	49.10	GSL	8:00 p.m.—12:45 a.m.
7.26	41.32	GSU	8:15 p.m.—12:45 a.m.
9.51	31.55	GSB	10:15 p.m.—11:30 p.m.
6.15	48.78	GRW	10:15 p.m.—11:30 p.m.
2.88	104.2	GRC	10:15 p.m.—12:00 Mid.
7.12	42.13	GRM	10:45 p.m.—11:30 p.m.

BBC transmitters that are broadcasting news reports daily to the Western Hemisphere.

11:00 p.m. (Daily)—Radio Newsreel (repeat for Pacific Coast).

11:15 p.m. (Sunday)—Topical Survey (repeat); (Monday)—Current Events (repeat); (Tuesday)—Stanley Maxted (repeat); (Wednesday)—George Blake (repeat); (Thursday)—London Letter (repeat); (Friday)—World Affairs (repeat); (Saturday)—British Tommy (repeat).

11:30 p.m. (Sunday)—Feature: Daniel Defoe (repeat); (Monday)—Feature: Welfare Officer (repeat); (Tuesday)—Famous Names (repeat); (Wednesday)—Record Review; (Thursday)—Radio Theater (repeat); (Friday)—Scots Guards Band; (Saturday)—The Old Town Hall (repeat).

11:45 p.m. (Tuesday)—Cross Section (repeat).

12:00 Midnight (Sunday, Monday)—Regimental Band Music; (Tue., Wed.,

Fri., Sat.)—Music; (Thursday)—Sir Nicholas Micklem (repeat).

12:05 a.m. (Tue., Wed., Fri., Sat.)—War Review (repeat).

12:15 a.m. (Sunday)—North American Guest Night (repeat); (Monday)—J. B. McGeachy (repeat); (Tuesday)—What War Means to Me (repeat); (Wednesday)—Music; (Thursday)—World Perspective (repeat); (Friday)—William Holt Reports (repeat); (Saturday)—Transatlantic Quiz (repeat).

12:30 a.m. (Daily)—News.

Reception reports from short-wave listeners are very much desired from all parts of the world by the Editor of *International Short-Wave*. Simply address: Kenneth R. Boord, % RADIO NEWS, 540 No. Michigan Ave., Chicago 11, Illinois.

—30—

QTC

(Continued from page 52)

nearly impossible to make such an assignment as there is the possibility that the vessel's movements might be changed after departure and be away from the U. S. for several months. Another thing, these men are already engaged in an essential job and would be unable to obtain a needed release from their present position, so most outfits would be unwilling to take a chance on losing an experienced man for a few months whom they would be unable to replace. The idea if it could be worked out would be fine during the present marine radio officer shortage and would help materially to give the men regularly assigned a ship a much needed vacation.

A NEW issue of ACA's official publication "MSG" features a front cover picture of the *S.S. Lawrence Gianella* named for an ACA member who went down with his ship trying to get off a message to save the crew after the ship was torpedoed. The enlarged 40-page issue has much of interest to marine department members. The ROU, under the able direction of Fred Howe, is still battling for better accommodations for radio officers aboard the ships that now are carrying three men. There are rooms designed for three men (radio) aboard a good many of the ships.

WASHINGTON reported that during the first three months of this year only one Allied merchant ship was sunk by U-boat action, as contrasted with 47 during the same period

last year and 100 in the same period of 1942. The War Shipping Administration is still urgently looking for ex-marine radio operators who are available to return to sea duty again. Men who have held FCC licenses in the past (Radiotelegraph first class) can obtain the Temporary 2nd class licenses by passing the code test only; for others the examination consists of the usual 2nd class questions but a percentage of only 50 will net the temporary grade license so it really is not difficult to get back into the old brass pounding game again. WSA and the various marine radio unions are still on the lookout for men with the necessary "ticket."

KEEP in mind the appeal of WSA for first or second class licensed radio operators, if you know of any ex-marine man who is available have him contact the WSA through any of its officers or get in touch with any U. S. Employment Office.73

—30—

Clear View of Electronics

AN engineer was delivering a talk on electronics to a group of electricians. Apparently he did not feel it necessary to go into the matter too deeply. The following paragraph is an abstract from a writeup that the electricians gave the lecture in their magazine.

"The talk by Mr. W. was very interesting from an equipment standpoint. The slides showed various pieces of apparatus all nicely sealed up in boxes with two wires hanging out. If we can find where to put those two wires, 'Presto', Electronics!"

—30—



Electro-Voice MICROPHONES

The extent of our line is but partially illustrated in this advertisement. Our current production is now being utilized in essential services. Soon, however, there will be Electro-Voice Microphones available for civilian use... and these will be described fully in subsequent advertisements.

In our South Bend laboratory, we have complete facilities for accurate frequency checking, harmonic wave analysis, measurement of ambient noise, etc. Electro-Voice Microphones reflect painstaking care in design and construction by superior performance in the field. They serve you better... for longer periods of time.

If your present limited quantity needs can be filled by any of our Standard Model Microphones, with or without minor modifications, we suggest that you contact your nearest radio parts distributor.

Paper Packs a War Punch . . . Save Every Scrap

ELECTRO-VOICE MANUFACTURING CO., INC. • 1239 SOUTH BEND AVENUE • SOUTH BEND, INDIANA
Export Division: 13 East 40th Street, New York 16, N. Y. — U. S. A. Cables: ARLAB



***Old Man Centralab**
 "Old Man" is right
 ... for he is a real
 "old timer". There
 is no substitute for
 experience, and
 the "Old Man"
 now, as in the past
 twenty-two years,
 is still your best bet.

**Still your
 best bet for
 replacements**

Centralab
 VOLUME CONTROLS



Centralab

Division of GLOBE-UNION INC., Milwaukee

If you want



- CRYSTALS
- CABLES
- HARNESES
- ELECTRONIC ASSEMBLIES
- CABINETS

Telephone Peru, Indiana
 151

Serving the Radio and Electronic Industries with precision engineered products.

Wm. T. WALLACE MFG. CO.
 General Offices: PERU, INDIANA
 Cable Assembly Division: ROCHESTER, INDIANA

Sound on Cellophane

(Continued from page 58)

3000 cycles. No attempt has been made to foster the recorder and cellophane for any other purpose such as music, although music has been successfully recorded and played back.

Several models have been built and distributed to universities, local governmental institutions, and a number have been placed in the control towers of an airline on a 24-hour schedule for two-way conversation in landings and takeoffs, which permanently preserves all evidence in event of future disputes over causes of accidents.

Cellophane can be bought in any length desired. Usually it has been sold outright but the plan is to sell it on a length-of-time basis, and, generally, comes in three sizes, for one, two, or eight hour recordings. However, if desired, any other length including three to seven hours may be obtained. A smaller machine can be used to record up to two hours if wanted. To date, this smaller machine has not been sold.

The cellophane tape recorder was ready before the war. Nevertheless, it was not publicly demonstrated until January 19, 1944, when it was formally introduced to members of the press and several engineers at the formal presentation held at the Waldorf-Astoria. At that meeting, a tape which had been played 2000 times was shown and replayed, demonstrating the long life and durability of cellophane as a recording medium.

This new sound recording instrument features the records up to eight hours of playing continuously without supervision. It has been publicized by the makers as an "ideal reference recorder for airport control towers, radio broadcasting, Army and Navy reference transcriptions, diplomatic and intelligence activities and innumerable governmental, industrial and business uses."

With the proposed ruling by the Federal Communications Commission that all broadcasting stations are compelled to keep transcriptions of all their programs for a full year, a vast market has opened up for just this kind of recorder.

The over-all frequencies range from 50 to 10,000 cycles and can be increased past that point. However, the point has been made that the public is not appreciative of the higher frequencies at present so there is no need to go to the upper frequencies. About 7500 cycles is said to be sufficient.

In the home, the anticipated uses of the recorder range from catching an infant's early cooing to reproducing symphony orchestras. Cellophane records, unlike discs, cannot be produced in quantities by molding from a master record but no great difficulty is anticipated in finding ways to achieve mass production.



When the Bugle Blows "Cease Firing!"

Soon after the bugler's call announces war's end, CLARION'S peace-time bugler will herald the dawn of an era in which civilian radio needs may again be served in the normal way.

Radio dealers who respond to that second call will be better equipped to serve a public eager to buy, because CLARION is prepared to extend cooperation both in finer merchandise and more complete sales promotion help.

Back of you always will be a company and a name that have represented the best in radio since 1922.

Be ready to march with CLARION to the most profitable radio business you have ever enjoyed.



WARWICK MANUFACTURING CORPORATION
4640 W. HARRISON ST. CHICAGO 44, ILL.

**TABLE MODELS • PORTABLES • FARM SETS
RADIO PHONOGRAPHS • FM • TELEVISION**



BECAUSE: *You have so much to do in so little time.*

BECAUSE: *HARVEY has in stock, or can quickly obtain for you, supplies of*

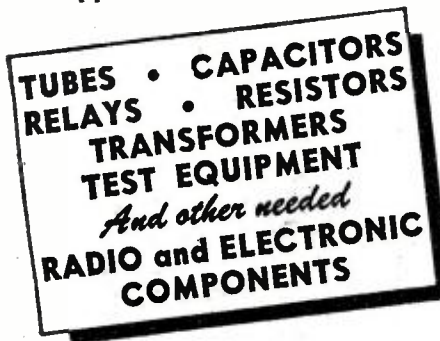

AND BECAUSE: *HARVEY can advise you on technical or priority problems.*

WE SUGGEST: *that you come to HARVEY for your next order. 17 years experience enables us to fill orders efficiently, and expeditiously.*

And, WE DELIVER ... within 24 hours, if possible.

TELEPHONE ORDERS TO LONGACRE 3-1800.



Problems of a Serviceman

(Continued from page 47)

on furloughs furnish a good but uncertain labor supply. By lending a hand, these fellows help clean up some of the accumulation of radios to be fixed. Other than taking advantage of this labor source, I have found no permanent solution to my problem of help.

In order to save gas, tires and valuable time, home calls have been practically eliminated. Only those sets which cannot be transported except by truck are serviced in the customer's home. As a further incentive to the customer to bring his work in, sets so handled are serviced first, taking precedent over home calls. This means that the customer who brings in his set for repairs will have it within a week, with any luck, while the customer who requests a home call may have to wait from six to eight weeks for a serviceman to have a free half-day available.

By using "Victory parts" which are now available in fair quantity, I have been able to avoid the use of salvaged parts. Often the salvaging of parts represents a real financial loss in man-hours both in the performance of the salvaging operations and in the labor expended on returns.

There does seem to be a new demand on the part of the public for sets to be repaired and put in good shape, rather than the often heard request of several years ago to "just make it play." Whether this new attitude is due to the customer's ability to pay for elaborate repairs or whether it is due to the fact that no new sets are available, I cannot say, but this trend is on the upswing. The quality of repair work being requested is keeping radios out of the repair shop on repeats.

One of the biggest headaches in the business today is the amateur repairman who, because of training received in the armed forces or on the job, feels qualified to repair his and his neighbor's radios. This means a real repair job when the sets are brought in to us in a cardboard box with some of the parts broken or missing. The busy shop could avoid a lot of trouble if they could educate their customers to bring their radios in for servicing rather than permit any untrained but well-intentioned person to attempt the job.

On the whole the servicing information furnished by the manufacturer is adequate but there is a definite need for standardization. Confusion results from the use of terms with double and triple meanings. Steps taken to correct this situation will be in the right direction.

Circuit diagrams and parts lists included by the manufacturer on the chassis have not been too satisfactory as they either become detached and are lost or they are too small to be of any real value in repairing the set. Model numbers should be plainly

marked in some manner so that over a period of years a service man could be able to tell the exact model of a radio to be repaired. This marking should be on the chassis and *not* on the cabinet.

As far as the postwar prospects are concerned, I plan to operate in a similar manner as before. The store will handle radios, refrigerators and ranges when they again become available. I will also handle television sets, automatic record players and other kindred merchandise. Postwar planning by the dealer is next to impossible because he is waiting for the manufacturer or the jobber to make his plans and when that is done then the dealer can say that he may or may not like certain manufacturers' plans and this will enable him to line up with the product whose producer is going to do business the way the dealer wants to operate. Let this be notice to manufacturers and jobbers to make their postwar plans and advise their dealers of such planning before the dealer makes different arrangements of his own.

In connection with television sales, I feel that manufacture of postwar receivers should be held up until new standards are agreed upon and adopted. The customer who buys a television receiver as soon as the war is over will be receiving merchandise which is five or ten years behind developments. This customer will not be an enthusiastic television user when a year or so later he views the sets in which the war born engineering improvements have been incorporated. It behooves the radio sales and servicemen to tread carefully in this field. On one side, are immediate profits, while on the other side are potentially dissatisfied customers.

One of the most important aspects of handling television receiver sales successfully is proper antenna installation. Unlike the average AM or FM set, the television antenna cannot be strung to a nearby tree. A real engineering job is involved in the proper installation of the television antenna depending on location and topographic conditions surrounding the installation. It is my plan, at the present time, to have a fully trained antenna installation crew which will take care of the work not only for my shop but for those in the vicinity. By a pooling of this sort, every buyer of a television receiver will be assured of proper antenna installation. Such a crew would be insured against the hazards of this work and their use would cut costly accidents and the delays such as an accident might cause.

As I see it, the future looks fairly bright for the radio serviceman who can hold onto the business he has now and at the same time plan ahead for the postwar boom. Customers will want new radios and we'll be there to sell them as soon as the sets are off of the assembly lines. Until that time, we will keep the old ones playing.

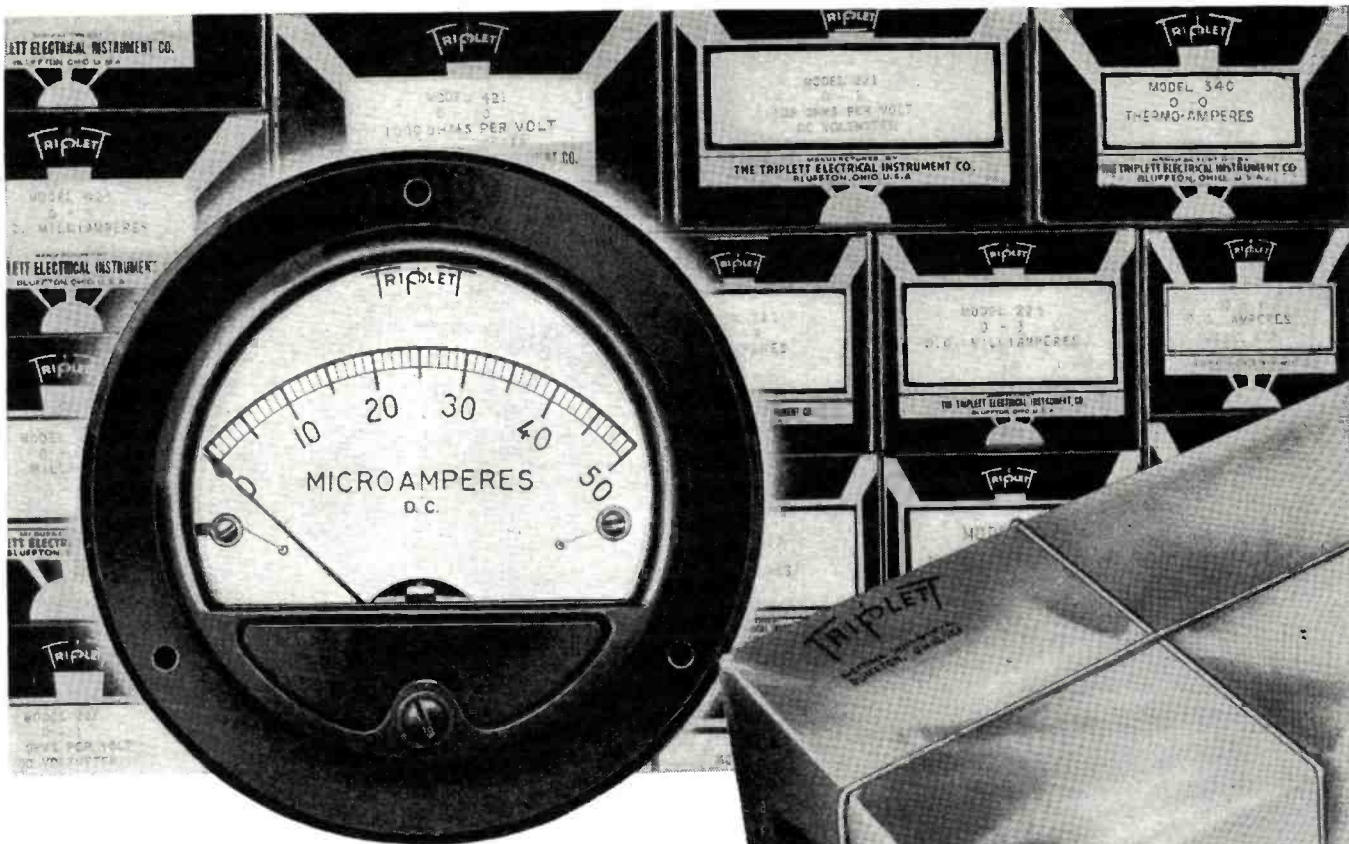

INSTRUMENT DELIVERIES!

American Instrument production is catching up with the needs of our armed forces—closing the gap between too little and enough. Caring for those needs has expanded Triplet production lines unbelievably far beyond previous capacities. And the experiences of war, added to more than forty years of instrument manufacturing, have bettered the products coming off those lines.

Now—instruments—better than ever before—are ready for general use. Better place your orders, at once, with Triplet—headquarters for a complete line of instruments made to one fine standard of engineering.

D'Arsonval Moving Coil D.C. Instruments Electrodynamicometer A.C.-D.C.
 Double Iron Repulsion A.C. Instruments R.F. and Rectifier Types; Sizes 2" through 7"

Triplet

ELECTRICAL INSTRUMENT CO.
 BLUFFTON OHIO ***

STANDARDS ARE SET BY



- ★ *Greater Production Capacity*
- ★ *Better Instrument Quality*
- ★ *Complete Line of Instruments*
- ★ *One Source of Supply*
- ★ *Prompt Deliveries*
- ★ **SEND YOUR ORDERS TO TRIPLET NOW**

Crystal Processing

(Continued from page 28)

shadow and light is formed. If white light is used as a source, a pattern of colored rings is formed due to the fact that different wavelengths (determining different colors) are rotated various amounts. Plane polarized light passing along the X or Y axis will result in change of intensity of light, i.e., from light to dark, when the Z axis lies in the polarizing planes, each 90° of angle.

For proper wafering, quartz is to be positioned in the following manner: Z axis parallel to the mounting surface as well as parallel to the reference edge of the glass; X axis perpendicular to the surface of the glass; Y axis parallel to the surface of the glass and perpendicular to reference edge of the glass.

Faced quartz is clamped onto a jig on a natural face so that the Z axis is parallel to the reference edge of the jig. A cut is then made parallel to the Z and perpendicular to the natural face. The quartz is mounted on glass upon the resultant cut, being held in a fixed position with the thermoplastic cement. Its orientation is checked by use of the stauroscope, an instrument which gives the extinction point when viewed along the X or Y axis. The electrometer then is used in order to determine the polarity. Pressure is applied along the X (electrical) axis and recorded on a meter as a positive or negative charge.

The positive or negative charge terminating on the mounting surface is marked on the glass. The remaining factor is to determine the hand of



Taking X-ray measurements for angles of cut (angles from crystallographic axes) and direction.

the quartz, all quartz being right or left handed. This is done by cutting a small piece perpendicular to the Z axis. This piece is placed in a refractive liquid and viewed along its Z axis through polarized light. When the analyzer is rotated clockwise (right) or counter clockwise (left), the concentric circles will converge toward the thickest point on the piece of quartz. All factors now known, the direction of the cut is marked on the glass and the quartz is ready for wafering.



"We've modernized our smoke signals."

Unfaced material requires a more involved method because nothing can be determined from the physical structure of the rock as to the location of the X or Y axes. Therefore, when the Z is established, a mounting face parallel to the Z is ground on a lapping wheel. One method is to use the X-ray spectrometer to determine the X and Y axes after the Z has previously been found. Then a cut is made in the YZ plane and the quartz mounted on the cut face.

Another method is to make a cut along the XY plane perpendicular to and at each end of the Z. When a pin point of light is passed along the Z, a triangular etch pattern is visible. From that pattern the hand of the quartz as well as the location of the X and Y axes can be determined. A YZ plane is cut and the quartz is mounted on the cut surface. It is then handled the same as faced material. The determination of angles, as outlined in this procedure, is of prime importance in producing oscillators of good activity and proper temperature coefficient.

Next in the quartz-producing process is the saw room operation, where the material is cut to specified angles. In sawing, a blade charged with diamond dust is used. This is necessary because quartz has a hardness of 7 whereas that of the diamond is 10, hence the latter is the cutting agent. The mounted quartz is placed on a plate-like protractor and clamped tightly in a saw that is held securely to a cement base to eliminate shock and vibration. The first cut is made, the wafer being placed in a polariscope to determine the direction of the Z axis. It is then sent to the X-ray for a reading. If the reading is the desired one, a few wafers are cut from the bar, which is checked again for the steadiness of the angles. If it proves itself, the remainder of the bar is cut to the desired thickness.

Here it should be pointed out that the frequencies of the more common crystal types are determined by their thickness, whereas with contour oscillators, the frequencies are determined by width and length, thickness being given consideration merely for greater activity and clearer response. The commonly used thickness oscillators are designated by AT and BT cuts, the former generally for frequencies between 500 and 5000 kc. For frequencies above 5000 kc. the AT cut is mechanically weak, hence the BT cut is used, this having a higher thickness constant. For frequencies below 500 kc. contour crystals of CT, DT or GT cuts, or other special cuts, are used.

For AT cut crystals the saw is set to cut at an angle from the optic axis (B angle) of 35° and the angle of deviation from the X axis or A angle is 0°. The direction of the cut is toward parallelism with the minor apex face, or may be determined by the hand and electrical polarity of the quartz. For BT cuts the B angle is 49° with the A angle same as the AT, but in the direction toward parallelism with the major face. The reason for these an-



There's Little Enough Time
To Do a Service Job the First Time

And No Time
To Do It Over!

SPENDING valuable man hours to do a job over because a replacement part has failed wastes your time and money, uses critical material and helps to hinder America's war effort.

Your service work can be only as good as the replacement parts you use. By using Mallory parts, you avoid the danger of failure and the necessity of re-doing a job. Whenever the repair calls for volume

controls, vibrators, capacitors, switches or resistors, use Mallory replacements and be safe.

Years of outstanding service and a reputation for long life and dependability in the replacement field make Mallory parts the right parts to do the job right the first time.

They're available through Mallory distributors from coast to coast.

P. R. MALLORY & CO., Inc., INDIANAPOLIS 6, INDIANA



MYE TECHNICAL MANUAL
—408 pages of complete data on capacitors, noise suppression, receiving tubes, loud speakers, vibrators, phono-radios, automatic tuning and other valuable information. Available from your Mallory distributor...Price, \$2.00.

4TH EDITION RADIO SERVICE ENCYCLOPEDIA ... Complete information on repairing any make or model of receiver. Circuit references, original part numbers and recommended replacements. Available from your Mallory distributor ... Price, 95 cents.



Your Wisest Investment—
Government War Bonds



gles is to hold frequency changes, due to temperature fluctuations, to a minimum.

In making the sample cut of a quartz bar, the approximate thickness is .030". The projected optic axis is marked on this sample by means of polarized light equipment, or the polariscope, then placed in the X-ray spectrometer to determine the angles of the cut. The saw is adjusted from these readings until the resultant cut is within 10 minutes of arc of the required angle. The remainder of the material is cut with checks every few blanks to insure holding the angle to tolerances. In special cases, where frequency drift, due to temperature changes, is extremely critical, the tol-

erances must be held to a plus or minus 3 minutes of arc.

The thickness to which the blanks are cut is determined by the thickness required for the particular frequency plus the required thickness of quartz to be removed in processing.

It is in the X-ray room that constant checks are made of the angles and directions at which the blanks are cut from the raw quartz. In making X-ray spectrometer readings, the Bragg method of crystal analysis is used. This method is based on the principle that monochromatic X-rays are reflected from fixed spacing of the atomic structure at definite angles. For this work an X-ray tube, having a copper target or anticathode is used

because the typical wavelength of copper emission gives Bragg angles which are easy of computation and use.

With known atomic spacing in certain predetermined structural planes in the crystal, an ionization chamber may be set at twice the Bragg angle and by rotating the crystal in the holder of the goniometer, the ionization chamber output indicates when the atomic planes are properly aligned. The angle between this known plane and the face of the crystal is used in computing the angle at which the crystal has been cut from the quartz axes.

There are numerous imperfections in quartz—twinning, optical and electrical; cracks; bubbles; veils; phantoms; and inclusions—all of which are disclosed in the etching process. The twinning is a crystallographic flaw, while the others may be listed as mechanical. Optical twinning is caused by an interruption in the symmetric crystalline arrangement of the atoms of which the quartz is composed, or a growth of left-hand quartz in a right-hand mother or vice versa. Electrical twinning is caused by two crystal structures of the same hand joined together with a reversal in polarity with respect to each other along their common X axes.

Optical twinning may be detected by the use of polarized light, but this does not detect the electrical. Quartz containing either or both is nonusable. The only means by which both can be detected in one operation is by etching in hydrofluoric acid or other fluorine compounds. After etching, a projected light reflected from the etched surface of the crystal accentuates the twinning. The twinned areas are marked out and only good areas are used for the manufacture of oscillators. The crystals are then inspected by transmitted light for mechanical flaws.

When the wafers are received from the flaw inspection room, they are marked with a pencil to a dimension oversized to the finished crystal. This is done by means of a transparent masking shield cut in the center to the oversized dimensions. All twinned and mechanically flawed parts are discarded, but by the use of pencil markings the greatest number of finished crystals from each wafer is assured.

The wafers are then cut along those marked lines to form blanks, the cutting device being a diamond saw in which the metal or resinoid bond is impregnated with diamond dust. The blanks then go to a No. 320 grit diamond-charged grinding wheel where they are squared closer to dimensions; then to a finer diamond polishing wheel which makes use of a dimension-limit jig for final dimensioning of the crystal and polishing of the edges. These operations are done with the greatest care so that the edges are free of chips and fractures, assuring good activity and a blank that is perfectly squared. After this the blanks are sent to the inspection department for further checking of flaws and edges.



For Good Jobs TODAY... TOMORROW... LEARN RADIO ELECTRONICS DeFOREST'S A-B-C WAY

DeFOREST'S prepares you for a wide range of interesting, good pay jobs in the fascinating Radio-Electronics Industry.

THE fast-moving Opportunity Field of Radio-Electronics needs many trained men! Let us show you how to get ready to take advantage of the breaks—the good jobs—the satisfying pay checks of today, and the bright postwar opportunities of tomorrow. Write for DeFOREST'S big, free book—"VICTORY FOR YOU!"

You see how you may cash-in on a field that includes F. M. Radio, Communication Radio, Electronics, Broadcast Radio, Motion Picture Sound, Radio Sales and Service, or a Radio business of your own.

You see how DeFOREST'S has helped many get their start in Radio-Electronics—helped them to good pay jobs in essential industries—helped others to preferred military classifications with higher ratings and better pay. Helped others to full and part time sales and service businesses of their own. Mail the coupon NOW—TODAY! See how DeFOREST'S can help YOU get started toward this fascinating work by means of its effective "A-B-C" Training Method—in your spare time, at home.

A YOU GET INTERESTING, PRACTICAL LOOSE-LEAF LESSONS

DeFOREST'S TRAINING includes 90 modern, well illustrated loose-leaf lessons, prepared under the supervision of one of the world's foremost Radio authorities, Dr. Lee DeForest—inventor of the Audion tube which helped make modern Radio possible.

B YOU WORK AT HOME WITH THIS PRACTICAL EQUIPMENT

You "learn-by-doing" with eight big kits of standard Radio parts and assemblies—working out 133 interesting experiments to gain valuable experience at home. You experiment with Light Beam Transmission. You build and operate an Aviation Band Radio Receiver, Wireless Microphone, 5-tube Superheterodyne Receiver, an intriguing "Electric-Eye" device—and many other projects.

C YOU SHOW MOVIES AT HOME

You use a genuine DeVRY 16mm Motion Picture Projector and Films to help you learn Radio faster, easier. Hidden Radio-Electronic action comes to life! You see Electricity in motion—Electrons on the march!

DeFOREST'S also provides an active EMPLOYMENT SERVICE which has long-established contacts with employers with whom we have placed many trained radio men. Act now! Mail the coupon! See how you may get ready to cash-in on both today's and postwar's promising future in the broad and exciting field of Radio-Electronics.

Mail the Coupon TODAY!

READ WHAT THESE DeFOREST MEN SAY!

"Let me say that since being on this job I have many times expressed the fact that I wouldn't take a lot of money for the training I had from your organization. It has helped me immensely."
—Richard Stroshul, Oklahoma.

"Your course was the only important training I received in order to make the transition from a Radio-telegrapher to Radio Engineer with a fine salary."
—Samuel Freedman, Connecticut.

"I have obtained employment with the ... Mig. Company. You may be interested to know they speak very highly of DeForest's students and state they have had excellent results with your men whom they have employed."
—Clifford Taylor, Mass.

"As a result of DeForest's Training, I am doing very well. If my income doesn't range between \$50.00 and \$75.00 per week, I figure something is wrong."
—Lyle Rielly, Wis.

DeFOREST'S TRAINING INCLUDES INSTRUCTION IN MOTION PICTURE SOUND EQUIPMENT F-M RADIO AND TELEVISION



DeFOREST'S TRAINING INC., Chicago, Ill

DeFOREST'S TRAINING, INC. 2533-41st Ave., Dept. 11-1 Chicago, Ill. 14, Illinois

Please send me your "VICTORY FOR YOU" book and KIT FOLDER, FREE and without obligation.

Name Age

Address

City State

Check here, if under 16, for Special Information.

electricity comes of age



In the radio and electronic equipment serving the armed forces, electricity is performing new functions, and performing old functions more efficiently, through the application of electronic principles.

There is more than a military significance in this accomplishment. For electronics is essentially a means of *controlling and disciplining* electricity to serve man better, and, as such, it will enrich the peace it is helping to win.

Whatever electronic developments the future may hold in store, this much is sure: Delco Radio will build good, dependable products

that make the most of electronic knowledge. They will be characterized by the same precision workmanship and progressive engineering that earned Delco auto radios a place on millions of cars, and that now safeguard the performance of Delco Radio equipment for America's land, sea and air forces.

**Make Your Dollars Fight
BUY MORE WAR BONDS**

Delco Radio
DIVISION OF
GENERAL MOTORS

Following this is the automatic lapping operation, through which the blanks are ground to approximate final thicknesses depending upon the frequency of crystal required. There are three operations. The first removes the majority of fractures from the surface caused in the sawing operation, a coarse grinding compound being used. During this and the following lapping operations the positions of the blanks in the lap are systematically reversed and transposed to insure that all blanks in one lap are flat and even. The equipment used is similar to a drill press with an offset spindle in place of the drill, and a pair of grooved lapping plates on the bed of the press, between which the crystals

are rotated while held in a thin work holder.

In the second operation, the blanks are lapped to within .001" of the finished thickness. For this operation a finer grinding compound is used for a finer finish. They are then checked by the quality and inspection department. On the final lapping operation, a fine optical polishing compound is used to remove all pits and scratches left by the coarse and faster grinding compounds. After the blanks are polished, they are checked on a limit gauge against a master blank and returned to the lap until they are between .00002 and .00006 thicker than the master.

The operations up to this time have

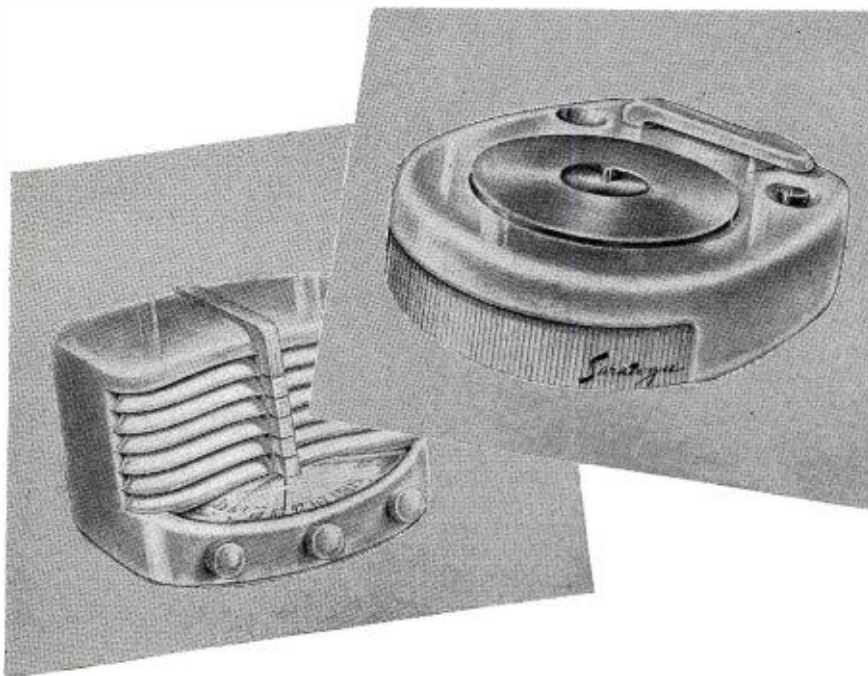

Just Picture these Possibilities

Meck Radios and Phonographs are designed to *anticipate* the preferences of the great post-war market. Remember—Meck Products are

*Built to Perform and
Priced to Sell!*

 **MECK** RADIOS AND PHONOGRAPHS
★ ★ ★
INDUSTRIAL SOUND EQUIPMENT

JOHN MECK INDUSTRIES, PLYMOUTH, INDIANA, U. S. A.

New York 18: 500 Fifth Ave., Chickerling 4-3545 • Chicago 11: 540 N. Michigan Ave., Delaware 1561

been checked mechanically; hereafter the closer tolerances must be checked electrically.

The next operation—electrical checking and frequency classification—is an accurate check on dimensions and frequency characteristics. The crystals are first checked for activity and strength of oscillation. If they do not meet activity requirements, they are put into an edging device, which is a modified tumbler, for further polishing and rounding of edges to increase activity. Then all crystals meeting requirements are checked on a frequency-measuring device, by which they are assorted into frequency channel groups according to deviations from the master crystal. The crystals are separated roughly into groups of 30 kc. or less below frequency.

To raise the frequency of the crystals to closer limits and improve quality, they are now given in groups to rough etchers, who increase the frequency to approximately 3 kc. of the desired frequency indicated by etching in a fluoric compound and checking against a master crystal of the desired frequency in a comparison oscillator. Timing plays an important part in this etching process. At the same time the activity is improved by hand edge grinding on an abrasive covered glass plate. The crystals are then returned to the inspection department for final inspection of flaws.

Matching to frequency, the operation through which the crystals are raised to exact frequency by fluoric etching, is the next operation. Here the prepared blanks are issued in lots of 30 to each of the finishers, along with holders, springs, and electrodes. Each crystal is measured for activity and frequency in a comparison oscillator using a known crystal as a standard. Then follows etching to closer frequency and rinsing in running water. In the next step, each crystal is washed carefully with soap and brush and then rinsed again.

The crystal or blank is now placed between the electrodes and frequency and activity carefully measured. If further etching is necessary to reach the required frequency, the process is repeated. If activity is not high enough, the crystal is edge ground to remedy this condition.

When the crystal is acceptable it is placed in the electrodes together with a spring and assembled into a bakelite holder. The holders are then placed on a moving belt whereby they are transported to the end of the work table and deposited before assemblers who attach the cover and gasket with screws. They are loosely put on, and the unit placed upon another moving belt which takes the holder through a temperature oven at approximately 100° C, which removes the moisture. At this point, the cover is tightened securely, and the unit is placed again upon the belt and goes through another oven which restores the temperature to 90° C.

The crystal in the holder is then checked for activity and frequency, a

MAKE MORE MONEY

IN
Radio TELEVISION
& ELECTRONICS

Now!

GET THESE 3 BOOKS

FREE!

You men already in radio know how great the demand is for trained, experienced service men, operators and technicians. You know how fast the field is growing and how important it is to keep up with developments—F M receivers, television, electronics.

Or even if you are merely INTERESTED in radio as an amateur, you must recognize the WONDERFUL OPPORTUNITY right within your grasp to cash in on your natural talent. Make it pay dividends. Get into the EXPERT RADIO SERVICE Line. Be a TELEVISION specialist—OWN A BUSINESS OF YOUR OWN. Fill out and mail the coupon below for all the details.

**Get the Latest Inside Information—
Trade Secrets by**

SHOP-METHOD HOME TRAINING



1. A complete catalog describing the industry and the extensive training facilities of National Schools.

2. You receive a sample lesson illustrating the modern "Shop Method" instruction technique.

3. The vast opportunity field of Electronics, "The Dawn of a New World," is revealed in this fully illustrated book recently published.



Learn by Doing

Use Actual Radio Equipment
Furnished With Your Course

Experience is the best teacher. You learn by experience with the exclusive National Shop-Method of Home Training—actually build many circuits and do experiments with the big kits of standard radio parts included in your training equipment at no extra cost to you.

In the course of your study you actually build various types of receivers—a powerful superheterodyne, a signal generator, an audio oscillator and others. You make tests and conduct experiments that show you the why and how of things. You understand what makes the various elements of electronics operate because you actually see them work for you. Not only do you gain a marvelous actual experience by this method of learning but you have valuable equipment you will use on the job in the practice of your profession as an electronics expert. Mail the coupon and learn what this means to you.



Now the famous National Schools brings its exclusive Shop-Method of training right in your own home. You can learn the most up-to-date, approved projects, systems and hook-ups step by step in your spare time. This is the sound, practical training you want and need—the development of experienced instructors working with thousands of students right in the shops and experimental laboratories of National Schools—ones of the most advanced trade educational centers of the world.

This is the MODERN SYSTEM OF TRAINING. It matches the rapid progress constantly being made in radio, television and electronics. It is TIME TESTED too. National Schools has been training men for more than a third of a century. In essence this is the very same training that has helped thousands to more pay and greater opportunity.

You owe it to yourself—your future—to read the book "Radionics"—FREE to you when you send in the coupon.

National Trained Men Now Making the Best Money in History
 The real value of National training shows up in the quick progress our men make on the job. Joe Grumich of Lake Hiawatha, N. J., turned down a job most men would welcome. He writes: "My latest offer was \$5,800.00 as radio photo engineer, but I am doing well where I am now National." I am deeply indebted to

Ely Bergman, now on Station WOR, told us: "My salary has been boosted considerably and at the present time I am making over \$3,000.00 per year. Learn the facts of this exclusive shop-method of home training. See for yourself! DECIDE FOR YOURSELF!

month. I will say that I honestly owe all this to the excellent training I had at National."

National is proud of the progress graduates are making all over the world. Read about their records yourself in the books we send you FREE.

Make Extra Money Right From The Start

You get ahead fast with National Training. Many beginners make good money on the side fixing radios and doing service work. You can turn your knowledge into cash after the first few lessons. Progress is rapid. You can actually SEE YOURSELF GET AHEAD, because the National Shop Method is so sound and practical.

Now, right now, is the time to grasp the opportunity of today—a successful career for tomorrow. Get into the big money, rapid advancement, a position of importance. A BUSINESS OF YOUR OWN. Radio, television and the whole field of electronics invites you. The industry is crying for trained men everywhere. A rapidly expanding industry—probably the greatest in history—holds out the promise of a rich future—prosperous security.

Train While You Are In Service

Prepare, right now, while you are in uniform, for a glorious secure future in the field of radio and televi-



sion when the war is over. Make good use of your spare time by taking your National Training now. Men in our armed service, or about to enter, get better ratings and more pay almost right from the start if they are trained in radio, television and electronics. The government needs experienced men in nearly all branches of the service. Prepare for present advancement and a sound future. Learn how easy it is the National way. We are so enthusiastic because we have seen the marvelous results of National Shop Method Home Training. Send in your coupon today and see for yourself.

NATIONAL SCHOOLS
 LOS ANGELES 37, CALIFORNIA EST. 1905

MAIL OPPORTUNITY COUPON FOR QUICK ACTION

National Schools, Dept. 8-RNR
 4000 South Figueroa Street, Los Angeles 37, California

(Mail in envelope or paste on penny post card)

Mail me FREE the three books mentioned in your ad including a sample lesson of your course. I understand no salesman will call on me.

NAME..... AGE.....

ADDRESS.....

CITY..... STATE.....

Include your zone number

FREE LESSON INCLUDED

Examine the exclusive National Shop Method of Home Training. See for yourself how sound and practical it is. Be convinced that you can learn radio—electronics, television—quickly and easily in your spare time. You can't tell until you try. This trial is ABSOLUTELY FREE. And you may keep all the valuable material we send you without any obligation of any sort. Fill out the coupon immediately while you are thinking about it and drop it in the mail at once.

Thousands of men in the Army, Navy and Coast Guard have trained at National under U. S. government sponsorship. You are the man who must be satisfied.

Mail the coupon here for the three books that tell you the complete story of the marvelous new system of training in radio electronics and television. Learn the facts of this exclusive shop-method of home training. See for yourself! DECIDE FOR YOURSELF!

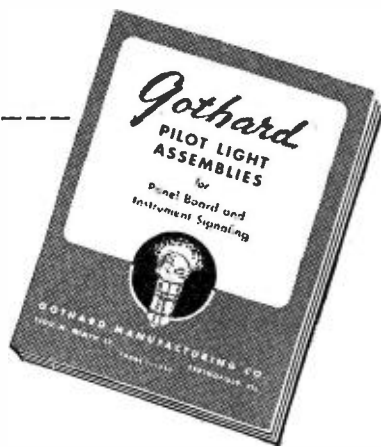

**You'll Want This
NEW
Gothard
PILOT LIGHT
DATA BOOK**

This new 24 page data book contains information important to every pilot light user. In addition to illustrating and describing a complete range of styles and sizes of both variable intensity and fixed units for practically any application and voltage you could want, it also goes into detail on brackets, bulbs and accessories. A copy will be promptly sent to you on request.

**Gothard
MANUFACTURING
COMPANY**

1350 No. Ninth Street, Springfield, Ill.

**FADA'S
S.M. 81
SERVICE
MANUAL**

**AN
INDISPENSABLE
AID TO THE
SERVICE MAN**

Here's the
Book You've
Been Waiting for!
Contains all
available Service
Data on all
FADA Receivers

\$1.00 Plus
Postage
Send for it Now!

FADA OF NEW YORK
928 BROADWAY NEW YORK, N. Y.
Large Stock of Replacement Parts & Cabinets

comparison oscillator being used. If it passes the specifications, it is replaced on the belt and continued through another oven which reduces the temperature to approximately 30° C. A test of activity and frequency is made again, and if the unit still meets specifications, it continues on the belt through another temperature chamber which reduces the temperature to minus 50° C, where a last and final check is made. If the crystal again meets the specifications, it is ready for the final test. Since the frequency of the crystal varies somewhat with temperature, and the allowable frequency variation is known, it must be tested through the full range of temperature it may encounter in actual operation.

The purpose of the final test is to check the activity and frequency of each crystal unit over a temperature range set by specifications. This is a continuation of the tests started on the matching table, but different in that the unit is given a temperature point check throughout the range rather than the three point check given on the table. This is done to eliminate any possibility of the crystal failing to meet the specifications at other than the end limits of the temperature specified.

After the crystals are tested they are separated into acceptable and rejected lots. The acceptable crystals are subjected to further tests involving vibration for several hours and submersion in water to check their usability under differing operational and climatic conditions.

The equipment used for these tests was especially designed and constructed by engineers of the Federal Telephone and Radio Corporation. The temperature boxes consist of rotating wheels with the crystals held firmly on the circumference. The temperature of the box is adjusted by the use of dry ice and heaters to cover the desired range. As the temperature changes from cold to hot, the wheel rotates once every two degrees and each crystal is automatically measured for activity and frequency—once for each rotation.

The frequency- and activity-measuring equipment consists of a comparison oscillator using a standard crystal, the frequency of which has been checked carefully against a primary standard and associated frequency-measuring equipment. Each standard crystal is checked several times daily to assure its accuracy.

The accuracy, the efficiency and volume of Federal's quartz crystal production, and the greater knowledge of their characteristics and use thus gained, point to the better control function, the economy and the wider application of this vital unit. Here is another striking instance where the demands of war brought forth a fundamental development of tremendous military worth that will be of expanding value to every phase of living when peace comes again to the world.

-30-

What Is Electronics?

(Continued from page 23)

through the filament of a 100-watt incandescent lamp at the normal rate required to operate the lamp, this pound of electrons would supply the current for this lamp for over 16 years!

The ease of movement of these electrons from place to place varies in different materials, in some materials it is relatively easy to cause a drift of electrons from atom to atom; in other materials it is difficult, so that we have our conductors and insulators simply explained, as long as our conductors are solids or liquids. For conductors of that nature we are accustomed to seeing copper wire, the tungsten filaments of our lamps, the cast iron of a resistor grid or the electrolytes in our batteries. It is when the material of the conductor ceases to be solid and definite, something we can lay our hands upon, and turns to a tenuous gas or the comparative emptiness of a vacuum that we enter a field of devices that appear strange and different, devices in which the old tried and true laws of electric conductors apparently fail.

We say "apparently", since if we train ourselves to understand these new devices in a thorough and fundamental manner, we find that our failure to understand their operation was in reality a failure to understand the true deep laid fundamentals of all electrical engineering.

This change in the material of the conducting path from something definite and tangible to the intangibility of a gas or vacuum seems to be the only basic difference between power electricity and electronics. We are led then to a simple and concise answer to the question of "What is Electronics?"

Electronics is the field of devices that operate by the passage of electrons through gas or vacuum.

This definition rules out electric motors, incandescent lamps, electrolytic tanks and other devices of that nature as it should, since they are not accepted as being electronic, although they operate on electric current. It includes within its limits radio tubes, gas-filled tubes, X-ray tubes, fluorescent lamps, spark plugs, circuit breakers and switches among the electronic devices. The last three are not ordinarily considered electronic but a little thought shows them to be rightly included.

Spark plugs depend for their operation upon the ionization of the gas in the electrode gap in order that the current may be carried across the gap. Ionization of gas is considered an electronic fundamental.

A few years ago spark plugs were developed with their electrodes alloyed with polonium, a radioactive material. This caused easier ionization of the gap and sparking at a lower voltage. This was an electronic application to improve an electronic device.

Need a Motor that can lift 500 times its own weight?

THIS electric motor weighs only a pound. But more power is packed in that one pound of motor than has ever been before.

With Lear gearing it can handle a quarter-ton load.

And it has to be ready to do that in an instant. Because this motor moves control flaps, and heater shutters on warplanes. And air pressures mount high at the speed these ships fly.

On aircraft, even the weight of a coat of paint has to be considered. So this motor had to be light.

There's little room in an airplane. So it had to be small.

Designing it meant starting from scratch. There was no precedent for this kind of engineering.

You may never need a motor like this. It may cost more than you might want to pay.

But if you are looking ahead toward manufacturing some peacetime product, we want you to know that such a motor has been developed along with 250 other Lear products.

And equally important, we want you to know that there is available the kind of engineering thinking that could conceive and produce it.

PLANTS: Piqua, O., and Grand Rapids, Mich. BRANCHES AT:
New York, Los Angeles, Chicago, Detroit, Cleveland, Providence.

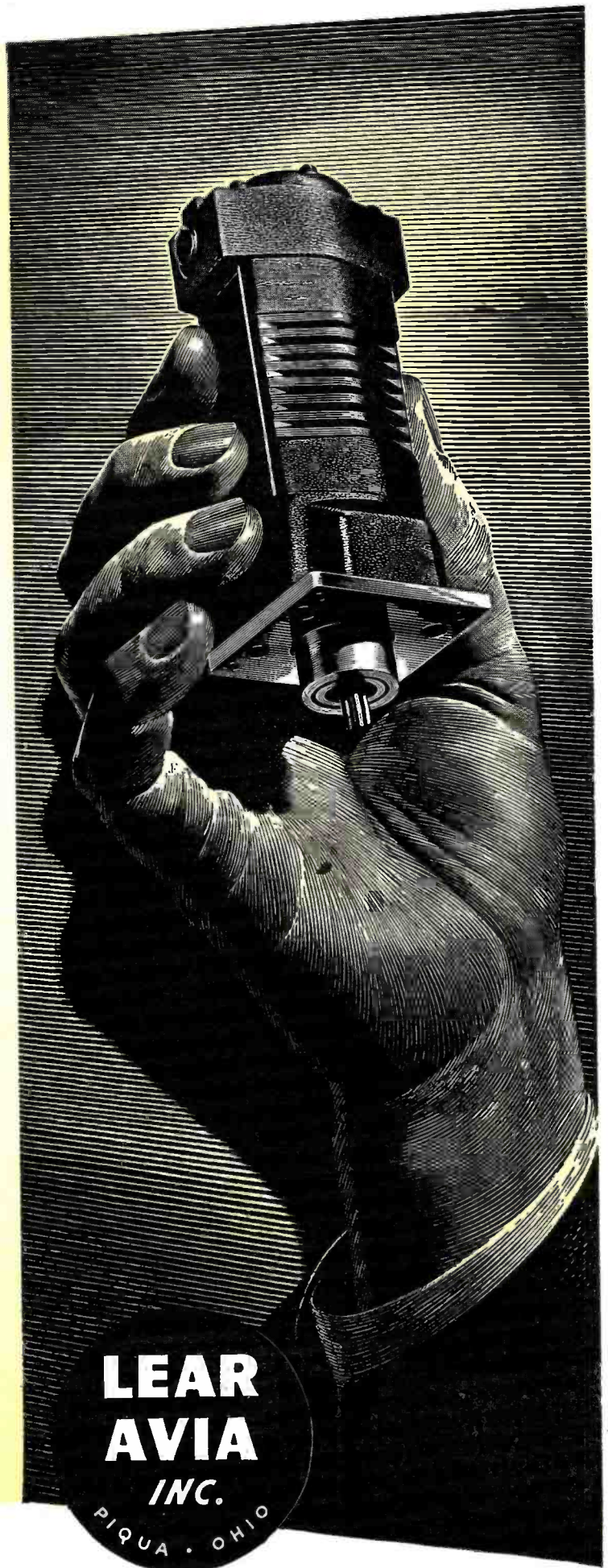

**LEAR
AVIA
INC.**

PIQUA • OHIO

**IF YOU CANNOT REPLACE RADIO PARTS
REPAIR THEM WITH *Walsco* PRODUCTS**



Walsco RADIO CHEMICALS

- Speaker Cements
- Cements For Plastics
- Special Adhesives
- Contact Cleaning Fluids
- Noise Eliminating Compounds
- Radio Lubricants

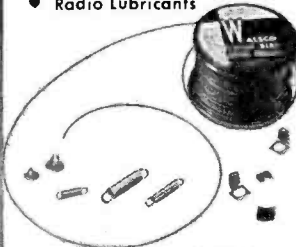

Walsco RADIO HARDWARE

- Dial and Knob Springs
- Trimounts, Set Screws

Walsco CABLES, BELTS

WALTER L. SCHOTT CO.
Manufacturers of

WALSCO PRODUCTS

For Communication Equipment Manufacturers,
Laboratories, Schools and Radio Repair Men

9306 Santa Monica Blvd., Beverly Hills, Calif.

Dept. RN-1

Of course—we are concentrating our efforts on war production—but not for a second are we neglecting the RADIO SERVICEMEN who require so many WALSCO RADIO PRODUCTS to keep the radios of their customers in perfect working order. Write today for WALSCO Catalogue No. 112, giving complete information about WALSCO PRODUCTS.

**Send Only 25c for this Handy
TUBE-BASE CALCULATOR**

**SPECIAL
GET-ACQUAINTED
OFFER**

Here's just the calculator you've wished you had time and again. Designed especially for you by Wholesale Radio Laboratories engineers, this lightning-fast, slide-rule type indicator tells you in a jiffy tube characteristics that enable you to substitute available tubes for those hard to get. Leo, W9GFQ, wants to send it to you at a fraction of its cost—just to get acquainted.

Durable in construction, simple to operate, this calculator is a handy, time-saving device you can't afford to be without. Send for yours today. We pay the shipping expense. Mail 25c to Leo, W9GFQ.

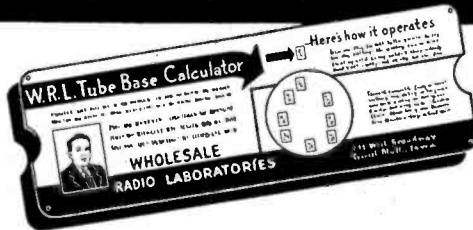

**FOR HARD-TO-GET
PARTS WRITE LEO**

I've got thousands of hard-to-get items including speakers, meters, test meters, transformers, tubes, telegraph operator keys and equipment. All types of radio hardware at unusually low prices. Send today for free flyer.

HALLICRAFTERS

I have always been a big distributor of Halli-crafter equipment. I'll buy used Halli-crafter rigs, highest prices. Other sets, parts too. Write. I'll quote top prices for your used equipment.

MAIL COUPON TODAY

**WHOLESALE
RADIO
LABORATORIES**

744 W. BROADWAY
COUNCIL BLUFFS, IOWA

Leo, W9GFQ
Wholesale Radio Laboratories
744 West Broadway, Dept. RN-8
Council Bluffs, Iowa.

- You bet I want one of the tube base calculators. Here's my 25c.
- While you're at it, send your free flyer of hard-to-get items.

Name.....

Address.....

Town.....State.....

I am service man; experimenter; amateur.

In circuit breakers and switches, an arc or spark jumps as the circuit is opened. This arc or spark passes through ionized air, making the breaker an electronic device. A study of this arc stream from the electronic viewpoint showed that if the ions could be more quickly removed, the speed of arc rupture could be increased. We now have breakers and switches with deion shields designed as a result of this electronic study.

We still have the Thomson magnetic blowout built into many of our contactors and switches. The operating principle of the magnetic blowout is studied in electronics under the name of electron ballistics, and is also related to the basic principle of the magnetron tube, one of our modern generators of ultra-short radio waves.

In electric power devices we think of our phenomena, or explain the operation of the devices, in terms of the conductors through which the current flows. In electronic devices the electrons follow no tangible path so that an explanation of the nature used for an electric motor is impossible.

Since we cannot think in terms of physical conductors then it is necessary to think in terms of the carriers of the current, the electrons. This seems a far more basic viewpoint—is it not more fundamental to say "The force on an *electron* moving in a magnetic field is—" than to use the older method of expression "The force on a *conductor carrying current* in a magnetic field is—" ? In both cases we have electrons moving, but the older manner of statement clutters up our vividly clear picture of a moving particle being pushed around in a field, with a copper conductor which serves merely as a pipeline. We usually finish the explanation with the idea of the force being exerted on the conductor, whereas the force is actually exerted on the current, and the force exists so long as there is a current, conductor or no conductor.

There is some argument for the viewpoint which, for lack of a better term, is called the older viewpoint—the one which most of us have studied. In electric power devices terrifically large numbers of electrons move at very small drift velocities, usually less than one inch per second, to constitute an electric current. In electronic devices relatively few electrons move at high speeds, thousands of miles per second, to reach the same current value. The "en masse" viewpoint of the electron of the older system was adequate for its purpose and led to simplifications, one of which is Ohm's Law. In electronics it is more convenient to view and study the electron as an individual, because of their smaller numbers.

The only argument that can be advanced for the electronic viewpoint is that it is more fundamental, and had it been used as a study method it would have been easy to build from it up to the "en masse" viewpoint for power devices, whereas now it seems very difficult for many people to re-

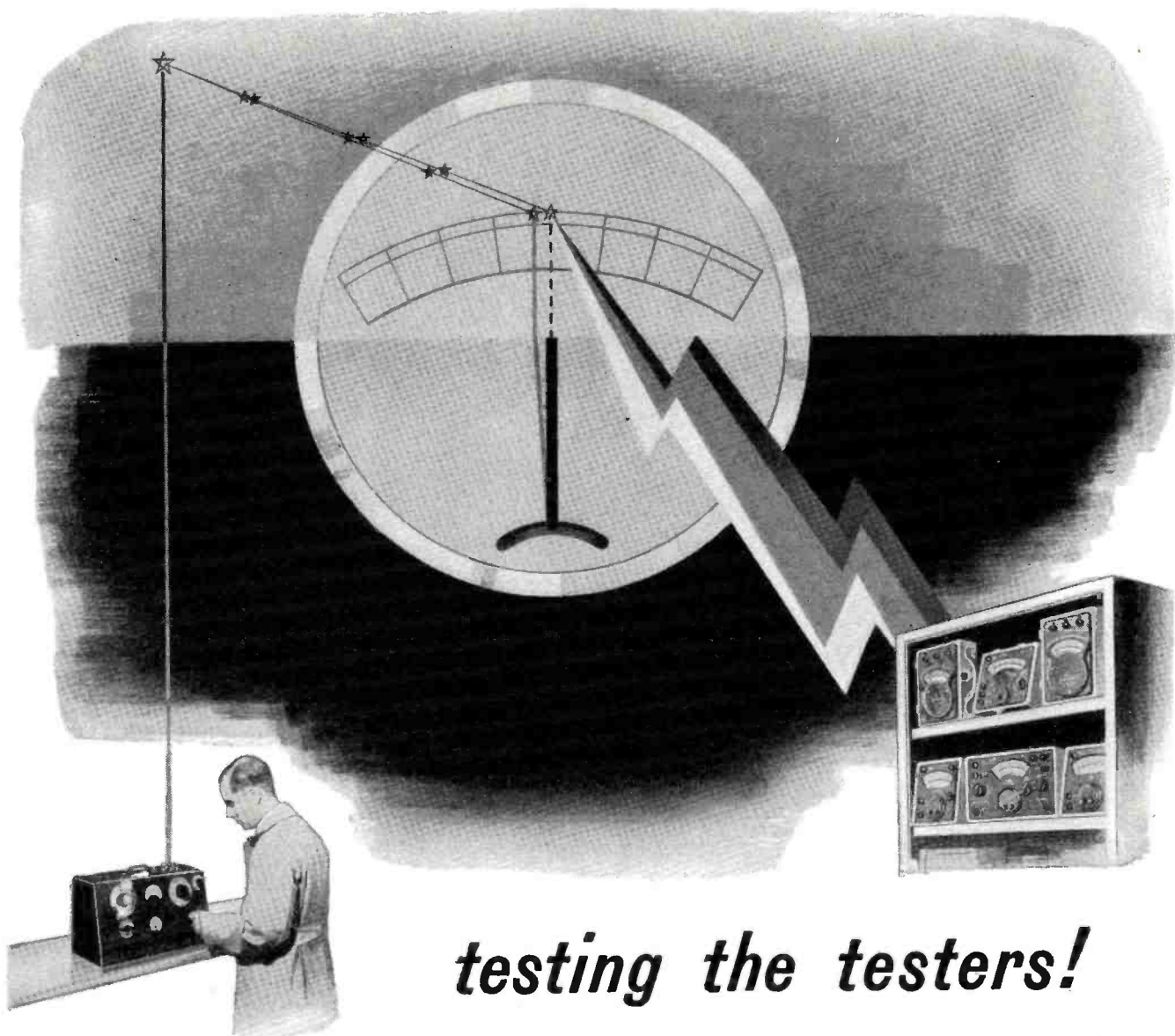

testing the testers!

Tests are meaningless unless the testing equipment is accurate. Utah's "bureau of standards" is kept under guard to assure absolute accuracy . . . these special testing devices, used to check the testing equipment on the line, are operated only by specially trained men and are never allowed to reach full-scale reading.

Because of this testing of testing equipment, the results of Utah's com-

plete testing laboratory can always be relied upon—failures due to inadequate, inaccurate testing are avoided.

These comprehensive testing techniques which have been developed by Utah engineers are playing an important part in the adaptation of the many new

radio and electronic ideas to military needs today—and will play an equally vital part in meeting commercial requirements tomorrow.

★ ★ ★

Every Product Made for the Trade, by Utah, Is Thoroughly Tested and Approved



Keyed to "tomorrow's" demands: Utah transformers, speakers, vibrators, vitreous enamel resistors, wirewound controls, plugs, jacks, switches and small electric motors.

Utah Radio Products Company, 824 Orleans Street, Chicago 10, Ill.

Wherever Precision Counts Most...

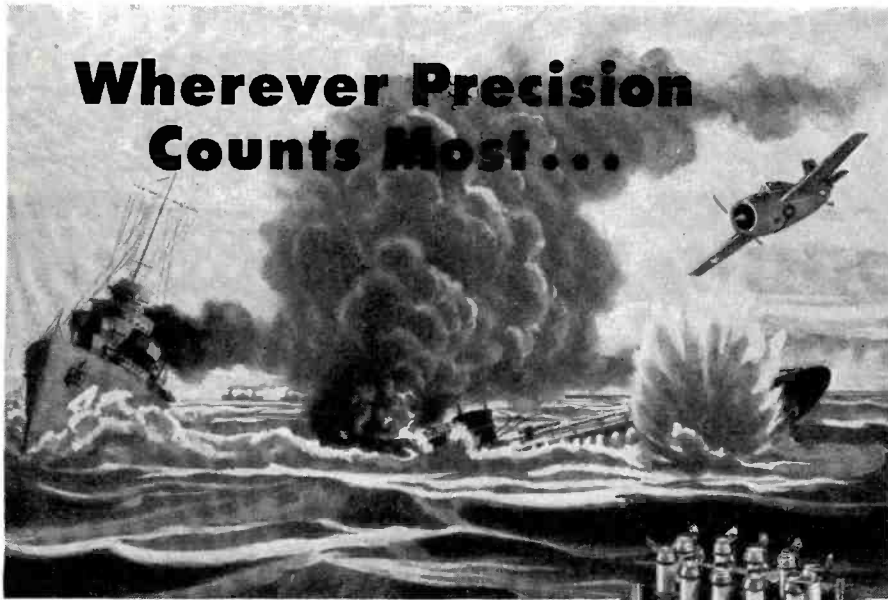

Products of "MERIT" are passing the test

Complying with the most exacting requirements for precision workmanship and durable construction, MERIT has established its ability to produce in quantity and deliver promptly—

Transformers • Coils • Reactors • Electrical Windings of All Types for Radio, Radar and Electronic Applications.

Today these dependable MERIT precision parts are secret weapons; tomorrow when they can be shown in detail as MERIT standard products you will want them in solving the problems of a new electronic era.

Illustrated: High Voltage Transformers A-2123 (small) and A-2124. Designed for high altitudes. Oil-filled and Hermetic sealed.

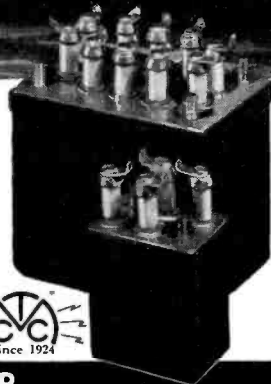

MERIT COIL & TRANSFORMER CORP.
311 North Desplaines St. CHICAGO 6, ILL.

A New TWIST TO CRYSTAL CLEANING

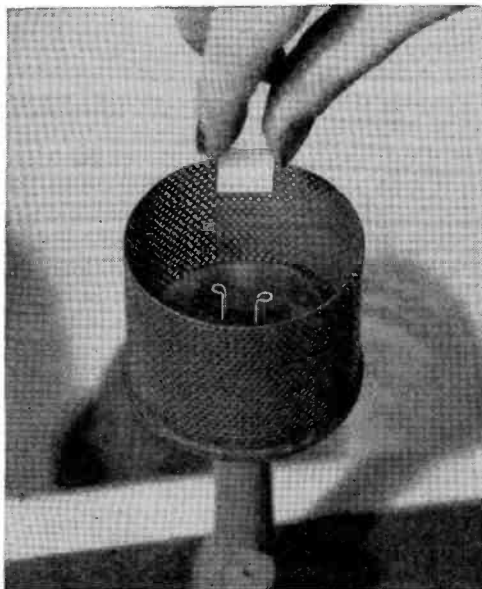

THIS is an actual photograph of the centrifugal air drier, or "spinner," used in Bliley production to facilitate clean handling of crystals during finishing and testing operations. Quartz blanks are dried in 5 seconds in this device which is powered with an air motor and spins at 15,000 r.p.m.

Little things like lint or microscopic amounts of foreign material can have a serious effect on crystal performance. The "spinner" eliminates the hazards encountered when crystals are dried with towels and makes certain that the finished product has the long range reliability required and expected in Bliley crystals.

This technique is only one small example of the methods and tests devised by Bliley Engineers over a long period of years. Our experience in every phase of quartz piezoelectric application is your assurance of dependable and accurate crystals that meet the test of time.

BLILEY ELECTRIC COMPANY . . . ERIE, PA.



verse the procedure and build a bridge down to the fundamental viewpoint of electronics.

As an example of this, the power engineer is well acquainted with the root-mean-square volt, frequently too well acquainted. It is well known that electrons have never been to college and so have never had our advantages in learning of the r.m.s. volt. An electron knows only of the forces acting on it instant by instant; these forces may be due to a voltage or current which must then be known by its instantaneous value if its effect on the electron is to be predicted.

To one trained in power electrical engineering this is frequently surprising, since his thinking is inherently in r.m.s. values. The more fundamental electronics training, however, shows up the root-mean-square volt as a true straw man, a mere mathematical fiction used solely for ease in calculation, and having no physical existence in fact.

So we come once more to the question at the head of this article "What is Electronics?" While to keep the peace with the electrical profession as a whole we will have to abide by our previous definition, yet might not electronics also be defined as "the study of the fundamentals of electricity"?

-30-

R.F. Impedance Matching

(Continued from page 51)

Assuming the output power to be 400 watts, then the current I_1 flowing in L_1 can be obtained from Ohm's law:

$$P = I_1^2 R_1$$

$$I_1 = \sqrt{\frac{P}{R_1}} = \sqrt{\frac{400}{40}} = 3.16 \text{ amperes.}$$

This current should be flowing in L_1 because a resistance of 40 ohms has been reflected in series with the coil. If the Q of L_1 is 200, L_1 would have a resistance (which will dissipate energy) of

$$R = \frac{X_1}{Q_1} = \frac{400}{200} = 2 \text{ ohms.}$$

Thus the power dissipated in L_1 would be

$$I_1^2 R = (3.16)^2 \times 2 = 20 \text{ watts.}$$

This would represent a loss of $20/400 \times 100 = 5\%$.

Similarly, if the size of the coil L_2 is known, the power dissipated there could be computed. Assuming it to be the same as the power dissipated in coil L_1 , for instance then it, too, would contribute a 5% loss. The efficiency of the matching network would then be 90%, and the over-all efficiency in converting from d.c. supply to the plate, to power delivered to the 72-ohm line, would be

$$90\% \times 70\% = 63\%.$$

The input power, therefore, would be

$$\frac{400}{0.63} = 635 \text{ watts input.}$$

-30-

PANORAMIC

SHOWS
A WIDE
BAND OF
FREQUENCIES
ALL
AT ONCE

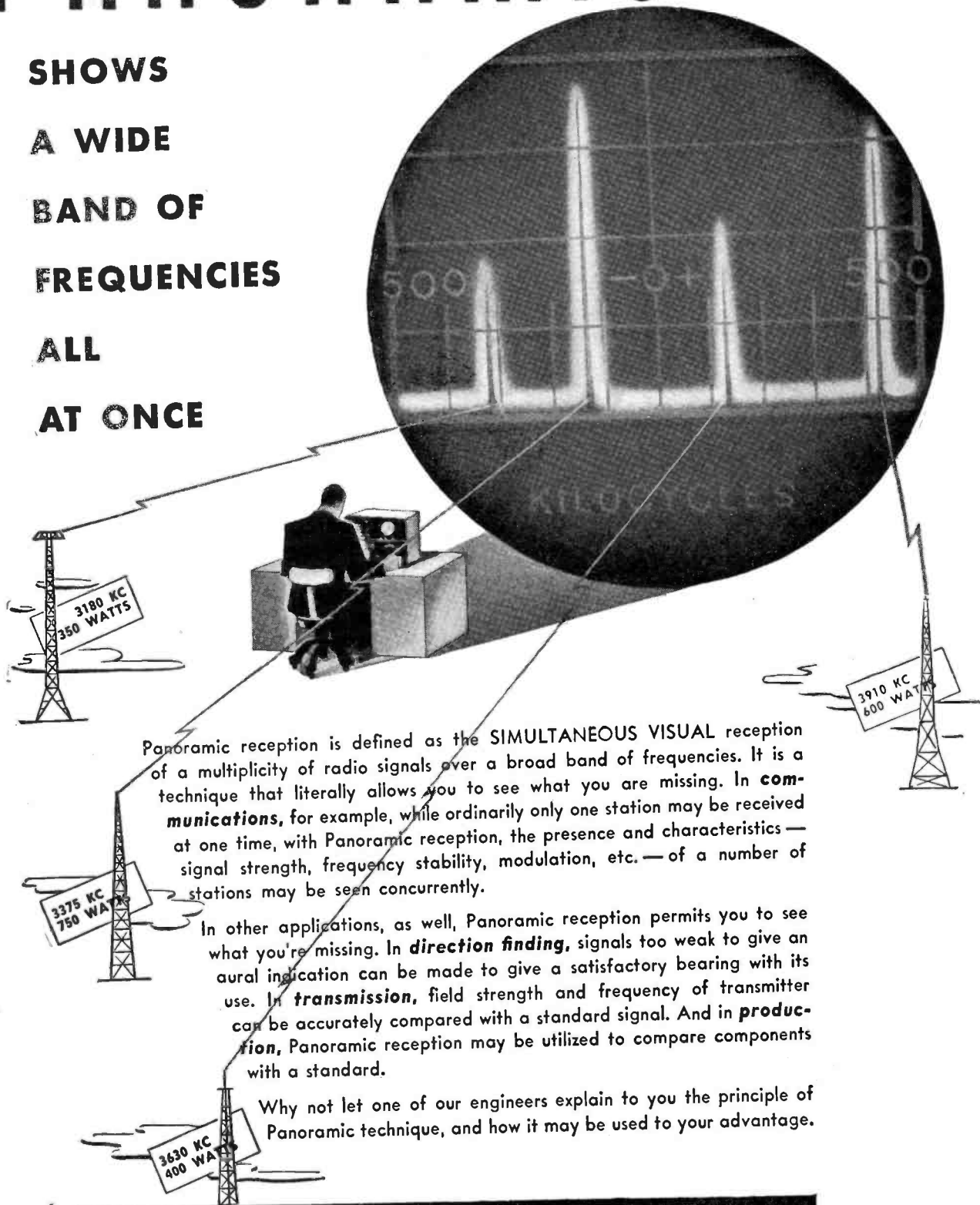

Panoramic reception is defined as the **SIMULTANEOUS VISUAL** reception of a multiplicity of radio signals over a broad band of frequencies. It is a technique that literally allows you to see what you are missing. In **communications**, for example, while ordinarily only one station may be received at one time, with Panoramc reception, the presence and characteristics — signal strength, frequency stability, modulation, etc. — of a number of stations may be seen concurrently.

In other applications, as well, Panoramc reception permits you to see what you're missing. In **direction finding**, signals too weak to give an aural indication can be made to give a satisfactory bearing with its use. In **transmission**, field strength and frequency of transmitter can be accurately compared with a standard signal. And in **production**, Panoramc reception may be utilized to compare components with a standard.

Why not let one of our engineers explain to you the principle of Panoramc technique, and how it may be used to your advantage.

PANORAMIC



RADIO CORPORATION

242-250 WEST 55TH ST., New York 19, N.Y.

WHAT'S NEW IN RADIO

New products for military and civilian use.

CONNECTORS

Hysealug is the name given to a new line of water seals for cable ends being manufactured by *Burndy Engineering Company*.

These lugs are made from pure copper and then are silverplated. The barrel of the Hysealug is indented onto the conductor, while the shroud is compressed over the insulation to form a watertight cable-end seal. Installation is made by means of a

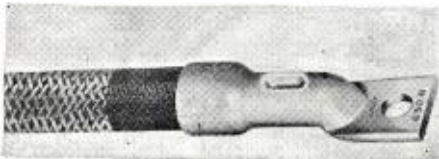

Burndy Hypress and a dual die which indents the connector and compresses the shroud in one operation for cables up to 1000 MCM. Hysealugs above 1000 MCM are installed with separate dies for indentation and compression.

Sizes are available for cables from single conductor types to cables from No. 4 to 2000 MCM. Full details will be sent to interested users by the *Burndy Engineering Co., Inc.*, 107 Bruckner Blvd., New York 54, New York.

UNIVERSAL BRIDGE

A wide-range universal bridge is being manufactured by *White Research* for general production testing uses.

Resistance measurements from one micro-ohm to 100 megohms, capacitance measurements from 100 μf to 100 μf , and inductance measurements from 100 μh to 100 henrys are possible with this instrument.

Inductance of iron core chokes and transformers can be measured with up to 500 ma. of d.c. flowing, while facilities for the measurement of frequency, Q and power factor are included in the bridge.

This unit is complete and self-contained. Provision has been made to plug in external facilities such as outside standards, oscillators, and null indicators to extend the usefulness of the bridge.

Inquiries regarding this bridge will receive prompt attention when addressed to *White Research*, 899 Boylston Street, Boston 15, Mass.

POWER SUPPLIES

Selenium Rectifier Power Supply units of 1, 5, and 10 amperes at 115-volts d.c., designed for use in the operation of magnetic equipment, d.c. motors, relays, circuit breakers, car-

bon arc lamps, and battery chargers have been added to the line of power supply equipment manufactured by *Federal Telephone and Radio Corporation*. In addition to standard sizes, custom-built power supplies to specifications are available.

The units are designed for wall or bench mounting with no special connections needed. They are equipped with a 6-foot input lead with male connector and a standard convenience receptacle for the output. The 10-ampere unit is furnished with an 11-point selector switch for maintaining 115 volts from no-load to full-load.

These units are conservatively rated to assure trouble-free performance over a long period of time.

Descriptive literature with ratings and engineering data is available from the *Federal Telephone and Radio Corporation*, Newark, New Jersey.

UNIVERSAL TESTERS

Test equipment that is both wide-range and portable has been announced by the *Radio City Products Company* in introducing their RCP Model 422 Supertester and their Model 420 Pocket Multitester.

The Supertester has the equivalent of 27 instruments in one compact unit, with both very low and very high ranges. Of particular value for general circuit testing, this unit includes facilities for current measurements in both a.c. and d.c. up to 25 amperes, voltage measurements in both a.c. and d.c. up to 5,000 volts and resistance



measurements up to 10 megohms. Batteries are replaceable without the use of a soldering iron. This unit is supplied, complete with batteries, in a natural wood case, 6½"x7"x2¾".

The Pocket Multitester which weighs only 25 ounces is an open-faced instrument 6½"x3½"x3". Meter movements are guaranteed accurate within 2%. A db. meter, output meter, milliammeter and ohmmeter provide a total of 23 ranges.

Details of both instruments, as well as other electrical and electronic testing instruments manufactured by the company are contained in a new RCP Catalog No. 128 which may be secured by writing direct to *Radio City Products Company*, 127 West 26th Street, New York 1, New York.

RESISTANCE BRIDGE

A unit which combines both the Kelvin and Wheatstone bridges is being marketed as the Shallcross Type 638-2



Bridge for resistance measurements in the range from 0.0001 ohms to 11.11 megohms.

The convenience of being able to make practically all resistance measurements with one portable instrument makes this an ideal instrument for laboratory, school, and production work.

An accuracy of 0.3% or better is assured when the unit is used as a Wheatstone bridge for measurements between 1 ohm and 1 megohm. Low resistance measurements using the Kelvin bridge utilize current and potential terminals to eliminate lead and contact resistance. The accuracy of Kelvin measurements at ranges lower than 0.1 ohm is on the order of 3%. The rheostat is variable in steps of 1 ohm for Wheatstone bridge measurements and 1 micro-ohm for Kelvin bridge measurements.

Full details will be sent on request to the *Shallcross Manufacturing Company*, Jackson and Pusey Avenues, Collingdale, Pa.

OSCILLOGRAPH

A new portable instrument incorporating two units, the oscillograph and the power supply, has been announced by the *Allen B. DuMont Labs., Inc.*

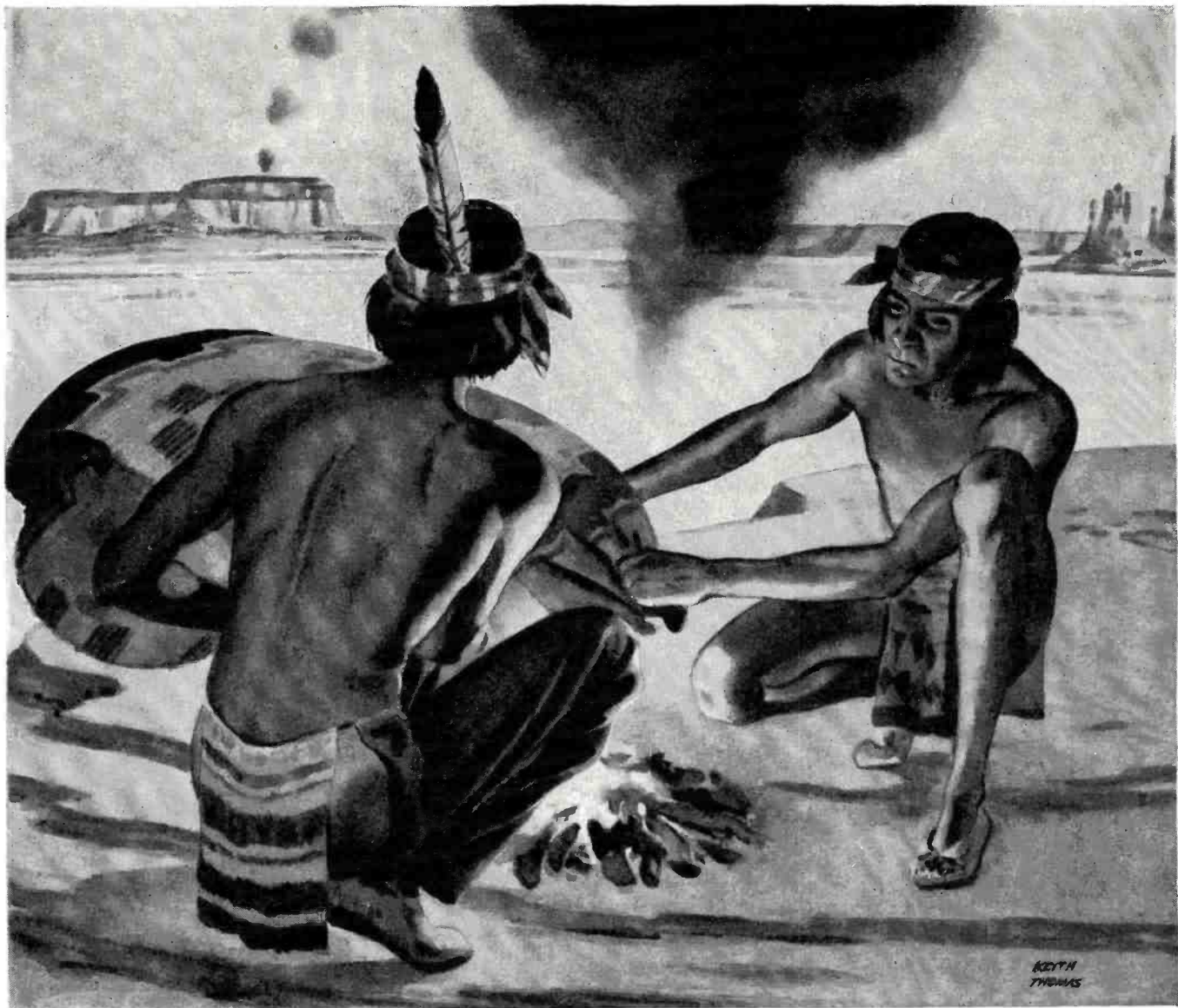

History of Communications Number Four of a Series

SMOKE SIGNAL COMMUNICATIONS

While the puffs of our early American smoke Signals were not as complicated as the Morse Code, this type of communication was a speedy and effective means of communication at that time and could be seen for scores of miles on a clear day. Used for transmitting their battle messages, smoke signals in the days of the early American meant a progressive means of communication.

Restricted by climatic conditions this type of communication was limited in its use. Universal microphones in the part they play in modern electronic voice communication must withstand the climates of the Arctic and the Tropics all in a day's work. Built to accomplish a specific job, Universal Microphones are "getting the message through" on every Allied front.

Model T-45, illustrated at left, is the new Lip Microphone being manufactured by Universal for the U. S. Army Signal Corps. Shortly, these microphones will be available to priority users through local Radio Jobbers.



UNIVERSAL MICROPHONE COMPANY
INGLEWOOD, CALIFORNIA



FOREIGN DIVISION: 301 CLAY STREET, SAN FRANCISCO 11, CALIFORNIA -- CANADIAN DIVISION: 560 KING STREET WEST, TORONTO 1, ONTARIO, CANADA

LAKE RADIO CABINETS



Beautiful Hand-rubbed walnut cabinet for table model phonograph combination. Inside size 16" wide, 11" high, 14" deep. As illustrated above. Specially priced at..... **\$7.95**

Replacement cabinet in dark walnut finish plastic. Inside dimensions 10W x 6 1/2H x 6D. Price..... **\$1.95**

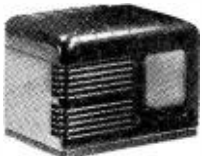

Dark walnut finish plastic cabinet to accommodate practically any Tiny Tim radio. Size 7W x 4 1/2H x 4D. Price..... **\$1.50**

Also blank table cabinets of walnut veneer in the following sizes:

8 1/4W x 5 1/2H x 4D **\$1.95**

10 1/4W x 6 3/8H x 5D **\$2.75**

13 1/2W x 7 3/8H x 6 1/4D **\$3.25**

Cabinets available in ivory color and Swedish Modern. Write for prices.

14" SPEAKERS

14" electro-dynamic speakers, 900 ohm field, 8-8 ohm voice coil, 6V6 push-pull transformer, 15 watt output. Special, only..... **\$450**

All types of radio parts available in today's market can be obtained at Lake's money-saving prices. Large stock listed in our new Bargain Bulletin. Write us for your copy. It's free.

LAKE RADIO SALES CO.

615 W. Randolph Street Chicago 6, Ill.

Short-Cut Mathematics

COMBINED WITH
Practical Mechanics Simplified

NEW 2-in-1 reading course! Now you can learn the speedy, simplified system of calculation used by draftsmen, engineers, accountants, "master minds" on the stage. Learn easy way to multiply 4 figures by 4 figures without using old-fashioned multiplication; add long columns of figures this lightning short-cut method. Learn horsepower, slide rule, micrometer, logarithms, wood measure, puzzles, etc. Large illustrated volume complete with answers, only \$1 postpaid. Satisfaction or refund. Amaze your friends with your magic-like mental powers.

FREE Complete details... mail coupon TODAY!

NELSON CO., 321 S. Wabash, Dept. 3459, Chicago 4, Ill. Please send free details about "Short-Cut Mathematics and Practical Mechanics Simplified." No obligation.

Name
Address

Known as the Type 248, this unit is available at moderate cost for laboratory or production testing work. A removable cover protects the oscillograph panel when the instrument is not in use. The power supply which is connected to the oscillograph by a 6-foot plug-in shielded cable, weighs 80 pounds and the oscillograph weighs 30 pounds. The dimensions of each unit are 14"x18"x21".

This instrument reproduces either transient or recurrent phenomena. It also accommodates phenomena of inconstant repetition rate. The leading edge of a short pulse is visible. The accelerating potential applied to the cathode-ray tube is great enough to permit study of extremely short pulses with low repetition rates, usually possible only with specialized and costly oscillographic equipment. Time markers are available for quantitative or calibration purposes.

Further information and details of specific applications may be obtained by writing directly to *Allen B. DuMont Labs., Inc.*, 2 Main Avenue, Passaic, New Jersey.

OIL CAPACITORS

A new and complete line of rectangular oil-type capacitors has been announced by the *Capacitron Company*.

This unit is made in standard container sizes and in voltage ratings up to 6000 d.c. working volts. The capacitron is designed to meet Army and Navy specifications including the total salt-water submersion tests.

In order to provide more complete information and data about their product, the company has issued a Bulletin 104 which lists all pertinent engineering data including capacities, voltage

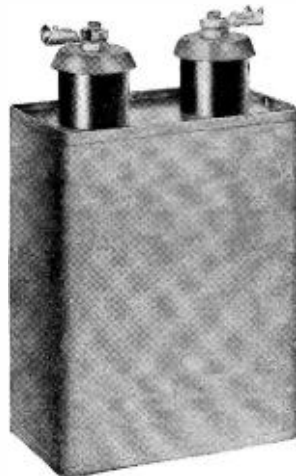

rating, container sizes, types of terminals and mounting arrangements. This bulletin may be obtained by writing directly to *The Capacitron Company*, 318 W. Schiller Street, Chicago 10, Illinois.

ARPIN RECTIFIER

To meet the demand for a rectifier that will withstand rough use, vibration and high-peak inverse voltages with no arc back, the *Arpin Manufacturing Company* has redesigned and re-engineered their standard rectifier.

Special protection is provided against loose anodes. The cathode shield is oversize, extremely heavy and is made with an edgewise-wound ribbon filament of a new alloy which provides the cathode with large emission

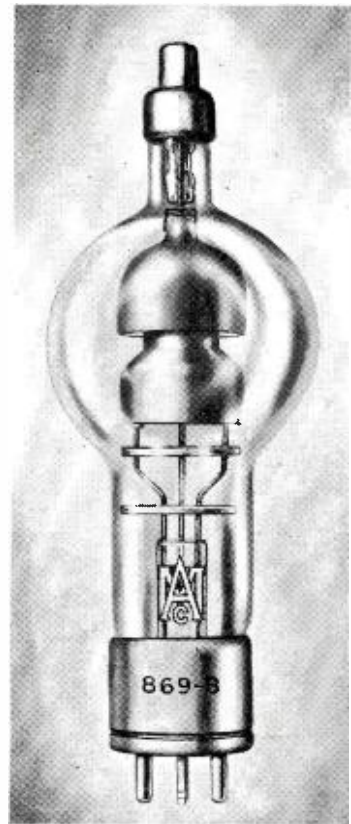

reserve and longer life. This new rectifier, known as the No. 869-B, is especially recommended for broadcasting and induction heating equipment.

Further details, including engineering specifications, may be obtained by writing directly to *Arpin Manufacturing Company*, 422 Alden Street, Orange, New Jersey.

EXPONENTIAL RULE

A new and handy rule for simplifying the methods involved in the solution of engineering problems and the plotting of curves is being offered by *Louis B. Sklar*.

The original rule was issued in 1932 and since that date revisions and improvements have been made. This exponential rule is the result of 12 years' work of simplifying its operation and construction.

By means of this instrument, it is possible to get direct readings without interpolations, the characteristics and mantissas of numbers ranging from one up to one-hundred thousand and from one down to one hundred thousandths, as well as natural and common logarithms, exponentials and reciprocals.

This rule may be used in applications pertaining to radio, telephone and power engineering.

Inquiries should be addressed to *Louis B. Sklar*, 816 North Sixth Street, Philadelphia 23, Pa.

BREEZE SHIELDING CONDUIT

**BREEZE
M A R K**



CLEARING all Wires!

Breeze Flexible Conduit Shields and Protects Communications and Wiring Systems

Any current-carrying wire in an aircraft electrical system is a potential source of interference with radio communications unless properly shielded. Breeze Flexible Shielding Conduit, produced in a wide range of diameters, can be used in conjunction with Breeze Conduit Fittings and Multiple Electrical Connectors to meet practically any shielding requirement.

The custom design of complete radio ignition shielding harnesses is a Breeze specialty, based on years of pioneering experience in the field.

Breeze Flexible Shielding Conduit is in service today with fighting units of land, sea, and air, supplementing the many other well-known items of Breeze equipment that are helping the United Nations along the road to Victory.

Breeze 

CORPORATIONS, INC. NEWARK, N. J.

PRODUCTION FOR VICTORY • PRODUCTS FOR PEACE

August, 1944

www.americanradiohistory.com



Breeze Shielding guards communications against high frequency interference from spark plugs and ignition system circuits.

Spot News
(Continued from page 16)

duced. The picture is then projected onto the screen," said Mr. Beal.

At the present time there are two such light valves available: one is the skiatron, developed by Scophony, and the other is the cathode-ray control suspension valve, developed by RCA.

RELAYING BY TELEVISION has become more than an experiment. Recently, New York was linked to Philadelphia with an NBC television show that originated in New York. This new relay link, operated between

WNBT and WPTZ, the Philco station in Philadelphia, with transmitter at Mt. Rose, New Jersey, is the first regularly scheduled commercial television station in the nation. Present plans call for its operation every Monday night. According to James H. Carmine, vice president in charge of Philco merchandising, similar links constructed for about fifteen-thousand dollars and located about fifty miles apart, may form the basis for a nationwide television system in the postwar era.

IF A POSTWAR SAVINGS PLAN of a New York bank is applied nationally, over a million and a half people might be expected to buy television

receivers in the postwar. The unique savings plan, initiated by the Franklin Square National Bank of Nassau County, New York, calls for the earmarking of savings for specific postwar purchases. According to Arthur T. Roth, executive vice president, twenty-two per cent of the savings plan participants are saving for television receivers estimated to cost about four-hundred dollars each. Mr. Roth indicated that if this same plan were employed nationally, over five-hundred million dollars would be accumulated for such purchases.

ANOTHER LEADING MOTION PICTURE COMPANY entered the television scene a few weeks ago. RKO announced the formation of a subsidiary television company to be known as RKO Television Corporation, with executive offices at 1270 Sixth Avenue, New York City. Frederic Ullman, Jr., Pathe News director, is president of the new unit. Ralph B. Austrian, who was named executive vice president, said that RKO believes that television has reached a point in its development where it cannot be neglected by the motion picture industry. The new corporation will be concerned with the production of programs, and will maintain a talent and casting division.

ALL-OUT SUPPORT OF FM appears to have been given by the U. S. Office of Education. They have prepared a plan which calls for the active participation of states in broadcast systems for primary and secondary schools and colleges. FM will be the system used to provide such service. Over fifty colleges and universities have appointed representatives to study FM, and a number of states have requested their Departments of Education to do likewise. Charts showing possible locations of transmitters, power and antenna heights have been prepared by the U. S. Office of Education. Dr. R. R. Lowdermilk, radio specialist in this office, who has made a rather exhaustive study of the projected installations, has included service areas in his charts. He has also set up an installation cost chart. Plans are already available for installations of from one to fourteen transmitters, with costs running from \$25,000 to close to \$300,000.

Standards of equipment for use in these systems were discussed in Cleveland recently at special sessions held in the studios of FM station WBOE.

A request has already gone forward to FCC for ten additional channels for educational use.

The move to put radio in schools has also gained momentum in Canada. At a recent meeting of the Parliamentary Radio Committee, M. J. Coldwell, leader of the Cooperative Commonwealth Party, said that receivers should be a part of every school in Canada. At the present time, he pointed out, there are forty-three hundred schools equipped with radios. He urged the government to undertake a

ADVANCED ENGINEERING
demonstrated by
THORDARSON
COMPACT
HERMETICALLY-SEALED
TRANSFORMER
for
AIRBORNE SERVICE

A type of hermetic seal construction to meet the newest rigid requirements of the Armed Forces.

High efficiency in a small package...this compact high frequency power transformer (60 to 2600 c.p.s.) fills a difficult airborne application.

Since the terminal seal employs metal and glass, absolute protection is assured against all performance difficulties usually caused by climatic changes.

THORDARSON
TRANSFORMER DIVISION
THORDARSON ELECTRIC MFG. CO.
500 WEST HURON STREET, CHICAGO, ILL.

Transformer Specialists Since 1895
... ORIGINATORS OF TRU-FIDELITY AMPLIFIERS

• In active service on the fighting fronts . . . helping in the production of planes, tanks, ships and guns on the home front . . . Simpson Electrical Instruments are doing a vital job supremely well.

Simpson
INSTRUMENTS THAT STAY ACCURATE

BUY WAR BONDS AND STAMPS FOR VICTORY

SIMPSON ELECTRIC CO., 5200-5218 Kinzie St., Chicago, Ill.

Submerged

IN SALT WATER . . .

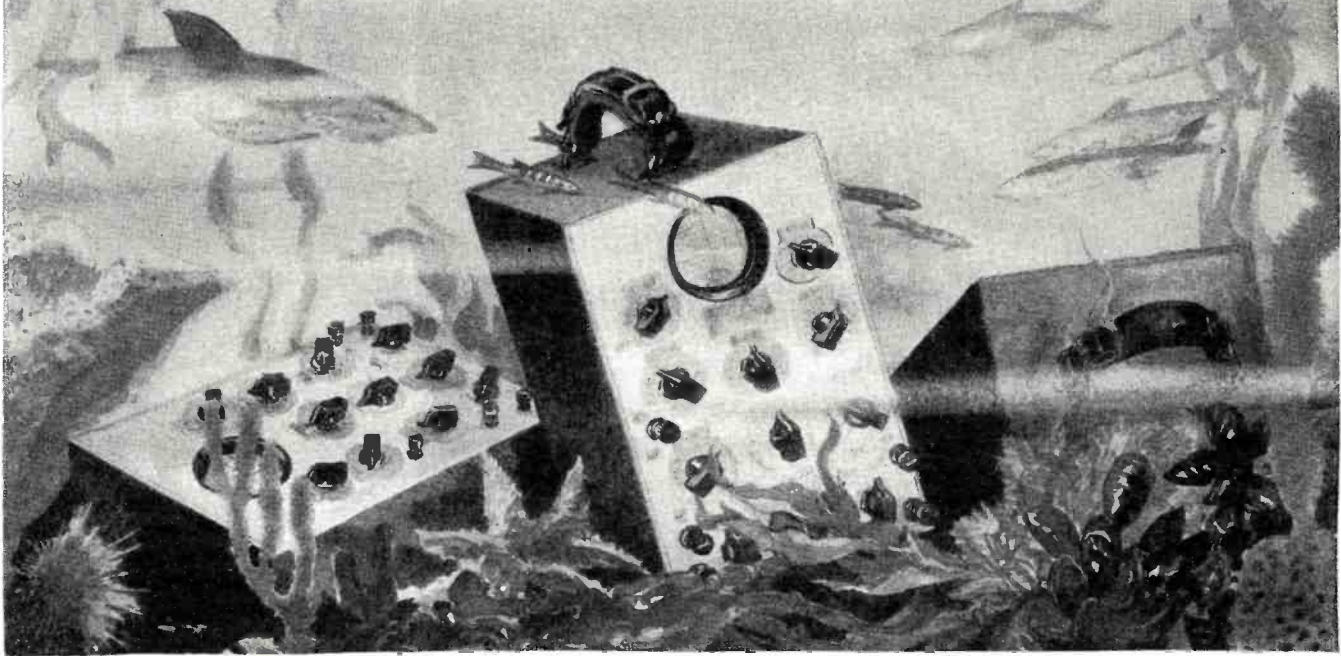

YET FOUND STILL OPERATIVE WHEN CHECKED UP

◆ Quite by accident, three DuMont Type 164E 3-inch oscillographs were submerged in salt water. Duly recovered, they were returned for salvage—repair, if at all possible; otherwise, replacement.

Our service engineers were frankly disconcerted by the mud, silt and even seaweed found amidst the multitudinous components. Finally cleaned up, the instruments were checked for necessary repairs and replacements. And then the surprise:

Two instruments were found still operative! The third required only a potentiometer replacement for restoration to full operative condition!

► DuMont cathode-ray tubes and oscillographs in both standard and special types are found in many branches of the armed forces; in many industries engaged in war and civilian production; in engineering and research activities.

Be sure you have our new catalog and manual just off the press, in your working library. Otherwise write for your copy. And submit any unusual problems for our engineering collaboration, recommendations, specifications, quotations.

While we do not recommend dunking as a regular thing, we submit this case as still another proof of the ruggedness of DuMont equipment. It is certainly reassuring when you face extra-severe service conditions. Likewise indicative of years of trouble-free life.

DUMONT

Precision Electronics & Television

ALLEN B. DUMONT LABORATORIES, INC., PASSAIC, NEW JERSEY • CABLE ADDRESS: WESPEXLIN, NEW YORK



program that would eventually provide a receiver to every other school in the Dominion.

A survey just made public shows that there are already forty-four FM stations on the air in this country, and one hundred and fifty-four applicants for FM transmitters. According to this report, these applicants will spend ten-million dollars for broadcast equipment alone when these installations are completed.

THERE'LL BE MANY A BRISK DEBATE about the virtues of various types of signalling safety systems, when members of railroads appear before the Kilgore Subcommittee of the Senate investigating railroad safety systems. Wendell Berge of the Attorney General's office already has been rebuked by W. R. Triem, communications superintendent of the Pennsylvania Railroad, in a memorandum that was filed with the Kilgore committee. Mr. Triem stated that the recent criticisms hailed at railroads were far from justified. He said that his company and others have been conducting experiments for years in an effort to find a telephone system that was capable of operation on both moving and standing trains. He cited other improvements such as the "cab signal," pioneered by the Pennsylvania Railroad and installed between Lewistown and Sunbury, Pennsylvania, in 1923. He explained that an experimental department has been set up at Altoona, Pennsylvania, where signalling experiments of all types have been carried out at an annual cost of over a million dollars. In this laboratory are over two hundred and seventy-five men, of which sixty-two have college degrees in chemical, mechanical, electrical and civil engineering. Mr. Triem indicated that there are other methods besides

radio that are suitable for safety signalling.

Notwithstanding Mr. Triem's comments, several railroads have found radio to be of inestimable value. Into the Santa Fe yards at Chicago arrived recently the "Spud Special" from Bakersfield, California, the first transcontinental train to use two-way radio communication between caboose and locomotive. The arrival of this test run followed the departure of the first permanently equipped mile-and-a-quarter long train with radio from the Rock Island Burr Oak yards in Kansas City. Rock Island line officials state that railroad radio is now expediting the daily movement of more than three-thousand freight cars in these yards. FM installations have been made in two Diesel locomotives, operating on a frequency of 39.54 megacycles and with ten watts of power. The railroad system also uses 120-megacycle walkie-talkies for emergencies such as wrecks or washouts. There is also a portable duplex system which was recently used to bridge a thirty-mile break in telephone lines caused by storms.

Commenting on the success of the "Spud Special" trip, engineers stated that the radio system should be invaluable in stormy weather when it is practically impossible to identify signals from the brakemen and conductors. They are also enthusiastic about its use out in the West where the rising mountains sometimes prevent full vision of the entire length of the road.

The use of two-way radio in taxicabs, predicted many months ago in these columns, now appears to be becoming a reality. In Cleveland the Yellow Cab Company has applied to the FCC for permission to use a two-way taxicab radio system. At the present time plans call for three main

transmitters, with four channels. The proposal asks for the assignment of one-hundred cabs to each channel. The plan is being worked out by D. L. Chesnut, G. E. commercial engineer, and the Cab Research Bureau Inc., who are representing the taxicab industry. Approval of these plans will introduce a method of communication that will prove invaluable in expediting traffic control, eliminating dead mileage and conserving materials, and in emergency uses by the police, fire or hospital departments.

A MEMORABLE DAY—D-DAY—served as the opening day of the twentieth annual RMA conference in Chicago recently. Commenting on this dramatic moment, Major General William H. Harrison, chief of the procurement and distribution service of the office of the Chief Army Signal Officer, told members of the association that they can face the European invasion tenseness with "knowledge that the forces in combat lack no essential signal equipment . . . judgment that your job has been well done." He also praised the production efforts of the industry. He said that the 1944 program totals more than three billion dollars, which is about twenty-five per cent greater than in 1943. And during the first five months, with forty per cent of the year elapsed, forty per cent of the program has been completed. Describing 1945 plans, he said that procurement plans must be on the basis of the continuation of the war in all theaters. Unless we have an early victory, he said, during the first half of 1945 the level of production should be around fifteen to twenty per cent under the present rate.

One of the highlights of the conference was a talk by WPB Radio and Radar Division director, Ray C. Ellis, on radio in Russia. Mr. Ellis, who has just returned from Russia, said that when Germany invaded Russia in June, 1941, many of the greatest factories as well as the research and development activities were centered in the west. However, by October, 1941, the entire industry had been evacuated to central Siberia, over twenty-five hundred miles away.

According to Mr. Ellis, the radio industry in Russia prior to the war was very small. There were only about fifteen factories which did very little development work, for designs and development originated with a central government planning agency. Participating in the development work were the universities at Leningrad and Moscow. These development programs consisted mostly of planning of high-power transmitters, television, and special tubes. Very little work was done on receiving tubes, short-wave sets, or FM. Incidentally, Mr. Ellis said, Russia did have two experimental television stations in operation.

"The picture has changed considerably since 1941," explained Mr. Ellis. "One tube plant alone now employs

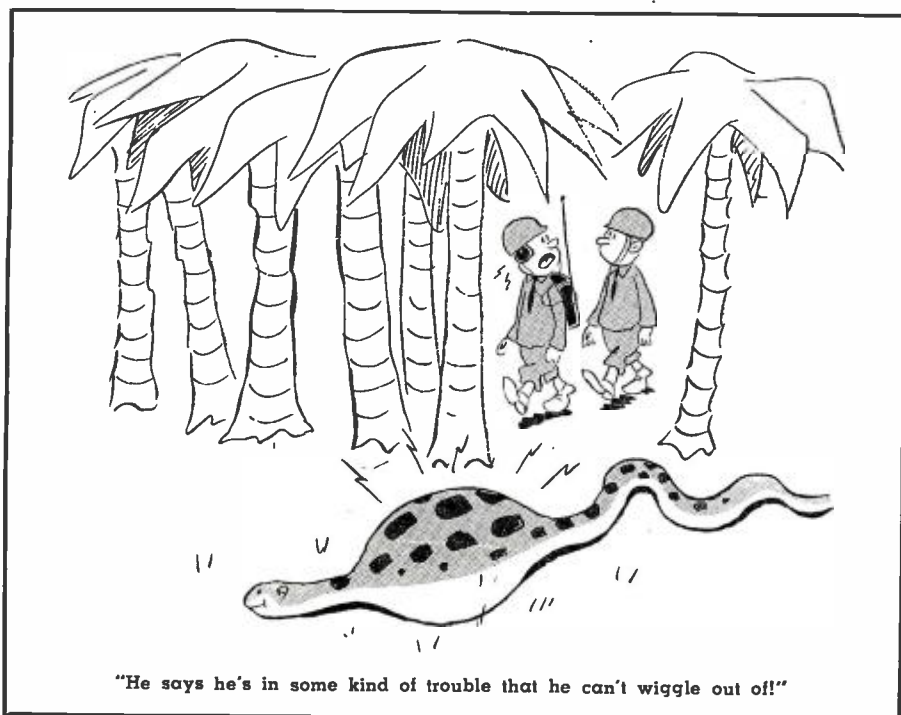

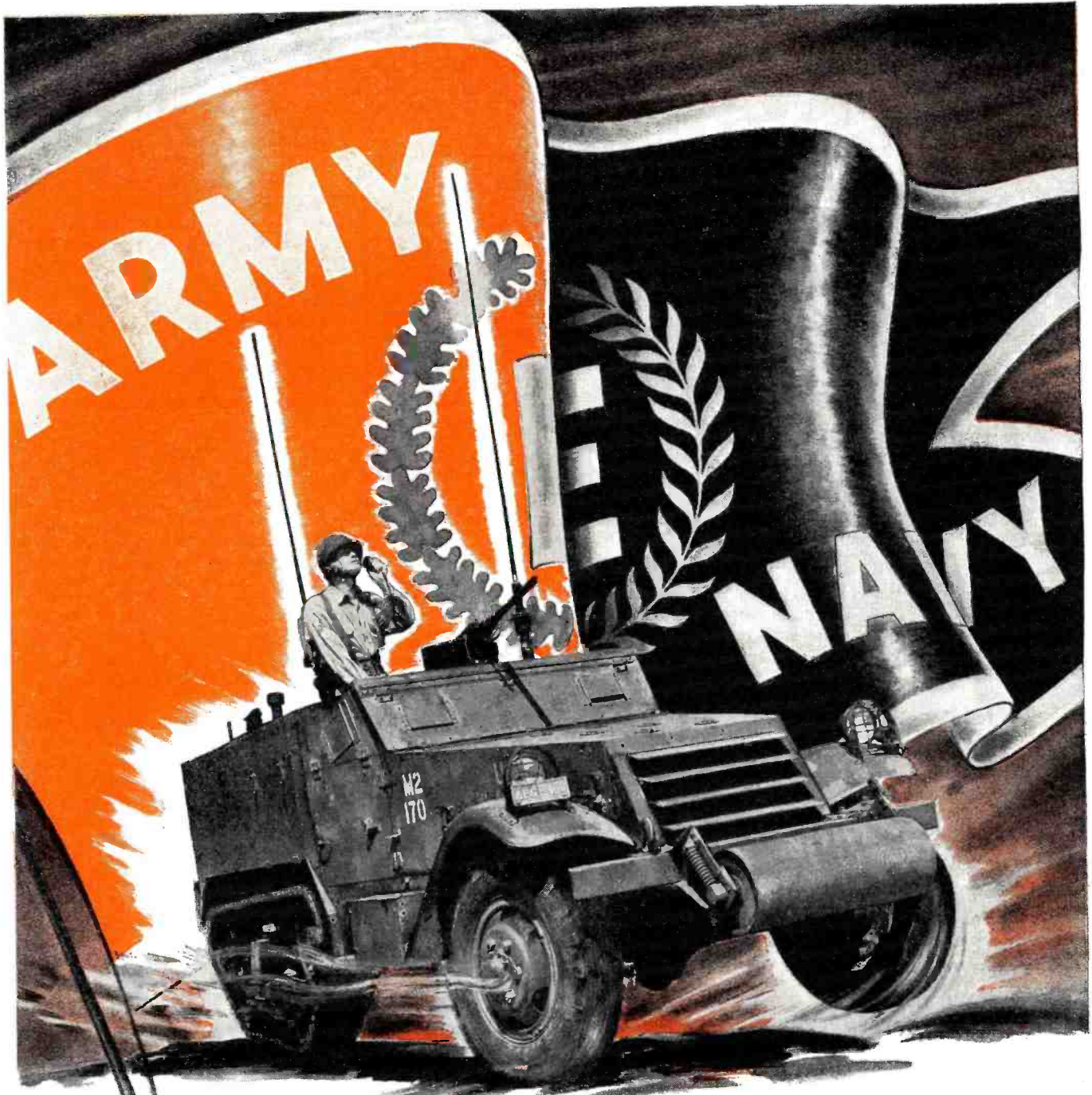

Yesterday and **TODAY**

The Army-Navy Production Award for outstanding achievement in producing vitally important materials essential to the war effort will be an added incentive to the management and employees of

WARD PRODUCTS CORPORATION to keep producing more and better equipment for the men who are doing the fighting. While yesterday WARD Antennas were accessories for pleasure, today they are implements of War.



WARD
Antennas

THE WARD PRODUCTS CORPORATION, 1523 EAST 45TH STREET, CLEVELAND, OHIO

two-thousand persons producing various types of metal and glass tubes. Water-cooled power tubes up to a hundred kilowatts are now being made in Russia. And eighty-five per cent of the employees are women, ranging from fourteen to fifty-five years," cited Mr. Ellis. "Today," said Mr. Ellis "production and engineering in Russia now compares very favorably with our large American units."

A general engineering conference, conducted by the RMA engineering department at the meeting, revealed plans for standardization practices in the future. It was also learned that the engineering department had arranged for a series of automobile interference tests on television and FM, and other receivers. These tests will be conducted through the cooperation of the Society of Automotive Engineers. An appropriation of five thousand dollars was made for this work.

During the annual election, Ray C. Cosgrove of Crosley was elected president, succeeding Paul V. Galvin. Five vice presidents were elected too. They include E. A. Nicholas, set division chairman; David T. Schultz, tube division chairman; Robert C. Sprague, parts division chairman; Thomas A. White, amplifier and sound equipment division chairman; and Walter Evans. Leslie F. Muter was re-elected treasurer; Bond Geddes was re-elected to the executive vice president-general manager post; and John W. Van Allen was reappointed as general counsel.

The annual meeting of the RMA of Canada was also held recently. R. M. Brophy of the Canadian Marconi Company was elected president, and S. L. Capell of Philco was named vice president. Retiring president, L. A. Young, in describing Canadian radio activities, said that in 1943 the industry had

reached a level of over a hundred-million dollars. At the present time, he pointed out, the industry is approaching peak production and is expected to pass the two-hundred and fifty million dollar mark during 1944.

RADIOODDITIES

The word *talk*, one of those most frequently used in radiotelephony, is also one of our most frequently mispronounced. The "t" is silent.

Our largest number of radio and electrical terms arise from the Greek root *elektron*, which literally means "amber."

A. Ohm of Buffalo is an inventor of electrical fixtures.

At the time of U. S. entry into World War I, this country's "Ham" population totalled only about 2,000, less than 1/30 of the number forced off the air by our entry into the present conflict.

Before our familiar "helloing" started over telephone wires, *ahoy* was the word. Bell used it himself.

A Mr. Speaker does audio research at the Abington, Pa., Memorial Hospital.

Alexander Graham Bell was a teacher of the deaf. He discovered the telephone principle while actually seeking a new kind of telegraph. Today, years after his invention, the telephone principle is being applied to hearing aids for the deaf.

The FCC Foreign Broadcast Monitoring Service handles more than 900,000 words daily.

In London the Radio Industries Club also recently held an annual meeting, their thirteenth. Guest of honor was Colonel David Sarnoff, RCA president. Sir Noel Ashbridge, deputy director general of the BBC, was unanimously re-elected president of the club. Colonel Sarnoff described American radio,

pointing out that the Army would have about ten-billion dollars worth of radio equipment this year. He stressed the importance of radio in the war, indicating that it had been a vital agent in our defensive and at present offensive activities. He said that the last chapter in the great history of radio has not yet been written.

OVER NINE-HUNDRED STATIONS WERE IN OPERATION

during 1943 in the United States. The total income of 796 of these stations was over forty-six million dollars, more than a fifty per cent increase over the total for 1942. According to FCC, NBC which in 1942 earned 137 per cent on the value of its property, in 1943 earned a return before income tax, of 190 per cent. FCC also reports that CBS' return jumped from 97 per cent in 1942 to 158 per cent in 1943. Returns of the Blue Network jumped from 8 per cent to 149 per cent. The combined Mutual Network earned a return of 84 per cent in 1943, as against 59 per cent in 1942.

The average broadcast income per station rose from \$38,534 in 1942, to \$58,393 in 1943.

THE STEVENS HOTEL IN CHICAGO WILL PLAY HOST

to a conference of the Electronic Parts and Equipment Industry on October 19, 20, and 21. This session will be a joint gathering of the Electronic Parts and Equipment Managers, Sales Managers Club, eastern group, and the National Electronic Distributors Association. No formal program has been issued as yet, but it is expected that many specialists from the civilian and military will address the members of the conference.

TWO OF THE NATION'S LEADING RADIO SCIENTISTS

have been honored by the War Department. Dr. Edwin H. Armstrong, professor of electrical engineering at Columbia University, and inventor of FM systems, and Dr. H. H. Beverage, associate director of RCA laboratories in charge of communications research, have been awarded the Chief Signal Officer's Certificate of Appreciation.

Dr. Armstrong received the award for the use of his FM patents and his loyal and patriotic services rendered to the Signal Corps of the Army in the accomplishment of its vital mission during a period of national emergency.

Dr. Beverage was granted the Certificate of Appreciation for his "tireless effort and valuable advice during the installation of a radioteletype circuit in a North Atlantic route."

RULINGS THAT TEEM WITH GOOD NEWS will soon be forthcoming from WPB. Donald Nelson, WPB chairman, has indicated that manufacturers will soon be able to build working models of any postwar products which they plan. Manufacturers will

ELECTRICITY for RADIO WORK ANYWHERE

Plant shown is W3S. 3000-watt, 115-volt, 60-cycle; engine is 2-cyl. water-cooled.

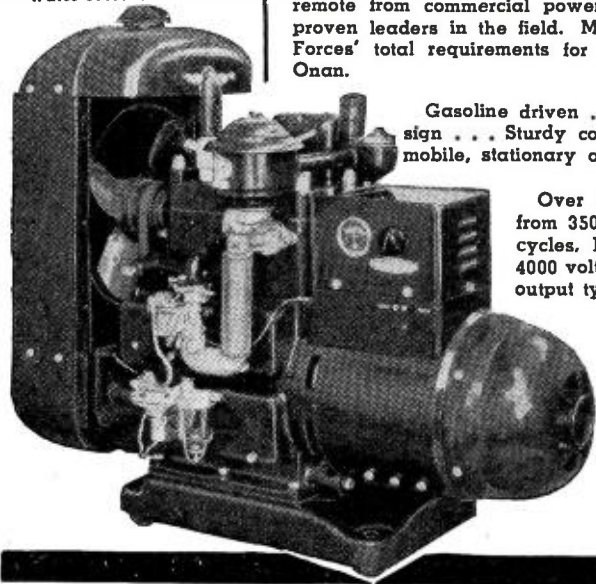

For a dependable source of electricity on all radio projects remote from commercial power. Onan Electric Plants are proven leaders in the field. More than half of the armed Forces' total requirements for power plants are built by Onan.

Gasoline driven . . . Single-unit, compact design . . . Sturdy construction . . . Suitable for mobile, stationary or emergency service.

Over 65 models, ranging in sizes from 350 to 35,000 watts. 50 to 800 cycles, 115 to 660 volts, A.C.—6 to 4000 volts, D.C.—Also dual A.C.-D.C. output types.

Descriptive literature sent promptly on request.

D. W. Onan & Sons, 2151 Royalston Ave., Minneapolis 5, Minn.

ONAN
ELECTRIC PLANTS

Electronic Wizardry

Philco Engineers Create a "Master Mind"

that THINKS...

READS...CALCULATES

...CALIBRATES

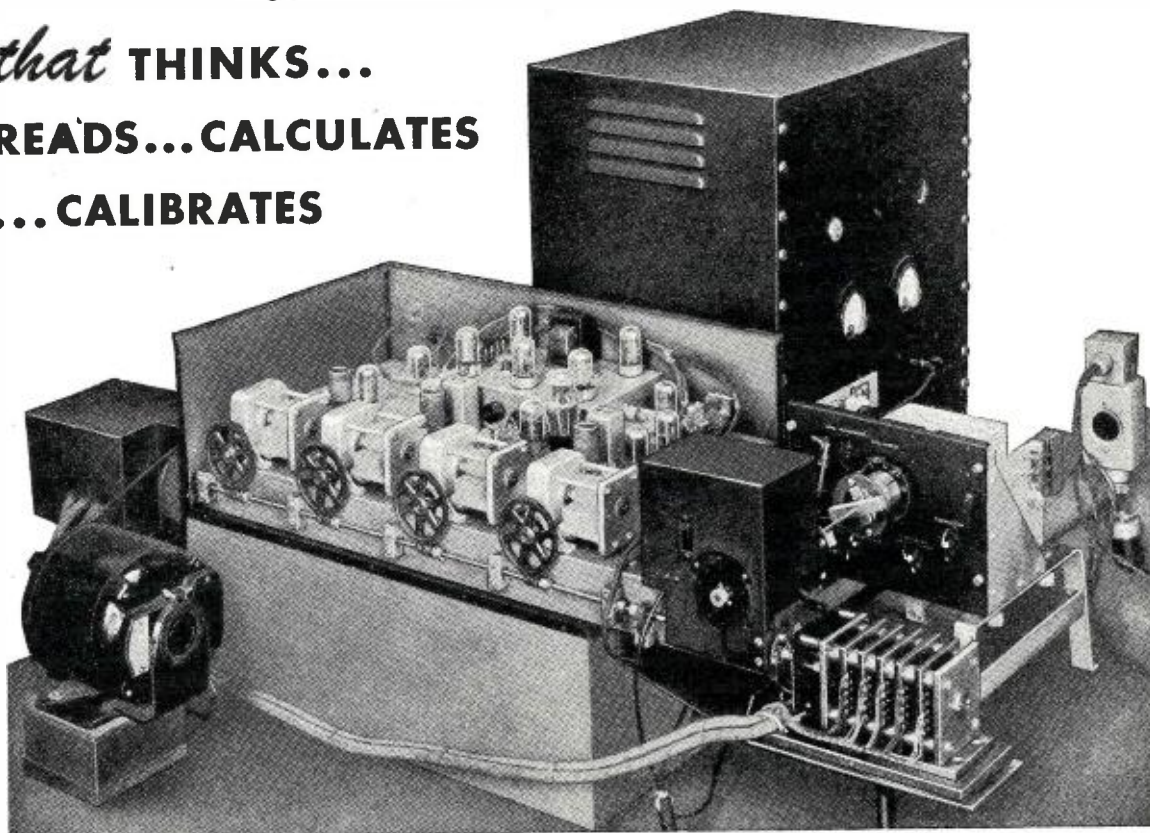

AMONG PHILCO'S many contributions to the war effort was the creation of the electronic "master mind" pictured here. Last year alone, it saved 144,000 man-hours of labor and, with other economies, reduced the cost of one type of radio equipment to the Government by \$1,170,000.

Perfected only after many months of exhaustive research and development by Philco engineering ingenuity, this device replaced a tedious and intricate hand calibrating operation, which was slow and subject to human error. Employing 126 tubes, the Philco "Master Mind" can "think," calibrate, calculate, and record

dial readings many times faster than any human being—at a great saving of time and without danger of error.

Another example of Philco research and engineering "know-how" which, while fulfilling emergency war needs, promises important peacetime applications in industry after Victory!

PHILCO

CORPORATION



NO TIME FOR FAILURE

Split-second decisions on the invasion fronts are possible only because of constant and immediate communications between fighting units and their headquarters—and we are proud that Halldorson Transformers are helping to maintain these communication lines—giving dependable performance even when the going is "rugged".

Homefront communications must also be maintained, so we now make—in limited quantities, of course—a complete line of Victory Type transformers. Built to meet Halldorson standards, these replacement transformers will assure continued operation of civilian radios.

**THE HALLDORSON COMPANY, 4500
Ravenswood Avenue, Chicago 40, Illinois**

JOBBER: We'll be glad to send you complete information regarding Halldorson Victory Type Transformers upon request.



HALLDORSON *Vacuum Sealed* TRANSFORMERS



be authorized to acquire enough materials and components to produce and test a single working model of any product. Instructions have been issued already by WPB to revoke orders limiting the use of magnesium and aluminum so that these materials may be used for test and essential end products, whenever and wherever manpower is available. Castings, foil and forgings still carry restrictions, but these are also expected to be lifted soon.

Effective July 1st, manufacturers were allowed to purchase machinery, tools and dies for civilian production whenever possible out of existing surpluses listed with the WPB and the DPC (Defense Plants Corporation).

This important step in peacetime planning will probably be followed by other rulings effecting relaxation of restrictions on steel, copper, zinc and lumber as soon as the supply situation permits, according to WPB.

Personals . . .

George H. Payne, former FCC commissioner, is now vice president and director of Finch Telecommunications Inc. Mr. Payne served on the FCC from its inception in 1934 until last June. . . . **Glenn C. Henry**, chief of the audio and industrial section of the Radio and Radar division of WPB, has resigned to accept a post with the sound and industrial department of RCA. He will be in charge of industrial sound, with headquarters at Camden, New Jersey. . . . **Arthur Daniel Lord**, former president of the old DeForest Radio Company, died suddenly recently. . . . **George H. Clark**, vice president of Formica, has been elected a director of the Society of the Plastics Industry. . . . **Major T. A. Haish** has resigned from the V-Loan Division of the United States Army, and is now with D. E. Replogle and Company, consulting engineers, as assistant to Mr. Replogle. . . . **Charles Robbins**, Emerson Radio vice president, recently delivered a lecture on sales management at Columbia University. . . . **Dr. George R. Town** is now research and engineering manager of Stromberg-Carlson. . . . **Garet W. Denise** has become general manager of plant operations of the Chicago plant of Littelfuse Inc. . . . **Bob Halligan**, son of **W. J. Halligan**, president of Hallicrafters, has entered West Point. . . . **Robert O. Driver** is now president of the Wilbur B. Driver Company, Newark, New Jersey. He succeeds his father, **W. B. Driver**, who becomes chairman of the board. **Sidney A. Wood**, formerly sales manager, is now vice president in charge of sales. . . . **Earl R. Sayre** has been appointed application engineer of P. R. Mallory & Company. . . . **H. M. Bateman** and **Mrs. E. M. Aalberg** have been elected vice presidents of Peerless Electrical Products Company, Los Angeles. . . . **William Y. Elliott** is now vice chairman of the Office of Civilian Requirements,

succeeding **Arthur D. Whiteside**. . . **Grant Shaffer**, formerly with the city of Chicago as electrical engineer is now sales manager in charge of the jobber division of Standard Transformer Corporation, **Norman A. Koetke** is the new merchandising manager for Stancor. . . **Alfred K. Higgins** has become advertising director of the Collins Radio Company, Cedar Rapids, Iowa. . . **Harold B. Donley** was recently appointed manager of the new Westinghouse radio receiver division in Baltimore, Maryland. . . **Paul E. Carlson** will direct the merchandising of DuMont postwar electronic and television products. . . **Ralph D. Power** has reopened his own office to serve technical clients as radio counsellor. . . **Philip Lauter**, executive partner at Electro Motive Manufacturing Company has returned to active duty. . . **M. A. Gardner** has been appointed Chief Purchasing Agent at Templetone Radio Company.

-30-

Local Broadcast Station

(Continued from page 39)

influence on advertising agencies and potential time buyers. It can not be gainsaid that as a class it is high priced. This, however, is offset in a number of ways. The installation problem is utterly simple. One can almost literally uncrate it, connect a few wires, and be ready to broadcast. The unit is already approved by the FCC and no delay in issuance of license will take place due to lack of compliance with some minor suggestion. Exact replacement parts are available from the factory. The product is guaranteed against defects for a substantial length of time. As the station expands, higher powered apparatus from the same manufacturer is designed to work in conjunction with existing low power equipment, thus saving expense and loss of investment.

Consideration of the studio both as to technical aspects and location ranks next in importance to the transmitter. The location of the studio has no direct bearing on its operation. It is required that it be located in the principal city which the station serves but special permission may be obtained for other locations. Accessibility by the staff and artists should primarily determine the final location. The amount of visiting carried on in a small station proves to be slight and sales customarily are made by contacting the potential buyer at his store or office. Thus advantage may be taken of less expensive locations on bus lines out of high rent areas. Studios need not be elaborate in design but must be acoustically treated and free of vibration and noise. Two rooms are sufficient. In one may be located two turntables selected for operation at 78 or 33.3 r.p.m. with a choice of vertical or lateral reproducers. This, in conjunction with a suit-

able control panel for the announcers, and microphone locations will make an efficient working space for routine duties. Another larger room can be used to house a piano and be equipped with several microphone locations. At some point adjacent to both these rooms the studio technical equipment may be placed. Adequate vision must be maintained. Provision must be made for the mixing, or blending, of the various microphones, control of the loudness or level of the program, and the termination of incoming and outgoing telephone lines. Such circuits are used to connect the studio with the transmitter at the outskirts of the city, receive programs from remote locations, and tie into network programs

at the Telephone Company's toll test board. It is safe to advise against building any of this apparatus due to the availability of satisfactory equipment at reasonable prices. The trend is toward console design capable of operating two studios and an audition channel at the same time. These units can be obtained complete with desk giving ample drawer and working space. The connection terminals are accessible and many variations of operation can be achieved to suit local conditions. The operating characteristics of the apparatus for the proposed installation may be obtained from the manufacturer's specifications. Not to be overlooked is the need for two or more portable amplifiers to use on

HOWARD Crystal Holders, precision made, accurate, and dependable, will serve the radio, electronic and allied fields in peace as they have the armed forces in war. Undisputed leadership in the manufacture of Crystal Holders, and proved performance of HOWARD Holders calls for: "Specifications to HOWARD."

★ BUY WAR BONDS ★

HOWARD MANUFACTURING CORP.

COUNCIL BLUFFS, IOWA

CUT HOLES FAST



in radio chassis

No tedious drilling... no reaming... no filing! Saves hours of work. Cuts clean, accurate holes for sockets, plugs, other receptacles. Tool has three parts: punch cuts through chassis, die supports metal and prevents distortion, cap screw is turned with wrench to cut hole. Sizes for holes 3/4" to 3/4". For complete information write Greenlee Tool Company, 1888 Columbia Ave., Rockford, Illinois.

WRITE FOR FREE FOLDER S-119

Get Ready with Greenlee!

REGISTERED TOOLS
GREENLEE
FOR THE CRAFTSMAN

MEN whether you are 16 or 50 PREPARE FOR AN ESSENTIAL JOB NOW-AND A PEACE-TIME FUTURE



Learn ELECTRICITY IN 12 WEEKS ON REAL MOTORS, GENERATORS, ETC

Ill Finance Your Training

Trained Electrical men needed now. It's not how young you are, or how old you are. The question is are you trained—Prepare for an essential job now with a peace time future—GET AN ELECTRICAL TRAINING NOW!
Here at Coyne you can train in 12 weeks—in a practical way on real actual electrical machinery and apparatus. You "Learn by Doing". And you don't need much money. I'll finance your tuition and you can pay it in easy monthly payments after your training period is over. Then if you are short of living expenses we'll get you a part time job to "earn while you learn". After graduation we give you lifetime employment service.
Right now I'm including extra training in INDUSTRIAL ELECTRONICS at no extra cost.

Mail coupon for my big free book. Get the training you need for a good electrical job. WRITE NOW.

Also have facilities for men with physical disabilities. Write.

H. C. LEWIS, President, COYNE ELECTRICAL SCHOOL
500 S. Paulina Street, Dept. C4-81, Chicago 12, Illinois
H. C. Lewis, President, Coyne Electrical School
Dept. C4-81, 500 S. Paulina St., Chicago 12, Ill.
Send Free Book with Facts on Coyne. "Pay After Graduation" Plan and extra Industrial Electronics training now included.

NAME.....
ADDRESS.....
CITY..... ZONE STATE.....

mote pickups such as dance bands and ball games. It is well to point out that in some instances the transmitter and studio can profitably be combined and this possibility should not be ignored in smaller stations.

No undertaking should be entered into without considering the costs involved. In radio station operation these can be divided into two parts: the initial and the operating. The initial costs must make allowance for the proposed transmitter, studios, engineering, and litigation, plus an allowance if the application should be designated for hearing. The FCC has prepared an estimate of the minimum amount of money required to properly construct a station, including transmitter and studios. This is shown in Table two.

With respect to operating costs more and different factors are involved. Some of these may not be too apparent. A list of representative major items should include salaries, rent, taxes, insurance, depreciation, power costs, maintenance parts and tubes, copyright fees, music, transcription library, news service, telephone line charges, and promotional activities.

In conclusion, it should be stressed that the filing of an application with the Federal Communications Commission does not mean that a quick decision will be made. Do not expect a reply in a day, or even a week. Your application will be given careful consideration by all the branches of the FCC before it comes to the attention

of the Commission members for final vote. It is unsafe to say how much time will be involved but one should think in terms of months rather than weeks.

If an application is granted work must be started on the construction within a period of sixty days and completed within six months. Thus it behooves the applicant to have at least some fairly definite preliminary plans formulated during the period when the application is being reviewed by the FCC. No binding agreements or commitments are necessary. But items such as options on sites, tentative studio locations and selection of apparatus can be safely carried out. Equipment manufacturers realize the position of the applicant and are most willing to set delivery dates subject to the approval of the application. If these details are properly cared for action can start at once.

It must be borne in mind that the construction permit is not a license to operate. It gives the possessor legal right to build a broadcast station described by the permit. When the construction is completed, the FCC must be contacted for permission to conduct equipment tests, and program tests. When this permission is granted the operation is virtually on a normal basis, but not until the license covering the construction permit is issued will the station be on a final operating basis in the eyes of the Federal Communications Commission.

-30-

5,000 to 20,000 Watt Stations

DURING the year 1943 there were 221 standard broadcast stations operating with power of 5 to 20 kw. One of these stations was located in Alaska, 1 in Hawaii, 4 in Puerto Rico, 2 in the District of Columbia, and 213 were in 45 of the States. There are no stations operating with this power in the States of Nevada, Vermont, and Wyoming. Included in the 221 stations are 15 noncommercial stations. There also were 6 outstanding construction permits. Forty of these stations operate on clear channel frequencies and 181 on regional frequencies, and may be grouped as follows:

Number of Stations	Power	Time
1	20 kw.	Limited
9	10 kw.	Unlimited
1	10 kw.	Limited
1	7 1/2 kw.	Unlimited
1	5 kw.-N-10 kw.-D	Unlimited
1	1 kw.-N-10 kw.-D	Unlimited
154	5 kw.	Unlimited
3	5 kw.	Limited
10	5 kw.	Daytime
37	1 kw.-N-5 kw.-D	Unlimited
2	500 watts-N-5 kw.-D	Unlimited
1	100 watts-N-5 kw.-D	Unlimited

221
One hundred and seventy-one of these stations have filed revenue reports for the year ended December 31, 1943, reporting "net time sales"

amounting to \$51,207,000, and the same stations reported \$42,051,000 for the year 1942, an increase of \$9,156,000 or 21.8%.

Five of the 171 stations showed a decrease in net time sales and the remaining 166 showed increases ranging from \$1,000 to \$182,000, and may be grouped as follows:

5 stations reporting decreases of \$1,000 to \$56,000.
37 stations reporting increases of \$1,000 to \$25,000.
49 stations reporting increases of \$25,000 to \$50,000.
45 stations reporting increases of \$50,000 to \$75,000.
19 stations reporting increases of \$75,000 to \$100,000.
18 stations reporting increases of \$100,000 to \$182,000.

One hundred and fifty-six of the 206 commercial stations serve as outlets for the four major networks as follows:

Blue	32 stations
Blue and Mutual.....	6 stations
Blue and National.....	2 stations
Columbia	49 stations
Columbia and Mutual.....	2 stations
Mutual	20 stations
National	45 stations

Total 156 stations

-30-



FOR TOUGH MILITARY CONDITIONS

Sperti HERMETIC SEALS

IMPROVED TYPE! Seal out dust, moisture and fungus from transformers, relays, vibrators and other sensitive component parts.

FUSED INTO ONE PIECE. Glass-to-metal vacuum tight hermetic seal. Resists corrosion. Thermal operating range of -70°C to 200°C . Insulation leakage resistance, 30,000 megohms, minimum, after Navy immersion test.

SOLDERING TEMPERATURE NOT CRITICAL. Simple, easy to attach by means of high frequency, oven-soldering or standard soldering iron.

WRITE, WIRE OR PHONE TODAY for information. Complete details will enable us to make specific recommendations and send appropriate samples.

NOW IN

Volume production

Sperti INCORPORATED



Electronic Division, Dept. RN-2
RESEARCH • DEVELOPMENT • MANUFACTURING
CINCINNATI 12, OHIO

NOW—A REALLY HIGH-POWERED— Radio Engineering Library

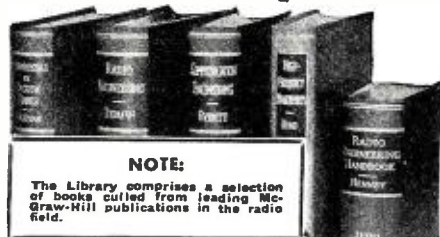

NOTE:

The Library comprises a selection of books culled from leading McGraw-Hill publications in the radio field.

- especially selected by radio specialists of McGraw-Hill publications
- to give most complete, dependable coverage of facts needed by all whose fields are grounded on radio fundamentals.
- available at a special price and terms

THESE books cover circuit phenomena, tube theory, networks, measurements, and other subjects—give specialized treatments of all fields of practical design and application. They are books of recognized position in the literature—books you will refer to and be referred to often. If you are a practical designer, researcher or engineer in any field based on radio, you want these books for the help they give in hundreds of problems throughout the whole field of radio engineering.

• VOLUMES, 3559 PAGES, 2558 ILLUSTRATIONS

1. Eastman's FUNDAMENTALS OF VACUUM TUBES
2. Terman's RADIO ENGINEERING
3. Everitt's COMMUNICATION ENGINEERING
4. Hund's HIGH FREQUENCY MEASUREMENTS
5. Henny's RADIO ENGINEERING HANDBOOK

10 days' examination. Easy terms. Special price under this offer less than books bought separately. Add these standard works to your library now; pay small monthly installments, while you use the books.

10 DAYS' FREE EXAMINATION—SEND COUPON

McGRAW-HILL BOOK CO.,
330 W. 42nd Street, New York 18, N. Y.

Send me Radio Engineering Library, 5 vols., for 10 days' examination on approval. In 10 days I will send \$3.00 plus few cents postage, and \$3.00 monthly (till \$24.00 is paid, or return books postpaid. (We pay postage on orders accompanied by remittance of first installment.)

Name

Address

City and State

Position

Company RN-8-44



Get High Speed Without Nervous Tension

Amazing Book Shows How "Crack" operators rely on something besides practice to develop their high speeds and proficiency: it explains the "knack" of sound-send and sound-consciousness—the secret of speedy sending and receiving. Once you acquire these mental processes, reading code becomes almost second nature to you: just as the swing rhythm of a dance band becomes automatic to musician and dancer.

Champions Endorse the Candler System

Used in training commercial operators, Amateurs, and Radiotelegraph Specialists in Signal Corps, Navy, Marine Corps, Coast Guard, Naval Reserve, Airlines. Wherever the fastest and most efficient operators are found, there you will find Candler trained men.

If you want s-p-e-e-d, if you have any difficulties in operating technique, if 40-50 and more w.p.m. seem fantastic speeds to you—send for this revealing book now. It's yours without cost or obligation. Simply send your name and address.

CANDLER SYSTEM CO.

P. O. Box 928 Dept. 2-J
Denver 1, Colorado, U.S.A.
and at 121, Kingsway, London, W.C. 2, Eng.

Portable Transmitter

(Continued from page 50)

fier is loaded to a predetermined value to reflect the proper load to the modulator.

The audio gain control is adjusted

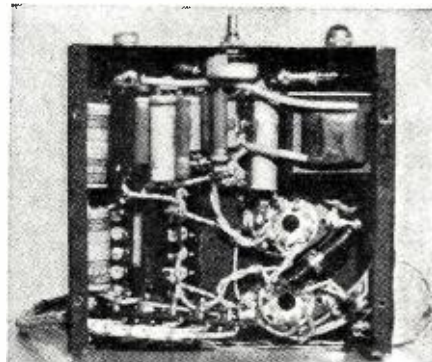

Bottom view of audio-frequency chassis.

so that the amplifier plate current barely moves at maximum modulation percentage.

An idea of the compactness of the entire transmitter may be gained from the photograph showing the entire unit, including microphone, set up on a small table generally used for a telephone stand.

—30—

Theater Acoustics

(Continued from page 31)

near these, a matching transformer can be used to step up the impedance of the twisted pair line, which may be 5 ohms, to whatever value the input impedance happens to be. An output transformer reversed and having the proper turns ratio can be used where the input impedance is high; in other cases, a line-matching transformer must be used. The turns ratio, of course, is equal to the square root of the impedance ratio.

Fig. 5 shows the low-impedance cir-

cuit. The advantage of using the record player or radio is that no projection room equipment need be placed in operation during the tests, but once the acoustic treatment has been worked out fairly well, a final polish may be put to the job by running the sound track and making slight changes if necessary.

The theory of sound is often involved, but the man who does this type of work, and who has the opportunity to do it, is not the physicist or engineer, but the practical public-address specialist, a fact which is easily overlooked, and there is no real reason for going into the measurement of reverberation time, particularly since you cannot buy equipment for its measurement at present and in any event the final results generally must be determined by experiment.

Practical methods can and do yield satisfactory results in a reasonably short interval of time. It is true, however, that more precise techniques often are extremely useful and that the more exact the method, the better the results are likely to be. Perhaps one of the most important factors is the noise level. As mentioned previously, street noises and vibrations may be heard. The extent to which they are heard will play an important part in the treatment of the theater. If the building has already been constructed, there is little or nothing that can be done by the sound man to prevent street vibrations from shaking the walls of the building and perhaps the steel frame. A certain amount of noise may be expected in all but the most elaborate structures. The noise levels may be measured with a sound-pressure meter. Recently, the American Standard's Association Committee on Acoustical Measurements and Terminology agreed upon the level of 10^{-12} watt per square centimeter as the reference level for all noise measurements. The intensity level is specified in decibels above the power of 10^{-12} watt/sq.cm which is zero db. Usually in public buildings, noise levels of 15 to 25 db. above reference level will not be very objectionable. A well-insulated

Pacific Coast Listening Post

THE photograph shows the listening post of August Balbi, of Los Angeles, who began DX'ing in 1933. Since 1937, Balbi has served as director, second district; vice-president, and co-editor of *The Globe Circler* (organ of the IDA), of the *International DX'ers Alliance*. He is also chairman of his local chapter of IDA. Balbi is an observer for N.R.C., Buffalo, New York, and monitor for several broadcasting corporations (such as BBC and ABC).

For two years he relayed prisoner-of-war messages from Manchukuo, Java, and Tokyo. He understands several languages, which is a great help to a monitor.

Balbi uses a 15-tube Holmes (custom built) receiver; an NC 100, and a Hallicrafters' S20, including RME

preselector, with a 100-foot and 40-foot antenna system, the shorter antenna being a vertical.

—30—

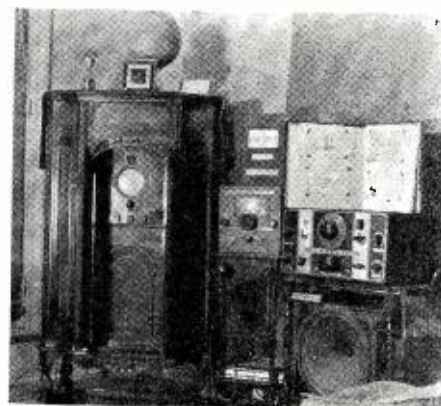

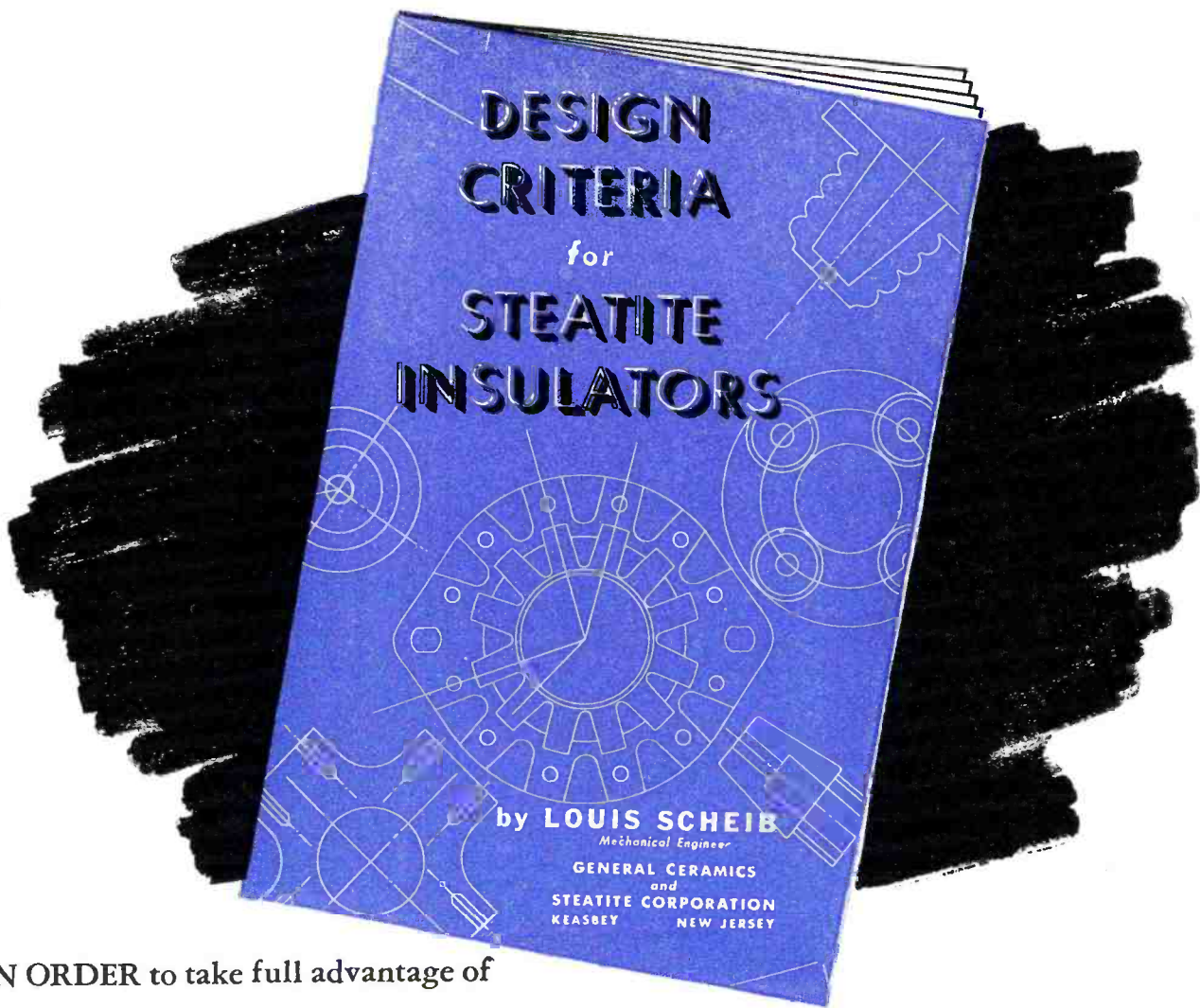

IN ORDER to take full advantage of General Ceramics & Steatite Corporation's facilities for the production of high quality steatite insulators, we are offering a new booklet, "DESIGN CRITERIA". This booklet describes the various methods of manufacture and outlines in detail the characteristics peculiar to good steatite insulator designs. Adherence to the principles outlined in this booklet in the design of new insulators will result in lower costs, quicker delivery and improved quality.

WRITE FOR YOUR COPY TODAY



theater with no audience present may have a noise level of perhaps 18 db. A poorly insulated one may have a level of 35 db. The noise level in a quiet residence, for comparison, might be about 22 db.

The measurement of the noise level is a straightforward job. The measurement of the reverberation time is somewhat more involved. The job can be done using a calibrated organ pipe to provide a test sound of 512 cycles. The sound is produced and then suddenly the sound source is shut off. The amount of time required between shut off and the obtaining of a level of 60 db. below the shut off level, at the observation point, is the reverberation time in seconds. A stop watch is used for taking the time accurately during

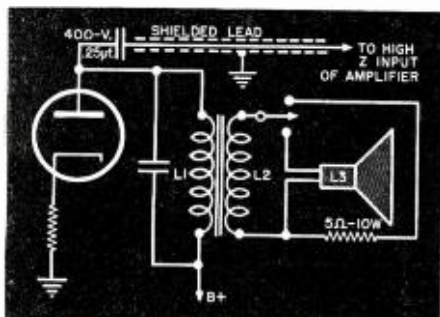

Fig. 4. Proper connection of the output of a radio receiver to a high-impedance input amplifier.

the interval. A portable setup is shown in Fig. 2 and may give fairly good results. It was developed originally by Hale J. Sabine.

The equipment is capable of indicating directly the decay of reverberant sound in decibels per second. The complete apparatus includes the reverberation meter proper and a General Radio Noise Level Meter. A sound source is, naturally, also required. This sound source may consist of the amplifier itself, with the horn speakers doing the radiating. Into the amplifier input can be fed a standard test frequency of 512 cycles taken from an audio generator. A key can be placed in series with one lead of the oscillator to permit suddenly breaking the circuit, or the key may be used as a short circuit across either the output of the oscillator or the input of the amplifier. The technique involved in measuring the reverberation time is simply that of producing a sound, quickly cutting off the source and timing the interval required for the sound to die down to one millionth of the original value or 60 db. The value so obtained is the reverberation time in secs. In effect, the equipment is an electric ear having a threshold which can be varied in 10-db. steps, plus a Leeds and Northrup synchronous timer clock. Selection of the desired test frequency by means of a bandpass filter will help in rejecting unwanted noise. The 10-db. step attenuator in the noise meter is used as the variable threshold control. Output terminals are added to the noise meter and a switch is provided to

shift the output of the amplifier from the db. meter to the output terminals. As the amplifier is heavily loaded while the sound source is operating, it is necessary to remove the meter from the circuit to avoid damaging it.

The reverberation meter proper consists of a conventional amplification stage working into a copper-oxide rectifier and a low-pass filter section. These two elements convert the a.c. output of the amplifier tube into a steady positive voltage for driving the grid of the thyatron. A variable negative C bias furnished by the battery and potentiometer associated with it is made to act in series with the thyatron grid and the resultant algebraic sum voltage is the effective voltage on the grid, which controls the plate current of the thyatron. This plate current flows only when the positive voltage due to the sound input is high enough to bring the grid potential to a point where it is more positive than the discharge potential of the tube, which in this case would be approximately -2 volts. The variable negative bias serves as a threshold control which is supplementary to the 10-db. step attenuator, since the more negative this bias is, the more positive must be the sound input voltage to cause the tube to discharge. (The schematic diagram of the portable reverberation meter is shown in Fig. 1.) By this means, it is possible to set the threshold of the entire system just above the noise level existing in the theater.

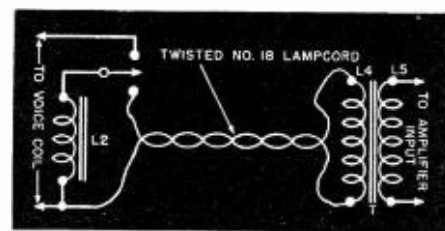

Fig. 5. Low-impedance circuit used to connect output of radio to amplifier.

The plate current of the thyatron operates a relay which in turn controls the starting of the special Leeds and Northrup synchronous timer, and the stopping of the timer. This mechanism has a very rapid and positive clutch operated by a pair of opposing magnets. The clock movement is actuated by a standard synchronous clock geared to complete one revolution in 10 seconds. The dial is graduated in tenths of a second but may easily be estimated to hundredths. The push button in the plate circuit of the thyatron is so arranged as to turn on the sound source simultaneously with the breaking of the plate circuit when pressed and when released it cuts off the sound source and closes the plate circuit, thus allowing the clock to start the instant the source is stopped, so that the time interval, the reverberation time in seconds, can be measured. The plate of the thyatron is supplied with 115 volts a.c. from the line, and with this arrangement the plate current automatically will be turned on and off as the grid voltage is varied

Radio and Instrument Hook-Up Wire.

THE War Production Board, according to Raymond G. Zender, WPB consultant, has long since foreseen the existing bottleneck in the production of radio and instrument hook-up wire, and as early as February, 1943, took the necessary action to keep in step with production demands by recommended standardization.

The standardization of hook-up wire by the American War Standards Committee, was started by drawing up a monitor specification in June, 1943. This specification was re-edited in preparation for an Industry Meeting held by the AWS Committee in July, 1943.

The U. S. Signal Corps Standards Agency effected the completion of the standardization of Radio Hook-up Wire. As a result, Signal Corps Standards Specification 71-4943 was approved on March 7th, 1944, covering Radio and Instrument Hook-up Wire. A mailing of this specification was effected by the Radio and Radar Division to all End Products Manufacturers. Extra copies can be obtained from the Signal Corps Standards Agency, 12 Broad Street, Red Bank, New Jersey.

It was hoped at the time of the organization of the Signal Corps Standards Agency, a joint Army-Navy Signal Corps Standards would be fortncom-

ing; however, due to variance of operating conditions between Ground Forces and the Navy, a separate Bureau of Ships, Insulated Radio and Instrument Hook-up Wire Specification is in the making. Preliminary Draft dated April 1st, 1944, of this specification 15-C-20 (INT.) has been sent out for Industry Comment only. This specification does not differ too greatly from that of the Signal Corps specification and when adopted will result in two standard specifications, one for the Signal Corps, and another for the Bureau of Ships. Attention of Equipment Manufacturers is called to these specifications as many are not aware of the extensive work being done by Laboratories of the Armed Forces, Radio and Radar Division, and Copper Section of the War Production Board. The two aforementioned wire specifications are performance specifications broad enough to permit the development of new types of insulations, and also the use of several different types of material now available.

In recommending the use of these specifications, no attempt is being made to restrict development of new types of wire or dictate material to be used except where a critical supply situation necessitates controlled use.

A PRECISION LABORATORY INSTRUMENT

FEDERAL

U. H. F.

SIGNAL GENERATOR

MODELS

804-CSI

also 804-CS2.

FOR MORE DETAILED INFORMATION WRITE TO DEPT. ...

Carefully and difficultly acquired experience enabled **Federal** to produce more Ultra High Frequency Test Signal Generators than were ever thought possible—and quickly, too.

Breaking the tightness of demand by the Army and Navy, these high quality laboratory precision instruments are available to research laboratories and industrial manufacturers engaged in the production of electronic equipment.

Your inquiries are invited.

CARRIER FREQUENCY RANGE: 7.6 to 330 megacycles plus or minus 2%, direct-reading in 5 bands, 6th band available for use with blank coil form supplied.

OUTPUT VOLTAGE RANGE: Calibrated Attenuator continuously variable from 1 to 20,000 microvolts, accuracy plus or minus 10%.

MODULATION: Internal Modulation 1,000 cycles; external modulation up to 20,000 cycles; 0 to 60% direct-reading modulation meter.

STRAY FIELD LEAKAGE: Held to a minimum by improved shielding and R.F. Filters.

VIDEO OR PULSE MODULATION: Can be pulse modulated externally with signals having very steep wave fronts.

VOLTAGE REGULATED POWER SUPPLY: 115 or 230 volts, 40 to 60 cycles, single-phase.

Manufactured by arrangement with the General Radio Company of Cambridge, Massachusetts, and in accordance with their designs.

FEDERAL
U. H. F.
SIGNAL
GENERATOR
MODELS
804-CSI

also 804-CS2.

FOR MORE DETAILED INFORMATION WRITE TO DEPT. ...

CARRIER FREQUENCY RANGE: 7.6 to 330 megacycles plus or minus 2%, direct-reading in 5 bands, 6th band available for use with blank coil form supplied.

OUTPUT VOLTAGE RANGE: Calibrated Attenuator continuously variable from 1 to 20,000 microvolts, accuracy plus or minus 10%.

MODULATION: Internal Modulation 1,000 cycles; external modulation up to 20,000 cycles; 0 to 60% direct-reading modulation meter.

STRAY FIELD LEAKAGE: Held to a minimum by improved shielding and R.F. Filters.

VIDEO OR PULSE MODULATION: Can be pulse modulated externally with signals having very steep wave fronts.

VOLTAGE REGULATED POWER SUPPLY: 115 or 230 volts, 40 to 60 cycles, single-phase.

Manufactured by arrangement with the General Radio Company of Cambridge, Massachusetts, and in accordance with their designs.

ARMY
E
NAVY

FOR THE FOURTH TIME

BACK THE
INVASION ...
KEEP BUYING
MORE WAR BONDS

Federal Manufacturing and Engineering Corp.
Manufacturers of Federal Photographic Equipment and Federal Electronic Devices
BROOKLYN 5 NEW YORK

**WHAT DOES THE
"BL BUTTON"
MEAN?**



In the case of the Frequency Meter shown above, the "BL button" (shown below) means that by using it, transmitters can be kept "right on the button." On any piece of equipment it means sound design, rugged construction, fair price. Watch for the "BL button" after the war.

BROWNING
LABORATORIES, INC. WINCHESTER, MASS.

**RADIO-ELECTRONICS
HOME-STUDY COURSE**

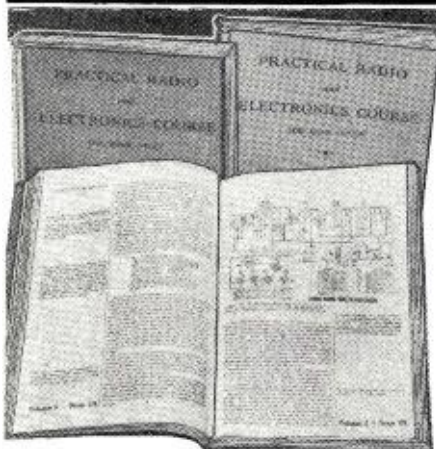

New home-study course in 3 volumes. Covers every topic of radio and electronics. Brush-up on useful radio fundamentals, use the practical service hints, prepare for a future in Electronics and Radio.

- Volume 1. **Fundamentals of Radio and Electronics**
Use the 13 lessons of this volume to really understand radio and electronics. Parts, tubes, circuits, tests, 172 large pages, all lessons size 8 1/2 x 11", with instructor's tips, 201 charts and pictures, index. **\$1.50**
- Volume 2. **Receivers, Transmitters, & Test Equipment**
Superhets, communication receivers, oscillators, transmitters, repair, adjustment, antennas, meters, electronic test equipment, signal tracers, AFC, television, and other topics. In 9 large lessons and index. 103 helpful illustrations. Large size: 8 1/2 x 11 in. **\$1.50**
- Volume 3. **Applied Electronics and Radio Servicing**
Lessons on photo-cell equipment, special radio receivers, radio compass, frequency meters, life-boat transmitter, U.H.F. heating, electronic shaping circuits, aircraft direction finders, absolute altimeter, radar, metal locators, special tubes, welding controls, voltage regulators, X-rays, magnetron, electronic gages, facsimile, recording, intercomms. Also lessons on radio servicing, cased histories, diagrams. Manual contains 31 lessons. Size: 8 1/2 x 11 in., 102 illustrations, index. **\$1.50**
- All 3 Volumes, 53 Lessons, only. **\$3.95**
Clip this ad. Check manuals wanted. Enclose your remittance. Books sent postpaid. Money back guaranteed.

SUPREME PUBLICATIONS

328 S. Jefferson St. Chicago 6, ILL.

back and forth through the critical period. Under actual test conditions, the sound decay takes place with rather wide fluctuations of about an average value, due to the interference patterns and reflections, so that the sound intensity may pass through a given value several times before finally dying down below that value. Due to the automatic on-off action of the thyratron, the clock integrates the total time during which the sound intensity has a value above the threshold, averaging out the fluctuations in the decay curve.

The procedure used in making the measurements may be stated as follows: The 10-db. attenuator is set so that it is at its lowest possible value, the lowest threshold obtainable, and the potentiometer marked "threshold control" which varies the fixed bias on the thyratron is adjusted so that the voltage on the grid produced by the small amount of noise present in the theater is sufficient to cause the thyratron to discharge.

This setting is left unchanged during any one series of 10-db. steps along the decay curve. The sound source

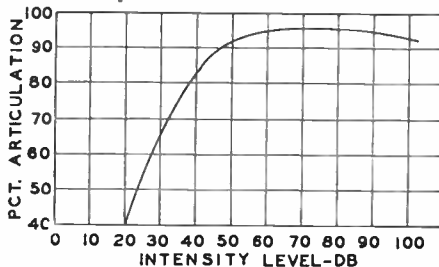

Fig. 6. The relationship between percentage articulation and sound intensity level.

is turned on for a few seconds by pressing the push button, and on releasing it, the clock registers the time of sound decay to the threshold. The attenuator is then set 10-db. higher, and a shorter time is obtained to this threshold. By setting the attenuator to successive steps until the threshold is brought higher than the initial sound level itself, in which case the clock does not operate at all, a series of points along the decay curve is obtained. A single series of points will normally deviate from a straight line because of the fluctuations in the decay of the sound previously mentioned.

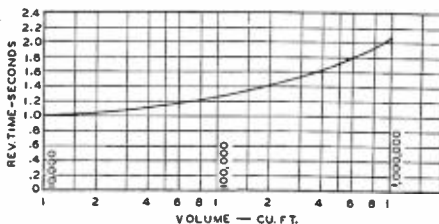

Fig. 7. Optimum reverberation time at 512 cycles for movie theaters.

By taking a number of readings and changing the position of the microphone used in the sound meter between each series of tests, the deviations will be reduced considerably and the average values will fall along a

(Continued on page 144)

Tube Substitutions

(Continued from page 42)

change the output transformer. By and large, though, the reliable set manufacturer can be trusted to put in the correct output transformer.

For a few practical examples, let us investigate the 50L6. By referring to a tube chart it is found that the load resistance is approximately 2,000 ohms. Now starting at the beginning, let a list be made of every power tube that could be used with this load transformer.

6Y6	25C6
25B6	70L7
25L6	35A5
35L6	117N7
7A5	

Naturally the one to be chosen depends on which tube is available plus how much additional trouble there would be involved in making the change. Those are matters that concern the serviceman and he is the best judge. There is very little discussion here about the need for changing bias, socket connections, etc., since this is something every good serviceman can do without being told. All that is needed is a tube manual and a working knowledge of Ohm's law.

It should be noticed above, that no triodes are mentioned, nor is it suggested that any pentode be used as such. The reason is simple enough when it is recalled that the load impedance of the output transformer is only 2,000 ohms. Most triodes, or pentodes used as such, need a greater load than we have available here. Remember that while a higher load will only decrease the power output of a triode combination, a lower load value would, in addition to decreased power, raise the distortion beyond our arbitrary figure of 12 per cent. Hence, triode tubes should only be considered when the tube being replaced worked into a fairly high load. To illustrate this, let us suppose that a 6K6 needed replacing. From the tube manual, this tube with 100 volts on the plate worked into a load resistance of 12,000 ohms. A 6L6 used as a triode needs a 5,000-ohm load, but with only a small loss in power will work nicely even

**Radiophotos from
Normandy Beachhead**

THE first ten days of assault on the Normandy peninsula saw more than 400 news photographs radioed from London to Washington by U. S. Army Signal Corps radiophoto circuits.

Of these 185 were Army pictures, 105 were still pool pictures, and the other 20 were Navy pictures. The Washington AP bureau wirephotoed 158 pictures in four and one-half days to American papers, easily topping any comparable time. Most of these were invasion photos.

*Another Lesson Learned at Pearl Harbor**

GATES TRANSMITTERS GIVE MORE PERFORMANCE HOURS - PER DOLLAR !

A recent survey of Gates installations reveals:

**MAINTENANCE COSTS FOR 80 GATES
TRANSMITTERS IN THE 2½ YEARS SINCE
PEARL HARBOR HAVE BEEN LESS THAN \$1000!**

Just figure it—an average maintenance cost of \$12.50 for 2½ years—forty some cents per month! Today, when equipment is at the “critical stage,” efficiency is not only important, it is a *must*. Years of experience in transmitter designing has enabled Gates engineers and skilled craftsmen to design and build transmitter equipment that measures up to today’s heavy-load requirements. And that’s a sound reason why the less you have to spend, the more important it is to buy Gates equipment and enjoy more performance hours *per dollar*!

If you'd like to know more about the Model 250C Transmitter illustrated, write for technical bulletin which gives complete data and details. Consult us on any maintenance problem, without obligation. (War-time restrictions do not allow the sale of new broadcasting equipment without priority; therefore, this equipment is presented merely to acquaint you with Gates developments.)

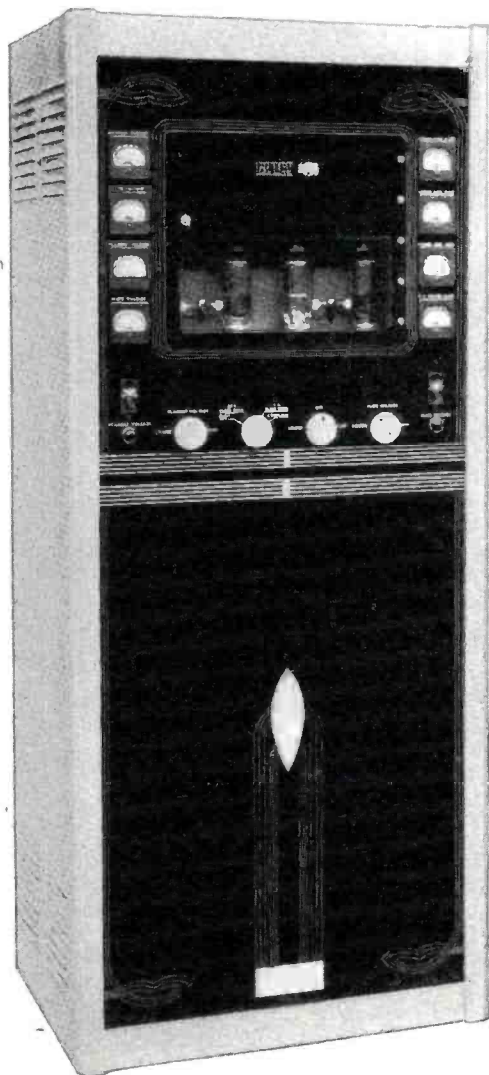

**Model 250C
Transmitter
"Showmanship
with a Plus
Performance!"**

GATES RADIO AND SUPPLY CO.

Quincy, Illinois, U.S.A.

Manufacturers of Radio Broadcast Transmitters, Speech Equipment, Recording Apparatus and Allied equipment in the electronic fields.

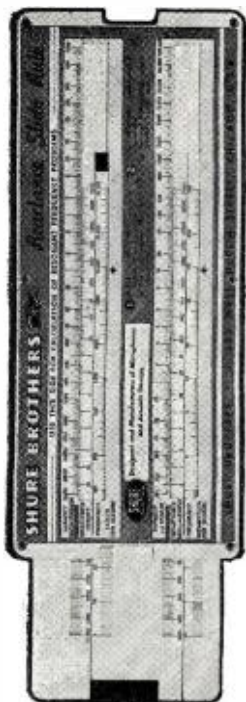

**have you
sent for
your SHURE
REACTANCE
SLIDE RULE?**

Thousands of engineers and technicians find the Shure Reactance Slide Rule helpful in radio computations. Simplifies problems in resonant frequencies, circuits, inductances, condensers. Range 5 cycles per sec. to 10,000 megacycles. Complete with instructions. Send 10c in coin to cover handling.

SHURE BROTHERS
225 W. Huron St., Chicago

Dept. 174X

Designers and Manufacturers of Microphones and Acoustic Devices



**VACO AMBERYL
PLASTIC MALLETS**

for a wide variety of uses

These units are especially helpful to sheet metal workers, jewelers and others working with pre-finished and soft sheet non-ferrous metals. Readily take the place of scarce mallets such as copper, rawhide, rubber, etc. Made of dense, resilient, break-proof Amberyl plastic, they stand a tremendous amount of abuse without damage. Heads may be refaced for special jobs. Handles of selected hickory. Available in 5 sizes, from 3/4" to 2" diameter heads.

Write for more complete descriptions and our catalog showing 173 types of screw drivers and small tools.

VACO PRODUCTS CO.

319 E. Ontario St. Chicago 11, Ill.

Canadian Branch Warehouse:
560 King St. W. Toronto 2, Ont.

	TRIODE	PENTODE
Heater Voltage	6.3	6.3
Plate Voltage	250	250
Screen Voltage	Tied to plate	250
Peak A-F Input Signal Voltage	-20	-14
Plate Resistance	1700 ohms	22,500 ohms
Load Resistance	5,000 ohms	2,500 ohms
Power Output	1.4 watts	6.5 watts
Total Harmonic Distortion	5.0 %	10 %

Table 1. Operating conditions of a 6L6 tube, connected either as a triode or pentode.

with a 12,000-ohm load since, as pointed out previously, a triode may work into a load higher in value than its optimum figure but not much below. Even such triodes as the 6A5-G, 6AC5 and 6B4-G may be used to replace the 6K6. These are in addition to the power pentodes that may also find application here, tubes like the 6F6, 6G6, and 7B5. Thus, by knowing the limits of the various tubes, it is possible to make tube substitutions with a greater variety of tubes.

As a general rule, any power pentode (and beam power tube) used as a triode will work satisfactorily into a load of 5000 ohms or above with less harmonic distortion and less power. There are not many exceptions to this rule; only one comes readily to mind, that being the 6G6 which needs about a 12,000-ohm load. Hence, to replace the above 6K6, such tubes as the 6F6 and 6V6 which would not work very well as pentodes here, would fit in nicely as triodes.

The rules as laid down in the preceding paragraphs are subject only to the restrictions given with each explanation. If anything, the tendency has leaned toward the conservative, but in the long run this will pay off to our benefit.

For push-pull combinations it is possible to revise many of the preceding rules to the extent that almost any power pentode (in push-pull) may replace any other power pentode, also in push-pull. The reason is quite simple.

Push-pull amplifiers suffer only from third harmonic distortion, very little fifth harmonics being present. By working a pair of tubes into a load that is higher than the desired or optimum value, this third harmonic distortion will not increase to any great extent, as far as the human ear can detect. Tests have shown that it takes 5 per cent of the third harmonic frequencies to be present before the distortion becomes noticeable to the human ear. Assume a pair of 6L6's in push-pull working into a load of 5,000 ohms (plate to plate). At this value the total harmonic distortion is only 2 per cent. Even at a load of 10,000 ohms, should this distortion rise to 5 per cent, it would still be acceptable to most people. Other possible replacements might include the 6F6, 7C5, 42 and any other tube commonly used in push-pull applications. In none of these does the total harmonic content run above 5 per cent. Thus, in replacing pentodes and triodes in the output stage, the really tough problem concerns itself more with tube sockets and bias resistors than with matching output transformers.

It should be stated, lest the wrong idea be conveyed, that tube replacements should be attempted only when all other methods fail. It is at this point that the above rules come into play. And, although battery type tubes have not been mentioned above, the same set of regulations would apply to them.

-50-

Fig. 7. Harmonic distortion and power output of a pentode tube, shown in Fig. 1, with a variation of load impedance.

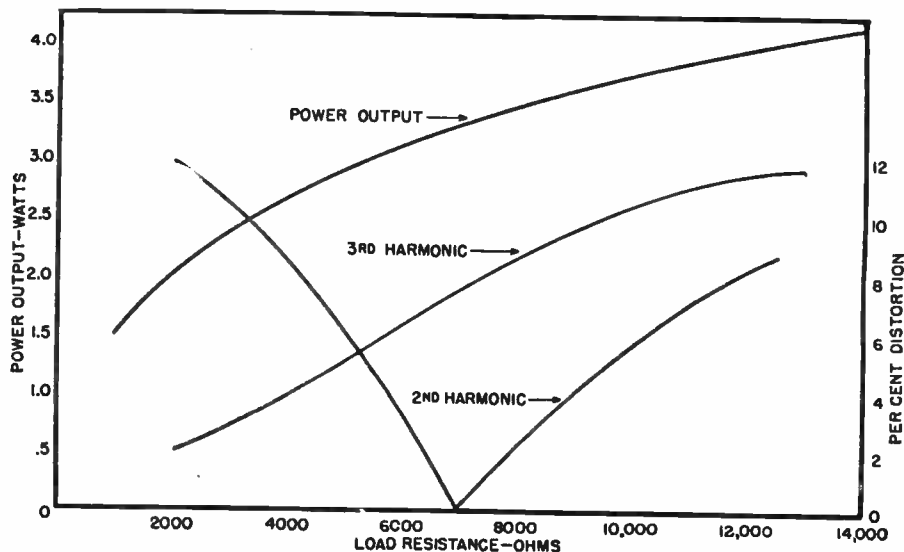

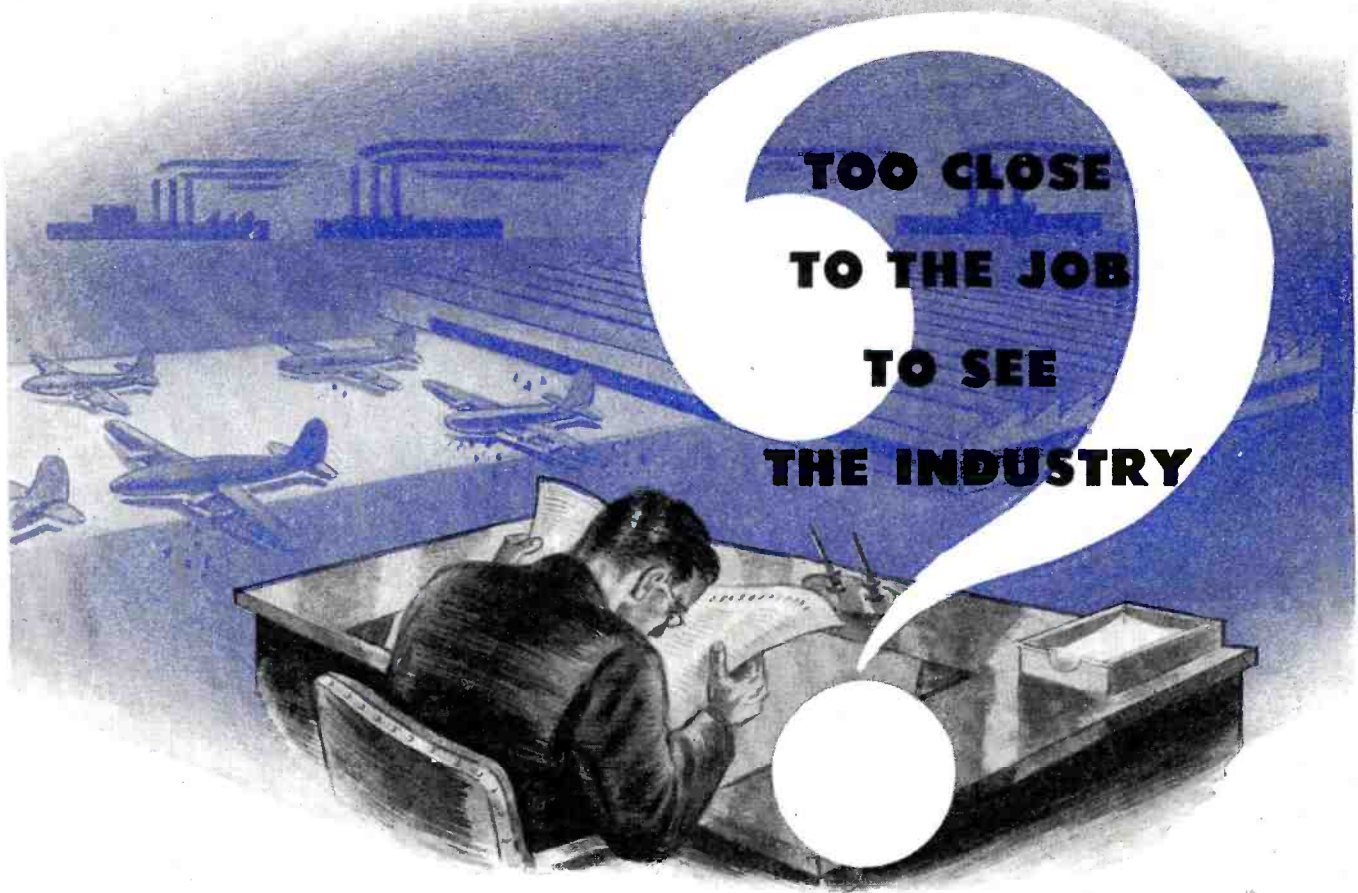

**TOO CLOSE
TO THE JOB
TO SEE
THE INDUSTRY**

Industrial Aviation
MAY 1944

Topics: Aerodynamics, Accessories, Welding, Metallurgy, Materials, Aircraft Descriptions, Inspection, Machines, Engines and Descriptions, Plastics and Plywood, Flight Testing, Production, Instruments, Propellers, Research, Finance, Management.

BROADEN YOUR PERSONAL PERSPECTIVE . . .
Send This Coupon

What You Need Is "Industrial Aviation" Once A Month

Many an aircraft executive has been tied to his desk these last busy years—so closely that the rest of the industry of which he is a functioning part, was out of focus. But in the next phase a man will need to see the picture clearly, as a whole.

That's why the appeal of **INDUSTRIAL AVIATION**, which appeared first as a special section of *Flying*, was so enormous. Key men found it a quick way to keep in touch. They approved it so thoroughly that **INDUSTRIAL AVIATION** outgrew the original plans for it . . . stepped out on its own as a full-fledged magazine. This publication is so edited that it brings the aviation industry to busy executives! Concise, vital, **INDUSTRIAL AVIATION** covers factory management, design theories, engineering data, new equipment, personnel problems and their solution—all the information that aircraft executives need, written to be quickly read yet thoroughly grasped!

By becoming a regular subscriber to **INDUSTRIAL AVIATION** you can get a quick monthly survey of your industry. Stay at your desk—that's what the times demand—but travel through your industry regularly and thoroughly in the pages of **INDUSTRIAL AVIATION**. Available only by subscription to key executives, purchasing men, production men, engineers, and designers, **INDUSTRIAL AVIATION** is keyed to your requirements. *Don't miss a single issue—subscribe today.*

Please enter my subscription for **INDUSTRIAL AVIATION** for
 One Year . . . \$2.00 Two Years . . . \$3.50

Name _____
 Address _____
 City _____ Postal Zone No. _____ State _____
 Firm _____
 Product _____
 Your Title _____

Additional charge for Canada of 50c per year. Please send check or money order. Remittance enclosed. Bill me later.

ZIFF-DAVIS PUBLISHING COMPANY
 540 North Michigan Avenue, Chicago 11, Illinois
 Offices: New York • Washington • Los Angeles • London • Toronto

BIG VALUES IN TECHNICAL
PERFECTION



**RCP TUBE
TESTER**
NEW MODEL 314

This new tube tester is simple to operate, flexible and speedier for testing Octal, Loctal, Bantam Jr., Miniature, Midget and all acorn tubes. Designed to test all present filament voltages from 1.1 to 117 volts—a range that anticipates voltages of the near future. Has sockets for all receiving tubes; no adapters required; individual connections for each element.

Lever type switching controls each tube prong, checks roaming filaments, dual cathode structures and multi-purpose tubes. Separate plate tests on diodes and rectifiers. Neon short tests detect leakage between elements while tube is hot. 4" square meter with "Poor-Good" scale. Pilot Lite indicator; double fused plug protects transformer. Durable Oak carrying case—14¼"x13"x6". Weight: 12¼ lbs. Complete ready to operate—Price: 48.50 60 cycle 110V; \$49.95 50-60 cycle 220V. Code: ATLAS.

Only one, out of the complete RCP line that built a reputation for quality and value before the war—today, packed with still greater technical advancements, better engineering, smarter design. Write for catalog No. 128 of standard commercial models.

RADIO CITY PRODUCTS CO., INC.
127 West 26th Street, New York 1, N. Y.



**PLUG-IN
CONDENSER**

Plug-in capacitors with a wide range of voltages and capacities are one of the many different paper and electrolytic capacitors manufactured by the Illinois Condenser Company. This unit is hermetically sealed and built to operate under the severest conditions. We also manufacture condensers for special applications with a wide temperature range of from -50° C to +85° C and from one volt to 500 volts D.C. working on the electrolytic types.

**ILLINOIS CONDENSER
COMPANY**
1160 NORTH HOWE STREET
CHICAGO 10, ILLINOIS

Manufacturers' Literature

Readers are asked to write directly to the manufacturer for the literature. By mentioning RADIO NEWS, the issue and page, and enclosing the proper amount, when indicated, delay will be prevented.

CRYSTAL MANUFACTURE

An informative 36-page booklet entitled "How Quartz Crystals Are Manufactured" is being offered by the *North American Philips Company* to persons interested in the processing of this important electronic component.

The booklet covers such subjects as the inspection, grading and classification of quartz, orientation of crystals, sawing and orientation devices, lapping and finishing and crystal testing.

This discussion is written by Mr. Sidney X. Shore, senior engineer of the crystal division of the company. Excellent photographs are included to supplement the textual material. Line drawings and graphs give further information regarding the characteristics of the material to be processed.

For persons interested in the manufacture and control of quartz crystal, the booklet will provide a complete and easy-to-read story which will be a valuable addition to their technical literature. Copies may be obtained by writing *North American Philips Company, Inc.*, 100 East 42nd Street, New York 17, New York.

ADHESIVE BULLETIN

The *B. F. Goodrich Company* has just issued a new catalog on its line of adhesives or cements, which is available for distribution to those using this type of bonding material.

This bulletin covers the service requirements and classification of various adhesives and then lists and discusses each type offered. Instructions on application and data on the company's standard containers are included along with approximate shipping weights.

Many of these cements are, at the present time, sold only under the rubber restriction order so can be used only for permissible purposes.

Interested persons who require adhesives, fabric coatings, binders or sealers are invited to write for this bulletin, Catalog Section 9160. Address *The B. F. Goodrich Company*, Akron, Ohio.

CENTRALAB BULLETINS

Two new bulletins covering Silver Mica Capacitors and Insulated Ceramic Capacitors have been issued by *Centralab*.

The Silver Mica Capacitors are special purpose oil impregnated capacitors for use in high frequency applications. They are made of mica discs, individually silvered for maximum stability. The outside metal ring or cup connects to one plate of the capacitor;

the center terminal connects to the other plate by means of a rivet. Other metal parts are silver-plated brass. Four types are available with various kinds of terminals. These capacitors are described in Bulletin 586 Revised.

The tubular Ceramic Capacitors with axial leads have electrical characteristics which are identical with the standard *Centralab* tubular capacitors. The mechanical construction is modified so that wire leads are attached parallel to the body and the assembly may then be inserted in a steatite tube. The extra tube has no capacitor function, providing mechanical insulation only. This unit is described in Bulletin 819.

Both of these bulletins may be obtained by writing to *Centralab*, 900 East Keefe Avenue, Milwaukee, Wisconsin.

TUBE CATALOG

An essential characteristic catalog for tubes manufactured by *Ken-Rad* is being distributed by the company to interested persons.

This booklet covers metal, glass, miniature, cathode-ray and transmitting tubes. Characteristics of various types of tubes are covered in chart form for quick reference. Outline drawings of all tubes as well as base connections are given to facilitate design and repair work involving *Ken-Rad* tubes.

Of particular value are the characteristic charts for special type tubes including cathode-ray, power-amplifier, oscillator and transmitting tubes. Seldom is this material provided in such a handy form in a single handbook and this feature alone makes this catalog an important adjunct to the engineering department reference material.

Copies of the book may be obtained from the company by addressing requests to *Ken-Rad Tube and Lamp Corporation*, Owensboro, Kentucky.

MACHINE SCREWS

Machine screws for all types of radio and electronic work are covered in a new catalog issued by *Progressive Manufacturing Company*.

Standard types of screws, nuts, and bolts are included in this catalog as well as many types of special or custom-built products. Specifications for all types are included to facilitate choosing the proper screw for the job.

The company will be glad to send Catalog 18 on request or engineer special jobs if specifications are forwarded to the *Progressive Mfg. Co.*, Torrington, Conn.

-50-

U.H.F. Course
(Continued from page 55)

the custom in many electrical textbooks to show electric and magnetic fields by means of lines, these lines being called either lines of flux or what is the same thing, lines of force. Arrows usually are put at the end of these lines to indicate the direction in which the forces act. To indicate that a certain region has a greater electric or magnetic force it has been the custom to put more lines of force per inch than in other portions of the region where the force is not quite as great. Fig. 4 shows what is meant. In part of this diagram is shown a region in which, for this example, an electric force is acting. The force may be due to a group of electrons or any other charged body that is capable of exerting an electric force. In the middle of the diagram the field is supposed to be concentrated or strongest and this is shown by the group of four lines bunched together. Moving away from the center on either side, the bunching of the arrows grows less, showing that the strength of the field decreases. At the extreme right and left margins there are no lines, indicating that here the strength of the electric field has diminished to zero. If the diminution in electric field strength from the center was accomplished gradually, a di-

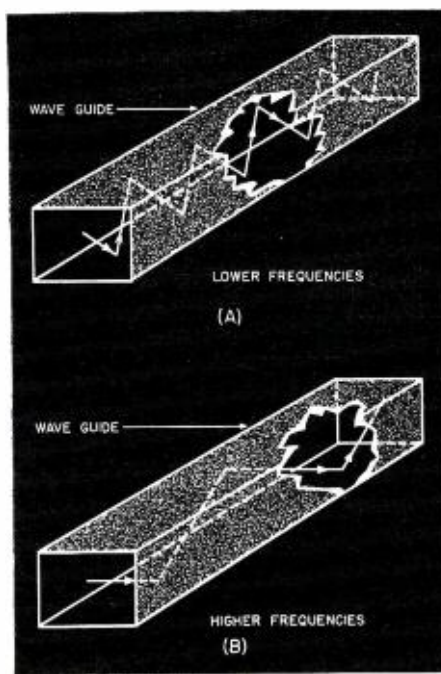

Fig. 8. Illustrating how waves move down a wave guide in a series of reflections: (A) lower frequencies; (B) higher frequencies.

agram such as shown in part (A) of Fig. 4 can be used. This is equivalent to a half wavelength of an a.c. wave where the same conditions exist, such as a maximum value in the middle and zero at either end.

Fig. 6 shows what sort of electric

field distribution is obtained when it is desired to get a full-wave variation from one side of the wave guide opening to the other. For the first half wave the field is shown going in one direction while in the other half wave, the electric field is naturally going in the opposite direction just as the current reverses in going from one half cycle to another in ordinary a.c. circuits. The process is continued for one more illustration in Fig. 7 where a variation in electric field strength equal to a wavelength and a half is shown. Following this line of reasoning, any number of cycles can be drawn.

Since in any illustration of an electromagnetic wave there are both magnetic and electric lines of force, the magnetic lines are shown as dashed in order to distinguish between them and the electric lines of force. The important point to remember is that the greater the number of lines shown at a point, the stronger is the field strength at that point.

In sending an electromagnetic wave down a wave guide, it might at first be thought that the energy travels in a straight line through the interior or dielectric of the guide. If this were true, and the dielectric used consisted of air, then there should be no difference between the velocities of the wave measured inside or outside the rectangular guide. But it was found that the measured velocity inside the wave guide was always slower than the cor-



Available from local dealers or by writing factory direct.

Yours for the asking!

Universal Stroboscope

PHONOGRAPH AND RECORDER AID

This handy phonograph turntable speed indicator, complete with instructive folder, is now available gratis to all phonograph and recorder owners through their local dealers and jobbers. As a recorder aid the Universal Stroboscope will assist in maintaining pre-war quality of recording and reproducing equipment in true pitch and tempo.

Universal Microphone Co., pioneer manufacturers of microphones and home recording components as well as Professional Recording Studio Equipment, takes this means of rendering a service to the owners of phonograph and recording equipment. After victory is ours—dealer shelves will again stock the many new Universal recording components you have been waiting for.



UNIVERSAL MICROPHONE CO.

INGLEWOOD, CALIFORNIA



"You are the virile, red-blooded type who loves adventure. Nothing daunts you. You could fight your way through the wilds of the jungle; across the blistering desert sands. Read TRUE, The Man's Magazine!" (One of the great family of Fawcett Publications.)

ELECTRICIANS! RADIO MEN!

Earn More Money!

Get this new
GIANT SIZE

**ELECTRICAL
and RADIO
TROUBLE
SHOOTING
MANUAL**
GUARANTEED BY
COYNE

Yours 5 Days Free

**OVER
500**

Large Size
Electrical and
Radio
Shop Prints
-How to read
and use them

Needed by war workers, maintenance men, beginners, old timers! Nothing else like it. Saves time, helps boost your pay... **4 GREAT BOOKS IN ONE!**
1. New Step-by-Step Trouble Shooting Course. 2. 500 Shop Prints. 3. Electrical Dictionary. 4. Spare Time Jobs.

FREE! 1 yr. Technical Counsel by mail from COYNE staff, on trouble-shooting problems.

SEND NO MONEY! See offer below. Satisfaction guaranteed by famous COYNE "Learn-by-Doing" Electrical School. Rush coupon now!

H. C. LEWIS, Pres., Dept. C4-M9
COYNE ELECTRICAL SCHOOL
500 S. Paulina St., Chicago 12, Ill.

Send, with all shipping charges paid, your new COYNE Electrical and Radio Trouble Shooting Manual. Within 5 days after getting it I'll either return it or send \$5, then \$3 monthly until total of \$8.95 is paid. [] Cash price \$8.00—you save over 10%. Same 5-day free trial and return privilege.

NAME _____
ADDRESS _____
CITY _____ STATE _____

Specify SAUERISEN
ACIDPROOF CEMENTS—COMPOUNDS
FOR
Tanks, Sewers, Stacks, Floors
Technical cements for all purposes.
Send sketches or samples
Sauereisen Cements Company • Pittsburgh 15, Penna.

responding velocity taken in free space. This difference could only be explained if the path inside were greater than the outside distance and this could only be true if the interior waves followed a zig-zag path off the walls. Fig. 8 shows how the reflections take place in order to bring about this increase of distance. The action could have been predicted to a certain degree, since the energy waves that leave any of our land-based antennas usually have a series of reflections from the Kennelly-Heaviside layers and the surface of the earth as they travel along. For rectangular wave guides, the velocity of each wave is found to possess the following characteristics:

1. It is dependent on the frequency, that is, varies inversely as the wavelength although in no case exceeding that of light.

2. Dependent also on the width of the guide.

If the walls of the guide were perfect conductors, the energy of the wave would not decrease as it bounced back and forth along the length of the guide. However, the actual materials used, such as copper or brass, introduce losses that increase as the number of reflections increase and these increase as the wavelength gets longer. Referring to Fig. 8 it can be seen that the longer wavelengths bounce off the walls more often as they are propagated down the guide. Each one of the reflections introduces losses and so these wavelengths are attenuated much faster. In fact, as the frequency is lowered, a point is soon reached where the wave just bounces back and forth at the mouth of the wave guide and is not transmitted at all. This is known as the cut-off frequency of the guide, and represents the upper wavelength limit that can be transmitted. In this respect is seen one of the important properties of a wave guide, namely, its action as a high pass filter. All waves of a certain frequency will be transmitted more or less freely, whereas waves with frequencies lower than this cut-off frequency will have a high attenuation and will not be transmitted at all, or at least not very far. For the $TE_{0,1}$ type of wave pictured in Fig. 5, the cut-off frequency is given by

$$\text{cut-off} = \frac{c}{2b} \frac{\text{cycles}}{\text{sec.}}$$

where

c = velocity of light

b = the width of the wave guide.

For the $TE_{0,2}$ type of wave guide, the cut-off frequency is twice as great and is given by

$$\text{cut-off} = \frac{c}{b} \frac{\text{cycles}}{\text{sec.}}$$

The above means that with both the $TE_{0,1}$ and $TE_{0,2}$ types of field patterns there is a definite filter effect but the $TE_{0,2}$ cuts off at a higher frequency than the $TE_{0,1}$.

To show what all this means in actual frequencies, take a numerical case where the dimension b is found to be

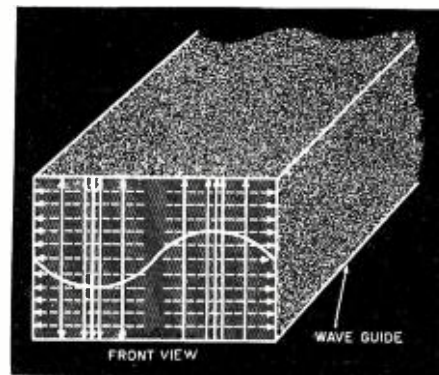

Fig. 9. Arrangement of the electric and magnetic lines of force of a $TE_{0,2}$ type of wave.

10 centimeters. Substituting in the formula for the $TE_{0,1}$ case it is found that

$$= \frac{3 \times 10^{10}}{2 \times 10} = 1500 \text{ mcs./sec.}$$

Using the same guide for the $TE_{0,2}$ wave it is seen that 3000 megacycles per second is the cut-off frequency. Thus the important factors determining the cut-off frequency are the width of the guide and the type of wave being transmitted down this guide.

(To be continued)

LEARN CODE

the way you'll be using it

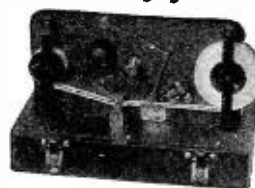

by SOUND

The best way to learn to read code is by listening to code. The best way to learn to send code is by hearing your own

sending repeated back to you. With the new All-Electric Master Teleplex Code Teaching Machine, you learn code the natural, easy, fascinating way. Only instrument ever produced which records your sending in visible dots and dashes—then SENDS BACK your own key work at any speed you desire. There are NO PERFORATIONS—NO INK. Far superior to anything ever developed... a marvel of simplicity. That's why practically every school teaching code uses MASTER TELEPLEX. We furnish complete course, including the All-Electric Master Teleplex, give you personal instruction with a MONEY-BACK GUARANTEE—All at a surprisingly low cost. Write today for FREE catalog RN-6. No obligation.

TELEPLEX CO., 107 HUDSON ST. JERSEY CITY, N. J.

WOMEN IN RADIO?

Certainly. Making good, too—as radio technicians in broadcast stations, with airline companies, police radio networks, radio laboratories and radio mfg. plants. Our thorough course prepares for all these fascinating fields. Write for details, stating age and education. No salesman will call.

VALPARAISO TECHNICAL INSTITUTE
Dept. W Valparaiso, Ind.

Guaranteed Rebuilt VIBRATORS—\$1.00 ea.

Send old vibrator. For very prompt delivery, enclose remittance and return postage. We rebuild any make or kind of vibrator or relay. Send your old vibrator to

BEST VIBRATOR CO., Box 5802
Cleveland 1, Ohio

Use This Vital Publication

Keep in Touch

WITH YOUR INDUSTRY'S TRENDS

For a clear, helpful hook-up with current technical development in research, new applications, and the use of electronics in communications, television and allied fields, you need Radio-Electronic Engineering edition of Radio News.

Designed especially for engineers, Radio-Electronic Engineering serves as a big *centralized laboratory* where all the challenging developments of the coming months are kept under observation at once. It brings to the individual subscriber (who must be qualified by his job and business) a monthly flow of informative and timely articles, plus broad news coverage... the background needed by men responsible for charting the pres-

ent and future development of their companies.

There is no newsstand circulation of Radio-Electronic Engineering edition of Radio News! The right to subscribe is limited to the engineers and the executives directly connected with the industry... and the designers and purchasing men allied with them. This makes possible brevity and directness in editorial treatment of each vital development... gives qualified readers what they want in their own language. *If you belong to the groups named, the thing to do at once is to make sure Radio-Electronic Engineering reaches your desk regularly. Mail the coupon TODAY.*

RADIO NEWS: Editorially and pictorially this long-established publication covers the radio world in its broader aspects. Hams, servicemen, dealers, etc., will find a wealth of material. Everyone identified with radio should include Radio News as "must" reading.

Subscribe Today!

Ziff-Davis Publishing Company
540 N. Michigan Ave., Chicago 11, Illinois

Enter my subscription to Radio News. Enclosed find check for ...
1 year, \$3.50 ... 2 years, \$5.50

Name _____

Address _____

Firm Name _____

City _____ State _____



" I'm sorry
I invented
the pocket! "

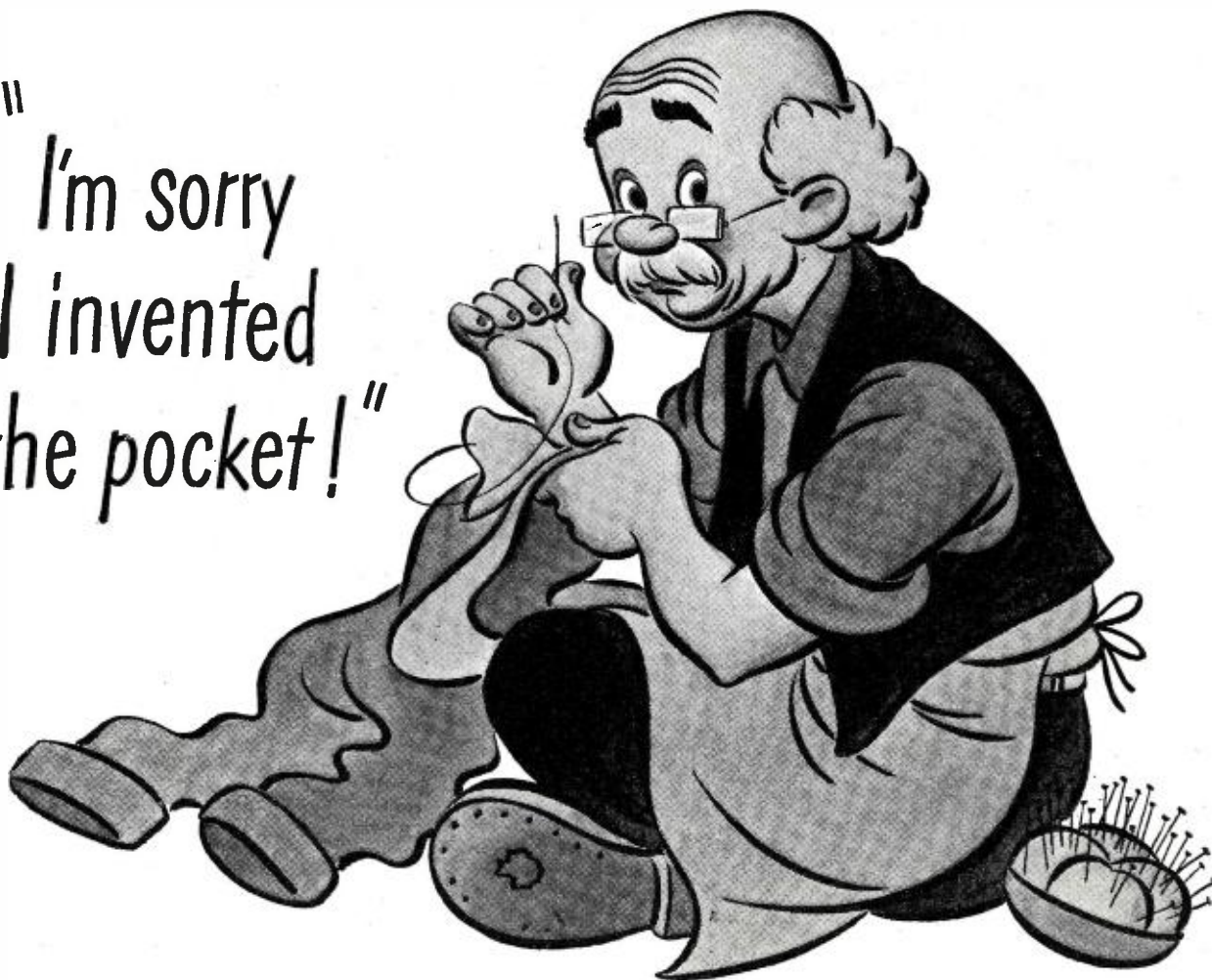

IF I HAD KNOWN that some Americans would be using pockets to hold all the extra money they're making these days I never would have invented them.

POCKETS ARE GOOD places to keep hands warm.

Pockets are good places to hold keys...and loose change for car-fare and newspapers.

But pockets are no place for *any* kind of money except actual expense

money these days.

The place—the *only* place—for money above living expenses is in War Bonds.

Bonds buy bullets for soldiers.

Bonds buy security for your old age.

Bonds buy education for your kids.

Bonds buy things you'll need later—that you can't buy now.

Bonds buy peace of mind—knowing that your money is in the fight.

Reach into the pocket I invented. Take out all that extra cash. Invest it in interest-bearing War Bonds.

You'll make me very happy if you do.

You'll be happy too.

WAR BONDS to Have and to Hold



ZIFF-DAVIS PUBLISHING COMPANY

This is an official U. S. Treasury advertisement—prepared under auspices of Treasury Department and War Advertising Council

..... LETTERS FROM OUR READERS

THE AMATEUR

CONGRATULATIONS on your splendid editorial in the April, 1944 issue of RADIO NEWS concerning radio amateurs. 'For the Record' it is the best I have read yet. Not many have come out as bluntly as you. In behalf of all amateurs and the K6 gang, thank you."

Aloha,
GEORGE STILLMAN (K6 5BM),
Lanikai, Oahu, Hawaii.

Thanks om! We've received many similar letters like yours. Many come from overseas. Yes, we're still optimistic!

TEST EQUIPMENT

I HAVE noticed in recent issues of RADIO NEWS, your appeal to civilians to sell their test equipment to the Signal Corps.

"I hope your articles have met with success and brought the situation to the attention of the public. I think that if some such appeal or campaign was started to get parts for the test equipment we have, the situation would be eased considerably.

"As an instrument repairman, I have seen numerous test sets, tube checkers, etc., tagged 'Beyond Repair' because of the lack of such parts as a moving coil or a hair spring. We dislike junking equipment which we know is costing huge sums of money but there is nothing we can do. When a moving coil in a meter of a tube checker burns out, we have no way of rewinding it and no replacements, so we have no alternative but to tag it, 'Beyond Repair.'

"To me it seems a darn shame that a set that might cost a hundred dollars new, can't be fixed because of the lack of a part that wouldn't cost more than a couple of dollars."

Respectfully,
SGT. ROBERT E. GADD,
APO 538, New York.

Sounds like a good idea. No doubt steps are being taken to ease this situation abroad.

SW SECTION

I HAVE just purchased the June issue of RADIO NEWS in which your new department appears. At long last a magazine has come out with a good SW section and I must say yours is the best I've ever seen.

"I've looked over the West Coast Tips and have found them to be very accurate as to listings. I was surprised that the West Coast list didn't include the BBC North American Service. I receive it here very excellently from 5:00 p.m. to 9:45 p.m. (PWT) GSC on 9.58 mcs. seems to be the loudest, with GSU a close second.

Other stations are heard faintly. Tokyo's JLG-2 has very good sigs in the mornings, fair weather or foul; and Melbourne's 10:00 p.m. (PWT) over VLG-4 is also a powerhouse. Berlin's DZD on 10:543 is also heard up to 9:30 p.m. PWT or later with nice sigs at times.

"I have been unsuccessful in receiving TPC-5 on 15:24 or any Swiss or Swedish stations, although I have a good receiver. I have not been able to receive Russia either.

"Keep up the good column. I'll be reading it every month."

Very truly yours,
CHARLES BOEHNKE,
Sherman Oaks, California.

We are glad that you find the column helpful. We hope that others who are getting good results with the short-wave listings would write us and let us know about it.

HELPFUL SUGGESTIONS

I AM not in the habit of writing letters to 'Editors,' either of magazines or newspapers, but I am of the opinion that you are open to suggestion as to subjects for articles in RADIO NEWS. I would like to mention a couple of subjects that I am pretty sure would be of general interest to your many readers.

"First, I would like to compliment you and Mr. Kiver for the excellent series, 'Theory and Application of UHF.' I have found these articles of intense interest to me and I am sure to thousands of others. Mr. Kiver has a way of expressing his subject which makes it easy to grasp his meaning. His chapters on transmission lines have cleared up many points for me.

"RADIO NEWS, in my estimation, has improved immeasurably these last two years, but there are a couple of subjects that I notice you have not covered. First, the theory and application of cathode followers. I have been able to find very little material in magazines and technical books on this phase of radio and I thought you might start a series on that subject. I am under the impression that cathode followers are not only used for audio purposes but also in r.f., such as low-impedance methods of coupling an r.f. amplifier to the antennas and possibly interstage coupling. I believe, to judge from what I have already seen and heard about cathode followers, that they will be of considerable interest in the near future.

"Second, the subject of magnetic tape recording might be more fully covered. This appears to be the coming method of recording unless I have been misinformed. I realize it has been in use for a long time, but I understand that a vast improvement in technique has been made lately. Pos-

7 Days Free Examination

PRACTICAL RADIO INFORMATION

Including Frequency Modulation—Television, etc.
Inside Radio Information for all Servicemen—Aircraft Pilots, Students. AUDELS RADIO-MAN'S GUIDE contains 772 Pages, 400 Diagrams & Photos is complete—gives Authentic Principles & Practices in Construction, Operation, Service & Repairs. Covers clearly and concisely Radio fundamentals — Ohm's Law—Physics of sound as related to radio science—Measuring Instruments—Power supply—Resistors—Inductors—Condensers—Transformers and examples—Broadcasting stations—Radio Telephony—Receivers—Diagrams—Construction—Control systems—Loud speakers—Antenna systems—Auto Radio—Phonograph pickups—Public Address Systems—Aircraft & Marine Radio—Radio Compass—Beacons—Automatic Radio Alarms—Short Wave—Coil Calculations—Testing—Cathode ray oscillographs—Static Elimination—Trouble Pointers—Underwriter's standards—Units and tables—Frequency Modulation—REVIEW QUESTIONS & ANSWERS, Ready Reference Index.

\$4 COMPLETE • PAY ONLY \$1 A MO.
Get this practical information in handy form for yourself—Fill in and MAIL COUPON TODAY—

AUDEL Publishers, 49 W. 23rd St., N.Y.
Mail AUDELS NEW RADIO-MAN'S GUIDE for free examination. If O.K., I will send you \$1 in 7 days; then remit \$1 monthly until \$4 is paid. Otherwise I will return it.

Name _____
Address _____
Occupation _____
Reference _____ R.N

Katolight A. C. Generators

Furnish Same Current as
City Power Lines

Kato Engineering products are carrying
out an important job in the War Effort.

A maneuvering fighting force cannot arrange for a power line hook-up. KATOLIGHT GENERATORS furnish electricity on the field of battle which permits equipping our fighting forces with the most modern electrical appliances.

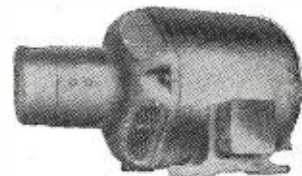

"10 K.W. Revolving Field Generator"

Fighting forces need guns, planes, tanks, trucks, kitchens, emergency hospitals, lights, etc. To keep this equipment going, complete repair equipment such as drills, grinders, saws, air-compressors, etc., are needed. Standard A.C. electricity, the same as you get from the power line, must be had for operating these devices. Portable Katolight generators supply this electricity. They also supply current for radio transmitters, beacons, landing field controls, etc.

Available in all standard voltages and sizes up through 25,000 watts. Also manufacturers of rotary converters, frequency changers, motor-generator sets, gas engine driven battery chargers, high frequency motor-generators and converters.

KATO ENGINEERING CO.
116 Rock St. Mankato, Minn., U. S. A.

The Pick of the Whole Blooming Industry

— Monthly by Mail

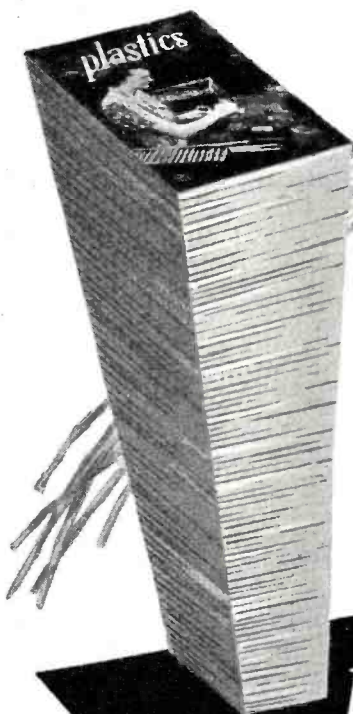

COLOR ILLUSTRATIONS
FROM THE DESIGNERS

TIMELY ARTICLES BY
DISTINGUISHED TECHNICIANS

STORIES FOR
NON-ENGINEERING READERS

PRODUCTION
WRINKLES

CHART DIAGRAMS

NEWS FROM THE
LABORATORIES

It IS a blooming industry—from manufacturers of plastics equipment to users of plastic parts. After a long pre-war period of budding promise, many phases of the business are blossoming and bursting with new developments—big future possibilities.

The pick of all this activity is presented in a visual and extremely legible form—once a month by mail—in *Plastics Magazine*. This editorial selection is made to keep any reader with a definite stake in the plastics industry POSTED on PROGRESS in ALL PHASES.

If that describes you and you stand to gain as the industry gains, you ought to be a *Plastics* subscriber. The publishers restrict subscriptions to those actually in or of the industry, but those who qualify are welcomed. Use the coupon, if convenient, to start getting *Plastics* at once.

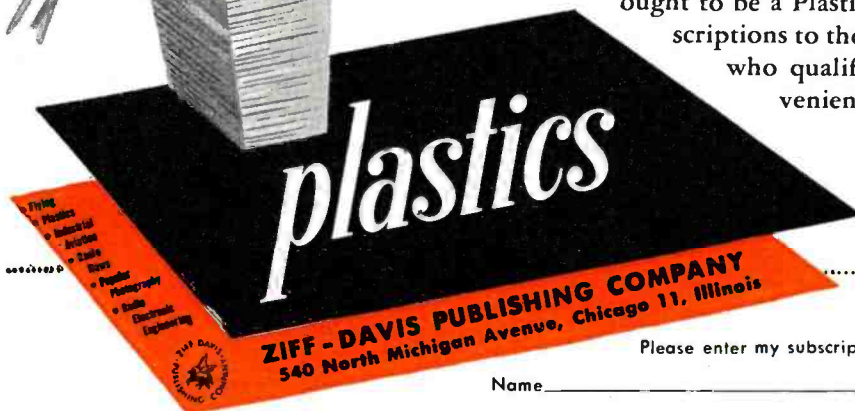

ZIFF-DAVIS PUBLISHING COMPANY
540 North Michigan Avenue, Chicago 11, Illinois

Please enter my subscription to *Plastics* for 1 year, \$5.00; 2 years, \$8.00.

Name _____

Address _____

City _____ Zone _____ State _____

Company Name _____ Title _____

NOTE: Subscription to *Plastics* is open only to business executives, engineers, designers, and production men; be sure to fill in company name and title above.

Please enter my Subscription to
PLASTICS Magazine

sibly you could see your way clear to publish an article on that subject, written by someone who has built one and can give complete construction data. I realize, of course, that at the present time, it is impossible to obtain steel tape, at least I have found it so.

"Although I am not a subscriber to RADIO NEWS, I am a steady purchaser of the magazine at the newsstand and for my money, it is the best radio magazine of them all."

Yours truly,
C. Brown,
Verdun, Quebec, Canada.

Our thanks to Mr. Brown for his suggestions on subject matter. A complete description of the Armour Research Foundation's Magnetic Wire Recorder was given in the November issue of Radio-Electronic Engineering edition of RADIO NEWS by the inventor, Marvin Camras.

SCREWDRIVER MECHANICS

RATHER belatedly, I have gotten around to reading 'For the Record' by the Editor in the May, 1944 issue.

"I would like to add a few pertinent remarks both pro and con to the thoughts expressed therein. I have put 15 years into the radio game, so I consider myself a 'citizen.'

"The statement hailing the demise of the 'screw-driver' mechanic with the advent of complicated electronic devices and radio receivers amuses me. Reports of his 'death' have been grossly exaggerated ever since the inception of multi-band receivers, a.v.c., high-fidelity amplifiers, television, and FM sets.

"The 'screw-driver' radio-service mechanic is now patronized for several reasons; if he is in business for himself, his prices, availability to local consumers and his good business ability; if he is working for someone else, low wages, ability to get a price and ability to do a fair repair job within a reasonable time, make his services desirable.

"The 'screw-driver' mechanic is here to stay. All that can be done about him is to reduce the threat he represents to 'legitimate' radio service. I believe we can go a long way toward accomplishing this by means of the combined responsibility of the radio manufacturing industry and radio servicemen.

"... The answer to this problem lies in licensing of radio servicemen. Examinations must be frequent, perhaps, three or four times a year. The license should be valid for at least a year, maybe more. The scope of the examination should cover theory of all radio, television, and FM receiver circuits, and a practical test using the latest type test instruments for analysis of faults. Additional credit should be allowed for "Ham" license holders and each year of experience in radio service. This will take a lot of time, but how else can we get the public to recognize ability, back-breaking

work, and hours of study and expenditures for expensive test equipment.

"The idea behind the examination and license should be to guarantee to the customers the ability of the technician to do a job on his radio—and not to keep men and women from entering the radio servicing field. Phonies will either 'bone up' or give up in the face of this competition.

"There are several ways that the manufacturer can help the serviceman. The chassis and loudspeakers should be removable from the cabinet after loosening one wing bolt or nut. Every part should be labeled, and where this is not possible, the chassis space just adjacent to the part ought to bear the schematic reference number. A full, complete technical bulletin and parts list should be part and parcel of the equipment. Complete technical information on the functioning of each circuit should be included with each set. The more data available on each set, the easier it is to keep it 'on the ball.'

"To recapitulate, there should be some changes made, 'but quick.' What do the readers think?"

SAMUEL BERGER,
Eatontown, New Jersey.

Well, readers, what do you think about the licensing suggestions?

-50-

Book Review

(Continued from page 60)

termines the popularity of such favorites as Bob Hope, Fibber McGee and others was set up to give unbiased reports to the companies who sponsor your evening's entertainment.

Beside the background material, briefly sketched above, the authors have gone into the details of conducting such a survey and the reasons why such a study is necessary. They freely admit that no survey of this type can be all-inclusive as the group so sampled is not completely representative (they must be listed in the telephone book, for example) but the results are accurate enough to justify the publishing of regular Hooper ratings from which radio stations and sponsors alike may decide what sort of programs we shall be hearing from our loud speakers next year.

The information given in this book is of interest not only to those who are at the sending end of the programs but to the listening public as well. If you enjoy a little "behind the scenes" view of this popular medium of entertainment, you will like this book.

ERRATUM

In the June issue of Book Review, we quoted the price of Audel's "Radio-man's Guide" as \$2.00. This price should have been listed as \$4.00. We regret this error occurred and hope that no great inconvenience has been caused our readers.

-50-

NEWCOMB Portable SOUND SYSTEM



READY for immediate action anywhere... only 39½ pounds... a complete, powerful sound system. Remarkable volume! Users report: practical on land up to ½ mile; at sea, up to 2 miles.

Ideal for use in amphibious operations, ship-to-ship communications where radio might be dangerous, life saving operations, civilian or prisoner control, cadet training, field instruction, any similar activity.

Unit includes: microphone, amplifier, power supply, loudspeaker. Write today for complete specifications.



UNDER 4 FLAGS

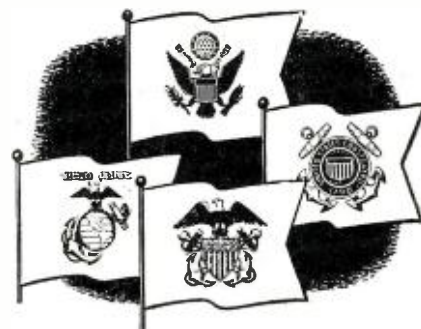

RIDER BOOKS

are training Radio men

In addition to use as texts in all the armed services, Rider Radio Books are also found in leading libraries and famous technical schools; to mention a few: Georgia Tech., Univ. of Pennsylvania, Northwestern Univ., Virginia Polytech., Manhattan College, M I T, Univ. of Delaware, Carnegie, Duke, Harvard, Syracuse and Univ. of Alabama.

Send Today for New Catalog

JOHN F. RIDER, Publisher, Inc.

404 FOURTH AVENUE • NEW YORK CITY
EXPORT DIV.: ROCKE-INTERNATIONAL ELEC. CORP.
100 VARICK STREET, NEW YORK CITY. CABLE: ARLAB

CAREERS

for
ENGINEERS

at
**NATIONAL UNION RADIO
CORPORATION**

You who join our research and engineering staff now to help us with the important war work we are doing will be embarking on a career. Our plans for the future offer unusual opportunities for able men. Our staff today forms a friendly capable team of scientists and engineers whose accomplishments have brought national recognition. You'll enjoy working with them, growing with them.

THESE ARE OPPORTUNITIES. We are adding to our staff engineers who specialize in

- ELECTRONIC TUBES
- PRODUCTION
- DEVELOPMENT
- MEASUREMENTS
- PHYSICS
- ELECTRICITY
- TRANSMITTING TUBES

Our laboratories in Newark, N. J., offer ideal working conditions. We prefer that you have a degree in electrical engineering, physics, chemistry or mathematics—your experience, however, may be sufficient.

Why don't you find out whether there's a place for you with our fine staff of specialists. Write and tell us about yourself or Phone HUmboldt 2-5252, Ext. 72, for appointment.

**NATIONAL UNION RADIO
CORPORATION**

50 Spring Street, Newark 2, N. J.

★ INDUSTRIAL ★ MAN-POWER BUREAU

PRESS WIRELESS INC.

Has openings for persons with radio communication and manufacturing experience.

- ENGINEERS
- TECHNICIANS
- OPERATORS
- SCHOOL INSTRUCTORS
- LABORATORY MEN
- MANUFACTURING FOREMEN
- ELECTRICAL DRAFTSMEN
- SERVICEMEN

Apply: Personnel Division

230 W. 41st Street
NEW YORK
OR
435 North Michigan Ave.
CHICAGO, ILLINOIS

RADIO STATION TECHNICIANS

Transmitting or Receiving

MEN AND WOMEN

for Point-to-Point International Radio-communications Stations in the United States and abroad.

Applicants, possessing at least an F. C. C. Radiotelegraph Commercial License, are preferred.

Essential workers need release statement.

Apply weekdays, except Saturdays, between 10 a.m. and 3 p.m. or write

PERSONNEL DEPARTMENT

R.C.A. COMMUNICATIONS, Inc.

64 Broad Street
NEW YORK 4, N. Y.

JUNIOR AND SENIOR ASSISTANT DESIGN ENGINEERS

One of the country's leading designers and manufacturers of radio equipment, now engaged totally in critical war production of small intricate mechanical and electrical mechanisms, has a substantial opportunity for several men or women with at least three years of practical mechanical design and drafting experience. Must be able to make neat, accurate parts drawings with complete specifications, assembly drawings and layouts; assume responsibility, and have knowledge of general standard shop and field practices. Write fully stating age, education, experience, draft status, and compensation required. Must comply with W. M. C. regulations.

COLLINS RADIO CO.
CEDAR RAPIDS, IOWA

FIELD SERVICE ENGINEERS

For domestic and foreign Service. Also instruction book writers. Good knowledge of Radio and Or experienced in technical writing.

Essential workers need release.

**HAZELTINE
ELECTRONICS CORP.**

58-25 Little Neck Parkway
Little Neck, Long Island

RADIO ENGINEERS

At least two years' design and development experience with Radio Communications Equipment manufacturer on items subsequently satisfactorily produced in quantity. Knowledge and experience in two-way mobile equipment, low power transmitters, receivers, and control equipment essential. Permanent position. West Coast Manufacturer. Will pay expenses to coast for interview if qualifications satisfactory. Write giving complete past experience, employment record, salary received, and technical references.
BOX NO. 356 c/o RADIO NEWS

"This section is designed to help the radio industry obtain trained, experienced, technical men to facilitate vital war production. Before applying for any of these positions consult your local United States Employment Service office to determine War Manpower Commission regulations concerning the changing of jobs. If you are already employed in war work at your highest skill, stick to your present job."

ELECTRONIC

ENGINEERS
TECHNICIANS
DESIGNERS
DRAFTSMEN
TUBE TECHNICIANS

EXCELLENT OPPORTUNITIES
IN A MAJOR POST-WAR FIELD!

Openings available at our Research Laboratories and Electronics Manufacturing Unit. Leaders in the design and development of vital electronic equipment for the Armed Forces.

Essential workers need release.

Write, stating Experience, Education, Draft Status, Salary. Include snapshot if available. Or apply to

SPERRY

GYROSCOPE COMPANY, INC.
RESEARCH LABORATORIES
STEWART AVE. & CLINTON RD.
GARDEN CITY, NEW YORK

WANTED— SENIOR RADIO ENGINEERS

Executive type with thorough practical and educational background in radio and electronics. Must have substantial experience and demonstrated initiative in design, research, and development. Capable of supervising development and production engineers. Excellent working conditions. Permanent positions with ample opportunity for advancement. Outline complete details of qualifications, experience, and when available. Salaries open. Confidential inquiries respected. Write.

PERSONNEL DIRECTOR
Air Communications, Inc.
Kansas City 10, Missouri

Technical Writers Wanted!

Engineers and physicists who have had experience in (spare time) writing technical manuscripts on electronic design or applications including radio, television, facsimile, etc. Highest rates.

Reply Box 310, c/o RADIO NEWS
540 N. Michigan Ave., Chicago 11, Ill.

RADIO SALES ENGINEER

Available immediately; 15 years electrical & radio sales. Last with Government industrial planning in electronics. Fine record of sales achievement and hard hitting high integrity. College graduate seeks connection with radio or elect. allied lines in post-war product sales. Prefer Chicago or New York locale. Salary or comm. or both. Age 41. State of avail. & uses consent. Box 358, Radio News.

Wanted ENGINEERS

- Radio
- Chemical
- Electrical
- Electronic
- Mechanical
- Metallurgical
- Factory Planning
- Materials Handling
- Manufacturing Planning

Work in connection with the manufacture of a wide variety of new and advanced types of communications equipment and special electronic products.

Apply (or write), giving full qualifications, to:

C. R. L.
EMPLOYMENT DEPARTMENT

Western Electric Co.

100 CENTRAL AV., KEARNY, N. J.

Applicants must comply with WMC regulations

SYLVANIA ELECTRIC PRODUCTS INC.

has openings for

ELECTRICAL ENGINEERS
MECHANICAL ENGINEERS
MACHINE DESIGNERS
RADIO TECHNICIANS

to work with us on the design, development and production of radio tubes, fluorescent lamps, electronic equipment and devices.

We want men who have the "know how" of getting things done under pressure, and who would like to become associated with a company whose post-war future is indeed encouraging.

Reply giving age, education, and experience to our

INDUSTRIAL RELATIONS
DEPARTMENT

500 Fifth Avenue New York (18), New York

POSITIONS OPEN

Design Engineers
Field Installation
and
Maintenance Engineers
at

WESTINGHOUSE

For Field Service Work
with
Micro-Wave Equipment

Opportunity for Service
Outside the United States
If Desired.

Radio Engineers and Electrical Engineers acceptable for brief training course prior to field assignments.

No one employed at his highest skill in essential industry should apply.

Applicants living outside the Baltimore area must obtain a "Statement of Availability" from their nearest United States Employment Service office.

Apply in Person or by Letter to

RADIO DIVISION
WESTINGHOUSE ELECTRIC &
MANUFACTURING COMPANY
2519 Wilkins Avenue
Baltimore, Maryland

ELECTRONIC ENGINEER OR ELECTRICAL ENGINEER WITH HIGH FREQUENCY EXPERIENCE

A desirable position is open in the Electronic Research Division of one of our clients, a stable, well established, industrial concern in the northwest part of Chicago. Man with mechanical engineering background preferred. Position has to do with the manufacturing problems of industrial electronic equipment and is permanent. Give full information as to extent and nature of education and experience, salary expected, age, draft and marital status.

Business Research Corporation

79 West Monroe Street
Chicago 3, Illinois

**★ INDUSTRIAL ★
MAN-POWER BUREAU**

Continued

**Wanted
at once!**

- FOR RADAR PRODUCTION
- ELECTRONIC ENGINEERS
- ELECTRONIC TECHNICIANS
- LABORATORY MEN
- MANUFACTURING FOREMEN
- ELECTRICAL DRAFTSMEN
- SERVICEMEN
- INSPECTORS

Permanent positions, excellent pay and working conditions. A job with a future. Wire to Wayne Davis, Personnel Director, immediately!

**WATERS CONLEY
COMPANY**
ROCHESTER, MINNESOTA

**RADIO DESIGN
ENGINEERS**

Radio Design Engineers thoroughly experienced on design of radio receivers. Position offers an excellent permanent opportunity with a well established New York company for war and post war work. Write giving full particulars, background and experience.

c/o RADIO NEWS BOX 357

WANTED

Engineer

**CAPACITOR LABORATORY
ELECTROLYTIC OR PAPER DESIGN
MICAMOLD RADIO CORP.**

1087 Flushing Ave., Brooklyn, N. Y.
STagg 2-9820, Ext. 43 WMC Rules

(Continued from page 130)

straight line or a curve. A closer approximation may be obtained by warbling the test frequency instead of using a steady frequency, or by increasing the number of mike positions. Typical curves are shown in Fig. 8. Each curve represents one of three widely separated positions of the mike used for picking up sound. Each point is the average of three secondary positions, the curves being fitted to the points by a statistical method. The figures along the vertical axis are the settings of the attenuator and the horizontal axis shows the actual clock readings obtained in seconds. The reverberation times indicated are secured by extension of each curve to a 60-db. range and taking the corresponding time interval. The average of the three values shown is 2.06 seconds.

The optimum reverberation time is something else again. Fig. 7 shows the best reverberation times based on experience. The reverberation time is governed to a certain extent by the absorption. For a live room, or one containing a small amount of sound absorbing material, the Sabine formula

yields rather fairly accurate results: $t = .05 V/a$ seconds, where t is the reverberation time in seconds, V is the volume of the room in cu.ft., and a is the total absorption of the room in sabin. The sabin is a unit equivalent to the absorption of 1 sq. ft. of a surface of unit absorptivity.

This equation was used for nearly thirty years; even the fallacious conclusion to which the equation leads for a room with totally absorptive surfaces (namely that $t = .05 V/S$ instead of zero, where S is the total surface area of the room) was overlooked or was not sufficiently disturbing until comparatively recent years when acoustics developed considerably as a science. A more accurate formula, due to Eyring, is:

$$t = \frac{.05 V}{-S \log_e (1-a_{av})} \text{ seconds}$$

$$\text{where } a_{av} = \frac{a_1 S_1 + a_2 S_2 + a_3 S_3 \dots}{S_1 + S_2 + S_3 \dots}$$

$a_1, a_2, a_3 =$ absorption coefficients of the various surfaces S_1, S_2, S_3 .

and the proper operation of the set.

Fig. 8. Typical curves obtained when using reverberation time-measuring equipment.

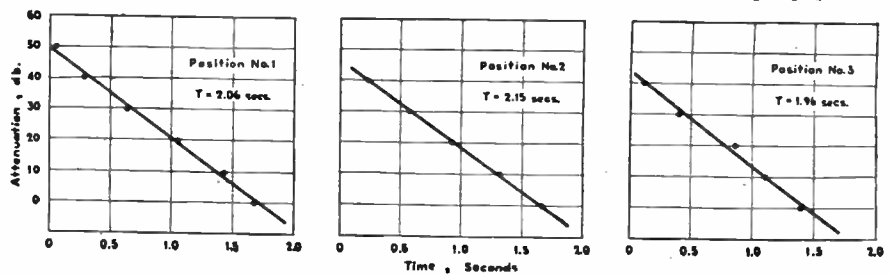

**Wartime Care of Your
Radio**

THERE are many things which the radio dealer-serviceman can do to keep his prewar customers although parts are scarce and merchandise is nonexistent.

One of the interesting "contact keepers" which has come to our attention is a small four-page folder entitled "Wartime Care of Your Radio" written by D. A. Hill of the Northwest Radio Laboratory.

This little booklet is written for the guidance of the radio user and the material is handled in an informal and nontechnical manner.

Mr. Hill has outlined five general operating tips which include the proper placing of the instrument in respect to radiator and window locations, the length of time the set should be operated in view of existing tube shortages and the procedure to follow if the set fails to operate or is noisy. Servicemen will agree heartily with Mr. Hill's admonition to users not to attempt amateur repairs.

In a second section of the folder, the care and use of a.c.-d.c. sets is discussed with special emphasis on avoiding the grounding of antenna wires

The radio-phonograph combinations are covered in a separate section, and include operating instructions for manual and automatic record changers. Proper lubrication of the instrument by a serviceman is stressed for good performance results.

The car radio is discussed with various operating procedures for the radio correlated with the operation of the car in order to provide maximum protection for the radio and minimum battery drain.

Four pertinent points about the serviceman and the job he is doing today in keeping sets in operation are given to solicit customer cooperation and understanding.

A box where the service shop may insert its own name is left so that this message may be personalized for the serviceman's customers.

Radio shops who are interested in making these booklets available to their customers should write to Mr. D. A. Hill, Northwest Radio Laboratories, 6509 Germantown Avenue, Philadelphia 44, Pa., for prices and deliveries.

PHOTO CREDITS

Page	Credit
29.....	Celotex Corporation
32 (top).....	U. S. Army Signal Corps
37.....	Westinghouse
39.....	Owens-Illinois Glass Co.
41, 47.....	Frank Ross, Staff Photographer
43, 45, 46.....	Underwood and Underwood
64.....	Acme

Radio AND ELECTRONIC DEVICES



BURSTEIN-APPLEBEE CO.
1012-1014 McGee St. • Kansas City 6, Missouri

Correspondence Courses in **RADIO and ELECTRICAL ENGINEERING**

ELECTRICAL ENGINEERING Get good grasp of wide electrical field. Prepare yourself at Low Cost, for secure future. Modern courses. So simplified anyone can understand quickly.

RADIO ENGINEERING Extra fine course in radio, public address, photo-electric work. Trains you to be super-service man, real vacuum-tube technician. Services needed badly. Diploma on completion.

Send postcard or letter for Free Copy of school catalog, full details, all about deferred payment plan, etc. **SEND NOW!**

WRITE TO: LOW \$25 Either AS Course

LINCOLN ENGINEERING SCHOOL, Box 61R-SB Lincoln, Nebr. (Formerly of Washington, D. C.)

TUBES • PARTS

RADIO DEALERS—SERVICEMEN

Send for our list of available tubes and repair parts. Sylvania, Tung-Sol, National Union.

M. V. MANSFIELD CO.
937 Liberty Ave. Pittsburgh, 22. Pa.

COMMERCIAL RADIO INSTITUTE

A radio Training center for over twenty-four years.

RESIDENT COURSES ONLY.

Pre-Induction, Broadcast, Marine Telegraphy, Aeronautical, Television, Service.

Classes now forming for Fall term. Oct. 9th. Literature upon request.

Dept. D., 38 W. Biddle St. Baltimore 1, Md.

RADIO TECHNOLOGY

RCA Institute offers an intensive two-year course of high standard embracing all phases of Radio and Television. Practical training with modern equipment. Also shorter specialized courses in Commercial Radio Operating, Radio and Television Servicing, and Aviation Communications. For Free Catalog write Dept. RN-44.

RCA INSTITUTES, Inc.
A Radio Corporation of America Service
75 Varick St., New York 13, N. Y.

PEN-OSCIL-LITE

Extremely convenient test oscillator for all radio servicing; alignment • Small as a pen • Self powered • Range from 700 cycles audio to over 600 megacycles u.h.f. • Output from zero to 125 V. • In use by Signal Corps.

GENERAL TEST EQUIPMENT CO.
38 Argyle Buffalo 9, N. Y.

S = total exposed area in room or theater
e = natural log base.

It should be noted, incidentally, that there will be a smaller change in the reverberation time of a theater equipped with leather upholstered seats, having high absorption, than in one having wood seats and a much smaller absorption for a change in the number of people in the audience.

A brief tabulation of sound coefficients for some of the more common materials is given in Fig. 3.

The reverberation time affects the articulation in speech. The relationship is illustrated by Fig. 9. Each curve gives the relation of the percentage articulation to the reverberation time when the average loudness is held at the indicated level.

Fig. 6 shows that the highest possible articulation is secured at an intensity level of 70 db.; that lower levels result in a decrease in the articula-

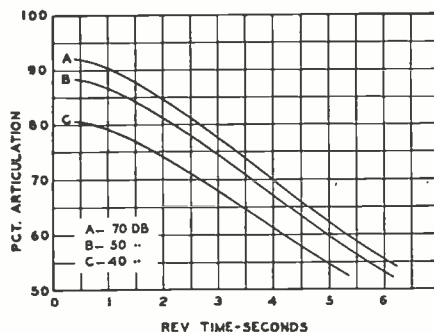

Fig. 9. The relationship between the percentage articulation and the reverberation time is shown by these curves, for a theater of any size, with speech amplified to various intensity levels.

tion and intelligibility is demonstrated by the curves in Fig. 9. With the level maintained constant at 70 db. for speech, hearing will be best. There is a small change in hearing conditions for the levels of 70 and 60 db., but going down to a level of 50 db. results in rapid falling off of the intelligibility beyond that 50-db. level. The reverberation time must then be held to within a narrower range to secure satisfactory hearing.

\$600 Prize Contest

IN endeavoring to prepare themselves as completely as possible to further the postwar interests of servicemen, Burlingame Associates of New York have just announced an unusual contest.

\$600.00 in Bonds (\$100.00 per month for 6 months) will be given for best letters on the subject, "My Idea of the Ideal Postwar Radio and Television Service Bench." First prize each month is a \$50.00 War Bond. Monthly second and third prizes are each a \$25.00 War Bond.

For further details and rules see page 76 of this issue.

Order From RADOLEK



RADIO PARTS ELECTRONIC APPARATUS SOUND SYSTEMS

Make Radolek your dependable buying source for everything in radio, sound and electronics. We can supply essential merchandise to repair any radio—tubes, condensers, resistors, controls, transformers, etc.—all at lowest prices.

Large Stocks: Radolek's large stocks assure the finest and most complete selections of all available items. Thousands of servicemen rely on Radolek for their entire requirements.

Fast Service: Streamlined handling of every order simplifies procurement problems and gives you the fastest possible delivery. Whatever your need—for industry, the Armed Forces or civilian replacement—ordering from Radolek saves time, effort and expense.

Get This Free Buying Guide



SEND TODAY!

RADOLEK CO., Dept. B-93,
601 W. Randolph St., Chicago, Ill.
Please send your FREE Buying Guide.

Name

Address

DEALER SERVICEMAN SOUND ENG.

SAVE AT RADOLEK

BACK THE ATTACK!

Buy an additional bond today.

Learn RADIO-ELECTRONICS

12 WEEKS TRAINING IN COYNE SHOPS ON REAL RADIO—ELECTRONICS EQUIPMENT! FOR MEN 16 UP TO 50

Prepare for a great Peace time future and a good job in Radio—Electronics now. Coyne "LEARN BY DOING" training covers latest developments in this field. Prepare quickly, easily. Fascinating well paid work in maintenance, installation and servicing Radio—Electronic equipment.

ELECTRONICS AND TELEVISION

Tremendous expansion in Radio, Electronics, Frequency Modulation and Television predicted after the war—a world of new opportunities. Get ready for a Peace time future and a good job NOW with practical Coyne Radio Training.

I'LL FINANCE YOUR TRAINING!

Get training first—then pay for it in easy monthly payments starting 60 days after your training period is over. I assist you in getting part-time work while at COYNE to help pay living expenses. Job Service when trained. **ALSO HAVE FACILITIES FOR MEN WITH PHYSICAL DISABILITIES.** WRITE!

FREE BOOK! Whether you're 16 or up to 50 get facts. Special Industrial Electronics training included at no extra cost now. Mail coupon today.

H. C. LEWIS, Pres., RADIO DIV., COYNE ELEC. SCHOOL
500 S. Paulina St., Dept. CA-1K, Chicago 12, Illinois

H. C. LEWIS, Pres., RADIO DIV., COYNE ELEC. SCHOOL
500 S. Paulina St., Dept. CA-1K, Chicago 12, Illinois

Send me FREE BOOK, "Your Future in Radio-Electronics", and details of Industrial Electronics training included at no extra charge and easy "Pay-After-Graduation" plan.

NAME.....AGE.....

ADDRESS.....

CITY.....STATE.....

INDEX OF Advertisers

August 1944

COMPANY	AGENCY	PAGE No.	COMPANY	AGENCY	PAGE No.
Aerovox Corporation	Austin C. Lescarboursa & Staff.	147	M. V. Mansfield	Western Advertising Agency	145
Air Communications, Inc.	Henry H. Teplitz, Adv. Agency	143	Meck, John Industries	Ross Llewellyn, Inc.	104
Allied Radio Corporation	Evans Associates, Inc.	64	Merit Coil & Transformer Co.	Equity Advertising Agency	144
American Phenolic Corporation	Grant & Wadsworth, Inc.	82	Micamold Radio	James Millen, Inc.	12
Audel, Theodore & Co.	Beaumont and Hohman Inc.	139	Millen, James, Mfg. Co., Inc.	John A. Smith & Staff	68
Belmont Radio Corporation	W. S. Hill Company	20, 21	Murdock, Wm. J. Co.	Graydon Smith, Advertising	73
Best Vibrator Co.	Shappe-Wilkes, Inc.	136	National Company, Inc.	Van Sant, Dugdale & Co.	94
Bliley Electric Company	Burke Dowling Adams & Co.	110	National Electronic Supply	The Mayers Co.	3
Bogen, David Company	Charles Brunelle	74	National Radio Institute	Kennedy & Co.	105
Breeze Corporations, Inc.	O'Callaghan Advertising Agy., Inc.	115	National Schools	Hutchins Adv. Co., Inc. 2nd Cover	80
Browning Labs., Inc.	Frank C. Whalen Adv. Co.	130	National Scientific Products Co.	A. N. Baker Adv. Agency	142
Burlingame Associates	Van de Mark Advertising, Inc.	76	National Union Radio Corp.	Dozier Graham Eastman Adv.	114
Business Research Corporation	Henry J. Kaufman	143	Nelson Co.	Henry H. Teplitz	59
Burstein-Applebee Co.	Gustav Marx Adv. Agency	145	Newcomb Audio Products	Pioneer Advertising	120
Candler System Co.	J. R. Hamilton Adv. Agency	126	Ohmite Manufacturing Co.	Shappe-Wilkes, Inc.	111
Capitol Radio Engineering Institute	Wilson & Haight, Inc., Adv.	78	Permoflux Corp.	Turner Advertising Agency	84
Centralab	Reiss Advertising	96	Philco Corporation	Hutchins Advertising Company	121
C. P. Clare & Co.	Hart Lehman Advertising	70	Press Wireless, Inc.		142
Collins Radio Company	Burton Browne Advertising	142	Radio & Technical Division of		
Commercial Radio Institute	McJunkin Adv. Co.	145	Murray Hill Books, Inc.	Harry P. Bridge Co., Adv.	67
Connecticut Telephone & Elec. Div.	MacDonald-Cook Co.	87	Radio City Products	Reiss Advertising	134
Cornell Dubilier	Shappe-Wilkes, Inc.	124, 136, 145	R.C.A. Communications	A. Frank-Guenther Law, Inc.	142
Cornish Wire Company, Inc.	Sternfield-Godley, Inc.	79	R.C.A. Engineering Division	Kenyon & Eckhardt, Inc.	77
Consolidated Radio Products Co.	Hill Advertising, Inc.	60	R.C.A. Institutes		145
Coyne Electrical School	Shappe-Wilkes, Inc.	75	R.C.A. Victor Division	Kenyon & Eckhardt, Inc.	93
DeForest's Training, Inc.	Zimmer-Keller, Inc. Adv.	124, 136, 145	Radolek Company	Turner Advertising Agency	145
DeJur-Amsco Corporation	Austin C. Lescarboursa & Staff.	102	Rider, John F., Publisher, Inc.	Lansford F. King	141
Detrola Corporation	Burton Browne Advertising	61	Sauersein Cements		136
Distillations Products, Inc.	Shappe-Wilkes, Inc.	86	Schott, Walter L. Co.	Barton A. Stebbins	108
DuMont, Allen B. Lab., Inc.	Shappe-Wilkes, Inc.	117	Shure Brothers	Henry H. Teplitz	132
Echophone Radio Co.	Sternfield-Godley, Inc.	19	Simpson Electric Co.	Kreicker and Meloan, Inc.	116
Electronic Corp. of America	Hill Advertising, Inc.	71	Snyder Mfg. Co.	Phillip Klein Advertising Agency	122
Electro-Voice Mfg. Co., Inc.	Shappe-Wilkes, Inc.	95	Solar Manufacturing Corp.	O. S. Tyson and Company, Inc.	13
Fada Radio & Electric Co.	Marschalk & Pratt Co.	11	Sperti, Inc.	Stockton West, Burkhardt, Inc.	125
Fawcett Publications	Henry J. Kaufman	6, 106	Sprague Products Co.	The Harry P. Bridge Co.	63
Federal Mfg. & Engineering Corp.	O. S. Tyson and Company, Inc.	136	Sprayberry Academy of Radio	The Harry P. Bridge Co.	15
Federal Telephone & Teleg. Corp.	N. W. Ayer & Son, Inc.	129	Sperry Gyroscope, Inc.	Equity Advertising Agency	143
Gates Radio & Supply Corp.	Campbell-Ewald Company	11	Standard Transformer Corp.	Burnet-Kuhn Advertising Co.	66
General Ceramics Company	Suzanna Hayman, Advertising	131	Stevens-Walden, Inc.	Howard-Wesson Co.	91
General Electric Co.	Merchandising Advertisers	127	Superior Instruments	Loewy Advertising Agency	14
General Motors, Delco Division	Howard H. Monk and Associates	9	Supreme Instruments Corp.	O'Callaghan Adv. Agy., Inc.	16
General Test Equipment	Kennedy & Co.	103	Supreme Publications	Henry H. Teplitz	130
Gothard Manufacturing Co.	Burton Browne Adv.	106	Sylvania Electric Products	Arthur Kudner, Inc.	8, 143
Greenlee Tool Co.	5, Back Cover	124	Teleplex Co.	Terrill Belknap Marsch Assocs.	136
Guardian Electric Mfg. Co.	Roeding & Arnold, Inc.	3rd Cover	Templeton Radio Co.	Peck Advertising Agency	85
Hallcrafters	Shappe-Wilkes, Inc.	24	Thordarson Electric Mfg. Co.	S. Duane Wanamaker Adv.	116
Haldorson Company	Shappe-Wilkes, Inc.	98	Tobe Deutschmann Corp.	Franklin Bruck Adv. Corp.	148
Hammarlund Mfg. Co., Inc.	Equity Advertising Agency	24	Triplet Electrical Instrument Co.	Western Advertising Agency	99
Harvey Radio Co.	Boszell & Jacobs, Advertising	142	United Transformer Corp.	Shappe-Wilkes, Inc.	15
Hazeltine Electronics	Henry A. Loudon Advertising	123	Universal Microphones Co., Ltd.	Ralph L. Power, Ph. D.	113, 138
Howard Manufacturing Corporation	Sander Rodkin Advertising Agy.	17	Utah Radio Products	The Buchen Company	109
Hytron Corporation	Burton Browne Advertising	7	Vaco Products	S. Duane Wanamaker Adv.	132
Illinois Condenser Co.	David, Inc.	88, 89	Valparaiso Technical Institute	Smith, Benson & McClure, Inc.	136
Jensen Radio Co.	Turner Advertising Agency	88, 89	Wallace, Wm. T. Mfg. Co.	Michael F. Mayger	96
Johnson, E. F. Co.	Shappe-Wilkes, Inc.	139	Ward Leonard Electric Co.	E. M. Freystadt Associates, Inc.	10
Kato Engineering Co.	Sander Rodkin Adv. Agency	69	Ward Products	Burton Browne Advertising	119
Knights, James Co.	Arthur Kudner, Inc.	90	Warwick Manufacturing Co.	Agency Service Corporation	97
Lafayette Radio Corp.	Buchanan-Thomas Adv. Co.	114	Waters Conley Company		144
Lake Radio Sales	Shappe-Wilkes, Inc.	107	Western Electric Co.	Deutsch & Shea	143
Lear Avia, Inc.	Shappe-Wilkes, Inc.	145	Westinghouse Electric & Mfg. Co.	Fuller & Smith & Ross, Inc.	81, 143
Lear Avia, Inc.	Aitkin-Kynett Co., Advertising	101	Wholesale Radio Labs	Allen & Reynolds Advertising	108

Classified
Rate 20c per word, Minimum, 10 words

CORRESPONDENCE COURSES

PREPARE now for tremendous opportunities in new fields of Radio after the war. Training for Federal licenses. Write for particulars. American Radio Institute, 44 East 23rd St., New York 10, N. Y.

USED Correspondence Courses and Educational Books sold or rented. Inexpensive. Money-back guarantee. Write for Free Catalog listing 4000 bargains.—(Courses Bought.)—Lee Mountain, Pisgah, Ala.

CORRESPONDENCE Courses and self-instruction books, slightly used. Sold. Rented. Exchanged. All subjects. Satisfaction guaranteed. Cash paid for used courses. Complete information and 92-page illustrated bargain catalog FREE. Write Nelson Company, Dept. 2-59, Chicago 4.

RADIO ENGINEERING

RADIO Engineering, Broadcasting, Aviation and Police Radio, Servicing, Marine Operating and Electronics taught thoroughly. Expenses low. Write for catalog. Valparaiso Technical Institute, Dept. N, Valparaiso, Ind.

FOR SALE

FULL wave Selenium Rectifiers, maximum load 2½ amperes, 50 volts input, \$3.49, 1½ lb. transformers 115 volt, secondary 30 volt 3 amperes, \$2.29, 6 pounds. Bargain list free. Milton Bursma, 105 Avondale, Jackson, Mich.

BRAND new, five-tube, AC-DC superhet kits! Crystal kits, and other radio parts. No priority needed! Complete price list, 10c. Melvin Okin, 915 Bryant Ave., Bronx, New York, N. Y.

MISCELLANEOUS radio equipment: Slightly used in Signal Corps training program. All sales F. O. B. Newark, N. J. McElroy keyers and tape pullers, \$65.00. Tapes, per reel, \$1.00. Code keys, \$1.25 and \$2.50. Riders Manuals, 13 volumes, \$125.00. Utah, Collins, Stancor, and National transmitters, never used (write for prices). Radio compass, \$175.00. RCA, TT-5 television receiver, \$100.00. National FB-7 receiver, speaker, five sets coils, 20, 40, 80, 160 meters, \$75.00. D.C. to A.C. Panatropo Converter, \$35.00. Send money order to R. G. Dougherty, 158 Market Street, Newark, N. J.

PATENT ATTORNEYS

INVENTORS—Before disclosing your invention to anyone, send for Form "Evidence of Conception"; "Schedule of Government and Attorneys' Fees" and instructions. Sent free. Lancaster. Allwine & Rommel, 414 Bowen Building, Washington 5, D. C.

MISCELLANEOUS

50, 35 and 12 SERIES tubes repaired (about 50%) 75c ea. 50c ea. if 25 or more. Cullien Radio, 798 Third St., San Bernardino, Calif.

WANTED

WANTED: Phono-recorder with or without playback arm. Robert Hiles, 358 W. 13th St., Peru, Ind.

WANTED: Any or all radio equipment; urgently require five or nine inch oscilloscope; transformers, chokes, rectifiers and condensers for 2, 3, 4 kw power supply; 25, 50, 75, 100, 125, 150 kc crystals; square wave generators; electronic switch; 110/220 V.A.C. 10,000 watt gas-driven generator; PR833A or 450TL; contractors to manufacture special equipment—write for details—name your price. H. N. Luke, 2113 Somerset Place, Oklahoma City, Okla.

WANTED—Knight 93-100 phono amplifier; Girard record changer; Jensen 15" waxial JHP 52 or JAP 60. Quote price, condition. Winter, 6071 Harper, Chicago 37.

RADIO EQUIPMENT

RADIO Service men and experimenters send for our giant radio catalogue. Save dollars. United Radio Co., (1000M) Newark, N. J.

Meeting Precision Capacitance
Tolerances to Plus/Minus 1% ...

SILVERED-MICA Capacitors



● Aerovox silvered-mica capacitors are designed for the most critical applications requiring precise capacitance values and extreme stability. Although otherwise similar in external construction and dimensions to the smaller molded bakelite units, they are encased in molded XM low-loss red bakelite for immediate silvered-mica identification.

A silver coating is applied to the mica and fired at elevated temperatures. This insures not only a positive bond but permanent stability of the capacitance



with respect to time, temperature and humidity. Units are heat-treated and wax-impregnated externally for ultimate protection against moisture penetration.

Ideal for use in circuits where capacitance must remain constant under all operating conditions. These capacitors are specifically designed for use in push-button tuning, oscillator padding circuits, fixed tuned circuits, and as capacitance standards, etc., where accuracy and stability are prime considerations.

● Write for literature ...

Average positive temperature coefficient of only .003% per degree C.—a remarkably low value.

Excellent retrace characteristics; practically no capacitance drift with time; exceptionally high Q.

Available in three types, 1000 v.D.C. test: Type 1469, .000005 to .0005 mfd.; Type 1479 (illustrated), .0001 to .001 mfd.; Type 1464, .00075 to .0025 mfd., and .001 mfd. in 600 v. D.C. test.

Standard tolerance plus/

minus 5%. Also available with tolerances of plus/minus 3%, 2% and 1%.

Minimum tolerance for capacitances up to and including 10 mmf. (.00001 mfd.) plus/minus ½ mmf. Minimum tolerance available for all other

capacitances, plus/minus 1% or plus/minus 1 mmf., whichever is greater.

Aerovox is prepared and ready to accept orders for Mica Capacitors which will meet American War Standards.



Capacitors

INDIVIDUALLY TESTED

AEROVOX CORPORATION, NEW BEDFORD, MASS., U. S. A. SALES OFFICES IN ALL PRINCIPAL CITIES
Export: 13 E. 40 ST., NEW YORK 16, N. Y. • Cable: 'ARLAB' • In Canada: AEROVOX CANADA LTD., HAMILTON, ONT.

Sandy Hook
Lighthouse,
built in 1764.

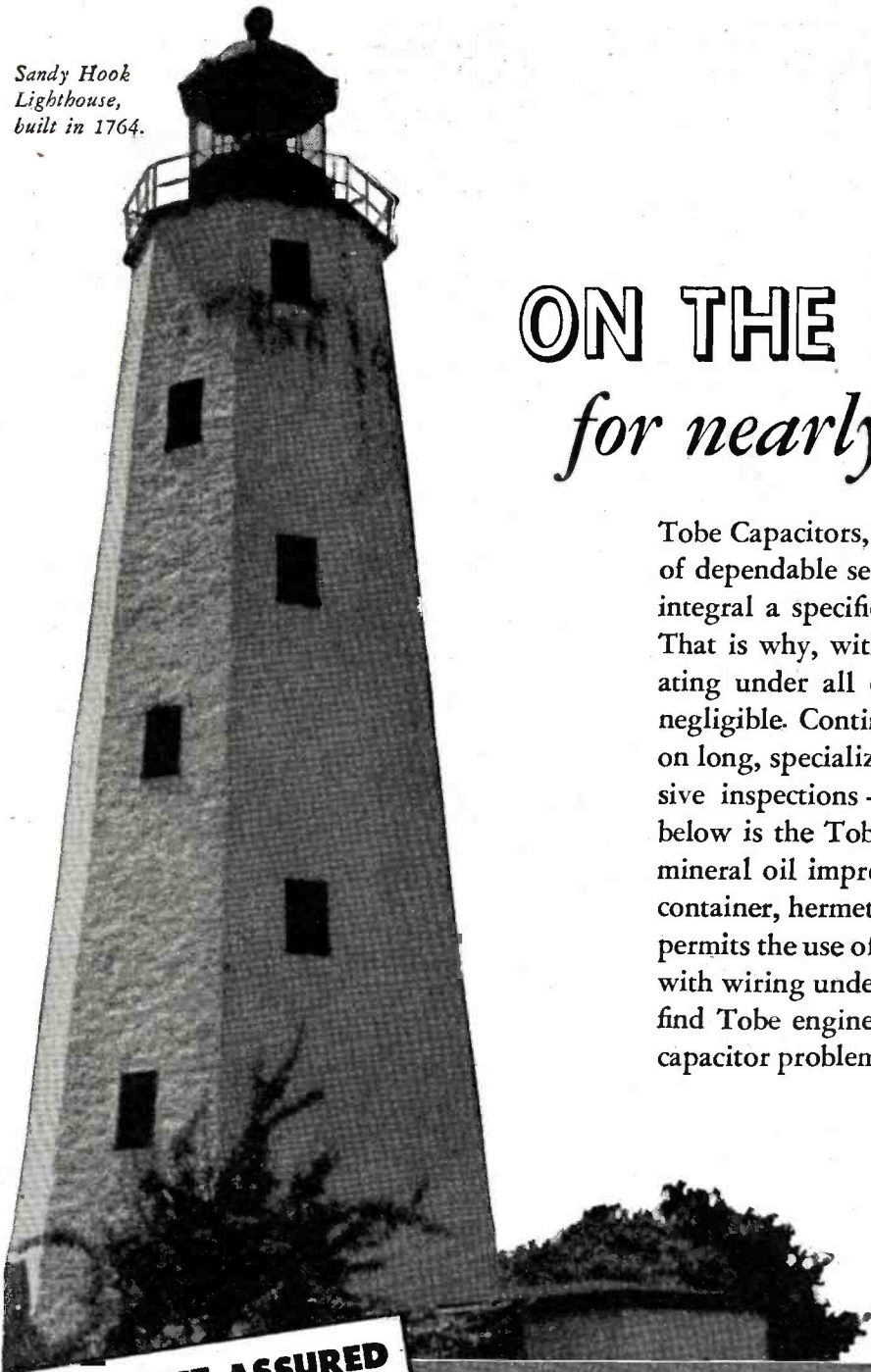

ON THE BEAM-

for nearly two centuries

Tobe Capacitors, too, are "on the beam"—giving years of dependable service . . . for, at Tobe, *long life* is as integral a specification as the dimensions themselves. That is why, with millions of Tobe Capacitors operating under all conditions, "returns" are practically negligible. Continuation of this enviable record rests on long, specialized manufacturing experience—intensive inspections — and constant research. Illustrated below is the Tobe OM-Capacitor. This capacitor is a mineral oil impregnated unit in a streamlined drawn container, hermetically sealed. The hold-down bracket permits the use of either inverted or upright terminals, with wiring underneath or on top of chassis. You will find Tobe engineers ready to cooperate on your own capacitor problems. Why not inquire now?



LONG LIFE ASSURED

OM-601
1.0 MFD.
600 V. D. C.

OM-601
1.0 MFD.
600 V. D. C.

OM-601
1.0 MFD.
600 V. D. C.

This new separate mounting is stronger and helps prevent leaks caused by breaks in can. This outstanding Tobe design takes the minimum amount of space.

SPECIFICATIONS

OM-CAPACITORS

TYPE OM-*

RATINGS05 to 2.0 mfd. 600 V. D. C.
.05 mfd. to 1.0 mfd. 1,000 V. D. C.

STANDARD CAPACITY TOLERANCE 20%**

TEST VOLTAGE Twice D. C. rating

GROUND TEST 2,500 Volts D. C.

OPERATING TEMPERATURE -55° F to 185° F

SHUNT RESISTANCE
.05 to 0.1 mfd. 20,000 megohms
.25 to 0.5 mfd. 12,000 megohms
1.0 to 2.0 mfd. 12,000 megohms

POWER FACTOR
At 1,000 cycles—.002 to .005

CONTAINER SIZE
Width 3/8", length 15/16", height 2 1/4"

MOUNTING HOLE CENTERS 1 1/2"

MIDGET OM-CAPACITORS

TYPE OMM-*

RATINGS05, .1 and
2 x .05 600 V. D. C.
.05 x .1 1000 V. D. C.

STANDARD CAPACITY TOLERANCE 20%**

GROUND TEST 2,500 V. D. C.

OPERATING TEMPERATURES -55° F to 185° F

SHUNT RESISTANCE 20,000 megohms

POWER FACTOR At 1,000 cycles—.0075

CONTAINER SIZE
Width 5/8", length 1 5/16", height 1 1/4"

MOUNTING HOLE CENTERS 1 1/2"

*Data sheets showing complete code number for units having a specific capacitance value and voltage rating available on request. **Other tolerances available.

A SMALL PART IN VICTORY TODAY...A BIG PART IN INDUSTRY TOMORROW

wherever a tube is used...

for example

THE ELECTRONIC CALIBRATOR

A recently designed automatic calibrator for frequency meters used in conjunction with adding machines largely eliminates tedious hand calibration, saves man hours, reduces element of human error, speeds production.

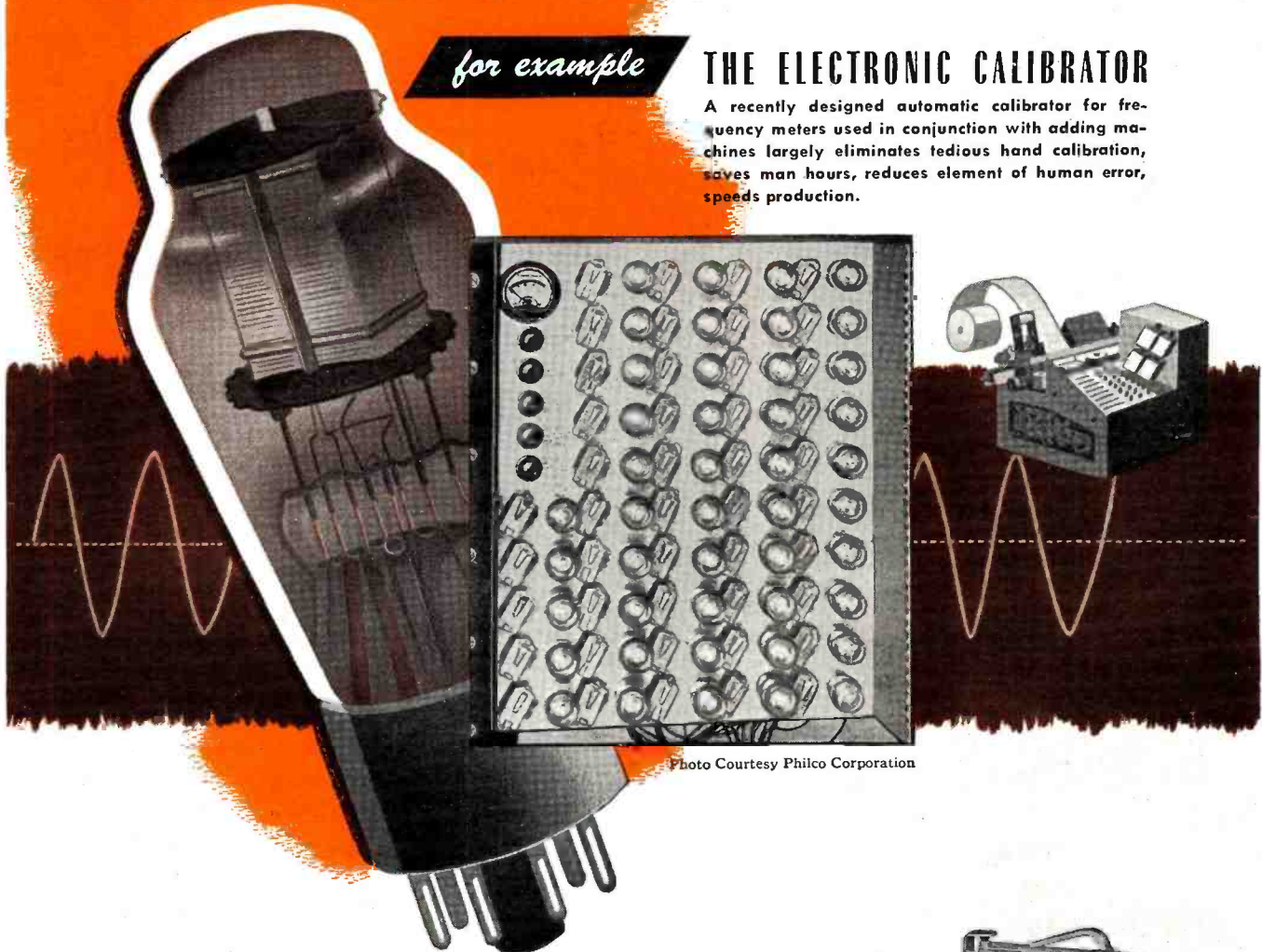

Photo Courtesy Philco Corporation

THERE'S A JOB FOR

Relays BY **GUARDIAN**

The Philco 126-tube Electronic Calibrator employs a system of fast and slow-acting relays and solenoids to bring about desired end actions. One application is the transferring of readings from the storage bank (shown above) to the keyboard of the adding machine. Operated by the plate current of OA4G tubes the relays on the storage bank energize the adding machine solenoids which press the proper number key of the adding machine.

The Guardian Series 120 relay used in this application is a small, sensitive unit having a minimum power requirement of 0.5 VA and an average of 2 VA. Coils are available in resistances from .01 to 6,000 ohms. Contact combinations up to single pole, double throw with 12.5 amp. points. Send for Bulletin 120.

The solenoid is Guardian Series 4 available for either A. C. or D. C. use. Series 4 A. C. at a maximum stroke of 1" permits a pull of 14 oz. intermittent duty, 3 oz. continuous duty. Series 4 D. C. at a maximum stroke of 1" permits a pull of 6 oz. intermittent duty, 1 oz. continuous duty. Send for information.

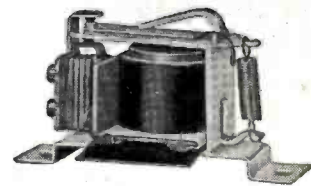

Series 120 Relay



Series 4 Solenoid

Consult Guardian whenever a tube is used—however—Relays by Guardian are NOT limited to tube applications but are used wherever automatic control is desired for making, breaking, or changing the characteristics of electrical circuits.

GUARDIAN ELECTRIC

1630-J W. WALNUT STREET

CHICAGO 12, ILLINOIS

A COMPLETE LINE OF RELAYS SERVING AMERICAN WAR INDUSTRY



MEET YOUR NEW NEIGHBOR...

Holland is a tiny nation, proud and independent. In time of peace, it was thought of as a land of dikes and windmills, of tulip beds and pleasant, industrious people. . . . But, there will be much to learn about Holland, its love for freedom and its implacable fight against tyranny and oppression . . . There will be much to learn about every nation of our world, important things for understanding and tolerance that will mean a better peace. . . . One of the finest means of studying our World Neighbors is shortwave radio. With it, you can reach any nation almost instantaneously to know the history and politics of that nation even while they are happening. . . . Look to Hallicrafters, when Peace is won, for the world's best short wave receivers —the results of over fifty million dollars worth of war research and developments in Radio.



HALLCRAFTERS RADIOS are the Radioman's Radio. Designed and built for experts, they are the world's finest shortwave receivers. Victorious Allied Armies all over the world will attest to their excellence. **THE HALLCRAFTERS COMPANY, CHICAGO 16, U. S. A.**

hallicrafters RADIO

www.americanradiohistory.com

BUY A WAR BOND TODAY