

RADIO NEWS

JULY, 1944 25c
In Canada 30c





GOOD NEWS FOR TELEVISION!

Since National Union established new production records on cathode-ray tubes—the dream of low-cost television for the average post-war home has taken a long step toward fulfillment.

Consider the fact that National Union has succeeded in raising its cathode-ray tube production to a volume many times greater than the combined pre-war C-R tube output of the entire industry! To achieve such a production miracle required, of course, completely new techniques, new mechanical aids to operators, new quality control measures. But above all, it required imagination and technical capacity to cut loose from the long prevalent conception that the manufacture of cathode-

ray tubes was strictly a laboratory project. N. U. engineers proved that these laboratory techniques *could* be adapted to high speed streamline mass production. And, it is significant that N. U. C-R tubes have acquired at the same time an international quality reputation, with special distinction for their superior fluorescent screens.

In the post-war expansion of television, as in other applications of electronic tubes for home and industry, National Union achievements in engineering and production have set new horizons. Remember to *count on* National Union.

NATIONAL UNION RADIO CORPORATION, NEWARK, N. J.
Factories: Newark and Maplewood, N. J.; Lansdale and Robeson, Pa.



NATIONAL UNION

RADIO AND ELECTRONIC TUBES

Transmitting, Cathode Ray, Receiving, Special Purpose Tubes • Condensers • Volume Controls • Photo Electric Cells • Panel Lamps • Flashlight Bulbs

J. E. SMITH,
PRESIDENT
National Radio
Institute
30th Year of
Training Men
for Success
in Radio

I WILL TRAIN YOU TO START A SPARE TIME OR FULL TIME RADIO SERVICE BUSINESS WITHOUT CAPITAL

You Build These and Many Other Radio Circuits with 6 Kits of Parts I Supply

By the time you've conducted 60 sets of Experiments with Radio Parts I supply, made hundreds of measurements and adjustments, you'll have valuable PRACTICAL Radio experience for a good full or part-time Radio job!

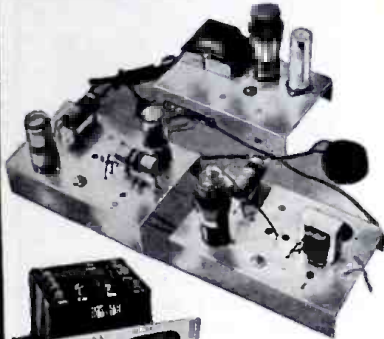

You build MEASURING INSTRUMENT above early in Course, useful for Radio work to pick up EXTRA spare time money. It is a vacuum tube multimeter, measures A.C., D.C., R.F. volts, D.C. currents, resistance, receiver output.

Building the A. M. SIGNAL GENERATOR at right will give you valuable experience. Provide amplitude-modulated signals for test and experimental purposes.

You build the SUPERHETERODYNE CIRCUIT above containing a preselector oscillator-mixer-first detector, I.F. stage, diode-detector-a.v.c. stage and audio stage. It will bring in local and distant stations. Get the thrill of learning at home evenings in spare time while you put the set through fascinating tests!



The men at the right are just a few of many I have trained at home in their spare time, to be Radio Technicians. They are now operating their own successful spare time or full time Radio businesses. Hundreds of other men I trained are holding good jobs in practically every branch of Radio, as Radio Technicians or Operators. Doesn't this prove that my "50-50 Method" of training can rise you, in your spare time at home, BOTH a thorough knowledge of Radio principles and the PRACTICAL experience you need to help you make more money in the fast-growing Radio industry?

Right now you have excellent opportunities to get a good job in this busy field with a bright peacetime future! So mail the Coupon and I'll send you—FREE—my 64-page, illustrated book, "Win Rich Rewards in Radio." It describes many fascinating types of Radio jobs, tells how N.R.I. trains you at home in spare time—how you get practical experience building and testing Radio Circuits with SIX BIG KITS OF RADIO PARTS I send!

Big Demand Now for Well Trained Technicians, Operators

Keeping old Radios working is booming the Radio Repair business. Profits are large, after-the-war prospects are bright too. Think of the new boom in Radio Sales and Servicing that's coming when new Radios are again available—when Frequency Modulation and Electronics can be promoted—when Television starts its postwar expansion!

Broadcasting Stations, Aviation Radio, Police Radio, Loudspeaker Systems, Radio Manufacturing all offer good jobs now to qualified Radio men—and most of these fields have a big backlog of business that has built up during the war, plus opportunities to expand into new fields opened by wartime developments. You may never see a time again when it will be so easy to get a start in Radio!

Many Beginners Soon Make \$5, \$10 a Week EXTRA in Spare Time

The day you enroll for my Course I start sending you EXTRA MONEY JOB SHEETS that help show how to make EXTRA money fixing Radios in spare time while still learning. I send you SIX big kits of Radio parts as part of my Course. You LEARN Radio fundamentals from my illustrated, easy-to-grasp lessons—PRACTICE what you learn by building real Radio Circuits—PROVE what you learn by interesting tests on the circuits you build!

Find Out What N.R.I. Can Do for YOU

MAIL THE COUPON for a Sample Lesson and my 64-page book FREE. My book "Win Rich Rewards in Radio" is packed with facts—things you never knew about opportunities in Broadcasting, Radio Servicing, Aviation Radio, other Radio fields. Read the details about my Course—"50-50 Training Method"—6 Experimental Kits—EXTRA MONEY JOB SHEETS. See the fascinating jobs Radio offers and how you can train at home. Read many letters from men I trained telling what they are doing, earning. No obligation. Just MAIL COUPON in an envelope or passed on a penny postcard—J. E. SMITH, President, Dept. 4FR, National Radio Institute, Washington 9, D. C.

I Trained These Men

SPARE TIME RADIO BUSINESS



"I really don't see how you can get so much for such a small amount of money. I made \$600 in a year and a half, and I have made an average of \$10 a week—just spare time."—JOHN JERRY, 1337 Kalamath St., Denver, Colo.

"I am engaged in spare time Radio work. I average from \$5 to \$10 a week. I often wished that I had an amount sooner, because all this EXTRA money sure does come in handy."—THEODORE K. DUBREE, Horsham, Pa.



"I am doing spare time Radio work, and I am averaging around \$500 a year. These EXTRA dollars mean so much—the difference between just barely getting by and living comfortably."—JOHN N. WASHINGTON, 97 New Cranberry, Hazleton, Penna.

I Trained These Men

FULL TIME RADIO BUSINESS



"For several years I have been in business for myself making around \$200 a month. My business has steadily increased. I have N.R.I. to thank for my start in this field."—ARLIE J. PROHNER, 300 W. Texas Ave., Coosco Creek, Texas.

"Thought I would drop a line to let you know how well I have done in Radio. You certainly put the truth in your advertising, for this year my income has run about \$3,000. I have taken in a total of about \$5,000 but my parts cost \$1,700."—HERBY DICKNEY, 351 P. Ave., New Castle, Ind.



"I am now operating a radio shop for myself and own all my equipment. For over a year I have only repaired radios due to the fact there have been no radios to sell. In 1942 I averaged \$200 a month and in 1943 \$250 a month."—J. M. SCRIVENER, III, Aberdeen, Md.

SAMPLE LESSON FREE

I will send you a FREE Lesson, "Getting Acquainted With Receiver Servicing," to show you how practical it is to train for Radio at home in spare time. It's a valuable lesson. Study it—keep it—use it—without obligation! Tells how Superheterodyne Circuits work, gives hints on Receiver Servicing, Locating Defects, Repair of Loudspeaker, I.F. Transformer, Gang Tuning Condenser, etc. 31 illustrations.



My Radio Course Includes
**TELEVISION • ELECTRONICS
FREQUENCY MODULATION**

GOOD FOR BOTH 64 PAGE BOOK SAMPLE LESSON FREE

J. E. SMITH, President, Dept. 4FR
National Radio Institute, Washington 9, D. C.

Without obligating me, mail your Sample Lesson and 64-page book, FREE. I am particularly interested in the branch of Radio checked below. (No salesman will call. Please write plainly.)

- | | |
|---|---|
| <input type="checkbox"/> Radio Service Business of My Own. | <input type="checkbox"/> Operating Broadcasting Stations. |
| <input type="checkbox"/> Service Technician for Radio Stores and Factories. | <input type="checkbox"/> Army, Navy Radio Jobs. |
| <input type="checkbox"/> Spare Time Radio Servicing. | <input type="checkbox"/> Operating Police Radio Stations. |
| <input type="checkbox"/> Government Civilian Radio. | <input type="checkbox"/> Operating Ship and Harbor Radio. |
| <input type="checkbox"/> Aviation Radio. | |

(If you have not decided which branch you prefer—mail coupon for facts to help you decide.)

Name..... Age.....
Address.....
City..... State..... Dept. 4FR





"Reg. U. S. Pat. Off."

JULY • 1944

VOLUME 32, NUMBER 1

25th Anniversary Issue

FEATURES

| | | |
|--|--------------------------------|-----|
| Microwaves for Postwar Railroads..... | <i>Samuel Freedman</i> | 21 |
| Photronic Code Machine..... | <i>Thomas M. Morse</i> | 25 |
| Signal Corps Radio School..... | | 28 |
| Multivibrator for Checking Receiver Sensitivity..... | <i>McMurdo Silver</i> | 30 |
| Radiometric Elements..... | <i>Albert A. Shurkus</i> | 32 |
| Wartime V.T.V.M. Circuits..... | <i>Rufus P. Turner</i> | 47 |
| Hams in Arctic Service..... | <i>George W. Shuart, W2AMN</i> | 53 |
| Servicing Hints on Tube Substitutions..... | <i>M. S. Kay</i> | 54 |
| Amplitude Modulation Measurements..... | <i>Guy Dexter</i> | 60 |
| Observations of Postwar Radio-Electronics..... | | |
| | <i>Raymond B. Frank, W9JU</i> | 92 |
| Television's Postwar Possibilities..... | <i>P. Glanzer</i> | 120 |

ANNIVERSARY SECTION

| | | |
|---|---------------------------|----|
| Milestones in the Radio Industry..... | <i>Lee de Forest</i> | 36 |
| Radio Between Two Wars..... | <i>James G. Harbord</i> | 39 |
| 25 Years of Amateur Radio Progress..... | <i>Oliver Read, W9ETI</i> | 43 |

DEPARTMENTS

| | | |
|---|-------------------------|----|
| For the Record..... | | 8 |
| Spot Radio News..... | | 10 |
| International Short-Wave..... | <i>Kenneth R. Boord</i> | 50 |
| QTC..... | <i>Carl Coleman</i> | 52 |
| Manufacturers' Literature..... | | 70 |
| Technical Book and Bulletin Review..... | | 72 |
| What's New in Radio..... | | 81 |

Copyright, 1944
ZIFF-DAVIS PUBLISHING COMPANY
 Editorial Offices: 540 N. Michigan Ave., Chicago 11, Ill.
 Member of the Audit Bureau of Circulations

RADIO NEWS is published monthly by the Ziff-Davis Publishing Company at 540 N. Michigan Ave., Chicago 11, Ill. New York Office, 270 Madison Ave., New York 16, N. Y. Washington, D. C., Office, Earle Bldg. Los Angeles Office, William L. Pinney, Manager, 815 S. Hill St., Los Angeles 14, Calif. London Editorial Representative, A. Spenser Allberry. Subscription Rates: In U. S. \$3.00 (12 issues), single copies, 25 cents; in Mexico, South and Central America, and U. S. Possessions, \$3.00 (12 issues); in Canada \$3.50 (12 issues), single copies 30 cents; in British Empire, \$4.00 (12 issues); all other foreign countries \$6.00 (12 issues). Subscribers should allow at least 2 weeks for change of address. All communications about subscriptions should be addressed to: Director of Circulation, 540 N. Michigan Ave., Chicago, 11, Ill. Entered as second class matter March 9, 1938, at the Post Office, Chicago, Illinois, under the Act of March 3, 1879. Entered as second class matter at the Post Office Department, Ottawa, Canada. Contributors should retain a copy of contributions. All submitted material must contain return postage. Contributions will be handled with reasonable care, but this magazine assumes no responsibility for their safety. Accepted material is subject to whatever adaptations, and revisions, including "by-line" changes necessary to meet requirements. Payment covers all authors, contributors or contestants rights, title, and interest in and to the material accepted and will be made at our current rates upon acceptance. All photos and drawings will be considered as part of material purchased.



COVER PHOTO
 By U.S. Army Signal Corps

Radio operator reporting troop movements from concealed position. Field unit is late model FM transmitter and receiver designed for armored vehicles. It is demountable and occasionally set up for field service.

- | | |
|---|---|
| WILLIAM B. ZIFF <i>Publisher</i> | |
| B. G. DAVIS <i>Editor</i> | C. R. TIGHE <i>Ass't to Publisher</i> |
| OLIVER READ, W9ETI <i>Managing Editor</i> | |
| WM. A. STOCKLIN <i>Associate Editor</i> | HAROLD S. RENNE <i>Technical Editor</i> |
| JOE MARTY, JR. <i>Field Editor</i> | FRED HAMLIN <i>Washington Editor</i> |
| E. H. SEHNERT <i>Chief Draftsman</i> | HERMAN R. BOLLIN <i>Art Director</i> |
| K. R. PORTER <i>War Correspondent</i> | FRANK ROSS <i>Staff Photographer</i> |
| GEORGE BERNER <i>Advertising Director</i> | S. L. CAHN <i>Advertising Mgr.</i> |
| R. B. FRANK, W9JU <i>(on leave)</i> | J. M. ECKERT <i>Midwest Adv. Mgr.</i> |
| H. G. STRONG <i>Circulation Director</i> | H. J. MORGANROTH <i>Production Director</i> |



FIRST ON THE NORMANDY COAST

The Army's SCR-299's went ashore with the wave of Allied assault troops that split the 2nd front wide open. These mobile radio units rolled up on the beachhead early in the battle to serve as vitally important front line communications weapons to coordinate and direct the striking power of the land, sea and air forces. . . . In truck or duck, the Hallicrafters-built SCR-299's go anywhere and are sturdy enough to withstand front line action. Highly dependable and powerful, they "get the message through."

hallicrafters RADIO
THE HALLCRAFTERS CO., MANUFACTURERS OF RADIO
AND ELECTRONIC EQUIPMENT, CHICAGO 16, U. S. A.



BUY A WAR
BOND TODAY!



It's CQ from the Battlefield Today!



You remember him, the kid next door who tinkered with short wave radio. Well, he's in uniform now, calling his CQ from foxholes in Italy and steaming Pacific jungles. Maybe, he's a radio operator on a bomber ... perhaps, he's an instructor. Whatever it is, you can be sure that his knowledge and experience are serving to help build a wartime communications system. Yes, from the hams came ready trained instructors, operators and engineers at a time when skilled technicians were vitally needed.

The radio amateur will be back one of these days, back to his much-loved tinkering. He'll want new equipment to add to his short wave rig. . . . He'll be looking for a JENSEN speaker because he wants highest fidelity in music, code and voice reproduction. There is no finer acoustic equipment than JENSEN reproducers.

*Manufacturers and Designers
of Fine Acoustic Equipment*

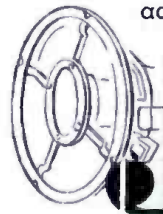

Jensen

RADIO MANUFACTURING COMPANY
6601 S. LARAMIE AVE., CHICAGO 38, U. S. A.

INTERSTAGE FILTERS BY

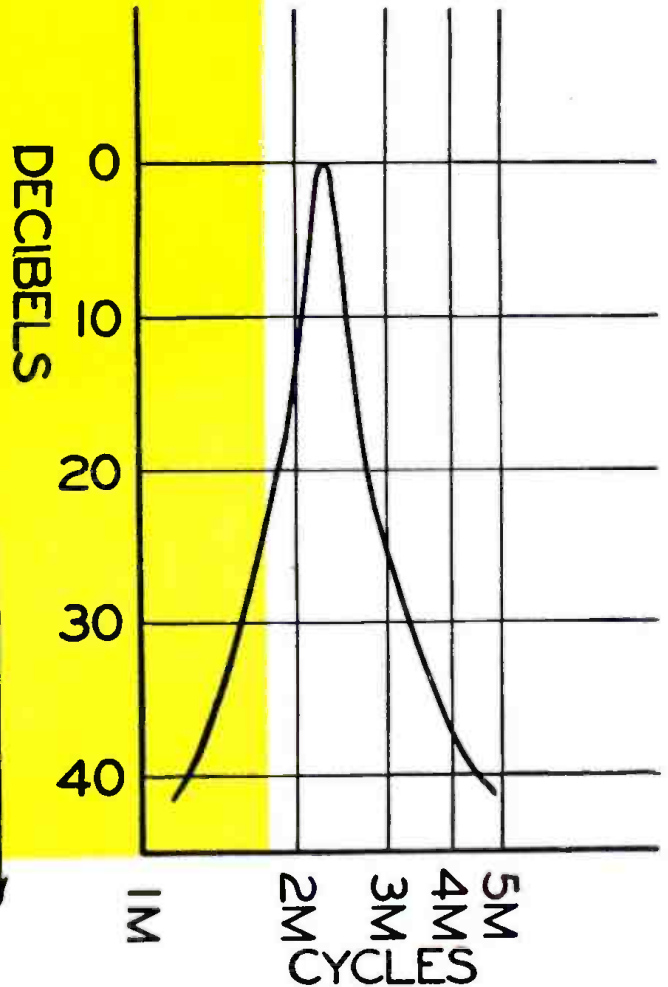
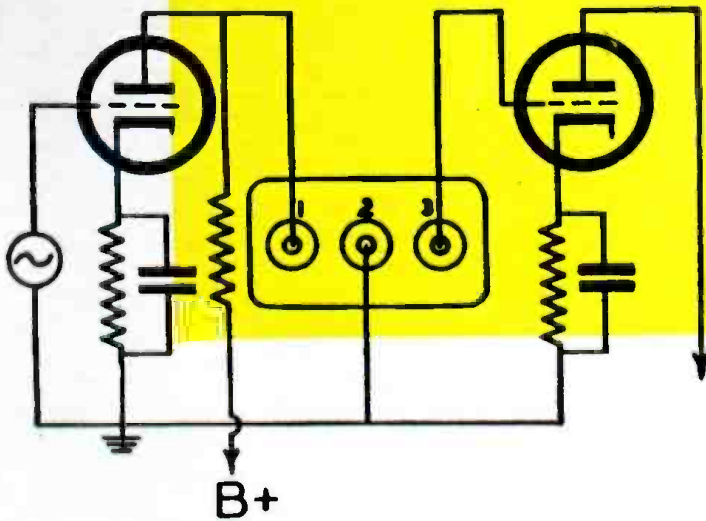
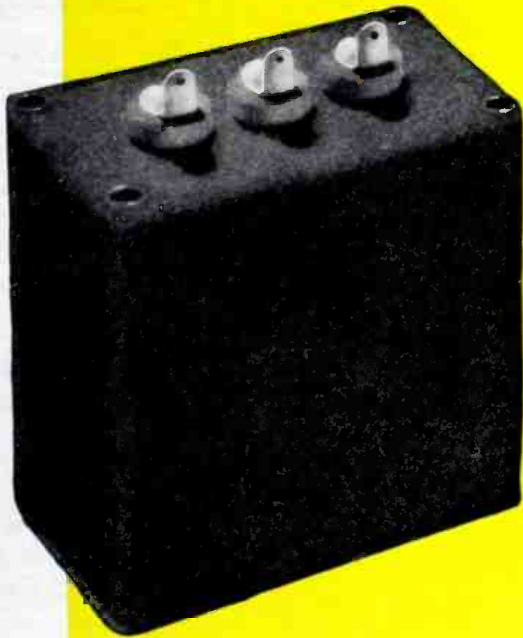

Interstage filters lend themselves to effecting gain simultaneously with their frequency discrimination. The unit illustrated is a band pass unit which provides a 2:1 step-up ratio, with band pass attenuation of 40 DB per octave. This unit employs a dual alloy magnetic shield which reduces inductive pick-up to 150 Mv. per gauss. The dimensions in its hermetically sealed case are 1½ x 2½ x 2½. Filters of this type can be supplied for any band pass frequency from 200 to 10,000 cycles.

May we cooperate with you on design savings for your application . . . war or postwar?

United Transformer Co.
150 VARICK STREET NEW YORK 13, N. Y.

EXPORT DIVISION: 13 EAST 40th STREET, NEW YORK 16, N. Y., CABLES: "ARLAB"

AUDAX

★
RELAYED-FLUX
Microdyne

Long before this war began
..AUDAX Pickup were in..

SELECTIVE SERVICE

Since pickups first became important commercially, the distinguished products of AUDAX have been SELECTED wherever and whenever the requirements were exacting.

Today AUDAX magnetically powered pickups are SELECTED for War contracts that demand the highest standards of performance, regardless of climatic variations or severe handling.

Our stern peacetime standards, maintained for so many years, have proven comfortably adequate to meet government specifications.

The sharp, clean-cut *facsimile* reproduction of MICRODYNE is a marvel to all who have put it to the only test that really matters... the EAR TEST.

AUDAX COMPANY
500 Fifth Avenue New York City

Creators of High Grade Electrical
and Acoustical Apparatus Since 1915

Send for your copy of our informative
"PICK-UP FACTS"

★ BUY
WAR BONDS

"The Standard by Which Others
Are Judged and Valued"

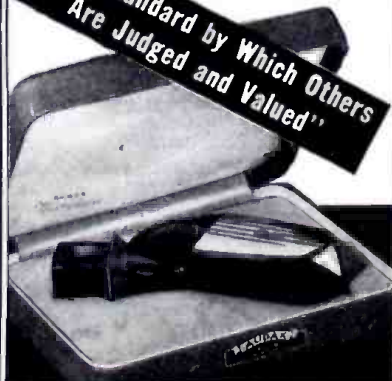

For the Record

BY THE EDITOR

ONCE again television, which has been "just around the corner" for many years, appears in the headlines. This time it is a discussion of the pros and cons of standards. Up to now the problem has been tossed back and forth between the broadcasters, the Government, and the manufacturers. With the termination of the present war now appearing somewhere over the horizon, this problem child once again comes up for its annual scrutiny.

It all boils down to whether or not we should proceed with prewar standards of television, or, with a bit of delay, to adopt new standards which would make for far better pictures. There are advantages and disadvantages to consider whichever program is pursued. Reviewing the present state of the art, we find that the prewar black and white picture, commonly referred to as 525-line, contains 480 lines from top to bottom of the visible picture and the other 45 lines cut off beyond the edges of the picture. The prewar television picture was transmitted on a 6-megacycle channel.

While the prewar picture was considered by many to be highly satisfactory, later experiments have proven that far greater definition can be obtained with the adoption of new standards. These would require approximately a 16-megacycle channel instead of the prewar 6-megacycle channel. This compares with three octaves on a piano to eight octaves. Engineers point out that the relative amount of picture detail is an all-important factor in obtaining black-and-white contrast.

Color television likewise has been improved tremendously during the past few years. The public would have much to gain as far as brilliance of picture is concerned and in detail if new standards were adopted and used for the transmission of such pictures. The disadvantage here lies in the fact that considerably more space would be required in the ether, but many feel that sufficient space could be allotted to take care of the demand for increased spectrum.

On the other side of the ledger, we find that many are opposed to any further delay and feel that prewar standards are sufficiently adequate to give the public satisfactory video reception. Several companies have invested thousands and thousands of dollars to perfect equipment based on prewar standards. Many television receivers have been built and sold to the public, but the total number of sets is but a frac-

tion of 1% of American broadcast receivers.

All now indicates that a *mutual decision* must be reached on the part of all concerned as to whether or not we are willing to wait a few months more, at the end of the war, in order to redesign new equipment for the new proposed standards, or to proceed "as is" and let the public enjoy television programs immediately following the conclusion of hostilities.

One must consider that there is bound to be a heavy postwar demand for broadcast receivers that will keep the manufacturers taxed to the limit in order to keep up with the public's demand for new sets. During this period engineers should be able, according to many, to design television sets with the new standards and to get them into production in but a few months' time.

As yet, the radio serviceman has not been able to give his opinion on the matter. Therefore, we invite his comments. We would like to know whether or not he would prefer to sell prewar television as soon as sets are available, or whether he would rather wait a few months longer in order to be able to sell and service video sets designed on postwar standards which would certainly satisfy his customers and enjoy a greater market for the sale of his merchandise.

OUR War Correspondent, Kenneth R. Porter, returned from the European Theater of Operations recently to give us firsthand information as to the performance of American-made radio-electronic equipment that has played such an important role in that theater. He is now again on the job in the British Empire and will supply RADIO NEWS readers with a complete up-to-the-minute report on radio communications during the forthcoming invasion of the German Reich.

WE celebrate with this issue the 25th anniversary of RADIO NEWS. Under normal peacetime circumstances we would celebrate with an oversized issue commemorating the occasion. Now, we are at war and we are faced with a critical shortage of paper—the same as all publishers. Therefore, we have included, as part of our editorial content this month, a special section devoted to a review of the progress made in radio during the past 25 years and to rededicate ourselves to the task of keeping our readers abreast on all radio subjects in future years. O. R.

RADIO NEWS

THAT *Extra Margin* OF PERFORMANCE
 IS *Designed* INTO FEDERAL
 COMMUNICATIONS EQUIPMENT

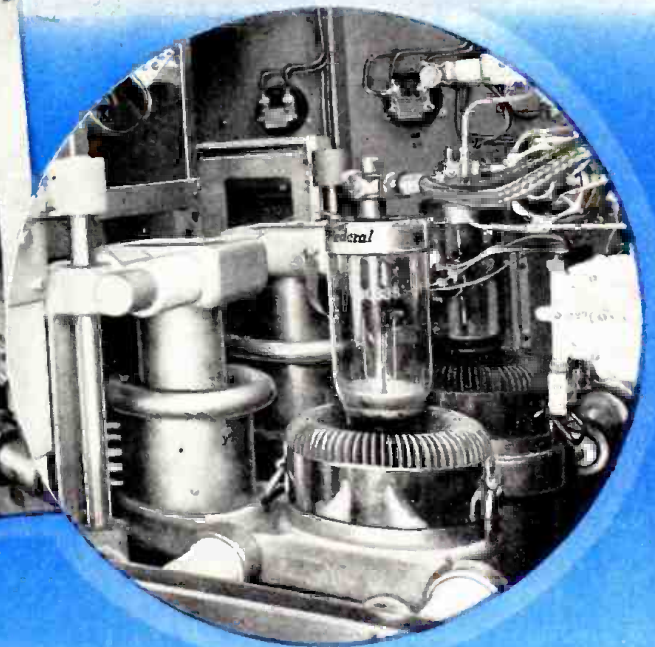
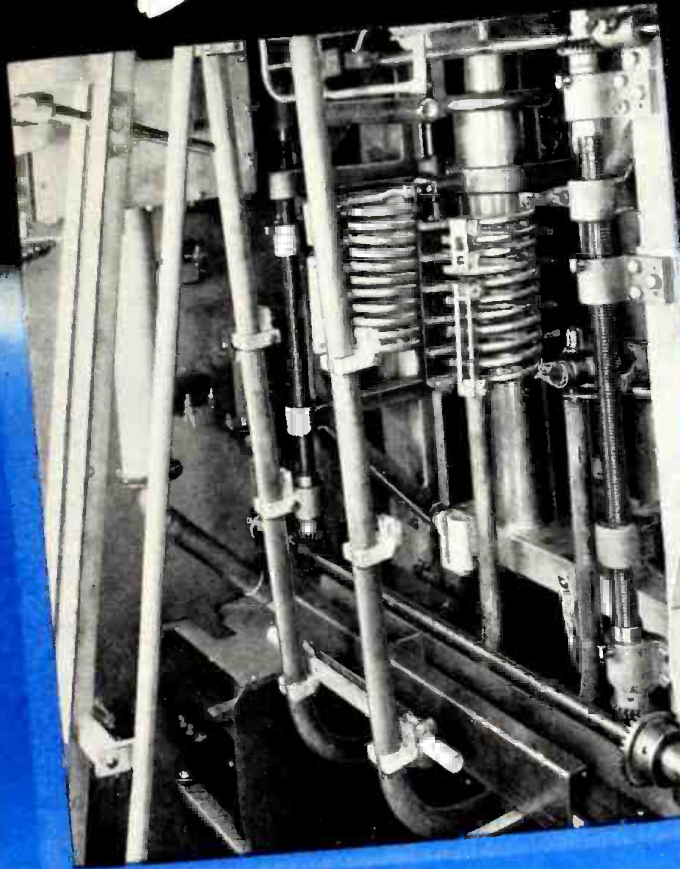

Federal, long recognized as a manufacturer of better vacuum tubes, now leads with new production methods resulting in still greater tube efficiency and length of life. Everywhere, it's Federal tubes for superior transmitting and industrial power performance.

The Federal name on communications equipment signifies exacting radio-mechanical design built in . . . plus every extra performance-giving factor.

Federal research and design development are continuous . . . adding new concepts of operation over and beyond accepted performance ratings. This extra care adds ruggedness and high performance dependability to Federal equipment.

Transmitters built by Federal are designed for smooth adjustment over the full frequency range. They are made in a great variety of frequency ranges and

power sizes . . . from walkie-talkie to 200 KW transmitters . . . in frequencies of 16 Kilocycles to the upper limit of the radio frequency spectrum.

Back of every Federal transmitter are almost three decades of engineering and manufacturing experience which assure the ability to produce any type or power of communications equipment . . . for point-to-point, broadcast, radio telephone or telegraph or for aircraft, marine or mobile stations.

Look to Federal for the finest in radio communications equipment . . . now and in the future!

Federal Telephone and Radio Corporation



Newark 1, N. J.

Designed for



Application



The 33888 Shield and the 33008 Socket

Another exclusive Millen Designed for Application product is the No. 33888 shield for use with the 33008 octal socket. By its use, the electrostatic isolation of the grid and plate circuits of single-ended metal tubes can be increased to secure greater stability and gain.

**JAMES MILLEN
MFG. CO., INC.**

MAIN OFFICE AND FACTORY
**MALDEN
MASSACHUSETTS**



Spot Radio News

By RADIO NEWS Washington Correspondent

Presenting latest information on the Radio Industry.

AN EMPHATIC EXPRESSION OF FAITH IN BROADCASTING'S future was projected by Harold Ryan upon assuming his post as president of the National Association of Broadcasters in Washington recently. He said that broadcasting's duty to its sponsors is clear cut . . . to enable them through its medium to speak honestly and sincerely of their products to the public. This concept, he explained, is as historically American as the pioneer trading post which patterned it.

"I have utter faith in America's broadcasters," he stressed. "United States broadcasters," he said, "owe to the people of the United States, good and clean programming and entertainment, honest reporting of the news and a fair interpretation of it, conscientious support of worthy community projects, and the true reflection of political and social matters.

"I believe radio is here to stay, and I have an overpowering presentiment that the Federal Communications Commission is also," said Mr. Ryan. "Both have a common objective and should be able to attain it by understanding cooperation."

In explaining the future objectives of the NAB, Mr. Ryan pointed out that the Association should continue vigorously its program for obtaining new legislation patterned to meet the requirements of an industry that has proven itself worthy.

"I believe the Association should direct its influence toward technical improvements, for in that direction lies greatest service to the people; I believe it should devote itself to removing whatever scar-tissue remains from earlier days, when broadcasting's objectives had not come into clear focus," said Mr. Ryan.

FM DISPLAYED ITS POPULARITY among newspapermen at the recent American Newspaper Publishers Association convention, held at the Waldorf Astoria in New York. Newsmen filled the huge ballroom of the Waldorf to hear the story of frequency modulation as presented by Major Edward H. Armstrong, Dr. W. R. G. Baker, of General Electric, and Walter J. Damm, vice president of the Milwaukee Journal and president of FMBI, the trade association of the frequency-modulation broadcast industry.

Analyzing FM for the newsmen, Major Armstrong said that FM is destined to replace the greater part of the AM system in a relatively short

time. He said, "Today we know FM is working up to three or four horizons, and, given suitable elevation, will outwork the standard fifty-kilowatt stations in most instances."

Dr. Baker predicted a ten-fold expansion of FM broadcasting. He said, "I fully believe that there will be a decrease in the number of standard broadcasting stations from 912 to 750, and an increase in FM stations from 53 to 500 within five years after the war."

During a question and answer period, a number of interesting facts about FM were disclosed. For instance, the latest figures compiled by FMBI indicate that there are approximately 500,000 receivers in use today. New York has 120,000 of these; Philadelphia, 20,000; Chicago, 80,000; Boston, 35,000; Milwaukee, 21,000; and Detroit, 25,000.

A COMPILATION OF THE MANY FM questions and answers presented at the round-table conference at the fifth annual meeting of the FMBI during the early part of the year, has just been completed. Some mighty interesting facts are disclosed in this Q & A digest. For instance, the answer to the question . . . "Is a limiter tube absolutely necessary in an FM receiver, and what is the purpose of this tube?" . . . as presented by Major Armstrong, disclosed that some device which will wipe out response to amplitude changes is essential. He said, "The basis of the invention is to have a receiver which responds only to wide frequency changes in the transmitted wave, and not to amplitude modulations or to small frequency changes. The limiter is the simplest way of wiping out the effect of amplitude changes. You could have, of course, a quick-acting automatic volume control or you could use counter feedback in some way to wipe out the effects; or, a synchronous oscillating tube. I am inclined to think that the ordinary limiter or perhaps a double limiter will be found to be as simple and cheap as any method which can be employed to wipe out the defects of amplitude disturbances."

The question of horizon transmission is also answered in this digest, by Major Armstrong. He was asked: "I understand that FM signals read only to the horizon. Won't this mean that many more FM stations than AM stations will be needed to assure complete United States coverage?"

He replied, "That question also covers a good deal of ground and requires

RADIO NEWS

SPRAYBERRY RADIO TRAINING

Gives you Both

TECHNICAL KNOWLEDGE
SKILLED HANDS



FULL RADIO SET SUPPLIED FOR SHOP PRACTICE!



HERE'S THE ONE PRACTICAL WAY TO TRAIN FOR BIG EARNINGS AHEAD IN RADIO-ELECTRONICS & TELEVISION

The offer I make you here is the opportunity of a lifetime. It's your big chance to get ready for a wonderful future in the swiftly expanding field of Radio-Electronics INCLUDING Radio, Television, Frequency Modulation and Industrial Electronics. Be wise! NOW'S the time to start. No previous experience is necessary. The Sprayberry Course starts right at the beginning of Radio. You can't get lost. It gets the various subjects across in such a clear, simple way that you understand and remember.

I'll Show You a New, Fast Way to Test Radio Sets Without Mfg. Equipment

The very same Radio Parts I supply with your course for gaining pre-experience in Radio Repair work may be adapted through an exclusive Sprayberry wiring procedure to serve for complete, fast, accurate Radio Receiver trouble-shooting. Thus under Sprayberry methods you do not have one cent of outlay for manufactured Test Equipment which is not only expensive but scarce.

Prepare You for a Business of Your Own or Good Radio Jobs . . . Civilian or Military

My training will give you the broad, fundamental principles so necessary as a background no matter which branch of Radio you wish to specialize in. I make it easy for you to learn Radio Set Repair and Installation Work. I teach you how to install and repair Electronic Equipment. If you enter the Army, Navy or Marine, my training will help you win higher rating and better pay.

EASY TO START

You can master the Sprayberry course in your spare time. It will not interfere in any way with your present duties. Get the facts about my training now. Take the first important step toward the money-making future of your dreams. All features are fully explained in my big, illustrated Free Book. Write for it at once!

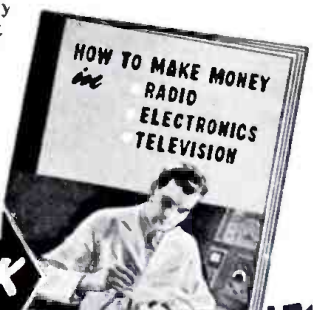

GET FREE BOOK

SPRAYBERRY ACADEMY OF RADIO
F. L. Sprayberry, Pres.
Box 500 WC
Pueblo, Colorado

Please rush my FREE copy of "HOW TO MAKE MONEY IN RADIO, ELECTRONICS and TELEVISION."

Name Age.....
Address
City State.....
Tear off this coupon, mail in envelope or paste on penny postcard.

POINT OF SALE
DISPLAYS

SYLVANIA SERVICEMAN SERVICE

by
FRANK FAX



BANNER—boldly printed in black and green on special Duckline fabric — 46 x 28-inch size just right for truck sides or any spot you pick inside or outside your shop. Comes with six brass grommets for reenforced hanging. Price: 40¢ each or 3 for \$1.00.



FLANGE SIGN—green and white enamel baked on heavyweight sheet metal — is weatherproof. Size: 16¼ x 11¼ inches. Five flange holes give sturdy mounting. Price: 25¢.



DECALCOMANIA—easy transfer of green, black and white design on windows — 7 inches in diameter. FREE.



If your distributor does not have these items in stock, send your order to Frank Fax, Sylvania, Emporium, Pa.

SYLVANIA

ELECTRIC PRODUCTS INC.
RADIO DIVISION

a definition of the horizon. Actually at stations like Alpine and Paxton, they are working three or four horizons. By horizon I mean the distance that you could see from the top of the tower if it were at sea level. From a thousand feet that would be roughly 35 or 36 miles. Actually, Alpine is working out between 100 and 125 miles. Paxton, being on a greater elevation than Alpine, is working farther. Gordon Gray's station on Clingman's Peak, which is 6,000 feet high, when operating with 50 kilowatts will certainly go close to a couple of hundred miles.

"Mount Washington, with just a few kilowatts, on a mountain of the same height, will operate over 100 miles on about 5 kilowatts power. The conductivity of the soil in New England, or the effectiveness of radio transmission up there, is such that no 50-kilowatt station would do what Mount Washington does with 3 kilowatts.

"Let me take the other extreme, that is, out on the Midwestern prairies where the conductivity is good. If we put it only on the basis of conductivity, then an FM station will not give what might be considered the equivalent of AM service out to the same distance; AM will go farther.

"Up to 100 miles, however, FM will give a service which is so much better than AM that were the listener to make his choice he would listen to the FM station.

"Let's go a little farther and take the case where the AM stations have other stations operating on the same frequencies. There you will find the AM range will be pushed in at night-time perhaps to 25 per cent of its effective day range. The range of the FM station will continue to be the same as it is in the daytime.

"The reason for that is that FM has a peculiar property which is that unless an interfering signal is somewhere between 25 and 50 per cent of the strength of the signal that you want to hear, it will not cause any disturbance at all. On the other hand, an AM station, having 1 or 2 per cent of the strength of the signal that you want to listen to will be sufficiently strong to cause interference, which makes reception undesirable to listen to.

"I think that there will be places in the Middle West where for quite a time to come the AM stations will continue without serious competition from the FM stations. But the radio relay part of this development is coming along so fast that I wouldn't venture to say what length of time it will take before FM coverage with relays will supplant AM even in the wide open spaces."

The subject of the use of FM and television sound tracks appeared in a question which was answered by FCC Commissioner E. K. Jett (then, FCC chief engineer). The question was: "Why don't we do away with the 40-50 megacycle band for FM and allow FM broadcasting in the sound channel of

television in those hours that the television and sound channels won't be working together?"

Mr. Jett replied, "I don't think it makes good sense, engineeringly speaking. In the first place, we have only 18 channels for television sound tracks and not 35. In the second place, those 18 channels would be spread out all the way from 50 megacycles to 300 megacycles, because that is the band in which the 18 television channels lie. You would have to design a receiver that would have a range 150 megacycles wide and then for a part of the day you would have no FM broadcasting service as such, but, rather, a sound track accompanying television.

"As I said before, I don't think the two things are strictly competitive. They should stand alone."

RADIO'S CONTRIBUTION TO THE WAR EFFORT will be publicized soon in a national way through the facilities of the Radio Manufacturers Association. Newspapers and magazines will carry stories of the wartime accomplishments of the radio industry. Within the limits of official security, the scientific contributions being used to effect a successful conclusion of the war will be featured. The campaign will also encourage the immediate purchase of radios that will be available when production is resumed. Editorials will correct the erroneous impression, however, that new developments will be available on "V" day. This sincere approach will be appreciated by the American public.

Wholesale and retail distributing agencies will be told through these editorials just what the current and postwar plans of the industry are and how they might utilize them for the best results. Editorials also will stress the benefits to be derived from radio, and encourage its use as an educational necessity in schools. As a matter of fact, the slogan "A radio in every classroom in the nation" will be a major feature of this portion of the campaign.

The RMA project is headed by John S. Garceau of Farnsworth Television and Radio Corporation. All member companies of the RMA are expected to cooperate in this project by contributing information, individually and collectively.

Watch for this interesting campaign.

RAILROAD RADIO INTEREST continues to grow. In our previous columns we pointed out that the Senate Committee on Interstate Commerce was inquiring as to the feasibility of using radio on railroads. The FCC has now entered upon the scene. They have ordered an investigation as to the use of radio as a safety measure and for other purposes in railroad operation. The ICC has been invited to cooperate with the FCC in this inquiry.

Evidence of the growing belief that radio has a definite place in railroad

They all read
the C-D CAPACITOR

*the radio service man's
monthly digest*

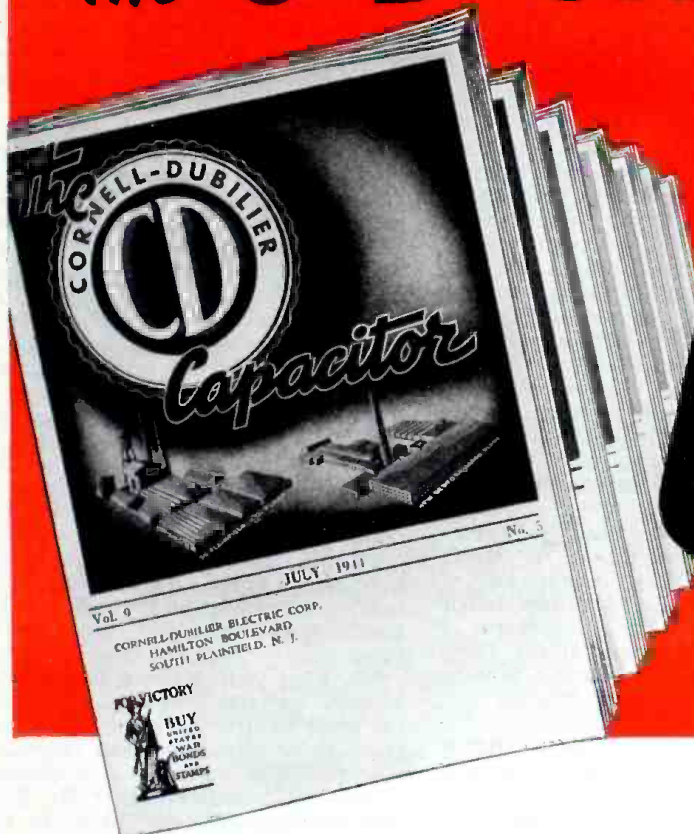

**get on the
mailing list
get this helpful
magazine...FREE**

It contains usable data, engineering views and facts, interesting articles - culled from the radio trade press and condensed for quick reading.

This pocket-size monthly magazine is read by thousands of radio service men for its authoritative data on capacitor applications, equipment, instruments and other matters.

Eagerly awaited and watched is the section - "The Radio Trading Post" - with its offers to swap, trade, buy or sell, or obtain a position. Ads are free to C-D Capacitor readers.

This publication will be sent to you every month without charge - on request. Send for your first copy TODAY. Write to Cornell-Dubilier Electric Corporation, South Plainfield, New Jersey.

WORLD'S LARGEST MANUFACTURER OF CAPACITORS

CORNELL-DUBILIER ELECTRIC CORPORATION

South Plainfield, New Jersey • Providence, Rhode Island
Worcester, New Bedford, Brookline, Massachusetts





**GOOD
MECHANICS
LIKE
WALDEN
WORCESTER
TOOLS**

Ask Your Jobber

Send for Catalog

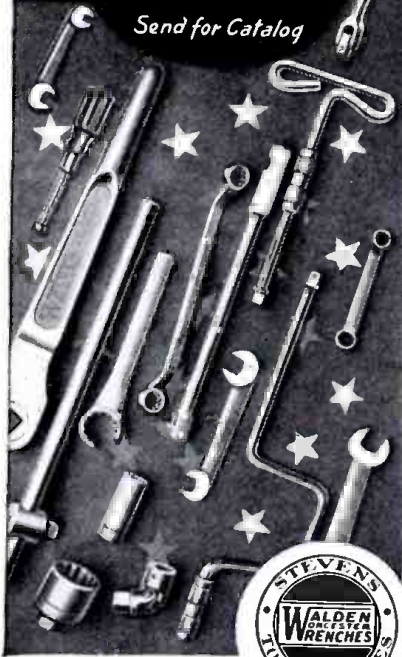

STEVENS WALDEN, INC.
465 SHREWSBURY STREET
WORCESTER, MASSACHUSETTS

operation appears in the increased list of applications that have been forwarded to the Commission. Since March 21st, 1944, applications for twenty-two experimental radio railroad stations involving two-way systems have been received by the FCC. Some of the applicants include the Baltimore & Ohio Atlantic Coastline; Chicago, Burlington and Quincy Railroad Company; Atchison, Topeka and Santa Fe Railroad Company; Chicago, Rock Island and Pacific Railway Company; the Reading Company; Bendix Radio; Westinghouse Radio Stations; and Jefferson Travis.

Construction permits for nine experimental stations to be used on the B & O between Baltimore and Pittsburgh, and on the Burlington road between Chicago, Denver and into Montana, have already been authorized by the FCC. It is understood that experimenting has also begun on the Denver and Rio Grande Western road.

The use of walkie-talkies for flagmen and brakemen is being discussed by railroad men. Several applications have indicated its possible application. In the pending applications two-way communications between the dispatcher and trains in motion, between trains and between the head-end and rear-end of each train have been described as the systems that will probably be used.

When the FCC hearings begin, representatives from the ODT, BWC, IRE, RMA, RTPB, Association of American Railroads, Railway Labor Executive Association, Secretary of War and the Secretary of the Navy are expected to appear to present their views.

DEALERS AND SERVICE MEN WILL NOW HAVE TO ABIDE BY

a new ceiling price schedule for replacement tubes and tube testing services. These new rules which went into effect May 20th were promulgated because of widespread black market activities caused by the reduced supply of receiver tubes. Numerous instances have been brought to OPA's attention showing that consumers were charged from three to four times the proper price of tubes. It is also reported that jobber discounts and returns have frequently been shortened with the resulting increase of the net price to the dealer. As a result, many dealers discontinued over-the-counter sales reserving tubes for sale only in connection with repair services, or adopting various examination testing and inspection charges.

Under the new ruling, no charge may be made by a dealer or repairman for testing tubes when they are brought to his shop by a customer, since no charge was made for this service before. However, when a portable or table model radio or phonograph is delivered to a shop for a tube test or replacement, a maximum charge of fifty cents for testing of all the tubes may be made. And if it is necessary to remove the chassis, a

maximum charge of a dollar can be made for the tube test.

Retail ceiling prices for some of the most commonly bought tubes for portable, table, console and auto radios are as follows: Portables . . . 1A5GT, \$1.10; 1A7GT, \$1.30; 1H5GT, \$1.10; 1N5GT, \$1.30. Table models (a.c.-d.c.) . . . 12SA7GT, \$1.30; 12SQ7GT, \$1.00; 25L6GT, \$1.10; 35Z5GT, \$0.85; 50L6GT, \$1.10. Console and auto radios . . . 5Y3G, \$0.70; 6F6G, \$0.90; 6SA7GT, \$1.10; 6SK7GT, \$1.10; 6V6GT, \$1.10; 42, \$0.85; 80, \$0.70. These prices include the ten per cent manufacturer's Federal excise tax which became effective on October 1, 1941. The April 1, 1944 Federal excise tax does not apply to radio receiver tubes.

THE RETURN OF RAY C. ELLIS,

director of the radio and radar division of WPB, to Washington recently after a two months absence, has solved the "where is Ellis" mystery. Mr. Ellis was in Russia studying the electronic equipment requirements of the Soviet Union. His trip was prompted by the increased needs of the Russians for tubes and parts for 1944 and 1945. It was necessary to determine whether the parts being made during that period would be adaptable to the Soviet equipment. Mr. Ellis also analyzed our production plans for the Soviets so that they could plan their production and timing to balance with our systems and thus expedite a flow of the necessary components that they will need. Our many priority and material procedures were explained to them also.

Mr. Ellis visited many factories in Moscow and the Ural region to study the equipment being made by the Soviets, their production and organization facilities, and also development trends. It is believed that Mr. Ellis also discussed postwar plans in the radio and allied fields with Soviet officials.

A complete report on this trip is expected to be presented to the special committees of the House soon for reference and study.

THIS HAS BEEN A MONTH OF RESIGNATIONS.

Two of the nation's leading radiomen have sent in their "notices." They are FCC Commissioner T. A. M. Craven, whose term as a member of the FCC expires on June 30, 1944, and Frank H. McIntosh, chief of the domestic and foreign branch of the radio and radar division, WPB, who resigned effective June 1st.

Commissioner Craven has been one of the most outspoken critics of some of the powers held by FCC. On one occasion he bluntly stated that the FCC, with its powers of censorship, had been "more of a hindrance than a help" to the Armed Forces before and after Pearl Harbor. He was also the first to warn that there could be no "real freedom of radio" as long as the FCC was permitted to use its sweeping authority to license broadcasting sta-

(Continued on page 90)

"THEN I'LL PUT IT THIS WAY—THE
JEEP AND YOUR **ECHOPHONE EC-1**
ARE BOTH REMARKABLE!"



Echophone Model EC-1

(Illustrated) a compact communications receiver with every necessary feature for good reception. Covers from 550 kc. to 30 mc. on three bands. Electrical band-spread on all bands. Beat frequency oscillator. Six tubes. Self-contained speaker. Operates on 115-125 volts AC or DC.



Echophone Radio Co., 540 N. Michigan Ave., Chicago 11, Illinois

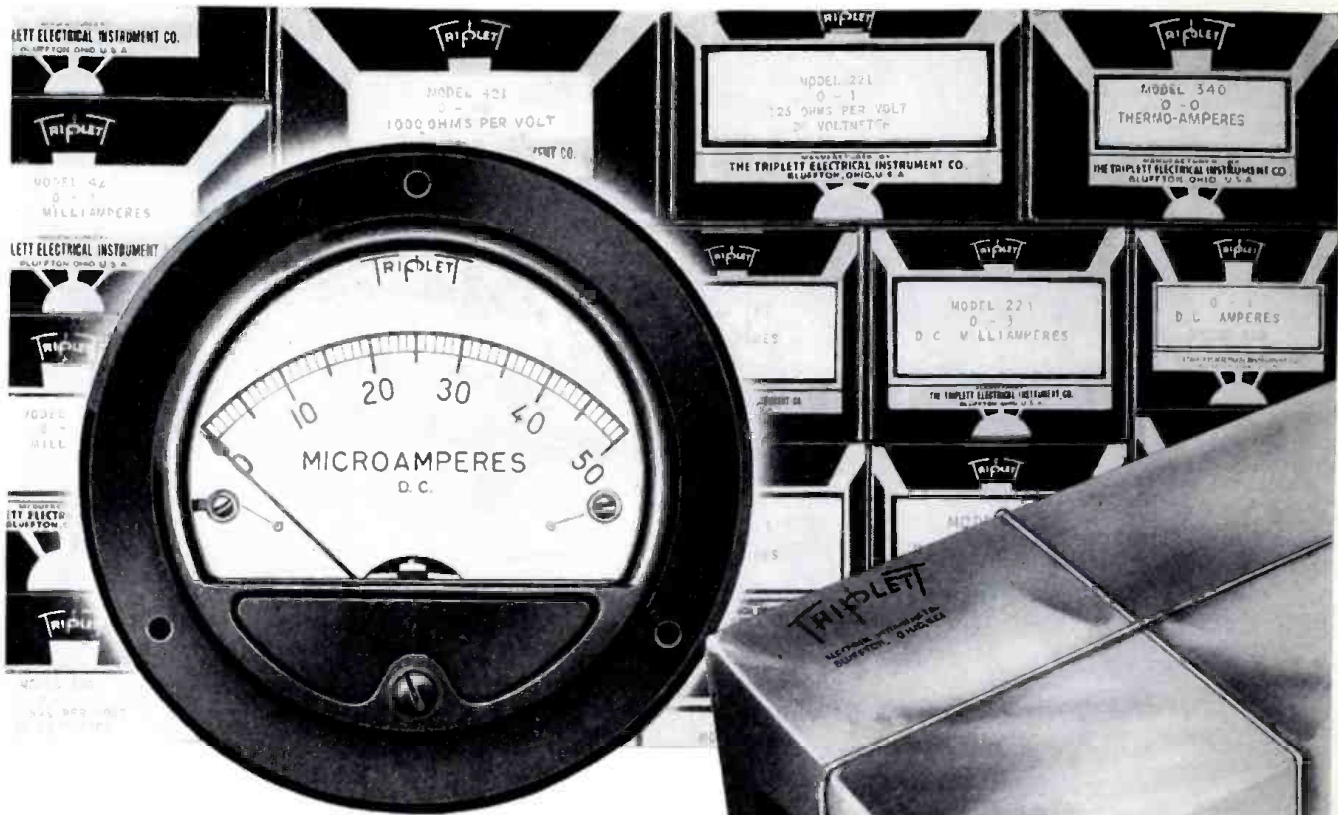

INSTRUMENT DELIVERIES!

American Instrument production is catching up with the needs of our armed forces—closing the gap between too little and enough. Caring for those needs has expanded Triplet production lines unbelievably far beyond previous capacities. And the experiences of war, added to more than forty years of instrument manufacturing, have bettered the products coming off those lines.

Now—instruments—better than ever before—are ready for general use. Better place your orders, at once, with Triplet—headquarters for a complete line of instruments made to one fine standard of engineering.

D'Arsonval Moving Coil D.C. Instruments Electrodynamometer A.C.-D.C.
Double Iron Repulsion A.C. Instruments R.F. and Rectifier Types; Sizes 2" through 7"

Triplet

ELECTRICAL
BLUFFTON



INSTRUMENT CO.
OHIO ***



- ★ *Greater Production Capacity*
- ★ *Better Instrument Quality*
- ★ *Complete Line of Instruments*
- ★ *One Source of Supply*
- ★ *Prompt Deliveries*
- ★ **SEND YOUR ORDERS TO TRIPLET NOW**



Into These Hands...

These are the hands of a boy — any boy — who grew up in America. These are the strong, determined hands of Freedom. These are the hands that are teaching Democracy's truths to the enemy. All of the communications instruments that Fada makes, superior and perfected though they be, are valueless until a human hand is at the controls. Only then do they become mighty weapons, helping us to hit harder, more often and with deadly accuracy. When competent hands and superior equipment have won the Victory, Fada will adapt these war-inspired improvements to the perfection of portable radios, small table models, frequency modulation and television receivers of unique beauty, durability and tonal reproduction.

PLACE YOUR FAITH IN THE

FADA
Radio

OF THE FUTURE

Famous Since Broadcasting Began!

FADA RADIO AND ELECTRIC COMPANY, INC., LONG ISLAND CITY, N. Y.

RESISTORS ON 24-HOUR WATCH

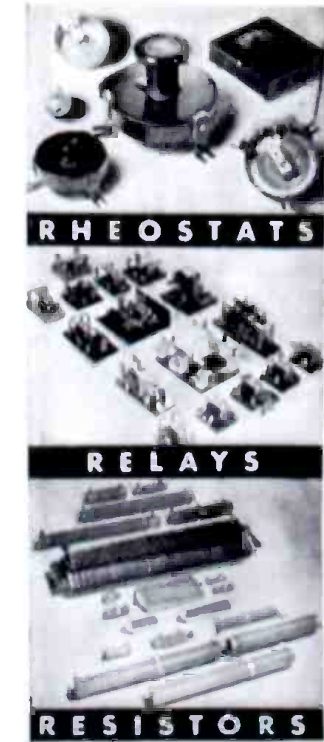

Electrical equipment aboard ship has no off-duty time. Radio, inter-communication, air conditioning, ventilation, refrigeration, deck machinery, gun operation and innumerable other vital services employ resistors in their control circuits. These resistors must be dependable to function at all times. Ward Leonard Vitrohm Resistors have measured up to their responsibilities. Their ability to withstand moisture, temperature change, shock and vibration makes them particularly well fitted for sea duty. Resistors with the same ruggedness as those used by the Navy and Merchant Marine are available to all industry engaged in victory production. Send for data sheets.



WARD LEONARD

Electric control  devices since 1892.

WARD LEONARD ELECTRIC COMPANY, 47 SOUTH STREET, MOUNT VERNON, NEW YORK

HERMETIC SOLDER-SEALING

MAKES PRESTITE

TERMINAL BUSHING

Leakage-proof



ACTUAL SIZE

High altitudes . . . humidity condensation . . . thermal shocks . . . cannot affect the performance of Solder-Sealed apparatus. The 100% hermetic bond assured by the metal-to-PRESTITE seal assures trouble-free service of terminal bushings.

The bushing consists of a PRESTITE tube on which are Solder-Sealed a terminal cap and a stud. Similar bushings are available without hardware for Solder-Sealing to other parts on the manufacturer's own production line.

Solder-Sealed PRESTITE assemblies offer immediate help to manufacturers in many available standard forms. They also open up many new and added possibilities in postwar uses. For complete information, send for booklet B-3244. Westinghouse Electric & Manufacturing Company, East Pittsburgh, Pa., Dept. 7-N. J.05142

Westinghouse
PLANTS IN 25 CITIES . . . OFFICES EVERYWHERE

COMMUNICATIONS EQUIPMENT

INSTRUMENTS
D-C CAPACITORS
HIPERSIL CORES



DYNAMOTORS
RECTOX RECTIFIERS
INSULATING MATERIALS

OLD WAY

(SEVEN PIECES)

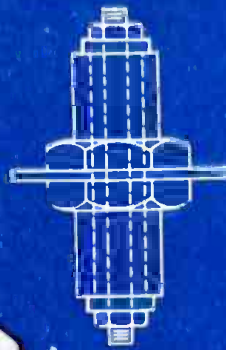

CONTAINER LID

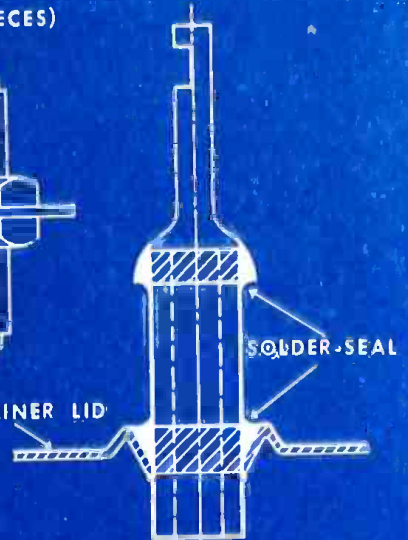

NEW WAY

(ONE PIECE . . . HERMETICALLY SEALED)

Westinghouse Solder-Sealed PRESTITE Terminal Bushing, S. # 1309762.

Other PRESTITE methods of taking leads through partitions



APPARATUS ENCLOSED SOLDER-SEAL BUSHING—combination insulator, cover and terminal board—has a hollow construction which permits placing small devices inside.

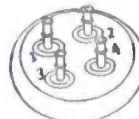

SOLDER-SEAL ASSEMBLY—for vibrator packs, but can be used in similar apparatus, combining jack and terminal board.



SOLDER-SEALED BUSHING—for use with thicker gage covers of larger size transformers and capacitors. Bushing is Solder-Sealed to a metal ring which is soldered to the container cover.

PRESTITE is a dense nonporous ceramic compacted under high pressure and vacuum by the patented PRESTITE method of manufacture. This eliminates minute air pockets in the material, thus minimizing distortion in voltage gradients and eliminating internal corona discharges. PRESTITE is impervious to moisture and all chemicals except hydrofluoric acid. The quality of PRESTITE is consistently uniform, thus eliminating the need for the exaggerated safety factors common in other ceramics.

Built to take it!

Because they are built to take it
— built to do the job with a wide
margin of safety — Hammarlund
variable condensers are used in
every type of military equip-
ment from planes to battleships.

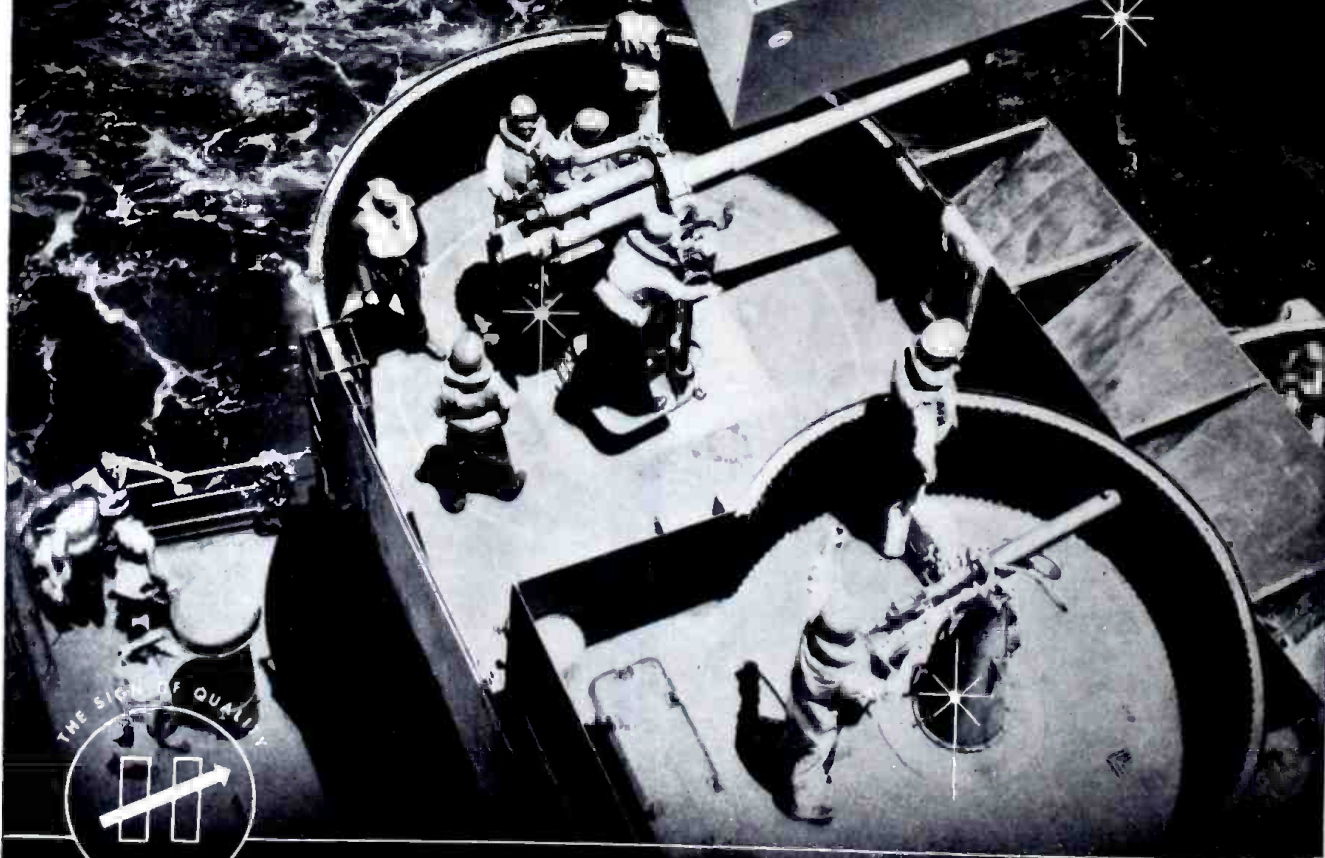
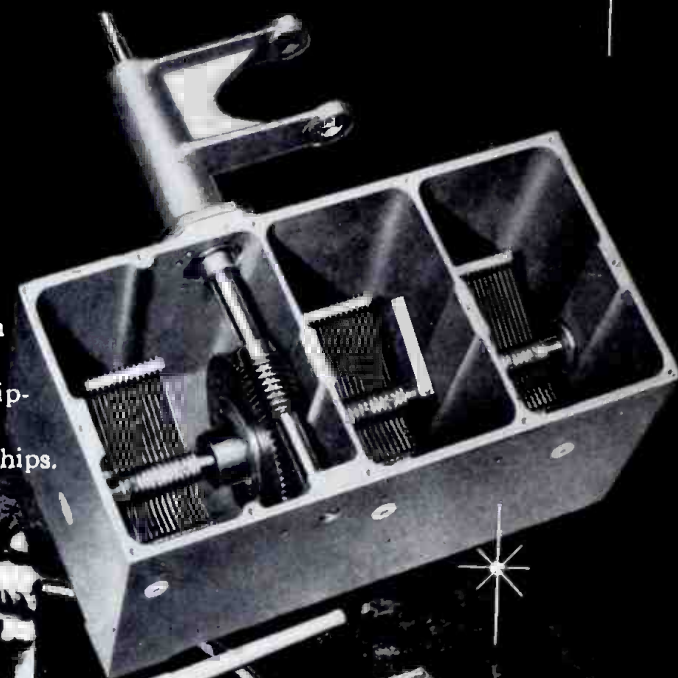

ESTABLISHED 1910

THE HAMMARLUND MFG. CO., INC., 460 W. 34TH ST., N.Y.C.
MANUFACTURERS OF PRECISION COMMUNICATIONS EQUIPMENT

OFFICIAL U.S. NAVY PHOTO

MICROWAVES FOR POSTWAR RAILROADS

By **SAMUEL FREEDMAN**

Lt. Commander, USNR

Presenting the advantages of microwave equipment as a possible postwar solution to problems confronting railroad communications.

EDITOR'S NOTE: The author has spent many years on the application of ultra-high frequencies to two-way communications and presents herein his solution to the railroads' problems of adapting radio communications to their field. Many problems confront the railroads today and a very reasonable solution, as the author points out, is the application of equipment designed for microwaves. Many of the statements contained herein were not considered possible prior to the outbreak of war. However, during the last few years, extensive research work has been done on radio equipment, working at these very-short wavelengths. The results of this vast research work must be kept secret for obvious reasons. The author presents his ideas on the application of microwaves to railroads with a full understanding of what has been accomplished. Regardless of the fact that many constructional problems are still unsolved, the application of microwaves may prove to be the answer to existing problems.

TWO-WAY communication with moving trains will soon be widely enough adopted to contribute greatly to the efficiency and safety of railroad transportation. The major railroad disasters in recent months have aroused the public, the press and prominent radio reporters to demand two-way radio communication on railroad trains. Two major accidents, involving the loss of over 150 lives and many millions of dollars of damage, as well as temporary disruption of main line railroad services, were entirely avoidable had two-way radio existed with those trains.

Labor Day, 1943, the Congressional Limited of the Pennsylvania Railroad had a hotbox afire unknown to anyone aboard the train. It was visible and known to persons as the train rushed by but they had no way of getting word to the train in time before it was

wrecked. On December 16, 1943, in the middle of the night in freezing and unfavorable weather, the northbound Tamiami East Coast Champion of the Atlantic Coast Line did not know that the southbound Tamiami East Coast Champion had been derailed in an isolated stretch of road. Forty minutes later it collided with the derailed train which had straddled the track. The only radio communication available was that provided by a North Carolina State Police Car afterwards which was of great value in summoning assistance. Aside from the great loss or maiming of human life, the financial losses from railroad accidents or disasters during a single year such as 1943 could meet most if not all the cost of radio facilities for all the railroads in the United States . . . permanently installed and paid for.

Two types of planning are being con-

Streamlined "City of San Francisco" when equipped with suitable radio communications will present greater safety to passengers and crew.





The application of microwave equipment will have an added advantage in mountainous terrain by the presence

ORGANIZATION OF THE ASSOCIATION OF AMERICAN RAILROADS

☆☆☆

John J. Pelley, President
 Telegraph and Telephone Section
 Mr. W. A. Fairbanks, Secretary
 30 Vesey Street, New York, N. Y.

☆☆☆

Committee of Direction
 Committee on Nominations
 Special Committee on Savings and Improvements in Service
 Member Board of War Communications
 Special Committee on Conservation of Copper
 Special Committee on Inexpensive Carrier Designs

☆☆☆

COMMITTEE No. 1 . . . OUTSIDE PLANT

Landlines, poles, guying, anchors, insulators, etc.

COMMITTEE No. 2 . . . INSIDE PLANT

Furniture, switchboards, equipment, rectifiers, layouts, printers, batteries, relays, wire circuits, etc.

COMMITTEE No. 3 . . . COMMUNICATION TRANSMISSION

Repeaters for voice and carrier systems—also handles bibliography of technical papers on telephony and telegraphy.

COMMITTEE No. 4 . . . RESEARCH AND DEVELOPMENT

Recent project included PBX switchboards.
 Surveys of existing apparatus, circuits, equipment and material.
 Specifications for radio broadcast receivers on trains.
 Communication on freight trains.
 Fixed points to moving trains or engines within limited areas including humpyard operation.
 Application of radio to harbor craft operation.
 Point to point communication by use of ultra-high frequency.
 Use of FM radio equipment emergency point to point communication.
 Consider feasibility of radio communication in emergencies when all other means fail.
 Application of wire carrier systems to lines along railroads.
 Contact with government activities affecting status of railroads with respect to radio.
 Assist any railroad to obtain license from FCC.
 Loudspeaker communication systems.

COMMITTEE No. 5 . . . NEW DEVICES

Collect and distribute data.

COMMITTEE No. 6 . . . COMMUNICATION PLANT OPERATION

Traffic procedures, statistical data, data on schools, etc.

COMMITTEE No. 7 . . . INDUCTIVE COORDINATION

Induction interference to communications and remedies.

considered by the railroads in order to provide communication with moving trains. The first is a 100% radio system requiring frequency channel allocation and authorization by the Federal Communications Commission. The second is to be as independent as possible of the FCC by using a variety of methods that either are or can be classed as being very similar to wired wireless systems of carrier transmission.

The single important reason why railroads have not had radio on trains heretofore can be attributed to the lack of frequency channels that could be spared for such utilization. The solution must come from the development of higher frequency spectrums as well as the development of equipment and techniques suitable for such very-high frequencies. It is now possible to state that this will be definitely possible immediately after the termination of hostilities. At that time the necessary materials, competent personnel and new microwave techniques will be made available to the railroads. Over 100 times more frequency channel space exists in the microwave band than heretofore used by all radio stations in the world on frequencies lower than that spectrum. It is believed that this will end further attempts to improvise substitutes for radio communication. Should any communications be provided before postwar conditions make microwaves available, there is considerable likelihood that they will become obsolete and require replacement.

The railroads of the United States, Canada and Mexico are banded together in an organization known as the Association of American Railroads. Two hundred and eleven railroads have full membership in the Association and represent 283,197 miles of road operated with an annual revenue exceeding seven billion dollars. Of these railroads, 201 are located in the United States where they operate 233,527

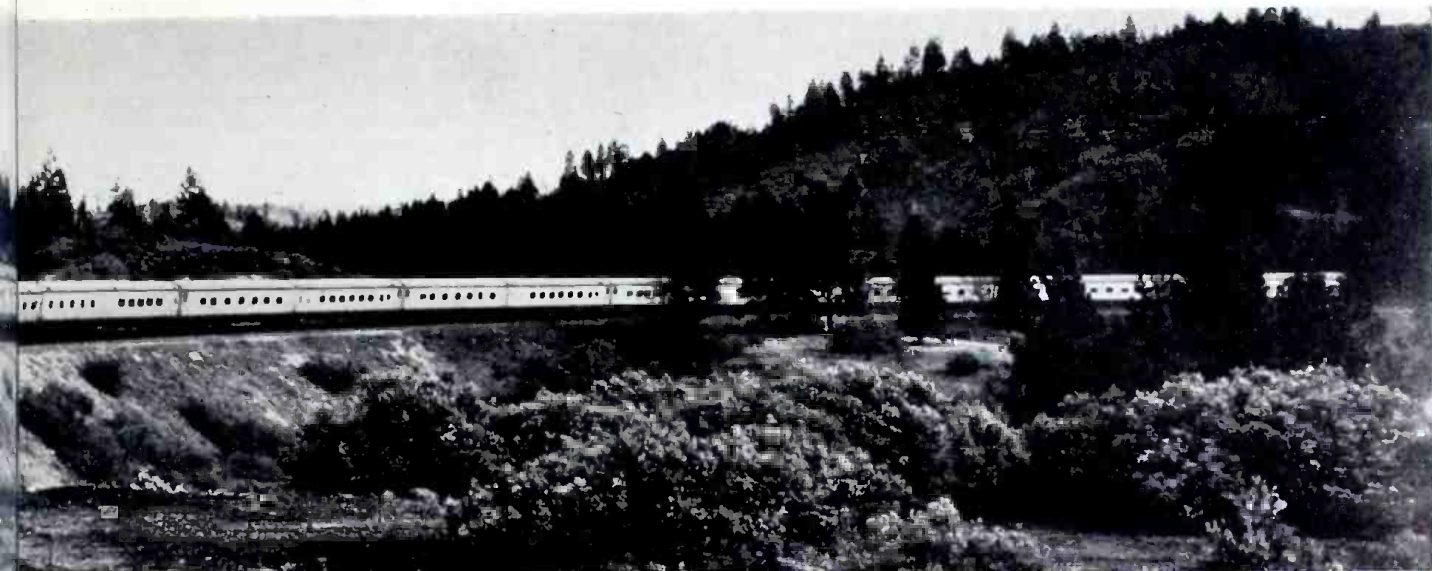

of nearby water or snow, railroad trackage, overhead power lines, and multiwired telegraph and telephone wires.

miles of road. In addition, there are 175 railroads holding associate membership who operate a total of 54,541 miles of road.

The chart on page 22 indicates the organization of the Telegraph and Telephone Section of the Association of American Railroads. The Association is usually referred to as the AAR by railroad men. This Section is the one which concerns the radio field. It functions by means of committees and subcommittees. The committee most concerned with radio development for railroad utilization is Committee No. 4—"Research and Development." The membership of these committees and subcommittees is made up of the leading communication officials of the most important railroads in the United States and Canada. Usually there are consulting members included in the committee roster from selected manufacturers of signalling and electrical equipment.

It should be recognized that the railroads are headed by men who have had lifelong experience in their field. Their entire lives have been devoted to perfecting their communication systems to a high degree of development with understanding of and careful attention to details. The fact that they have made very little progress in actually utilizing radio facilities is not entirely their fault. Some of the fault lies with the radio industry and the priority enjoyed in allocation of frequencies by the emergency, aeronautical and maritime services. Having insufficient channels available for allocation in the past, the Federal Communications Commission has been requested to give first consideration to services where radio is the only possible form of communication under any condition. The FCC gave railroads secondary rather than primary consideration because their needs in part could be handled by landlines and wayside signals.

The railroads did not proceed very far with radio development because in

the beginning no suitable equipment was available when channels could have been had prior to broadcasting, aviation and police radio. Later, when suitable equipment began to appear, such as FM type police radio, there were no appropriate channels available to them. Railroads could not be classed as an emergency service and were not entitled to the same privileges that federal, state or municipal governments enjoy in that respect.

Radio tests made thus far have been permitted by the Federal Communications Commission only on temporary experimental licenses. This might be merely the experimental or portable calls allowed manufacturers by the FCC in trying out equipment. Some reluctance to become involved with radio may have been formed from premature attempts in the days of sparks, arcs, long waves and crystal receivers with half a car of equipment oper-

Fig. 1. Two suggested microwave railroad communication systems.

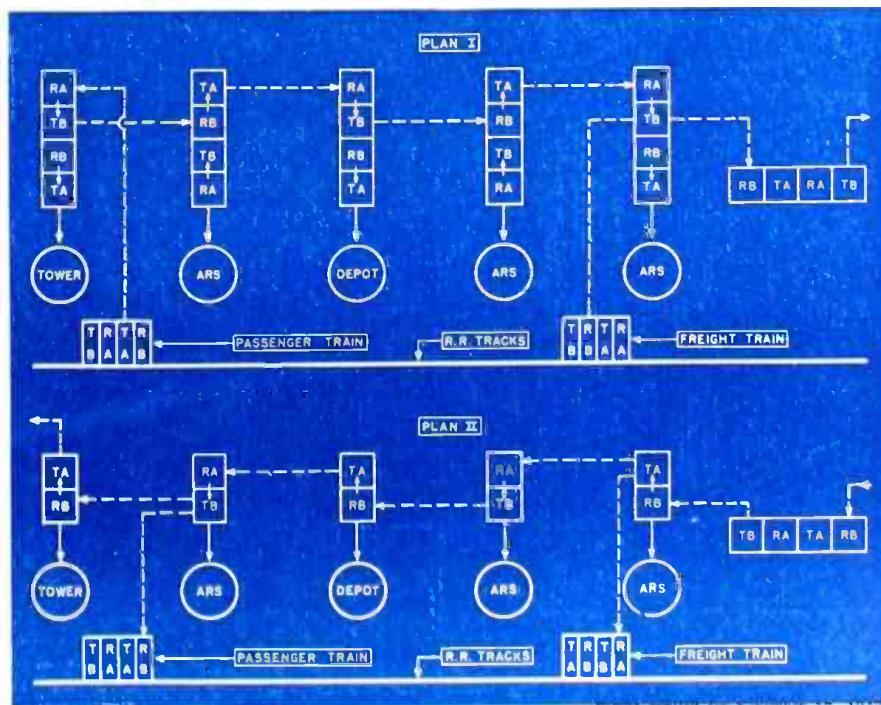

ABBREVIATIONS

- TA—Transmitter of channel A.
 - TB—Transmitter of channel B.
 - RA—Receiver of channel A.
 - RB—Receiver of channel B.
 - ARS—Automatic Relay Station.
- All stations use voice which may be frequency modulated with carrier operating in the microwave band between 1 meter and 1 centimeter. Preferred frequency range 300 to 30,000 megacycles.

FOR COMMUNICATION BETWEEN FOLLOWING TYPES OF STATIONS:

- (1) Division point to any moving or stationary train. Also vice versa.
- (2) Any train to any other train whether in motion or stationary.
- (3) Any intermediate railroad stations and towers.
- (4) Any other extension of service including both interdivision and intradivision with any fixed or mobile station within the limits of the railroad system.



An early two-way railroad radio experiment conducted on the New York Central Railroad in 1926. This involved frequencies where sky-wave ionosphere reflections occurred.

ated by special personnel. The complexity, bulk, cost, rapid obsolescence, legislation, regulation and licensing of stations, as well as personnel, has had a retarding effect on railroad radio. Finally it can be said that the railroads have had their attention diverted by inductive or carrier forms of communication which required no special frequency allocations by the Federal Communications Commission that would conflict with existing radio services. These diversions were frequently sponsored by railroad supply firms of signal or electrical equipment who were already well known and trusted by railroad officials.

Useful functions of two-way radio that now are impossible, or at the best are crudely improvised, comprise a large number. They include front-to-rear communication for all freight and passenger trains. Nowadays a freight train frequently is over 100 cars extending over a mile and a half in length. The majority of officials agree that this is the most important need of communication and must be solved.

It will improve the all-round efficiency and the competitive position of railroads with respect to other forms of transportation. Much more can be done with a given number of locomotives, tracks, sidings and terminal facilities. What is very important, so there shall be no misunderstanding or hostility, is to realize that it can be done without reducing the amount of employment and the compensation per employee. When radio steps into a new field, it is frequently viewed with suspicion by entrenched persons trying

to safeguard their seniority and livelihood and what may be the only jobs they are qualified for. Not once has two-way radio ever reduced employment or compensation per employee. In virtually every case it has slightly increased employment and substantially increased wages.

Two-way communication will be handled by voice. It therefore becomes feasible in most cases for the principals to speak with each other directly. The errors of relaying, telegraphy, third party handling, etc., will be avoided. Delays and misunderstandings can be avoided as both question and answer can take place during one transmission. The originator will know that the addressee has not only received his message, but he has also acknowledged it, understood it and had no further question regarding it.

Radio is particularly important where each locomotive has to handle hundreds of freight cars per day at a freight classification or hump yard. It may seem amusing but locomotives actually do get "lost" in busy terminals and much time can be wasted in again locating and properly dispatching them. When freight trains are being broken apart to detach cars or conversely are being made up into complete trains, radio is invaluable between the caboose and the locomotive. It is also very useful where two locomotives are necessary on a single train.

For trains in motion, radio will simplify stopping, starting, speeding up or slowing down trains. They can be speeded to a siding and clear the track without losing any time stopping and

starting again. When the train stops, the conductor can direct the engineer where to spot certain cars at a station, backing or moving the train ahead as may be desired. Communication can be instantly had with any train going in the opposite direction or that may be ahead or behind. Frequently this will avoid accidents and human failures. There is no reason why the system cannot be arranged so each engineer hears all the messages in the division of all trains and thereby be cognizant of what is going on all along his route. The engineer can tell the conductor what is wrong ahead and when things become normal again, the conductor can ask the engineer to modify the operation of the train on occasion. Should the train part or any part of the rolling equipment develop trouble, arrangements can be made to stop or to proceed to a suitable point for repairs and inspection.

It will be a simple and instantaneous matter to orally instruct the engineer of a train on mishaps such as a disaster or accident ahead. Stalled trains can warn other trains of their predicament and avoid collisions. It will be possible to summon or provide medical assistance in case of an accident or if a passenger on a train or train employee is stricken; to avoid stopping or slowing down in order to see if there are any orders; and to file information or to pick up orders. Communication will be at voice speeds, which are about 200 words per minute. A curt warning can be handled in about ten words taking 3 seconds to utter. Radio is always independent of fog, rain, snow, sleet, ice, darkness, wind, noise, landlines, special insulation of train chassis from the wheels, bonded rails, insulated rails, floods, etc. It usually works best when conditions of weather are worst because of better ground conductivity at such times.

Radio is very flexible. Any mobile unit can serve in lieu of a fixed or portable station. Walkie-talkie sets can be used by persons afoot to talk with other persons afoot, on trains, at fixed points, etc. Even the man on the handcar or the repair crew can be equipped with radio communication.

The use of microwave frequencies provides the large amount of channel space required by railroads for intercommunication between trains, fixed points and other activities involving portability or mobility.

The railroads of the United States have become exceptionally interested in two-way radio with moving trains because of new developments that place it within their reach. The Association of American Railroads recently has been admitted to membership on the Radio Technical Planning Board as the first major step towards universal use of radio by railroads.

The adoption of two-way radio is now merely a question of time . . . whether it shall be done now using anything available or whether it shall be planned now and commenced imme-

(Continued on page 132)

Photronic Code Machine

by **THOMAS M. MORSE**

Assoc. Instructor. AAF

A novel, continuous-film type code recorder and reproducer used by Army Air Forces for code training.

EDITOR'S NOTE: Many of our readers will recall the RADIO NEWS-sponsored inventors' contest which was held in 1942, and that the first prize award went to Thomas M. Morse and J. M. Petty for their invention of a "Photronic Signal Impulse Reproducer." This invention finally has been constructed into a practical working model, which has been in use for several months at the Army Air Forces Radio School at Scott Field, Illinois. The machine, which gives promise of becoming the standard code machine in all radio schools, has proven that the staff and judges did not err in judging its merit.

Since the conclusion of the RADIO NEWS contest, Mr. Morse has been presented with another award, the second honor being for submitting ideas for victory, under a program sponsored by the War Department.



Fig. 1. The inventor, Mr. Morse (left), inspecting the projector and photocell-relay keying panel. In the rear can be seen the Panoram movie screen.

DURING the latter part of 1942, orders came through from higher headquarters of the U. S. Army Air Forces to discontinue teaching radio students code produced by a code machine, and to substitute actual hand sending in its place. This was a

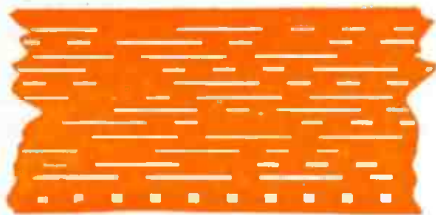

Fig. 2. Code film showing the 12 separate tracks. Each track is recorded at different speeds and selected by means of a rotary switch.

the development of a machine that would record hand sending and faithfully reproduce it with all its individual human characteristics. Such a machine had previously been invented by Mr. John M. Petty and the writer. In fact, a simple working model of this machine had been demonstrated to the Signal Corps in 1942.

Accordingly, Mr. Orville L. Dawson and the writer set out to develop this invention with a view toward its adoption in all radio schools. During the Fall of 1943 a demonstration of this machine was made before Army Air Forces officials at Scott Field, Illinois.

Much impressed, these officers authorized construction of a machine for use in the Army Air Forces radio school at Scott Field. Fortunately, all necessary parts for this code machine are commercially produced. In fact, the Panoram sound movie cabinets contain the most important items necessary for construction of an elaborate model. It so happened that there were several Panoram movie machines at Scott Field and one of these was made available. On December 4, 1943, the first machine was installed in the radio school and it has been operating successfully ever since. A second machine

wise move. It was necessitated by complaints that students, who had been taught code entirely from a machine, met with difficulty in receiving hand sending when they arrived in the various theaters of operations. It so happened that all successful code machines at that time used a mechanically perforated tape with the result that the code reproduced therefrom had a mechanical sound completely devoid of the individual characteristics of human hand sending.

Accordingly, instructors were assigned to hand send to the code students in the several Army Air Forces radio schools. This required a great number of instructors. It had the added disadvantage that instructors who send several hours per day are in danger of tiring and developing "glass arms." There was obviously room for

Fig. 3. The recording lightproof camera box now being used at Scott Field. The projector and reel, wound with unexposed film, are shown housed in one end of the box.

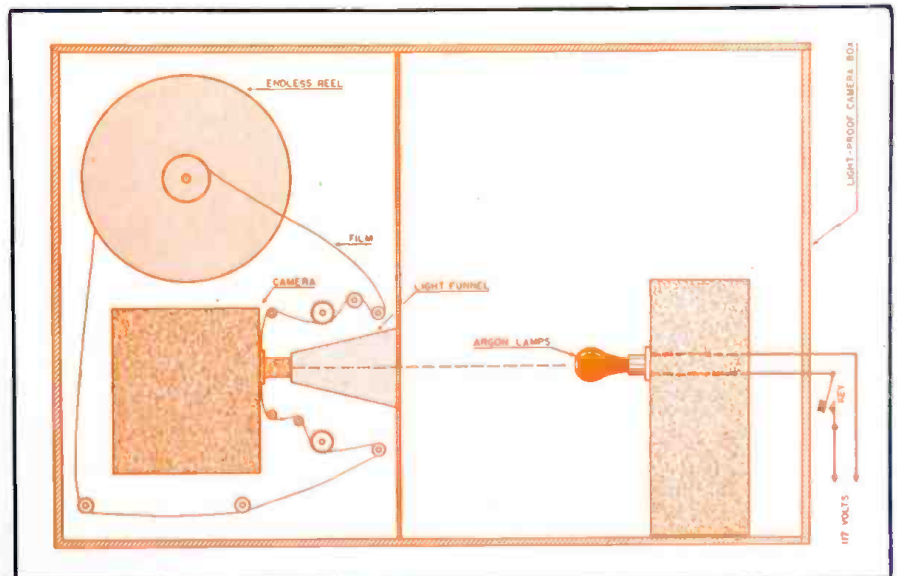

has been constructed since and others are contemplated.

The Photronic code machine could be designed to occupy much less space and to cost much less than do the Panoram sound movie machines. In fact, all that is actually required is a motion picture projector and the photocell-relay keying panel (to be described later). However the Panoram machines are commercially produced and were available, and it was therefore expedient to make use of them. Also, the Panoram machines, because of their many novel features, are ideally suited for conversion to code machines such as are needed in large military schools.

The following paragraphs give a complete description of the Photronic code machine as converted from the Panoram sound movie machine.

Construction and Operation

The Photronic code machine in use at Scott Field is capable of reproduc-

ing twelve separate International Morse Code speeds (or tracks). For example, the code speeds of 4, 8, 10, 12, 14, 16, 18, 20, 22, 25 and 30 w.p.m. as well as a light signal blinker are at present being transmitted simultaneously by this one machine. These are all the code speeds normally required in a radio school.

The most important item necessary for construction of a Photronic code machine is a motion picture projector with a constant speed motor built to stand up under thousands of hours of continuous operation, and which is capable of being geared down so as to pull the film at a speed between five and ten feet per minute. The projectors in use at Scott Field are geared down so that the film is pulled through at a rate of about 9.5 feet per minute. All framing mechanisms such as the shutter and claw pins are removed from the projector so that the film will be pulled through at a steady rate.

In Fig. 4 is shown the general lay-

out of equipment in the machines. The film is carried on an endless (repeating) reel. This reel will hold 2000 feet of film but best operation was found when it contained from 600 to 800 feet. Eight hundred feet of film will operate one hour and twenty-four minutes before repeating. Since the film has 12 tracks, 800 feet of film actually contains 9600 feet of code. The use of the endless reel obviates the necessity of ever rewinding the film. This simplifies the operation of the machine to the point where all the operator has to do is to throw a switch to start and stop the machine at the beginning and end of each code period. Since the machine will seldom start or stop at the same place on the film, it becomes extremely difficult for a student to memorize any of the code, even when shorter films are used.

The actual appearance of the code on the negative film is shown in Fig. 2. As the dots and dashes are pulled through the projector light gate, the resulting picture is projected and focused upon a bank of photoelectric cells placed about five feet away. Referring again to Fig. 4, it can be seen that the light beams first strike mirror No. 1 where they are reflected to mirror No. 2 and thence to the bank of pick-up photoelectric cells. Directly behind the photoelectric cells is a screen upon which appears an impressive panorama of the dots and dashes as they pass the light gate. The screen is useful in that it affords a means of visually monitoring the code at any speed desired, and also because it affords a means of inspecting the film for dirt formation, etc. In Fig. 5 is shown the appearance of the screen when the machine is operating on a film negative. If operating on a positive (as it should), the dots and dashes would appear reversed, that is, as light on a black background. The photoelectric cells are silhouetted against the screen, and moving past each cell, from bottom to top, is its respective code track. As the dots and dashes move across the photoelectric cells, minute electrical currents are set up within the cells. These currents are amplified through a single stage and then used to key a relay which, in turn, keys a tone source in accordance with the dots and dashes being projected across the cells. The rear of each photoelectric cell is painted black to prevent stray light from striking it through the screen. The screen itself may be partially covered if necessary to keep out external light variations.

If the proper type relays are used, excellent keying results are obtained, although a key click filter may be necessary in some cases. Obviously, electronic (tube) relays may be used in place of the mechanical relays but this complicates the machine and is of questionable advantage except where speeds in excess of 50 w.p.m. are desired. When operating on a film negative, the relay contacts are closed by spring action instead of by the armature. For that reason, film developed

Fig. 4. General layout of equipment in the machine. Lacquered film up to 2000 feet can be carried on the endless repeating reel.

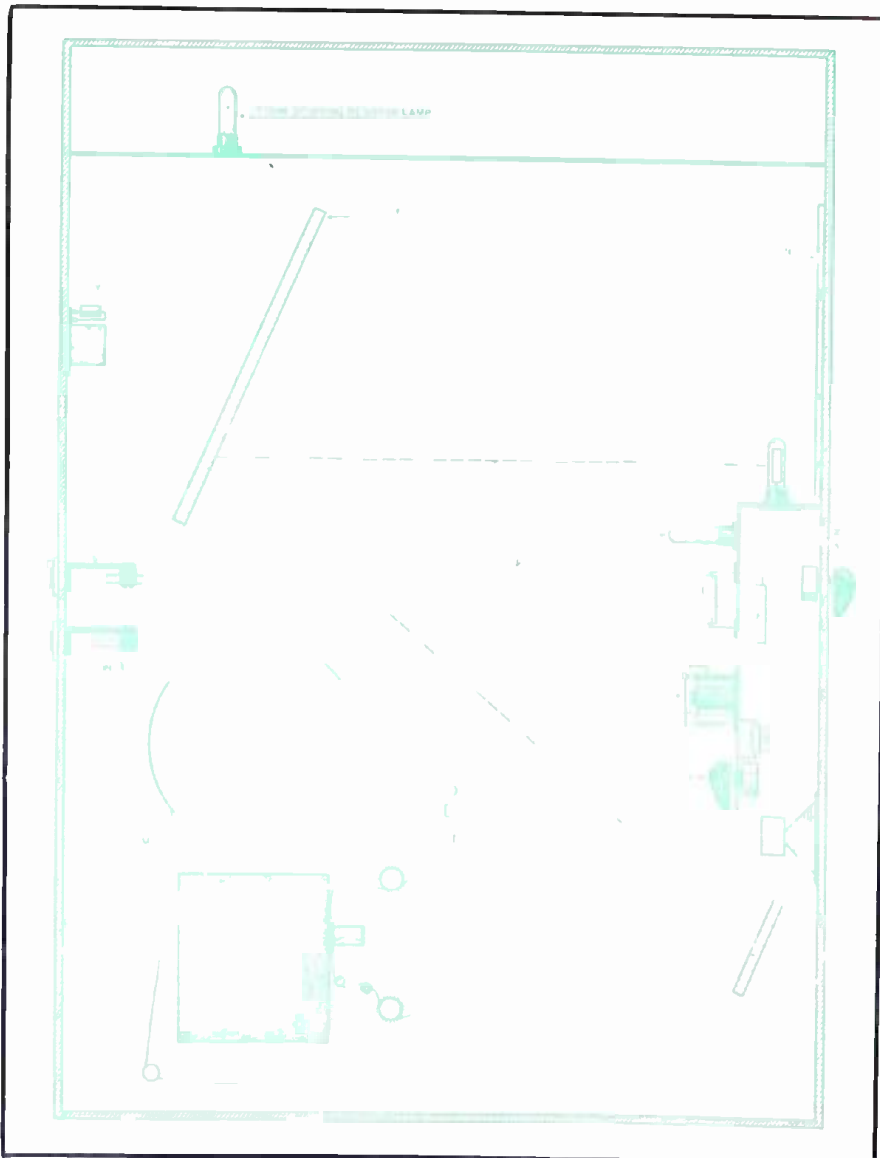

as a positive should be used to insure the best possible results when the armature closes the contacts.

The projector itself is equipped with a relay which automatically stops the machine if the film breaks. This prevents the film from unwinding on the floor of the machine. This relay also turns off the projector lamp so that it will not damage the film as it would do if the film should stop with the lamp still burning. The film will very seldom break if proper splices are made. Our film has broken about once a month and each time it was at a poorly made splice. Splices can be made in a minute or two while the film is in the machine. However, it is recommended that a spare reel of film be on hand for quick interchange.

After running continuously for several days, the film will become dirty. An automatic film cleaning device is part of the original Panoram equipment. This film cleaning device uses carbon tetrachloride as the cleaning agent. The carbon tetrachloride drips on two cleaning pads through which the film is pulled while being cleaned. This device enables the film to be cleaned with a minimum of effort while in actual operation. Small particles of dirt or scratches on the film do not effect the operation of the machine. A film will last for several months of continuous operation.

The original Panoram sound movie cabinets contain six loud-speakers. One of these speakers is used in conjunction with a rotary selector switch, so that the operator may monitor any code speed desired.

The cabinets also contain an amplifier. This was originally used for the purpose of amplifying the sound track on the moving picture film. It has been converted into an oscillator-amplifier and is being used as a tone source. The final stage of the tone amplifier has two 6L6's in push-pull and delivers enough power to supply tone for all code speeds in a large radio school. This means that the Photronic code machine is a complete unit within itself and, when located at a central location in a radio school, it can send all the code necessary for all students in the building.

Referring to Fig. 4 it can be readily seen that the photoelectric cells, amplifier tubes, relays, resistors, and condensers are mounted on a single panel which is called the photocell relay keying panel. Two screws hold this panel in place in the cabinet. The panel can be replaced in a minute or two if necessary, and a spare panel is available in case some part fails in the original panel. All electrical equipment is operated conservatively and therefore failure of any part will be very infrequent. The machine at Scott Field has been operating about eighteen hours per day for almost three months at the time of this writing without a single part failure on this panel. Of course, the photoelectric cells and amplifier tubes plug into the panel and may be readily replaced in event of failure.

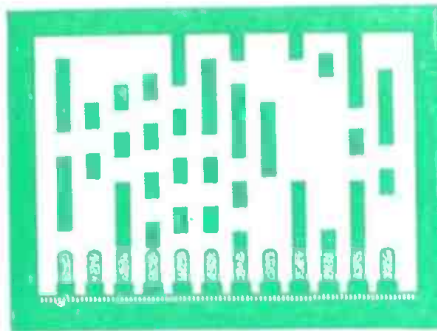

Fig. 5. The appearance of the code traces on the screen when the machine is in operation. Respective code tracks move past each photocell from bottom to top.

Fig. 6 shows the complete diagram of the photoelectric cell keying circuit. Values shown in this diagram are practical.

All vital parts of the Photronic code machine are constructed so that they can be replaced in two or three minutes in case of failure. These quickly replaceable parts include the projector, the projector lamp, photoelectric cells, amplifier tubes, the photoelectric cell keying panel, the film reels, the oscillator-amplifier, etc. This means that, if spare parts are available, the machine need never be nonoperative for over two or three minutes. Failures of any kind will be rare.

It was thought at first that the projector lamp would require frequent replacement. However, a 7-ohm dropping resistor was connected in series with the projector lamp, with the result that the life of each lamp was increased from 5 to over 500 hours. Projector lamps rated at 100, 200, 300 or 400 watts may be used. Projector lamps of over 200 watts should not be used without the series resistor. For a series dropping resistor we use the 750-watt projection lamp that was furnished with the original Panoram projector.

Reconversion to a Sound Motion Picture Machine

One man can convert a Panoram sound motion picture machine into a complete Photronic code machine in

approximately one week's time, provided, of course, that he has all necessary parts for the conversion on hand and provided that the projector speed is geared down in a machine shop. Once the Photronic code machine is complete, it takes but half an hour for a skilled man to reconvert it into a Panoram sound motion picture machine and another half hour to convert it back to a code machine.

Doubtlessly, there are other possibilities in this code machine. For example, the sound track is not even being used in the present machines. Tone of varying pitch and volume could be recorded on this sound track and used thereafter as the tone source in order to simulate more nearly actual reception conditions where volume and pitch may vary.

Recording

Recording the code is, of course, the reverse of reproduction. In short, all it amounts to is the replacing of the pickup photoelectric cells with electric lamps which are keyed with the desired code and photographed. In fact, the same projector (or one like it) used in reproduction is also used for recording. The same endless reel is also used to carry the unexposed film.

Fig. 3 shows the lightproof camera box being used at Scott Field for recording. The projector (camera) and reel are housed in one end of the box. In the other end of the box, separated from the projector by a lightproof sliding panel, are the lamps which are keyed with the code. A rectangular hole is cut in the sliding panel to allow the projector lens to "see" the lamps. A lightproof "funnel" allows the lamp light to pass to the projector lens while excluding all unwanted light. This light, emanating from argon lamps, is focused upon the film by the projector lens. While recording, the projector lamp and its reflector are removed so that they will not throw unwanted light on the film.

There are several types of 110-volt lamps which may be keyed for recording. Among these are the argon and neon glow lamps. Rather surprisingly, (Continued on page 112)

Fig. 6. Wiring diagram of relay unit. A single 50L6 tube is used while on the tone oscillator the amplifier utilizes push-pull 50L6 tubes.

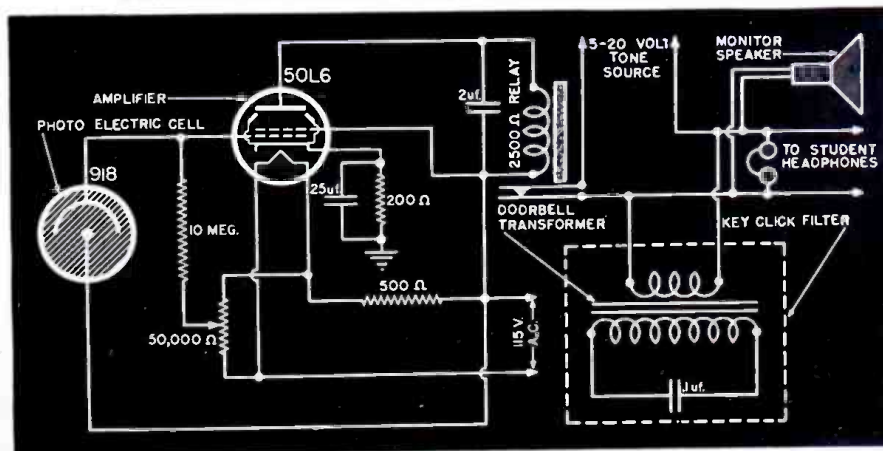

SIGNAL CORPS RADIO SCHOOL

Signal Corps officers and enlisted men are now receiving training in radio transmitter operation at a prominent broadcast station.

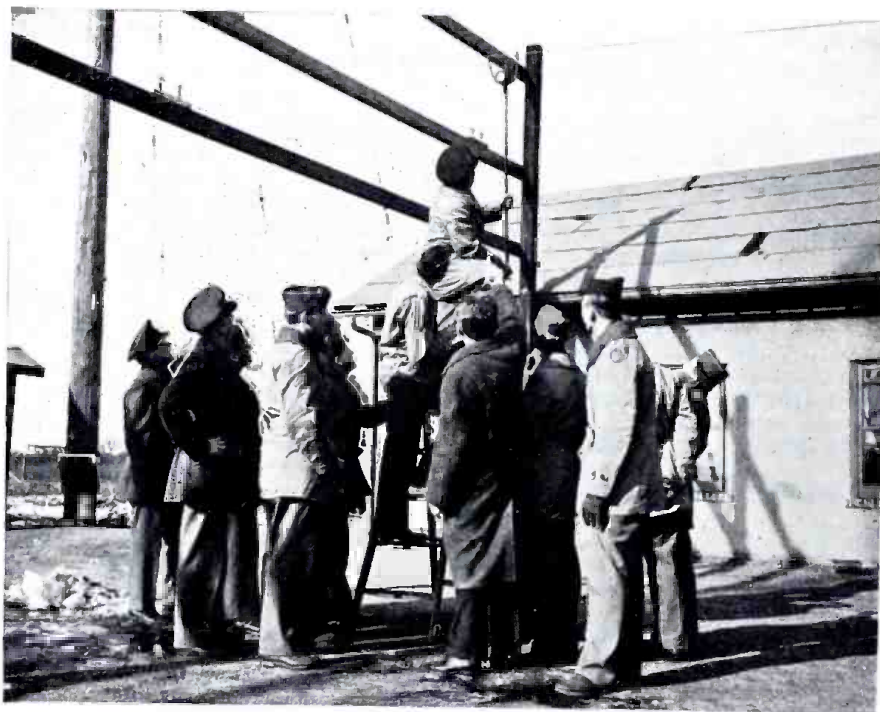

Students measuring standing waves present on transmission line.

GOING to school in one of the world's largest radio transmitter stations is the lucky lot of Signal Corps men who are sent to Press Wireless, Inc., at Hicksville, Long Island, New York, for special training calculated to help them speed up the job of smashing the Axis.

It is one of the larger schools in radio transmitter instruction at a radio transmitting station. The students there learn how to install and operate high-power radio transmitters, how to detect and quickly remedy troubles and they gain other highly practical radio knowledge which will be of special value to them in the field.

This training on "live" transmitters, the instructors declare, has been found invaluable. Some students are given permission to work nights in the station, under the guidance of shift engineers. In the factory they have an opportunity to see the big transmitters packed, an experience that will be of aid at the unpacking end later on. The courses are so planned that the equivalent of several months of instruction is gained within a few weeks.

Besides the transmitter station, the company's factory is a constant reference room for the students who not only see and study the transmitters in action but also learn how they are built.

The school was established less than two years ago. It quickly outgrew its

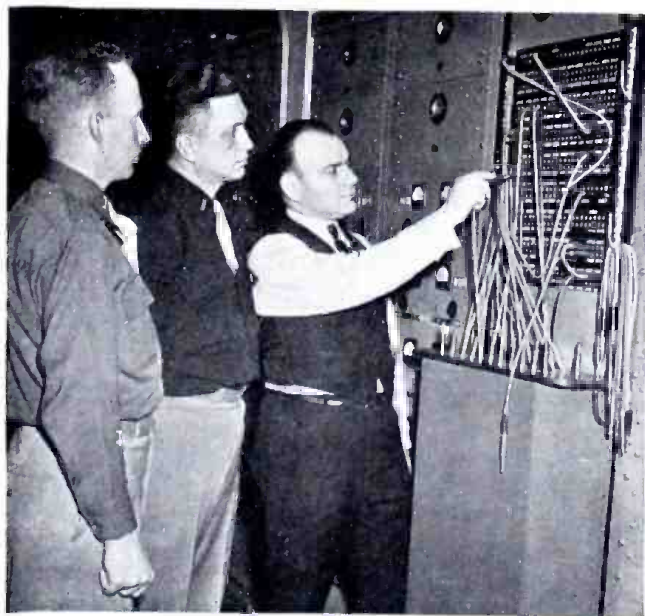

Officers receiving instructions on control panel operation.

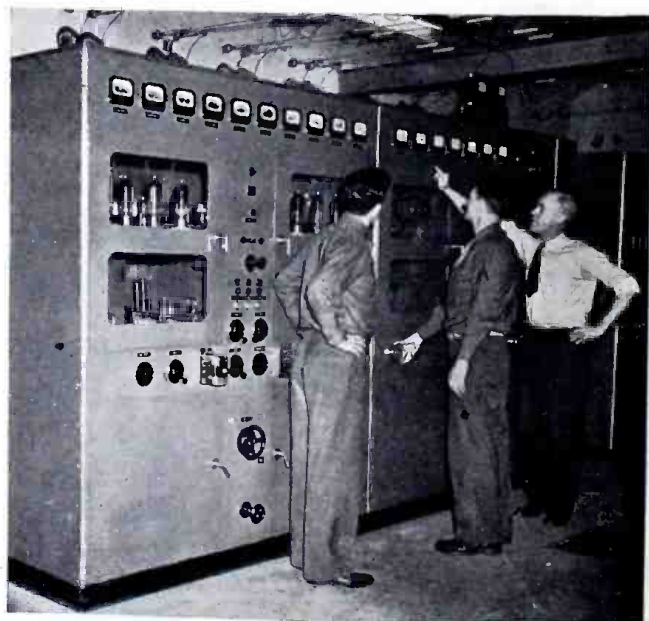

Studio technician explaining various meter indications.

original quarters in a remodelled farmhouse on the Press Wireless grounds. Space was cleared in the transmitter station and the school moved there. Since it was started, men from nearly every state in the Union have attended and a wide variety of occupations has been represented. Many of the Signal Corps personnel have had previous radio experience or were actually engaged in radio before entering the service, but there are lawyers, theater managers, cabinet makers, school teachers, printers and men of many other callings in the classes.

At least once during the courses of instruction, each class is conducted to the Press Wireless receiving station at Baldwin, Long Island, and to the central control headquarters in Times Square, New York City, so that they may gain a better perspective of the details and organization of a fully-equipped radio communications terminal. The students also have the advantage of the Press Wireless antenna installations outside their school house so that they can study the various types first hand and in direct relation to the working transmitters in the station.

Officers as well as enlisted men attend this school which now has graduates on the communications fronts of every theater of the war.

-50-

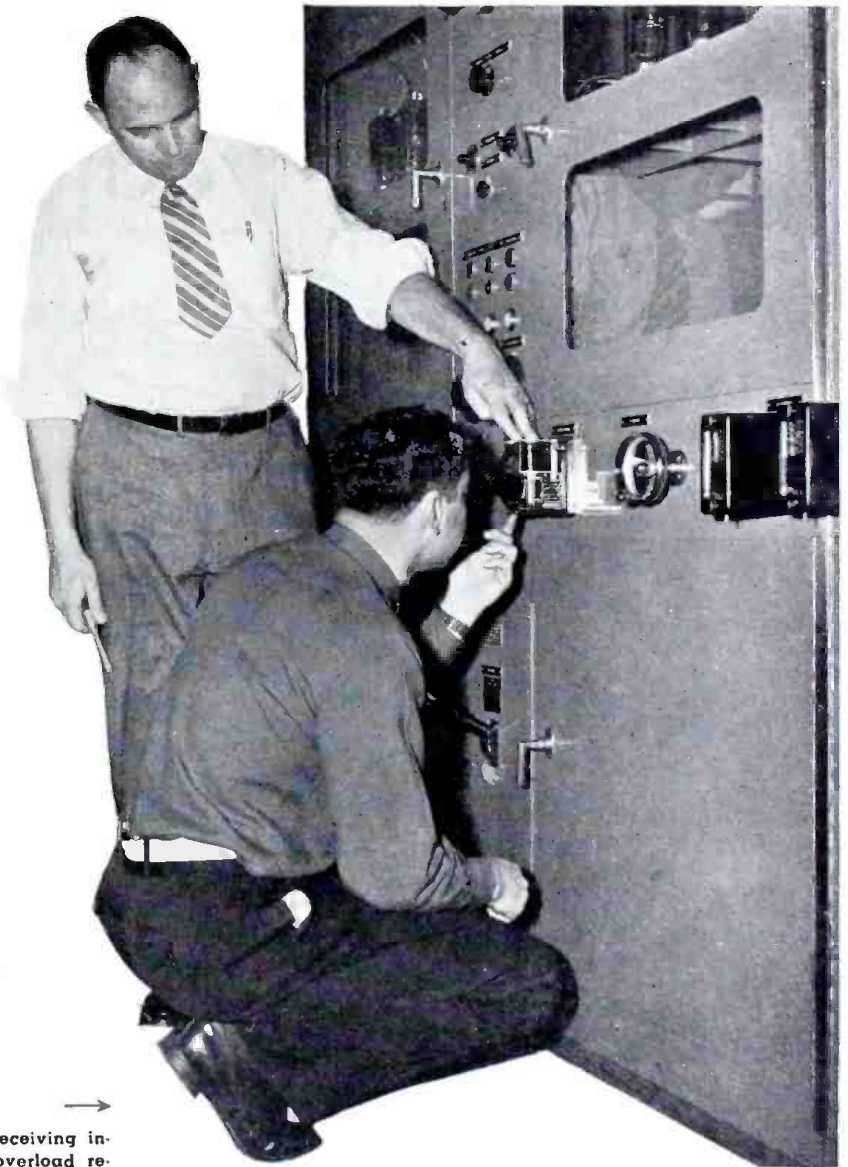

→
Signal Corps student receiving instructions on the d.c. overload relay of a 15-kilowatt transmitter.

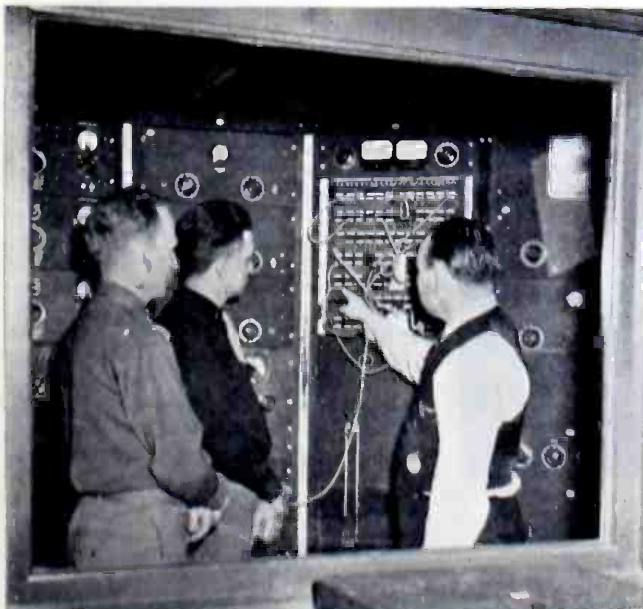

Control panel operation being explained to student officers.

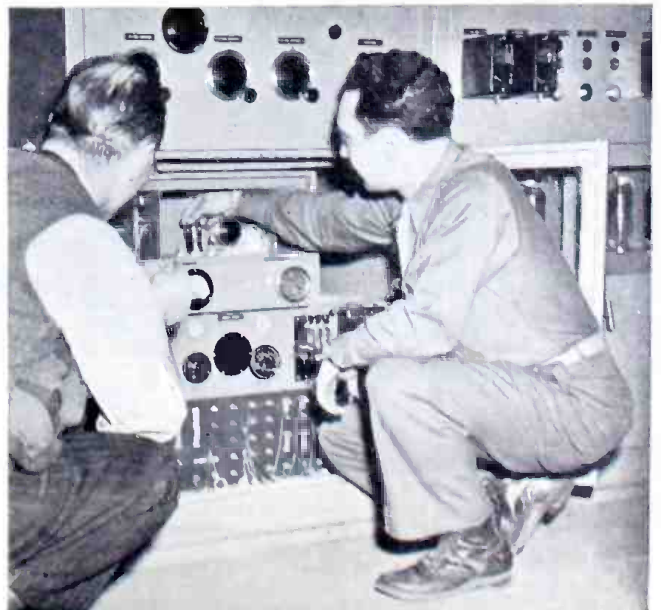

Student obtaining details of 2.5-kw. crystal oscillator unit.

MULTIVIBRATOR For Checking Receiver Sensitivity

By **McMURDO SILVER**

Vice Pres., Grenby Mfg. Co.

Service men can save considerable time by employing this multivibrator unit for checking over-all sensitivity of all-wave broadcast receivers.

IN EITHER the initial manufacture or the subsequent inevitable servicing in the field of radio receivers, the matter of sensitivity is of extreme importance. This is because correct sensitivity for a given circuit design is a function of correct operation of almost all of the individual circuits and sections or levels going into the make-up of the receiver. More specifically, correctness of tracking adjustments for gang-tuned radio-frequency circuits, correctness of alignment of cascaded tuned circuits in the intermediate-frequency amplifier, condition of vacuum tubes, and even proper power supply operation, are tightly bound up in the question of sensitivity.

It is customary in receiver manufacture, especially in the case of the superheterodyne type of circuit almost universally used today, to initially align the i.f. amplifier circuits and in the same process to measure combined i.f. and a.f. amplification. This can be both a rapid, as well as an effective method of testing. R.f. circuits, on the

other hand, are most usually aligned at three specific frequencies only within each of their tuning ranges. On the broadcast band, for example, the conventional alignment frequencies are customarily 1400, 1000 and 600 kcs. If sensitivity checks properly at these three frequencies, it is assumed that it will be correct at all other frequencies between possibly 1700 and 550 kcs.

To even the uninitiated, consideration of these figures should evidence the fact that a three-frequency check may not in itself always be adequate to assure proper sensitivity and circuit tracking at other relatively widely separated frequencies within the tuning range of the circuits. Early in the life of a well-designed receiver the usual three-frequency-test assumption has some foundation in fact, for correct sensitivity can seldom be obtained at all three frequencies if the various tuned r.f. circuits are not possessed of characteristics so as to reasonably assure approximately proper sensitivity throughout the entire tuning range.

Yet there can develop variations which can operate to deny the validity of the assumption with time. This becomes increasingly true after circuit components have been subjected to alternate heating and cooling, accumulation of dust, and other factors productive of variation from initial characteristics as the receiver grows old.

For the broadcast band, the assumptions made by the three-frequency test are not beyond reason, as is evidenced by widespread subscription to the practice. At high frequencies, as on the short-wave bands of typical radio receivers, these basic assumptions become less and less tenable. The simplest explanation for this statement is the fact that in conventional manufacture it is not economical to hold the high-frequency circuit components to as relatively rigorous tolerances as are possible at low frequencies. Thus, the actual frequency change caused at high frequencies by a percentage change so small in the broadcast band as to be justifiably neglected can become significant indeed.

Finally, the assumption that application of the conventional three-frequency test will tell an adequately conclusive story for each frequency range or band so tested must of necessity rest upon its correct and thorough application. This is possible in the better-equipped factories using expensive laboratory type signal generators and where the test involves not only circuit alignment and tracking, but actual gain measurements besides. In the case of the radio serviceman called in to locate a fault which his client may describe as "weak signals on the 31-meter band," the problem assumes a much darker aspect. It is more than probable that he will employ a signal generator of low-priced construction with the voltage output leaving much indeed to the imagination. He is thus in no position to make more than rough quantitative checks of sensitivity, even when he goes beyond the three-frequency test and attempts to measure gain at every offending frequency on the receiver undergoing service. Even if his signal generator is one of the reliable types which usu-

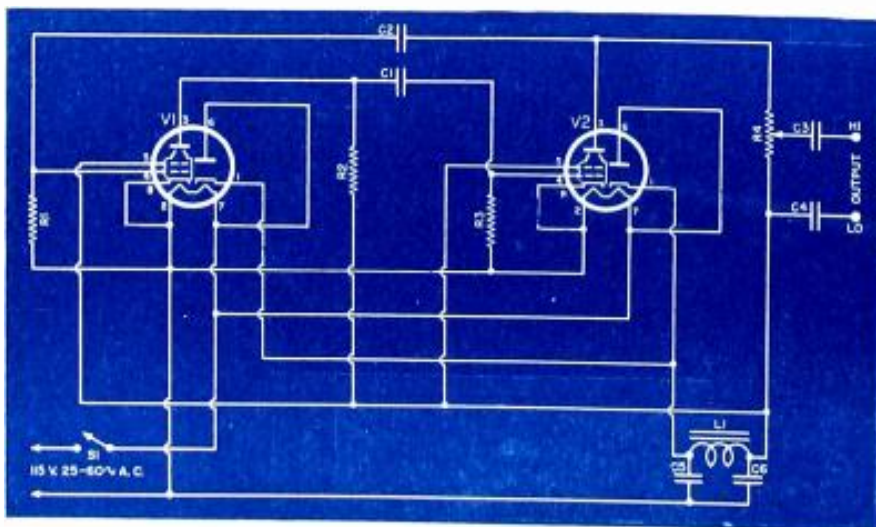
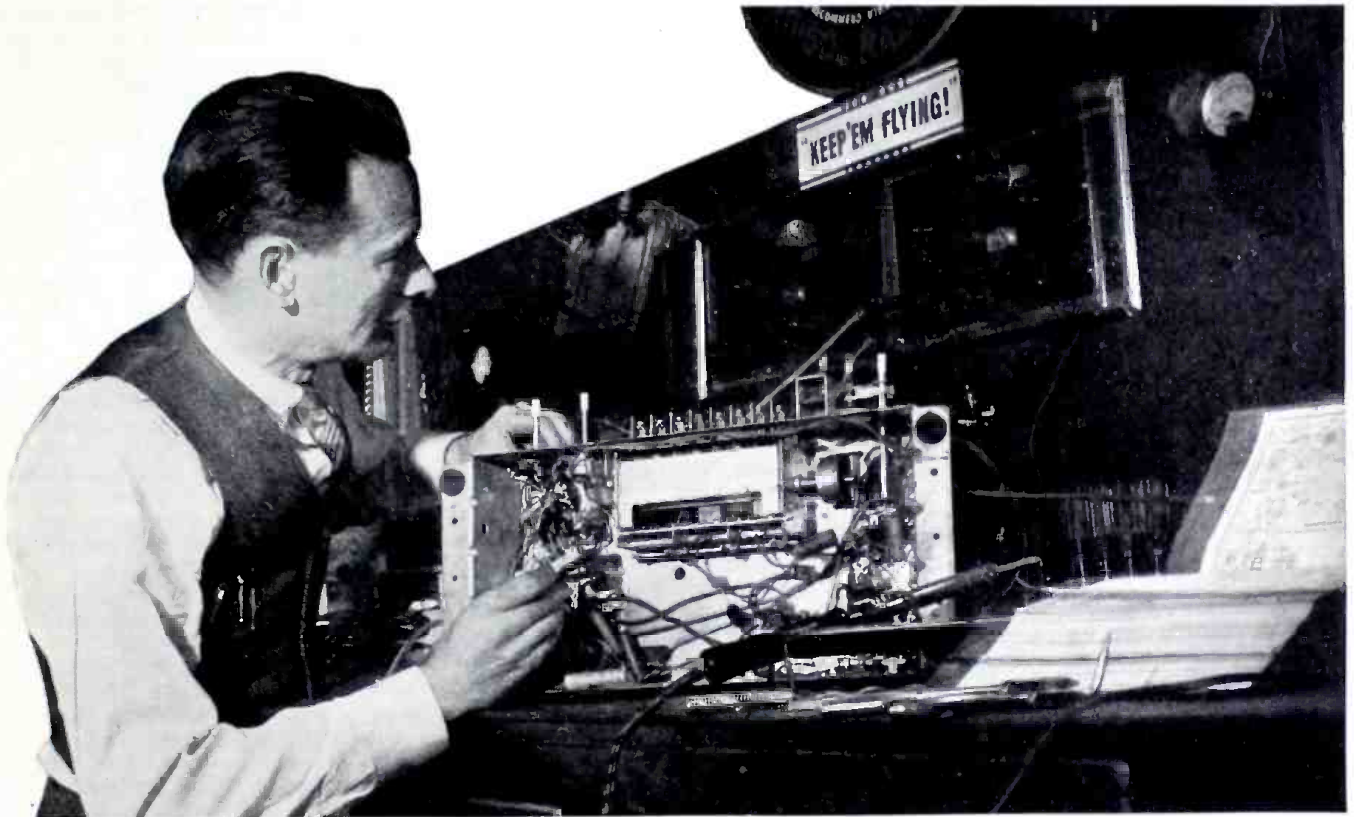

Fig. 1. Multivibrator unit, producing useful output up to 30 mcs., can be constructed from available parts. Fundamental frequency is approximately 5000 cycles.

R_1, R_2 —100,000 ohm, $\frac{1}{2}$ w. res.
 R_3 —10,000 ohm, 2 w. res.
 R_4 —10,000 ohm, 2 w. pot. w.w.
 C_1, C_2 —.001 μ d. mica cond.
 C_3, C_4 —.01 μ d. 400 v. cond.

C_5, C_6 —8 μ d. electrolytic, 200 w.v. cond.
 L_1 —10 henries, 50 ma. filter choke
 S_1 —Toggle switch, s.p.d.t.
 V_1, V_2 —117L7GT



Signal generator being used to check i.f. selectivity. For r.f. sensitivity measurements, the multivibrator unit will save considerable time.

ally costs \$400.00 or more, he must make not three, but probably seven or more sensitivity and alignment tests per wave-band—a sizable waste of time and effort.

The foregoing analysis of an ever-present situation suggests the desirability of some method which would permit a rapid and at least qualitative check of receiver sensitivity at every frequency in every wave-band without the expenditure of the time necessary for such a laborious operation by usual signal generator-output meter technique. Such a method exists, and can be most advantageously added to the serviceman's repertoire, as well as to his equipment, at quite low cost—probably from odd parts on hand.

Just why this method has not gained popularity is something of a mystery, for some few years ago at least one manufacturer offered a unit permitting of its employment. The writer has regarded it with favor, found it distinctly useful, and so believes that the progressive serviceman can gain more satisfied clients at a considerable saving in time and mutual annoyance by its utilization.

The method involves the use of a signal generator which simultaneously produces frequencies closely spaced to one another, and in sufficient number to cover the entire frequency range of the receiver under test. This may sound like a very large order at first thought, but its realization is extremely simple indeed. Given such a signal generator, the serviceman need only connect it to antenna and ground binding posts of the receiver under test,

tune the receiver successively over each band, and by noting any significant increase or decrease in audible output, determine if "hot" or "weak" spots are present. Once so located, the offending circuits may be treated by conventional trouble-shooting and correction techniques.

The practical form which this multi-signal generator may take is that of a simple, unsynchronized multivibrator, combined with a compact and inexpensive a.c.-d.c. power supply. The whole unit may be made sufficiently small to fit into a coat pocket for easy transportation directly to the home of that inevitable client who complains that his, or her, radio is weak on some stations. Briefly, far from being costly, complicated, and cumbersome, the practical multisignal generator may be inexpensive, simple indeed, and most portable. Intelligently utilized, it can save hours of work on tough receiver problems, and rapidly locate points of low sensitivity quite hard to localize by conventional servicing means. It permits determination of uniformity of receiver sensitivity within each wave-band in a matter of seconds.

Ordinary small, dry-battery-operated buzzers have sometimes been used in the past to shock-excite the antenna circuits of receivers as a means of accomplishing the same result. They appear definitely less desirable, however, than a multivibrator with controllable output voltage because of the masking of some operating functions which can occur when an extremely strong shock is rapidly applied to a tuned circuit

such as an antenna-coupling transformer. The multivibrator does not produce the same characteristic of impact excitation, and is additionally desirable because of the relatively slight fall-off in amplitude of successive harmonics of its fundamental frequency. Multivibrator harmonics up to the several thousandths are detectable upon sensitive receivers, while the diminution in amplitude of successive harmonics is relatively slight, and smoothly progressive in over-all effect.

The circuit of Fig. 1 diagrams a simply-constructed multivibrator which has been found to yield useful output, in terms of the typical multiband broadcast receiver, up to 30 megacycles and even higher. Its fundamental frequency is in the neighborhood of 5000 cycles, the exact frequency of an unsynchronized multivibrator being rather hard to determine precisely, and of little consequence for the proposed application in any case. For the curious, it may be stated that, assuming the plate resistors of the two tubes to be small in relation to the grid resistors, the fundamental frequency will be:

$$\frac{1}{f} = R_1 C_1 + R_2 C_2$$

The elements in the above formula are the first grid resistor R_1 in ohms times the first grid capacitor C_1 in farads plus the second grid resistor R_2 , in ohms times the second grid capacitor C_2 in farads. R_1 should be equal in value to R_2 , and C_1 should be equal to C_2 . Operational characteristics of
(Continued on page 76)

Radiometric Elements

By ALBERT A. SHURKUS

Fundamental principles of photoelectric devices and their various electrical characteristics.

WHEN radiant energy, notably those wavelengths between 2,000 and 15,000 Å, falls upon certain photoactive materials, an electron flow is produced which is proportional to the intensity of the illumination. It was this effect that was one of the key factors in the formulation of the quantum theory. The maximum energy of the electrons released, however, is independent of the intensity of the illumination but dependent upon the frequency of the radiation. In general, devices utilizing this effect fall into three general categories: the photoconductive, the photovoltaic, and the photoemissive. In the first two types the electron flow is internal, while in the last it is external.

The photoconductive cells (for example, crystalline selenium cells) contain a semiconducting solid whose resistance to the flow of an electric current is inversely proportional to the amount of light falling upon it. It might be mentioned in passing that so far the photoconductive cells have proved to be of little more than academic interest. The photovoltaic cells (for example, cuprous oxide-cupric oxide or selenium-iron) convert the light energy falling upon them into an electromotive force. The photoemissive cells or tubes function by the actual emission of electrons from certain

metallic surfaces due to the incident light.

Since photoelectric elements are limited in their response to the visible, and near visible, spectrum, they are unsuited for use in infrared measurements where the radiant energy is of much longer wavelengths. For these measurements, non-selective detectors dependent upon the heating effect of radiation are used. This class of detector is represented by the thermopile, the bolometer, the radiomicrometer, and the radiometer.

Photoconductive Cell

The photoconductive effect was discovered in 1873 by Willoughby Smith, who noted a change in the resistance of crystalline selenium with illumination. Present-day cells are made by the condensation of selenium vapor upon a conducting grid laid upon a glass surface.

To be used, these cells must be in series with a source of potential. Although this selenium film presents considerable resistance even though not illuminated, these cells still pass appreciable dark current. When dark, the resistance of commercial cells ranges from about 100,000 ohms to 25 megohms. The ratio of light to dark currents may be as high as 25 but is more commonly about 8 or 10 (see

Fig. 2). In Figs. 3 and 4 are shown the current-illumination characteristic curve and the spectral response curve of a typical selenium cell. The peak of the spectral sensitivity curve is well in the red and is quite different than that exhibited by the eye.

Although these cells are used occasionally in relay circuits as shown in Fig. 13, they are seldom, if ever, used in the measurement of radiant energy. The photovoltaic and the photoemissive cells are much more suitable.

Photovoltaic Cell

The photovoltaic effect was first observed in 1839 by Becquerel, who found that an electromotive force was set up when one of two electrodes immersed in an electrolyte was illuminated. Present-day cells, however, dispense with the need for immersion and are made either by the deposition of a film of cuprous oxide upon copper (as in the Westinghouse Photox cell) or by the deposition of iron selenide upon iron (as in the Weston Photronic cell).

The chief advantage of the photovoltaic, blocking layer, barrier layer, or simply photocell, as it is variously called, is that it requires no external voltage supply. Because of this, extremely compact and moderately sensitive devices can be made for the measurement of radiant energy. The photoelectric exposure meters now so much in use by photographers are an outstanding example of this. Many other applications have been made of the photocell connected directly to a galvanometer or microammeter. Some of the applications—just to mention a few—have been opacimeters, glossmeters, pyrometers, colorimeters, and densitometers. But, as soon will be evident, this simple circuit is not well adapted to precise measurements of light intensities.

Variable Factors Affecting the Photocell

The primary difficulty experienced in the use of photocells is that the current output is never strictly proportional to the intensity of the illumination, and this proportionality is drastically affected by changes in the resistance external to the cell (Fig. 5). Deviations from the linear may amount to as much as 20% when the illumination is changed from 40 to 100 foot-candles. It should be noted, too, that even the short circuit current is not absolutely linear.

Another malfeature is that the response is not independent of temperature (Fig. 6). Under certain conditions one can expect a change of as much as 5% for a change in ambient temperature of 20°C. Furthermore, there is likely to be a change in spectral sensitivity with temperature.

A defect that needs only recognition to be readily corrected through use of the proper filters is that the spectral response curve is not the same for photocells as it is for the eye. But for that matter, no photosensitive surface matches the eye in spectral sensitivity.

Fig. 1. By rotating a photocell, the normal errors inherent in cells of these types are minimized. Curves show the sensitivity of several cells in respect to the frequency of rotation.

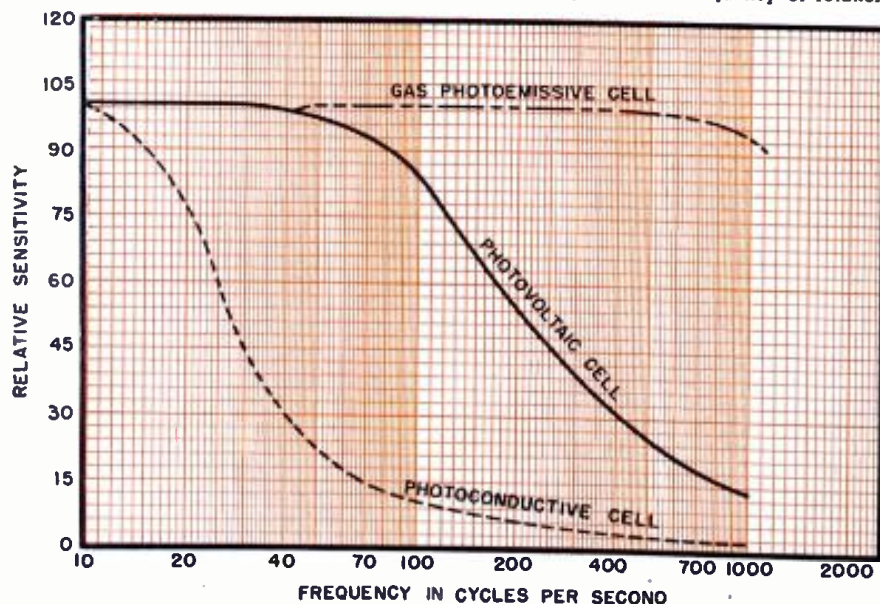

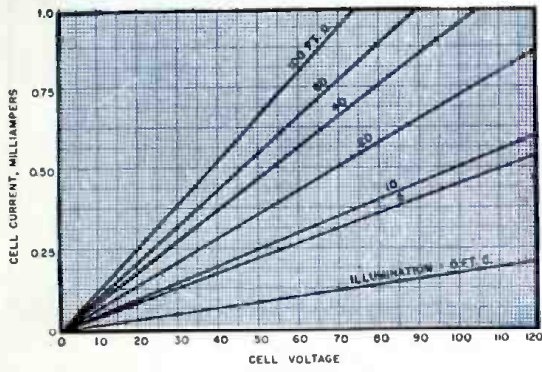

Fig. 2. Photoconductive cell output with a variation in illumination intensity and cell potential.

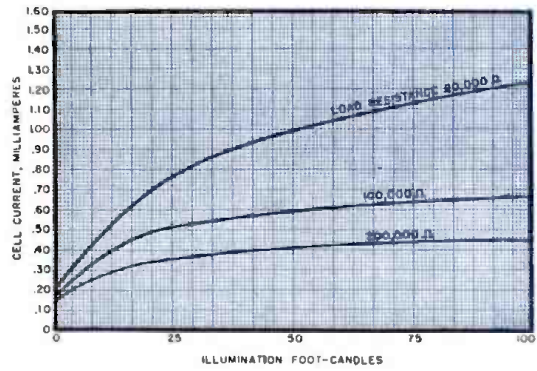

Fig. 3. Current-illumination characteristic curves of a photoconductive cell with various loads.

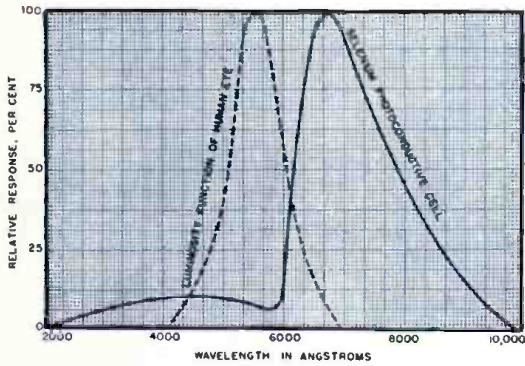

Fig. 4. Spectral response curve of a typical selenium cell in relation to that of the human eye.

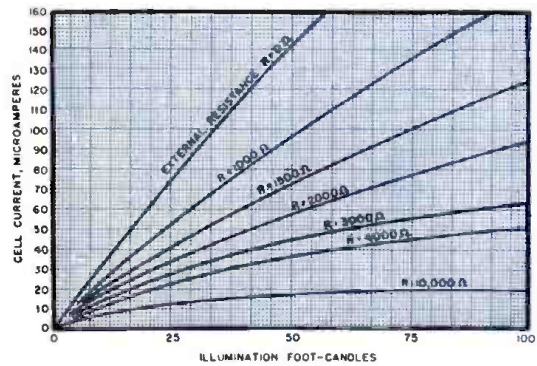

Fig. 5. Illustrating the nonlinearity of the current output of standard photocells.

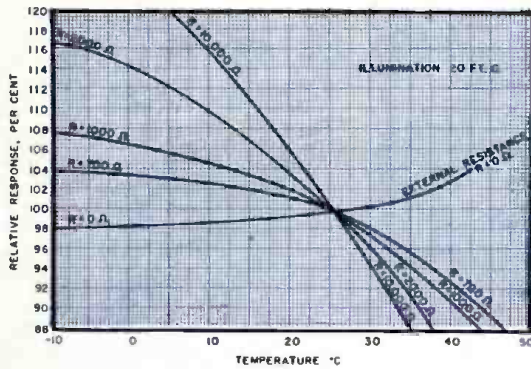

Fig. 6. Variations of relative response of photocells in relation to temperature changes.

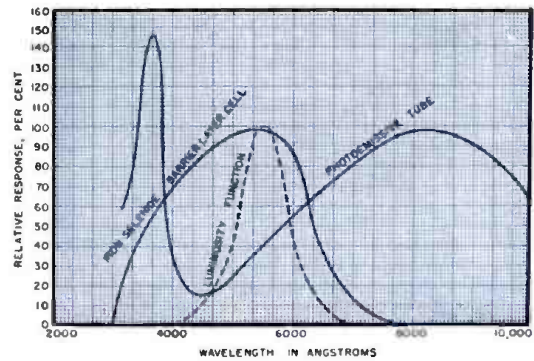

Fig. 7. Spectral response curves of several types of photoelements, plotted in Angstrom units.

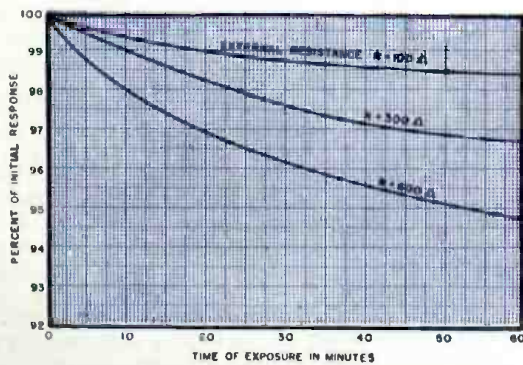

Fig. 8. Initial drift effect (fatigue) of photocells in relation to the time of exposure.



Fig. 9. Recovery curve of standard photocell from period of complete darkness to full illumination.

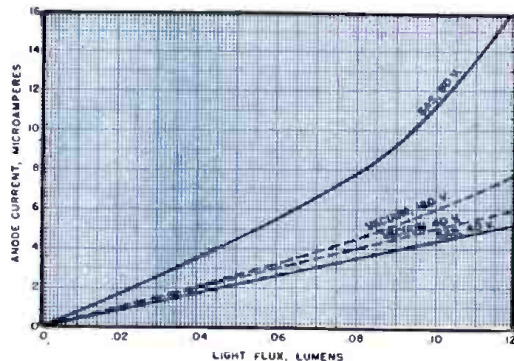

Fig. 10. Current-illumination characteristics of the gas and vacuum type phototubes.

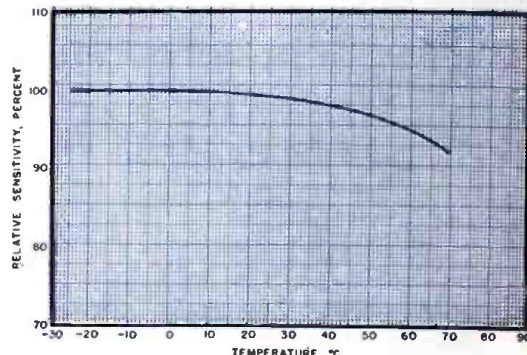

Fig. 11. Sensitivity-temperature curve of phototube, showing improvement over photocells.

Curves showing the spectral response of the various types of photoelements are given in Fig. 7.

In photocells there is, however, an initial drift effect—fatigue—which is very objectionable when measurements are desired over a period of time. This decay in current may be of a duration varying from 15 minutes to several days. (See Fig. 8.) The history of the cell for at least 24 hours previous to use must be known for precise work since the rate of recovery from illumination is slow (Fig. 9). Indeed, permanent injury may result to a photocell from prolonged exposure to extremely intense illumination. It has been found, too, that fatigue may vary with the spectral quality of the light.

It should be evident, now, that in consideration of all these variable factors affecting the photocell, it is extremely difficult, if not impossible, to avoid errors when using the photocell as a direct-reading radiometric element.

More Precise Photocell Methods

Many attempts have been made to overcome the inherent defects of photocells discussed above. For the photometry of lamps, Wilson¹ has rotated a single photocell and measured the commutated current with a galvanometer of long period. Using this method, errors caused by fatigue and temperature changes are cancelled. However, if the frequency of rotation, which results in an a.c. potential produced by the photocell, attains any appreciable

Fig. 13. Photoconductive cells may be used effectively in many types of relay circuits.

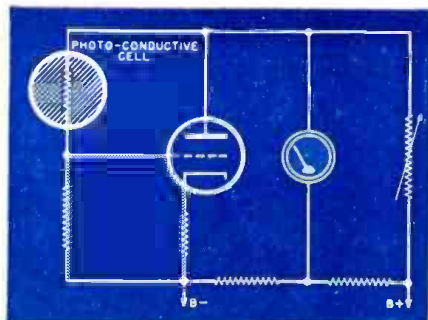

value, there will be a decrease in sensitivity (Fig. 1) due to the decreasing capacitive reactance presented by the condenser formed by the film and the base plate.

The compensating² or differential³ circuit for photocells has been widely used to overcome the troubles of the single photocell. In this circuit (Fig. 12) linearity of the current-illumination characteristic is obtained over approximately the same range as for the single photocell. When this circuit is used as a null indicator, it is distinctly superior to other circuits in stability and reproducibility. The circuit, too,

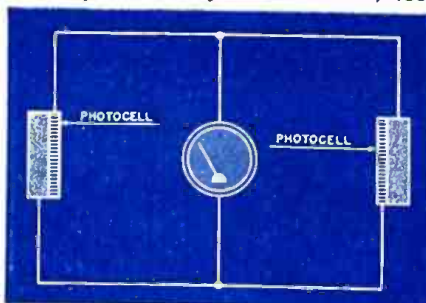

Fig. 12. Differential circuit using two photocells to overcome single photocell errors.

is relatively insensitive to light source fluctuations when properly applied.

In practice, the reading scale of an apparatus employing this circuit may be furnished by the deflection of a galvanometer, by a device for continuous variation of intensity such as a movable photocell or lamp, neutral wedge, variable aperture, variable depth of liquid, or by a variable resistance. An accuracy of about 0.2% has been claimed for this circuit.

MacGregor-Morris and Stainsby⁴ have carried the differential cell method one step further and have rotated two cells back to back and have measured the commutated current. For this arrangement they have claimed an accuracy of 0.1% and a self-consistency of four to five times that obtained by visual means.

When extreme accuracy, or when very low light levels are to be measured, it is well to replace the photocell with a phototube and amplifier,

since the photocell does not readily lend itself to amplification.

Phototube

The photoemissive effect was discovered in 1887 by Hertz (of the Hertzian waves) in the course of his experiments with electric oscillations and electric waves. The phototube, that is, the photoemissive cell, suffers from the same defects, theoretically, as do the other photoelements. As can be seen from Fig. 10, for low anode voltages the current-illumination characteristic of either the gas or vacuum phototube is linear. For higher anode voltages the vacuum, or "hard," as it is sometimes called, phototube departs very slightly from linearity, while the departure of the gas, or "soft," tube is appreciably more. But for the measurement of light intensities the hard phototube is invariably used, gas tubes being used more for relay applications. Thus, the departures from linearity of the phototube photometers are much less than those using the photocell. And considering the curves of Figs. 1 and 11 it can be seen that the phototube exhibits much less of a variation with temperature or light modulation frequency than do the photocells. Since these factors affect the phototube to a much smaller extent, it is the opinion of Reich⁵ that "from the point of view of linearity of response, absence of time lag, freedom from fatigue and temperature effects, the phototube is far superior to either the photoconductive or photovoltaic cell."

Thermoelectricity

When the junction of two dissimilar metals is exposed to radiation, a thermoelectric voltage is generated. This is known as the Peltier effect. True, this thermoelectric force is small for a single junction, being of the order of microvolts, but when a plurality of thermoelectric junctions are placed in series, the voltages are additive and can be made of a sufficient magnitude to enable radiant energy measurements far out into the infrared. This plurality of junctions, the thermopile, is of great importance today in the

(Continued on page 126)

RADIO NEWS

Okay!

ENTER MY SUBSCRIPTION

- Payment enclosed
 Bill me

- ONE YEAR \$3.00
 TWO YEARS \$5.00
 THREE YEARS \$7.00

Canadian subscriptions \$3.50 per year; British Empire \$4 per year, flat. Other foreign subscriptions \$6 per year flat. South and Central America same as U.S.A.

PLEASE SEND CHECK OR MONEY ORDER.

NAME _____
 STREET _____
 CITY _____ LOCAL ZONE _____ STATE _____
 Occupation _____
 Employed by _____
 Type of Business _____

NJ44

ENTER MY SUBSCRIPTION FOR

RADIO-ELECTRONIC Engineering

- 1 YEAR \$3.50
 2 YEARS \$5.50
 3 YEARS \$7.00

CANADA 50¢ PER YEAR EXTRA

- Remittance Enclosed
 Bill Me Later

NAME _____
 ADDRESS _____
 CITY _____ LOCAL ZONE _____
 STATE _____
 COMPANY _____
 TYPE OF BUSINESS _____
 TITLE _____

PLEASE SEND CHECK OR MONEY ORDER.

IMPORTANT NOTICE: LIST OF ELIGIBLE SUBSCRIBERS

Subscriptions to this special edition of RADIO NEWS are limited to the following classifications: executive and engineering personnel of companies manufacturing radio, electronic and associated equipment and producers and fabricators of raw materials; Broadcast Engineers and Station Directors and General Managers; Production Engineers; Engineers of police and municipal communications; Army and Navy Engineers and Procurement Officers. NOTE: Your title and company connection must be indicated in the space above.

NJ44

some future possibilities for new applications that will result from wartime developments.



1919



1944

FIRST CLASS
 PERMIT NO. 3365
 SEC. 510, P. L. & R.
 CHICAGO, ILL.

BUSINESS REPLY CARD
 NO POSTAGE NECESSARY IF MAILED IN U. S. A.

2c Postage will be Paid by



540 NORTH MICHIGAN AVENUE
 CHICAGO 11, ILLINOIS



FIRST CLASS
 Permit No. 3365
 Sec. 510, P. L. & R.
 CHICAGO, ILLINOIS

BUSINESS REPLY CARD
 No Postage Necessary if Mailed in U. S. A.

2c Postage will be Paid by

Radio-Electronic Engineering
 EDITION OF RADIO NEWS

540 NORTH MICHIGAN AVENUE
 CHICAGO 11, ILLINOIS

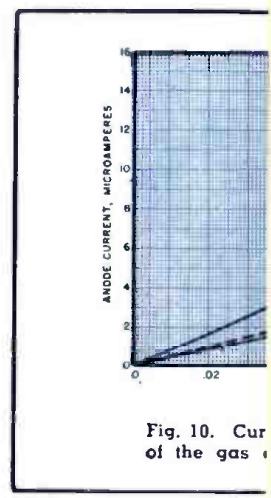

Fig. 10. Cur of the gas

Curves showing the sp of the various types of are given in Fig. 7.

In photocells there is an initial drift effect—fairly objectionable when they are desired over a period of time. The decay in current may be varying from 15 minutes to several days. (See Fig. 8.) The cell for at least 24 hours before use must be known for since the rate of recovery is slow (Fig. 9) permanent injury may result from prolonged extremely intense illumination. It has been found, too, that fatigue with the spectral quality.

It should be given consideration of all the factors affecting the photocell. It is extremely difficult, if not impossible, to avoid errors when using a direct-reading instrument.

More Precise Photocell Methods

Many attempts have been made to overcome the inherent defects of photocells discussed above. For the photometry of lamps, Wilson¹ has rotated a single photocell and measured the commutated current with a galvanometer of long period. Using this method, errors caused by fatigue and temperature changes are cancelled. However, if the frequency of rotation, which results in an a.c. potential produced by the photocell, attains any appreciable

Fig. 13. Photoconductive cells may be used effectively in many types of relay circuits.

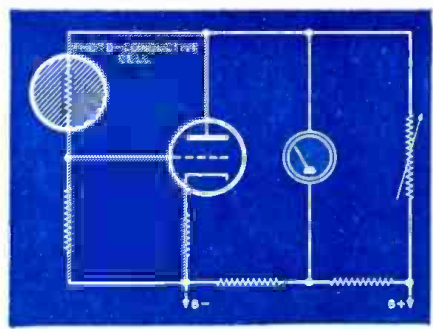

Fig. 12. Differential circuit using two photocells to overcome single photocell errors.

is relatively insensitive to light source fluctuations when properly applied.

In practice, the reading scale of an apparatus employing this circuit may be furnished by the deflection of a galvanometer, by a device for continuous variation of intensity such as a movable photocell or lamp, neutral wedge, variable aperture, variable depth of liquid, or by a variable resistance. An accuracy of about 0.2% has been claimed for this circuit.

MacGregor-Morris and Stainsby⁴ have carried the differential cell method one step further and have rotated two cells back to back and have measured the commutated current. For this arrangement they have claimed an accuracy of 0.1% and a self-consistency of four to five times that obtained by visual means.

When extreme accuracy, or when very low light levels are to be measured, it is well to replace the photocell with a phototube and amplifier,

less than those using the photocell. And considering the curves of Figs. 1 and 11 it can be seen that the phototube exhibits much less of a variation with temperature or light modulation frequency than do the photocells. Since these factors affect the phototube to a much smaller extent, it is the opinion of Reich⁵ that "from the point of view of linearity of response, absence of time lag, freedom from fatigue and temperature effects, the phototube is far superior to either the photoconductive or photovoltaic cell."

Thermoelectricity

When the junction of two dissimilar metals is exposed to radiation, a thermoelectric voltage is generated. This is known as the Peltier effect. True, this thermoelectric force is small for a single junction, being of the order of microvolts, but when a plurality of thermoelectric junctions are placed in series, the voltages are additive and can be made of a sufficient magnitude to enable radiant energy measurements far out into the infrared. This plurality of junctions, the thermopile, is of great importance today in the

(Continued on page 126)

25TH ANNIVERSARY RADIO NEWS

RADIO NEWS, with this 300th issue, marks its 25th year of uninterrupted publication. The special articles appearing in this section summarize briefly the tremendous strides made in radio and electronics in the past and indicate some future possibilities for new applications that will result from wartime developments.



1919



1944

MILESTONES IN THE

RADIO INDUSTRY



Lee de Forest

Dr. Lee de Forest, "The Father of Radio,"

*reviews historical developments which have
made possible the miracles of modern radio.*

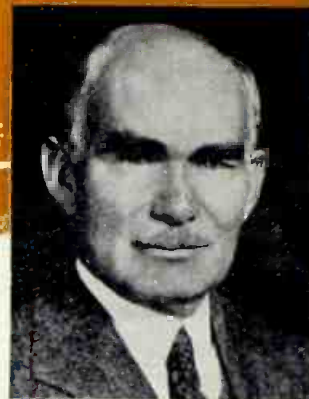

Born Council Bluffs, Ia., 1873. Holds Ph.B., Yale Univ., 1896, Ph.D., 1899, Sc.D., 1919; D.Eng., Lewis Inst., 1937. Am. Wireless pioneer; inventor of radio tube, detector, amplifier, and oscillator, permitting world-wide wireless, long-distance telephony, broadcasting, talking motion pictures, television, etc. Called Father of Modern Radio, Father of Broadcasting. Awarded Cross of Legation of Honor, Elliott Cresson, John Scott, I.R.E. Medal of Honor.

FROM where I sit today one needs a long-focus binocular to view the developments which have taken place in radio since that distant era when I began to grow with the industry.

I can recall the early beginnings of wireless, with its crude equipment, hard for the modern radio engineer to visualize, the four-tuned circuit system, open spark gap transmitters, and electrolytic detectors. Later the crystal detector made its appearance, lacking wave-meters and the sorely needed decimeters. Refinements appeared in the form of the quenched and rotary gaps, with 500-cycle generators; and the Audio detectors, the first variable condensers or inductance variometers for really sharp tuning.

It was on the Pacific Coast that undamped wave transmissions from the Poulsen arcs of the Federal Telegraph Company were used, with "compensation frequency" keying, using the Logwood tikker as a detector. In 1912, also

Dr. de Forest in his Los Angeles laboratory, assembling parts of a radio tube used by the U.S. Navy for short-wave diathermy machines.



in California, the Audion amplifier, with one, two, or three stages in cascade, was first employed. The first successful high-speed wireless telegraph, using the Poulsen wire telegraphophone which incorporated the advantages of fast recording and slow reproduction, took place in this year. A punched tape was used at the transmitter, an early advance which was later discontinued and is only now beginning to be found useful again.

About this time, the telephone company realized that radio must be part of their future planning, and intensive development work was begun by them and the De Forest Company to improve the Audion all along the line; refined, high-vacuum amplifiers, "large" transmitter tubes of 250 watts or more, the all-essential feedback circuits, and new and better production methods necessitated by the growing demands of the first World War, were subject to this development work.

For a period of eight years, high-powered arc transmitters, with a few examples of the Alexanderson high-frequency generators, had to meet the growing demands of our military and commercial communication organizations for transoceanic telegraph service to Europe, then later to China and Japan.

In all of this development work, ever since 1904, with the exception of the powerful high-frequency transmitter generators of Telefunken, America continued to lead the world in wireless, and later radio developments. With the awakening of the profession to the undreamed of possibilities of the grid tube (paced by the keen eagerness of the American Ham to explore the fascinating new fields thereby opened), radio really began to function, to come into its own, and to grow apace.

Beginning in 1915 and 1916, the fragmentary broadcast service at Highbridge, New York, with its cult of listeners, began to expand, at times reaching as far west as Cleve-

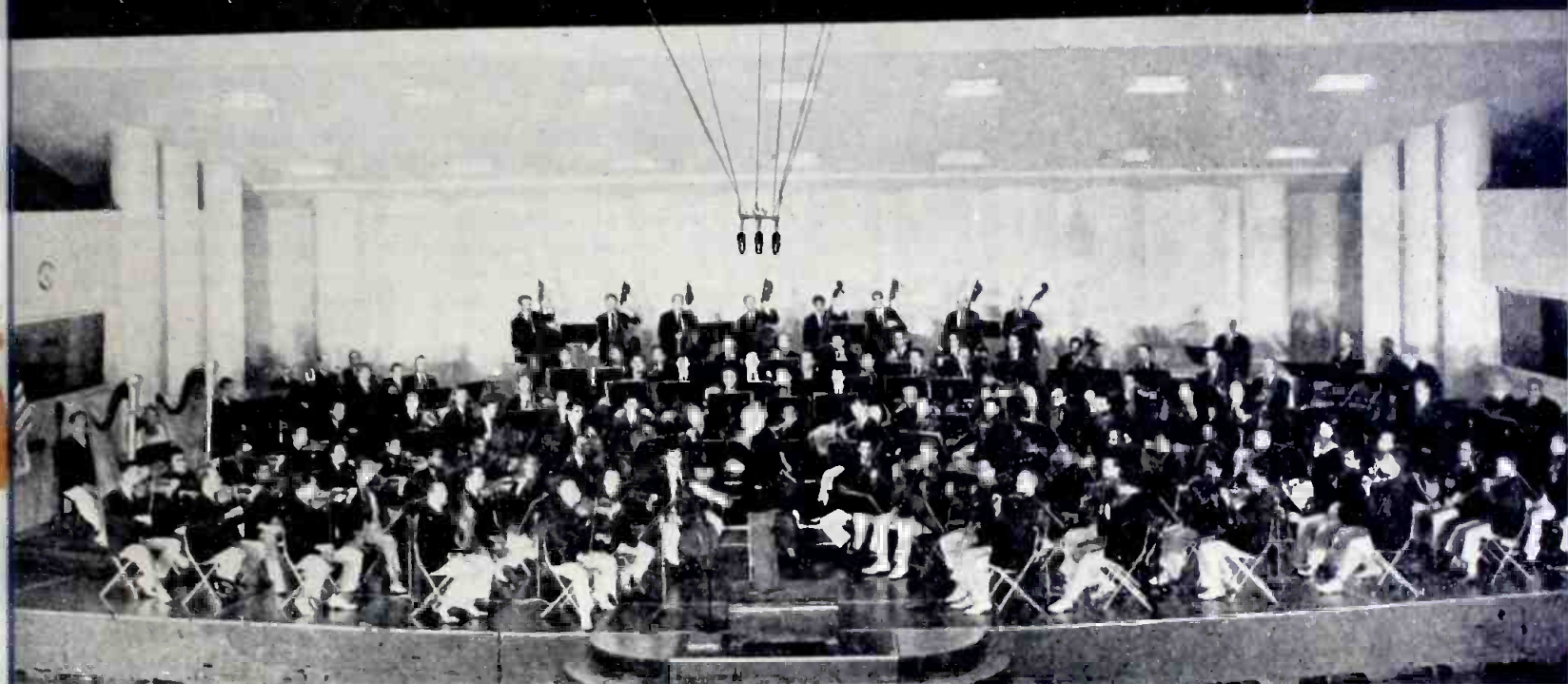

Maestro Arturo Toscanini and his Symphony Orchestra in a nationwide broadcast from station WEAF, world's largest studio, Radio City, N. Y.



Station WEAF studio on opening day, August 16, 1922, an interesting comparison with the modern studio depicted above.

land. The first real news broadcast, the Presidential election of November, 1916, came just before the government clamped its ban on all but military and other necessary radiotelegraph services. The first World War, like the war today, hastened the technical development of radio and multiplied greatly the number of trained radio operators and engineers.

Thus, a small stage was well set for the debut of an instrument, utterly new in human annals, which was destined to grow up with mushroom speed. The public's acceptance of radio demanded the concomitant expansion of the new radio industry which was destined to make appear primitive and amateur all that had preceded radio broadcasting.

Throughout the Twenties, this unprecedented development surged along all of the known and some new engineering lines; the design and perfection of hundreds of types of electron tubes, together with the development of intricate machines and processes for the quantity production of such tubes, the use of hundreds of novel techniques which evolved with the demands of new millions intrigued by the new modes of learning, thinking and living which radio encouraged, was stimulated.

Prompt to appreciate the value of this new medium, our Government early took effective means to protect the pro-

tagonists and their public by issuing rational licenses to broadcasters, limiting the wave-bands and requiring precision-tuned transmitters. In fact, the public was protected from the whims of the broadcaster in all respects except that pertaining to the type of program which was permitted on the air. Program restrictions seemingly contrary to the American Bill of Rights, were not imposed, thus allowing the program sponsor to moronize the American public to his heart's content.

The enormous possibilities of radio broadcasting in the role of educating and elevating the cultural tastes of the listening public remain too little appreciated in practice by those who now direct the policies and destinies of radio.

This war has revealed in an impressive manner, the gigantic power of radio broadcasting and short-wave trans-global communication. Here at last we witness, in daily demonstration, the potent ability of radio to spread political propaganda, to acquaint the beleaguered masses with the message from across their verboten frontiers that their slow salvation is on its resistless march, keeping hopes alive and readying the uprisings which will substantially aid the invasion. To friendly or neutral lands, our daily programs are gradually working to remove ancient antagonisms, suspicions inherent between strangers, and thus inevitably forwarding that distant dawn of mutual global understanding and civilized cooperation. Such was radio's predestination, now being realized.

Early in the annals of broadcasting, second in importance only to the development of the electron tube, came the knowledge of the unique precision control of frequencies by the piezo crystal. The debt which today's radio owes to those pioneers, Drs. Cady and Pierce, is perhaps too little appreciated considering the importance of their work. The value of their work is emphasized today by the fact that millions of frequency controlling crystals are being ground out monthly by a score of busy factories to meet an ever insatiable demand.

The outstanding radio development of the Thirties was the amazing engineering triumph of television, which added a new dimension to radio. The refinement of the cathode beam tube, and its twin sister, the Iconoscope, brought the 525-line picture to the point of well-nigh photographic fidelity to the few prewar screens. These developments and the now feasible projection tubes stand ready to give us a revolutionary form of entertainment and education which surpasses all that we have witnessed in broadcasting during its third decade.



1 This era embraces advances in long coaxial networks, automatic relay stations which permit live spectacles to be spread over wide areas. Rating next to television in importance was the introduction of frequency-modulated broadcasting, not hindered, but enormously stimulated by the demands of our military communications. The original, intricately complicated circuits for FM transmitters have now been largely supplanted by greatly simplified circuits, notably those of the General Electric Company, so that in the postwar period, we may expect nationwide application of this method of transmission to all metropolitan and small urban districts.

Television and FM together have opened up entirely new sections of the ultra-high-frequency spectrum and an immense amount of research in these engaging studies has resulted.

The war has also brought into being, through radar requirements, a knowledge, already profound, of the decimeter and centimeter range of wavelengths, harking back to Hertz and Rayleigh, Lodge and Bose, for useful applications of the Maxwellian field equations in the design of reflectors, wave guides, and resonance chambers, so that now, by utilizing the cathode beam as an indicator, we can accurately measure time in fractional microseconds, and distances from 100 miles to a few feet instantaneously, measure altitudes, ground speeds, as well as direct searchlights, gun fire, and robot planes. Postwar blind landings will become routine; collision with mountains and between planes and vessels, inexcusable.

The study and development work undertaken on the Promethean electron tube and the cathode ray of television was chiefly responsible for the intensified knowledge leading up to engineering of new equipment in the late Thirties. From this work came the electron-multiplier, the electron microscope which has already revealed heretofore unknown regions of nature, and the atom-smashers such as the Cyclotron of Lawrence and the Betatron of Kerst. These instruments provide the entering wedges to the synthesis of the elements and ultimately will provide an exhaustless source of atomic energy before wastrel man has squandered all of our present fuels.

Beginning with short-wave diathermy apparatus and techniques, engineers have developed in recent years high-power radio oscillators. This equipment has been introduced to industry and is being used on such a scale that already the kilowattage in industrial heating applications far exceeds the generated power of all of the world's communication transmitters. Its uses for smelting, brazing, soldering, and tempering operations embrace a degree of refinement and accuracy impossible with the old, classic methods. The plywood industry and plywood construction are being rapidly remade by virtue of kilocycle heating, with an economy of time aggregating years during a single working year.

Radiothermics is entering the field of chemistry, the culinary and domestic field and as yet there seems to be no limit to its application, useful or benign.

Thus has radio developed in less than half a century, from its humble beginnings to its position in the forefront of science today.

-30-

1 An early 500-watt radio transmitter, WJZ, built by Westinghouse in 1921. Ray Guy announcing.

2 Kennedy model 110 Universal receiver. Note the magnetic type speaker and rotatable loop antenna.

3 Diversity receiving system at RCA's receiving center, Riverhead, L. I., used for transatlantic service.

Radio Between Two Wars



**Outstanding events in radio since
1918, and its apparent possibilities
in the forthcoming postwar period.**

J. G. Harbord
Chairman of Board, RCA

Lt. Gen. James G. Harbord (retired) was born in 1866. Graduated Kansas State Ag. Col., 1886. Enlisted in 4th Inf., 1899. Appointed Major, 2nd U.S. Vol. Cavalry, Torry Rough Riders, in war with Spain. Graduated War College, 1917, promoted Lt. Col. Chief of Staff to Gen. Pershing until 1918, meanwhile made Brig. Gen. Assigned to command Services of Supply, 1918; reappointed Chief of Staff, A.E.F., 1919, until sent to Near East as Chief of Amer. Mil. Mission to Armenia. Commanded 2nd Div. until 1921. Retired from Army and joined RCA, 1922.

IN ONE of the hit songs of the current musical comedy "Oklahoma" a young cowhand describes to his amazed friends back home the marvels he beheld on a trip to Kansas City—which then was just emerging from the gaslight era. Each verse, relating new wonders of the early 1900's, ends with the awed assertion: "They've gone about as fur as they can go." That was the way I felt about it myself when I first saw Kansas City in 1889.

The delighted chuckles with which the song is greeted by audiences is traceable in part to the fact that everyone who hears it can recall occasions when he has had the same attitude as the young Oklahoman. The more dramatic the advance by which we are confronted, the more likely we are to conclude that it represents the ultimate of progress in its field. Long before the beginning date which RADIO NEWS is observing in its twenty-fifth anniversary issue, there had been some intelligent men who already had decided that radio had just about achieved its ends. They contemplated its startling accomplishments at sea, where it had ended the communication silence of centuries and where it had no competitor, and said: "It will never do much on land."

Experimental large-screen television receiver. The translucent screen retractable and slides down into cabinet when not in use.

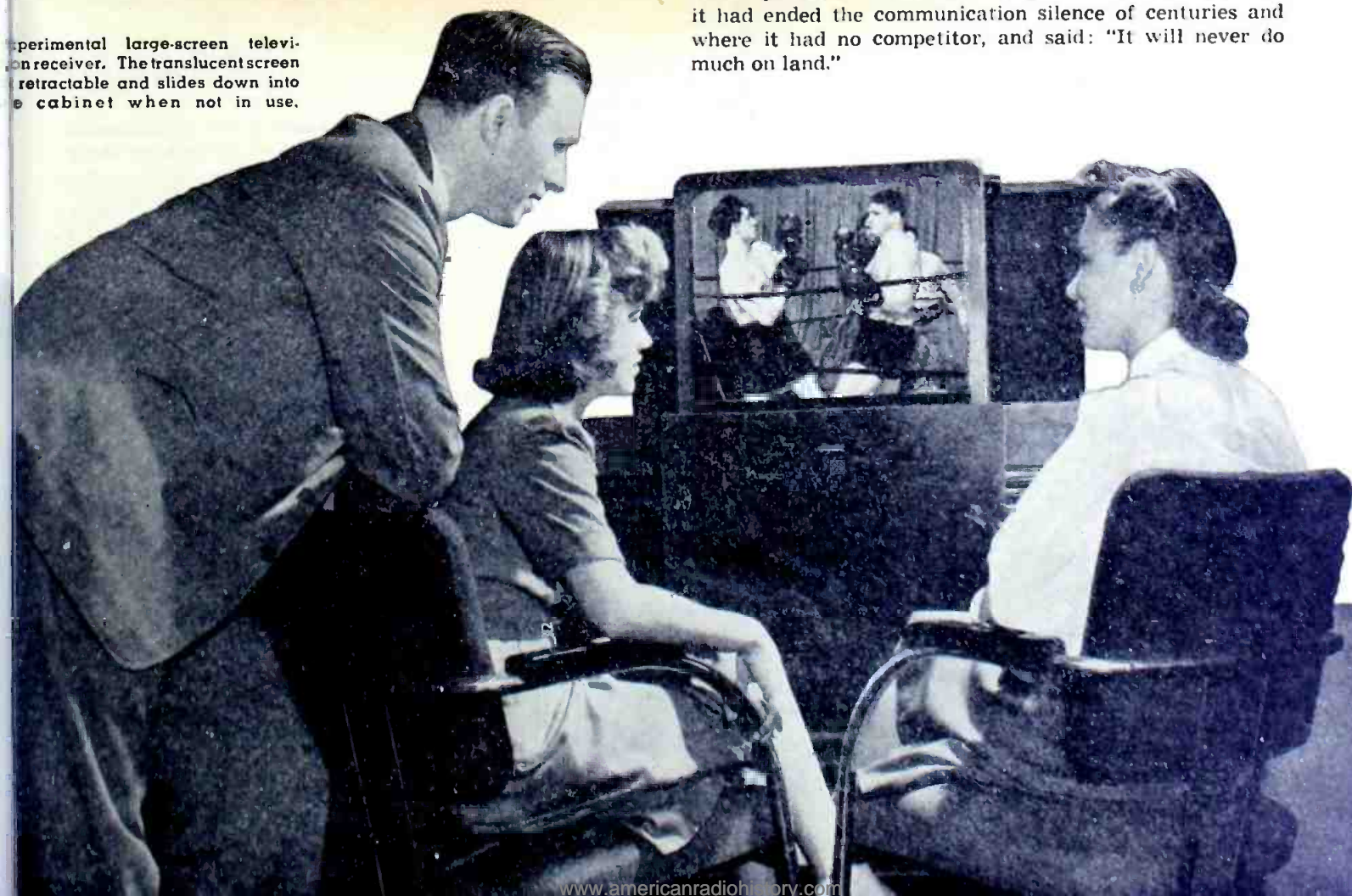

The quarter-century which RADIO NEWS now celebrates has proved that radio discourages its prophets far more often by outstripping their bold prediction than by failure to reach it. I know of no better way to catch some glimpse of the bright future prospects of this still young, still swiftly advancing science and industry than to glance briefly at some of the milestones of radio between our two World Wars.

Radio entered the first World War as an awkward rookie. The belligerent powers, appreciating its potential value, spent large sums for its development. Our laboratory and field test section in the A.E.F. in France, aided by research in America, made many improvements in the French sets upon which we had to rely when we entered the conflict. A program to create radio apparatus to fill the special requirements of our Army was nearing completion when the Armistice was declared. Broadcast information as known then could hardly be recognized as even remotely related to the present service. Time was broadcast from the Eiffel Tower station by the Allies, and various field transmitters sent out meteorological data. In the final months, Station POZ at Nauen made a feeble stab at propaganda by daily bulletins in French, English and German, glorifying German successes and pooh-poohing Allied gains. The entire number of radio operators who heard those bulletins did not greatly exceed the number of excuses Herr Goebbels has offered for Nazi retreats in North Africa, Sicily and Russia.

The first radio research laboratory of RCA, located in a tent at Riverhead, Long Island, New York, in 1919.

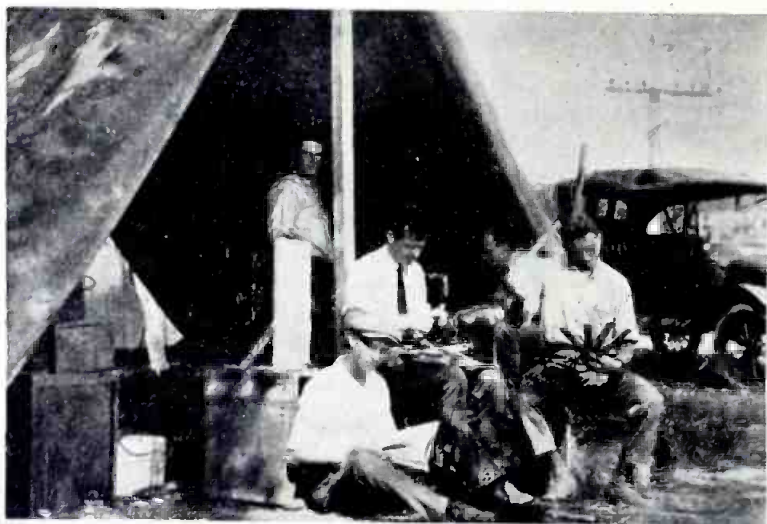

Looking back, we can see that the radio in which we took considerable pride was still somewhat of a rookie when peace came in 1918. It was useful for exchange or delivery of messages, on a scale which seems trivial when compared to its applications today. Its astounding advances and successes came in its adjustment to civilian life, an adjustment which some of us war veterans found rather difficult.

It would be superfluous, even if space permitted, to trace in detail for readers of RADIO NEWS all the familiar outstanding events which marked radio's rise to its present stature. My purpose in mentioning a few of the many striking achievements is to indicate how each separate achievement has led, and continues to lead, to forward strides in the various related fields of radio.

The first great stride of radio after World War I came as a result of the realization in the United States of that war's lesson in what could be accomplished by directed research and by the adjustment of patent claims and counterclaims of rival organizations. The encouragement which the Government gave to the organization of radio in the United States on a practical business basis was followed quickly by the first message flashed across the Atlantic by the Radio Corporation of America, on March 1, 1920, immediately after the return of the high-powered stations that had been under Government control in the war. That was the dawn of an era in which American radio communications companies have linked our nations to all the important countries of the globe.

Broadcasting, talkative, singing, jovial younger brother of radiotelegraphy, had just begun to say a few words and sing a few songs at the time. Some months off was the early public appearance which stands out most prominently in the nation's memory, the announcement of the Harding election returns in November of 1920 from Station KDKA in Pittsburgh. When Americans read their newspapers the next morning they saw that "normalcy" would soon include a development of which most of them had not even dreamed—music and information and entertainment by living voices sent directly into their homes.

Marine and transoceanic radiotelegraphy, which had only recently been regarded as the ultimate objectives and

Present-day RCA laboratory at Princeton, N. J. The advancement of the radio industry is clearly shown by these two photos.



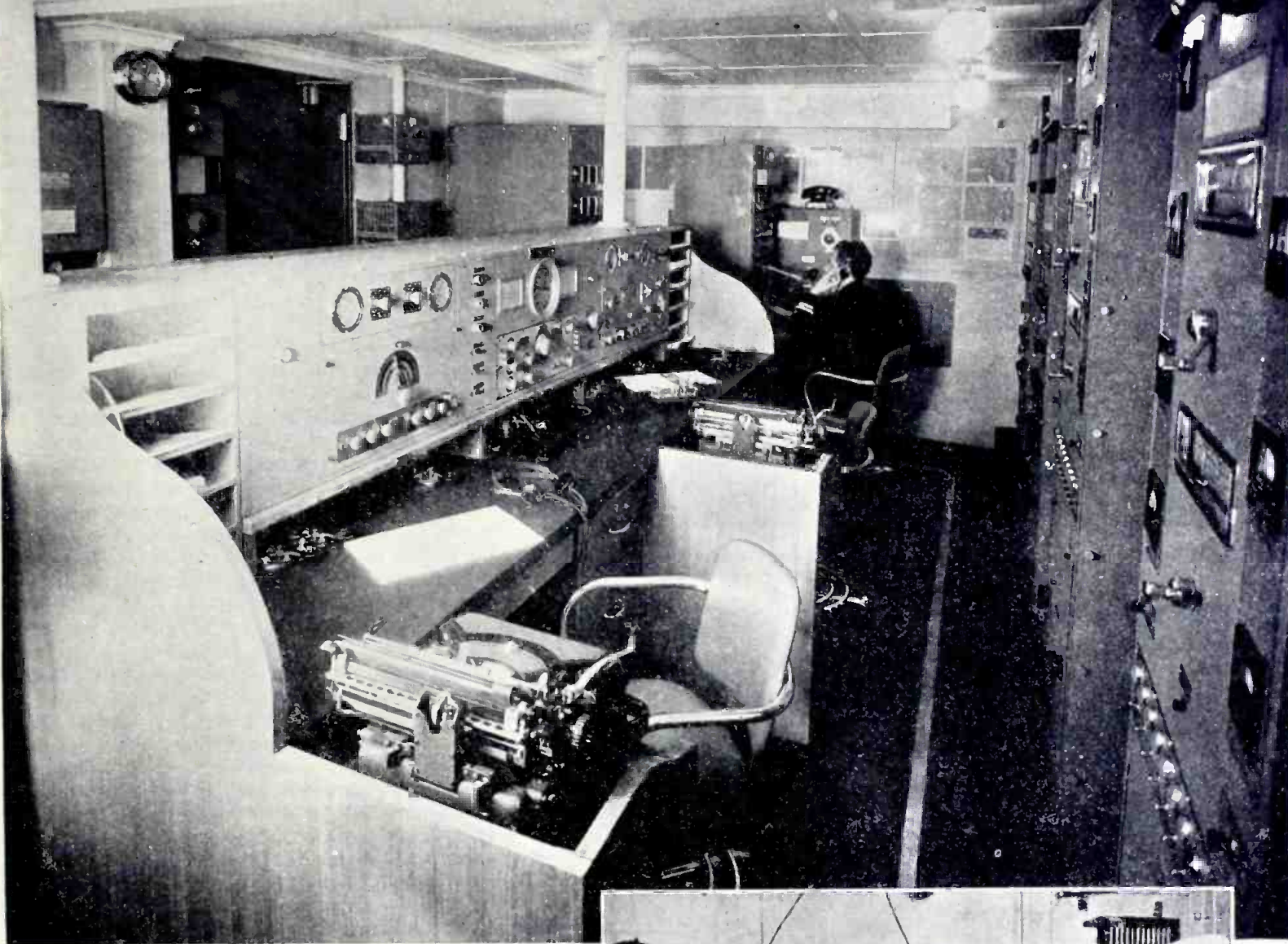

Modern marine installation. Included are five radio transmitters, vacuum-tube type; five receivers; and auto alarm.

limitations of radio, were overshadowed by the general public acclaim of the new marvel of broadcasting. But they were not overshadowed in the minds of radio engineers. These men of the research laboratories saw the spectacular advent of broadcasting as an opening to great, new possibilities in all the branches of radio.

What had been learned and what continued to be learned about radio transmission and reception in marine and shore-to-shore radio was applied to broadcasting. Broadcasting returned the favor by contributing discoveries which were of tremendous value in radiotelegraphy. The experiences of those who were occupied in transmission and reception were of great assistance to the engineers and manufacturers who designed and made radio tubes and receiving sets.

The first commercial marine vacuum-tube transmitting apparatus was installed in the coastal station at Chatham, Mass., late in 1921, introducing a new system of long-distance communication with ships by efficient use of continuous waves. On October 15 of 1922, for the first time in history, vacuum-tube transmitters successfully carried radio messages between New York, England and Germany. In that same year the establishment of a nationwide distribution and merchandising system for broadcast receiving sets and tubes showed that broadcasting had progressed from the status of a novelty to recognition as a permanent feature of the American scene. The vast contribution which radio was destined to make to other industries and services was indicated also in 1922 by successful two-way telephone conversations between the *S.S. America* at sea and ordinary telephones in homes and offices.

The next year found engineers investigating the prop-

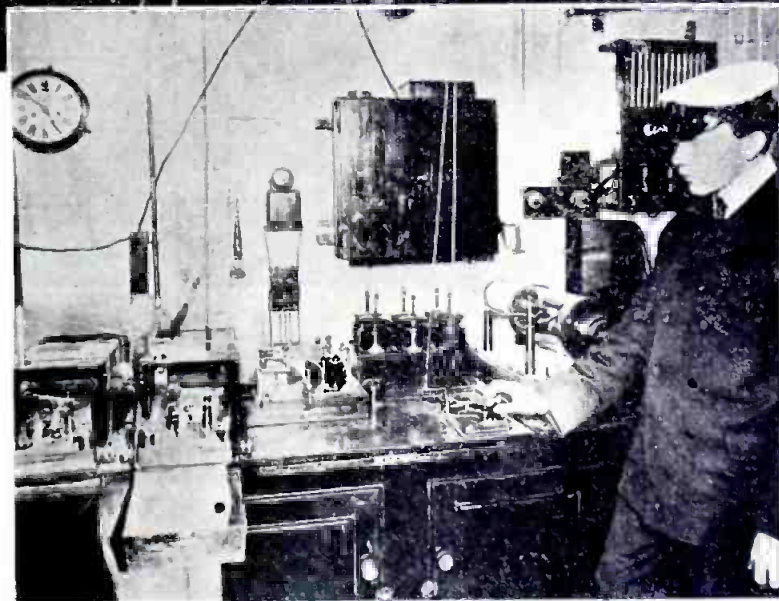

Spark type marine installation, by the British Marconi Co. in 1903. Shown at the left are the screened receiver and coherer.

erties of short waves. This was a quest which revealed radio treasures immediately, a quest which has gone on to this day and will continue to go on into the future, delving deeper into the spectrum and adding wider potentialities. The first use of broadcasting in a national political campaign in the Republican and Democratic conventions of 1924 came in the year when the superheterodyne receiving set first was marketed. International broadcasting made its formal debut in the next year when speech and music broadcast in England were retransmitted to American audiences.

The application of short waves to marine communication made possible the attainment of the ultimate distance in world communication in 1926 when contact was maintained



Early ship installation, British Marconi 1902 spark transmitter. (Left) shielded receiver and coherer; (right) open-type spark-gap.



Present-day RCA Transoceanic radio facsimile recorder in operation at Broad Street Central operating office, New York City, N. Y.

with the *S.S. Carintia* around the globe. On May 1 of that year, commercial facsimile service was inaugurated between New York and London by RCA for the transmission of photographs, and on September 9 the National Broadcasting Company was organized to provide network programs.

A.c. radio tubes, eliminating all batteries, were an outstanding achievement of 1927, the year in which radio collected weather reports for the transatlantic flights of Lindbergh and Byrd and communicated with Byrd's radio-equipped plane throughout most of its historic leap to the coast of France. A sound-on-film method for synchronized talking motion pictures came at about the same time, based on radio principles. Within twelve months diversity reception and directional transmission had been applied commercially to give short-wave international communication far greater reliability. They were designed for radiotelegraphy, but without them we could never have had the excellence of international broadcasting which has changed all previous ideas of the dissemination of historic world news in the second World War.

We could continue reviewing radio's advances, point by point down to the present day and find continuously recurring evidences of the interrelation and the exchange of knowledge between each of radio's separate fields. The whims of chance do not determine its future, because its

development did not come by chance. It is a product of directed research, tested in its growth by the application of theory to the exacting standards of daily use. Vacuum tubes, for example, did not reach their present perfection in a vacuum of pure guesswork. They were planned by scientists, tried in everyday commercial practice, replanned and retried to meet every new requirement. If one may borrow from a well known authority, "We planned it that way."

Substantial symbols of radio's scientific parenthood are seen in the industry's laboratories, including the RCA Laboratories at Princeton, N. J., opened proudly in the spring of 1942 as a center of research and pioneering and dedicated to increasing the usefulness of radio and electronics to the nation, to the public, and to the industry.

War has intensified both research and production. In its third year of the present war, radio is providing services which were not dreamed of by those who knew it as an undeveloped rookie in the A.E.F. of the first World War. Radio production in the United States, all for the armed services, now amounts to \$250,000,000 a month, according to recent reports, as compared to \$30,000,000 a month last year. This is the industry which boasted of the almost unbelievable production of receiving sets with a total value of \$2,000,000 in the year 1920!

Radio at war rides with and guides our ships on all the seas. It flies with our planes, shares life-saving rafts with our sailors, goes into foxholes as a walkie-talkie, onto beachheads as a handy-talkie, calls the shots as radar. It reports the war's events to all America every hour of the day and night, takes music, news and entertainment from home to our fighting men at distant points, slices through all barriers to talk to the people of enemy and occupied countries. It helps to time the attack, to find the enemy and assist the artillery in aiming its fire. It coordinates ground, sea and air operations and sustains the precision with which bomber squadrons range and strike deep into hostile territory.

When the complete story of radio in the second World War can be told there will be disclosures which will surprise even those who are close to the industry. The war's developments will stand ready for adoption to peacetime use, along with other developments held up by the war for commercial introduction. All indications are that after victory—on which the industry is now concentrating all its efforts—there will be a surge of radio progress.

Television looms among the prospects for a postwar era in which reconversion of factories will be a problem and the creation of jobs an essential objective of industry and the nation. This service which the public is awaiting eagerly cannot be developed in a day, a week or within a few months. But when it does come, it will open tremendous opportunities for radio. Paul Hoffman, president of the Studebaker Company and Chairman of the Committee for Economic Development, has estimated that in television there is a potential source of 4,600,000 new jobs within a decade of its full commercialization.

Frequency modulation on ultra-short waves, extension of the use of radio heating in industry, increased applications of the electron microscope and the electron micro-analyzer, and tiny tubes which will make possible much more compact apparatus are also among the near or more distant promises of the years after victory.

The greatest promise of radio rests upon the fact that it is a science as well as an industry producing vital services. Science knows virtually no boundaries. So long as keenly inquiring researchers seek new discoveries, so long as invention, independent enterprise, and individual initiative are encouraged, it can never be said truthfully of the workers in radio: "They've gone about as far as they can go."

*Highlights of Ham events
that were recorded through
the years from 1919-1944.*

25 years

The author's 1919 rig had panels of Sheetrock, UV-202 osc., and 3-coil honeycomb audion detector.

OF AMATEUR RADIO PROGRESS

By **OLIVER READ, W9ETL, (Ex.9BGV)**

Managing Editor, RADIO NEWS

RADIO NEWS (July, 1919) was in existence long before the first broadcast station went on the air, as it was not until November 2, 1920, that KDKA, the world's first station, was put into operation. Dr. Frank Conrad, 8XK, radio amateur, and prominent engineer of Westinghouse had been consistently experimenting with voice transmission, occasionally sending out programs of phonograph music and talks over his Ham station. A newspaper carried the advertisement of a Pittsburgh store offering radio receivers which would enable one to tune in the broadcasts of 8XK. The rest is history. Westinghouse officials decided that radio should be developed as a publicity medium rather than a straight communications service and early in 1920 plans for the operation of KDKA were made.

Mirroring the development of radio for the past 25 years, RADIO NEWS has recorded the progress of radio virtually from the "stone age" of reception when the crystal receiver was intriguing the imagination of the amateur up to the high standards of communications now in existence. RADIO NEWS not only has acted as a historian of radio progress, but the various departments of amateur radio and broadcasting have been crystallized, based on the pioneering of many articles which have appeared in early issues. Such developments as television, synchronization of two or more stations on the same wavelengths and the first radio musical instruments were all pioneered developments of RADIO NEWS' writers.

During the initial year of RADIO NEWS' publication, crystal sets costing from \$15.00 to \$25.00 were in vogue. One-tube sets were too

expensive for the average purse, considering how slightly better they were than crystal sets. Soon the regenerative receiver made its appearance. Dr. de Forest, for example, put out the MR-6 which sold for approximately \$150.00 without accessories. It consisted of a honeycomb coil tuner and two stages of audio-frequency amplification. Shortly thereafter, Radiola came out with a model that resembled a small table radio phonograph having a lid and concealed horn. It operated from dry batteries and used four WD-11 tubes. It was considered a luxury to have accessories in those days. Some horns, to which a headset could be attached, sold for around \$15.00. Even grid leaks and rheostats cost as much as \$2.50 each, while other components were comparatively as costly. When the famous 201A tube came out, dealers were getting premium prices for them as there were no

Armstrong super-regenerative 3-tube set with 2-step audio-frequency amplifier, and UV-202 (VT-2 modulators) were features of the 1922 station in Evanston, Ill.

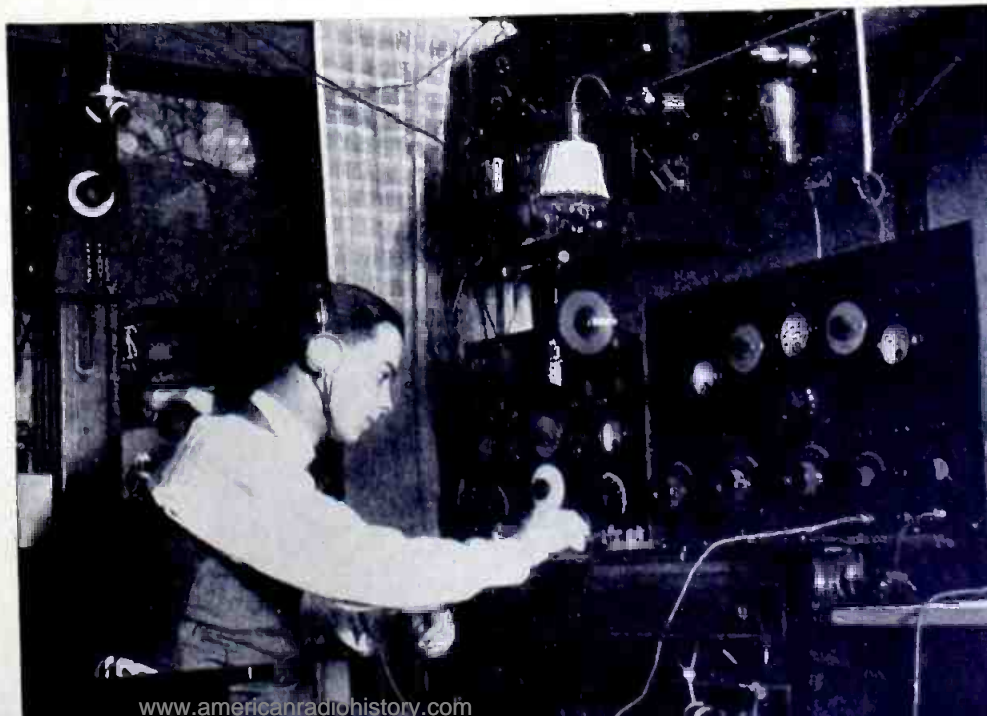

July, 1944



Author's 50-watt transmitter, in 1923, used seven Western Electric VT-2 modulators in parallel. Mercury-arc rectifier (on left) was tipped to start arc. Transmitting antenna was 6-wire "cage" with counterpoise.

"ceilings" in those days. Many Hams paid ten dollars apiece for these cherished "bottles."

The entire progress of broadcasting is due largely to the efforts of the amateur, even though he seldom got a break from the authorities who regulated activities in those early days. All BC stations were operating on 360 meters, while the Hams were found from 200 meters and below. They were then putting on amateur talent shows from their own stations and most of the entertainment was by means of phonograph records and musical instruments.

The Department of Commerce then relegated them to the short waves and banned entertainment directed to the public. Their transmissions were confined thereafter to code and voice. They bowed gracefully to the decree and pushed on to explore the new realms which were opened to them with the fear that as soon as these were developed they, too, would be taken from them.

Throughout the years, RADIO NEWS has recorded the ever growing development of the radio amateur since the early trail-blazing days of such prominent Hams as Major Edwin H. Armstrong of regenerative, superregenerative and superheterodyne fame; John Grinan; Dick Richardson, the Princeton boy who had one of the few operator's licenses during World War I; J. O. Smith, the first amateur to install c.w. in place of spark; Ralph Waldo Emerson Decker; Frank Conrad; Lloyd Hammarlund; and a host of others.

The first issue of RADIO NEWS (15,000 copies) included a release to the effect that amateur stations were permitted to re-open on April 15, 1919 following World War I. *Approximately ten times as many copies of RADIO NEWS are now printed monthly.* In this same year, a young man by the name of A. H. Grebe was working on amateur apparatus after analyzing the outstanding features of the new types of equipment that were being used by the radio amateurs in government service and who were returning to their peacetime vocations following the signing of the Armistice. Dr. Lee de Forest, in his article "The Audion and The Radio Amateur" told of the advantages of using the vacuum tube and the superior performance that it was capable of providing over existing detector methods.

On October 1, 1919, all restrictions on amateur radio

stations were removed. A warning was issued by G. K. Thompson, American Radio and Research Corporation, to amateurs that unless they cultivated at once a conscientious respect for Federal radio regulations, the liberties of amateur radio would be doomed. Considerable work was being done with underground antenna systems, but this method was soon discarded in favor of flat-top and cage systems. Maj. Gen. George O. Squier, then Chief Signal Officer, United States Army, in his article "Tree Radio Telephony and Telegraphy," August, 1919, RADIO NEWS, described further experiments, which he had started as early as 1904, in the use of growing trees for antenna systems for radio telegraphy. Amateurs were using loop antennas commonly in their shacks. In fact, many of them were attempting to take advantage of their directional properties by using them for transmission as well as reception. Moulded and oil-immersed condensers were finding wide acceptance in amateur stations. Crystal detectors of many varieties were still popular.

During the year 1920, considerable work was done by the amateur on the development of audio amplifiers. Several special tubes made their appearance and these were quickly purchased and tried out by the Ham in an effort to enhance the performance of his receiver. The tendency to purchase parts instead of making them at home really took hold during this year.

In 1921 amateurs, in cooperation with the Government, were giving daily market reports to farmers, newspapers, and local telephone exchanges. On April 15, 1921, the Bureau of Markets, United States Department of Agriculture, sponsored an extended system of disseminating news of marketing conditions by means of amateur radio.

On September 3, 1921, the Radio Exposition was held in Chicago. 2,000 delegates attended the convention held under the auspices of the *American Radio Relay League*, marking the first national convention of the Association. 300 sectional clubs affiliated with the League represented more than 6,500 amateur wireless stations. Plans were perfected at the convention for transatlantic wireless tests to take place in December.

In 1922 a warning was given to amateurs using wavelengths in excess of those authorized in their licenses which had resulted in much unnecessary interference.

Following tentative reports of the Department of Commerce on radio telephony, waves were allocated according to class of service. The Amateur Committee accepted the recommendation that the band for amateurs be 150 to 275 meters and that the limits be fixed by law under the Department of Commerce. On December 8, 1921, the first amateur overseas transmission took place and later Dr. Lee de Forest gave his first demonstration of the "talking movie" with perfect synchronization. With or without accompanying pictures, he could photograph sounds, vocally or instrumentally, on an ordinary moving picture film and from the same standard film reproduce the photographed sounds. 1922 was also the year that Edward H. Armstrong developed the famous Armstrong regenerative receiver. He was also one of the designers and constructors of station 1BCG which was heard in Scotland.

This interest in radio was demonstrated by the applications for amateur transmitting stations of which there were 16,467 on September 1, 1922. On June 30, 1921, there were only 10,809 amateurs authorized to send radio communications, an increase of 5,658 during that short period.

Fighting hard to demonstrate the real mettle of the radio amateur, Mr. Louis Bastain of New Orleans, Louisiana, 5HB, during the American Legion Convention, sent two complete messages to another radio amateur, 7SC, at Seattle, Washington some 2200 miles distant. Bastain's homemade transmitting set, although having a rating of but 20 watts, reached out to every state in the Union and Canada.

A new world's record was established for daylight transmission by using a Beverage antenna. This took place on October 28, 1922 and spanned the distance of 2800 miles from Honolulu to Seattle. The station was operated by Thomas Marshall, 6ZY.

Amateur station licenses increased from 10,809 to 15,504 between June 30, 1921 and June 30, 1922. The total on December 1, 1922 showed 16,888. The increase in amateur interest was gratifying to the Government and it recognized the fact that these young men constituted a reserve of trained operators, some of whom had already contributed to the radio art. They had learned that during World War I that many amateurs were found to be superior to the average commercial operator in resourcefulness, technical knowledge, and operating efficiency.

The ARRL, December 1922, made plans to attempt two-way transatlantic amateur radio communications. 316 amateurs succeeded in spanning the Atlantic. The highest honor for amateur radio, the Hoover cup of the ARRL, was awarded in 1923 to Fred B. Ostman, 20M. This cup, awarded annually, was given to the best all-around amateur radio station.

The year 1923 found Donald H. Mix, 1TS, chosen as wireless operator to accompany Dr. Mac-Millan on his famous Polar Expedition and to transmit from the ship Bowdoin a story once a week on his Arctic adventure. Later the same year, Jack Barnsley, 9BP, Prince Rupert, B. C. communicated with the S. S. Bowdoin then in the Arctic.

In September, 1924 the Government extended radio channels for amateurs. General and restricted amateur station

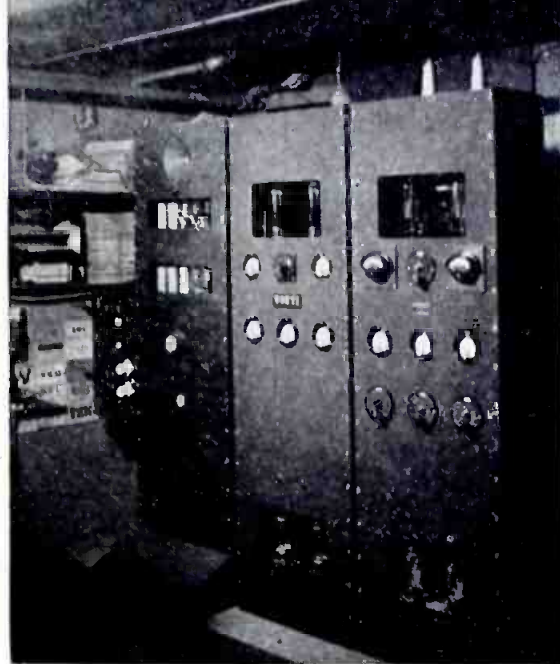

Enclosed cabinets housed the 1937 kilowatt rig. Transmitter used 849 modulators and HD203A final. Input was 1 kw. on 4 bands.

licenses were issued permitting the use of the wavelengths between 75 and 80 meters; 40 and 43 meters; 20 and 22 meters; and 4 to 5 meters for pure c. w. telegraphy 24 hours a day. This was great news for the Ham and the field of experimenting was thrown wide open. Shortly thereafter the 13,000 miles separating London and New Zealand was bridged successfully for the first time when two British amateurs exchanged radio messages using low powered homemade apparatus. Other events of equal importance followed immediately thereafter, opening up further possibilities for the amateur.

1925 was the year when the French experimenter, Pierre LaFond, F8CN, experimented with resistance-coupled amplifiers which have now become commonplace. A combination transmitter and receiver called the "Uni-Set" was described in the March, 1925 issue of RADIO NEWS by H. M. Towne, 1ADG. The use of short waves and wire interconnection of stations was developed at a rapid pace in 1925. Short waves had finally found their place in commercial and amateur transoceanic communications and transmission of rebroadcasting, both at home and to

All-aluminum panels dressed the 1932 units. X'mtr had push-pull 400-w. screen-grid bottles, screen-modulated by 211-E's. Mike was double button carbon.





A new address for the 1937 setup that saw service during the Ohio River Valley Flood of January and February of that year.

places across the seas. The Regenerative Neutrodyne also made its appearance that year and John L. Reinartz, 1QP-1XAM—wrote an interesting article telling how amateurs were exploring the short waves below 40 meters.

Yes, 1925 was a banner year for the Ham. The Government, realizing the potential possibilities of the Ham, was giving more leeway and cooperation with short-wave experiments already under way and special schedules of transmissions were formulated. Short-wave tests had proven very successful over long distances and the Government, at that time, had planned to equip Naval District Communication Centers with small high-frequency receiving sets for practical and training purposes. They had a definite interest in developing amateurs into prospective Naval Reserve radio operators.

Pre-Pearl Harbor station had two 1-kw. and one 500-watt transmitters (phone-c.w.) with complete safety protection and remote control.

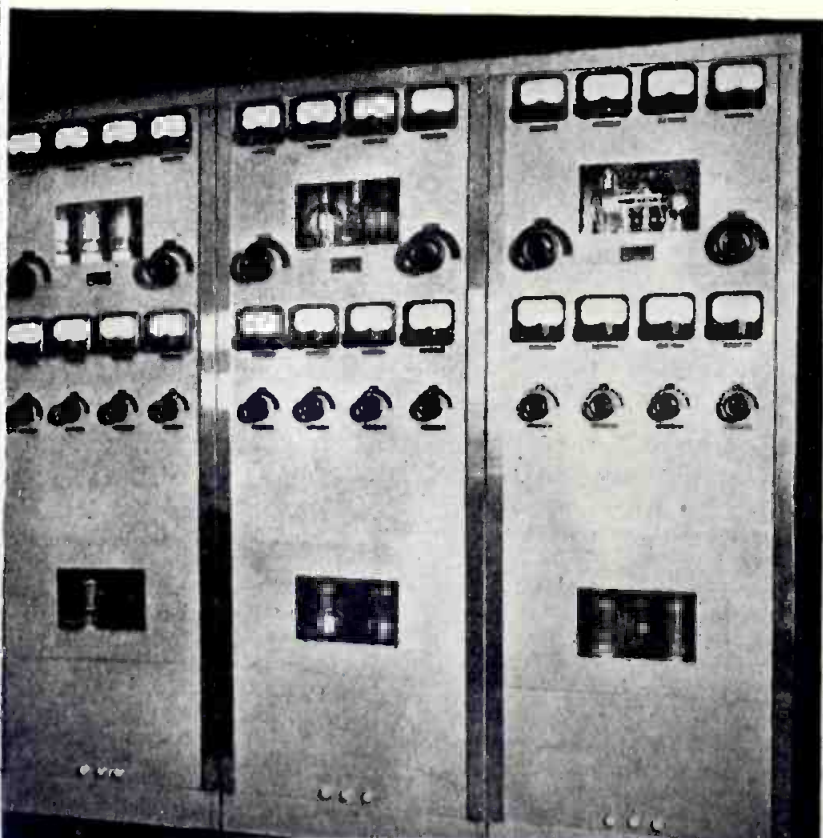

The Signal School at Ft. Monmouth, New Jersey (1924), recommended that a system be organized so that radio amateurs of the United States could join an Army amateur radio system (AARS) and a board of officers was ordered to get together with officials of the ARRL to work out a plan of organization and operation. This was approved by the War Department on September 28, 1925 and with this official blessing the newly created AARS went to work. Some 300 members were included in the initial membership but its growth thereafter was slow. Although the plan aroused much enthusiasm among radio amateurs who were willing to do their part, the lack of funds and personnel prevented the Signal Corps from giving proper attention to the organization. Soon many lost interest in the AARS and resigned. Something more timely—something more within the dream of the average amateur—was needed to make the AARS click. This vital something was introduced when a revised plan was put into effect on January 1, 1929. It emphasized as its prime objective full cooperation with the American Red Cross.

On May 17, 1926 George W. Linn, Jr., 2CJE, established radio communications between the Byrd North Polar Expedition and the Navy Department at Washington, D. C.

Down in Australia, in the year 1927, amateur radio played an important part by maintaining communications during the severe cyclone and flood which cut off all telegraph service. In this emergency the authorities fell back on the assistance of amateur radio. Licensed amateurs, working on short waves, were invaluable in maintaining communications during the disastrous New England flood of 1927. They were also contributing during that period to the progress of civilization by keeping exploring expeditions in touch with their home bases. In that year, Col. Clair Foster, 6HM, succeeded in working South Africa and China on the same day, thus completing his coveted record of all continents on the same tube—a common 201A and dry batteries. Contacts were made on 38.2 meters; except for a communication with an English amateur on 20.2 meters.

During the period from 1927 to 1941 the ultra-high frequencies were developed largely through the efforts of the amateur. Public address systems, facsimile, amateur television, sound-on-film recording, tape recording and many other new developments were being worked on in many a Ham shack.

When the United States entered World War I thousands of amateurs were eager to serve with the Signal Corps and other branches as radio operators, technicians, etc., and on the home front thousands more joined up with industry to produce the finest military communications equipment—almost overnight.

When RADIO NEWS first made its debut in July, 1919 amateur radio was still in its swaddling clothes of spark coils and oatmeal box receivers. The Ham had already seen service in World War I and his value had been recognized by Uncle Sam and steps were being taken to preserve his hobby. To cover the many contributions of the Ham during past 25 years in one article would be impossible and for that reason we have touched only a few of the important highlights that have appeared through these many years in RADIO NEWS.

The value of the amateur to the American public during the past 25 years cannot be questioned. He must be allowed to continue as he has in the past. He has earned this right!

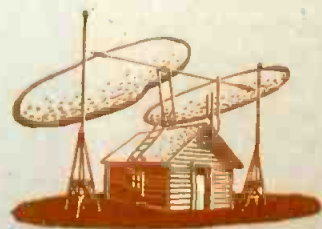

WARTIME V.T.V.M. CIRCUITS

By **RUFUS P. TURNER**

Consulting Eng., RADIO NEWS

Constructional details of vacuum-tube voltmeters, permitting servicemen and experimenters to use available meters and tubes.



Vacuum-tube voltmeter described in the September, 1943 issue of RADIO NEWS. This instrument utilized a 0-200 microammeter. Circuits described herein will show how less sensitive meters can be substituted.

THE repeated appearance of vacuum-tube voltmeter circuits following certain well-known notions and specifications has encouraged an almost static viewpoint regarding these arrangements. Standard thus has favored a single "active" tube which invariably is a triode (or two such tubes in a bridge-type circuit), a low-range current meter having a full-scale deflection of 1 milliamper or less, and a half-wave circuit for diode probes. Few circuits published during the last two years have departed markedly from these conventionalities.

The situation has been altered somewhat by wartime scarcities of high-sensitivity meters and specific tubes. 0-1 milliammeters are harder to obtain than they were in the lush days; 0-200 and 0-500 microammeters are now rarely seen. All meters are hard to get, but the ones referred to are proverbial nuggets of gold. Particular tube types, without which most readers have believed a v.t.v.m. circuit would not work, likewise have disappeared from many store shelves. But, in experimental junk-boxes there may still be found the "less desirable" d.c. milliammeters (those with higher ranges) and numerous tube types seldom, if ever, specified by the designers of v.t. voltmeters.

With civilian stockpiles now somewhat more plentiful in high-range milliammeters than in the low-reading variety, and with certain odd tube types more readily available than those usually specified for instrument applications, inquiry is prevalent regarding use of these components in v.t. voltmeters. In answer to this question, we aim to show in this article how the reader may use large-size meter ranges and, to some extent, whatever tubes he has on hand in constructing these instruments.

Tube and Meter Matching

In the past, simplicity has dictated use of triodes in v.t.v.m. circuits. By eliminating the screen electrode, both

voltmeter and d.c. power supply circuits have been kept rudimentary and initial adjustments simplified. In the more advanced instruments, degeneration, obtained in the d.c. stage by means of a large unbypassed cathode resistor, divorced instrument response from tube characteristics. In other circuits, for both a.c. and d.c. measurements, meter deflection for a given test voltage has been determined by tube transconductance. An example of the latter case is the arrangement of a triode, such as type 27, 6AE6-G, 7C6, etc., with a transconductance of 1000 micromhos, to give a 1-milliamper plate current increment for a 1-volt impressed grid-voltage increment. In general v.t. voltmeter design, it has

Fig. 1. With high-range meters, a single high-transconductance tube can be used (A). With low G_m tubes, two tubes can be connected in parallel (B).

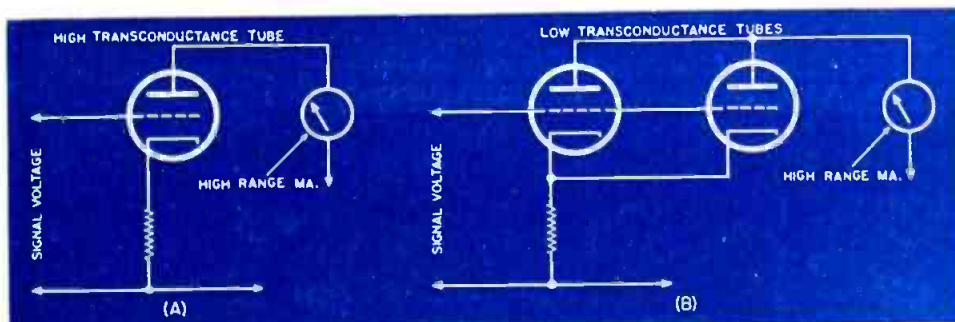

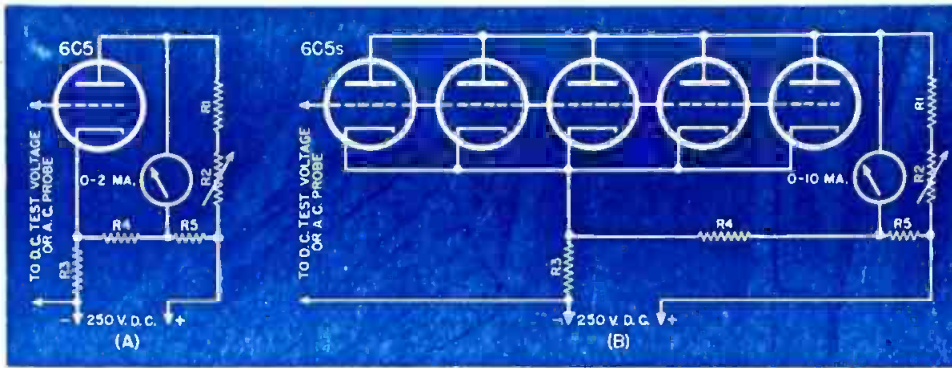

Fig. 2. (A) Single 6C5 tube normally employed with a 0.2 millimeter. (B) Five 6C5 tubes connected in parallel so that a 0.10 millimeter may be employed.

been customary to employ triodes, such as types 2A6, 6F5, 6K5, and 6Q7, which have amplification factors between 70 and 100 and E_p/I_p ratios in the neighborhood of $\frac{1}{4}$ megohm.

Tubes available to experimenters today, either on most store shelves or in spare-parts boxes, include tetrodes, pentodes, and beam power types, as well as triodes; and those found most frequently are in the high-transconductance class, having G_m values above 1000. Prevalence of high G_m values is a rather happy coincidence in this case, since this characteristic ties in very favorably with the high-range milliammeters lying idle.

Available tubes may be matched with available milliammeters, for use in v.t.v.m. circuits, by means of the familiar transconductance formula:

$$G_m = \frac{dI_p}{dE_g} (10^6) \dots \dots (1)$$

where G_m is transconductance in micromhos;

dI_p , a change in plate current (amperes);

dE_g , a change in grid voltage (volts).

Here is an example: A vacuum-tube

Fig. 4. Four-tube arrangement used to obtain higher voltage output than that of the doubler type probe (Fig. 3).

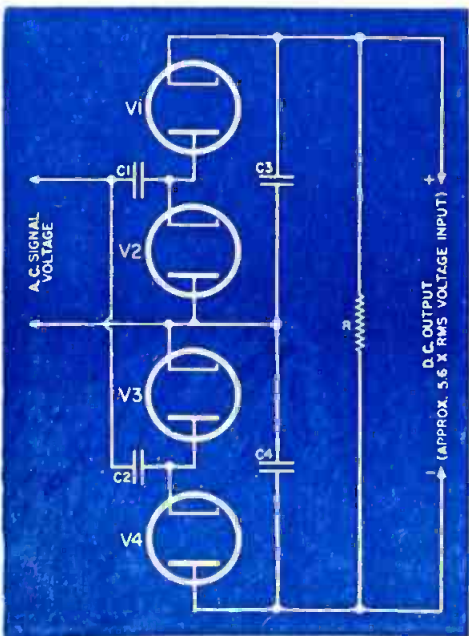

voltmeter is usually arranged with the 1-volt range as a basis. Let us assume that a 0-10 d.c. milliammeter is on hand and we wish to obtain full-scale deflection of this meter when an unknown signal of 1 volt is applied to the v.t.v.m. input terminals. Our problem is to find a tube with the proper transconductance to enable a 10-milliamper plate current increment for a 1-volt grid-voltage increment. This required transconductance value may be determined at once by means of Equation (1), thus:

$$G_m = .01/1 \times 10^6 \\ = .01 \times 1,000,000 \\ = 10,000$$

The nearest G_m values to this desired figure are 9000 (for the 6AC7/1852) and 11,000 (for the 6AG7). One volt will give a deflection of 9 milliamperes with the first tube, or 11 milliamperes with the second. A test voltage of 1.1 will be required for full-scale deflection (10 ma.) with the 6AC7; 0.909 volt with the 6AG7.

Working the other way around, when matching a meter to a tube, the following equation will be employed to determine desired meter range:

$$dI_p = dE_g (G_m) 10^{-6} \text{ amps.} \dots (2)$$

Which for a 1-volt test signal becomes simply:

$$I = G_m \times 10^{-3} \dots \dots (3)$$

where:

I is the full-scale deflection of the meter in milliamperes, and

G_m , the tube transconductance in micromhos.

As an illustrative example, let us assume our job to be selection of a milliammeter to match a 6J5 tube. This tube has a transconductance of 3000, and we desire to obtain full-scale deflection with an input test-signal voltage of 1 volt. Employing Equation (3), we find the full-scale deflection required to be $3000 \times 10^{-3} = 3000 \times .001 = 3.0$. This means that 1-volt applied to the grid input terminals of the v.t.v.m. circuit will give a plate current shift of 3 milliamperes, and that a 0.3 d.c. milliammeter will be most desirable for the job.

In each of the illustrative examples, it will be noted that the signal voltage is taken as 1 volt. The equations do not restrict the experimenter to this figure, however, except in the case of the simplified Equation (3). The 1-volt

input happens to be a convenient value for the fundamental full-scale range of the instrument, all higher voltages in decade relationship to the first being stepped down to this value by means of a high-resistance input voltage divider (range selector).

High G_m and Parallel Tubes

From the foregoing discussion, it is readily seen that high-transconductance tubes permit meters with full-scale values higher than usual to be used for common v.t.v.m. signal voltages. This scheme is illustrated by Fig. 1A. This technique may be exercised freely by the experimenter who has on hand a number of odd-type tubes and high-range milliammeters. The high-characteristic tube may be of either triode, tetrode, pentode, or beam power type. Any of the common v.t. voltmeter circuits may be employed, provided recommended plate, screen, and bias voltages are supplied and appropriate adjustments are made in the values of resistors in the zero-adjusting circuit.

To aid the reader in selecting from his own stock tubes with high transconductance, Chart I has been arranged to list all types which have G_m values of 1500 and higher. One or more of these tubes and a matching meter doubtlessly will be available among spare parts.

In connection with the use of Chart I, the reader is cautioned that a number of the tubes listed are high plate cur-

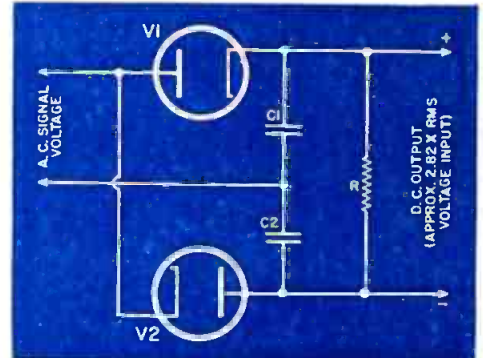

Fig. 3. Twin diode connected as a full-wave voltage doubler to obtain increased output.

rent types and that, when using these, a series-limiting resistor of adequate ohmage must be employed in conjunction with the zero-adjusting rheostat to prevent damage to the meter. The "off-zero" current through the meter will in this way be limited to a safe value. The high-current tubes have been marked in the table, as indicated in the footnotes.

In spite of the convenience of the scheme of employing high- G_m tubes, it is likely that in many cases transconductance values appropriate for an available high-range milliammeter will not be found among spare parts. But there is another scheme for obtaining the desired high plate current shifts, and this scheme may even be employed with lower G_m values: Two or more tubes may be connected in parallel in the v.t.v.m. circuit, as indicated in Fig.

1B. The signal voltage is applied simultaneously to both grids. The total plate current and plate current shift, however, are the sums of the individual values. It is possible by use of the parallel arrangement to obtain a larger plate-current shift for a given test voltage than is possible with a single tube of given transconductance.

In this connection, consider the case of a tube with a transconductance of 2000 (such as type 6C5). One such tube, connected in a v.t.v.m. circuit, will yield a plate current increment of 2.0 milliamperes when its grid signal voltage passes through an increment of 1.0 volt. But when two of these tubes are connected in parallel in the circuit, the same 1-volt signal produces a change of 4 milliamperes in plate current (this latter value being the combined plate current increments of both tubes). While the single tube would necessitate the use of a 0.2 millimeter, the parallel connection would permit use of a 0.4 or 0.5 type. The effect of the parallel connection is to add the individual transconductance values.

It is not imperative to employ identical tube types in the parallel connection, as long as the tubes chosen require the same values of grid, heater, plate, and screen voltage. However, it is advisable not to attempt connection of filament-type tubes with cathode types. When the parallel-connected tubes have different G_m values, it is merely necessary to add the individual values for the electrode voltages employed, to obtain the total apparent transconductance.

When the same type of tube is employed in each position, the group should have characteristics as nearly identical as possible. This applies chiefly to transconductance. If reasonably careful matching is carried on, the total transconductance may be estimated simply by multiplying the transconductance of a single tube by the number of tubes.

An important factor which must not be overlooked when contemplating the parallel arrangement of tubes is the increased input capacitance of the combination. This will be the sum of the individual grid-cathode capacitances; and when the v.t. voltmeter is to be employed for r.f. measurements, the larger capacitance and grid current level will increase circuit loading.

The problem of circuit loading by parallel tube input capacitances is of little consequence in the case of electronic d.c. voltmeter circuits, where the frequency is zero. If grid current drain is kept at the lowest practicable minimum in these circuits, it likewise will introduce no considerable difficulty. But if grid current levels are high, it must be borne in mind that the increased input current, due to the grid

(Continued on page 114)

| TYPE | NAME | TRANSCONDUCTANCE (Max.) | MA. DEFLECTION FOR 1 v. INPUT |
|-------------------------|--|-------------------------|-------------------------------|
| *1Q5-GT/G | Beam Power | 2200 | 2.2 |
| *1N4 | Pentode | 1575 | 1.57 |
| *2A3 | Triode | 5250 | 5.25 |
| *2A5 | Pentode | 2550 | 2.55 |
| *3A5 | Twin Triode | 1800 | 1.8 |
| *3Q4 | Pentode | 2150 | 2.15 |
| *3Q5-GT/G | Beam Power | 2200 | 2.2 |
| *3B4 | Pentode | 1575 | 1.57 |
| *6A3 | Triode | 5250 | 5.25 |
| *6A4 (LA) | Pentode | 2900 | 2.9 |
| 6AB7/1853 | Pentode | 5000 | 5.0 |
| 6AC7/1852 | Pentode | 9000 | 9.0 |
| *6AC5-GT | Triode | 3400 | 3.4 |
| *6AD7-G | Pentode Section | 2500 | 2.5 |
| *6AE7-GT | Twin-Input Triode (cathodes tied together; grids likewise) | 3000 | 3.0 |
| 6AG7 | Pentode | 11,400 | 11.4 |
| *6AK6 | Pentode | 2500 | 2.5 |
| 6C5 | Triode | 2000 | 2.0 |
| 6C8-G | Twin Triode (one section) | 1600 | 1.6 |
| 6D6 | Pentode | 1600 | 1.6 |
| *6E6 | Twin Triode (one section) | 1700 | 1.7 |
| *6E7 | Twin Triode (one section) | 1600 | 1.6 |
| 6F5, 6F5-G, } 6F5-GT | Triode | 1500 | 1.5 |
| *6F6 | Pentode | 2550 | 2.55 |
| *6F6-G | Twin Triode (one section) | 3000 | 3.0 |
| 6F8-G | Pentode | 2300 | 2.3 |
| *6G6-G | Triode | 3000 | 3.0 |
| 6J5 | Pentode | 2300 | 2.3 |
| *6K6-GT/G | Pentode | 2300 | 2.3 |
| 6K7, 6K7-G, } 6K7-GT | Pentode | 1650 | 1.65 |
| 6L5-G | Triode | 1900 | 1.9 |
| *6L6, 6L6-G | Beam Power | 6000 | 6.0 |
| *6N7, 6N7-GT/G | Twin Triode (Both sections in parallel) | 3200 | 3.2 |
| *6R7, 6R7-GT/G | Triode Section | 1900 | 1.9 |
| 6R7, 6R7-G | Pentode | 1750 | 1.75 |
| 6SF5, 6SF5-GT | Triode | 1500 | 1.5 |
| *6SF7 | Pentode Section | 2650 | 2.65 |
| 6SG7 | Pentode | 4000 | 4.0 |
| 6SH7 | Pentode | 4900 | 4.9 |
| 6SJ7 | Pentode | 2500 | 2.5 |
| 6SK7, 6SK7-GT/G | Pentode | 2350 | 2.35 |
| 6SL7-GT | Twin Triode (each unit) | 1600 | 1.6 |
| *6SN7-GT | Twin Triode (each unit) | 3000 | 3.0 |
| *6SR7 | Triode Section | 1900 | 1.9 |
| 6S7, 6S7-G | Pentode | 1750 | 1.75 |
| 6SS7 | Pentode | 1930 | 1.93 |
| *6ST7 | Triode Section | 1900 | 1.9 |
| 6U7-G | Pentode | 1600 | 1.6 |
| *6V6, 6V6-GT/G | Beam Power | 4100 | 4.1 |
| *6Y6-G | Beam Power | 7100 | 7.1 |
| 7A4 | Triode | 3000 | 3.0 |
| *7A5 | Beam Power | 6000 | 6.0 |
| 7AT-LM | Pentode | 2000 | 2.0 |
| 7B4 | Triode | 1500 | 1.5 |
| *7B5-LT | Pentode | 2300 | 2.3 |
| 7B7 | Pentode | 1700 | 1.7 |
| *7C5-LT | Beam Power | 4100 | 4.1 |
| *7E6 | Triode Section | 1900 | 1.9 |
| *7E7 | Pentode Section | 1600 | 1.6 |
| *7F7 | Twin Triode (each unit) | 1600 | 1.6 |
| 7G7/1232 | Pentode | 4500 | 4.5 |
| 7H7 | Pentode | 3800 | 3.8 |
| 955 | Acorn Triode | 2200 | 2.2 |
| 956 | Acorn Pentode | 1800 | 1.8 |
| *12A5 | Pentode | 2400 | 2.4 |
| *12A6 | Beam Power | 3000 | 3.0 |
| 12AH7-GT | Twin Triode (each unit) | 1900 | 1.9 |
| 12B8-GT | Triode Section | 2400 | 2.4 |
| 12F5-GT | Triode | 1500 | 1.5 |
| 12J5-GT | Triode | 3000 | 3.0 |
| 12K7-GT/G | Pentode | 1650 | 1.65 |
| *12L8-GT | Twin Pentode (each section) | 2150 | 2.15 |
| 12SF5, 12SF5-GT | Triode | 1500 | 1.5 |
| 12SF7 | Pentode Section | 2050 | 2.05 |
| 12SM7 | Pentode | 4000 | 4.0 |
| 12SM7 | Pentode | 4900 | 4.9 |
| 12SM7 | Pentode | 2500 | 2.5 |
| 12SJ7, 12SJ7-GT | Pentode | 2350 | 2.35 |
| 12SK7, 12SK7-GT/G | Pentode | 2350 | 2.35 |
| 12SL7-GT | Twin Triode (each unit) | 1600 | 1.6 |
| *12SN7-GT | Twin Triode (each unit) | 3000 | 3.0 |
| *12SR7 | Triode Section | 1900 | 1.9 |
| 14A7/12B7 | Pentode | 2350 | 2.35 |
| *25A6, 25A6-GT/G | Pentode | 2450 | 2.45 |
| * # 25A7-GT/G | Pentode | 1800 | 1.8 |
| 25AC5-GT/G | Triode | 3800 | 3.8 |
| *25B6-G | Pentode | 5000 | 5.0 |
| 25B8-G | Triode Section | 1500 | 1.5 |
| | Pentode Section | 2000 | 2.0 |
| *25C6-G | Beam Power | 7100 | 7.1 |
| *25L6, 25L6-GT/G | Beam Power | 9500 | 9.5 |
| * # 32L7-GT | Beam Power | 6000 | 6.0 |
| *35A5 | Beam Power | 5900 | 5.9 |
| *35L6-GT/G | Beam Power | 5900 | 5.9 |
| *41 | Pentode | 2500 | 2.5 |
| *42 | Pentode | 2550 | 2.55 |
| *43 | Pentode | 2450 | 2.45 |
| *45 | Triode | 2175 | 2.17 |
| *46 | Dual Grid (grid #2 connected to plate) | 2350 | 2.35 |
| *47 | Pentode | 2500 | 2.5 |
| *48 | Tetrode | 3900 | 3.9 |
| *50 | Triode | 2100 | 2.1 |
| *50L6-GT | Beam Power | 9700 | 9.7 |
| *59 | Pentode | 2500 | 2.5 |
| * # 70L7-GT | Beam Power | 7500 | 7.5 |
| *71-A | Triode | 1700 | 1.7 |
| *89 | As Triode | 1800 | 1.8 |
| | As Pentode | 1800 | 1.8 |
| *112-A | Triode | 1800 | 1.8 |
| * # 117L7-GT | Beam Power | 5300 | 5.3 |
| * # 117M7-GT | Beam Power | 2300 | 2.3 |
| * # 117N7-GT | Beam Power | 7000 | 7.0 |
| * # 117P7-GT | Beam Power | 5300 | 5.3 |
| *183/483 | Triode | 1700 | 1.7 |

* High plate current. A limiting resistor must be connected in series with zero-adjustment rheostat to prevent damage to milliammeter.
 † Connect diode plates to cathode at socket.
 ‡ Tube contains fertilizer which may be used to supply d.c. voltages to v.t.v.m. circuit.

Chart 1. List of tubes that have a transconductance of 1500 micromhos or more. One or more of these tubes and a matching meter probably will be available among spare parts.



Edited by **KENNETH R. BOORD**

BETWEEN midnight and 7 a.m. (EWT) BBC transmitters beam their transmissions to Australia, New Zealand, Pacific Area, the Far East, India, Burma and Malaya, Iraq and Iran, the Near and Middle East and East Africa, South Africa, West Africa, Algiers, North Africa and Mediterranean Area, and additional points. Reports from various sections of the United States, however, indicate that these transmissions are usually heard well in America. So we are listing below a few of the frequencies and schedules used by the BBC during the early morning hours, for the benefit of readers who wish to tune in London between midnight and 7 a.m. (EWT):

12:00 midnight to 3:15 a.m.—GSB (9.51); GVU (11.78).

12:00 midnight to 12:45 a.m.—GRJ (7.32).

1:00 a.m. to 3:15 a.m.—GWC (15.07); GSW (7.23); GSF (15.14); GSD (11.75).

1:00 a.m. to 4:15 a.m.—GRM (7.12).

1:00 a.m. to 5:00 a.m.—GVZ (9.64); GRV (12.04); GWD (15.42); GRH (9.825).

3:30 a.m. to 5:00 a.m.—GVQ (17.73).

3:45 a.m. to 5:00 a.m.—GSN (11.82).

Between 6:00 a.m. and 7:00 a.m. (some of these continue through the next three or four hours) — GSD (11.75); GSB (9.51); GRP (17.87); GWC (15.07); GWE (15.435); GSF (15.14); GSE (11.86); GRG (11.68).

Newscasts from London are given approximately every hour or hour and a quarter—usually at 15 minutes before the hour—during the transmis-

sions listed in the various services of the BBC.

* * *

WEST COAST REPORT

August Balbi, Los Angeles, veteran West Coast monitor, reports that the Europeans and most South and Central American stations are heard only infrequently in that region. Best bets on the Pacific Coast seem to be the stations in the Far East and Oceania.

He reports, however, that London reception is improving; Berlin is scarcely audible until 7 or 8 p.m. (PWT) on the 7-megacycle band, and again after 10 p.m. (PWT) on their Asia beam. Berne is not heard on 10.36 or 9.11 megacycles on the South American Transmission, 7:30 p.m. to (Continued on page 118)

INVASION BROADCASTS FROM BRITAIN

SCHEDULES AND FREQUENCIES OF THE BBC TRANSMISSIONS, DIRECTED DAILY TO THE WESTERN HEMISPHERE, FOR READERS WHO WISH TO KEEP UP WITH INVASION NEWS BROADCAST DIRECTLY FROM BRITAIN.

GENERAL OVERSEAS SERVICE

| EWT | BEAMED TO | CALL | FREQ. |
|-----------------------|-------------------------------|------|--------|
| 7:00 a.m.—8:00 a.m. | South America | GSF | 15.14 |
| 1:00 p.m.—6:00 p.m. | South America | GWE | 15.435 |
| 5:15 p.m.—10:15 p.m. | South America | GSD | 11.75 |
| 5:15 p.m.—10:15 p.m. | South America | GSB | 9.51 |
| 7:00 p.m.—10:15 p.m. | South America | GRJ | 7.32 |
| * * * * * | | | |
| 7:00 a.m.—8:00 a.m. | West Indies & Central America | GVU | 11.78 |
| 2:00 p.m.—6:00 p.m. | West Indies & Central America | GWC | 15.07 |
| 5:00 p.m.—10:15 p.m. | West Indies & Central America | GSD | 11.75 |
| 5:15 p.m.—10:15 p.m. | West Indies & Central America | GSB | 9.51 |
| 7:00 p.m.—10:15 p.m. | West Indies & Central America | GRW | 6.15 |
| * * * * * | | | |
| 6:00 a.m.—7:15 a.m. | North America | GRG | 11.68 |
| 7:15 a.m.—10:00 a.m. | North America | GSP | 15.31 |
| 10:15 a.m.—12:00 noon | North America | GSP | 15.31 |
| 12:15 p.m.—5:00 p.m. | North America | GSP | 15.31 |
| 3:15 p.m.—8:00 p.m. | North America | GRG | 11.68 |
| 5:15 p.m.—10:15 p.m. | North America | GRX | 9.69 |

EWT

BEAMED TO

CALL

FREQ.

| | | | |
|----------------------|---------------|-----|------|
| 8:15 p.m.—10:15 p.m. | North America | GRB | 6.01 |
| 6:15 p.m.—10:15 p.m. | North America | GRC | 2.88 |

* * * * *

NORTH AMERICAN SERVICE

| | | | |
|-----------------------|---------------|-----|-------|
| 5:15 p.m.—8:00 p.m. | North America | GVX | 11.93 |
| 5:15 p.m.—12:45 a.m. | North America | GSC | 9.58 |
| 8:15 p.m.—12:45 a.m. | North America | GSU | 7.26 |
| 8:00 p.m.—12:45 a.m. | North America | GSL | 6.11 |
| 10:45 p.m.—11:30 p.m. | North America | GRM | 7.12 |
| 10:15 p.m.—12:40 a.m. | North America | GRC | 2.88 |

* * * * *

| | | | |
|-----------------------|-------------------------------|-----|------|
| 10:15 p.m.—11:30 p.m. | West Indies & Central America | GSB | 9.51 |
| 10:15 p.m.—11:30 p.m. | West Indies & Central America | GRW | 6.15 |
| 10:15 p.m.—11:30 p.m. | West Indies & Central America | GSB | 9.51 |

* * * * *

AFRICAN SERVICE

| | | | |
|-----------------------|-------------------------------|-----|-------|
| 12:00 noon—12:15 p.m. | West Indies & Central America | GWD | 15.42 |
| 12:00 noon—12:15 p.m. | South America | GVQ | 17.73 |
| 12:00 noon—12:15 p.m. | North America | GSP | 15.31 |

AROUND THE CLOCK WITH THE WAR NEWSCASTS IN ENGLISH

MORNING

| EWT | LOCATION | CALL | FREQ.* |
|------------|-----------|------|--------|
| 7:00 a.m. | London | GSP | 15.31 |
| 7:00 a.m. | Perth | VLW3 | 11.83 |
| | | VLW6 | 9.68 |
| 7:00 a.m. | Melbourne | VLR | 9.58 |
| | | VLI4 | 7.22 |
| 7:30 a.m. | Berlin | DJ8 | 15.20 |
| 7:50 a.m. | Tokyo | JLG2 | 9.505 |
| 8:00 a.m. | Melbourne | VLG2 | 9.54 |
| 8:30 a.m. | Tokyo | JLG2 | 9.505 |
| 9:00 a.m. | Manila | PIAM | 9.64 |
| | | | 6.14 |
| 9:00 a.m. | Hongkong | JZHA | 9.47 |
| 9:00 a.m. | Tokyo | JZI | 9.535 |
| | | JZH4 | 6.13 |
| 9:30 a.m. | Berlin | DJ8 | 15.20 |
| 9:30 a.m. | Hsingking | MTCY | 6.12 |
| 10:00 a.m. | Saigon | R.S. | 11.775 |
| 10:00 a.m. | Tokyo | JZI | 9.535 |
| | | JZH4 | 6.13 |
| 10:00 a.m. | Chungking | XGOA | 5.98 |
| | | XGOY | 6.05 |
| 10:15 a.m. | Melbourne | VLG | 9.58 |
| 10:45 a.m. | Saigon | R.S. | 11.775 |
| 11:00 a.m. | Ceylon | | 4.90 |
| 11:00 a.m. | London | GSP | 15.31 |
| | | GRG | 11.68 |
| 11:00 a.m. | Stockholm | SBT | 15.155 |
| 11:00 a.m. | Tokyo | JZI | 9.535 |
| | | JZH4 | 6.13 |
| 11:00 a.m. | New Delhi | VUD2 | 6.19 |
| 11:00 a.m. | Melbourne | VLG | 9.58 |

* * * * *

AFTERNOON

| EWT | LOCATION | CALL | FREQ.* |
|------------|------------------|------|--------|
| 12:00 noon | London | GSP | 15.31 |
| | | GRW | 6.15 |
| | | GRU | 9.445 |
| 12:00 noon | Tokyo | JZI | 9.535 |
| | | JZH4 | 6.13 |
| 12:50 p.m. | Vichy | TPC5 | 15.24 |
| 1:00 p.m. | Tokyo | JZI | 9.535 |
| | | JVW2 | 9.675 |
| | | JZH4 | 6.13 |
| 1:15 p.m. | Shonan-Singapore | | 9.555 |
| 2:00 p.m. | London | GSP | 15.31 |
| 2:00 p.m. | Tokyo | JZI | 9.535 |
| | | JZH4 | 6.13 |
| 2:45 p.m. | Brazzaville | FZI | 11.97 |
| 3:45 p.m. | London | GRG | 11.68 |
| 4:45 p.m. | London | GSP | 15.31 |
| | | GSC | 9.58 |
| 5:15 p.m. | Moscow | | 15.11 |
| | | | 15.23 |
| 5:45 p.m. | London | GRG | 11.68 |
| | | GSC | 9.58 |

* * * * *

EVENING

| EWT | LOCATION | CALL | FREQ.* |
|-----------|----------|------|--------|
| 6:15 p.m. | Tokyo | JZI | 11.80 |
| | | JLG2 | 9.505 |
| 6:45 p.m. | London | GRG | 11.68 |
| | | GSC | 9.58 |
| | | GSL | 6.11 |
| 6:47 p.m. | Moscow | | 15.11 |
| | | | 15.23 |
| 7:00 p.m. | Berlin | DJD | 11.77 |
| | | DXJ | 7.24 |
| | | DXP | 6.03 |

| | | | |
|----------------|---------------------|-------|--------|
| 7:45 p.m. | Brazzaville | FZI | 11.97 |
| 8:00 p.m. | Berlin | DXL25 | 7.28 |
| | | DXJ | 7.24 |
| | | DXP | 6.03 |
| 8:15 p.m. | Leopoldville | OPL | 9.785 |
| 9:00 p.m. | London | GSC | 9.58 |
| | | GRJ | 7.32 |
| | | GSU | 7.26 |
| | | GRW | 6.15 |
| | | GSL | 6.11 |
| 9:00 p.m. | Djarkarta | | 18.13 |
| 9:00 p.m. | Tokyo | JZJ | 7.24 |
| | | JLG2 | 9.505 |
| 9:00 p.m. | Berlin | DXL25 | 7.28 |
| | | DXJ | 7.24 |
| | | DXP | 6.03 |
| 9:15 p.m. | Moscow | | 15.11 |
| | | | 15.23 |
| 9:20 p.m. | Tokyo | JLG4 | 15.105 |
| 9:30 p.m. | Bern | HER4 | 9.54 |
| 10:00 p.m. | Bern | HE13 | 7.205 |
| 10:00 p.m. | Berlin | DXL25 | 7.28 |
| | | DXJ | 7.24 |
| | | DXP | 6.03 |
| 10:00 p.m. | Rio de Janeiro | PRL8 | 11.72 |
| 10:15 p.m. | Djarkarta | | 18.13 |
| 10:45 p.m. | London | GSC | 9.58 |
| | | GSB | 9.51 |
| | | GRW | 6.15 |
| | | GSL | 6.11 |
| 11:00 p.m. | Berlin | DXJ | 7.24 |
| | | DXP | 6.03 |
| 11:15 p.m. | Moscow | | 15.11 |
| | | | 15.23 |
| 11:40 p.m. | Tokyo | JZJ | 11.80 |
| | | JLG2 | 9.505 |
| 12:00 midnight | Berlin | DXJ | 7.24 |
| | | DXP | 6.03 |
| 12:00 midnight | Durban (So. Africa) | ZRD | 5.945 |

* * * * *

AFTER MIDNIGHT

| EWT | LOCATION | CALL | FREQ.* |
|------------|---------------------|------|--------|
| 12:30 a.m. | Durban (So. Africa) | ZRD | 5.945 |
| 12:30 a.m. | Johannesburg | ZRH | 6.007 |
| 12:30 a.m. | Capetown | | 5.882 |
| 12:30 a.m. | London | GSL | 6.11 |
| 1:00 a.m. | Tokyo | JZJ | 11.80 |
| | | JLG2 | 9.505 |
| 1:00 a.m. | Berlin | DXJ | 7.24 |
| | | DXP | 6.03 |
| 1:00 a.m. | London | GRW | 6.15 |
| 1:15 a.m. | Melbourne | VLG4 | 11.84 |
| 1:30 a.m. | Hsingking | MTCY | 11.775 |
| 2:00 a.m. | Tokyo | JZJ | 11.80 |
| | | JLG2 | 9.505 |
| 2:00 a.m. | Suva (Fiji Island) | VPD2 | 6.135 |
| 2:00 a.m. | London | GRM | 7.12 |
| | | GRW | 6.15 |
| 2:30 a.m. | Hsingking | MTCY | 11.775 |
| 3:00 a.m. | Tokyo | JZJ | 11.80 |
| | | JLG2 | 9.505 |
| 3:45 a.m. | London | GRG | 11.68 |
| 4:00 a.m. | Suva (Fiji Island) | VPD2 | 6.135 |
| 4:00 a.m. | Melbourne | VLG4 | 11.84 |
| | | VLR | 9.58 |
| | | VL14 | 7.22 |
| 4:00 a.m. | Perth | VLW3 | 11.83 |
| 4:45 a.m. | London | GSC | 9.58 |
| 5:30 a.m. | Tokyo | JLG2 | 9.505 |
| 5:45 a.m. | London | GSC | 9.58 |
| 6:30 a.m. | Shonan-Singapore | | 9.555 |
| 6:45 a.m. | London | GSC | 9.58 |

*Frequencies shown are in megacycles. To convert to meters divide 300,000,000 by the frequency.



By CARL COLEMAN

THE U. S. Navy is still seeking volunteers for its radio training courses. Men are to train under a special training program which will guarantee them a First Class Seaman's rating. The base pay for men accepted will be \$66 a month, starting from the day of induction. The course offers excellent chances to train for a civil profession. Applications will be accepted from men between the ages of seventeen and fifty and one-half years. Applicants should apply at the Navy Recruiting Station, 383 Madison Ave., New York City. Those who have passed preinduction tests and prospective inductees are both eligible to apply for the course and are encouraged to do so.

All candidates for the course are required to pass an aptitude test to demonstrate their knowledge of basic mathematics, fundamentals of electricity, elementary physics, simple shop work practice and practical radio. Candidates who are successful in passing the above tests and are accepted for training will spend one month in an indoctrination school and five in secondary school where they will qualify within a few months after their graduation for a rating of Radio Technician, First Class, which carries a base pay rate of \$114 a month.

The above is for the information of those about to be inducted into the Armed Forces who wish to get started in the radio end of things. For those of you who are working ashore and wish to get back into radio, if you are a former merchant marine radio officer by all means get in touch with one of the local radio unions or the War Shipping Administration office nearest you.

The War Shipping Administration has recently reported that the recruiting of an expected forty-three thousand experienced officers and seamen for the U. S. Merchant Marine has been falling behind the quotas that are required for the new vessels which are being constructed.

MALCOLM GORDON has taken a shore berth, as has K. Skaren. Jack Baxter is still with Isthmian and reports a new H/F receiver. G. Morgan has taken out a Liberty, F. Buches is out on a tanker assignment. H. Meisinger was in town recently on leave from his duration assignment in the U. S. Air Forces, where he is undergoing pilot training. T. C. Evans is out on a Liberty, as is C. Barry. L.

W. Passano was transferred to Nola, from the west coast quite some time ago, we learn. Jim Ellis is still on his old freighter assignment, which he has been with for a long spell.

FRED HOWE, general secretary-treasurer of the Radio Officer's Union, furnishes the following additional "hints" on getting started in the merchant marine, which we are quite sure will be appreciated by the newcomers. "Insofar as the merchant marine is concerned you do not require a release from your employer; however, if you are 'frozen' in your job by the War Manpower Commission, you will require such a release. Ask your employer, your Selective Service Board or consult the nearest U. S. Employment Office, or an office of the War Manpower Commission."

Fred continues with a couple of points we have mentioned on past occasions, "If you are in 1-A you may enter the merchant marine and hundreds have done so, but the law requires that one obtain permission from his Local Board to leave the United States. This is usually given verbally, but it is sometimes given in writing. Your Local Board has complete jurisdiction over your draft status. Visit your Lo-

cal Board and ask them about this.

"There are no particular or special physical requirements for the merchant marine. Each steamship company, however, has its own medical standards. Some companies require physical perfection, or nearly so, while others have no physical requirements whatsoever. If one has a good heart, good lungs, and is not afflicted with hernia, he will pass the majority of physical examinations given by steamship companies. The average voyage during the war is approximately four months long. Some are completed in six weeks, others as long as nine months. The length of the voyage ordinarily depends on the destination, but it does at times depend on other factors, such as waiting for cargo, or waiting for troop or military movements. You will be on the payroll while the vessel is in port in almost all cases, the exceptions being when the ship is required to spend several weeks in a ship repair yard. In such cases the crew is usually discharged. Ordinarily, the Radio Officer is kept on full pay during time in port. He is never taken off the payroll in a foreign port.

"One must have at least a Second Class Radio Telegraph license or one of the 'pink' tickets known as the 'TLT.'"

Fred further suggests that for the beginner to enjoy his first voyage, "Work efficiently, be pleasant and courteous to everyone on board. Remember that the Captain is by law the *master* of the vessel, in war time much more so than in peace time. He demands a certain amount of courtesy and consideration, but no salutes, no subservience, just plain, ordinary everyday politeness. The Captain is the only man on board who can order you around. He is the only man who can order you to work overtime, and he is the only man aboard the ship who can approve of such overtime.

"Many believe that if they join up with the merchant marine, they are exempt from military service. This is not true. Merchant seamen, including radio officers, are subject to military service the same as anyone else; however, arrangements have been made by which legitimate seamen are deferred. Such arrangements do not apply to men who wish to join the merchant marine for the first time. It applies only to men who have had considerable experience as merchant seamen and who have followed their calling since the war began.

"Under the new rules issued by the Selective Service System, registrants between the ages of 18 and 22 may not be (Continued on page 58)





Men of the U. S. and Canada have combined to form a compact, powerful fighting force. Trained shoulder to shoulder, the hand-picked volunteers, many of them former radio amateurs, form the First Special Service Force, an organization of specialists.

A HANDFUL of men put ashore on the barren wastelands of the far North. All they had with them were crates of supplies and cases of equipment, and there they stood, looking at the boxes, wondering what next—no shelter, no local USO to dash into for a quiet cup of coffee—just snow and ice and *plenty cold*. First they had to make a shelter of some sort. They had many weeks of hard construction work ahead of them and no one knew—perhaps it would be a year or two before the ship returned.

After building a shelter to take care of their immediate needs, they began erecting their antenna tower. Weeks were spent assembling small sections and laying the footing, or foundation. Much of the construction work was done on the top half by climbing up and down and adding one part at a time, and just to make it easy, there were about four inches of ice formed around the steel uprights and cross-braces.

After that came the construction of small buildings for equipment—a tough problem. The Diesel-driven generators had to be located in one shack, the transmitters in another, and the receivers in a third. It wasn't like home where you could put everything under one roof. Here the noise of the generating equipment had to be removed as far as possible from the receiving position so as not to interfere with reception. Transmitters, too, had to be

Hams in Arctic Service

By **GEORGE W. SHUART, W2AMN**

Former radio amateurs are playing an important part in keeping open radio communications under extreme conditions.

in a separate building, all of which was further complicated by the intense cold and lack of modern mechanical devices generally used in construction. Despite the many handicaps, the transmitter shack was completed and the station got on the air without a mishap.

One incident which caused some dismay for awhile concerned the cable connecting the transmitter and receiver buildings. The transmitter was located on the other side of what was thought to be a slight knoll and the cable between it and the receiver was laid on the tops of small bushes which were scattered over the hillside. When the thaw came, something went wrong with the cable and a repair crew immediately set out to fix things up. They remembered the bushes and started hunting for them, but found

not a single one. They did, however, notice a few large trees. A glance at the tops of them revealed the cable on the very tips. That hill was a large snowdrift around a grove of trees and what was thought to be bushes were actually tree tops.

All was not smooth sailing even in so remote a place as this. There was always some excitement. One evening, when everything seemed to be going smoothly, a fire broke out in the receiving house. Some of the boys went to work on the fire and others got to work unhooking receivers and other equipment. The situation finally became so serious that they had to throw the receivers and typewriters out of the windows and jump out behind them. This was rather rough treatment. (Continued on page 89)

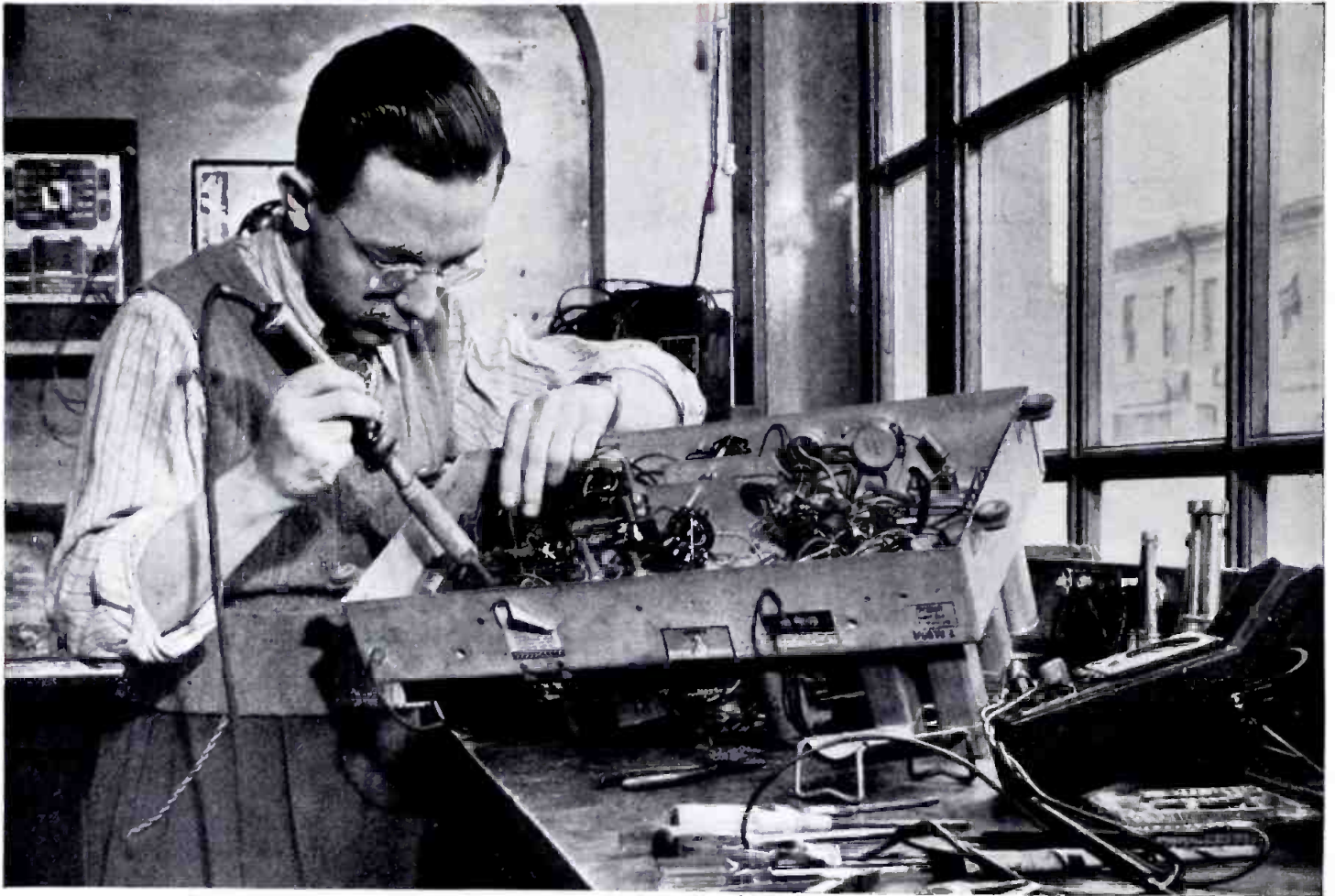

Fig. 2. Louis Piazza, repairman for Ragona Radio, Philadelphia, Pa., converting Philco chassis for new tube replacement.

SERVICING HINTS— ON TUBE SUBSTITUTIONS

By M. S. KAY

Timely tube substitutions, including necessary circuit changes for replacing hard-to-get tubes.

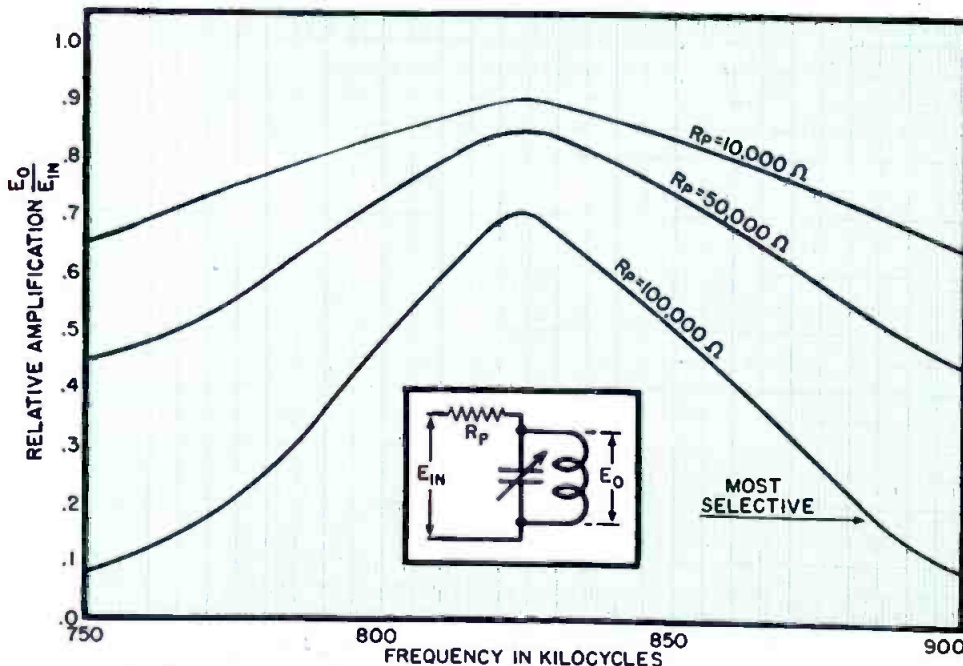

Fig. 1. Illustrating the effect of the tube's plate resistance on the selectivity of a radio- or intermediate-frequency tuned circuit.

THE war has brought with it many additional headaches to radio servicemen, and by far the worst is tube replacement. Tubes that are the hardest to replace seem, at the same time, to be the most popular. While other parts, such as resistors, condensers, or transformers, may be improvised from old parts or eliminated altogether, no such easy remedy can be found for tubes. Either the tube is replaced by a similar one, or the set remains inoperative. Radio servicemen have tried many schemes, some of which work and some that do not, to meet this emergency.

One of the most popular methods is the so-called tube substitution charts that seem to be in great abundance

and each seems to have its own selections for these tube replacements. What usually is not explained is just how these suggested tubes were arrived at nor any other circuit changes that might be needed besides the obvious filament voltage change. Surely the serviceman has a right to know why certain tubes were picked as replacements to the exclusion of others that seem to be just as good. With this knowledge would come a better appreciation of the problems that beset the design engineer and it would allow the serviceman to deal with these radio sets in a more intelligent manner. It is the purpose of this article to point out what may or may not be done and at the same time to show the reasons underlying the statements made.

To start with, let us take what might be called a typical receiver and see just how much leeway there is in tube replacements. This typical receiver will have

- 1—Radio-frequency (r.f.) tube
- 1—Mixer or Converter
- 1—Intermediate-frequency (i.f.) stage
- 1—Detector and audio
- 1—Power output tube.

With the above line-up, each stage in most receivers will be touched on. If, for example, a set should have two r.f. stages or two i.f. stages or two audio

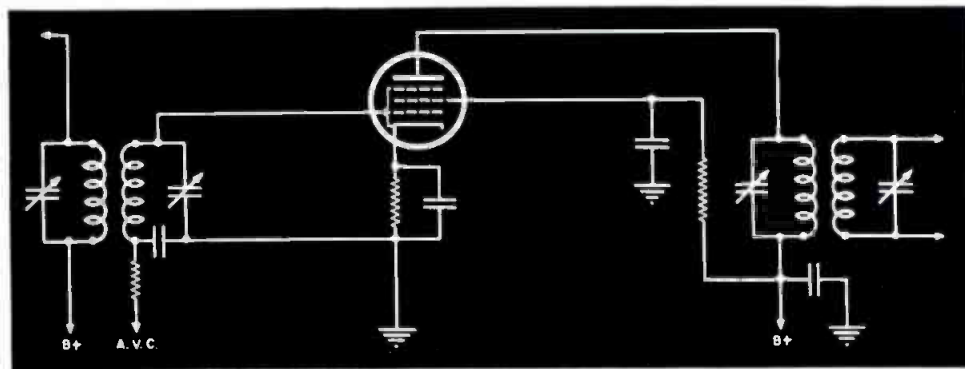

Fig. 3. A typical intermediate-frequency amplifier stage used in modern receivers.

Current is of secondary importance. In Fig. 2 is shown a typical circuit of an r.f. amplifier with the plate circuit primary coil untuned and the secondary, leading to the grid of the mixer, tuned. The purpose of this resonant circuit is twofold:

1. To act as a high impedance to the signal going through and to disregard all others; and
2. To transfer this voltage from the primary to the secondary, or grid of the next tube.

The second purpose need not concern us here since any set the serviceman is called upon to repair will have the coupling and the number of turns between the primary and secondary fixed and nothing can be done at this point. The situation will have to be accepted as found. However, a good insight into number 1 above will certainly help in any replacements that might be necessary in tubes. For example, it might be instructive to see what effect the plate resistance of a tube will have on the Q or selectivity of a tuning circuit. The results are given in Fig. 1 where the curves drawn show what happens to the voltage across the coil when the plate resistance of the tube, which can be considered as in series with this circuit, is changed. One glance will reveal quickly the desirability of large plate resistances. For this purpose a pentode tube fits in nicely, not only because it has a high plate resistance (usually near one megohm) but also

a large amplification factor, another valuable feature. Couple this combination with a small interelectrode capacitance which tends to eliminate feedback and oscillations and you will quickly see why triodes are no longer found as r.f. or i.f. amplifiers. Since automatic volume control (a.v.c.) is usually employed in most sets, a pentode having an extended cut-off characteristic must be used. A sharp cut-off tube, such as a 6C6 or 6J7, would distort too easily on high signals and so could not satisfactorily be considered as a replacement tube without killing the tone quality on strong input voltages. Thus, our line is clear and sharp, and a pentode with a remote cut-off characteristic is necessary.

Turning from the r.f. to the i.f. amplifier (a typical stage being given in Fig. 3), it is seen that identical conditions prevail with just one exception. The primary coil is also tuned here. This may give rise to a greater selectivity in the i.f. transformer, but that is about all. Everything said above still holds true, including the use of a.v.c. Generally the same tube can be employed in either the i.f. or r.f. stages.

Now how would all of the preceding discussion be of help to servicemen in replacing tubes? Just this—suppose a set is brought in which has a bad 6SK7 in either the r.f. or i.f. stages and there is no replacement of this type on hand. Knowing that a variable-mu pentode was desirable, he might thumb through a tube manual and end up with any of

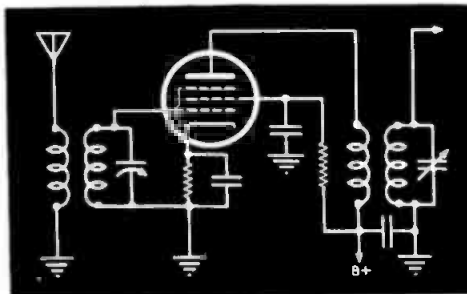

Fig. 2. Standard r.f. amplifier stage used in most present-day radio receivers.

voltage amplifiers, then what will hold true for one generally will hold for two. Thus, while a six-tube set is being discussed (counting the power supply), actually it may run to as high as 9 or 10 tubes depending on how many multiples of the above stages are used. For the present, no mention will be made regarding push-pull arrangements, since these call for less rigid rules than for single-ended output amplifiers. Mention will be made after all other tubes have been discussed.

R.F. and I.F. Amplifiers

For voltage amplification ahead of the second detector, there are the r.f. and i.f. stages, both having very much in common. Almost without exception, the modern radio set employs pentode tubes of the variable-mu type so that it is possible to consider these without reference to any tetrodes or triodes. Voltage amplifiers, as distinguished from power amplifiers, have as their goal the task of putting the greatest amount of undistorted signal voltage on the grid of the succeeding tube.

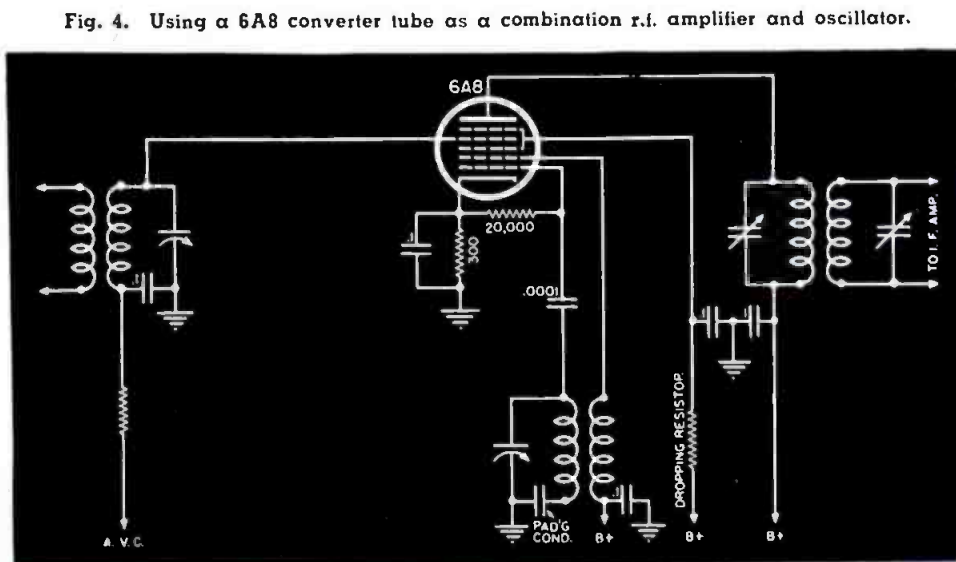

Fig. 4. Using a 6A8 converter tube as a combination r.f. amplifier and oscillator.



In Resistance Control

OHMITE EXPERIENCE MAKES A DIFFERENCE

You get the benefit of Ohmite experience in meeting the varied requirements of innumerable applications . . . in pioneering new rheostat, resistor and tap switch developments . . . in producing the widest range of types and sizes to answer every control need. Add to this, the long service-record of Ohmite Units—their proved ability to function under the most severe operating conditions. Such experience in resistance control is invaluable to engineers designing new devices to defeat the enemy or planning new products for the postwar era.

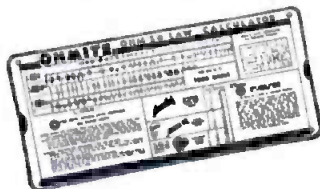
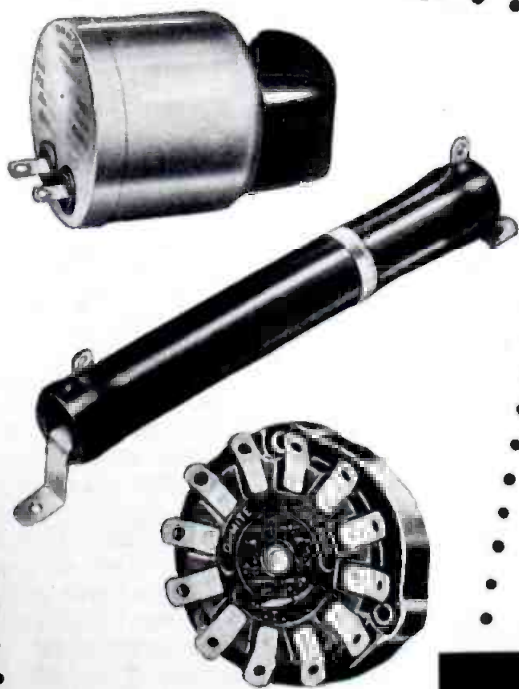

Send for Ohm's Law Calculator
Helps you figure ohms, watts, volts, amperes—quickly. Solves any Ohm's Law problem with one setting of slide. Send only 10c in coin to cover the cost of handling and mailing.

OHMITE MANUFACTURING COMPANY
Foremost Manufacturers of Power Rheostats, Resistors, Tap Switches
4883 FLOURNOY STREET ★ CHICAGO 44, U. S. A.

Be Right with **OHMITE**
RHEOSTATS • RESISTORS • TAP SWITCHES

“...DOUBLE *their* WAR BONDS”*

If only the people back there could see where their money is going and doing I bet they would double their War Bonds, and I'm not kidding one bit!

ASSUREDLY if only every citizen could take a jaunt along a battle front, and **SEE** what our taxes and bonds are purchasing toward Victory — they would double their War Bonds, cheerfully! Yes, **CORWICO** wires are there, too

**William Ogert of Cornish Wire Co. had a letter from his son, now serving overseas, part of which is quoted here.*

cornish

WIRE COMPANY, INC.



15 Park Row, New York City, New York

"Made by Engineers for Engineers"

QTC

(Continued from page 52)

deferred for any purpose; however, a majority of Local Boards will usually grant permission for such registrants to accept employment in the merchant marine. Under the Selective Service System and the law on which it is based, the Local Boards have almost supreme jurisdiction over all registrants. A Local Board may grant you deferment or it may not, depending entirely on how it feels in the matter. If it refuses to defer a registrant, he may appeal the decision, provided he has any legitimate grounds on which to base his appeal.

"The War Shipping Administration will usually ask for a Radio Officer's deferment, provided he has had previous marine radio operating experience. Deferments usually are requested only for new men during times of Radio Officer shortages in the merchant fleet."

The above observations by Fred Howe will give the newcomer to the merchant marine an idea of the "how and why" of things one should know and keep in mind. Mr. Howe speaks from many years of experience in being and working with and for Radio Officers of the U. S. Merchant Marine.

J. MARTSON and O. Roones are out on new cargo job assignments. R. Scott, E. Smith, and R. Neill are among the new tanker assignments. R. Martin is out on a Liberty, and Kaplan also is out on the same type of craft. Frank Grimes and A. Sacholt are both on freighter assignments. Leif Hvidsten has been transferred to Mississippi. Gordon Berch is on a Liberty, as is J. Giglio. C. B. Hughey and C. P. Hoffman, two former airways men have taken assignments out of the Gulf. C. G. Landman is back with the Isthmian Line after a long spell ashore. H. Smith is on a Liberty. Ted Pataky is likewise on a cargo vessel of the same type. P. A. Barker is on a new tanker assignment out of the East Coast. New tanker men are K. Gravdal, E. Bryn and L. Fredrik. Liberty assignments include H. D. Breeland, C. Crayton and K. Haeme. C. Seymour, S. Copeland and G. Carlson are all out on freighter jobs.

TWENTY-NINE members of the crew of an Army cargo ship owe their lives to the radio operator of their vessel, Sgt. William T. Betts, Jr., who sent out the SOS which brought about their rescue. Sgt. Betts lost his own life during the sinking. Many men who have lost their lives during the earlier part of the war will be listed as heroes of the present conflict. The Radio Officers who came to the aid of their country in time of war will never be forgotten for their heroic deeds whether in the Army, Navy, merchant marine or various branches of the Armed Forces. 73.

24-HOUR TESTS FORECAST 15 YEARS OF SUSTAINED OPERATION



What will happen in 1959 nobody can foretell. One fact is clear, however, The DeJur potentiometer that you buy today is so designed and constructed as to provide at least 15 years of efficient operation. This figure . . . and it is a conservative one . . . is based on simulated production-line tests in our laboratory as well as reports from the field.

Operating at half-cycle, at as many as 2,500,000 revolutions over a 24-hour period, a specially-developed rotation tester checks the endurance of DeJur potentiometers. The wiper travels from minimum to maximum resistance at rates stipulated in American Standards Association specifications. Mechanical and electrical characteristics are checked under abnormal as well as normal conditions. Effects of day-in and day-out performance are analyzed. Out of these tests come DeJur potentiometers whose dependability can be counted on for extended period of time. Data sheets upon request.

Support the Fifth War Loan Drive



DeJur-Amsco Corporation

MANUFACTURERS OF DeJUR METERS, RHEOSTATS, POTENTIOMETERS AND OTHER PRECISION ELECTRONIC COMPONENTS
SHELTON, CONNECTICUT

NEW YORK PLANT: 99 HUDSON STREET, NEW YORK 13, N.Y.

CANADIAN SALES OFFICE: 560 King Street West, Toronto



Amplitude Modulation Measurements

By GUY DEXTER

Fundamental theory of amplitude-modulation code and voice radio transmissions, including principles of laboratory measuring techniques.



Fig. 1. Commercially constructed modulation monitor for checking modulation percentage of radio transmitters.

AMPLITUDE modulation has not been supplanted by frequency and phase modulation systems, and there is no indication that a complete transition soon will occur. The economic importance of amplitude modulation still is considerable—a total investment of several million dollars is tied up at present in amplitude-modulated communication and broadcast transmitters and receivers and in amplitude-modulated instruments for testing these systems.

Certain classes of code and voice radio transmissions will continue to require amplitude modulation; and even in the event that frequency modulation (FM) and phase modulation should displace this system in some types of communication, numerous electronic control applications and narrow-band radio communication still will demand it.

A thorough understanding of the mechanics of amplitude modulation and of the methods of testing the performance of AM systems will continue to be vital as long as these systems survive. Heretofore, little complete quantitative information has been found in one place in the textbooks and periodicals concerning both the mechanics of amplitude modulation and

the practical measurements employed in commercial practice. This article aims to consolidate this material in concise form for two types of readers: (1) those who, like aspirants to the professional radiotelephone operator license, must acquire fresh knowledge of the subject quickly; and (2) those who are in need of a refresher on the subject.

Mechanics of AM

In amplitude modulation, the successive peaks of a *carrier* (both positive and negative) are modified at a rate corresponding to the *modulating frequency*. The modulating frequency is usually the lower frequency of the two. Fig. 4 shows the appearance of a continuous-wave carrier before and during modulation.

The unmodulated carrier voltage is shown at B in Fig. 4, the modulating voltage at A, and the carrier voltage during modulation at C. Observe that both positive and negative peak amplitudes are altered by the same amount, with the result that peaks on each side of the zero axis trace out a pattern, and that the *modulation envelope* corresponds to the modulating voltage in frequency, voltage and waveform.

The extent to which the carrier is

modified (or moulded) by the process of amplitude modulation is expressed by the term *modulation depth*. Greatest depth is obtained when the peak modulating voltage is high enough, with respect to the peak carrier voltage, to reduce the latter instantaneously to zero. (See Fig. 3.)

Fig. 3 illustrates various depths of modulation. In Fig. 3A, the peak modulating voltage is insufficient to reduce the carrier peaks instantaneously to zero (undermodulation); in Fig. 3B, the peak modulating voltage is higher than the value required for reduction of carrier peaks instantaneously to zero and the carrier disappears completely for short intervals (overmodulation); and in Fig. 3C, the peak modulating voltage is of the proper value to reduce the carrier peaks instantaneously to zero (complete modulation).

Since the modulating voltage is symmetrical in shape, the reduction of carrier peaks on one half-cycle of modulating voltage is followed by an increase by the same amount on the next half-cycle of modulating voltage. The modulation upswing is thus equal to the downswing. It is seen from Fig. 3B that the overmodulation pattern is characterized by high instantaneous carrier peaks as well as cut-off periods.

SPRAGUE TRADING POST



A FREE Buy-Exchange-Sell Service for Radio Men

Important Notice!

We discourage offers to buy or sell anything beyond the O.P.A. ceiling prices, and will not knowingly accept such ads for the Sprague Trading Post.

WANTED—One Echophone EC-1 receiver, new or used. C. C. Collier, Class 44-J, Bks. 1, Room F, Sdn. 5, 201st A.A.F. F.T.D. Corsicana, Texas.

FOR SALE—6-tube Crosley console, like new, 5 push buttons, two band, \$80 cash. Or will trade on Echophone EC-1, or Hallcraft S22R Skyrider Marine. M. L. Grigsby, Granger, Iowa.

FOR SALE OR EXCHANGE—RCA ACR111 Comm. type 16-tube, 550 to 35,000 kc. full-band coverage receiver with matched speaker; Sky Buddy communications receiver complete; Collins 32-B radio telephone-telegraph transmitter capable full coverage any freq. between 1600 to 15,000 kc. complete ready for 110v. A.C. 60 cycle power line operation. Is certified and registered with F.C.C. as per regulations. Would like to get good all-wave console home receiver with record changer. Geo. J. Pasquale, 601 Bashford Lane, Alexandria, Va.

FOR SALE—Hammarlund "Comet Pro" complete, 15-500 M. tubes, 8" P.M. spkr., \$35 f.o.b. J. Repke, 1553 E. 18th St., Brooklyn, N. Y.

FOR SALE—Hallcraft SX-24 complete with speaker in matching cabinet, perfect condition, \$85. Fred E. Fratlick, Box 222, Salem, Ore.

WANTED FOR CASH—Good capacitor analyzer, or will trade Powers GA projector mechanism, lens and stand, without motor or lamphouse. Vincent Machek, Jr., De Pue, Ill.

URGENTLY NEEDED—Comm. receiver, 6 to 8 tubes for AC-DC operation. Echophone EC-1 or EC-4, Howard 445, or similar. Cash. Theodore Lyszczarz, 300 Nichols St., Utica, N. Y.

FOR SALE—Bogen CX-30 amplifier with treble and bass controls, in carrying case. Matched speakers in separate split cases. Willard Strayer, 946 W. Princess St., York, Pa.

WANTED—V-O-M. Weston preferred. Describe fully. F. J. Case, 735 W. Henry St., Pontiac, Ill.

WANTED—Cathode Ray tube, 1, 2, or 3", new or used. Julius R. Bartz, 1412 N. 28th St., Milwaukee 5, Wis.

WANTED—Echophone EC-1 or Sky Champion S-20H; also G-E multimeter or Radio City 419. Bob Knellinger, Box 295, Velasco, Texas.

FOR SALE—RME 9D receiver, many transmitting tubes, SW3 receiver. John E. Thompson, 1410 W. 47th St., Chicago 9, Ill.

WANTED—Will buy or trade for 100 kc. crystal or any std. make of 50 or 100 kc. frequency standard. Plenty of trading stock available. D. A. Brown Radio Service, 135 E. Church St., Marion, O.

WANTED—1A7, 1R5, 1N5, 1P5, 1H5, 1A5, 3Q5, 1L6, 1LA6, 1L85, 1J14, 1LA4, 35Z5, 12SA7, 7A8, 12SK7, 12SJ7, 12SQ7, 50L6, 35L6, 12A8 tubes. E. L. Carter, P. O. Box 104, Timmonsville, S. C.

FOR SALE—Two F-123-A Federal xmitting tubes; two #10 xmitting tubes, RCA; five 6L6 tubes, RCA; seven 1N5G and one type A5C tubes. All new in sealed cartons. E. E. Backle, 3165 De Saix Blvd., New Orleans 19, La.

URGENTLY NEEDED—One meter for Jackson #642 multimeter; also two 0A3 tubes. Cash. Jacks Service Shop, 2212 Meredith Ave., Omaha 11, Nebr.

WANTED FOR CASH—Carter genemotor, 400 V d-c 200 mls. or 400V d-c 250 mls. 6V input. William Macres, 154 Woodland Ave., Campbell, Ohio.

WANTED—Two 3525 tubes and two 5" speakers of 450 and 2000 ohm fields. Also want other tubes, parts, and eqpt. incl. phono pickups and motors. Have some parts for sale. What do you need? Jerry M. Peterson, 1116 Elm St., Clarkston, Wash.

FOR SALE—Rider's manuals Nos. 5 and 7; Hickok T-53 tube checker; Supreme Giant 320 set tester; J. T. Slocumb 1" micrometer; set of 9 shockless nut drivers; Economy P-300 P.M. speakers; Green Flyer 78 r.p.m. 110V, 60 cy. phono motor; two steel storage cabinets 13 1/2 x 10 1/2 x 11 1/2"; six drawers; set N.R.I. radio course; 680 Philco receiver; 14" G.E. dynamic speaker. Roland Gullmahn, 53 Francesca Ave., Somerville, Mass.

WANTED—Two 0-1 ma. meters, Triplett 321, 3" round meter, Norman Lefcourt, 510 Robbins St. S.W., Atlanta, Ga.

FOR SALE OR TRADE—Automatic record changer, compl. with amp. Holds ten 10" records, plays both sides, has 20 push buttons, 15" speaker. \$150 cash or what have you? Don T. Arata, Denson, Ark.

WILL TRADE either a 6A8, 6C5, 6K7, 6L6 metal for a 117Z6 rectifier tube. All new tubes. Will not sell. Frank A. Smith, Box 371, Midland, Texas.

FOR SALE—Hickok 55XX tube tester, completely modern; Rider's manuals 1-12 incl. like new; about 60 popular tubes; good stock of resistors & condensers; some vol. controls; one metal chassis stand. Will sell all or part. Floyd Wilcox, Box 184, Akron, Iowa.

WANTED FOR CASH—#542 Supreme V-O-M; Rider's manuals; 1A7; 1H5; 1N5; 3Q5; 35Z5; 50L6 tubes; RCA Rider channalyst. G. S. Hobbs, P. O. Box 397, Suffolk, Va.

WANTED—Signal generator, Hickok #18 or P.S.G. 15. Must be A-1. P. Calabrese, 725 Elton Ave., Bronx, New York 55, N. Y.

FOR SALE—New tubes, one, two and three of each, as follows: 1A1P; 1A5GT; 1A7G; 1C5G; 1D7G; 1F7M; 1G4G; 1H40; 1H5G; 1N5G; 1A6; 2N3; 5W4; 6A8; 6F6; 6J8M; 6L7; 6Q7; 6SQ7GT; 6V6G; 12K7GT; 12SQ7; 19; 26; 27; 30; 31; 33; 34; 31M; 41; 42; 75. Will pay cash for one 70L7GT and one 12A8M or GT tubes. Chas. Isford, 2907—6th St., New Westminster, B. C., Canada.

FOR SALE—One supertester, model 411 K, D.C. Price \$30 or will trade for Supreme diode analyzer #333. Pfc. Aaron Hollandmoltz, 313 M.P.E. Gd. Co., Angel Island, Calif.

WANTED—Communication receiver such as Hallcrafters S-20H; Echophone EC-3; National NC-45A, or Howard 457A. Pvt. Ethwood K. Davis, HQ Company, 1318 Eng. Const. Bn., Camp Sutton, N. C.

FOR SALE—Melssner all-wave tuner for 456 kc. I.F. no L-P trans. Used, but in A-1 condition. \$22.50 F.O.B. Channalystograph 18" P.M. speaker, factory serviced. \$75 F.O.B. M. A. Porter, 1713 Larrabee St., Chicago 14, Ill.

FOR SALE—N.I.I. servicing course complete except lessons 1 to 5. \$12 cash, or will trade for critical tube types. Doty Radio Service, 1034 S. Broadway, Dayton 8, Ohio.

FOR SALE—RCP #702 sig. generator, new cond., used 2 months. Sell for cash or will swap for good std. condenser bridge, or what have you? Walt's Radio Service, 911 Shawnee St., Pittsburgh 19, Pa.

WANTED FOR CASH—RCI AC-DC multimeter with instructions or equivalent type tester. Ralph C. Davis, 2121 Second St. S.E., Canton 4, O.

WANTED—Good tube tester, multimeter, and an all-wave sig. generator in good cond., not more than 2 years old. Carlton W. Evans, 110 N. Stuart St., Baltimore 21, Md.

WANTED—Tube checker & multimeter, late model, good condition. Bob Knellinger, Box 295, Velasco, Texas.

WANTED—Good analyzer, tube tester, sig. generator, etc. A. T. Rivelro, 1817—22nd Ave., Tampa 5, Fla.

WANTED—Complete set of Rider manuals 1-13 incl. Also want Rider or Melssner channalyst. Cherokee Radio Service, 112 W. Main St., Cherokee, Okla.

FOR SALE—Hickok tube tester, dynamic mutual conductance model T53. Used only 1 year. Raymond Lemmons, Rt. 1, WaKeeney, Kansas.

WANTED—Good used recorder and playback unit, any make. B. Stog, 336 Whitaker St., Sudbury, Ont., Canada.

WANTED FOR CASH—Returned serviceman starting back in business will buy shop equipment. What have you? M. D. Quinlivan, 49 Dickinson St., Binghamton, N. Y.

URGENTLY NEEDED—Good used ohm checker, sig. generator, late tube tester. Cash. Hood Electric Co., 3512—53rd St., Sacramento 17, Calif.

URGENTLY NEEDED—Sprague, C-D HF50; Jackson, Solar, or Aerovox condenser checker, also Philco 930 signal tracer. Jack's Radio Service, 34 W. Hoffmann Ave., Lindenhurst, N. Y.



HOW TO SUBSTITUTE CAPACITATORS Accurately

Besides listing the "Victory type" Sprague Atom Electrolytics and TC Tubulars for wartime service use, this folder contains helpful information on making these 18 Capacitor types do the work of the 473 capacitors normally included in our catalog. Send a post card today for your copy.

FOR SALE—One practically new in-structograph with 10 tapes and sounder and inst. book, A-1 condition, \$28.50. Shirley Ince, Route 1, Ilco, Texas.

FOR SALE—National CRO oscilloscope, \$25; Sound system with two speakers, \$20. Want Rider manuals 6, 7, 9, 10, 12, and 13, also Clough-Bronckle sig. generator; Rider channalyst; and record player. Arends Radio Service, Box 362, St. Clair Shores, Mich.

FOR SALE—New tubes: 1Q5GT; 1A6; 79; 77; 39; 1T1; 6R7G; also 2" Reardite 0-1 ammeter, 50c; Utah 20V a-c tuning motor, \$1; neon test lamp with socket & cord, \$1; antenna coupling transformers, 20c; chassis pan for 3 tubes (incl. sockets), 50c. N. J. Cooper, 4617 N. Damen Ave., Chicago, Ill.

FOR SALE OR TRADE—Several new 6-tube ac-dc superhet kits. Need following tubes: 50L6; 12SA7; 12SK7; 12SQ7; 35L6; 35Z5; 1A7G; 1H5GT; 1N5GT; 117Z6; 80; 5Y3; 43; 6SA7; 6K8. Melvin Oskin, 915 Bryant Ave., Bronx, New York 59, N. Y.

YOUR OWN AD RUN FREE!

This is Sprague's special wartime advertising service to help radio men get needed parts and equipment, or dispose of radio materials they do not need. Send your ad today. Write PLAINLY—hold it to 40 words or less. Due to the large number received, ads may be delayed a month or two, but will be published as rapidly as possible. We'll do everything we can to help you—and the fact that thousands of pieces of Radio-Electronic equipment are in operation today as a result of sales or "swaps" made through The Trading Post offer convincing proof of the far-reaching effectiveness of this service. Ads offering equipment for sale bring best results, and will be given priority.

Different Trading Post ads appear monthly in Radio Retailing-Today, Radio Service-Dealer, Service, Radio News, and Radio Craft. Sprague reserves the right to reject ads which do not fit in with the spirit of this service.

When buying Capacitors—please ask for Sprague's by name. We'll appreciate it!

HARRY KALKER
Sales Manager

SPRAGUE PRODUCTS CO., DEPT. RN-74, NORTH ADAMS, MASS.



SPRAGUE CONDENSERS KOOLOHM RESISTORS

Obviously, Sprague cannot assume any responsibility, or guarantee goods, services, etc., which might be exchanged through the above advertisements

Your best bet!

...for Everything in
RADIO and ELECTRONICS

You can get *all* your needs *faster* from this *one* central source. Here's why:

- (1) Largest and most complete stocks under one roof
- (2) Over 10,000 radio and electronic items on hand for rush delivery ... tubes, parts, kits, test equipment, public address ... for training, research, engineering, production and maintenance
- (3) Close contact with all the leading manufacturers
- (4) Centralized procurement and expediting
- (5) Technical assistance.

Whether you need one item, or a hundred ... *Call Allied First!*

Write, Wire or Phone Haymarket 6800

ALLIED RADIO CORP.

833 W. Jackson Blvd., Dept. 1-G-4 Chicago 7, U.S.A.

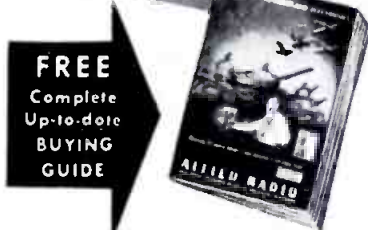

FREE
Complete
Up-to-date
BUYING
GUIDE

**REPAIR AND
REPLACEMENT
PARTS
AVAILABLE
WITHOUT
PRIORITY**

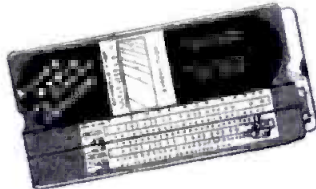

NEW Rapid R-F Resonance and Coil Winding Calculator

New, dual-purpose Calculator devised by Allied for fast and accurate determination of resonance factors and coil winding data. Simple, easy to use. Send for it now. No. 37-955.
Price net, only.....25c

6 VALUABLE RADIO BOOKS FOR 75c

Specially prepared by technical experts for radio training and for helpful reference. Priced only to cover cost of preparation and mailing.



RADIO BUILDERS' HANDBOOK. Simplified theory and projects. No. 37-750 . . . 10c

RADIO-FORMULAS & DATA BOOK. Handy, pocket-size manual. No. 37-752 . . . 10c

SIMPLIFIED RADIO SERVICING. Short cuts in troubleshooting. No. 37-755 . . . 10c

DICTIONARY OF RADIO TERMS. Easy-to-understand definitions. No. 37-751 . 10c

RADIO CIRCUIT HANDBOOK. Schematics and Pictorials. No. 37-753 . . . 10c

RADIO DATA HANDBOOK Formulas—Tables—Charts No. 37-754 25c

ALL SIX BOOKS No. 37-799 75c

Write for Quantity Quotations

ALLIED RADIO CORP., Dept. 1-G-4
833 W. Jackson Blvd., Chicago 7, Illinois

Please send the following items (\$_____ enclosed)

37-750 37-752 37-754
 37-751 37-753 37-755
 All 6 Radio Books Free Catalog Calculator

Name _____
 Address _____
 City _____ State _____



Fig. 2 illustrates modulation depth for complete modulation, corresponding to the pattern in Figure 3C. For this condition, the peak modulated amplitude (M) is equal to twice the unmodulated amplitude (C). Peak amplitude of the modulating voltage is represented by (m).

For quantitative determinations of

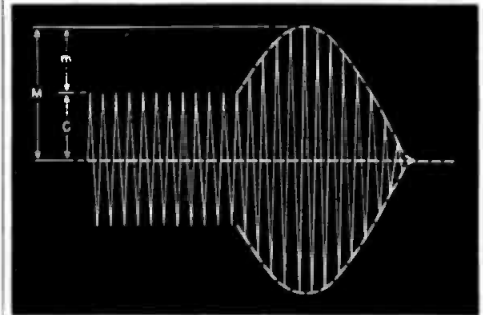

Fig. 2. Modulation depth for 100% modulation, corresponding to pattern shown in Fig. 3C.

modulation depth, the extent of modulation may be expressed by the ratio of peak modulating voltage to unmodulated carrier voltage, termed the *modulation factor*;

$$\text{Mod. Factor (F)} = \frac{m}{C} = \frac{M-C}{C} \dots\dots (1)$$

From the foregoing discussion, it is seen that the modulation factor for complete modulation is unity, since (from Fig. 2) M is equal to 2C. It is seen also that for complete modulation, the peak unmodulated carrier voltage must be equal (m = C, or M-C = C). In cases of undermodulation, the factor is some value less than unity because the peak modulating voltage is less than the peak unmodulated carrier voltage. Conversely, in overmodulation, the factor is greater than 1, since the peak modulating voltage is higher than the peak unmodulated carrier voltage.

Depth of modulation may be expressed as a percentage by multiplying modulation factor by 100;

$$\% \text{ Mod.} = \frac{M-C}{C} (100) \dots\dots (2)$$

In expressing modulation depth, it is customary to employ the *percentage modulation* figure. Complete modulation (factor of 1) is thus 100 percent.

Amplitude modulation is accomplished by superimposing the alternating modulation voltage upon one of the direct voltages of the carrier generating tube. Thus, the modulating voltage may be introduced in series with the direct plate, screen, grid, suppressor, or cathode voltages.

In power-modulated amplitude-modulation systems (e.g. plate, screen, or plate-screen) the efficiency of the carrier voltage generator remains constant. The a.c. modulating voltage is equal to the d.c. electrode voltage and is added to the latter on one half-cycle and subtracted on the next, thereby swinging the direct voltage between zero and twice its unmodulated value during complete modulation. Input

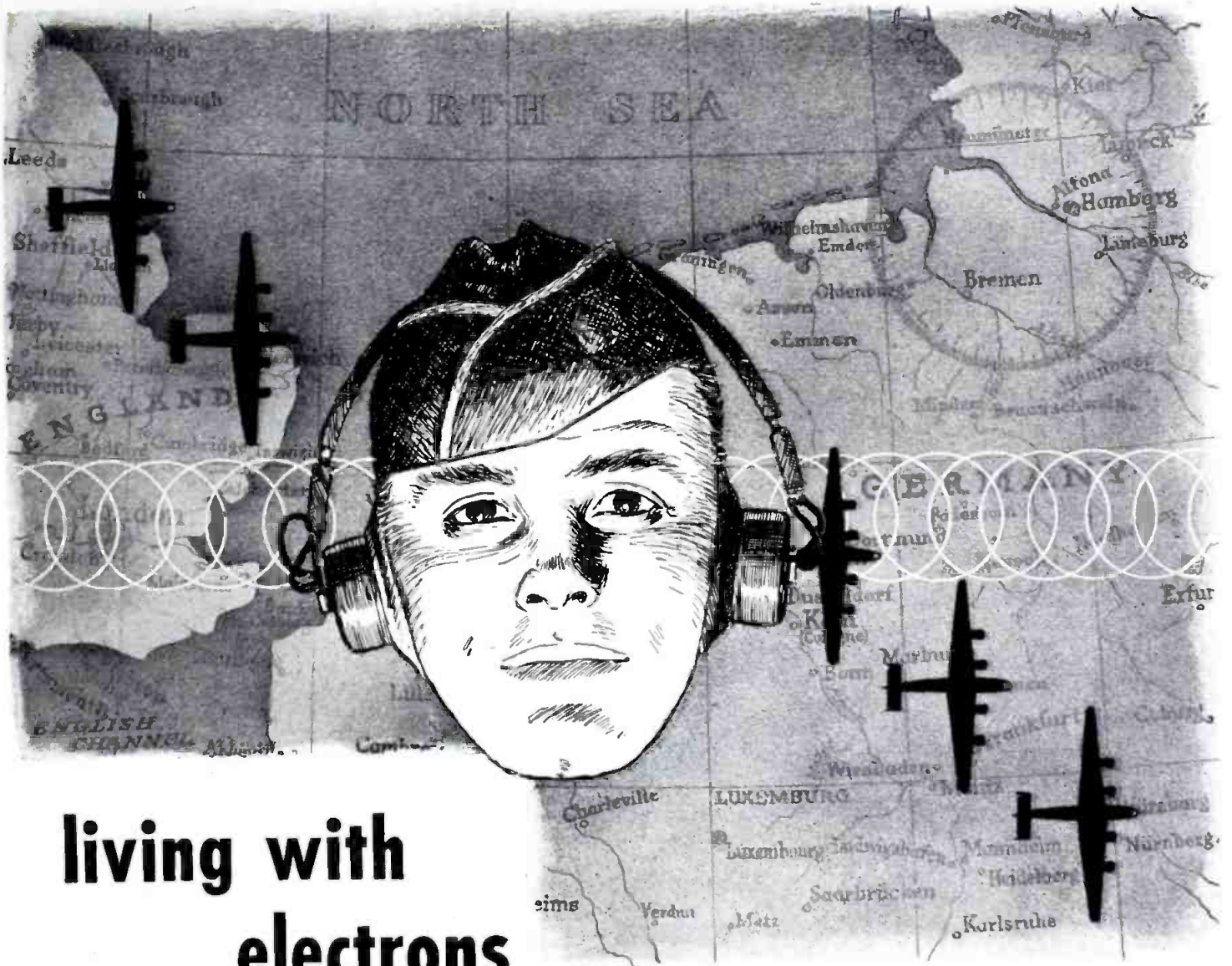

living with electrons

Only a short time ago—when the principles of radio were discovered—men began dimly to realize the versatility of electrons. But it was not until war came, with its deadly challenges, that men really began living with electrons, utilizing them in amazing applications in ships and planes and battle vehicles. Their versatile performances promise future applications that will make electronic devices a part of our daily lives.

Delco Radio has been working in close cooperation with Army and Navy engineers to help make electronics an increasingly effective "weapon" of war. The assignment has called for full utilization of Delco Radio's research laboratories, engineering background and production

facilities, by means of which principles have been explored and exploited, designs evolved to apply these principles, and complete equipment manufactured with speed and skill. To all radio and electronic applications, Delco Radio brings its long experience in volume production of precision radio instruments.

**DO MORE THAN BEFORE—
BUY MORE WAR BONDS**

Delco Radio
DIVISION OF
GENERAL MOTORS

HARCO

RADIO MASTS and TOWERS

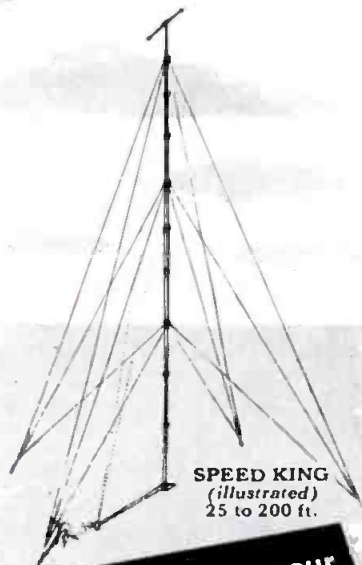

are the solution to your PROBLEMS (present or post-war)

because -

1. **LOW TRANSPORTATION COST.**
Shipping expense reduced to a minimum because total weight and shipping space is extremely small. Also low storage and handling costs.
2. **MINIMUM ERECTION COST.**
Speedy erection insured—due to elimination of Bolts and because customary erection labor expense has been reduced by shop fabrication. All connections reduced to simplest form.
3. **CAN BE ERECTED WITH INEXPERIENCED LABOR.**
HARCO MASTS AND TOWERS are easy to put up. Emphasis placed on portability—no sections are too heavy for one man. No skill required for making connections. None of the usual hazards exist. Ground assembly optional.
4. **CAN BE ERECTED UNDER ADVERSE CONDITIONS.**
Erection accomplished under all weather conditions and extreme temperatures by men wearing gloves. Rigid construction is the result of all sections having a high strength-weight ratio, and the type of connections and bracing used. Every safety precaution possible has been taken.

Whatever your problems may be, HARCO can solve them from every Engineering angle. If none of our 16 Standard Designs meet your requirements, we can give you a "Custom Built" job.

Please send complete design specifications when inquiring for detailed information.

HARCO

STEEL CONSTRUCTION CO., Inc.
Elizabeth 4, New Jersey

power is thus varied at the modulation rate.

In efficiency-modulated systems (e.g. control grid, suppressor, grid bias) the efficiency of the carrier generator varies cyclically throughout the modulation cycle. Input power remains constant and output power is varied at the modulation rate.

Advantage of Complete Modulation

From Fig. 3A, it is apparent that an appreciable percentage of the total carrier voltage is unaffected by the low-value modulating voltage. Undermodulation thus does not make fullest use of the available carrier.

Fig. 3B indicates that a very high modulating voltage is applied, but the waveform of the latter has been distorted, and the cut-off periods resulting from the large negative swings of modulating voltage introduce the effects of an interrupted wave. Notable among these effects, due to high damping, is a broadening of the entire modulated signal.

The 100-percent modulated wave

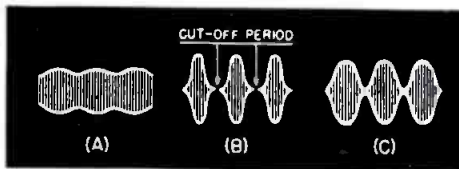

Fig. 3. Illustrating the various depths of modulation. (A) Undermodulated. (B) Overmodulated. (C) 100% modulated.

(Fig. 3C) utilized the maximum modulating voltage which may be combined with the carrier voltage without waveform distortion or cut-off periods. This condition makes possible maximum use of the carrier.

Required Measurements

Modulation Percentage.

Modulation percentage is checked by measuring the peak modulating voltage for a given carrier voltage, or by comparing peak modulation and carrier voltages. Electronic modulation meters are employed in the former op-

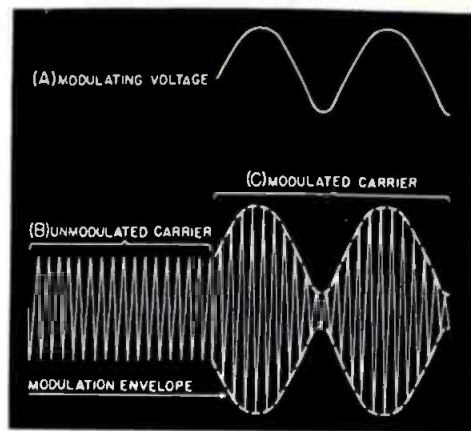

Fig. 4. The appearance of a continuous wave carrier before and during modulation.

eration, cathode-ray oscilloscopes in the latter.

Carrier Shift.

In a distortionless AM system, there must be no change in the average value of carrier voltage throughout the modulation cycle. Carrier shift undermodulation results in carrier frequency instability. Carrier shift is detected by a diode-type v.t. voltmeter, the deflection of which remains constant in the absence of carrier shift. This meter is generally a part of the standard modulation percentage meter.

Frequency Distortion.

Since all harmonic components of the modulating voltage act to modify the carrier voltage amplitudes, frequency distortion will be present in the modulated signal whenever modulating voltage harmonics are appreciable. Frequency distortion occasionally is introduced also by various factors in the modulation process.

Distortion meters are available for checking harmonic content of both the modulation envelope and modulated signal.

Noise and hum level in both the modulation envelope and modulated signal may be checked by means of the standard distortion meter. Provision is generally made in these instruments for measuring the voltage due to noise or hum and in some instances for distinguishing between the two.

Fig. 5. Circuit of modulation monitor as depicted in block diagram form in Fig. 8. Photograph of complete professionally-constructed unit is shown in Fig. 1.

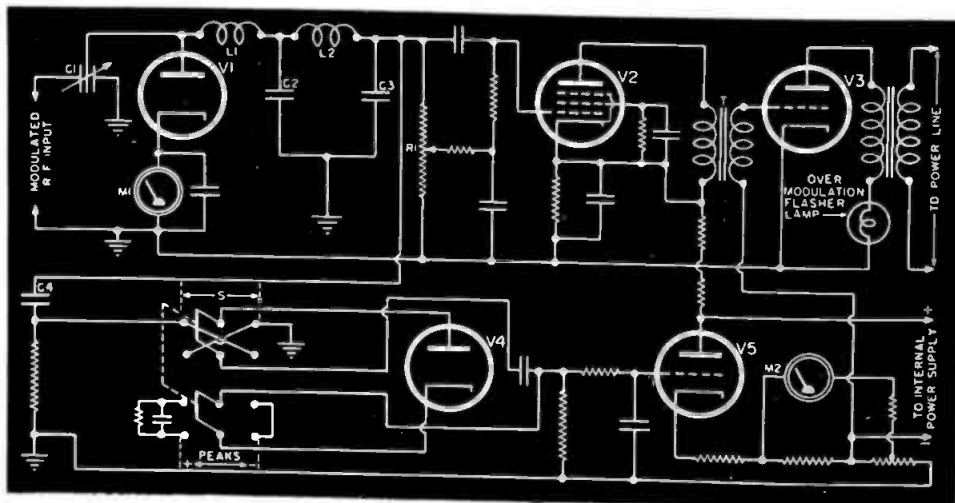

Three attitudes that hamper war production

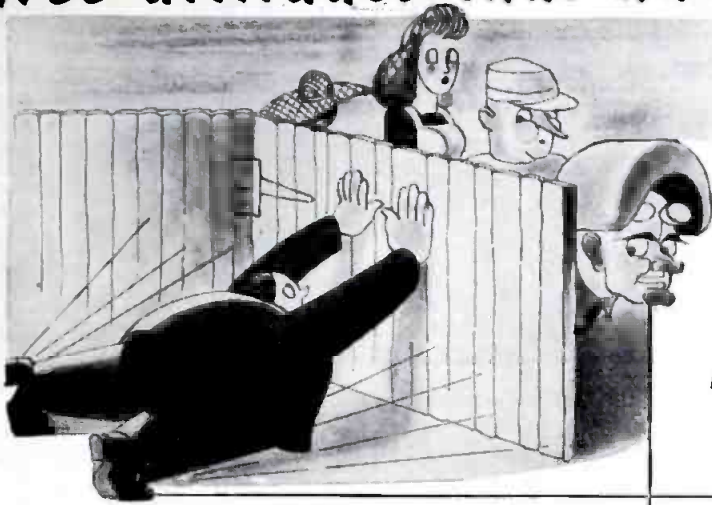

KEEPING LABOR ON LABOR'S SIDE OF THE FENCE

Ignoring successful examples of many progressive plants, some executives still choose to utilize the craftsmanship but not the wholehearted cooperation of labor. Labor appears to be non-essential around the conference table.

ONE EYE SHUT TO WORKING CONDITIONS

A healthy and contented worker is a good worker — but, unfortunately, some men close one eye to this well-established fact. Provisions for maintaining general comfort and morale on the production line are shrugged aside, and then there's wonderment if output lags.

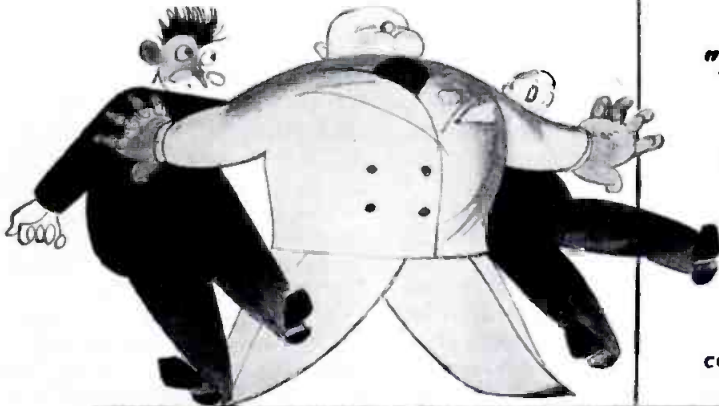

"I'M BETTER THAN HE IS"

While boys of different colors and races and religions fight and die side-by-side, here at home there are those who practice an un-American form of discrimination. Overlooked is the actuality that harmonious relationships of all peoples can, and must, be achieved.

THERE IS NO PLACE IN THIS COUNTRY FOR SUCH ATTITUDES

At ECA, even as in your plant, we have questioned these three attitudes . . . experimented . . . eliminated them. Carrying the fundamental principles of the American dream into our organization, management and labor function as a single democratic unit. Periodic meetings have been established . . . ideas of benefit to both groups are exchanged. Here we gather suggestions for economy and efficiency. Here originate recreational facilities, group insurance and medicine plans, our extensive home front activities. Here developments are born whose value to the country have been effectively demonstrated. Here our policy of assigning jobs on the basis of merit rather than heritage is reaffirmed. Has our plan worked? Efficiency steadily increases and production, for example, today is six times greater than it was twelve months ago. This record gives added support to our proposition that, regardless of color or creed, to advance is the common birthright of all men . . . and that mutual cooperation between the man-in-the-front-office and the man-who-puts-things-together is not only highly desirable but highly essential.

ECA

ELECTRONIC CORP. OF AMERICA

45 WEST 18th STREET • NEW YORK 11, N. Y. WATKINS 9-1870

REPRINTS OF THIS ADVERTISEMENT AVAILABLE.

SHAPPE-WILKES INC.



MR. LITTLE and MR. BIG

One wants radio and electronic components and equipment in dozen units—the other calls for hundreds. One needs help on priorities—the other has a ticklish technical problem. One can use non-critical parts—the other asks for made-to-order apparatus. Big or little, whatever the requirements, Lafayette Radio Corporation acts as a friendly cooperative agent. As leaders in the field, we have the confidence of leaders. We service industry, government agencies, the military forces, schools, laboratories, dealers, etc. Why don't you, too, get acquainted with the Lafayette Radio Corporation's method of doing business?

Note! Write or wire for our new 8-page circular listing needed radio parts, available for immediate delivery . . . coils, controls, speakers, condensers, relays, switches, resistors, transformers, etc. All merchandise subject to prior sale.

Dept. E-7

Lafayette Radio Corp.
 901 W. Jackson Blvd. 265 Peachtree Street
 CHICAGO 7, ILLINOIS ATLANTA 3, GEORGIA

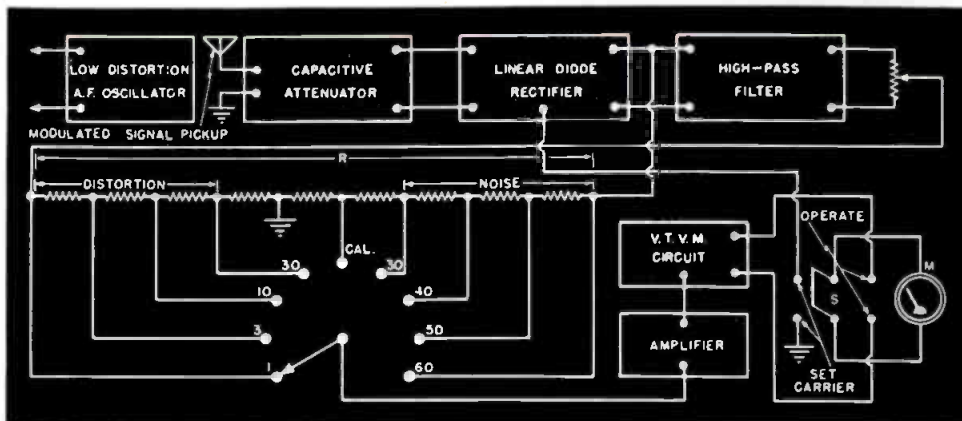

Fig. 6. Wiring diagram of a noise and distortion meter.

Instruments for AM Measurements

An efficient *modulation monitor* for checking modulation percentage and carrier shift is illustrated in block diagram form in Fig. 8. Its skeleton circuit is shown in Fig. 5, and an over-all external photograph in Fig. 1. This instrument is widely used in checking amplitude-modulation radio transmitters continuously while on the air.

This instrument is arranged to operate directly on radio-frequency energy picked up from the amplitude-modulated transmitter, gives direct readings in modulation percentage, and provides a visual overmodulation alarm which will act at once when any preset level of modulation between 5 and 100 percent is exceeded. It measures modulation percentage on both positive and negative modulation peaks and requires no direct connection to the transmitter being monitored.

The principle of operation of the modulation monitor may be understood from Figs. 5 and 8. The modulated signal, picked up by an antenna consisting of a short length of wire, is delivered to a shunt-type linear diode rectifier, V_1 , in which the carrier and modulation envelope are separated by rectifier action. The d.c. component of rectifier output passes through the d.c. milliammeter, M_1 , whose deflection is proportional to the average carrier value. In normal operation, input to V_1 is adjusted by means of the capacitive voltage divider, C_1 , to give center-scale deflection of M_1 . This deflection does not change as long as no carrier

shift takes place in the modulated signal.

Both d.c. and modulation components of the rectifier output are presented to the grid of amplifier V_2 , a.c. through a coupling capacitor and the low-pass filter, $L_1-L_2-C_2-C_3$, which removes radio-frequency components, and the d.c. through the potentiometer, R_1 . The latter is controlled by dial graduated 0-100 "nominal modulation peaks," seen in the center of the front panel of the instrument.

The grid of the amplifier, V_2 , thus receives two voltages—one alternating, corresponding to the modulation envelope, and the other direct, corresponding to the average carrier. The latter serves as grid bias, the value of which is adjustable through R_1 , while the former is the actual signal. For any prearranged modulation peak value, V_2 is biased to cutoff by means of the potentiometer R_1 , when the modulation signal peaks exceeds this value, the grid bias of the tube V_2 will become less negative. At this point, V_2 passes a signal through the coupling transformer to trip the gaseous triode, V_3 , and flash the overmodulation alarm lamp.

A portion of the a.c. output of diode V_1 is also delivered through coupling capacitor, C_4 , to a second diode rectifier, V_4 . The latter tube rectifies the alternating voltage (which is equivalent to the modulation envelope) and presents it to the vacuum-tube voltmeter comprised by V_5 and the indicating meter M_2 . This meter is graduated directly in modulation percentage (0 to

Fig. 7. The application of the oscilloscope for the measurement of modulation percentage.

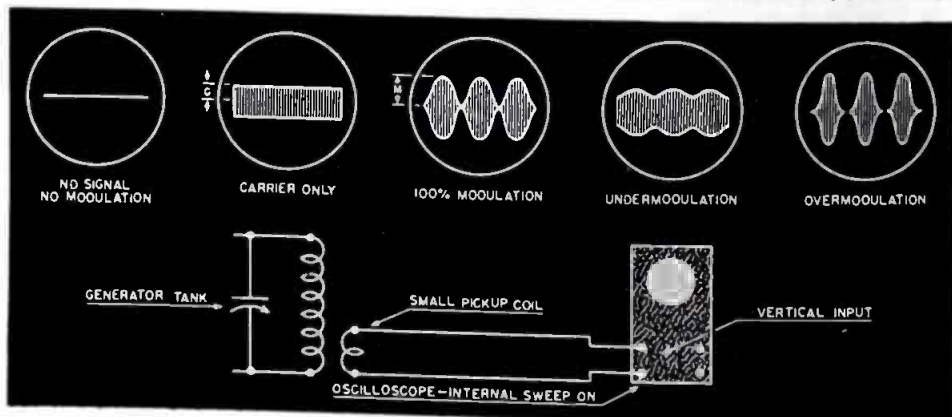

Small and Medium **TRANSFORMERS**

*to meet airborne communications
equipment specifications*

Consolidated Radio Products Company specializes in 400 cycle transformers to meet Army and Navy specifications on airborne communications equipment, and also, supplies prime contractors of the Signal Corps and Maritime Commission.

Greatly expanded production facilities on a wide range of small and medium transformers include Pulse Transformers, Solenoid Coils, Search Coils. Other products include Range Filters and Headsets.

Consolidated Engineers will also design transformers for special applications or will build to your specifications.



Electronic and Magnetic Devices
CONSOLIDATED RADIO

Products Company
380 W. ERIE ST., CHICAGO, ILL.

“I'll want them when I get home”



Vital to Victory
Our Signal Corps fighters know Murdock Radio Phones. They like the comfort — they clearly hear every command.

Important to Peace
Since 1904, Murdock has given commercial users exacting, precision-engineered Radio Phones. When peace comes, they'll be on the job again.

Sub-Contracts
Although we're busy, we still have facilities for making more Radio Phones and related parts on a sub-contract basis. Write us if you need outside manufacturing aid in this field.

MURDOCK RADIO PHONES

could only come from long experience. They have the tested advantages users like:

- long listening without discomfort.
- ventilation to prevent condensation.
- super-sensitivity to get all that's sent.
- two-way adjustment to control position.
- "solid-built" construction to keep fine adjustments constant.
- concealed terminals — long cords — lightness — comfort.

In war or peace, remember — it's MURDOCK! See these headsets. Send for new catalogue today!

WM. J. MURDOCK CO.
128 Carter St., Chelsea 50, Mass.

110) and in corresponding decibels, S is a reversing switch by means of which either the positive or negative modulation peaks may be selected for monitoring.

The modulation monitor is frequently made part of a complete transmission monitoring assembly consisting of modulation monitor, distortion and noise meter, and low-distortion audio oscillator.

Distortion and Noise Meter.

The noise and distortion meter is illustrated in functional block diagram form in Fig. 6. Its operation in distortion measurements is explained as follows:

Output voltage of the low-distortion oscillator (operated usually at 400 or 1000 cycles with very low harmonic content) is applied to the audio system of the amplitude-modulated transmitter. Use of this oscillator insures a minimum of harmonic distortion arising from the audio signal source.

The modulated signal is picked up by means of an antenna consisting of a short length of wire, and is applied to a linear diode rectifier through a capacitive attenuator. When the meter, M, is switched (through switch S in set position) to the diode circuit, the input signal level may be adjusted to a reference level.

Output of the diode passes through a high-pass filter which removes the modulation frequency fundamental, but permits all harmonics to pass with little attenuation. This total harmonic

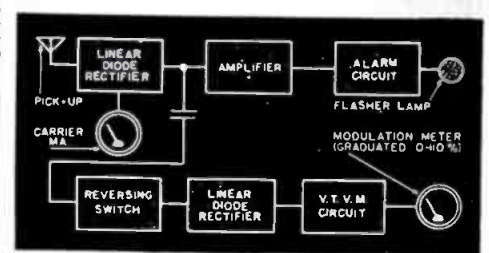

Fig. 8. Block diagram of a modulation monitor for checking modulation percentage.

voltage is then indicated by the calibrated attenuator, R, and the vacuum-tube voltmeter (switch S in operate position).

In order to facilitate distortion measurements in terms of the modulation fundamental, a *calibrate* position is provided on the attenuator. When the potentiometer switch is in this position, the output meter may be standardized in terms of the oscillator frequency by adjusting the voltmeter-amplifier gain for full-scale meter deflection when a known portion of the total modulation amplitude is applied to the amplifier input.

When making noise and hum measurements, the transmitter is first modulated at the level with which noise is to be compared. The output of the diode rectifier is applied through a radio-frequency filter to an attenuator, and the calibration adjustment is made. The modulation is then removed, whereupon the meter will indicate the noise and hum level directly in decibels

(Continued on page 124)

If "Drippers"



RUIN YOUR REPAIR REPUTATION . . .

Change to

DURASEALED

"DRIPPERS"
"Dripper" means
Wax running out of
seal.

"DURASEALED"
"Durasealed" for high
temperature uses . . . No
End Wax to run out.



PAT. PEND.

The NEW Dumont "DURASEALED" has its ends sealed in Bakelite Resinoid . . . therefore they cannot drip out under any temperature . . . they are highly moistureproof.

| Catalog Number | Capacity Mfd. | Dimensions | | Voltage D.C. | List Price |
|----------------|---------------|------------|--------|--------------|------------|
| | | Diameter | Length | | |
| P6-1 | .00025 | 3/16" | 3/4" | 600 | .30 |
| P6-2 | .0005 | 1/4" | 3/4" | 600 | .30 |
| P6-3 | .001 | 1/4" | 3/4" | 600 | .30 |
| P6-4 | .002 | 3/8" | 3/4" | 600 | .30 |
| P6-5 | .005 | 3/8" | 1" | 600 | .30 |
| P6-6 | .006 | 3/8" | 1" | 600 | .30 |
| P6-7 | .01 | 7/16" | 1" | 600 | .30 |
| P6-8 | .02 | 7/16" | 1 1/2" | 600 | .30 |
| P6-9 | .05 | 9/16" | 1 1/2" | 600 | .35 |
| P6-10 | .10 | 9/16" | 1 3/4" | 600 | .40 |
| P6-11 | .25 | 3/4" | 2" | 600 | .50 |

Important

Suitable for operation for requirements at 95% to 100% humidity.



If your jobber cannot supply you write to us.

BUY
MORE BONDS
TILL THE
WAR IS
OVER

DUMONT
ELECTRIC CO.
MFR'S OF
CAPACITORS FOR EVERY REQUIREMENT

34 HUBERT STREET
NEW YORK, N. Y.

RED HOT VALUES in RADIO PARTS!



Combination Table Cabinet

Modern table type phono cabinet, highly finished walnut. Dimensions: 14" front to back, 16" side to side, 5½" bottom of table panel to top, height over all, 13". In original cartons—while they last **\$7.95**

7½ V. C. BATTERY

4" W. x 2¾" H. x ¾"
D. 39c each
10 for \$3.50



2 CELL 1½ V. A. BATTERY

Heavy Duty
3¾" H. x 1" D. x
1¾" W.



35c each. 10 for \$3.00

THE YEAR'S BIGGEST OFFER!

A 10-pound assortment of various usable radio parts. Every serviceman should have one of these kits. Only..... **\$2.95**

Master Drafting Machine

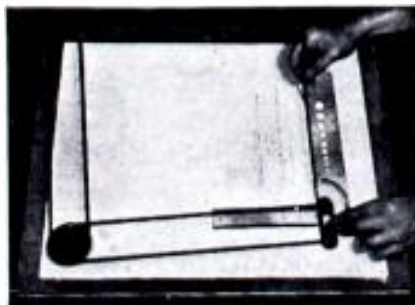

• Biggest time-saver for dimensioned sketches, lettering and layouts ever sold at this low price. Size, 20"x24". Limited supply. While they last **only \$3.95**
Order Today!

FREE: Servicemen write today for free catalog listing thousands of replacement parts.

10% Minimum Deposit Required with Order

RANDOLPH RADIO

609 WEST RANDOLPH ST., CHICAGO 6, ILL.

"Millions of Parts for Millions of Radios"

Manufacturers' Literature

Readers are asked to write directly to the manufacturer for the literature. By mentioning RADIO NEWS, the issue and page, and enclosing the proper amount, when indicated, delay will be prevented.

MICRO-INCH MEASUREMENTS

A twenty page booklet written for both the novice and the expert on the subject of measuring in micro-inches has been issued by *Continental Machines, Inc.*

This booklet deals with the fundamentals of precision measurements, and shows how these principles are applied to production in the daily control of product quality.

Many photographs are used to show the new and useful applications for gage blocks, vernier gages, sine bars, master parallels, flats and other precision measuring instruments. Charts and drawings are used to illustrate the relationship of various dimensions as affected by the temperature of the materials being measured.

A number of new gaging instruments are introduced and a brief description of the new mobile inspection unit is given. The booklet is available on request by writing *Continental Machines, Inc.*, 1301 Washington Avenue, South, Minneapolis 4, Minnesota.

SOLAR CAPACITOR CATALOG

An unusual booklet has been issued by the *Solar Manufacturing Corporation* in which the story of capacitors is presented in simple and non-technical language.

In both war and peace, the *Solar* capacitors have been serving the public and the story of achievement is reflected in this catalog.

A glowing tribute is paid to the work of the United States Army Signal Corps. The work of this branch of the Armed Services is illustrated by sixteen pages of colored photographs taken by the Signal Corps and featured in the Signal Corps issue of *RADIO NEWS* (February, 1944).

This booklet makes interesting reading and copies are available upon application to *Solar Manufacturing Corporation*, 285 Madison Avenue, New York 17, New York.

SWITCHBOARD CONNECTORS

A catalog containing information, photographs, drawings and data on the *Cannon Line* of laboratory and switchboard connectors is now available for distribution.

Included in this bulletin are surface and submounting plugs and receptacles, straight cord plugs and receptacles, switching plugs and experimental switchboards.

This particular series of connectors is adaptable to use in various laboratory and switchboard applications of

experimental laboratories both in schools and industrial concerns.

This 12-page bulletin will be sent upon request to *Cannon Electric Development Company*, 3209 Humboldt Street, Los Angeles 31, California.

JEFFERSON CATALOG

A catalog covering its line of fluorescent lamp ballasts has been issued by the *Jefferson Electric Company*.

The line covers single, two, three, and four lamp ballasts and an enlarged group of bottom lead ballasts which are now available. Data, dimensions, wiring diagrams for ballasts and lamp switches, and comparative mounting dimensions are also included.

Copies of this catalog, No. 441-FL, are available from the *Jefferson Electric Company*, Bellwood, Illinois.

BATTERY CATALOG

Willard Storage Battery Company has just issued a new "Special Lines" Catalog which illustrates and describes the *Willard Aircraft, Charge-Retaining, Marine, Stationary and Radio Storage Batteries*.

The catalog is available in two editions, a bound edition for those who are interested in all "Special Line" batteries and also the edition published in loose leaf form for those interested in specific batteries or applications.

Either type of catalog is available from the *Willard Storage Battery Company*, Cleveland, Ohio.

ALEMITE CATALOGS

Four new catalogs have been issued by the *Alemite Division of Stewart-Warner Corporation* giving information regarding industrial lubrication.

The problem of keeping machinery in working condition has been aggravated by the heavy production schedules which require 24-hour service. In order to care for the lubrication of this equipment rapidly and thoroughly, the *Alemite* engineers have designed several pieces of hydraulic equipment for single or multiple machine lubrication.

The four systems, as discussed in these catalogs, are *LubroMeter* system, *Progressive* system, *Dual Progressive* system, and *Dual Manifold* system. Each of these types of equipment is designed to do a specific job of lubrication and details of the job to be handled may be forwarded to the *Alemite Industrial Lubrication Division, Stewart-Warner Corporation*, 1826 Diversey Parkway, Chicago, Illinois.

THE WORLD'S MOST FAMOUS BOOK FOR RADIO-ELECTRONIC BEGINNERS (No previous training necessary)

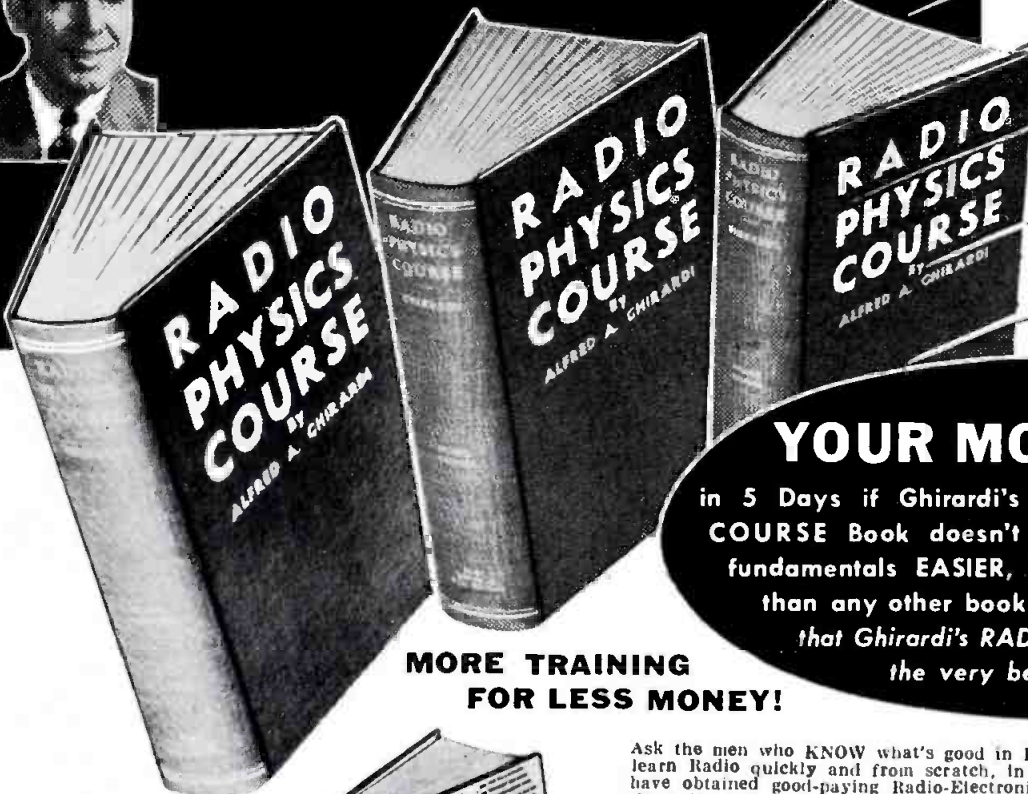

LEARN RADIO EASIER BETTER FASTER for Only \$5.

YOUR MONEY BACK
 in 5 Days if Ghirardi's 972-page RADIO PHYSICS COURSE Book doesn't teach you Radio-Electronic fundamentals EASIER, FASTER and at LESS COST than any other book! That's how sure we are that Ghirardi's RADIO PHYSICS COURSE is the very best in the field!

MORE TRAINING FOR LESS MONEY!

HERE'S HOW TO "TEST" A RADIO IN TWO MINUTES—or LESS

Then fix it in half the time you'd expect to take!

If you repair radios for a living—or even if you only "tinker" with sets occasionally, the big new, completely revised edition of Ghirardi's famous RADIO TROUBLESHOOTER'S HANDBOOK is a book you cannot afford to miss.

This big 744-page manual-size book is a complete guide to trouble diagnosis, locating, and fast repairing for practically every type of Radio Receiver now in use. It eliminates extensive testing—helps you do two jobs in the time normally required for one—repair cheap sets at a profit—substitute vacuum tubes and parts properly—train new helpers, etc.

WORK TWICE AS FAST

"It has helped me fix twice as many radios in a day as I could fix before owning this book," writes Vernon Taylor of Elgin, Texas. H. V. Kells of Elgin, Ohio, writes: "Time saved on two jobs, paid for the book. I wouldn't be without it!"

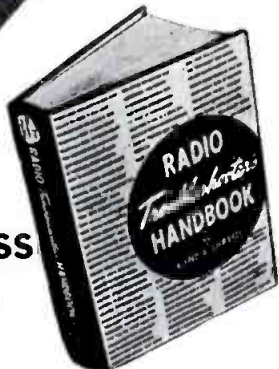

3RD REVISED EDITION

Now contains valuable 404-page Case History compilation giving the common trouble symptoms, their causes and remedies for over 4800 receiver models—17 alignment benches for over 20,000 superheterodyne big sets on 11 trans-tribes, and hundreds of other tables, graphs, charts and data sections, including a BIG NEW TUNE CHART ESPECIALLY DESIGNED FOR WARTIME SERVICE. ICF NEEDS when changes and substitutions often have to be made.

This big Handbook is yours COMPLETE for ONLY \$5 (\$5.50 foreign)—and you get it on our famous 5-Day MONEY-BACK GUARANTEE BASIS. See money-saving offer in Coupon!

THIS GHIRARDI WINNER WILL TEACH YOU RADIO SERVICE WORK!

How would you like to have Radio's most widely acclaimed servicing expert at your side to teach you everything you need to know to help make you an accomplished radio service man? Actually, ownership of Ghirardi's MODERN RADIO SERVICING means just about that! It is the only simple, inexpensive book that gives a thorough and easily understandable explanation of test instruments; receiver trouble-shooting procedure; circuit analysis; parts testing and repair; maintenance, etc. 1300 pages with 700 illustrations, 720 review questions, 710 different typical only \$5 complete (\$5.50 foreign).

See Money-Saving Offer In Coupon!



Ask the men who KNOW what's good in Radio Training—the men who have had to learn Radio quickly and from scratch, in the Armed Forces; the men who already have obtained good-paying Radio-Electronic jobs in industry! Nine out of ten of them (as proved by a recent survey) will tell you that Ghirardi's famous RADIO PHYSICS COURSE is their first choice as the easiest-to-learn from, most thorough and inexpensive Radio book on the market.

MOST POPULAR FOR ARMY-NAVY AND CIVILIAN RADIO TRAINING

This same inexpensive book has given more people their basic Radio-Electronic training than any other ever published. It is more widely endorsed by men who know. Because of its sheer merit, it is more universally used for home study, and more widely employed in U. S. Army Signal Corps, Navy, and civilian schools and colleges than any other book on the subject. Would you want any better proof than this?

EVEN IF YOU DON'T KNOW ANYTHING ABOUT RADIO!

Even if you've had no previous Radio or Electrical training or experience, it's easy to learn from Ghirardi's RADIO PHYSICS COURSE! Everything that can be done to make learning easy has been done for you. It painstakingly explains everything in detail so you cannot fail to understand. Over 500 specially prepared illustrations help you to visualize every action. You don't have to know a single thing about Radio in advance. All you need is a little spare reading time and a desire to get started RIGHT for a profitable future in any of Radio-Electronics' many branches—from service work

to aviation, Military, broadcasting, manufacturing, Public address and many others.

SCOPE OF 36 COURSES IN ONE BIG BOOK

Actually, RADIO PHYSICS COURSE gives you the scope of 36 different courses in one convenient, inexpensive big book. Nothing is left out. Nothing is condensed. Nothing is left to chance. You learn all you need to know. You don't need to wait for monthly lessons. You progress as rapidly as you wish in your spare time and in the comfort of your own home.

A \$50 VALUE—ONLY \$5 COMPLETE

RADIO PHYSICS COURSE is acclaimed everywhere as the "biggest bargain" available in Radio-Electronic training. If it were broken into sections and sold as a course, you'd regard it as a bargain at \$50 or more—but you actually buy it all here complete in one big 972-page handsomely bound book for only \$5 (\$5.50 foreign) and with our absolute 5-Day MONEY-BACK GUARANTEE. Get the book and see for yourself. Compare it with any other book or course on the market—at any price. See how much more complete it is, how much better illustrated, how much easier to understand! You be the Judge! You cannot lose!

WARNING! Paper shortages may make it impossible for us to continue meeting the tremendous demand for all Ghirardi Radio Books. Don't take chances! Order yours today while they're still available. Use this Order Form.

RADIO & TECHNICAL DIVISION OF MURRAY HILL BOOKS, INC.
 Dept. RN-74, 232 Madison Ave., New York 16, N. Y.

Enclosed find \$_____ for books checked; or send C.O.D. for this amt. plus postage. If I am not fully satisfied, I may return the books within 5 days and receive my money back.

RADIO PHYSICS COURSE \$5.00 (\$5.50 foreign)

3rd Edit. RADIO TROUBLE-SHOOTER'S HANDBOOK \$5.00 (\$5.50 foreign)

Special "MONEY-SAVING" Combination MODERN RADIO SERVICING with the HANDBOOK \$9.50 (\$10.50 foreign)

MODERN RADIO SERVICING \$5.00 (\$5.50 foreign)

Name _____

Address _____

City _____ City Dist. No. _____ State _____

REPAIR ANY KIND OF RADIO EQUIPMENT

PREPARE YOURSELF FOR A BETTER JOB AT HIGHER PAY IN THE RADIO-ELECTRONIC FIELD



electronics

and what it can mean to post-war sales

Look ahead . . . Prepare your Salesmen For the Peacetime Electronic Era to Come!

● Where will you fit in the fiercely competitive markets that will come with the war's end? Your position can be determined now, by the methods you employ now, in the design and engineering of your post-war products. Right now, with the aid of seasoned electronic and mechanical engineers, your peacetime items can be started toward top-rank positions in their respective fields.

Alert manufacturers, with a view toward post-war sales and quick acceptance of their products, are urged to consult with National engineers now, on matters electronic, electrical or mechanical. Write today—Your inquiry will receive prompt attention.

-----QUARTZ CRYSTAL PROBLEMS-----

Our engineers and crystallographers are ready and willing to help you on the following items:

| | | |
|----------------------------|---------------------|---------------------|
| Radio Receivers | Crystal Oscillators | Supersonic Devices |
| Television Receivers | Filters | Control Devices |
| F-M Receivers | Stabilizers | Diathermic Devices |
| Transmitters | Timing Equipment | Induction Heating |
| H. F. Inter-Communications | Police Transmitters | Frequency Standards |

Address your inquiry to—Crystal Division

Electrical and Mechanical Engineering

NATIONAL SCIENTIFIC PRODUCTS COMPANY

Designers and Manufacturers of Electrical and Mechanical Devices

5015-25 NORTH KEDZIE AVE., CHICAGO 25, ILLINOIS

TECHNICAL BOOK & BULLETIN REVIEW

"PRIMER OF ELECTRONICS" by Don P. Caverly. Published by McGraw-Hill Book Co., Inc., New York. 235 pages. Price \$2.00.

This latest book to come from the technical department of McGraw-Hill Book company, is designed to acquaint the average man with some of the many aspects of electronics.

Of particular value to executive personnel who must possess at least a basic knowledge of this much talked of subject, this text presents the subject in an easy-to-read manner. The fundamentals of the subject are covered in a systematic manner which will enable persons who have forgotten more of their college physics than they remember to get in step with the science of electronics.

The most elementary concepts of the field, including the theory of electric current, magnetism, electromagnetic radiation and basic electronics, are presented. A mastery of this material should give the reader an intelligent picture of the broad outlines of the science which will so vitally affect the lives of all of us after the peace is won.

"HOW TO PASS RADIO LICENSE EXAMINATIONS" by Charles E. Drew. Second edition. Published by John R. Wiley and Sons, New York. 320 pages. Price \$3.00.

In this new and revised second edition, Mr. Drew has presented much valuable information for the benefit of those preparing to take the FCC radio license examinations.

The author has avoided the inclusion of extraneous and nonessential information and has presented a clear-cut picture of the type of question which is asked of examinees. In the first chapter he has covered basic radio law as included in the examinations. His presentation is in the question and answer form, which helps the student to become familiar with the license examination.

Sections of the FCC regulations as they apply to the radio operator are included in this text and reference is made to specific articles to facilitate quick reference to this particular subject.

This text is not intended for instructional purposes where the student has no knowledge of radio but is designed for persons who have a knowledge of radio and merely wish to refresh themselves in preparation for the examinations. Mr. Drew has not included fundamental material or elaborate explanations of circuits and principles.

Rules governing commercial radio operators, fundamental radio laws, "Q" code, and frequency and wavelength tables are included in the appendix for ready reference.

Much new material has been added



**Braze small parts faster
and at lower cost with G-E
electronic heating**



**The G-E pliotron and G-E phanotron
supply the high-frequency current for
electronic heaters**

ELECTRONIC heating for brazing, soldering, and surface hardening reduces operation time from minutes to seconds. High-speed production, in volume figures, may be attained with unskilled labor. Electronic heating causes no excessive scale or blackening—making cleaning easy.

Electronic heating makes it possible to apply the exact amount of heat at exactly the right spot—without affecting surrounding areas. In fact, the heating pattern may be so closely controlled that

a completely uniform product may be turned out in volume. Single or multiple operations are readily possible. Illustrated is a typical assortment of parts brazed by electronic heating:

1. Threaded steel collar brazed to a steel elbow. 3000 parts per hour may be produced with one electronic heater.
2. Carboloy cutting tip brazed to $\frac{3}{4}$ " steel tool shank. From 150 to 300 parts per hour may be produced with one electronic heater, depending on the set-up.

3. Threaded brass collar brazed to brass tube. 300 parts per hour may be produced with one electronic heater.

4. Tinned copper connections brazed to nickel-chrome resistance wire. 1500 parts per hour may be produced with one electronic heater.

There is a complete line of G-E electronic tubes for innumerable industrial jobs. Through its nation-wide distributing system, General Electric is prepared to supply users of electronic devices with replacement tubes.

"HOW ELECTRONIC TUBES WORK"

This booklet will be mailed to you on request—without charge. Address *Electronics Department, General Electric, Schenectady, New York.*

• Tune in "The World Today" and hear the news direct from the men who see it happen, every evening except Sunday at 6:45 E.W.T. over CBS. On Sunday listen to the G-E "All Girl Orchestra" at 10 P.M. E.W.T. over NBC.

G.E. HAS MADE MORE BASIC ELECTRONIC TUBE DEVELOPMENTS THAN ANY OTHER MANUFACTURER

GENERAL  ELECTRIC

162-C8

CREI Shows You The Sure Way

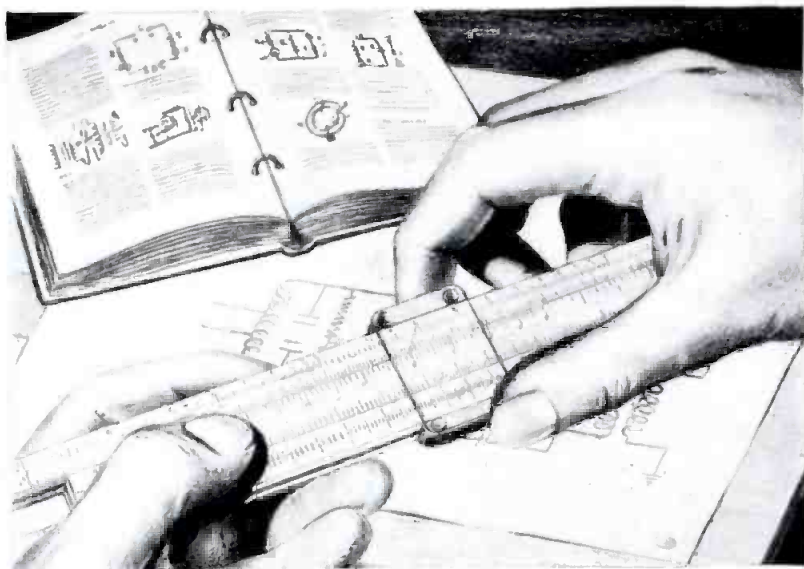

To A Better Job and Secure Career In RADIO-ELECTRONICS

*Add Technical Training to Your Practical Experience
and Enjoy the Security of an Important Engineering Job*

CREI home-study training in practical radio-electronics engineering enables you to go after—and get the better jobs that mean something in radio. There's no priority on success—but the better jobs are "rationed" to those men who have the necessary technical ability.

Jobs that provide security—jobs that will mean something long after "tomorrow" has come and gone—must be won and held on ability. The men who will retain the important radio engineering positions after the war is over are those men whose positions are essential—whose abilities are specialized.

CREI home-study courses in Practical Radio Engineering have been studied by more than 8,000 professional radiomen. Today, hundreds of ambitious men, just like yourself, are taking our specialized spare-time training to give them the technical skill to supplement their present ability . . . to earn a better living . . . and to create a secure place for themselves in the great post-war world of radio and electronics.

Don't say YOU haven't the time. CREI courses are designed to be studied in the most crowded schedules. You can study a few hours a week without interfering with your present work. So, write for all the facts now—for this is the time to make sure that your preparation for post-war success shall not be "too little, too late!"

CAPITOL RADIO ENGINEERING INSTITUTE

HOME STUDY COURSES IN PRACTICAL RADIO-ELECTRONICS
ENGINEERING FOR PROFESSIONAL SELF-IMPROVEMENT

Dept. RN-7, 3224—16th Street, N. W., Washington 10, D. C.

Contractors to U. S. Navy—U. S. Coast Guard—Canadian Broadcasting Corp. - Producers of Well-trained Technical Radiomen for Industry.



WRITE FOR
FREE 32-PAGE
BOOKLET

*"Your Opportunity
in the New
World of Elec-
tronics"*

If you have had professional or amateur radio experience and want to make more money—let us prove to you we have something you need to qualify for a better radio job. To help us intelligently answer your inquiry—PLEASE STATE BRIEFLY YOUR BACKGROUND OF EXPERIENCE, EDUCATION AND PRESENT POSITION.

to this edition, including additional information on modulation, oscillators, amplifiers and rectifier power supplies.

"SHOP JOB SHEETS IN RADIO"
by Robert Neil Auble, Book One, Fundamentals. Published by *The Macmillan Company*, New York. 134 pages. Price \$1.50.

A systematic presentation of the fundamentals of radio is made in this manual designed for laboratory work. The manual is intended for use in conjunction with lectures in order that the student may have a practical, as well as theoretical knowledge of radio.

The author has stressed the importance of good tools and their proper application, and in order that the student may acquire a facility in the use of laboratory and shop equipment, the text opens with shop projects in soldering, correct wiring and proper use of tools.

After the student has learned to use and operate meters and various measuring devices, he is introduced to simple continuity checking, replacement, salvage, and coil winding.

The work increases in complexity until an introduction to the action of the rectifier tube is made, the more advanced work to be covered in a later publication.

This manual should be brought to the attention of teachers and those conducting fundamental radio courses either in schools or in industry as the material included and the style of presentation makes this a worthwhile supplement to lectures on theory and application of radio.

"ELECTRICAL ESSENTIALS OF RADIO" by Morris Slurzberg and William Osterheld. Published by *McGraw-Hill Book Company*, New York. 512 pages. Price \$4.00.

As the title of this book implies, this text presents the fundamentals of electricity necessary for the radio and electronic worker.

The authors have written this book for the student who has little mathematical background and a working knowledge of arithmetic is the only prerequisite for an understanding of the mathematics covered in this text. Additional mathematics which are necessary for an understanding of the electrical theories introduced are covered thoroughly and in a careful manner which permits easy understanding.

By means of everyday symbolism, radio signals, electronic theory and various other electrical concepts are presented to the student in a manner which allows understanding of the subject by the layman and those untrained in electricity or radio.

The book is profusely illustrated with commercial units and line drawings which make for easy recognition of the subject under discussion. An appendix includes most of the electrical data and circuit formulas most often encountered in electrical work.

The authors prepared this text as a source book for their high school elec-

The Legion of Life...

An army within an army... the 75,000 doctors and nurses of the Army Medical Department have the job of saving, rather than taking life. The victory they are winning is magnificent beyond praise. Want facts?

In the last war, eight of every hundred wounded men died. Today, ninety-seven of every hundred wounded recover. And that is not the whole story, either... the tragic toll of men suffering amputation, prolonged hospitalization, recurrent operations and permanent disability is being drastically reduced.

The wartime products of Connecticut Telephone & Electric Division (field telephone equipment, electronic devices, and aircraft ignition components) are helping the Army Medical Department to practice its skill and devotion with greater promptness than ever before.

Here at home, Connecticut Telephone & Electric hospital communicating and signalling equipment (installed before the war) is also lending a helping hand. Civilian doctors, nurses, and volunteer aides in understaffed institutions are doing a job under trying conditions which too few of us appreciate. "Connecticut" equipment adds to their efficiency in hundreds of American hospitals.

After the war, needed hospital construction will be one of the most active and important elements of the nation's building program. "Connecticut" engineers are planning even now to return to the hospital field with new and better systems for communications, signalling, paging and "electronic supervision".



CONNECTICUT TELEPHONE & ELECTRIC DIVISION
GREAT AMERICAN INDUSTRIES, INC. • MERIDEN, CONNECTICUT





RMS
REPLACEMENT
Cabinets

for Cash sales
TODAY...
for Good-will
TOMORROW

These are the Cabinets that are piling up good profit sales for Dealers & Service-Men everywhere ... Not only are they answering urgent needs today ... they're also building New Prospects for TOMORROW

Ask your Jobber ...
He knows about their success!

Complete Line available on
L-265 Certification

Sold through all Leading
Jobbers from Coast to Coast

RADIO MERCHANDISE SALES

730 EAST 149th STREET • NEW YORK 55, N. Y.

BLANKS

To accommodate
various size chassis

also

"EXACT"

Replacements

Complete line
to fit all standard sets
(In fine Walnut Veneers)



SPEAKER-BAFFLES

(Wall Type)

5 Sizes ...
Walnut & Leatherette



PORTABLES

For 10" or 10" & 12" Records

PHONO

(Also in Walnut Table Model)

**PHONO & AMPLIFIER
RECORD CHANGER**

(Above in Leatherette)

*All mounting panels in blank for
any required adaptation

tricity classes and for students in technical and trade schools. It is not intended for the experienced or advanced student, but fills a definite need for a truly elementary text. Most books which profess to be elementary texts presuppose an advanced mathematical background and some work in physics, but in this book the student and layman alike could secure a fundamental working knowledge of the electrical problems of radio.

"MARINE RADIO MANUAL" edited by M. H. Strichartz. Published by *Cornell Maritime Press*, New York. 528 pages. Price \$4.00.

This manual is the first of its kind to be devoted exclusively to the problems of the marine radio operator, and Ensign Strichartz of the Merchant Marine has written from his experience as Ship Radio Officer.

This book should prove of value to all ship radio operators and students in training for maritime radio license examinations. Included are sample radio telegrams and charts, two maps of Navy and Commercial coast stations giving working frequencies and corresponding wavelengths which are open to public correspondence, two maps showing the radio beacon system and other pertinent data of value to the marine radio operator.

The book includes twenty-five chapters covering such diversified subjects as radio station bookkeeping, maritime radio history, safety and first aid, auto alarms, and other information which the radio operator must have for the legal and efficient operation of his station.

-30-

Multivibrator

(Continued from page 31)

usual multivibrator circuits are generally such that application of the above formula yields only an approximation of the required values, which usually must finally be determined empirically when they must be precisely known. Again, this has little significance in the present case, since the exact frequency of the multivibrator has little significance. The important factors are that it be high enough so that the highest harmonic required in operation shall not be too weak to be useful, and that the fundamental frequency shall not be so high as to space the signals of successive harmonics too far apart. The choice of 5 kcs. as a fundamental, for example, can yield usefully strong output for receiver testing up to 30,000 kcs., the 6,000th harmonic. The separation of 5 kcs. between successive harmonics is desirably small so that when the multivibrator output is listened to on the loudspeaker of a receiver under test, the successive harmonics tend to blend together into a continuous harsh, raspy tone, easy to identify and through its continuous character, permitting of an

"Right On The Button"

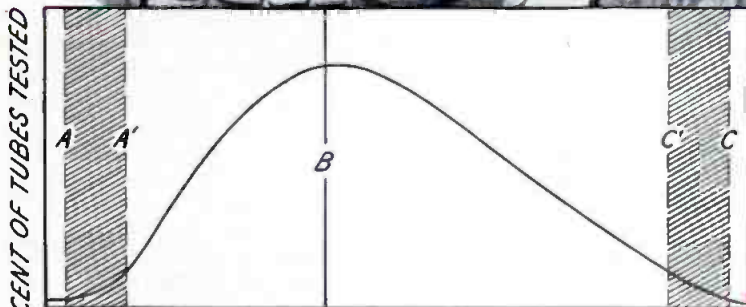
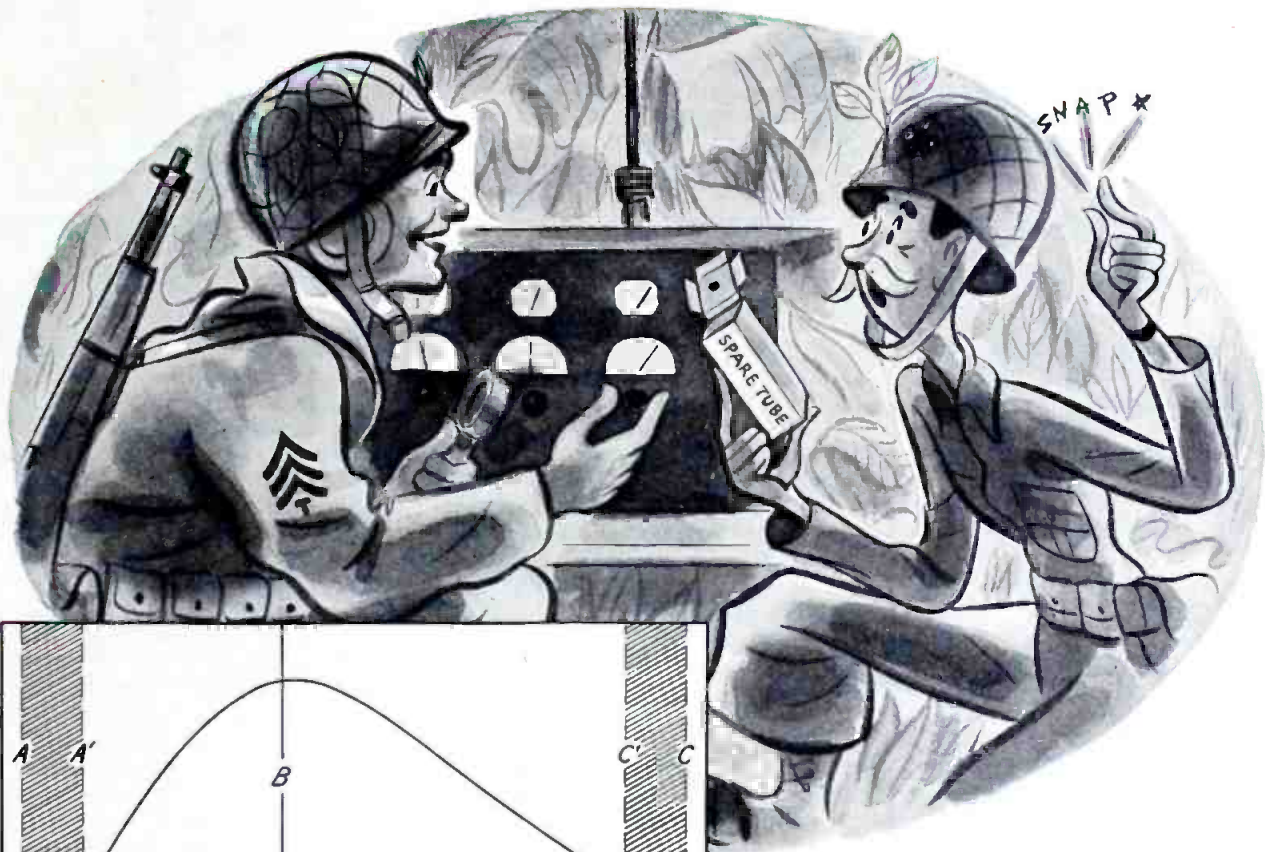

MUTUAL CONDUCTANCE
DISTRIBUTION CURVE—TRANSCONDUCTANCE

Conscientious electronic equipment manufacturers avoid special selection of tubes. When a battlefield tube replacement is made, they want "on the button" performance. They allow for possible additive effects of tolerances for other components — and for the many minor differences of equipment assembly, wiring, and adjustment. Also they realize it is impracticable to manufacture all electronic tubes of a given type exactly alike. Yet they demand and deserve close observance of their tolerances for each tube characteristic. (See A and C on the distribution curve.) Hytron insists on still tighter fac-

tory specifications. (Compare A' and C'.)

Hytron goes still further. Based on past experience — its own and others' — whenever practicable a "bogie", or desired goal, for each characteristic is set. (Compare B.) Controlled design and production aim at producing the majority of tubes with this preferred value, which is not necessarily and arbitrarily midway between tolerances. It is rather the ideal for peak performance — dictated by experience and attainable if exact duplication were possible.

Specify Hytron for tighter specifications — for "bogie"-controlled production — for uniform performance.



OLDEST EXCLUSIVE MANUFACTURER OF RADIO RECEIVING TUBES

HYTRON
CORPORATION

ELECTRONIC AND
RADIO TUBES

SALEM AND NEWBURYPORT, MASS.



**BUY
ANOTHER
WAR BOND**

SUPREME

BY COMPARISON

* Current Supreme Models



Model 504-A
Tube and Set Tester



Model 542
Pocket Multimeter

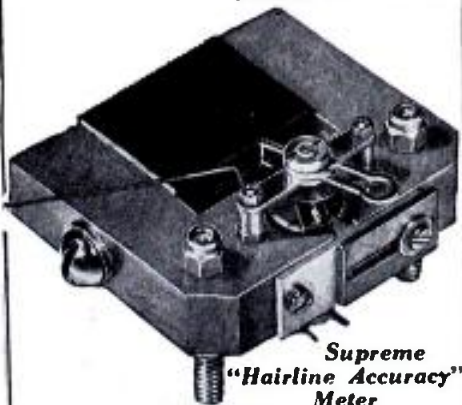

Supreme
"Hairline Accuracy"
Meter

Whats New-

IN TEST EQUIPMENT?

Military secrecy precludes our answering that now. But radical new developments in testing techniques have been and are being perfected. Because of these important advances, when Victory comes your NEW Supreme Test Equipment will be, more than ever, "Supreme By Comparison."

SUPREME INSTRUMENTS CORP.
Greenwood, Miss., U. S. A.

easy estimate of variation in receiver sensitivity through observation of variations in amplitude of receiver output volume.

The simplicity of the multisignal generator is evidenced by Fig. 1. It is seen to consist basically of but two 117L7GT beam power amplifier-rectifier tubes and a few ordinary resistors, capacitors, a small a.c.-d.c. filter reactor, an output volume control, two tube sockets, on-off switch and ordinary cord and plug. The constants and values of these component parts are not at all critical, and in this day of war-imposed material shortages during which service time is at a premium and the multisignal generator therefore particularly helpful, most of the required parts can be salvaged from the junk box.

The beam power amplifier sections of both 117L7GT tubes are used in a two-stage resistance-coupled amplifier, with output fed back to input through C2. Phase relationships are such that the amplifier then oscillates at a frequency primarily determined by the formula already quoted. Variable output voltage is taken from the movable contact arm of the potentiometer R4 constituting the plate load resistor of V2. The reason for variability in output voltage is because of the progressive fall-off in amplitude of increasingly high harmonics of the multivibrator's fundamental frequency. Output will be sufficiently high to overload a sensitive receiver in the broadcast band, diminishing as frequency is increased. The variable output control allows adjustment of the input to the receiver to suitable test levels over the frequency range of well below the broadcast band on up to about 30 megacycles, the high limit depending only upon receiver sensitivity.

The power supply, which can preferably be built right onto the small chassis of wood or metal carrying the multivibrator, is the simplest sort of a.c.-d.c. power supply. The heaters of the two 117L7GT tubes, being rated at 117 volts, are connected directly across the a.c. input after the on-off switch. With rectifier plates and cathodes connected in parallel, the two rectifier sections of the two 117L7GT tubes function as paralleled half-wave rectifiers, their d.c. output filtered by C5, C6 and L1. If L1 is unobtainable for some reason, both it and C6 may be omitted, in which case the multivibrator output will be modulated by the a.c. line frequency. This may even be desirable as a means of providing casier identification of the signal heard in the receiver.

The entire unit can be assembled in almost any form convenient to the builder, using such parts as he has available. Almost anything can serve as a chassis, though it is suggested that the instrument be assembled upon a chassis about 2" wide by 7" or 8" long. It may be enclosed in a small metal or wood cabinet.

Once built, operation is so simple that if parts are not defective or of

markedly incorrect values, the multisignal generator will function "right off the bat," assuming wiring to be correct and tubes good. If a metal chassis and cabinet are used, there is no danger of shock from the a.c. mains voltage, since the a.c. circuit is not conductively connected to the chassis, and reaches ground and output circuits only through the .01- μ fd. insulating capacitors C3 and C4. These capacitors also isolate mains a.c. as well as high-voltage d.c. from the output, so that neither damage nor deleterious interaction therefrom with the receiver under test need be anticipated.

Use involves only connection of the two output terminals to the antenna and ground binding posts of the receiver to be tested, and adjustment of R4 to a level which will give a usefully loud signal through the receiver, but not so great as to seriously overload it at low frequencies. It will be noted that the amplitude of the harsh, raspy note will diminish as receiver frequency is increased. In testing, however, and assuming the receiver is in good condition, an average reference level of loudness may be established from one band to the next by noting the similarity in loudness between the signal heard at the high-frequency end of one band, and at the same frequency at the low end of the band next higher in frequency. If receiver sensitivity is equal from band to band, signal loudness should be identical.

Not only is this simple multisignal generator the means of fast and effective checks of receiver sensitivity throughout each and all bands, but it is a very convenient means of checking limiting action in frequency-modulated receivers, since it generates what amounts to amplitude noise when seen by a good FM receiver. While the multisignal generator output is low in the range of 40 to 50 megacycles, the sensitivity of any good FM receiver is high enough to make up for this.

Should the experimentally-inclined builder not like the 5 kcs. separation between output frequencies of the multisignal generator, he may increase it by decreasing values of R1, R3 or of C1, C2. Conversely, he may lower fundamental frequency, and harmonic separation, by increasing the values of these components, keeping each resistor or capacitor substantially equal in making such changes. Increasing frequency will provide more individually identifiable harmonics, which is of little advantage except as a means of increasing upper useful frequency limit. Decreasing frequency will tend to gather all of the successive harmonics, as seen by a receiver, into one continuous raspy tone. This is most convenient for qualitative estimating of receiver sensitivity, but will lower the upper frequency limit at which usefully strong output may be obtained. Investigation reveals that 5,000 cycles fundamental, up to possibly 10,000 cycles, is a practical optimum.

-30-

W. A. PATTERSON, President of United Air Lines



"...YOU SAY VIBRATOR POWER SUPPLIES CAN INCREASE SAFETY AND COMFORT IN PLANES?"

MR. W. A. PATTERSON, President of United Air Lines, recently said—

"It is our belief that the war has advanced public acceptance of the airplane as a mode of transportation by 20 years. The airlines, like every other service that caters to the public, must anticipate their passengers' expectations of new facilities for greater comfort and safety. United will put in service new, huge 44-50 passenger Mainliners offering comforts, conveniences and thoughtful appointments surpassing anything heretofore known, and flying from coast to coast in 11 hours with new devices to assure safe flight."

E-L is ready right now with Vibrator Power Supplies to bring passengers the greater comfort of fluorescent lighting as well as the convenience and safety of radio and radio-telephone. E-L Black Light equipment is available as a safety device for instrument panel illumination at night to eliminate blinding interior glare and to provide clear, sharply defined instrument calibration. Engineered to specific space and voltage requirements, Electronic Laboratories products are used wherever current must be changed in voltage, frequency or type. E-L engineers invite inquiries.

E-L STANDARD POWER SUPPLY MODEL 307

For the operation of standard 110 volt AC equipment, such as radios and small motors, from a 6 volt battery. Characteristics: Input voltage, 6 v. DC; Output voltage, 115 v. AC; Output power, 100 watts; Output frequency, 60 cycles.

Dimensions: 7½x8¼x10¼ in. Weight: 23¼ pounds.



Write for further information of this and other models of the extensive E-L line.

Electronic

LABORATORIES INC.

INDIANAPOLIS

VIBRATOR POWER SUPPLIES FOR LIGHTING, COMMUNICATIONS, AND ELECTRIC MOTOR OPERATION • ELECTRIC, ELECTRONIC AND OTHER EQUIPMENT

THIS IS THE VOICE OF FRANCE



Instead of the silvery Seine — the murky Congo. Instead of well-tended fields and spotless villages — African jungle. Instead of a nation of Frenchmen — a handful of over-worked technicians and hundreds of African natives.

Yet here, three hundred miles up the Congo, is the true voice of France. Here at Brazzaville a gallant group of Free French brought in American equipment and erected one of the most powerful short-wave transmitters in the world. Every hour of the day, the voice of Free France thunders from Brazzaville, speaking in twenty different languages—spreading truth among the conquered peoples of the world—sending bulletins to the Free French fleet.

This tiny outpost is one of the most important voices of France —and Freedom—in the world.

H.R.O. receivers are standard equipment used exclusively in this station for monitoring and rebroadcasting. Brazzaville is the Voice of France, and these receivers are the Ears of Brazzaville.

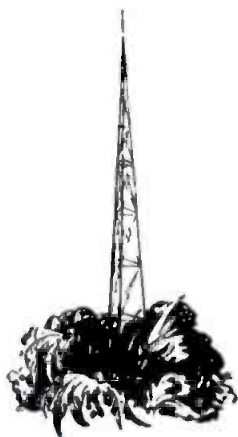

NATIONAL COMPANY

MALDEN



MASS., U. S. A.

NATIONAL RECEIVERS ARE IN SERVICE THROUGHOUT THE WORLD

WHAT'S NEW IN RADIO

New products for military and civilian use.

LABORATORY HARDWARE KIT

A kit which is designed to hold 1500 pieces of radio hardware has been announced by *Walker-Jimieson Company* of Chicago.

Of special value to the laboratory worker, this kit is housed in an 18-com-

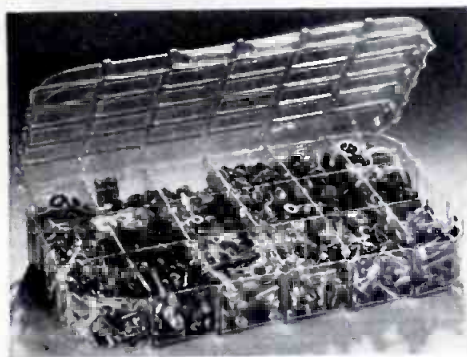

partment, clear plastic box and contains small, medium and large screws with service binder, washer and round heads, nuts and screws with assorted lock washers, Parker-Kalon self-tapping screws, spade bolts, rivets, and switch and volume control hardware.

The majority of the items are of brass stock and several assorted finishes are included, namely, nickel, copper, oxidized, cadmium and parkerized.

Prices and shipping data may be obtained by writing directly to *Walker-Jimieson*, 311 South Western Avenue, Chicago, Illinois.

SOLDERING PENCIL

A new, lightweight, compact and easy-to-handle soldering instrument, designed for speedy precision production has been placed on the market by *Harry A. Unger, Inc.*

This pencil is now being used by the Armed Forces as well as many of the contractors supplying communications equipment. The over-all length of this unit is 7 inches and the total weight is 3.6 ounces.

The heating unit draws 17 watts and will heat in 90 seconds. The heating unit is completely replaceable. Al-



though originally designed for small, hard-to-reach soldering operations, the pencil can also be used for handling larger, bulkier production problems.

Priority is required on all orders, but

interested persons should write directly to *Harry A. Unger, Inc.*, 615 Ducommun Street, Los Angeles 12, California, for further details.

SOLDERLESS CONNECTORS

A new method, whereby the soldering of terminal connections may be eliminated from the assembly, has been developed by *Aircraft-Marine Products, Inc.*

By means of this connector, the work of fitting and adjusting separate pieces of insulation sleeving over terminal connections is no longer necessary, and visual inspection of the connections is possible at all times. A saving of material is also effected since insulation sleeving in various sizes is not required.

The insulated terminal incorporates another advance in that it also supplants conventional soldering methods. Press dies, or simple hand tools resembling a pair of pliers, crimp the terminal connection and the wire it holds, into a homogeneous mass, making a perfect electrical and mechanical connection. This method permits uniform results in the hands of the un-

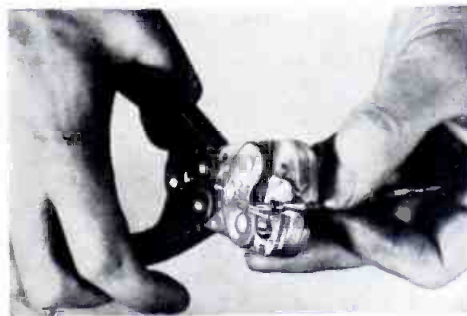

skilled worker as well as the trained technician.

Further information regarding the details of the method may be obtained from *Aircraft-Marine Products, Inc.*, Harrisburg, Pennsylvania.

ELECTRICAL CONNECTOR

The newest *Cannon* electrical connector in the Army-Navy Specifications line is the type known as the AN3101, according to the proposed AN-W-C-591a specifications.

Although in general appearance this type looks like a plug, it has been designated as a "receptacle" inasmuch as it has a male coupling thread similar to types AN3100 and WN3102.

All standard *Cannon* parts are used in conjunction with a special barrel. Shell material is aluminum alloy, with sand blast and clear lacquer finish.

Thread lubricant is used on threads.

Available sizes include, 8s and 16s and 12 to 36, inclusive. All tooled *Cannon* insert arrangements are adaptable

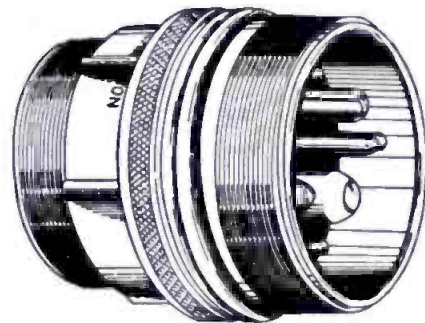

and interchangeable in *Cannon* type AN3101.

A new booklet describing this line of connectors is available upon request to *Cannon Electric Development Company*, 3209 Humboldt Street, Los Angeles 31, California. Specify Bulletin AN3101.

CUTTING HEAD

A new, guaranteed cutting head, known as the Van Eps-Duotone, is now available for distribution.

The cutting head has a reed armature which acts as its own damper, thus eliminating rubber and other deteriorating materials which usually cause cutting heads to change from day to day. The measured distortion is 1.8% at 400 c.p.s.

The head is easily installed and is equipped with an extra mounting plate for instant mounting and interchanging when other heads are used. Each head is tested at the laboratory and a graph of the performance accompanies the head.

Further information may be obtained from *Duotone Company*, 799 Broadway, New York 3, New York.

BATTERY CONNECTOR

A new development in quick disconnect battery connectors, particularly adapted to G-1 standard batteries conforming to AN-W-B-141 specifications has been designed and manufactured by *Cannon Electric Development Company*.

Based on the screw jack principle, this new fitting speeds removal of batteries and banishes shorting and fire hazards. The large handwheel which turns a gear and disengages the battery is notched and easily operated by a gloved hand in subzero temperatures. The pin contacts in the receptacle are so enclosed by its shell that the con-



War Gem Today

WHAT WILL THE QUARTZ CRYSTAL DO TOMORROW?

The fabled princes of Hindustan or the wealthy Nizam of Hyderabad never owned a gem more valuable.

The quartz crystal is doing more than rubies or emeralds to protect our way of life against the aggressor.

Cut into tiny wafers the quartz crystal is performing with merit wherever fixed radio frequencies are a "must".

Federal is mass producing frequency control crystals for military use. How many difficult jobs they are doing is a war secret. But their versatility is unlimited.

Even now — in the great FTR research laboratories — men are finding new uses for

quartz crystals — pointing the way to widespread industrial and civilian use after the war is won.

Not alone in communications — but in such widespread applications as precision timing and measuring devices, television, supersonics, pressure gauges, filters, generators, induction heating devices and automatic control equipment, crystals will find new uses . . . a war gem will become a peacetime servant.



Megatherm, Federal's pioneering induction and dielectric heating equipment, is giving outstanding production line performance in the metals, plastics, food, textile and other industries.

To achieve mass production Federal has installed new machinery and new methods to speed crystals on their way to war — and will continue to be a leader in crystal production. Now is the time to get to know Federal.

Federal Telephone and Radio Corporation



Newark 1, N. J.

Each coil, condenser or resistor may be opened or, where it will not damage the unit, shorted out to simulate actual conditions in defective receivers. Safety features have been built into this unit, to insure protection to the novice working with the equipment.

This unit has been developed by *Lafayette Radio Corporation*, 901 West Jackson Boulevard, Chicago, 7, Illinois.

INSULATION TESTER

A new insulation tester capable of handling 500 volts at 10,000 megohms has been announced by *Radio City Products, Inc.* This instrument includes two unique features, a comprehensive electronic multitester and a capacity meter measuring as low as 0.0000025 μ fds. and up 2,000 μ fds.

The insulation tester, known as the Model 665, includes VR 105-30 voltage regulator tube and its associated circuits, which insures freedom from error caused by line voltage fluctua-



tions. Thirteen a.c. and d.c. voltage scales, measuring from a fraction of a volt to 6,000 volts, are included.

The Model 665 is described in further detail in the new RCP catalogue No. 128, which is available on request to *Radio City Products Company, Inc.*, 127 West 26th Street, New York 1, New York.

NEW BUILDING WIRE

A new small diameter type SNW Flamenol building wire for wet locations has been added to the standard type SN Flamenol for dry location to complete the Flamenol building wire line, according to an announcement made by *General Electric Appliance Division*.

This wire has a special thermoplastic insulation with low moisture absorption. It is designed for use in accordance with Section 3035 of the National Electrical Code for installations in raceway systems in wet locations, and is approved by the Underwriters' Laboratories in sizes 14 to 4/0 inclusive.

It is superaging, high in dielectric strength and resistant to oils, acids and alkalis, is flame resistant and will not support combustion. The temperature rating is 50 degrees C.

This wire is self-protecting and re-

Products of "MERIT" means Fine Radio Parts

... PARTS manufactured exactly to the most precise specifications.

Long manufacturers of component radio parts, MERIT entered the war program as a complete, co-ordinated manufacturing unit of skilled radio engineers, experienced precision workmen and skilled operators with the most modern equipment.

MERIT quickly established its ability to understand difficult requirements, quote intelligently and produce in quantity to the most exacting specifications.

Transformers—Coils—Reactors—Electrical Windings of All Types for the Radio and Radar Trade and other Electronic Applications.

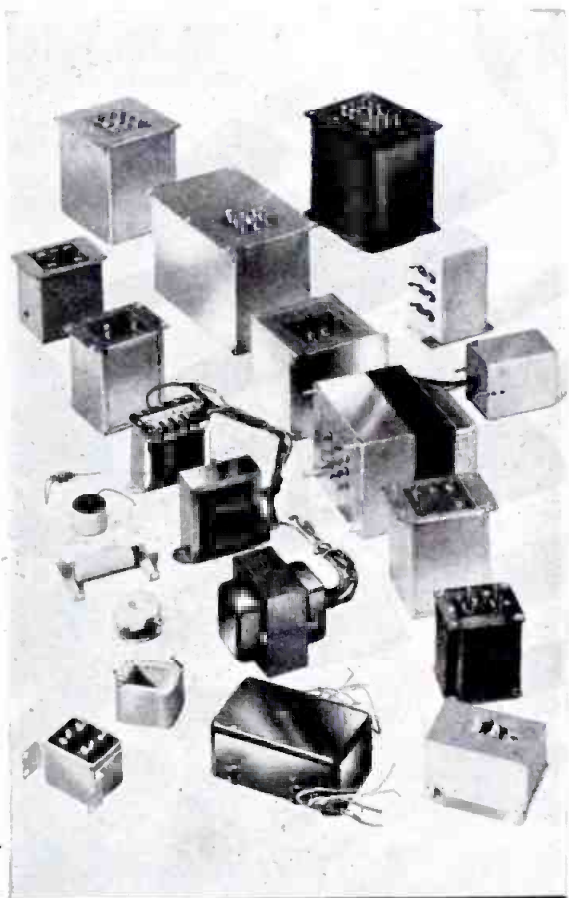

MERIT COIL & TRANSFORMER CORP.
311 North Desplaines St. CHICAGO 6, ILL.

ACCURATE



Accuracy and dependability are built into every Bliley Crystal Unit. Specify BLILEY for assured performance.
BLILEY ELECTRIC COMPANY
IRIE, PENNSYLVANIA



Bliley Crystals

AMCON

AN AMERICAN SOLUTION TO
YOUR CAPACITOR PROBLEMS

ALL TYPES - BY-PASS
AND ELECTROLYTIC

DATA SHEETS
ON REQUEST

AMERICAN CONDENSER CO.

4410 No. Ravenswood Ave. • Chicago 40, Ill.

quires no braid. It has a hard finish, is smooth and glossy and is striped for grade identification. The small diameter of this wire saves space permitting more conductors to be used in one conduit or duct, or permitting smaller conduits or ducts to be used.

Further information about this item may be obtained directly from *General Electric Company*, Appliance Division, Schenectady, New York.

VISUAL TRAINING AIDS

A series of discussional slide film kits are now available for training and re-training programs in industrial plants and schools.

Three different subjects are covered



including mathematics, physics and mechanical drawing and drafting. The kit on mathematics covers 24 subjects, and includes 1,087 individual photographs, drawings and graphs. These exhibits develop mathematical concepts for introductory, refresher or review purposes.

The kit on Air-age physics (mechanics) contains 846 individual pictures to aid in establishing a visual and mathematical relationship between fundamental principles and their application. The basic and more advanced geometric constructions and drawings are covered in the third series which contains 1,112 individual pictures.

Prices, delivery and further applications are available from *Jam Handy Organization*, 1775 Broadway, New York, New York.

HIGH HARDNESS ELECTRODES

A new line of refrigerated resistance welding electrodes with replaceable Frostcaps of Mallory-3 metal has been announced by *Frostrade Products*.

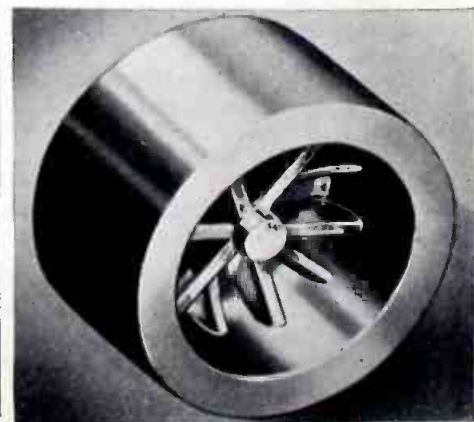

VISION

SNYDER
MANUFACTURING CO.
PHILADELPHIA, U. S. A.

When days of Peace return, our increased facilities and manpower will not only continue in the production of better Radio and Automotive equipment, but will also turn to pioneering other developments to make the post-war period worth while fighting for—Patience—please.

ANTENNAE and Associated Products

FIRST OF THE U. H. F. CABLES

Offered in 1937 by **AMPHENOL**

First Today—
Is Amphenol Polyethylene, Solid Dielectric, Low-Loss, High-Frequency, Coaxial Cable

That first ultra-high-frequency cable was a polystyrene bead cable—born of much study and endless laboratory work. It took the place of ceramic and fibre insulated lines. Thus, Amphenol became the pioneer in low-loss cable manufacture—a logical development of leadership in quality radio equipment—firmly established with radio experimenters and “ham” operators long before war developments required the mass production of U. H. F. cable.

Since that first polystyrene bead cable Amphenol has worked shoulder-to-shoulder with the designers and developers of equipment for radio, frequency modulation, television... since 1941 at the right hand of Army and Navy engineering officers playing an important part in wartime electronic developments.

Today, Amphenol's RG Polyethylene standard—Army-Navy type—cables feature quality materials, Amphenol workmanship in every inch... product of Amphenol's latest type extruding equipment, skilled personnel, seasoned staff and second-to-none laboratory. Write for the catalog of AMPHENOL RG Cables.



Clean, smooth, properly centered polyethylene covered wire is extruded by this machine.



By a dozen different searching tests Amphenol RG Cable is proved before it is shipped.

Depend upon
AMPHENOL
Quality
AMERICAN PHENOLIC CORPORATION
1830 S. 34th Avenue, Chicago 30, Illinois

Connectors
Fittings
Conduit
Cable
Radio Parts
Synthetics

It's the Little Things That Count

OR, WHAT MAKES THE 155-C DIFFERENT FROM OTHER 3" OSCILLOSCOPES?

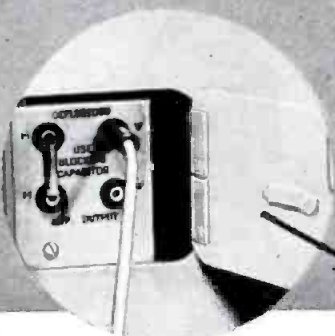

1 "direct deflector connections"—For observations at radio frequencies when such are desirable.

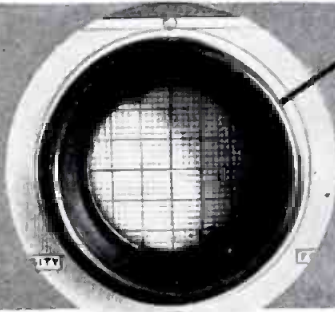

2 "built-in light shield"—The front of the tube is recessed; you can see transients even in bright light.

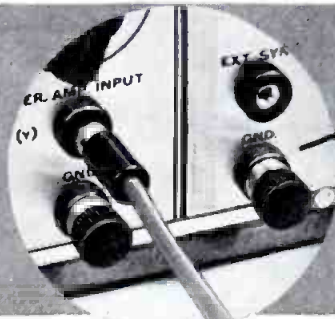

3 "binding jacks"—Can be used with removable binding posts or with locking pin plugs.

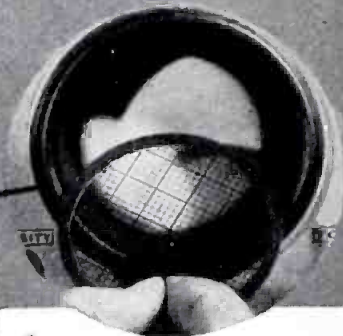
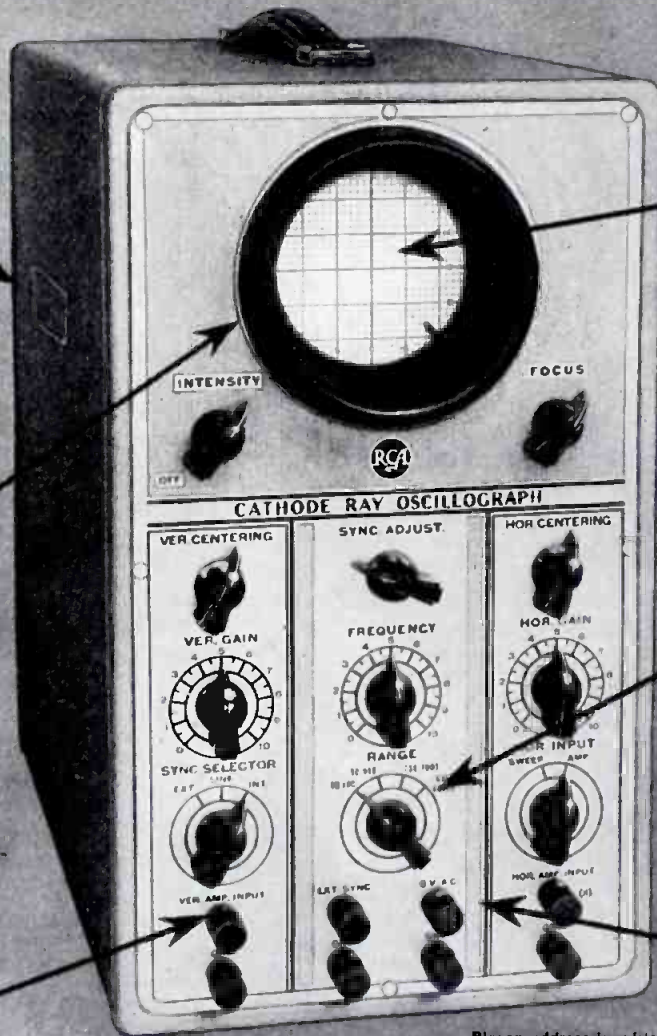

4 "removable graph screen" to permit special observations—Place or replace it with a twist of the wrist.

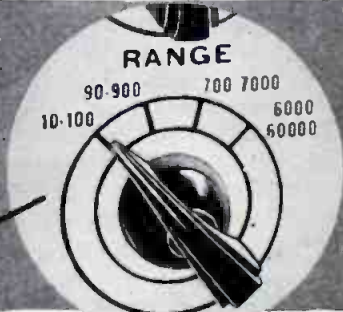

5 "improved timing axis oscillator"—Range extended to 60 kilocycles—more linear sweep.

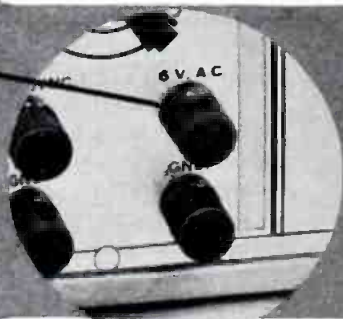

6 "6-volt AC terminals"—For obtaining a handy sine wave ordinate for calibrating purposes.

Please address inquiries to Test and Measuring Equipment Section, Radio Corporation of America, Camden, N. J.



BUY MORE WAR BONDS

RADIO CORPORATION OF AMERICA

RCA VICTOR DIVISION • CAMDEN, N. J.

LEADS THE WAY.. In Radio.. Television.. Tubes.. Phonographs.. Records.. Electronics

These electrodes are designed for welding operations requiring high electrode pressures, as well as severe high production service. Construction of the electrode is similar to other types of Frostpoints designed for normal electrode pressures in which hard drawn copper is used for maximum electrical and thermal conductivity. The finned internal surfaces distribute the coolant uniformly, assuring accurate control of cooling and resulting in reduced "pick up," more spots before cleaning and longer electrode life.

These electrodes are available in $\frac{5}{8}$ " and $\frac{3}{4}$ " O.D., and may be used with any standard or offset Frostpoint electrode.

Further information regarding this electrode may be obtained by writing directly to *Frostrode Products*, 19003 John R Street, Detroit 3, Michigan.

WIRE MARKERS

Wire markers for identifying circuits, permanently and at low cost are available from *William Brand and Company*. This product is marketed under the trade name of Turbo.

These wire markers are manufactured from standard Turbo insulation tubing and possess a high degree of weather and wear resistance, besides conserving critical material.

These markers are available in any size and may be installed rapidly and easily. Identification may be marked on the marker or may be made according to color.

Samples of this product are available to qualified persons by addressing a request to *William Brand and Company*, 325 West Huron Street, Chicago, Illinois or to their New York office at 276 Fourth Avenue.

-50-

Hams in Arctic Service

(Continued from page 53)

ment for radio equipment, but the whole station was back on the air within a couple of hours. Then, on another occasion during the very cold season, the transmitter refused to operate. Close inspection led to the discovery that the mercury rectifier tubes were not operating. It was so cold the mercury would not vaporize. Temporary measures, perhaps a plumber's blowtorch, were put to use, but this called for more permanent treatment. The cold weather was expected to last for several months. Discussing the matter among themselves, the boys decided that the only heat available was that given off by the Diesel engines in the generator house. They then set to work building a large duct between the buildings to bring the heat from the generator house into the transmitter shack. We have been told that they installed a tricky regulating system whereby it was possible to admit cool fresh air into the generator house, heat it, and then pass it on to the transmitter building, resulting in a some-

what crude, but very effective air conditioning system.

Further improvements and still lower outside temperatures resulted in the ducts being used by the men for traveling back and forth between the two houses without going out into the cold.

That was real Yankee ingenuity, typical of most American boys and out of that same spirit has come all of our great inventions.

The last authoritative report received almost two years ago showed that at the time there were about 15,000 radio amateurs doing service with the Armed Forces, but that figure must have increased considerably since then. Discussion of this subject with officials who should be in a position to

know suggests a grand total of over 30,000 men in the Armed Forces, either active Hams at the time of Pearl Harbor, or with previous amateur experience. While there are only about 60,000 amateurs on record, one must remember that there was considerable turnover each year, as new Hams became active and older ones permitted their licenses to expire. In an army of eight to ten million, this group of 30,000 is relatively small, but important, because of previous technical experience.

Many people are now displaying considerable concern for the future of amateur radio, and they seem to think that no one is giving any thought to the subject. On the contrary, much

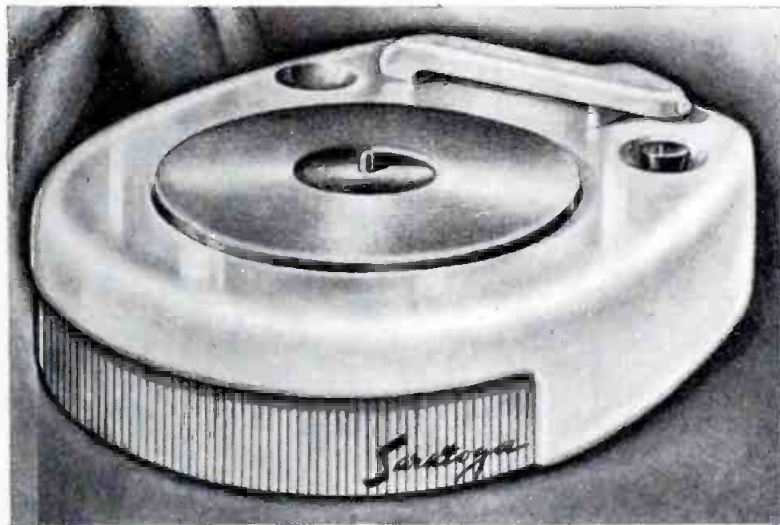

Built to Perform Priced to Sell

When your Ration Book is a souvenir and civilian production again "begins to hum", Meck Mirror-Tone Phonographs and Sound Equipment will be ready for Volume distribution because they will be "Built To Perform and Priced to Sell"

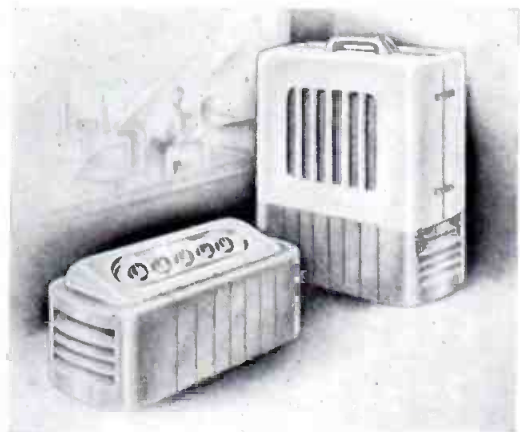

MECK MIRROR-TONE PHONOGRAPHS
* * *
INDUSTRIAL SOUND EQUIPMENT

JOHN MECK INDUSTRIES, PLYMOUTH, INDIANA, U. S. A.

New York 18: 500 Fifth Ave., Chickering 4-3545 • Chicago 11: 540 N. Michigan Ave., Delaware 1561

thought and planning are taking place at this very moment, but remember—there is still a war to be won, and the winning of the war must be put above all else.

Then, too, there is little that can be done about the future of amateur radio since it is well known that the signing of the armistice means just the beginning of many problems, not the answer to them. The same goes for amateur radio. While Hams will undoubtedly be permitted to resume activities at the conclusion of hostilities, the main problem will be to fit amateur radio into the permanent peace plans, and there at the international conference will be decided the future of amateur radio.

-30-

Spot News (Continued from page 14)

tions in weapon form. His arguments against the FCC plan to bar newspapers from ownership of radio stations threw great weight on the final decision in favor of newspaper ownership.

Like Commissioner E. K. Jett, Commissioner Craven was also chief engineer of the FCC, for two years. His term with the FCC covered a period of nine years, and except for a period of five years between 1930 and 1936, his service with the government has been continuous for thirty years.

Commissioner Craven is expected to join the Cowles interests in a technical

capacity. The Cowles are publishers of newspapers in Des Moines and Minneapolis, and Look Magazine, and also control several broadcasting stations.

A letter from President Roosevelt to Commissioner Craven expressed regret at his retirement, and offered good wishes on his new assignment.

As the present writing no successor to Commissioner Craven has been mentioned.

Frank McIntosh who joined WPB two years ago, returns to private industry as a consulting engineer with temporary offices in Chevy Chase, Maryland. He will be succeeded by John Creutz, who has been assistant to Mr. McIntosh for the last eighteen months.

Before Mr. McIntosh joined the government services he was a technical supervisor for the Fort Industry Company of Toledo, Ohio. He was also associated with Graybar Electric and Bell Laboratories. During his tenure he solved many industry problems and accelerated material and equipment flow.

There have been several other changes in the WPB radio and radar division. Fred S. Boland, chief of the program branch, has left to join Federal Telephone and Telegraph Company. Succeeding him is Lorenz A. Adams, formerly with the research and statistics department. Wesley Smith is now head of the Component Recovery section. Kenneth Hathaway is now in the resistor section, and Robert G. McCurdy now directs the test equipment section. Smith, Hathaway and McCurdy were formerly with ANEPA.

W. E. Wilson who has been with WPB for about a year, is now in the transformer division, while M. J. McNicholas has taken over the end products branch. James E. Wallen has returned to private practise, and Leo Holleran has succeeded him. Mr. Holleran has been loaned by RCA as a consultant on vacuum-tube production.

THERE HAS BEEN INTENSE ACTIVITY ON THE TELEVISION FRONT during the past few weeks, and the interest appears to be gaining in momentum daily. A great deal of the accelerated interest was prompted by the "status of television" statement made by the Columbia Broadcasting System.

The statement contained a policy decision on postwar television, which advocated a delay in postwar production of receivers utilizing prewar standards. They said that the improvements which wartime discoveries have made possible will permit broadcasters to offer better and larger pictures. Thus it is important, they stated, that we have concentration by laboratories to complete experiments that will provide this improved service.

While it is true that the public has invested a couple of million dollars in
(Continued on page 101)

WHAT'S YOUR IDEA OF THE IDEAL POST-WAR RADIO AND TELEVISION SERVICE BENCH?

\$600 GIVEN IN WAR BONDS FOR BEST LETTERS!

Each Month for 6 Months, One Letter Will Win a \$50.00 War Bond, 2nd and 3rd Letters, a \$25.00 War Bond Each.

Contest Begins With This Issue of Radio News and Ends December 31, 1944.

RULES OF THE CONTEST

1. Simply write a letter (500 words or less) on the subject: "My Idea of the Ideal Post-War Radio and Television Service Bench."
2. Contest is open to all readers of Radio News (excepting employees of Burlington Associates, their relatives, or their Advertising Agency).
3. You need not own a Radio Shop or possess any of the equipment you describe.
4. No detailed technical description of the apparatus is required or desired, nor the names of the manufacturers.
5. Mention of elaborate testing equipment suitable only for exhibition use will detract from the value of the letter. The inclusion of useful confidence-creating apparatus, however, is recommended.
6. Literary ability is not required. Anyone writing in understandable English, giving a good word description, has an equal opportunity of winning one of the prizes.
7. Write only on one side; sign your name and address CLEARLY in the upper-right-hand corner; number each sheet.
8. Contest runs 6 months, July 1, 1944, through December 31st, 1944. Each month's contest begins first of that month with deadline for entries the last day of that month. Enter as often as you like.
9. No letters will be returned. Letters, contents and the ideas contained therein become the property of Burlington Associates.
10. Judges' decisions will be final and duplicate prizes awarded in case of ties.

THINK OF IT—
You can win a War Bond just by putting down your ideas as to what the ideal post-war Radio Service Bench should be. How many and what type of testing instruments for use on Radio, F.M. Television and so forth. How it must be arranged to render most efficient service—confidence. Your Ideal Service Bench.

ANYONE CAN WIN—
YOU can win. We want opinions from everyone interested in Radio and Television Service—Old Timers—Beginners. Experience will help—newcomers with good ideas can win.

ENTER EACH MONTH—
If you don't win this month, write again next month—and next—for all six months of the contest. Remember, it is your opinion that wins, not literary ability.

IT'S EASY TO ENTER AND THE RULES ARE SIMPLE! GET THAT FIRST LETTER OFF TO US TODAY!

SEND ALL ENTRIES TO
BURLINGAME ASSOCIATES
10 MURRAY STREET • NEW YORK 7, N. Y.

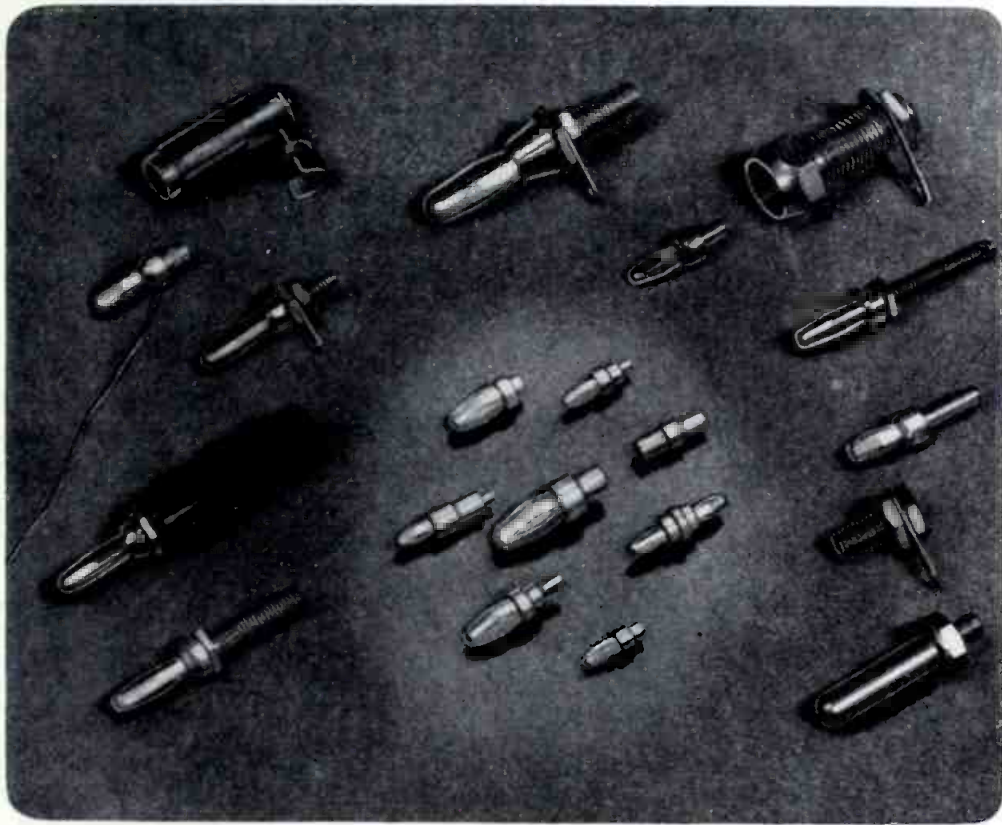

and it's JOHNSON

That is the plus element you get at no extra cost.* Many manufacturers are producing plugs and jacks, some are very clever copies and some are not so clever. Some of these manufacturers are experienced in making electrical parts and many are not.

In Johnson you get the benefit of a quarter of a century of experience in manufacturing radio transmitter components and assemblies—a manufacturer who knows transmitter parts requirements and in fact, to assist the war effort, is actually building transmitters for the armed forces. Johnson engineers are therefore thoroughly familiar with the applications and functional requirements of all transmitter parts and these parts become more than mere mechanical assemblies. Many products are original Johnson designs and considered standard for comparison by the industry.

Whether the new "miniature" plugs featured above, the "standard" plugs manufactured by Johnson for years, or "specials" for particular applications, Johnson plugs and jacks are designed by the same engineers, produced by the same skilled hands, and carry the same Johnson guarantee of quality.

If you have a plug or jack problem, write or call for Johnson's recommendations and quotation. Johnson is especially well equipped to furnish complete assemblies of plugs and jacks, using any insulating materials, and in combination with other metal parts.

*In most cases Johnson plugs and jacks are actually less because of quantity production.
Do you have the new catalog 968Z?

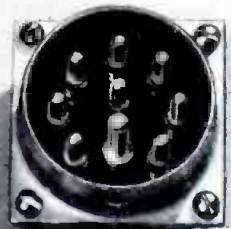
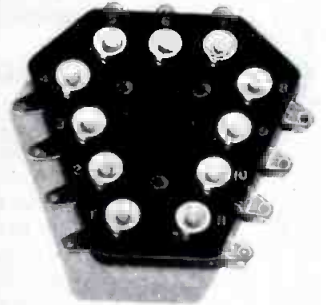

JOHNSON

a famous name in Radio

E. F. JOHNSON COMPANY • WASECA • MINNESOTA

Observations of Postwar RADIO-ELECTRONICS

By **RAYMOND B. FRANK, W9JU**

*Forecasts of the future developments in the various branches
of radio, including television, electronics, and amateur radio.*

AT THE present time it is difficult to forecast the ultimate postwar future of radio, not knowing all of the present and future secret developments being used by the military. However, a smattering of some of the developments has probably leaked out, and, from what is already known, the probable future course of postwar radio can be charted, with a reasonable degree of accuracy.

There has been much speculation and forecast by the Sunday feature writers, who view many of the new developments in the light of Buck Rogers inventions. This viewpoint has little foundation from the standpoint of known facts, except possibly in the field of the radiolocation devices which will have some commercial applications. Many of the new inventions are suited only for military use and will have little or no effect on the general public. In addition, it is highly improbable that the various governments will release any substantial amount of information on these secret devices. Most of the new developments are not "inventions" in the true sense of the word, but rather improvements and refinements. Of course, some of these have been developed to an amazing degree of perfection and are a far cry from the original ideas. The fundamental principles of radio, however, remain unchanged, and anyone with a good basic knowledge will be able to understand any of the secret developments released.

Probably the greatest result of the present wartime activity in the field of radio research will be the vast expansion in usable frequencies, giving much needed space and permitting the relocation of some of the present services so as to allow their present frequencies to be used

by services which are now badly cramped for space. In addition, these new frequencies will be far more suitable than the ones used at present. Of course, most of these uses will be commercial and will affect the public only indirectly. Undoubtedly, the greatest application of radiolocation devices will be for obstacle detection. Ships, planes, trains, and possibly even automobiles will be able to proceed in fog and darkness with perfect safety with the protection afforded by these devices. The possibilities of this particular phase of radio are almost limitless, and the many applications will no doubt amaze even the most optimistic of radiomen. The present plane protective devices such as the absolute altimeter, homing devices and landing beams will be improved to such an extent that travel by air will exceed even rail travel in safety. Ships, by the employment of radiolocation combined with supersonic devices, will be enabled to sail waters now considered dangerous with absolute safety. Icebergs and derelicts will no longer present a menace to ships equipped with these protective devices. Railroad trains should be able to maintain much higher speeds

through mountainous country and areas of heavy traffic. In addition, some of the new developments have possibilities of being used to detect breaks or weak spots in the track or roadbed.

The application of these protective devices to the family automobile of necessity will await development of more simple and inexpensive forms of these outgrowths of war. Because of the complex nature and high cost of these units it will probably be many years before there is much general application in the field of the family auto.

Broadcast

In the standard broadcast band there will be little change and within a few months of the war's end again we probably shall be deluged with the usual run of \$14.95 midget receivers. However one of the real inventions of this war that undoubtedly will have much application in all fields of radio is the static eliminator. This device should not be confused with those sold in the past on street corners for 25 cents or so. Its application to the family broadcast receiver will be limited at first to the receivers in the higher price class, with further research bringing it into general use. With its use, manmade static will no longer be a problem and reception that is now highly unsatisfactory in many areas due to the high level of manmade noises will rival that of the best locations.

Inductor tuning will be used in the majority of home receivers due to its lower cost. Permeability tuning has progressed to the point where its use at the ultra-high frequencies gives performance that is superior to that of the conventional coil and condenser. In addition, the higher Q obtained with circuits of this type allows greater gain per stage, with the possibility of eliminating one or more tubes and obtaining the same over-all result.

Great strides have been made in receivers for high frequencies with the result that receivers for FM reception can be produced at a lower cost, giving a greater number of people the advan-

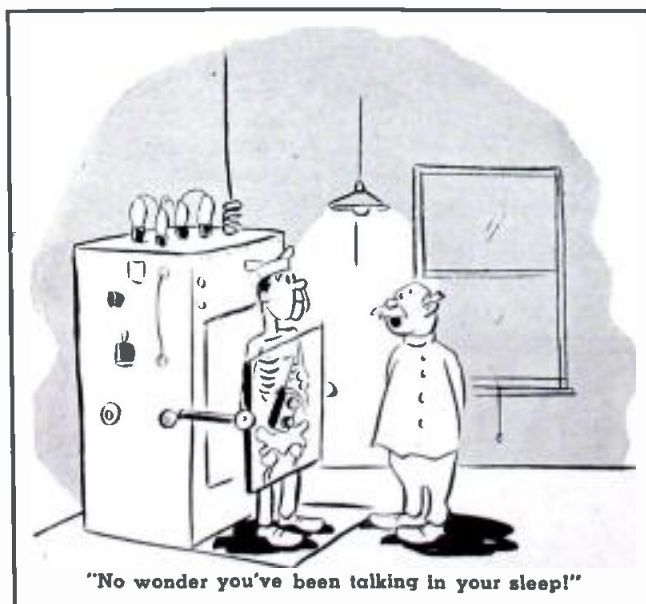

"No wonder you've been talking in your sleep!"



Electro-Voice DIFFERENTIAL MICROPHONE Model T-45 is its U.S. ARMY DESIGNATION

Developed by Electro-Voice engineers in collaboration with the Fort Monmouth Signal Laboratory, this Differential "Lip Mike" carries the voice clearly and distinctly above the roar of battle. Ambient sounds and reverberation are reduced to negligible levels.

- ◆ Frequency response substantially flat from 200-4000 cps.
- ◆ Low harmonic distortion
- ◆ Cancellation of ambient noise, but normal response to user's voice
- ◆ Self-supporting, to free both hands of the operator
- ◆ Uniform response in all positions
- ◆ Usable when gas mask, dust respirator or oxygen mask is required
- ◆ Unaffected by temperature cycles from -40° F. to $+185^{\circ}$ F.
- ◆ Ability to withstand complete immersion in water
- ◆ Physical strength to withstand 10,000 drops
- ◆ Weight, including harness, cord and plug, less than 2 ounces.

Electro-Voice MICROPHONES

Our full line includes Carbon, Dynamic and Velacity models . . . all at popular prices . . . for public address, industrial sound, sound recording and speech transmission applications. Consult your local radio parts jobber.



ELECTRO-VOICE MANUFACTURING CO., INC. • 1239 SOUTH BEND AVENUE • SOUTH BEND 24, INDIANA
Export Division: 13 East 40th Street, New York 16, N. Y. — U. S. A. Cables: ARLAB

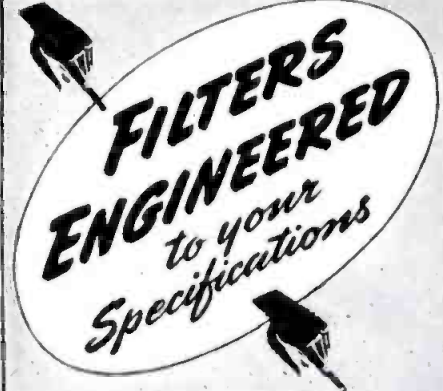

FILTERS ENGINEERED
to your Specifications

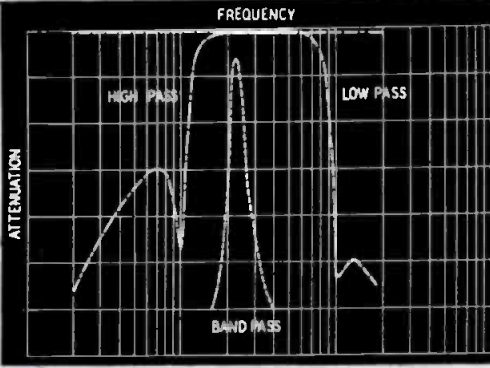

Maximum attenuation of rejection frequencies and minimum insertion loss at pass band frequencies, together with close tolerances and stability, are the usual filter requirements of the audio engineer.

The special design of Thordarson filter coils insures the desired Q at pre-determined frequencies. Time-tested production and inspection methods result in uniform performance to meet your exact needs. Thordarson filters are available with glass seal terminals, as illustrated, for complete hermetic sealing.

WRITE US REGARDING YOUR FILTER PROBLEMS



THORDARSON

TRANSFORMER DIVISION
THORDARSON ELECTRIC MFG. CO.
505 WEST HURON STREET, CHICAGO, ILL.



Transformer Specialists Since 1895
ORIGINATORS OF TRU-FIDELITY AMPLIFIERS



Still your best bet for replacements

Centralab
VOLUME CONTROLS

Centralab
Division of GLOBE-UNION INC., Milwaukee



***Old Man Centralab**
"Old Man" is right . . . for he is a real "old timer". There is no substitute for experience, and the "Old Man" now, as in the past twenty-two years, is still your best bet.

tages of noise-free, static-free, high-fidelity reception. The outbreak of war prevented the public, rapidly becoming interested in FM, from obtaining the receivers they desired. This interest has not abated and undoubtedly there will be a tremendous buying rush for receivers as soon as they become available. Increased production of these receivers combined with the newer developments will result in a product within the reach of all.

Many FM broadcast stations that were planned had to be shelved for the duration due to the lack of necessary material, and as rapidly as this material becomes available they will be put into service. The present disadvantage of FM, in that it is limited to a small area and local programs because of its limited range characteristics, will be solved by the use of relay stations, strategically located to serve all areas. As a greater listening area is served, the larger sales of receivers will bring down the cost.

Improvement in audio circuits and reproducers will be incorporated in these receivers along with new tone control circuits that add new life and realism to music. With the advent of high-fidelity receivers that require a large cabinet for proper baffle area, more of the radio-record player combinations will be sold.

The interest in home recording, gaining rapid impetus before the war, continues unabated with many people sending records to friends and relatives in service. Although home recording was originally a gadget and not too much attention was paid to the quality of the recorders, a great many people developed an interest in high-quality home recording as evidenced by the large sales of semi-professional home recorders. With this interest and the desire of more people to make home recordings comparable in quality to commercial products, the future should see the quality of home recorders greatly improved. The many excellent orchestras on the air coupled with the current musicians' ban on recording will tend to increase the desire of people to make their own records.

One of the bugaboos of home recording, the maintenance of proper cutting level, can be easily solved by the use of self-leveling amplifiers. In this manner the dangers of overcutting or insufficient volume can almost be eliminated.

Communications

The war has effected little change in equipment for standard communications use. Receivers and transmitters are pretty much the same with any refinements, being due solely to adapting the equipment to specific purposes. Some improvements have naturally been made but in general they are a result of the need for doing particular jobs better. The shortage of certain critical materials has caused the substitution of other materials, and in many cases materially improved the

When life or death is a matter of Split Seconds,

"HANDIE-TALKIE"
Delivers

In a war of vast spaces, swift movement and violent action . . . Radio communication must not fail. The front line scout, spotting the location and strength of the enemy, gets his vital information back to the command post with split second speed via the Handie-Talkie, the bantam-weight portable two-way radiotelephone. The signalman listens, receiving instructions.

The Handie-Talkie was conceived and developed by Motorola, makers of Motorola Radios for Home and Car, Automatic Phonograph-Radios and F-M Police Radiotelephone Systems.

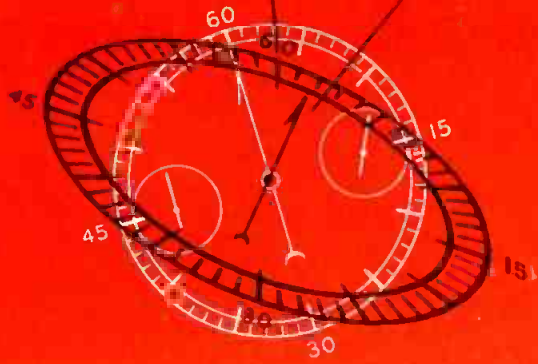

**HANDIE-TALKIE
IS ANOTHER
Motorola
Radio
"FIRST"**



performance of the equipment. A marvelous job has been done in the development of compact, rugged gear that will work under almost any and all conditions. True, the circuits are conventional but the mechanical and electrical designs necessary to crowd all the components in a limited space and still obtain peak performance are nothing short of phenomenal.

The value of FM for difficult communications jobs has been definitely proven in this war, under the worst possible conditions. Tanks rely on this form of communication exclusively as it is the only equipment that has proven satisfactory under such adverse conditions. With the advent of peace we will probably see the almost com-

plete adoption of this method of communication by police departments and other emergency services. Prior to the war, most departments had either begun changing over to this system or were contemplating the change. For the same transmitter power the service range in most cases is twice as great with FM as with conventional transmissions.

For short-range communication, such equipment as is typified by the walkie-talkie and the handie-talkie will probably find much application due to its extreme compactness and limited range. The day of general use of this equipment, such as exemplified by newspaper articles of a man calling his wife to tell her he will be late for

dinner appears to be several years in the future. The greatest application of this form of equipment appears to be in construction work and the like where it is necessary for workers to keep in touch with the foreman or office.

A very definite improvement has been made in both crystal control and variable frequency oscillators. Crystals have been made smaller, capable of handling more power, and the keying characteristics considerably improved. In addition, the stability of crystals with variations in loading and temperature changes has been improved greatly. The tremendously increased manufacturing facilities will bring the cost of crystals down to a level that will permit an almost unlimited use.

Electron-coupled oscillators have been improved to the point where for stability they are better than the best crystal oscillators. New designs permit the resetting of these oscillators to the exact frequency time after time.

The Amateur

Opinion seems to be general that Hams will be restored to the air. The frequencies that will be assigned are not known but in the immediate post-war days will probably be those which prevailed prior to Pearl Harbor. What the result of the international conferences to be held at some future date will be is impossible to determine at this time, but we can rest assured that all possible will be done to protect the interests of the Ham, both by the A.R. R.L. and the United States government. Services of Hams have been invaluable in this war in forming the nucleus of the hundreds of thousands of radio operators and radio technicians it has been necessary to train. The experience gained by someone who works at a hobby for his own benefit and pleasure can not be matched by that obtained by a short but excellent course of schooling.

Probably half the entire amateur fraternity is represented in the Armed Forces at the present time. Almost all of these are in some branch of radio or other. The staffs of most of the government radio schools are made up mostly of amateurs. Provisions for the continuation of a hobby that trains such valuable men cannot be overlooked by any far-sighted government. In addition, we have the many thousands employed in war work, either as technicians and engineers or in factory positions. A roster of the personnel of any of the radio or electronic manufacturers reads like a Ham convention. Many of the Hams employed in war work have given up more lucrative positions in order to apply their talents where they are needed most. All these factors added up should be sufficient to convince the government in short order that the restoration of Hams to the air as soon as possible after the cessation of hostilities is absolutely necessary.

In addition to the 60,000 prewar

GET INTO

RADIO

ELECTRONICS

LEARN AT HOME DEFOREST'S A-B-C WAY

PREPARE NOW!
FOR A BETTER FUTURE

What will YOU be doing AFTER the war?

ASK YOURSELF THESE 3 QUESTIONS

1. What's going to happen to my present job when Peace comes? ... when war production ends? 2. Have I the skilled training that could lead to a preferred job at good pay in peacetime industry—or to start a business of my own? 3. Have I considered the many good present jobs and future opportunities in the billion-dollar Radio-Electronics industry?

Get into this bright OPPORTUNITY FIELD of TODAY and TOMORROW

TODAY—A working knowledge of Radio-Electronics can help you to a better job and good pay check in Essential Industries. It can pave the way toward a part-time or full-time Radio-Electronics Sales and Service Business of Your Own. Or—if you are eligible for military service—it can help you toward better military ratings and higher pay.

TOMORROW—FM Radio, AIR-CRAFT Radio, RAILROAD Radio, MARINE Radio, POLICE Radio, and other exciting branches of the Billion Dollar Radio-Electronics Industry will need trained men. Sight and Sound Motion Picture Studios and Theaters will employ trained Radio-Electronic technicians. The improvements in Radio Picture Projection ... the increasing use of PUBLIC ADDRESS SYSTEMS ... the peacetime uses of such war-born discoveries as RADAR ... INDUSTRIAL ELECTRONICS—all promise bright futures for trained men.

"Learn-by-Seeing"
FASTER... EASIER
With the Aid of
HOME MOVIES

YOU GET A 3-WAY TRAINING

DeForest's Training teaches you Radio-Electronics at home with the aid of: (A) a genuine DeVry movie projector and instructive movie films to help you "learn by seeing" faster, easier; (B) 8 big kits of Radio parts and assemblies for working out 133 Radio experiments; and (C) 90 illustrated lessons prepared under the supervision of DR. LEE DEFOREST, often called the "Father of Radio." You READ ... you SEE ... you WORK ON EQUIPMENT AT HOME ... the DeForest's Way. And when trained, you get real EMPLOYMENT SERVICE.

DeForest's Training includes Instruction in MOTION PICTURE SOUND EQUIPMENT, FM RADIO, and TELEVISION

SEND FOR COMPLETE INFORMATION

See how you may prepare to make YOUR START toward a Radio-Electronic future. Simply PRINT name and address neatly on coupon below—mail it. This brings your illustrated book "VICTORY FOR YOU" and KIT FOLDER, containing complete details. No obligation.

YOU CAN BUILD 133 FASCINATING EXPERIMENTS WITH THIS EQUIPMENT

DEFOREST'S

TRAINING INC. CHICAGO 14, ILL. U. S. A.

LET THEIR EXPERIENCE GUIDE YOU

Dr. Leo DeForest supervised the Preparation of DeForest's Training.

PUT YOURSELF IN THIS PICTURE

Dr. Herman A. DeVry—Visual Education Pioneer—founded DeForest's Training.

DeFOREST'S TRAINING, INC.
 2533-41 N. Ashland Ave., Dept. R-8
 Chicago 14, Illinois.

Without cost or obligation, send me "VICTORY FOR YOU" book and KIT FOLDER—showing how I may prepare to make my start in RADIO-ELECTRONICS.

Name..... Age.....
 Address.....
 City..... State.....

Check here, if under 16, for Special Information.

JAMES

Crystals

KNIGHTS

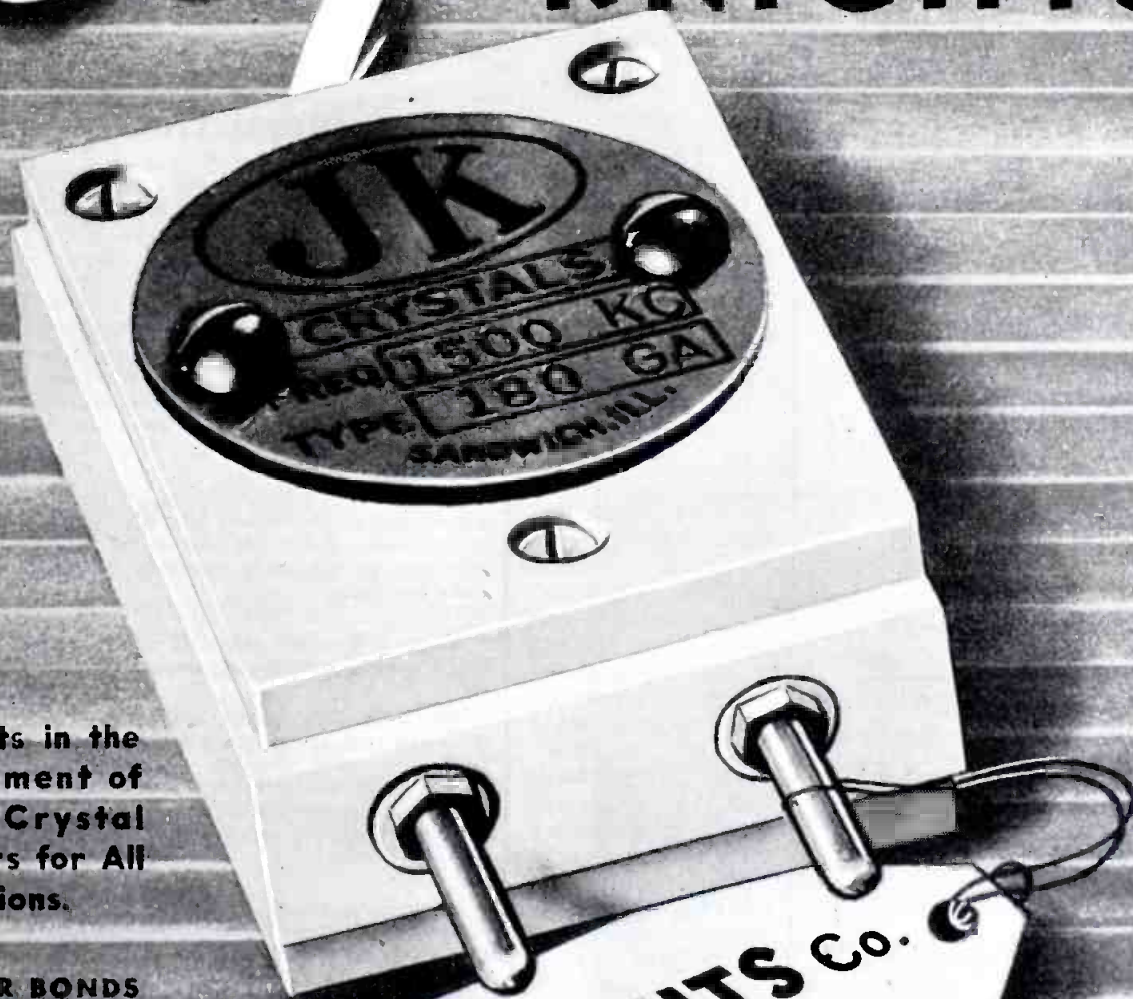

Specialists in the
Development of
Quartz Crystal
Products for All
Applications.

**BUY WAR BONDS
FOR VICTORY!**

The **JAMES KNIGHTS** Co.
SANDWICH, ILLINOIS



CRYSTALS

CRYSTALS FOR THE CRITICAL

LAKE RADIO CABINETS



Beautiful hand-rubbed walnut cabinet for table model phonograph combination. Inside size 16" wide, 11" high, 14" deep. As illustrated above. Specially priced at..... **\$7.95**

Replacement cabinet in dark walnut finish plastic. Inside dimensions 10W x 6 1/2 H x 6D. Price..... **\$1.95**



Dark walnut finish plastic cabinet to accommodate practically any Tiny Tin radio. Size 7 1/2 W x 4 1/2 H x 4D. Price..... **\$1.50**

Also blank table cabinets of walnut veneer in the following sizes:

- 8 1/4 W x 5 1/2 H x 4D **\$1.95**
- 10 1/4 W x 6 3/8 H x 5D **\$2.75**
- 13 1/2 W x 7 5/8 H x 6 1/4 D **\$3.25**

These cabinets available in Ivory color.

14" SPEAKERS

14" electro-dynamic speakers, 900 ohm field, 6-8 ohm voice coil. #V6 push-pull transformer. 15 watt output. Special, only **\$4.50**

All types of radio parts available in today's market can be obtained at Lake's money-saving prices. Large stock listed in our new Bargain Bulletin. Write us for your copy. It's free.

LAKE RADIO SALES CO.
615 W. Randolph Street Chicago 6, Ill.

Short-Cut Mathematics COMBINED WITH Practical Mechanics Simplified

NEW 2-in-1 reading course! Now you can learn the speedy, simplified system of calculation used by draftsmen, engineers, accountants, "master minds" on the stage. Learn easy way to multiply 4 figures by 4 figures without using old-fashioned multiplication; add long columns of figures this lightning short-cut method. Learn horsepower, slide rule, micrometer, logarithms, wood measure, puzzles, etc. etc. Large illustrated volume complete with answers, only \$1 postpaid. Satisfaction or refund. Amaze your friends with your magic-like mental powers!

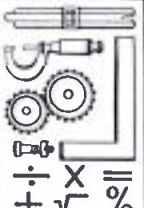

FREE Complete details... mail coupon TODAY!

NELSON CO., 321 S. Wabash, Dept. 3C59, Chicago 4, Ill.
Please send free details about "Short-Cut Mathematics and Practical Mechanics Simplified." No obligation.
Name
Address

Hams we will have many new ones who have developed an interest in radio through their war training. All in all, probably upwards of two million people have received some training in radio as a result of the war. Certainly many of these will retain an interest in radio after the cessation of hostilities and will turn to amateur radio as a means of expression. The results of an army of perhaps a million Hams are many and far reaching. A tremendous market will be opened for manufacturers searching for post-war markets. Increased sales will result in lower production costs so that the individual can afford better equipment. Research in ways and means of manufacturing equipment for the specific use of the Ham will be greatly stimulated.

One of the dark clouds on the horizon that appears to the far-minded amateur as he contemplates a million or so stations trying to work in the far too narrow bands is the tremendous confusion and chaos that will result. This is probably unnecessary worry as many of the new Hams have been trained in the new ultra-high and microwave equipment and will concentrate their efforts in this direction. In addition, sensible use of the available frequencies forced on us by necessity will prevail, so that the interference will be no worse than in prewar days. Certainly, much of the haywire, unstable, poorly designed equipment of former days will have to be junked. Conditions simply will not tolerate its use.

Equipment in general will be the same as that formerly used, with more emphasis placed on mechanical and electrical stability. The developments originated by the military for conventional frequencies are suited essentially to their specific purpose and will find little Ham application. It is in the higher frequency bands from 56 mc. up that we will find most room for experiment. These frequencies have been the amazing developments of the war and only the unavailability of the special apparatus required has prevented more wartime development of these frequencies by Hams. With the cessation of hostilities much of this equipment will become available

and rapid application of these frequencies to Ham use should follow.

The antennas used at these frequencies become very small and capable of directing an extremely narrow beam, which in itself will serve to alleviate interference. We shall probably see more interest in antenna construction than ever before. In no other way is it possible to increase the range of transmitters and receivers so greatly at so low a cost.

Tubes at present restricted to military uses will make operation on these microwave frequencies as simple as the broadcast band. By methods now a secret it will be possible to obtain many times the power output from these tubes that is obtained by conventional methods. Transmitters will be remarkably simple for the stability obtained, and will be far removed from present high-frequency equip-

ment with its long strings of doublers and amplifiers.

FM, again in the case of the Hams, will find many new applications due to its great superiority for reliable communication. A narrow-band FM transmitter occupies no more space in the frequency spectrum than a conventional transmitter using amplitude modulation and has the additional advantage of being noise and interference free. Probably, popular demand will result in the assignment of some frequencies in the present bands for this purpose.

Much of the information on the secret developments of the war will probably

never be made public. However, it is the particular applications that are secret and not the fundamental circuits. Information on the basic circuits of transmitters has been published and differs but slightly from the conventional high-frequency circuits we are accustomed to. From these fundamental circuits it will be possible for the advanced amateur to develop equipment suited to his own needs. From this starting point, coupled with the traditional amateur ingenuity and engineering skill, the development of the many new postwar applications should be rather rapid. However, the novice radio amateur will find some difficulty in keeping pace with the immense broadening of radio and electronic applications.

RADIOODDITIES

In the Australian interior, Dr. J. G. Woods has flown thousands of miles to see the sick who summon him by means of radio transmitters operated by bicycle-operated generators.

The fingerprint division of the Malden, Mass., police department has made a collection of "Ham" QSL cards from operators fingerprinted at their headquarters in compliance with Government regulations.

The dry cell, which was regarded with some misgivings when it was first introduced, because it is not renewable, is the only one of the early primary cells in wide use today.

There is a motor effect in generators, and a generator effect in motors.

The Color Comparator is analogous to the wave analyzer of the radio laboratory. While the wave analyzer evaluates the fundamental and harmonics of a complex electric wave, the color comparator does the same with the fundamental and harmonics of colors.

Its "singing effect" (obtained by feedback from receiver to microphone) ranks the telephone as the first electrically-operated radio regenerator.

THIS PIVOT PROVES A POINT

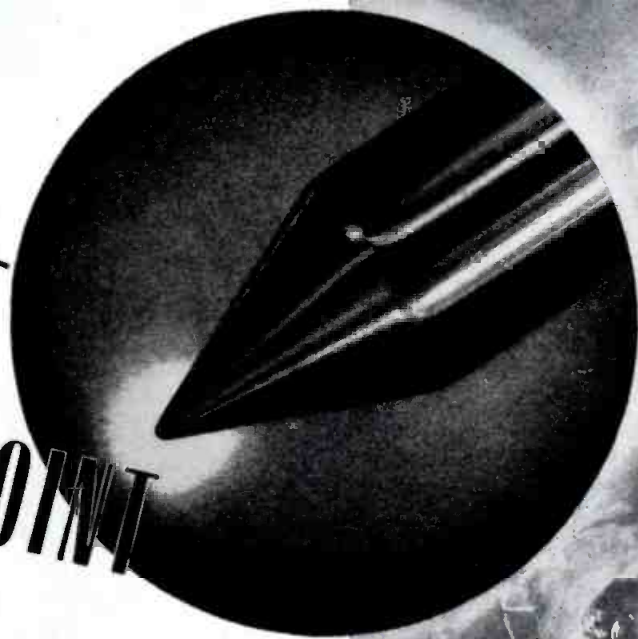

THIS unretouched photomicrograph, approximately 50 times actual size, shows pretty clearly what we mean by the value of experience, when it comes to the making of electrical instruments and testing equipment.

Pivots play an important part in determining an instrument's life and accuracy. In the Simpson-made pivot above, you have what is truly a masterpiece of its kind . . . perfect in contour . . . all surfaces brilliantly polished to prevent rusting . . . rounded end properly correlated with radius of jewel to minimize friction and withstand vibration and shock . . . heat-treated for an unusual combination of strength and hardness.

The obvious explanation for this excellence rests in the fact that Simpson employs some processes others do not, and safeguards every step of manufacture by the finest and most complete control modern science can provide. But in the final analysis, it is only Simpson's long experience which makes such a pivot possible.

That experience reaches back more than 30 years. From it has come new shortcuts in manufacture, new refinements in design, which today permit Simpson to make "instruments that stay accurate" in greater volume than ever before. From this long specialization has come too a sound basis for further advance; in your postwar Simpson Instruments you will see still more forcefully the value of this experience.

SIMPSON ELECTRIC CO.
5200-5218 Kinzie St., Chicago 44, Ill.

Simpson

INSTRUMENTS THAT STAY ACCURATE

Buy War Bonds and Stamps for Victory





... miles of enemy-held coast has been gained. . . .

Everest Topped by Flier's Find?

(At a U. S. Air Base) An American flier said today that while flying an uncharted route across part of China, he was surprised to find that his altitude of more than 30,000 feet left him still some 2,000 feet below the peak of a mysterious mountain which reared its cloud-shrouded heights alongside his course.

Mt. Everest, world's highest known peak is 29,141 feet high. Thus, it appeared that the new, unnamed mountain might prove to be a record-breaking height if later exploration corroborates the aviator's observations.

st
push
distal
Ac
tima
unfol
on N
front
perish
Wi
cut
Brit
gain
esti
ori
lar
Bis
rea
mi
ra:
tu
see
ber
ya

a new HIGH...

The war's end will bring the day when scientific expeditions may verify a new high on the world's roof. When that time comes, the world will also know a new high in the quality of electronic products . . . through radio and other electronic devices built by

BUY WAR BONDS
5th
WAR
LOAN
Buy More Than Before

DETROLA RADIO

DIVISION OF INTERNATIONAL DETROLA CORPORATION • BEARD AT CHATFIELD, DETROIT 9, MICH.

C. RUSSELL FELDMANN  PRESIDENT

The field of television was making rapid strides just prior to the outbreak of war and probably by this time would have been a firm fixture in the public entertainment field. Interest even at the present time runs high in spite of the mediocre shows and limited broadcast schedules. Many of the wartime developments also can be applied to television and peacetime should see the production of a greatly improved receiver within the popular price class. The tremendous use of cathode-ray tubes in wartime radio equipment has expanded the manufacturing facilities for these tubes to such an extent that large tubes capable of giving a television picture of a size to entertain the entire family, can be produced at low cost.

Prior to war many of the television broadcasters had begun the conversion of their equipment to FM and higher power. By this conversion the greatest fault of television, limited range and spotty pictures, due to manmade static are eliminated. As the television audience gains in size, the quality and frequency of the broadcasts will improve. Much work has been done on television cameras with the result that actual field pickups are now possible, as a regular procedure. Installation of receivers is still a problem with the most satisfactory installations being made by the most experienced servicemen. However, experience is rapidly obtained, and with the advent of more powerful stations and better antennas, installation should present no problem to the serviceman with a good basic knowledge.

The word electronics has probably been used more than any other in describing postwar conditions, with the result that the public has been led to believe that it is almost a cure-all for man's ills. Certainly, great strides have been made in this field with the result that many tasks can be performed far more satisfactorily by electronic devices than by the former methods. However, it is evident that before an electronic device is installed to do a particular job it must first sell itself as a more satisfactory method. The installation of an electronic device, with its attendant service and maintenance problems, to do a task at present being performed satisfactorily by a mechanical or manual device is not economically sound. Either superior performance or a saving in time must result before its use is justified.

We recall one case in which a manufacturer had a problem in heating castings before fabricating them. A well-known electronic manufacturer offered to solve the problem free of cost provided the necessary equipment was purchased from them. After about two thousand dollars had been expended in experiments with little results, the deal was called off. The casting fabricator found that the problem could be solved simply by immersing the castings in boiling water immediately before fabricating!

The field, however, for electronic de-

vices is almost unlimited. Use of electronic devices has been growing rapidly for some time but publicity has been poor with the result that the public does not realize that they are using such devices every day without being aware of it. The ordinary household radio and temperature control devices used on furnaces are but two of the examples. Electronic eyes used to open doors, for alarm systems, or counting traffic are some other examples. The electronic organ and allied musical instruments are encountered almost daily but are accepted as a matter of fact without the realization that they, too, are electronic devices.

-50-

Spot News

(Continued from page 90)

television receivers, and manufacturers and broadcasters have invested some twenty million dollars, the statement said that this total investment is comparatively trivial to what the public and manufacturers will spend when television production gets under full swing. CBS therefore urged that production be restricted in the postwar era until equipment utilizing really advanced design is available.

"Under such a plan," said CBS, "present broadcasters could continue



TODAY in WAR.. TOMORROW in PEACE

On mile-a-minute PT boats, as on hurtling jeeps, rumbling tanks, amphibian tractors and "walkie-talkies", Brach Antennas are doing their part in the vital task of communications. Today, our entire output goes exclusively to the nation's armed forces—on land, on sea, and in the air. But after the war, for the best in radio antennas and accessories, remember the name—BRACH.

L. S. BRACH MFG. CORP.

World's Oldest and Largest Manufacturers of Radio Antennas and Accessories
55-65 DICKERSON STREET • NEWARK N. J.

NOW—A REALLY HIGH-POWERED— Radio Engineering Library

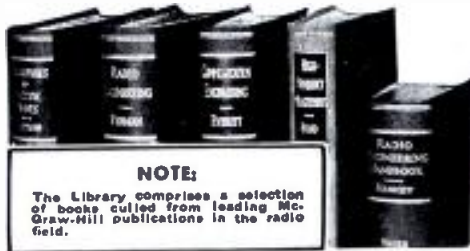

NOTE:

The Library comprises a selection of books culled from leading McGraw-Hill publications in the radio field.

- especially selected by radio specialists of McGraw-Hill Publications
- to give most complete, dependable coverage of facts needed by all whose fields are grounded on radio fundamentals.
- available at a special price and terms

THESE books cover circuit phenomena, tube theory, networks, measurements, and other subjects—give specialized treatments of all fields of practical design and application. They are books of recognized position in the literature—books you will refer to and be referred to often. If you are a practical designer, researcher or engineer in any field based on radio, you want these books for the help they give in hundreds of problems throughout the whole field of radio engineering.

5 VOLUMES, 3559 PAGES, 2558 ILLUSTRATIONS

1. Eastman's FUNDAMENTALS OF VACUUM TUBES
2. Terman's RADIO ENGINEERING
3. Everitt's COMMUNICATION ENGINEERING
4. Hund's HIGH FREQUENCY MEASUREMENTS
5. Henny's RADIO ENGINEERING HANDBOOK

10 days' examination. Easy terms. Special price under this offer less than books bought separately. Add these standard works to your library now; pay small monthly installments, while you use the books.

10 DAYS' FREE EXAMINATION—SEND COUPON

McGRAW-HILL BOOK CO.,
330 W. 42nd Street, New York 18, N. Y.

Send me Radio Engineering Library, 5 vols., for 10 days' examination on approval. In 10 days I will send \$3.00 plus few cents postage, and \$3.00 monthly till \$24.00 is paid, or return books postpaid. (We pay postage on orders accompanied by remittance of first installment.)

Name

Address

City and State

Position

Company RN-7-44



Basic electrical and radio theory in the simplest possible language, written especially for those without mathematical or technical training.

Dozens of complete how-to-build-it descriptions of many types of receiving, transmitting, and test equipment show practical applications. Hundreds of diagrams and large photographs.

Enlarged war-training chapters include: expanded basic principles, more test equipment which can be field-built, and mathematics for solving simple radio problems.

Over 600 pages, durably clothbound, gold-stamped. From your favorite dealer, or from us, postpaid; please add any applicable taxes.

\$22.00 in Continental U.S.A. Elsewhere, \$25.25

EDITORS AND ENGINEERS

1420 North Highland Avenue, Los Angeles

COMMERCIAL RADIO INSTITUTE

A radio Training center for over twenty-four years.

RESIDENT COURSES ONLY.

Pre-Induction, Broadcast, Marine Telegraphy, Aeronautical, Television, Service. Classes now forming for Fall term, Oct. 5th. Literature upon request.

Dept. D., 38 W. Biddle St.
Baltimore 1, Md.

Government specialists also entered into the debate. Newly appointed FCC commissioner E. K. Jett said that if materials and manpower become available at a reasonably early date for the production of television transmitters and receivers, the wisest course of action would be to proceed under existing commercial standards of the Commission.

"In other words," he emphasized, "there should be no delay in promoting the full commercialization of television beyond the time required to manufacture equipment in conformity with existing frequency allocations and engineering standards of the Commission. He went on to say that the public is certainly entitled to know that a better system of television may be adopted after the war, as a result of secret wartime research and development, but such a system, including the allocation of suitable channels, cannot be made before one or two years.

"The possibility, therefore, of two commercial television systems in the future becomes apparent," said Mr. Jett; "that is, the present system or a slight modification thereof which can be accepted at an early date, and the vastly improved system which will be introduced as a more permanent system of television some time after the war. Using this as a basis of thought," explained Mr. Jett, "a dual form of transmission can be set up so that the public would have a good system of television under existing commercial standards immediately after the 'freeze' is lifted. And such a system could be continued for an indefinite period after a new system is placed in commercial operation. Under such a plan," he emphasized, "there may be a period when broadcasters will be transmitting all of their television programs on two transmitters, on the old and on the new standards. While this may introduce some difficulties," he said, "they would not be insurmountable and would provide receiver owners with a means of receiving all that is being transmitted.

"Many may argue that this plan would waste valuable frequencies," he explained. "However, we have a similar situation in FM and AM, where we are planning for the continued use of both bands.

"The same situation exists in television," he explained, "and thus a similar approach should be applied."

Chairman James Lawrence Fly of the FCC, expressing his views on the subject, said, "It has been my view that the highest developments which our television technicians are capable of producing should be made available to the public as soon as may be feasible, consistent with the over-all economic picture. At the same time, it would be foolhardy to lock down future television service to prewar levels. Wartime research has been very productive.

"The public interest is paramount. American families should be given the benefit of the many technological im-

provements created in the laboratories in the stress of war. . . . Time should be taken now in doing this job rather than in debating what the engineering standards would be if the Commission were to fix them today.

"The Commission is concerned with the orderly introduction of any new standards which may be deemed desirable. This it will do in ample time to clear the way for production when production is possible.

"I assume that the FCC will not take any official action by changing television standards until the Radio Technical Planning Board completes its present researches and submits its recommendations. Engineers of the Commission have been working closely with the Board and with other interested agencies.

"I have every reason to believe that the broadcasting industry, the manufacturers, and the public will maintain an attitude of cooperation, patience and understanding while these problems are being thrashed out.

"It should be remembered that public discussion of television developments in war laboratories is handicapped by the lack of specific information which is, of course, a closely-guarded military secret."

The only major organization, but probably one of the most important, that did not offer an opinion on the projected problem, was the Radio Technical Planning Board. The chairman of the board, Dr. W. R. G. Baker, said that the television panel and its six committees had not as yet concluded their work. When they do, a statement will be issued.

It is believed, however, that at this writing the RTPB has concluded its deliberations and submitted its report on television to the general membership. Some of the recommendations that are said to have been made cover an improved system of six-megacycle black and white transmission, and provision for thirty channels, 20-megacycles wide, operating in the 600- to 2000-megacycle band.

Members of the committee on Panel Six who will review these standards include D. B. Smith of Philco, chairman, and I. J. Kaar of General Electric, vice chairman.

The report of the RTPB should contain the answer to the problem, and that answer will be presented in these columns as soon as it is available.

Notwithstanding the pro and con debate of television's status, engineers haven't halted their planning in the development, designing and construction of equipment. Out on the coast, for instance, a new television transmitter will soon rise on top of Mt. Wilson, some six-thousand feet above sea level. The transmitter, which will be operated by station W6XYZ of Television Productions, operating on the Paramount Picture Studio lot, will have a peak output of 4 kw. Programs will be relayed from the studio some eighteen miles away by a 210-megacycle transmitter, with call let-

PROVED IN SERVICE

FOSTER TRANSFORMERS

MEET EVERY NEW NEED WITH THE SAME
DEPENDABLE PERFORMANCE THAT HAS MADE
THEM "FIRST" IN ELECTRONIC REQUIREMENTS.



FOSTER IS FIRST AGAIN WITH
THEIR NEW "VITROSEAL" TERMINAL
a development that has definite advantages over
other types of hermetic seals for tropical use.

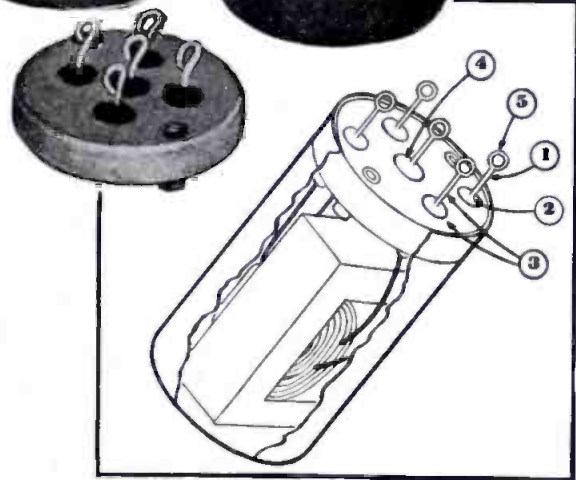

- 1 The electrode can be bent at an angle 90° from the upright position without breaking the glass in the seal. In fact, it can be bent and straightened several times and then the terminal will break before the glass is damaged.
- 2 Extremely high resistance to thermal shock.
- 3 The metallic parts are cold rolled steel, rather than expensive alloys.
- 4 The terminals are fused directly into the metal in multiple. Ordinary seals are made up individually and are soldered into holes in the transformer case.
- 5 A loop is provided for easy hook-up.

UNITS USING SAME TERMINAL CONSTRUCTION

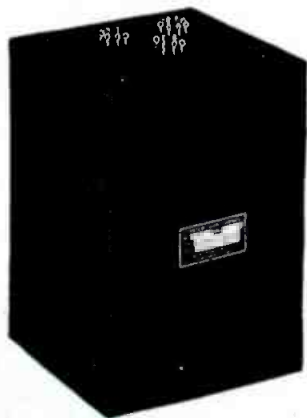

500 VA Plate Transformer

Plate Reactor

Filament Reactor

Dual Bias Reactor

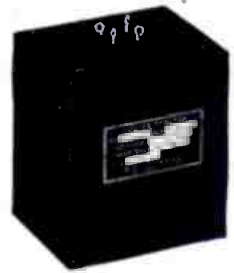
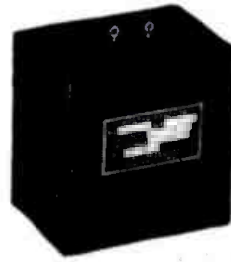

SPECIALISTS IN BUILDING TRANSFORMERS SINCE 1938

A. P. FOSTER COMPANY

TRANSFORMER ENGINEERS & MANUFACTURERS
719 WYOMING AVENUE, LOCKLAND 15, OHIO

ters W6XLA. The peak output of this transmitter will be 100 watts (25 watts carrier). The new transmitter and relay equipment is being built by the engineering staff of W6XYZ under the supervision of Klaus Landsberg, who directs the station.

According to Mr. Landsberg, the new transmitter which will undoubtedly be the highest television station in the world, should be on the air before the end of the year. Incidentally, at the present time this station is on the air twice a week in two-hour programs, with all live shows.

Westinghouse has shown its interest in television by applying for three television licenses for stations in Phil-

adelphia, Pittsburgh and Boston. Supervision of the installation of the new stations, when the FCC grants licenses and materials are available, will be under the direction of Franklin P. Nelson, director of television and short-wave broadcasting activities at Westinghouse.

Show-folk interest in television has also grown during the past few weeks. The famous director, Cecil B. DeMille, has joined the Television Broadcasters Association with his production unit. Anticipating the need for talented and attractive girls, Harry Conover, the cover girl impresario, has rented over a thousand additional feet of space near his headquarters in New York

City, for conversion into a studio to train models.

Television appears to have captured the interest of everyone.

THE IMPORTANT PART RADIO AMATEURS are playing in the war was emphasized in talks given at the first wartime "hamboree" of the Chicago Area Radio Club Council in the Hotel Sherman, Chicago, recently. The affair was sponsored by the manufacturers and jobbers.

Speakers included Commander James E. Parrott, USNR, district communications officer of the Ninth Naval District; Kenneth R. Porter, RADIO NEWS foreign correspondent who recently returned from the European Theater; Cyrus T. Read, assistant secretary of the American Radio Relay League, and Clifton Byrne, acting regional representative of the War Shipping Administration.

More than 500 radio amateurs of the Chicago area and representatives from every call area in the United States participated in the evening's sessions.

PVT. MORSE M. PETERMAN, who at one time worked on the Universal Microphone Co. account via the Ralph L. Power agency, Los Angeles, was awarded the silver star for gallantry in action near Cassino. He volunteered three and a half years ago and has been with Field Artillery, Antitank and Combat Engineers. His two years overseas service has included the campaigns in North Africa, Tunisia, Sicily and Italy. A year ago he was in the battles of Faïd and Kasserine Passes.

FAVORABLE REACTION TO THE RECENT statements issued by Charles Robbins, vice president of Emerson Radio and Phonograph Corporation, New York City, on the radio distributors' and dealers' positions in the postwar era, has been wide-spread. Letters, telegrams and telephone calls have been pouring in to Mr. Robbins commending the equitable stand he has taken.

In response to many queries as to what should be done in the case of those distributors and dealers who closed their businesses because of lack of merchandise, or for innumerable other reasons, and drifted into other businesses and fields of endeavor, Robbins declared that they are confronted today with a made-to-order situation.

"With the scarcity of servicemen throughout the country, Mr. and Mrs. John Q. Public are troubled by the fact that they find it exceedingly difficult to have their present radio sets properly and promptly repaired. While, admittedly, some of this is due to lack of parts and tubes, I am firmly convinced that in many cases it can be attributed to the small number of repair shops that are available to the public."

Asserting that in his travels and contacts he was deeply impressed by the ingenuity of service shops in utilizing substitutes for scarce and unavail-

Replacement Tube Adaptors

| Adaptor No. | Use Tube Type | To Replace Tube Type |
|-------------|---------------|-----------------------|
| 1 | No. 5U4G | No. 80—No. 5Z3—No. 83 |
| 2 | No. 7A8 | No. 12A8 |
| 3 | No. 7C6 | No. 12SQ7 |
| 4 | No. 14A7 | No. 12SK7 |
| 5 | No. 35Z3 | No. 35Z5 |
| 6 | No. 14A7 | No. 12SA7 |
| 7 | No. 7A8 | No. 12SA7 |
| 8 | No. 1LA6 | No. 1A7 |
| 9 | No. 1LC6 | No. 1A7 |
| 10 | No. 43 | No. 25L6 |
| 11 | No. 7B7 | No. 12SA7 |
| 12 | No. 14B8 | No. 12SA7 |
| 13 | No. 14Q7 | No. 12SA7 |
| 14 | No. 14B6 | No. 12SQ7 |
| 15 | No. 39/44 | No. 6K7 |
| 16 | No. 7Y4 | No. 6X5 |

\$1.25 list price, less 10% discount or 75 cents net, EACH

Many other types of tube adaptors available and coming in every day.

1/3 Deposit with Order. Balance of Order C.O.D.

Chicago Novelty Company, Inc.

1348 Newport Avenue

Chicago 13, Illinois

ELECTRICITY for RADIO WORK ANYWHERE

Plant shown is W3S. 3000-watt, 115-volt, 60-cycle; engine is 2-cyl. water-cooled.



For a dependable source of electricity on all radio projects remote from commercial power. Onan Electric Plants are proven leaders in the field. More than half of the armed Forces' total requirements for power plants are built by Onan.

Gasoline driven . . . Single-unit, compact design . . . Sturdy construction . . . Suitable for mobile, stationary or emergency service.

Over 65 models, ranging in sizes from 350 to 35,000 watts. 50 to 800 cycles, 115 to 660 volts, A.C.—6 to 4000 volts, D.C.—Also dual A.C.-D.C. output types.

Descriptive literature sent promptly on request.

D. W. Onan & Sons, 2150 Royalston Ave., Minneapolis 5, Minn.

ONAN
ELECTRIC PLANTS

For a Low-Cost 1 KW* Transmitter

*input power rating

Use a Pair of Famous
RCA-810's or RCA-8000's

WHEN you are limited to a kilowatt of input power and want to keep tube cost low, you will find it hard to do better than with a pair of RCA-810's or RCA-8000's. They're rugged tubes, built for hard service, whether you're thinking about experimental equipment or some commercial application, such as electronic heating or diathermy.

One of the big advantages of these tubes is their high output at moderate plate voltage. That's due to their high perveance—a design feature you'll find in the RCA power tube line. High perveance means economy in power supply design—lower plate voltage, smaller capacitors, fewer insulating problems—than you would experience with low perveance tubes. Both the 810 and the 8000 require little driving power.

The two tubes differ chiefly in amplification factor; the 810 has a mu of 36, the 8000 a mu of 16.5. The 8000 is a favorite of designers of medium-power radio-frequency equipment. The 810 is especially suitable for audio service. Each, however, will handle frequencies up to 100 Mc at reduced ratings, and up to 30 Mc at full ratings. In intermittent service, the ICAS ratings make a bigger power peak available.

Condensed technical data are given at the right; additional data are available in technical data sheets which you can obtain free by writing to the address below. Ask for them by tube type number. For suggested circuits, see the RCA Guide for Transmitting Tubes—35¢ through your RCA distributor, or direct from: Radio Corporation of America, 727 So. Fifth Street, Harrison, N. J.



TECHNICAL DATA: 810 & 8000

Fil. Volts 10 Fil. Amp. 4.5

Amplification Factor: 810, 36; 8000, 16.5

Typical operation—Class C telegraphy—Single Tube

| | CCS | ICAS |
|----------------------|------|------|
| Plate Volts | 2000 | 2250 |
| Plate Milliamperes | 250 | 275 |
| Driving Power, Watts | 12 | 12 |
| Power Output, Watts | 8 | 9 |

Typical operation—Class B Modulator—Two Tubes

| | CCS | ICAS |
|--------------------------------|------|------|
| Plate Volts | 2000 | 2250 |
| Plate Milliamperes—max. signal | 420 | 450 |
| Driving Power, Watts | 10 | 13 |
| Power Output, Watts | 6.5 | 7.9 |

Max. Dimensions, both types: length, 9 1/16";
radius, 2 1/4".



BUY
WAR
BONDS

RADIO CORPORATION OF AMERICA

RCA VICTOR DIVISION • CAMDEN, N. J.

LEADS THE WAY.. In Radio.. Television..
Tubes.. Phonographs.. Records.. Electronics



Get Your Copy—35¢

RCA, 727 So. Fifth St., Harrison, N. J.

Please send me the newly revised
72-page RCA Transmitting Tube Guide.
Enclosed is 35¢.

Name

Call

Address

City State

able parts, such as interchanging one type of tube for another, etc., Robbins pointed out that "by further practice of this ingenuity by more service organizations, I believe they would be instrumental in putting into operating condition a large number of the several million radio sets currently reported to be inoperative for lack of parts. And here is where distributors and dealers can perform an outstanding service for the public, and at the same time re-establish their customer contacts in anticipation of heavy postwar demand.

"An excellent opportunity exists today for distributors and dealers who have shut up shop for one reason or another, to reopen their establishments and develop service work and not only capitalize on the huge backlog of radio sets awaiting repairs but at the same time begin building a firm foundation for the large postwar radio potential. Such a setup could be extremely flexible so that as the occasion required, additional personnel, space and facilities could be acquired.

"The re-entry of these distributors and dealers into the radio picture is only logical and desirable, for they help constitute the resale framework that enabled the radio industry to market an all-time high of over 12,000,000 receivers in the last prewar year. And they will be even more essential in postwar years.

"Seldom in one's business life has such an opportunity for rehabilitation presented itself. Those distributors

and dealers with vision, seeking to get into the swim again, will at once recognize the tremendous current possibilities. And in addition to helping themselves, they will be rendering a sorely needed service that will be welcomed by numerous radio owners."

CAPTAIN HENRY E. J. SMITH, Signal Corps (ex CT2BK and CP1AA), recently returned from North Africa, Sicily and Italy where he has been serving with the Forces since 1942. He is being retired from the Army with physical disabilities and returns to work with International Telephone and Telegraph Corp., with whom he was previously associated as Managing Director of one of their South American subsidiaries. Captain Smith and his family are leaving shortly to take up his new permanent assignment in Rio de Janeiro, Brazil.

RAYTHEON PRODUCTION CORPORATION of Newton, Massachusetts, manufacturers of Raytheon radio tubes and electronic equipment, was recently host to war hero, Captain Alden C. Dinsmore.

Captain Dinsmore spent almost a year at New Caledonia where he trained his troops and had the novel experience of having under his command the only French speaking Kanakas who later became a mobile reconnaissance squadron.

Presented by A. M. Stockbridge, Director of Employees Service, Captain Dinsmore described the harrowing life

at Guadalcanal and warfare with the Japs. Captain Dinsmore wears three stars for major engagements in the South Pacific area.

He congratulated the Attendance Contest Winners: "Without the unselfishness of people on the homefront, the men and women on the warfront couldn't carry on."

Captain Dinsmore's father, Alvin Dinsmore, has been a Raytheon employee for many years, and Mrs. Alden C. Dinsmore was employed as correspondent during the two years Captain Dinsmore spent in the South Pacific area. He related his personal experiences in the reconnaissance unit before the winners of "Raytheon's" Attendance Contest Winners.

TALK-A-PHONE MFG. CO. has recently moved into new quarters at 1512 S. Pulaski Road, Chicago 23, Illinois. With their added facilities, the manufacturers hope to be able to offer greater service in the future to the users of their products.

FURTHER ADDITIONS TO THE HONOR ROLL of Army-Navy Production Awards have been made during the past month.

Belmont Radio Corporation employees have won their fourth award. Robert P. Patterson, Under Secretary of War, has authorized the addition of the third White Star to the "E" flag which flies above the Chicago plant.

The Hallicrafters Company has also received its fourth Army-Navy "E" award, adding the third star to its "E" flag. This is one of the first exclusive radio manufacturers to be so honored.

The Lansdale Division of the National Union Radio Corporation has recently received the honor of the Army-Navy "E" flag. This plant was built shortly after the bombing of Pearl Harbor and within this short time, production reached the point which merited the "E" award.

The third "E" award was made to the three plants of the Sprague Electric Company of North Adams, Mass., designers, engineers and manufacturers of Sprague Capacitors, Koolohm Resistors and other Electrical Components.

For the second time in seven months, the Solar Manufacturing Corporation of New York has been awarded an additional White Star to its plant at West New York, N. J. Solar was one of the first employers of blind workers in assembling precision parts for electronic equipment.

Another of the few companies in the nation to receive the coveted Army-Navy Production Award for the fourth time, the Motorola Division of the Galvin Manufacturing Corporation of Chicago, adds a third white star to its "E" flag.

Price Brothers Company of Frederick, Maryland, was awarded the "E" flag recently. This company is engaged exclusively in the manufacture of relays and sensitive controls for the communications branches of our Military Services.



*Talk About "FORWARD DESIGNING"
...it's Here Today in XCELITE Tools*

Take, for Example, This Unique
XCELITE

← **"Combination Detachable" Screwdriver**

• Here's just one of the many XceLite "idea tools" for faster, more accurate work. The XceLite "Combination Detachable" Screwdriver is actually two screwdrivers in one—designed with a dual purpose shaft which fits into genuine shockproof, fire-resistant XceLite handle. Shaft has genuine Phillips blade at one end, standard blade at other. Also available in STUBBY size (3" overall length). Most XceLite Tools now available on satisfactory priorities—delivery necessarily delayed by war conditions. Ask your regular dealer, or write Dept. 1.

PARK METALWARE CO., Inc.
Orchard Park New York
BACK THE ATTACK...KEEP THE WAR BONDS YOU BUY



**QUALITY TOOLS
PREFERRED BY THE EXPERTS**

RADIO TECHNOLOGY

 RCA Institute offers an intensive two-year course of high standard embracing all phases of Radio and Television. Practical training with modern equipment. Also shorter specialized courses in Commercial Radio Operating, Radio and Television Servicing, and Aviation Communications. For Free Catalog write Dept. RN-44.

RCA INSTITUTES, Inc.
A Radio Corporation of America Service
75 Varick St., New York 13, N. Y.

WANTED PRECISION TEST AND LABORATORY APPARATUS

by Communications Development Laboratory. Give full details and best price for immediate sale. Box No. 354.



History of Communications Number Three of a Series

PRIMITIVE COMMUNICATIONS



An early communications instrument was the Tom-Tom—to prove its efficiency, it is still used by the natives of Africa. Tom-Tom signals are “Beat out” along jungle lined rivers, but even then distance is a handicap, and “repeater” stations are many.

Like all means of communications, other than voice communication, translation of coded signals must take place in which additional skill is required, and another chance of error is presented. As in the case of the Tom-Tom beater: knowledge of the Tom-Tom code was restricted to a special family within the tribe, and was handed down from generation to generation.

Today, Universal Microphones in the hands of the fighting men of the Allied Armed Forces are performing a simple but vital need in electronic voice communications where their quality and efficiency are bringing us one step closer to victory.

< Model T-30-S, illustrated at left, is but one of several military type microphones now available to priority users through local radio jobbers.

UNIVERSAL MICROPHONE CO., LTD
INGLEWOOD, CALIFORNIA



FOREIGN DIVISION: 301 CLAY STREET, SAN FRANCISCO 11, CALIFORNIA • CANADIAN DIVISION: 560 KING STREET WEST, TORONTO 1, ONTARIO, CANADA

If You Belong at This
MONTHLY MEETING



Reserve a Place for Yourself!

Once a month, executives, engineers, designers and production men get an opportunity to meet with outstanding authorities in the plastics field! If you are one of this group—if your industry uses plastics now, or plans to use them in the future—PLASTICS gives you the chance to share the opinions of these experts on the course of the expanding industry, to read their informative articles on the "what" and "wherefor" of these new materials.

For PLASTICS anticipates the rapid developments in this growing industry . . . covers authoritatively and completely, the diversified interests of an ultra-modern field. Dedicated to the visual presentation of plastics and their numberless applications, PLASTICS brings to its selected readers the sight, feel and under-

standing of these materials in terms of their own products and facilities.

Leaders in industries which are now using plastics, or will use them in the future, need this magazine for the wealth of knowledge it will bring them.

Participate in these monthly "meetings"—each one offering an opportunity to grasp quickly essential facts that will help chart a course in this growing industry. Sold by subscription only, Plastics is limited to the group mentioned above.

Don't miss a single issue—subscribe today.

Subscribe Today

plastics



ZIFF-DAVIS PUBLISHING COMPANY

540 North Michigan Avenue, Chicago 11, Illinois

Offices: New York • Washington • Los Angeles • London • Toronto

Ziff-Davis Publishing Company
 540 N. Michigan Avenue, Chicago 11, Illinois

Please enter my subscription to Plastics for _____ 1 year, \$5.00;
 _____ 2 years, \$8.00.

Name _____

Address _____

City _____ Zone _____ State _____

Company Name _____

Title _____

NOTE: Subscription to Plastics is open only to business executives, engineers, designers, and production men; be sure to fill in company name and title above.

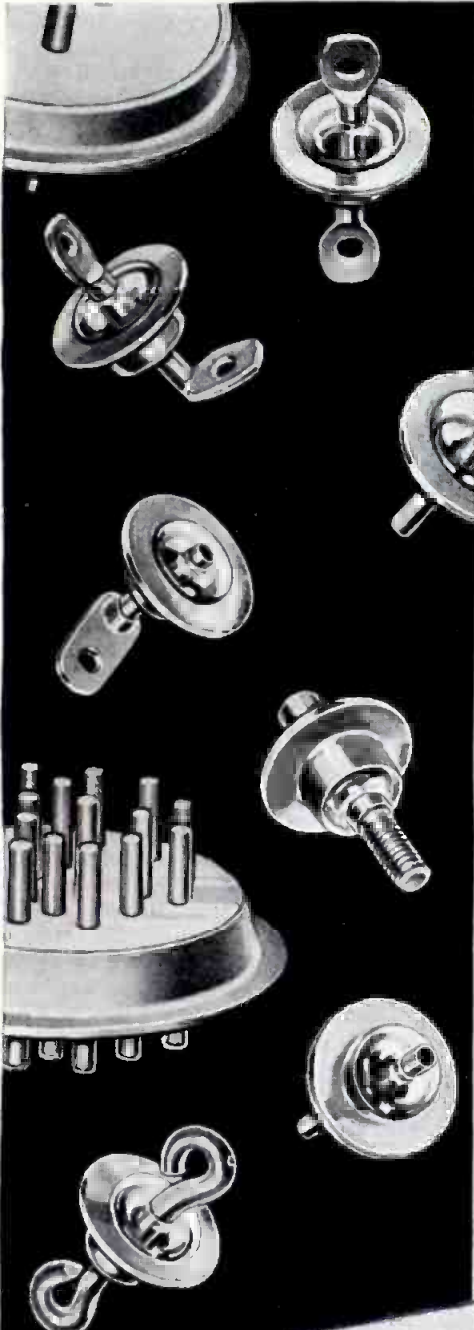

Sperti HERMETIC SEALS

NOW IN

Volume production

Arm your equipment to meet tough military conditions—anywhere—with these improved Hermetic Seals that seal out dust, humidity, moisture and fungus from transformers, relays, vibrators and other sensitive component parts.

FUSED INTO ONE PIECE. Vacuum tight hermetic bond. Resists corrosion. Has thermal operating range of -70°C to 200°C . Insulation leakage resistance, 30,000 megohms, minimum, after Navy immersion test.

SOLDERING TEMPERATURE NOT CRITICAL. Simple, easy to attach by means of high frequency, oven-soldering, or standard soldering iron.

WRITE, WIRE OR PHONE TODAY for information. Send us complete details on your problem so we can offer specific recommendations and furnish samples.

Sperti INCORPORATED

RESEARCH, DEVELOPMENT, MANUFACTURING · CINCINNATI, OHIO

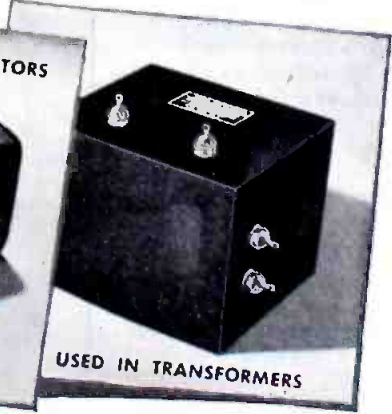
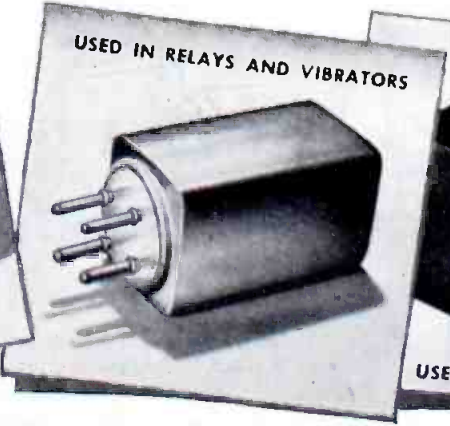
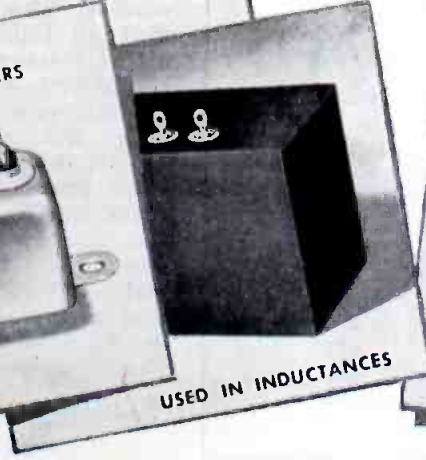
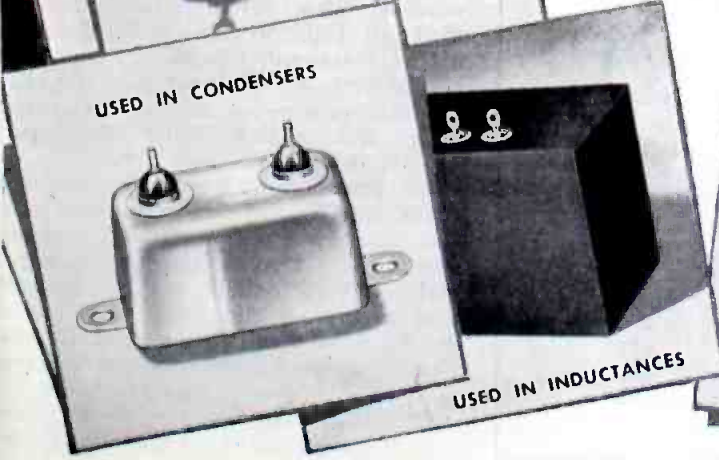
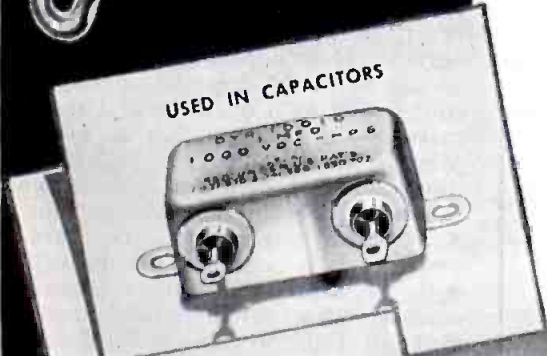

Adding the White Star to their "E" flag, the Ampere Electronic Products Inc. of Brooklyn, N. Y., has received the Army-Navy Award for proficient production for the second time within six months.

Personals . . .

H. I. Hoffman, president of Hoffman Radio Corporation, Los Angeles, was recently elected president of the West Coast Electronic Manufacturers Association. **Jack Kaufman** was named as vice president; **Herb Becker**, secretary; and **Howard Thomas**, treasurer . . . **Dr. George R. Town** is now manager of research and engineering of Stromberg-Carlson . . . **Raymond Bierman** has been appointed chief engineer of the Permo-flux Company, Chicago. He was formerly with NBC as studio field engineer . . . **Owen D. Young** has been re-elected chairman of the G. E. board, and **Gerard Swope** has been re-elected president . . . **Ricardo Muniz**, formerly chief engineer and plant manager of Radio Navigational Instrument Corporation, is now engineering director of Espey Manufacturing Company, New York . . . **Ralph P. Glover** is now in the consulting engineering business with offices at 1024 Superior Street, Oak Park, Illinois. He was formerly in charge of engineering sales coordination, and acting manager of the voltage regulator division of Webster Products, Chicago, Illinois . . . **Elmer R. Crane** has resigned from the WPB and joined Lear Avia Inc. as general manager of the radio division. He will be stationed in Grand Rapids, Michigan . . . **Chester A. Cole** will manage the 500 Fifth Avenue, New York City, offices of John Meek Industries, Plymouth, Indiana . . . **P. R. Mallory** has appointed **John M. Smith** as vice president in charge of manufacturing. He was formerly general manager of manufacturing for RCA Victor . . . **Leon L. Adelman** has gone into the representative business. Among the accounts he will represent are Solar Capacitor Sales in metropolitan New York . . . **M. F. Blakeslee** is now eastern regional manager for RCA Victor covering the areas of Maine to Virginia and New York to Cleveland . . . **Ludwig Aruson**, president of Radio Receptor Company, recently addressed the New Jersey and south New York sections of the International Municipal Signal Association on airport control . . . **Theodore W. Case**, pioneer sound and talking motion-picture inventor, died on May

13th. Mr. Case worked on the development of Movietone and sold his interests to Fox Films. He was also responsible for the development of the infrared signalling system that provided ships with the means of secret communications during the first World War . . . **Stuart Ballantine**, world famous radio scientist, died on May 7th after a short illness. Over a score of basic patents in radio and communications are credited to the late Mr. Ballantine . . . **R. D. Burnet**, secretary and comptroller of Zenith Radio, has been elected president of the Illinois Manufacturers Costs Association . . . **Fritz Behrendt**, president of Recoton Corporation and of Selectar Manufacturing Corporation, died recently.

-30-

Code Machine

(Continued from page 27)

a 7-watt filament type lamp quenches fast enough to record speeds up to 30 w.p.m. After considerable experimentation it was decided to use argon glow lamps. These lamps are extremely fast and will follow variations up to several thousand per second. Their high quenching speed results in a nice clean make and break on the recorded dots and dashes. Another advantage of using argon glow lamps is that they give off a blue light which falls in the same part of the light spectrum to which slow films are sensitive. It is a great advantage to be able to use slow film because the chances of fogging due to stray light are minimized, and because a bright red safe-light can be used when handling the film in the dark room.

The argon lamps are placed about two or three feet in front of the projector. Twelve lamps are permanently placed, one for each code track. A single argon lamp may be used for recording provided it is moved to the position

of the next track after each track is completed. Black masking tape covers each lamp except for a small hole through which light is emitted. The width of this hole is determined by the width desired in the code track on the film. The height of the hole should be about one-half its width. The lamps are keyed by instructors using ordinary telegraph keys. It is possible to record twelve speeds simultaneously, but it was found better to record only one or two speeds at a time because this allows better supervision of the sending. The film is recorded in 200-foot lengths which means that an instructor must send for only 21 minutes while recording one complete track.

In order to give an indication of when a track has been completely recorded the film is notched on one edge at the starting point. This notch allows a roller riding on the edge of the film to make an electrical contact which shuts the projector motor off after the 200 feet of film has traveled completely around the endless reel. The equipment is then ready for recording the next track (or tracks). The motor is started again by pressing a push-button which releases the relay previously thrown when the roller riding on the edge of the film made electrical contact through the notch in the film.

When recording, the 110-volt line is keyed directly. Because the argon lamps follow the variations of 60-cycle a.c. either d.c. or high-frequency a.c. should be used. We are using a 470-cycle, 110-volt generator as the source of power for the argon lamps. This 470-cycle generator had been the source of tone for the school. An advantage of using a high-frequency a.c. for keying the argon lamps is that it readily provides an audible tone so that the instructor, when recording, can monitor his own sending.

The best type of film to use, both for recording and making prints, is Safety Positive. This is a slow film, sensitive only to blue light. The usual procedure is to develop the original recorded film as a negative and then to make the desired number of positive prints from this master negative. The film is developed in the same manner that any other motion picture film is developed where extreme contrast is desired. It is possible to make prints with the same equipment used in recording. However, it is recommended that all film processing be done at a properly-equipped film laboratory where such work is routine. The cost of such processing is not extremely high and professionally developed film is desirable.

We are looking forward to the day when the Photronic code machine will be standard equipment in all radio schools, both government and commercial. It will then be possible for all film recording and processing to be done at one central location in the United States. A radio school desiring new film tapes will receive them by mail. This will make for standardization of code in all radio schools. How-





No use trying to step on it until the war is over

Are You Caught in War-Time Cobwebs?

by Don Herold

I know a lot of folks who are sitting this war out. Oh, they may be hustling some, but they are giving their real brains and will-power a three or four-year vacation.

No use, they figure, to hump their cerebral muscles until peace comes.

I wouldn't put any radio service men in this class, but, just the same, a popular national business magazine tells of a radio dealer in Brooklyn who hadn't changed his window display since Pearl Harbor. An irate prospect for a scarce

facturers are preparing new products and there's bound to be an upsurge in competition too. The way for established service men to get their share of the clover is



to keep informed on developments, keep a live, neat shop, and cultivate future customers.

Smart dealers always cash in on the real and prestige value of using and talking about famous radio parts, such as International Resistance Units.



radio tube insisted that the dealer take a tube out of one of three sets in his window. Dealer insisted there were no sets in the window, and nearly collapsed when he saw 'em.

Dealers who don't get ahead in their thinking now, are going to be behind when peace comes. Manu-

No. 6 in a series of special messages prepared by America's famous business writer, humorist and cartoonist, Don Herold. . . In sponsoring these Don Herold "broadcasts," IRC pays tribute to the thousands of Radio Service Men who, whenever possible, specify and use IRC resistance units in their work.



INTERNATIONAL RESISTANCE CO.

401 N. Broad St. • Philadelphia 8, Pa.

IRC makes more types of resistance units, in more shapes, for more applications than any other manufacturer in the world.



RADIO CHASSIS PUNCH



Saves hours of work cutting clean, accurate holes in radio chassis—for connectors and other receptacles. Simply insert cap screw in hole to be enlarged (drill small hole if necessary), turn with ordinary wrench to force punch through the metal. No reaming or filing—hole is smooth and clean. No distortion—die supports metal. Ten sizes from $\frac{3}{8}$ " to $2\frac{1}{4}$ "; also up to $3\frac{1}{2}$ " for meters. Write for free catalog 33E to Greenlee Tool Co., 1887 Columbia Ave., Rockford, Ill.



ILLINOIS CONDENSERS WORTH CONSIDERING!

DEPENDABILITY, long life and efficient performance are inherent qualities in every one of the paper and electrolytic capacitors which bears the "ILLINI" name. Countless satisfied users attest this fact. That's why we say Illinois Condensers are worth your consideration. Data and price listings on both War and Victory types available upon request.



ILLINOIS CONDENSER COMPANY

1160 NORTH HOWE STREET
CHICAGO 10, ILLINOIS

ever, should any school desire a film containing special code, they will need only to mail their request to the recording and processing station, where the desired film can be made and mailed back to the school in a week or two. All negatives will be saved and catalogued, and, in time, negatives will be on hand containing every conceivable type of code—perhaps even Japanese, if there are any Japs left.

—50—

Wartime V.T.V.M. Circuits

(Continued from page 49)

circuits in parallel, will reduce the input resistance of the electronic circuit inversely as the number of tubes.

Careful consideration of the characteristics of tubes which may be connected in parallel in v.t. voltmeter circuits will enable the experimenter to obtain any reasonable plate current shift for the convenient 1-volt signal voltage. He will in this way be allowed the advantage of high-transconductance tubes when the latter are not to be found in his stock.

No discussion of parallel-connected v.t.v.m. tubes would be complete without a word of caution that this connection increases the level of off-zero plate current flowing through the milliammeter. In order to protect the instrument against damage and almost certain burn-out, a limiting resistor must be included in the zero-adjusting bridge circuit. The resistor should be so chosen in ohmic value that the maximum amount of current flowing through the meter when the bridge circuit is unbalanced does not exceed 150 percent of the maximum full-scale deflection. And it is highly desirable that operation be confined even to closer limits.

The plate power supply must be capable of furnishing, with good regulation, the increased plate (and screen) current demanded by the parallel combination, and the low-voltage secondaries of the transformer must be capable of supplying the increased heater current.

Parallel connection is not necessarily restricted to a pair of tubes. The number may be increased almost without restriction up to the limit of space requirements, power supply capability, grid-cathode capacitance restrictions, and allowable grid current. As an example, Fig. 2B shows a circuit containing five 6C5 type tubes parallel-connected to give a 10-milliamperere plate current swing when 1 volt d.c. is applied to the grid circuit. The apparent transconductance of this combination accordingly is 10,000! A single 6C5 (G_m 2000) gives a 2-ma. shift for a 1-volt grid signal. The circuit normally employed with one tube is given with its constants in Fig. 2A.

In the circuit of Fig. 2A, off-zero plate current is 8 ma. at 250 volts. The required negative bias of 8 volts is developed across resistor R3. Re-

sistance of the 6C5 plate-cathode path (31,250 ohms) acts with the resistance arms R1-R2, R4 and R5 to form a four-arm bridge for setting the meter initially to zero. Recommended resistor values, in this case, are: R1-R2, 31,250; R3, 200; R4, 3025; and R5, 3025 ohms. The total resistance of the R1-R2 arm is divided between the fixed and variable portions—R1, 31,000 and R2, 500 ohms. At balance, R2 will be set at half-range, and the ratio of R1 to R2 is proper to restrict the off-zero plate current to a safe value when the variable resistor is in other positions.

When additional tubes are connected in parallel (as in Fig. 2B) in any v.t. voltmeter circuit, the increased plate current of the combination lowers the plate resistance value for which the bridge resistor values were calculated. The bridge resistor values for the parallel combinations will accordingly be lower than those figured for single-tube circuits. In the five-tube 6C5 circuit shown, R_p and the bridge resistors are reduced to one-fifth of the single-tube values. Constants for Fig. 2B are: R1, 6200; R2, 100; R3, 40; R4, 605; and R5, 605 ohms. It must be borne in mind, however, that the single-tube resistor values may be divided by the number of tubes only when identical tubes (or tubes with identical characteristics) are employed. Otherwise, it will be mandatory that the total plate current of the parallel-connected tubes be determined experimentally at the recommended plate voltage, and that the four-arm bridge be designed according to the E_p/I_p ratio obtained from this measurement.

In the single-tube circuit (Fig. 2A), the d.c. power supply is called upon to furnish only 8 ma. to the tube and 40 ma. to the bleeder circuit. With good safety factor, a 75-100-ma. unit would be entirely satisfactory. In the five-tube version, on the other hand, the tubes require a total plate current of 40 ma. and the bleeder 200 ma.

Allowable grid current is usually the factor, in the final analysis, limiting the practical number of parallel-connected tubes. As grid current flow increases, the high-input impedance, which renders the v.t. voltmeter so useful, is lost. A condition is soon reached where the voltmeter circuit presents no higher resistance to the voltage source than does a common voltmeter, and the advantage of the electronic circuit disappears. Expected grid current for any parallel combination may be determined by applying 1-volt d.c. to the grid of a single tube operated at recommended plate (and screen) voltages. The positive terminal of the 1-volt source is connected to the grid; negative to cathode, and a d.c. milliammeter is connected at any point between voltage source and grid input circuit. The value of grid milliamperes is then multiplied by the number of tubes to be used, to obtain the total grid current to be expected. In order for the v.t. voltmeter circuit to be advantageous, the grid current must not exceed a few microamperes. (Cur-

Again Available

TO MEET MOST PRODUCTION SCHEDULES!



At WESTON, production finally has outstripped the overwhelming war demand for panel and other instruments . . . making WESTONS again obtainable on a basis to meet most war production schedules.

To experienced instrument users, this means they again can obtain the instruments whose design and manufacture incorporate the broadest instrument experience in surmounting the requirements of exacting applications. The instruments whose consistent, uniform performance simplifies their problems of inspection, handling and other burdensome procedure . . . and whose dependable, long-term accuracy assures better operating performance from the devices into which they're built.

Why not discuss your instrument schedules with WESTON, today . . . and be sure of obtaining the added product efficiency which authentic WESTONS provide.

Weston Electrical Instrument Corporation
618 Frelinghuysen Avenue, Newark 5, New Jersey

- Panel & Switchboard Instruments (DC, AC, and Thermo)
- Precision DC and AC Portables
- Instrument Transformers
- Specialized Test equipment
- Laboratory Standards
- Sensitive Relays
- Light Measurement Instruments
- Aircraft Instruments
- Electric Tachometers
- Dial Thermometers

FOR OVER 55 YEARS LEADERS IN ELECTRICAL MEASURING INSTRUMENTS

Katolight A. C. Generators

Furnish Same Current as
City Power Lines

Kato Engineering products are carrying
out an important job in the War Effort.

A maneuvering fighting force cannot arrange for a power line hook-up. KATOLIGHT GENERATORS furnish electricity on the field of battle which permits equipping our fighting forces with the most modern electrical appliances.



"10 K.W. Revolving Field Generator"

Fighting forces need guns, planes, tanks, trucks, kitchens, emergency hospitals, lights, etc. To keep this equipment going, complete repair equipment such as drills, grinders, saws, air-compressors, etc., are needed. Standard A.C. electricity, the same as you get from the power line, must be had for operating these devices. Portable Katolight generators supply this electricity. They also supply current for radio transmitters, beacons, landing field controls, etc.

Available in all standard voltages and sizes up through 25,000 watts. Also manufactures of rotary converters, frequency changers, motor-generator sets, gas engine driven battery chargers, high frequency motor-generators and converters.

KATO ENGINEERING CO.

115 Rock St. Mankato, Minn., U. S. A.

OHMITE
OHM'S LAW CALCULATOR
Solves Any
Ohm's Law Problem with
One Setting of the Slide

Used everywhere today! Set the slide — read the answer. Figures ohms, watts, volts, amperes—quickly, easily. No slide rule knowledge necessary. All values are direct reading. Simplifies solution of electrical problems. Send only 10c in coin to cover handling and mailing. Available in quantities. **ONLY 10¢**

OHMITE MANUFACTURING CO.
4883-C Flournoy Street, Chicago 44, U.S.A.

Be Right with OHMITE
RHEOSTATS · RESISTORS · TAP SWITCHES

rent required by the conventional 1000-ohms-per-volt meter is 1 ma. for the common type employing a 0-1 d.c. milliammeter).

Voltage-Multiplying Probe

The conventional diode-type v.t.v.m. probe, which permits the conventional d.c. circuit to be employed for the measurement of alternating voltages, employs a half-wave rectifier circuit. The d.c. voltage it delivers to the grid circuit is equal approximately to the peak value of the signal voltage.

In some instances, more convenient operation might be obtained if the diode output voltage were higher. For example, smaller a.c. voltages might be measured with a v.t. voltmeter having normal ranges. Likewise, the less sensitive instruments built under wartime restrictions might be adapted for low-voltage tests.

A convenient way of obtaining increased probe output is the connection of a twin diode as a full-wave voltage doubler, as shown in Fig. 3. This type of probe requires no larger mounting head than the conventional half-wave model and delivers a d.c. output voltage equal approximately to twice the signal peak voltage.

In Fig. 3, V1 and V2 are the two halves of a small twin diode, such as type 6H6. C1 and C2 are mica capacitors, each having a total capacitance of .02 μ fd., and are each made up of two .01- μ fd. units connected in parallel. Load resistor R is 50 megohms.

Where higher voltages than those delivered by the doubler-type probe are required, the quadrupler arrangement, shown in Fig. 4, may be employed. In this circuit, V1 and V2 are the diode sections of one 6H6, while V3 and V4 comprise a second tube of the same type. C1, C2, C3, and C4 are each .02 μ fd. mica capacitors of the same type described for the doubler probe. Load resistor R is 50 megohms. Output voltage (d.c.) of the quadrupler probe is approximately four times the signal peak voltage—twice the level of that delivered by the doubler probe.

When the v.t. voltmeter is built into some other instrument, such as a signal generator, audio oscillator, or bridge, space requirements will generally be comparatively liberal and the space taken up by the input probe section will not be restricted. In such instances, the size of capacitors C1 to C4 may be increased to obtain more efficient doubler or quadrupler operation, by connecting more mica units in parallel. When low frequencies only (powerline and audio range) are to be encountered, it is entirely permissible to employ high-grade oil capacitors, .1 μ fd. and higher in capacitance, in the doubler and quadrupler probes.

Both doubler and quadrupler probes present a large amount of input capacitance to the unknown-voltage source. They also demand an appreciable amount of current from the voltage source. These input circuits accordingly are not recommended for use where light loading is important. All

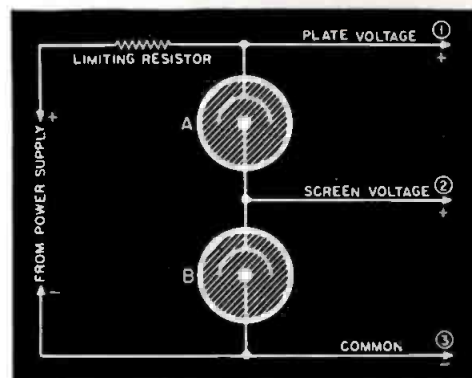

Fig. 5. Regulator tubes used to hold constant both the plate and screen voltages of v.t.v.m. circuits.

such voltage-multiplying probes are best suited to measurements in the audio-frequency spectrum and at low radio frequencies (20 to 500 kc.), and then only when input capacitance will not interfere with normal operation of the measured circuit, and when considerable power may be delivered by the latter.

Screen Voltage Supply

No discussion involving the possible application of screen-grid tubes in v.t. voltmeter circuits would be complete without a word of caution regarding d.c. screen voltage. The presence of the extra electrode brings into the picture further considerations which are to be recognized in the interest of instrument efficiency.

Response of the voltmeter circuit, as well as permanence of calibration of the instrument, will depend upon maintaining the screen constantly at its recommended d.c. voltage value. With some tubes, particularly the beam power type, output variations are more closely related to screen circuit than plate circuit changes. The screen voltage accordingly must be set carefully at the proper value for the tube, with respect to other electrode values, and the d.c. power supply must be capable of maintaining this potential.

In most cases, it will be sufficient to obtain the screen voltage from a tap along a voltage divider. Usually, the series screen resistor will not be satisfactory in v.t. voltmeter circuits. The voltage-divider resistor must be of ample size, being capable of dissipating several times the amount of power which normally will flow through it, and its screen-voltage tap must be set with the tube in operation, the voltage value being measured with a high-resistance d.c. voltmeter (1,000 ohms per volt or better). In most cases, it will be desirable to by-pass the screen electrode at the socket with a capacitance of at least .1 μ fd.

When it is desired to obtain regulated screen voltage for the v.t.v.m. circuit, gaseous regulator tubes of the VR type may be employed to regulate both screen and plate voltages, as indicated by Fig. 5. Two or more of these tubes are connected in series with each other, and the combination is connected in parallel with the d.c. output



●●● PLANNED QUALITY

Every order for Runzel material... whether it is to fill some special need or is part of our regular production... has back of it more than one "shirt-sleeve conference," dedicated to the maintenance of highest quality standards.

- Runzel cords, wires and cables for the telephone industry—for radio and electronics, and for many other uses, not only have the quality that comes from employing the best raw materials, but also the quality which comes from coordinated planning and carefully watching every manufacturing step.
- Runzel executives, engineers and factory personnel, working as a unit, have made "planned quality" a vital factor in building more serviceable products.

Runzel
CORDS · WIRES · CABLES

RUNZEL CORD & WIRE CO.
4723-31 MONTROSE AVENUE • CHICAGO

**WHAT DOES THE
"BL BUTTON"
MEAN?**

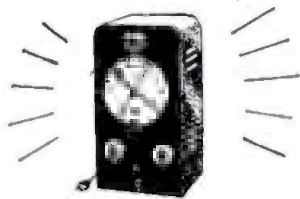

In the case of the Frequency Meter shown above, the "BL button" (shown below) means that by using it, transmitters can be kept "right on the button." On any piece of equipment it means sound design, rugged construction, fair price. Watch for the "BL button" after the war.



BROWNING

LABORATORIES, INC. WINCHESTER, MASS.

of the power supply. Terminals 1 and 3 will then supply regulated plate voltage, while 2 and 3 will supply regulated screen voltage. When more than two tubes are employed, several screen and plate voltages are made available by appropriate taps.

The voltage available across the combination will be the total of the voltage drops across the tubes. For instance: if A is a VR105 and B is the same type, the output voltage (delivered to the plate) will be 210 volts. Likewise, the voltage available between the common terminal (3) and a tap will be the voltage drop across all tubes between those terminals. In the above example, the voltage at the tap (delivered to the screen) will be 105 volts. If tube B were a VR90, the screen voltage accordingly would be 90 volts, while the plate voltage (total of the drops) would be 195.

-30-

International Short-Wave
(Continued from page 50)

9 p.m. (EWT). (Note: Berne is heard well in the Eastern United States.)

Brazzaville and Leopoldville (Africans) are tops in signal strength, and are the most consistent stations heard on the West Coast, Balbi reports.

"The Tokyo boys pound in day and night," he comments, "some in the Home Service; others to the United States, Australia, India, Europe, and South America."

Melbourne is excellent between 8:00 and 8:50 a.m. (EWT) on VLG2 (9.54) to East Coast; same again at 11 to 11:45 a.m. (EWT) on VLG6 (15.23), and is very strong and clear to West Coast.

London's GWO (9.62) and GSW (7.23), 12:15-12:45 a.m. (EWT) to India are strong on West Coast, where many of their European beamed programs on the 9- and 7-megacycle bands may be heard after 1:00 a.m. (EWT). Evenings, the General Forces Programs from London are very good for West Coast listeners.

USSR on 15.37 is local after 12 mid-

night at times in California. Leningrad (11.63) is also heard like a local after 1:00 a.m. Best is 12.27 megacycles from 11 p.m. to 2 a.m., or later, with music and native language, in parallel with 9.565 megacycles at times (EWT).

Other information of interest to Pacific Coast listeners, as well as listeners the country over, is furnished by Mr. Balbi, as follows:

* * *

EASTERN WAR TIME

Djarkata, Java (18.135), heard irregularly, 1:00 a.m. to 2:00 a.m., beamed to Australia. News, 1:00 a.m.

MTCY, Hsingking, Manchukuo (15.33), broadcasts 1:00 a.m. to 3:00 a.m. to the United States; 4:00 a.m. to 5:00 a.m. to Europe, replacing the 11.775 megacycles frequency. News, 1:30 a.m., 2:30 a.m. Prisoner-of-war messages, 1:00 a.m.

PIRM, Manila, Philippines (15.32), broadcasts 12:00 midnight to 1:00 a.m. to the United States. News, 12:30 a.m. Prisoner-of-war messages, 12:15 a.m.

Khabarovsk, USSR (13.13), broadcasts in native language from 1:00 a.m. to 2:40 a.m. (strong signal).

Brazzaville is heard on 11.97 between 1:00 a.m. and 2:30 a.m.

XMHA, Shanghai (11.86) is heard between 1:00 a.m. and 2:00 a.m. Weak. Full schedule is unknown.

DJD (11.77) is heard 1:00 a.m. to 3:00 a.m. transmitting to Asia. Weak signal.

JRAK, Tokyo (11.74) is heard irregularly, 12:00 midnight to 1:00 a.m., Home Service, same as JLG3 on 11.705 megacycles.

XGRS, Shanghai (11.695) is scheduled 1:00 a.m. to 12 noon. News, 1:15, 10:15 a.m. Strong during the early mornings.

GRG, London (11.68) heard well between 1:30 a.m. and 3:00 a.m. with the General Forces Program.

XGAP, Peiping (10.27) has moved from 6.105 megacycles. Signs off at 11:40 a.m.

RNB, Leopoldville (9.785) is heard on the West Coast at 11:00 a.m.; also, 12:00 midnight to 1:30 a.m.

(Continued on page 122)

MEN *whether you are* **16 or 50**
HERE'S THE QUICK WAY TO AN ESSENTIAL JOB-A GOOD FUTURE



Learn **ELECTRICITY**
IN 12 WEEKS

ON REAL MOTORS, GENERATORS, ETC.

All Finance Your Training

Trained Electrical men needed now. It's not how young you are, or how old you are. The question is—have you the training for a real peace-time future in a field that is vital now? Not all "essential" jobs offer such opportunities. **ELECTRICITY** does—when you're prepared!

Here at Coyne you can train in 12 weeks—in a practical way on real actual electrical machinery and apparatus. You "Learn by Doing". And you don't need much money. I'll finance your tuition and you can pay it in easy monthly payments after your training period is over. Then if you are short of living expenses we'll get you a part time job to "earn while you learn". After graduation we give you lifetime employment service.

Right now I'm including extra training in **INDUSTRIAL ELECTRONICS** at no extra cost.

Mail coupon for my big free book. Get the training you need for a good electrical job. **WRITE NOW.**

Also have facilities for men with physical disabilities. Write.

H. C. Lewis, President
Coyne Electrical School, Dept. R4-81,
500 S. Paulina St., Chicago 12, Ill.
Send Free Book with Facts on Coyne. "Pay After Graduation" Plan and extra Industrial Electronics training now included.

NAME.....
ADDRESS.....
CITY..... STATE.....

RADIO TOKYO TRANSMISSION

BROADCAST SCHEDULE OF RADIO TOKYO BEAMED TO THIS HEMISPHERE. COMPILED THROUGH THE COURTESY OF D. BUCHAN OF THE BBC, NEW YORK OFFICE.

| MEGACYCLES | CALL | TIME (EWT) | BEAMED TO: |
|------------|---------------|---|---|
| 9.535 | JZI | 9:00 a.m.—10:45 a.m. 11:00 a.m.— 2:40 p.m. | E. North America and Brazil W. North America |
| 9.565 | JRAK (Paulau) | 7:00 p.m.— 8:00 p.m. | E. North America and Brazil |
| 11.725 | JVW3 | 7:15 a.m.— 8:15 a.m. 9:00 a.m.—10:45 a.m. 11:00 a.m.— 2:40 p.m. | Latin America E. North America and Brazil W. North America |
| 11.80 | JZJ | 6:15 p.m.— 8:15 p.m. 8:30 p.m.— 9:30 p.m. | E. North America and Brazil Latin America |
| 11.897 | JVU3 | 11:00 p.m.— 4:00 a.m. 6:15 p.m.— 8:15 p.m. | W. North America and Latin America E. North America and Brazil |
| 15.160 | JZK | 11:00 p.m.— 4:00 a.m. 11:00 p.m.— 4:00 a.m. | W. North America and Latin America Latin America |
| 15.225 | JLT3 | 6:15 p.m.— 8:15 p.m. 11:00 p.m.— 4:00 a.m. | E. North America W. North America and Latin America Latin America |
| 15.325 | JLP2 | 7:15 a.m.— 8:15 a.m. 8:30 p.m.— 9:30 p.m. 11:00 p.m.— 4:00 a.m. 8:30 p.m.— 9:30 p.m. | Latin America W. North America and Latin America Latin America |

Newscasts from Radio Tokyo are read on the hour, and are followed during all news-periods (mornings and evenings) by messages from American prisoners of war.

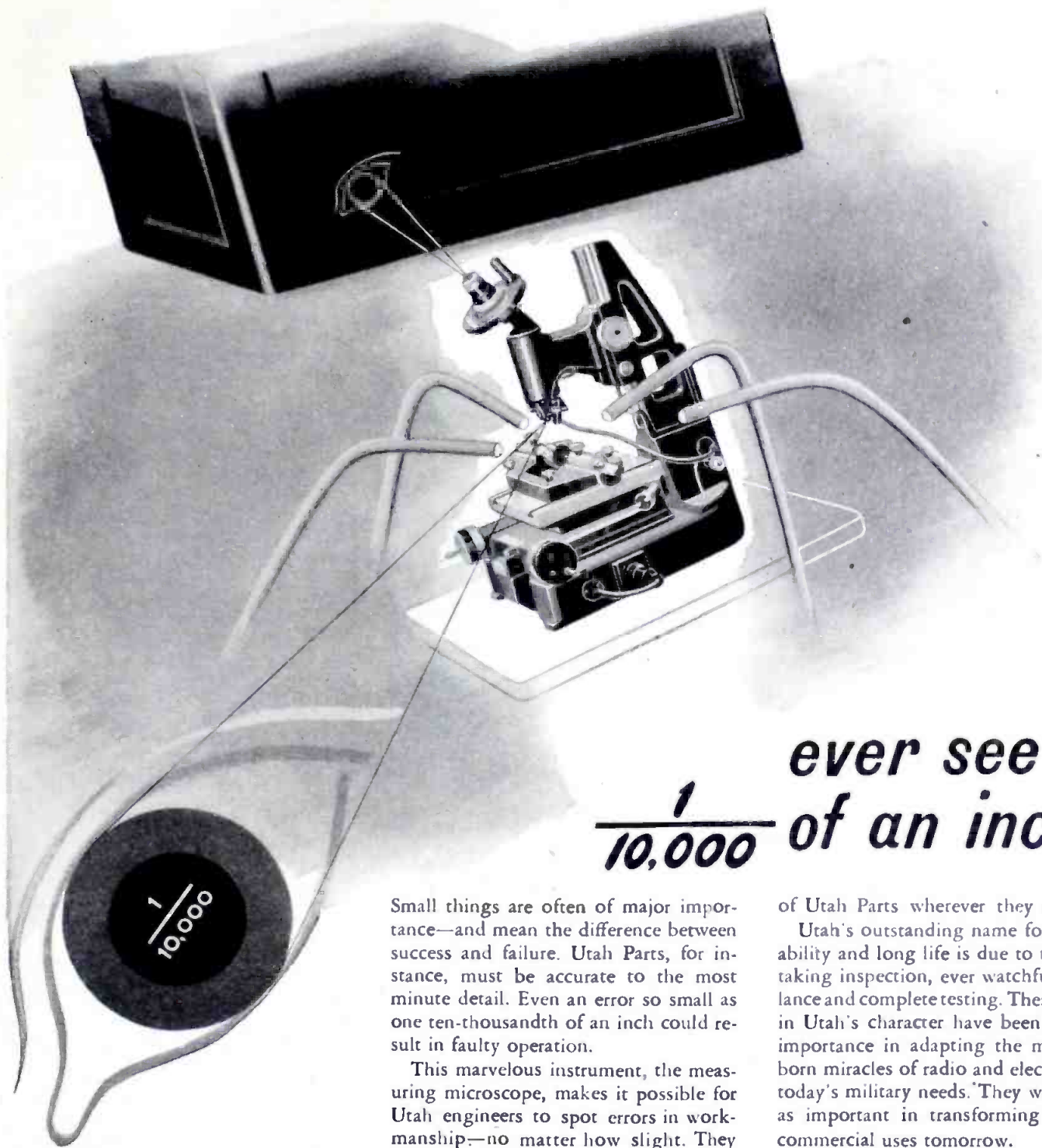

ever see
 $\frac{1}{10,000}$ *of an inch?*

Small things are often of major importance—and mean the difference between success and failure. Utah Parts, for instance, must be accurate to the most minute detail. Even an error so small as one ten-thousandth of an inch could result in faulty operation.

This marvelous instrument, the measuring microscope, makes it possible for Utah engineers to spot errors in workmanship—no matter how slight. They are able to make infallible measurements to the ten-thousandths of an inch —just one reason for the split-hair accuracy

of Utah Parts wherever they are used.

Utah's outstanding name for dependability and long life is due to the painstaking inspection, ever watchful surveillance and complete testing. These "traits" in Utah's character have been of prime importance in adapting the many war-born miracles of radio and electronics to today's military needs. They will be just as important in transforming them to commercial uses tomorrow.

★ ★ ★

Every Product Made for the Trade, by Utah, Is Thoroughly Tested and Approved

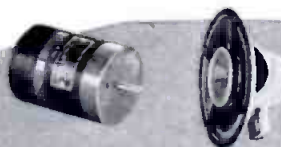

Keyed to "tomorrow's" demands: Utah transformers, speakers, vibrators, vitreous enamel resistors, wirewound controls, plugs, jacks, switches and small electric motors.



Utah Radio Products Company, 824 Orleans Street, Chicago 10, Ill.



Television's Postwar Possibilities

By P. GLANZER

Many new applications of television to postwar industry and homes are now apparent in view of new developments.



General Electric's television station presents tips to hunters in the Schenectady, N. Y., area.

NEW television developments of startling application to postwar industry and homes were disclosed in Detroit recently by Ralph R. Beal, assistant to the vice-president in charge of RCA laboratories, in a speech to the Engineering Society of Detroit.

Predicting the use of a newly-perfected television "eye" for factory control, this electronics authority explained how an astonishing device makes possible the extension of human sight over almost any distance. Simply by pressing a button, an observer is enabled to look instantly into any place where the "eye" is located.

See with Safety

An entirely new prospect of factory control thus is opened. Executives and engineers will have the power to bring before them on a viewing screen, the living details of activities within a plant which may be miles away from their offices. Similarly, a mother could keep constant watch over her children while she worked or entertained in a remote part of the house.

Of keenest interest to engineers and safety officials was Mr. Beal's description of how the new "eye" can be used "to make a close-up inspection of places where it is impossible or extremely dangerous for a human being to venture." This "looking from a safe distance" will be invaluable for examining mine shafts, tunnels, holds of ships, furnaces, manholes, inaccessible machinery and countless other hazardous places. Emergency vehicles equipped with the "eye" will be rushed to the scene of certain kinds of disasters to "study" the situation before rescuers or repair crews risk their lives.

The new device has far greater possibilities than the familiar photoelectric "eye," which merely registers light or shadow. The television viewer actually provides a vividly clear picture, identical to what the human eye would see if it were in the place where the viewer is mounted. While the engineer sits comfortably at his desk, an automatically travelling television device could tirelessly "walk up and down" a production line for him.

A ship's captain could bring his vessel up to its pier or through crowded shipping lanes with safety never before possible. Multiple television "look-outs" will keep watch on all sides at once. From central stations, police will be able to observe traffic at any point throughout the largest city. The new device has extraordinary possibilities for the safety control and dispatching of trains.

Widespread application of this latest triumph of electronics will follow immediately upon the release of war-essential materials and manpower. It is the culmination of 20 years of RCA television research, costing more than \$10,000,000.

Astonishing facts about application of the new practical television developments in the theater and home were



The Facts about MOLDED PAPER CAPACITORS

MOLDED PAPER VERSUS MICA CAPACITORS

—wartime equipment has definitely proven the ability of Micamold Molded Paper Capacitors to function satisfactorily in by-pass, coupling and filter applications above .001 mfd. As strategic mica is scarce, Micamold Molded Paper Capacitors not only fill the breach but materially assist in maintaining the flow of equipment to the Armed Services.

MOLDED VERSUS METAL HOUSED PAPER CAPACITORS

—here again Micamold Molded Paper Capacitors serve as adequate alternates for capacities of .25 mfd. or less. As compared to metal encased paper capacitor the plastic molded types save space, weight and cost.

IN BOTH CASES

—considerable economies in time, labor and materials have resulted. Manufacturers who utilize Micamold Molded Paper Capacitors instead of mica and metal housed paper types can effect substantial savings in their own production.

Manufacturing facilities have been further increased . . . prompt deliveries of large production quantities.

IF YOU HAVE A CONDENSER DESIGN PROBLEM, CALL ON MICAMOLD . . .

we design and build molded paper and mica, oil and electrolytic capacitors for all radionic and electrical applications. We will be glad to cooperate with you on any project . . . for war or postwar assignments.

NO LET-UP AND
NO LET-DOWN . . .
KEEP BUYING MORE
WAR BONDS

MICAMOLD RADIO CORPORATION
1087 FLUSHING AVENUE
BROOKLYN 6, N. Y.

AT 100 MC DILECTENE

A C-D Engineered
U-H-F Insulation

POWER FACTOR
0.0033

◆
**STABLE
UNDER**

DIELECTRIC
CONSTANT
3.57

◆
High Humidity

◆
Temperature
Extremes

READILY
MACHINED

◆
Mechanical
Stress

◆
Chemical
Conditions

For complete technical
data, send for Bulletin DN

**CONTINENTAL-DIAMOND
FIBRE COMPANY**
NEWARK 49, DELAWARE

NEED PARTS?

National can supply you quickly with most of those hard-to-get parts at exceptional prices. Take a look at these bargains—

STANCOR MIDGET OUTPUT TRANSFORMERS, 1.6 to 3-6 Ohms, Mounting strap center 1 1/2".....Each, 55c; 10 for \$4.95

10 WATT PIGTAIL WIREWOUND RESISTORS—500, 1000, 1250, 1500, 1750, 2000, 2500, 3000, 4000, and 5000 ohm sizes in stock. Each, 24c; 10 for \$2.19

AERIAL KIT containing aerial wire, rubber coated lead-in, insulators, ground clamp, window strip, etc.Each, 89c

24 MFD 150WV Tubular Electrolytics. One Year Guarantee.....Each, 36c; 10 for \$3.35

12 MFD 450WV Tubular Electrolytics. One Year Guarantee.....Each, 43c; 10 for \$4.21

CLAROSTAT 1 MEG. (#6 Curve) VOLUME CONTROL WITH SWITCH. Shaft 3/4" x 1". Each, 44c; 10 for \$3.90

100 Ohm (Tapped at 30) WIRE WOUND CEMENT COATED RESISTORS 30 Watt. Each, 45c; 10 for \$3.90

8" PAPER RECORDING DISCS. Good one side only.....Each, 5c; 100 for \$3.99

ASSORTMENT OF 137 FIRST LINE 600WV TUBULAR BY-PASS CONDENSERS CONSISTING OF 61 .01-600WV, 52 .02-600WV, 24 .05-600WV, 27 .1-600WV. One Year Guarantee. List Price, \$33.30. Your cost only. **\$11.95**

20% Deposit required on all C.O.D. orders. Don't forget L-205 or AA-3 Certification. Orders of \$25.00 or more, accompanied by payment in full, will be shipped prepaid.

Free Bulletin No. 104 lists hundreds of other radio parts and supplies. Write for it today!

**NATIONAL
ELECTRONIC SUPPLY**

77 W. Washington Blvd. Chicago 2, Ill.

also given recently in RCA Rockefeller Center offices. Credit for discoveries on which the equipment is based goes chiefly to physicist V. Zworykin, of electron microscope fame. He has invented a new electronic "eye" which looks at a scene and transforms it into a flow of high-frequency impulses. The currents pass to an electronic "brain." From there they may be transmitted by new type cables or radio waves.

At the receiving end another Zworykin invention called the kinescope projector reproduces the scene with amazing fidelity. Unlike the small, crude, cathode-ray type of viewing screen, the new Zworykin device gives vividly clear pictures 18 by 24 inches.

This size is for home use. But a similar apparatus permits enormous magnification. Already demonstrated is a huge television viewer, 15 by 20 feet, the size of a regular movie theater screen. On this viewer the clarity of the scene is excellent. Sound track problems have been solved to the point where television music has high fidelity.

Secret of this revolutionary new theater equipment is Dr. Zworykin's high-frequency reflecting optical system. This is built around a lens made of plastic and giving four times greater brightness of light on the screen than is possible with the finest glass lens. The plastic lenses are made by a simple moulding process. Immediately following the war's end these lenses will be mass produced. The cost will be one-tenth that of a glass optical system.

Serve 25-Million

Plans just completed call for an eastern television broadcasting network to serve 25,000,000 people in the New York-Boston area. Already every police station in New York City is fitted with television receivers. Two-hundred thousand air-raid wardens were trained in their duties with this equipment.

Another new development of interest is an automatic relay station which will make possible long distance television service. It should be practical even for sparsely settled areas. These stations enormously extend television broadcasting range. They require no operators and need little more attention than airway radio beam towers.

When asked if motion picture exhibitors were justified in fearing that home television may doom the neighborhood theater, it was indicated that television to theaters would probably supplement regular movie programs. This would be done by showing "live" prize fights, travel shorts and outstanding news events on the screen as they actually occurred.

But having just seen both a live television show and a television movie—first in New York experimental studios and then in a comfortable viewing room, the writer is convinced that Lee de Forest's prediction of five years ago holds true. It seems obvious that millions will prefer to see movies by television in their own homes, rather than in theaters.

On the other hand, television will give a tremendous boost to movie production. Television movies can be viewed from an armchair in the company of friends, and be enjoyed more fully. But the live studio production was an attempt to combine radio and vaudeville shows, and the result was very unsatisfactory. Even allowing for the present crude technique, the show has a "corny" effect. This, despite the fact that numbers included the famous New York impersonator, Cam Andrews, the distinguished illustrator Tom Webb, stars of the circus world and very capable musicians.

Like radio, a live television program must go on the air without a hitch. The production difficulties are enormous. With batteries of blazing light, terrific heat, and all characters wearing special make-up, the studio is like a Hollywood movie set in miniature, except that there is no possibility of cutting a broadcasting show dead to have a retake. The best Hollywood producers and artists require very frequent halts and repetitions of scenes. How television dramas can overcome this difficulty is hard to see. They must go right on past breaks, and the effect is much more painful than the worst amateur radio show.

Also clearly evident is the fact that television shows lose all the subtle effects developed by the heard-but-not seen radio production technique. Nothing is left to one's imagination. For that reason alone it cannot be seen how television will replace radio drama and comedy as we know them now. For a long time to come the important television show will be the broadcast movie for home viewing. This combines marvelously the advantages of both movie and radio entertainment.

This is just one observer's opinion, however. But the experts were inclined to deliver the same verdict.

—30—

International Short-wave

(Continued from page 118)

GRX, London (9.69) is heard between 3:30 a.m. and 4:30 a.m., beamed to Japan.

VLW6, Perth, Australia (9.68), heard 7:00 a.m. to 11:30 a.m. QRM'd by JYW2, was on 9.615 for a few days recently.

JZI, Tokyo (9.535) is heard between 12:00 midnight and 2:30 a.m., Home Service Program; 4:15 a.m. to 7:30 a.m., beamed to Europe.

VLQ3, Brisbane, Australia (9.66), is heard 12 midnight to 3:15 a.m. BBC news is relayed at 2:00 a.m.

XGOI, Shanghai (7.48) is heard 7:15 a.m. to 10:00 a.m. Also on 9.66 megacycles. Native programs usually.

VLQ2, Brisbane, Australia (7.215), is heard 3:30 a.m. to 6:30 a.m.

XGOY, Chungking (7.17) has an English newscast at 10:00 a.m.

CBRX, Vancouver, British Columbia, gives a newscast at 1:00 a.m. and at 1:15 a.m.

Here
FM
will
also
mean
Finest
Made

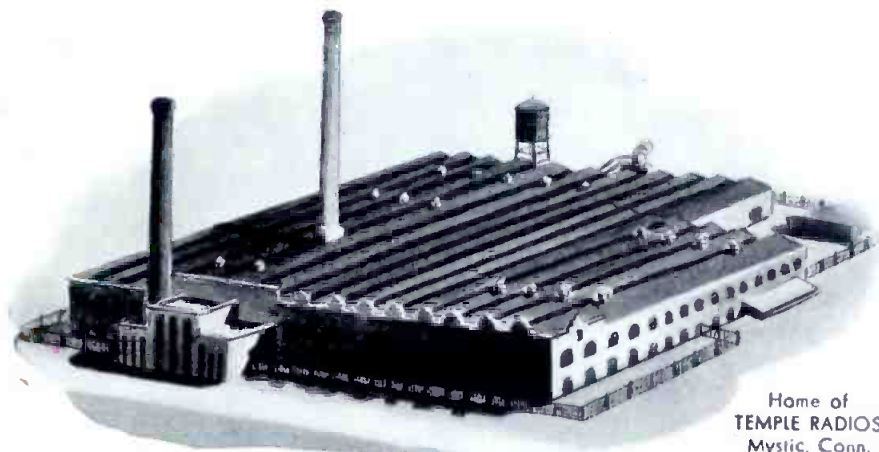

Home of
TEMPLE RADIOS
Mystic, Conn.

—and here's what it will mean to YOU

- It will mean that in Temple FM receiving sets you will offer your customers radios embodying every proven FM engineering advance.
- It will mean quality materials and quality craftsmanship to insure lasting worth—and lasting customer-satisfaction.
- It will mean visible beauty as well as superlative performance—obvious, super-excellence to invite ready purchase.
- It will mean outstanding Value that commands both Profit and Volume.
- It will mean, Mr. Dealer, that "it pays to team up with Temple".

**TEMPLE TONE RADIO COMPANY
MYSTIC, CONN.**

FM...TELEVISION...RADIO-PHONO COMBINATIONS



licensed under
Armstrong & RCA Patents

Back the Attack with War Bonds—Buy more than before

VACO DISPLAY BOARDS

... such as that shown below ... normally seen on counters everywhere (and soon to be again) help account for the great popularity of Vaco drivers and small tools with workers in industry, and in the home.



If you are an executive of a plant, and require special drivers or small tools to speed production, or as equipment accessories... let our creative department make suggestions, without obligation.

VACO PRODUCTS CO.
319 E. Ontario Street, Chicago 11, Ill.
Canadian Branch Whse.—560 King St. W., Toronto

UNDER 4 FLAGS

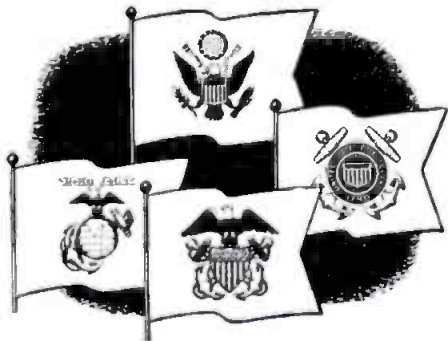

RIDER BOOKS

are training Radio men

In addition to use as texts in all the armed services, Rider Radio Books are also found in leading libraries and famous technical schools; to mention a few: Georgia Tech., Univ. of Pennsylvania, Northwestern Univ., Virginia Polytech., Manhattan College, M I T, Univ. of Delaware, Carnegie, Duke, Harvard, Syracuse and Univ. of Alabama.

Send Today for New Catalog

JOHN F. RIDER, Publisher, Inc.

404 FOURTH AVENUE • NEW YORK CITY
EXPORT DIV.: ROCKE-INTERNATIONAL ELEC. CORP.
100 VARICK STREET, NEW YORK CITY. CABLE: ARLAB

VDP2, Suava, Fiji Island (6.135), is heard between 1:15 a.m. and 6:00 a.m. (Saturday only), with newscasts in English at 2:00 a.m. and 4:00 a.m.

SHONAN (SINGAPORE) TRANSMISSIONS

The Japanese-controlled short-wave transmitter at Shonan (formerly Singapore) is heard from 6:00 a.m. to 2:10 p.m. (EWT) daily on 9.555 megacycles, with newscasts in English at 6:00, 6:45, 10:00 in the morning, and at 1:15 in the afternoon.

This Malayan station also radiates a program between 7:00 a.m. and 10:00 a.m. (EWT) on 7.22 megacycles, with a newscast in English at 9:00 a.m. (EWT).

ABSIE IS NEW AMERICAN FORCES STATION IN BRITAIN

According to the BBC, over its Radio Newsreel program of Saturday, May 20, ABSIE is the new American service forces station set up in Britain. Beginning on that date, instructions to the peoples of the occupied countries of "Hitler's Europe" are being given daily over ABSIE and the powerful transmitters of the BBC in the latter's French, Flemish, Belgian, Dutch, Danish, and Norwegian Services.

MESSAGES FROM GERMAN-HELD PRISONERS

Following the 10 p.m. (EWT) news

broadcast from Berlin over DXL25 (7.28), DXJ (7.24) and DXP (6.03), messages from American prisoners of war interned in Germany are read by a woman announcer every evening except Sunday.

Over these same stations on the 11:00 p.m. (EWT) newscast, news of American pilots wounded in action is generally relayed by the Berlin radio service.

Berlin newscasts are heard on the hour, 6:00 p.m. through 12 o'clock midnight (EWT) over the stations listed above.

THANKS!

We wish to extend thanks to the following for reports received recently:

August Balbi, Los Angeles; D. Buchan and T. Lawrence, of the BBC; E. Harriet Donlevy, of the World Wide Broadcasting Foundation (WRUL), Boston; the Canadian Broadcasting Corporation; W. H. Hauser, of WBOS; Gertrude H. Bevan, of the International Broadcasting Division, the General Electric Company; the Coordinator of Inter-American Affairs, Washington 25, D. C.; the United Network, San Francisco; Blanche Spence of WLWO-WLWK; Charles A. Mangano, of the NBC International Division; and Charlie Gonder, of Pittsburgh.

Reports of reception, frequencies, schedules, and other pertinent data from readers will be welcomed.

-30-

AM Measurements

(Continued from page 68)

below the modulated signal level.

Cathode-Ray Oscilloscope

The oscilloscope may be used for the measurement of modulation percentage in the manner indicated in Figs. 7 and 9. The first connection yields wave-envelope patterns; the second trapezoidal patterns.

In Fig. 7, a small amount of modulated signal voltage is derived from the transmitter and applied to the vertical input terminals of the oscilloscope. The internal sweep oscillator is set at the modulation frequency or some satis-

factory multiple thereof. Percent modulation is then determined by means of vertical measurements of length along the wave patterns to obtain values of C and M (as indicated in Fig. 7) for use in Equations (1) and (2).

In the second system (Fig. 9), a small modulated signal is delivered to the vertical plates, and a portion of the modulating voltage, selected by potentiometer R is applied to the horizontal plates. In the trapezoidal patterns, the unmodulated carrier amplitude is C, and the modulated carrier amplitude, h_m . It will be observed from examination of the trapezoid corresponding to 100 percent modulation that a 2 to 1 ratio exists between modulated and unmodulated carrier amplitudes.

-30-

Fig. 9. Using inputs to both the horizontal and vertical plates of the oscilloscope to obtain trapezoidal patterns for measuring modulation percentage.

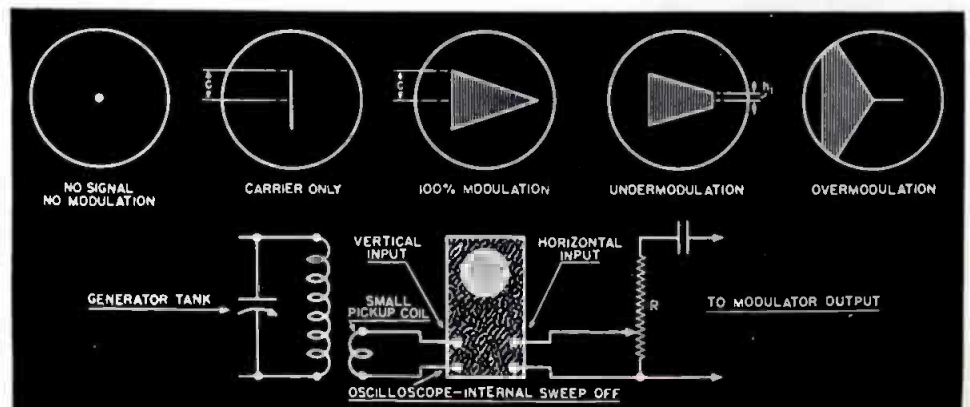



OUR SIGHT *is on your Future*

Today, behind closed doors, I. C. E. strives for perfection in the rush schedules of war... tomorrow, when the fruits of our labors have helped to win the peace, you can look to the precision engineering skill of I. C. E. to help mold your drafting-board dreams into reality. ☆ Perfected in the merciless crucible of war ...I.C.E. will have the key to many of your post-war radio-application problems.

Electronics

... the promise of great things to come



INDUSTRIAL & COMMERCIAL ELECTRONICS
BELMONT, CALIFORNIA

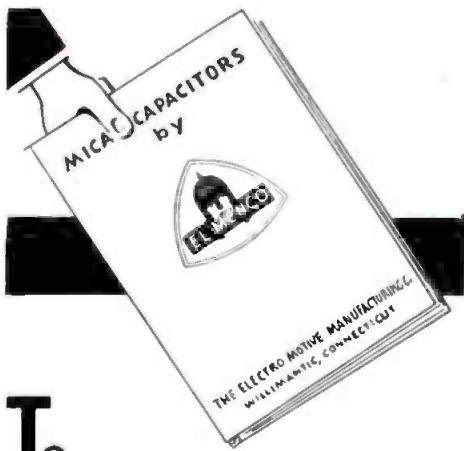

To MANUFACTURERS OF ELECTRONIC EQUIPMENT

Serving unobtrusively, but with complete efficiency at countless vital spots in war communications equipment, *El Menco Molded Mica Capacitors* are earning the reputation which will make them tomorrow's choice among manufacturers of quality electronic equipment.

These manufacturers are invited to send for new catalog—using firm letterhead.

The Electro-Motive Mfg. Co.
Willimantic, Connecticut

El-Menco



MOLDED MICA CAPACITORS

Electronics RADIO ENGINEERING

NEW COURSES FOR MODERN NEEDS

RADIONICS, the science of electronic applications, is widening its horizon hour by hour. There's a secure future in this field for YOU—provided you put **OUR TRAINING ON YOUR** must list NOW.

Needed at once are specialists in Marine Radio, Police Radio, Aviation Radio, Broadcasting, Television, Frequency Modulation, High Frequency Broadcasting, and Commercial Radio Telegraph. That need will continue.

Our school is co-educational. It offers to women as well as men streamlined elementary and advanced courses for Radio Servicemen, Radio Engineering Assistants, Radio Test and Maintenance men. The work is thorough, practical, void of frills. The courses are approved by State Vocational Departments, Major Airlines, State Police Systems, Radio manufacturers, and hundreds of Broadcasting Stations.

Credit is given for Army radio courses and experience toward any of our courses. High school graduation or its equivalent necessary for advanced courses. Tuition at pre-war levels. Send for catalog today.

MAIL THIS COUPON NOW!

VALPARAISO TECHNICAL INSTITUTE,
Dept. R., VALPARAISO, Ind.

NAME.....

P. O. ADDRESS..... AGE.....

CITY and STATE.....

CATALOG REQUEST—RADIO NEWS

Radiometric Elements

(Continued from page 34)

control of the manufacture of petroleum products and synthetic rubbers, since the composition of these hydrocarbons is readily determined from their infrared absorption spectra. Thermopiles are being used also, as they have been for years, in the measurement of furnace temperatures.

The problem in thermopile construction is to secure a low resistance (in order to match the resistance of the galvanometer necessarily used), a low heat capacity and heat conductivity, and a high thermoelectric power. In general, the heat capacity can be minimized through use of very fine wire, .06 to .08 mm. in diameter. Fine wire, too, as a rule will reduce the heat conductivity. A low heat capacity is necessary to enable the thermopile to respond to relatively quick changes in energy. Thermoelectric power is dependent upon the materials chosen for the construction of the junction. Antimony-bismuth and copper-constantin junctions are widely used. The sensitivity of a thermopile varies as the square root of the area of the receiving surface—a condition which imposes a low limit upon the number of junctions that can be used practically.

Radiomicrometer

The radiomicrometer is essentially a moving coil galvanometer the coil of which is but a single loop of wire with a thermoelectric junction at one end. When radiant energy falls upon this junction, the resultant thermoelectric force causes a current flow which in turn causes the loop to rotate in the magnetic field by an amount proportional to the incident radiant energy. The amount of rotation is measured through use of a mirror in the same manner as upon a moving coil galvanometer. In a radiomicrometer the connecting loop has negligible resistance and there is no advantage in using more than one junction, for, as the electromotive force is increased by adding junctions, the resistance is increased in proportion and the current through the loop remains unchanged. This instrument was invented independently and almost simultaneously by d'Arsonval and by Boys.

In the opinion of Coblentz⁷ the evacuated radiomicrometer can be made to excel the sensitivity of the thermopile, bolometer, or radiometer. This is true only when the radiomicrometer is shielded from sudden changes in temperature. Magnetic shielding is unnecessary for the device is insensitive to such disturbances. All of its good features are nullified, however, by its extreme sensitivity to vibration and its lack of portability, both due to the extremely delicate suspension which must be used to give it a good response. This fine suspension also gives the device a long period (as long as a minute), making readings with it tedious. Because of these

things it is seldom used today, being replaced by either the thermopile or bolometer.

Bolometer

The bolometer is considered by many as the best radiation measuring device yet made. It is a very simple device, being merely a Wheatstone bridge, two arms of which are made of very thin blackened strips of high electrical thermal resistivity, one or both of which being exposed to radiation. The maximum sensitivity of a bolometer is limited by the size of the strip exposed to the radiation and is proportional to the square root of the area of this surface. The sensitivity is also directly proportional to the bolometer current, but this is limited by the resistance of the bolometer strips.

The metals generally used in their construction are nickel, platinum, tin, and iron, although for various reasons platinum is generally used.

One complaint against the bolometer is that it is subject to variations caused by air currents and magnetic disturbances. The effect of magnetic fields can be minimized by concentration of the components into as small a space as possible, and the effects of air currents can be removed by enclosing the bolometer in an evacuated chamber.

A further complaint is that the zero, or balance point will drift due to a gradual drop in battery voltage across the bridge. The underlying reason for this drift is that it is a practical impossibility to cut strips of exactly the same dimensions, resistance, and radiation characteristics. Hence, if the battery current varies, the resistance of one arm of the bridge will vary more than the other and the bridge will become unbalanced. This drift can best be remedied through use of a battery with a very large capacity.

The radiometer started as an interesting scientific toy made by Sir William Crookes for his children but was eventually developed by others into a true scientific instrument. It consists, in one form, of two similar thin vanes of blackened mica or platinum attached to a horizontal arm and suspended in a vacuum by means of fine quartz fiber. The radiant energy to be measured is allowed to fall upon one of the vanes, warming it slightly. This causes the residual gas molecules to rebound from the blackened surface with increased vigor, causing a slight rotation of the suspended system proportional to the incident energy. Experimental results have shown that for small areas the deflection is proportional to the area of the exposed surface of the vane. The rotation is observed, as in the radiomicrometer, through use of a small mirror attached to the system.

REFERENCES

1. Wilson, E. D., *Jour. Opt. Soc. Am.*, 29, 1939, p. 35.
2. Brice B. A., *Rev. Sci. Inst.*, 8, 1937, p. 279.
3. Wood, L. A., *Rev. Sci. Inst.*, 5, 1934, p. 295.
4. MacGregor-Morris, J. T., and Stainsby, A. G., *Proc. Phys. Soc. (Lond.)*, 55, 1941, p. 585.
5. Reich, H. J., "Theory and Applications of

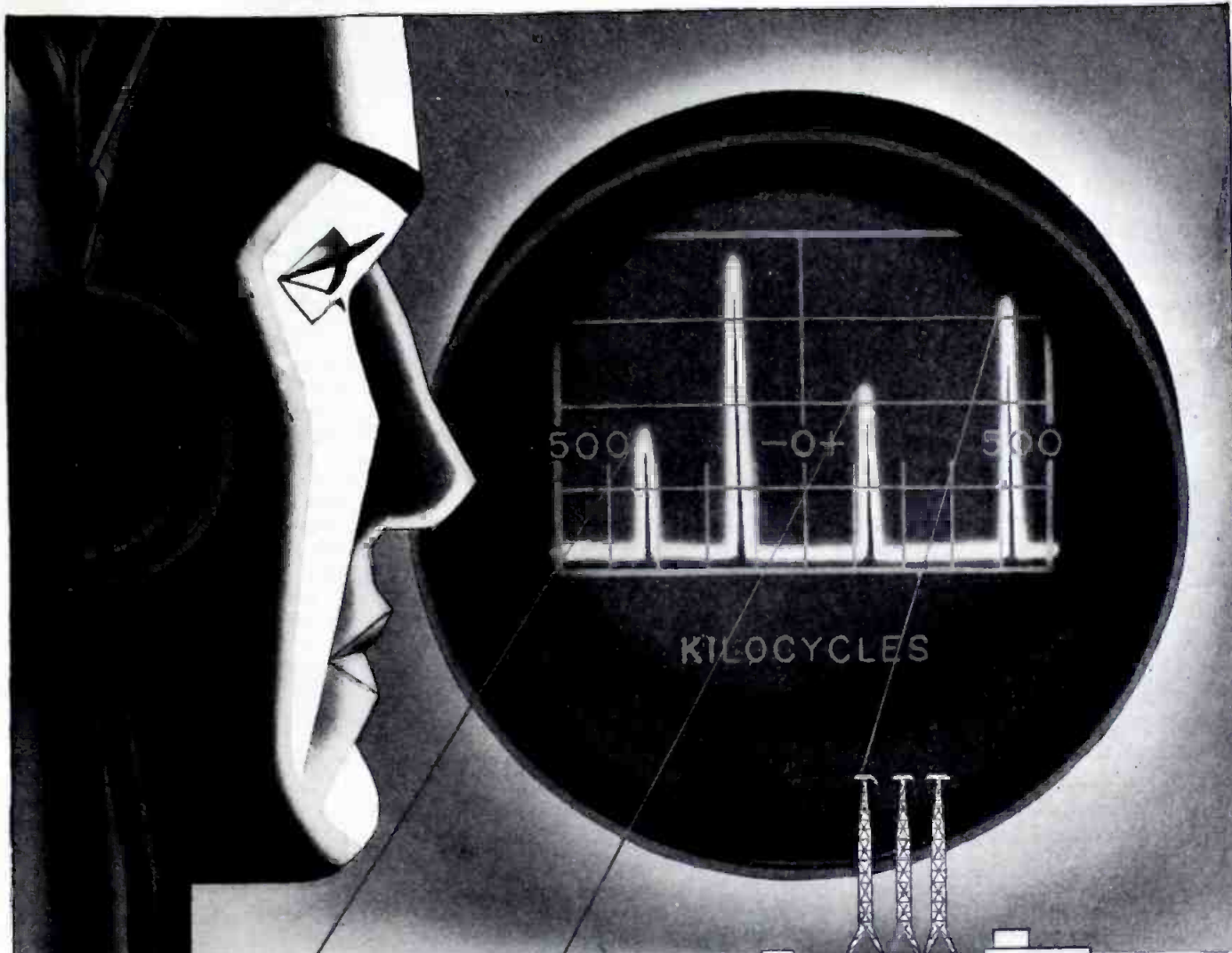

PANORAMIC RECEPTION

SIMULTANEOUS VISUAL OBSERVATION OF SIGNALS OVER A BROAD BAND OF FREQUENCIES

Panoramic Reception is the technique of viewing simultaneously a multiplicity of signals received over any given portion of the radio frequency spectrum. Its uses include the measurement and comparison of frequency, inductance, capacitance, and resistance. The Panoramic Radio Corporation has conceived and pioneered the major developments in this field, yet we feel that we have but scratched the surface of the tremendous sphere encompassed by Panoramic Reception. Its successful use in communications, direction finding, navigation, production, and the laboratory presents only an incomplete picture of its possibilities. Why not let our engineers demonstrate how much of your work can be expedited by Panoramic equipment?

PANORAMIC  **RADIO CORPORATION**
 242-250 WEST 55th ST. New York 19, N.Y.

7 Days Free Examination

PRACTICAL RADIO INFORMATION

Including Frequency Modulation—Television, etc.
Inside Radio Information for all Servicemen—Aircraft Pilots—Students. AUDELS RADIO MANS GUIDE contains 772 Pages, 400 Diagrams & Photos is complete—gives Authentic Principles & Practices In Construction, Operation, Service & Repairs. Covers clearly and concisely Radio fundamentals—Ohm's Law—Physics of sound as related to radio science—Measuring Instruments—Power supply—Resistors—Inductors—Condensers—Transformers and examples—Broadcasting stations—Radio Telephony—Receivers—Diagrams—Construction—Control systems—Loud speakers—Antenna systems—Auto Radio—Phonograph pickups—Public Address Systems—Aircraft & Marine Radio—Radio Compass—Beacons—Automatic Radio Alarms—Short Wave—Coil Calculations—Testing—Cathode ray oscillographs—Static Elimination—Trouble Pointers—Underwriter's standards—Units and tables—Frequency Modulation—REVIEW QUESTIONS & ANSWERS. Ready Reference Index.

\$4 COMPLETE • PAY ONLY \$1 A MO.
Get this practical information in handy form for you!—Fill in and MAIL COUPON TODAY.

AUDEL Publishers, 49 W. 23rd St., N.Y. Mail AUDELS NEW RADIO MANS GUIDE for free examination. If O.K., I will send you \$1 in 7 days; then remit \$1 monthly until \$4 is paid. Otherwise I will return it.

Name _____
Address _____
Occupation _____
Reference _____ R.N.

Order From RADOLEK

RADIO PARTS ELECTRONIC APPARATUS SOUND SYSTEMS

Make Radolek your dependable buying source for everything in radio, sound and electronics. We can supply essential merchandise to repair any radio—tubes, condensers, resistors, controls, transformers, etc.—all at lowest prices.

Large Stocks: Radolek's large stocks assure the finest and most complete selections of all available items. Thousands of servicemen rely on Radolek for their entire requirements.

Fast Service: Streamlined handling of every order eliminates procurement problems and gives you fastest possible delivery. Whatever your need—for industry, the Armed Forces or civilian replacement—ordering from Radolek saves time, effort and expense.

Get This Free
Buying Guide



SEND TODAY!

RADOLEK CO., Dept. B-92,
601 W. Randolph St., Chicago, Ill.
Please send your FREE Buying Guide.

Name _____
Address _____
 DEALER SERVICEMAN SOUND ENG.

SAVE AT RADOLEK

Electron Tubes" McGraw-Hill Book Company, Inc., New York (1939).

6. Johansen, Ann. d. Phys., 33, 1910, p. 517.

7. Coblenz, W. W., Bull. Bur. Stds., 9, 1913, p. 48; also, Coblenz, W. W., Bull. Bur. Stds., 4, 1908, p. 391.

—50—

Tube Substitutions

(Continued from page 56)

Tube "A" is the one with the higher current rating.

Tube "B" is the one with the lower current rating.

For the above case of the 12SK7 replacing the 6SK7, tube B would be the 12SK7, tube A the 6SK7.

Before closing the subject on i.f. and r.f. replacement tubes, one mention might be made about tubes like the 6B7, 6B8 and 7E7 which are duo-diodes and also pentodes. Conceivably, the pentode sections could be used for i.f. amplifiers with the diodes remaining idle. However, the nonutilization of one portion of a tube is not the best practice and, if possible, should be avoided. It is for this reason that the list given above made no mention of these tubes as substitutes for the regular pentodes used for r.f. and i.f. amplifiers.

The Mixer

The next point to concern us is the mixer stage. In most sets designed for the broadcast band, one tube, called a pentagrid converter, is used, this tube acting as the mixer and oscillator at the same time. Under this category would fall such tubes as the 6A8, 6A7, 6SA7 and 6D8. Another type of converter actually involves a triode and either a heptode or hexode such as the 6J8, or 6K8. Here the triode section acts as the oscillator and transfers this frequency to the other portion of the tube through an internal connection. Finally, there is the pentagrid mixer using the 6L7-G tube. Nearly all of these, while seemingly different, are interchangeable in one form or another with a few simple circuit changes. To better understand the nature of these changes, however, it is best to examine a typical example of each circuit to see just what liberties may or may not be taken.

Fig. 4 shows a typical circuit using the 6A8. The signal is fed into the fourth grid, with grids 1 and 2 acting as the oscillator control grid and plate. This circuit is very well suited for the broadcast band and the upper wavelengths of the short-wave band. Usually a.v.c. is applied to the signal grid, in which case this portion of the circuit is opened to allow insertion of the a.v.c. resistor. This type of tube is sensitive to voltage changes, the result being a slight shift in frequency of the oscillator. Also, at the higher frequencies, coupling takes place in the tube itself between the input grid and the oscillator portion, so it would be much better not to use the 6A8 as a replacement in an all-wave set unless such a tube was already incorporated

in the circuit and fully compensated for. The 6A7 and 6D8, being similar to the 6A8, would be subject to the same conditions.

A special modification of the 6A8 is the 6SA7, shown in Fig. 5. Here a Hartley oscillator, using only one tapped coil, is needed and this arrangement results in simplicity and good stability with high gain on the regular broadcast channels. However, it is not as good on the short-wave frequencies as on the broadcast band. This type tube is not as sensitive to voltage changes as the preceding tubes and a.v.c. may be used without fear of resultant variations in the oscillator frequency. It might now be instructive to see just how these two types of oscillators may be wired so as to use each other's tubes. For example, Fig. 7 shows how a 6A8, 6D8 or 6A7 could be adapted for a circuit formerly using a 6SA7. On the other hand, Fig. 6 shows how to employ a 6SA7 in a 6A8 circuit. The changes necessary in each case are simple and would not take very long to accomplish. Probably the set will now need realignment, but this might be true in cases where even the same type tube is replaced. The mixer is one circuit that is especially sensitive to capacitance changes in tubes, even slight ones.

The next type of mixer utilizes the 6K8 in a circuit such as shown in Fig. 8. It is seen to be essentially the same as the 6A8 schematic with the oscillator section separate and distinct from the mixer grids. The oscillator coils from a 6A8 could quite easily be connected to the triode section of the 6K8 with good results. Generally speaking, a 6K8 would have less gain at the broadcast frequencies than the 6A8; its greatest use is in all-wave sets where a stable oscillator is needed at the high-frequency end of the band. No difficulty should be encountered when using a 6K8 in a circuit formerly occupied by either the 6A8 or 6SA7 tubes, providing the necessary socket connections are made. Use the above mentioned illustrations as your guide. When the 6K8 is used to replace the aforementioned tubes, the possibility of over-excitation may occur. In that case, either the number of turns on the tickler coil should be reduced, or the plate voltage of the oscillator anode made less. Generally the latter is the easiest to accomplish.

Continuing on, the 6J8 presents a slightly modified circuit over the 6K8 just described. The oscillator is internally connected to grid number 3 of the heptode section of this 6J8, a point that received the signal voltage in the 6K8. This tube is usually considered as the most stable of this group of mixers or converters and so finds wide use in sets having broad frequency coverage. Structurally it may be compared to the 6L7 which will be described in the next paragraph, with the addition of the triode section which is our oscillator. In the 6L7 this oscillator is external, usually employing a triode like the 6C5 or 6J5. In using the triode of the 6J8 for the oscillator, the

THE WAR WILL END ON



(YOU FILL IN THE DATE)

Think of it! You as a civilian have the power to decide when the war will end. Use that power to the utmost—NOW—by

1. Buying war bonds to the limit of your capacity.
2. Working harder, longer, and uninterruptedly turning out implements of war.
3. Donating your blood to the Red Cross to save lives on the battle field.
4. Collecting waste paper and other scrap for which the government is asking.
5. Avoiding black markets as you would the plague. (Black markets cause the plague of inflation.)

All of these are weapons of war—weapons that strike terror in the hearts of our enemies. Use them.

We, the management and employees alike, at Kenyon, are building better transformers than we ever built before—and building them faster for the armed forces.



THE MARK OF

EXCELLENCE



KENYON TRANSFORMER CO., Inc. 840 BARRY STREET
NEW YORK, U. S. A.

*A Magazine, too,
Is Judged by the
Company It Keeps*

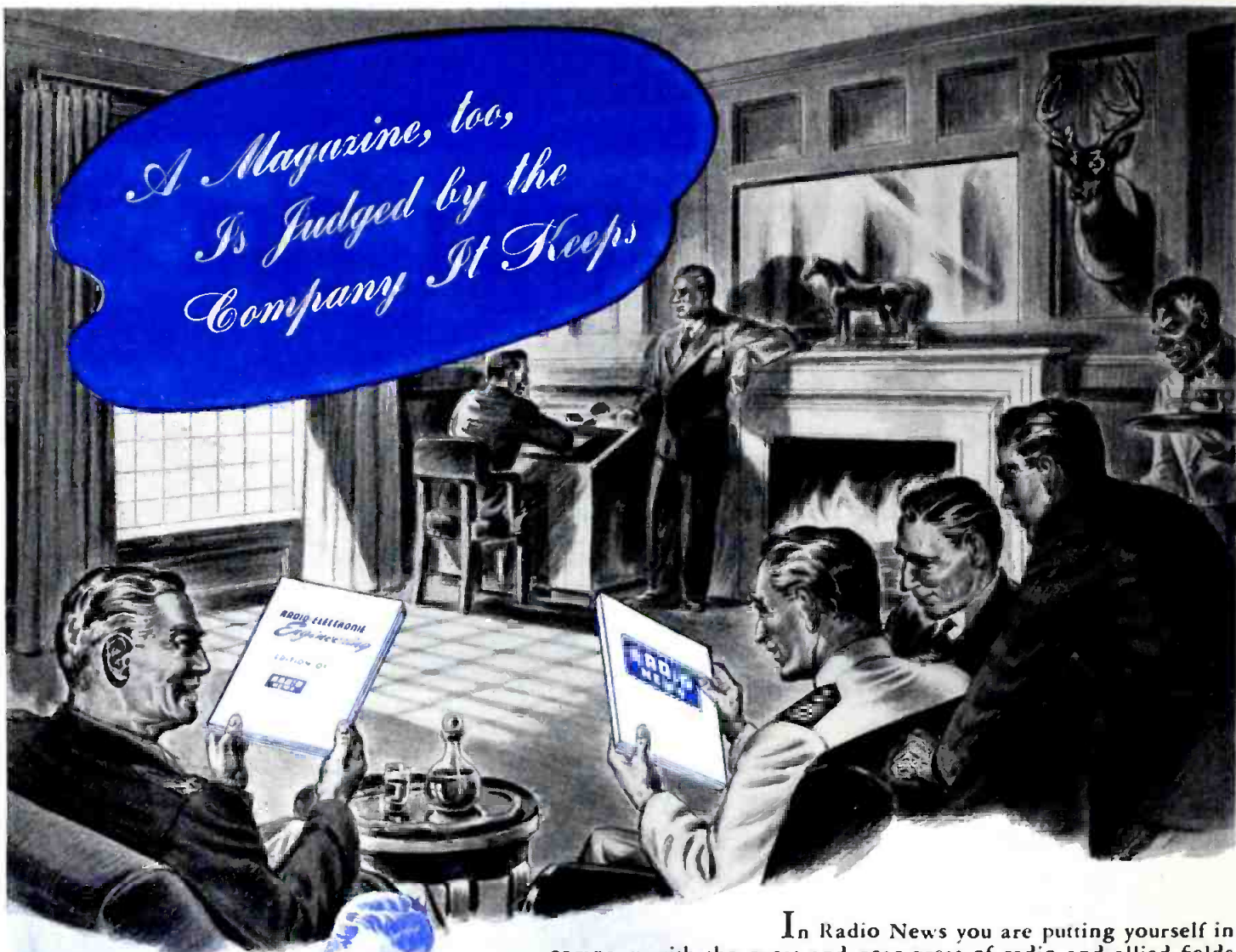

In Radio News you are putting yourself in company with the great and near-great of radio and allied fields who find informative entertainment in this magazine. Our list of subscribers includes: Senators—Members of the House of Representatives—Generals, Admirals and other high ranking officers of the armed forces—High Government Officials, including the Secretary of the Interior and the Secretary of the Navy—Leaders in Radio—Corporation Officers, Scientists, etc.

This distinguished host reads Radio News because they find in it:

Editorial quality without peer in the radio field, to keep the reader informed on the latest news and developments in radio.

Up-to-the-minute articles by authors who are on a par with Radio News' distinguished readership.

Judged the outstanding magazine in the field, Radio News attracts, and holds its readers through consistent editorial leadership.



RADIO NEWS and
Radio-Electronic Engineering **FIRSTS**

U. S. Army Signal Corps issue,
November, 1942

U. S. Army Signal Corps issue,
February, 1944

U. S. Aviation Communications,
June, 1943

Feature Articles Which Were Scoops
The Saga of the Vacuum Tube
The Wire Recorder

Other Firsts in RADIO NEWS

Four-color sections

Four-color covers



ZIFF-DAVIS PUBLISHING COMPANY

540 North Michigan Ave., Chicago 11, Illinois • Offices: New York • Washington • Los Angeles • London • Toronto

FIX ANY RADIO

Amazing New Invention

Simplified Radio Servicing by Comparison Method

Find radio faults with a new simplified method. Repair radios in minutes instead of hours. Revolutionary, different Comparison technique permits you to do expert work almost immediately. Most repairs can be made without test equipment. Simple point-to-point, cross-reference, circuit suggestions locate faults quickly and easily.

COMPLETE \$1.50 ONLY SPECIAL OFFER READ THE DETAILS



REPAIR ANY RADIO IN MINUTES

Learn how to locate the source of trouble in any radio without equipment. Make needed tests, measure voltage, trace the signal, by using only a resistor, small condenser, and a crystal detector. Inject signals without any signal generator. Test parts by the new Comparison method. Test tubes without equipment. Repair any radio expertly following illustrated, simplified plans. Improve your radio servicing ability. Examine the plan without obligations, without risk. Read details at right and send coupon.

FOR BEGINNERS OR EXPERTS

Learn important short-cuts in trouble-shooting; find any radio fault with ease. Follow the comparison tests given on 16 large trouble-shooting blueprints. Over one thousand practical repair hints. Hundreds of simplified tests using a 5c resistor and a filter condenser. Covers every radio set—new and old. Introductory material included for beginners will serve as a review for experienced radio men. Also several chapters on test equipment. Presented in manual form, 112 illustrated pages, 8½x11 inches. Entire plan is stark new and will help you get ahead in radio quickly.



Developed by M. N. Beitman, radio engineer, teacher, author, & serviceman.



PRACTICAL USEFUL FACTS AND HINTS

Hundreds of service hints, trouble-shooting ideas, simplified tests, repair suggestions, and alignment methods are included. Material on all types of sets. Benefit by the experience of others. Use this practical method for finding the fault quickly and making the repair expertly.

REPAIR MOST SETS WITHOUT TESTERS

Follow the COMPARISON technique and repair 4 out of 5 sets without equipment. Speed up your work; locate faults quickly; make repairs efficiently. Be fair with yourself and try this new plan without obligation. Take advantage of our "no-risk" trial. Send coupon today. Use this time-saving, money-making radio servicing technique for 10 days without any obligations. See how quickly you will learn these helpful methods. Save time on every radio job every day. Learn new short-cuts in radio servicing. Get ahead in Radio. Amaze others with your ability to find radio faults and make repairs. Make more money repairing radios in less time. Prepare for an essential job; or earn higher rank in the Army. Act today.



SATISFACTION GUARANTEED

You must be entirely satisfied or your money will be refunded without a question. The training will more than pay for itself on the first radio job or with higher rank in the Army. Examine and use this unique plan for 10 days at our risk. Send coupon right now—use the plan this week.

Other Supreme Publications

How to MODERNIZE Radios for Profit



Cash-in by improving audio circuits, modernizing cabinets, adding features usually found on late model sets. Practical job-sheets with schematics and photographs make the work easy. You are told how to obtain modernization work, what to charge, and how to complete the job quickly and efficiently. The complete, large size, 8½x11 in. manual is priced at only **\$1.00**

PRACTICAL RADIO for War Training

This new, 1943 manual will clarify the important radio facts, explain the principles which may have puzzled you, and point the way to faster radio repairing. You will find hundreds of practical hints for mounting parts, testing components, trouble-shooting, using instruments. Needed useful theory in each chapter is followed with practical applications. This is the book that will help you repair radios faster, or obtain a good radio War-job, or get ahead in the Armed Forces. Use this book as your ready reference for finding the right answer to every radio problem. Written by M. N. Beitman, the right answer to every radio problem. Printed on thick, enamel paper. 112 large pages, 8½x11 inches. Sold with a money-back guarantee. Price only **\$2.95**

MOST-OFTEN-NEEDED RADIO DIAGRAMS



The most-popular radio diagrams available in low priced manuals. Large size: 8½x11 inches.

| | |
|--|-----------------|
| 1942 Manual, Volume 5, 192 pages... | } \$2.00 |
| 1941 Manual, Volume 4, 192 pages... | |
| 1940 Manual, Volume 3, 208 pages... | |
| 1939 Manual, Volume 3, 192 pages... | |
| 1938-39 Manual, Volume 1, 244 pages, with alignment, hints, parts lists... | \$2.50 |

PRACTICAL RADIO MATHEMATICS



Introduces and explains the use of arithmetic and elementary algebra in connection with units, color code, meter scales, Ohm's Law, alternating currents, ohmmeter testing, wattage rating, series and parallel connections, capacity, inductance, mixed circuits, vacuum tubes, curves, the decibel, etc., etc., with numerous practical examples. Net only **25c**

SEE YOUR RADIO JOBBER OR SEND COUPON

NO RISK TRIAL COUPON

SUPREME PUBLICATIONS

328 S. Jefferson St. Chicago 6, Illinois

Slip the complete Simplified Radio Servicing by COMPARISON Method manual. I am enclosing \$1.50, full price. I must be entirely satisfied or you will refund my total remittance.

Also send

NAME:

ADDRESS:

(Use Coupon or Write Order in a Letter)

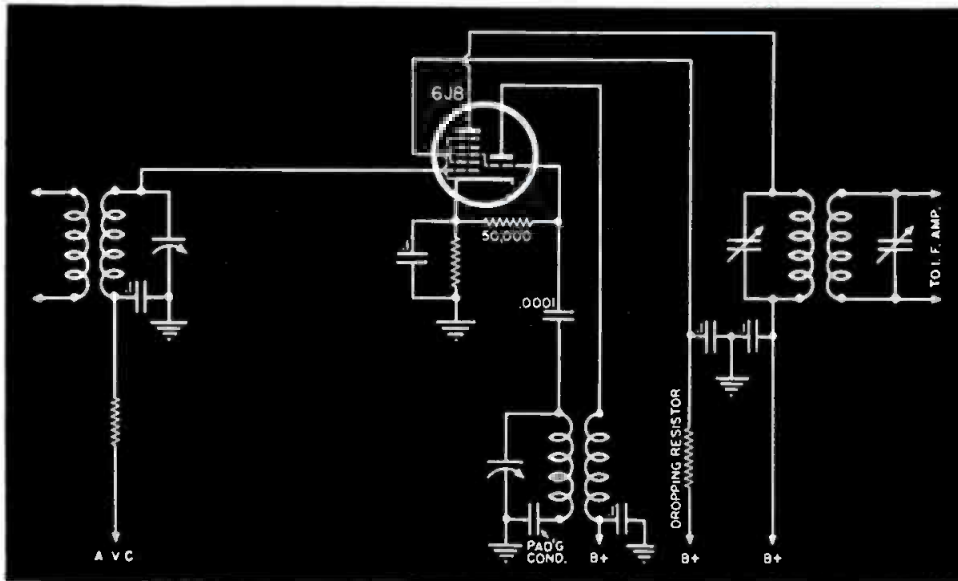

Fig. 9. A 6J8 tube used as an r.f. amplifier and oscillator. The oscillator is grid tuned; however, many sets have been manufactured with plate tuning.

tuned circuit may be placed in either the plate or grid circuits. The grid tuned 6J8 oscillator circuit is shown in Fig. 9. A careful study of the mixing circuits of the 6J8 and any of the other oscillators should enable the serviceman to change around any of the tubes mentioned above. One point of caution should be observed, however. This refers to the respective plate and grid voltages applied to the various elements. Of these, the screen voltage of the mixer portion of the tube and the oscillator plate voltage are the most critical. The best guide to follow is a good tube manual, something every radio man knows and has. This will indicate the correct voltages that should be applied to the various elements. By following these as closely as possible, little trouble should be encountered.

The last circuit to be described uses the 6L7 as the mixer with a separate oscillator tube. This process may be called the true mixing procedure, the only function of the 6L7. Its circuit (see Fig. 10) is quite simple and due to the separate oscillator, this arrange-

ment is common in all-wave sets because of its excellent stability at the high frequencies. To replace a 6L7, the first choice would be a 1612. Failing in this, then either a 6K8 or 6J8 could be used, in each case not making use of the triode section inherent in these tubes. A quick glance at the circuit diagrams of these tubes will show how they should be hooked up. Any remarks made above regarding special points to be observed with either the 6K8 or 6J8 would be applicable here.

With the above, the discussion of pentagrid converters and mixers is completed. While the most important methods of interchanging these tubes have been mentioned, there are other modifications that would also work. The most critical adjustment that might be met in any of the above would be the voltages on the various elements and the stability of the power supply. Oscillators will vary in frequency, sometimes over wide ranges, for any extensive voltage variations. An extra filtering condenser may solve

Fig. 10. A conventional mixer using a 6L7 tube, with external oscillator incorporating a 6C5 tube. This type of circuit is usually used on all-wave receivers.

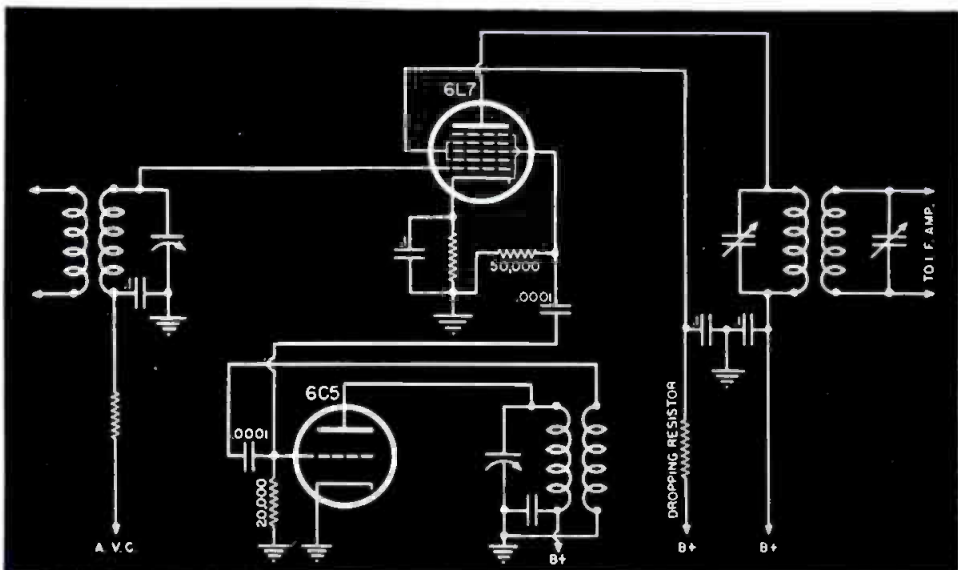

this problem quickly and easily. Sometimes extensive coupling may take place between the oscillator and signal grid. If this occurs, reduce the voltage applied to the oscillator anode. In any event, for best guidance, use the voltage suggestions that are found in the tube manuals.

-30-

Postwar Railroads

(Continued from page 24)

diately after the war. Indications are that it cannot be more than a token undertaking now. The extensive procurement and installation of radio equipment must wait until immediately after the termination of hostilities for several reasons. These include procurement difficulties at present and new techniques, such as the use and allocation of microwaves, as well as the impossibility and undesirability of assigning the type and quantity of personnel and equipment necessary to do the job. To do it now would mean overloading the radio industry and interfering with the flow of electronic equipment to the Armed Forces for prosecution of the war. Industry neither needs nor wants this business on any extensive scale at present. It will need and want it badly at the termination of hostilities. At that time it will do a better job with better component materials and much lower costs. It will then receive major attention and the purchaser will be in the "driver's seat." Invaluable new employment will result for displaced war workers and returning exceptionally qualified persons from the Armed Forces. This will be in connection with design, manufacture, installation, maintenance and utilization of two-way equipment.

The story of railroad radio is the story of adequate allocation of frequencies in terms of kilocycles. To get sufficient channels of sufficient band width without trying to deprive more important services on lower frequencies necessitates the use of microwaves. It can be shown that microwaves have incomparable advantages for railroad communication with moving trains for the following reasons:

1. Unlimited frequency channel space.

2. The simplest possible way to confine the radiation down a narrow railroad right of way.

3. Freedom from interference or squeal if signals overlap, because frequency modulation is best adapted on such frequencies.

4. High efficiency in equipment performance because of the greater deviation ratios possible at those frequencies with frequency modulation.

5. Incomparable quality of modulated signals because of the frequency deviation that can be permitted.

The allocation of the least conceivable amount of wavelength spectrum ever proposed up to now will provide



U. S. Army Signal Corps Photo



YESTERDAY *and* TODAY!

Before Pearl Harbor, the leading line of sectional and telescopic antennas used by manufacturers of automobiles, radios and portable radios carried the WARD trademark.

Of course, today, all production is going to further the war effort, and men in tanks, planes, command cars—in communication units of all kinds—are becoming familiar with the name of WARD. It appears on antennas used on communication equipment all over the fighting front.

The expertness of design and manufacture that made WARD the leader in the pre-war period and during wartime, is being supplemented by knowledge gained from the war effort. After the armistice is signed, there will be new and improved products. If the use or specifying of aeri-als is included in your post-war planning, or if you are a distributor, look to WARD!

WARD

Antennas



THE WARD PRODUCTS CORPORATION
1523 E. 45TH STREET, CLEVELAND, OHIO

Learn RADIO-ELECTRONICS

12 WEEKS TRAINING IN COYNE SHOPS ON REAL RADIO - ELECTRONIC EQUIPMENT! FOR MEN 16 UP TO 50



Prepare for a great Peace time future *H.C. Lewis* and a good job in Radio and Electronics now. Coyne "LEARN BY DOING" training covers latest developments in this field. Prepare quickly, easily. Fascinating well paid work in maintenance, installation and servicing Radio and Electronic equipment.

I'LL FINANCE YOUR TRAINING!

Start now—pay tuition after graduation. My plan has helped thousands. I assist you in getting part-time work while at COYNE to help pay living expenses. Job Service when trained. Also have facilities for men with physical disabilities. Write!

ELECTRONICS AND TELEVISION

Tremendous expansion in Radio, Electronics, Frequency Modulation and Television predicted after the war—a world of new opportunities. Get ready for a Peace time future and a good job NOW with practical Coyne Radio Training.

FREE BOOK! Whether you're 16 or up to 50 get facts. Special Industrial Electronics training included at no extra cost now. Mail coupon today.

H.C. LEWIS, Pres., RADIO DIV., COYNE ELEC. SCHOOL
500 S. Paulina St., Dept. 84-1W, Chicago 12, Illinois

Send me FREE BOOK, "Your Future in Radio", and details of Industrial Electronics training included at no extra charge and easy "Pay-After-Graduation" plan.

NAME.....AGE.....
ADDRESS.....
CITY.....STATE.....

LEARN CODE

the way you'll be using it

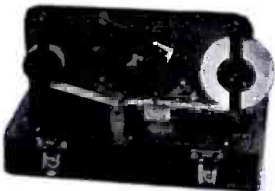

by SOUND

The best way to learn to read code is by listening to code. The best way to learn to send code is by hearing your own

sending repeated back to you. With the new All-Electric Master Telex Code Teaching Machine, you learn code the natural, easy, fascinating way. Only instrument ever produced which records your sending in visible dots and dashes—then SENDS BACK your own key work at any speed you desire. There are NO PERFORATIONS—NO INK. Far superior to anything ever developed... a marvel of simplicity. That's why practically every school teaching code uses MASTER TELEPLEX. We furnish complete course, including the All-Electric Master Telex, give you personal instruction with a MONEY-BACK GUARANTEE—all at a surprisingly low cost. Write today for FREE catalog RN-8. No obligation.

TELEPLEX CO., 107 HUDSON ST., JERSEY CITY, N. J.

Radio AND ELECTRONIC DEVICES

BURSTEIN-APPLEBEE CO.

1012-1014 McGee St. • Kansas City 6, Missouri

PEN-OSCIL-LITE

Extremely convenient test oscillator for all radio servicing: alignment • Small as a pen • Self powered • Range from 700 cycles audio to over 600 megacycles u.h.f. • Output from zero to 125 V. • In use by Signal Corps.

GENERAL TEST EQUIPMENT CO.

38 Argyle Buffalo 9, N. Y.

more channel space than the railroads would need for a generation. For example, if the Federal Communications Commission authorizes wavelengths between 10 and 12 centimeters for railroad radio, it would immediately make available 500,000 kilocycles of channel space. That would correspond to a frequency spectrum of between 2500 and 3000 megacycles, or 2,500,000 to 3,000,000 kilocycles.

If the FCC will allocate an additional channel between 30 and 40 millimeters in wavelength corresponding to 3 to 4 centimeters, 2,500,000 kilocycles more would immediately become available. This corresponds to a frequency spectrum of 7500 to 10,000 megacycles, or 7,500,000 to 10,000,000 kilocycles.

For further experimental use, probably not needed during this generation, a band 1 millimeter wide in the wavelength spectrum between 1 millimeter and 1 centimeter would provide as much as 25,000,000 additional kilocycles. Centimeter wavelengths will be available immediately postwar. Millimeter communication is still under development since it is inconceivable at present to see a need to use such frequencies. For the first time, two-way radio can have more channel space than it could ever possibly need.

For railroad applications, microwaves can be adapted admirably from the standpoints of efficiency and privacy. Communication is only required along the surface of the railroad right of way. It is neither needed nor desired to the right or left, above or below the level that trains travel along the railroad track. It therefore becomes most desirable to use beamed antenna radiation. For the beam width required to cover a railroad track, gains from 400 to 1, to 2000 to 1 are feasible. This is equivalent to raising the power or developing a gain from 400 to 2000 times available for increased signal strength and extended range.

To beam a transmission in such a narrow width would be physically and financially impracticable on any existing wavelength or frequency outside of the microwave band. It must be associated with the dimensions of a half wavelength for the antenna or wave guide. On the standard broadcast band a half wavelength is more than 300 feet long. On the ultra-high frequency two-way police radio band used to transmit back from police cruiser automobiles, it still is more than 10 feet long. However, on the 10- to 12-centimeter microwave band it would only be 2.36 inches long. On the 3- to 4-centimeter band it would be .68 inch long, while on the millimeter band it is only about a tenth of an inch long. Any number of reflectors and directors are possible if conventional antenna design is used. If wave guide techniques are employed, the resultant plumbing becomes of the size used for oil burner tubing or the tubing gauged with automobile indicating gauges in your car. Signals can

be squirted out down the railroad track as ridiculously simple as squirting water out of a garden hose.

In order to appreciate in simple terms what a tremendous gain is possible with directive radiation by railroads on the microwave band, it is suggested that one associate it with the globe of the world. Examine the globe and see what a sector of 5 degrees latitude and longitude at the equator represents in dimension as compared to the entire global sphere. Whatever the denominator of the fraction is, that will be the amount of gain. If a certain beam width occupies only 1/1000th part of a sphere, then the gain is 1000 to 1. There is no limit in sight to the amount of gain eventually to be achieved by directive transmission. It can in time be no more than a needle point through space. That will be with the millimeter part of the microwave band.

In the case of long-range communication systems such as might be required to cover an entire railroad division 100 to 200 miles in length, automatic relay stations may be necessary. Since there undoubtedly will be signal overlap caused by two or more trains within one horizon or by having the relay stations overlap in coverage, FM must be employed.

In the case of amplitude modulation, there would be a heterodyning squeal or howl whenever two or more signals were on the air at one time or close to the same frequency. This would make reception most difficult. For AM it is necessary for the louder signal to be 30 to 100 times stronger in order to wipe out the weaker signal. If stations have signal strengths nearly equal, communication might even be hopeless and completely unintelligible on voice.

It is definitely essential, therefore, that railroads use only frequency modulation methods through space. FM signals when picked up by a receiver designed for wide-band frequency-modulated reception can come in without number as well as be free from squeals or howls. What happens instead is that the loudest signal takes control in any area. It does this completely when the louder signal is more than twice as strong as the weaker signals. This does not have to represent much difference in actual radiated power since the signal strength falls off as the inverse square of the distance. Only a small change in distance or terrain conditions can accomplish this.

For a moving train travelling over variable terrain and earth of varying conductivity, two signals might fluctuate in relative signal strength with respect to each other. The loudest one always will be heard. It alternates back and forth and faithfully hangs onto the loudest signal at any moment and location, doing it faster than the human ear can detect.

If two signals are received of exactly equal strength, both might be heard simultaneously, or they might flutter with one slightly predominating over



mum's the word...NOW

**...BUT TIME WILL REVEAL
THE STORY OF
Doolittle ENGINEERING**

Long before Pearl Harbor . . . "specialized communications equipment by Doolittle" was well and favorably known to aviation, broadcast and police radio engineers.

Since then . . . Doolittle Engineers have constantly been at work developing and producing vital equipment for the Naval Aircraft Factory and the Bureau of Aeronautics, to hasten Victory.

Their added experience will bring important benefits to future peacetime communications. *Look ahead . . . with Doolittle.*

***Doolittle* RADIO, INC.**

Builders of Precision Radio Communications Equipment
7421 South Loomis Boulevard, Chicago 36, Illinois.

Back the Attack
Buy More War Bonds

CALLING ALERT MEN
CALLING ALERT MEN
CALLING ALERT MEN

IF YOUR SPEED IS LESS THAN 50 WPM.

Send for this FREE 52-page Book. It shows that "crack" operators rely on something besides practice to develop their high speeds and proficiency; it explains the "knack" of sound-sense and sound-consciousness—the secret of speedy sending and receiving. Once you acquire these mental processes, reading code becomes almost second nature to you; just as the swing rhythm of a dance band becomes automatic to musician and dancer.

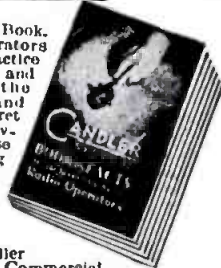

Champions endorse the Candler System. It is used in training Commercial Operators, Amateurs, and Radiotelegraph Specialists in Signal Corps, Navy, Marines, Coast Guard, Naval Reserve, Airlines. Wherever the fastest and most efficient operators are found, there you will find Candler trained men.

If you want speed, if you have any difficulties in operating technique, if 40-50 and more w.p.m. seem fantastic speeds to you—send for this revealing book now. It's yours without cost or obligation. Simply send your name and address.

CANDLER SYSTEM CO.

P. O. Box 928 Dept. 2G
Denver, Colorado, U. S. A.
And at 121 Kingsway, London, W. C. 2., England

LES Correspondence Courses in **RADIO and ELECTRICAL ENGINEERING**

ELECTRICAL ENGINEERING Get good electrical field. Prepare yourself at Low Cost, for secure future. Modern course. So simplified anyone can understand quickly.

RADIO ENGINEERING Extra fine course in radio, public address, photo-electric work. Train you to be super-service man, real vacuum-tube technician. Services needed badly. Diploma on completion.

WRITE Send postcard or letter for Free LOW \$25 Either Course of school catalog, full details, all about deferred payment plan, etc. **SEND NOW!**

LINCOLN ENGINEERING SCHOOL, Franklin St., Box 61-R67 (Formerly at Lincoln, Neb.) WASHINGTON, D. C.

Guaranteed Rebuilt VIBRATORS—\$1.00 ea.

Send old vibrator. For very prompt delivery, enclose remittance and return postage. We rebuild any make or kind of vibrator or relay. Send your old vibrator to

BEST VIBRATOR CO., Box 5802
Cleveland 1, Ohio

WOMEN IN RADIO?

Certainly. Making good, too—as radio technicians in broadcast stations, with airline companies, police radio networks, radio laboratories and radio mfg. plants. Our thorough course prepares for all these fascinating fields. Write for details, stating age and education. No salesman will call.

VALPARAISO TECHNICAL INSTITUTE
Dept. W Valparaiso, Ind.

RADIO ENGINEERING!

Radio today offers great future for women as well as men. Demand for graduates exceeds supply. Courses also in Civil, Electrical, Mechanical, Chemical, Aeronautical Engineering; Business Administration, Accounting, Secretarial Science. Tuition, living costs low. 61st year. Cosmopolitan student body. Enter June, Sept., Jan., March. Catalog.

TRI-STATE COLLEGE 1674 College Ave. Angola, Ind.

DEGREE IN 27 MONTHS

Specify SAUERISEN ACIDPROOF CEMENTS—COMPOUNDS FOR

Tanks, Sewers, Stacks, Floors
Technical cements for all purposes.

Send sketches or samples
Sauereisen Cements Company · Pittsburgh 15, Penna.

the other. Even then there need be no squeal and the signal still would be intelligible. It then would be comparable to two persons talking in one room and the listener paying attention to either one. If both signals are the same transmission, which would be the case for railroad radio, no difficulty would be encountered in any case since they would blend together. In actual practice a situation where both signals would be of identical strength would occur only on the rarest occasions where one station is in motion. When both stations are in motion it is even more remote. It would only last for the shortest imaginable period, such as less than a second of time for a speeding train.

Echo effects are not present on the microwave band since there are no ionospheric reflections or indirect transmissions. The high frequencies employed assure no sky wave reflections. At the same time, the great directivity of transmission for railroad radio minimizes or prevents the possibility of any slight FM distortion. The distortion of frequency-modulated signals caused by reflections from mountainous terrain and produced by multipath reception of the same signal would not occur in the case of railroads as it does on long-range relay broadcasting in the FM broadcast band.

The writer has always stressed the importance of the deviation ratio in an FM transmitter as being as great as the natural bandpass of the FM receiver. For example, an FM receiver on the 10- to 12-centimeter band might have an inherent characteristic of being responsive to all signals 1 megacycle each side of mean frequency. It would take a deviation ratio of 300 to 1 to fully use up the receiver's maximum bandpass. On the 3- to 4-centimeter band, the deviation ratio could be 1000 to 1 while on the millimeter band it could conceivably be 10,000 to 1. This means that revolutionary performance and new conceptions of radio possibilities are at hand. Such advantages never have and never can exist on long waves, medium waves, short waves or ultra-short waves. It is solely the prerogative of microwaves. The deviation ratio is the amount that the radio wave changes in frequency for any given amount of speech, music or tone frequency fed into the microphone. It is the ratio between the radio-wave frequency deviation and the audio frequency employed. For example, prewar police FM systems on ultra-high frequencies using voice up to 3000 cycles were allowed to have that amount of change in the radio-frequency 15,000-cycle carrier. That meant a deviation ratio of 5 to 1. A 5 to 1 deviation ratio was the maximum the FCC could spare on the roomiest band used prewar, namely the ultra-high-frequency spectrum. The deviation ratio is of importance in several ways simultaneously. In simple terms a deviation ratio of 100 to 1 means that the signal strength is 100 times greater, the fidelity of speech or music is also

100 times greater while the "bugbears" of radio such as static, induction, interference, usually coming in as variations of amplitude rather than frequency, will become 100 times less. Nothing could be more pleasing to the engineer and the users of two-way radio.

Microwaves may be "what the doctor ordered" for railroads. The only argument against it will be that it has no usable sky wave. Time and practice will prove that this is its great advantage, not disadvantage. Sky waves were used in various tests by railroads for over 20 years and proven impracticable for dependable communication. In fact, much of railroad radio's past dissatisfaction has been caused by depending on wave lengths where sky wave reflections from the ionosphere were unavoidable. Sky waves mean inconsistent and erratic performance and atmospheric disturbances. Sky waves are not desired for the following reasons:

1. They change with every hour of the day, night, season and sunspot cycle, both in range and signal to noise ratio.
2. Sky waves mean static and atmospheric disturbances that are annoying on any frequency, even short waves.
3. Sky waves take multipath and complex routes in reaching the listener, thereby causing echoes and erratic performance. The ionized layers from which they are reflected vary in density and height above the earth's surface. Furthermore, the sky waves refract and reflect from more than one layer to further complicate ideal reception.
4. Sky waves are present only on the lower frequencies, usually below 8000 kilocycles for ranges lasting any important part of the 24 hours. Between 8000 and 30,000 kilocycles where they are also present, they are partially present for minor portions of a 24-hour period becoming increasingly less as the frequency increases.
5. Because of the lower frequencies where sky waves are possible, there are insufficient channels available.
6. In addition to less channels, two or more users cannot use the same channel within a thousand miles and in the case of short waves, they would interfere regardless what part of the world they were in, some part of the time.
7. Frequency modulation is not feasible or possible because no important amount of frequency deviation could be spared there. Even at the higher end of 8000 kilocycles, the entire spectrum for the world would only accommodate 200 voice stations or 40 broadcast stations using 5 to 1 deviation ratios.
8. It becomes physically and financially impracticable to use a narrow beamed radiating antenna because of the huge dimensions involved.
9. They are unpredictable and

MAKE MORE MONEY

IN Radio TELEVISION & ELECTRONICS

Now!

GET THESE 3 BOOKS

FREE!

You men already in radio know how great the demand is for trained, experienced service men, operators and technicians. You know how fast the field is growing and how important it is to keep up with developments—FM receivers, television, electronics.

Or even if you are merely INTERESTED in radio as an amateur, you must recognize the WONDERFUL OPPORTUNITY right within your grasp, to cash in on your natural talent. Make it pay dividends. Get into the EXPERT RADIO SERVICE Line. Be a TELEVISION specialist—OWN A BUSINESS OF YOUR OWN. Fill out and mail the coupon below for all the details.

Get the Latest Inside Information—
Trade Secrets by

SHOP-METHOD HOME TRAINING



Learn by Doing

Use Actual Radio Equipment
Furnished With Your Course

Experience is the best teacher. You learn by experience with the exclusive National Shop-Method of Home Training—actually build many circuits and do experiments with the big bits of standard radio parts included in your training equipment at no extra cost to you.

In the course of your study you actually build various types of receivers—a powerful superheterodyne, a signal generator, an audio oscillator and others... You make tests and conduct experiments that show you the why and how of things. You understand what makes the various elements of electronics operate because you actually see them work for you. Not only do you gain marvelous actual experience by this method of learning but you have valuable equipment you will use on the job in the practice of your profession as an electronics expert. Mail the coupon and learn what this means to you.



Now the famous National Schools brings its exclusive Shop-Method of training right in your own home. You can learn the most up-to-date, approved projects, systems and hook-ups step by step in your spare time. This is the sound, practical training you want and need—the development of experienced instructors working with thousands of students right in the shops and experimental laboratories of National Schools—one of the most advanced trade educational centers of the world.

This is the MODERN SYSTEM OF TRAINING. It matches the rapid progress constantly being made in radio, television and electronics. It is TIME TESTED too. National Schools has been training men for more than a third of a century. In essence this is the very same training that has helped thousands to more pay and greater opportunity.

You owe it to yourself—your future—to read the book "Radio Electronics"—FREE to you when you send in the coupon.

National Trained Men Now Making the Best Money in History

The real value of National training shows up in the quick progress our men make on the job. Joe Grumlich of Lake Hiawatha, N. J., turned down a job most men would welcome. He writes: "My latest offer was \$5,800.00 as radio photo engineer, but I am doing well where I am now engaged. I am deeply indebted to National."

Ely Bergman, now on Station WOR, told us: "My salary has been boosted considerably and at the present time I am making over \$3,000.00 per year. Thanks to National Training." And from the far-off Hawaiian Islands, Wallace Chols sends this: "I am averaging \$325.00 a

month. I will say that I honestly owe all this to the excellent training I had at National." National is proud of the progress graduates are making all over the world. Read about their records yourself in the books we send you FREE.

Make Extra Money Right From The Start

You get ahead fast with National Training. Many beginners make good money on the side fixing radios and doing service work. You can turn your knowledge into cash after the first few lessons. Progress is rapid. You can actually SEE YOURSELF GET AHEAD, because the National Shop Method is so sound and practical.

Now, right now, is the time to grasp the opportunity of today—a successful career for tomorrow. Get into the big money, rapid advancement, a position of importance. A BUSINESS OF YOUR OWN. Radio, television and the whole field of electronics invites you. The industry is crying for trained men everywhere. A rapidly expanding industry—probably the greatest in history—holds out the promise of a rich future—prosperous security.

Train While You Are In Service

Prepare, right now, while you are in uniform, for a glorious secure future in the field of radio and television when the war is over.

1. A complete catalog describing the industry and the extensive training facilities of National Schools.
2. You receive a sample lesson illustrating the modern "Shop Method" instruction technique.
3. The vast opportunity field of Electronics, "The Dawn of a New World," is revealed in this fully illustrated book recently published.



Make good use of your spare time by taking your National Training now. Men in our armed service, or about to enter, get better ratings and more pay almost right from the start if they are trained in radio, television and electronics. The government needs experienced men in nearly all branches of the service. Prepare for present advancement and a sound future. Learn how easy it is the National way. We are so enthusiastic because we have seen the marvelous results of National Shop Method Home Training. Send in your coupon today and see for yourself.

NATIONAL SCHOOLS

LOS ANGELES 37, CALIFORNIA EST. 1905

MAIL OPPORTUNITY COUPON FOR QUICK ACTION

National Schools, Dept. 7-RNR (Mail in envelope or paste on penny post card)
4000 South Figueroa Street, Los Angeles 37, California

Mail me FREE the three books mentioned in your ad including a sample lesson of your course. I understand no salesman will call on me.

NAME..... AGE.....

ADDRESS.....

CITY..... STATE.....

Include your zone number

DECIDE FOR YOURSELF!

FREE LESSON INCLUDED

Examine the exclusive National Shop Method of Home Training. See for yourself how sound and practical it is. Be convinced that you can learn radio—electronics, television—quickly and easily in your spare time. This trial is ALL-OUTLETA FREE. And you may keep all the valuable material we send you without any obligation of any sort. Fill out the coupon immediately while you are thinking about it and drop it in the mail at once.

Thousands of men in the Army, Navy and Coast Guard have trained at National under U. S. Government sponsorship. You are the man who must be satisfied. Mail the coupon here for the three books that tell you the complete story of the marvelous new system of training in radio electronics and television. Learn the facts of this exclusive shop-method of home training. See for yourself! DECIDE FOR YOURSELF!

CAREERS

for

ENGINEERS

at

NATIONAL UNION RADIO CORPORATION

You who join our research and engineering staff now to help us with the important war work we are doing will be embarking on a career. Our plans for the future offer unusual opportunities for able men. Our staff today forms a friendly capable team of scientists and engineers whose accomplishments have brought national recognition. You'll enjoy working with them, growing with them.

THESE ARE OPPORTUNITIES. We are adding to our staff engineers who specialize in

ELECTRONIC TUBES
PRODUCTION
DEVELOPMENT
MEASUREMENTS
PHYSICS
ELECTRICITY
TRANSMITTING TUBES

Our laboratories in Newark, N. J., offer ideal working conditions. We prefer that you have a degree in electrical engineering, physics, chemistry or mathematics—your experience, however, may be sufficient.

Why don't you find out whether there's a place for you with our fine staff of specialists. Write and tell us about yourself or Phone Humboldt 2-5252, Ext. 72, for appointment.

NATIONAL UNION RADIO CORPORATION

50 Spring Street, Newark 2, N. J.

★ INDUSTRIAL ★ MAN-POWER BUREAU

Wanted ENGINEERS

- Radio
- Chemical
- Electrical
- Electronic
- Mechanical
- Metallurgical
- Factory Planning
- Materials Handling
- Manufacturing Planning

Work in connection with the manufacture of a wide variety of new and advanced types of communications equipment and special electronic products.

Apply for writel, giving full qualifications, to:

C. R. L.
EMPLOYMENT DEPARTMENT

Western Electric Co.

100 CENTRAL AV., KEARNY, N. J.

Applicants must comply with WMC regulations

ELECTRICAL ENGINEERS

● OLD ESTABLISHED CHICAGO MANUFACTURER IS INCREASING ITS ENGINEERING STAFF ON PRODUCTS WHICH WE HAVE MADE FOR 45 YEARS AND ARE NOW CLASSED AS 100% DEFENSE WORK. WE PREFER MEN WITH DEGREE IN ELECTRICAL ENGINEERING WHO ARE INTERESTED IN THEIR PRESENT AND POST WAR POSSIBILITIES.

ELECTRONIC DESIGN, PRODUCTION METHODS, QUALITY CONTROL ON VARIOUS TYPES OF X-RAY AND RADIO VACUUM TUBES.

PRODUCT DESIGN, TRANSFORMERS (ALL COMMERCIAL FREQUENCIES INCLUDING INDUCTOTHERM RANGES), CONTROL CIRCUITS, AND SWITCH PANELS WITH FOLLO THROUGH TO COMPLETED PROJECT. IN REPLY STATE AGE, EDUCATION, EXPERIENCE, DRAFT STATUS AND SALARY REQUIREMENTS. W.M.C. RULES ENFORCED.

c/o RADIO NEWS BOX NUMBER 353

WANTED RADIO SALES ENGINEER

or technician of high calibre, thoroughly familiar with all types of parts, tubes, meters, test equipment, receivers, transmitters, etc., capable of dealing with our industrial accounts. Permanent position; exceptional salary to the right man.

SUN RADIO & ELECTRONICS CO.
212 FULTON ST. NEW YORK 7, N. Y.

PRESS WIRELESS INC.

Has openings for persons with radio communication and manufacturing experience.

ENGINEERS
TECHNICIANS
OPERATORS
SCHOOL INSTRUCTORS
LABORATORY MEN
MANUFACTURING
FOREMEN
ELECTRICAL DRAFTSMEN
SERVICEMEN

Apply: Personnel Division

230 W. 41st Street
NEW YORK

or

435 North Michigan Ave.
CHICAGO, ILLINOIS

RADIO-ELECTRONIC ENGINEERS TESTERS TECHNICIANS

EXCELLENT OPPORTUNITIES
IN A MAJOR POST WAR FIELD

Openings available at our Research Laboratories and Electronic manufacturing unit. Leaders in the design and development of vital electronic equipment for the armed forces.

Essential workers need release statement.

Write, stating experience, education, draft status, salary requirements or apply to

SPERRY

GYROSCOPE CO., INC.
RESEARCH LABS. & ELECTRONIC
PLANT
STEWART AVE. & CLINTON RD.
GARDEN CITY, NEW YORK

RADIO ENGINEERS

At least two years' design and development experience with Radio Communications Equipment manufacturer on items subsequently satisfactorily produced in quantity. Knowledge and experience in two-way mobile equipment, low power transmitters, receivers, and control equipment essential. Permanent position. West Coast Manufacturer. Will pay expenses to coast for interview if qualifications satisfactory. Write giving complete past experience, employment record, salary received, and technical references.

BOX NO. 352

c/o RADIO NEWS

"This section is designed to help the radio industry obtain trained, experienced, technical men to facilitate vital war production. Before applying for any of these positions consult your local United States Employment Service office to determine War Manpower Commission regulations concerning the changing of jobs. If you are already employed in war work at your highest skill, stick to your present job."

RADIO STATION TECHNICIANS

Male or Female

TRANSMITTING OR RECEIVING

For Point-to-Point International Radio-communications Stations in the United States.

Applicants possessing at least an F.C.C. Radiotelegraph Commercial License preferred.

Essential workers need release statement.

Apply weekdays except Saturdays, between 10 A.M. and 3 P.M., personnel dept., or write

R.C.A. Communications, Inc.

66 Broad St.

New York 4, N. Y.

SYLVANIA ELECTRIC PRODUCTS INC.

has openings for

**ELECTRICAL ENGINEERS
MECHANICAL ENGINEERS
MACHINE DESIGNERS
RADIO TECHNICIANS**

to work with us on the design, development and production of radio tubes, fluorescent lamps, electronic equipment and devices.

We want men who have the "know how" of getting things done under pressure, and who would like to become associated with a company whose post-war future is indeed encouraging.

Reply giving age, education, and experience to our

**INDUSTRIAL RELATIONS
DEPARTMENT**

500 Fifth Avenue New York (18), New York

POSITIONS OPEN

*Design Engineers
Field Installation
and
Maintenance Engineers
at*

WESTINGHOUSE

For Field Service Work
with
Micro-Wave Equipment

Opportunity for Service
Outside the United States
If Desired.

Radio Engineers and Electrical Engineers acceptable for brief training course prior to field assignments.

No one employed at his highest skill in essential industry should apply.

Applicants living outside the Baltimore area must obtain a "Statement of Availability" from their nearest United States Employment Service office.

Apply in Person or by Letter to

**RADIO DIVISION
WESTINGHOUSE ELECTRIC &
MANUFACTURING COMPANY
2519 Wilkins Avenue
Baltimore, Maryland**

POST-WAR TELEVISION OPPORTUNITIES

Allen B. DuMont Laboratories, Inc., has immediate positions available for men and women.

Company training courses will prepare those without previous experience.

ENGINEERS

Mechanical
Research
Development
Electrical
Design

INSPECTORS

Elect. Components
Glass

TESTERS

Electronic Tubes
Oscillographs
Licensed Station Operators

CATHODE-RAY TUBE DIVISION

Glass Lathe Operators (all shifts)
Exhaust Position Operators (all shifts)
Mount Assemblers (1st shift)

Radio service men and hams urgently needed as
Laboratory Technicians, Supervisors, foremen.

EMPLOYMENT FOR WOMEN

Wiring ★ Assembly ★ Testing
Secretaries ★ Clerks
Cafeteria Workers

Certificate of availability required

Allen B. DuMont Laboratories, Inc. ★ 2 Main Avenue ★ Passaic, N. J.

INDUSTRIAL
MAN-POWER BUREAU

Continued

WANTED:
Technical
Writer-Editor

Are you a Communications Engineer, preferably a college graduate, with operating, maintenance and possibly design experience?

Can you write *instructively* about the subjects with which you are familiar, and edit the writing of other engineers?

If so, we have the job you may want. This was a good job before the war. It is a good job now—and will be a good job for years and years after the war.

Tell us about yourself, your education, your experience and your salary requirements. Let's see if we can come to a mutually satisfactory and profitable understanding.

Box 355. c/o Radio News
540 N. Michigan Ave.
Chicago 11, Illinois

WANTED
Designers—Draftsmen—Detailers

For work on small electro-mechanical devices. Also fractional horsepower motors. Excellent post-war opportunities available for qualified personnel.

Apply by letter giving age, experience and draft status to

LEAR AVIA INCORPORATED
PIQUA, OHIO

Attention: R. J. Biggs

All applicants must comply with W.M.C. regulations.

Technical Writers
Wanted!

Engineers and physicists who have had experience in (spare time) writing technical manuscripts on electronic design or applications including radio, television, facsimile, etc. Highest rates.

Reply Box 310 c/o RADIO NEWS
540 N. Michigan Ave., Chicago, 11, Ill.

work worst when needed the most, such as during very bad weather.

On the other hand microwaves are incomparably more advantageous for railroad communications for the following reasons:

1. They are consistent in signal strength and range. Their performance is predictable within close limits for all times, areas and conditions.

2. They have thousands of times the frequency channel space as compared to frequencies having sky wave phenomena.

3. The same vast radio-frequency spectrum, roomy as it is, becomes available again for reassignment every two optical horizons.

4. They can accommodate unlimited frequency deviation ratios to get the fullest advantages of frequency modulation with regard to signal strength, intelligibility and freedom from amplitude forms of interference.

The minimum reliable working ranges for microwaves are 15 to 50 percent further than the maximum optical horizon. The optical horizon can be computed as being 1.225 times the square root of the combined heights of transmitting and receiving antennas and terrain.

The following factors increase the range beyond the optical horizon in the case of railroads using microwave communication.

1. Total antenna heights of transmitting and receiving points plus the height of their respective terrain.

2. Any improvement in ground conductivity better than that resulting from sand or rock.

3. Any condition resulting in the presence of moisture or humidity greater than that of desert, aridity or clear hot weather.

4. Any metallic paths such as railroad trackage and nearby telephone, telegraph or power line wires.

5. Wave guide and reflection effects produced by tunnels, canyons and tortuous terrain.

This means that during the worst conditions of weather and visibility when radio communication is most likely to be needed under emergency conditions, microwaves give their finest performances. At such times the likelihood of any substitute for two-way radio being available is least likely. In fact, many people may be surprised to learn that ground conductivity then becomes such as to even enable the signal to ignore physical barriers. Instead, it takes moisture or metallic paths around and even over these barriers.

Relay facilities to extend a railroad system several hundred miles may be of two forms. The first method provides for automatic relay stations mounted on existing poles, towers, structures or terrain elevations along the railroad right of way. These use two frequencies called "A" and "B" as shown in Fig. 1. For example, frequency "A" might be 2400 megacycles

while frequency "B" might be 2450 megacycles. A train along the track can initiate a communication on either A or B or both simultaneously. The nearest relay station picks the loudest signal. Suppose it is frequency A. Whatever the receiver of the automatic unattended relay station picks up on frequency "A," it immediately and automatically retransmits on its transmitter on frequency "B." At the next relay point it is received on frequency B and automatically retransmitted on frequency A. It then alternates between A and B to the destination or the limits of the railroad system. The equipment can be designed so that it uses a set of skip frequencies in the eastward direction and the opposite set in the westward direction.

The second form of relaying would be to provide no special relay stations. Their function can be performed automatically as a collateral task by every fixed and mobile station along the railroad at which communication is provided or required. Most railroads have passenger or freight stations less than five miles apart. Where they are farther apart, they usually have unusual horizon conditions such as clear country or hills to increase antenna horizon.

The complete equipment to provide two channels of reception and transmission on the microwave band is less than one-foot cube weighing about 20 pounds net and drawing about 200 watts under continuous operation for RA, RB, TA, and TB together or about 100 watts when only one transmitter and receiver is employed per station.

The minimum ranges will be between two walkie-talkie sets used by railroad personnel afoot with both being on same level. That will be about 4 miles maximum. Between two trains on same level it will be about 6 miles maximum. Any additional heights such as on a station building, tower, hilly land, or atop a mountain will serve to increase the range until in the mountainous areas the ranges will be over 100 miles, regardless if it is a train or a fixed station, without resort to a relay.

-30-

PHOTO CREDITS

| Page | Credit |
|---------------------------------|---|
| 21, 22, 23 | Union Pacific, North western & Southern Pacific Lines |
| 24 | New York Central |
| 25 | U. S. Army Air Forces |
| 28, 29 | Press Wireless, Inc. |
| 31, 54 | Staff Photo, Frank Ross |
| 36 | Wide World |
| 37 (top) | NBC |
| 37, 38, 39, 42 (all bottom), 40 | RCA |
| 38 (top) | Westinghouse |
| 41 (top) | Radiomarine Corp. of America |
| 41 (bottom), 42 (top) | British Marconi Co. |
| 53 | U. S. Army from Acme |
| 60 | General Radio Co. |
| 120 | General Electric |

ELECTRICIANS... RADIO MEN See These Great Pay Boosters FREE!

I'LL SEND YOU MY
FAMOUS REFERENCE BOOKS ON
7 DAYS FREE TRIAL



H. C. Lewis Pres. Coyne Electrical School

FREE WITH SET



Here's a great triple-header **EXTRA VALUE** I'll give you **FREE** with the 3-volume set if you act at once: (1) Big book of 150 shop prints, motor and radio diagrams and how to read them; (2) One-year consultation service by mail on your technical problems; (3) Subscription to **Technical News Bulletins** — ALL **FREE** with the Reference Set.

AMAZING 3 VOLUME REFERENCE SET

Yes! . . . Truly amazing! These 3 up-to-the-minute volumes actually contain more material than many sets selling for 2 or 3 times the price. Covers entire field of electricity and radio—motors, generators, auto and aviation electricity, air conditioning, refrigeration and hundreds of other subjects, complete, thorough, authoritative. Equally valuable for beginner or old timer—for home study or on-the-job problems. See these books at my risk! Send coupon below—keep set 7 days! Then either return it or send \$3 and \$3 a month until \$13.95 is paid. Cash price \$12.55 saves you 10% if sent within 7 days after books reach you.

TROUBLE-SHOOTING MANUAL

At last, the thoroughly practical Manual long needed by men in **ELECTRICITY, RADIO and REFRIGERATION**. Nothing else like it. Saves you time—helps win advancement and bigger pay. Really 4 **GREAT BOOKS IN ONE**. 600 page volume. (1) New step-by-step Trouble-Shooting course. (2) 500 Shop Prints. (3) Electrical-Radio Dictionary. (4) Spare-time job suggestions. Examine 7 days at my risk and then return it or send \$3 and \$3 a month until \$8.95 is paid. Cash price \$8.00 saves you 10%.

ELECTRONICS—New—Authoritative

Get ready for big things to come with my sensational new **Electronics Manual—ONLY BOOK OF ITS KIND!** A gold-mine of up-to-the-minute facts, graphic illustrations and easy-to-understand diagrams. Describes each type of tube—its uses, installation, servicing for electric devices. Get up-to-date on this new development that experts say will revolutionize post-war industry. **Special introductory price \$4.95 (Cash or C.O.D.)**

ELECTRICAL DICTIONARY

Simply, exactly defines over 1100 electrical and radio terms—contains many useful electrical and radio diagrams. A great help to beginner or veteran. Only 50c postpaid.

SEND NO MONEY:

I will ship any or all of the above books on 7 **DAYS FREE TRIAL**. Look them over for 7 days. If not 100% satisfied, ship them back. Otherwise pay for them as indicated in coupon. If your order totals \$5.00 or more you may pay \$3.00 within 7 days and \$3.00 a month. Rush coupon.

COYNE ELECTRICAL SCHOOL
Dept. B4-3T1
500 S. Paulina St. Chicago 12

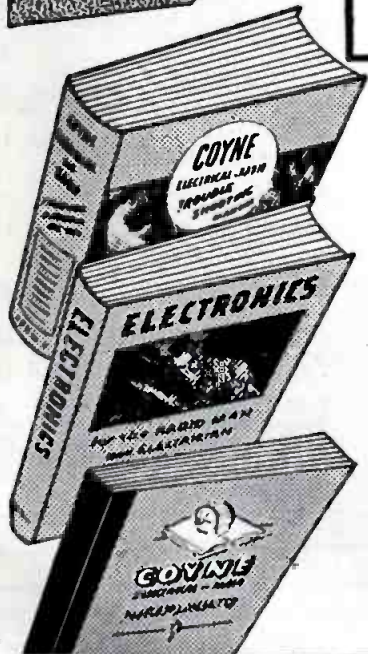
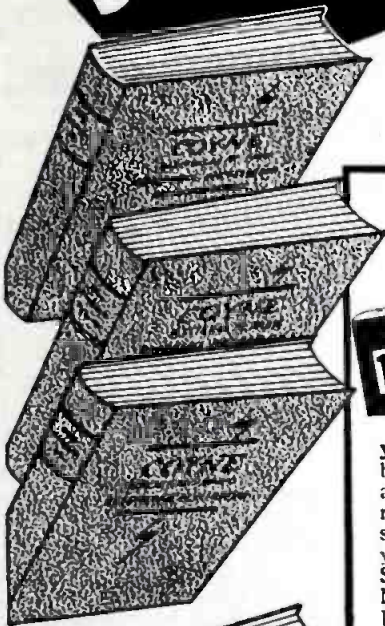

TROUBLESHOOTING MANUAL

612 Big Pages, Hundreds of pictures and diagrams. New 1944 edition.

PRACTICAL ELECTRONICS

New! Latest miracle of science is made easy to understand. Only book of its kind now on sale!

ELECTRICAL DICTIONARY

Over 1100 Electrical and radio terms defined and illustrated. Needed by every electrical worker or student.

FREE TRIAL COUPON - NO MONEY DOWN

- COYNE 3 VOL. REFERENCE SET:** Price complete \$13.95 payments, or \$12.55 cash. **BOOK** of 150 shop prints included **FREE**. Includes one year Free Consultation Service and Technical News Bulletins.
- COYNE TROUBLE-SHOOTING MANUAL: (1 VOL.)** Price \$8.95 payments, or \$8.00 cash. Includes one year Free Consultation Service and Technical News Bulletins.
- COYNE MANUAL OF ELECTRONICS: (1 VOL.)** Price \$4.95. Includes one year Free Technical Bulletins.
- 150 SHOP PRINTS AND MOTOR DIAGRAMS: (1 VOL.)** Price \$1.95. (Free with reference set or can be bought separately.)
- COYNE ELECTRICAL & RADIO DICTIONARY (1 VOL.)** Price 50c.

If you wish to pay the postman the cash price when books are delivered, check here. Same 7-Day Money-Back Guarantee of Satisfaction.

H. C. Lewis, President—Coyne Electrical School
500 S. Paulina St., Dept. B4-3T1 Chicago 12, Illinois

Send me the books checked at the left on 7 **DAYS FREE TRIAL**. I'll either return them in 7 days and owe you nothing or pay for them according to the plan I select as outlined above.

Name..... Age.....

Address.....

City..... Zone.... State.....

Name of Employer.....

| COMPANY | AGENCY | PAGE NO. |
|---|---------------------------------|---------------|
| Aerovox Corporation | Austin C. Lescarbours & Staff | 143 |
| Allied Radio Corporation | Henry H. Teplitz Adv. Agency | 62 |
| American Condenser Corp. | C. Wendel Muench Agency | 86 |
| American Phenolic Corporation | Evans Associates, Inc. | 87 |
| Audak Company | Hart Lehman Advertising | 8 |
| Audel, Theodore, & Co. | Grant & Wadsworth, Inc. | 128 |
| Best Vibrator Co. | | 136 |
| Billay Electric Company | W. S. Hill Company | 85 |
| L. S. Brech | United Advertising Agency | 101 |
| Browning Labs., Inc. | Charles Brunelle | 118 |
| Burlingame Associates | O'Callaghan Adv. Agency, Inc. | 90 |
| Burstein-Applebee Co. | Frank E. Whalen Adv. Co. | 134 |
| Candler System Co. | Galen E. Broyles Co. | 136 |
| Capitol Radio Engineering Institute | Henry J. Kaufman | 74 |
| Centralab | Gustav Marx Adv. Agency | 94 |
| Commercial Radio Institute | | 104 |
| Connecticut Telephone & Electric Division | Wilson & Haight, Inc. | 75 |
| Consolidated Radio Products Co. | Burton Browne Advertising | 67 |
| Continental Diamond Fibre | Harry P. Bridge Co., Adv. | 122 |
| Cornell Dubilier | Reiss Advertising | 13 |
| Cornish Wire Company, Inc. | Hart Lehman Advertising | 58 |
| Coyne Electrical School | McJunkin Adv. Co. | 118, 134, 141 |
| Chicago Novelty Co. | Sander Rodkin Adv. Agency | 106 |
| DeForest's Training, Inc. | MacDonald-Cook Co. | 96 |
| Dadur-Asasco Corporation | Shappe-Wilkes, Inc. | 59 |
| Detrola Corporation | Zimmer-Keller, Inc. | 100 |
| Doolittle Radio | Henry H. Teplitz Adv. Agency | 135 |
| DuMont, Allen B. Laboratories, Inc. | Austin C. Lescarbours & Staff | 139 |
| DuMont Electric Co. | Rothschild Advertising Agency | 69 |
| Echophone Radio Co. | Burton Browne Advertising | 15 |
| Editors and Engineers, Ltd. | | 102, 104 |
| Electro Motive Mfg. Co. | | 126 |
| Electro-Voice Mfg. Co., Inc. | Shappe-Wilkes, Inc. | 93 |
| Electronic Corp. of America | Shappe-Wilkes, Inc. | 65 |
| Electronic Laboratories, Inc. | Sidener & Van Ripper, Inc. Adv. | 79 |
| Fada Radio & Electric Co., Inc. | Sternfield-Godley, Inc. | 17 |
| Foster, A. P., Company | Gotham Advertising Co. | 105 |
| Federal Telephone & Radio Corp. | Marschalk & Pratt Co. | 9, 84 |
| Galvin Mfg. Corp. (Motorola Div.) | Gourfain-Cobb Adv. Agency | 95 |
| General Electric Co. | N. W. Ayer & Son, Inc. | 73 |
| General Motors, Delco Division | Campbell-Ewald | 63 |
| General Test Equipment | Suzanna Hayman, Adv. | 134 |
| Gothard Manufacturing Co. | Merchandising Advertisers | 102 |
| Greenlee Tool Co. | Howard H. Monk and Assocs. | 114 |
| Guardian Electric Mfg. Co. | Kennedy & Co. | Third Cover |
| Halicrafters | Burton Browne, Adv. 2nd Cover, | 5 |
| Hammerlund Mfg. Co., Inc. | Roeding & Arnold | 20 |
| Harco Steel Construction Co. | M. L. Lewis Advertising | 64 |
| Hytron Corporation | Henry A. Loudon Adv. | 77 |
| Illinois Condenser Co. | Sander Rodkin Adv. Agency | 114 |
| Industrial & Commercial Electronics | Garfield & Guild | 125 |
| International Resistance Co. | Lavanson Bureau | 113 |
| Jensen Radio Manufacturing Co. | Burton Browne Advertising | 6 |
| Johnson, E. F., Co. | David, Inc. | 91 |
| Kato Engineering Co. | | 116 |
| Kenyon Transformer Co. | Jasper, Lynch & Fishel, Inc. | 129 |
| Knights, James Co. | Turner Advertising Agency | 97 |
| Lafayette Radio Corp. | Shappe-Wilkes, Inc. | 66 |
| Lake Radio Sales Co. | Sander Rodkin Adv. Agency | 98 |

| COMPANY | AGENCY | PAGE NO. |
|---|----------------------------------|----------------|
| Lear Avia, Inc. | Arthur Kudner, Inc. | 140 |
| Lincoln Engineering School | Buchanan-Thomas Adv. Co. | 136 |
| McGraw-Hill Book Co., Inc. | | 104 |
| Mallory, P. R., & Co., Inc. | Aitkin-Kynett Co., Adv. | 103 |
| Meck, John, Industries | Western Advertising Agency | 89 |
| Merit Coil & Transformer Corp. | Ross Llewellyn, Inc. | 85 |
| Micarnold Corporation | Shappe-Wilkes, Inc. | 121 |
| Millon, James, Mfg. Co., Inc. | James Millen Inc. | 10 |
| Murdock, Wm. J., Co. | John A. Smith & Staff | 68 |
| National Company, Inc. | Craydon Smith, Advertising | 80 |
| National Electronic Supply | | 122 |
| National Radio Institute | Van Sant, Dugdale & Co. | 3, 140 |
| National Schools | The Mayers Company | 138 |
| National Scientific Products Co. | Kennedy & Company | 72 |
| National Union Radio Corp. | Sayre M. Ramsdell Associates. | Back Cover, 38 |
| Nelson Co. | A. N. Baker Adv. Agency | 98 |
| Ohmite Manufacturing Co. | Henry H. Teplitz Adv. Agcy | 57, 116 |
| Onan, D. W., & Sons | Pioneer Advertising | 106 |
| Panoramic Radio Corp. | Shappe-Wilkes, Inc. | 127 |
| Park Metal Ware Co., Inc. | Melvin F. Hall Adv. Agency | 108 |
| Pross Wireless, Inc. | | 138 |
| Radio & Technical Division of Murray Hill Books, Inc. | Harry P. Bridge Co., Adv. | 71 |
| RCA Communications | Albert Frank, Guenther, Inc. | 139 |
| RCA Engineering Division | Kenyon & Eckhardt, Inc. | 88 |
| RCA Institutes | | 108 |
| RCA Victor Division | Kenyon & Eckhardt, Inc. | 107 |
| Radolek Co. | Turner Advertising Agency | 128 |
| Randolph Radio Co. | | 70 |
| Rider, John F. Publisher, Inc. | Lansford F. King | 124 |
| Radio Merchandise Sales | DaKoven, Advertising | 76 |
| Runzel Cord & Wire | Duane Wanamaker Adv. | 117 |
| Sauersein Cements | | 136 |
| Shure Brothers | Henry H. Teplitz Adv. Agency | 83 |
| Simpson Electric Co. | Kraecker and Meloan, Inc. | 99 |
| Snyder Manufacturing Co. | Philip Klein Adv. Agency | 86 |
| Spertl, Inc. | Stockton, West, Burkhardt, Inc. | 111 |
| Sprague Products Co. | Harry P. Bridge Co. | 61 |
| Sprayberry Academy of Radio | Harry P. Bridge Co. | 11 |
| Sperry Gyroscope Co., Inc. | Equity Advertising Agency | 138 |
| Standard Transformer Corp. | Burnet-Kuhn Advertising Co. | 82 |
| Stevens Walden, Inc. | Howard-Wesson Co. | 14 |
| Sun Radio & Electric Co. | | 138 |
| Supreme Instruments Corp. | O'Callaghan Adv. Agency, Inc. | 78 |
| Supreme Publications | Henry H. Teplitz Adv. Agency | 131 |
| Sylvania Electric Products | Arthur Kudner, Inc. | 12, 139 |
| Teleplex Co. | Terrill Belknap Marsch Assocs. | 134 |
| Templeton Radio Co. | Peck Advertising Agency | 123 |
| Thordarson Electric Mfg. Co. | Duane Wanamaker Adv. | 94 |
| Tobe Deutschmann Corp. | Franklin Bruck Adv. Corp. | 144 |
| Triplett Electrical Instrument Co. | Western Advertising Agency | 18 |
| Tri-State College | Clem J. Steigmeyer Adv. | 136 |
| United Transformer Corp. | Shappe-Wilkes, Inc. | 7 |
| Universal Microphone Co., Ltd. | Ralph L. Power, Ph. D. | 109 |
| Utah Radio Products | The Buchen Company | 119 |
| Vaco Products Co. | Duane Wanamaker Adv. | 124 |
| Valparaiso Technical Institute | Smith, Benson & McClure, Inc. | 126, 136 |
| Ward Leonard Electric Co. | E. M. Freystadt Associates, Inc. | 18 |
| Ward Products Corporation | Burton Browne Advertising | 133 |
| Western Electric Co. | Deutsch & Shea | 138 |
| Westinghouse Electric & Mfg. Co. | Fuller & Smith & Ross, Inc. | 19, 139 |
| Weston Electrical Instrument Corp. | G. M. Basford Co. | 115 |

Classified
Rate 15c per word, Minimum, 10 words

FOR SALE

TRANSMITTING Insulators: Thousands of new Johnson No. 107 @ 48c, No. 112 @ 60c Net. Excellent 85 W. soldering irons \$6.50, solder 90c lb. Arrowhead Radio Co., 1216 D St., San Bernardino, Calif.

REPAIR Parts-Shop Stock. Write J. C. Thimijan, Lake City, Minn.

FULL wave Selenium Rectifiers, maximum load 2 1/2 amperes, 50 volts input, \$3.49, 1 1/2 lb. transformers 115 volt, secondary 30 volt 3 amperes, \$2.29, 6 pounds. Bargain list free. Milton Bursma, 105 Avondale, Jackson, Mich.

200 TUBE Substitutions including 12SA7 50L6GT 3Z5GT Adaptor Data, \$1.00. Jones, 1210 Dudley, Union 3, N. Y.

WANTED

WANTED: Test Equipment, any kind, condition. Lapham, 1746 Procter, Port Arthur, Tex.

CORRESPONDENCE COURSES

PREPARE now for tremendous opportunities in new fields of Radio after the war. Training for Federal licenses. Write for particulars. American Radio Institute, 44 East 23rd St., New York 10, N. Y.

USED Correspondence Courses and Educational Books sold or rented. Inexpensive. Money-back guarantee. Write for Free Catalog listing 4000 bargains.—(Courses Bought.)—Leo Mountain, Placah, Ala.

CORRESPONDENCE Courses and self-instruction books, slightly used. Sold. Rented. Exchanged. All subjects. Satisfaction guaranteed. Cash paid for used courses. Complete information and 92-page illustrated bargain catalog FREE. Write Nelson Company, Dept. 2-59, Chicago 4.

RADIO ENGINEERING

RADIO Engineering, Broadcasting, Aviation and Police Radio, Servicing, Marine Operating and Electronics taught thoroughly. Expenses low. Write for catalog. Valparaiso Technical Institute, Dept. N, Valparaiso, Ind.

PATENT ATTORNEYS

INVENTORS—Before disclosing your invention to anyone, send for Form "Evidence of Conception"; "Schedule of Government and Attorneys' Fees" and instructions. Sent free. Lancaster, Allwine & Roumel, 414 Bowen Building, Washington 5, D. C.

MISCELLANEOUS

50, 35 and 12 SERIES tubes repaired (about 50% 1.75c ea. 50c ea. if 25 or more. Cullen Radio, 798 Third St., San Bernardino, Calif.

12 to 30 VOLT Tubes repaired, 50 cents each. 50% repairable. Pierce, 201 W. Washington, McAlester, Okla.

MIDGET OIL-FILLED Capacitors

... used as Mica-Capacitor Alternates
and in Space-Saving Assemblies

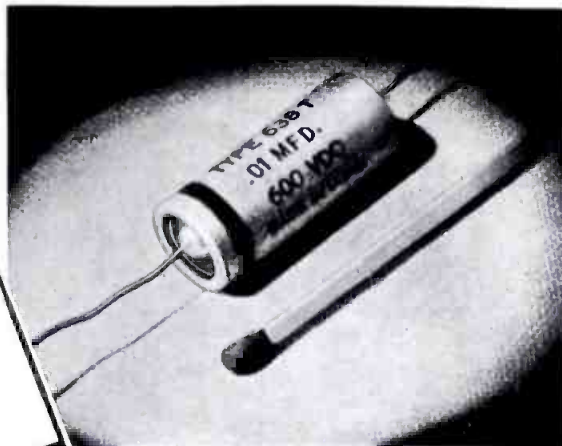

● Aerovox tubular oil-filled capacitors combine top performance with extreme compactness. Smaller Type '38 units serve as mica-capacitor alternates, meeting all standard test specifications as such.

These capacitors are hermetically-sealed in tiny metal cans or tubes. The Aerovox double-rubber bakelite terminal insulator assembly is used (or other suitable gasket material, depending on impregnant and fill). Case normally insulated from section, but grounded cases are available. Smaller Type '38 normally supplied without insulating outer tube. Larger Type '89 normally supplied with insulating outer tube and center mounting strap.

Covering a wide range of working voltages and capacitance values, these oil-filled tubulars are contributing notably to still better radio and electronic assemblies.

**WRITE FOR
LITERATURE**



Smaller Type '38: 300, 500 and 600 v. D.C.W., .001 to .01 mfd.; and 800 v., .001 to .005 mfd.

Larger Type '89: 400 v., .015 to .5 mfd.; 600 v., .015 to .25 mfd.; 1000 v., .006 to .1 mfd.; and 2000 v., .006 to .05 mfd.

Unless otherwise specified, units are supplied with Aerovox Hyvol oil impregnant and fill. Available also with mineral oil.

Type '38 tolerances up to but not including .01 mfd., minus 20% plus 50%; .01 mfd., minus 10% plus 40%.

Type '89 tolerances up to .009 mfd., inclusive, minus 20% plus 50%; .01 to .09 mfd., minus 10% plus 40%; higher than .09 mfd., minus 10% plus 20%.



Capacitors

INDIVIDUALLY TESTED

AEROVOX CORPORATION, NEW BEDFORD, MASS., U. S. A. SALES OFFICES IN ALL PRINCIPAL CITIES
Export: 13 E. 40 ST., NEW YORK 16, N. Y. Cable: 'ARLAB' In Canada: AEROVOX CANADA LTD., HAMILTON, ONT.

THE GIANT TORTOISE, believed to outlive all vertebrates. Its usual life span is up to 100 years, but records show one to have been at last 152 years old and possibly 200.

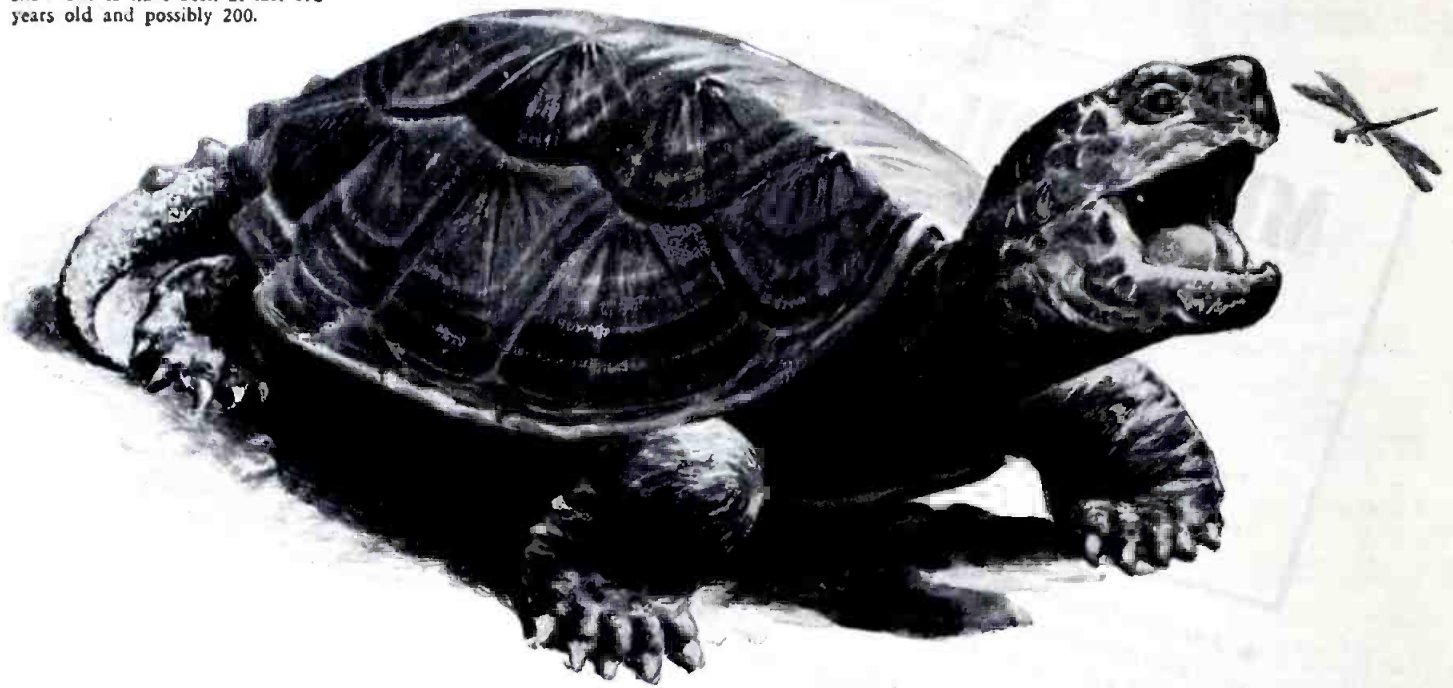

STANDARD OF STAMINA

What you want most in a capacitor is what you are sure of getting in TOBE Capacitors: . . . *long life!* Your proof is in Tobe's enviable record of practically no "returns". Frequent, rigid inspections eliminate uncertainty. Constant research brings constant improvement. The original capacitor with hold-down bracket, Tobe OM-601, offers many definite advantages. This capacitor is strong, compact and space-saving. The hold-down bracket permits the use of either inverted or upright terminals, with wiring underneath or on top of chassis. Write for details and samples (1.0 mfd and 2.0 mfd). Tobe engineers are glad to be of service.

This new separate mounting is stronger and helps prevent leaks caused by breaks in can. This outstanding Tobe design takes the minimum amount of space.

LONG LIFE ASSURED!

SPECIFICATIONS TOBE OM-601 CAPACITORS

| | |
|---|--|
| TYPE OM | SHUNT RESISTANCE |
| RATINGS .05 to 2.0 mfd. 600 V. D. C. | .05 to 0.1 mfd. 20,000 megohms |
| .05 mfd. to 1.0 mfd. 1,000 V. D. C. | .25 to 0.5 mfd. 12,000 megohms |
| STANDARD CAPACITY TOLERANCE . . . 10% | 1.0 to 2.0 mfd. 12,000 megohms |
| TEST VOLTAGE . . . Twice D. C. rating | POWER FACTOR |
| GROUND TEST . . . 2,500 Volts, D. C. | At 1,000 cycles—.002 to .005 |
| OPERATING TEMPERATURE . . 55°F to 185°F | CONTAINER SIZE |
| MOUNTING HOLE CENTERS 1/2" | Width 3/8", length 1 1/16", ht. 2 1/4" |



A small part in Victory Today . . . A BIG PART IN INDUSTRY TOMORROW

Printed in U. S. A.

wherever a tube is used...



for example

R. F. SHORT WAVE THERAPY

Radio Diathermy is used in therapeutic treatment of bruises, sprains, dislocations, arthritis, fractures, respiratory and sinus diseases. Oscillator type tubes generate the required high frequency.

THERE'S A JOB FOR

Relays BY **GUARDIAN**

The filaments of oscillator type tubes require a "warm up" of 20 to 30 seconds which is usually provided by a time delay relay such as Guardian's Type T-100. In this relay the time delay is adjustable between 10 and 60 seconds and is accomplished by means of a resistance wound bi-metal in series with a resistor. The contact capacity of the T-100 is 1500 watts on 110 volt, 60 cycle, non-inductive AC. The power consumption of coil and time delay during closing of the thermostatic blade is approximately 10 VA; after closing, 5.5 VA.

A similar relay giving almost the same performance but costing somewhat less is the Series T-110. This relay may be equipped with an extra set of open or closed contacts, if desired. In industrial control, both relays may be used in applications requiring the changing of circuits after a predetermined interval.

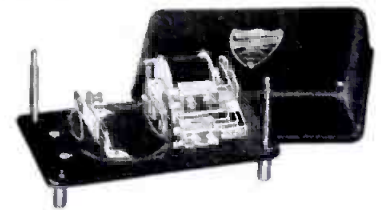

T-100 Laminated Time Delay Relay
Send for Bulletin R-5

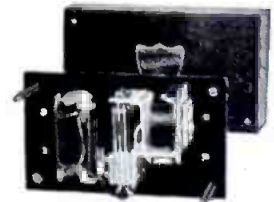

T-110 Time Delay Relay (not laminated)
Send for Bulletin R-5

Consult Guardian whenever a tube is used—however—Relays by Guardian are NOT limited to tube applications but are used wherever automatic control is desired for making, breaking, or changing the characteristics of electrical circuits.

GUARDIAN  **ELECTRIC**

1630-H W. WALNUT STREET

CHICAGO 12, ILLINOIS

A COMPLETE LINE OF RELAYS SERVING AMERICAN WAR INDUSTRY



GENERAL DWIGHT D. EISENHOWER
Commander in Chief of the Allied Forces

Tom Dolan

YOU HAVE A DUTY, TOO...

It's YOUR job, AMERICAN, to get behind the invasion drive. . . . What you are asked to do is easy compared to the job of him who is actually doing the fighting. You don't have to meet screaming steel. . . . The sniper's bullet can't touch you nor do you sleep in mud and rain. . . . No, you live safely and comfortably. . . . But your job IS an important one, MIGHTY important. SUPPORT THE FIFTH WAR LOAN! Buy more and *more* and MORE BONDS! That is YOUR job, AMERICAN. Don't let HIM over there down! *Back the Attack . . . Buy More Than Before.*



hallicrafters RADIO



THE HALLICRAFTERS COMPANY, MANUFACTURERS OF RADIO AND ELECTRONIC EQUIPMENT, CHICAGO 16, U. S. A.