

# RADIO NEWS

OCTOBER  
1943  
25c  
In Canada 30c



**DRAWN . . . . .**  
**DIE CAST . . . . .**  
**FORMED . . . . .**  
**MOLDED . . . . .**  
**EXTRUDED . . . . .**



A



B



C

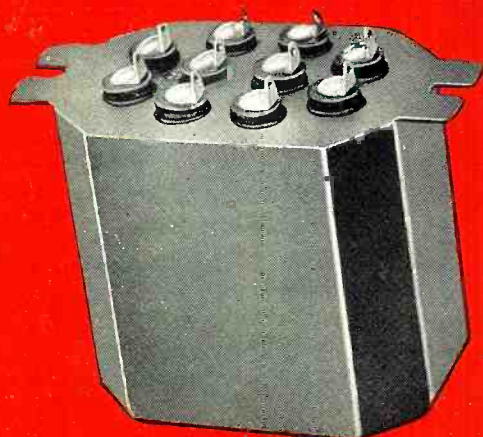

D

No one type of housing structure is suitable for all transformer applications. UTC units are housed in structures ranging from heavy sand castings to bakelite cases made in 30 cavity molds. A few structures, with their relative advantages for specific functions, are illustrated below.

**A-** The extruded can used on the now famous UTC Ouncer unit affords submersion test construction a minimum of weight, and sufficient metal thickness in the base opposite the terminal board for tapped mounting holes. Pioneered by UTC, the Ouncer unit is probably the most popular item in aircraft communication equipment.

**B-** Drawn round cans are ideal for many applications. The type illustrated effects small base dimensions with screw mounting. The cylindrical shape lends itself ideally to hermetic sealed units.

**C-** This unit is a tunable inductor in a die cast housing. The casting itself incorporates facilities for the internal mounting of the unit, mounting of the terminal board, tapped mounting facilities, and tapped set screw hole. The only screw used in this entire item is that for setting the inductance.

**D-** Drawn octagonal cans are simple in construction, and effect a minimum of volume. The two hole flange type mounting permits the construction of a unit poured with compound, having the same overall and mounting dimensions as an equivalent open channel mounting unit. Four hole mounting octagonal cases are used where additional mounting strength is required.

*May we design a unit to your war application?*

**UNITED TRANSFORMER CO.**

150 VARICK STREET



NEW YORK, N. Y.

EXPORT DIVISION: 100 VARICK STREET NEW YORK, N. Y. CABLES: "ARLAB"

# WE CAN TRAIN YOU TO START A SPARE TIME OR FULL TIME RADIO SERVICE BUSINESS WITHOUT CAPITAL

J. E. SMITH  
President  
National Radio  
Institute  
Established  
28 Years

## You Build These and Many Other Radio Circuits With Kits I Supply!

By the time you've conducted 60 sets of Experiments with Radio Parts I supply—have made hundreds of measurements and adjustments—you'll have had valuable PRACTICAL experience!

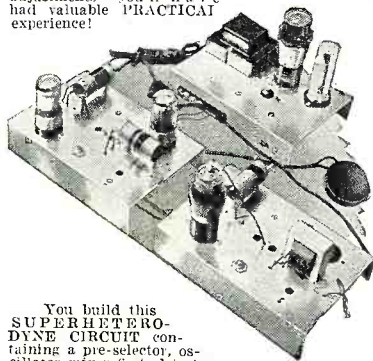

You build this SUPERHETERODYNE CIRCUIT containing a pre-selector, oscillator-mixer-first detector, i.f. stage, diode-detector-a.v.c. stage and audio stage. It will bring in local and distant stations. Get the thrill of learning at home evenings in spare time while you put the set through fascinating tests!



You build this MEASURING INSTRUMENT yourself early in the Course, useful for practical Radio work on neighborhood Radios to pick up EXTRA spare time money. It is a vacuum tube multimeter, measures A.C., D.C. and R.F. volts, D.C. currents, resistance, receiver output.

Building this A.M. SIGNAL-GENERATOR will give you valuable experience. Provides amplitude-modulated signals for test and experimental purposes.



### \$600 BEFORE GRADUATING, KITS HELPED



"From your Experimental Kits I learned how electricity worked, how to connect the three stages of a Radio together, also the practical basis for the operation of different parts of a set. I made about \$600 or \$700 before I graduated!"—S. G. PIERSON, Box 71, Dry Creek, W. Va.

## FREE TRIAL LESSON

I will send you FREE a Sample Lesson, "Getting Acquainted with Receiver Servicing," to show you how practical it is to train for a good pay Radio job at home in spare time. It's a valuable lesson. Study it—keep it—without any obligation whatsoever. Tells how Superheterodyne Receivers work—why Radio Tubes fail—how to fix Electrodynamo Loudspeakers and Output Transformers—how Gang Tuning Condensers work. Gives hints on I.F. Transformer Repair—how to locate defective soldered joints—Antenna, Oscillator Coil facts—Receiver Servicing Technique—dozens of other hints, facts, explanations. Illustrated with 31 photos, sketches, drawings. Get your copy at once—mail the coupon NOW!

### TRAINING MEN FOR VITAL RADIO JOBS

I Trained These Men

### These Men Have SPARE TIME BUSINESSES



"I repaired some Radio sets when I was on my tenth lesson. I really don't see how you can give so much for such a small amount of money. I made \$600 in a year and a half, and I have made an average of \$10 a week—just spare time."—JOHN JERRY, 1337 Kalamath St., Denver, Colo-rado.

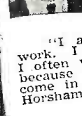

"I am engaged in spare time Radio work. I average from \$5 to \$10 a week. I often wished that I had enrolled sooner because all this extra money sure does come in handy."—THORODRE K. DuBREE, Horsham, Pa.



"I am doing spare time Radio work, and I am averaging around \$500 a year. These extra dollars mean so much—the difference between just barely getting by and living comfortably."—JOHN WASHINGTON, 97 New Cranberry, Hazleton, Penna.

I Trained These Men

### These Men Have FULL TIME BUSINESSES



"For several years I have been in business for myself making around \$200 a month. Business has steadily increased. I have N.R.I. to thank for my start in this field."—ARLIE J. FROEHNEL, 300 W. Texas Ave., Goose Creek, Texas.

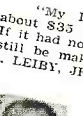

"My Loudspeaker System pays me about \$35 a week besides my Radio work. If it had not been for your Course, I would still be making common wages."—MILTON I. LEIBY, JR., Tipton, Pa.



"I started Radio in the Month of 1917. Later I started studying Radio in N.R.I. I recommend N.R.I. Training to any man no matter how long he has worked in Radio. I now have my own business."—CHARLES F. HELMUTH, 16 Hobart Ave., Absecon, N. J.

The men above are just a few of many I have trained at home in spare time to be Radio Technicians. Today they are operating their own successful spare time or full time Radio businesses. Hundreds more of my men are holding good jobs in practically every branch of Radio, as Radio Technicians or Operators. Aren't these men PROOF that my "50-50 Method" of training gives you, in your spare time at home, BOTH a thorough knowledge of Radio principles and the PRACTICAL experience you need to help you make more money in the fast-growing Radio industry?

### More Radio Technicians Now Make \$50 a Week Than Ever Before

There's a big shortage today of capable Radio Technicians and Operators. Fixing Radios pays better now than ever before. With new Radios out of production, fixing old sets, which were formerly traded in, adds greatly to the normal number of servicing jobs. Broadcasting Stations, Aviation and Police Radio, and other Radio branches are scrambling for Operators and Technicians. Radio Manufacturers, now working on Government orders for Radio equipment, employ trained men. The Government, too, needs hundreds of competent civilian and enlisted Radio men and women. You may never see a time again when it will be so easy to get started in this fascinating field.

### Be Ready to Cash in on Jobs Coming in Television, Electronics

Think of the NEW jobs that Television, Frequency Modulation, Electronics, and other Radio developments will open after the war! You have a real opportunity. I will train you to be ready to cash in when Victory releases the amazing wartime Radio developments for peace-time uses!

### TRAINING MEN FOR VITAL RADIO JOBS

## GOOD FOR BOTH 64 PAGE BOOK FREE

J. E. SMITH, President, Dept. 3KR,  
National Radio Institute, Washington 9, D. C.

Without obligating me, mail your Sample Lesson and 64-page book, FREE. I am particularly interested in the branch of Radio checked below. (No salesman will call. Write plainly.)

- Radio Service Business of My Own
- Service Technician for Radio Stores and Factories
- Spare Time Radio Servicing
- Government Civilian Radio
- Aviation Radio
- Operating Broadcasting Stations and Army, Navy Radio Jobs
- Operating Police Radio Stations
- Operating Ship and Harbor Radio

(If you have not decided which branch you prefer—mail coupon for facts to help you decide.)

Name..... Age.....

Address.....

City..... State..... ZIP.....

### Many Beginners Soon Make \$5, \$10 a Week EXTRA in Spare Time

Right now, probably in your neighborhood, there's room for more spare and full time Radio Technicians. Many N.R.I. Students make \$5, \$10 a week EXTRA MONEY fixing Radios in spare time while learning. I send EXTRA MONEY JOB SHEETS that tell how to do it!

My "50-50 Method"—half building and testing real Radio Circuits, half learning from easy-to-grasp, illustrated lessons—is a tested, proved way to learn Radio at home in spare time. Within a few months you can be ready to run your own Spare Time Shop, fix the Radios of your friends and neighbors—get paid while learning!

### Extra Pay in Army, Navy, Too

Men likely to go into military service, soldiers, sailors, marines should mail the coupon now! Learning Radio helps men get extra pay, extra more interesting duties, MUCH HIGHER PAY. Also prepares for good Radio jobs after service ends. Over 1,700 service men now enrolled.

### Mail Coupon for Sample Lesson and 64-page Book—Both Free

MAIL THE COUPON. I'll send you a FREE Lesson and my valuable, 64-page, illustrated book. They're packed with facts about Radio. You'll see snapshots and letters from men I trained, so you can know what N.R.I. did for others. You'll read a description of my Course—"50-50 Method"—6 Experiments—Extra Money Job Sheets. You'll have my free lesson to keep. And you'll see many fascinating jobs Radio offers and how YOU can train at home. No obligation—no salesman will call. If you want to JUMP YOUR PAY—Mail Coupon in an envelope or pasted on penny postcard! J. E. SMITH, President, Dept. 3KR, National Radio Institute, Washington-9, D. C.



## CONTENTS

### FEATURES

AVIGATION BY RADIO.....	Larry LeKashman	19
WAR-FRONT COMMUNICATIONS .....		22
WAVE GUIDES.....	John Williams	24
THE SAGA OF THE VACUUM TUBE.....	Gerald F. J. Tyne	26
MARINE RADIO DIRECTION FINDERS.....	Richard Grafton	28
RADIOS FOR OUR BOMBERS.....		30
X-RAY AND GEIGER MUELLER TUBES.....	C. D. Prater	32
FUNDAMENTAL A.C. CIRCUIT DEMONSTRATOR.....	S. A. Procter	35
METER SUBSTITUTES.....	Rufus P. Turner	38
REPLACEMENT POWER SUPPLIES.....	Robert F. Scott	42
DETERMINING CLOUD DEPTHS.....	S. R. Winters	44
SABOTAGE.....	R. R. Lyons	46
NEW MACHINE GUN TRAINER.....		47
AN AUTHOR'S RESPONSIBILITY.....		62
HIGH-FREQUENCY HEATING.....		111

### DEPARTMENTS

PRACTICAL RADIO COURSE, PART 18.....	A. A. Ghirardi	48	
BOOK REVIEW .....	40	QTC .....	40
WHAT'S NEW IN RADIO..	41	MFRS.' LITERATURE.....	46
SPOT RADIO NEWS..... 8			

Cover Photo—Army Air Force Technical Training Command, Camp Truax, Wis.

WM. B. ZIFF, *Publisher*                      B. G. DAVIS, *Editor*                      C. R. TIGHE, *Ass't to Publisher*

OLIVER READ, W9ETI  
*Managing Editor*

WM. A. STOCKLIN <i>Associate Editor</i>	R. B. FRANK, W9JU <i>Tech. Ed. (on leave)</i>	JOE MARTY, JR. <i>Field Editor</i>	J. M. ECKERT <i>Assistant Editor</i>
K. R. PORTER <i>War Correspondent</i>	HERMAN R. BOLLIN <i>Art Director</i>	S. L. CAHN <i>Advertising Mgr.</i>	H. G. STRONG <i>Circulation Director</i>

Copyright, 1943  
ZIFF-DAVIS PUBLISHING COMPANY  
Editorial Offices: 540 N. Michigan Ave., Chicago 11, Ill.  
Member of the Audit Bureau of Circulations

RADIO NEWS is published monthly by the Ziff-Davis Publishing Company at 540 N. Michigan Ave., Chicago, Ill. New York Office, 270 Madison Ave. Washington, D. C., Office, Earle Bldg. Special Washington Representative, Col. Harold E. Hartney, Occidental Hotel. London Editorial Representative, A. Spenser Allberry. Subscription Rates: In U. S. \$3.00 (12 issues), single copies, 25 cents; in South and Central America and U. S. Possessions, \$3.00 (12 issues); in Canada \$3.50 (12 issues), single copies 30 cents; in British Empire, \$4.00 (12 issues); all other foreign countries \$6.00 (12 issues). Subscribers should allow at least 2 weeks for change of address. All communications about subscriptions should be addressed to: Director of Circulation, 540 N. Michigan Ave., Chicago, 11, Ill. Entered as second class matter March 9, 1938, at the Post Office, Chicago, Illinois, under the Act of March 3, 1879. Entered as second class matter at the Post Office Department, Ottawa, Canada. Contributors should retain a copy of contributions. All submitted material must contain return postage. Contributions will be handled with reasonable care, but this magazine assumes no responsibility for their safety. Accepted material is subject to whatever adaptations, and revisions, including "by-line" changes, necessary to meet requirements. Payment covers all authors, contributors or contentants rights, title, and interest in and to the material accepted and will be made at our current rates upon acceptance. All photos and drawings will be considered as part of material purchased.



**HISTORY WILL PROBABLY RECORD** the fact that Yankee ingenuity played a greater part in the winning of the war for the Allies almost more than any other single contribution. The history of radio itself bears witness to the fact that electronic industries have attained their present full measure of growth through a very liberal application of this same ingenuity. Without this ingredient the success story of many firms and individuals in the radio industry would not now be possible. Perhaps the one thing which contributed more to the growth of the art than any other was the ability of the early pioneers to adapt themselves to the various stages of development. Since radio is a relatively new art, experimentation as well as ingenuity was necessary in order that each development could be adapted to the use found most practicable. Nowhere else in the world could we have an example of a huge industry growing from such a very small beginning in such a short space of time. The American system of free enterprise can be credited with providing the environment necessary for this phenomenal growth.

Today we see further evidences of this ingenuity, particularly as applied to our war effort. It should be realized that the research and development engineering laboratories of this industry have, in all probability, completed twelve years of work since Pearl Harbor. It was necessary for radio and communications industries to provide instant, continuous and rugged means of communications between all branches of our armed forces and their headquarters in whatever section of the world it was found necessary to station them. To old-timers in the industry no less than to the newcomers it is amazing what has been accomplished in the past two years. Inventions that were merely laboratory playthings at that time have been re-engineered and developed and are today in common use. Evidence is at hand of manufacturers converting  
*(Continued on page 100)*

# ELECTRONICS... A MIGHTY WEAPON

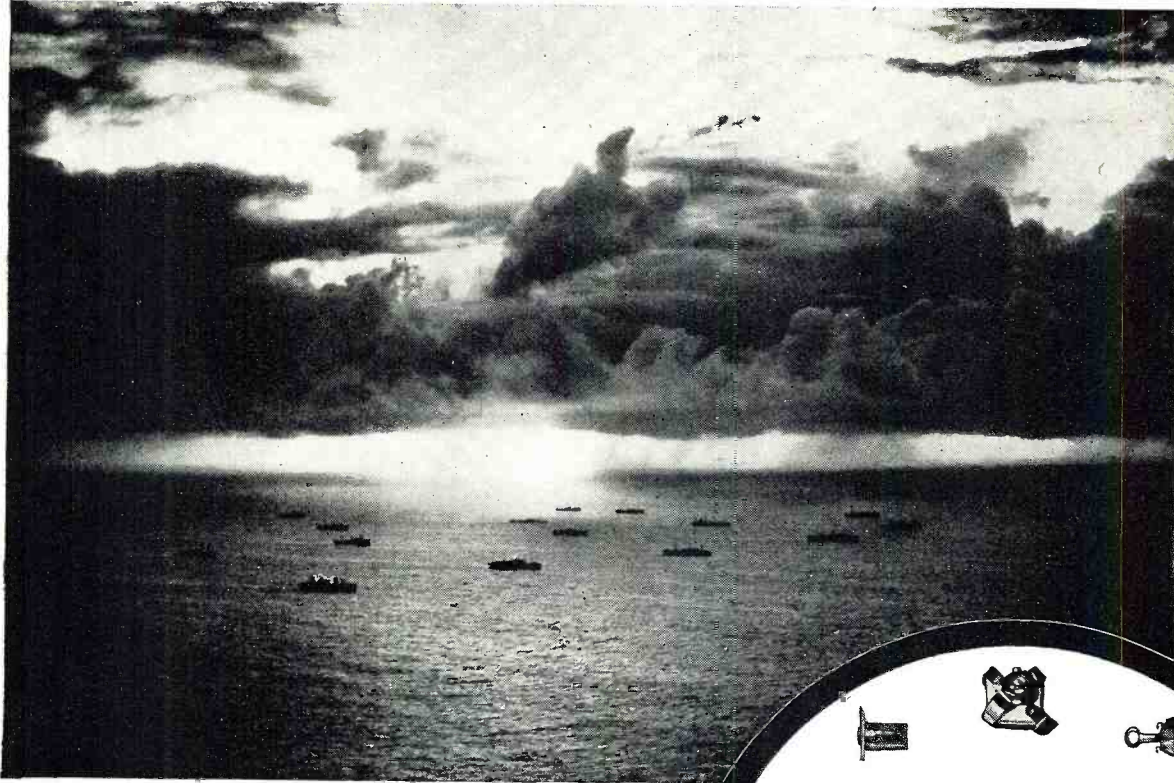

This is **ELECTRONICS** in operation . . . but not until the full facts are released will you be able to see all the technical developments.

## ELECTRONIC DEVICES

physically, are assemblies of components, each one contributing its share toward making the instrument function. Among the many activities of American Radio Hardware is the manufacture of over one hundred parts used in **ELECTRONIC** equipment and applications. That our components are used in the production of this mighty weapon is in itself a fine tribute to our skill and our facilities.

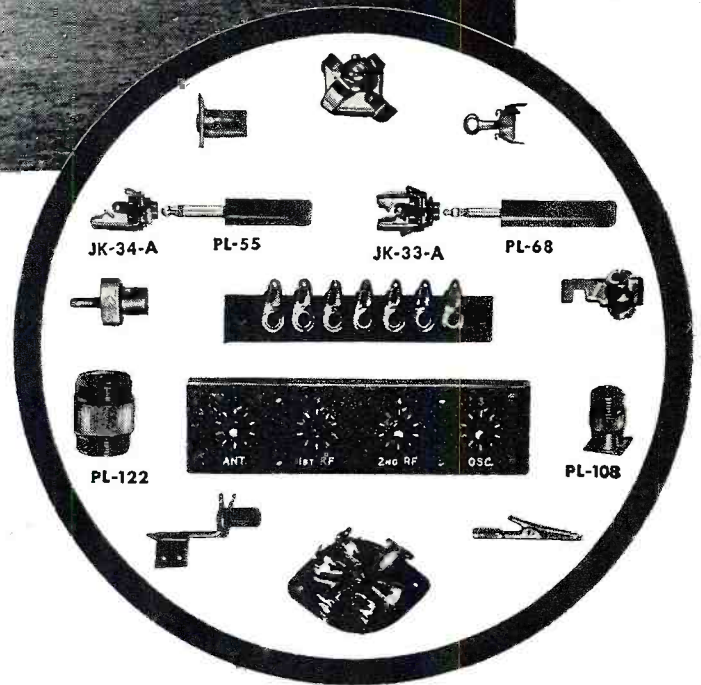

**ELECTRONIC** equipment is comprised of many individual components . . . plugs, jacks, insulators, etc.



With electrical and mechanical tolerances as critical as they are nowadays, all of our components have been improved to a commanding degree. When they are released for general use, they will be able to serve you better than ever before. Your inquiries regarding the entire ARHCO line are welcomed.

*American Radio Hardware Co., Inc.*

476 BROADWAY • NEW YORK 13, N. Y.

MANUFACTURERS OF SHORT WAVE • RADIO • TELEVISION • SOUND EQUIPMENT

# LITTLE GIANTS OF DEPENDABILITY

## JAMES KNIGHTS

# Crystals



### **Crystals For Victory!**

The men of the James Knights Company have pioneered in the manufacture of Crystals since 1932. Increased production during the present emergency period came naturally as already existing production facilities were called up. James Knights will be making Crystals too when this war is over—supplying them to those who demand the utmost in dependability and efficiency.

Any Type,  
Cut or  
Frequency

**PRECISION CUTTERS OF QUARTZ  
FOR COMMUNICATIONS AND OPTICAL USES**

**The JAMES KNIGHTS Company**  
SANDWICH, ILLINOIS      PHONE 65

# How an RCA Electron Tube



## Can Help Dress a Woman



REMEMBER how radio once mystified people? "What? Hear music from 1000 miles away through a bunch of tubes in a wooden box?" Well, you know the rest of that story. You helped write it!

Now it's Electronics—*your* biggest opportunity for tomorrow.

Today, thanks to an RCA electron tube, a device might even be built to stop a cloth-printing press the instant the uniformity of the printed color changed in the slightest. It's been estimated that such a modern "electric eye" can analyze and sort out 2,000,000 separate color variations. Think what that can mean to the woman who insists on perfect color matching—and to the textile industry that has to supply her.

You, Mr. Distributor, may well find yourself one day selling electronic equipment for this and a thousand other uses. And you, Mr. Serviceman, installing and maintaining it.

Just bear in mind two things: First—that its operation will largely depend on circuits, tubes, and parts already familiar to you from your radio days. Second—that *the Magic Brain of All Electronic Equipment Is a Tube and the Fountain-Head of Modern Tube Development Is RCA! RCA Victor Division, Radio Corporation of America, Camden, N. J.*

**TUNE IN "WHAT'S NEW?"**—RCA's great new show, Saturday nights, 7 to 8, E.W.T., Blue Network



*This electronic automatic recording spectro-photometer is used at RCA for testing luminescent materials for cathode-ray tubes. In 2 minutes it does accurately what a trained man formerly did, but not as well, in 2 weeks*



# RCA ELECTRON TUBES

Designed for



Application



Another exclusive Millen "Designed for Application" product. Combination high voltage terminal and thru-bushing. Tapered contact pin fits firmly into conical socket providing large area, low resistance connection. Pin is swivel mounted in cap to prevent twisting of lead wire. Easy to use. 1/4" o.d. insulation high voltage cable fits into opening in cap. Bared conductor passes thru pin for easy soldering to pre-tinned tip of contact plug.

Standard 37001 available in either black or red bakelite. No. 37501 is low loss mica filled yellow bakelite for R.F. applications.

**JAMES MILLEN  
MFG. CO., INC.**

MAIN OFFICE AND FACTORY  
**MALDEN  
MASSACHUSETTS**



# Spot Radio News

## IN DEFENSE AND INDUSTRY

by **LEWIS WINNER**  
RADIO NEWS Washington Correspondent

*Presenting latest information on the Radio Industry-*

**RADIO HAS FINALLY BEEN GIVEN** an official White House nod. Hereafter, the meetings with the President will be known as . . . press and radio conferences . . . and not just press conferences. To Walt Dennis, NAB news bureau chief, radio men are indebted for this acknowledgment. Dennis wrote to Stephen T. Early, secretary to President Roosevelt, explaining the extreme importance of radio as a news disseminating medium. The original request was for a change of the word . . . press . . . to news. However, Mr. Early went one better and put our friend, radio, right in with the press. We feel quite official now!

**WHEN A NEW 5000-WATT STATION** goes on the air during wartime, that's news of real import. The new station is WJW, and the location is Cleveland. The call letters were formerly those of the station in Akron, Ohio. A frequency of 850 kc. is being used by WJW, while the 1240 kc. frequency vacated by the removal of the station to Cleveland, has not been assigned, as yet.

There are several interesting items concerning this new station. For instance the owner, William J. O'Neil, still owns Mutual network facilities in Akron. And his new station is the new Blue outlet in Cleveland. In addition his father, William F. O'Neil is president of the General Tire & Rubber Company, who recently acquired ownership of the Yankee network in New England. Whether or not the junior O'Neil will be permitted ownership of the Akron facilities, has not been determined by the FCC yet. Operators of WSTV, Steubenville, Ohio, have formed a new company, the Buckeye Broadcasting Company, with a view towards purchasing the Akron station. An application for permission to use the 1240-kc. channel on 250 watts, unlimited, has already been filed by this new company.

The FCC sure has its problems!

**ONE OF RADIO'S CLOSEST FRIENDS** has left Washington. William D. Terrell, has given up his post as chief of the FCC Field Division, after 32 years of Government service. Mr. Terrell, who is now 72, was a wireless ship inspector, way back in 1911, in the radio department of those days . . . Department of Commerce. His

staff then, was his co-worker, the late R. Y. Cadmus, who too, was an inspector. In 1915, he headed a staff of 35, as radio inspector in charge. When ex-president Herbert Hoover, became Secretary of Commerce, Mr. Terrell was given full charge of radio regulation in the old radio division. When the Federal Radio Commission was formed in 1926, he continued his inspection work. And in 1934 when the FCC assumed control over all communications, Mr. Terrell was promoted to head the field division.

Everyone in radio, in and out of Washington, will miss Mr. Terrell of the FCC. Good luck, Mr. Terrell on your well-earned vacation.

**THE POSTWAR INDUSTRY COMMITTEE** officially identified as the Radio Technical Planning Board, has just completed its program plans. The RTPB composed of committees of the Institute of Radio Engineers and the Radio Manufacturers Association whose respective chairmen are Haraden Pratt and A. S. Wells, will be a technical advisory body. They will formulate recommendations to the Federal Communications Commission and other government as well as industrial agencies on the technical aspects of radio developments including spectrum utilization and system standardization for public services such as television and frequency modulation. The board will also develop studies, investigations, recommendations and standards that may be required. This data will be submitted to the FCC and other agencies for final action.

It will be recalled that FCC chairman Fly discussed this board during a luncheon at the NAB Convention in Chicago. The proposed plans ran into a snag for a while because of the difference in the IRE and RMA postwar beliefs. However, that has all been ironed out now and a sturdy representative program has been organized.

To provide the widest possible analysis of conditions to come, other industrial organizations have been invited to participate on the board. They include the American Institute of Electrical Engineers, American Institute of Physics, American Radio Relay League, FM Broadcaster's Inc., National Association of Broadcasters, and the National Independent Broad-



*Night and Day*  
**COMMUNICATIONS**  
on all fronts are better  
because of...



**Runzel.**  
CORDS · WIRES      CABLES



Turning out important material for ALL branches of our armed forces, the Runzel plant—because of our recent **BIG INCREASE** in plant capacity—can consider even **MORE WAR WORK**. If you are a prime contractor needing help in this field, we cordially invite you to consult us at once.

**RUNZEL CORD & WIRE CO.**  
4723-31 MONTROSE AVENUE • CHICAGO

A TECHNICAL  
"MUST"

# SYLVANIA SERVICEMAN SERVICE

by  
**FRANK FAX**



**A**T the risk of repeating myself, I'm plugging again the new revised Sylvania Technical Manual on Radio Tubes, because it should be a "must" on the bench or in the pocket of everyone interested in radio sales and service. Particularly now, because it has the basic data behind the Correlation for Substitution Chart and the Characteristics Sheet.

One section of this 275-page handbook lists new types of tubes released since issue of the last Manual. There is also a new section on panel lamps. Thus, it is as complete as possible at this time.

A plastic-ring binder allows the book to lie flat and remain open at whatever page is being consulted. Data arrangement remains the same, as do the easy-to-use index tabs.

The new revised Technical Manual still sells for the prewar price of 35 cents. If your jobber is unable to supply you, write to Frank Fax, Dept. N-10, Sylvania Electric Products Inc., Emporium, Pa.



Complete and reliable technical data on radio tubes—recently revised—price only 35 cents.

# SYLVANIA

**ELECTRIC PRODUCTS INC.**  
RADIO DIVISION  
Formerly Hygrade Sylvania Corporation

casters. Present plans also indicate that other major nonprofit radio organizations and communication, aeronautical and similar groups may be included on the board later.

Serving on the RMA committee now, in addition to chairman Wells are H. C. Bonfig, W. R. G. Baker, R. C. Cosgrove, Walter Evans and Fred C. Williams. On the IRE Committee, in addition to chairman Pratt, are Alfred N. Goldsmith, B. J. Thompson, and H. M. Turner.

Unanimous approval of cooperating with the technical planning group has already been agreed upon by one of the invited sponsors . . . the FM Broadcasters, Inc. This decision was reached at the special conference held in Milwaukee a short while ago. Thirty FM broadcasters attended this meeting. Included in this conference were Dr. Edwin H. Armstrong, well known for his FM contributions; George F. Adair, assistant chief engineer of the FCC in charge of broadcasting; Dr. Ray Manson of Stromberg-Carlson, and Dr. W. R. G. Baker of General Electric. A variety of very interesting post war plans were discussed at this meeting. Dr. Armstrong, for instance, discussed the allocation problem. He told of the errors that had been made in the past 25 years in allocating bands. He criticized the allocation of all of the wave lengths below 200 meters to the amateur. A second "blunder" according to Dr. Armstrong was the assumption that a 5000-cycle modulation band was all that would ever be required for good broadcasting. According to Dr. Armstrong, this has resulted in a "permanent impairment of the quality of the transmission on the standard broadcast band." He also criticized the television allocations, declaring that in these channels the modulating frequency was a large percentage of the carrier frequency.

A discussion of postwar problems by Dr. Baker covered the high standards that FM receivers must possess when manufacture is resumed. Methods must be developed, he said, to produce receivers that will operate without the use of special antennas. According to Dr. Baker, we should not expect too many of the drastic new postwar improvements immediately upon cessation of hostilities. It may take from five to six years to reap the benefits of the wartime technical advances. In his concluding remarks, Dr. Baker pointed out that FM is technically better than the present regular broadcast systems and accordingly cannot fail of acceptance.

The programs of other industry organizations, such as the FM broadcasters, will undoubtedly reveal many important postwar plans . . . plans that will undoubtedly create one of the most interesting eras in the history of broadcasting.

**THE ORIGINAL PLAN OF HALTING THE FCC** investigating activities of the Cox committee until Congress returns in the Fall, has been discarded. Action has shifted to New

York City, where every day sees another station owner, announcer or engineer on the stand before Cox counsel Eugene Garey. And the action has been far from dull, with claims and counterclaims being fired to and fro.

Prior to the New York session, many sessions had been held in Washington. Members of the committee and Washington officials attended. And during several days Commissioner Tunis A. M. Craven was on the stand. Commissioner Craven was chief engineer of the FCC from 1935 to 1937. In 1937 he was appointed commissioner to succeed Irwin Stewart. During the questioning, Commissioner Craven pointed out that he was in favor of clarification of the present Radio Act because of the May 10 Supreme Court decision.

In commenting on the activities of the committee, James Lawrence Fly, chairman of FCC, said that he is waiting for the public hearing to analyze the criticisms of the committee. Chairman Fly also told the newsmen at a conference that the President's order refusing to allow Army and Navy officers to appear before the committee was based on an adequate record, which the President had.

Although the committee will continue its examinations up until the Congressional return, no conclusions will be available until the reconvening of the Houses. Decisions will come then . . . and fast and furious.

**THE ARMY HAS SENT OUT ANOTHER PLEA** for radio equipment.

The Emergency Purchase Section, Philadelphia Signal Corps Procurement District, 5000 Wissahickon Ave., Philadelphia, Pennsylvania, is asking for a variety of short wave sets, oscilloscopes, signal generators, tube checkers, etc. The receivers required include those made by Hallicrafter, National, RCA, RME, Howard or Hammarlund. The instruments required include RF signal generators covering the 14 to 215 megacycle range, 30- to 15,000-cycle audio signal generators, 3 or 2" oscilloscopes, a.c. and d.c. voltmeters, ammeters, volt-ohm-milliammeters, chanalysts, etc. Transmitters of Collins, Temco and Hallicrafter design are also urgently needed.

If you have this type of equipment, write to the Emergency Purchase Section. Describe the equipment you have and state the price at which you can offer each item, f.o.b. Philadelphia. Do not ship any material without specific directions from that office. Price consideration will be based upon your net cost less reasonable depreciation for use, age and condition of equipment. Since all equipment is being purchased f.o.b. Philadelphia the cost of packing and shipping can be shown separately so that an allowance for the cost can be made when the material is accepted.

In discussing the subject of government purchases with a WPB officer, I was told that a program designed to move idle and excess frozen inventories into the war effort has been un-

# HERE'S YOUR SUCCESS CHANCE

BE A

# RADIO-ELECTRONIC TECHNICIAN!

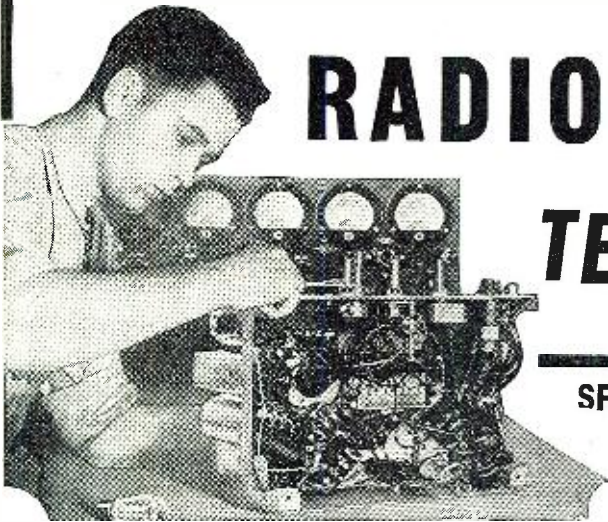

**SPRAYBERRY TRAINS YOU  
QUICKLY FOR WAR  
AND PEACETIME WORK**

**IF YOU REMAIN A  
CIVILIAN OR ENTER  
MILITARY SERVICE . . .  
Radio Training Will  
Enhance Your Future!  
• READ THESE LETTERS •**

**One Job Nets About \$26.00**

"Since last week I fixed 7 radios, all good-paying jobs and right now I am working on an amplifier system. This job alone will net me about \$26.00. As long as my work keeps coming in this way, I have only one word to say and that is "Thanks to my Sprayberry training," and I am not afraid to boast about it." — ADRIEN BENJAMIN, North Grosvenordale, Conn.

**Sprayberry Graduate Wins  
Out in Army Test**

"Since I completed your elegant Course in Radio I have been drafted into the Army and put into the Signal Corps. I had to compete to get the job I now hold and as a result of my training with you, I made the best grade and got the job. The point I am driving at is if it hadn't been for your thorough course in Radio I would probably be peeling potatoes now. I recommend your training to all because it is written in language that the average layman can understand." — ARCH PLUMMER, JR., Fort Meade, Md.

**Student Makes \$15.00 to \$20.00  
A Week in Spare Time**

"After starting your Course I began doing minor radio service jobs and I want to say that I have been flooded with work. So much so that I have had to neglect my lessons. I want to say your training has done a great deal for me. I am making \$15.00 to \$20.00 a week in spare time. Even so, I'm going to go back to my studies and finish the Course." — SANFORD J. CHICOINE, Whitley, Ontario, Canada.

**You Learn in Easy Step-by-Step Stages  
No Previous Experience Needed**

The offer I make you here is the opportunity of a lifetime. It's your big chance to get ready for a wonderful future in the swiftly expanding field of Radio-Electronics INCLUDING Radio, Television, Frequency Modulation, and Industrial Electronics. Be wise! NOW is the time to start. Aside from future considerations, just think of the IMMEDIATE possibilities in Radio during war time. They're tremendous! Best of all, it's easy for the beginner to get started through my quick, practical training.

**PREPARES YOU FOR A BUSINESS OF YOUR OWN  
. . . . or Good Radio Jobs, Civilian or Military**

The Sprayberry course is short, intensive, and interesting. It starts right at the beginning of Radio. You can't get lost. It gets the various subjects across in such a clear, simple way that you understand and remember. I make it easy for you to learn Radio Set Repair and Installation Work . . . by practical proven, time tested methods. I teach you how to install and repair Electronic Equipment,

and give you the broad fundamental principles so necessary as a background no matter what branch of radio you need to specialize in. Soon you'll be qualified for a good paying job in one of the nation's Radio plants doing war work OR, if you enter the Army, Navy, or Marines, my training will help you win higher rating and better pay. Let me prove what Sprayberry training can do for you.

**JUST OFF THE PRESS!**

**"How to Test and Repair Radio  
Sets Without Meters"**

Developed in the Sprayberry laboratory, this instructive volume tells about an amazingly simple, yet efficient method for Radio troubleshooting and repair without use of regular equipment made scarce due to war. Send for this free book now while the supply lasts and along with it, I will send you another big free book describing my Radio - Electronic training. Mail coupon.



**SPRAYBERRY ACADEMY OF RADIO**  
F. L. Sprayberry, Pres.  
625-K University Place, N. W.  
Washington, 9, D. C.

Please rush my FREE copies of "HOW TO TEST AND REPAIR RADIO SETS WITHOUT METERS" and "HOW TO MAKE MONEY IN RADIO."

Name ..... Age .....

Address .....

City ..... State .....

Tear off this coupon, mail in envelope or paste on penny postcard.

**NOW! BECOME A MONEY-MAKING RADIO SPECIALIST**

# RADIO PARTS LOWEST PRICES!



## Combination Table Cabinet

Modern table type phono cabinet, highly finished walnut. Dimensions: 14" front to back, 16" side to side, 5½" bottom of table panel to top, height over all, 13".

In original cartons—while they last..... **\$7.95**



## Just Received

**40,000—New, First Quality Discs  
Recording Type—Paper Base**

**H**IGH-QUALITY, double faced recording discs. Uniformly coated to mirror-smoothness. Non-inflammable. Made of durable paper-bond base. Low surface noise. While they last.

Diam.	Quantity	Net
8"	10 in Pkge.	\$1.45
10"	10 in Pkge.	1.75

## Genuine PHILCO

### ADJUST-TENNA AERIAL

Side-cowl or fender type 3 section Auto Aerial, Extends to 60", 3 ft. Heavy Lead-In.

While they last..... **\$3.29**  
Lots of 10.....Ea. **3.00**

### SPECIAL RESISTOR ASSORTMENT

¼-1½-1-2-3 wt. ALL VALUES—R. M. A.  
Coded-100..... **79c while they last.**

**SERVICEMEN'S SPECIAL!—10**  
lbs. Radio Parts Kit. Consists of all  
usable radio parts..... **only \$2.95**

**FREE!** Servicemen write today for free catalog listing thousands of parts bargains... hardware and replacement parts.

**We Save You Money  
Drop a Post Card Today**

## RANDOLPH RADIO

609 WEST RANDOLPH ST., CHICAGO, 6, ILL.

"Millions of Parts for Millions of Radios"

der way under the jurisdiction of the United States Treasury Department. Under this plan the War Production Board locates the buyers for surplus material ranging from ropes to anchors and the Procurement Division of the Treasury Department then negotiates the sale. This particular procedure follows the presidential executive order of August 30, 1942, naming the functions of the Procurement Division so far as the distribution of surplus Federal property is concerned. According to the WPB officer, equipment used by various government agencies is declared surplus when an agency no longer has use for the equipment or when the equipment no longer serves the purpose for which it was intended. There is no desire on the part of the government, explained the WPB official, to compete with private enterprise in the sale of these articles belonging to the government. The government is in the same position as you or I, he said, when we have some material and desire to sell it, when the need for it no longer exists.

Price ceiling limitations are adhered to. In the case of critical materials, preferences granted on the basis of need determined by WPB prevail. However, non-critical materials are often sold through a competitive bidding within the ceiling price. Radio equipment has not played a major role in many of these transactions. But there have been some types of radio equipment, no longer useful to the government but necessary in private industry, that have re-entered private industry via this surplus sale route. Much of the material has come from the defunct peace time government agencies. Present plans call for the sale of much of the material used by the defunct peacetime government future. Radio equipment will be found on the surplus lists of these agencies.

When a critical item is declared surplus, the Treasury Department determines first whether it is still usable by Federal agencies. If it is not, the WPB is notified. If the WPB has an eligible customer for that item, the Procurement Division is directed to make the sale. The sale can also be made to a tax-supported agency, such as a city or county. If there is no need for this equipment by either of the above two sources, then the item is put on sale to the general public who can purchase through competitive bidding. The general public is notified of these sales in two ways. Those who are on a list of prospective buyers, consisting of those who previously placed requests with the government, receive the information. In addition, all post offices and public places contain notices of these sales.

Incidentally, the various divisions of the military have utilized these channels very effectively in acquiring a variety of necessary material. This agency also has been of immense assistance to industry, at large, in supplying equipment and material for many vital phases of production.

**DID YOU EVER HEAR A RECORDING OF A FISH?** Submarine experts have. According to a report issued by the Fish and Wildlife Service of the Interior Department, of which Harold L. Ickes is Secretary, fish grunt, purr, drum, grind their teeth and make a medley of other sounds that create strong underwater vibrations even when inaudible on the surface. These odd sounds often confuse the boys with the earphones inside the submarine. For they sound sometimes like the hum of an enemy propeller. Accordingly, the Fish and Wildlife Service assisted by the Navy has made a series of recordings of fish noises. Every submarine man who wears earphones is being given fish-recording lessons. These chaps listen to the fish recordings until they know every sound by heart and can quickly differentiate between the burp of a fish and the roar of an alien propeller.

Incidentally, sound man, toadfish has probably the healthiest voice of all the fish. The volume of his output, according to the records, is as intense as that of a steamboat whistle. The report also mentions the odd fact that fishes capable of making these queer sounds are found both in fresh and salt water and in all parts of the world. Too bad the fish can't send their records back home!

## TRANSMISSION BY LIGHT WAVES

is in the offing, according to F. E. D'Humy vice president of Western Union. During a recent hearing on the proposed merger of Western Union and Postal Telegraph, Mr. D'Humy said that the use of light waves has already been tried to beam telegrams. It has worked very successfully. The possibilities are beyond the human scope of the imagination, he said. The system, identified as Telefax, is comparable to the methods used by television, according to Mr. D'Humy.

This is but one of a series of facsimile methods of transmission that we will undoubtedly hear much about in the postwar era. Radio, wire and power companies have been studying the vast possibilities of transmission on a variety of frequencies with and without wires. The wire application, of course, concerns the use of carrier current, which up till now has been used by but a comparatively few groups. Where it has been applied, the results have been most successful. It has been possible to transmit messages and signals over the power lines that may cover hundreds and hundreds of miles of overhead or underground travel, without in any way interfering with the actual distribution of power itself. The use of supersonics or those waves that are above the audible limit to which the human ear can respond (between 10,000 and 100,000 cycles per second) will also probably be used extensively in television and facsimile transmission. Such transmission will provide the sending of moving or fixed subjects; that is

# NEW

# G-E RADIO-NOISE FILTERS *for Aircraft*



Available in ratings of 25, 50, 100, and 200 amp, d-c, at 50 volts

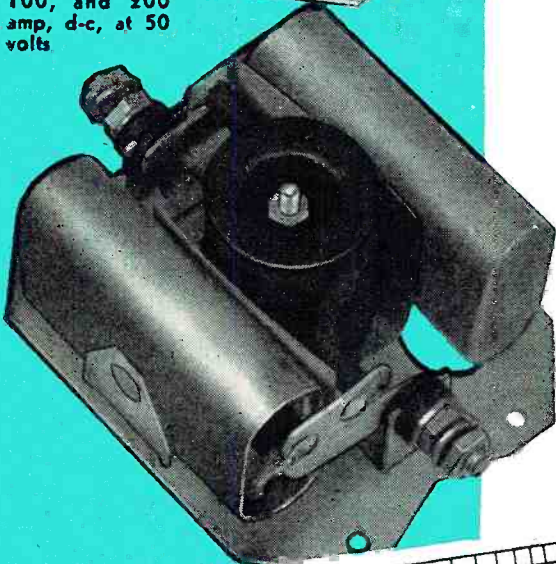

***They provide excellent noise suppression —especially from 200 to 20,000 kc***

**T**HESSE filters help immeasurably in providing the high-fidelity radio reception so important in aerial warfare. They attenuate radio-noise voltage on aircraft electric systems (on circuits with such equipment as generators, amplidyne, inverters, and dynamotors). They are particularly helpful in systems where open wiring is used to save weight.

## FEATURES

- High attenuation characteristic results in excellent noise reduction
- Compact and lightweight (For 100-amp rating, shown at left, approx 2 1/5 lb, measuring approx 5 by 4 by 2 1/2 in.)
- Can be mounted readily in any position
- Operate efficiently over a wide temperature range (— 50 C to 50 C)
- Comply with U.S. Army Air Forces specifications, including the stringent requirements as to vibration and acceleration

★ ★ ★

**FOR FURTHER DATA** Ask your G-E representative for Bulletin GEA-4098, or write to General Electric, Schenectady, New York.

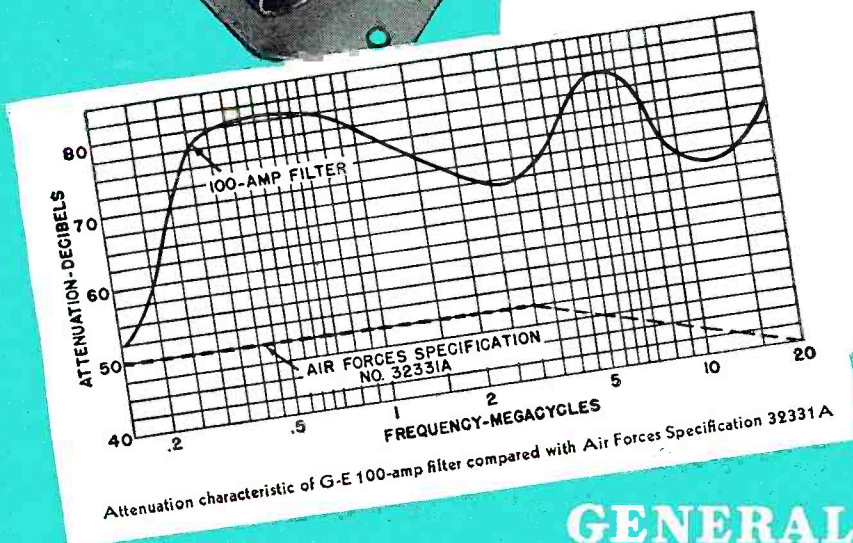

**GENERAL ELECTRIC**



**SPINTITE  
SPEED WORKING  
TOOLS** are a necessity.



**SPINTITE**  
—the wrench  
that works like  
a screw driver.

Standard sizes in Single  
Hex Sockets. 3/16" to  
1/2". SPINTITE offsets,  
knurled and square sockets  
for special applications are  
made to order.



Submit your  
problem for quotation

**STEVENS WALDEN, INC.**  
465 SHREWSBURY STREET  
WORCESTER, MASSACHUSETTS

motion pictures or still pictures, telegrams, advertisements, etc.

The predictions, of many years ago, that we will be able to sit in our homes and see, hear and receive in printed form the events of the day, do not appear to be fantastic anymore. The predictions have become facts and it won't be long before American homes, offices, and factories will boast of these amazing devices.

**WIRE RECORDING HAS BECOME HEADLINE NEWS** everywhere. The recent developments of recording on wire seems to have struck the fancy of the public as well as the scientific world. Newspapers, motion pictures, and most recently national magazines have been devoting columns and columns to this new method of "canning." One national magazine devoted to discussions of the business world, set aside complete pages to a discussion of the properties of "sound through magnetism."

It will be recalled that when we described this method of transmission many months ago, and then disclosed the interesting demonstration in Chicago but a couple of months ago, we cited the enthusiasm of everyone for this interesting recording system. Apparently the methods have intrigued everyone. Scientists and business men predict an outstanding field for the magnetized wire form of recording.

**ALTHOUGH THE PRESENT TRANSCRIPTION TIEUP** by union chief Caesar Petrillo has been the subject of countless conferences in industry, Congress took little official interest until last May. For then, it can now be revealed, a transcription bill with long teeth, S. 1332 was introduced in the Senate by Senator Tunnell. The bill would make it unlawful for any person to prevent the manufacture or production of records for radio transcription. The bill which was read twice and referred to the Committee on the Judiciary, went on to say that it would be unlawful for any person to threaten or compel stations or other broadcasters to refrain from the use of transcriptions because of the objection to the manner in which such records were manufactured or because the transcriptions were not produced by particular persons or organizations. The bill provides a penalty of \$5,000 fine or five year imprisonment or both, if the provisions were violated.

The industry looks forward with interest as to what action will be taken on this bill and several others . . . even stiffer . . . that will come up for a vote in the Fall months.

**NEW TRANSMITTING TUBES** may not be as easy to secure during the balance of 1943 and the coming year, according to a manufacturing survey. This scarcity will prevail particularly among the higher power type tubes.

The transmitting tube situation during the past 21 months of wartime op-

eration, hasn't been too bad. There have been some types that have been difficult to obtain, but on the whole the situation has been generally satisfactory. Contributing to this condition have been the relaxation rulings of the FCC, and also the expansion of tube repair facilities. Broadcast stations have only requested new tubes when absolutely necessary. This relaxed ordering schedule facilitated tube production and eased bottlenecks on production lines.

The tube situation, of course, is still a critical one on the overall front. Every precaution must therefore be made to care for each tube.

**MR. LUDWIG ARNSON**, president of *Radio Receptor Company, Inc.*, 251 West 18th Street, New York City, announces that the men and women of his company have been notified by Under Secretary of War Robert P. Patterson that they have again earned an award for continued outstanding production. This is the white star to be placed on their Army-Navy "E" flag.



Mr. Ludwig Arnson.

Radio Receptor has been engaged in manufacturing Ground-to-Air Radio Navigational Communications, Airport Traffic Control Equipment, and other electronic devices since 1922.

"Our men and women have worked hard to win this coveted award," said Mr. Arnson. "I have implicit faith that this recognition will stir them on to even greater achievements."

**FARM RADIO BATTERY PRODUCTION** has improved considerably. According to WPB, production at this point is better than in the second quarter, when 1,350,000 packs were produced.

Oddly enough, it isn't the shortage of metal that is causing trouble on many production lines, but corn starch, believe it or not.

Although the battery situation is holding its own, many large mail order houses have decided not to list farm radio batteries in their fall catalogs. Companies will accept deliveries of their regular quota of batteries of suppliers, however. The mail order houses are not listing farm batteries, because they say catalog readers usually assume that all articles listed there, are instantly available for purchase. The companies feel that such delivery may not be possible at all times and accordingly would rather supply available batteries upon specific requests.

Neville Miller, NAB president, recently wrote to the Hon. James F. Byrnes, director of the Office of War Mobilization, citing the battery problem. The letter was forwarded to the

(Continued on page 64)

# SCR-299

## Vanguard of Invasion!

The SCR-299 Mobile Radio Communications unit played a great part in the invasion of Africa and Sicily . . . these units were used as mobile radio stations, transmitting voice commands to fast moving armored units while in action, or as permanent radio stations . . . even under the most difficult operating conditions.

A leading military authority said, "My observations in the theatres of war make it possible to say that the SCR-299 hit the jack pot in the mobile radio field as has the jeep in transportation."



THE WORLD'S LARGEST EXCLUSIVE  
MANUFACTURER OF SHORT WAVE  
RADIO COMMUNICATIONS EQUIPMENT



BUY  
MORE  
BONDS!

the hallicrafters co.  
CHICAGO, U. S. A.



# TURNER

**URNS TO THE FUTURE**

Now, while Turner Microphones are proving of inestimable worth on war and industrial fronts, Turner engineers are diligently developing those microphones which are to serve mankind in the dawning "Air-Age" of the world—the age when communication and transportation ride the sky-ways, and time and space shrivel away.

Microphones will take on new shapes; their uses will be multiplied — to mention some of these now would seem fantastic. But of this you can be sure: for whatever purposes Turner Microphones are being developed, they will incorporate those principles of sound engineering which have gained for them the overwhelming preference of users desiring a rugged unit, built for accuracy, utility, dependable intelligibility and freedom from distortion under any acoustic or climatic condition.

Today, orders are being filled for those whose needs meet priority requirements. Send now for your free copy of the Turner Microphone Catalog. Fully illustrated in color, it gives complete details about available units, as well as valuable information on how to keep your present mike in perfect operation.

And if your plans for the future include communications, feel free to ask our engineers to assist you in those plans. Write today to the Turner Co., Cedar Rapids, Iowa.

**TURNER**

Pioneers in the  
Communication  
Field



# PAN AMERICAN USES THEM

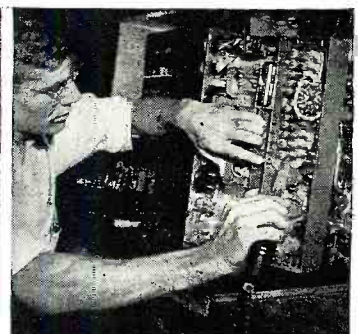
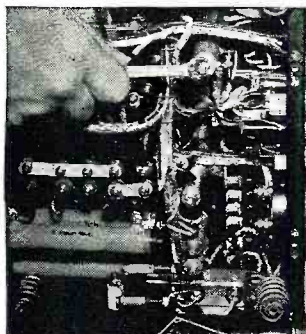
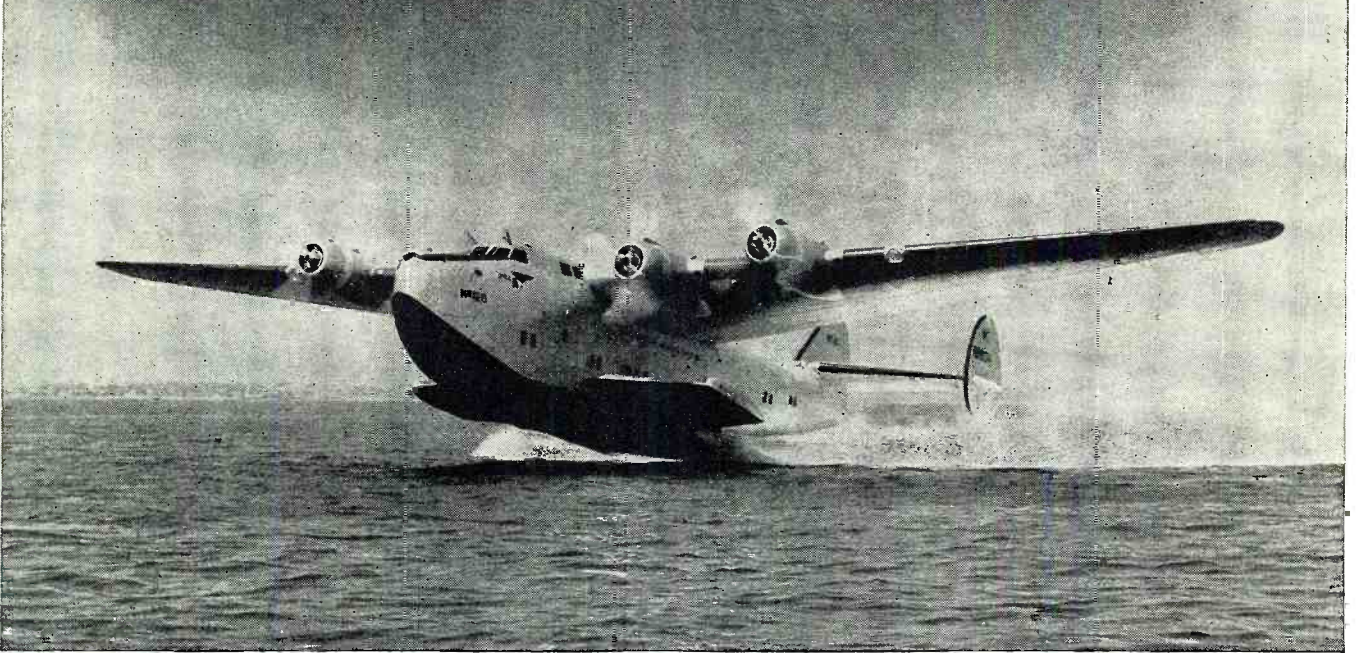

The Ward Leonard Vitreous Enamel, Wire Wound Resistors shown are used on maintenance and operation equipment at the Miami Clipper base of Pan American World Airways.

## WARD LEONARD

RELAYS • RESISTORS • RHEOSTATS

Electric control  devices since 1892.

WARD LEONARD ELECTRIC COMPANY, 47 SOUTH STREET, MOUNT VERNON, NEW YORK

October, 1943

17

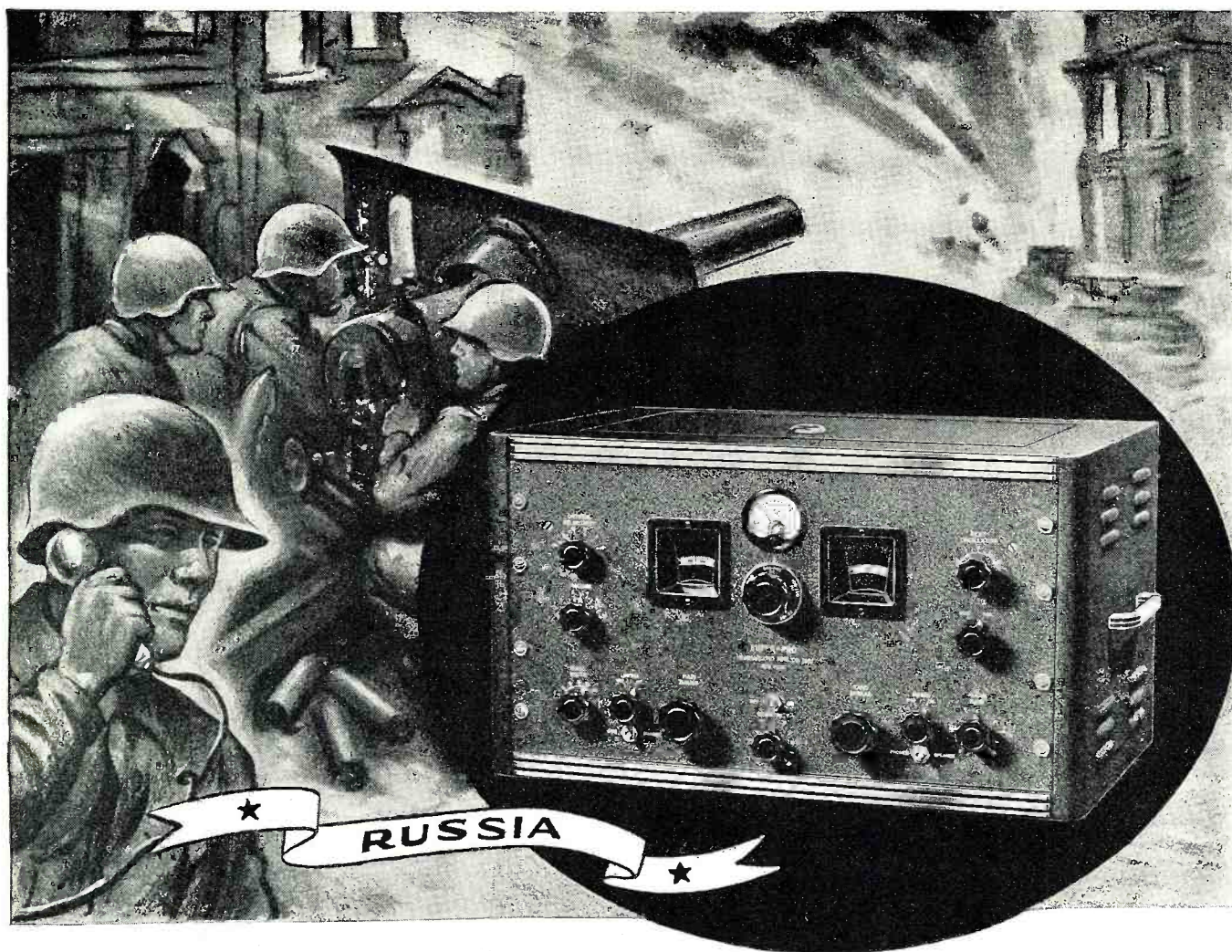

Attack Signals MUST Get Through

... the SUPER-PRO "SERIES . 200"

WHERE there is an important job to be done—where absolute dependability is essential—where vital messages are counted on to come through at precisely the right moment, there you'll find a "SUPER-PRO." And well chosen, too, for engineers know they can rely on the "SUPER-PRO."

THE HAMMARLUND MFG. CO., INC.  
460 West 34th Street, New York, N. Y.



**HAMMARLUND**

The operation of direction finding equipment and its application in air navigation, used by our military planes in global flying.

# AVIGATION BY RADIO

By LARRY LeKASHMAN

THE success of trans-oceanic flying, largely taken for granted as an aeronautical engineering feat, is on a commercial basis, indebted to radio in a measure unsuspected by the laymen. It is unlikely that even the radioman is familiar with a branch of communications almost entirely developed and matured through its infancy by one company. In the extension of aircraft avigation, radio was a logical means of supplementing the already familiar celestial type of navigation. The germination of this idea, the exhaustive study on how to apply the radio direction finder loop to avigation, and finally the formulation of a standard system of application, has made the radio equipment aboard aircraft a primary tool in successful flying where radio range facilities are inadequate. In an age of global flying the area which may be so designated, that is, inadequately equipped with ranges, is the majority of the earth's surface. Thus radio avigation is a major consideration in international flying.

In the limited confines of a single article it would be impossible to cover thoroughly the multiple phases of radio avigation. The discussion of the broadest applications of radio and a review of actual procedure in some of them, as applied to avigation, should serve the purpose of indoctrinating the radio technician in this rapidly expanding field. Like many new industries and professions which are born through some technological development, the immediate demands of radio avigation resulted in the birth of the Flight Radio Officer. By no means to be confused with the flight radio operator, an aerial telegraphist born of the exigencies of war, the profession of the Flight Radio Officer warrants careful attention. As a member of the flight crew ranking with pilots and Engineering Officers, the Flight Radio Officer is responsible for the maintenance and operation of all electronic devices aboard the aircraft. This not only includes transmitters and receivers, but such diversified units as the inter-phone amplifiers, range filters, direction finders, primary power sources, etc. With the colossal en-

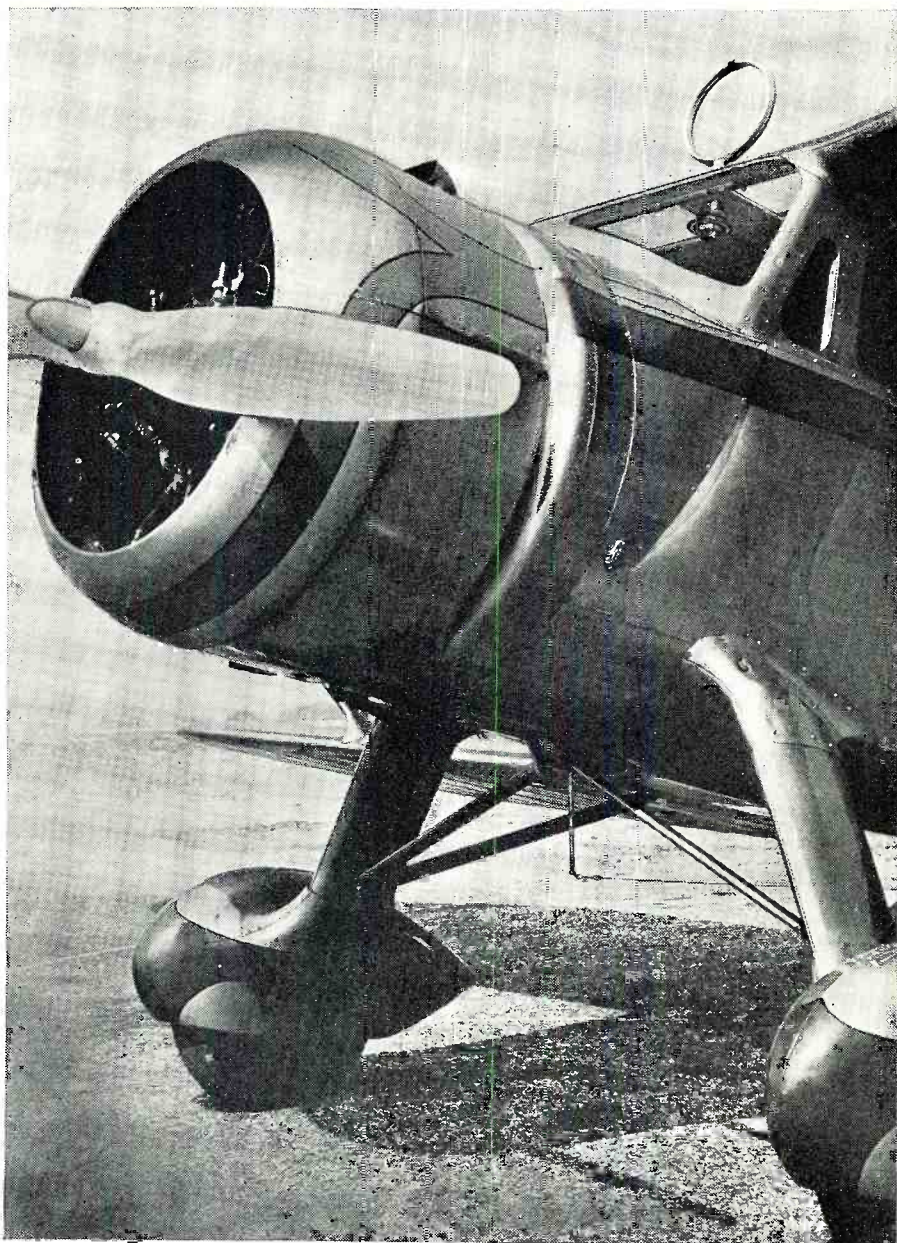

A directional loop antenna, manufactured by RCA, for use on civilian planes. The loop makes direction finding possible with a conventional aircraft receiver. A double-ended pointer is used on the indicator at the end of the loop control shaft. One end shows the bearing to which the loop is rotated, while the other end indicates the calibration correction for the bearing being taken. The corrections may be inscribed directly on the blank space provided on the azimuth scale.

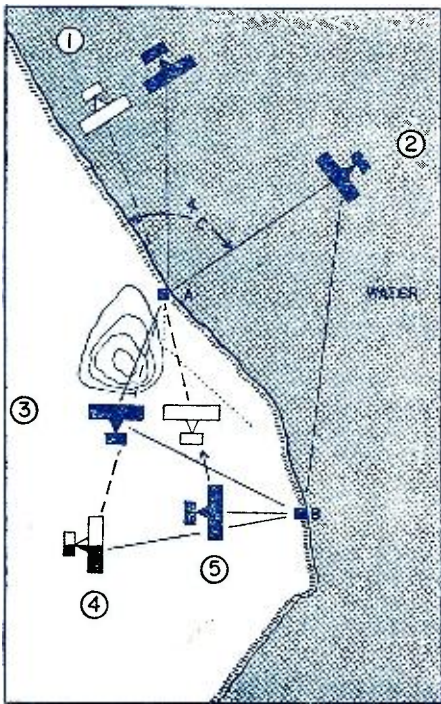

Fig. 1. Angle C should be greater than 30° to avoid coast line effect. (1) Effect of coast line when aircraft is taking bearing. Black position is actual; white is indicated. This condition would also exist, to a lesser degree, if bearings were taken on Station B. (2) Ideal condition for DF. (3) Effect of hill on track bearings. Black position is actual; white indicated by terrain distortion. Satisfactory bearings can be taken on Station B. (4) Similar conditions to three. (5) Good bearings on A and B, although caution must be observed in using A, since path of wave is still close to obstruction. Dotted line shows danger of reflection and the effect that obstructions would have on signals.

largement of the electronic field under the stimulus of war, the inventions applicable to aircraft communications and aviation emphasize the increasing importance of the flight officer responsible for their full utilization. Actual operating consumes only a nominal percentage of the radio officer's time. Radio aviation is one of his cardinal duties, one which he can perform successfully only with a careful theoretical background and a most intensive period of practical education in this subject.

Under good flying conditions with astrological bodies available for celestial navigation, radio plays a secondary role and is used more as a supplementary check. This condition is not likely to remain static as increased facilities are made ready for aircraft direction finding work, and as previously mentioned, improvements already used on military aircraft are installed on civilian planes. At such a time as all the known improvements in DF are merged with existing apparatus as a basis for development it is not unlikely that radio aviation will entirely supplement celestial aviation in most instances.

Radio is used entirely when the aircraft is flying through an overcast; to aid in daytime aviation in conjunc-

tion with sun-lines and in place of celestial fixes; to make instrument approaches and blind landings; for homing; and as a contributory aid during clear weather night flying. The type of instrument approach made using a DF loop is radically different from those executed by domestic airlines with the aid of fan markers and similar blind landing aids. For this reason the instrument approach will be discussed in more detail later in the article. Looking at the picture as it is today, it becomes apparent that the safety of the aircraft is often completely dependent upon the radio aviation facilities and how well they are operated.

Radio bearings are employed in a multitude of specific operations. They are used for radio fixes; for track bearings; as speed lines; to check distances away from stations; to determine the relative position of the plane and the signal source; to determine wind direction and velocity; for homing, and, of course, for the instrument approach and blind landings. Intelligent application of radio DF equipment, because of these many uses, is virtual insurance that the plane cannot get lost or even stray appreciably from its desired course.

If radio is so good, the sceptical individual might be inclined to ask why such skill is required to handle DF equipment and why more than just an average telegraph operator is essential to the safety of the aircraft. The answer to the latter part of such a question should be self-evident when the intricacies of radio aviation are examined. The radio direction finder is not infallible. Mechanically and electrically they can be perfected, duplicated and checked to a point where actual breakdowns are infrequent. Natural error on the other hand, the phenomena of shifting, false minimums, terrain distortion, etc., calls for the utmost skill on the part of the aviator to avoid fallacious readings. Man-made error can be detected and compensated for with relative ease. Natural phenomena must

be observed, watched for with the utmost vigilance, and each separate bearing treated for whatever inaccuracies seem apparent to the radio officer. Towards this end an analogy may be drawn between the doctor and the aviator. Many diseases have been studied and their cure prescribed, although there are rarities which still defy medical science. Once the doctor has made the correct diagnosis the cure is often relatively simple and certain. Once the aviator has determined whether his bearings are free from natural error and if not, what effect this error manifests itself in, he can readily avoid incorrect bearings. In DF work too, there are some cases where error may exist for a remote or illogical reasons. Fortunately such cases are infrequent and other than to mention they exist, no discussion is necessary. We are thus able to lay our finger on the causes of most radio direction finder error from natural phenomena.

Night effect, terrain effect, and coast line effect are the salient offenders in radio aviation. Night effect is a condition experienced from approximately two hours before sunset to two hours after sunrise. It will be prevalent throughout the hours of darkness, although the symptoms generally are strongest during the hours noted, especially at the actual time the sun sinks and rises. Night effect causes the minimum to shift or actually disappear as the aural null grows weak and indistinct. It is deceptive in that a bearing may shift and start to "hunt" and give other indications of a normal bearing while it is actually a false minimum. (Hunt implies slight variations on either side of the true bearing by an ADF.) The remedy for this is diligent observation of bearings taken during hours when night effect is suspected. An aid in minimizing night effect is proper selection of the signal source. Night effect is the direct result of horizontal pick-up in the loop which introduces a counter-emf in opposition to the vertical signal component and causes a phase shift. Since

FIG. 2. CHART SHOWING A COMPILATION OF BEARINGS TAKEN ON A NUMBER OF STATIONS.

STATION CALL	WCSH	RANGE AW	WCSH	CAPE COD Q	WLBZ
Time (GMT)....	1117	1147	1148	1148	1203
Frequency .....	940	990	940	302	620
Split .....		30			
Minimum .....		185			
Observed DF....	176	215	181	125	267
Corrected DF...	180	214	182	125	270
Compass .....	92	91	90	99	170
Corrtd. Compass	90	90	89	96	171
Magnetic QTE ..	270	304	271	221	441
	- 360	- 360	- 360	- 360	- 360
Magnetic QTE ..	270	304	271	221	81
Variation .....	- 18	- 17	- 17	- 17	- 19
True QTE .....	252	287	254	204	62
	= 180	= 180	= 180	= 180	= 180
Reciprocal .....	72	107	74	24	242

higher frequency stations have a stronger sky-wave than low frequency stations and consequently a greater horizontal signal component, wherever possible low frequency stations should be used for DF purposes. During the daytime stations as high as 2000KC may have very little sky-wave, but as skip lengthens, stations in the 200 to 500KC band are the most reliable. Since horizontally polarized waves are to be avoided it stands to reason that stations utilizing vertical radiators will have a material advantage over others. For this reason broadcast stations and low frequency stations who generally use a vertical radiator are most satisfactory in eliminating night effect and giving the most accurate daytime bearings. There are a substantial number of stations on the air today, especially in the 200 to 500KC band, who supply nothing but a signal source for aircraft to use in DF work. These stations are designated as phares, with the prefix *automatic* if the transmission and identification is sent automatically. Where phares are not available, broadcast stations, radio beacons for ships, and even ranges whose legs are not advantageous, may be utilized as signal sources.

Terrain effect is difficult to determine on an unknown station because there is no audible or visual indication that a bearing is not completely normal. If a course is flown consistently, by checking radio bearings against celestial fixes, an occasional landmark, or against the landfalls on arrival, terrain effect may be resolved into a definite error which may be allowed for at all times. Terrain effect, which presents a distorted and untrue picture of the plane's position and course, may be avoided by not taking bearings on stations behind hills, mountains . . . in fact any kind of obstruction. In particular terrain effected bearings, or bearings even remotely suspected of being under such influence, should be avoided for tail bearings if any other signal source is usable. For homing this does not necessarily hold true since the bearings will lead to the station even if by a somewhat circuitous course. Unless the error has been previously determined, and there need not always be one, any station not close to the coast or lying behind unobstructed land of mineral free influence should be regarded with suspicion and either checked against other stations for terrain effect or due allowance made for possible error.

Coast line effect is so similar to terrain effect that it is, in reality, nothing but a variation of terrain error. While it bears no outward signs of an inaccurate bearing it can be readily anticipated and all but eliminated by a careful choice of signal sources. Should no alternate stations be available it is feasible to make allowances for coast line effect although the amount of error which actually exists cannot be accurately estimated by

(Continued on page 86)

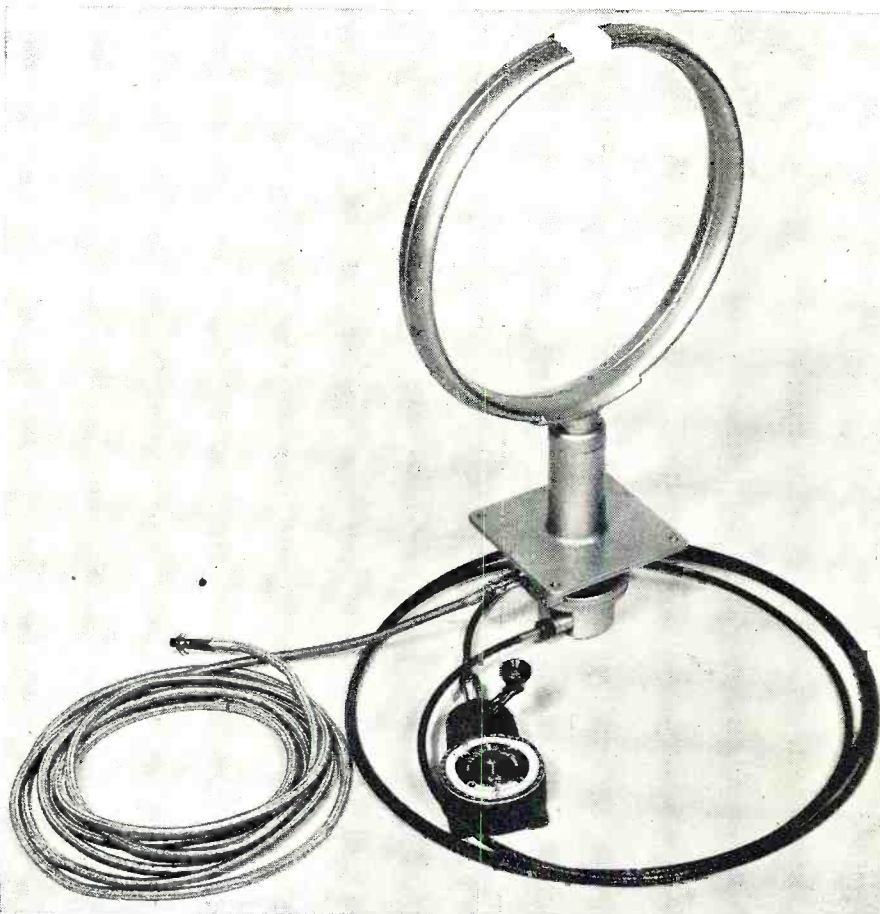

Professional-type direction finding loop assembly. Note the well-shielded cable.

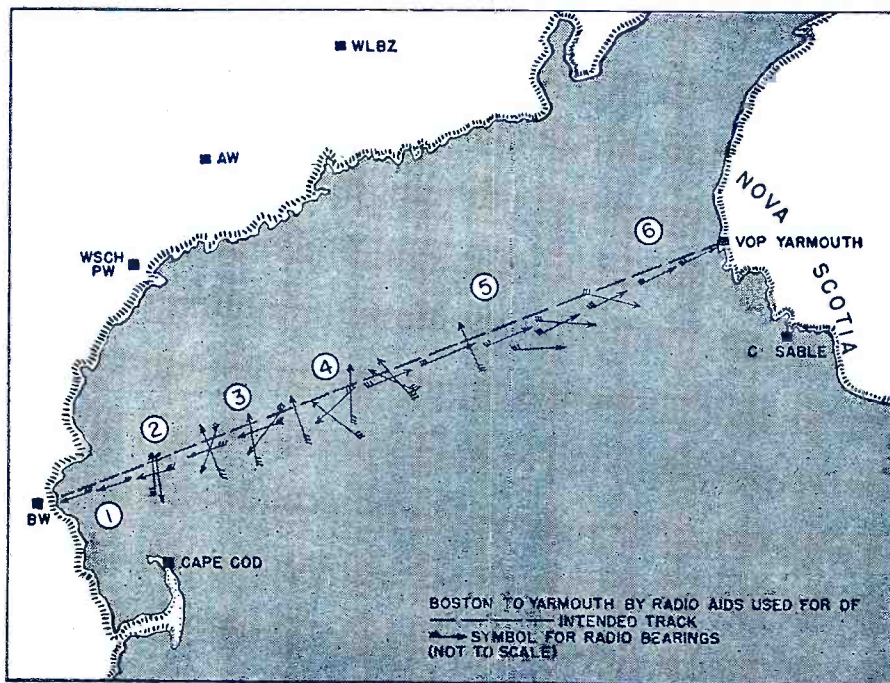
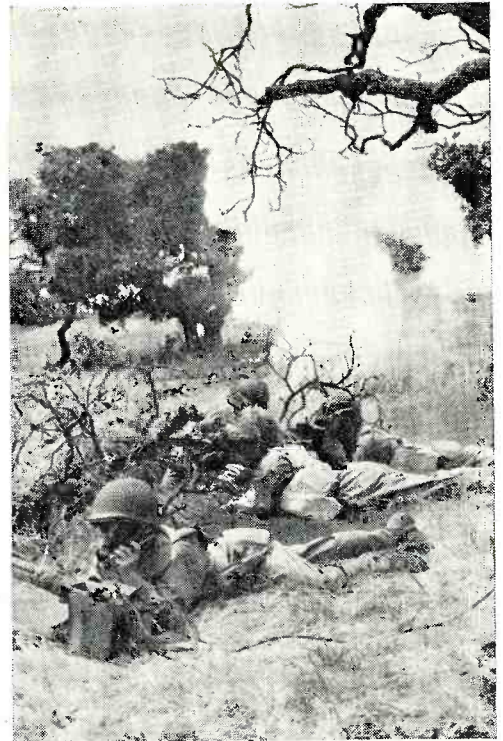

Fig. 3. Chart actually used on aircraft would include time of fixes and hourly positions marked. Abeam bearings would also include time. (1) Track bearings off tail. (2) Three station fix using abeam bearings. (3) Normal fix showing allowable spread between bearings. Center of triangle is position. (4) Two stations used for cross, then single speed line, followed by fix using station ahead as one signal source. (5) Track bearings showing a case where slight error may make angle of bearings unusable for cross. Bearings are shown gradually improving. (6) Track bearings with aircraft finally homing in. Cape Sable is not used for bearings close to land because of coast line effect. Atmospheric conditions will generally influence the distance, bearings are reliable over. On such a trip as this fixes might be taken all the way across.



American troops on the island of Attu, Aleutian islands. Radio operator directs landing operations from the shore, by means of a loud speaker.



Walkie-Talkie operator being covered by a .50 calibre machine gun crew.

# WAR-FRONT COMMUNICATIONS

**M**EN of our armed forces are daily endangering their lives for the preservation of our civilization. Communications equipment of various types are playing a vital role in this achievement; however, a great amount of work is being done on our world-wide battle fields to make communications equipment operative. Industry has aided in simplifying these tasks by constructing, sturdily built equipment, which can be easily assembled and repaired on world-wide battlefields and thereby decrease the dangers encountered by our fighting forces.

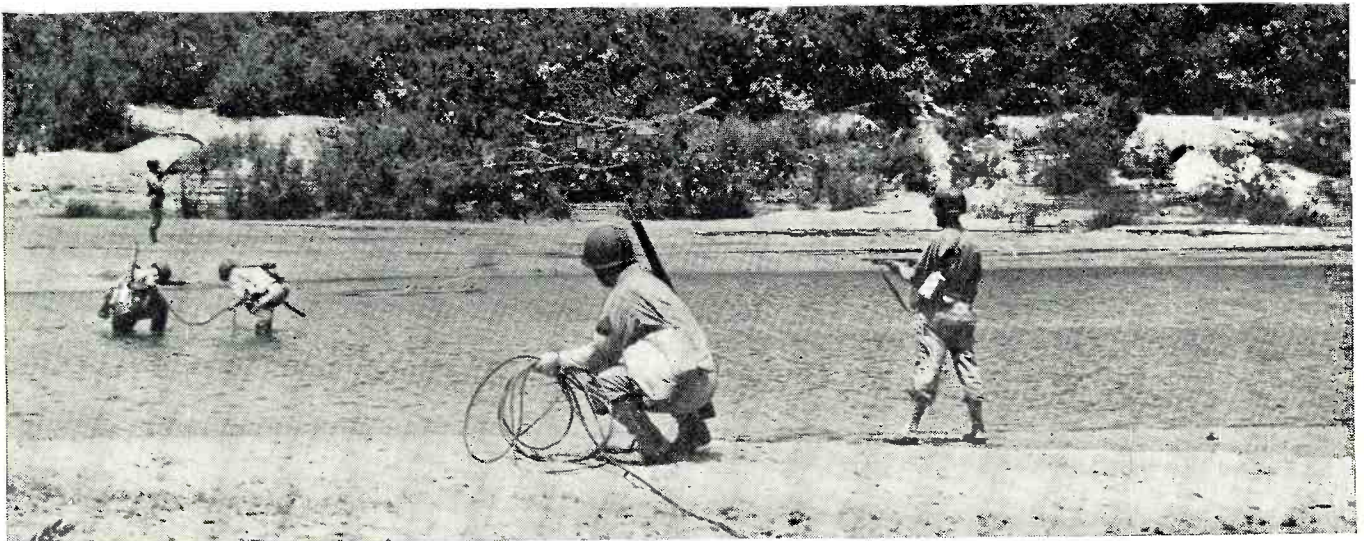

Guards are constantly on the alert as members of the Signal Corps string wire across a stream. The unit in East Garrison has as its chief function, the establishment of communication system between an army and its various divisional units.



Radio-equipped tank bumping clumsily over the uneven terrain of Central Tunisia while moving into the battle area. American units launched their biggest thrust in the Bir Marbott Pass forcing the Nazis to flee northward, up the road to Gabes.



A powerful post-hole digging machine, capable of digging thirty holes an hour, can be operated by a two-man team.

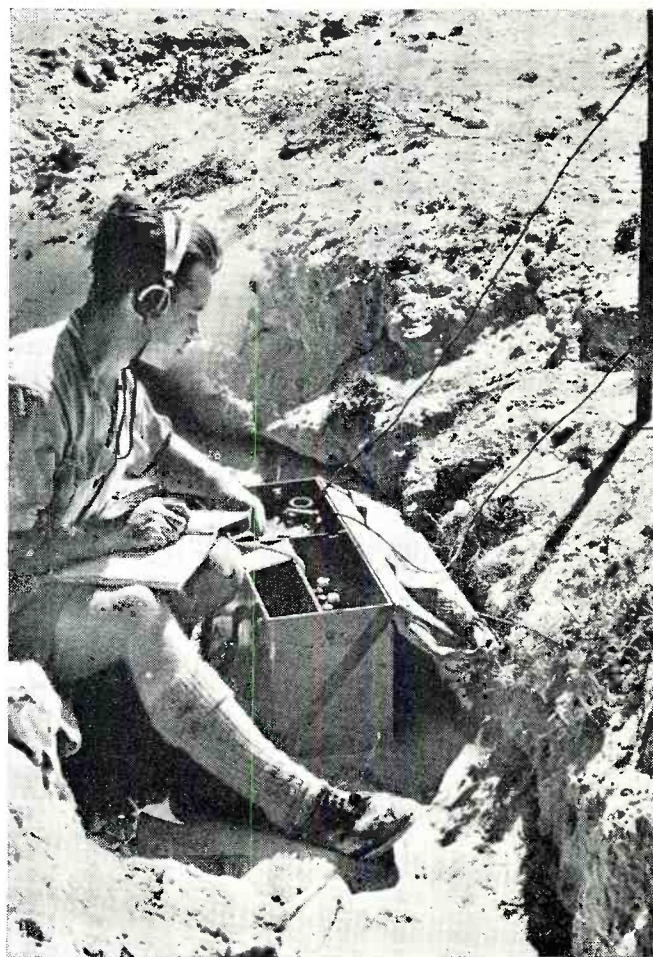

Wireless operator receiving message from another post somewhere in the Western Desert, near the Egyptian frontier.

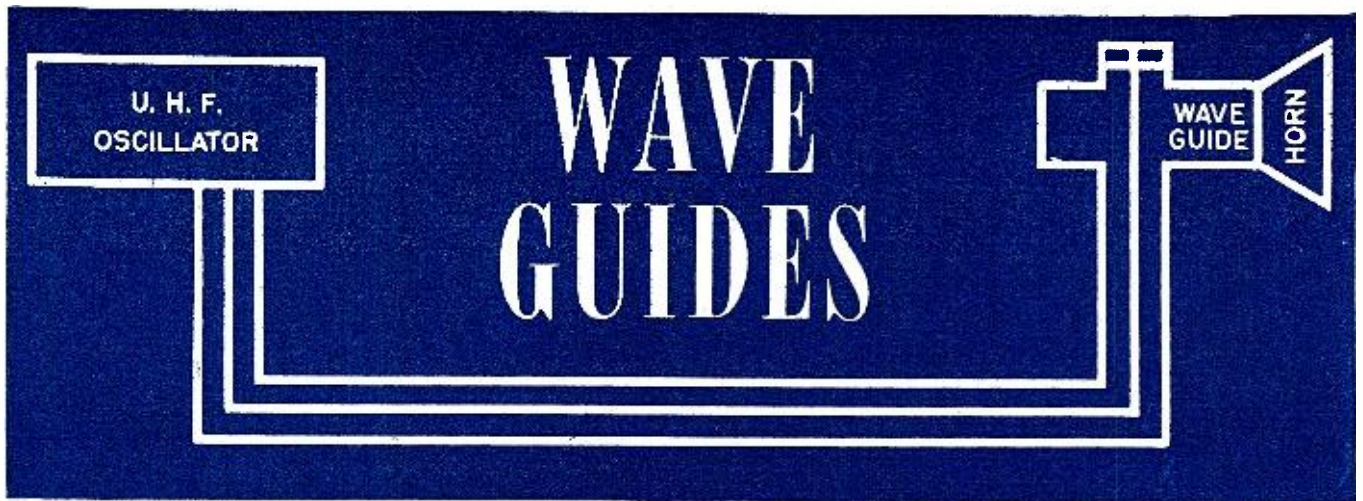

Fig. 1. A block diagram of a wave guide used to transmit ultra-high frequencies.

by **JOHN WILLIAMS**

***A thorough coverage of the basic theory and application of wave guides as used in conjunction with UHF equipment.***

HERE are usually two general waves sent out by a transmitter — a ground wave and a sky wave. The ground wave will continue along the surface of the earth for a way and finally be dissipated. The sky wave, if the frequency isn't too high, will be bent back to earth, either to be entirely absorbed, or as is generally true, to be reflected again several times before finally dying away.

These waves can be expressed by means of Maxwell's equations and their behavior fairly well predicted. Maxwell's equations, in case you are not familiar with them, relate electric and magnetic fields of a wave. Every electromagnetic wave is made up of two parts, an electric field of force and a magnetic field of force. Each field sustains the other and the energy in the wave alternates between the two, until finally all of this energy is dissipated. The wave has then died out.

In ordinary two-wire circuits at low frequencies it is easier to deal with the currents produced rather than the electric and magnetic fields. However, when we reach the ultra-high frequencies, the modes of transmission of energy make it more expedient to resort to Maxwell's equations rather than current flow. And it is only from this point of view that wave guides have been attacked. So, it is better to get used to the ideas of electric and magnetic lines of force and to visualize them as moving down the wave guide rather than to try to picture go and return circuits as found in ordinary electrical apparatus.

Actually all materials that confine and direct electric and magnetic disturbances can be called wave guides. However, due to usage and some slight custom, only those hollow conductors used at U.H.F. are thusly named.

Let us look closely at one of the hollow rectangular guides and see what goes on in them. Some sort of trans-

mitting antenna is located at one end and waves are sent out. These waves, like those sent out by any transmitter, are confined by the surroundings, in this case the conducting walls of the wave guides. And just as the ordinary sky wave is bounced back and forth between the earth and the ionized Heaviside-Layer in the sky, so will the waves in the guide be bounced back and forth against the walls and so propagated down the guide.

Fig. 2. The electrical and magnetic lines of force in a half-wave wave guide. The horizontal lines indicate the magnetic lines of force while the vertical lines are the electrical lines of force. The curved line represents the distribution of the electrical lines of force within the guide, as shown, with a resultant value of zero at both ends.

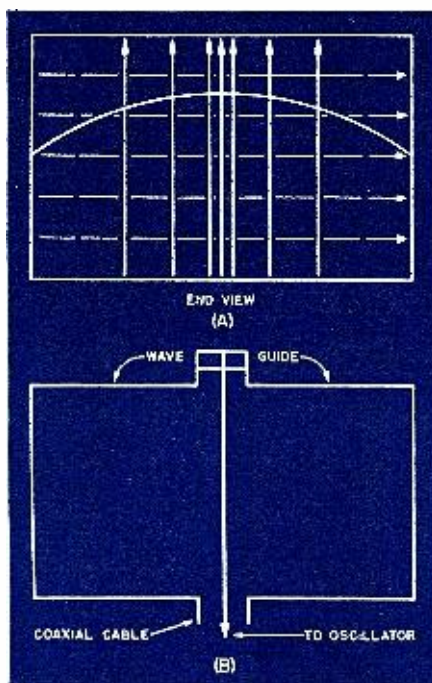

If the end of the guide is open most of the wave will continue out into the air and part will be reflected back. If the end of the guide is flared into the shape of a horn, then various directional patterns will be obtained, analogous in many ways to the acoustical horns. These horns (in this case called electromagnetic horns) are in reality coupling devices between the guide and the air.

Considerable amount of work has been done with these electromagnetic horns and various directional patterns obtained. The radiation patterns depend on the frequency of the wave, the angle of the flare, and the length of the horn. In general, while the throat of an acoustical horn is far smaller than the wavelength of the transmitted wave, in the electromagnetic horn the two are comparable.

A diagram of a wave guide set-up is shown drawn in Figure 1.

We will assume that the sides of the wave guide (still rectangular) are made of a material that has infinite conductivity. They will not support any potential difference because an "infinite" current flow would immediately take place, neutralizing the potential difference. Any electric lines of force that we have must cut the surfaces at right angles, since at this angle the electric field would not cause any current to flow. In addition, at their points of crossing, the magnetic lines of force and the electric lines will have to be at right angles to each other. Furthermore, it should also be remembered that magnetic lines of force form complete paths. A look at Figure 2A will show an end view of a rectangular wave guide (looking into the horn of Fig. 1). In the diagram the closer the solid arrows are bunched together, the stronger the field. At the two sides, of course, we must not have any electric lines of force because then a current would flow, dis-



torting the original field. A half wave fits in nicely, because we have maximum intensity in the middle and zero intensity at the edges.

If we wanted a full wave, we would get Figure 3A. One way of getting the pattern shown in Figure 2A is given in Figure 2B. Figure 3B shows how to get the pattern depicted in Figure 3A. Here it will be noted that the two wires are fed 180° out of phase. This can easily be had from an oscillator by coupling a coil and using the ends of this coil which are automatically 180° out of phase with each other. Now, while many modes of vibration are possible, those mostly used at present are those shown.

It will be noted from the first few diagrams that the electric lines of force terminate on the sides of the guide and that none of the magnetic lines of force extend into the space beyond the guide. This will allow wave guides to be run next to each other

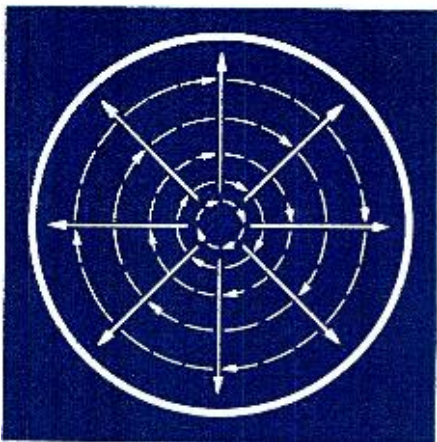

Fig. 5. Distribution of electrical and magnetic fields in a circular wave guide.

with no interference between the various waves.

Experiments also have shown that solid dielectric tubes which have no metal associated with them have the property of guiding energy from one place to another, although in this case the electric lines of force continue on into the space beyond the guide. Another objection to the use of dielectric wave guides is the high loss.

So again we see that our ordinary theory of conductors and insulators has to be revised. They are much more accurately attacked by means of our wave equations. The only thing that can be said against Maxwell's equations is the fact that advanced mathematics must be used.

A peculiarity that is not true at low frequencies, but very true at U.H.F. is that of cut-off frequency. Electromagnetic waves will not be freely transmitted in hollow conductors at all frequencies but only at certain ones determined by the material of the guide and its dimensions. Any frequency below this so-called critical frequency will not propagate.

The formulas for the cut-off frequency vary with the type of wave sent and while this may seem to cause

confusion because of the large variety of waves possible, yet the simpler types are well worked out and are used most of the time anyway.

For one type of wave sent in a rectangular wave guide the formula for the cut-off frequency  $f_0$  is:

$$f_0 = \frac{c}{2b}$$

where:

$c$  = velocity of light

$b$  = is the width of the guide shown in Figure 4

As an example consider the cut-off frequency for a guide where  $b$  is 10 cms. Then substitution in the above

formula shows  $f_0$  to be  $\frac{3 \cdot 10^{10}}{2 \cdot 10} = 1500$

mc./sec. Thus the guide acts like a high pass filter which will transmit only frequencies above 1500 mc./sec.

You will recall that the velocity of electric waves in low frequency conductors in a particular medium is very nearly that of light for that medium. In other words, it is equal to the velocity of light in free space divided by the index of refraction. The velocity in the wave guides depends on these same properties and also on the dimensions of the wave guide as well.

To properly match guides to input and output impedances, we must know something about their characteristic impedance. Whenever any transmission line is terminated in its characteristic impedance, all the energy in the line is transferred without reflection. For rectangular guides, variation of either  $a$  or  $b$  (Figure 4) will cause the characteristic impedance ( $Z_0$ ) to vary. Keeping  $a$  smaller than  $b$  will allow a maximum value of approximately 500 ohms to be attained while varying both will give almost any value desired. At the cut-off frequency the characteristic impedance approaches infinity, while at frequencies below the cut-off frequency,  $Z_0$  becomes imaginary.

The variation of the electric field in the wave guides can be investigated by means of a small antenna to which is attached a crystal detector or rectifier. The rectified current can then be read with a sensitive ammeter. In order to find the direction of the field the small antenna is moved until the maximum amount of current is flowing as shown by the meter. At this point the orientation of the field is the same as the antenna wires. The whole apparatus is unbelievably small,

Fig. 4. Wave guide dimensions.

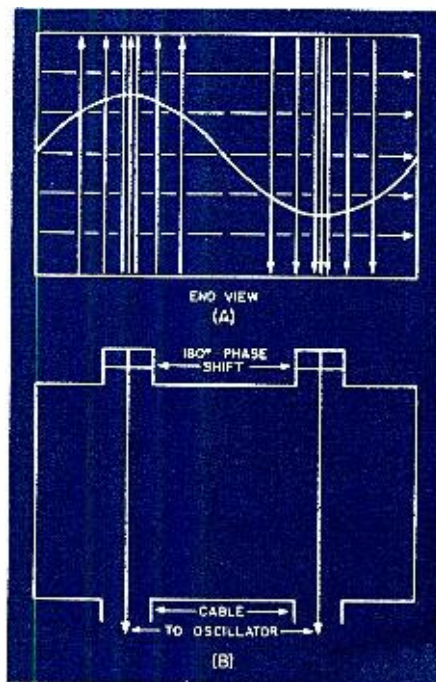
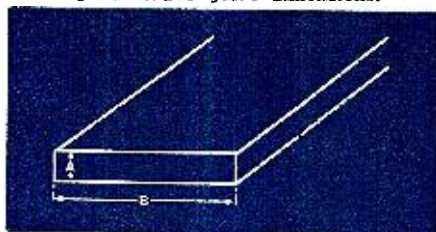

Fig. 3. A full-wave wave guide. The various lines of forces are symbolically the same as in Figure 2.

at times being no larger than perhaps an inch or two. The smaller the probe the more accurate will be the results since the material of the probe itself has an effect on the field, tending to change the direction and spacing of the lines of force. Probes can be constructed which will respond to waves with no more than a few milliwatts of power.

It has been found from these measurements that wave guides are subject to less loss than either our ordinary parallel wire system or the coaxial cable. In fact, one type of wave produced in wave guides shows that the attenuation decreases as the frequency is increased. The point might be raised now as to why wave guides aren't used exclusively if they have such low loss properties. The answer is simply that at the low frequencies the sizes become inconvenient. Using the formula given before ( $f_0 = \frac{c}{2b}$ ) figure

out how large a wave guide would have to be in order to work at 100 kc.

Although in the preceding discussion all examples were taken using rectangular guides, it is evident that comparable results can be had using cylindrical guides. In Figure 5 is shown the field arrangement for one type of wave in a circular guide. The electric lines meet the requirement that they intersect the outer conductor at right angles, at the same time, cross the magnetic lines at 90° angles. The magnetic lines are circular. One means of producing such a wave is to bring the transmitting antenna in at one end of the guide for a short distance. For this particular wave the antenna is located at the center of the cylinder. These cylinders, like the rectangular guide previously discussed,

(Continued on page 72)

# THE SAGA OF THE VACUUM TUBE

by **GERALD F. J. TYNE**

Research Engineer, N. Y.

**Part 7 of the series, covering the period during which the first commercial grid-type Audion tube was manufactured for civilian use.**

THE first public disclosure of the grid-type Audion was made at the Brooklyn Institute of Arts and Sciences on March 14, 1907 by Dr. Lee de Forest, in connection with a paper on "The Wireless Transmission of Intelligence."

Immediately after this disclosure de Forest organized the "De Forest Telephone Company" and its subsidiary, the "Radio Telephone Co." to manufacture and market wireless apparatus on which he owned or controlled patent rights. Directly thereafter the first grid-type Audion was manufactured for commercial use. It was made with a narrow flat plate mounted near a metal filament. Between these two was fixed a grid wire.

In 1909, in order to increase the conductivity of the tube, and to enable the use of larger energy, the use of two grids and two plates, one set on either side of the filament, was introduced. These were called "double Audions" and were sold at a higher price.<sup>140</sup> A photograph of one of these Audions is shown in Figure 44. Some of these double Audions had separate leads brought out from each grid and plate, as shown in the tube in Figure 45.

The filament structure was changed

in 1913 to the so-called "Hudson X" type developed by Dr. Walter Hudson. Dr. Hudson was an independent worker, an avid wireless fan, who had used the tantalum filament type Audion, and found it more emissive than the tungsten type. However, the tungsten filament had a longer life, and Hudson conceived the clever idea of combining both elements, by wrapping a short piece of tantalum wire around the tungsten. He induced McCandless to build up some bulbs of this type, which proved superior to the tungsten filament type, and were in correspondingly greater demand thereafter, even though sold at a higher price. A double grid, double plate Audion employing the Hudson type filament is shown in Figure 46. The tantalum wire wrapping can be seen on the top arc of the filament.

Having briefly outlined the various steps in the evolution of the structure of the earlier Audions, let us now see how they were made available to the purchaser. As far as the author has been able to determine the first Audions offered for sale to the amateur were advertised on page 288 of the September, 1909, issue of "Modern Electrics," in an advertisement by the

Radio Telephone Company. This company had been advertising wireless apparatus in that magazine since January, 1909, but the September advertisement was the first to mention "Audion Detectors." A reproduction of this advertisement is shown in Figure 47. The Audions were offered for sale as part of an assembly denoted as the "RJ4 Detector." The designation "RJ," meaning "Radio Junior" was adopted for pieces of equipment that were developed especially for sale to amateurs, and distinguished from the so-called "professional equipment" intended for commercial use.

The bulbs first sold with the RJ4 Detector were spherical and contained a double horseshoe filament, a single grid, and a single "wing" or plate, and were fitted with a candelabra base. The center contact of the base was connected to the common point of the two filaments. The second end of one filament was connected to the threaded shell of the base, and the second end of the other filament was brought out on a wire which came out just above the base, but insulated therefrom by a piece of cotton sleeving. There was a heavy knurled rubber band placed on the base, just below the line where the bulb emerged. The bulb was used until the first filament burned out. Then the projecting wire was wrapped around the base and held in contact therewith by slipping the rubber band over it, thus anchoring it firmly in position. This brought the second filament into use. The life of the average filament was 35-100 hours, despite the higher values claimed in the advertisements.

These detectors were regularly furnished with the regular or so-called "S" grade of Audion bulb which had a tantalum filament. An extra-sensitive or so-called "X" grade bulb could be obtained at an additional cost. After the development of the Hudson type filament, bulbs using this filament could be obtained in both the "S" and "X" grades, but at a higher price than the tantalum filament bulb. A typical advertisement offering the RJ4 and RJ5 Detectors for sale, and listing the various bulbs is shown in Figure 48.

The RJ4 Detector consisted of a ma-

Fig. 44

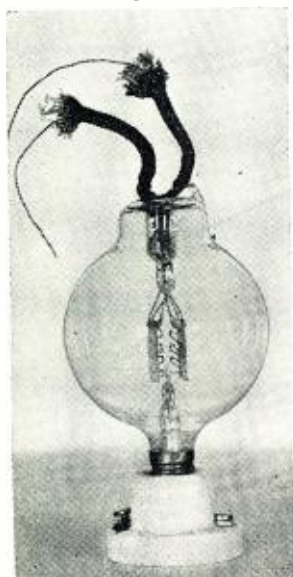

Fig. 45

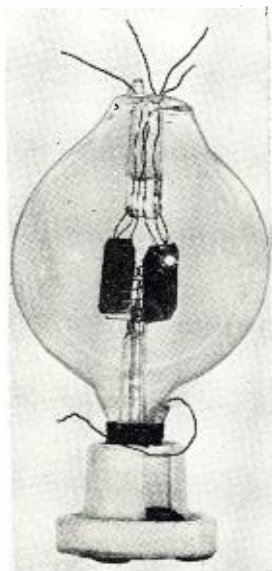
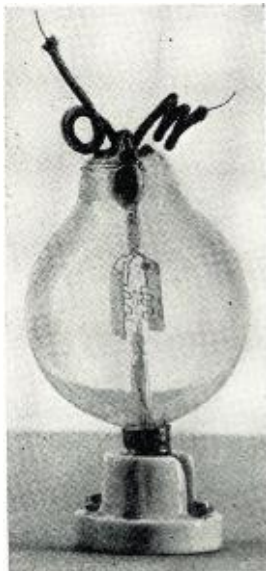

Fig. 46



hogany box, in which were placed the flashlight cells which were used as the "B" battery. On the front of the box were two switches. The one at the left of the "street-light" bracket from which the bulb hung was a tap switch on the "B" battery. The one on the right was the "Off-On" switch for the filament. The filament current was controlled by a porcelain-based rheostat mounted on the right hand end of the box. Binding post connections were provided for the filament battery, the terminals of the input circuit (which was usually the secondary of a "loose-coupler"), and the telephones. The earlier RJ4 Detectors were equipped with a three-point switch for controlling the "B" battery voltage.

For a long time after the Audion was put on sale, it could be obtained from the Radio Telephone Company only by the purchase of a complete detector instrument, such as the RJ4. (*The author understands, however, that audion bulbs were also sold by the H. W. McCandless Company on an over-the-counter basis to customers who came looking for them.*) Owners of such detectors could procure renewal bulbs only on the return of the old bulb at the time the order for the renewal was placed, except as noted below. The price of the RJ4, the cheapest of the RJ series of detectors, was \$18, as will be noted from the advertisement shown in Figure 48. This represented a small fortune to many an experimenter. Hence, ways and means were sought to circumvent the necessity of such a purchase.

The only element of this detector which the amateur could not readily acquire was the Audion bulb itself. The rheostat, batteries, switches, etc., were all common articles of commerce. The early Audion bulbs were extremely fragile pieces of apparatus. In fact, they were popularly known as "onion-skins." In order to obviate the necessity of returning broken bulbs, in cases where accidents occurred, a renewal bulb could be obtained if, in lieu of the complete bulb, the grid and plate from the broken bulb were returned. Since the earliest bulbs had only one grid and plate, the return of one grid and plate was sufficient to permit the purchase of such a renewal.

When the double grid, double plate Audion was placed on the market it became a means whereby the less plutocratic amateurs might obtain the coveted Audions. When one of these bulbs passed to its eternal reward the fortunate owner thereof promptly broke it up, returned one set of elements for his renewal, and sold the other set to someone less blessed with this world's goods, who could then return the second set and thus purchase a bulb for himself. This was such a common practice that old-timers will remember advertisements in the "swap" columns of the amateur magazines of that day, offering to buy and sell such elements.

The first popular article on the grid-  
(Continued on page 78)

# De Forest Apparatus

DESIGNED BY EXPERTS

WIRELESS TELEGRAPH AND TELEPHONE

RECEIVING OR TRANSMITTING

HIGH CLASS APPARATUS OF ALL SORTS AT REASONABLE PRICES

Variometers, Loose Couplings, Variable Condensers of all sizes, Helices and Spark Gaps, large and small, Heavy Transmitting Keys, Audion and Radiion Detectors, Wavometers, Telephone Receivers of extreme sensitiveness, Complete Commercial Tuners, etc., etc.

Our R. J. Variometer comprises two instruments in one—a Variable Tuning Coil without sliding contacts, and a loose coupling of novel design. Our R. J. Wavometer comprises THREE instruments in one—it will measure either SENT or RECEIVED wave lengths, is a Tuned Receiving Circuit, or can be used as a Variable Tuning Condenser. We find our Radiion the best of mineral-type Detectors.

Technical advice and assistance will be gladly given to all purchasers by our expert engineers.

If you wish a REAL Wireless Station go to those who KNOW HOW! Address

SALES DEPT.

RADIO TELEPHONE CO.

1 Madison Avenue, New York City

Fig. 47

Fig. 48

## DeFOREST AUDION DETECTORS

Incomparably Superior to Any Other  
Known Type



Type RJ4 Audion Detector

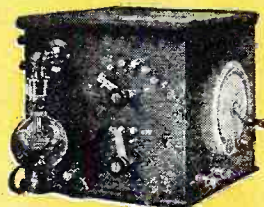

Type RJ5 Audion Detector

If you desire long distance reception of messages, you must have an Audion Detector. Tests of the Bureau of Standards show it to be the most sensitive and reliable detector ever invented. It stays in adjustment even where a transmitting set is used, and can be depended upon, absolutely, at all times.

The above types are regularly furnished with regular, or "S" grade, tantalum filament Audion Bulbs. Fitted with other grade bulbs at the difference of price of bulbs as listed below. A 4-volt storage battery or three dry cells are needed to light the filaments of the detectors, but are not furnished at these prices.

Bulbs are sold only for purposes of renewal, and then only upon return of the old bulb.

### Price List, F. O. B. New York

Type RJ4 Audion Detector, with regular "S" grade bulb.....\$18.00 net  
Type RJ5 Audion Detector, with regular "S" grade bulb..... 25.00 net

### Renewal Bulbs

Type "S" Regular Grade Audion Bulb (Tantalum Filament).....\$3.50 net  
Type "X" Extra Sensitive Audion Bulb (Tantalum Filament)..... 5.00 net  
Type "S" Regular Grade Audion Bulb (Hudson Filament)..... 5.00 net  
Type "X" Extra Sensitive Audion Bulb (Hudson Filament)..... 7.50 net

Hudson Filament Bulbs have a very long life, between 800 and 1,000 operating hours, which is about three times the life of tantalum filament bulbs

All reliable wireless dealers handle Audion Detectors and renewal Bulbs. If you do not know your local dealer, we will give you his name.

For further information, see your dealer, or write us.

DeForest Radio Telephone & Telegraph Co.

101 PARK AVE.

NEW YORK

# MARINE RADIO DIRECTION FINDERS

by RICHARD GRAFTON

*Illustrating the procedure of taking direction bearings and methods of calibration as applied to marine radio direction finding equipment.*

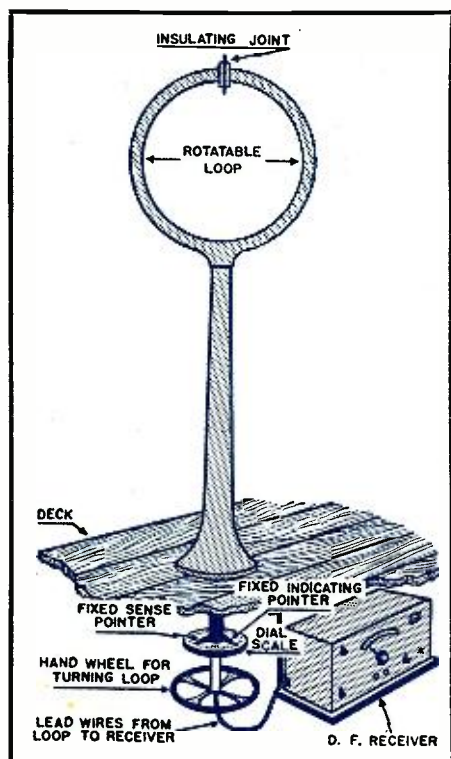

Fig. 1. Radio equipment and deck assembly.

THE propagation of a radio transmitter's wave, radiating away from the antenna in a great circle route, can be utilized for the purposes of radio direction work. Although there appear to be many mysteries and problems connected with the operation and use of radio direction finders, such is not the case if a few of the main principles involved are taken into consideration.

A brief description of a simplified radio direction finder which might well be used aboard ship is given in order to illustrate the methods and systems involved in the taking of bearings and in the calibration of such an instrument to correct for its deviation from a true reading caused by objects in the loop vicinity and other variations such as electrical unbalance in the loop proper. The mechanical arrangement of the loop, dial and receiver with the interconnecting leads are shown in the sketch of Figure 1. The entire equipment must be constructed and mounted in a rigid mechanical manner and be of sufficient strength to withstand physical shock and exposure to the elements as will be encountered aboard ship; this must be kept in mind as the vessel may at times encounter winds and storms of hurricane force in the vicinity of sixty miles per hour or more. It should be noted in Figure 1 that the readings of the bearings are taken from the indicating pointer, which is located directly in front of the dial when one is in front of the instrument, in position to take bearings. At a point ninety degrees to the operator's left it should be noted that there is another pointer (usually painted red) which is known as the "sense" pointer. The dial rotates with the loop.

In Figure 2 is shown a simplified schematic diagram, of a radio direction finder and loop arrangement, in order that its operation may be more clearly understood.

As the rotatable loop antenna is varied throughout its 360-degree swing, it will be noted that there are two positions of maximum intensity and two positions of minimum signal strength, which are due to the directional characteristics of the loop, maximum signal occurring when the plane of the loop is parallel to the direction along which the radio waves travel from the radio beacon transmitter station.

The position of minimum signal is used for indicating direction rather than that of maximum because the

percentage of change of signal strength with a relatively small change in loop position is much greater in the vicinity of the minimum pick-up of the loop. Likewise the human ear notices slight changes in volume of weak signals more readily than it does with those of higher intensity. Following the above information it can be seen that there are two positions of minimum intensity during the rotation of the loop throughout its complete circle of 360 degrees. The determination of the correct bearing of these two, or "sense", as it is known is accomplished by means of a small vertical antenna used in conjunction with the loop.

The sense antenna should be run as close as possible to the loop and in a vertical position, usually a length of about fifteen or twenty feet is used in practice.

From the schematic diagram it can readily be seen that this antenna in the direction finder position is connected to the rotor plates of the "balance" condenser. In this position the antenna is used to balance the loop, and by proper adjustments of the loop position and the correct setting of the balance condenser a very sharp minimum signal position may be obtained. When the sense antenna switch is placed in the "sense" or "one-way bearing" position it can be seen that the connection to the rotor plates is removed and the antenna now connected directly to one side of the loop leads. In this position the signals picked up by the antenna are now fed to this side of the loop, thus giving the loop a much greater pick-up on one side than that which it has on the other side. In this manner it can be understood whereby it is possible to deter-

Table of bearing corrections.

Visual Bearings	Radio Bearings	Correction Necessary
0	0	+ 0
6½	5	+ 1½
13	10	+ 3
19¼	15	+ 4¼
25½	20	+ 5½
31½	25	+ 6½
37½	30	+ 7½
43	35	+ 8
48½	40	+ 8½
54	45	+ 9

*Bearings as shown above should be taken for the entire rotation, every 5 or 10 degrees and the curve plotted as shown in Fig. 3.*

*Note: The dial should be set at the start to zero, so that bearings dead ahead are correct and this used as the starting point.*

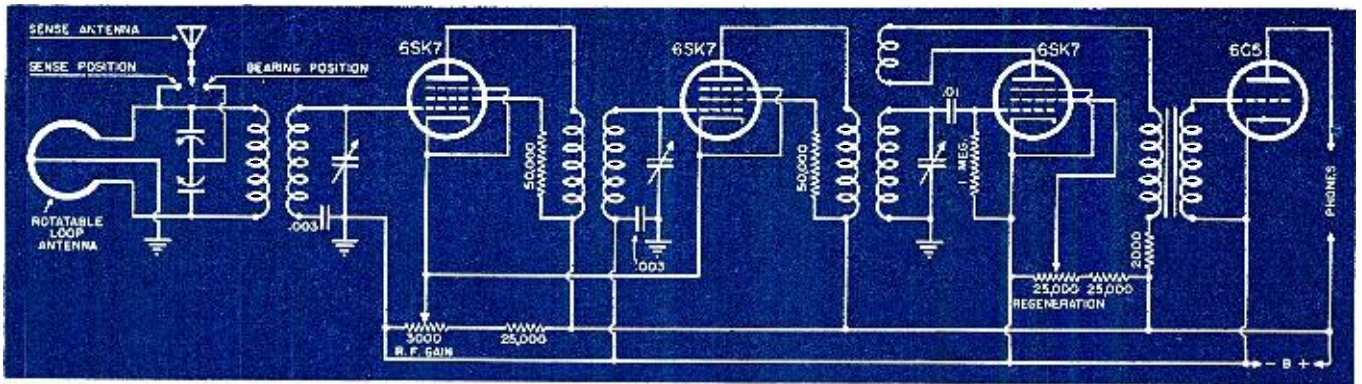

Fig. 2. Schematic diagram of a radio receiver as used for radio direction finding.

mine from which of these two directions the signal is coming, through knowing which side of the loop is picking up the greatest signal. This can be readily adjusted on a known station the position of which can be checked visually in relation to the loop position aboard the vessel.

When taking direction bearings the ship's main radio antenna, as well as any other antenna in the vicinity should be in an "open" position, that is free and not connected to either ground or any piece of equipment. Steel hallways and stays in the vicinity of the loop should likewise be fitted with insulators so that they are also ungrounded. When large grounded objects such as the above are in the loop's immediate vicinity, distortion results due to signal reflection with a resultant poor minimum in the loop's operation.

After the signals from the radio beacon transmitter, on which a bearing is to be taken, have been tuned in and the volume adjusted to moderate intensity, the loop should be rotated until a position of minimum signal appears, the balancing control should be adjusted for a better "null" or minimum point, at the same time turning the loop back and forth until an absolute null point is obtained. This minimum point should be very sharp, in most cases, one degree or less when the equipment is in order and correct

adjustments have been made. A second null point, approximately one hundred and eighty degrees from the first will also be noted, the determination of the correct bearing from these two readings will be explained in a later paragraph.

When bearings are obtained over long distances it may be noted that the minimum signal sector is somewhat wider than usual, in this case the bearing can be determined quite accurately by "splitting," or taking the center of the silent or minimum sector. The accuracy and calibration of the direction finder should be checked from time to time in clear weather when opportunity presents itself by means of simultaneous sight and radio bearings on beacon stations whenever possible.

The following methods may be used in the calibration of the equipment in determining the deviation or "error curve." First the vessel must be in position whereby it can make a complete circle in order that bearings may be taken throughout the entire loop rotation. A pelorus, an instrument for the taking of visual bearings, must be set up in as clear a position as possible, free from obstructions which might cause interference with the sighting of the beacon station throughout its entire scale of 360 degrees. The pelorus must be accurately aligned with the ship's keel fore and aft, with

the scale set in position so that the zero degree line is toward the bow of the vessel. After the pelorus has been set up in the manner described a visual sight of a beacon station transmitter with the instrument may for example show that it is bearing 30 degrees (which will be off the starboard bow) while at the same instant a minimum taken with the radio direction finder shows a bearing of 26 degrees of the station, this therefore shows that the direction finder is in error by minus four degrees and that at 26 degrees reading of the loop dial it is therefore necessary to add four degrees to the reading obtained in order to compensate for the error encountered at that portion of the loop position. This error varies considerably during the complete rotation of the loop throughout its 360-degree swing, due to the general construction of the ship and to objects in the field of the loop, such as stack, rigging, masts, etc. An entire set of readings, taken every five or ten degrees, for the entire rotation of the loop, while the vessel is making a complete circle, should be taken and then plotted in graph form as shown in Figure 3.

During the operation of the direction finder it will be noted that there are two minimum or "null" points as previously explained, approximately 180 degrees apart, one obviously being

*(Continued on page 76)*

Fig. 3. Curve showing the corrections to be made in the actual direction bearings, due to grounded objects aboard ship.

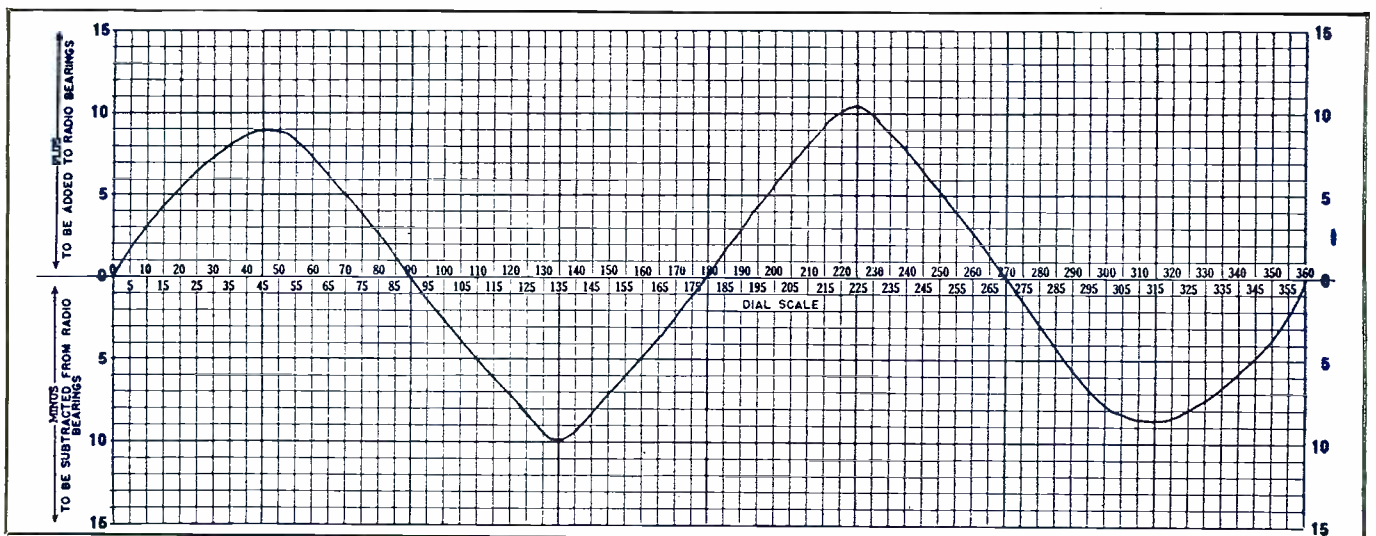

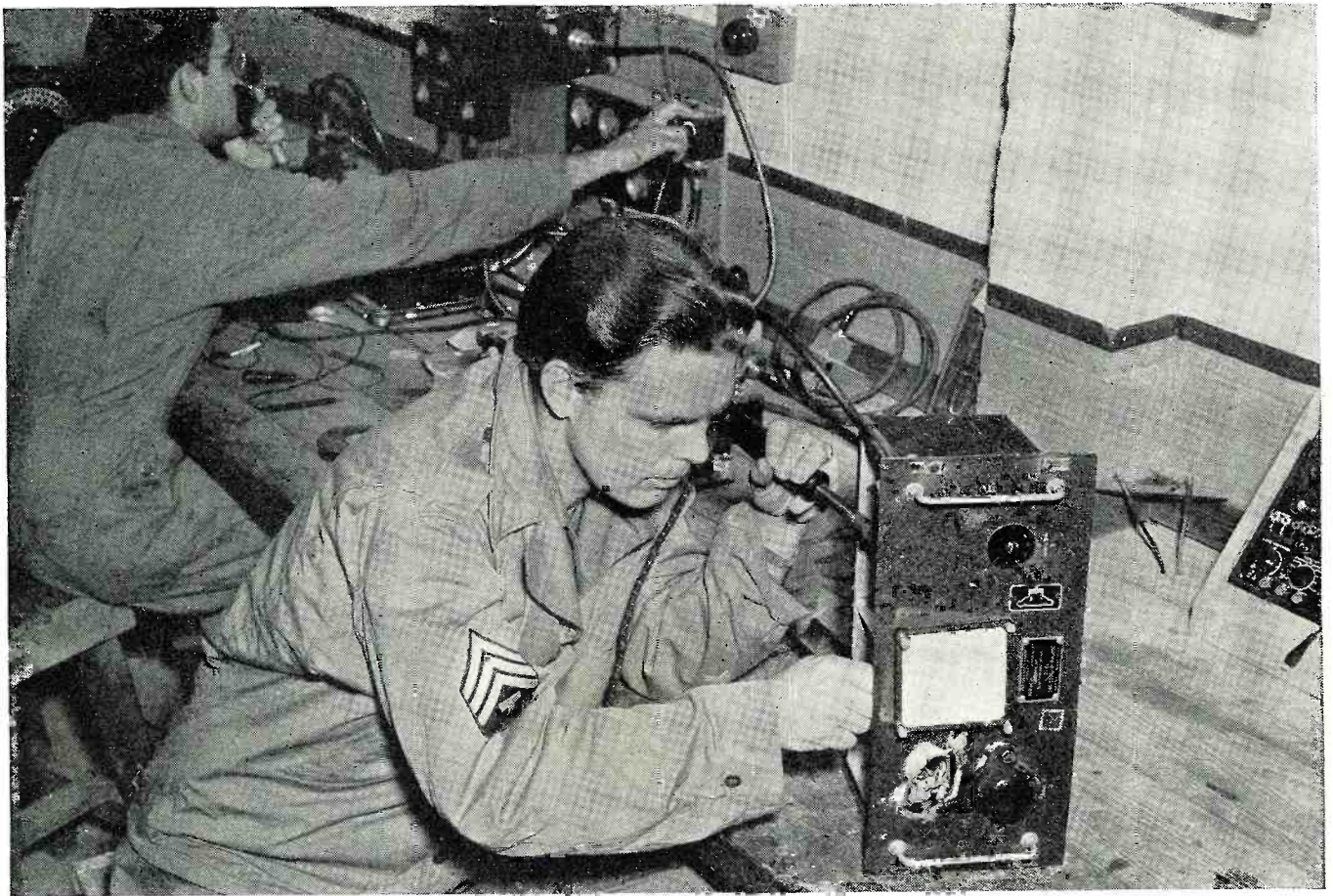

These Signal Corps men work with one thought uppermost in their minds—protect the men who fly the planes to Germany.

# RADIOS FOR OUR BOMBERS

**The primary function of these Signal Corps men is the maintenance and supply of radio equipment for the 8th Air Force**

**N**AYBE you think you're lucky to have two radios in your home. But you are "radio poor" compared to the equipment used in Eighth Air Force planes on their junkets over Naziland.

There are seven complete sets, for instance, in each Flying Fortress!

If you like to be technical, they are the radio compass, command set, very high frequency set, identification, intercommunication system, liaison set and range receiver.

Though delicate in function, each of these radios is as rugged as the fellows who fly the ships and man the guns.

All aviation communications, which include plane radios, are serviced and repaired by Signal Corps men attached to the Eighth Air Force Service Command. These men have their own shops and a unique and workable plan of repairing radios.

Take a plane that has been damaged on a mission. Usually it is brought to

a repair depot to be made shipshape for another crack at Adolf & Co.

One of the first checks made of a damaged plane concerns the radio equipment and wiring. If any of the radio units are damaged, the complete set is pulled out of the plane and another substituted. The plane is ready for action again as far as the radio equipment is concerned.

What happens to the damaged unit is another operation. First, it enters the Signal receiving room. Here it is tested to see whether the unit is repairable or salvageable.

If repairable, it is sent to the main repair room along with the diagnosis, and work is started to clean up the unit and new parts are installed. When this has been done and completely tested, it is put on the shelf ready for another plane, Germany-bound.

If the unit is tagged for salvage, it is completely torn down. The usable parts are stored away in the spare parts room by a technician. The dam-

aged sections are salvaged for metal.

The men who repair these damaged units are highly trained.

They're trained to be expert on at least three pieces of equipment, and practically all of them have had training on most plane radios.

We face a lot of technical headaches, but, together, these men have enough combined knowledge to combat any problem in radio or electronics that may come up. This was best illustrated when they constructed their own testing equipment when we first came over here and government equipment was not available.

Sgt. Reith, incidentally, is the inventor of a test oscillator for very high frequency. His model is less than one-fourth the size of the regular GI model. Where the regular unit carries its own batteries, Sgt. Reith's takes its power off the unit being tested.

Most of the men were radio "hams" in civilian life. They are making the most of their present opportunities to

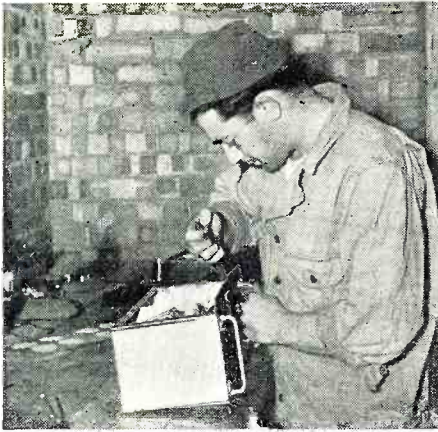

Damaged tuning unit of a liaison transmitter being repaired by technician.



Signal Corps men repairing radio equipment from planes that are bombing the Reich.



Completing the final testing of a repaired transmitter which will again be used. This transmitter is one of seven complete radio-sets installed in all Flying Forts.

By

**Lt. H. J. ANDREWS**

P.R.O. Air Force Service Command

learn all there is to know about radio. They spend a lot of their time after work in research and study. They do this to further their own knowledge which, they say, may help to hasten the day of unconditional surrender.

They are constantly on the alert for improvements, too. One day while repairing a damaged unit they noticed that high altitude flying had caused the antenna loading coil to arc over. They discovered a method to prevent a recurrence of this trouble by treating all coils and re-insulating them before putting them back into the ships.

One thing is paramount in their minds. They want to do more than is expected of them to protect the lives of the flying men of the Eighth Air Force.

A number of inspirational signs hang in their shop. A typical one reads—"Can you look the pilot in the eye and say:

The equipment is perfect.  
DO NOT GUESS!"

-30-



In the main repair room a damaged unit is being reassembled by Signal Corps men. Soon it will be ready for a new bombing mission over widely scattered targets.

# X-ray and Geiger Mueller Tubes

by

**C. D. PRATER**

Bartol Research Foundation

*A historical review of the discovery, development and basic theory of X-ray's and Geiger Mueller tubes.*

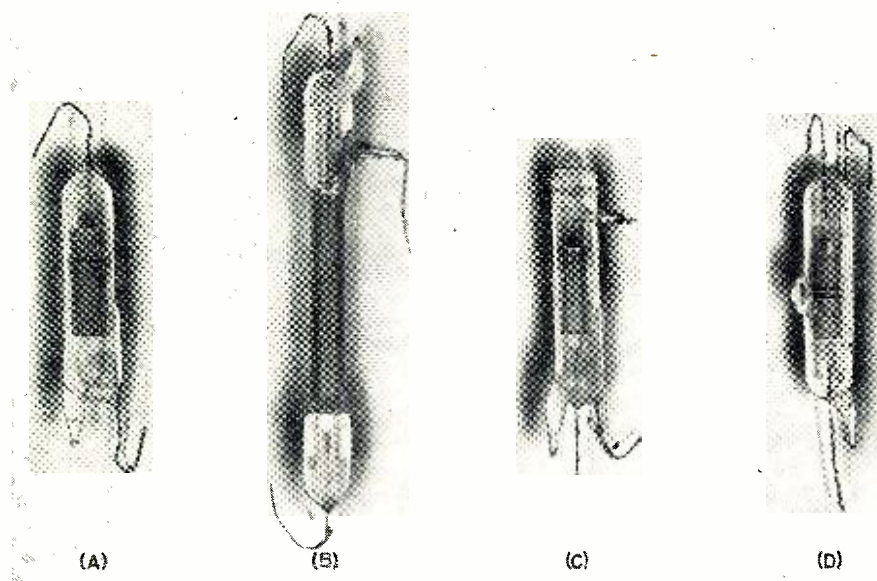
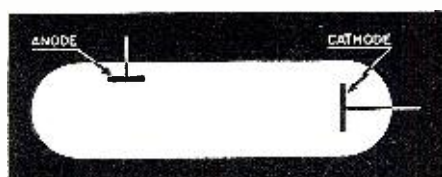

Fig. 1. Various types of commercial Geiger Mueller tubes.

IN 1895, William Conrad Roentgen, while studying electrical discharges in a gas-filled tube such as is shown in Fig. 3, observed that barium platinocyanide placed in the neighborhood of the tube glowed even though the tube itself was wrapped in black paper. Continuing his studies of this phenomenon, he found that the radiation given off by this tube would affect photographic plates and would penetrate aluminum, wood and flesh. The radiation produced by these tubes was called X-rays by Roentgen because of their unknown nature. The radiation in Roentgen's tubes came from the glass walls of the tube itself. The process of the development of the X-ray tube was very rapid because it was seen that the medical profession could put it to immediate use. Three years after Roentgen made his first observation, the metal target was added to the tube. The tube as it appeared at this time is shown in Fig. 2. In this year, J. J. Thompson gave the explanation for the production of the continuous spectrum which will be given later. The X-ray tube remained essentially the same until 1913 when Coolidge introduced the hot cathode into the tube.

The production of X-rays depends upon high velocity electrons being de-

Fig. 3. The type of tube Roentgen used to discover the X-ray phenomenon.



celerated on striking a solid object. In the gas-filled tubes the electrons are produced by the ionization of the gas in the tube. They receive most of their acceleration within the cathode dark space since this is the place where the voltage drop in the discharge is greatest.

X-ray radiation is termed hard or soft according to the predominant wave lengths present. A hard radiation has a shorter wave length than a soft radiation. The hardness of the X-rays produced depends upon the velocity with which the electrons strike the target. The intensity of the X-ray beam depends upon the number of electrons striking the target. One of the major difficulties encountered in using the gas-filled X-ray tube is that the intensity of the X-rays cannot be controlled independently of their hardness. Since in a gas discharge, in order to produce more electrons the voltage has to be raised, the electrons acquire a greater velocity which makes the X-rays produced harder. Another disadvantage of the gas-filled tube which was overcome to a considerable extent is the absorption of the gas present in the tubes by the tube walls and metal parts. This causes the pressure within the tube to fall.

The electrons produced by any given voltage will decrease in number, thereby decreasing the intensity of the beam. This can continue until it is no longer possible to maintain the discharge at this operating voltage. The voltage must then be raised in order to maintain the discharge. This increases the hardness of the X-rays. The hardness of the X-rays desired is determined by the use to which the

X-rays are to be put. Therefore, the X-rays cannot be increased in hardness beyond a certain point for any given use. The tube will after a length of time become useless for a given operation. This difficulty is overcome by placing within the tube some device by means of which a small amount of gas can be liberated in the tube whenever the operator so desires.

When Coolidge placed the hot cathodes within the X-ray tube both of these difficulties were overcome. With the hot cathode the tube could be exhausted to a high vacuum and the

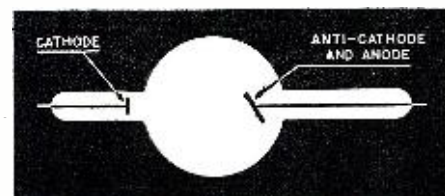

Fig. 2. X-ray tube as it appeared three years after the discovery of X-rays.

metal parts outgassed just as in high vacuum radio tubes. The beam can be controlled independently of the hardness since the number of electrons formed is determined only by the temperature of the cathode and the hardness only by the potential between the electrodes of the X-ray tube.

There are two sources of X-rays when an electron strikes a target. One, due to the rapid deceleration of the electrons, causes a continuous spectrum. The other, due to disturbances produced within the atoms of the target material caused by the fast moving electron striking the target, produces a line spectrum. By line



spectrum is meant that only certain narrow regions of wave lengths are present. Since a rapidly moving electron constitutes an electric current, when this electron strikes the metal target, it will radiate electromagnetic waves because the rapid deceleration of the electron is a rapidly varying current. This is analogous to the production of radio waves by the antenna of a transmitter when the current in that antenna is varying rapidly, except that in the case of the electron striking the metal target, the rate of variation of the current is so great that the wave lengths produced are X-rays instead of radio waves. This will produce a continuous spectrum since the electron will be decelerated at various rates.

If an electron has sufficient energy, it can cause internal disturbances in the atoms of the target by causing one of the electrons in one of the inner rings of the atom to move to an outer ring. In order to accomplish this the initiating electron loses energy to the atom since it requires work to move this inner electron to an outer orbit.

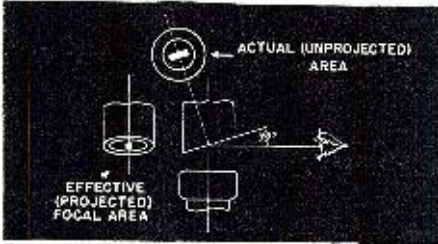

Fig. 5. X-ray tube "line focus" principal.

After the initiating electron has passed on, the atom is left in an unstable state. The electron that was moved to an outer orbit falls back into the inner orbit, giving up the energy it absorbed from the initiating electron in the form of radiation. The radiation produced when this happens is an X-ray.

The amount of energy which is absorbed in moving an electron from an inner orbit to an outer orbit can be only a certain definite amount depending upon the element and the orbits involved in the change. Since the atoms radiate this amount of energy as X-rays, quantum mechanics say that the wave-lengths of the X-rays will always be the same every time the same orbit change is made within a given element. A line spectrum will therefore be formed by this process. What is usually obtained is a line spectrum superimposed upon a continuous spectrum since both processes usually contribute to the X-rays formed. The target metals usually used to produce line spectra, and therefore monochromatic X-rays are copper, iron, cobalt and sometimes molybdenum, depending upon the hardness of the monochromatic X-ray desired. Tungsten and molybdenum are usually used for the production of continuous spectra.

The production of X-rays is a very inefficient process. Less than one percent of the energy applied to the X-

ray tube is converted into X-rays. The remainder appears as heat in the target. This makes the engineering of the X-ray tube difficult since means must be provided for removing the heat as fast as it is formed. The maximum power that an X-ray tube can dissipate is determined by how well the surface temperature of the metal composing the target can be kept below the evaporation point of the metal. This surface temperature may be very high because of the finite time it takes for the heat to be conducted away through the metal. It is often necessary to have the source of X-ray as near a point source as possible. A good example of a case where this is a necessity is in X-ray photography. The sharpness of the image depends upon the smallness of the source. This makes the problem of surface temperature a very great one. Various methods have been proposed for overcoming this difficulty to some extent. The two most widely used methods are the line focus and the rotating target methods. The principle of the line focus is shown in Fig. 5. It depends upon the fact that when a line is viewed from an angle it appears shorter. If a beam of electrons which is wider than it is high is allowed to fall upon a target placed at an angle to it, the actual surface involved in the production of X-rays will be a long, narrow strip, but when viewed from the side it will have the appearance shown in Fig. 5 if the initial beam size and the angle are right. This enables the production of an X-ray beam of higher intensity but smaller focal spot than would otherwise be possible without this additional spreading. The mechanism of the rotating anode tube can be seen from Fig. 4. An induction motor is built onto the tube using the target as a rotor. The field coils are placed on the outside of the envelop. The beam of electrons is placed off the center of the tube so that they strike the slanted portion of the rotating head which is covered by any metal desired. This tube combines the line focus with the rotating anode. This enables very intense beams to be produced without over-heating.

Many safety devices have been incorporated in the modern X-ray tube to protect the operator from the highly dangerous X-rays produced and the high voltage used. The high voltage source may be either a.c. or d.c. since the hot cathode X-ray tube can act as its own rectifier. If d.c. operation is desired, specially built rectifiers are used to rectify the high voltage a.c. These rectifiers are built in much the same manner as X-ray tubes since

Fig. 6. A modern rayproof X-ray tube.

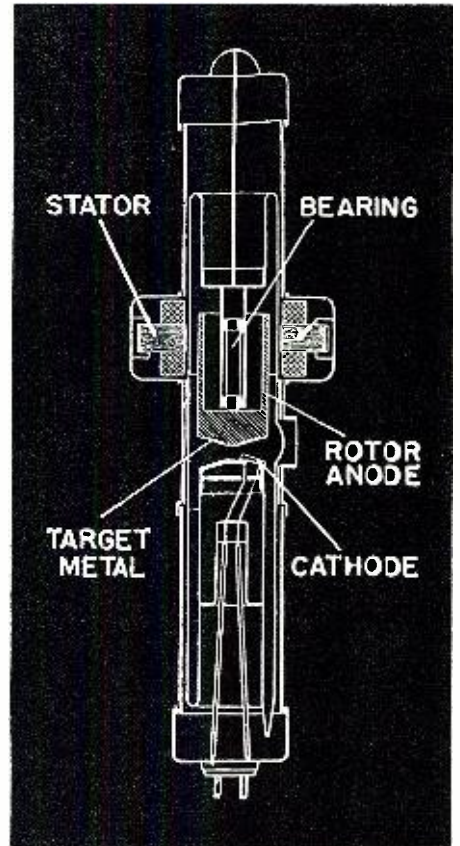
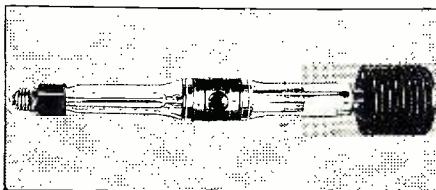

Fig. 4. A rotating anode X-ray tube.

they have to withstand high voltages and dissipate considerable power. A typical modern X-ray tube is shown in Fig. 6. The tube is of interest because the center portion of the walls of the tube is made of a chrome-iron alloy to which glass can be sealed directly. This makes the walls surrounding the chamber in which the electron beam is located be an equal potential surface and prevents the collection of a charge upon the walls. When the X-ray tube is made of all glass, this portion has to be made large to keep a charge from being collected on the glass walls of the tube. If the walls are allowed to accumulate a charge, there is danger of a breakdown occurring.

X-rays are used commercially for such purposes as X-raying castings, locating crystal planes in crystals so they may be cut for use as oscillator control crystals, and the study of metals by X-ray defraction methods.

### Geiger Mueller Tubes

An interesting electronic device which has received very little attention from the radio engineers is the Geiger Mueller tube. This tube can be made to be sensitive to the radiations of radioactive substances, X-ray, ultra violet light, ordinary light, cosmic rays and nuclear particles. It has an amplification factor so high that the presence of one electron within the counter tube is sufficient to cause the tube to operate a relay tube directly without any further amplification. The tube appears deceptively simple. It is merely a metal cylinder cathode and a coaxial wire anode enclosed in a glass

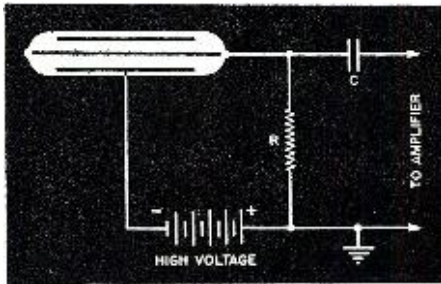
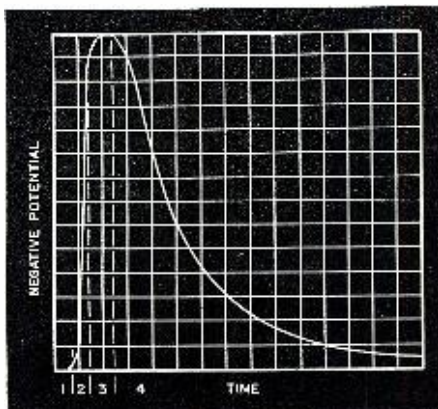

Fig. 7. Circuit using Geiger Mueller tube.

envelop. The tube is filled with some gas to a pressure of a few centimeters of mercury. This gas is usually a mixed gas. A typical mixture consists of argon, 94% and oxygen, 4% used in the tube at a pressure of about 10 centimeters of mercury. Vapors of various organic compounds such as ethyl-ether and ethyl-alcohol are also used in the tube. The circuit for this tube is shown in Fig. 7.

The mechanism for this tube was not explained until the tube had been in existence for a number of years. If an electron is formed anywhere in the region between the cylinder and the wire, it will be drawn towards the positively charged wire by the high potential, usually from 500 to 1500 volts. The electron, in passing through the gas when it is accelerated by this high voltage, will ionize the gas molecules giving rise to other electrons, and these electrons will in turn be accelerated by the electrical field and ionizing gas forming more electrons. Therefore, one electron is able to start an electron avalanche towards the wire. The field conditions in a Geiger Mueller tube are such that most of the ionization takes place within a few thousandths of an inch of the wire. The positive ions formed in the ionization process, being many times heavier than the electrons, do not have time to move any appreciable distance from their place of formation by the time the electrons have all arrived at the anode. Thus, a positive ion sheath is present around the anode wire so that there can be very little variation of potential on the wire until the positive ions move away, and as they move away the potential on the wire becomes more and more negative until the positive ions reach the negative cylinder. When the positive ions have

Fig. 9. Geiger tube pulse curve.



arrived at the cathode the wire has reached its maximum negative value. The potential of the wire then begins to fall due to the leakage of charge on the wire through the high resistance R in Fig. 7.

The type of pulse obtained from this tube for every incident that causes it to operate is shown in Fig. 9. At the end of the time corresponding to the right hand boundary of region 1 of Fig. 9, the electron avalanche has arrived at the wire and as can be seen very little potential variation has occurred. During the time corresponding to region 2; the positive ion sheath is moving through the region of high potential variation in the immediate vicinity of the wire. A large change of voltage will occur on the wire although the ions have moved only a very small fraction of the distance towards the cathode. Region 3 shows the potential variation of the wire caused by the movement of the ions during the rest of their journey to the cathode. Region 4 shows the variation of the potential of the wire due to the charge on the wire leaking off through the resistance R. The length of time it takes for the potential on the wire to fall to  $1/e$  of its value where  $e$  is the base of the natural logarithm is determined by the product RC where R is the value of the leakage resistance R in Fig. 7 expressed in ohms, and C is the capacity in farads between the anode and cathode of the Geiger Mueller tube. The time is then given in seconds. A Geiger Mueller tube working in this manner acts as a proportional counter to count the number of initial electrons formed because as can be seen if there are two initial electrons, there will be twice as much ionization in the tube, and the pulse will be twice as high. These initial electrons are formed in the tube by the various radiations which may excite the tube either by photoelectric process or by the ionization of the gas by fast moving atomic particles which come from the outside of the tube and constitute the radiation which passes through the tube.

As the voltage on the tube is raised, a point is reached at which the electrical field within the tube is not only great enough to give the electrons enough energy to form ions from the gas molecules but to also cause the gas molecules to radiate electromagnetic waves with a wave-length within the region of ultra-violet or soft X-radiation. The discharge of a proportional counter was confined to the very small region of the tube in which the initial electron was formed, but now the radiation given off by the gas molecules under bombardment of the electron or electrons will cause some gas molecules which lie out of the region in which the discharge would normally take place to become ionized. New initiating electrons are thus formed to start other avalanches which in turn produce radiation which ionizes other gas molecules in other regions and so on until the discharge has spread

throughout the whole Geiger Mueller tube.

This formation of ions would proceed until all of the gas was ionized if it were not for the fact that the positive ions formed, lower the electrical field strength in the region between the electrodes of the tube. A point will be reached when sufficient positive ions have been formed such that the field existing within the tube will be too small for the electrons to acquire sufficient velocity to cause the gas molecules to radiate. The formation of ions then stops as soon as all electrons have arrived at the wire. The positive ions then cause a variation in potential of the central wire just as in the case of the proportional counter since this entire process takes place before the positive ions have had a chance to move from the region in which they were formed. The pulse shape is therefore essentially the same as that obtained with the proportional counter. It is much higher since there was a much greater number of electrons formed.

Since a constant number of positive ions is always required under any

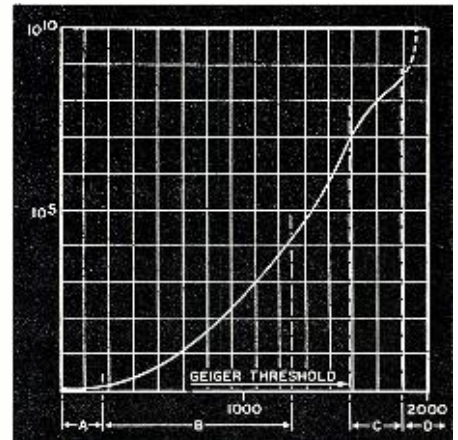

Fig. 8. Amplification curve of Geiger tube. (A) Region of no gas amplification. (B) Proportional counter operation. (C) Geiger counter region. (D) Continuous discharge action.

given operating conditions in order to make the field conditions such that the formation of ions is stopped, the pulse size is always the same for a given operating condition regardless of the number of initiating electrons present. When the Geiger Mueller tube is run in this manner it is known as a Geiger counter. A graph of the amplification plotted against voltage is shown in Fig. 8. As can be seen the proportional counter can give an amplification as high as several millions while a Geiger counter can give an amplification of thousands of millions of times.

Some actual Geiger Mueller tubes are shown in Fig. 1. The Geiger Mueller tube in Fig. 1a is used for the detection of hard X-ray radiation, gamma radiation from radium and cosmic rays. It consists of a metal cylinder cathode and an anode wire down the center sealed within a glass envelop. The radiation, for which this

(Continued on page 102)

# FUNDAMENTAL A.C. CIRCUIT DEMONSTRATOR

by S. A. PROCTER

THIS version of the electronic switch is designed to be used in conjunction with a cathode-ray oscilloscope and is capable of providing two independent time bases on the single scope screen.

Although the oscillograph is the ideal instrument for the analytical study of a.c. voltages, its value can be greatly increased by using it in conjunction with an electronic switch. Used alone the scope generally employs a saw-tooth oscillator for horizontal displacement of the spot on the screen. The saw-tooth voltage causes the spot to move uniformly across the screen and return to its starting point almost immediately. The length of time required for the spot to complete its travel across the screen is the reciprocal of the frequency of the saw-tooth oscillator. If the oscillator is operating at 50 cycles per/sec. the time base would be 1/50 of a second. With a time base of 1/50 sec. if we place on the vertical plates an a.c. voltage of 100 c/s the scope will trace two complete cycles.

By use of the electronic switch it becomes possible to have two time bases on one screen and to impress different voltages on each time base. This makes possible the comparison of two voltages for phase, distortion and relative amplitude levels by literally laying the trace of one directly over the other. The patterns are then said to be superimposed.

To better explain the two time base relations, Horizontally Displaced (H.D.) and Superimposed (S.I.) let us consider the scope screen divided into quadrants. See Fig. 4-A where the time bases placed on the X axis with one free to be deflected vertically in quadrants 1 and 4 and the other free to be deflected in quadrants 2 and 3. Fig. 4-C illustrates two signals of the same frequency, in phase, but of different amplitudes as they appear when impressed on the Horizontally Displaced time bases. This placement of the time bases occurs when the frequency of the scopes sweep oscillator is equal to the frequency of the electronic switch oscillator. If we double the frequency of the scopes sweep oscillator and not change that of the electronic switch both time bases will cover the full length of the X axis. Fig. 4-B. By Manipulation of positioning control R-4 (Fig. 5) we can place



**The application of an electronic switch in determining the characteristics of resistive, inductive, and capacitive circuits.**



one time base above the X axis and one below, or we can place them both on the X axis in which case we say they are Superimposed, (S.I.). To obtain the S.I. time bases the scope sweep must be twice the electronic switch oscillator frequency.

Fig. 4-D illustrates two signals of different amplitudes and 90 degrees out of phase as they appear on the S.I. time bases.

It will be shown how the scope and the electronic switch can be used to visually demonstrate the fundamental ideas of a.c. circuits and in addition make dynamic measurement of capacity, inductance and resistance without the use of meters.

The R and C values of the multivibrator in conjunction with R<sub>1</sub> will provide switch frequency of from approximately 100 c/sec. to 150 c/sec. By the use of ganged switches the R-C values may be changed so that the sweep frequency may be varied over a wider range. For most experimental and demonstration set-ups it is not necessary to add this complication and expense.

In construction of the switch the only critical factor is the screen voltage of the 6SJ7's. The 8,000-ohm re-

sistor should be varied above and below this value until the proper screen voltage is obtained. When these tubes are properly operated it should be possible to obtain full size undistorted patterns on a three-inch scope with its vertical amplifiers out and the time bases should overlap with R<sub>1</sub> near its center position.

### Features:

By proper manipulation of R<sub>1</sub> and positioning controls of the scope, these time bases may be placed (a) One anywhere in quadrants 1 & 4 (H.D.) and the other anywhere in quadrants 2 & 3. Using this arrangement one time base will be as much above the X axis as the other is below or they both may rest on the X axis. (b) One covers quadrants 1 & 2, the other covers quadrants 3 & 4 (S.I.). They may be positioned about the X axis as desired, moving parallel to the Y axis and when not directly overlapping, one will be as far above the X axis as the other is below.

A signal may be impressed upon one time base without, in any way, affecting the other.

By use of separate gain controls for the two channels it is possible to check changes in ratio. A large signal may be fed to one channel, with the attenuator cut down and a weak signal to the other with the attenuator fully open, making the two patterns equal in size. When changes are introduced which it is thought may make a difference in the ratio of the two voltages the increase or decrease of the patterns will be by the same amount if the ratio does not change. If, after increasing or decreasing in size, one is larger than the other, a change in ratio, as well as direction of change, is indicated. This is particularly suited to checking the gain factor in ampli-

Fig. 1. Circuits to be used with electronic switch for proportional measurements.

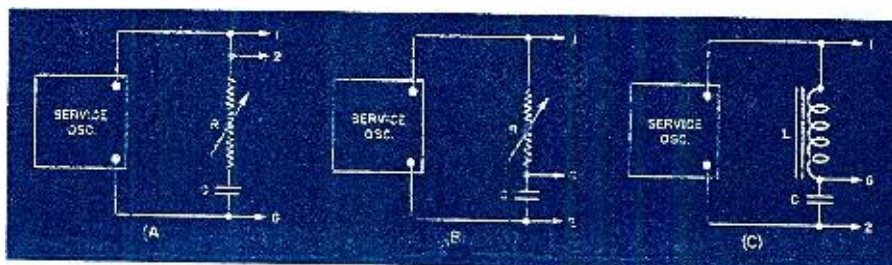

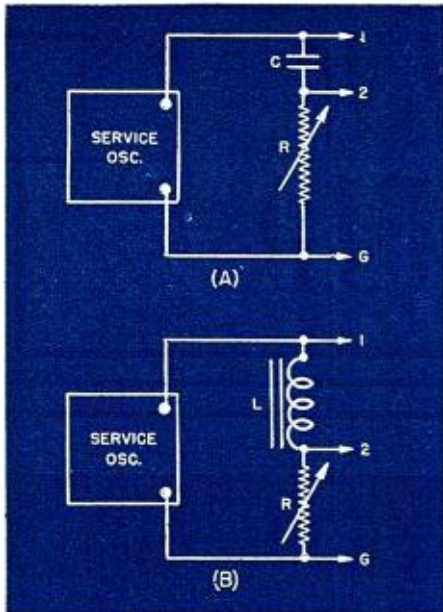

Fig. 2. Additional circuits to be used for demonstrating A.C. fundamentals.

riers as the frequency varies, loading is changed or band-pass filters encountered.

**STABILITY:** (Refer to schematic diagram Fig. 5). By use of interlocking circuits the frequency of the square-wave generator is held constant by pulses from the output of the electronic switch which is an amplified version of the signal under observation. Pulses from the switching circuit lock the saw-tooth osc. within the scope, resulting in steady patterns on the screen. Slight changes in frequency, such as occur in most a.c.-operated test osc., will not cause the patterns to drift.

### Circuit Functions

The multivibrator generates a semi-square wave and its grids are signal biased. Frequency is controlled by varying resistance and capacity, no inductors being used. The multivibrator is direct coupled to a push-pull, class A circuit which is overdriven, delivering a square-wave output through coupling condensers and current-limiting resistors to the suppressor grids of push-pull, sharp cut-off pentodes. During the negative half of cycle on suppressor grids these tubes become inoperative and since their plates are tied together and fed to the scope, the scope will trace the signal from one tube and then from the other. The cathodes have separate return circuits and by controlling the bias of the tubes we control the operating point of the plate, which in turn determines the relative position of its time base traced on the screen of the scope.

Individual gain controls enable operator to determine relative size of patterns on screen and to develop patterns of same size from voltages of different amplitudes.

### Measurement and Demonstration

These circuits were developed around the electronic switch for pur-

poses of demonstration of the fundamentals of a.c. circuits. They have a much greater value in enabling the operator to make accurate dynamic measurements of resistance, capacity, inductance and impedance without the use of meters.

**SERIES CIRCUIT:** It may be used to measure resistance, frequency, capacity, inductance or impedance. It may also be used to demonstrate the distribution of voltage in series a.c. circuits.

In testing or demonstration by proportion it is important that a reference setting be made first. In this particular test circuit this is best done by connecting No. 1 and No. 2 test leads (Fig. 5) to the same a.c. source (Fig. 1A) and adjusting gain controls for patterns of the same size, using S.I. time bases. Adjust controls so that pattern completely fills screen. This serves as a reference level of the output of the signal osc. Connect circuit 1b, using H.D. time base and vary service osc. until both patterns are of the same size. This indicates that the voltage across the condenser is the same as the voltage across the resistor and since it is a series cir.  $X_c$  equals  $R$ .

Therefore, we may use the following equation:

$$R = \frac{1}{6.28fC}$$

Since this equation contains resistance, frequency, and capacity it is possible to solve for any one by knowing the other two.

As a demonstration circuit, it illustrates that though the voltage from the test osc. is applied across a series cir. composed of two sections of equal impedance the voltage across each section is more than one-half the applied voltage. Further, by varying the freq. of the test osc. it will be observed that the pattern developed across the condenser will increase as the frequency decreases, due to  $X_c$  increasing, which in turn will reduce the current flowing in the circuit and the pattern developed across the resistor will consequently decrease.

By substituting an inductance in place of the condenser, varying the freq. until the patterns are equal, we may compute freq., resistance or in-

Fig. 3. Parallel network consisting of inductance and resistance in one branch and capacitance and resistance in the other, used to demonstrate current and voltage relations and phase characteristics.

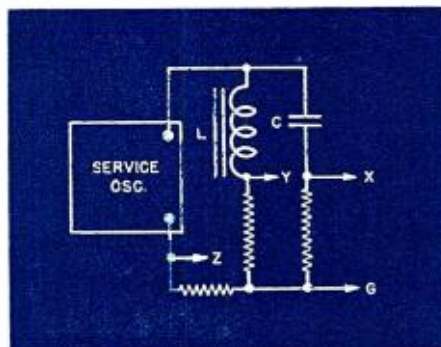

ductance; using the following equation:

$$R = 6.28fL.$$

It may be demonstrated that the behavior of an inductive circuit is the inverse of a capacity circuit as the frequency varies.

In using circuit 1C, set the reference level (Fig. 1A) so that the patterns when developed from the same source are equal in size and fill about one-half the screen. Connect as in Fig. 1c and adjust freq. until patterns are same size. As in above operations this indicates that  $X_L = X_c$ . Then by using the equation:

$$f = \frac{1}{6.28\sqrt{LC}}$$

we may compute any one of the three by knowing two. It may be demonstrated that the voltage distribution varies as in the  $RC$  and  $RL$  circuits but more sharply and that, at resonance, the voltages across each branch are equal to each other and greater than one-half of the applied voltage.

The circuit in Fig. 2a may be used to demonstrate the phase relation of voltage to current in an  $RC$  circuit.

Use S.I. time base (Fig. 1A). Adjust switch freq. ( $R_s$ , Fig. 5), service oscillator and sweep oscillator of oscilloscope so that two or three cycles appear on the screen, overlapping to make one pattern. With this reference both patterns are developed from the same source and the phase difference is zero. This reference setting must be made either with the condenser shorted or the resistance open (Fig. 1A). Restore circuit as indicated in Fig. 2a. Readjust gain controls so that the pattern representing the applied voltage (No. 1) is slightly larger than the pattern representing the current (No. 2). Both of these patterns are voltage developed but since the voltage appearing across the resistance is the product of that resistance and the condenser current, it is in phase with the current through the condenser. . . No. 2 pattern is in phase with the condenser current.

By adjusting  $R$  we change the phase relation of  $E$  and  $I$  in the circuit and the patterns will be displaced proportionately, with the smaller representing  $I$  (current), leading the larger  $E$  (voltage) by an amount determined by the equation:

$$\text{Tan}\phi = \frac{X_c}{R}$$

By making the resistance considerably higher than the reactance of the condenser the two patterns will approach their reference position, indicating zero phase relation between  $E$  and  $I$ . When the resistance is much smaller than the reactance the current pattern will lead the voltage pattern by nearly ninety degrees (with this arrangement it is impossible to develop a pattern of exactly 90 degrees but we can easily achieve pattern shift of 85 deg.). In above operations, as the resistance is varied, adjust the gain control to channel No. 2 ( $R_s$ , Fig. 5) so that the  $I$  pattern remains slightly smaller than the  $E$  pattern. None of

the other adjustments should be disturbed.

It can also be demonstrated that increasing the resistance in a circuit has the same effect on phase relation as increasing the frequency and that these variables have opposite effects on the current.

By using Fig. 2b it is possible to demonstrate the relations existing between  $E$  and  $I$  in an  $RL$  circuit. The same procedure is to be followed and it will be observed that the inductive  $I$  phase will vary from nearly zero to nearly 90 degrees lag; that increasing the freq. has the same effect on phase as decreasing the resistance and that decreasing the freq. has the same effect on  $I$  as decreasing the resistance.

By using Fig. 3 it is possible to demonstrate phase relation of the three currents in a parallel a.c. circuit. With the G lead of the switch connected as shown and the channel leads connected to x and y, with their gains  $R_2$  &  $R_3$  exactly equal, it can be demonstrated that when the currents are equal they are 180 degrees out of phase; that when freq. is above resonance the current through the capacitive branch is greater than the current through the inductive branch. With exception of phase, this particular phenomena can best be demonstrated by using the H.D. time base so that there is no confusion as to which current is which. For demonstrations of phase, it is necessary to use the S.I. time bases.

To demonstrate amplitude relation of feed current to circulating current; set channel gains  $R_2$  &  $R_3$  so that they are exactly equal, connect channel leads to x and y, adjust test osc. to resonant freq. of the circuit. Remove one channel lead and connect to point z. This pattern will be substantially smaller than the one indicating the current within the circuit and will have a slight lag or lead due to the resistance in the circuit. Whether it lags or leads will depend on whether the lead for z was taken from terminal x or y.

These examples dealing with series and parallel circuits furnish sufficient basis for making tests and demonstrations involving series-parallel and bridge circuits.

Any of the above can be used with good effect in demonstrating the why and how of practically any circuit to which a.c. is applied at any frequency, if the same ratios exist in an  $RC$ ,  $RL$ ,  $LC$  or any combination thereof it's behavior will be the same at 1,000 c.p.s. as at 1,000,000 c.p.s. providing that the same ratios exist between the units.

### Conclusion

1. The circuit applications of the electronic switch, as herein developed, provide a clear and comprehensive method of visual education in the field of radio and allied sciences. This article has been presented in the hope that various instructors, both civilian and military, may use this material in teaching a.c. fundamentals by the proportional method. This can be done

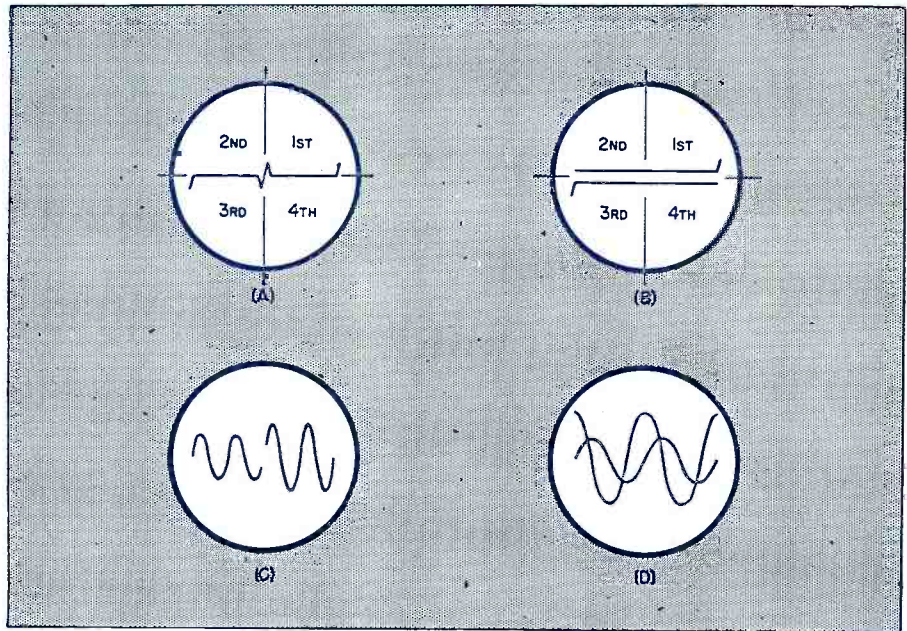

Fig. 4. (A) Horizontally displaced time bases (HD), when sweep frequency equals the switch frequency. By adjustment of centering control, bases can be placed in line with each other. (B) Super-imposed (SI) time bases when sweep frequency is twice the switch frequency. By adjusting centering control, bases will merge to make a single trace. (C) Two voltages of unequal amplitude but of the same frequency on HD time bases. Developed from circuit Fig. 1 or 2. When patterns are of same size  $R=X_L=X_C$ . (D) Voltage across an inductance (large pattern) and current through the inductance (small pattern). Developed from circuit Fig. 1C or 2B. In (A) and (B) are shown the X and Y axis and the quadrants 1st, 2nd, 3rd, and 4th, contained therein.

with a little ingenuity on the part of the instructor to develop proper laboratory equipment.

2. The proportion system of measurement, if adopted, will replace scarce and expensive laboratory instruments designed for measuring inductance,

mutual inductance, impedance and capacity. It's accuracy is sufficient for all educational programs.

The use of proportion and mathematics in place of meters should prove most beneficial at the present time.

-30-

Fig. 5. Circuit diagram of the electronic switch used in conjunction with an oscilloscope to demonstrate a.c. fundamentals. Oscilloscope connections are shown.

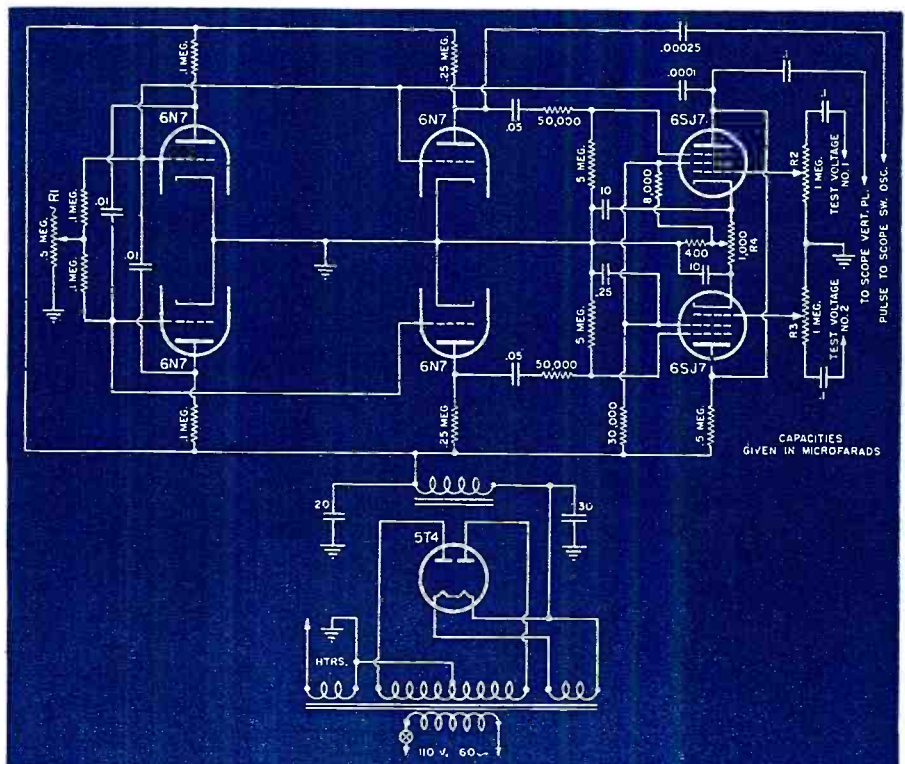

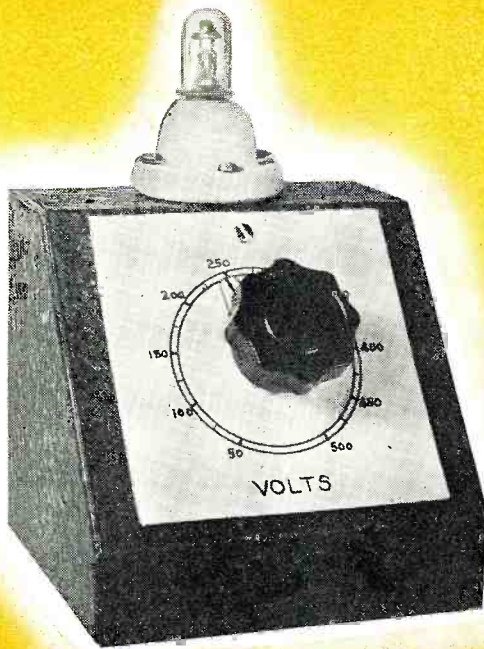

Neon-bulb voltmeter using circuit of Fig. 1.

# METER SUBSTITUTES

by **RUFUS P. TURNER**  
Consulting Eng., RADIO NEWS

**Emergency devices and circuits that may be used for voltage-current measurements in view of meter shortages.**

**W**ITHOUT a high priority, it is very nearly impossible today to replace a burned-out meter. And even when eligibility can be demonstrated, long waits are frequently necessary. The demands of military and industrial radio leave virtually no new instruments for civilian use.

Few servicemen and experimenters can afford to be very long without some means of measuring current or voltage. Fewer still possess the skill, patience, and facilities necessary to make a reliable home-made meter. When instruments were plentiful, there was little need to think about meter substitutes; but now that a keen shortage exists, no possible substitute should be overlooked.

In exploring the subject of meter substitutes, the writer tried building a d'Arsonval milliammeter movement, rebuilding a junked automobile dashboard ammeter to read milliamperes, constructing a solenoid-plunger-type milliammeter, and building one of the "physics class" galvanometers made with a coil of fine wire wound about a magnetic compass. In each of these projects, it was aimed to use only the tools and skill possessed by the average serviceman.

The results obtained in each case were far from gratifying and the writer is of the opinion that high-sensitivity meters of good accuracy cannot be produced by the serviceman or experimenter with the materials and tools commonly available to them. Attention was consequently turned to

substitute devices. The meter substitutes described in this article have been tested painstakingly and may be depended upon to pinch-hit to the limit of the claims made for them.

### Neon-Lamp Indicator

One of the simplest, yet most overlooked of voltage indicators is the low-wattage neon bulb. The ignition and extinction voltages are so constant for a given bulb that, once carefully measured, flash-on or flash-off of the lamp may be taken as a reliable indication of ignition or extinction potentials. Higher voltages may be referred to these two points through a calibrated potentiometer.

By a series of tests in which the voltages were determined several dozen times at which a quarter-watt neon bulb just flashed on and off, the writer concluded that these two points are sufficiently reliable for voltage indication. However, the flash-on point appears to be the more foolproof of the two, since the bulb abruptly "pops"

into glow in an unmistakable manner but extinguishes itself in a more gradual manner so that the exact point of extinction of the glow is difficult to detect.

The quarter-watt bulb connected successively across variable-a.c. and variable-d.c. power supplies, with a Voltohmyst as the indicator, was observed to pop into glow at voltages of 50 d.c. and 76 a.c. (These values will very likely differ slightly with individual bulbs which accordingly should be checked with a voltmeter before use). As the voltage was subsequently increased upward from zero, the point at which the neon glow just started invariably indicated either 50 volts d.c. or 76 volts a.c.

The simple neon-bulb circuit shown in Figure 1 was arranged as an a.c.-d.c. voltmeter incorporating the principle just described. The input terminals are connected directly to the ends of a 1-megohm volume-control potentiometer. The 1/4-watt neon bulb is connected to the contact arm and common terminal.

In operation, an unknown voltage is applied to the input terminals, with the contact arm at the bottom of the potentiometer. The contact arm is then slowly rotated toward the high end of the potentiometer until the neon glow just pops on. The voltage across the bulb at this point is the ignition potential ( $E_n$ ), and the unknown voltage  $E_x$  is equal to  $(E_n R)/r$ ; where  $E_n$  is the d.c. or a.c. ignition potential of the bulb (depending upon which type of voltage is being measured),  $R$  is the

Fig. 1. Basic circuit.

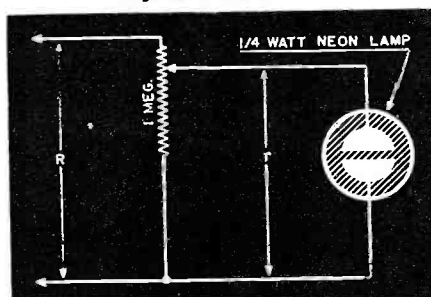

total potentiometer resistance, and  $r$  is the resistance of that portion of the potentiometer included across the bulb. Direct voltages between 60 and 600 and alternating voltages between 76 and 760 were measured with the circuit of Figure 1.

This meter substitute may be assembled compactly into a small box. The potentiometer should be provided with a generous dial which may be graduated directly in volts, one scale for a.c. and another for d.c. Voltage calibration will be very simple: The ignition potential of the neon bulb, for both a.c. and d.c., is first carefully measured. A number of known alternating and direct voltages are then applied successively to the input terminals and the potentiometer adjusted, always moving upward from the zero setting, until the point is reached at which the neon glow just starts. The known value of input voltage is then marked on the dial at this point, and so on for a number of such points.

The topmost setting of the potentiometer will correspond to the bulb ignition potential, and some setting near the bottom of the potentiometer to the highest readable voltage. The greater the dial circumference, the more accurately the intermediate values may be read.

Chief attributes of the simple neon-bulb voltmeter are its simplicity, com-

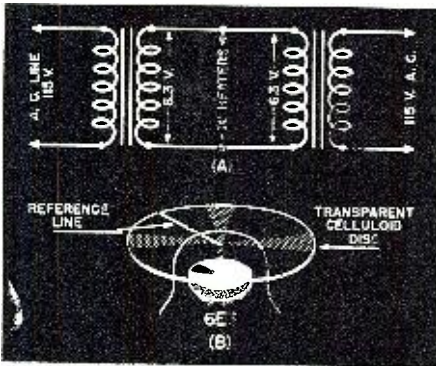

Fig. 4. Using two filament transformers to obtain a voltage ratio of 1:1 as in Fig. 3.

compactness, and low cost. Its chief drawback is its inability to measure voltages lower than its ignition potential.

#### Neon-Bulb V. T. Voltmeter

A more versatile neon-bulb voltmeter for a.c. measurements is shown in Figure 2. In this circuit, which constitutes an audio-frequency v.t. voltmeter, an amplifier is placed ahead of the bulb indicator, making it possible to measure voltages both above and below the neon ignition potential. With the constants shown in the circuit diagram, the writer has readily measured voltages between 0.25 and 500 RMS, employing the voltage-indicating potentiometer,  $R_1$ , in the same manner as explained in the description of the simple neon-bulb meter.

The arrangement shown in Figure 2 may be modified to employ whatever tubes the reader may have on hand. Amplifier requirements are not particularly critical, and any equivalent

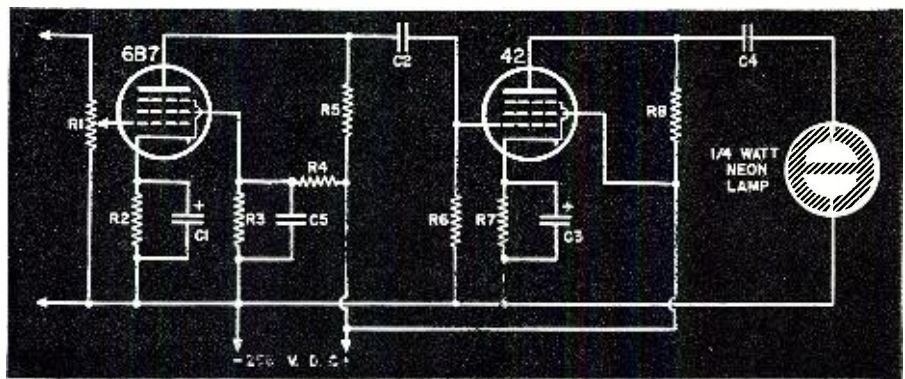

Fig. 2. Voltage-measuring device using neon lamp as indicator.

$C_1, C_2$ —10- $\mu$ f. 25 d.c.w.v. midget tub. elec.—Aerovox FR5  
 $C_3, C_4$ —0.1- $\mu$ f. 400 v. tub. condenser—Aerovox 484  
 $C_5$ —1- $\mu$ f. 400-v. tub. condenser—Aerovox 484  
 $R_1$ —2-megohm pot.—IRC Type CS

$R_2$ —800 ohms 1 watt—Aerovox  
 $R_3$ —20,000 ohms 1 watt—Aerovox  
 $R_4, R_5$ —100,000 ohms 1 watt—Aerovox  
 $R_6$ —0.5 Megohm  $\frac{1}{2}$  watt—Aerovox  
 $R_7$ —500 ohms 2 watts—IRC Type BT-2  
 $R_8$ —7000 ohms 10 watts—Ohmite

tubes might be employed to obtain the same results. The 6B7 functions only as a voltage amplifier which is resistance-coupled to the 42 power stage. Other satisfactory combinations are 2B7-2A5, 6C5-6F6, 6J5-6V6, etc. In general, any combination of voltage amplifier and power amplifier will suffice, since the reader will make an individual calibration of his own circuit. Satisfactory values for resistors for tubes other than those shown in the circuit may be obtained from manufacturer's tube data. The capacitor values and  $R_1$  will remain the same for any tube combination.

Only  $\frac{1}{4}$  volt RMS is required at the grid of the 6B7 to "pop" the neon glow. A considerable voltage range is thus possible along the length of  $R_1$ . As in the case of the simple neon-bulb meter, this potentiometer may be provided with a dial marked directly in volts, and may be calibrated by applying a number of known a.c. voltages successively to the input terminals and noting the dial setting for just initiating the neon glow. An alternative method would be to mark off the dial according to the percentage of the total resistance represented by certain settings, assuming some convenient maximum voltage value. The accuracy of this method will depend upon the precision with which the builder may measure the various resistance values.

Advantages of the amplifier-type neon-bulb voltmeter are its high input resistance and wide range. Unfortu-

nately, it is not adaptable to d.c. measurements. It may be employed as a milliammeter or as an ammeter for a.c. by measuring the voltage drop produced by the unknown current across a resistor through which it flows. For milliammeter measurements, it will be desirable to employ a small resistance value, such as 1 ohm. For larger currents, higher resistance values may be used. In either case, however, the resistor must be non-inductive.

For very precise measurements of voltage over a wide frequency range, it will be necessary to correct for frequency error. This is because of the response of the amplifier. Initial calibration will very likely be made at 60 cycles and the voltage indications at other audio frequencies, such as 1000 or 5000 cycles, will be somewhat in error. Inspection is best made by feeding in known voltages at various frequencies from an audio oscillator and recording differences between these values and those indicated by the  $R_1$  dial. A curve, showing deviation of dial from true values, may then be drawn.

#### Magic-Eye V. T. Voltmeters

Magic-eye indicator tubes, such as type 6E5, make excellent meter substitutes in vacuum-tube voltmeter circuits. Such circuits are fundamentally d.c. voltmeters, but they are readily adapted to current measurements and

(Continued on page 82)

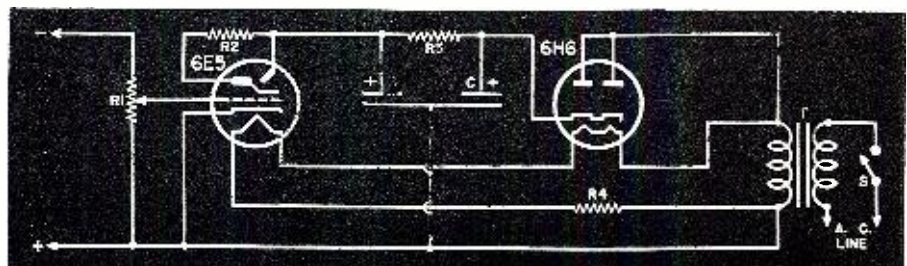

Fig. 3. Using an electric eye for voltage-measurement indication.

$R_1$ —2-megohm pot.—IRC Type CS  
 $R_2$ —5 megohm  $\frac{1}{2}$  watt—Aerovox  
 $R_3$ —1500 ohms 1 watt—Aerovox  
 $R_4$ —340 ohms 75 watts—Ohmite

C-C—Dual 16  $\mu$ f. 450 d.c.w.v. midget tub. elec.—Aerovox FR5  
 $S$ —3-p.s.t. on-off toggle switch—Arrow  
 $T$ —1:1 ratio power transformer—Kenyon

## TECHNICAL BOOK & BULLETIN REVIEW

**"RADIO OPERATORS' CODE MANUAL** with touch typing," by Wayne Miller. Published by Wayne Miller, the Engineering Building, Chicago, Illinois.

This book is ideally suited to the young man about to enter military service particularly if he is to make a definite attempt to join the Army Signal Corps. It covers a complete method whereby the International Morse Code may be learned in the shortest possible time with the added advantage that the art of touch typing is included so that the student may become a proficient radio operator if he will follow the carefully worked out plan presented. The student is shown how to construct his own hand key as well as a simple buzzer and other items essential for code practice. Lessons are divided into various groups and the art of conquering the code with rhythm gives the student a firm background for preliminary technique which makes the learning of the International code similar to the learning of a foreign language. The book includes an appendix which includes the Federal Communications Commission Rules and Regulations governing Commercial Radio Operators, Field Offices of The Federal Communications Commission, Abbreviations to be used in radio communications, miscellaneous abbreviations and the International Morse Code with extracts from the list of punctuations and other signs contained in the Telegraph Regulations of the Cairo Conference.

**"ABC OF RADIO,"** prepared by the Electronics Department. Published by the General Electric Company. 68 pp. paper bound. Price 25c.

This 68 page primer is intended to help the beginner to understand the fundamentals of radio. The book is the outgrowth of a training course in radio prepared for people employed in non-technical positions in the radio industry. The scope of the material is broad, with mechanical and engineering treatment on fundamental theory held to a minimum. Hence, the point of view of the practical serviceman has been adopted rather than that of the advanced engineer.

**"MATHEMATICS ESSENTIAL TO ELECTRICITY AND RADIO,"** by Lt. Nelson M. Cooke and Dr. Joseph B. Orleans. Published by McGraw-Hill Book Company, New York City. 418 pp. Price \$3.00.

Electrical and radio engineering students have a direct need for a course in mathematics that is directly concerned with applications to electrical and radio circuits. This book provides those students with a sound mathematical background and furthers their understanding of the basic principles  
(Continued on page 102)



By **CARL COLEMAN**

**D**URING the first World War it was considered a wonderful piece of work (which it was at that time) to transport the A.E.F. some 3,000 miles across the Atlantic to war-torn Europe even with much of their equipment supplied by England and France. Today with battlefronts scattered around the globe from the frozen Arctic to the coral reefs of the islands in the South Pacific the world is engaged in warfare such as has never before been seen in history. Many thousands of tons of equipment, food, tanks, planes, guns, ammunition, trucks and many other items must be sent with each fighting unit. These must be transported not 3000 miles but in some cases 8000 and 10,000 miles or more across oceans where enemy submarines and surface ships lurk and where enemy bombers may be flying overhead. Only the larger bombers manufactured in this country can be flown to their destinations, all other material, even the smaller planes must be shipped by vessels of the merchant marine.

The merchant marine will need an increasingly large number of trained radiomen to man ships as increased production of Liberty and Victory ships takes place. To those who have

licenses and can pass the necessary examination for a "ticket" the merchant marine offers very attractive positions to radio officers aboard ship in a position where you will be serving your country in a most commendable manner. Those engaged ashore in vital work connected with our war effort can likewise do their part by helping to render fast, reliable service to speed the day of final victory and last but by no means least can invest to the limit of their ability in war bonds—just think what a fine bonus a profit of one-third of your initial investment will make ten years hence—which if you are like most of us you certainly will be able to use.

Several recent letters from those about to take license examinations and become sea-going radio operators have contained the following questions which we answer to the best of our ability in the hope that they will be of some slight value to those in the same position:

**Q.** I believe that radio operators positions are assigned by unions rather than by the steamship companies. If so to what union should I make application?

**A.** In most cases radio service companies supply operators to the various shipping firms. The radio service organizations then call upon the unions for the men; thus the men are actually supplied and assigned by the radio unions. The two largest unions in this country are: 1—American Communications Association, with headquarters at 5 Beekman Street, New York City. 2—The Radio Officers Union, with offices at 265 West 14th Street, also in New York City. The A. C. A. is affiliated with the C. I. O. and the R. O. U. with the A. F. of L. Both are large organizations with representatives in various ports throughout the country and are established for the protection and assistance to  
(Continued on page 96)

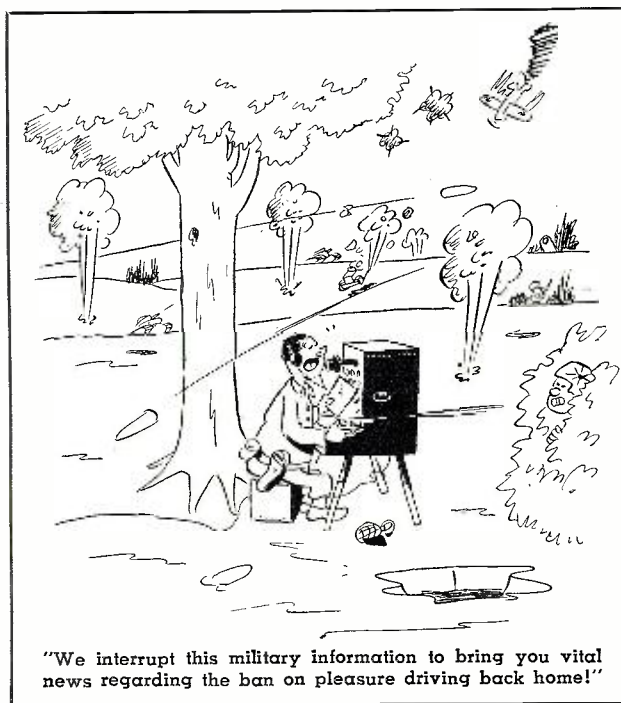



# WHAT'S NEW IN RADIO

## New products for military and civilian use.

### CIRCULAR SLIDE-WIRE RHEOSTAT

Designed especially for low resistance, low wattage applications, this *Ohmite* rheostat-potentiometer has found several applications in the instrument field. The provision of three

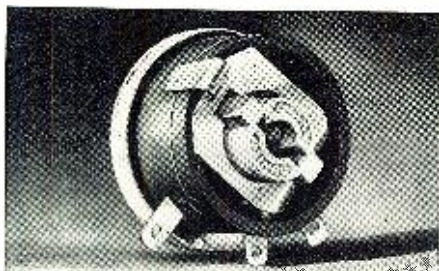

terminals allows the unit to be used as a potentiometer or voltage divider. The maximum resistance which can be supplied on this unit is approximately 1 ohm while the minimum total resistance can be made approximately 0.1 ohm. Since the contact arm travels along the wire from end to end, the resistance variation is stepless. Shafts for knob control or for screw driver control can be supplied. These units are made to order to suit the particular application and inquiries on this basis are welcomed. *Ohmite Manufacturing Company*, 4835 West Flournoy Street, Chicago 44, Illinois.

### TWO-TERMINAL OIL CAPACITOR

Already a highly popular type of oil capacitor because of its handy inverted screw mounting and compact dimensions, the *Aerovox* Type 10 is now further improved by the new double-terminal feature. Heretofore this capacitor has had a single insulated terminal and grounded can, although when screw-mounted on a metal chassis it could be fully insulated by an insulating washer.

The new double-terminal feature means that both terminal lugs are insulated from the "floating" can and no insulating washer is required. These capacitors are hermetically sealed and will pass all immersion



tests required by Governmental agencies. This is accomplished by the use of the new one-piece molded bakelite

terminal assembly which prevents penetration of moisture and leakage of oil. These capacitors, available on high priorities only, are filled with either *Hyvol* vegetable oil or mineral oil, rated up to 4.0  $\mu$ fd. at 600 v. d.c. and to .5  $\mu$ fd. at 1500 v. d.c. A product of the *Aerovox Corp.*, New Bedford, Mass.

### SPOT-O-GRAPH

A brand new record-marking device has just been brought out, called the "Spot-O-Graph." It makes possible the individual timing of sound effects and music with considerably more accuracy and precision than ever before.

It is designed in the form of an ordinary record, but with a cone-shaped partition down the center, on each side of which there is a minutely graded scale, so that the needle can fit exactly in the right spot.

Since all notations and markings are made on the Spot-O-Graph instead of spoiling and defacing the record itself, as heretofore, and since it is no



longer necessary to guess where to place the pick-up, a great deal of precious time is saved, and the record or transcription is preserved and its usefulness prolonged.

The Spot-O-Graph can be of immeasurable service not only to broadcasting stations and recording studios, but also to radio schools, universities, collectors of rare or very fine records, and stage and screen sound engineers. It can even be very useful where the phonograph method of learning a foreign language is employed. It comes in 10, 12 and 16-inch sizes, and is a product of *Heroservice*, 45 West 45th Street, New York City 19.

### TANDEM POWER RHEOSTATS

Compact, sturdy tandem power rheostat assemblies of two or more sections are announced by *Clarostat Mfg. Co., Inc.*

These assemblies are made up of two 25-watt or two 50-watt rheostats rigidly coupled together and held in

a metal cradle. The usual one-hole mounting and locking-projection features are retained. The individual rheostats can be of any standard resistance value, taper, tap and hop-off, and all units go through the same degree of rotation as the single shaft

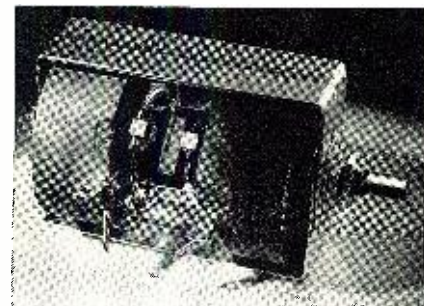

is turned. The units are fully insulated from each other and from ground. Because of the wide choice of resistance values and other factors, such assemblies are necessarily made only on special order to the *Clarostat Mfg. Co., Inc.*, 285-7 N. 6th St., Brooklyn, N. Y.

### FUSE EXTRACTOR POST

What is considered a most important advance in fuse extractor post construction comes from *Littelfuse Incorporated*, 4747 Ravenswood Ave., Chicago 40, Illinois.

Anti-vibration side terminals are now mechanically connected by electrical welding to the metal shell inside the bakelite body and backed up by soft solder. The new welding process makes the terminal connection in effect one-piece, integral with the metal parts—permanent and unshakable against all forces. The terminal is protected against heat and severest vibration.

The new *Littelfuse* Extractor Post No. 1075 for fuses to 15 amps., is used for radios, auto-radios, amplifiers, fractional h.p. motors, magnets, control circuits, relays, rectifiers, plate circuits, etc. Overall length is 2½".

The knob not only pulls the fuse, it holds it. A specially designed grip

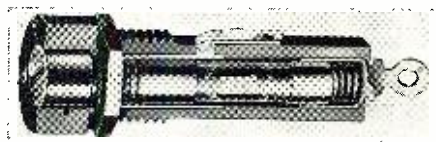

prevents the fuse from ever dropping out. The fuse can be taken from the knob only by hand. Manufactured by *Littelfuse Inc.*, 4747 Ravenswood Ave., Chicago 40, Ill.

(Continued on page 72)

# REPLACEMENT POWER SUPPLIES

By **ROBERT F. SCOTT**, ex W4FSI

**Due to the curtailment of parts for civilian use, the need for power supplies has turned to the substitution of available material.**

**W**ITH the advent of priorities on radio parts and equipment there has been a demand from schools, civilian defense organizations, and experimenters for many types of equipment, both new and used to fill their needs. In the days of the "Ham," what you couldn't buy had to be designed and built. The writer believes that there is more truth in this phrase today than ever before. Because of the limitations on the purchases of batteries, wet and dry, and power supply equipment and parts, the task of designing equipment that can be constructed with material now on hand, has been undertaken. Practically all of our present-day radio and electronic equipment will require power supplies capable of furnishing suitable filament voltages as well as a source of high voltage direct current. Most of the supplies described here are capable of supplying the necessary heater voltages along with 300 volts of direct current at a drain of approximately 100 ma.

One of the many designs of portable and emergency equipment Vibrapacks, Genemotors and Dynamotors would be the ideal solution to the problem. However, investigation will show that these items are only available, in limited quantities and require very high priority ratings for purchases. The use of Genemotors and Dynamotors is prohibitive in many cases due to the difficulties that will arise should an emergency repair become necessary. Any repairs to the windings of this type of equipment are likely to be time-consuming major repairs and cannot be done by the average repairman.

The limitations on the purchases of vibrator type equipment are much the

same as those applying to the aforementioned types of power supplies.

It has been shown that the vibrator-type of supply is the ideal for most applications, so plans have been drawn to show how easily many of the present a.c. supplies can be converted to the vibrator-type or to the combination 110 volt a.c. and 6 volt d.c. supplies.

After completing the basic design on the drafting board and consulting material published by leading manufacturers of vibrators and transformers, it was decided that the average a.c. transformer can be converted to do double duty quite easily. The first of the vibrator-type supplies to be built by the writer was one assembled from transformers available on the market. This supply (Fig. 5) was capable of supplying 370 volts d.c. at 250 ma. Due to the exceptionally heavy current drain from the storage battery, under full load, it was decided to use the commercial combination manufactured by Thordarson (T14R40). Two of these transformers were salvaged from a mobile PA system. The transformers were connected in parallel and the output of the rectifiers fed into a common filter section.

A very convenient feature of these transformers is that they are equipped with dual primary windings. One is designed to operate from 6 volts d.c. and the other to operate from 110 volts a.c.

Since this type of supply should never be operated on a.c. with the vibrators in the sockets, a switching arrangement was made in the two power input plugs, so that when the set is used on a.c. the vibrators are removed from the circuit.

Since the commercial transformers of this type are no longer available to

the public, it has become necessary to rebuild available transformers to the specifications. The first requirement is to obtain a replacement transformer or one from the junk box that will supply the necessary secondary voltages when they are operated from an a.c. source. If the transformer is taken from the old receiver that you have in the attic, you will probably find a few filter condensers and a couple of filter chokes in good condition.

If the output voltages of the trans-

- $T_1$ —Power transformer with 110 volt primary removed and 6 volt winding added
- $T_2$ —Standard vibrator transformer
- $T_3$ —Power transformer with two heavy duty 6.3 volt windings
- $T_4$ —Commercial dual primary power transformer, Thordarson T14R40 or equivalent
- $RF C_1$ —2.5 mh. r.f. choke. 200 ma. capacity
- $RF C_2$ —15 turns #14 s.c.c. (or heavier) on 1/2" form
- $Ch_1$ —8 to 15 henry filter choke capacity 200 ma. (may be wound on old transformer core. See text)
- $C_1$ —Buffer condenser, .001 to .01  $\mu$ fd. rated at 1000 volts or higher
- $C_2$ —Filter condenser, 8  $\mu$ fd., 450 volts
- $C_3$ —.01  $\mu$ fd., 450 volt tubular
- $C_4$ —5  $\mu$ fd., 150 volt tubular
- $C_5$ —.0008  $\mu$ fd., mica, 1000 volt
- $V_1$ —80, 83, 5Z3. (2.5 volt rectifiers may be used if the transformer has the proper filament winding)
- $V_2$ —6X5, 6W5, 6Y5, 84/6Z4
- Vib—Heavy duty non-synchronous vibrator or converted synchronous vibrator (see text)
- $F_1$ —Fuse, low voltage 20 ampere
- $SO_1$ —Socket, bakelite octal
- $SO_2$ —Socket, bakelite 5 prong or 7 prong
- $Pl_1$ —DC input plug
- $Pl_2$ —AC input plug ( $Pl_1$  and  $Pl_2$  may be commercial power plugs or old tube base may be used)
- $Sw_1$ —Heavy duty S.P.S.T. toggle switch. 10 amps. current
- $Sw_2$ —Heavy duty D.P.D.T. toggle switch
- $D$ —Device to be powered. A cable from the power supply with plugs and sockets (or old tube sockets and bases) can be used when required

## Parts list for circuits Fig. 1 to Fig. 5.

former are not known, measure them and mark the leads carefully before disassembling the core and windings. If your transformer is not equipped with two 6.3 volt filament windings, it will be necessary to remove all of the secondary windings but the high-voltage one. Since the filament windings are usually on the outside of the other windings, this can be done with very little trouble. While unwinding the coil, carefully count the number of turns in the coil. The number of turns in the coil divided by its voltage will be equal to the "turns-per-volt" ratio. It is necessary to know this ratio to wind the proper number of turns for the new primary winding.

Before beginning to wind on the new primary for vibrator operation, it will be necessary to determine the wire size to carry the current. This will have to be determined by consulting a wire

Fig. 1. Vibrator-type power supply using standard transformer and components.

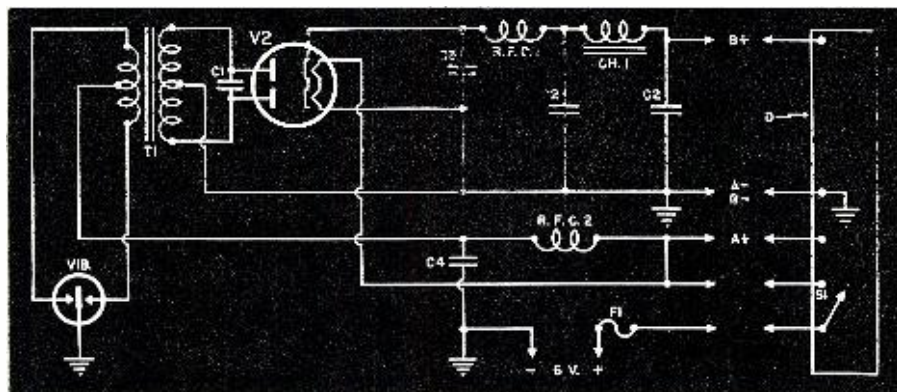

table after computing the power drain of the secondary windings by using the formula:  $W = EI$ .

Since the transformer does not permit a perfect transfer of energy; it will be necessary to add about 10% to the total secondary wattage. When this has been done, the results must be divided by the primary input voltage to obtain the current existing in the primary under full load. Since only half of the primary is carrying current at any portion of a cycle, the heating effect will be approximately equivalent to only one-half of the existing current. The total primary current divided by two will yield the figure from which the wire size is determined. This information may be found in practically any amateur or experimenter's radio manual.

**EXAMPLE:** If the transformer selected has a secondary output of 300 volts at 100 ma., and no filaments secondaries, the total secondary power is equal to the product of  $EI$  or  $300 \times .100$  or 30 watts. Adding 10% or 3 to the total will yield 33 watts. This will closely approximate the primary wattage, and this divided by 6 (d.c. voltage) will give 5.5 amperes as the current of the primary under load. One-half of the result will yield 2.75 amperes but using 3 amperes as a practical value it is found that this current can be safely handled by No. 15 enameled wire.

While in the process of winding on the turns of the primary coil; all of the spacing possible should be given between turns and each layer should be carefully insulated from the other by the use of "fish paper" or transformer tape. If these materials are not obtainable, Scotch tape or friction tape may be used. After the primary has been insulated against all chances of shorting to the core or to the secondary, the transformer is ready to be assembled. The laminations of the "E" are interleaved and the coil slipped over the center of the "E," as in Fig. 7 (Transformer A). The remaining laminations are pushed into place and a shield placed around the unit. If the transformer was not equipped with a shield, one should be made out of sheet metal.

If it is desirable to use your home-built supply as a combination supply to operate from 110 volts a.c., it is only necessary to make use of the original high-voltage primary winding and by making use of one of the switching schemes, Figs. 3 and 4.

There are two common types of home-built combination supplies. The more common type is made by winding on the core an additional primary winding. The other one utilizes transformers having two 6.3 filament windings, connected in series aiding. The former type is the more efficient due to the fact that the primary winding is usually wound with heavier wire than the types using the filament windings. Both of these types use the storage battery as a source of filament

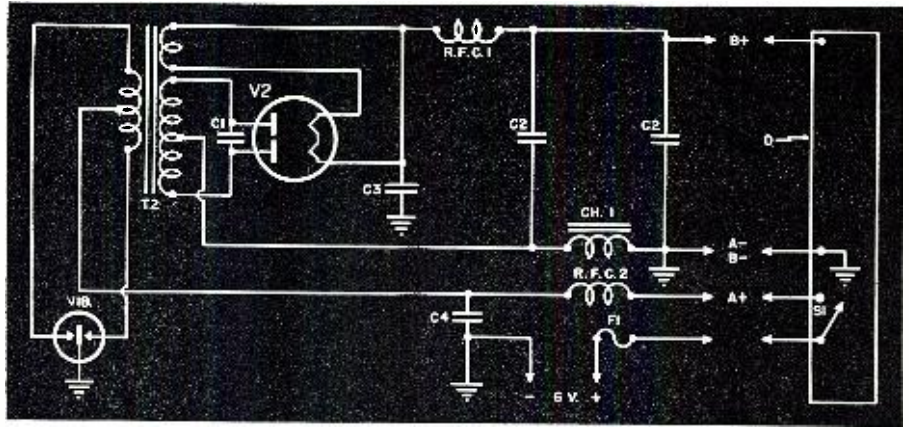

Fig. 2. Power supply for vibrator operation using a converted power transformer.

current while operating from a d.c. source. The total primary drain is limited by the current carrying capacity of the filament windings, in the latter case. The former type is illustrated in Fig. 4, and the latter in Fig. 3.

One of the inherent features of the vibrator supply is "Hash." This is usually a very broad r.f. signal originating in the vibrator. Hash in any form can be intolerable in sensitive radio and electronic equipment.

The complete reduction of hash can only be accomplished by absolute shielding of the whole supply and the use of r.f. filters in the primary and secondary circuits as well as in the leads running from the battery to the supply and from the supply to the apparatus to be operated. The filters in the primary circuits should be about 15 turns No. 14 s.c.c. on a form 1/2" in dia., close wound. Any chokes that may be included in the output section of the supply may be of the 2.5 mh. receiving types.

Since a transformer will not operate on a direct current it is necessary to utilize some type of current reversing switch to perform this operation. The vibrator is the magnetically operated switch to perform the current reversing operation. The average vi-

brator is so designed to operate at a frequency of about 115 cycles per second. With each "break" of the circuit; there will be a back e.m.f. surge that will be quite high and will have a tendency to rupture the filter condensers and to break down the insulation of the transformer. This back e.m.f. will also cause the vibrator points to arc and stick as well as cause rapid wear of the points. These "bugs" can be killed by having the vibrator work into a tuned circuit. With the low inductance of the primary winding, it will require a very large value of capacity to tune the winding to the required frequency. If the tuning or "buffer" condenser is placed across the high voltage winding, and this winding is tuned to the correct frequency, this tuning will be effectively reflected back to the primary.

It is highly important that the buffer condenser be chosen carefully because if it is too high it will be a cause of excessive wear and hum. If it is too small the effect will be very much the same as no condenser at all.

The average experimenter can approximate, closely, the correct value for the condenser by removing the rectifier tube from the circuit and connecting a 0 to 15 d.c. ammeter in one

(Continued on page 52)

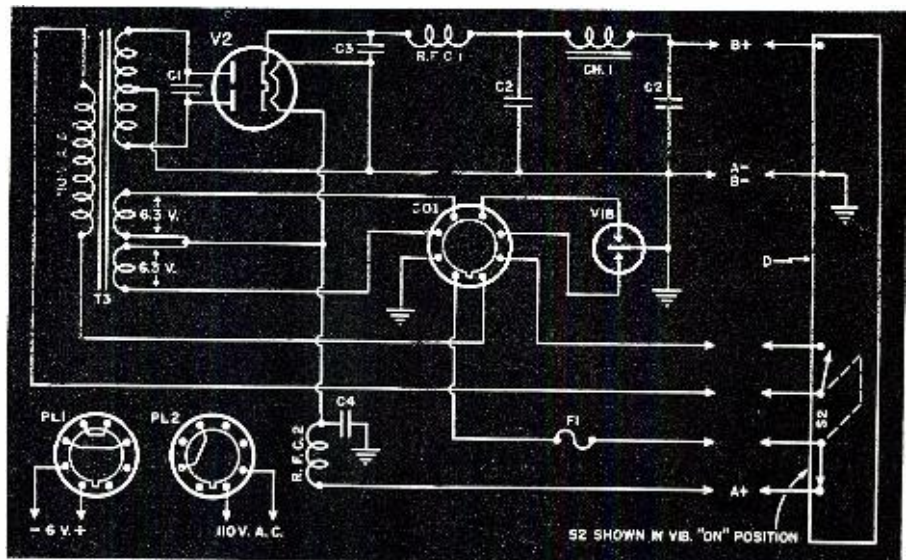

Fig. 3. Universal power supply for 110-volt A.C. and 6-volt battery operation.

# DETERMINING CLOUD HEIGHTS

by S. R. WINTERS

**Electronic photo-cell equipment is used to determine density and thickness of cloud banks, essential for safe aircraft flights.**

DESIGNED to make flying in cloudy weather safer, a radio-controlled robot not only measures the thickness and height of clouds but also determines the presence of layers of clouds—counting them and measuring their thickness. If clouds are hidden behind other clouds, this balloon-borne radio transmitter together with an “electric eye,” or photoelectric cell, discloses such a lurking menace to aviators. If there is no ceiling, as is true when a fog or cloud is blanketing the earth, this electronic

Thus, we are told, the height and thickness of the clouds; their numbers and layers are ascertained with unflinching fidelity.

This new radio “yardstick” for measuring the clouds, as a “safety factor” in aviation, is not to be confused with the conventional equipment of the United States Weather Bureau, in which tiny radio transmitters are borne aloft by balloons for gathering such data as temperature, barometric pressure, and altitude. Quite true these balloons, or “radiosonde” apparatus,

layers. Instances are apparent where such knowledge would be the determining factor whether the pilot should climb through the cloud-layer or remain under it. By a like token, if there is no ceiling—the clouds extending to the ground—information of the height to the top of this cloud-layer would be a “barometer” whether the pilot could take off safely and easily climb above the layer.

The equipment for dispensing this vital information includes, in general, a free, manless balloon carrying a small battery-operated, ultra-high-frequency radio transmitter, provided with a special type of oscillation modulator. A photoelectric tube—popularly described as an “electric eye”—(or a series of them) is switched into this special form of “relaxation type of oscillator modulator.” The frequency of the latter varies with the amounts of light present in the clouds. That is to say, this ultra-high-radio-frequency carrier wave is, therefore, modulated at a frequency corresponding to the brightness of the light. A very short-wave radio receiver is employed on the ground, coupled with a graphic-frequency recorder, calibrated in terms of light-brightness. Height may be revealed by knowing the rate of climb of the balloon or by switching in, alternately, with the photoelectric tube any one of the currently used radio-meteorograph indicators, such as the pressure-operated commutator, the Oland clock type, etc. Inasmuch as the light-brightness is a function of cloud conditions the graph of the light-brightness may be translated in terms of cloud heights and thicknesses. In one form of this invention, the “electric eye” is faced downward; in another

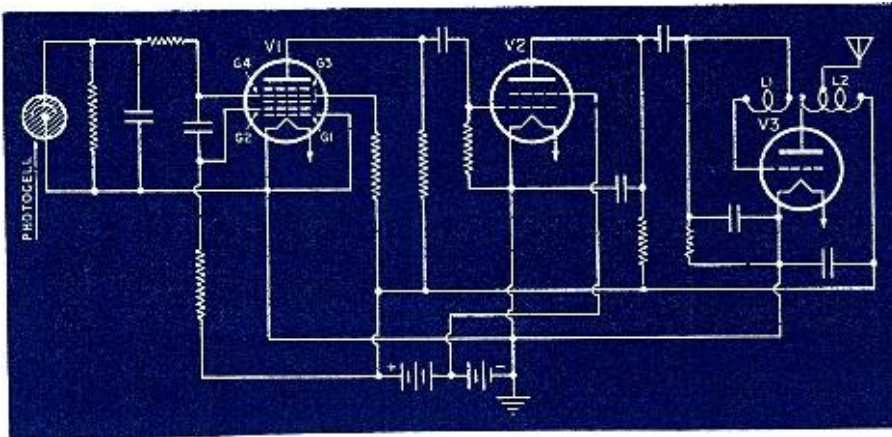

Fig. 1. Diagram of transmitter used to send signals in relation to light intensity.

instrument indicates whether the pilot can climb above the cloud or fog blanket.

Invented by Francis W. Dunmore of the Radio Laboratory of the National Bureau of Standards—a pioneer in the development of radio aids to navigation and co-inventor of the humless a.c. radio receiver—this cloud height and thickness measurer employs a balloon-carried radio sending set and a receiver on the ground for picking up and recording the wireless signals automatically. Additionally, for the first time in the history of the science of electronics a photoelectric cell is carried aloft for registering the changing light conditions from clear to cloudy weather.

An electric current is generated, which modifies the frequency of the radio transmitter. As the balloon leaves a cloud, this change is noted by the “electric eye” and thus the radio-sending frequency is modulated. The receiving set on the ground records these weather changes, together with the signals which indicate altitude.

function along the same principle as the Dunmore cloud-measurer. However, the Weather Bureau equipment ascertains the ceiling of the bottom of the cloud but does not determine its thickness. The new device of the Bureau of Standards—patent rights to the invention having been assigned to the Government—obtains this additional data automatically—and in so doing becomes a vital contribution to the ever-increasing safety devices designed to promote flying.

With this global war having accentuated the importance of air navigation, any invention disclosing cloud height and thickness is a welcome contribution to the science of aeronautics. Such apparatus is a potential multiplier of the days that bombers and fighters may remain in action on the far-flung battlefield. The Dunmore device may prove to be an information-dispenser at ground points in any kind of weather, divulging the thickness of cloud layers (even if extending to the ground), the height to the top and bottom of each, and the number of

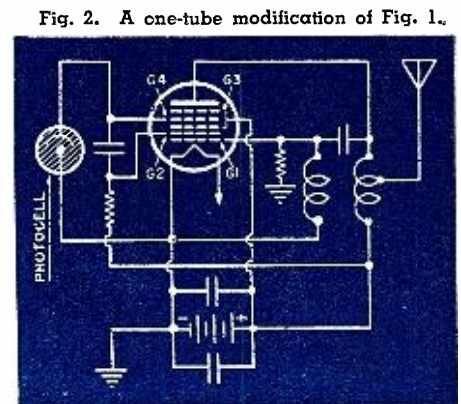

Fig. 2. A one-tube modification of Fig. 1.

set-up, two photoelectric tubes are switched into the circuit, one facing up and the other down.

Paralleling the schematic diagram illustrating this article, a more detailed descriptive text of the apparatus would include, first, Figure 1, a circuit arrangement of the radio transmitter carried aloft by the balloon; secondly, a photoelectric tube of standard design, sensitive to the visible and ultraviolet spectrum, and an oscillator tube, preferably of the type 1A6.

The output of the oscillator tube from the plate passes through a coupling condenser to the usual type of audio-amplifier tube and circuit. Thence it goes through another coupling condenser to a conventional high-

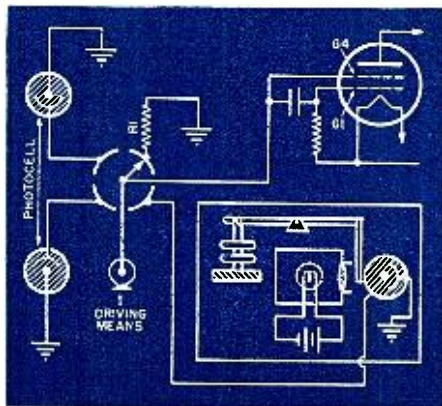

Fig. 3. Transmitter using two photo-cells.

frequency oscillator, associated with the antenna. The operation of this circuit is such that any variation of brightness of light from the clouds on the photoelectric cell causes its resistance to change. The circuit arrangement of the oscillator tube is such that any variation in resistance of the input circuit of grid G4 results in a change in the audio-oscillation frequency produced by the tube, so that the audio-frequency of the tube is a function of the light-brightness falling on the photocell. The tube V1 serves to modulate the radio-frequency oscillator, comprised of the tube V3 and inductors L1 and L2. The carrier wave emanating from the antenna of the balloon is, therefore, modulated at a frequency which is a function of the amount of light-brightness falling on the light-sensitive cell.

The receiving set on the ground is of no special design and may be connected to either a directive or non-directive aerial. It is, of course, an ultra-high frequency receiver and tuned to the transmitted wave-length of the sending set in the balloon. A band-pass filter excludes all frequencies other than the one wave-length to which it is tuned. The output of the band-pass filter is associated with a direct-reading frequency meter. The latter gives a current output that is a direct function of the frequency input. This current output may be connected to a graphical-recording milliammeter, which consists of the usual magnets, moving coil, and an arm. The latter, in this case, carries a recording pen,

which comes into play on paper, moved under it by a motor, operating a shaft which, in turn, is attached to the roll of paper. This motor, preferably, is of the synchronous time-keeping type, so that the graphic record will be in step with "Father Time." The "autograph" of this pen is proportional to the frequency applied to the input of the frequency meter. This frequency, in turn, corresponds to the amount of light-brightness falling upon the photocell, located in the balloon as it soars, perhaps 10 or 15 miles above the surface of the earth.

As illustrated in Figure 2, one electron tube may perform the twofold function of audio-oscillator and radio-frequency oscillator. In this circuit, G1 is the oscillator grid, G2 the anode grid, G3 the screen grid, and G4 the control grid. The audio-oscillator portion of this circuit operates on the negative characteristic produced between grids G2 and G4. The audio-frequency determining circuit consists, in the main, of a condenser and the total resistance of the centro-grid circuit. This consists, in part, of the photocell, facing downward as the balloon climbs into the stratosphere.

An arrangement of two light-sensitive cells is illustrated in Figure 3, one facing up and the other down—connected to commutators. The segment of one of the commutators is connected to a "ground" through a calibrating-resistor unit R1; whereas the segment of the other commutator is associated with the "electric eye," the resistance of which is a function of altitude. This is feasible through illumination supplied by a battery, the light being housed and illuminates the photocell through a lens. A shutter in front of the latter is operated by a pressure-actuated element—thus adjusting the amount of light falling on the light-sensitive cell, depending upon the atmospheric pressure. The arm of this pressure unit is revolved over four segments by a driving mechanism, which may be of the spring, electric or wind-driven type. This arm is connected to

Fig. 4. Combination for night observations.

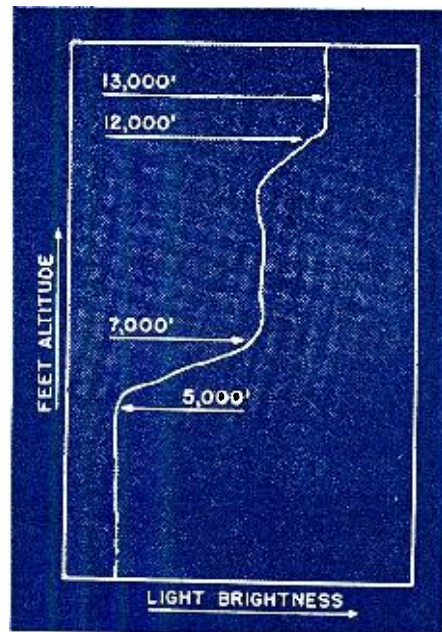
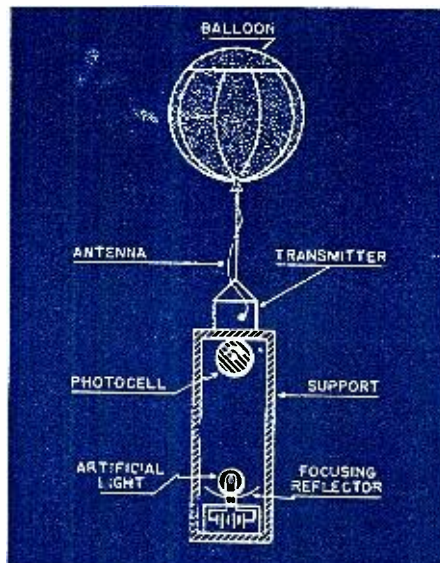

Fig. 5. Record obtained of two cloud layers.

the control grid G4 of the relaxation oscillator tube. The rest of this circuit associated with the oscillator tube is identical with that of Figure 1. As the pressure-unit arm rotates, like an organ peeling forth music, audio notes are sent, which are a function of light-brightness from below, light-brightness from above—the value of the resisting unit being constant and acting as a calibration check, and a note which is a function of altitude.

Still another modification of this invention is shown in Figure 4, whereby the thickness of clouds may be measured at night. This is accomplished by locating a source of light in such relationship to the photoelectric cell that the formation of clouds may influence the transmission of light from the artificial source to the element. The light may be hung below the light-sensitive cell, or vice versa, and the artificial light may be provided with a reflector. If a parallel beam, or light-focusing reflector is employed, the support for the reflector and light source should take the form of a rigid arm to avoid variation of light intensity other than that due to clouds. This support may be located 10 or 20 feet below the radio transmitter housing, supported by the balloon, and the artificial light may be battery-operated.

This after-dark cloud-measurer operates in the following manner; if no cloud passes between the light source and the photocell, the audio note received by the radio set on the ground will remain constant. However, when a cloud intervenes the audio note changes its "tune" in proportion to the density of the cloud. If the experimenter wishes to tinker with this outfit, he may put it into reverse action—the cell, light, reflector, and battery occupying positions reverse to the above-described set-up. The light received by the photocell from the lamp is fairly constant, except when clouds

(Continued on page 106)

# Manufacturers' Literature

Our readers are asked to write directly to the manufacturer for this literature. By mentioning RADIO NEWS and the issue and page, we are sure the reader will get fine service. Enclose the proper sum requested when it is indicated. This will prevent delay.

## NEW INSTRUMENT PUBLICATION

A new *General Electric* publication, "Electric Instruments, Principles of Operation," presents a concise discussion of the characteristics of instruments, what makes them operate, and the individual limitations of the various types. Designated GET-1173, it is available on request to the Company at Schenectady.

The introduction to the publication points out that the use of electricity in manufacturing processes has become so general that the important question of whether it is being used in the most economical way is sometimes overlooked. Electric instruments are defined simply as the tools for obtaining essential information about electric circuits. Thus, a study of their construction and application invariably points the way to lower costs and improved manufacturing methods, according to the publication.

## NEW SPRAGUE "VICTORY" LINE FOLDER

A colorful new folder recently issued by the *Sprague Products Company*, North Adams, Mass., illustrates and describes "Victory Line" *Sprague* Atom Midget Dry Electrolytic Capacitors and TC Tubulars which will be supplied regularly through its distributors in conformity with wartime limitations on capacitor production for civilian use.

Although the *Sprague* "Victory Line" is necessarily limited to only nine Atom types and nine TC Tubulars, these have been carefully selected as to capacities and voltages to enable servicemen to handle practically any replacement job. Of utmost importance, is an article included as part of the folder "How to Use Victory Line Capacitors." This contains many helpful hints on how to substitute the few "Victory Line" Capacitors for the many varieties of standard types. Subjects covered include: "Connecting Capacitors in Parallel to Make Capacity Values Not Available in a Single Unit"; "Replacing Filter Applications Higher Than 450 V. D.C. with Victory Line 450 V. Capacitors."

Servicemen will find this folder an invaluable guide to present day capacitor replacement procedure. Copies may be obtained direct from *Sprague Products Co.*, North Adams, Mass., or through authorized distributors.

(Continued on page 102)

# SABOTAGE

by R. R. LYONS

*A sergeant of the AAFTTC in action, teaching radio troubleshooting to aviation cadets.*

**L**EROY ZIMMERMAN is a saboteur and destroyer of government property—and the Army is encouraging him. As a matter of fact, they're paying him \$114 a month to do his dirty work. If he continues to improve, they intend to up his pay another \$24 a month.

Before the mysterious-looking gentleman reading over your shoulder starts any rumors, it had better be explained that the Zimmerman variety of vandalism, or "professional gremlinism," as it is sometimes called, is in the interests of a worthy cause. Uncle Sam wants Zimmerman to wreak havoc on used aircraft radio equipment so that aviation cadets taking the Army Air Force Technical Training Command's Radio Communications course at Yale University, New Haven, Conn., can learn how to repair them rapidly and efficiently.

The Radio Communications school trains aviation cadets in the theory, operation, and maintenance of all phases of plane-to-plane radio transmission and ground-to-plane transmission and reception. Leroy Zimmerman—Technical Sgt. Leroy Zimmerman—conducts a class every day at the radio maintenance division of the school.

With a Mephistophelian glitter in his eyes, he cuts and files delicate wires, shorts-out relays so they won't operate, puts bad wires where good ones stood before, and mangles everything on which he can lay his pliers. When he gets through—the Technical Training Commandos call it "putting trouble in a set"—he hands the remains to a cadet, who checks with electric meters and testing devices to locate the sabotage and get the thing working again. Occasionally cadets are required to

build part replacements out of odd scraps.

If the cadet is adept at looking for trouble, he can have the set back in working order and as good as new within three quarters of an hour. The more training he receives, the quicker he is expected to repair a damaged set. By the time he completes his course and receives his commission as a second lieutenant—after 20 weeks—the cadet is a top-flight radioman. The training he has received will prove invaluable later in combat zones, where the rapidity with which an expert can repair aircraft equipment may mean the difference between life and death.

Zimmerman didn't begin his career in radio as a wrecker of equipment. As a civilian back in Kankakee, Ill., he picked up his knowledge of the subject from books and magazines in libraries. Then he took a course in electricity at the Chicago Engineering Works, returned to Kankakee, and opened up a radio and electrical repair shop—dedicating himself to *fixing* equipment.

But along came the Selective Service Act, and Zimmerman beat his draft board to the punch by enlisting in the Air Corps. He was sent for a brush-up course to the radio school at Scott Field, Ill., and his grades there were so high that he was made an instructor. Then, after a short period at the field, instructing officers and cadets in radio fundamentals and the study of aircraft radio equipment and maintenance, he was sent on to Yale. That began it.

Today, Zimmerman is proud of his work, and thinks he's a darned good saboteur—but he's haunted by a certain memory. Once a student challenged him to do his worst with a set. "I went to work and blitized that set

fifty-seven ways," Zimmerman says. "When I got through with it, I would have sworn that Edison, Marconi, and Einstein would have given up in despair at the thought of trying to repair it. Well, the cadet not only fixed the set but he finished it in only six minutes flat.

"Of course," the sergeant adds, looking comforted, "I later found out that the cadet had been one of the country's best radio maintenance men before enlisting."

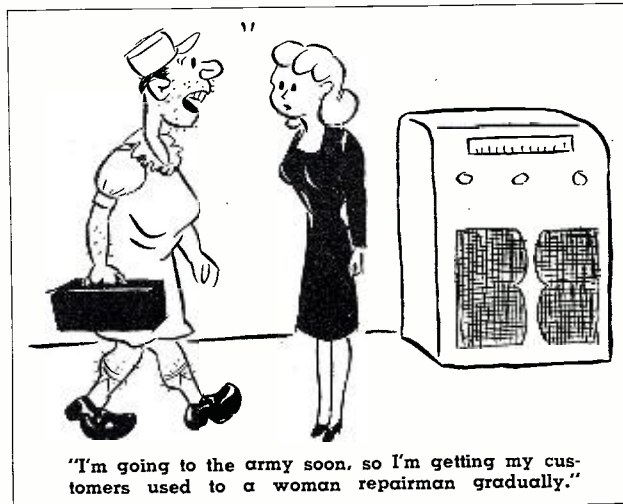

-30-

# NEW MACHINE GUN TRAINER

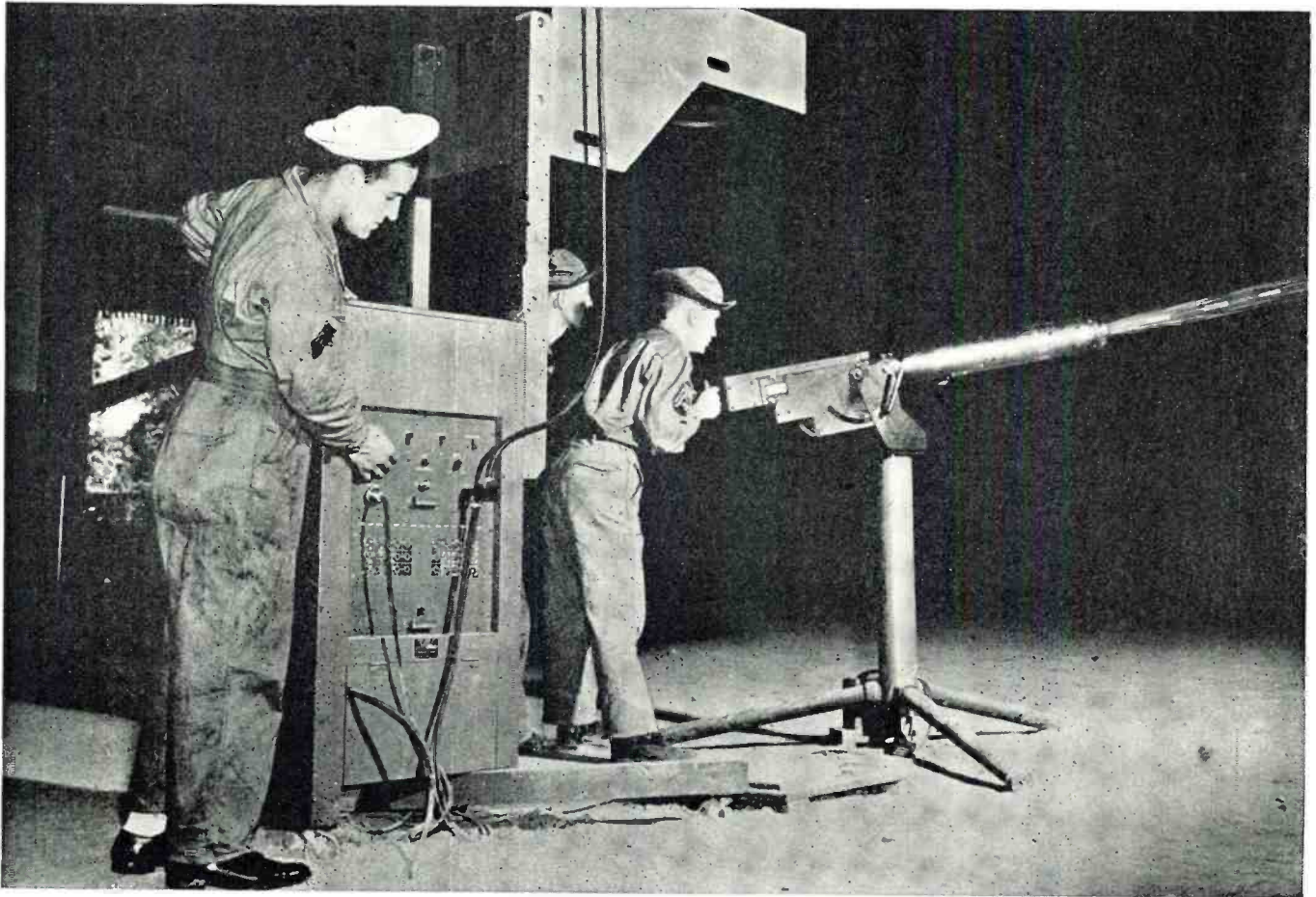

Electronically-operated machine gun trainer simulates actual battle conditions, even to noises of planes and cannon.

THE Army War Show of the Sixth Service Command now on tour has as one of its prize exhibits a machine gun trainer that saves \$10,800 every hour in ammunition cost! Since there are an estimated 1,000 of these trainers in use, they save Uncle Sam a total of \$10,800,000 worth of ammunition every hour they are used for training purposes.

That not only cuts down the cost of the war but it means every bit of ammunition goes to blast the Axis instead of being used up in training camps!

The novel trainer is the joint development of Edison General Electric Company, makers of "Hotpoint" appliances, and Operadio Manufacturing Company. "Hotpoint" engineers worked out the electro-hydraulic machine gun, and Operadio's laboratory developed the sound amplifying unit that reproduces the report of an actual 50-calibre machine gun with background noises of tanks, dive bombers, screaming bombs and bullets, and heavy guns.

Soldiers trained with the new equipment are reported better fitted for action than if they used real machine guns without the battle noises so faithfully reproduced by the Operadio Electronic Sound Equipment.

The Hotpoint-Operadio machine gun trainer has been front-page news in some of the biggest cities of the nation, and is being demonstrated complete in every detail as an educational feature of the Army War Show.

-30-

Operator of simulated machine gun going through practice maneuvers.

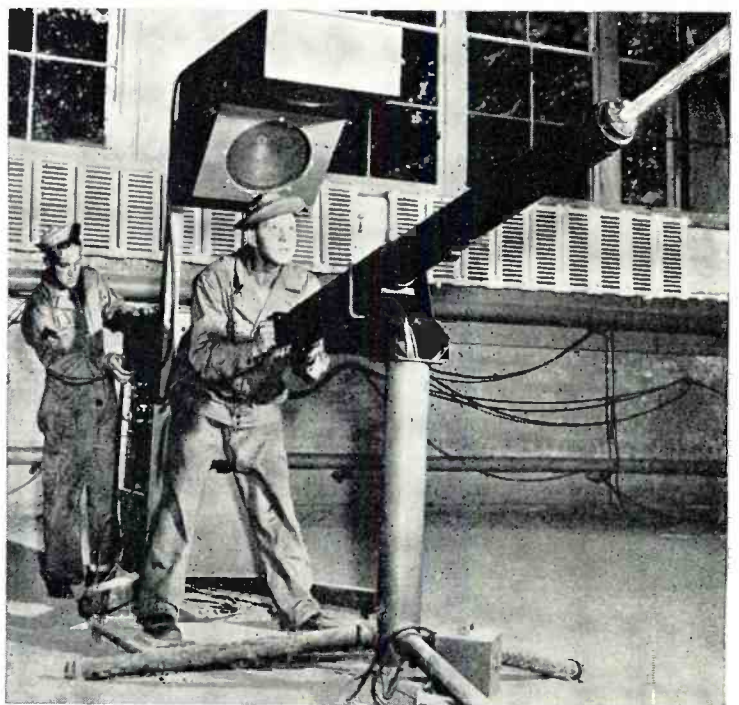

# PRACTICAL RADIO COURSE

by ALFRED A. GHIRARDI

## Part 18. Push-pull voltage amplifier and output stages and how they eliminate even-order harmonics.

**N**OW that we understand how the push-pull amplifier circuit arrangement amplifies the signal, we are ready to learn how it eliminates from the output signal the 2nd, and all other *even-order*, harmonic distortion components generated by the two tubes.

Before proceeding further the reader should carefully review the explanation of the action of the push-pull amplifier that appeared at the end of last month's lesson (September issue RADIO NEWS)—also Figs. 1 and 2 of that lesson.

### How the Push-Pull Amplifier Eliminates 2nd Harmonic Distortion

Assume that the correct grid bias voltage is being applied to the two tubes connected in push-pull, and that a value of sine-wave signal voltage that will not overload them is applied. Then, due to the curvature of the dynamic operating characteristic of each tube (caused by the plate load impedance), the plate current changes of VT1 will vary according to the distorted wave-form shown by the solid curve in Fig. 1A. At the same instant the plate current changes of VT2 (which are 180° out of phase with those of VT1) are as indicated by the distorted waveform shown at (B) drawn directly underneath (A). As explained in last month's lesson, each waveform having this particular type of distortion can be considered to be the resultant wave of a *fundamental* wave of the same frequency and a *second harmonic* wave (double the frequency) of smaller amplitude, as shown by the dotted curves

at (C) and (D). It is obvious that the *fundamentals* of the plate current waves of the two tubes are 180° out of phase in the plate circuits (while one is increasing, the other is decreasing). Since they flow in *opposite* directions through an equal number of turns in the center-tapped primary winding of the output transformer (see Fig. 2 repeated here from last month's lesson), the effect of *changes of opposite* nature in them is *additive* both as regards change of "magnetism" in the core and signal voltage induced in the secondary. The second harmonics (and all other *even-order* harmonics present), however, are *in phase* with each other in the plate circuits of the tubes so they neutralize each other in the output transformer and thus are eliminated. Therefore the output signal to the loudspeaker is practically an amplified replica of the fundamental wave only, as shown in Fig. 1E. All second and other *even-order* harmonic distortion caused by the curvature of the tube characteristic has been eliminated by the push-pull circuit arrangement. (Any *third* or other *odd-order* harmonic distortion will not be eliminated.) Because twice the output of a single triode tube can be obtained with *less* even-order harmonic distortion through use of the push-pull connection, it is possible to obtain *more* than twice the output with the *same* distortion as that given by a single tube.

### Push-Pull Connection Does Not Correct Distortion Originating in Preceding Stages

It should be remembered that the ef-

fect of the push-pull connection is to balance out in the output transformer the second harmonic (and other even-order harmonic) distortion *produced by the tubes only*. Any such distortion which may be present in the signal prior to its reaching the push-pull amplifier stage is *not* balanced out because the secondary of the input transformer then applies this distorted wave (containing the harmonics) to the grids of the two tubes 180° out of phase. Therefore these harmonics add together in the output transformer in exactly the same manner as does the fundamental, and they are still present in the output signal passed on to the loudspeaker. Consequently, while a push-pull amplifier stage will correct the second harmonic distortion produced by its own tubes, it will not correct any which might have been caused by a previous amplifier stage, nor will it eliminate any such distortion existing in the input signal voltage due to the sound program itself, microphones, phono-pickups, etc.

### Additional Advantages of Push-Pull

It should be noted from the foregoing discussion that the total plate current of both tubes ( $I_{p1} + I_{p2}$  in Fig. 2) is constant at all times when the bias and input signal voltages are correct, because any increase in the plate current of one tube due to the signal is accompanied by an equal decrease in the plate current of the other tube. As a result, no fluctuating audio signal current flows through the "B" power supply line and no audio coupling can take place in the impedance of the "B" power supply insofar as the push-pull stage is concerned. This reduces the possibility of instability of the amplifier, and disagreeable "motorboating" effects are not so apt to occur.

The fact that the total plate current in a well-balanced push-pull amplifier stage is always constant permits the use of self-bias circuit arrangements that need not be bypassed, because no alternating signal voltage will be developed across the self-bias resistor.

Another desirable characteristic of push-pull amplification results from the fact that any plate current ripple caused by incomplete filtering of an a.c. operated "B" power supply will produce equal and opposite magnetic field variations when acting in the two halves of the primary winding of the output transformer. Consequently, they automatically cancel out and no hum voltage will be induced in the

Fig. 1. Wave-form of a push-pull stage showing 180° phase shift.

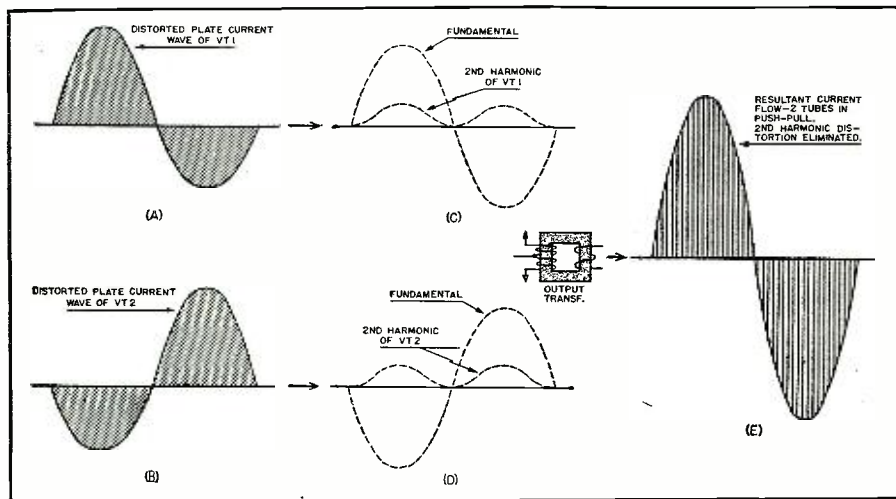



secondary. This means that a push-pull stage does not require as much plate supply filtering as does a single-tube stage, hence the filter in the plate power supply can be made more simple and less expensive. However, this advantage applies only to plate current ripple (hum) introduced into the push-pull stage, since hum introduced in any of the preceding stages will be amplified just as is the signal voltage.

The push-pull amplifier circuit has another important advantage. Because the filament, grid-bias and plate supply sources are common to both tubes, they will both have similar voltages applied to their electrodes, and if the tubes are matched, i.e., have similar operating characteristics, the d.c. component of the plate current of each tube will be the same. Since these also flow through the equal halves of the output transformer primary winding in opposite directions, the equal magnetic fields they produce tend to magnetize the transformer core equally in opposite directions. The net magnetization of the core due to these currents is therefore zero. This is another advantage of the push-pull connection over the single-tube or parallel-tube connection. For a given power output and amount of harmonic generation caused by non-linear flux variation due to saturation of the output transformer core, the output transformer in a push-pull amplifier stage may be smaller, lighter in weight and less expensive than the one in a single-tube or parallel-tube output stage, because it is not necessary to provide as large a core with an air gap to prevent the magnetic saturation and waveform distortion ordinarily caused by the d.c. component of the plate current in single-tube power stages.

### Maximum Power Output of a Triode Push-Pull Class A Amplifier Stage

It was shown in the previous lesson that for any given signal input voltage the power output of an amplifier tube is a *maximum* when the a.c. plate resistance  $R_p$  and the load resistance are equal. (This condition of maximum output disregards, of course, the harmonic distortion that may be produced by the tube operating under this condition.)

In a push-pull amplifier, therefore, since the total output is equal to the sum of the outputs of the two tubes, maximum total output is obtained when *each* tube is delivering its maximum output. This occurs when the tubes feed into an output transformer whose total primary impedance (plate-to-plate terminals) is equal to twice the a.c. plate resistance of one of the tubes. Since each tube feeds into one-half of the total output transformer primary, it will then be feeding into a plate load impedance equal to its own a.c. plate resistance (see Fig. 3). Under these conditions, the maximum power output for the entire Class A push-pull stage is:

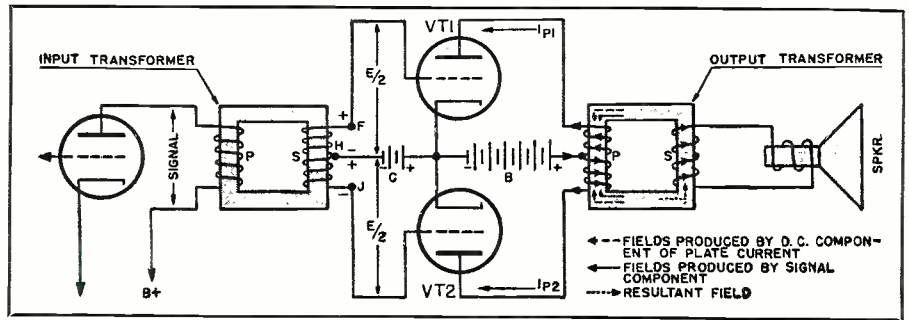

Fig. 2. Transformer-coupled push-pull triode output stage and driver.

$$P = \frac{(\mu e_c)^2}{2 \gamma_p}, \text{ or } \frac{(\mu E_r)^2}{4 \gamma_p}$$

where  $e_c$  is the *r.m.s.*, or effective, value of the signal voltage applied between the grid and cathode of *each tube* (equals one-half the total signal voltage developed across the secondary of the input transformer) and  $E_r$  is the *peak* value of this voltage.  $\gamma_p$  is the a.c. plate resistance of a *single* tube.

If the effective plate-to-plate load resistance in a push-pull amplifier is  $R_L$ , the plate-to-center tap load resistance (for each tube plate circuit) is  $R_L/2$  (see Fig. 3). For example, if two tubes, each having an a.c. plate resistance of 2,000 ohms, are used in a push-pull circuit, and feed into an output transformer having a *total* primary impedance (plate-to-plate terminals) of 4,000 ohms, it would be equivalent to each tube feeding into a load impedance equal to its a.c. plate resistance (2,000 ohms). On the other hand, if the total output transformer primary impedance is 8,000 ohms, then the effective plate circuit load on each tube would be 4,000 ohms. This is

Fig. 3. Reflected load impedance of a push-pull output power stage.

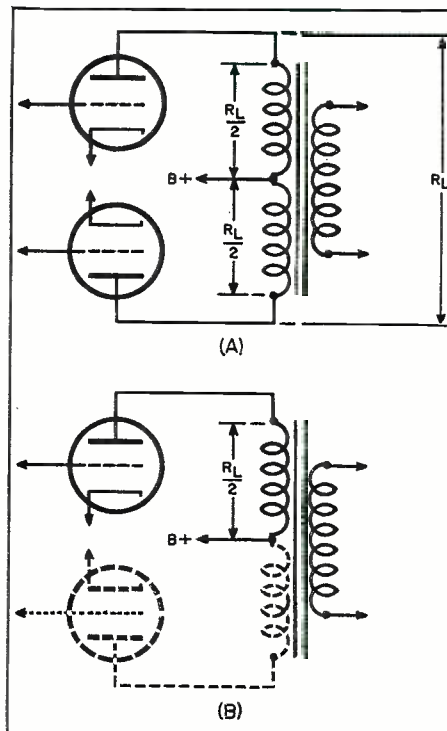

equal to twice the a.c. plate resistance of the tube.

The output power of a push-pull stage is equal to twice the output power of either tube working into half the plate-to-plate load resistance.

### Maximum Undistorted Power Output of a Triode Class A Push-Pull Amplifier

The conditions that govern the maximum power output that may be obtained with a prescribed amount of second harmonic generation from a push-pull amplifier are quite different from those for a single tube amplifier.

When a single triode tube is operated as a Class A amplifier, *maximum* power output can be obtained from it by using a load resistance approximately equal to its a.c. plate resistance  $R_p$ . However, such a low value of load resistance causes excessive curvature of the characteristic and results in a large amount of second harmonic distortion. If undistorted output is required (total distortion—mainly 2nd harmonic—less than 5%), a higher value of plate load resistance must be employed. However, any increase in plate load reduces the output power obtained. Therefore, a compromise must be affected between allowable distortion and power output. The maximum *undistorted* power output (less than 5% total harmonic distortion) is obtained when the plate load resistance is made approximately equal to *twice* the plate resistance. This power output is, of course, much less than the maximum power output (distorted) of which the tube is capable.

Now in a push-pull connected amplifier, the second-harmonic distortion generated by the tubes is balanced out in the output transformer, as we have seen. We can take advantage of this fact by operating triodes in push-pull, working each tube into a load resistance equal to its a.c. plate resistance so that maximum power output will be obtained. Since the high 2nd harmonic distortion that will be generated by the tubes when operated with such a low plate load is now automatically balanced out in the output transformer, it does not appear in the amplified output and therefore is not objectionable. For this reason, in a triode Class A push-pull amplifier the tubes can be operated with a sufficiently low value of plate load so that *maximum possible* output is be-

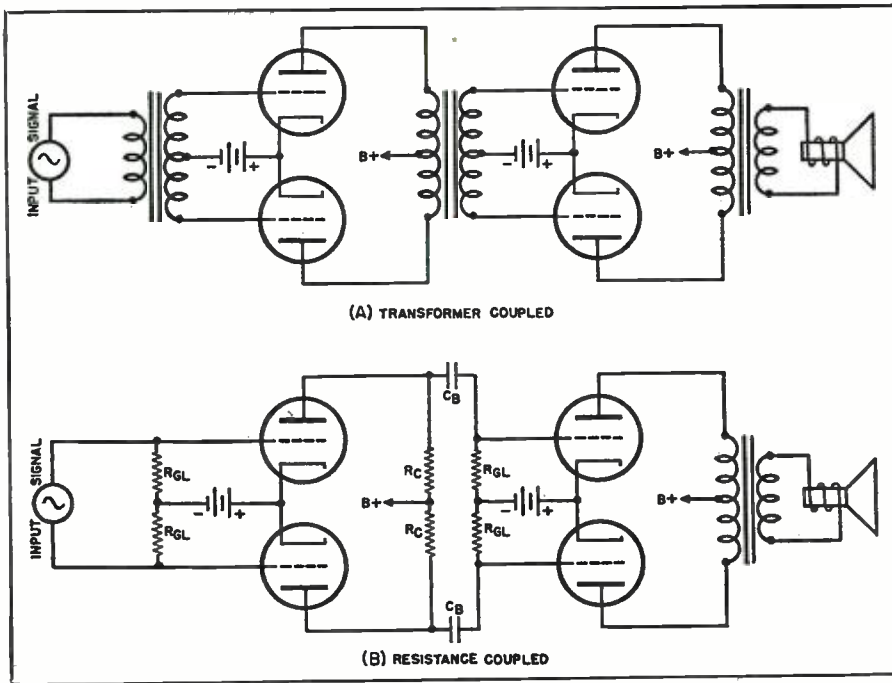

Fig. 4. Transformer and resistance-coupled push-pull stages.

ing obtained, and this output will be undistorted (no second harmonic, and practically no higher harmonic distortion). Thus the maximum undistorted power output can be made practically equal to the *maximum possible* power output of the two tubes.

The maximum power output that can be obtained from two triodes in push-pull (assuming a prescribed amount of second harmonic content is allowable in the *combined output*) is greater than *twice* as much as that deliverable by a tube of the same type operating singly under the same voltage conditions, and with the same prescribed amount of second harmonic content in its output. These are important advantages of the push-pull circuit.

It is clear at this point that the push-pull Class A a-f amplifier using triodes offers a means of obtaining very high-quality amplification, in fact, it is usually used in preference to other types when output quality is of prime importance above everything else. In such amplifiers it is sometimes used

even in voltage amplifier stages as well as in the power stage, in order to eliminate the second-harmonic distortion generated by the voltage amplifier stage tubes. However, it is not as efficient as certain other types, so it is not widely used. The power pentode amplifier has supplanted it for many applications.

#### Dual Push-Pull Amplification

In ordinary practice, the use of push-pull amplification is usually confined to the power amplifier stage. However, to prevent the production of second harmonic distortion in any stage of an amplifier, push-pull stages are sometimes used throughout the entire amplifier or, in other cases, only the power amplifier stage and the voltage amplifier stage immediately preceding it are of push-pull design. Strictly speaking, only the latter arrangement may correctly be called "dual" push-pull amplification because only two stages are then involved. This "dual" or "multiple" push-pull design is applicable to transformer, resis-

Fig. 5. Circuit diagram of a simple phase-inverter for push-pull output stage.

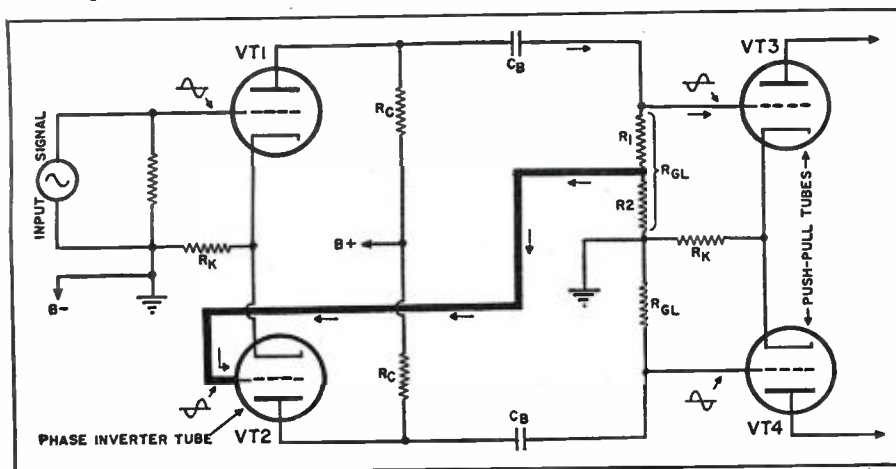

tance, or impedance coupling, as shown at (A) and (B) of Fig. 4. Impedance coupling, of course, is the same as the resistance-coupled arrangement in (B) except that impedance coils replace the plate circuit load resistors ( $R_c$ ).

Notice that in the transformer-coupled arrangement shown at (A) it is immaterial whether or not one side of the input circuit is grounded, because the grids of the tubes are fed from the secondary winding of the transformer. However, in the resistance-coupled circuit at (B), neither side of the input circuit may be grounded, as such a connection would ground the grid of one of the tubes and render that tube inoperative. For this reason, input devices used to feed push-pull resistance-coupled P. A. amplifiers (microphones, phonographs pickups, etc.) cannot have either of their terminals grounded and must be equipped with a *two conductor* shielded cable having an independent and entirely separate shield. That is, the shield cannot form part of the input circuit.

#### Phase Inversion

One of the fundamental requirements of a push-pull stage of amplification is that the *signal voltage be fed 180 electrical degrees (one-half cycle out of phase to the two push-pull grids)*. Furthermore, the voltage delivered to each grid should be of the same amplitude so that equal changes in plate current, due to the signal voltage, will be produced in each of the push-pull tubes. When transformer coupling is used a single-tube amplifier stage may be coupled to a push-pull stage in a straightforward manner because the center-tapped secondary winding of the input transformer applies equal signal voltages 180° out of phase to the push-pull grids, as previously explained. However, in order to eliminate the push-pull input transformer and use resistance coupling instead, it is necessary to employ a *phase inversion* arrangement.

A widely used phase inverter circuit is shown in Fig. 5. Here, VT1 is the amplifier tube of the stage preceding the push-pull stage; VT2 is the phase inverter tube; VT3 and VT4 are the push-pull tubes. The two resistors marked  $R_K$  are for the purpose of providing grid bias to the tubes and play no part in the phase inversion action. The departure from the use of batteries to indicate grid bias voltage supply is employed in this case because it would not permit the simple arrangement shown as it is used in actual practice. It will be noticed that VT1 and VT3 are connected in a conventional resistance-coupled circuit (as are VT2 and VT4), with the exception of the tap on the grid leak  $R_{GL}$  of VT3. Ordinarily, two separate resistors  $R_1$  and  $R_2$  are connected in series to form this grid leak. Now, the plate voltage variations of an amplifier tube are 180 electrical degrees out of phase with the signal voltage variations impressed upon the grid of the tube. Some people

(Continued on page 70)

# OHMITE RESISTORS

**A Type and Size for Every Electronic Need**

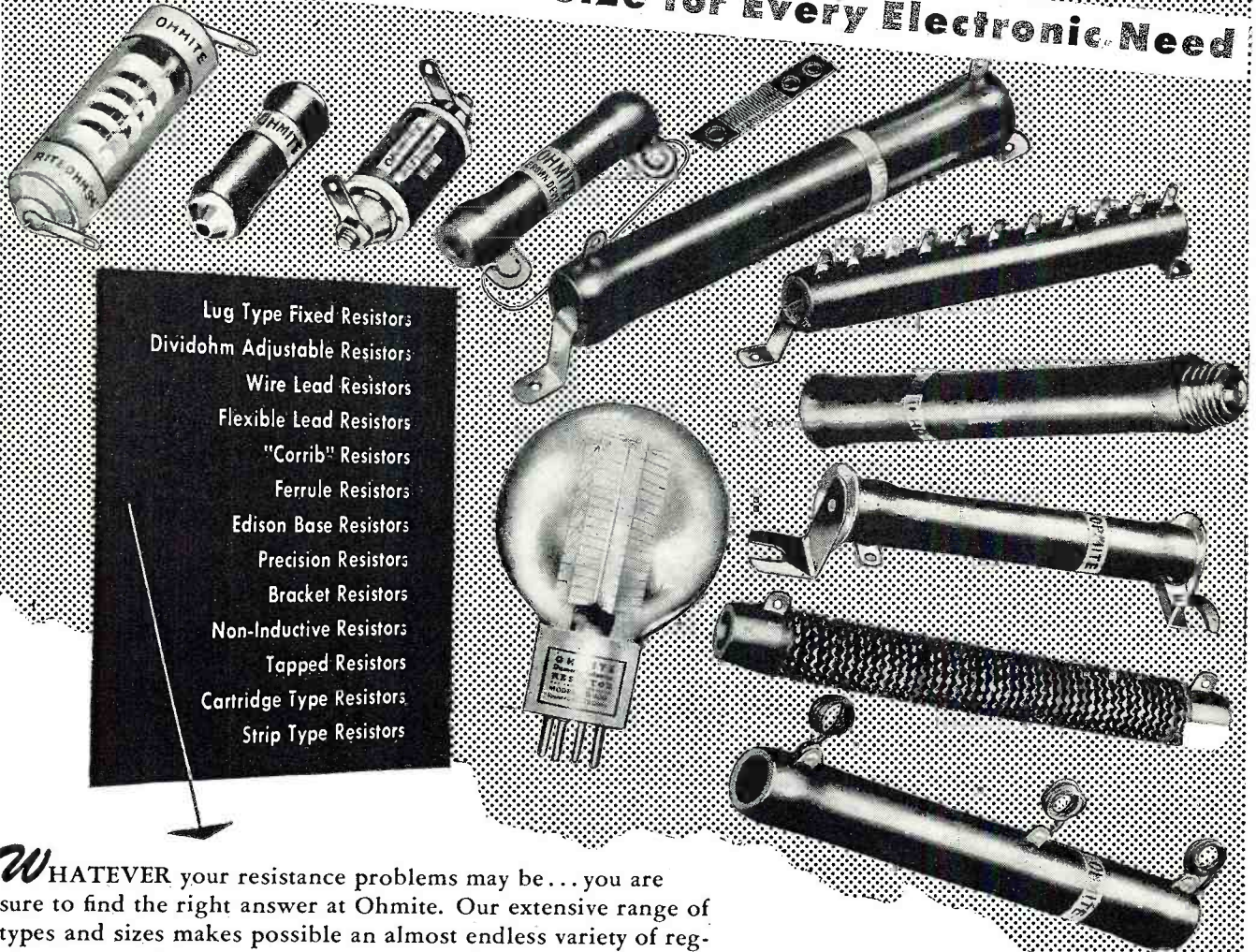

- Lug Type Fixed Resistors
- Dividohm Adjustable Resistors
- Wire Lead Resistors
- Flexible Lead Resistors
- "Corrib" Resistors
- Ferrule Resistors
- Edison Base Resistors
- Precision Resistors
- Bracket Resistors
- Non-Inductive Resistors
- Tapped Resistors
- Cartridge Type Resistors
- Strip Type Resistors

**W**HATEVER your resistance problems may be... you are sure to find the right answer at Ohmite. Our extensive range of types and sizes makes possible an almost endless variety of regular or special resistors to meet every requirement. Core sizes range from  $2\frac{1}{2}$ " diameter by 20" long to  $\frac{5}{16}$ " diameter by 1" long... and are produced with standard or special windings, terminals and other features. Many are stock units.

Because of their extra dependability under the most critical operating conditions, Ohmite Resistors are used today in all types of electronic and electrical applications... in planes, tanks, ships, in laboratory research and development, in scientific instruments and in the production tools of war.

### Send for Handy Ohm's Law Calculator

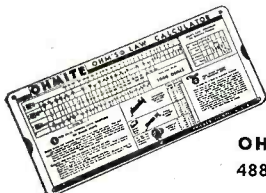

Helps you figure ohms, watts, volts, amperes—quickly. Solves any Ohm's Law problem with one setting of slide. Send only 10c in coin for handling, mailing.

**OHMITE MANUFACTURING CO.**  
4883 Flournoy St., Chicago 44, U. S. A.



### Cut-away view of Ohmite Vitreous Enameled Resistor

The resistance wire is evenly wound on porcelain core, rigidly held in place, insulated and protected by Ohmite vitreous enamel. Dissipates heat rapidly—prevents hot spots and failures. Core sizes range from  $2\frac{1}{2}$ " diameter by 20" long to  $\frac{5}{16}$ " diameter by 1" long.



Switch SW-141

# Voice Communication Components



Plugs PL-54  
and PL-55



UNIVERSAL high quality plugs, jacks and switch assemblies have been made available to prime and sub-contractors for earliest quantity deliveries. Catalog No. 830 contains complete details.

## Universal Microphone Co. Ltd.

INGLEWOOD, CALIFORNIA

FOREIGN DIVISION  
301 Clay Street, San Francisco 11, Calif.  
CANADIAN DIVISION  
560 King St. W., Toronto 2, Ontario

## Power Supplies (Continued from page 43)

of the leads running from the battery to the supply and adjusting the condensers to give the minimum no-load current drain. The value will probably vary from .005 to .01  $\mu$ fd., depending on the inductance of the winding. Buffer condensers should be rated at 1000 volts and over. The oil impregnated types are best for this service.

For the well equipped builder or experimenter, who has at his disposal a good "scope," it will be well to use it in selecting the correct value for the buffer condenser.

There are two schools of thought regarding the use of the scope in adjusting the buffer condenser. One group contends that the load and filter should be removed from the transformer before tests are made while the author and others contend that since the vibrator is operated under load, it should be tested under operating conditions.

The "scope" is turned on and allowed to come to operating temperature. If there is no spot visible on the viewing screen—the INTENSITY control is turned until a spot is visible and is about one sixty-fourth of an inch in diameter. The FOCUS control should be varied until the spot is clear and without a "fuzz" or halo around the edges. The INTENSITY control is now turned down as a precaution against burning the fluorescent coating of the tube. The beam is then centered by using the VERTICAL controls.

Connect one side of the transformer primary winding to the VERTICAL binding post and the primary center tap to the GROUND of the scope.

Turn the SWEEP control to LINEAR and advance the HORIZONTAL GAIN until the trace fills about 90% of the horizontal area of the screen. Turn the SYNC. INPUT to INTERNAL. Turn on the power supply, with normal load, and vary the VERTICAL GAIN until the total height of the trace is 80% of the effective screen

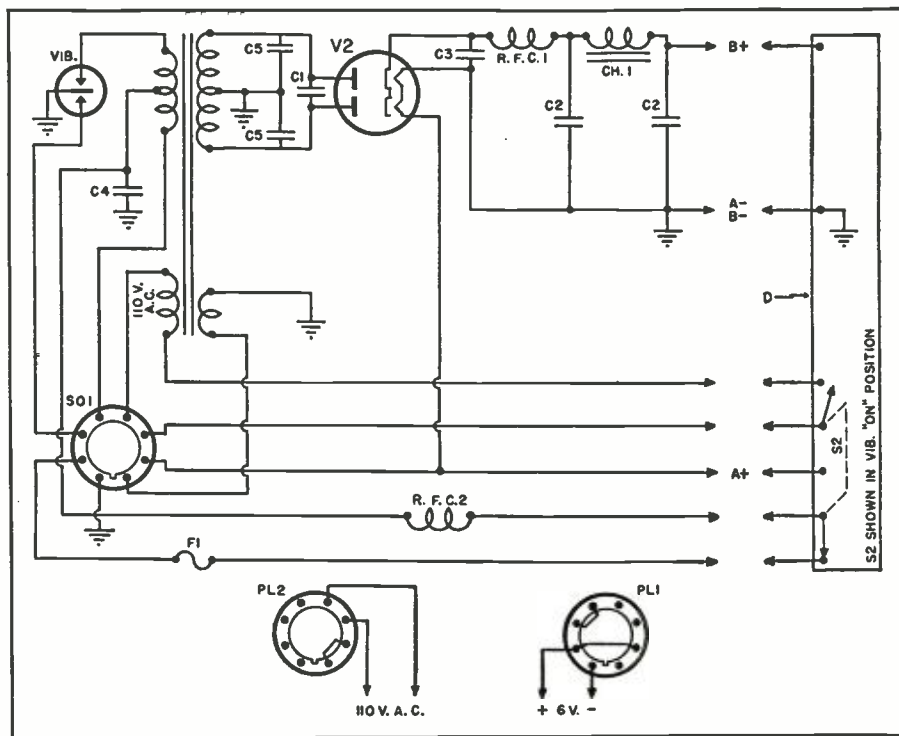

Fig. 4. Universal power supply using a reconstructed power transformer.

The popular vibrator manuals may be consulted in either case.

After a careful study of non-synchronous vibrators, it will be assumed that analysis of the buffer characteristics should be made under load. There may be changes in the secondary circuit which cause radical changes in the performance.

The first test to be made is to ascertain if the vibrator will start at voltages ranging from 5 to 8 volts. For making this test a heavy-duty rheostat may be inserted in one leg of the primary leads, and the voltage varied between the two values. If the vibrator refuses to start at 5 volts, it should be discarded as defective.

The various patterns shown in Fig. 6 will enable one, by comparison with the actual figures obtained, to analyze the actual operating conditions and will give a clue to all possible ills and their cures.

When the correct value of buffer condenser is being used the figure on the "scope" will correspond very closely to Fig. 6a. It should be noticed that the horizontal trace occupies about 80% of the total length of the cycle. It may be difficult to actually observe the vertical trace of the cycle even though the slanting part of the trace is visible. The INTENSITY control should be increased until the vertical trace is visible.

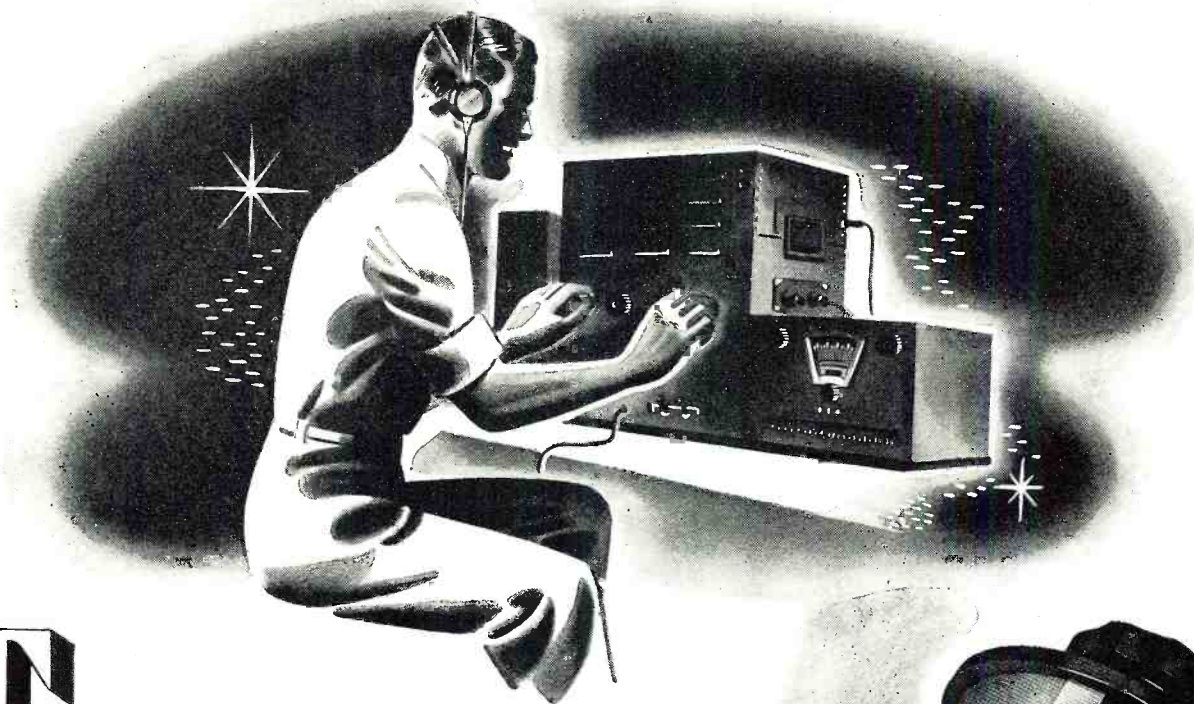

# THEY LISTEN...

Around the clock, from Monday to Monday, America's "monitors of the air" sit at their posts—and listen. Serving in a thousand different ways, they check foreign news and propaganda, send and receive weather reports, keep air channels clear, ferret out renegade radio stations. Of prime importance in the apparatus used by monitors are meters and rheostats which assure absolute control and give accurate indications of volume, power, modulation and recording. In many instances the components chosen for dependability are products of DeJur laboratories. Built of the finest materials to exacting precision standards, DeJur instruments are backed by a tradition of twenty-five years of outstanding electrical accomplishment.

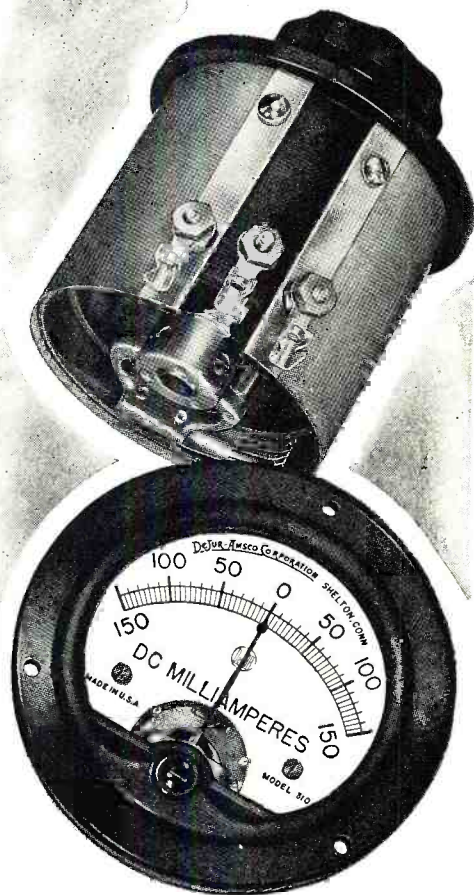

**BACK THE ATTACK . . . SUPPORT THE THIRD WAR LOAN DRIVE**

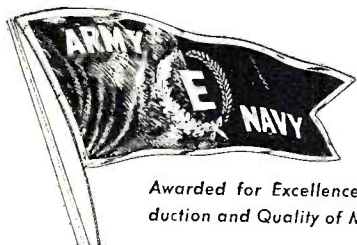

*Awarded for Excellence in Production and Quality of Material*

## DeJUR-AMSCO CORPORATION

**SHELTON, CONNECTICUT**

**NEW YORK PLANT:** 99 Hudson Street, New York City • **CANADIAN SALES OFFICE:** 560 King Street West, Toronto



**W**HEN the squadron leader snaps instructions into his microphone, it's not time for doubt or confusion on the receiving end.

In manufacturing headsets for the use of our fighting forces, the main thing is to be certain each one is as perfect as it is possible to make it.

Experience since the early days of the telephone helped us, of course, but it wasn't enough to be sure that we were building mighty good equipment on the average. We developed special instruments which enable us to give each receiver a thorough test in a matter of seconds, right on the production line. Thus we kept output high, and quality a known factor.

Connecticut has been identified with "communications" for half a century. It has never been known as the largest, but always as among the very best, in design, engineering, and precision production. If your post-war plans involve the use of precision electrical devices, in connection with product development or production control, perhaps we can help you eliminate the "question marks".

## CONNECTICUT TELEPHONE & ELECTRIC DIVISION

MERIDEN,



CONNECTICUT



*For the second time within a year, the honor of the Army-Navy Production Award has been conferred upon the men and women of this Division.*

© 1943 Great American Industries, Inc., Meriden, Conn.

The vertical peaks will appear only when the buffer is of the incorrect value and the supply is operating under load. If the buffer condensers are of a value that is not correct, the pattern will be very similar to Fig. 6b.

Most of the vibrator type supplies described in this article use six volt rectifier tubes so that the tube can be heated directly from the primary power source. It has been found that these tubes, 6X5, 6W5-G, etc., are difficult to obtain at this time. There is one solution that cannot be overlooked. By using a five volt rectifier and supplying its heater current from the original rectifier winding of the transformer, excellent results may be obtained with the cost of only about 10 watts additional drain from the power source. The type of rectifier tubes that can be used may be obtained in quantities and it is quite possible that every experimenter has one in his junk box. This type of supply is shown in Fig. 2.

If the builder has on hand a few old burned out transformers or filter chokes, the purchase of chokes will not be necessary because chokes can be wound very easily by using salvaged wire and the core iron from old transformers and chokes.

The well designed filter choke is so constructed as to offer a high impedance to the a.c. ripple and current changes and to offer a very low resistance to the flow of direct current.

A very efficient choke of the semi-swinging type with inductance ranging from about 8 henries to 15 henries with a current carrying capacity of 200 ma. can be used in any of the vibrator type supplies and can be easily wound from the following specifications:

Core areas .....1½" x 1½"  
 Wire size .....27 en.  
 Pounds of wire.....1¼  
 Wire length .....3000'  
 Air gap .....1/32"

The air gap is included in the choke to insure that the inductance does not vary too much with the normal current changes that will be experienced in operation. This choke will give good voltage regulation with small Class B amplifiers and in CW transmitters.

The air gap is maintained by inserting a piece of nonmetallic insulating material between the "E" pieces and the "I" pieces. This material may be a thin sheet of fiber board or other material.

It is highly recommended that the core be of the "E" type as shown in Fig. 7 (choke "A"), but if the square type (choke "B"), has to be used it is wise to add about 25% more turns to compensate for the small magnetic path.

Ample insulation should be used between each layer of winding and also between winding and core. The same type of insulation should be used as is used in the winding of transformers. It is well, though seldom used, to place the chokes in the negative side



**T**HIS picture might have been taken almost anywhere. All over the world small groups of soldiers are guarding our outposts against attack. Vigilant, lonely and unafraid, these men rely on their skill . . . and on radio. Radio for warnings. Radio for help when needed. Radio for coordination. Radio for entertainment. Radio for Victory.

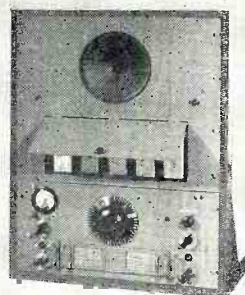

PHOTO BY  
U. S. ARMY SIGNAL CORPS



**NATIONAL COMPANY**  
MALDEN, MASS. U. S. A.





*In War...*

*In Peace...*

**OUR BUSINESS IS  
MAKING LOUD SPEAKERS**

*Now being used for military communication, detection and similar war time uses...*

*built to those high standards of precision, durability and performance born of habitual peace time practice.*

**Jensen**  
**RADIO MANUFACTURING COMPANY**  
6601 SOUTH LARAMIE AVENUE, CHICAGO

of the power supply and to ground the core. This will result in a very low potential difference between the winding and the core and therefore insulation breakdown between the two is minimized.

**Transformerless Supplies**

The transformerless a.c. supply is next to be considered. The full and half-wave rectifiers found in the a.c.-d.c. receivers is the first that is likely to come to mind. However, the ones described here are not suitable for use on direct current because of the voltage multiplying features included in the supplies to be discussed herein. Voltage multiplication can only be used with an alternating current and for this reason the author does not call them a.c.-d.c. supplies as it would be erroneous to do so when they only perform with full efficiency from an a.c. source.

One of the most outstanding advantages of the transformerless supply is its low weight and compactness. With the elimination of the power transformer the cost of the supply will also be reduced considerably.

Figs. 8A and 8B show the circuits most commonly used in the smaller a.c.-d.c. radios of today. Fig. 8A is the half-wave voltage doubler and Fig. 8B is the full-wave bridge. Fig. 9 is essentially the same as Fig. 8B. The only difference is that two filter condensers are connected in series and the midpoint is connected to one side of the line. The four diodes, in the

two tubes, are connected so that one diode in each tube is connected in parallel with a diode of the other.

The supply in Fig. 9 will supply 175 volts at 100 ma. This will meet the average requirements for a small amplifier or receiver.

So far, we have only solved the problem of supplying the "B" voltage. The heater voltages for the rectifier tubes may be obtained by using a voltage dropping resistor. This is inserted in

finding the correct value for the line dropping resistor, and is all that is necessary if all of the tubes in the circuit have the same filament current rating.

However, a combination of tubes can be had for a five-tube receiver wherein no dropping resistor is necessary. This combination would consist of the following tubes: 50L6, 35Z5, 6SQ7, 6SA7, and 6SK7. Each of these tubes would have a current rating of

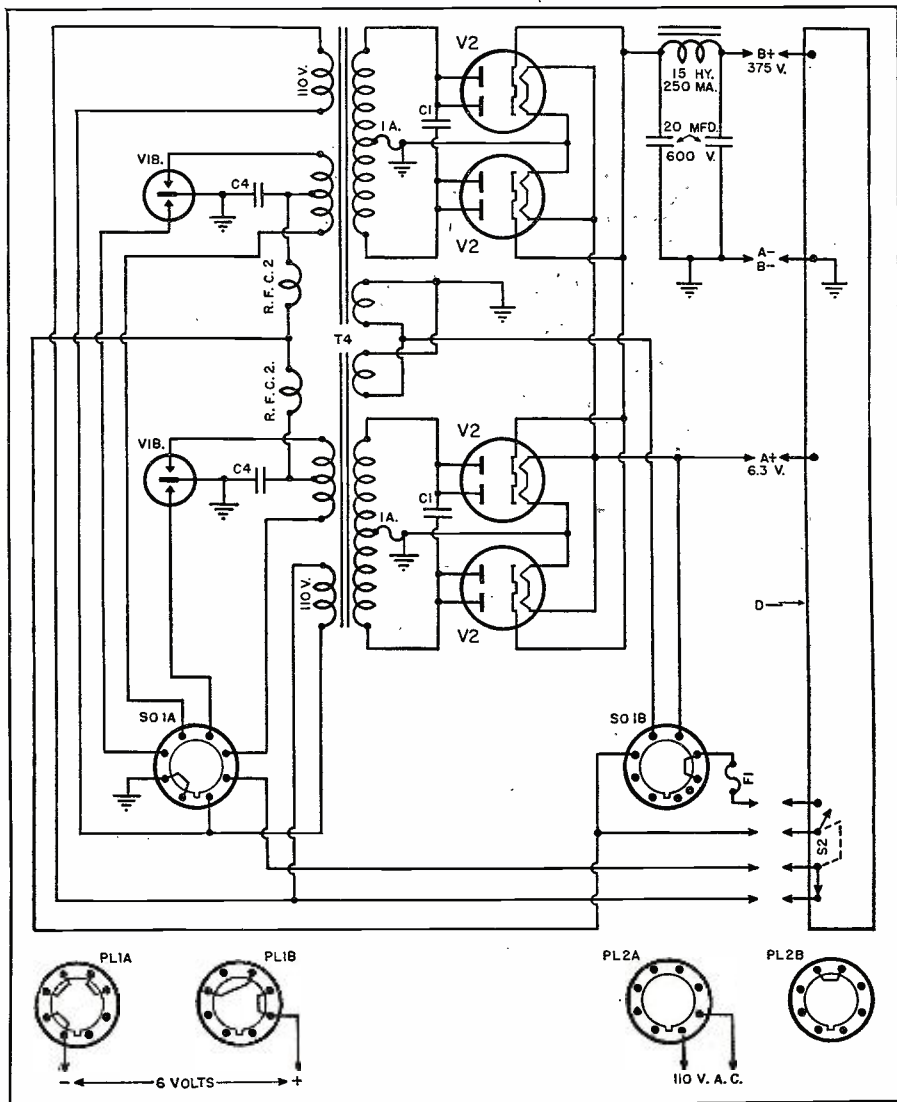

Fig. 5. Reconstructing available power transformers for universal power supply.

series with one side of the line and the tube filaments. The filaments are in all cases connected in series.

The correct value for this resistor can be calculated from the use of Ohm's law. ( $R$  equals  $E/I$ ).  $R$  represents the resistance while  $E$  and  $I$  are symbols for voltage and current respectively. It will be necessary to make some conversion in the law before the formula can be used. The formula as used for the purpose of calculating resistance of series dropping resistors is as follows:

$$\text{Required resistance} = \frac{E \text{ input} - E \text{ consumed}}{I \text{ tubes}}$$

The formula stated is used only in

150 ma. If one were to use a combination of 300 ma. tubes in series, it is quite likely that a dropping resistor would be needed.

In a.c. receivers the tubes in the most sensitive parts of the circuit are located on the end of the circuit nearest the ground. This will minimize the voltage between heater and cathode and will make the circuit far more insensitive to hum and other a.c. disturbances.

**Practical Considerations**

If the transformer or choke that you have selected to rewind has been impregnated with pitch or other sealing-compound, which is often troublesome to remove but not at all impos-

For VICTORY Buy United States War Bonds and Stamps

**POLYMET**  
CONDENSER CO.

699 EAST 135th ST.  
NEW YORK, N. Y.

CONTINUOUS  
DEPENDABLE  
SERVICE

FOR  
JOBBER &  
DISTRIBUTORS

# Another **TAYLOR** Triumph! "Processed Carbon Anodes"

## **New Metalizing Method... Eliminates Loose Graphite Particles**

Taylor's exclusive Processed Carbon Anodes allow higher anode voltages. These amazing new type anodes open new fields for tube design.

Seamless, and without high resistance weld spots, they are accurately machined from solid graphite, then entirely metalized to combine the desirable characteristics of carbon with the advantages of other type anodes. Because they do not warp, they provide insurance against efficiency loss due to changing electrical characteristics. A special method of fusing lead wire to anode assures positive continuity between tube connection and anode. And too, this new Taylor Process allows complete and permanent degassing of the anode.

You will hear more about this far-reaching development as its applications continue to increase Taylor Tube efficiency on a "More Watts Per Dollar" basis.

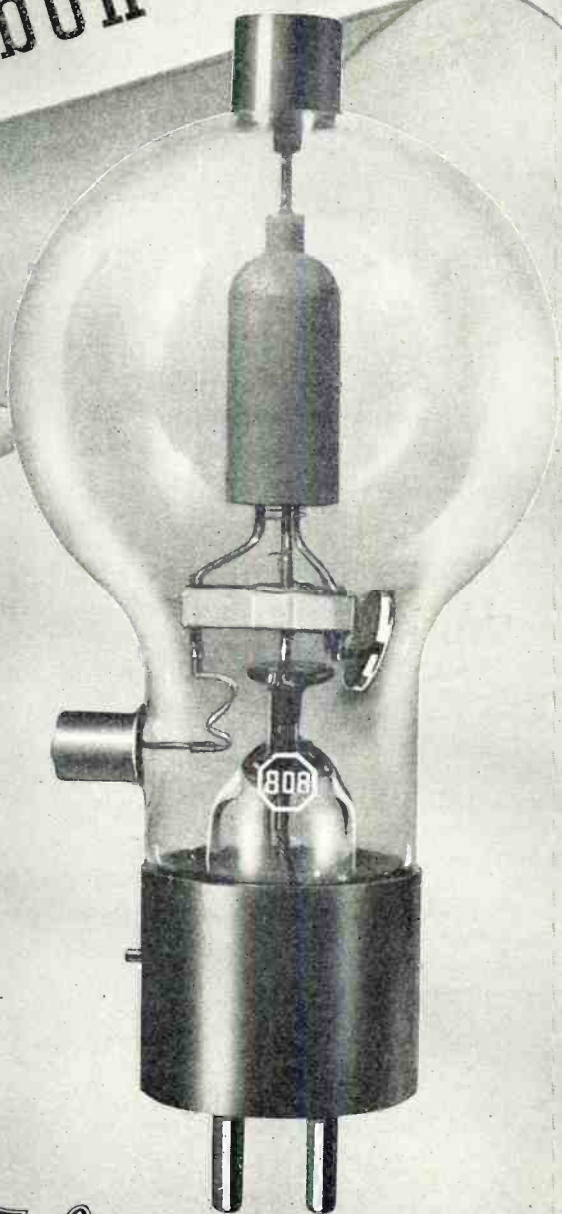

**Taylor** **HEAVY** **CUSTOM BUILT** **DUTY** **Tubes**

**TAYLOR TUBES, INC.,  
2312-18 WABANSIA AVE., CHICAGO, ILL.**

*Means*  
**LONGER TUBE LIFE!**



# Murdock Radio Phones

**M**URDOCK Radio Phones have stood the most gruelling tests precision instruments can undergo—the *battle tests* of two World Wars! They have given our armed forces the same top-notch, *never-failing* performance that has distinguished Murdock's service to Industry for 39 years.

## SUB-CONTRACTS INVITED

We're busy with orders, but we still have plant facilities for manufacturing more Radio Phones and related parts on a sub-contract basis. If you need outside manufacturing aid in this field, we invite your correspondence.

Now—perfected to the Nth degree of scientific engineering—Murdock Radio Phones stand ready to serve American Business better than ever before—when the war is over.

To win the post-war battles of industrial competition you'll need the most perfect communication instruments science can devise. You'll need the "clear-as-a-bell" reception of Murdock Radio Phones—their super-sensitivity—rugged construction—long-lived, trouble-free dependability!

## Get the Full Story of What These Famous Radio Phones Can Do for YOU!

Write to Dept. 47  
for Catalogue

W<sup>m</sup> J. Murdock Co.  
Chelsea, Mass.



sible, the safest method is to place some water in a shallow pan and place a flat pie-tin over it as a lid. The water in the lower pan is brought to a

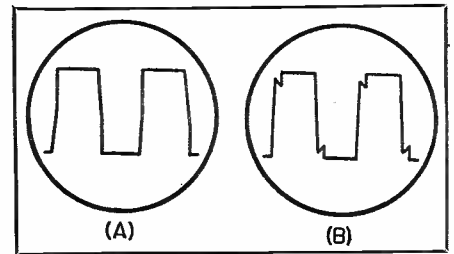

Fig. 6. Vibrator output wave shape.

boil and the transformer is placed in the pie-tin. The process may be a little slow but it is best to apply a low slow heat that is not too hot because excessive heat may cause the insulation on the wires to deteriorate and it

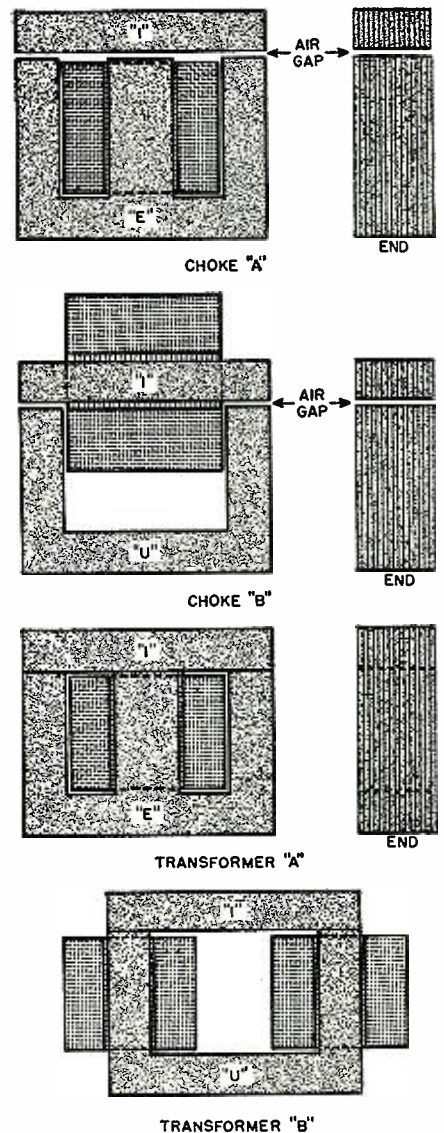
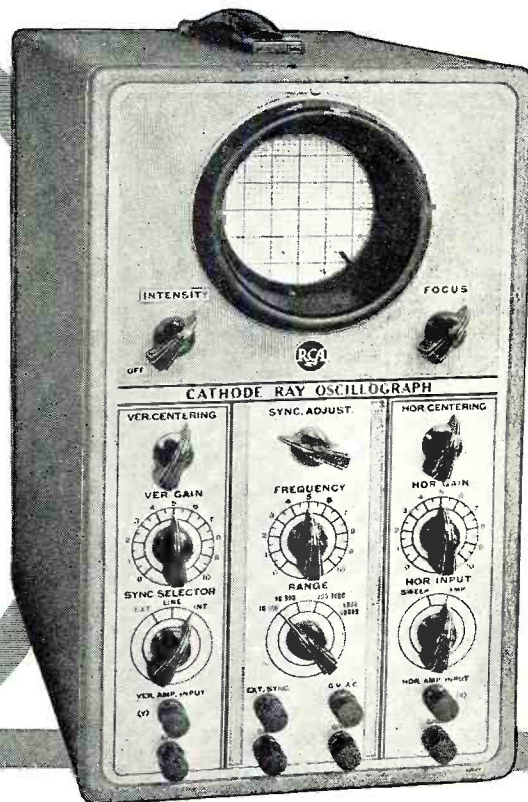

Fig. 7. Transformer and choke assemblies.

is possible the insulating compound may even begin to burn.

Most of the vibrator type supplies utilize the 6X5 tube. If the tube has a tendency to arc between the plate and cathode and this cannot be cured by the usual means it is wise to use

# The New RCA 3-INCH CATHODE RAY OSCILLOSCOPE No. 155-C



#### 10 TO 60,000 CYCLES!

New improved timing axis oscillator provides extraordinarily wide range—10 to 60,000 cycles—never before available in a 3-inch 'scope.

#### EXTRA-BRILLIANT IMAGE!

New built-in, deep, light-shield makes image appear surprisingly brilliant—even in bright daylight. Screen is quickly removable—easily changed.

#### DIRECT DEFLECTOR PLATE CONNECTION!

A special side opening in case is provided for direct deflector plate connection—facilitating use of tube for the higher frequencies.

#### NEW RCA UNIVERSAL BINDING JACK!

Extremely handy. A combination binding post and pin jack for universal application. Permits quick, positive connection with any type lead terminals. An exclusive RCA feature.

Rugged enough to withstand every-day field and service usage, yet built throughout to exacting laboratory standards, this RCA 155-C 3-Inch Cathode Ray Oscilloscope is particularly recommended for all-purpose requirements. Note its unusual features, briefly described on this page. Write for special RCA Bulletin containing complete information about this fine instrument. Address Test Equipment Section 44A, RCA Victor Division, Radio Corp. of America, Camden, N. J.



## RCA TEST AND MEASURING EQUIPMENT



#### 3-INCH CATHODE RAY TUBE!

Three-inch cathode ray tube assures adequately detailed image for practically all applications.

#### VERSATILE, PORTABLE, FOR LABORATORY AND SERVICE WORK!

Especially intended for the better class service engineers. For field service, industrial testing, and general commercial and laboratory work.

the filament type rectifier with the five volt filament. These tubes will carry a higher voltage and current without any trouble and are much easier to obtain in an emergency.

If it is impossible to obtain filter condensers with an operating voltage high enough to withstand the impressed voltage, two or more condensers, of equal operating voltage may be connected in series to form a condenser with a small capacity but with a voltage rating equal to the rating of one unit multiplied by the number of units in series. Each of the condensers should be shunted by a resistor having a value of 5,000,000 ohms and a rating of at least 1 watt. Condensers connected in series are connected positive to negative. When using condensers which have the can as one terminal, it is necessary that the can be insulated from the chassis and from each of the other cans.

Vibrators may or may not be difficult to obtain in these times. However, most any one of the friendly radio service shops specializing in auto radios may have quite a few unserviceable vibrators on hand that they would be

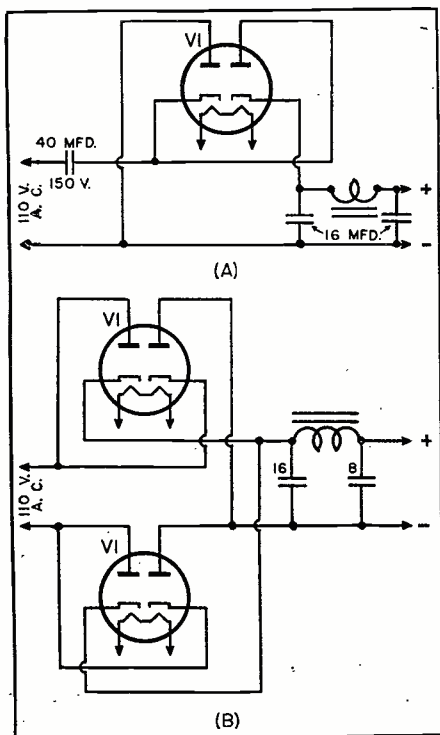

Fig. 8. Half-wave doubler (A) and full-wave bridge (B).

glad to give to someone. Many of these vibrators may have a broken lead on the inside that can be easily repaired with a drop of solder. Although the vibrator cans are usually sealed they can be opened for inspection by applying a little heat from a soldering iron or by crimping the can from around the bakelite case. If synchronous vibrators are available they may be used by connecting the primary contacts in parallel with each of the secondary contacts. This will often double the contact area and therefore have a greater current carrying capacity. Whenever vibrators

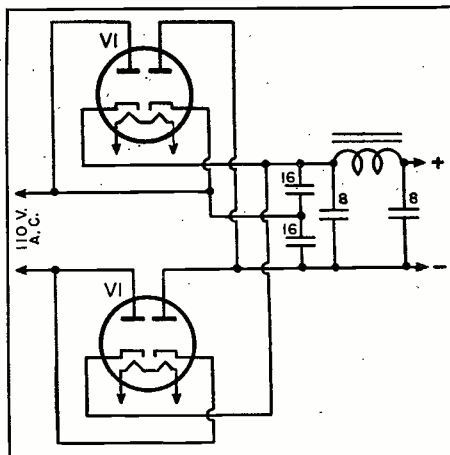

Fig. 9. Circuit diagram of voltage doubler

are changed in a home-built supply, one of the methods described in this article should be used to determine if the buffer condenser is the correct size for the vibrator. If one of the sets of contacts has been welded together or is badly pitted, the other

set can be used if the vibrator happens to be of the synchronous type.

On the supplies used here, the off-on switch is not mounted on the supply but it is on the device to be operated. The switch for d.c. should be as heavy as possible and should always be capable of carrying at least 10 amperes. All battery leads and filament leads should be of such size to handle the current without excessive voltage drop.

The primary circuit should be protected by a fuse with a current carrying capacity of 20 amperes and the secondary should be fused between the high voltage center tap and ground connections by a 1 ampere fuse.

In conclusion, it is hoped that the supplies described here will be just what someone has been waiting for and that they will be more than repaid, for the trouble taken to construct them. The purpose of this article was not to describe any one item but to give a hint as to the capabilities and availability of several types of equipment.

-50-

## AN AUTHOR'S RESPONSIBILITY

THE writing of an easily understood instruction course or book on so highly technical a subject as radio is no easy matter. It is in many ways much more difficult for a brilliant scholarly man to succeed as the author of such a course than for one who has himself had difficulties in mastering the principles. There are many points which are so straightforward and so obvious to the scholarly genius that he can't understand why they should present the slightest difficulty to people of less nimble brains and background knowledge. As a result, such an author is apt to take the understanding of these important fundamentals too much for granted when writing instruction courses for the more or less uninitiated. The result is not a happy one. Students and readers may acquire a kind of "parrot" knowledge without really knowing what it is all about—and never acquiring that state of mental ease which comes of truly knowing and understanding a subject.

But the writer who has had to do a bit of puzzling over the text books of his own student days appreciates realistically the struggles that face those who are making their first acquaintance with a department of science that is brand new and more or less a mystery to them. He realizes the shortcomings of most text books that have been written "high on the mount" in quiet privacy and seclusion by men of high capabilities and high standing in their profession, but who lack the several important abilities essential to the production of basic texts that are easily understandable and really helpful to a beginner.

One of these is the ability and the desire to leave no stone unturned to explain the *How* and the *Why* of the subject to the student every step of the way and to do this clearly and thoroughly at all times. This necessitates being able to put oneself in the place of the student; to get down to the level of his mentality, experience, background knowledge of the subject being taught and all other subjects related to it, so that one will not take the understanding of fundamentals far too much for granted and will explain thoroughly all those things that need to be explained and in such a way that the student really and truly understands them. Not only must the author be thoroughly familiar with every phase of the subject himself, he must also learn which things are easily grasped by his students and which ones require more detailed explanations. He must be constantly searching his mind for the best ways to explain the difficult things, always choosing his words properly so the explanations will readily be followed and understood by the student. Explanations have to be tried and tested over and over, reworded dozens of times if necessary until the right combinations that "click" with the student are discovered.

All this is *hard work!* At times it is sheer drudgery, the only real lasting reward for which is the keen satisfaction that one has done a difficult job well and has lighted the lamp of knowledge and understanding for a fellow human being.

But, hard work or not, the author must be the type of capable person

LET'S ALL PITCH IN TO HELP SHORTEN THE WAR . . . BACK THE THIRD WAR LOAN DRIVE

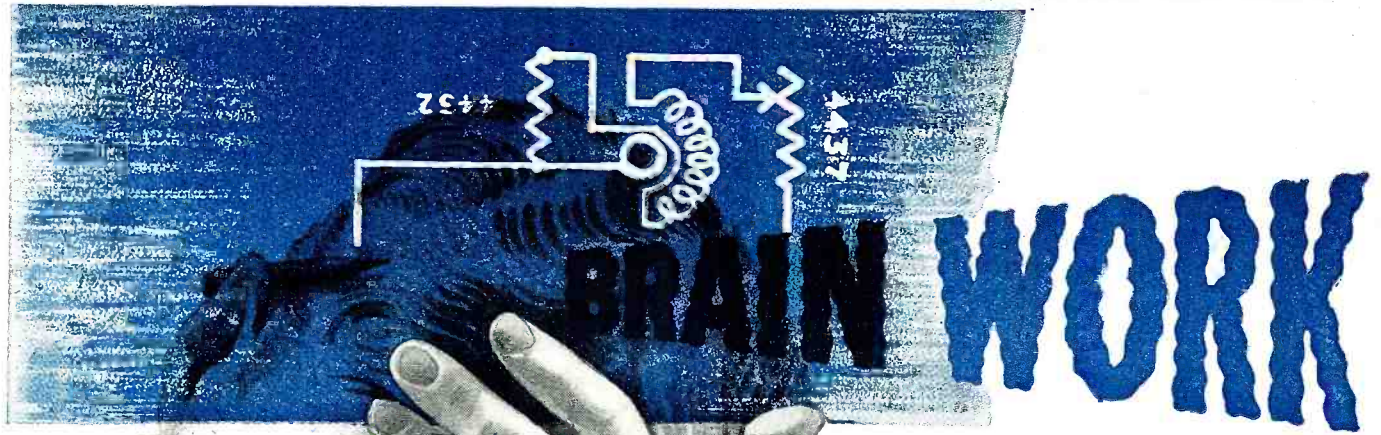

Late into the night, after production shifts have changed and office personnel gone home, men called engineers are still in laboratories . . . breathing life into ideas . . . working their minds and hearts to a breaking point. Cloaked in anonymity, it is they who have solved many a bottleneck. It is they who have given "muscles" to America's might. Maybe there are no callouses on their hands, but these are equalled by sweat-drenched brows and terrific mental pressure.

Such are the engineers of McElroy, too . . . forever probing new and unfamiliar corridors of electronic progress. Out of their work tonight will come another advancement in the art of wireless telegraphy. Out of their work tonight will come industrial developments for a world of tomorrow.

TED McELROY AND HIS STAFF  
ARE CREATIVE ENGINEERS

WE NEVER COPY...NEVER IMITATE  
WE CREATE . . . DESIGN . . . BUILD  
PLEASE FEEL FREE TO CALL UPON US  
WHENEVER WE CAN BE OF SERVICE

**McElroy**

**MANUFACTURING CORP.**  
82 BROOKLINE AVE., BOSTON, MASS.

WORLD'S LARGEST MANUFACTURER OF AUTOMATIC RADIO TELEGRAPH APPARATUS

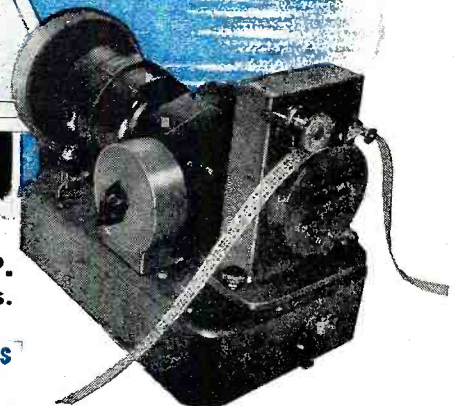



**Quick  
complete  
centralized  
service on  
Everything in  
Radio and  
Electronics**

**FREE**  
Send for today's most  
complete up-to-date  
**BUYING GUIDE**

**Save Time . . . Call ALLIED First!**  
**Get all your needs — from this one source!**

**REPAIR AND  
REPLACEMENT  
PARTS  
AVAILABLE  
without priority**  
Get the radio and elec-  
tronic parts you need  
for maintenance and  
repairs—faster—from  
our large stocks!

By ordering from this one central source, you  
simplify procurement—save time—speed delivery.  
Allied has the *world's largest stocks* under one  
roof . . . over 10,000 radio and electronic items  
from all *leading* manufacturers . . . training kits,  
tubes, parts, test equipment, public address for  
the Armed Forces, war industry, laboratories,  
training centers. Our experienced staff also helps  
solve your technical problems . . . cooperates in  
radio training programs. For quick service, call  
Allied **FIRST**. Write, wire or phone Haymarket 6800.



**6 VALUABLE RADIO BOOKS FOR 75c**

Specially prepared by technical experts for radio training and for help-  
ful reference. Priced only to cover cost of preparation and mailing.

**RADIO BUILDERS' HAND-  
BOOK.** Simplified theory and  
projects. No. 37-750 . . . 10c

**RADIO-FORMULAS & DATA  
BOOK.** Handy, pocket-size  
manual. No. 37-752 . . . 10c

**SIMPLIFIED RADIO SERVIC-  
ING.** Short cuts in trouble-  
shooting. No. 37-755 . . . 10c

**DICTIONARY OF RADIO  
TERMS.** Easy-to-understand  
definitions. No. 37-751 . . . 10c

**RADIO CIRCUIT HAND-  
BOOK.** Schematics and Pic-  
torials. No. 37-753 . . . 10c

**RADIO DATA HANDBOOK.**  
Formulas, Tables, Charts.  
No. 37-754 . . . 25c

Write for Quantity Quotations



**ALLIED RADIO CORP.** Dept. 1-K-3  
833 W. Jackson Blvd., Chicago 7, Illinois

Please send following books ( . . . . . \$ enclosed)

- 37-750       37-752       37-754
- 37-751       37-753       37-755
- Free Catalog     Send All Six Books

Name \_\_\_\_\_  
Address \_\_\_\_\_  
City \_\_\_\_\_ State \_\_\_\_\_

who sees his job and does it faithfully and conscientiously without thought of making things easy for himself at the expense of his reader's easy understanding. Only by repeatedly testing his explanations and methods upon the very type of men the book is intended to teach can he find out which parts of his course are easily grasped and understood by his students and which parts still fall short and need revision and improvement. Nothing—absolutely nothing—should be taken for granted. "Pointers" are of little value unless one can remember them, and the best way to remember them is to learn the reasons back of them.

-50-

**Spot News**  
(Continued from page 14)

Consumer's Durable Goods Division who handle batteries. In the reply from this division, a promise to provide increased production of batteries was made. The letter stated in part that . . . "we are doing everything we can to induce other battery manufacturers who previously had a very small radio battery production to rearrange their facilities for increased production of this item. . . . There are no less than 3,200,000 farmers who depend on dry batteries for their radios and we believe it of prime importance to provide them with between 1½ and 2 sets of batteries a year. At the present capacity of the industry we can provide about 1¼ batteries a year if materials are made available for this production."

Since it appears as if the WPB will bend every effort to provide the necessary materials, the anticipated production, stated above, will probably be met.

**A SUPREME COURT DECISION RENDERED SEVERAL MONTHS AGO** showed that the legal value of the American patent of Marconi was null because Dr. John Stone, who died in California recently, had been granted a patent on practically the same device two years prior to the Marconi patent.

It took a suit that was filed by RCA to reveal this interesting fact. The suit covered claims filed by RCA covering a sum of over \$42,000 plus interest, accumulating since 1919, when the Marconi patent and the assets of the Marconi Company were acquired. According to the court, Dr. Stone's patent obtained in 1902, covered a four-circuit wireless telegraph system substantially similar to the system specified and patented by Marconi. Chief Justice Stone who delivered the Court's ruling stated that the work of Pupin, Fessenden, Large and Tessler also anticipated the discoveries of Marconi.

Thus it appears that after nearly forty years the Marconi patent has now been canceled.



ACTUAL-SIZE  
ILLUSTRATIONS

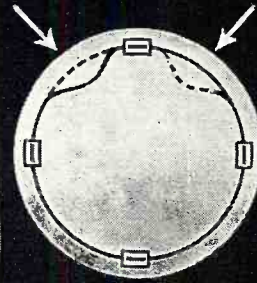

INDENTS  
FACILITATE  
TAPPING  
OF ANY  
TURN!

**No. 1590**

Single winding with indents. Weight complete, only 3 1/4 ounces. Coil 2" diam. x 4" long. 3 1/4" overall height.

**No. 1591**

Double winding (tapped outer coil with inner winding for coupling to a low-impedance load). Weight complete, 2 3/4 ounces. Coil 2" diam. x 3" long. 3 1/4" overall height.

**MADE "SPECIAL"—MADE FAST—  
and MADE RIGHT!**

These two Air-Wound units, designed for ship-to-shore radio telephone transmitters, are typical of B & W small coils now being produced to meet exacting specifications by modern production methods *at the rate of 1200 a day!*

Many outstanding advantages accrue to these coils as a result of the famous B & W Air-Wound construction: Exceptionally light weight; mechanical ruggedness (they are not

likely to be put out of commission by dropping or rough handling); adaptability to design or engineering changes in laboratory or field use; and the ease with which *ANY* of the closely-wound turns may be tapped, thanks to the special indent feature.

B & W Air Inductors of this general type are available for all normal frequency ranges. Literature on request.

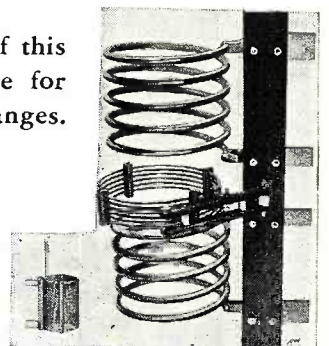

**BIG COILS, TOO!** →

Here you see the small No. 1591 Air Inductor shown in comparison to a B & W high-power unit for 10 KW. service. Details on any type gladly sent.

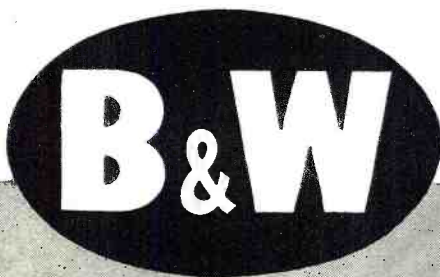

**AIR INDUCTORS**

*Air-Wound and Ceramic and Phenolic Form Types*

**BARKER & WILLIAMSON, 235 Fairfield Ave., Upper Darby, Pa.**

# SLIDERULE OR SCREWDRIVER

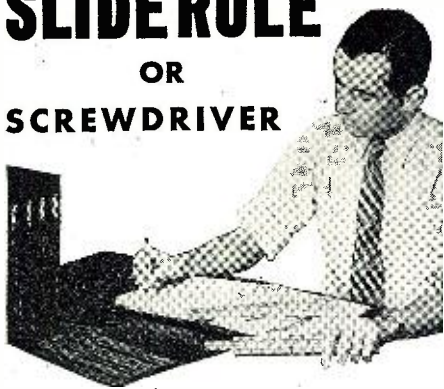

...which will YOU be  
using 2 years from now?

Add Technical Training to Your Present Experience — THEN Get That BETTER Radio Job You Want!

Thousands of new men have joined the ranks of the radio industry for the duration. But after the war, even more thousands will return from the armed forces. War production will settle down to supplying civilian needs. *Where will you fit into this picture?*

If you are wise, you will look ahead and prepare for the good-paying jobs in radio-electronics and industrial electronics. Every man in radio today has the opportunity to see the amazing developments that are taking place, as well as the unlimited opportunities available to men with modern technical training.

It is up to you to decide if you will be a "screwdriver" mechanic or a real technician in a responsible engineering position.

CREI can help you prepare by providing you with a proven program of home study training that will increase your technical ability and equip you to advance to the better-paying radio jobs that offer security and opportunity. The facts about CREI and what it can do for you are printed in a 32-page booklet. It is well worth your reading. Send for it today.

### • WRITE FOR FREE 32-PAGE BOOKLET

If you have had professional or amateur radio experience and want to make more money — let us prove to you we have something you need to qualify for a better radio job. To help us intelligently answer your inquiry—PLEASE STATE BRIEFLY YOUR BACKGROUND OF EXPERIENCE, EDUCATION AND PRESENT POSITION.



## CAPITOL RADIO ENGINEERING INSTITUTE

Home Study Courses in Practical Radio  
Engineering for Professional Self-Improvement

Dept. RN-10, 3224—16th Street, N. W.  
WASHINGTON 10, D. C.

Contractors to U.S. Signal Corps—U.S. Navy—  
U.S. Coast Guard, Producers of Well-trained Technical Radiomen for Industry

**THE SERVICEMAN IN CANADA** is being given special consideration on his gasoline requirements. A recent authorization issued by the Oil Controller's office, states that servicemen may apply for a special group rating permitting the allotment of more gas than under ordinary circumstances. The servicemen must, of course, prove that the gasoline will be used for service work only and not for sales efforts.

**THE FIRST RELAXATION AMENDMENT** to WPB Limitation order 76, prohibiting the production of many types of radio tubes, was recently made. The amendment allows the unrestricted manufacture of the 5Y3G tube. This permission was granted since it was learned that the equipment required to produce the tube is almost identical to that used for the 80 type. The limitation order previously permitted manufacture of the 5Y3GT/G tube, but production problems prevented its being produced in effective quantities.

In view, of course, of the military demands for the materials used for this tube, not too many can be expected to flow into civilian channels. However, some production is better than nothing at all.

**THE PROPOSED SALE OF THE BLUE NETWORK KEY** station WJZ, one of the Eastern pioneer stations, the two affiliated stations WENR of Chicago and KGO of San Francisco, and the associated network of some 160 stations to Edward J. Noble, owner of WMCA, for \$8,000,000, has prompted reams and reams of comment, and a law suit as well. We say proposed sale, for although David Sarnoff, president of RCA, owner of the Blue system, agreed to the sale, the FCC still has to approve. And in addition, Mr. Noble has to sell WMCA before he can assume control of the network. This step is necessary to conform to the FCC requirements covering multiple ownership of stations in the same community. Since this proposed sale also involves several new problems to consider, such as the transfer of an entire national network for the first time, extreme caution will prevail in FCC actions. Since, of course, networks are not licensed, FCC can only approve of the transfer of the three stations. However before approving of the sale of these stations, FCC will undoubtedly study the public service merit of the stations and the affiliated network.

The consensus of experts in Washington and New York is that the FCC will undoubtedly act favorably in the consummation of the transfer, if Mr. Noble can sell WMCA. And there appears to be the real problem, at this writing. For although Mr. Noble has had many bidders, he is stymied by a motion for a temporary injunction to restrain such sale. The motion was brought about by Donald Flamm, former WMCA owner. According to the affidavit of Mr. Flamm, who would like to have the original sale rescinded, he was an "unwilling seller" at the

time the sale was made. The Flamm suit asks for the return of the station at the purchase price of \$850,000 and an accounting of the profits.

In the meanwhile, Mr. Noble, who was first chairman of the CAA, former Undersecretary of Commerce and is at present head of a candy mint company, has formed the American Broadcasting System to acquire the outstanding stock of the Blue Network and operate the system.

In the application filed with the FCC, Mr. Noble stated that he had already deposited \$1,000,000 against the proposed sale. The remaining \$7,000,000 will be paid to RCA, upon the granting of FCC approval. Of the total cost of the system, Mr. Noble proposes to pay half personally. The remainder will be borrowed from three New York banks.

Although negotiations for the sale had been under way for months and months, very few knew the intimate details. The conferences were kept so confidential that even the top executives were in the dark until the very morning David Sarnoff made the announcement. According to Mr. Sarnoff and Mr. Noble, the present staff from Mark Woods, the Blue Network president, down, will be kept intact.

The removal of the WJZ transmitter from its present site to one fifteen miles closer to New York City, revealed last month, will not be halted, pending a ruling on the sale of the Blue. And thus far, it appears as if the same studios and offices of WJZ in the RCA building will be maintained.

It will be strange indeed to see the RCA symbol severed from the WJZ letters, after all these years!

**SUN SPOTS WERE ON THE RAMPAGE** recently again. The sun spot condition which occurs once or twice annually, completely upset all forms of radio transmission for nearly six hours in August. Although sun spots have been severe before, their severity was so intense this time, that the London Overseas Radio was forced off the air, for the first time. Oddly enough, sunspot interference does not cover paths in all directions. For, for instance, transmission to the West coast and to South America continued with no interruption. This time, wire service, which usually is affected too, did not suffer from the interruption.

Although sun spot interference has been known to scientists for close to a half century, it has been impossible to date to find ways and means of avoiding it. A variety of circuits and antennas have been devised but the results have not been too satisfactory. It is said that developments, dictated by the problems of war, will probably offer solutions to the complicated and vexing problem of sun spots.

**RADIOS WERE NOT TOO PROMINENT** at the recent National Association of Music Merchant's Conference. In past years, the booths were replete with radio displays. This year, only three of the leading manufac-



# I the war should end tomorrow . . .

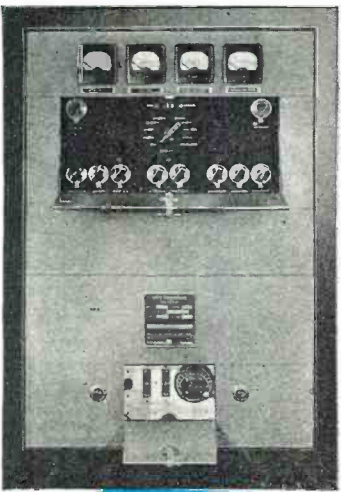

**R**AUDIO RECEPTOR, with a wealth of experience encompassing the entire history of radio, would be ready to convert its greatly expanded facilities to the construction and installation of Ground-to-Air Navigation, Communications and Airport Traffic Control Equipment for civilian use.

Now devoted to the war effort, these engineering and production facilities that built the first commercial ultra-high-frequency airport control units, which were installed at Washington National Airport for the Civil Aeronautics Administration, will be in a position to provide all advanced types of airport radio equipment—for municipal and private fields—under a single contract, if desired.

Today, RADIO RECEPTOR installations assure increased safety and efficiency in airports throughout the world. We'll be glad to send a copy of our revised booklet, "HIGHWAYS OF THE AIR", now in preparation. Please write on your business stationery to our Executive Offices, 251 West 19th Street, New York 11, N. Y.



Awarded for Meritorious Service on the Production Front

SINCE 1922 IN RADIO AND ELECTRONICS



## Under Fire!

When the Signal Corps moves its equipment up to advanced posts both men and equipment take terrific punishment. Signal Corps communications equipment rides in the rumbling tanks . . . crouches in foxholes and behind shell-blasted tree-trunks . . . marches into the thick of battle with the infantry. *It's got to be good!*

CONSOLIDATED RADIO headphones are withstanding all the unprecedented rigors of modern warfare. CONSOLIDATED RADIO is proud to be manufacturing headphones that are fighting side by side with the invincible infantry.

**Consolidated Radio's Modern Mass Production Methods Can Supply Signal Corps and Other Headphone Units in Quantities to Contractors**



Electronic and Magnetic Devices

# CONSOLIDATED RADIO

Products Company

350 W. ERIE ST., CHICAGO, ILL.

turers exhibited. However, the record companies had many booths with elaborate display material.

In view of the generally disappointing interest and lack of displays, it is doubtful that the conference will be held for any extended period next year. Officials, of course, hope that by next year, WPB will relax some of the manufacturing restrictions on receivers and phonographs, and that accordingly more manufacturers will be tempted to exhibit their wares.

Thus far the NAMM officials are not in too happy a mood.

**MANY ADVERTISEMENTS TODAY** include exciting themes. For instance, the recent series prepared by a fruit-line freighter company is devoted to the progress of radio. In one of the striking advertisements entitled "Sparks in the Night" a fascinating story of radio beginning in 1903 is told. It was then, when long waves were quite the fashion and coherers were the last word in radio technique. With the advent of short waves in the late 1920's, progress became rapid, this advertisement points out, permitting not only ship to shore operation, but intercontinental contact too.

It was only a spark gap in the beginning covering but a few miles, but what a difference today.

### PERSONALS . . .

**Colonel Carroll O. Bickelhaupt** who has been on active duty in the Signal Corps since 1941 in Washington, has become the commanding officer of the Eastern Signal Corps Replacement Center, at Fort Monmouth, New Jersey. The Colonel who is on leave as a vice president from A. T. and T. succeeds **Brigadier General Edward L. Clewall** who is now in Chicago as head of the Signal Corps Procurement District there. . . . **Dr. L. Grant Hector**, chief engineer of National Union has been appointed production consultant on miniature tubes in the radio division of WPB. . . . **Peter J. Faber**, assistant manager of the radio department and purchasing manager of Montgomery Ward, has been appointed WPB consultant on radio receivers, receiver repair parts and distribution. . . . Several new posts have been filled at General Electric during the past month. **Ralph J. Cordiner**, formerly vice chairman of WPB is now assistant to the president of General Electric. **W. P. Gillen** has been named manager of manufacturing of the tube division of General Electric Electronics Department. **I. J. Kaar** is now manager of the receiver division of General Electric Electronics Department and **G. W. Nevin** is manager of the tube division. . . . **Roy C. Corderman**, formerly assistant chief of the OWI Bureau of Communication Facilities, has returned to his former commercial affiliation with Western Electric. . . . **Clarence G. Stoll** recently celebrated his fortieth anniversary as president of Western Electric. . . . **Samuel R. Rosen-**



The Hytron 807—peacetime all-purpose favorite—is now a veteran. Before it joins its battle-scarred brothers, however, like all Hytron tubes it must pass Hytron factory specifications which weed out the 4-F's as efficiently as Army doctors at an induction center. Unless a Hytron 807 is in top fighting condition, it never leaves the factory. Let's look at a few of the many test hurdles it must surmount.

#### BUMP TEST



Ever stop to think of what a leaping, bouncing jeep or peep can do to a tube's "innards"? One answer to the question of a tube's ability to withstand such punishment, is the Bump Test. Several resounding smacks by a heavy, swinging hammer loosens up the weak sisters pronto!



#### IMMERSION TEST

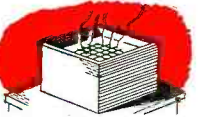

A "PT" boat leaning back on its stern, and plowing a foaming furrow through steaming tropical waters would spell disaster to poorly-cemented bases and top caps. That is why Hytron 807's are thoroughly soaked in a hot bath, before they are O.K.'d.



#### LIFE TEST



Day and night, Hytron 807's on life-testracks are proving that they can give long, dependable service. Soaring skyward in our big bombers, these tubes have a big investment in men and matériel to protect. Long after the big fellows have been patched for the last time, these tubes are still doing their jobs.



#### VIBRATION TEST



Link-trainer for 807's aspiring to tank service is a motor-driven eccentric arm which shakes the tube like an angry terrier while a v. t. voltmeter in the plate circuit records the ability of the elements to take it like the iron men who ride those clanking, thundering monsters.



#### HYTRON TOLERANCES

tighter than

#### CUSTOMER TOLERANCES

No manufacturer makes all tubes of a given type exactly alike. Hytron does manufacture its tubes to tight specifications which insure against slight inaccuracies due to meters and the human element. Engineered to these narrower limits, Hytron tubes fit exactly the circuit constants with which they must operate.



OLDEST EXCLUSIVE MANUFACTURER OF RADIO RECEIVING TUBES



# HYTRON CORPORATION

ELECTRONIC AND RADIO TUBES

SALEM AND NEWBURYPORT, MASS.

baum, president of WFIL is now a Lieutenant-Colonel in the United States Army Special Reserve, Division of Military Government for service in Occupied Territories. **Roger W. Clipp** has been named an executive vice president and will assume presidential powers during Mr. Rosenbaum's absence. . . . **James Beloungy**, for the past year in charge of vacuum tube rebuilding plant of Freeland and Olschner, is now chief engineer of the CBS central division. He succeeds **Major Frank B. Faulkner**, now in the Army. . . . **L. W. Teegarden** has been promoted to the post of assistant general manager of the RCA Victor Division of the Radio Corporation of America. . . . **J. H. Swenson** and **R. A. Trago** of the CBS Maintenance and Construction Department have been commissioned Captains in the United States Army. . . . **David Davis**, supervisor of the CBS Engineering Dep't. will undertake Swenson's position in addition to his other activities. . . . **Roland J. Young** has joined the CBS Construction and Building Department as manager of construction and building operations. **Mr. Carlos V. del Mercado** has been recently appointed Export Sales Manager of the Majestic Radio & Television Corp., Chicago, Illinois.

In keeping with Majestic's desire to strengthen their organization with men of proven ability in their respective fields, they have engaged Mr. del Mercado, under whose direction their plans for the development of the overseas market will be formulated.

Mr. del Mercado is one of the outstanding men in the radio export field. His knowledge of markets and the particular radio requirements of each foreign country is unique in the radio industry.

-50-

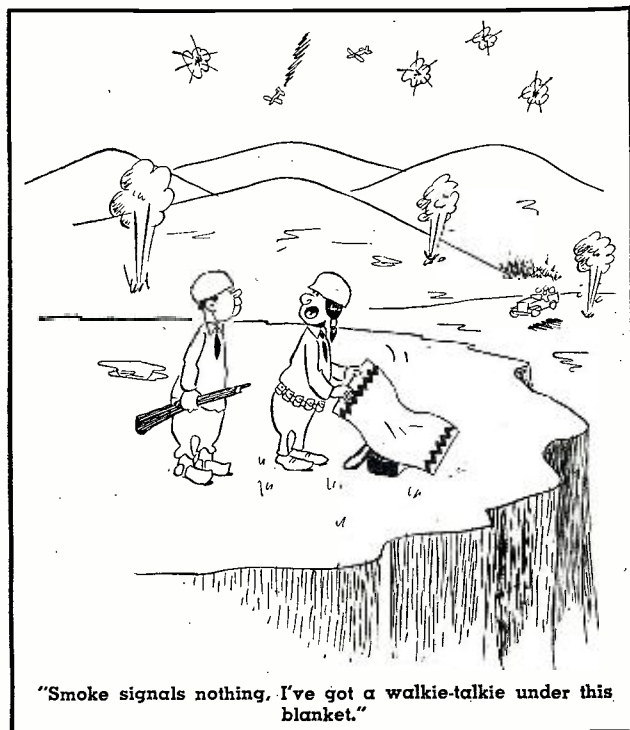

## Practical Radio Course

(Continued from page 50)

describe this condition by saying, "the signal voltage undergoes a reversal of phase in passing from the grid to the plate circuit of an amplifier tube." While this is not a technically correct statement, it facilitates the visualization of what actually happens.

The amplified signal voltage of VT1 appears across the grid leak  $R_{GL}$  of VT3 and its voltage variations are  $180^\circ$  out of phase with the input signal voltage. This phase relationship is indicated by the sine waves drawn near the grids of each of these tubes. If a small portion of the signal voltage appearing across  $R_{GL}$  is tapped off between  $R_1$  and  $R_2$  and fed to the grid of VT2, as shown by the heavily-drawn line in Fig. 5, it will be amplified by VT2 and appear across the grid leak  $R_{GL}$  of VT4 with its phase reversed again, as illustrated by the sine waves drawn near the grids of VT2 and VT4. Now, examination of the sine wave notations indicating the phase relationship of the signal voltages applied to VT3 and VT4 clearly shows that the signal voltage is applied to the push-pull grids  $180^\circ$  out of phase. Thus, one of the requirements for push-pull operation is achieved through the phase inversion action of VT2.

The other requirement for push-pull amplification is that the signal voltage applied to each of the push-pull grids should be of the same magnitude. That is, equal (but out-of-phase) signal voltages should be applied to the grids of VT3 and VT4. Since VT1 and VT3 are operated as a normal resistance-coupled amplifier, the problem is to match the input signal voltage of VT4 to that of VT3.

It is obvious that the value of the signal voltage delivered to VT4 depends upon the characteristics of VT2, the circuit constants of the network between VT2 and VT4, and the amplitude of the signal voltage applied to the grid of VT2. The latter, of course, is the voltage existing across  $R_2$  (which also acts as the grid leak for VT2). Now, in ordinary commercial practice, VT1 and VT2 are identical tubes or even more often, a twin triode tube such as the type 6SC7, 6F8, etc., is used, making the characteristics of VT1 and VT2 exactly alike. Also, the circuit constants of the coupling networks to the push-pull tubes are designed to provide the maximum voltage amplification, hence they

too are alike. Therefore, if the input signal voltage to VT2, tapped off across  $R_2$ , is equal to the input signal voltage to VT1, both the voltage amplifier tube and the phase inverter tube will deliver the same amount of voltage to the grid circuits of VT3 and VT4, respectively. Thus, the second requirement for push-pull operation is met.

In order to evaluate  $R_2$  with respect to  $R_1$  (that is, to determine the ratio of the voltage divider  $R_1/R_2$ ) so that the value of signal voltage tapped off across  $R_2$  will be the same as the original input signal voltage, it is necessary to refer back to a previous discussion regarding the voltage amplification obtainable from a tube.

From this, it can be seen that under practical circuit conditions assuming that the usual triode is used for VT1, the voltage amplification obtained from VT1 will be roughly about 80% of the mu of the tube, or the voltage appearing across  $R_{GL}$  (this resistance is  $R_1 + R_2$ ) is equal to the input signal voltage multiplied by  $0.8\mu$ . Let  $E_s$  be the signal voltage applied to VT1. Let  $I$  be the signal current appearing in  $R_{GL}$ . Then for proper phase inversion, the voltage drop across  $R_2$  must equal  $E_s$ . That is:

$$IR_2 = E_s$$

But the voltage drop across  $R_{GL} = 0.8\mu E_s$ . Therefore:

$$I(R_1 + R_2) = 0.8\mu E_s$$

Substituting for  $E_s$  in this equation its equivalent value  $iR_2$ , we get:

$$I(R_1 + R_2) = 0.8\mu IR_2$$

Dividing both sides by  $IR_2$  we get:

$$\frac{R_1 + R_2}{R_2} = 0.8\mu, \text{ from which}$$

$$R_2 = \frac{R_1 + R_2}{8\mu}$$

Consequently,  $R_2$  should be made equal to  $\frac{1}{0.8\mu}$  of  $(R_1 + R_2)$ .

For example, if VT1 and VT2 have a mu of say 20,  $R_2$  should be made equal

to  $\frac{R_1 + R_2}{0.8 \times 20} = \frac{1}{16}$  of  $(R_1 + R_2)$ , or in

another form:  $R_2 = \frac{1}{15} R_1$ .

Let us check this by the following reasoning. If VT1 and VT2 have a mu of 20, the amplified signal voltage appearing across  $R_1 + R_2$  (this resistance is  $R_{GL}$ ) will be  $0.8 \times 20$ , or 16 times the input voltage. It is obvious then, that  $\frac{1}{16}$ th of the amplified signal voltage appearing across the whole of  $R_{GL}$  is equal in magnitude to the signal voltage input to VT1. Therefore, if  $R_2$  is  $\frac{1}{16}$ th of  $(R_1 + R_2)$ , the same value of signal voltage will be fed to the grid of VT2 as is originally fed to the grid of VT1.

(To be continued)



BETTER BANK ON THE **HUMAN** ELEMENT, TOO

In the excitement of electronic discoveries and predictions, one great and important factor—the *human* element—stands forlorn. Machines and uses are, after all, only the offspring of man's experience and ingenuity. The more capable the man, the more dependable his product.

This is the *human* element upon which the Electronic Corporation of America places a high evaluation. And this, we suggest, is the element you should seek when planning your future program. Find out more about your man and his background. Is he an old-timer or a "war baby"? Does he have the ability and facilities to produce? How high are his standards? These are questions we'll gladly answer. We're 100% in war work now . . . but, occasionally production schedules enable us to accept additional contracts . . . *communicate with us.*

**A CALL FOR GREATER EFFORT . . .** The WPB reports that war production has fallen off considerably. This is a challenge to industry and labor, and it's up to us to find the reason, whether it be optimism, internal strife, working conditions, discrimination, etc. The roar of battle is thousands of miles away, but, if you listen closely, you can hear the screams of a dying soldier. Can it be because we failed him?

**ELECTRONIC CORP. OF AMERICA**

45 WEST 18th STREET • NEW YORK 11, N. Y. • WATKINS. 9-1870

## Wave Guides

(Continued from page 25)

can be used for the transmission of many waves at the same time.

One method of doing this is to have several transmitting antennas oriented differently with respect to each other. Then each antenna could send its own wave, and at the receiving end only the antenna that is placed in the same position as the one at the transmitting end will respond to the wave. At these small wavelengths polarization plays a very important part in the receiving of the signals. A few degrees off could be enough to completely ob-

literate the detection of the signal.

Another way of differentiating between various frequencies in wave guides is by means of a filter. This filter consists of a constriction in the pipe. If you will recall, the diameter of the guide determines which frequencies go through and which are strongly attenuated. By varying the size of the guide we could allow only the shorter wave-lengths (or higher frequencies) to pass through freely. Instead of actually constricting the pipe, however, we could more easily put in a circular stop with an opening in the center whose diameter could be controlled. This has been tried and has been found to work very well. Another use for wave guides is as resonant lines or

chambers. With a detector placed at a suitable point, all we have to do is to move a piston with a screw arrangement along the guide and note the various maxima and minima currents the detector receives. In this case, we use much the same technique as with a Lecher wire system for measuring wavelengths. Values gotten this way are reliable if done with a little care. The detector is usually placed not far from the open end of the wave guide receiving the microwaves. The  $Q$  of these chambers can be made very high, at times even reaching a value above 10,000. Compare this with the values we get in our ordinary coil and condenser arrangement.

And so we see that although we have had to approach wave guides from an angle not previously used in our study of radio circuits, the transition was not too difficult and many of the properties found were not too entirely new to the individual.

A quantitative study would necessitate the use of Maxwell's equations, never too easy, even when simplifying assumptions are made. However, as we have seen, that has not stopped us from visualizing the workings of wave guides nor should these equations stop us from experimenting with various kinds of hollow lines. Perhaps after the war, many new uses for microwaves will bring these guides into more popular use.

-30-

# Immediate Delivery

## on Meissner Iron Core I. F. Transformers

No. 16-5740  
frequency range  
360-600  
(456 kc. input)

No. 16-5742  
frequency range  
360-600  
(456 kc. output)

Price \$2.20 each



**D**esigned primarily as original parts in high-gain receivers of superior quality... Wide frequency range and greater selectivity permit almost universal application for replacement use... all units are double-tuned with ceramic base. Mica-dielectric trimmers, windings are of high grade Litz wire, thoroughly impregnated. Black finish shield 1 1/8" square by 3 1/2" high.

Meissner

MT. CARMEL, ILLINOIS

PRECISION-BUILT ELECTRONIC PRODUCTS

## What's New

(Continued from page 41)

### REPLACEMENT CONDENSER

In these days of critical material shortages it is always a pleasure to find an item that helps to keep radios

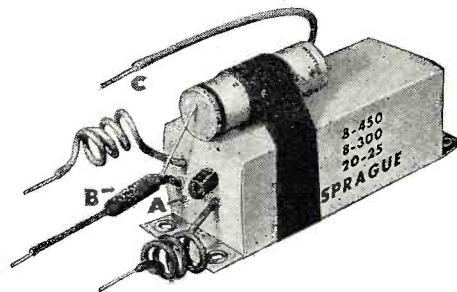

operating. The Sprague Co. of North Adams, Mass., has contributed to the ability of the serviceman to maintain receivers with the announcement of a condenser that permits the repair of a defective section without discarding the entire unit, thereby effecting a considerable saving in critical material as well as servicemen's time.

The accompanying illustration demonstrates how a Sprague UT-8 8  $\mu$ fd. 450 volt Atom Midget dry electrolytic could be used to replace the 8  $\mu$ fd. 450 volt section of a 3-section condenser rated at 8  $\mu$ fd. 450 v., 8  $\mu$ fd. 300 v., and 20  $\mu$ fd. 25 v.

(A) Cut lead to defective section and tape end.

(B) Connect cathode (-) side of



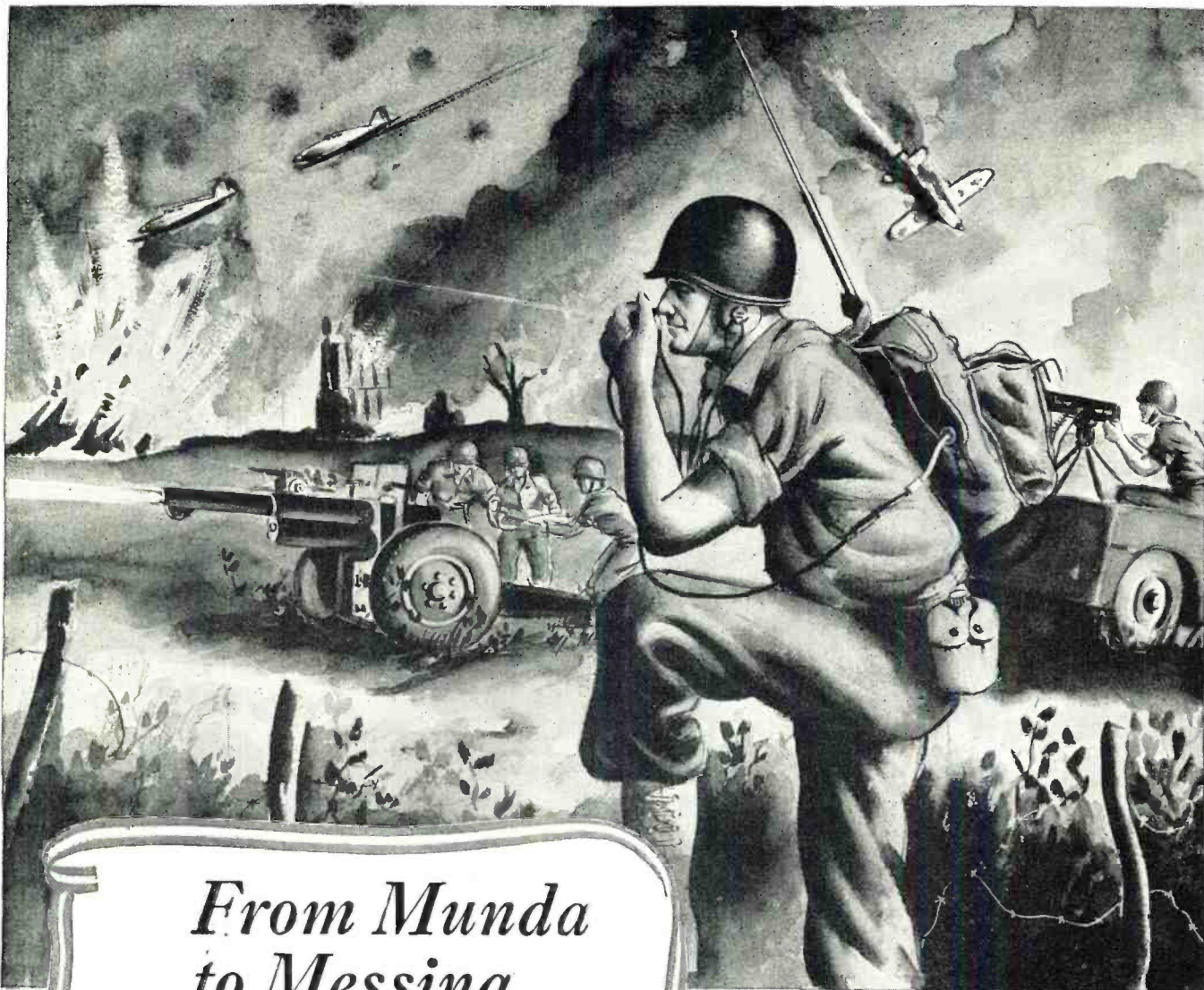

## *From Munda to Messina...*

Sturdy Majestic-built Walkie-Talkies are carrying our military communications into the very jaws of the enemy's guns. In the air, on the ground, other Majestic-built electronic equipment, including infinitely precise crystals by the thousands, are serving our armed forces on every front. And today — the Majestic production lines are longer and busier than ever.

No task has been too complex—no schedule too severe, Majestic is doing it well—is looking for more and bigger jobs to do.

But none of this would have been possible without the help and cooperation of our parts and materials suppliers. Whatever credit Majestic may earn in the war production program, we pass on in generous measure to these companies, with a "Well done—and thank you."

★ ★ ★

*\$1000 Prizes in War Bonds for the most helpful answers to 3 simple questions. Write for them today!*



**Majestic**  
MIGHTY MONARCH  
OF THE AIR

MAJESTIC RADIO & TELEVISION CORP.  
2600 WEST 50th STREET CHICAGO, ILLINOIS

*Builders of the Walkie-Talkie—Radio of the Firing Line*



Atom to common minus lead of multi-section condenser.

(C) Connect cut circuit lead to positive (+) side of Atom.

By following this procedure, you'll find that it is seldom necessary to replace an entire multi-section condenser simply because one section has gone bad. Most defective sections can be replaced by using a *Sprague* Atom of the proper capacity and voltage in the manner illustrated. The Atom can either be fastened by tape to the multi-section container, or simply held in place by means of its sturdy wire leads.

#### KITS TO TRAIN RADIO MEN

*Lafayette Radio Corp.* of Chicago and Atlanta, is now able to offer radio

training kits in quantity, to military and private training programs. The one and two tube regenerative kits are designed to provide complete basic receiver training at the lowest cost.

The one tube kit, when assembled, demonstrates grid leak detector operation and the effects of regeneration on a detector circuit. With the addition of a minimum of parts an r.f. stage can be added without redrilling the chassis or moving any component parts of the detector circuit. Alignment procedure can then be demonstrated in its simplest form. These kits may be operated either from power supplies or from batteries when proper tubes are used. For information write to the *Lafayette Radio Corp.*, 901

Jackson Blvd., Chicago 7, Illinois or 265 Peachtree St., Atlanta 3, Georgia.

#### NEW PILOT LIGHTS

This new series of *Gothard* Pilot Lights is designed for grounded pilot light panels, and presents many note-

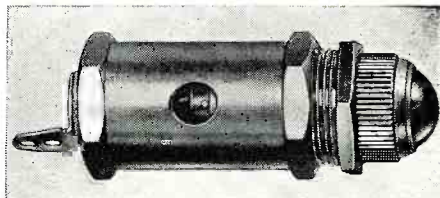

worthy installation and maintenance features. Measuring approximately 2" in length, they mount on 1" centers permitting a number of units to be incorporated within a very small space. Body of hexagon design facilitates the use of a socket wrench in installation and, therefore, insures a solid mounting that will not work loose over a long period of operation. Bulb change is accomplished from the front of the panel without disturbing body mounting or wiring. The bulb automatically comes out when the Jewel holder is unscrewed. Bayonet socket lamps (long or round) may be used.

Available with either faceted or plain jewels. Complete information and prices may be had by writing direct to the manufacturer, the *Gothard Manufacturing Company*, 1300 N. Ninth Street, Springfield, Illinois.

#### RADIO TRAINING KITS BROCHURE

*Lafayette Radio Corporation's* Special Department for handling the needs of instructors and school management has just prepared this new brochure to aid schools in their government training courses.

Engineers have expressly designed the kits mentioned in this folder to fit



present training programs. Starting with fundamentals and progressing to basic receiver and transmitter operation, a progressive training program may be built up around these kits. *Lafayette Radio Corporation*, 901 W. Jackson Blvd., Chicago, Illinois.

#### VERSATILE TALK-A-PHONE

A Master Station and Sub-station is in the *Talk-A-Phone Mfg. Co.*, new line of inter-communication equipment. Engineers have succeeded in the development of this system so that it

**THE PEACETIME  
MEASURES OF  
REFLECTION AND  
DEFLECTION . . . .  
WILL BE READ FROM**

**TRIPLITT**

**ELECTRICAL MEASURING INSTRUMENTS**

**WITH CONFIDENCE  
AND ECONOMY**

THE TRIPLITT ELECTRICAL INSTRUMENT CO., BLUFFTON, OHIO

**BACK UP YOUR BELIEF IN AMERICA...BUY WAR BONDS**

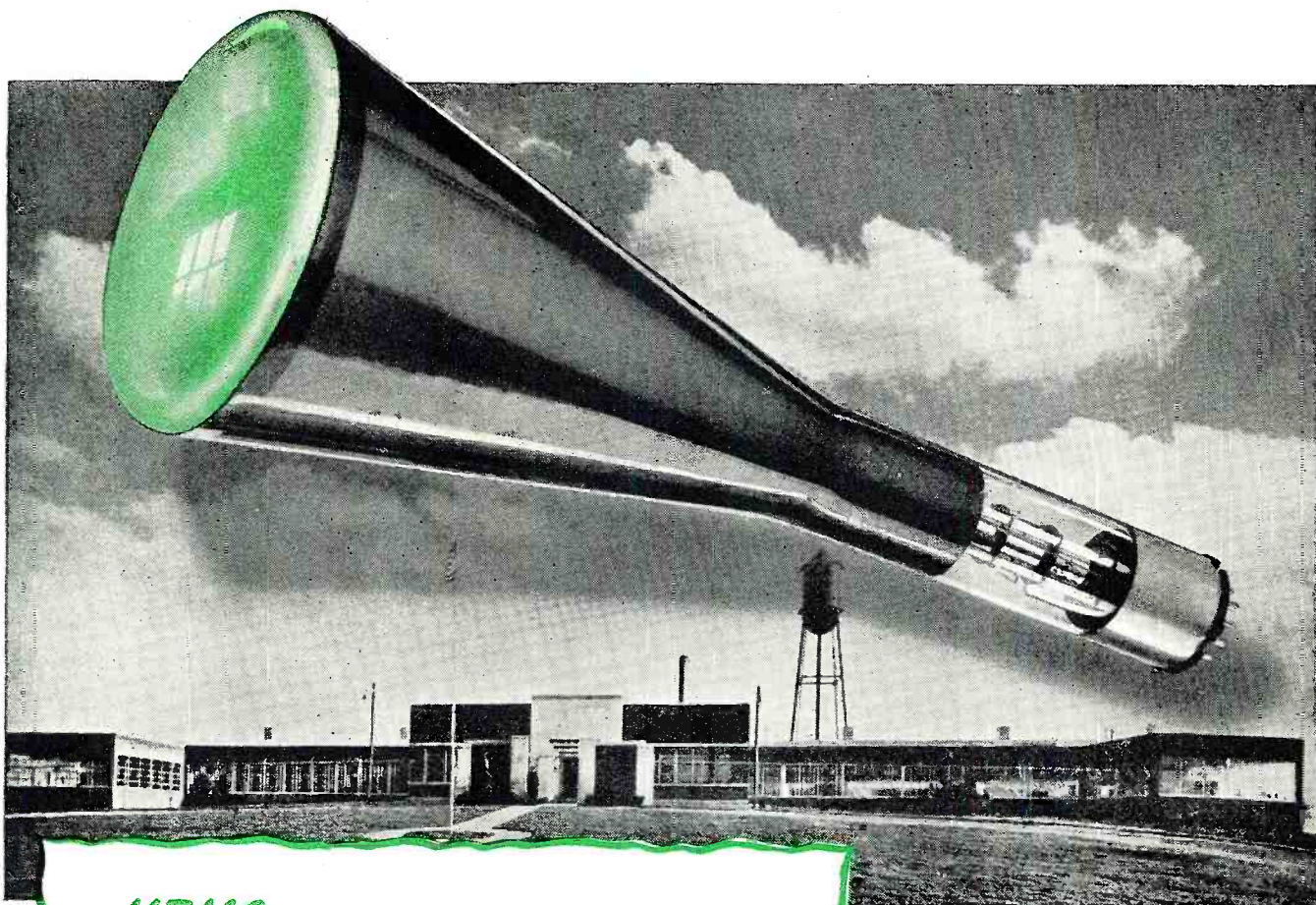

**MEMO** for Post-War Reference:

NATIONAL UNION IS ONE  
OF THE LARGEST PRODUCERS  
OF CATHODE-RAY TUBES

In our cathode-ray tube production record, now climbing upward week by week, we see the working out of plans made long ago. Here are the dreams of our engineers come true. Here is the model factory they planned and equipped especially for cathode-ray tube manufacture—one of the Industry's

largest. Here are the mass production machines they designed—built by this company's own equipment division. Here are the hundreds of skilled workers to whom they taught this special art of tube making that calls for the utmost precision and accuracy. Here are their laboratories with research continuing

at an even greater pace, as though their work had just begun. And here are the results of all this thought and effort—National Union Cathode-Ray Tubes *by the carload*. Today, enroute to those who need them most—our fighting forces! Tomorrow, destined to bring to millions of homes a marvelously improved kind of television with larger images, with greater sharpness, reality, at mass-market prices—and to thousands of factories many new precision testing and measuring devices.

*Count on National Union for the things you'll need—tubes, test equipment, engineering data—to keep your post-war service in step with electronics progress.*

NATIONAL UNION RADIO CORPORATION

NEWARK, N. J.

LANSDALE, PENNA.



**NATIONAL UNION**  
**RADIO AND ELECTRONIC TUBES**



# Radio Parts Available!

You can still get radio replacement parts for maintenance and repair and non-critical consumer applications without a priority? Send for this new flier No. 92—chock-full of radio parts. Prompt delivery! All new merchandise!

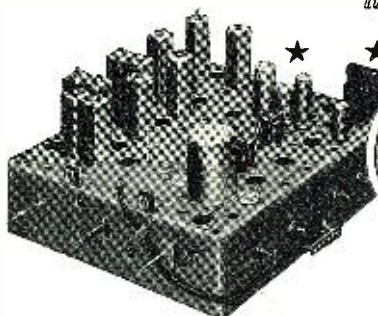

## Attention UHF

### EXPERIMENTERS! RCA TELEVISION CHASSIS

A remarkable buy in one of the finest television receiver chassis ever manufactured! Complete sound and picture channels for 5 bands. All components are ideal for high-frequency experimentation: Uses 3 6AC7, 2 6J5, 5 6AB7, 2 6H6, 1 6SQ7, 1 6SK7, 4 6N7, 1 6Y6G, 1 6L6, 1 5V4G and 1 1803-P4 or 1 1804-P4. We removed the tubes and sent them to war, but the parts alone are worth more than the price we are asking. Complete with circuit diagrams and instructions. Chassis measures 17x16x8½ inches over-all. See below for Power Supply. **C22263—Your Cost—Television Chassis Only \$29.50**

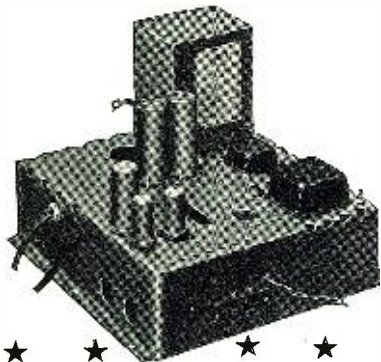

### SPEAKERS! Advance offering of Quality Speakers at Sensational Low Prices for maintenance and repair. Precision built of pre-war quality materials:

- ★ C19139 4" PM Speaker Special Price . . . \$1.39
- ★ C19426 5" PM Speaker Special Price . . . 1.89
- ★ C19141 8" PM Speaker Special Price . . . 5.25
- ★ C19142 10" PM Speaker Special Price . . . 6.15
- ★ C18900 12" 2000 ohm Speaker. Spec. Pr. 5.29
- ★ C19184 12" Dynamic Speaker Special Price . . . 4.95
- ★ C19144 15" Dynamic Speaker Special Price . . . 21.95

### RCA HIGH VOLTAGE POWER SUPPLY

Although this power supply was designed for use with the Video chassis listed above, it will find many useful industrial and experimental adaptations as well. Delivers 7300 volts DC for Kinescope anode, 2.5 volts at 2 amps., 5 volts at 3 amps., 500 volts at 250 MA., 6.3 volts at 1 amp., 6.3 volts at 3 amps. Supplied less tubes, it requires 1 5U4G and 1 2V3G for operation. Over-all size 15x13¼x10 in. Complete with circuit diagram and instructions. **C22264—Your cost—Power Supply Only \$49.50**

**RCA Television Chassis plus Power Supply—Your Cost for both \$69.50**

Write today for your copy of FREE 130 page catalog of Radio and Electronic Parts and Equipment. Address Dept. 10E3



# LAFAYETTE RADIO CORP.

★ 901 W. JACKSON BLVD. CHICAGO 7, ILLINOIS  
★ 265 PEACHTREE STREET ATLANTA 3, GEORGIA

is now a standard part and is available for immediate delivery at an extremely low price. This system is known as Model LP-77.

The LP-77 utilizes in any combination up to ten, both master stations and a new "selector type" sub-station. Now, in one system, master stations may carry on a completely private conversation between each other without interruption or eavesdropping by the remote stations, and, in addition, may communicate with the different sub-stations at will. Any master station may also have a private sub-station with which no other master can communicate or listen in on.

Master stations are housed in sturdy walnut cabinets, and sub-stations are completely enclosed in durable metal cases. These systems are available in 10, 20, 30, 40, 50, etc., stations.

An 8-page catalog illustrating in detail all of the Talk-A-Phone Intercommunication systems, may be had by addressing the Talk-A-Phone Mfg. Co., 1219 W. Van Buren St., Chicago, Ill.

-30-

### Direction Finders

(Continued from page 29)

the reciprocal of the correct bearing. To determine which is the correct bearing, a small antenna is provided (sense antenna) and is switched in after the first two null points have been obtained and the reading of each noted. This "sense" can be correctly adjusted by connecting the lead from the switch to the proper side of the loop pick-up leads, if incorrect it should merely be removed and connected to the other outside loop lead. It is usually connected so that when the signal is loudest as explained in taking a "sense" bearing below the direction is the correct one.

After the two minimum points have been noted, turn the loop so that one of these readings is under the red pointer (located 90 degrees from the indicating pointer) and connect the sense antenna through the switch to the "sense" position, then rotate the loop until the other reading is under the red pointer and observe which of the two readings gives the louder signal when in this position under the red pointer. The signal giving the loudest signal in this position is the correct bearing. For example a bearing taken of a station shows a minimum at 10 degrees (off the starboard bow) another minimum will also appear at approximately 190 degrees (off the port quarter). Turn the loop until 10 degrees is under the red pointer located to the left of the indicating pointer, put the "sense" switch in, noting the intensity of the signal then turn the loop so that the 190 degree mark is below the red indicator, likewise observing the volume of the received signal, if the louder signal is heard when 10 degrees is under the red pointer, then ten degrees is the correct bearing, if it

# The SPRAGUE TRADING POST

EXCHANGE — BUY — SELL

## Your own ad run FREE!

The "Trading Post" is Sprague's way of helping radio servicemen obtain the parts and equipment they need, or dispose of the things they do not need during this period of wartime shortages. Send in your own ad today—to appear free of charge in this or one of the several other leading radio magazines on our list. Keep it short—WRITE CLEARLY—and confine it to radio items. "Emergency" ads will receive first attention. Address it to:

SPRAGUE PRODUCTS CO., Dept. RN310  
North Adams, Mass.

### TUBES AND EQPT. FOR SALE

Closing out my business and offer the following: 1500 brand new radio tubes in factory-sealed cartons. 252 of these are of the most popular types—mostly metal and GT/G. Price all in one lot is 70c ea., or in lot of 300, 75c ea. Also offer late Precision model 914 Tube, Battery, and Paper Condenser Tester—counter type that tests all modern tube types. Brand new condition, complete with inst. book, \$80. Also one Supreme 504 tube and set tester, 1939 model in excellent condition, \$35. Also, 9 vols. (3 to 11) Rider's Manuals in brand new condition—never used—for \$70. Also, one Midwest 16-tube radio phonograph and recording combination console with automatic record changer, 1942 model in new condition complete with micromer and short wave aerial. Bargain for \$140. Write for details on any unit. Gonzalez, 169 Brook Ave., Bronx, New York, N. Y.

**WANTED**—V.O.M., tube tester, and signal generator of reputable make and in A-1 condition. Vincent A. Longo, 16151 Sussex Ave., Detroit, 27, Mich.

**FOR SALE** — RCA portable model 4816 record player, 110 volts, 12 in. turntable. Burcher's Elec. Store, 513 Main St., Honesdale, Pa.

**WANTED AT ONCE** — A combined volt-ohm milliammeter and tube checker. Good make. Must cover tubes from 1937 to today. Will pay cash. Harold Wagner, 1201 So. 109th St., West Allis 19, Wisc.

**URGENTLY NEEDED**—Want battery-operated tube tester (late model), also condenser tester. Have lots of parts to trade or will pay cash. Pleasant Valley Radio Service, Armstrong, B.C., Canada.

**WANTED AT ONCE**—Volt-ohm-milliammeter, tube tester, and all types of test equipment. Also want B battery eliminator and radio parts such as variable condensers, electrolytics, tubes, hook-up and coil-winding wire, transformers, chokes, etc. State price, condition, make. R. Watts, P.O. Box 807, Short Hills, N. J.

**WILL PAY CASH** for Jensen Model JHP-52 15 in. coaxial speaker with high-frequency control switch, with or without cabinet. Give full details. Also want heavy-duty 12 in. PM speaker such as Jensen A-12PM. Bill Pollock, Jr., 104 Spence Place, Knoxville 15, Tenn.

**WANTED FOR CASH**—Broadcast coil set for HRO receiver. Must be practically new and perfect. Write, stating price and condition. H. L. Bumbaugh, Columbia University, Division War Research, Box 271, New London, Conn.

**WILL TRADE**—Four 2-amp. battery chargers; 6-volt fluorescent converter; 1936 Dodge "Arvin" auto radio in perfect condition; Sterling 0-3 AC voltmeter; also 0-15 DC Ma.; 30-amp. time switch; two half ampere battery chargers; 6 air gauges; quart blow torch, etc. Need typewriter, Hawaiian guitar, or what have you? Stanley, 2748 Meade, Detroit 12, Mich.

**WANTED**—Am badly in need of three of each of the following tubes: 12SA7GT; 12SK7GT; 125Q7GT; and 35Z5GT. Seth Clark, 98 South St., Milltown, Me.

**WANTED**—Tube and multi-tester for testing latest tubes. Also want Jewell or Weston V.O.M. C. D. Bolt, 908 N. Oklahoma St., Okmulgee, Okla.

**CASH FOR NEW TUBES** — New tubes of the following types wanted: 50L6, 35L6, 35Z5, 25Z5, 25Z6, 70L7, 117Z6, and numerous 12S' series. Sgt. Frank Lee Hood, Communications Section, H & S Co., 241st Engr. Bn., U. S. Army, Fort Belvoir, Virginia.

**HEADPHONES WANTED**—Cheap set of headphones wanted (not more than \$1). Harry Aichner, Jr., 1116 W. 25th St., Erie 6, Pa.

**SERVICE NOTES WANTED** — Want 1931-32-35-36-37-38-40-41-42 bound volumes of RCA service notes. Also G-E bound volume. The Radio Hospital, 420 N. Hudson, Oklahoma City 3, Okla.

**WANTED**—Rider's Manuals Nos. 9 to 12, incl. Also want all wave test oscillator. Gustave Mondrush, 600 Beechmont, Dearborn, Mich.

**FOR SALE**—Philco all wave signal generator model 070 almost new. Will take \$25. Frank P. Rose, Glasgow, Missouri.

**WILL PAY CASH** for an oscillator and a late model tube tester. Must be in A-1 condition. E. V. McCuffey, Box 917, Kilgore, Texas.

**WANTED** — C-D, BF-50 capacitor analyzer, or Jackson model 650A condenser tester; Supreme 592 dual-sensitivity tester or Radio City model 414 multimeter; Precision E-200 signal generator; Precision EV-10 V-T multi-range tester or Hickok Electronic A.C.-D.C. multi-tester model 202. Harland Fifield, 26 Weston St., Augusta, Me.

**WANTED**—Portable Recordio with xtal microphone, Marconi-Victor record wireless course. Have radio equipment and parts to swap or pay part in cash. H. E. Leigh, Sr., 801 Clintonia Ave., San Jose 10, Calif.

**WANTED**—A good condenser tester and Rider's Manuals, Vol. 6 and later. J. J. Sibley, Whittemore, Mich.

**COMMUNICATIONS RECEIVER WANTED** — Describe fully. Robert W. White, 747 E. Main St., Belleville, Ill.

**WANTED**—2 in. or 3 in. oscilloscope, and National one-ten receiver, also high quality 33-78 turntable and 16 in. transcription pickup. Can also use several small UHF transmitting tubes. Floyd Donbar, 112 Damon St., Flint, Mich.

**WILL SELL OR SWAP**—Modern AC short wave regenerative receiver; 5-852 tubes; 5-203A tubes; 1-801 tube; 1-4 in. Weston meter 0-15 volts AC; and one 4 in. Weston 0-500 mills. DC. Floyd Donbar, 112 Damon St., Flint, Mich.

**TUBES WANTED**—Want the following tubes: 50L6, 35L6, 35Z5, 12ST7, 12SQ7, 12SK7, 12A8, and 5Y3. Give quantity and details. Radio Hospital, 311 E. Florence Ave., Los Angeles, Calif.

**CHANNEL ANALYZER WANTED** — Superior preferred. Fred V. McDowell, Bolivar, Pa.

**EQUIPMENT WANTED**—Want a multimeter for AC and DC; also all-wave signal generator and a tube tester. A combination of multimeter and tube tester is acceptable. Frank Micriotti, 1006 Warden St., Baltimore, Md.

**ROTARY CONVERTER FOR SALE**—Electric Specialty Co. rotary converter, 115 DC to 110 AC, 60 cycles, 160 watts. Burcher's Elec. Store, 513 Main St., Honesdale, Pa.

**V.O.M. WANTED** — any make or model. Write, giving price and description. Michael J. Gulas, 1216 N. 17th St., Clarksburg, W. Va.

**CHANALYST FOR SALE**—Rider Chanalyst complete with inst. book and probes. A-1 condition. Highest offer takes it. L. F. Smith, 19 Palmer St., Passaic, N. J.

**ROTARY CONVERTER FOR SALE**—Jannette 32-volt input, 110-volt output, AC, 150 watts. Will take \$20 or \$25 for it, or trade on new RCA or Philco model PT-7 new radio. L. W. Middleton, Toston, Montana

## FREE SERVICE DATA: Making 18 "Victory Line" Capacitors do the Work of 473

Vital materials *must* be conserved for war uses—and this means that servicemen are now faced with the problem of making a "Victory Line" assortment of 18 Capacitors do the work of the approximately 473 replacement types and sizes previously supplied for this work. But servicemen will cooperate accordingly! They'll use 'em—and they'll make these 18 types fill the bill! What's more, they'll get all the help Sprague can give them in solving the headaches that are bound to arise. **WRITE TODAY** for your free copy of the Sprague "VICTORY LINE"

Folder. In addition to listing the 9 Atom Electrolytics and the 9 TC Tubulars now available under wartime restrictions, this contains helpful data for those applications where some real "juggling" must be involved to make replacements properly. It tells you, for instance, how to replace 600 volt Capacitors with available 450 volt types; how to use dries on wet electrolytic jobs, and much more.

It's a folder that will prove invaluable in your daily work and we want to make sure every serviceman has a copy. **DON'T MISS IT!**



SPRAGUE PRODUCTS CO.  
North Adams, Mass.

# SPRAGUE CONDENSERS AND KOOLOHM RESISTORS

Obviously, Sprague cannot assume any responsibility, or guarantee goods, services, etc. which might be exchanged through the above advertisements.

is the weaker of the two then 190 degrees is the correct direction.

There are several methods employed to give direct readings of the corrected bearings in which the error is already compensated for by mechanical means, the most common types employing a roller and cam arrangement, usually a flat disk has the curve plotted around its circumference and the cam cut out as per the resultant curve which is somewhat elliptical in shape. This, of course, must be calibrated in the usual manner and then the necessary curve drawn and the disk cut as required. As there are many variations of these compensation systems, details of types of course, vary greatly with the different manufacturing concerns.

-30-

## Saga of Vacuum Tube

(Continued from page 27)

type Audion which the author has been able to find appeared in the October, 1908 issue of "Modern Electrics."<sup>141</sup> This article was written by John V. L. Hogan, Jr., one of de Forest's early assistants, and now a consulting engineer. In this article the statement was made that there were at that time six distinct varieties of Audion. These were: (1) the flame Audion, (2) the arc Audion, (3) the two-element U-wing type, (4) the external electrostatic control type, (5) the external magnetic control type, and (6) the grid type. In this article the grid type Au-

dion is described in the following:

*"The grid audion is usually a 6-volt, low candlepower incandescent lamp with a tantalum filament having a small platinum plate (approximately 10 x 15 millimeters) fastened approximately 3 millimeters from the filament and a grid bent from rather large (say number 22) platinum wire placed nearly midway between the two."*

Despite the fact that the title of the patent on the first three-electrode Audion was "Device for Amplifying Feeble Electrical Currents," the three-element Audion was for many years used only for detection. De Forest and his associates are said to have attempted even at that time to use the grid Audion to obtain audio-frequency amplification, but were unsuccessful. It is probable that attempts to so utilize it were failures because of insufficient knowledge of the characteristics of the device, and the use of high frequency type coupling in an attempt to obtain audio-frequency amplification. Of course, it is probably true that the grid type Audion operated as the sensitive detector that it was, by virtue of its inherent amplifying properties, but it was not used as such by de Forest or by anyone else in the United States as an amplifier *per se* until 1912, about five years after its development.

Many reasons have been advanced to account for the fact that the Audion, throughout the first years of its existence was employed in radio telegraphy only to a limited extent. "Wireless" as a commercial utility suffered damaging setbacks in that period because of sundry stock-jobbing schemes<sup>142</sup> based on earning claims many years in advance of what was likely to be possible. Other reasons sometimes given are: that the majority of users of wireless receivers were boys working as amateur experimenters, to whom the high cost of Audions, previously noted, acted as a deterrent to their use; that the Audion was erratic and little more sensitive than the best of the crystal detectors, which were quite inexpensive devices; and that patent litigation or the threat thereof prevented its use by those who operated ship and shore stations in marine service.

De Forest, following the events of 1912-14, was subjected to no little criticism for having nursed the Audion through infancy and adolescence without discovering the full potentialities of the device. In considering the justification for such criticism the following should be borne in mind. During this period the Audion came into some attention on the part of scientists, engineers, and the more serious wireless experimenters. These men also failed to realize the possibilities inherent in this Aladdin's lamp.

Such a hiatus is not unusual in the development of a new device or system. It will be recalled that a period of seven years elapsed between the announcement by Hertz in 1888 and the achievements of Marconi in 1895.

**WHEN THE LIGHTS COME ON AGAIN**

# AUDIOGRAPH

THE FIRST NAME IN SOUND

When our thoughts turn to praise for blessings instead of prayers for Victory, Audiograph will find its place, as a gratifying acoustical aid. Audiograph is one of our Family of Activities in the field of electronics—a field destined for service to man.

**JOHN MECK INDUSTRIES**  
PLYMOUTH, INDIANA

EXCELLENCE IN SOUND AND LIGHT RECORDING INSTRUMENTS

# RONAME



Precision Units  
and Controls  
for Radio and  
Communication  
Equipment

— 3 Plants Over Five Acres Of Manufacturing Space —

**CROWE NAME PLATE & MFG. CO.**

3701 RAVENSWOOD AVE.

CHICAGO, 13 ILLINOIS

From 1906 to 1912 the de Forest companies were involved in financial difficulties, and de Forest took a job with the Federal Telegraph Company on the Pacific Coast. There he found the Federal Company using continuous wave arc type transmitters, and attempting to transmit telegraphy at high speed. This development brought with it the problem of getting energy enough to make a record of the high speed signals, for later reproduction and transcription at lower speeds. They were attempting to use the Poulsen telegraph as a recorder, but the energy of the received signals was insufficient to record satisfactorily. Realizing that what was needed was a device to

“boost” the energy of the received signal, deForest took up the Audion anew and attempted to get it to amplify. The problem was one of obtaining amplification at audio frequencies.

In the spring of 1912, de Forest obtained an assistant, H. B. Van Etten. Van Etten was familiar with audio frequency circuits and apparatus, having previously worked for the telephone company in New York. In May and June of 1912, Van Etten, under de Forest's supervision, started experimenting with audio frequency transformers with which to better interconnect a radio detector with receiving head phones.

In July and August, 1912, they suc-

ceeded in getting real amplification out of a “double Audion.” Later, while still trying to improve the arrangement as an amplifier, they got a howling feedback circuit, and thus was born the Audion oscillator.

De Forest then got in touch with his friend John Stone Stone, also a former telephone company employee, and through him arranged to demonstrate the Audion for use as a telephone repeater. The results of this demonstration, and the process by which the Audion was developed into a practical telephone repeater, will be discussed in a later article. For the present it is sufficient to say that the rights to the Audion for use as a telephone repeater were purchased by the American Telephone and Telegraph Company.

With this transaction the Audion passed out of the realm of the individual inventor into that of the industrial research laboratory. Though de Forest did not know it at the time this was to be the final touch to the years of tribulation he had suffered with his brain-child. He thought his feet were firmly planted on the threshold of success when he saw his child being trained to serve a new master. But when the new master succeeded in developing the child, and had groomed him to perform a specific task, de Forest's paternity was overshadowed by the new developments.

Did de Forest drop his own work on the Audion? Not for long!

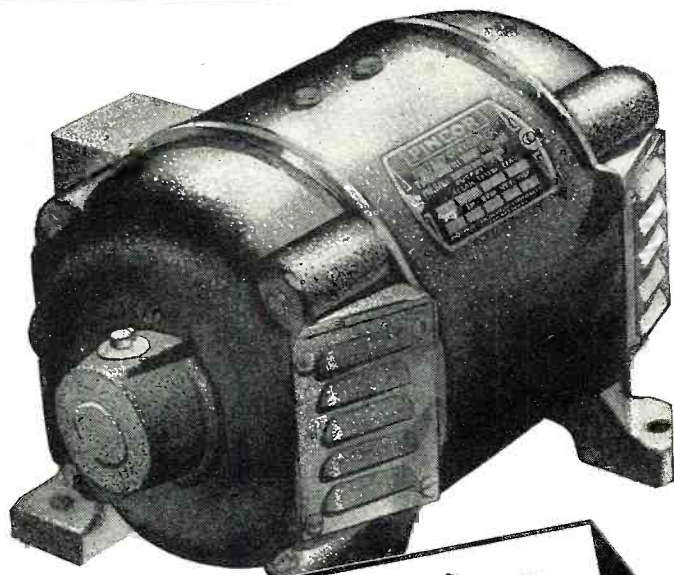

**Keep 'Em Running FOR THE DURATION!**

It is difficult to secure new Generating Sets or new Rotary Converters . . . Pioneer is devoting all of its resources toward winning the war . . . but we can, and will, help you keep your present equipment running for the duration.

Send your service problems, by letter, to Pioneer's Customer Service Department.

**PINCOR Products**

PIONEER GEN-E-MOTOR

CHICAGO, ILL. • EXPORT ADDRESS: 25 WARREN ST., NEW YORK CITY  
CABLE ADDRESS: SIMONTRICE, NEW YORK

DYNAMOTORS • CONVERTERS • GENERATORS • DC MOTORS • POWER PLANTS • GEN-E-MOTORS

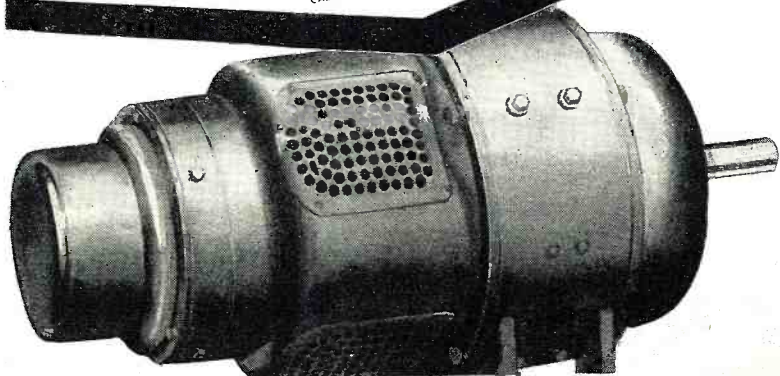

### Figure Captions

Figure 44. First type of “Double Audion.” This specimen has tantalum filament. Photograph courtesy Radio Corporation of America.

Figure 45. Double Audion with separate leads from each plate and grid. Photograph courtesy Bell Telephone Laboratories.

Figure 46. Double Audion with Hudson type filament. The tantalum wire wrapping can be seen on the top arc of the filament.

Figure 47. Reproduction of the first advertisement offering the Audion for sale to the radio amateur. Reproduced from *Modern Electrics* of September, 1909.

Figure 48. Advertisement showing RJ4 and RJ5 Detectors, and giving prices on various grades and types of Audion bulbs. Reproduced from *Modern Mechanics* of February, 1915.

### References

140. de Forest, Lee: “The History of the Radio Tube, 1900-1916.” *RADIO NEWS*, Vol. 24, No. 6, December 1940, p. 8.

141. Hogan, John V. L., Jr.: “The Audion: A Third Form of the Gas Detector.” *Modern Electrics*, Vol. 1, No. 7, October 1908, pp. 232-233. The diagram given in this article is incorrect, but a correction appears on p. 275 of the November 1908 issue.

142. Fayant, Frank: “The Wireless Telegraph Bubble.” *Success Magazine*, New York, Vol. 10, No. 158, July 1907, pp. 387-389, 450, 451. Vol. 10, No. 153, July 1907, pp. 481-483, 508, 509.

(To be continued)





# Give Scrap Wisely

## for War Production

**G**ive your scrap metal to help make guns, tanks and planes. Or sell it . . . don't hold old material when it can aid the War effort.

Give—but give wisely. Salvage usable parts—nuts, lock washers, screws, solder lugs, etc. Parts like these are fabricated by automatic screw machines and punch presses and their output is needed for essential War production. Don't discard parts which must be repurchased in the near future.

Your good common sense will tell you what to scrap and what to save. But act now! Don't hold on to an old receiver simply because it has some parts that you may use some day. Salvage the parts which may be used for replacements—and give the rest for scrap.

That will be three-way help for the War effort—salvaging usable parts to “keep 'em listening”, relieving busy machines, and providing scrap to keep War production in high.

*Do your part! Get busy today.*

**P. R. MALLORY & CO., Inc.  
INDIANAPOLIS • INDIANA**

**P. R. MALLORY & CO. Inc.**  
**MALLORY**



**Approved Precision Products**

**CABINETS** **CHASSIS**  
**PANELS** **RACKS**

*Skill in Metal*

Serving the Electronics Field Exclusively

Write for Catalogue No. 41-A

Though manufactured by modern high-speed methods, Par-Metal products have a definite quality of craftsmanship - that "hand-made" quality which is born of years of specialization.

**PAR-METAL PRODUCTS CORPORATION**  
32-62—49th STREET . . . LONG ISLAND CITY, N. Y.  
Export Dept. 100 Varick St., N. Y. C.

**THICKSKINNED BATTLESHIPS HAVE NERVES!**

Beneath their many inches of armor-plate, Uncle Sam's battlegroups are as finely co-ordinated as champion boxers... instantly responsive to commands. A network of nerves... the lines of electric communication... runs through the ship. The command, "Battle Stations!" is electric... literally.

To keep these nerves alive with energy is one of the war jobs now being done by Stancor Transformers. When peace is won, American industry will enter a new age of electronics... the transformation of electric power to build and serve a happier world. Stancor engineers are preparing, by foresighted research, to serve the needs of peace after victory.

**STANCOR**

STANDARD TRANSFORMER CORPORATION • 1500 N. HALSTED ST. • CHICAGO



### Meter Substitutes

(Continued from page 39)

may be fitted for a.c. and r.f. measurements by providing diode rectifiers for use ahead of their input terminals. The two types of magic-eye circuits recommended for general use are shown in Figures 3 and 5.

In Figure 3, an unknown d.c. voltage is applied to the two input terminals and the potentiometer  $R_1$ , adjusted to close the eye-shadow angle down to some reference value. A given reference angle always indicates the same value of negative voltage at the grid of the magic-eye tube, so the setting of  $R_1$  will be proportional to the applied voltage.  $R_1$  may thus be provided with a dial graduated directly in volts, as recommended for the neon-bulb meters. Measuring voltages will then consist of applying the unknown value to the terminals,

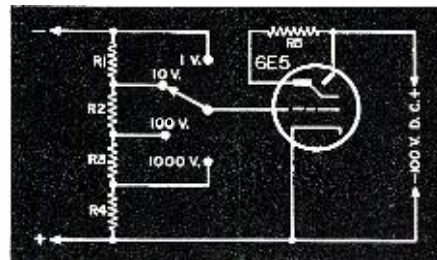

Fig. 5. Standard voltage-divider input circuit.

- $R_1$ —900,000 ohms 1 watt (0.5 and 0.4 meg. in series)—Aerovox
- $R_2$ —90,000 ohms 1 watt (50,000 and 40,000 in series)—Aerovox
- $R_3$ —9000 ohms 1 watt—Aerovox
- $R_4$ —1000 ohms 1 watt—Aerovox
- $R_5$ —0.5 megohm 1/2 watt—Aerovox

setting  $R_1$  to close the shadow down to the reference angle, and reading the voltage value from the  $R_1$  dial.

In most magic-eye arrangements, the reference angle is taken as zero degrees; i.e., the circuit is adjusted to close the eye completely. However, the point of exact closure is not clearly defined in most of these tubes, a portion of the shadow closing before other parts, and little agreement exists with regard to what is meant by *exact* closure. It seems better, therefore, to employ some reference angle intermediate between the open and closed conditions. Any point is satisfactory, and it may be indicated by a line drawn or inscribed on clear celluloid and mounted rigidly in front of the tube, as shown in Figure 4-B. Thus, only one side of the shadow need be monitored, and the Potentiometer may easily be adjusted until the edge of the shadow coincides with the reference line.

The circuit (Figure 3) embraces a 6E5 indicator and 6H6 rectifier. The eye-tube anode voltage is 100 volts d.c. It is not recommended that this instrument be a.c.-d.c. powered, since the low input terminal will be "hot." Instead, a 1:1 ratio isolating transformer,  $T$ , is employed for safety, and heater voltage for the two tube heaters

**"HOGARTH'S ECHOPHONE EC-1  
SURE SOOTHES THE SAVAGE BREAST"**



***Echophone Model EC-1***

(Illustrated) a compact communications receiver with every necessary feature for good reception. Covers from 550 kc. to 30 mc. on three bands. Electrical bandspread on all bands. Six tubes. Self-contained speaker. 115-125 volts AC or DC.



**ECHOPHONE RADIO CO., 201 EAST 26th ST., CHICAGO, ILLINOIS**

in series may be obtained from the secondary through the dropping resistor,  $R_4$ . If a 1:1 transformer is not obtainable, the reader may employ two small filament transformers connected back-to-back, as shown in Figure 4A, and the latter arrangement will probably require less chassis space as well. The power supply filter consists of the 1000-ohm resistor,  $R_3$ , and the dual 16- $\mu$ fd. electrolytic capacitor C-C.

The voltage-indicating potentiometer,  $R_1$ , may be either 0.25, 0.5, 1, or 2 megohms, depending upon the voltage range which is to be covered and the order of input resistance desired for the meter. The lowest measurable voltage will depend upon which shadow angle is chosen for reference. The closer this angle is to the open-eye

state, the lower will be this minimum measurable voltage.

The second type of magic-eye v. t. voltmeter is shown in Figure 5. This type requires no potentiometer adjustment for voltage measurements, but utilizes the shadow angle directly as the indicating element. The deflection of one edge of the shadow may thus be referred directly to a voltage scale marked off on transparent celluloid and mounted in front of the eye. Such a scale is shown in Figure 7 and is based upon the values of negative grid voltage which will produce corresponding shadow deflections.

By preparing the scale for deflections between 45 and 25 degrees (total shadow angles between 90 and 50 degrees), the voltage range 0-1 is ob-

tained and this foundation value may be multiplied to 10, 100, and 1000 volts by the input multiplier  $R_1$ -to- $R_4$ .

It is urged that the reader prepare his own voltage scale by applying various d.c. voltage values between 0 and 1 to the grid of the 6E5, noting the shadow angles and marking lines on the transparent viewing screen corresponding to these deflections. The longer the reference lines of the viewing scale, the greater will be the accuracy of reading. After the scale is installed, the eye tube may be rotated until one edge of its wide-open angle coincides with scale zero.

In every other respect, the second circuit does not differ from that of Figure 3, power supply components and hookup remaining the same.

Both of the magic-eye voltmeters may be adapted for a.c. and r.f. measurements by means of the diode-rectifier measuring head illustrated in Figure 6. The tube used may be any small diode, such as 1A3, 6H6, etc., or it may

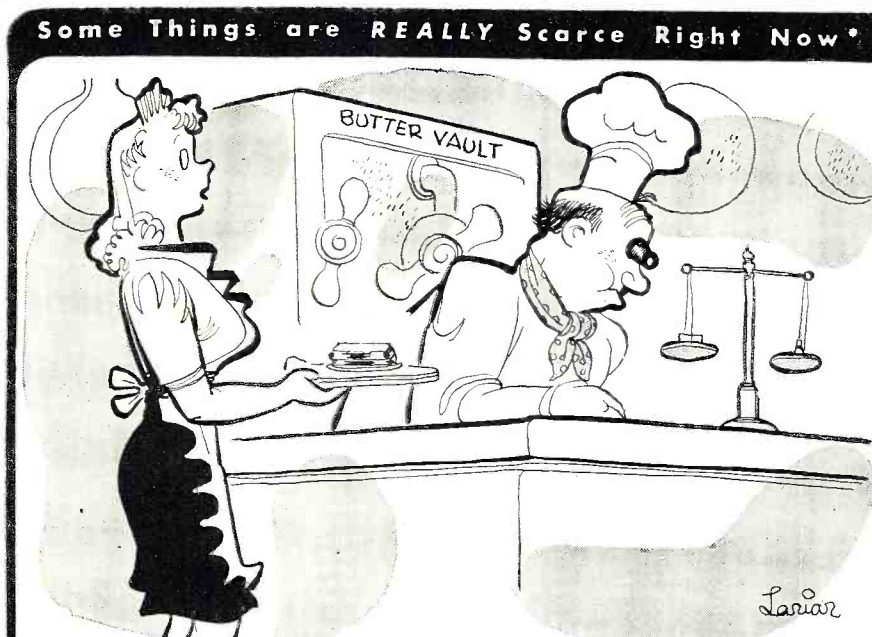

*(Especially Radio Servicemen's Time)*

**T**HERE are no substitutes for some things that are scarce today. There are no "ersatz" servicemen to take the places of those called to the colors.

But, there are just as many, and more, sets needing repair. And you, brother 3A or 4F, have to see that they're repaired.

Today it's your patriotic duty to ration your time; use it so you get the utmost production out of each unit of labor.

Use your testing instruments—employ the latest servicing techniques—and reach for one of your thirteen RIDER MANUALS before you begin each job. These volumes lead you quickly to the cause of failure; provide the facts that speed repairs.

It isn't practical or patriotic to waste time playing around, guessing-out defects. Today you must work with system and certainty. RIDER MANUALS provide you with both.

#### RIDER MANUALS

Volumes XIII to VII.....\$11.00 each  
 Volumes VI to III..... 8.25 each  
 Volumes I to V, Abridged.....\$12.50  
 Automatic Record Changers and Recorders 6.00

#### OTHER RIDER BOOKS YOU NEED

The Cathode Ray Tube at Work  
 Accepted authority on subject.....\$3.00  
 Frequency Modulation  
 Gives principles of FM radio..... 1.50  
 Servicing by Signal Tracing  
 Basic method of radio servicing..... 3.00  
 The Meter at Work  
 An elementary text on meters..... 1.50  
 The Oscillator at Work  
 How to use, test and repair..... 2.00  
 Vacuum Tube Voltmeters  
 Both theory and practice..... 2.00  
 Automatic Frequency Control Systems  
 —also automatic tuning systems..... 1.25  
 A-C Calculation Charts  
 Two to five times as fast as slide rule.  
 More fool-proof. 160 pp. 2 colors..... 7.50  
 Hour-A-Day-With-Rider Series—  
 —On "Alternating Currents in Radio Receivers"  
 —On "Resonance & Alignment"—On "Auto-  
 matic Volume Control"—On "D-C Voltage  
 Distribution"..... 90c each

#### JOHN F. RIDER PUBLISHER, INC.

404 Fourth Avenue • New York City

Export Division:  
 Roeko-International Electric Corp.  
 100 Varick Street, New York City  
 Cable: ARLAB

**RIDER MANUALS**  
**SPEED REPAIRS — AND VICTORY**

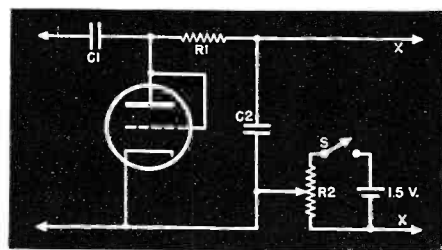

**Fig. 6. Diode-rectifier measuring head.**

$C_1, C_2$ —0.02  $\mu$ fd. mica (two 0.01's in parallel)  
*Aerovox*  
 $R_1$ —1000 ohms 1 watt—*Aerovox*  
 $R_2$ —1000 ohm p.w. pot.—*IRC Type CS*  
 $S$ —S.p.s.t. on-off toggle switch—*Arrow*

be any small triode with grid and plate tied together. The small dry cell and 1000-ohm potentiometer are for bucking out the contact potential due to electron action within the diode.

In operation, the measuring head is connected to the magic-eye voltmeter through terminals X-X. A deflection of the shadow will be noted. The 1000-ohm potentiometer is then adjusted to open the eye fully once more, establishing meter zero. Unknown a.c. or r.f. voltages may then be applied to the measuring-head input terminals. The voltage reading will be equal approximately to the peak value of the a.c. or r.f. above 10 volts and somewhat less than the peak value at lower voltages. A special calibration will be necessary for the lower voltages.

The magic-eye v. t. voltmeters, without the a.c. measuring head, may be employed as d.c. ammeters, microammeters, or milliammeters and as ohmmeters. The unknown current is caused to flow through a non-inductive resistor of known value and the voltage drop across this resistor is measured with the eye voltmeter. The current value may be calibrated, or the meter scale may be calibrated in current units obtained from the relation:  $i = E/R$ ; where  $i$  is the current in amperes,  $E$  the indicated voltage, and  $R$  the resistance (ohms) of the standard resistor. For measurements of

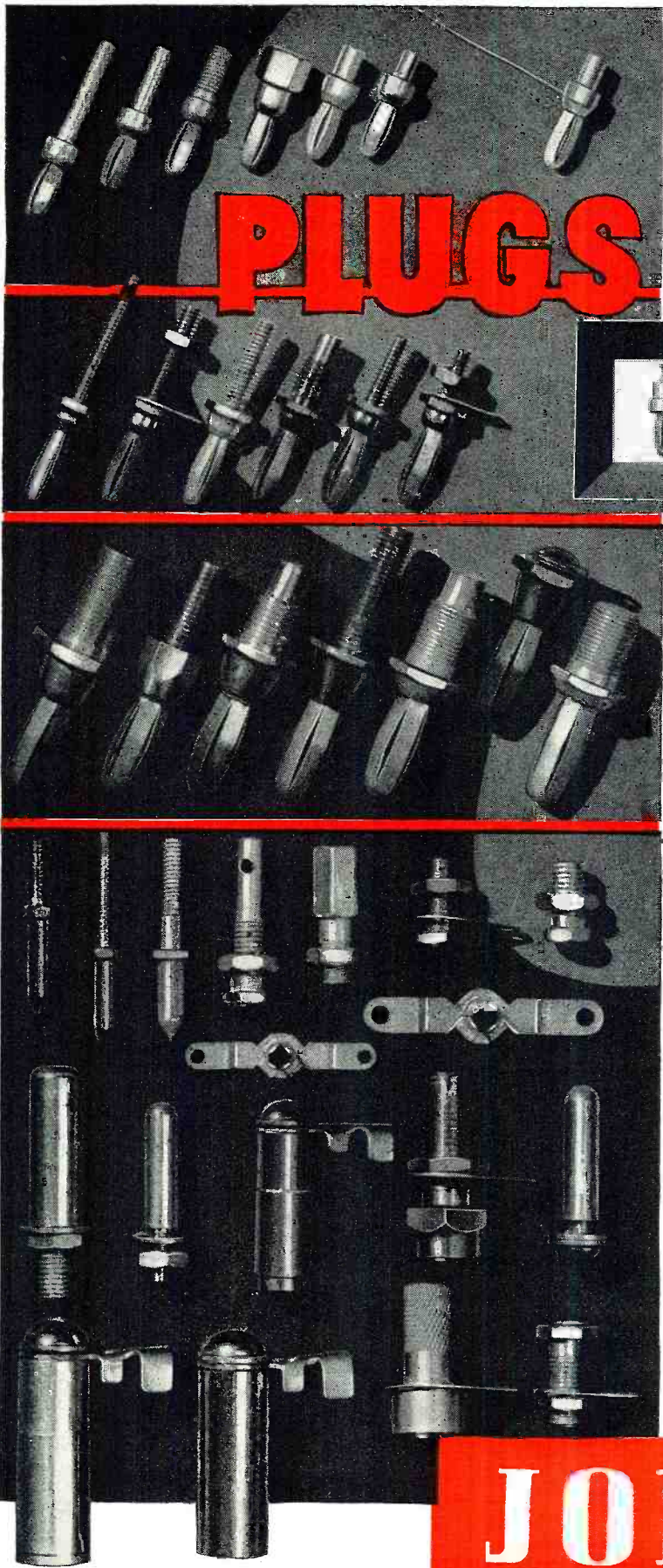

# PLUGS

*are Vital*



Where connections must be made and broken quickly and where these connections occur thousands of times in the life of the apparatus, only plugs are practical. In most cases, proper functioning of the apparatus demands a perfect connection, combining qualities of low resistance, mechanical stability and long life.

Now, the lives of our fighting men depend on such small things as plugs. There can be no compromise in engineering design, in the quality of materials, in the honesty of manufacture. A few cents per thousand in the cost of plugs can cost the lives of hundreds of men in Europe or the Pacific.

Let Johnson, one of the pioneers in the manufacture of plugs and jacks, suggest a plug and jack combination for YOUR requirements in YOUR apparatus. Johnson has production capacity and a type for every requirement. Samples are available. Inquire today.

*Free on Request*  
CATALOG 967Z



# JOHNSON

*a famous name in Radio*

E. F. JOHNSON COMPANY . WASECA . MINNESOTA

October, 1943

# ACCURATE

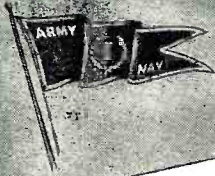

Accuracy and dependability are built into every Bliley Crystal Unit. Specify BLILEY for assured performance.  
BLILEY ELECTRIC COMPANY  
ERIE, PENNSYLVANIA

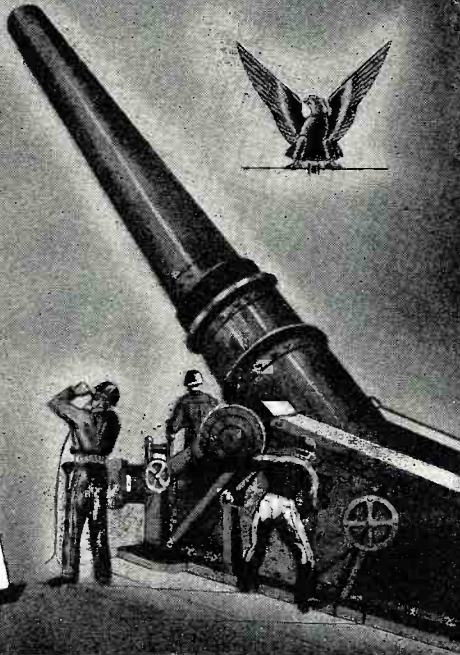

## Bliley Crystals



Specialists  
in all Types

**RADIO  
WIRE and  
CABLE**

with  
"Plastite" Insulation



**WHITNEY BLAKE CO.**  
NEW HAVEN, CONN.

Distributed by Graybar

## CABINETS and RADIO PARTS

LAKE can still supply you with combination, console and table model cabinets, in styles and finishes to suit your requirements.

Our large stock of output and power transformers, capacitors, resistors, volume-controls, by-pass condensers, toggle and slide switches, ballast tubes, speakers and other radio components is now listed in our new Bargain Bulletin. Write for your free copy. Order all the parts you need from one source  
.....LAKE!

### 14" SPEAKERS

14" electro-dynamic speakers. 900 ohm field, 6-8 ohm voice coil. 6V6 push-pull transformer. 15 watt output. **\$4.49**  
Special, only.....

### Still Available!!!

3" to 12" Dynamic Speakers  
(Any desired field)  
3" to 6" P.M. Speakers

New Bargain Bulletin lists Money Saving Values in Radio Parts. Send for it TODAY!

**LA E RADIO SALES CO.**  
615 W. Randolph St. Chicago

small current values, such as microamperes and milliamperes, the standard shunt resistor should have a value

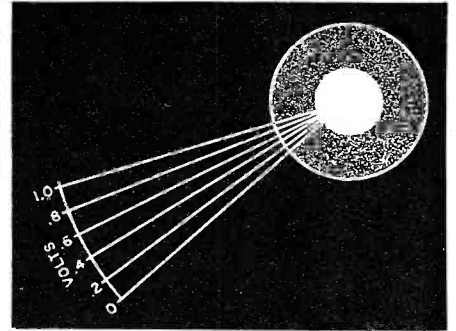

Fig. 7. Dial scale calibration.

of one ohm, in order that the amount of resistance introduced into the circuit might be kept small.

A standard microammeter may thus be constructed by providing the d.c. eye voltmeter with a standard shunt. This instrument may then be employed as an ohmmeter in the usual fashion.

-50-

## Radio Avigation

(Continued from page 21)

dead reckoning. A bearing under the influence of the coast line is refracted by the coast as it passes over. Bearings taken on the aircraft will indicate it further out from the coast than it actually is. Conversely, bearings taken by the plane on ground stations will indicate the plane closer to the coast than its true position. Coast line effect is done away with by taking bearings when the plane is more than 30° from the coast. A bearing taken over land is not influenced by this error, which is maximum when the plane is directly over the coast. (Fig. 1.)

The man-made error is generally allowed for with a deviation curve for the DF or by internal compensation in the direction finder. In either case the amount of error is obtained by swinging the aircraft, much in the same manner as a compass is swung. A signal source is lined up in different positions on the compass rose, perhaps every 10°, using a pelorus or other accurate angle measuring instrument. Deviation from the true measurement as indicated by the difference between the bearing on the loop and the actual angle sighted, is plotted and compensated for by whatever system the particular loop is adapted to. Correction for deviation permits compensation for the many errors, large and small, introduced by countless items aboard the plane. A common practice to reduce electrical failure in DF equipment which would make the apparatus inoperative for any length of time is to supply the radio officer with spare parts of essential items known to be habitual offenders, or which might even have a tendency to give trouble. In all too many cases, particularly involving inexperienced men who have not received sufficient training, equip-

**TOMORROW'S RADIO**

**TODAY**

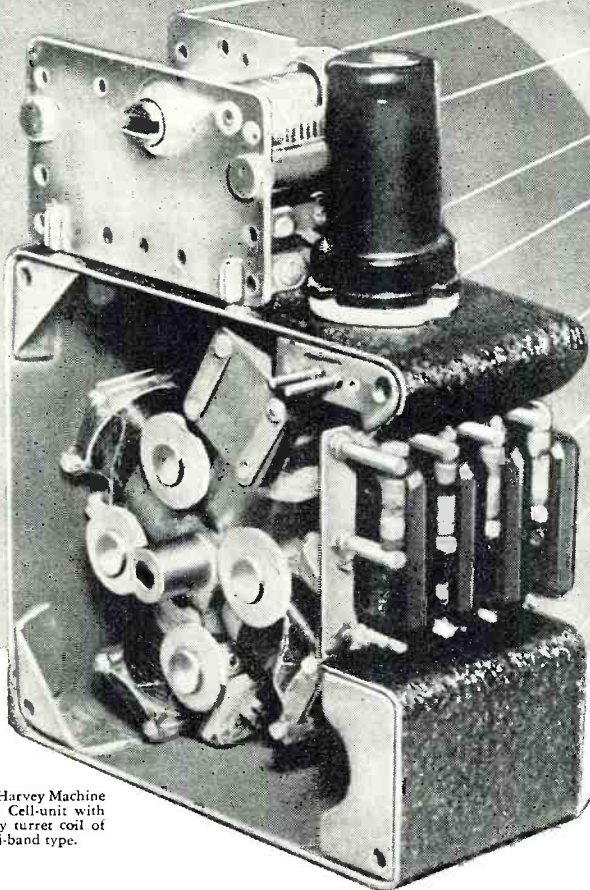

The Harvey Machine  
R. F. Cell-unit with  
rotary turret coil of  
4-band type.

**1 TUBE TYPE, 3 BASIC  
CELL UNITS, 75% LESS  
HOOK-UP WIRE**

**HARVEY "UNITIZED" RECEIVERS**

**Streamlined Production** through use of standardized cell-units requiring only one tube-type, one capacitance of tuning condenser, a minimum of resistor types, and only two values of by-pass condensers.

**Streamlined Assembly** with standardized R. F., I. F. and Audio cells, which are basic for all electronic assemblies — assembled to provide selectivity, sensitivity, and frequency bands to meet customer requirements.

**Streamlined Servicing.** In event of damage to a cell-unit, replacement is as simple as tube changing — for quick repair. No solder, special tools, or circuit diagrams needed.

**Other Divisions**

Aircraft • Ordnance • Special Machinery

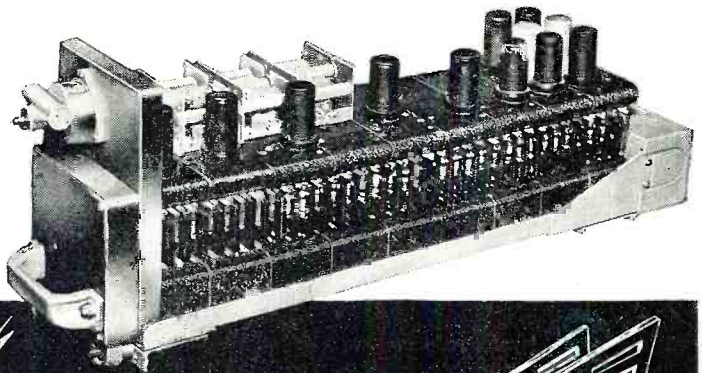

*Electronics Division*

**HARVEY**

**MACHINE CO., INC.** • 6200 Avalon Blvd., Los Angeles, California

for over a quarter century geared for flying production

★  
MASS PRODUCTION

★  
CUSTOM-BUILT  
PERFORMANCE



# Masterpieces IN QUARTZ



Precision made, utilizing automatic, electronic testing and control, these tough little DX Xtals can take the hard knocks at  $-30^{\circ}$  or  $130^{\circ}$  F. Ample production facilities now available for large lots or individual crystal orders.

**BUY AN EXTRA BOND, TODAY!**

## DX CRYSTAL CO.

GENERAL OFFICES: 1841 W. CARROLL AVE., CHICAGO, ILL., U.S.A.



ment is incapacitated because of blown fuses or similar simple items. The flight radio officer's training becomes invaluable when equipment trouble develops because in the complicated gear now in general operation, technical difficulties may be confused with things like natural phenomena. An illustration of this might be sluggishness in an ADF actually caused by a poor tube and inadvertently laid to night effect. A mistake like this might render the DF useless for many hours until the true source of trouble became obvious. The experienced aviator-radio officer by a combination of "know-how" and easily made tests would not be misguided by confusing symptoms.

With a thorough knowledge of loop error, taking good bearings is tremendously simplified. The procedure, despite its several steps, with practice becomes as automatic as writing one's own name. A signal source at a known location is tuned in and a relative bearing obtained. Loop deviation is applied, the reading becoming the CORRECTED RELATIVE BEARING. At the same instant the bearing is taken, or as soon thereafter as possible, the compass reading is obtained. With few exceptions a deviation curve will be found for each compass aboard the plane. This error must be applied to the reading and the subsequent resultant will be the CORRECTED COMPASS HEADING. The corrected loop reading and corrected compass readings are added, the sum of which is equal to the aircraft's MAGNETIC HEADING (QDM). If this sum is greater than  $360^{\circ}$ , the number must be reduced by subtracting  $360^{\circ}$ . The magnetic heading is reduced to the TRUE BEARING (QTE), which is the actual bearing we desire, by subtracting the magnetic variation. This figure, while it is actually the true bearing, is of no value in its present form. In order to plot it on the chart, the reciprocal must be taken . . . that is from the QTE subtract or add  $180^{\circ}$ , whichever quantity is applicable to the sum. Before illustrating the entire process a number of points should be amplified.

Magnetic variation can only be calculated by dead reckoning the approximate position of the aircraft and determining the numerical value of the variation from the chart. If, after the bearings are plotted, it is seen that the actual position is in considerable error from that obtained by dead reckoning, the variation may be re-applied and the position re-plotted. The rule for applying variation is that EASTERLY variation is ADDED; WESTERLY variation SUBTRACTED. The necessity for applying variation is plainly seen by the fact it may run over  $20^{\circ}$ .

The step to obtain the reciprocal of the true bearing for plotting is essential since to plot from the true bearing the position of the plane must be known and this is the information we desire to end up with. It is of marked concern that this manipulation should not be confused with taking what is



## BEFORE DURING AFTER

BEFORE the war SNYDER products satisfied the nation's peacetime Antennae requirements for more than a decade.

DURING these war years, use has demonstrated the correctness of design and operation of their products. Their record of accurate and dependable performance is the basis of their war-wide acceptance.

AFTER the war is won post-war plans include SNYDER's continued leadership in the field.

ANTENNAE & ASSOCIATED PRODUCTS



## PILOT Light..

WHEN  
and AS  
—you want it

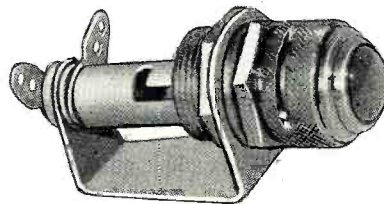

Complete graduation of light—from bright through intermediate glows to total dark within  $90^{\circ}$  rotation of the shutter is a feature of this Gothard Series 430 Shutter Type Pilot Light. Particularly applicable for aircraft, marine, signal and similar applications that require various intensities of light under constantly changing conditions. Sturdy construction — rigid non-short terminals — faceted or plain jewels. Also available with polarized lens. Colors: red, green, amber, blue or opal. Ask for complete information and prices.

**Gothard** . . .  
MANUFACTURING COMPANY  
1350 N. NINTH STREET, SPRINGFIELD, ILLINOIS



Said the War Correspondent to the Folks Back Home:

**"Tanks storm rail center  
—smash counterattack"**

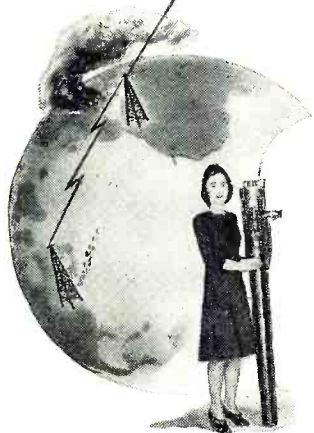

*Whether for beaming a headline across the world or bringing it into your home, Federal is a leading manufacturer of radio transmitting and receiving tubes, including the giant tubes used by Mackay Radio in its world-wide Communications Service*

In your morning paper  
It's only an arrow  
Creeping toward a dot on the map . . .

But out there  
Where the angry earth  
Convulses under your feet  
From the thundering steamroller charge  
It's hell on wheels  
As the tanks attack at dawn

And close on their clawing heels  
Spattered with the same mud and lead  
As the mopping-up forces  
Comes the soldier with the typewriter . . .  
The war correspondent

When you read his eye-witness account  
Of how this town was taken  
Read between the lines  
And give a thought  
To the man under the helmet

Whose only command is . . .  
*Get the story!*

\* \* \*  
Helping him get the story *through*  
Relaying it from field radio  
To command outpost  
To towering Mackay Radio  
Trans-Atlantic radio telegraph station  
Is the voice and ear of electronics  
*The vacuum tube . . .*  
Giving wings to his words  
Just as it helps plane and tank  
*"Work together better  
Because they can talk together"*

\* \* \*  
Here at I. T. & T.'s manufacturing associate  
Federal Telephone and Radio Corporation  
Where a great many of these tubes are made  
Our hats are off  
To the men who use them  
To speed victory . . .  
Some day they'll help men  
Build a better world

**IT&T**

**INTERNATIONAL TELEPHONE AND TELEGRAPH CORPORATION** 67 Broad St., New York 4, N. Y.

*Manufacturing Associate:*

FEDERAL TELEPHONE AND RADIO CORPORATION

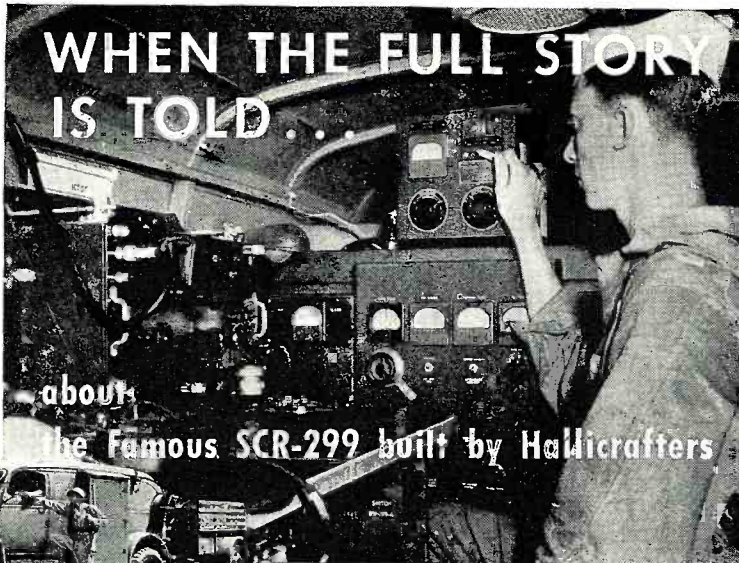

Since  
1924

MERIT will take justifiable pride in its manufacture of precision parts for this miracle mobile unit which has contributed so much to the victories of our armed forces, and gives but a glimpse now of the limitless post-war future.



Now manufacturing for every branch of the Armed Services, enlarged facilities enable us to offer prompt shipment on priority orders.  
Transformers—Coils—Reactors—Electrical Windings of All Types for the Radio Trade & other Electronic Applications.

**MERIT COIL & TRANSFORMER CORP.**  
311 North Desplaines St. CHICAGO 6, U.S.A.

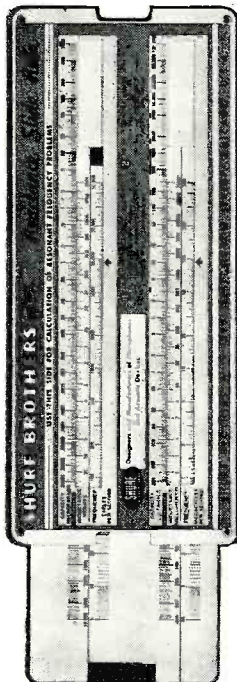

have you  
sent for  
your SHURE  
REACTANCE  
SLIDE RULE?

Thousands of engineers and technicians find the Shure Reactance Slide Rule helpful in radio computations. Simplifies problems in resonant frequencies, circuits, inductances, condensers. Range 5 cycles per sec. to 10,000 megacycles. Complete with instructions. Send 10c in coin to cover handling.

**SHURE BROTHERS**  
225 W. Huron St., Chicago  
Dept. 174X

Designers and Manufacturers of Microphones and Acoustic Devices.



## RADIO CHASSIS New 1942 Model

8 Tubes

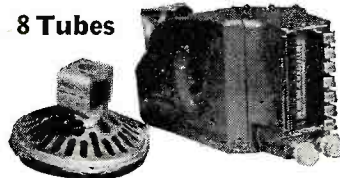

Powerful standard superheterodyne radio. American broadcast band; electric push-button tuning; 3 position color-illuminated tone control. Custom built, ideal for the following purposes:

**AUTO RADIO**—Custom built for 1941 or 1942 Plymouth, Dodge, DeSoto or Chrysler cars.

No. 381 List price \$54.85. **\$36.95**  
Net.....

**FARM RADIO**—Operates on any 6 volt battery.

No. 381 List price \$54.95. **\$36.95**  
Net.....

**HOME RADIO ASSEMBLY**—Above unit complete with special power transformer and 14-inch speaker. These units are not converted. WPB authorization is required.  
No. 383 List price \$75.00. **\$46.95**  
Net.....

### SPECIALS

1942 speakers, 14" 800 ohm field, 6-8 ohm voice coil, 15 watts output. List price, \$13.20.

No. 14D Single units.....Each, **\$4.95**

Lots of four.....Each, **\$4.00**

De Luxe record cutting arm No. BR27.....**\$9.95**

Philophone intercommunicating system complete with 3 remote stations. Net, **\$44.95**

Write For Special Bulletin Today

**MUTUAL RADIO PRODUCTS CO.**  
2926 Shakespeare Ave. Chicago 47, Illinois

known as a reciprocal bearing in the initial step, when the relative bearing is observed. If the relative bearing turns out to be a reciprocal it is absolutely incorrect to subtract 180° and compute it in the normal manner. The bearing must be discarded and re-taken! A reciprocal bearing will evidence itself in plotting if it is only a careless mistake, but if the plane is lost or it is not actually known in which direction the station lies, by a simple process to be discussed shortly as an orientation problem this information may be secured.

Finally, it is a good policy to observe caution in taking the compass reading. In rough weather with the aircraft pitching and yawing inaccuracies are apt to appear in the compass due to lag and swinging. In any kind of turbulence the compass should be read by a second person who can average a series of readings for at least 30 seconds before and after the DF observation. If the pilot is informed that bearings are being taken he can make a special effort to steady the plane and considerably reduce error in both loop and DF readings.

The actual setting up of a bearing is usually done on some sort of a form. It is customary to allow space for unusually wide splits, making it unnecessary for the aviator to keep the figures in his head. This diminishes the chance for error, as does the keeping of an orderly form. The aviator is able to confirm figures which may become confused through a miscalculation not evident until the impossibility of the bearing is seen on the chart. A typical composition is shown in Figure 2.

In the sample form the first bearing is a single track bearing used to determine if the aircraft is on-course. The second, third, and fourth are units in a three station fix, whereas the fifth is used as an abeam bearing to check the speed of the plane against the dead reckoned position for that particular hour. These five specimens by no means cover the full extent and scope of radio bearings, but are typical of the more general applications. A chart showing bearings as they might actually be employed is shown in Figure 2.

Cases will arise, it was pointed out previously, where it is not definitely known if the bearing is 180° in error. This may be positively determined by orientation of the aircraft. The plane is turned from its course until a relative bearing of either 90° or 270° is observed. The new course is flown until the bearing changes noticeably, sufficient to preclude the possibility of shifting. If the bearing INCREASES the station is on the RIGHT, if the bearing DECREASES the station is on the LEFT. The relative bearing naturally follows in a positive sequence, one of 0° indicating the signal source is ahead; 90° to the right or starboard side; 180° off the tail; and 270° to the left or port side. For example, assume a relative bearing of 300° was taken with the manual loop and then an orientation problem was executed. The

# OIL IMPREGNATED



(ACTUAL SIZE  $\frac{1}{16}$  SQUARE)

## To Meet the Higher Temperature Requirements of Your Present and Future Equipment

The molded paper capacitors, supplied by *Micamold* for a number of years, have been wax impregnated. Now we have added a comprehensive line of oil impregnated capacitors which are being widely used in radio and electrical equipment. Of these, the types 336 and 337 are the same size as the familiar postage-stamp mica capacitors.

We will be glad to acquaint you with the complete line of *Micamold* Capacitors. Perhaps you are now working on a project where a *special* molded paper capacitor can be designed to fit in with your requirements. Can we help you? Communicate with us.

Remember, there's a **MICAMOLD CAPACITOR** for all communications and electronic applications

RECEIVING AND TRANSMITTING MICA CAPACITORS • MOLDED PAPER CAPACITORS • DRY ELECTROLYTIC CAPACITORS

OIL IMPREGNATED PAPER CAPACITORS • MOLDED WIRE WOUND RESISTORS



### MICAMOLD RADIO CORPORATION

1087 FLUSHING AVENUE

BROOKLYN 6, N. Y.

**BACK THE ATTACK — GET BEHIND THE THIRD VICTORY WAR LOAN DRIVE**

October, 1943

91

# VICTORY...in the Making

Here, at Doolittle, we are coordinating every effort and skill to help provide the communications equipment so essential for Victory. This will mean better peace-time communications after our battles are won.



To Assure Victory  
Buy More U. S. War  
Bonds and Stamps

## Doolittle

**RADIO, INC.**

Builders of Precision Radio Communications Equipment  
7421 S. Loomis Blvd., Chicago, U. S. A.

course was altered to 270° relative and then held for a twenty-five minute period, during which time the bearing increased to 320°. The bearing increased and therefore must be on the right. The original bearing of 300° is a reciprocal and in error by 180°. The correct relative bearing is 120° and the rule for working towards the true bearing from the proper bearing, never the reciprocal, is inexorable! In the instances where automatic DF's are employed there is less danger from reciprocals because they utilize a sense antenna which eliminates ambiguity and they become unidirectional. Even ADF's however, do take reciprocal readings especially under the influence of natural phenomena. Should any question arise involving the safety of the aircraft because of station location the standard orientation procedure should be followed. The time and fuel expended in confirming the true course to be flown by means of orientation is a minimum price for the information upon which the very existence of the plane may depend.

Homing is an important consideration in aviation since it is the cumulation of all other steps which lead to this operation. When a plane is homing the DF is tuned on the signal source and a 0° relative bearing flown. If a manual loop is used, frequent track bearings serve the same purpose. When wind of any velocity is present, allowances must be made for wind drift to avoid a parabolic course. If, when a plane has homed almost to the base and terminal weather conditions are such that an instrument let-down is necessary, the final and most critical operation becomes the descent through the overcast.

Generally either an approach on QDM's or a box type approach is made. In the QDM approach a magnetic heading is flown for a certain number of minutes, altered and flown, gradually descending through a series of such pre-determined maneuvers. In order to have a starting point for the basis of these calculations an abeam or overhead is made on the station. From that point the approach is predicated. By means of the pattern leading the plane back over the station after a certain elapsed time the success of the let-down may be gauged and if required reflown before a dangerously low altitude is reached. In boxing a station a series of abeam readings are flown, on any heading the pilot may choose, forming a box around the signal source. This box is reduced in size until the aircraft is letting down almost directly over the station. The plane is thus able to avoid surrounding obstructions until it breaks through the overcast. Normally these approaches are used to descend to an altitude where there is some visibility, even if limited... and only in an emergency because of fuel exhaustion or no available alternate base, would the landing be made completely blind all the way to the ground or water. This condition is brought about by the present state of

**A LEADER can't rest on his laurels!**

For real leadership requires constant vigilance... constant research... constant unwillingness to admit that perfection is ever attained!

That explains why Thordarson engineers... in good times or in bad... in peace-time, or in the midst of war, are forever experimenting, investigating, striving in every way to develop transformers that are ready to fill every need... not only AS the need arises, but even BEFORE the need arises.

**THORDARSON**  
ELECTRIC MFG. COMPANY  
500 WEST HURON STREET, CHICAGO, ILL.

*Transformer Specialists Since 1895*  
**ORIGINATORS OF TRU-FIDELITY AMPLIFIERS**

# WEIGHT 2 LBS., CHRISTENED RADIOSONDE

*... talks fluently from birth!*

This tiny brainchild of meteorologists renders an invaluable service for all its short-lived existence!

Upper air soundings—to determine the pressure, temperature and relative humidity at various altitudes—are obtained by the use of the Radiosonde. It is carried aloft by a free balloon, and radio signals are transmitted to a ground receiving station where the signals are converted into respective readings.

When the balloon bursts—usually in the 20,000 feet vicinity—the instrument is carried down by means of a small parachute. Some thirty-odd stations throughout the U. S. make observations by this method.

This is only one of the innumerable peacetime applications of electronic tubes. With the advent of new advancements in the field of electronics, ELECTRONIC ENTERPRISES can be expected to achieve an important position—equal to that now assimilated in war work—in the development and production of these vital units. Inquiries are invited.



**ELECTRONIC  
ENTERPRISES, INC.**

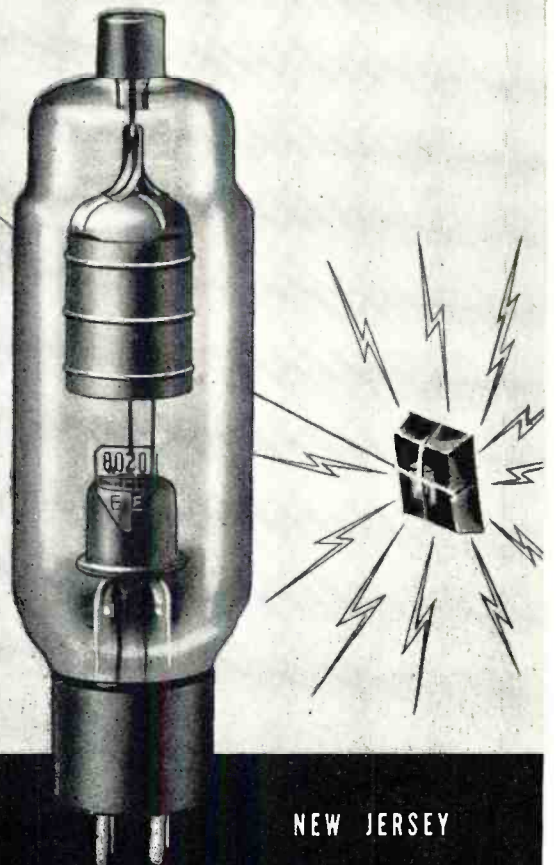

GENERAL OFFICES: 65-67 SEVENTH AVENUE, NEWARK

NEW JERSEY

## Short-Cut Mathematics COMBINED WITH Practical Mechanics Simplified

NEW 2-in-1 reading course! Now you can learn the speedy, simplified system of calculation used by draftsmen, engineers, accountants, "rooster minds" on the stage. Learn easy way to multiply 4 figures by 4 figures without using old-fashioned multiplication; add long columns of figures this lightning short-cut method. Learn horsepower, slide rule, micrometer, logarithms, wood measure, puzzles, etc., etc. Large illustrated volume complete with answers, only \$1 postpaid. Satisfaction or refund. Amaze your friends with your magic-like mental powers.

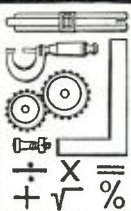

Complete details... mail coupon TODAY!

NEILSON CO., 321 S. Wabash, Dept. 209-K, Chicago  
Please send free details about "Short-Cut Mathematics and Practical Mechanics Simplified." No obligation.  
Name .....  
Address .....

## Buy War Bonds and Stamps

**RADIO ENGINEERING DEGREE IN 27 MONTHS**

Intensive, specialized course, including strong basis in mathematics and electrical engineering, advanced Radio Theory and Design. Modern laboratory. Low tuition. Self-help opportunities. Also 27-month courses in Astronomical, Chemical, Civil, Electrical and Mechanical Engineering. Participation in Civilian Pilot Training Program. Enter Dec., Mar., June & Sept. Catalog.

**INDIANA TECHNICAL COLLEGE**  
783 E. Washington Blvd., Fort Wayne 2, Ind.

## NOW—A REALLY HIGH-POWERED— Radio Engineering Library

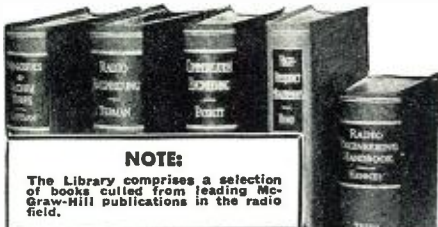

### NOTE:

The Library comprises a selection of books culled from leading McGraw-Hill publications in the radio field.

- especially selected by radio specialists of McGraw-Hill publications
- to give most complete, dependable coverage of facts needed by all whose fields are grounded on radio fundamentals
- available at a special price and terms

THESE books cover circuit phenomena, tube theory, networks, measurements, and other subjects—give specialized treatments of all fields of practical design and application. They are books of recognized position in the literature—books you will refer to and be referred to often. If you are a practical designer, researcher or engineer in any field based on radio, you want these books for the help they give in hundreds of problems throughout the whole field of radio engineering.

5 VOLUMES, 3319 PAGES, 2289 ILLUSTRATIONS

1. Eastman's FUNDAMENTALS OF VACUUM TUBES
2. Terman's RADIO ENGINEERING
3. Everitt's COMMUNICATION ENGINEERING
4. Hurd's HIGH FREQUENCY MEASUREMENTS
5. Henney's RADIO ENGINEERING HANDBOOK

10 days' examination. Easy terms. Special price under this offer less than books bought separately. Add these standard works to your library now; pay small monthly installments, while you use the books.

10 DAYS' FREE EXAMINATION—SEND COUPON

McGraw-Hill Book Co.,  
330 W. 42nd Street, New York 18, N. Y.

Send me Radio Engineering Library, 5 vols., for 10 days' examination on approval. In 10 days I will send \$3.00 plus few cents postage, and \$3.00 monthly till \$24.00 is paid, or return books postpaid. (We pay postage on orders accompanied by remittance of first installment.)

Name .....  
Address .....  
City and State.....  
Position .....  
Company ..... RN-10-43

development of radio equipment in general use aboard transport and cargo planes on international flying. It is a foregone conclusion that this is only a temporary situation as apparatus on the military secret list already sufficiently supplements that available to a degree **where** it is possible to make safe blind **landings** without elaborate marker systems.

The method of transcribing the bearings from the numerical form to a graphical representation is relatively simple. Almost without exception the Mercator type projection is used for aviation. The features of the Mercator projection that make its acceptance so widespread are that locations can be plotted with a straight line and any course connecting two points will be a straight line making equal angles with all parallels of latitudes or meridians. Courses will be a rhumb line indicating the true direction of any point from any other point. Radio bearings which are taken fifty miles or more from the station must be corrected before plotting on a Mercator chart. A Mercator correction table is in most navigation reference books or the plane's papers. In north latitude when the station is  $\frac{EAST}{WEST}$  of the air-

craft the correction is  $\frac{-}{+}$ . In south latitude when the station is  $\frac{EAST}{WEST}$  of the aircraft the correction is  $\frac{+}{-}$ .

If the bearing is taken by the ground station the sign of the corrections are reversed. After the Mercator correction, which usually runs a few degrees, is applied, the radio bearing may be plotted on the chart as a straight line.

The radio avigator must work in close cooperation with the celestial avigator as has been pointed out. Among his duties will be supplying the proper time through the medium of time ticks. The error caused by improper time in shooting celestial fixes is tremendously magnified by the speed of the aircraft. Time ticks of the continuous type by WWV, the international systems, the United States standard, and the British Broadcasting 6 dot method must all be familiar to the radio officer.

In aviation the factors which will influence the track include many that are negligible in surface vessel sailing. Error may increase with almost arithmetic progression . . . every minute the plane flies off its course makes it that much more difficult to resume the original track. Combining celestial and radio aviation has already over 185,000,000 miles of scheduled trips by America's greatest international airline as testimony to its effectiveness. Radio, the electronic and radionic fields, are destined to assume an ever increasing prominence in the aeronautical world. This brief glimpse into radio aviation, if it does nothing else, should stir the imagination. Another field as unlimited as the horizons it will span is open for development by

## FOR SALE

### Super-Heterodyne Radio Kits

Eagle Brand, 5 tubes with speaker, dial, and dial indicator. No cabinet. Brand new in original crates (with schematic diagrams). \$12.95 each.

### Head Phones

Trimm, Brandes, Cannon, I.C.A., New Yorker, Philmore, Frost, Chicago Telegraph. Slightly used. \$2.00 each.

### Code Keys

McElroy, Signal, Navy, Brach, Speedex. Slightly used. \$2.00 each.

Also some cheap Speedex keys. \$1.00 each.

### McElroy Code Pullers and Transmitters

(Slightly used.) Model 813-642 and Model 890-642. \$50.00 each.

### Vibroplex Speed Keys

Like new, \$12.95.

### Halicrafters

Two S-22-R ..... \$74.50 each  
1 Sky Champion ..... 54.50 each  
1 Skywriter Defiant ..... 74.50 each  
1 RME 69 Special ..... 75.00 each  
1 7-tube National (Old) ... 40.00 each  
1 5-tube National (Old) ... 25.00 each

Also thousands of other pieces of radio equipment. We publish no catalog, and are unable to give technical information as our technical staff have all been called into service. This merchandise has been used until August 13, 1943 by a large radio school teaching army signal corps enlisted personnel.

Send U. S. Money order to

R. G. DOUGHERTY

786 Broad Street, Newark, N. J.

All prices F.O.B., Newark

First come—First served



Send for this FREE 52-page Book

It shows that "crack" operators rely on something besides practice to develop their high speeds and proficiency: it explains the "knack" of sound-sense and sound-consciousness—the secret of speedy sending and receiving. Once you acquire these mental processes, reading code becomes almost second nature to you; just as the swing rhythm of a dance band becomes automatic to musician and dancer.

Champions endorse the Candler System. Used in training commercial operators, Amateurs, and Radiotelegraph Specialists in Signal Corps, Navy, Marine Corps, Coast Guard, Naval Reserve, Airlines. Wherever the fastest and most efficient operators are found, there you will find Candler trained men.

If you want s-p-e-e-d, if you have any difficulties in operating technique, if 40-50 and more w.p.m. seem fantastic speeds to you—send for this revealing book now. It's yours without cost or obligation. Simply send your name and address.

### CANDLER SYSTEM CO.

P. O. Box 928 Denver 1, Colorado, U. S. A.

and at 121, Kingsway, London, W. C. 2 Eng.

# IRC DISTRIBUTORS SUPPLY VALUABLE WAR AID BOOKLET

## *to Radio Service Men*

ANOTHER **IRC** DEVELOPMENT

To help Service Men in their important job of keeping home radio sets working, IRC has published the new "Here's How" Booklet. It contains new ideas, data and charts on how to make Volume Control replacements and repairs when new parts are unobtainable and includes valuable information on Resistor applications . . . IRC distributors will make this Booklet available to their customers.



*Among the first in the industry to win an E flag, IRC also won a Star for sustained production.*



**INTERNATIONAL RESISTANCE COMPANY**

Dept. O • 401 N. BROAD STREET • PHILADELPHIA 8, PA.



# Parts by Centralab

- Stealite Insulators
- Ceramic Trimmers
- High Frequency Circuit Switches
- Volume Controls
- Ceramic Capacitors
- Wire Wound Controls
- Sound Projection Controls

Div. of Globe-Union Inc., Milwaukee, Wis.

the imaginative and creative radio engineer. There are many new equipment designs that are proving themselves during this war, which for obvious reasons cannot be mentioned now. However, these designs themselves will open new fields in radio aviation.

-50-

## QTC

(Continued from page 40)

radiomen and one would do well to contact them.

**Q.** Are draft deferments automatic as soon as I sail or must one make application in the same manner as is done in cases of other war jobs?

**A.** You must keep in touch with your local draft board; deferment will be granted without difficulty as this is a vital occupation.

**Q.** What is the approximate time interval between taking the radiotelegraph operators license examination and actually receiving the license?

**A.** The Federal Communications Commission advises that approximately six to eight weeks may elapse provided the applicant furnishes a passport size photograph and a copy of his birth record at the time of making application for the license; a longer delay if this is not done. However a provisional certificate may be issued to eliminate this delay if you have a job available at once.

**Q.** How does the radio officers' pay compare with rates paid before the war?

**A.** Average radio officer's pay aboard a cargo vessel before the war was in the vicinity of \$125.00 per month, at the present time, including bonus the average radioman collects two to three times this amount. Your earnings will depend on the vessel you are employed on and its particular voltage.

**Q.** Is the radio operator required to do other than radio work aboard ship?

**A.** Clerical work is performed by the radiomen aboard some ships. They are, however, paid an additional amount for this service.

**Q.** How are the unions connected with the various steamship companies?

**A.** The Unions mentioned above are affiliated with the organizations indicated but are not connected with the steamship companies. They do, however, have signed contracts with the various steamship companies.

**Q.** What papers are necessary in order to ship out as radio operator?

**A.** First you must have the necessary license issued by the Federal Communications Commission. You will require also a Certificate of Identification and a Certificate of Service which can be obtained from the U. S. Shipping Commissioner. One must have a copy of his birth record or naturalization papers to obtain these certificates. A Seaman's Passport, obtainable from



## New PHONE PLUG!



Double Phone Plug (No. 24) features ribbed barrel for greater ease in handling.

Just one of the new improved items in the large ICA line of:—

- Metal Cabinets, Chassis, Panels
- Metal Stampings
- Plugs and Jacks
- Completely Assembled Screw Machine products
- Hardware and essentials



INSULINE

Write for this 12-page Industrial Catalog

# INSULINE

CORPORATION OF AMERICA  
INSULINE BUILDING  
(36-02 35th AVENUE)  
LONG ISLAND CITY, N.Y.

## ERROR-PROOF COPIES

in a *Jiffy*

Confidential records, letters, bids, contracts and financial data — in photo-exact copies made fast — in complete privacy, with A-PE-CO. You need A-PE-CO for executive use. All department work with A-PE-CO. Its speed copying will amaze you.

Photo-Copies made fast by anyone — anytime

### A-PE-CO "Photo exact"

PHOTO-COPYER

# \$5500

**Non-Fading Photo-Copies of**

- letters
- documents
- records
- blueprints
- pictures
- drawings

Same-size copies of anything up to 18"x 22". Accepted as legal evidence. Eliminates stenotyping, tracing, proof-reading. Photo-copies direct from blueprints, graphs, tracings, telegrams, receipts, shop orders — anything written, printed, drawn, photographed. Endless uses for A-PE-CO. Needed by all departments. Big savings. Thousands in satisfactory use.

**No Camera — No Darkroom — Low Cost**

Simple, fast. No focusing. Conserves man-hours. Any office employee quickly becomes expert. Low cost per copy, lowest investment in equipment. Saves other equipment. Put A-PE-CO on any available desk or table. Immediate delivery. Representatives in principal cities and Canada. Write for A-PE-CO folder.

**AMERICAN PHOTOCOPY EQUIPMENT CO.**  
2849 N. Clark St. Dept. HK-10, Chicago 14, Illinois





# FADA Radio

*Mechanically*

*Readable to*

*1 Part in*

*140,000 . . .*

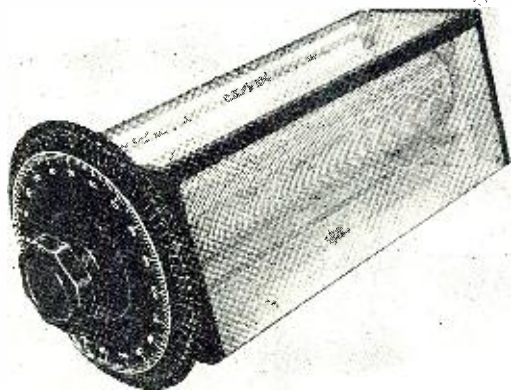

The rotary inductor illustrated at the left in its transparent plastic dust-cover is the heart of a new frequency measuring instrument designed by FADA engineers as one of our many war production tasks. The problem presented was to make a sizeable improvement in the readability and resetability of the best available portable frequency meter

This "best" was a gear train requiring precision hand work to the point where cost and production speed left much to be desired.

FADA brought to the problem no hide-bound precepts . . . . cast out before starting the old concept that the proper way to do the job was to connect a fine indicating dial to the controlled circuit element through a gear train. Instead FADA engineers reasoned that this usual method was exactly the wrong way to reach a solution. Turning 180° away from custom, we built a variable inductance-fixed capacitance tuning circuit where the fine indicating dial was directly fastened to the shaft of the frequency-determining element—1:1 dial ratio . . . seemingly no chance here to read closely. By skillful, original design, we made it necessary to rotate this dial 70 turns . . . not the usual half-turn . . . to tune from 1000 to 2000 kcs. Making the dial 4" in diameter allowed graduation into 200 well-spread divisions . . . times 70 complete rotations equaled 14,000 readable dial divisions. Adding a precision decimal indicator . . . and dial readability became 1 part in 140,000 . . . a seeming mechanical impossibility.

By this original attack, all precision gears . . . bearings . . . precision, temperature-sensitive variable condensers . . . were thrown right out the window. What was "impossible" became simple "duck soup" . . .

Just another concrete . . . tangible . . . example of what FADA research is creating today . . . more proof that when peace is won FADA will produce a startlingly changed . . . simplified . . . improved radio/electronics . . . for you . . . post-war.

**FADA RADIO AND ELECTRIC COMPANY, INC.**  
**LONG ISLAND CITY, N.Y.**

1920 SINCE BROADCASTING BEGAN 1943

# EARN MORE MONEY IN RADIO



Send for  
**FREE RADIO LESSON**

and our book of Radio facts, "Victory For You!" Convince yourself that DeForest's Training can prepare you quickly in your spare time at home for a GOOD JOB in Radio—then actually help you GET STARTED. Only DeForest's provides you with this combination of major HOME TRAINING ADVANTAGES—(1) Radio Assemblies and Parts to work out 133 fascinating home experiments, PLUS (2) instructive Home Movies to help you master Radio's fundamentals quicker, easier, PLUS (3) modern Loose-Leaf Lessons prepared under the supervision of a foremost authority—Dr. Lee DeForest. Mail coupon at once for complete facts!

DEFOREST'S TRAINING, INC.

DEFOREST'S TRAINING, INC.,  
2535-41 N. Ashland Ave., Dept.  
RN, Chicago 14, U. S. A.

I am interested in Radio. Please send me FREE and without obligation, your Sample Radio Lesson and big illustrated book, "Victory For You!"

Name \_\_\_\_\_ Age \_\_\_\_\_  
Address \_\_\_\_\_  
City \_\_\_\_\_ State \_\_\_\_\_

Do not reply if under 17



## 110-VOLTS AC from DIRECT CURRENT

with KATO KONVERTERS. Furnish standard 110-volt AC from 32, 110, or 220-volts DC. Good deliveries on sizes 350 through 1500 watts.

PIONEERS IN THE BUILDING  
OF SMALL ROTARY KONVERTERS



Katolight Rotary Konverter, 225 Watt

Good deliveries on 5, 7½, 15 and 25 KW AC generators. Mfr.'s DC generators, motor generators, frequency changers, high frequency generators.

Kato's entire production at present must be confined to orders with high priorities.

KATO ENGINEERING CO.  
530 N. Front St. Mankato, Minn., U.S.A.

the passport bureau of the Department of State is also required; offices will be found in most ports and large cities. A U. S. Coast Guard Identification Card will also be necessary in order to obtain entrance to the various docks and piers. It can be obtained from the local Coast Guard offices.

Q. What class of license must I hold in order to apply for a position aboard ship?

A. At present there are three classes of license issued by F. C. C. which will permit you to act as radio operator aboard ship. 1—Radiotelegraph First Class, which can only be obtained after you have had one year or more ship experience and can pass the necessary examination. 2—Radiotelegraph Second Class and 3—Temporary Limited Radiotelegraph Second Class Operator License. The latter is issued to those who can copy 16 words per minute in code groups and can pass a theoretical examination and obtain a 50 percent grade, or to anyone who has previously held a radiotelegraph first or second class license without examination provided they can pass the above code test. This temporary license is good for the duration and six months thereafter.

As this goes to press, have just received a nice letter from Mr. Harry A. Morgan, who as most of you know is Vice President of the Marine Department of the A. C. A. Mr. Morgan will I hope have some material of interest to those of you in his organization for the next column. We will be only too glad to submit the questions and information offered from any of the various unions or individuals, however boys keep in mind that all of the comments offered in these columns must be of an unbiased attitude insofar as it concerns the merits of the various unions. In other words we want everyone to have an equal chance without any hard feelings toward the other fellow.

The following which is entitled The Merchant Marine was sent along by Mr. Fred Howe, of the Radio Officers Union and hits the spot so well that we are printing it in its entirety with Fred's permission:

### The Merchant Marine

Planes, tanks, guns, munitions, oil, food, and a thousand other necessities of war must be delivered across ten thousand miles of water to the men who are dying for \$42.00 per month. These are delivered in vessels of the American Merchant Marine. Is it dangerous? No more so than driving an automobile. One hundred thousand persons are killed yearly in the United States by automobiles. Every weekend, every holiday, takes its deadly toll; yet, everyone owns a car. No one would hesitate to drive across the United States in an old jalopy. What chance has one to escape uninjured when his old jalopy meets another car head-on at 60 miles an hour? You have a far better chance to survive when your ship is struck by a torpedo. Remember that when a ship is tor-

## RADIO ENGINEERING

DEGREE IN 2 1/2 YEARS

• Complete Radio Engineering Course in 27 months. Bachelor of Science Degree. Radio (television), talking pictures and the vast electronic field offers unusual opportunities for women as well as men. Demand exceeds the supply. Courses also in Civil, Electrical, Mechanical, Chemical, Aeronautical Engineering; Business Administration, Accounting, Secretarial Science. Tuition, living costs low. During the War 3-yr. high school students with good record admitted. Special Preparatory Dept. Enter January, March, June, September. 60th year. Write for catalog.  
1610-3 COLLEGE AVE. ANGOLA, IND.



## TRI-STATE COLLEGE

### USE SUBSTITUTE PARTS IN RADIO REPAIRING

Make all needed radio repairs with available replacement parts. Learn what substitutions are permissible. Change circuits to eliminate critical components. Tables of equivalent tube types. Hundreds of helpful suggestions, practical illustrations and examples included. This is the aid you need for war-time radio servicing. Complete manual, sent postpaid, only.....

**25¢**

Supreme Publications 328 S. Jefferson St.  
Chicago 6, Illinois

LES Correspondence Courses in  
RADIO and ELECTRICAL ENGINEERING

**ELECTRICAL ENGINEERING** Get good grasp of wide electrical field. Prepare yourself at Low Cost, for secure future. Modern courses. So simplified anyone can understand quickly.

**RADIO ENGINEERING** Extra fine course in radio, public address, wireless, electric work. Trains you to be super-service man, real vacuum-tube technician. Service men needed badly. Diploma on completion.

Send postcard or letter for Free Copies of school catalogs, full details, all about deferred payment plan, etc. **SEND NOW!**

**WRITE LOW \$25 Either Course AS**

LINCOLN ENGINEERING SCHOOL, Franklin Stn., Box 61-R 58  
(Formerly at Lincoln, Neb.) WASHINGTON, D. C.

## BIGGER PAY for ELECTRICAL & RADIO Trouble Shooters!

GET THIS SENSATIONAL NEW TROUBLE-SHOOTING MANUAL ELECTRICIANS! RADIO MEN! Beginners, old timers! This new COYNE Trouble Shooting Manual saves time, avoids errors. Helps you do better work, make more money. Examine 5 days FREE—mail coupon.

**4 BOOKS IN ONE!**  
Big 8 1/2 x 11" volume contains:  
• 500 Shop Prints, Wiring Diagrams on Motors, Radios, Electronics, etc. • New "Step-by-Step" Trouble Shooting Course. • Electrical - Radio Dictionary. • Spare Time Work Lessons.

**FREE!** 1 Yr. Technical Service by mail from Coyne Staff, on your trouble-shooting problems.

**SEND NO MONEY!**  
See amazing offer below. You need this practical book NOW. Act!

**5 DAY FREE TRIAL**

**COYNE ELECTRICAL & RADIO TROUBLE SHOOTING MANUAL**

H. C. LEWIS, Pres. Dept. 73-5  
COYNE ELECTRICAL SCHOOL  
500 S. Paulina St., Chicago 12, Illinois

Send postpaid, now COYNE Electrical & Radio Trouble Shooting Manual. Within 5 days after receiving, if I either return it or send \$1.95 and then \$3 monthly until total of \$7.95 is paid. (Cash price \$7.15—YOU SAVE 10%. Same 5-day free trial and return privilege.)

NAME \_\_\_\_\_  
ADDRESS \_\_\_\_\_  
CITY \_\_\_\_\_ STATE \_\_\_\_\_

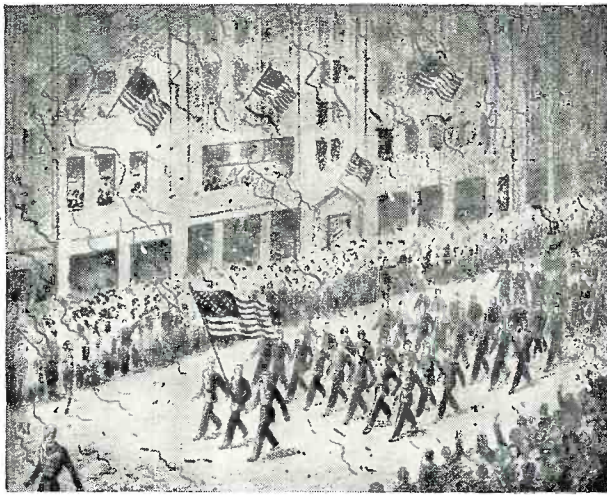

**THE DAY OF VICTORY COMES...**

*Look Again to*

**MIDWEST**

*For the Finest in Radio*

**At Lowest FACTORY-TO-YOU Prices**

**D**URING the 22 years since its establishment, MIDWEST RADIO CORPORATION has made and sold millions of dollars worth of fine radios. Hundreds of thousands of MIDWEST RADIOS are still in use in every corner of the world.

We have nothing to sell you now. Uncle Sam has signed up MIDWEST for the duration . . . to build war-winning radio and electronic equipment for our Armed Forces. But when Victory has been achieved,

MIDWEST will be back at the same old stand . . . producing highest quality radios and offering them to you, as always, at lowest FACTORY-TO-YOU prices . . . with savings up to 50%.

So look to MIDWEST again, after Victory . . . look for leadership in new features . . . in new developments. Watch for, wait for MIDWEST Victory model radios . . . and, as always, expect the best from MIDWEST!

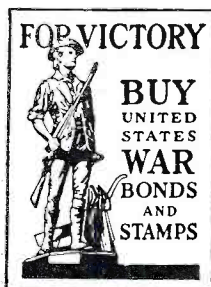

**MIDWEST RADIO CORPORATION**  
**DEPT. 11-C** **CINCINNATI, OHIO**

pedoed, 25,000 other ships sailed safely through the danger zones that very day. There is a war, and it encompasses the whole world. Every ocean is a danger zone. Every land is a danger zone. High-flying bombers drop their deadly missiles on the most populous cities of the world. Some believe that our own great cities may soon feel the sting of high explosives. It is dangerous. Life is dangerous. We are not safe anywhere; but brave men do not run from danger. This is a man's world. It is a dangerous world in which there is no room for cowards. America was not built by cowards. It will not be preserved by cowards. America belongs to the strong, the brave. Those who first settled America set themselves down in a wilderness filled with terrors; savage beast, and still more savage man, lurked in every forest. Yet, the wilderness was cleared; the frontier was pushed back; it was pushed back again and again, until America was built—an America, strong, unafraid, confident. We live today in a world conflagration. Civilization is being put to fire and sword. Whether we like it or not, we are in it, and in it we will stay until victory is won. There is no turning back. We cannot flee from danger. Our soldiers will not turn back. They will always march forward.

The precious cargoes must be carried to the men who are fighting for us. They must be carried across the oceans. They will be carried in vessels of the Merchant Marine. We, the seamen of the American Merchant Marine, will carry them as a duty and a solemn obligation. The motto of the American Radio Officers is: *sail the ships; to hell with the submarines.*

To those who possess a commercial radio operator's license and to those who expect to obtain one in the near

future, we say: America is calling you. Your country needs you. You are needed in the Merchant Marine. Let us sail those ships. If you possess a radio operator's license, it is your duty to present yourself for immediate duty. If you do not possess one, get one as quickly as possible.

-50-

### For the Record

(Continued from page 4)

their entire plants and personnel to new and untried fields of endeavor at the request of the government. The radio industry can point with utmost pride to the fact that it has been totally converted for war since March of 1942. No other industry, we believe, equals this record. Examples are numerous where members of the armed forces have applied this same ingenuity necessary to get a job done with nothing more than their bare hands and a few odds and ends of equipment.

At the risk of being a "spectre at the feast" we feel it our duty to inject a note of warning for the future. We stand upon the threshold of what is probably going to be the greatest period of industrial development in the history of the human race. We must tread softly because the way ahead is not clear. The same ingenuity that has given us our industry can become a two edged sword with the power to cut us down and nullify all the gains we have made in the last 20 years. Caution must be used in releasing the numerous developments to the public so that such release will be orderly and can be assimilated with as little disruption of normal economic life as possible. Manufacture, sales and distribution must receive liberal applications of ingenuity in order that the or-

derly process of moving goods into the consumers' hands may be done as efficiently as possible.

Wise council, recognition of obligation, and sound business principles will become a *must* in the postwar world. It is only by recognizing its obligations to the public that the radio industry can continue to fulfill its destiny. We look to the past with pride and to the future with confidence.

**PRELIMINARY FIGURES** from a survey made recently amongst representative jobbers in distributing areas throughout the country reveal the fact that there is not nearly so great a shortage of radio servicemen as we have been led to believe. While the armed forces have no doubt inducted into their ranks a very large number of radio servicemen, this survey tends to show that these men were of the border-line type. The well-established old-timer who has made radio sales and servicing his livelihood seems to still be doing business at the old stand. Most of these men are in their middle or late thirties and have established businesses and families. These factors operated to prevent their being drafted. The efforts of various well-meaning organizations to provide additional radio servicemen have not resulted in any appreciable number being made available. These efforts, however well-meaning they may be, have resulted in more harm than good to the radio servicing industry. The two greatest problems confronting the service industry today are the dearth of parts and tubes necessary to do the job well and the restrictions on pick-ups and deliveries necessitated by the tire conservation program. Greater service could be done to the industry in solving these last two problems than in trying to recruit untrained, un-equipped personnel.

**THE INDUSTRY** is maintaining an attitude of watchful waiting as regards the tube situation. Promises by various high officials within the government should begin to bear fruit within the near future. The greatest single contribution that can be made to the war effort will be the maintenance of receivers in the homes of the listening public. This can only be done by providing an adequate supply of tubes and parts immediately.

**WITH THE RETURN** to private ownership of the many small craft now on war duty and with the numerous planned installations of short wave radio equipment for ship-to-shore use, a vast new field of endeavor will be opened up for progressive radio servicemen. As this is a specialized field, radio servicemen interested in this type of work should begin to prepare themselves now. The article in this issue on Marine Radio Direction Finders has much of value to offer for those readers who are interested in this new field.

73 . . . OR

**RADIO NEWS**



# ONAN

## ELECTRIC PLANTS

**Electricity for Any Job Anywhere**

**ONAN GASOLINE DRIVEN ELECTRIC PLANTS** provide electricity in locations where it is not otherwise available, and for emergency and standby service for all communications work.

Thousands of these reliable, sturdy Plants are doing a winning job on all the fighting fronts by providing electricity for communication and other vital war tasks. Ratings from 350 to 35,000 watts. A.C. 50 to 800 cycles, 110 to 660 volts. D.C. 6 to 4000 volts. Also dual A.C. and D.C. output models. Air or water cooled.

Details gladly furnished on your present or post-war need for Electric Plants.



**D. W. ONAN & SONS**

**1833 Royalston Ave., Minneapolis, Minn.**

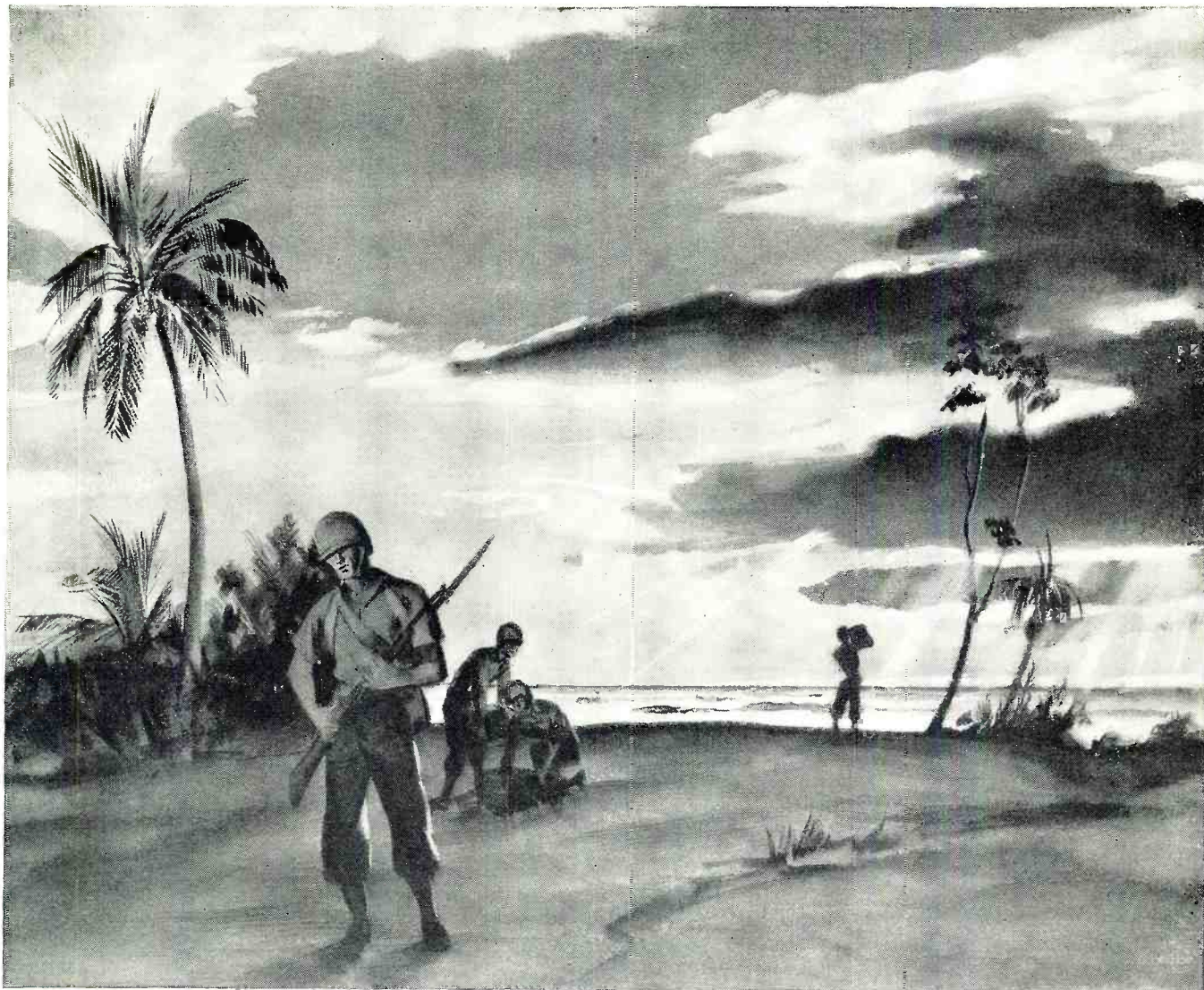

## TESTED ON AN ATOLL

ON a tiny strip of coral . . . an observation post pierces the dawn with cryptic messages that may spell the difference between victory and defeat. Duty on this speck on your map calls for iron men and dependable equipment.

Under the toughest of conditions . . . under the roughest of handling . . . far from sources of replacement . . . parts must work—for men's lives hang in the balance. Utah Parts are passing this final test on tiny atolls, in steaming jungles, on burning sands in all parts of the world—from pole to pole.

A shooting war is also a talking war. The weapons of communications must have the same dependability and non-failing action as weapons of destruction. These qualities are built into Utah Parts at the factory where

soldiers of production are working 100% for Victory. In Utah laboratories, engineers and technicians are working far into the night developing new answers to communication problems—making improvements on devices now in action.

But "tomorrow" all this activity, all this research, all this experience learned in the hard school of war, will be devoted to the pursuits of peace. Thanks to the things now going on at Utah—there will be greater convenience and enjoyment in American homes . . . greater efficiency in the nation's factories. UTAH RADIO PRODUCTS COMPANY, 824 Orleans Street, Chicago, Ill. Canadian Office: 560 King Street West, Toronto. In Argentine: UCO Radio Products Co., SRL., Buenos Aires. Cable Address: UTARADIO, Chicago.

**PARTS FOR RADIO, ELECTRICAL AND ELECTRONIC DEVICES, INCLUDING SPEAKERS, TRANSFORMERS, VIBRATORS, VITREOUS ENAMELED RESISTORS, WIREWOUND CONTROLS, PLUGS, JACKS, SWITCHES, ELECTRIC MOTORS**



## MASTER DRAFTING MACHINE

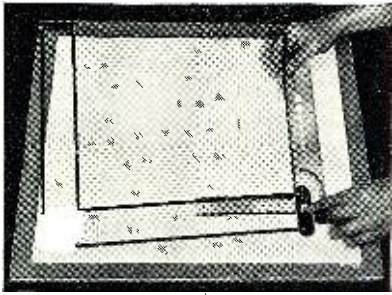

• **Biggest time-saver for dimensioned sketches, lettering and layouts ever sold at this low price. Size, 20" x 24". Limited supply. While they last only \$3.95**

Order Today!

### RANDOLPH RADIO

609 W. RANDOLPH ST., CHICAGO 6, ILLINOIS

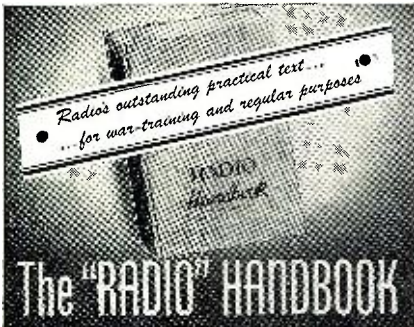

Basic electrical and radio theory in the simplest possible language, written especially for those without mathematical or technical training.

Dozens of complete how-to-build-it descriptions of many types of receiving, transmitting, and test equipment show practical applications. Hundreds of diagrams and large photographs.

Enlarged war-training chapters include: expanded basic principles, more test equipment which can be field-built, and mathematics for solving simple radio problems. Over 600 pages, durably clothbound, gold-stamped. From your favorite dealer, or from us, postpaid; please add any applicable taxes.

\$2.00 in Continental U.S.A. Elsewhere, \$2.25

EDITORS AND ENGINEERS

1420 North Highland Avenue, Los Angeles



## RADIO

Made Easy

**Do Radio Work Immediately**  
Begin doing practical radio work with the first chapter. Use any small home-radio for many instructive, safe experiments. Learn how to test radio sets and parts. Simplified, picture-clear explanations make basic radio knowledge easy to understand and to apply. This large manual is just like a complete course in radio. Repair radios for fun and profit. Get a well-paying radio war-job. Earn higher rank and pay in the Army.

**Practical Radio Training**  
This amazing, different home-study manual will teach you quickly to do radio work. At first you will learn about parts, tubes, tests, simple circuits. Later chapters cover receivers, transmitters, testers, trouble-shooting. New, up-to-date, 1943 edition, includes material on Electronics and Radar. Follows U. S. Office of Education outline.

**SEND NO MONEY — USE 10 DAYS**  
Examine the complete Practical Radio Manual for 10 days, without risk or obligation. See how easy it is to advance in radio this new way. Send no money. Simply pay your mailman only \$2.95, plus a few cents postage. You must be satisfied or your money will be refunded in full. Write today.

**NEW JUST OUT**  
336 large pages  
Over 300 pictures  
Manual binding  
Leatherette cover

ONLY \$2.95

**SUPREME PUBLICATIONS** 328 S. Jefferson St. Chicago 6, Illinois

## Mrs.' Lit.

(Continued from page 46)

### PRIMER ON ELECTRONIC TUBES

A 24-page nontechnical book titled "How Electronic Tubes Work" has been produced by the *General Electric Electronics Department* at Schenectady, N. Y. It is designed primarily for industrial engineers. Illustrated with 117 sketches and photographs, the book is a primer whose main emphasis is on how the electronic tube operates. The eight basic types of industrial electronic tubes and their uses are described. The book (GEA-4116) is available free on request to Dept. 6-215, Publicity Divisions, *General Electric Company*, Schenectady, New York.

-30-

### X-ray—Geiger Tubes

(Continued from page 34)

type of tube is used to detect, can penetrate the metal cylinder walls. Soft X-rays cannot penetrate these metal walls so the metal anode is replaced by a layer of colloidal graphite deposited on the glass tube walls. This is shown in Fig. 1b. Since the alpha and beta radiations of radium are helium nuclei and electrons, respectively, they cannot penetrate the thick glass wall of the tube unless they are moving relatively fast.

A tube such as that shown in Fig. 1c is used to detect rather slow moving alpha and beta rays. It has a metal cathode just as the tube for the hard X-rays and gamma radiations, but a very thin window is provided in one end of the tube to admit the alpha and beta rays. This glass window may be only a few ten-thousandths of an inch thick. If a thin glass window or a quartz window is placed opposite a hole in the side of the metal cylinder cathode so that ultra violet light can strike the opposite wall of the metal cylinder, the tube will be sensitive to ultra-violet light. This is shown in Fig. 1d.

It is obvious that if a photosensitive surface is placed on the opposite metal wall, the Geiger Mueller tube can be made sensitive to visible light. This tube will be extremely sensitive to light. It can be used for such purposes as the measurement of the light intensity of the stars. Tubes of this sort have not been very reliable to date because of the difficulty encountered in maintaining a photosensitive surface under the conditions in which the Geiger Mueller tube functions best. By an ingenious method the Geiger Mueller tube can be made sensitive to the uncharged atomic particle, the neutron which cannot ionize the gas. This is accomplished by filling the tube with boron-trifluoride gas. When the neutron strikes the nucleus of a boron atom, it causes the boron nucleus to give up an alpha particle which, as said before, is the nucleus of a helium atom,

and since it is positively charged it is capable of ionizing the gas that is present in the Geiger Mueller tube.

The Geiger Mueller tubes are being put to many practical uses as an examination of the patent gazettes will disclose. The post war period should see much use made of the Geiger Mueller tube: A few of the very important uses made of the Geiger Mueller tubes at present are the determination of radioactive materials in oil wells, the location of cement placed in oil wells and the location of the planes of quartz crystals by X-rays so that they may be cut for use as crystal controls for oscillators. An interesting use which the medical and biological professions make of the Geiger Mueller tube is in the tracing of artificially radioactive substances, for example, common table salt throughout the body when this salt is fed a living organism. Other uses will suggest themselves to the reader.

-30-

## Book Review

(Continued from page 40)

of electricity. The student who has had some high school mathematics will find that the earlier chapters form a comprehensive review and will aid him in applying mathematics to radio and electricity in circuit theory. The text follows a sequential arrangement of electrical theory without any loss of mathematical continuity. A double system of article, problem, and figure numbering facilitates cross reference to a given article, problem, or figure in a minimum of time. The material is presented in simple and nontechnical language. Included is an especially understandable explanation of Ohm's Law and Kirchhoff's Laws. All radio and electrical terms are lucidly and completely defined. Well-planned illustrations supplement the text, illustrative examples preceding each group of new problems. All rules are set in italic for ready reference.

### "RADIO MATERIEL GUIDE."

by Francis E. Almsted, Lt. U.S.N.R. and F. R. L. Tuthill, Cmdr., U.S.N.R. Published by *McGraw-Hill Book Company*, New York City. 235 pp. plus index. Price \$2.00.

This book includes the standard fundamentals required of a radio operator or of a person who desires a background for studying the technical aspect of radio material. These fundamentals are described in a direct manner understandable to those who have not had previous technical experience. The book can be used to greater advantage by pre-induction classes, by Army and Navy communication officers, by Armed Force schools for the training of radio and Signal Corps men. The subject matter can be covered in a course of sixteen weeks. Or, the book can be used as a quick reference by men in action ashore or afloat. Radio material is divided into two

# YOUR MONEY BACK IN 5 DAYS

**IF** Ghirardi's big 972 page **RADIO PHYSICS COURSE** doesn't teach you **RADIO-ELECTRONIC** fundamentals **FASTER** and at **LESS COST** than any other book or course!



**A. A. GHIRARDI**  
Radio's most widely read Author

## THE MOST WIDELY USED TRAINING BOOK OF ITS KIND IN THE WORLD

Here, in a single, big 972-page volume, is a miracle of modern Radio-Electronic Training—sold at a small fraction of the price you might expect to pay—and backed with a **5-DAY MONEY BACK GUARANTEE** that

makes you the sole judge of whether or not you want to keep it. *You cannot lose!*

### NO PREVIOUS TRAINING REQUIRED

Everything that can be done to make learning Radio easy for you at home has been done in Ghirardi's **RADIO PHYSICS COURSE**. No previous training is required. All you need is a little spare reading time—and a desire to get started **RIGHT** for a profitable, interesting future in any of Radio's many branches, from Radio and Electronic servicing, to Aviation, Military, Broadcasting, Manufacturing, Public Address, and many others.

There is no guesswork when you buy Ghirardi's famous **RADIO PHYSICS COURSE**. You **KNOW** you'll get complete, time-tested Radio-Electronic training and get it right **BECAUSE**:

1. *This same inexpensive book has given more people their basic training than any other ever published.*

2. *It is more widely endorsed and recommended by men already in Radio.*

3. *It is more universally used for home study, and more widely used in more U.S. Army Signal Corps, Navy, and civilian schools and colleges than any other.*

### Would you want any better proof?

What other books and courses skim over, **RADIO PHYSICS COURSE** painstakingly explains in detail so that you cannot fail to understand clearly. It even contains over 300 pages devoted to the all-essential foundation knowledge of Electricity without which no Radio Training could possibly be complete or understandable.

### MORE TRAINING FOR YOUR MONEY

Such features are highly important. They explain why thousands of civilians and men in the armed forces report that **RADIO PHYSICS COURSE** makes the study of Radio-Electronics easier, more interesting, and more genuinely helpful to them than any other book or course they've ever seen.

Actually, this famous volume gives you the scope of 36 different courses in one—packed into an easy-to-follow 972-page book with 508 clear illustrations, and 856 self-testing review questions—all for the price of only \$5 complete (\$5.50 foreign). Send for it today!

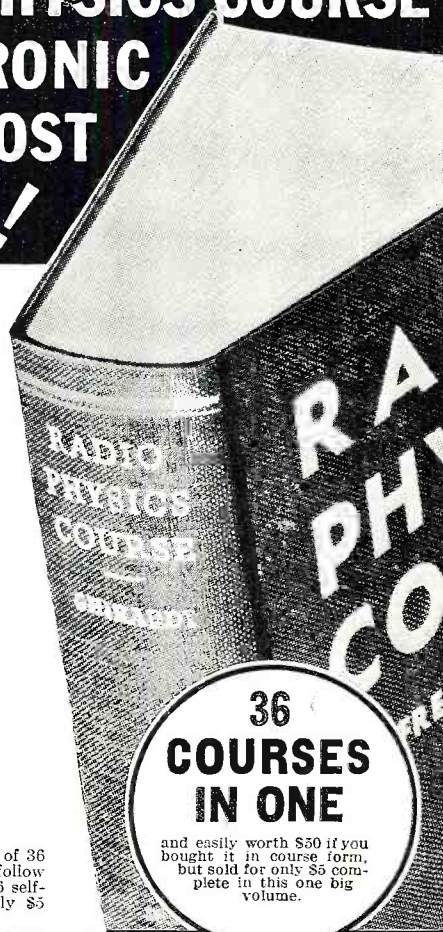

**36 COURSES IN ONE**

and easily worth \$50 if you bought it in course form, but sold for only \$5 complete in this one big volume.

## NEW! Ghirardi's Wartime Guide for **DIAGNOSING, LOCATING, AND REPAIRING RADIO RECEIVER TROUBLES**

(**RADIO TROUBLESHOOTERS HANDBOOK** — Now in its 3rd Revised Edition)

Stop guessing on radio service jobs—stop wasting time **THAT ACTUALLY COSTS YOU MONEY!** . . . Here is the most important book any repair shop or individual can own during these war shortage days! Enables you to cut corners on jobs—cut troubleshooting and repair time **IN HALF**—train new helpers—repair cheapsets at a real profit—substitute available tubes and parts properly—handle tough

jobs in half the usual time—and much more.

### COVERS 75 VITAL SUBJECTS

This new 3rd, Special Wartime Edition of Ghirardi's popular **RADIO TROUBLESHOOTERS' MANUAL** has been completely revised, greatly enlarged, and contains nine entirely new and additional sections of vital new material—including the finest, most up-to-the-minute tube chart you've ever seen.

Its 404-page Case History Compilation

gives common trouble symptoms (their Causes and Remedies), for over 4,800 models of the 202 most popular makes of receivers—and that is just the beginning of the book's usefulness. 74 other big subjects include all the various kinds of information you need to help you repair more radios in less time and at better profit to you.

Sold for only \$5 complete (\$5.50 foreign) on a **5-DAY MONEY-BACK GUARANTEE**. Folder free.

**JUST OUT!**

## GHIRARDI'S FAMOUS **MODERN RADIO SERVICING**

Another indispensable volume by Radio's best known technical author is Ghirardi's **MODERN RADIO SERVICING**—the only single text book covering modern radio testing instruments, troubleshooting, and repair procedure **COMPLETELY**. Actually, it is a 1300-page home-study course on the entire art of Radio repair, complete with 706 illustrations, and 720 self-testing review questions. Sold for only \$5 complete (\$5.50 foreign).

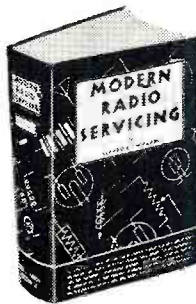

See Money-Saving Combination Offer in Coupon!

## THE 3 GREATEST VALUES IN MODERN RADIO TRAINING

Radio & Technical Publishing Co., Dept. RN-103  
45 Astor Place, New York (3), N. Y.

- Enclosed find \$..... in payment for books checked below; or
- Send C.O.D. for this amount plus postage. In either case, if I am not fully satisfied, I may return the books at the end of 5 days **AND RECEIVE MY MONEY BACK.**
- Ghirardi's **RADIO PHYSICS COURSE** \$3.00 (\$5.50 foreign)
- NEW 3rd Revised Edition of RADIO TROUBLESHOOTERS' MANUAL** \$3.00 (\$5.50 foreign)
- MODERN RADIO SERVICING** \$5.00 (\$5.50 foreign)

### MONEY-SAVING COMBINATION OFFER

Troubleshooter's Handbook and Modern Radio Servicing at a special price of only \$9.50 FOR THE TWO (\$10.50 foreign).

Name.....  
Address.....  
City..... State.....

## REPAIR ANY MAKE OF RADIO EQUIPMENT!

Prepare Now for a Good-Paying Job in the Radio-Electronic Field

ELECTRICAL ENGINEERS  
ELECTRONIC ENGINEERS  
CIRCUIT ENGINEERS  
CHEMIST  
MICRO-CHEMIST  
ELECTRONIC DRAFTSMAN  
PHYSICIST

For war and post-war development work with major manufacturer in the field of electronics.

Write, stating education, experience, and salary requirements.

**TUNG-SOL**  
**LAMP WORKS, INC.**  
370 Orange St., Newark

Persons in war or essential activity not considered without availability statement.

## LEARN CODE

the way you'll be using it

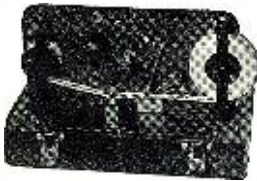

by SOUND

The best way to learn to read code is by listening to code. The best way to learn to send code is by hearing your own sending repeated back to you. With the new All-Electric Master Telex Code Teaching Machine, you learn code the natural, easy, fascinating way. Only instrument ever produced which records your sending in visible dots and dashes—then SENDS BACK your own key work at any speed you desire. There are NO PERFORATIONS—NO INK. Far superior to anything ever developed... a marvel of simplicity. That's why practically every school teaching code uses MASTER TELEPLEX. We furnish complete course, including the All-Electric Master Telex, give you personal instruction with a MONEY-BACK GUARANTEE—All at a surprisingly low cost. Write today for FREE catalog RN-6. No obligation.

**TELEPLEX CO.,** 107 HUDSON ST., JERSEY CITY, N. J.

### LIMITED QUANTITY OF EMERGENCY CODE PRACTICE EQUIPMENT



#### Prac-to-Code Oscillator

A self-contained code practice oscillator complete with tubes and a spring lever type, practice key—housed in a beautifully finished solid oak cabinet—ample power output to handle several pairs of headphones or a small loudspeaker.

Postpaid.....\$9.95

#### Prac-To-Key

A simple and foolproof spring lever type practice key mounted on a substantial metal base. Postpaid...\$9.95  
Sales Restricted to Radiotelegraph Students in Training for the War Effort

**WAYNE MILLER**

205 W. Wacker Drive Chicago 6, Illinois

## Vibrator Supply

For FARM RADIOS

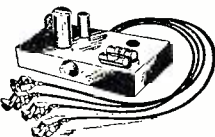

**MODEL "Y".** Adapts any standard 1 1/2-olt Farm Radio for 6-volt Storage Battery Operation. Low drain. No radio changes. Weight 4 lbs. Complete (wholesale), \$6.95

**MODEL "Z".** Adapts 4, 5 or 6 tube, 2-volt radios for 8-volt operation. Complete (wholesale), \$7.95  
**BARGAIN BULLETIN**—on radio and electrical parts. Prompt shipment. Large stock. Sent on request. Write today.

**McGEE RADIO & ELECTRIC CO.**  
R-1225 McGee St. Kansas City, Mo.

classifications; technical and general. The academic materials found in technical treatments assume the knowledge of the standard fundamentals of mathematics and electricity. The technical classification has as its objective radio engineering principles or the scientific discussion of the operation and maintenance of advance equipment. The subject matter covered by the general classification is the standard information on general electricity, simple circuit behaviors, and the operation of essential equipment. The material contained in this book has been tested by the authors in actual classroom conditions.

**"PRACTICAL RADIO FOR WAR TRAINING"** by M. N. Beitman. Published by *Supreme Publications*, 328 So. Jefferson St., Chicago, Illinois. 332 pp. plus index. Price \$2.95.

This single volume presents to the student needed theory of electricity and radio and explains the practical side of radio repair, adjustment, operation, and alteration. No previous knowledge is assumed on the part of the student but those having had previous experience will progress at a faster rate than those lacking the necessary background. This book may be used for home study, for brush-up for former servicemen and in high school pre-induction radio classes to good advantage. The suggested radio work and experiments can be performed with parts that are available from the junk box or taken from an old radio set. The student is introduced to real radio equipment, in fact to an entire radio set, in the very first chapter. The book is very complete in its scope and serves as a handy reference as well as being ideally suited for use by the newer radio student.

**"A COURSE IN RADIO FUNDAMENTALS,"** by George Grammar. Published by *The American Radio Relay League, Inc.*, West Hartford, Conn. 103 pp. Price 50c.

This book presents an idea unique in the radio educational field. It is not a text book; instead it contains those elements of a course of classroom study which lay outside the text book proper. The material was prepared originally in response to the demand for a course of study covering those fundamentals upon which practical radio communication is built. It is equally suited for use for home study courses or as a classroom guide for teachers. The material is presented in eight parts and includes electricity and magnetism, Ohm's Law for d.c. and a.c., resonant circuits, vacuum-tube fundamentals, radio-frequency power generation, modulation, receiver and antennas. These parts are subdivided into thirty-six study assignments and with each is a group of examination questions carefully designed to test the student's grasp of each of the significant points brought out in the text.

-30-

## 7 DAYS Free Examination

### PRACTICAL RADIO INFORMATION

Including Frequency Modulation—Television, etc. Inside Radio Information for all Servicemen—Aircraft Pilots, Students. **AUDELS RADIO-MANS GUIDE** contains 772 Pages, 400 Diagrams & Photos is complete—gives Authentic Principles & Practices in Construction, Operation, Service & Repairs. Covers clearly and concisely Radio fundamentals—Ohm's Law—Physics of sound as related to radio science—Measuring instruments—Power supply—Resistors—Inductors—Condensers—Transformers and examples—Broadcasting stations—Radio Telephony—Receivers—Diagrams—Construction—Control systems—Loud speakers—Antenna systems—Auto Radio—Phonograph pickups—Public Address Systems—Aircraft & Marine Radio—Radio Compass—Beacons—Automatic Radio Alarms—Short Wave—Coil Calculations—Testing—Cathode ray oscillographs—Static Elimination—Trouble Pointers—Underwriter's standards—Units and tables—Frequency Modulation—REVIEW QUESTIONS & ANSWERS, Ready Reference Index.

**\$4 COMPLETE • PAY ONLY \$1 A MO.** Get this practical information in handy form for yourself—fill in and

**AUDELS Publishers, 49 W. 23rd St., N.Y.** Mail AUDELS NEW RADIO-MANS GUIDE for free examination. If O. K., I will send you \$1 in 7 days; then remit \$1 monthly until \$4 is paid. Otherwise I will return it.

NAME \_\_\_\_\_  
ADDRESS \_\_\_\_\_  
OCCUPATION \_\_\_\_\_  
REFERENCE \_\_\_\_\_ RN

## VICTORY LINE

These products always stand at the head of the line, we're lucky to have them—you're lucky to get them. Acovox Condensers, Ken-Rad Tubes, Mueller Clips, Duotone Recording Blanks, Pickup Needle screws. Send deposit with tube orders.  
**ANCHOR RADIO DISTRIBUTING SERVICE CO.**  
ITHACA BOX 21 NEW YORK

## 7 Days FREE TRIAL

-Costs You Nothing to Examine  
Amazing New 3 Vol. set of  
REFERENCE BOOKS on  
PRACTICAL

## ELECTRIC TY

For BEGINNERS or "OLD TIMERS"

Say, do you want to learn about Electricity, Radio and Electronics? Would you like to have this knowledge at your finger tips. Then you need the 3-vol. COYNE REFERENCE ENCYCLOPEDIA 2000 illustrations—over 2000 subjects all plainly indexed. It can add money to your pay check. You can be the authority. Doesn't cost you a cent to see and examine it in your own home for 7 days.

Read the coupon below—then fill it in and send it to me. I'll send you your set. Then you decide if you want to keep it. Mail the coupon right *A. C. Lewis* now.

**FREE WITH SET!** Big extra book of 150 Coyne Shop Prints, wiring diagrams, radio hook-ups. Also 1 year Technical Service by mail from Coyne staff.

**H. C. LEWIS, Pres. Dept. 73-71 COYNE ELECTRICAL SCHOOL, 500 S. Paulina St., Chicago 12, Illinois**  
Send me the big 3-volume Coyne Electrical and Radio Reference Encyclopedia, postpaid, and 150 Shop Prints FREE. Within 7 days, after receiving books, I'll either return them or send you \$3.00 and \$3 a month until advertised price of \$18.95 is paid.

NAME \_\_\_\_\_  
ADDRESS \_\_\_\_\_  
CITY \_\_\_\_\_ STATE \_\_\_\_\_  
OCCUPATION \_\_\_\_\_ AGE \_\_\_\_\_  
**SAVE 10%.** Send cash price, \$12.55, with order, if preferred— you save \$1.40. Same 7-day free trial.



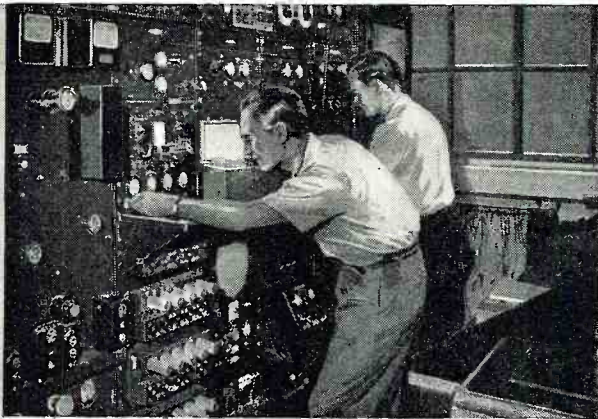

### ELECTRONICS RESEARCH

Technicians of Delco Radio are carrying forward pioneer research in the field of radio and electronics.

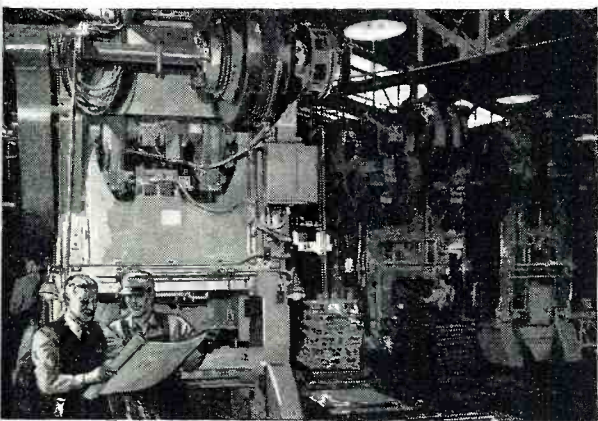

### PROCESS ENGINEERING

Delco engineers are equipped through years of experience to translate swiftly the product of research and design into practical, useful products.



### PRECISION ON A PRODUCTION BASIS

Delco specializes in the ability to mass-produce highly intricate products. Years of experience in the automotive radio field qualify Delco for vehicular radio production for war.

# PROBLEMS were made to be solved

For many years before the war, Delco Radio engineers were meeting and solving the problems of automotive radio . . . and putting their answers into mass production on the assembly line.

This practice gave Delco Radio technicians a head start on the problems of automotive radio for war, and prepared Delco Radio for the task of producing intricate war radio parts, components and assemblies in large quantity and of uniformly high quality of manufacture at a lower cost. Ability quickly to combine research engineering with mass-production methods has been applied in full measure to meeting the needs of the armed forces.

Whether the task at hand is one of pure research, or of mass-production methods, or a combination of both, Delco Radio is adequately equipped and experienced to do the job. Delco Radio Division, General Motors Corporation, Kokomo, Indiana.

★ ★ ★ ★ ★ ★ ★

## Back the Attack — WITH WAR BONDS

# Delco Radio

DIVISION OF  
**GENERAL MOTORS**

**FOR SALE**  
**(Tremendous SACRIFICE)**

**Code Operator's Tables**

Used in Signal Corps Training Program. Beautifully made. "Well" for standard size typewriter. Completely wired. Tablet arm with standard make and code key attached. Also includes standard pair of headphones with phone jack and toggle switch, etc. These tables originally cost \$50 each, fully equipped. Will sell for

**\$14.95** each

Price includes crating for F.O.B., Newark, N. J. Send money order to

**NEW YORK TECHNICAL INSTITUTE OF NEW JERSEY**

786 Broad Street

Newark, New Jersey

Limited number available. First come — First served!



**BURSTEIN-APPLEBEE CO.**  
1012-14 McGee St. Kansas City, Mo.

**RADIO PARTS**  
**SOUND SYSTEMS**  
**ELECTRONIC APPARATUS**

**Depend on**  
**RADOLEK**

**Send Now for the**  
**Big RADOLEK**  
**Buying Guide!**

Make Radolek your dependable source for essential radio, sound and electronic replacement parts—tubes, condensers, volume controls, resistors, transformers, etc.—all at lowest prices. Orders for industry, Government services and war training programs are given special attention. Thousands rely on Radolek for their entire requirements. Send for the big Radolek Buying Guide NOW!

**FREE! Lowest Prices**  
**Fast Service**

Radolek quality, low prices and prompt service save valuable time and money. For complete satisfaction send your orders to Radolek.



**SEND TODAY!** POSTS ON A POST CARD  
**RADOLEK CO., Dept. B-83**  
601 W. Randolph St., Chicago, Ill.

Please send the Big FREE Buying Guide

Name .....

Address .....

DEALER  SERVICEMAN  SOUND ENG.

**SAVE AT RADOLEK**

**Determining Cloud Depths**

(Continued from page 45)

intervene. Then the light passing from the lamp to the cell is reduced in direct relationship to the cloud density. That is to say, the density of the condensed moisture particles is in direct proportion to the related radio signal, and when the latter is plotted there is an indication of increase or decrease of light intensity corresponding to the increase or decrease of clouds density, as the balloon ploughs through layers of clouds.

Dunmore, the inventor, literally and figuratively, "lived" in the clouds, as he dreamed theories and pursued actualities in constructing and testing his brain-child. Unlike some cloistered scientists, he was not content with theorizing. The device was put to gruelling tests at altitudes from 5,000 to 13,000 feet. The graph, Figure 5 shows the results. Light-brightness, it was discovered, remains fairly constant up to 5,000 feet—the bottom of a vast cloud-layer. This was anticipated, as indication of the quantity of light penetrating the cloud-layer above. From levels of 5,000 to 7,000 feet, the light-brightness increased at accelerated paces, thus indicating that the balloon was penetrating a light-absorbing cloud. From 7,000 to 12,000 feet, the light-brightness was unalterably steady—equivalent to that reflected from the top of the cloud-layer below—indicative of a clear space. But as the free balloon climbed from 12,000 to 13,000 feet, again there was an increase of light-brightness suggesting the presence of a second cloud-layer. Beyond this upper limit of 13,000 feet, no further cloud-layers were encountered and, consequently, the light-brightness remained a constant factor.

Thus, this graphic chart illustrates two extensive cloud-layers—the photoelectric cell receiving a greater reflection of light when above the first cloud-layer, due to the sun hitting the top of it through scattered clouds.

When science can transplant its laboratories from sedate and sequestered quarters on terra firma to thousands of feet in the skies—well, the realm of the imagination is not only stretched but visions above the earth and into the clouds become realities.

-30-

**Photo Credits**

Page Number	Credits
8	Drucker-Hilbert Co., Inc.
22 (upper right and bottom), 23	Acme
22 (upper left)	U. S. Navy
30, 31	U. S. Army Air Forces
32 (top), 33	Phillips Metalix Corporation
47	Sixth Service Command, U. S. Army

Be a Govt. Licensed  
**RADIO OPERATOR**

Good Jobs in Aircraft Radio, Broadcast Studios, Talking Pictures, Police & Marine Radio, Television, etc.



**"Learn-by-Doing" on REAL RADIO EQUIPMENT in the COYNE SHOPS**

Get ready for a great Victory future in Radio Operating. Expert training at Coyne prepares for Govt. License test quickly, easily. Fascinating, well-paid work in Airports, Radio stations, Movie studios, etc. A few weeks now—big opportunities ahead!

**I'LL FINANCE YOUR TRAINING!**

Start now—pay tuition after graduation. My plan has helped thousands. I assist you in getting part-time work while at Coyne to help pay living expenses, too. Real Employment Service when trained.

**LEARN RADIO and ELECTRONICS**

Sensational new field of Industrial Electronics—electronic equipment designed for industrial application and high frequency devices—no extra charge. A world of opportunities awaits you!

**FREE BOOK!** Mail coupon, get facts now. Big Radio Future for trained men whether you're 16 or up to 50 years old. Send today!

H. C. LEWIS, Pres., RADIO DIV., COYNE ELEC. SCHOOL  
500 S. Paulina St., Dept. 73-1K, Chicago, Illinois  
Send FREE BOOK, "Your Future in Radio", and details of easy "Pay-After-Graduation" plan.

NAME.....  
ADDRESS.....  
CITY..... STATE.....

**Add a Language**  
**To Your Assets**  
**by LINGUAPHONE**

In War, in Peace, ability to speak another language is an asset which will tip the scales in your favor... open new opportunities, earn promotion.

*Speak* { ITALIAN POLISH  
SPANISH NORWEGIAN  
PORTUGUESE FRENCH  
RUSSIAN GERMAN  
JAPANESE  
or any of 20 other languages

**Quickly, easily, correctly by LINGUAPHONE Ear-Eye METHOD**

This amazingly simple and delightful way to learn to speak any of 29 languages in your own home is the work of 150 of the foremost language teachers of famous universities.

Endorsed by educational authorities, Linguaphone is used by Army, Navy, Flying, Signal, Medical Corps and other services; by 14,000 schools, colleges and by more than one million home-study students. Do not confuse Linguaphone Ear-Eye Method with any other.

Send for FREE book.  
Call for FREE Demonstration.

**LINGUAPHONE INSTITUTE**  
30 R.C.A. Building, New York (20), N. Y.

**Pre-Induction RADIO COURSES**

for Civilians and those entering Military Service  
New classes now starting for men and women.  
• Radio Operating • Code  
• Radio Servicing • Radio—Electronics  
**NEW YORK Y.M.C.A. SCHOOLS**  
7 West 63rd Street, New York City

**Radio Operators' License Manual**

Complete and authentic question and answer manual on commercial radio operator license examinations. 1297 questions and answers, 230 pages of vital information for radio operator license candidates. \$3.00 Postpaid or write for descriptive circular.

**WAYNE MILLER**  
1943 205 W. Wacker Drive  
Edition Chicago 6, Illinois

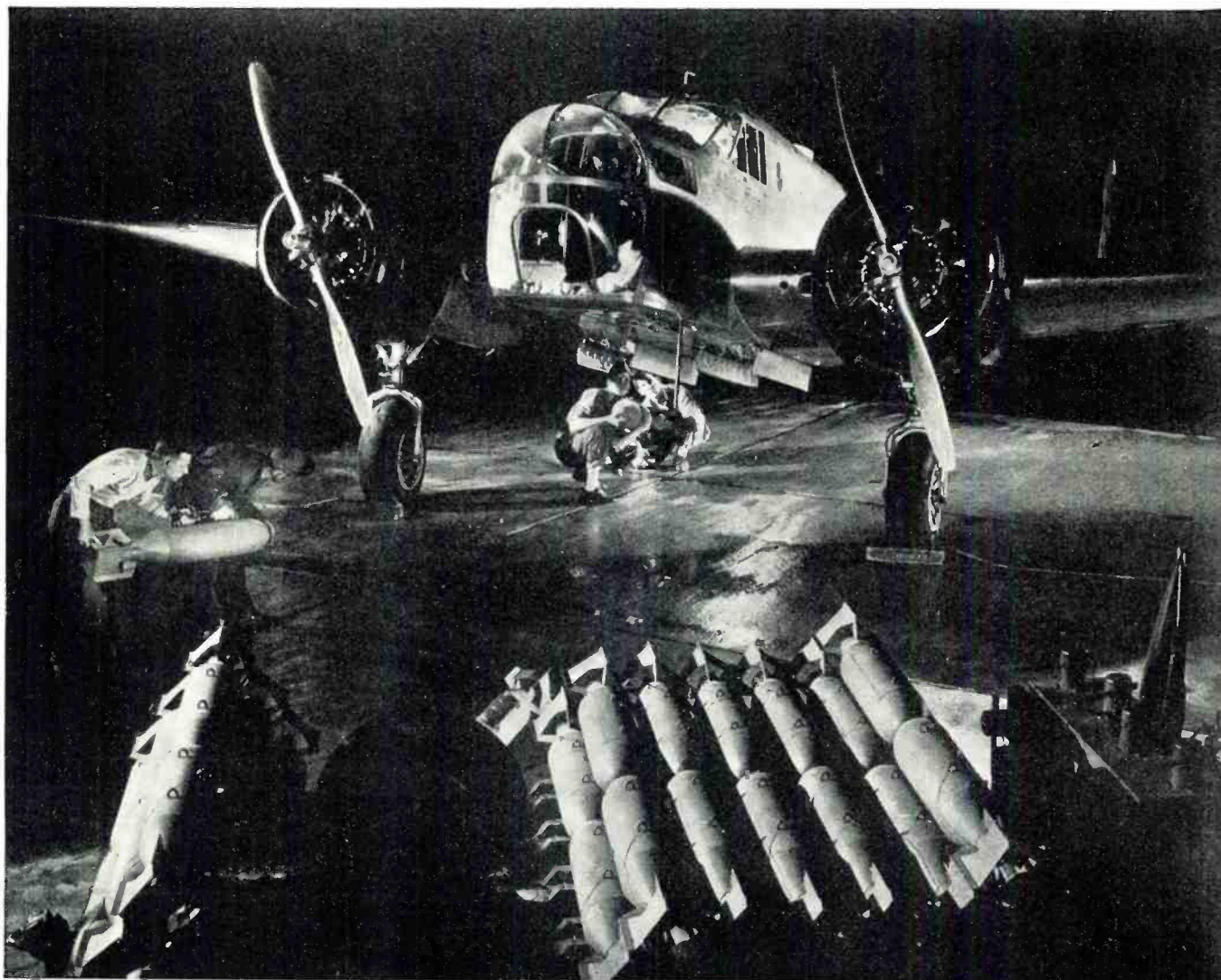

## he complete story of the U. S. Army Air Forces at war!

The editors of RADIO NEWS' sister publication, FLYING, are proud to present in the Special 364-page October Issue a dramatic and comprehensive report of the U. S. Army Air Forces at war.

Compiled under the direction of the Air Staff of the USAAF, this complete story of the very spearhead of our arms is revealed in thirty-five informative, brilliantly illustrated articles, including: "AAF On the Offensive" by Hon. Robert A. Lovett and "Air Strategy for Victory" by Gen. Henry H. Arnold.

Of particular interest to the readers of RADIO NEWS is the stimulating article on Radio which discloses how the Communications Wing conducts the AAF's huge network.

This volume is replete with striking action photographs—dynamic shots captured by ace cameramen, including many pictures taken especially for this issue and flown to the United States from the various war theaters—featuring: three special pictorial portfolios . . . (1) 32 pages in brilliant natural color . . . (2) 16 pages in beautiful rich duotone . . . (3) 16 pages in fine blue-black gravure of true salon quality.

Because of the wartime paper curtailment, the print order on this special issue was strictly limited . . . so get your copy immediately. If you are unable to obtain a copy from your newsdealer, we suggest that you borrow one; and if you do secure a copy, please share it with someone else.

**SPECIAL 364-PAGE U. S. ARMY AIR FORCES AT WAR ISSUE**  
NOW FEATURED AT NEWSSTANDS EVERYWHERE—50¢ PER VOLUME

**FLYING**

October, 1943

107

# ENGINEERS

**NATIONAL UNION  
OFFERS A GREAT  
OPPORTUNITY**

National Union Radio Corporation, long acknowledged as a national leader in vacuum tube manufacture, is building a greater research and engineering staff. Our contribution to the war effort has been substantial; our plan for the future knows no bounds. If you get into this electronic tube picture now, you have a brilliant future, unlimited horizons ahead.

Our laboratories are in Newark, New Jersey.

We prefer men with a degree in electrical engineering, physics or mathematics and a knowledge of vacuum tubes; however, if your experience warrants, a degree is not absolutely essential. You must be draft exempt and not now employed full time at highest skill in a war industry.

## CAN YOU QUALIFY AS:

- Electronic tube engineer  
Metallurgist
- Production engineer
- Development engineer
- Measurement engineer
- Physicist
- Electrical engineer

Write at once and tell us your experience, education, draft status, salary requirements.

**NATIONAL UNION  
RADIO CORPORATION**  
48 Spring St., Newark, New Jersey

## ★ INDUSTRIAL ★ MAN-POWER BUREAU

### Radio Circuit Engineers Electronic Engineers Test Equipment Engineers

Engineers with backgrounds for acoustics, broadcasting, frequency modulation, ultra-high frequencies. Wide experience in radio receiver, transmitter, communications or test equipment is necessary, particularly engineers with experience in layout and design for mass production.

Women with technical knowledge will be considered.

Salaries are commensurate with background and experience. Factory now engaged wholly in war work, but positions will lead to others of greater scope and importance after the war.

State education, experience, salary desired, draft status, and age in first letter.

Box 322, % RADIO NEWS  
540 North Michigan  
Chicago 11, Illinois

### Radio and Electronics ENGINEERS PHYSICISTS

A progressive electrical concern now producing products that are playing a vital role in hastening Victory, as well as pioneering in the birth of new post-war electronic devices has several excellent openings for men with experience on the design, development and production of electronic tubes and equipment.

Write concisely giving age, education, experience and present salary to Box No. 323, % RADIO NEWS, 540 North Michigan, Chicago 11, Illinois.

## CAN YOU FILL ONE OF THESE MOST IMPORTANT WAR JOBS?

If you have a college education (not necessarily a graduate) and know theory and practice, you are urgently needed by a non-profit, non-commercial organization assigned to vital war research.

- Electronic Engineers
- Radio Engineers
- Electrical Engineers
- Physicists
- Mechanical Engineers
- Electrical Designers
- Electronic Designers
- Acoustical Specialists
- Communication Engineers
- Geophysicists
- Seismograph Technicians

*If you are in one of the above categories and your highest skill is not being utilized to help save lives and materials, to help shorten the war, please write! ACT NOW!*

Salaries range from \$3,000 to \$8,000, depending upon experience, ability, education and past earnings. In addition, we will pay all expenses of transportation, moving, etc., for you and your family. You must be free to travel. Living quarters will be made available. If granted an interview, we will compensate you for all expenses incurred in coming to New London. Don't wait! Write, stating background and experience to . . .

## PERSONNEL DEPT.

P. O. Box 271, New London, Conn.

## IMMEDIATE OPENING

Mechanical Engineer  
Tool Design Engineer  
Shop Foreman  
Radio Engineer

●  
For Radio Transmitter  
and Parts Production

●  
*State qualifications  
and salary expected.*



**E. F. JOHNSON CO.**  
44814, MINNESOTA

"MANUFACTURERS OF RADIO TRANSMITTING EQUIPMENT"

Men with Sales Personality and  
Background in Electronics or  
Hydraulics Needed for  
War and Post War Development  
**COOK ELECTRIC COMPANY**  
2700 Southport Chicago, Ill.

This section is designed to help the radio industry obtain trained, experienced, technical men to facilitate vital war production.

# WANTED

## TECHNICAL SPECIALISTS

### MEN and WOMEN

The Colonial Radio Corporation needs immediately for War Radio Work the following technically trained personnel:

#### RADIO ENGINEERS

AERONAUTICAL  
COMMERCIAL  
RESEARCH

#### PHYSICISTS—RADIO

#### VACUUM TUBE ENGINEER

PRODUCTION CONTROL

These are NOT temporary positions. Satisfactory employees may expect PERMANENT employment. Qualified applicants, NOT now in war work, should write, giving full history of education, experience, and salary desired.

## COLONIAL

### RADIO CORPORATION

254 RANO ST.

BUFFALO, N. Y.



#### ELECTRICAL DRAFTSMAN

Wanted by aggressive concern offering post-war security. Must be capable of taking over duties as chief draftsman. Those now in essential industries will be engaged only in compliance with WMC rulings.

The Triplett Electrical Instrument Co.  
Bluffton, Ohio

#### TECHNICAL WRITERS WANTED!

Engineers and physicists who have had experience in (spare time) writing technical manuscripts on electronic design or applications including radio, television, facsimile, etc. Highest rates.

Reply Box 310, c/o RADIO NEWS  
540 N. Michigan Ave., Chicago 11, Ill.

# WANTED

COMPANY NOW ENGAGED solely in production of aircraft and ground station radio receiving and transmitting equipment has openings for persons qualified to fill the following jobs:

*Radio Engineers*—well grounded in radio and electronic fundamentals. Very high frequency experience desired. Must be qualified to assume charge of engineering a project through production.

Also Mechanical Design Draftsman.

Physicist, electronic {5 to 10 years radio or electronic experience}.

This progressive radio receiver and transmitter manufacturing organization is now producing communicating equipment for our armed forces. But a long range program will provide opportunities in the post war period for the production of all types of civilian radio receiving and transmitting equipment.

Write at once, giving complete details of past experience. Interviews will be arranged for all who qualify for positions available.

AIRADIO, INCORPORATED  
2 SELLECK STREET  
STAMFORD, CONN.

*Applicants presently employed in War Work will be required to present a statement of availability.*

# SEEBURG

## ★ WANTS ★ ENGINEERS

The J. P. Seeburg Corporation has been manufacturing fine musical instruments since 1902. In recent years automatic phonographs, radio remote control equipment, and home record changers have been our principal products. We have made important contributions to the war effort in aircraft transmitter equipment, aircraft radio controls, tank communications equipment, aviation training devices, and aircraft gun turret equipment.

We are increasing our engineering staff to handle our 100% war work, keeping in mind our future place in the phonograph, radio, and electronic fields. Openings are available for men qualified to fill the following positions:

### RADIO & ELECTRONIC ENGINEERS—

College graduates with experience in radio receivers, transmitters, and tube circuits in general.

### MECHANICAL ENGINEERS—

experienced in design of intricate mechanisms and familiar with manufacturing practices and requirements.

### SPECIFICATION MEN—

experienced in making up bills of material, parts lists, and writing specifications from drawings.

### DRAFTSMEN—

should have considerable experience in product design, layout, and/or detailing.

Please write fully to Mr. M. W. Kenney, Chief Engineer, outlining education, experience, draft status, and salary requirements. Preference given to married men with children or otherwise draft deferred.

## J. P. SEEBURG

**CORPORATION**  
1500-1524 N. Dayton Street  
CHICAGO, ILLINOIS

### TUBE PLANT MANAGER

Man with extensive experience in the management of radio tube manufacturing plant together with tube engineering. State education, experience, salary desired, draft status, and age in first letter. Box 321, c/o Radio News, 540 North Michigan, Chicago 11, Ill.

## ★ INDUSTRIAL ★ MAN-POWER BUREAU

*Help!*  
*We need Engineers*  
*and Laboratory Assts.*

We're  
going places  
in electronics—  
NOW and after the war.

### Want to come along?

If you are not now using your full talents for the war effort, you may participate in the development of new and revolutionary communications methods. Outline your education, experience, marital status and salary requirements. Address

BOX 318, c/o RADIO NEWS  
540 N. Michigan Ave., Chicago 11, Ill.

### RADIO ENGINEER WANTED

Graduate radio engineer, familiar with laboratory measurements and calculation, mechanical design and development, particularly in ultra high frequency field. Starting salary \$4000. Location Red Bank, N. J.

Address  
Box 320, Radio News  
540 N. Michigan Ave.  
Chicago 11, Ill.

### RADIO ENGINEERS TESTERS ENGINEERING AIDES

For development and production work on receivers, transmitters and test equipment. Technical background required, preferably with 2 years' experience or holding amateur radio license. If now on war work release necessary.

AIR KING PRODUCTS CO.  
1523 63d St., Brooklyn, BE 2-6700

### TWO IMPORTANT, PERMANENT ENGINEERING POSITIONS ARE OPEN

Connecticut Telephone & Electric Division of Great American Industries, Inc., needs two experienced men in its Meriden, Connecticut, plant.

The first man should have a thorough knowledge of acoustics and experience with magnetic circuits and acoustical measurements.

The other man must be familiar with the application and molding technique of plastics. He should have several years of design experience on small electrical apparatus, and an understanding of magnetic and electrical circuits.

"Connecticut Telephone" is a prime war contractor with an assured peacetime future. The two engineers described above will work on both wartime and postwar projects. Write, phone or wire Mr. William R. Curtiss, Chief Engineer, Connecticut Telephone & Electric Division, Great American Industries, Inc., Meriden, Connecticut.

Persons in Essential Activity or Critical Occupation not considered without statement of availability.

**GREAT AMERICAN  
INDUSTRIES, INC.**  
70 Britannia Street  
Meriden, Connecticut

## ENGINEERS

Junior, Semi-Senior, and Senior  
Male or Female

Wanted for developmental work with an outstanding manufacturer of electronic components. Interesting work. Good living conditions. Salary in keeping with experience and background. Write stating qualifications in full. Interview arranged promptly.

Write to: Personnel Dept.

**SPRAGUE SPECIALTIES COMPANY**  
North Adams, Mass.

*Those now employed in essential industries will be engaged only in compliance with the War Manpower Commission rulings.*

This section is designed to help  
the radio industry obtain trained,  
experienced, technical men to  
facilitate vital war production.

## RADIO TESTERS for Westinghouse

We can place in our Test Department at Baltimore, Maryland, men or women with training and experience in Radio theory and practice. The work will provide experience with the latest electronic equipment. A high school education or equivalent, including courses in mathematics and physics, is required and, in addition, at least one of the following qualifications:

1. Completion of a course in fundamental radio transmitter or receiver theory (preferably a resident course, in a recognized radio school).

2. One year's experience as a radio amateur during the last five years, plus at least one year's recent experience in radio testing.

3. Two year's recent experience in radio service work.

Employment depends on satisfactory personal interview and a physical examination.

No one employed at his highest skill in essential industry should apply. Applicants living outside the Baltimore area must obtain a "Statement of Availability" from their nearest United States Employment Service office.

Apply in person or by Letter to

RADIO DIVISION  
WESTINGHOUSE-ELECTRIC &  
MANUFACTURING COMPANY  
2519 Wilkens Avenue  
BALTIMORE, MARYLAND

## WANTED

**Radio Engineers**  
**Mechanical Engineers**  
**Electrical Engineers**  
**Radio Technicians**

Seniors and Juniors with design development and production experience.

Excellent post war opportunities for engineers seeking permanent connections in this field of Radio, Radar, and Electronics.

All hiring done in accordance with War Man-Power Regulations.

Write to

The F. W. Sickles Company  
165 Front St., Chicopee, Mass.

## WANTED

1. RADIO, ELECTRONIC ENGINEERS preferably with experience in radio, ultra high frequencies, general electronics.
2. RECENT GRADUATES — in electronics or physics.
3. TECHNICIANS—experienced in radio and electronics.
4. MECHANICAL ENGINEERS—experienced in the design of high production items and familiar with manufacturing practices and requirements.
5. DRAFTSMEN — experienced in production, layout and detailing, also those unexperienced but trained.

This increase in staff is required to take care of war work of high military urgency and for post-war requirements.

If you are employed in essential war work to the full extent of your skill, do not apply.

Write to: PERSONNEL OFFICE  
Delco Radio Division  
GENERAL MOTORS  
CORPORATION  
KOKOMO, INDIANA

## RADIO-ELECTRONIC ENGINEERS TESTERS TECHNICIANS

EXCELLENT OPPORTUNITIES

in a major post war field.

Openings available at our Research Laboratories and Electronic manufacturing unit. Leaders in the design and development of vital electronic equipment for the armed forces.

War workers at highest skill do not apply without availability statement.

Write, stating experience, education, draft status, salary requirements or apply to

### SPERRY

GYROSCOPE CO., INC.

RESEARCH LABS & ELECTRONIC PLANT  
STEWART AVE. & CLINTON RD.  
GARDEN CITY, NEW YORK

## SOUND EQUIPMENT TECHNICIANS

with engineering training. Must have recent experience for constructing and testing work on shipboard loud speaker equipment. Want men capable of being trained as field engineers and construction supervisors. Must be draft exempt. 100% war industry. Write stating experience, training, and salary expected to

REMLER COMPANY, LTD.  
2101 Bryant Street San Francisco, California

## RADIO TECHNICIANS

Laboratory assistants and trouble shooters (Male or Female). Good opportunities in war plant. Persons in war work or essential activities not considered without statement of availability.

CARDWELL

81 Prospect St., Brooklyn, New York

## HIGH-FREQUENCY HEATING

HIGH-frequency heating at 200,000 cycles per second to melt tin, electrolytically deposited on a steel sheet, saves critical tin, speeds production, increases corrosion protection and facilitates the mechanical handling of the plated sheet. Already at work in one steel mill, this latest result of electronic research flows 12 square feet of tin in seven tenths of a second, much faster than was previously practical with gas furnaces or huge vats of hot oil.

This high-frequency method of fusing tin makes practical the final step in electrolytic tinning which saves two-thirds of the war-scarce tin. The electrolytic coating of only 30 millionths of an inch on each side of the strip, or less than one-hundredth the diameter of a human hair, cuts 60 millionths of an inch off the coating applied by the old hot dip process. Additional saving in both tin and steel sheet may be realized by high-frequency heating, since no waste is encountered from scoring or from marking the sheet by either electrical or mechanical action. In the induction system it is possible to melt and quench the tin plate between guide rolls. As the power input to the inductor coil, which determines the amount of heat generated, can be immediately and automatically adjusted to correspond with any change in speed of the strip, the proper temperature to melt the tin is maintained and oxidizing of the strip eliminated.

The frequency at which the required current can be induced in the strip without using abnormally high voltage depends upon the thickness of the sheet. Since tinplate usually is of the order of .008" to .011", a frequency of approximately 200,000 cps is most practical for this thickness of sheet.

The inductor heater coil is rectangular in form; wound as close to the strip as mechanically possible. It acts as the primary of a transformer while the strip itself constitutes a single turn secondary. The induced current flows across the strip paralleling the turns of the inductor heater coil. The heat generated in the strip is due to the resistance of the strip and the current flowing through it.

Company	Page No.	Company	Page No.
Aerovox Corporation	113	Majestic Radio & Television Corp.	73
Airadio, Incorporated	109	Mallory, P. R. & Co., Inc.	81
Air King Products Co.	111	McElroy Manufacturing Corp.	63
Allied Radio	64	McGee Radio	104
American Photocopy Equipment Co.	96	McGraw-Hill Book Co.	94
American Radio & Hardware Co., Inc.	5	Meck Industries, John	78
Anchor Radio Distributing Service Co.	104	Meissner Mfg.	72
Audel Publishers	104	Merit Coil & Transformer	90
Barker & Williamson	65	Micamold Radio Corporation	91
Belmont Radio	Back Cover	Midwest Radio Corporation	99
Bliley Electric Company	86	Millen Mfg. Co., Inc., James	8
Burstein Applebee Co.	106	Miller, Wayne	104, 106
Candler System Co.	94	Murdoch Co., Wm. J.	60
Capitol Radio Engineering Institute	66	Mutual Radio Products Co.	90
Cardwell	111	National Company	55
Centralab	96	National Radio Institute	3
Classified	112	National Schools	56
Colonial Radio Corporation	109	National Union Radio Corporation	75, 108
Commercial Radio	112	Nelson Co.	94
Consolidated Radio Products Company	68	North American Philips	108, 110
Connecticut T & E Division	54, 110	N. Y. Tech. Inst. of N. J.	94, 106
Cook Electric Company	108	N. Y. Y. M. C. A. School	106
Coyne Electrical School	98, 104, 106	Ohmite Manufacturing Co.	51
Crowe Name Plate & Mfg. Co.	79	Onan, D. W. & Sons	100
DeForest Schools	98	Par-Metal Products Corporation	82
Delco Radio	105, 111	Pioneer Gen-E. Motor	80
DeJur-Amsco Corporation	53	Polymet	58
Dodge Radio	112	Radio & Technical Publishing Co.	103
Doolittle Radio, Inc.	92	Radio Receptor Co., Inc.	67
DX Crystals Co.	88	Radolek Co.	106
Echophone Radio Co.	83	Randolph Radio	12, 102
Editors and Engineers	102	RCA Institute	112
Electronic Corp. of America	71	RCA Mfg.	7, 61
Electronic Enterprises, Inc.	93	Remler Company, Ltd.	111
Fada Radio and Electric Company, Inc.	97	Rider Publisher, Inc., John F.	84
Flying	107	Runzel Wire & Cord	8
General Electric	13, 3rd Cover	Seeburg, J. P. Corporation	110
Gothard Manufacturing Company	88	Shure Brothers	90
Great American Industries, Inc.	110	Sickles Company, The F. W.	111
Hallicrafters Co., The	15	Snyder Manufacturing Co.	88
Hammarlund Mfg. Co., Inc., The	18	Sperry Gyroscope Co., Inc.	111
Harvey Machine Co., Inc.	87	Sprague Products Co.	77
Hytron Electronic and Radio Tubes Corporation	69	Sprague Specialties Company	110
Indiana Technical College	94	Sprayberry Academy of Radio	11
Insuline Corporation of America	96	Standard Transformer Corporation	82
International Resistance Company	95	Stevens Walden, Inc.	14
International T & T Corporation	89	Supreme Publications	98, 102
Johnson Co., E. F.	85, 108	Sylvania Electric Products, Inc.	10
Jensen Radio Manufacturing Company	57	Taylor Tubes, Inc.	59
Kato Engineering Co.	98	Teleplex Co.	104
Knights Company, The James	6	Thordarson Electric Mfg. Co.	92
Lafayette Radio Corp.	76	Tobe Deutschmann Corp.	114
Lake Radio Sales Co.	86	Triplett Electrical Instrument Co., The	74, 109
Lincoln Engineering School	98	Tri-State College	98
Linguaphone	106	Tung-Sol Lamp Works, Inc.	104
		Turner Co.	16
		United Transformer	Second Cover
		Universal Microphone Co., Ltd.	52
		Utah Radio Products Company	110
		Ward Leonard Electric Company	17
		Westinghouse	111
		Whitney Blake Co.	86

## GOOD JOBS in RADIO For Both Men and Women

Prepare now for jobs in Radio Engineering; Broadcasting; Marine, Aviation, Police Radio; Servicing; Radio Manufacturing. Our streamlined courses give excellent preparation for Army and Navy Service. Expenses low. Write for free catalog.

**THE DODGE TELEGRAPH & RADIO INSTITUTE**  
409 Monroe St., Valparaiso, Indiana

## RADIO TECHNOLOGY



RCA Institute offers an intensive two-year course of high standard embracing all phases of Radio and Television. Practical training with modern equipment. Also shorter specialized courses in Commercial Radio Operating, Radio and Television Servicing, and Aviation Communications. For Free Catalog write Dept. RN-43.

### RCA INSTITUTES, Inc.

A Radio Corporation of America Service  
75 Varick St., New York 13, N. Y.

## COMMERCIAL RADIO INSTITUTE

A radio training center for twenty-three years. Resident Courses only.

Pre-Induction, Broadcast, Service and Radio Telegraphy classes now forming for October 4th. Literature upon request.

Dept. D, 38 W. Biddle St., Baltimore-1, Md.

## Classified

Rate 15c per word. Minimum, 10 words

### CORRESPONDENCE COURSES

RADIO Communications courses qualifying for all Federal licenses. Home study and resident courses. American Radio Institute, 44 East 23rd St., New York, N. Y.

USED Correspondence Courses and Educational Books sold or rented. Inexpensive. Money-back guarantee. Write for Free Catalog listing 4000 bargains.—(Courses Bought.)—Lee Mountain, Pisgah, Ala.

CORRESPONDENCE Courses and self-instruction books, slightly used. Sold. Rented. Exchanged. All subjects. Satisfaction guaranteed. Cash paid for used courses. Complete details and 84-page illustrated bargain catalog free. Write Nelson Company, 321 S Wabash, Dept. K-237, Chicago.

### PATENT ATTORNEYS

INVENTORS—Before disclosing your invention to any one send for Form "Evidence of Conception": "Schedule of Government and Attorneys' Fees" and instructions. Sent free. Lancaster. Allwine & Rommel, 414 Bowen Building, Washington, D. C.

### RADIO ENGINEERING

RADIO Engineering, broadcasting, aviation and police radio, servicing, marine and Morse telegraphy taught thoroughly. All expenses low. Catalog free. Dodge Institute, Elm St., Valparaiso, Ind.

### RADIO EQUIPMENT

RADIO Service men and experimenters send for our giant radio catalogue. Save dollars. United Radio Co. (1000M), Newark, N. J.

THOUSANDS of pieces of radio equipment for sale—see page 94. New York Technical School of New Jersey.

### WANTED

WANTED to Buy: Two RCA Rider Chanalysts, two sets Rider Manuals, two 546 Supreme Oscilloscopes, two Supreme 581 Signal Generators. Munroe Radio Service, 111 Shelby Street, Kingsport, Tenn.

### HELP WANTED

HELP Wanted: Two experienced radio servicemen. Permanent position, good salary, and modern equipment with which to work. Write L. E. Munroe, 111 Shelby St., Kingsport, Tenn.

ELECTRICAL Engineers: Development work in radio and general transformer applications. Also junior engineers for drafting and layout 100% war work. Excellent post war potential in research laboratory or sales engineering department. If you are not utilizing maximum skill at present position apply by letter at once. Sola Electric Company, 2525 Clybourn Avenue, Chicago 14, Ill.



# Continuous Service Rating Data

## TYPES 1550-1560-1570-1580-1590

Maximum Current in Amperes—Maximum Ambient Temperature 60° C



Type 1590

### TYPE 1590

Catalog Number	10,000 kc.	3000 kc.	1000 kc.	300 kc.	100 kc.	Cap. Mfds.	Test Volts Eff.	Catalog Number	10,000 kc.	3000 kc.	1000 kc.	300 kc.	100 kc.
1590-200	7.	4.5	1.5	.5	.01	8000	1590-217	16.	20.	15.	8.		
1590-201	8.5	6.	3.	1.	.01	6000	1590-218	16.	20.	15.	8.		
1590-202	6.	4.	2.	.7	.02	5000	1590-219	18.	20.	17.	10.		
1590-203	10.	8.5	4.5	1.5	.03	4000	1590-220	18.	20.	18.	12.		
1590-204	8.	7.	3.5	1.2	.04	4000	1590-221	18.	23.	20.	12.		
1590-205	11.	11.	7.5	2.5	.05	4000	1590-222	18.	25.	22.	12.		
1590-206	9.	8.	6.	2.	.05	2000	1590-223	18.	25.	22.	12.		
1590-207	12.	14.	10.	5.	.1	2000	1590-224	18.	25.	22.	12.		
1590-208	9.	10.	3.	3.	.1	1000	1590-225	18.	25.	22.	12.		
1590-209	12.	14.	6.	6.	.2	600	1590-226	18.	25.	22.	12.		
1590-210				4.	.25	600	1590-227	18.	25.	22.	12.		
1590-211					.3	600	1590-228	18.	25.	22.	12.		
1590-212					.4	600	1590-229	18.	25.	22.	12.		
1590-213					.5	600	1590-230	18.	25.	22.	12.		
1590-214					.6	600	1590-231	18.	25.	22.	12.		
1590-215					600	1590-232	18.	25.	22.	12.			
1590-216					600	1590-233	18.	25.	22.	12.			

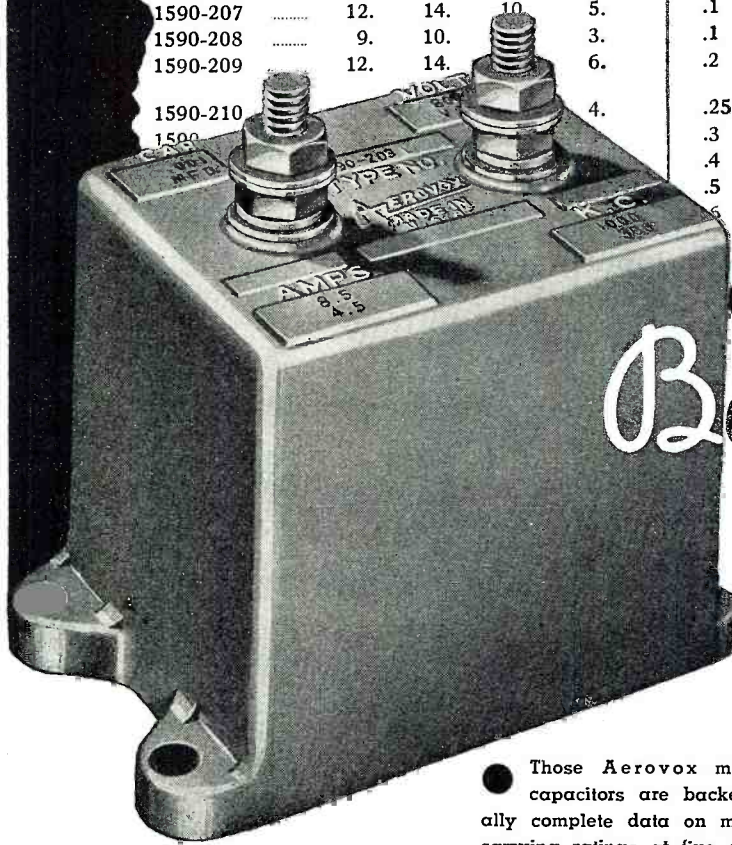

Backed by

the most complete  
**CONTINUOUS SERVICE  
RATING DATA**

Aerovox mica transmitting capacitors are available in the widest range of types, capacities, working voltages. Type here shown is the bakelite-cased 1590 series for medium-duty high-frequency current-handling functions.

● Those Aerovox mica transmitting capacitors are backed by exceptionally complete data on maximum current-carrying ratings at five different frequencies, in addition to capacity and test-voltage ratings. The unit best suited for given current at given voltage and frequency may thus be selected quickly and precisely. This data, the accumulation of years of research and experience based on extensive tests conducted with special test equipment, was determined in connection with standard

circuits in which such units are extensively used.

Good capacitors, plus good application data, account for the tremendous popularity which Aerovox transmitting capacitors enjoy today.

Consult the local Aerovox jobber regarding your capacitor requirements and problems. Ask him for a free subscription to the monthly Aerovox Research Worker. Or write us direct.



Capacitors

**INDIVIDUALLY TESTED**

AEROVOX CORPORATION, NEW BEDFORD, MASS., U. S. A. • SALES OFFICES IN ALL PRINCIPAL CITIES  
Export: 100 VARICK ST., N. Y. C. • Cable: 'ARLAB' • In Canada: AEROVOX CANADA LTD. HAMILTON, ONT.

# A Long Life

## AND A USEFUL ONE

On the job doing their duty all the time—that's the reputation of Tobe Capacitors, earned through an almost complete absence of "returns!"

This record, far from making Tobe engineers complacent, acts as a spur to even higher quality, through constant research in materials and methods. Each Tobe Capacitor continues to be rated with ultra-conservatism.

The Tobe Oil-Mite Capacitor, shown here, is impregnated and filled with mineral oil. It is performing day-in, day-out duty as a filter condenser in war equipment. Inquiries in connection with your condenser problems will receive our prompt attention.



### LONG LIFE ASSURED

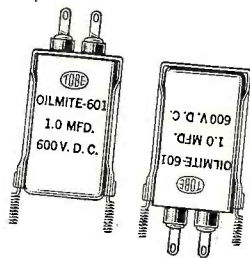

Note new hold-down bracket that allows inverted or upright terminals. Takes less space and permits wiring either underneath or on top of chassis.

### CHARACTERISTICS OF TOBE OIL-MITE CAPACITORS

STANDARD CAPACITY TOLERANCE.	= 10%
TEST VOLTAGE	Twice D.C. rating
SHUNT RESISTANCE	.05 to 0.1 mfd. 20,000 megohms. .25 to 0.5 mfd. 12,000 megohms. 1.0 to 2.0 mfd. 12,000 megohms
RATINGS	.05 mfd. to 2.0 mfd. 600 V.D.C. .05 mfd. to 1.0 mfd. 1,000 V.D.C.
GROUND TEST	2,500 Volts D.C.
POWER FACTOR	At 1,000 cycles—.002 to .005



**A SMALL PART IN VICTORY TODAY—A BIG PART IN INDUSTRY TOMORROW**

Printed in U. S. A.

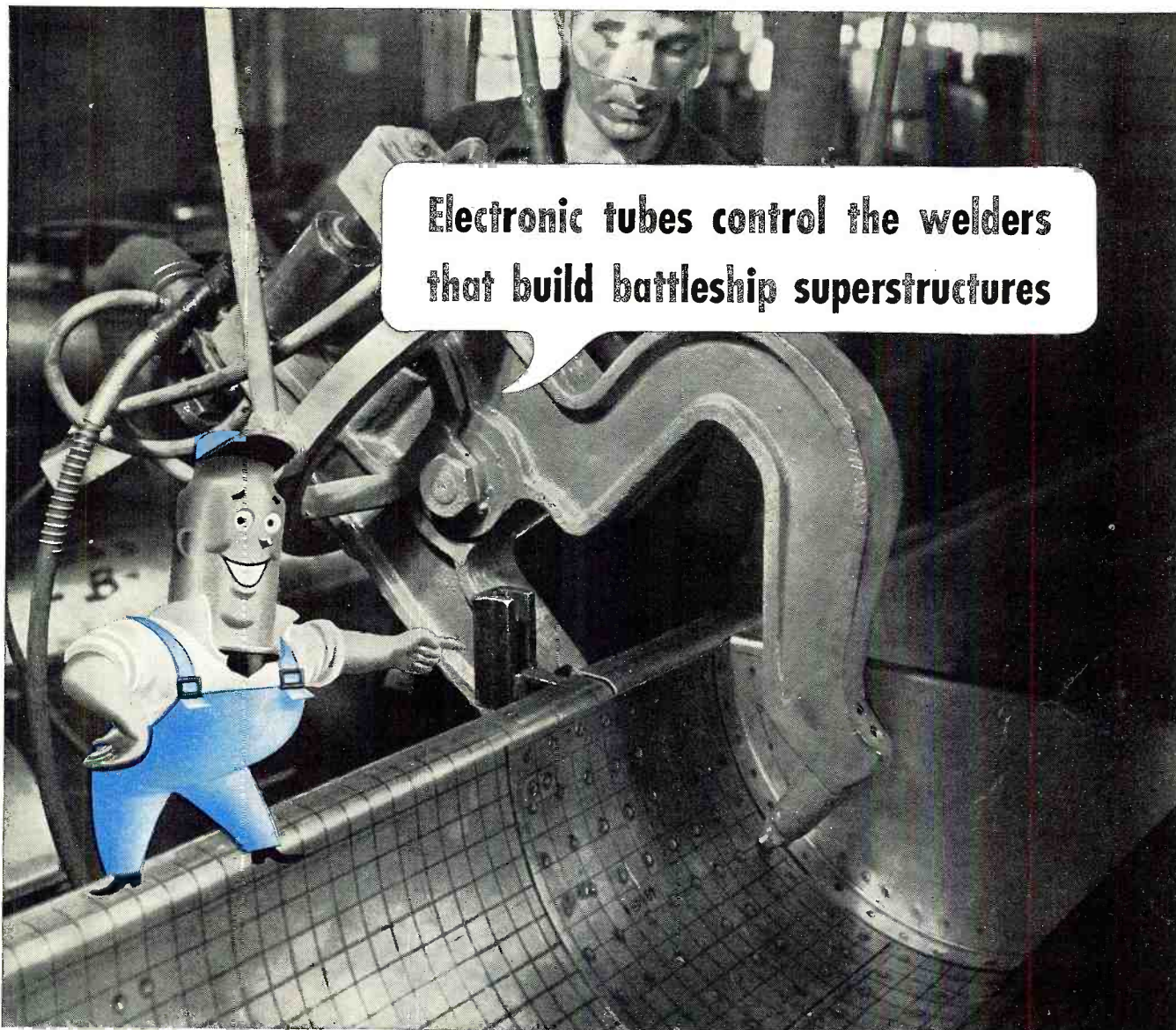

**Electronic tubes control the welders  
that build battleship superstructures**

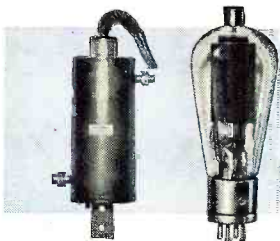

**The G-E ignitron is the power tube  
and the G-E thyatron is the timer**

THIS husky steel claw is a heavy-duty spot welder—a machine controlled by General Electric electronic tubes which turns out superstructure sections for Uncle Sam's Navy.

Three sheets of stainless steel or aluminum, each .109 inch thick, are placed between electrodes. In a fraction of a second, electric current heats the metal at the point of contact, and fuses the sheets in permanent bond.

The special heavy-duty welding electrodes exert a pressure of 3000 pounds,

requiring a current of 12,000 amperes for 17 cycles—17/60 of a second.

Two types of electronic tubes make possible this high-speed, heavy-duty welding. The G-E *ignitron* is the power tube which provides the high current. The G-E *thyatron* is the precision timer, an automatic switch controlling the passage of current. And these are only two of the G-E

electronic tubes at work in industry.

It is the purpose of the G-E electronic tube engineers to aid *any* manufacturer of electronic devices in the application of tubes. General Electric, through nation-wide distribution, is also prepared to supply *users* of electronic devices with replacement tubes.

**FREE BOOKLET ON ELECTRONIC TUBES**

We will mail without charge the illustrated book, "How Electronic Tubes Work," written in understandable language. Address *Electronics Dept., General Electric, Schenectady, N. Y.*

\* Tune in "THE WORLD TODAY" and hear the news direct from the men who see it happen, every evening except Sunday at 6:45 E.W.T. over CBS. On Sunday listen to "The Hour of Charm" at 10 P. M. E.W.T. over NBC.

162-B13-8850

**GENERAL  ELECTRIC**

THERE IS A G-E ELECTRONIC TUBE FOR EVERY OCCASION



## CAN YOU LOOK HIM IN THE EYE?

They found him slumped by his gun on the cartridge-strewn ground he had so fiercely defended, as still as the enemy dead huddled there around him. Though three times wounded, he stuck to his post—firing until unconsciousness finally dragged his finger from the trigger.

He wouldn't quit then. And he won't quit now! In a few more weeks, when his wounds have healed, he'll go back to help finish that job in the jungle. Can you look him in the eye and truthfully tell him that you, too, are doing all that you can to finish the job?

In the days ahead, can he count on you to stick to your war post as faithfully as he sticks to his? Can he expect you to buy War Bonds in the willing spirit he shows when he steps to the front as a volunteer? Can he rely on you to give a little blood to the Red Cross as ungrudgingly as he gives up his on the battlefield? Can he really depend on you to fight inflation over here while he is fighting oppression over there?

When your conscience tells you you're worthy of the sacrifices he's making for you—only then can you proudly look him in the eye!

This message has been prepared as a tribute to America's fighting men and in the hope that it may hold a measure of inspiration for those who must carry on the battle here at home. Belmont Radio Corporation, 5921 West Dickens Avenue, Chicago 39, Illinois.



**Belmont Radio**  
TELEVISION \* FM \* ELECTRONICS