

RADIO NEWS



JULY
1943
25c
In Canada 30c

Designs for War... Transformers

The requirements in war transformers differ considerably from those of commercial units. The UTC engineering staff has pioneered many of the design features which make possible modern war transformers. A few typical designs are illustrated.

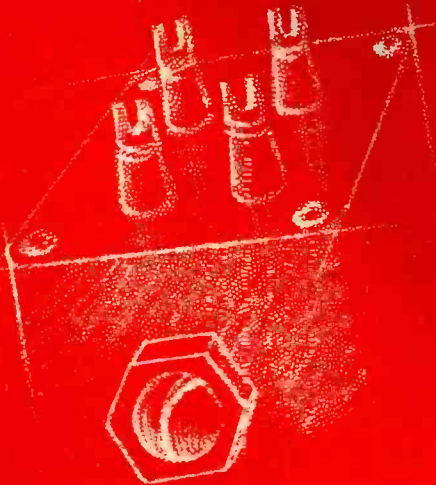

This transformer is tunable... ideal for signal frequency amplifiers.



This oil filled transformer is hermetically sealed with glass high voltage terminals solder-sealed to case.



Designed for minimum amplitude distortion... this unit has distortion under .01% for a power range of 100:1... Q over 150.

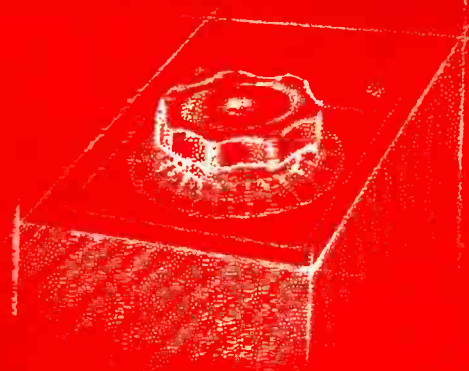

This Varitran supplies fixed filament and bias voltages, as well as variable plate voltage all in one unit.

May we design a War Unit to your application?

UNITED TRANSFORMER CO.

150 VARICK STREET ★ NEW YORK, N. Y.
EXPORT DIVISION: 100 VARICK STREET NEW YORK, N. Y. CABLES: "ARLAB"

FREE Lesson in Radio

Here is a Partial List of Subjects This Lesson Teaches

With 31 Photos, Sketches, Radio Drawings

- How superheterodyne receivers work
- How to remove tubes, tube shields
- Three reasons why Radio tubes fail
- Electrodynamic loudspeaker:
 - How it works
 - Replacing damaged cone
 - Recentering voice coil
 - Remedies for open field coil
- Output transformer construction, repair
- Gang tuning condenser:
 - Construction of rotor, stator
 - How capacity varies
 - Restraining dial cord
 - Straightening bent rotor plates
- I.F. transformers—
 - What they do, repair hints
 - How to locate defective soldered joints

GETTING ACQUAINTED WITH RECEIVER SERVICING

- Inside story of carbon resistors
- Paper, electrolytic, mica, trimmer condensers
- How condensers become shorted, leaky
- Antenna, oscillator coil facts
- Power transformer: construction, possible troubles
- Installing power cord
- Troubles of combination volume control, on-off switch
- Tone controls
- Dial lamp connections
- Receiver servicing technique:
 - Checking performance
 - Testing tubes
 - Circuit disturbance test
 - Isolating defective stage
 - Locating defective part

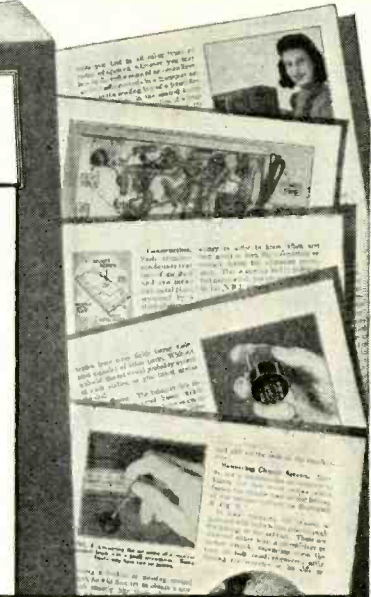

See For Yourself How I Train You at Home to BE A RADIO TECHNICIAN

J. E. SMITH, President NATIONAL RADIO INSTITUTE Established 28 Years

Mail the Coupon for a FREE lesson from my Radio Course. It shows how N.R.I. trains you for Radio at home in spare time. And with this Sample

Lesson I'll send my 64-page illustrated book, "Win Rich Rewards in Radio." It describes many fascinating jobs Radio offers, tells how you can train for them at home in spare time!

More Radio Technicians and Operators Now Make \$50 a Week Than Ever Before

There's a big shortage of capable Radio Technicians and Operators because so many have joined the Army and Navy. Fixing Radios pays better now than for years. With new Radios out of production, fixing old sets, which were formerly traded in, adds greatly to the normal number of servicing jobs.

Broadcasting Stations, Aviation and Police Radio, Ship Radio and other communications branches are scrambling for Operators and Technicians to replace men who are leaving. You may never see a time again when it will be so easy to get started in this fascinating field. The Government too needs hundreds of competent civilian and enlisted Radio men and women. Radio factories, with huge war orders to fill, have been advertising for trained personnel. And think of the NEW jobs Television,

Frequency Modulation, Electronics and other Radio developments will open after the war! This is the sort of opportunity you shouldn't pass up.

Many Beginners Soon Make \$5, \$10 a Week Extra in Spare Time

There's probably an opportunity right in your neighborhood to make money in spare time fixing Radios. I'll give you the training that has started hundreds of N.R.I. students making \$5, \$10 a week extra within a few months after enrolling. The N.R.I. Course isn't something just prepared to take advantage of the present market for technical books and courses. It has been tried, tested, developed, perfected during the 28 years we have been teaching Radio.

Find Out What N.R.I. Can Do For You

MAIL COUPON NOW for FREE Sample Lesson and 64-page illustrated book. You'll see the many fascinating jobs Radio offers and how YOU can train at home. If you want to jump your pay—mail Coupon at once in an envelope or paste on a penny postcard—J. E. SMITH, President, Dept. 3GR, National Radio Institute, Washington, D. C.

TRAINING MEN FOR VITAL RADIO JOBS



\$10 a Week in Spare Time

"I repaired some Radio sets when I was on my tenth lesson. I really don't see how you can give so much for such a small amount of money. I made \$600 in a year and a half, and I have made an average of \$10 a week—just spare time." JOHN JERRY, 1337 Kalamath St., Denver, Colorado.

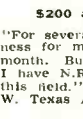

\$200 a Month in Own Business

"For several years I have been in business for myself making around \$200 a month. Business has steadily increased. I have N.R.I. to thank for my start in this field." ARLIE J. FROEHLER, 300 W. Texas Ave., Goose Creek, Texas.



N.R.I. Graduate Now Lieutenant in U. S. Army Signal Corps

"I cannot divulge any information as to my type of work, but I can say that N.R.I. training is certainly coming in mighty handy these days." (Name and address omitted for military reasons.)

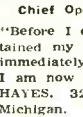

Chief Operator Broadcasting Station

"Before I completed your lessons, I obtained my Radio Operator's license and immediately joined Station WMFC where I am now Chief Operator." HOLLIS F. HAYES, 327 Madison St., Lapeer, Michigan.



Service Manager for Four Stores

"I was working in a garage when I enrolled with N.R.I. I am now Radio Service Manager for the M. Furniture Co. for their four stores." JAMES E. RYAN, 119 Pebble Court, Fall River, Mass.

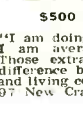
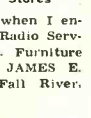

\$500 per Year in Spare Time

"I am doing spare time Radio work, and I am averaging around \$500 a year. Those extra dollars mean so much—the difference between just barely getting by and living comfortably." JOHN WASHKO, 97 New Cranberry, Hazleton, Penna.



Extra Pay in Army, Navy, Too



Men likely to go into military service, soldiers, sailors, marines, should mail the Coupon Now! Learning Radio helps Servicemen get extra rank, extra prestige, more interesting duties, MUCH HIGHER PAY. Also prepares for good Radio jobs after service ends. Over 1,700 Servicemen now enrolled.

GOOD FOR BOTH 64 PAGE BOOK SAMPLE LESSON FREE

MR. J. E. SMITH, President, Dept. 3GR NATIONAL RADIO INSTITUTE, Washington, D. C. Mail me FREE, without obligation, Sample Lesson and 64-page book, "Win Rich Rewards in Radio." (No Salesman will call. Write plainly.)

Age.....
 Name.....
 Address.....
 City..... State..... 4PR



CONTENTS

FEATURES

THERAPEUTIC RADIONICSS. R. Winters 17
 A DIRECT-READING Q METER.....Rufus P. Turner 20
 130-210 mc. RECEIVER FOR
 FM-AM COVERAGE.....Clark E. Jackson 23
 PHOTOELECTRIC PHENOMENA.....C. D. Prater 26
 THE SAGA OF THE VACUUM TUBE.....Gerald F. J. Tyne 30
 WARTIME PROGRESS IN RADIONICS.....Robert Eichberg 33
 PORTABLE LIFEBOAT
 TRANSMITTER.....Carl Coleman and J. T. Donnelly 35
 POWER OUTPUT METERS.....Guy Dexter 38
 QUIET, PLEASE!Walter Fernald 41

DEPARTMENTS

PRACTICAL RADIO COURSE, PART 15.... Alfred A. Ghirardi 43
 BOOK REVIEW 37 QRD? de Gy..... 37
 THE TUBE COLLECTOR.. 40 WHAT'S NEW IN RADIO.. 40
 SPOT RADIO NEWS..... 8

Cover Photo by U. S. Army Signal Corps

WM. B. ZIFF, <i>Publisher</i>	B. G. DAVIS, <i>Editor</i>	C. R. TIGHE, <i>Ass'ts to Publisher</i>
OLIVER READ, W9ETI <i>Managing Editor</i>	WM. A. STOCKLIN <i>Associate Editor</i>	
R. B. FRANK, W9JU <i>Tech. Ed. (on leave)</i>	JOE MARTY, JR. <i>Assistant Editor</i>	J. M. ECKERT <i>Assistant Editor</i>
HERMAN R. BOLLIN <i>Art Director</i>	S. L. CAHN <i>Advertising Mgr.</i>	H. G. STRONG <i>Circulation Director</i>

Copyright, 1943
 ZIFF-DAVIS PUBLISHING COMPANY
 Editorial Offices: 540 N. Michigan Ave., Chicago, Ill.
 Member of the Audit Bureau of Circulations

RADIO NEWS is published monthly by the Ziff-Davis Publishing Company at 540 N. Michigan Ave., Chicago, Ill. New York Office, 270 Madison Ave. Washington, D. C., Office, Earle Bldg. Special Washington Representative, Col. Harold E. Hartney, Occidental Hotel. London Editorial Representative, A. Spenser Allberry. Subscription Rates: In U. S. \$3.00 per year, single copies, 25 cents; in South and Central America and U. S. Possessions, \$3.00 per year; in Canada \$3.50 per year, single copies 30 cents; in British Empire, \$3.75 per year; all other foreign countries \$6.00 per year. Subscribers should allow at least 2 weeks for change of address. All communications about subscriptions should be addressed to: Director of Circulation, 540 N. Michigan Ave., Chicago, Ill. Entered as second class matter March 9, 1938, at the Post Office, Chicago, Illinois, under the Act of March 3, 1879. Entered as second class matter at the Post Office Department, Ottawa, Canada. Contributors should retain a copy of contributions. All submitted material must contain return postage. Contributions will be handled with reasonable care, but this magazine assumes no responsibility for their safety. Accepted material is subject to whatever adaptations, and revisions, including "by-line" changes, necessary to meet requirements. Payment covers all authors, contributors or contestants rights, title, and interest in and to the material accepted and will be made at our current rates upon acceptance. All photos and drawings will be considered as part of material purchased.

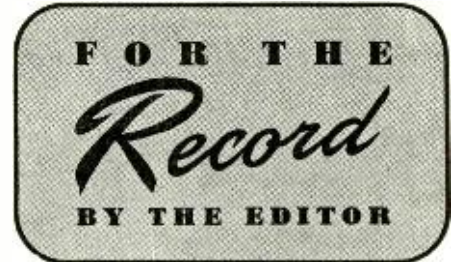

WHO invented Radar? It seems as though everyone is claiming credit for inventing this device. There has been considerable hullabaloo in the press and various trade publications of late regarding this secret weapon. It is a matter of record that the actual development began back in 1922 when two research scientists in the *Naval Aircraft Radio Laboratory* at Anacosta observed the reaction to radio signals from ships and other metal objects that passed by a transmitter and receiver operating at very high frequencies. They were Dr. A. Hoyt Taylor and Leo C. Young. They saw the possibilities whereby destroyers located on a line a number of miles apart could be aware of the passage of an enemy vessel between any two ships in line even if fog, smoke or darkness were present. In June, 1930, L. A. Hyland, working with Dr. Taylor, made the observation that an aircraft crossing a line between a transmitter and receiver which were operating directionally gave an interference pattern indicating the presence of the aircraft. In June, 1931, the *Radio Division* of the *Bureau of Engineering* issued an order to the laboratory to investigate the use of radio for detection of enemy vessels and aircraft. In October of the same year, proposals were sent from the *Bureau* to the *Laboratory* and were found to have practical possibilities based on previous demonstrations in the laboratory.

In January, 1932, the findings were brought to the attention of the *War Department*, and included the following:

"Certain phases of the problem appeared to be of more concern to the *Army* than the *Navy*. For example, a system of transmitters and associated receivers might be set up about a defense area to test its effectiveness in detecting the passage of hostile aircraft in the area." Later that same year, another progress report showed that airplanes in motion had been detected under certain conditions from a distance of nearly 50 miles, and that

(Continued on page 70)

ARHCO Varieties of 1943

2008 Wartime Essentials

We do stamping, screw machine work, moulding and general Radio and Radar communications assemblies. Illustrated are but a mere handful of the 2008 wartime essentials which we are now manufacturing. Your inquiries will receive prompt attention.

Now, more than ever, it is important that you keep on buying War Bonds and Stamps.



*American
Radio
Hardware* CO., INC.

476 BROADWAY, NEW YORK, N. Y.

MANUFACTURERS OF SHORT WAVE • TELEVISION • RADIO • SOUND EQUIPMENT.



TO PRESERVE THE FOUR FREEDOMS!

... freedoms that are uppermost in the heart of every American. Workers in industry have toiled unceasingly to build peak production to enable their country to be the world's best equipped fighting forces to protect these freedoms.

The Hallicrafters employees have twice been cited by their country for excellence in production... once with the Army-Navy "E" Burgee... and now the addition of a star to this Burgee for continued excellence in producing communications equipment so vitally needed by our boys on all fronts.

This new honor will serve as an additional incentive to greater production.

**BUY
MORE
BONDS!**



hallicrafters
CHICAGO, U.S.A.

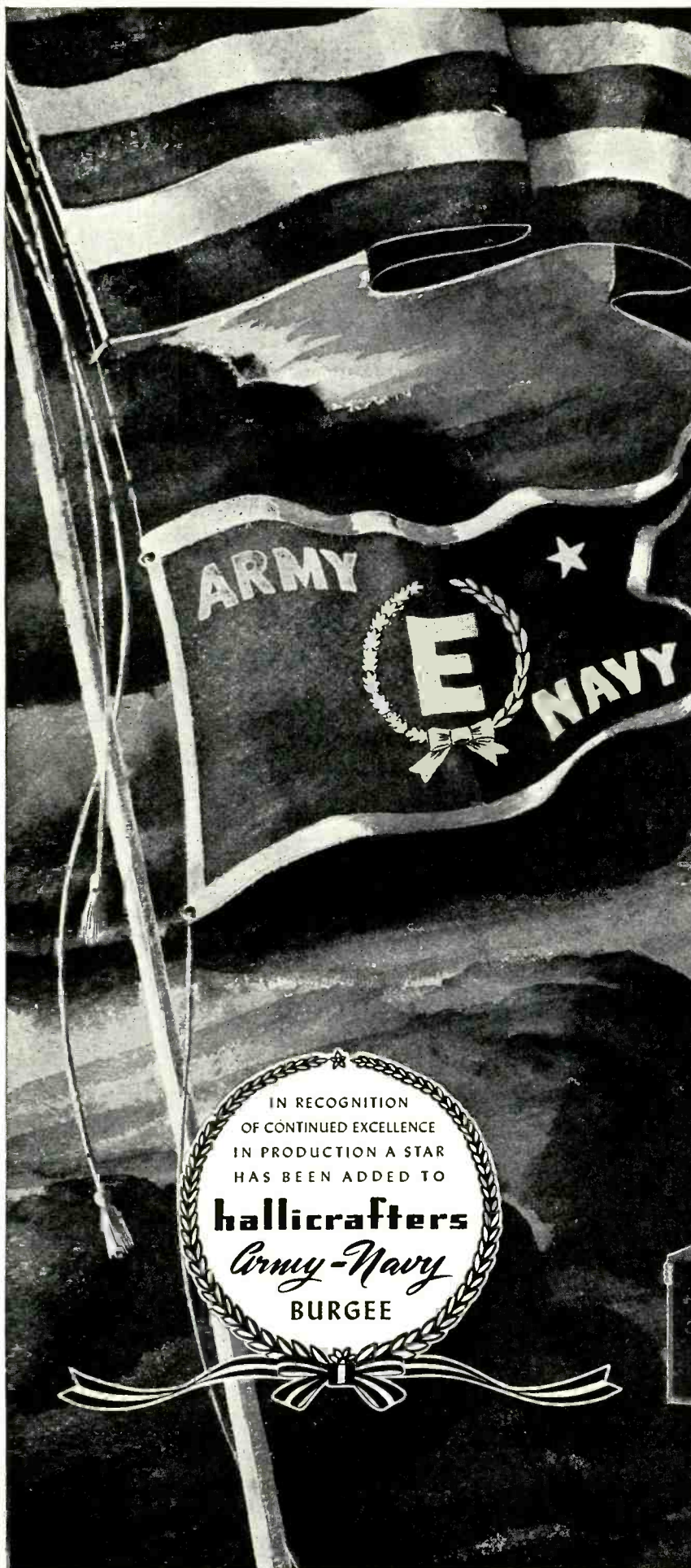

with but a
Single
thought



Gertrude Fontaine, mount operator at Hytron's Salem plant, and soldier in the Army of Production.

Miss Fontaine concentrates her nimble fingers and keen young eyes (assisted by a microscope) upon spot-welding and assembling minute parts of a 954.

On another floor, a Hytron engineer is giving lavishly, night and day, of his long training and experience as he designs and develops a new War tube in record time. The driving force urging them — and all of us at Hytron — on to superhuman effort, stems from a single thought, a single purpose: to supply our courageous fighting men with tools to win. Hytron employees have but one goal — a mounting flood of top-quality tubes to serve as the "hearts" of electronic and radio equipment helping our boys to blast the way to speedy and permanent Victory.

Oldest Exclusive Manufacturer of Radio Receiving Tubes

Hytron

ELECTRONIC AND
RADIO TUBES



Corporation

SALEM AND

NEWBURYPORT, MASS.

Designed for



Application

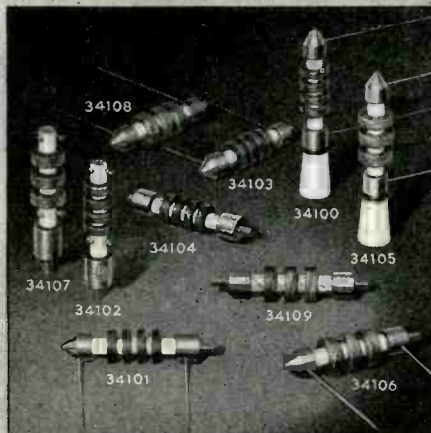

THE 34100 SERIES RF CHOKES

Many have copied, few have equalled, and none have surpassed the genuine original design Millen Designed for Application series of midget RF Chokes. The more popular styles now in constant production are illustrated herewith. Special styles and variations to meet unusual requirements quickly furnished on high priority.

General Specifications: 2.5 mH, 250 mA for types 34100, 34101, 34102, 34103, 34104, and 1 mH, 300 mA for types 34105, 34106, 34107, 34108, 34109.

JAMES MILLEN MFG. CO., INC.

MAIN OFFICE AND FACTORY
MALDEN
MASSACHUSETTS



Spot Radio News

IN DEFENSE AND INDUSTRY

by **LEWIS WINNER**
RADIO NEWS Washington Correspondent

Presenting latest information on the Radio situation.

THE RECEIVING TUBE PROBLEM now appears to be nearer to a solution than ever before. Tubes during the past few months have been increasingly difficult to obtain, and although many steps were taken to alleviate the situation, balky problems intervened. Aware, however, of the importance of tubes for receivers, WPB, manufacturers and the military conferred constantly. The result has been a *civilian allotment plan*. It was first described by Frank McIntosh, assistant director, Radio and Radar Division, WPB, at the War Conference of the NAB in Chicago. This plan permits the distribution of the two million tubes that will be made monthly to civilian sources. Manufacturers have been making this amount of tubes for civilian use, but unfortunately they did not reach the consumer, since the military and other government agencies used this source of supply to a great extent. From now on, according to Mr. McIntosh, these agencies will direct their purchases to the manufacturers and only go to distributors or dealers in extreme emergencies. And every effort will be made to see to it that these emergencies are kept at a minimum. The two million tubes made will include only the 117 types adopted recently in the standardization program. Although these tubes were originally supposed to carry the general brand name of *victory line*, they will instead carry the familiar brand names of the various manufacturers.

The anticipated twenty-four million tubes a year production for 1943 will be about nine million less than that of 1942. However, the 1942 production covered a variety of different types while the presently planned production covers comparatively few types. Surveys by trade organizations and government agencies indicate that the standardized tubes will satisfy better than 90% of the receivers. The 117 tubes chosen will not, however, be frozen for the remainder of the year. If it is found that other types are needed they will be added, pointed out Mr. McIntosh.

The only black cloud in this plan, is the difficulty of getting the tubes into immediate distribution and on the shelves. According to Mr. McIntosh, this distribution will take at least sixty days more to equalize itself.

Barring unforeseen emergencies, this means that at least a satisfactory supply of tubes should begin to appear on dealers' shelves in August. Of course, it must be remembered that the dealers' shelves will not be stocked as completely as prior to Pearl Harbor. However, there should be sufficient quantities available to provide for the maintenance of at least one receiver in every home. And incidentally, the *one-receiver-in-every-home* maintenance program is receiving the full favor of the WPB and other allied government agencies. Every effort is being made and will be made to maintain that status quo.

BATTERIES FOR FARM RADIOS, another problem child, also appear to be on the solution side now. New schedules of battery production provided for by the Consumers' Durable Goods Division of the WPB will afford farmers with an increased supply, that may be 50% to 75% more than earlier supplies. Due to the increase of battery-operated radios on farms, from a pre-war 2,200,000 to a present 3,200,000 and an increase in listening time from three to five hours, even a return to production on a pre-war scale of 4,500,000 batteries, which, of course, is utterly impossible at the present time, would not provide the necessary batteries for all farm radios. However, every effort is being made to supply a substantial quantity which will permit operation of at least one receiver on every farm or receiver for several farms within a small area. This receiver rationing plan, while not the most approved method is, however, a medium of solution in some quarters, particularly in those communities where there are a greater percentage of radios to a small area.

To provide increased production of batteries for farm radios the production of batteries for portable radios has been prohibited. Thus the miniature pocket-sized personal radios become orphans of the war, unfortunately. It is true that there are many of these portable units on the farm. Fortunately, however, in most instances these receivers are additional or spare units. Where, of course, such receivers are the only source of reception, it will be necessary to use the larger type batteries somewhere outside the cabinet. This destroys the

RADIO NEWS

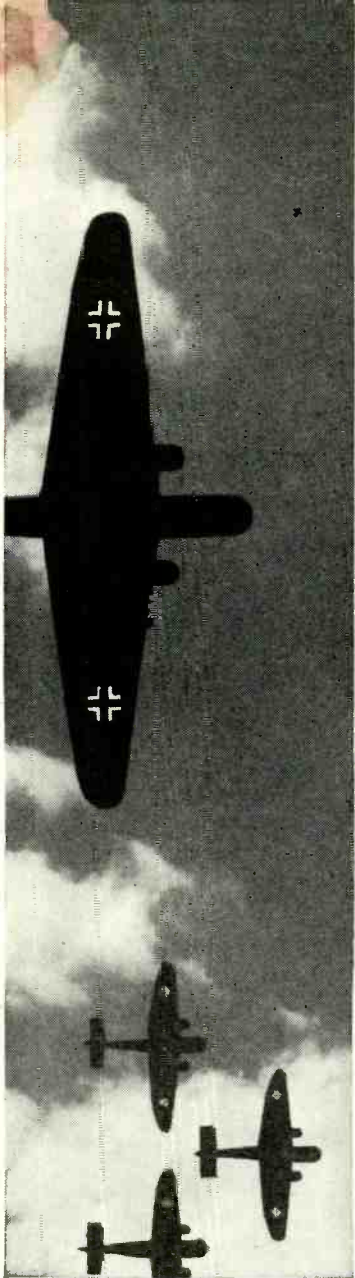

1. Enemy planes rise from distant airfields.

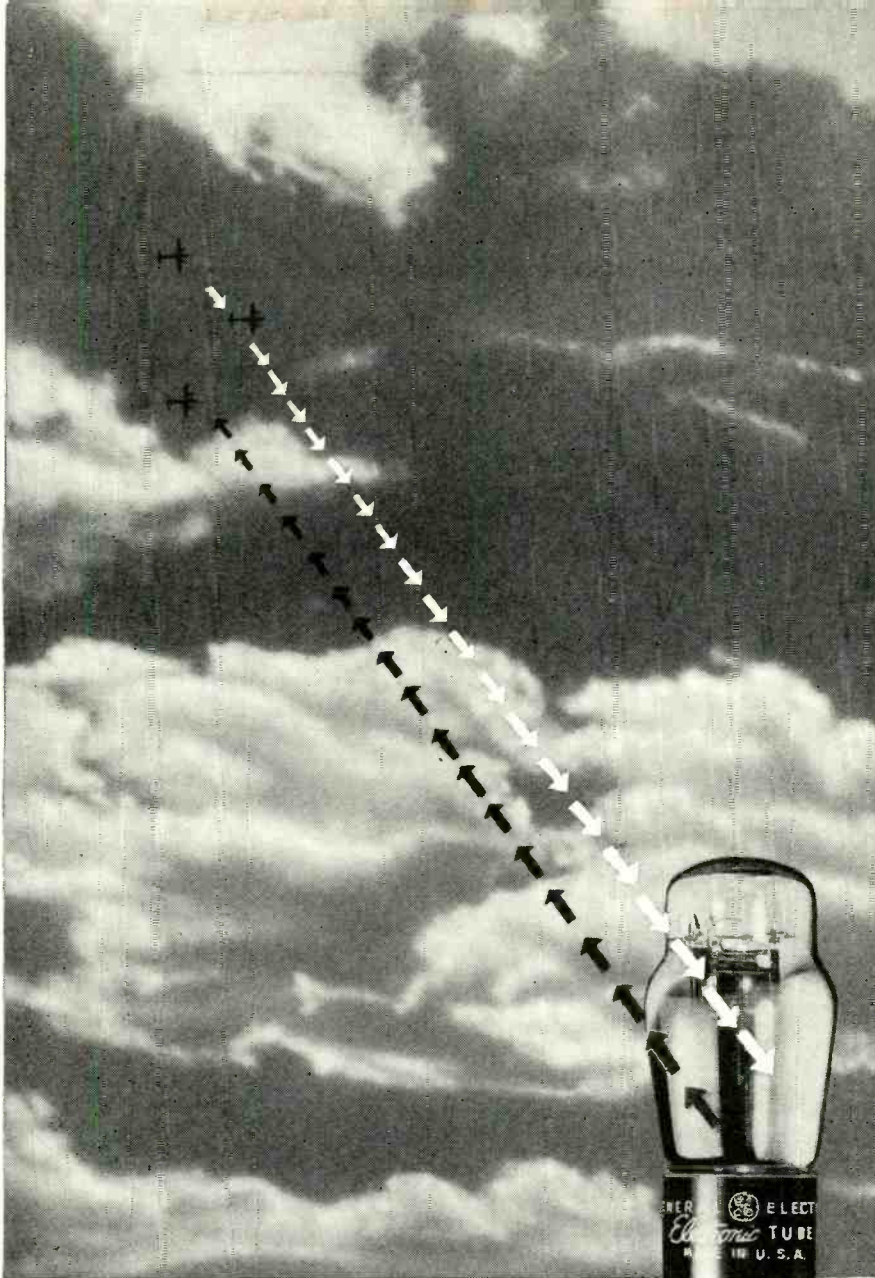

2. Radar sends out beam of ultra-high-frequency waves, reflected back to instruments which determine planes' location, speed, and direction.



3. Interceptor planes then surprise and destroy the advancing enemy.



The facts about RADAR

"The whole history of Radar has been an example of successful collaboration between Allies on an international scale."

THE NEW YORK TIMES, MAY 16

THIS amazing electronic invention that locates distant planes and ships despite darkness and fog is a great co-operative achievement of Science and Industry.

In this country and in the British Isles, over 2000 scientists and engineers, some

working alone, some in the Army and the Navy, many in research laboratories of colleges and industrial firms, joined eagerly in the search for Radar knowledge.

Team-work that succeeded. Once this electronic device had been perfected, industry after industry rallied to the nation's call to manufacture Radar. General Electric is proud to have played a large part, with other manufacturers, in supplying to the Army and Navy this key weapon whose peacetime applications hold so high a promise.

As early as the Twenties, G-E engineers and scientists were developing the kind of high-frequency tubes, circuits and apparatus that make Radar possible. Thus long before Pearl Harbor, G.E. was able to build Radar equipment.

Post-war applications will be many. Radar will guard and guide the flight of great commercial transports. Planes will land blind. Transoceanic liners will slip safely into fog-bound harbors — all with Radar detection equipment.

In addition to Radar, General Electric is supplying to the Army, Navy, and Marines radio transmitters, antennae and receivers, carrier-current equipment, all kinds of electronic measurement equipment, and monitors. *Electronics Department, General Electric, Schenectady, N.Y.*

Tune in General Electric's **WORLD TODAY** and hear the news from the men who see it happen, every evening except Sunday at 6:45 E.W.T. over C.B.S. . . . On Sunday evening listen to the G-E Mazda Lamp program over N.B.C. network.

GENERAL ELECTRIC

G-E employees are now purchasing over \$1,000,000 in War Bonds Weekly

July, 1943

9

A TECHNICAL
"MUST"

SYLVANIA SERVICEMAN SERVICE

by
FRANK FAX



At the risk of repeating myself, I'm plugging again the new revised Sylvania Technical Manual on Radio Tubes, because it should be a "must" on the bench or in the pocket of everyone interested in radio sales and service. Particularly now, because it has the basic data behind the Correlation for Substitution Chart and the Characteristics Sheet.

One section of this 275-page handbook lists new types of tubes released since issue of the last Manual. There is also a new section on panel lamps. Thus, it is as complete as possible at this time.

A plastic-ring binder allows the book to lie flat and remain open at whatever page is being consulted. Data arrangement remains the same, as do the easy-to-use index tabs.

The new revised Technical Manual still sells for the prewar price of 35 cents. If your jobber is unable to supply you, write to Frank Fax, Dept. N-7, Sylvania Electric Products Inc., Emporium, Pa.



Complete and reliable technical data on radio tubes—recently revised—price only 35 cents.

SYLVANIA

ELECTRIC PRODUCTS INC.
RADIO DIVISION
Formerly Hygrade Sylvania Corporation

portability usage, but it cannot be avoided. The prime purpose of the production of batteries for farm radios is to provide reception. Slight inconveniences will just have to be tolerated now.

Thus far, there are no preference ratings required for the purchase of these batteries, distribution being entirely in the hands of the retail dealer. It is up to him to see to it that batteries are fairly and equally distributed. It is up to him, too, to be sure that batteries for farm radios are not diverted to other purposes. His knowledge of the receivers for which batteries are intended and his friendship with his customers should help in routing batteries to the authorized sources only.

THE PART-FOR-PART METHOD of sale, described in these columns several times during the past months, has been officially adopted under the limitation order L-265. This new ruling provides for the turning in of a tube to receive a tube, or a component to receive an equivalent component. Thus, if three condensers are to be purchased for repair or maintenance, of course, three condensers must be turned in to the dealer or service man. Then the dealer or service man uses that defective part or tube as a basis for signing a supplier's certificate. This certificate is sent to the jobber or distributor along with the order. The consumer when turning in his part does not have to sign a certificate.

The defective parts that are turned in are not sent to the jobber. They must be disposed of through scrap or disposal channels, within sixty days, or reconditioned for sale. If the defective part can be repaired or reconditioned, a new part cannot be purchased by the dealer. And all defective components accumulated before April 24, cannot be used for application of new parts. They must be sold as scrap or reconditioned.

For those who buy by mail, or who have lost the part which has to be replaced, allowances have been made under this ruling. Such a buyer must sign a certificate stating that the part purchased is for repair purposes only.

This new ruling does not guarantee that the dealer or distributor will be able to supply every part requested. For it is entirely possible that some factories may have preference orders to fill, that may delay shipment of replacement parts required. It is believed, however, that the allotment of raw materials, assigned for the production of replacement parts, will be available for replacement parts to permit fabrication.

This new ruling supersedes the famous L-44 and L-44A limitation orders issued last year, and applies generally to radios and phonographs but not to hearing aid devices, electric batteries and power and light equipment. The manufacture of radio equipment, except to fill orders of the services, orders rated AA-4 or higher, or such

equipment for which the material is available under the CMP plan, is now prohibited under this ruling.

The ruling has its gaps which will be corrected. However, it must be remembered that such adjustments depend on field experiences, to a great extent. It is thus vital that the maximum degree of cooperation prevails on all fronts. The government agencies say they will do their share. We know that the consumer, dealer, service man, distributor and manufacturer will do their share, too!

HOME RECEIVER REPAIRS are the concern of broadcast stations, too, today. The size of the listening audience is a very important factor in station operation. Accordingly, the tube, materiel and manpower problem are of deep concern to them. Where, therefore, there has been evidence of weakness in receiver maintenance, stations have instituted several methods of solution. Several stations in the mid-west have actually become service stations. In these particular areas there has been a terrific manpower drain, and thus many receivers have been left unattended. The stations have taken these receivers in, and have had them repaired by their technicians or routed them to service men in nearby communities, who, because of transportation problems, could not effectively serve the station area directly. Where servicing was of an involved nature requiring extensive repairs, that might leave the home without a radio for a week or so, the broadcast stations have loaned receivers to those persons.

While broadcast stations are not particularly keen about entering this phase of business, they feel it is their duty to serve the community in emergencies as is apparent now. Every effort, therefore, is being made to coordinate servicing activities, so that receiver maintenance will be held to an effective level.

THE MATERIAL FRONT appears to be a favorable one in other fields, too, this month. We have learned that a new synthetic rubber . . . Paracon . . . developed by Bell Labs is being produced in substantial quantities. This is important news for many. This new material, according to Drs. C. S. Fuller and B. S. Biggs and their associates of the Laboratories, looks and feels like ordinary rubber, resembles it fairly closely in mechanical properties and has many important advantages over rubber. It is, for instance, highly resistant to oil or gasoline. It is said to be highly plastic in its raw state and thus well adapted to moulding into intricate shapes. It can also be used in producing rubberized fabrics. The developers of the substitute say that its basic raw materials are different from those required for other synthetic rubbers. Interference with other synthetic rubber production is thus avoided. Agricultural and coal products, and coal and petroleum sources, can be used as sources for this new synthetic

ELECTRONICS

offers sensational opportunities to

RADIO MEN

who will learn—

ELECTRICITY

Famous COYNE ELECTRICAL SHOP TRAINING . . . NOW in Book Form
... Prepares You for Vital War Work and a Big Peace-Time Future!

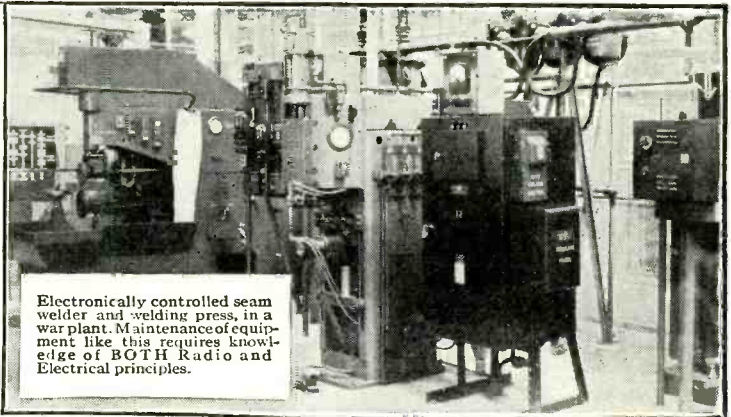

Electronically controlled seam welder and welding press, in a war plant. Maintenance of equipment like this requires knowledge of BOTH Radio and Electrical principles.

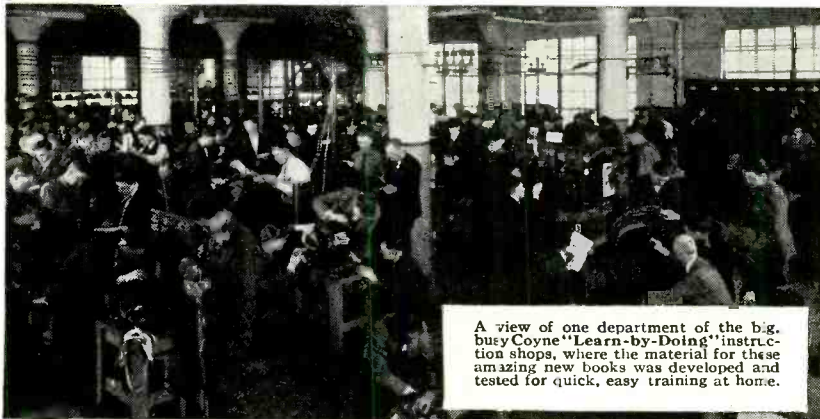

A view of one department of the big, busy Coyne "Learn-by-Doing" instruction shops, where the material for these amazing new books was developed and tested for quick, easy training at home.

Industrial Electronics—the wonder field of opportunity—is based on Radio Principles applied to electrical installations. Add a knowledge of Practical Electricity to your own Radio experience, and you're ready to "go places" in this fast-growing new, uncrowded field!

Amazing 3-Volume Reference Set **-FREE 7-DAY TRIAL!**

Here's the quick, easy way to train at home for a real job in Electronics! A course of instruction built step by step on the world-famous Coyne "Learn-by-Doing" Shop Training in Practical Electricity! Simple, clear, easy-to-understand. For "beginner" or "old timer".

NEW! Latest Up-to-the-Minute Developments in ELECTRONICS

This set gives you the fundamentals of Electricity on which all Radio and Electronics depends. You study electro-magnetism, induction, wiring, A.C. and D.C. motors, switchboards, batteries, etc. Then you get newest facts on Radio, Television, Aircraft Radio, Cathode Ray, Photo-cell and Industrial Electronics. Just off the press—authoritative, practical, complete.

Look Them Over in Your Own Home 7 Days Free!

Don't send a penny. Just mail coupon below and receive your set postpaid. Examine books in your own home for 7 days. Then if you don't agree they're the best practical electrical set you ever saw regardless of price, return the books and YOU WON'T OWE A CENT. WE PAY ALL SHIPPING CHARGES. Rush coupon now!

H. C. LEWIS, President
 COYNE ELECTRICAL SCHOOL
 500 S. Paulina St., Dept. B3-T1, Chicago, Ill.
 Send me the big 3-volume NEW EDITION Coyne Electrical Reference and Instruction Encyclopedia. Within 7 days after receiving the books, I'll either return them or send you \$1.95 and then \$2 a month until the total price of \$13.95 is paid. We pay the shipping charges.

NAME.....
 ADDRESS.....
 CITY..... STATE.....
 OCCUPATION..... AGE.....
SAVE 10% Send cash price, \$12.55, with order if preferred—you save \$1.40. Same 7-day free trial and return privilege.

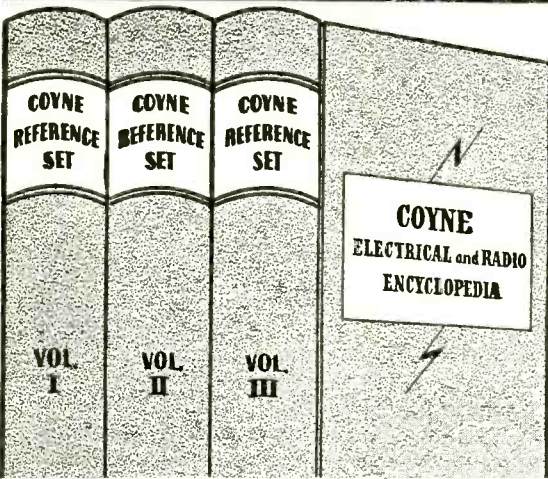

44 YEARS' EXPERIENCE
 in Practical "Learn-by-Doing" Shop Methods, Packed into This Great Three-Volume Set!
 The material in these books duplicates in book form, the practical "Learn-by-Doing" training given in the shops of the Coyne Electrical School. They are written around our practical course of training.

Over 2000 Pictures and Diagrams. Over 1200 Large Pages.

Each book is 8½x11 inches in size. These 3 big books contain far more material than many sets of 6 or 8 books, yet because we are able to get so much material in each book and there is less binding in 3 books we are able to sell the Coyne Set to you for far less money. Fully illustrated throughout, with pictures, diagrams and complete index that make it a set you can use every day on the job. Handsome Red and Gold Leatherette binding—a set you will treasure all your life!

MAIL COUPON NOW!

H. C. LEWIS, Pres.
COYNE ELECTRICAL SCHOOL
 500 South Paulina Street
 Dept. B3-T1, Chicago, Ill.

BOOK OF 150 SHOP PRINTS FREE Wiring Diagrams, Radio Hookups, etc.
 WITH YOUR REFERENCE SET!
 Just what every Radio Man and Electrician wants! Book of 150 big 8½"x11" prints covering every type of job, now yours FREE with big 3-volume COYNE REFERENCE SET.
 Right now I am also including 1 Year of Personal Technical Counsel by mail on any electrical or radio problem—FREE with your set. Mail coupon Today!

**"NAZI TANKS BEHIND
NEXT HILL ON LEFT—
WATCH OUT!"**



RADIO STOPS A FLANK ATTACK!

Out of the sky by radio flashes quick warning of an ambush. Our tanks wheel to meet it—and turn disaster into victory!

It's this kind of *instant*, sure communication that saves the day in war. With split-second timing must go clear, undistorted radio reception—never-failing dependability.

Because it knows these qualities distinguish MURDOCK Radio Phones, the U. S. Signal Corps uses these time-tested receivers.

Take a tip from the leaders—use MURDOCK Radio Phones! Write Dept. 44 for catalogue.



**Wm J. Murdock Co.
Chelsea, Massachusetts**

rubber. Since the method of production is also different from that of other types of synthetic rubbers, this phase will not compete with or delay other types of production.

Information on the processes has been turned over to several chemical manufacturing companies, one of whom is already producing Paracon on a semi-commercial scale. One of the co-developers of Paracon, Dr. Fuller, has been granted a leave of absence to serve in the office of the Rubber Director in Washington.

Those who are interested in synthetic rubbers should read the new booklet entitled *The Five Commercial Types of Synthetic Rubber* recently released by the United States Rubber Company. The development of synthetic rubber from its laboratory stages are effectively traced in this presentation. The publication includes photographs of synthetic rubber manufacture processes, and diagrams and charts. One chart included in this booklet shows the relative physical and chemical properties of natural rubber and of the five types of synthetic rubber. This booklet is now being used for study in several technical schools and colleges throughout the country.

The Russian rubber producing dandelion . . . kok-saghyz, has entered our rubber picture very effectively too. This plant, which is said to have produced 50 pounds of rubber per acre, is being grown on 20 acres of Government owned land here. An additional 5-acre tract on an adjacent experimental farm has also been seeded and an additional 35 acres have been leased for further planting. The main objective this year is to secure seed, although a small portion of the crop will probably be harvested and subjected to experimental processing for the extraction of rubber. This plant is said to have a distinct advantage over other rubber producing plants in that it can be harvested and processed within a single year. The Russian dandelion is similar to the American dandelion, except that its rubber content, which is found in the tubes of the roots, has been increased through breeding and selection. About two million acres of kok-saghyz were planted by the Russians in 1942.

FUNDS FOR INSTRUMENT LANDING SYSTEMS and ultra-high frequency receivers for planes have been granted to the Civil Aeronautics Administration. Approximately \$22,000,000 was appropriated for equipment and auxiliary services. While this sum is considerably under the 1943 request, it will serve nevertheless to provide the essential air navigation facilities required. During the discussion of the appropriation it was learned that the instrument landing systems originally priced at \$75,000, are now available for \$50,000 apiece.

Outstanding work of the CAA has been a major factor in the rapid growth of our aircraft transportation

systems. The CAA is one of the most progressive divisions of the government agencies and can always be depended upon in any undertaking.

A RADIO TECHNICAL PLANNING BOARD to study post-war communication services for the public was discussed recently by James Lawrence Fly, FCC Chairman. This board would, with the assistance of the RMA and IRE, as well as the FCC and other government agencies, develop post-war use of ultra-high frequencies, according to Mr. Fly.

The IRE, which was linked to this plan, believes that such a program would be best served by a radio technical planning association. It has empowered a special committee under the chairmanship of Haraden Pratt, past president of the Institute, to draft such a program and the organization of sponsor bodies. The association, the IRE says, will be representative of a broad cross section of the entire radio industry, including all points of view, providing a forum before which problems can be dealt with in all their aspects. The association will assign specific tasks such as frequency allocation plans, to groups of engineers charged with the prompt development of such proposals.

Both plans have merit. They differ in their approach but they both are directed to the ultimate premise of progress. Conferences between the IRE and the RMA are being held in an effort to program the most suitable method of planning. A complete report on the progress made will appear in these columns.

HERE'S GOOD NEWS . . . backlogs of orders for fine wire used in resistor production in military radio equipment are rapidly declining. Thus the present offers a good time for buying. So said S. K. Wolf, chief of the Resources Branch of the Radio Division, WPB. While it is true, he pointed out, that the production of some sizes of fine wire are not progressing rapidly, it is still possible to secure a variety of sizes. This paradox is prompted by bottlenecks in the facilities for some sizes and yet more than adequate production facilities for other sizes. In many instances, Mr. Wolf pointed out, production capacity is below normal. He suggests that those who have experienced difficulties in securing fine wire (.002 and smaller) should seek the direct assistance of the Resources Branch offering such data as the name of the supplier, purchase order number, size, quantity, description, delivery date promised, and date required.

FEW MATERIALS HAVE HAD AS STRENUOUS a campaign for alternates as mica. And although many successful alternates have been developed, mica is still a very vital and necessary material. Its service in radio as an insulating medium, particularly in capacitors for military purposes, has required tons and tons of mica, in ex-

JAMES

Crystals

KNIGHTS

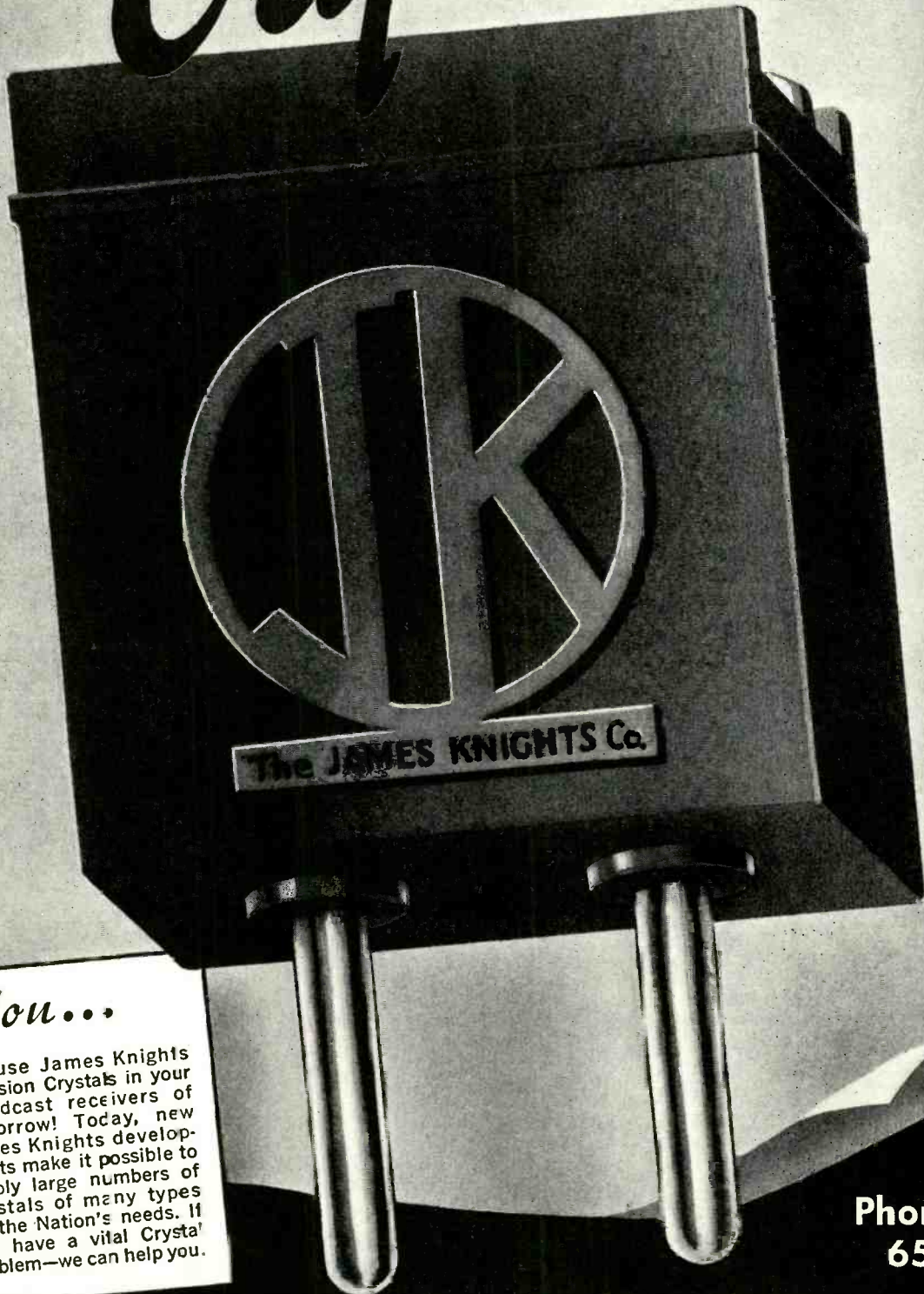

You...

will use James Knights Precision Crystals in your broadcast receivers of tomorrow! Today, new James Knights developments make it possible to supply large numbers of Crystals of many types for the Nation's needs. If you have a vital Crystals' problem—we can help you.

Phone
65

PRECISION CUTTERS OF QUARTZ
FOR RADIO AND OPTICAL USES

The JAMES KNIGHTS Co.
SANDWICH, ILLINOIS



Portable
or A. C.
Models

For Field, Aircraft, Marine,
Factory, Laboratory or Shop Use

- Extremely easy to operate. No calibration or tuning charts necessary.
- Transmits accurate frequency carrier signals every 10 KC and every 100 KC from 100 kilocycles to 45 megacycles; also marker carriers every 1000 KC from 1 megacycle to 120 megacycles. Also used for frequencies of less than multiples of 10.
- Sets transmitters that are not crystal controlled on any desired frequency.
- Checks accuracy of field or production oscillators, signal generators and frequency meters not crystal controlled.
- Checks frequency characteristics of crystal controlled transmitters, receivers.
- Aligns and calibrates receivers in both I.F. and R.F. stages.
- Monitors transmitted signals.
- "ON-OFF" Switch permits use of modulated or unmodulated signal.

● Portable Model 18C illustrated is equipped with Bliley dual-frequency crystal, "A" and "B" batteries, and tubes (1299 oscillator, 1LA6 class "C" amplifier, 1291 multi-vibrator and 1LB4 modulator). Size 7½" x 10½" x 12". Weight 12 lbs.

Send for New "Telrad" Bulletin
FRED E. GARNER CO.
43 E. Ohio St., Chicago, Ill.

FRED E. GARNER CO.
Mfrs. of Radionic and Optical Equipment

cess of our normal requirements. The alternate materials have served well, but they have not been effective in some projects.

Mica, with its high dielectric constant and perfect cleavage, makes it ideally suited as a layer material in stacked capacitors. From India has come our best mica or muscovite (potassium mica). We have been receiving mica from South America, but the grade has not been as good as the Ruby mica which originates in India. Incidentally, the Indians are acknowledged specialists in the art of splitting mica to uniformly thin sheets.

One substitute for mica as a dielectric in capacitors has been the ceramic, steatite. Steatite is prepared from mixtures of 60% or more of talc, 30% or less of clay or kaolin and the remainder usually of alkali or alkaline earth oxides or compounds that will decompose and furnish fluxing oxides. Since, however, these ceramic materials can only be manufactured in comparatively thick sections, their use as an insulating medium in place of mica has been naturally restricted. To overcome this, another ceramic known as rutile, has been used quite effectively. According to Hans Thurnauer of American Lava, this material has a negative temperature coefficient of dielectric constant which is in direct contrast to other solid dielectric materials which have a positive temperature coefficient. By combining this new element with materials of the positive temperature characteristics, it is thus possible to obtain ceramic dielectrics with coefficients ranging from plus 120×10^{-6} to minus $750 \times 10^{-6} \mu\mu\text{fd.}$ per $\mu\mu\text{fd.}$ per degree centigrade, according to Mr. Thurnauer.

Tubular forms coated inside and outside with a layer of silver connected to the ceramic surface by a firing process constitute the conventional way of making ceramic condensers. Ceramic trimmer condensers have also been designed using rutile, with a silver layer fired on to it.

High voltage type fixed condensers using this ceramic can be made up in capacities as high as 1500 $\mu\mu\text{fd.}$ And it is possible to go beyond that, too, with special types. Because of the rather high power factor of these ceramics, however, they can at present only be used for bypass action. However, developments have been progressing and we are certain to have ceramic capacitors for use in a variety of circuit applications.

Another alternate for mica, in certain applications, that has recently come to the foreground, has been the thermoplastic resin known as Polecron. It is said to have unusual high softening temperature, low dielectric loss and water resistant characteristics. Tests of Polecron have shown that it has a . . . (1) heat distortion temperature, 140-160° C.; (2) power factor (one kilocycle to one megacycle at 25° C.), 0.10% or less; (at one kilocycle from 25° C. to 100° C.) 0.10% or less; (3) specific resistivity at 400

volts, more than 10^{10} ohm cms.; (4) dielectric constant (one kilocycle to one megacycle), 3.0; (5) dielectric strength, more than 1,000 volts per mill.

OVER ONE BILLION DOLLARS was spent in 1942 for the production of radio and Radar equipment for military and civilian applications. Specifically the sum spent was \$1,200,000,000, according to Donald M. Nelson, chairman WPB. This was more than three times that spent in 1941. And in 1943 even this huge sum has been exceeded.

SOUND EFFECT TECHNIQUES, as an art, were described recently by Frederick G. Knopfke, manager of NBC's sound effects division, at a meeting of the Radio Club of America. Minute shadings of sound, even as to the opening and closing of doors by a child and by an adult, were analyzed by Mr. Knopfke.

After discussing these odd problems in studio technique, Mr. Knopfke told of a phase of sound technique that has thus far evaded the skill of sound technicians. This concerned binaural reception. Although binaural or plastic hearing, which is the perception of sounds due to the motion of the object producing the sound, has been accomplished in the laboratory and even in motion pictures such as *Fantasia*, it cannot be made available in the home. This is unfortunately due to the single source of sound projection employed . . . the loudspeaker.

In plastic hearing we are able to determine whether the sound is coming from the right or from the left and with various degrees of tone and volume shading. We cannot, of course, do this with a single loud speaker. If a multiple microphone set-up and a multiple transmitter array could be used, in conjunction with multiple receivers and multiple loudspeakers in the home, plastic hearing could be available. The inability to reproduce this results in the flatness of many sound effect recordings, such as street traffic. Hope was expressed that solutions to these problems may be forthcoming in the post-war era.

TELEVISION appears to be gaining tremendous headway these days. Many problems, such as camera pickup, studio composition and transmission coverage are nearing rapid solution. According to Allen B. DuMont, programming has reached a definite formula, with trained studio personnel and a host of entertainers with actual telecasting experience currently available.

To solve the problem of presentations at different points throughout the country, not within reach of network links, traveling shows will probably be used in much the same manner as the vaudeville troupe of the old days.

Extensive production of cathode-ray
(Continued on page 46)

NEW

G-E RADIO-NOISE FILTERS for Aircraft

Available in ratings of
20, 50, 100, and 200
amp, d-c, at 50 volts.

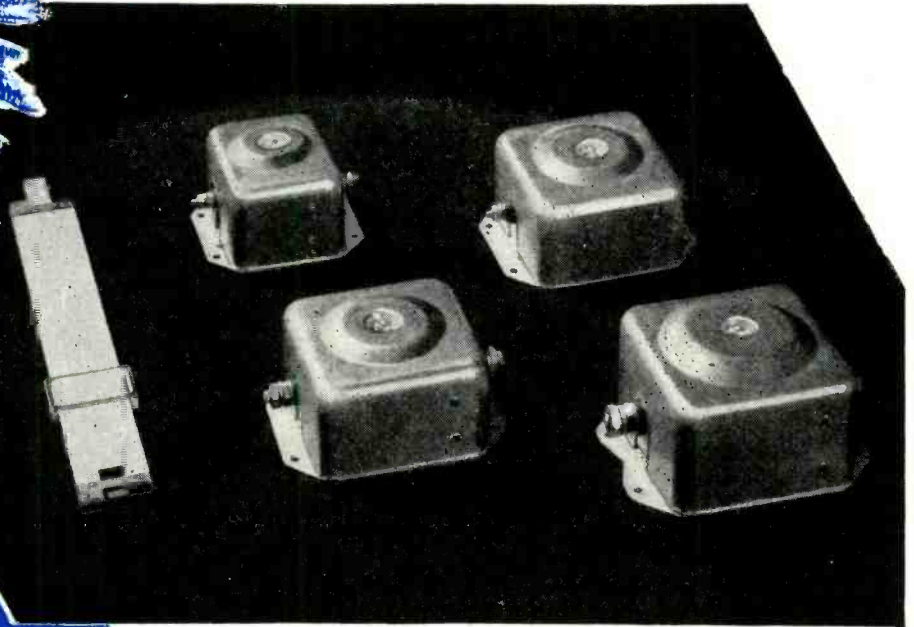

**They provide excellent noise suppression
—especially from 200 to 20,000 kc**

These filters help immeasurably in providing the high-fidelity radio reception so important in aerial warfare. They attenuate radio-noise voltage on aircraft electric systems (on circuits with such equipment as generators, amplidynes, inverters, and dynamotors). They are particularly helpful in systems where open wiring is used to save weight.

FEATURES

- High attenuation characteristic results in excellent noise reduction
- Compact and lightweight (For 100-amp rating, shown in left foreground above, approx 2 1/5 lb, measuring approx 5 by 4 by 2 1/2 inches)
- Can be mounted readily in any position
- Operate efficiently over a wide temperature range (-50 C to 50 C)
- Comply with U.S. Army Air Forces specifications, including the stringent requirements as to vibration and acceleration

FOR FURTHER DATA on these filters ask your G-E representative for Bulletin GEA-4098, or write to General Electric Company, Schenectady, New York.

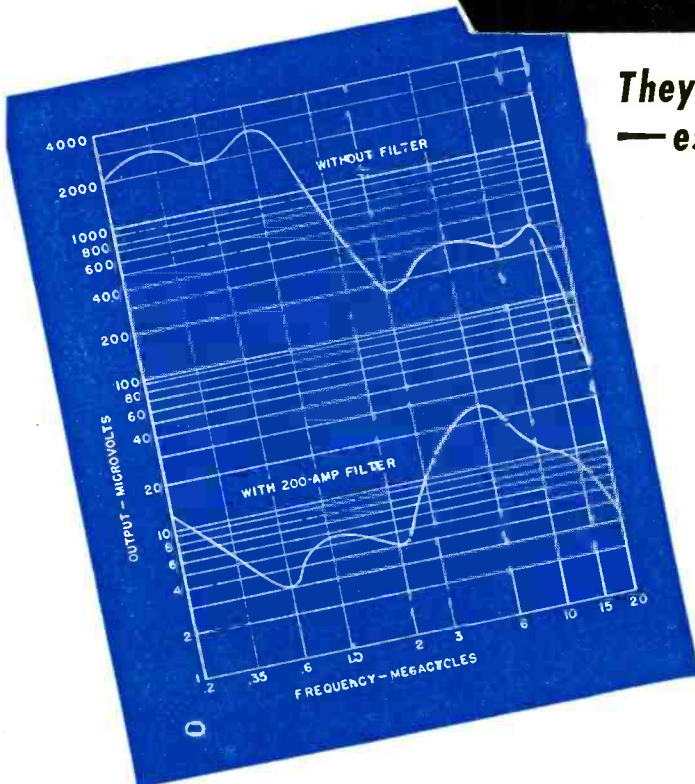

Radio-noise voltage measured on aircraft generator with and without G-E 200-amp filter

GENERAL ELECTRIC

407-58-3700

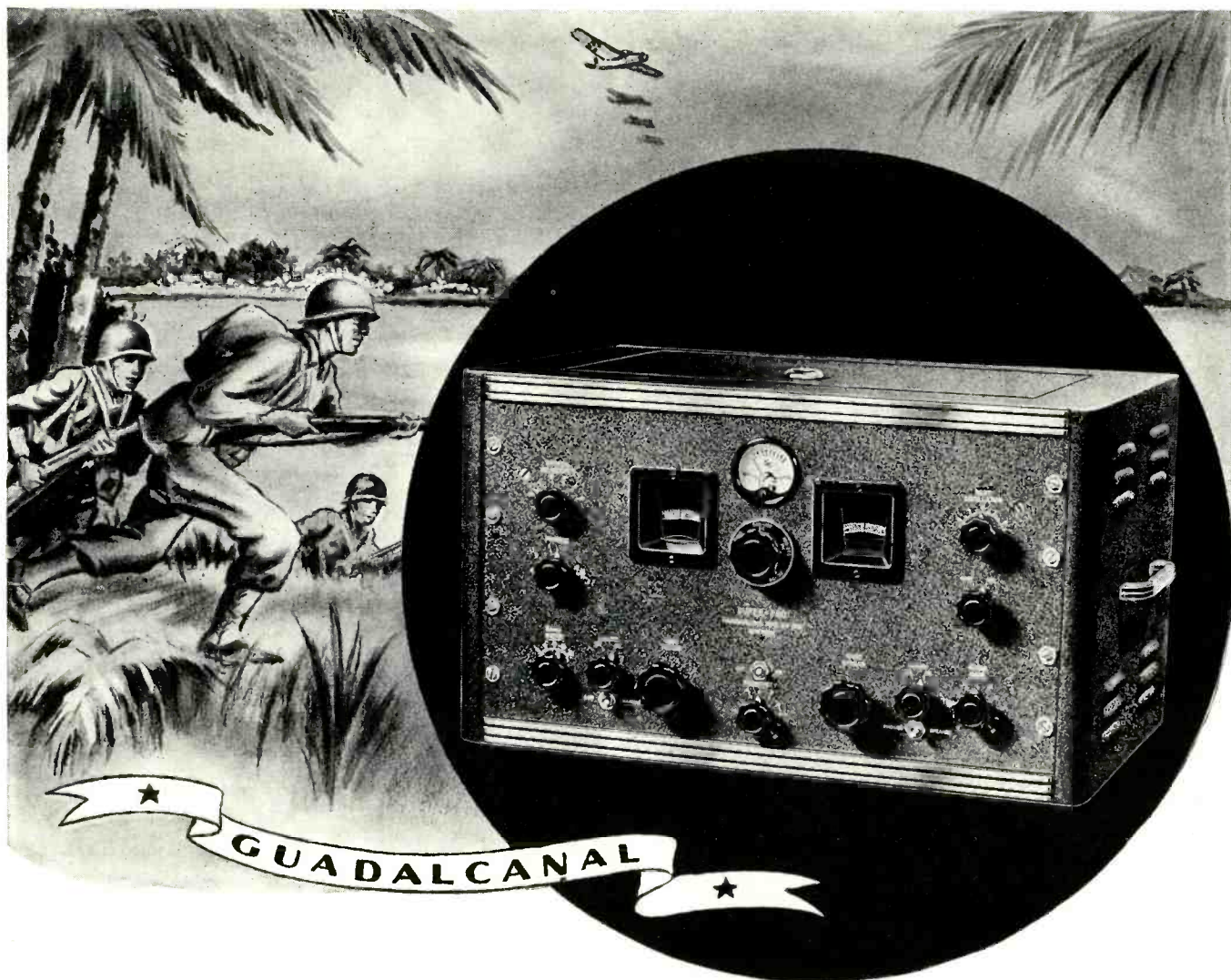

Serving on all our fighting fronts . . . the SUPER-PRO "SERIES . 200"

IT REQUIRES STAMINA to withstand the steaming wet climate of the Pacific Islands, or the frigid temperature of the far North. Our boys and our equipment are proving a match for the elements as well as our enemies. We of HAMMARLUND are proud to have aided in the successful battles of Guadalcanal.

THE HAMMARLUND MFG. CO., INC.
 460 West 34th Street, New York, N. Y.



HAMMARLUND

THERAPEUTIC RADIONICS



Test tubes, containing solutions of virus and bacteria to be used in ultra-violet radiation experiments, are kept in incubator.



Pressure discs being applied to foot before recording walking-gait characteristics, with oscillograph using galvanometers.

by **S. R. WINTERS**

Scientists of today, through the use of radionic equipment, are aided in determining symptoms of future physical ailments and thereby prevent instead of cure.

DELIVERING a doctor by parachute was a recent accomplishment in a remote area of a western state, where rugged terrain and difficult topography discouraged conventional modes of transportation. This airplane was equipped with two-way radio communication facilities and the parachute contained a compact radio transmitter and receiver for communication with ground stations as he hurtled through space.

The name of the first doctor to travel by a radio-equipped parachute escapes the writer's memory—anyway, that is unimportant because he was more than an individual. He was a symbol and a forerunner of the radionic doctor. For his diagnostic kit may have included a complete set of

radionic instruments—an electrocardiograph for detecting and measuring the heartbeats of unborn children; a short-wave diathermy unit for healing sprains and fractures; an ultra-violet lamp for arresting harmful mold and bacteria that may endanger the health of soldiers and civilians alike; and a portable X-ray outfit for treatment of skin disorders, acute infections, inflammations, or gas gangrene.

Still another radionic instrument recently made available for the treatment of infantile paralysis and industrial and war cripples is a 12-element oscillograph developed by the University of Rochester School of Medicine. This device records the foot and muscle action of an individual with the surety and constancy of a shadow fol-

lowing a man. The outgrowth of 17 years' research by Dr. R. Plato Schwartz, this apparatus has the capacity to study foot function, while walking, in its many essential factors. Resistance discs, smaller but slightly thicker than a dime, are placed at six points on the bottom of each foot under observation. Records may be made of barefooted individuals or of persons fully shod. Radionic current passed by each of these dime-sized discs is in exact proportion to the pressure exerted upon it as the patient ambles along. A cable connects each disc to one of the twelve sensitive General Electric Company galvanometer elements. A tiny mirror in each galvanometer reflects a beam of light no larger than a pin point, as these



Recording walking-gait of patient. Elaborate equipment is necessary and many tests made before graphs can be obtained.



Testing General Electric therapy tubes. These tubes have made possible the design of our present day therapeutic equipment.

Fig. 1. Top view of the radionic inhalator, showing the panel layout. This device is a.c. operated and sufficiently compact for bedside use.

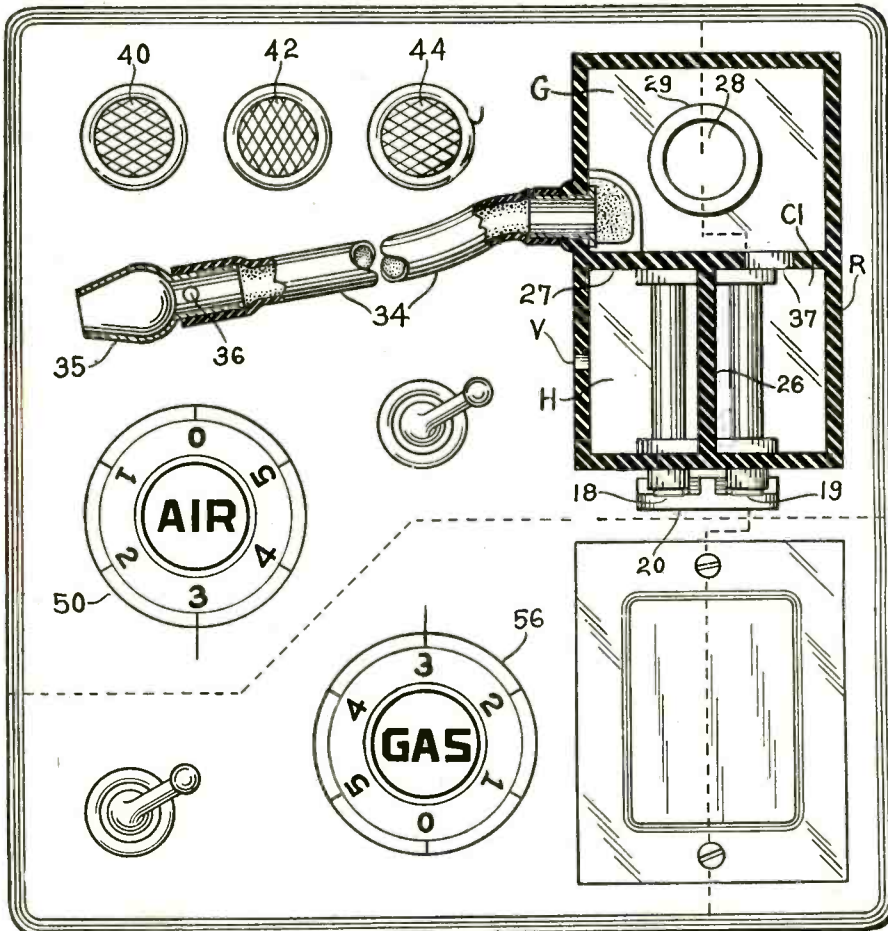

sensitive instruments sway to and fro in responding to the varying amounts of pressure placed on the different discs.

This pin-point-sized ray of light, when focused through an optical device, strikes a strip of photographic paper, which is caused to pass a slit opening at a constant speed by a synchronous motor. Inasmuch as these tiny rays of light swing at right angles to the direction in which the photographic paper travels, twelve curves are the result, these disclosing the function of six areas on the foot. These curves are said to indicate the duration, the amount, and the sequence of simultaneous pressure changes, with an accuracy of five percent less than perfect. Already, an analysis of about 4,000 records has resulted in the formulation of standard time and pressure values for normal walking. Comparison of values gained from records of patients subjected to treatment with the standards affords a certain check on the effectiveness of foot therapy. Such procedures may be applied to any disease relating to a

- Nos. 18-19, terminals
- No. 20, block
- No. 26, electrolytic sump
- No. 27, reservoir partition
- No. 28, air passage
- No. 29, inlet tube
- No. 34, flexible tubing
- No. 35, nasal tip
- No. 36, air inlet
- No. 37, port
- Nos. 40, 42, 44, signal glass
- Nos. 50-56, control knobs
- G—collection chamber
- H— and C, compartments of septum 26
- R—electrolysis reservoir
- V—vent

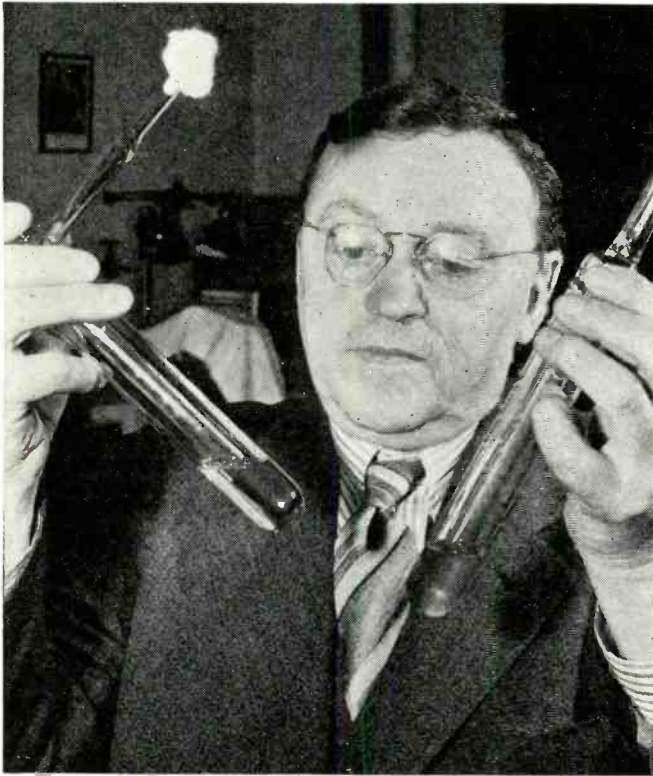

Scientist with tube (left) containing solution of parasitic virus which feeds on bacteria from the other test tube.



A horseshoe-shaped ultra-violet ray lamp used by a large industrial plant to prevent spreading of foot infections.

person's ability to walk. Likewise variations in foot function resulting from differences in heel height have been recorded; also differences resulting from other factors in shoe construction and design are matters of "on-the-record".

As an offshoot of the use of this oscillograph in studying walking, it has been applied in recording muscle-action curves. For this specific use, four high-gain radionic amplifiers have been constructed and matched to the galvanometer elements. These records are of value in studying infantile paralysis (of which President Roosevelt is high exemplar of the victims that have recovered) and other forms of neuro-muscular pathology. These records afford a medium for demonstrating the presence of spasms in muscles formerly thought to be unaffected by infantile paralysis.

Of related and even more far-reaching significance is the epochal medical achievement of Dr. The Svedberg of the University of Upsala (Nobel Prize Winner) in using a radionic microscope in photographing the insidious virus that produces human infantile paralysis. The photograph which was sent from Sweden to London and thence radioed to New York City shows a myriad of tiny dots, representing the individual virus molecules, magnified 50,000 times by the new radionic microscope, similar to the type demonstrated recently by the Radio Corporation of America in Washington, D. C. The Swedish scientist reports that the infantile paralysis virus is a Goliath of a chemical molecule.

(Continued on page 74)

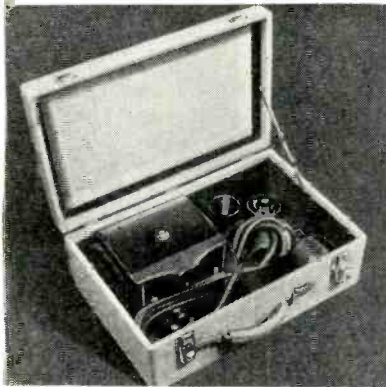

A compact portable X-ray machine.



Electrocardiograph—measures heartbeats.



Inductotherm—used to generate fever.

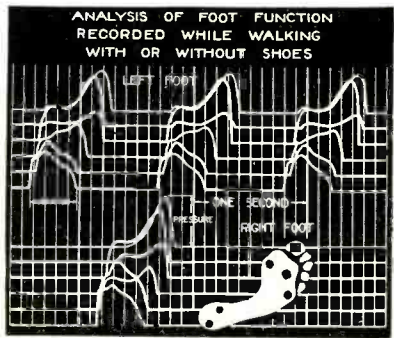

PATTERN picture taken with oscillograph.

A Direct-Reading Q Meter

by

RUFUS P. TURNER

Consulting Engineer, RADIO NEWS

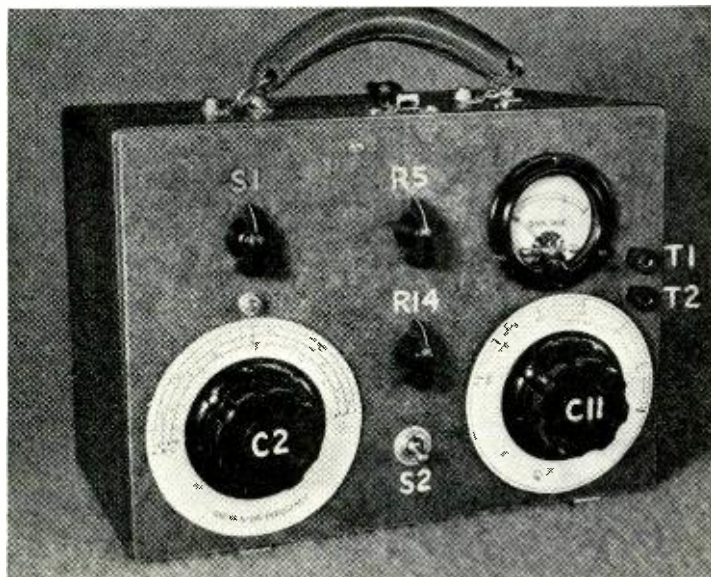

Front panel layout of the home-constructed portable Q-meter.

Constructional details and schematic for a coil-testing Q-meter that is both easy-to-build and inexpensive.



THE standard determination of coil quality is a measurement of Q. When high-Q coils were readily obtainable, few private experimenters felt the need of an instrument with which coil quality might be checked reliably. But now that war-time urgencies have reduced the civilian supply of radio parts, many experimenters, workers, and students are winding their own coils or resurrecting discarded units of questionable quality. At the same time, classes in radio theory and private testing laboratories now abound, and the demand for simple and effective Q-meters has received considerable impetus.

Test equipment, like radio parts, is likewise hard to obtain without high priorities—and then only after trying months of waiting. This article describes an effective Q-meter which may be constructed readily by any painstaking radio technician. Furthermore, the average radio or electronic hobbyist very likely will find all the parts required for the instrument in his collection of stray equipment.

While no extraordinary claims are made for accuracy of this instrument, it may be safely guaranteed that the Q-meter described will, if carefully built and accurately calibrated, meet the every stern demand of the laboratory unable to afford a more elaborate factory-built model. This meter will enable ready comparison of coils of every type with respect to electrical quality, and will give quick, definite Q readings without calculations. Final excellence of the instrument depends upon the completeness and accuracy of calibration of its main tuning con-

denser against reliable capacitance standards.

The Q-meter, shown in the photograph, is readily portable, being small in size and light in weight. It is entirely self-contained and is fully a.c. operated. The controls are held to an absolute minimum, and its operation is simple enough to permit its use along an assembly line by non-technical workers. The inductance range of coils that may be checked with this instrument extends from 0.5 microhenry to 5 millihenries. The frequency range of the self-contained, variable-frequency oscillator is 100 kc. to 13 mc. in three bands, selected by means of a rotary panel switch. All coils are checked with a maximum of high-Q capacitance in the measuring circuit.

In a coil of high Q, the ratio of reactance to resistance (X_L/R) is high; while in a coil of low Q, the higher

value of equivalent series resistance acts to reduce this ratio. Actually, of course, this ratio is the Q of the coil. The effect of radio-frequency resistance in the coil is to broaden the selectivity of an L-C circuit containing the coil. The shape of the selectivity curve of a resonant circuit (with frequency plotted against either the current through the circuit or the voltage across the circuit) is thus an indication of the coil Q, provided that the condenser employed to resonate this circuit has a high Q value. The latter condition may readily be obtained by employing an air condenser with high-grade insulation applied sparsely.

In determining the selectivity characteristic of a resonant circuit embracing a high-Q condenser and a coil of questionable Q, it is generally desirable to measure the voltage across the tuned circuit, rather than the current flowing in this circuit. For this purpose, a vacuum-tube voltmeter with high input impedance is satisfactory. The indication given will be that of the tuned-circuit Q, rather than the Q of the coil alone. However, the condenser Q may be made infinite by employing a high-quality air unit, and the Q indications thus become almost totally those of coil quality.

The width of the selectivity curve of a test circuit containing an "unknown" coil may be investigated in two fashions: (1) Energy from a variable-frequency r.f. oscillator of reasonably high-voltage output is coupled into the measuring circuit (Figure 1) containing the coil and the high-quality test condenser. A v.t. voltmeter is employed to measure the voltage across

Fig. 1. Voltage curve of tuned circuit.

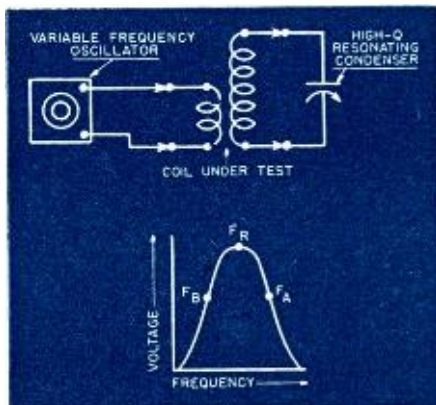

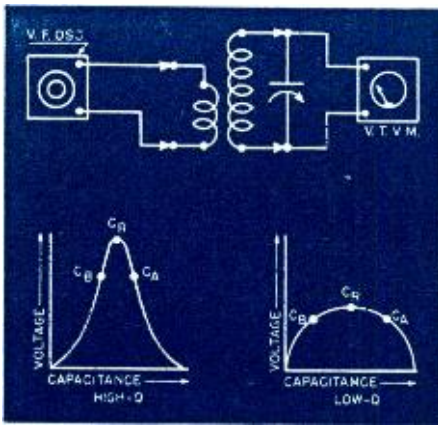

Fig. 2. Resonance—high and low Q circuit.

the coil and condenser. With the circuit condenser capacitance constant, being at or near the maximum value of the condenser, the oscillator frequency is varied until peak deflection of the v.t. voltmeter indicates that the resonant frequency of the L-C circuit has been reached. Above resonance and below resonance, this voltage falls to some lower value and eventually to zero. If the signal frequency is increased to a value such that the test circuit voltage falls to 70.7% of its peak (resonant) value, we will obtain a new frequency value (read from the oscillator dial) which we may designate f_a . (See curve in Figure 1). And if the signal frequency is decreased below the resonant point (f_r), to a value such that the test circuit voltage again falls to 70.7% of its resonant value, we will obtain a frequency f_b . At these frequencies f_a and f_b , the reactance and the resistance are equal, and the distance measured from f_a to f_b at this level indicates the curve width. In actual kilocycles, this amounts to $f_a - f_b$. The Q of the coil may then be determined by dividing the resonant frequency by the curve-width frequency difference:

$$Q = f_r / f_a - f_b$$

(2) The signal frequency may be maintained at a single value and the test-circuit capacitance varied on each side of resonance to obtain the same result: The capacitance at resonance, as indicated by peak reading of the v.t. voltmeter, is then C_r , while the capacitance values corresponding to 70.7% voltage readings above and below the

Fig. 3. Simplified circuit of a Q-meter.

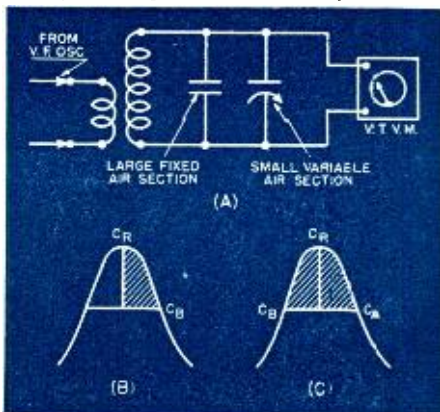

resonant point are respectively C_a and C_b . Q obtained by this capacitance-variation method is equal to twice the resonant capacitance divided by the curve-width capacitance difference:

$$Q = 2C_r / C_b - C_a$$

(See curves in Figure 2.)

The connections for oscillator, test circuit, and v.t. voltmeter, applicable to either method of Q determination, are shown in Figure 2. In system 1, it is evident that the signal frequencies must be known with accuracy; while in system 2, the dial controlling the test-circuit condenser must be accurately graduated in micromicrofarads. In most laboratory-table set-ups, the frequency-variation method would be preferred, since the frequency calibration of a commercial test oscillator might be accepted as sufficiently accurate, while considerably more inconvenience is occasioned by providing a dial calibration of the test condenser. However, our instrument will employ the capacitance-variation method, since, as we shall see, this method readily lends itself to direct dial indications of Q values.

The principle upon which this direct-reading instrument is based is illustrated by the circuit and selectivity curves of Figure 3. In this arrangement, the test circuit is tuned by a large fixed air condenser and a small variable air condenser connected in parallel, as in 3-a. The small section (trimmer) is initially set at maximum capacitance, such that the total circuit capacitance, neglecting the distributed capacitance of the coil, is equal to some convenient value for Q calculation. The signal frequency is then varied until the resonant frequency of this combination is discovered. The value C_r at this frequency (3-b) is then the total capacitance of the two air condensers.

The trimmer alone may then be varied, moving away from the maximum-capacitance setting, until the circuit voltage falls to 70.7% of its resonant value. Its capacitance corresponding to that voltage is then C_b on curve 3-b. If the trimmer dial has been graduated in micromicrofarads, the trimmer capacitance change may be observed directly to yield the denominator of the Q formula. However, since the initial setting of the trimmer will always be its maximum capacitance for any test, the initial setting may be designated zero, and the dial might as easily be graduated in capacitance variation, rather than in capacitance. Likewise, since the total circuit capacitance is a fixed value at resonance, for any coil test, the numerator of the Q fraction will always be the same, and the trimmer dial might be marked off directly in Q values corresponding to capacitance differences.

When the trimmer moves in one direction from the resonant capacitance, as described above, only one side of the selectivity curve is explored. This corresponds to the shaded portion of curve 3-b. The Q formula for such an adjustment then becomes: $C_r / C_r - C_b$.

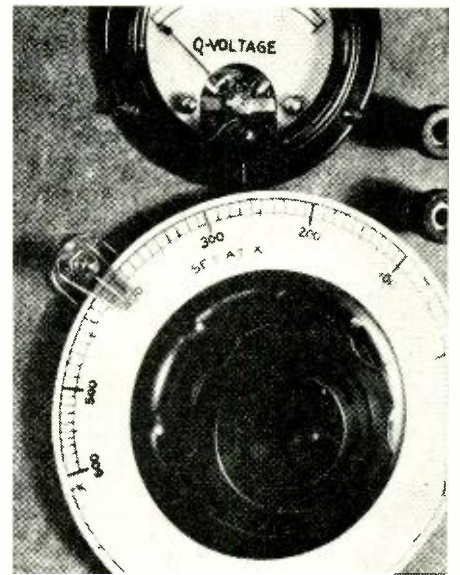

FIG. 4.—SLIDING ZERO INDICATOR.

This indicator affords greater accuracy since it permits the entire bandwidth to be measured. It was added to the meter after the first instrument, shown in the overall photo, was pictured, in order to obtain this greater accuracy. It operates on the side of the dial shown, since the meter rim and the ground binding post on the other side of the dial would offer obstruction to its movement. However, it is free to move, as it is over a much larger portion of the dial than formerly required. However, the reader may keep the index rotation entirely around the top portion of the dial by moving the meter up and the binding posts to the right. When extreme accuracy is not necessary, as when comparative Q indications are sufficiently close, a stationary index, such as inscribed just above the Q dial on the rim of the meter case or which might be obtained by not rotating the sliding pointer, may be employed. The stationary index, as pointed out in the article, allows measurement of only one side of the selectivity curve. Furthermore, this Q reading will be correct only if the unmeasured side of the curve is of the same size and shape (most often the separate sides are not identical).

This measurement assumes that the curve is symmetrical, i.e., is of the same shape on each side of resonance; otherwise we will not be measuring exactly one-half the total width. Considerable error may be introduced in the numerical Q values by non-uniformity of the selectivity curve, although for some comparative purposes, this error might be immaterial.

The error might be eliminated, however, and the direct-reading Q dial retained by making our zero point, corresponding to C_b in curve 3-c, the capacitance which gives the high-capacitance 70.7% voltage indication. The trimmer capacitance at resonance would then be one-half of its total maximum capacitance, and the total circuit capacitance at resonance would equal this trimmer value plus the capacitance of the fixed air section.

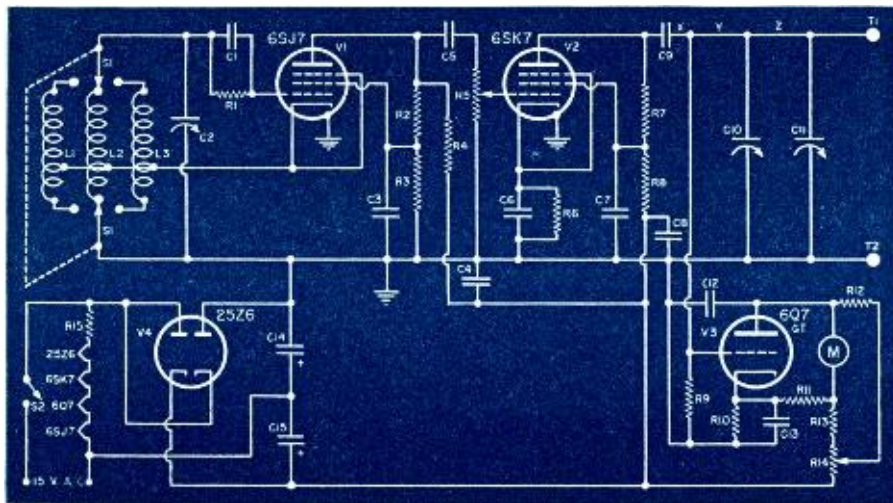

Fig. 5. Schematic diagram of the a.c.-d.c. powered portable Q-meter.

C_1 —0.0001 μ fd. mica, Aerovox 1467
 C_2 —1000 μ fd. variable, Cardwell XR-500-PD with connected sections
 $C_3, C_4, C_5, C_7, C_8, C_{12}, C_{13}$ —0.1 μ fd. 400 volt tubular, Aerovox
 C_6 —0.01 μ fd. mica, Aerovox 1467
 C_9 —0.01 μ fd. (Silver mica) 400 volt tubular, Aerovox
 C_{10} —500 μ fd. variable (midget broadcast-type with improvised polystyrene insulation. See text)
 C_{11} —25 μ fd. ceramic-insulated midget, National UM25
 C_{15} —16 μ fd. 450 d.c.w.v. electrolytic, Aerovox PR5
 R_1 —20,000 ohm $\frac{1}{2}$ watt, Aerovox
 R_2, R_3 —100,000 ohm $\frac{1}{2}$ watt, Aerovox
 R_4 —0.25 megohm 1 watt, Aerovox
 R_5 —2000 ohm wirewound pot., I.R.C. W-2000

R_6 —300 ohm 1 watt, Aerovox
 R_7, R_8 —50,000 ohm 1 watt, Aerovox
 R_9 —50 to 100 megohm $\frac{1}{2}$ watt, Aerovox—units in series
 R_{10} —1400 ohm 1 watt, Aerovox (one 1000-ohm and one 400-ohm in series)
 R_{11} —240,000 ohm 1 watt (200,000 and 40,000 ohm in series)
 R_{12} —20,000 ohm 1 watt, Aerovox
 R_{13} —7000 ohm 1 watt, Aerovox
 R_{14} —3000 ohm wirewound potentiometer, I.R.C. W-3000
 R_{15} —237-ohm Cardohm line cord unit
 L_1, L_2, L_3 —See text
 M —2-inch 0-1 d.c. milliammeter Triplett Model 221
 S_1 —2P3P rotary selector switch, Centralab
 S_2 —SPST toggle switch, Arrow
 T_1, T_2 —Insulated binding posts, Gordon

In operation, the trimmer would be set to one-half maximum capacitance. This set-up point must be marked plainly on the trimmer dial. The signal frequency would then be adjusted until the v.t. voltmeter peak deflection indicated resonance. The trimmer would then be tuned in the direction of its maximum capacitance until the meter deflection dropped to 0.707 of the resonant voltage value. The trimmer dial reading at this point would be the zero position, or starting point, corresponding to point C_5 on curve 3-c. Finally, tuning the trimmer away from this zero point in the direction of minimum capacitance, the dial would be rotated to pass back through resonance, as indicated by the meter, and to a point at which the voltmeter once again drops to 0.707 of the resonant deflection. The trimmer dial reading at this setting then corresponds to the point C_6 on curve 3-c.

This dial distance from C_5 to C_6 would then be the width of the entire selectivity curve, and once again the trimmer dial might be graduated directly in Q units, as described in the foregoing paragraphs. Here, the total curve width is explored, and uniformity of shape will introduce no error. Consequently, Q will in this case be equal to $2C_7/C_6-C_5$. For ease in calculating Q values to be marked on the trimmer dial, C_7 (corresponding to the total circuit capacitance at resonance) might be made some convenient value, such as 500 μ fd. The numerator of the Q fraction would thus become 1000.

It is seen from the foregoing explanation that the zero point on the trimmer dial will shift for different curve widths; hence, some provision must be made in the Q-meter for shifting the trimmer dial index line in order that the dial zero for any coil test may always be the same and in order that the total resonant capacitance may always be the same. Figure 4 shows a scheme for accomplishing such a mechanical shift of the trimmer dial pointer. The dial index line is inscribed on a transparent blade of celluloid, other plastic, or metal, and this blade is mounted free-moving on a panel bushing through which the trimmer condenser shaft passes. The index line may, with this arrangement, be moved from the horizontal to the vertical to locate the actual zero point on the dial, wherever it may be for a particular 0.707 voltage point. Any zero-shifting arrangement of this general type will permit the dial to be graduated directly in Q units, rather than in micromicrofarads, and will obviate all calculations on the part of the operator.

In the system just described, it is obvious that, since the major part of the test-circuit capacitance is fixed, various inductance values will require various different test frequencies. Thus, some coils will necessarily be measured at a low frequency, while others will be measured at a high frequency. In most cases, this will present no difficulty, since quality checks will almost always be made on coils of the same inductance but of different

types of construction or questionable material, and these checks will all be at the same frequency.

Operation of the instrument is resolved to a matter of (1) setting the trimmer dial to a marked set-up point corresponding to mid-capacitance, (2) obtaining the initial voltmeter deflection by adjusting the signal frequency for peak meter reading, (3) rotating the trimmer dial toward maximum capacitance until the meter deflection falls to 0.707 of the resonant voltage, (4) mechanically shifting the trimmer dial index until it coincides with the zero point on the dial, (5) rotating the trimmer dial in the direction of minimum capacitance until the meter deflection passes through peak and again falls to 0.707 of this value, and (6) at this point reading the Q value directly on the trimmer dial.

It is evident from the explanation that only two points need be marked on the voltmeter scale—full-scale deflection (with no regard to the actual magnitude of this value) and 0.707 of this value. By choosing a total resonant-circuit capacitance of 500 μ fd. and a maximum trimmer capacitance of 25 μ fd., the Q dial attached to the trimmer will indicate Q values from 50 to 600, an ample range for coil measurements.

Chart I lists Q values, pre-calculated for the reader, on a basis of the above circuit capacitances. The first column lists "delta C", or capacitance-difference values. The actual trimmer capacitance corresponding to either of these delta values may be found by subtracting the delta value from 25. With this tabulation of Chart I, the reader need only calibrate his trimmer (within the instrument) in μ fd.

It is recommended that the large test-circuit capacitance be a semi-fixed unit. This might be a standard variable condenser so arranged that it might be adjusted to a critical value at the time of instrument calibration, remaining untouched except when the Q-meter is periodically serviced. At resonance, the fixed capacitance plus one-half the trimmer capacitance is 500 μ fd. This means that the fixed section must be pre-set to 487.5 μ fd. in order to total 500 with the 12.5 μ fd. trimmer.

Description of Q-Meter

The operating principles just described have been applied to the Q-meter shown in the photograph and illustrated technically by the schematic of Figure 5.

Referring to Figure 5, the Q-meter embraces a variable-frequency r.f. oscillator stage with the band-switched coils, L_1 , L_2 , and L_3 , and the pentode oscillator tube V1. This stage is followed by an amplifier-coupler stage designed around the pentode V2. The voltage output of this tube to the test circuit is controlled by the panel gain control R_5 . The test circuit, embracing the two condensers C_{10} and C_{11} , is shunt-coupled to the amplifier plate

(Continued on page 64)

130-210 mc. RECEIVER

FOR FM-AM COVERAGE

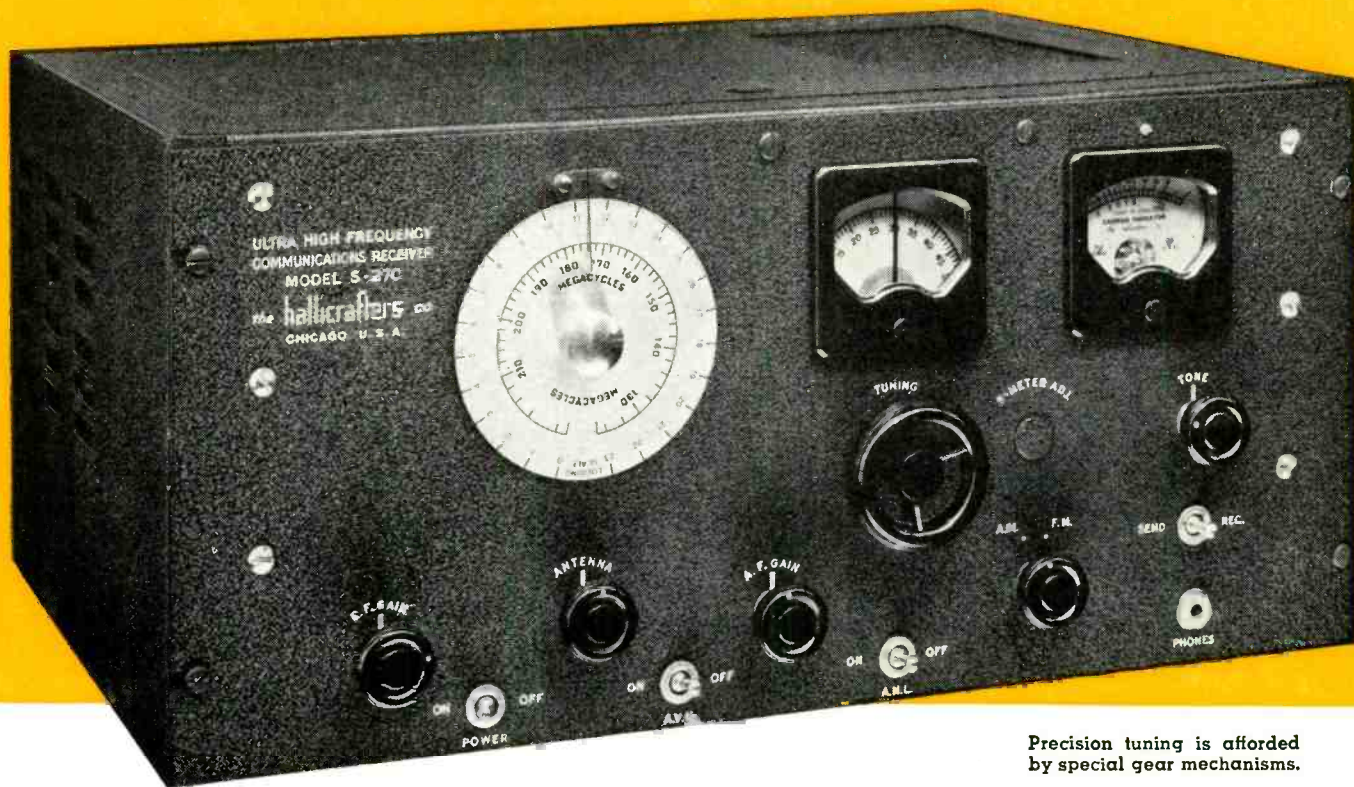

Precision tuning is afforded by special gear mechanisms.

by **CLARK E. JACKSON**

First analysis of a newly developed receiver that was engineered to cover the all-important 130-210 mc. channel.

THE recent adoption of new channels for airline communications and other services has made it necessary to design entirely new receivers, which will be capable of performing *efficiently* at the ultra-high frequencies. War services, too, have relied more and more upon high frequency communications to "get their message through." Engineers and American manufacturers of radio equipment have devoted considerable research to this problem and have found new means for overcoming many of the technical difficulties that are certain to be present in the design of such equipment. The war itself has hastened the development of such sets, and with new techniques and parts, it has been possible to combine the advantages of each and to produce receivers that are far better suited to the reception of the ultra-highs than their predecessors. Such a receiver

is the *Hallicrafters S-27C*, designed for the "very high frequencies."

Continuous coverage within the range of from 130 to 210 mc. is realized at an efficiency heretofore not found in equipment of this type. Such a receiver must, of necessity, be designed from scratch. It is not enough to take an existing type and to add refinements in order to achieve an outstanding design. The very fact that continuous coverage must be achieved with good stability, sensitivity and over-all performance makes it imperative that individual circuit problems be tackled in specific order, and bugs removed before the various portions may be tied in with one another in such a manner that they will all contribute to the final performance of the set.

The popularity of FM, occupying some of the channels within the range of this receiver prompted the inclusion

of special circuits so that both FM as well as AM reception could be had, using a simple change-over system and by the use of two separate detector systems.

A specially designed intermediate frequency amplifier was required which would operate efficiently with both types of signals. Considerable experimentation showed that a frequency of 16 mc. afforded the necessary characteristics for the design of that portion of the circuit. Sufficient voltage gain was obtained, and freedom from images was had by the adoption of that frequency.

One of the main problems in the design of U.H.F. receiving circuits is in the general mechanical layout of the chassis. The ordinary broadcast receiver is usually laid out so that the front panel presents a pleasing appearance to the user, and very often the actual mechanical layout is abused

SCHEMATIC DIAGRAM—ULTRA HIGH FREQUENCY FM-AM RECEIVER-MODEL S-27C

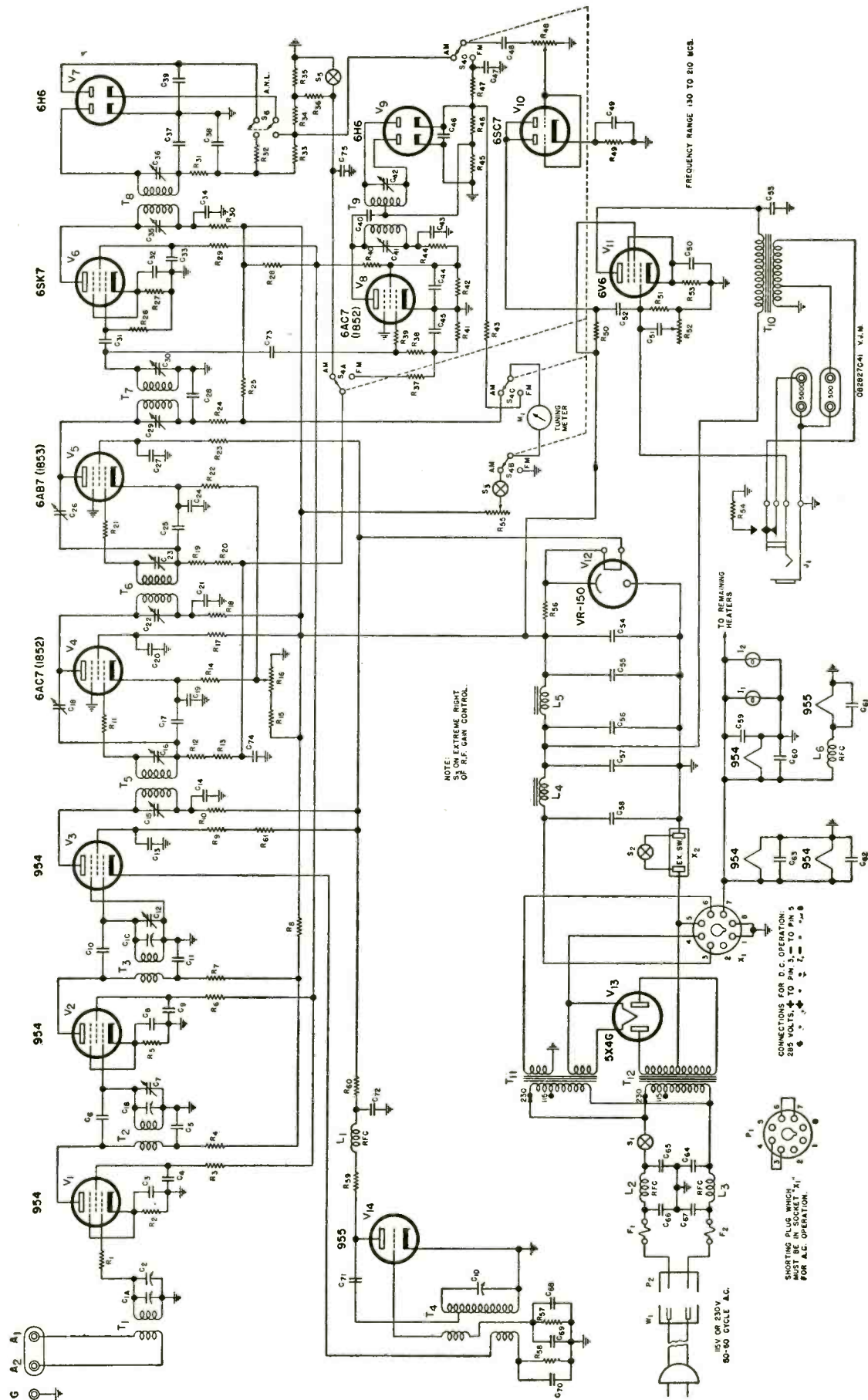

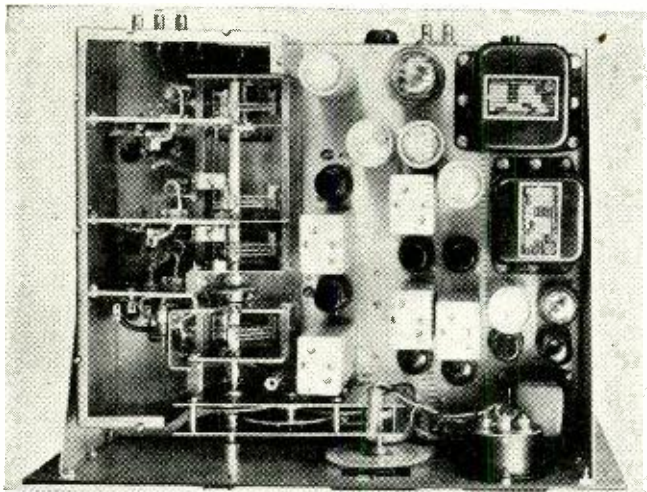

Bird's-eye view showing the carefully baffled r.f. tuning assembly and the elaborate tuning drive.

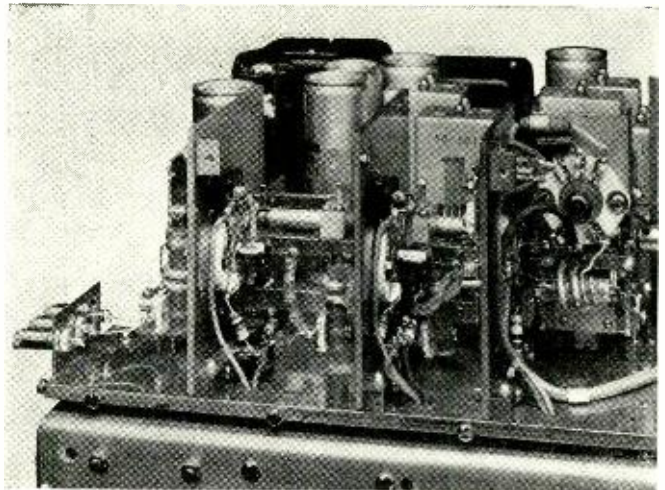

Side view shows the mounting of the UHF tuner. The Acorn tubes are located with greatest care.

insofar as standard engineering practice is concerned. Not so with the U.H.F. receiver. Here we find it necessary to lay out the various circuits so that the shortest possible lead lengths may be obtained which connect to the various parts and tubes. As the frequency increases, so do the general requirements for efficient mechanical layouts. For example, specially designed tuning condenser assemblies are mounted so that the contacts from both the rotors and the stators are in close proximity to their associated tubes and component parts. In fact, each particular r.f. stage must be designed as a separate assembly with special care given to the frequencies through which it must tune.

Every connecting wire or lead becomes an inductance, no matter how short. Its position with respect to the surrounding metal baffles and the chassis must also be considered as they will affect the general tuning and also present other difficulties which will impair efficiency of that particular stage.

Sufficient room must be provided between the various gangs in order that parts will not be unduly crowded and which will permit a careful layout with due consideration given to the alignment facilities which will be required on each particular stage.

The tube lineup is as follows:

V₁—Type 954 (Acorn) first radio frequency amplifier

V₂—Type 954 (Acorn) second radio frequency amplifier

V₃—Type 954 (Acorn) first detector-mixer

V₄—Type 6AC7 or 1852 first I.F. amplifier

V₅—Type 6AB7 or 1853 second I.F. amplifier

V₆—Type 6SK7 third I.F. amplifier

V₇—Type 6H6 A.M. detector and automatic noise limiter

V₈—Type 6AC7 or 1852 F.M. limiter

V₉—Type 6H6 F.M. detector

V₁₀—Type 6SC7 first audio amplifier

V₁₁—Type 6V6 output audio amplifier

V₁₂—Type VR150 voltage regulator

V₁₃—Type 5X4G rectifier

V₁₄—Type 955 HF oscillator.

A forerunner of this receiver was designed to cover the range from 27 to 145 mc. This was divided into three bands. Many problems were encountered—especially in the HF Oscillator and in the r.f. switching circuits—that required a great deal of laboratory research before they were completely licked. The best features were incorporated in the S-27C.

A voltage-regulated supply feeds a 955 acorn oscillator. The frequency tuning range of the oscillator is always lower than that of the signal frequency. For example: If the receiver dial is set at 200 mc., and a signal generator's voltage output increased approximately 5,000 times, and the generator then adjusted to a frequency (twice the IF frequency lower than 200 mc. now 168 mc.), another signal (image) will be heard.

Several oscillator circuits were tried, including the Hartley. However, this produced considerable hum modulation, and it was discarded. This hum was produced by a modulation of the cathode-to-ground impedance by the emission of the heater-cathode.

A plate-tuned circuit, with other refinements, produced an oscillator which is free from hum and highly stable for the frequencies encountered. Easy control over parasitics was had by employing the use of low-value carbon grid resistors in the tickler circuit.

The use of very short heater and ground leads enhanced the over-all performance to a great extent. The plate supply for the oscillator is fed through a network consisting of R₃₀, R₆₀, L₁, and C₂₂. It greatly reduces the loading effect (of the resistor) upon the tuned plate circuit.

Special tuning condensers were designed that were free from end play and other mechanical distortion. Spring wipers provided good electrical conductivity from the rotors to ground. Ball-bearings are used between the shaft and front plate. The use of wipers also eliminates loading effects which are due to the varying resistance of the ball-bearing contacts across the oscillator inductance.

The socket for the 955 oscillator is mounted directly to the frame of the condenser to keep the lead lengths as short as possible. In addition—other cushioning is employed to remove shock from the assembly.

In an earlier model, a peculiar absorption occurred in the oscillator circuit when a two-inch lead from a padder condenser on a low-frequency band resonated with the capacity of its plates to the metal casing. The trouble was eliminated by spacing the padder away from the frame.

When designing ultra-high frequency circuits, it should be borne in mind that undesirable resonant circuits are likely to appear. Every lead is an inductance—no matter how short, and has a natural period of resonance when tuned by its capacity to ground.

Decoupling resistors are employed to all r.f. stages to offset the tendency for circuit absorption effects. They also reduce the Q of any tuned circuit that might be formed.

Two stages of tuned radio frequency amplification, using 954 type tubes, in highly stable circuits give a signal gain far in excess of any previous models. The "Acorns" are mounted in much the same manner as the 955 oscillator. By keeping all r.f. leads extremely short, stability and improved performance is realized.

The mixer tube is also a 954. Its screen and plate is fed from the regulated portion of the supply. The cathode return is made through the coupling coil on T₁, and then through resistor R₃₅. The cathode coupling method of conversion was adopted only after many attempts with other circuits. The impedance of the cathode circuit depends primarily upon how close its parallel resonance approaches that of the signal frequency. By mounting the socket with greatest care, it was possible to place the natural resonant frequency far removed from that of the cathode circuit. Uniform gain was then secured.

In order to understand the complete functioning of the circuits, the following—
(Continued on page 78)

PHOTOELECTRIC PHENOMENA

by C. D. PRATER

Bartol Research Foundation

Summary of the fundamental theory on which the phenomena of photoelectric equipment design and operation are based.

IT WAS Heinrich Herz, the discoverer of radio waves, who made the first observation of photoelectric phenomena. By photoelectric phenomena is meant the effect of light on some component of an electrical system.

Light is an electro-magnetic radi-

quency given. The frequency is related to the wave length by the formula

$$f = \frac{c}{\lambda}$$

where C is the velocity of light, λ is the wave length, and f is the fre-

adjacent to it will be of interest in the study of photoelectric phenomena. The boundaries between the various regions indicated are not sharp but overlap.

If the amount of radiation corresponding to a given wave length given off by a hot tungsten filament is plotted against the wave length, a curve like that shown in Fig. 3 will be obtained when the filament is 2600° C. It can be seen that the maximum amount of energy is radiated in the near infra-red region at about 9000 A. This placement of maximum energy is of great interest in the application of photoelectric devices since often the amount of energy which they can collect in a very short time is of great importance because it determines the amount of amplification necessary. Most photocells are more sensitive in the ultra-violet and are not sensitive in the infra-red at all. The question might be asked could a light not be made which would give the maximum in the ultra-violet or the near ultra-violet.

Since the easiest source of light is a

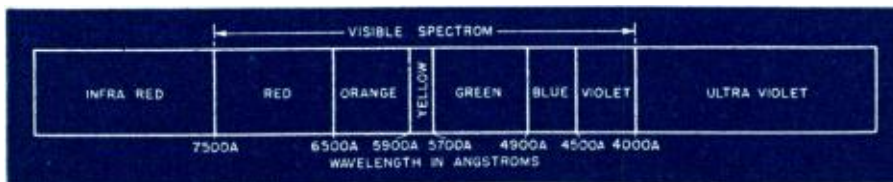

Fig. 1. The visible region of the light spectrum, including infra-red and ultra-violet.

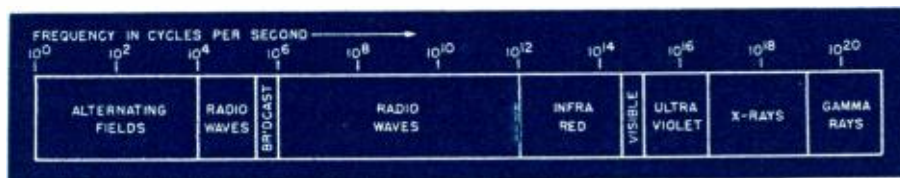

Fig. 2. The entire radiant energy spectrum from the lowest audio frequency to the gamma rays.

tion just as radio waves are, but it is much shorter in wave length. The color of light depends upon the wave length. The wave length of red light is approximately 8×10^{-5} cm. and violet light is approximately 4×10^{-5} cm. Red light is the longest wave length, and violet light is the shortest wave

quency. In the first part of the spectrum with a frequency vibration from 10^0 to 10^4 are the electro-magnetic radiations given out by alternating currents of audio frequencies in a wire. The region of frequency from 10^4 to above 10^{12} are the familiar radio waves. The position of the broadcast band is shown. From about 10^{12} to 7.5×10^{14} are the infra-red radiations. These include what is commonly known as heat radiations. Then comes the very narrow region which comprises the visible range. To the right of the visible range up to a frequency of about 5×10^{16} is the ultra-violet. The regions from 5×10^{16} to 10^{19} are X-rays. Above them are the gamma rays given off by radium. The region of the visible spectrum and a small part of the ultra-violet and infra-red

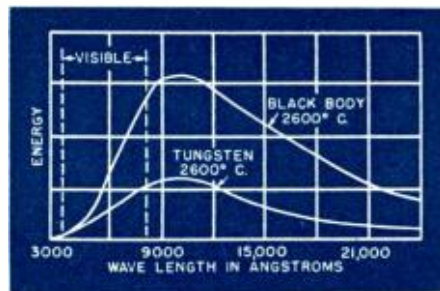

Fig. 3. Energy curves for two hot bodies.

length the eye can detect. The wave lengths for different colors are shown in Fig. 1.

It is convenient to use a smaller unit than the centimeter in measuring the wave length. The unit used is the Angstrom which is 10^{-8} cm. Red light would then be 8000 A and violet light would be 4000 A. The relationship between the various radiations can be readily seen.

The complete electro-magnetic spectrum is shown in Fig. 2 with the fre-

Fig. 4. Sensitivity curve for the human eye.

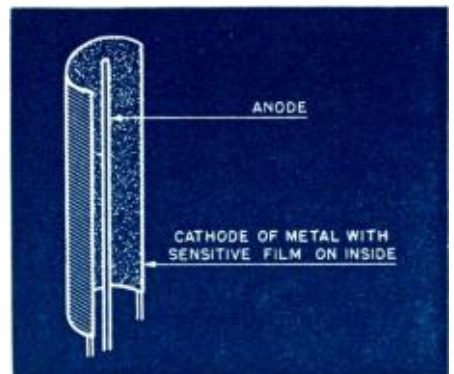
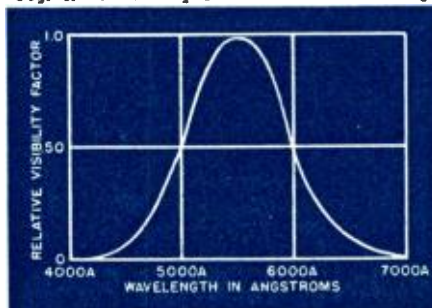

Fig. 5. Construction of a photoelectric cell.

hot body such as the hot tungsten wire mentioned above, it will be well to examine this source first. The maximum temperature that can be obtained is determined by the vapor pressure of the metal at that temperature since this determines how soon the filament will burn out by evaporation of the metal. The short time maximum temperature is determined by the melting point of the metal. The best metal from all points of view is tungsten which has a maximum operation of about 3000° C., but the life of the filament is short at this temperature. The maximum in energy is moved towards the visible by this increase in

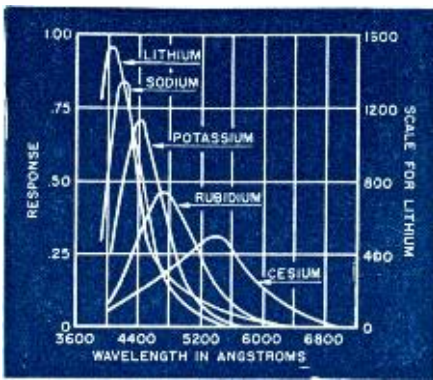

Fig. 6A. Color curves for alkali metals.

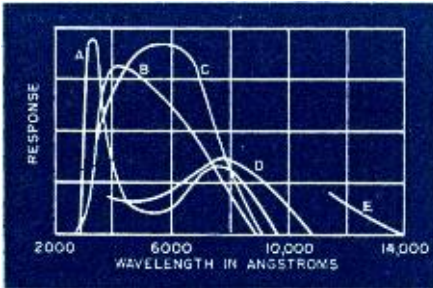

Fig. 6B. Color curves for cesium oxide cells.

temperature but only by a relatively small amount. The maximum is still about 9000 A. So the search must be in another direction. The question is asked, is there not some other material, which although it operates at a lower temperature will give a better placed maximum. The most perfect radiator is an absolutely black body. The radiation curve for it is shown in Fig. 3 above that of tungsten at the same temperature. It will be seen that the maximum is in the same region of the spectrum. The conclusion is that when the intensity is small either photocells must be used which

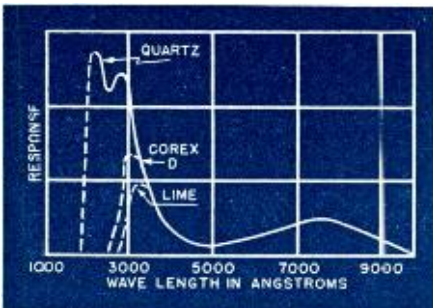

Fig. 7. Response of glass in the ultra-violet.

are sensitive in the infra-red or a lamp which radiates great intensities in the ultra-violet must be found.

If the gas discharges are examined, it will be found that one of them, the mercury arc, gives large amounts of ultra-violet. The use of ultra-violet has a serious drawback in that all the glass parts must be made from quartz or some special glass which is transparent to ultra-violet. Ordinary glass is opaque to ultra-violet. The mercury arc is not as convenient mechanically as the tungsten lamp as a source of radiation. Gas discharge lamps have been developed in recent years which

have good efficiency of radiation in the visible region of the spectrum.

The visual sensitivity curve of the human eye is shown in Fig. 4. It will be of interest later to compare the sensitivity of various photocells with this. Often a photocell is required which "sees" things as nearly as possible as they are seen by the eye.

The standard for measurement of luminous intensity of a source of radiation is the candle power. The intensity of illumination is measured in foot-candles. This is the intensity on a screen placed 1 foot from a source of 1 candle power. The amount of light falling on each square foot of this screen is called 1 lumen. The amount of light falling on a square foot varies as the square of the distance from the source. For instance, the amount of light falling on a square foot of a screen placed two feet away from a 1 candle power source will be 1/4 as much as for a screen placed 1 foot away. The comparison of intensity of a source is made visually and therefore the units above will correspond to different energy measured in watts for different parts of the spectrum because of the variation of visual sensitivity of the eye shown in Fig. 4.

Photoelectric effects can be divided into three major classes; photoemissive effects, photovoltaic effects, and photoconductive effects. All of these effects depend on the freeing of electrons from atoms in a substance under the action of light. The first represents an actual liberation of an electron into space as in thermal emission of electrons; in the second the electron takes part in chemical and physical changes to produce an electro-motive force; and the third is the change of electrical resistance of a semi-conductor by the liberation of electrons in the semi-conductor. The first to be considered, and the most important practically, is the photoemissive effect.

If the surface of a metal is irradiated with light of sufficiently high frequency it will be found to emit electrons. It will be found that there will be a frequency below which no electrons will be emitted. This is called the threshold frequency, and it depends upon the work necessary to remove one electron from the metal and is the same, in certain instances, as the work function met with in thermionic emission discussed in the second article of this series (RADIO NEWS, Feb. 1943, page 11).

Fig. 8. Current voltage curve of a photocell.

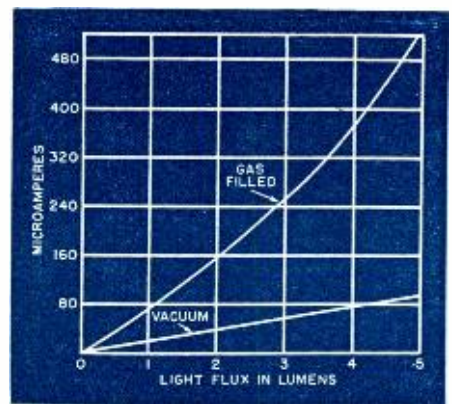
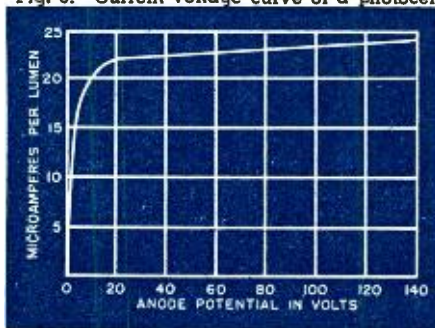

Fig. 9. Photocell illumination curves.

There are two laws of photoelectric action which came out of the early work with photoemissive effects. They are: (1) the number of electrons released per unit time at a photoelectric surface is directly proportional to the intensity of the light fall on it, and (2) the maximum energy of electrons released at a photoelectric surface is independent of the intensity of incident light but is directly proportional to the frequency of the light. These two laws made the scientist change his concept of light. The light here be-

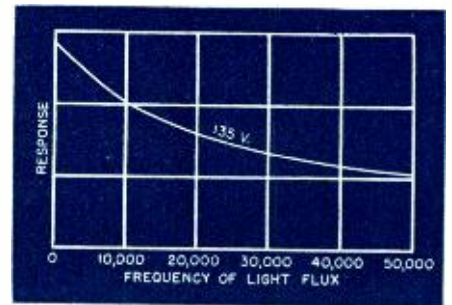

Fig. 10. Response curve—gas-filled photocell.

comes as if it were discrete particles of energy, each with the same energy striking the photoelectric surface and knocking the electrons from it. The number of such particles striking the surface, i.e., the intensity of the beam would determine the number of electrons released which corresponds to the first law. The energy that these particles have to impart to the electron will determine the maximum velocity with which the electrons are liberated. There will be an energy below which no electrons can be removed from the surface because of the work required to remove the electrons. Not all of the electrons come out with the same velocity, but they come out all possible values of velocity below the maximum because the electrons come from various depths in the metal and have to make their way up through the metal after they are released by the light and therefore lose energy. These light particles are called "quanta".

Einstein was the first to show that photoelectric effects could be accounted for in this way. He gave an equation which now bears his name, $\frac{1}{2}mv^2 = hf + P$



Fig. 11. Distortion of a square light pulse.

where m is the mass of the electron, v is the velocity, h is a constant known as Planck's constant, f is the frequency of the light and P is the work that must be done on the electron to remove it from the metal. The quantity $\frac{1}{2}mv^2$ will be recognized as the kinetic energy which the electron possesses. If this equation is restricted just to those electrons which come off with a maximum velocity, the P will be determined by the same work function as in thermionic emission. For P , hf , can be substituted, where f_0 is the

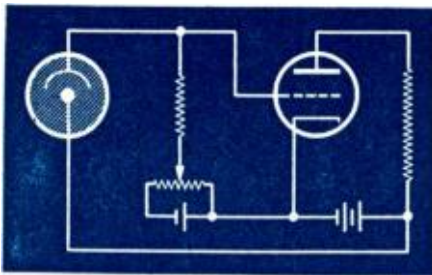
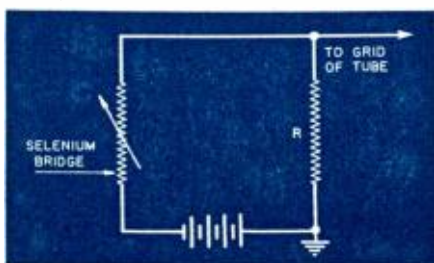

Fig. 12. Typical photo-electric cell circuit.

threshold frequency of the metal. This equation includes both of the laws of photoelectric emission.

The threshold frequency for most common substances lies up in the ultra-violet, and since the cell needs to be sensitive to visible radiation at least, if not all the way down into the infra-red, a substance is needed with as low a work function as possible. This is the same problem that was met in thermionic emission. It is somewhat simplified in this case because the electrode does not need to be heated and this makes possible its use of a substance with a high vapor pressure. More stable films can also be formed. The best photoelectric emitters are then, as for thermionic emitters, the alkali metals and the alkali earth metals in this order, calcium, lithium, strontium, sodium, barium, potassium, rubidium, and cesium, going from the poorest to the best. Of these only the last five are used in photoelectric cells. If a film of one of these metals is deposited on a surface of the oxide of that metal which in

Fig. 13. Circuit for selenium bridge.



turn is deposited on a base metal, the work function will be lowered still further. Cesium-cesiumoxide-silver is a good example of this and is one that is used to a great extent today. They are called cesium-oxide cells.

In the practical construction of photoelectric cells, the metal may be deposited directly on the glass envelop or may be deposited on the half cylinder cathode, as shown in Fig. 5. The anode is a small rod placed in the center of the bulb. The cathode is illuminated either through the side of the half cylinder left open or through an uncovered portion of the bulb walls when the bulb wall itself is covered.

The color sensitivity curves for five alkali metals are given in Fig. 6a. It will be noted that the maximum response of cesium lies in the middle of the visible range. If a cell is made from sodium or potassium and a hydrogen glow discharge is made between the coating and the anode, the sensitivity of these cells can be raised 100 times over their initial value. Cesium is the only alkali metal which is not affected appreciably by glowing in hydrogen. The explanation of this increase in sensitivity is probably that a composite film is formed like the cesium-cesiumoxide-silver films. Sulphur can be used in much the same way on potassium and sodium. Sometimes organic dyes are used to stain the surface of the film to increase the sensitivity to longer wave lengths in

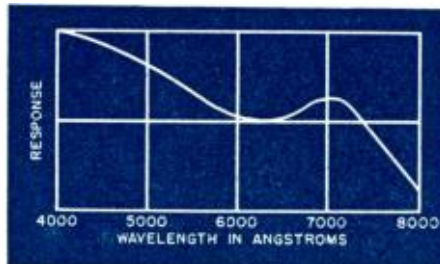

Fig. 14. Response curve of selenium bridge.

much the same way these dyes are used in sensitive photographic emulsions for longer wave lengths. The cesium-oxide cells are of interest as an illustration of the differences in cells due to slightly different methods of treatment in making. These curves are shown in Fig. 6b. The curve c is a good approximation to the visual sensitivity curve shown in Fig. 4. The curve d would represent a good cell to use with a tungsten filament lamp for such applications as sound pictures. Cesium-oxide cells can be made by special processes which have sensitivity in the infra-red in the region of 12,000 A.

Cells which have sensitivity in the ultra-violet are no problem since ordinary metals as well as cesium-oxide cells can be used if a glass which is transparent to ultra-violet is used for the bulb. The color curve for a cesium-oxide cell is shown in Fig. 7. The dashed curves represent the cut-off by the different types of glass. The region of fall in the curve about 5000 A is not

well understood. The sensitivity of hydrogenated potassium cells is about 0.2 microamperes per lumen, that of cesium cells about 2 microamperes per lumen. Experimental cesium-oxide cells with a sensitivity of as high as 50 to 65 microamperes per lumen have been made. A typical cesium-oxide

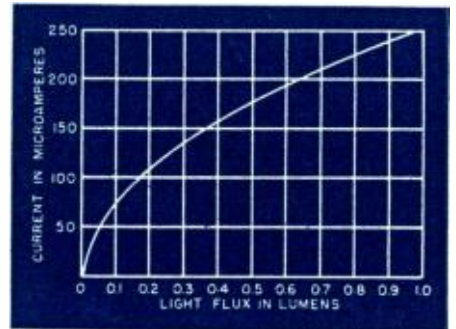

Fig. 15. Light curve of selenium bridge.

cell has a sensitivity of about 10 microamperes per lumen.

If the sensitive film is located in a high vacuum, the phenomena that are observed are in many ways similar to those observed in high vacuum thermionic tubes. There is a space charge limited region and an emission limited region just as in the case of a high vacuum tube as can be seen in Fig. 8. Photoelectric cells are operated in the emission limited regions rather than in the space charge limited regions as thermionic vacuum tubes are for the obvious reason that changes in the emission are what are to be followed. This causes the high vacuum photocells to have a linear response with light flux. The dynamic characteristics of a vacuum photoelectric cell are flat because there is no time lag in the emission of the electrons. By dynamic response is meant the ability of the photoelectric cell to follow variations in light intensity exactly.

Since the output of vacuum photocells is so small and consequently has to be amplified so much, gas photocells are made. These gas photocells are filled with one of the inert gases so that the sensitive film will not react with the gas. This gas is usually argon. Gas photoelectric cells behave in much the same way that gas-filled thermionic tubes behave. A typical

Fig. 16. Current vs. freq. of selenium bridge.

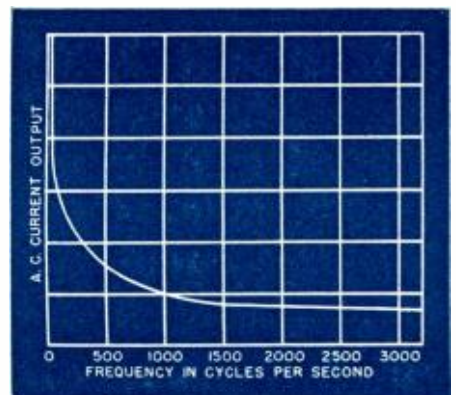

current-illuminator curve for a gas-filled photocell is shown in Fig. 9. The increase of amplification obtained in a gas-filled cell over the vacuum cell can be seen by comparing the two curves shown in Fig. 9. The current illumination curve for a gas-filled cell is not quite linear and the dynamic response curve is not at all flat but falls off with increase in frequency as can be seen in Fig. 10. This causes non-linear frequency amplification. There is a distortion of the wave form at high frequencies or with square pulses as can be seen in Fig. 11. The dotted lines show the square light pulse applied to the photocell, and the heavy lines show the output wave form of the photoelectric cells. This is caused by the time it takes the electrons to build maximum ionization in the gas and the time it takes for the gas to deionize at the end of the light pulse.

A typical circuit for the use of a gas or a vacuum photoelectric cell is

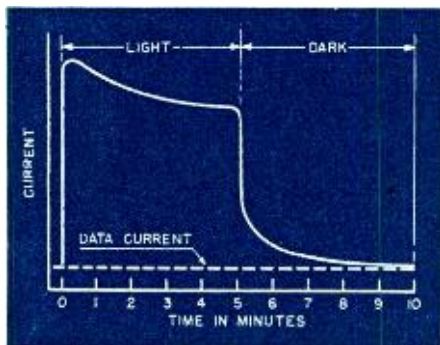

Fig. 17. Time function of selenium bridge.

shown in Fig. 12. Amplification is necessary since the only apparatus that even a gas-filled photoelectric cell will operate is a galvanometer. Since the photoemissive cell produces a current, and the thermionic amplifier requires a voltage, a high resistance must be used in the input stage in order to produce a voltage drop great enough to amplify.

Selenium is the substance usually used in photoconductive cells. The first observation of photoconductive phenomena was made by Willoughby Smith in 1873. A rod of selenium which he was using as a resistance in an experiment with the transatlantic cable was found to be a much better conductor of electricity when it was exposed to light than in the dark. If a piece of selenium is used as a variable resistance bridge as shown in Fig. 13, the voltage drop across resistance R will vary as the resistance of the selenium changes. The selenium bridge is usually made in the form of a thin layer of selenium deposited on glass and separating two gold or platinum electrodes also deposited on the glass. Since the resistance of selenium is high, only a very narrow strip of selenium is used to separate the electrodes. The selenium bridge is mounted in a vacuum to protect the selenium. If a potential is applied to the selenium bridge, a small current will be found

to flow when the cell is in the dark. When the cell is illuminated the current flowing will increase. Selenium bridges have a resistance of from .1 to 25 megohms and a light to dark ratio of about 10 although it may be as high as 25. The color response of a selenium bridge is shown in Fig. 14, and the current-light curve is shown in Fig. 15. The current varies as the square root of the illumination and not linear or nearly linear as for the photoemissive cells. The dynamic response of a selenium bridge is rather poor as can be seen from Fig. 16. The selenium bridge is a sluggish device and does not recover very readily. Fig. 17 shows how a typical selenium cell behaves on illuminating its surface with a light of constant intensity for five minutes and then placing the cell in the dark. It can be seen that the current delivered by the cell is not at all constant and does not fall to the initial value as soon as the light is removed. Selenium is the most widely used material for photoconductive bridges, but thallos sulfide has also been used for this purpose. Selenium-tellurium cells have also been used but the thallium sulfide and selenium cells are the only ones on the market at the present time.

In 1839 a French scientist, E. Becquerel, discovered that when light fell upon one of the two electrodes in certain types of batteries that a change in the electro-motive force was produced. This was the discovery of the photovoltaic effect. A simple photovoltaic cell is made as follows: A piece of copper is oxidized in a flame, and then the black oxide on the surface is changed to red oxide, cuprous oxide, by treating with dilute sulfuric acid, and then this electrode is submerged in a solution of lead nitrate with a lead electrode as the other electrode. The electro-motive force which the cell will develop will vary as the intensity of the light falling upon the copper-copper oxide electrode varies. If the external resistance of such cells is very small, the response of this type of cell is linear. The dynamic response of these cells is such that audio-frequencies can be reproduced with them, but they are not flat. The frequency response falls off as the frequency increases. These cells have a sensitivity of about 100 to 150 microamperes per lumen.

The photoelectrons liberated by this process come from the region between the oxide layer and the mother copper. A simple piece of oxidized copper with a properly placed electrode on the surface of the oxide can be used as a dry photovoltaic

Fig. 18. Secondary emission of a P.E. cell.

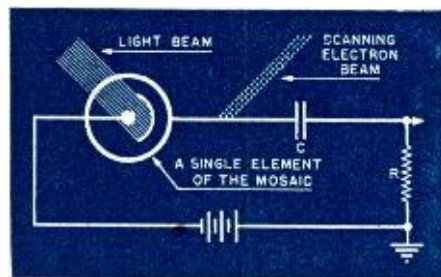
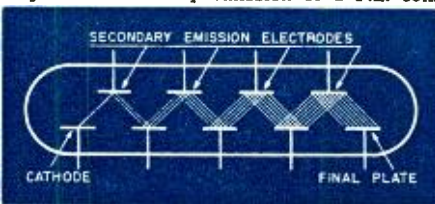

Fig. 19. Condenser action of a mosaic cell.

cells using other types of electrodes have been made. One of them is an iron selenide on iron which is said to deliver 300 microamperes per lumen. The Rayfoto cell and the copper-oxide type of photovoltaic cell have been manufactured in large quantities in the past, but the iron selenide on iron type is made on a limited scale only.

Photocells can be modified in various ways: by the placement of grids in the inclosure and even screen grids for particular applications. One special type of gas cell, known as the photoglow cell, is a gas discharge device in which there is a light sensitive cathode which is used to initiate the gas discharge. The voltage and gas pressure in the cell are such that as long as there is no light striking the cathode no discharge takes place. As soon as the light strikes the cathode, electrons are emitted which cause the tube to break down. The only way in which the discharge can be stopped once it has been started is by lowering the plate voltage until the discharge goes out just as is done for various gas discharge devices. This type of tube will operate relays directly since it can pass rather large currents.

One ingenious method used commercially to increase the amplification of vacuum photoelectric cells is by placing a number of plates within the photoelectric cell so that the electrons which leave the photoelectric cathode and strike the first plate give off three

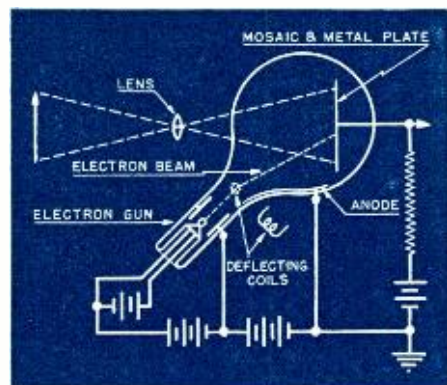

Fig. 20. The Iconoscope tube.

or four secondaries for each electron coming from the cathode, and these electrons then go to another plate where, on striking this plate, they give off three or four electrons for each electron striking the plate, and so on for as many times as needed. The plates are made of special material

(Continued on page 52)

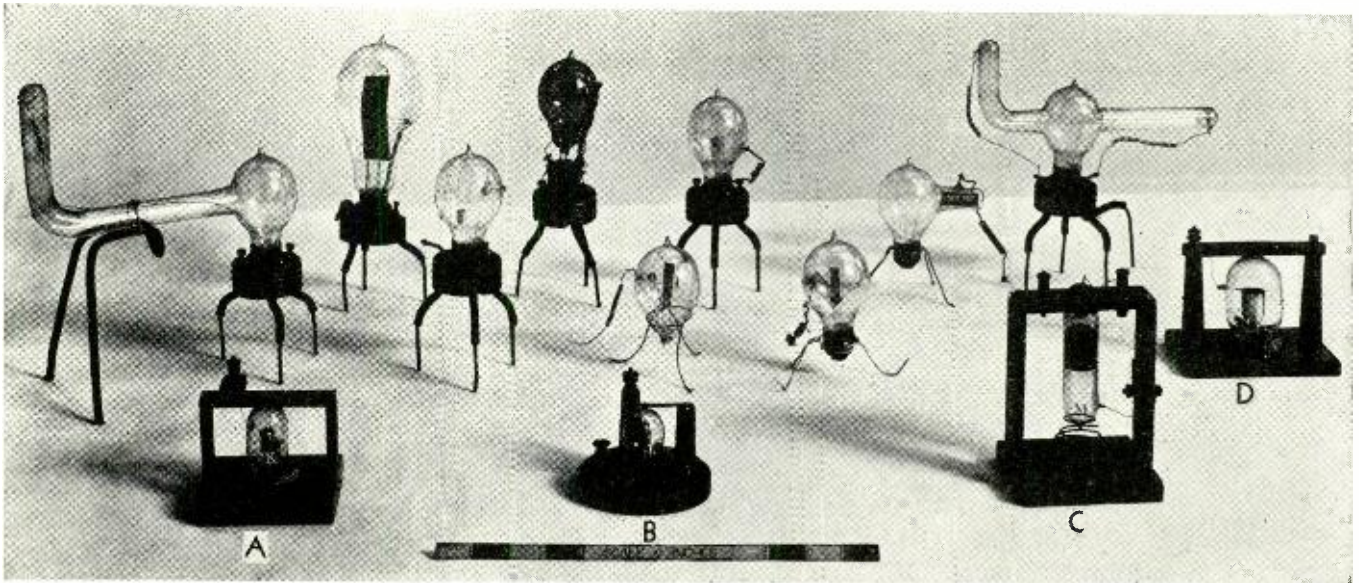

Fig. 16. Group of Fleming valves preserved in the Science Museum at South Kensington, England.

tivity it left much to be desired. In wireless the receiver continued to be a weak element of the system, so that one of the problems which Fleming set himself was that of developing a new type of detecting device. Since he was the victim of a progressive deafness he sought a device which would be capable of operating a recording mechanism, so that the signals might be fixed to be later translated by eye rather than by ear.

The most sensitive current indicating device in use at that time was the d'Arsonval type of mirror galvanometer, which operates only on unidirectional currents. Consequently, Fleming set about finding some means of utilizing this sensitivity, and realized that he needed some device which would act as a rectifier for the incoming high frequency oscillations, in order to have them actuate this type of galvanometer. At that time the available commercial rectifiers were of the electrolytic variety, such as the "Nodon" type. Fleming tried to use these arrangements for the rectification of high frequency oscillations but found them inoperative. This may have been due to the high capacitance of the electrolytic cells, or the fact that their chemical action was too slow. At any rate, he was unsuccessful in their use. Then Fleming did the thing which has so often produced revolutionary developments in many fields. He drew on the knowledge which he had gained by experiment in a totally different field, that of the incandescent lamp. He recalled to mind the work he had done many years before on the Edison effect, and decided to find out by experiment whether the known unidirectional conductivity of the vacuous space for direct current, and its rectifying action at low frequencies, would also exist at the high frequencies of the oscillations used in wireless telegraphy.

Accordingly, in October, 1904—but let us hear his own account of the discovery:¹⁰³

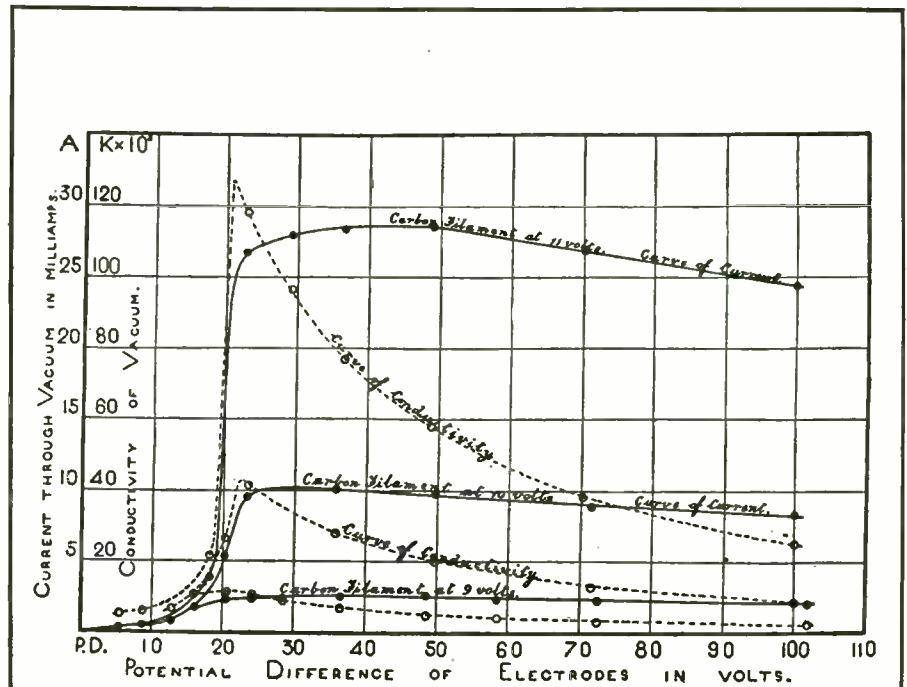

Fig. 17.



Fig. 18.

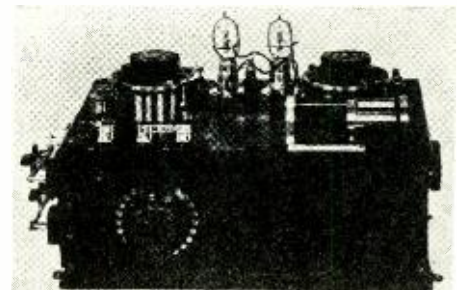

Fig. 19.

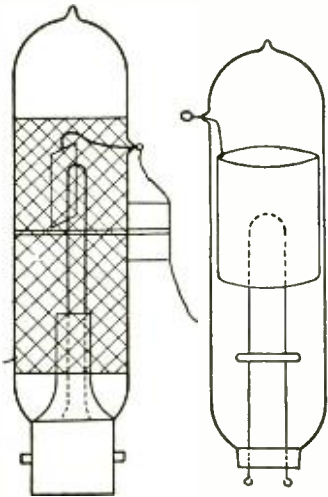

Fig. 20.



Fig. 21.

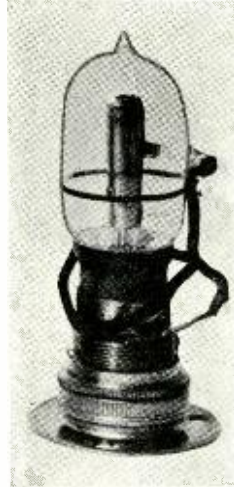

Fig. 22.



Fig. 23.



Fig. 24.

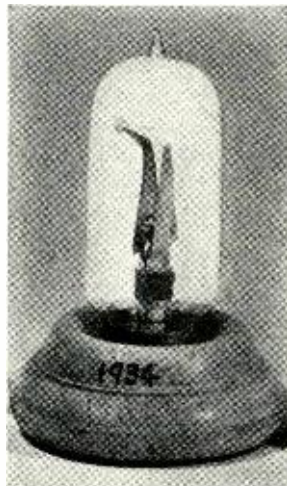

Fig. 25.



Fig. 26.

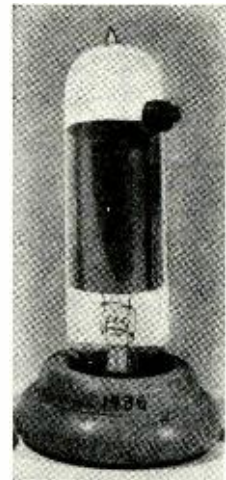

Fig. 27.

"—I was pondering on the difficulties of the problem when my thoughts recurred to my experiments in connection with the Edison effect.

"Why not try the lamps?" I thought. Then and there I determined to see if they would serve the purpose. I went to a cabinet and brought out the same lamps I had used in my previous investigations. My assistant helped me to construct an oscillatory circuit with two Leyden jars, a wired wooden frame, and an induction coil. We then made another circuit, in which we inserted one of the lamps and a galvanometer, afterward tuning it to the same frequency as the first circuit.

It was about five o'clock in the evening when the apparatus was completed. I was, of course, most anxious to try the experiment without further loss of time. We set the two circuits some distance apart in the laboratory and I started the oscillations in the primary circuit.

To my delight I saw the needle of

the galvanometer indicate a steady direct current passing through, and found that we had in this peculiar kind of electric lamp a solution of the problem of rectifying high frequency wireless currents. The missing link in wireless was found—and it was an electric lamp."

Fleming gave the name "oscillation valve" to the Edison effect lamp as thus utilized, and today in England all types of vacuum tubes are still known as valves. In fact, all such electron discharge devices are, in general, considered by the British as lineal descendants of the Fleming valve.

It cannot be emphasized too strongly, however, that Fleming did not invent the device to which he gave the name "oscillation valve." What he did was to apply the Edison effect lamp, a well known device, to the rectification of high frequency oscillations. His patent was not a patent on the device, *per se*, but on the combination of that known device, with mi-

nor modifications to suit the application, and a circuit in which it functioned as a rectifier of high frequency oscillations.

Actually Fleming was not the first to use a thermionic device as a rectifier, for just ahead of him was the pure thermionic device with the oxide-coated cathode devised and patented by Wehnelt, as we shall see. Also it is hardly fair today to read the term "valve" as taken from Fleming, on the three element and multi-element tubes used in today's amplifiers, since in this role the device cannot be classed as a rectifier.

In this connection the following passage, from a British text published in 1921, is of interest:³⁰⁴

"Fleming, in 1904, utilized the Edison effect, and Elster and Geitel's apparatus in a modified form, to produce a wireless detector, rectification being brought about owing to the unidirectional conduction already mentioned—

(Continued on page 58)

WARTIME PROGRESS IN RADIONICS

by **ROBERT EICHBERG**

Radionic Research Engineer

A review of recently issued patents shows the trend of highly developed radionic equipment for military and civilian use.

PERSONS who do not live in the major urban areas are frequently annoyed by fluctuations in the volume of output of their radio receivers. These variations in sound pressure are commonly traceable to variations in line voltage, caused usually by large changes in the load being placed upon a power source of limited capacity.

Various types of automatic voltage regulators have been used to maintain a constant voltage reaching the power supply of the receiver. Even in the days of the battery-operated sets, such devices were in quite common use. Some of the most popular consisted merely of a piece of fine wire sealed in a vacuum. The resistance of such a wire increased tremendously as its temperature was increased. Ordinarily the wire would operate cold, serving merely as a path for the current, but when the voltage was increased considerably, the wire would reach incandescence and its resistance would go up, thus keeping the voltage approximately normal.

But though devices of this sort have a limited efficiency, some more elaborate and flexible system is needed for use in modern transmitter and receiver design. Fig. 1, from a recent article in *Proceedings of the Institute of Radio Engineers*, shows one such circuit. In this diagram, the portion of the circuit up to resistor R_b is an ordinary full-wave rectifier; the balance of the circuit is a bleeder and voltage regulator.

C_3 is of low capacity, if used at all; R_b , R_6 , R_7 and V_2 act together as bleeder resistance. At the same time, V_2 keeps the cathode of V_3 at a constant potential (E_r) above the negative side of the circuit, and E_s will be kept relatively constant if R_6 is of sufficient value. Thereby the grid voltage of V_3 is kept close to the cut-off point, and the grid current of this tube is negligible.

The author of the article, A. B. Bereskin, of the University of Cincinnati, points out that the following relation is established:

$$E_s = \frac{R_1}{R_1 + R_2} E_o$$

He explains the operation by saying that if, for any reason, E_o tends to increase when the circuit has once been balanced, a corresponding increase is produced in E_s , causing the

grid of V_3 to become more positive and thus increasing the plate current in this tube. This produces a greatly amplified voltage increase across R_3 , and thus makes the grid of V_1 more negative, which decreases the load current and brings E_o back to its original value. If the output voltage, E_o , had decreased, the opposite of the results

fit virtually any set of circumstances.

The same issue of that periodical contains an interesting article by H. E. Roys, of RCA, on the measurement of speed variations in turntables used for playing electrical transcriptions—or, of course, ordinary phonograph records. The usual method of checking the speed of a turntable is to place

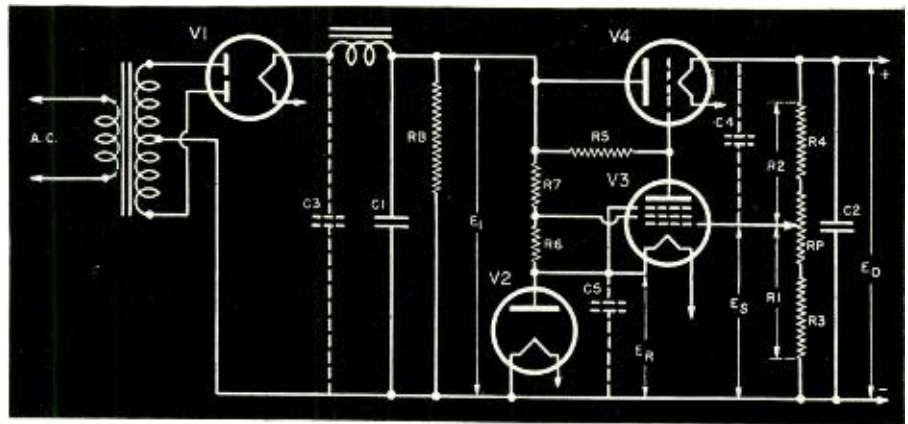

Fig. 1. Schematic diagram of a recently developed automatic voltage regulator.

just mentioned would have taken place, and the output would have been increased (instead of decreased) to normal.

E_o is determined by the formula:

$$E_o = \frac{R_1 + R_2}{R_1} E_s$$

In order to afford variable output voltage, the author suggests that R_1 and R_2 may be composed of two fixed resistors, R_3 and R_4 , plus a potentiometer, R_p . A voltage regulator tube may be used in place of R_6 .

The article in *Proceedings* gives sufficient data to make possible the design and construction of a voltage regulated power supply of this type to

upon its spindle a disc marked into the proper number of alternate black and white segments, and to observe its rotation in the light of a neon lamp operated from the same a.c. source as drives the turntable motor. While this gives an indication of whether the turntable is revolving too fast, too slow, or normally, it does not give an accurate indication of the degree of variation, if any, from normal speed.

The Wowmeter, as Mr. Roys calls his device (with no reference to the Women Ordnance Workers, who are also known as Wow's) is not particularly new; the author refers to one designed in 1929—but the increasing interest in the reproduction of re-

Fig. 2. Basic diagram of a Wowmeter—for measuring turntable speed variations.

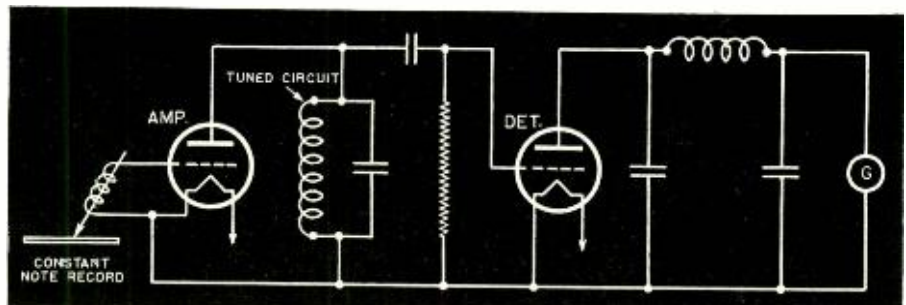



Modernistic corridor of the new 3-story RCA Laboratory Building into which open many laboratory bays. Each corridor is 488 feet long.

corded programs makes it a fresh subject. Fig. 2 shows a simple Wowmeter which Mr. Roys developed some years ago. The pickup is placed on a constant note (e.g., 1000 cycle) record, and the amplified output applied across the tuned circuit, which was tuned to a frequency slightly higher than that of the note. Thus when the record speeded up, the frequency increased and, as operation was normally on one side of the resonance curve, the voltage across the tuned circuit increased. The opposite was true when the record ran slower than normal. The turntable, varying in speed, produced an FM signal through the pick-up; the tuned circuit changed this to an AM signal, which was then detected, freed of its 1000-cycle component in the filter circuit, and measured on the sensitive galvanometer in the plate circuit of the detector.

Fig. 3. Curve showing how variation is obtained.

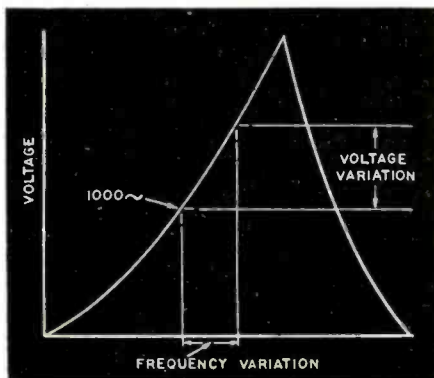

Fig. 3 shows how voltage variation is derived from frequency variation.

The circuit now employed in RCA's laboratories for Wow measurement is basically the same, but has been improved as shown in Fig. 4. A magnetic tone wheel, consisting of a laminated, toothed disc, replaces the record formerly used; it does not wear out. Two pickups, placed diametrically opposite each other, and connected in series, replace the single pickup formerly used. The tone wheel produces 1000 cycles at 78 r.p.m., and 426 cycles at 33.3 r.p.m.; the tuned circuits can be adjusted for either frequency. This, however, is precision laboratory equipment, and is considerably more elaborate than is necessary for the average field worker. It will measure variations as low as 0.5 cycles.

The meter employed is of the rectifier type; a thermocouple meter is recommended by the author.

The Official Gazette of the United States Patent Office is a particularly fertile source of information this month; the inventive genius of America is becoming increasingly manifest. Yet, though the number of patents being granted at present is about the same as in former years, it is interesting to note that most of those now receiving their final papers are ones on which application was filed prior to the outbreak of war.

Despite the fact that the application was filed 'way back in March, 1939, C. E. Swartz was concerned with the conservation of strategic material and

the efficient conduction of electric current. The patent, No. 2,311,138, assigned to the Cleveland Graphite Bronze Co., makes use of the "skin effect"—the fact that alternating currents tend to travel on the surface of a wire. This same principle has been used in copper-clad steel wire, the thin outer layer of highly conductive copper being given greater tensile strength by the inner core of solid steel. But Mr. Swartz's invention goes a step farther. He bonds a strip of highly conductive metal, such as densely compacted copper (or aluminum, according to the patent!) to a strip of strong steel. The whole is then formed into a tube, with the conductive metal on the outer side, which presents the greatest possible conductive surface for a minimum quantity of material.

Methods of interference elimination constantly crop up, and the more ingenious methods are covered by H. B. Rubin in Patent No. 2,311,696. The reader will recall various basic ideas which have been employed to this end; one which used a cut-off circuit to quench all signals which were of greater amplitude than the maximum modulation—another, of course, is FM—and still a third used two antennas, one to pick up signal plus interference, the other to pick up interference only. The two components were then balanced out in the receiver, and only the signal permitted to come through.

Mr. Rubin's system appears to be a further development of the latter idea, for he uses a balancing-out method, but avoids the need for two antenna systems. In his circuit, the incoming

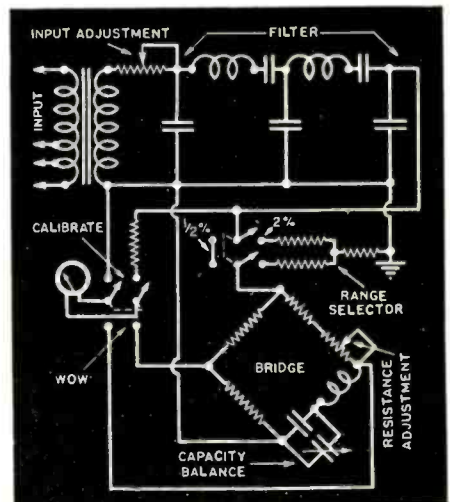

Fig. 4. Improved RCA version of the Wowmeter.

wave is picked up in the usual way and fed through the r.f. stages of the receiver. The output of the r.f. is the carrier, plus modulation, plus interference. This is divided between two circuits, one portion going to the mixer in the usual way, the other to a rather elaborate network which is designed to separate the interference from the other components of the complex received wave, feeding this interference

(Continued on page 72)

DUE to the present conflict many new ideas and developments have arisen in the communications field, and experiments are constantly being carried out in all phases of radio. In the various branches of war production it is of vital importance that we seek constant improvement in the construction of new, better and more efficient equipment. This is especially true in the radio industry, which as we know is playing a major part in the present emergency.

Today our men are fighting on many fronts throughout the world and in order to transport men and materials to these various war fronts, shipping lanes must of necessity be maintained. The tremendous task of keeping a steady stream of men and material flowing to all corners of the world is being ably handled by the U. S. and Allied naval and merchant marine forces, but the dangers in submarine infested waters are many.

Much has been done, and is being done, to safeguard the lives of our heroic seamen, and radio has been of priceless value in this work.

Being an emergency ship repair firm and seeing the need of modern equipment, this company made plans to produce such material as would safeguard the lives of our merchant marines and naval seamen to a greater extent than heretofore.

One of the many new pieces of equipment for the marine field designed after much experimentation and development work is a new type of marine lifeboat radio transmitter which has been constructed employing a hand driven generator as a source of power supply (in place of the usual battery). This set has recently been approved by the Federal Communications Commission. The transmitter is composed essentially of four units, all of which are contained in a watertight and shockproof box of very solid construction, the lid of which is fitted with a heavy rubber gasket, arranged to make the container completely watertight. Eight clamps hold the cover in position. All components are mounted in a solid manner to insure the equipment against rough handling, physical shock and exposure to the elements.

The components are a manually driven hand generator, a three tube radio transmitter, an antenna loading coil unit and the antenna and ground assembly equipment.

The manually driven hand generator is operated by two hand cranks and it is designed to be driven at approximately sixty revolutions of the hand cranks per minute. This will supply an alternating current to the primary of the transformer within the transmitter. The tubes are connected in a self rectifying circuit with a resultant type A-2 (I.C.W.) emission. The generator, which is of special design, requires no lubrication and is fitted with a clamp for mounting on a lifeboat seat or other object. The hand generator eliminates the usual difficulties

PORTABLE LIFEBOAT TRANSMITTER

by **CARL COLEMAN**
and **J. T. DONNELLY**

Arnessen Electric Co.

An automatic SOS transmitter designed for lifeboat operation to safeguard the lives of our seamen.

The completed unit built in a portable case showing panel layout and accessories.

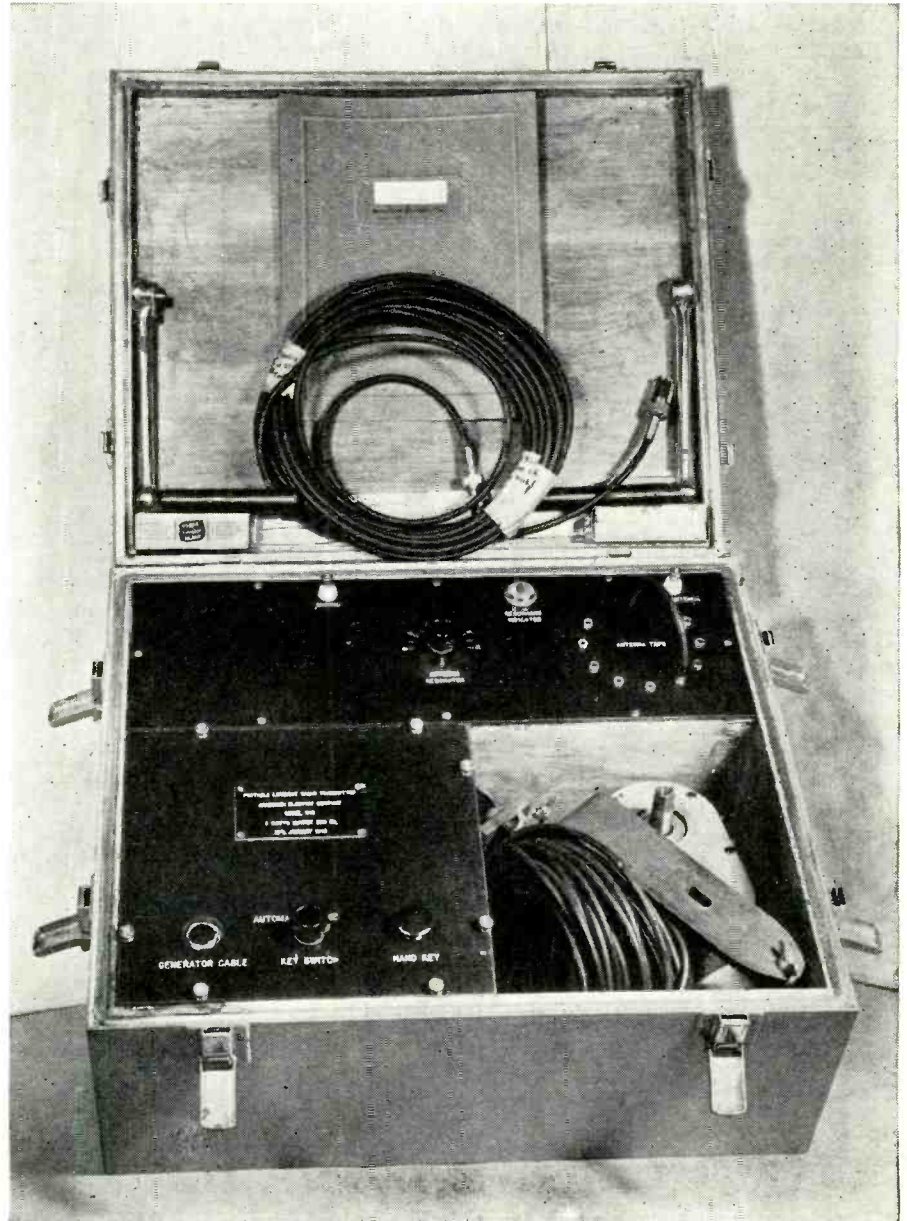

**TECHNICAL BOOK
& BULLETIN REVIEW**

"PRE-SERVICE COURSE IN ELECTRICITY," by William C. Shea. Published by John Wiley & Sons, Inc., 404 Fourth Ave., New York City. 270 pp. plus index. Price \$2.00.

This book follows an outline of a basic course for pre-induction training in the fundamentals of electricity, the material for which was drawn from technical and field manuals of the War Department. The outline was prepared by Army curriculum specialists and civilian educators, working under the joint direction of the War Department and the United States Office of Education.

The thirteen recommended units are planned as material for one semester's work of ninety teaching periods. Each topic is presented as simply and concisely as possible without sacrificing accuracy and thoroughness. Numerous applications and illustrations have been drawn from Army sources to make the text more useful as a pre-induction training aid. A large number of typical problems, fully worked out, have been included. These illustrate the principles involved in the subject matter and will aid the pupil in solving for himself the problems at the end of each chapter.

The principles, fundamental to the subject, are presented in a practical manner so as to develop a technical intelligence about the practical working of electrical equipment, its operation, maintenance and care.

"TECHNIDATA HANDBOOK," by Edward Upton Page, B.S. Published by the Norman W. Henley Publishing Co., 17 W. 45th St., New York City. 64 pp. Price \$1.50.

This book is a condensed classified summary of the usable information on the fundamental exact sciences. Whoever uses mathematics, physics, chemistry, mechanics or engineering will find this book of inestimable value. As a student, the author found himself carrying around too many books and spending a great deal of time looking for information which often proved to be scattered elsewhere. He compiled for his own use the data contained in this book which, in its compactness, contains nearly all the essential information needed on these subjects. The value in this book lies in the following reasons: 1. Derivations, unnecessary or little used data and wrong explanations have been omitted. 2. Formulas with short explanations of terms have the units and common constant given.

3. The book is well organized, compact, fundamental, and will not go out of date. 4. Data scattered in many places is herein combined.

-30-

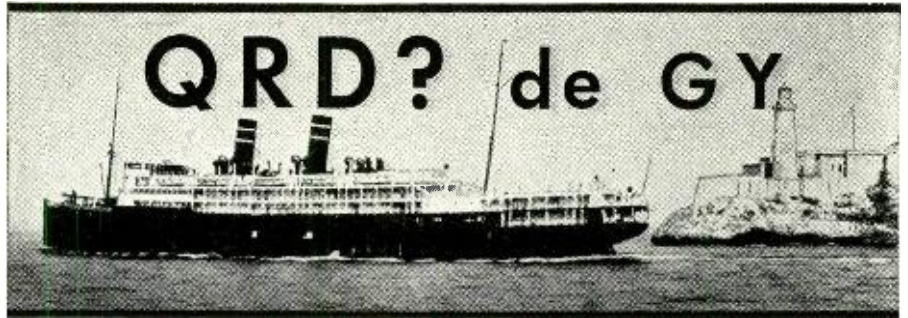

by **JERRY COLBY**

THE versatility of radiops is well known but when we receive this epistle from Brother Paul Nelson on letterhead paper showing he owns his own manufacturing corporation we feel this is one for the books. He says, "just happened to pick up a copy of the News for May and am wondering if I shouldn't qualify for membership in that 'Wandering Hand Society.' You see, in the early twenties I happened to be Chief Op on the Munson flagship Pan America; incidentally the sweetest operating ship of them all. And before that I was on the long and short wave marine watches at old NBD where, believe it or not, we used to take a heap of traffic from all those babies including the Martha, the George, the Presidents, and all those liners to South America. I recall the Aeolus too and the special test arrangement made with her during one of her trips south. And I still have a copy of that write-up somewhere! We carried Secstate Hughes to South American on the PanAm and we didn't have to relay much of the heavy traffic either, working direct clear thru to the Cape and, as I recall, a little south of it. All that with only a 2 kw. arc and a 1 kw. spark. Of course

the spark took a lot of elbow grease (quenched gap) and the boys got tired at times but we sure had our fun. And . . . ah! The Jockey Club in Rio . . . and the Cafe Colon and the all girls orchestra! My! My! It seems so long ago." Which just goes to show how the scent of the sea keeps coming back into the nostrils of old timers regardless of how long they have been away from it.

ANOTHER of those versatile guys is Brother Hamilton Lee Hardy, former owner of N'Oleas Broadcasta WCGU, and radio technician of exceptional ability, who is now one of the finest woodworking pattern makers in a Los Angeles plant. How he became involved in this side line is a mystery that even he would not divulge but his hotel room carries various volumes of radio works that shows that his first and last love will be radio work. He is another one of those souls who has been bitten by the radio bug and can't get it out of his system.

BROTHER ANDY McDONALD, radio officers' Union prexy, says that if anyone's worried about the recent AFL - CIO armistice and merger talk they shouldn't be. He says the main object of the peace talks probably was to strengthen the move to get Dan Tobin into the Secretary of Labor's post, but it should be remembered that Phil Murray's hold on the CIO left-wing Unions is only a temporary one, and some sort of door has to be left open against the changing of the party line and the left-wing swing back to John L. Lewis and District 50 fold. 'Tis a thought. He furthermore says that any of you young chaps sailing on a Temporary Limited Certificate should do your best to get your license. Although you are needed, (Continued on page 54)

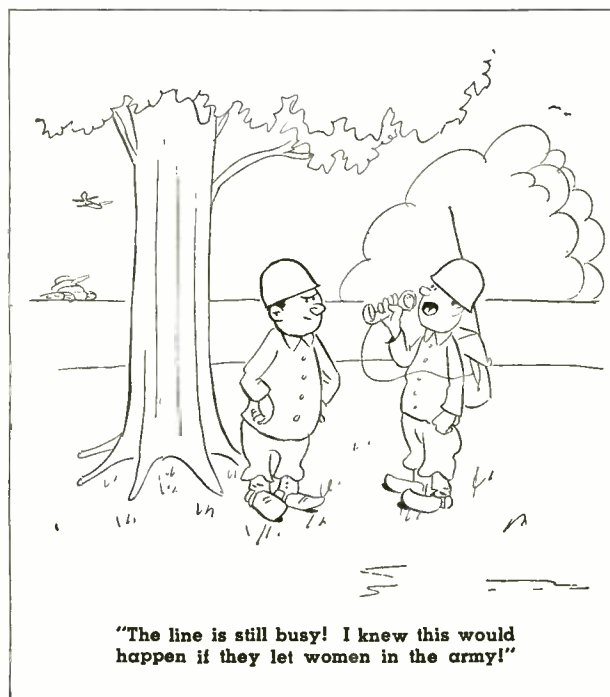

POWER OUTPUT METERS

**Easy-to-build and simple to calibrate Power Output Meter.
Measures audio frequency wattage of radionic equipment.**

by **GUY
DEXTER**

RADIO, radionic, and amplifier technicians readily concede that an audio-frequency wattmeter which presents little or no load to the power source under test and which indicates power levels directly in watts (even if scale factors need be applied mentally to some of the readings) is an adjunct to the test bench. In trouble shooting and in experimentation alike, this instrument pays large dividends by eliminating much guess work.

P. A. men particularly feel the need for this type of meter when they put amplifiers through their paces. With it, they are freed from burdensome computations of power output and the errors attendant to such figuring. But available instruments have long been in the laboratory class and have been priced accordingly, and the amplifier technician with an average clientele has been forced to get along without direct-reading wattmeters.

A satisfactory audio wattmeter may be constructed of spare parts by any radio or amplifier man. Several well known circuit arrangements are available. The layout chosen will be a matter of availability of the required equipment and access to calibration equipment. We have looked over the various circuits and systems and finally selected a design which lends itself to easy duplication. For calibration, all that is needed is a source of variable a.c. voltage and a reliable voltmeter.

Standard audio watt-meters for radio and amplifier use are either a.c. voltmeters or a.c. ammeters connected to deflect on either the voltage drop across a known load resistor or the current flowing through this resistor. Since these deflections are proportional to the power dissipation in the load, the meter scale may be marked off directly in watts.

Obviously, the power calibration

Fig. 1. Showing VTVM connections.

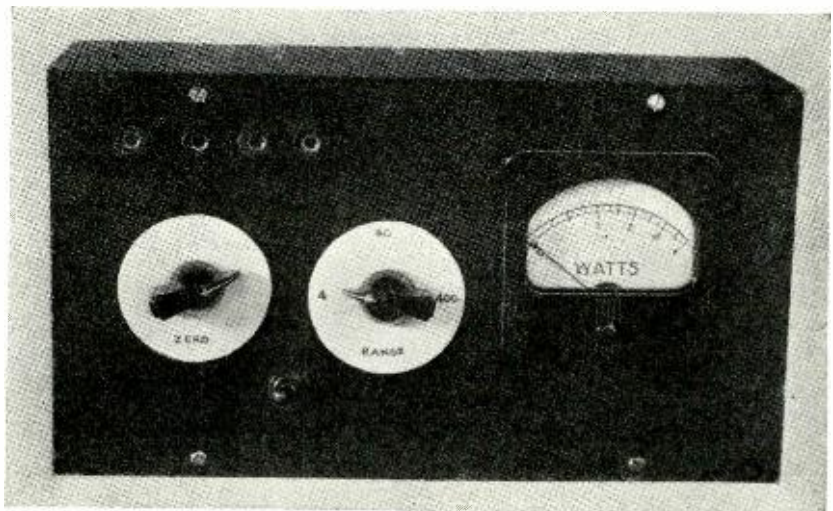
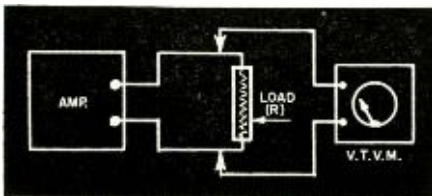

Front view of test unit showing panel layout of controls and meter.

will hold for only one value of load resistance. And since a number of load values are generally encountered in amplifier output circuits, some provisions must be made to convert all impedances to the value associated with the indicating meter or to convert wattage readings in accordance with various impedance values.

In the standard laboratory-type audio wattmeter, the indicating voltmeter is shunted across a fixed resistance in which the power to be read is dissipated. And by means of a tapped input transformer, numerous common impedance values are converted to the value of this resistance. Thus, the meter is always actuated by the voltage drop across the standard load resistor. In the impedance-switching operation, various losses in the transformer, as well as the varying voltage ratio attendant to the changing impedance ratio, are compensated for by auxiliary resistors which are automatically cut in and out by the impedance range switch.

This type of instrument, while of the best design, does not lend itself easily to duplication at this time chiefly because of the special transformer required. None of the common multi-match amplifier-type transformers are suitable for this application, since they do not provide the proper primary and secondary taps for wide-range amplifier testing. The special transformer is not immediately available because of the present shortage of materials, and it may not easily be built unless

the constructor has had considerable experience in the manufacture of high-quality a.f. transformers. Accordingly, the design we have chosen to present measures the voltage drop across the actual amplifier load or across an auxiliary load resistor and interprets this voltage in terms of watts.

It is essential that the wattmeter function independently of the frequency of the measured power. For this reason, we have employed a simple vacuum-tube voltmeter rather than an oxide-type a.c. voltmeter.

Operating Principle

The operating principle of the simple wattmeter is illustrated by the block diagram in Figure 1. The power source, which is shown here as an a.f. amplifier, is connected in the normal manner to its load device. While the latter is shown simply as a pure resistance (R), it might easily be an impedance instead. In practice, such a load device might be the speaker into which the amplifier operates, or it might be a transmission line.

The v.t. voltmeter, which might be of any convenient type possessing high input impedance, is shunted across the load to indicate the voltage developed across the latter. Its reading is proportional to the power developed in the load by the amplifier and may be used to find the actual power level from the relationship:

$$P = E^2/R = E^2/Z.$$

It is apparent that the meter scale

might be graduated directly in watts on the basis of the above relationship. However, it is easily seen that the value of load resistance or impedance must be known, otherwise the calibration would be meaningless. For example: a reading of 10 volts might indicate either 25 watts in 4 ohms, 10 watts in 10 ohms, 20 watts in 5 ohms, 1 watt in 100 ohms, etc., etc. Moreover, the calibration would hold only for the particular value of load with which it was made.

These discrepancies may be offset by making the calibration for some value of load resistance which will facilitate mental multiplications or divisions of wattage readings when other impedance values are employed.

Figure 2 shows a convenient arrangement of the functional equipment. Here the load resistance has been included in the instrument itself to take the place of the missing amplifier load device. Power measurements are frequently made in this manner in order to permit removal of the speaker which would give rise, during the measurement, to considerable disturbance. The resistor R must have

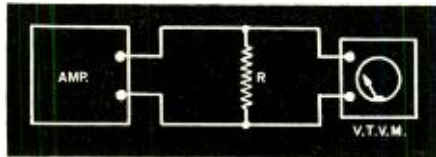

Fig. 2. VTVM used to measure output load.

the same ohmic value as the normal load device and must have a wattage rating sufficient to enable it to dissipate safely the maximum amplifier output power. A load resistor so employed should preferably be of the non-inductive power type in order to eliminate the errors introduced by the impedance of inductive, wire-wound power resistors, unless the L/R ratio of the wire-wound unit is extremely low.

Most audio power measurements will be made directly across the load device, coupling transformer, or line, and the arrangement of Figure 1 will be applicable. However, it is frequently desirable to have the wattmeter terminate the power source in lieu of the normal load device, so provision has been made in the complete instrument for the insertion by binding post connection of a load resistor of suitable resistance and wattage. Since at least forty load values are commonly encountered in audio-frequency work, no attempt was made to build a high-powered, bulky switched-resistance load into the wattmeter. When the operator desires to employ the wattmeter as the amplifier load, he will need only to insert the one resistor connection into the binding posts provided for the purpose. When employing the instrument in the manner indicated in Figure 1, the resistor is removed.

In order to obtain complete isolation of the wattmeter, battery operation of the v.t. voltmeter unit has

been adopted. This prevents return paths ordinarily encountered through the power line when both the power source under test and the v.t. voltmeter are operated from the a.c. line. The meter circuit has been made as simple as possible, and low-voltage batteries are employed.

The complete circuit diagram is shown in Figure 3. This schematic reveals the wattmeter to be a specially calibrated electronic voltmeter with high input resistance. The circuit has three voltage (power) ranges: 0-2 volts, corresponding to 0-4 watts; 0-6.32 volts, corresponding to 0-40 watts; and 0-20 volts, corresponding to 0-400 watts. These ranges are afforded by the input voltage divider comprised by resistors R1, R2, and R3, totaling 1 megohm, and the rotary selector switch S1.

The indicating instrument M is a Simpson 0-500 d.c. microammeter. This is the most desirable current range for this instrument, although larger or smaller instruments might be employed with corresponding changes in the power ranges. Thus, a 0-1-milliammeter would afford a full-scale power deflection of approximately 16 watts on the lowest range.

The "B" battery B2 is a midget flat 7½-volt "C" type battery (Eveready 773). The small size of this component (4" x 2¾" x 1¼") makes it possible to keep the dimensions of the complete instrument small. The filament battery B1 and meter-bucking battery B3 are regular 1½-volt flashlight cells (Eveready No. 950).

The tube employed is a 1Q5-GT with screen and plate connections tied together. The total no-signal plate current is quite low at the low value of plate voltage employed, being approximately the full-scale deflection of the microammeter. The meter is therefore not endangered by this current when the zero-adjustment resistor R4 is off adjustment.

No-signal plate current is bucked out of the meter by the rheostat R4 and the 1½-volt cell B3 which make a



Professional unit suitable for output measurements. VTVM included.

smooth and efficient zero adjusting combination. Both the filament circuit and the meter-bucking circuit are closed simultaneously by the double-pole, single-throw toggle switch (the two sections of which are shown as S2 and S3), thus both batteries are removed from drain circuits when the instrument is switched off. The negative terminal of the filament battery and the circuit returns are connected to the #7 pin of the tube, this being the side of the filament to which the beam element is connected within the tube.

The 0.1-μfd., 200-volt tubular bypass condenser C provides a low-impedance path for any a.c. passed by the interelectrode capacitance of the tube.

The input voltage divider (R1-R2-R3) is made up of three sections—684,000, 216,000, and 100,000 ohms respectively. (Continued on page 79)

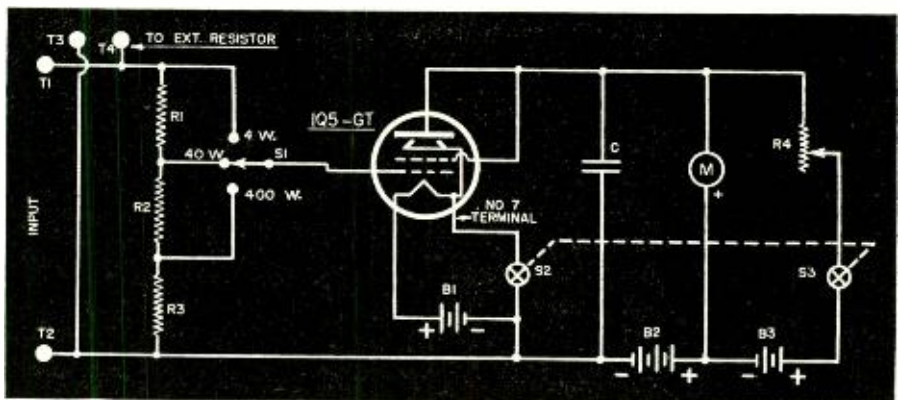

Fig. 3. Schematic diagram of the VTVM output tester.

R₁, R₂, R₃—See text
 R₄—100,000-ohm midget rheostat—I. R. C.
 C—0.1-μfd., 200-volt tubular condenser—Aerovox 284
 S₁—Three-position, single-pole rotary switch—Centralab
 S₂-S₃—D. P. D. T. toggle switch—Arrow

M—0-500 d.c. microammeter—Simpson
 B₁, B₃—1½-volt flashlight cells—Eveready No. 950
 B₂—Midget, flat 7½-volt battery—Eveready No. 773
 T₁, T₂, T₃, T₄—Bakelite binding posts—Gordon
 Tube—1Q5-GT R.C.A.

The TUBE COLLECTOR



IN answer to our invitation for comments regarding entrance into the Tube Collector, we think that the following letter, written by one who has been collecting tubes for many years would be of considerable interest. The writer, a well known radio authority, brings up some excellent arguments.

"Having noted the questions propounded in the 'Tube Collector' column, page 73, May, 1943, issue of RADIO NEWS, the writer feels that he should like to present some personal thoughts of possible interest to your readers.

"These thoughts are based upon the experience gained in many years spent in antique collecting in two (2) different fields, in both of which have arisen the questions which your correspondent propounds.

"The first field was the collection of Colt revolvers which so closely parallels the field of collecting old vacuum tubes and radio equipment that a few words seem appropriate. In the period from 1836 to 1870, it is doubtful if Sam Colt produced over twelve or thirteen (12 or 13) different basic types of revolvers. Nevertheless, for any single model or type, it is possible to find anywhere up to twenty or more different variations thereof due to the fact that minor improvements or changes seem to have been incorporated by Colt in almost every new run of arms of the same model put into production in the Colt plant. Thus the Colt collector can be content with a small number of arms, which will be representative of every basic type produced, or he can go "whole hog" and go in for the decorated and engraved variations of the basic types. If he chooses to be academic, he can expand the possible field of his collecting tremendously by seeking out for and including in his collection every possible mechanical variation upon the basic type.

"For example, the first Colt military revolver was actually made in the plant of Eli Whitney in Whitneyville, Conn., under contract for Colt. It is today variously known as the Model 1847 Army revolver, the Walker Colt, The Whitneyville Colt, or the First Model Dragoon. It is of an outstanding or distinctive type paralleled by no earlier or later Colt production. Only one thousand (1,000) of these arms were made for the U. S. Army during
(Continued on page 56)

WHAT'S NEW IN RADIO

New Products for Military and Civilian Use

UNIVERSAL DE LUXE MULTITESTER

The new R.C.P. Model 419 Multitester combines in one instrument, a.c.-d.c. voltmeter, milliammeter ammeter, capacity-meter, ohmmeter and inductance-meter, thus making this unit ideally suited for a wide range of shop, laboratory and field applications.

The model 419 incorporates in its design the new R.C.P. system of a.c. measurements, eliminating the copper oxide rectifier. A.c. scales are linear with d.c. scales. Sensitivity of meter is 2,000 ohms per volt—accurate to within 2%. Capacity-meter is direct reading with widespread scales. Ohmmeter has self-contained power supply. Sensitivity of low ohm range makes it excellent for checking shorts, measuring of contact resistance, resistance of voice coils, etc. Meter is fused and supply line double fused.

Model 419 is available in three types.



Model 419P is supplied in a hand rubbed natural finish maple case with cover and carrying handle. Model 419C is an open face bench type instrument with a 4½" meter. Model 319V-7 is an upright instrument in a crackle finish steel case with a 7¼" rectangular meter. Prices range from \$34.50 to \$44.50.

Further information can be obtained upon application to the manufacturer: Radio City Products Co., Inc., 127 West 26th Street, New York City.

SHUTTER TYPE PILOT LIGHT

The Gothard Manufacturing Company, 1300 N. Ninth Street, Springfield, Illinois, is now manufacturing a new Shutter Type Pilot Light which is

particularly suited to aircraft, marine, signal and similar applications where various intensities of light are desired under constantly changing conditions. These new Pilot Lights permit a gra-

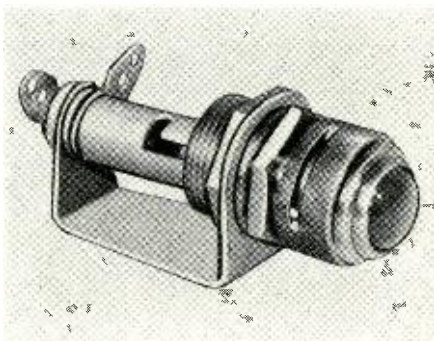

duction of light from bright, thru intermediate glows, to total dark with 90° rotation of the Shutters. Known as the Gothard Model 430 (with Faceted Jewel) and Model 431 (with Plain Jewel), these lights are available with Red, Green, Amber, Blue or Opal lens—also with polarized lens.

A copy of the Gothard catalog may be obtained by writing direct to the Gothard Manufacturing Co., 1300 N. Ninth Street, Springfield, Ill.

NEW MOSSMAN LEVER SWITCH

Donald P. Mossman, Inc., 6133 N. Northwest Highway, Chicago, has published a General Data Bulletin No. 82 on their new O-42 Lever Switch.

The Mossman O-42 Lever Switch is primarily designed for use in Aircraft, Radio, Communication, Annunciator and Fire Alarm Systems, Testing Apparatus and a wide range of Industrial applications. It is available in an almost unlimited series of combinations of contact assemblies.

Diagram and complete information is given in the General Data Bulletin

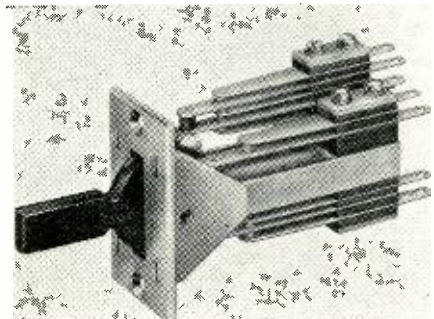

No. 82, which will be furnished by the manufacturer, Donald P. Mossman, Inc., 6133 N. Northwest Highway, Chicago, upon request.

-30-

QUIET, PLEASE!

by **WALTER FERNALD**
Signal Corps Laboratories

The suppression of electrical interference in motored vehicles. Its application in war time and post-war periods.

THIS article in its entirety is dedicated to the Engineers, Technicians, and the entire personnel of the Signal Corps General Development Laboratories at Fort Monmouth, New Jersey, and Detroit, Michigan, and is but a sample of the important technical work being carried on by the Civilian Branch of this great organization.

The Signal Corps has always been designated and consequently thought of as a military organization, a branch of our regular Army. Yet, the civilian personnel have played a major rôle in the prosecution of the war effort. Design, development, and research have been the most important contributions. Via the civilian program carried on by the War Department, our government has been given access to an enormous amount of technical knowledge and our armed forces have been molded into the most efficient fighting units through the medium of this technical knowledge.

The subjects covered at the Signal Corps Laboratories are varied and deal with communications of every type and description, the goal, the finest in communications equipment for our armed forces. Even with the finest equipment available our fighting units would still be without efficient and reliable communications had it not been for the fine work that had been done by the men behind the men who man the guns. It would have been virtually impossible to carry on efficient and reliable communication had the problem of electrical interference not been overcome—electrical interference caused by the ignition systems of the thousands of vehicles of all descriptions resulting in disturbances commonly called motor noise which in turn can disrupt communications to a greater extent than is realized.

This article deals with "The Suppression of Electrical Interference" and although much in the way of types, numbers, data, ratings, etc., has been left out due to the secret nature of the subject pertaining to the military, the reader can gain much knowledge concerning the men who work behind striving to give the best to those who work and fight at the front.

Suppression in the Past

Looking back over the period before Pearl Harbor, we can find very little

in the way of subjects and articles dealing with suppression. Yet, even at that time the importance of suppression was felt and realized by many of the radio profession. True, there were many gadgets on the market advertising the elimination of electrical interference, yet, how many of these so-called gadgets actually worked according to expectations? Many of you built and designed line filters that did work and there were a few manufactured types that actually performed well enough to be given the title of filter. Yet, in all the applications, one very important one was overlooked, overlooked to an extent that it became probably one of the most important assignments, an assignment that had to be tackled and overcome immediately before communications could be put on an efficient basis. This assignment, the complete suppression of electrical interference in military vehicles, was actually tackled before Pearl Harbor, but did not really reach its perfection stage until after this country's entry into the second World War.

We of the radio service profession never actually gave the word "suppression" much more than a second

thought, and taking the motor noise out of a radio equipped pleasure car was just another part of our day's work. A condenser here and there, a suppressor on each plug in tough cases, a bond or two on the motor block and good antenna shielding most always did the job. But, did it really do the job from a technical standpoint? From a practical standpoint, yes, with the motor running if no appreciable amount of motor noise was present the job was OK. Sometimes we encountered wheel static, but that was always fairly easy to overcome.

Then at times we would encounter a tough case of motor noise and after the old cut and try method plus a lot of cussing we would finally lick it at least to a point where the noise was not too objectionable. Yet from a technical standpoint, the vehicle we had suppressed or at least thought we had suppressed was actually far from being suppressed. The application of suppression to vehicles as is common practice in our armed forces today is a far cry from the crude methods used only a year and a half ago. The post-war era will bring to the radio minded public much in the way of advance-

Fig. 1. Block diagram of typical ignition system in a 6 cylinder motor vehicle.

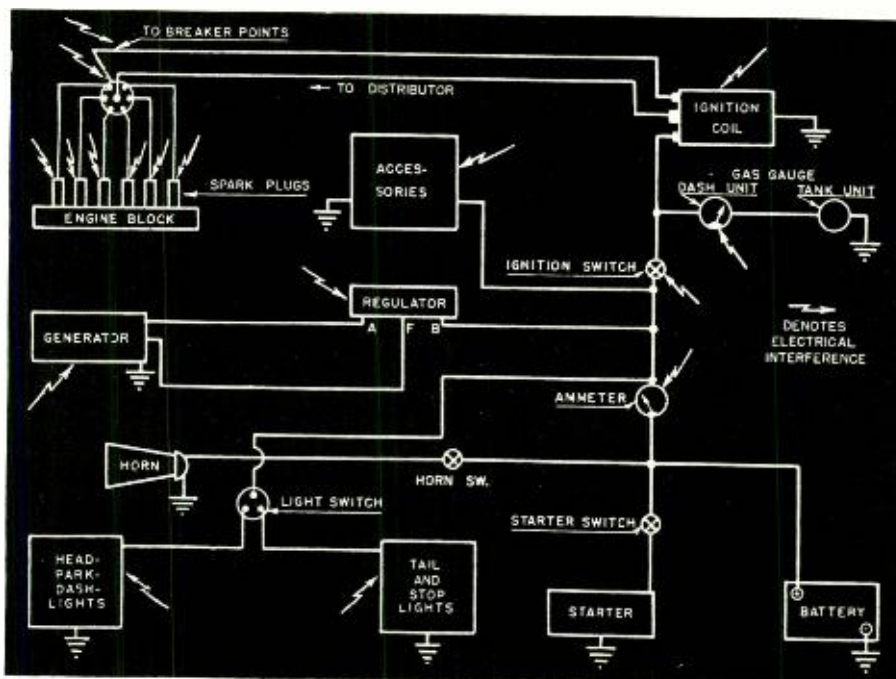

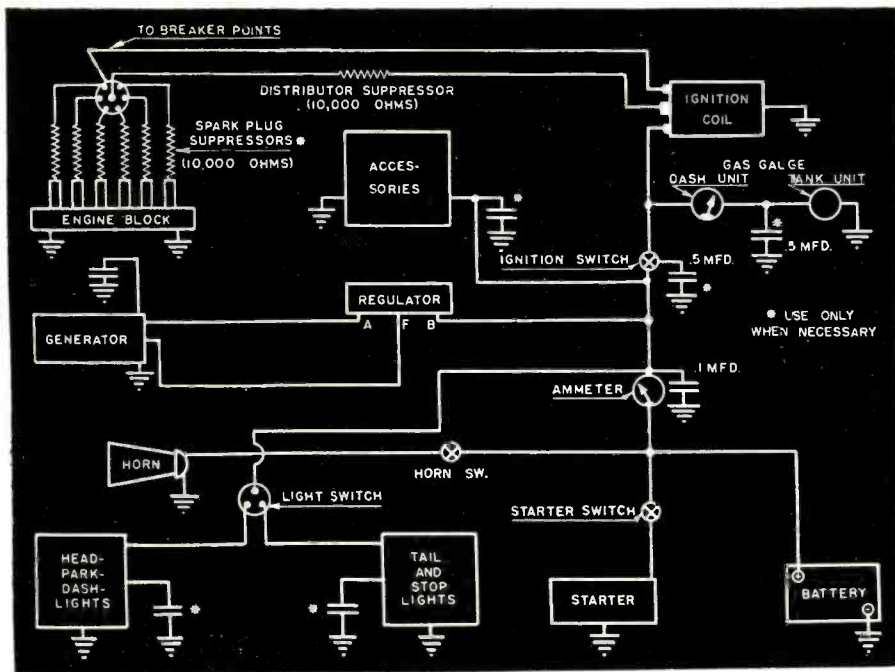

Fig. 2. Typical application of suppression for 6 cylinder pleasure automobiles.

ment in the art of radio and just one of the many items to be released will be the approved method of the suppression of electrical interference.

The Application of Suppression in War Time

The application of suppression to motor vehicles as is common practice in our armed forces today differs considerably from the old conventional methods used in the past. Reference is made to Figure No. 1 which for all practical purposes represents a typical ignition and charging system of an automobile motor. Note the various sources of electrical interference, each a miniature broadcasting station of its

own, generating interference of different types and proportions.

In our pleasure car application of suppression referring to Figure No. 2, we have by-passed with suitable capacitors what we considered as the principal sources of motor noise. The application in some cases consisted of but a distributor suppressor, a generator capacitor, and the usual ammeter by-pass. This small application of suppression for all practical purposes cleaned up our motor noise to a point where radio reception in the vehicle itself was passable. In all cases, shielding of the antennal leadin constituted probably the most important operation.

Note the application as pointed out in Figure No. 3, which is typical of suppression as applied to army vehicles. Quite a contrast to our pleasure car application shown in Figure No. 2. Note the absence of capacitors on some of the sources of interference, substituted by correctly designed filters of the π and L type design. The result is almost complete suppression and elimination of motor noise. The absence of motor noise is not only noticed in the vehicle's own radio equipment but also in any other installations located in the immediate vicinity such as other radio equipped vehicles and ground stations.

Filters used in military applications were designed by the Engineers and Technicians of the Signal Corps Laboratories in collaboration with various manufacturers throughout the country. Tests of all types and descriptions were made before final approval and acceptance were given. All this was necessary in order to insure for the armed forces the best possible in noise free reception which ultimately resulted in fast, efficient and accurate communication under any conditions. The necessary specifications were decided upon after exhaustive testing and research and were written up not only for the construction of the filters needed but also for each different application. This in itself was quite a task and an achievement as there are many different types of vehicles in the military service and the manufacturers represented are quite large in number. Tanks, jeeps, command cars, weapons carriers, half-tracs, etc., are just a few of the many types of vehicles, each representing a different type of application. Yet with all the usual obstacles not to mention the time element, all vehicles for military use are being delivered to our armed forces completely suppressed. This is in addition to the various types and numbers of vehicles and tanks being delivered to our allies under Lend-Lease arrangements.

Let us delve a little farther into the subject of "Filters" as applied to vehicles for the suppression of motor noise. Filters used, as was previously mentioned, are of the π and L Type designs, some with balanced π sections and others with unbalanced π sections, depending on the manufacturer's own facilities and designs. A typical filter is the Type (?) designed for use in the charging circuit of a motor vehicle. The current-carrying capacity is 55 amperes at 30 volts d.c. This type filter is designed to give an attenuation or DB loss of not less than 30 DB for the frequency range 0.5 to 1.7 megacycles; 45 DB from 1.7 to 3.0 megacycles; and 60 DB from 3.0 to 30 megacycles. The π design consists of two 600 volt rated d.c. capacitors of suitable capacitance together with a coil of suitable inductance capable of handling an overload of 110 amperes in the case of the 55 ampere filter. The components are mounted by firm mechanical means in a corrosive proof

(Continued on page 85)

Fig. 3. Application for suppression of noise in a 6 cylinder military vehicle.

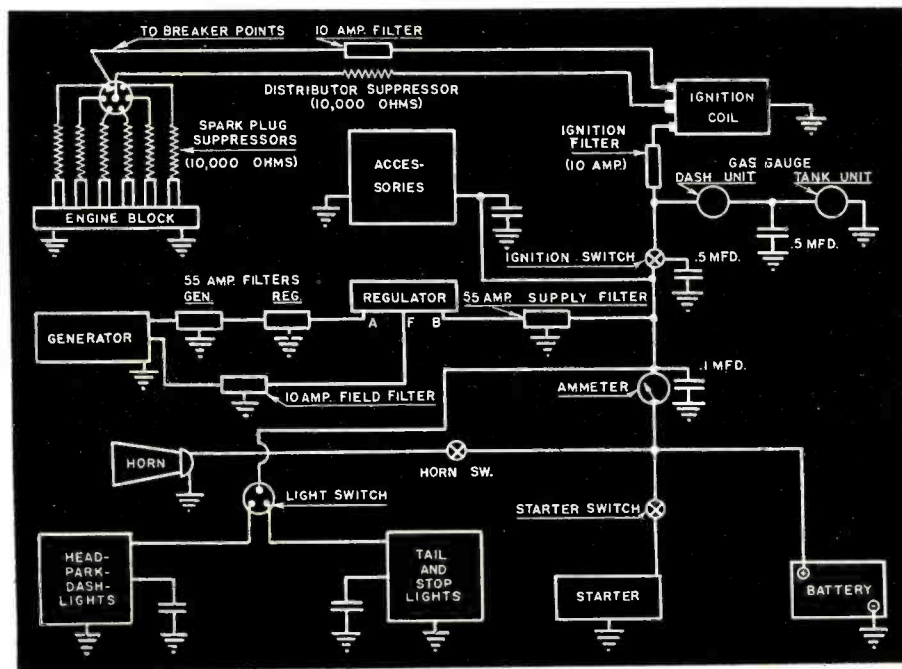

PRACTICAL RADIO COURSE

by **ALFRED A. GHIRARDI**

Part 15, covering additional circuit arrangements used for coupling individual stages of multistage audio voltage amplifiers.

CONTINUING our study of voltage and power amplification by means of vacuum tubes, we are now prepared to study other methods of interstage coupling beside the resistance-coupling arrangement discussed in the last lesson.

Impedance-Coupled Voltage Amplifier

Impedance-coupled audio amplifiers are characterized by the use of an iron-core inductance or choke, L , as the plate load instead of the plate load resistors employed in the resistance-coupled amplifier. Fig. 1 shows the basic circuit of an impedance-coupled amplifier employing triode tubes. Notice its similarity to the resistance-coupled amplifiers illustrated in the previous lesson. The choke or impedance coils employed are constructed so as to have relatively low d.c. resistance, and consequently only a relatively low d.c. voltage drop occurs across them. Therefore, practically

high enough so that its inductive reactance at the lowest frequency to be amplified will be several times the internal plate resistance of the tube in order that high voltage-amplification at the low frequencies will be obtained. Although the inductive reactance at the high frequencies is much greater (since $X_L = 2\pi fL$), the amplification is prevented from increasing accordingly, due partly to the increasingly large bypassing effect of the stray interelectrode and circuit capacitances at these higher frequencies, and also due to the fact that after the plate load reactance has reached a value equal to 4 or 5 times the internal plate resistance of the tube practically the full μ is being realized and very little additional increase is obtainable.

The equivalent circuit of the impedance-coupled amplifier is illustrated in Fig. 2. It may be analyzed in exactly the same manner for the low, intermediate, and high-frequencies as was done for resistance-coupled amplifiers

as shunting the choke coil inductance, as shown. C_p represents the plate-to-cathode capacitance and output circuit stray capacitance of tube 1, combined. C_g is the total grid input circuit capacitance of tube 2. Together with C_L they act to reduce the high-frequency response of the amplifier. R_L is the d.c. resistance of the choke coil winding.

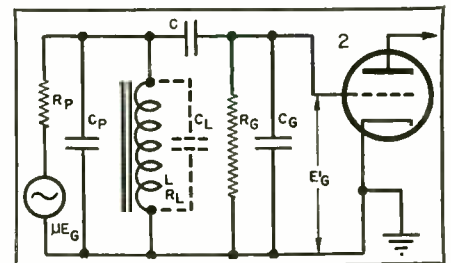

Fig. 2. Equivalent circuit.

In general, a well designed impedance-coupled amplifier is capable of giving a mid-frequency voltage gain nearly equal to, or slightly higher than that of a corresponding resistance-coupled amplifier. However, it does this with the application of a much lower plate supply voltage, since there is no appreciable loss in the direct voltage through the coupling choke. On the other hand, the frequency-response characteristics are inferior to those of a well-designed resistance-coupled amplifier since the substantially flat portion is narrower than for the resistance-coupled (R-C) amplifier.

At the low frequencies the gain drops off more rapidly than for the R-C amplifier due to the combined effect of the increase in reactance of C and to the fact that the inductive reactance of the choke decreases at the low frequencies and therefore the load impedance presented to the tube becomes less. At the high frequencies

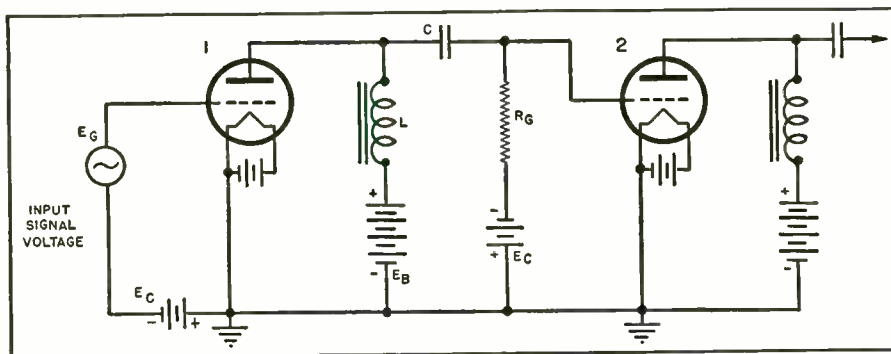

Fig. 1. Basic circuit of an impedance-coupled amplifier employing triode tubes.

the full d.c. voltage of the plate supply source is available at the plates of the tubes. Consequently, for a given operating plate voltage, the plate supply source in an impedance-coupled amplifier does not need to supply anywhere near as high a voltage as is required for a corresponding resistance-coupled amplifier. This is the main advantage of impedance coupling over resistance coupling.

Since the plate-circuit choke coil contains a large number of turns of fine wire wound on a core of highly permeable magnetic material it has a very high inductance. Accordingly, it presents a high reactance to the flow of the A.F. signal currents and a large proportion of the μ of the amplifier tube, with which it is used, is realized. The inductance of the coil must be

in the previous lesson. An additional stray capacitance (C_L) due to the distributed capacity of the winding comprising the choke coil acts in this circuit. For convenience it is considered

Fig. 3. Basic circuit of transformer-coupled amplifier employing triode tubes.

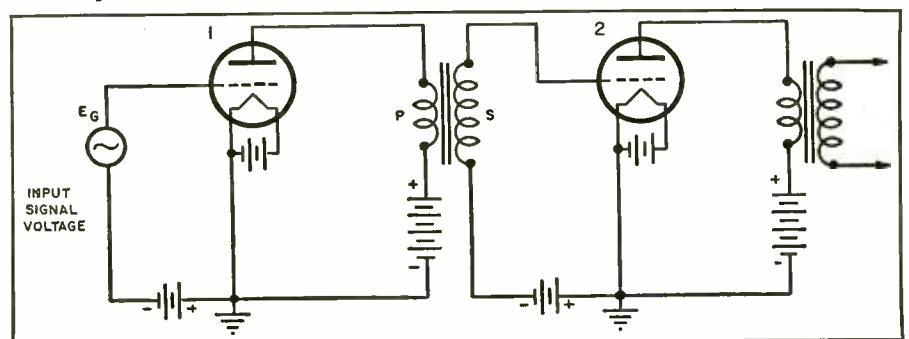

the gain drops off more rapidly than for the R-C system due to the shunting effect of the comparatively large C_L combined with C_p and C_s . The gain in the frequencies intermediate between these is higher than for the R-C amplifier, provided that the inductance of the choke is sufficiently large so that the reactance of L at these frequencies is large compared with the load resistance R_L of the comparable R-C system. Because of these deficiencies and because the choke is much more expensive and bulky than the plate load resistor employed in a re-

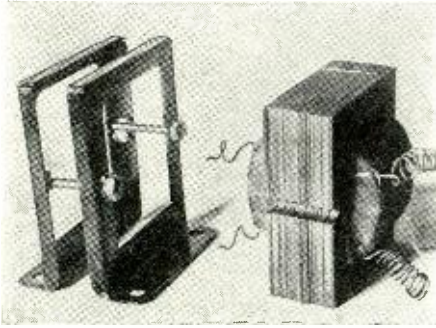

Typical coupling transformer.

sistance-coupled stage, the latter is more widely used in voltage amplifiers for radio equipment.

Transformer-Coupled Audio Voltage Amplifiers

Audio transformers having laminated steel cores were formerly used quite extensively to couple together vacuum tube voltage amplifier stages using triodes. Fig. 3 illustrates the basic circuit of such an amplifier and an actual audio transformer is also illustrated. The primary winding P is connected in the plate circuit of the first tube, and constitutes the plate circuit load. The varying signal cur-

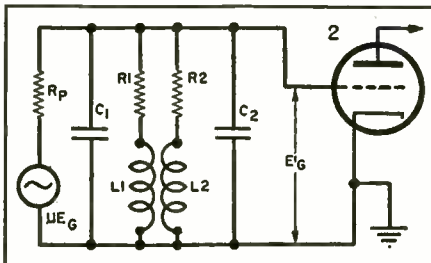

Fig. 4. Equivalent circuit of a transformer coupled amplifier stage.

rent flowing through this winding produces a corresponding varying magnetic field in the laminated steel core, which in turn induces a similar varying signal voltage in the secondary winding S. The secondary voltage is applied to the grid circuit of the second tube. By constructing the transformer with more turns in the secondary than in the primary an extra step-up or gain in signal voltage is obtained.

As this increases the gain per stage over that obtained in a corresponding resistance-coupled or impedance-coupled amplifier it is one of the advantages of transformer coupling. Another advantage over resistance cou-

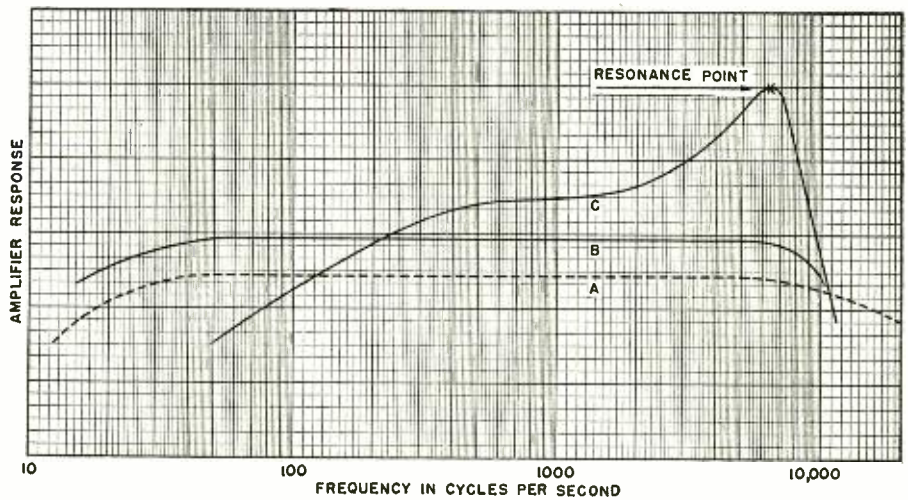

Fig. 5. Fidelity curve showing the variation between resistance and transformer coupling.

A—Resistance-coupled amplifier. B—Transformer-coupled amplifier using more modern type transformer. C—Transformer-coupled amplifier using old type transformer.

pling lies in the fact that since the d.c. voltage drop across the transformer primary is low, the plate supply source in a transformer-coupled amplifier does not need to supply nearly as much voltage as is required in a resistance-coupled amplifier operated with the same plate voltage. This is important in some amplifier applications such as in portable battery-operated radios, hearing aids, etc., where the size and weight of the plate-supply battery (number of cells) is important.

Analysis of Transformer-Coupled Voltage Amplifier Stage

The detailed analysis of transformer-coupled amplifiers is quite involved, because to study the performance at all audio frequencies many factors such as the individual inductance of the primary and secondary windings, mutual inductance, stray capacitance, distributed capacitance of each winding, leakage reactance, etc., must be considered at each frequency band. However, an approximate study sufficiently accurate for our purposes may be made by omitting consideration of some of these and assuming the equivalent circuit of the amplifier to be as illustrated in Fig. 4.

L_1 and L_2 are the no-load inductances of the primary and secondary windings respectively, and R_1 and R_2 represent their d.c. resistance. C_1 represents the

distributed capacitance of the primary winding together with the plate-to-cathode capacitance of tube 1 and the stray capacitance in the tube socket terminals, wiring, etc., between this tube and transformer. Similarly, C_2 represents the sum of the distributed capacitance of the secondary winding and the grid-input and stray input capacitances to the second tube.

An approximate expression for the gain-per-stage of a transformer-coupled amplifier may be found if it is assumed that the transformer is an "ideal" one; that is, that the coefficient of magnetic coupling between the primary and secondary windings is unity (no stray leakage of magnetic flux occurs) and the effects of the distributed and stray capacitances are negligible. We will assume these conditions for the intermediate values of frequency, as they are fairly true for these frequencies.

The alternating signal voltage E_s impressed on the grid of the first tube appears as an amplified voltage μE_s in the plate circuit. At intermediate values of signal frequency (between the lowest and the highest) the primary impedance of the transformer of a well-designed transformer and stage is high in comparison with r_p , and therefore substantially all of this amplified voltage will appear across

(Continued on page 82)

Fig. 6. Shunt-feed type transformer coupled amplifier stage using triode tubes.

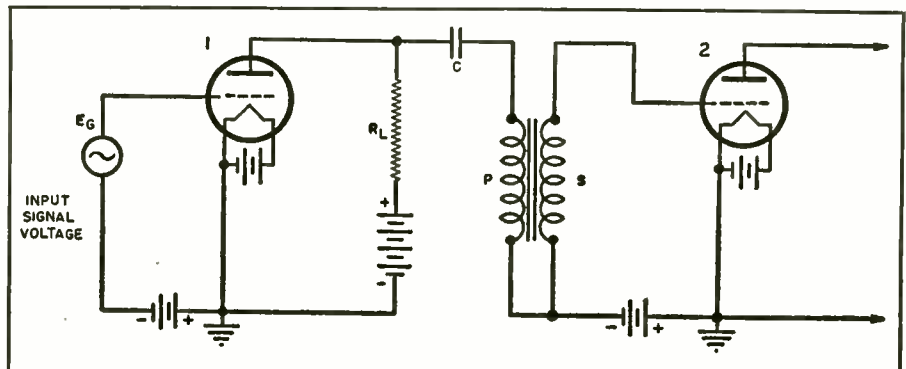

ABOVE

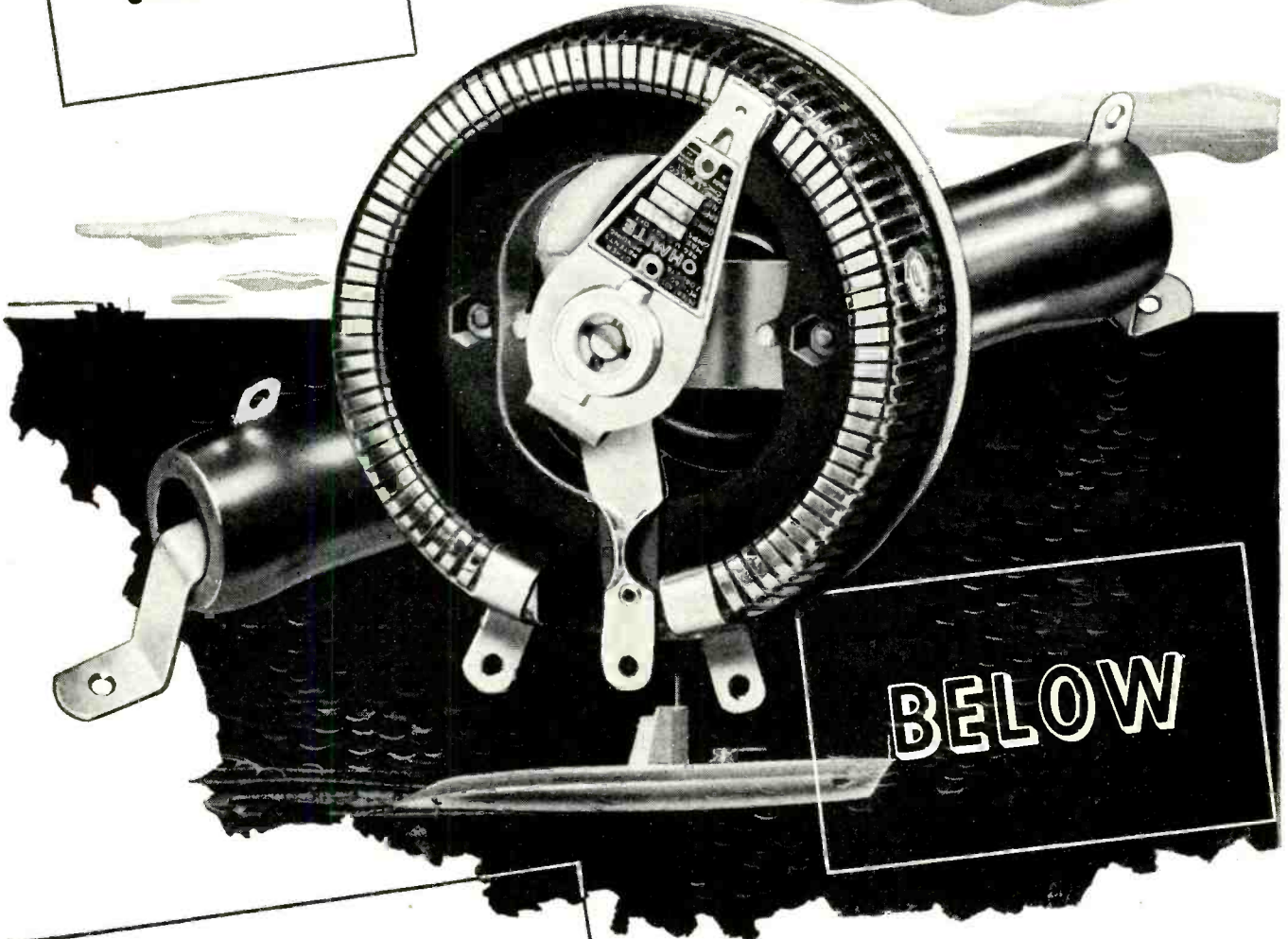

BELOW

OHMITE
Resistance Units
*do the job...
and do it well!*

Consistent performance day-after-day in all types of critical applications . . . that's the story of Ohmite Rheostats and Resistors. This time-proved dependability has enabled them to meet the toughest requirements of military service. Today, they "carry on" above the clouds and below the waves—on land and on sea—in planes, tanks, warships and submarines—to help speed Victory. Tomorrow, these rugged units will be ready to meet new peacetime needs. Widest range of types and sizes assure the right unit for each purpose. Experienced Ohmite Engineers are glad to assist you on any resistance-control problem.

Handy Ohm's Law Calculator
Helps you figure ohms, watts, volts, amperes—quickly. Solves any Ohm's Law problem with one setting of the slide. All values are direct reading. Send for yours—enclose only 10c in coin for handling and mailing.

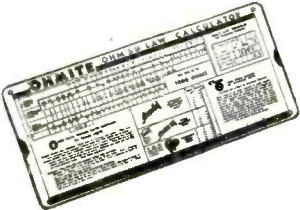

Send for Catalog No. 18
It's FREE! Gives helpful information on the wide range of Ohmite stock resistors, rheostats, chokes and switches used in all types of applications. Send for yours, now!

OHMITE MANUFACTURING CO.
4883 Flournoy St. • Chicago, U. S. A.

Here's How YOU



Can Qualify for a BETTER RADIO JOB!

••• CREI technical training is preparing others for good-paying radio jobs —WHY NOT YOU?

Are you finding yourself in a routine job—a job that any other man can handle just as well as you? Today, radio JOBS are many—but radio CAREERS are few! Now is the opportune time for you to equip yourself with the necessary technical training to qualify you for an important engineering position with a secure future.

NOW when industry needs men, is the time for you to investigate radio career training for the extraordinary opportunities that await you not only today, but in the coming new world of radio and industrial radionics. Your present radio experience backed by modern CREI technical training will equip you to share in the good-paying jobs that await trained men. CREI home study courses are prepared for experienced radiomen who realize the necessity of CREI advanced technical training if they are to rise above the routine jobs to make good in the important engineering positions that lead to security and happiness!

• WRITE FOR FREE 32-PAGE BOOKLET

If you have had professional or amateur radio experience and want to make more money—let us prove to you we have something you need to qualify for a better radio job. To help us intelligently answer your inquiry, PLEASE STATE BRIEFLY YOUR BACKGROUND OF EXPERIENCE, EDUCATION AND PRESENT POSITION.



CAPITOL RADIO ENGINEERING INSTITUTE

E. H. RIETZKE, President

Home Study Courses in Practical Radio Engineering for Professional Self-Improvement

Dept. RN-7, 3224—16th Street, N.W.

WASHINGTON, 10, D. C.

Contractors to the U. S. Signal Corps—U. S. Coast Guard. Producers of Well-trained Technical Radiomen for Industry.

Spot News

(Continued from page 14)

tubes for military purposes has solved many production problems making it possible to produce these tubes at a strikingly low price. Whereas, before the war, but a few thousand of these tubes were made for civilian purposes, hundreds of thousands are now being made. Other components incident to television equipment have also reached the solution stage in view of advanced design and mass production methods. Accordingly, even the most elaborate post-war equipment will carry a price below that of the ordinary television receiver of pre-war days.

As was reported in these columns several months ago, television is attracting the interest of many. Not only is this evident from many post-war plans discussed but from the increased filing of applications for future television licenses. There's no doubt that television will be a vital post-war factor.

TODAY THE BBC operates on a twenty-four-hour-a-day schedule, and offers seven program services. These are known as the Home program service covering 17¼ hours a day; the Forces program for 16½ hours a day; Empire service in English, or the Red Network, for 21¼ hours a day; Empire service in non-English languages, or the Green Network, for 3½ hours a day; the Blue Network, covering news and information service to Europe, for 20¼ hours a day; Yellow Network for supplementary European service, covering 10¼ hours a day and the Brown Network for Latin American service covering 4¾ hours a day. It is expected that the number of networks will be increased to thirteen and most of the services will occupy a major part of the 24-hour schedule.

The operations department of BBC, today, has a staff of 2,600, of which 500 are trained engineers. The peacetime staff consisted of a thousand persons, of whom 800 were engineers. Many on the staff, today, are women who although not professional engineers are nevertheless filling many important posts and providing outstanding service.

WITH THE RESIGNATION OF Frederick R. Lack has come a reorganization of the Army-Navy Electronic Production Agency, with Frank Douglas Tellwright as the new director. Mr. Lack is back at Western Electric as vice-president, in charge of radio. It will be recalled that Mr. Lack is the brilliant engineer who was responsible in part for the development of the famous A T cut crystal, that revolutionized crystal production.

ANEPA, as the agency is popularly called, had its inception in August, 1942. The expediting staff of the Signal Corps Procurement Division was combined with the corresponding group

of the Navy Bureau of Ships at that time to eliminate bottlenecks of procurement. The chairman of this agency is a Signal Corps officer and the vice-chairman is a Navy Officer. This agency is really an emergency unit. They determine, where there is a limited quantity of material available or in a state of partial manufacture how the material shall be used for the purpose that is considered most urgent in our war plans. In this capacity, ANEPA acts with the advice and authority of the Army and Navy Munitions Board, the Joint Communications Board (representing the Joint United States Chiefs of Staff) and the combined Communications Board (representing the Combined Chiefs of Staffs of the United Nations). The final authority in allocating signal equipment is the Munitions Assignment Board headed by none other than Harry Hopkins.

Representing the Signal Corps on ANEPA is Major General Roger B. Colton, chief of the Signal Supply Services. The Navy is represented by Captain A. J. Spriggs, director of the Electronic Division of the Navy Office of Procurement Material.

ANEPA has been a potent force in expediting an endless variety of vital projects. It has done a splendid job meriting the applause of everyone.

THE DYNAMIC VALUE OF RADIO was echoed throughout the world when Prime Minister Winston Churchill made a broadcast recently from London. He said . . . "the ceaseless improvements in wireless and the wonders of radio location applied to the arts of peace, will employ the radio industry . . . what with the modern methods of locomotion and the modern amusements of the cinema and the wireless, to which will soon be added television, life in the country and on the land ought to compete in attractiveness with life in the great cities."

In Mr. Churchill, radio has one of its greatest friends. The praise given above has been featured in many other talks of the Prime Minister. Radio is indeed grateful to Mr. Churchill for his enthusiasm of this truly great science.

THE ARMOUR INSTITUTE OF TECHNOLOGY DEVELOPMENT of recording on steel wire, reported in these columns some months ago, has become a valuable tool of the Army. This medium of recording and playing back instantaneously on a spool of steel wire, has been accepted by the Army as an effective way of recording both eye witness accounts and official reports of battle-front action. Since the spool of wire is but about four inches in diameter and thus compact and very lightweight, it can be flown back to official headquarters, a recording studio or a broadcast station for instantaneous playback. The messages can be quickly erased and the wire used again for recording.

The device incorporating the steel

More than ever

With the struggle becoming increasingly fierce . . . now, more than ever . . . the quality of American men and equipment stand out in bold relief. We cannot tell you where . . . but we do know that somewhere on all the fronts . . . the quality of DeJur Aircraft and Electrical Instruments, Potentiometers and Rheostats is being subjected to the severest of tests. Thanks to 25 years of experience and research, our products will not be found wanting.

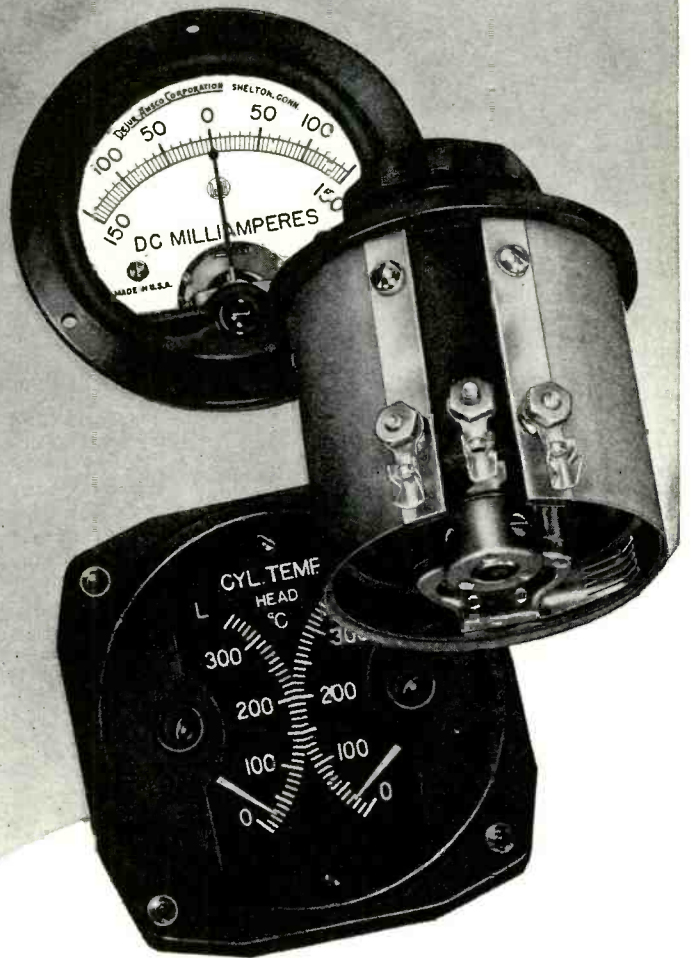

Awarded for Excellence in Production and Quality of Materiel



DeJUR-AMSCO CORPORATION

SHELTON, CONNECTICUT

NEW YORK PLANT:
99 Hudson Street, New York City

CANADIAN SALES OFFICE:
560 King Street West, Toronto

MORE THAN EVER . . . it's important to keep buying War Bonds and Stamps

July, 1943

47

ALLIED...

ARSENAL of SUPPLY for
EVERYTHING in RADIO
and ELECTRONICS.



GET all your
Radio and
Electronic needs
quickly from this

ONE dependable central source of
supply...over 10,000 items for the
Armed Forces, for Radio Training,
for Research Laboratories, for War
Industries, and for Service Replace-
ment. Our large complete stocks
speed delivery. Our experienced staff
is ready to help you..

USE THE NEW
ALLIED CATALOG!
Most Complete
Up-to-date
Buying Guide
Free

6 Radio Books for 75c

- | | | | |
|---|-----|---|-----|
| Dictionary of Radio Terms.
No. 37-751 | 10c | Radio Data Handbook.
No. 37-754 | 25c |
| Radio Circuit Handbook.
No. 37-753 | 10c | Radio Builders Handbook.
No. 37-750 | 10c |
| Radio Formulas & Data Book.
No. 37-752 | 10c | Simplified Radio Servicing.
No. 37-755 | 10c |

Write for Quantity Prices

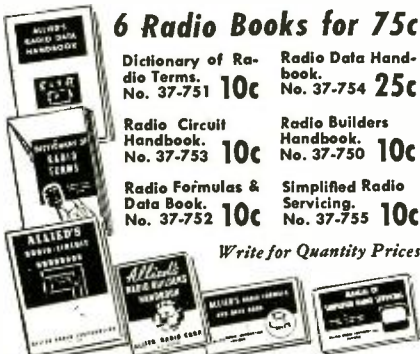

ALLIED RADIO CORP., Dept. 1-G-3
833 W. Jackson Blvd., Chicago, Ill.
Please send following books (.....c enclosed)
 FREE 37-750 37-752 37-754
 1943 Catalog 37-751 37-753 37-755
 Send All Six Books

Name.....
Address.....
City..... State.....

ALLIED RADIO

wire system is about as large as a popular-priced table model radio. It is completely self-contained with its own loud speaker. Reproduction is excellent. Your correspondent had the pleasure of listening to many recordings, including his own, and was really amazed at the fidelity provided. It was even possible to pick up speech and music from a radio and phonograph with unusual effectiveness. Again the quality was excellent. No specifically designed microphone need be used as long as it matches the input circuit and is suitable for either battlefield or studio work.

This development is another example of American ingenuity.

ONE OF THE GARDEN SPOTS OF NEW YORK STATE, the Adirondack Mountains, will play host this summer to those women who enlist in the Womens' Army Auxiliary Corps or WAAC to become radio specialists for service with the Signal Corps. Graduates of women's colleges have been invited to enlist in this new program which began on June 15th and will run for six months.

The course provides training for this specialized field, first of a pre-service nature, and later of the customary indoctrination training, which of course, will take place at a training center. At the Adirondacks school the women, who may be between the ages of 21 and 45, will attend classes eight hours a day, six days a week learning how to overhaul, maintain, repair and inspect Signal Corps equipment.

Although the initial recruiting plea was made to college graduates, the courses are open to anyone who has a high school diploma and has completed a course in elementary algebra.

Other military divisions have also used the talents of women in Signal Corps work quite effectively. We refer, of course, to the SPARS, and the WAVES. Incidentally, WAVES refers to Women Accepted for Volunteer Emergency Service and SPARS represents a contraction of the Coast Guard's Latin slogan Semper Paratus, which means *always ready*.

That women are quite adept at radio was fully acknowledged by H. M. Newton of the British Broadcasting Corporation, who said in a recent interview, that 25% of the BBC staff are women. They serve, he said, in not only the studios, but right out at the transmitters themselves. And said he, they do a mighty fine job.

THE STATE OF MONTANA is one of the most radio-minded States in the union. In view of the mountainous terrain and wide spans of wooded land, Montana officials have adopted radio for effective state coverage. Although the systems cost many thousands of dollars, the investments have been more than worthwhile. Millions of dollars of damage to crops, timber, homes and general acreage have been avoided thanks to radio. Radio and Montana are inseparable pals today.

A NEW SERIES OF COURSES, under the Engineering, Science and Management War Training Program, is now under way in the colleges of New York City. These courses, which cover a variety of subjects including ultra-high frequency studies, are offered tuition free to those who upon completion of the courses will enter war effort employment or the Armed Forces.

A very complete training program of radio is being given at Brooklyn Polytechnic Institute. The courses here cover... Introduction to Microwave Theory; Introductory Experiments in Microwaves; Theory of Cathode-Ray Circuits; Experiments in Cathode-Ray Circuits; Experiments in Ultra-High Frequency Generators and Receivers; Measurements at Ultra-High Frequencies, and Advanced Theory of Ultra Short Electromagnetic Waves.

These courses cover from nine to twelve weeks and usually cover one evening per week, two hours per evening.

A PLEA TO INDIVIDUALS FOR QUARTZ CRYSTALS has been issued by the WPB. Individual crystals weighing at least one-half pound, an inch thick and three inches long, clear and colorless on the inside, are needed. Although light smoky quartz can be used, milky quartz, rose quartz and purple or amethyst quartz are not required.

Anyone owning suitable quartz crystals should contact the Miscellaneous Minerals Division, War Production Board, temporary R Building, Washington, D. C. If you have samples of the quartz you would like to sell, send them on. Don't send clusters, groups or grainy masses. If you haven't any quartz crystals, but know of others who do, tell them of this need.

AN IN-ACTION DEMONSTRATION of military transmitters and receivers, to illustrate conditions that demand such rugged construction was recently viewed by the employees of some plants. And when they watched a seventy-five millimeter gun fire, with the breach recoiling to within a few inches of the radio equipment, it didn't take much imagination to tell them that that piece of communication equipment had to really take it or else. Demonstrations of other mobile equipment further demonstrated the need for an unheard of degree of ruggedness in construction that must be a part of every communication unit produced. These radios must be tough. They must take it and take it, and come back for more.

PERSONALS . . .

One of the most colorful personalities in radio died recently. He was **CAPTAIN WILLIAM SPARKS**, president of the Sparks-Withington Company. Captain Sparks was a pioneer in the development of automotive radio. . . . The radio industry also

LETHAL WEAPON

IN THE WAR ON U-BOATS



THE NEW SCIENCE OF ELECTRONICS has profoundly changed the art of war. On land, in the air, above and below the surface of the sea, our forces fight today with electronic weapons of incredible power, speed, precision. It is satisfying to the men of Radio to know that these weapons have proved so successful on every battlefield where our boys, planes, tanks and ships have come to grips with the enemy.

The revelations concerning RADAR and its part in the war came as no surprise to those whose job is to supply our fighting forces with modern electronic equipment. Since before Pearl Harbor these Americans have been working shoulder to shoulder with our armed forces in applying the power of electronics to the art of war. Out of this united effort have come fighting weapons never before known—on land, at sea or in the air. In

this pioneering work it has been National Union's privilege to play a progressively increasing part. A greater National Union has been built to cope with vastly larger responsibilities in the coming "Age of Electronics". To service engineers this is assurance of even greater cooperation—more complete merchandising help—than ever before. National Union with its unequalled record of assistance to servicemen, can and will see to *that!*

NATIONAL UNION RADIO CORPORATION • NEWARK, N. J. • LANSDALE, PA.

NATIONAL UNION RADIO AND ELECTRONIC TUBES

Transmitting Tubes, Cathode Ray Tubes, Receiving Tubes, Special Purpose Tubes, Condensers,
Volume Controls, Photo Electric Cells, Exciter Lamps, Panel Lamps, Flashlight Bulbs

mourned the loss of **GEO. E. DEMING**, vice-president and secretary of Philco, and **WARREN BOOKWALTER**, Signal Corps Engineer at Squire Laboratory. . . . **C. H. THOR-DARSON**, who founded the company named after him nearly a half-century ago, resigned as president of that company recently. **R. E. ONSTAD** became president and general manager. Mr. Thordarson will be company consultant. . . . To the Airborne Instruments Laboratory of Columbia University in New York has gone **ARTHUR G. PECK**, former studio engineer for CBS and WCCO, Minneapolis-St. Paul. . . . The General Electric receiver engineering section at Bridgeport, Connecticut now has a twenty-one year old woman engineer. She is **MAR-**

GARET ALLEN who joined General Electric last year as a student in a special training program. . . . The son of **D. J. O'CONNOR**, president and co-founder of Formica Insulation Company, has been appointed assistant chief-engineer of that company. . . . **JOHN BALLANTYNE** has been elected president of Philco. **JAMES T. BUKLEY**, former president, was elected chairman of the executive committee. . . . **S. N. SHURE**, general manager of Shure Brothers, was recently honored at a special dinner commemorating the recent Army-Navy "E" Production Award, by the Association of Electronic Parts and Equipment Manufacturers (formerly known as the Sales Managers Club, Western group). . . . **GEORGE**

WASHINGTON PIERCE, whose Pierce oscillator circuit has become a standard of use in communications systems, was recently awarded the Franklin medal at the Franklin Institute in Philadelphia. Professor Pierce is also the author of such books as *Principles of Wireless Telegraphy* and *Electric Oscillations and Electric Waves*. . . . **REAR ADMIRAL STANFORD CALDWELL HOOPER**, U.S.N. (ret.), has become a technical consultant to Automatic Electric. . . .

Mr. **DUDLEY E. FOSTER** has been named Vice-President in charge of Engineering and Mr. **ARTHUR W. FREESE** named Vice-President in charge of production of the Majestic Radio & Television Corporation, it was announced today by Mr. E. A. Tracey, President and General Manager of the Corporation.

-30-

Some Things are REALLY Scarce Right Now*



*(Especially Radio Servicemen's Time)

THERE are no substitutes for some things that are scarce today. There are no "ersatz" servicemen to take the places of those called to the colors.

But, there are just as many, and more, sets needing repair. And you, brother 3A or 4F, have to see that they're repaired.

Today it's your patriotic duty to ration your time; use it so you get the utmost production out of each unit of labor.

Use your testing instruments—employ the latest servicing techniques—and reach for one of your thirteen RIDER MANUALS before you begin each job. These volumes lead you quickly to the cause of failure; provide the facts that speed repairs.

It isn't practical or patriotic to waste time playing around, guessing-out defects. Today you must work with system and certainty. RIDER MANUALS provide you with both.

RIDER MANUALS

- Volumes XIII to VII \$11.00 each
- Volumes VI to III 8.25 each
- Volumes I to V, Abridged \$12.50
- Automatic Record Changers and Recorders . 6.00

OTHER RIDER BOOKS YOU NEED

- The Cathode Ray Tube at Work
Accepted authority on subject \$3.00
- Frequency Modulation
Gives principles of FM radio 1.50
- Servicing by Signal Tracing
Basic method of radio servicing 3.00
- The Meter at Work
An elementary text on meters 1.50
- The Oscillator at Work
How to use, test and repair 2.00
- Vacuum Tube Voltmeters
Both theory and practice 2.00
- Automatic Frequency Control Systems
—also automatic tuning systems 1.25
- A-C Calculation Charts
Two to five times as fast as slide rule.
More fool-proof. 160 pp. 2 colors 7.50
- Hour-A-Day-With-Rider Series—
On "Alternating Currents in Radio Receivers"
—On "Resonance & Alignment"—On "Auto-
matic Volume Control"—On "D-C Voltage
Distribution" 90c each

JOHN F. RIDER PUBLISHER, INC.

404 Fourth Avenue • New York City

Export Division:
Rocke-International Electric Corp.
100 Varick Street, New York City
Cable: ARLAB

Lifeboat Transmitter
(Continued from page 36)

connects the generator output to the primary of the transformer and the automatic S O S keying cam contacts to the keying circuit. Either hand keying, by means of a telegraph key mounted on the transmitter unit, or automatic transmission of the international distress signal S O S may be selected by means of a switch on the panel. The secondary of the transformer has two windings, one which supplies the filament voltage for the three tubes and another tapped winding for the high potential of both oscillator and amplifier tubes.

The master oscillator circuit is tuned to 500 kilocycles, the output of which is fed to the two amplifier tubes through a coupling condenser. Each plate of the amplifier is connected through a condenser to the tank circuit that is inductively coupled to the antenna loading coil, which is fitted with the variometer and plug tapping arrangement. The only adjustments necessary after the ground and antenna connections are made to tune the antenna to resonance, is to place the tap connection plug into the proper tap and adjust the antenna variometer until the neon glow indicator lights to its greatest brilliance.

Provided in the transmitter box is a mica condenser to be used as an artificial antenna for testing the equipment during periodic tests, as may be required. The leads from this condenser are connected to the antenna and ground terminals of the transmitter and the set tuned to resonance as previously explained when it is desired to test the unit without erecting the antenna system.

The generator unit is also furnished in another form, mounted on a tripod stand fitted with a seat, in order that the generator unit may be operated by foot power. This arrangement is used by the land forces of the Allied nations.

-30-

RIDER MANUALS ★ ★ ★
SPEED REPAIRS — AND VICTORY ★ ★ ★

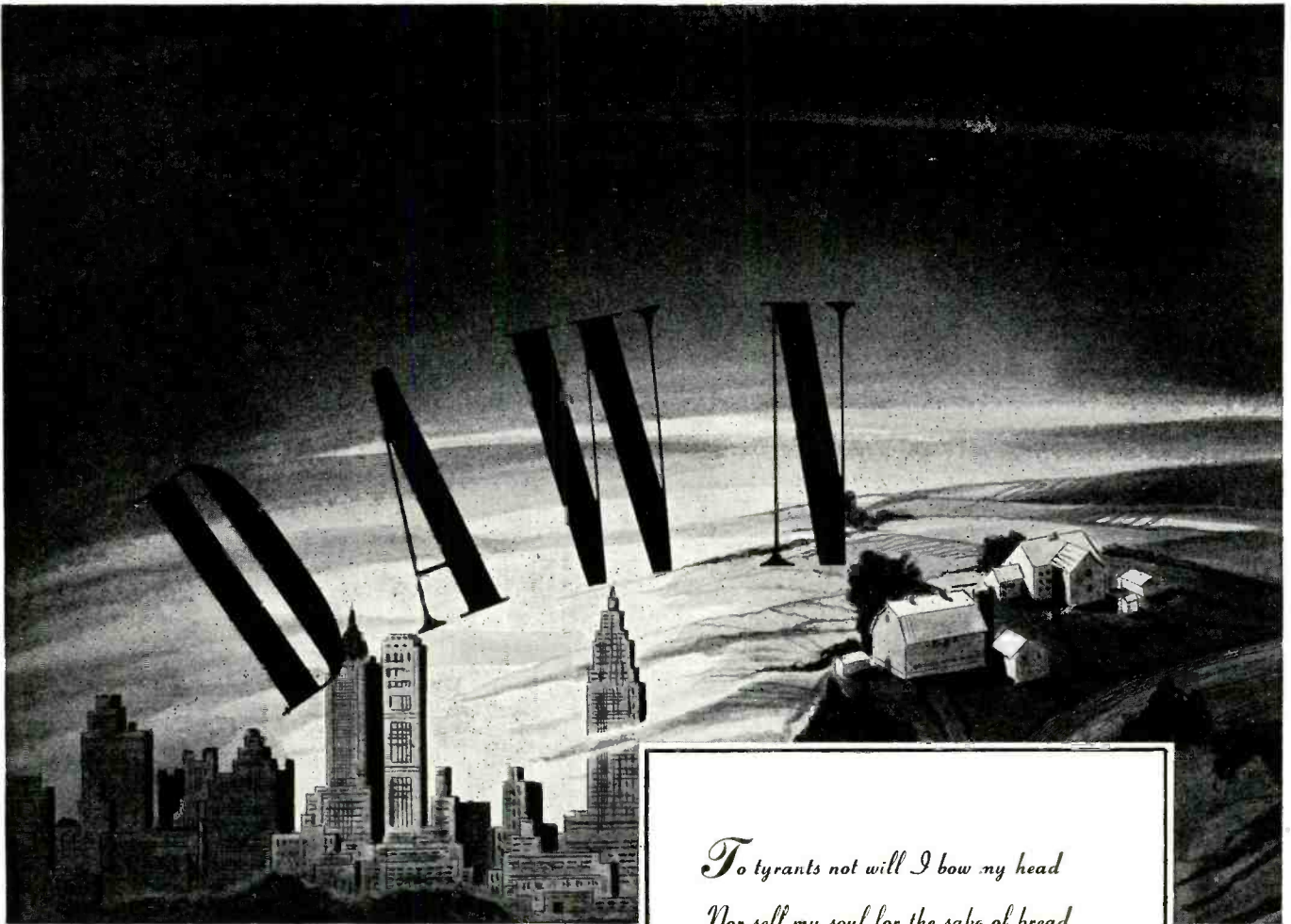

*To tyrants not will I bow my head
Nor sell my soul for the sake of bread
Willingly I bear sacrifice and pain
Willingly I serve in democracy's name
Until my debt to humanity has been paid
Will I face the dawn unafraid*

From the Atlantic to the Pacific;
from the great cities to the tiny ham-
lets; from the mighty and the hum-

ble—come tangible evidences of America's payment
to humanity. Giving of our sons and our resources
and our dollars . . . to free the world from dictators
and tyrants. We of Kenyon know that building a
better transformer is but a small accomplishment

when you consider the whole of the war effort. How-
ever, that is our part, and we're giving it our best . . .
and when the dawn of peace-day breaks, we'll be tre-
mendously thankful that we did. Come on—every-
body—faster, better—better, faster!



THE MARK OF

EXCELLENCE

KENYON TRANSFORMER CO., Inc. 840 BARRY STREET
NEW YORK, U. S. A.

YOUR PINT OF BLOOD CAN SAVE A SOLDIER'S LIFE... VISIT YOUR LOCAL RED CROSS BLOOD BANK TODAY!

July, 1943

51

Photoelectric Phenomena

(Continued from page 29)

which is a good secondary emitter. A tube of this kind is shown in Fig. 18. With this arrangement the amount of vacuum tube amplification is lessened to a very great extent. This improves the noise to signal ratio at the output of the entire circuit.

One of the most important uses of photoelectric cells is in the sound reproduction in motion pictures. The sound is recorded on a very small strip at the side of the motion picture film by two different methods: (1) the variable density method in which the density in this area varies as the sound varies and (2) the variable area method in which the area occupied by a region of constant density is varied. The source of light which passes through this film is usually a tungsten filament lamp. A vacuum photocell or a gas photocell with a properly corrected amplifier is used.

A most interesting device and one which will find great uses after the war is the iconoscope developed by V. K. Zworykin of RCA. This is the most practical television pickup method developed to date. The apparatus for televising the object looks at individual points on the object at different intervals of time and the impulse received from each point is

transmitted separately. A good television picture is represented by 240 lines of "looks" at the object making up the vertical axis of the picture. The frequency of the signal required to produce a picture 3 x 4 inches having 240 lines must be 768,000 cycles when the picture is repeated 20 times per second. In order to form one picture the device has to look at the object in 76,000 places. If the device looks at the object 24 times per second and it must look at the object at least 20 times per second to keep the picture from flickering, the time the photocell has to collect light for each transmission is only $1/1,824,000$ th of a second. A camera having a f4.5 lens will have a total light flux of .1 of a lumen falling on the photographic plate for a bright outdoor picture. If a photoelectric cell of 10 microamperes per lumen sensitivity is used with this lens, a current of 1.3×10^{-11} amperes would flow for each picture element. The total charge flowing for each element will be the current times the time it flows and will be $.7 \times 10^{-17}$ coulombs. The charge on one electron is 1.59×10^{19} coulombs so only about 44 electrons will flow during each picture element. The amplification of such currents is practically impossible. In order to avoid this limitation of the ordinary photoelectric cell as a television, the iconoscope uses a mosaic of miniature photoelectric cells. These individual photoelectric cells are mi-

nute cesium-oxide coated silver particles deposited on a mica sheet on a metal base. Each individual particle and the metal plate form a minute condenser which, when the mosaic is placed in a vacuum and a common anode in the form of a silvered portion of the glass envelop is used, are charged up by the photoelectric effect when they are connected as shown in Fig. 19.

In Fig. 20 is shown a schematic diagram of the iconoscope. Its action can be seen by referring to Fig. 19. The light falling on the individual mosaic elements causes the condenser *c* to charge. The electron scanning beam then comes along and discharges the condenser through the resistance *R* since the cathode has acquired a positive charge due to its loss of electrons under the action of the light. All of the accumulated effect of light over a period of time is suddenly set loose by the scanning beam causing a signal to appear on resistance *R*. If the image is scanned 24 times a second, that means that each element has $1/24$ th of a second to collect instead of the $1/1,824,000$ th of a second as before. This represents a gain of 76,000 times in signal strength if the iconoscope was 100% efficient. With only 10% efficiency it still represents a gain of 7,600 times. The present iconoscope has about a 10% efficiency. This is ample for televising outdoor subjects.

-50-

FADA Radio

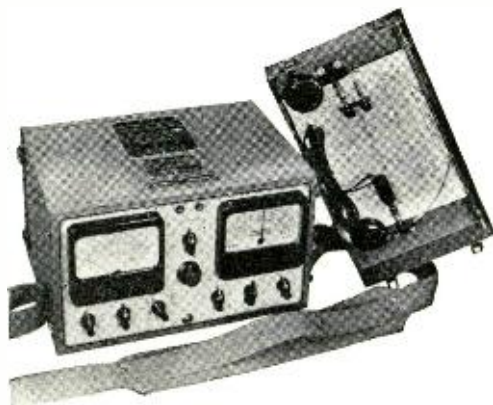

Electronic Field Intensity and Radio Noise Meter

"Breathes there a man with ears so deaf" is probably most amateurish paraphrasing of Edward Everett Hale's immortal "Man Without A Country." But translate it into a query about noise interference in radio reception and there is no question at all but that every adult is only too familiar with its devastating effects in home radio reception. Multiply home interference problems to the "nth" degree they attain in military and naval aircraft, tanks, jeeps, ships and it is obvious that radio noise is a vitally serious matter.

FADA is justifiably proud that our government has had recourse to its engineering and production skill to produce an instrument capable of directly measuring the intensity radio noise and the field intensity of transmitting stations. Less than one half cubic foot in size, complete with self-contained 50-hour-life dry batteries, it may be carried about by one man by means of its shoulder/chest strap in such position that, with its 2-meter whip antenna extended, the absolute intensity of noise ranging from 10 to 100,000 microvolts may be measured and its sources individually localized. All this — and much more — may be done anywhere between 150 and 18,000 kcs. with this versatile FADA instrument.

It is illustrated and described not as a vague generalization, but as a real, tangible example of the new equipment you will get from FADA when the war is over — one of a multitude of instruments FADA is today building for many departments of our government . . . examples which indicate concretely that FADA will be the source of startlingly changed . . . simplified . . . improved radio/electronics . . . for you . . . post war.

FADA RADIO AND ELECTRIC COMPANY, INC.
LONG ISLAND CITY, N.Y.

1920 SINCE BROADCASTING BEGAN 1943

The SPRAGUE TRADING POST

EXCHANGE — BUY — SELL

Your own ad run FREE!

The "Trading Post" is Sprague's way of helping radio servicemen obtain the parts and equipment they need, or dispose of the things they do not need during this period of wartime shortages. Send in your own ad today—to appear free of charge in this or one of several other leading radio magazines on our list. Keep it short—WRITE CLEARLY—and confine it to radio items. "Emergency" ads will receive first attention. Address it to:

SPRAGUE PRODUCTS CO., Dept. RN37
North Adams, Mass.

TRADE OR SELL—Superior Channel Analyzer, slightly used; Superior Signal Generator 1230, new; Superior model 1220 volt-ohm-milliammeter a.c.-d.c. volts, 5000 ohms resistance per volt; set of Rider's blue manuals with index book, 1 to 6, good condition. Want good, used combination recording, automatic play-back with built-in amplifier, speaker and crystal mike. A. W. Sullivan, 222 John St., Fall River, Mass.

FOR SALE—DeForest radio course; speakers for 6-, 2-, and 110-volt sets, good condition; also used parts from many sets; turn-table with Green Flyer motor, like new. J. J. Kadletz Radio Shop, Box 398, Chatfield, Minn.

WANTED—Second-hand tube tester. State price, condition and make. Cornelius R. Price, 20 Klein Ave., Trenton, N. J.

NEEDED IMMEDIATELY—All types of test equipment, in good condition, for cash. Will sell or trade precision 5840 K.C. crystals; also 12SA7, 12SQ7, 35L6, 80 Tubes. L. C. Woodard, Signal Section, 328th Sub-Depot, Ft. Sumner, N. M.

TRADE OR SELL—803 and socket (20 hours) guaranteed perfect; Eimac 50 mfd. vacuum condenser. Want 2" or 3" scope and commercial VTVM. R. W. DuBose, R.R. 2, Brownsville, Texas.

WILL SWAP—Power-rack generator 110 V. AC, 100 AMPS, for two 3½ ft. trumpet type speakers. Gibbs Electric Service, Box 616, Mellen, Wisconsin.

WANTED FOR CASH—RCA-Rider Junior Voltohmyst, Model 163; or Hickok, model 202 electronic vacuum tube voltmeter, or similar instrument. If wanted, will swap in partial payment, a model 39-A Marlin .22 lever action rifle with Lyman peep sights. Bradford Radio Service, 88-17 Whitney Ave., Elmhurst, L. I., N. Y.

CASH FOR—12- to 20-watt portable sound system complete, or amplifier with cases to house same, together with two speakers. May be less speakers. Also need Superior channel analyzer, AC meters, multi-meters, signal generators (AC only);

pocket testers AC-DC; analyzers, etc. Write complete description, ranges covered, age, condition and lowest price. Grey's Radio & Sound Systems, Inc., Bridgewater, Conn.

R-F SIGNAL GENERATOR WANTED—Describe fully, giving frequencies covered, and price. John Kara, 673 Cortland St., Perth Amboy, N. J.

WANTED—0005 mfd. var. cond., will trade for 370 mmfd. var. cond.; also will trade 365 mmfd. var. cond. for ½ lb. spool of No. 22 O.C.C. wire; and aerial insulator, 4-6 prong tube bottoms; 1—4 prong tube socket and crystal detector for 20 ohm rheostat. Gaudio Imbruglia, 8 Upland Rd., Brookline, Mass.

FOR IMMEDIATE SALE—Amplifier rack with 2 input, 4 channel 10-watt units, 4 output 30-watt units, total 120 watts with output meter; 2 speed turntable. Trutan pickup; 4 Cinaudagraph HWA units with SW horns; 1 University PAH unit with Lh horn, all with line trans.; 2 model 55B Shure Unidynes; 1 RCA 50-A inductor mikes with stands; 1 Brush B1 hand mike; 3 shielded low imp. line to grid trans.; 5—100 ft. lengths mike cable with Amphenol connectors; 6 Oxford 12" dynamics with horns; 2—12" PMs with steel horns; 1 RFO-4 Hickok Oscillograph. All like new. Best offer takes all. John's Radio Shop, 32 Maple St., Perry, Ohio.

WANTED—Meissner Signal Shifter, new or in excellent condition. State condition and price. R. G. Soule, Jr., Franklin St., Fayetteville, N. Y.

WILL SELL OR TRADE—No. 1230 Superior signal generator—\$7.50; 1—DF (test all tubes) tube tester—\$15; 1—"333" Supreme Volt-ohm-meter—\$12; Vol. 7 Gernsback's Service Manual—\$8.50; several Hi-V transformers, 4½ mfd. oil-filled cond. at 3000 V.—\$4.50. All new or like new. Need—Rider's Manual No. 8; Rider's Chanalyst; 22 cal. rifle; 5 ampere battery charger, one battery size, or 6 battery size. John O. Robert's Radio Service, St. Louis, Michigan.

URGENTLY NEEDED—Volt-ohm-meter and tube tester, also parts. Cash promptly. Sgt. Lawrence A. Steinberg, 316 East 15th St., Sioux Falls, So. Dak.

WILL BUY FOR CASH—RCA Junior Voltomyst or Hickok Model 210-S; also RCA model 156-B or 156-C, or Hickok mutual conductance tube tester or similar equipment. State model, condition and price. Horace H. Koepke, Box No. 267, Junction City, Kansas.

CASH RIGHT AWAY—For any good voltmeter, ohmmeter, tube-tester, signal generator, and all types of unused tubes. Send list of what you have and price. Jack Hunt, RFD, Box 134, Riverside Ave., Riverside, Conn.

WILL TRADE—15 Vols. Blackstone's Modern American Law for all-wave oscillator, modern set analyzer, battery transmitter, correspondence course, boat motor, or tent. C. M. Hamilton, Springbrook, Wis.

WANTED—Volt-ohmmeter, output meter, modern tube-tester, capacitor analyzer. Theodore Lohr, 140-28—247th St., Rosedale, L. I., N. Y.

FOR SALE—1 Philco signal generator and 1 Weston analyzer, style 660, both for \$50. Smith Music Shoppe, 16 East North St., Danville, Ill.

SIGNAL GENERATOR WANTED—InA-1 condition; also, will pay list price for following radio tubes: 80-5Y3, 12SA7, 12SK7, 50L6, 35Z5 and 6SA7. R. McDonald, 506 N. Ward St., Benton, Ill.

FOR SALE—Hickok tube-tester, 530P—\$55; Hickok Sig. Gen. 177X—\$60; Meissner Sig. Tracer, 9-1040—\$75; Supreme multimeter, 592-593—\$75; Cornell cond. checker,

BF50—\$25; Aerovoc LC checker No. 95—\$25; Rider's Manuals 1-10—\$75; Clough-Brengle subst. speaker—\$15; latest models, all practically new. Sent express collect. O. Marder, 1694 Selwyn Ave., Bronx, New York.

WANTED—Volt-ohm-milliammeter and signal generator. Urgently needed. M. G. Dozier, 1208 College Avenue, Tifton, Georgia.

WILL SELL OR SWAP—1 Pre-amp 4 mike inputs, 3" meter, 500 ohms or high imp.; 1 Sky Buddy; 1 Astatic tt-30-TT mike, 25 ft. cable; 1 pair Brush crystal phones; 1 Tranceiver handset, 200 ohms mike, 2000 ohms earphone; 1 B battery eliminator; 1—6" and 1—8" speaker in Bud metal cases; 60 new tubes in factory sealed cartons; many condensers; 400 carbon resistors, etc. Would like tube tester or Rider's Manuals. Quality Radio Service, N. 1523 Cook, Spokane, Wash.

WANTED—A late model 3" or 5" Hickok, RCA or Du Mont oscilloscope; also a 1941-42 Model 912-P Precision portable tube-tester 4½" meter; and a Model CE Solar examiner A Triplet model 1672 vibrator tester. Paul Capito, 637 W. 21st St., Erie, Pa.

HERE'S THE PATRIOTIC WAY TO REPLACE A DEFECTIVE CONDENSER SECTION



When you find one bad section in a multi-section dry electrolytic condenser, don't replace the entire unit! Most defective sections can be replaced by using a Sprague Atom of the proper capacity and voltage, as illustrated here. The Atom can either be fastened by tape to the multi-section unit, or simply held in place by means of its sturdy wire leads. You'll save time and money—and you help conserve essential war materials as well!

Atoms are made in a complete line of capacities and voltages, as well as in many combinations.

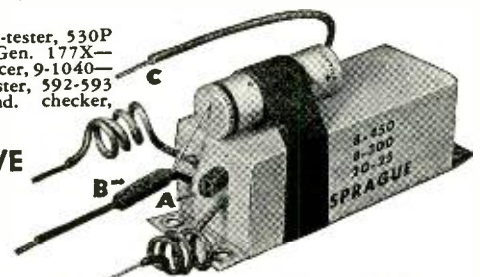

Illustrating how a Sprague Atom Type UT-8 (8 mfd. 450 volt) replaces the 8 mfd. 450-volt section of a 3-section condenser rated at 8 mfd. 450 V.: 8 mfd. 300 V., and 20 mfd. 25V.:

- (A) Cut lead to defective section and tape end.
- (B) Connect cut circuit lead to positive (+) side of Atom.
- (C) Connect Cathode (-) side of Atom to common minus lead of multi-section condenser.

SPRAGUE
PRODUCTS CO.

North Adams, Mass.

SPRAGUE CONDENSERS AND KOOLOHM RESISTORS

Obviously, Sprague cannot assume any responsibility for, or guarantee goods, etc. which might be sold or exchanged through above classified advertisements.

QRD? de Gy
(Continued from page 37)

you are going to be more necessary after the war is over. He quotes Mr. D. Steward Iglehart, Grace Line President, who states: "It is certain that all our ships, all the British and United Nations' ships, and even the surviving ships of the enemy nations, will be needed long after peace in the task of repairing damage and restoring world commerce."

WE have often joined the Radio Officers' Union in many of their controversies anent the Radiops and

we again agree with them that merchant seamen should not man any guns but let the Navy take care of this detail. As Brother Mac says, it isn't that the merchant seaman couldn't man the guns as ably and fight as well as the Navy crews, but what would be their status as a civilian if they went into action. It is always considered by belligerents that civilians who handle fire arms are considered as guerillas if captured. Life for Radiops is tough enough without asking for more trouble. On one hand the NMU et al fights any suggestion to put their members in uniforms yet they want their members to take over the duties of the armed guard which certainly would place them in uniform. This inconsistency is remarkable on the face of

it. We hope that those in the know will handle this matter with due regard for any behind-the-scenes reasons for the NMU's demands.

A RECENT complaint by the guy who feels that the Auto Alarm should either be made fool proof or replaced by a couple of extra Radiops. He says he left an East Coast port and the alarm went haywire. It was reported to the proper authorities and representatives of the Radio Service Company came on board and fixed it. But it still wouldn't work properly. Further on it was reported again out of order but somebody said that it was O.K. but that the radio officer did not know how to use it. Another inspector came to the ship and found it was not O.K. This inspector knew his stuff and he fixed it but in less than two days it was out of order again. The British solved the Auto Alarm problem by placing three radio officers on all their merchants vessels.

RADIO Officers' Union states that in addition to the 44 members who have lost their lives as a result of enemy action, 102 men have had their ships torpedoed from under them and have lived to tell the story. Some of these men spent many days in a life boat and one was on a raft for 29 days. Brother D. M. Daley is enjoying a well earned vacation in New Orleans. He has been torpedoed twice but they don't seem to bother him much. As soon as he is paid off from one sinking he is ready to take another ship out. He has already been assigned to another vessel and we trust that this time he will be able to bring the ship back as well as take it out. Brother W. Adrian Hanks reports that he has been safely repatriated after his torpedoing in the North Atlantic a few months ago. Brother B. R. Pinz, who spent 8 days in a life boat after seeing his ship go down, is now an officer in the Navy. Ben received an Ensign's rating and we all extend our heartiest congratulations. Incidentally, we understand that he can take 72 words per minute which is known as "speed." Brother Arnold I. Johnson, who took to the briny when his ship was smacked in the South Atlantic, is back on duty again. He is an old timer who rode them in World War I, and afterwards, and his courage is of the highest. We hope he has better luck this time.

AS you can see our President Roosevelt's admonishment "damn the torpedoes, full speed ahead" is being carried out to the fullest by our Radiops who are the unsung heroes of this shindig. Our hat's off to these men who are making it possible for our fighting forces to get their equipment and supplies on schedule. When the full story of this war is told, after Victory is ours, credit will, and must, be given to them for their part in bringing this Victory to our Country. And with best 73, cheerio, de..... GY

AUDIOGRAPH
THE FIRST NAME IN SOUND

Natural
PROJECTION
OF SOUND

In homes, in factories, offices, stores and wherever else there are ears to hear, Audiograph will play an increasingly important part when we can turn wartime lessons into the channels of peacetime living. Audiograph Sound Equipment is a senior member of our Family of Activities in the Field of Electronics. It will serve you well.

JOHN MECK INDUSTRIES
PLYMOUTH, INDIANA



"TELL 'EM WE COULDN'T DO WITHOUT THE PARTS THEY'RE GIVING UP"

"Yeab, the folks back home are helping us plenty by giving up those radio and communication parts. See—over those hills! There's a bridge there. We just bombed hell out of it—cutting off an enemy tank column. With inadequate commuāications, we couldn't have done it!"

COMMUNICATIONS are vital in this war of rapid movement—where success demands "co-ordination" of widely dispersed units.

When a swift PT boat gets its radio orders to torpedo an enemy transport . . . when a bomber drops its eggs over a submarine base . . . when an allied tank column, keeping in contact by radio, speeds over Sahara's sands . . .

Utah Parts are playing their role in this war of communications.

Soldiers of production build dependability into those parts at the Utah factory. Utah engineers plan it in the laboratories . . . as they pore over blueprints far into the night.

Constantly, research is going on at Utah . . . new and better methods of production are being developed . . . to help keep the ears of the armed forces open. Tomorrow—when peace comes—this research and experience will be reflected in the many civilian products being planned at the Utah Laboratories. Utah Radio Products Company, 824 Orleans Street, Chicago, Ill. Canadian Office: 560 King Street West, Toronto. In Argentine: UCOA Radio Products Co., SRL, Buenos Aires. Cable Address: UTARADIO, Chicago.



PARTS FOR RADIO, ELECTRICAL AND ELECTRONIC DEVICES, INCLUDING SPEAKERS, TRANSFORMERS, VIBRATORS, UTAH-CARTER PARTS, ELECTRIC MOTORS

Tube Collector
(Continued from page 40)

the Mexican War and the collector who today possesses one is the envy of his fellows. Yet the writer, being of an academic turning of mind, had been able in his own collection to acquire four (4) examples of this arm, each different in significant but minor details of manufacture. He is familiar with a fifth and sixth variation wherein apparently left over parts from the original run were used up in combination with parts of a later model with the result today that they represent extraordinarily rare 'bastard' pieces.

"Turning to the field of vacuum tubes, the basic types UX-199, UV-200, and UV-201-A, were made by a multiplicity of manufacturers. The less-ambitious tube collector might therefore satisfy himself in a basic simple collection with but one 201-A type, for example. The more ambitious collector might add a few of the variations upon this type in terms of the essentially equivalent tubes produced by RCA and Cunningham. The still more ambitious collector might seek as many possible variations of the same basic type such as were produced by a multiplicity of different manufacturers.

"This latter collector could go on almost indefinitely, for it is believed that

there is today no clean-cut record of the number of manufacturers producing tubes of the basic 201-A type. Only the other day, the writer came across, to him, an utterly new and unknown 201-A.

"This almost infinite variety of single types of vacuum tubes is one of the attractive aspects of vacuum tube collecting to the serious collector. He may go on indefinitely without the fear of losing interest probable in other fields of collecting, since there is almost the certainty that no matter how far he may progress, there will still be types of vacuum tubes which he may look forward to obtaining in order to render his collection more complete.

"To answer the question 'What Do you Call a Type?' seems simple. A tube type is exactly that—a round Audion is one type; a round Ultra-Audion (double grid, double plate) is another type; deForest 50 watt Oscillation is still another. Carrying this thought on to simpler types, it would seem safe to say that any vacuum tube carrying a commercial number is a type. Developing the thought further, there will be upon certain types, such as cited 201-A, a multiplicity of variations. Thus 201-A, as produced by different manufacturers, are still 201-A's—one basic type, the different tubes produced under this same type number by the different manufacturers representing variations.

"It is believed that the thoughts expressed above indicate that the tube collector may most easily think of vacuum tubes, in terms of basic types as one group, and variations upon these types as another. If he confines his collection to basic types, he will still have a very sizable task in getting one example of every known vacuum tube together. If he expands his thinking to the point of seeking variations upon the basic types, he will find that his field of collecting has expanded simply tremendously. Rather than making his task more difficult, this very expansion makes it more interesting—particularly so as the collector can frequently solace himself by picking up economically a variation upon some less rare commercial type, while he is still hopefully seeking an example of the basic type such as a round Audion, a Fleming Valve, an Oscillation, an early deForest Singer Transmitting Tube.

"Lest the 'Tube Collector' feel that the writer is too presumptuous in advancing the above thoughts, it is respectfully stated that his collecting experience goes back over a period of some thirty years.

Cordially yours,
McMurdo Silver,
Executive Vice-President
Fada Radio & Electric Co."

We should like to hear from other active or potential tube collectors, in order to make final preparations regarding qualifications needed for membership in The Tube Collectors Club.

DEPENDABLE COILS!

Meissner coils have, for many years, been the accepted standard by servicemen who insist upon high quality performance . . . Meissner precision coil construction never varies . . . they are the best that engineering research and modern production methods can make.

When you specify a Meissner coil you have the assurance of long, trouble-free operating life . . . backed by a name that is synonymous with precision-built electronic products.

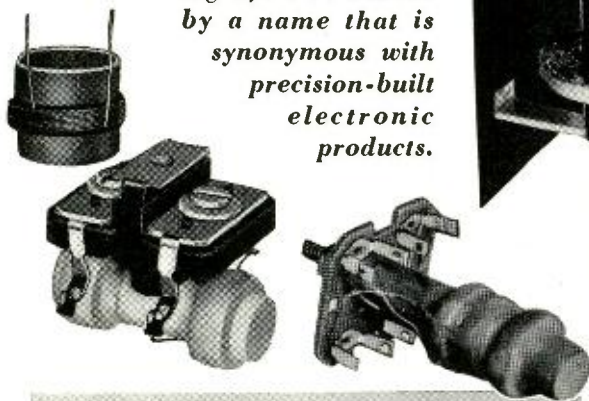

Meissner
MT. CARMEL, ILLINOIS

"PRECISION-BUILT ELECTRONIC PRODUCTS"



A COMPLETE LINE OF LOW-LOSS CONNECTORS FOR SOLID DIELECTRIC COAX AND TWINAX CABLES

(To Army and Navy Specifications)

EASY TO ASSEMBLE
Amphenol Low-Loss Connectors



1. Strip insulation as per diagram.
2. Unscrew coupling ring and slip over outer sheath of cable.
3. Insert conductor into hole in contact (B) and twist insulation into tapered threaded sleeve (C) until shielding passes solder holes (D) in sleeve.
4. Solder conductor to tip of contact, making sure no surplus solder extends beyond the diameter of the pin; (otherwise good contact with socket contact will not be made).
5. Solder shielding to connector by flowing solder into holes (D) after fluxing with non-corrosive flux.
6. Screw coupling ring in place.

UNIFIED ENGINEERING—Connectors and Cables

Approved by the Army and the Navy for use on standard coax and twinax cables... Water-proof, small in size, rugged... Easy to assemble anywhere with ordinary tools... Electrical discontinuity is sufficiently small to permit operation at ultra-high frequencies and constant characteristics are maintained... Cables are connected to the plug only—there is but one type of assembly operation for each size of cable.

Available now five types
for three cable sizes:

- Solid Dielectric Coax Cables—
410" O.D.—290" Dielectric
- Solid Dielectric Twinax Cable—
410" O.D.—290" Dielectric
- Solid Dielectric Twinax Cable—
630" O.D.—475" Dielectric

Write for information on these Cables and Connectors.



AMERICAN PHENOLIC CORPORATION • CHICAGO
IN CANADA—AMPHENOL LIMITED • TORONTO

THE COMPLETE LINE — ULTRA-HIGH FREQUENCY CONNECTORS AND CABLES

Saga of Vacuum Tube

(Continued from page 32)

The Fleming valve was purely and simply a rectifier or detector. In no way was it an intensifying device, it did not use a very high vacuum, as is the case in the modern valves of Langmuir and Meissner, and it was not a means of generating oscillations like these later valves.

Whilst Fleming must be credited as being the first to apply thermionic phenomena to wireless detection, the claim that he is alone the originator of the present-day thermionic valve is

rather exaggerated, since the intensifying properties of the present-day valves are far more important than its detecting properties—.”

Fleming applied for patents on the use of the valve as a detector of oscillations in wireless telegraphy, which patents were granted in Great Britain, Germany, and the United States.¹⁰⁶ Fleming believed that to get complete rectification it was necessary to have the best possible vacuum in the valve. In his United States patent application (See Figure 15) he stated:

“As a very high vacuum should be obtained in the bulb a, and as a considerable quantity of air is occluded

in the conductors, these should be heated when the bulb is being exhausted. The filament can be conveniently heated by passing a current through it, while the cylinder can be heated by surrounding the bulb with a resistance coil through which a current is passed, the whole being inclosed in a box lined with asbestos or the like.”

This insistence by Fleming on the obtaining of the highest vacuum possible, and the use of only one battery, the filament battery (See Figure 15), should be carefully noted by the student, for comparison with the work of de Forest on the Audion.

Figure 16 shows a group of Fleming valves of great historic importance, all of which are preserved in the Science Museum at South Kensington, England.¹⁰⁶ Those marked A, B, C, and D are the later types as actually used in the detection of wireless signals.

Immediately after these first experiments, Fleming had made by the Edison and Swan United Electric Company some new lamps in which the filament was of treated carbon, and of such a size that it would be brought to the operating temperature by a battery of 12 volts. These were of the types marked A, B, C, and D (Figure 16) and had a plate in the form of a sheet metal cylinder, surrounding but not touching the filament. This cylinder was fixed to a platinum wire sealed through the glass. The vacuum was pushed to the highest possible point and during the exhaust the filament and the glass bulb were heated in the manner described in Fleming's patent.

Fleming, on February 8, 1905, read to the Royal Society of London a paper¹⁰⁷ wherein he described experiments to determine the apparent conductivity of the vacuous space. In this paper he describes one of the valves used in this experiment as follows:

“A bulb containing a 12 volt carbon filament rendered brightly incandescent by a current of 2.7 to 3.7 amperes was employed. The filament was surrounded by an aluminum cylinder. The length of the carbon filament was 4.5 cm., its diameter 0.5 mm., and surface 70 sq. mm. The aluminum cylinder had a diameter of 2 cm., a height of 2 cm., and surface of 12.5 sq. cm. The filament was shaped like a horseshoe, the distance between the legs being 5 mm.”

In this paper Fleming described the use of a separate insulated battery for sending current across the vacuous space, the negative terminal of the battery being connected to the negative terminal of the filament. In this paper he gives data from which the curves shown in Figure 17 were plotted. He also describes experiments using an a.c. potential on the plate. He further showed how two valves might be used to rectify both halves of the oscillation in order to obtain greater output.

On March 23, 1906, Fleming pre-

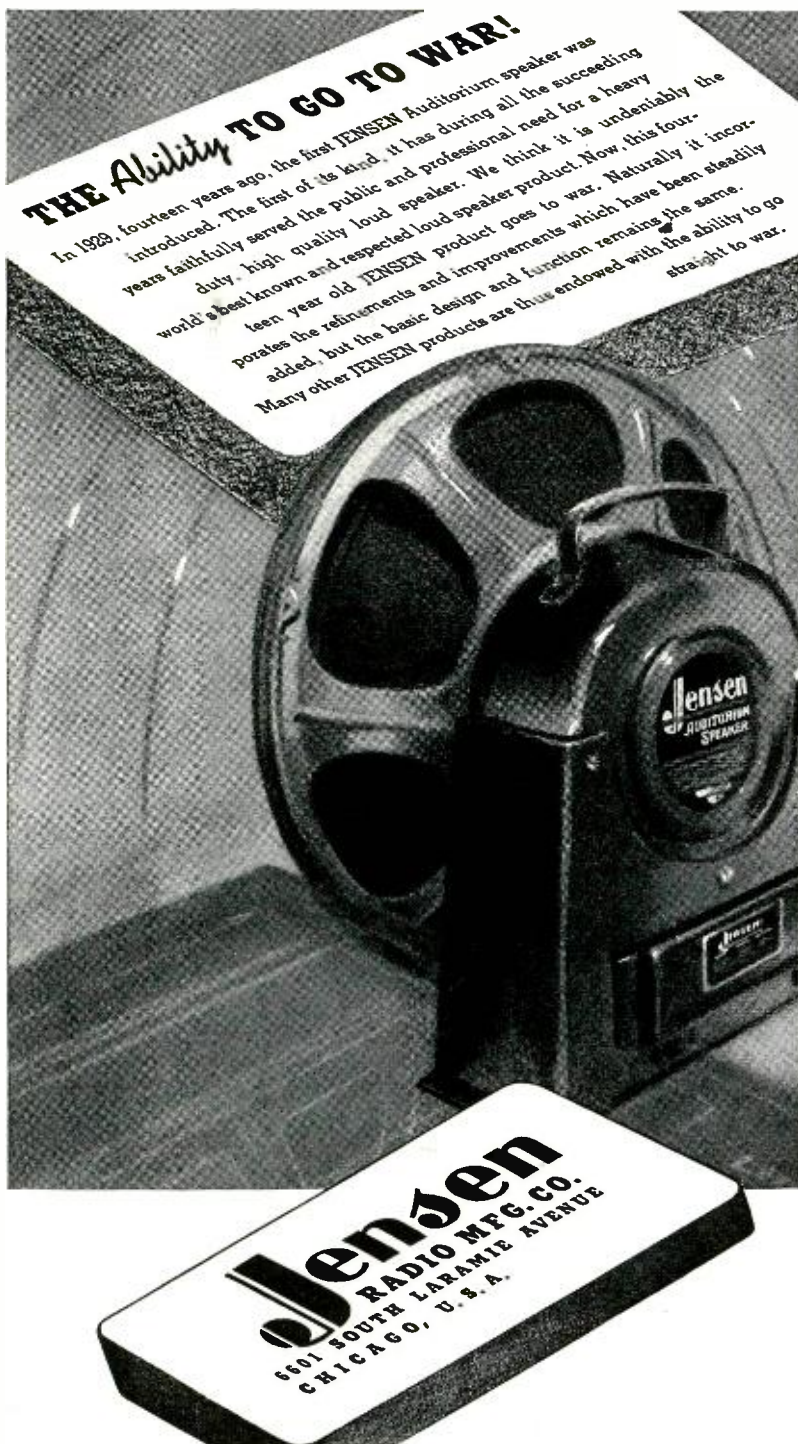



*Where Sustained
Power is Vital..*

Depend on

TAYLOR TUBES

Wherever our boys are fighting, Taylor Tubes are daily proving their reliability, efficiency and extra stamina. In many battle positions they operate twenty-four hours a day — providing the power to help keep essential communications going through — delivering the same dependable service that established and maintained Taylor's peacetime reputation for high quality tube performance.

Taylor factories are turning out more tubes than ever before — supplying them where needed for the all out Victory program. After V Day, the same quality Taylor Tubes that are meeting today's urgent demands will provide "More Watts Per Dollar" service for all.

√ TRANSMITTING √ ELECTRONIC
√ RECTIFIER √ INDUSTRIAL



Taylor

HEAVY

CUSTOM
BUILT

DUTY

Tubes

TAYLOR TUBES INC., 2312-1B WABANSIA AVE., CHICAGO, ILLINOIS

sented another paper,¹⁰⁸ this time before the Physical Society of London. In this paper he presented a number of experiments using his oscillation valves, and showed that they were usable to make quantitative determinations of high frequency oscillations.

On June 15, 1905, or shortly after presenting the Royal Society paper previously mentioned, Fleming sent to Marconi at Poldhu, Cornwall, five of his oscillation valves for trial in service.¹⁰⁹ Marconi at once began to use these valves, a photograph of one of the earliest types of which is shown in Figure 18. Many more of these valves were supplied in 1905 and 1906. In 1907

the British Marconi Company began to manufacture these valves for themselves. These valves were made for use in combination with a special form of receiving circuit in a complete receiver, known as a "Marconi-Fleming Valve" Receiver. This receiver is shown in Figure 19.

Fleming describes the valves first used commercially as follows:¹¹⁰

"The valves first supplied were made with carbon filaments and with sheet nickel cylinders or collecting plates, the filament being of such size that it required about 12 volts to bring it to an incandescence corresponding to 3.0 watts per candle. —It was, in fact soon found that for radio telegraphic

purposes a small four volt lamp made with a metal cylinder embracing, but not touching, the filament was as effective as a detector as a larger lamp, and required as a heating battery the use of only a couple of portable cells."

Because of the effects of nearby electrically charged bodies on the action of these valves, it was soon found necessary to shield them by means of a covering of copper gauze, which was grounded.

The practical pattern of the Fleming valve which then came into use is described as follows by Fleming:¹¹¹

"The enclosing glass vessel consists of a tube of glass about 1 inch in diameter and 3.5 to 4 inches long. This was equipped at one end with a stem carrying a horseshoe filament of carbon, or later of tungsten wire. The filament was of such a length as to be brightly incandescent at some voltage between 10 and 12 volts. This cylinder is surrounded by a cylinder of copper or nickel sheet attached to a platinum wire sealed through the glass. In a type of valve once used by the Marconi Company, the collecting plate is a single flat plate of copper about 1 cm. square, held near to the carbon or tungsten loop which forms the filament of the valve with the flat surface of the collecting plate parallel to and a few millimeters from the plane of the horseshoe filament loop. The lamp is finished off with the usual bayonet or bottom contact pins so as to work in a standard electric lamp socket.

Figure 20, reproduced from Fleming's book, shows drawings of these valves. This is the first indication of the use of flat plates, or flat anodes, in Fleming valves. Figures 21 and 22 show two commercial valves of the cylindrical anode construction.

Later, in Marconi wireless telegraph receivers, other constructions of Fleming valves, with various types of trapezoidal plates were used. Some of these valves are shown in Figures 23, 24, 25, 26, and 27. Other types using cylindrical anodes were also used, as in Figure 26. Some of those with the trapezoidal plates had spring tension devices to maintain the filaments, which were of inverted "V" shape, type.

CAPTIONS FOR ILLUSTRATIONS

Figure 15. Fleming's United States Patent for the Utilization of the Edison Effect Lamp as a Rectifier of High Frequency Oscillations in Wireless Telegraphy.

Figure 16. Group of Fleming Valves Preserved in the Science Museum at South Kensington, England. Photograph Copyright by H. M. Stationery Office.

Figure 17. Characteristic Curves of Fleming Valves. Reproduced from Proc. Roy. Soc. London.

Figure 18. Early Type of Fleming Valve Using Cylindrical Plate. Photograph Courtesy R. McV. Weston.

Figure 19. Marconi-Fleming Valve Receiver. Two valves are used, with

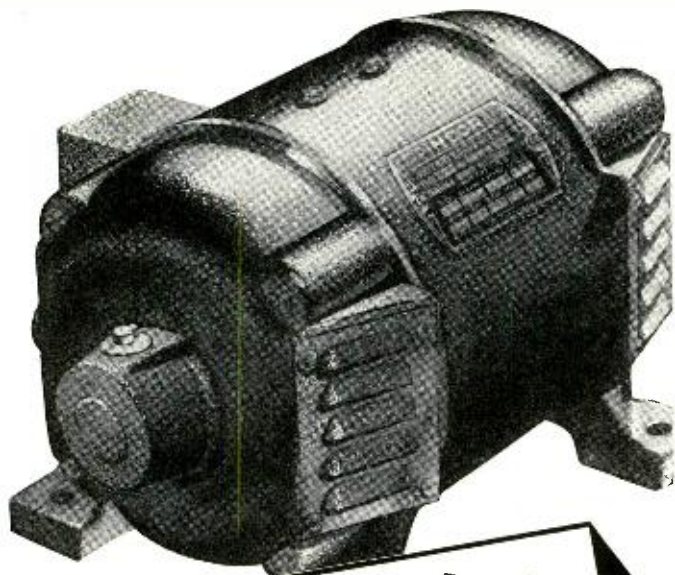

Keep 'Em Running FOR THE DURATION!

It is difficult to secure new Generating Sets or new Rotary Converters... Pioneer is devoting all of its resources toward winning the war... but we can, and will, help you keep your present equipment running for the duration.

Send your service problems, by letter, to Pioneer's Customer Service Department.

DYNAMOTORS • CONVERTERS • GENERATORS • DC MOTORS • POWER PLANTS • GEN-E-MOTORS

PINCOR Products

PIONEER GEN-E-MOTOR

CHICAGO, ILL. • EXPORT ADDRESS: 25 WARREN ST., NEW YORK CITY
CABLE ADDRESS: SIMONTRICE, NEW YORK

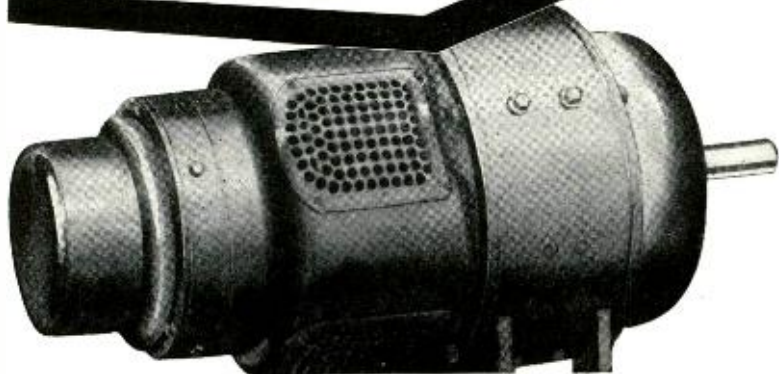



Cut Yourself a Slice of Cake

COOKED BY RADIOTHERMICS . . . SERVICED BY RADIO MEN

Maybe you've never tried a slice of delicious cake, home-baked to perfection by Radiothermics. *But you may!*

Maybe you've yet to see bread baked inside out (with the crust on the inside, if that's where you want it) by this same amazing method. *But you may!*

Or, perhaps, you haven't been around busy industrial plants where heating, drying, case-hardening, and similar jobs which formerly took hours by conventional methods are now being done better and, frequently, *in minutes* the Radiothermic Way.

Distributing, installing, and maintaining equipment for such purposes may well be a part of the job of the busy "Radio" man of the future. Classify these new developments

under whatever general heading you will, they all add up to expanding opportunities for you.

All of these developments use Electron Tubes as their "Magic Brain." Just as RCA Tubes helped to make Radio what it is today, so will they contribute to this vast related industry of tomorrow.

"Electrons in Action at RCA"—BOOKLET FREE!

Did you know that modern RCA Tubes could not be precision-made in quantity without employing equally modern tubes in the operations used in their manufacture? This profusely illustrated 32-page book tells the story of electrons in action at RCA, and contains many valuable pointers on possible electron tube applications in other fields. Copy gladly sent on request. Ask for Booklet No. 1F8159.



RCA RADIO-ELECTRON TUBES

RCA Victor Division, RADIO CORPORATION OF AMERICA, Camden, N. J.

★ DEDICATED TO

Victory



BRACH Antennas and other radio and electrical products are now enlisted for the duration—serving, as in the First World War, to hasten the day of Victory. Their high peacetime standards, today applied to the needs of war, reflect our 36 years' experience in "QUANTITY-plus-QUALITY" manufacture.

L. S. BRACH MFG. CORP.

World's Oldest and Largest Manufacturers of Radio Aerial Systems

55-65 DICKERSON STREET • NEWARK, N. J.

changeover switch for quick transfer in case of burnout.

Figure 20. Drawings of Early Commercial Forms of Fleming Valve. Note bayonet base for mounting in Ediswan type lamp socket. Reproduced from J. A. Fleming's *The Thermionic Valve and Its Developments*.

Figure 21. Early Commercial Form of Fleming Valve, using Cylindrical Plate. Photograph Courtesy Radio Corporation of America.

Figure 22. Later Commercial Form of Fleming Valve, using Cylindrical Plate, and mounted in Ediswan Socket. Photograph Courtesy R. McV. Weston.

Figure 23. Commercial Form of Fleming Valve. Photograph Courtesy Bell Telephone Laboratories.

Figure 24. Commercial Form of Fleming Valve. Later development showing improvement in mechanical design. The filament is supported by a tension spring. Commercial product—1913. Photograph Courtesy Bell Telephone Laboratories.

Figure 25. Commercial Form of Fleming Valve. This valve has an improved filament support, and the plates are supported by a collar attached to the stem of the bulb. Commercial product—1913. Photo Courtesy Bell Telephone Laboratories.

Figure 26. Commercial form of Fleming Valve. Similar in construction to previously made tubes, except that the plate surface is increased and the filament lengthened. Commercial product—1913. Photograph Courtesy Bell Telephone Laboratories.

Figure 27. Commercial Form of Fleming Valve. This valve has cylindrical element, and filament is supported by glass arbor inside plate structure. The specimen shown has Ediswan bayonet base, but this valve was also made with Edison medium screw base. Photograph Courtesy Bell Telephone Laboratories.

REFERENCES

103. Fleming, J. A.: "How I put electrons to work in the radio bottle." *Popular Radio*, Vol. 3, No. 3, March 1923, pp. 175-182.
104. Leggett, Bernard: "Wireless telegraphy with special reference to the quenched spark system." London, 1921, p. 160.
105. Fleming, J. A.: Patent No. 24,850 of November 16, 1904, in Great Britain. Patent No. 803,684 of April 19, 1905, in the United States. Patent No. 186,084, Klasse 21a, Gruppe 68, of April 12, 1905, in Germany.
106. Exhibit No. 20: Catalogue of the Science Museum at South Kensington—*Electrical Communication II*, 1925, p. 21. This catalogue entry describes these valves and tells the purposes for which they were used in Fleming's work.
107. Fleming, J. A.: "On the conversion of electrical oscillations into continuous currents by means of a vacuum valve." *Proceedings of the Royal Society of London*, Vol. 74, 1905, pp. 476-487.
108. Fleming, J. A.: "The construction and use of oscillation valves for rectifying high frequency electrical currents." *Proceedings of the Physical Society of London*, Vol. 20, 1906, pp. 177-185. See also *Philosophical Magazine*, 6th series, Vol. II, No. 65, May 1906, pp. 659-665.
109. Fleming, J. A.: Transcript of record of proceedings in the case of Marconi Wireless Telegraph Company of America vs. De Forest Radio Telephone and Telegraph Company. U. S. Circuit Court of Appeals, Second Circuit, Equity No. 12/31. Deposition of J. A. Fleming, p. 128.
110. Fleming, J. A.: "The thermionic valve and its developments in radiotelegraphy and telephony." London, 1919, p. 62.
111. Fleming, J. A.: See reference 110, pp. 65-66.

● In active service on the fighting fronts . . . helping in the production of planes, tanks, ships and guns on the home front . . . Simpson Electrical Instruments are doing a vital job supremely well.

○ SIMPSON ELECTRIC CO., 5200-5218 Kinzie St., Chicago, Ill.

Simpson

INSTRUMENTS THAT STAY ACCURATE

BUY WAR BONDS AND STAMPS FOR VICTORY

WANTED:
more
war work



Electronic Corporation of America is now engaged exclusively in war work. Here, manufacturing ingenuity, modern mass production methods, engineering skill and highly trained workmanship are all focused on the one supreme job of turning out more and better electronic equipment to serve the men on the fighting fronts. All American industry is performing formerly unheard-of feats on the production lines . . . but we can do more! ECA is determined to do everything in its power . . . and then a little more . . . to insure a quicker Victory.



"Let's Win the War Now! . . . with the Utmost in Production"

To Manufacturers and Government Agencies

The Electronic Corporation of America is perfectly set up for the manufacture and assembly of electronic devices and equipment. ECA invites inquiries from manufacturers and government agencies who can make use of our facilities and experience to help win the war sooner.

Buy More—AND MORE—War Bonds!

ELECTRONIC CORPORATION OF AMERICA
45 WEST 18th STREET, NEW YORK CITY • • • PHONE WAtkins 9-1870

A lifetime of
"KNOW-HOW"
has made Thordarson
the **LEADER!**

It takes more than mere "book learning" more even, than an "all out" determination to succeed, in order to build a leader. Nothing else can take the place of long experience, painstakingly accumulated through years of conscientious research and the burning of the midnight oil. Thordarson engineers have always followed this tradition. The result is a type of leadership, accepted and unquestioned among all who appreciate real transformer quality.

THORDARSON
ELECTRIC MFG. COMPANY
300 WEST HURON STREET, CHICAGO, ILL.

Transformer Specialists Since 1895
ORIGINATORS OF TRU-FIDELITY AMPLIFIERS

Direct Reading Q-Meter

(Continued from page 22)

circuit through the silver mica capacitor C_6 . The coil to be tested is connected to the binding post terminals T₁ and T₂. The v.t. voltmeter associated with the test circuit includes the triode section of a 6Q7-GT tube, V₃, a miniature 0-1 d.c. milliammeter, M, and the zero control, R₁₁. The entire instrument is powered by the voltage doubler stage comprising the rectifier V₄ and the electrolytic capacitors C₁₁ and C₁₂.

The oscillator tuning condenser C₂ is 1000 $\mu\text{fd.}$ maximum capacitance and approximately 35 $\mu\text{fd.}$ minimum capacitance. This is a dual 500 $\mu\text{fd.}$ unit, a Cardwell XR-500-PD with the two sections connected. The oscillator coils L₁, L₂, and L₃ are chosen for tuning through the following bands: L₁—100 to 550 kc., L₂—500 kc. to 2.6 mc., and L₃—2.5 to 13 mc. L₁ is a standard 2.5 m.h. radio-frequency choke, such as National R100, with the tap connected between the first and second pies above ground end. L₂ is 80 turns of No. 24 enamelled wire closewound on a 1½-inch diameter form. Tap is 25 turns from lower end. L₃ is 15 turns of No. 20 enamelled wire spaced to a winding length of 2 inches on a 1½-inch diameter form. Tap is 4 turns from lower end. The coils are selected by means of a double-pole, three-position rotary switch S. In order to prevent stray pickup of signals by the v.t. voltmeter tube, it is necessary to shield the entire oscillator in a small shield box of steel, tin-steel, or aluminum.

IF YOU CANNOT REPLACE RADIO PARTS
REPAIR THEM WITH *Walsco* PRODUCTS



Walsco RADIO CHEMICALS

- Speaker Cements
- Cements For Plastics
- Special Adhesives
- Contact Cleaning Fluids
- Noise Eliminating Compounds
- Radio Lubricants



Walsco RADIO HARDWARE

- Dial and Knob Springs
- Trimounts, Set Screws

Walsco CABLES, BELTS

Of course—we are concentrating our efforts on war production—but not for a second are we neglecting the RADIO SERVICEMEN who require so many WALSCO RADIO PRODUCTS to keep the radios of their customers in perfect working order. Write today for WALSCO Catalogue No. 112, giving complete information about WALSCO PRODUCTS.

WALTER L. SCHOTT CO.
Manufacturers of
WALSCO PRODUCTS

For Communication Equipment Manufacturers,
Laboratories, Schools and Radio Repair Men
9306 Santa Monica Blvd., Beverly Hills, Calif.
Dept. N

CHART I

ΔC	Q	ΔC	Q
20	50	3.03	330
16.69	60	2.94	340
14.29	70	2.86	350
12.50	80	2.78	360
11.11	90	2.70	370
10.0	100	2.63	380
9.10	110	2.56	390
8.35	120	2.50	400
7.70	130	2.44	410
7.14	140	2.38	420
6.67	150	2.32	430
6.25	160	2.28	440
5.88	170	2.22	450
5.56	180	2.18	460
5.26	190	2.13	470
5.00	200	2.08	480
4.76	210	2.04	490
4.54	220	2.00	500
4.34	230	1.96	510
4.16	240	1.92	520
4.00	250	1.89	530
3.84	260	1.85	540
3.70	270	1.82	550
3.57	280	1.79	560
3.45	290	1.75	570
3.33	300	1.72	580
3.22	310	1.70	590
3.12	320	1.67	600

The test circuit contains C₁₀, the "semi-variable" unit, which is entirely

.... Get into **RADIO** now!

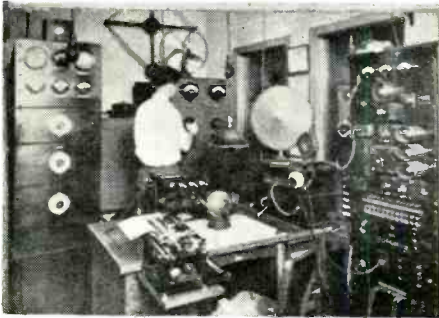

GET ON TECHNICAL FRONT

Do you want to make money—real money? Then train your brain and let it work for you in the booming RADIO profession. You can keep your present job while you easily learn at home by National Schools' amazing shop method, based on resident school principles, tested over a period of 38 years. You quickly advance in knowledge of *Radionics*, which includes Radio, Electronics and Television. Today and after the War as a trained Radio Technician your trained services will be in big demand. You owe it to yourself to investigate this great Master Radio Course—*today*.

FREE TRIAL LESSON
proves
you can learn
quickly

You can learn while earning.
Men of all ages are enrolling.
Men subject to Military service can be particularly aided by this time-tested training.



SHOP METHOD HOME TRAINING

fully qualifies you for bigger pay jobs

For 38 years National Schools has successfully trained ambitious men for good pay jobs. The same technique, the identical shop methods that are so successful in training Radio men at the School, are now available to you by National's Plan of Home Training. You are assigned a progressive series of instructive lessons and you learn step-by-step. It's the shop-method Training Plan developed for men who want practical, easy-to-grasp instruction in Radio.



Many men in Military Service have enrolled.

TRAIN FOR THESE JOBS

- Radio Servicing
- Radionics Expert
- Studio Technician
- Aircraft & Marine
- Sound & Television
- Industrial Electronics

FASCINATING WAY TO LEARN RADIO

You learn by the most practical shop-laboratory methods—using the same instructions and technique as employed in radio shops, studios, production plants and U. S. Gov't. services. Your training assignments grow more fascinating as you progress, step-by-step, through fundamentals of radio, construction, layouts, operating routine, etc. Amazing as it may seem, you acquire this useful workable training AT HOME. Qualify for good pay job with assured success not only in war-time but later, after the war ends, when Radio will continue its vast expansion.

A REAL, ESTABLISHED
TECHNICAL SCHOOL
brings Training to you

Don't confuse National Schools' Radio Training Plan with the correspondence school type. National Schools is one of the old established schools where thousands of men have received thorough Radio-Television instruction. The same basic methods used in instructing students at the School in Los Angeles are now extended to ambitious men everywhere. Back of your training is a School with an enviable reputation. Just to prove to you the soundness of National's method of instruction, we will forward a Free Trial Introductory Lesson. Study it. Analyze it. Note how easy you can learn Radio right in your home. Mail the Coupon.

FREE OPPORTUNITY BOOK also sent

Investigate! Send for Trial Lesson and Big Opportunity Book Today.

NATIONAL GRADUATES WIN GOOD POSITIONS



Fred Hoffman

National Schools are pioneers in practical training. Thousands of graduates attribute their success to National. You can duplicate the success of these Graduates.

WITH WIBX

"I have been in the broadcasting field since graduating from National. Am with Station WIBX. I recommend your School."

Fred Hoffman,
Utica, N. Y.



Pierre Berube

AIRLINES EXPERT

"I cannot praise the training I received at National too highly. It has repaid itself many ways. Am with Eastern Air Lines."

Pierre Berube,
Jackson Hts., N. Y.

2 BOOKS FREE



NATIONAL SCHOOLS

Los Angeles
California

ESTABLISHED
1905



MAIL OPPORTUNITY COUPON FOR QUICK ACTION

National Schools, Dept. RN-7 (Mail in envelope or 4000 So. Figueroa, Los Angeles, Calif. paste on penny postal)
Mail me FREE, without obligation, one Lesson and Opportunity Book, with full details about how I CAN become a RADIO Technician.

NAME _____ AGE _____
ADDRESS _____
CITY _____ STATE _____

— THE START TO SUCCESS COUPON

TURNER

101 CARDIOID

Stops

BACKGROUND

NOISES



*Offers best features of
both Velocity and Dynamic*



Free

Write for
your copy
of Turner's
new
catalog.

Utilizing a 2-element generator, 101 offers true cardioid characteristics; extremely sensitive to sounds originating in front of the microphone, the rear may be considered dead. Where the going is tough and acoustic conditions practically impossible, Turner 101 assures complete intelligibility. Equipped with tilting head, balanced line output connection and heavy duty cable. Available in Standard, DeLuxe and Broadcast models.

The TURNER Co. . . Cedar Rapids, Iowa



*Parts
by*
Centralab

- Steatite Insulators
- Ceramic Trimmers
- High Frequency Circuit Switches
- Volume Controls
- Ceramic Capacitors
- Wire Wound Controls
- Sound Projection Controls

Div. of Globe-Union Inc., Milwaukee, Wis.

contained within the instrument case, it being set only once. This unit is a broadcast midget-receiver type with the original bakelite insulation replaced with polystyrene strips. The trimmer C_{11} , to which the Q dial is attached, is a straightline capacity 25 μfd . midget with low-loss insulation. Recommended for this position is the National type UM25 which is an isolantite-insulated model with constant characteristics. For most efficient Q-meter response, the high terminal T_1 should be mounted on a polystyrene or mica strip, and should clear the panel through a large hole.

The v.t. voltmeter circuit is built around a 2-inch 0-1 Triplet d.c. milliammeter M; and, as will be seen in the photograph, the original scale of this meter has been replaced by a white Bristol board card with only two line graduations—one at maximum full-scale deflection and the other at 70.7% of this value. The RMS voltage calibration to be expected of this voltmeter circuit is given by Chart II. The actual voltage values, however, are of little account unless the reader desires to use this meter for other measurements, since only full-scale and 70.7% values are important to the functioning of the Q-meter.

Throughout the construction of the Q-meter it is imperative that rigid mounting and short leads be employed. The top-cap connector of the v.t. voltmeter tube, for example, must be mounted directly at the terminal T_1 . In the writer's instrument the grid grip for this tube is actually a part of the T_1 . The lead from the plate of the amplifier tube to the test circuit should be as short as practicable and must be run well away from nearby metal bodies. It is highly desirable to mount this tube at an awkward angle in order that the leads of the capacitor C_1 may form a short, direct path from the 6SK7 to the measuring circuit. Likewise, connecting leads in the test circuit, between the terminals and the condensers C_{10} and C_{11} must be short, rigid, and made of heavy conductor. These leads must either be made of copper tubing or $\frac{1}{2}$ -inch wide copper or phosphor bronze strip, avoiding all sharp bends in forming the connectors. The panel must be cut from heavy stock in order to prevent movement of the circuit components when the instrument controls are handled. The writer's panel is constructed of Masonite with a back facing of tightly fitting copper sheet. However, the reader with a supply source might employ $\frac{1}{8}$ -inch metal for the panel. The writer's case is a wooden box lined with copper, but here again metal might be employed by the builder who has a cabinet available.

The entire Q-meter measures 11" x 8" x 6". The two dials are standard 4-inch diameter models with white Bristol board scales, marked off with India ink, cemented on the original faces. To prevent soiling, the new dial faces have been covered with transparent celluloid discs. All com-

**YOU'LL OPEN YOUR EYES WHEN
YOU SEE MY ECHOPHONE EC-1**



Echophone Model EC-1

6 tubes, 3 bands. Tunes from 550 kc. to 30 mc. Beat frequency oscillator. Bandspread logging scale. Self-contained speaker. Electrical bandspread on all bands. AC/DC. 115-125 volts. ECHOPHONE RADIO CO., 201 EAST 26TH ST., CHICAGO, ILLINOIS

ponents, such as tube sockets, tuning condensers, and the like are best mounted directly on the heavy front panel, employing long, thick metal studs for the purpose, although a short chassis of heavy stock might be employed provided it is well braced by the panel.

The 25Z6 rectifier tube is mounted well away from the oscillator and test circuits in order to prevent shifts in characteristics due to heating.

Calibration

After wiring of the Q-meter has been verified, calibration of the instrument may be carried out in accordance with the following steps:

VTVM

(1) Open the line along (X) between C_3 and the test circuit.

(2) Replace the milliammeter scale with a plain scale of white Bristol board.

(3) Provide a source of variable a.c. input voltage (furnishing variable voltage between 0 and 10 volts RMS) monitored by a reliable a.c. voltmeter. Set this source to zero and connect it to the terminals T_1 and T_2 .

(4) Switch on the instrument power supply and allow a few minutes for it to come up to normal operating temperature.

(5) Set the milliammeter to zero by adjusting R_{11} .

(6) Increase the voltage supplied by

CHART II
VTVM CALIBRATION

Volts (RMS)	Milliamperes
5.4	1.00
5.2	0.95
5.0	0.90
4.6	0.85
4.4	0.80
4.2	0.75
3.9	0.70
3.6	0.65
3.4	0.60
3.2	0.55
2.8	0.45
2.5	0.40
2.3	0.35
2.1	0.30
1.8	0.25
1.6	0.15
1.4	0.10
1.1	0.05

the variable-a.c. source slowly until the deflection of the milliammeter is full-scale. At this point, note the reading of the monitoring voltmeter, and inscribe a line on the meter card to note the position of maximum deflection.

(7) Decrease the input a.c. voltage to exactly 0.707 of this full-scale value, as indicated by the monitoring voltmeter, and inscribe a second line on the milliammeter scale to indicate this voltage.

(8) The v.t. voltmeter calibration is

now complete. The meter scale graduations may now be inked in and the connection between C_3 and the test circuit restored.

Test Circuit

(1) In order to make the capacitance calibration, the same line must be reopened, this time at the point (Y) so as to remove both the amplifier and v.t.v.m. circuits from the test circuit, and the Q-meter power is switched off.

(2) An accurate capacitance bridge, capacitance test oscillator, or similar instrument is then connected to the terminals T_1 and T_2 .

(3) Open the line along (Z) so that only the 25- μ fd. condenser is connected to the test terminals, and proceed to make a capacitance calibration by setting the bridge or oscillator to numerous values between 25 μ fd. and zero, marking these capacitance readings lightly on the Q dial attached to C_{11} . It will be noted that the capacitance curve of this condenser is linear over approximately three-quarters of its range, becoming non-linear as minimum setting is approached.

(4) After the C_{11} calibration has been completed, Chart I may be consulted for the delta-C values corresponding to various Q readings. With 25- μ fd. as the zero, or starting, point, various capacitance-difference values may be stepped off along the dial and the corresponding Q values marked in. When all such values are thus inscribed, the markings are made permanent with India ink. The point corresponding to 12.5 μ fd. (mid-capacitance of C_{11}) is marked "X" on the dial, and the (Z) connection may be restored.

(5) With the bridge or oscillator connected still to the test terminals and adjusted to 500 μ fd., set the Q dial to the "X" point and adjust C_{10} until the total circuit capacitance indicated by the bridge is 500 μ fd. C_{10} is then not touched again until the instrument is subsequently serviced.

Oscillator

After the two preceding calibrations have been completed, an oscillator frequency calibration may be carried out in the conventional manner, using another oscillator or a frequency standard, together with a radio receiver or simple monitor, to obtain as many frequency points as possible for the Oscillator Frequency dial attached to C_2 . This technique is so well understood by radio men that space will not be devoted here to a repetition of the procedure. After completing the frequency calibration, the Q-meter will be ready for use.

Operation

Operation of the Q-meter is simple and straightforward; and after a reasonable amount of practice, the operator should acquire a degree of speed in its manipulation:

(1) Switch on the instrument and allow a few minutes for it to reach normal operating temperature. Sta-

NOSE TO THE GRINDSTONE

"Our noses are held to the grindstone of war production . . . but our eyes are fixed on the future." This is how one Stancor engineer described our present operating policy. War problems are urgent, challenging, and stimulating. To solve them calls for midnight oil; but the lessons learned and discoveries made apply also to the problems of peace. When the war is won, industry will be confronted by a revolutionary development of electronic engineering . . . and Stancor engineers, seasoned by war demands, will be ready to serve you.

STANCOR

STANDARD TRANSFORMER CORPORATION • 1500 NORTH HALSTED STREET • CHICAGO

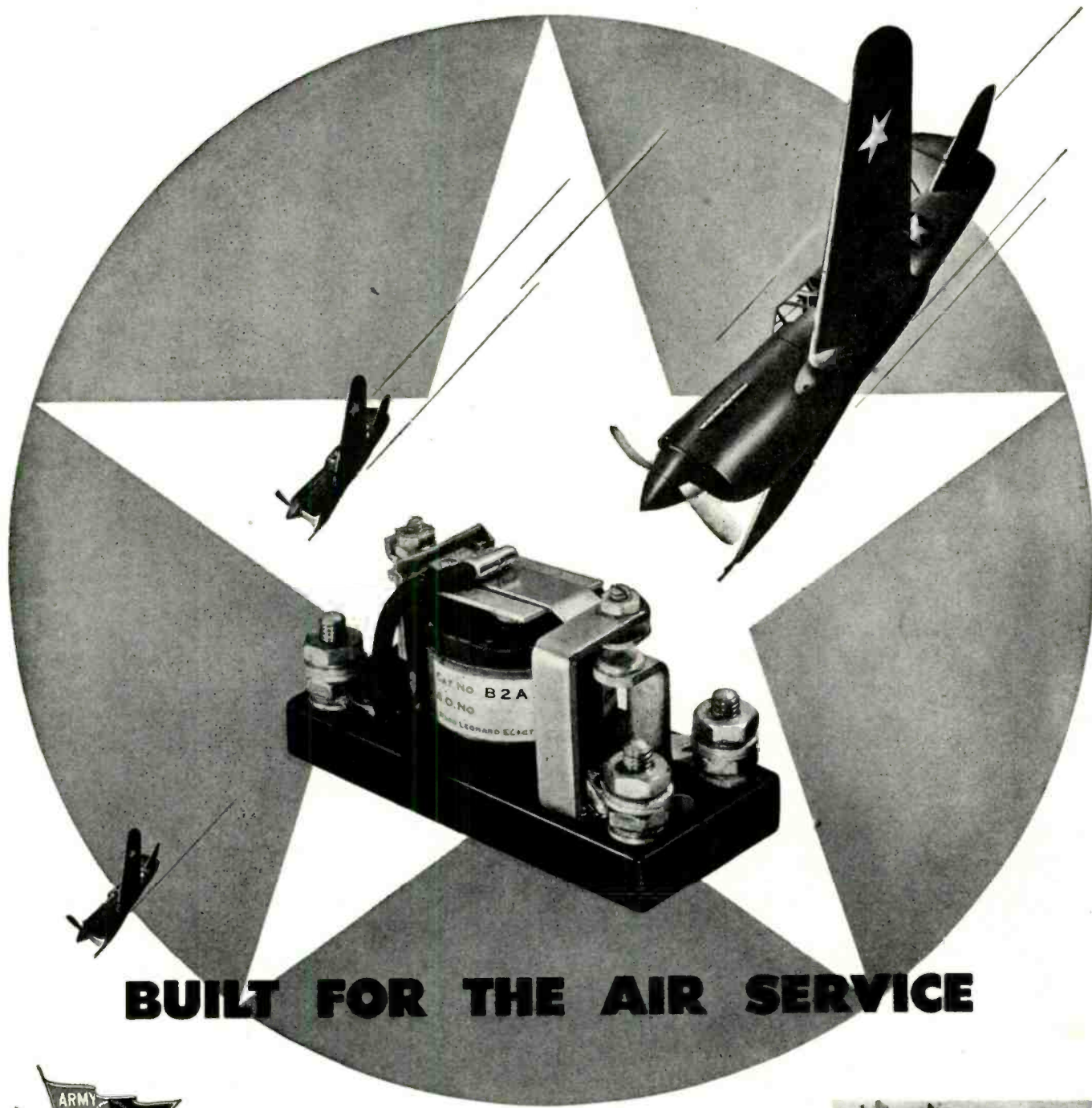

BUILT FOR THE AIR SERVICE



When Ward Leonard developed their B-2A Relay to meet the Army Air Corps tests for vibration and acceleration, they went further than required. They incorporated features in it not found in any other relay.

The layer-wound coils are thoroughly impregnated by a vacuum process that assures better insulation under humid conditions. The tail spring and contact gap are readily adjustable, thus enabling perfect adaptation to the required circuit. The anchorage for the terminal screws molded in the base assures rigidity of the entire relay under vibration.

Yes, this relay is used on aircraft, but the very features that make it desirable for airplane use make it equally desirable for any purpose when a rugged, positive, crisp-acting relay is required. Send for bulletin No. 103.



WARD LEONARD

RELAYS • RESISTORS • RHEOSTATS

Electric control  devices since 1892.

WARD LEONARD ELECTRIC COMPANY 47 SOUTH STREET MOUNT VERNON, NEW YORK

July, 1943

69

RADIO PARTS LOWEST PRICES!



Combination Table Cabinet

Modern table type phono cabinet, highly finished walnut. Dimensions: 14" front to back, 16" side to side, 5½" bottom of table panel to top, height over all, 13".

In original cartons—while they last. **\$7.95**

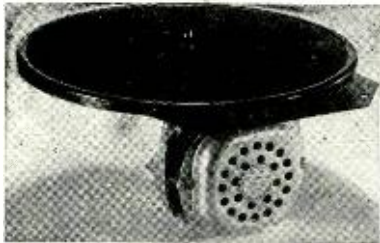

NEW PHONO MOTOR Model CX 78 RPM. Gear Driven. 9" turntable. Quiet operation. Powerful synchronous motor, rubber insulated from turntable. Positive direct drive through silent helical cut gears sealed in oil. Depth from mounting plate to bottom 3¾".

Special now at. **\$6.45 each**



5" P. M. SPEAKERS!

All new—Thousands in original cartons, Good heavy Construction. V.C. Impedance 3-4 ohms. (Less transformers) . . .

Each **\$1.10**

RECORDING DISCS! Thousands of Bristol base acetate coated discs . . . amazingly good quality at lowest price for quick sale . . . minimum background noise—coated on 2 sides—non-inflammable . . . With Labels.

6½" in lots of 10. 57c	in lots of 100. . . \$3.50
8" in lots of 10. 77c	in lots of 100. . . 7.50
10" in lots of 10. 97c	in lots of 100. . . 9.50

FREE! Servicemen write today for free catalog listing thousands of parts bargains . . . hardware and replacement parts.

**We Save You Money
Drop a Post Card Today**

RANDOLPH RADIO

609 WEST RANDOLPH ST., CHICAGO, ILL.

"Millions of Parts for Millions of Radios"

bility will generally be indicated by a settling down of the v.t. voltmeter deflection.

(2) Set the v.t. voltmeter to zero by adjusting R_{11} .

(3) Connect the "unknown" coil to terminals T_1 and T_2 , avoiding long leads.

(4) Set the Q dial to the "X" position.

(5) Tune the oscillator through its three bands until a deflection of the voltmeter indicates arrival at the resonant frequency of the test circuit. The oscillator should be tuned from its lowest frequency upward, in order to avoid possible harmonic response.

(6) Tune the oscillator precisely for peak meter deflection. If this deflection is higher or lower than the top meter graduation, adjust the gain control R_6 together with the frequency dial until deflection is *exactly* full-scale.

(7) Tune the Q dial toward maximum capacitance to a point at which the meter deflection falls exactly to the lower graduation. At this point, swing the Q dial index around to coincide with zero on the dial.

(8) Retune the Q dial, this time in the direction of minimum capacitance, observing that the meter reading again passes through maximum and then drops once more to the lower line. Be sure this setting is exact.

(9) At this point, read the Q of the coil on the Q dial.

The Q indication obtained with the instrument shown in this article is really the *effective Q*. This value differs from true Q by an amount determined by the distributed capacitance of the coil under test. The relationship is:

$$Q = Q_e \left(\frac{C_1 + C_d}{C_1} \right)$$

Where Q is true Q,
 Q_e , effective Q as indicated by the instrument.

C_1 , resonant circuit capacitance,

C_d , distributed capacitance coil

But, because of the high value of resonant capacitance employed in this Q-meter, C_1 will always be several hundred times larger than the distributed capacitance of the coil. Hence the Q-multiplier will always be 1 plus a very small fraction, and true Q will not differ greatly from effective Q obtained by measurement. As an example: the popular pi-wound 2.5 millihenry r.f. choke gives a Q check with the meter of 40. The distributed capacitance of this choke, according to its manufacturer is 1 micromicrofarad. True Q is then $40 (501/500) = 40 (1.002) = 40.08$. This represents a 0.2% difference between true Q and effective Q as indicated by the instrument — an immaterial difference.

For the Record (Continued from page 4)

now the problem was to develop installations which would show the position, angle and speed of the approach of objects in the air. Further developments continued during 1933. Many various types of apparatus were developed, and the laboratory was able to outline theoretical military applications. In 1935, the *Naval Appropriations Committee* of the House was allotted \$100,000.00 to be spent for laboratory research.

In June, 1936, a demonstration was given at the laboratory, and Rear Admiral Harold Bowen directed that plans be made for the installation of detecting equipment for use aboard ship. One of these sets was installed on the *U.S.S. New York* in 1938, and exhaustive tests were given at sea. Commenting upon the tests, Vice-Adm. Alfred F. Johnson said: "The equipment is one of the most important radio developments since the advent of radio itself."

It was a Scotsman, Robert Alexander Watson Watt, attached to the *British Air Ministry*, who developed the *Radiolocator* (British) system. Many of you reading these lines will remember the article titled, "British Radio Combats Blitz," which appeared in *RADIO NEWS*, August, 1941. This article explained in much detail the very fundamentals underlying our present system of Radar. The following are excerpts taken from that article:

" . . . In technical terms, how does the Radiolocator operate? That's what the Editors of *RADIO NEWS* commissioned me (the author) to find out for our readers, but I soon learned that there would be no schematic diagrams given out on *this* system. I was advised, good-naturedly, by responsible authorities that the amount of technical information available for public release was "—the fact was that it was exactly zero! . . ."

After interviewing the Scotsman, the *RADIO NEWS* representative was able to gather enough facts from which the following observations were made:

" . . . First, the system is essentially that of radio-signal transmission, reception and detection. The system is composed of hundreds of ultra-short wave transmitters and receivers which cover the countryside. These transmitters broadcast a constant 'barage' of radio 'feeler' waves which cover the country like a gigantic invisible tent. When an object such as an enemy airplane passes into this radio-tented area, the 'feeler' waves are reflected from the enemy plane and these feeble, minute signals are picked up by *Radiolocator* stations. By applying the principles of radio-direction-finding, and other basic radio principles, the position in the sky of the unwelcome intruder is plotted very accurately, and this information is used by defense fighter planes and

anti-aircraft batteries with telling effect.

Thus, we might easily compare the operation of the *Radiolocator* to an *Absolute Altimeter* operating in reverse. The original altimeters used in airplanes measured all altitudes in feet above sea level. The *Absolute Altimeter* measures the actual distance of the plane above the ground by timing the echo of a short-wave signal.

With the *Radiolocator*, a sharply focused wave is projected into space and 'scans' a certain section of the sky like a searchlight. When the wave strikes an enemy aircraft, it is deflected back to earth. This 'rebound' wave is picked up by the sensitive *Radiolocator* receiving device and the results are used to calculate the position in space of the plane. . . ."

" . . . The important point to grasp in this whole proposition is that the art is an entirely new one—so new that a name had to be coined for it—*Radiolocation*. It is a field which has vast future possibilities, because Air Chief Marshal Sir Philip Joubert has made the statement that, when peace comes, the art of *Radiolocation* will be applied to commercial aviation and will add greatly to the safety of flying. It may also be used on ships to guard against a collision between ships, or against piling up on a treacherous reef. In fact, speaking about its use at sea, *Radiolocators* may be the answer to the submarine menace.

Thus, we can get a peep into the future and visualize a completely new branch of radio work—*Radiolocation*. So far, the United States has a reciprocal agreement with Britain on such devices and thus has full information on the art of *Radiolocation*. . . ."

The following information is based upon the recent O.W.I. release:

Radar, meaning *Radio Detecting And Ranging*, concerns itself with the microscopic measure of a reflected wave. Radar equipment transmits an ultra-high frequency wave which continues on its path until it strikes an object. It then is bounced back or reflected. The time it takes for this wave to start its journey and to return provides data as to the distance of the object it met or struck during its travel. This time interval can now be measured. The intervals involved are smaller than a split-thousandth of a second. Of course, it is not only necessary to know the distance, but the direction and the height of the object that was struck, so that it is possible to arrive at an exact position of the struck object. And this object can be a plane or a ship or any moving project for which a search may be on.

Radar is actually the result of several developments that have taken place over the past decade. In 1932, for instance, when the absolute altimeter was developed, a theory very similar to that used in Radar was employed. Extremely high frequencies were used. As a matter of fact, some

CONQUERORS OF THE Sky



.. use Consolidated Radio Headphones

The superior flying skill of American pilots demands split-second response of all of their equipment. Rugged, dependable Consolidated Radio headphones are helping American flyers gain mastery of the air on the battle fronts of the world.

Consolidated Radio is proud that the Army Air Force is using its products to aid in the defeat of the enemies of world peace. We pledge to continue to devote all our energy and engineering skill to the production of headsets with built-in dependability.

Consolidated Radio's Modern Mass Production Methods Can Supply Signal Corps and Other Headphone Units in Quantities to Contractors



**CONSOLIDATED
RADIO PRODUCTS CO.**

SPECIALISTS IN MAGNETIC AND ELECTRONIC DEVICES.

350 W. ERIE ST., CHICAGO, U. S. A.

NOW! SPRAYBERRY RADIO TRAINING PAYS OFF 3 WAYS



**TRAIN
IN SPARE
TIME AT
HOME OR
AT CAMP . . .**

The greatest OPPORTUNITY that ever existed in Radio is open to you RIGHT NOW! Don't miss it! My practical Home Training will fit you quickly for a profitable Radio Repair business of your own . . . OR for a good-paying job in one of the Nation's Radio plants at work on equipment for planes, tanks, ships, etc. . . . OR for higher rating and better pay if you enter the Army, Navy or Marines.

No Previous Experience Needed

Sprayberry Training starts right at the beginning of Radio. You can't get lost. My tested and proved methods will get each subject across to you in simple, understandable style. Your success is my full responsibility. You learn Aviation Radio, Radio Set Repair and Installation Work, Mobile Radio (Auto-Tank), Television, Frequency Modulation, Signal Tracing, etc. You will be prepared to cash in on the coming great era of Electronics and Electronic equipment.



Read What Graduate Says

"Salary Has Increased"

"Since I have finished your Radio training I had to enlarge my laboratory with additional equipment, as I have all the Radio repair work that I can handle. My salary has increased to 50 to 75 dollars a week. I install transmitter equipment and public addressing systems. Money can not buy the training that I received through your Academy." Asa Smith, Post Box 528, Ft. Leavenworth, Kansas.

Earn While You Learn

Along with your Training, you will receive my famous Business Bullets which can bring you in a nice profit shortly after you begin my Course. No matter if you remain a civilian or enter military service, my Radio Training will give you the background and knowledge to cash in on the marvelous future that lies ahead.

EASY TO START . . .

Remember it is not necessary for a Sprayberry student to have any previous experience in the field of Radio. You can master the Course in your spare time. It will not interfere in any way with your present duties.

GET THE FACTS ABOUT MY TRAINING—NOW! TAKE THE FIRST IMPORTANT STEP TOWARD THE MONEY-MAKING FUTURE OF YOUR DREAMS. ALL FEATURES ARE FULLY EXPLAINED IN MY BIG, ILLUSTRATED FREE BOOK. WRITE FOR IT AT ONCE.



RUSH THIS COUPON FREE for BIG FREE BOOK

DON'T DELAY! ACT NOW!

SPRAYBERRY ACADEMY OF RADIO
F. L. SPRAYBERRY, Pres.
625-G University Place, N.W., Washington, D. C.

Please send me FREE copy of "HOW TO MAKE MONEY IN RADIO."

Name Age

Address

City State

Tear off this coupon, mail in envelope or paste on penny postcard.

of the first ultra high frequency diodes were used at that time. This device replaced the barometric pressure altimeter as a height indicating instrument. Triangulation was used then as it is in Radar to a certain extent. We must not forget either the radio direction finders which also contributed to the progress and development of moving-body location methods.

It was the British, who in 1941 introduced the method of radio location effectively for aircraft, thanks to the development work of Sir Robert Watt. It will be recalled that, when this development was first announced, American volunteers were called upon to go to Britain and man this equipment. Sir Robert visited the United States in 1941 and 1942 to discuss with the U. S. Army and Air Forces the development of an American Radar system.

Incidentally, records reveal that some of the basic fundamentals of Radar were covered in patents of a now unknown Frenchman. Oddly enough the patents had nothing to do with protection of any nature. They simply discussed the possibility of measuring reflected waves.

We mentioned a few paragraphs ago that Radar could be used to detect seacraft as well as aircraft. An interesting and very effective illustration of the value of Radar to seacraft was supplied by Frank McIntosh at the recent War Conference in Chicago. He mentioned that the destruction of a Japanese warship which was roaming about, miles away from American craft, was accomplished wholly by Radar. The ship could not be seen, nor could it be heard, yet Radar found it, and found it with such accuracy that a salvo of gun fire destroyed the enemy warship immediately. It was truly a triumph for Radar.

Note the similarity to the above statements, which brings us to the point at hand. Why do certain self-styled prophets lay claim to the fact that they were the first to predict the use of radio for the location of metal objects including aircraft many years after it had actually become a reality? We think those who have engaged in the development of this highly important weapon should receive proper credit. Don't you agree?

WHO'S Kidding Who? The Government says tubes for civilian radios will be available during the next two months. Industry is sceptical and wants to know what happened to deliveries promised for the first quarter of 1943. Manufacturers say the armed forces take all they can produce whether marked for civilian use or not. Claims and counter claims! To shed a little light on the subject RADIO NEWS made a few inquiries and presents the following picture of the situation. There are large numbers of radio receivers out of operation at the present time due to the tube shortage. There are very few homes without the

service of at least one radio. Until John Q. Public is completely without radio in his home and he starts writing to his congressman, then and only then will we see action on the civilian tube situation. In the meantime who can deny that we have a war to win and that doing without one, or even two, radio sets is a small enough price to pay if it will help us to achieve ultimate victory?

73 . . . OR

Progress in Radionics

(Continued from page 34)

into the mixer, but with its phase opposing that of the interference component of the signal fed directly to the mixer from the r.f. In this way, the interference is caused to cancel itself out, according to the patent claim.

The network used for separating the interference from the other signal components merits some mention. The complete signal from the r.f. is fed to a "splitting transformer," which has a single primary, but two secondaries. One of these carries the high side-band plus interference, the other the low side-band plus interference. A pair of mixers and rectifier circuits separate the a.f. modulation from the carrier, permitting the passage of the interference, which is fed to a pair of primaries (high side and low side) of the output transformer, the secondary of which feeds interference in reversed phase, to the mixer tube of the receiver.

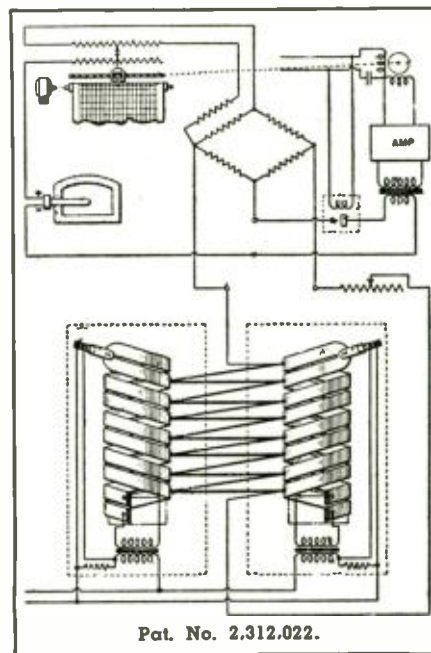

Another new means of doing an old task has been patented by H. B. Brooks and assigned to the Brown Instrument Co. It deals with a means for maintaining a constant voltage d.c. from a standard commercial a.c. or d.c. source, which may be subject to wide variations in voltage. Those who recall the days of battery-operated receivers will

remember the widespread use of resistors which increased in value as the applied voltage (and, consequently, current drain) was increased, and so maintained a relatively constant current (and voltage) at their output ends. Others are familiar with the same principle applied to electric powered sets, and to the more recent constant voltage transformers. But the Brooks patent, No. 2,312,022, is quite different from any of these; it amounts to an electronic generator.

The power from the supply lines is used to generate heat, the temperatures produced being maintained at a constant value—a relatively simple problem. Note that *temperatures* is plural, for two temperatures are produced, and the difference between them is kept constant. Thermo-couples energized by this heat differential are used to produce the constant-voltage d.c. which is desired.

Time delay circuits, too, have long been a source of study, and one familiar method has been to use a long electrical path, which called for considerable expenditure of wire; another was to induce currents which were compelled to follow a long path in order to secure the desired delay. Now a purely electronic means has been devised by G. S. P. Freeman, of London, and assigned to Electric & Musical Industries Ltd., of Great Britain.

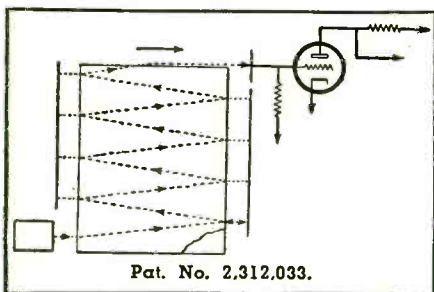

As disclosed in Patent No. 2,312,033, a beam of electrons is modulated with the signal which it is desired to delay. The electronic beam is directed through an electromagnetic field. Normally it would follow the lines of force directly, but an electrostatic field is provided at right angles to the electromagnetic field. By controlling the intensity of the electrostatic field, the electron beam can be made to cross the electromagnetic field the desired number of times as it travels from its source (such as an electron gun) to the target. The greater the number of times it crosses the field, the longer the path travelled, and the longer the time delay. The beam can be transformed into audio frequencies or used in other desired ways.

Another—a German patent, No. 2,312,429, covers a circuit for the ignition (starting) and operation of electric discharge tubes (fluorescent lights). In series with the tube there is a choke coil for starting the discharge; it is paralleled by a resistor the resistance of which *decreases* when its temperature rises. A ballast re-

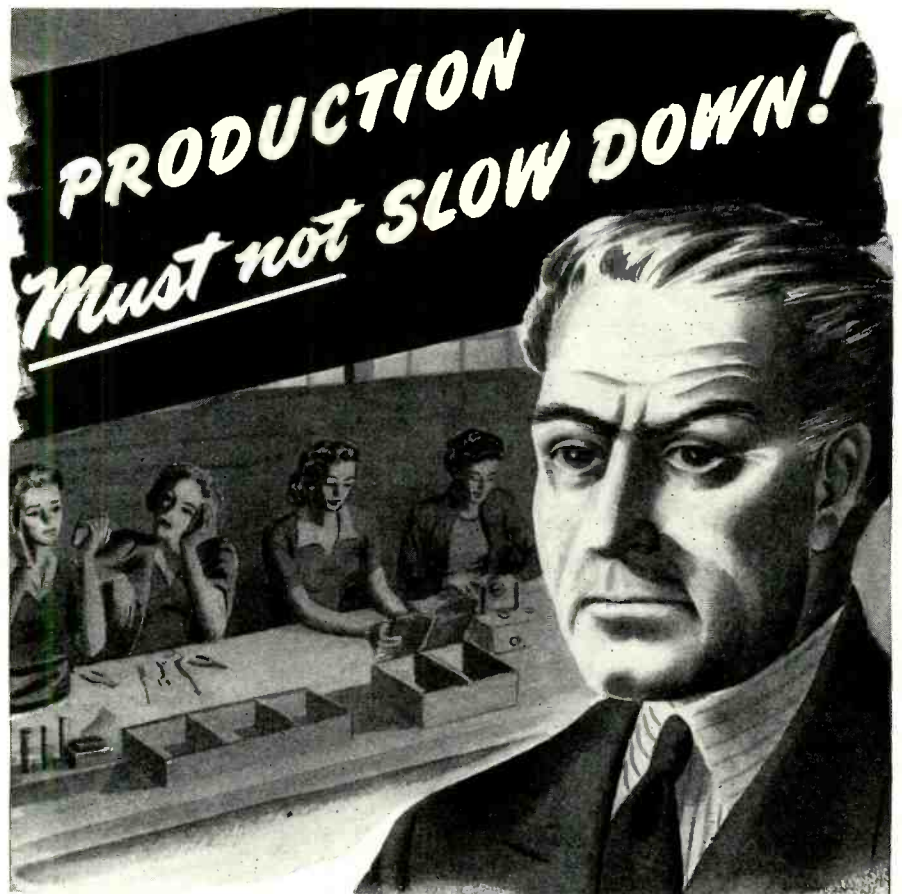

GET NEEDED RADIO PARTS Quickly!

Don't allow *your* production lines to slow down for lack of essential parts. Lafayette Radio Corp. is headquarters for all radio and electronic parts and equipment of every nationally known manufacturer in the field. Let Lafayette help you keep your production humming and save *your* time—one single order to Lafayette will insure *prompt* delivery on all hard-to-get parts and equipment your program may require.

Thousands of manufacturers, electronic engineers and private and military training program directors know Lafayette's reputation for complete stocks and extensive procurement facilities. We can fill *your* needs too—*quickly!*

Write today for Free 130 page Radio and Electronic Parts and Equipment Catalog—
Address Dept. 7E3



LAFAYETTE RADIO CORP.

★ 901 W. JACKSON BLVD.

★ 265 PEACHTREE STREET

CHICAGO, ILLINOIS
ATLANTA, GEORGIA

sistor is in series with the L-R combination. A solenoid operated switch, in addition to the main switch, automatically opens and closes a by-pass circuit around the tube to provide virtual self starting.

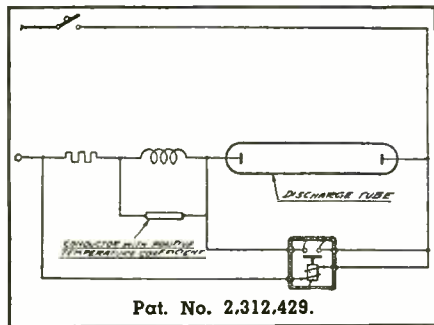

Pat. No. 2,312,429.

A group of Dutch (*not* Deutsch) inventors, A. van der Ziel, M. J. O. Strutt, and K. S. Knoll, has been granted patent No. 2,312,510 on an ultra-short wave amplifier, and No. 2,312,509.

The circuit on which the three men collaborated, however, has a number of novel points. It is a push-pull circuit employing a pair of pentodes, and it is stipulated that as short a lead as possible connects the two cathodes, so that negligible impedance is produced. The screen grid of each tube is connected to the cathode of the same tube through a choke coil to provide zero or negative input damping, and the plate of each tube is connected to its screen grid through a tuned circuit which connects to the choke mentioned.

A somewhat similar circuit, by van der Ziel and Strutt, as disclosed in patent No. 2,312,739, uses a single center-tapped tuned circuit, the outer ends of which are connected to the plates of the push-pull tubes, the tap being connected to the cathodes through the plate voltage sources. It is claimed

that the circuit will eliminate input damping, but will not resonate at any frequency near the operating frequency.

Returning to American invention, a remarkably simple transceiver for communication over short distances has been patented by F. H. Kroger. The patent, No. 2,312,824, has been assigned to RCA. The set is a 3-tube, loop operated one, with a two-position switch for sending and receiving, and for cutting either the microphone or

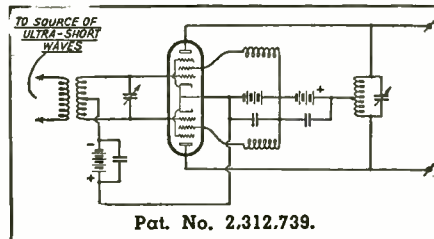

Pat. No. 2,312,739.

the loud speaker into the circuit. The interesting phase of this set is that communication is principally by induction between the loops of one which is transmitting and another which is receiving. The carrier is of low frequency "of such order," says the patent, "that at distances from the transceiver where the induction field is smaller than the radiated field the intensity of said radiated field is too small to cause interference with other signalling systems." This would permit a large number of such sets to operate simultaneously in a restricted area.

Considerable activity has also been manifested in the field of color television. While manufacturers cannot release anything at this time, research has been going steadily forward, and it is hoped to present a discussion of such developments in an early article.

-30-

Therapeutic Radionics

(Continued from page 19)

Some day in the near future hundreds of physicians and research workers will use radionic microscopes, declares Dr. Simon Romo of the General Electric Company. "This tool will render visible things which are more than ten times too small to be seen with the aid of the best light microscopes," Dr. Romo said, in discussing the subject of "Extending Man's Vision." "The desire and need for research workers," he continues, "as an example, for glimpses into the minute details of microscopic organism, is being satisfied by the microscope. The reproduction is thousands of times larger than the real thing—which may be a tiny particle of dust less than one-tenth-thousandths of an inch in size. The image produced is created by radionics striking a plate covered by fluorescent material—material emitting light when bombarded by fast-moving electrons. The more electrons striking the plate, the brighter the light produced. So the problem is to create a pattern of electrons hitting the target that will reproduce, in the excited fluorescence, a replica of the lights and shades of the original scene. All of this takes place in an evacuated radionic tube. We observe the image through the glass wall of the tube."

Dr. Lee de Forest, who invented the grid element of the vacuum tube, may be said to be furthering the realization of the radionic doctor. He is manufacturing short-wave diathermy machines for the United States Navy, and he envisions a futuristic time when ultra-violet rays emanating from such apparatus will abolish epidemics of colds in offices and factories. These radionic rays are beneficial in the treatment of manifold ailments, ranging from arthritis to pneumonia. These short-waves penetrate the human body, warming the tissues and bones and dilating the capillaries so that the blood stream can siphon off toxic conditions or accumulated poisons. The Westinghouse Electric and Manufacturing Company has installed more than 100,000 ultra-violet lamps in manufacturing plants, theaters, hotels, and hospitals. These health-imparting radionic waves combat bacteria and mold, conserving the health of a nation at war and at the same time lessening spoilage of perishable food products, valued at millions of dollars. In air-conditioned offices and other buildings these bactericidal lamps are installed in the ducts of the air-conditioning systems, freeing the recirculated air of microscopic organisms and purifying it for man to breathe. A recent installation was made in a large plant manufacturing toothpaste, saline compounds, and toilet creams. The installation consists of a forest of 104 radionic lamps, each 30 inches long, and they shoot rays through 40,000 cubic feet of air per minute in a

ONAN

ELECTRIC PLANTS

Doing a Winning Job in War Communications

ONAN ELECTRIC PLANTS are doing a winning job on all our Fighting Fronts, supplying electricity for critical war communications work and for many other purposes.

Thousands of ONAN ELECTRIC PLANTS are in production in ratings from 350 to 35,000 watts, A.C. or D.C. or dual output; 50 to 800 cycles; 6 to 4000 volts; Gasoline driven; Air or water cooled.

COMPACT, STURDY, RELIABLE

Ideal for all radio applications. We'll be glad to send you details on your present or post war need for Electric Plants.



D. W. ONAN & SONS

1459 Royalston Ave.,

Minneapolis, Minn.

specially-designed section of an air-conditioning duct. These radionic waves not only purify the atmosphere for the employees to breathe but the articles manufactured and packaged are free from dust and are sterile.

The disease-carrying virus, spreader of epidemics in war, has an Achilles heel, vulnerable to radionic rays, according to Dr. Harvey C. Rentschler, director of research of the Lamp Division of the Westinghouse Electric and Manufacturing Company. So-called "bullets" of ultra-violet rays must strike a certain area in the virus with deadly precision if the breeding ground of influenza, infantile paralysis and the common cold is to be destroyed. Out of thousands of tests during a two-year period, it has been discovered that airborne bacteria can be annihilated completely when bombarded with sufficient radionic radiation at a correct wavelength, but in the case of bacteriophage, a type of virus, strange results are apparent. For example, it was found that 6 arbitrary units of radionic radiation would inactivate 50 percent of the bacteriophage sample, and that 12 units would destroy 75 percent. When 400 units were administered nearly 100 percent—99.9, to be exact—of the virus particles were inactivated.

Viruses, which some scientists believe are simply chemical compounds and not living organisms in the form of bacteria, have been indicated as the villain causing many diseases in man, animals, plants, and insects. These viruses are so tiny that they pass through filters and can only be observed momentarily, in rough outline, by a powerful radionic microscope. The Westinghouse research director has been conducting what he describes as "test-tube wars," in which literally millions of bacteria are blitzed, like the operations of earlier

Nazi panzer units, and destroyed by an invisible parasite. Scientists are thus enabled to study virus which feeds on bacteria and destroys it with bombardment of radionic rays from the "Sterilamp." The presence of active specimens can be proved only after they have dissolved a test-tube of bacteria. Dr. Rentschler points out that one way viruses are spread is by a cough or sneeze—thus if a virus is in the atmosphere we breathe, we are exposed to disease germs. Now data is being sought to determine the amount of radionic rays necessary to annihilate

a certain quantity of virus, so that ultra-violet lamps may be installed to the best effect in schools, homes, offices, and armament plants. This data, however, is obtained only after time-consuming and painstaking effort—96 hours being necessary to complete a single test.

A "merry-go-round" of radionic lamps has been devised in a few American armament factories whereby ten workers ride simultaneously, receiving ultra-violet rays to combat colds and fatigue. This revolving platform accommodates 100 workers an hour.

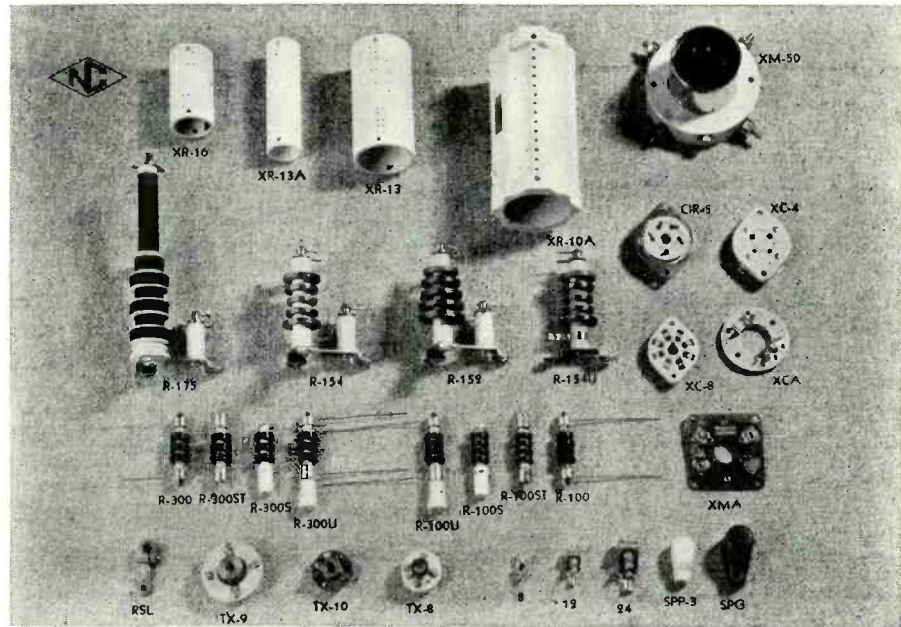

AVAILABLE FOR REASONABLY PROMPT DELIVERY

 Enlarged manufacturing facilities have enabled National to offer reasonably prompt delivery on many small parts to those who have the necessary priorities. The sockets, coil forms, RF chokes, grid grips, couplings and rotor shaft locks shown in the photograph above are available on especially good delivery schedules, and in the case of a few items, limited quantities may even be shipped from stock.

NATIONAL COMPANY, INC. MALDEN, MASS.

CHANGER-RECORDER



DELUXE MODEL 280

RECORD CHANGER-RECORDER automatically plays 10" or 12" records. Sensitive crystal pick-up, magnetic cutting arm, manual and reject control. Clutch type recording mechanism. Size 14" x 14" x 5½" high. Price..... **\$44.95**

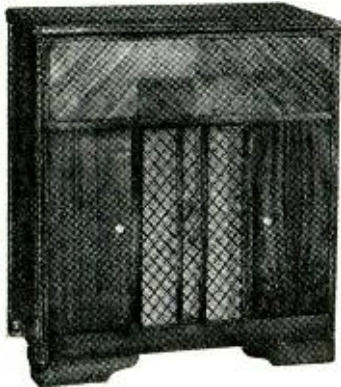

No. 872 HEPPLEWHITE Radio-Phonograph Combination Cabinet. Panels of straight grain, matched veneer front, are finished in French Walnut with a dull rubbed lacquer. Left door utilized for albums and microphone shelf. Mounting board 6½" from top lid. Cabinet 34" high, 31" wide, 18" deep. (Future Delivery only.) Quantity discounts. **Single unit price \$34.95**

SPECIALS

Philophone intercommunicating system complete with master and remote station..... **\$29.95**
 Zenith 14" dynamic speakers—800 ohm field, 8 ohm voice coil, 15 watt output. List price. \$13.20
 Single unit..... **\$4.95** Lots of four..... **\$16.00**
 De Luxe combination cabinet No. 890 (Future Delivery only)..... **\$49.95**
 Astatic crystal microphone No. R3. **\$7.50**
 Crosley console cabinet No. 03CB..... **\$27.95**

Write Today for Bargain Bulletin

MUTUAL RADIO PRODUCTS CO.

1579 Milwaukee Avenue • Chicago, Illinois

"Buy War Bonds"

LENSES

NEW Finely ground and polished, new but edges very slightly chipped.

For magnifying, making telescopes, and for hundreds of uses in photography. Directions included.

JUST THE THING FOR THE PHOTOCCELL HOBBYISTS!

Set # 1-R "Our Advertising Special" 15 Lenses for \$1.60, Postpaid
 Set # 5-R "The Gadgoater's Delight" 35 Lenses for \$5.00, Postpaid
 Set # 10-R "The Experimenter's Dream" 70 Lenses for \$10.00, Postpaid

EDMUND SALVAGE COMPANY

Dept. 6, 41 W. Clinton Avenue, P. O. Audubon
NEW JERSEY

Another unit of importance is the radionic inhalator which consists of a low-voltage transformer, a low-amperage rectifier, and a pair of electrodes acting upon a solution of sodium chloride. As shown in the diagram, it is employed on alternating current to generate chlorine, the electrodes being mounted in a small capacity electrolyte reservoir. This has a cover and the container resolves itself into two compartments—thus segregating the chlorine from the ever-present hydrogen. As insurance that the same electrode will yield the chlorine at each applied action, friction-contact terminals engage the electrodes in one position only, so that the polarity of the electrodes cannot be reversed. Ways are available for mixing air with the chlorine, and a nose-tip tube is handy for ready inhaling of the chlorine.

This radionic inhalator is portable, being sufficiently compact for convenient carriage to the bedside of a patient or patients, the device being connected to an a.c. outlet. Any number of cold or sinus patients may be treated, although they may be situated at various points—the chlorine being administered in rotation. The rate of electrolysis depends upon the conductivity of the electrolyte, the size of the carbons, and the extent of their immersion in the electrolyte—all of which influences the electrical amperage and, consequently, the generation of the chlorine. It can be generated satisfactorily with a flow of 1 ampere and 4.5 volt direct current. The amperage may vary from .5 to 1.5 amperes, and the voltage may range from 4 to 6 volts direct current. In excess of 6 volts is extravagance, putting a needless burden on the transformer and disturbing the smooth functioning of the rheostat control.

The integral units of this radionic inhalator are housed within a casing having a face plate, upon the outside of which is mounted the manually-operated parts. The face plate may be a part of the casing or superimposed thereon. The transformer is on the underside of the face plate and the transformer coil extends through an opening in this plate. A cap covers the coil—and two bolts hold the transformer and its cap in cousin-like relationship with the face plate. Close by the transformer is a rectifier, mounted on the underside of the transformer. Two terminals are mounted on the outside, upon face plate and in the circuit rectifier. The electrolysis reservoir is positioned on the outside, subject to demounting, on the face plate with the two electrodes, in frictional contact with two terminals. The electrodes are in the form of rods and are either of carbon or graphite, because most other metals are subject to the corroding effect of sodium chloride electrolysis. A preferred form of the reservoir, as seen in Figure 1, shows three compartments—a collection chamber, and amelectrolyte sump, having a septum, dividing it into two

compartments. The septum terminates a short distance from the bottom of the sump and the electrolyte liquid resolves itself into a seal to segregate the hydrogen gas from the chlorine.

Not unlike a telephone girl's message receiver, resembling also the headset of the crystal radio, a special radionic device worn by airplane pilots flying at high altitudes determines whether the blood is red or pale. At different altitudes the variation of the oxygen content changes the color of the aviator's blood; this "electric eye" decides the actual amount of oxygen needed by the flier at great heights to survive the thinning air.

The "off" and "on" method used heretofore is giving place to this newly invented radionic signal device, which sounds an alarm if the color of the pilot's blood indicates a low supply of oxygen. A tiny light passes through the lobe of the aviator's ear to a photoelectric cell and its output is multiplied a large number of times by a radio amplifier; and the instrument board of the airplane receives the message for visual observation by the flier. The security and well-being of the high-altitude aviator can be checked constantly during the flight and the flow of oxygen governed to suit his needs, flowing to him properly. The photoelectric tube with its companion unit of a lamp or source of light is able to distinguish between 2,000,000 shades of color, and in this strange role of grading the color of a pilot's blood its manifold uses increase speedily.

Before the Westinghouse Electric and Manufacturing Company placed the phototube and tiny lamp into the ears of fliers navigating in the stratosphere, often above 20,000 feet, the oxygen content was determined in a haphazard manner, only a sense of insecurity of the pilot dictating to him his hazard. By the scientific and progressive flashing of the visual signal on the airplane's instrument boards, with the aid of the "electric eye," the amount of oxygen in the aviator's blood is "seen," whenever the supply is dangerously low. The color of the blood changes with the oxygen fluctuation.

Radionics is useful in the service at Fort Knox, Kentucky, where sailors, soldiers and marines receive training for combat duty. This Fort Knox laboratory is the only one of its kind where men are tested to withstand varying atmospheric conditions from a temperature as low as 30 degrees below zero—such as experienced on severe winter days in Siberia, Russia to a high of 130 degrees above—simulating the hottest day in Death Valley, California.

In make-believe flying in high altitudes, the "electric eye" acts as a signal station. If the acting test pilot, in an air-compressed chamber, feels a dizziness approaching a swoon a radionic device measures the supply of oxygen, signaling a warning. Fort Knox, Kentucky is that place where

gold reserve is stored and fortified deep in the ground; it may eventually be guarded by radionic devices.

When England has equipped the engines of her fighter planes for air super-chargers, functioning from sea-level pressure up into the stratosphere 40,000 feet, this phototube and its source of light as a reader of the color of blood of fliers as the oxygen content increases or decreases, will become a necessary gadget on every plane.

At hospitals in North Africa, in New Guinea, or in other American battle areas a radionic "detective" is employed to locate shell fragments, splinters, or other metallic substances in wounded soldiers. Analogous to the United States Bureau of Mines in using a sensitive gravity meter to locate bauxite, from which war-precious aluminum stems, this radionic detector of metallic foreign bodies enables the surgeon to formulate a scientific decision—whether the shell fragments are in a harmless location or dictate an emergency operation to remove the splinters.

By a radionic device, war surgeons can take radiographs which record X-ray images on a sensitized film—making possible examination of the skull, the bones of the hand, spine and chest. By use of the fluoroscope, invented by the late Thomas A. Edison, physicians can study internal organs as they function normally. Then, too, by the same instrument Army dentists can disclose hidden cavities or explore troubles at the roots of teeth. Radionic "snapshots," in stop-motion fashion, can be made of the heart in a split second. These same radionic "pictures" are a sort of "flashlight" for guiding the surgeon in setting a bone or knitting a rib in hospitals adjacent to the jungles of New Guinea. Gall stones, kidney stones, and bladder stones, may be revealed in a similar manner, and tuberculosis and silicosis may be detected in the early and curable stages. Moreover, ulcers and tumors may be discovered before they have ravaged the human body beyond repair.

The electrocardiograph as an instrument for detecting and measuring human heartbeat—even the faint heart murmuring of an unborn child—is standard equipment in the medical profession. However, quite recently Dr. Arthur J. Geiger of New York City has been experimenting with a pre-amplifier for boosting the tiny pulses of the fetus (unborn child) sufficiently to be audibly detected on the electrocardiograph. This radionic amplifier consists of two No. 19 tubes or 1G4-G's, battery-operated, in a direct-coupled circuit. The second or output tube has, in its plate circuit, a tapped load resistance, which allows steps of amplification to be "sliced off" and applied to the electrocardiograph itself for recording purposes. The electrodes are two metal discs, placed upon the abdomen of the pregnant mother. From these electrodes, lead wires run to the pre-amplifier and thence to the



EE8-A

THE EE8-A field telephone is one good reason why American-built communications equipment has a reputation for being the best there is. It is an *unclassified* (not secret) instrument, but we, whose prime war job is to build it, doubt that the enemy can match the EE8-A phone. You see there *is* a secret to it—the secret of American know-how. For instance:

- How to turn out such delicate, and at the same time, rugged instruments by the tens of thousands, and still have each the equal or superior of a handmade product.
- How to devise instruments to give each unit a complete "laboratory" test, in a few seconds, right on the production line.
- How to make telephones that will operate equally well whether they serve in arctic cold or tropic moisture.

America has the answers. Major credit belongs to Signal Corps engineers, but *Connecticut* is proud to have had a part in making the EE8-A a weapon for helping our boys get the jump on the enemy wherever they find him.

In your postwar planning of products and factory method, you will need American know-how in the design, engineering and manufacture of precision electrical devices. We believe *Connecticut* can help you.

CONNECTICUT TELEPHONE & ELECTRIC DIVISION



MERIDEN, CONNECTICUT



For the second time within a year, the honor of the Army-Navy Production Award has been conferred upon the men and women of this Division.

© 1943 Great American Industries, Inc., Meriden, Conn.

electrocardiograph. The latter converts the radionic impulses into the movement of a recording pen, which writes "autographs" on a strip of paper. A permanent record is obtained in this manner for a study of the heartbeats of an unborn child in its progress of coming into the world. The interposing of a radionic amplifier between the patient and the electrocardiograph adds up to greater sensitivity of the recording instrument—6 cm. per mv., contrasted with 1 cm. per mv. on the electrocardiograph without a boosting amplifier.

Another radionic device bearing the unwieldy medical term of the "Inductotherm," means the generation of artificial fever, joining nature in the cure of certain diseases. Radionic

tubes generating curative heat, penetrate deeply into human tissue. Coils of insulated cable, like a snake coiled to strike, are nestled around the diseased portion of the body and this heat from high-frequency currents soothes and accelerates the healing of a soldier's wounds and fractures.

Radionics may never displace the human element in ministering to the ills to which the flesh is heir, but these scientific instruments constitute a powerful ally in the hands of war-rationed physicians scattered thinly around the globe. These devices have therapeutic value and when handled by competent doctors treatment of diseased bodies is speeded up, and human suffering thus ameliorated.

-50-

130-210 mc. Receiver

(Continued from page 25)

ing step-by-step analysis will give the reader a clear picture of the functions in the many circuits:

Entering at the primary of T_1 , the signal is induced in the secondary where it is applied to the grid of V_1 (the first RF tube), shown in schematic. The signal may be that of any frequency within the 130-210 mc. range.

The amplified signal, now flowing through the plate circuit of V_1 and transformer T_2 , induces a voltage to the secondary winding and to the grid of the 954 RF amplifier tube V_2 . The amplified signal then passes through the tuned circuit of T_3 , and feeds into the mixer grid of V_3 .

A separate oscillator tube, V_{14} , and associated component T_4 , provide their signal which is injected to the cathode of V_3 .

These two frequencies heterodyne one another in the plate circuit of V_3 to produce a beat frequency of 16 mc. which has been chosen for the IF.

The resultant voltage (at 16 mc.) induces a voltage across the secondary of T_5 , and feeds to the grid of V_4 .

The signal is then amplified at the intermediate frequency through transformer T_6 and tube V_5 , and is further amplified through T_7 and tube V_6 . The output of V_6 is coupled through T_8 to one of the diodes of V_7 (AM detector and automatic noise limiter).

The signal is rectified at this stage and the amplitude modulation of the carrier causes a similar audio frequency signal to appear across resistors R_{33} , R_{34} and R_{35} in series.

The operation of the volume control R_{45} adjusts the amount of voltage that will be applied to the grids of the two triodes (in parallel) of V_{10} . The AF voltage appearing in the plate circuit of V_{10} feeds to the grid of V_{11} , to the tone control R_{52} and C_{51} , and to the headphone jack J_1 .

The output of V_{11} flows through transformer T_{10} (output). There is a choice of either 500 or 5,000 ohms at the secondary of this transformer so that proper match may be made for high impedance PM speaker or for 500 ohm lines.

Note that the voltage applied to the grid of V_8 is also fed, in part, to the grid of V_9 (the limiter for FM). The function of V_9 is to limit the voltage in its plate circuit to a pre-determined value that has been selected for best reception of FM transmissions.

Amplitude modulation of the carrier, whether it be intentional or caused by man-made interference or static, is effectively reduced to a value that will not be apparent to the listener.

When the carrier is frequency-modulated, however, the circuit will be unaffected. The signal (limited in amplitude) now appears across the primary of T_9 , and voltage is induced in the secondary. This reacts with the

YOUR MONEY BACK!

...if Ghirardi's Big, 972-page RADIO PHYSICS COURSE doesn't teach you Radio faster, easier and at less cost than any other book!

STOP WISHING FOR A BETTER JOB...Study this book and get one!

Are you one of the thousands of men who'd like to learn Radio, for work in the armed forces or civilian life, but can't seem to make up their minds just what to do, or how to get started for a profitable, interesting career? If so, this is your opportunity! Ghirardi's famous RADIO PHYSICS COURSE book is exactly what you need to teach yourself right from the ground up, at home in spare time. It's the easiest, quickest, and most inexpensive way of getting started. That's why it has given more people their basic training than any other book ever published. That's why it is used in more U. S. Army Signal Corps, Navy, and civilian schools and colleges, and for more home study, than any other radio text book of its kind. Would you want any better proof than this?

WHAT ABOUT ELECTRONICS?

You've probably been reading a lot lately about the tremendous post-war future in the amazing Electronic industry. But did you know that vacuum tubes and circuits closely similar to those used in Radio are the basis of practically all Electronic developments—and that a knowledge of the electric and electronic fundamentals such as is given in RADIO PHYSICS COURSE is your "Open Sesame!" to this vast new industry, as well as to Radio itself!

NO OTHER COURSE LIKE IT!

Starting right at the beginning, Ghirardi teaches you, step by step. He takes nothing for granted. He explains every last detail so that it is crystal-clear before you go on to the next. Because of this thoroughness, RADIO PHYSICS COURSE is a large volume—far larger than any other book of its type. Actually, it gives you the scope of 36 different courses in one, packed into nearly 1,000 pages, made easily understandable by more than 500 special illustrations, and containing 856 self-testing review questions. You'd expect to pay lots more for such thorough, superior instruction. At the price of only \$5 it's an unmatched bargain. Compare it with any other radio book. Then get started NOW for a fascinating, well-paying Radio-Electronics future in industry, in the Signal Corps, Navy, Aviation, commercial broadcasting, television, in a business of your own, or in any one of the many other branches. Mail the coupon today! Our 5-day MONEY-BACK Trial offer enables you to examine this great book without assuming any risk whatever!

RADIO & TECHNICAL PUBLISHING CO.
Dept. RN73, 45 Astor Place, New York 3, N. Y.
Rush me a copy of your big 972-page RADIO PHYSICS COURSE book. \$5 enclosed (\$5.50 foreign).
 Send C. O. D. for \$5 (\$5.50 foreign) plus postage. In either case, I may return the book within 5 days for refund.
 Send free illustrated folder:

Name.....
Address.....
City..... State.....

Easily worth \$50 if you bought it as a course

LEARN RADIO AT HOME, IN SPARE TIME

Easier....

Better....

Faster....

...and for only \$5 COMPLETE

Big Illustrated Folder FREE

COMPLETE BASIC RADIO TRAINING in one big volume!

voltage, which is coupled through condenser C_{40} , to produce a frequency-discriminating action.

When the signal frequency flowing through T_6 is exactly 16 mc., the voltages present across resistors R_{45} and R_{46} will be both equal but of opposite polarity.

A change of frequency in one direction will produce a positive difference between the voltage across R_{45} - R_{46} . Likewise, a frequency change in the opposite direction will produce a negative voltage difference.

Frequency modulation of the received carrier produces a similar audio voltage across resistors, R_{45} and R_{46} . The resultant is applied through the high frequency de-emphasis network, R_{47} , and from C_{47} to the audio gain control R_{48} . It then terminates at the input to the audio frequency amplifier.

Returning to the tube V_7 , we see that the other diode is used as an automatic noise limiter. The action of this circuit is to reduce the amplitude of sharply peaked interference when receiving AM signals. Hash from ignition systems etc. is effectively reduced and intelligibility greatly enhanced.

The incoming supply from the power line is fed through the filter network that includes C_{66} , L_{67} , C_{65} , C_{67} , L_{68} and C_{69} . Line disturbances are removed or greatly reduced by this filter.

The use of a voltage regulator tube V_{12} furnishes constant voltage to the plate supply of the HF oscillator tube V_{11} , the screen and plate of the mixer tube V_8 , and the screen of V_5 .

Tuning is simplified by the use of a tuning (S meter) designated as M_1 . It indicates the strength of the carrier input by changes in plate current of V_5 . An increase of carrier strength increases the automatic volume control voltage supplied to this tube. This, in turn, reduces the plate current, causing a change in reading of M_1 .

FM transmissions must be accurately tuned for true reproduction. The same tuning meter (M_1) is used for the purpose. It is connected through a high resistance, R_{35} , and across resistors, R_{36} and R_{37} , when in the FM position. The meter indicates "O," when the set is tuned accurately to an FM carrier. Any slight deviation in the tuning from the zero setting will cause the meter indicating pointer to deflect in either direction.

Conclusion

The design of special receivers for the military has been greatly simplified by the vast amount of research that has gone into sets of the type described. New methods are being found that will be applied to the mass construction of high frequency receivers for the post-war amateur.

One thing is certain—the entire picture of amateur radio will have been changed by the addition of thousands of new participants. The higher frequencies are the logical solution to the problem of finding enough channels to accommodate them.

Power Output Meters

(Continued from page 39)

tively. The two former sections are of odd resistance value and must each be made up of several lower values connected in series. Resistors employed are ½-watt. R_1 may thus be made up by connecting in series one each 600,000 ohms, 70,000 ohms, and 14,000 ohms. Likewise, R_2 is made by connecting in series one each 200,000 ohms, 15,000 ohms, and 1,000 ohms. The accuracy of the two higher-wattage ranges will be dependent entirely upon the accuracy of these resistors. R_3 could be a 1-megohm volume con-

trol, R_4 a 250,000-ohm control, and R_5 a 250,000-ohm control. During the calibration process, to be described presently, these controls may be set *exactly*, as they might also be during recalibration when the tube is subsequently replaced.

The voltage calibration of this v.t. voltmeter circuit is given in Chart I and the corresponding power (watt) values in Chart II.

The binding-post terminals T_1 and T_2 accommodate the test leads or other connections made to the power source under test, while the posts T_3 and T_4 are for the external load resistor when this type of unit is employed.

The voltmeter circuit possesses ex-

JUST OUT!

3rd Edition of Ghirardi's RADIO TROUBLESHOOTER'S HANDBOOK

STOP GUESSING ON RADIO SERVICE JOBS

Every Wasted Minute Costs YOU Money!

Here is the most important book any service shop or individual can own during these critical times—bar none! Enables you to cut corners—save valuable troubleshooting and repair time—train new technicians—repair cheap sets at a real profit—handle tough jobs in half the usual time—and much more. Now in its 3rd Edition, completely revised, bigger than ever, and CONTAINING NINE ADDITIONAL SECTIONS OF VITAL NEW MATERIAL.

Its 404-page Case History Compilation gives common trouble symptoms, their causes and remedies, for over 4,800 models of the 202 most popular makes of receivers. Often, these entirely eliminate the need for testing. ALMOST ALWAYS, they save from 25% to 50% of the time you would normally require to repair a set.

NOW COVERS 75 IMPORTANT SUBJECTS

This feature, however, is ONLY ONE OF 75 IMPORTANT SUBJECTS covered in this brand new HANDBOOK. Never before has such a wide variety of useful servicing information been presented so authoritatively within the covers of a single, inexpensive volume! There are scores of charts, graphs, etc.—all designed to HELP YOU REPAIR MORE RADIOS EASIER AND IN LESS TIME! There are I-F alignment peaks for over 20,000 super-hets; a big data section on I-F transformer troubles—AND THE MOST UP-TO-THE-MINUTE TUBE CHART you've ever seen. This contains complete information on EVERY tube type and with practical tips on how the types may be interchanged or replaced by more readily available types.

REPAIR MORE RADIOS IN LESS TIME!

Dozens of other charts, tips and helps make this RADIO TROUBLESHOOTER'S HANDBOOK absolutely indispensable to busy servicemen at a time when test equipment is scarce, when parts often have to be substituted, and when it is more necessary than ever before to have COMPLETE SERVICE REFERENCE DATA at your fingertips.

EXAMINE IT FOR 5 DAYS!

Sold for only \$5 on an ABSOLUTE 5-DAY MONEY-BACK GUARANTEE BASIS. Order your copy today while the available supply lasts. Your money will be cheerfully refunded if you don't agree within 5 days that this book is the finest service investment you can possibly make!

RADIO & TECHNICAL PUBLISHING CO., Dept. RN73
45 Astor Place, New York 3, N. Y.

Rush me a copy of the new 3rd REVISED Edition of your RADIO TROUBLESHOOTER'S HANDBOOK.

\$5 enclosed (\$5.50 foreign)

Send C. O. D. for \$5 (\$5.50 foreign) plus postage

Send free illustrated folder.

In either case, if I am not fully satisfied, I may return the book within 5 days of receipt for full refund.

Name.....

Address.....

City..... State.....

COMPLETELY REVISED—GREATLY ENLARGED Contains 9 Additional Sections

3rd Revised Edition

RADIO Troubleshooter's HANDBOOK



**ALFRED A. GHIRARDI'S
BIG, WARTIME
SERVICE
HANDBOOK**

The Data Book That Pays for Itself in Time Saved on the Very First Job

only \$5 Complete

Big Illustrated Folder FREE

MONEY-BACK GUARANTEE... You Cannot Lose!

**QUALITY
ABOVE ALL...**



CAPACITORS

**DRY ELECTROLYTICS
WET ELECTROLYTICS
PAPER CAPACITORS
MICA CAPACITORS
"ELIM-O-STAT" SUPPRESSORS
CAPACITOR ANALYZERS**

SOLAR

**MANUFACTURING CORP.
Bayonne • New Jersey**

**GENERAL INDUSTRIES
SMALL-POWER MOTORS**



More Power for Victory

• There are innumerable places where small-power motors are required in this mechanized war, and General Industries is making them by the thousands. Not only motors but electronic and other precision-made devices of many types. Producers for Victory find it to their advantage to look to General Industries for accurately machined equipment. Let us discuss your requirements with you.

THE GENERAL INDUSTRIES CO.

ELYRIA OHIO



tremely low zero drift. In fact, we have been unable to detect any drift upon the microammeter scale.

The wattage readings given in Chart II are based upon 1 ohm load impedance, this being a convenient value to which other load impedance ratings may be quickly referred when reading the meter. The constructor will find that the voltage calibration given in Chart I will correspond within a fraction of a dial division to the individual calibration he will make.

Mechanical Construction

The watt-meter, as shown in the photograph, was built of materials that happened to be available. The instrument case is a coated steel chassis, 5½" x 10" x 3" in size. The front panel is a sheet of thin metal stock originally cut to serve as a base plate for the chassis. The panel is held to the chassis by four self-tapping screws seen along the top and bottom edges. There is ample "breathing space" inside this case, since its overall size is somewhat in excess of that actually required as a minimum. The reader is free to exercise considerable latitude in dimensioning his own unit, since the placement of parts is not at all critical, and the components of the instrument do not occupy a great deal of volume.

CHART I

Voltage Calibration (S1 in 2-volt position)

Microamperes	Volts (RMS)
500.....	2.0
465.....	1.90
450.....	1.85
430.....	1.80
400.....	1.70
370.....	1.60
350.....	1.50
310.....	1.40
300.....	1.35
285.....	1.30
260.....	1.20
250.....	1.15
235.....	1.10
210.....	1.00
200.....	.95
180.....	.90
165.....	.85
155.....	.80
150.....	.78
140.....	.75
130.....	.70
115.....	.65
100.....	.60
90.....	.55
80.....	.50
55.....	.40
50.....	.35
40.....	.30
22.....	.20
10.....	.10

The binding post terminals for meter input and for the external load resistor (when the latter is employed) are arranged along the top left edge of the panel. These posts are mounted with shoulder-type fiber washers so that their terminal screws are insulated from the panel through which they pass. The tube socket is mounted

RIGHT ON THE NOSE!

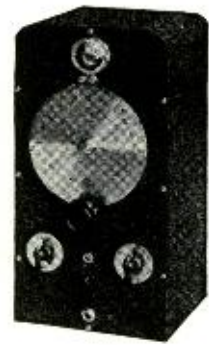

That's what Browning Frequency Meters do for transmitters—put them "right on the nose." Write for complete literature on Types S-1 and S-2, with over-all accuracy of, respectively, .01% and .005%.

A PRODUCT OF BROWNING
LABORATORIES RESEARCH



Gothard

**DETACHABLE
SNAP-SOCKET
PILOT LIGHT**

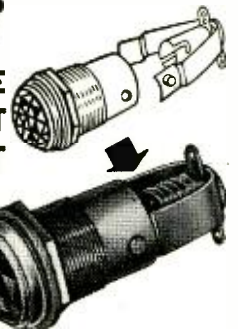

WITH NEW
STYLE RIGID
TERMINALS

Gothard Series 800 Pilot Lights are very popular for switchboard and similar mounting. Socket and new style rigid terminals that cannot work loose or twist are integral parts of the spring member, which locks firmly into Jewel housing. Socket is easily removed with spring member for replacement of lamp bulb. Bulb may also be inserted from front of panel by removing slip-ring mounted Jewel. Range of Jewel colors—plain or faceted—miniature or candelabra screw sockets, or miniature bayonet sockets.

Request the Gothard Pilot Light Assemblies Catalog for complete information.

**Gothard
MANUFACTURING COMPANY
1350 N. NINTH STREET, SPRINGFIELD, ILLINOIS**

on the panel by means of 1½" long 6-32 screws which support the socket away from the panel. Batteries are held to the case (chassis) by means of spring-brass clips which the writer formed from scrap stock. Here again, the reader may exercise his own ingenuity in mounting these components. Leads were soldered directly to the battery terminals, since the low current drain of the instrument makes it possible to operate for long periods of time without changing batteries and any quick-change scheme was deemed unnecessary.

The on-off toggle switch is mounted directly below the two controls, seen along the center line of the front panel in the photograph. The left-hand control is the meter zero adjustment rheostat R4. The right-hand control is the single-pole, three-position rotary wattage range switch S1.

If carbon resistors are used in the R1, R2, and R3 positions, they may be connected directly between the terminals of S1. If volume control type rheostats are employed, they may be mounted on a narrow subpanel which may be supported from the front panel by means of long screws. All wiring is cabled, since no trouble with circuit interaction, feedback, etc., is experienced at the frequencies at which the instrument is operated.

After the instrument has been completely assembled and wired and the wiring has been checked, the calibration may be carried out in the following manner:

1. Turn on the on-off switch S2. The meter M will immediately be deflected and will read somewhere along its scale. It is not likely that it will be found standing at zero with the current switched on. However, if there is no movement of the pointer, slowly rotate R4, watching the pointer which should be moved up or down the scale depending upon the direction in which R4 is rotated. Allow the instrument to heat up for two minutes before proceeding with the rest of the operations.

2. Bring the meter pointer to zero by ad-

justing the zero-set control R4 either to the right or left.

3. Provide a variable source of a.c. voltage at any convenient frequency. This will generally be a 60-cycle voltage obtained by means of a potentiometer or variac.

4. Connect the range switch S1 to the 2-volt position, adjust the variable-voltage source to zero and connect the latter to the input binding posts T1 and T2.

5. Connect a reliable a.c. voltmeter

(with several ranges) also to the input terminals designated on the diagram as T1 and T2.

6. Adjust the voltage source, bringing the voltage up until the monitoring a.c. voltmeter shows that a voltage of 2 is applied to the input terminals. This voltage will cause a full-scale deflection of the microammeter.

7. Drop the input voltage successively to voltages lower than 2 v., obtaining numerous calibration points along the meter scale. Compare the

OUT OF INQUIRING MINDS AND PROGRESSIVE SPIRITS...

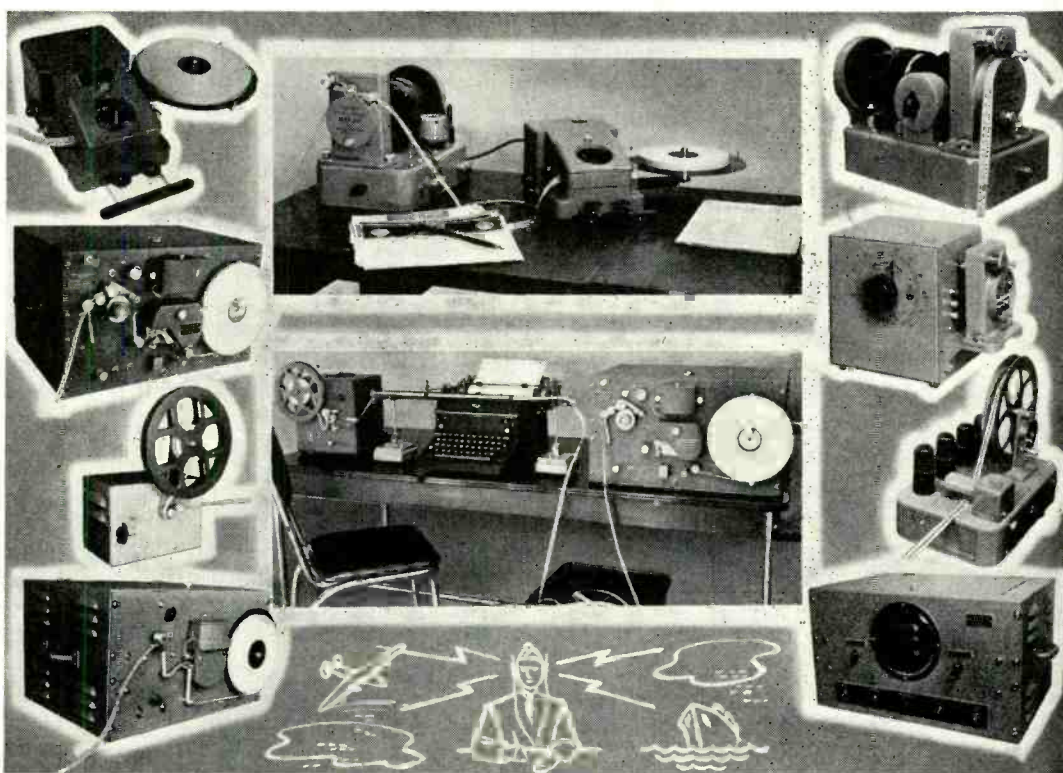

Led by Ted McElroy, undisputed authority in the world of wireless communications, our corps of creative telegraphic engineers have produced, and are producing, a bumper crop of equipment for the transmission and reception of dots-and-dashes. Out of their inquiring minds and progressive spirits have come high speed transmitters for perforated tape, Wheatstone tape perforators, high speed recorders, photo tube units, radio beam keyers, high speed automatic radiotelegraph assemblies . . . and they're far from calling it a day.

Seemingly, McElroy engineers never sleep . . . they're constantly "on the search." McElroy men never copy and never imitate. Theirs is the job of creating . . . designing . . . building. If you have a problem in radio telegraphy, or an application incorporating electronic design, the services of these men are at your disposal.

McElroy MANUFACTURING CORPORATION
82 BROOKLINE AVENUE BOSTON, MASSACHUSETTS

LEARN CODE

the way you'll be using it

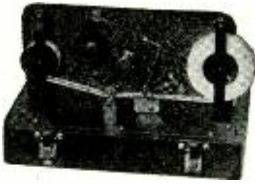

by SOUND

The best way to learn to read code is by listening to code. The best way to learn to send code is by hearing your own sending repeated back to you. With the new All-Electric Master Teleplex Code Teaching Machine, you learn code the natural, easy, fascinating way. Only instrument ever produced which records your sending in visible dots and dashes—then SENDS BACK your own key work at any speed you desire. There are NO PERFORATIONS—NO INK. Far superior to anything ever developed... a marvel of simplicity. That's why practically every school teaching code uses MASTER TELEPLEX. We furnish complete course, including the All-Electric Master Teleplex, give you personal instruction with a MONEY-BACK GUARANTEE—All at a surprisingly low cost. Write today for FREE catalog RN-6. No obligation.

TELEPLEX CO., 107 HUDSON ST. JERSEY CITY, N. J.

COMMERCIAL RADIO INSTITUTE

A radio training center for over twenty years. Well equipped. Excellent faculty. Practical RESIDENT COURSES in Radio Telegraphy, Broadcast, Servicing, Industrial, Television, Aeronautical, Drafting, Mathematics and Studio Technique. Placement Bureau. Day and Evening Classes Now Forming for Aug. 9th. Catalog upon request.

Dept. C, 38 W. Biddle St., Baltimore, Md.

NOW—A REALLY HIGH-POWERED— Radio Engineering Library

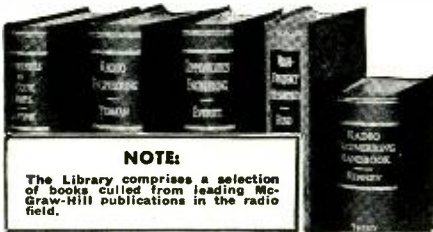

NOTE:

The Library comprises a selection of books culled from leading McGraw-Hill publications in the radio field.

- especially selected by radio specialists of McGraw-Hill publications
- to give most complete, dependable coverage of facts needed by all whose fields are grounded on radio fundamentals
- available at a special price and terms

THESE books cover circuit phenomena, tube theory, networks, measurements, and other subjects—give specialized treatments of all fields of practical design and application. They are books of recognized position in the literature—books you will refer to and be referred to often. If you are a practical designer, researcher or engineer in any field based on radio, you want these books for the help they give in hundreds of problems throughout the whole field of radio engineering.

5 VOLUMES, 3319 PAGES, 2289 ILLUSTRATIONS

1. Eastman's FUNDAMENTALS OF VACUUM TUBES
2. Terman's RADIO ENGINEERING
3. Everitt's COMMUNICATION ENGINEERING
4. Hundt's HIGH FREQUENCY MEASUREMENTS
5. Henney's RADIO ENGINEERING HANDBOOK

10 days' examination. Easy terms. Special price under this offer less than books bought separately. Add these standard works to your library now; pay small monthly installments, while you use the books.

10 DAYS' FREE EXAMINATION—SEND COUPON

McGraw-Hill Book Co., 330 W. 42nd Street, N. Y. C.

Send me Radio Engineering Library, 5 vols., for 10 days' examination on approval. In 10 days I will send \$3.00 plus few cents postage, and \$3.00 monthly till \$24.00 is paid, or return books postpaid. (We pay postage on orders accompanied by remittance of first installment.)

Name

Address

City and State

Position

Company RN-7-43

CHART II

Wattage Levels Corresponding to Voltage Calibration (Assuming 1-ohm Load)

RMS Volts	RMS Watts
0.1	0.01
0.2	0.04
0.3	0.09
0.4	0.16
0.5	0.25
0.6	0.36
0.7	0.49
0.707	0.50
0.8	0.64
0.86	0.75
0.9	0.81
1.0	1.0
1.1	1.21
1.11	1.25
1.2	1.44
1.22	1.50
1.3	1.69
1.32	1.75
1.4	1.96
1.41	2.00
1.5	2.25
1.58	2.50
1.6	2.56
1.65	2.75
1.7	2.89
1.73	3.00
1.8	3.24
1.87	3.50
1.9	3.61
2.0	4.00

readings obtained with the sample values given in Chart I. The two should not show a great difference.

8. After the 2-volt scale calibration is completed, turn range switch S1 to the 6.32-v. position and bring up the input voltage to 6.32.

9. This voltage should produce a full-scale meter deflection. If it does not, the resistors must be adjusted until the deflection is exactly full-scale.

10. Next, set S1 to the 20-volt tap and bring up the input voltage to 20. If full-scale deflection is not obtained in this case, it is likely that only R3 need be adjusted slightly until full-scale deflection is obtained.

11. Remove the indicating meter from the panel and remove the meter carefully from its case. Remove the microampere dial from the meter and make a new dial by tracing around the old one on thin white Bristol board with a sharp pencil. Mark off a new scale on the card and transfer the various voltage positions corresponding to wattage values (see Chart II) to this new scale.

12. When a sufficient number of wattage points have been inked-in and marked, replace the meter in its case and re-install on the front panel.

Application

The watt-meter described in the foregoing is intended for measuring power levels across known values of impedance or resistance. When the power source under test is not equipped with a normal load device, however, a load resistor of the proper ohmage and wattage is connected to

the special terminals designated as T3 and T4.

When measuring power across a known load, connect heavy leads from the two ends of the load device (such as a transformer, voice coil, or line) to the input terminals T1 and T2. Energize the power source (such as an amplifier) either by switching it on to produce power output or (as with an amplifier) exciting it with a signal from an oscillator. The watt-meter will be deflected. If the deflection is greater than full-scale, set the range switch S1 to the next highest position. (Standard practice is to start measurements at the highest range and to progress to the lower ones for greater readability, in order to prevent damage to the indicating meter.) Read the power level directly on the scale of the watt-meter.

The direct-reading scale applies only to power levels developed in a 1-ohm load. For all other load values, the meter readings must be divided by a suitable factor. If, for example, the load resistance is 1000 ohms, mentally divide the meter readings by one-thousand (or multiply by 0.001). If the load impedance is 100, divide by one hundred (or multiply by 0.01). If the load impedance is 30 ohms, divide by thirty (or multiply by 0.3), etc., etc.

-30-

Practical Radio Course

(Continued from page 44)

the primary. That is, $E_p = \mu E_s$. If the winding and voltage step-up ratio of the transformer is N, then the voltage developed in the secondary of the transformer will be $E_s = \mu E_p N$. The voltage gain per stage will be, therefore:

$$\text{gain per stage} = \frac{E_s}{E_p} = \frac{\mu E_p N}{E_p} = \mu N$$

This illustrates the important fact that in a transformer-coupled amplifier, a total stage amplification greater than that of the tube alone can be secured. For very good reasons which we shall discuss later, present-day high-quality interstage audio transformers generally have step-up ratios of only 1 to 4, or less.

The amplification and the frequency response are evidently fairly uniform throughout the range of frequencies over which these ideal conditions are closely approximated. These ideal conditions cannot be assumed at the very low, or the high frequencies, however, because at these frequencies some of the factors neglected at the intermediate values of frequencies become too important. First, since the reactance of the primary of the transformer decreases with decrease in signal frequency, at the low frequencies the reactance of the transformer primary winding will no longer be large compared with the total resistance $r_p + R_1$ of the primary circuit (later we will see that because of the large

distributed capacitance that would result, it is not practical to build audio transformers with sufficient primary turns to make the inductance and reactance large enough for good tube loading at the low frequencies). For example, at a frequency for which the inductive reactance of the primary is equal only to the total resistance of the primary circuit (i.e. when $2\pi fL_1 = r_p + R_1$), the gain is only 70.7% of the value μN obtained at the intermediate frequencies at which $2\pi fL_1$ considerably exceeds $r_p + R_1$. The effect of this decrease of the reactance of the primary winding is to cause decreased gain at the low frequencies, as shown in the typical transformer-coupled amplifier frequency-response curve C in Fig. 5. As the frequency is decreased, the gain continues to fall, approaching zero at zero frequency. Compare this with the more uniform but lower-gain frequency response obtained from a well designed resistance-coupled amplifier stage at A.

At the high frequencies the gain also falls off due mainly to the shunting or by-passing effect of the distributed capacitances of the transformer windings, the mutual capacitance between them, and the interelectrode and stray capacitances. These may all be summed up and represented collectively by C_1 across the primary, and C_2 across the secondary, as illustrated in Fig. 4. At high frequencies the impedance of these capacitances becomes

very low ($= \frac{1}{2\pi fC}$), and their shunting effect causes the signal voltage appearing across the secondary (and consequently the gain) to drop off rapidly as shown by the right-hand end of graph C in Fig. 5.

There is one compensating action that tends to raise the high-frequency response at some definite point, often resulting in actual overcompensation (evidenced by the hump or peak which occurs near the right-hand end of the response curve of C in Fig. 5). This is caused by the fact that there is a frequency at which series resonance occurs (when the total effective leakage reactance equals the total effective shunting capacitive reactance of the circuit, both referred to the primary circuit of the transformer). This condition tends to raise the output voltage at this frequency to an amount above its mid-frequency value. At this frequency the magnitude of this effect is largely dependent upon the series resonant current that is able to flow. This, in turn, is limited by the sum of the total effective resistance R (referred to the primary circuit) in series with resistance r_p , since a low series resistance will permit a comparatively large signal current to flow through the series resonant circuit, producing an increased output voltage across the condenser. On the other hand, a high series resistance will reduce or even entirely eliminate the resonance effect. For frequencies above the resonance point, the react-

ance of the capacitance acts merely as a shunt across the output, and the output voltage rapidly falls to zero.

These effects are plainly illustrated by graph C of Fig. 5, where both the falling off in gain at low frequencies due to the decrease of the primary inductance, and the resonant rise in voltage at the higher frequencies, followed by the falling off due to the shunting effect of the total effective capacitance are plainly evident. Graph B shows the improved type of response obtainable when a more modern improved type of audio transformer is used. The same effects are present, but in much less magnitude. The response obtained is much more uniform throughout the frequency range.

One simple method of suppressing the peaking of a transformer frequency-response curve due to resonance consists of shunting the secondary of the transformer with a resistor (values of 0.1 meg. to 0.5 meg. are often used). This serves to increase the load on the secondary and so reduces the magnitude of the resonance peak. However, it also causes the mid-band gain to reduce, so the uniformity of response is secured at the expense of some gain.

Practical Difficulties in Constructing Audio Transformers for High Stage Gain

The foregoing detailed explanation of the actions taking place in a transformer-coupled amplifier at various signal frequencies reveals three important requirements of good audio transformers that have made their design difficult. First, for good low-frequency response the transformer should have extremely high primary inductance so that its inductive reactance will be sufficiently higher than the internal plate resistance (r_p) of the tube to enable a large proportion of the μ factor of the tube to be obtained at these low frequencies. Second, the higher the Sec-Prim turns-ratio of the transformer, the greater will be the theoretical voltage gain obtained in it. Third, the lower the distributed capacitance of the transformer windings, the less will be the falling off of gain at the high frequencies.

Now, the inductance of the primary winding of the transformer can be increased by either of the three following methods: (1) by increasing the number of turns it contains; (2) by using a core of large cross-section area; (3) by using a core metal of very high magnetic permeability (such as Permalloy, Hiperm, Mu Metal, etc.). Increasing the primary inductance by increasing the number of primary turns has limitations, since the secondary turns must also be increased proportionately in order to maintain the Sec.-to-Pri. turns ratio. Besides increasing the cost and bulk of the transformer considerably, such a large number of primary and secondary turns results in windings having excessive distributed capacitance, and also ex-

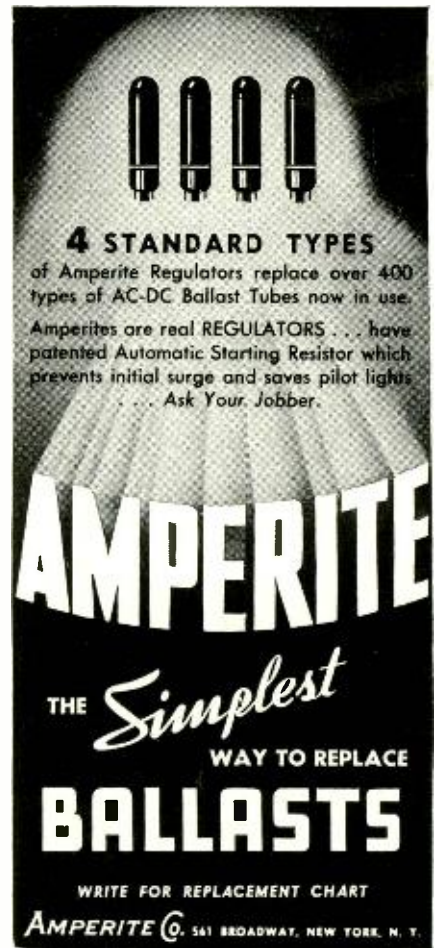

4 STANDARD TYPES
of Amperite Regulators replace over 400 types of AC-DC Ballast Tubes now in use.
Amperites are real REGULATORS... have patented Automatic Starting Resistor which prevents initial surge and saves pilot lights.
Ask Your Jobber.

AMPERITE

THE *Simplest* WAY TO REPLACE

BALLASTS

WRITE FOR REPLACEMENT CHART
AMPERITE Co. 541 BROADWAY, NEW YORK, N. Y.

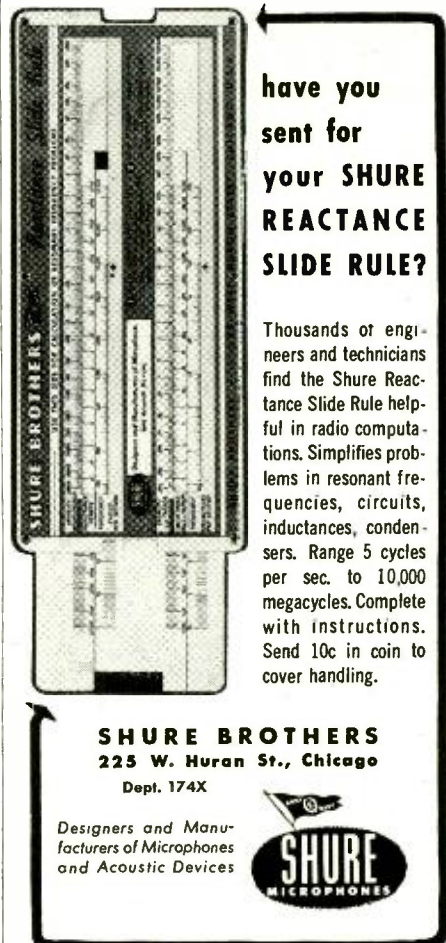

have you sent for your SHURE REACTANCE SLIDE RULE?

Thousands of engineers and technicians find the Shure Reactance Slide Rule helpful in radio computations. Simplifies problems in resonant frequencies, circuits, inductances, condensers. Range 5 cycles per sec. to 10,000 megacycles. Complete with instructions. Send 10c in coin to cover handling.

SHURE BROTHERS
225 W. Huron St., Chicago
Dept. 174X

Designers and Manufacturers of Microphones and Acoustic Devices





Specialists
in all Types

**RADIO
WIRE and
CABLE**

with **"Plastite" Insulation**



WHITNEY BLAKE CO.
NEW HAVEN, CONN.

Distributed by Graybar

TRIPLETT
Combat line
TESTERS

Pocket
Size
MODEL
666H



VOLT-OHM-MILLIAMMETER

Although some older designs are no longer obtainable, several alternate models are available to you under Government requirements.
TRIPLETT ELECTRICAL INSTRUMENT CO., BLUFFTON, OHIO

cessive mutual capacitance between them. This, as we have seen, ruins the high-frequency response. Increasing the turns-ratio in order to obtain an appreciable theoretical voltage step-up in the transformer also results in a large number of secondary turns and resulting high distributed capacitance, so we find that audio transformers usually have a fairly low turns-ratio, usually 1 to 3 or 4, or less.

Increasing the cross-section of the core is possible, but it tends to make the transformer both bulky and costly. It has been found more desirable and practical to achieve high primary inductance by employing a comparatively small number of primary turns and a core of one of the high-permeability materials already mentioned. The use of a grounded electrostatic shield between the windings, and the use of a special pancake-type secondary to maintain a low voltage-difference between adjacent layers of the winding, also help to reduce the undesirable distributed capacitance. The leakage inductance often is proportioned so that any resonance peaking produced will occur either outside the working frequency range, at a frequency where it is beneficial, or at some frequency where it is not particularly harmful. Secondary windings of high-resistance wire have also been employed to suppress the resonant peak where it is particularly objectionable. Graph B in Fig. 5 illustrates the types of frequency response obtainable from such a modern improved type of audio transformer. Well-designed transformer-coupled amplifiers employing good transformers can give fairly uniform amplification over a frequency range from about 30 to 10,000 or 15,000 cycles per second. Those used for interstage coupling in voltage amplifiers for the amplification of voice and music frequencies usually have a step-up turns-ratio not greater than 1 to 3 or 4.

Parallel-Feed Transformer Coupling

Proper operation of high-quality transformers employing cores of one of the special high-permeability materials often requires the removal of the direct plate current component from the primary winding, because this causes saturation of the magnetic core. Such materials saturate at lower magnetic flux densities than do the ordinary grades of transformer steel, and so are more susceptible to this condition. The objection to operating the transformer with its core magnetically saturated is that the variations in the signal current component flowing through the primary then do not produce corresponding variations in the core flux. Consequently the induced secondary signal voltage is very low, and its waveform will not be similar to that of the input signal—i.e., distortion results.

A very simple way of preventing this is to employ the *parallel-feed*, or *shunt-feed*, arrangement illustrated in

Fig. 6. A filter consisting of a resistor R_L and a blocking condenser C is employed. This condenser blocks the direct plate current and prevents it from passing through the transformer primary, but it is of large enough capacitance to allow the audio-frequency signal to get through. The load resistor R_L is inserted in the plate circuit of the tube in a manner similar to that in the resistance-coupled amplifier. Its resistance should be at least 3 or 4 times the plate resistance of the tube. Higher values of R_L result in decreased maximum output voltage, and increased distortion at low frequencies. Lower values of R_L result in lower gain and increased distortion at all frequencies. When the parallel-feed arrangement is employed, the "B"-supply voltage must be increased to compensate for the voltage drop which occurs in R_L due to the plate current of the tube flowing through it.

The optimum value of C is dependent upon the transformer primary inductance. For example, corresponding inductance and capacitance values often employed are 20 henries, 2 μ fd.; 50 henries; 1.0 μ fd.; 100 henries, 0.5 μ fd., etc. Use is sometimes made of resonance between C and the inductance of the primary to give a certain degree of bass note boosting. By this means, the transformer may be made to give more uniform response down to a lower frequency than would otherwise be the case. Note that the internal plate resistance of the tube, in parallel with R_L , forms a series resistance in the resonant circuit. Therefore the lower the plate resistance the more pronounced will be the resonance effect.

Use of Pentode Tubes in Transformer-Coupled Voltage Amplifiers

Pentodes are not widely used in transformer-coupled audio amplifiers because of their very high plate resistance. It is difficult and expensive to attempt to construct audio transformers having a sufficiently high primary inductance to obtain good gain at the low and medium frequencies with such tubes, and yet have sufficiently low distributed capacitance so that the gain does not fall off seriously at the high frequencies. When pentode tubes are to be employed, resistance coupling is usually used since the high load resistance that is required to realize the high amplification which these tubes are capable of producing may be provided more easily, inexpensively and compactly.

Tube Types Commonly Used in Transformer-Coupled Audio Amplifiers

The triode tubes commonly used with transformer-coupled amplifiers are usually of the general-purpose types having a μ that is not so high as the high- μ tubes used in resistance-coupled amplifiers, or so low as the low- μ tubes commonly used in power

CABINETS and RADIO PARTS

LAKE can still supply you with combination, console and table model cabinets, in styles and finishes to suit your requirements.

Our large stock of output and power transformers, capacitors, resistors, volume-controls, by-pass condensers, toggle and slide switches, ballast tubes, speakers and other radio components is now listed in our new Bargain Bulletin. Write for your free copy. Order all the parts you need from one source
..... LAKE!

14" SPEAKERS

14" electro-dynamic speakers. 900 ohm field, 6-8 ohm voice coil. 6V6 push-pull transformer. 15 watt output. Special, only **\$4.49**

3 1/2" SPEAKERS

3 1/2" square shape P.M. speakers with 4 ounce magnet. Special, only **\$1.15**

Still Available!!!

3" to 12" Dynamic Speakers
(Any desired field)
3" to 12" P.M. Speakers

New Bargain Bulletin lists Money Saving Values in Radio Parts. Send for it TODAY!

LAKE RADIO SALES CO.
615 W. Randolph St. Chicago



Accuracy and dependability are built into every Bliley Crystal Unit. Specify **BLILEY** for assured performance.

BLILEY ELECTRIC CO. Erie, Pa.

FADA FACTORY SERVICE DEPT.

has a large stock of Record Changer Parts. Also replacement parts for all FADA MODELS, as well as a completely equipped SERVICE DEPARTMENT.

FADA OF NEW YORK

928 Broadway, New York, N. Y.
Tel.: GRAMERCY 7-0951-2

amplifiers. A μ of 8 to 20 for such tubes represents about average practice. Such tubes usually have a plate resistance in the neighborhood of 7,000 to 15,000 ohms.

Since the cost of a transformer-coupled amplifier having a linear response over a wide frequency range is considerably higher than that of a resistance-coupled amplifier giving equally good response, transformer coupling is now generally used only in amplifier stages where its particular advantages are important. Some of these applications are where:

- (1) High gain is required and the available B-supply voltage is limited.
- (2) Stepping up from, or down to, low-impedance lines
- (3) When used with a split or center-tapped secondary for the operation of a push-pull stage
- (4) When a low d.c. resistance is essential in the grid circuit of the following stage, as when driving power tubes under certain conditions of operation.

(To be continued)

Quiet Please

(Continued from page 42)

metal container of suitable dimensions and hermetically sealed against moisture, dust and the elements. Two correctly placed insulated terminals on the container properly marked with the proper indications are used for the necessary connections to the filter and represent the end terminals of the filter network. Before release to the vehicle manufacturer for installation purposes, all filters are given a rigid production test so as to conform to specifications set by the Signal Corps Laboratories. Installation of all filters and suppression components is also made according to specifications in order to avoid any discrepancies in the various applications.

Filters of the 10 ampere type, similar in construction to the 55 ampere type, are used in the ignition system for the suppression of ignition noise. For applications of larger current there are the 100 and 150 ampere types, somewhat larger in dimensions but fundamentally the same as the 55 and 10 ampere types. The attenuation or DB loss varies with each different type of filter but is sufficient in all cases for proper suppression when installed in the correct designated spot as set forth in the specifications. Bypass capacitors are also used but only for the suppression of interference originating in the various electrical devices such as: electric heaters, fans, wipers, small motors, in tanks, lights, etc. Shielding is used only where absolutely necessary. This also applies to bonding such as: to the motor block, body, fuel tanks, radiators, hood, steering column, etc. Bonding is made in such a manner so as to insure against the existence of any floating metal

For VICTORY Buy
United States War
Bonds and Stamps

POLYMET CONDENSER CO.

699 EAST 135th ST.,
NEW YORK, N. Y.

**CONTINUOUS
DEPENDABLE
SERVICE**

**FOR
JOBBER &
DISTRIBUTORS**

FIX ANY RADIO

Amazing New Invention

Simplified
Radio
Servicing
by
Comparison
Method

Learn to repair radios in minutes instead of hours. Revolutionary, different **Comparison** technique permits you to do expert work almost immediately. Most repairs can be made without test equipment or with only volt-ohmmeter. Simple point-to-point, cross reference, circuit suggestions locate faults quickly and easily.

FOR BEGINNERS OR EXPERTS

Find any radio fault with ease. Follow the comparison tests given on 16 large trouble-shooting blueprints. 112 fact pages. Over 1,000 practical repair hints. Hundreds of simplified tests using a 5c resistor and a filter condenser. Covers every radio set—new and old. Introductory material for beginners and to serve as a review for experienced radio men. Also several chapters on test equipment. Presented in manual form, 8 1/2 x 11 inches. Entire plan is stark new and will change servicing methods. Used in schools, Armed Forces, and by thousands of radiomen.

SATISFACTION GUARANTEED

Take advantage of our "no-risk" trial. Send coupon today. Use this time-saving, money-making radio servicing method for 10 days without any obligations. See how much time you will save every day on every radio job. Learn new short-cuts in radio servicing. Then decide to keep **Comparison Method Manual** or return it and receive a cash refund. You cannot lose—but you owe yourself a chance to look at this plan. Price, complete, only \$1.50.

NEW 1943 EDITION

The training will more than pay for itself on the first radio job. Examine and use this unique plan for 10 days at our risk. Send coupon right now—use the plan this week.

Developed by
M. N. Beitman,
radio engineer,
teacher, author,
& serviceman.

TRIAL ORDER COUPON

SUPREME PUBLICATIONS, 328 Jefferson St., Chicago, Ill.

Ship the new manual, **Simplified Radio Servicing by Comparison Method**, for examination. I am enclosing \$1.50, full price, send postpaid. I must be satisfied or you will refund my money.

NAME:.....

ADDRESS:.....



WANTED: RADIO OPERATORS

You should have this FREE 52-Page Book if you want good pay, adventure, interesting work! Army, Navy and Commerce need thousands of men who can send and receive Radio-telegraph Code. Learn Code at home or improve your proficiency and rating through the famous Candler System... the same easy, simple system used in training Radio-telegraph Specialists in Signal Corps, Navy, Marines, Coast Guard, Naval Reserve, Airlines and Amateurs. Big opportunity after the war in new fields on land, sea, and air.

Qualify quickly through home study. No long-drawn-out studies. Candler System established over quarter century. Candler System has trained T. R. McElroy, Official Champion Radio Telegrapher of the World, and other experts in telegraph communications. It teaches you fast sending and receiving technique at home. Tremendous new field for operators both in and out of Armed Services.

Instruction for beginners and operators. You can learn code or increase your w.p.m. speed and improve proficiency. We help you qualify in half the usual time for amateur, commercial license, or high rating.

Write today for FREE Candler Book of Facts. It costs you nothing.

CANDLER SYSTEM CO.
P.O. Box 928, Dept. 2-H, Denver, Colo., U.S.A.
Craven House, 121, Kingsway, London, W.C.2.



Basic electrical and radio theory in the simplest possible language, written especially for those without mathematical or technical training.

Dozens of complete how-to-build-it descriptions of many types of receiving, transmitting, and test equipment show practical applications. Hundreds of diagrams and large photographs.

Enlarged war-training chapters include: expanded basic principles, more test equipment which can be field-built, and mathematics for solving simple radio problems.

Over 600 pages, durably clothbound, gold-stamped. From your favorite dealer, or from us, postpaid; please add any applicable taxes.

\$2.00 in Continental U.S.A. Elsewhere, \$2.25

EDITORS AND ENGINEERS
1420 North Highland Avenue, Los Angeles

RADIO ENGINEERING!

RADIO Engineering offers unusual opportunities for WOMEN as well as MEN. Modern laboratory, latest equipment. Courses also in Civil, Electrical, Mechanical, Chemical, Aeronautical Engineering. Special Preparatory Dept. 60th year. Catalog.

TRI-STATE COLLEGE 1673 College Ave. Angola — Indiana

**COMING
NEXT
MONTH!**

**The Army's
SCR-299
MOBILE UNIT**

concerned. Television and frequency modulation are in use at the present time but to a very limited degree. Frequency modulation is considered noise free so the balance of this article will concern television and amplitude modulated signals, our present form of broadcasting.

Noise or electrical interference (regardless of its source) in its present unsuppressed state is a constant menace to ideal reception in practically every community in these United States. True, there are a few communities that have adopted local ordinances in regard to electrical interference and these communities can be considered as more or less noise free locations. The noise free communities are very few in number in comparison to the balance of the country where noise runs rampant.

Let us consider the automobile for instance. Here is a potential source of interference that is to be found in every community in the country. Complete suppression of all types of these vehicles would ultimately result in a general cleaning up of motor noise in all parts of the country. This type of interference is particularly disturbing to short-wave reception and has always been a constant source of annoyance to the public in general.

It is believed that short-wave reception after the war will have reached a stability stage comparable to that prevalent in our present day broadcast reception. It is assumed that at that time the majority of our pleasure cars will be equipped with receivers having short-wave bands in addition to the regular broadcast bands. This practice had already been adopted by several radio manufacturers in 1941, but due to the enormous problem of interference radiating from passing and nearby vehicles, reception on the short wave bands was not very satisfactory.

By the application of a low cost method of complete suppression of all vehicles before release from their respective factories, the automobile owner can be assured of noise free reception to a much greater extent than has heretofore been possible. This, the first step towards the elimination of electrical interference, would not be of a very costly nature and the additional cost to the automobile owner would be quite small in comparison to the enjoyment from noise free reception.

Our second problem concerned with electrical interference is of the type caused by such common everyday appliances as electric razors, clippers, mixers, cleaners, cash registers, blinkers, motors, etc.

It has been proven and is an accepted theory that: electrical interference is only suppressed when the application of suppression is made at the source and the source only. The majority of appliances creating electrical interference can be suppressed in a very short time by the installation of suitable filters or capacitors. The cost to the appliance owner for an installa-

RADIO-TELEVISION ELECTRONICS VITAL to War Effort

Enroll now with new groups. Opportunity under war conditions and real future in peacetime. Day and Evening Classes.

Radio-Television Institute
Dept. R. C.
480 Lexington Ave., New York, N. Y.
Telephone Plaza 3-4585

Victory Lines
Aerovox Condensers, Ken-Rad Tubes
Mueller Clips, J. F. D. Products
Send dime for prices.

Anchor Radio Distributing Service Co.
Box 21 Dept. R
Ithaca, New York

Correspondence Courses in
RADIO and ELECTRICAL ENGINEERING

ELECTRICAL ENGINEERING Get good grasp of wide electrical field. Prepare yourself at Low Cost for secure future. Modern course. So simplified anyone can understand quickly.

RADIO ENGINEERING Extra fine course in radio, radio address, photo-electric work. Train you to be super-service man, real vacuum-tube technician. Servicemen needed badly. Diploma on completion.

Send postcard or letter for Free LOW \$25 Course
Copies of school catalogs, full details, all about deferred payment plan, etc. SEND NOW!

LINCOLN ENGINEERING SCHOOL, Franklin Stn., Box 61-R 55
(Formerly at Lincoln, Neb.) WASHINGTON, D. C.

Classified

Rate 15c per word. Minimum, 10 words

CORRESPONDENCE COURSES

RADIO Communications courses qualifying for all Federal licenses. Home study and resident courses. American Radio Institute, 44 East 23rd St., New York, N. Y.

USED Correspondence Courses and Educational Books sold or rented. Inexpensive. Money-back guarantee. Write for Free Catalog listing 4000 bargains.—(Courses Bought.)—Lee Mountain, Pisgah, Ala.

CORRESPONDENCE Courses and self-instruction books, slightly used. Sold. Rented. Exchanged. All subjects. Satisfaction guaranteed. Cash paid for used courses. Complete details and 84-page illustrated bargain catalog free. Write Nelson Company, 321 S. Wabash, Dept. G-237, Chicago.

INSTRUCTION

LEARN Code: Set of four Phonograph recordings, \$4.00 set, or \$1.25 each. War Stamps accepted. Limited Supply available. V. Howardel's, 102 Hancock Ave., Jersey City, N. J.

PATENT ATTORNEYS

INVENTORS—Before disclosing your invention to any one send for Form "Evidence of Conception"; "Schedule of Government and Attorneys' Fees" and instructions. Sent free. Lancaster. Allwine & Rommel, 414 Bowen Building, Washington, D. C.

RADIO ENGINEERING

RADIO Engineering, broadcasting, aviation and police radio, servicing, marine and Morse telegraphy taught thoroughly. All expenses low. Catalog free. Dodge Institute, Elm St., Valparaiso, Ind.

RADIO REPAIR

METERS and testing equipment repaired. Center Radio Laboratory, 111 Center St., Clifton, N. J.

RADIO EQUIPMENT

RADIO Service men and experimenters send for our giant radio catalogue. Save dollars. United Radio Co. (1000M), Newark, N. J.

MISCELLANEOUS

ANALYZER, tube tester, tubes and parts wanted for cash. T. Singer, c/o Hempstead Typewriter Exchange, 114 Main St., Hempstead, L. I., New York.

WANTED used Rider Manuals. Write Room 222, 328 South Jefferson, Chicago.

Index to Advertisers

COMPANY	PAGE No.
Aerovox Corp.	89
Allied Radio Corp.	48
American Phenolic Corp.	57
American Radio Hardware, Inc.	5
Amperite Co.	83
Anchor Radio	88
Audel, Publishers	87
<i>Belmont Radio Corp. Back Cover</i>	
Bliley Electric Co.	85
L. S. Brach Mfg. Corp.	62
Browning Radio Laboratories	80
Burstein-Applebee Company	87
<i>Candler System Co. 88</i>	
Capitol Radio Eng. Inst.	46, 86
Centralab	66
Classified	88
Commercial Radio Inst.	82
Connecticut Telephone & Electric Corp.	77
Consolidated Radio Products Co.	71
Coyne Electrical School	11
<i>DeJur-Amsco Corp. 47</i>	
Dodge Institute	87
<i>Edmund Salvage Company 76</i>	
Echophone	67
Editors & Engineers	88
Electronic Corporation of Am.	63
<i>Fada of New York 85</i>	
Fada Radio & Elec. Co., Inc.	52
<i>Garner Co., Fred E. 14</i>	
General Electric Company	9, 15
General Industries Company	80
Gothard Mfg. Co.	80
<i>Hallcrafters Co. 6</i>	
Hammarlund Mfg. Co., Inc.	16
Hytron Corp.	7
<i>Jensen Radio Mfg. Co. 58</i>	
Kenyon Transformer Corp.	51
The James Knights Co.	13
<i>Lafayette Radio Corp. 73</i>	
Lake Radio Sales Co.	85
Lincoln Eng. Schools	88
<i>P. R. Mallory & Co., Inc. Third Cover</i>	
McElroy Mfg. Corp.	81
McGraw-Hill Book Co.	82
Meissner Mfg. Co.	56
John Meck Industries	54
James Millen Mfg. Co., Inc.	8
Wm. J. Murdock Co.	12
Mutual Radio Products Co.	76
<i>National Company, Inc. 75</i>	
National Radio Institute	3
National Schools	65
National Union Radio Corp.	49, 86
Nelson Co.	87
<i>Ohmate Mfg. Co. 45</i>	
D. W. Onan & Sons	74
<i>Panoramic Radio Corporation 86</i>	
Pioneer Gen-E-Motor Corporation	60
Polymet Condenser Co.	85
<i>Radio Corporation of America 61</i>	
RCA Institutes, Inc.	87
Radio & Tech. Publ. Co.	78, 79
Radio-Television Institute	88
Randolek Co.	87
Randolph Radio	70, 87
John F. Rider Publ. Inc.	50
<i>Walter L. Schott Co. 64</i>	
Shure Brothers	83
Simpson Electric Co.	62
Solar Mfg. Co.	80
Sprague Products Co.	53
Sprayberry Academy of Radio	72
Standard Transformer Corp.	63
Sun Radio Co.	86
Supreme Publications	85
Sylvania Electric Products, Inc.	10
<i>Taylor Tubes 59</i>	
Teleplex Co.	82
Thordarson Electric Mfg. Co.	64
Tohe Deutschman Corporation	90
Triplet Electrical Instrument Co.	84
Tri-State College	88
Turner Co.	66
<i>United Transformer Co. Second Cover</i>	
Utah Radio Products Co.	55
<i>Ward Leonard Electric Co. 69</i>	
Western Electric Co.	86
The Whitney Blake Company	84

While every precaution is taken to insure accuracy, we cannot guarantee against the possibility of an occasional change or omission in the preparation of this index.

tion of this type is very nominal from a noise-free reception viewpoint.

The best, although probably the most difficult solution to the problem, is by the application of suitable suppression at the various factories manufacturing so-called interference type appliances. This could be accomplished quite easily provided all manufacturers concerned cooperated in the suppression program to the fullest extent. This too would also mark another very important step towards the final elimination of electrical interference throughout the country.

Other sources of interference such as electrical distribution systems, etc., could no doubt be cleared up by the companies involved and it is safe to say at this time that complete cooperation from these various companies with any noise elimination program would be forthcoming when requested. Interference from high-voltage distribution systems has always been a source of considerable annoyance to the radio listener and can best be at least partially eliminated by correct installation of receiver and antenna with the possible inclusion of a suitable line filter in the source of power. Each case of high line interference takes on different aspects and would therefore have to be treated accordingly.

Television reception is greatly impaired by the presence of images on the cathode ray screen, representing different types of electrical interference. This is another phase of radio which can never be enjoyed to the fullest extent without the application of suppression. It is believed that in the future, suppression will be applied to a much greater extent than heretofore thought possible.

Communications will be just as vital in peace time as it has proven to be in war time and the application of the various forms of suppression will open up a new and interesting field to the post-war serviceman with opportunities of unlimited proportions.

The quicker the radio-minded public realizes the need for complete suppression of all types of electrical interference, the quicker the day will come when uninterrupted communications can be carried on and radio reception enjoyed as it should be, to the fullest extent. We of the radio profession can help considerably by stressing the need for noise-free reception in our daily work. This aim can only be accomplished by making the radio-minded public noise-free conscious.

-30-

PHOTO CREDITS

Page Numbers	Credits
17	Westinghouse
17, 18, 19	G.E.
31	British Information Services
34, 39	RCA



- Priorities and rationing notwithstanding, you can still get high-grade electrolytic capacitance in these Type PBS condensers. Compact dimensions. Sturdy cardboard-case construction. Adjustable metal mounting flanges for single or stacked mounting. Separate polarity-indicating colored leads. Dependable in every way—at low cost.

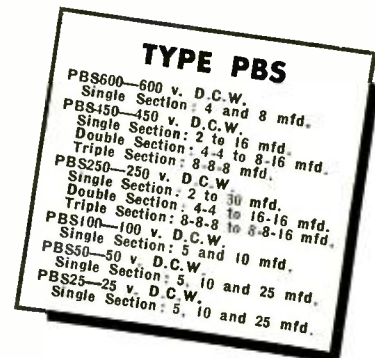

- Ask Our Jobber . . .

Ask for these PBS electrolytics. Ask for latest catalog—or write us direct.

AEROVOX
Capacitors
INDIVIDUALLY TESTED

AEROVOX CORP., NEW BEDFORD, MASS., U. S. A.
In Canada: AEROVOX CANADA LTD., HAMILTON, ONT.
Export: 100 VARICK ST., N. Y. C. • Cable: 'ARLAB'

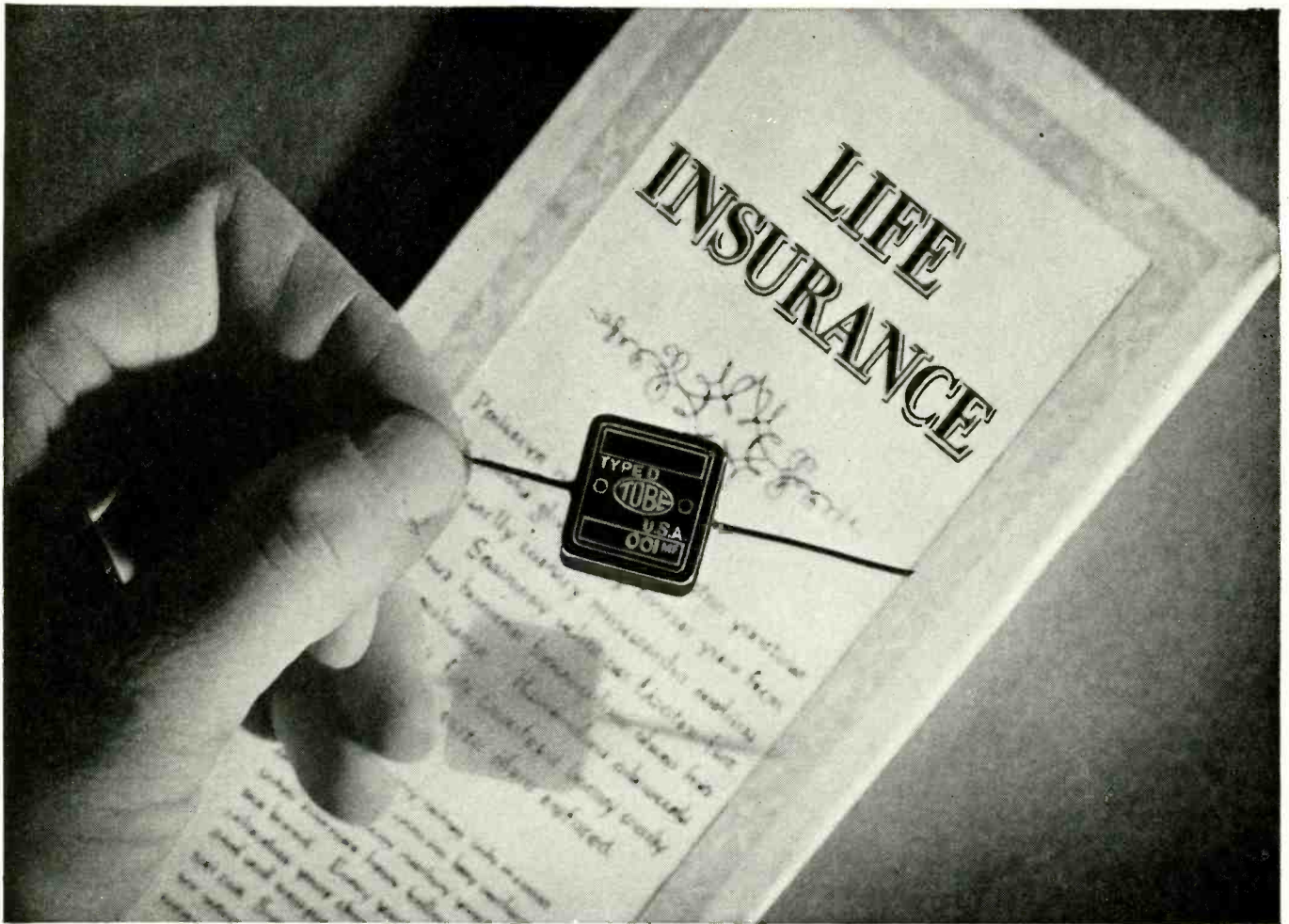

NOW AVAILABLE FOR YOUR PRODUCTION REQUIREMENTS!

The first oil-impregnated condenser to be found physically and electrically interchangeable with the majority of mica capacitors used in the by-pass and coupling circuits of radio and radar equipment.

The Tobe Type DP Molded Paper Capacitor has *long life built into it* through every step of manufacture. Rigid inspections maintain a standard that is exceptionally

high—so high, in fact, that “returns” are almost completely unknown.

For the first time since its introduction we are *now* in a position to accept immediate orders for Type DP, with *prompt delivery assured*. They will be filled in order of receipt and we suggest you act promptly. For production samples or further information write TOBE DEUTSCHMANN CORP., CANTON, MASS.

SPECIFICATIONS—TYPE DP CAPACITOR

CAPACITANCE001 to .01 mfd.
WORKING VOLTAGE	600 volts DC—flash test 1800 volts DC
SHUNT RESISTANCE	At 185° F.— 1000 megohms or greater At 72° F.—50000 megohms or greater
WORKING TEMPERATURE RANGE	Minus 50° F. to plus 185° F.
OPERATING FREQUENCY RANGE	Upper limit 40 megacycles Q at one megacycle—25 or better
POWER FACTOR	At 1000 cycles—.005 to .006

These capacitors meet Army and Navy requirements for immersion seal.



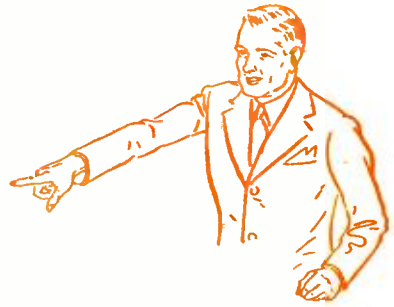

Will You Pinch Hit

It is getting hard in many communities to service home radio sets properly in order to "keep 'em listening."

The shortage of radio service engineers is acute—the military forces have priority on radio technical skill.

But, those of you who remain on the home front have the chance of a lifetime to render important service to your community. Make a list of the names of all the "old timers" you can remember. See and talk to each one. Chances are they're still radio "bugs" and will be willing and anxious to help if told of the need that exists.

Organize a service club in your community... see to it that every bit of existing knowledge is put to work. We will help you. Now is the time to pinch hit to "keep 'em listening." Will you do your part?

P. R. MALLORY & CO., Inc., INDIANAPOLIS, INDIANA

P. R. MALLORY & CO. Inc.
MALLORY



Approved Precision Products

Head in the Clouds ...EARS TO THE GROUND

Yesterday, he was just a young man in an office. Today, his feats would make a pagan god turn green! He rides the wind . . . sends his voice through space. Above the clouds he hears whispers from the ground. And on his foes, he hurls down thunderbolts from the sky!

All about him, too, other man-made magic fights on his side . . . unseen waves that go out from tanks, from listening posts, from ships at sea . . . the electronic forces of Radar Equipment and Frequency Modulation Radio.

Though secret now, many of these war developments will, one day, be described by Belmont. You will read of them in terms of what they mean to you in a peacetime world. Keep your eyes on Belmont! BELMONT RADIO CORP., Chicago, Ill.



Belmont Radio
TELEVISION * ELECTRONICS

