

SEPTEMBER

1942

25c

In Canada 30c

RADIO NEWS



Wiring Experts at W. E. Plant



EMERGENCY FM-AM SYSTEM

avesdropping by the Army ★ Induction Controlled Inter-Com.

Announcing

The Book You've Waited For

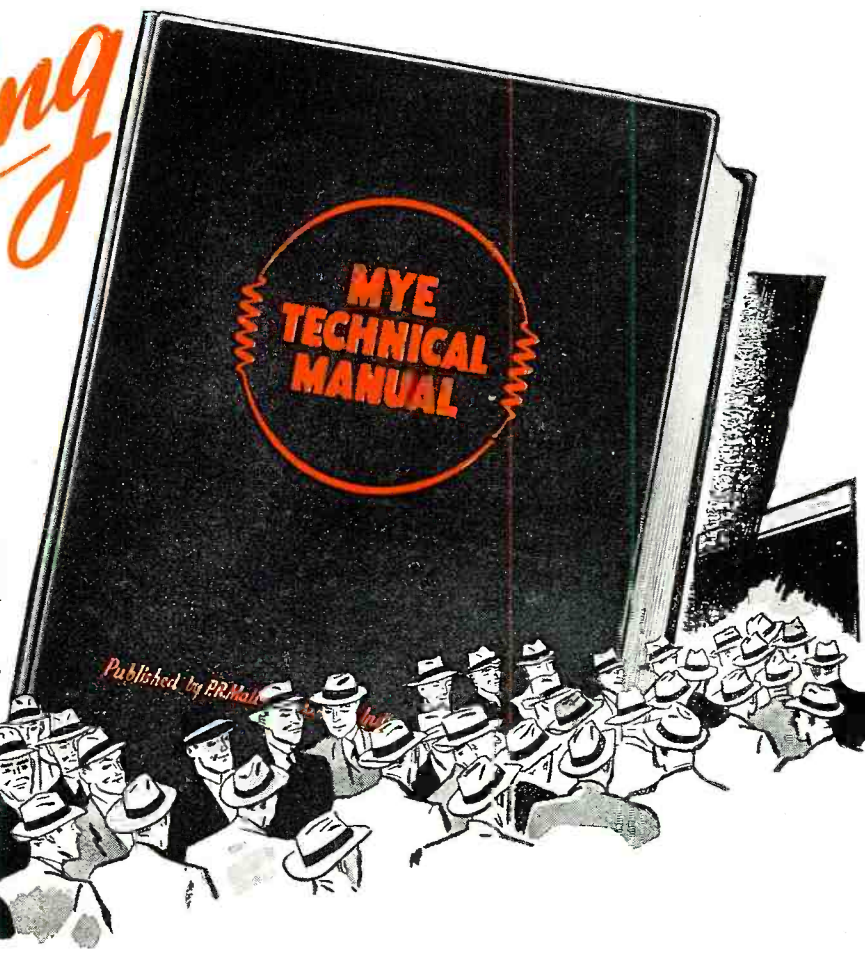

When 300 radio servicemen who are known to be outstanding write letters offering to buy a book before it's even printed, chances are it's a good book. And then, if military radio engineers decide to use 2000 copies to train the men in America's fighting forces . . . you *know* it's a good book.

That, briefly, is part of the story behind this new MYE TECHNICAL MANUAL. Just glance over this list of chapter headings, and you'll know why you want a copy.

- 1 Loud Speakers and Their Use
- 2 Superheterodyne First Detectors and Oscillators
- 3 Half-Wave and Voltage Doubler Power Supplies
- 4 Vibrator and Vibrator Power Supplies
- 5 Phono-Radio Service Data
- 6 Automatic Tuning—operation and adjustment
- 7 Frequency Modulation
- 8 Television—suggestions for the post-war boom
- 9 Capacitors—how to overcome war-time shortages
- 10 Practical Radio Noise Suppression
- 11 Vacuum Tube Voltmeters
- 12 Useful Servicing Information
- 13 Receiving Tube Characteristics—of all American tube types

Here's a suggestion. If you want to reserve a copy of this 392-page book, bound beautifully in hard cloth . . . go around to your Mallory Distributor today. The supply of manuals for civilian distribution, at the price of \$2.00, is limited. Order your copy now! Your Mallory Distributor has it!

P. R. MALLORY & CO., Inc.
INDIANAPOLIS, INDIANA

Cable—PELMALLO

P. R. MALLORY & CO. Inc.

MALLORY

Approved Precision Products

The illustration shows several Mallory electronic components: a vacuum tube, a capacitor, a transformer, and a box labeled 'MALLORY'. The box is orange and black with the Mallory logo and 'Approved Precision Products' written on it.

A FREE LESSON SHOWED BILL HOW HE COULD MAKE GOOD PAY IN RADIO

BILL, YOU'RE ALWAYS FOOLING WITH RADIO -- OUR SET WON'T WORK -- WILL YOU FIX IT?

I'LL TRY, MARY, I'LL TAKE IT HOME TONIGHT

I CAN'T FIND OUT WHAT'S WRONG -- GUESS I'LL MAKE A FOOL OF MYSELF WITH MARY

HELLO, BILL -- GOT A TOUGH ONE TO FIX? LET ME HELP YOU

HELLO JOE -- WHERE'VE YOU BEEN LATELY -- AND WHERE DID YOU LEARN ANYTHING ABOUT RADIO?

I'VE BEEN STUDYING RADIO AT HOME, BILL, WITH THE NATIONAL RADIO INSTITUTE. YOU OUGHT TO TAKE THEIR COURSE. I'VE GOT A GOOD RADIO JOB NOW. LET'S MAKE A CIRCUIT DISTURBANCE TEST -- STARTING WITH THE AUDIO OUTPUT STAGE AND TESTING EVERY STAGE RIGHT BACK TO THE ANTENNA. LISTEN FOR THE CLICKS WHEN I TAP THE GRID LEADS

SAY -- WHERE DID YOU LEARN THAT TEST? IT'S A GOOD ONE

HERE'S THE TROUBLE, BILL, IN THE FIRST I.F. AMPLIFICATION STAGE. I LEARNED THAT TEST EVEN BEFORE I STARTED TAKING THE COURSE, BILL. IT'S DESCRIBED IN A FREE LESSON WHICH THE NATIONAL RADIO INSTITUTE SENDS YOU WHEN YOU MAIL A COUPON FROM ONE OF THEIR ADS

I'VE SEEN THEIR ADS BUT I NEVER THOUGHT I COULD LEARN RADIO AT HOME -- I'LL MAIL THEIR COUPON RIGHT AWAY

I'M CONVINCED NOW THAT THIS COURSE IS PRACTICAL AND COMPLETE. I'LL ENROLL NOW

AND THEN I CAN MAKE REAL MONEY FIXING RADIO SETS

OR GET A JOB IN A BROADCASTING STATION OR AVIATION RADIO OR POLICE RADIO

THE GOVERNMENT NEEDS CIVILIAN RADIO OPERATORS AND TECHNICIANS. IF I'M DRAFTED, KNOWING RADIO CAN WIN ME EXTRA RANK AND PAY. HUNDREDS OF N.R.I. TRAINED MEN HAVE GOOD RADIO JOBS

OR INSTALL AND SERVICE LOUD SPEAKER SYSTEMS

I will send you a Lesson on Radio Servicing Tips FREE

TO SHOW HOW PRACTICAL IT IS TO TRAIN AT HOME FOR

GOOD JOBS IN RADIO

Every man who works on a Radio Receiver, either professionally or as a hobby, should have a copy of my Free Sample Lesson, "Radio Receiver Troubles--Their Cause and Remedy." I will send you your copy without obligation if you will mail the Coupon below. It will show you how practical my lessons are--give you a real idea of the vast amount of information my Course gives you.

More Now Make \$30, \$40, \$50 A Week Than Ever Before

The Radio Repair business is booming now because manufacture of new Radio sets has been discontinued and the 57,400,000 home and auto Radios require more repairs, tubes, parts as they get older. Many Radio Technicians have their own Radio businesses. The 882 Broadcasting Stations employ Radio Technicians and Operators. Radio factories are receiving millions of dollars of Government orders. Aviation, Commercial, Police, Ship Radio stations, Public Address Systems are other opportunity fields. The Government needs many Radio Technicians for good Civilian jobs.

EXTRA PAY IN ARMY, NAVY, TOO

Men likely to go into military service, soldiers, sailors, marines, should mail the coupon NOW! Learning Radio helps men get extra rank, extra prestige, more interesting duties, much higher pay. Also prepares for good Radio jobs after service ends. IT'S SMART TO TRAIN FOR RADIO NOW!

Know Radio as Trained Technicians Know It

My Course is thorough, practical. I give you basic training in Radio Theory and Practice--the working principles of both Commercial and Military Radio equipment. You understand your work--know just what to do instead of just relying on mechanical ability to fix a few common faults and make a few simple adjustments. That's why many men who have been in Radio before enrolling report that my Course helped them make more money, win success. I train you, too, for Television, a promising field of future opportunity.

Beginners Quickly Learn to Earn \$5 to \$10 a Week Extra in Spare Time

Nearly every neighborhood offers opportunities for a good part-time Radio Technician to make extra money fixing Radio sets. I give you special training to show you how to start cashing in on these opportunities early. You get Radio parts and instructions for building test equipment, for conducting experiments that give you valuable, practical experience. My 50-50 method of training--half with Radio parts, I send you, half studying my Lesson Texts--makes learning Radio at home interesting, fascinating, practical.

MAIL THE COUPON

Get my Sample Lesson and 64-page Book "Rich Rewards in Radio" at once. They're free. See what Radio offers you as a skilled Radio Technician or Operator. Learn how practical I've made my Course. Read letters from more than 100 men I have trained telling what they are doing, earning. Mail the Coupon NOW--in an envelope or paste it on a penny postal.

J. E. SMITH, President, Dept. 2JR
National Radio Institute
Washington, D. C.



J. E. SMITH, President National Radio Institute Established 27 Years

He has directed the training of more men for the Radio Industry than anyone else.



YOU CERTAINLY KNOW RADIO. SOUNDS AS GOOD AS THE DAY I BOUGHT IT.

THANKS! IT CERTAINLY IS EASY TO LEARN RADIO THE N.R.I. WAY. I STARTED ONLY A FEW MONTHS AGO, AND I'M ALREADY MAKING GOOD MONEY.

THIS SPARE TIME WORK IS GREAT FUN AND PRETTY SOON I'LL BE READY FOR A FULL TIME JOB

OH BILL -- I'M SO GLAD I ASKED YOU TO FIX OUR RADIO. IT GOT YOU STARTED THINKING ABOUT RADIO AS A CAREER, AND NOW YOU'RE GOING AHEAD SO FAST

OUR WORRIES ARE OVER. I HAVE A GOOD JOB NOW, AND THERE'S A BIG FUTURE AHEAD FOR US IN RADIO

Mr. J. E. Smith, President, Dept. 2JR
National Radio Institute, Washington, D. C.

Mail me FREE, without obligation, Sample Lesson and 64-page book "Rich Rewards in Radio," which tells about Radio's opportunities and explains your 50-50 method of training men at home to be Radio Technicians and Operators. (No salesman will call. Write plainly.)

Name..... Age.....

Address.....

City..... State..... 14X1



Trade-Mark Registered

VOL. 28 NO. 3

★ LEADING THE INDUSTRY SINCE 1919

The Technical Magazine devoted to Radio in War, including articles for the Serviceman, Dealer, Recordist, Experimenter and Amateur



Contents for September 1942

FEATURES

EMERGENCY FM-AM SYSTEMS.....	Lewis Winner	6
EAVESDROPPING BY THE ARMY.....	Andrew R. Boone	10
MODERN TONE CONTROL CIRCUITS.....	L. J. Markus	12
ELECTRONIC CAMERA HAS X-RAY EYE.....	S. R. Winters	16
WAR PLANT SOUND SYSTEMS.....	Sidney Harmon	22
A LOW COST AIRPLANE DETECTOR.....	Glen Prescott	25
INDUCTION CONTROLLED INTERCOM... ..	Wilbert T. Peterson	26
BUILD THIS TIME-SIGNAL RECEIVER....	David W. Jeffries	28
PRACTICAL TRANSFORMER DESIGN....	William A. Stocklin	32

INDUSTRY

SPOT RADIO NEWS.....	Lewis Winner	36
----------------------	--------------	----

DEPARTMENTS

THEORY & PRACTICE OF DISC RECORDING, PART 9.....	Oliver Read	18
AVIATION RADIO COURSE, PART 5.....	Paul W. Karrol	30
PRACTICAL RADIO COURSE, PART 7.....	Alfred A. Ghirardi	34
WHAT'S NEW IN RADIO.. 21	BOOK REVIEW	20
QRD? DE GY.....		20

Copyright 1942

ZIFF-DAVIS PUBLISHING COMPANY

Member of the Audit Bureau of Circulations

W. B. ZIFF
Publisher

B. G. DAVIS
Editor

C. R. TIGHE
Ass't to Publisher

OLIVER READ, W9ETI
Managing Editor

R. B. FRANK, W9JU
Tech. Ed. (on leave)

WILLIAM A. STOCKLIN
Associate Editor

HERMAN R. BOLLIN
Art Director

S. L. CAHN
Advertising Mgr.

J. M. ECKERT
Midwest Adv. Mgr.

H. G. STRONG
Circulation Mgr.

RADIO NEWS is published monthly by the Ziff-Davis Publishing Company at 540 N. Michigan Ave., Chicago, Ill. New York Office, 270 Madison Ave. Washington Bureau, Occidental Hotel, Lt. Col. Harold E. Hartney, Mgr. Subscription Rates: In U. S. \$3.00 per year, single copies, 25 cents; in South and Central America and U. S. Possessions, \$3.00 per year; in Canada \$3.00 per year, single copies 30 cents; in British Empire, \$3.75 per year; all other foreign countries \$6.00 per year. Subscribers should allow at least 2 weeks for change of address. All communications about subscriptions should be addressed to: Director of Circulation, 540 N. Michigan Ave., Chicago, Ill. Entered as second class matter March 9, 1938, at the Post Office, Chicago, Illinois, under the Act of March 3, 1879. Entered as second class matter at the Post Office Department, Ottawa, Canada. Contributors should retain a copy of contributions. All submitted material must contain return postage. Contributions will be handled with reasonable care, but this magazine assumes no responsibility for their safety. Accepted material is subject to whatever adaptations, and revisions, including "by-line" changes, necessary to meet requirements. Payment covers all authors, contributors or contestants rights, title, and interest in and to the material accepted and will be made at our current rates upon acceptance. All photos and drawings will be considered as part of material purchased.

Transmitter Registration

THIS is a final warning to you Hams who have not as yet registered your transmitters. The recent order requiring registration has been extended until August 25. Each and every transmitter must be registered separately. The necessary blanks may be obtained from the Radio Inspector in your district. Serious consequences will result by failure to observe this ruling.

Better act at once! If your rig is in other hands—see that it is registered at once!

Signal Corps Equipment

ONCE again there comes the urgent cry for test equipment to be used in various Signal Corps Schools throughout the country. Practically any type, of standard make with instruction sheets is needed. If you have any surplus meters, oscillators, oscilloscopes, or the like and can possibly do without them, by all means contact the Signal Office nearest you. They will pay reasonable prices and the equipment will be placed where it will do the most good.

Special Issue Coming

WE are already hard at work on the preparation of the largest issue ever produced in the long history of RADIO NEWS since its inception way back in 1919. The entire contents are being written by top ranking officers of the Signal Corps and will reveal in complete form the entire history and activities of this famous organization from the very first unit up to and including the many branches now coming under its supervision. There will be approximately 200 pages packed full of color photos and vital information of interest to all radio men.

This will be our November Issue and we are giving you this information well in advance so that no reader will miss receiving his copy. Don't miss it . . . it's a scoop!

(Continued on page 52)



MEET THE MIGHTY RAF THROUGH THE BRILLIANT SPECIAL ROYAL AIR FORCE ISSUE OF FLYING

Bringing you the stirring story of England's gallant air-warriors, the terror of Axis powers, told by men actually directing the war operations. Of particular interest to radiomen is the article **SIGNALS AND RADIO** by Air Vice-Marshal C. W. Nutting, C.B.E., D.S.C., Director-General and Inspector of Signals. In this exclusive article, amazing details are revealed about how signals are sent quickly, surely and with the utmost secrecy all over the world . . . how radiolocation measures reflected radio energy to determine the whereabouts of the reflecting object—so that no attacking agency can be invisible . . . how safety and strength have resulted from intelligent use of signals in the RAF.

FINEST AVIATION PHOTOGRAPHY IN FULL COLOR AND GRAVURE

Also included in the special September Issue of **FLYING** are: Articles by Commanders in Chief of Bomber, Fighter, Coastal and other commands; disclosures available from no other source about specialized aspects of air defense and offense; summaries of activities of such supports for the RAF as the WAAF, the Balloon Barrage, Photography, Production, Personnel and other vital war agencies; and hundreds of official photographs, including special gravure and full color sections. You'll cherish your volume of the Special Royal Air Force Issue for years! Get your copy today!

The Special

SEPTEMBER

ROYAL AIR FORCE ISSUE

FLYING

NOW ON SALE AT ALL NEWSSTANDS

September, 1942



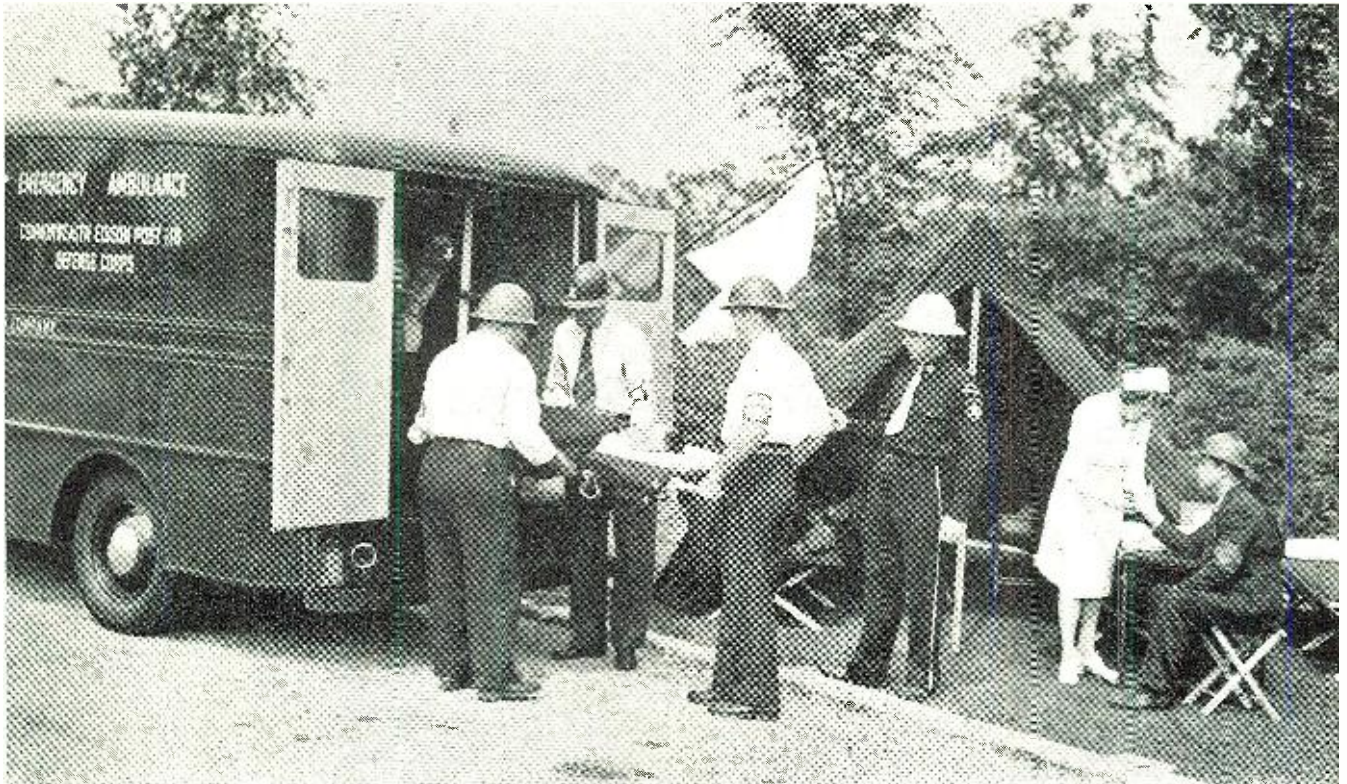

First aid squad stages practice session. This truck has two-way F-M radio.

EMERGENCY FM-AM SYSTEMS

by LEWIS WINNER

The art of F-M transmission has resulted in the adoption of new systems designed primarily for war-time emergency use.

WITH the development of fool-proof compact portable and mobile equipment for a.m. and f.m. the realization by many civic and commercial circles that such apparatus had many vital properties particularly for emergency control, came a new era, a new role for radio. It was a role that received recognition from the FCC. And with this recognition came new and important allocations of frequency channels in the u.h.f. band that spurred design and manufacture, until today, such equipment is in the iron-clad essential class. Today, lighting companies, ambulances, surface systems, highways, pipelines, underground transits, boats, forest services, general repair systems and other allied departments in addition to the various branches of the Government are among those who insist on two-way radio systems for the regular dispatch of daily activities and emergencies.

The importance of these services has

also been effectively emphasized by a survey recently conducted by the Signal Corps. They found that in the past four years, an amazing series of systems has been installed, systems that have proven invaluable in the work of the ordinary day and will thus be probably more valuable in the days of war. For such systems will provide contact during emergencies in areas where ordinarily such coverage would be impossible. Now, a new and unusual emergency network will be available, should such demands be made.

In these systems, two forms of receiving and transmission are used, dependent upon the mobility desired, the terrain to be covered and coverage required. Although f.m. has been a mainstay of design in most of the systems, a.m. is still a factor, because of the very peculiarities of its makeup. In a.m., exceptional compactness is possible, compactness that, for instance,

allows for production of portable packs. Since f.m. requires many more tubes and thus larger units, it has been restricted to mobile installations, but the restriction hasn't been too confining, since most of the systems use mobile units.

In f.m., we have, of course, many outstanding characteristics. For instance, the effect of natural static is negligible in those bands that are most suited for transmission. Even lightning storms do not seriously interfere with reception or transmission. This is of particular value to electric light companies, where emergency conditions are created by lightning and other forms of storms accompanied by lightning. In addition, mountainous areas do not necessarily prevent entirely satisfactory two-way coverages up to twenty miles or more. And man-made static, very troublesome on the ordinary systems, can be completely controlled with f.m.

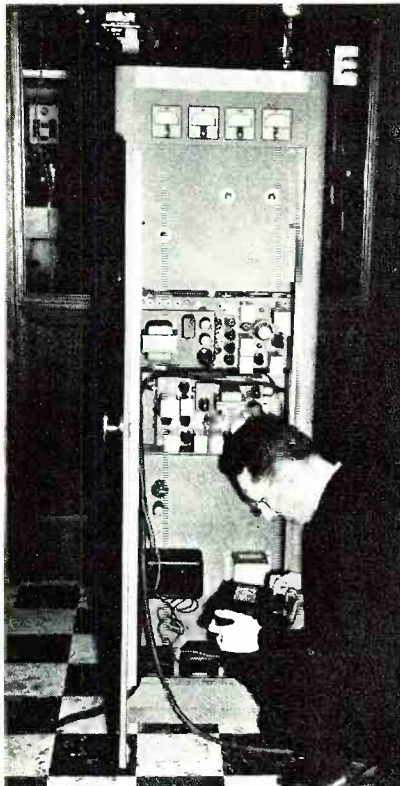

Testing a 250 watt F-M transmitter.

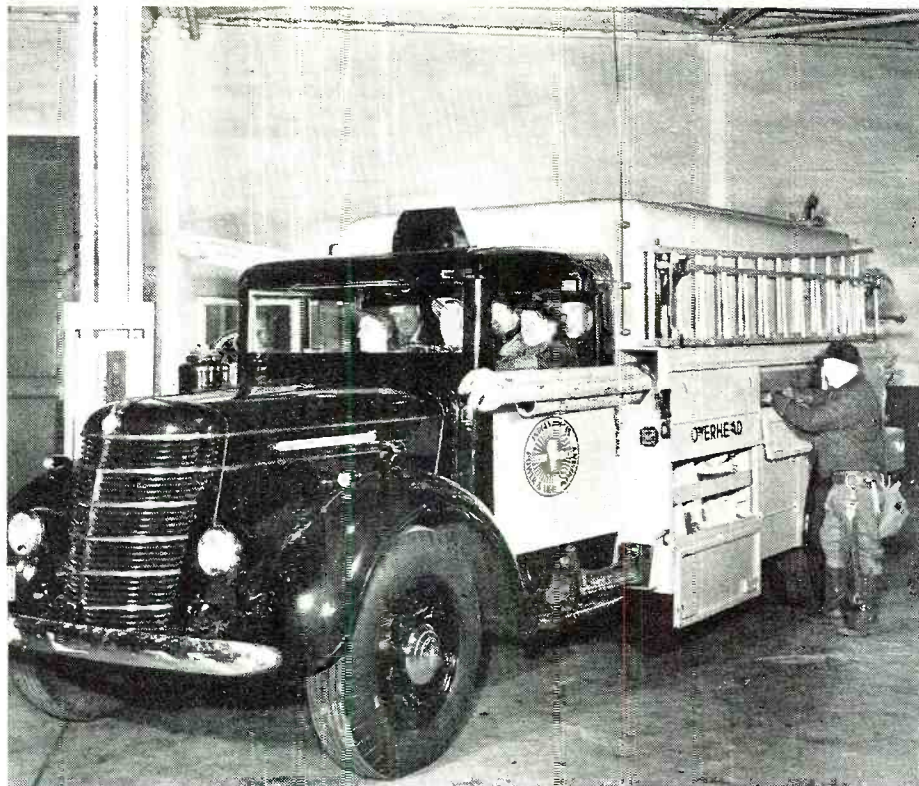

Radio-equipped repair truck, showing antenna mounted beside driver's cab.

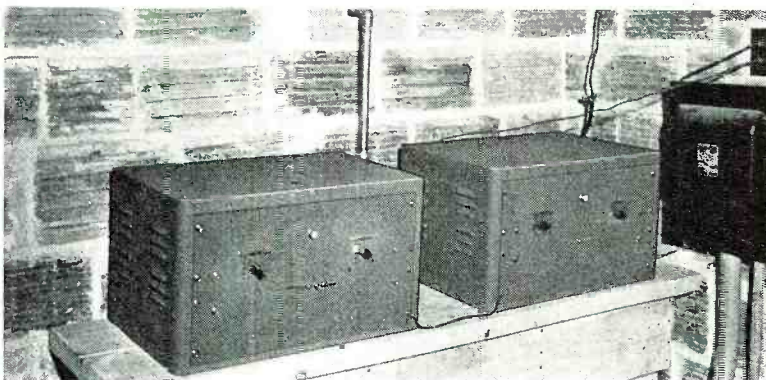

Ultra-high frequency receiver picks up 118 mc. automatic relay signals.

Zone supervisor using two-way F-M radio communications unit in car.

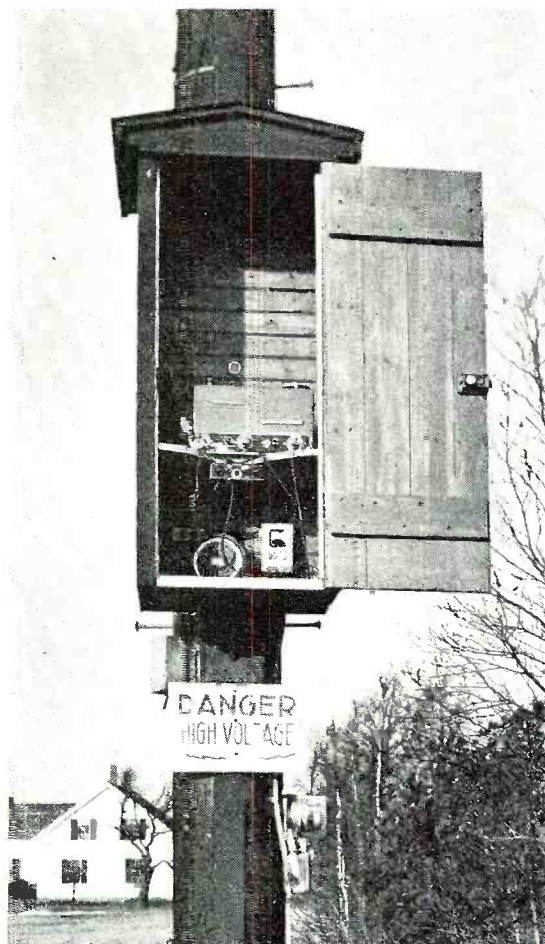

F-M remote pick-up installation 1,000 ft. above sea level provides State-wide range.

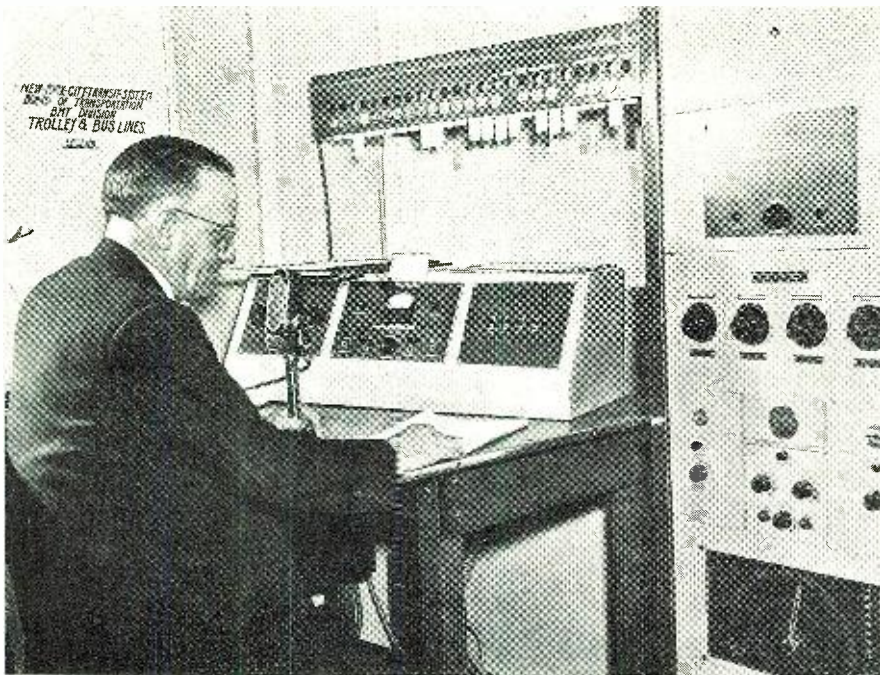

Central control equipment of the New York City Transit System in operation.

It is also a well known fact that f.m. offers superior sensitivity. But to capitalize on this feature, it is necessary to resort to special types of installations. It is necessary, for instance, to select reception points of low noise level for most consistent performance. This is usually accomplished by installing a receiver at a distance from the main receiving point, a point that is well illustrated by the system installed by Basil Cutting in the *New Hampshire State Police*. In this link, the low-noise level remote pickup point is at the top of a 1000 foot mountain. The receiver is mounted in a waterproof box attached to a telephone pole and the antenna is mounted at the top of the pole. The output from this receiver is carried over telephone wires to police headquarters, which is six miles from the pickup point. A second low-noise pickup point is provided by an automatic u.h.f. relay unit installed atop Mt. Kearsage. All transmission from the mobile units is received by a receiver which includes a relay and a squelch system. The received signal automatically turns on a 118 mc. transmitter, and the output of the receiver modulates the transmitter, so that the message is relayed to headquarters twenty-two miles away from the transmitter.

With these two pickup points, it is possible to attain complete coverage of New Hampshire.

The squelch system, mentioned in the preceding paragraphs, is one of the most important characteristics of f.m. car-to-car operation. The sensitivity of such a system is especially important, for in this system, the voltage is generated by the noise selected by a high pass filter above the modulating frequencies used in the system. This positive voltage in the

direction of the squelch closes the squelch and therefore the squelch will tend to open when a carrier is introduced at the input of the receiver, so that the noise output of the receiver is reduced. To further increase the sensitivity of the squelch system, the rectifier noise voltage is connected in series with a potential supplied by a resistor in the grid circuit of the limiter. A carrier at the input of the receiver will increase this voltage supplied by the limiter resistor, and will tend to open the squelch. Accordingly



Radio-equipped F-M mobile unit.

the introduction of a carrier to the input of the receiver will result in the changing of the two voltages, one of which is *reduced* to open the squelch, and the other which is *increased* to open the squelch. The sum of the two voltages will be the voltage acting to open the squelch.

The use of noise for squelch operation provides an automatic compensating system for external noise. Where the noise level is low, a very weak signal will surpass the inherent noise in the receiver sufficiently to operate the squelch system. At a higher level noise reception point, a stronger carrier is necessary to operate the squelch system.

A very effective f.m. installation that takes full advantage of f.m. properties exists in Indianapolis, where the *Indianapolis Power and Light Company* has such a system in operation. An area of approximately 400 square miles is covered, with the most distant customer being within twenty miles of operating headquarters.

A 250 watt main station transmitter and ten 25 watt mobile units are used. The transmitting tower is a two-hundred foot, four-side pre-fabricated steel affair, erected atop a three story administration building, approximately two miles from the building where all operating and engineering facilities are located. Rising above the tower, which is 275 feet up, is a two-inch galvanized pipe and associated shield arms constituting a shunt-fed antenna system. This system is grounded to the tower and affords excellent lightning protection.

Eight of the ten original mobile units were installed in light trucks designed for trouble and maintenance duty. The remaining two units were added to line trucks. In locating the equipment, many problems had to be considered. For it was necessary to have the equipment readily accessible for inspection and testing and yet protected from mechanical damage. In addition, it was also important to keep the antenna cable as short as possible without sacrificing antenna height.

The line truck, with its seven-man cab, has side compartment space for the equipment, with the receiver being mounted on a shelf directly above the transmitter. The control cables are run through compartments to the control position, which are conveniently located in a recessed area on the driver's side and at the end of the rear cab seat.

As mentioned, the antenna height is quite an important factor, for it has a direct bearing on the distance over which reliable communication is possible. In some of the installations, an unusual height of thirteen feet from ground to top of antenna was achieved. Although this was responsible for some difficulties in touring, they were solved. The high antenna provided a distinct advantage in that the shielding effect ordinarily experienced from the car mass was much less pronounced.

The system, in the first two months of its operation, covered 181 calls; covering wires down, transformer failures, poles down, fires, street light trouble, and other emergencies. In all but a few instances, the signals came through with regularity. All receivers are operated with the squelch adjustment set to give almost maximum control or conversely minimum receiver sensitivity within the range of this control because of high existing noise levels. It was found that sufficient signal strength from the station was available anywhere on the system to permit opening of the squelch adjustment in the cars.

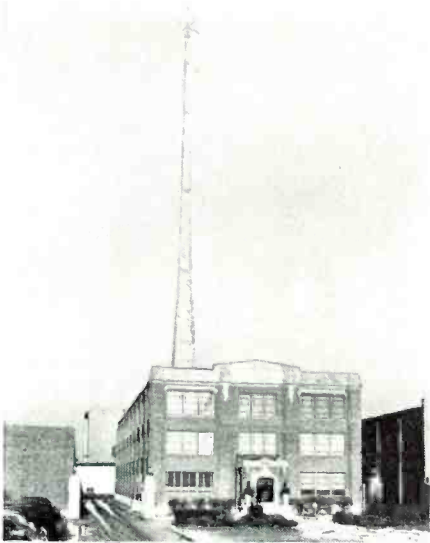

Turnstile antenna mounted on steel tower.

During tests, it was found that loss in signal strength, as a result of shielding, was more pronounced where the shielding effect was provided either by the car or the earth. Shielding from overhead objects, such as trolleys, transmission lines, and buildings was no problem. For instance, it was possible to take a mobile unit into long underpasses, beneath railroads, and still talk with the station as readily as when the car was in the clear—certainly an important advantage in the maintenance of contact, especially in an emergency. Other tests have shown that the main transmitter can be heard fifty-two miles away.

According to company officials, this installation has made possible the assignment of certain employees to routine and maintenance work, with the assurance that they will be available for emergencies as they arise. Formerly it was necessary to have these employees stand-by during the greater part of their time at strategic locations over the system. Under the old system sufficient employees were on duty to always leave on reserve at least one man for extreme emergencies. Now it is possible to operate with only two to four second-class men on duty for minor duty and first class men on regular assignments subject to call by radio.

In Pennsylvania, a radio system for forest fire, flood control and highways, contact with both a.m. and f.m. is in operation, the exact form of transmission being predicated on the services required.

In the forest fire and flood control, a.m. is used for most of the system, while f.m. is used almost exclusively in the highways project.

Six automatic, unattended a.m. relay stations located at strategic points on mountain tops solve the line of sight difficulties encountered with u.h.f. equipment in the fire and flood control system. And in addition, noise-free areas of reception are also pro-

(Continued on page 57)

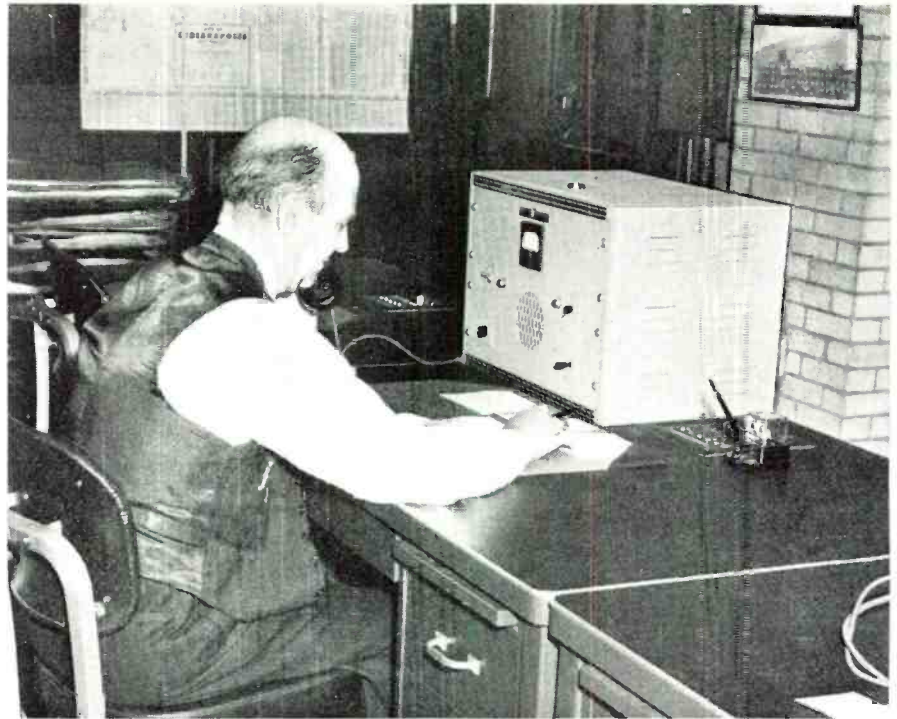

The remote-control unit shown with monitor speaker takes little space.

* * *

25-watt F-M radio on desk of dispatcher for Cleveland Railway Company.

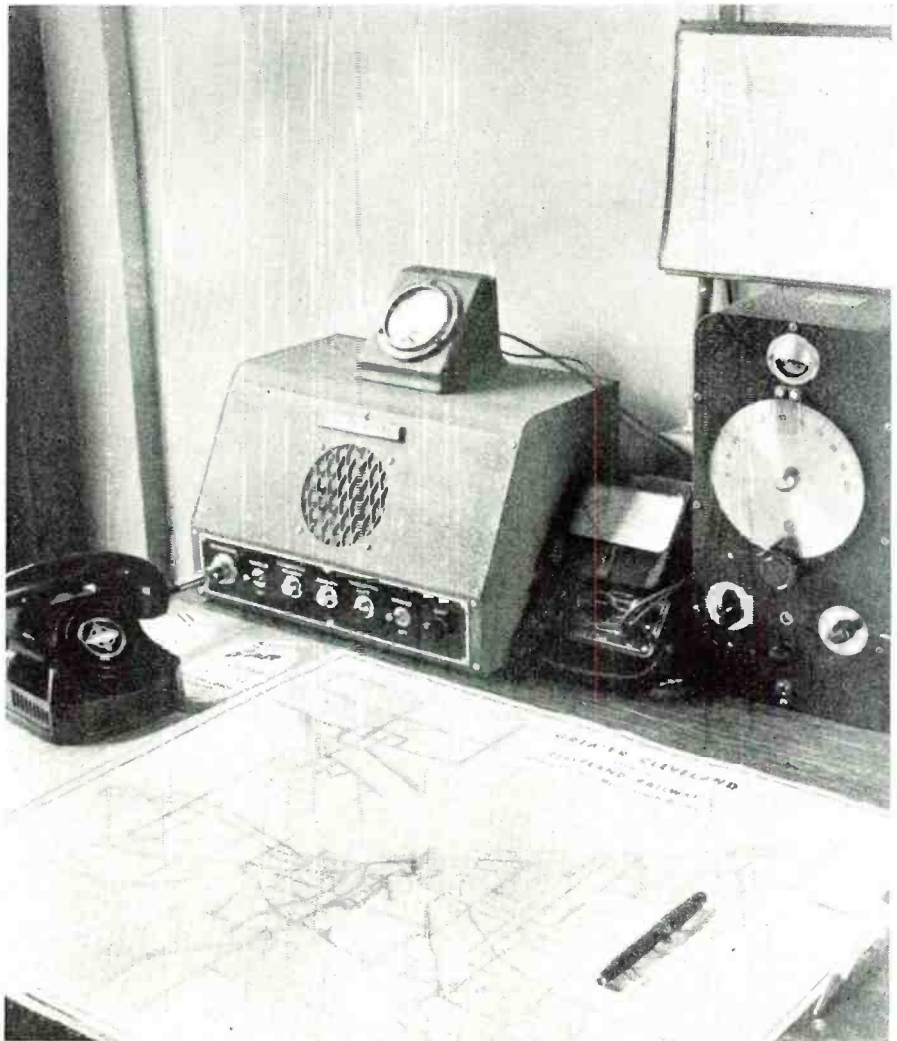

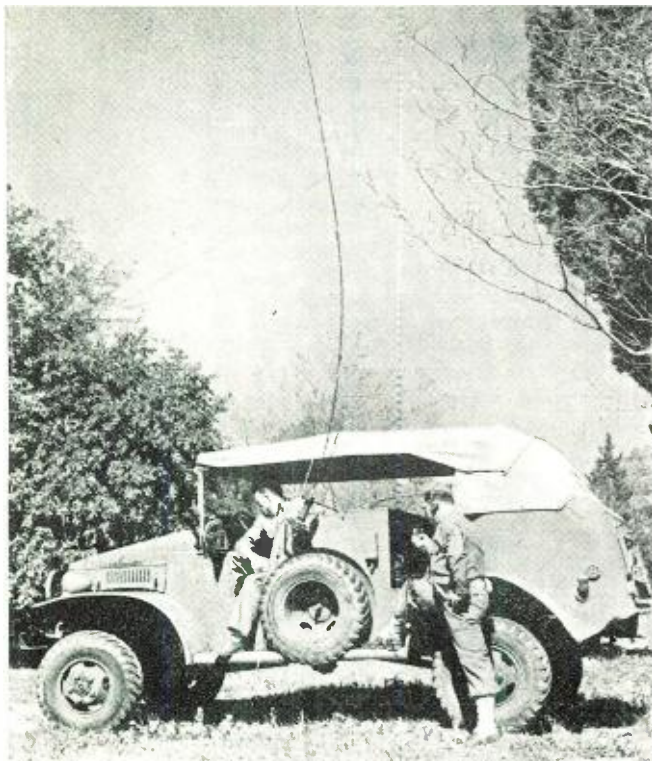

Command cars move at high-speed. Note vertical type antenna equipped with secondary directional wire.



Orders are sent over this portable switchboard to direction-finders in the field to locate enemy.

EAVESDROPPING BY THE ARMY

by **ANDREW R. BOONE**

Bearings taken by field stations are reported back to the intercept room. Findings are then projected on map to determine enemy transmitter.

"PICKING up Nigori, sir," reports an army corporal, pecking away on a typewriter as he listens intently through a pair of earphones. "Contact the direction finder stations," orders the second lieutenant in command of the radio intelligence detachment, operating not far from a command post. "Have all stations take bearings on 3900 kilocycles."

At a nearby telephone switchboard, another enlisted man plugs neatly into four circuits, repeats the command. Within seconds, operators at the direction finders, highly secret portable radios fitted with rotating antennae, begin swinging their loops toward the

signals. Setting their antennae toward the strongest signals, they report back to the intercept headquarters: "142 degrees . . . 150 . . . 210 . . . 173."

At intercept headquarters, an enlisted man plots the lines according to the radioed reports. Deftly he moves black threads along lines from the known positions of the direction finders. They cross each other near the edge of a low hill, alongside a dirt road a few miles back of the enemy front. Where the lines intersect . . . there is the enemy.

From the intercept room, this information is quickly passed on to higher headquarters. Shortly artillerymen or bomber pilots are consulting

maps, and if the listeners have been good listeners and have done their jobs well, high explosives are raining down on that hidden spot where the black threads cross.

Adding to the difficulties faced by enlisted men intercepting enemy messages is the fact they must learn several foreign codes. One of these is the Japanese Nigori, a branch of the Kana code. They first must learn to put dots and dashes together to form English letters, then automatically interpret Japanese dots and dashes, which may mean something entirely different. "Just like a truck driver getting into a non-standard gear shift truck," remarked one of the army's best eavesdroppers to the other. These examples from U. S. and Nigori will give you an idea of how rapidly an operator must shift his mental processes:

Signal	U.S.	Nigori
....	F	BE
.	E	JI
...	L	GA
..	N	DA
....	Z	BU

The eavesdroppers, working in batteries of two or more, hidden in a building or under camouflage, somewhere near the front, are virtually seeking a needle in a haystack when searching out enemy messages. Theirs is a round-the-clock job, for they never know when the enemy will be sending, on what frequency, how long he may be on the air, what his call signs will be, or what code he may use.

Excepting when they communicate with each other, the radio intelligence
(Continued on page 51)



Message is recorded on wax cylinder when the traffic is too heavy or sent at excessive speed.



Non-commissioned officer in command car talks with intercept headquarters. Note key on his leg.



Army private records Japanese coded message. Note the SW receiver.



Stretching antenna to nearby tree. Second wire gives directional effect.

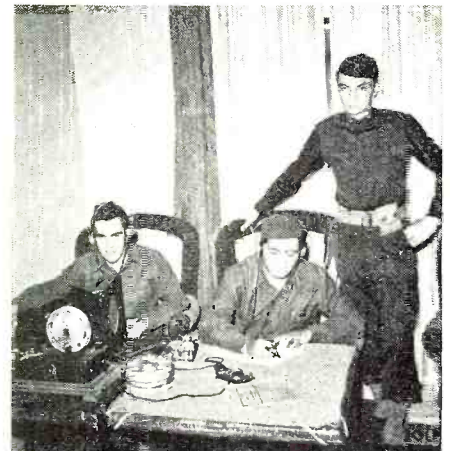

Radio intelligence officer instructs men who are learning foreign codes.



Operating in hidden buildings or tents. Recording messages on mils.

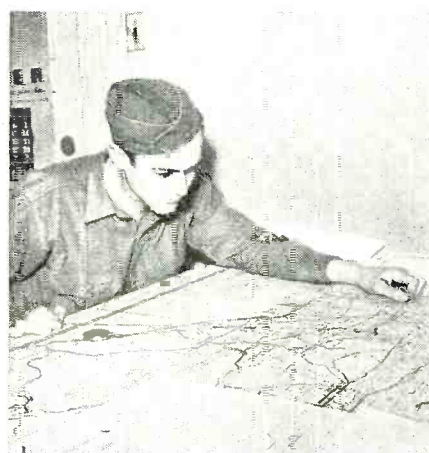

Plotting the intersection of bearings onto map of surrounding area.



It's not easy to send code when the car is in motion over rough terrain.

Modern Tone Control Circuits

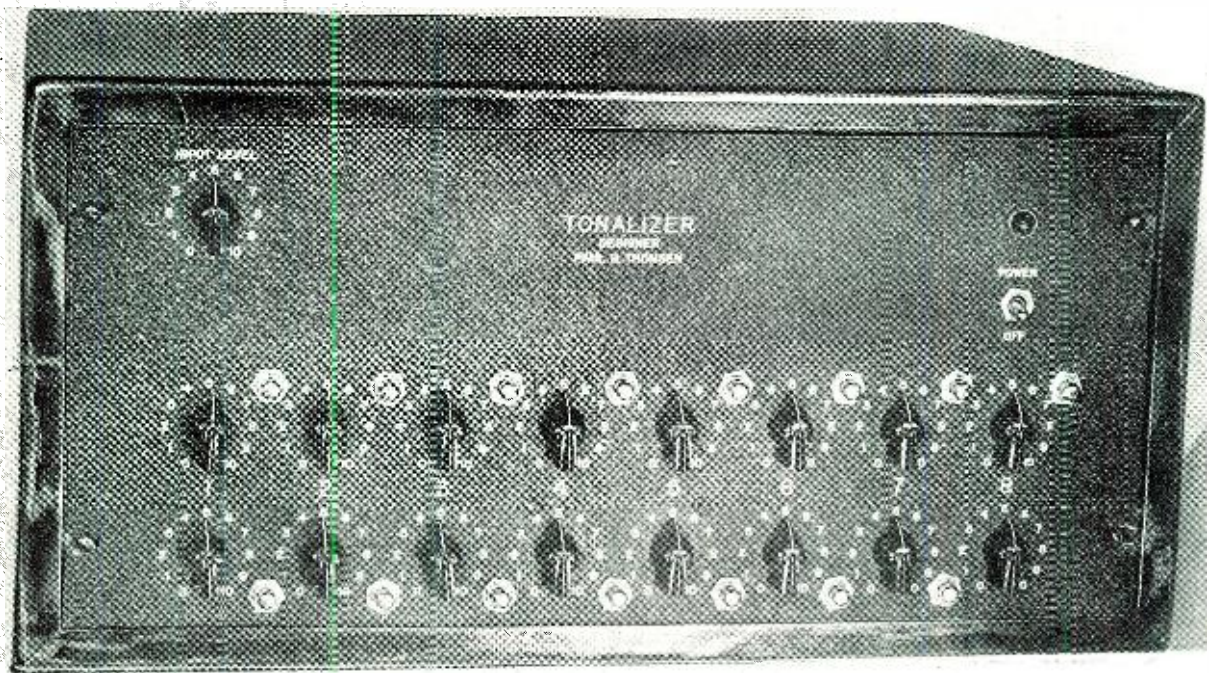

The commercial version of the Tonalizer, designed for full tone equalizing.

THE introduction of frequency modulation broadcasting, with its breathtaking naturalness and perfection of tone, has done more, perhaps, than any other factor to make radio listeners demand more faithful reproduction of programs by radio receivers. In addition to all-wave reception, push-button tuning and all the other features which make for a good radio receiver, listeners are today demanding of their high-quality receivers the ability to reproduce programs in homes exactly like they sounded in the broadcasting studios.

It is a puzzling peculiarity of radio that no one fixed design of receiver circuit will give the perfect fidelity demanded by the public. Many factors outside of the receiver cause the program that the listener hears to be different from the original studio program, and the only way we can compensate for these factors is by means of tone controls.

Before considering the various types of tone controls which are to be found in modern radio receivers, therefore, let us first consider in turn the three major causes of poor quality in a reproduced radio program—the imperfection of the human ear, the imperfection of the average receiver-loudspeaker combination available today, and the widely varying acoustical conditions in homes.

by **L. J. MARKUS**

The human ear is responsive to frequencies that include a very complex waveform. The use of special circuits makes it possible to set the tone range for preferred taste.

Weaknesses of the Human Ear

If you have average human ears, they do a pretty good job of responding to the various audio frequencies when you sit within ten feet or so of a brass band or walk through a boiler factory. Placing this statement in the form of a conventional graph, we can let curve A in Fig. 1 represent the response of the human ear at different frequencies in the audio range. This curve represents a variation in apparent loudness as heard by an average person when a sound having a definite intensity level (about 80 db as indicated by a meter) is varied in frequency over the audio range. The flatness of the curve indicates that the ear is hearing all the frequencies about equally well at this loudness level. Unfortunately, a level like this is too loud for the average home.

Curve B represents a loudness level more nearly corresponding to that which we find in the home when the radio set is turned on. The curve shows the intensity level needed at each audio frequency to make the sounds at all frequencies seem to have the same low loudness to the ear. Note that at low audio frequencies, around 100 cycles, the sound level as indicated by a meter must be much higher than at 1000 cycles in order to make the ear hear these two frequencies with the same loudness.

Actually, at this low loudness level the ear is most sensitive to frequencies around 4000 cycles, and has increasingly more difficulty in hearing frequencies deviating in either direction from this value.

When we speak of the intensity level of a sound, we mean the actual

level measured by a sound level meter which is connected to a microphone designed to pick up all sound frequencies equally well. Loudness level, on

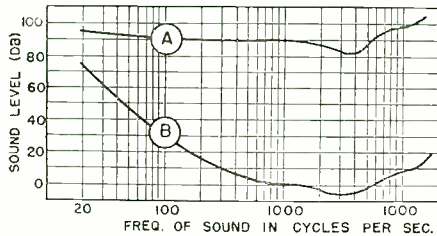

Fig. 1.

the other hand, is the human response to sound, and cannot be measured with instruments.

Receiver-Loudspeaker Limitations

Although it is possible to build receiver circuits which amplify all audio frequencies just about equally well, we do not ordinarily encounter this condition in manufactured receivers. Furthermore, loudspeakers which reproduce all frequencies uniformly well are quite rare. Radio design engineers can correct these deficiencies within practical limits when permitted to do so, but such correction is not ordinarily possible economically in the lower-priced receivers on the market today. This is the reason why such great differences in tone quality are to be found in receivers in use or on display in radio stores.

Acoustics of Homes

The studios in which most radio programs originate are built to rigid acoustical specifications, with rugs on floors, drapes or other sound-absorbing materials on walls, and ceilings made from material which will reflect only a limited amount of sound waves. Modern studios even have provisions for varying the acoustics by changing drapes or moving wall panels, to get particular reverberation effects for certain programs. Assuming it were possible to have an absolutely perfect radio broadcasting system from microphone through the loudspeaker, and assuming the program in the home was at exactly the same loudness level as that at the studio, a trained ear would notice distortion if the home acoustics differed from that of the studio.

The importance of room acoustics can readily be demonstrated by anyone. Operate a radio receiver for a while in a bare room—hard walls and ceiling, no rugs on the floor, no furniture, no curtains, and only one person in the room—then try out this same

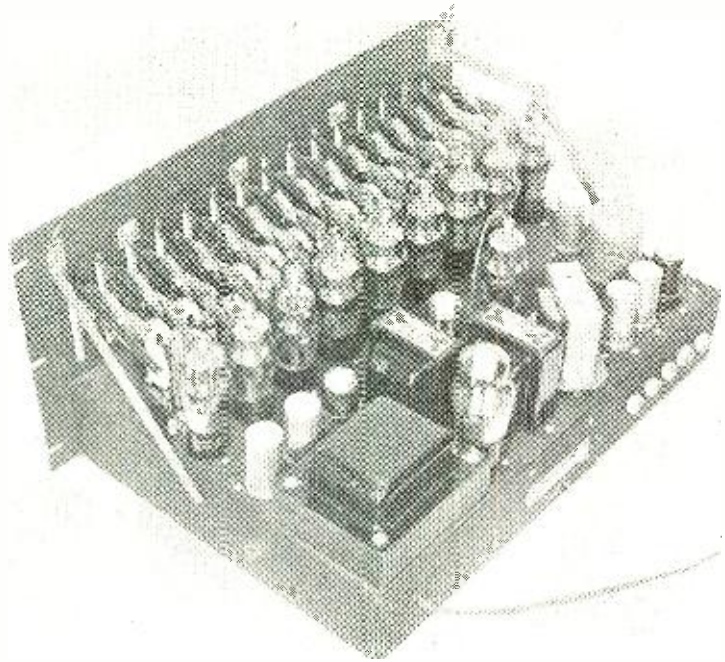

An elaborate setup for complete equalizing networks. Fig. 11.

receiver in a completely furnished room. In the bare room you hear a great deal of reflected sounds along with the direct sound from the loudspeaker, whereas the soft sound-absorbing materials in a furnished room absorb sound waves and prevent most of the reflections.

What a Tone Control Does

One purpose of a modern tone control is to make the reproduced radio program more nearly perfect in tone at loudness levels desired in average homes, despite deficiencies in the human ear, the receiver and the room in which the receiver is located. Another equally important purpose is to make it possible for each set purchaser to adjust the tone to suit his particular taste.

Thus, some people prefer a boomy bass tone in a radio set even though this may produce severe distortion of the original program. People who are annoyed by needle scratch noise in their radio-phonograph combinations will set the tone control to suppress this noise even though they thus cut out the higher recorded frequencies also. Circuit and static noise can often be suppressed in the same way with a tone control.

From a more technical standpoint, a tone control can be highly useful in public address work. The tone control can often be adjusted to reduce acoustic feed-back from loudspeakers to microphone in public address systems, for feed-back usually occurs first at some particular frequency at which the response of the system is a maximum. By setting the tone control or an equivalent equalizer network to suppress this frequency, much greater volume can be provided without feed-back and without too much distortion.

The simplest practical method which can be used in modern receivers to

control tone is a condenser connected across a signal circuit. An example of this is shown in Fig. 2, where the condenser and its control switch are connected between the plate of an a.f. amplifier tube and ground. The value of the condenser will be somewhere around .01 mfd.

When the tone control knob of this arrangement is in position 1, the condenser is out of the circuit and hence all audio frequencies are passed uniformly. You may find this position labeled BRILLIANT, BRIGHT or TREBLE. Setting the switch at position 2, which might be labeled MELLOW or BASS, shunts the condenser across the signal path, thereby attenuating the medium and high audio frequencies. The resulting effect is that of boosting the bass notes, giving a boomy tone which is usually preferred by listeners when the receiver is being operated at the customary low loudness level for background music in a home.

A condenser like this can be used as a tone control because at low audio frequencies its reactance is so high in comparison to the load that there is negligible by-passing of low-frequency signals. As the signal frequency increases, the reactance of the condenser goes down, since it varies inversely with frequency. Thus, more and more of the audio signal is by-passed to ground without passing through the load, as frequency goes up. Keeping some of the higher audio frequencies out of the load in this manner makes the lower frequencies predominate and thereby gives an apparent bass-boosting effect.

Four-Position Tone Control

A choice of four different tones can be obtained with three condensers and a four-position switch arranged as shown in Fig. 3. The response curves

Fig. 2.

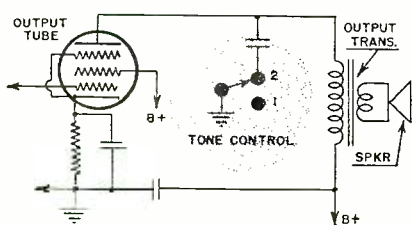

below the circuit diagram are numbered to correspond to the four switch positions. Note that curve 1 is the *normal* response of the receiver as obtained without any tone control condenser. At low volume levels, this does not emphasize the bass notes

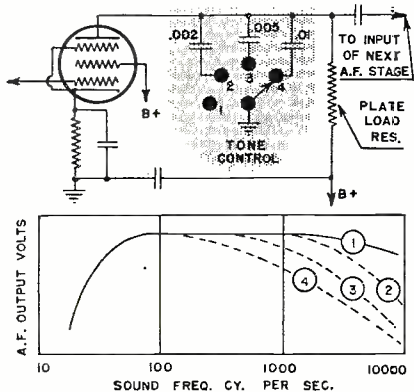

Fig. 3.

enough to compensate for the lowered response of the ear to weak bass sounds. Curves 2, 3 and 4 show how increasingly greater shunt capacity values provide increasingly greater suppression of higher audio frequencies. To the ear, then, setting 4 would seem to give maximum boosting of bass.

Setting the tone control at position 4 when the volume control of the receiver is turned up will give greater amplification of bass notes than is required by the human ear, and the program will sound boomy. Many people actually prefer this effect even though it constitutes distortion, and will leave the tone control set at this position just about all the time.

Strictly speaking, the placing of a shunt condenser in a signal circuit would lower the loudness level a certain amount in a receiver which did not have a.v.c. The reduction is not great, however, and is just about completely offset by the a.v.c. system in a modern receiver.

Continuously Variable Tone Control

Another common tone control arrangement is that shown in Fig. 4, which uses a rheostat in series with a condenser to provide exactly the desired amount of apparent bass boosting at any loudness level. When the rheostat is set at zero resistance, the condenser is directly across the signal path and high audio frequencies are almost completely suppressed. Increasing the amount of resistance in series with the condenser by advancing the tone control rheostat increases the impedance of the tone control path to ground, and thereby reduces the shunting effect of the high frequencies. When the entire 100,000 ohms of the rheostat is in the circuit, the impedance is so high that practically all signals take the path through the plate load, and all frequencies get through equally well.

You will often find this combination

condenser-rheostat tone control arrangement across the grid circuit of an a.f. stage. The capacity value will be lower (about .005 mfd.) and the rheostat value will be about 1 megohm, but the action is still the same.

Another tone control arrangement used in various forms in many modern receivers is shown in Fig. 5. It uses three parts, a resistor, rheostat and condenser. When the rheostat is set at zero resistance (point 1), it shorts the condenser and leaves only the fixed resistor shunting the signal path. All a.f. signals are then passed uniformly.

Moving the rheostat arm away from point 1 places a small resistance value in parallel with the condenser, giving this condenser a shunting effect now which increases with frequency. The combined impedance of this tone control path to ground now increases a certain amount at the lower audio frequencies, with the result that more voltage is developed across the grid circuit at these frequencies and we have boosting of lows.

The more the tone control arm is moved away from point 1 (towards point 2), the greater is the effect of the condenser on the total shunt im-

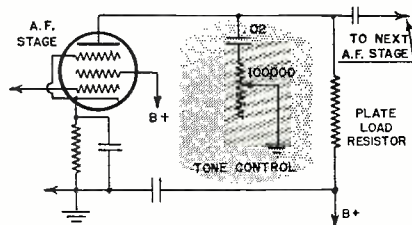

Fig. 4.

pedance and the more noticeable is the increase of lows. The net result is increasingly greater emphasis of low audio frequencies as this tone control rheostat is advanced. Maximum bass tone is obtained when the rheostat is entirely in the circuit (set at point 2).

Resonant Tone Control Circuit

In Fig. 6 is an example of a parallel resonant circuit used to control the bass response of a receiver. The condenser and the iron-core choke coil together have a resonant frequency of about 50 cycles, obtained usually with about .1 mfd. and 100 henrys. Assuming that the bass control rheostat is set at zero resistance, this circuit at resonance acts as a high resistance, and this in series with fixed resistor R (about 10,000 ohms) gives a high plate load impedance for the stage at audio frequencies at or near 50 cycles. This in turn gives increased amplification at the frequency range around 50 cycles.

At frequencies above 50 cycles, the parallel resonant circuit acts as a reactance having low ohmic value, so the 10,000-ohm resistor R is essentially the only plate load. High audio frequencies are therefore not affected by the tone control circuit.

Since the insertion of resistance in series with a parallel resonant circuit lowers the resonant resistance, the

bass control rheostat in the circuit of Fig. 6 serves to lower the resonant resistance when less bass boosting is desired. When all of the rheostat resistance is in the circuit, the resonant resistance is quite low in comparison

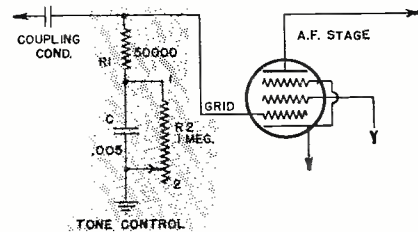

Fig. 5.

to the 10,000-ohm value of the fixed resistor, hence there is little or no extra amplification of bass signals.

Automatic Bass Compensation

A certain amount of correction for the low-volume shortcomings of the human ear can be accomplished automatically with the automatic bass compensation (a.b.c.) type of volume control arrangement, shown in Fig. 7. When volume is reduced by moving the volume control arm toward the grounded end, there is increased attenuation of high frequencies and resultant bass emphasis as required by the ear at lowered volume levels.

The action is best explained by considering the volume control from the standpoint of a voltage divider. The impedance between point P and ground in comparison to the total volume control impedance determines how much voltage is applied to the grid of the next a.f. stage. The portion of the volume control which is shunted by C and R in series has an impedance which drops with frequency, due to the shunting effect of the condenser. As

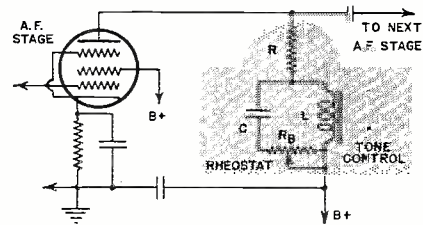

Fig. 6.

volume is reduced by moving P toward ground, this high-frequency shunting action upsets the division of voltages in such a way that high frequencies get a different division of voltage than lows, in a way which gives the bass-boosting effect.

The Tonalizer

Although the tone control arrangements ordinarily found in radio receivers give satisfactory results for the average radio listener under the intended conditions of use, they by no means give the near-perfect correction often required by recording engineers, broadcast engineers, public address system operators and theater sound system technicians.

Perfect tone correction means individual control over each frequency in

the audio spectrum, so that amplification at each frequency could be changed whenever the loudness level of the reproduced program is changed. Of course, a perfect system like this is both an engineering and economic

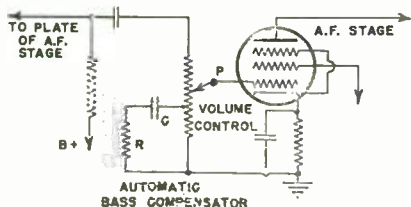

Fig. 7.

impossibility at the present time, but a practical approach to it, which fully meets the requirements of all high-fidelity a.f. amplifier systems, has been developed by Mr. Paul H. Thomsen, in the form of a multi-channel amplifier known as the Tonalizer. This unit, shown with its inventor in Fig. 8, provides individual control over different groups of frequencies in the audio spectrum.

Basically, the Tonalizer consists of a number of selective channels in parallel, each having its own amplifying stage and a selective input circuit which responds to a different limited band of frequencies in the audio spectrum. This parallel group of channels is preceded by a master voltage amplifier stage containing the master gain control, and followed by a suitable matching network of resistors and condensers to permit inserting the

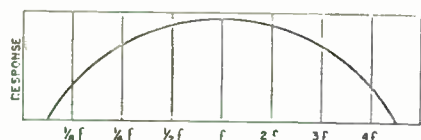

Fig. 10.

Tonalizer in the a.f. system whose tone is to be corrected. The basic circuit arrangement is shown in Fig. 9.

The Tonalizer has its own power pack of conventional design, and is thus a completely self-contained unit which can be inserted into an a.f. amplifier system and plugged into a 115-volt a.c. outlet ready for use in a few minutes.

About sixteen separate selective channels are ordinarily used, but this number can be increased or decreased to meet special requirements. The more channels there are, the closer the instrument comes to control of individual frequencies and hence the more perfect is the control of tone.

In each channel is a voltage-dividing network which uses two condensers and two resistors to give a response curve like that shown in Fig. 10. The values of the condensers and resistors determine the value of the peak frequency f , hence these parts values are different for each channel. The channels are identical in all other respects.

After passing through the input voltage amplifier stage in Fig. 9, audio signals which make up a program di-



Fig. 8.

vide over the sixteen-odd channels, in accordance with the impedance to ground offered by the various channels. Since the response curve is quite broad, the channels overlap considerably and any given frequency will be found in several adjacent channels.

Each selective circuit contains a series element $C1-R1$ and a shunt element $C2-R2$. An analysis of how the voltage-dividing action of this circuit varies with frequency will show how control of tone is achieved.

As the response curve in Fig. 10 indicates, the reactances of the series and shunt elements vary with frequency in such a way that maximum voltage is developed across $R2$ for transfer to the grid of the amplifier tube in the channel only at one particular frequency. The amount of this voltage actually getting to the grid depends upon the setting of potentiometer $R2$, and hence this potentiometer provides a control over the strength of the narrow band of frequencies passing through the channel.

The selective action of this R-C net-

work can be explained as follows: At low audio frequencies we can neglect the reactance of $C2$, which leaves only $R2$ in the shunt element. In the series element, however, the reactance of $C1$ will be high at low frequencies and will make the net impedance of the series element high in comparison to the net impedance of the shunt element. Therefore, at low audio frequencies (lower than f in Fig. 10), most of the signal voltage is dropped across series element $C1-R1$, and only a relatively small voltage is available across $R2$ for transfer to the amplifying portion of the channel.

At high audio frequencies (above f) the reactance of $C1$ is so low that $R1$ becomes the principal factor in the series element. The reactance of $C2$ is likewise low (much lower than the value of $R1$), so the net impedance of the shunt element is much lower than that of the series element now. Most of the signal voltage is now dropped across $R1$, and again we have little voltage across $R2$ for transfer to the

(Continued on page 49)

Fig. 9.

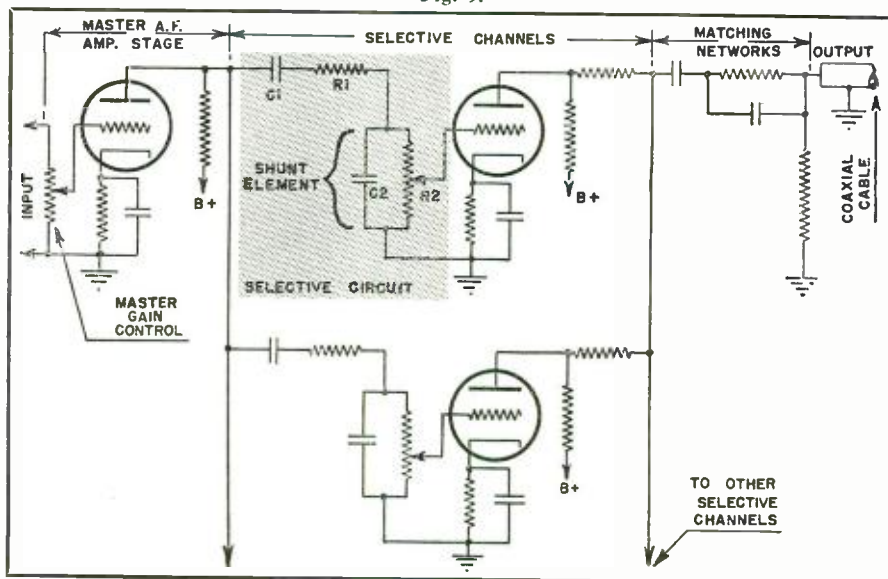

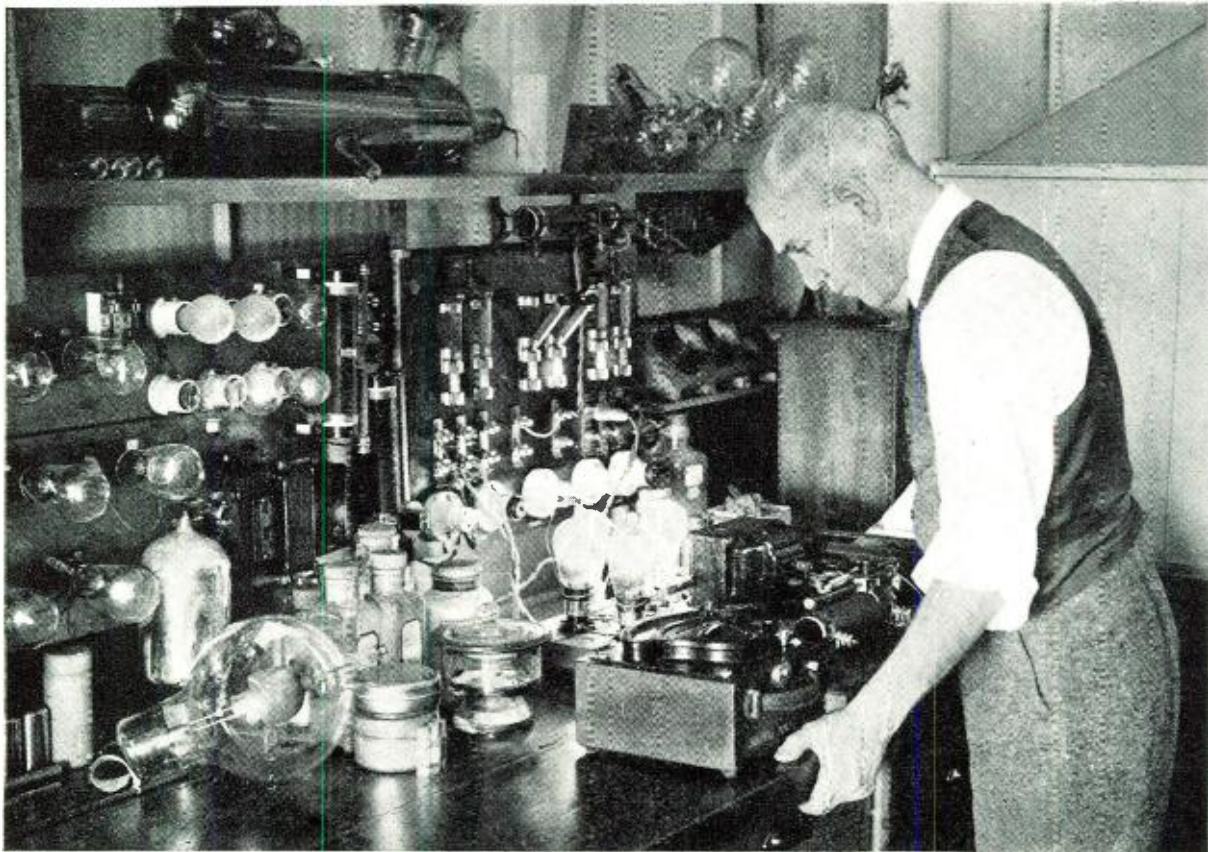

Investigating electronic tubes in laboratory of prominent manufacturer.

ELECTRONIC CAMERA HAS X-RAY EYE

by **S. R. WINTERS**

Washington, D. C.

Using a principle similar to the X-ray machine—the Electronic Camera writes its own records by diffraction.

AN electron diffraction camera which is so self-contained and readily adjustable that various metals and similar materials may be X-rayed and studied under operating conditions, has been designed by John E. Ruedy of Merchantville, New Jersey. (The rights to the apparatus have been assigned to the *Radio Corporation of America*.)

This improved electronic camera writes its own autographs in the form of photographic records of electron diffraction patterns—or the observer may determine visually what happens when an "electron gun" bombards a specimen of metal or alloy. The principal of operation is similar to that of

an X-ray machine, except that the latter penetrates deeply with its "seeing eye," whereas the electronic camera skims along the surface of materials under observation. Uncannily, however, this camera affords a minute study of the atomic surface structure of various materials. Thus, scientists can determine the changes in metals or alloys resulting from various treatments.

The study of a photo or secondary electron-emission from a complex substance, is also facilitated by a knowledge of the atomic structure of the photo-emissive specimen, as it is subjected to different treatment. That is to say, study and observation of the

surface structure of a photo or other secondary electron-emitting material is possible, as the electron gun of this camera bombards the former, with a stream of electrons. This is accomplished by a high-intensity electron beam focused, kodak-like, and caused to graze the surface of a strip of metal. This specimen is mounted in a specially-designed holder, which permits adjustments of its lateral angle, as well as its vertical position.

This "electronic X-ray" consists of a multiple of units—a system, as it were, including: Electron guns; an improved specimen holder which permits the selection and accurate positioning within the camera of anyone of a num-

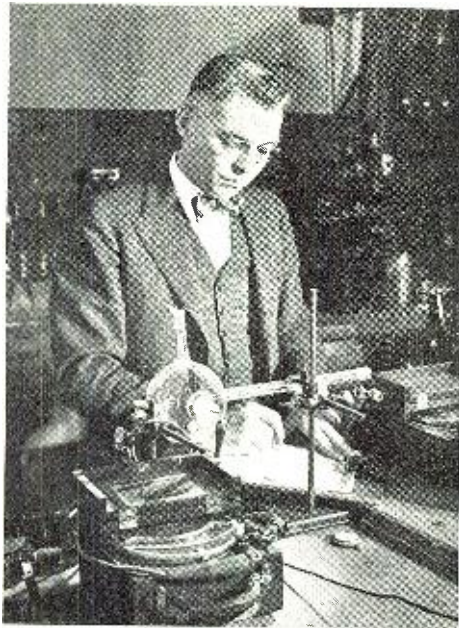

Measuring electron concentrations.

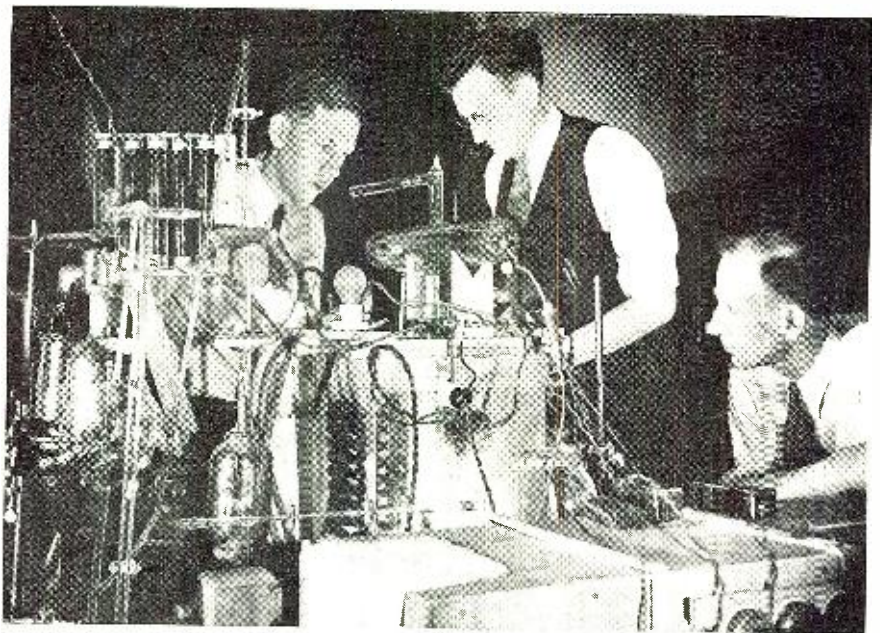

At work on problems of high-voltage electron tubes.

ber of specimens; provision of an improved arrangement for mounting the primary electron source at the end of the camera chamber; improved shutter mechanism adjacent to the fluorescent screen or photographic plate of the camera by means of which a selected portion of the screen or plate may be exposed to the electron beam; an evacuated chamber; and metallic bellows for sealing this chamber against leakage at the various control points.

As illustrated in one of the schematic diagrams, the camera includes an electron gun (mounted on one end of an evacuated cylindrical chamber, the other end of which is sealed by a glass plate). The inner surface of this plate is coated with a fluorescent substance. Within the chamber, an apertured diaphragm is located between the electron gun and the specimen of metal under observation. A shutter is mounted across the chamber close to the fluorescent screen and the glass plate, as a means of shielding the screen or plate against electrons from the gun during preliminary adjustments of the apparatus. A film chamber includes a photographic plate and holder, which may be moved across the path of the electrons when de-

(Continued on page 44)

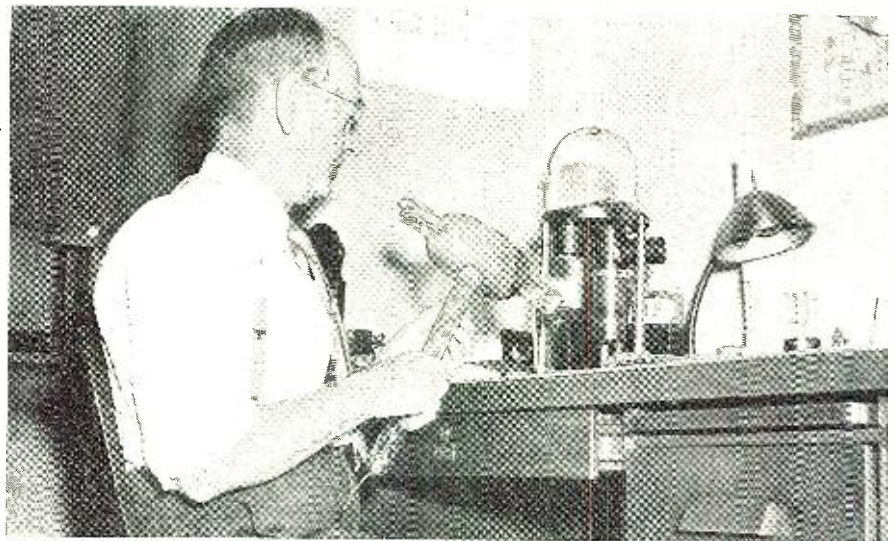

Engineer examines carefully, delicate electron tube.

CODE REFERENCE

- | | |
|---|----------------------------|
| 7 = Electron Gun | 27 = Grid chamber |
| 9 = Cylindrical chamber | 28 = Plate cover |
| 11 = Glass plate coated with fluorescent material | 29 = Anode chamber |
| 12 = Apertured diaphragm | 31 = Second anode chamber |
| 15 = Specimen to be studied | 33 = Glass press |
| 17 = Shutter | 37 = Glass tube |
| 19 = Film chamber | 65 = Deflecting electrodes |
| 20 = Film holder | 72 = Socket bearing |
| 21 = Photographic plate | 81 = Large shutter |
| 22-43-69-89-96 = Flexible metallic bellows | 85-87 = Small shutter |
| 23 = Second electron gun | 97 = Lever |
| 25 = Cathode wire | 99 = Small window |
| | 101 = Mirror |

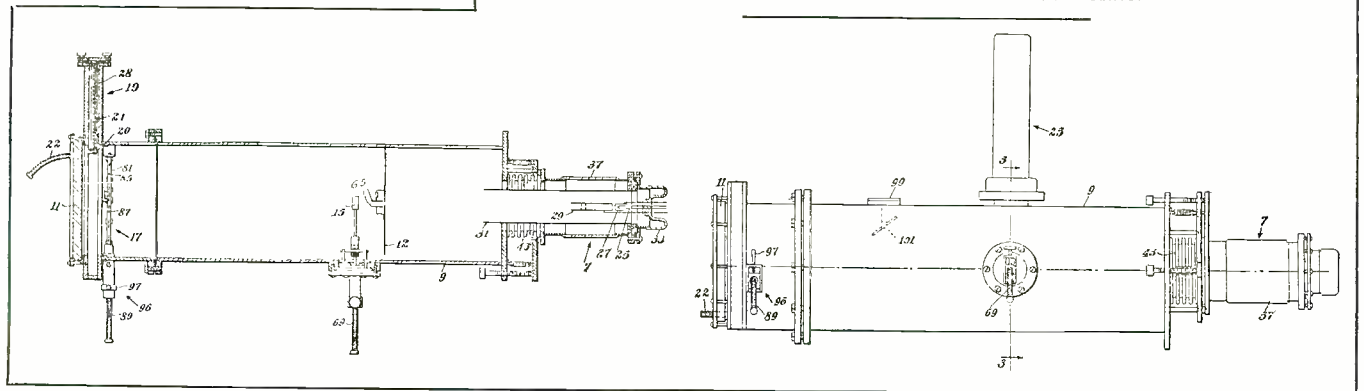

Theory and Practice of DISC RECORDING

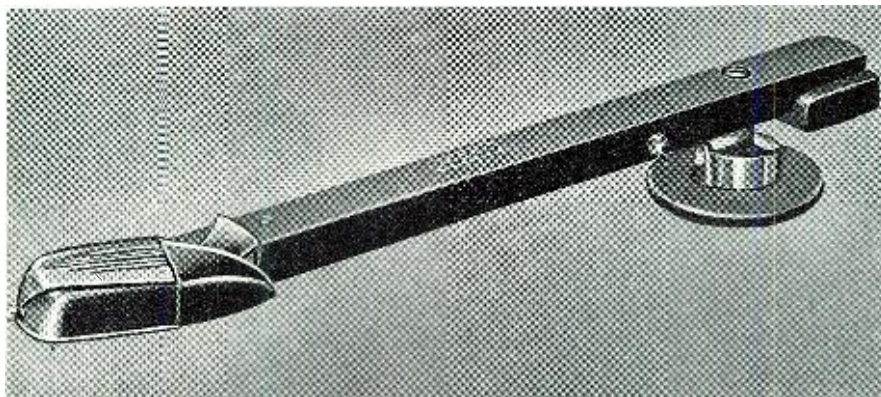

High-quality magnetic pickup for transcriptions.

by **OLIVER READ**

Managing Editor
RADIO NEWS

The magnetic pickup has been developed to a degree of high perfection during the past months. It is largely responsible for the quality reproduction now possible from the studios.

THE manufacturers of recording equipment have spent thousands of dollars in making improvements on their products, particularly prior to the present emergency. For example there has been a concentrated effort to improve the fidelity and over-all response of the phono pickup or reproducer. Inasmuch as upon this unit depends a major share of responsibility for true reproduction of phono records, we will attempt to analyze and compare several types in order that the reader might be better acquainted with the revolutionary changes in design and structure that have gone into these highly important parts.

In contrast to the heavy "brute force" type of unit which was in common use up until a few years ago, we now find that the trend has been towards a reduction of weight and mass in the design of the modern reproducer. There was considerable error in the belief that a pickup for reproducing lateral records of necessity had to be a massive device and that such

a unit required considerable reinforcement of its structure as a means for protection. Contrary to this belief was the realization that the vertical type

of pickup was, of necessity, rather delicate and fragile and due consideration was not given to the lateral or commonly employed type with the result that this unit did not receive its share of attention until recently.

The early type of magnetic pickup was designed as illustrated in Fig. 1. The assembly consisted of a horseshoe magnet, pole pieces, the coil and a vibrating armature assembled in the manner shown. In order to assemble the armature properly, rubber dampers were placed in such a position that they provided the sole support for the assembly. When this type of pickup was used, the frequency range of reproduction was limited due to the inherent stiffness of the armature and its associated support. Furthermore, the use of rubber offered a distinct handicap, inasmuch as the life of the rubber was not sufficiently of long duration and in time rotted. During this change of characteristic viscosity, the damping effect varied and it was necessary to make adjustments to the assembly at regular intervals in order

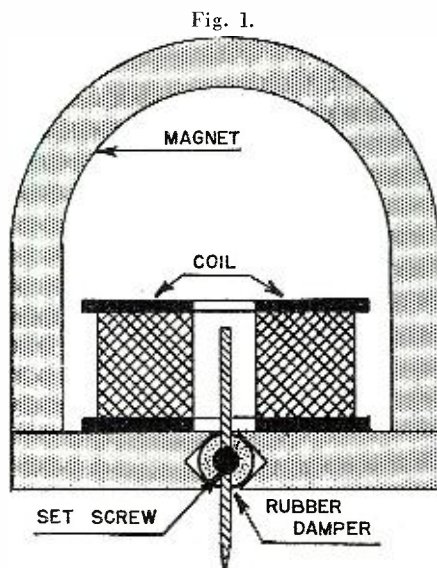

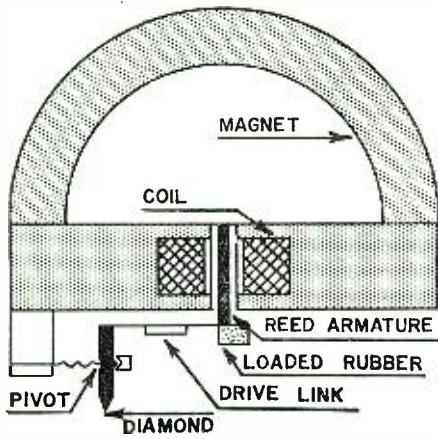

Fig. 2.

to maintain a fairly satisfactory performance.

Another drawback to this assembly was that the rubber dampers also served to center the armature within the coil. If this were allowed to move too far either way, "chattering" would result due to the striking of the armature against either the pole pieces or within the side walls of the coil.

One of the newer types of magnetic units is illustrated in Fig. 2. Note that the use of a rubber damper as a means for pivoting has been eliminated. The coil is inserted down into the pole piece assembly so that the field becomes more concentrated. The armature is driven by a light channel link connected to the short end of the stylus lever. The point of high-frequency cut-off is determined by the stiffness of this linkage and the effective mass of this moving system, and compliance of the stock from which the record is pressed. The pickup illustrated uses what is known as a balanced, clamped reed armature assembly. The armature impedance is substantially reduced by employing a lever system and the record sees but little impedance beyond that of the permanent diamond point together with the extremely light weight mounting post. Vertical flexibility is provided which permits the stylus to rise and fall at twice the signal frequency during normal pinching while reproducing lateral cut records. The motion generates no voltage; therefore, has no harmful effects.

The illustration shown in Fig. 3 shows the design of a highly efficient reproducer featuring the "relayed-flux" type of construction. This is used in conjunction with a specially-designed magnetic circuit and the unit has negligible moving mass and a reasonably high voltage output. It is known as *Audak Microdyne*. The maximum displacement of this mass is .00015", when reproducing the highest recorded amplitudes. The outstanding feature of this design is that the combination of mass together with small displacements makes for small vibratory momentum ($M = mv$ where M is the "vibratory momentum," m is the vibrating mass and v is the velocity of this mass). It will be observed that a pickup may have a small

vibrating mass and still have a high vibratory momentum. On the other hand, a pickup may have a larger vibrating mass and still have a lower vibratory momentum. This pickup has a low needle impedance and will track with the needle-point pressure as low as 15 grams. It is flat within plus or minus 1 d.b. to over 10,000 cycles. It has a comparatively high output of minus 30 d.b. (reference level being .006W). Note that a tiny vibrating reed is employed as seen in Fig. 3. This connects to the reproducing needle in such a manner that the reproducer may be adjusted to exert proper pressure onto the disc for fullest efficiency.

While on the subject of discs, it might be well to point out that there is a definite limitation to the frequency range that can be reproduced from commercial discs. Much has been said about the frequency range of crystal pickups. Many claim that reproduction up to including 10 or even 15 k.c. can be had with existing equipment, forgetting that there is a definite limitation that can be reproduced.

If we assume a pickup being capable of a range of 10 k.c. or over, such a pickup will not be able to properly reproduce a frequency of 10,000 cycles from a 10" disc except at the outside edge of the record, the reason being that the wave lengths at such a frequency become too short for the point of the stylus to properly engage them.

The design of this pickup repre-

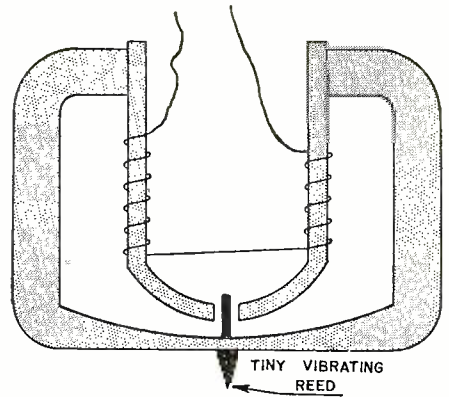

Fig. 3.

sents a considerable departure from conventional designs. Although the moving-mass ratio of this pickup in comparison to the bulky armature is on order of 1-80, it does not represent the total improvements in design that have been made. The inertia of the "exciter unit" is several hundred times less than that of the moving armature and other type units. Therein lies the secret of the remarkable performance of this design. According to the inventor, the "exciter" relays the flux to the fixed armature. Hence, the term "relayed-flux." The virtual elimination of moving-mass results in the location of the exciter resonance above audibility. This freedom from resonant peaks insures freedom from shock-excitation from the moving system by impulses of large amplitude and this eliminates that unpleasant "ringing effect" often noticed when reproducing records.

In actual tests, we have found a very low harmonic distortion when using this particular reproducer and the quality has been most excellent. There is sufficient weight from the pickup structure so that "groove-skating" will be avoided.

We covered the characteristics of crystal type pickups in earlier chapters in this series. Both have definite features and the choice of one type or another will depend largely upon the personal likes of the user. Those of you that are engaged in using portable recording equipment "out on location" will find the magnetic type highly suited for this application, inasmuch as exposure to the direct rays of the sun will in no way impair the efficiency of the unit. When using crystal devices, on the other hand, such exposure often results in a damaged unit.

Electrical Connections

Fig. 4 shows several methods that may be used to match properly the magnetic pickup either to existing amplifiers or in new equipment. Fig. 4A is recommended for connecting high-impedance units to regular amplifier input channels that are provided with the conventional potentiometer across the input terminals. It is common practice for these to have a value of approximately 1/2 megohm.

Many prefer to have a bass-boost
(Continued on page 50)

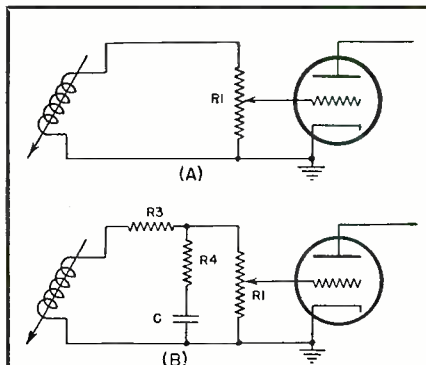

Fig. 4.

$R_3 = 12,000$ to $25,000$ ohm
 $R_1 = 4,000$ to $10,000$ ohm
 $C = .01$ to $.03$ mfd.

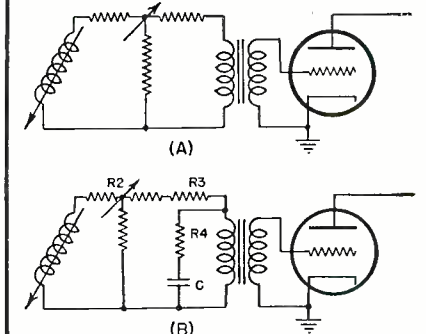

Fig. 5.

$R_2 =$ Equal to pickup impedance
 $R_3 = 500$ ohms for 200 ohm pickup
1250 ohms for 500 ohm pickup
 $R_4 = 200$ ohm for 200 ohm pickup
500 ohm for 500 ohm pickup
 $C = .5$ to 2 mfd.

"FUNDAMENTALS OF RADIO," by Edward C. Jordan, Paul H. Nelson, William Carl Osterbrock, Fred H. Pumphrey and Lynne C. Smeby; edited by William L. Everitt. Published by Prentice-Hall Inc., 70 5th Ave., New York City. Price \$5.00. 400 pp.

Circumstances brought about by the present emergency have shown a definite need for a concise treatise on fundamentals of radio that could be mastered by the average student in the shortest possible time. This is one of the most complete and authoritative books in the field of basic radio. Each of the authors is a recognized authority and has had extensive experience in the radio field. It has been especially designed to include material on radio subjects required for all types of radio work, both civil and military. Three principal themes have been followed: 1, to satisfy men seeking pre-induction and pre-enlistment preparation for the military service; 2, for radio operators in police and airway radio stations, broadcasting stations and similar fields; 3, radio men for industry and equipment manufacturers. "Fundamentals of Radio" covers the course outline recommended by the National Association of Broadcasters for teaching the fundamentals of radio to men of no previous radio knowledge. No high mathematics are used. Instead, the book opens with a concise, convenient review of all the mathematics the reader must know to understand the treatment. All subjects are dealt with in clear cut simple form. The entire field of basic communications is covered, from the simplest a.c. and d.c. circuits, through vacuum tube theory and applications. Also chapters on wire telephony and audio systems, including F.M. transmission. Partial contents include electronic principles, rectified power supplies, sound and its electrical transmission, audio amplifiers, vacuum tube instruments, electro-magnetic waves, F.M., radio wave propagation and radio antennae.

This book will fit in admirably with the educational part of our war effort. It is recommended for all students contemplating entrance to our various radio departments.

"PRINCIPLES OF RADIO," Fourth Edition, by Keith Henney. Published by John Wiley & Sons, Inc., New York City. Price \$3.50. 536 pp. plus index.

Back in 1929 the first edition of this popular reference text was first published. It was written originally for students who have had little background in radio upon which to build and yet who wanted to know the basis upon which radio and communication existed. The problem of the student who must do his learning without ben-

(Continued on page 60)



by **JERRY COLBY**

WE'VE been noting the AFL-CIO brotherly love act recently publicized by the press and our thoughts naturally turning to "what does this mean for ACA-ROU coalition." It was only a few years ago that the ROU had the rank and file of ACA in for a chat just on this get-together idea with fine results until the ACA brethren went back and reported the confab to their officials who sabotaged the whole matter. Why this happened is not of interest right now. But with everything and everyone going all-out for American unity, with unions forgetting their longstanding feuds, inter-union rivalries, etc., what the good brothers of ACA and ROU will do causes us concern. If the leadership of these two great labor unions can bury the hatchet, forget their differences for the duration, couldn't the ACA-ROU brothers do the same? Of course, we're with the ROU in defending their rights as Radio Officers to remain as Officers and not to be thrown in with seamen or any other departments aboard ship which has been advocated by certain ACA officials. So if the ACA organization will finally and definitely throw this thought into the sea plus a few other ideas that have stemmed from sources not considered to be 100% American, we firmly hope that this coalition comes to pass . . . if only for the duration.

Of course, we haven't the right nor even a desire to tell Uncle Sammy how to spend his money, but we do believe we have the right to tell what is going on in the RADAR setup that is throwing good radiops and radio technicians to the outside of this war effort. If any of youse guys don't know about RADAR may we inform you that this is one of the government sponsored educational setups which is helping radiomen become Electrical Engineers. Uncle Sam is putting out the dough to give this education of college-class to his nephews. Some of the boys are being sent to top-flight schools all over the country. But here's our beef: Why try to cram three years college

mathematics into five weeks to men who have been out of school for more than ten years and who have a touch and go acquaintance with algebra, no less calculus. One of the boys recently returned to civilian status via the Special Order Discharge route. He was bitter over the fact that although he was a good practical radioman, a radiop of the old school, he was let out because his math was faulty. He sez mathematics is absolutely the sine qua non or something. Anyhow, if you ain't up in your math, and we don't mean one and one makes six, but right up into calculus, you might as well not stick your nose into this affair. Of course, this is OK for the young uns who have had primary college background, but how many good radiops, and we mean good ones who can handle a key at 40 WPM, tune a receiver and xmtr, trace a circuit from antenna to ground, rewind coils without blueprints, know their rules and regs, etc., have had this college foundation? Very few, if any. Yet elderly boys with families and responsibilities willing to help US lick the dictators with their radiop ability have gone to these schools and been shoved out because they did not know the sine and cosine of tangents or the method of figuring why and how many ergs in a wire of such and such a size. Practical experience counted for nothing, theory being paramount. There are different schools of thought on this idea but our suggestion is for the brass hats to classify each student and place him where his practical knowledge is an advantage over a theoretical back-

(Continued on page 46)



"Hey, girls! We gotta radio in ours!"

WHAT'S NEW IN RADIO

New R.C.P. Vacuum Tube Voltmeter

Accurate measurements throughout the entire audio frequency range, including the ultra-high audio frequencies, are simplified by RCP's new Model No. 666, a vacuum tube voltmeter specifically designed by *Radio City Products Co.* for that purpose.

Essentially a peak type of voltmeter, Model 666 has a constant input impedance resistance of 16 meg-



ohms. Although designed for 105-130 volt, 60 cycle operation, provision has been made for external battery operation through appropriate terminal connections and a throw-over supply switch.

Readings are made quickly and easily on this latest RCP model, a time-saving feature that insures immediate popular acceptance. The instrument is equipped with a 4½-inch rectangular meter having a movement of 0-200 microamperes.

Ranges are 0-3-6-30-150 volts. Tubes used are type 6K6GT, 6X5GT, 6H6 and VR105-30. The latter is a voltage regulator, eliminating errors due to line voltage fluctuations.

The RCP Vacuum Tube Voltmeter combines attractive appearance with characteristic RCP stamina and features of convenience. Model 666 comes in a handsome grey finish steel case with sturdy leather strap handle. Manufactured by the *Radio City Products Co.*, 127 W. 26th St., N. Y., N. Y.

New Bulletin on G-E Control Switches

A new four-page bulletin illustrating and describing improved *G. E.* circuit control switches for industrial applications, has been announced by the accessory equipment section of

General Electric Company's appliance and merchandise department at Bridgeport, Conn. Switches shown in the bulletin are for use in signalling equipment, communication apparatus, instrument panel boards, utility lighting systems, specialized lighting equipment, aircraft circuit control systems, etc.

The bulletin shows 26 toggle and push button switches. Toggle switches include single pole, double pole, three way (single pole-double throw), double pole-double throw, two-line-two-circuit, and three point. Many of the switches are made to Navy specifications.

Wiring diagrams of all switches, and specifications of assembly parts are given. Copies of the bulletin are available on request from the *General Electric Co.*, 570 Lexington Ave., New York, N. Y.

New Portable A-C and D-C Instruments

New P-14 portable a.c. and d.c. instruments for general field service use where an inexpensive unit is required, are announced by the *Westinghouse Electric and Manufacturing Company.*

Modern design, accuracy, sturdiness and reliability are the outstanding features of these new units. The molded cases are fully insulated and magnetically shielded from stray field influence. These instruments are available either with or without covers. The scale length is 3.2 inches a.c. and



2.8 inches d.c. and the units have an accuracy of + or - 1 per cent of full scale. The instruments are equipped with a mirrored dial and a knife-edge pointer which aids in making close and accurate readings.

The P-14 embodies a variety of sin-

gle, and multi-ranges providing for the measurement of a.c. volts, amperes and milliamperes; d.c. volts, amperes, milliamperes, and microamperes. Ranges and combinations of ranges have been carefully chosen to meet every need of test men, laboratory technicians and research engineers. Combinations such as four current and three voltage ranges make this the most complete and flexible instrument available in this classification.

Additional information may be secured from *Westinghouse Electric and Manufacturing Company*, 7-N 20, East Pittsburgh, Pennsylvania.

Tandem Timer

The "Tandem Timer" is a new timing device that presents unusually versatile features which will be of particular value in production departments, laboratories, and for life testing of electrical apparatus. It permits practically any timing sequence

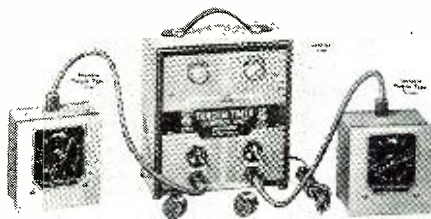

that may be desired. The "Tandem Timer" is essentially a control unit with two individual and variable plug-in type timing elements. With the timing elements adjusted to their correct respective time intervals, each cycle of operation will follow the other continuously in regular sequence. When the timer dials are once set at the time interval desired, further adjustments are unnecessary until a new sequence is required. The automatic reset features of the "Tandem Timer" makes a continuous, as well as a single cycle of operation possible. Plugging in of different timing elements is accomplished in a matter of seconds.

The timing elements are synchronous motor driven, automatic resetting timers, of sturdy design and construction, contained in a formed steel box which measures 5" x 5" x 3". A graduated dial and pointer knob allows quick and accurate selection of timing period. The simplicity of this entire unit is one of its outstanding features.

Manufactured by the *Industrial Timer Corp.*, 113 Edison Place, Newark, New Jersey.

SOUND SYSTEMS FOR WAR PLANTS

by **SIDNEY HARMON**

The David Bogen Co.

The design of a sound system for our new war production plants requires a careful analysis and many special radio circuits.

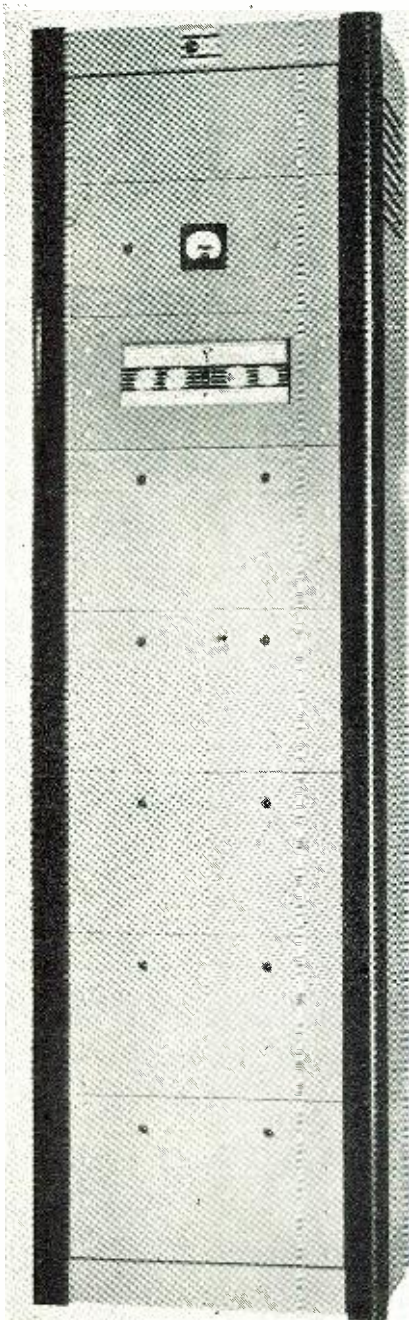

THE phenomenal conversion of American industry to war production has amazed the most optimistic of our friends and confounded the most careful of our enemies. Ambitious schedules of production have been proved picayune—American plants have rolled up their sleeves and planes, tanks, munitions—all instruments of war are moving off production lines at a rate never before believed possible.

In every corner of the nation old plants are stepping up efficiency and expanding. New plants are under construction and additional plants are daily taking shape on the tables of architects.

Centralized Sound Equipment has become a basic tool of war production and almost without exception, old plants are installing such equipment and new plants are being designed to include it.

This article concerns itself with a system designed by a prominent manufacturer for one of the new and largest munitions plants in the country. Because of the wide experience of their engineers in the surveying of plants and the design of centralized sound equipment, a thoroughly accurate system was planned in terms of the architectural drawings of the plant—months before the foundation was laid.

Discussions were held with the architects and the plant management in order to determine what functions were desired and in what manner they should operate. It was decided that general paging and announcements should be issued from a local microphone control at the switchboard. Alarm announcements, night shift paging; air raid and all clear alarms were established as functions of the guardhouse.

Plant engineers readily agreed that air raid alarms were the most important signals to be transmitted and that precedence should be given to them over all speech announcements.

The "All Clear" quite obviously would have to interrupt the actual air raid alarm. Since the operation of the guardhouse controls is essentially *emergency* in character, those controls were to be given precedence over the controls at the telephone operator's station. It was determined that some calls and announcements would be required to be heard by the plant workers only, others should be heard by the office workers only and others would be heard by both. Each microphone control station was, therefore, to be provided with a three-way switch which would provide for the accomplishment of this function.

Essentially, the procedure employed consisted of examining the various sections of the plant in terms of area, noise levels, number of workers, type of equipment in operation and materials used in construction. These factors were, of course, predetermined through discussion with the architects and as a result of experience with similar plants.

Exhaustive tests had been made with the various industrial type speakers so that complete information was available concerning their efficiency and handling capacity. Thus, it was known that a particular unit, when driven with 7 watts of power would produce a level of, let us say, 93 db. on a center of 80 feet. Since plant noise levels could be accurately predetermined and since in order to be heard above existing plant noise level, sound must be 3 db. higher, it can be seen that "knowing what the speakers could do" made it possible to establish a speaker layout and to determine the total amount of power required with complete accuracy.

Working in the manner outlined above, it was determined that 25 radial reflex trumpets, four projector type reflex trumpets, and ten office cone type speakers; a total of 39 speakers were required to completely cover the plant. Five hundred watts of audio power was required to drive the speakers and five *Bogen E100* boosters were, therefore, used in the central control rack.

Left: The amplifier and boosters are protected by steel cabinets.

Reference to the functional schematic will show that two control stations are provided. Station #1 is located at the telephone switchboard and station #2 is located at the remote guardhouse.

When the telephone operator issues a call in order either to locate someone in the plant or to issue bulletins to the workers, selection of speakers is first accomplished by depressing the proper key which opens the relay circuit, controlling the speaker sections to which the call is not to be issued. Thus, if it is desired to send a call to the factory only, eliminating the office speakers, the telephone operator depresses the factory key. This causes the relay circuit controlling the office speakers to be opened and the factory speakers only receive the call. It must be understood, however, that no relay action occurs until the talk key is depressed.

Should the guardhouse issue an emergency announcement or initiate Air Raid or All Clear signals, the telephone operator's station is eliminated automatically because when any signal is initiated at the guardhouse, the telephone operator's control relay circuits are automatically opened through the interlocking circuit. For example: if an air raid alarm is initiated, the air raid relay is closed, thereby interrupting the flow of current to the telephone operator's relay, opening up her circuit and preventing the distribution of any call which she might initiate.

The precedence of air raid alarm over the telephone operator's call is a most important feature of this type of equipment and in the system which we are describing, precedence has been established in the following order: (1) *All Clear*, (2) *Air Raid*, (3) *Main Gate* (Guardhouse), (4) *Telephone Operator*. All Clear will take precedence over all other calls; Air raid will interrupt Guardhouse microphone calls and the telephone operator's calls, and the Guardhouse, which is essentially a protective factory unit, can take any call away from the telephone operator. The chaos which would develop if precedence were not so designed and established, can well be imagined. Calls might conceivably be issued simultaneously by both the telephone operator and the guardhouse, and no intelligibility or efficiency could be expected at all.

It can readily be seen that a central control unit as large as the one illustrated drains considerable current and creates considerable heat. It was after many months of research and development that the manufacturer finally established an exclusive method for controlling the power supply for the amplifiers in the control rack (standby position).

Early methods consisted of controlling the a.c. input to the various amplifiers through a master relay. This caused a time-delay in operation while waiting for the filaments to heat up,

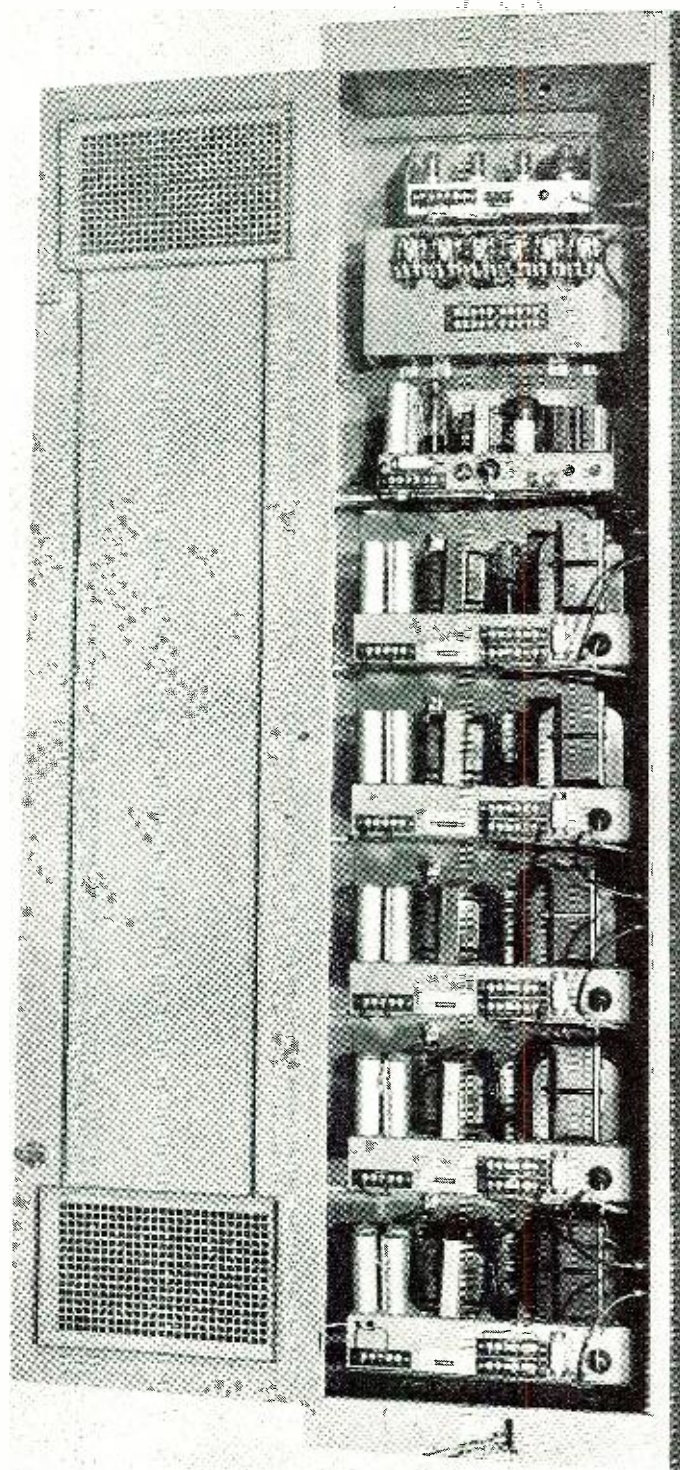

Relays, main amplifier and several booster units may be seen in this view.

and as a result, efficiency of operation was compromised. Today's method controls the plate supply in each amplifier by use of an individual relay. The filaments are maintained permanently at operating temperature and when the key is depressed, plate supply is provided and the system is ready for immediate operation. The current drain is, of course, very greatly reduced in this manner.

Further reference to the functional schematic will show that the standby position (the various booster plate

supply relays marked XX) is controlled by the Air Raid Relay which is also on when the All Clear Signal is sounded. When the All Clear is sounded, an additional relay is thrown which eliminates the variable or warbled signal of the air raid, providing a constant tone.

Attention is called to the Emergency Generator feature of this system. When, for any reason, the normal a.c. line is interrupted, the throwover relay, automatically drops into Emergency Position, permitting the oper-

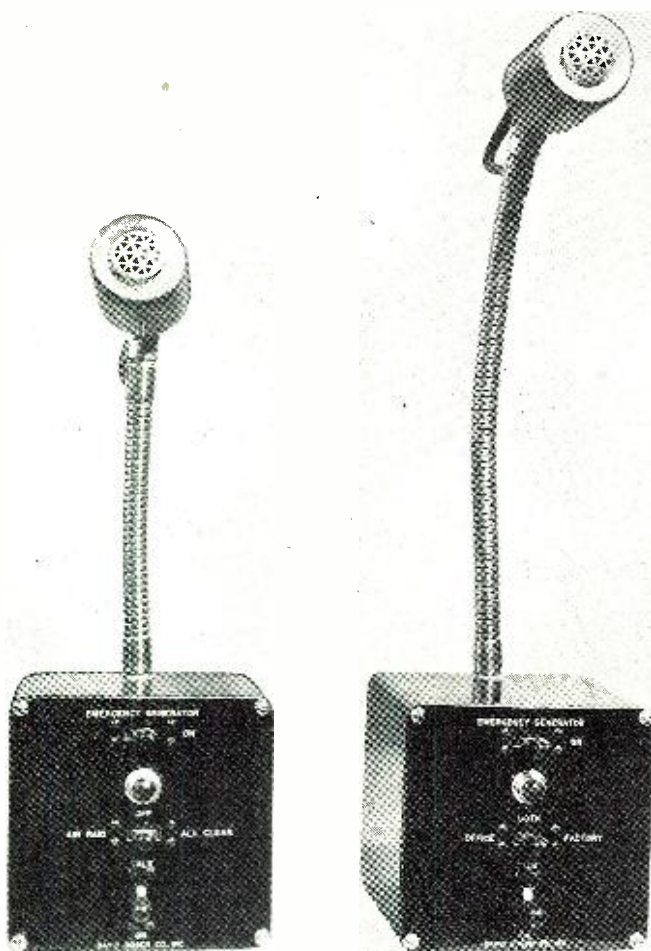

Dynamic microphones mounted on flexible tubing for proper placement.

ator at either the switchboard or guardhouse to start the generator which then supplies an emergency source to the system. Should the normal a.c. service be resumed, the throw-over relay then automatically stops the emergency supply and throws the system back to the normal a.c. source.

This system has been designed solely for use in a particular factory, and is synonymous with the many manufacturing centers of our industrial war effort. It is in these centers that many millions of our men and women are employing every effort to produce enough equipment to allow

our armed forces and our allies to continue until ultimate victory is obtained. The only possible precaution that can be taken towards the prevention of an anticipated air raid is through an air raid alarm system. It is not a remote idea that our industrial centers can be attacked from the air, particularly in our coastal regions. With this thought in mind, every effort should be made to install the proper equipment, both air raid warnings and shelters where any number of men are congregated.

Many factories have installed and have, in operation, elaborate paging networks, which may be utilized for "air-raid" and "all clear" signals by means of adding the necessary equipment and a simple change in wiring. The equipment that would be needed is reasonable in cost, although cost should not be a factor. This equipment consists of an electronic oscillator, variable in frequency over the equivalent siren response range, and a number of switches, which can be connected directly into the present Public Address System. This equipment should be housed in a separate room, preferably a so-called guard-house, and may be operated by the watchman or guard that is on duty at all times.

May we stress the importance of consulting someone who is experienced in this particular field—one who can make all necessary observations of a particular installation, decide on the proper equipment necessary, and follow through the electrical circuits so that the unit will function properly, and most of all, operate when needed at any time, day or night.

Let us not overlook the millions of people who live in congested housing areas, who should also be pre-warned. This condition is somewhat more difficult, as the area to be covered is spread out considerably. The solution

(Continued on page 49)

Layout of the extensive system.

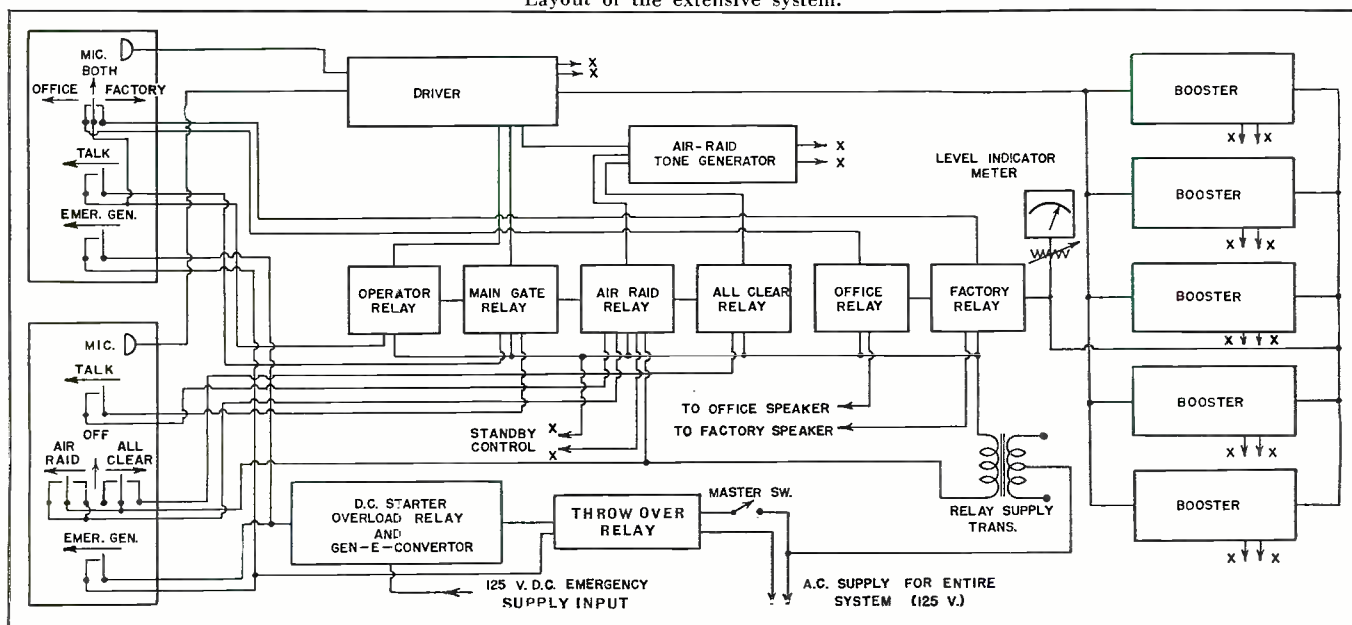

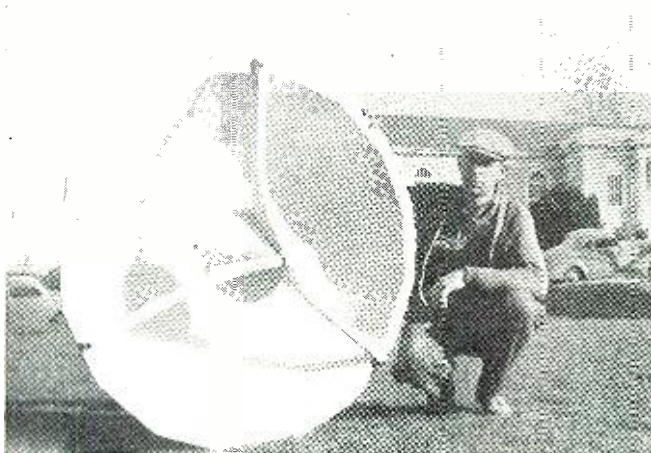

Max Crowson, W7BQK, holds reflector on edge to show the details of the completed unit, ready for service.

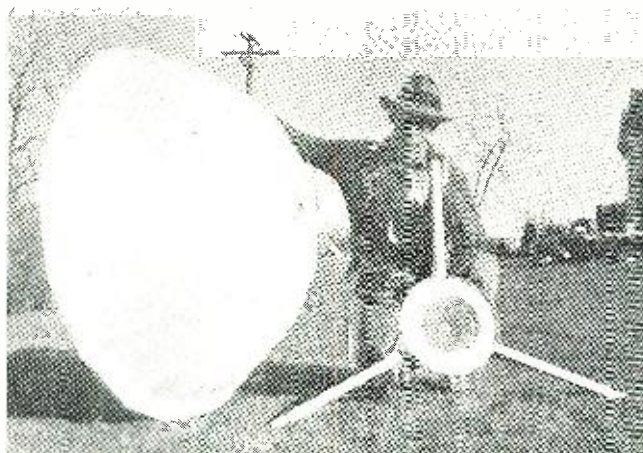

Glen Prescott shows reverse side of reflector. The speaker assembly mounts onto a separate framework.

WITH the entry of the United States into the war and the subsequent curtailment of amateur radio activities, the *Ashland Radio Club* of Ashland, Oregon turned to national defense for activity. An airplane "detector" seemed to be the most urgent need at present. Air raid warning shelters so often offer little in the way of comfort, especially in cold weather. To enable the warden to detect planes without having to stay outside in adverse weather the *Ashland Radio Club* lent its efforts.

We had discussed various types of "detectors" or "spotters" but had never produced very much in the way of results. The writer had run sound for a number of outdoor Shakespearean dramas recently and we recalled how well the nightly transport plane was picked up by the several mikes hung around the stage. However it was more or less out of the question to use microphones because of the high cost involved, so we gathered up among our junk piles a couple of permanent magnet speakers which proved to work better than the regular mikes because of the larger diaphragms.

To make a preliminary test, a four-way baffle that used a single 12-inch speaker was mounted on a short

A LOW COST AIRPLANE DETECTOR

by **GLEN PRESCOTT**

The airplane detector illustrated and described in this article was built by the combined efforts of many craftsmen.

tower and connected to a small amplifier of about 7 watts output. An output transformer of the ordinary variety was used as a voice coil to Grid transformer, it being mounted on the amplifier to permit using a low impedance line. This eliminated need of using shielded cable. After about two weeks of preliminary testing, this setup showed us that we were on the right track but the pickup was "too good." Noise from nearby highway made it difficult to distinguish air-

planes from trucks. Ground noises would have to be eliminated or nearly so before the rig could function properly.

Some sort of a reflector that would not pick up the surface noises readily seemed to be the answer, especially as it was decided not to make it directional. So the club purchased a sheet of quarter-inch plywood 4 feet by 8 feet. The reflector or "soup tureen" as it was dubbed was made of sixteen

(Continued on page 56)

Closeup view of the pickup speaker. Note the matching transformer.



Showing relative position of pickup speaker as it would appear when in actual airplane detecting.



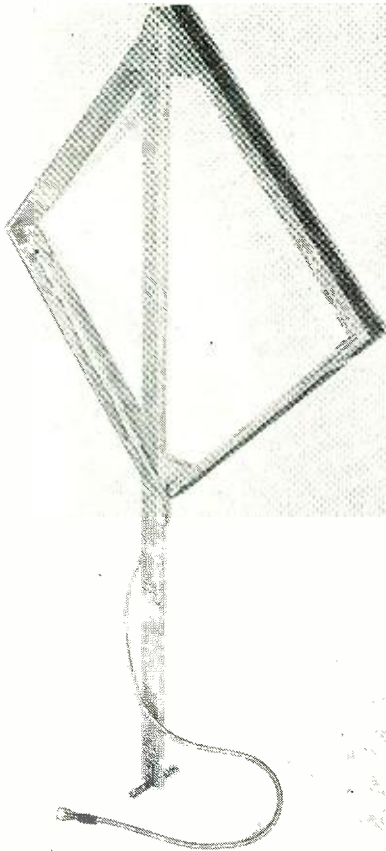

Loop antenna is easily made.

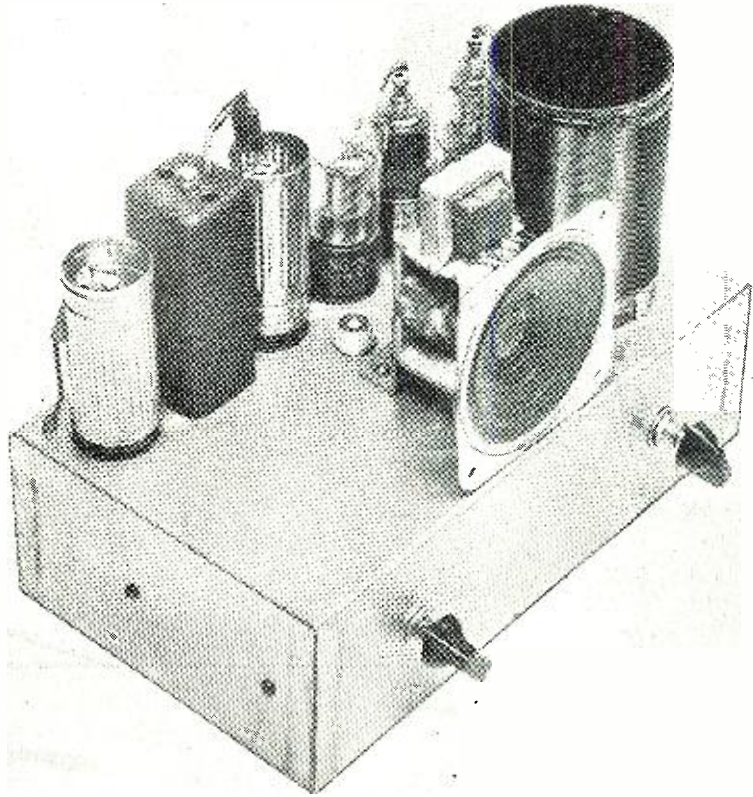

The completed unit may be housed into a wood or metal cabinet or box.

Induction-Controlled Intercom

by **WILBERT T. PETERSON**

This unit will fill the bill for those who have requested full constructional data.

THE numerous advantages of a completely portable intercommunicating system prompted the development of this unit which utilizes the principal of "induction transmission" to convey information from one station to another instead of using wires.

Two or more of these units can be set up instantly within several hundred feet of each other and communication maintained. It is independent of any power facilities as it contains its own battery power supply. It is well suited to military needs.

The object of employing a wireless intercom system, of course, is to eliminate the installation of the connecting wires between stations. In many cases intercom installations are continually being dismantled and rewired as offices are changed, desks moved, new rooms added, etc.

This disadvantage is entirely eliminated by using a simple induction-controlled system which can be set up instantly at any place within the office or factory provided it is within range of the induction field. This range is governed by the frequency and power

of the transmitter and the sensitivity of the receiver and is limited by a ruling of the FCC, which states that the signal strength of an induction transmitter at a distance of the wavelength divided by 2π must not exceed 15 microvolts per meter.

Since battery type tubes are used with a low plate voltage, the transmitter in this unit is not quite capable of emanating this signal strength at the specified distance of 900 feet for the frequency used (170 kc.). In tests made with a duplicate unit, reliable communication was maintained up to 500 feet which is sufficient for a majority of intercom purposes.

Description of Circuit

The basic design of this little unit is a simple TRF receiver and separate

transmitter. The tube complement of the receiver is a 1N5GT r.f. amplifier, 1N5GT grid leak detector, and 1Q5GT audio amplifier. In the receive position, the loop is connected to the grid circuit of the 1N5GT r.f. amplifier, which amplifies the signal and feeds it to the 1N5GT detector through a standard 175 kc. i.f. transformer. Here the signal is rectified in the grid circuit and amplified and sent to the 1Q5GT audio amplifier tube feeding the three-inch p.m. speaker.

In the transmit position the speaker is connected as a microphone in the grid circuit of a 1N5GT. Here the audio signal is fed into the control grid of a 1A7GT. The oscillator section of the tube is connected to a tank circuit supplying the 170 kc. r.f. signal

which is mixed with the audio signal resulting in a 170 kc. modulated signal in the plate circuit. The loop is in series with a .01 fixed condenser to this plate circuit when transmitting; thus the d.c. plate voltage is kept out of the loop circuit. The plate receives its d.c. through a choke coil.

There are only two controls to operate the device; one switch to turn the filaments on or off, and the other being a spring-return switch controlling four circuits for either send or receive. In switching from receiving to sending, the loop is changed over from the grid of the 1N5GT r.f. amplifier tube to the plate circuit of the 1A7GT mixer tube. The speaker transformer is switched from the plate circuit of the 1Q5GT to the grid circuit of the 1N5GT audio amplifier tube, and the B battery voltage is switched from the receiver to the transmitter circuits. This spring return switch is wired for receiver operation in the normal position, thus allowing the receiver to be in continuous operation as long as the battery switch is on.

All the tubes with the exception of the 1Q5GT are designed to operate at 0 volts bias, eliminating the usual cathode bias resistors and condensers. The 1Q5GT receives its bias voltage of four volts from a 300 ohm resistor in series with the negative side of the B batteries. The entire plate and screen currents of the receiver pass through this resistor placing a voltage drop of about 4 volts through a 100,000 ohm resistor to the grid of the 1Q5GT. Since these tubes have no cathodes and one side of their filaments are grounded, fixed bias must be used. The only disadvantage in using this system is that the B voltage of both transmitter and receiver is lowered by a few volts.

The 140 mmf variable condenser is in parallel with the loop in both receiving and transmitting positions. This is possible as both transmitter and receiver are tuned to the same frequency.

Construction

The entire unit is built on a 10"x6"x3" chassis. The general layout can be seen from the photographs, the tubes lined up along the rear of the chassis with the speaker and switches in front. After the tube sockets and i.f. coil are mounted, wiring is begun with the filaments wired first, taking care that number 7 pin is grounded on all sockets. It is good practice to ground the shield contact of all tubes except the 1Q5GT, however; tube shields are only used on the r.f. and detector tubes of the receiver.

Since several extra pins are available on most of the tube sockets, they may be used as tie points for connecting resistors and condensers, etc. Practically all of the resistors are mounted directly under the socket in this manner.

The 3" speaker may be mounted next with an angle bracket to the

(Continued on page 60)

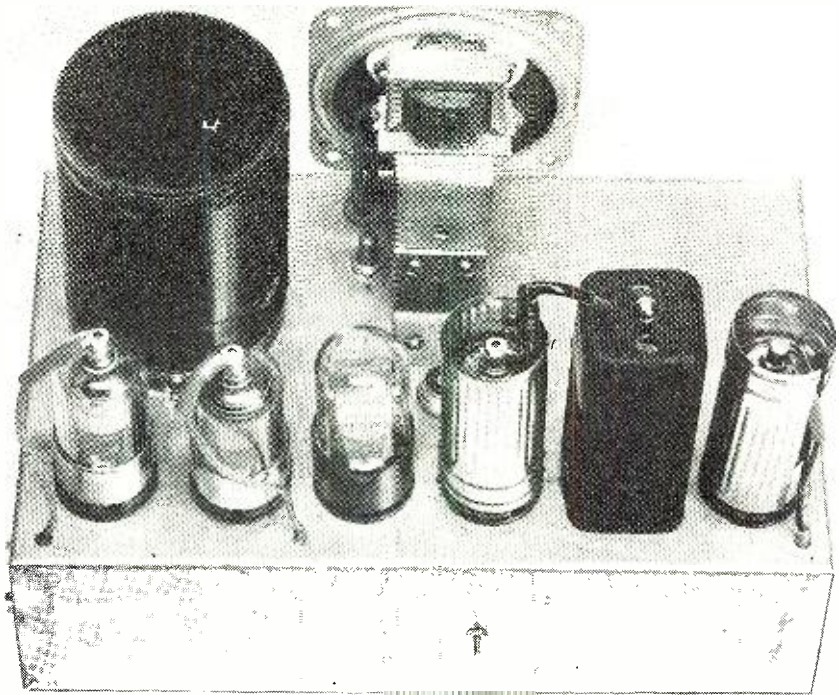

Parts may be mounted wherever most convenient. Small can is I.F. transformer.

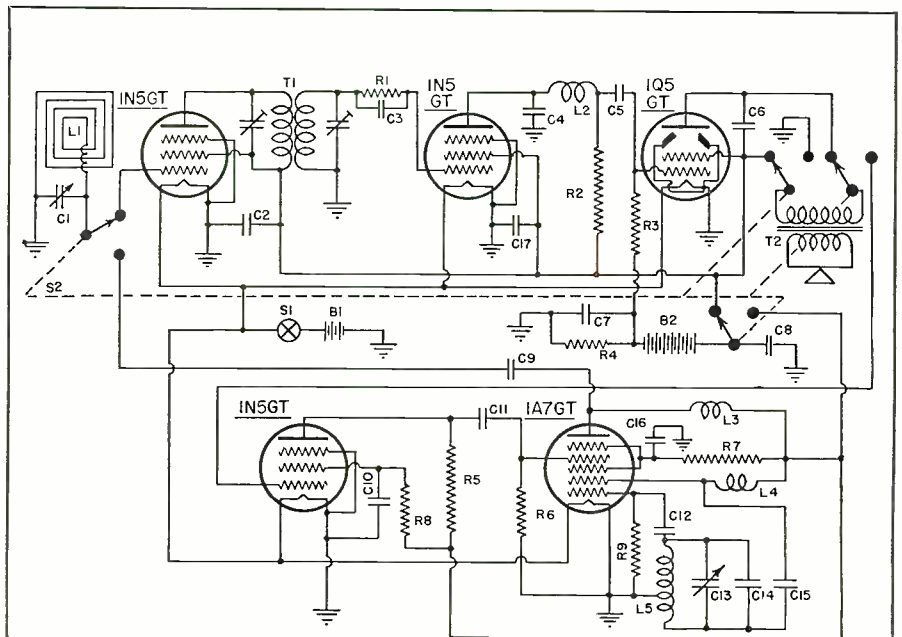

- C₁—140 mmfd. variable cond., Meissner
- C₂, C₁₀, C₁₆, C₁₇—1 mfd. @ 200 v. cond., Mallory
- C₃, C₁₂—.0005 mfd. mica cond., Mallory
- C₄—250 mmfd. mica cond., Mallory
- C₅, C₉, C₁₁—.01 mfd. @ 200 v. cond., Mallory
- C₆, C₁₅—.003 mfd. mica cond., Mallory
- C₇, C₈—8 mfd. @ 150 v. Elec. cond., Mallory
- C₁₃—250-800 mmfd. Padder, Meissner
- C₁₄—1000 mmfd. mica cond., Mallory
- R₁—2 megohm ½ w., Centralab
- R₂, R₃, R₅—100,000 ohm ½ w., Centralab
- R₄—300 ohm ½ w., Centralab
- R₆—500,000 ohm ½ w., Centralab
- R₇—25,000 ohm ½ w., Centralab
- R₈, R₉—200,000 ohm ½ w., Centralab

- S₁—S.P.S.T. switch, Arrow
- S₂—4PDT spring return switch, Centralab
- L₁—Loop antenna (see text)
- L₂—10 millihenry choke (R.F.), Meissner
- L₃, L₄—25 millihenry choke (R.F.), Meissner
- B₁—1 or 2 dry cells 1.5 volt. Burgess
- B₂—Two 45 v. "B" batteries (in series), Burgess
- T₁—175 K.C. I.F. transformer (input), Meissner
- T₂—Output transformer, Thordarson
- Tubes—Three 1N5GT, RCA
- One 1Q5GT, RCA
- One 1A7GT, RCA
- Chassis—10"x6"x3", Par Metal
- ½ lb.—#28 enameled wire.
- ¼ lb.—#22 enameled wire
- Speaker—3" (P.M.), Utah



Knob for pitch adjustment is in panel center—Regeneration control on side.

Build This TIME SIGNAL RECEIVER

by DAVID W. JEFFRIES

This receiver may be used for accurate time checks, or for broadcast relay where permitted.

IN the field of time signal broadcasting, the long wavelengths of 2500 meters and beyond still hold their own, even in this day of high and ultra-high-frequency development, offering a transmission medium of unparalleled reliability for this important service.

Each hour on the hour, excepting at 11:00 A.M. and 11:00 P.M., the *United States Naval Observatory* broadcasts time signals from its master chronometer in Washington, time checks accurate to better than one-tenth second. Transmitted from the Navy station, NSS, at Annapolis, on the 113-kilocycle channel, a wavelength of 2655 meters, for hundreds of miles in all directions these signals are altogether free from fading and skip effects.

In this article, the writer has two thoughts in mind. First, to acquaint a large circle of radio experimenters, broadcast engineers, radio amateurs, jewelers and watchmakers, with the excellence of long wave reception, particularly over the several hundred mile area in which short wave time signals are blotted out by fading and skip-

distance phenomena. Second, to describe the several outstanding features of the fixed-tuned, four-tube superheterodyne receiver developed at WCED for daily rebroadcasting of time signals.

The Navy broadcasts highly corrected time signals from Washington on a number of frequencies, among them 113, 4390, 9425 and 12630 kilocycles. By Navy authority, broadcasting stations are permitted to relay impulses picked up on any of these channels, with the one restricting provision that no mechanical relays of any sort may be employed in the rebroadcasting circuit with consequent introduction of time lag. By this, it is apparent that a locally-keyed oscil-

lator actuated by the NSS signal, while producing a clean and stable note for rebroadcasting, would not assure freedom from time lag. In other words, a direct rebroadcast of the actual keyed impulses from the Navy station offers the one practicable method of relaying without perceptible time delay. And, for direct rebroadcasting, the long wave channel of 113-kilocycles offers, in many cases, the greatest reliability and freedom from transmission faults.

To explore the potentialities of long-wave time signal reception, then quite unknown to the writer, a simple regenerative receiver was put together in the well known haywire manner, the only "research" consisting of an

approximation of the proper coil and condenser values necessary to tune to the extremely low frequency.

It was found that even so simple a device as a regenerative detector and one-step audio brought in comparatively strong signals from the Annapolis transmitter. However, general instability and broadness of tuning, so common in regenerative receivers unaccompanied by radio frequency amplification, made obvious the necessity of choosing a circuit of greater refinement.

The superheterodyne hook-up of the completed receiver was chosen for two reasons in particular. It provides greater gain and stability for a given number of tubes and practically eliminates interference arising from the intense field set up by a broadcasting transmitter operating only a few feet away.

Briefly, the receiver comprises a type 6A8 combined oscillator-first detector, a 6K7 intermediate amplifier stage peaked at 465 kilocycles, a type 6J7 combined second detector-beat frequency oscillator, followed by a conventional 6C5 triode audio amplifier, the output of which is transformer-coupled to match the usual 500 or 600-ohm input circuits encountered in broadcasting stations. Certain modifications could, of course, be incorporated to accommodate individual tastes should the receiver be constructed for purposes other than rebroadcasting. For instance, the 6C5 plate circuit could be coupled to the audio section of any available broadcast receiver for loudspeaker operation, or a pentode could be substituted and direct loudspeaker volume secured.

No effort has been made to specify a "B" voltage supply. Almost any existing power pack can be utilized to furnish 250 volts at a drain not in excess of thirty milliamperes. The intermittent use to which the receiver probably would be subjected suggests that the additional cost of a special

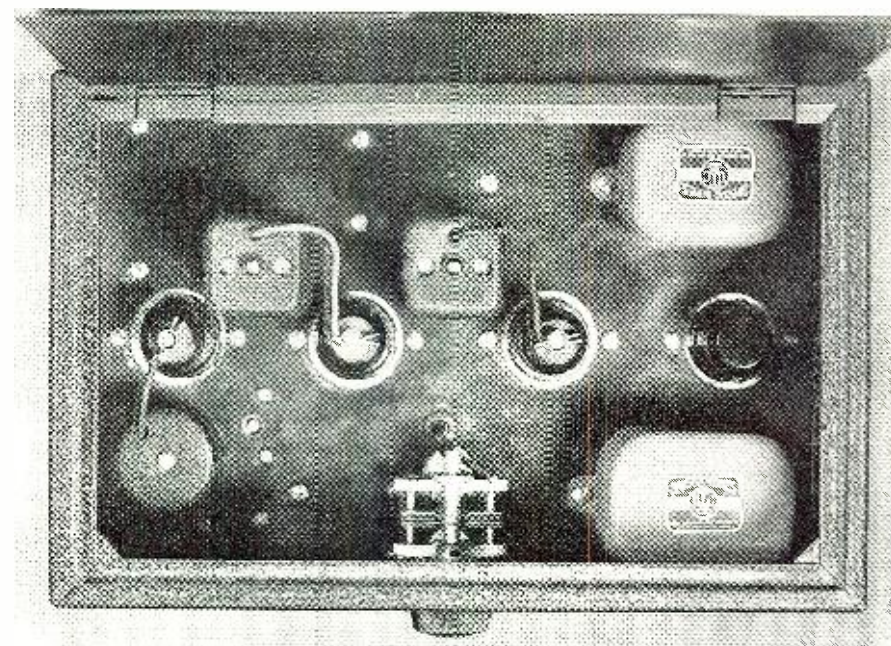

Looking inside, cover lifted. Tubes are, left-to-right, 6A8, 6K7, 6J7 and 6C5. Tuning condensers are mounted under the chassis.

power supply be dispensed with. Here at WCED, the "B" voltage was taken from the source supplying the studio console amplifier. Filaments, of course, are lighted from the transformer mounted atop the receiver chassis. Incidentally, experimentation showed the circuit and tubes in question operate quite satisfactorily on a plate voltage as low as 100 to 125 volts, the only sacrifice being a noticeable loss of gain.

The receiver, being of the fixed-tuned "police type" variety, requires no relatively expensive tuning dials and knobs, this adding to the general simplicity and low cost of the unit. A "neutralizing" tool or suitable screw driver serves to enable the constructor to line up the circuits and, once this preliminary tune-up is completed, only the band spreading condenser, C9,

need be adjusted from time to time. It is, of course, simplicity itself to adjust this capacitor to secure a beat-note of desirable tone.

In practice, the second detector is placed in regeneration and tuned to zero-beat the incoming time signal by adjusting the secondary tuning capacitor in the L4 assembly. During this adjustment, C9 should be midway between minimum and maximum capacity. Now, by increasing or decreasing the capacity of C9, it is possible to secure beat-note reception of NSS on either side of the carrier as desired. In case of interference from other telegraph stations, tuning to the opposite side of the NSS zero-beat usually will clear up the difficulty. After determining which sideband gives the bet-

(Continued on page 48)

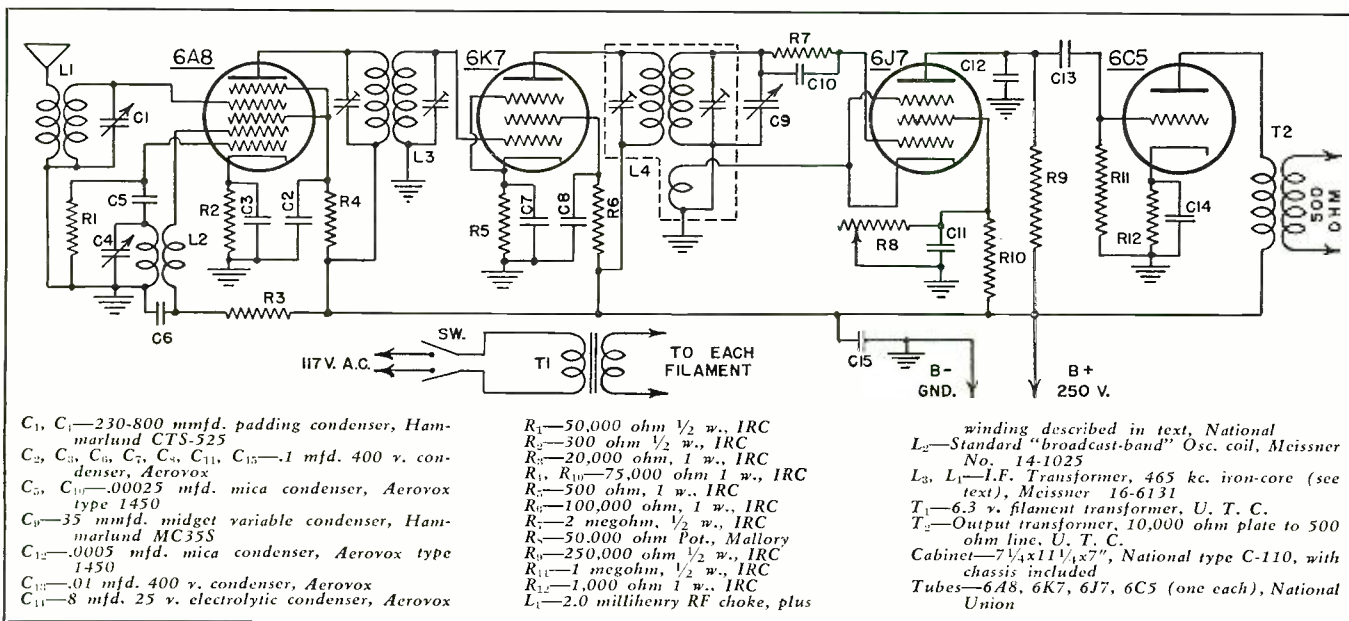

AVIATION RADIO COURSE

by PAUL W. KARROL

The student must master the theory and operation of loop antennae if he expects to qualify as an aviation radio op.

A SUBJECT with which all aviation radio technicians should be familiar is aircraft radio compasses. Although direction finder (DF) and radio compass are terms which may be used synonymously, we will refer to the latter more frequently in this lesson.

It is known that radio compass apparatus has been used successfully as far back as World War I. Immediately after the war period, a few installations could be found in a few ground stations, dirigibles and aircraft. However, it wasn't until the early thirties that radio compasses for aircraft were considered as important radio aids to air navigation. Today we find that radio compass equipment is being used extensively to great advantage by pilots the world over.

Although there are many types of compass equipment being used today, we will approach our subject from the standpoint of generalizing as much information as possible and still cover some specific types. With a good understanding of rudimentary principles, it will not be a difficult task to comprehend most of the data on radio compass operation, etc. Radio compass theory should be thoroughly understood before attempting installation, adjustment, and maintenance of radio compass equipment.

The component around which the radio compass is designed and con-

structed, is basically the loop antenna. Because it has unusual directive characteristics, the loop antenna is responsive to waves approaching from definite angles. That is, when the loop is in the proper position with respect to the transmitted waves, viz., the plane of the loop is in a direction toward the transmitting station, maximum current is induced in the loop windings. When the loop is perpendicular to the direction of the propagated waves, minimum current will of course be induced in the loop windings. The angle at which the loop is turned where minimum signal is either visually or aurally indicated, is called the null, zero signal, or dip position.

Let us assume for a moment that we have two coils wound exactly the same. Taking these coils, we connect one to a signal generator and the other to a detector which in turn is connected to a pair of phones. We find that we hear the strongest signal when our two coils are end to end. When we turn either coil so one end is perpendicular to the other's center we have minimum signal; this is the null point. Now then, if our signal generator is transmitting a fairly strong signal wherein it is possible for us to go some distance away from the generator and still hear the signal, we can with some accuracy tell in which way the coil is oriented. However, we cannot accurately determine which

end of the coil (if marked) is pointed in a certain direction. The reason will soon be apparent.

Nearly always, an azimuth scale which is calibrated from 0° to 360° is attached to the lower vertical axis of the loop antenna. This scale is made an integral part of the loop and will move with it when rotated. In the automatic DF installation, the loop is rotated automatically and electrically. When it is in any position other than the correct dip or null position, a control circuit will deliver power to the electric motor which turns the loop to the correct position, i.e., null or zero signal position.

Because a loop antenna has two null positions which are 180° apart and because the loop's pattern resembles a double 00 or a figure 8, the direction of the transmitting station cannot always be instantly determined (with older types of direction finding apparatus). It is therefore necessary that an antenna (vertical or balanced T) having no pronounced directional characteristics be employed conjunctively with the loop antenna in order to obtain proper relative bearings (bearings obtained from the azimuth scale). This is accomplished by feeding the non-directional antenna's signal into the common channel and combining it with the loop's signal. Then by rotating the antenna between 180° from both readings, all the while noting signal intensity of the two readings obtained, it is possible to choose the correct reading which will be used with subsequent readings for triangulating position fix. (Position of aircraft with respect to ground transmitting stations at a given time.) With the right-left (R-L) type of compass, if when the loop is rotated to the right the needle goes to the right from the original null position, then the first reading obtained is the correct reading. However, if the needle swings to the left when the loop is rotated right, then the reading obtained is erroneous and should be disregarded. The erroneous, or reciprocal bearing is never used, other than an indication that the relative bearing is approximately 180° removed from the former. The operation of determining whether the bearing obtained is the relative or reciprocal bearing is commonly called sensing or spotting.

There are two purposes for which the radio compass used in aircraft was designed; the first being the determination of the aircraft's position with respect to a ground radio transmitting station or stations, and the second being its use for a "homing" device.

These units comprise the essentials for complete direction-finder.

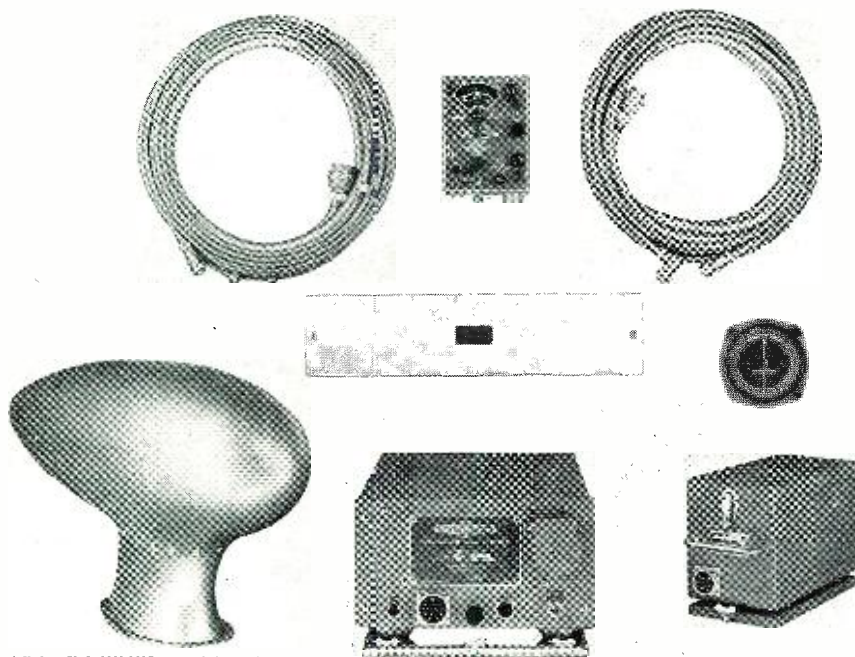

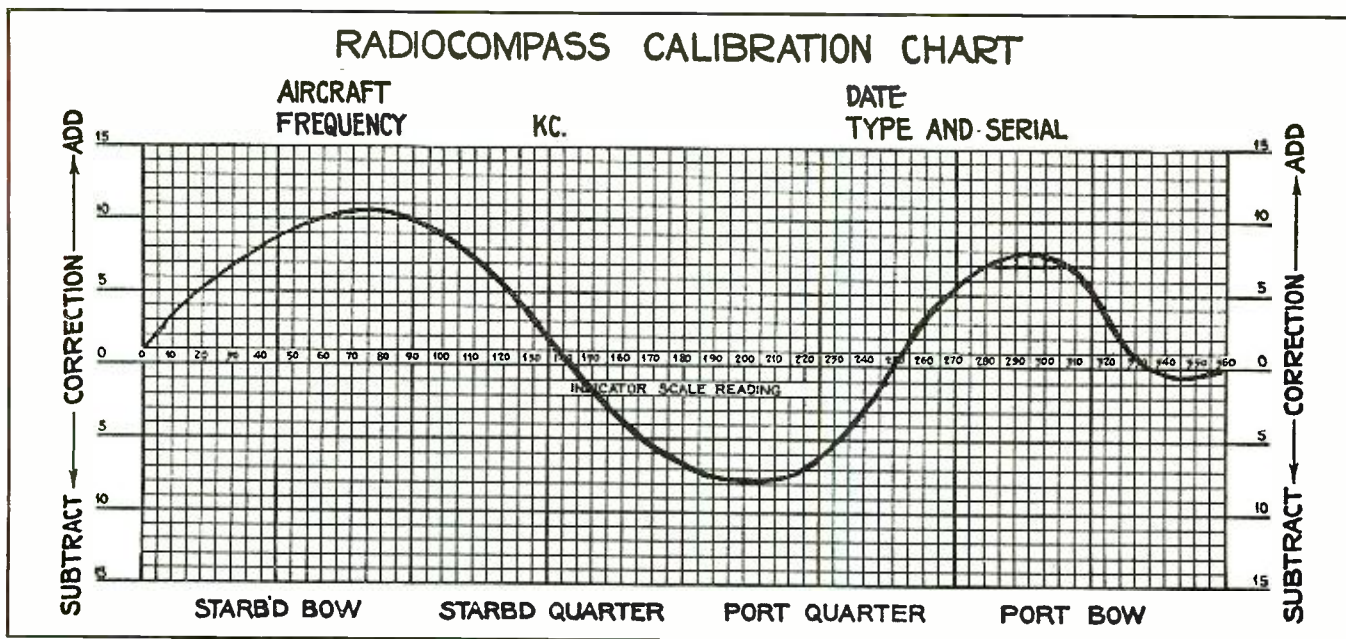

Fig. 1.

Determining the aircraft's position with respect to known ground stations is not difficult if the compass equipment is operated correctly, and using the compass as a homing device (wherein a radio station at the aircraft's destination transmits a signal which is followed by the aircraft) depends upon how accurate the compass is and whether corrections have been made to compensate for drift.

The relative bearing is not always correct because of the introduction of errors introduced by the following: night effect or layer shift; metal mass reflection; and improper compass calibration. Also, if frequencies used are above 2000 kilocycles, other errors are introduced. Errors resulting from flying over mountainous country, large bodies of water, etc., are also noticeable in the majority of cases.

When the Heaviside layer shifts position (especially at night) the effects produced are readily apparent to the compass operator. Swinging signals make for inaccurate bearings, especially if automatic DF apparatus is not used. Night effect or layer shift is noticeably pronounced when those frequencies being used are being radiated by a horizontal antenna. Signals

(Continued on page 62)

Fig. 2.

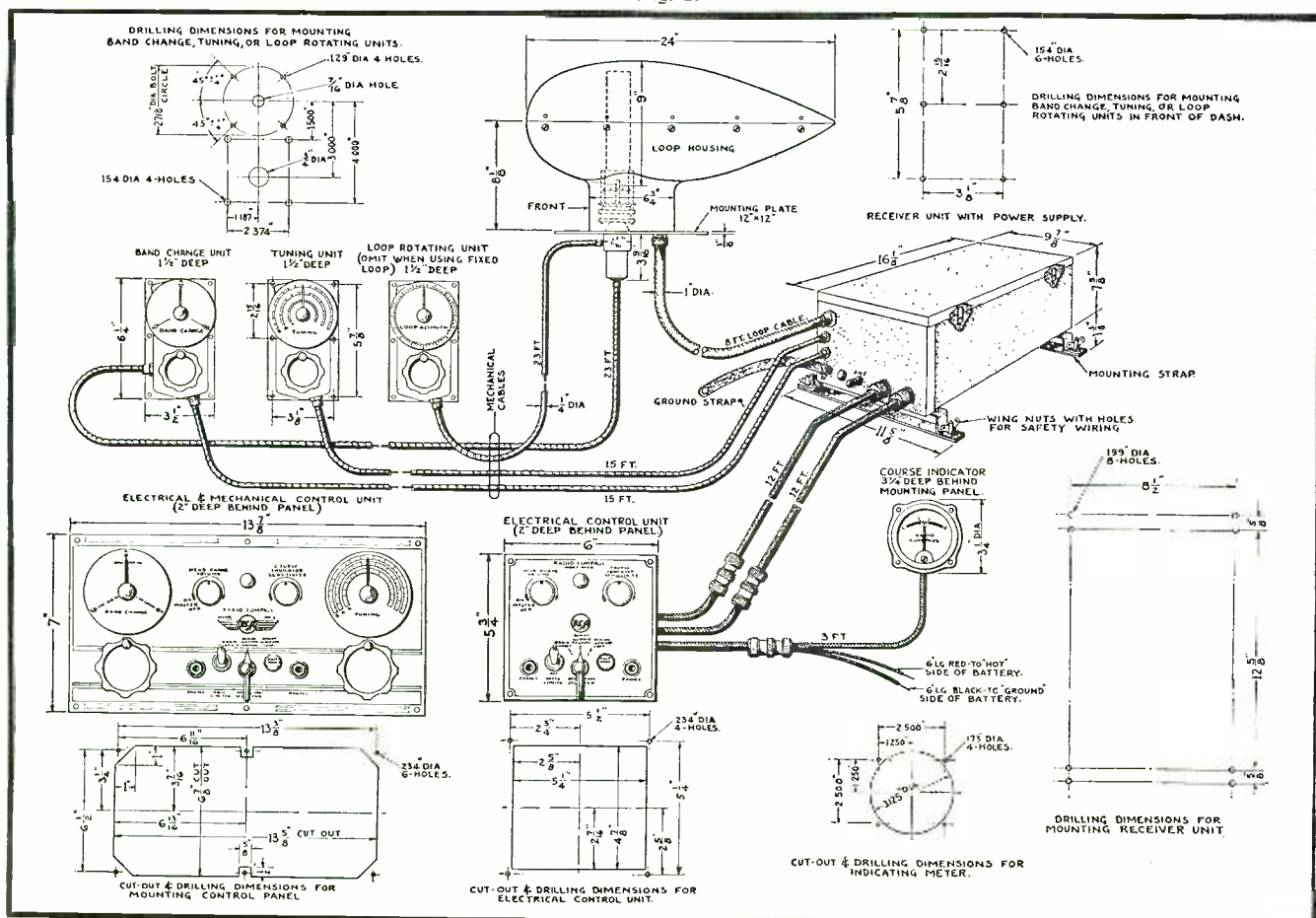

PRACTICAL TRANSFORMER DESIGN

by **WILLIAM A. STOCKLIN**
Associate Editor, RADIO NEWS

The author continues his discussion of transformer design problems and tells how to construct units of several types.

THE automatic winding machine has been the greatest contributor towards the reduction of cost for constructing transformer coils. This machine makes it possible to wind as many as 10 to 24 coils (depending on the coil length) at one time, providing the windings are wound with approximately a 24-gauge wire or smaller. If the wire size is larger, the coils must then be wound individually by hand.

However, the average radio man is not fortunate enough to have available such a machine and must resort to one of several manual methods to wind these coils. The most practical would be to rig up some form of a variable speed motor, equipped with an automatic counter or, if this is not available, to mount a hand drill in a vise using its chuck to mount the coil. The latter method is rather crude, but does serve the purpose for winding coils with rather large wire. It is practically impossible to wind, without considerable difficulty, any coil having a large number of turns or a wire size of No. 30 or smaller, using a hand drill.

It is difficult at the present time to purchase the necessary laminations and wire for the construction of transformers and therefore we must resort to old and obsolete transformers and speaker field coils for this material. Field coils are usually wound with a

copper wire between the sizes of No. 32 and No. 39. Output transformer primaries contain wire between the sizes of No. 35 to No. 41 while the secondaries may be wound with wire between the sizes of No. 20 to No. 25. Wire sizes larger than No. 20 can generally be obtained from the filament windings of power transformers.

The complete design of a transformer's electrical and magnetic circuits is largely a matter of cut and try and former experience. It is not only necessary to know the magnetic characteristic of the laminations to be used, but the outside dimensions, mounting and winding area are all factors which must be juggled, from which a compromise is made to obtain the final design. Therefore, bearing this in mind and taking into consideration what was covered in the previous article published in the August issue of RADIO NEWS, we will go into the design of a simple filament transformer. For example, one may prefer to use two 2A3 output tubes that are on hand and cannot obtain the 2.5 volt filament voltage, while all the other transformers are available.

Referring to a tube manual, we find that the filaments of two 2A3's will draw 5 amperes at 2.5 volts. Therefore the transformer must be designed to supply 2.5 v. @ 5 amps from a primary of 117 v. 60 cycles. The sec-

ondary wire size to carry 5 amps and to operate at a conservative value of 650 circular mils would be No. 15 gauge. If this wire size is not available, it is permissible and practical to use two No. 18 gauge wires wound side by side and connected in parallel. Note that the circular mil area of two No. 18 gauge wires is equivalent to one No. 15 gauge wire.

To determine the primary wire size, we must first determine the current which would flow in the primary winding when the secondary is connected to the load. Accordingly, the primary wattage would be the secondary wattage plus the core losses which would be 12.5 watts (2.5x5) plus 5 watts (assumed total core loss) respectively, a total of 17.5 watts. 17.5 w. divided by the primary voltage of 117 v. would be .15 amp. that the primary wire would carry. The primary wire size for this current operating at 800 circular mils would be a No. 29 gauge.

The next part to be determined is the lamination size necessary for this design. We will judge from past experiences that this would be about a $\frac{7}{8}$ " lamination. Now fill in all the information accumulated thus far on a form sheet similar to the one illustrated in Fig. 1.

The coil length may be determined from the window opening ($1\frac{1}{2} \times \frac{7}{8}$) and allowing $\frac{1}{64}$ " on each side. The winding length is determined from the coil length allowing approximately $\frac{1}{8}$ " on each side. The number of turns per layer is determined from the wire diameter and the winding length, assuming that approximately 90% of the winding length may be utilized.

$$\frac{1\frac{1}{2} \times 90\%}{.0121} = 75 \text{ turns per layer on the primary.}$$

Again we will make an estimate this time as to the number of primary turns, roughly about 1050. Then the secondary turns would be 24:

$$\frac{110}{1050} = \frac{2.5}{N. \text{ sec. turns}}$$

The effective primary voltage is assumed to be 110 v. allowing a 7 v. I.R. copper loss.

Adding up the thicknesses of the various parts in the coil (paper and

Fig. 1.

TUBE SIZE	7/8 x 3/4		TYPE Filament			
WINDING	Primary		Secondary			
TUBE	4L-008 Kraft					
TURNS	1050		24			
WIRE SIZE	29		15			
COIL LENGTH	1 9/32		1 9/32			
WINDING LENGTH	1 1/32		1 1/32			
TURNS PER LAYER	75 - 90% - 14 layers		12 - 68% - 2 layers			
PAPER LAYERS	.002 glassine		.006 Kraft			
WRAPPER	2 layers .005 Kraft		2 layers .005 Kraft			
KIND OF TERMINALS-	Start & end (Black) #22 stranded 6" long		Continuation of Winding 6"			
TREATMENT	Max. or Varnish					
LOAD VOLTS & WATTS	117 volt 60 cycle		2.5 volt 12.5 watts			
AMPERES	.15 amp.		5 amp.			
D.C. RESISTANCE						
PR. LOAD IMP.	PR. WTS.	D.C. M.A.	A.C. VOLTS	FREQ.	SEC. IMP.	TURNS RATIO
LAM. NO.	7/8"	STEEL & GAUGE	26 Ga. Audio C	METHOD OF LAM.	4 X 4	GAP

wire) to obtain the coil thickness, we find that the coil *build-up* is approximately .3708". This is 85% of the total window height of .4375" (1/2 of 7/8"). This indicates that the original estimate of 1050 turns on the primary is ideally suited for this size lamination, as it is always considered good practice to allow 15% of the window height for the additional build-up due to excess interlayer paper and curvature of the coil. Otherwise it would be necessary to press the coil into its rectangular shape which may cause damage.

The final calculation is to determine the lamination stack:

$$B'' \text{ max.} = \frac{E \text{ effec.} \times 10^8}{4.44 f N A'' K} \text{ lines}$$

per square inch.

B'' max. = lines per square inch of core area.

E effec. = R. M. S. Primary voltage.

N = Number of primary turns.

f = frequency in cycles per second.

A = cross section of the magnetic path (center leg) in sq. inches.

K = Stacking factor assumed at 90%.

$$\therefore B'' \text{ max.} = \frac{117 \times 10^8}{4.44 \times 60 \times 1050 \times A'' \times .9}$$

For a conservative design, we will assume B'' max. to be 70,000 lines per sq. in. and

$$A = \frac{70,000}{B'' \text{ max.}} \times \text{stack (S)}$$

then

$$S = \frac{117 \times 10^8}{4.44 \times 60 \times 1050 \times 70,000 \times \frac{70,000}{B'' \text{ max.}} \times .9}$$

S = .75 or 3/4".

It is now quite apparent that a transformer constructed to this design, which has worked out successfully, would be quite efficient. If one were to redesign this transformer to reduce cost, it would be permissible to reduce the primary wire size to a #30 gauge wire (operating at 665 cm.) and to recalculate the core area for a flux density of 85,000 lines per sq. in. This transformer may then be designed around a 3/4" lamination which would reduce cost considerably, sacrificing, of course, efficiency.

In constructing a transformer to our original design, first make the tube (7/8" x 3/4") on a separate form and then proceed to wind the smaller wire winding first—in this case, the primary; then continuing to the windings having larger wire.

It will be necessary to solder to the ends of each winding, if the winding wire size is less than a #23 gauge, a lead to be used for the external connection which should be taped rigidly inside the coil proper. On windings having a wire size #23 gauge or larger, it is permissible to extend the original wire for use as an external connection.

After the coil is completed, insert the laminations. The laminations are to be inserted 4x4; i.e., four in one direction and then four in the opposite direction alternately until the stack

reaches 3/4". Where cost is not an important item and to reduce the core losses, it is suggested that the core be laminated 1x1 instead of 4x4.

After the coil and laminations have been assembled, it is ready for impregnation, there are several types of impregnating compounds used, but basically they all consist of some type of varnish or wax.

The coil and lamination assembly should first be heated until the coil is completely free from moisture, then immediately dipped into a wax or varnish compound.

The transformer is now complete except for mounting.

Now let us cover a somewhat more complicated design, one that has been specified as follows:

Pri. = 117 v. 60 cy.

Sec. #1 = 300 v. 80 ma. d.c. at input of filter, 8 mfd. and a type 80 full-wave rectifier.

Fil. #1 = 6.3 v. 2 amp.

Fil. #2 = 5 v. 2 amp.

Assuming the rectifier tube about 80% efficient, the secondary #1 total load wattage would be equivalent to 30 watts.

$$300 \times .08 \div 80\% = 30 \text{ watts.}$$

Referring to any tube manual we find that the a.c. voltage per plate necessary to produce the specified rectified d.c. potential would be 320 v. per plate.

The formal theoretical method to determine the necessary wire size of the secondary #1 winding would require consideration of the efficiency of the rectifier tube and the wave form of the alternating current, bearing in mind that this current flows only during one-half of the cycle. This method is rather lengthy and complicated. Through years of experience by many engineers, it has been found that the heating effect of the a.c. in this type of winding may be considered equivalent to the heating effect of the d.c. load current and therefore this method is being used throughout the industry.

From this information it is now possible to determine the necessary wire sizes for the separate windings (refer to chart illustrated in Fig. 2).

Sec. #1: #32 gauge 810 c.m.

Pri.: #25 gauge 665 c.m.

Fil. #1: #19 gauge 643 c.m.

F.I. #2: #19 gauge 643 c.m.

A fairly good estimate as to the lamination size necessary to make this a practical design would be a 1 1/8" lamination. Following through the same procedure, as mentioned previously, in determining the maximum number of turns which may be wound on the core (remembering that the core build-up of approximately 85% of the window height can only be utilized) we get a design as shown in Fig. 2.

After specifications of the coil have been determined, calculate the core stack. For a less conservative designed transformer, we will use 80,000 lines per sq. in. for the flux density.

This concludes the design and the unit is now ready for impregnation, mounting, etc.

The designing of transformers as practiced by our leading transformer manufacturers is not quite as simple as shown by this article. Bear in mind that there are an innumerable number of men that are capable of designing transformers. However, the outstanding engineers are those that have sufficient foresight and knowledge to design transformers that may be constructed at the least possible cost and yet meet all operating specifications. Cost is always an essential factor as quantities as high as 100,000 units are made from one particular design. This involves a thorough study of the various types of laminations and their electrical characteristics, the production facilities and methods for a particular plant and also the market prices of copper and steel. For an example, if the prices of copper increase, it would be quite apparent that redesigning a particular transformer, reducing the amount of copper and increasing the core area (laminations) would give an equivalent electrical design at a lower constructional cost.

Fortunately the reader is primarily interested in the design or rebuilding of transformers, utilizing equipment and materials which may be on hand.

(To Be Continued)

Fig. 2.

TUBE SIZE	1 1/8 x 1 1/4	TYPE	Power	B.U. 36.5%			
WINDING	Secondary		Primary	Fil #1	Fil #2		
TUBE	5L-008 Kraft	---	---	---	---		
TURNS	2520 tapped 1260	---	433	25	20		
WIRE SIZE	32	---	25	19	19		
COIL LENGTH	1 21/32	---	1 21/32	1 21/32	1 21/32		
WINDING LENGTH	1 13/32	---	1 13/32	1 13/32	1 13/32		
TURNS PER LAYER	140 - 86% - 18L.	---	62 - 83% - 7L	1 layer	1 layer		
PAPER LAYERS	.0015 glassine	---	.003 Kraft	---	---		
WRAPPER	2L-.005 Kraft	---	2L-.005 Kraft	2L-.005 Kraft	2L-.005 Kraft		
KIND OF TERMINALS-	#22 stranded covered lead wire St. & End - Red. Center Tap - Red & Yellow.	---	#22 stranded covered lead wire. Black.	Continuation of winding. Green sleeving.	Continuation of winding. Yellow sleeving.		
TREATMENT	Varnish or Wax						
LOAD VOLTS & WATTS	320 volt A.C. per side	---	117 volt 60 cycle	6.3	5		
AMPERES	300 volt D. C. 8 mfd. input	---	---	2.	2		
D.C. RESISTANCE	80 ma D.C.	---	---	---	---		
	A.C. voltage = 320 volt	---	---	---	---		
PRI. LOAD IMP.		PRI. HYD.	D. C. M. A.	A. C. VOLTS	FREQ.	SEC. IMP.	TURNS RATIO
LAN. NO.	1 1/8"	STEEL	G. GAUGE 26	Ge. Audio C.	METHOD OF LAM. 4 x 4	GAP	

PRACTICAL RADIO COURSE

by ALFRED A. GHIRARDI

The study of Induction is very fascinating and its application is found in nearly all radio circuits.

Self Inductance

THE last lesson explained the method by which e.m.f. is generated in an a.c. or a d.c. generator by moving electrical conductors across a magnetic field (electromagnetic induction), and pointed out the essential difference between the construction of a.c. and d.c. generators. Various commercial generators, designed to be used with radio equipment, were illustrated.

The phenomenon of electromagnetic induction also finds very important application in other components of radio equipment—for example, in tuning

of force induces in it an e.m.f. The phenomenon is commonly termed *self-induction*.

The self-induced e.m.f. is always in such a direction that it tends to prevent any *change* that may be taking place in the current at the moment. If the current is on the increase, the self-induced voltage tends to prevent it from increasing; if the current is on the decrease, the self-induced voltage tends to prevent it from decreasing. Self-induction, therefore, acts as an opposition to any change in the current flow. It differs from the *ohmic* resistance of conductors in that it sets up an opposition only when the current is *changing* in some way, whereas the opposition caused by ohmic resistance is effective at all times whether the current is changing in value or whether it is flowing at a steady value.

Also, since the self-induced e.m.f. opposes any change whatever in the current flow, it is evident that in those circuits in which this inductive effect is present to any great extent, it takes a longer time for the current to build up to its full value when e.m.f. is applied to the circuit, and a longer time for the current to decrease to zero value when the e.m.f. is removed. The effect is somewhat similar to that of

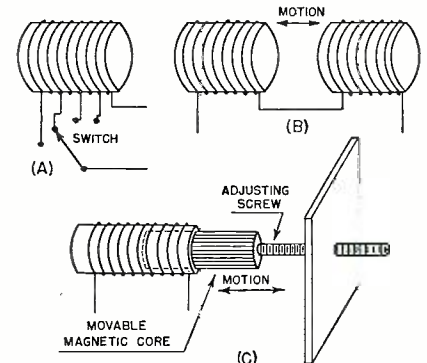

Fig. 4.

Inductance is represented by the symbol L . Because many inductive devices employed in radio equipment have an inductance very much smaller than one henry, subdivisions of the unit are often needed to express their inductance conveniently: the *millihenry* (equal to one-thousandth of a henry) and the *microhenry* (equal to one-millionth of a henry).

The self-inductance of a given conductor comprising an electric circuit depends greatly on its physical arrangement. If it is in the form of a straight wire, or a single-turn loop, its inductance is comparatively low, for then any one element of the conductor is cut only by the lines of force created by the current flowing through it alone (see (A) of Fig. 1). If the same conductor is wound into the form of a 2-turn coil, as in (B) of Fig. 1, the inductive effect and therefore the *inductance*, is increased. Each turn is now linked and unlinked, not only by its own magnetic field but also by an equal field of the turn adjacent to it.

The self-induced e.m.f. *per turn* is twice as great as before. Since there are two turns, the total self-induced e.m.f. is four times as great as it was for the one-turn coil at (A). It follows that the self-inductance of a coil of wire increases greatly with the number of turns—in fact, increases in proportion to the *square* of the number of turns.

Whenever strong self-induction is required, the conductor is wound into a concentrated coil having a great many turns, the magnetic fields, created by the many turns, acting mutually on each other to produce a strong total inductive effect. The inductance also depends on the manner in which the wire is wound—naturally, if it is wound into a tight, concentrated coil, so that *all* the lines of force of each

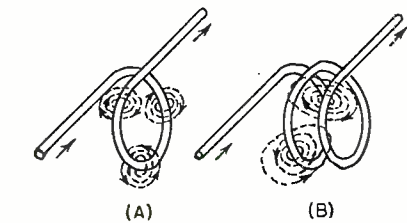

Fig. 1.

coils and in various types of transformers. These are the subject of the present study.

It has been stated frequently in earlier lessons that a current flowing in a conductor produces a magnetic field surrounding the conductor. The strength, or *intensity*, of this magnetic field is proportional to the current. Therefore, whenever the current in the conductor changes in value, the intensity of the magnetic field surrounding the conductor likewise changes. When the current is *increasing* in value, the magnetic flux created by it also increases by expanding outward from the center of the conductor. In doing so, it *cuts across* the conductor on its way out. Whenever the current is *decreasing* in value, the magnetic flux also decreases by contracting inward toward the center of the conductor, thereby *cutting across* it in the opposite direction. This cutting of the conductor by its own lines

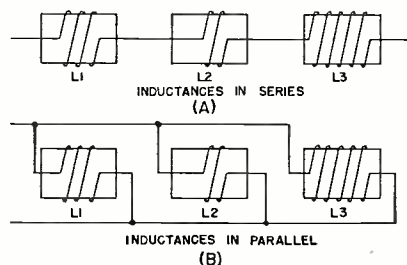

Fig. 3.

inertia in mechanical devices, the inertia tending to oppose any increase or decrease in the speed of motion.

The property of an electric circuit or device which determines, for a given rate of change of current in the circuit, the electromotive force induced in the same circuit is called its self-inductance.

The unit of self-inductance is called the *henry*, named in honor of Joseph Henry, the famous experimenter who independently discovered the effects of electromagnetic induction only a few months after Michael Faraday.

A circuit has a self-inductance of one henry if a current changing at the rate of one ampere per second in it induces a self-induced e.m.f. of 1v.

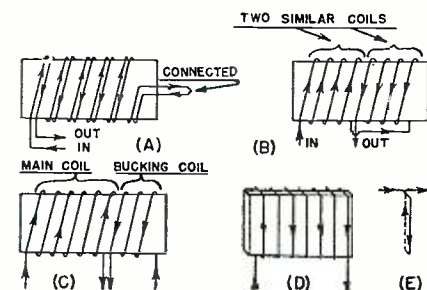

Fig. 2.

turn link and unlink with every other turn of wire in the coil, maximum inductive effect is produced.

If it is wound as a long, loose coil, the inductive effect is less (even though there are the same number of turns), for the lines of force of some turns do not reach other turns, therefore do not link and unlink with them

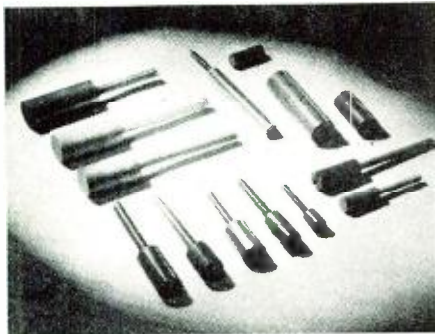

Fig. 5.

to produce self-induced e.m.f. The self-inductance of a coil also depends greatly on the material on which it is wound. If it is wound on iron (a good permeable magnetic material), the inductance is greater because the current through the coil produces a more intense, concentrated magnetic field, and hence more lines of force cut across each turn in the coil.

There are a number of complicated formulae by which can be calculated the inductance of coils of various forms and sizes. The formulae for air-core coils differ, of course, from those for coils containing a core of magnetic material.

Practical Inductance Forms

In radio receiver circuits carrying high-frequency currents, the inductance coils are often wound of insulated wire on a non-magnetic supporting form; these, for all practical purposes, are considered to have an *air* core. For these circuits, too, during the past few years, coils having cores of special, finely-divided iron particles pressed together have come into wide use. These have made it possible to

Fig. 6.

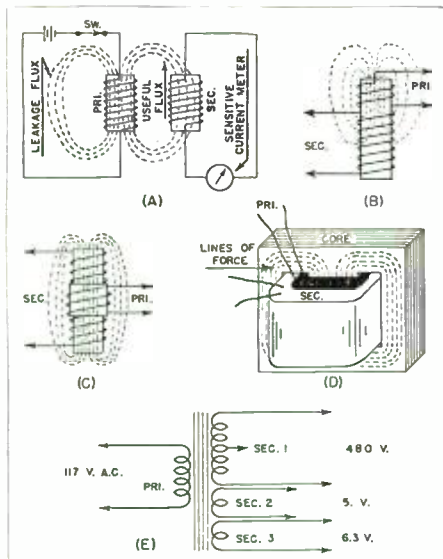

construct, with a minimum of copper wire, compact inductance coils having appreciable inductance in a very small space.

These coils find important use in small portable, miniature automobile and aircraft radios, as well as in home receivers. In circuits carrying audio-frequency or power-frequency currents, iron in the form of thin laminations is used as a core for the inductance coils in order to build up large inductances, with minimum copper wire, in small spaces.

Self-inductance is often encountered as an integral part of some electrical device or circuit, the chief purpose of which is not necessarily to provide self-inductance. Thus, as will be discussed later, both the primary and secondary windings of every transformer have self-inductance. The field coil of an electrodynamic loudspeaker has appreciable self-inductance—so much, in fact, that this field coil is often used simultaneously as a *choke* coil to help smooth out current variations in the receiver.

The self-inductance of the secondary winding of tuning transformers or transmitter and receiver coils, is the important factor which determines the frequency or wavelength range to

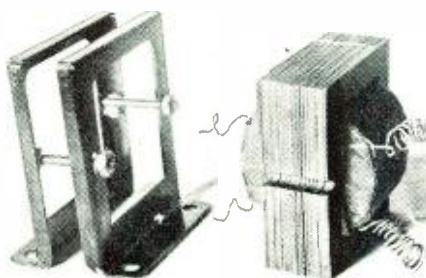

Fig. 7.

which they tune when properly connected to a given condenser. When devices are purposely constructed and added to electric circuits to introduce self-inductance in them, they are frequently distinguished by the name *inductor*. More often, however, they are called by the particular names given them in the trade through long usage—such as choke coil, impedance coil, radio-frequency choke, audio-frequency choke, filter choke, etc. These are names which immediately identify their use and the particular circuits in which they are employed.

Non-Inductive Coils

In some electrical devices in which a long length of wire (usually of a resistance alloy) is purposely inserted in the circuit to introduce a required amount of resistance for some particular purpose, the wire must be coiled to occupy very little space; but it is often desirable, indeed necessary, that it not introduce any inductance into the circuit even though it is in coiled form. The resistance coils in many electrical instruments such as voltmeters, multimeters, bridges, etc., are examples of these.

One of the simplest, most practical

ways of winding a coil containing a large number of turns of wire so that it will be non-inductive, is to wind the wire double, as shown at (A) of Fig. 2, then connect the two starting ends together. Since the current then flows in opposite directions in the two wires, as indicated by the arrows, the magnetic effects produced by the current flowing through one wire are exactly



Fig. 8.

equal in strength and opposite in direction at every point to those produced by the current in the other wire. The magnetic fields, therefore, neutralize each other and no effective self-induced e.m.f. is produced. This is one very popular form of non-inductive winding.

Another method of winding a non-inductive coil—more practical when ordinary simple coil winding machinery is employed, since the wire is wound single instead of double—is illustrated at (B) of Fig. 2. Here the total wire is wound in the form of two similar coils, each having an equal number of turns, equal to half the total turns required in the entire coil. The coils are then placed end to end and the proper ends connected as shown (depending upon the directions of the two windings), so the current flows through the two coils in *opposite* directions. Their magnetic fields then neutralize each other.

Sometimes it is more practical to neutralize the inductive effect of one coil by sending current through a separate *bucking* winding, of the proper

(Continued on page 54)

Fig. 9.

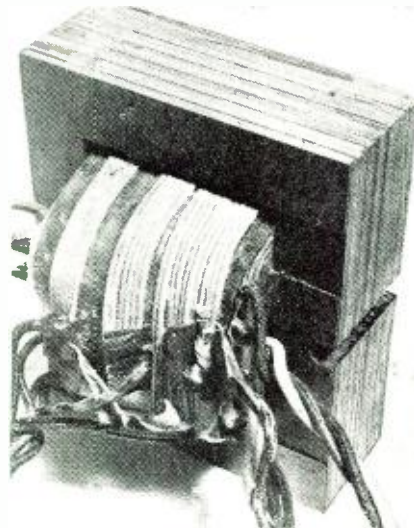

Spot Radio News

I N D E F E N S E A N D I N D U S T R Y

Presenting latest information on the Radio situation.

by LEWIS WINNER
RADIO NEWS WASHINGTON CORRESPONDENT

MILLIONS OF DOLLARS OF RADIO apparatus have been approved every day in the past months, by the *Signal Corps*. This represents double the flow of material in the preceding corresponding period. Approximately 1500 prime contractors and more than 10,000 subcontractors are engaged in the production of this equipment, for which approximately four billion dollars has been appropriated, beginning as far back as July 1, 1940. Today, the *Signal Corps* is supplying 34,000 items of equipment and parts, which is quite a contrast to the scene in 1919 when from 20 to 50 pieces were required and few of them were available from any single *Signal Corps* contractor.

AN EXTENSIVE PROGRAM OF STANDARDS for radio materials and parts has been taken on by the *American Association of Standards* at the request of the WPB. It is being carried on in close cooperation with the *Army* and *Navy* so as to bring about better standardization of quality and to eliminate differences between the requirements of the Services. Thus far, 6 projects have been selected for the Radio and Radar section of the WPB, one of these being on moulded mica capacitors, where 18 standards are needed for these capacitors.

The RMA has set up five divisions, namely, military components section, military tube section, military receiver section, military transmitter section and military electronics application section, each of which have suitable working committees for the development of appropriate standards. These sections are working under the direction of Dr. W. R. G. Baker, director of the *RMA Engineering Department*, and Mr. L. C. F. Horle, coordinator of military standardization.

In addition, several forms of standards of design and operation have been developed by the IRE, their latest being on Standards on Radio Wave Propagation, in which measuring methods are analyzed. The IRE have been studying the problems of standardization since 1912, when the first standards committee was appointed. The next year saw the appearance of the first report on definitions of terms, letter and graphical symbols, and methods of testing and rating equipment. In successive years, they published standards on electroacoustics, electronics, transmitters and antennas,

radio receivers, facsimile. They have also cooperated with the ASA in the preparation and publication of standards on vacuum tube bases and socket dimensions, and manufacturing standards for broadcast receivers.

These standardization reports are excellent for research and study and should be additions to the library. Incidentally, they only cost from twenty to fifty cents a copy.

REMEMBER BALSA WOOD and the fine speakers it helped to make years ago? It's now a full fledged member of the military production forces, having been placed under full import control. This familiar light wood that served to make such ideal baffles, is quite an essential item in the manufacture of airplane parts, life rafts and other similar projects where lightness, yet sturdiness is vital. South America is the major producer in this wood.

Small diamond dies, used in drawing wire, essential in producing fine instruments, have also joined the list of the restricted. There is no shortage of diamonds, but rather of the skilled workers who can perform the difficult and delicate operation of drilling holes $\frac{1}{8}$ the diameter of a human hair through diamonds. France was formerly the center of the die-making industry, where it existed for decades as a cottage trade. Switzerland was also a haven and still is for these fine tool-smiths. Only recently has it been possible to step up production of these delicate components in this country.

Sapphires, a member of the restricted group for some time, may soon find that it isn't as important to the instrument industry as prior to the war. For glass substitutes have been produced by F. K. McCune and J. H.

Gross of General Electric that have provided results so equivalent to that of sapphires, that it has been impossible to note any difference. Sapphires were also pet items of manufacture among the Swiss, jewel-smiths having devoted their full time in not only learning this delicate art, but teaching it to others in their families.

"IMAGINE MacARTHUR REPORT-ING by Beacon Fires and Imagine Generals Giving Commands by Smoke Columns" title the first two of a striking series of advertisements prepared by *Stromberg Carlson*, devoted to an analysis of methods of war communications of yesterday and today. In the first advertisement, a drawing of King Agamemnon reporting the fall of Troy in 1184 B.C., is shown. He was among the first to use what was then the latest form of communications . . . a series of beacon fires. In the second advertisement, the Indian smoke column is depicted. In those days, the height, body and flow of smoke told a vital story. Today the flow of smoke also tells a tragic story, but a different type of story that may mean good news or bad news . . . news though that radio will tell us quickly and accurately.

TO LEND A HAND to students . . . and help speed training . . . for technical and professional jobs, a fund that will afford monthly loans, has been voted by Congress. The loan fund of \$5,000,000, will be made available in allotments of up to \$500 a year, at $2\frac{1}{2}\%$ interest annually, and cancelled if the student is drafted during training. The funds will be available from colleges and universities, and by public or college connected agencies. These loans will be made to students in engineering, physics, chemistry, etc., who are *within two years of completing their work*. In other words, if the course is a two-year course, the student will be able to make the loan, or if he has entered the third year of his course, he will be able to make the loan. The purpose of restricting it to this two-year period is prompted by the accelerated educational programs now in progress and essential to the present wartime schedule. The student making the loan will have to sign an agreement, stating that he or she will participate until otherwise directed by the chairman of the WMC, in accelerated programs of study in



Engineers inspecting new 5 ft. model circular antenna at I.R.E. Convention.

any of the authorized fields, and that in addition, he or she will engage for the duration of the wars in which this country is engaged, in such employment or service as may be assigned by officers or agencies, designated by the chairman of the WMC, Paul V. McNutt.

INDUCTION OF CIVILIAN TRAINEES for the *Signal Corps* reached a new high in New York City recently when 400 were sworn in for training in a mass ceremony in front of the City Hall. After the ceremonies, the trainees, who in six months will be radio repairmen, went to their classes in reconstructed rooms in the old World Building on Park Row in the lower part of the city. They will be instructed in three groups, eight hours a day each. Those of the trainees of draft age and in class 1-A will be enrolled in the Enlisted Reserve of the *Signal Corps*. Those of the trainees who show aptitude will be sent to advance schools, and then to officers training school. Other schools are opening rapidly in other locations in New York and other states.

In many states, radio schools have been taken over in their entirety by the *Signal Corps* for the training of radio men. In these instances, the schooling parallels the training at the regular *Army* schools, with *Army* supervisors in charge. Those who are being trained here, are of the regular *Army*, subject to the complete discipline of the *Army*, even though they are not on direct grounds of *Army* quarters. In Washington, D.C., one of the largest and oldest radio schools is now a full-fledged *Army* Radio Training School. The courses used are for the most part similar to those used at most *Army* schools, as previously mentioned. Deviations are made when the individual courses of the schools are found to contain a number of features that would be to the advantage of the trainee.

MANY ITEMS HAVE APPEARED LATELY calling attention to the importance of girls as service workers. Before a Canadian group of dealers, a well-known specialist listed a few traits of girls that should serve them well in becoming efficient radio women. He said that, for instance, girls are quick to learn and readily become adept at skilled mechanical operations, although he said their early training does not as a rule enable them to grasp the underlying theory with the same facility as the boys. Feel better now . . . boys?

REWRITING OF THE COMMUNICATIONS ACT was suggested by FCC member, T. A. M. Craven, before a meeting of the *House Interstate Commerce Committee*. Mr. Craven disapproves of the present structure, and asked for a provision of the pending legislation to split the commission into two divisions. He stated that with the

present methods of operation, there were too many important matters that were not receiving attention at all.

These committee meetings, which have been going on for many weeks, have been the scene of many controversial debates. Although it is true that there are certain features of the Act, written as it was so many years ago, that are outdated and require revision, the revisions required are not as drastic as many have requested. It is particularly difficult to revise the Act now, in view of the period of emergency under which we are now operating. Accordingly, it is possible that temporary measures will be invoked, for the duration, with provision for Act reconstruction after the war. Because of the very policies involved in some of the revisions, prompting delay actions on matters that affect the networks, critical debate is bound to follow until all moves are complete. This, as we have just said, makes it all the more difficult today. We hope that all sides will set aside their personal grievances . . . study the present critical necessities . . . and adopt such measures that might be necessary, quickly.

BOOKS ARE WEAPONS reads a circular that is being distributed in the East, as a prelude to conferences on the need for books . . . the value of books . . . and the general mobilization of everyone in the book industry to do their share during wartime. In radio, the call for cooperation was heeded a long time ago. As a result the greatest collection of educational books ever prepared, has made its appearance. Books have been written by specialists in all fields of radio . . . in simple styles . . . in advanced styles . . . for the student and for the engineer. Some of these have been . . . *Basic Radio* by Hoag . . . *Electronics* by Millman and Seely . . . *Fundamentals of Radio* by Everitt, Jordan, Nelson, Osterbrock, Pumphrey and Smeby . . . the *Handbooks of ARRL*, etc. Yes . . . books are weapons . . . use them wisely!

RADIO, TELEPHONE, TELEGRAPH and all other forms of communication are in Class 11 of the new allocation classification system devised by the WPB. This system has been designed to provide a means of identifying the



This antenna radiates substantially uniform energy in all directions.

ultimate uses and users of various products and materials as well as a means of transmitting such identifications down through industry to original suppliers. With this information, WPB can then allocate materials more judiciously and also reduce the forms and rules which are the bane of so many. The new regulation provides that all purchase orders or contracts, other than retail, placed after June 30, 1942, must have indicated on them the appropriate Allocation Classification Symbol and Purchaser's Symbol. In addition, all orders, regardless of when placed, which call for delivery after July 31, must also carry these symbols. Customers who have already placed orders for delivery after July 31, must have, before that date, notified the supplier of the appropriate symbols applying on such orders.

The exact allocation symbol of radio in this new simplification move is 11:20. There are five different purchaser's symbols that are used to indicate the end user of the material. They are . . . U S A for the *United States Army* . . . U S N for the *United States Navy* . . . LL for *Lend-Lease* . . . FP for other foreign purchases . . . and DP for domestic purchases.

In view of the complexity of various rulings involving procurement of materials, many schools have set up special classes. *New York University*, for instance, has inaugurated a course of five weeks, two evenings a week in their School of Commerce. They say these courses are designed to help the businessman interpret such rulings and understand the conditions under which they were made. That's quite a job . . . on some of the rulings now in force!

PRIME MINISTER WINSTON CHURCHILL and our famed "Walkie-Talkies" became fast friends during trips to various army bases, on his last visit to the United States. These little wonder radios served to bring him a vivid demonstration of not only the completeness of the communications systems of the *Signal Corps*, but of the perfect operations of coordinated air, land and sea units. He listened with amazement to the accuracy of paratroop maneuver orders issued from planes to paratroopers, with the assistance of the "walkie-talkie." Time and time again, he commented on the effectiveness of these lightweight, self-contained, transmitter-receivers, that serve to maintain so high a standard of communications for our armed forces.

TELEVISION DEVELOPMENT HAS NOT BEEN waylaid, as many have been prone to assume. Although some development has been curtailed, because of wartime restrictions, several laboratories and affiliated units are maintaining a healthy schedule of operations, in accordance with plans suggested at the recent television conference. Among those who are con-

tinuing with their television studies and plans are Philco and Television Productions on the coast. These companies stated, at the recent conference, that they were willing to continue the full time study of television and construct stations, or relay units, as the instances may require. And accordingly, they have been granted construction permits, Philco, for instance, having been authorized to build an experimental relay station to be located between Wyndmeer, Pennsylvania and New York City. This station will be used for relaying programs originating at WNBT, the NBC station in New York City, that also feeds programs to WGRB, the General Electric station at Schenectady. These relayed programs will eventually be fed to WPTZ, Philco's television main transmitter for rebroadcasting. Philco was also granted a modification of their construction permit, authorizing a new commercial television station, for a move of the transmitter, the making of changes in their antenna system and an increase in power. In Los Angeles, W6LA was granted the construction permit for the new television relay station. This station will operate on channels 11 and 12 with 800 watts of peak visual power. The Philco station will operate on channels 13 and 14.

These stations are able to maintain these operations because they do not require the purchase of any new materials. This is in accordance with a policy declared by the FCC during the latter part of April. Such stations that require new materials, will, unfortunately, not be able to construct new stations. Falling in this unfortunate classification was the DuMont Laboratories, whose request for a television construction permit for Washington, D. C., was denied. There are possibilities that if the need for such stations is proven vital to the wartime activities of the Nation, grants for construction will be made.

THE "SWAN-SONG" CONVENTION of the Institute of Radio Engineers . . . for the duration . . . was recently held in Cleveland. Over 300 engineers who attended this conclave, heard some twenty-one papers on subjects ranging from a truly miniature receiver for the deaf . . . only six inches high and about an inch and a half in thickness . . . to a huge scanning electron microscope capable of scanning in thousands of diameters. Frequency modulation and television were pet topics of most of the engineer-authors. J. E. Keister of General Electric, for instance, discussed the television relay system that is in use at Schenectady by station WGRB. (This is a system similar to the proposed relay systems mentioned above.) Programs are relayed from WNBT over a 130 mile span, even though station WRGB is a mile below the

line of sight from WNBT. Among the receiving station characteristics affording this unusual link, are a 400 foot long and 150 foot wide single rhombic antenna, supported by four steel towers 128 feet high.

Six amplifier stages, operating at the incoming signal frequency, afford an increase in the low input level. In the first five stages are 6SG7 tubes and in the last is a GL-1614. The input and each succeeding plate to grid circuit is a double tuned inductively-coupled transformer. This coupling and the secondary loading of each stage is adjusted to give a band width of 4.75 mc., with an over-coupled voltage dip of 3% at the center. As a result, a resulting over-all gain of 250,000 is obtained. During actual use, the signal strength at the receiver input is better than 300 microvolts.

Another General Electric engineer, H. B. Fancher, described the complete main high power transmitter of WGRB, located in the Helderberg mountains, 1200 feet up. In this transmitter, low level modulation is used. This means that all of the stages from the modulated stages to the final output stage must be linear and pass without attenuation frequencies from .75 mc. below the carrier, to 4 mc. above. While operating from the studio in Schenectady, the signal passes through a total of twenty-eight class A or class B linear stages. Modulation takes place at the studio, where the composite signal modulates a pair of 6J5 tubes. Another feature of the television transmitter is a horizontally polarized antenna, which is a stacked array of four bays of large diameter, shortened half wave dipoles with driven directors. The elements are

phased to give maximum radiation in the horizontal plane and are connected to the transmission line by a system of matching sections, according to Mr. Fancher. These consist of parallel bar, quarter wave transmission lines with adjustable spacing. The complete antenna is enclosed in a wooden structure so as to avoid any detuning effect of ice or snow that may collect on the antenna.

Still another television topic discussed was that of lighting by H. A. Breeding, also of General Electric. He described new water cooled mercury lamps, the development of which began with tubes installed at the New York World's Fair in 1939. Among the tubes described were those of a 1000 watt capacity, affording approximately 65,000 initial lumens. It is possible, according to Mr. Breeding, to build up intensity over a 10 by 15 by 10 foot high scene to 650 or more foot-candles of general lighting, with the upper portions of the scene reaching 1000 footcandles. By supplementing this lighting with floor lamps, good pictures are produced, with little or no discomfort to the performers, remarked Mr. Breeding.

Frequency modulation which is closely allied to television, operating as it does in the higher frequencies and in conjunction, in many instances, with video systems, was effectively analyzed by W. F. Goetter of G.E., in his description of a new studio-transmitter relay system. In this system is a 25 watt transmitter using the direct frequency modulation principle of an oscillator having its mean frequency stabilized by a crystal. The sixth harmonic of the modulated oscillator and the sixth harmonic of a temperature controlled, highly stable crystal oscillator, are combined to produce an i-f of 3 mc. in this unit. The third harmonic of the modulated oscillator is then combined with the twenty-fourth harmonic of the same crystal oscillator used for the frequency control circuit. These two frequencies, when added together, produce a signal, which when tripled, according to Mr. Goetter, becomes the transmitter output frequency. The receiver used in this system is a crystal controlled, double conversion, superheterodyne, featuring cascade limiting, and carrier-off suppression. The two audio channels, for programming and monitoring, use resistance-capacitance de-emphasis circuits. The frequency is thus maintained level over the entire range (30-16,000 cycles). Still another important feature of this system is the antenna. This consists of two horizontally polarized co-linear arrays spaced three-quarters of a wavelength apart, and fed in the proper phase for maximum radiation in the desired direction. Each co-linear array consists of five half-wave radiating elements connected by phase inverting elements.

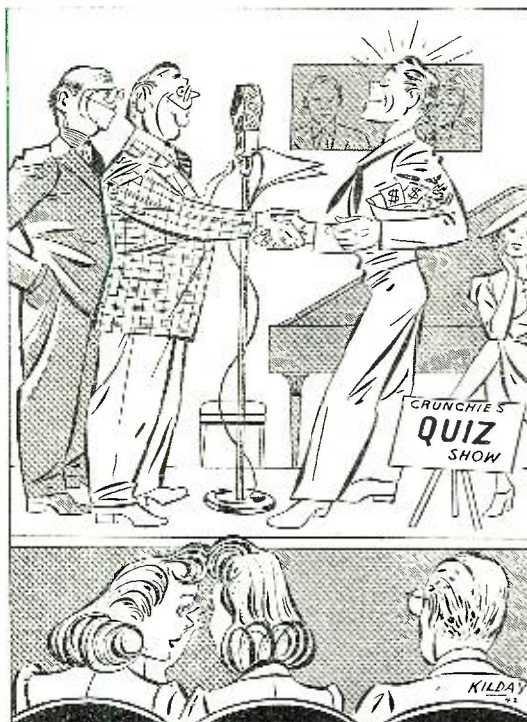

"He's a RADAR man and sure knows the answers!"



TO KEEP 'EM LISTENING... HOME SETS MUST BE SERVICED

Second in importance only to direct war work is your job and ours of keeping the family radio sets of the country in good repair for the quick and widespread dissemination of information.

To furnish the resistors and controls so vitally needed for all the equipment required for speeding up the war effort is now our No. 1 job and will continue to be until Victory is won. Actually, our greatly increased manufacturing facilities are 100% utilized three shifts per day on this all-important war work.

However, we have devised means for furnishing a supply of the resistors and controls needed for servicing home sets and it will not be necessary for servicemen to use substitutes of unknown or doubtful quality for replacements.

TYPE BT METALLIZED RESISTORS—These famous resistors will be furnished from our stock from which we formerly supplied leading radio set manufacturers. These resistors will be of exactly the same quality, ranges, and tolerance used by the large manufacturers before they discontinued making home sets.

VOLUME AND TONE CONTROLS—Plans have been completed to simplify the IRC service replacement line, eliminate special units that can be replaced with universal types, and assemble new stocks from materials and parts on hand which can be done without interference with production for war needs. As in the past, you can count on the well-known IRC construction and noise-eliminating features to assure long, quiet performance on any service replacement job. IRC quality standards will be rigidly maintained.



INTERNATIONAL RESISTANCE COMPANY 401 N. BROAD STREET
PHILADELPHIA, PENNA.

Power is fed to each array through a matching section at the midpoint of the center radiating elements. All radiating elements, phase inverters and matching sections are completely enclosed with a new insulating substance, known as Herkolite tubing. This tubing, according to Mr. Goetter, is air tight. It is connected so that the entire antenna as well as the transmission line may be pressurized, if found necessary. In addition, this special enclosure protects the antenna against sleet and ice-melting.

A phonograph reproducer, or pickup, designed so that a frequency modulated signal could be reproduced, was described at the convention by C. M. Sinnett of RCA Manufacturing, who with G. L. Beers, also of RCA, developed this new unique unit. The device has a metal frame or mounting block

that serves as a support for an insulated plate which is the high potential side of the pickup. To this mounting block is attached a thin metal ribbon. This is mounted in a plane parallel to the insulated plate and spaced from it by a small air gap. It is placed under tension in order to increase the natural resonance frequency of the system. Displacement of the stylus laterally results in a change in the position of the ribbon with respect to the fixed plate, and thus produces a change in capacity, said Mr. Sinnett. An oscillator and frequency discriminator-rectifier circuit used in conjunction with this unit, was also described. In this circuit, a simple resonant system is used to convert the oscillator frequency variations into changes in the amplitude of the signal applied to the diode portion of a 6R7 tube. A powdered

iron tuning inductance tunes the circuit so that the mean oscillator frequency falls at approximately the 70% response point on one side of the selectivity characteristic.

Probably one of the outstanding features of the convention was the announcement of a new type of antenna . . . a circular antenna . . . developed by L. M. Leeds and M. W. Scheldorf of G.E. The antenna, described by Scheldorf affords a new low mutual between vertical bays, which greatly improves adjustments of multibay installations, and covers a wide frequency range with one physical structure. In addition, the antenna may be easily mounted to a pole of any diameter and grounded to that pole, so that there is lightning protection. It may be applied, too, to automobiles and trucks. The antenna consists of upper and lower circular elements, each being a quarter wavelength long, and shortened by a physical quarter wavelength by an end capacity. The original single unit used as a basis for the description at the convention, is now in operation at the New York City Muzak station W47NY (the f-m station). Stations in Philadelphia, Chicago are also installing this new and unusual antenna, the design of which even affords sleet melting, if desired.



RELAYS by GUARDIAN

★ You need Relays and Solenoids for timing, fusing and releasing bombs . . . Solenoids to fire the guns . . . Relays to control the radio—floodlights—landing gears—navigation aids—turrets.

Used in practically every type warplane . . . government specified Relays by Guardian are the finest electrical controls we've ever designed . . . more control in less space . . . more room for guns and bombs . . . all done with a "know how" that's unmistakably—Guardian Electric!

- GUN SWITCH HANDLES
- REMOTE FIRING EQUIPMENT
- TURRET CONTROLS
- RADIO CONTROLS
- NAVIGATION CONTROLS
- AIRCRAFT CONTROLS
- BOMB RELEASES
- SOLENOID CONTACTORS

Samples of Approved Controls Available on Short Notice

GUARDIAN  **ELECTRIC**

1630 WEST WALNUT STREET

CHICAGO, ILLINOIS

LARGEST LINE OF RELAYS SERVING AMERICAN WAR INDUSTRY

FIFTEEN THOUSAND PORTABLE receivers are now in use on the mine-sweepers, sloops, submarines, torpedo boats and corvettes of the British Royal Navy, as a result of a voluntary fund of \$125,000, raised to buy them. Employing a non-radiating circuit, essential to avoid divulging positions, the receivers have been offering outstanding service, electrically and morally. Batteries affording some 240 hours of service, provide several months service, under normal conditions. The Royal Air Force has about 5,000 of these portables, and the Army has some 8,000. They are being used in many remote districts of Britain as well as in Iceland and the Middle East.

THE TREND OF CATALOGS of some mail order houses has seen some historic changes lately. This huge retailer—formerly one of the largest listers of radio items—is no longer illustrating radios which have been omitted in the latest Sears, Roebuck presentation. For the first time, radios, and other electrical equipment, receive no space, because of priority restrictions. Although originally some space had been set aside for radio selling, sharp curtailments in production made it necessary to delete them from the book. Most of the Sears stores still have receivers for sale. But since no new receivers are expected, selling is being restricted to "on-the-floor" only. Batteries, too, are becoming more and more difficult to purchase, but most dealers still have plenty on hand. Users of portables will soon be limited.

Score a Dividend for Substitution!

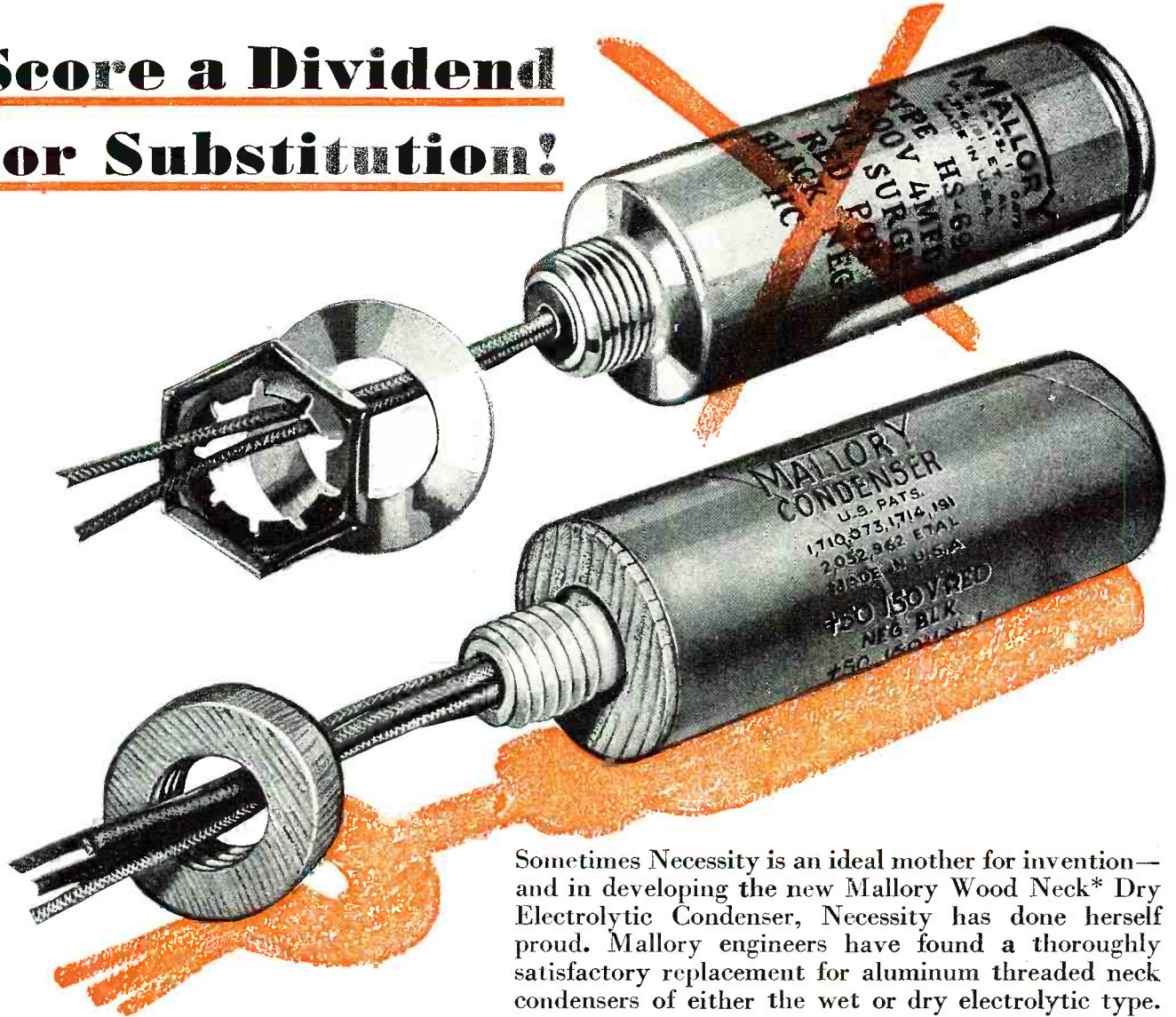

Sometimes Necessity is an ideal mother for invention—and in developing the new Mallory Wood Neck* Dry Electrolytic Condenser, Necessity has done herself proud. Mallory engineers have found a thoroughly satisfactory replacement for aluminum threaded neck condensers of either the wet or dry electrolytic type.

They are designed for the emergency but we predict they will be popular long afterwards.

Using an absolute minimum of raw materials vital for war production, these new Mallory Condensers employ an impregnated cardboard tube container and threaded wooden neck. Ingeniously providing the same mounting convenience as the aluminum can condensers they replace, they are handsome, trouble free and long-lived. You can use Mallory Wood Neck* Condensers with confidence—and recommend them enthusiastically.

Free—from your Mallory Distributor—a chart showing how to select and use Wood Neck* Condensers to replace wet and dry aluminum can units.

You can depend on Mallory and Mallory Distributors to help you lick the problems that war imposes . . . and meet the challenge to “keep ’em listening” with receiving sets in good repair.

**Patent Applied For*

P. R. MALLORY & CO., Inc.
INDIANAPOLIS INDIANA
Cable Address—PELMALLO

P. R. MALLORY & CO., Inc.

MALLORY

Approved Precision Products

MAGNETIC RECORDING ON STEEL, received a new jolt of interest recently, with the announcement of the development of a new method of recording on hair-thin wire by Marvin Camras, assistant physicist at the *Armour Research Foundation*. Employing the familiar method of magnetizing and demagnetizing on steel, Mr. Camras has devised a system that permits the use of fine steel wire . . . eight hours of recording, for instance, on a spool of wire, approximately five inches in diameter and two inches wide . . . instead of the usual ribbons and other heavy steel media that permitted the recording of comparatively small portions of transmissions. The

new steel thread is 4/1000 of an inch thick.

As early as in 1900, magnetic steel wire recording achieved popularity, when Valdamar Poulsen, the Danish scientist, introduced this method of recording for copying high speed arc system signals. Since suitable amplifiers were not available then, the quality was bad. In 1924, Dr. Stille, a German engineer, began a thorough study and search of the possibilities of this form of recording. He soon found that steel tape offered better recording possibilities than wire. He thereupon developed an electromagnetic system, resulting in a reduction of wave form distortion. Years brought on other de-

velopments, until the steel tape became suitable for broadcasting purposes, the first evidences of which came to light in 1932, when the *British Broadcasting System* transmitted the Christmas Day speech of his Majesty, the late King George V, by this method. Today, the *New York Telephone Company* uses the steel tape system. Their method includes the use of a steel tape about 30 feet long, that passes across the poles of electro-magnet at a rate of about a foot a second. Speech currents produce a varying magnetism on the tape.

The quality and uniformity of the tape guide the results of the system. Tungsten magnet steel is oftentimes the choice of most, for it provides a minimum of magnetic aging. This aging problem is one of the peculiarities that is not present in the new method, according to the inventor. He says that his method affords the retaining of the recorded signals for years. In addition, storing does not affect the quality or volume of the signal, a feature that is not possessed completely by the steel tape.

Both the steel wire and tape permit "erasing" of any recorded signal. On the steel tape unit, the "erasing" is done with the same machine that records. In other words, the tape rides through a recording magnet and an "erasing" magnet. To "erase" it is only necessary to increase the magnetic field, that neutralizes the heavy magnetic field and "erases" the message. A similar system is used on the steel wire.

The messages impressed on the tape at the telephone company vary from 25 to 38 words, with a level of 33 words for an average. With the steel wire, thousands of words can be recorded, says the inventor, and with fidelity that is reported to be as high as 5000 cycles.

Disadvantages of the steel wire or any magnetic wire form of recording, in radio applications are that the recorded wire cannot be reproduced in quantities as in the case of transcription pressings. It is also difficult to spot the messages recorded, since there is no visible trace on the wire as the recordings are being made. Oscilloscopes and other visible methods are necessary. However, there are many advantages too, in that it affords recording of hours and hours of signals; it can be stored away in small containers; it does not age; properly packed, it will survive bombings and crashes and thus is of inestimable value for military and civilian records.

THE ADVANTAGES AND DISADVANTAGES of various types of focusing and deflection methods used in television were effectively presented recently by B. J. Edwards before the Wireless Section of the *Institution of Electrical Engineers*, in London. He pointed out, for instance, that the advantage of electro-static deflection was that it eliminated ion burn



WHAT NOW?

No one can predict what changes may have to be made in condensers, or what additional types may yet have to be eliminated to conserve vital materials for War needs—BUT . . .

The fact remains that Sprague jobbers can still supply Sprague Atom Midgets and EL prong-base dry electrolytics plus TC Paper Tubulars—and these three famous condenser types will handle practically any radio set replacement job, including replacement of most wet electrolytics. The size may be different, mounting might occasionally require some ingenuity—but you can count on Sprague quality, and that's the all important thing.

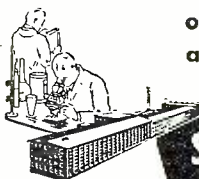

SPRAGUE PRODUCTS CO., North Adams, Mass.

Quality Components—Expertly Engineered—Competently Produced



Atoms are smaller, more dependable, cost less. Available in all ranges and in many combinations.



Sprague EL prong-base electrolytics are ideal for replacing can dries and can wet electrolytics.

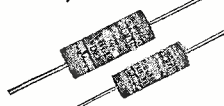

TC's meet every tubular-type by-pass condenser need—efficiently and economically.

trouble, while its disadvantages were . . . higher cathode ray tube cost due to the increased cost of materials and increased shrinkage. In addition he showed that there is distortion due to non-uniform lens action between deflection plates. This means, he explained, that deflection potentials should be kept low, which in turn eliminates the possibility of a short cathode ray tube. Another disadvantage is that the time base generators require separate high voltage supplies.

Magnetic deflection, however, has many advantages, such as lower cathode ray cost due to decreased material content and decreased shrinkage. Also the distortion of the spot can be arranged to be very small, even on a short cathode ray tube. The tube can be operated with the cathode grounded, thereby making d.c. connections possible. This system requires fewer tubes; permits the use of time base generators from ordinary high voltage supply. Disadvantages of the system are that it requires a higher power for scanning and the ion burns are liable to show up on the screen, owing to the ions not being fully deflected by the magnetic field.

Electrostatic focusing is satisfactory, since it affords focusing that is not critical and therefore not liable to drift. But it has many disadvantages . . . such as . . . ion spot concentration into small area, causing intense burn, unless electrostatic deflection is used . . . high potentials required for focusing and these are costly, since extra de-coupling and by-passing condensers are necessary, a highly insulated voltage divider is required, and the power consumed by the voltage divider causes loss of high voltage, thus requiring two high voltage smoothing condensers. Magnetic focus-

ing has the advantage of affording a greater focused beam current for a given high voltage.

Disadvantages are that focusing may drift owing to change of magnetic flux, which is due to heat.

Personals . . .

It's strange where you'll find some folks in time of war. Take **CLYDE**

DOERR, the famous radio saxophonist, for instance.

He's making tools now, in a machine shop in the East. Tools were always his hobby, so he's back to what he's always loved, he says.

. . . **COLONEL DAVID SARNOFF**, president of RCA, recently addressed graduates of Signal Corps at Camp Murphy. Col. Sarnoff entered serv-

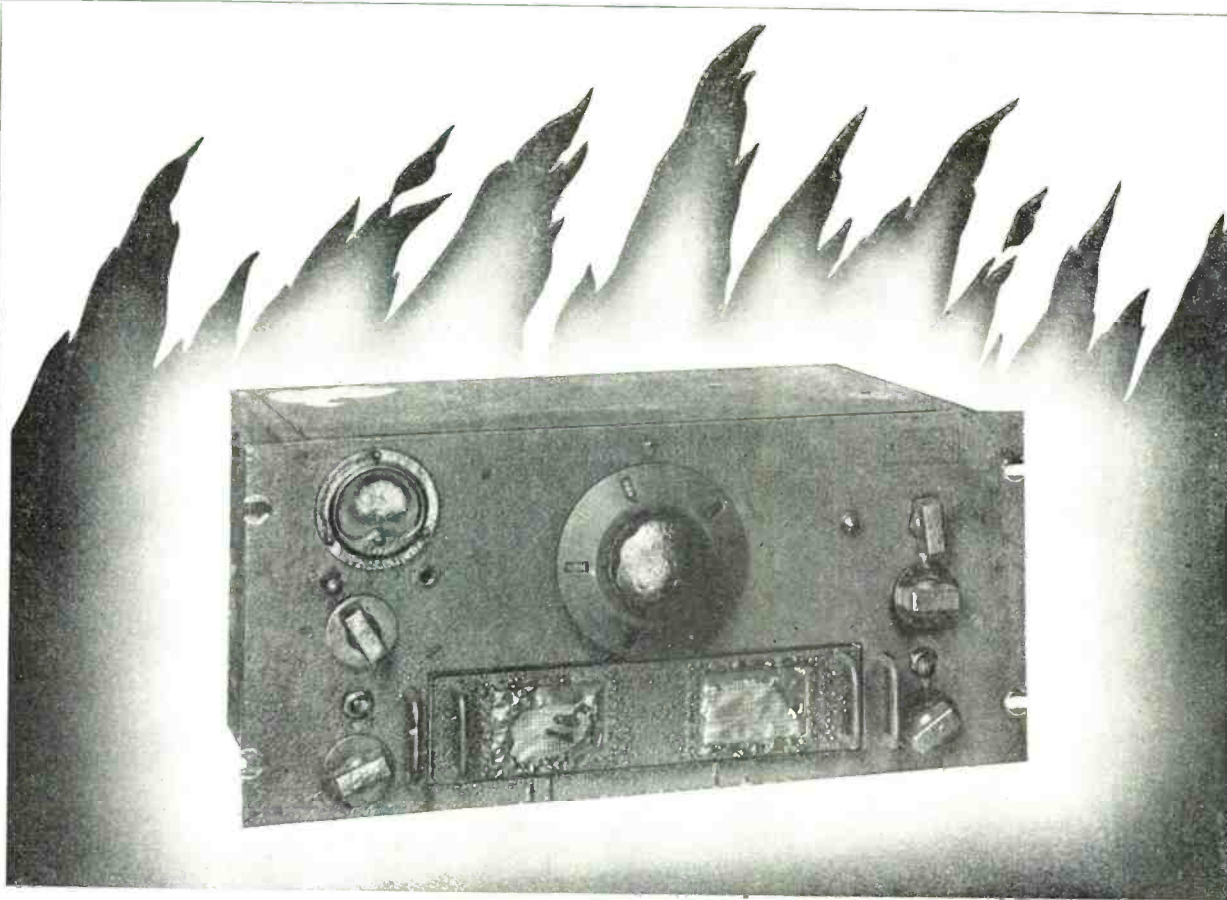

HELL—AND HIGH WATER

The HRO Receiver shown above was one of four in a building severely damaged by fire. The heat was so intense that it blistered paint and distorted Bakelite parts on all four receivers. Without any repairs, two of the four receivers tested normal in all respects except for some noise when tuning. This defect was eliminated by wiping soot from the rotor contacts. The remaining two HRO's required only minor resistor replacements, after which they likewise showed superb performance.

Two HRO's being loaded on a ship were dropped into the salt water of the harbor when a loading sling broke. They were recovered, and returned to us. One, without any repair or adjustment, showed performance that approached normal, except on one coil range which had an open circuit. The second receiver gave satisfactory performance on one coil range, after that coil had been baked in an oven. In spite of the delays in shipment to us, salt water still dripped from the coils when the equipment was received at our plant. ☞ Incidentally, we do not recommend this type of treatment.

NATIONAL COMPANY



MALDEN, MASS., U.S.A.

ice on June 24, on special assignment of Major General Olmstead, Chief Signal Officer. . . . **H. C. L. JOHNSON** has been promoted to the post of advertising manager of Hygrade Sylvania. . . . **R. J. BAHR**, formerly buyer for the receiver division of GE, is now purchasing agent for the radio and television department of G.E. . . . **ARTHUR L. NELSON**, has been made chief engineer of the Kansas City division of Aircraft Accessories Corporation. He was formerly with Farnsworth. . . . **M. F. BALCOM**, vice-president and general manager of Hygrade Sylvania was re-

cently elected vice-president of the RMA. . . . **P. C. SANDRETTO**, superintendent of the *United Air Lines'* communications laboratory in Chicago, has become a major in the Communications Directorate of the *Army Air Forces* in Washington. . . . **F. A. RAY**, manager of the Musaphonic division since its inception was recently named eastern regional sales manager of the receiver division of GE at Bridgeport. . . . **COLIN B. KENNEDY**, pioneer radio man, died recently. When he died he was serving as a civilian adviser to the *Army Signal Corps*.

-30-

Electronic Camera

(Continued from page 17)

sired, by use of a rack and pinion situated at the bottom of the plate holder. This rack is operated by a crank sealed within a flexible metallic bellows. The covered plate and holder are placed in the chamber which is then sealed by a rubber gasket. Turning the crank moves the holder and plate into the camera. The plate cover, however, is held stationary so that the section of the plate within the camera, is uncovered.

A second or auxiliary electron gun is mounted on the evacuated chamber, so as to "shoot" a stream of low-velocity electrons directly onto the surface of the specimen of metal under study. An anode electrode, is mounted near this specimen to collect the secondary electrons. The electron gun serves a two-fold purpose: (1) allows observation of the surface of the secondary electron-emitting material when under "fire" of the electrons; (2) it has been discovered that specimens of insulating material, such as mica, evidence a tendency to accumulate a static charge of electricity by reason of the effect of the electron beam.

This static charge is wholly undesirable inasmuch as it tends to deflect or distort the electron ray, and thus interfere with scientific observations. If the specimen is a nonconductor, its grounding will not remove the charge of static electricity. The alternative is to control the intensity of the directly bombarding electrons from the auxiliary electron gun, thus secondary electron-emission may be produced of such sufficiency as to maintain the static potential of the study specimens at a low value. Thus, the accumulation of electrons from the primary gun, which tends to produce a negative charge on the specimen, is counteracted by an equal loss of secondary electrons, produced by the impinging electrons from the auxiliary electron gun.

The primary electron gun, while not subject to a straight-jacket of specifications, may preferably consist of the following elements: A small tungsten wire cathode, a grid cylinder having an opening of about .030 of an inch, and a first anode cylinder of the same diameter, spaced .040 of an inch from the grid cylinder.

The first anode cylinder, through which the electrons stream, contains three successive openings, the diameters of which are .0005, .020, and .030 of an inch, respectively, in the order named, from the grid electrode. A second anode cylinder of the larger diameter and enclosing the cathode, grid, and first anode electrodes, and an accelerating cylinder (which is the main body of the evacuated chamber), complete the elements necessary for producing and focusing the primary electron beam. While the electrical connections are not illustrated in the diagrams, the inventor tells us that it

It Shouldn't be Repaired But It MUST BE!

What if the set IS ten or twelve years old—If it goes dead you still **have** to fix it. Even your customer might admit "it's ready for a new one"—if a new one could be bought!

Mr. and Mrs. America are depending on their radios more than ever—and depending on you to keep 'em playing. The only way you can handle your share of this tremendous volume is to work more efficiently — use your Rider manuals more regularly. Stop spending valuable time trying to "guess out" servicing data—look it up in one of your thirteen volumes of Rider Manuals. If you don't have all thirteen—better order today.

RIDER MANUALS

Volumes XIII to VII.....\$11.00 each
Volumes VI to III..... 8.25 each
Abridged Volumes I to V.....\$12.50
Automatic Record Changers and
Recorders..... 6.00

FOR EARLY PUBLICATION

"Inside the Vacuum Tube"—complete elementary explanation of fundamentals of vacuum tubes.

**JOHN F. RIDER
Publisher, Inc.**

404 Fourth Ave., New York

Export Division:

Rocke-International Elec. Corp.

100 Varick Street, New York City

Cable: ARLAB

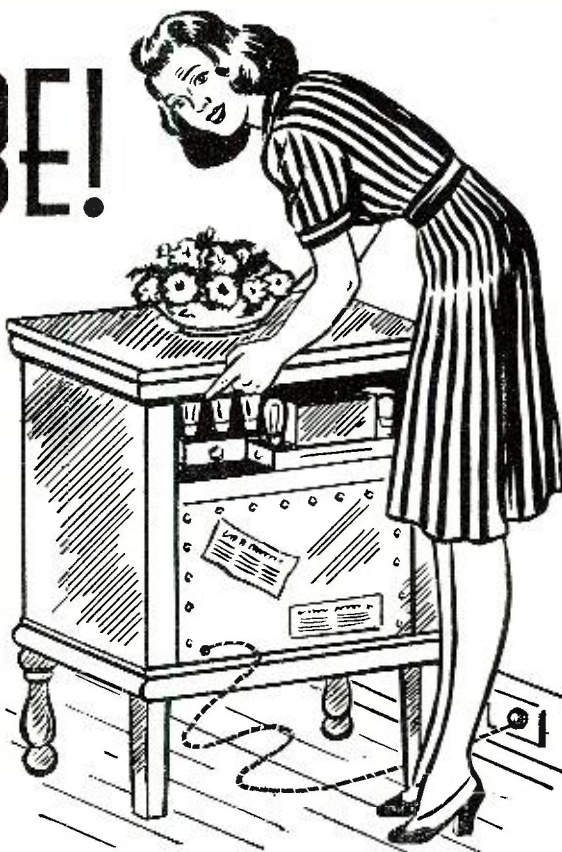

OTHER RIDER BOOKS YOU NEED

The Cathode Ray Tube at Work.....\$3.00
Frequency Modulation..... 1.50
Servicing by Signal Tracing..... 3.00
Meter at Work..... 1.50
Oscillator at Work..... 2.00
Vacuum Tube Voltmeters..... 2.00
AFC Systems..... 1.25

HOUR-A-DAY-WITH-RIDER SERIES—on "Alternating Currents in Radio Receivers"—on "Resonance & Alignment"—on "Automatic Volume Control"—on "D-C Voltage Distribution." 90c each

JUST OUT!

A-C CALCULATION CHARTS—Two to five times as fast as a slide rule—and more fool-proof. All direct reading—operative over a frequency range of from 10 cycles to 1000 megacycles. 150 pgs.—2 colors—9½ x 12 in.—\$7.50.

**YOU NEED RIDER MANUALS
TO 'CARRY ON'**

is preferable to operate the cathode at a high negative potential, and the accelerating electrode (the main chamber of the camera) at ground potential. Other negative potentials are applied to the anode and grid electrodes in the usual manner common to the science of electronics.

The cathode, grid, and first anode, are mounted on a glass press, which is sealed to a brass ring (also supporting the second anode cylinder.) The complete assembly is connected by a glass tube to a mounting ring or plate through suitable sealing agents—these effecting vacuum-tight connections. The mounting ring or plate is sealed to the end plate, of the main vacuum chamber by use of a flexible bellows. This permits the position of the electron gun to be adjusted in such a manner that it "trains" the electron beam precisely on the opening in the diaphragm.

As shown in one of the illustrations the electron beam, after passing through the diaphragm, goes through a pair of oppositely disposed deflecting electrodes, which are connected to suitable sources of d.c. current. This potential is utilized to control the direction of the beam in the usual manner. The diaphragm, like the "eye" of a conventional camera, sharpens the electron beam and chisels off stray electrons.

The mounting for the observation specimen is graphically described in the diagrams. This device is perched on a suitable opening in one side of the camera chamber, and is equipped with a rubber gasket for insuring a vacuum-tight seal. The mounting element itself consists of a base plate, which is screwed into the camera chamber—supporting the other elements of the apparatus. A piece of drill rod is given passage through a central opening in the base plate and is mounted therein on pivots for rotation by means of a ball and socket bearing. This allows only

limited freedom of movement, vertically. A portion of the outer end of the drill rod is bent at a small angle to the major axis of the rod to form a crank. The metallic bellows, previously referred to, surrounds the outer portion of the rod. The outer end of the bellows is closed to form a vacuum-tight seal. The inside of the bellows is soldered at a point to the base plate, thus forming a vacuum-tight seal around the crank rod.

The portion of the specimen-supporting device which extends within the camera chamber, includes a supporting plate, which is pivotally supported by the base plate. A horizontal adjusting screw is threaded into the plate and keyed for rotation with the inner end of the drill rod. One or more samples of metal which are to be subjected to study, are supported by the adjusting screw in any suitable way. For instance, an extension rod



BESIDE the general run of scrap metal found in most homes, hams usually have a fine assortment of old wire, aluminum, panels and chassis, as well as many other iron, steel and brass gadgets, all of which can be turned into real active war material. . . . Do as Elmer has, "get in the scrap."



HAMMARLUND

THE HAMMARLUND MFG. CO., INC., 460 WEST 34TH STREET, NEW YORK, N. Y.

may be employed to support the specimen in the electron path. It is noted that translational motion of the sample in the direction of the vertical diameter of the camera chamber, is obtained by turning an adjustable thumb screw. The specimen may be rotated about a horizontal axis by turning the crank formed by the bent section of the bellows and the drill rod. One complete revolution of this crank will cause the study sample to move along the axis of the rod by a distance determined by the pitch of the horizontal adjusting screw. By mounting four specimens at oppositely positioned points about the axis of rotation, any one of the four may be selected for study, by rotating the crank.

Additionally, the angle of incidence of the electron beam on the specimen, may also be adjusted by a slight twist of the crank. Different positions of the surface of the path of the specimens may be brought across the path of the electron ray, by rotating the crank continuously, until the adjust-

ing screw has moved in or out the desired distance.

If the illustrating sketch is not quite adequate, a few words of amplifying text about the camera shutter mechanism, may not be amiss. Actually, the mechanism includes three distinct shutters at the rear—that is, toward the source of electrons—is a large shutter, which wholly shields the fluorescent screen or photographic plate (whichever may be in use at the moment). It is pivotally mounted on a rod which extends across the camera chamber at a distance somewhat below its horizontal diameter. Furthermore, a pair of small shutters are similarly perched on a rod and are so shaped that either half of the fluorescent screen or photographic plate may be shielded from the electron beam. The three shutters are equipped with spring-biasing means, for maintaining them in a normally vertical position, parallel to the fluorescent screen.

To facilitate visual observation of the pattern produced by electrons

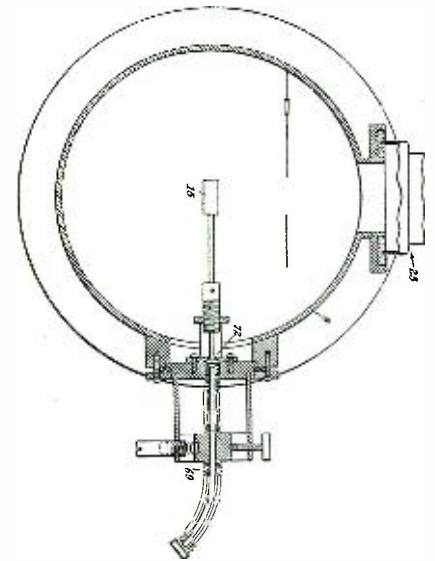

Details of specimen holder.

upon a surface, a small window has been provided in the camera chamber. A mirror is mounted below this window through which the inner surface of the shutter upon which fluorescent material has been purposely deposited, can be readily observed.

It is a far cry—and a strange one, too—from an electronic camera and its gun bombarding millions of electrons, to the amplifying and broadcasting of the silent tread of filthy house flies—but such is the versatility of the science of electrons.

-30-

QRD? de Gy

(Continued from page 20)

ground. Where a brass-pounder can rule the roost in his position and the college man hold his chair down in his setup. Each man for the spot wherein he fits best is our motto and lets keep the oldsters pounding brass not acting like an overgrown schoolboy with a slide-rule in his mit.

AND another beef is the thoughtlessness of the USO organizations in forgetting about the Radio Officers who are manning the ships making it possible to continue this war. These men are being forgotten when they land in port. After all, shouldn't these men who are risking their lives every day, getting themselves torpedoed, bombed, shelled and in many instances drowned, be given a little entertainment and home-like atmosphere when they get ashore? We suggest that the USO open their doors to these men, too. So let's go USO, give these boys a break; these boys who are "delivering the goods" to all our farflung fighting fronts. Make them at home because it may be their last one.

BROTHER A. B. ANDERSON, that will o' the wisp, hither and thither delegate for the ROU finally advises us that he's settin' toposide of this

Still YOUR BEST BET ON REPLACEMENTS!

Centralab MIDGET RADIOHMS

Servicemen recognize the "plus-performance" that these sturdy controls give on every replacement job... Old Man Centralab's good advice to "ALWAYS SPECIFY CENTRALAB" was never more timely than now . . . when it is so important to keep the "radio ears" of the nation properly tuned to the events of these critical moments in our history . . . For smooth, silent, sure attenuation . . . specify CENTRALAB MIDGET RADIOHMS.

CENTRALAB: DIV. OF GLOBE-UNION INC. MILWAUKEE, WISCONSIN, U. S. A.

"vale of tears." After many months of wondering whatinell happened to him we received the following bon mot. Quote Hi OM, guess you thought I had forgotten you but such is not the case. Just been busy gadding about on the high seas trying to do my stuff as any seagoing op should in these times. Couldn't see myself ensconced in a nice "safe" office acting like a stuffed shirt while the rest of the gang were out there giving. Especially, after what those %;#/" ex! japs pulled on us at Pearl Harbor. Soooooo being too old and ornery to enlist I upped and grabbed me an oil tanker. Things picked up, but fast along the Atlantic Coast. And believe me, Jerry, it's anything but monotonous. What with those dern tin fish popping off all over the place! Of course, I can't blame some of the boys for getting the jitters and quitting the sea. But there are many others who are taking their places with but one thought in mind . . . keep them sailing. I, personally, couldn't be in a soft billet and cheer the boys who were facing the grief. So I hit the deck again. Well, OM, I'm sorry I can't give you any real dope but no can name ships, ports or cargoes but if you don't hear from me again cross another radiop off your list. Give my best 73 to all the boys on the West Coast and keep your fingers crossed. Andy. unquote.

A PROPOS of the above we find Karl Baarslag, Charlie Luck and a few others, officials of the CTU Marine Division, doing their stuff at their chosen profession. Karl now holds a commission in the Navy and is stationed in Washington, Charlie is holding down a "shack" in the Merchant Marine like Andy. Who said "all union officials are desk warmers and afraid to take chances?" "Tain't so," sez we.

GRAPEVINE report to the gang: Chet Jordan, ACA official in San Pedro, Calif., is now a radio instructor at a school in Long Beach, Calif. We hear he's sticking to "straight radio" instruction.

Murray Winocur, Vice President of ACA Marine Division, was reportedly removed from a vessel in a Gulf Port. Seems he got one of those notices sent out by the Navy telling him he could no longer sail on an American Flag vessel. So Murray hiked himself down to Washington where he beefed that he should not be persecuted for his "political beliefs." But evidently the government did not agree with him. He is still prohibited from sailing on American ships. Which goes to prove . . .

Fred Howe, CTU Marine Division official is reportedly looking for a government job or else he'd like to relieve

the operator shortage. Noble idea, OM. Although his ticket is lapsed for these past years a new ticket can be had from your local RI just by presenting your old ticket. This new license is a 2nd class rating and only good for the duration in Marine work.

What's happened to Freddie Ulrich? Haven't heard from him in over a year. Anyone knowing his whereabouts please advise. . . .

And has Athan Cosmas gone through with his plans to get hitched with that certain YL, we'd like to know?

Also, what about John Walker (not of the liquor family)? Last heard of

he was sailing one of Alcoas' passenger wagons to the Caribbean. Wonder if one of Adolph's tin fish caught up with him? Your friends would like to hear from you feller. So how about dropping 'em a line?

WELL, now that we're in this fight to the finish just keep betting on ol' Uncle Sammy to come out of the fracas on his two feet. So keep on betting he'll win by buying war bonds, keeping the ships sailing . . . and chins up. So cheerio and ge . . . 73 . . . GY.

-30-



**"Portables"
Speed-Up
War Production
Testing**

Triplet Portables speed up electrical testing with the dependable accuracy that is a vital part of war production.

And whether your particular interest lies in laboratory service, production line testing, experimental work, field service, or plant maintenance, you will find your need provided for, with exacting and lasting accuracy in the expanded line of Triplet Portables.

In the drive of production-line testing, Triplet Portables supply the full-scale accuracy, the consistent performance, the hair-trigger answers that result from the Triplet method of safe-guarding quality, by making every essential part in the Triplet plant.

If you, like the writer of the letter quoted below, want to back up our armed forces with time-saving production practices, write for complete details on other Triplet Portables, panel electrical measuring and test equipment.

Excerpt from letter of a prominent manufacturer (original in our files):

"With the Ohm Meter we have on order we can do in . . . seconds, what now takes a couple of hours."



Model 625

Models 625 D.C. and 635 A.C. Portables are unequalled for today's rush in production testing or the rigid requirements of laboratory checking. These highly attractive molded case instruments have long 4.58" hand calibrated mirror scales. The hinged cover closes when instrument is not in use, for added protection. Black molded case for D.C. instruments; A.C. is red. Size is 6" x 5 1/2" x 2 1/2". Has detachable leather strap handle.



Model 425

Another new Portable combining attractive symmetrical case proportions, a long readable scale, and requiring a minimum of bench space when in use. A real beauty in design for those preferring something different. Case and base are molded; base size 5" x 4 3/4". Model 425 D.C. (3.12" hand calibrated mirror scale); Model 435 A.C. (2.88" hand calibrated mirror scale.)

THE TRIPLETT ELECTRICAL INSTRUMENT CO.
BLUFFTON, OHIO

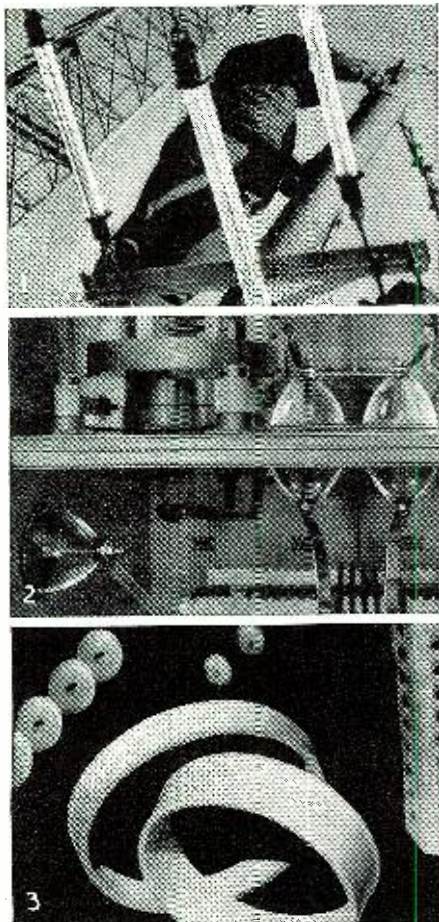

ARE YOU UP-TO-DATE ON GLASS INSULATION?

WHERE fine performance is demanded, you'll find Pyrex brand Strain, Entering, and other standard insulators. For example, at KDKA (Fig. 1); in Westinghouse 50-H.G. Transmitter (Fig. 2). But that's not all. *New* intricate shapes, *new* ranges in size and tolerance are now possible through advanced glass manufacturing techniques. Bushings, line spacers, coil forms, and anode bushing rings (all Fig. 3) are examples. Write Insulation Div., Corning Glass Works, Corning, N. Y.

DO YOU KNOW HOW HIGH GLASS RATES AS AN INSULATING MATERIAL?

PROPERTY	BOROSILICATE GLASS	LOW-LOSS STEARITE	PORCELAIN	CELLULOSE ACETATE	PHENOLIC RESINOID
High scratch hardness	6	5	3	1	2
Low thermal expansion	6	4	5	1	2
High dielectric strength	5	2	1	3	4
Low dielectric constant	6	3	5	4	1
High volume resistivity	5	4	3	2	1
Total point score	28	18	17	11	10

Pyrex Insulators
BRAND

"PYREX" is a registered trade-mark and indicates manufacture by Corning Glass Works.

Time-Signal Receiver

(Continued from page 29)

ter reception, the circuits throughout should be peaked at that particular frequency.

The receiver, as shown, is housed in a black crackle cabinet, 7¼x11x7" in size. If standard relay rack mounting is desired, however, the parts arrangement can be modified to suit the builder and no difficulty from instability or circuit interaction should be experienced as long as shielding of the revised layout is maintained to an equivalent degree.

Standard, readily-available parts are used throughout and any necessary substitutions encountered due to shortages should not materially alter the operation of the tuner. A slight deviation from specified electrical values is permissible in view of the fact that at such low frequencies such variations have comparatively little effect.

To obtain optimum results with a minimum of tubes, experimentation was undertaken to determine the possibility of incorporating regeneration into the second detector, thus eliminating the tube ordinarily required to develop local oscillation for beat-note reception of CW signals. The thought worked out well in practice, the only problem being that of adding a cathode "tickler" coil to L4. As was feared, available catalogues listed no intermediate transformers featuring a third, or tickler, winding.

Standard practice seems to call for a separate BFO circuit and tube but, undaunted, an attempt was made to add the missing winding to a standard iron-core I.F. transformer.

Adding the tickler for regeneration was accomplished by pulling down the L4 unit and, midway between the primary and secondary coils, winding on ten turns of No. 28 or No. 30 cotton-covered wire. As one side of the new winding is common to one terminal of the secondary, or grid, winding, it is necessary only to supply a mechanically-secure terminal connection for the cathode side of the added tickler. This can be left up to the ingenuity of the builder. Correct winding polarity should be observed, of course, or regeneration will not result. In practice, the cathode section should be wound in the same direction as the secondary, or grid, winding. Scramble winding of the tickler is permissible, as long as the proper inductive relation is maintained. Regeneration is controlled by R8, brought out on the right side of the cabinet. Adjustment, of course, is required only if the plate voltage should become considerably reduced.

It may be necessary to resort to cut-and-try methods in obtaining a suitable L1 inductance. A standard two-millihenry radio frequency choke suffices for the secondary, or grid, coil, but some experimentation may be necessary to secure sufficient energy

transfer from the primary, or antenna, coil. This latter winding may consist of a choke of somewhat lesser inductance than the one employed for the secondary. It should, of course, be brought into close inductive relation with the latter. In the receiver described, a hand-wound primary gave highly satisfactory results. It is necessary only to devise a suitable form upon which to wind the coil close alongside the secondary. It may be well to describe the particular construction used in this case.

A 1½-inch brass machine screw is run through the adequate opening in the choke used for the secondary. Over the protruding ¾-inch is placed a half-inch piece of fibre sleeving, or tubing. Anything will do, the idea being to build up a suitable core, or form, upon which to wind the primary turns. At the outer edge of the sleeving, away from the choke, a circular piece of flat fibre is placed, after being center-drilled to accommodate the screw. This disc should be of diameter equal to that of the choke coil. The whole assembly then should be made mechanically secure with judicious use of hardware. The finished transformer can be mounted on the chassis in a number of ways, keeping in mind that r.f. losses are comparatively negligible at low frequencies.

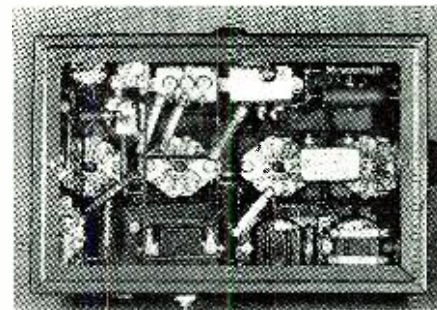

Bottom view of Receiver.

Now, the winding, itself. On the form built up, wind at random a quantity of No. 28 or No. 30 cotton-covered wire, an amount sufficient to fill the space provided between the fibre disc and the secondary choke. Terminals should be provided for the various leads and the completed unit is ready for inclusion in the receiver.

A six-pronged socket, with plug to match, is mounted on the rear of the cabinet and serves to provide means for supplying connections to furnish "B" voltage, 115-volt a.c. for the transformer, and to take the audio from the set. No special arrangement of pin connections is necessary from the insulation standpoint, inasmuch as separation between adjoining pins is adequate for the voltages employed.

A wire approximately one hundred feet in length, including lead-in, and placed well in the clear, will furnish plenty of signal pick-up at locations a few hundred miles from Annapolis. In Western Pennsylvania, an appreciably greater length of wire tends to

cause overloading of the second detector. At relatively great distances from the Naval transmitter, an antenna several hundred feet in length would, no doubt, give an improved signal-to-noise ratio, particularly if the aerial's directional properties could be utilized. At WCED, two hundred miles from Annapolis, the 113-kilocycle signal is so intense that merely grasping the antenna binding post of the receiver will give pick-up sufficient to produce an audible sound.

Should the completed receiver be operated in close proximity to a broadcasting station of great power, that is, within a few hundred feet of the radiating towers, it may be necessary to insert a simple wavetramp in the antenna circuit, tuned, of course, to the frequency of the interfering wave.

-30-

War Plant Sound

(Continued from page 24)

to such a problem would be to install separate Public Address networks, each covering a portion of the area and operated either locally or from some main control room. Large sound projectors operated from high-powered amplifiers are being used at the present and can cover areas up to and including several square miles.

In metropolitan areas, the various buildings, such as hotels, movie houses, etc., should have separate networks controlled from their main office.

One cannot stress sufficiently the importance of protecting our men, women and children from this imminent danger. *Let's act now to forestall disaster and tragedy.*

-30-

Modern Tone Control

(Continued from page 15)

amplifier tube.

At some intermediate frequency (f in Fig. 10), the net impedance of each channel is such that we get a maximum voltage developed across R2. It is at this frequency that the channel gives maximum output.

An outstanding design feature is the fact that the voltage output of one channel can be changed without appreciably affecting the signal output levels of the other channels.

The general output level for all frequencies is governed by the setting of the master gain control preceding the channels. The potentiometers in each channel then become tone controls, each controlling the strength of definite bands of audio frequencies. When all tone controls are set at the same position, the over-all response is perfectly flat.

The lowest peak frequency (f) employed in a sixteen-channel unit is 15 cycles. Each succeeding channel has a peak value about 1.6 times that of



The bomber must be built and the crew must be trained.

In war plants and in training stations throughout America, **BOGEN CENTRALIZED SOUND SYSTEMS** are helping to build the ships and train the men — expediting production, locating vital men instantly, issuing orders and automatic signals and alarms.

May we tell you how?

DAVID BOGEN CO., INC.
663 BROADWAY,
NEW YORK CITY



RADIO OPERATORS' LICENSE MANUAL

1942 EDITION



The most complete and authentic question and answer manual on commercial radio operator license examinations. 1297 questions and answers, 230 pages of vital information for radio operator license candidates.

\$3.00 Postpaid or write for descriptive circular.

WAYNE MILLER

222 North Wells St. CHICAGO

NEW CATALOG

OF SOUND AMPLIFYING SYSTEMS
AUDIOGRAPH Sound Systems represent the latest in Public Address equipment—a complete line plus pre-tested accessories.

NEW LOWER PRICES

Outstanding quality and performance at prices that help you meet any competition.

WRITE FOR YOUR FREE COPY

AUDIOGRAPH

THE FIRST NAME IN SOUND

John Meck Industries—Liberty of Pennsylvania Ave., Plymouth, Ind.

MODEL 1230 SIGNAL GENERATOR



WITH FIVE STEPS OF SINE-WAVE AUDIO

SPECIFICATIONS:

1. Combination R.F. and A.F. Signal Generator, R.F.—100 K.C. to 90 Megacycles, A.F.—200 to 7500 cycles; Sine-Wave, — WITH OUTPUT OF OVER 1 VOLT. All direct reading, all by front panel switch manipulation.
2. R.F. and A.F. output independently obtainable, alone or with A.F. (any frequency) modulating R.F.
3. Latest design full-range attenuator used for controlling either the pure or modulated R.F.
4. Accuracy is within 1% on I.F. and broadcast bands; 2% on higher frequencies.
5. Giant dial etched directly on front panel, using a new mechanically perfected drive for perfect vernier control.
6. Operates on 90 to 130 V. A.C. or D.C. (any frequency).

The Model 1230 comes complete with tubes, shielded cables, molded carrying handle and instructions. Size 14" x 6" x 11". Shipping weight 15 pounds. **\$14⁸⁵**
Only

SUPERIOR INSTRUMENTS CO. 227 Fulton St., Dept. RN-9
NEW YORK, N. Y.

The name is new
... the Purpose
is not Changed

On July 30, 1942,
the stockholders of
HYGRADE SYLVANIA
CORPORATION
voted to change
the company name
to
SYLVANIA
ELECTRIC
PRODUCTS INC.

AS of July 30, 1942, the Hygrade Sylvania Corporation became Sylvania Electric Products Inc.

Needless to say, the change is one in name only.

There is no change in the high quality of our products, no turning from our purpose to bring forth the finest lighting and radio equipment our skill and experience can create.

And that means we will continue to provide you with an incomparable line of radio tubes, backed by all the technical assistance and promotional help you need to do a first-rate selling job.



SYLVANIA

ELECTRIC PRODUCTS INC.

formerly

HYGRADE SYLVANIA CORPORATION

Emporium, Pa.

Also makers of Incandescent Lamps,
Fluorescent Lamps and Fixtures

the preceding value, making the other fifteen peak values 23, 37, 60, 96, 154, 245, 394, 630, 1,000, 1,600, 2,500, 4,100, 6,550, 10,300, and 16,480 cycles respectively. The overlapping responses give smooth control between these peak frequencies, with a maximum possible variation of about 5 db. from one channel to the next.

The overlap, combined with the width of the response curve for each channel, makes it impossible to cut out a frequency completely with one control. Thus, for complete suppression of the response at 15 cycles, the first six tone controls would have to be set at zero. This would drop the response at 15 cycles to 30 db. below the original level, which is just about complete suppression from a practical standpoint.

The latest model of the *Tonalizer* uses an ingenious system of levers to rotate the potentiometers in the channel controls. The levers project from the front panel, and their positions with respect to each other actually trace out the over-all response curve which the unit is giving. A rear view of this model is shown in Fig. 11, and the front panel can be seen in Fig. 8. A front view of a 16-channel *Tonalizer* using ordinary control knobs is shown at the beginning of the article.

Fidelity and stability are just two of the outstanding problems which have been successfully solved in the final design. Neither amplitude nor frequency distortion are introduced—an essential requirement in any instrument which is to correct and check fidelity. Stability and simplicity of operation are such that the unit can be reset accurately to any particular type of response.

Applications

To determine the over-all response of an a.f. amplifier with the aid of the *Tonalizer*, connect the unit between a constant-voltage, variable-frequency a.f. signal generator and the input of the amplifier being tested. The tone control levers or knobs are then adjusted until the output of the amplifier is the same at all frequencies. The settings of the sixteen tone controls now represent the response at the sixteen peak frequencies. From this information, the response curve can be plotted, and R-C equalizer circuits can readily be designed and inserted in the amplifier circuit to give it a flat response or to change the response in any desired manner.

In a similar manner, the response curves of microphones, loudspeakers and phonograph pick-ups can be determined, using a supplementary high-quality a.f. amplifier.

The response of a theater sound system can be adjusted accurately by introducing the *Tonalizer* into the a.f. system, then setting the control levers to give the desired tone balance as determined by listening in the audience when the show is running. From the control settings, the required compensation can be calculated and the neces-

sary equalizer can be inserted the next morning when the show isn't running, with assurance that results of the previous evening will be duplicated.

The *Tonalizer* has been used successfully for trouble-shooting in many large p.a. systems. In one particularly interesting job, a permanent p.a. installation in a church having very poor acoustics, five technicians had tried in turn without success to produce results acceptable to the church directors. All used high-quality equipment having flat electrical response. Tests with the *Tonalizer* showed, however, that this location required a rise of about 20 db in response between 50 and 5000 cycles to offset the acoustic conditions of the church and make the system seem flat to listeners. When R-C equalizers were inserted in the church amplifier to duplicate the *Tonalizer* settings, fidelity was so natural that listeners could scarcely tell whether or not the p.a. system was turned on.

-30-

Disc Recording

(Continued from page 19)

effect. This may be achieved either by suitable networks at the input or in some part of the electrical system within the amplifier. Fig. 4B illustrates a suitable network for high-impedance pickup where the amplifier volume control is of 50,000 or 100,000 ohms resistance. In no case should the resistance be less than 50,000 ohms.

For those wishing flexibility for direct control of the amount of bass-boost, resistors R3 and R4 can be made variable. Be sure that these are completely shielded to prevent hum pickup. Condenser C should be of good grade, preferably enclosed in a metallic tube or inserted into braided copper shielding—the latter being grounded.

Most professionals use a low-impedance magnetic pickup. Suitable input networks are shown in Fig. 5. For best results, the gain control should be equal to the rated impedance of the pickup. The control should, preferably, be of a type that contains a constant load for the pickup on one side and the transformer on the other, such as a "T" pad, or the like.

With the control in the primary as shown in Fig. 5A, the load on the secondary, if there be any, should not be less than 150,000 ohms. The so-called "Ouncer" transformers are suited ideally for this application. If the amplifier is already provided with an input gain control, it should be removed. The transformer secondary should connect directly to the first grid. Fig. 5B shows connections for using low-impedance pickups where additional bass-boost is desired. The volume control should match the impedance of the pickup in all cases. When connected as shown, the load on the secondary should not be less than 150,000 ohms.

Shielding is not critical with low impedance pickups except from the output of the matching transformer to the grid of the first tube. Suitable resistance and capacity values are given for 200 ohm and 500 ohm pickups. These are the values most commonly used.

The introduction of filter networks usually results in a loss of voltage entering the amplifier. As a rule, high-grade pickups require a greater amplifier gain than do the more inexpensive types. This also holds true for crystal units. Consequently more gain must be provided in the reproducing amplifier to compensate for lower input voltages when using high-quality pickups.

In conclusion it should be remembered that a great amount of force is required to swing a reproducing stylus at high frequencies. The hardness of the disc material and the coupling between the groove and stylus is not sufficient to allow the faithful excursions over the contours of the groove. This "coupling" is added to the design of the pickup illustrated with the result that the stylus is able to follow the peaks within the grooves with greater accuracy and is able to avoid many of the short cuts around the peak modulation engraving. Because of the finite size and the use of the burnished edge on the recording stylus, a deterioration takes place of the wave shape with the consequent loss of high-frequency response. This loss of high-frequencies is known as "translation loss." The vibratory systems of some reproducers set up a resonant condition—depending also upon the disc material. On many of the softer discs, this resonant frequency may fall within the range of the reproducer. Naturally this is something to avoid and high grade pickups are designed to do away with this condition.

Gone are the days of the old massive reproducer and its steel needle for transcription work. The trend is to light needle pressure and the use of sapphire or diamond styli mounted permanently or used separately in highly efficient reproducers.

Next month we will discuss the magnetic cutter and show many suitable circuits for correct applications.

(To Be Continued)

Eavesdropping by Army

(Continued from page 10)

outfits never send. They always listen, to both friendly and enemy transmitters. Monitoring American army operators serve the purpose of checking to make sure no one is sending straight messages which should be coded for secrecy, and keeping them on assigned frequencies.

If supposedly secret messages reach the air uncoded, the offending outfit soon hears from its commander. Coded messages, whether Italian, German or

Japanese, are passed on to intelligence authorities for decoding.

How the radio locators are constructed and operated constitutes one of the army's most closely guarded secrets. Without the semi-portable intercepting equipment, and the direction finders, which may be picked up and moved at the drop of a hat, American troops could be spied upon and their movements reported to enemy headquarters if their front line transmitters were allowed to continue to operate.

As it is, only a few minutes elapse after first pickup of the signals until the little black threads mark out the location and action is taken to silence the enemy's aerial voice.

-30-

**U. S. ARMY SIGNAL CORPS
ISSUE COMING FOR
NOVEMBER
Don't Miss It!**

RADIO EXPERTS

NEEDED

- ★ by owners of home sets for service and repair work!
- ★ by broadcasting stations, police departments, air lines, public address system operators, etc.!
- ★ by U. S. Armed Forces, which give higher rating and pay to trained radio experts!

YOU can become a trained radio technician—NOW!

WHEN your Uncle Sam said, "No more new radio sets for civilians!", it meant *increased opportunity* for trained radio technicians to make *big money*—servicing and repairing radios that would normally be "junked."

When your Uncle Sam said, "We're going to blast the living daylight out of the Fascist rats!", it meant that both the Army and Navy needed (*and still need*) trained radio technicians—who get *higher ratings, higher rank, and are much higher paid!*

In addition, radio stations, air lines, police departments and other civilian enterprises still employ many thousands of radio technicians at *good salaries*—and when the war is won, television will probably make radio a new "boom industry"!

So now's the time to mail this coupon, and learn how *quickly* a low-cost I. C. S. Radio Course can fit you for Success and Prosperity in this golden field of opportunities!

Thousands of I. C. S. Radio Course graduates are today earning real money—because their careers were founded on

sound, practical, up-to-date I. C. S. training. IT IS NOT TOO LATE FOR YOU TO FOLLOW THEIR EXAMPLE!

FREE information on low-cost I. C. S. Radio Courses if you mail this coupon at once!

• **EARNINGS INCREASED 50%!** "Very largely as a result of I. C. S. training and your fine recommendation, I am now Engineer for the Pape Broadcasting Company operating Station WALA. I am earning more than 50% over what I made on the old job."

Herman L. Kramm, Mobile, Alabama

• **HEAD OF SERVICE DEPT.** "As a result of completing your course, I am employed as head of Service Department for M— Bros., Inc. I strongly urge any one considering a radio career to enroll now for the I. C. S. Course."

Thornton Hogley, Danville, Illinois

• **COMPLETE AND INFORMATIVE!** "I cannot praise your fine Radio Course enough. It was even more complete and informative than I expected."

W. H. Humphrey, Jr., Chief Engineer, Police Radio, Wilmington, N. C.

MARK AND MAIL THIS COUPON NOW!

INTERNATIONAL CORRESPONDENCE SCHOOLS

Box 8280-X, Scranton, Penna.

Explain fully about your course in the subject marked X:

- | | |
|--|---|
| <input type="checkbox"/> GENERAL RADIO | <input type="checkbox"/> SOUND TECHNICIAN |
| <input type="checkbox"/> RADIO OPERATING | <input type="checkbox"/> SOUND-PICTURE |
| <input type="checkbox"/> PRACTICAL RADIO SERVICING | <input type="checkbox"/> PROJECTIONIST |

Name _____ Age _____

Address _____

City _____ State _____



Send for FREE Ohmite Stock-Unit Catalog No. 18. Very handy for quick reference.



The extras built into Ohmite Resistance Units make them electrically and physically fit for the toughest service. Ohmite units, for instance, were on the planes that bombed Tokyo. They're widely used in ships and tanks, too—in communications and electronic equipment—in research and production—in training centers and industrial plants. It's well worth remembering, when you build original equipment or make vital replacements—today and tomorrow.

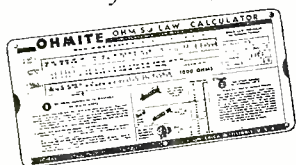

Send 10c for handy Ohmite Ohm's Law Calculator. Helps you figure ohms, watts, volts, amperes—quickly, easily.

OHMITE MANUFACTURING COMPANY
4885 Flournoy Street, Chicago, U. S. A.



For the Record

(Continued from page 4)

R.A.F. Issue of *FLYING*

ONE of our sister publications, *Flying and Popular Aviation*, has just gone to press with a sensational coverage of the activities of the Royal Air Force. Of particular interest to you radiomen will be the feature, "Signals." It tells the complete story of radio activities in the fighting force of the R.A.F. It is profusely illustrated with several equipment shots and we note a great resemblance to our own American radio sets. Radio is one of the prime factors which has made possible the coordinated bombing missions over enemy territories. Without it, such coordination would be impossible. We pass this info along to you ops, knowing that you are vitally interested in radio as it is used by our Allies.

Distinguished Visitors

DURING the past month, we have had the pleasure of being hosts to several outstanding celebrities. Among these have been Col. C. N. Sawyer, Signal Officer, Sixth Corps Area and Col. Arthur I. Ennis, Chief, Public Relations U. S. Army Air Forces. Both of these gentlemen are fully aware of the importance of radio communications in our war effort and we were able to learn much from our interesting conversations with them. They are typical of the type of men under whose guidance lies the destiny of our highly efficient military machine.

Other visitors have been Gene Astry, famous radio and screen cowboy and idol of thousands of young folks; Squadron Leader Ben Travers, Security Officer representing the R.A.F. in Washington and Albert Spenser Allberry, Assistant Press Officer of the Air Ministry in London, who flew over in a bomber from Scotland for the express purpose of writing for the R.A.F. Issue of *Flying*, described above . . . only to mention a few.

A Workable Plan

IN London, you can use your old set in part exchange for a new one. New models are being released for sale when an old set is taken in part exchange. This old equipment will be overhauled and offered for sale in due course, say published sales cards, and guaranteed to operate perfectly. This policy will ensure continuity of supply, continues this sales message. This is a plan that will probably be adopted here when the dealers' shelves begin to empty out. In many communities in the rural areas, where stocks never were too heavy, this trade-in practice will probably be adopted sooner than we felt. This method is unlike the standard practice of simply bringing in a set and receiving an attractive price on a new one. For, in practically all cases, you could buy a new set at the same attractive price, whether or

not you brought in an old set. Today, however, the old receiver becomes an important factor, not as a medium of price barter, but rather as a medium of trade necessity. Today, your old receiver has a definite value . . . and purpose.

Pass This on to Your Customers

F.M. receiver owners are having quite a time in tracking down dipole antennae so essential to the successful operation of F.M. units. Since they are made of aluminum, seamless tubing or hardened copper . . . all metals that have become precious today . . . practically none are being made. And those that are being made or are now available are for some reason or other unusually costly. There are, of course, several sources of supply from whom nominal cost dipoles are available, but unfortunately, those sources of supply are quite meagre. Accordingly, an associated group of F.M. broadcasters have issued a release explaining how to construct one of these dipoles from practically odds and ends around the house. The information is so complete that it's being offered to you.

Here's what they say . . . "What you need, first-off, is two short lengths of copper wire, of as heavy gauge as possible (#12 is nice; #10 is better), three glass or porcelain insulators, some twisted lampcord and a bit of rope. Also if you have a soldering iron around the house, bring it out and heat it up. . . . To begin, you take one of your insulators, and to each end of it, fasten a piece of copper wire. This insulator will form the center of the dipole. Measure out 5½' along each piece of wire, then attach another insulator at the end of each of these wires (being careful when you cut them to allow enough extra wire for twisting around the end insulators). You should now have two pieces of wire of identical length, each measuring 5½' from the center holes of the insulators and separated in the middle by a single insulator. . . . To each of the wires, which form the two halves of your dipole, you should now fasten the feedline which is to run down to the receiver. Get enough of the two-wire twisted lampcord to reach from the place where you intend to hang your dipole to the set. . . . Now, unravel one end of your twisted lampcord for about 8". Bare each of the wires for maybe 2", being sure to scrape them clean. Then scrape the copper dipole wires on either side and right next to the center insulator. To each side attach one half of the lampcord, soldering it cleanly if you have a soldering iron. In any event, make the joint tight, and wrap it with tire or adhesive tape, so that corrosion cannot eventually weaken the connection.

The dipole is now ready for hanging. Hang it from the end insulators with rope, attached between two suitable supports such as trees, house and tree, etc., taking care to keep the dipole out in the clear. It is not advisable to

use wire for this support. Rope is best because at the u-h-f on which F.M. stations operate, any supporting wires might absorb so much of the collected energy that the dipole would not be efficient. The antenna should be hung out in the clear, and facing broadside to whatever stations are to be heard. If the stations are located in several directions, turn the antenna toward the ones that are normally weakest. Take care to see that the dipole doesn't sag excessively in the middle and that your feedline travels away from it at right angles for at least six feet. Don't run the feedline toward the receiver through metal conduits or under any metal gutters. Avoid, too, any large bodies of metal like tin roofs or water tanks. And don't run the feedline parallel to water or gas pipes.

It is not always necessary to install the dipole outdoors. Excellent results may often be attained if you live in a frame house by supporting it inside the attic. Some dipoles are sometimes even mounted on wall moldings directly above the receiver.

Air Raid Devices Circular

"DEVICES for Air Raid Warnings" is the title of a circular letter prepared by the U. S. Department of Commerce, National Bureau of Standards, Washington, D. C., that should be read by every research and developmental engineer and manufacturer. An unusual collection of data

covering such topics as frequency, quality of sound, loudness, ease of coding signal, type of device, effects of weather, directional characteristics and sound intensity measurements, are presented and analyzed thoroughly. Types of air raid warning devices made by various companies, of which there are a dozen, are discussed in a frank and deliberate manner. The bands the devices cover and their respective levels in decibels are shown. In those instances where air is used, signal strength and air consumption are shown for the various sizes made. If you're in the business, and need pertinent data on this vital subject, be sure and locate a copy of this letter immediately. It's known as circular letter LC-865.

Amateurs—Take Note!

HUNDREDS of small sea craft were called into service recently to provide a variety of off-shore to shore contacts. Unfortunately, all of these boats were not equipped with radio, and thus a call went out for all types of low powered transmitters. In the East, many amateurs loaded their transmitters into cars, busses and what have you, and brought them to the local quarters, where Uncle Sam paid a nominal price for them. The need for transmitters and other amateur equipment for other military and civilian defense activities is also acute. Every amateur is urged to visit his

local command and offer what he can . . . and as quickly as he can. Don't delay!

WE have just returned from our vacation where we had the opportunity of visiting many radio men now in the services of Uncle Sam. They are all eagerly awaiting the post-war radio period and many of them are extremely anxious to find their place in the radio industry upon their return to civilian life. They all agree that the future of radio appears very bright and the consensus of opinion seems to indicate that the "electronic age" will revolutionize many of our daily habits. We agree with them.

73, OR

-30-

RADIO

KEEPS THE PUBLIC INFORMED.

★

"Keep 'em playing!"

★★★

MAKE REAL MONEY NOW!
Trained RADIO MEN
Urgently Needed for

WAR WORK

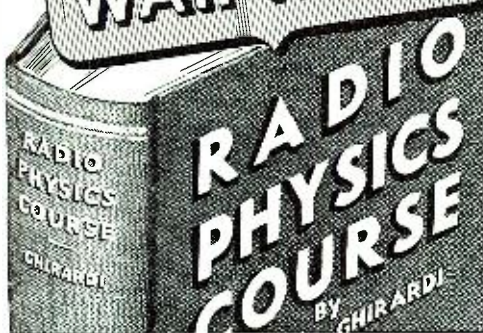

RADIO PHYSICS COURSE
BY GHIRARDI

36 VOLUMES IN 1 BIG BOOK
Complete Training In

Broadcasting systems . . . Sound, Music . . . Electron Theory, Electric Current . . . Ohm's Law . . . Elec. Circuits, Batteries . . . Electromagnetism . . . Inductance . . . Condensers . . . Filters . . . Instruments . . . Receiving . . . V. T. Characteristics and Construction . . . V. T. Detector and Amplifier Action . . . "Super-lights" . . . R. F. Amplifiers . . . Loudspeakers . . . Battery Receivers . . . Power Supply Units . . . Auto and Aircraft Radio . . . Phono Pickups, Public Address . . . Short Waves . . . Phototubes, Television . . . Testing: Servicing . . . Sound Pictures.

GET EXTRA PAY IN ARMY & NAVY

Prepare now in advance of induction or enlistment. Radio knowledge gets you quick promotion, extra pay, more interesting duty. Learn at home from the very same text used and praised so highly by instructors of the Signal Corps, Air Corps, Navy, Coast Guard, ESMDT and leading civilian radio schools.

LEARN RADIO this EASY way . . .

TRAIN AT HOME in spare time . . .

with GHIRARDI'S world-famous

RADIO PHYSICS COURSE

Easy as A-B-C. All in ONE big, 972-page book, the most complete, most highly praised radio training text published. Thousands now making good money in important radio jobs, in industry, thousands more now in the radio divisions of our armed forces, got their basic training in Electricity, Sound, Radio and Television from this famous book that explains step-by-step, everything from simple fundamentals of sound and electricity right through the entire field of radio, photo-tubes, cathode ray and television applications.

GIVES YOU COMPLETE BASIC TRAINING for EVERY branch of radio work—servicing, aviation, broadcasting, electronics, public address, radio manufacturing—in industry or military.

"We find your book by far the best of 20 or more we have tried, both for beginners, and for those who know something about radio. Student praise of it is the highest."—F. S. Bailey, Chief Engr., Radio Operators School, Brownsville, Texas.

A

\$50.00 COURSE

Complete \$5.00 for only \$5.00



Alfred G. Ghirardi:
World-famous authority on radio instruction. For 10 years chief radio instructor of a leading technical school. His books are written so clearly and understandably that radio men the world over have only the highest praise and recommendation for them.

MORE GHIRARDI BOOKS TO HELP YOU

New 2nd Ed. Radio Troubleshooter's Handbook

Ghirardi's famous on-the-job servicing data handbook. Brand new 710-page manual size edition; 400 pages of new charts, tables and data never before published. Servicemen say: "Saves up to 25% of time taken to locate troubles." Pays for itself first day. Only \$5.00

Modern Radio Servicing

Ghirardi's famous big 1300-page How-To-Do-It home-training course in radio repair work. All about Test Instruments, Trouble-shooting, Adjusting, repairing all makes of receivers. 700 illustrations and diagrams, make learning at home easy. Only \$5.00

MAIL NOW!

RADIO & TECHNICAL PUBLISHING CO., Dept. RN92
45 Astor Place, N. Y.

Enclosed find payment for books I have checked (on 5-day trial). I understand that if I am not fully satisfied I may return them at the end of the 5 days and receive my money back.

Radio Physics Course \$5.00 (\$5.50 Foreign)
 Revised Radio Troubleshooter's Handbook \$5.00 (\$5.50 Foreign)
 Modern Radio Servicing \$5.00 (\$5.50 Foreign)
 The Handbook and Modern Radio Servicing at Special Money-Saving Combination Price \$9.50 (\$10.50 Foreign)
 Rush free literature

NAME..... STATE.....
 ADDRESS.....
 CITY.....

TRY IT. 5 DAYS AT OUR RISK

SAVE MONEY ON—
CABINETS, RECORDERS,
CHANGERS, and RADIO PARTS

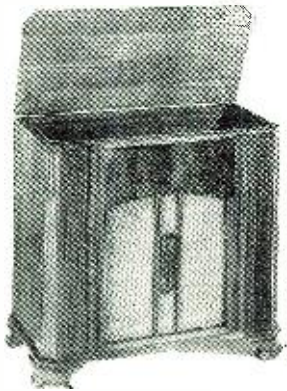

OXFORD TYPE PD. A beautiful hand-
 rubbed, piano-finished cabinet. Made of five-
 eighths stock. Rose Mahogany and Walnut.
 A real piece of furniture 33"
 high, 32" long, 17" deep, Phono
 compartment 31 x 15 x 6"..... **\$2695**



"LAKE SPECIAL" CHANGER-RECORDER
 Magnetic cutting head, crystal pickup, 1 3/4
 ounce needle pressure. 14" wide, 14" long,
 5" high above board. 3" depth below board.
 78 RPM. Records on discs up to 10" in diam-
 eter. Plays all records. Self-starting dynam-
 ically balanced induction motor. Enables you to
 build a combination recorder and record-
 changer in a single unit.
 This month, only..... **\$2495**



Deluxe Changer
 Ideal for small cabi-
 nets. Only 12" x 13"
 x 4 1/2" high. Plays
 10 12" or 12 10"
 records. Crystal pick-
 up, offset record sus-
 pension, reject
 switch, smooth
 action..... **\$1295**

1942 "Velvet Action" Record Changer
 Plays 10 12" or 12 10" records. 14" by 14"
 by 5" high. Crystal pickup. Reject switch—
 automatic or manual change—two point re-
 cord suspension. 115 volt, 60
 cycle. Only 7 seconds to change
 records. Easy to install..... **\$1695**

Victory Special . . . — . . . — V
NATIONALLY-KNOWN, HEAVY
DUTY MOTOR. Silent, dependable, in-
 duction type, self-starting motor; 9" turn-
 table, 78 RPM. Enclosed gears.
 For 110 v. 60 c. \$11.50 List. **\$465**
 Now only.....

New Bargain Bulletin Arouses Nation!
 Gigantic money saving values
 help Servicemen, Jobbers, Radio
 Dealers and Sound Men . . . Everyone
 can save money and help "Keep 'Em
 Listening" . . . Everybody can improve
 their business this easy, money saving
 way. A new cabinet or a new com-
 bination radio and phonograph will
 help make any home a better place to
 live in. We also save you money on
 all radio parts. SEND NOW FOR
 NEW FREE BULLETIN.

LAKE RADIO SALES CO.
 615 W. Randolph St. Chicago

Practical Radio

(Continued from page 35)

numbers of turns, placed near it as shown at (C). The bucking coil is so connected that its magnetic effect equals and opposes that of the main field.

If the coil does not contain very many turns of wire, a condition of little or no self-inductance can be achieved by winding the wire on a very thin supporting form of insulating material as illustrated at (D). Such a coil is practically non-inductive because the opposite sides of each turn of wire lie so close together that their magnetic fields, produced by current flowing in opposite directions, neutralize each other. The sketch of one turn at (E) illustrates the directions of the current flow in each half. This is a simple, practical way of winding non-inductive resistors, extensively used when space permits. It also presents considerable surface area for cooling the resistance wire.

Series and Parallel Inductances

Inductive coils may be connected in series or in parallel. When connected in series, as shown at (A) of Fig. 3, the total effective inductance in the circuit is equal to the sum of the individual inductances (if the individual inductances are isolated magnetically from each other). This is so because each one helps to oppose any change in the common current flowing through the entire system. Thus, for inductances $L_1, L_2, L_3,$ etc., in series (with no magnetic coupling between them),

$$L = L_1 + L_2 + L_3 + \dots \text{etc.}$$

It is common to connect separate inductance coils in series with a circuit to increase its total inductance. Such coils are commonly called *loading* coils. Loading coils are sometimes connected into the aerial or tuning circuit of radio transmitters or receivers for this purpose.

When inductances are connected in parallel with each other, as illustrated at (B), their combined inductance is found from the formula:

$$\frac{1}{L} = \frac{1}{L_1} + \frac{1}{L_2} + \frac{1}{L_3} + \dots \text{etc.}$$

where L is the total or combined inductance of the coils, the individual self-inductances of which are $L_1, L_2, L_3,$ etc. Here again, it is assumed that no magnetic coupling exists between the individual coils.

(Notice that the respective formulae for inductances in series and in parallel are similar to those given in an earlier lesson for resistances in series and in parallel.)

Variable Inductors

Inductors must often be made so that their self-inductance can be varied easily. Many arrangements for accomplishing this have been developed but at the present time, only the few illustrated in Fig. 4 are employed to any extent. The inductance of the coil at (A) is made variable in steps by means of the switch and taps taken from the winding. The inductance is varied by increasing or decreasing the number of turns included in the circuit. At (B) the inductor is made in two parts, placed close together and connected in series.

A mechanical arrangement makes it possible to move them closer together or farther apart to vary the magnetic coupling, and hence the total inductance, between them. This method has the advantage of providing a smooth variation of inductance. In the coil shown at (C), the inductance is varied by changing the amount of magnetic core inserted in the coil. The farther the core is inserted into the coil, the greater is the inductance. This is the method employed for varying the inductance of most iron-core radio-frequency and intermediate frequency tuning coils in modern radio receivers for purposes of receiver circuit alignment. The core is usually moved in and out by a simple threaded screw arrangement. Several compressed powdered-iron cores for this purpose are shown in Fig. 5. They are provided with screw inserts for positional adjustment in the coils.

Mutual Inductance

Part 6 of this series of articles explained how a voltage can be induced in a conducting circuit by means of a magnetic field—the example described there employed the field of a permanent magnet. It is also possible to induce a voltage in a conducting circuit by means of the magnetism produced by current flowing in another electrically *separate* circuit. This can be demonstrated experimentally by the simple apparatus illustrated at (A) of Fig. 6.

One electric circuit consists of the battery connected to a coil of wire through the switch. Placed close to the coil, but not electrically connected to it, is another coil connected to a sensitive current indicating instrument. Every time the switch in the circuit of the first coil is opened or closed, a momentary current will be indicated in the circuit of the second coil. This current is induced by the lines of force, created by the first coil, linking with the turns of wire of the second coil each time the current in the first coil is started, and unlinking from them each time the current is stopped. This simple arrangement constitutes a *transformer*. The coil receiving the original current is called the *primary*; the one in which the voltage is induced by electromagnetic induction is called the *secondary*.

The same action takes place if a source of alternating current is sup-

plied to the primary circuit. No switch is then needed to start and stop the primary current, to make the lines of force link and unlink with the secondary winding, for alternating current itself decreases to zero value twice every cycle. In fact, transformers are commonly operated from a.c. current courses, and then have alternating voltage induced in their secondary windings.

The coil arrangement shown here would not constitute a very efficient transformer, for many of the lines of force produced by the primary (those shown at the left) do not link and unlink with the secondary coil, therefore do not induce in it any e.m.f. These lines are termed the *leakage flux*. To reduce the leakage flux and make the transformer more efficient, the primary coil can be wound on the same supporting form with the secondary, and close to it, as illustrated at (B). Notice that there is less leakage flux now, but the flux may not link with *all* of the secondary turns—specifically, those at the lower end. By winding the primary coil directly over the secondary at its center, as at (C), the leakage flux is further reduced. Practically all the lines of force created by the primary current now cut the secondary coil and contribute toward inducing voltage in it.

The primary and secondary coils at (B) are *loosely* coupled magnetically; those at (C) are *tightly* coupled. Air-core transformers having primary and secondary windings arranged as shown in these two illustrations are commonly used in the radio-frequency amplifying circuits of radio receivers.

The transformers illustrated at (B) and (C) are termed *air-core* transformers because the magnetic field exists wholly in air. If a path through a good permeable magnetic material (soft magnetic steel or compressed iron dust), is provided for the lines of force, they are kept in the desired path and there is less leakage flux. In addition, a core of good magnetic material causes the primary current to create a much stronger magnetic field for the same current and number of turns of wire in the primary coil, and therefore contributes to a higher induced secondary voltage.

A popular arrangement, making an efficient iron-core transformer, is illustrated at (D). Notice that the primary and secondary coils are wound directly over each other for good coupling, and that the iron core provides a good path for the magnetic field. In transformers which are to operate from alternating current sources of low frequencies (60 cycle power line frequencies up to audio frequencies of about 16,000 cycles per second), the core is usually made of thin sheets of silicon steel, punched to shape and assembled as shown. Such transformers are commonly used in the power and audio-frequency circuits of radio receivers. A commercial audio-frequency transformer, removed from its mounting frame, is illustrated in Fig. 7. Notice

the similarity between this and (D) of Fig. 6.

When the iron-core transformer is to operate at higher frequencies, a special compressed iron-dust core is employed because it has lower losses at high frequencies. Such transformers are used commonly in the radio- and intermediate-frequency tuning circuits of portable, automobile, aircraft and many home receivers because they are very compact and contribute a high voltage step-up. A radio-frequency transformer, having a compressed iron-dust core, is illustrated in Fig. 8.

A transformer may have more than one secondary winding; in fact, such transformers are used commonly in the power circuits of a.c. receivers. When they are, the source of power is conveniently the 110-volt a.c. power line. As illustrated schematically at (E) of Fig. 6, and actually in the photograph of Fig. 9, such a transformer consists of a primary winding fed from the 110-volt a.c. power line and several independent secondary windings, all placed on the same magnetic core so the lines of force created by the primary link and unlink with all of them, inducing voltages in all of them. The relation between the primary and secondary voltages in any transformer is simple and definite—it depends directly on the ratio of the number of turns in each winding (if the magnetic leakage is kept very low). For example, if there are twice as many secondary turns as primary turns, the voltage developed across the secondary winding is double that applied to the primary.

Therefore, by properly proportioning the number of turns in the primary winding and the number of turns in each secondary winding, any desired voltages can be obtained from the secondaries. For example, in the transformer at (E), secondary No. 1 develops 480 volts for the plate circuits of the rectifier, secondary No. 2 develops 5 volts for the filament circuit of the rectifier tube, secondary No. 3 develops 6.3 volts for the filament circuits of the remaining tubes in the receiver. Notice that secondary winding No. 1 develops a higher voltage than that supplied to the primary, while the others develop lower voltages. The windings on a transformer of this kind are illustrated in Fig. 9. In the case of secondary No. 1, there is a *step-up* in voltage; in the case of the other two secondaries, there is a *step-down* in voltage.

This illustrates how electrically flexible the transformer is. It can be designed to do practically anything in the way of stepping up or stepping down alternating voltages. Because of this property, the fact that it has no moving parts to wear out, and that it is comparatively inexpensive to build, it is a very important and widely used electrical device in both radio and general electrical work.

(To be continued)

FASTER, BETTER TESTS with RCP VOLT-OHM-MILLIAMETER

Speed, accuracy and economy feature RCP's 3-in-1 Multitester—the Volt-Ohm-Milliameter you need for wartime servicing. Save precious time, save costly errors and—above all—save money. This popular instrument has *everything* required for fast, accurate work, without needless, price-boosting frills and gadgets. Just check a few of its features!

RCP MODEL NO.

423

Complete,
ready to operate
only \$23⁵⁰

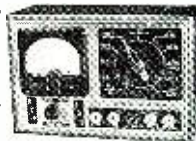

- ★ Three-inch, 2% accurate meter with sensitivity of 2,500 ohms per volt.
- ★ Uniform AC-DC voltmeter sensitivity of 1,000 ohms per volt.
- ★ High ohmmer range 10 megohms. Center to full scale ratio 125. Low ohm scale reads 5 ohms at center and each of first ten divisions read 0.1 ohms.
- ★ Each shunt and multiplier individually calibrated to tolerance of plus or minus 2%.
- ★ Multipliers individually matched in pairs for overall accuracy within 1%.
- ★ Suppressor type copper oxide rectifier for AC measurements.
- ★ Completely self-contained with necessary batteries in hardwood walnut finish case. (Portable model in walnut carrying case at \$25.95 equipped with complete set of test leads.)

Radio City Products Company
INC.
127 WEST 26th STREET NEW YORK CITY

SENSATIONAL SALE! OF WEBSTER RECORDING UNITS!



MODERNIZE YOUR RADIO with this fine recording and playback assembly. Plays records up to 12" dia. Cuts records up to 10" dia. outside-in at 110 lines per inch. 78 RPM induction type motor employs an internal rim-drive to the turntable. Assembly includes 10" turntable, motor, cutting mechanism, crystal cutting head, 1 3/4 ounce low-pressure crystal pickup, with full instructions for connecting to any radio set or amplifier. Size 10"x15". Shipping weight 16 lbs. While they last, only.....

\$16⁹⁵

OTHER SPECIALS

- 8" P. M. SPEAKERS, 12 oz. magnet, 6-8 ohm voice coil, only.....\$2.95
- 12" P. M. SPEAKERS, 18 oz. magnet, 6-8 ohm voice coil, only.....\$5.45

All prices F. O. B. Chicago. C. O. D. orders must be accompanied by a deposit of at least 25%.

**WRITE TODAY
FOR NEW FREE BARGAIN LIST!**

ARROW RADIO CO.
902 W. Jackson Blvd. Chicago, Illinois

BARGAINS IN RADIO PARTS!

*Guaranteed All New
and 100% Perfect...
in Original Packages*

RECORDING DISCS! . . . thousands of Bristol base acetate coated discs . . . amazingly good quality at lowest price for quick sale . . . minimum background noise—coated on 2 sides—non-inflammable . . . With Labels.

6 1/2" in lots of 10. **57c** In lots of 100. **\$5.50**
8 " in lots of 10. **77c** In lots of 100. **7.50**
10" in lots of 10. **97c** In lots of 100. **9.50**

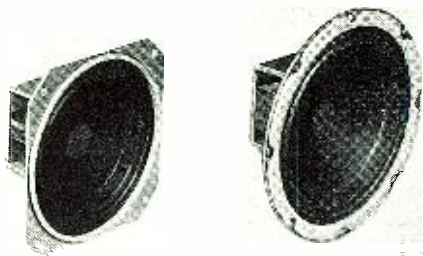

P. M. SPEAKERS!—All new—thousands in original cartons. 4" and 5", good heavy construction. V. C. impedance 3-4 ohms. (Less transformers) 4" at **89c** each. 5" at **\$1.10** each.



ASTATIC CRYSTAL PICK-UPS!—high grade, low pressure pick-up. Statuary brown finish with single hole mounting bracket. Mounting center 7". Plays up to 12" records . . . your new low price **\$2.95** each

SERVICEMEN'S SPECIAL!—10 lbs. Radio Parts Kit. An assortment of controls, switches, coils, variables, resistors, condensers, etc., all perfect and brand new! . . . only **\$2.95**

PUSHBACK WIRE . . . No. 18 . . . stranded . . . assorted colors . . . assorted lengths (one to six feet) . . . exceptional buy . . . per lb. **60c**

FREE! Servicemen write today for free catalog listing thousands of parts bargains . . . hardware and replacement parts.

**WE SAVE YOU MONEY! . . .
DROP A POST CARD TODAY**

RANDOLPH RADIO
609 W. RANDOLPH ST., CHICAGO, ILL.
"Millions of Parts for Millions of Radios"

JOIN THE MARINES!

THE United States Marine Corps needs a large number of officers with electrical background for duty in the supervision and maintenance of radio aircraft warning devices, allied radio equipment and installations.

A call to civilians between 20 and 40 years of age to apply for commissions in the Corps has been issued by the Commandant Lieutenant General Thomas Holcomb.

Candidates for commissions should be able to fill one of the following:

1. Hold a degree of Bachelor of Science of Electrical, Radio, or Communication Engineering or Electronic Physics awarded by an accredited college, or:
2. Hold a degree of Bachelor of Science in any engineering subject and have had reasonable practical experience in radio or electrical work, or:
3. Have successfully completed at least two years of electrical, radio or communication engineering subjects at a college, university or commercial school of recognized standing and have considerable experience in one of those fields, or:
4. Have the equivalent of any of the above by reason of extensive practical experience in the field of radio where the applicant has been connected with the design, erection or maintenance of ultra high frequency radio transmitting or reception.

Men who are commissioned will be sent to an officer's school for three months for an indoctrination course in military training.

Anyone interested in applying for a commission in this specialized field who lives in the Western Division comprising the states of Arizona, California, Colorado, Idaho, Nevada, New Mexico, Montana, Oregon, Utah, Washington and Wyoming is advised to write a letter to Lieutenant Colonel Raymond W. Conroy, Naval Reserve Aviation Base, Oakland Airport, Oakland, California, or The Commandant, U. S. Marine Corps, Headquarters, Washington, D. C.

In this letter a statement of qualifications should be made, and information giving age, full name and complete address should be included.

Applicants must meet other standard qualifications of the Marine Corps.

Air Force Radio Instructors

The new Air Force Technical School, opened recently in Chicago, is in need of hundreds of qualified radio men capable of teaching code, theory, maintenance and operation. Amateurs as a rule are the type possessing such qualifications. Salaries begin at \$1800 annually and men are employed under *Civil Service* for the duration and six months thereafter. Send your qualifications to the school at 720 S. Michigan Ave., Chicago, Illinois, U. S. A.

Airplane Detector

(Continued from page 25)

sections, making almost perfect curves. These sections were triangular in shape, being a bit rounded on the two longer sides.

The bowl measured nearly four feet across the rim and twenty inches deep. Cloth tape was glued over the seams on the outside. Between the seams, stove bolts served to clamp one section to the next. Inside, cracks were sealed with plastic wood and patching plaster. Five coats of paint inside and out make the bowl practically weather proof. A pipe flange on the outside where all the sections come together, makes an ideal binder. A hole was drilled in the bottom of the tureen to let water out.

The pickup speaker was mounted in an inverted position over the bowl, covered by a metal cone to protect the paper speaker cone from the elements. See accompanying photos.

When the unit was completed, it was installed on a tower about 12 feet high on a knoll considerably above surrounding territory. A two-hundred-foot low impedance line connects the pickup with the amplifier in the air raid station proper. An output transformer mounted in an aluminum case fitted with an ordinary phone plug makes it possible to plug into any amplifier. In looking around for an amplifier that would stand 24-hour service, an Ashland restaurant owner donated the use of one that had been built out of an old *General Electric* broadcast receiver. 2A3's were substituted for the original 45's. A 57 was used as an input stage into a 56 driver. The whole thing was transformer coupled. The original power supply and audio transformers were utilized. Plenty of shielding and filtering is necessary as the gain is practically wide open.

Preliminary tests show that the "soup tureen" really does the business. Ground noises have been reduced by 75%. As near as can be determined, planes can be heard at a distance of five miles or even more. So far, local defense officials are very enthusiastic about the setup.

Actual cash outlay, outside of the amplifier of course, was considerably less than \$5.00.

-30-

Leading the Industry

Since 1919

Read RADIO NEWS

-30-

Emergency FM-AM

(Continued from page 9)

vided with these relays.

Although both the fire and flood control systems use the same towers and equipment to a great extent, they actually function independently. Available for both systems are approximately one hundred transceivers for emergency work and about 200 stationary transmitter and receiver units. All equipment is battery operated.

For flood prediction and control, men stationed at thirty-two points along prominent river watersheds report twice daily and hourly during emergencies to a central station by way of the relay stations. The headquarters unit collects the data and makes up and sends out forecasts and warnings. By means of these continuous reports, the *Department of Forests and Waters* can predict flood stages twenty-four hours in advance.

detector for reception. The terminal output is $\frac{1}{2}$ watt.

The tower transmitter receiver consists of two distinctly separate sections built on a single chassis and housed in a small desk cabinet. Both the transmitter and receiver sections are operated in conjunction with a common antenna system and switching is arranged so that the receiver normally connected to the antenna is in continuous operation. The crystal-controlled carrier power is approximately two watts. A single self-restoring key permits rapid changeover to transmitter operation. The transmitter is normally inoperative and arranged to consume no battery power when not in actual use.

A year was spent in the installation of this equipment, with four of the engineers who contributed to the design living in a trailer in the woods during that period and supervising the work.

Many utilities have converted their a.m. installations to f.m., in view of

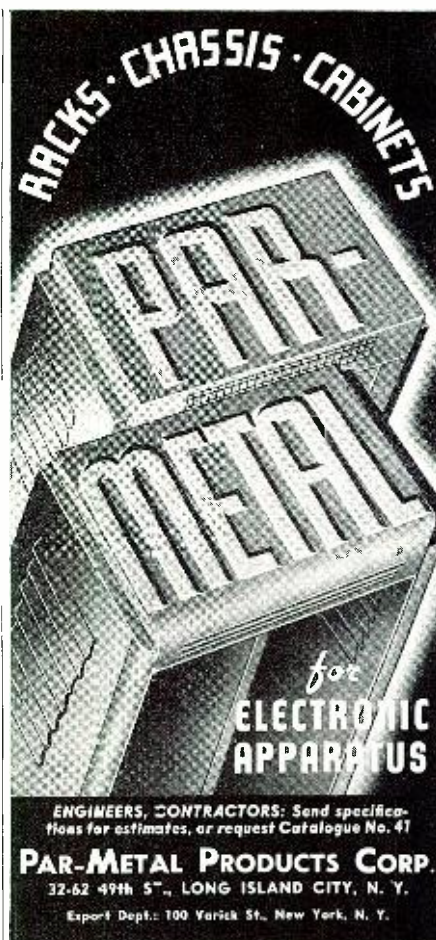

RACKS · CHASSIS · CABINETS

for ELECTRONIC APPARATUS

ENGINEERS, CONTRACTORS: Send specifications for estimates, or request Catalogue No. 41

PAR-METAL PRODUCTS CORP.
32-62 49th St., LONG ISLAND CITY, N. Y.
Export Dept.: 100 Varick St., New York, N. Y.

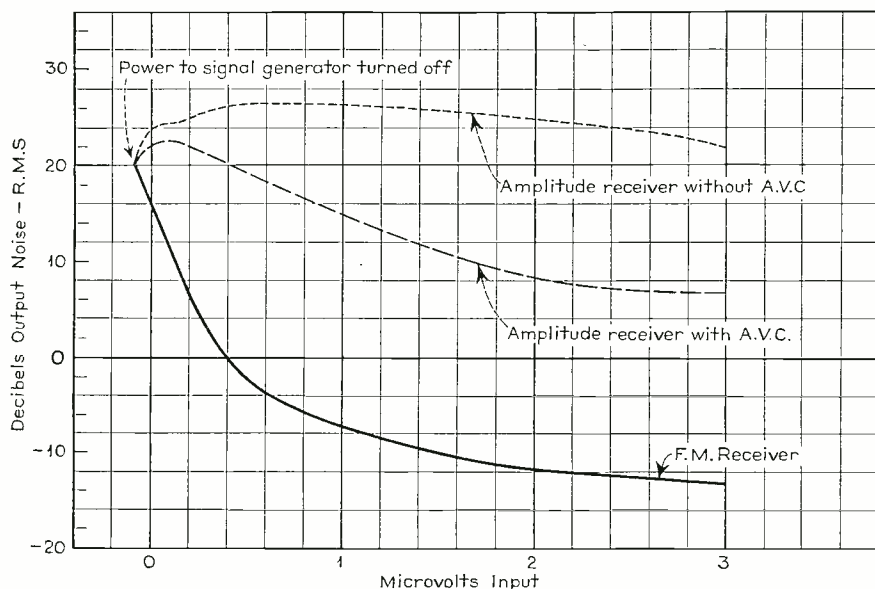

Output tube noise plotted against carrier input level of an FM-AM set.

For fire prevention, there are ninety-seven fire towers, each with receiving and transmitting equipment. These are divided into sixteen districts, inter-related and nominally subject to control from the main station, but with enough authority to handle fires in their own districts.

The portable transceiver is a four tube unit, with a half wave antenna, carbon microphone and a pair of headphones. Its total weight is thirty pounds. A flexible wire antenna is put into service by simply throwing its far end over a tree branch. A two-tube audio amplifier, using types 30 and 31 for input and output respectively, also serves as a microphone input and modulation amplifier for transmission. A pair of 30 tubes are used in a push-pull r.f. stage, to serve as a modulated oscillator for transmission and self-quenched super-regenerative

the f.m. characteristics that are ideally suited to their work. Among those who have "changed-over" are the *Dayton Power and Light Company*. Originally the equipment consisted of a 500 watt fixed station and ten mobile units. The equipment that they are now installing includes one 500-watt, five 250-watt, one 50-watt and twenty-five 35-watt mobile units. The greatest radial distance that they have to cover is about seventy-five miles. That is why it is necessary to use so many fixed stations, spotted at advantageous locations.

The antenna at the Dayton installation is mounted on a 300 foot steel tower, which in turn is supported on the roof of a building seventy-five feet off the sidewalk level. In addition to this, they employ the familiar remote receive pickup system. Their receiver is located about six miles

HELP YOURSELF and YOUR COUNTRY

WE PAY highest cash prices for used communications receivers and transmitters.

If you wish to convert your equipment into cash, contact us at once. You will help win the war because we are supplying the government with equipment.

Write, telephone or telegraph us description of your used receivers and transmitters of standard make; you will be paid cash immediately without bother or red tape.

We also have a store at 2335 Westwood Blvd., West Los Angeles, Calif.

HENRY RADIO SHOP
BUTLER, MISSOURI

"WORLD'S LARGEST DISTRIBUTOR OF COMMUNICATIONS RECEIVERS"

Complete Home - Study Course in sending and receiving RADIO CODE

- a textbook-type systematic treatment of radio code
- with all necessary instructions and practice material
- presenting PROFESSIONAL sending and receiving, the way it is taught in leading radio schools

Use it to learn code from the very beginning—to raise your speed to highest professional requirements—to master this important and better-paying skill in the most convenient and inexpensive way, by home study.

Just Out—Arthur R. Nilson's RADIO CODE MANUAL

Price, only \$2.00

Here is a complete course in radio code—how to send it and how to read it—in practical form for self-study or classroom use. Gives 20 lessons, beginning with simplest code characters and leading up to the handling of actual messages and press dispatches, weather reports, and distress messages.

The 20 lessons are a carefully worked out, progressive series, very similar to courses offered in Navy, Signal Corps, and other radio schools. Each lesson contains instructions and pointers and ample practice material. Besides this direct drill in code, the book also gives you, in 7 other chapters, a great deal of helpful information on training yourself in the code and on becoming a good operator generally.

Shows you:

- how to make your own practice apparatus
- how to fix the code characters in your mind
- how to practice them for quickest progress
- how to develop sending and receiving speed
- how to get past the "plateau of slow learning"
- how to handle messages etc.

10 DAYS' FREE EXAMINATION

McGraw-Hill Book Co., 330 W. 42nd St., New York

Send me Nilson-Radio Code Manual for 10 days' examination on approval. In 10 days I will send you \$2.00 plus few cents postage, or return book postpaid. (We pay postage if remittance accompanies order.)

Name

Address

City and State

Position

Company

MODERN PARTS for MODERN CIRCUITS

THAT HAVE BEEN

"Designed for Application"

CATALOG UPON REQUEST

JAMES MILLEN MFG. CO. INC.
150 EXCHANGE ST. MALDEN, MASS.

RADIO ENGINEERING DEGREE IN 27 MONTHS

Intensive, specialized course, including strong basis in mathematics and electrical engineering, advanced Radio Theory and Design. Modern laboratory. Low tuition. Self-help opportunities. Also 27-month courses in Aeronautical, Chemical, Civil, Electrical and Mechanical Engineering. Participation in Civilian Pilot Training Program. Enter September 8, December, March, June. Catalog.

INDIANA TECHNICAL COLLEGE

732 E. Washington Blvd., Fort Wayne, Ind.

from the main station tower at a very quiet spot, which enables them to operate with the squelch circuit almost entirely open.

The Commonwealth Edison Company of Chicago uses f.m. systems in its twenty-four hour daily vigil of the electric supply of the city. Radio patrol cars cover established "beats," but their itineraries are frequently changed so that their appearance at a specific location at any given time cannot be anticipated. All members of these radio patrols are licensed radio operators.

The cars are always close to major electric production, transmission and distribution centers in the territories they patrol, so that a message from the central radio operator will bring them to any location within a few minutes.

The guards in the cars are deputized by the Chicago Police Department. In addition, a tie-in with the Chicago station of the Illinois State Police affords further cooperation in emergencies.

A Commonwealth Edison Post Defense Corps, formed several months ago, employs f.m. emergency equipment in a variety of important phases. There are four divisions in this corps, each assigned to a definite zone. Eight Edison delivery trucks have been rebuilt to serve as ambulances, while four others have been converted to mobile field conditions. Half of the ambulances have two-way f.m. equipment and have already demonstrated on trial tests their remarkable properties of communications.

In New York, a two-way system, using a.m., speeds along millions of bus and trolley passengers. For the dispatching of these surface lines, a division of the New York transit system employs a fleet of twenty patrol cars. This system relays emergency calls to cruising cars in less than 30 seconds.

Traffic trouble comes in many forms which this radio system helps to solve. When a fire threatened to block the converging point of four bus and trol-

ley lines recently, a radio dispatcher was able to contact three patrol cars immediately. They were sent to the two diversion points and to the fire. As a result all but two of the trolleys were diverted through parallel streets. Had other means of communication by telephone been attempted, hundreds of passengers would have been delayed, traffic would have been snarled and accidents would have resulted. And had the telephone lines been down, the results would have been catastrophic, a condition that might well prevail in wartime too. The surface system serves an area of approximately eight by sixteen miles, with some 1,235 street cars and 300 buses.

Ten of the patrol cars have 15-watt transmitters, as well as receivers. The other ten cruisers have receivers only. There are receiving sets on five heavy duty emergency trucks, one light emergency truck, two line department automobiles and one track patrol car.

The dispatching equipment consists of a 50-watt transmitter with its antenna on top of a building near the heart of the patrolled area. The antenna is 240 feet above street level. It is operated by remote control from the dispatcher's office at the headquarters of the system. At the dispatcher's desk are seven automatic headway recorders which check the time of cars as they pass various control points. A signal board indicates the number of patrol cars in service. A remote control transmitter, receiver, and direct telephone lines to stations of street inspectors constitute the remainder of the equipment at this post.

All receivers are frozen to the specific frequency used by the dispatcher. Radio car drivers ask the dispatcher if they may come in, before they start talking to him. This prevents overlapping of reports. During an average day around a hundred calls are issued. The system, however, is so designed that many times more could be worked in, without straining the service or efficiency.

Another transit system that is using radio successfully is the Cleveland

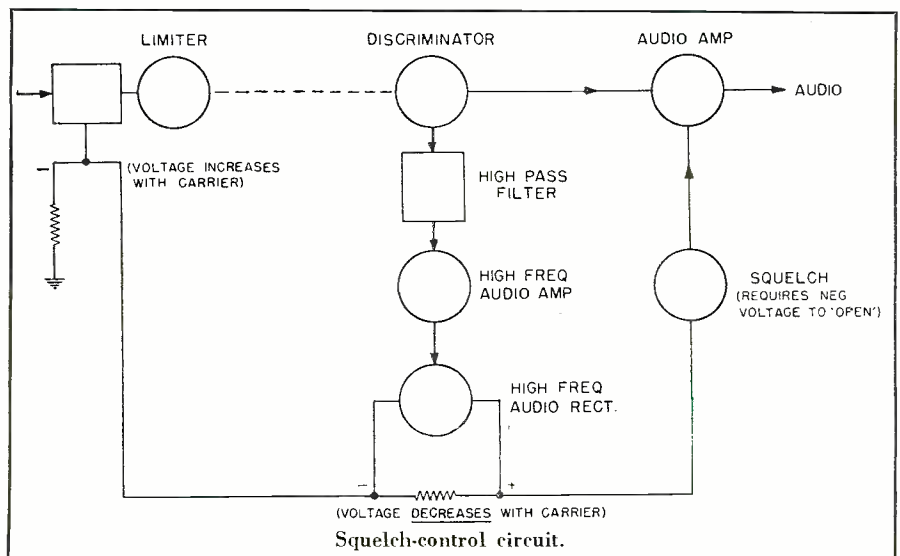

Railway Company. Two-way f.m. with a 250-watt dispatcher and ten 25-watt mobile units constitute the system.

Since the installation of this emergency network, delays in car service have been shortened and in many instances completely eliminated by the ability of the zone supervisors to reach a congested area quickly and restore the flow of vehicles or direct the replacement or repairs of damaged equipment.

Ten zone cars patrol the city and maintain contact with the central office. A 270-foot antenna located on the main building sprays signals effectively over the entire area.

Unique radio service with sea patrols is also now available. At Boston Harbor, two-way f.m. communication between United States quarantine tugs and the Quarantine Administrative Headquarters is a daily practice. The equipment in the vessels consists of a twenty-five watt transmitter and a suitable receiver. Engineers operating this equipment have made tests as far out to sea as 30 miles and report excellent results. Static caused by compressors and other machinery in nearby piers is completely eliminated. Thus far this service has not only afforded the ordinary completion of daily business, but has afforded many emergency contacts, heretofore impossible.

Emergency service for motorists driving through one of Pittsburgh's mile long tunnels is now also available by a system originally designed for broadcast service. The system was made possible by an accidental discovery during the installation of power lines several years ago. It seems as if during the course of some repair work, a wire was strung along the top of each tube and motorists who had better than average receivers found that they could pick up a weak signal. Thus the installation of a permanent system was decided upon. To bring the signals in consistently, an outside antenna and lead-in were found to be required. The obvious location for the outside or pickup antenna was on top of Mt. Washington. Fortunately the buildings containing the ventilating equipment for the tunnels were located on top of the hill, directly above the center of the tunnels. There were air shafts cut from the buildings to the tunnels, 250 feet below. Through these shafts the lead in wires were dropped, and connected to the wires in the tunnels.

In testing, the signals received were found to be quite weak, or less than $\frac{1}{2}$ microvolt. Accordingly a three stage amplifier was designed to offset this loss. This was installed in one of the ventilation buildings. But despite this push, the signals were still too weak. The next step was to install a second wire in each tunnel. This did not help much, since the second wire was too close to the wall of the tunnel, prompting earth absorption. It was then decided to lower the first wires, which had been hung

from the lighting fixtures in the center of each tube. This solved the problem, but not completely. The next decision was to move the outside antenna and amplifier from the top of the hill to the foot, at the Pittsburgh end of the tunnels. Here stations from all five Pittsburgh stations can be picked up without reflection from the hill, and fed directly to the wires inside of the tunnels. This change brought an increase in signal to 60 microvolts.

While this system is for broadcast only, it provides a method of contact heretofore impossible, and extremely essential in emergencies.

In the remote areas of Montana, an unusual emergency radio system is now in operation. Because lines run through inaccessible areas, the *Montana Power Company* operating gas transmission and electric circuit lines, decided to use radio as a means of contact with patrolmen. The units used are extremely portable and are of the transmitter-receiver type used by the Department of Agriculture forest service. In view of the mountainous country, ultra-high-frequencies are not used. And since none of the receivers or transmitters are in the areas of man-made static, equipment using a.m. could be used effectively. Output powers of fixed stations vary from 30 to 12 watts. With these low powers, distances up to 200 miles have been covered with consistency. And since for normal emergency work, it is not necessary to operate farther than 50 miles, there is a large factor of safety. The battery operated portables have an output of $2\frac{1}{4}$ watts. The reason for using low power even on the sets normally operated off the lighting circuits, say the company engineers, is to permit the use of gas line cathodic protection 40 volt d-c generators and batteries as emergency radio equipment power supplies.

One-half wave hertz off-center fed antennae are used for both transmitting and receiving. Future installations will require remote controlled receivers for transmitting and receiving.

In hundreds of cities throughout the Nation, a wide variety of emergency systems similar to those described herein are in effective operation today, affording an unprecedented service . . . a service that means instant action in Peace and War!

-30-

**RADIO TRAINING
FOR THE
NAVY
IN
OCT. RADIO NEWS**

**BUY WAR
SAVINGS
BONDS &
STAMPS**

**Victory
is in the air
WITH
POLYMET**



We are now supplying the Army and Navy contractors with POLYMET Condensers. Uncle Sam comes first with us. However, expansion of our facilities enables us to fill regular requirements with very little delay.

**POLYMET
CONDENSER CO.**
699 E. 135th St.
NEW YORK, N. Y.



FIX ANY RADIO
Amazing New Invention

Simplified
Radio
Servicing
by
Comparison
Method

Learn to repair radios in minutes instead of hours. Revolutionary, different **Comparison** technique permits you to do expert work almost immediately. Most repairs can be made without test equipment or with only volt-ohmmeter. Simple point-to-point, cross-reference, circuit suggestions locate faults quickly and easily.

FOR BEGINNERS OR EXPERTS

Find any radio fault with ease. Follow the comparison tests given on 16 large trouble-shooting blueprints, 112 fact pages. Over 1,000 practical repair hints. Hundreds of simplified tests using a 5c resistor and a filter condenser. Covers every radio set—new and old. Introductory material for beginners and to serve as a review for experienced radio men. Also several chapters on test equipment. Presented in manual form, 8 $\frac{1}{2}$ x 11 inches. Entire plan is stark new and will change servicing methods. Protected by U. S. Copyright.

SATISFACTION GUARANTEED

Take advantage of our "no-risk" trial. Send coupon today. Use this time-saving, money-making radio servicing method for 15 days without any obligations. See how much time you will save every day on every radio job. Learn new short-cuts in radio servicing. Then decide to keep **Comparison Method** Manual or return it and receive a cash refund. You cannot lose—but you owe yourself a chance to look at this plan.

NEW 1942 EDITION

The training will more than pay for itself on the first radio job. Examine and use this unique plan for 15 days at our risk. Send coupon right now—use the plan this week.



Developed by
M. N. Beitman,
radio engineer,
teacher, author,
& serviceman.

TRIAL ORDER COUPON

SUPREME PUBLICATIONS, 323 Jefferson St., Chicago, Ill.
Ship the new manual, "Simplified Radio Servicing by Comparison Method," for examination. I am enclosing \$1.50, full price, send postpaid. I must be satisfied or you will refund my money.

NAME:

ADDRESS:

"Henney" is still an easy book..



WITH OR WITHOUT the aid of a teacher, with or without technical training, "Henney" is on hand in a new edition ready to guide you in easy stages to a working knowledge of radio. Emphasis is on the problems you are likely to face in practice.

PRINCIPLES OF RADIO

Fourth Edition
By KEITH HENNEY
Editor, ELECTRONICS

What's new: The fourth edition of "Henney" contains the latest on detection, ultra-high frequencies, television, radio-frequency amplifiers, vacuum tube detectors, antennas, etc. Considers the applications of radio which are important *now*.

549 pages 316 illustrations
5 1/4 by 7 3/8—\$3.50

ON APPROVAL COUPON

John Wiley & Sons, Inc.
440 Fourth Avenue, New York, N. Y.
Kindly send me a copy of Henney's "Principles of Radio," on ten days' approval. If I decide to keep the book I will remit \$3.50; otherwise, I will return the book postpaid.

Name

Address

City and State

Employed By

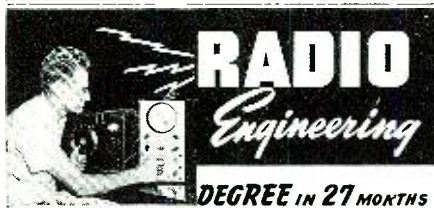

★ Complete Radio Engineering course in 27 months. Bachelor of Science degree. Radio (television, talking pictures and the vast electronic field) offers unusual opportunities. Demand exceeds the supply. Courses also in Civil, Electrical, Mechanical, Chemical, Aeronautical Engineering; Business Administration, Accounting and Secretarial Science. Tuition, living costs low. Distinguished for technical 2 1/4 year courses. Special preparatory department for those who lack required high school work. Enter September, January, March, June. Cosmopolitan student body. 59th year. Write for catalog.

1692 College Ave., Angola, Ind.

TRI-STATE COLLEGE

INVENTORS

PROTECT your idea with a Patent. Secure "Patent Guide" and "Record of Invention" form—Free. No charge for preliminary information. Write today!
CLARENCE A. O'BRIEN and
HARVEY B. JACOBSON
Registered Patent Attorneys
2106-J Adams Building, Washington, D. C.

Book Review (Continued from page 20)

effit of the teacher was not forgotten. Every attempt was made to make the text lucid and practical. This viewpoint has persisted through subsequent conditions. The Fourth Edition has been brought up to date, new problems have been added, new phases of radio science have taken the places of other phases which have disappeared. The book has been in constant use in trade schools, for which it was intended.

In preparing this new edition, the author has not been unmindful of his responsibility. Many men now in uniform will get part of their training from this book; so will many civilians, soon to be in uniform or soon to carry on the essential radio jobs being vacated by men who are leaving them for their country's sake. Many new chapters have been added and the book has been brought up to date in every respect. The very latest antenna systems, for example, are discussed completely. Frequency modulation is covered adequately for all but the advanced student. Short cuts have been used wherever possible and the book appears to be free from constant repetition. Hundreds of illustrations serve to clarify the essential subjects and there is a complete tube table placed where it may serve as an easy-to-get-at reference.

"RADIO OPERATORS' LICENSE MANUAL," written and published by Wayne Miller, 222 N. Wells St., Chicago, Ill. 1942 edition. Price \$3.00. 230 pp.

The questions contained in this book are stated verbatim from the "Study Guide and Reference Manual for Commercial Radio Operators' Examination," as issued by the *Federal Communications Commission*. They represent a scope of material from which examination questions will be prepared. The answers are not to be considered official, but represent the author's opinion of what constitutes reasonable solutions. A few questions can be incorporated in more than one way. In such cases one or more possible conditions are assumed and the answer or answers based on the assumed condition. Ordinary slide rule accuracy is acceptable in all computations; the mathematics used in the solutions are of ordinary high school scope. The answers do not attempt to constitute complete subjects covered, but in certain cases have been elaborated upon in order to provide a basic working knowledge of the fundamental principles involved.

Induction Intercom (Continued from page 27)

chassis. The spring switch and rotary on and off switch are then assembled on the front of the chassis.

Two flashlight batteries were used connected in parallel affording less frequent battery changing. The covers are stripped from these batteries and they are wedged into a holder fashioned from 26 gauge sheet metal mounted under the chassis. The top connections may be made with a spring clip or a soldered connection.

The "B" supply used in this particular unit were two *Minimax* layer built hearing aid batteries which happened to be available at the time for construction. These were mounted with a bracket made of 1/16" brass stock, connections being made with the snap clips used with these particular batteries. If longer battery life is desired, however, the standard 45 volt units common to most portable broadcast receivers may be used. These can be mounted on top of the chassis merely by mounting the speaker closer to the tank coil.

At this stage the oscillator tank coil can be constructed. The hardest task here is to obtain the 2 3/4" bakelite coil form. If none can be obtained, the old oatmeal box or some facsimile thereof can be used. A total of 125 turns of No. 22 enamel wire is used. The tap for grounding the coil is about 32 turns from the plate end. Enough wire can be left at each end of the coil to terminate under the chassis. The coil itself is then mounted by two small angle brackets to the chassis.

The wiring is now completed, with the terminals of the oscillator coil connected across the 500 mmf. padder under the chassis. The 1000 mmf. silvermica condenser is also connected across this padder.

The receiver is sufficiently shielded and bypassed to avoid oscillation, but if this should occur because of close proximity of the large loop, make sure that all grid and plate wiring hugs the chassis, with special precaution taken to wire bypass condensers as close to the tube contacts as possible.

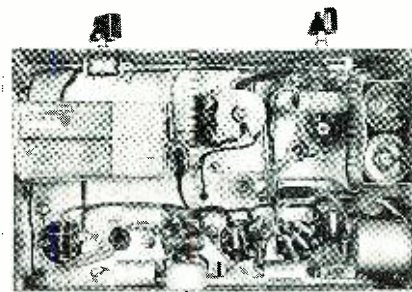

Underside view shows batteries.

Construction of the loop involves some elementary carpenter work, using four pieces of $\frac{3}{8}$ " plywood, two corner pieces and one length of $1\frac{1}{2}$ " x $\frac{1}{2}$ " stock. Two of the pieces of plywood are cut to 17 " x 2 " the other two, $17\frac{3}{4}$ " x 2 ". They are joined together forming a square and held together by angle brackets off to one side. The two wood corner braces are attached with wood screws to two opposite corners. The $1\frac{1}{2}$ " x $1\frac{1}{2}$ " stock of about 4 feet in length is then bolted to each wood brace, the tip sawed off to a point to match the corner of the square.

Seventy-six turns of number 28 wire are then close-wound, beginning the wiring on the side opposite the corner braces and angle brackets. The winding is terminated at two tie lugs to which the loop cable is attached. This loop connector cable consists of about three feet of shielded antenna sleeving with number 32 wire as the inner conductor. The shield is soldered to one of the loop lugs, with the inner conductor to the other. The opposite end of this loop cable is connected to a standard microphone female screw type connector.

Tuning Operations

Aligning the receiver is a rather simple matter and requires the use of a test oscillator capable of supplying a 170 kc. signal. The oscillator is connected to the grid of the 1N5GT r.f. amplifier tube and set for a modulated 170 kc. signal. The i.f. transformer is now resonated for maximum audio signal in the speaker. If an output meter is available it should be used. However, the adjustment is comparatively broad and the ear will suffice for alignment purposes.

After the i.f. transformer is aligned, the next step is to wrap a single turn of hookup wire around the loop and connect the test oscillator across its two ends. The 140 mmf. condenser under the chassis is now adjusted until maximum signal is again obtained.

At this time oscillation may be experienced. It may be necessary to move the loop away from the receiver. If this does not help, the screen voltage of the detector may have to be lowered slightly by inserting several thousand ohms in series with the screen and bypassing with a .1 mfd. condenser. This is usually not necessary and should only be used as a last resort. With the receiver properly aligned, a slight background noise should be heard in the speaker.

The transmitter alignment is next in line, the main objective being to align the transmitter exactly on the same frequency as the receiver. The easiest way to do this is to procure another "B" supply of 90 volts and temporarily connect the positive to the transmitter plate and screen supply, and the negative to the chassis. The transmit and receive switch is left normal or in the receive position.

The test oscillator is now again placed across the hook up wire around

the loop, but it is switched to the unmodulated position. The 500 mmf. trimmer across the oscillator tank is adjusted until a beat note is heard in the speaker. The trimmer is adjusted until zero beat is obtained in the speaker. At this point the oscillator tank will be aligned to the same frequency as the receiver, and since the loop is also resonated at this frequency, it will therefore be tuned to the transmitter. The temporary "B" supply is removed and the unit is ready for operation.

Operation

It is understood, of course, that two of these units, or this unit and a like transmitter and receiver, must be utilized for two-way communication. If it is desired to have one permanent installation, with the other unit portable, the permanent installation may use a.c. or d.c. power facilities for its operation, using 6 volt tubes with a few changes in the circuits. This unit described is merely a basic unit to which the average home radio constructor can add to or change at his discretion. If greater range is desired, perhaps another r.f. stage in the receiver or another linear amplifier output stage in the transmitter may be added.

The most important thing to look for when operating Induction systems is to see that the receiving and sending loops point towards each other. In other words the planes of the two loops should never be perpendicular, especially when they are operated at some distance from each other.

During local storms, some interference may be experienced at the induction field limits. However, this is only occasional and may serve to bring back memories of the days when we sat for hours at our ham rigs trying to pull a weak signal through on twenty meter phone.

When experimenting with induction transmission, it is wise to remember the FCC rule of not permitting the signal to exceed 15 μ v. per meter at a distance of $\lambda/2\pi$.

Make every attempt to obtain a calibrated field strength meter to measure the output of your induction oscillator. If nothing else, stick to low-power receiving type tubes for the oscillator, and try increasing the sensitivity of your receiver if greater range is desired. *Such a meter appeared in the August issue of RADIO NEWS.—Ed.*

-30-

**MORE FEATURES
ON INDUCTION
CONTROL
Next Month**

**IT'S ALLIED ALWAYS
FOR EVERYTHING IN
RADIO AND
ELECTRONICS**



Your ALLIED Catalog is the key to Everything in Radio and Electronics — lists Test Equipment, Tools, Tubes, PA Systems—over 15,000 Radio and Electronic Parts for industrial application, for war use, for instruction, for service replacement. And all this is backed by radio's most complete stocks and speediest service! ALLIED SERVES.

WAR INDUSTRY



American War Industry counts on ALLIED for its Radio and Electronic equipment used in industrial research and production operations. Priority orders are given special attention; quotations covering all Electronic equipment are promptly furnished.

ARMED FORCES



ALLIED is at the service of our Armed forces, supplying thousands of Radio and Electronic items to every branch of the services for active use as well as for instruction purposes. War service has the "green light" first at ALLIED today.

RADIO TRAINING PROGRAM



ALLIED specializes in supplying the needs of War Program Radio Training classes. Our Educational Division has helped hundreds of schools plan and carry out their projects. Radio Training instructors are invited to write for valuable information.

THE HOME FRONT



ALLIED helps to keep American radios working at top efficiency by cooperating with radio servicemen, supplying service data help and replacement parts in a manner consistent with the requirements of the war effort.

**KEEP YOUR ALLIED CATALOG HANDY
FOR EVERYTHING IN RADIO!**

ALLIED RADIO CORP.

833 W. Jackson Blvd., Dept. 1-J-42
Chicago, Illinois

Send me your FREE 1942 Radio Supply Catalog.

Name.....

Address.....

City.....State.....

WHY GROPE?

You Can Get That

BETTER RADIO JOB

—insure your present position with the help of CREI

modern Technical Training in PRACTICAL RADIO ENGINEERING

● Don't play "blind man's buff" with your future! Take advantage of today's opportunities to increase your technical ability . . . not only to meet the demands of your present job, but to rise to a still better job. There are good technical positions for experienced, trained radiomen in manufacturing, broadcasting, aviation and governmental fields. CREI home study course in Practical Radio Engineering will help you to acquire the necessary technical knowledge to qualify for the better, higher-paying positions. Act now!

Write for Details

about CREI Home Study Courses

If you have had professional or amateur radio experience and want to make more money — let us prove to you we have something you need to qualify for the BETTER career-job opportunities that can be yours. To help us intelligently answer your inquiry — please state briefly your education, radio experience and present position.



Free Booklet Sent

CAPITOL RADIO ENGINEERING INSTITUTE

Dept. RN-9, 3224-16TH ST., N. W., WASH., D. C.

DETROLA CHANGER



MODEL 451 Plays 12—10" records and 10—12" records automatically. Easy to install. Size 14½" x 13¼" x 5½" high. List Price \$27.50. **NET \$16.50**
PRICE.....



RECORD PLAYER-RECORDER. Rim drive self-starting induction motor. Size 15" x 10". **MODEL 230. \$16.95**
Quantity limited. **NET.....**

Write TODAY for Free Circular showing changers, chassis, and cabinets available for immediate delivery.

MUTUAL RADIO PRODUCTS CO.
771 ARTHINGTON ST., CHICAGO, ILL.

Aviation Radio

(Continued from page 31)

from vertical antenna are affected to a lesser degree than when emitted from a horizontal antenna, and for this reason pilots are encouraged to take advantage of those stations employing vertical antenna. A great deal of refraction of signals does not take place when vertical antenna are utilized and because they are more or less nondirective can be used to great advantage for homing purposes.

Metal mass reflection is the error introduced by metal structures of an aircraft such as metal wings, propeller, etc. This error (often referred to as "quadrantal error") comes in the form of wave-front distortion but can readily be compensated for.

Improper compass calibration will tend to introduce errors in resultant bearings. After installation the compass installation is inspected and adjusted; and immediately after the adjustments have been consummated, the installation is flight tested. If the adjustments are not accurately made, the errors introduced by carelessness may prove serious. It is therefore mandatory that radio technicians be careful and painstakingly accurate when making compass adjustments.

The rotatable loop should be calibrated throughout the 360° rotation in a manner similar to that of "swinging" the ship's magnetic compass. A beacon can generally be used. Calibration should be made at a distance of one mile or more from the beacon station. The position of the ship with respect to a beacon beam must be such that a steady dash or on-course signal is received.

The following method of calibrating the rotatable loop is given: Take the ship into the clear on the landing field in a clearing away from power lines, all-metal structures such as hangars, etc., preferably in a clearing where it is possible to see the transmitting station. The exact location of the transmitter should be known with respect



Antenna system for azimuth indicator beam.

to the heading of the ship. The ship is headed directly toward the station and a distant object picked out for pelorus sighting. The ship is then placed in flying position with the tail being held up by a dolly with the fuselage in line of level flight. The ship is pointed (longitudinal axis) towards the station. The loop is rotated until the indicating meter (if one is used) is on center scale, and the loop azimuth is set to zero. Calibrations should be made at the frequencies most generally used. With the ship in flying position swing it slowly around (counterclockwise rotation) about a vertical axis taking simultaneous radio compass and pelorus bearings and recording the readings. The pelorus should be situated as close to the loop as possible and readings taken simultaneously approximately every 5 or 10 degrees of rotation while the ship is swung through at least two complete revolutions. The results of the calibration are plotted on a calibration chart similar to the one shown in Figure 1.

After it is determined which reading is to be taken off the loop azimuth scale, corrections are applied to the reading using the calibration chart; the ship's compass is consulted and the true bearing obtained. After three

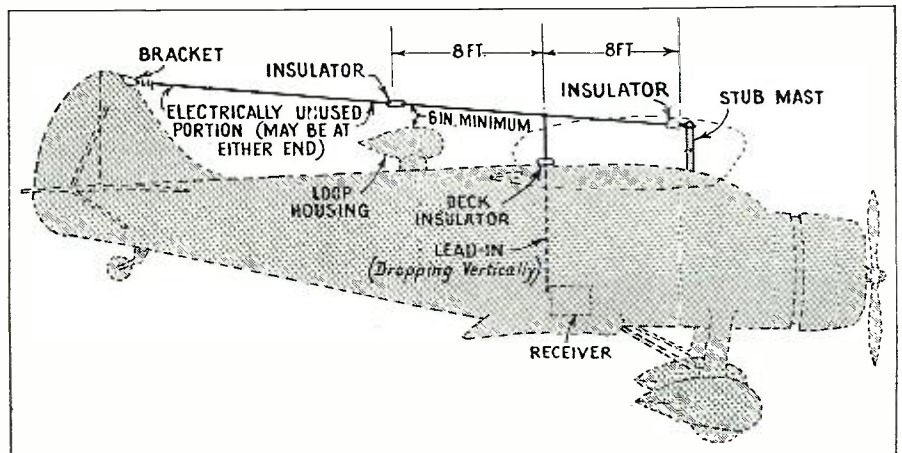

T antenna and loop installation.

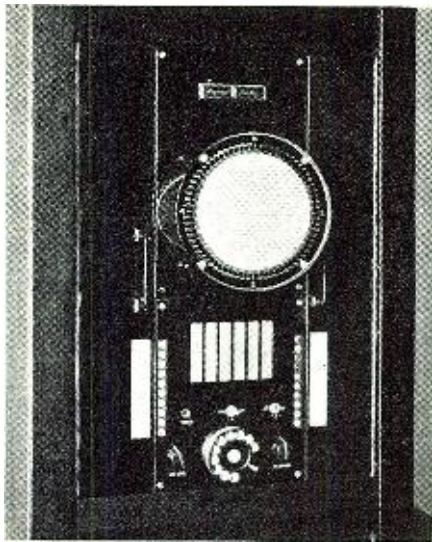

Azimuth indicating receiver.

true bearings are obtained (two may be used) they are plotted on a map of the area now flown, using a protractor. Where the lines intersect on the map, we will find our position fix.

The early type compasses were nearly all aural null type indicators. That is, headphones were used to determine zero signal or null position. However, due to the amount of noise encountered in the average aircraft it was found that the L-R type compass (visual indicator) was more accurate.

The need for applying corrections to the relative bearing obtained from the loop azimuth scale, etc., have been eliminated by the automatic DF unit. With the older types of compasses it was necessary that some time be spent in arriving at the true bearing and necessitated the manipulation of the loop antenna, adjustment of various controls, and allowed the pilot little time to do anything else.

The L-R type compass employs both the loop and non-directional antenna, an indicator of the zero-center design and is a fine instrument for homing purposes. The operation of the L-R compass is as follows: a station is tuned in (preferably at the aircraft's destination); the loop oriented properly, plane toward bow; and the ship flown until the needle comes to center or zero. If the plane goes to the left, flying farther to the left will bring the needle back to zero or on-course position. If the ship goes to the right, the ship is flown right until the needle

Tuning azimuth receiver.



again centers itself. By keeping the needle on center and making proper calculations for drift, an aircraft can be flown directly to a station. If an aural indicator (not recommended) is used the plane is flown so that minimum signal is always heard; by noting signal intensity as the plane drifts to the right or to the left it is possible to make certain whether the ship is going forward or in the reverse direction. (Remember our 180° ambiguity.)

The automatic radio compass (ARC) or direction finder, seems to be superseding the R-L and aural types of compass. (Figure 2 shows a complete ARC, Model MN-31 manufactured by Bendix Radio.) By employing two of these compasses, it is possible for a pilot to fly a straight line between two designated points. These points are of course radio stations. One receiver is tuned on a station in back of the aircraft and one station is tuned to a station ahead and on-course. Drift is automatically compensated for and without the aid of other instruments a pilot can travel from one station to another (right across the United States) by using only his dual compasses.

No mystery surrounds the ARC. All circuits are conventional but highly complex and it takes more than a man of ordinary experience to service these intricate instruments. Proper instruments must be used to properly adjust the ARC and one slip of the wrist can make the whole installation inoperative.

The ARC consists of five units: the radio compass unit, the bearing indicator, the remote control unit, automatic loop unit, and the loop director unit, as illustrated in Figure 2. Employing both a vertical and loop antenna the 180° ambiguity in direction is eliminated; and immediate bearing indications are read directly off an azimuth scale of the bearing indicator unit. Time is an all-important element in modern day flying and the least amount of work necessary to operate accessory equipment is highly desirable. With the ARC it is only necessary that the unit be tuned to a station, noting minor corrections in direction and reading the azimuth scale.

Two signals are fed into the radio compass unit, i.e., one from the vertical antenna and one from the loop antenna. These two signals are shifted in phase, then combined and utilized

Azimuth plane set. (Fig. 3)

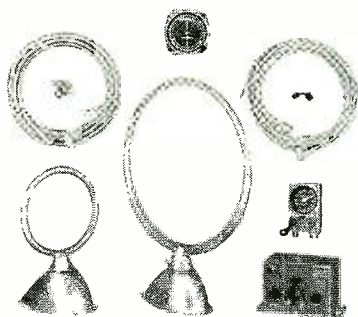

VELOCITY P.G. DYNAMIC

THE FINEST MICROPHONES

AMPERITE

FOR PUBLIC ADDRESS & RECORDING

MICROPHONES THAT SURPASS THE HIGHEST REQUIREMENTS OF BROADCASTING, PUBLIC ADDRESS, AND RECORDING

KONTAK MIKES

Write for Catalog

AMPERITE COMPANY
561 BROADWAY • NEW YORK, N. Y.

SPRAYBERRY RADIO TRAINING

includes

FULL EQUIPMENT

Experience Easily Acquired at Home

You Do Practice-Giving Experiments. Many Special Features . . . ALL Designed to Help You Make Fast Progress.

SPRAYBERRY Training starts right at the beginning of Radio. You easily learn Television, Frequency Modulation, Signal Tracing, Mobile Radio (Auto, Truck, Aviation Radio), Electrons, Facsimile Radio, Radio Set, Repair and Installation work.

Training Prepares You for a Business of Your Own . . . Or Good Radio Jobs at Excellent Pay

The great fast-growing and progressive field of Radio offers many opportunities to the man who wants to get ahead. My Training is designed to give you quick access to these opportunities. SPRAYBERRY Methods are thorough and practical. Your Training will not interfere with your present work. No previous experience is needed.

You Get a Dual-Purpose Radio Set I supply you with Radio Parts which you use to gain pre-experience in repair work. These same Parts are used as a Modern Signal Generator and for Signal Tracing, Electric Eye Tube, etc.

Earn While You Learn My BUSINESS BUILDERS show you how to put your equipment to actual use in handling money-making Radio Service Jobs shortly after you begin Training.

THE SPRAYBERRY COURSE IS SOLD UNDER MONEY BACK AGREEMENT

RUSH COUPON for BIG FREE BOOK

SPRAYBERRY ACADEMY OF RADIO
F. L. Sprayberry, President
525-J University Place, N. W.
Washington, D. C.

Please rush my FREE copy of "HOW TO MAKE MONEY IN RADIO."

Address
Name
City State
(Mail in envelope or paste on penny postcard)

WANTED— RADIO CODE OPERATORS

THE Army, Navy, Merchant Marine and Civilian industry want trained radio code operators right now! Time is money and you can save both by having the Candler System train you right in your own home, the same as thousands of other successful radio code operators. The Candler System has had over a quarter of a century experience training amateur and commercial radio operators. It costs you nothing to investigate and no salesman will call. The Candler course is a proven short cut. It's easy to learn code the Candler way or boost your code proficiency! You can do it right in your own home.

FREE BOOK! Your free copy of Candler's Book of Facts is waiting for you—Write for it today. Tells you all about this easy way to a better position—Gives you all the inside facts—Drop a post card today—There's no obligation.

CANDLER SYSTEM CO.
Box 928
Dept. N-9, Denver, Colorado



Accuracy and dependability are built into every Bliley Crystal Unit. Specify **BLILEY** for assured performance.

BLILEY ELECTRIC CO., Erie, Pa.

NEW! FREE CATALOG

RADIO SOUND ELECTRONICS PARTS SUPPLIES

FAST EMERGENCY SERVICE

WRITE TODAY

The BIG book of BIG values! Everything in standard radio and test equipment. Plus a wide variety of parts for Radio-Electrical and Electronic assemblies. Nationwide service with Teletype connections for speed and dependability. Engineers, laboratory workers, defense plants look to Lafayette for everything in radio. Write for catalog RN942 today.

Lafayette RADIO CORP.
901 W. JACKSON, CHICAGO
265 PEACHTREE ST. ATLANTA

Correspondence Courses in RADIO and ELECTRICAL ENGINEERING

ELECTRICAL ENGINEERING Get good electrical field. Prepare yourself at Low Cost, for secure future. Modern course. So simplified anyone can understand quickly.

RADIO ENGINEERING Extra fine course in radio, public address, photo-electric work. Train you to be super-service man, real vacuum-tube technician. Experimental kits furnished. Diploma on completion.

WRITE Send postcard or letter for Free Copies of school catalogs, full details all about deferred payment plan, etc. **SEND NOW!**

LOW \$25 Either AS Course

LINCOLN ENGINEERING SCHOOL, Box 931-R45, LINCOLN, Neb.

to operate the control circuit which rotates the loop in the correct direction and gives the correct indication of direction, as read off the azimuth scale.

The radio compass unit contains a loop amplifier (used for amplifying loop signals); a 90° phase shifter; a balanced modulator; a superheterodyne receiver; an audio amplifier; an audio oscillator; and compass voltage amplifier. The loop control unit consists of a 400 cycle power supply; a motor control circuit; a thyatron control circuit. Tuning and sensitivity controls are coupled to the superhet receiver and the audio amplifier. The bearing indicator is mounted separately (preferably near the operator).

In many instances, manufacturers produce certain types of receivers which may be used effectively for direction finding by the addition of a loop antenna, vertical antenna, loop amplifier, azimuth scale, tuning mechanisms, etc. As a point of illustration see Figure 3. The equipment shown is the Bendix MN-13 direction finding equipment which may be used with their RA-1 aircraft radio receiver.

The MN-13 amplifier provides for the use of a sense antenna, the output of which is mixed with the signal from the loop to permit uni-directional bearings. The equipment may be used for either bi-lateral or uni-lateral direction finding, with a switch providing the choice. The azimuth control has a specially designed mask which may be used to obtain accurate uni-directional bearings without the necessity of the usual mental calculations.

The procedure followed is to set the switch on the amplifier panel for uni-lateral operation and rotate the loop for maximum signal. The azimuth mask is then set so that the index is over the pointer and a bi-lateral bearing is taken. The mask, which of course does not move with the azimuth pointer, covers all of the azimuth scale except that section within which the proper uni-lateral bearing should fall. Thus the sharp, bi-lateral null indication is used to provide uni-directional indication of bearing.

By employing either a 9- or 18-inch loop (MN-20-MN-24), satisfactory service is rendered depending upon the type desired. The larger loop is approximately four times as sensitive as the 9-inch loop and is therefore better suited for long-distance direction finding. It stands to reason that the greater area available the greater the sensitivity. However, as signals decrease in intensity and as stations are a greater distance from the receiving station the null, of course, will be wider; and as the aircraft approaches the station the null will be much narrower.

Nearly all loop antenna are shielded. When the compass is used as a beacon receiver and a range is flown, static caused by precipitation, snow, ice, etc., the shielded loop will af-

Read **RADIO NEWS**
Published
Since 1919

Classified

Rate 15c per word. Minimum, 10 words

CORRESPONDENCE COURSES

RADIO Communications courses qualifying for all Federal licenses. Home study and resident courses. American Radio Institute, 1123 Broadway, New York, N. Y.

USED Correspondence Courses and Educational Books sold or rented. Inexpensive. Money-back guarantee. Write for Free Catalog listing 4000 bargains. (Courses Bought.) Lee Mountain, Pisgah, Alabama.

CORRESPONDENCE Courses and educational books, slightly used. Sold. Rented. Exchanged. All subjects. Satisfaction guaranteed. Cash paid for used courses. Complete details and bargain catalog free. Write Nelson Company, 500 Sherman, Dept. I-237, Chicago.

MISCELLANEOUS FOR SALE

R. C. A. Oscillator 150 Oscillograph 151. Multi purpose Triple Tester Voltmeter. Tools and bench. R. W. Hoxie, 523 Lake Ave., Worthington, Minn.

KOLORKARD—The most practical Code Memorizing method ever devised. Complete lessons and Material—\$1.00. KolorKard (WSRW) Bluffton, Ohio.

USED Riders Manuals. Roxy Radio Repair Service, Mitchell, S. Dak.

PATENT ATTORNEYS

INVENTORS—Before disclosing your invention to any one send for Form "Evidence of Conception"; "Schedule of Government and Attorneys' Fees" and instructions. Sent free. Lancaster, Allwine & Rummel, 414 Bowen Building, Washington, D. C.

115 MECH. MOVEMENTS—Just what you may need to complete your invention. 48-page illustrated book contains valuable information for inventors. Yours—FREE. Write today. Victor J. Evans & Co., 612-K Victor Building, Washington, D. C.

RADIO ENGINEERING

RADIO Engineering, broadcasting, aviation and police radio, servicing, marine and Morse telegraphy taught thoroughly. All expenses low. Catalog free. Dodge Institute, Elm St., Valparaiso, Ind.

RADIO EQUIPMENT

WANTED: Oscilloscopes, Volt-ohm-milliameters, Vacuum-tube Voltmeters—RCA, Hickok, Supreme, Precision or equivalent makes. Also 0-1 milliammeters and 0-5, 0-10, 0-25 AC or DC ammeters, 3-inch size. Required in War Training. Send equipment for liberal appraisals to Allied Radio Corporation, Dept. 1-J-C, 833 West Jackson, Chicago.

PORTABLE RECORD PLAYER!

FOR SALE—RCA portable phonograph motor and pick-up assembly Model No. M14829, Serial No. P1013. What'll you offer? Box 102, c/o RADIO NEWS, 540 North Michigan Avenue, Chicago.

RADIO TECHNOLOGY

RCA Institutes offer an intensive course of high standard embracing all phases of Radio and Television. Practical training with modern equipment at New York and Chicago schools. Also specialized courses in Aviation Communications, Radio Servicing and Commercial Operating. For Free Catalog Write Dept. RN-42.

RCA INSTITUTES, Inc.
A Radio Corporation of America Service
75 Varick St., New York

RADIO NEWS

HOW TO LEARN CODE

Whether you wish to enter radio as a career or merely add another valuable and fascinating accomplishment to your achievements, the All Electric Master Teleplex Code Teaching Machine will show you how. Teleplex records your sending in visible dots and dashes on a specially prepared waxed paper tape and then sends back to you at any speed you desire. It does not merely show you code. It is code. No experience needed. There are NO PERFORATIONS—NO INK. Far superior to anything ever developed... a marvel of simplicity. While not designated as standard equipment, Teleplex is used at many U.S. Army Posts, Naval Training Stations as well as by the American Tel. & Tel. Co. Also by practically every private school in the U.S. teaching code; and many foreign governments. We furnish you a complete course, including practice messages, the All Electric Master Teleplex, plus a personal service on a low cost, easy terms.

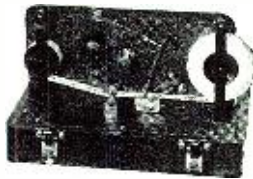

MONEY BACK GUARANTEE. Without obligation write for booklet "R.N.O."
TELEPLEX CO., 107 HUDSON ST. JERSEY CITY, N. J.

BIG FREE CATALOG

EVERYTHING IN RADIO

Sets, parts, supplies, public address systems, amateur equipment, testers, kits and fluorescent lighting at lowest prices. Huge stocks, bought months ago... ready for shipment the same day your order is received. The Defense Program is making big demands on our industry but because of our advance buying we are able to fill your orders promptly and efficiently.

BURSTEIN-APPLEBEE COMPANY
 1012-14 McGE, KANSAS CITY, MO.

RADIO CATALOG NO. 58
 164 PAGES SETS-PARTS SUPPLIES FLUORESCENT
 Burstein-Applebee Co.

New Handy UNIVERSAL REPLACEMENT

Write for Catalog

SOLAR MFG. CORP., Bayonne, N. J.

GOOD JOBS in RADIO for young men age 17 to 20

As older men leave for the Army, RADIO calls for recent high school graduates. Prepare now for jobs in Radio Engineering; Broadcasting; Marine, Aviation, Police Radio; Servicing; Radio Manufacturing. Our streamlined courses give excellent preparation for Army and Navy Service. Expenses low. Write for free catalog.

THE DODGE TELEGRAPH & RADIO INSTITUTE
 409 Monroe St., Valparaiso, Indiana

RADIO COURSES
 Start Sept., Day and Evening Classes

- RADIO OPERATING • RADIO AMATEUR CODE • RADIO SERVICING • RADIO TECHNICIANS

New York Y. M. C. A. Schools
 7 West 63rd Street New York City

COMMERCIAL RADIO INSTITUTE

A radio training center for over twenty years. Well equipped. Excellent faculty. Practical RESIDENT COURSES in Radio Telegraphy, Broadcast, Servicing, Industrial, Television, Aeronautical, Drafting, Mathematics and Studio Technique. Placement Bureau. Day and Evening Fall Classes Now Forming for October 5. Catalog upon request.

Dept. C, 38 W. Biddle St., Baltimore, Md.

ford much quieter operation. If provisions are made for switching the vertical antenna and loop antenna into the input of the receiver separately, the vertical antenna should be used when static conditions are not bad. Another point to remember when using range beams for homing and when a R-L type compass is utilized is that the proper zeroing of the azimuth (proper null) should always be checked. When on the "A" or "N" leg a slight wavering of the needle will be noticed and the adjustment of the compass should be made so that an average "swing" on the needle is obtained. In some compasses this is readily compensated for by a special circuit which allows maximum indication regardless of signal amplitude.

The installation of radio compass equipment should be approached from an exacting angle. The over-all efficiency of the entire installation is dependent upon initial installation standards. The aviation radio technician should familiarize himself with standard installation procedure and prior to installation of equipment with which he is not familiar should consult the manufacturer's manual covering that set.

The antennae system is usually installed first. Armed with the manufacturer's recommendations and the recommendations of the aircraft manufacturer, the technician should have no difficulty in installing the antennae system.

The larger units of the compass equipment are then installed, and may include the receiver, power unit (if separate from receiver proper), remote control units and lastly jack boxes if used.

If the aircraft in which the installation is being made contains other radio equipment such as a transmitter, receiver, etc., the plane will more than likely be properly bonded and various circuits shielded. If no other equipment is found installed it would be wise to check bonding, shielding, and filtering of low power supply circuits.

Prior to installation, all units of the DF should be carefully inspected and, if possible, bench tested. Bench testing each unit will save much time after all parts are correctly placed in the plane.

The shop in which radio compass equipment is serviced and repaired should be a room which is thoroughly shielded by copper screening or metal screening which can be readily grounded at many points. Spurious signals emanating from signal generators used in other parts of the shop will be eliminated by employing a shielded room and will add to better adjustment of the unit.

Common troubles often experienced with radio compass equipment are as follows in the order of occurrence: Sensitivity drops off... check tubes, cleanliness of volume and sensitivity controls, loop connections, cable connections between power units and receiver, etc., (if used); and last, check

SERVICEMEN! Get This Handy New RADIO CHEMICAL LABORATORY

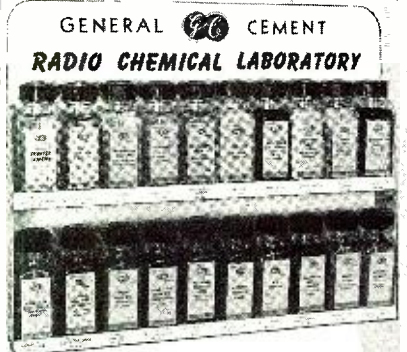

GENERAL CEMENT RADIO CHEMICAL LABORATORY

SAVES TIME—MONEY—TROUBLE
Repair Old Parts with Chemicals
 A real professional outfit! Contains every essential radio chemical and cement—everything you need for instant service on speakers, coils, contacts, dials, volume controls, cabinets, etc. Permanent indexed table for easy use on bench or wall. Every efficient radio man should have this complete Laboratory.

Contains 20 Most Needed Radio Cements and Chemicals
 Twenty large 2 oz. bottles contain cements, solvents, contact cleaners, non-slip dial chemicals, lubricants, insulating varnish, cabinet stains, glue, liquidops, paraffin, etc. Use it a week and you'll wonder how you ever got along without it. Get one today! Dealer net cost only \$4.90 with FREE BACK.

ORDER FROM YOUR RADIO JOBBER

Brushes Attached to Caps



GENERAL CEMENT MFG. CO.
 Rockford, Illinois, U.S.A.

BOOST Service Profits

LOWEST PRICES... FASTER DELIVERY at RADOLEK

Radolek stocks replacement parts to repair any radio—every type of tube, transformer, speaker, condenser, volume control, resistor, auto radio accessories—everything you need at rock bottom prices. And too, Radolek understands service problems—gets your order to you in double-quick time. Order from Radolek for complete satisfaction!

RADOLEK REPAIR SERVICE
 Let Radolek repair your damaged or burned out transformers, coils, speakers, test apparatus, etc. Guaranteed equal to new. Write for prices.

FREE! BIG NEW RADIO SERVICE GUIDE!
 Buying from Radolek means Greater Values, Better Service and More Profits. Send today for the big FREE Radolek Service Guide.

SEND TODAY! FASTER ON A POST CARD

RADOLEK CO., Dept. B-70
 601 W. Randolph St., Chicago, Ill.

Please send the Big FREE Radio Service Guide

Name

Address

DEALER SERVICEMAN SOUND ENG.

SAVE AT RADOLEK



A real good
**PRONG-BASE
 Electrolytic**



● Those Aerovox refinements in prong-base electrolytics are worth noting. Especially so since Aerovox Type F condensers cost no more than other corresponding units. And even more so since you now want your servicing to stand up under the increased hours of wartime listening. So insist on . . .

- Leakproof construction. Soft-rubber-sealed base and prongs prevents seepage of electrolyte and eliminates corrosion, inside and outside.
- Rigid lugs which don't wobble or loosen, because of ingenious Aerovox construction. Lugs are riveted on bakelite disc.
- Positive pin-hole vent instantly responsive to excess gas pressure, yet normally self-sealing against electrolytic seepage.
- Elimination of cathode-shearing trouble, due to square-shoulder can design and cap with rubber gasket resting solidly in place, without sharp edges.
- Adequate choice of voltage and capacitance combinations to meet usual replacement requirements.

● Ask our local jobber for Type F prong-base electrolytics. Ask for latest catalog—or write us direct.



the aircraft's battery. On R-L compasses the indicator will sometimes cease to function or it will give erroneous readings. Check for the following: Weak or faulty tubes; check indicator's coils and exterior connections, faulty loop and vertical antenna connections, then check supply voltages. If the compass seems noisy, check the dynamotor for dirty or worn commutators; check dynamotor's filter; check audio output tubes; check faulty bonding and shielding. In some instances the generator condensers may be open and should be replaced; and voltage regulators may have worn dirty contacts.

If selectivity drops to a low "minimum," check band switch contacts, alignment of tuned circuits and tubes. If volume cannot be readily controlled, check volume and sensitivity controls and make a careful circuit analysis using a signal tracer. If a cathode ray type indicator is used, check supply voltages, sweep circuits, if the unit does not function properly. If bearings seem to be off, check the quadrantal chart's accuracy and if the azimuth scale is of the detachable type, its orientation should be checked by comparing loop settings if possible with a similar installation.

If the radio compass is installed and additional radio equipment is then installed, the quadrantal error introduced by other antenna should be checked. Because additional antenna systems add to the overall metal mass of the aircraft, additional error is introduced which must be compensated for and added to the calibration chart mentioned in the forepart of this lesson.

Direction finding using *Adcock* antenna systems has been and is being successfully used in ground stations. Using the higher frequencies it is possible for a ground station to plot an aircraft's position as much as 1000 miles or more distant. This necessitates transmitting a signal from the aircraft at specific intervals. After the ground station has obtained a bearing it transmits this to the aircraft via radio in flight. Automatic azimuth indicators using a cathode ray tube as the azimuth indicator has proven successful and is one form of DF apparatus.

There no doubt will be many new aids to air navigation introduced during the next ten years. However, it will be much longer until an instrument is found which will have given the pilot the assistance that our present day compasses have already rendered.

It is up to the aviation radio technician to constantly investigate new compass design in order that he may render the efficient service demanded of those who have taken it upon themselves to provide virtually, the "eyes and ears" of our pilots.

(To be continued)

Printed in U.S.A.

PHOTO CREDITS

Page Numbers	Credits
Cover.....	General Electric Co.
6.....	Allison Lighthall
7, 9.....	Hirschburg, Dunlap, General Electric Co.
16, 17.....	General Electric Co.
18	Audak
22, 23.....	The David Bogen Co.
26, 27.....	Piper Studios

Index to Advertisers

COMPANY	PAGE No.
<i>Aerovox Corp.</i>	66
<i>Allied Radio Corp.</i>	61
<i>Amperite Co.</i>	63
<i>Arrow Radio Co.</i>	55
<i>Bliley Electric Co.</i>	64
<i>David Bogen Co.</i>	49
<i>Burstein-Applebee Co.</i>	65
<i>Candler System Co.</i>	64
<i>Capitol Radio Eng. Inst.</i>	62
<i>Centralab</i>	46
<i>Classified</i>	64
<i>Commercial Radio Inst.</i>	65
<i>Corning Glass Works.</i>	48
<i>Dodge Institute</i>	65
<i>General Cement Mfg. Co.</i>	65
<i>Guardian Electric Mfg. Co.</i>	40
<i>Hallcrafters Co.</i>	Third Cover
<i>Hannmarlund Mfg. Co., Inc.</i>	45
<i>Bob Henry</i>	57
<i>Hygrade Sylvania Corp.</i>	50
<i>Hytron Corporation</i>	Back Cover
<i>Indiana Technical College</i>	58
<i>International Correspondence Schools</i> ..	51
<i>International Resistance Co.</i>	39
<i>Lafayette Radio Corp.</i>	64
<i>Lake Radio Sales Co.</i>	54
<i>Lincoln Eng. Schools</i>	64
<i>P. R. Mallory & Co., Inc.</i>	Second Cover & 41
<i>McGraw-Hill Book Co.</i>	58
<i>John Meck, Industries.</i>	49
<i>Wayne Miller</i>	49
<i>James Miller Mfg. Co., Inc.</i>	58
<i>Mutual Radio Products Co.</i>	62
<i>National Company, Inc.</i>	43
<i>National Radio Institute</i>	3
<i>New York YMCA Schools</i>	65
<i>O'Brien and Jacobson</i>	60
<i>Ohmite Mfg. Co.</i>	52
<i>Par Metal Products Corp.</i>	57
<i>Polymet Condenser Co.</i>	59
<i>R. C. A. Institute, Inc.</i>	64
<i>Radio & Tech. Publ. Co.</i>	53
<i>Radio City Products</i>	55
<i>Radolek Co.</i>	65
<i>Randolph Radio</i>	56
<i>John F. Rider Publ. Co.</i>	44
<i>Solar Mfg. Co.</i>	65
<i>Sprague Products Co.</i>	42
<i>Sprayberry Academy of Radio</i>	63
<i>Superior Instruments Co.</i>	49
<i>Supreme Publications</i>	59
<i>Teleplex Co.</i>	65
<i>Triplet Electrical Instrument Co.</i>	47
<i>Tri-State College</i>	60
<i>John Wiley & Sons</i>	60



Panoramic **RECEPTION!** **THE VISIBLE SPECTRUM OF RADIO FREQUENCIES**

Research and development engineering in the Hallicrafters laboratories goes constantly forward . . . keeping ahead of the fast moving pace of today's defense requirements for communications equipment.

Panoramic reception is only one of the many new developments Hallicrafters will be the first to introduce when short wave equipment is again available for civilian use.

the hallicrafters co.
CHICAGO, U. S. A.
Keep Communications Open!

SELECTED for SERVICE



PROUD indeed is Hytron that its HY615 and HY114B have been selected for vitally important service in the armed forces. Built-to-order for exceptional performance on the ultra-high frequencies, these two Hytron designs automatically fell into Class I-A, and were found ideally "fit" for the most grueling combatant service.

FIRST IN PEACE

During peace time, the radio amateur put the HY 615 and HY 114B through their paces. To the HY 615 over one and a half years ago, went the still-unbroken, 135-mile world's record for reception and transmission on 224 mc; to the HY 114B, instantaneous recognition as the tops for battery-operated U-H-F equipment. While records in themselves may mean little, that the HY 615 record has remained unbroken over such a long period of time, added to the fact that the HY 615 and HY 114B were more widely used than any other types, indicates that Hytron U-H-F tubes were in first place before the war.

FIRST IN WAR

Now in war, engineers in the armed forces and in industry have found that the record-breaking performance and the national popularity of these two unique tubes were deserved. The amazing efficiency of these HY 615 and HY 114B tubes has, therefore, been promptly called to serve in many ingenious U-H-F applications designed for VICTORY. Prove to yourself that the same high quality and unequalled engineering design that made these little power houses record performers in peace, make them dependable and efficient in war. Select the HY 615 and HY 114B for your war-time U-H-F applications.

JUST

An Example

Among the host of HYTRON tubes selected for service in the Victory program, the HY 615 and HY 114B furnish but two examples. Consult Hytron first whether your tube needs are for standard receiving or transmitting types, U. S. Government types, United Nations types, or special types designed to fit your particular needs.

HYTRONIC LABS.

SALEM . . . MASS.

Manufacturers of Radio Tubes Since 1921



A DIVISION OF
HYTRON CORP.