

MAY

1942

25c

In Canada 30c

# RADIO NEWS

Communicating with  
Observation Planes

## RADIO IN WAR

ARMY • NAVY • MARINE • CIVILIAN • CAA  
POLICE • AIR-RAID • ENGINEERING • TRAINING



# DAVEGA

AMATEUR DIVISION, 63 Cortlandt St., N. Y., N. Y.  
World's Largest Radio Dealer

## HALLICRAFTERS S-19R

Continuous coverage 550 kc. to 44 mc., four bands, electrical bandspread, built-in 5" Dynamic Speaker, six tubes, built-in line filter.



**\$32<sup>50</sup>**



## Echophone Model EC-3

Now you can buy all these communications features at moderate prices. Echophone, Model EC-3: Crystal filter (four position variable selectivity). Calibrated bandspread, automatic noise limiter. Preselection on all bands. Two stage IF amplifier. Flywheel tuning. Separate 6" PM speaker housed in matching cabinet. CW monitor. 10 tubes. 3 bands. Covers from 550 to 2100 kc.—2.1 to 8.1 mc.—7.9 to 30 mc. Electrical bandspread. Operates on 115 volts AC/DC. Echophone (Model EC-3) \$59.50.

### World's Largest Stock of Recorders and Accessories

Immediate Delivery  
 PRESTO—PROFESSIONAL RECORDERS  
 FEDERAL—PROFESSIONAL RECORDERS  
 WILCOX GAY — PROFESSIONAL Dual Turntable Recorders  
 Recording Discs—  
 10" Aluminum Seconds Lightweight—Dozen \$3.00  
 12" Aluminum Seconds Lightweight—Dozen \$4.20  
 10" Steel Seconds Heavyweight—Dozen \$3.25  
 12" Steel Seconds Heavyweight—Dozen \$4.80  
 Federal 6" Steel—Dozen \$1.00  
 Federal 8" Steel—Dozen \$1.50  
 Stellite Recording Needles—79c  
 Steel Recording Needles—15c  
 No order of less than \$5.00 accepted.

## HALLICRAFTER MODEL S29 Sky Traveler

The Sky Traveler—Take it with you or use it at home. A Hallicrafters designed to communications tolerances—Frequency coverage from 550 kc. to 30.6 mc. (545 to 9.8 meters) on four bands. Self-contained antenna with high gain coupling circuit provides truly remarkable reception throughout its tuning range. 9 tubes. Operates on either 110 volt AC or DC or from its self-contained batteries. 18 lbs. Price.....

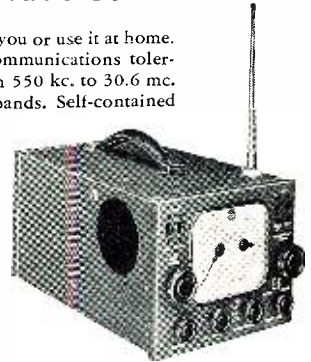

**\$69<sup>50</sup>**

★ *Specials!* ★

GARRARD HT6 Phono Pickup List \$16.00 SPECIAL \$7.50	GARRARD A8C Motor and Turntable Regular \$22.50 SPECIAL \$14.50
--	---

★ Largest Stock of Webster and Erwood Record Changers Write for Special Prices ★

## HALLICRAFTER MODEL SX-28 Super Sky Rider \$179<sup>50</sup>



The new 1942 Super Skyrider Model SX-28 sets a new high in quality performance. 15 tubes, two stages preselection, calibrated bandspread inertia controlled, micrometer scale tuning inertia controlled, Tone and AC on-off, beat frequency oscillator, AF gain, RF gain, crystal phasing, adjustable noise limiter, send-receive switch, AVC-BFO switch, bass boost switch, phono jack, 80/40/20/10 meter amateur bands calibrated, band pass audio filter, push-pull high fidelity audio output, 6-step wide range variable selectivity. \$179.50.

AMATEUR DIVISION  
63 CORTLANDT STREET  
NEW YORK, N. Y.

# DAVEGA



# A FREE LESSON SHOWED BILL HOW HE COULD MAKE GOOD PAY IN RADIO

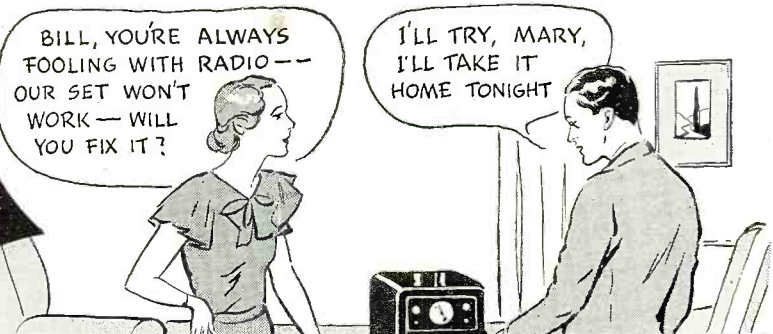

**I will send you a Lesson on Radio Servicing Tips FREE TO SHOW HOW PRACTICAL IT IS TO TRAIN AT HOME FOR GOOD JOBS IN RADIO**



Every man who works on a Radio Receiver, either professionally or as a hobby, should have a copy of my Free Sample Lesson, "Radio Receiver Troubles—Their Cause and Remedy." I will send you your copy without obligation if you will mail the Coupon below. It will show you how practical my lessons are—give you a real idea of the vast amount of information my Course gives you.

**Know Radio as Trained Technicians Know It**  
My Course is thorough, practical. I give you basic training in Radio Theory and Practice—the working principles of both Commercial and Military Radio equipment. You understand your work—know just what to do instead of just relying on mechanical ability to fix a few common faults and make a few simple adjustments. That's why many men who have been in Radio before enrolling report that my Course helped them make more money, win success. I train you, too, for Television, a promising field of future opportunity.

**Beginners Quickly Learn to Earn \$5 to \$10 a Week Extra in Spare Time**

J. E. SMITH, President National Radio Institute Established 27 Years

He has directed the training of more men for the Radio Industry than anyone else.



**More Now Make \$30, \$40, \$50 A Week Than Ever Before**

The Radio repair business is booming now, due to the shortage of new home and auto Radios, offering an unusual number of full-time and spare-time opportunities. Many Radio Technicians have their own Radio businesses. The 832 Broadcasting Stations employ Radio Technicians and Operators. Radio factories are receiving millions of dollars of Government orders. Aviation, Commercial, Police, Ship Radio stations, Public Address Systems are other opportunity fields.

**EXTRA PAY IN ARMY, NAVY, TOO**

Men likely to go into military service, soldiers, sailors, marines, should mail the Coupon Now! Learning Radio helps men get extra rank, extra prestige, more interesting duty at pay up to several times a private's base pay. Also prepares for good Radio jobs after service ends. IT'S SMART TO TRAIN FOR RADIO NOW!

Nearly every neighborhood offers opportunities for a good part-time Radio Technician to make extra money fixing Radio sets. I give you special training to show you how to start cashing in on these opportunities early. You get Radio parts and instructions for building test equipment, for conducting experiments that give you valuable, practical experience. My 50-50 method of training—half with Radio parts I send you, half studying my Lesson Texts—makes learning Radio at home interesting, fascinating, practical.

**MAIL THE COUPON**

Get my Sample Lesson and 64-page Book "Rich Rewards in Radio" at once. They're free. See what Radio offers you as a skilled Radio Technician or Operator. Learn how practical I've made my Course. Read letters from more than 100 men I have trained telling what they are doing, earning. Mail the Coupon NOW—in an envelope or paste it on a penny postal.

J. E. SMITH, President, Dept. 2ER National Radio Institute Washington, D. C.

Mr. J. E. Smith, President, Dept. 2ER National Radio Institute, Washington, D. C.

Mail me FREE, without obligation, Sample Lesson and 64-page book "Rich Rewards in Radio," which tells about Radio's opportunities and explains your 50-50 method of training men at home to be Radio Technicians and Operators. (No salesman will call. Write plainly.)

Name..... Age.....

Address.....

City..... State..... 14X1



# STACKPOLE PRODUCTS SPEED UP PRODUCTION

## SPECIFY STACKPOLE SWITCHES

- Slide Operated Switches
- Rotary Operated Switches
- Toggle Operated Switches

There's a Stackpole Switch for every small circuit use—from single pole, single throw to four pole, double throw—and all combinations between. If you want positive action and sturdy construction, specify *Stackpole* — the little switch that does a *big job!*

## SPECIFY STACKPOLE RESISTORS

- Variable and
- Fixed

For every type of volume, tone and sensitivity control, as well as special applications for other uses. All Stackpole controls are made with materials satisfactory to the various government branches, and available in complete resistance ranges and curves.

## SPECIFY STACKPOLE IRON CORES

- Fixed Inductance
- Variable Inductance
- Station Tuning

Stackpole can supply you with any type of powdered iron cores, with or without adjusting screws. All are superior in mechanical strength and uniform throughout in construction. In requesting samples, please send test coils and complete data.

WRITE for SAMPLES & PRICES  
Sold to Manufacturers Only

**STACKPOLE  
CARBON COMPANY**  
ST. MARYS, PENNA

Vol. 27

# RADIO NEWS

Trade-Mark Registered

No. 5

The Technical Magazine devoted to RADIO in WAR, including articles for the Serviceman, Dealer, Recordist, Experimenter and Amateur

## Contents for May, 1942

### FEATURES

Introduction.....	Lt. Gen. Brehon B. Somervell	9
Radio Industry Goes To War.....	Lewis Winner	10
UHF Antennae in Aviation Radio.....	J. C. Hromada	14
Radio—A Factor in Aviation Safety.....	William E. Jackson	16
What Servicemen Can Do to Aid Our War Effort..	John F. Rider	21
Radio Ski Troops.....	S. R. Winters	22
Radio Training in the Coast Guard.....	Capt. Robert Donohue	25
Alert Receiver Circuits.....	Rufus P. Turner	28
Civilian Air Raid Warning.....	Thomas J. Taaffe, Jr.	30
CAA Radio Equipment.....	Reeder G. Nichols	33
Photoelectrics for Industrial Safety.....	R. E. Appel	36
Our Mechanized Cavalry.....	Stanley Johnson, W9LBV	38
Our Police Radio Telegraph Networks.....	Arnet A. Curry	40
Television: The Wartime Instructor.....	Austin Lescarbourea	42
Leathernecks Pound Brass.....	Capt. John V. Sandberg	44
Radio for Forest Protection.....	Clark E. Jackson	46
Radio for Blackouts and Power Line Failures.	Peter T. Williamson	51

Pictures in this issue were furnished by courtesy of the U. S. Army Signal Corps, U. S. Forest Service, NYA, Acme, OEM, U. S. Marine Corps, N.B.C., Dexheimer-Carlson, Westinghouse and from photos owned by RADIO NEWS.

Copyright 1942  
ZIFF-DAVIS PUBLISHING COMPANY  
Member of the Audit Bureau of Circulation

RADIO NEWS is published monthly by the Ziff-Davis Publishing Company at 540 N. Michigan Ave., Chicago, Ill. William B. Ziff, Publisher; B. G. Davis, Editor; Oliver Read, W9ETI, Managing Editor; Raymond Frank, W9JU, Technical Editor (on leave); William A. Stocklin, Associate Editor; Herman R. Bollin, Art Director; H. G. Strong, Circulation Manager; S. L. Cahn, Advertising Manager, New York Office, 270 Madison Ave. Washington Bureau, Occidental Hotel, Lt. Col. Harold E. Hartney, Mgr. Subscription Rates: In U. S. \$2.50 per year, single copies 25 cents; in South and Central America and U. S. Possessions, \$2.50 per year; in Canada \$3.00 per year, single copies 30 cents; in British Empire, \$3.50 per year; all other foreign countries \$6.00 per year. Subscribers should allow at least 2 weeks for change of address. All communications about subscriptions should be addressed to: Director of Circulation, 540 N. Michigan Ave., Chicago, Ill. Entered as second class matter March 9, 1938, at the Post Office, Chicago, Illinois, under the Act of March 3, 1879. Entered as copy of contributions. All submitted material must contain return postage. Contributions will be handled with reasonable care, but this magazine assumes no responsibility for their safety. Accepted material is subject to whatever adaptations, and revisions, including "by-line" changes, necessary to meet requirements. Payment covers all authors, contributors or contestants rights, title, and interest in and to the material accepted and will be made at our current rates upon acceptance. All photos and drawings will be considered as part of material purchased.

**RADIO NEWS**



Radio Amateurs!  
Radio Servicemen!  
Radio Engineers!

# Be a **RADAR** Specialist with the United States Navy . . .

Here is your opportunity to serve your country and advance yourself at the same time. The U. S. Navy needs 5,000 picked men to install, operate, maintain and repair RADAR equipment—the secret ultra high frequency apparatus used to locate airplanes. If you are an Amateur, Serviceman or Engineer YOU may be eligible.

You go into the Navy as a Petty Officer with food, quarters, uniforms, medical and dental care supplied *plus* pay of from \$60.00 to \$106.00 monthly. After the

successful completion of eight months technical training you are eligible to immediate promotion to the rank of Chief Radioman with pay up to \$175.00 monthly the first year and up to \$200.00 per month thereafter—with opportunities to remain in the service permanently.

Go to your nearest Navy Recruiting Station TODAY (generally in your local post office) and find out how YOU can take advantage of your technical knowledge. **THE NAVY NEEDS YOU!**

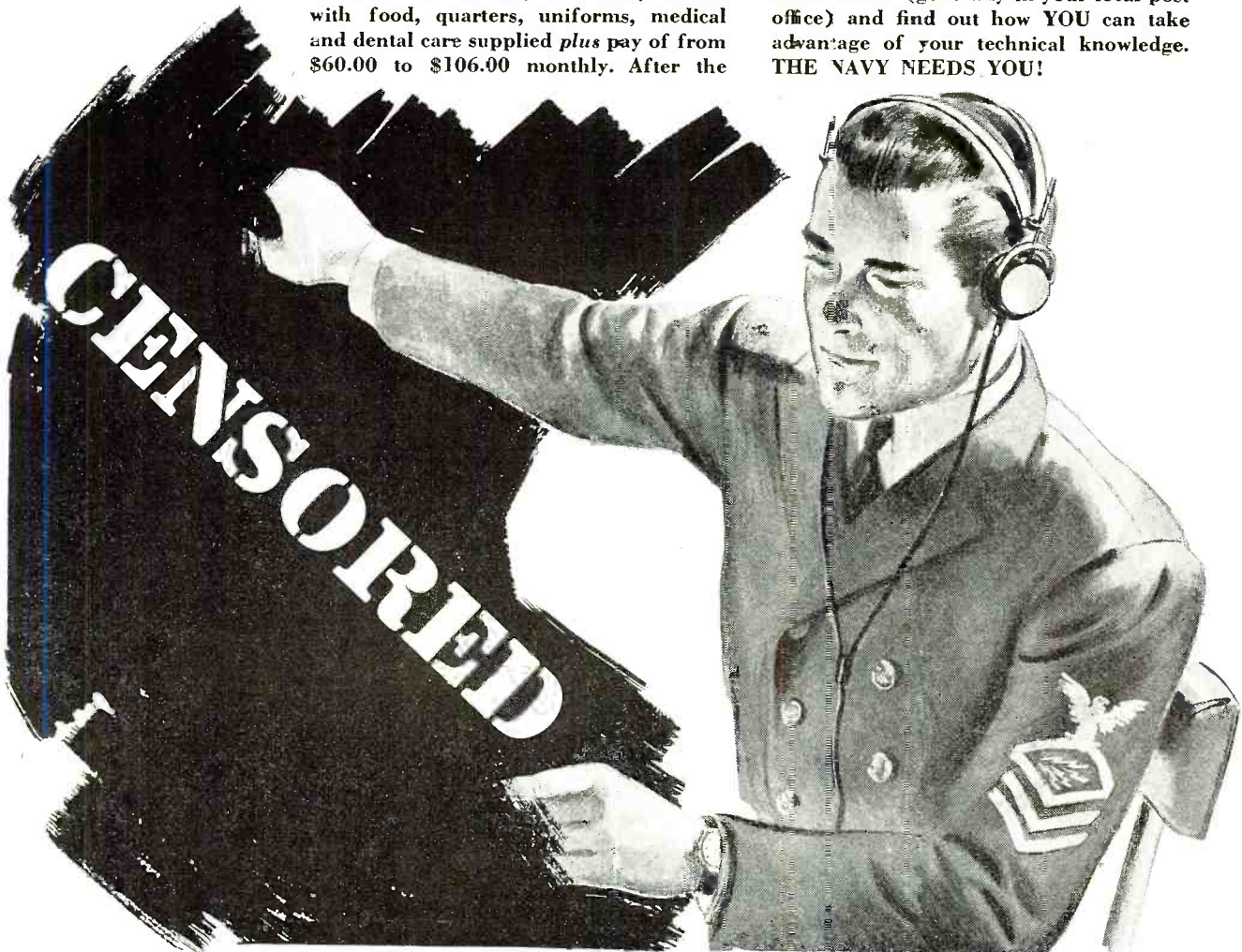

**UNITED STATES NAVY**  
*Ask at Your Local Post Office*



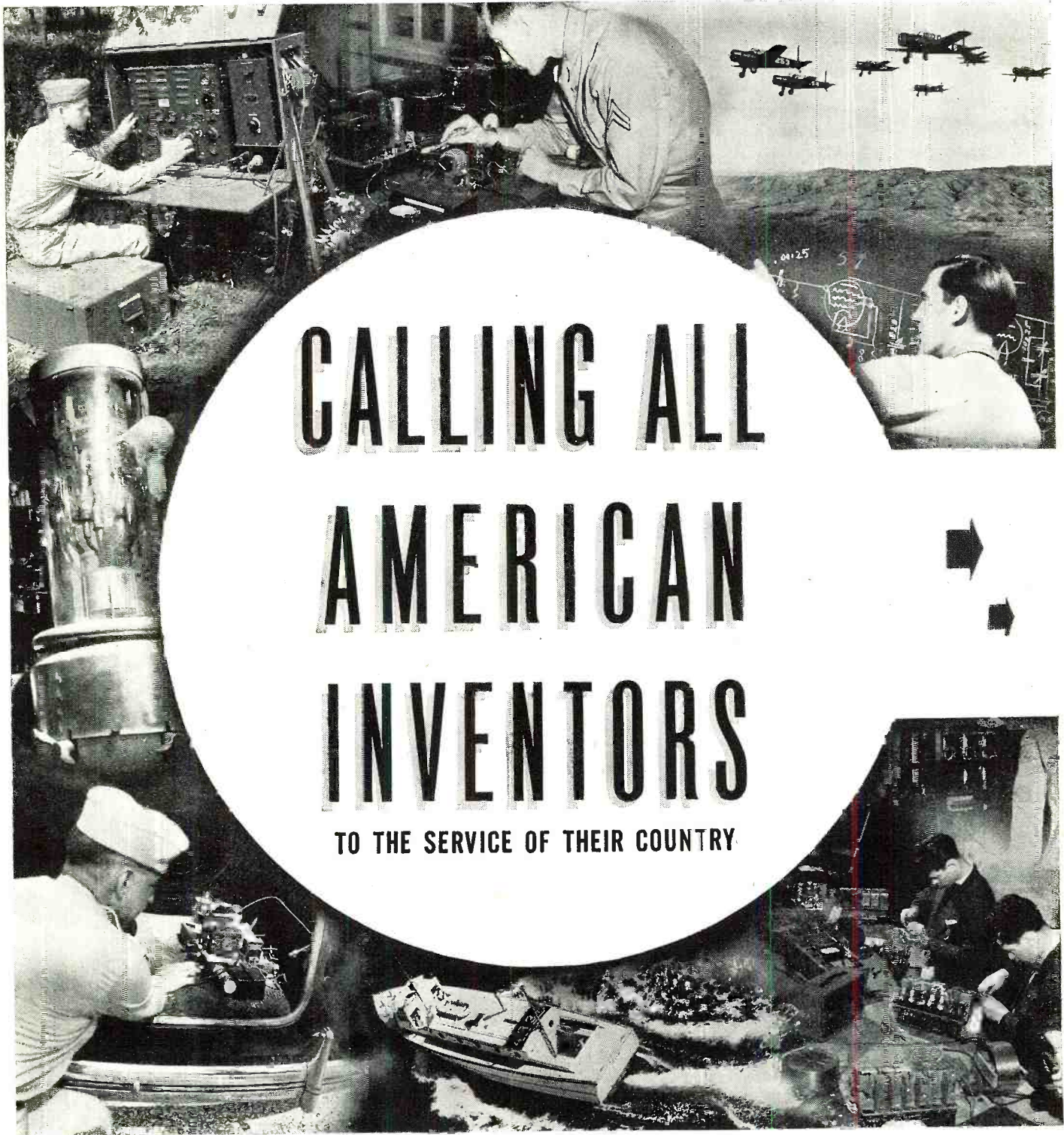

# CALLING ALL AMERICAN INVENTORS

TO THE SERVICE OF THEIR COUNTRY

## THE RULES

1. Any citizen of the United States or of a nation friendly to the United States (except employees of Ziff-Davis Publishing Company or RADIO NEWS and members of their families) may enter the National Competition for Radio Inventions. As many entries as desired may be submitted by each contestant.
2. \$200, \$125 and \$75 will be awarded by RADIO NEWS as 1st, 2nd and 3d prizes respectively, and ten awards of \$10 each will be presented as 4th through 12th prizes. In case of ties, duplicate prizes will be awarded. Honorable Mention designations will go to other entries of outstanding merit.
3. Address entries to National Competition for Radio Inventions, RADIO NEWS, 540 North Michigan Avenue, Chicago. They must be mailed flat, via first class mail. To be eligible, entries must be postmarked not later than midnight, October 1, 1942.

4. Entries must be typed, double-spaced and must not exceed 3,000 words in length. The first page of the manuscript or a securely attached entry blank must bear the author's name and address legibly printed or written and certification of the originality of the invention. Sharp photographs, at least 5x7 inches in size, and/or diagrams, which may be pencilled, may be included with the entry where required. Models may not be submitted save when requested by the judges.
5. While reasonable care will be taken of all material entered in the contest, RADIO NEWS cannot be responsible for loss of or damage to manuscripts or illustrations. Every effort will be made to return material entered in the contest if return postage is enclosed.
6. Inventions now being commercially manufactured or which have been described in detail in any radio magazine in the United States are excluded from the contest because they do not further the contest's efforts to stimulate new inventions.
7. Judges will be P. DeOrto, Assistant Chief Engineer, Belmont Radio Corporation; Albert Williams, Assistant

Chief Engineer, Galvin Manufacturing Corporation, and T. S. Trzyna, Chief Engineer, Quam-Nichols Company. These three, in conjunction with the technical staff of RADIO NEWS will select the prize-winners. All decisions of the judges will be final. Technical value, military and/or civilian application, accuracy of the conception and originality form the basis of the judging. Ideas are more important than professional type of preparation and presentation.

8. RADIO NEWS reserves the right to publish all prize-winning articles providing that (a) publishing of the article would reveal no secrets which might interfere with the writer's obtaining private patents; (b) nothing of military value would be revealed in the published material, and (c) none of the commercial value of the invention to the writer would be lost.
9. All suggestions deemed by the judges to be of value to the United States government or agencies supplying the government with war materials, whether the suggestions are award-winners or not, will be forwarded on behalf of the entrant to the National Inventors Council of the U. S. Department of Commerce with the judges' recommendation.



**SEND FOR YOUR ENTRY BLANK AND**

**ADDRESS: NATIONAL COMPETITION FOR RADIO INVENTIONS,**



# RADIO NEWS ANNOUNCES

## A NATIONAL COMPETITION FOR RADIO INVENTIONS

### THE AWARDS

**\$600**

IN CASH PRIZES!

FIRST PRIZE.....	<b>\$300.00</b>
SECOND PRIZE.....	<b>\$125.00</b>
THIRD PRIZE.....	<b>\$75.00</b>
FOURTH THROUGH THIRTEENTH PRIZES, EACH \$10.....	<b>\$100.00</b>

### THE COMPETITION

This being no time for frivolity, The National Competition for Radio Inventions is just what its name implies: an effort to bring out into the open the finest products of American ingenuity, products that can help our war efforts on the battle fronts, in production, in civilian defense.

If your invention seems in any way suitable for the Army, Navy, Marine Corps, Coast Guard, Civilian Defense, aviation, prevention of sabotage, promoting safety in industry or stepping up war production—then, by all means, *enter it in this competition!* You can't lose by helping your government and yourself. And you may win revenue, honor, and that good feeling of having Served.

Our engineers will study each entry carefully—not solely from the standpoint of its prize-winning potentialities, but also for its practicality. When the soundly conceived material has been weeded out from the impractical ideas, suggestions with merit in advancing the cause of military victory and civilian defense will be forwarded to the *National Inventors Council* of the Department of Commerce, with the recommendation of RADIO NEWS' Board of Judges.

### THE INVENTIONS

Here are just a few of the possible types of inventions that may win awards. This list does not, however, pretend to set boundaries for entries:

**RECEIVERS**—Improved circuits, parts substitutions, simplified design, improved noise silencer circuits, alert receivers, miscellaneous or specialized equipment, U.H.F., short wave, long wave, all wave, broadcast, etc.

**TRANSMITTERS**—Aircraft, ultra-high-frequency, amateur emergency, commercial facsimile, television, etc.

**F-M TRANSMITTERS**—Transmitters for use in military vehicles, aircraft, police, civilian defense, etc. Simplified circuits and methods for obtaining desired results, etc.

**AVIATION EQUIPMENT**—Receivers, transmitters, altimeters, homing receivers, loops, direction finding equipment, etc.

**ANTENNAE**—Directional and non-directional systems, U.H.F. fixed and mobile antennae,

commercial and directional beams, improved radiators for greater coverage, special antennae, etc.

**TEST EQUIPMENT**—Signal generators, vacuum tube volt meters, signal tracers, general meters, special meters, etc.

**FACSIMILE**—Improved methods for transmission and/or reception of existing equipment, preferably using simplified circuits, etc.

**REMOTE CONTROL DEVICES**—U.H.F., control of torpedoes, ships, aircraft, gun batteries and all other equipment used in military and civilian defense or offense. Simplified dial mechanism for control of apparatus over existing telephone or power lines, etc.

**POWER SUPPLIES**—Emergency packs for mobile or emergency use, utilizing existing parts for emergency application, emergency charging circuits, etc.

**FULL DETAILS OF COMPETITION TODAY!**

RADIO NEWS, 540 NORTH MICHIGAN AVE., CHICAGO, ILLINOIS



YOUR COUNTRY URGENTLY NEEDS TRAINED RADIO TECHNICIAN

I'LL TRAIN YOU QUICKLY FOR  
**GOOD RADIO JOBS**  
... CIVILIAN OR MILITARY!

I GIVE YOU FULL RADIO EQUIPMENT  
to do Practice-Giving Experiments!

You Learn Easily in Spare Time  
... at Home or at Camp!

The Sprayberry Course is specially designed for easy understanding. Many practical features are included to help you make fast progress. Beginners need have no fear of "getting lost". The course starts right at the beginning of Radio . . . unfolds each step in a simplified, logical style. You quickly develop a thorough-going knowledge of Radio Set Repair and Installation Work, Mobile Radio (Auto-Tank), Signal Tracing, Aviation Radio, Electronics, Television, Frequency Modulation, etc.

Training Prepares You for a Business of Your Own . . . or Good Radio Jobs at Excellent Pay

Right now . . . more than ever before, Radio offers amazing opportunities for trained men. Curtailment of new Radio set production insures an ever-increasing volume of civilian Radio Service work . . . to keep the nation's home Radio receivers in good working order. Sprayberry training will give you quick, easy access to a profitable business of your own. Or you can choose an interesting, well-paying Radio job in one of the nation's Radio factories at work on Radio and electrical equipment for planes, tanks, ships, etc. These and many more are the civilian opportunities open to you. Should you enter the armed forces, your Radio training will qualify you for a higher rating—better pay and interesting work. Bear in mind, too, if you enter the Service after you start your Sprayberry course you can easily continue your studies at camp as countless fellows are now doing.

No Previous Experience Needed

It makes no difference what your education has been. I can fit you quickly for a good-paying radio job. Your success is my full responsibility. I make it easy for you to grasp Radio principles and remember them. Moreover, your training need not interfere with your present work.

Complete Radio Set...EARN WHILE YOU LEARN

With the Radio Parts given (everything needed to build a Complete Receiver) . . . you conduct interesting, informative experiments . . . with your own hands. Also you are supplied a modern TESTER-ANALYZER. Along with your training you will receive my BUSINESS BUILDERS which will show you how to put your equipment to actual use in handling money-making Radio service jobs shortly after you begin training.

EASY TO START

You can get complete details about my course by writing for my new, valuable FREE CATALOG. Mail coupon. No obligation.

IF YOU REMAIN A  
CIVILIAN OR ENTER  
MILITARY SERVICE . . .  
Radio Training Will  
Enhance Your Future!

• READ THESE LETTERS •

"Grossed Between \$150 and \$200"

"Since finishing your training I've started in the Radio repair business. I have about all the work I can take care of. I have grossed between \$150 and \$200 in the last few months in my spare time. I think your Course is tops." W. Francis Waseka, Fountain City, Wisconsin

"Salary Has Increased"

"Since I have finished your radio training I had to enlarge my laboratory with some new equipment, as I have all the radio repair that I can handle. My salary has increased to 30 to 75 dollars a week. I install transmitter equipment and public addressing systems. Money can not buy the training that I received through your academy. To all young men that are interested in radio training the Sprayberry Training is the only training. You can not go wrong for I am the one that knows." Asa Smith, Post Box 528, Ft. Leavenworth, Kansas.

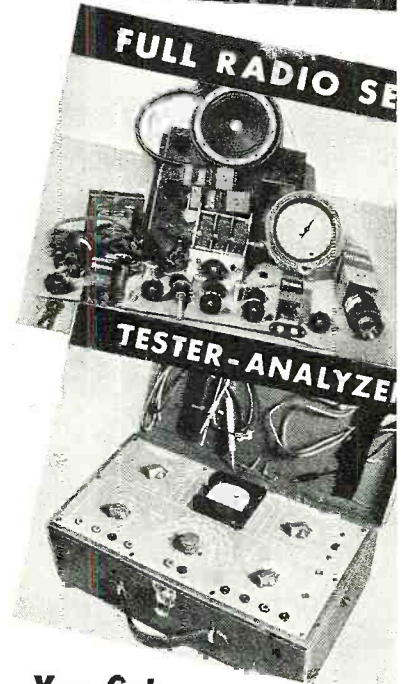

You Get  
PROFESSIONAL TEST  
EQUIPMENT . . . plus

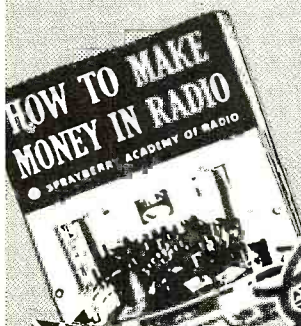

Get **FREE BOOK**

SPRAYBERRY ACADEMY OF RADIO  
F. L. Sprayberry, Pres.  
525-E University Place, N. W.  
Washington, D. C.

Please send me FREE copy of "HOW TO MAKE MONEY IN RADIO".

Name . . . . . Age . . . . .

Address . . . . .

City . . . . . State . . . . .

Tear off this coupon, mail in envelope or paste on penny postcard.







# Introduction

by  
**Lieutenant General**  
**BREHON B. SOMERVELL**  
Commanding General, Services of Supply

ONE of the most crucial phases in the great problem of supplying the armies of the United States with the tools they need to win this war is the procurement of the right kind of radio equipment in sufficient quantities and in ample time to meet the varied needs of our fighting forces. The importance of swift and reliable communications in the modern war of movement cannot be over-emphasized. It is conceivable that upon the proper functioning of a single radio tube may depend the outcome of a battle.

The American radio industry, in cooperation with the Army Signal Corps, has already gone far toward meeting the tremendous challenge which confronts it. It has prepared not only to convert its civilian production to military purposes, but also to multiply its rate of production. The national emergency calls for the full inventive talent of the radio industry, for the kind of management that will make one machine do the work of two, and for long hours and painstaking labor by the men and women at the work bench. From research engineer to machine operator to assembler and inspector, every individual at work in the war-converted radio industry bears a significant responsibility in maintaining the Army's life line of communications.

A handwritten signature in dark ink, which appears to read "Brehon B. Somervell". The signature is written in a cursive style with a large, prominent initial "B".



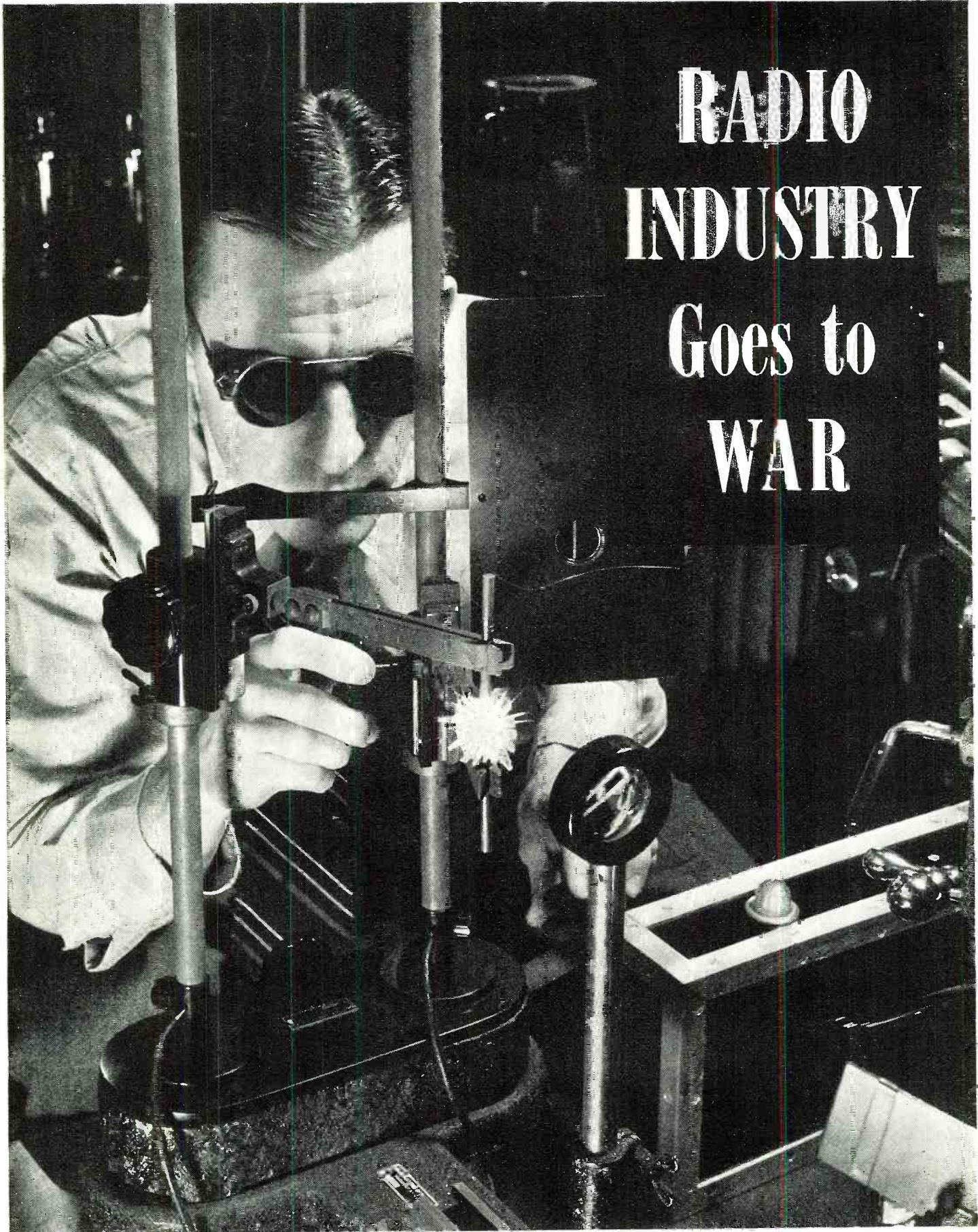

# RADIO INDUSTRY Goes to WAR

This arc welder is representative of the type of skilled labor being employed in the conversion from peace-time to war-time radio production. American radio personnel are meeting the challenge by going on an all-out-for-victory schedule.



# **Equipment produced for our military effort is most unusual in many respects and thus involves revolutionary changes in research, development, and radio production technique.**

by **LEWIS WINNER**

Market Research Engineer

**W**ITH the issuance of the sweeping curtailment order L-44-a, the radio industry takes on the most important job in its history. It takes on an assignment that is unparalleled in its toughness; an assignment that assumes the proportions of a *challenge* to its skill and vision that will be met with only one result . . . success and victory.

Industry is fully aware that in this all-out effort, it will be imperative to develop and produce at a pace unprecedented in any civilian practice. It will be necessary to bear down as never before; change all methods of operation, convert tools, machinery and associated equipment, and train workers in a variety of new duties. In many plants where war production has been in progress in varying degrees, complete changeover has already been effected. In others, immediate steps are being taken to make all the conversion necessary.

Since, of course, it has also been acknowledged that radio is an essential too, its maintenance will be facilitated by the continued manufacture of replacement parts. While the quantity and variety of parts to be made will, of necessity, be restricted, there should be sufficient to maintain suitable receiver operation for an extended period. Thus, some plants will continue to devote a major percentage of their activities towards this manufacture. It is also reliably reported that at least two types of receivers will probably be made in very limited quantities to bridge the gap of receivers that will be relegated to the junk heap and those receivers essential in areas where there are none at present.

This is similar to the practice in Canada, where a few selected companies have been permitted to produce a limited number of receivers, known as the V models. They are of the portable style, having five tubes, and have been advertised in both the trade and popular press. Production here will be spread over an extended period, unless of course, sudden shortages are imminent. And this is likely, if overzealous buyers raid the receiver market. Such a practice might lead to rationing, which thus far has been completely negated in the curtailment plan.

The manufacture of frequency modulation receivers will also be halted by this new ruling, although it is hoped that some relaxation will take place here for the benefit of many areas where only F. M. has been successful in penetrating. This relaxation may

be included in the V set program. Television also receives a jolt with this ruling, although a television conference recently called by the *Federal Communications Commission* may appease the situation.

It is undoubtedly difficult to realize why such harsh and restrictive measures had to be enacted in the radio industry, the products of which are so important to public morale. But when one sees the tremendous demands of warfare and the vast necessities for all types of communication equipment and the vital mission it performs, our own needs do not seem important anymore. Material economies are now most essential, for civilian receiver manufacture last year accounted for the consumption of 10,000 tons of copper, 70,000 tons of steel, 2,100 tons of aluminum and 280 tons of nickel. But most important of all, plant facilities are essential, so essential that many plants outside of radio have had to be recruited for radio work.

The curtailment plan follows very closely that in use in England since January, 1941. At that time deliveries of materials for new sets were stopped, though manufacturers were allowed a small amount of steel to finish some work that had been in progress. From

February to July, there was a ban on the production of tubes. In July, production was resumed and tubes were made for maintenance and replacement purposes, but in 1942 the number of types was limited. Arrangements were made to classify those tubes being kept in production, so that alternative types would be available. For 1942, there is very little possibility that any new civilian receivers will be produced, although replacement parts will be available.

Equipment produced for the military effort is most unusual in many respects and thus involves revolutionary changes in research, development and production. For instance, it is impossible for anyone to imagine the strain experienced by equipment in a screaming dive bomber, or a speeding submarine, or a racing, smashing 60-ton tank. Conditions can be aptly classified as just "impossible," but nevertheless the apparatus just *must* work.

Alibis don't help the pilot, or the sub commander, or the others in the thick of the bullets. Thus, design is an exceedingly complicated matter, involving a material-physical knowledge as well as an extensive application of electrical and radio engineering ad-

This parts manufacturer is now making essential items for aircraft.

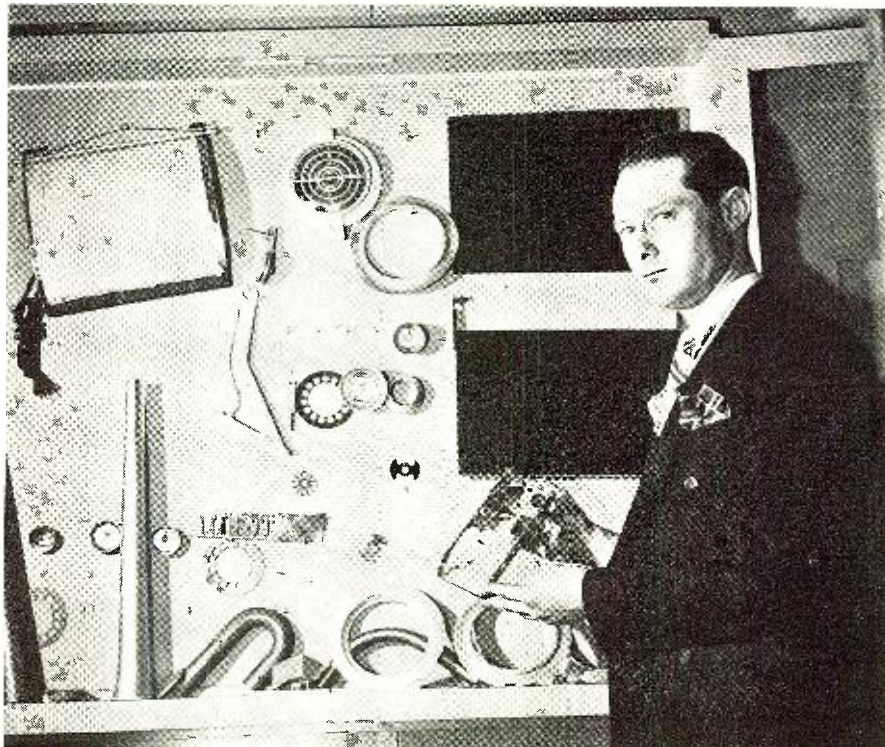





Razor plants turn out precision parts. Operator checking V block.

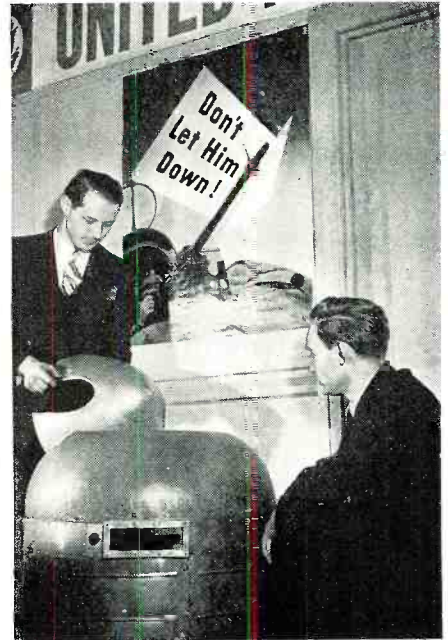

Engine covers are produced by a former egg poacher manufacturer.

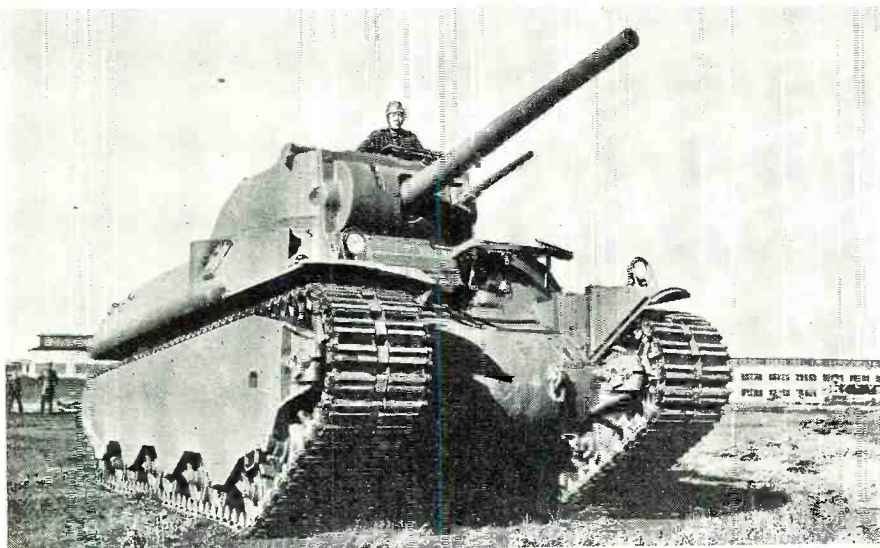

This tank was produced by the famous Baldwin locomotive works.

Radio-equipped "jeep" produced by former automobile company.



vancements. This is exemplified in the recent design of an apparently simple antenna mast for one of our bombers. It was necessary in this instance to apply a material that would resist the terrific stresses set up by wind pressure that existed up and above speeds of 400 miles per hour.

In addition, the shape of the design had to be such that the aerodynamic drag was exceedingly low, for the power required to draw such a protuberance through the air can mount to a considerable magnitude. Weight was another factor in this latter problem. Thus, it was essential to select a material that was unusually light, strong, and with, of course, good electrical properties. In this instance, macerated fabric filled phenol-formaldehyde molding powder was used for the cap of the mast. The base, serving as the bottom closure and attaching mount, used this material plus five laminations of canvas, integrally molded around the flange. The thin-wall tapered mast was constructed as a molded laminated tube.

Another recent design that exhibited wartime design practice was a voltage regulator for use in planes and other high altitude equipment. Here is another apparently simple device that nevertheless required tremendous research to permit operation under strained conditions. In its completed state, this improved regulator operates at temperatures ranging from  $-40^{\circ}$  to  $+130^{\circ}$  F. and from sea level to more than 35,000 feet up, affording suitable current supply to communication and other associated equipment. This unit weighs but two pounds, yet handles three times more current than its predecessors. The smallest regulator for industrial use weighs 13 pounds, and is almost four times the size of this newer unit.

Even simple dielectric tubes made of



kraft or fish paper have today been developed to a high degree of usefulness in this all-out effort. The new tubes have lower absorption properties, as a result of a new form of steel die operating prematurely through a heated compression die. Increased winding area is another feature of this new improvement.

Many laboratories have constructed actual condition tests that run the projected component through every possible "in-use" application, an important factor in war efficiency. One plant, for instance, now tests its relays at temperatures from  $-70^{\circ}$  to  $200^{\circ}$  F. In addition, it places these components in a three- and four-pound vacuum to simulate ionization; runs them through dirt blasts to see if the contacts will be acceptable to dirt; gives them a salt spray test, water immersion test, a rigid vibration test ( $\frac{1}{4}$ " amplitude for an artificial simulated gravity up to 209), and a series of electrical tests including reaction tests at frequencies as low as 50 mc. In some of these electrical tests, elevations up to 40,000 feet are simulated. One switch recently developed is said to be rated at 25 amperes at 28 volts direct current at this elevation.

In view of the trend towards the use of alternate metals many of which are radically new to radio work, microscopic tests have become of increasing importance. The electron microscope has been of invaluable help in this work, having supplied data on alloys heretofore never available. At a recent demonstration, for instance, results of the structure of martensite were shown. This material is made by chilling heated carbon steel very rapidly, and is used in lathes and other machine tools for cutting metal at high speed. The tests showed that actually the martensite consists of alternate plates of iron and iron carbide, a finding that will afford many other important applications in our wartime effort.

Since the curtailment of many metals common to radio, such as copper and tungsten, we have been hearing quite a bit about sterling silver. There is no doubt that this material is much more expensive as a bulk replacement, but it can be used in small quantities in many instances to afford very effective results. One of the best examples of this application is in the high speed tool. There is no need to have such a tool made entirely of high speed steel. Only a small tip need have the tungsten bearing alloy. Practically all of the rest can be of carbon steel, because of the brazing alloys that help to make a secure joint between the two other metals. A joint less than .003" thick turns the trick. Thus we have an important substitute that will further expedite production.

The importance of the necessity for tough characteristics was shown effectively during a recent demonstration of a magnetic contactor that had served a hectic period during a machine-gunning spell aboard a freighter.

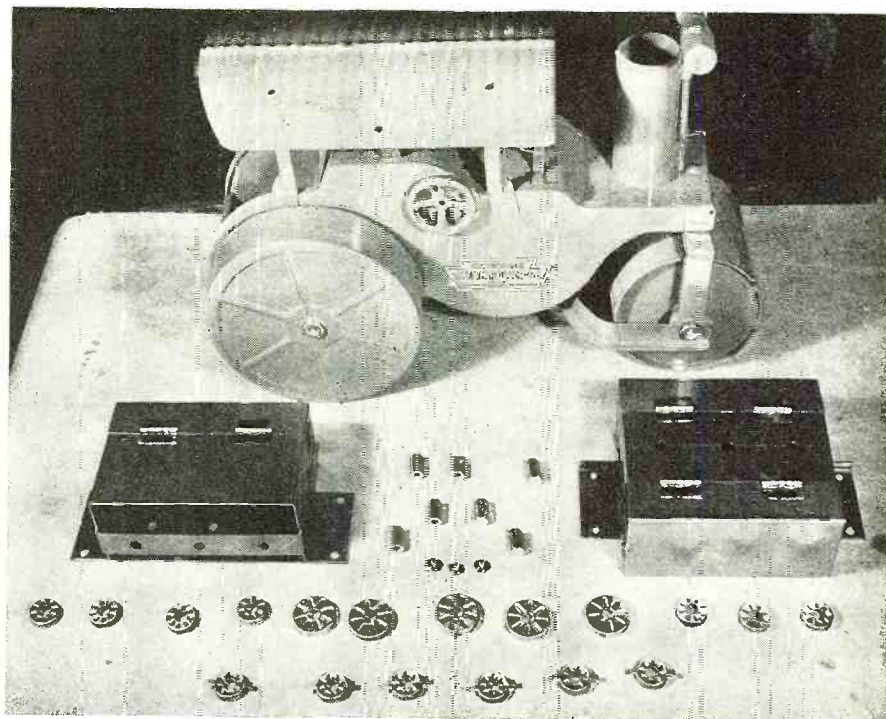

Before and after conversion. Radio filter boxes replace former toys.

Because of the unusual design and construction of this device, the radio apparatus was kept on the air, even though a bullet had made a jagged hole in the contactor cover, shattered the asbestos and plastic bases and even cut the resistor wires deeply.

Receivers, transmitters and associated equipment used in tanks, planes, fast motor boats, trucks and the countless other mobile units have a multitude of problems unlike any ever met in home or even standard commercial equipment that only careful adherence to the strictest standards will solve.

These standards are correspondingly unlike many applied in civilian practice, and thus will necessitate close study and analysis in this new work.

Just as many plants, completely outside of the radio manufacturing realm, have been called in to produce precision radio components for which their machines are adapted, some plants formerly engaged in radio manufacture have also been called in to make war implements that their machines seem well adapted to produce. One such radio manufacturer, who made

*(Continued on page 52)*

Women workers of electric company inserting screws into terminals.





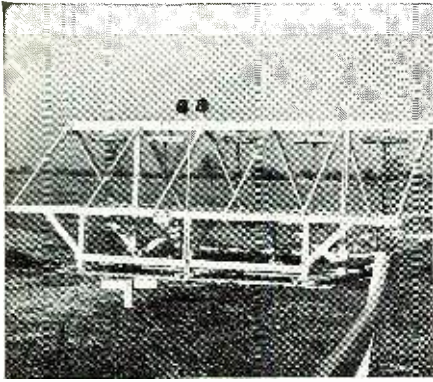

Fig. 1. Experimental 5-loop system.

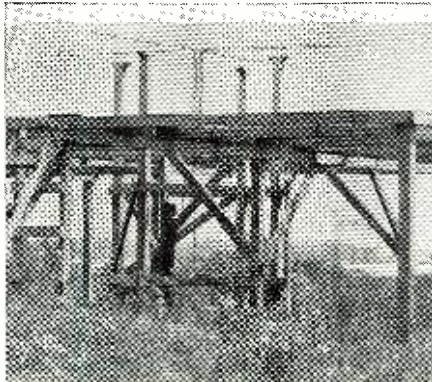

Fig. 2. Typical Z marker antennae.

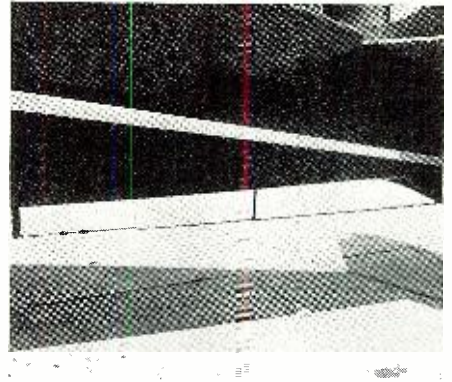

Fig. 3. Marker antenna on Waco plane.

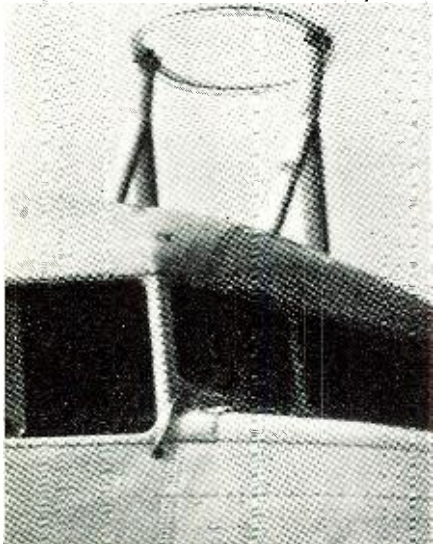

Fig. 4. UHF loop on DC-3 Airliner.

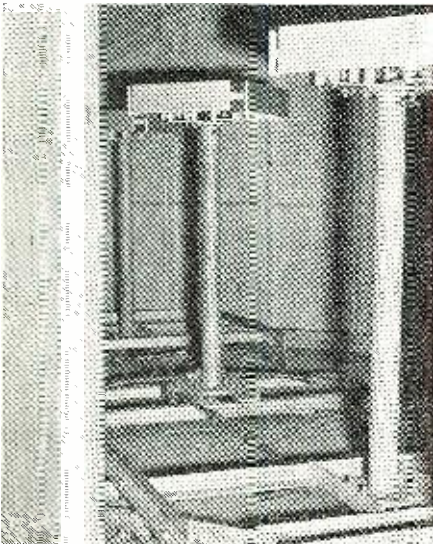

Fig. 5. Loops for aural range.

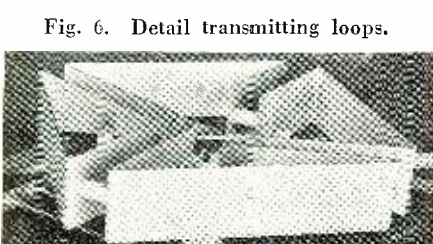

Fig. 6. Detail transmitting loops.

# UHF ANTENNAE IN AVIATION RADIO



by **J. C. HROMADA**  
Chief, Experimental Station, CAA

Born in Chicago, in 1906, graduated from the Armour Institute of Technology as an Electrical Engineer in 1929 and has spent all of his professional life in the service of the CAA and its predecessor organizations. Author of many CAA radio technical publications. Co-author with William E. Jackson, Chief of the Radio Section, of the chapter on Air and Marine Radio in the Handbook for Electrical Engineers.

*The development of antenna systems for Aviation radio has taken great strides and is continuing at an increasing rate.*

**C**ONTRARY to many popular notions, the application of the ultra-high frequencies to aviation radio has not been a matter of connecting a short piece of wire or whip to the antenna terminal of a receiver or transmitter, nor has it in any way lessened the requirements for carefully designed and developed antenna systems. In fact, greater care must be exercised in the design of antenna elements and transmission lines than ordinarily would be required at the lower frequencies because ultra-high-frequency antennas are small and are placed preferably on structures free from obstructions and more or less remote from the transmitter or receiver. Thus, the ordinary "lead-in" must be replaced with a transmission line whose losses must be kept low, in order that a maximum amount of power may be transmitted or received for the greatest efficiency.

For some applications, such as station location and fan markers, the or-

inary dipole radiator has been chosen by the engineers of the *Civil Aeronautics Administration* as having satisfactory characteristics. In these instances radiation directly upward is desired, hence the horizontal dipole finds application. In the case of a station location or Z marker, it is desired to produce a radiation pattern directly upward and restricted to a rather small radius in the horizontal plane. This is secured by arranging an array of four horizontal dipoles, as shown in Figure 11. Radiators 1 and 2 are fed with equal currents, in-phase, as are radiators 3 and 4. Pair 1-2 is then phased in quadrature with pair 3-4 to produce a circular horizontal field pattern. A view of such a Z marker antenna installation is shown in Figure 2.

During the last year this antenna has been modified by engineers at the *Administration's* Experimental Station at Indianapolis, Indiana, to an eight-element array, shown diagrammatically in Figure 13. This array, having



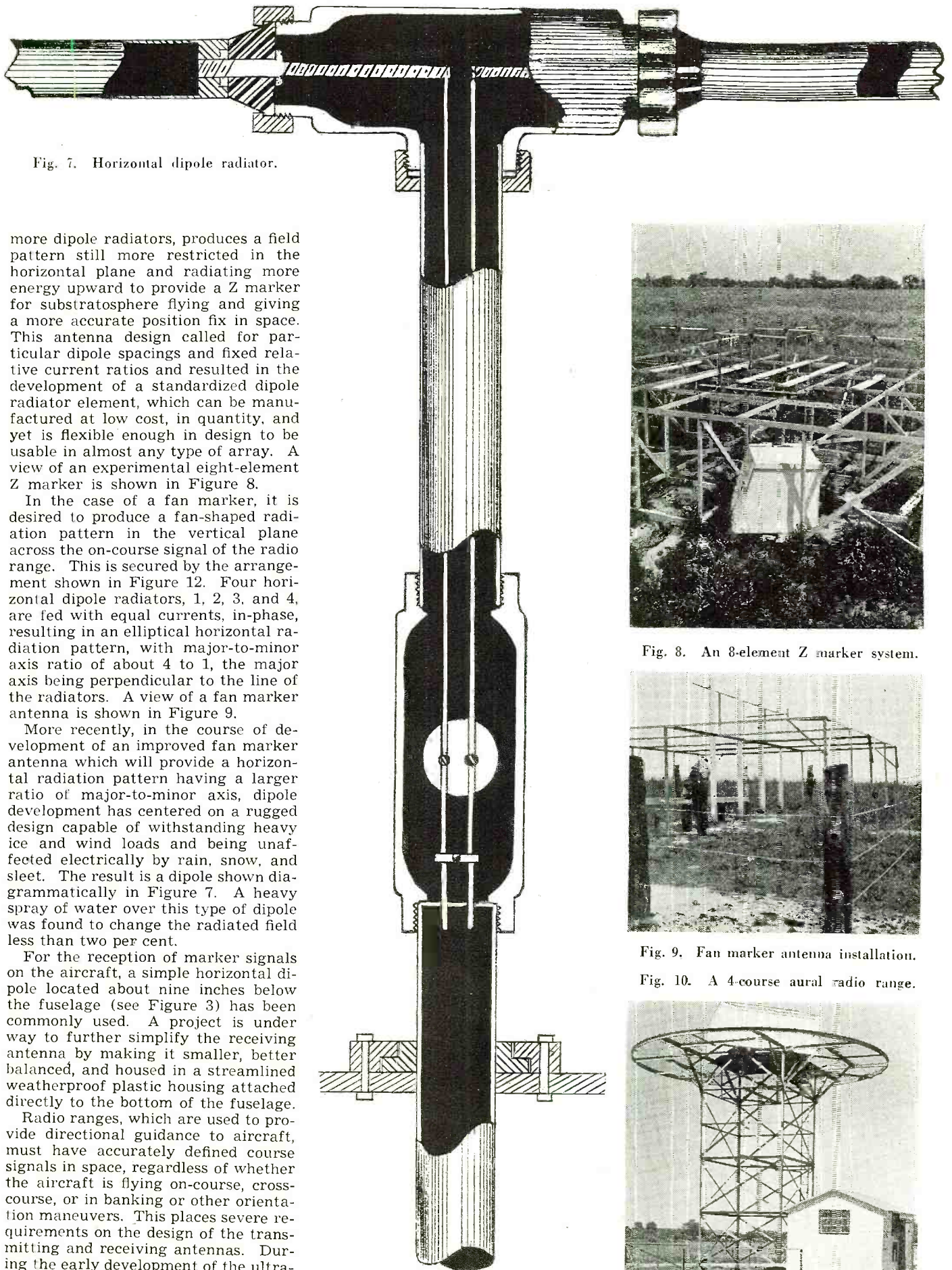

Fig. 7. Horizontal dipole radiator.

more dipole radiators, produces a field pattern still more restricted in the horizontal plane and radiating more energy upward to provide a Z marker for stratosphere flying and giving a more accurate position fix in space. This antenna design called for particular dipole spacings and fixed relative current ratios and resulted in the development of a standardized dipole radiator element, which can be manufactured at low cost, in quantity, and yet is flexible enough in design to be usable in almost any type of array. A view of an experimental eight-element Z marker is shown in Figure 8.

In the case of a fan marker, it is desired to produce a fan-shaped radiation pattern in the vertical plane across the on-course signal of the radio range. This is secured by the arrangement shown in Figure 12. Four horizontal dipole radiators, 1, 2, 3, and 4, are fed with equal currents, in-phase, resulting in an elliptical horizontal radiation pattern, with major-to-minor axis ratio of about 4 to 1, the major axis being perpendicular to the line of the radiators. A view of a fan marker antenna is shown in Figure 9.

More recently, in the course of development of an improved fan marker antenna which will provide a horizontal radiation pattern having a larger ratio of major-to-minor axis, dipole development has centered on a rugged design capable of withstanding heavy ice and wind loads and being unaffected electrically by rain, snow, and sleet. The result is a dipole shown diagrammatically in Figure 7. A heavy spray of water over this type of dipole was found to change the radiated field less than two per cent.

For the reception of marker signals on the aircraft, a simple horizontal dipole located about nine inches below the fuselage (see Figure 3) has been commonly used. A project is under way to further simplify the receiving antenna by making it smaller, better balanced, and housed in a streamlined weatherproof plastic housing attached directly to the bottom of the fuselage.

Radio ranges, which are used to provide directional guidance to aircraft, must have accurately defined course signals in space, regardless of whether the aircraft is flying on-course, cross-course, or in banking or other orientation maneuvers. This places severe requirements on the design of the transmitting and receiving antennas. During the early development of the ultra-

(Continued on page 64)

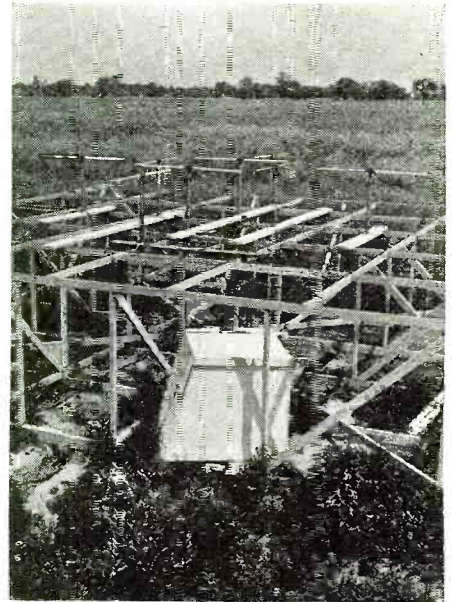

Fig. 8. An 8-element Z marker system.

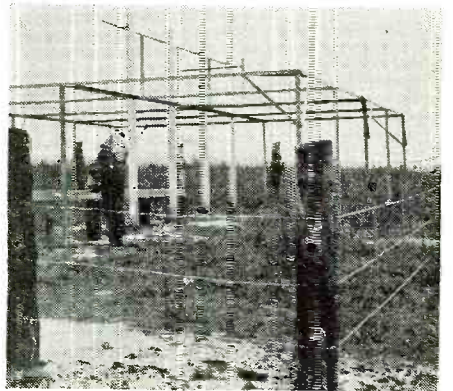

Fig. 9. Fan marker antenna installation.



Fig. 10. A 4-course aural radio range.



# RADIO —

## a Factor in Aviation Safety

by **WILLIAM E. JACKSON**

Radio Development Section Chief

Born in Bridgewater, Mass., May 8, 1904. Employed as a radio engineer by G.E. from 1925 until 1927, then served as radio engineer in the Airways Division, Department of Commerce. Since 1933, he has been chief of the Radio Development Section, first under the Bureau of Air Commerce and then under its successor, the Civil Aeronautics Administration. Under his guidance, the Radio Development Section has been particularly active in the development of ultra-high-frequency air navigational aids, such as modern instrument landing facilities, radio ranges, markers, etc.

**The development of the ultra-high radio frequencies has been one of the most important contributions to aircraft safety**

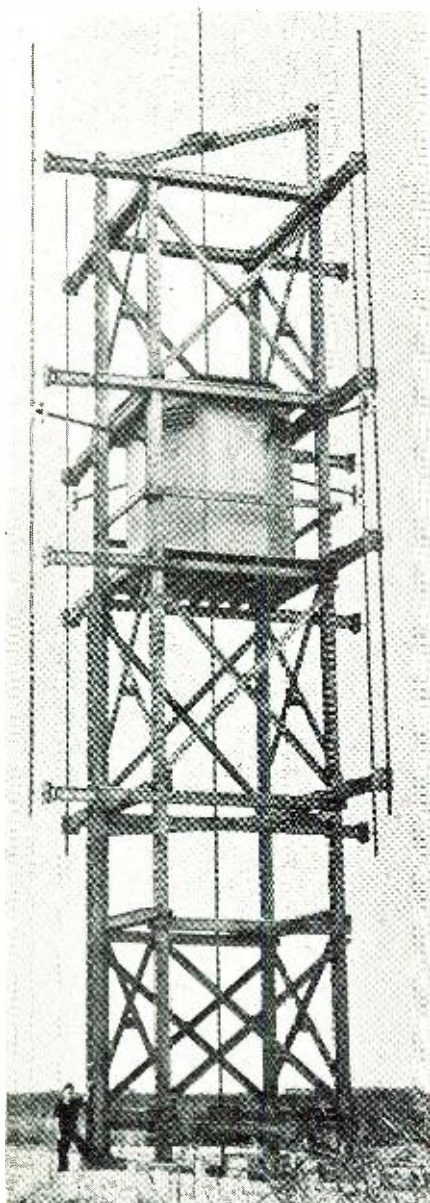
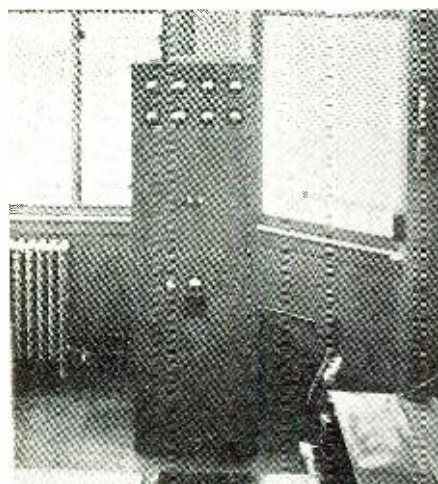

Fig. 1. High-frequency direction finder antenna system consisting of vertical doublets.



Fig. 2. UHF airport traffic control transmitter at eastern airport.



**T**HE Civil Aeronautics Administration operates a system of aviation radio aids serving the nationwide network of civil airways in the United States. These radio navigational aids have played an important part in the growth of aviation by contributing to the safety of flight and dependability of service. Facilities as used at present consist essentially of communication stations for broadcasting weather information and radio-telephone communication with aircraft in flight, radio range stations to provide directional guidance, and radio marker stations to indicate the location of strategic points on airway routes.

Their operation, with the exception of marker beacons which are on the ultra-high frequencies, has been mainly in the band 200-400 kilocycles. However, low frequencies have been found to have definite limitations due to atmospheric interference, rain static, snow static, dust static, multiple course phenomena caused by reflections from the earth's surface, and interference between stations caused by reflections from the ionosphere. Consequently, development work during the past few years has been devoted almost exclusively to the development, installation, and testing of new ultra-high-frequency facilities or to the modifying of existing facilities to operate on the ultra-high frequencies. These frequencies have been found remarkably free from interference. This article will deal chiefly with these new developments.

### Instrument Landing

First, as one of the most important

radio aids, instrument landing will be considered. During the past twelve years, a number of schemes have been advanced which were designed to facilitate the landing of aircraft under conditions of poor visibility. The most practicable of these employed radio waves. However, none of these, up to a year or so ago had been universally recommended by the military services or by the airlines as being entirely satisfactory. During 1938, a set of specifications was drawn up by the *Radio Technical Commission for Aeronautics* giving their recommendations as to the features essential to an ideal instrument landing system.

A development contract for a system incorporating all these features was awarded by the *Civil Aeronautics Administration* to the *International Telephone Development Company* to cover this development. This system was installed at Indianapolis, Ind., and has been in operation for approximately two years. It has been modified and finally approved by the *Radio Technical Commission for Aeronautics* and its installation at other locations for further testing and pilot training recommended by the *National Academy of Sciences*.

Additional installations are being made by the *Civil Aeronautics Administration* at Washington, D. C.; and Oakland, Calif. Also, six systems have been ordered and will be installed at Atlanta, Ga.; Cleveland, Ohio; Chicago, Ill.; Los Angeles, Calif.; Kansas City, Mo.; and New York, N. Y. Equipment has been completed by the contractor and factory inspection made. The first of these will be in operation by the time this article is printed.



The instrument landing system as installed at Indianapolis and to be duplicated at the above points is a three-element system, consisting of localizer, glide path, and two marker beacons for one runway. Fig. 3 is an aeronautical chart showing this installation.

The localizer provides lateral guidance to permit the pilot to bring his airplane from the airway radio range course to a position in line with and to follow the exact center line of the runway on which the landing is to be made. The localizer transmitter operates on a frequency of 109.9 megacycles and is modulated at two audio frequencies, 90 and 150 cycles. Two overlapping bean-shaped patterns are produced and modulated at 90 and 150 cycles respectively.

The intersection of the two patterns creates a radio range course when received by a conventional receiver and the output is applied to two selective audio frequency filters which are used to operate a differential meter. The result is an indicating instrument which will deviate to the right or left of zero center, depending on which side of the course the plane is flying. Fig. 9 shows the schematic diagram of the antenna system and the mechanical modulator which is used to produce the patterns. Fig. 7 shows the resulting pattern from this type of antenna. The main array shown in Fig. 9 produces the bean-shaped patterns in Fig. 7 shown as (A) ORIGINAL.

Improved operation was obtained by installing the auxiliary antennas shown in Fig. 9, which produced the pattern indicated as (B) FINAL in Fig. 7. Improved operation was obtained because of the increased sharpness of the localizer course and because less energy was transmitted toward reflecting objects such as the Airport Administration Building.

The glide path provides vertical guidance to permit the pilot to keep his airplane always on the correct path of descent at a prescribed distance above the obstructions on the approach and to a definite point of contact on the airport runway. An essentially straight line glide path six miles long and inclined so that rate of descent when the glide path is intercepted at 1500 feet does not exceed 500 feet per minute has been developed. This glide path is produced by an intricate antenna system (Fig. 10) which radiates a specially shaped field pattern as shown in Fig. 14.

The transmitter operates on a frequency of 93.9 megacycles and is modulated at 60 cycles. A crystal controlled receiver in the airplane operates the horizontal needle of the cross pointer instrument by means of the rectified 60 cycle output.

The markers serve as distance guides and check points during the approach procedure. They operate on a frequency of 75 megacycles. The outer marker is usually located along the course about two miles from the runway. It is modulated at 400 cycles

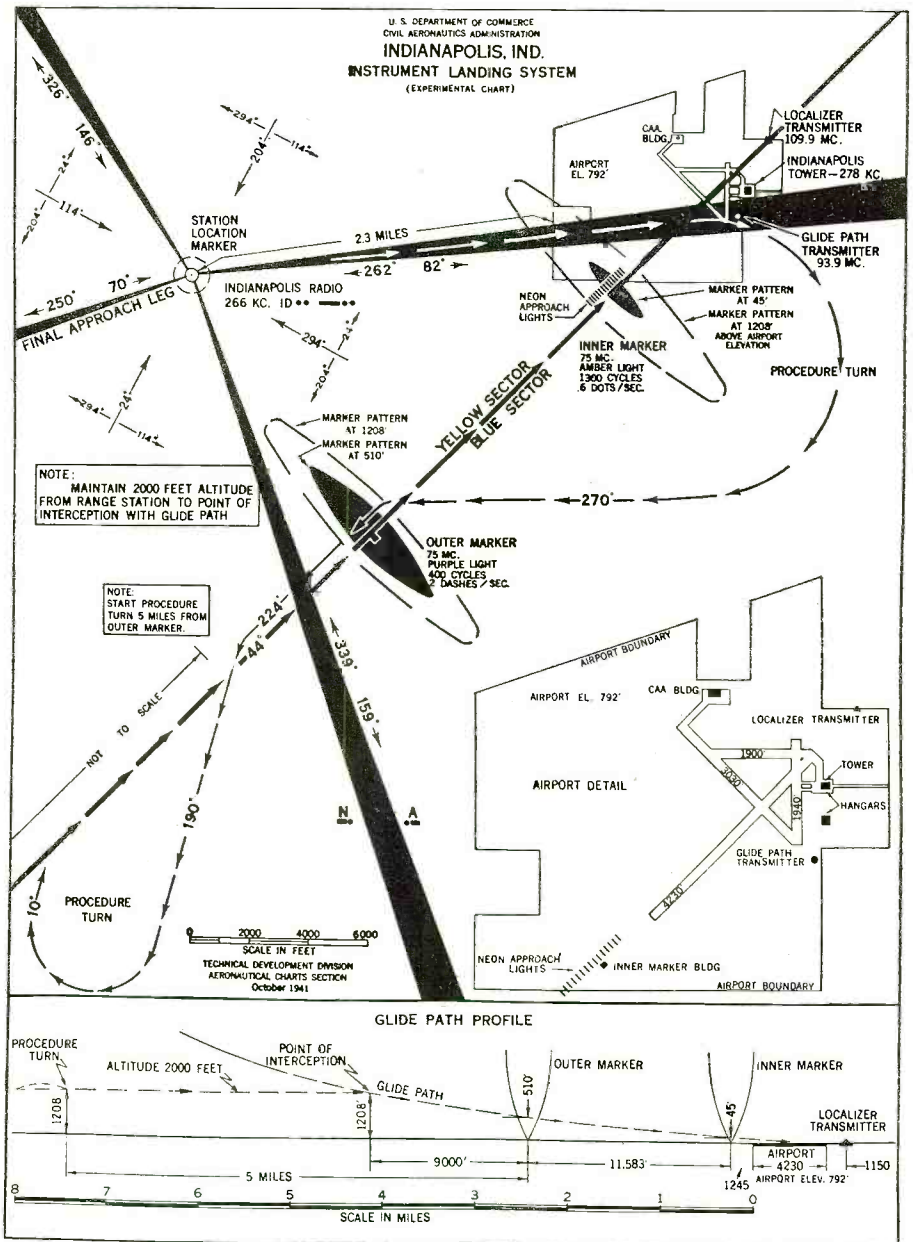
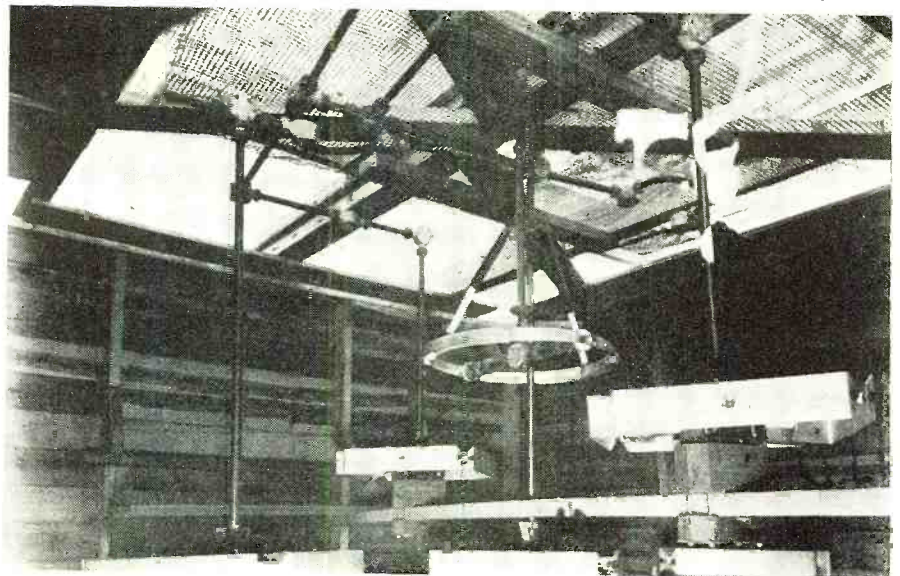

Fig. 3. These diagrams show how aircraft is guided by radio to a safe landing.

Fig. 4. Antenna system of typical two-course ultra-high-frequency radio range.





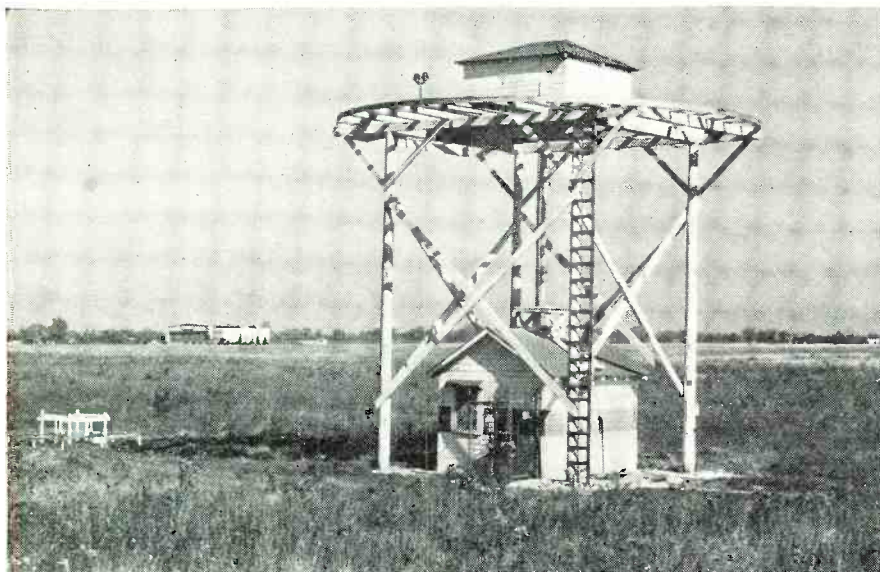
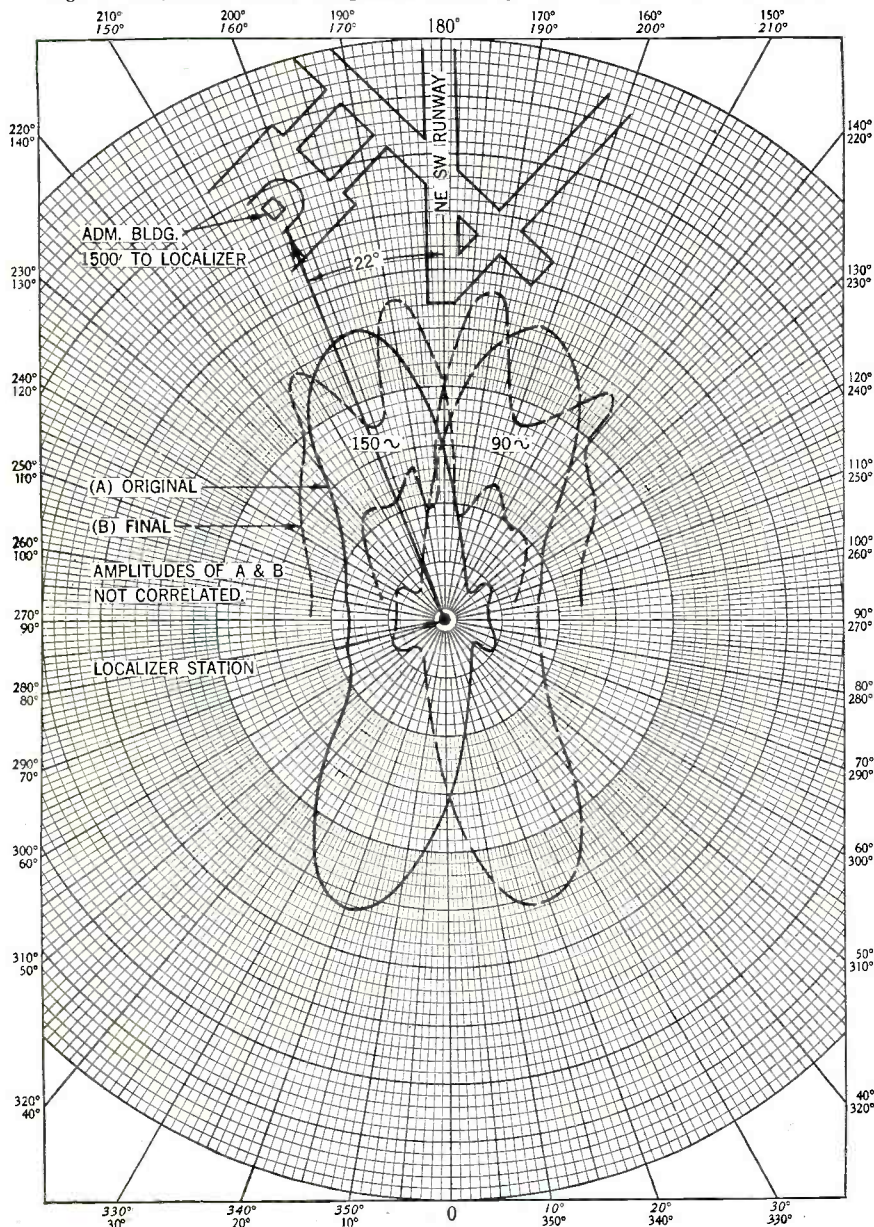

Fig. 5. Two-course ultra-high-frequency radio range with Sector Identification.



Fig. 6. Azimuth indicator located at one of our large eastern airports.

Fig. 7. This chart shows the pattern resulting from the latest localizer system.



and keyed at the rate of two dashes per second, and operates a purple light in the cockpit of the airplane. The inner marker is usually located at the boundary of the field at the approach end of the runway. It is modulated at 1300 cycles and keys dots continuously at the rate of six dots per second and operates an amber indicator light in the cockpit.

Care has been taken to locate equipment so that it does not constitute an obstruction to flight. The localizer building is usually 14 feet high and is preferably located 1300 feet beyond the end of the runway. In several cases, when it has become necessary to locate the equipment closer to the runway, it has been necessary to put the transmitting equipment underground in a waterproof basement and install the antennas in a low wooden building, 7 feet high. The glide path building is also 14 feet high and is located 1300 feet to either side of the runway. The inner marker is about three feet high and located at the boundary of the field in line with the center of the runway.

### Radio Ranges

After several years of intensive development work, an ultra-high-frequency four-course aural range was developed and installations made on the Chicago-New York airway for service testing during 1941. Stations are located at Easton, Pa.; Sunbury, Pa.; Black Moshannon, Pa.; Millbrook, Pa.; Cleveland, Ohio; Toledo, Ohio; Millersburg, Ind.; and Chicago Heights, Ill. These stations operate on the frequencies 123.0, 123.3, 123.6, and 123.9 megacycles. These frequencies are repeated as required.

Fig. No. 15 is an aeronautical chart showing the layout of this airway. Service testing has not been completed to date, but tests made have indicated a pronounced improvement over the low-frequency radio ranges from the





Fig. 8. UHF Airport Traffic Control Antenna System at large Eastern Airport.

standpoint of fewer multiple courses, almost complete elimination of atmospheric disturbance and the elimination of interference between radio stations frequently caused by reflection of transmitted waves from the ionosphere.

Simultaneously, a two-course radio range with sector identification has been developed in compliance with specifications prepared by the *Civil Aeronautics Administration* and installed at Indianapolis, Ind. With the two-course visual system, an instrument in the cockpit provides a constant indication of the airplane's position in relation to the course while an aural code signal at regular intervals identifies not only the station, but the sector in which the aircraft is flying.

This offers a distinct advantage over the four course radio range in that the pilot knows which leg of the range he is flying without the necessity for any orientation procedure. The pattern of this range is as shown in Fig. 11. Fig. 5 shows a view of the two-course station with aural sector identification. Fig. 12 shows a view of the transmitting equipment used in the station, and Fig. 4 the antenna system located in a small wooden building on top of the counterpoise. This stage of the development as called for in the original specifications was satisfactorily completed at Indianapolis.

However, during the development, it was apparent that an aural course at right angles to the visual course could be obtained by means of interlocked sector identification signals and this additional course would be useful. The necessary steps were taken to incorporate this feature in the equipment. Interlocked D-U signals are transmitted continuously except for brief periods every 30 seconds when station identification letters are transmitted first in the D sector and then in the U sector. The interlocked DU signals are used instead of the conventional

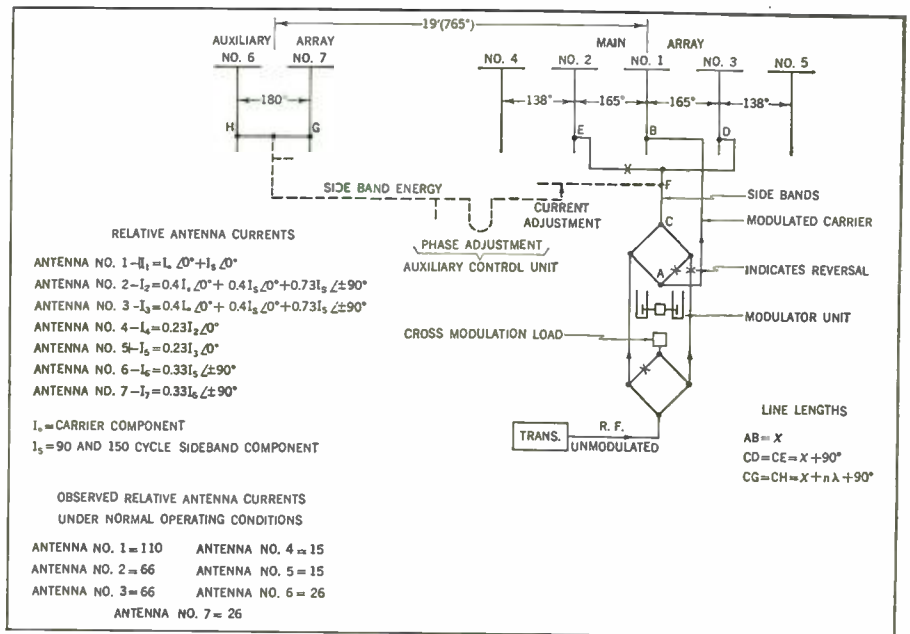

Fig. 9. Diagram of Localizer Antenna Array and Mechanical Modulator Unit.

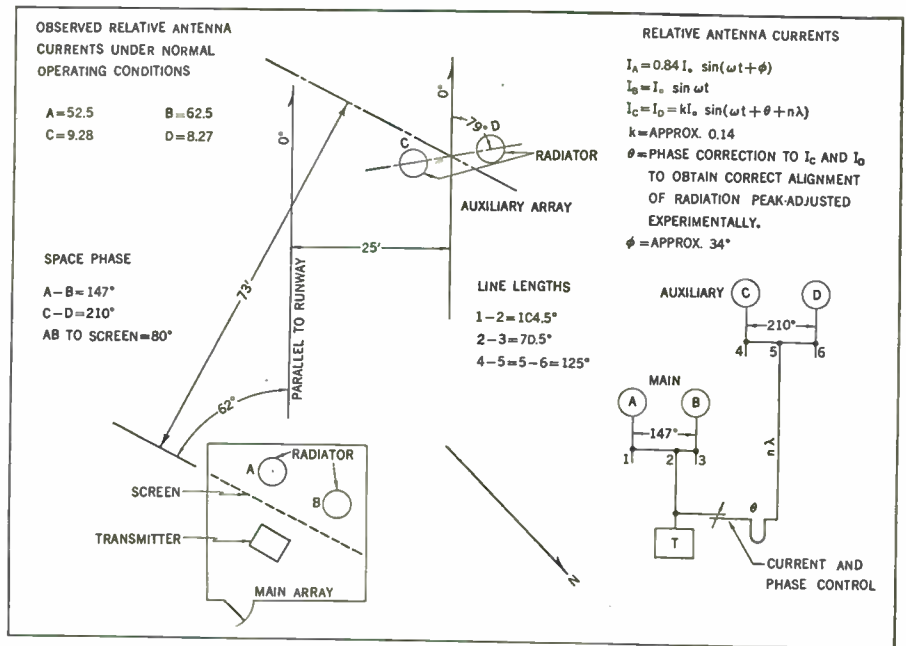

Fig. 10. Diagram of Antenna System used for CAA-RTCA Glide Path systems.

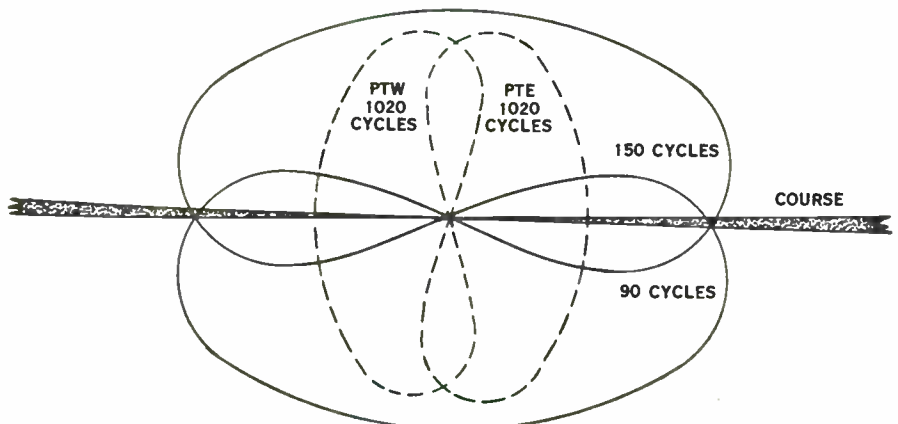

Fig. 11. Visual Two-Course Range pattern with aural sector identification.



U.H.F. RADIO RANGE STATIONS, INDIANAPOLIS, INDIANA

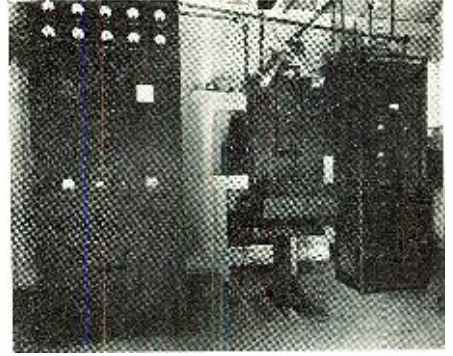
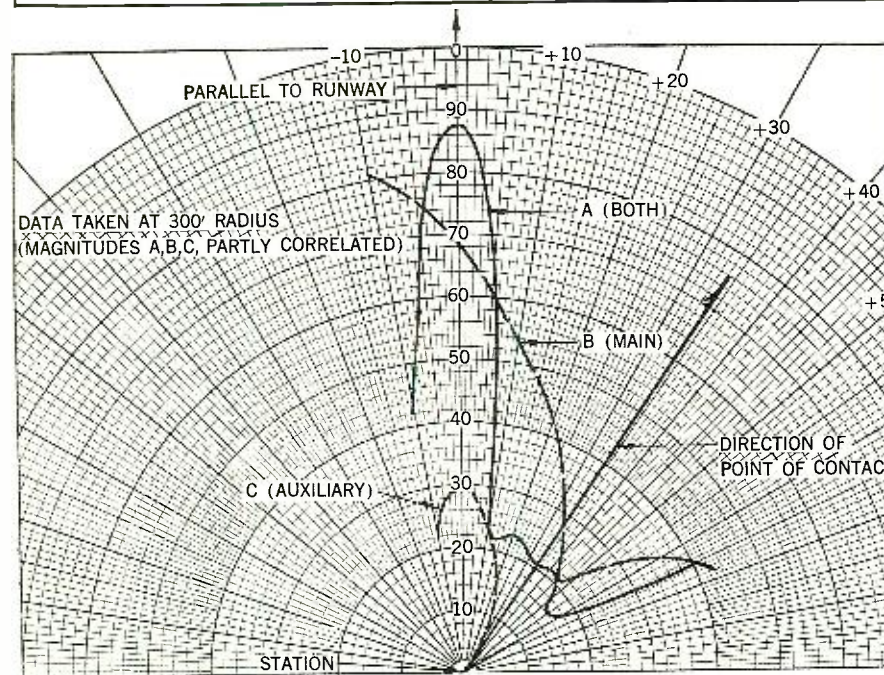
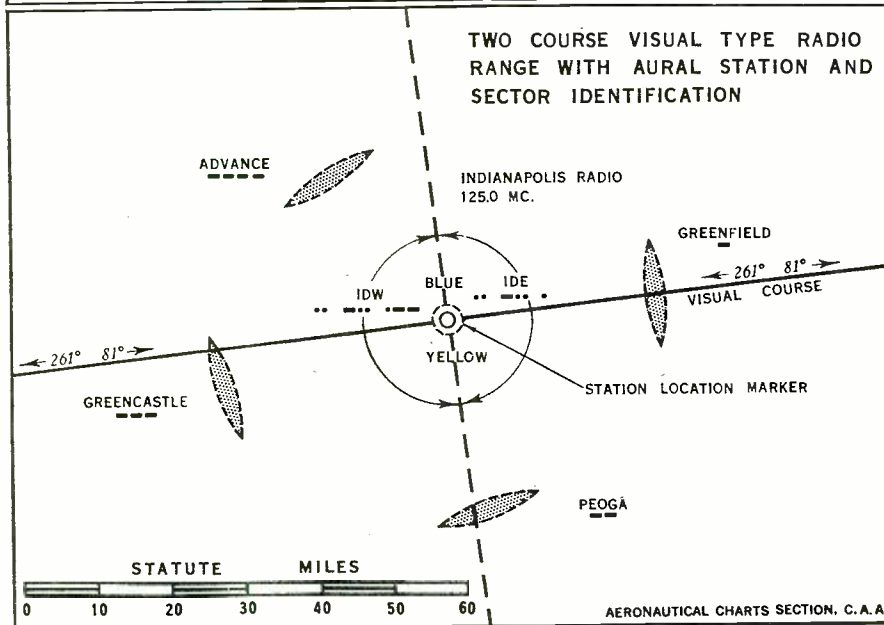
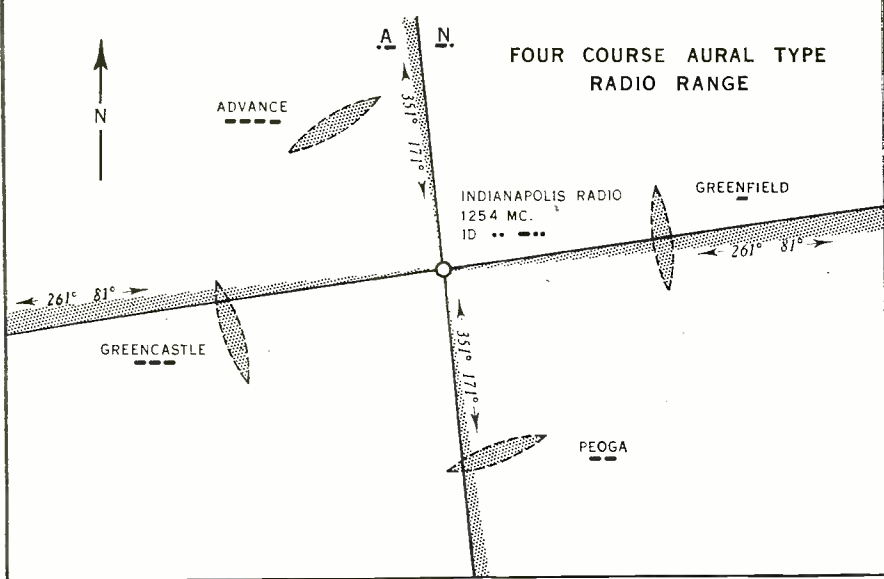

Fig. 12. Above: UHF Two-course units.  
Fig. 13. Left: Orientation of 4-course.

NA interlocking signals in order that the pilot may easily differentiate between this type and the low frequency radio range.

The visual indicator always points to the sector in which the airplane is located. The sector which includes the true north meridian line is called the blue sector and is so shown on the map, Fig. 13. The other sector is called the yellow sector. The aural D sector is to the east side of the station when the visual course extends east and west while the U sector is to the west side of the station. Thus, it may be seen that the pilot can determine at all times which course he is on or the particular quadrant in which he is located by first observing the color to which the visual indicator points and then listening to determine the relative ratio of D to U signals.

Fig. 13 is a chart showing the two-course visual type radio range with aural station and sector identification and the four-course aural type radio range, mentioned above, as recently demonstrated at Indianapolis to the *Radio Technical Commission for Aeronautics* and to the *Air Line Pilots Association*. It has been definitely recommended by the *Radio Technical Commission for Aeronautics* that the two-course radio range with aural sector identification, using DU signals, be installed throughout the country and that simultaneous voice be applied to all ultra-high-frequency radio ranges.

Therefore, the third step in this development program is the application of the simultaneous voice feature to this range. This will offer the distinct advantage that airway traffic control operators can keep in constant touch with all pilots using the UHF radio range. It is believed that when this has been accomplished, a satisfactory simultaneous ultra-high-frequency radio range will be available for nationwide installation to replace existing low-frequency facilities. Work is now being concentrated at the Indianapolis Experimental Station to this end, and it is believed that a satisfactory solution to the problem should be available in the near future.

(Continued on page 67)

Fig. 14. Left: Field Pattern of Glide Path Antenna System installation.



**“WHAT** can the radio serviceman do to aid the present war effort?”

That question is upon many lips today. To say that servicemen should go into the services of the armed forces has already been said and already is being done. In fact, only recently we visited a certain military establishment, which for very obvious reasons we shall not name, where we saw large numbers of ex-radio servicemen undergoing serious training in the operation and repair of a certain very valuable military device. It was like “old home week” for us, for there we met men whom we have not seen for fully ten or twelve years—men who were our students in a radio school which we conducted during the evenings many years ago. Every one of the men we saw—and we spoke to many—was in high spirits and fully aware of his future responsibilities. They were working and studying hard, absorbing details concerning equipment which was much different from the kind they handled in commercial life, far more complicated, but they tackled the job with a spirit of earnestness and zeal that merited the highest approval.

But, as we all appreciate, all the radio servicemen of the nation cannot enroll to do similar work. Some are not physically fit and others have dependents. Still others are too old. All in all, the radio repairmen of the nation are divided into two groups: those who are associated with the armed forces and those who have their tasks to perform on the home front. About those who are in the armed forces or doing work for the various military branches of the nation, they already are doing their jobs . . . It is those on the home front who are the subject of this discussion.

Everyone agrees that properly operating radio receivers are vital to the morale and general welfare of the people of the nation. Everyone agrees that the radio receiver in the home will play its important part not only in keeping the people informed of what things are happening but also as the means whereby those who are today confronted with the stupendous task of bringing this war effort to a successful culmination upon the multitudinous fronts, can speak to the public at large. It is through the radio in the home that the people of the nation as a whole can be counseled, warned, calmed, in general, spoken to by those whose messages are vital to us all.

As important as all of that may be and important as the proper operation of a radio receiver may be, other tasks still remain which must be delegated to the radio repairmen of the nation. We recognize to the fullest extent the many difficulties which confront the present day radio repairman in the fulfillment of his obligations. The shortage of man power in the radio repairing field has made the job of properly maintaining America's radio receivers very difficult. The curtailment of new receiver production for the

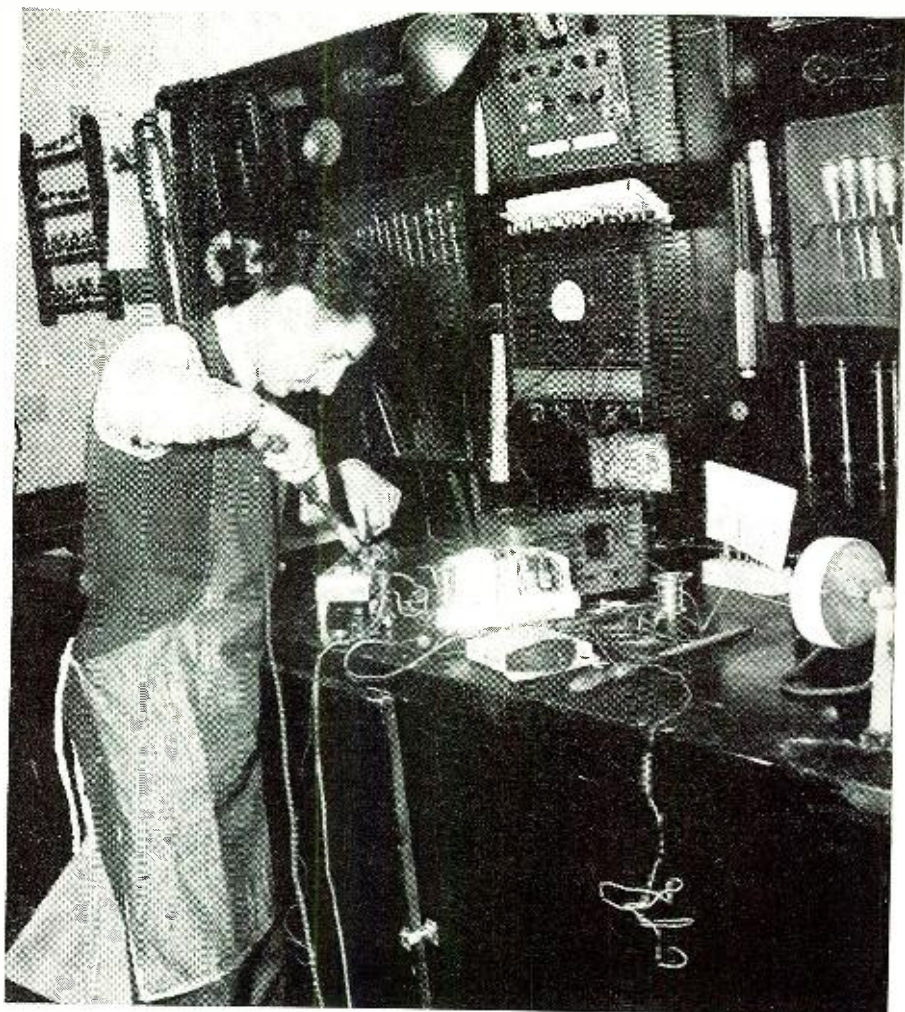

The American radio servicemen's shop plays a vital role in our defense.

## What Servicemen Can Do to Aid Our War Effort

by JOHN F. RIDER

*The shortage of manpower in the radio service field is increasing daily.*

commercial market on April 22 of this year will bring into the repair shop many hundreds of thousands of radio receivers which otherwise would have been discarded and replaced by new units. With new receivers not available, the old ones must be made to work.

All of this means a boom in the industry, a state of activity which the radio industry has never experienced. It means profitable operation—a sellers' market with all that it implies . . . The industry views with alarm the increasing shortage of technical

help—the possibility that the present well of replacement parts may eventually run dry and not in the too far distant future at that . . . But the true state of affairs is far more serious than the possibility of the occurrence of events and conditions which may impair the financial advancement of the radio repair industry.

The nation is at war . . . All its resources must be used to the fullest advantage. Among these resources are many thousands of men who are radio specialists—the radio repairmen . . .

*(Continued on page 60)*



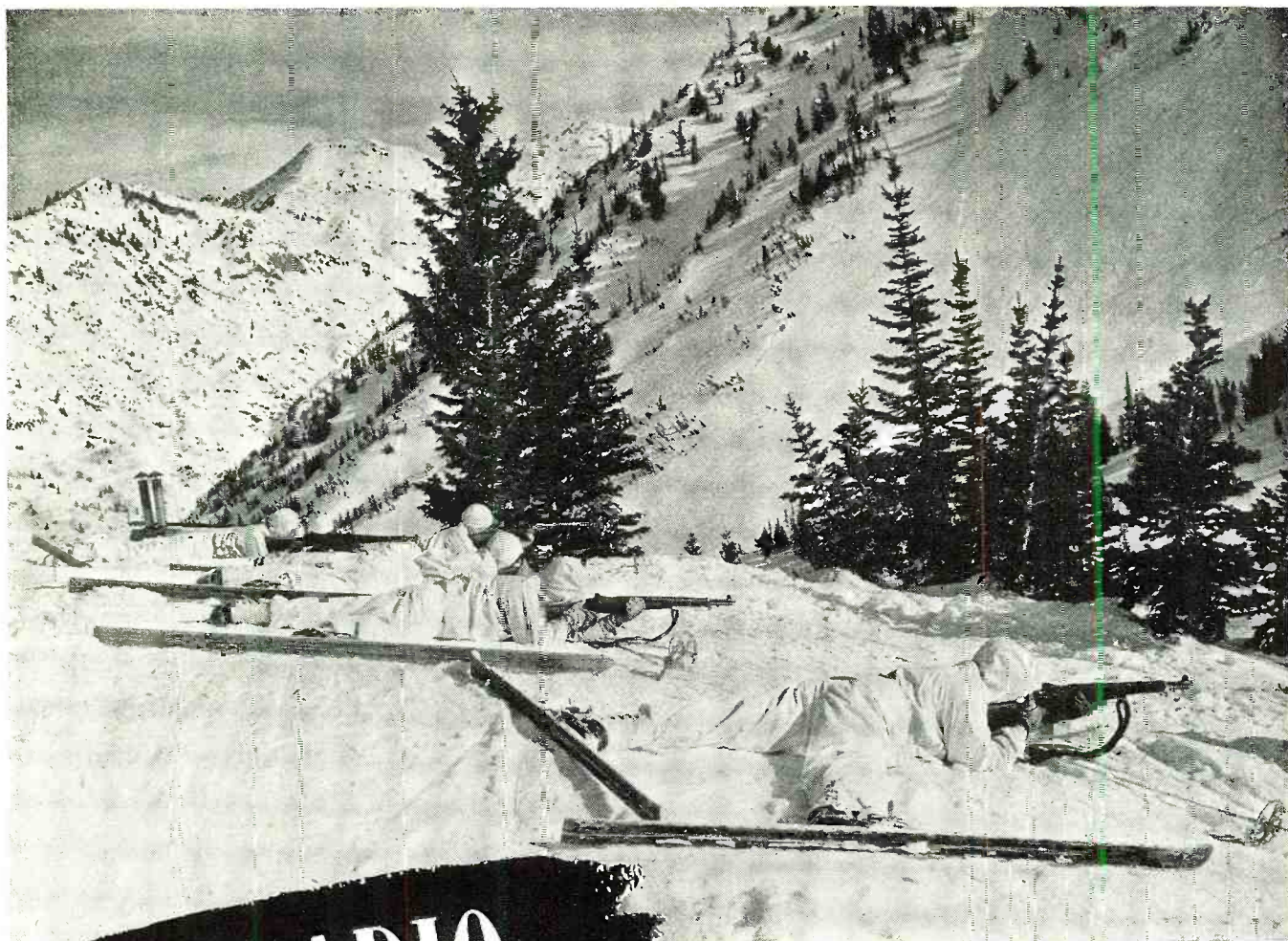

Almost completely camouflaged are these para-troopers in action.

# RADIO SKI TROOPS

by  
**S. R. WINTERS**

*Russian ski troops have been most effective. Our forces will be similarly equipped.*

**W**ITH Russian ski troops skimming over the frozen battle-fronts around Smolensk and with American "para-ski" troopers in training atop Mount Baldy, Utah, uncommon interest is attached to a 10-pound portable radio outfit suitable for communication between ski battalions and their headquarters. Oddly enough, this compact vest-pocket edition of radio was originally developed as an instrument of peace, for salvaging human lives by summoning medical aid when skiers were seriously injured while indulging in winter sports. Now, however, its quick conversion to an agency of warfare accents its immediate use as a weapon of destruction in our all-out victory effort.

This complete radiophone unit, together with power supply, weighs only

10 pounds and has a two-way communication range, over optical paths, of approximately 50 miles. With short antennae and over level terrain, this maximum distance may be reduced to three or four miles, if desired. A panel switch permits selection of any of three transmitting frequencies, any or all of which may be crystal controlled. The receiver is practically non-radiating. The provision for selecting any of the three crystal-controlled wave lengths renders the equipment adaptable for operation in fixed-frequency networks, and permits ready transfer from one network to another.

Radio communication in the National forests and parks was originally in the two to four-megacycle band. This part of the radio spectrum, easily utilized by single channel transmitters,

and evidencing the least variation in diurnal and seasonal sky-wave propagation, is equally adaptable for communication between ski troops. Antenna lengths influenced the Forest Service in selecting the higher limit of the frequency band. To secure the greatest efficiency in the use of portable equipment, horizontal half-wave antennae were employed. Densely forested areas make it difficult to find spaces large enough to stretch antennae. This difficulty increases with the length of the radiating system. The Forest Service found that a 140' antenna was an effective compromise.

The installation of ultra-high frequency stations has increased rapidly within the past few years. Selection of frequencies in this portion of the spectrum represents a compromise be-



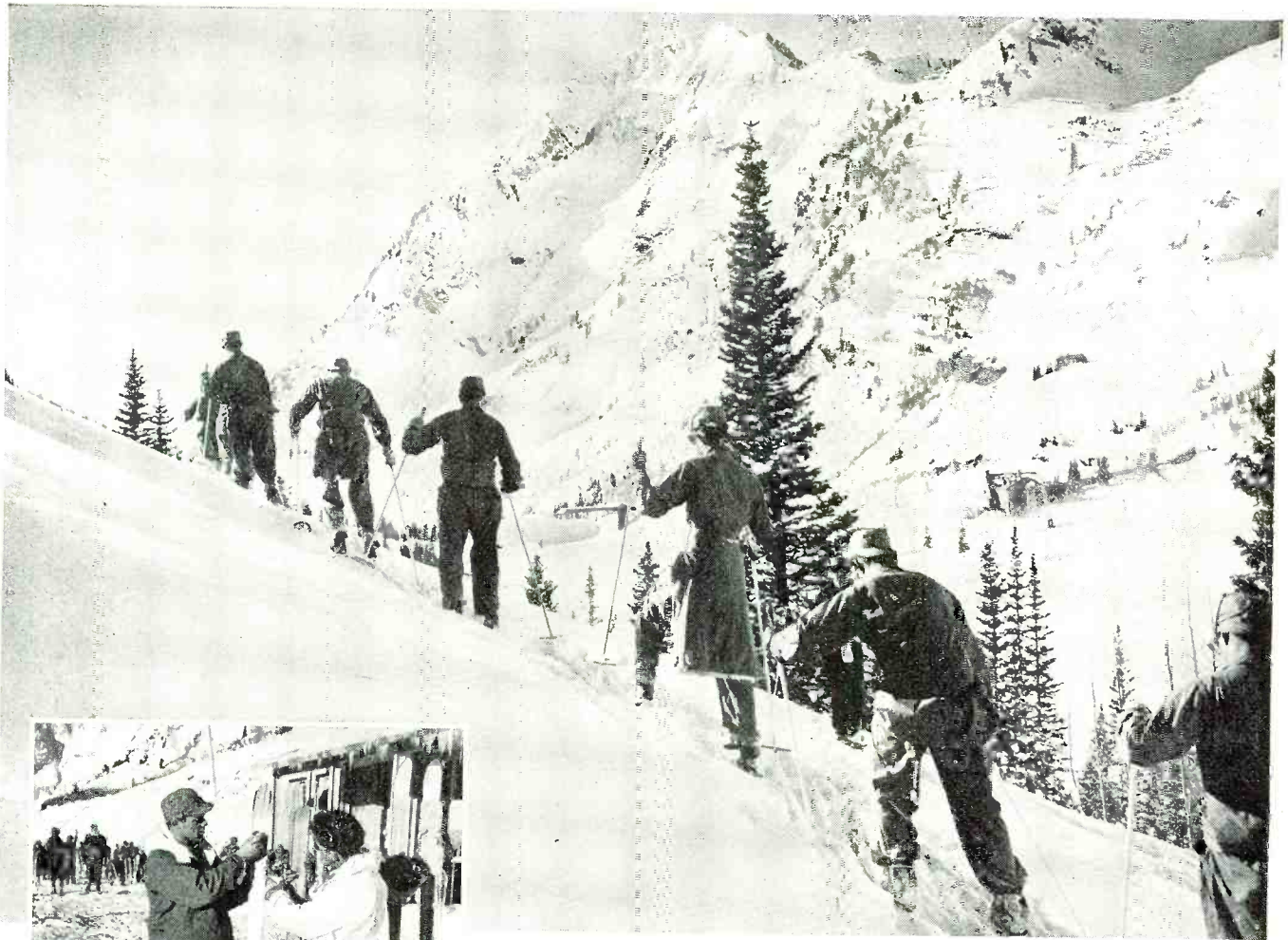

Para-ski Troopers undergo extensive training. Many of these men had never seen snow until their arrival at the scene. Mt. Superior seen in background.



Skis must be kept in perfect condition and be inspected regularly.

District ranger Harold Engles shown operating one of the field radio sets used for man hunts, counter-espionage, and other military or civil duties.



tween desirable characteristics of the ultra-high frequencies, such as minimum static, short antennae, lack of circuit deficiencies, and better coverage below the line of sight obtainable with low frequencies. Strangely enough, ultra-high frequency systems have developed more rapidly in mountainous regions than in flat or rolling country. It has been found that "blind" spots behind sharp mountains and ridges are not as sharply defined as in areas where slopes are less precipitous.

In operation, the ultra-high "wave-sprinklers" receive the intelligence from one station and automatically retransmit it to another. The relay, however, must have very nearly an optical path to both stations. The transmitter section is of conventional



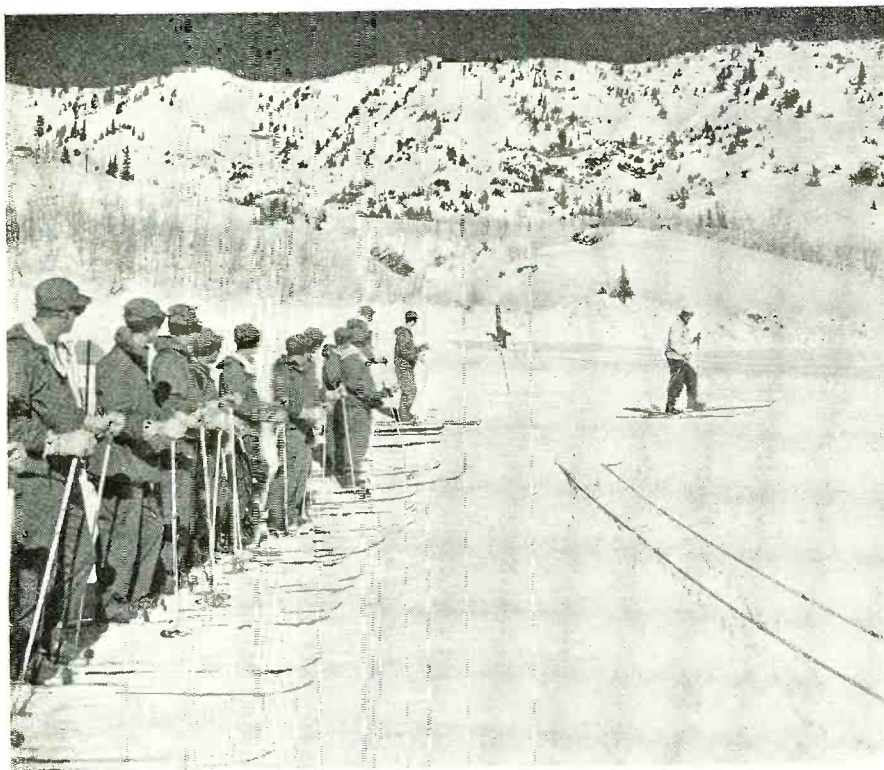

Para-ski Troopers of Co. B, 503rd Parachute Battalion get their first training.

design and has an output of two watts. The receiver presents some interesting features. Twelve radio-frequency stages, first detector, crystal oscillator, frequency multiplier, three intermediate-frequency stages, second detector (AVC), 15-kilocycle noise amplifier and rectifier, relay control tube, and audio amplifier.

The principle of operation of the re-

lay control is based upon inherent circuit noise and variations of this noise with signal input. A filter which passes a narrow band centered at 15 kilocycles is branched off from the audio input circuit. The resultant 15-kilocycle noise component is amplified and rectified to produce control bias for the relay tube. The system operates with the relay, which controls the

The operator is summoning help from headquarters for the injured ski-trooper.



transmitter, *off* under maximum circuit noise, static crashes or other heavy noise, and relay *on* when an application of a signal causes a reduction in the 15-kilocycle noise component.

The radio equipment of the forest ranger or ski trooper must, of necessity, be able to "take it." Controls must be fool-proof. Operation must be so simplified that even an untrained operator can manipulate it. Parts must be standard in design and available through commercial sources. The word "portable" to the skier must be interpreted literally. Other equipment which he normally carries weighs between 25 and 35 pounds. Thus, ten or eleven pounds is about the practical limit of additional weight he can bear for purposes of communication. Since portable radios must be low-powered, the supply of energy is also restricted on semi-portable forest units. An insufficient number of frequencies makes it necessary to repeat the same wavelengths within the interference range in order to keep power at a minimum; in this way the portable radio equipment is protected against interference from the high-powered mobile and semi-portable equipment, also in use throughout isolated sections.

The value of ski troop training has been forcefully demonstrated by the Russians. In recent months, the United States Army has stepped up its activities in this direction and has been preparing troops in the mastery of skis for duty in whatever snow-covered battlefields our war effort may bring us.

The modern use of skis in offensive and defensive warfare has brought about the increases of popular treks to skiing areas. Skis as a mode of transportation have assumed a definite place in our national life. The Norwegians were using skis as early as the fifteenth century. Their first use as an aid to military forces was in 1904 when the Norwegians organized a military ski school at Briancon for the French Army.

Aiding the Forest Service in patrolling winter sports areas is a group of expert skiers of the *National Ski Association*. Members of this association volunteer their services for scheduled and systematic patrols of ski trails in the National Forests. Each member who contributes his time to this growing national pastime is an expert skier, qualified to give first aid. Without the help of the volunteer patrol in policing the trails, assisting in rescues, and summoning aid, the forest ranger would find his winter unceasing. The Forest Service pays enthusiastic tribute to this group and to their sponsor, Roger Langley.

Recognizing the need for outdoor exercise and relaxation as a means to maintaining public morale in times of war, it has been decided to continue the ski trains and busses which have been operating to and from winter playgrounds. The National Park Service has just announced the opening of a new ski lodge in Mount Rainier Na-

(Continued on page 59)



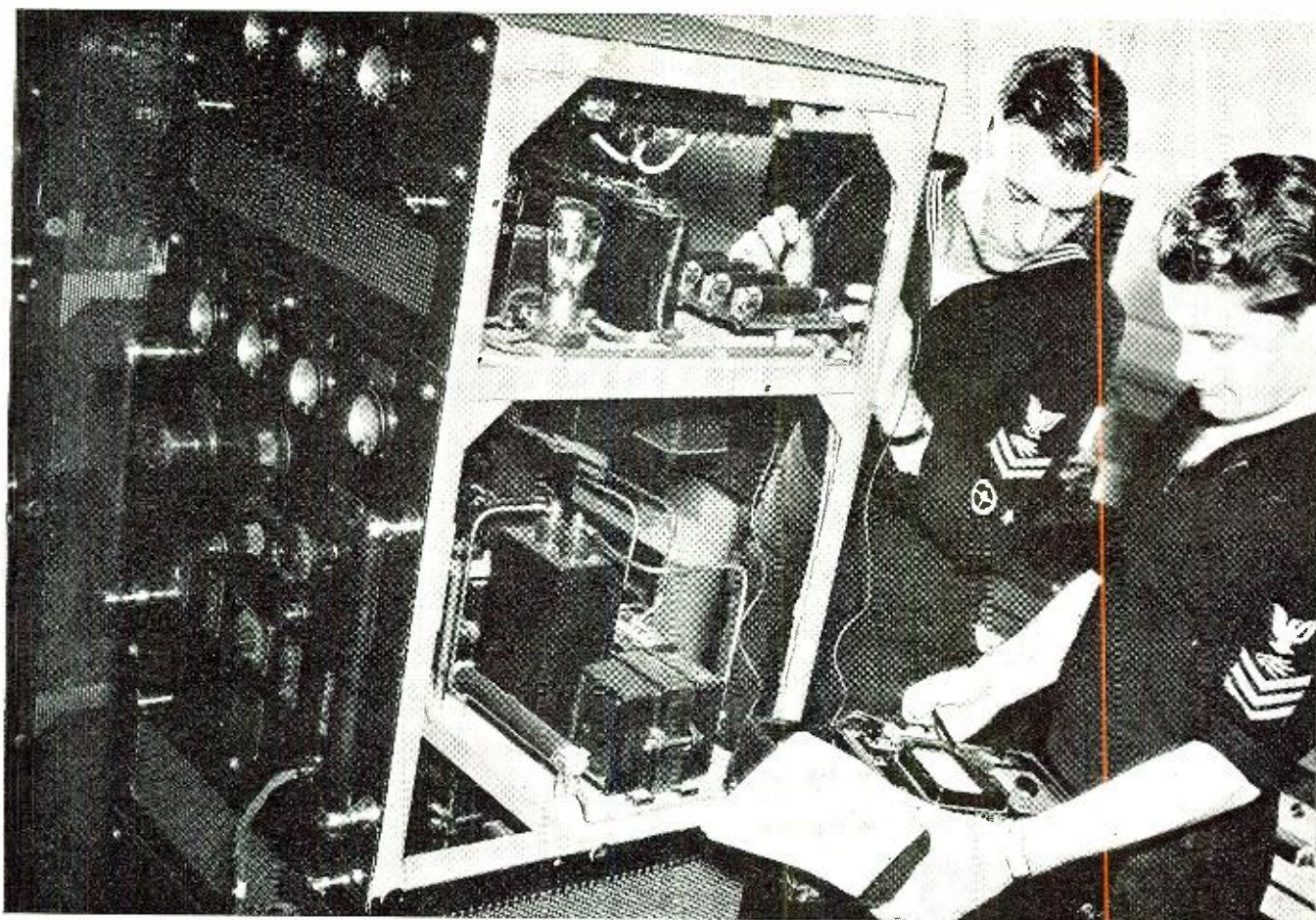

Complicated circuits hold no fear for the operator after completion of course.

# Radio Training in the Coast Guard

by Capt. ROBERT DONOHUE

Commander, New London Base

**T**HERE is probably no service in which radio plays such a varied role as in the *U. S. Coast Guard*, and certainly no service in which radio plays a more important part. Today the *Coast Guard*, distributed as it is not only along the coasts, inland waterways and *Great Lakes* of this continent, but among all U. S. possessions as well, requires a very comprehensive radio system just for communications within its own elements. Add to this the need for regular and emergency contact with commercial ship and shore points, dissemination of weather reports and storm warnings, the operation of direction-finding and beacon stations, the provision of 2-way communication with lightships, and its many other miscellaneous radio functions, and some idea is gained of the extent and importance of radio in the *Coast Guard*.

To meet the requirements for qualified operators the *U. S. Coast Guard Resident Radio School* was established at Fort Trumbull, New London, Conn., back in 1926. Its training program has been recognized as one of the finest in

*Graduated from the Coast Guard Academy and was commissioned in 1913. Since that time he has served as a qualified aviator, a qualified engineer, and a line officer. His interest in the training and education of enlisted personnel brought about his assignment as Superintendent of the Maritime Service Training Station at Fort Trumbull from whence followed a further assignment in October, 1940, as Commander of the New London Base.*



***Training facilities in the Coast Guard for radio operators is expanding at a fast rate.***

existence, and as one which requires unusually high standards of performance on the part of the men who complete it. Today this school is still functioning at full speed, and a similar school has been started at Curtis Bay, Maryland, to meet the increased demand for trained operators arising out of the present emergency. Training facilities at New London are being expanded as rapidly as possible and it is expected that before many more months have elapsed there will be

enough radio operators being turned out to meet the rising needs of the *Coast Guard* service.

In the meantime however, there is a need for experienced radio men—radio amateurs or ex-commercial operators who are qualified in their code speed and technical knowledge to step right into operators' berths, or others whose knowledge and ability are such as to enable them to qualify as operators with appreciably less than the usual training necessary to a man who



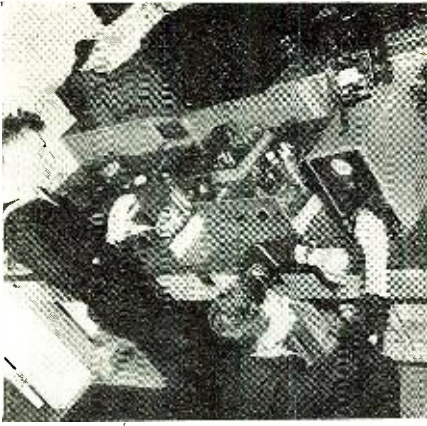

Coast Guard ops "learn by doing."



Checking contactors on beacon unit.



Students testing radio transmitter.

Practical study in the laboratory.



starts from the very beginning.

Men who enlist and qualify as operators enter the *Coast Guard* service with rating and pay corresponding to their ability. While the normal pay on enlistment is \$21.00 per month (it may have been increased along with the initial pay for all branches of military service by the time this appears in print), qualified radio operators can obtain up to \$72.00 or \$84.00 per month right from the start. These are the pay rates of 2nd and 1st Class Radiomen, respectively, and are in addition to lodging, food, uniforms, etc.

What about young men with little or no radio experience but who desire to enlist for radio service, influenced perhaps by the knowledge that upon return to civil life they will be qualified for jobs as commercial radio operators, or perhaps by the fact that radio offers an excellent chance for rapid advancement within the service?

It is usually not possible to accept enlistments with a specified type of service. Tests might disclose a lack of aptitude for radio, there might be more urgent need for men for other types of work, and so on. However, a man upon enlistment can state his preference, and his desires will be honored insofar as this is possible and is for the good of the service.

Any man who has a fair understanding of radio theory or practice, or who is able to transmit and receive code will, of course, have an excellent chance of getting into the radio end. If he applies himself he will find it possible to advance rapidly. It is often said of the *Coast Guard* that it offers advantages over the other uniformed services in that it is smaller and individual ability is more quickly recognized. Certain it is that every man who desires it has constant opportunity for self improvement. Correspondence courses are available to him when on active duty and there are resident courses for which he can make application. All of this training is, of course, without charge of any kind so far as the enlisted student is concerned.

Briefly the radio training consists of three parts, an elementary resident course by means of which a beginner is converted into a full-fledged radio operator, a technical correspondence

course by means of which operators can prepare themselves for advancement while on active duty, and an advanced resident course which qualifies the student as an expert maintenance and repair man.

### **The Elementary Course**

This is a resident course given at the *U. S. Coast Guard Resident Radio School* at the New London Base, New London, Conn. It is a six-month, full-time training course, the graduates of which are fully qualified radio operators capable of copying code directly on a typewriter at a speed of 25 words per minute, familiar with the operation of standard *Coast Guard* transmitting and receiving equipment, and thoroughly acquainted with message-handling procedure, and the other duties involved in station operation.

A hundred men are in training at one time in this school, of which Lieutenant M. H. Griffith is Officer in Charge, assisted by Ensign W. W. Ballowe and a staff of six instructors. The school itself is a rambling 2-story building in which the lower floor is occupied by the code room, laboratory, lecture hall and other rooms where the practical instruction on the operation of CG equipment is given. The barracks where the students live occupy the second floor.

Study hours are from 8:00 a.m. to 4:30 p.m. from Monday through Friday of each week. Saturdays are given over to weekly tests and examinations by means of which each student's progress is closely followed. If these weekly tests disclose delinquency on the part of any students, these are given extra evening sessions the following week to enable them to catch up. Failure of a student to keep up with his group will result in his transfer to some other type of work. This is not necessarily a reflection on such students (who constitute between 10 and 15 percent of those who undertake the training), but provides definite indication that these men are not cut out to be radio operators.

During the first 3 months of the training the school day is divided as follows:

- 8:00 to 9:15 a.m. Theory lecture
- 9:15 to 9:30 a.m. Recess
- 9:30 to 11:45 a.m. Code practice

Study of direction finding equipment.



Section of the transmitter room.

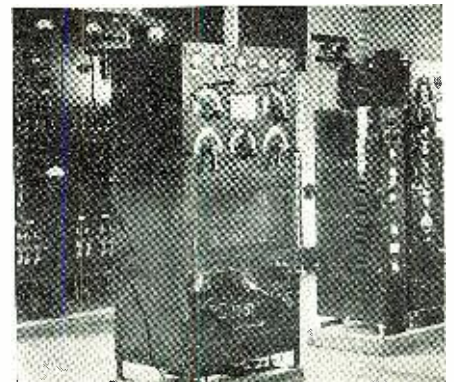



11:45 to 12:00 n. Sweeping up  
 12:00 to 1:00 p.m. Lunch  
 1:00 to 2:45 p.m. Procedure lecture  
 2:45 to 3:00 p.m. Recess  
 3:00 to 4:30 p.m. Code practice

The term "code practice" also includes touch typewriting practice, as all code reception, right from the very beginning, is copied on the typewriter. It has been found that in this way the code symbols for a given letter automatically associate themselves with the corresponding key on the typewriter in the mind and reflexes of the student and that he gains speed faster. During the second week transmitting practice is started by each student and in this connection a great deal of effort is concentrated on the development of good sending "fists." One means toward this end is to have the students listen to perfectly keyed transmission and to accompany this transmission with their own keying. In this way any undesirable tendencies are readily detected and remedied before they become habits.

It is an interesting fact that code reading speed increases at the rate of approximately one word per minute each week. Also that a speed key or "bug" when properly adjusted and operated provides better "copy" for receiving practice than does a straight key. All code characters are made at a 20 w.p.m. rate regardless of the actual number of words transmitted per minute (until the student's speed exceeds 20 w.p.m.).

The study of procedure is based on *Coast Guard-Navy, Army* and commercial practice and includes study of radio laws and regulations, various government publications relating to the subject, etc.

The study of theory utilizes as its text the elementary section of the "Practical Radio Engineering" course of the Capitol Radio Engineering Institute. The scope of the theory studies is self evident from the following list of subjects covered:

- Arithmetic
- Elementary Algebra
- Electron Theory
- Current and Voltage
- Conductors and Insulators
- Series-parallel Circuits
- A.C. Generators
- Batteries and Charging

Operating procedure class in session

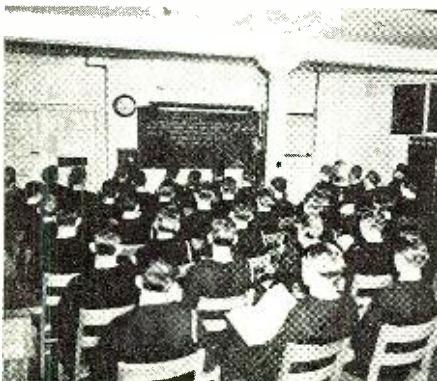

D.C. Generators, Motors, Meters  
 Inductance and Capacitance  
 Radio Circuits and Constants  
 Vacuum Tubes and Circuits  
 Radio Receivers  
 Transmitting and Receiving  
 Antennas

Types of Radio Transmissions  
 Radio Transmitters  
 Radio Direction Finders

During the second three months of this course practical laboratory work, procedure drills and actual watch-standing practice are substituted for the daily lectures on theory and procedure. As a result of this thoroughgoing, practical experience, most graduates are able, when they leave the school, to immediately take over a radio watch without additional instruction at the place of assignment.

Upon graduation from this resident school, students receive a rating of Radioman 3rd Class, carrying with it pay of \$60.00 per month. Considering the fact that most of them enter as Apprentice Seamen with pay of \$21.00 per month, this is rapid progress. (These are the pay scales in effect during the early part of March when this is being written and may be increased, perhaps before this appears in print, by pending legislation.)

For those who enter the service with fairly extensive radio knowledge and experience, but not enough to qualify immediately as operators, there is a special course given at this resident school. This course enables these experienced men to complete their basic training in three months instead of the usual six.

From the New London elementary school, or from the similar school at Curtis Bay, Md., the student is assigned to active duty. His first assignment is likely to be aboard ship. Here he will accumulate operating practice in actual service.

#### **The Coast Guard Institute**

When the operator goes on active duty, his study for advancement need not stop. In fact, every man is required to continue. For this purpose facilities are provided the operator through enrollment at the Coast Guard Institute, a Service correspondence school long established at the New London Base to provide enlisted

*(Continued on page 53)*

Equipment used for "standing watch"

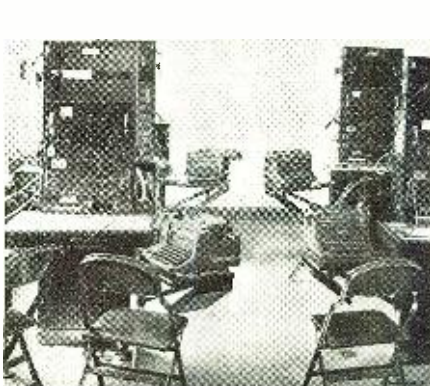

Instructor explains tuning procedure



Proper keying habits are studied here



This Class is studying radio theory

Code reading and touch typing class







Special sets are needed for sounding air alarms.

# ALERT RECEIVER CIRCUITS

by **RUFUS P. TURNER**

Consulting Engineer, RADIO NEWS

***Today, more than ever before, the technicians have a real opportunity to develop remote-control devices.***

**A** SMALL number of civilian radio men handled remote control equipment prior to the war. A larger number consumed thousands of words of printed matter on the subject. The bulk of amateur interest in control gear seems to have centered about the manipulation of model planes in flight. But whatever the motivating impulse, the art of controlling distant mechanisms by means of radio never failed to open wide new vistas to all who dipped into its mysteries.

Today, when every technical skill has enlisted for defense, radio control is finding real, practical jobs to do. The amateur, serviceman, or experimenter who has dabbled in "remoting" can summon up his knowledge of the subject, tackle one of these jobs, and do his community a full-sized service. The opportunity that beckons at the moment is the construction and installation of *alert receivers*—robot sets that turn on alarms automatically

when a local radio station transmits a raid-warning signal—and working out alert-signal systems with local broadcast, police, or special emergency stations. An opportunity is afforded at the same time for close cooperation with local civilian defense authorities.

A substantial number of "extra" receivers can be converted into alert sets with little constructional difficulty. Another prolific source of supply is the ham junk box which will doubtless yield sufficient parts for building many more such sets. Alert receivers do not have to be showy, but they must stand watch with the faithfulness of a fine timepiece and be built against breakdown.

In this article are shown several receiver circuits and transmitting systems which may readily be comprehended by the average radio builder. There are numerous other possible circuits and systems, as well as a flood of elaborations of the schemes we show. We believe the circuits appear-

ing on these pages to contain the essentials of any alert-receiver system and recommend them to radio men looking over the proposition from scratch.

Each receiver will require a particular kind of transmitted signal; and before building any set, the radio man will need to confer with local radio stations (who will, in turn, query the F. C. C. and D. C. B.) to ascertain if that type of signal will be authorized for transmission in his locality.

### ***Receiver Requirements***

In order to be dependable and reasonably fool-proof, the alert receiver must:

1. Require no outside antennae.
2. Operate on line power or batteries, and possess means for automatically switching-in batteries on failure of the line power.
3. Be capable of remaining tuned to the alarm station over long periods of non-maintenance.



4. Possess high safety factor in all components, to insure against break-downs or faulty operation.

5. Be capable of operating a powerful alarm, such as a large bell, heavy horn or siren, or strong danger lights.

The first requirement almost makes the superheterodyne type of receiver the sole choice. However, some efficient T.R.F. circuits possess sufficient local sensitivity to operate satisfactorily with loops or short lengths of wire. The loop receiver is strongly favored, since it is compact, complete, and readily portable and may be moved quickly from one location to another.

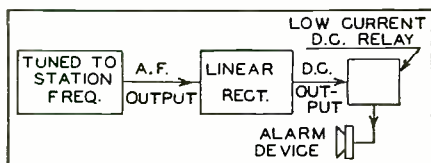

Fig. 1.

Any satisfactory receiver may be made to satisfy the second requirement by rewiring the power supply circuit, as shown in Figure 7, so that standby batteries are automatically switched in at the instant of line voltage failure.

The third requirement calls for sturdy mechanical construction in the receiver, good tuned circuit design, fresh tubes, and shock-proof mounting of the set. This does not mean that the builder will be required to design a set from the very start. A careful inspection of a potential alert receiver will reveal faulty tuning condenser insulation, which gives rise to poor tuned-circuit Q and resultant instability. This material may be replaced, or the entire condenser gang changed. Excessively long r.f. leads may be shortened. Tuning condenser end bearings may be tightened, rotor brushes cleaned and tightened, sockets and glass tube envelopes washed down with benzene or lacquer thinner. Loose coils may be rewound, and all faulty soldered joints remade.

Requirement 4 is an important one that calls for "over-designing" the set. By-pass condensers, filter condensers, filter chokes, resistors, power trans-

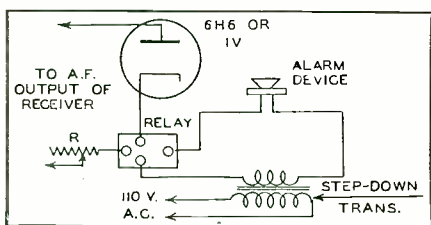

Fig. 2.

formers, and rectifier tubes should be replaced with components rated to withstand higher voltages and currents than appear in the circuits.

By the use of satisfactory electronic relay schemes, as will be shown in the receiver circuits, requirement 5 may be satisfied. The type of alarm signal will be a matter of individual choice.

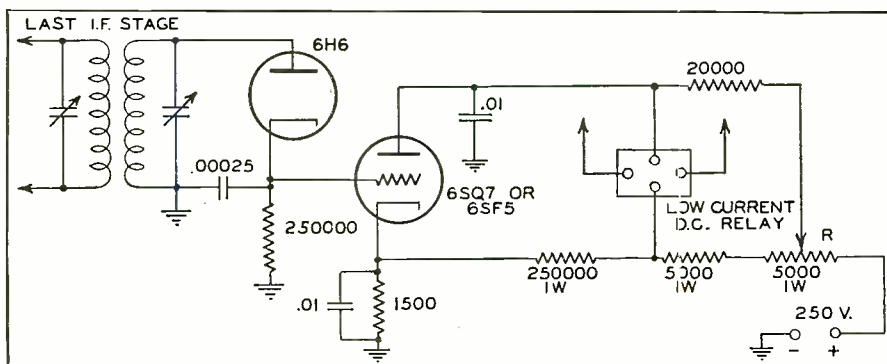

Fig. 5.

### Circuits and Systems

In order to operate a distant alarm, the transmitted signal must fall into one of these categories: (1) pure c. w. carrier, keyed or sustained; (2) tone-modulated carrier, modulated at audible, sub-audible, or supra-audible frequency; and (3) tone-modulated carrier, modulated within the audio spectrum, the modulation percentage of

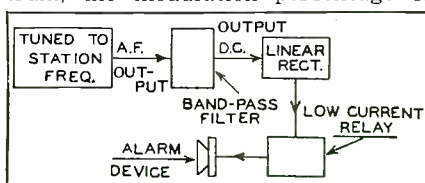

Fig. 3.

which may be varied to actuate the alarm.

Carrier-operated systems may be made very simple. For example; an emergency transmitting station may be set up to operate on an exclusive, or semi-exclusive frequency. A simple receiver to pick up emergency transmissions from such a station might consist of a single r.f. amplifier and detector, and a sensitive, low-current d.c. relay might be connected into the de-

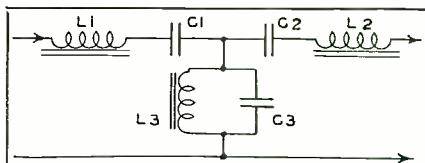

Fig. 4.

tector plate circuit to be actuated by the change in plate current when the emergency signal is picked up. The secondary circuit of the relay is then connected to a battery and bell. Each time the emergency carrier is switched on, the change in detector plate current at the distant receiver will cause the sensitive relay to close, sounding the bell signal.

However, simple carrier receivers

are not entirely practical for alert purposes. In addition to requiring the services of a special station operating on a particular frequency, such simple sets are subject to static, both man-made and atmospheric, interfering signals, and poor sensitivity. For these reasons, the use of extremely simple carrier-operated alarms is not recommended, except in cases where an ultra-high frequency emergency station may be authorized for the locality and a superregenerative receiver is employed. Accordingly, only one carrier-operated alarm is shown in this article and that is the relatively advanced superhet arrangement of Figure 5 which will be described presently.

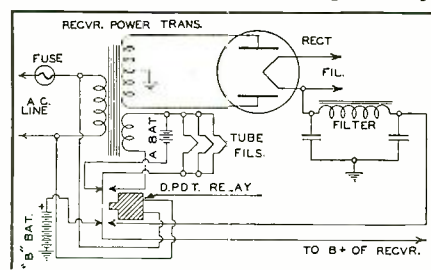

Fig. 7.

Figures 1 and 3 show tone-operated alert receivers. While it may be supposed that, since these are single frequency responsive sets, a special transmitting station will be required, it is assumed that the special tone will be transmitted by a regular broadcast or police station.

Referring to the explanatory block diagram of Figure 1, the receiver is tunable to the station frequency and left operating at all times. The audio-frequency output voltage from the receiver is applied to a linear diode detector which rectifies it and delivers the direct currents to low-current d.c. relay. If the a.f. output is taken directly from the detector stage, this re-

(Continued on page 56)

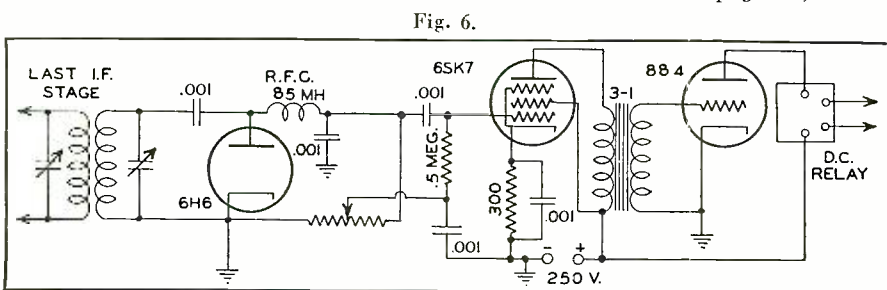
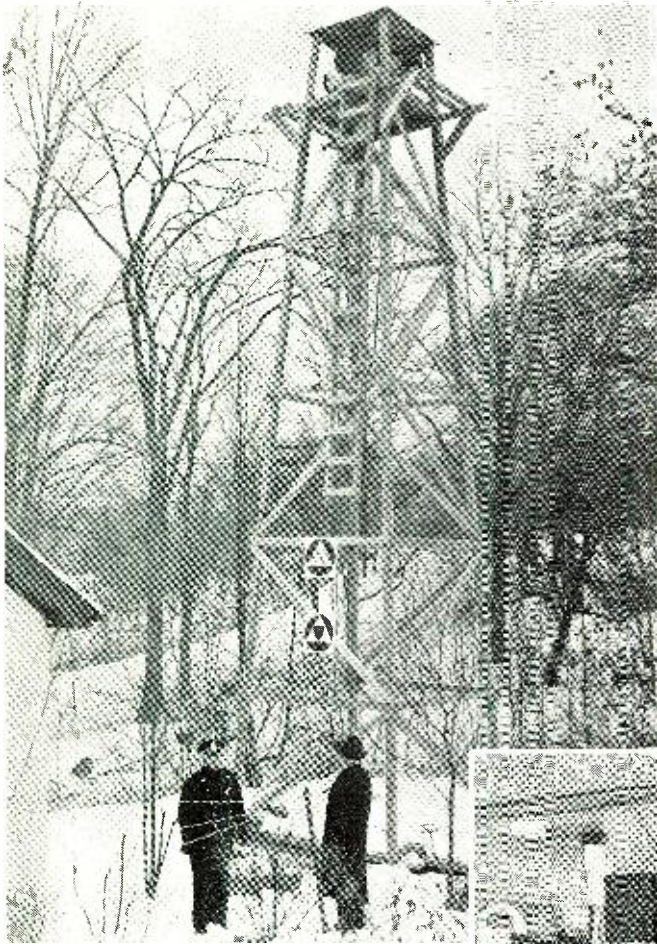

Fig. 6.





A 34' air raid tower showing the speakers mounted on a platform.

**T**ODAY'S watchword throughout the country is all out for Victory, and with this utmost in our minds, it therefore becomes necessary to coordinate our manpower, our resources, and our equipment. It is the purpose of this article to show the vital necessity modern communications may play in our defense plan. Having erected and installed the first official Air Raid Warning Tower in this section of the country, this article will describe the proper procedure to have an Air Raid Tower made *official*.

The problem in our section, as in many sections of the country, is what is known as a "dead-spot," that is, locations where we cannot hear any signals from the official fire houses. With this condition in mind, it was therefore necessary to turn to the modern method of receiving an official signal, and erecting a tower and associated equipment that would enable us to send forth an approved signal, such as is used for fire whistles as in our section. To have a better understanding of the modern means of communication, and how it may be used in your own community, we shall describe, briefly, this theory.

Referring to suggested communications, Air Raid Emergency chart, you will notice that the "alert" signal will originate at Army Headquarters. This



The author shows the system to Capt. Philip McQuillan of the Greenburgh police. Note the insignia appearing on the panel of the power amplifier on the right.

signal is then sent through the teletype system to the teletype headquarters. The teletype headquarters branches off to the various Police Stations having teletype receivers.

The central point of communications in which we are interested, is our local Police Headquarters for the handling of messages, teletype, telephone and radio. In the majority of cases, Police Headquarters have this equipment.

Branching off from Police Headquarters, we have the two-way radio cars, the various fire houses, schools, factories, industries, and Air Raid

Warning Towers. The chart will clearly show the type of communications which should be used between these various centers. The working of this system is as follows:

On the teletype system, there are three signals given, yellow for precaution, blue for caution, and red for air raid warning. Army Headquarters originates these signals. Assuming that this is put into operation, the following would take place. The yellow signal is given by Army Headquarters over the teletype system to teletype headquarters. The teletype headquarters sends out the yellow sig-

# Civilian Air Raid Warning

by **THOMAS J. TAAFFE, Jr.**

*Here is a complete workable plan that may be followed to advantage for hundreds of towns and cities.*



nal to the various receivers that are hooked up to this center, the local Police Headquarters being one of them. Upon receiving this yellow signal, Police Headquarters notify the various fire houses, factories, industries and Air Raid Warning Towers by telephoning that the yellow signal has been given. This warning is accompanied by an official signature of the officer giving the call. After giving the yellow call by telephone to these points, the Operators in these air raid warning posts, turn on their radio receivers which are tuned in to the local Police Headquarters only. Police Headquarters, through their radio transmitter, again give the yellow signal accompanied by an authorized signature.

From here on all communications with reference to the receiving of the blue or the red signal, are given by radio. It would be well to remember that this is a four-check system, before an alarm is given out, and that an accurate station log should be kept to enter all official calls received, time they were received, signal that was received, and officer who authorized the call. This is very important, as one of the main objects is to eliminate any possibility of false alarms.

Assuming that the red signal is received, it is then the duty of the various Air Raid Warning Stations to send out the proper air raid warning signal. When this signal is sent out, all volunteers and equipment should report to their designated fire houses, which shall be predetermined, and divided into districts, according to the number of fire houses, and the size of the territory being covered. All Air Raid Wardens and Senior Wardens, will naturally take their positions in their designated sectors.

All Officials and Directors of the emergency work shall report to Police

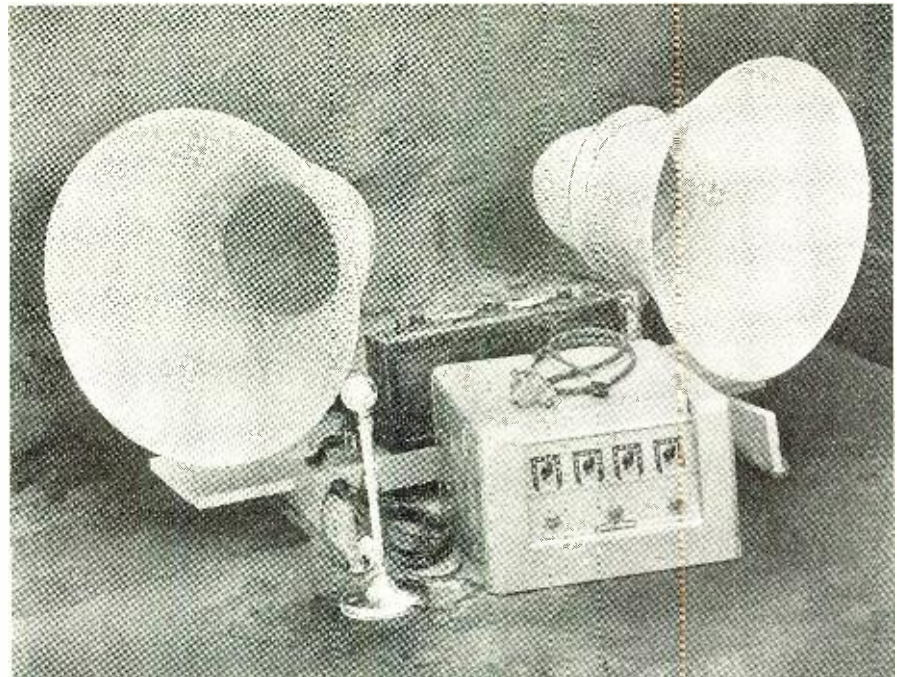

Traffic control car equipment includes 30 watt amplifier, mike and speakers.

Headquarters. Each school shall have a telephone dispatcher who will report to the school post. These schools are to have a direct telephone line to Police Headquarters.

**Sending Emergency Equipment and Auxiliaries to a Given Point in Case of Necessity**

The Wardens in need of help are to give their messages to the Senior Wardens by personal contact, the Senior Warden in turn, reports by telephone to the school district to which he is assigned. The dispatcher at the school reports by telephone to Police Headquarters. As there may be many calls coming in at one time from various districts in need of help, Officials at

Police Headquarters will determine where and what type of equipment, and Auxiliaries are needed. The call is then sent out over the Police Radio to the fire house where these Auxiliaries are constantly on the alert.

At the same time, the call is given to the Police Radio Squad Car to proceed to the location of trouble, and to meet the Auxiliaries and report back to Headquarters from the location of trouble. In this manner, it is possible to be in direct contact, and know exactly the conditions in the field, and it is also possible to send these various units wherever they may be needed, communications in this case being between Police Radio Car and Police Headquarters. This chart should be

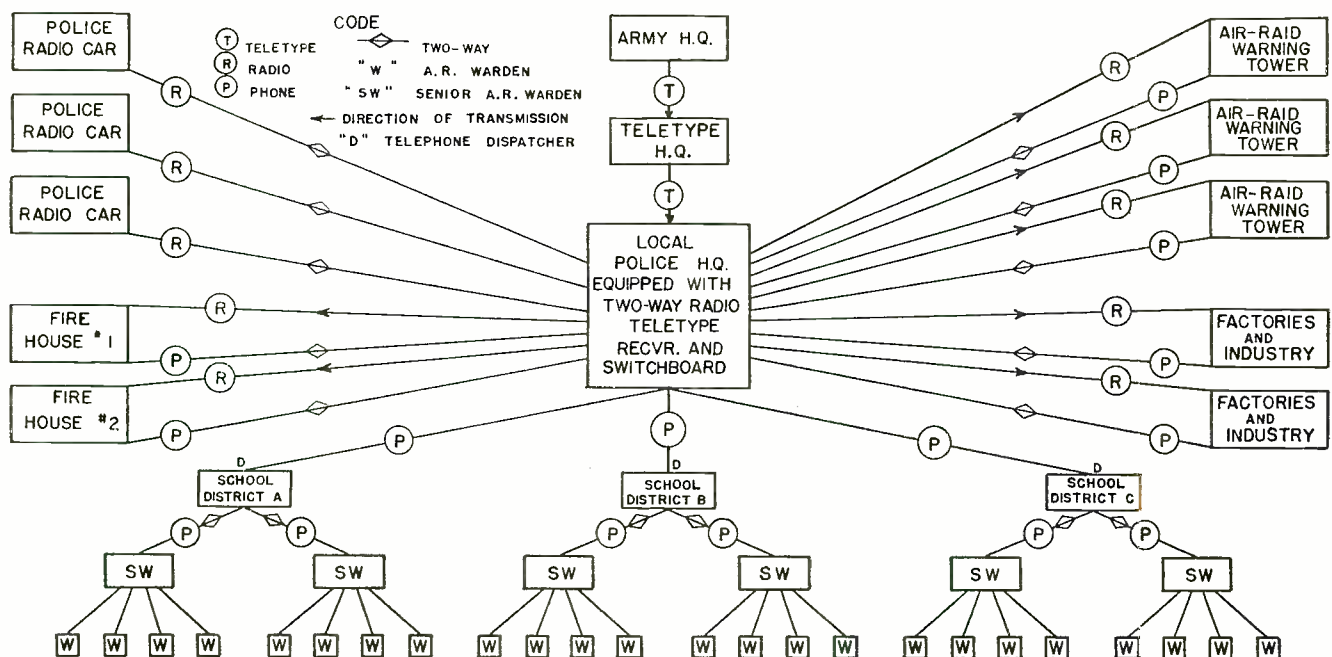





Traffic Control Car with full equipment mounted. Left-to-right: Fred Sutherland, P. McQuillan, H. Medovich, C. Bukes, Howard Kinch, and William Stillman.

drawn up to meet the requirements of your own community.

**The Official Air Raid Warning Tower**

The first step in this procedure is to determine that you are in a dead spot, and that enough people are affected so as not to be able to hear the

company working in the neighborhood. Camouflage paint was supplied by a local resident. Official signs for the tower were donated by a local sign painter. Upon completion of the work, refreshments were served by a local tavern owner to all those who participated in the project.

This is the typical American spirit, and I am sure you will find it in your community as we did in ours.

**Equipment for the Tower**

The problem of equipping the Air Raid Warning Tower is quite a simple one, as all standard equipment is used throughout. You may even find, in your community, many of the necessary parts. Of course, it would always be advisable to have your local radio man, or sound technician, work with you on the laying out, and the setting up of this equipment. We are equipped with a *Hallicrafter*, all-wave receiver.

This receiver was chosen because our Police Radio Station is working

on a frequency of 33.1 megacycles. It should be kept in mind that only a very reliable communications receiver should be used as this is the center of your receiving the alarm information. Connected with this receiver, we are using an antenna of a type recommended by the manufacturer.

This receiver is left tuned to our Police Station at all times, and the on-and-off operation of this receiver is worked through a separate 110 volt switch box which is equipped with a green light, showing "on" for the radio, and a red light showing "on" for the amplifier system which generates the signal to the speakers in the tower. The amplifier in use here is a standard make, with an output of 100 watts.

Any standard public address amplifier of sufficient power can be used for this purpose. To determine the power of the amplifier that may be needed for your particular location, and the amount of area which you desire to cover, again it would be advisable to get this information from the manufacturers of amplifiers, or your local men as stated before. By using a standard amplifier, it becomes apparent that we may generate any type of signal that we desire, in our case, of generating a signal similar to the blast of a fire horn, we are using a standard oscillator that emits a 400 cycle note.

The output of this oscillator is fed into the input of the amplifier. The line connecting the oscillator and the amplifier has a switch in it which enables us to send a given alarm which in our township is the No. 5 signal; four rounds, which is eighty blasts. If in the future, it is decided that a siren is to be used instead of an air type signal, all that has to be done to this equipment is to hook a microphone up to your amplifier in conjunction with a small electrically driven siren, thereby amplifying this siren to great proportions.

The output of this amplifier is fed to four loud speakers which are mounted in large parabolics, and are placed on top of the tower, one speaker in each direction. These speakers are equipped with transformers to match the output of the amplifier. Here, again, is the necessity of using good

*(Continued on page 69)*

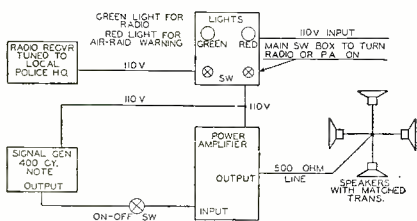

Block diagram of complete system.

signal from the fire houses. It will be found that in these locations, you will have any number of people who belong to the various auxiliaries. By gathering these organizations together, and working out the problem with the Civilian Defense Council, the Chief Air Raid Warden, and the Police Department, you will find that they will be very willing to cooperate, and officially recognize a warning tower that your community may wish to set up. In our own community, the true American spirit of cooperation was predominant. The idea was started by five of the Police Auxiliary, of which the author is one.

By the time the tower and its associated equipment were completed, we had received the cooperation of fourteen union carpenters who received permission from their unions to work on this tower. The lumber for the tower was donated by a construction

W Q K Z						
GREENBURGH POLICE RADIO LOG						
On Watch .....			M		Operator .....	
Off Watch .....			M		Date .....	
Time	Operator	To	From	Message		
Time	Operator	Radio	Phone	Signal Given	Authorized by	All Clear Time Date

This is the special warning log sheet.



# CAA RADIO EQUIPMENT

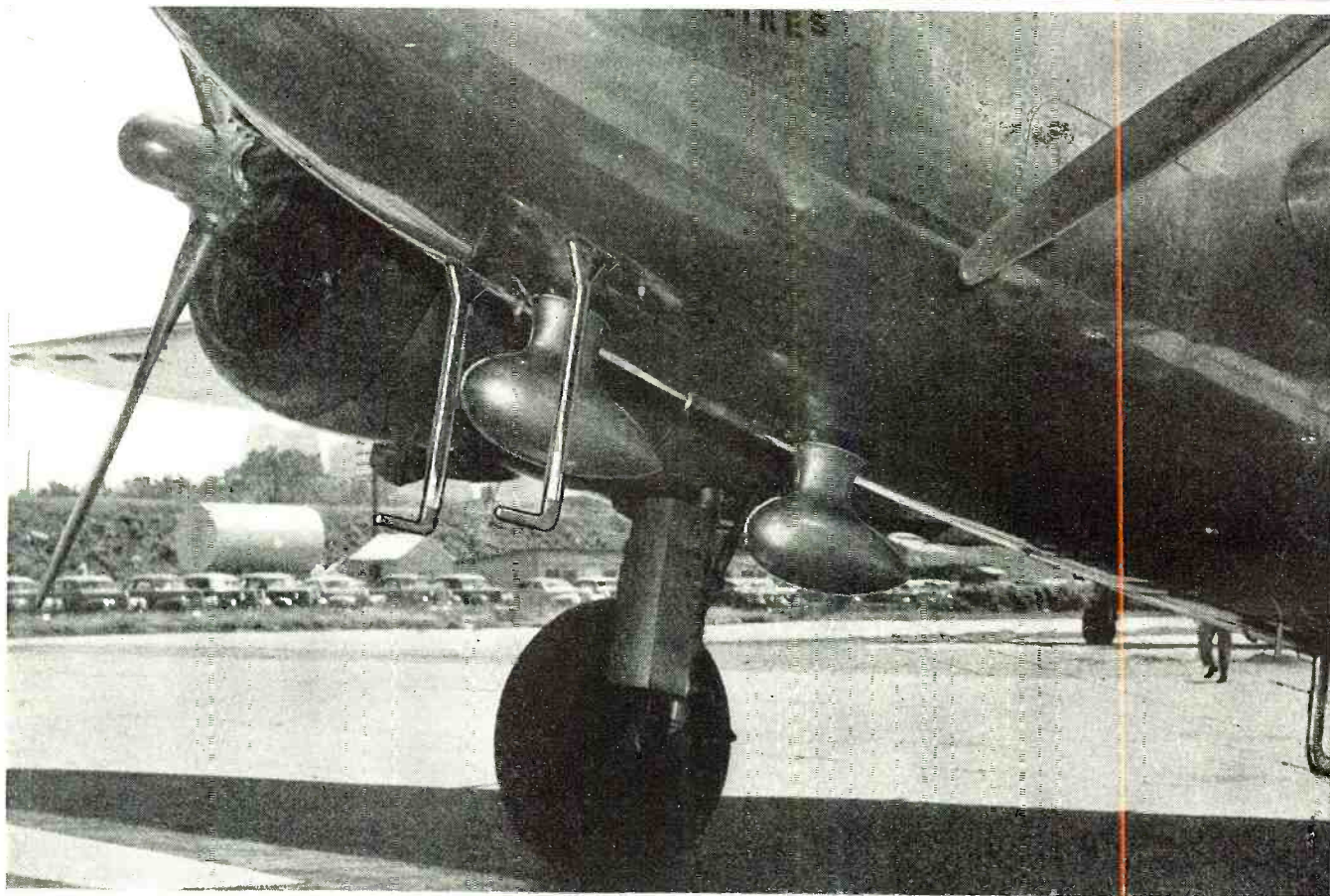

Dual loops installed on Mid-Continent Lockheed Lodestar plane.



by **REEDER G. NICHOLS**

Civil Aeronautics Administration

*Has been active in all phases of aeronautical radio communication and navigation. In 1934 he was radio operator and assistant navigator with Roscoe Turner and Clyde Pangborn in the England to Australia air race. On this trip he broke all existing records for communication from aircraft to ground stations, maintaining unbroken half-hourly schedules with Bergen, Norway, and San Francisco, California, at distances of 1,500 to 11,400 miles. He is now head of the CAA radio and electrical inspection service, a position which he organized and has headed for six years.*

***One of the most progressive departments in radio is the Civil Aeronautics group that serves military and civil needs.***

**T**HE element of speed in air transportation places a demand on communications and radio navigation not shared by other means of transportation. In surface transportation, efficient dispatching and signalling systems are necessary for efficiency and, to a great extent, the safety of operations. Air transportation requires an efficient communication and navigation system for its routine operation, and under conditions of

adverse weather this system must be expanded to utilize every resource of the radio engineering art, not only for safety reasons but for its very existence in the field of competitive forms of transportation.

An air transportation system that functions only during the period when the sun shines does not offer any advantage over competitive means of surface transportation. The sun may be shining in Cleveland while it is rain-

ing in New York and Chicago. Recently a meteorologist directed my attention to a weather map of the United States explaining that it was possible, at that moment, to fly from Los Angeles to New York by visual reference to the ground alone. This condition of good weather is so unusual that when it occurs it is worthy of note.

Airplanes of our scheduled air lines are dispatched from coast to coast as a matter of routine, and at some point along the route will encounter weather conditions requiring instrument navigation. Instrument navigation therefore establishes the requirements for radio communication and navigation equipment. Prudence and a healthy respect for safety demands that under these conditions the radio equipment will not fail, or in the event of failure of an individual unit from unforeseen causes, another alternative unit or system can be utilized to fill the breach.

The average passenger transport plane is equipped with the following units of radio equipment:

- |                                      |                                     |
|--------------------------------------|-------------------------------------|
| (1) Transmitter                      | } Comprising two-way radiotelephone |
| (2) Receiver                         |                                     |
| (3) Radio range receiver system, and |                                     |



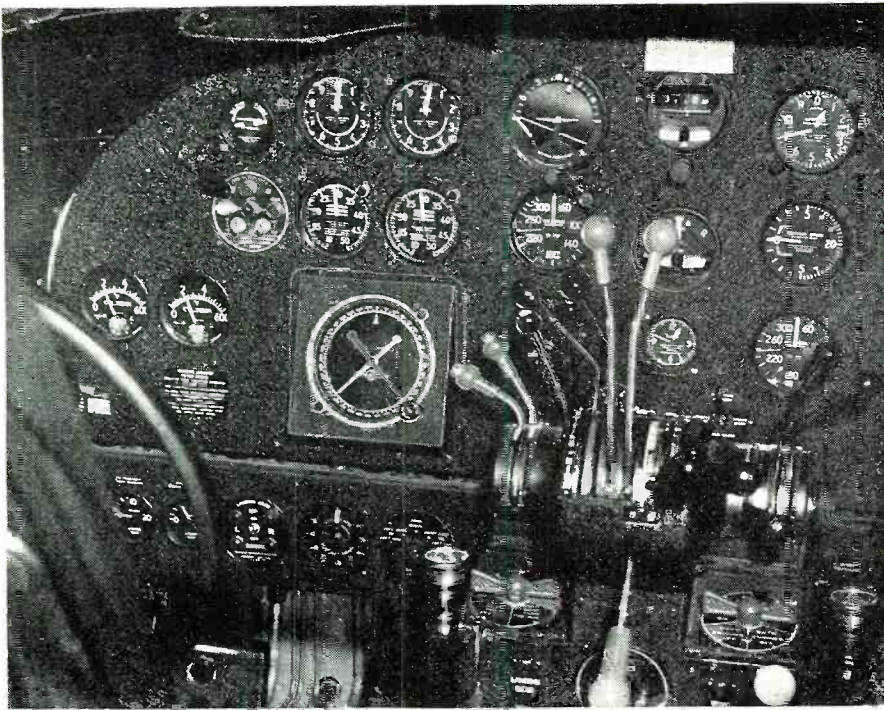

Nerve center of the modern airliner is the radio compass.

- (4) Auxiliary range receiver system, and
- (5) Radio direction finder system (may be incorporated with 3 or 4) and
- (6) Anti-Precipitation static antenna system (may be incorporated with 5 for use on 3 and/or 4) and
- (7) Auxiliary power supply (to be used with 3 and/or 4)
- (8) Simultaneous audio filter system
- (9) 75 megacycle marker beacon receiving system
- (10) Two headsets
- (11) Two microphones

Note: A properly designed auto-

matic direction finder may be used to meet the requirements of 3, 5, and 6, or 4, 5, and 6.

An analysis of the above tabulation will show that the requirements for radio equipment aboard scheduled air line aircraft is more complex than a simple transmitting and receiving system. A brief description of the units comprising this system are outlined below:

*Item 1—Transmitter*—Transmitters used in transport aircraft range in power from 50 to 100 watts. They are of the multi-frequency type, the more modern types providing up to ten (10)

frequency channels and, with some modifications, provisions are made for as many as fourteen (14) frequencies. The need for so many frequencies is explained as follows: An air line is assigned a day (4000 to 6600 kilocycles) and a night (2800 to 4000 kilocycles) frequency for each major division.

One factor which determines the length of a frequency division may be the volume of traffic handled. In the case of one of the major transcontinental air lines, as many as fifteen (15) airplanes may be in the air at one time on one frequency division such as the New York to Chicago run. A second frequency division would be the operation between Chicago and Salt Lake City, a third between Salt Lake and Seattle, while a fourth division is the company's operation between Seattle and San Diego. Thus, it is seen that with a day and night frequency for each of the aforementioned divisions a total of eight (8) of the ten (10) available frequencies may be used by one airplane in less than twenty-four (24) hours of flight operations.

In addition, Airport Control Towers and *Civil Aeronautics Administration* Communication Stations along the route are contacted on 3117.5 and 6210 kilocycles. Thus, all ten (10) of the available channels in the transmitter are utilized. These frequencies are invariably crystal controlled and the r.f. circuit generally consists of a crystal controlled oscillator, a doubler or buffer stage and a final stage using either a pair of 807's, or one 803 tube. The audio system consists of a single button carbon microphone with zero d.b. output level, a low gain amplifier and a pair of modulator tubes which, in the case of the 50 watt transmitters, are 616's, and 830B's in the other.

Anode voltage is obtained from a dynamotor with 12 or 24 volt primary input and 500 to 1050 volts secondary. The primary input is from the electrical system of the ship, consisting of two 105 ampere hour batteries charged by two voltage regulated flight engine driven 50 ampere, 15 volt generators. Filament lighting is obtained direct from the electrical system of the ship. In the case of transmitters using cathode type oscillator or speech amplifier tubes, provisions are made for the filament to be on at all times the airplane is operating, while the filaments of the modulator and power amplifier tubes are controlled by an on-off switch on the master radio panel in the cockpit.

The dynamotor and antenna transfer relay are controlled by a push-to-talk relay on the hand type microphone. The transmitter is generally installed above the baggage compartment in the space between the cockpit and the passenger cabin, and is completely remote controlled from the pilot's cockpit. The antenna lead-out is routed direct to a lead-out insulator immediately above the transmitter and feeds into the forward end of a longitudinal inclined antenna from the

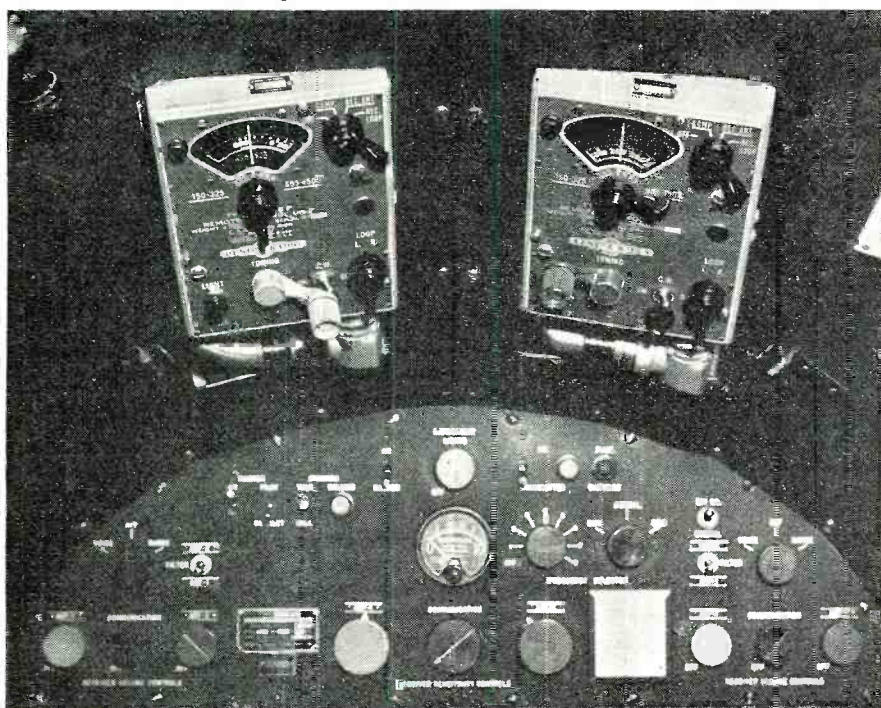

Remote control tuning units for dual automatic direction finding equipment.



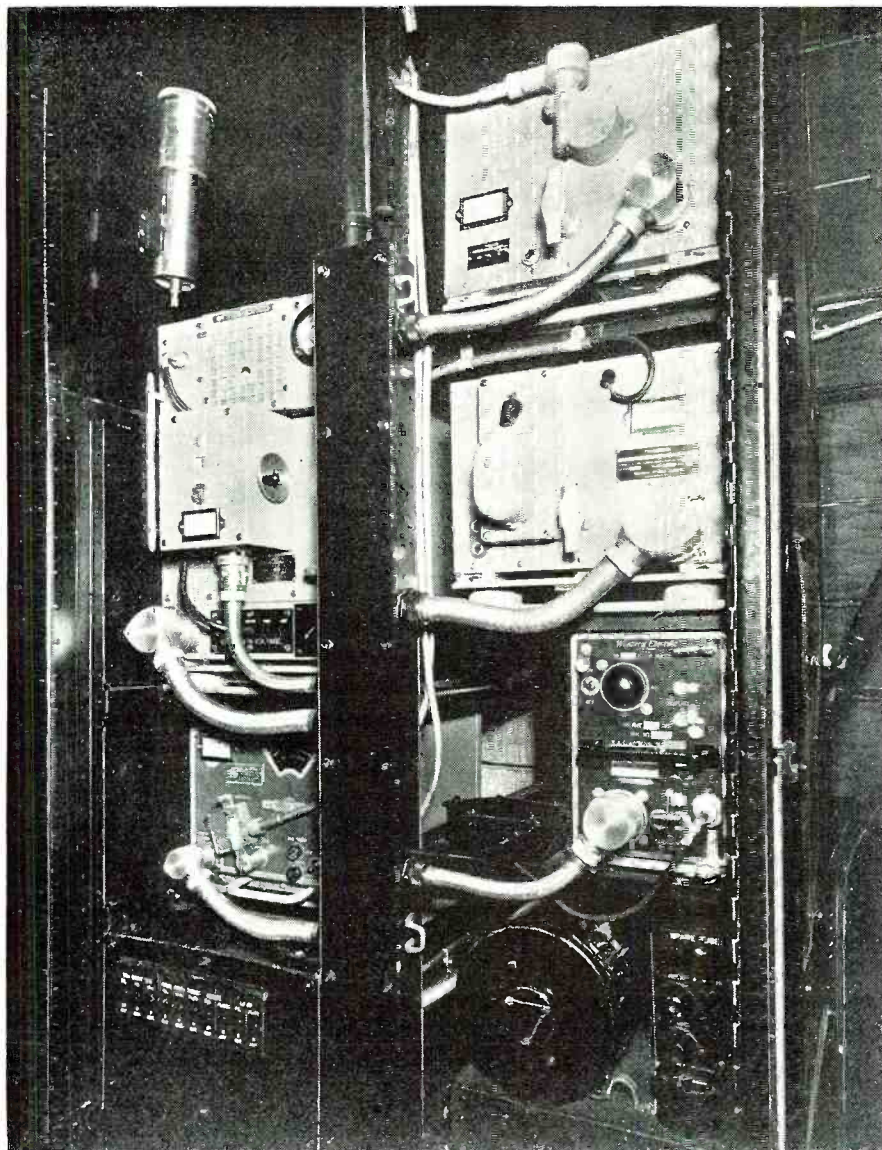

Rack installation in Northwest Airlines' DC-3 airplane, including 8 channel 100 watt transmitter, auxiliary receiver, range, communications, and marker sets.

★ ★

Radio remote-control panel installed in a Lockheed Lodestar airplane. Note the special knobs which are designed for easy handling when wearing gloves.

forward top part of the fuselage to the vertical fin, a length of approximately 45 feet, and rising to a height of approximately 7 feet at the vertical fin. Although this is a representative antenna and is physically fixed in length for all frequencies, the output circuit of the transmitter is required to couple efficiently into any antenna with resistance characteristics of 1 to 100 ohms and reactance of 100 ohms inductive to 300 ohms capacitive, in order that efficient tuning for any frequency between 2500 to 13,000 kilocycles may be obtained.

The audio system is generally designed to provide good intelligence at voice frequencies only and, in the interest of saving weight, the audio fidelity is limited to plus or minus 3 d.b. from 1000 cycles within the range of 500 to 3000 cycles with the response down at least 20 d.b. at 100 cycles. Permissible distortion is generally 10% at 95% modulation, measured at 1000 cycles.

*Item II—Receiver*—This receiver is used for reception of company owned ground stations which are established primarily for dispatching and general communication work as distinguished from the *Civil Aeronautics Administration* range stations which are used for radio navigation and are received on receivers listed under items 3, 4, and 5. The receiver generally consists of 8 or 10 pre-tuned crystal controlled channels operating on the same frequency as dialed up on the transmitter. Like the transmitter, the receiver is remotely controlled from the pilot's cockpit, and its control mechanism is actuated simultaneously with the transmitter frequency selection.

The crystals are usually ground to a fundamental frequency which is higher than the carrier frequency by an amount equal to the intermediate frequency of the receiver. The intermediate frequency of recent types has been standardized at 455 kilocycles. The selectivity characteristics are generally specified as a total band width of not more than 20 kilocycles at 60  
(Continued on page 71)

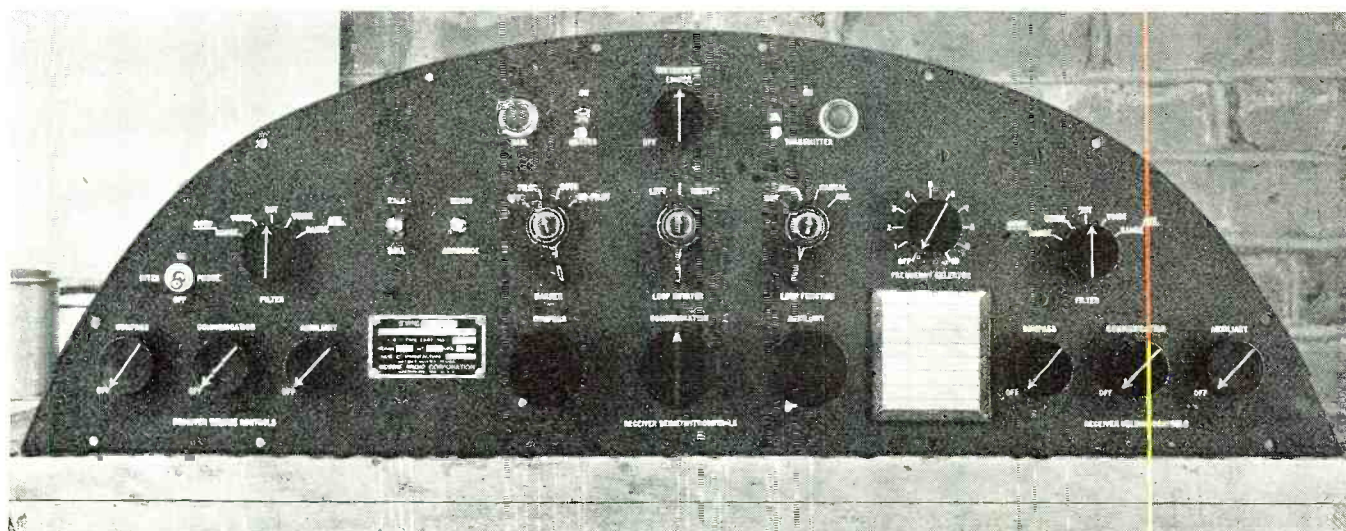





Here is a typical outdoor installation of photocell light source and receiver.

# Photoelectrics for Industrial Safety

by **R. E. APPEL**

Electronic Engineer

*Photoelectric equipment using the invisible infra-red rays has been found to be highly suited for the protection of defense plants.*

**W**HEN the sudden shock of Pearl Harbor jarred loose the last remaining notions that we were isolated from the theatre of war it also jarred loose some other false notions of security. We learned that every enemy country has infested our land with spies and saboteurs, ready to pounce on any unguarded properties that can in any way contribute to the success of our prosecution of the war. Among the objectives of saboteurs are the following:

- Water supplies and other municipal utilities
- Power Plants
- Docks
- Warehouses
- Shipyards
- Distilleries
- Ore Mines
- Factories
- Shops
- Coal Yards
- Coal Mines
- Granaries
- Refineries
- Oil & Gas Storage Plants

Oil & Gas Pipe Lines  
Munition Plants

Communication systems, etc.

In other cases the objectives of the enemy are not destruction but observation, and espionage agents abound to ferret out information that may serve their ends. This brought about the need for vigilance in guarding drafting rooms, experimental laboratories, tool rooms, precision measuring and testing equipment, and the like.

Photoelectric equipment using invisible (infra red) light has proved to be one of the best protective means. A leading manufacturer of photoelectric equipment has developed special Light Source and Receiver sets for anti-sabotage to which they refer as an "Invisible Fence." This name is aptly descriptive of its function and operation; for in effect it puts a fence around the property to be protected and at the same time is invisible. The units are small and easily camouflaged.

Among the various sales and service organizations none is so well suited to enter the field of Anti-Sabotage Equip-

ment as the Radio Sales and Service Companies located everywhere from the tiniest hamlet to the biggest city. Already the demand for Photoelectric Anti-Sabotage equipment far exceeds the supply of organizations that are prepared to sell and install the sets. This is not because any great amount of training is needed to perform this valuable service. It simply springs from the fact that war conditions have been thrust upon us so suddenly that we have not yet become aware of what is required of us.

This article, together with the information available from manufacturers of Photoelectric Anti-Sabotage Equip-

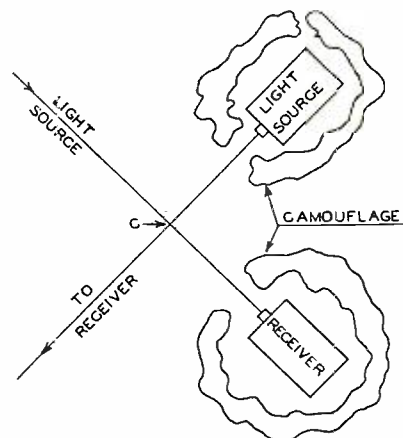

This is the proper way to direct the beam to its mate at the far corners shown on the diagram.





This type of commercial equipment is especially suited for industrial uses.

ment will give all the information needed to enter the important and patriotic work selling and installing the protective equipment that is so badly needed. Equipment itself is available in ample amount for manufacturers have no difficulty in getting priorities for the material they need.

Radio dealers who enter this important field will at the same time be preparing themselves for serving important peace time markets which will follow the war. Industrial applications of Photoelectric Equipment are too numerous to discuss in this article, and such equipment will be used in still greater volume when peace comes. There will be no lack of radio technicians when the war is over for they are being trained by the thousands in the service—one or more for every ship, lifeboat, tank, infantry unit, armored car, scout car and airplane. One form of training they will not get in the service is that pertaining to industrial production and now is the time for the radio dealer to get that

training while at the same time he renders a great service to his country.

To make proper recommendations for protecting any area one must be familiar with the kind of equipment available and the things to consider when making a survey of the property to be protected.

True Anti-Sabotage Equipment, although similar to other Photoelectric Equipment, has certain important refinements. A set consists of a light source designed both on the principles of electronics and optics. It projects a concentrated beam of invisible light through a filter that cuts off the rays at 7200 Angstroms. The beam enters a receiver containing a photoelectric cell. As long as the beam strikes the cell a current flows in the circuit of which the cell is a part. Any interruption of the beam caused by an object passing through it will operate a relay which in turn will set into action any alarm system to which the Receiver is connected.

The receiver is likewise designed according to both optics and electronics. It concentrates the beam so it will pass through a small diaphragm in order to enter the photocell chamber and excludes, as far as possible, all light except that which is projected by the Light Source. These features are of primary importance because without them a saboteur could pass through the beam without giving an alarm simply by shining a flashlight into the receiver in passing. True Anti-Sabotage Equipment is so accurately "aimed" that a flashlight beam could not enter the photocell chamber unless the flashlight were placed directly in the beam from the Light Source. This, of course, would give an alarm before the flashlight beam could strike its mark.

Anti-Sabotage sets are made with

weatherproof housings for outdoor installations and the best protected outdoor sets also have visors to keep out the rain and snow.

Three main types of equipment are supplied. One is for small indoor installations where only one beam is required and reflections from special focusing mirrors will criss-cross the single beam a sufficient number of times to cover the area to be protected. For such an installation no central control station is needed and all relays, including the one which operates the alarm, are within the Receiver. In the case of the Receiver is a lock switch for setting the equipment in operation. When the beam has been interrupted the alarm can only be shut off by the possessor of the key to the lock switch.

A second type of equipment is used in installations requiring a number of Anti-Sabotage Sets. In this case it is necessary to shut off the alarm and reset the equipment from a central station. A central control cabinet is provided and it contains all relays necessary for operating the alarm system

(Continued on page 77)

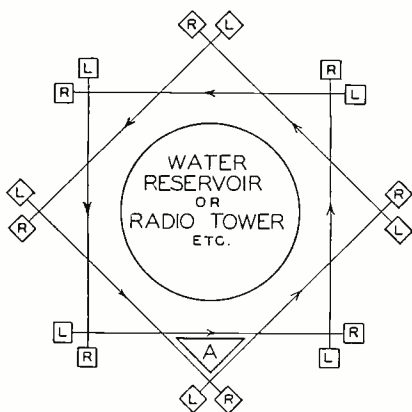

This vital water supply tower is protected against saboteurs by a network of photocell equipment.

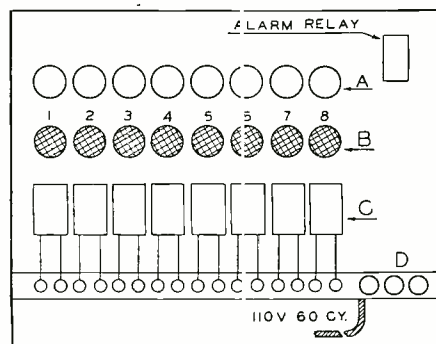

Panel for centralized control of a number of photoelectric units. Any number of stations may be used.



# Our Mechanized Cavalry

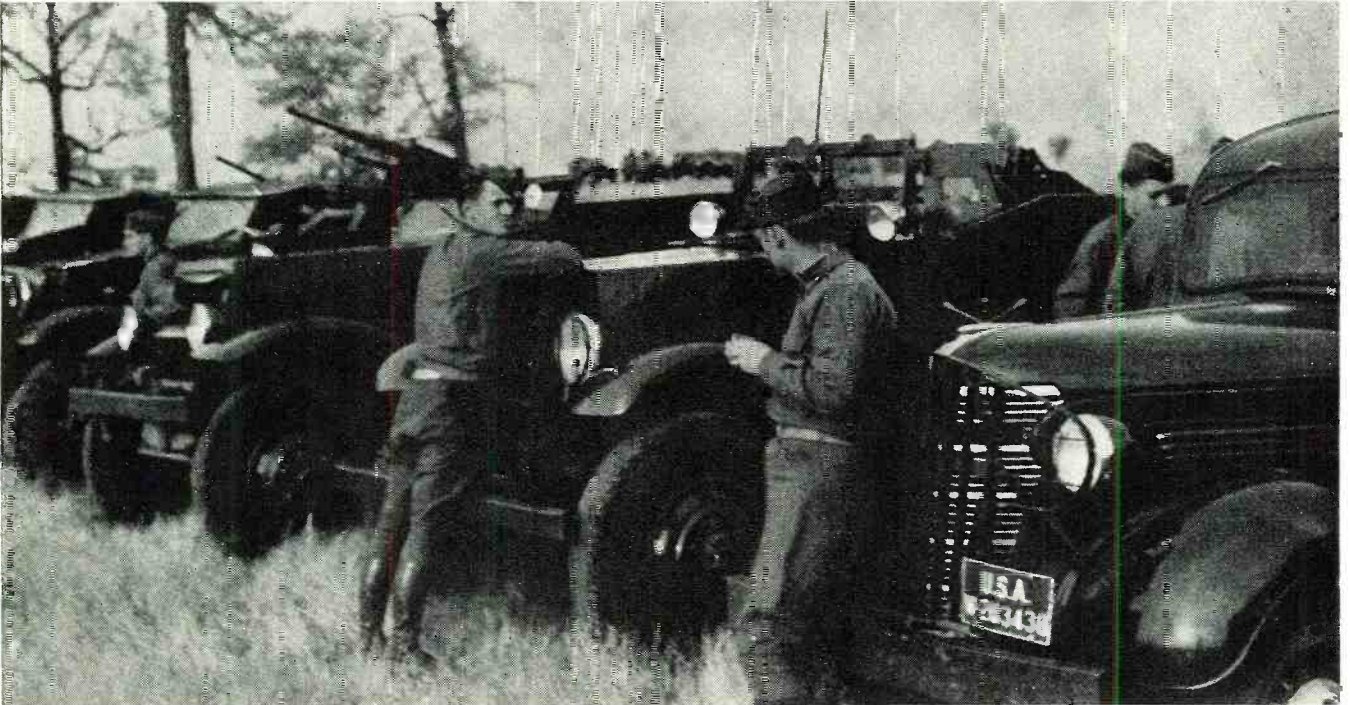

The Mechanized Cavalry puts up for the night. These are radio-equipped armored cars in which the officers ride enroute.

by  
**STANLEY  
JOHNSON, W9LEV**

**M**AXIMUM efficiency in our mechanized forces cannot be realized if there is a lack of coordination between each unit in the field. Radio is the principal contributing factor in maintaining speedy contact with these various portable units and operation is maintained by a force of specially trained radio men. The equipment includes many new innovations.

Radioman leans against one of the tank guns as last of the cars arrives in camp.



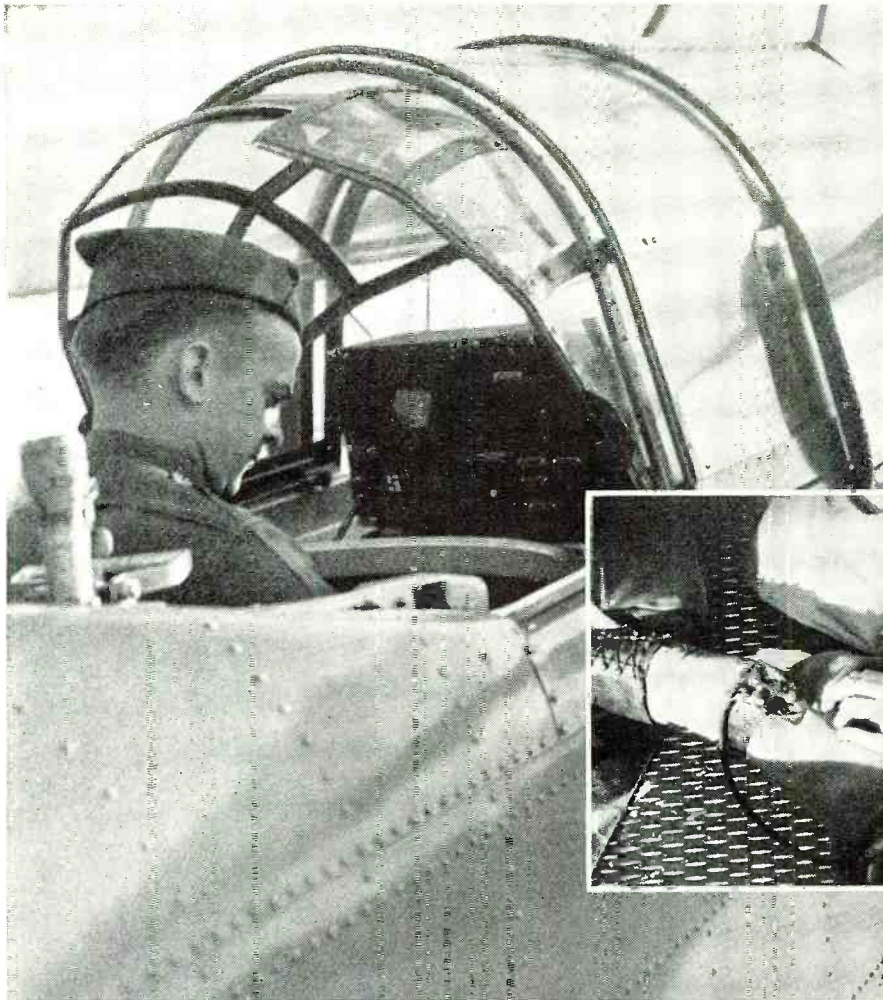

Planes, too, cooperate with the ground forces. This one is engaged in scouting for the moving trucks below.



The radio key is clamped to the leg of the operator. When the roads are rough, keying becomes most difficult.

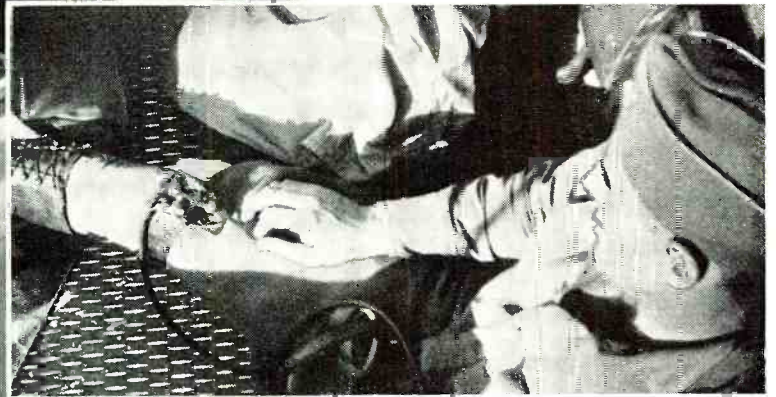

Radio-chief Nelson keys an order. CW is used widely for most communication.





# OUR POLICE RADIO



by

**ARNET A. CURRY**

Chief Radio Engineer, Communications, Indiana State Police

*Graduated from Purdue University in 1929 with a B.S.E.E. degree. In 1931 became an instructor in charge of Radio Engineering at the Indiana Technical College. Installation work had just begun on the Indiana State Police Radio System in 1935 when he joined that organization. He served as transmitter engineer for one year, then as chief radio engineer for the following six years. During the past year he has been in charge of the Communication Division. An active member of the national organization of Associated Police Communication Officers having served as Chairman of the Engineering Reports and Research Committee for the past three years.*

Below: Interior of the State Police radio station shows operator on duty. Note the three National HRO receivers and separate speakers. Lower right: Exterior of transmitter house with antenna in background.

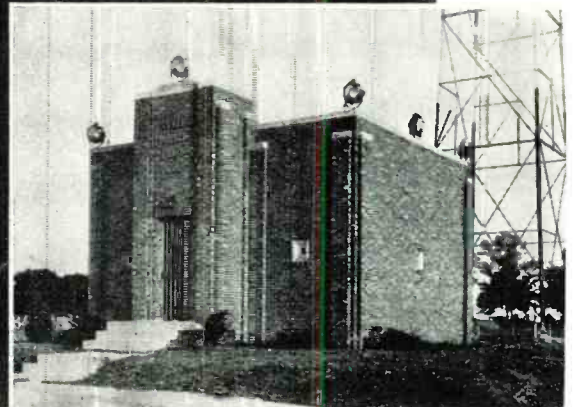



# TELEGRAPH NETWORKS

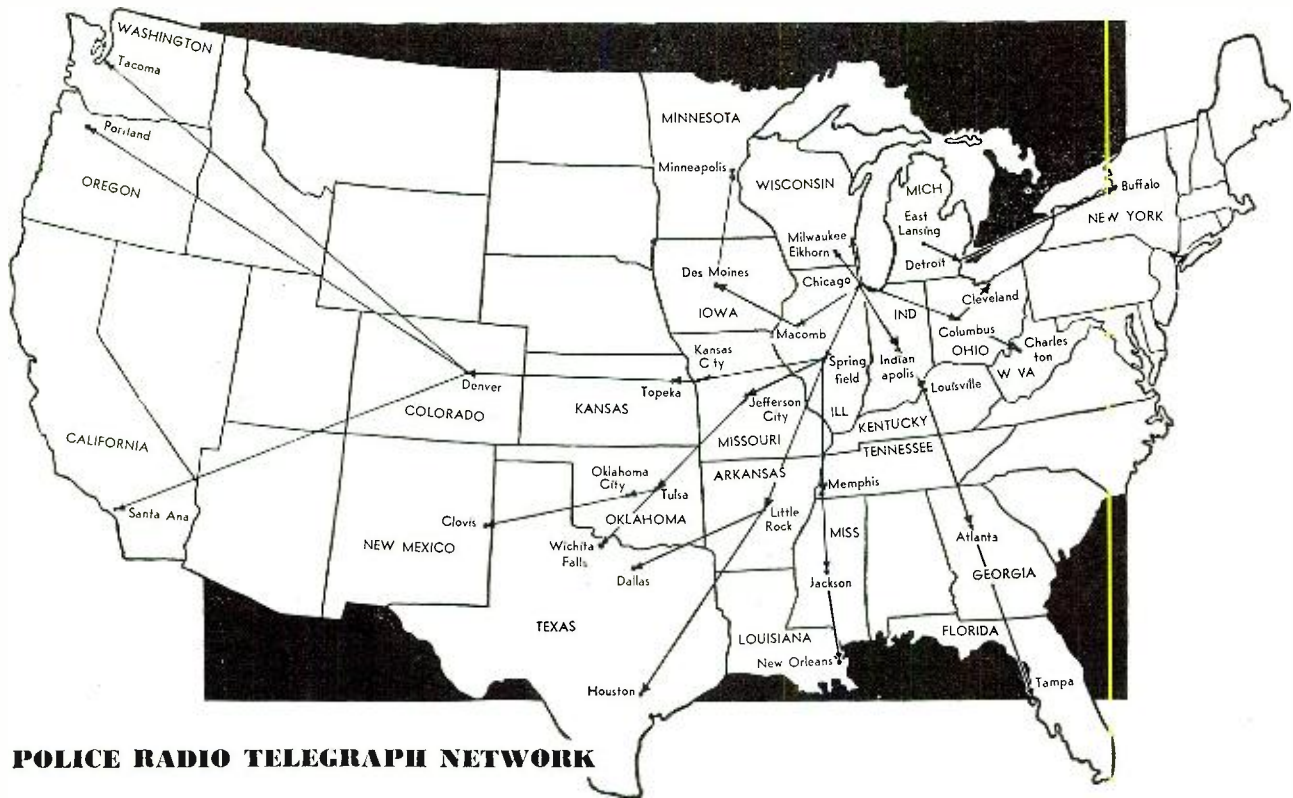

**POLICE RADIO TELEGRAPH NETWORK**

*Our vast police radio networks reach into principal States and handle traffic that may be either military or civil in nature.*

**T**HE usual concept of police radio communication is the broadcasting of police messages from a station to a squad car or vice versa, or from one station to another. However, another very important role in police work is being played behind the scenes in approximately 100 of our police stations scattered throughout the country.

These stations form a radio-telegraph network reaching into forty states, resulting in the rapid dissemination of police data from one part of the country to another.

In 1934, when the number of state and municipal police radio telephone stations was increasing rapidly, considerable interference resulted as the stations in various cities began to communicate with one another. Since the frequencies were limited and the traffic became greater, some other means of intercity communication had to be established.

At this time the *Associated Police Communication Officers* in their yearly convention in St. Louis adopted a plan to supplant intercity radio telephone communication with a radio telegraph system. In 1936 the FCC granted licenses to a few of the stations who had installed CW equipment in their stations.

Since that time the network has

grown to 70 zone police and 30 interzone police radio stations extending into the eight state eastern states teletype net and the California teletype system.

At present nine frequencies are available to the police radiotelegraph service in the 7000, 5100 and 2800 kc. bands. These stations are classified as zone or interzone or both. Stations licensed for zone operation communicate only with other zone stations usually within their own state. Interzone stations communicate with other such stations usually in surrounding states.

These zone and interzone stations are state or municipal stations licensed for telegraph operations. In a state police radio system, the usual method is to license the control station of the state for both zone and interzone operation, and the other stations merely for zone operation. Some of the larger cities however such as Detroit, Buffalo, Milwaukee, Indianapolis, etc., are municipal stations also operating interzone.

The 7000 kc. and 5011 kc. bands are used by the interzone stations for daytime operation, and the 5100 kc. band used at night. Zone stations operate on the 5100 kc. and 2800 kc. band during the day, and 2800 kc. at night.

Operating procedure among the sta-

tions follow along the same line as Naval radio operations with Z signals universally used. Code grouping and preamble and such terms as WPPA and WPPB are also in accordance with Naval procedure.

If a police message such as a check for wanted, or an attempt to locate message, or a plain wanted message is filed at an interzone station, it is either sent as a WPPA to all stations if the destination of the subjects concerned is unknown, or as a WPPB to a certain group of stations located in the area where the subjects may travel. If a message is urgent, the letter P is used after the call to designate priority traffic.

Messages originated at a zone station are sent to the local interzone station on the zone frequencies and then relayed to another interzone station closer to its destination if necessary.

The manner in which this Police radiotelegraph network becomes such a valuable aid to police work can be described as follows.

Messages originating in one part of the country and destined for another part are either sent direct by the interzone stations or relayed depending upon the distance involved. A message from the east coast to the west may be relayed six times before it is

*(Continued on page 65)*



# TELEVISION: The Wartime Instructor

by **AUSTIN LESCARBOURA**

*Mass instruction of air raid wardens is essential to our war effort. Television is proving to be a remote school teacher.*

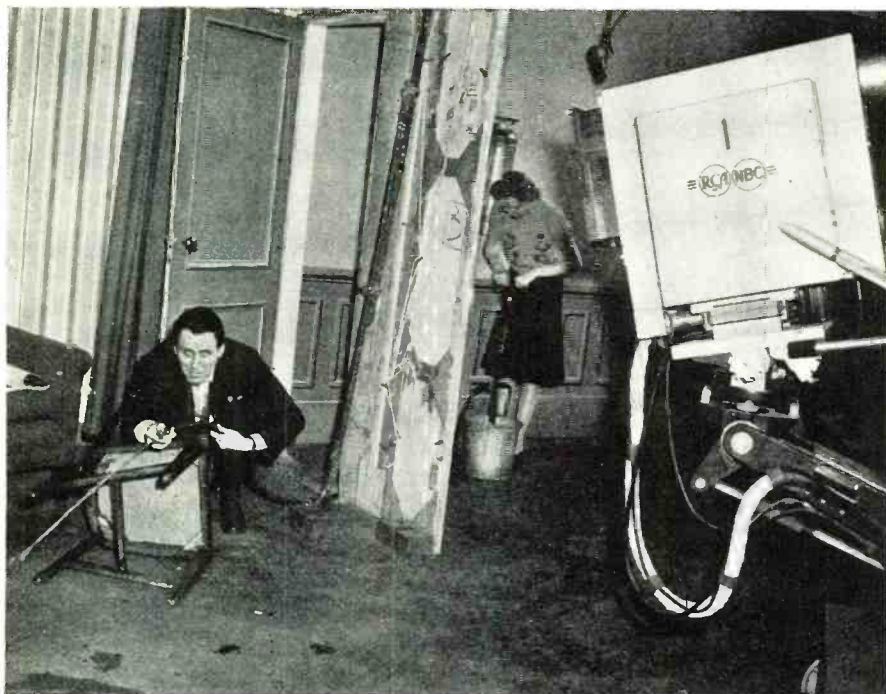

Studio scene in front of television camera shows "Mr. and Mrs. Brown" in action.

The stirrup pump is considered the best for combating incendiaries.



Police lieutenant acting as instructor for air raid television class.



**T**HE stars and stripes fade away with the closing strains of our National Anthem; the "Discussion Period" sign appears on the now silent television screen; and the local group sits down again to review the lecture and demonstration just attended by thousands of prospective air wardens scattered throughout the New York, Schenectady-Albany and Philadelphia areas, not to mention dozens of smaller communities all around. This is the greatest classroom in the world—and in all history. Indeed, even if television failed to offer the slightest entertainment value—and we know it is rich in entertainment values even at this early date; even if television never attained that popular price level to make it commonplace in the home—and we know it will make that popular price level in the near future; even if television continued to be little more than an interesting stunt—and we know it is far more than a stunt, already: right here and now television would still glitter as the outstanding mass instruction means of all time. Such is history in the making.

More specifically, sixty thousand or more prospective air wardens in those metropolitan areas, with more to follow, have been attending television classes for basic instruction. The fact is that they have compressed a good six months' training into as many weeks, while American ingenuity has demonstrated still another means of catching up with ruthless enemies that have several years' headstart in playing this modern game of all-out war.

These exceptionally fortunate air wardens have been listening face-to-face, and therefore most attentively, to leading civilian defense experts. They have seen and examined incendiary and demolition bombs, and witnessed the diabolical results of such destructive agencies in London and elsewhere via documentary films. They have studied poison gases and effective counter-measures. They have had a preview of swarms of bombers coming over for the attack, and the answering fire of anti-aircraft guns in action. They have gone through all the details of a blackout, and have become familiar with sand pail, long-handled shovel, stirrup pump and other tools of their wartime avocation. They have studied maps, sketches, plans, diagrams. Best of all, they have in some measure become acclimated to the surprise, shock, excitement and teamwork of realistically-staged air raids in company with the typical "Brown" family, that most efficient Post Warden, "Arthur Smith," and other fellow Americans on the television screen, thereby cultivating a growing immunity to that war of nerves upon which





Here are makings for three scenes in corner of NBC video studios.

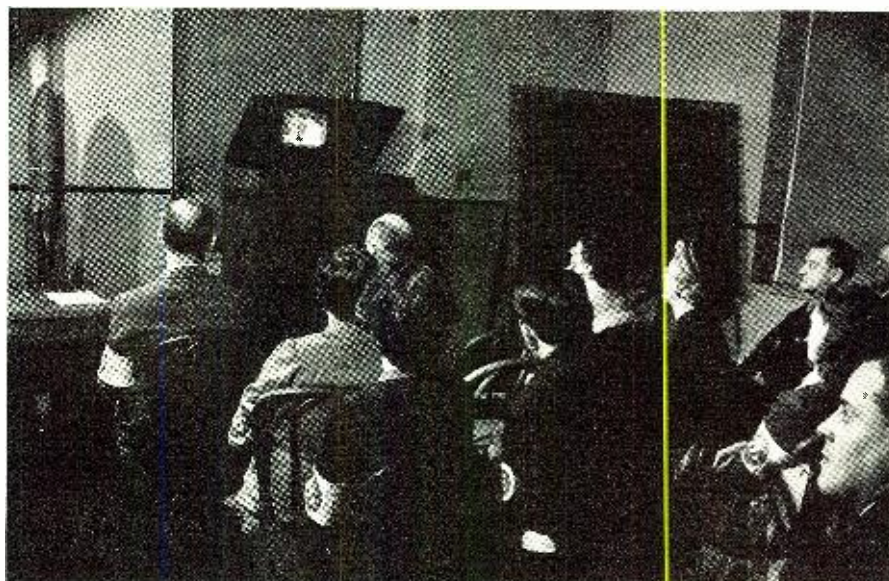

Typical television classroom in action. Prospective wardens are observing the action of instructors on the screen of the receiver in the classroom.

our enemies place such importance in softening up intended victims. Yes, sir, these properly instructed air wardens are being made tough and ready, if it should happen here.

The television classroom for prospective air wardens is a truly cooperative effort in which the *New York Police Department*, *Civilian Defense* authorities, the *National Broadcasting Company*, and leading manufacturers of television receivers have taken part in the New York metropolitan area, while these same facilities have been expanded to the Schenectady-Albany and the Philadelphia territories by *General Electric* and *Philco*, respectively. Thorough use has been made of all existing television sets out in the field, plus many more installed where necessary through the courtesy of the *Allen B. Du Mont Laboratories, Inc.*, *Radio Corporation of America*, *General Electric*, and *Philco*. Thus all precincts and districts now have necessary receiving facilities for the instruction of local air wardens.

The technical success of this mass instruction program rests in largest measure on the wide coverage of NBC's television transmitter, Station WNBT, atop the lofty Empire State Building in New York. This transmitter has a dependable transmitting range of 60 to 75 miles, taking in such distant communities as Poughkeepsie, Middletown, Newburgh, New Brunswick and even Trenton, most of Long Island, and Bridgeport. At this distance the usual television receiver is directly operated with satisfactory results. In fact, the writer recently installed a *Du Mont* television receiver in 20 minutes flat, simply assembling the dipole and reflector rig, placing same on the rafters under a slate roof, dropping the twin-conductor cable some 35 feet to the playroom in the basement, and tuning in a perfect television image with synchronized sound. All this, at a distance of some 30 miles

from WNBT, indicates a powerful and dependable signal certainly workable at two or three times this distance under favorable and proper receiving conditions.

It is interesting to note how this television air raid warden classroom program has made full use of the first available television network. After hearing so much discussion as to the almost insurmountable difficulties of establishing television networks especially by means of costly coaxial cable lines, we are now made aware of the simple relay network in daily operation. The GE relay station atop Helderberg Mountain, south of Schenectady, picks up the WNBT signal direct at a distance of 129 miles, due of course to the lofty location of both transmitter and receiver. Here the signal gets its one and only boost for three miles to the main WRGB transmitter for rebroadcast to the Schenectady-Albany-Troy area. This relay service was experimentally worked out early last year, and arrangements made to resume the relay service last December.

Although there is an AT&T coaxial line available between New York and Philadelphia, same having been employed at the time of the Republican National Convention for transmitting a video account of the proceedings to New York for television dissemination, the present network tie-up is again via radio, direct. WNBT's signals are

picked up by relay station W3XP at Wyndmoor, Pa., 32 miles away, and sent on some 8 miles to the main transmitter WPTZ in North Philadelphia.

Thus three leading metropolitan areas are tied in together in the training of their air wardens. In the New York area alone, it is estimated that the first group totalled 54,000 prospectives.  
(Continued on page 75)

Map shows present coverage of instruction.

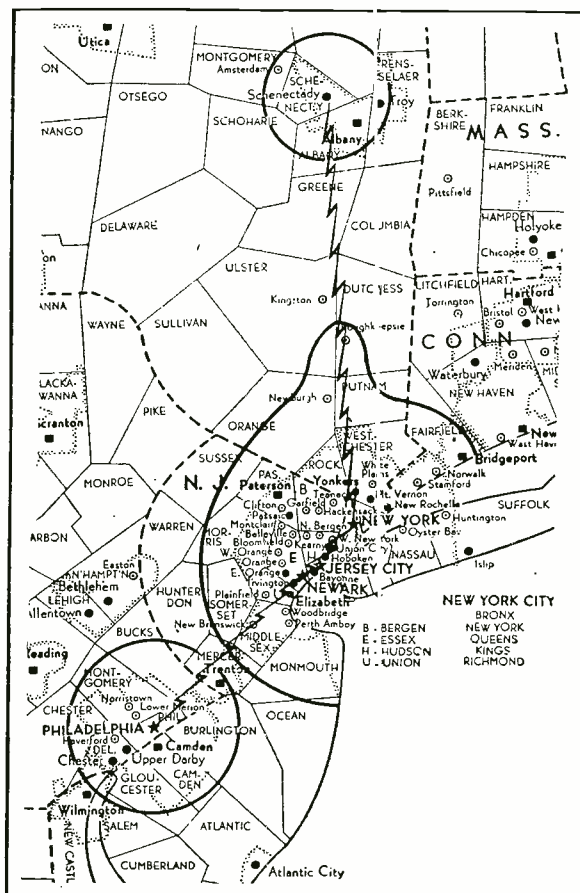



Staff Sgt. Slack sending code to radio students.

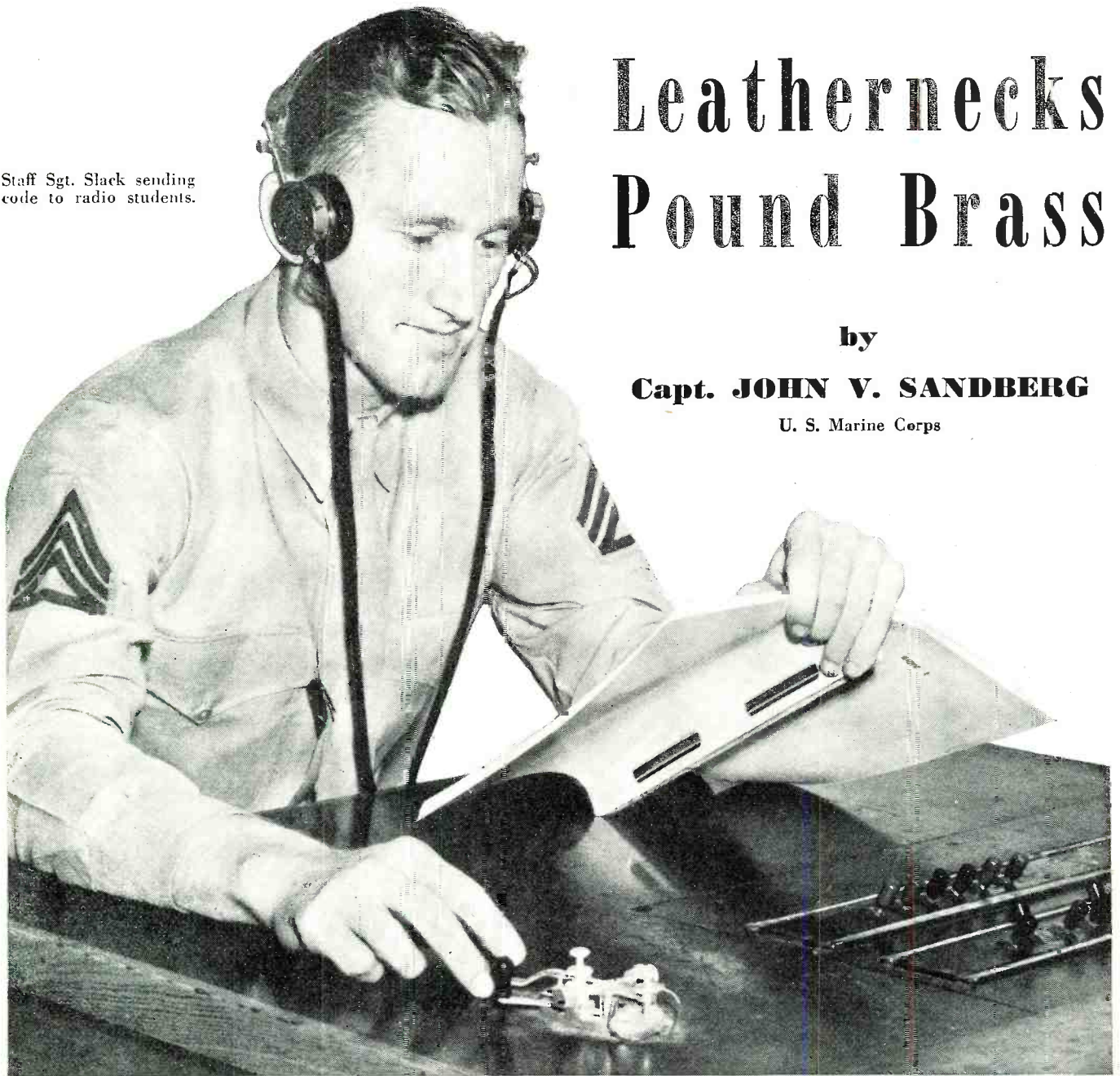

# Leathernecks Pound Brass

by

**Capt. JOHN V. SANDBERG**

U. S. Marine Corps

***THE Marine Corps is equipping its force with the finest radio equipment available. Schools are maintained under the leadership of prominent men.***

**T**HE United States Marines are known for their versatility. Their service covers a wide variety of activities, on land, at sea, and in the air.

Although an adjunct of the Navy, the U. S. Marine Corps is older than the Navy itself—having been authorized by an act of Continental Congress on November 10, 1775. During the course of its colorful existence, the U. S. Marines have participated in every major battle in which the United States has been involved. In the performance of their duties as "Soldiers of the Sea," the U. S. Marines function as a complete unit within itself. As

such, it must contain all necessary divisions for operation wherever it is called upon to serve.

Consequently, the Marine Corps has its own Aviation unit, infantry, artillery, and anti-aircraft, and only recently began an intensive program of organizing its own parachute troops. They train their own men in specialized operations, having twenty-seven vocational courses available to any man who cares to learn a particular trade.

Since radio is now a vital connecting link in all modern warfare, the Marine Corps is constantly selecting and training men for work in this

technical branch of the service. It is a thorough training, complete not only from a military standpoint, but would fit those men thus trained for an occupation in civilian life.

Indicative of the Marine Corps attitude on the importance of radio is the fact that they operate two radio schools. One is at Marine Barracks, Quantico, Virginia, the other at Marine Corps Base, San Diego, California.

At San Diego, under the competent direction of its commanding officer, the instructors and men work together to the end that the Marine Corps will have a radio communication system second to none.



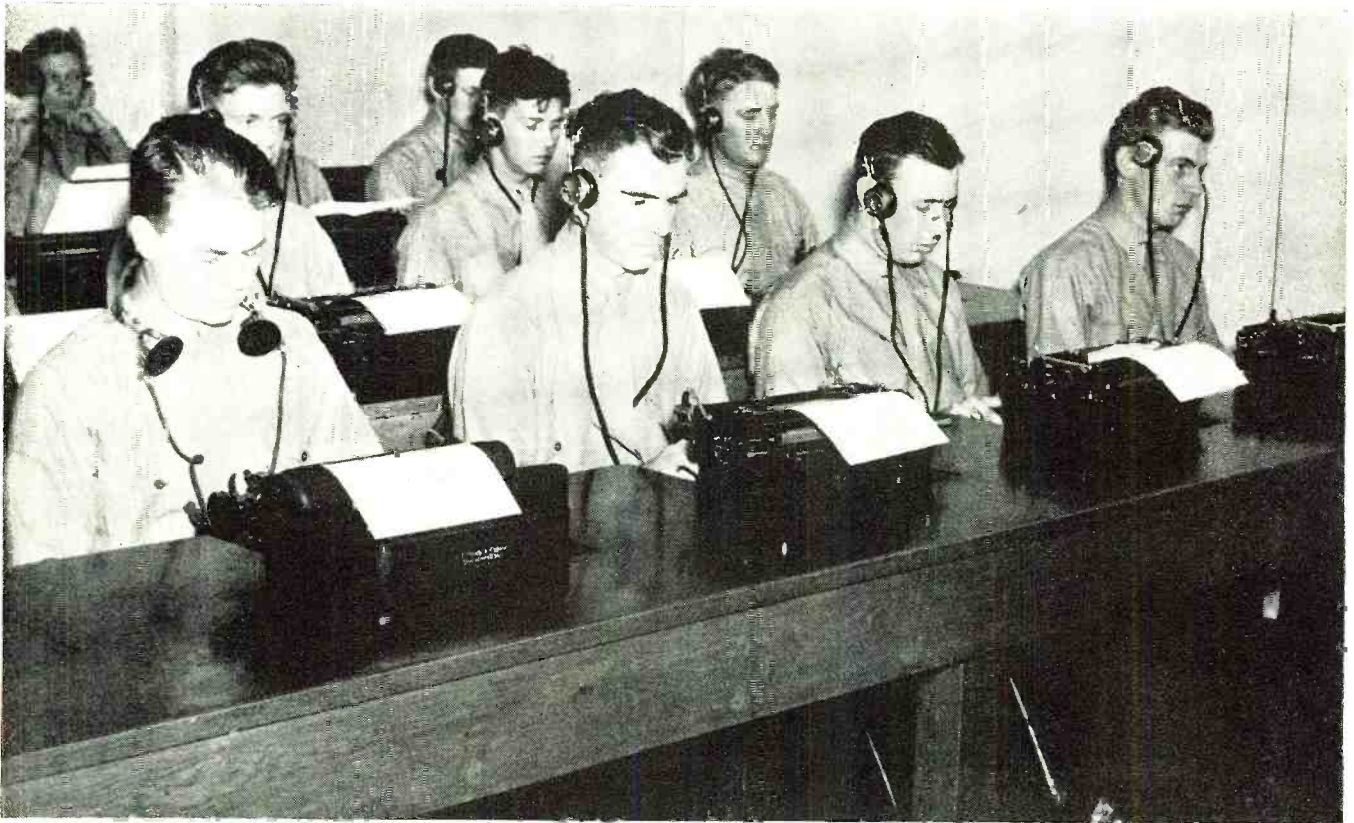

In the front row are four lads from Chicago at the famous Marine Corps Radio School.

Those men entering Radio School are not so placed by chance but on the basis of written aptitude examinations which are taken during their preliminary training. Every two weeks a new class of approximately thirty men start on a twelve weeks schedule of training. During this twelve week period the men are in the field and laboratory.

They are taught typing so that they will be able to handle messages in an efficient manner and keep reports. Elementary radio theory and elementary electricity courses provide them with the necessary background for a better understanding of operations. Naturally a great deal of time is spent in sending and receiving so that each

man becomes proficient in pounding the key. The Marines also study naval radio procedure and the intricacies of field radioc sets.

Upon completion of the course, the men receive a specialist rating with increased pay and are assigned to various units of the Marine Corps.

-30-

These students are studying the technicalities of modern radio technique.

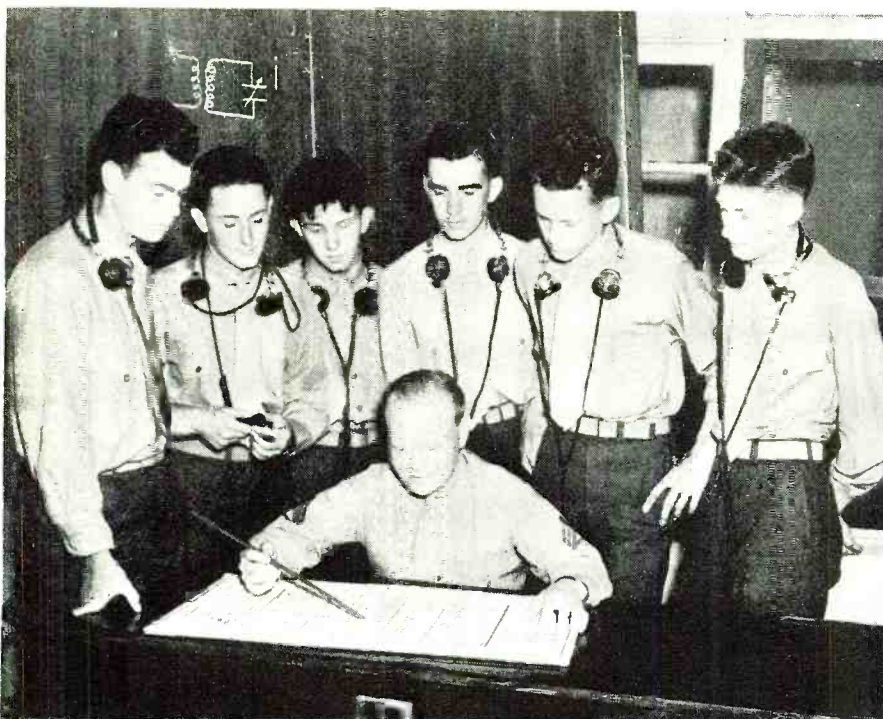

School is out!





# Radio for Forest Protection

by

**CLARK E. JACKSON**

*One of the largest users of radio  
equipment is the Forest Service.  
These forces are vital to defense.*

Actual scenes of fire fighting crews in action in the Mt. Hood National Forest. Note portable radio equipment in foreground in operation.





ONE of Uncle Sam's most far-flung radio networks is utilized by the United States Forest Service in its unceasing battle with fire throughout our 175,000,000 acres of national forests.

There are 3,200 portable voice radiophones now in operation; more than 200 bell-ringing automatic radio devices for broadcasting fire warnings in the forest have been installed; and other radio equipment ranges from a mobile transmitter on fire trucks and other vehicles to a miniature receiving set weighing only six pounds and about three-quarters the size of a loaf of sandwich bread. It all adds up to what is probably the greatest aggregation of radio devices in use by a single civilian organization in the world.

The radio equipment which has been devised by the *United States Department of Agriculture Forest Service* to meet the demands of fire-fighting forces of the national forests is readily portable and of extremely light but tough construction. It serves ground crews and smoke-chasers as well as the smoke-jumpers who parachute to back country fires from airplanes.

The 3,200 small transmitting and receiving outfits are carried by the smoke-jumpers so that they can talk to the delivery plane or call headquarters when they have parachuted to a fire.

A bell-ringing radio for lookout towers has been placed in more than 200 locations, and radio "wave sprinklers" or automatic radio relay stations—of which several are already in use—are being installed as rapidly as possible. Operating automatically to re-broadcast messages from smaller radios, the relay station was installed on a number of mountain tops last

summer. Its antenna of metal cross-arm and upright in the shape of a cross aids searching parties or fire-fighters unable to communicate with each other or with headquarters except by means of its power. The automatic stations require infrequent visits from attendants and make it possible for field crews to carry light instead of heavy radio equipment.

A mobile radio transmitter costing only a few dollars and using a fish-pole type antenna is employed on fire trucks and other vehicles. Trucks dispatched to a fire can be stopped if the alarm is found to be false, or re-routed to more serious outbreaks, or quick contact can be established with fire crews working on roads or in situations where they can not be reached by telephone.

*Forest Service* radiophones operate in two groups of assigned frequencies. The high-frequency group includes frequencies between 2,900 and 3,500 kilocycles, and the ultra-high-frequency group includes frequencies between 32 and 39 megacycles (32,000 and 39,000 kilocycles). The various types of radiophones are classified in two groups according to the frequency range in which they are intended to operate.

Any of the radiophones will communicate with any other *Forest Service* radiophone in the same frequency range, but will not communicate with a radiophone intended to operate in the other range. The high-frequency equipment is built to operate on any frequency between 2,000 and 6,000 kilocycles. The ultra-high-frequency equipment may operate on any frequency between 30 and 40 megacycles.

Radio in forestry is used mainly during fire emergencies, although fire is not the only condition the forester



Forester using shortwave portable near the Guard training school.

Fire Scout Geo. Clisby with the famous U. S. Forest Service group.



Emergency radio station, fire line, Spud Hill fire. Note featherweight phones.





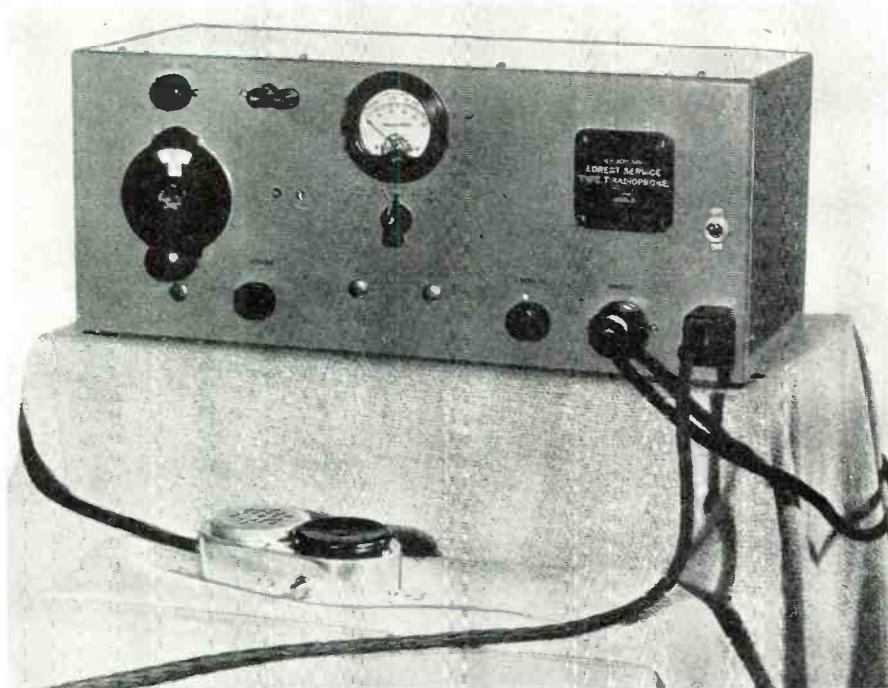

Forest Service portable radio equipment equipped with bell-ringing device.



SPF radio in 3/4 ton fire truck.

has to meet with it. For example, radio has been used for long-distance diagnosing and prescribing for appendicitis and other ailments. A California ranger received a funeral service by radio which he was asked to read at the burial of two victims of a back-country hiking accident. Radio has played an important part in locating airplane crashes, in searching for lost persons, and in rescue work during floods. To meet a sudden emergency up in Alaska, a local resident was sworn in as deputy marshal via the *Forest Service* radio.

The backbone of forest fire detection is the fire lookout system. Basically, it consists of trained observers stationed at observation towers or in lookout houses situated on prominent mountain peaks. Some means of communication, principally telephone, is provided so the lookouts can report the location of new fires to the central fire dispatcher or to the fire suppression crews.

This telephone system has many drawbacks. The fire hazard changes from day to day with variations in weather, with the number and type of

forest visitors, and also because the effectiveness of the lookouts varies as visibility is modified by smoke, haze, or low clouds.

The desirable situation, obviously, is one where the number of lookouts and their location can be changed according to the dictates of fire hazard and visibility. That is, on days of low hazard and good visibility, the number of lookouts may be reduced to a minimum. On bad days or when poor visibility reduces the effectiveness of the lookouts, they can be augmented by a force of emergency lookouts and patrols.

Portable radio makes full development of such an arrangement possible because it enables the lookout to carry his means of communication with him wherever he goes. It isn't necessary now to build and maintain a telephone line to a potential lookout point in order to have it available for emergency use. Lookouts and patrolmen equipped with portable radios are no longer limited to locations where telephones are available.

Radio also permits more effective use of fire-fighting forces. Organized suppression crews can be used on such work as timber stand improvement, road construction and hazard removal when not actually fighting fire, if they are equipped with portable or mobile radio so they are constantly on call.

In the handling of large fires, radio is invaluable. Fire organization and fire-fighting methods vary greatly in different parts of the country. In certain types of timber, fires are relatively short-lived and not extremely difficult to control. On the other hand, in the heavily forested regions of the Pacific Northwest, controlling a wide conflagration is especially difficult and

*(Continued on page 55)*

Lookout using fire finder unit.

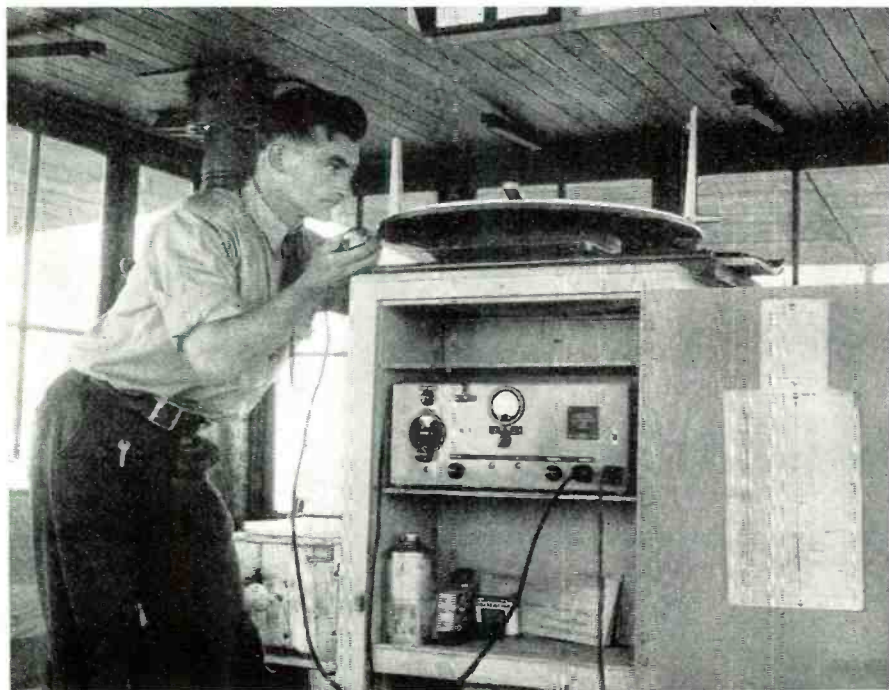





# RESISTOR SPECIALISTS

Since  
1921

INTERNATIONAL RESISTANCE COMPANY  
401 North Broad Street, Philadelphia, Penna.





**AGE  
BEFORE  
DUTY!**

**B**EFORE Sylvania tubes are pronounced fit for duty, they must prove their merit on a number of tough proving grounds.

In the picture above you see them in the aging rack—where time and the action of a battery of lamps stabilize the electrical characteristics of the finished product.

From the aging rack the tubes pass on to still other tests and processes designed to establish their readiness for service. It's a strait-laced routine that exemplifies the degree of specialized skill Sylvania brings to every step of tube manufacture.

Yet it's only what you would expect of an organization consecrated to one task *and only one* in radio. For all Sylvania resources and energies are directed to the sole end of

providing better, more efficient, longer-lasting tubes.

And because our sales organization is imbued with this same singleness of purpose, the franchise we offer the trade is straightforward, without hedges or loopholes.

Out of this concentration on the one job comes a product whose name is a symbol of excellence, a safeguard of reputation.



**SYLVANIA**  
RADIO TUBE DIVISION

## HYGRADE SYLVANIA CORPORATION

New York City

EMPORIUM, PA.

Salem, Mass.

*Also makers of HYGRADE Incandescent Lamps, Fluorescent Lamps and Fixtures.*



# Radio for Blackouts and Power Line Failures

by **PETER T. WILLIAMSON**

*Air raid wardens should be equipped with an efficient portable set for use in the community to receive vital information.*

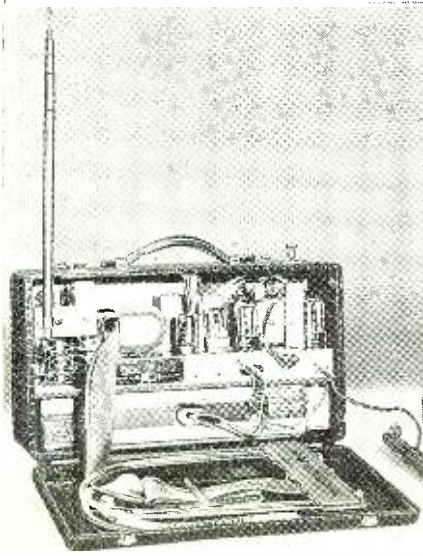

An ideal type of set for Wardens.

**R**UMPUS rooms are becoming family refuge rooms in thousands of homes as America prepares for defense against air raids.

In the average well-built house, the basement has the essential attributes of safety—solid walls, protected windows, space and comfort. Protection is assured against practically every danger except that 2,000 to one chance of a direct hit. Experience in Europe has indicated that direct hits are risks against which there is no insurance except good luck, and that people are safer in their homes than in public shelters.

Controversy over the best place for the family refuge and its equipment probably will continue until Americans have had personal experience with bombing raids and American families discover what their particular needs for protection may be. However, there are certain universal needs—communication, protection, sustenance and sanitation.

Essential equipment for the family refuge room is a portable radio preferably of the trans-oceanic type operating on batteries when the electric current fails and equipped with multiple aerials to assure reception under any circumstances of weather or location. One prominent radio manufacturer in Chicago has made such a radio available to meet current conditions. When air raids come, telephone service will cease for all *except defense services*. Consequently the average family must depend upon the radio for contact with the outside world.

In fact, radio promises to play an important part in defense efforts. Through its use defense authorities immediately can reach millions of people with alert and alarm signals, all-clear reports and other important information. If local broadcasting stations are forced off the air, resort will be made to shortwave broadcasting facilities and to the hundreds of amateur stations which dot the country.

Here again such a portable with provision for short wave reception fully meets their needs.

In view of these conditions the refuge room needs a portable radio which will receive shortwave as well as regular broadcasts, and which has sufficient receptivity to overcome weather disturbances and the handicaps of solid-walled basements.

This set should operate on 110 volt a.c. or d.c. electric current, or on its own batteries when current fails. Its aerials must insure reception to the extent that daily logging of foreign and domestic stations is guaranteed.

The short wave portable illustrated has been designed for the use of de-

fense authorities, because it can be operated effectively in any locality and uses both loudspeaker and earphones. Should raids terminate radio broadcasting by commercial stations in any one area, this set would bring in distant-American, Canadian or even overseas short wave stations.

Protection is well assured in the basement, especially if the windows are walled. Cellar windows opening above ground may be protected from flying bomb fragments by sandbags, planks, or thick shrubbery. In any event the windows should be covered with building paper or shielded by blankets, to prevent light from shin-

*(Continued on page 74)*

Officers listening to war news in basement rumpus room during blackout.





## Radio Industry

(Continued from page 13)

radio dials, chassis, control devices, has today converted his machinery to produce percussion caps, struts, flap hinges and other bits and pieces for aircraft. Another manufacturer engaged in the production of thermal units, has converted his plant to produce shell boosters.

This device required the exacting skill of workmen such as those in this plant who were accustomed to the handling of delicate meter needles, and

mercury tubes in their other work. The booster, incidentally, is not as simple a device as it sounds. It consists of a small container of powder and a safety device which protects this powder against premature explosion. During the shell's flight, the safety device is swung by centrifugal force into a position that permits the powder to be detonated by the shell fuse, and in turn, sets off the main charge in the projectile.

Still another company formerly completely engaged in the manufacture of condensers has now devoted a high percentage of its facilities towards the production of gas masks.

There are the other companies who never saw a radio part that have been placed in the business by conversion. One such company, formerly engaged in the manufacture of toys, now produces filter condenser boxes.

A majority of the radio manufacturers will however not only continue to produce communication equipment, but sub-contract hundreds of thousands of dollars to those in and out of radio, if necessary.

Although the radio workman or girl may find themselves faced with the prospect of testing material density of copper instead of mica, or tubing instead of threads, their past training will enable them to offer a maximum degree of proficiency. And there are thousands of other operations for which the radio worker is correspondingly trained, a training that will expedite a variety of manufacturing operations that may be comparatively new.

There are some manufacturers who produced devices with a few radio basics who now will be in on the scene of radio operation for the military services. Prominent among these are the "juke box" and the pin-ball producers, whose products, by the way, for civilian markets have also been placed on the curtailment program.

Still other industries who will aid in producing radio equipment are those making vacuum cleaners, electric fans, eyeglasses, etc. Eyeglass manufacturers, for example, have been enlisted to assemble quartz crystals into units for controlling the frequency bands of transmitters.

In their transformation to unfamiliar products, these manufacturers are aided by expediting engineers sent out by the procurement division of the *Chief Signal Officer*. The signal procurement division now operates on a 24-hour, seven-day basis. It assigns expeditors to plants where bottlenecks seem to be developing. These civilian expediting engineers, armed with *War Department* authority give advice, and help cut through red tape to speed up schedules and deliver necessary equipment.

A free exchange of methods and designs has also been put into effect in this new conversion program. There are innumerable instances where engineers from companies, previously considered competitive, have been invited to study methods of design and manufacture so that additional production can be effected. In one case several years of research costing hundreds of thousands of dollars were involved in the development of a method of making an advanced type of variable condenser, using such special metals as invar. Yet, in view of the emergency, this company invited engineers from other companies to study their methods and adopt them in their plant for similar manufacture.

In the manufacture of parts for home receivers, we may see a wave of standardization placed into effect. Many are already developing pro-

# NEW UTAH AC FIELD EXCITED SPEAKERS

## SUBSTITUTE FOR PERMANENT MAGNET SPEAKER NOW AVAILABLE

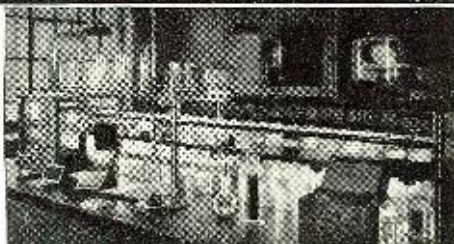

● A serious problem for the radio and sound equipment industry has again been solved by Utah engineering. Several months ago critical shortages occurred in the raw materials needed for the fabrication of permanent magnet speakers. The condition made it necessary to develop a line of speakers to replace those in which materials vital to national defense were used.

Utah solved the problem! A complete line of AC Field Excited Speakers is now available—humless in operation and equivalent in performance to the famous Utah Permo-Dynamic line. A speaker has been designed for every public address and sound requirement. They require only the addition of the AC Field Supply shown at right to substitute for any Permo-Dynamic application. The new Utah speakers have standard Utah weather-resistant construction.

In the laboratories of the Utah Radio Products Company, engineers are constantly engaged in new developments and in intensive research—working day and night to meet the demands of the National Defense Program and its necessary restrictions of some materials. All the experience, knowledge and skill of the Utah production staff are required to comply with the ever-increasing demand for Utah Speakers, Transformers, Vibrators, and Utah-Carter Parts.

## NEW UTAH AC FIELD EXCITATION SUPPLY PROVIDES HUMLESS OPERATION

This AC Field Supply is properly designed for humless operation of any of the speakers listed below. At 117 volts, 60 cycle input, the maximum output is 12 watts at 105 mills. The supply may be mounted directly in the speaker baffle. A separate supply should be used for each speaker. The price does not include rectifier tube, but includes ballast and plug. No cord is furnished. 1-50 Y6 GT rectifier tube is required. New Utah AC Field Excitation Supply, U.S.A. list price \$4.75. Special Bracket P-9030 for Mounting Field Supply on 12" Speaker, U.S.A. list price 25c.



If Your Jobber Can't Supply You Write Us Direct



## USE STANDARD UTAH OUTPUT TRANSFORMERS



Utah Transformers assure reliability and satisfactory performance under all operating conditions. They avoid failure due to

moisture because of the complete impregnation of interlayer insulating paper by Utah's vacuum pressure methods.

Be sure to insist on Utah products. Look for the Utah trademark. Utah Radio Products Company, 824 Orleans Street, Chicago, Illinois. Canadian Office: 560 King Street, W., Toronto. In Argentina: UCOA Radio Products Company, SRL Buenos Aires. Cable Address: Utaradio. Chicago

NEW UTAH AC FIELD EXCITED SPEAKERS						
STOCK NO.	CONE DIAM.	VC IMP.	VC DIAM.	NORMAL WATT.	PEAK WATT.	U.S.A. LIST PRICE
8AC30	8"	6-8 Ohm	1 1/4"	12	18	\$9.50
10AC12	10"	6-8 Ohm	1"	9	14	6.60
12AC12	12"	6-8 Ohm	1"	10	15	7.75
12AC20	12"	6-8 Ohm	1"	13	20	10.00
12AC40	12"	6-8 Ohm	1 1/4"	16	24	12.50
12AC75	12"	6-8 Ohm	1 1/2"	21	32	19.25

# S P E A K E R S

VIBRATORS • TRANSFORMERS • UTAH-CARTER PARTS



grams, with one particular plant preparing an assortment of charts that will show how one unit may be used as an alternate for several dozen applications. It will be strange to hear a manufacturer stating that it isn't necessary to use a different unit for each section of the circuit, but instead just one or two. But we will have surprises; surprises that will eventually turn into standards of practice. For such standardization actually affords real economy to everyone concerned, and most particularly the manufacturer himself. And speaking of standardization, it is a practice that will be applied in all forms of development and manufacture of the military components to effect accelerated production and conservation of materials as well.

The fact that the radio industry is on a full war-footing does not necessarily mean that all development, research and design will have to stop. In fact, it will continue on an even more increased basis that will stir the imagination. Although there will be improvements that will, of necessity be restricted, there will be many that will be adaptable to civilian practice.

There is one particular inclination the public must guard against, when industry shutdown is ordered and that is the panicky buying wave. Such a trend builds the path towards rationing and eventual actual scarcity. With the radio industry halting all manufacture, there may be the desire to create such a wave of buying. It must not happen, and should be watched carefully. Individual policing will be helpful in this effect.

-30-

**COMING**  
**Induction-**  
**Control for**  
**Model Planes,**  
**Ships, Etc.**

**Coast Guard**  
(Continued from page 27)

personnel with correspondence courses in their particular specialty, at no cost. These courses range from elementary through intermediate to advanced courses so that the students training

advances through progressive stages. Under existing regulations no enlisted man may be advanced to a permanent rating until he has completed the prescribed Institute course for the rating. The radio operator, upon leaving the resident school, must complete the courses prescribed for him up to and including Chief Radioman before being permitted to take up elective subjects.

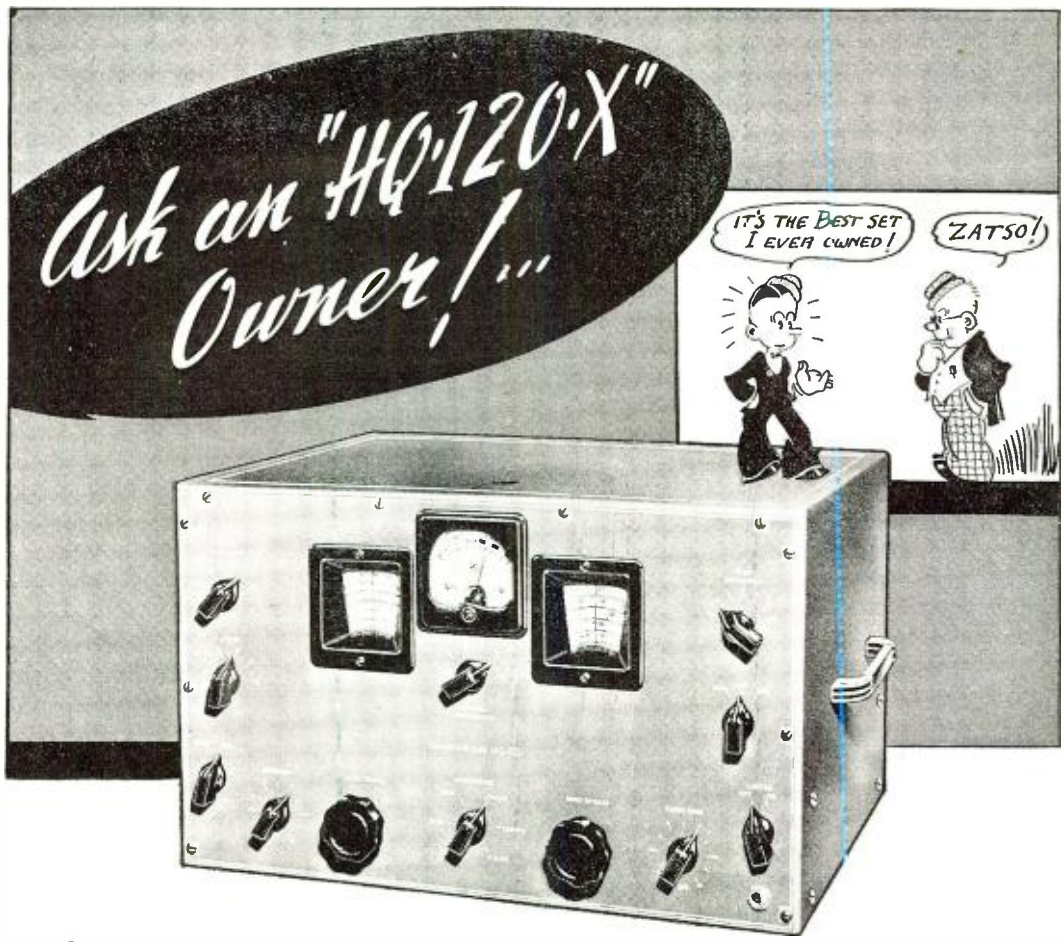

"HQ-120-X" owners are continually expressing their enthusiastic approval of this fine receiver. That is why we say, "Ask an 'HQ-120-X' owner." The variable selectivity crystal filter and the calibrated band spread dial have hit a vital spot with the amateur. Many say they would never be without these features again. This new crystal filter has everything for CW that crystal filters have ever had, and in addition, there are four wide band ranges, one for medium CW selectivity, and three for phone reception without spurious responses. It is absolutely smooth and stable. The calibrated band spread dial can be set for exceptional accuracy. Four amateur bands, 80, 40, 20, and 10 have scales of over 310 degrees. These are, by no means, the only features—talk to someone who owns an "HQ-120-X" and get the real low-down. You will be amazed.

We have prepared a 16-page booklet containing complete technical information — curves and diagrams included. If you do not have a copy of this booklet, ask your jobber for one or write direct to the factory. It contains a lot of useful information.

**HAMMARLUND MFG. CO., INC.**  
424-438 W. 33rd St., New York City

Please send "HQ" Booklet RN-5

Name.....

Address.....

City.....State.....

Canadian Office: 41 West Ave.  
No., Hamilton, Ontario



**HAMMARLUND**



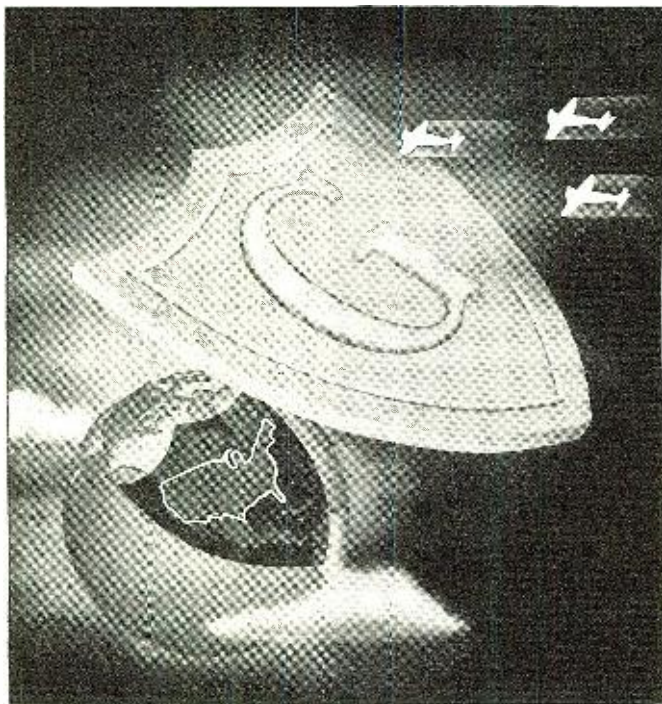

## AMERICA DEPENDS ON RELAYS BY GUARDIAN

★ **Better relays and more relays for planes—ships—guns—tanks . . . Guardian is doing a 100% "all out" job for America.**

**GUARDIAN . . . APPROVED SUPPLIER TO LEADING RADIO MANUFACTURERS OF SPECIAL CONTROLS REQUIRED TO PRODUCE GOVERNMENT ORDERS . . .**

**Modern as tomorrow's airplane—Relays by Guardian must be up-to-the-minute because they're specified on the planes of tomorrow as well as today's Trainers—Fighters—Bombers—Tanks—  
—for Transmitters—Turrets—Bombing Equipment—Fire Control—  
—or practically every defense job you figure.**

**GUARDIAN'S CONTRIBUTIONS TO RADIO DEFENSE are in the "walkie-talkie", tank radios, radio directional navigation and a long line of special communications controls . . . ever-improving . . . ever producing to end the war speedily . . . conclusively.**

**T O D A Y** — samples of Approved Controls by Guardian are immediately available, with production time open for war work only.

**T O M O R R O W** — keep a date with these *higher capacity and smaller size* Relays by Guardian. You'll find them better than ever for commercial production in 1942.

**WRITE • WIRE • PHONE**

**GUARDIAN**  **ELECTRIC**

1630 West Walnut Street

Chicago, Illinois  
DEFENSE

LARGEST LINE OF RELAYS SERVING AMERICAN  INDUSTRY

Thus, with the resident school training, practical experience as an operator, and study of correspondence courses, the enlisted man is afforded an opportunity to become well grounded in his profession.

### **Coast Guard Radio Engineering School**

The last major step in the training of *Coast Guard* radio operators consists of a 12-week intensive course in maintenance and service work at the *Coast Guard Radio Engineering School*, New London Base. This is a training program which was developed specifically to meet the needs of the CG. A civilian engineer-instructor Mr. E. B. Redington is now in charge of this school, assisted by Mr. E. G. Holden, Chief Radioman.

Its purpose is to familiarize operators with the internal workings of the radio equipment which they operate, and to instruct them in the function and use of all sorts of test and measurement equipment. All this to the end that they will be qualified to locate and remedy trouble that may develop in transmitting or receiving equipment.

Little theory is taught in this course. Most of the theory involved is already known to the students. The primary objective is to give them the maximum amount of actual experience in trouble shooting, making operating measurements and adjustments, and correcting causes of faulty operation. To aid in this work the equipment available to each student includes laboratory type signal generators, Chanalysts, set analyzers, c.r. oscilloscopes, capacity and impedance bridges, meters of all sorts including standard multi-range volt-ohmmeters, tube testers, etc. Also there are a number of standard transmitters, receivers, radio compasses, automatic radio beacons, etc., to serve as the subjects on which these students gain their measurement and maintenance practice.

As a means of familiarizing themselves with the practical operation of various circuits, students actually build up "breadboard" layouts of oscillators, modulators, Class C amplifiers, and of various receiver circuits. Or they may be given assignments to replace the wiring which has been partly removed from a standard receiver or transmitter, to rebuild a damaged one and so on.

After 12 weeks of this sort of practical training, the *Coast Guard* operator is well qualified to maintain and service any radio equipment which may be put in his charge. The knowledge gained enables him to keep his equipment operating at peak efficiency at all times, and if trouble should develop, to locate it and correct it if it is such as can be corrected without actual repair shop facilities.

Students taking this final radio training are sent to New London Base for the purpose and live there during the 12-week period. After it they are again assigned to active duty, this time some of them perhaps as maintenance men rather than operators.

As mentioned earlier, the *Coast Guard* is particularly desirous of obtaining experienced radio operators who will, with a minimum of training, be ready for assignment to active duty. It is also anxious to enroll men who have sufficient radio knowledge or experience to require less than the full training time to qualify as operators. To these and others who enter its radio service there is the promise of never ending variety, of advancement and of a radio training which should prove highly valuable in later return to civil life. Above all these, of course, is the opportunity to render valuable service to our country at this time.

*(Just a reminder. Uncle Sam's fighting forces are in need of thousands of radio men. Full particulars are available from your local recruiting office.—Ed.)*

—30—



## Forest Protection

(Continued from page 48)

calls for the last word in high-powered methods.

Combatting a forest fire in such a country presents an organization and administration problem comparable to a military operation. Thousands of men must be transported, bedded, fed and given first aid as required. A huge amount of machinery, automobiles, trucks, tractors, trail-builders and special equipment must be kept in operation. Adequate and well-organized transportation and communication facilities are vital.

Suppose that an unfortunate combination of weather, topography and fuel has developed a fire of about 50,000 acres. The perimeter or boundary lines of the fire will be about 75 or 100 miles. Several thousand fire-fighters will be employed, split up in camps of about 200 men each, spaced appropriately along the fire line. Helping the fire chief, who is in charge, is an assistant chief, chief of service of supply, transportation chief, communication chief, head scout, paymaster and sector bosses. Each sector boss is directly responsible to the fire chief for his sector of the fire.

If such a widespread operation is to function effectively, it must be fully

coordinated. Such coordination is possible only where there is instantaneous communication with all units. Here is where radio is most effective.

About nine different types of two-way voice radiophones have been developed and are currently in use—each designed for a special purpose. Low power is used throughout; the maximum is 25 watts. The lowest powered radiophone has about one-tenth watt output.

The use of radiophones designed by the *United States Forest Service* is not limited to the *Service*. Among the other forest protection agencies by which they are used to some extent are the *British Columbia Forest Service*, the *Australian Forest Service*, state forestry organizations, federal government agencies such as the *Indian Service*, *National Park Service*, *Reclamation Service*, and non-forestry agencies such as the *Lighthouse Service* and the *Navy*.

*Forest Service* radios also find other uses than fire-fighting. The most recent call for them was from the *American Geographical Society* for use on an expedition to explore and map a 200-mile area northwest of White Horse near the Canadian-Alaskan boundary last summer. The short-wave outfits used by the expedition weighed 21 pounds, had a working range of 20 miles, and are the type used by the *Forest Service* for fire

crews, rangers, guards and pack strings. Some of them were dropped by parachutes with other supplies in localities that members of the mapping party did not reach until some days later, and, consequently, endured some rough treatment by curious bears.

Existing radiophone models are constantly improved to keep step with technical advances; new radio uses and operating technique are continuously being explored. Some of the current development projects in the *Forest Service* are: Automatic relay station to extend the communication range of the ultra-high-frequencies beyond the line-of-sight, radio facsimile transmission of fire maps and messages, portable radio direction finders to orient and otherwise aid smoke-chasers in locating "sleeper" fires where it is difficult to follow a compass course.

-30-

## NEXT MONTH

Constructing an  
Electronic  
Volt-Ohm-Milliammeter



FOR INDUSTRY • RADIO TRAINING • GOVERNMENT

# How To Put Your Hand On All The Radio Equipment You Need

ALLIED RADIO makes it easy for you to get the essential Radio and Electronic parts you need. Our complete stocks of Everything in Radio are at the instant service of Wartime Industry, of our Armed Forces, of Government . . . for use in radio training, on the production lines, in the control laboratories, in the research division . . . There's no red tape, no cumbersome delays caused by placing a maze of individual orders—you get everything you need at one time from one central source of supply—ALLIED RADIO where we understand your problems and where our sole interest is to serve you quickly, accurately, completely. Time and Service count today. Reach for your ALLIED Catalog and get your hand on all the Electronic and Radio Equipment you need!

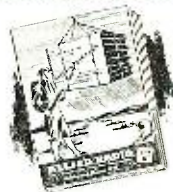

For quick and helpful reference, you'll want the ALLIED Catalog handy. Here's Everything in Radio and Electronic Equipment for engineering communications, laboratory and research use, industrial application, maintenance, radio training, etc. For your FREE copy, write Department 1-E-2.

★  
**ALLIED RADIO**  
833 W. JACKSON • CHICAGO  
★



## Alert Receiver Circuits

(Continued from page 29)

lay must be rated to close positively with a current flow of 1 milliampere or so. The *Sigma* type 3-A miniature relay is designed for this application. If the a.f. voltage is taken from an output audio stage, however, the relay may be a larger-current model.

The linear rectifier circuit is shown in detail in Figure 2. The rectifier tube is a diode which may be a 6H6 with the separate units connected in parallel, or a type 1-V. The load re-

sistor, R, is a 10,000-ohm wire-wound potentiometer and is set for rated relay current. It is desirable to obtain the highest possible resistance setting consistent with proper relay operation in order to minimize the static current of the diode. The alarm device, while shown as an automobile horn, might be a bell, siren, lamp, or any other signal gadget desired by the individual builder. This device might be operated in the secondary circuit of the relay by a local battery or, as shown in Figure 2, through a step-down transformer.

Operation of the alert receiver of Figure 1 is explained as follows: The

signal from the broadcast station may be modulated by a frequency within the a.f. range or outside of either end of the audio spectrum. If sub-audible and super-audible frequencies are employed, the receiver will have to be designed especially to pass those frequencies. The transmitter will likewise have to be fitted particularly for modulation at these unusual frequencies.

If audible tone modulation is employed, the frequency must be chosen out of the range of the instruments normally played at the station. Such a frequency might, for example, be 6000 or 7000 cycles. The audio amplifier of the receiver is "peaked" for the emergency tone frequency which will then give a larger a.f. voltage output than any other of the tones riding in on regular broadcasts. The load resistor (Figure 2) is then set to a value which will make the sensitive relay non-responsive to regular broadcast voltages.

When the emergency tone signal rides through, the linear rectifier passes the positive audio peaks into the relay, closing the latter and sounding the alarm device.

The tone-actuated alert receiver shown in Figure 3 is more foolproof in that it is equipped to pass only a narrow band of audio frequencies to the linear rectifier and relay, the predominant frequency of that band being the emergency tone. This is accomplished by means of the band-pass filter which is interposed between the receiver and rectifier.

Following is a list of band-pass filter component values for various frequencies that might be used as the alert tone. The filter circuit is given in Figure 4:

### Band-Pass Filter Data

Mid-Frequency kc.	L1	L2	L3	C1	C2	C3
	Henries			Microfarads		
3000	0.53	0.53	0.000663	0.0053	0.0053	4.24
4000	0.398	0.398	0.000497	0.00398	0.00398	3.18
5000	0.3185	0.3185	0.000398	0.00318	0.00318	2.55
6000	0.2655	0.2655	0.000332	0.00266	0.00266	2.12

This data is for single-section filter sections with characteristic impedance of 500 ohms.

The filters are intended to pass the alert-tone frequency (filter mid-frequency), and the narrow band about this frequency, with the maximum transmission and to attenuate all other tone frequencies. Builders who possess the necessary inductance- and capacitance-measuring instruments may proceed to build their own band-pass filters. Others will prefer to purchase ready-made units.

Working ideally, the alert receiver of Figure 3 will be relatively non-responsive to the audio frequencies of a regular broadcast, although it will deliver voltage at these frequencies to its output circuit. When the emergency tone is transmitted, however, the band-pass filter transmits appreciably more voltage to the linear rectifier and sensitive relay. In order to

# Kits for DEFENSE RADIO TRAINING

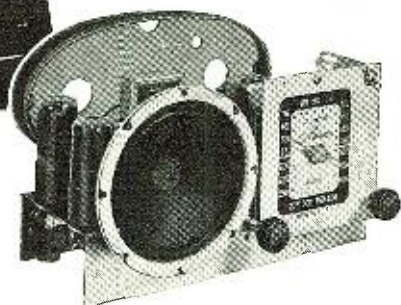

### 5-Tube AC T.R.F. Kit

Here's a Kit that is low in cost and high in quality. Operates from 110 volt 50-60 AC with a frequency range of 530 to 1600 kc. (187 to 565 meters). Complete kit includes all parts necessary for construction of the receiver with exception of tubes and speaker. Meissner pictorial diagrams make this set extremely easy to build. Kit—\$27.00 list.

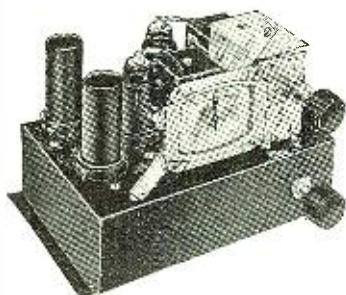

### 5-Tube AC-DC Super-het Kit

Using a small number of tubes, this Meissner engineered 5 tube AC-DC Super-het is compact in size and contains a factory wound loop antenna. Only two controls are used, making the set very simple to operate. It's simple to build . . . you can easily follow the schematic and pictorial wiring diagram. The Kit is complete — there is nothing else to buy. Kit with tubes—\$31.25 list.

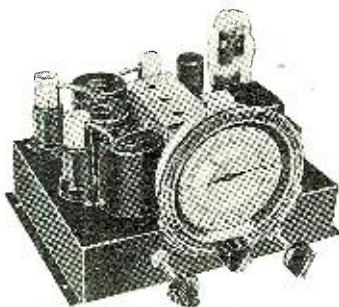

### 4-Tube AC-DC T.R.F. Kit

Here is a very small compact receiver with exceptional sensitivity and tone quality. Frequency coverage of 530 to 1600 kc. Compact, high gain shielded coils are tuned with a two gang precision tuning condenser. Provision for mounting 5-inch dynamic speaker. Kit contains all parts except tubes and speaker. Pictorial diagrams aid you to construct this receiver easily and quickly. Kit—\$19.50 list. See your nearest Meissner jobber.

Write for complete new catalog. Address Dept. RN-5.

# Meissner

MT. CARMEL, ILLINOIS

"PRECISION-BUILT PRODUCTS"



insure non-response of the relay to frequencies outside of the filter pass-band, the linear rectifier load resistor (R in Figure 2) may be set to such a value by experiment that only the high voltage afforded by the alert tone signal will produce sufficient diode current to close the relay. Thus, the alarm becomes responsive only to the alert signal.

Tone-operated alert systems may be put into operation on any carrier frequency—broadcast, long-wave, short-wave or ultra-short wave. If a local ultra-high frequency station is available for the transmissions, obvious advantages may be realized by utilizing frequency modulation. The introduction of the signal at the transmitter will not ordinarily present difficulties unless the tone frequency is super-audible or sub-audible. In that case, special equipment will be necessary to modulate the carrier amplitude or frequency, and considerable experimentation may be required.

For transmission of tone signals within the range of hearing, various means may be employed. These might include introduction of a.f. voltages directly into the amplifier system or modulator, sounding of a buzzer or a.f. oscillator before a live microphone, chopping the r.f. output of one of the low-level stages (ICW) at an audio rate, etc. In any case, the regular broadcast will be interrupted for the signal transmission.

### Improved Carrier-Operated Circuit

A more elaborate outfit than the simple carrier-operated alert receiver is shown in Figure 5. In this circuit, the alarm-sounding mechanism follows the last intermediate-frequency stage of a superheterodyne tuned to a special alert-signal station. The circuit is actuated by the r.f. voltage output of the last i.f. stage and is relaxed until the transmitter of the special defense station goes on the air.

Operation is accomplished specifically in the following manner: When the receiver "hears" the unmodulated alert carrier, the last intermediate frequency amplifier delivers r.f. voltage to the diode detector, 6H6. The detector rectifies this voltage, producing a voltage drop across its cathode load resistor. This drop is due to the flow of direct current, corresponding to the average carrier, through the cathode resistor.

This d.c. voltage is applied to the grid circuit of the 6SQ7 tube which acts as a triode vacuum-tube voltmeter with a sensitive d.c. relay in its plate circuit in place of the usual indicating meter. The relay is connected in a resistance bridge circuit, in order that the initial plate current may be balanced out and the relay "zeroed." The potentiometer, R, is the variable leg of the bridge circuit and is adjusted to bring the relay contacts wide open when no signal is applied to the

triode grid. With the tubes shown the relay may be one requiring only 1 milliamperes, or so, for complete closure.

When the rectified r.f. signal is applied to the grid of the 6SQ7, the bridge circuit is unbalanced, since the tube plate resistance changes with this change in grid voltage (the tube plate resistance is one of the bridge legs). This unbalance sends current through the relay which closes and sounds the local alarm.

An advantage of this alert receiver circuit, unlike other carrier-operated sets, is that it may be set to respond only to a very strong local carrier, such as the emergency station carrier. This is accomplished by raising the value of the 6H6 load resistor until only the husky alert station carrier will swing the triode grid. In this condition, the relay circuit would, according to usual standards, be called very insensitive. But it is lack of sensitivity exactly that is desired in this case, since such condition will render the alert receiver unresponsive to weak carriers from distant stations, static, and other forms of interference.

The leading disadvantage of the carrier-operated set is the necessity for a special transmitting station. However, it is likely that some provision may be made for such special transmitters if sufficient need is shown for them in national defense operations. Inasmuch as a licensed opera-

## TRAIN AT HOME + LEARN RADIO this easy way!

FOR QUICK PROMOTION IN THE ARMY, NAVY, INDUSTRY

BEGIN AT ONCE TO TRAIN AT HOME IN SPARE TIME WITH

# GHIRARDI'S RADIO PHYSICS COURSE

**\$50.00**  
RADIO TRAINING  
COURSE \$**5.00**  
complete  
for  
only

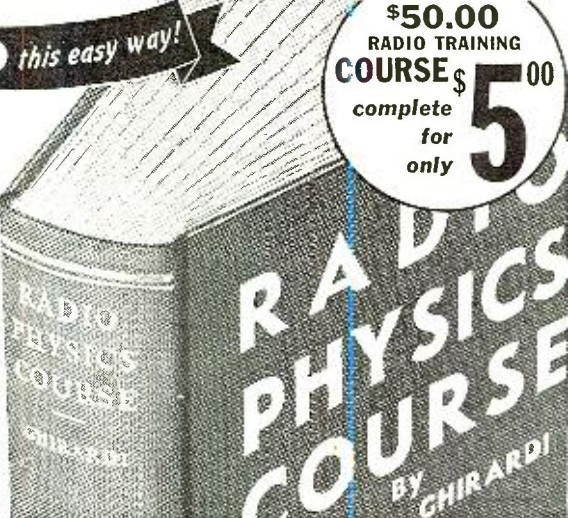

**36 Volumes in 1 Big Book** Broadcasting systems... Sound, Speech, Music... Electron Theory, Electric Current... Elec. Units, Ohm's Law... Electric Circuits, Batteries... Magnetism... Electromagnetism... Electromagnetic induction... Inductance... Capacitance... Condensers... A. C. Circuits... Filters... Measuring Instruments... Radio Waves... Broadcasting... Receiving... Vacuum Tube Principles... V. T. Characteristics... Vacuum Tube Construction... V. T. Detector and Amplifier Action... Radio Frequency Amplification... "Superhets"... V. T. Amplifiers: Tuning Coils... Audio Amplifiers... Loudspeakers... Battery Receivers... Power Supply Units... Electric Receivers... Auto and Aircraft Radio... Phono Pickups: Public Address... Short Waves... Photoelectric Cells: Cathode-Ray... Television... Antennas and Grounds... Testing: Servicing... Sound Pictures

**Radio's leading home-study course all in one convenient volume!** THE BIG BOOK contains all the essential foundation electro-physical and radio knowledge to prepare you for your place in any kind of radio work. Whatever your goal—Aviation, Marine or Military Radio—Broadcasting, Manufacturing, Servicing... Electronics, here is your basic training. You teach yourself—easily—quickly, with this book.

**Here's Convincing Proof by an Authority!**

S. M. Mitchener, Dir. of Training, Canada's War Emergency Training Programme, writes: "We have just received six copies of Ghirardi's Radio Physics Course. This is our second set. We find it excellent in training our radio Air Force trainees. We are well pleased with your other books and can recommend their use to any school following the line of training such as we are in our country."

**What These Army, Navy Men Have Done, You Can Do!**

**Typical of the reports from men in service:**

PEC C. G. Cole, Anti-Tank Co., 110th Infantry, APO 28, Camp Beaugard, La. declares: "Your book was recommended by a Radio Tech. Sergeant of a Tank Destroyer Battalion. Since receiving the book, I have been able to make rapid progress in its study with very, very little outside help, and yet with a very clear understanding of subject. There is no doubt that after I complete my study I will be much better suited for my job."

Sam Samuels, U. S. Naval Training School, San Diego, Calif., writes: "This book was recommended to me by our 1st Class Radio-

man. It is the very best in our work in the Navy for promotion. I recommend it to all of my fellow radio-men."

**Easy as A-B-C**

This easy-to-read, easy-to-understand radio training course covers the whole science of radio, sound and television! More than 500 photos and diagrams make everything clear and easy.

**Extra Pay in Army and Navy**

Pay is good, promotion fast in the Army and Navy for men with radio knowledge and skill. \$72 a month for single men; \$106.50 if married. Begin training at once in your spare time for extra pay and higher rank.

**5 Days To See For Yourself!**

Thousands of men now making good money in important radio jobs—with the Army, Navy and industry—got their basic training from this same book by studying at home in spare time. What they have done, you can do! Make this investigation today! Send coupon at once for your copy of Ghirardi's RADIO PHYSICS COURSE for a 5-day trial examination. If you don't agree that this remarkable book will give you the knowledge you are seeking in the quickest, easiest, most inexpensive way, return it. Your money refunded immediately.

### OTHER GHIRARDI BOOKS TO HELP YOU!

**Revised & Enlarged Radio Troubleshooter's Handbook**

Ghirardi's famous on-the-job servicing handbook in a brand new edition. Saves time and labor in troubleshooting and repair. Completely revised with 400 pages of new material added. Now 710 normal-size pages of practical working data to make the serviceman's job easier and more profitable. Nowhere else will you find all the helpful battery-checked information contained in this single volume. **Complete \$3.50 now. \$5.00 after May 1.**

**Modern Radio Servicing**

A practical How-To-Do-It radio servicing course in 1800 easy-to-understand pages. Train you at home in spare time, like all Ghirardi textbooks, for profitable radio servicing... takes you step by step through Test Instruments, Troubleshooting, Testings, and Repair.

**Only \$5.00!**

**SPECIAL! Money-Saving Combination Offer**

Brings you those two great books, MODERN RADIO SERVICING and RADIO TROUBLE-SHOOTER'S HANDBOOK, at the one low price of \$8.00. (\$9.50 after May 1, 1942.)

**Get This New Battery Replacement Wall Chart!**

Leading radio distributors now display prominently Ghirardi's Radio Books. Examine them without cost or obligation at your dealer's. Also, be sure to get a copy of Ghirardi's helpful new Replacement Battery wall chart. Lists the manufacturer's type numbers of all "comparable" and "replacement" batteries for 1250 models of 100 makes of portable battery-operated radio receivers. Only 10¢, but worth many dollars to you. If a visit soon to your dealer is not convenient, check this coupon and mail at once.

**MAIL THIS COUPON NOW**

**RADIO & TECHNICAL PUBLISHING CO., Dept. RN52**  
45 Astor Place, New York, N. Y.

Enclosed find payment for books I have checked (on 5-day trial). I understand that if I am not fully satisfied I may return them at the end of the 5 days and receive my money back.

Radio Physics Course, \$5. (\$5.50 foreign)

Revised Radio Troubleshooter's Handbook, \$3.50 (\$5.00 after May 1st.)

Modern Radio Servicing, \$3. (\$5.50 foreign)

The Handbook & Modern Radio Servicing at Special Combination Price, \$8. (\$9.50 after May 1)

Wall Chart of Replacement Batteries for 1250 Models of portable radio receivers, 10¢

NAME.....

ADDRESS.....

CITY..... STATE.....

**See Your Distributor or Mail This Coupon Now!**



tor would be required at all hours, it might be a good plan to establish an emergency carrier-signal station at local defense headquarters.

**Alarm-Receiver Operated by Overmodulation of Broadcast Signal**

Figure 6 shows a proposed alert receiver that operates on an entirely different principle. Here, the local alarm is set off by overmodulating any radiophone carrier to which the set is tuned. This scheme should prove attractive in many quarters, since it imposes no requirement of making special broadcasts or setting up special transmitting stations. It might be set

to any local broadcast station designated as the alarm station, and that station would, without interrupting its regular programs, set the alarm off by raising its modulation above the pre-scheduled limit.

Radio technicians will recognize the circuit as essentially that of the familiar broadcast percent modulation meter. Figure 6 shows only the alarm circuit, operated after the last i.f. stage of a suitable superheterodyne.

Operation of the circuit takes place in this manner: radiofrequency voltage from the last i.f. stage is impressed across the 6H6 linear rectifier through the 1000-mmfd. coupling condenser by the received signal. This

voltage consists of an a.c. component (the modulation envelope) and a d.c. component (the carrier). The diode output current contains these two components, which are delivered to the 6SK7 amplifier tube.

The diode current develops a voltage drop across the potentiometer, R, and this direct current voltage is applied to the 6SK7 grid as bias. The a.c. component of diode output is also impressed upon the 6SK7 grid through the 1000-mmfd. coupling condenser following the r.f. filter (RFC and the grounded condenser).

As long as the a.c. and d.c. components are equal, the 6SK7 tube passes no signal through the primary of the coupling transformer. This relation between the two signal components corresponds to the condition of 100-percent modulation. Lower values of modulation likewise will not permit a transformer signal.

When, however, the modulation percentage is exceeded, the a.c. component on the grid of the 6SK7 will exceed the d.c. component, the tube will send a signal current through the transformer, the 884 gaseous triode will be tripped, and the alarm relay will close.

It is not imperative that the alert signal be 100-percent modulated. Settings along the potentiometer, R, will correspond to various percentages from 10 to 100, and may be located by experiment. In actually making this setting, signals of various modulation percentages are fed into the receiver and the potentiometer adjusted until the alarm just sounds. The resistance is then backed off slowly until the alarm just stops.

The resistance must not be left at the very threshold of response, however, since in normal broadcasts, the modulation percentage might unintentionally operate the alarm during occasions of slight overmodulation. The instrument is responsive to an increase in modulation percentage amounting to about 10% of the nominal value. Thus, if the resistance is set to accommodate 100% modulation, 110% values will trip the alarm.

This instrument is very pleasing in its action. However, it requires that the alert broadcast station police its modulation percentage diligently. A momentary overmodulation peak might easily set off local alert receiver alarms if its percentage is high enough.

**Automatic Battery-AC Switching Circuit**

All alert receivers must operate continuously and without the slightest interruption. Batteries must be provided for operation in the event of line-power failure, and means must be provided for switching these batteries into the circuit automatically without hand work.

Figure 7 shows such a circuit. This scheme is entirely automatic and will switch both A and B batteries into the circuit if line power is lost either be-

**AVAILABLE FOR PROMPT DELIVERY!**



**MODEL 1230  
SIGNAL GENERATOR  
WITH  
5 STEPS OF  
SINE-WAVE  
AUDIO**

**SPECIFICATIONS:**

1. Combination R.F. and A.F. Signal Generator, R.F.—100 K.C. to 90 Megacycles, A.F.—200 to 7500 cycles; Sine-Wave,—WITH

- 2. R.F. and A.F. output independently obtainable, alone or with A.F. (any frequency) modulating R.F.
- 3. Latest design full-range attenuator used for controlling either the pure or modulated R.F.
- 4. Accuracy is within 1% on I.F. and broadcast bands; 2% on higher frequencies.
- 5. Giant dial etched directly on front panel, using a new mechanically perfected drive for perfect vernier control.
- 6. Operates on 90 to 130 V. A.C. or D.C. (any frequency).

The Model 1230 comes complete with tubes, shielded cables, molded carrying handle and instructions. Size 14" x 6" x 11". Shipping weight 15 pounds. Only **\$14<sup>85</sup>**

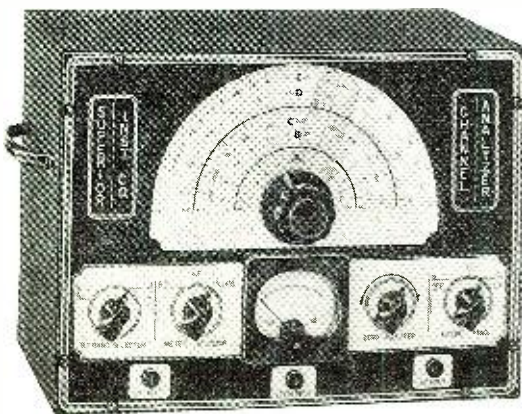

**THE NEW  
CHANNEL ANALYZER  
FOLLOWS THE  
SIGNAL  
FROM ANTENNA TO  
SPEAKER OF ANY SET**

The well-established and authentic SIGNAL TRACING METHOD of locating the very circuit in which there is trouble, and the very component that causes the trouble, is now for the first time available at a price any radio serviceman can afford.

**THE CHANNEL-ANALYZER WILL**

- ★ Follow the signal from antenna to speaker through all stages of any receiver ever made.
- ★ Instantly track down exact cause of intermittent operation.
- ★ Measure both Automatic-Volume-Control and Automatic-Frequency-Control, voltages and circuits without appreciably loading the circuit, using built-in highly sensitive Vacuum-Tube Voltmeter.
- ★ Check exact gain of every individual stage in receiver.
- ★ Track down and locate cause of distortion in R.F., I.F., and A.F. amplifier.
- ★ Check exact operating voltage of each tube.
- ★ Locate leaky condensers and all high-resistance shorts, also show opens.
- ★ Measure exact frequencies, amount of drift and comparative output of oscillators in superhets.
- ★ Track down exact cause of noise.

The Superior Channel-Analyzer comes housed in shielded cabinet and features an attractive etched aluminum panel. Supplied complete with tubes, three specially engineered shielded input cables, each identified as to its purpose. Also full operating instructions. Size 13" x 10" x 6". Shipping weight 19 pounds. Only **\$21<sup>75</sup>**

**SUPERIOR INSTRUMENTS CO.** 227 Fulton St., Dept. RN5  
NEW YORK, N. Y.



cause of failure of the line or short-circuit of the receiver power transformer.

Here is how this circuit operates: The heart of the scheme is a double-pole, double-throw 110-volt a.c. relay. This unit is *Ward-Leonard* 507-511 which has a 33 ma. 110-volt field coil. Its contacts handle 4 amperes each and the relay is non-chattering. This relay is connected directly across the a.c. input to the alert receiver so that the armature is continuously held down as long as a.c. power is available.

The heater winding of the power transformer and the positive output terminal of the power supply are connected to "closed" contacts of the relay so that the a.c. supply is normally switched in. The A and B Batteries are connected to the "open" contacts, the heater string to one armature and the B-plus string to the other.

When the a.c. input from the power line fails, the relay armatures are released, making contact with the "open" contacts. This disconnects the heater winding from the heater string and the filter output from the B-plus string, connecting in their place the A and B batteries.

When subsequently, the power is restored, the armatures are again drawn down into contact with the power supply circuits, whereupon the batteries are both disconnected.

Note that the receiver fuses are connected between the source of a.c. power and the relay. This is in order that the relay might kick out (switch to battery position) should the set fuses be blown by a short-circuit in the transformer or rectifier tube.

This automatic combination may be included in any of the alert receivers described or in any other such equipment that must operate continuously. The relay indicated is fast-acting, cutting batteries in and out rapidly as the line power is interrupted.

-30-

## Radio Ski Troops

(Continued from page 24)

tional Park.

One of the major responsibilities of the forest ranger is that of administering first aid and securing quick medical care for any skiers, ice skaters, and sight-seers who may have met with mishaps. Also to be reckoned with are those hardy, adventurous souls who, for reasons unknown, leave the marked snow trails for distant horizons and frequently find themselves unable to retrace their ski tracks. Searching parties must locate the lost persons in the shortest possible time when sub-zero temperatures prevail.

The use of radio in winter recreational areas is becoming increasingly important in combating the whimsies of man and the vagaries of nature. There are 254 such areas throughout the United States, covering over 50,000 acres of forests and mountainous

terrain. It is now possible to control these areas through radio and ski schools which must be attended by the rangers in charge. Portable radio-phones are standard equipment carried by rangers and, since the recent installation of ultra-high frequency radio "wave-sprinklers," or automatic relay station on strategic mountain tops, communication lines have been extended to the most isolated regions.

Ski schools for forest rangers cover every phase of proper administration of winter sports areas, including that of directing parking of automobiles along winter roads plowed in a single track. A ski ranger must be able to select areas which will be suitable for

the novice and still attract the expert. He must know that the best skiing grounds require western or southwestern exposures. He learns to mark out trails, and set up tows and shelters.

The use of radio in winter sports has its lighter side. Part of a ski ranger's training is devoted to the study of organizing and directing winter sports. The most hazardous and exciting of these is, of course, the Slalom, a race usually entered only by expert skiers. The radio equipment of the Forest Service starts the race and records the time consumed in making the intricate switchbacks and flagged points, and thus decides the winner.

-30-

## OHMITE Meets Today's Critical Needs in Radio and Electronic Applications

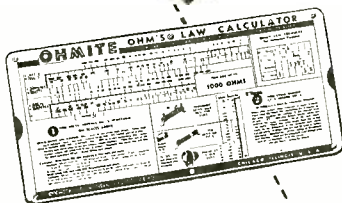

### Handy Ohm's Law Calculator

Figures ohms, watts, volts, amperes—easily. All values are direct reading. No slide rule knowledge is necessary. Yours for only 10c to cover handling cost.

THE service-record of Ohmite Products has proved their dependability on land, sea and in the air. That's why Ohmite Rheostats, Resistors, Chokes and Tap Switches are used in endless variety and number in military, radio, electronic and industrial applications. Widest range of types and sizes make it easier to meet each need. Many stock items. Units produced to Government specifications or engineered for the job.

OHMITE MANUFACTURING CO.  
4884 Flournoy St., Chicago, U. S. A.

### New Stock Catalog 18

Especially useful today for quick reference. Gives up-to-date information on Ohmite stock resistors, rheostats, chokes, and tap switches. At Ohmite Jobbers or write today—it's FREE.

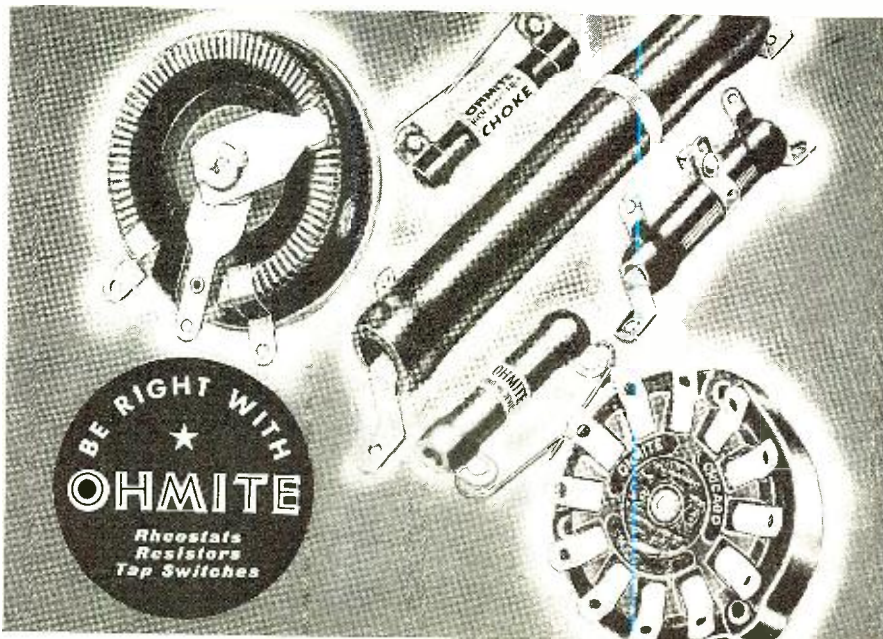



## Servicemen Can Aid

(Continued from page 21)

Their brains—their capabilities—their material equipment must be mustered to be of the greatest benefit to the fighting forces as well as those at home . . . Granting that the repair of radio receivers used at home is a war effort, it must also be realized that

such activity was a peacetime operation as well. In other words, important though it may be that every home has a properly functioning radio receiver, the work being done is not a direct contribution to the war effort . . .

It is not an easy matter to point one's finger upon forms of activity which could be described as being direct contributions to the effort to win the war, for many limitations are im-

posed upon the individual by the need for coordinated action. Everyone cannot do that which his spirit dictates no matter how greatly he may wish to do it, because if such were permitted people would be getting in each other's way and in a very short time actually interfering with planned effort of vital character.

That each man cannot be on his own does not necessarily mean that he is prevented from making his contribu-

tion. He can and should do what is valuable as a part of the concerted effort of the industry. For example, there is need for complete registration of man power available in the radio repairing industry throughout the nation. Some governmental agency should have in its possession not only a listing of radio repairmen, but full information about every piece of test apparatus possessed by these men as well as their experience and technical knowledge. We are aware of the fact that various lists of specialized personnel have been and are being compiled. But these lists differ from the type we are suggesting.

What we have in mind is not a roster of people and their technical background and education, but also a roster of their operating capabilities—the work they can do and the equipment they have to work with . . . Because of knowledge or hobby activities some servicemen are familiar with transmitters, whereas others are not . . . Some are more familiar with meters than others; some know far more about signal generators or signal sources in general, than others . . . Throughout this nation are numerous establishments where various kinds of electronic apparatus are employed in connection with defense production . . . These units may go bad and it is imperative that when this occurs they must be repaired . . .

# It's not all hard work!

National Receivers lighten the moments of the Army "at ease" with the same carefree performance that makes them a consistent choice for serious work.

**NATIONAL COMPANY, INC., Malden, Mass.**

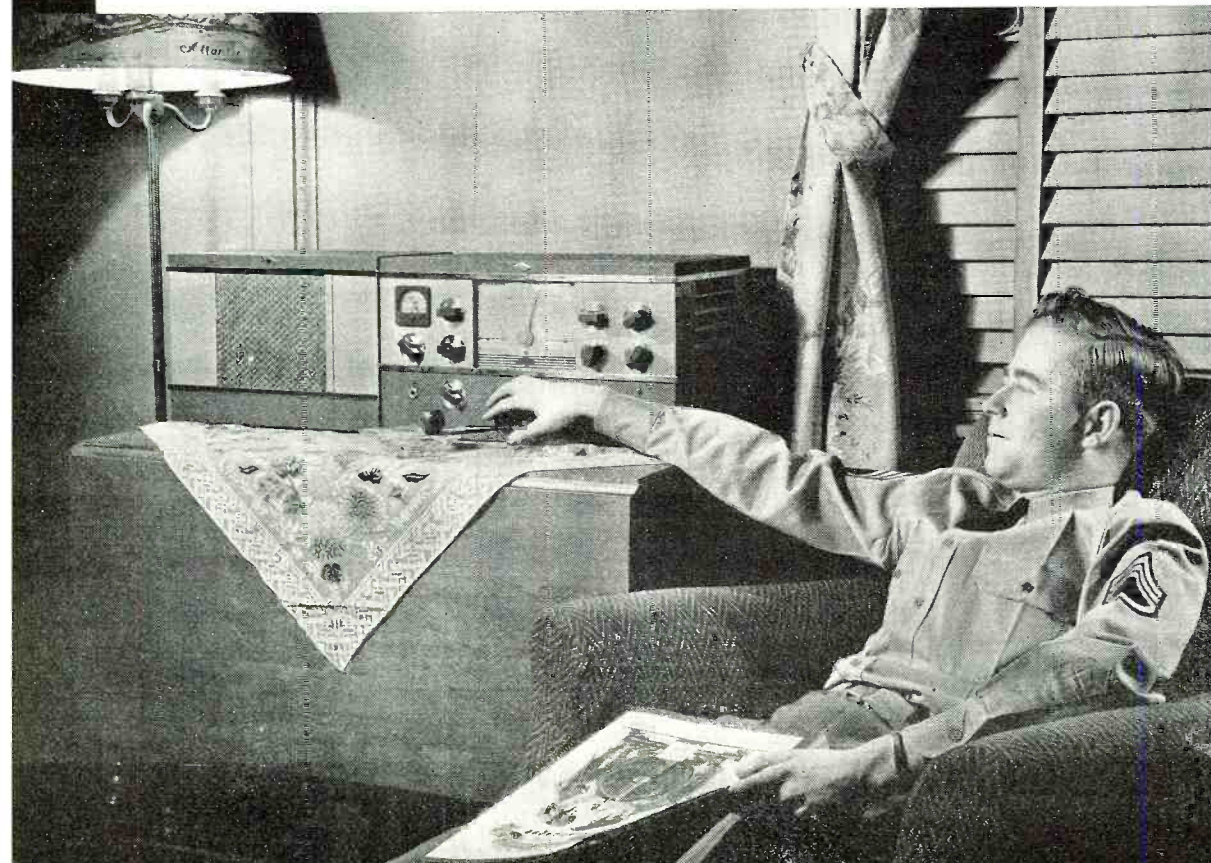

**RADIO NEWS**



The facilities of the original manufacturers of such apparatus are now taxed to the limit and much vital time is lost when such defective apparatus is shipped back to the original manufacturer for repair . . . A record should be available of all service shops capable of carrying out such repair, so that any organization requiring such repair facilities can acquire them with minimum effort and loss of time . . . This is no pipe dream! It's being done in a few isolated cases!

Many radio repair shops possess testing equipment which they are not using, especially meters of various kinds . . . In turn there are numerous establishments in this country which are in need of different kinds of meters but find it difficult to procure them because their ratings are not in the A1 class. If such a list of radio repair shops were available, there is no doubt of the fact that many manufacturing plants could get the meters they needed in order to expedite the production of equipment needed to win this war . . .

If not meters, then oscillographs . . . There are thousands of oscillographs in radio service shops. And they are not being used! The technique of radio servicing used in many shops does not embrace the cathode-ray oscillograph . . . So the 'scope is not a vital piece of apparatus in that service shop . . . It is resting on the shelf gathering dust . . . Somewhere else there is a slowing down of production because sufficient oscillographs are not available . . . So that you'll know it, there is a definite shortage of oscillographs of the 3-inch variety . . . Manufacturing plants' and schools' laboratories of many kinds need them badly . . . Is it not shameful that there are many oscillographs lying idle, when they are sorely needed in other places? Such a list as we have in mind would bring these 'scopes to the fore and they could be sold to those who need them . . . When something is needed badly, people are not concerned with whether or not it is brand new!

Then there is the matter of education of men sorely needed in the radio field . . . Radio schools are mushrooming all over the nation . . . All branches of industry are yelling their heads off for radio men . . . The government needs them—the manufacturers of war supplies need them—the radio repair industry needs them . . . A youngster going to school needs practical experience . . . The radio repair industry can make a direct contribution to war effort by utilizing some of the boys who are studying radio and in that way enhance the knowledge of these boys while they are securing their practical experience . . . Not only will they be helping the students, but they will also be helping themselves, for whatever work such a student can do, cannot help but relieve the pressure on the service shop . . .

Granted that after the boy passes out of the student age and has gathered sufficient practical experience, he

will leave the shop and secure employment somewhere in war supply production work . . . What about it? . . . At least the personnel of the radio repairing industry is making direct contributions to winning the war by providing industry with the kind of man power it needs—or providing the government with men who have had radio experience and training . . .

There are many radio men who fear the future of their industry after the war, is over . . . They now worry about the great number of radio trained men who will be available after the war . . . In other words, they are worrying about future competition . . . That's silly . . . Maybe there will be an overabundance of

radio men when the war is over, although we doubt it . . . But suppose there are too many men to do a job—at least they'll be free men and not slaves—IF we provide the proper number of men who can do their share in the various communication branches of the armed forces—so that we'll win the war . . .

As to the radio men after the war . . . We don't think there will be too many, for the level of radio development made necessary by this war will create a new electronic age which will benefit the people of the world IF we do what we can today, to see that the *United Nations* bring this struggle to a victorious end . . . Radio is vital to offense as well as defense in this pres-

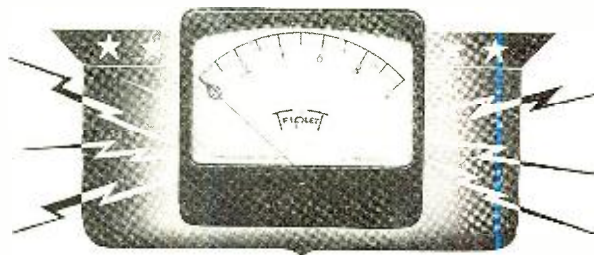

## “THERE IS A BRIGHT SIDE”

### An Open Letter to Users of Electrical Measuring Instruments

Much more than instruments is needed to fill the vast requirements of America's gigantic production program. Experience gained by many years of actual instrument manufacturing is vital. Triplett's broad experience in filling peace-time needs is answering the call to arms—is doing its part in re-establishing in the world the Democratic ideals of freedom.

Private business must undergo restrictions for the sake of National security. As good Americans we will bear these willingly.

And there is a bright side. Rapid expansion, new fields and improved processes mark today's instrument program. New developments unbelievably revolutionary in their scope are growing out of the vast proving ground of war-time production. When war ends, these advantages will be passed on to all of you. From the experience of today will come many new and greatly improved instruments to better serve the peaceful world of tomorrow.

*N. A. Triplett*

Sales Manager

The Triplett Electrical Instrument Co.

**FOR DEFENSE**



**BUY  
UNITED  
STATES  
SAVINGS  
BONDS  
AND STAMPS**

### We Can Also Help In Another Way

Buy Defense Stamps and Bonds. Buying them regularly is the best way you can help General MacArthur and our fighting men. We must all pull together now, and your dollars can best serve in stamps and bonds.

**THE TRIPLETT ELECTRICAL INSTRUMENT CO.**  
Bluffton, Ohio







who would need the services of men possessed of radio knowledge. Such services as we have in mind are not enlistment. Those men who enlist or are drafted are doing their share. We have in mind those who, for any one of a number of legitimate reasons, are not part of the armed forces.

There is no small effort, which if multiplied does not eventually mount to sizable proportions. Even such a small thing as becoming more familiar with what apparatus is in the average service shop so as to employ any one piece of equipment to the greatest extent and in that way obviate the need for other apparatus, is important. If ever that day may come when test equipment may be requisitioned, the servicing industry will then be in a position to give more freely and if requisitioning does not come, then the greater the successful utility of any one piece of apparatus, the more the equipment left free for use by the armed forces and other groups who need it badly.

Most careful use of whatever test equipment a serviceman may have so as to prolong its useful life, is a patriotic duty. Granted that new apparatus is difficult to secure, the fact that some are still available may lead some servicemen to operate in "business as usual" fashion . . . A little care exercised here and there and your parts jobber will have more apparatus which he can deliver to industry and schools and colleges where it is badly needed; apparatus for which some of these manufacturers, laboratories, and the like now wait many months.

A better acquaintance with radio in general, which may mean more extended study than heretofore, is also a contribution, for the occasion may arise when much improvising will have to be done in radio repairing. Even if some replacement parts will be generally available, there may develop shortages in those items which employ vital metals like copper, brass, aluminum, nickel, chrome, and others. Since it is necessary that America's receivers be kept in working order, substitutions and circuit changes will have to be made to make up for the replacement parts which cannot be procured.

The list of possible contributions to the war effort is endless. Let it suffice to say that every act which will enable more rapid production; will free manpower for more vital tasks; will prevent loss of time in any form of war effort; will speed up the education of those whose technical knowledge may be of value to the government or industry, are efforts to bring this war to a successful conclusion. Let each serviceman and the industry as a whole analyze its activities; make himself and itself more efficient, reduce the wasteful and useless effort and devote but one hour a day to some form of active participation so that it may be said that the radio servicing industry is doing its share to Let Freedom Ring.

-30-

## AFTER APRIL 22<sup>nd</sup>

# You Will Carry The Whole Load



Now you will have to carry the **WHOLE** load—the correction of sets with minor defects **AND** the rebuilding of sets which would have heretofore been thrown away.

Are you prepared to assume your responsibility? The operation of radio receivers is vital to the welfare of the public—the people depend upon you to keep them operating—remember, there will be no new receivers after April 22.

Shortage of competent help, difficulty of obtaining replacement parts, elimination of new sets, all throw a burden on you that you **MUST** carry. Many of the sets you get will be five, six, even ten years old, so you'll need **ALL THIRTEEN Rider Manuals**.

### RIDER MANUALS

Volumes XIII to VII . . . . . \$11.00 each  
 Volumes VI to III . . . . . 8.25 each  
 Abridged Volumes I to V . . . . . \$12.50  
 Automatic Record Changers & Recorders . . . . . 6.00

### FOR SPRING PUBLICATION

Inside the Vacuum Tube—complete elementary explanation of fundamentals of vacuum tubes. A-C Calculation Charts—146 charts covering A-C calculations from 10 c to 1000 mc.

### OTHER RIDER BOOKS YOU NEED

The Cathode Ray Tube at Work . . . . . \$3.00  
 Frequency Modulation . . . . . 1.50  
 Servicing by Signal Tracing (English) . . . . . 3.00  
 Spanish Edition . . . . . 3.50  
 Meter at Work . . . . . 1.50  
 Oscillator at Work . . . . . 2.00  
 Vacuum Tube Voltmeters . . . . . 2.00  
 AFC Systems . . . . . 1.25

**HOOR-A-DAY-WITH-RIDER SERIES**—on "Alternating Currents in Radio Receivers"—on "Resonance & Alignment"—on "Automatic Vol. Control"—on "D-C Voltage Dist." . . . . . 90c each

**JOHN F. RIDER PUBLISHER, Inc.**  
 404 Fourth Avenue New York City  
 EXPORT DIVISION: Roca-International Elec. Corp.,  
 100 Varick Street, New York City. Cable: ARLAB

**JUST OUT**  
**RIDER MANUAL VOL. XIII**  
 1672 Pages . . . . . \$11.00  
 We were fortunate in being able to publish this new volume in such complete form and at the regular price.  
**ORDER NOW! Avoid Disappointment**  
 that may result in putting off buying until "tomorrow."

**YOU NEED RIDER MANUALS TO 'CARRY ON'**

**NEW INVENTIONS** *Urgently Needed*

The need for practical new inventions to meet changed conditions of warfare and commerce is greater today than ever before. Your ideas, regardless of their nature, may fill urgent present needs. For analysis of current requirements, ask by number for the following **FREE** bulletins:  
 No. 1—WHAT TO DO, **NOW**, WITH MILITARY INVENTIONS.  
 No. 2—TODAY'S MARKET FOR COMMERCIAL INVENTIONS.  
**CHARTERED INSTITUTE OF AMERICAN INVENTORS**  
 DEPARTMENT 118, BARRISTER BUILDING WASHINGTON, D. C.

**Theory and Practice of Disc Recording**  
*will be continued in the big*  
**JUNE ISSUE OF RADIO NEWS**





# ANTENNAS FOR OFFENSE

**Light-Weight Sturdy  
Telescoping Designs.**

**Developed in  
ALUMINUM  
MONEL  
STEEL**

Standard for marine service, ship-to-shore, mobile units—in two-way communication for defense purposes—the sturdy, lightweight Premax Antennas are doing excellent work.

Fully telescoping and adjustable designs have been found to meet the rigid defense specifications in every detail.

Premax Antennas are built in a number of standard designs in monel, aluminum and steel, both for fixed and mobile installations.

If you have a defense problem which requires light-weight, strong, weather-resisting telescoping antennas and mountings, let us know your requirements.

*Send for Bulletin No. 42-R  
which shows many types of  
antennas and mountings.*

**Premax Products**

Division of Chisholm-Ryder Co., Inc.  
4220 Highland Avenue, Niagara Falls, N. Y.



## U.H.F. Antenna (Continued from page 15)

high-frequency radio range at 63 megacycles, vertical half-wave dipoles were successfully used. Later, when the frequency was shifted to 125 megacycles (the band of 123 to 127 megacycles was permanently assigned for radio range service), considerable difficulties were encountered with both horizontal and vertical dipoles.

Extensive flight tests showed it is very essential that an antenna system possessing an essentially pure polariza-

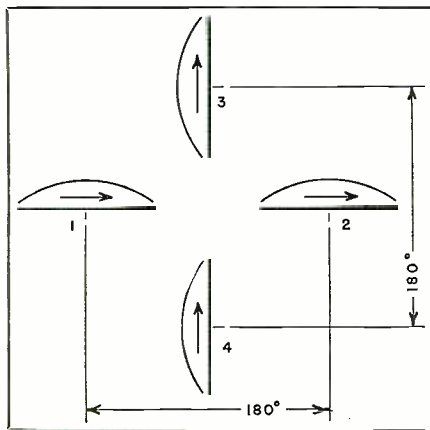

Fig. 11.

tion be provided at the radio range and on the aircraft. For this purpose neither vertical nor horizontal dipoles are entirely suited because the polarization of the electric field contains both vertical and horizontal components and the course indication received on the aircraft becomes a function of the orientation of the aircraft receiving antenna. Impure polarization is apt to cause splits, bends, and displacements in the courses.

The same phenomenon was observed on localizer courses in the development of the CAA-ITD instrument landing system at the Experimental Station, and was solved by the introduction of the ultra-high-frequency loop, Figure 6. This loop is a form of magnetic dipole having a pure horizontal polarization of the electric field at any point in space. The loop has omnidirectional radiation properties similar to those of the vertical dipole and can likewise be used in combination in an antenna array, as vertical dipoles are often used.

Referring to Figure 14a, the loop is shown as comprising four horizontal

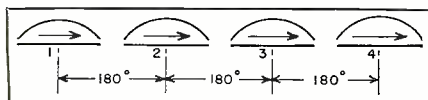

Fig. 12.

radiators, 1, 2, 3, and 4, each carrying equal currents, in-phase. The instantaneous direction of the currents and the standing wave distribution are shown in the diagram. For convenience in terminating the transmission

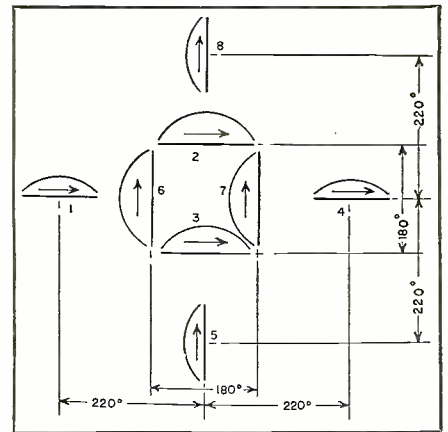

Fig. 13.

line, a closed stub building-out section is used. This resonates the loop and a portion of the transmission line (see Figure 14b).

Since the radiation resistance of a loop approximately one-eighth wavelength on the side is only about 25 ohms, care must be taken in the design of the resonant portion of the line in order that its losses may be kept to a minimum. Usual practice is to construct the radiators of wide metal bands to provide a low surge impedance, thereby keeping the voltage on the radiators low. The efficiency of a carefully designed loop runs in the order of 98 per cent, and varies approximately as the square of its area.

The loop may be square, rectangular, circular, or elliptical in shape, and several different types have been successfully used in practice, such as that shown in Figure 14b. Figure 10 shows the Goshen, Indiana, four-course ultra-high-frequency radio range. Three of the five loops can be seen in the view shown in Figure 5. Eight stations of this type are installed and operating between Chicago and New-

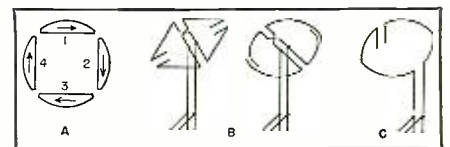

Fig. 14.

ark. In Figure 1 is illustrated an experimental antenna array used in a localizer of the instrument landing system.

Another type of loop, somewhat simplified over those described above, is shown on Figure 14c. This type of loop has been used mainly for receiving installations on aircraft. The type shown in Figure 4 on a Douglas DC-3 airliner was used extensively in experimental work. The radiators are enclosed within lucite tubing and sealed against the weather. Wide-band loops, completely enclosed in a plastic air-foil section housing supported on streamline masts, capable of operating from 110 to 140 megacycles without any tuning, are in process of manufacture for use by the airlines.



## Police Radio

(Continued from page 41)

delivered. For an example, if a message originated at the Dunes Park, Indiana State Police radio station destined for San Francisco, California Police, it is sent by the zone station Dunes Park to the interzone station at Indianapolis who in turn relays it to Springfield, Illinois. Springfield sends the message to Kansas City, Missouri, who relays it to Denver, Colorado.

Denver then sends the message to Santa Ana, California, where the message is placed on the California teletype network to San Francisco. Six

motor vehicle information, etc., from the local zone stations.

As an example, if a state police officer near Sterling, Illinois, holds up a truck on the highway for improper credentials and desires to see if the truck is registered according to its license plate, he files the message with the zone station at Sterling who immediately sends the message to the interzone station in Springfield. Springfield obtains the necessary information from the Secretary of State's file and sends the answer back to Sterling who in turn dispatches it to the officer in the patrol car. This information may be handled by radio-telephone; however, it may cause a serious delay in

case another station in the network has an urgent dispatch for one of its cars.

Traffic between two zone stations may occur in the following instance: A man wanted for larceny in LaFayette, Indiana, is known to be staying in a hotel in Gary, Indiana. A message is then sent from the zone station at LaFayette to the zone station at Dunes Park who in turn delivers it by radio-telephone to Gary. When the pickup is made by the Gary police the return message is sent in the same manner.

Since the advent of radio-telegraph, these intercity messages are now handled accurately and speedily, allowing

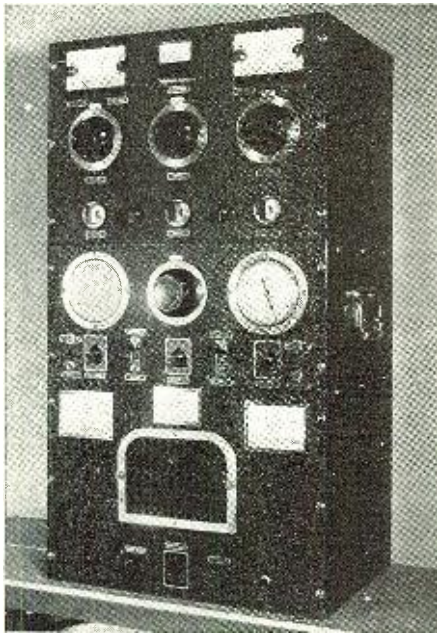

WSPI's portable emergency transmitter.

radio telegraph stations have handled this message before it reached its destination. Many of these relays are, of course, eliminated at night when it is possible for two interzone stations to work each other although they are hundreds of miles apart.

If a subject is wanted for forgery in Tacoma, Washington, and he is believed headed for his home in Niles, Michigan, the message is filed by the Tacoma Police Department and sent by the interzone station at Tacoma to Denver where it is relayed to Kansas City. Here it is again passed on to Springfield, Illinois, and relayed to East Lansing, Michigan. The message is now sent on the zone band to the zone station at Paw Paw who forwards it to Niles by radio-telephone.

A greater part of the police radio telegraph traffic, however, is between zone stations themselves and between zone stations and the local interzone station. Most of the state police interzone stations are the control stations for the state police nets, and are situated in the capital of the state. These stations are heavily loaded with routine traffic such as license checks,

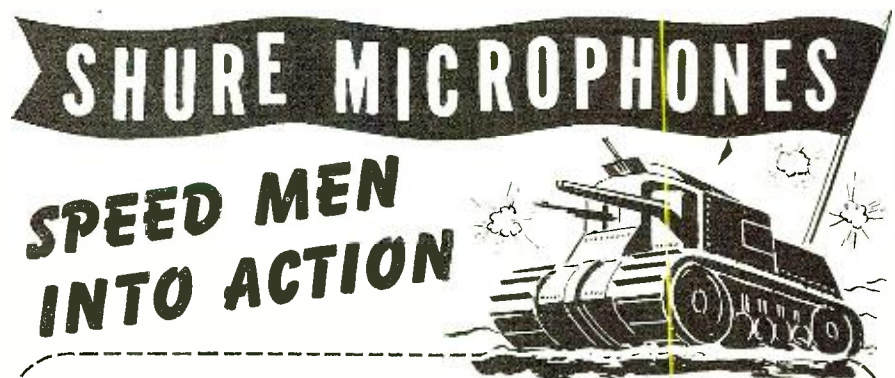

IT may be an order for battle formation—a broadcast to the Nation—a word to industrial workers—a call to police or civilian defense crews . . . on every front, Shure Microphones do their part. As the tempo of the war effort grows faster, Shure Microphones help speed men into action and maintain morale at home.

### CARBON, DYNAMIC, MAGNETIC, CRYSTAL

Many important advancements in Microphone design and performance are the result of Shure specialized engineering. Today, Shure Engineers devote their skill and their energy to the production of Carbon, Dynamic, Magnetic and Crystal Microphones in a determined effort to help win the war.

### SHURE BROTHERS

Designers and Manufacturers of  
Microphones and Acoustic Devices  
225 W. Huron St., Chicago, U.S.A.





**SAVE MONEY on Console Cabinets  
Radios and All Radio Parts**



**OXFORD TYPE PD.** A beautiful hand-rubbed, piano-finished cabinet. Made of five-eighths stock. Rose Mahogany. A real piece of furniture 33" high, 32" long, 17" deep. Phono compartment 31 x 15 x 6"..... **\$2695**



**1942 "Velvet Action" Record Changer**  
Plays 10 12" or 12 10" records, 14" by 14" by 5" high. Crystal pickup. Reject switch—automatic or manual change—two point record suspension. 115 volt, 60 cycle. Only 7 seconds to change records. Easy to install..... **\$1695**



**Deluxe Changer**  
Ideal for small cabinets. Only 12" x 13" x 4 1/2" high. Plays 10 12" or 12 10" records. Crystal pickup, offset record suspension, reject switch, smooth action..... **\$1295**

**Victory Special . . . — . . . V**  
NATIONALLY-KNOWN, HEAVY DUTY MOTOR. Silent, dependable, induction type, self-starting motor; 9" turntable, 78 RPM. Enclosed gears. For 110 v. 60 c. \$11.50 List. **\$465**  
Now only.....

We carry a complete line of uncut cabinets. Table models \$1.75 and up; consoles \$5.95 and up; Combination Consoles \$15.95 and up. New complete illustrated bargain bulletin lists many styles as well as all radio parts at money saving prices. **SEND FOR FREE BULLETIN NOW!**

**LAKE RADIO SALES CO.**  
615 W. Randolph St. Chicago

**MODERN PARTS for  
MODERN CIRCUITS**

THAT HAVE BEEN

*"Designed for  
Application"*

CATALOG UPON REQUEST

**JAMES MILLEN MFG. CO INC.**  
150 EXCHANGE ST. MALDEN, MASS.

the radio-telephone circuits to remain open for dispatches and messages to squad cars greatly increasing the efficiency of our police departments.

The type of transmitters used by the police CW stations range from home made band switching jobs to deluxe commercial units with push button frequency selection. The maximum power allowed for this type of service is 500 watts output. Receivers are conventional communication superhets generally with crystal selectivity. Since approximately 100 of these stations must operate on only nine frequencies, considerable interference results especially at night.

One of the three frequencies in each band is designated as the calling fre-

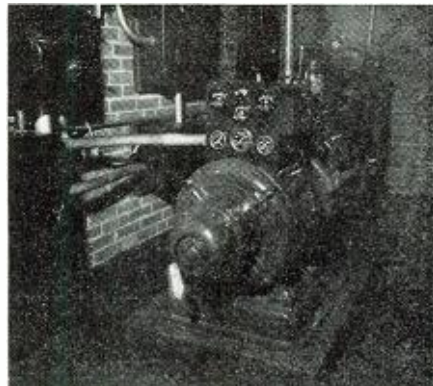

Emergency supply generator.

quency, with the other two as working frequencies. Most of the stations maintain a 24-hour watch on the calling frequencies while others close down after midnight.

Each station or group of stations have their own types of message blanks for sent, received or relayed messages. When one station calls another he denotes whether he has a local or relayed message to the station called, allowing the receiving operator to use the proper blank.

The average speed at which traffic is handled is approximately 25 wpm., however, some of the more experienced operators handle traffic up to as high as 40 wpm.

Each individual police CW station has its own group of contacts in its area. For instance the zone and interzone station at Chicago, Illinois, has immediate contact either direct or by relay with police stations in the Chicago area.

It is generally the aim of all municipal stations to have some form of contact with the zone or interzone station in its locality in order to increase the efficiency of its own department by having a means of sending police messages to other parts of the country via the CW net.

The part which our police telegraph networks are now playing in our defense efforts is extremely valuable. As previously explained the network is a nation-wide affair, and together with the individual small networks built around each zone and interzone station, messages may be sent to thou-

sands of small remote villages or municipalities. Since a great number of the police radio stations have facilities for emergency power operation and many more making preparations for such installations, local power failures would not hinder the delivery of communications.

Instant communication is one of the most valuable assets to the militia in defending our country in modern warfare, where the enemy can strike in a moment's notice by means of aircraft. If this line of communication is suddenly broken by the failure of power, or breakdown of wire lines, the results would be disastrous.

The police radio-telegraph operators have been accustomed to handling messages of an emergency nature, and they have attained remarkable speed and accuracy in the handling and delivering of these messages. A large amount of traffic handled by these men relate to death notification messages, where public service has failed. As an example, a person is killed in Louisville, Kentucky, and the address of the nearest relative of the deceased person is in Wichita Falls, Texas. However, this nearest relative has moved recently, and the public service message is returned undelivered.

The Louisville Police Department now files a message with the interzone radio operator at Louisville, and he promptly sends it on to the Wichita Falls station probably by relay through Memphis. The Wichita Falls Police Department receive the message and details an officer to attempt to locate the relative. He is usually successful if the party has not moved from the city. If so, this information is then returned to the Louisville police.

Death notifications, attempts to locate messages, criminal pickup messages, and other types of emergency messages are daily occurrences for the police radio telegraph networks, and since these operators are accustomed to handling this type of work, they are ideally suited for the increasing amount of defense traffic being placed on the networks.

Police departments throughout the country are cooperating with the army in furnishing escorts for convoys and troop movements from one state to another, and the routes and destinations of these movements can be relayed from one police department to another by these zone and interzone stations. Secrecy of these movements can be obtained by coding messages.

The quartermaster corps, whose duties are to provide meals and lodging for the troops along the line of march can be greatly assisted in making their necessary arrangements by means of police radio and the telegraph net.

In case the enemy should attack us on our own land, and wire communication disrupted, they will be backed up with a radio communication system second to none with experienced radio men at the key ready to handle communication to practically any place in the United States.



# RADIO SPEAKER SALE!

**First Come—First Served.**

15,000 P-M Speakers—4" and 5" (less transformers) V. C. impedance 3-4 ohms. 4"—89c each. 5"—\$1.10 each.

Super Coil Kit. One pair Pi-Wound 456 KC I.F. One oscillator coil. One antenna coil. One 2 gang variable condenser to match. \$1.89 per kit.

## BARGAINS! BARGAINS! BARGAINS!

- All brand new in original packages.
- I.F. coils (456 kc.) each.....39c
- Recording Discs, metal base, slight imperfections.  
6 1/2".....10c 8".....15c
- Magnetic Speakers, 5"—each.....69c
- Pushback Wire in assorted lengths.  
.....60c per lb.
- Mica Condensers, 100 assorted values.  
.....\$1.45

**Write to Us for Parts and Save Money!**

FREE! Write today for free catalog of hardware and replacement parts for the serviceman.

## RANDOLPH RADIO

609 W. RANDOLPH ST., CHICAGO, ILL.  
"MILLIONS OF PARTS FOR MILLIONS OF RADIOS"

We have a large stock of

## HALLICRAFTERS NATIONAL HAMMARLUND RME HOWARD

RECEIVERS, transmitters and all radio supplies of all sorts at lowest wholesale prices. Order from us for immediate delivery. We will help you get the best equipment for your use and cooperate with you to see that you are 100% satisfied. Your inquiries and orders invited.

- YOU get 10-day trial
- YOU get best trade-in

We also have a store at 2335 Westwood Blvd., West Los Angeles, Calif. Write, fone, telegraph us anytime about any radio supplies. It will pay you to deal with us.

## HENRY RADIO SHOP

Butler, Missouri

"World's Largest Distributors of Communications Receivers"

Radio compasses have long been used as a means of directional guidance on board aircraft by private pilots, military services, and air carriers as a supplementary aid to air navigation. Satisfactory types for operation on low and medium high frequencies are commercially available today. However, the need for an ultra-high-frequency automatic aircraft direction finder for use in conjunction with ultra-high-frequency radio ranges has been realized by the *Civil Aeronautics Administration* and specifications to cover this type direction finder have been prepared.

The CAA is endeavoring to obtain by means of a development contract an aircraft automatic direction finder which will give simultaneous heading and position indications to operate within the bands from 108 to 111 and 119 to 127 megacycles. When this contract is completed, all navigation can be conducted on ultra-high frequencies, with their more reliable characteristics, throughout the United States or wherever ultra-high-frequency facilities are available. Due to the line of sight properties of ultra-high frequencies, transoceanic and intercontinental flying will always have to de-

pend on the use of low or medium high frequencies for directional guidance.

### Markers

The list of ultra-high-frequency facilities would not be complete without the mention of Z markers and fan markers. The Z marker (sometimes called the cone of silence marker) was developed to meet the need for a positive position indicator for marking the location of radio range stations along the Federal airways for use when flying on instruments. The transmitter operates on 75 megacycles with an antenna output of 5 watts and is 100% modulated with a frequency of 3000 cycles. An egg shaped space pattern is produced by this marker.

The fan marker is usually located about 20 miles from the radio range stations and was developed to provide a positive indication of position. This has been found necessary in conjunction with airway traffic control. The fan marker likewise operates on 75 megacycles, but has an antenna output of 100 watts and is 100% modulated at 3000 cycles and keyed with an identification signal. An elliptical or fan shaped field pattern is produced. The modulation is keyed with 1, 2, 3, or 4

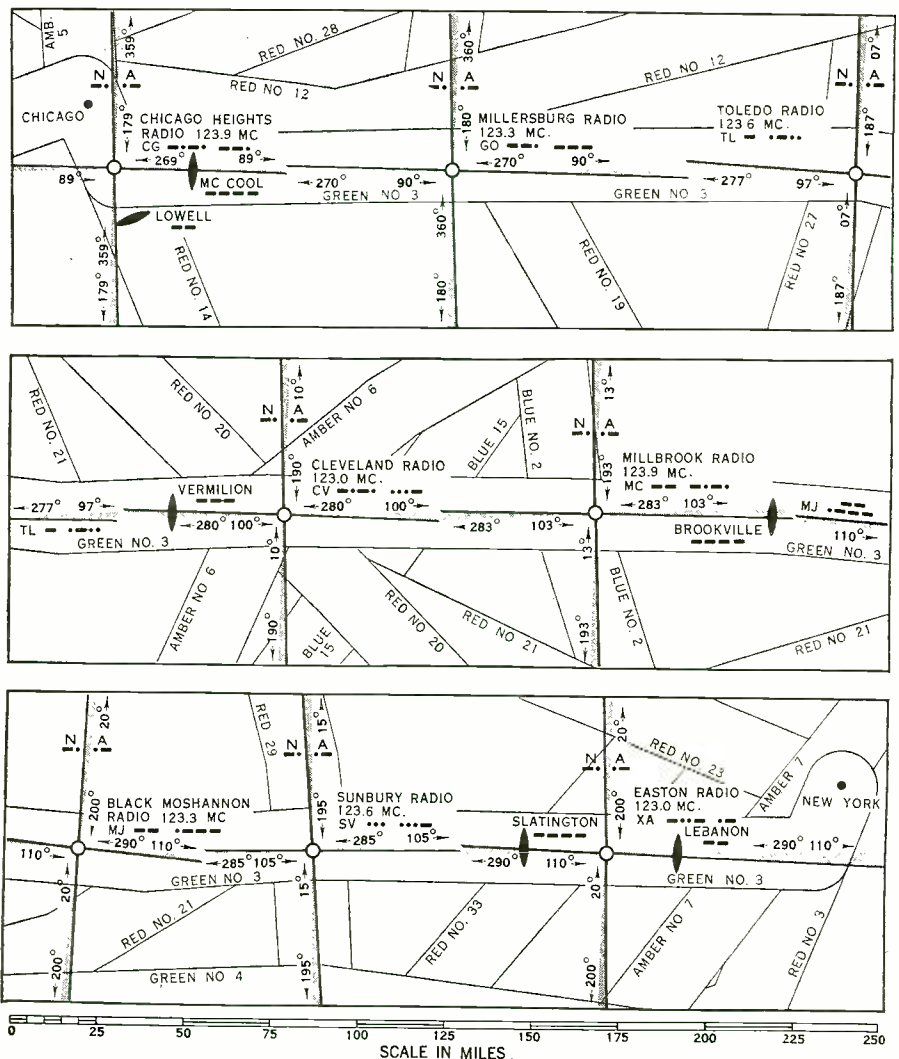

Fig. 15.



**Aviation Safety**  
(Continued from page 20)

**Airport Traffic Control**

Tests have indicated that the utilization of ultra-high frequencies for airport traffic control will provide two important advantages over the present low-frequency service due to the elimination of interference between stations and the freedom from atmospheric disturbances. Dependable voice communication between airport traffic control towers and aircraft is absolutely essential to the success of modern scheduled air carrier transportation.

Tests have been completed on three ultra-high-frequency airport traffic control stations located at LaGuardia and Floyd Bennett Airports in New York City and at the Municipal Airport, Philadelphia, Pa. The ground equipment as installed is as follows: A crystal controlled transmitter which is capable of delivering 100 watts of power to the antenna at any frequency between 129 and 132 megacycles; a monitor meter on the transmitter for indicating both the percentage modulation and amplitude of the r.f. carrier; a speech amplifier operating between the microphone and transmitter; a *Western Electric* induction type microphone having a control switch; and a transmitting antenna which radiates horizontally polarized waves and has a field pattern which is nearly circular in the horizontal plane.

Fig. 2 is a photograph of the transmitter and Fig. 8 a photograph of the antenna. The aircraft equipment consists of a tunable aircraft receiver which uses triple detection and a 125-megacycle horizontal loop type receiving antenna.

The service area of each station was found to be greater than 30 miles at an altitude of 500 feet and at higher altitudes the area increases, giving satisfactory reception for over 100 miles at an altitude of 5000 feet. The equipment used was manufactured by the *Radio Receptor Company, Inc.*, New York City.

Frequency modulation airport traffic control equipment is being obtained on contract from the *General Electric Company*. This equipment is comprised of three complete transmitting units, a microphone, amplifier, and monitor, and three receivers, including remote control units and cables.

Factory inspection of the equipment has been made and the equipment will be shipped in the near future to LaGuardia Airport, New York City; Newark Airport, Newark, N. J.; and to the Municipal Airport, Philadelphia, Pa. At these points, comparative tests will be made to determine whether amplitude or frequency modulation gives the most satisfactory results in airport traffic control.

**RACKS · CHASSIS · PAR-METAL · CABINETS · PANELS**



Shown here, Cabinet Rack #ER-225  
Typical of a complete line listed in our Catalog No. 41.

A De Luxe job, typical of Par-Metal quality, this rack is in use on many commercial installations.

**STANDARD & CUSTOM-BUILT RACKS & CABINETS**

Engineers who expect style, skill, and precision in metal work as a matter of course, will find that PAR-METAL thinks along this line.

And we are equipped for *volume* business. So why not consult us when bidding on defense orders. Estimates submitted promptly.

**ENGINEERS: Write on Company letterhead for our Catalog No. 41**



**PAR-METAL PRODUCTS CORP.**  
32-62 49th ST., LONG ISLAND CITY, N. Y.  
Export Dept.: 100 Varick St., New York, N. Y.



**RHYTHM BREAKS A RECORD!**

The U.S.S. ALAEAMA—launched 9 months ahead of schedule—and music scores the Victory! THORDARSON booster amplifiers with loud speakers installed throughout the shipyards set the work to music. In "Serving America with Service," THORDARSON SCORES A VICTORY.

**THORDARSON**  
ELECTRIC MFG. COMPANY  
500 WEST HURON STREET, CHICAGO, ILLINOIS

**TRANSFORMER SPECIALISTS SINCE 1895**

*New Handy* **UNIVERSAL REPLACEMENT** Capacitors



Write for Catalog  
**SOLAR MFG. CORP., Bayonne, N. J.**

**BUY U. S.  
DEFENSE BONDS  
& STAMPS!**



dashes to indicate whether the marker is on the northerly, easterly, southerly, or westerly leg of the range. These markers and the Z markers have been installed extensively throughout the United States.

### Monitors

A contract has been issued to *Airguide, Inc.*, to cover the development of a set of equipment for monitoring the fan type marker. The equipment will consist of receiving equipment located from 10 to 15 miles from the marker, depending on local terrain, and monitor alarm equipment located in the airway communication station. The receiving and control equipment will be connected by wire line facilities. This equipment is now ready for inspection and if found satisfactory, it will be installed at Washington, D. C., for test to determine its suitability for installation throughout the United States.

A set of automatic radio range monitor equipment is being developed by *Airguide, Inc.*, for the *Civil Aeronautics Administration* to be used to indicate the position of approach courses of radio range stations now in use and to sound a siren whenever the course deviates more than 3 degrees from the specified alignment. In addition, a special warning signal will be transmitted over the radio range system at the beginning of each A-N keying cycle to notify pilots using the range that the approach course alignment is not correct. This equipment is almost complete and it will be installed at Indianapolis, Ind., and tested to determine its suitability for use throughout the United States.

### Ground Direction Finders

The installation of three high-frequency ground direction finders for the CAA is now being completed under a contract issued to the *Graybar Electric Company*, Washington, D. C. These direction finders are located at Pittsburgh, Pa., New York City, and Washington, D. C., and will permit the determination of the position of an airplane by triangulation. By agreement, the *Administration* is to provide direction finding facilities for transatlantic air routes terminating in the United States. The New York installation will be used to study the limitations of the automatic direction finder for this service.

This installation has been commissioned and placed in actual service operation, and it is expected that the direction finders at Pittsburgh and Washington, D. C., will be commissioned in the near future.

The azimuth indicating radio receiver (Fig. 6), as developed by the *Western Electric Company* for these installations, is a 10-frequency, fixed, tuned, remote controlled superheterodyne radio receiver, having the additional feature of remote automatic instantaneous and unilateral azimuth indication. The receiver includes a "codan" which acts to disable the re-

ceiver in the absence of signal. The bearing indication is automatic, requiring no manual operation other than that of tuning the receiver to the frequency of the transmitter on which the bearing is to be taken.

A single two-wire line suffices to connect the receiver to the remote control unit for all its functions. The apparatus is designed for a nominal frequency range of 2.8-6.6 megacycles and any selected ten frequencies in this range may be received. A calibrating oscillator has been supplied for use in checking the calibration of the direction finder from time to time. The frequency of this test unit is crystal controlled with a tolerance of .02 applying under all operating conditions. The receiving equipment for each station has been installed in a small building on the site. A 60 ft. tower, illustrated, has been erected at each site. Remote control quarters are at the airport and are usually located in the communications station.

It is expected that these direction finders may be used as a secondary aid to navigation in cases of emergency.

This outline of new radio developments now underway is not complete, but it does give an indication of the work which is being conducted by the *Civil Aeronautics Administration* to make radio an even more important adjunct to the safety of air transportation.

-50-

### Air Raid Warning

(Continued from page 32)

equipment for these loud speakers must be able to handle the tremendous volume which will be put into them when the alarm is given. The tower which we are using is 34' high, constructed from 2 x 4's, and is well cross braced and guyed. This same type of equipment, including the radio receiver, the signal generator, and the microphone, if desired, can be used to great advantage in factories and industries. Instead of having speakers placed in a tower on these installations, the various loud speakers may be placed at strategic points, and all the equipment and controls may be placed handy to the switchboard.

In the operation of our tower, there are two of us in the vicinity of the controls, practically twenty-four hours a day, but in case the police were unable to contact us on the telephone, they have arranged to send a squad car over to the tower, and these officers have been trained in the operation of the tower. This eliminates a possibility of any failure to notify our section, of an alarm. We are also using a traffic control car in conjunction with the police work. This car and equipment has been highly praised by the Police Department. It consists of a 30-watt mobile amplifier which is manufactured by the *Webster-Rauland Corporation*. Two heavy duty p.m.



MR. JOHN GEO. COLEMAN  
Radio Maintenance of Westchester  
110 Mt. Vernon Ave., Mt. Vernon, N.Y.

"N.U. products have always been of the highest quality. The N.U. plan has helped me get those much needed pieces of testing equipment."

WHERE YOU FIND  
**NATIONAL UNION**  
YOU FIND BETTER  
**RADIO SERVICE**

**PREMIUM**  
*Quality*

**TUBES**



**BATTERIES**



**CONDENSERS**

also Transmitting tubes, panel lamps, cathode ray tubes, exciter lamps, sound equipment, photo electric cells, sound accessories, dry batteries, flash light bulbs.

**NATIONAL UNION invites . . .**

All radio service dealers to enjoy the benefits of the N. U. Shop Equipment Plan. The latest in tube testers and test equipment are available to you . . . prompt delivery. More than 60,000 completed deals prove the success of this plan. Investigate now.

Ask Your N. U.  
Distributor or Write



**NATIONAL UNION**  
*Radio Corp.*  
**57 STATE ST., NEWARK, N. J.**



## AUTOMATIC RECORD CHANGER



### DE LUXE MODEL 300

CRYSTAL PICKUP with permanent needle. Newly designed dependable smooth operation. Plays twelve 10" or ten 12" records. Reject switch. Automatic or manual operation. Easy to install. 14" x 14" x 5" high. 60 c. 115 v.

LIST, \$39.95 **\$19.95**  
YOUR PRICE

**CABINETS**—Complete assortment 1942 uncut consoles, \$9.95 and up. Custom built combination cabinets \$14.95 and up; also Modern and Period Mahogany or Blonde cabinets. (Quantities Available.)

### SPECIALS

**Model 100 AUTOMATIC RECORD CHANGER.** Plays ten records automatically. List \$29.95. **YOUR PRICE \$14.95.**  
**Model 150 RECORD PLAYER-RECORDER.** Single speed (78 R.P.M.). Cuts and plays. List \$39.95. **YOUR PRICE \$19.95.**  
**Model 200 RECORD PLAYER-RECORDER.** Two speed (78 and 33 1/2 R.P.M.). List \$49.95. **YOUR PRICE \$24.95.**  
**Model 250 AUTOMATIC CHANGER-RECORDER.** Our top quality, precision unit. List \$89.95. **YOUR PRICE \$44.95.**  
**Model 22 SIX TUBE CHASSIS.** Tone control. Complete with tubes and speaker. **YOUR PRICE \$17.95.**

Complete line of radios and equipment in stock. Write us today for special bargain list.

**MUTUAL RADIO PRODUCTS CO.**  
771 ARTHINGTON ST., CHICAGO, ILL.

## TO DO YOUR BIT—Better!

We're producing more RCP Test Equipment than ever on war orders. Some are available to you if you are servicing an "essential" industry or institution. Because time today is doubly precious, remember for fast, accurate testing, RCP provides all wanted features at the lowest possible cost. Compare Model 702, point-for-point, with instruments selling at far higher prices.

## SIGNAL GENERATOR

Complete only

**\$27<sup>95</sup>**



### MODEL 702

- A complete instrument for modern service shop or experimental lab. Embodies latest improvements in circuit and mechanical design. Range 95 Kc. to 100 Mc. Direct reading. Continuously variable.
- Unmodulated, or modulated 30% at 400 cycles; 400 cycle output for external connection. Can be used with outside sweep circuit and sobbulator for oscillographic wave analysis.
- Five-step calibrated attenuator, 1 to 500,000. No dead spots, ripple or feedback through line. Highly attractive, portable counter case. AC operated.

To qualify under P-100 preference rating, see your distributor. Catalog 125, showing RCP's full line of tube and set testers, mailed on request.

**RADIO CITY**

PRODUCTS COMPANY, INC.

88 PARK PLACE • NEW YORK, N. Y.

RCP  
dependable  
TEST  
instruments

## AIR RAID WARNING

Teletype { Yellow ..... Precaution ..... Headquarters Call Fire Departments.  
Blue ..... Caution ..... Headquarters Call Fire Departments.  
Red ..... Headquarters to Notify Fire Depts. to Sound Alarm.

Sounded from Air Raid Tower { (1) Police and Auxiliary Police..... 9... 4 Times..... 36 Blasts  
(2) Auxiliary Firemen ..... 7... 4 Times..... 28 Blasts  
(3) Air Raid ..... 5... 4 Rounds..... 80 Blasts  
(4) Clear ..... 3... 2 Rounds..... 24 Blasts

This chart is placed at every key point in the system.



These A.P.'s cooperated in constructing this project and operate the system.

speakers mounted in large parabolics.

These speakers are placed on top of the car on a wooden frame which was constructed to hold them. The microphone is placed in the car, and the police officer in charge gives the orders. This system has excellent coverage, and although it is called the traffic control car, it can be used for many other purposes, such as, covering minor dead spots, giving orders to a great number of people in case of emergency, etc.

If a system of this type is adopted by a community, they will have the

satisfaction of knowing that they have the finest means of communications that is known, and that they will be able to cope with any situation with lightning speed and precision. This is an excellent time for the radio men, and sound men to aid their country by advising their communities properly along these lines. It should be kept in mind that all the equipment on hand in use today should remain in use, but it will also be found that this field will have to be enlarged, to cover the current needs, and meet the existing emergency. —30—

**DON'T MISS**  
**“R. F. Coil Analyzer” and**  
**“Beginners Dynamic Demonstrator”**  
(PART TWO)  
in the  
**JUNE ISSUE**



## CAA Radio Equipment

(Continued from page 35)

d.b. down. Undesirable responses are specified as 60 d.b. or greater, up to 10,000 kilocycles, and not less than 50 d.b. above 10,000 kilocycles. Sensitivity is on the order of 2 microvolts for an output of 50 milliwatts with a signal to noise ratio of 6 d.b., the carrier modulated at 400 cycles to a depth of 30%.

Automatic volume control requirements permit not more than 6 d.b. variation for input variation from 2 microvolts to .1 of a volt. The receiver must not block with any input up to 10 volts. The overall audio response must be substantially linear (plus or minus 3 DB) from 300 to 2500 cycles. The output circuit requires two independent channels, each to supply 300 milliwatts to a 500 ohm resistive load with maximum permissible harmonic distortion established at 15%, measured at 1000 cycles. Cross talk between channels is required to be down at least 50 d.b. for all frequencies heard in the headphones.

The communications receiver, as well as all other receivers installed in the airplane, is provided with two independent output channels, one for the pilot and one for the copilot. This requirement was established in order that the pilot or copilot may select any combination of receiver outputs without regard to what the opposite member of the crew has selected, thus making it possible for the pilot to listen to the radio range receiver while the copilot can listen to the range receiver plus the communications, marker, or automatic direction finder, or any combination thereof.

*Item III—Radio Range Receiver System*—Due to the 3 kilocycle allocation of radio range station channels, extreme channels, extreme selectivity is required in the design of radio range receivers, in order to eliminate adjacent channel interference. A radio range receiver must be extremely stable, and all image and spurious responses must be eliminated. Sensitivity should be at least 2 microvolts for 50 milliwatts of output at a signal to noise ratio of 6 d.b. Conventional automatic volume control cannot be used on a range receiver as variation in output with changing field strengths is used to determine whether the aircraft is proceeding to or flying away from the station; however, delayed automatic volume control action is utilized to prevent blocking of the receiver and consequent reversal of the range quadrant signals.

This delayed action must not occur prior to reaching an output of 300 milliwatts. Expressed in another way, the output of a range receiver must increase with increasing input until at least 300 milliwatts of audio power is developed, and with further increasing field strength the output must not decrease below the 300 milliwatt level.

The range receiver is usually located on a shelf above the baggage compartment or in a rack at some distance from the cockpit. It is remote controlled by means of a "tach" shaft. The antenna may be a 60 or 72 inch "whip" or balanced "T" located on the belly of the plane.

If the lead-in distance exceeds 6 feet a low impedance transmission line is used between the antenna lead-in and the receiver input terminal to avoid antenna losses. The coupling transformer is located inside the skin of the ship at the lead-in base. The input circuit of the receiver provides for a choice of either high or low impedance input.

*Item IV—Auxiliary Receiver*—The auxiliary receiver may be a duplicate of the range receiver listed under Item 4, or it may be a multi-band receiver providing an additional auxiliary two-way communication band covering the frequency range of 2,400-6,600 kilocycles. The range band should possess all the desirable characteristics for a range receiver as listed under Item 3. Due to the fact that the communication band is seldom used, some of the refinements desirable in the communication receiver described under Item 2 may be omitted. This receiver is also remote controlled from the cockpit.

*Item V—Direction Finder System*—Within the continental limits of the United States the radio range is generally considered to be the primary system of navigation. The direction finder aboard the plane is therefore a supplementary navigation aid. However, in certain cases where courses from range stations are not projected over the route the direction finder may be used as the primary navigation system. The use of the direction finder also permits bearings to be obtained from off-line station, and are therefore of immeasurable value in determining "fixes" and ground speed.

The modern direction finder is designed to automatically and continuously indicate the relative bearing of the station to which it is tuned. Space does not permit a detailed technical description or explanation of the principles of automatic direction finders. The rotatable 8 or 10 inch loop is contained within a tear-drop streamlined housing mounted on the belly of the fuselage. This loop is motor driven and its motor is controlled by action of the direction finder receiver and associated modulator circuits to create an automatic null seeking system.

The position of the rotated loop relative to the longitudinal axis of the airplane is transmitted back to the cockpit by means of a "tach" shaft or autodyn system to an azimuth indicator. Auxiliary means are provided so that the loop may be manually rotated and "auralnull" bearings obtained should failure occur in the "automatic" circuits. Inasmuch as the receiver portion of the automatic direction finder system provides all of the desirable characteristics necessary for a high

## What can a radio man learn from this photo?



IN THIS test, a string of "Pyrex" suspension insulators was subjected to power arcs so intense that they opened heavy breakers all along the lines. Yet their high electrical strength enabled these units to come through in perfect shape. The interesting fact to a radio man is that the insulators shown are made of the same borosilicate glass used in Antenna, Lead-in, Strain, Stand-off and other Pyrex brand radio insulators for amateur and professional use. To their high electrical strength add other advantages like corrosion and thermal resistance, low conductivity and high strength-to-weight ratio and you can see why shrewd radio men choose Pyrex brand for superior insulator performance and long life. Write today for free catalog, Insulation Division, Corning Glass Works, Corning, New York.

DO YOU KNOW HOW HIGH GLASS RATES AS AN INSULATING MATERIAL?

PROPERTY	BOROSILICATE GLASS	LOW-LOSS STEATITE	PORCELAIN	CELLULOSE ACETATE	PHENOLIC RESINOID
High scratch hardness	6	5	3	1	2
Low thermal expansion	6	4	5	1	2
High dielectric strength	5	2	1	3	4
Low dielectric constant	6	3	5	4	1
High volume resistivity	5	4	3	2	1
Total point score	28	18	17	11	10

**Pyrex Insulators**  
BRAND

"PYREX" is a registered trade-mark and indicates manufacture by Corning Glass Works.



# FOR DEFENSE



**BUY  
UNITED  
STATES  
SAVINGS  
BONDS  
AND STAMPS**

## AMERICA ON GUARD!

Above is a reproduction of the Treasury Department's Defense Savings Poster, showing an exact duplication of the original "Minute Man" statue by famed sculptor Daniel Chester French. Defense Bonds and Stamps, on sale at your bank or post office, are a vital part of America's defense preparations.

## NOW—A REALLY HIGH-POWERED— Radio Engineering Library

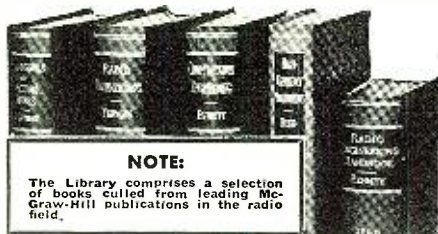

**NOTE:**

The Library comprises a selection of books culled from leading McGraw-Hill publications in the radio field.

- especially selected by radio specialists of McGraw-Hill publications
- to give most complete, dependable coverage of facts needed by all whose fields are grounded on radio fundamentals
- available at a special price and terms

THESE books cover circuit phenomena, tube theory, networks, measurements, and other subjects—give specialized treatments of all fields of practical design and application. They are books of recognized position in the literature—books you will refer to and be referred to often. If you are a practical designer, researcher or engineer in any field based on radio, you want these books for the help they give in hundreds of problems throughout the whole field of radio engineering.

**5 VOLUMES, 3319 PAGES, 2289 ILLUSTRATIONS**

1. Eastman's FUNDAMENTALS OF VACUUM TUBES
2. Terman's RADIO ENGINEERING
3. Everitt's COMMUNICATION ENGINEERING
4. Hund's HIGH FREQUENCY MEASUREMENTS
5. Henney's RADIO ENGINEERING HANDBOOK

10 days' examination. Easy terms. Special price under this offer less than books bought separately. Add these standard works to your library now! pay small monthly installments, while you use the books.

**10 DAYS' FREE EXAMINATION—SEND COUPON**

McGraw-Hill Book Co., 330 W. 42nd Street, N. Y. C.

Send me Radio Engineering Library, 5 vols., for 10 days' examination on approval. In 10 days I will send \$3.00 plus few cents postage, and \$3.00 monthly till \$24.00 is paid, or return books postpaid. (We pay postage on orders accompanied by remittance of first installment.)

Name .....

Address .....

City and State .....

Position .....

Company ..... RN. 5-42

quality range receiver, the automatic direction finder may be used as a range receiver, and it is therefore frequently substituted for the auxiliary range receiver in order to reduce the overall weight of the radio system.

Some air lines have installed two automatic direction finders, replacing the range and auxiliary range receivers. Figure 2 shows two loops installed on the belly of a Lockheed "Lodestar" while Figure 3 shows the installation of the azimuth indicator and the two indicating needles associated with the direction finders. This system provides many interesting and useful navigation problems which can be solved with a minimum of effort on the part of the crew. If one of the direction finders is tuned to a station ahead of the aircraft while the other is tuned to a station behind the plane, it is easy to see that the plane will be on a straight course between these two stations when the two needles are 180 degrees apart. Should the plane drift off of its course due to cross winds that fact is continuously and instantly shown by the relative position of the needles.

*Item VI—Anti-Precipitation Static Antenna System*—The anti-static antenna system generally consists of the electro-statically shielded loop antenna of the direction finder, although some lines use a separate statically shielded loop antenna fixed in the fore and aft plane of the ship and connected to the range receiver instead of the direction finder. The purpose of this electro-statically shielded antenna is to reduce, as much as possible, interference caused by the charging and discharging of the plane while flying through areas of high electrical activity.

This interference is generally considered to be caused by charged particles such as rain, snow, sleet, or fine dust striking the plane. This charging and discharging at times may reach such value as to create a corona effect that can be seen during the hours of darkness. When this action occurs, it creates a strong field of interference generally considered to be principally electro-static in nature. The static shielding of the loop antenna reduces, to a great extent, this type of interference.

*Item VII—Auxiliary Power Supply*—With the design of larger transport ships such as the Douglas and the Lockheed Lodestar the need for a separate auxiliary power supply is provided for by the second generator-battery system which is standard equipment with these planes. Some of the smaller ships were provided with only one flight engine driven generator and battery. Failure of the battery or generator would disable the radio system. Therefore, a separate dry battery has been developed that is capable of supplying filament and plate voltages for at least one of the range receivers for a period of four hours. The installation of the second generator and battery system on the larger

planes has eliminated the need for this power supply system and its use is not required when one of the battery-generator systems is capable of carrying the emergency electrical running load of the airplane.

*Item VIII—Simultaneous Audio Filter System*—This filter system, in its simple form, consists of a band-pass reject audio filter and a suitable selector switching network. It is used to separate the 1020 cycle range tone modulation from the voice frequency modulation that are simultaneously transmitted from the airway range stations. One section of the filter network offers maximum attenuation of audio frequencies peaked at 1020 cycles. The other section offers minimum attenuation of the 1020 cycle tone and maximum attenuation for all other frequencies within the audio range. The filter is connected to the output circuit of the range receivers, and by proper selection of a "Voice-Range-Both" switch the pilot and copilot may have their choice with respect to the reception of the two types of signals transmitted from the airway range station.

*Item IX—75 Megacycle Marker Beacon Receiving System*—This system is used to indicate to the pilot the progress of the flight along the airway by the reception of marker signals transmitted on a frequency of 75 megacycles. At a point approximately 20 miles from the range stations one of these markers, commonly referred to as "Fan" markers, radiates a curtain of signal across the airway to a width of approximately 12 miles, and 3 to 5 miles thick. A plane flying at any altitude up to 20,000 feet will receive these 75 megacycle signals.

The signals modulated at 3,000 cycles will cause a small light to glow on the instrument board. This light will follow the keying of the 3,000 cycle tone and indicates one, two, three, or four short dashes in groups to identify the particular marker being received. In addition to the fan markers, each of the range stations is equipped with a 75 megacycle transmitter radiating a continuous 3,000 cycle signal in a cone shape above the station. This signal is used to confirm the usual cone of silence indication of the low frequency range. In addition to the 3,000 cycle fan and cone signals, the receiver can receive signals modulated at 400 and 1300 cycles which will be used for inner and outer markers in connection with the new instrument landing systems now being installed at a number of the larger terminal airports.

*Item X—Two Headsets*—The headsets used in aircraft service are generally of the low impedance type and of exceptionally rugged construction. Special damping diaphragms are used to eliminate the peak intensity of static disturbance.

*Item XI—Two Microphones*—The microphones used in aircraft radio systems are, with few exceptions, of the single carbon button type encased



in a plastic hand shell. A push-to-talk switch forms a part of the microphone assembly and is used to control the dynamotor and actuate the antenna transfer relay in the transmitter unit.

#### Testing of Equipment

A review of the list of equipment shows that an alternate unit of equipment is provided for each of the required items with the exception of the transmitter. A transmitter failure will not preclude continued radio navigation and due to its weight, as well as the fact that a real need for two units does not exist under flight conditions, duplication of this unit has not been required on the domestic air lines. Two units are carried on trans-oceanic flights. •

In order to establish an adequate yardstick to measure the reliability of aircraft radio equipment, the *Civil Aeronautics Administration* has established a procedure of type certification for air line aircraft radio equipment. An effort is made to determine a unit of equipment's expected reliability factor by requiring it to be subjected to intensive testing prior to its use on the air lines. These tests have been built around the objective of duplicating insofar as possible the adverse factors that the equipment will have to operate under in actual service. These factors are: extreme ranges of temperature, humidity, vibration, landing shock, and variation in atmospheric pressures that tend to reduce insulation integrity. There follows here-with a brief description of the tests:

**Temperature Test**—The unit is placed in a cold chamber and is required to complete several operational cycles at a temperature of minus 35 degrees Centigrade. At this time, 20% subnormal and abnormal input voltages are applied to ascertain that relays will continue to function, dynamotors will freely start with reduced voltage and that no evidence of circuit instability will result from the simultaneous introduction of higher operating voltages and the increased efficiency of electrical circuits as the Q of radio frequency coils are increased with greater conductance at depressed temperatures.

The equipment is then placed in a hot chamber and stabilized at a temperature of 55 degrees Centigrade. It is then operated at 20% abnormal temperature for a period of one hour to determine that condenser and transformer wax does not melt and permit loose foil and transformer wiring to be subjected to damage caused by vibration. Spot checks are made of the component parts to ascertain that they will not operate in excess of the manufacturers' rating. The 20% subnormal voltage is applied to ascertain that relay and solenoids have not lost their effectiveness as a result of the increased resistance of copper at these high temperature ranges.

**Humidity**—Either before or after the temperature test the equipment is placed in a humidity chamber maintaining a relative humidity of 95% at

50 degrees Centigrade for a period of 48 hours. The equipment is not operated during this exposure period as the heat generated by its operation would exert a drying effect, nullifying the effects of the humidity exposure. At the end of this exposure period the equipment must operate satisfactorily and show no signs of corrosion or other conditions that would militate against the continued satisfactory operation of the equipment.

**Vibration**—The equipment is then subjected to four hours of vibration on a shake table, vibrating at a frequency of 30 to 60 cycles per second with a wave form and amplitude sufficient to produce an acceleration of 10 times

the force of gravity. This test is admittedly more severe than will be encountered in service, but only by excessive amplitude of vibration can the effect of long periods of vibration be readily ascertained in the laboratory.

During the vibration the equipment must operate satisfactorily, and a visual and operating check at the conclusion of the test must not reveal any condition, the presence of or continuance of, which would be detrimental to the performance or reliability of the equipment. In addition to the fixed frequency vibration of four hours duration, the equipment is further subjected to vibration in the frequency range of 30 to 60 cycles and is observed

**"PRODUCING FOR WAR..  
PLANNING FOR PEACE"**

**WILCOX-GAY CORPORATION**  
Manufacturers of  
**RECORDIO**  
RECORDER • RADIO • PHONOGRAPH COMBINATION  
CHARLOTTE, MICHIGAN

**PROTECT that 40%**

Now more than ever the jobber and service man must protect the standing which he has built. Condenser replacements account for about 40% of all radio repair jobs. Dependable condensers are therefore essential to the building of the utmost in customer satisfaction and in holding your clientele.

**CONTINUOUS DEPENDABLE SERVICE**

For 21 years the manufacturers of POLYMET electrolytic and by-pass condensers have striven to improve quality and service. Add to this a liberal and reasonable mark-up and the fact that no fly-by-night "bargain catalogs" can undersell you on POLYMET. You're protected, your customer is satisfied, your profits and volume increase. We're conserving vital defense materials by limiting sizes to those most universally used. These will serve practically every need, replacing larger electrolytics when proper capacity and voltage are used. Complete listing of available types and prices will be forwarded upon request.

**POLYMET CONDENSER CO.**  
699 E. 135TH. ST., NEW YORK, N.Y.



## This is YOUR CHANCE!

No matter what the job is, you always see the trained fellow in the best position. This is YOUR CHANCE RIGHT NOW! Radio code operators are wanted by the Army, Navy and in the Commercial Communications fields. Our Merchant Marine wants 40,000 trained radio operators now! You can learn this interesting way to a better future without leaving your own home.

The Candler System has, for over a quarter of a century shown the way to learn code and develop code proficiency at home by their simplified method. You owe it to yourself to take advantage of this opportunity. Why not write today—there is no obligation, no salesman will call—find out how you too can have a better future.

### Get the Free Book

Drop a post card today for this interesting BOOK OF FACTS which tells you all about the fascinating way to quickly learn in code and acquire speed and skill. A copy of this 52 page book is yours—write for it!



**CANDLER SYSTEM CO.**  
BOX 928  
DEPT. N-5, DENVER, COLORADO

## RADIO Engineering

**DEGREE IN 27 MONTHS**

★ Complete Radio Engineering course in 27 months. Bachelor of Science degree. Radio (television, talking pictures and the vast electronic field) offers unusual opportunities. Defense needs call for the engineer. Demand exceeds the supply. Courses also in Civil, Electrical, Mechanical, Chemical, Aeronautical Engineering; Business Administration, Accounting and Secretarial Science. Tuition, living costs low. Distinguished for technical 2 1/4 year courses. Special preparatory department for those who lack required high school work. Enter June, September, January, March. Cosmopolitan student body. 59th year. Write for catalog.

1652 College Ave., Angola, Ind.

**TRI-STATE COLLEGE**

## RADIO ENGINEERS NOW IN DEMAND

### PREPARE TO SERVE

in Civilian or Military Radio positions. Excellent opportunities for trained men to aid America's strides to ultimate victory. Recent high school graduates and young men having some college training should investigate at once.

Our courses have the approval of State Vocational Departments, Major Airlines, State Police Systems, hundreds of Broadcast Stations, the War Department and Radio Manufacturers.

We have been "swamped" with requests for trained radio technicians. A choice of radio employment is open to those who avail themselves of our training NOW! Ask our graduates about DODGE training. Let us send you our catalog without obligation.

**GRADUATES EARNING \$150-\$250 A MONTH—MAIL FOR FREE CATALOG**

**THE DODGE TEL. AND RADIO INST.**  
208 Monroe St., Valparaiso, Ind.

Name .....

Address .....

City..... State.....

under a stroboscopic light to determine if resonance vibration exists in the wiring or component parts.

**Drop Test**—Each unit of equipment is subjected to 100 free drops ranging from six to eighteen inches on a solid platform with one inch of commercial sponge rubber interposed as a damping medium.

**Pressure Test**—All equipment with high voltage electrical circuits is subjected to this test. The equipment is placed in a vacuum chamber and the pressure reduced to 8.52" of mercury, or the equivalent of 3,000 feet of altitude above normal sea level pressure. Under this condition the equipment must show no evidence of voltage breakdown.

Equipment that has been tested in accordance with the above tests can generally be considered to be free of design weakness, but no test can be devised that will anticipate all engineering "bugs" except actual operation under service conditions. This period of service testing is conducted under the closest supervision of the air lines' communication personnel in collaboration with the air line Inspectors of the Civil Aeronautics Administration.

—30—

## Radio for Blackouts

(Continued from page 51)

ing out. Taping the window glass with strips of gummed paper prevent injuries from flying glass should the window be broken by concussions or fragments.

Essential to protection of the home are long-handled shovels and axes, hose and spray pump, pails of water and buckets of sand. The basement laundry tubs and all available pails and other containers should be filled with water when a raid starts, first for protection against fire, and second to provide a temporary supply of water should municipal service be interrupted.

Long-handled shovels and sand are used to combat incendiary bombs, which burn with intense heat and explode if doused with water. Fire extinguishers make the bombs more dangerous, but are helpful in extinguishing fires set by the bombs. Approved procedure for handling incendiary bombs is to heap sand near the bomb, push the bomb onto the sand with the shovel, and cover with more sand. In this way oxygen is excluded and the bomb extinguished. Another method is to spray the bomb with water from hose or spray pump. Spray pumps used in the garden in fighting insect pests are convenient and frequently available. However, the water must hit the bomb in the form of a spray or mist. Heat and light from incendiary bombs are so intense that eyes and skin must be protected, indicating a need for dark glasses and heavy gloves.

Sustenance for the family means food and clothing, beds and bedding, easy chairs and books, toys and games, unflinching light, and the radio again, this time for the reception of music and entertainment to relieve mental strain and worry. Glassed foods, small stoves burning canned fuel, simple recipes, and an inventive cook are great comforts for a family forced by repeated or continuing raids to spend a week or more in the refuge room. Sanitation calls for an adequate supply of water for drinking and washing, and for permanent or temporary toilet facilities.

For many families, equipping the refuge room is the comparatively simple task of moving porch, beach, or camp furniture to the basement and putting it to emergency use. Porch, steamer, and beach chairs are comfortable enough for sleeping. Beach rolls, sleeping bags, and folding cots can be used. If worse comes to worse, just plain mattresses will do. Plenty of blankets and additional clothing are definite needs.

Candles, lanterns, and flashlights are necessities. Ends of candles left over from dinners and parties can be put to use. Lanterns are good so long as the kerosene lasts. Chances are that electric service will be maintained, but a basement can be terrifyingly dark without light. On the other hand, with light, food, sleeping accommodations and a radio it can be a cosy place even during raids.

Once the refuge room is equipped, the family can prepare to flee hurriedly to it if all personal necessities are packed and waiting conveniently. These might include insurance and other legal papers, licenses, records, money, jewelry, and personal needs, such as eye-glasses and dentures. Pets may be taken along with the family. Dogs are frightened by air raids but stick them out, while cats tend to become hysterical menaces and must be confined.

Necessary also is a complete but not elaborate first-aid kit.

Choice of food is determined by family preferences. Fruit juices help to allay thirst, as does gum. Canned soups are nourishing and easy to prepare. Good old standbys are pork and beans, hash, oatmeal and flapjacks. Some folks will insist upon coffee, but British refugees have lived for days on tea. Hot drinks and foods can be kept in thermos containers.

Best advice to refugees from their first raids is to keep cool, collect personal necessities, put out the lights, and hurry the family to the shelter. All should keep away from windows, lie on the floor and get under tables when bombs come near. With a candle lighted, everybody comfortable and safe, the radio playing cheerful music broadcast from peaceful regions, the basement refuge room isn't such a bad place to be! As a matter of fact it is exactly the place defense officials want people to be during raids.

—30—



## Television

(Continued from page 43)

tive air wardens scattered throughout the five boroughs, attending the television classes held in all police stations. It is safe to assume that at least another 6,000 prospective air wardens, and no doubt far more, have been attending television classes in private homes, taverns, clubs, radio stores and elsewhere in the other main areas, not to overlook the hundreds of suburban communities surrounding those main areas.

Dealing with first hand experience, the writer has had as many as 22 air wardens and auxiliary policemen of his little community attending the television classes in his basement playroom. The men and women have been most attentive. Not a word has been spoken during the lecture. Following the half-hour session, there has



Actor doubles as Post Warden.

been lively and profitable discussion. And each one attending has found it far easier to study manuals and instructions already available, due to the dramatization and high-lighting provided by the television presentation.

Now as for the television classroom curriculum proper, we must go back to January 5th of this year, when at the request of the *New York City Police Department*, the television facilities of NBC were made available for air raid warden instruction purposes. Anywhere from one to forty sets were located in most of the 100-odd air raid zones in the five boroughs of Greater New York, and these were pressed into service. Suitable films were shown, along with a 40-minute lecture by a lieutenant from the *Police Academy*, and a demonstration of air warden tools. The response was so encouraging that an extensive course of air warden lectures and demonstrations via television was decided upon.

The first course just drawn to a close consisted of six telecast lessons in basic training. These lessons, telecast at the rate of one a week, have been drawn from official defense publications, London's experience, and the work of the *New York Police Department* experts. Although there was one

new lesson each week, it should be noted that the same lesson was given twice in the morning, twice in the afternoon and twice in the evening, on Monday, Tuesday and Wednesday, so as to accommodate the tens of thousands of prospective air wardens with the limited number of television receivers available. The choice of morning, afternoon, and evening sessions has fitted in nicely with the normal workaday activities of women and men alike.

The lessons have been written by NBC television program men, supervised by Police Commissioner Lewis J. Valentine. The first lesson was on the general duties of the air raid warden. The second covered the incendiary or fire bomb. The third dealt with blackouts. The fourth was devoted to gas warfare. The fifth and sixth lessons were review sessions, with that invaluable element of repetition to make the facts sink in thoroughly.

These television classroom sessions are far from pedagogic humdrum. In fact, the television screen action has all the graphic and moving appeal of a Hollywood production. The first lesson had Maurice Wells as Post Warden "Arthur Smith," directing pedestrians to shelter and halting traffic on a street scene during an imaginary raid. The second lesson depicted a "bombing" of New York's famous Times Square with the assistance of actors, stage sets, sound effects and motion pictures. The "Browns," television's typical New York family, also fought down a spluttering fire bomb that fell into their apartment during the "raid." This scene was a masterful blending of live actors, stage settings, still photos and motion pictures that baffled everyone but the television studio technicians.

In each of the lessons which, as previously mentioned, are repeated 18 times during the first three days of the week, a uniformed member of the staff of the *Coordinator for Police Department Civilian Defense* faces the television cameras in NBC's sight-sound studios at Radio City. He states the several points to be covered in the lesson. At intervals other cameras bring the words of the defense expert to life with dramatized demonstrations of rules laid down by the *Office of Civilian Defense*. For 30 minutes the prospective air wardens follow the fascinating and theatrical presentation. Then, after the telecast is over, they retire to discuss points raised, under the leadership of the precinct defense officer.

Nothing like this has ever been attempted before anywhere in the world. It is something new, not only in radio but in education. And its success in practice pretty much parallels its daring in conception.

The new television school was born of war's necessity. With the job of training upwards of 200,000 voluntary workers in New York City alone, the Police Department faced a difficult situation. Television classroom pro-

# GL-807

ONLY  
\$3.50



UP TO  
**75** WATTS

60-MC **FM** INPUT  
with  
**1/4-WATT DRIVING POWER**  
**NO NEUTRALIZING**  
**QUICK BAND CHANGE**

Free . . . . .

- Complete Ratings of GL-807 (GET-756)
- A Tribute to the Radio Amateur (GEA-3052A)

General Electric, Section 161-13A, Schenectady, N. Y.

**GENERAL ELECTRIC**  
161-18

# MATHEMATICS FOR RADIO AND COMMUNICATION

by **GEORGE F. MAEDEL, A.B., E.E.**  
Chief Instructor, N. Y. School, RCA Institutes

To master the technicalities of radio—to read engineering literature intelligently—you must have the mathematical groundwork covered by these absorbing books prepared for home study. Book I (314 pp.) covers the algebra, arithmetic, and geometry; Book II (329 pp.) covers the advanced algebra, trigonometry, and complex numbers necessary to read technical books and articles on radio.

MAEDEL PUBLISHING HOUSE Room 109  
593 East 38 Street, Brooklyn, New York

Send me Mathematics for Radio and Communication as checked below. I enclose payment therefor with the understanding that I may return the book(s) within 5 days in good condition and my money will be refunded.

Name .....

Address .....

- Book I at \$3.75 plus 3c postage
  - Book II at \$4.00 plus 3c postage
  - Books I and II at \$7.75 postage prepaid
- Canadian prices 25c per volume higher.



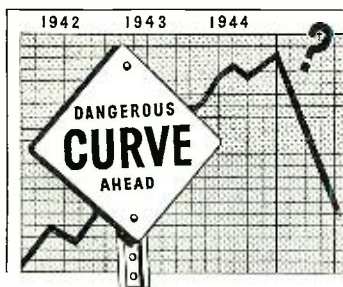

## Technical Training Now Will Insure You of a Secure Career in the Future

Believe in Signs? NOW is the time to make sure of the road ahead. Any thinking radioman will realize that the future belongs to those men who are equipped to handle technical assignments. After the present emergency, thousands of untrained, unprepared radiomen will be left behind. That's why CREI stresses the need now for a planned program of training . . . to increase your technical ability so that you will be in a position to command an important job when the inevitable readjustment comes after the war. Make your present radio job pay you dividends in the years to come by investing in CREI home study in Practical Radio Engineering. CREI specialized training will lead you to advancement, increased pay and security in your chosen profession.



Free Booklet Sent

### Write for Details

about CREI home Study Courses  
If you are a professional radioman and want to make more money—let us prove to you we have something you need to qualify for the BETTER career-job opportunities that can be yours. To help us intelligently answer your inquiry—please state briefly your education, radio experience and present position.

**CAPITOL RADIO ENGINEERING INSTITUTE**  
Dept. RN-5, 3224-16TH ST., N. W., WASH., D. C.

# ★ PROFIT ★

AND PATRIOTISM GO TOGETHER WHEN YOU SELL THE NEW WORNER

# BLACKOUT ★

# ★ WARDEN



**AUTOMATICALLY  
TURNS OFF  
LIGHTS**

Business men do not have to stay after hours waiting for possible blackout. BLACKOUT WARDEN turns off lights automatically.

### NEEDED BY EVERYONE WHO HAS

Show Windows Electric Signs  
Portal Lights Billboards  
Marquees Floodlights

And All Other Display Lighting

[ This fast selling unit is the ideal item for Radio Dealers, Servicemen and Amateurs. ]

## GET THIS BUSINESS NOW

CONTACT YOUR JOBBER AND SEND FOR BULLETIN No. 109B

**WORNER PRODUCTS CORP.**  
DEPT. D  
1019 W. LAKE ST., CHICAGO, ILL.

vided the answer. With one or more receivers in each precinct station house, hundreds of wardens could see and hear a single instructor simultaneously. That would economize the time of the department's experts and introduce standardization to the training. No longer would there be the confusion arising from conflicting interpretations. Drawings, diagrams and close-ups would clarify problems left obscure by words alone. And dramatization would lend added force to the instruction. Thus in weeks, rather than drawn-out months, a competent air warden force has been brought into being by truly American genius for getting things done.

The first series of lessons already completed, the television school will continue. NBC's television men expect that it will go on indefinitely. The basic series will doubtlessly be repeated. New courses will be given, particularly more specialized instruction for all categories of defense workers included in New York's air raid protection scheme. And then there may be other courses such as for Red Cross workers who may have the benefit of viewing First Aid, Bandage-Rolling and other demonstrations by leading experts, for those interested in wartime nutrition, for ardent students of war strategy as discussed with maps by authorities, and so on. Certainly the television school is here to stay, in wartime especially, but for peacetime reconstruction and rehabilitation, as well.

Meanwhile, other sections of our country are likewise conducting television classes in our national war efforts. The Thomas S. Lee-owned television station W6XAO in Hollywood has been running a schedule of defense programs for Southern California on alternate Saturday evenings from 8:00 until 9:30 P.M. Initial lessons have been in the form of suitable films, such as the "Safeguarding Military Information" released by the Office of Production Management, the "Front of Steel" depicting Hitler's tremendous war effort as far back as 1938 and the subsequent efforts in Canada to meet this menace, the "Fight for Liberty" and the "Building a Bomber." There are several hundred telecast receivers in that territory that can be tuned in for such instructional programs. Present plans are for live demonstrations similar to those in the East, based on Director Lubcke's enthusiasm after seeing what has been done by NBC.

So smooth is the television presentation that the looker-in fails to appreciate the vast amount of time, effort and sheer hard work that goes to make it possible. The writer attended one of the air warden sessions at the NBC studio for the purpose of telling you just a few of the many details involved.

First and foremost, television pickup is many fold more involved than conventional sound broadcasting, since there must be an image as well as a

sound pickup. This means scenery. Here the Hollywood technique comes into play, but on a very obviously condensed basis since the television studio is relatively limited in size as compared with the movie stage or lot. The scenery is ingeniously worked out for the necessary street scenes, roof shots, indoor scenes, close-ups of the instructor, the American flag blown by an electric fan, which opens and closes the session, and so on. Powerful lighting is provided by batteries of reflector-type incandescent lamps mounted on sturdy racks above, at the sides and in front of each scene. Microphones are suspended by extension boom or otherwise directly above the players but out of range of the camera's field. This technique was described fully in Dec., 1941, RADIO NEWS, Pg. 6. ED.

Three cameras are available in the studio, permitting wide latitude of action and also permitting constant flow from one scene to another without a break.

The cameraman at each camera wears earphones. All cameramen and the control room are tied in on a party line, so to speak. Instructions come from the control room, telling each cameraman when and where to shoot. Control room operators have the script before them, with the complete dialogue. Heavy black markings indicate when each camera is to be made ready on a given shot, and when that particular pickup is to be cut in by the man at the control desk who flips the necessary switches.

The control room operators—director, technical supervisor and audio and video control engineers—have before them the monitor screens showing images picked up by the respective cameras, as well as the master monitor screen with the image being released to the transmitter. The video control engineer also has cathode-ray oscillographs before him, showing the technical intricacies of the signals and guiding him in his shading and other corrections. Another operator monitors the sound level, as on conventional sound broadcasting, and also handles the electrical transcription pick-ups. The technical supervisor sits at the side of the director, making "cuts" and "fades" and relaying directions to cameraman on the studio floor below. Meanwhile the television stage manager is out on the studio floor, using hands and arms and grimaces to guide the action, since he must remain silent during the show. A private line phone connects him with the director in the control room.

The actors must be thoroughly rehearsed for their roles. Obviously no script can be read during the performance, since this is "seeing" as well as "hearing" by the audience. Therefore, the lines must be mastered before the television show begins, which means that actors with legitimate stage training have advantages over those with broadcasting or movie training only. That there is a definite television staging is obvious to the visitor



to the television studio. Standing in the control room and watching the various monitor screens, one can account for the momentary pickup of three cameras. Camera No. 1 may be kept trained on the Police Lieutenant who is the lecturer, but is standing by while Camera 3 is picking up a diagram illustrating some technical point. Meanwhile Camera 2 may be wheeled into position to pick up a corner of the "Browns" living room where husband and wife are listening to Post Warden "Smith." But at that very moment the picture going to the transmitter may be a battery of anti-aircraft guns in action, with actual sound effects, obviously coming from the film pickup. Three cameras, film pickup, electrical transcription turntables, actors and lecturer are all blended together into a smooth, convincing, thrilling presentation, because those chaps in the control room are following the script word by word, cuing each cameraman when to get ready and what to pick up, and telling the control desk operator what camera to switch in and out, with beautiful precision.

The television classroom has profound implications. In this war, it is indispensable. Tens of thousands—even millions—have to be taught certain essential things. Months must be compressed into weeks, weeks into days, days into hours. Time is the very essence of our successful preparedness.

But beyond all this wartime service of television, there must be a long-range silver-lining value when peace comes again. To one familiar with the discouraging deadlock of visual education—schools waiting for good educational films to be made and local films libraries to be established, on the one hand, and film producers waiting for schools to raise the necessary huge sums to warrant special film production, on the other—this television classroom idea has intriguing possibilities. It may be that video broadcasting will prove the logical answer. Certainly it will make a single lecturer or instructor simultaneously available to hundreds of scattered schools in a given metropolitan area. It will likewise make one demonstration available to thousands and even tens of thousands of students. It will help standardize given instruction. It will provide timely, up-to-the-minute, living subjects in the case of direct pickups, or, where the same subjects are to be given over and over again, a single film economically produced in the absence of prints, will appear simultaneously before many scattered classrooms.

Originally thought of mainly in terms of entertainment, it may well be that television will find its earlier and most valuable application in our schools. Particularly at first, because what might be a considerable price for the average home will be very little indeed for the typical classroom. So be sure to watch television during the

next few months! It may soon appear in cap and gown, as it assumes that very logical role of the greatest mass instructor of all times.

-30-

### Photoelectrics (Continued from page 37)

as well as the indicators showing location of the particular unit that has caused the alarm.

The third type is for use where a number of sets are to be installed and a control panel is already a part of the equipment of the user. The object is to use his panel and thus avoid duplication of equipment. For this purpose the Anti-Sabotage Sets are

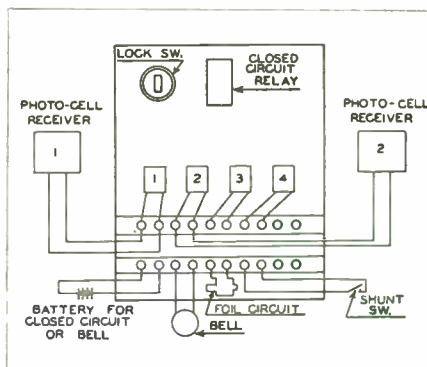

Fig. 1.

made to contain their own impulse relays which actuate the alarm relay on the panel.

Following are some of the considerations to be given when surveying an area to be protected—

1. Kind of area to be protected: Whether outdoor or indoor, large or small, centrally located as, for example, a radio tower, or spread out like a power plant.

2. Type of property to be protected: Is it something a saboteur has to get close to in order to harm or can he do damage from a distance?

3. Kind of terrain: In the case of an outdoor installation it is important to consider the profile of the ground. In places where a sharp rising knoll would intercept a long beam then a number of short beam units must be used.

4. Method of saboteur's approach: If the property is surrounded by a wall which is too well guarded to allow a saboteur to chop his way through it then the most likely approach would be for him to scale the wall. In that case the beam should be parallel to the wall but high enough so the head of an innocent pedestrian walking along would not intercept it. Too many variations occur to permit giving rules for all circumstances but the proper solution is dictated by the common sense of the person making the survey.

5. Analysis of present protective system: Photoelectric Anti-Sabotage

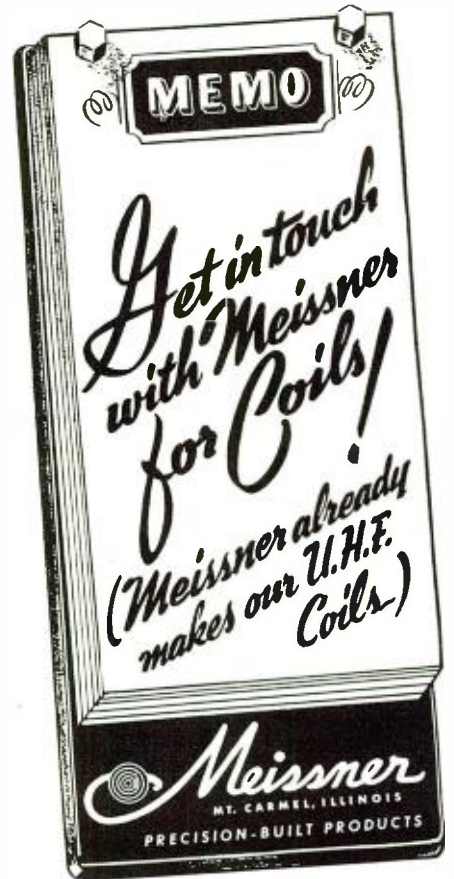

Write for  
NEW 1942 CATALOG  
Address—Dept. RN-5

## AERONAUTIC RADIO

for OPERATORS, PILOTS, MECHANICS



PRINCIPLES, SELECTION, INSTALLATION, OPERATION, MAINTENANCE  
Prepares for Aviation Radio License Exams

By MYRON F. EDDY, Lieut., U. S. Navy Ret.; Member Institute of Radio Engineers; Chief Instructor in Aircraft Radio, Stewart Tech. School



This author writes from a background of more than 20 years' experience as Naval Radio Operator, Pilot and as Instructor in Aeronautic Radio in U. S. Navy Ground Schools and leading Commercial Schools. Every Student, Pilot, Mechanic, Operator & Air Transport Executive needs this important 502 Page Manual. It covers the requirements of Federal Communications Commission and regulations of the C.A.R., also the actual approved usage of the latest equipment for both communications and special purposes. It contains over 150 Illustrations with Clear Explanations which are Easily Understood even by Beginners. The 200 Questions will enable you to test your grasp of the information provided in the text.

The interesting & informative chapters cover: Aviation Radio Communications; Fundamentals of Electricity; Radio Electricity; Basic Circuits; Radio Tubes; Batteries; Power Supplies; Radio Telegraph; Transmitters; Radio Range Transmitters; Receivers; Direction Finders; Instrument Landing Systems; Radio Traffic Control; Installation of Equipment; Maintenance; Trouble Shooting and Servicing.

Now is the time to speed up your knowledge of this important branch of Radio. Sent on 5 Days' Examination. Mail Coupon Today. **\$4.50** Postpaid

THE RONALD PRESS CO., Dept. M602, 15 East 26th St. New York, N. Y. (Est. 1900)

Send copy of AERONAUTIC RADIO by Myron F. Eddy. I agree to inspect the book and either pay \$4.50 (plus few cents postage) within 5 days or return it. (We pay postage when cash is sent with order. Same return privilege.)

Name .....

Address .....

Reference .....

CHECK HERE FOR CATALOG OF PUBLICATIONS ON AERONAUTICS.



**NEW! HEARING AID**  
**IN KIT FORM**

**Enables You to Get Profitable Hearing Aid Business**

Servicemen, now you can build your own hearing aid business. Be first in the market with this compact hearing aid. It outperforms 2-tube instruments and has less battery drain. Easily built by craftsmen. Its small batteries give long service. This means you can assemble an excellent hearing aid at low cost. Never before has anyone been able to reach this profitable market with all these advantages. Write today for information.

Complete kit, all components guaranteed ..... **\$3750** USF

Servicemen and Dealers: Write for Discounts Today!  
*Microtubes used by four governments*

**MICROTUBE LABORATORIES**  
2414 W. Lawrence Ave. — Chicago, Ill.

**LEARN CODE**  
the way you'll be using it

**by SOUND**

The best way to learn to read code is by listening to code. The best way to learn to send code is by hearing your own sending repeated back to you. With the new All-Electric Master Teleplex Code Teaching Machine, you learn code the natural, easy, fascinating way. Only instrument ever produced which records your sending in visible dots and dashes—then SENDS BACK your own key work at any speed you desire. There are NO PERFORATIONS—NO INK. Far superior to anything ever developed. . . . a marvel of simplicity. That's why practically every school teaching code uses MASTER TELEPLEX. We furnish complete course, lend you All-Electric Master Teleplex, give you personal instruction with a MONEY-BACK GUARANTEE—All at a surprisingly low cost per month. Write today for FREE catalog RN-5. No obligation.

**TELEPLEX CO.,** 107 HUDSON ST. JERSEY CITY, N. J.

**OUT OF THE Present Emergency**



will come  
**Better Products**  
For A New Amateur Radio

**BLILEY ELECTRIC CO., ERIE, PA.**

**"KEEP 'EM PLAYING!"**

Equipment is sometimes used in connection with a closed foil system and this subject will be discussed more fully in another part of this article.

6. Are guards employed? In some cases where guards are employed the Anti-Sabotage Equipment is used to supplement the watch work of the guards and in other cases it is arranged to protect the lives of the guards themselves.

7. Who is to be warned of trespass? In some cases the warning signals are to come into an executive office. In other cases they go to one main guard house or to a number of individual guard stations. In addition to giving alarm on the property to be protected the equipment may also be connected to directly notify the regular law enforcement agencies.

8. Method of notification of trespass: Either visible or audible alarms or both may be used. The alarm system may be so connected that it not only gives a general alarm but also shows the point of trespass within 500 feet. When it is desirable to take the trespasser by surprise no audible alarm is given but signals such as lights used on a switchboard are turned on. In some cases where armed guards are on duty the equipment is connected to turn on surprise floodlighting which puts the trespasser "on the spot" and makes him a target for the armed guards.

After acquiring a knowledge of the types of equipment available and the facts to be determined in a survey the next knowledge to be acquired is that pertaining to making a layout of the installation. It is not permissible to reproduce here the layouts used in any actual installations for that would give information to enemies. However, certain general instructions may be given.

Referring to the protective system of Photoelectric Anti-Sabotage Equipment as an "invisible fence" and using the same terms as are applied to fences will aid in giving a clear description of the principles of layouts. The fence corner does not have photoelectric unit right at the corner. Instead the units are arranged so that the point where two beams cross is the fence corner. This is illustrated by point "C" in Figure 1. This also shows how the units of equipment may be camouflaged.

For outdoor installations the cases housing the units are fitted on the bottom with screw flanges. These are threaded to receive 1½ inch pipe which is used for supports. The other end of the pipe is imbedded in a block of cement to make a rigid stanchion which will not throw the beam out of line because of wind or vibration due to traffic running parallel to the "fence" line.

Figure 2 shows the layout for protecting a drinking water reservoir and the method of wiring the system to a gong. A saboteur wishing to poison a city water supply would put the

**Classified**  
Rate 15c per word. Minimum, 10 words

**CORRESPONDENCE COURSES**

COMMERCIAL radio licenses speedily obtained through non-mathematical, easily understood, home study course. Moderate tuition fee. American Radio Institute, 1123 Broadway, New York, N. Y.

USED Correspondence Courses and Educational Books sold or rented. Inexpensive. Money-back guarantee. Write for Free Catalog listing 4000 bargains. (Courses Bought.) Lee Mountain, Pisgah, Alabama.

CORRESPONDENCE courses and educational books, slightly used. Sold. Rented. Exchanged. All subjects. Satisfaction guaranteed. Cash paid for used courses. Complete details and bargain catalog free. Nelson Company, 500 Sherman, Dept. E-237, Chicago.

**INSTRUCTION**

PREPARE. Learn Code by EZ. Phonograph Record. \$1.00 collect. Dwight Studios, 10½ Hancock Ave., Jersey City, N. J.

**PATENT ATTORNEYS**

MAX D. ORDMANN, Registered Patent Lawyer. Inventions developed, patents promptly procured. 11 West 42nd St., New York. Telephone Longacre 5-7385.

INVENTORS—Before disclosing your invention to any one send for Form "Evidence of Conception", "Schedule of Government and Attorneys' Fees", and Instructions. Sent free. Lancaster, Allwine & Rommel, 414 Bowen Building, Washington, D. C.

**PRINTING**

ANYTHING printed cheap. State requirements. Quotations, samples free. W8DED, Holland, Mich.

**WANTED**

YOUNG MEN NEEDED to serve on U. S. merchant ships. Age 18-23. Free training. Pay while learning to be a deck man, radio operator, steward or engineer. Free transportation, clothing, food and quarters. Jobs at high wages available after training. Serve your country in the merchant marine. Ask for information at any State employment office, or write the United States Maritime Commission, Washington, D. C.

**RADIO ENGINEERING**

RADIO Engineering, broadcasting, aviation and police radio, servicing, marine and Morse telegraphy taught thoroughly. All expenses low. Catalog free. Dodge Institute, Elm St., Valparaiso, Ind.

**New Direct-Coupled FM-AM AMPLIFIER MANUAL**

By **A. C. SHANEY**  
Chief Engineer, Amplifier Co. of America  
For the Layman, Serviceman  
Recordist and Engineer

Regardless of whether you are interested in the finest type of phonograph reproduction, high fidelity recording, sound-on-film applications, FM or AM programs, you will find invaluable information in this practical handbook. Written by the leading exponent of direct-coupled amplifiers who has spent more than 10 years improving and perfecting the famous Lortin-White circuit.

- Explains the theory and practical application of:**
- Variable Speed Non-Overloading Push-Pull Expansion
  - Non-Frequency Discriminating Scratch Suppression
  - Push-Pull Balanced Direct-Coupled Amplification
  - Push-Pull High-Frequency Equalization
  - Push-Pull Low-Frequency Equalization
  - Push-Pull Volume Compression
  - Automatic Volume Limitation
  - Automatic Volume Control
  - Calibrated V.U. Indicator
  - Audio Spectrum Control
  - Remote Control

If you are interested in the latest audio developments, you can't afford to be without this complete compilation of authentic articles on Direct-Coupled Amplifiers, 32 pages 5½" x 8". Over 100 diagrams and illustrations.

Priced to Cover Cost of 20c  
Printing and Mailing  
Send Stamps or Coin

**AMPLIFIER CO. of AMERICA**  
NINETEEN WEST 20TH ST. NEW YORK, N. Y.

**CAN AN INVENTOR MAKE MONEY TODAY?**

In 1941 alone over 4,000 Assignments of Patents a month were made by inventors to manufacturers or individuals. This shows today's demand for new patented inventions. If you have ideas, write for our FREE BOOK, "Protect, Finance and Sell Your Invention" that gives you the complete facts. Special form "Invention Record" also mailed FREE. No Obligation.

**McMORROW & BERMAN**  
Registered Patent Attorneys  
213-A Barrister Building Washington, D. C.



**BIG FREE CATALOG**

**EVERYTHING IN RADIO**

Sets, parts, supplies, public address systems, amateur equipment, testers, kits and fluorescent lighting at lowest prices. Huge stocks, bought months ago... ready for shipment the same day your order is received. The Defense Program is making big demands on our industry but because of our advance buying we are able to fill your orders promptly and efficiently.

**BURSTEIN-APPLEBE COMPANY**  
1012-14 MCGEE, KANSAS CITY, MO.

**RADIO CATALOG NO. 58**  
164 PAGES SETS-PARTS SUPPLIES FLUORESCENT

*Burstein-Applebe Co.*

**NEW CATALOG**

**OF SOUND AMPLIFYING SYSTEMS**

AUDIOGRAPH Sound Systems represent the latest in Public Address equipment—a complete line plus pre-tested accessories.

**NEW LOWER PRICES**

Outstanding quality and performance at prices that help you meet any competition.

WRITE FOR YOUR FREE COPY

**AUDIOGRAPH**  
THE FIRST NAME IN SOUND

John Mack Industries—1313 W. Randolph Street, Chicago, U. S. A.

**RADIO SERVICEMEN:**  
Double or Triple Your SERVICE BUSINESS

By using our new streamline service sales plan. Quick, efficient and proven over a period of ten years. Just the thing for beginners. Write

CERTIFIED PRODUCTS CO., Dept. 918, Louisville, Ky.

**RADIO ENGINEERING DEGREE IN 27 MONTHS**

Intensive, specialized course, including strong basis in mathematics and electrical engineering, advanced Radio Theory and Design. Modern laboratory, low tuition. Self-help opportunities. Also 27-month courses in Aeronautical, Chemical, Civil, Electrical and Mechanical Engineering. Participation in Civilian Pilot Training Program. Enter June, September, December. Catalog.

**INDIANA TECHNICAL COLLEGE**  
752 E. Washington Blvd., Fort Wayne, Ind.

**RADIO TECHNOLOGY**

**RCA** Institutes offer an intensive course of high standard embracing all phases of Radio and Television. Practical training with modern equipment at New York and Chicago schools. Also specialized courses in Aviation Communications, Radio Servicing and Commercial Operating. For Free Catalog Write Dept. RN-42.

**RCA INSTITUTES, Inc.**  
A Radio Corporation of America Service  
75 Varick St., New York 1164 Merchandise Mart, Chicago

**LES** Correspondence Courses in **RADIO and ELECTRICAL ENGINEERING**

**ELECTRICAL ENGINEERING** Get good electrical work. Prepare yourself at low cost, for secure future. Modern course. So simplified anyone can understand quickly.

**RADIO ENGINEERING** Extra fine course in radio, public address, photo-electric work. Train you to be super-service man, real vacuum-tube technician. Experimental kits furnished. Diploma on completion.

14¢ per week. Send postcard or letter for Free **LOW \$25** Either course details, all about deferred pay-**AS** Course  
ment plan, etc. **SEND NOW!**

**LINCOLN ENGINEERING SCHOOL** Box 933-RA, LINCOLN, Nebr.

**COMMERCIAL RADIO INSTITUTE**

A radio training center for over twenty years. Well equipped. Excellent faculty. Practical **RESIDENT COURSES** in Radio Telegraphy, Broadcast, Servicing, Industrial, Television, Aeronautical, Drafting, Mathematics and Studio Technique. Placement Bureau. Day and Evening Classes Now Forming. Catalog upon request.

**Dept. C, 38 West Biddle St., Baltimore, Md.**

poison in a bottle having a soluble cork and toss the bottle into the reservoir. The Invisible Fence would therefore have to be far enough from the reservoir to give alarm before the trespasser could get within throwing distance. Figure 2 shows a typical layout with the guardhouse "A" also protected by a "fence" line. The power supply to all of the receivers and light sources "R" and "L" respectively are to be controlled from the guardhouse. The control relays from each receiver are to be connected directly through a pair of wires, to the control panel in the guardhouse.

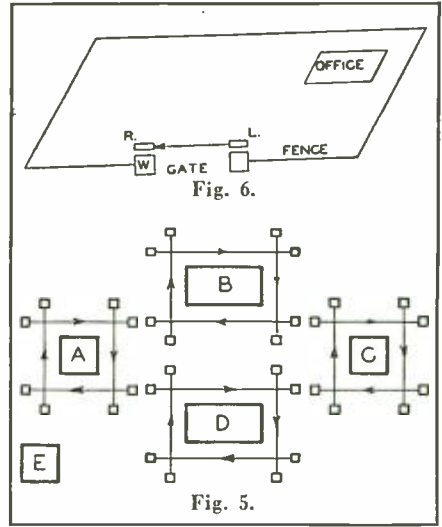

Actual wiring diagrams cannot be published here for fear of giving aid to saboteurs, but are furnished by manufacturers to bona fide installation men. Figures 3 and 4 illustrate roughly a simple control panel and wiring that may be used in conjunction with certain conditions.

Referring to Figure 3, "A" Push-button switches to restore relay after it has been actuated. "B" Pilot lamps indicating location of eye causing alarm. "C" Relays which are actuated by photoelectric cells, one relay for each receiver and the number of relays can be extended to accommodate any particular case. "D" Connections from alarm relay to actuated externally, an alarm bell, siren, floodlights, etc.

Figure 5 shows an area in which several buildings are located, such as storehouses for oil, power, paint, etc. These are surrounded by their individual "fences" and each one is connected to a signal panel in a central guardhouse. They are wired so that the fence may be turned off while employees are getting stores and turned on again afterward, with all controls operated from the guardhouse.

Figure 6 shows an installation which requires only a single beam as, for example, in guarding a gate. Here the layout is quite simple, consisting of a single beam across the driveway at the entrance to the guard. When any person desires to enter the enclosure, permission must first be given by the watchman, who in turn will turn the

**RADIO DIAGRAMS**  
and Servicing Information

**PRACTICAL MANUALS YOU NEED**

**1942** Newest manual of all popular recent radio sets of all types. 4 out of 5 circuits you will ever need are here. 204 pages. Large size: 8½x11 in. Price...\$2.00

**1941** Covers 1941 models. Gives alignment data, circuits, service hints, I.F. peaks, and parts lists. Compiled by M. N. Bellman, radio serviceman for many years, author, and teacher. 192 pages, 8½x11 inches. Price...\$2.00

**1940** This one manual will give you 80% of 1940 circuits you will need. Data on F.M., portables, recording. 208 pages. Net...\$2.00

**1939** Another condensed manual of most popular diagrams you need. Make service work easier. Diagrams of 39 manufacturers. 192 pages...\$2.00

**1926-38** Most Popular Manual of the series. 427 diagrams of most-used radios. 244 pages, 8½ x 11 in. Special price, only...\$2.50

General Electric Manual, 64 pages... 50c  
Arvin (Nobilit-Sparks) Diagram Manual... 50c  
Stewart-Warner Popular Diagrams... 50c  
Record Players and Records, 128 pages... \$1.50  
Radio Servicing Course-Book, 22 lessons... 2.50  
Servicing by COMPARISON Method... 1.50  
How to Modernize Radios for Profit... 1.00  
Practical Radio Mathematics... 25c  
Television Facts, New Edition, 64 pages... 40c

See these books at your jobber.

**SUPREME PUBLICATIONS**  
3727 W. 13th St. Chicago, Ill.

**4 STANDARD TYPES**  
of Amperite Regulators replace over 400 types of AC-DC Ballast Tubes now in use.

Amperites are real REGULATORS... have patented Automatic Starting Resistor which prevents initial surge and saves pilot lights... Ask Your Jobber.

**AMPERITE**

THE *Simplest* WAY TO REPLACE **BALLASTS**

WRITE FOR REPLACEMENT CHART

**AMPERITE CO.** 541 BROADWAY, NEW YORK, N. Y.



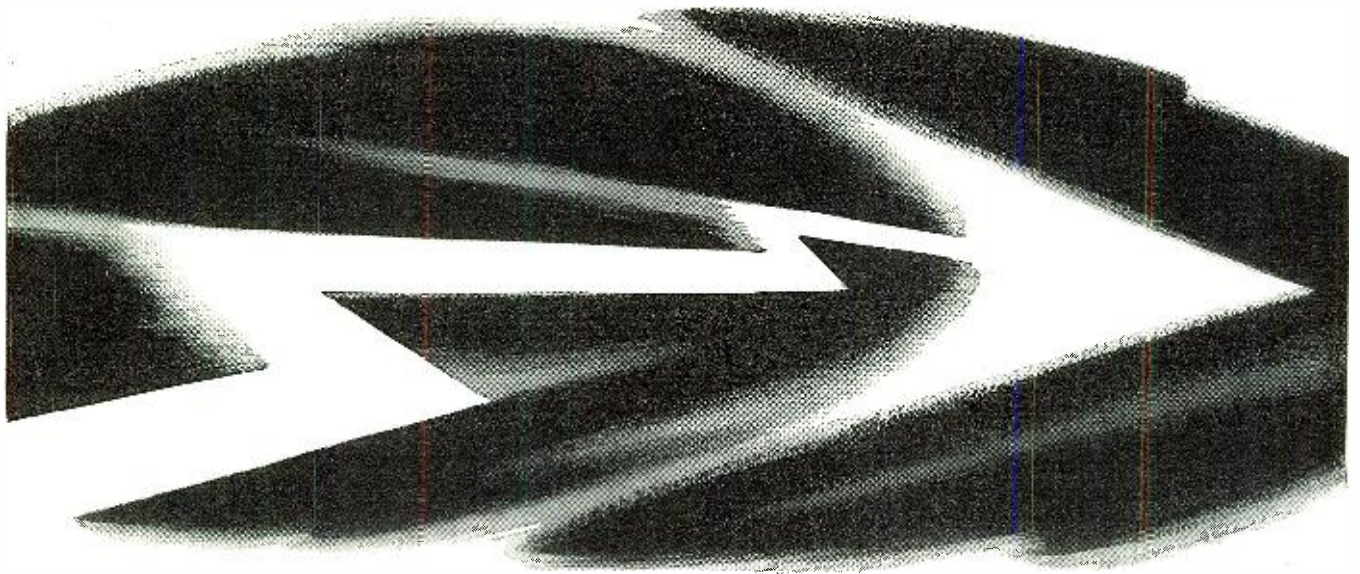

## RADIO: SPEARHEAD OF VICTORY!

COMMUNICATION, swift and certain — to coordinate every unit in action — is the first requirement of modern “lightning” warfare. Radio is keyed to the demands of such communication. And, fortunately, America has the greatest radio equipment in the world . . . thanks to research and engineering.

R. C. A. Communications, Inc., transmits and receives messages regularly and reliably to and from more than 45 foreign countries. Equally efficient is the ship-to-shore service of Radiomarine Corporation of America. In the plants of RCA Manufacturing Company, radio equipment for military purposes is coming off the production-

lines in volume—equipment that could not have been constructed in *any* quantity only a few short years ago! Through the National Broadcasting Company and the Blue Network, radio serves on still another front—keeping Americans unified and informed, through 55 million radio receivers!

On the overseas front, NBC operates two powerful short-wave stations—WRCA and WNBI at Bound Brook, N. J. They help to hurl America’s answer in the “war of words.” Their short-wave beams carrying authentic news, are spearheads of truth through the darkness of war. Today freedom rides America’s radio beams to all the world.



## RADIO CORPORATION OF AMERICA

Radio City, New York

*The Services of RCA:*

RCA Manufacturing Co., Inc. • R.C.A. Communications, Inc. • Radiomarine Corporation of America  
RCA Laboratories • National Broadcasting Co., Inc. • Blue Network Co., Inc. • RCA Institutes, Inc.



alarm off from his office "W." If watchman does not OK entry or if he is overpowered and a forced entry is committed, the alarm will sound in the main office calling the police to action.

Figure 4. Earlier in this article reference was made to using Anti-Sabotage Units in connection with a closed circuit system. Such a system consists of a strip of foil attached to the inside of all windows and glass doors bordering the frame. The foil forms a continuous electric circuit and contacts at the door jambs and window jambs complete the circuit so that if any door or window is forced open or broken the circuit opens and operates a relay which sounds the alarm. This system does not guard the approach to any area but is used to prevent a forced entry into a building. It is quite effective in many cases but has limitations which make it advisable to supplement such a system with Anti-Sabotage Photoelectric Equipment.

The presence of the foil is obvious to anyone and warns the would-be trespasser that a closed circuit foil system is installed. He then plans to make his entry through a floor or ceiling of the building or if the adjoining building is not protected he may break a passage through the wall. The actual case history of such an entry to evade a foil system was recently broadcast on the radio program "Gang Busters." In that case a \$50,000 robbery was successfully carried out and the criminals were caught later. —50—

## 7 DAYS FREE EXAMINATION PRACTICAL RADIO INFORMATION

Including Frequency Modulation—Television, etc.

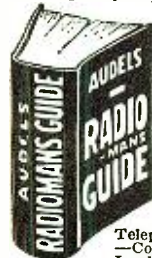

Inside Radio Information for all Servicemen—Aircraft Pilots, Students. AUDELS RADIO-MANS GUIDE contains 772 Pages, 400 Diagrams & Photos is complete—gives Authentic Principles & Practices in Construction, Operation, Service & Repairs. Covers clearly and concisely Radio fundamentals—Ohm's Law—Physics of sound as related to radio science—Measuring instruments—Power supply—Resistors—Inductors—Condensers—Transformers and examples—Broadcasting stations—Radio Telephony—Receivers—Diagrams—Construction—Control systems—Loud speakers—Antenna systems—Auto Radio—Phonograph pickups—Public Address Systems—Aircraft & Marine Radio—Radio Compass—Beacons—Automatic Radio Alarms—Short Wave—Coil Calculations—Testing—Cathode ray oscillographs—Static Elimination—Trouble Pointers—Underwriter's standards—Units and tables—Frequency Modulation—REVIEW QUESTIONS & ANSWERS, Ready Reference Index.

**\$4 COMPLETE • PAY ONLY \$1 A MO.** Get this practical information in handy form for yourself—Fill in and MAIL COUPON TODAY—

**AUDEL Publishers, 49 W. 23rd St., N.Y.** Mail AUDELS NEW RADIO-MANS GUIDE for free examination. If O. K., I will send you \$4 in 7 days; then remit \$1 monthly until \$4 is paid. Otherwise I will return it.

Name \_\_\_\_\_  
Address \_\_\_\_\_  
Occupation \_\_\_\_\_  
Reference \_\_\_\_\_ RN

### Index to Advertisers

COMPANY	PAGE NO.
Aerovox Corp. ....	82
Allied Radio Corp. ....	55
Amperite Co. ....	79
Amplifier Co. of America. ....	78
Audel, Publishers ....	81
Bliley Electric Co. ....	78
Burstein-Applebee Co. ....	79
Candler System Co. ....	74
Capitol Radio Eng. Inst. ....	76
Centralab ....	62
Certified Products Co. ....	79
Chartered Inst. of Am. Inventors. ....	63
Classified ....	78
Commercial Radio Inst. ....	79
Corning Glass Works. ....	71
Crowe Name Plate & Mfg. Co. ....	62
Davega ....	Second Cover
Dodge Institute ....	74
General Electric Co. ....	75
Guardian Electric Mfg. Co. ....	54
Hammarlund Mfg. Co., Inc. ....	53
Bob Henry ....	68
Hygrade Sylvania Corp. ....	50
Hytron Corp. ....	Back Cover
Indiana Technical College. ....	79
International Resistance Co. ....	49
Inventors' Contest ....	6 & 7
Lake Radio Sales Co. ....	66
Lincoln Eng. Schools ....	79
Maedel Publishing House. ....	75
P. R. Mallory & Co., Inc. ...	Third Cover
McMorrow & Berman. ....	78
McGraw-Hill Book Co. ....	72
John Meck Industries ....	79
Meissner Mfg. Co. ....	56 & 77
Microtube Laboratories ....	78
James Millen Mfg. Co., Inc. ....	66
Mutual Radio Products Co. ....	70
National Company, Inc. ....	60
National Radio Institute ....	3
National Union Radio Corp. ....	69
Ohmite Mfg. Co. ....	59
Par-Metal Products Corp. ....	67
Polymet Condenser Co. ....	73
Premax Products ....	64
R. C. A. Institute, Inc. ....	79
Radio Corporation of America. ....	80
Radio & Tech. Publ. Co. ....	57
Radio City Products Co., Inc. ....	70
Radolek Co. ....	81
Randolph Radio ....	68
John F. Rider Publ. Co. ....	63
The Ronald Press Co. ....	77
Shure Bros. ....	65
Slur Mfg. Co. ....	67
Sprayberry Academy of Radio. ....	8
Stackpole Carbon Co. ....	4
Superior Instruments Co. ....	58
Supreme Publications ....	79
Telexplex Co. ....	78
Thordarson Electric Mfg. Co. ....	67
Triplett Electric Instrument Co. ....	61
Tri-State College ....	74
Utah Radio Products Co. ....	52
Wilcox-Gay Corp. ....	73
Worner Products Corp. ....	76

# BOOST Service Profits

LOWEST PRICES...  
FASTER DELIVERY at  
**RADOLEK**

LARGEST STOCK OF  
EVERYTHING IN RADIO



Thousands of progressive servicemen rely on Radolek for their complete requirements of repair materials. Radolek has in stock for prompt delivery replacement parts to repair any radio—every type of tube, transformer, speaker, condenser, volume control, resistor, auto radio accessory, etc. Everything you need at lowest prices. You get what you want when you want it—Radolek understands service problems—gets your order to you in double-quick time. Buying from Radolek means Greater Values, Better Service and More Profits. The big new Radolek Radio Service Guide is yours FREE for the asking. Send for your copy today!

**RADOLEK P. A. SYSTEMS  
FOR EVERY REQUIREMENT**

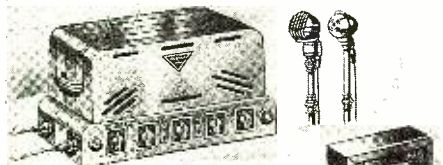

Thousands of successful Radolek P.A. installations are proof of quality, superior design and top performance. Complete systems for permanent, portable or mobile use—wide choice of microphones, speakers and related equipment. Radolek P.A. Systems give you more for your money in Performance, Styling, Dependability and Reserve Power. Select the P.A. apparatus you need from Radolek's big new FREE catalog.

### RADOLEK REPAIR SERVICE

Let Radolek repair your damaged or burned out transformers, coils, speakers, test apparatus, etc. Many items cannot now be replaced and therefore repairing is the only alternative. Trained craftsmen, using precision tools and factory methods, assure perfect jobs equal to new. Write for prices or better still, send in any article to be repaired. It will be handled promptly.

**FREE!**



SEND FOR NEW FREE  
RADIO SERVICE GUIDE

RADOLEK CO., Dept. B-66  
601 W. Randolph St.  
Chicago, Ill.

Please send the big FREE Radio Service Guide.

Name \_\_\_\_\_

Address \_\_\_\_\_  
 DEALER  SERVICEMAN  SOUND ENG.

**SAVE AT RADOLEK**



**THIS IS --  
WAR**

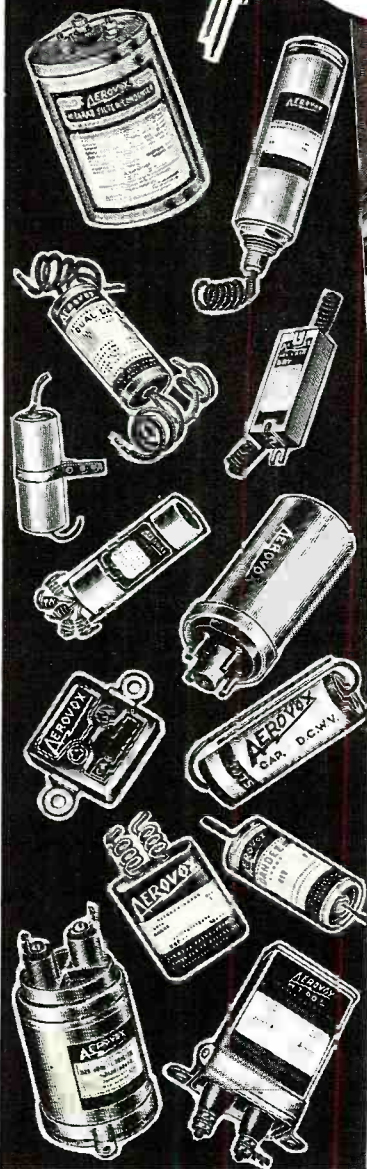

• Yes, this is war! And Aerovox pledges its ALL to both the fighting and the home fronts.

Geared to an all-time production high, Aerovox is meeting the tremendous and still growing requirements of our soldiers, sailors, aviators. Likewise in large part the demands of other United Nations. Many new types have been developed. Startling production methods have evolved. Marked econo-

mies have been effected. Essential to today's battle, these developments promise a still greater peacetime radio and electronic era.

Meanwhile, Aerovox is straining every resource to keep the trade and public supplied with essential condensers. Those home sets will be kept "perking", regardless.

You can count on Aerovox—on both the fighting and the home fronts.

*Ask Our Jobber:*

Ask for copy of the 1942 Aerovox Catalog just issued. Ask for FREE subscription to the monthly Aerovox Research Worker. Or write us direct.

**NEW BEDFORD, MASS.,  
U. S. A.  
Sales Offices in All  
Principal Cities**

**AEROVOX**  
CORPORATION



**In Canada  
AEROVOX CANADA LTD.  
Hamilton, Ont.  
EXPORT: 100 Varick St., N. Y.  
Cable 'ARLAB'**



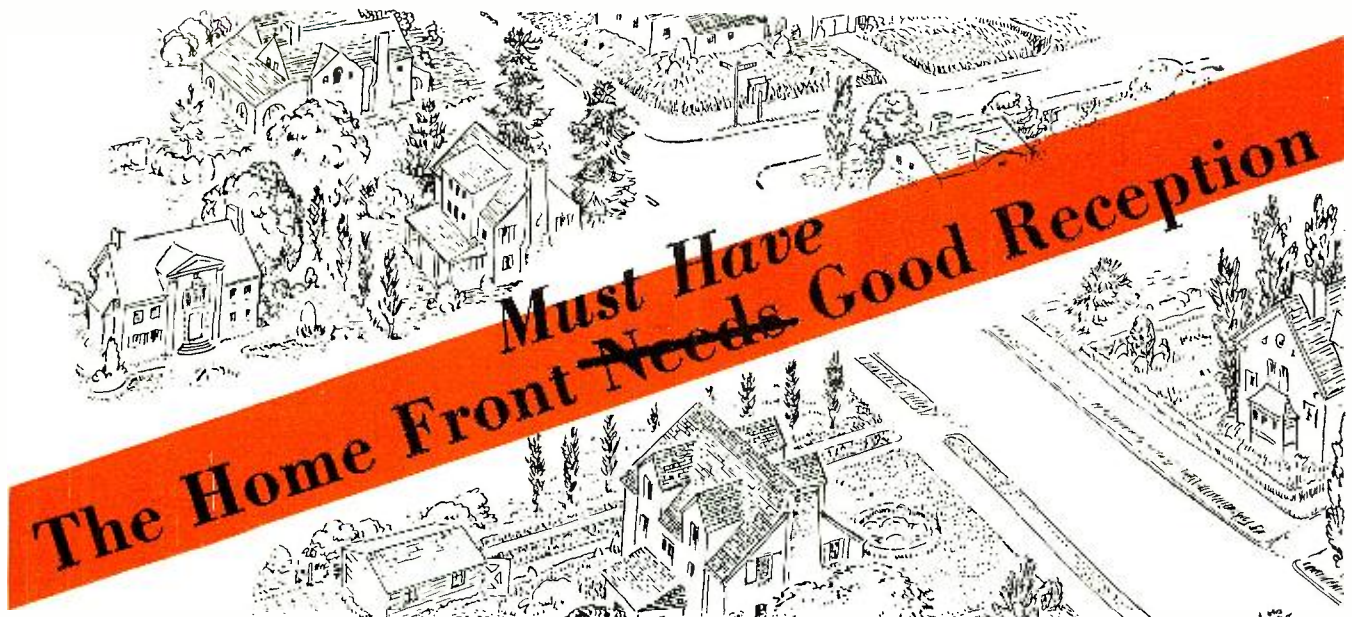

"Keep 'em listening!"

Despite restricted production and material shortages, as a radio service engineer, we urge you to "keep 'em listening!"

We know how essential a home front job you perform. And, you know you can depend on Mallory for practical help in meeting the brain-racking radio service problems imposed by current shortages and restricted production.

Although we are up to our ears in wartime production, we haven't forgotten your needs for one instant.

We are making every effort to provide adequate supplies of Mallory Approved Precision Parts. Our research laboratories are working night and day, coping with the present, anticipating the future. Problems induced by material shortages have, in many cases, resulted in engineering adaptations that mean real progress in good servicing.

And we are getting a fine demonstration of how beautifully the Mallory policies of standardizing parts and simplifying lines have operated to aid servicemen.

You can depend on Mallory and Mallory Distributors for real help, while you work to "keep 'em listening."

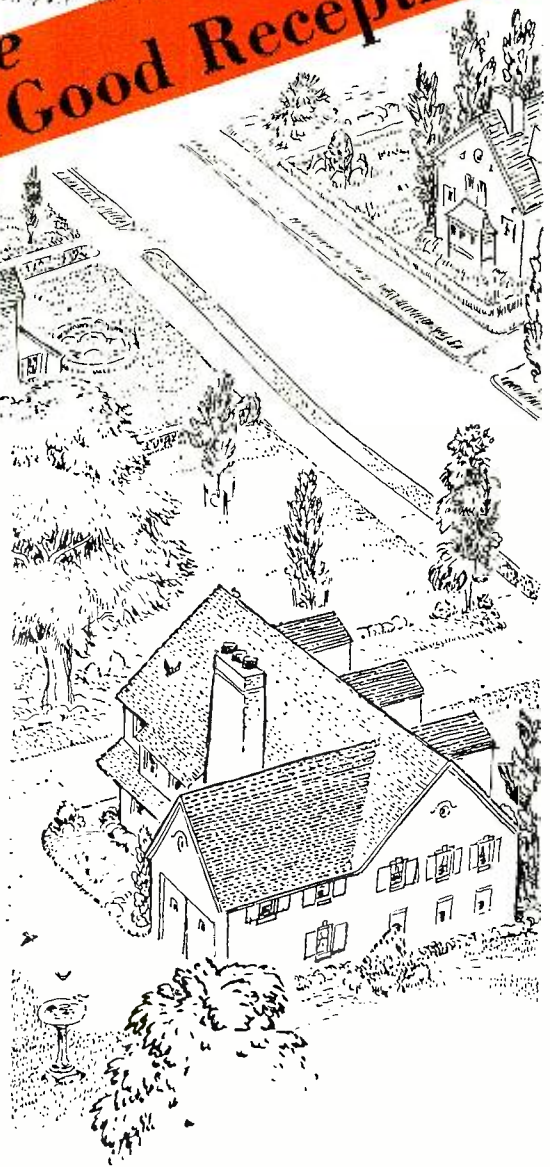

**P. R. MALLORY & CO., Inc.**  
**INDIANAPOLIS                      INDIANA**  
 Cable "Pelmallo"

**P. R. MALLORY & CO. Inc.**

# MALLORY

*Approved Precision Products*





**P**ROUD indeed is Hytron that its HY615 and HY114B have been selected for vitally important service in the armed forces. Built-to-order for exceptional performance on the ultra-high frequencies, these two Hytron designs automatically fell into Class I-A, and were found ideally "fit" for the most grueling combatant service.

**Alternate Sources of Supply**

Hytron supports 100% our government's policy of guaranteeing itself more than one source of supply. It has been Hytron's pleasure to cooperate by granting other manufacturers permission to employ the HY615 and HY114B type designations, and thus to avoid confusion regarding type numbers. Further willing cooperation has been freely given by Hytron, even to the extent of disclosing trade secrets regarding the manufacture of these tubes, so that there may be alternate emergency facilities for production.

**Specify HYTRON—The Original**

Only when you specify HYTRON, are many years of experience in making the HY615 and HY114B, at your command. The "know-how" that comes only after the development of specialized skill by producing thousands of these tubes week after week is available to you at Hytron alone. Also expanded production made possible by the additional plant at nearby Newburyport, means that Hytron can BEST help you when you do select for service these national U.H.F. favorites.

**JUST**  
**An Example**

Among the host of HYTRON tubes selected for service in the Victory program, the HY615 and HY114B furnish but two examples. Consult Hytron first whether your tube needs are for standard receiving or transmitting types, U. S. Government types, United Nations types, or special types designed to fit your particular needs.

**HYTRONIC LABS.**  
**SALEM . . . MASS.**



**A DIVISION OF**  
**HYTRON CORP.**

**Manufacturers of Radio Tubes Since 1921**